

17th Early Career Researchers' Workshop (ECRW 2023)

Sunday 2nd July 2023

IPL-YRW Impulse Lecture “Phyllobilins – An Underexplored Family of Natural Products at the Center of a Scientific and Personal Journey”

Author [Simone Moser¹](#)

Institute **1** Department of Pharmacy, Pharmaceutical Biology, Ludwig-Maximilian-University of Munich, Butenandtstr. 5-13, Munich, Germany

DOI [10.1055/s-0043-1773810](#)

Despite the rising popularity of herbal remedies and improved phytochemical profiling, the active principles of many phytotherapeutics are not completely understood. The focus of my research lies on phyllobilins, a compound class derived from the degradation of chlorophyll, which have remained overlooked as bioactive ingredients in medicinal plants for a long time. Despite their discoveries in the late nineties, potential bioactivities, and contributions to efficacies of phytomedicines have been disregarded. Among this natural product family, yellow phyllobilins (phyloxanthobilins, PxBs) in particular, which are known to play a part in the autumn colors [1], possess pharmaceutically relevant bioactivities: PxBs were recently shown to contribute to the effects of stinging nettle, having potent anti-oxidative and anti-inflammatory effects [2]. Once the active ingredient(s) is identified, the investigation of the mode of action as well as direct targets remains a challenge. In a functional screening of cancer cells, the cytoskeletal protein actin was identified as the first human target for PxB [3]; actin as target is involved in the anti-cancer activity of PxB, which has been demonstrated earlier [4]. The investigated bioactivities and the identification of a protein target in human cells open the door for the thorough study and relevance of this diverse natural product family in medicinal plants. In this impulse lecture, the scientific path from the discovery of chlorophyll degradation products in higher plants and elucidation of their structure, to eventually unraveling the first results on their bioactivities is outlined.

References

- [1] Moser S, Ulrich M, Muller T et al. A yellow chlorophyll catabolite is a pigment of the fall colours. *Photochem Photobiol Sci* 2008; 7: 1577–1581
- [2] Karg CA, Doppler C, Schilling C et al. A yellow chlorophyll catabolite in leaves of *Urtica dioica* L.: An overlooked phytochemical that contributes to health benefits of stinging nettle. *Food Chem* 2021; 359: 129906
- [3] Karg CA, Wang S, Al Danaf N, Pemberton RP, Bernard D, Kretschmer M, Schneider S, Zisis T, Vollmar AM, Lamb DC, Zahler S, Moser S Tetrapyrrolic Pigments from Heme- and Chlorophyll Breakdown are Actin-Targeting Compounds. *Angew Chem Int Ed* 2021; 60: 22578
- [4] Karg CA, Wang P, Kluibenschedl F et al. Phylloxanthobilins are Abundant Linear Tetrapyrroles from Chlorophyll Breakdown with Activities Against Cancer Cells. *Eur J Org Chem* 2020; 4499–4509

SL-YRW-01 Short Lecture “Chemical mappings for the flowers of *Abeliophyllum distichum* using metabolomics tools”

Authors [Yeong-Geun Lee¹](#), [Jeong Eun Kwon¹](#), [Jin Woo Jeang¹](#), [Nam-In Baek¹](#), [Se Chan Kang¹](#)

Institute **1** Kyung Hee University, Yongin-si, South Korea

DOI [10.1055/s-0043-1773811](#)

Abeliophyllum distichum, (Oleaceae), is the only member of its species and genus and is found only on the Korean Peninsula. Studies have been rarely reported on its metabolites and activities, to date. Five variants of this plant have been reported and were classified based only on morphological characteristics like the colour of the petals/sepal or the shapes of the fruit. There are many opinions on the taxonomic identities of this plant, and some documents even suggest that each variant had the same taxa. Accordingly, phytochemical investigations and chemical maps for the variants should be valuable.

In this study, metabolomics was applied to estimate the dissimilarities in the chemical compositions of the variants of its flowers to understand the dissimilarities of the morphological characteristics. As a result, twenty-nine metabolites including four new metabolites were isolated from *A. distichum* flowers. NMR, UHPLC-TripleTOF-ESI-MS/MS and GC/MS based metabolomic studies were performed to understand chemical differentiation among the five variants and 35 metabolites, 43 secondary metabolites and 108 hydrophobic primary metabolites were identified, respectively. Primary and secondary metabolites showed different patterns among all variants based on morphological characteristics. Also, the metabolic flux analysis of five variants was confirmed through correlation analyses of the primary and secondary metabolites. Their metabolic flux was revealed, and we reconstructed metabolic pathways based on dissimilarities in morphological characteristics in the five variants of *A. distichum* flowers.

SL-YRW-03 Short Lecture “Putting a new face to the natural product therapeutic lead discovery via innovative computing methods”

Authors [Julien Cordonnier¹](#), [Pierre Darme^{1,2}](#), [Simon Remy¹](#), [Sandie Escotte²](#), [Stéphanie Baud⁴](#), [Dominique Aubert^{2,3}](#), [Jean-Hugues Renault¹](#), [Isabelle Villena^{2,3}](#)

Institutes **1** Université de Reims Champagne Ardenne, CNRS, ICMR 7312, Reims, France; **2** Université de Reims Champagne Ardenne, ESCAPE EA7510, Reims, France; **3** Université de Reims Champagne Ardenne, P3M, National reference Centre on Toxoplasmosis, Reims, France; **4** Université de Reims Champagne Ardenne, CNRS UMR 7369, MEDyC, Reims, France
DOI [10.1055/s-0043-1773812](#)

The emergence of antibiotic resistance and novel diseases highlights the need for new therapeutic approaches [1, 2]. The immense chemical diversity of natural products has long been recognised as an interesting reservoir for drug discovery [3]. Despite the initial enthusiasm for high-throughput screening (HTS), natural products have faced several issues (presence of pan-assay interfering compounds, low bioactive compounds rate, compatibility etc.).

To address these limitations, virtual molecular docking, such as AMIDE [4], has emerged as a promising alternative for improving efficiency while predicting the binding affinity between biological targets and ligands. Its use enabled the implementation of inverse virtual screening (IVS) for large-scale chemical ligand docking on a dataset of proteins, providing a more comprehensive exploration compared to traditional blind docking methods [4]. This study focused on a more efficient version of AMIDE [5], to search for inhibitors of *T. gondii*, a parasite that causes widespread toxoplasmosis [6]. An initial set of 400 drug-like molecules, known as PathogenBox were screened against 25 protein 3D homology-modelled essential targets for parasite survival [7]. The Ligand-Protein couples were ranked based on the binding free energy and population, and the inhibitory effect of each compound was assessed in vitro. A second set of Pinaceae related structures, containing triterpene derivatives with *T. gondii* inhibitor activity [6], were then screened against the same targets (▶ Fig. 1).

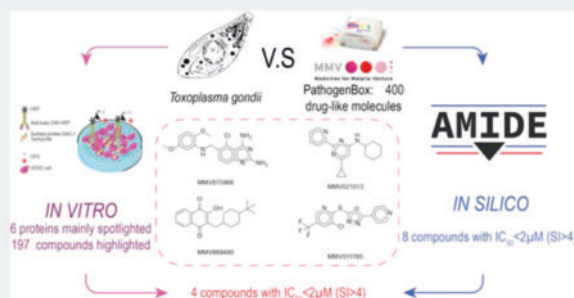

▶ Fig. 1 Parallel workflows (in vitro and in silico) for *Toxoplasma gondii* new therapeutic strategies research.

The PathogenBox investigation revealed 8 compounds with $IC_{50} < 2 \mu M$ and $SI > 4$. Six proteins were mainly highlighted, related to 8 ligands, including 4 of previous compounds. Overall, this study demonstrated the potential of IVS in discovering new biological targets and/or new hits.

Conflict of Interest The authors declare no conflict of interest.

References

- [1] Meganck RM, Baric RS. Developing therapeutic approaches for twenty-first-century emerging infectious viral diseases. *Nat Med* 2021; 27: 401–410
- [2] Mancuso G., Midiri A., Gerace E et al. Bacterial antibiotic resistance; the most critical pathogens. *Pathogens* 2021; 10:
- [3] Lautie E, Russo O., Ducrot P et al. Unravelling Plant Natural Chemical Diversity for Drug Discovery Purposes. *Front Pharmacol* 2020; 11:
- [4] Vasseur R, Baud S, Angelo Steffanel L et al. AMIDE-Automatic Molecular Inverse Docking Engine for Large-Scale Protein Target Identification 2014
- [5] Darne P., Dauchez M, Renard A et al. Amide v2: High-throughput screening based on autodock-gpu and improved workflow leading to better performance and reliability. *Int J Mol Sci* 2021; 22:
- [6] Darne P., Escotte-Binet S, Cordonnier J. et al. Anti-Toxoplasma gondii effect of lupane-type triterpenes from the bark of black alder (*Ajunc glutinosa*) and identification of a potential target by reverse docking. *Parasite*. 2022; 29:
- [7] Sidik SM., Huet D., Gamesum SM et al. A Genome wide CRISPR Screen in *Toxoplasma* Identifies Essential Apicomplexan Genes. *Cell* 2016; 166: 1423–1435.e12

SL-YRW-04 Short Lecture “Therapeutic potential of Murtilla extracts in ameliorating Huntington's disease symptoms in preclinical models”

Authors [Marisol Cisternas-Olmedo](#)^{1,2,3}, [Carla Delporte](#)⁴, [Rene Vidal](#)^{1,2,3}

Institutes 1 Center for Integrative Biology, Faculty of Sciences, Universidad Mayor, Santiago, Chile; 2 Biomedical Neuroscience Institute, Faculty of Medicine, Universidad de Chile, Santiago, Chile; 3 Center for Geroscience, Brain Health and Metabolism, Santiago, Chile; 4 Laboratorio de Productos Naturales, Faculty of Chemical and Pharmaceutical Sciences, Universidad de Chile, Santiago, Chile

DOI 10.1055/s-0043-1773813

Huntington's disease (HD) is an autosomal-dominant inherited neurological disorder caused by an unstable trinucleotide CAG repeat expansion at the N-terminus of gene encoding the huntingtin protein (Htt). The mutation results in the production of abnormal aggregation of Htt (mHtt) which promotes neuronal dysfunction and death of medium spiny neurons in striatum, resulting in altered motor control and cognitive function. Effective treatments for HD are still pending. Previously, our group identified the presence of polyphenols in leaves from the Chilean-native berry *Ugni molinae*, whose extracts showed a potent anti-aggregation activity in models of Alzheimer's disease. We evaluated the efficacy of 8 fruit extracts from different genotypes of *U. molinae* on reducing protein aggregation using cellular models of HD. One extract, ETE 19-1, significantly reduced polyglutamine aggregation levels. We aimed to investigate the effect of the 19-1 extract on preclinical models of Huntington's disease, both at the brain and intestinal levels. A R6/2 HD mouse model was treated with ETE-19-1 by gavage daily for one month. We evaluated motor capacity by Rotarod test, protein aggregation and neuroinflammation in the brain tissue and intestinal damage. Our results in HD preclinical models treated with ETE 19-1 shows that it improves motor function, reduces protein aggregates and neuroinflammation in striatum, and provides additional relief to the intestinal damage present in R6/2 mice. Bioactive components in extracts from *U. molinae* berries have positive effects on HD. This demonstrates the potential effect of native berries to treat neurodegenerative diseases associated with protein aggregates (► **Fig. 1**).

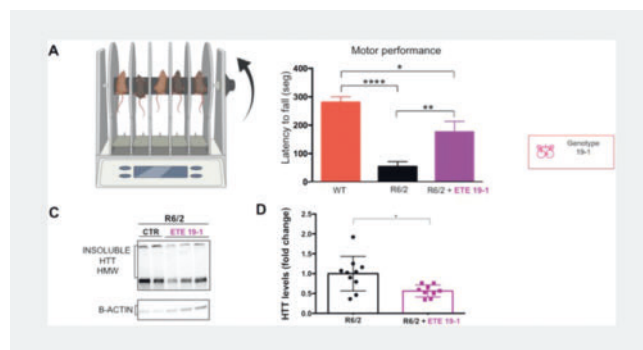

► **Fig. 1** ETE 19-1 chronic oral treatment improves motor behavior and decreases the levels of HTT in the striatum of R6/2 mouse models of HD. **a**) The Rotarod motor test consists of a rod that rotates at a set speed for a specified time. The mice are placed on the spinning rod, which causes the mice to start running. This test was carried out at a constant speed of 4 rpm, for a total time of 5 min (n = 10 animals per group). **b**) The total time (in seconds) that each animal spent on the wheel was recorded. (**p = 0.0067; ***p = < 0.0001). Healthy WT mice, R6/2 mice (without polyphenols) and R6/2 mice with polyphenols (ETE 19-1). **c**) The effect ETE 19-1 on HTT levels was analyzed by Western blot. B-Actin expression was monitored as a loading control **d**) Quantification of HMW levels of HTT (*p = 0.0101).

SL-YRW-05 Short Lecture “Application of DFT calculation for structure elucidation of selected alkaloids”

Authors [Ngoc-Thao-Hien Le](#)¹, [Luc Pieters](#)¹, [Emmy Tuentner](#)¹

Institute 1 Natural Products & Food Research and Analysis (NatuRA), University of Antwerp, Antwerp, Belgium

DOI 10.1055/s-0043-1773814

Structural elucidation has always been challenging and misassignment remains an issue in the field of natural products chemistry [1]. The growing interest in discovering unknown, complex natural structures accompanies the increasing awareness concerning misassignments in the community. The combination of various spectroscopic methods with quantum chemical calculations has gained popularity in recent years [1]. In this work, we demonstrated for the first time its power to revise the structure of macaridine and to fully elucidate the structure of four newly isolated Amaryllidaceae alkaloids (O-demethyl-norlycoperamine, 2-epi-pseudolycorine, 2β,10β-dihydroxy-9-O-demethyl-homolycorine, 9-de-O-methyl-11β-hydroxy galanthamine) and two known epimers in an epimeric mixture of 6-hydroxyhippeastidine [2, 3]. DFT calculation of chemical shifts was first performed to assist the assignment of planar structures. Furthermore, relative and absolute configurations were established in three different ways by computer-assisted structure elucidation (CASE) coupled with ORD/ECD/VCD spectroscopy.

Conflict of Interest The authors declare no conflict of interest.

References

- [1] Chhetri B.K., Lavoie S., Sweeney-Jones A.M., Kubanek J. *Nat. Prod. Rep* 2018; 35 (6): 514–531
- [2] Le HTN, Van Roy E, Dendooven E, Peeters L, Theunis M, Foubert K, Pieters L, Tuentner E. *Phytochemistry* 2021; 190: 112863
- [3] Le N.T.H., Vermeyen T., Aerts R., Herrebout W.A., Pieters L., Tuentner E. *Molecules* 2023; 28: 214

SL-YRW-06 Short Lecture “Spotlight on *Morus alba* root bark compounds and extracts in search of inhalable natural product formulations against acute respiratory infections”

Authors Sigrid Adelsberger^{1, 2}, Jacqueline Schwarzinger^{3, 2}, Gabriela Hädrich³, Judith M. Rollinger¹, Lea Ann Dailey³, Ulrike Grienke¹

Institutes 1 Department of Pharmaceutical Sciences, Division of Pharmacognosy, Faculty of Life Sciences, University of Vienna, Josef-Holaubek-Platz 2, 1090 Vienna, Austria; 2 Vienna Doctoral School of Pharmaceutical, Nutritional and Sport Sciences, University of Vienna, Josef-Holaubek-Platz 2, 1090 Vienna, Austria; 3 Department of Pharmaceutical Sciences, Division of Pharmaceutical Technology and Biopharmaceutics, Faculty of Life Sciences, University of Vienna, Josef-Holaubek-Platz 2, 1090 Vienna, Austria

DOI 10.1055/s-0043-1773815

High mortality rates associated with acute respiratory infections (ARI) together with related co-infections emphasize the need for new effective anti-ARI therapeutics [1]. Mulberry Diels-Alder adducts (MDAAs) from *Morus alba* root bark demonstrated significant antiviral and antibacterial in vitro effects [2, 3]. However, the oral bioavailability of MDAAs is reported to be low [4] which encourages the search for alternative application routes.

In this study, the suitability for inhalation was probed for two MDA extracts (MA21 and MA60, [5]) in comparison to their major constituents sanggenon C and D. Therefore, (i) toxicity, (ii) permeability tests (both in lung epithelium cell line Calu-3) and (iii) solubility tests (in different buffer solutions) were performed. As an efficient sample preparation step, liquid-liquid extraction with MTBE was found to be best suited. A UPLC-ESI-MS method using linear ion trap mass spectrometer in negative ionization mode and single ion recording was validated to quantitate the two major MDAAs. The calibration curves for both sanggenons showed good linearity ($R^2 > 0.999$) with 5.0 ng/mL as lower limits of quantification. Analytes were separated on a BEH C18 column within 6 min. Both extracts (up to 50 µg/mL) and sanggenon C and D (up to 20 µg/mL) were well tolerated by Calu-3 cells without cytotoxicity. As required for inhalable formulations, preliminary quantitative results corroborate the apparent permeability (P_{app}) coefficients to be lower than threshold markers. These findings and evaluation of thermodynamic solubility characterize all samples investigated as suitable starting materials for preclinical inhalation studies.

Funding FWF project P 35115

Conflict of Interest The authors declare no conflict of interest.

References

- [1] Bloom DE, Cadarette D. Infectious Disease Threats in the Twenty-First Century: Strengthening the Global Response. *Front Immunol* 2019; 10: 549. doi:10.3389/fimmu.2019.00549
- [2] Grienke U., Richter M., Walther E, Hoffmann E, Kirchmair J, Makarov V, Nietzsche S., Schmidtke M, Rollinger JM. Discovery of prenylated flavonoids with dual activity against influenza virus and *Streptococcus pneumoniae*. *Sci Rep* 2016; 6: 27156. doi:10.1038/srep27156
- [3] Wasilewicz A, Benjamin K, Bojkova D, Abi Saad M, Langeder J, Bütikofer M, Adelsberger S, Grienke U, Cinatl J, Petermann O, Scapozza L, Orts J, Kirchmair J, Rabenau H., Rollinger JM. Identification of natural products inhibiting SARS-CoV-2 by targeting the viral proteases: a combined in silico and in vitro approach. *J Nat Prod* 2023; 86 (2): 264–275. doi:10.1021/acs.jnatprod.2c00843
- [4] Thilakarathna SH, Rupasinghe HP. Flavonoid bioavailability and attempts for bioavailability enhancement. *Nutrients* 2013; 5: 3367–3387. doi:10.3390/nu5093367
- [5] Langeder J, Doring K, Schmietendorf H, Grienke U, Schmidtke M, Rollinger JM. (1)H NMR-Based Biochemometric Analysis of *Morus alba* Extracts toward a Multipotent Herbal Anti-infective. *J Nat Prod* 2023; 86 (1): 8–17. doi:10.1021/acs.jnatprod.2c00481

SL-YRW-07 Short Lecture “*Angelica L.* coumarins potential to modulate glucose- induced insulin secretion and their mechanism of action”

Authors Andrzej Patyra^{1, 2, 3}, Justine Vaillé¹, Soufian Omhmed¹, Sylvie Péraldi-Roux¹, Jean-François Quignard⁴, Anna Karolina Kiss², Jérémie Neasta¹, Catherine Oiry¹

Institutes 1 Institut des Biomolécules Max Mousseron, Université de Montpellier, CNRS, ENSCM, Montpellier, France; 2 Department of Pharmaceutical Biology, Medical University of Warsaw, Warsaw, Poland; 3 Doctoral School, Medical University of Warsaw, Warsaw, Poland; 4 Université de Bordeaux, Centre de Recherche Cardio-Thoracique de Bordeaux, INSERM U1045, Pessac, France

DOI 10.1055/s-0043-1773816

Pancreatic β -cell function and notably glucose-induced insulin secretion play a pivotal role in glucose homeostasis. We have previously shown that natural molecules like flavonoids or ellagitannin metabolites potentiate glucose-induced insulin secretion through a mechanism implicating the activation of L-type Ca^{2+} (CaV) channels and ERK 1/2 [1–3]. According to some studies, extracts from *Angelica L.* species showed similar effects on insulin secretion [4, 5]. Thus, this study aimed at isolating and studying active constituents of three pharmacopeial *Angelica* roots.

Twenty-two coumarins were isolated from the roots of *Angelica archangelica L.*, *Angelica dahurica* (Hoffm.) Benth. & Hook.f. ex Franch. & Sav., and *Angelica pubescens* Maxim through Soxhlet extraction in n-hexane, and column and preparative chromatography methods. The structures of the compounds were analysed and confirmed using UHPLC-DAD-MS and NMR methods. Pharmacological experiments were performed on the INS-1 β -cell line. Insulin release was quantified by the homogeneous time-resolved fluorescence method. The mechanism of action was studied using patch clamp and FACS techniques.

Some of the studied compounds were able to modulate glucose-induced insulin secretion by acting on the membrane potential, as well as by activating voltage-gated calcium channels and increasing intracellular calcium concentrations. Overall, the results demonstrate a new pharmacological activity of coumarins present in traditionally used *Angelica* roots.

References

- [1] Bardy G, Virsolvy A, Quignard JF et al. Quercetin induces insulin secretion by direct activation of L-type calcium channels in pancreatic beta cells. *British Journal of Pharmacology* 2013; 169: 1102–1113. doi:10.1111/bph.12194
- [2] Bayle M, Neasta J, Dall’Asta M et al. The ellagitannin metabolite urolithin C is a glucose-dependent regulator of insulin secretion through activation of L-type calcium channels. *Br J Pharmacol* 2019; 176: 4065–4078. doi:10.1111/bph.14821
- [3] Toubal S, Oiry C, Bayle M et al. Urolithin C increases glucose-induced ERK activation which contributes to insulin secretion. *Fundam Clin Pharmacol* 2020; 34: 571–580. doi:10.1111/fcp.12551
- [4] Leu YL, Chen YW, Yang CY et al. Extract isolated from *Angelica hirsutiflora* with insulin secretagogue activity. *J Ethnopharmacol* 2009; 123: 208–212. doi:10.1016/j.jep.2009.03.027
- [5] Park EY, Kim EH, Kim CY et al. *Angelica dahurica* Extracts Improve Glucose Tolerance through the Activation of GPR119. *PLoS One* 2016; 11: e0158796. doi:10.1371/journal.pone.0158796

SL-YRW-08 Short Lecture “Preparation and antitumor investigation of new nature- inspired estradiol- protoflavone hybrids”

Authors Gábor Girst¹, Barnabás Molnár², Éva Frank², Renáta Minorics³, István Zupkó³, Hui-Chun Wang⁴, Attila Hunyadi¹

Institutes 1 Institute of Pharmacognosy, University of Szeged, Szeged, Hungary; 2 Department of Organic Chemistry, University of Szeged, Szeged, Hungary; 3 Institute of Pharmacodynamics and Biopharmacy, Interdisciplinary Excellence Centre, University of Szeged, Szeged, Hungary; 4 Graduate Institute of Natural Products, Kaohsiung Medical University, Kaohsiung, Taiwan

DOI 10.1055/s-0043-1773817

Please note: article SL-YRW-07 was changed according to the following erratum: The authors name Soufiyan Omhmed was misspelled, which is now corrected.

Nature is a great inspiration for drug discovery. The majority of small molecule approved drugs are of natural origin at least concerning their inspiration. In recent years molecular hybridization gained significant attention as a strategy for rational drug design and natural products provide highly valuable fragments to produce potent multitarget hybrid molecules. Steroids are natural organic compounds with crucial biological roles both in the animal and the plant kingdom. In a recent study, the preparation of new estradiol-flavone hybrid compounds was reported from estradiol through the synthetic modification of its A ring [1]. Such a modification reduces hormonal effects, while it may give rise to improved antitumor effects.

Protoflavones are typically fern-originated, rare natural flavonoids with a non-aromatic, oxidized p-quinol B-ring. These compounds exert an antitumor effect through inducing oxidative stress and apoptosis and interfering with the ATR-mediated activation of checkpoint kinase 1 [2]. Semisynthetic protoflavone 1'-O-alkyl-ether derivatives are particularly interesting due to their improved efficacy and chemical stability.

In the current study, we aimed to synthesise new protoflavone-inspired antitumor compounds from 4-hydroxyphenyl-containing estradiol-flavone hybrids and test their antiproliferative effects on multiple cell lines (► Fig. 1). Three new compounds were prepared that had sub-micromolar IC₅₀ values on at least one cell line, the best being 0.24 ± 0.07 µM against MDA-MB-231 triple-negative breast cancer (TNBC) cell line. According to our results, such compounds may provide valuable leads against TNBC.

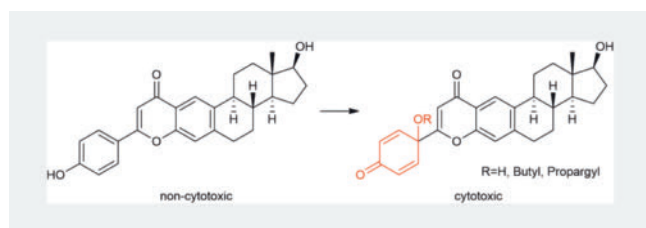

► Fig. 1 Nature-inspired estradiol-protoflavone hybrids.

Acknowledgments NKFI K-134704, TKP2021-EGA-32 and ÚNKP-22-4-SZTE-164

References

- [1] Molnár B et al. *Steroids* 2022; 187: 109099
- [2] Wang HC et al. *Mol Cancer Ther* 2012; 11: 1443–1453

SL-YRW-09 Short Lecture “Integrated ¹H-NMR and LC-HRMS based metabolomics for the discovery of *Pistacia lentiscus* L. var. *Chia* leaves biomarkers”

Authors Christodoulos Anagnostou¹, Stavros Beteinakis¹, Theodora Nikou¹, Anastasia Papachristodoulou¹, Maria Halabalaki¹

Institute 1 Division of Pharmacognosy and Natural Products Chemistry, Department of Pharmacy, National and Kapodistrian University of Athens, Panepistimiopolis, Zografou, 15771, Athens, Greece

DOI 10.1055/s-0043-1773818

Metabolomics by means of fingerprinting or metabolite profiling is an emerging field of study in natural products, where small molecules and especially secondary metabolites are observed and correlated with specific responses to different environmental stimuli, either natural or human made. Especially the untargeted metabolite profiling targets the whole metabolome of a biological system, e.g. a plant organism, towards the identification of relevant features and, finally, biomarkers. In this context, the present work focuses on the comparison of two widely used analytical platforms, NMR and LC-HRMS, for the metabolite profiling of *Pistacia lentiscus* L. var. *Chia* leaves. The leaves are an underrated part of the mastic tree, an endemic plant of Greece widely known for its resin. More than ninety leaves samples were collected from four different areas of the “Mastichohoria” region, in different collection periods and growth stages. The two techniques were compared and combined using multivariate

analysis (MVA) for the first time in *Pistacia lentiscus* var. *Chia* leaves. Novel statistical tools, Statistical Total Correlation Spectroscopy (STOCSY) [1] and Statistical Heterospectroscopy (SHY) [2] were also employed and correlated for dereplication processes. Advantages and pitfalls of each technique were underlined, making evident the complementarity of the two platforms. Lastly, certain biomarkers responsible for the classification of different subregions or branch age were identified.

Funding ERDF, “RESEARCH–CREATE–INNOVATE”, Hyper-Mastic (project code T2EAK-00547)

Conflict of Interest The authors declare no conflict of interest.

References

- [1] Beteinakis S, Papachristodoulou A, Kolb P et al. NMR-Based Metabolite Profiling and the Application of STOCSY toward the Quality and Authentication Assessment of European EVOOs. *Molecules* 2023; 28(4): 1738. doi:10.3390/molecules28041738
- [2] Crockford DJ, Holmes E, Lindon JC et al. Statistical heterospectroscopy, an approach to the integrated analysis of NMR and UPLC-MS data sets: Application in metabonomic toxicology studies. *Anal Chem* 2006; 78: 363–371. doi:10.1021/ac051444m

SL-YRW-10 Short Lecture “Unravel the variation of metabolites of maidong medicine (*Ophiopogon japonicus* and *Liriope spicata*): A feature-based molecular network approach”

Authors Feiyi Lei¹, Luiz Leonardo Saldanha², Laurent Bigler³, Reto Nyffeler¹, Caroline Weckerle¹

Institutes 1 Department of Systematic and Evolutionary Botany, University of Zurich, Zurich, Switzerland; 2 Faculty of Sciences, São Paulo State University (UNESP), Bauru, Brazil; 3 Department of Chemistry, University of Zurich, Zurich, Switzerland

DOI 10.1055/s-0043-1773819

The tuberous roots of *Ophiopogon japonicus* and *Liriope spicata* have long been used as herbal medicine in China to treat respiratory ailments and are collectively referred to as maidong. They are rich in flavonoids and steroidal saponins. In the present study, we conducted a mass spectrometry-based metabolomic approach to obtain an overview on the metabolites of maidong derived from different origin. To enhance result interpretation, multivariate analyses are combined with molecular networking and *in silico* annotation to identify biomarkers. Results demonstrated an overview of the chemical class and type variation among maidong, highlighting homoisoflavans as characteristic metabolites of maidong derived from *O. japonicus*. Notably, our results confirmed several co-existing steroidal saponins (e.g., Ophiopogonin D, Ophiopogonin B), whereas each species possesses unique steroidal glycosides. This approach contributes to the identification of new chemically related biomarker groups, and ultimately safeguards the efficacy and the safety use of maidong medicine (► Fig. 1).



► Fig. 1 Distribution of maidong medicine in China and LC-MS-based metabolomic molecular network.

Conflict of Interest The authors declare no conflict of interest.

Animal Healthcare and Veterinary Phytotherapy Pre-Congress Symposium Sunday 2nd July 2023

IPL-VET-01 Impulse Lecture “Traditional Chinese veterinary herbal medicine: from historical roots to actual applications”

Author [Sabine Vollstedt](#)¹

Institute 1 Practice for Traditional Chinese Equine Medicine, Hauptstrasse 53, 25335 Bockholt-Hanredder, Germany

DOI [10.1055/s-0043-1773820](#)

Traditional Chinese Veterinary Medicine has been developed during thousands of years. From the beginning of the first settlements up to controlling the vast empire of China, animals and especially horses have played an important role and have been studied intensively by early knowledgeable people like Bo Le and Yuan Heng. Their observations were written down and handed down from generation to generation so that today there is a huge treasure trove of experience.

Although living situations have changed enormously, nowadays the importance of animals for their owners has grown and they are willing to do anything to support their health and well-being. However, climate change has resulted in new problems, especially health problems which are not easily controlled and treated anymore. Equine asthma is an excellent example of such a newly developed disease, which is not easily treated. Only with a combination of good stabling management, intensive monitoring and early intervention is it possible to treat affected horses. TCM diagnosis is an important tool to become aware of possible problems and Chinese herbs can be used for early intervention as well as additional treatment in severely affected horses. Therefore, integrative veterinary medicine gives veterinarians another set of options to treat and care for their patients.

IPL-VET-02 Impulse Lecture “How French vets are networking around phyto- aromatherapy: the RéPAAS?”

Author [Isabelle Lussot-Kervern](#)¹

Institute 1 RéPAAS, Avriillé, France

DOI [10.1055/s-0043-1773821](#)

Veterinarians in practice are very often asked about therapeutic use of medicinal plants. To acquire reliable scientific information on this subject some vets followed postgraduate programs in Pharmacy Universities. Until recently, French veterinary schools did not include courses in herbal medicine in their curriculum. Three French veterinary technical organisations AFVAC*, AVEF**, SNGTV*** created the RéPAAS● in 2018. This veterinary network was funded with a grant from the DGAL (French general directorate of food -Ministry of Agriculture) as part of the Eco-Antibio plan.

In France, farmers and animal owners often use herbal products, mainly feeds or dietary supplements, mixtures of various plants of unknown quantity and quality. Unfortunately, these practices are not supervised by vets (neither at prescription stage nor during follow-up), mainly due to limitations imposed by the current regulatory frame on maximal residue limit.

Vets are the only professionals able to make an accurate diagnosis and ensure traceability and efficiency evaluation of their treatments. They must stay up to date with the scientific literature and share their empirical practical experiences. This can now be done via the RéPAAS website, which will also help implement research protocols.

The ANSES (French National Agency of Sanitary Safety) Plants workgroup also works together with the RéPAAS network, as a reliable body to share information to promote an evolution of the current farm animal legislation.

*AFVAC : Association Française des Vétérinaires pour Animaux de Compagnie

**AVEF : Association Vétérinaires Equine Française

***SNGTV : Société Nationale des Groupements Techniques Vétérinaires

<https://www.repaas.org/>

KL-VET-01 Keynote Lecture “The eubiotic perspective on utilization of tannins in phytotherapy and nutrition of pigs”

Author [Jakub Piwowarski](#)¹

Institute 1 Medical University of Warsaw

DOI [10.1055/s-0043-1773822](#)

Tannins are commonly considered as anti-nutritional factors in piglets' nutrition. However, certain tannin-containing plants are well known for their anti-diarrheal properties, which have been utilized since ancient times in veterinary medicine but had been superseded by antibiotics, since discovery of penicillin in 1928 and introduction of antimicrobials in farm animal production since the 1950s. Decades of extensive antibiotic use in prevention and therapy of infections in animals significantly contributed to the spread of antimicrobial resistance, leading to the restrictions on their use in farm animals. As a consequence, the development of novel preventive and therapeutic strategies targeted on maintaining piglets gut health, which are based on pleiotropic mechanisms, is urgently needed.

The conducted studies have shown that selected condensed and hydrolysable tannins-rich plant formulations are able to inhibit the enteropathogenic *E. coli* growth and adhesion to intestinal epithelial cells, and stimulate intestinal barrier formation through enhancement of TJ proteins expression. The tested tannin sources did not negatively affect diversity and metabolism of intestinal microbiota of post-weaning piglets *ex vivo*.

The conducted studies support the historically attributed anti-diarrheal properties of tannin-containing plant preparations revealing their eubiotic effects that not only respect the ecological context of preserving the homeostasis of intestinal microbiota but also support intestinal epithelium development in post-weaning piglets. The obtained results serve as an initial point for further studies on development of novel, sustainable feed additives dedicated to farm animals as scientifically based alternatives to antibiotics.

Funding Financially supported by Polish National Science Centre grant OPUS LAP UMO- 2020/39/1/NZ7/02547.

ISL-VET-01 Invited Short Lecture “Bioavailability of thymol as a natural feed additive in humans and animals”

Authors [Iveta Placha](#)¹, [Kristina Bacova](#)¹, [Radoslava Kristofova](#)¹

Institute 1 Centre of Biosciences of Slovak Academy of Sciences, Institute of Animal Physiology, Kosice, Slovakia

DOI [10.1055/s-0043-1773823](#)

Herbal remedies historically represent the first pharmacological compounds used in the treatment of many diseases. Despite being considered safer than synthetic drugs, food and drug interactions must be extensively evaluated in terms of their absorption, excretion, distribution and metabolism. Plants containing thymol have been used in traditional medicine for the treatment of various diseases, such as cardiovascular diseases, cancer and diabetes. To understand the bioavailability of thymol in animal organisms and to establish the suitable concentration for beneficial effects on animal health, its metabolic path needs to be understood at the molecular level. Oral bioavailability represents the fraction of administered thymol reaching the systemic circulation and is a key parameter that affects its efficacy. Therefore, to propose an appropriate dose, the study of thymol oral bioavailability has received significant attention. Information concerning the bioactivity of thymol and its metabolites in animal organisms could also be applied to human medicine and may help in the utilization of herbal medicine in humans and in veterinary healthcare. However, relatively few studies on the bioavailability and pharmacokinetics of thy-

mol are available to date. According to our knowledge from the current literature, thymol metabolites, mostly thymol sulphate and glucuronide, were detected in the plasma and urine of humans and in the plasma, intestinal content, faeces and tissues in rats, pigs, chickens, horses and rabbits. To precisely understand the metabolic processes and biological activity of thymol and its metabolites within organisms, more clinical studies are necessary, with pre-clinical comprehensive research on animal models.

Funding VEGA 2/0009/20

CSL-VET-01 Contributed Short Lecture “*In vivo* efficacy assessment of an essential oils-based solution on controlling red mites and egg residues in laying hens”

Authors [Hoa Bui](#), [Sorphon Suor-Cherer](#), [Mohammed el Amine Benarbia](#)

Institute 1 [Nor-feed, Angers, France](#)

DOI [10.1055/s-0043-1773824](#)

Red mite (PRM) is the tricky issue in poultry welfare and performance. Besides, the excess use of synthetic compounds to control PRM causes risk of resistance and bioaccumulation that alerts public health concern. Hence, sustainable alternatives are in demand. Natural essential oils (EOs) are the promising solution thanks to their documented repellent effect. The objectives of this study were to evaluate a standardised essential oil mixture (STEOs), named Nor-Mite, in controlling PRM and its possible residues in eggs.

Nine hens were divided into 2 groups: STEOs group fed ($n = 4$) with standard feed supplemented with STEOs; CT group ($n = 5$) received an un-supplemented standard feed. The repellency of hens to PRM was determined by letting 50 starving female PRMs freely choose hens for blood meals through a Y-shaped olfactometer route. Residues were analysed using an adapted GC-EI-MS method on eggs laid by STEOs-supplemented hens during 10 months compared to eggs from un-supplemented hens. Two major compounds, geraniol and eugenol were targeted.

In vivo study showed that up to 78% of tested PRM was recorded feeding on CT hens while only 14% of PRM choose STEOs hens. These results showed significant repellent effect against PRM of STEOs hens compared to CT hens ($P < 0.001$). By detection limit, no aromatic compound was detected from all eggs of both groups.

STEOs demonstrated the via-feed-supplement repellent effect. Residual accumulation in eggs laid by hens supplemented with STEOs in feed for 10 months was absent. Thus, indicating that dietary STEOs is the efficient, residue-free solution to prevent PRM.

KL-VET-02 Keynote Lecture “Ethnoveterinary research in Benin – an overview”

Author [Hospice Dassou](#)¹

Institute 1 [University Of Abomey-calavi, Abomey-Calavi, Bénin](#)

DOI [10.1055/s-0043-1773825](#)

Across Benin, local people typically rely on plant-based veterinary knowledge readily available to manage common animal health problems. Despite the ancient origin of these practices, formal ethnoveterinary research is still an emerging field in the country with most studies to date focusing on documenting plants used. The most comprehensive checklist includes 241 plant species (c. 9% of total flora of Benin) to treat 45 animals' signs and diseases. Despite this rich diversity, ethnoveterinary flora has received little attention from chemists and pharmacologists. This is related to the inadequate funding for research and poor equipment in scientific laboratories. Therefore, the major challenge is to initiate a joint vibrant and robust research and development program on ethnoveterinary plants, notably those traditionally used to tackle emerging diseases like zoonosis, in order to find out their effectiveness but also to strengthen the human and technical capacities.

Conflict of Interest There author declares no conflict of interest.

ISL-VET-02 Invited Short Lecture “Contribution of the observation of animal self-medication behaviours to ethno-veterinary medicine: Mahout-Elephant interactions in Thongmyxay district – Laos”

Author [Jean Marc Dubost](#)¹

Institute 1 [Museum National d'Histoire Naturelle, Paris, France](#)

DOI [10.1055/s-0043-1773826](#)

Until recently, based on convergent uses of traditional remedies in human and veterinary medicine, it was somehow assumed that the ethnoveterinary pharmacopoeia was a subset of the human pharmacopoeia extended to animal care. However, studies conducted over the last two decades comparing the plant species locally used in these two domains show that a significant proportion of species are dedicated to animal treatments, raising the question of the origin of these practices, while the multiplication of studies on animal self-medication is giving ground to the idea, found in many folk accounts, of an animal origin of part of the human pharmacopoeia.

Relying on the close relationship that mahouts maintain with their elephants in Laos, we have studied these interactions between animal observation and traditional medicine.

We have highlighted different processes by which observed elephant behaviours interpreted as self-medication can lead to the emergence of various ethnoveterinary practices, ranging from facilitating access for sick elephants to the plants they seek in such cases, to the integration of these items with elements from the local pharmacopoeia into elaborate ethnoveterinary preparations. Furthermore, mahouts uses of some plant items in their own households appear to be more consistent with their observation of elephants' self-medication behaviour than with the use of these items by local healers, supporting the hypothesis of medicinal knowledge transfer from animals to humans.

These data show that traditional human medicine and ethnoveterinary medicine are mutually enriching and that the observation of animals contributes to the development of practices in both areas.

CSL-VET-02 Contributed Short Lecture “Ethnoveterinary use of herbal mixtures in the treatment of livestock – a survey in Bavaria”

Authors [Theresa Schlittenlacher](#)¹, [Gabriela Knubben-Schweizer](#)², [Ariane Maeschli](#)¹, [Michael Walkenhorst](#)¹

Institutes 1 [Research Institute of Organic Agriculture FiBL, Frick, Switzerland](#);

2 [Clinic for Ruminants with Ambulatory and Herd Health Services, Ludwig-Maximilians-University Munich LMU, Oberschleißheim, Germany](#)

DOI [10.1055/s-0043-1773827](#)

While mixtures are common in traditional Chinese veterinary medicine, they seem to be rare in Western veterinary phytotherapy. From 2018 till 2021, we conducted an ethno-veterinary study on Bavarian farms to evaluate how frequently medicinal plant mixtures are used in practice.

A total of 77 interviews were carried out with 101 farmers. Altogether 884 use reports (UR) were recorded, comprising detailed information about plant species, plant part and further natural substances used, the manufacturing process for the end product, dosing, administration and therapeutic intention. Among them, 159 UR described the use of mixtures (each contained between two and 19 ingredients (mean: 4)) corresponding to 155 different plant species and 17 different natural substances (e.g. salt, sugar, propolis).

The most frequently mentioned plant species in mixtures were: *Calendula officinalis* L. (27 UR), *Salvia officinalis* L. (24 UR) and *Cinnamomum verum* J.Presl (24 UR).

The most frequently reported UR were for “Alimentary tract and metabolism” (QA) followed by dermatological indications (QD) and respiratory tract diseases (QR). Purchased products were used for 36% of the UR (► **Fig. 1**). Popular purchased products among the farmers were ColoSan SaluVet with 10 UR for digestive disorders and “Schwedenbittertrunk” for use in skin diseases or mastitis (8 UR). Overall, the farmers surveyed preferred single preparations (448 UR compared to 159 UR of mixtures used).

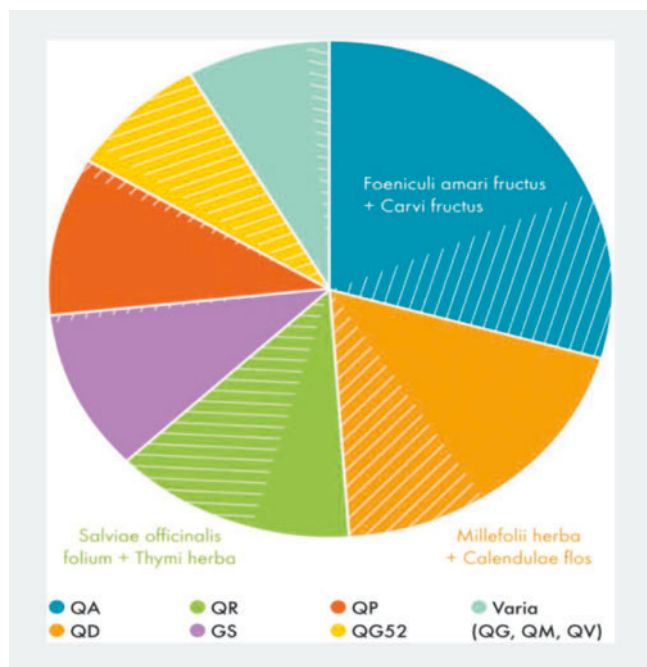

► **Fig. 1** Classification of the 159 mixture UR (out of a total of 884 UR) according to ATC-Vet codes incl. representation of the share of purchased mixtures (shaded area) – and with the two most frequently reported drugs, respectively.

Conflict of Interest The authors declare no conflict of interest.

KL-VET-03 Keynote Lecture “Pyrrolizidine alkaloids – medicine for insects?”

Author Michael Boppré¹

Institute 1 Albert-Ludwigs-Universität, D-79085 Freiburg, Germany

DOI 10.1055/s-0043-1773828

Since toxicity is not a character but an effect of a chemical on a certain organism, it not only depends on the dose but also on the receiver. 1,2-dehydropyrrolizidine ester alkaloids (PAs), although harmful secondary plant chemicals for vertebrate animals including humans, do have beneficial effects for particular, adapted insects. Some actively gather PAs from dead or injured plant tissues by a peculiar behaviour performed independently of, and in addition to feeding: PA-pharmacophagy (► **Fig. 1**).

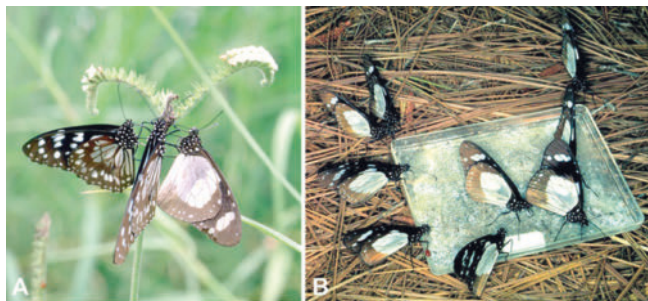

► **Fig. 1** Self-medicating milkweed butterflies. Males of *Tirumala petiverana* and *Amauris ochlea* (Lepidoptera: Nymphalidae: Danainae) taking up pyrrolizidine alkaloids from a wound at an inflorescence of *Heliotropium indicum* (a) and from a dish containing pure PAs (b) to potentially increase their chances of survival and biological fitness.

This talk will discuss examples of PA-pharmacophagy and their peculiarities. PA-pharmacophagy is not necessary for maintaining life but serves (potentially) to increase chances of survival and/or biological fitness, sometimes also providing such a benefit for sex partners and/or offspring. It is not an insect-plant relationship in the common sense, but an insect-chemical relationship, often shown by one sex only and never continuously engaged, only temporarily. Similar behaviours for taking advantage of natural products not essential for life are also known from other insects (animals).

Are we dealing with self-medication? This term is used for taking chemicals capable of curing an acute pathological situation, preventing a disease, or boosting general well-being. When insects are in focus, insufficient understanding about their state of health, sentience and welfare makes any definition of self-medication challenging. However, behavioural activities that relate to specific chemicals not essential for living and gathered from peculiar sources, are distinct from general activities of the species and performed only temporarily, and serve to enhance chances of survival and/or biological fitness, can surely be regarded as self-medication, too.

KL-VET-04 Keynote Lecture “Porcupines, plants and pathogens: an overview of the multi-disciplinary evidence for self-medication in the crested porcupine and other rodent species”

Authors Michael A Huffman¹, Emiliano Mori², Andrea Viviano²

Institutes 1 Wildlife Research Center, Kyoto University, Inuyama, Japan;

2 Consiglio Nazionale Delle Ricerche, Istituto Di Ricerca Sugli Ecosistemi Terrestri, Sesto Fiorentino, Italy

DOI 10.1055/s-0043-1773829

Dietary selection is an important process for the maintenance of health homeostasis. From the potential plants available in one’s environment, choices are made to assure a proper balance of nutrients for energy, growth, maintenance, reproduction, and sometimes even their nesting material. Animals also select such plants for their medicinal properties. This rapidly growing field of research is known as animal self-medication. An overview of the ethnomedicinal, behavioural and ecological evidence suggests that rodents in the wild are no exception. We review our research on the dietary habits of populations of crested porcupine (*Hystrix cristata*). In Central Italy we identified the seasonal ingestion of medicinal food species with antiparasitic properties. The seasonal ingestion of certain plant items coincides with peaks in parasite infection levels. In East Africa, self-medicating porcupine have been the inspiration for the discovery of a now widely used ethno-antibiotic treatment. It is also suggested that wood rats (*Neotoma fuscipes*) in North America and harvest mice in Japan place aromatic leaves (*Umbellularia californica*, *Artemisia princeps*) in their nests for the fumigation of nest-borne ectoparasites, supporting the growing body of evidence for the use of plants with antiparasitic benefits in wildlife species. The study of self-medicative behaviour and the plants used by animals in the wild is a promising bio-rational for expanding and advancing the use of phytotherapy in a veterinary setting.

Egon-Stahl-Award in Gold

Monday 3rd July 2023

ESA-GOLD “Natural Products: a Key to Open the Door to the Future”

Author Giovanni Appendino¹

Institute 1 Università del Piemonte Orientale, Dipartimento di Scienze del Farmaco, 28100 Novara, Italy

DOI 10.1055/s-0043-1773830

Combining tradition and innovation is probably the best recipe for success in natural products (NPs) research. When you have a history, tradition is unavoidable.

able, and NPs come with associated genetic, environmental and cultural connections. If innovation is the capacity to make connections, then progress in technology and advancements in our knowledge on the mechanisms of life have greatly increased the opportunity to integrate natural products in cutting-edge research. In this context, I believe there are three main areas that could inspire NPs-based innovation: environmental observations, human heritage and human ingenuity. Many interactions between living organisms are based on NPs. Their observation has triggered the discovery of antibiotics, but animal behaviour remains a still substantially untapped source of observations, while the ecological role of most plant natural products is unknown. Human cultural heritage (ethnopharmacology, traditional medicine) has triggered the development of modern medicine, but has not exhausted its role. Ethnic groups, i.e. people who share specific attributes, abound in our society, and the discovery of the modern uses of phytocannabinoids by marijuana smokers exemplifies the relevance of ethnopharmacology in modern medicine. Human ingenuity has generated novel areas of investigation like synthetic biology and advanced materials, which could be fertilized, with mutual benefit, by NPs. Finally, yet importantly, the field of NPs is full of “known unknowns” whose clarification could contribute to advance biomedical research. I will discuss how, rather than being relegated into a medical mausoleum, NPs remain, I believe, a marvellous source of opportunities to improve human life.

Willmar Schwabe | Young Talent Award

Monday 3rd July 2023

WSYTA “A Distillate of the LOTUS Initiative in Natural Products Research: Sharing Information, Building Knowledge, Extracting Wisdom”

Author [Adriano Rutz](#)¹

Institute [1 Department of Biology, Institute of Molecular Systems Biology, Swiss Federal Institute of Technology/ETH Zürich, Otto-Stern-Weg 3, 8093 Zürich, Switzerland](#)

DOI [10.1055/s-0043-1773831](#)

The LOTUS initiative has reached a pivotal stage, poised to unveil its latest advancements [1]. This initiative aims to revolutionize knowledge access and sharing in Natural Products (NP) research, holding relevance across diverse scientific disciplines, including pharmacognosy, drug discovery, chemical ecology, and chemotaxonomy. Despite the importance of NP data, current improvements in these fields often remain confined to specific domains, limiting the comprehensive interpretation, translation, and utilization of information within a broader context. Addressing this challenge necessitates seamless access to high-quality linked open data, facilitating cross-fertilization among various life sciences.

Wikidata integration emerges as a potent solution, highlighted by prior studies, establishing it as a powerful platform for sharing knowledge in life sciences [2]. This abstract showcases the versatility of Wikidata through different applications and complex queries it can adeptly address (<https://w.wiki/6rf2>), emphasizing its role as a valuable source of prior knowledge across scientific endeavours.

Driven by a collaborative spirit, the LOTUS initiative fosters an environment that encourages researchers to access and curate invaluable NP data while facilitating the exchange of their own findings. This collective endeavour holds the potential to advance our understanding of the intricate relationships between biological systems and natural products. Through the dismantling of silos and the promotion of knowledge sharing, the LOTUS initiative envisions accelerating scientific progress and contributing to innovative discoveries in NP research.

References

[1] doi:10.7554/eLife.70780

[2] doi:10.7554/eLife.52614

Keynote Lectures

Monday 3rd July - Wednesday 5th July 2023

KL-01 Keynote Lecture 1 “New directions in ethnobotany and ethnopharmacology of Turtle Island (North and Central America)”

Authors [John Thor Arnason](#)¹, [Pierre Haddad](#)², [Alain Cuerrier](#)³, [Cory Harris](#)¹, [José A. Guerrero-Analco](#)⁴, [Jon Ferrier](#)⁵, [Todd Pesek](#)⁶, [Victor Cal](#)⁷

Institutes [1 Biology Department University of Ottawa, Kitchissippi, Ottawa, ON Canada](#); [2 Département de Pharmacologie, Université de Montréal, Montréal QC, Canada](#); [3 Institut de Recherche en Biologie Végétale, Jardin Botanique de Montréal, Montréal QC, Canada](#); [4 Red de Estudios Moleculares Avanzados, Instituto de Ecología, A.C., Xalapa, Mexico](#); [5 Biology Department, Dalhousie University, Halifax NS, Canada](#); [6 Department of Health Sciences and Human Performance, Cleveland State University, Cleveland OH, USA](#); [7 Belize Indigenous Training Institute, Punta Gorda, Belize](#)

DOI [10.1055/s-0043-1773832](#)

Reconciliation with, and empowerment of Indigenous Peoples in North and Central America has led to collaborative ethnobotany and ethnopharmacology research on traditional medicines for safety and efficacy. The Team on Aboriginal Antidiabetic Medicines in collaboration with James Bay Cree Communities of Eeyou Istchee territories studied traditional foods, medicines and lifestyles that can reverse a growing epidemic of diabetes in First Nations communities. More than 51 consensus boreal plants identified by 148 elders were ranked using syndromic importance value. Among these, bioassay guided isolation and metabolomic techniques [1] identified novel phytochemicals with glucose lowering activity, adipogenic activity, and antiglycation activity. In a metanalysis of results [2], plants were ranked by Pharmacological Importance Value. Results were used in community public health projects in four First Nations. In a second Indigenous collaboration [3] with Q'eqchi' Maya Healers of Xna'ajeb' aj Ralch'o'och', Belize, the healers requested scientific assessment of their plants to gain recognition from local government. An ethnobotanical survey identified a tropical medicinal pharmacopoeia of 169 species in several use categories with a high informant consensus factor. Many wild species were cultivated for the first time in an Indigenous garden for primary healthcare. Bioassay guided isolation identified novel anti-anxiety, anti-inflammatory and antiglycation phytochemicals, with several results confirmed in animal models. One plant used dates back to the Classic period [4]. Despite the distance between them, Cree and Maya healers share a common cosmocentric world view and a belief that their medicines are most effective in a traditional context for healing.

Conflict of Interest The authors declare no conflict of interest.

References

[1] Arnason JT, Harris CS, Guerrero-Analco JA Phytochemistry in the Ethnopharmacology of North and Central America. *Front. Pharmacol.* 2022; 13: 815742

[2] Hall B., Rapinski M., Spoor D., Eid H., Saleem A., Arnason J.T., Foster B., Cuerrier A., Haddad P.S., Harris C.S. A Multivariate Approach to Ethnopharmacology: Antidiabetic Plants of Eeyou Istchee. *Frontiers in pharmacology* 2022; 12: 511078

[3] Arnason J., Cal V., Pesek T., Awad R., Bourbonnais-Spear N., Collins S., Otarola-Rojas M., Walshe-Roussel B., Audet P., Ta C.A., Balick M. A review of ethnobotany and ethnopharmacology of traditional medicines used by Q'eqchi' Maya Healers of Xna'ajeb'aj Ralch'o'och', Belize. *Botany* 2022; 100: 219–230

[4] Ferrier J., Pesek T., Caal F., Cal V., Balick M., Arnason J. A Classic Maya Mystery of a Medicinal Plant and Maya Hieroglyphs, *Heritage* 2020; 3 (16): 275–282

KL-02 Keynote Lecture 2 “Psychedelics in mental health – therapeutic potential and possible brain mechanisms”

Author [David Erritzoe](#)

Institute 1 Centres for Psychopharmacology and Psychedelic Research, Imperial College London, Hammersmith Hospital Campus, London, UK

DOI [10.1055/s-0043-1774759](#)

After a decades-long global arrest of research on psychedelic drugs, investigations into psychedelic-assisted therapies have recently provided promising results for a range of serious psychiatric conditions, including major depression and tobacco and alcohol addictions. In his talk David will focus on depression, hereunder address why it is important to explore new avenues for treating this condition - namely because not much has happened in the space for decades whilst depression is only becoming more of an issue in the ranks of global health. He will give an introduction to the psychedelic science work undertaken at Imperial College London, hereunder the clinical therapy model employed with these compounds. He will be highlighting recent clinical discoveries and discuss how these developments at Imperial and in the psychedelic scientific field in general show great promise for this treatment for depression as well as other non-psychotic mental health conditions. Additionally, he will show data related to possible psychological and neurobiological mechanism, and discuss how the model appears to differ significantly from conventional pharmacotherapy in mental health.

KL-03 Keynote Lecture 3 “African plants: valuable sources of phytogetic alternatives to antibiotic feed additives in poultry”

Authors [Lyndy Joy McGaw](#)¹, [Olasunkanmi Stephen Olawuwo](#)¹, [Prosper Jambwa](#)¹, [Gift Matope](#)², [Ibukun Michael Famuyide](#)¹

Institutes 1 Phytomedicine Programme, Department of Paraclinical Sciences, Faculty of Veterinary Sciences, University of Pretoria, Private bag X04 Onderstepoort 0110, Pretoria, South Africa; 2 Department of Veterinary Pathobiology, University of Zimbabwe, PO Box MP167, Mt Pleasant, Harare, Zimbabwe

DOI [10.1055/s-0043-1773833](#)

Poultry is one of the fastest growing animal industries and contributes substantially to food security and nutrition. Poultry diseases threaten public health and cause global economic losses. Bans on antibiotic feed additives due to their role in promoting antimicrobial resistance (AMR) gave rise to a need for alternative poultry and livestock growth promoters. Phytogetic feed additives (PFAs) may have useful properties such as antimicrobial, antioxidant, anti-inflammatory and immune modulatory activity. We investigated selected African plants used in traditional poultry healthcare, and those with known bioactivity, for future development of poultry PFAs. Extracts, fractions and purified compounds were subjected to *in vitro* bioactivity tests, and proximate analysis was conducted on active extracts to assess nutritional benefits. A pilot scale *in vivo* study was carried out in broiler chickens experimentally infected with zoonotic *Campylobacter jejuni*. *Morinda lucida*, *Acalypha wilkesiana* and *Erythrina abyssinica* had promising antibacterial activity with MIC values as low as 20 µg/mL against poultry bacterial and fungal pathogens. *Senna singueana* had excellent anti-inflammatory and antioxidant activity and bioassay-guided fractionation led to improved activity. Active compounds were identified, including luteolin from *S. singueana*, which may serve as chemical markers in development of standardised PFAs from botanical extracts. *Morinda lucida* had promising antibacterial and anti-biofilm activities, and adding nutrient rich *Morinda* leaf powder to the broiler diet improved feed conversion ratios and other parameters, compared to a standard antibiotic growth promoter. Further research concentrates on bioactivity of combined fractions from various plant species to develop a cost-effective PFA for enhanced poultry production.

Conflict of Interest The authors declare no conflict of interest.

KL-04 Keynote Lecture 4 “Deep dive into the world of medicinal plants – the chamber of secrets has been opened, enemies of HERBS... beware”

Author [Ioanna Chinou](#)¹

Institute 1 Lab. of Pharmacognosy & Chemistry of Natural Products, Dept of Pharmacy, NKUA, Zografou 15771, Athens, Greece

DOI [10.1055/s-0043-1773834](#)

The use of herbal medicine has increased worldwide, serving as a tool in many health systems. While an important aspect in preserving cultural diversity, assessment of efficacy, quality control and safety monitoring is necessary to secure the future regulatory status of plant-based preparations. Herbals have become widely available on the EU market offering plenty of preparations with significant differences in classification, under the categories of herbal medicinal products, medical devices, cosmetics or food supplements.

The EU has considered medicinal use of herbal products through mainly the Traditional Herbal Medicinal Products Directive (2004/24EC) and the Herbal Medicinal Products Committee (HMPC) at the European Medicines Agency recognising and assessing the data on benefits and risks from application experiences in health services research. However, considerable difficulties remain, with little application data available for the use of HMPs in special groups (pregnant and lactating women, children and patients with concomitant diseases and therapies).

Several non-European traditional therapies are in use in the EU (TCM, Ayurveda etc.) with many herbals in daily practice, while recently, medicinal cannabis has been introduced in the EU, if not yet in a fully harmonised way.

Thousands of food supplements under the umbrella of EFSA follow their own procedural schemes, while the educational system towards knowledge in herbal medicines in the EU remains mostly either unchanged or inadequate.

The value, phytochemical properties, health advantages, traditional and modern applications of herbs, along with their uses and given education in the EU, will be thoroughly discussed in this presentation and session.

Conflict of Interest The author declares no conflict of interest.

KL-05 Keynote Lecture 5 “A lymphatic route for oral polysaccharide to trigger immune responses”

Authors [Aiping Lyu](#)¹, [Quanbin Han](#)¹

Institute 1 School of Chinese Medicine, Hong Kong Baptist University, Hong Kong, China

DOI [10.1055/s-0043-1773835](#)

Many natural polysaccharides, especially those from Chinese medicines, being safe and effective, show great medicinal potential. But they are widely doubted due to their poor bioavailability. These highly polar macromolecules hardly pass through the lipophilic gut barrier and absorbed into blood. Although they have been reported to have many *in vitro* and *in vivo* bioactivities, there is a huge research gap regarding whether they can contact the target cells. Recently, the quickly increasing studies on gut microbiota indicated that these carbohydrates may work as carbon source for gut microbiota to produce short-chain fatty-acids that are associated with many beneficial effects. However, most of these studies finally focused on butyrate, which is weak to explain the diverse bioactivities of these so many different polymers. Radix Astragali Polysaccharide (RAP) is a good example, which has been reported to have many *in vitro* and *in vivo* immune-related bioactivities such as activating innate immune cells, anti-cancer, anti-viral, and immunomodulatory properties. Our previous study found that RAP quickly induced immune response in the intestinal Peyer's patches 2 hours after oral dosing, which happened before RAP arriving cecum where RAP will be degraded into SCFAs by gut microbiota. There must be another way for RAP to contact immune cells. Our further investigation revealed that RAP, remaining intact polymer, was quickly transported by M-cell into Peyer's patches where it directly targeted follicle dendritic cells and initiated antitumor immune responses. RAP was even transported by DCs to protect chemotherapy-suppressed bone marrow cells and hematopoietic stem cells (HSC) *in vivo* and *in vitro*. This route was already verified to apply to human

subjects. These findings refreshed people's knowledge regarding polysaccharide's oral bioavailability. This new absorption route eliminates the above research gap and provides new ideas for finding lymphatic-targeted new drug preparation. More importantly, RAP showed its great potential to work as the special carrier in a lymphatic-targeting drug delivery system. Especially, RAP may be a promising dual-function adjuvant for oral vaccine: immune-stimulator and lymphatic-targeting antigen carrier (► Fig. 1).

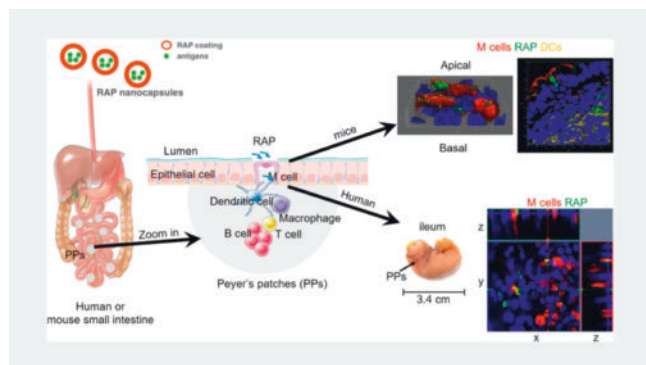

► Fig 1 RAP entered PPs via M-cell transcytosis and directly contacted DCs to trigger immune response after oral dosing.

Conflict of Interest The authors declare no conflict of interest.

KL-07 Keynote Lecture 7 “From the discovery of bioactive natural products to the development of innovative strategies for their chemo-diversification and generation of potential new leads”

Authors Robin Huber¹, Laurence Marcourt¹, Sylvain Schne², Jean-Luc Wolfender¹, Katia Gindro², Emerson Ferreira Queiroz¹

Institutes 1 Section des Sciences Pharmaceutiques, Université de Genève, CH-1211 Genève 4, Switzerland; 2 Agroscope, Plant Protection Research Division, Route de Duillier 50, P.O. Box 1012, 1260 Nyon, Switzerland
DOI 10.1055/s-0043-1773836

Over the past decade, we have witnessed a revolution in the methodologies applied to natural product research. Current approaches combine powerful metabolite profiling methods for compound annotation, and prioritization. Targeted isolation is performed using high-resolution chromatographic methods that closely match those used for analytical profiling. Thanks to these tools, minor bioactive compounds were identified. However, in plant extracts, the major compounds are generally common structures, apparently irrelevant for drug discovery. In this context, the chemical engineering of extracts and biotransformation could be an alternative to valorize them. The concept of these approaches is to start from abundant NPs present in plants to obtain active compounds using chemical and biological reactions. Given that 20% of marketed drugs contain halogen atoms, a methodology has been developed to allow controlled halogenation of compounds directly in plant extracts [1]. In addition, biotransformation reactions of single NPs using enzymes secreted by a phytopathogenic fungus have been successfully used to obtain a wide variety of compounds. A metabolite profiling by UHPLC-PDA-ELSD-HRMS analysis were used to monitor these different reactions and highlight the presence of the new compounds [2–4]. In most cases, it was possible to improve the chemical diversity by the generation of active compounds from inactive scaffolds. To isolate, characterize and study the biological activities of the generated compounds, the use of high-resolution preparative chromatographic methods was mandatory. At this level, significant improvements for the efficient targeted isolation of given NPs through dry load injection and chromatographic gradient transfer methods have been made [5]. The applications, possibilities and limitations of these latest technologies will be illustrated with recent investigations performed in our laboratory.

Conflict of Interest The authors declare no conflict of interest.

References

- [1] Neuenschwander A, Rocha VPC, Bastos TM et al. Production of highly active antiparasitic compounds from the controlled halogenation of the *Arabisidaea brachypoda* crude plant extract. *J Nat Prod* 2020; 83: 2631–2640. doi:10.1021/acs.jnatprod.0c00433
- [2] Huber R, Marcourt L, Koval A et al. Chemoenzymatic synthesis of complex phenylpropanoid derivatives by the *Botrytis cinerea* secretome and evaluation of their wnt inhibition activity. *Front Plant Sci* 2021; 12: 805610. doi:10.3389/fpls.2021.805610
- [3] Huber R, Koval A, Marcourt L et al. Chemoenzymatic synthesis of original stilbene dimers possessing wnt inhibition activity in triple-negative breast cancer cells using the enzymatic secretome of *Botrytis cinerea* Pers. *Front Chem* 2022; 10: 881298. doi:10.3389/fchem.2022.881298
- [4] Righi D, Huber R, Koval A et al. Generation of stilbene antimicrobials against multiresistant strains of *Staphylococcus aureus* through biotransformation by the enzymatic secretome of *Botrytis cinerea*. *J Nat Prod* 2020; 83: 2347–2356. doi:10.1021/acs.jnatprod.0c00071
- [5] Queiroz EF, Alfattani A, Afzan A et al. Utility of dry load injection for an efficient natural products isolation at the semi-preparative chromatographic scale. *J Chromatogr A* 2019; 1598: 85–91. doi:10.1016/j.chroma.2019.03.042

KL-08 Keynote Lecture 8 “Cannabis and the endocannabinoid system: translating basic research into clinical trials”

Author Jürg Gertsch¹

Institute 1 Institute of Biochemistry and Molecular Medicine, University of Bern, Switzerland

DOI 10.1055/s-0043-1773837

Since the discovery that Δ^9 -*trans*-THC specifically activates the G protein-coupled receptors CB₁ and CB₂ in the early 1990s, the “pandora box” of endocannabinoid signaling has been successively opened. As a result, the endocannabinoid system was uncovered as a fundamental biochemical system in the brain and in the periphery and is now the target of intensive drug discovery and development in very broad areas like neurodegenerative and neuropsychiatric disorders, chronic inflammatory diseases and metabolic illnesses. Rather surprisingly, the only approved evidence-based drugs targeting the system to date are *C. sativa* flos, the (–)-*trans*- Δ^9 -THC enantiomer (dronabinol) as an approved appetite stimulant and antiemetic, as well as cannabidiol (CBD) as adjunct treatment for pediatric forms of epilepsy. While the medical cannabis industry is booming and hopes related to the therapeutic potential of marijuana are spiraling upwards, tangible progress is primarily made in understanding the endocannabinoid system.

In this presentation, I review the complication of evidence-based medicine with cannabis-based APIs looking at data from GCP studies and patient anecdotes in the context of the known and unknown molecular mechanisms of action. Despite the unrelenting boom, phytochemistry, metabolomics and classical pharmacology remain the essential topics for the engineering of efficacious cannabis-based medicines. Moreover, challenges and opportunities in drug discovery and development of novel medicines targeting the endocannabinoid system in pharma industry will be discussed, providing examples from our own collaborative and translational research.

Conflict of Interest The author is a co-founder of Synendos therapeutics, a company developing selective endocannabinoid reuptake inhibitors (SERIs).

KL-09 Keynote Lecture 9 “Exploration of beneficial herb-drug combinations – will this advance the development and application of herbal medicines?”

Author Clara Bik-San Lau¹

Institute 1 Institute of Chinese Medicine and State Key Laboratory of Research on Bioactivities and Clinical Applications of Medicinal Plants, The Chinese University of Hong Kong, Shatin, New Territories, Hong Kong SAR, China

DOI 10.1055/s-0043-1773838

Herbal medicines have been traditionally used for over thousands of years worldwide. Despite the conventional therapies which most patients rely on, many patients would go for the complementary and alternative medicine, especially in situations of unmet medical needs. Hence, the combined use of herbs and conventional drugs has been increasing during the past decades, particularly for those patients suffering from chronic diseases such as cardiovascular diseases or cancers. Thus, apart from evaluation on the efficacies and toxicities of herbal medicines, research on the beneficial potential of combined use of herbal medicines with conventional drugs may even be more relevant to the clinical needs.

Over the years, my research team has been exploring the beneficial efficacies of the combined use of herbal medicines and conventional drugs using preclinical research platforms. For instance, we revealed the new roles of *Cistanche deserticola* on statin-induced muscle toxicity and the management of diet-induced hyperlipidemia and fatty liver [1]. We have also systematically demonstrated the adjuvant values of herbal medicines towards conventional medicines in cancer management, such as the combination of turmeric and bevacizumab in colon cancer [2], *Camellia sinensis* and metronomic zoledronate in metastatic breast cancer [3], as well as *Andrographis paniculata* and chemotherapeutics (5-fluorouracil and cisplatin) in metastatic esophageal cancer [4]. The findings on herb-drug combinations with both efficacy augmentation and toxicity reduction, together with evidence from future clinical trials, will undoubtedly benefit patients. Scientific evidences arise from these studies as proof-of-concept and are certainly important for the advancement of herbal medicines development.

Conflict of Interest The authors declare no conflict of interest.

References

- [1] Wat E, Ng CF, Koon CM, Zheng C, Gao S, Tomlinson B, Lau CBS. The adjuvant value of Herba Cistanches when used in combination with statin in murine models. *Scientific Reports* 2017; 7: 9391
- [2] Yue GGL, Kwok HF, Lee JKM, Jiang L, Wong ECW, Gao S, Wong HL, Lin L, Chan KM, Leung PC, Fung KP, Zuo Z, Lau CBS. Combined therapy using bevacizumab and turmeric ethanolic extract (with absorbable curcumin) exhibited beneficial efficacy in colon cancer mice. *Pharmacological Research* 2016; 111: 43–57
- [3] Luo KW, Ko CH, Yue GGL, Gao S, Lee JKM, Li G, Fung KP, Leung PC, Evdokiou A, Lau CBS. The combined use of *Camellia sinensis* and metronomic zoledronic acid in a breast cancer-induced osteolysis mouse model. *Journal of Cancer Research and Clinical Oncology* 2015; 141: 1025–1036
- [4] Li L, Yue GGL, Lee JKM, Wong ECW, Fung KP, Yu J, Lau CBS, Chiu PWY. The adjuvant value of *Andrographis paniculata* in metastatic esophageal cancer treatment – from preclinical perspectives. *Scientific Reports* 2017; 7: 854

KL-10 Keynote Lecture 10 “Centrifugal Partition Chromatography (CPC) – principles and applications in the recovery of natural products of pharmacological significance”

Author [Wirginia Kukula-Koch¹](#)

Institute 1 Department of Pharmacognosy with Medicinal Plants Garden, Medical University of Lublin, 1 Chodzki str., 20-093 Lublin, Poland

DOI 10.1055/s-0043-1773839

Centrifugal partition chromatography (CPC) is a type of counter-current chromatography, and an advanced form of liquid chromatography (LC) that was developed in 1964 and since then used for the separation of compounds present in the mixtures (mainly of plant origin). The CPC technique offers several advantages in terms of operation, including no need for a solid sorbent (the separation is performed between two immiscible solvent mixtures, one of which plays a role of the stationary phase and the other – of the mobile phase), low operation temperatures, a wide range of separating solvents of reagent grade to be applied, or an easy up-scaling protocol, which enables its application in preparative or industrial volumes [1].

Apart from the introduction of this valuable technique, the aim of the lecture is to discuss about the possibilities that CPC may offer for plant drug delivery.

Particular attention will be paid to the isolation of specialized metabolites with Central Nervous System targeting activity.

Details on the separation conditions, preparation of biphasic solvent systems and apparatus settings will be presented to discuss the efficiency of separation procedures in the recovery of plant derived secondary metabolites, e.g. from turmeric, ginger, horse chestnut, or others.

CPC is a powerful time- and reagent- saving separation technique providing high purity natural products even directly from crude extracts, and it covers analytical, preparative, and industrial scale operating conditions to efficiently facilitate the natural products recovery for medicinal purposes.

Funding The research was partially funded by the OPUS project from the National Science Centre in Poland (Grant number: 2021/41/B/NZ4/00337).

Conflict of Interest The authors declare no conflict of interest.

References

- [1] Foucault AP, Chevolut L. Counter-current chromatography: Instrumentation, solvent selection and some recent applications of natural product purification. *J Chrom A* 1998; 808: 3–22

KL-11 Keynote Lecture 11 “Pharmacokinetic considerations for inhaled natural product mixtures to treat lung infections”

Author [Lea Ann Dailey¹](#)

Institute 1 Department of Pharmaceutical Sciences, University of Vienna, Josef-Holaubek-Pl. 2, 1090 Vienna, Austria

DOI 10.1055/s-0043-1773840

Acute respiratory infections (ARIs) caused by viruses and/or bacteria are responsible for the most frequently occurring contagious diseases worldwide and the most common cause of death from communicable diseases. The high mortality rates associated with viral and bacterial ARIs highlight the need for the accelerated identification and assessment of new effective anti-ARI therapeutics. Poor oral bioavailability of many new classes of antibiotics and anti-infectives, especially those derived from natural product sources, can slow or hinder the development of promising treatment options. Inhalation administration of antibiotics/anti-infectives for the treatment of local lung infections may offer a sensible alternative to oral administration. However, it is not widely recognized that the local pharmacokinetics of drug compounds in the lung can be highly dependent on drug compound structure and formulation. For example, compound solubility and permeability will play an important role in determining whether inhalation administration is a feasible option and whether special formulation approaches, such as liposomal encapsulation, may be advantageous.

This presentation will:

- 1) provide an overview on pharmacokinetics of a wide variety of antibiotic compound classes in the lung
- 2) discuss how target product profiles and pre-formulation studies may streamline early product development
- 3) discuss how this knowledge may be extended towards the investigation of inhaled natural product mixtures
- 4) introduce the concept of pharmacokinetic synergy for natural product mixtures
- 5) demonstrate the effects of drug formulation strategies for controlling lung pharmacokinetics of inhaled drugs

Conflict of Interest The author declares no conflict of interest.

KL-12 Keynote Lecture 12 “NMR chemical profiling medicinal plants with new perspectives: how to do, what to expect and where to apply”

Authors [Young Hae Choi¹](#), [Özlem Erol](#), [Natali Rianika Mustafa¹](#), [Alana Kelyene Pereira¹](#), [Hocelayne Paulino Fernandes¹](#), [Hye Kyong Kim¹](#), [Robert Verpoorte¹](#), [Young Pyo Jang²](#)

Institutes 1 Natural Products Laboratory, Institute of Biology, Leiden University, Sylviusweg 72, 2333 BE Leiden, The Netherlands; 2 Division of Pharmacognosy, College of Pharmacy, Kyung Hee University, Seoul 02447, Republic of Korea
DOI 10.1055/s-0043-1773841

The turn of the century marked a change of paradigm in science: from hypothesis driven experiments to systems biology with observation driven experiments [1]. This change was due to the OMICS technologies that allow a holistic view on organisms under different conditions. In this approach, new hypotheses are generated based on various observed systemic data. Big Data obtained from analytical platforms, with high sensitivity and resolution, are processed and integrated with e.g., physiological data or biological activities. Data mining in databases of genome, transcriptome, proteome, and metabolome may eventually reveal new connections in signaling, metabolic and pharmacologic networks. Genome sequencing of many organisms has been launched. This opens the way to understand a plant's resistance against pests and disease, quality control of medicinal plants, or finding novel leads for medicines from plants. NMR- and MS-based techniques are utilized for metabolic profiling. NMR measures mixtures of compounds, MS usually measures separated compounds [2, 3]. Major difference is in quantitation. The intensity of NMR signal is based on molar concentration [4]. In MS based systems, absolute quantitation requires a calibration curve for each compound. Reproducibility of NMR is superior to MS. Our ¹H NMR database of Korean medicinal plants (ca. 250 species) enables searching for features such as synergism, and bioactivity markers for quality control of herbal medicine. In combination with DNA bar coding, metabolic profiling will give us next generation tools for quality control of medicinal plants. Eventually this avoids the need for pharmacological tests to prove and quantify the biological activity.

Conflict of Interest The authors declare no conflict of interest.

References

- [1] Verpoorte R, Choi YH, Mustafa RN, Kim HK. Metabolomics: back to basics. *Phytochem Rev* 2008; 7: 1192–1198
- [2] Verpoorte R, Choi YH, Kim HK. NMR-based metabolomics at work in phytochemistry. *Phytochem Rev* 2007; 6: 3–14
- [3] Kim HK, Choi YH, Verpoorte R. NMR-based plant metabolomics: where do we stand, where do we go? *Trends Biotechnol* 2011; 29: 267–275
- [4] Kim HK, Choi YH, Verpoorte R. NMR-based metabolomic analysis of plants. *Nature Protoc* 2010; 3: 536–549

KL-13 Keynote Lecture 13 “Dietary flavonoids and cardiometabolic health”

Author Aedín Cassidy¹

Institute 1 Institute for Global Food Security, Queen's University Belfast

DOI 10.1055/s-0043-1773842

Data from prospective cohort studies highlight the beneficial impact of higher habitual intakes of specific sub-classes of bioactive dietary constituents called flavonoids on both biomarkers of cardiovascular (CV) risk and disease outcomes including myocardial infarction (MI) and type 2 diabetes. Emerging data suggest that intake of specific flavonoids may also help with weight maintenance, cognitive function and depression.

Following ingestion, flavonoids are extensively metabolised (by Phase I & II metabolism and the gut microbiome) with the gut microbiome likely playing a key metabolic role, catabolising unabsorbed constituents into smaller molecules such as phenolic and aromatic acids, which are also absorbed. For flavonoids consumed in the diet, the parent compounds may not be responsible for bioactivity; instead this may be mediated by metabolites present in the systemic circulation. Data from limited available trials show that following intake there is extensive variability in metabolite levels. This wide inter-individual variability in metabolism (15–99% of the ingested intake recovered as a wide range of urinary metabolites) suggests that metabolism may be critical in explaining the differential responses in cardiovascular risk biomarkers observed in clinical trials (responders v non-responders).

The focus of the presentation will be on the developing evidence base for two sub-class of flavonoids (anthocyanins and flavan-3-ols), discussing the available data from clinical trials and large epidemiological studies.

Conflict of Interest The author declares no conflict of interest.

KL-14 Keynote Lecture 14 “Discovery of Anticancer Agents of Diverse Natural Origin”

Author A. Douglas Kinghorn¹

Institute 1 College of Pharmacy, The Ohio State University, Columbus, OH 43210, USA

DOI 10.1055/s-0043-1773843

Cancer remains a constant threat to human health worldwide, and the International Agency for Research on Cancer (IARC) projected recently there is a total mortality figure of about 10 million annually [1]. One well-established form of treatment for cancer is chemotherapy, and, according to an overview article, 100 (38.6%) of 259 small-molecule anticancer agents introduced into therapy in Western medicine from 1946–2019 were either unmodified natural products or semi-synthetic derivatives of natural products [2]. In this presentation, the design of a multidisciplinary, multi-institutional natural products drug discovery research program, funded through the NIH “program project” model will be described, involving collaborators from three primary universities and an industrial company. The overall objective of this program is the discovery of new anticancer agent lead compounds from selected organisms, including tropical plants and U.S. lichens and their mycobionts, aquatic and soil cyanobacteria, and filamentous fungi. The program project organization comprises three “projects” focused on the collection and chemistry of each major type of organism mentioned above, which are supported by three “cores” (i.e., administration and biostatistics; biological and mechanistic evaluation; medicinal chemistry and pharmacokinetics). Progress made in elucidating new bioactive lead compounds germane to cancer chemotherapy over the last five years has been summarized recently, with a quite broad range of lead bioactive compounds identified [3]. An emphasis will be made on how the various components of the program project are integrated with one another.

Conflict of Interest The author declares no conflict of interest.

References

- [1] Sung H, Ferlay J, Siegel RL et al. Global cancer statistics 2020: GLOBOCAN estimates of incidence and mortality worldwide for 36 cancers in 185 countries. *CA Cancer J* 2021; 71: 209–249
- [2] Newman DJ, Cragg GM. Natural products as sources of new drugs over the nearly four decades from 01/1981 to 09/2019. *J Nat Prod* 2020; 83: 770–803
- [3] Aldrich LN, Burdette JE, Carcache de Blanco EJ et al. Discovery of anticancer agents of diverse natural origin. *J Nat Prod* 2022; 85: 702–719

Monday 3rd July 2023 | Short Lecture Session A Metabolomics/Molecular networking/ Chemometrics/Profiling/AI

SL-A01 Short Lecture “*In silico* and *in vitro* search for inhibitors of *Trypanosoma brucei* and *Leishmania major* pteridine reductase 1 and dihydrofolate reductase”

Authors Katharina Possart¹, Fabian Christopher Herrmann¹, Thomas Jürgen Schmidt¹

Institute 1 Institute for Pharmaceutical Biology and Phytochemistry, University of Münster, 48149 Münster, Germany

DOI 10.1055/s-0043-1773844

The closely related protozoan parasites *Trypanosoma brucei* (Tb) and *Leishmania major* (Lm) are responsible for the insect-borne tropical diseases sleeping sickness, nagana and cutaneous leishmaniasis. They bear a significant health risk to millions of humans and animals living in tropical to subtropical climates,

threatening and debilitating affected populations. Stemming from the parasites' highly adaptive nature, the regularly occurring resistances to existing medication options require the identification of new drugs. Arising from a shared pteridine-auxotrophy known for *Trypanosomatidae*, Tb and Lm developed a corresponding enzyme system consisting of the dihydrofolate reductase-thymidylate synthase (DHFR-TS) and pteridine reductase 1 (PTR1). Expanding our previous work on this target, a comparative study of the respective *T. brucei* (TbDHFR, TbPTR1) and *L. major* (LmDHFR, LmPTR1) enzymes was employed to identify new lead structures, especially focusing on natural products with a dual inhibitory effect against PTR1 and DHFR of the respective parasites. Building on our results presented at the preceding conference, our pharmacophore-based *in silico* screening approach was used to identify further promising compounds for testing against recombinant DHFR and PTR1. The most active dual inhibitor **1** (► Fig. 1) exhibited an IC₅₀ of 20.1 µM against TbPTR1

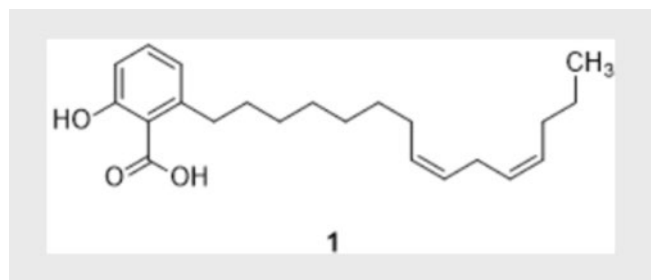

► Fig. 1 Structure of Compound 1

and 0.2 µM against TbDHFR as well as 10.2 µM against LmPTR1 and 2.6 µM for LmDHFR. Furthermore, the kinetic mechanism of action was investigated for selected inhibitors, using the data generated from the *in silico* and *in vitro* experiments. These results represent an important contribution for the future utilisation of the trypanosomatid pteridine metabolism as drug target.

SL-A02 Short Lecture "Computational investigation of 15-lipoxygenase-1 activation mechanism by different natural products"

Authors Veronika Temml¹, Paul Jordan², Lukas Peltner², Oliver Werz², Daniela Schuster¹

Institutes 1 Paracelsus Medical University, Salzburg, Austria; 2 University of Jena, Jena, Deutschland

DOI 10.1055/s-0043-1773845

15-Lipoxygenase-1 (15LOX1) plays a key role in the formation of specialised pro-resolving mediators (SPMs). It has been shown that 3-O-acetyl-11-keto-β-boswellic acid (AKBA) can stimulate SPM formation via direct binding to an allosteric binding site on 15LOX1.1 This binding site is also suspected of accommodating other natural products that are known for their modulatory effects on leukotriene formation. In this study a series of 33 well-known anti-inflammatory natural products (among them hyperforin, resveratrol, rosmarinic acid and cannabidiol) were investigated for their activating effects on 15LOX1. Biovia's Discovery Studio (vs 2020) was used to conduct a CHARMM molecular dynamics simulation of a human 15LOX1 homology model (AlphaFold Data Copyright (2022) DeepMind Technologies Limited) with known active AKBA to optimise the conformation of the allosteric binding pocket. A subsequent docking study in GOLD (vs 2020 3.0) was carried out to rationalise the SAR of the novel 15LOX1 activators. One of the most promising candidates was cannabidiol (see ► Fig. 1), displaying robust activation of 15LOX-1 in macrophages. The docking study revealed a consistent binding mode for the most active members of the series, placing them in a cavity close to Arg98 on the membrane binding domain and Arg134 on the catalytic domain. Binding patterns of docking poses within this cavity allowed for discrimination between active and inactive molecules and could be used for activity prediction and lead optimisation in the future within this novel approach for inflammation resolution phytotherapy.

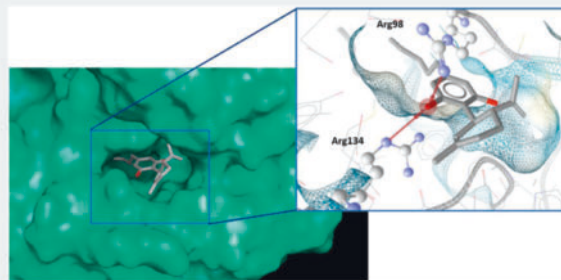

► Fig. 1 Predicted binding mode of Cannabidiol in 15-LOX1.

SL-A04 Short Lecture "The Hitchhiker's guide to multi-informative molecular networks: Discovery of anti-SARS-CoV-2 natural compounds"

Authors Andreas Wasilewicz^{1,2}, Julia Zwirchmayr¹, Benjamin Kirchweger¹, Denisa Bojkova³, Jindrich Cinat³, Holger Friedrich Rabenau³, Judith Maria Rollinger¹, Mehdi Ahmed Beniddir⁴, Ulrike Grienke¹

Institutes 1 University of Vienna, Department of Pharmaceutical Sciences, Division of Pharmacognosy, Vienna, Austria; 2 University of Vienna, Vienna Doctoral School of Pharmaceutical, Nutritional, Sports Sciences, Vienna, Austria; 3 University Hospital Frankfurt, Institute of Medical Virology, Frankfurt, Germany; 4 Université Paris-Scalay, CNRS, BioCIS, Équipe Chimie des substances naturelles, Orsay, France

DOI 10.1055/s-0043-1773846

The heartwood of *Pterocarpus santalinus* L.f. also known as red sandalwood is traditionally used in Ayurvedic medicine for the treatment of cold-related symptoms [1]. A pigment-depleted heartwood extract (PS-DE) showed promising anti-SARS-CoV-2 activity in Caco-2 cells with an IC₅₀ of 29.9 µg/mL. In order to predict the potential bioactives from the multi-component extract prior to isolation, molecular networking (MN) was performed [2]. Therefore, the extract was fractionated using high-performance counter current chromatography (HPLC). Eleven generated fractions were tested for anti-SARS-CoV-2 activity and analysed by UPLC-tandem mass (MS²) spectrometry. The MN was generated on GNPS combining the bioactivity data and MS² data. MN analysis indicated that multiple natural compound classes could be responsible for activity and fostered targeted isolation of seven compounds including three new plant metabolites. In total, 15 constituents from the heartwood belonging to pterocarpan and structurally related compounds were tested for anti-SARS-CoV-2 activity. Thereby, two pterocarpan, one isoflavonoid and one stilbene showed distinct antiviral activity (IC₅₀ < 40 µM) without cytotoxic effects (CC₅₀ > 100 µM) which corresponds well to the activity of the original extract PS-DE. Based on these findings, a structure-activity relationship (SAR) was established and indicated structural requirements for anti-SARS-CoV-2 activity.

Funding FWF project P 34028

Conflict of Interest The authors declare no conflict of interest.

References

- [1] Dahat Y, Saha P, Mathew JT, Chaudhary SK, Srivastava AkKumar D. Traditional uses, phytochemistry and pharmacological attributes of *Pterocarpus santalinus* and future directions: a review. *J Ethnopharmacol* 2021; 276114127
- [2] Olivon F, Remy S, Grelier G, Apel C, Eydoux C, Guilemot JC, Neyts J, De-lang L, Touboul D, Roussi F, Litaudon M. Antiviral compounds from *Codiaium peltatum* targeted by a multi-informative molecular networks approach. *J Nat Prod* 2019; 82 (2): 330–340

SL-A05 Short Lecture "Targeted isolation of new anti-infective natural products through multi-informative metabolite networks and HPLC-based bioactivity profiling using a 3R infection model"

Authors Olivier Kirchhoffer^{1,2}, Jahn Nitschke³, Louis-Félix Nothias^{1,2}, Nabil Hanna³, Laurence Marcourt^{1,2}, Pierre-Marie Allard⁴, Antonio Grondin⁵, Emerson Ferreira Queiroz^{1,2}, Thierry Soldati³, Jean-Luc Wolfender^{1,2}

Institutes 1 Institute of Pharmaceutical Sciences of Western Switzerland, University of Geneva, CMU, 1206, Geneva, Switzerland; 2 School of Pharmaceutical Sciences, University of Geneva, CMU, 1206, Geneva, Switzerland; 3 Department of Biochemistry, Faculty of Sciences, University of Geneva, Quai Ernest-Ansermet 30, 1205 Geneva, Switzerland; 4 Department of Biology, University of Fribourg, Rue A.-Gockel 3, 1700 Fribourg, Switzerland; 5 Pierre Fabre Research Institute, Green Mission Department, Herbal Products Laboratory, 31035 Toulouse, France

DOI 10.1055/s-0043-1773847

Mycobacterium tuberculosis (Mtb), along with the looming threat of Multidrug-Resistant Tuberculosis (MDR-TB), provide a strong incentive nowadays to extend beyond the scope of known TB antibiotics. To find new anti-infective compounds, we used an innovative 3R infection model system consisting of *Mycobacterium marinum* as a surrogate for Mtb and the amoeba *Dictyostelium discoideum* as a surrogate for macrophages. This host-pathogen system offers a double readout that allows us to evaluate a compound with regards to its activity on the host and the pathogen. In addition to that, a large chemodiverse set of 1600 plant part extracts was established and analysed through untargeted High Resolution tandem Mass Spectrometry (HRMS/MS) experiments. After different steps of assay optimisation (notably throughput improvements), the whole extract library was screened for anti-infective activities. Combining the results with metabolomics analysis yielded a prioritised subset of extracts to work on. In order to rapidly identify bioactive compounds, chosen extracts were taken through a process of High-resolution HPLC-based bioactivity profiling. Metabolite annotations of the fractions generated allowed for the targeted isolation of compounds of interest, while discarding already reported or pan-assay interference compounds (PAINS) at an early stage. Using this approach, a total of 53 compounds could be isolated from 13 different plants, 22 of which displayed previously unreported anti-infective activity. The workflow was partially automated and generic conditions were established, to enable rational characterisation of active principles in a given plant set, usually within a few weeks (► Fig. 1).

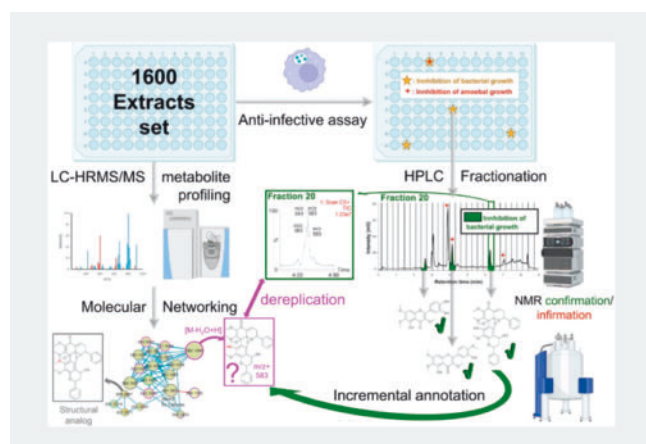

► Fig. 1 General workflow used for the isolation and characterization of new anti-infective compounds.

SL-A06 Short Lecture "Molecular Networking-guided identification of new secondary metabolites of a mushroom-associated fungus *Thyronectria* sp."

Authors Mostafa Alilou¹, Javad Mottaghipisheh¹, Ursula Peintner³, Ursula Fürnkranz⁴, Fabio Gsaller², Hubertus Haas²

Institutes 1 Unit of Pharmacognosy, Institute of Pharmacy, Center for Molecular Biosciences (CMBI), Universität Innsbruck, Innsbruck, Austria; 2 Institute of Molecular Biology, Medical University of Innsbruck, Innsbruck, Austria; 3 Institute of Microbiology, Universität Innsbruck, Innsbruck, Austria; 4 Pilzambulatorium, Schlüsselgasse 19, Vienna, Austria

DOI 10.1055/s-0043-1773848

Fungal natural products are characterised by a wide spectrum of biological activities that ensure the fungus adaptation to surrounding environment and they mediate the interactions with other organisms. Additionally, they are promising sources of pharmacologically active molecules. In a screening campaign aimed for discovery of antimicrobial natural products against three human pathogens *Trichomonas vaginalis*, *Candida albicans*, and *Cryptococcus neoformans*, we have identified a fungal hit-*Thyronectria* sp. isolated from fruiting body of *Hydnellum peckii*. Our previous study resulted in identification of a chlorinated resorcylic acid lactone derivative, radicol, as the major compound in the extract. In this study however, we aimed to identify potentially new resorcylic acid derivatives, and inspect the extract for producing potentially new classes of compounds using Feature-Based Molecular Networking of the GNPS platform and platforms embedded in, as well as SIRIUS for in silico annotations. By inspecting the network clusters and annotations results obtained from other platforms, we were able to perform targeted isolation and identification of at least three new chlorinated resorcylic acid lactone derivatives; a novel depsipeptide (5) and annotation of an additional three derivatives (6-8); as well as isolation and annotation of two dimeric cleistanthane-type diterpenoid analogues (9-10). The structure of compounds isolated elucidated using 1 & 2D-NMR spectroscopy and their absolute configuration established utilising DP4 + probability and circular dichroism calculations. Ultimately, the biological activity of isolates was evaluated against three aforementioned human pathogens. Our results shed new light on the metabolite profile of genus *Thyronectria*, as a promising source of bioactive natural products.

SL-A07 Short Lecture "A high-throughput and cost-effective metabolomic based platform to overcome natural products screening limitations for antimicrobial drug discovery"

Authors Alexandre Bory^{1,2}, Alexandre Luscher³, Sylvain Schnee⁴, Thilo Köhler³, Katia Gindro⁴, Jean-Luc Wolfender^{1,2}

Institutes 1 School of Pharmaceutical Sciences, University of Geneva, CMU, Geneva, Switzerland; 2 Institute of Pharmaceutical Sciences of Western Switzerland, University of Geneva, CMU, Geneva, Switzerland; 3 Department of Microbiology and Molecular Medicine, University of Geneva, Geneva, Switzerland; 4 Mycology Group, Research Department Plant Protection, Agroscope, Nyon, Switzerland

DOI 10.1055/s-0043-1773849

Antimicrobial resistance (AMR) is a major global health crisis and one way to tackle this issue is the imperative discovery of new antimicrobial compounds. In this context, microbial natural products have proven to possess very potent activities. However, the cultivation of microorganisms is a slow process and the frequent isolation of known antimicrobial compounds is a limitation when screening natural extracts. To circumvent this, we recently developed a drug discovery platform and applied it to a large collection of fungi. Culture, extraction, bioassays and metabolomics were performed in the standardised 96-well plate format thus allowing a high-throughput and compatibility across the platforms. All fungal extracts were enriched by solid phase extraction (SPE) and systematically submitted to antimicrobial bioassays and metabolomic profiling. All the generated data were incorporated into a massive and multi-informative

molecular network that is the core of our natural products prioritisation strategy to rapidly highlight potentially bioactive scaffolds within the chemical diversity of crude extracts collections. This study demonstrates the efficiency of our method to: 1) rapidly dereplicate known antimicrobial compounds (*Verticillium lateritium* to Chaetocin); 2) identify a hit and screen dozens of congeners to find a better producer and evaluate the best culture conditions prior to scale-up (*Penicillium expansum*), and 3) select an interesting hit for scale-up and compound isolation (*Phialophora gregata*). Our approach not only minimises the risk of rediscovering known compounds but also provides a streamlined and cost-effective way to accelerate the discovery of new antimicrobial agents and contribute to the fight against AMR (► Fig. 1).

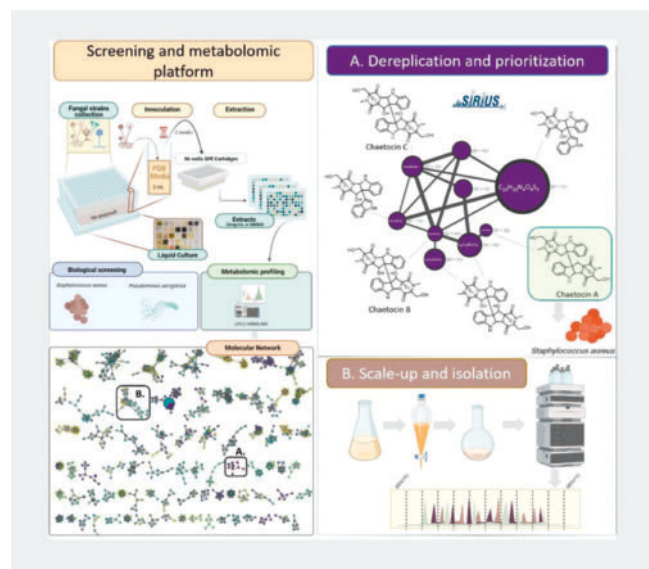

► Fig. 1 General workflow description.

SL-A08 Short Lecture "Phytochemical profiling of a cannabigerol-rich *Cannabis sativa* strain expands chemical and biological space of underexplored phytocannabinoids"

Authors Ernesto Gargiulo¹, Rosa M. Vitale², Orazio Tagliatalata Scafati¹, Luciano De Petrocellis², Giuseppina Chianese¹
Institutes 1 Department of Pharmacy, School of Medicine and Surgery, University of Naples Federico II, 80131 Napoli, Italy; 2 Institute of Biomolecular Chemistry (ICB) – National Research Council (CNR), 80078 Pozzuoli, Naples, Italy
DOI 10.1055/s-0043-1773850

Phytocannabinoids represent the hallmark of the secondary metabolism of *Cannabis sativa* [1]. Major phytocannabinoids, like tetrahydrocannabinolic acid (THCA) and cannabidiolic acid (CBDA), biogenetically derived from cannabigerolic acid (CBGA) and their content is closely related to genetic variations, resulting in five distinguishable *Cannabis* chemotypes [2]. In the frame of contribution to the field of phytochemical studies on less known *Cannabis* chemotypes [3, 4], here we present the first phytochemical characterisation of a *C. sativa* chemotype IV, a B₀/B₀ homozygotic breed, resulting in the presence of CBGA, as the major phytocannabinoid, and CBD (< 0.05%). A multi-step workflow developed in our studies for expeditious untargeted dereplication, extraction, fractionation and spectroscopic analysis of isolated metabolites can empower the exploration of minor phytocannabinoids, relevant for the identification of novel biological endpoints. Our analysis led to the identification of thirteen phytocannabinoids in pure form: in addition to CBGA, CBG, CBDA, CBD, nine new phytocannabinoids were obtained and structurally characterised. They resulted to be congeners of CBGA, showing different degrees of hydroxylation, double bond migration and isomerisation, or its derivatives

when cyclisation occurred. Moreover, two C-1' epimers, cannabifuranol A and B, have been isolated. They constitute an unprecedented chemotype of phytocannabinoids. All the isolated compounds have been evaluated for their profile of modulation on TRPV1, TRPA1, and TRPM8 expressed in HEK-293 (human embryonic kidney) cells, providing interesting clues on the bioactivity of this class of compounds, structure-activity relationships related to variations of the isoprenyl chain of CBGA and the enantioselectivity of the interaction on the tested endpoints.

References

- [1] Hanus LO, Meyer SM, Mufoz E, Tagliatalata-Scafati O, Appendino G. Phytocannabinoids: A unified critical inventory. *Nat. Prod. Rep.* 2016; 33: 1357–1392
- [2] de Meijer EPM, Hammond KM. The inheritance of chemical phenotype in *Cannabis sativa* L. (II): Cannabigerol predominant plants. *Euphytica* 2005; 145: 189–198
- [3] Chianese G, Sirignano C, Benetti E, Marzaroli V, Collado JA, De La Vega L, Appendino G, Munoz E, Tagliatalata-Scafati O. A Nrf-2 Stimulatory Hydroxylated Cannabidiol Derivative from Hemp (*Cannabis sativa*). *J Nat Prod* 2022; 85: 1089–1097
- [4] Salamone S, Waltl L, Pompignan A, Grassi G, Chianese G, Koeberle A, Pollastro F. That Favorably Reprogram Lipid Mediator Biosynthesis in Macrophages. *Plants* 2022; 11: 2130

Monday 3rd July 2023 | Short Lecture Session B Ethnobotany/Ethnopharmacology/Animal Health-care and Veterinary Phytotherapy

SL-B01 Short Lecture "Evidence-based ethnopharmacology – an important step in the globalisation of African traditional medicines"

Author Alvaro Viljoen¹
Institute 1 Tshwane University of Technology, Pretoria, South Africa
DOI 10.1055/s-0043-1773851

Southern Africa harbours an impressive floral diversity and ranks as one of the most biodiverse countries in the world. Interwoven within this botanical tapestry is a cultural heritage characterised by rich indigenous knowledge systems (IKS) which have moulded one of the oldest healing modalities, African Traditional Medicines (ATM). This unique blend of medicinal plant use and IKS has created a unique research opportunity in ethnopharmacology. Over the past 20 years, our group has endeavoured to provide a scientific rationale for medicinal plant use through an evidence-based research approach of traditional medicines. Several examples will be presented to demonstrate the challenging yet rewarding workflow to explore the chemistry and biological properties of the ethnomedicinal flora of South Africa. Using various *in vitro* and *in vivo* approaches, complemented by analytical methods and multivariate data analysis, we aim to contribute to the fundamental research base required to convert these botanical assets into tangible consumer products. The various challenges facing the globalisation of ATMs will be highlighted.

SL-B02 Short Lecture "Combining traditional and conventional medicines: A prevalence and interactive antimicrobial profiling study in South Africa"

Authors Zelna Booth¹, Sabiha Essack², Sandy van Vuuren¹
Institutes 1 University of the Witwatersrand, Johannesburg, South Africa; 2 University of KwaZulu-Natal, Durban, South Africa
DOI 10.1055/s-0043-1773852

In South Africa, the inequitable healthcare access intensified by high unemployment rates, drives reliance on traditional medicine. With evidence of interactions between traditional and conventional medicine, accurate statistics

quantifying potential combination use are necessary, to identify possible therapeutically beneficial or harmful combinations. The aim of this study was to investigate combination use of traditional and conventional medicines, among patients in public hospitals. The study further aimed to undertake the *in vitro* antimicrobial analysis of selected combinations for interactive antimicrobial profiling between conventional antibiotics and traditionally used medicinal plants. Firstly, a descriptive, self-administered survey was provided to consenting patients, in the pharmacy waiting areas, of two public hospitals (Charlotte Maxeke Academic Hospital (CMJAH) in Johannesburg, and the King Edward VIII Hospital (KEH), in KwaZulu-Natal). Additionally, common traditional medicinal plants used to treat infections, purchased from traditional medicine markets in close proximity to the hospitals, were tested by minimum inhibitory concentration assays in combination with conventional antibiotics, and the fractional inhibitory concentration was calculated. The survey revealed that 24% of CMJAH (n = 263) and 32% KEH (n = 307) participants, concurrently used traditional and conventional medicine. A number of potentially clinically relevant synergistic and antagonistic interactions were found during the *in vitro* testing. These interactions may possibly have major implications on patient treatment outcomes. This study emphasises the need for investigating the concurrent use of conventional and traditional medicine in relevant populations.

SL-B03 Short Lecture "Anthelmintic activities of the West African medicinal plants *Combretum mucronatum* and *Phyllanthus urinaria* against free-living and parasitic nematodes"

Authors Verena Spiegler¹, Jonathan Jato²,

François Ngnodandi Belga³, Luise Greiffer¹, Marie-Kristin Raulf⁴, Patrick Waindok⁴, Emmanuel Orman², Fabian Herrmann¹, Christian Agyare², Dieudonné Ndjonka³, Eva Liebau⁵, Christina Strube⁴, Emelia Oppong Bekoe⁶, Andreas Hensel¹

Institutes 1 University of Münster, Institute of Pharmaceutical Biology and Phytochemistry, Münster, Germany; 2 Kwame Nkrumah University of Science and Technology, Faculty of Pharmacy and Pharmaceutical Sciences, Kumasi, Ghana; 3 University of Ngaoundere, Faculty of Sciences, Department of Biological Sciences, Cameroon; 4 University of Veterinary Medicine Hannover, Institute of Parasitology, Centre for Infection Medicine, Hannover, Germany; 5 University of Münster, Institute of Integrative Cell Biology and Physiology, Münster, Germany; 6 University of Ghana, School of Pharmacy, College of Health Science Legon, Ghana

DOI 10.1055/s-0043-1773853

Tanniferous plants have been proposed as a sustainable control of helminth infections to overcome the problem of resistances to standard anthelmintics in livestock. *Combretum mucronatum* Schumach. & Thonn. (CM) and *Phyllanthus urinaria* L. (PU) which are used to treat soil-transmitted helminthiasis in West Africa were therefore explored for their anthelmintic properties. The procyanidin-rich hydroethanolic leaf extract from CM inhibited larval migration *in vitro* against *Ascaris suum*, *Ancylostoma caninum*, *Trichuris suis*, *Toxocara canis*, *Ostertagia ostertagi*, *Cooperia oncophora*, *Trichostrongylus colubriformis*, *T. axei* and *Haemonchus contortus* (IC₅₀ 2.1–310.0 µg/mL). The activity was further evaluated *in vivo* in goats infected with *Haemonchus contortus*. In the free-living nematode *Caenorhabditis elegans*, lethal effects (LC₅₀ 1809 µg/mL) and moulting inhibition in all larval stages were observed. Functional studies indicated the cuticle to be the main binding site for procyanidins, causing an increased rigidity. Further, expression of unique proline-rich proteins for tannin defense was upregulated. Similar to CM, an acetone-water extract from PU aerial parts inhibited larval migration in *A. suum*, *A. caninum*, *T. suis* and *T. canis* with large variation in the nematodes' susceptibility (IC₅₀ 24.3–1510 µg/mL). The major ellagitannins from PU were isolated and characterised by HR-MS and NMR. Geraniin was generally most active (IC₅₀ 0.6–804 µM), however, the activity of the respective isolated ellagitannins varied with different parasite species. In summary, the data supports the use of CM and PU as traditional remedies

against helminthiasis, reveal insights into their mode of action and underline strong species-specific differences in tannin susceptibility.

SL-B04 Short Lecture "Ontology based ethnobotany data management to support natural product-based drug discovery"

Authors Vijay Ingalalli¹, Jui-Hung Yuan¹, Lila Khederlarian², Sona Chandra¹, Andreas Bender¹

Institutes 1 PangeaAI, Pangea Botanica GmbH, Hardenbergstraße 32, 10623, Germany; 2 Pangea Botanica Ltd, 210 Euston Road, London, United Kingdom

DOI 10.1055/s-0043-1773854

For millennia and across cultures, plants have been utilised to treat human diseases. Despite recent efforts to organise this knowledge into databases and ontologies, attempts have so far been either limited to specific types of traditional medicines, or unable to practically support drug discovery tasks. In this work, we describe our work of creating ontologies and controlled vocabularies to describe ethnobotanical data, with the aim to achieve interoperability with chemical, biological, and medical datasets in order to be able to identify entry points for drug discovery. Ethnobotanical data comprises subdomains including species, preparation and usage methods, geo-location of usage, diseases and symptoms, etc. In order to organise ethnobotany data into structured ontologies and to establish links with drug discovery datasets we extracted structured and unstructured data from various sources and organised them into graph-structured knowledge bases using a Linked Data Model. Subsequently, we either leveraged established domain-specific ontologies such as DOID, SYMP, MeSH, Mondo, NCBITaxon, PO, etc., or developed new ontologies where needed. After establishing ontologies for all subdomains, we performed ontology alignment. Our ontologies are based on OWL and are built using Protégé which can be queried using SPARQL. By using the ontological framework described here, we not only gain analytical insights into existing knowledge about traditional medicines but are also able to draw novel inferences that are able to accelerate natural product-based drug discovery based on historical use information of medicinal plants.

Conflict of Interest The authors are employees of Pangea Botanica GmbH and Pangea Botanica Ltd.

SL-B05 Short Lecture "Use of herbal medicinal products in the geriatric population – data from the PhytoVIS study"

Authors Tamara Gramlinger¹, Olaf Kelber¹, Karin Kraft²

Institutes 1 Phytomedicines Supply and Development Center, Bayer Consumer Health, Steigerwald Arzneimittelwerk GmbH, Darmstadt, Germany; 2 Rostock University Medical Center, Rostock, Germany

DOI 10.1055/s-0043-1773855

Herbal medicinal products are used especially also in the elderly. However, scientific data on their use are still rare. The PhytoVIS study generated data from over 20,000 patients who had taken HMPs, including patients over 65 years. Parameters were analysed in two patient groups (66–75 years (group 1, n = 1,865) and over 75 years (group 2, n = 1,200)). The incidence of chronic complaints was much higher in both geriatric groups than in the total study population (n = 17,805), e.g. memory impairment and arthralgia. Long-term use of the HMP was reported by 48% of the patients (group 1) and 56% (group 2), but only by 28% of the total population. The proportion of comorbidities was also significantly higher, i.e. 76.0% resp. 82.8% vs. 39.8%, as was the proportion of patients with co-medication. Most patients of both geriatric groups rated effectiveness as moderate to very good (CGI-E). The proportion of patients not noticing any impairment by side effects was slightly higher in group 1 (91.9%) and in group 2 (93.8%) as compared to the total population (91.2%). PhytoVIS data confirm the age-dependent increase of multimorbidity and poly-medication. HMPs were well tolerated and had no or mild side effects, as e.g.

mild GI complaints. For an ageing population, HMPs are therefore an important and safe therapy option with a good efficacy-tolerability profile, also for the treatment of chronic diseases.

Acknowledgments: Thanks to Kooperation Phytopharmaka GbR, Bonn and to Esther Raskopf, Kija Shah Hosseini and Ralph Mösges, Cologne, Germany

SL-B06 Short Lecture “Clinical cure rates of endometritis in dairy cows after intrauterine application of an antibiotic or an herbal veterinary medicinal product”

Authors Valérie Menoud^{1,2,3}, Mirjam Holinger¹, Sandra Graf-Schiller⁴, Philipp Mayer⁴, Luc Gerber², Michael Walkenhorst¹, Gaby Hirsbrunner³

Institutes 1 Research Institute of Organic Agriculture (FiBL), Frick, Switzerland; 2 Clinique du Vieux-Château/JuraVet, Delémont, Switzerland; 3 Vetsuisse Faculty, University of Bern, Bern, Switzerland; 4 SaluVet GmbH, Bad Waldsee, Germany

DOI 10.1055/s-0043-1773856

Reproductive disorders represent one of the most challenging problems for dairy cattle farmers. We compared the clinical cure rates of endometritis after the intrauterine application of cephalixin (Metricure; cefapirin benzathin 500 mg per dosis; CEPH) or a herbal product (25ml of EucaComp PlantaVet containing alcoholic extracts of *Calendula officinalis*, *Melissa officinalis*, *Origanum majorana* and the essential oil of *Eucalyptus globulus* (EUC)). Totally, 169 cows between 21 and 35 days after calving were included and randomly assigned to one of the both treatment groups. Endometritis diagnosis was based on a scoring system for vaginal discharge. For final analysis, 136 cows (61 EUC and 75 CEPH) were maintained. In total, 64% (EUC: 61%, CEPH: 67%) of the endometritis cases were considered as clinically cured 14 ± 2 days after the first treatment without statistical difference ($p = 0.956$). Uncured cows 14 ± 2 days after the first treatment were treated again as for the first time and controlled 14 ± 2 days thereafter. This results in an overall clinical cure rate one month after initial endometritis diagnosis of 85% (EUC: 82%, CEPH: 88%; $p = 0.923$). In conclusion, there was no statistical difference between the clinical cure of dairy cows' endometritis after the intrauterine application of a herbal veterinary medicinal product or the antibiotic cephalixin. These results could contribute to reduce the antimicrobial use in the daily veterinary routine treatment of endometritis.

Conflict of Interest SaluVet GmbH (Bad Waldsee) financed the study.

SL-B07 Short Lecture "Silymarin – do we really know it all? Influence of silymarin on the motility of the gastrointestinal tract of broiler chickens"

Authors Urszula Latek¹, Magdalena Chłopecka¹, Wojciech Karlik¹, Marta Mendel¹

Institute 1 Warsaw University of Life Sciences, Institute of Veterinary Medicine, Warsaw, Poland

DOI 10.1055/s-0043-1773857

Silymarin, a complex of flavonolignans from milk thistle (*Silybum marianum*) is a very well-known compound with many beneficial properties. It is valued primarily for its hepatoprotective mode of action. It is widely used in humans in the treatment of liver diseases and in cases of dyspepsia and bile duct disorders. It is also becoming more and more popular in animal production as a feed additive, which positively affects both production indicators and shows, in addition to hepatoprotection, strong anti-inflammatory and antioxidant properties. There are countless studies on silymarin carried out *in vitro* and *in vivo*: mainly in laboratory rodents or human volunteers. However, these models do not seem to be suitable for evaluating the effect of silymarin on broiler chickens. Due to the growing popularity of silymarin as a feed additive for poultry, there is also a growing need for more in-depth research on its effects on the digestive tract of chickens. This study aimed to verify the effect of standardised *Silybum marianum* extract, containing 70% silymarin, on the motility of isolated segments

of various parts of the chickens' gastrointestinal tract. The experiments were conducted in *ex vivo* conditions, on tissue samples from routinely slaughtered birds. The effect of standardised *Silybum marianum* extract on spontaneous and ACh-induced activity was evaluated under isometric conditions. The experiments revealed a potent myocontractile activity towards spontaneous and chemically-evoked contractility. The results indicate that the use of silymarin can significantly change intestinal passage and consequently the absorption process.

Conflict of Interest The authors declare no conflicts of interest.

SL-B08 Short Lecture "Polyphenol composition and antioxidant capacity of multispecies pastures grown in Ireland – medicinal implications for sustainable ruminant nutrition"

Authors Samuel Rapisarda^{1,2}, Nissreen Abu-Ghannam^{1,2}

Institutes 1 Environmental Sustainability & Health Institute (ESHI), Technological University Dublin, Grangegorman, D07 H6K8 Dublin, Ireland; 2 School of Food Science and Environmental Health, College of Sciences and Health, Technological University Dublin, Grangegorman, D07 ADY7 Dublin, Ireland

DOI 10.1055/s-0043-1773858

Recent intensification of ruminant production systems has led to a rise in both nitrogen pollution and occurrence of animal diseases. Integration of multispecies pastures, comprising grasses, forage legumes and herbs, may offer a promising strategy to reduce nitrogen fertilizer usage, while also introducing a variety of phytochemicals with potential benefits for animal health. In particular, polyphenols have been linked to antioxidant, antimicrobial and anthelmintic properties. This study compares the phenolic composition of multispecies (comprising perennial ryegrass, timothy, white clover, red clover, chicory and plantain) to two other conventional grazing systems (monoculture ryegrass and binary-culture ryegrass and white clover) during the Irish summer grazing season (July–September). Polyphenolic concentrations and antioxidant capacity were assessed using colorimetric assays (TPC, FRAP and DPPH) and Liquid Chromatography–Mass Spectrometry/Mass Spectrometry. Total Phenolic Content (TPC) was found to be higher in multispecies (65.55 GAE mg/g) ($p < 0.01$), with concentrations having one-and-a-half-fold increase from July to September ($p < 0.01$). Multispecies had the highest mean levels of formononetin (7.76 mg/g) and biochanin A (2.80 mg/g) ($p < 0.05$). In contrast, chlorogenic acid was the predominant polyphenol in monoculture and binary systems, with 19.02 and 10.69 mg/g, respectively ($p < 0.05$), whereas multispecies contained 4.65 mg/g. Nonetheless, multispecies had the highest antioxidant capacity mean values (246.54 µM TroloxE/g and 34.17% DPPH inhibitory activity) among the three systems ($p < 0.05$). Combining different plant species in multispecies pastures can positively impact the environment, in addition to providing a synergistic effect on the medicinal properties of the feeding system.

Egon-Stahl-Award in Silver

Tuesday 4th July 2023

ESA-SILVER “Distribution and pharmaceutical potential of polyketide photoantimicrobials from Cortinariaceae”

Authors Bianka Siewert¹, Johannes Fiala¹, Ursula Peintner¹, Fabian Hammerle¹, Andrea Pannwitz², Julian Bösking², Michaela Lackner³, Pamela Vrabl¹, Sylvestre Bonnet⁴

Institutes 1 University of Innsbruck, Innsbruck, Austria; 2 University of Ulm, Ulm, Germany; 3 Medical University of Innsbruck, Innsbruck, Austria; 4 Leiden University, Leiden, The Netherlands

DOI 10.1055/s-0043-1773859

Fungi are an underestimated source of natural photosensitisers. In particular, polyketide pigment-producing fungi appear to use these metabolites as part of a sophisticated photoactivated chemical defence system [1]. Since fungi share their ecological niche with many microorganisms, we hypothesised that fungal photosensitisers are also active photoantimicrobials. Feature-based molecular network studies combined with a photoactivity assay highlighted species from the genus *Cortinarius* as highly potent. The next step was to screen the coloured fruiting bodies using a modified EUCAST protocol [2] against *Candida albicans*, *Escherichia coli*, and *Staphylococcus aureus*. A significant photoantimicrobial effect was detected for many extracts ($c < 25 \mu\text{g/mL}$). Isolation of the responsible pigments based on photoactivity led to the identification of two new potent photoantimicrobials, i.e. emodin and dermocybin. The latter was active against *S. aureus* and *C. albicans* under green light irradiation (PhotoMIC₅₃₀ = 39.5 μM and 2.3 μM , respectively) while being non-toxic to human cells. In summary, we will demonstrate the remarkable potential of fungal pigments against gram-positive and gram-negative bacteria and yeasts that cause unpleasant skin infections.

Conflict of Interest The authors declare no conflict of interest.

References

- [1] Siewert B. Does the chemistry of fungal pigments demand the existence of photoactivated defense strategies in basidiomycetes? *Photochemical & Photobiological Sciences* 2021; 20: 475–488
- [2] Fiala J, Schöbel H, Vrabl P, Dietrich D, Hammerle F, Artmann DJ, Stärz R, Peintner U, Siewert B. A New High-Throughput-Screening-Assay for Photoantimicrobials Based on EUCAST Revealed Unknown Photoantimicrobials in Cortinariaceae. *Frontiers in Microbiology* 2021; 12:

Tuesday 4th July 2023 | Short Lecture

Session C

Phytochemistry

SL-C01 Short Lecture "Chemical characterisation of glucosyl- hydroxydihydrochalconesulfites occurring in red grape pomace extract and red wine"

Authors Olaf Kunert¹, Lisa Laenger², Alena Klenner², Eva-Maria Pferschy-Wenzig²

Institutes 1 University of Graz, Institute Of Pharmaceutical Sciences, Pharmacognosy, Beethovenstraße 80, 8010 Graz, Austria; 2 University of Graz, Institute of Pharmaceutical Sciences, Pharmaceutical Chemistry, Beethovenstraße 8, 8010 Graz, Austria

DOI 10.1055/s-0043-1773860

Grape pomace is a highly abundant side-product of winemaking. Due to their high content of different classes of bioactive polyphenols, grape pomace extracts are widely used for pharmaceutical, functional food and cosmetic purposes [1]. In an anthocyanin-enriched grape pomace extract, hitherto unknown sulfur-containing compounds were detected by LC-HRMS analysis. Fractionation of the extract by various chromatographic methods allowed the preparative isolation of four compounds. 1D- and 2D-NMR spectroscopy and HRMS allowed their structural elucidation as new glucosyl- hydroxydihydrochalconesulfites (► Fig. 1), differing in substitution pattern at position 6 of the sugar moiety. The fact that the isolated compounds were easily degraded to respective anthocyanins in the presence of acid indicates that they are structurally closely linked to this compound class. The compounds were most likely formed during grape pomace extraction which had been performed under sulfite addition. However, it remains to be clarified, from which progenitors and by which mechanism they are formed. Interestingly, some of the newly isolated compounds could also be detected when various commercially available red wines were analysed by LC-HRMS analysis, indicating that they are also formed during red wine production and are constituents of commercially available red wine.

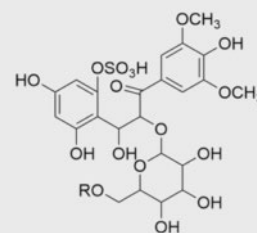

► **Fig. 1** Structures of compounds isolated from red grape pomace extract.

Acknowledgements NAWI Graz is thanked for supporting Central Lab Environmental, Plant & Microbial Metabolomics. We thank Breko GmbH & Grap'SUD Group for providing the grape pomace extract.

References

- [1] Anda M, Popitui M, Fierascu I et al. Grapevine Wastes: A rich source of antioxidants and other biologically active compounds. *Antioxidants* 2022; 11: 393

SL-C02 Short Lecture "Investigating the Insect Repellency of an Irish Bog Plant, Bog Myrtle (*Myrica gale* L.)"

Authors Sophie Whyms¹, Shipra Nagar¹, Maria Pigott¹,

Kin Aik Kok³, Hailey Luker², April Lopez², Tao Zhang³, Immo Hansen², Helen Sheridan¹

Institutes 1 NatPro Centre, School of Pharmacy and Pharmaceutical Sciences, Trinity College Dublin, Dublin 2, Ireland; 2 Department of Biology, New Mexico State University, 1200 S. Horseshoe Dr., Las Cruces, NM 88003, USA; 3 School of Food Science and Environmental Health, Technological University Dublin, Dublin 1, Ireland

DOI 10.1055/s-0043-1773861

Bog myrtle (BM) (*Myrica gale* L.), is a shrub with a wide occurrence across the northern hemisphere, particularly in Irish boglands. Bogs provide critical functions for hydrology, biodiversity and climate. Currently in Ireland there is a drive towards developing a bioeconomy, with the discovery of sustainable natural products from Irish biodiversity being of priority. In the quest for innovation with the natural product environment, the first step is often rooted in ethnobotanical and ethnopharmacological uses of species. Irish and international folklore reports use of BM for the determent of various insects such as midges [1–3].

This study aimed to enrich the knowledge surrounding BM and its potential as a natural insect repellent. After reporting systematic chemical profiling and anti-cholinesterase activity of essential oil samples (EOs), extracted from BM from a range of locations, plant parts and seasons [4, 5], work was advanced to testing for repellency. EOs with varied chemical profiles, their fractionated components, and a variety of combinations, were screened for repellency using arm-in-cage and Y-tube assays against *Aedes aegypti* mosquitoes. Results for BM-EO repellency showed great variance across all samples, dependent on chemical composition, with complete protection time (CPT) for contact repellency ranging from 7.22 – 36.02 minutes and 0 -> 240 minutes for long-distance repellency. Furthermore, CPT for BM was altered when EOs were combined with other oils and individual compounds. The best performing combination was BM and commercial clove oil (1:1) ratio. This study corroborates the traditional use of BM in deterring insects. Further studies are underway.

References

- [1] Hart H.C. The Flora of the County Donegal. Sealy, Bryers and Walker, Dublin 1898

- [2] Williams N Dólaim luibheanna. Sáirséal-Ó Marcaigh, Baile Atha Cliath 1993
- [3] Allen E.D., Hatfield G. Medicinal Plants in Folk Tradition. Timber Press 2004
- [4] Pigott M., Nagar S., Woulfe I., Scalabrino G., Sheridan H. Unlocking Nature's Pharmacy: Composition and bioactivity of essential oil of bog-myrtle (*Myrica gale*) grown on Irish boglands. *Planta Medica* 2022; 88 (15): 1521–1521
- [5] Nagar S., Pigott M., Whyms S., Berlemont A., Sheridan H. Effect of Extraction Methods on Essential Oil Composition: A Case Study of Irish Bog Myrtle-*Myrica gale* L. *Separations* 2023; 10 (2): 128

SL-C03 Short Lecture "Metabolodynamic analysis of metal ions as elicitors of steroidal saponins biosynthesis in *Agave salmiana* in vitro cultures"

Authors Enrique Rodríguez-de La Garza¹, César Armando Puente-Garza¹, Silverio García-Lara¹
Institute 1 Tecnológico de Monterrey (ITESM), Monterrey, Mexico
DOI 10.1055/s-0043-1773862

Agave salmiana is a Mexican domestic Agave originally used for alcoholic beverage production, but recently studied as a potential source of steroidal saponins, a key raw material for steroidal drug synthesis. Multiple studies have demonstrated the viability of metal ions as elicitors of saponins biosynthesis in Agave, but approaches oriented to understand the dynamic behaviour of such adaptive response have not yet been explored. To bridge this gap, the saponin profile and phenological characteristics of *in vitro* cultures of *A. salmiana* under elicitation treatments with 15, 60, and 150 mM macronutrient (Ca^{2+} , Mg^{2+}) and 25, 100 and 250 μM micronutrient (Co^{2+} , Cu^{2+} and Cd^{2+}) metal ions were tracked during five months. Saponins were identified and measured using HPLC-ELSD and UPLC-MS, while chlorophyll A/B ratio, biomass, and leaf and root number and length were measured for health monitoring. Biomass accumulation was hindered by increasing concentrations of macronutrient ions, while micronutrients impacted root structure and chlorophyll content. Saponin analysis revealed that concentrations of chlorogenin glycoside 2 (CG2) and hecogenin glycoside 2 (HG2) remained constant across treatments, while amounts of CG1, HG1, tigogenin G1 (TG1) and two unidentified saponins varied with ion identity and concentration in non-linear dose response effects. Moreover, saponin content and diversity increased over time and then decreased following full plant adaption to metal stress. This study demonstrates that the modulatory effect of metal ions on saponin profiles of *A. salmiana* in vitro cultures depends conjointly on ion identity, concentration, and treatment duration.

Conflict of Interest The authors declare no conflict of interest.

SL-C04 Short Lecture "Repellent efficacy of 20 plant essential oils on mosquitoes and ticks"

Authors Immo Hansen¹, Hailey Luker¹
Institute 1 New Mexico State University, Las Cruces, United States
DOI 10.1055/s-0043-1773863

Cases of mosquito- and tick-borne diseases are rising worldwide. Repellent products can protect individual users from being infected by such diseases. In a previous study, we identified five essential oils that display long-distance mosquito repellency using a Y-tube olfactometer assay. In the current study, the contact repellent efficacy of 20 active ingredients from the Environmental Protection Agency's (EPA) Minimum Risk Pesticides list were tested using *Aedes aegypti* and *Ixodes scapularis*. We utilised an arm-in-cage assay to measure complete protection time from mosquito bites for these active ingredients. To measure tick repellency, we used an EPA-recommended procedure to measure the complete protection time from tick crossings. We found that of the 20 ingredients tested, 10% v/v lotion emulsions with clove oil or cinnamon oil provided the longest protection from both mosquito bites and tick crossings. We conclude that in a 10% v/v emulsion, specific active ingredients from the EPA

Minimum Risk Pesticides list can provide complete protection from mosquito bites and tick crossings for longer than one hour.

SL-C06 Short Lecture "Synthetic homoisoflavonoids for the treatment of choroidal neovascularisation"

Authors Elisha Griffin¹, Dulcie Mulholland¹, Sianne Schwikkard², Timothy Corson³
Institutes 1 University of Surrey, Guildford, United Kingdom; 2 Kingston University, Kingston-upon-Thames, United Kingdom; 3 Indiana University School of Medicine, Indianapolis, USA
DOI 10.1055/s-0043-1773864

The process of choroidal neovascularisation is associated with debilitating ocular diseases such as age-related macular degeneration, retinopathy of prematurity and proliferative diabetic retinopathy, the former of which is the most prevalent cause of blindness in the ageing population. The existing treatments for these diseases consist of monoclonal antibodies and decoy receptors that bind to vascular endothelial growth factor to prevent excessive angiogenesis of the ocular vasculature. These high molecular weight biologics must be introduced to the patient via intravitreal injection, a painful process which is associated with a range of undesirable side effects and resistance issues. Homoisoflavonoids are a class of naturally occurring compounds that have been isolated from plant families such as Asparagaceae, species of which have been long used by traditional healers in Eastern and Southern Africa. Both synthetic and isolated homoisoflavonoid compounds have been shown previously to possess antiproliferative and antiangiogenic activities against human retinal endothelial cells (HRECs). This presents an exciting opportunity for the development of an alternative small molecule biologic to treat diseases associated with choroidal neovascularisation, which may provide a less invasive route of administration. Though homoisoflavonoid compounds may be found in nature, synthetic derivatives with a range of non-naturally derived heteroatoms and functional groups may provide exciting biological activity. We describe our syntheses of derivatised (E)-3-benzylidene-4-chromanones and 3-benzylchromanes (► Fig. 1). Initial screening showed promising results, with two synthetic homoisoflavonoids exhibiting growth inhibitory concentrations of 4.9 μM and 12 μM against the proliferation of HRECs.

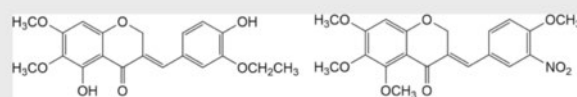

► Fig. 1 Examples of synthetic (E)-3-benzylidene-4-chromanone homoisoflavonoids.

SL-C07 Short Lecture "Development of analytical methods for the quantification of anti-oomycete diterpenoids from larch extracts"

Authors Linda Langat¹, Daniel Driscoll¹, Charlotte Baker¹, Kevin Stephens², Moses Langat³, Barbara Thuering⁴, Hans-Jakob Schärer⁴, Lucius Tamm⁴, Dulcie Mulholland¹
Institutes 1 University of Surrey, Guildford, United Kingdom; 2 BioExtraction (Wales) Limited, Tredegar, United Kingdom; 3 Royal Botanic Gardens Kew, Kew, United Kingdom; 4 Research Institute of Organic Agriculture (FiBL), Frick, Switzerland
DOI 10.1055/s-0043-1773865

The viticulture industry is the fastest growing sector in UK agriculture and is producing award winning wines. Green Laryxine is an Innovate UK funded project aiming to commercialise the use of Laryxine, a product containing two diterpenoids, larixyl acetate (1) and larixol (2) (► Fig. 1), from European larch bark, which are active against grapevine downy mildew, *Plasmopara viticola*,

that can cause 100% crop loss if left untreated. Currently, control of downy mildew in vineyards relies on copper fungicides that have unfavourable ecotoxicological profiles. Larixyne is effective in controlling downy mildew in both laboratory conditions and in field trials in southern Europe [1, 2]. We are developing HPLC and GCMS-based methods for quantifying the two active diterpenoids (**1**, **2**) and the co-occurring inactive, epimanol (**3**), to identify the high-yielding Larch sources.

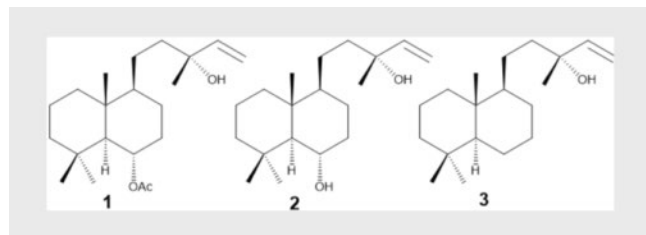

► **Fig. 1** Structures of larixyl acetate (**1**), larixol (**2**) and epimanol (**3**) present in Larch extracts.

Conflict of Interest The authors declare no conflict of interest.

References

- [1] Mulholland DA, Thuerig B, Langat MK, Tamm L, Nawrot DA, James EE, Qayyum M, Shen D, Ennis K, Jones A, Hokkanen H, Demidova N, Izotov D, Schärer H. Efficacy of extracts from eight economically important forestry species against grapevine downy mildew (*Plasmopara viticola*) and identification of active constituents. *Crop Protection* 2017; 102: 104–109
- [2] Thuerig B, James EE, Schärer H, Langat MK, Mulholland DA, Treutwein J, Kleeberg I, Ludwig M, Jayarajah P, Giovannini O, Markellou E, Tamm L. Reducing copper use in the environment: the use of larixol and larixyl acetate to treat downy mildew caused by *Plasmopara viticola* in viticulture. *Pest Management Science* 2017; 74: 477–488

Tuesday 4th July 2023 | Short Lecture Session D

Phytopharmacology/Phytotherapy

SL-D01 Short Lecture "A systems study of the biological effects of cordycepin"

Authors Steven Lawrence¹, Masar Radhi¹, Abdul Hafeez¹, Jialiang Lin^{1, 2}, Cornelia H De Moor¹

Institutes 1 University of Nottingham, Nottingham, United Kingdom;

2 Cygnus Biosciences Guangzhou Co Ltd, Guangzhou, China

DOI 10.1055/s-0043-1773866

Cordycepin is a bioactive compound from the caterpillar fungus *Cordyceps militaris*, which is widely used as a food supplement. Cordycepin has shown promising results in numerous pre-clinical models of age-related disease, including in our own study on pain in osteoarthritis [1, 2]. Despite over 70 years of research, the mechanism of action of cordycepin is not known. Cordycepin is rapidly converted to cordycepin triphosphate inside cells and this appears to be its primary active metabolite in most cell types. Cordycepin triphosphate is a known chain terminator for mRNA polyadenylation, and indeed we find effects on poly(A) tails in cells [3]. It is however unclear how these relate to the therapeutic effects. We conducted many individual experiments and 6 high throughput studies on the effect of cordycepin on gene expression and showed that cordycepin especially affects growth factor dependent and inflammatory response genes. A meta-analysis confirmed individual experiments that show that the cordycepin is likely to act through effects on MAPK and/or PI3K signalling, and treatment with a PI3K inhibitor closely mimicked the effects of cordycepin. Strikingly, we found that knockdown of polyadenylation factors had

similar effects on signal transduction and gene expression. The effects of cordycepin on signal transduction can explain the biological effects, but the causal link between polyadenylation and signal transduction needs further investigation.

References

- [1] Radhi M et al. *Molecules*. 2021; 26 (19): 5886
- [2] Ashraf S et al. *T Sci Rep*. 2019; 9 (1): 4696
- [3] Kondrashov A et al. *RNA*. 2012; 18: 2236–50

SL-D04 Short Lecture "Nutritional and phytotherapeutical value of the invasive *Carpobrotus edulis*: Seasonal and spatial variability"

Authors Catarina G. Pereira¹, Nuno Neng^{2, 3},

Professor José Nogueira², Luísa Custódio¹

Institutes 1 CCMAR – Algarve Centre Of Marine Sciences, Faculdade de Ciências e Tecnologia, Universidade do Algarve, Faro, Portugal, Faro,

Portugal; 2 Centro de Química Estrutural, Institute of Molecular Sciences, Departamento de Química e Bioquímica, Faculdade de Ciências, Universidade de Lisboa, Campo Grande, Lisboa, Portugal; 3 Laboratório de Ciências Forenses e Psicológicas Egas Moniz, Molecular Pathology and Forensic Biochemistry Laboratory, Centro de Investigação Interdisciplinar Egas Moniz, Egas Moniz School of Health and Science, Campus Universitário, Quinta da Granja, Caparica, Portugal

DOI 10.1055/s-0043-1773867

Carpobrotus edulis (L.) N.E.Br. (Aizoaceae) is a South African native plant inhabiting coastal areas worldwide, being considered a problematic invasive species. Mechanical removal to control this invasive plant leaves the removed plant material available as source of valuable natural phytochemicals with prospective commercial applications. The present work establishes a comparative analysis of nutritional, chemical, and bioactivity profiling of *C. edulis* aerial parts from three different locations of southern Portugal, throughout four seasons. Proximate and mineral compositions were assessed, along with phenolic composition, and *in vitro* antioxidant and anti-inflammatory properties. The halophyte's nutritional composition varied significantly between seasons and locations, with potentially more impact on variability from location rather than season, and representing a good supply of carbohydrates, proteins, and minerals. *C. edulis* extracts presented high levels total phenolics, with higher levels in spring and summer, the most abundant compounds detected being luteolin-7-O-glucoside, salicylic and coumaric acids. Extracts were also effective antioxidants, particularly stronger in spring for radical scavenging activity, and showed moderate anti-inflammatory properties. Overall, this invasive plant's usually discarded material may be appraised as a proper nutritional source with prospective biotechnological applications mainly in the food and pharmaceutical industries as an ingredient for value-added, functional, and/or preservative food products.

Funding This research received Portuguese national funds from FCT – Foundation for Science and Technology (projects UIDB/04326/2020, UIDP/04326/2020, LA/P/0101/2020, and PTDC/BAA-AGR/1391/2020) and Operational Programmes CRES Algarve 2020 and COMPETE 2020 (project EMBRC.PT ALG-01-0145-FEDER-022121). L.C. was supported by FCT Scientific Employment Stimulus (CEECIND/00425/2017).

Conflict of Interest The authors declare no conflict of interest.

SL-D05 Short Lecture "Antitumoral potential of sub-fractions obtained from *Ulex gallii* Planch. in human neuroblastoma (SH-SY5Y) and glioblastoma (U-87MG and U-373MG) cell lines"

Authors Lucía Bada^{1, 2}, Helle Wangenstein³,

Kari Tvete Inngjerdengen³, Jose Gil-Longo², Elías Quezada⁴, Dolores Viña^{1, 2}

Institutes 1 Group of Pharmacology of Chronic Diseases (CD Pharma), Molecular Medicine and Chronic Diseases Research Centre (CIMUS),

Universidade de Santiago de Compostela, Santiago de Compostela, Spain; 2 Department of Pharmacology, Pharmacy and Pharmaceutical Technology, Faculty of Pharmacy, Universidade de Santiago de Compostela, Santiago de Compostela, Spain; 3 Department of Pharmacy, Section for Pharmaceutical Chemistry, University of Oslo, Oslo, Norway; 4 Department of Organic Chemistry, Faculty of Pharmacy, Universidade de Santiago de Compostela, Santiago de Compostela, Spain

DOI 10.1055/s-0043-1773868

Ulex gallii Planch. (UG) is a thorny bush of the Fabaceae family. In popular medicine, plants belonging to the *Ulex* genus have been used for decades. Their applications in cancer are versatile, and there are several studies justifying their uses. However, few phytochemical and pharmacological data have been reported for UG. Due to this, it was proposed to carry out a study of its antitumor activity in human neuroblastoma (SH-SY5Y) and glioblastoma (U-87MG and U-373MG) cell lines. UG was extracted with methanol and subsequently partitioned into hexane (UgH), dichloromethane (UgD) and methanol (UgM) extracts. The three extracts were fractionated in Sephadex LH-20, obtaining 19 sub-fractions: UgH1,31-36 and 4, UgD1-8 and UgM1-4. UgD3-8 were selected for significantly reducing the viability of all the tumoral cell lines and for showing low toxicity in the human fibroblast cell line (MRC-5). Annexin-V/7-AAD analysis confirmed that the treatment of SH-SY5Y and U-87MG with the sub-fractions UgD7 and UgD8 involves an apoptotic process. Both fractions showed alteration in the cell cycle regulation. SH-SY5Y cells treated with UgD7 led to increased levels of p53, caspase-3, FAS, caspase-8 and the Y-h2ax. This could be related with the activation of the extrinsic pathway of apoptosis. UgD8 increased the levels of p53 and caspase-3 but not FAS. The same was observed for U-87MG. The chemical composition of UgD7 and UgD8 could justify the effects observed in the studies. The results obtained in U-373MG could imply another process of non- apoptotic cell death.

Conflict of Interest The authors declare no conflicts of interest.

SL-D06 Short Lecture "A withanolide analogue inhibits multiple myeloma cell proliferation through multiple signaling pathways"

Authors Julie Vérièpe-Salerno^{1,2}, Ms Angelica Ferro^{1,2}, Micaela Freitas Misakyan^{1,2}, Leslie Gunatilaka³, Muriel Cuendet^{1,2}

Institutes 1 School of Pharmaceutical Sciences, University of Geneva, 1211 Geneva, Switzerland; 2 Institute of Pharmaceutical Sciences of Western Switzerland, University of Geneva, 1211 Geneva, Switzerland; 3 Southwest Center for Natural Products Research, School of Natural Resources and the Environment, College of Agriculture and Life Sciences, The University of Arizona, Tucson, United States

DOI 10.1055/s-0043-1773869

Multiple myeloma is a hematological cancer originating from the bone marrow in which plasma cells abnormally proliferate and produce a large amount of monoclonal antibodies. It accounts for around 1% of cancer related deaths worldwide. Treatments using proteasome inhibitors, immunomodulators and monoclonal antibodies are currently used. However, those treatments have side effects, and drug resistance often appears. B-cell maturation antigen (BCMA) is a cell surface antigen found in nearly all cases of multiple myeloma, and needed for the survival of plasma cells. This makes it a key target for multiple myeloma therapeutics [1]. A withanolide analogue (W1), which displayed an IC₅₀ value around 80 nM against sensitive and bortezomib-resistant multiple myeloma cells, was identified. Moreover, its selectivity index towards normal cells was much more favourable than bortezomib, a proteasome inhibitor used in the clinics. Genomic and proteomic approaches were used to determine the genes and proteins involved in the mechanism of action of W1. Given the genes modulated by the compound and proteins it bound to, autophagy, a process that cells adopt to survive in unfavourable conditions by degrading and recycling non- essential proteins, was shown to be one of the involved pathways. Moreover, BCMA protein expression was down-regulated by 50-250 nM W1

starting 3 h after treatment and the inhibition was maintained for at least 48 h after removing W1. Given the strong current interest in BCMA-targeted treatment, W1 should be further evaluated alone or in combination in preclinical multiple myeloma models.

References

[1] Kleber M et al. J Clin Med 2021; 10: 4088

Bionorica Phytoneering Award

Wednesday 5th July 2023

BPA "Advanced Analytical Tools Employing Mass Spectrometry for the Investigation of Metabolism Aspects in Natural Products"

Authors Eleni V. Mikropoulou^{1,2}, Theodora Nikou^{1,2}, Maria Halabalaki¹
Institutes 1 Division of Pharmacognosy and Natural Products Chemistry, Department of Pharmacy, National and Kapodistrian University of Athens, Panepistimiopolis Zografou, 15771, Athens, Greece; 2 Equal contribution
DOI 10.1055/s-0043-1773870

The current research aims to shed light on the metabolism and bioavailability of bioactive natural products. Taking advantage of state-of-the-art analytical tools and metabolomics, our approach emphasizes on the pharmacokinetics and especially metabolism of two distinguished sources of bioactive compounds, namely Chios mastic gum (CMG) as well as olive tree, olive products and by-products focusing on olive biophenols (OBs). CMG is characterized by the presence of bioactive terpenoids (mainly triterpenic acids e.g. masticadienonic and isomasticadienonic acids) while OBs include a plethora of chemical classes e.g. phenyl alcohols, secoiridoids, lignans. Both, CMG and OBs are well known for their significant health benefits; CMG's therapeutic value has even been recognized by the EMA [1], while olive oil already possesses two EFSA health claims [2]. However, even though both have been extensively studied for their biological and pharmacological properties, there is a profound lack of data related to respective bioactives metabolism.

In the current research effort an interactive workflow including in vitro-ex-vivo models, animal studies as well as human interventions were employed towards the investigation of metabolism aspects. Special attention was given to the identification of triterpenic acids (CMG) and secoiridoids (OBs) metabolites using untargeted LC-HRMS/MS metabolite profiling approaches. Novel results were revealed towards the identification of the true active compounds regarding both chemical classes. Certainly, a lot of ground needs to be covered before we can unravel even a glimpse of the colorful puzzle of natural products metabolism.

Conflict of Interest The authors declare no conflicts of interest.

References

[1] Pachi V. et al. J Ethnopharmacol 2020; 254: 112485

[2] Nikou T et al. Front. Public Health 2020; 8: 558226

Synergy Award

Wednesday 5th July 2023

SA "Exploring the synergistic effects of essential oil combinations for use in the respiratory tract: A synergy study"

Authors Stephanie Leigh-de Rapper¹, Alvaro Viljoen^{2,3}, Sandy van Vuuren¹

Institutes 1 Department of Pharmacy and Pharmacology, Faculty of Health Sciences, University of Witwatersrand, 7 York Road, Parktown, 2193, South Africa; 2 Department of Pharmaceutical Sciences, Faculty of Sciences, Tshwane University of Technology, Private Bag X680, Pretoria 0001, South

Africa; 3 SAMRC Herbal Drugs Research Unit, Department of Pharmaceutical Sciences, Tshwane University of Technology, Private Bag X680, Pretoria 0001, South Africa

DOI 10.1055/s-0043-1773871

Scientific research in traditional and complementary medicine often focuses on isolated active compounds, neglecting the holistic approach of utilising the entire plant for therapeutic effects. This overlooks the potential synergistic efficacy of essential oil combinations. Addressing this knowledge gap, an extensive synergy study was conducted, examining 369 commonly indicated essential oil combinations for respiratory management. The study revealed antimicrobial synergy in 25.6% of the tested essential oil combinations. Additionally, 62.5% demonstrated anti-inflammatory effects while maintaining cell viability (80.4%–99.6% against A549 cells). Based on these findings, five notable essential oil combinations emerged as promising candidates for respiratory health: *Cupressus sempervirens* L. with *Melaleuca linariifolia* var. *alternifolia*, *Hyssopus officinalis* var. *angustifolius* with *Salvia rosmarinus* var. *angustifolius*, *Origanum majorana* L. with *M. alternifolia*, *Myrtus communis* L. with *M. alternifolia*, and *Origanum vulgare* L. with *M. alternifolia*. Utilizing SynergyFinder software, these promising combinations were optimised to enhance their holistic synergy. As a result, a nanoformulation containing a blend of *H. officinalis* and *S. rosmarinus* demonstrated improved antimicrobial effects, exhibiting an average six-fold improvement compared to the neat essential oil combinations. This study represents a significant advancement in synergy research, showcasing the potential of essential oil combinations for respiratory health. The findings highlight the importance of optimising essential oil properties and formulating refined end-point products. The results hold promise for future research in phytomedicine, presenting new avenues for exploring the translational synergy of traditional and complementary medicines.

Botanical Safety Council (BSC) Session Wednesday 5th July 2023

SL-BSC-01 Short Lecture “Enhancing the botanical safety toolkit: The strategic approach of the Botanical Safety Consortium”

Authors C. A. Mitchell¹, M. R. Embry¹, S. Gafner², H. Johnson³, D. S. Marsman⁴, O. Kelber⁵, H. A. Oketch-Rabah⁶, C. V. Rider⁷, E. Sudberg⁸, C. Welch⁹

Institutes 1 Health and Environmental Sciences Institute, Washington, United States; 2 American Botanical Council, Austin, United States; 3 American Herbal Products Association, Silver Spring, United States; 4 Procter & Gamble Health Care, Cincinnati, United States; 5 R&D, Phytomedicines Supply and Development Center, Bayer Consumer Health, Steigerwald Arzneimittelwerk GmbH, Darmstadt, Germany; 6 United States Pharmacopeia, Rockville, United States; 7 National Institute of Environmental Health Sciences, Triangle Park, Durham, United States; 8 Alkemist Labs, Garden Grove, United States; 9 US Food and Drug Administration, Silver Spring, United States

DOI 10.1055/s-0043-1773872

Botanical substances are widely used as medicinal products and as dietary or food supplements. The Botanical Safety Consortium (BSC), a public-private partnership between the US FDA, and the National Institutes of Health- National Institute of Environmental Health Sciences (NIEHS), and the Health and Environmental Sciences Institute (HESI), aims at enhancing the toolkit for the *in vitro* safety evaluation of botanicals, as a forum for scientists from government, academia, consumer health groups, industry, and non-profit organisations collaboratively developing *in silico* and *in vitro* methods and integrate them into a framework.

The intention is to apply toxicological tools available for single chemicals to botanicals as complex mixtures. The methodology involves identifying prag-

matic, fit-for-purpose, *in vitro* and *in silico* assays and evaluating them via comparison to available safety information, to facilitate a robust safety evaluation. Initial endpoints are genotoxicity, hepatotoxicity, absorption-distribution-metabolism-excretion (i.e. “ADME”), developmental and reproductive toxicity, cardiotoxicity, neurotoxicity, and systemic toxicity (► Fig. 1). Supportive working groups perform chemical and data analyses, and pharmacognosy. A number of well-known botanicals has been identified to evaluate the assays. With selection and prioritisation of botanicals as candidates, and pilot work on their chemical characterisation, the basis for evaluating a set of screening level assays has been established. The ultimate aim is a robust, predictive toxicology testing strategy that integrates existing data with *in silico* and *in vitro* tools to provide actionable safety data for botanicals, while minimising the need for mammalian animal testing.

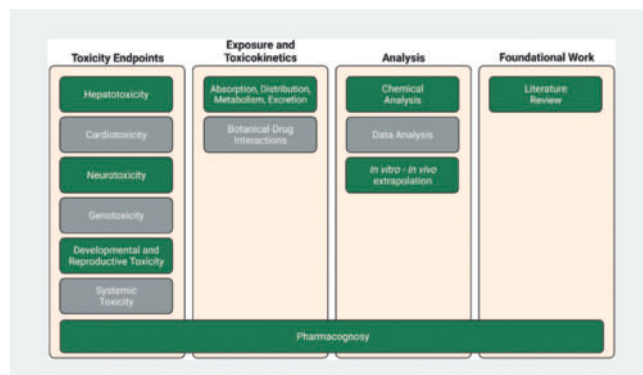

► Fig. 1 Thematic focus of the current working groups of the BSC

SL-BSC-02 Short Lecture “Botanical ingredient identity and its importance for a safety assessment”

Author Stefan Gafner¹

Institute 1 American Botanical Council, Austin, United States

DOI 10.1055/s-0043-1773873

One of the most important aspects of botanical ingredient quality control is to ensure the identity and authenticity of the labelled material. Despite this seemingly straightforward step to ensure consistent quality, literature is rife with examples of herbal dietary supplement products that have been accidentally or intentionally adulterated. A series of papers published by the ABC-AHP-NC-NPR Botanical Adulterants Prevention Program (BAPP) provides ample evidence for presence of mislabelled or adulterated ingredients and products on the global marketplace.

In most cases, the adulterants do not represent a safety risk for the consumer. However, this is not always true. Prominent examples of serious adverse events due to adulterated botanicals include adulteration of products containing *Stephania tetrandra* with the kidney-toxic plant *Aristolochia fangchi*, resulting in over a hundred cases of aristolochic acid-induced nephropathy in Belgium, or the sale of *Plantago* spp. contaminated with *Digitalis lanata*, leading to cases of hospitalisation due to intoxication with cardiac glycosides.

The biggest safety issue for dietary supplements currently based on enforcement actions by regulatory agencies is the sale of prescription drugs labelled as herbal dietary supplements. Such adulteration is particularly prominent in the erectile dysfunction, weight loss, and bodybuilding categories. However, other types of adulterants also pose a safety risk, and, at the same time, lead to ingredients being erroneously considered as causative agents for negative adverse effects. The presentation will emphasise the importance of identity testing and provide examples from the recent literature of adulterants that can be harmful to consumers.

SL-BSC-03 Short Lecture “Assessing the neuroactive potential of botanical extracts using novel *in vitro* methods”

Authors [Remco Westerink¹](#), [Regina van Kleef¹](#),
[Connie Mitchell²](#), [Michelle Embrey²](#)

Institutes **1** Utrecht University, Utrecht, Netherlands; **2** HESI, Washington DC, United States of America

DOI [10.1055/s-0043-1773874](#)

Due to their neuroactive properties, botanicals are often used to preserve and enhance human health and well-being. However, safety evaluations of botanicals are often inadequate and there is an urgent need to screen botanicals for their possible adverse effects.

Costly and ethically-debated animal experiments to investigate neurotoxicity are increasingly replaced with *in vitro* methods, for example using microelectrode array (MEA) recordings to measure changes in neuronal function. Rat primary cortical cultures consist of different types of neurons and supportive cells. The presence of multiple cell types and targets ensures that cortical cultures grown on MEAs are sensitive to many different toxicological pathways by which botanicals can alter physiological function. Moreover, these recordings can be multiplexed with cell viability to aid in prioritisation of botanicals for in-depth analysis.

As part of a cross-sector collaboration of the Botanical Safety Consortium (BSC, a public-private partnership formed by the US-FDA, NIEHS, and HESI), we evaluated the suitability of MEA recordings for neurotoxicity screening of botanical extracts.

Acute (30 min) exposure of cortical cultures to aconite extract (5-50 µg/mL) evoked an intense hyperexcitation, with mean spike rate (MSR), mean burst rate (MBR) and mean network burst rate (MNBR) increased to 230-700%. Contrary, extracts from kava and kratom resulted in a dose-dependent decrease in neuronal activity, whereas ginseng extract was largely inactive (up to 50 µg/mL).

These results provide an important first step in the *in vitro* safety evaluation of botanical extracts.

Conflict of Interest The authors declare no conflict of interest.

SL-BSC-06 Short Lecture “Regulatory perspective on safety of HMPs. The Public Statements”

Author [Ioanna Chinou¹](#)

Institute **1** Greek delegate at HMPC, National Kapodistrian University of Athens, Dept of Pharmacy Dir of Lab of Pharmacognosy and Chemistry of Natural products, Greece

DOI [10.1055/s-0043-1773875](#)

The Committee on Herbal Medicinal Products (HMPC) in the European Medicines Agency (EMA) is dedicated to scientific opinions on the safety and efficacy of herbal substances and their preparations for medicinal use among EU Member States.

Out of herbal monographs, several additional guidance documents in the areas of quality, safety and efficacy of herbal medicinal products have been developed, public statements among them. Selected examples of public statements on Pyrrolizidine alkaloids (PAs), estragole, pulegone and menthofuran as well as herbals for which there are special safety concerns (*Chelidonium majus*, *Salvia officinalis* ess oil, etc.) will be presented and discussed.

Wednesday 5th July 2023 | Short Lecture Session E

Analytical Developments/Delivery

SL-E01 Short Lecture "Improving efficiency in herbal drug analysis with complementary developing solvents in HPTLC"

Authors [Tiên Do¹](#), [Eike Reich¹](#)

Institute **1** CAMAG, Muttenz, Switzerland

DOI [10.1055/s-0043-1773876](#)

The standardisation of HPTLC for identifying herbal drugs and herbal dietary supplements has been achieved through the publication of the European Pharmacopoeia chapter 2.8.25 and the USP NF chapter <203>. The use of individual methods based on these general chapters can help the industry to improve the reliability and lower the cost of routine quality control. On the other hand, QC laboratories in a cGMP environment may face the challenge of maintaining numerous methods and keeping associated reference substances and solvents in stock. That represents a significant cost factor that cannot be ignored. This presentation explains the use of complementary developing solvents (CDS) which employs a set of three developing solvents with varying degrees of polarity and selectivity. Each sample is then analysed on three separate plates, each with a different developing solvent. Despite the fact that this triples the required chromatographic effort, the cost per sample for routine analysis can still be reduced. That is possible due to the ability to handle all types of samples in parallel and automate the HPTLC process. Furthermore, compared to information attained through conventional HPTLC methods, CDS offers a significantly amplified data set for herbal samples. As time progresses, the data generated by CDS can be accessed by algorithms and artificial intelligence. Consequently, the identification of separated substances can be facilitated through machine learning and data mining techniques. This involves the use of algorithms to predict RF values, or to search a database for potential matches for identification purposes.

SL-E02 Short Lecture "Optimisation and biochemometric analysis of *Morus alba* root bark extracts against acute respiratory infections"

Authors [Ulrike Grienke¹](#), [Julia Langeder^{1,2}](#), [Kristin Doering³](#), [Hannes Schmietendorf³](#), [Michaela Schmidtk³](#), [Judith Maria Rolling¹](#)

Institutes **1** Division of Pharmacognosy, Department of Pharmaceutical Sciences, Faculty of Life Sciences, University of Vienna, Vienna, Austria;

2 Vienna Doctoral School of Pharmaceutical, Nutritional and Sport Sciences, University of Vienna, Vienna, Austria; **3** Section of Experimental Virology, Department of Medical Microbiology, Jena University Hospital, Jena, Germany

DOI [10.1055/s-0043-1773877](#)

The increase in acute respiratory infections (ARIs) associated with viruses and bacteria emphasises the need for new effective therapeutics. Mulberry Diels-Alder adducts (MDAAs) from the white mulberry tree (*Morus alba*) demonstrated dual antiviral and antibacterial *in vitro* effects [1, 2]. The aims of this study were to (i) develop a protocol to enrich MDAAs in extracts, (ii) unravel whether there are further constituents with anti-infective potential contained in the extracts, and (iii) characterise a hit extract for *in vivo* studies. In contrast to leaves, fruits, and twigs, the root bark was identified as the most prolific source of MDAAs by using a validated UPLC-PDA method. Pressurised liquid extraction (PLE) was found to be the best technique to enrich extracts with MDAAs. Extracts with a total content above 20% exerted a potent dual anti-influenza virus and anti-pneumococcal activity [3]. For a detailed biochemometric analysis of the most bioactive molecules within the 26 extracts obtained by PLE, a ¹H NMR-based heterocovariance analysis (HetCA) was used [4]. According to this procedure,

MDAAs exclusively accounted for the *in vitro* anti-influenza viral effect. The anti-infective profile of the hit extract (MA60) investigated showed good tolerance by lung cells (A549, Calu-3) and pronounced *in vitro* activities against influenza viruses, SARS-CoV-2, *S. pneumoniae*, *S. aureus*, and inflammation [2, 3].

Funding FWF project P34028, NATVANTAGE Grant 2018

Conflict of Interest The authors declare no conflict of interest.

References

- [1] Grienke Sci.Rep 2016; 6: 27156
- [2] Wasilewicz J.Nat.Prod. 2023; 86: 264–275
- [3] Langeder J.Nat.Prod. 2023; 86: 8–17
- [4] Grienke Sci.Rep. 2019; 9: 11113

SL-E03 Short Lecture "Quality of oral solid formulation of herbal medicinal products – a case study with *Lavandula* species products"

Authors Banaz Jalil¹, Michael Heinrich^{1, 2}

Institutes 1 Pharmacognosy and Phytotherapy, UCL School of Pharmacy, London, United Kingdom; 2 Department of Pharmaceutical Sciences and Chinese Medicine Resources, Chinese Medicine Research Center, College of Chinese Medicine, China Medical University, Taichung, Taiwan

DOI 10.1055/s-0043-1773878

Several of the 39 *Lavandula* species, their hybrids and about 400 registered cultivars are important aromatic and medicinal plants in the phytopharmaceuticals, food, and cosmetics industry [1]. *Lavandula angustifolia* Mill. is used traditionally to treat restlessness, agitation, insomnia and intestinal discomfort linked to nervousness [2]. Silexan, a high-quality lavender oil, is registered as a medicine for the treatment of anxiety disorders in several countries. The flower extract is used as an infusion to treat respiratory conditions. The oil is also used externally for scar and wound healing, in insect bites and burns, and for its aroma [2]. As of April 2023, 415 clinical trials with lavender as the investigational product were registered (<https://trialssearch.who.int/>). We evaluate the chemical profile and *in vitro* disintegration and dissolution of 55 products from *Lavandula* species, including different oral dosage forms of single and multi-ingredients with different regulatory statuses, assessing the authenticity and predicting their *in vivo* performance. The phytochemical analysis detected considerable variability of the marker compounds (e.g., linalool, linalyl acetate, and cineole) between products, with some containing 'often/sometimes undeclared' amounts of rapeseed and sunflower oils. Out of 43 oral solid formulations (19 soft gel, 16 hard shell, and 8 tablets), 16 failed the disintegration testing; 5 soft gel, 8 hard shell, and 3 tablets, respectively. Pass rates for gelatine-based capsules were higher than for non-gelatin (cellulose-based) capsules. This work is ongoing, and our findings will have implications for the interpretations of the efficacy and safety of phytopharmaceuticals used in clinical trials [3].

Funding This project was funded by Dr Willmar Schwabe GmbH & Co. KG, Germany, manufacturer of Silexan through a charitable donation. The donor had no influence on the analysis and interpretation of the data.

Conflict of Interest The authors declare no conflict of interest.

References

- [1] Aprotosoaie AC, Gille E, Trifan A, Luca VS, Miron A. Essential oils of *Lavandula* genus: a systematic review of their chemistry. *Phytochemistry Reviews* 2017; 16 (4): 761–99
- [2] Edwards SE, da Costa Rocha I, Williamson EM, Heinrich M. *Phytopharmacy: An evidence-based guide to herbal medicinal products*. John Wiley & Sons; 2015
- [3] Heinrich M, Jalil B, Abdel-Tawab M, Echeverria J, Kulic Z, McGaw L et al. Best Practice in the chemical characterisation of extracts used in pharmacological and toxicological research-The ConPhyMP-Guidelines. *Frontiers in Pharmacology* 2022; 13: 953205

SL-E04 Short Lecture "Search for diversified miliusane compounds from *Milium* plants for anticancer drug discovery"

Authors Hongjie Zhang¹, Wen-Jian Xie¹, Yi-Xuan Xia¹

Institute 1 School of Chinese Medicine, Hong Kong Baptist University, Hong Kong SAR

DOI 10.1055/s-0043-1773879

Plants have been a constant source to provide bioactive compounds. During our exploration of the plant biodiversity of the regions in Southeast Asia, miliusanes have been discovered as a cluster of novel anticancer compounds from the *Milium* genus. Miliusanes are unique natural products with a γ -lactone spiro-ring system skeleton containing 18 carbons formed from a geranyl and homogentisic acid (► Fig. 1). We have isolated dozens of new miliusanes from *Milium* medicinal plants, and many of them have demonstrated with cancer cell killing activities against multiple cancer cell lines. The structures of the natural miliusanes are diversified, but their bioactivities depend on several key functional groups, which provided a viable strategy for functional group based-structure modification to obtain miliusane derivatives with enhanced activities. We have then synthesised various miliusane analogues, and analysed their structural-activity relationship (SAR). Several miliusanes were selected for further evaluation in the tumour-bearing mouse models, and they have been found to potently inhibit tumour growth against several types of cancer cells with low toxicity when compared with the clinically used drugs paclitaxel (PTX) and fluorouracil (5-FU). Our further biological studies determined that the anti-proliferative activities of miliusanes on cancer cells were positively correlated with their induction of senescence, rather than apoptosis. This experimental evidence clearly indicated miliusanes as promising lead molecules that have high potential for development as novel therapeutic drugs against cancerous diseases.

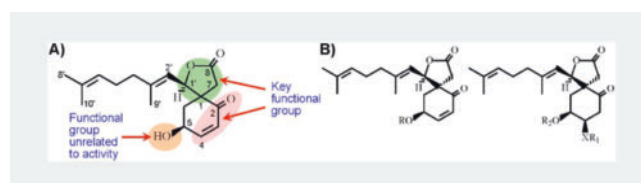

► Fig. 1 a) Chemical skeleton and activity associated key functional groups of miliusanes. b) Naturally occurred bioactive miliusanes and their synthetic derivatives (R = H, Ac, Ph, etc.; R₁ = H, CH₃, Ph, etc.; R₂ = H, Ac, Ph, etc.; X = O, NH, etc.).

Acknowledgement: This work is supported by the HKBU Initiation Grant for Faculty Niche Research Areas (IG-FNRA) 2021/22 (RC-IGFNRA/21-22/SCM/01).

Conflict of Interest The authors declare no conflict of interest.

SL-E05 Short Lecture "Exploring the antibacterial and antivirulence activities of natural and semisynthetic neolignans from *Krameria lappacea*"

Authors François Gauvin¹, Lauriane Lenen¹, Régine Janel-Bintz², Pierre

Fechter², Raphaël Grougnat³, Sabrina Boutefnouchet³,

Catherine Vontrhon-Sénécheau¹, Sergio Ortiz¹

Institutes 1 LIT, Université De Strasbourg, France; 2 Biotechnologie et Signalisation Cellulaire, Université de Strasbourg, France; 3 Université Paris Cité, France

DOI 10.1055/s-0043-1773880

Pathogenic bacteria are capable of deploying a collection of virulence factors that are not only essential for host infection and persistence, but also to escape

the host immune system and to become more resistance to drug therapies. With the aim of discovering new and innovates therapeutic alternatives to fight bacterial infections, we investigated the antibacterial and antivirulence activities of neolignans isolated from roots of *Krameria lappacea* (Dombey) Burdet & B.B.Simpson, a medicinal plant used in the traditional medicine of South America. Extraction procedures were performed by classical maceration and by supercritical fluid techniques at different polarity. The antibacterial and anti-biofilm *in vitro* activities of extracts were assessed by different methodologies against a panel of Gram-positive and Gram-negative bacterial strains. Chemical composition of extracts was analysed by HPLC-DAD-HRMS/MS and by molecular network approaches. The more non-polar extract KLD, obtained by maceration in dichloromethane was found to have the most promising antibacterial activity, with minimal inhibitory concentration (MIC) values of 3–12 µg/mL against referential and clinical isolates of Gram-positive bacteria. Bio-guided isolation allowed us to isolate 10 neolignans with antibacterial activity against reference and clinical bacterial strains *in vitro*. For two more promising derivatives ((+)-conocarpan and 2-(2-hydroxy-4-methoxyphenyl)-5-(3-hydroxypropyl)-benzofuran), their antibacterial activity was characterised as bactericide action by the minimal bactericide concentration (MBC). Moreover, these compounds exhibited antivirulence activity against *Pseudomonas aeruginosa*, inhibiting the production of pyocyanin (cytotoxic pigment) and increasing the membrane stiffness. Semisynthesis are in progress with the aim to identify the functional groups essential for this antibacterial activity (► Fig. 1).

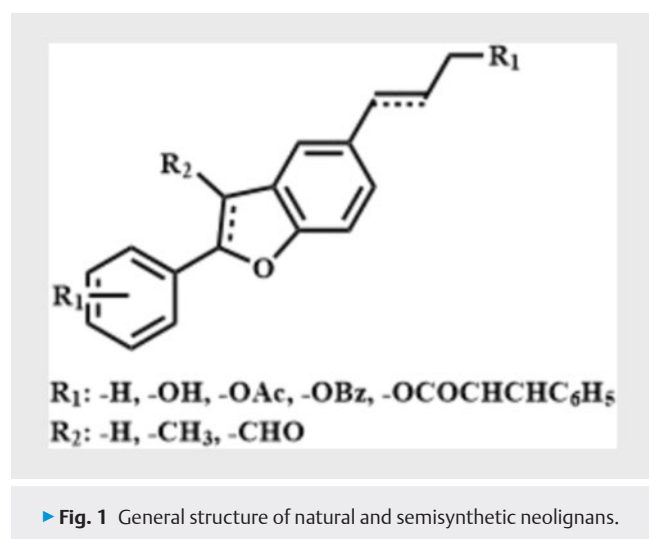

SL-E06 Short Lecture “Where nature’s toxins meet biologics: digital teaching of antibody-drug conjugates”

Authors Heng Mak¹, John Walsh^{2,3}

Institutes 1 University Hospitals Sussex NHS Foundation Trust, Brighton, United Kingdom; 2 School of Pharmacy and Pharmaceutical Sciences, Trinity College Dublin, Dublin 2, Ireland; 3 The NatPro Centre, School of Pharmacy and Pharmaceutical Sciences, Trinity College Dublin, Dublin, Ireland
DOI 10.1055/s-0043-1773881

Antibody drug conjugates (ADCs) have emerged in the last decade as an important armory in the treatment of many cancer types, with 10 such examples clinically approved since 2020. An ADC consists of an antibody, linker and cytotoxic warhead. Invariably the warhead used is a highly potent nature-derived cytotoxin with examples drawn from the dolastatin, maytansine, calicheamicin, camptothecin and pyrrolobenzodiazepines series of natural products. In this context, their inclusion into the curricula of both pharmacy and medical programmes is both timely and warranted. In designing this learning unit, ad-

vanced Storyline tools such as navigational buttons, mouseover, click-to-reveal functions, animations, transitions and sound effects were adopted and embraced by the student cohort. An in-depth treatment of the subject matter is given to students in year three of our five-year pharmacy (integrated) programme. A more top-level presentation on ADCs is given to our students on the MSc course in molecular medicine. The subject matter is presented in an accessible and interactive format that is available on the students' online learning hub, Blackboard.

Wednesday 5th July 2023 | Short Lecture Session F Macromolecules

SL-F01 Short Lecture “Role of gut microbiota in the anti-colitis effect of *Dendrobium officinale* polysaccharide”

Authors Chuying Huo¹, Quanbin Han¹

Institute 1 Hong Kong Baptist University, Hong Kong, China

DOI 10.1055/s-0043-1773882

Ulcerative colitis has become a health burden worldwide. *Dendrobium officinale* polysaccharide (DOP) has been reported to be a promising therapy. Although its effect on microbiota regulation was previously demonstrated, the role of gut microbiota in DOP's activity remains unclear. This research aims to verify its beneficial effect on the DSS-induced colitis mice model and explore the underlying mechanism. The results showed that DOP reduced the disease activity index, ameliorated colon shortening and colonic damage, suppressed colonic inflammation, and enhanced the intestinal tight junction in DSS-treated colitis mice. In addition, the result of 16S rRNA sequencing and metabolite analysis revealed that DOP altered the structure of gut microbiota and increased the production of short-chain fatty acids (SCFAs) in colitis mice. Interestingly, we found DOP undegraded in vancomycin-treated mice but not neomycin-treated mice. Moreover, the depletion of vancomycin-sensitive bacteria also blocked the anti-colitis effect of DOP in mice. By comparing the different abundant bacteria between colitis mice and DOP-treated mice, the gram-positive bacteria, genus *Allobaculum*, was identified as the key player for DOP's activity. Furthermore, the enzymatic product mannan endo-1,4-beta-mannosidase that breaks down DOP was positively correlated to the relative abundance of *Allobaculum*. Collectively, DOP alleviated DSS-induced colitis in mice by *Allobaculum*-mediated degradation to yield SCFAs (► Fig. 1).

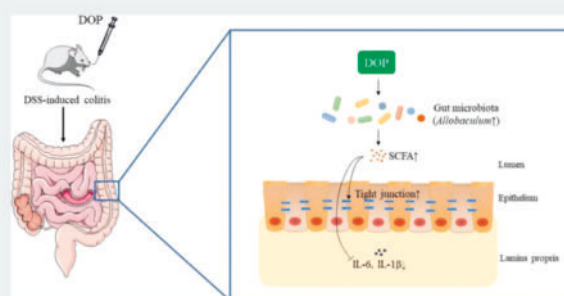

► Fig. 1 DOP reduced the disease activity index, ameliorated colon shortening and colonic damage, suppressed colonic inflammation, and enhanced the intestinal tight junction in DSS-treated colitis mice, which was mediated by production of microbiota-derived SCFAs.

Conflict of Interest The authors declare no conflict of interest.

SL-F02 Short Lecture "An oligosaccharide marker for rapid authentication of edible bird's nest"

Authors Huiyuan Cheng¹, Lifeng Li¹, Quanbin Han¹

Institute 1 Hong Kong Baptist University, Hong Kong

DOI 10.1055/s-0043-1773883

Edible bird's nest (EBN) is a popular and expensive food material. The limited supply and great demand result in the use of adulterants. The authenticity concern is raised due to the lack of appropriate quality markers. Herein, this study aims to provide a specific oligosaccharide marker for rapid EBN authentication. Comparing the benzocaine (ABEE)-labelled saccharide profiles of multiple batches of EBN and adulterants indicates seven unique EBN oligosaccharides. The most abundant one, named BNM001, was selected as a marker and characterised to be Neu-5-Ac-(2-3)-Gal by MS and NMR spectra. This new oligosaccharide marker enables a rapid authentication of EBN within 10 mins. ABEE labelling of this marker further upgraded the accuracy and sensitivity of the LC-qTOF-MS quantitative analysis. The relative marker content was associated with the quality of EBN products. These results suggest a specific and efficient quality marker for rapid authentication of EBN and related products (► Fig. 1).

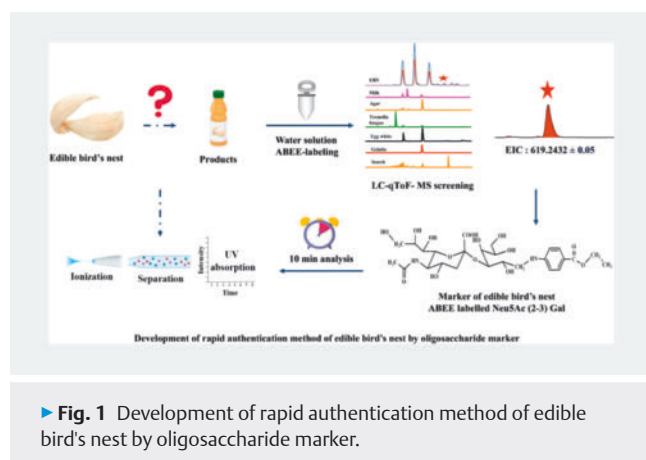

► Fig. 1 Development of rapid authentication method of edible bird's nest by oligosaccharide marker.

Conflict of Interest The authors declare no conflict of interest.

SL-F03 Short Lecture "Water-soluble heteropolysaccharides from medicinal plants and fungi interact with toll-like receptors"

Authors Håvard Hoel¹, Christian W. Wold¹, Alexandre Corthay^{2,3,4}, Kari Inngjerdigen^{1,4}

Institutes 1 Section for Pharmaceutical Chemistry, Department of Pharmacy, University of Oslo, Norway; 2 Tumor Immunology Lab, Department of Pathology, Rikshospitalet, Oslo University Hospital, Norway; 3 Hybrid Technology Hub – Centre of Excellence, Institute of Basic Medical Sciences, University of Oslo, Norway; 4 These authors are co-senior authors on this work

DOI 10.1055/s-0043-1773884

Naturally derived polysaccharides have the potential to trigger pattern recognition receptors (PRRs) on the surface of macrophages, thereby initiating an innate inflammatory immune response. When properly activated, macrophages can kill cancer cells, secrete cytokines for immune cell recruitment to tumors, and stimulate T cells to fight cancer metastases. Therefore, macrophages are attractive targets for novel antitumor immunotherapy drugs. We have recently identified polysaccharides from the medicinal fungus *I. obliquus* (Chaga) that were agonists of toll-like receptor 2 (TLR2), TLR4, and Dectin-1a, and able to elicit a tumoricidal pro-inflammatory response in macrophages. We are currently investigating further at how these polysaccharides from *I. obliquus* bind to several PRRs and its consequence for macrophage activation. We are also

screening novel water-soluble polysaccharides isolated from selected medicinal plants from Norway and Brazil for their ability to activate macrophages and for their potential use in cancer treatment. These include a heterogenous group of pectins, xylans and arabinogalactan-proteins among others. To identify polysaccharides of potential interest for immunotherapy, we take advantage of human embryonic kidney (HEK293) blue reporter cell lines transfected with specific PRRs (TLR2, TLR2-TLR6, TLR4, TLR3, Mincle, Dectin-1a and Dectin-1b). The ability of a single polysaccharide to bind to several PRRs opens the possibility of simultaneous activation of multiple receptors, thus leading to a potential synergistic effect. Further research on the active isolates will seek to demonstrate such a synergistic macrophage activation by polysaccharides, as well as structure-activity relationship through enzymatic degradation.

Conflict of Interest The authors declare no conflict of interest.

SL-F04 Short Lecture "Molecular imaging of isolated *Escherichia coli* peptidoglycans allows insights into the mechanism of natural products inhibiting bacterial cell wall synthesis"

Authors Leonardo Elsbroek¹, Daniel Amiteye¹, Sebastian Schreiber², Fabian Herrmann¹

Institutes 1 Institute of Pharmaceutical Biology and Phytochemistry, University of Münster, Münster, Germany; 2 Institute of Pharmaceutical and Medicinal Chemistry, University of Münster, Münster, Germany
DOI 10.1055/s-0043-1773885

Emerging resistances of prokaryotic pathogens are one of the major challenges of today's drug development research. Because of the decreasing efficacy of available antibiotic therapies against clinically relevant bacteria, innovative therapeutical options are urgently needed. Especially the unique prokaryotic cell wall is commonly known to constitute a highly relevant target for the development of antibacterial entities. Nevertheless, novel antibiotics inhibiting bacterial peptidoglycan synthesis are mostly missing today. This is primarily originated by difficulties in the kinetic assessment of single enzymes of the complex and co-dependent peptidoglycan synthesis machineries, e.g. the elongasome and divisome. Additionally, in the rather rare cases where a specific inhibitor of a murein synthesis enzyme was successfully identified, those leads were typically inactive against whole bacterial cells. With the intention to supply an alternative approach for the evaluation of leads potentially targeting bacterial cell wall synthesis, we present a facile and economic peptidoglycan isolation protocol allowing subsequent Atomic Force Microscopy-based molecular insights into peptidoglycan network ultrastructure. Applying this innovative technique, unprecedented insights into the mechanism of action of common peptidoglycan-targeting antibiotics as well as of the natural FtsZ-inhibitor berberin were established. This technique might serve as capable tool to evaluate or even identify novel inhibitors of peptidoglycan synthesis by an imaging-based approach.

SL-F06 Short Lecture "Metabolisation of *Hypericum perforatum* extract by human gut microbiota"

Authors Maria-Eleni Grafakou¹, Eva-Maria Pferschy-Wenzig¹, Ramy M. Ammar², Olaf Kelber², Rudolf Bauer¹

Institutes 1 Institute of Pharmaceutical Sciences, Department of Pharmacognosy, University of Graz, Graz, Austria; 2 Phytomedicines Supply and Development Center, Bayer Consumer Health, Steigerwald Arzneimittelwerk GmbH, Darmstadt, Germany
DOI 10.1055/s-0043-1773886

Hypericum perforatum L. is widely used for mild depression. Several clinical studies have been performed [1], and oral bioavailability of its key constituents is known [2, 3]. With an aim to investigate microbiome-mediated metabolisation, we subjected *H. perforatum* ethanolic extract to fermentation with human gut microbiota. As a first step, digestion in the upper GI tract was mimicked by successively incubating the extract with the respective enzyme and buffer mix-

es according to the Infogest protocol [4]. The Infogest intestinal phase was subsequently incubated with fecal samples from ten healthy donors (24h, anoxic, 37 °C) [5]. An UHPLC-HRMS method was optimised for the analysis and annotation of the constituents present in the preparation, in digestive phases, and after fermentation. Analysis indicated that the levels of most annotated constituents, including flavonoids, phenylpropanoids, procyanidins, xanthenes, and phloroglucinols, with the exception of hypericins, are stable towards the three Infogest digestive phases. However, subsequent fermentation with gut microbiota led to an intensive metabolisation of the constituents. Donors presented differences regarding the degree and velocity of metabolisation, however the majority of the annotated constituents have been metabolised by gut microbiota similarly in most donor samples, and several intermediate and final metabolites were formed. The newly formed metabolites, potentially possessing different pharmacokinetics and pharmacodynamics than the progenitor compounds, may provide new insights into the observed therapeutic effects of *Hypericum* extracts.

Conflicts of Interest The investigations and MEG have been funded by, and RMA and OK are fully employed by Steigerwald Arzneimittelwerk, Bayer Consumer Health.

References

- [1] www.ema.europa.eu/en/medicines/herba/hyperici-herba
- [2] Schulz HU, Schurer M, Bassler D, Weiser D. Investigation of the bioavailability of hypericin, pseudohypericin, hyperforin and the flavonoids quercetin and isorhamnetin following single and multiple oral dosing of a hypericum extract containing tablet. *Arzneimittelforschung* 2005; 55: 15–22
- [3] Schulz HU, Schurer M, Bassler D, Weiser D. Investigation of the effect on photosensitivity following multiple oral dosing of two different hypericum extracts in healthy men *Arzneimittelforschung* 2006; 56: 212–21
- [4] Brodkorb A, Egger L, Alminger M, Alvito P, Assunco R, Ballance S, Bohn T, Bourlieu-Lacanal C, Boutrou R, Carriere F et al. INFOGEST static in vitro simulation of gastrointestinal food digestion. *Nat Protoc* 2019; 14: 991–1014
- [5] Perez-Burillo S., Molino S, Navajas-Porras B. et al. An in vitro batch fermentation protocol for studying the contribution of food to gut microbiota composition and functionality. *Nat Protoc* 2021; 16: 3186–3209

Wednesday 5th July 2023 | Short Lecture Session G

Sustainability/Natural Products Supply

SL-G01 Short Lecture "A green process for the complete valorisation of *Olea europaea* leaves, based on limonene extraction, enrichment, and recycling"

Authors [Konstantina Vougiannopoulou](#)¹,

[Konstantinos F. Mavreas](#)^{1,2}, [Panagiota Papakotsi](#)², [Michail Tsakos](#)², [Ioannis K. Kostakis](#)³, [Alexios L. Skaltsounis](#)¹

Institutes 1 Division of Pharmacognosy and Natural Product Chemistry, Department of Pharmacy, National and Kapodistrian University of Athens, Panepistimiopolis Zografou, 15771, Athens, Greece; 2 PharmaGnose S.A., Oinofyta, 320122, Greece; 3 Division of Pharmaceutical Chemistry, Department of Pharmacy, National and Kapodistrian University of Athens, Panepistimiopolis Zografou, 15771, Athens, Greece

DOI [10.1055/s-0043-1773888](https://doi.org/10.1055/s-0043-1773888)

Olive leaves, the main CO₂ generating side-product of olive tree cultivation, are rich in bioactives, such as the secoiridoid oleuropein, the precursor of the bioactive oleocanthal present in olive oil [1], and oleanolic and maslinic acids with applications in skin care products [2]. Under the frame of circular economy, a novel and highly efficient fractionation of crude olive leaf extract was designed. Application of ultrasound extraction, supercritical CO₂ extraction and molecular distillation for recycling the green solvent (D-limonene), resulted in the efficient fractionation of olive extract into three enriched fractions

ready to be used as active ingredients, and recycling of D-limonene. Target compounds were quantified (HPLC-DAD/polyphenols, HPLC-ELSD/triterpenoids). Each extract was enriched in distinct chemical classes: chlorophylls and pigments; olive polyphenols (22.4% oleuropein); olive triterpenoids (75.3% oleanolic acid, and 16.9% maslinic acid). Oleuropein was further purified using state-of-the-art automated techniques (MPLC/HPLC, green solvents), and was used as a synthon for the green semisynthesis of novel, olive dialdehyde-based bioactive molecules, based on hydrolysis steps with the aid of enzymes in aqueous media. In conclusion, we report for the first time the complete valorisation of the main agricultural side-product of olive cultivation with the use of solely green techniques, for producing diverse active ingredients such as olive polyphenols and secoiridoids, and triterpenic acids.

Funding ERDF, "Synergies of Research and Innovation (ATTP4-0359462)", ROP of Attica, MIS 5185066.

Conflict of Interest The authors declare no conflict of interest.

References

- [1] Martins BT et al. *J Agric Food Chem* 2022; 70: 14109–28
- [2] Jing Z et al. *Curr Drug Targets* 2021; 22: 1496–506

SL-G02 Short Lecture "Sustainable "Mountain Cultivation" of medicinal plants such as *Panax ginseng* and *Coptis japonica* in Korea and Japan"

Author [Kenny Kuchta](#)¹

Institute 1 Albrecht von Haller Institute of Plant Sciences, Georg August University Göttingen, 37073 Göttingen, Germany

DOI [10.1055/s-0043-1773888](https://doi.org/10.1055/s-0043-1773888)

Although herbs like garlic (*Allium sativum*) were already domesticated crops in Sumerian times [1] others are not cultivated even today, making wild collections of questionable sustainability necessary. Unfortunately, the establishment of farming techniques for such wild medicinal plants may not be a viable solution. E.g. "wild" fox populations in European inner cities exhibit the same "domestication syndrome" in their body and skull structure [2] that was observed in domestication experiments [3], indicating that domestication may happen unintentionally. As "domestication syndrome" is also documented in plants [4], the "genetic sustainability" of wild herbs when entered into cultivation is questionable, as their inevitable evolutionary adaptation to cultivation may cause the loss of genetic information for relevant active metabolites. In Korea, so called "mountain cultivation", or literally "forestry cultivation", of ginseng (*Panax ginseng*) was established in the 14th century as wild ginseng is (in accordance with the above) traditionally regarded as more effective. Seeds are collected from wild plants in a reserve and germinated in pots to one-year-old seedlings. These are "released" into long, narrow beds in otherwise natural forests. This removes genetic pressures other than those of the wild biotope from the germ line guarantying "genetic sustainability". The roots are harvested after ca. 9 years and known in Korea as "mountain ginseng" or "wild-simulated ginseng". In the 18th century, "mountain cultivation" was imported to Japan and successfully applied to *Coptis japonica*. "Mountain cultivation" may in the future yield sustainable access to further medicinal plants that are currently still sourced from wild collection.

References

- [1] Kramer SN. The Sumerians: Their History, Culture, and Character Phoenix Books 1971
- [2] Parsons KJ et al. Skull morphology diverges between urban and rural populations of red foxes mirroring patterns of domestication and macroevolution. *Proc Biol Sci* 2020; 287 (1928): 20200763
- [3] Trut L, Dugatkin LA. How to Tame a Fox (and Build a Dog): Visionary scientists and a Siberian tale of jump-started evolution. University of Chicago Press; 2017
- [4] Allaby RG. Domestication Syndrome in Plants. In: Smith C. (eds) Encyclopedia of Global Archaeology. Springer; New York: 2014

SL-G03 Short Lecture "Plectranthus diterpenes: A promising therapy for glioblastoma treatment"

Authors Eva María Domínguez-Martín^{1,2}, Mariana Magalhães^{3,4,5,6}, Przemysław Sitarek⁷, Ana M. Gómez⁸, Ana María Díaz- Lanza², Thomas Efferth⁹, Célia Cabral^{5,6,10}, Patrícia Rijo^{1,11}

Institutes 1 Research Center for Biosciences and Health Technologies, Universidade Lusófona De Humanidades E Tecnologías, Lisbon, Portugal; 2 Universidad de Alcalá de Henares, Facultad de Farmacia, Departamento de Ciencias Biomédicas (Área de Farmacología); Nuevos agentes antitumorales, Acción tóxica sobre células leucémicas. Ctra. Madrid-Barcelona km. 33,600. 28805, Alcalá de Henares, Spain; 3 PhD Programme in Experimental Biology and Biomedicine, Institute for Interdisciplinary Research (IIIUC), University of Coimbra, Casa Costa Alemão, 3030-789, Coimbra, Portugal; 4 CNC—Center for Neuroscience and Cell Biology, University of Coimbra, Coimbra, Portugal; 5 Faculty of Medicine, Clinic Academic Center of Coimbra (CACC), Coimbra Institute for Clinical and Biomedical Research (iCBR), University of Coimbra, 3000-548, Coimbra, Portugal; 6 Center for Innovative Biomedicine and Biotechnology (CIBB), University of Coimbra, 3000-548, Coimbra, Portugal; 7 Department of Biology and Pharmaceutical Botany, Medical University of Lodz, ul. Muszyńskiego 1, 90-151, Lodz, Poland; 8 Instituto de Química Orgánica, IQOG-CSIC, Juan de la Cierva 3, 28006, Madrid, Spain; 9 Department of Pharmaceutical Biology, Institute of Pharmaceutical and Biomedical Sciences, Johannes Gutenberg University, Staudinger Weg 5, 55128, Mainz, Germany; 10 Centre for Functional Ecology, Department of Life Sciences, University of Coimbra, Calçada Martim de Freitas, 3000-456, Coimbra, Portugal; 11 Instituto de Investigação do Medicamento (iMed.U LISBOA), Faculty of Pharmacy, University of Lisbon, 1649-003, Lisbon, Portugal

DOI 10.1055/s-0043-1773889

Plectranthus genus (Lamiaceae) is known to be rich in bioactive diterpenes abietane-type royleanones, such as 7 α -acetoxy-6 β -hydroxyroyleanone (Roy), 7 β ,6 β -dihydroxyroyleanone (DiRoy), Parviflorone D (ParvD) and 6,7-dehydroroyleanone (DeRoy). Roy and DiRoy are frequently found in the extracts of the species *P. hadiensis*, ParvD in *P. ecklonii* and DeRoy in *P. aliciae*. These compounds can be considered as lead molecules to search new treatments against glioblastoma (GB) regarding their proven pro-apoptotic nature in H7PX cells. The bioguided isolation from *P. hadiensis* stem acetonic extract resulted in the obtention of Roy and DiRoy, which were the major compounds according to the HPLC-DAD profile of the extract. Among these compounds, Roy showed low IC₅₀ values (range of 6.21–56.91 μ g/mL at 24 h) among the different glioblastoma cell lines (U87, A172, U118, U373 and H4) in the Alamar blue assay. The uptake of the probe derivative BODIPY-Roy by GB cells increased intracellular fluorescence, supporting the strong antiproliferative effects of Roy. Also, the ParvD diterpene showed a mechanism by which it exerts pronounced inhibitory effects (with substantially lower doses than that of Temozolomide, the current first-line treatment) involving intrinsic apoptosis and G2/M cell cycle arrest. Currently, the study of the extraction optimisation of these bioactive compounds, their mechanism of action, their in-vivo activity and the synthesis of some derivatives is on-going to explore the huge potential of these diterpenoids and their derivatives to be used as a helpful source of new drugs to improve GB treatment and to overcome resistances.

Conflict of Interest The authors declare no conflict of interest.

SL-G04 Short Lecture "Valuable natural products from medicinal plant processing waste: content of shikimic acid in *Ginkgo biloba* production waste streams"

Authors Žarko Kulić¹, Jürgen Wolff¹, Elke Wilhelm², Vincent Schüler¹, Birgit Röck¹, Andreas Butterer¹

Institutes 1 Preclinical R&D, Dr. Willmar Schwabe GmbH & Co. KG, D-76227 Karlsruhe, Germany; 2 Analytical Development, Dr. Willmar Schwabe GmbH & Co. KG, D-76227 Karlsruhe, Germany

DOI 10.1055/s-0043-1773890

Industrial plant wastes from the production of herbal medicinal products and foodstuffs can be rich sources for valuable natural products. Herein, we show selected multistep extraction processes from *Ginkgo biloba*, with a focus on the proprietary extract EGb 761 [1], and the qualitative composition of valuable natural products in the multiple waste streams. One major share of the waste streams is shikimic acid, a valuable starting material for the synthesis of e.g. oseltamivir, an antiviral drug. Other constituents in the waste streams comprise other organic acids, carbohydrates, polyphenols and terpenic compounds, among others. We present numbers on shikimic acid amounts with a perspective on feedstock recycling on an industrial scale [2].

References

- [1] Kulić Ž et al. Front. Pharmacol 2022; 13: 1007746
- [2] Kulić Ž et al. ACS Sustainable Chem. Eng. 2023; 11: 4943–4947

Wednesday 5th July 2023 | Short Lecture Session H

Saffron and Cannabis

SL-H01 Short Lecture "Pharmacokinetics, behavioural and cannabinoids receptor binding profile of hemp derived (R/S)-Hexahydrocannabinol"

Authors Martin Kuchar¹, Lucie Janeckova¹, Klara Sichova², Tomas Palenicek²

Institutes 1 Forensic Laboratory of Biologically Active Compounds, Department of Chemistry of Natural Compounds, University of Chemistry and Technology, Prague, Prague, Czech Republic; 2 Psychedelics Research Centre, National Institute of Mental Health, Prague, Czech Republic
DOI 10.1055/s-0043-1773891

The use of cannabis plant dates to ancient China around 2500 BC. Cannabinoids, which are found naturally in plants, have been widely used for recreational and medicinal purposes. *Cannabis sativa* L. produces more than 150 cannabinoids, which most of them occurred in only trace amounts. Δ 9-THC is the main compound responsible for the intoxicant activity of cannabis plant and thus the plant containing higher amount of Δ 9-THC is regulated according to the UN Convention. The community of recreational cannabis users rediscovered the very rare natural cannabinoids (R/S)-Hexahydrocannabinol (HHC) as the demand for the legal alternatives of Δ 9-THC. HHC edibles and vape liquids are in the Czech Republic available freely in shops and even vendor machines, which cause a series of intoxications. Although the HHC was firstly synthesised from Δ 9-THC in 1947, the pharmacological and behavioural study has not been performed so far. We prepared the pure (R) and (S) enantiomers of HHC. Pharmacokinetics and behavioural tests in Wistar rats were performed following gastric administration of R/S HHC. Behavioural experiments (open field test, PPI, ASR and conditioned place preference) have a standardised design in order to obtain comparable data to Δ 9-THC. Pharmacokinetics profile was measured in rats' serum using LC-MS. The binding affinities of the both R/S HHC enantiomers to CB1 receptor and beta-arrestin2-CB1R interaction were compared to Δ 9-THC and WIN 55,212-2. Pharmacokinetics and behavioural profile in animal model with Wistar rats figured out similarities with Δ 9-THC but with significant differences of each enantiomer.

Conflict of Interest The authors declare no conflict of interest.

SL-H02 Short Lecture "Anti-inflammatory potential of components of *Cannabis sativa* L. with relevance to multiple sclerosis pathogenesis"

Author [Eric Downer¹](#)

Institute **1** Discipline of Physiology, School of Medicine, Trinity Biomedical Sciences Institute, Trinity College Dublin, Dublin, Ireland

DOI [10.1055/s-0043-1773892](https://doi.org/10.1055/s-0043-1773892)

Toll-like receptors (TLRs) are the sensors of pathogen associated molecules that trigger tailored innate immune signalling responses. TLRs have been implicated in many diseases, including neurodegenerative diseases such as multiple sclerosis (MS). *Cannabis sativa* L. (*C. sativa*) contains an array of plant-derived (phyto) cannabinoids, flavonoids and terpenes that continue to gain attention for their potential as novel therapeutics in many areas of biomedicine. In particular, the phytocannabinoids have shown efficacy in experimental autoimmune encephalomyelitis (EAE), the murine model of MS, and are in clinical development for the management of the symptoms of MS. A growing body of literature indicates that components of *C. sativa* may interact with TLR signalling events with relevance to neuroinflammatory disease processes. Data presented herein demonstrate that MS is associated with peripheral inflammation in immune cells from people with (pw)MS, when compared to immune cells from healthy volunteers. Original data from our laboratory will be presented demonstrating that two major phytocannabinoids, Δ^9 -tetrahydrocannabinol (THC) and cannabidiol (CBD), in addition to terpenes/flavonoids, are novel regulators of both viral and bacterial inflammatory signalling pathways controlled by TLRs in human immune cells associated with MS pathogenesis. This presentation will highlight TLR signalling as a mechanism to be investigated in the development of new cannabinoid-based therapeutics for the treatment of neuroinflammatory disorders such as MS.

Conflict of Interest The author declares no conflict of interest.

SL-H03 Short Lecture "Saffron: The "golden flower" of Ukraine"

Author [Olha Mykhailenko¹](#)

Institute **1** National University of Pharmacy, Kharkiv, Ukraine

DOI [10.1055/s-0043-1773893](https://doi.org/10.1055/s-0043-1773893)

Due to its medicinal properties, the global commercial demand for saffron (*Crocus sativus*) is constantly on the rise. Saffron has a long history of use as anti-cancer, hepatoprotective, and hypolipidemic agent, and is also recognised as a source of apocarotenoids, flavonoids, and triterpenoids. Over 418 tons/year of saffron is produced worldwide from 108,000 ha in Iran, 3,674 ha in India, and 1,000 ha in Greece. Since 2015, saffron has been cultivated in the Ukraine with a total volume of about 0.07 tons/year from 20 ha. From 75–100 saffron flowers, 225–300 stigmas are collected, from which only 0.5 g of dry stigmas are obtained. Saffron quality depends on environmental conditions, processing, value chains, handling etc., which has an effect on the main marker compounds content (crocin, picrocrocin, safranal). HPLC and UV-Vis analyses of 35 saffron samples from 12 Ukrainian regions made it possible to establish that the crocin and picrocrocin amount is higher in the northeastern regions of Ukraine and decreases closer to the southwestern areas of cultivation (► **Table 1**). Positive correlations were found for stigma yield with increasing light duration and less rainfall. Picrocrocin and safranal content in samples was influenced by longitude, latitude, rainfall amount, and duration of solar radiation. This chemical and agrotechnical research on saffron cultivation made it possible to develop and implement an SOP for saffron production in accordance with GACP recommendations, which significantly improved the quality of HMP.

► **Table 1** Details of saffron samples from Ukraine and their quality characteristics according to ISO.

Region of Ukraine	Altitude, m	Geographical coordinates	$E_{1.0\%}^{1.0\%}$	$E_{1.0\%}^{1.0\%}$	$E_{1.0\%}^{1.0\%}$
			257 nm	330 nm	440 nm
			Picrocrocin / Bitter	Safranal / Aroma	Crocins / Color
Kherson	58	46.80501°N, 33.57194°E	88.06 ± 1.24	58.04 ± 1.05	245.12 ± 4.31
Kharkiv	173	49.98194°N, 35.21194°E	83.05 ± 1.12	50.04 ± 0.95	254.17 ± 4.05
Zaporizhzhia	72	47.07222°N, 35.14583°E	83.64 ± 1.05	24.60 ± 0.43	198.85 ± 3.50
Chernihiv	110	51.33667°N, 31.94752°E	111.46 ± 1.95	37.69 ± 0.38	262.81 ± 4.11
Mykolajiv	74	48.79361°N, 29.98694°E	107.50 ± 1.15	27.58 ± 0.40	274.51 ± 4.70
Odesa	182	47.18010°N, 29.52181°E	96.02 ± 1.12	35.15 ± 0.03	243.22 ± 1.02
Vinnitsia	173	48.50511°N, 29.62111°E	86.47 ± 1.23	40.01 ± 0.63	232.08 ± 4.18
Khmelnytskyi	311	49.53639°N, 26.19722°E	108.5 ± 1.05	33.90 ± 0.35	272.20 ± 4.70
Volynsk	222	50.42944°N, 24.82361°E	30.45 ± 0.54	95.10 ± 1.10	253.10 ± 4.36
Transcarpathia	159	48.55111°N, 22.65528°E	102.30 ± 1.15	36.12 ± 0.64	218.35 ± 3.84
Sumy	152	51.17139°N, 34.78444°E	89.47 ± 1.32	28.46 ± 0.35	272.51 ± 4.70
Chernivtsi	110	51.33667°N, 31.94752°E	84.25 ± 1.20	30.84 ± 0.22	225.44 ± 4.05

Samples were collected during September – December vegetation period, were deposited at the Herbarium of the Botany Department of the National University of Pharmacy, Kharkiv, Ukraine; Geographical co-ordinates and elevation above the sea level were identified using GPS devices (Prestigio Geo/Vision 5050).

Conflict of Interest The authors declare no conflict of interest.

Monday 3rd July 2023 | Poster Session I

- Veterinary – Phytochemistry; Phytopharmacology; Phytotherapy (P-001 – P-016)
- Sustainability/Supply chain/Green Chemistry/ Valorisation (P-021 – P-028)
- New and emerging methods (P-029 – P-036)
- Cannabis and cannabinoids (P-037 – P-046)
- Phytochemistry I – General (P-047 – P-095)
- Phytopharmacology I – General; respiratory; cardiac (P-096 – P-143)
- Natural product synthesis (P-144 – P-146)
- Formulation/ Dissolution/ Dosage (P-147 – P-151)

P-001 Effect of phytogetic inclusion on performance and meat quality parameters in broilers

Authors [Basharat Syed¹](#), [Vladimira Ocelova¹](#), [Michaela Mohnl¹](#)

Institute **1** DSM – BIOMIN Research Center, Technopark 1, 3430 Tulln, Austria

DOI [10.1055/s-0043-1773894](https://doi.org/10.1055/s-0043-1773894)

The objectives of this study were to determine the effects of supplementing broiler diets with a phytogetic feed additive (PFA) on performance and meat quality parameters. For this purpose, 1170 male day-old Ross 308 broiler chickens were randomly assigned to two treatments, with 9 replicates each and 65 birds per replicate and reared for a period of 42 days. The treatments were a control diet without any feed additive and a treatment diet containing a PFA (phytogetic blend including bioactives of oregano oil and orange oil). The diet was corn-soybean based. Inclusion of PFA to the broiler feed improved body weight (2427 g) compared to the control (2418 g) and reduced the mortality of broilers in the PFA group (0.51%) compared to the control (1.02%). In the PFA group feed conversion ratio was significantly lower compared to the control group ($p < 0.05$). The ultimate pH of the meat was significantly better in the PFA group compared to the control group ($p < 0.01$). Breast meat drip loss was significantly ($p < 0.03$) lower in the PFA supplemented group. Additionally, breast yield was also improved numerically in the PFA group.

Thus, it can be concluded that phytogetic inclusion improved broiler performance, meat quality and breast yield.

Conflict of Interest The authors declare no conflict of interest.

P-002 Phytochemical Characterization of Lactobacterial-Fermented Horse Chestnut (*Aesculus hippocastanum* L.) Extracts

Authors [Peter Lorenz¹](#), [Lilo Mailänder¹](#), [Florian Stintzing¹](#), [Dietmar Kammerer¹](#)

Institute **1** WALA Heilmittel GmbH, Bad Boll, Germany

DOI [10.1055/s-0043-1773895](https://doi.org/10.1055/s-0043-1773895)

Horse chestnut (HC) extracts are applied in complementary medicine for the treatment of venous circulatory disorders and other ailments [1]. While the seeds of HC have been thoroughly studied in terms of their secondary metabolite profile, little is known about their microbial conversion upon fermentation. Therefore, we herein investigated the fermentation of *A. hippocastanum* seeds with two Lactobacteria strains (*Lactiplantibacillus plantarum* and *Pediococcus pentosaceus*). A pH decline from 5.8 to 3.3 due to lactic acid production yielded microbiologically stable aqueous extracts. LC-ESI-MSn investigations of n-butanol extracts from the fermentates revealed a complex spectrum of diverse metabolites, comprising indoleacetic acid-N-glycosides, kaempferol and quercetin glycosides, saponins (aescins) and C18-hydroxyfatty acids, the latter being characteristic Lactobacteria marker compounds. By measuring surface tension (bubble tensiometry) and via external calibration, contents of the saponin "aescin" complex in the extracts were found to range from 1.3 to 1.5 g/L, which may be interesting for eco-friendly applications requiring high amounts of surface active components. The results presented here together with future investigations into biological or pharmacological activities of fermented HC extracts may further be exploited for the manufacturing of novel phytopharmaceutical or cosmetic preparations (► Fig. 1).

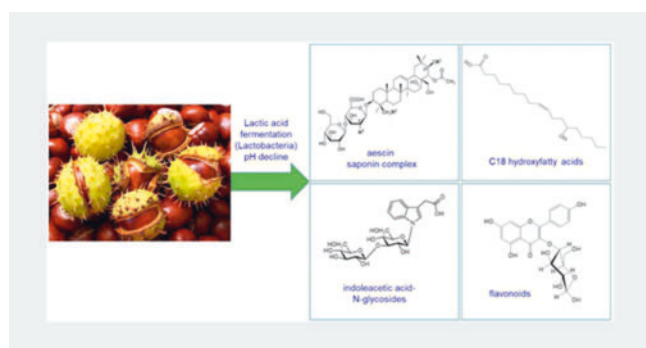

► Fig. 1 Products of Lactobacterial-Fermented Horse Chestnut (*Aesculus hippocastanum* L.) Extracts

References

[1] Owczarek-Januszkiewicz A., Kicel A., Olszewska M.A. *Aesculus hippocastanum* in the pharmaceutical industry and beyond – Phytochemistry, bioactivity, present application, and future perspectives. *Ind Crops Prod* 2023; 193: 116187

P-004 Traditional knowledge of medicinal plants used in animal healthcare in Bulgaria

Authors Anely Nedelcheva¹, Mila Dimitrova¹, Asen Stoyanov¹

Institute 1 Sofia University "St. Kl. Ohridski", Sofia, Bulgaria

DOI 10.1055/s-0043-1773896

The practice of tending livestock is among the fastest disappearing parts of traditional knowledge. Historically, the Bulgarian festive ritual character of traditional medical practice is key [1]. Detailed knowledge and scientific reconstruction of ethnological data are central to contemporary ethnobotanical studies.

Written historical sources and old medicinal manuscripts, covering the period up to modern animal husbandry were examined. Sixty-two plant taxa with an ethnoveterinary use were determined, alongside animal-based substances (6), minerals (8) and other materials of various origins (10). Only 11.3% of them do not occur in the wild. Widely used species with numerous use reports (3~5) are *Achillea millefolium*, *Allium sativum*, *Nicotiana tabacum*, *Teucrium chamaedrys* and *Veratrum lobelianum*. Thirty-two families were determined. Best represented (40.3% of all taxa) are the families Asteraceae, Lamiaceae, Poaceae, Rosaceae and Solanaceae. Their use shows a relatively stable connection between plant-disease-animal, e.g. *Verbascum phoeniceum* – for the treatment of „gur-

litsa“ in swine, which is also the common name of the plant. Most cited ailments are diarrhoea, different types of wounds, scabs and cold symptoms. A questionnaire intended for structured and semi-structured interviews was developed and tested with two knowledgeable informants. The historical profile of traditional ethnobotanical knowledge was drafted.

Funding The authors are grateful to the financial support of Bulgarian NSF at the Ministry of Education and Science, 2901/KP-06-China/15/17.12.2020.

References

[1] Nedelcheva A, Draganov S. Bulgarian medicinal ethnobotany: the power of plants in pragmatic and poetic frames. In: Pieroni A, Quave CL (Eds.) *Ethnobotany and Biocultural Diversities in the Balkans*. NY: Springer; 2014: 45–65

P-005 Comparison of different techniques used in UHPLC-MS/MS to quantify a standardized Dry Grape Extract in complete feeds

Authors Roxane Guichard³, Maxime Le Bot¹, Paul Engler^{1,2}, David Guilet^{2,3}

Institutes 1 Nor-Feed SAS, Beaucaouzé, France; 2 Joint Lab ANR FeedInTech, Beaucaouzé, France; 3 University of Angers, EA 921 SONAS/SFR 4207

QUASAV, France

DOI 10.1055/s-0043-1773897

The use of botanicals in animal nutrition is increasing rapidly. Their use requires the development of quantification methods to control the level of supplementation, homogeneity and stability in complete feeds. These regulatory and control requirements require methods that can be used routinely.

The use of botanicals is however a real challenge for quantification as they are mainly ingredients consisting of hundreds of molecules with incorporation thresholds in the ppm range. A representative molecule of the mixture called a phytomarker is often used for the quantification.

As the response thresholds are low, chromatography coupled to mass spectrometry associated with an adapted sample preparation is usually used for quantification. These methods are accompanied by a set of phenomena that can affect the accuracy of the quantification: loss of the analyte during extraction, mass ionisation and matrix effects.

The objective of this study was to compare several techniques used in UHPLC-MS/MS in order to quantify a standardized Dry Grape Extract in complete feed (Nor-Grape, Nor-Feed, France) at 30 ppm by following the phytomarker malvidin-3-O-glucoside.

External calibration, mismatched calibration, standard addition and internal standard techniques were tested to determine which one would be both accurate and suitable for routine use.

The results showed that the use of a double standard addition with an internal standard provides high accuracy for the quantification and saves considerable time on sample preparation. This makes it a suitable technique for routine control but needs interlaboratory validation to be fully validated.

P-006 Effect of saponin-rich plants blend to reduce methyl sulfide compounds in canine faeces

Authors Maxime Le Bot¹, Olga Noel¹, Mohammed Amine Benarbia¹

Institute 1 Nor-feed SAS, Beaucaouzé, France

DOI 10.1055/s-0043-1773898

Faeces aroma results from the particular combinations of odiferous volatile compounds. Methyl sulfide compounds have been shown to be characteristic of faecal aroma. The pet food industry uses natural alternatives, such as saponin-rich additives like *Yucca schidigera* to reduce odiferous compounds in faeces. However, *Y. schidigera* is harvested from wild ecosystems and its increasing use makes it an endangered natural resource. The aim of this study was to evaluate the effects of a commercial blend of saponin-rich plants consisting of four saponin plants (Norponin Opti, Nor-Feed) on reduction of methyl sulfide compounds in dogs' faeces.

Briefly, 4 dogs of different breeds, weight, ages and sexes were assayed in a Latin square experiment: a 25- day period without supplementation (CTL) and

a 25-day period supplemented with 200 ppm of rich-saponin blend (OPTI). Protein levels in feeds ranged from 18% to 27%. For each period, faeces of the last 3 days were collected and analysed by GC-TofMS in order to quantify dimethyl sulfide (DMS) and dimethyl disulfide (DMDS) and compare chromatograms of volatile compounds.

Results evidenced that supplementation of saponin-rich plants blend reduced DMS and DMDS by an average of 46% and 49% respectively. Chromatograms also showed a tendency to reduction of other volatile compounds present in the faeces with the supplementation.

The use of a saponin-rich plants blend appears to be an efficient solution in pet food formulations in order to reduce methyl sulfide compounds of canine faeces. However, further studies are needed to assess the impact of other volatile compounds.

P-007 Replacing antibiotics by natural polyphenol-rich extracts from grape marc in pig semen extenders for refrigerated storage: Physicochemical properties

Authors Estibaliz Lacalle Fernández^{1,2}, Estela Fernández-Alegre², Sonia Martínez-Martínez³, Felipe Martínez-Pastor^{1,4}, Beatriz Martín-Fernández^{1,4}
Institutes 1 INDEGSAL, University of León, León, Spain; 2 BIANOR Biotech S.L., León, Spain; 3 BACRESPI, Microbiology Fac. of Veterinary, University of León, León, Spain; 4 Molecular Biology (Cell Biology), University of León, León, Spain

DOI 10.1055/s-0043-1773899

Artificial insemination (AI) is critical for breeding in the modern pig industry. Nearly 14Ml/year of semen extenders with antibiotics are used in the EU, contributing to the generation of antimicrobial resistance.

The objective was to substitute antibiotics by natural polyphenol-rich extracts from grape marc (LIDSA-USC/i-Grape, Spain), testing the physicochemical properties of the formulations.

We tested Beltsville Thawing solution (self-made, BTS) and VitaseM (commercial, Magapor). Vehicles and extracts (1:1 water:vehicle, ethanol E, ethyl lactate EL, propyleneglycol PG) were tested at 2% and 0.625% in a pig semen storage protocol at 17 °C (sampling at days 0, 3, 7 for conductivity, pH, osmolality, and redox potential, ORP).

Conductivity (mS/cm) did not vary (BTS: 6.65 ± 0.02; VitaseM: 10.47 ± 0.01) between treatments, but pH (BTS: 7.74 ± 0.01; VitaseM: 8.05 ± 0.00) decreased in EL (BTS and VitaseM, 0.625%: 6.17 ± 0.01, 6.55 ± 0.01; 2%: 4.40 ± 0.06, 5.18 ± 0.08). Osmolality (mOsm/kg) increased with vehicle 2% (BTS: 319 ± 2, E: 515 ± 1, EL: 492 ± 1, PG: 483 ± 2; VitaseM: 299 ± 2, E: 489 ± 3, EL: 469 ± 1, PG: 453 ± 1). Only EL vehicle in BTS increased

ORP (182.1 ± 3.6, 0.625%: 216.8 ± 2.1, 2%: 307.9 ± 0.9). Extracts decreased ORP in all cases, showing the powerful antioxidant effect of polyphenols from grape marc.

In summary, vehicles modified pH and osmolality, but E and PG effects at 0.625% were not concerning. Polyphenol formulations showed potent antioxidant capacity inducing ORP-changes. Further experiments are in need to determine the effects on sperm conservation at 0.625%.

Acknowledgment The authors thank G. Rivas and Magapor SL (Spain).

Funding This study was supported by NeoGIANT H2020 project (UE 101036768).

Conflict of Interest The authors declare no conflict of interest.

P-008 Grape extract potential on intestinal health in pigs

Author Joanna Polak¹

Institute 1 Warsaw University Of Life Sciences, Warsaw, Poland

DOI 10.1055/s-0043-1773900

Grapes are rich in phenolic compounds with many health-promoting properties for animals and humans. Grape seed extract, grape skin extract and their mixture belong to the registered feed additives in the EU. The aim is to give a brief overview of the most important findings from in vitro and in vivo studies and to emphasise the beneficial impact of grape phenols on intestinal health in pigs. A total of 13 (2013-2023) studies were included in the analysis. In addition to the antioxidant, wound healing and anti-inflammatory properties, supplementation with GSP (Grape seed extract) also significantly reduced the incidence of diarrhoea in piglets. Studies in pigs showed that grape phenols have modulatory properties on the gut microflora by increasing the levels of beneficial bacteria and exhibiting antimicrobial activity against various pathogenic bacteria. They improve the morphology of the small intestinal mucosa, promote the growth of the small intestinal villi, and show promising properties regarding intestinal integrity and reduction of permeability, due to expression of genes encoding epidermal growth factor receptor, insulin-like growth factor 1 (IGF-1) and IGF-1 receptor in the duodenum, as well as an increased expression of TJ proteins. GSE has been also found to have dose-dependent positive and negative effects on the gut, although it is generally considered safe.

In conclusion supplementation with grape extracts showed potential for intestinal health in pigs and is recommended for further investigation in relation to specific intestinal disorders and under various challenging factors.

P-009 A pilot study on oral treatment of equine sarcoid with mistletoe extract (*Viscum album* L.)

Author Ulrike Biegel¹

Institute 1 Forschungsinstitut für biologischen Landbau, 5070 Frick, Switzerland

DOI 10.1055/s-0043-1773901

There are many therapeutic options for equine sarcoid (ES). Unfortunately, these are not satisfactory and often lead to recurrences. An RCT study on the use of a pine mistletoe injection preparation (PMP) showed astonishing results. The treatment group showed significantly higher cure and remission rates than the placebo group. However, repeated injections may lead to treatment refusal. The present study aimed to compare injection application with oral administration of PMP. An experimental group (EG) of 10 equids was treated orally with one vial TIW for 15 weeks, followed by continuous updates within one year. The setup was the same as in the previous RCT study. The EG was 3-10 years old, horses had between 1 and 10 ES. In only one horse the sarcoids continued to grow, in three the number of sarcoids decreased, five horses and one donkey were completely cured.

The results were compared to 20 placebo-treated horses from the previous RCT study. Both groups showed no significant differences before PMP treatment (mean ± standard deviation: number of ES placebo: 5.3 ± 3.2, PMP: 5.0 ± 3.1; surface ES placebo: 3.8 ± 2.1, PMP: 4.7 ± 2.6). The results show a significant reduction in number and surface area of the ES in horses orally treated with PMP (number of ES: placebo: +0.2 ± 2.5; PMP: -2.3 ± 2.1; surface area decline/months: placebo: +0.0145 ± 0.248; PMP: -0.234 ± 0.220). These results indicate that oral application of PMP may be effective in the treatment of ES.

P-010 *In vitro* bioactivity of *Combretum elaeagnoides* Klotzsch methanol leaf extract and fractions against pathogens causing bovine mastitis

Authors Rosemary Erhabor¹, Jean Paul Dzoyem², Lyndy McGaw¹

Institutes 1 University of Pretoria, Pretoria, South Africa; 2 University of Dschang, Dschang, Cameroon
DOI 10.1055/s-0043-1773902

Bovine mastitis, an inflammatory disease affecting cows, causes severe economic consequences in the dairy industry. The bioactivity of *Combretum elaeagnoides* methanol extract and fractions against six clinical isolates of *Staphylococcus aureus* (SA1-SA6) and two ATCC strains (*S. aureus* ATCC 29213, *S. epidermidis* ATCC 35984) was investigated. The antibacterial potential of the extracts was determined via serial microdilution. Quorum quenching (QQ) activity was ascertained via inhibition of violacein production in *Chromobacterium violaceum*. Antioxidant activity was determined using *in vitro* chemical assays. The 15-lipoxygenase enzyme and nitric oxide (NO) inhibition assays were utilised to ascertain the anti-inflammatory activity of the extracts. Tetrazolium-based colorimetric reduction assay was used to determine the cytotoxicity of the extracts against Vero and bovine dermis cell lines. The ethyl acetate fraction had the best inhibition against all test bacteria (MIC = 0.07–0.23 mg/mL). The dichloromethane fraction at different test times (T0, T24, T48) had the best biofilm biomass inhibition against most of the test strains with inhibition

≥ 50%. The extract and fractions had excellent QQ activity with IC₅₀ > 1.25 mg/mL and good lipoxygenase inhibition (IC₅₀ = 28 to > 100 µg/mL). All extracts had antioxidant efficacy against the DPPH and ABTS free radicals. The extract and fractions had moderate to good NO inhibition (IC₅₀ = 43.81 – 95.76 µg/mL). The methanol extract and fractions were non-toxic to the bovine dermis cells (LC₅₀ > 20 µg/mL). Thus, *C. elaeagnoides* extract or fractions may be recommended for the development of herbal preparations for the prevention and treatment of bovine mastitis.

P-011 Plant extracts effective against biofilm formation of *Salmonella* and *Enterococcus* pathogens relevant to the poultry industry

Authors Moipone Lebeloane¹, Ibukun Famuyide¹, Esameldin Elgorashi², Lyndy McGaw¹

Institutes 1 University of Pretoria, Pretoria, South Africa; 2 ARC-Onderstepoort Veterinary Research, Pretoria, South Africa
DOI 10.1055/s-0043-1773903

Salmonella and *Enterococcus* species are important foodborne pathogens in the poultry industry. Due to their persistent biofilm forming properties, simple strategies such as cleaning and sanitisation of surfaces in poultry processing are not entirely effective. In this study we examined the antibacterial and anti-biofilm activity of acetone and methanol plant extracts of sixteen South African plants preliminarily identified for their antibacterial activity. The minimum inhibitory concentration (MIC) against *Salmonella enterica* subsp. *enterica* serovar *Typhimurium* (ATCC 700720) and *Enterococcus faecalis* (ATCC 29212) was determined using a serial microdilution assay. Extracts were screened for cellular toxicity against Vero mammalian cells. The ability of the plant extracts at a sub-inhibitory concentration of 0.156 mg/ml to prevent biofilm formation was assessed using the crystal violet quantification method. The crude extracts had MIC values ranging from

0.313 to 2.5 mg/ml. Relatively low cytotoxicity was observed with selectivity index values of 2.21 and 1.39 against *S. Typhimurium* and *E. faecalis* respectively. The methanol extract of *Senegalia galpinii* inhibited 85.20% of *S. Typhimurium* and 97.27% of *E. faecalis* cell attachment after 24 h incubation, indicating anti-biofilm activity. Such bioactive plant extracts may be suggested for further development into antimicrobial and antibiofilm natural products to be used in

the poultry industry. Future studies include exploring mechanism of action and isolation of active compounds.

Conflict of Interest The authors declare no conflict of interest.

P-012 Potential of selected South African plants in the management of bovine mastitis caused by multi-drug resistant strains of *Streptococcus uberis*

Authors Ayodele Akinboye¹, Inge-Marie Petzer¹, Lyndy McGaw¹

Institute 1 University of Pretoria, South Africa
DOI 10.1055/s-0043-1773904

Streptococcus uberis is a significant pathogen causing bovine mastitis. Strains of *S. uberis* have shown biofilm-forming ability and alarming levels of antibiotic resistance leading to treatment failures. This study aimed to investigate the antibacterial and anti-biofilm activities of selected South African plants against isolated strains of multidrug resistant (MDR) strains of *S. uberis*. Plant selection was based on reported minimum inhibitory concentration (MIC) of less than 0.1 mg/mL against Staphylococcal bacteria of mastitis origin. The MIC values of acetone and ethanol extracts of four plants (*Searsia lancea*, *Indigofera frutescens*, *Erythrina caffra* and *Antidesma venosum*) were determined against seven clinical *S. uberis* isolates and *S. uberis* ATCC 700407 using a serial microdilution assay. Anti-biofilm activity and cytotoxicity in bovine dermis (BD) and Vero cells were determined using standard methods. MIC values ranged between 0.01 and 2.50 mg/mL, with the lowest MIC obtained with the acetone extract of *S. lancea* (0.01 – 0.09 mg/mL). Interestingly, the MDR isolates were more susceptible to the extracts than the ATCC strain. The ethanol extract of *S. lancea* had the highest mean selectivity index value of 25.70. The extracts were generally less toxic to BD cells than Vero cells. All the organisms demonstrated biofilm-forming ability. The acetone extract of *S. lancea* completely inhibited biofilm formation and disrupted preformed biofilm of *S. uberis* at three sub-MIC concentrations. These findings demonstrate the potential of these plants as effective ethno-therapeutic options in bovine mastitis. They are recommended for further investigation towards developing novel alternative formulations for mastitis management.

P-014 Studies on the antioxidative mode of action of phytogetic feed additives in rainbow trout

Authors Cristof Pristouschek¹, Manuela Pillinger¹, Vladimira Ocelova¹, Klaus Teichmann¹

Institute 1 DSM Austria GmbH, 3430 Tulln, Austria
DOI 10.1055/s-0043-1773905

In previous trials, two phytogetic feed additives were investigated for their impact on the antioxidant status. In previous trials [1], two phytogetic feed additives were investigated for their impact on the antioxidant status of rainbow trout fillets. One of the additives was rich in carvacrol (12 g/kg), while the other was rich in thymol (6 g/kg). In order to measure the antioxidant status, levels of glutathione reductase, glutathione-S-transferase, and malondialdehyde were assayed at day 0 and day 5 after slaughter. Phytogetic supplementations of rainbow trout feed improved the antioxidant status of fillets. Levels of malondialdehyde were significantly lower on day 5 and levels of glutathione-based enzymes were significantly higher at both time points compared to the control group. These findings gave rise to additional studies on antioxidative effects of phytoGENICS in rainbow trout to enhance our understanding of modes of action on the animal physiology. Primary cell cultures of intestinal epithelial cells were chosen as a model of the intestinal barrier which is crucial for animal health and growth. 25 fish were sampled within 5 months and a method to isolate primary gut epithelial cells (► Fig. 1) from different intestinal segments (pyloric caeca, mid and hind gut) was successfully established. The pyloric caeca are part of the mid gut and consist of a variable number of tubes that increase the gut surface area. In the current study, the pyloric caeca showed the highest success rate for isolation of growing cell cultures and

will be used for the upcoming investigations into the mode of action of phytochemicals to counteract oxidative effects induced by radical oxygen species.

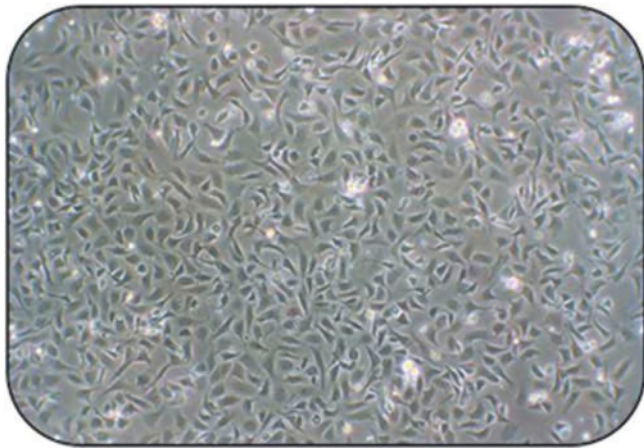

► **Fig. 1** Primary epithelial cells isolated from the pyloric caeca of a rainbow trout on day 2.

References

[1] Giannenas I, Triantafyllou EI, Stavrakakis S, Margaroni M, Mavridis, Steiner T, Karagouni Assessment of dietary supplementation with carvacrol or thymol containing feed additives on performance, intestinal microbiota and antioxidant status of rainbow trout (*Oncorhynchus mykiss*). *Aquaculture* 2012; 350-353: 26–32

P-015 Rosmarinic acid and chlorogenic acid as gut contractility modifier in swine – ex vivo study

Authors [Martyna Posłuszny¹](#), [Sorphon Suor-Cherer²](#), [Mohammed Amine Benarbia²](#), [Sekhou Cisse²](#), [Marta Mendel¹](#)

Institutes [1 Warsaw University of Life Sciences, Warsaw, Poland](#); [2 Labcom FeedInTech, Beaucauzé, France](#)

DOI [10.1055/s-0043-1773906](#)

Rosmarinic acid and chlorogenic acid are the main active substances of *Melissa officinalis* which is a very common herb with high palatability. It also has a long history of being used in traditional medicine. This study aimed to develop knowledge about *Melissa* extract and its main active substances with regards to swine jejunum contractility.

The experiments were conducted on longitudinal and circular jejunum samples collected from routinely slaughtered swine. The effect of rosmarinic [1] and chlorogenic [2] acid on spontaneous and ACh-induced activity was evaluated under isometric conditions.

The results revealed dose-dependent potency of chlorogenic acid to increase the magnitude of acetylcholine-induced and spontaneous contractions. Rosmarinic acid worked inconsistently. This phenolic acid increased the spontaneous activity of the circular jejunum muscle but did not significantly affect the spontaneous activity of longitudinal muscles. The strength of acetylcholine-induced contraction on circular muscle decreased gradually up to the highest concentration, where it suddenly increased significantly. In the longitudinal muscularis, the force of contraction decreased after adding rosmarinic acid, but only at higher doses.

The results of the performed study indicate that rosmarinic and especially chlorogenic acid can be used to control gastrointestinal motility of swine.

References

[1] Bazylko A, Zygmunt M., apa J, Strzelecka H., Filipek B. Determination of spasmolytic and antispasmodic activities of thyme extracts and one of their major components, rosmarinic acid, in isolated rabbit ileum and isolated rat aorta *Acta Biologica Cracoviensia. Series Zoologia* 2009; 51: 49–54

[2] Berman S.E., Huston J.L., Lail A.W., Piquette N.B., Njeti E.R. Chlorogenic Acid Increases Basal Tone with No Effect on Relaxation of Rat Ileal Smooth Muscles by Mechanisms independent of PKG Mediated Effects on Myosin Light Chain Phosphorylation. *The FASEB Journal* 2019; 33 (S1): 812–9

P-016 NeoGiANT – the power of grape extracts: antimicrobial and antioxidant properties to prevent the use of antibiotics in farmed animals

Authors [Trinidad de Miguel¹](#), [Marta Lores¹](#), [Maria Celeiro¹](#)

Institute [1 University of Santiago de Compostela, 15782- Santiago De Compostela, Spain](#)

DOI [10.1055/s-0043-1773907](#)

To overcome the challenges related to AMR derived from the misuse and abuse of antibiotics in farmed animals' production (in feeding, health and reproduction areas) and, in parallel, to improve the waste management in the wine sector, NeoGiANT offers innovative solutions. They are based on the known potent natural antimicrobial and antioxidant activities of grape marc extracts, due to their arsenal of phytochemicals, in particular their phenolic compounds content. Suitable bioactive molecules from white grape marc are identified, with a validation of their benefits (in vitro and in vivo) to produce final formulations to be used in animal production. These polyphenolic extracts are produced as a complement or alternative to classical compounds with antimicrobial and antioxidant capacities. NeoGiANT products are based on 3 pillars: (i) the use of local biomass sources, (ii) cost-effective, efficient, and sustainable products, (iii) functional ingredients obtained in sustainable circular economy production systems. In addition, they will meet consumer demand for animals' health solutions without side effects for the animals, as well as environmentally friendly products. These products will satisfy the actual demand for more affordable natural functional products from alternative sources. NeoGiANT final products, which are enhanced feed, natural therapies for animal production and semen extenders will not only avoid the growth of microorganisms but also improve the health and welfare of the animals, increasing profitability. In addition to assessing the eubiotic and antimicrobial activities of the formulations, the effects on the gastrointestinal tract and the immune system of the animals will also be studied.

P-021 Valorisation of the edible halophyte *Arthrocaulon macrostachyum* in a biorefinery perspective

Authors [Maria Rodrigues¹](#), [Dilara Diken¹](#), [Elia Fernandes¹](#), [Luísa Custódio¹](#)

Institute [1 Center of Marine Sciences, Faro, Portugal](#)

DOI [10.1055/s-0043-1773908](#)

Arthrocaulon macrostachyum is an edible halophyte plant from the Amaranthaceae family growing in saltmarshes along the Mediterranean region. It has a balanced nutritional profile and health-promoting properties and can be cultivated in saline soils or irrigated with brackish water or saline aquaculture wastewaters. However, its cultivation generates nonedible parts that are usually wasted. Thus, this work aimed at the valorization of edible shoots and nonedible parts (roots, woody aerial parts) by determining the antioxidant capacity, metal chelation and total contents in phenolics and flavonoids of their aqueous extracts. The woody aerial parts were the most active on copper chelation ($EC_{50} = 2.0$ mg/mL). In turn, the roots were most active towards DPPH radical ($EC_{50} = 5.9$ mg/mL). Regarding iron chelation the roots and edible shoots had similar activities ($EC_{50} = 2.0$ mg/mL). The roots showed the highest content in total phenolics (15.5 mg GAE/g DW) and flavonoids (13.8 mg QE/g DW). These results suggest that besides edible shoots, nonedible parts of *A. macrostachyum* can also be rich sources of antioxidants, phenolics and flavonoids, conferring on them a potential commercial value.

Funding Portuguese national funds from FCT – Foundation for Science and Technology through projects UIDB/04326/2020, UIDP/04326/2020 and LA/P/0101/2020; Partnership on Research and Innovation in the Mediterranean Area (PRIMA) program supported by the European Union (HaloFarMs: PRIMA/0002/2019). MJR was supported by FCT program contract (UIDP/04326/2020), LC by FCT Scientific Employment Stimulus (CEECIND/00425/2017) and EF by FCT PhD grant (UI/BD/151301/2121).

P-022 A sustainable extraction procedure for indole alkaloids from *Vinca minor*

Authors Verena Spiegler¹, Cristiano S. Funari²

Institutes 1 University of Münster, Institute for Pharmaceutical Biology and Phytochemistry, Münster, Germany; 2 São Paulo State University, Department of Bioprocesses and Biotechnology, Botucatu, Brazil
DOI 10.1055/s-0043-1773909

Monoterpene indole alkaloids (MIA) comprise a large subgroup of alkaloids with diverse biological activities [1, 2]. MIA enriched fractions are usually obtained by acidic or basic extraction of plant material, followed by two-step liquid-liquid extractions (LLE) using hydrochloric acid and dichloromethane (DCM) or chloroform as the most common solvents [3]. However, DCM and chloroform have been classified as hazardous substances due to their severe detrimental effects on health and the environment. The aim of the study was therefore; to improve the extraction procedure for MIA using solvents generally recognised as sustainable [4].

The experiments were performed using aerial parts of *Vinca minor* L., a well-known Apocynaceae in Europe. For LLE after acidic extraction (pH 1), DCM was replaced by ethyl acetate (EtOAc) or n-butyl acetate. The alkalized aqueous phase was then re-extracted in DCM, EtOAc or heptane. For alkaline extraction, an equal volume of DCM, n-butanol, EtOAc or heptane was added to the aqueous solution (pH 9). Organic partitions were subsequently extracted with citric acid (pH 1), which was then re-extracted using DCM, EtOAc or heptane after alkalization (pH 9). The success of each procedure was estimated at analytical scale by HPLC, comparing the content of the reference compound vincamine in the organic phases obtained from the second step of LLE.

Overall, with exception of n-butanol, all solvents replacing DCM were at least as efficient in enriching MIA, particularly EtOAc performed superiorly. The current study is therefore an encouraging example how principles of green chemistry can easily be introduced in routine phytochemical practice.

References

- [1] Cordell GA, Quinn-Beattie ML, Farnsworth NR. The potential of alkaloids in drug discovery. *Phytotherapy Research* 2001; 15: 183–205
- [2] Mohammed AE, Abdul-Hameed ZH, Alotaibi MO et al. Chemical Diversity and Bioactivities of Monoterpene Indole Alkaloids (MIAs) from Six Apocynaceae Genera. *Molecules* 2021; 26:
- [3] Dey P, Kundu A, Kumar A et al. Analysis of alkaloids (indole alkaloids, isoquinoline alkaloids, tropane alkaloids) In: *Recent Advances in Natural Products Analysis*. Elsevier; 2020: 505–567
- [4] Funari CS, Rinaldo D, Bolzani VDS, Verpoorte R. Reaction of the Phytochemistry Community to Green Chemistry Insights Obtained Since 1990. *Journal of Natural Products* 2023; 86: 440–459

P-023 The influence of green extraction methods on the chemical composition, antioxidant, α -amylase and α -glucosidase inhibitory activities of *Solidago virgaurea* extracts

Authors Gabriela Paun¹, Elena Neagu¹, Andreia Tache¹, Oana Ungureanu¹, Gabriel Lucian Radu¹

Institute 1 National Institute for Research-development of Biological Sciences, Bucharest, Romania
DOI 10.1055/s-0043-1773910

Solidago virgaurea L. is used in Romania for its diuretic, anti-inflammatory, antimicrobial or healing properties [1, 2]. In this work, we evaluated the influence of the extraction methods on polyphenol and flavonoid content, antioxidant and inhibitory α -amylase and α -glucosidase activities of *S. virgaurea* extracts. The extracts were obtained using: accelerated solvent extraction (ASE), ultrasound-assisted extraction (UAE) and laser extraction (LE) at 532 nm, 1064 nm, and 1550 nm. ASE revealed the high phenolic and flavonoid compounds (2126.57 μ g chlorogenic acid equivalent/mL and 197.14 μ g rutin equivalent/mL), followed by LE at 532 nm for total phenolic compounds (1557.53 μ g chlorogenic acid equivalent/mL) and at 1550 nm for flavonoids (191.79 μ g rutin equivalent/mL). The LE at 1064 nm highlighted the small values of the extracted compounds of interest. ASE and LE at 1550 nm proved the high antioxidant activity in the DPPH scavenging test (95.1% and 96.3%) and reducing power (96.8% and 95.6%, respectively). All extracts showed a moderate α -amylase inhibitory activity (IC_{50} ranging from 3291.8 to 4680.5 μ g/mL) but the strongest inhibitory effect on α -glucosidase (IC_{50} from 80.4 to 149.6 μ g/mL). This research is the first to present the α -amylase and α -glucosidase inhibitory activities of *S. virgaurea*.

Funding This work was supported by a grant of the Ministry of Research, Innovation and Digitization, CCCDI – UEFISCDI, project number PN-III-P2-2.1-PED-2021-1185, within PNCDI III.

References

- [1] Fursenco C., Calalb T., Uncu L., Dinu M., Ancuceanu R. *Biomolecules* 2020; 10 (12): 1–31
- [2] Thiem B., Goślińska O. *Fitoterapia* 2002; 73: 514–516

P-024 *Sonchus asper* (L.) Hill: from weed to high value product with antioxidant and hypoglycaemic potential

Authors Valentina Parisi¹, Valentina Santoro¹, Daniela Russo², Carla Caddeo³, Antonio Nisticò¹, Luigi Milella², Nunziatina De Tommasi¹
Institutes 1 University of Salerno, Fisciano, Italy; 2 University of Basilicata, Potenza, Italy; 3 University of Cagliari, Cagliari, Italy
DOI 10.1055/s-0043-1773911

The aim of this study was investigation of *Sonchus asper* (L.) Hill. (Asteraceae) to contribute to its rediscovery as a wild edible plant, both as raw and nano formulated products. *S. asper* is used as a food ingredient in South Italy traditional cuisine, but it is also a source of health-promoting specialised metabolites. In the extracts obtained from edible leaves 38 compounds, belonging to phenolic acids, flavonoids and polyunsaturated fatty acids, were characterised using LC-MS/MS analyses. The extract obtained from discarded leaves (SAD), not usually consumed as food, showed the same chemical composition as edible parts. Due to these similarities, and with the aim to propose the by-products utilisation as an antidiabetic supplement, the extract was incorporated in eudragit-coated liposomes. The evaluation of the potential hypoglycaemic effect of SAD extract was carried out in intestinal STC-1 cell line that represents a model cell line for gut hormones secretion and glucose uptake studies, due to their common features to L-enteroendocrine cells. The SAD extract exhibited a significant glucose uptake inhibition compared to untreated cells, in a dose-dependent manner, and interestingly the activity was maintained in the liposomal formulation. This study could contribute to the rediscovery of ancient dishes based on wild herbs together with the reuse of the discarded leaves as a high healthy-value supplement. Furthermore, an economical evaluation of *S. Asper* utilisation was carried out to demonstrate that the promotion of actions and strategies to preserve wild species could generate economic return to both landowners and the community.

P-025 Unravelling the *Eleutherococcus nodiflorus* global herbal supply chain to examine the extent of substitution with cardiotoxic *Periploca sepium*

Authors [Martin Fitzgerald¹](#), [Michael Heinrich²](#), [Anthony Booker^{1, 2}](#)

Institutes 1 University of Westminster, London, England; 2 University College London, London, England

DOI 10.1055/s-0043-1773912

Substitution of Chinese medicine *Eleutherococcus nodiflorus* (Dunn) S.Y.Hu (EN; wu jia pi (五加皮)) with *Periploca sepium* Bunge (PS; xiang jia pi (香加皮)) poses a potential health risk. EN is commonly used in medicinal wine, and the PS cardiac glycoside, periplocin, shows high solubility in alcohol. This investigation aimed to determine the extent and where the unexplained substitution of EN with PS occurs in the supply. 106 samples of EN, PS, and substitute *Eleutherococcus senticosus* (Rupr. & Maxim.) Maxim (ES), were sampled across mainland China, Taiwan, and the UK to determine their authenticity using high-performance-thin-layer-chromatography. The level of authenticity revealed the extent of EN substitution and when mapped onto an adapted Booker-Heinrich herbal supply chain model, showed where EN substitution occurred in the supply.

EN substitution is significant across the three global regions and occurs at most outlets in the supply, wherein 57% of EN was found authentic. Notable differences in authenticity were observed at 44% in traditional and 82% in modern-style pharmacies (► Fig. 1). More authentic EN was found at manufacturing sources where pharmacopoeia-based testing is required and less authentic where it is not, such as pharmacies and clinics. Furthermore, increasing EN substitution was found at further sampling distance from the larger markets at Bozhou and Anguo in mainland China. The extent of EN substitution with PS is significant and occurs at most sampling outlets. The reasons why variable substitution occurs at different sources in the supply chain require further investigation.

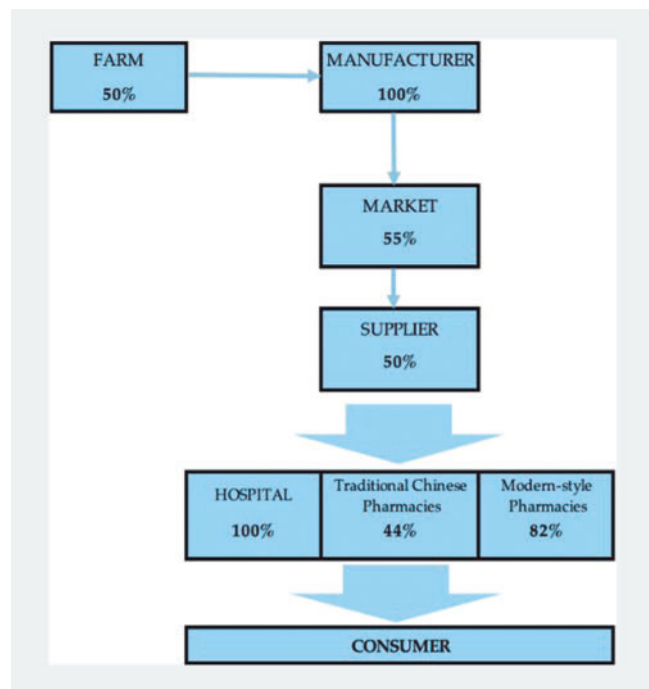

► Fig. 1 % Authentic *Eleutherococcus nodiflorus* – Wu jia pi samples. Variable levels of substitution along the supply chain. 106 samples analysed by HPTLC Association Method*
*Adapted from European Pharmacopoeia Monograph 2432 "Acanthopanax root bark, wu jia pi (*Eleutherococcus gracilistylus*)"

P-026 Lichens as a source of bio-inspiration for the development of green solvents

Authors [Camille Cousseau¹](#), [Nicolas Papaiconomou²](#), [Denis Morineau³](#), [Emmanuelle Limanton¹](#), [Béatrice Legouin¹](#), [Ludovic Paquin¹](#)

Institutes 1 Université de Rennes, ISCR – UMR CNRS 6226, Rennes, France; 2 Université Côte d'Azur, ICN – UMR CNRS 7272, Nice, France; 3 Université de Rennes, IPR – UMR CNRS 6251, Rennes, France

DOI 10.1055/s-0043-1773913

Lichens, composed of a fungal element and an algal element living in symbiosis, are a pioneer species capable of surviving extreme environmental conditions such as hydric stress or high temperatures. We assume that in order to survive, the lichen holds a non-aqueous liquid system in its physiological environment allowing it to withstand these environmental conditions. Based on these unique characteristics, we seek to develop these systems, named deep eutectic solvents (DES). They are a new generation of greener solvents due to their properties (non-volatile, low toxicity and good solvation and extraction properties). They are the result of the association of a donor(s) and an acceptor(s) of hydrogen bonds.

In this study, we used lichenic metabolite scaffolds as source of bio-inspiration for our formulations of new natural deep eutectic solvents (NaDES). To facilitate the choice of the syntheses to be carried out, we use prediction tools, such as COSMO-RS. These solvents are then used to extract metabolites of pharmaceutical or cosmetic interest from plants, algae and lichens. The dedicated properties of these extracts (anti-oxidants, bactericides etc.) will be further investigated.

These solvents could offer a wide range of advantages: do they have better solvation and extraction capacities than classical solvents for the targeted molecules? Do they increase the stability and/or preserve the properties of these molecules?

P-027 Total reflection X-ray fluorescence as a simple and sustainable analytical technique for the analysis of herbal infusions and teas

Authors [Jasna Jablan¹](#), [Lucija Čavara¹](#), [Marina Čavar¹](#), [Marijana Zovko Končić¹](#)

Institute 1 University of Zagreb Faculty of Pharmacy and Biochemistry, Zagreb 10000, Croatia

DOI 10.1055/s-0043-1773914

Herbal teas are used as medicines in many forms of traditional remedies and are a popular beverage worldwide. Therefore, it is important to obtain information on the multi-elemental composition of herbal teas and infusions, which has not been adequately studied. The introduction of environmentally friendly analytical methods has been one of the main goals of analytical chemistry in the last two decades. High-throughput analytical methods with low-cost multi-elemental analysis are attractive for the identification and quantification of elements in medicinal herbal infusions.

The aim of the present research work was to develop a low-cost and rapid method for multi-elemental analysis of pure black and green tea, decaffeinated black and green tea, and herbal teas with additives using Mo-TXRF system. The developed method was applied to investigate how the infusion time and water temperature affect the elemental content of herbal teas. In addition, the different types of water (tap water, mineral water, and high purity water) used to prepare the teas were considered. The study also demonstrates the potential of experimental design tools to select the best experimental conditions (i.e., sample amount, sample volume on reflector and measurement time) for preparing tea samples prior to TXRF analysis.

Despite the fact that a large number of samples should be considered for the study of differences between infusions, significant compositional differences can be detected using the developed method. It is expected that the developed TXRF method and the information obtained from this study can be useful in the fields of nutrition and health.

P-028 Mangiferin production from mango agro-industrial waste

Authors [Lilian Cherubin Correia¹](#), [Isabel Duarte Coutinho¹](#), [Alberto José Cavalheiro¹](#)

Institute 1 Natcrom, Araraquara, Brazil

DOI [10.1055/s-0043-1773915](https://doi.org/10.1055/s-0043-1773915)

Brazil is the seventh largest mango producer in the world [1]. During the mango juice production, agro-industrial residues represent around 20 – 40% v/v and are mainly made up of peels and almonds [2]. The main chemical constituents of the peels are phenolic compounds, natural pigments and biopolymers. Several biological activities have been attributed to the substances present in mango peels, however, only initiatives of low economic value have been used for the use of this residue [3]. Hence, the aim of this work was to obtain phytochemicals using mango peel residue (*M. indica* "Tommy Atkins") obtained from 2 different seasons. The samples were analysed by LC-DAD-MS and the main compound identified was mangiferin. After pulping, the peels were stored at room temperature and the mangiferin content was determined right after the pulping (T0), after 6 hours (T1) and after 24 hours (T2). The mangiferin content in different batches ranged from 0.04 – 0.14% w/w at T0. Mangiferin content significantly dropped at T2, indicating that after pulping, the peels must be extracted after at least 6 hours when stored at room temperature. Mango peels are a valuable resource for mangiferin production.

References

- [1] Mitra SK. Mango production in the world: Present situation and future prospect. *Acta Hort* 2016; 1111: 287–296
- [2] Banerjee J et al. A hydrocolloid based biorefinery approach to the valorization of mango peel waste. *Food Hydrocolloids* 2017; 1–10
- [3] Pierson JT et al. Phytochemical extraction, characterization and comparative distribution across four mango (*Mangifera indica* L.) fruit varieties. *Food Chemistry* 2014; 149: 253–26

P-029 Integration of semi-automatic tools for assessing health promoting effects of natural products in *C.elegans*

Authors [Martina Redl¹](#), [Judith Maria Rollinger¹](#)

Institute 1 University of Vienna, Vienna, Austria

DOI [10.1055/s-0043-1773916](https://doi.org/10.1055/s-0043-1773916)

The average life expectancy of the human population is constantly increasing. According to the WHO, the number of people aged 80 years or older will be tripled by the year 2050. Ageing itself is associated with the constant impairment of the general health status and the occurrence of age-related diseases [1]. As a multipurpose tool for the identification of health promoting agents from nature, this study aims to identify herbal and fungal natural products (NPs) able to decelerate the ageing process and to attenuate ageing-related diseases (e.g. neurodegenerative disorders or metabolic disorders). We therefore used the model organism *Caenorhabditis elegans* in a previously established phenotypic screening platform with liquid cultures in a 96-well plate format adapted to small scale extract screenings [2, 3]. Hit extracts selected based on their health-promoting phenotypic readouts are dereplicated by LC-MS/MS based chemical profiling. Bioactive constituents and their molecular mechanism will be identified using in silico predictions and target-oriented assays. To further improve and accelerate the screening of NPs in nematodes, we applied a semiautomatic IR-based wormtracker and optimized its methodological parameters in various *C. elegans* assays focusing on lifespan, health span and neurodegenerative disorders. The comparison of results obtained from probing 70 herbal and fungal extracts by means of time-consuming counting techniques with those from the semi-automated screening proved the robustness and suitability of the wormtracker as a valuable tool for NP screenings with medium and high throughput.

Funding Schwabe Phyto Innovation Challenge 2022 by Dr Willmar Schwabe GmbH & Co. KG

Conflict of Interest The authors declare no conflict of interest.

References

- [1] World Health Organization Ageing and health 2021 [cited 21.09.2022]; Available from: <https://www.who.int/news-room/fact-sheets/detail/ageing-and-health>.
- [2] Kirchweber B., Klein-Junior L.C., Pretsch D., Chen Y., Cretton S., Gasper A.L., Vander Heyden Y., Christen P., Kirchmair J., Henriques A.T. Azepine-Indole Alkaloids From *Psychotria nemorosa* Modulate 5-HT_{2a} Receptors and Prevent in vivo Protein Toxicity in Transgenic *Caenorhabditis elegans*. *Frontiers in neuroscience* 2022; 16: 826289
- [3] Zwirchmayr J., Kirchweber B., Lehner T., Tahir A., Pretsch D., Rollinger J.M. A robust and miniaturized screening platform to study natural products affecting metabolism and survival in *Caenorhabditis elegans*. *Scientific reports* 2020; 10 (1): 1–12

P-030 A novel cyclooxygenase-2-based thin-layer chromatography (TLC) assay to accelerate the detection of anti-inflammatory compounds

Authors [Aurélie Urbain¹](#), [Nidhal Trabelssi¹](#), [Valérie Bardot²](#)

Institutes 1 Université de Strasbourg, Illkirch, France; 2 PiLeJe Industrie, Saint-Bonnet-de-Rochefort, France

DOI [10.1055/s-0043-1773917](https://doi.org/10.1055/s-0043-1773917)

Non-steroidal anti-inflammatory drugs (NSAIDs) are among the most commonly used medications. But even if they help to relieve pain and swelling caused by inflammation, they can also cause side effects such as stomach irritations, nausea or allergic reactions. Therefore, there is a real interest in identifying alternative anti-inflammatory drugs, notably selective cyclooxygenase-2 (COX-2) inhibitors, called coxibs [1]. In order to accelerate the discovery of new drugs, researchers need fast, cost-effective, and reliable methods suitable for large screenings. In this context, we have developed a simple and sensitive assay for the rapid identification of COX-2 inhibitors. This test is based on the chromogenic reaction of a compound with the active enzyme on a thin-layer chromatographic plate, with or without prior chromatographic separation. After dot-blot or separation of the samples, the TLC plate is sprayed with a COX-2 solution and incubated for 10 minutes at 37 °C. Then a mixture of arachidonic acid and the co-substrate N,N,N',N'-tetramethyl-p-phenylenediamine (TMPD) is applied onto the plate. After a few minutes, TMPD is oxidized by the active enzyme into purple grey product; as a consequence, COX-2 inhibitors appear on the plate as clear spots against the coloured background [2]. Reagent concentrations have been optimized to assure a low-cost assay while maintaining good sensitivity (below microgram). This TLC assay enables the fast evaluation of individual compounds in complex mixtures, which is impossible with expensive 96-well kits. This newly developed technique will be useful to promote the discovery of anti-inflammatory drugs.

References

- [1] doi:10.1039/d1md00280e
- [2] doi:10.3390/separations9090238

P-031 Supercritical CO₂ extraction vs. hexane extraction and cold pressing: Evaluation of fatty acids and unsaponifiable matter in vegetable oils

Authors [Nina Kocevar Glavac¹](#), [Katja Schoss¹](#)

Institute 1 University of Ljubljana, Faculty of Pharmacy, Department of Pharmaceutical Biology, Ljubljana, Slovenia

DOI [10.1055/s-0043-1773918](https://doi.org/10.1055/s-0043-1773918)

Vegetable oils are extensively used in the pharmaceutical, cosmetic and food industries. Conventional methods for their production include organic extraction with hexane and cold pressing but are associated with disadvantages, e.g. high solvent consumption and solvent residuals in terms of toxicity, and low yields in terms of economic efficiency. A method that overcomes many of these limitations is supercritical CO₂ extraction.

We selected 7 oils with different fatty acid compositions: pumpkin (*Cucurbita pepo*), linseed (*Linum usitatissimum*), linden (*Tilia* sp.), poppy (*Papaver somniferum*), apricot (*Prunus armeniaca*), marigold (*Calendula officinalis*) and milk

thistle (*Silybum marianum*) seed oils, dominated by oleic, linoleic, linolenic or calendic acid. The main goal of our work was to compare the products of CO₂ and hexane extractions and cold pressing in terms of oil yield, the composition of fatty acids and unsaponifiable compounds, and antioxidative activity.

None of the methods resulted in significant changes in fatty acid composition and none was superior in terms of yield. However, when comparing hexane and CO₂ extraction, the latter gave a higher oil yield in 5 samples. CO₂ extraction was the most efficient in lower-yielding crops. Unsaponifiable matter of pumpkin and poppy seed oils showed the highest and the lowest antioxidative activity, respectively. We found a positive correlation between antioxidative activity and the content of cycloartenol and squalene [1–2].

We conclude that CO₂ extraction is an efficient and environmentally friendly method for the production of vegetable oils, and will become an important part of vegetable oil production in the future.

References

- [1] Poljsak N, Kocevar Glava N. Vegetable butters and oils as therapeutically and cosmetically active ingredients for dermal use: A review of clinical studies. *Front Pharmacol* 2022; 13: 868461
- [2] Schoss K, Kocevar Glava N, Dolenc Koce J, Anzlovar S. Supercritical CO₂ Plant Extracts Show Antifungal Activities against Crop-Borne Fungi. *Molecules* 2022; 27 (3): 1132

P-032 A new fluorescent probe for the detection of acetylcholinesterase inhibitors using HPTLC Effect Directed Assay in complex matrixes

Authors [Maël Gainche¹](#), [Norberta Delporte¹](#), [Clément Michelin¹](#), [Elodie Jagu¹](#)

Institute 1 [UCA/ClermontAuvergne INP/CNRS/ICCF, Clermont-Ferrand, France](#)

DOI [10.1055/s-0043-1773919](#)

High Performance Thin Layer Chromatography (HPTLC) is a method allowing an effect-directive analysis that enables separation and identification of biologically active substances on a TLC plate and allows a high throughput screening for enzymatic inhibition activity. Bioautography became, in the last decades, a very efficient way to find out new active compounds in complex matrixes such as bacteria, plant or fungus extracts. This presentation/poster shows a new bioautography method for the detection of acetylcholinesterase (AChE) inhibitors using a coumarin derivative fluorescent probe, 4-methylumbelliferyl acetate. Discovery of new AChE inhibitors could be a main target for the development of new treatments for Alzheimer's disease. Our method combines advantages of bioautography and the high sensitivity detection of a fluorescent probe. Accordingly, we managed to decrease by three times the limit of detection and quantification (between 0.3 and 1 ng per band for galanthamine) usually obtained with a chromophore method on this enzyme activity detection. We validated this method analytically, as well as the evaluation of true and false positives. Therefore, our new method was applied on 14 mushroom extracts, and we highlight a new potential AChE inhibitor (variegatic acid) in an extract of *Xerocomellus chrysenteron* (► [Fig. 1](#)).

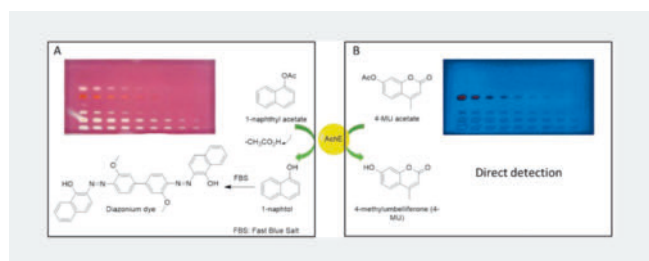

► **Fig. 1** Comparison of the current naphtol and FBS method (a) and the new fluorescent 4-MU method (b) for the detection of potential Acetylcholinesterase inhibitors using HPTLC.

P-033 The Atomic Force Microscope (AFM) as an innovative tool to evaluate the bioactivity of anti-infective natural products

Authors [Fabian Herrmann¹](#)

Institute 1 [University of Münster, Münster, Germany](#)

DOI [10.1055/s-0043-1773920](#)

A large number of natural products (NPs) have been characterised by promising and selective activities against a variety of infectious pathogens. Nevertheless, the development of leads from natural origin to clinically applicable therapeutics is a tedious and time-consuming process. Especially the initial identification of a target protein and of a potential mechanism of action of a bioactive lead from natural origin constitutes a relevant bottleneck in successful drug development. Although analytical techniques, e.g. the different “omics”-approaches, have simplified the elucidation of a NP's mechanism of action, the large data sets yielded by those experiments are commonly difficult to interpret concerning an underlying biochemical target. In order to mediate the alternative initial assessment of a NP's target structure and subsequently of a potential mechanism of action, approaches analysing the nanoscopic morphology of pathogens before and after treatment with anti-infective NPs are presented. By the development of an innovative preparation technique, allowing facile and economic access to the internal ultrastructure of virtually any biological material by Atomic Force Microscopy (AFM), statistically relevant assessments of ultrastructural changes of pathogenic organisms induced by NP treatment became accessible in a timely manner. In order to present the relevance of the morphology-based assessment of a NP's bioactivity, two exemplary studies on the mechanisms of action of anthelmintic tannins and quassinoids by AFM are discussed.

P-034 Unfolding the structural complexity of natural products using alternative NMR methods

Authors [Stavros Beteinakis¹](#), [Vasiliki K. Pachi¹](#), [Pedro Lameiras²](#), [Emmanuel Mikros³](#), [Maria Halabalaki¹](#)

Institutes 1 [Division of Pharmacognosy and Natural Products Chemistry, Department of Pharmacy, National and Kapodistrian University of Athens, Panepistimiopolis, Zografou, 15771, Athens, Greece](#); 2 [Université de Reims Champagne-Ardenne, CNRS ICMR UMR 7312, 51097, Reims, France](#);

3 [Division of Pharmaceutical Chemistry, Department of Pharmacy, National and Kapodistrian University of Athens, Panepistimiopolis, Zografou, 15771, Athens, Greece](#)

DOI [10.1055/s-0043-1773921](#)

NMR spectroscopy is a well-established analytical platform with many applications in natural products. Aside from its conventional use in structure elucidation or quantification, less common NMR approaches such as pure shift (PSYCHE), J-Resolved (JRES) or Diffusion-Ordered Spectroscopy (DOSY) could provide a different angle in the analysis of complex natural matrices. Therefore, the current work is aimed to exploit an NMR-based platform and alternative tools in the study of natural products. As a case study, different plant resins were analysed. Initially, two-dimensional (2D) and pseudo-2D spectra, among them JRES and PSYCHE, were used for chemical characterisation. Additionally, taking advantage of variations in the molecular translational diffusion of different compound classes, DOSY was successfully implemented for the first time in Chios Mastic Gum (CMG), managing to separate its polymer (poly-β-myrcene) and triterpenoids from other chemical categories. This approach could be applied to different matrices comprising compounds with various diffusion coefficients. Moreover, Statistical Total Correlation Spectroscopy (STOCSY), a novel tool in the study of natural products, was employed in an NMR-based metabolite profiling approach for the authenticity assessment of CMG [1–3]. Through STOCSY, peaks' correlations across ¹H NMR spectra were highlighted, aiding in the structure elucidation of tentative biomarkers. To conclude, alternative NMR approaches could have an extensive application and provide simplicity in rather complex natural media.

Funding ERDF, “RESEARCH–CREATE–INNOVATE”, Hyper-Mastic (project code: T2EΔK-00547).

Conflict of Interest The authors declare no conflict of interest.

References

- [1] Beteinakis S, Papachristodoulou A, Kolb P, Roesch P, Schwarzinger S, Mikros E, Halabalaki M. NMR-based metabolite profiling and application of STOCSY towards the quality and authentication assessment of European EVOOs. *Molecules* 2023; 28: 1738. doi:10.3390/molecules28041738
- [2] Lemus Ringele GB, Beteinakis S, Papachristodoulou A, Axiotis E, Mikros E, Halabalaki M. NMR Metabolite Profiling in the Quality and Authentication Assessment of Greek Honey-Exploitation of STOCSY for Markers Identification. *Foods* 2022; 11: 2853. doi:10.3390/foods11182853
- [3] Beteinakis S, Papachristodoulou A, Gogou G, Katsikis S, Mikros E, Halabalaki M. NMR-Based Metabolic Profiling of Edible Olives – Determination of Quality Parameters. *Molecules* 2020; 25: 3339. doi:10.3390/molecules25153339

P-035 Raman spectroscopy as a tool to study the incorporation of ibuprofen in PLA filaments for 3D printing

Authors [Evangelos Kyrials¹](#), [Eli Kampasakali¹](#), [Andreana Assimopoulou^{2,3}](#), [Dimitrios Christofilos¹](#)

Institutes **1** Aristotle University of Thessaloniki, Faculty of Engineering, School of Chemical Engineering & Physics Laboratory, 54124 Thessaloniki, Greece; **2** Aristotle University of Thessaloniki, School of Chemical Engineering, Laboratory of Organic Chemistry, 54124 Thessaloniki, Greece; **3** Center for Interdisciplinary Research and Innovation, Aristotle University of Thessaloniki, Natural Products Research Centre of Excellence (Nat-Pro-AUTH), 57001 Thessaloniki, Greece

DOI [10.1055/s-0043-1773922](#)

Ibuprofen loaded polylactic acid (PLA) filament, as basis material for 3D printed PLA scaffolds, was produced and studied by Raman spectroscopy to evaluate the uniformity of drug content and any effects from the filament extrusion process. Ibuprofen is the most frequently prescribed non-steroidal anti-inflammatory drug, acting as a cyclo-oxygenase inhibitor and leading to an important reduction of prostaglandins, key factors in the production of pain, fever and inflammation [1]. PLA, one of the most commonly used materials for 3D printing techniques [2], is an FDA approved biocompatible polymer of natural origin that besides its bioresorbability, also possesses appropriate rheological and mechanical properties to be used as scaffold material and as a drug carrier for wound healing and tissue engineering applications [3]. Commercial PLA filament for 3D printing was sliced, thoroughly mixed with polycrystalline ibuprofen powder (10% w/w) and fed to a filament extruder. Cross-sections of the produced filament were investigated by Raman measurements at micron-spaced points near the centre and anti-diametric areas of the filament. The intensity of the ibuprofen related Raman peaks indicates that the drug is well dispersed over the whole fibre volume. However, the Raman spectra of ibuprofen are differentiated from those of the pristine crystalline powder and resemble those of amorphous ibuprofen, pointing to a random environment of the drug molecules in PLA. These observations suggest that ibuprofen in PLA is finely dispersed yielding an excellent, homogeneously loaded filament for the fabrication of scaffolds using the fused filament fabrication printing process.

Funding This research has been co-financed by the European Regional Development Fund of the European Union and Greek national funds through the Operational Program Competitiveness, Entrepreneurship and Innovation, under the call RESEARCH – CREATE – INNOVATE (project code: T2EDK-01641)

Conflict of Interest The authors declare no conflict of interest.

References

- [1] Bushra R, Aslam N. An overview of clinical pharmacology of Ibuprofen. *Oman Medical Journal* 2010; 25: 155–1661. doi:10.5001/omj.2010.49
- [2] Valvez S, Santos P, Parente JM, Silva MP, Reis PNB. 3D printed continuous carbon fiber reinforced PLA composites: A short review. *Procedia Structural Integrity* 2020; 25: 394–399. doi:10.1016/j.prostr.2020.04.056

[3] Mohiti -Asli M, Saha S, Murphy SV, Grocz H, Pourdeyhimi B, Atala A, Lobo EG. Ibuprofen loaded PLA nanofibrous scaffolds increase proliferation of human skin cells in vitro and promote healing of full thickness incision wounds in vivo. *J Biomed Mater Res Part B* 2017; 105B: 327–339. doi:10.1002/jbm.b.33520

P-036 Linking tradition and future – first-time isolation of plant extracellular vesicles from the medicinal foxglove

Authors [Jennifer Munkert¹](#), [Pauline Kosney¹](#), [Arne Greif¹](#), [Gregor Fuhrmann¹](#)

Institute **1** Department of Biology, Friedrich-Alexander-Universität Erlangen-Nürnberg, Erlangen, Germany

DOI [10.1055/s-0043-1773923](#)

Extracellular vesicles (EVs) are membranous vesicles released by mammalian, plant or bacterial cells that carry complex cargos, including lipids, proteins, and nucleic acids and mediate cell-to-cell communication [1]. *Digitalis* species are pharmaceutically relevant plants as they contain cardiac glycosides that are used to treat cardiac insufficiency and show promising antiviral and antitumoral activities [2, 3]. In addition saponins, pregnane glycosides and phenylethanoid glycosides are the main natural compounds of this genus [4]. Here, we isolated plant EVs (PEVs) from the apoplastic fluid or the culture media from *Digitalis* shoot cultures (SC) as well as no-cardenolide-containing cell suspension cultures (CSC). Nanoparticle tracking analysis (NTA) verified the presence of particles with a particle concentration range from 109 to 1012 (P/mL) per g fresh weight (FW), presenting a predominant size from 115 to 190 nm. PEVs were isolated with a significantly higher yield and uniform size from CSC compared to SC. *Digitalis* PEVs remained stable for two weeks at 4 °C. Treatment of *Digitalis* CSC with 10 µM of IAA increased PEV production up to a particle concentration of 1013 (P/mL) per g FW. Cryo-TEM images showed spherical, oval or rod-shaped particles. Treatment of A549 NSCLC cell line for 24, 48 and 72 hours with PEVs isolated from *Digitalis* SC or CSC decreased cell viability to around 65% and lower. All in all, PEV derived from the medicinal plant *Digitalis* seem to have a bioactivity that is exciting to study further for example, in regard to their cargo of either secondary metabolites, proteins or miRNAs.

P-037 Inhibiting human dipeptidyl peptidase IV using cannabinoids and *Leonotis leonurus* extracts as a potential therapy for the management of diabetes

Authors [Lithalethu Mkabayi¹](#), [Zenobia Viljoen²](#), [Kevin Lobb¹](#), [Brett Pletschke¹](#), [Carminita Frost²](#)

Institutes **1** Rhodes University, Makhanda, South Africa; **2** Nelson Mandela University, Gqeberha, South Africa

DOI [10.1055/s-0043-1773924](#)

Diabetes is a chronic metabolic disorder that has been shown to affect a growing number of people worldwide. Controlling blood glucose levels is one of the possible strategies to treat type 2 diabetes mellitus (T2DM). It has been established that the inhibition of dipeptidyl peptidase IV (DPP-IV) prolongs the activity of incretin hormones, which serve as key stimulators of insulin secretion and regulation of blood glucose levels. Although several synthetic DPP-IV inhibitors are available, there is still a need for naturally sourced inhibitors that have fewer to no undesirable side effects. In this study, cannabinoids and *Leonotis leonurus* aqueous extracts were evaluated for their inhibitory effects against recombinant human DPP-IV. Their potential inhibition mechanism was explored using in vitro and in silico approaches. All tested cannabinoids and *L. leonurus* aqueous extracts showed significant inhibitory activity against DPP-IV. Phytochemical analysis of *L. leonurus* extract indicated the presence of diterpenoids and alkaloids, which might contribute to the inhibitory activity. In molecular docking studies, among different constituents known in *L. leonurus*, luteolin and marrubiin showed binding energy of -7.2 kcal/mol and cannabinoids (cannabidiol, cannabigerol, cannabinol and Δ9-tetrahydrocannabinol)

showed binding energies ranging from -6.5 to -8.2 kcal/mol. Molecular dynamics revealed that all tested compounds formed stable complexes with the enzyme during 100 ns simulation, indicating that they are good ligands. This study provided preliminary evidence for the potential application of the selected cannabinoids and *L. leonurus* in maintaining glucose homeostasis, suggesting that they could be suitable therapeutic candidates for managing T2DM.

P-038 A novel cannabinoid combination induces paraptosis-like death in breast cancer cells

Authors Amy de la Harpe¹, Natasha Beukes¹, Carminita Frost¹

Institute 1 Nelson Mandela University, Port Elizabeth, South Africa

DOI 10.1055/s-0043-1773925

Paraptosis, a caspase-independent mechanism of cell death, is characterised by cytoplasmic vacuolation arising from the endoplasmic reticulum and mitochondria [1]. The molecular mechanism of paraptosis is unclear; however, the literature indicates that it is biochemically and morphologically distinct from apoptosis and is often associated with calcium dysregulation and ROS production [2]. Recent studies have demonstrated that natural compounds can induce paraptosis in different tumour cell lines [3]. In this study, we aimed to identify and characterise the mechanism of cell death induced by a novel cannabinoid combination in MCF-7 cells. Extensive cytoplasmic vacuolation was observed within hours of treatment and significant cell death was observed after 24 hours. Combined with fluorescent DNA stains, staining for annexin V and lysosomes showed that neither apoptosis, necrosis, nor autophagy was induced. Ferroptosis was also ruled out, as experiments using ferroptosis inhibitors and fluorescent staining for lipid peroxides did not provide evidence for ferroptosis induction. Co-treatment with cycloheximide decreased vacuolation and cell death, suggesting paraptosis induction. Fluorescent staining showed a significant decrease in mitochondrial function and an increase in mitochondrial mass. Co-treatment with 4,4'-Diisothiocyanatostilbene-2,2'-sulfonic acid (DIDS), a voltage-dependent anion channel (VDAC) inhibitor, significantly reduced vacuolation, decreased cell death and improved mitochondrial function. This suggested that the cannabinoid combination may activate VDAC, leading to dysregulation of calcium signalling, significant alterations in mitochondrial function and subsequent paraptosis. These findings highlight the importance of activating alternative cell death mechanisms using natural compounds and expanding their potential for use as anticancer agents.

References

- [1] Sperandio S, de Belle I, Bredesen DE. An alternative, nonapoptotic form of programmed cell death. *Proc Natl Acad Sci U S A* 2000; 97: 14376–14381
- [2] Kim E, Lee DM, Seo MJ, Lee HJ, Choi KS. Intracellular Ca²⁺ Imbalance Critically Contributes to Paraptosis. *Frontiers in Cell and Developmental Biology* 2021; 8: 607844
- [3] Fontana F, Raimondi M, Marzagalli M, Di Domizio A, Limonta P. The emerging role of paraptosis in tumor cell biology: Perspectives for cancer prevention and therapy with natural compounds. *Biochim Biophys Acta Rev Cancer* 2020; 1873: 188338

P-039 An Analytical Study of Cannabinoids and Terpenes in Medicinal Cannabis

Authors Rime Bahij¹

Institute 1 University of Southern Denmark, Odense, Denmark

DOI 10.1055/s-0043-1773926

Cannabis sativa is approved for medical use in several countries in Europe. The focus has mainly been on Delta-9-tetrahydrocannabinol (Δ 9-THC) and Cannabidiol (CBD). Today's classification of different cultivars is based on the cannabinoid profile.

This study investigates if there is a correlation between the cannabinoid and terpene profiles in medicinal cannabis and thereby the possibility to predict a possible terpene profile based on the classification.

Six monoterpenes and eight cannabinoids are identified and quantified in 100 different cultivars of medicinal cannabis from a GMP medical cannabis production

in Denmark. The 100 different cultivars are divided between five classes. The terpene profile is analysed by Gas Chromatography – Flame Ionization Detector (GC-FID) and the cannabinoid profile is analyzed by High Performance Liquid Chromatography – Diode Array Detector (HPLC-DAD). The classification and correlation are analysed with two Principle Component Analysis (PCA) (► Fig. 1).

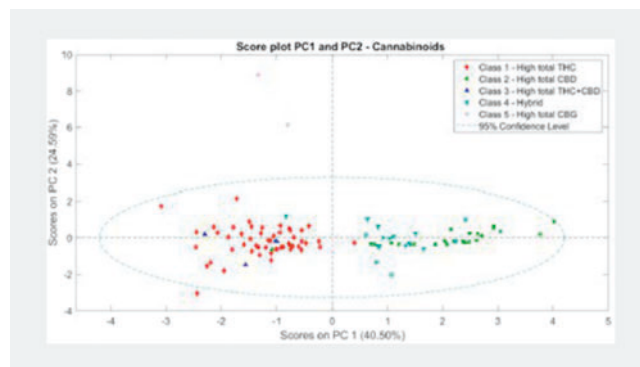

► Fig. 1 Score plot for cannabinoids explained by PC1 and PC2. Negative scores for PC1 represent total THC, positive scores for PC1 represent total CBD. Positive scores for PC2 represent total CBG.

The sample preparation method is validated by particle size and repeatability at %RSD at 10 [%]. The analytical instruments GC-FID and HPLC-DAD are optimized and validated by repeatability. The first PCA model made for the cannabinoid profile has two Principal components (PCs) and explains 65.09 [%] of the variation for the 100 samples.

The PCA model confirms two main classes of medical cannabis, a high total Δ 9-THC class, and a high total CBD class. The second PCA model is made for terpene profile. There is no clear trend in the terpene profile; however the results indicate samples classified as the high total Δ 9-THC class have a larger quantity of terpenes.

P-040 SOMAÍ: Setting New Standards in Medicinal Cannabis

Authors Raquel Pereira^{1,2}, Vera M.S. Isca¹, Iva Vinhas², António da Costa², Maria Céu Costa¹, Patrícia Rijo¹

Institutes 1 CBIOS – Universidade Lusófona's Research Center for Biosciences & Health Technologies, Lisbon, Portugal; 2 Somai Pharmaceuticals, Carregado, Portugal

DOI 10.1055/s-0043-1773927

Cannabis is a plant documented since ancient times as a provider of cloth, food and medicine, and has been found to have countless therapeutic usages. More than 100 cannabinoids have been found in the cannabis plant and it has been described as relieving symptoms of many illnesses, such as neurological illnesses for which therapy is still lacking promising medication that provides an improved quality of life for patients suffering from these ailments. Therefore, Cannabis is chemically a “treasure trove” of novel compounds to be studied and brought to the medical market.

SOMAÍ Pharmaceuticals works at the forefront of research, setting new standards for therapeutic innovation to provide relief for debilitating chronic conditions. We believe that all patients suffering from uncontrolled conditions should have access to effective medical cannabis products. At SOMAÍ Pharmaceuticals we pride ourselves in using the highest quality raw materials in order to formulate novel medications, with high bioavailability targeting the endocannabinoid system to provide relief for specific conditions.

To better understand the full capabilities of cannabis as well as the composition of its biomass, the goal of the present work was to characterize the purified extract as well as the residues obtained from SOMAÍ production. We will present the cannabinoids and non-cannabinoids (eg. phenolic compounds and

waxes) extracted and retained in the biomass leftover from the DEVEX ethnolic process. The cannabinoids and other phytoproducts identification and quantification (HPLC and GC techniques) will be presented for the future promising SOMAÍ products that will be integrated into new therapies.

P-041 Comparison of cannabinoid and terpene profiles of different hemp extracts obtained from Felina and Santhica varieties cultivated in Belgium

Authors [Carla Hamann¹](#), [Kateline Jullien¹](#), [Olivia Jansen¹](#), [MFrançoise Bafort²](#), [Arthur Libault²](#), [Alison Marotte¹](#), [Kristi Leka¹](#), [Allison Ledoux¹](#), [Michel Frédéric¹](#)

Institutes **1** Laboratory of Pharmacognosy, Center of Interdisciplinary Research On Medicines (CIRM), University of Liege, Avenue Hippocrate 15, Liege, Belgium; **2** Gembloux Agro-Bio Tech, Laboratory of Plant Pathology, University of Liège, Passage des Déportés 2, Gembloux, Belgium
DOI [10.1055/s-0043-1773928](#)

Hemp (*Cannabis sativa* L.) is a widely-distributed herbaceous plant known for its abundant secondary metabolites diversity, such as cannabinoids and terpenes. These compounds have been extensively studied for a wide range of therapeutic applications, making hemp a valuable resource in the medical field. Our study compares the phytochemical profiles of extracts from two hemp varieties (Felina and Santhica) cultivated in Gembloux (Belgium). Extractions were performed with either ethanol or acidified hexane (0.1 % acetic acid v/v) at different temperatures, using a Pressurized Solvent Extraction (PSE) instrument. Major cannabinoids were quantified by an HPLC-UV/DAD method aimed at separating acidic and neutral forms of cannabinoids. A GC-FID method using an internal standard was developed to quantitatively assess the terpene composition of the extract.

Our results showed that yield extraction was higher with ethanol (14 – 27 % w/w) than with hexane (5 – 14 % w/w) for both varieties. Interestingly, we observed that cannabinoid and terpene content is higher for the lowest extraction-yield solvent (hexane), indicating a better selectivity of hexane. Felina content in CBD-A and CBD (2.74 % w/w) was similar to the Santhica content in CBG-A and CBG (2.38 % w/w) in the raw material. However, metabolite contents decrease with increasing extraction temperature, especially for terpene compounds.

In conclusion, our study highlights the importance of understanding extraction parameters for obtaining high-quality hemp extracts with specific cannabinoid and terpene profiles. These findings could have a noteworthy impact on the advancement of hemp-based therapeutic products that require consistent and standardised compositions.

Conflict of Interest The authors declare no conflict of interest.

P-042 Analysis of phytocannabinoids in cosmetic creams by liquid chromatography coupled to mass spectrometry

Authors [Magdalena Vagnerova^{1,2}](#), [Alzbeta Nemeskalova¹](#), [David Sykora¹](#), [Martin Kuchar²](#), [Hana Walaska²](#)

Institutes **1** Department of Analytical Chemistry, UCT Prague, Czech Republic; **2** Forensic Laboratory of Biologically Active Substances, UCT Prague, Czech Republic

DOI [10.1055/s-0043-1773929](#)

Cannabis cosmetics currently represent a significant part of the legal hemp product market. Preliminary studies have shown the potential therapeutic effects of cannabinoids when administered to the skin, leading to a surge in popularity of cannabis creams, often marketed for their analgesic, anti-inflammatory, or moisturising properties. This has resulted in a greater need for analytical methods used for product quality control and the regulation of prohibited cannabinoids. Although validated analytical methods for hydrophobic cosmetics have been previously presented, the analysis of two-phase systems (oil-in-water creams and their water-in-oil counterparts) has proven challeng-

ing because of the high variability in the chemical composition of the different matrices. The main objective of this study was to develop and validate a comprehensive cream extraction method that is compatible with liquid chromatography-mass spectrometry and applicable to a wide range of creams. Our study showed that a separate extraction method was necessary for the two main cream types. While water-in-oil creams could be simply diluted and analysed, we observed that the emulsifiers used in their oil-in-water counterparts caused significant matrix effects, which impacted the quantitative analysis when a mass spectrometer was used. To eliminate these effects, a solid-phase extraction method was optimised, resulting in cleaner extracts and higher precision and accuracy of the analysis. Both extraction methods were validated and subsequently used to determine the levels of major cannabinoids in cosmetic creams purchased on the Czech market.

Conflict of Interest The authors declare no conflict of interest.

P-043 Can cannabidiol improve the symptoms associated with periodontitis?

Authors [Ruxandra Stefanescu¹](#), [Camelia Toma¹](#), [Robert-Alexandru Vlad¹](#), [Eszter Laczkó Zöld¹](#), [Dragoş Dan Sita¹](#)

Institute **1** George Emil Palade University of Medicine, Pharmacy, Science and Technology of Târgu Mureş, Romania
DOI [10.1055/s-0043-1773930](#)

Periodontitis is a chronic inflammatory disease that affects the gum and bone tissues supporting teeth, and there are currently a few effective treatment options. If left untreated, periodontitis can lead to tooth loss and other systemic diseases. Cannabidiol (CBD) is a non-psychoactive component of *Cannabis* sp. with anti-inflammatory and analgesic properties. In recent years, there has been a growing interest in the potential use of CBD for treating periodontitis, and different preclinical studies have evaluated several mechanisms of action. This study aims to provide an overview of the current state of knowledge about the effects of CBD on periodontitis, the mechanisms of action, therapeutic potential, and side effects. CBD may reduce inflammation and pain associated with the disease, and further promote the regeneration of bone and connective tissue by modulating the synthesis of pro-inflammatory cytokines. Additionally, CBD might have antibacterial properties to control the bacterial infection that causes periodontitis. Despite promising health effects, clinical evidence of CBD effects in periodontitis is still missing. Overall, CBD appears to have significant potential as a treatment for periodontitis, but further research is needed to fully understand its effects and ensure its safety and efficacy.

Funding This work was supported by the George Emil Palade University of Medicine, Pharmacy, Science, and Technology of Târgu Mureş Research Grant number 163/7/10.01.2023.

P-044 Medicinal cannabis grown in Germany – quality standards and stability

Authors [Cindy Ledderhose¹](#), [Werner Knöss¹](#)

Institute **1** Federal Institute for Drugs and Medical Devices (BfArM), Bonn, Germany
DOI [10.1055/s-0043-1773931](#)

The German Cannabis Agency at the Federal Institute for Drugs and Medical Devices (BfArM) was established in 2017 with the tasks of the control and management of the cultivation and production of cannabis for medical purposes in Germany. Thus, the Cannabis Agency is the distributor of cannabis flowers as medicinal products and legally acts as a pharmaceutical company and wholesaler.

The production sites of three contract partners must comply with the legal standards for narcotic, medicinal products and in particular GACP and GMP. Medicinal cannabis must meet the requirements of the Monograph “Cannabis flowers” of the German Pharmacopoeia (DAB) and the requirements of the European Pharmacopoeia (Ph. Eur.) and as well follow all guidelines addressing the quality of herbal medicinal products. An important objective is to provide

patients medicinal cannabis with a high level reproducible pharmaceutical quality.

Since its release in the market of the German Medicinal Cannabis in July 2021, only a few complaints on pharmaceutical quality have been reported and evaluated. In one case, an open package of Medicinal cannabis was reported. However, THC-content was still within the specified range after a period of seven months. In-use-stability could be demonstrated under conditions corresponding to the use in practice. In July 2021, the basic stability of medicinal cannabis cultivated and produced in Germany was set to 8 months. Now, ongoing stability studies and additional data indicate that there is an option to increase the stability to 12 months.

P-045 Investigating cannabinoid modulation of endosomal toll-like receptor signalling

Authors Melody Cui Sun¹, Almudena Ojalora Alcaraz¹, Rebecca Bateman¹, Eric J. Downer¹

Institute 1 Trinity College Dublin, Dublin, Ireland

DOI 10.1055/s-0043-1773932

The cannabis plant, *Cannabis sativa* L., contains many bioactive compounds of interest such as cannabinoids, terpenes, and flavonoids. Plant-derived phyto-cannabinoids such as Δ^9 -tetrahydrocannabinol (Δ^9 -THC) and cannabidiol (CBD) are of great interest in immunological research due to their anti-inflammatory properties. The use of cannabinoid-based therapeutics in autoimmune conditions such as multiple sclerosis (MS) further underscores their immunomodulatory therapeutic potential, however the exact mechanisms of action underlying their clinical efficacy remain to be elucidated. Of particular interest to our laboratory is the impact of cannabinoid treatment on innate immune signalling. Indeed, cannabinoids have been previously demonstrated to modulate the inflammatory signalling of a family of innate immune receptors termed the toll-like receptors (TLRs). Given that TLRs are important mediators of the immune response, and that TLRs have been indicated to play a role in MS disease pathogenesis, the targeting of TLRs by cannabinoids is an important and novel area of investigation. This study aimed to elucidate the impact of cannabinoids on TLR7/8/9-mediated inflammatory signalling using *in vitro* models of inflammation. The effects of Δ^9 -THC and CBD treatment were examined in human macrophage cell lines and primary immune cells. Furthermore, using a bank of human post-mortem specimens, this study aimed to investigate the neuropathological changes in the endocannabinoid and innate immune system associated with MS pathology. Our study has demonstrated promising anti-inflammatory effects of cannabinoids.

P-046 The effect of cannabinoid treatment on reactive human-induced pluripotent stem cell-derived astrocytes

Authors Magdalena Imiolek^{1,2}, Sarah McComish^{1,2}, Eric Downer^{1,2}, Maeve Caldwell^{1,2}

Institutes 1 Department of Physiology, School of Medicine, Trinity College Dublin, Dublin 2, Ireland; 2 Trinity College Institute of Neuroscience, Trinity College Dublin, Dublin 2, Ireland

DOI 10.1055/s-0043-1773933

There is growing evidence that inflammation plays a role in neurodegenerative diseases, including Alzheimer's. Astrocytes and microglia are thought to play a central role in neuronal dysfunction and/or death. This study utilises a human model of inflammation which involves differentiating astrocytes from human-induced pluripotent stem cells (iPSC), followed by stimulation with microglial-secreted factor tumour necrosis factor- α (TNF α). This stimulation causes the astrocytes to take on a reactive phenotype which permits the assessment of possible neuroprotective candidates.

One family of potential candidates are cannabinoids derived from the hemp plant *Cannabis sativa* L. (*C. sativa*). The two major plant-derived cannabinoids

are the euphoric compound Δ^9 -tetrahydrocannabinol (THC) and non-euphoric cannabidiol (CBD), both of which were utilised in this study.

The iPSC-derived astrocytes were stimulated with TNF α to induce reactivity and treated with CBD +/- THC to assess their potential role in attenuating pro-inflammatory states in astrocytes. The astrocyte reactivity profile was examined via ELISA. Alamar Blue and LDH cytotoxicity assays were also performed to assess cell viability. qPCR analysis was conducted to assess the potential receptors involved. This is an ongoing study, but early results will be presented. So far, our data suggest that the treatment with cannabinoids does not affect astrocyte viability and we anticipate that when administered with an inflammatory signal (TNF α), it can downregulate astrocyte reactivity. qPCR analysis revealed that in reactive astrocytes, the genes encoding for the CB1, PPAR α and PPAR γ receptors are significantly downregulated, regardless of treatment with CBD.

Conflict of Interest The authors declare no conflict of interest.

P-047 Homoisoflavonoids from the Asparagaceae family for use against ocular angiogenesis

Authors Hannah Jefford¹, Dulcie Mulholland¹, Moses Langat², Timothy Corson³

Institutes 1 University of Surrey, Guildford, United Kingdom; 2 Royal Botanic Gardens, Kew, London, United Kingdom; 3 Indiana University School of Medicine, Indianapolis, United States

DOI 10.1055/s-0043-1773934

Natural products chemistry involves the extraction of potentially active compounds from plants. A class of these active compounds is called homoisoflavonoids and they are frequently extracted from the Asparagaceae family. They are regarded as hopeful pharmacological candidates due to their anti-inflammatory, antibacterial and antioxidant effects. Due to their antibacterial and anti-inflammatory activity, these plants are often used in traditional medicine. In addition, homoisoflavonoids have been shown to exhibit antiangiogenic activity, reducing the excessive formation of blood vessels. Several homoisoflavonoids have been investigated as prospective treatments for various major causes of blindness: proliferative diabetic retinopathy, retinopathy of prematurity and wet age-related macular degeneration. These are all characterised by abnormal blood vessel growth at the back of the eye. As homoisoflavonoids are small molecules, they have potential for delivery as eye drops.

Homoisoflavonoids extracted from various plants in the Asparagaceae family, and synthesised homoisoflavonoids, have been screened for antiangiogenic activity. More recently, homoisoflavonoids extracted from *Eucomis bicolor*, *Eucomis autumnalis* and *Scilla peruviana* were screened and it has been determined that there are important structure-activity relationships. Notably, the presence and position of methoxy groups, the presence of the 3,9-double bond and the configuration at the chiral centre (C-3) are all important in the activity of the compound. ► Fig. 1 shows a compound with antiangiogenic activity extracted from *Eucomis autumnalis*, with a GI₅₀ value of 0.67 μ M.

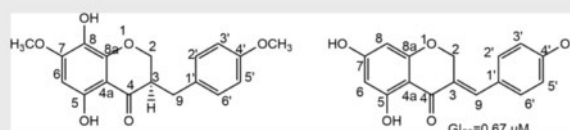

► Fig. 1 Homoisoflavonoid from *Scilla peruviana* (left) and homoisoflavonoid with anti-angiogenic activity from *Eucomis autumnalis* (right).

From this screening, targeted synthesis and further extractions from plants in the *Scilla* genus have taken place, in order to increase our library of compounds for screening.

P-049 Cytotoxic Sesquiterpenoids from the Cultured Soft Coral *Sinularia leptoclados*

Authors Jui-Hsin Su¹, Ping-Jyun Sung¹, Jing-Ru Weng²

Institutes 1 National Museum of Marine Biology and Aquarium, Pingtung, Taiwan; 2 Department of Marine Biotechnology and Resources, National Sun-Yat-sen University, Kaohsiung, Taiwan

DOI 10.1055/s-0043-1773935

From the cultured soft coral *Sinularia leptoclados* (► Fig. 1), four new guaiane-type sesquiterpenoids culeptoclados A–D (1–4) and three known sesquiterpenoids 5–7 were identified. The structures of all isolates were established using 1D and 2D NMR spectroscopic studies. The cytotoxicity of the marine natural products 1–7 was investigated against the growth of a restricted panel of cancer cell lines, including HL60, MDA-MB-231, DLD-1 and HCT-116 cancer cells. Culeptoclados A (1) demonstrated cytotoxicity against MDA-MB-231 and HCT-116 cancer cell lines with IC₅₀ values of 10.6 ± 2.0 and 16.8 ± 4.0 µg/mL, respectively, and culeptoclados B (2) showed cytotoxicity against MDA-MB-231 cell line with an IC₅₀ value of 15.1 ± 4.5 µg/mL. The anti-inflammatory results indicated that at a concentration of 10 µg/mL, the metabolites 1–7 did not suppress the production of inducible nitric oxide synthase (iNOS) and cyclooxygenase-2 (COX-2) compared with the control cells treated with LPS.



► Fig. 1 A picture of the cultured soft coral *Sinularia leptoclados*.

P-050 Tyrosinase inhibition by an *A. mollis* leaf ethanol extract

Authors Patrícia Matos^{1, 2, 3}, António Paranhos^{1, 4}, Maria Teresa Batista^{3, 4}, Artur Figueirinha^{1, 2}

Institutes 1 Faculty of Pharmacy of the University of Coimbra, University of Coimbra, Coimbra, Portugal; 2 LAQV, REQUIMTE, Faculty of Pharmacy, University of Coimbra, Coimbra, Portugal; 3 Univ Coimbra, CIEPQPF, FCTUC, Department of Chemical Engineering, Coimbra, Portugal; 4 Center for Pharmaceutical Studies, Faculty of Pharmacy, University of Coimbra, Coimbra, Portugal

DOI 10.1055/s-0043-1773936

Overexpression of melanin can cause skin hyperpigmentation (e.g. freckles, melasma and senile lentiginos), affecting aesthetics and increasing the risk of melanoma, an aggressive tumour that overexpresses tyrosinase. Therefore, melanin has been also seen as a relatively specific biomarker and therapeutic target for melanoma lesions. Although melanin biosynthesis is complex, involving several steps, a single enzyme known as tyrosinase is crucial in regulating this process. Melanogenesis is initiated by the oxidation of the L-tyrosine

(or L-DOPA) to dopaquinone by tyrosinase; the resulting quinone then serves as a substrate for subsequent steps leading to the production of melanin. Medicinal plants are considered a good source of tyrosinase inhibitors. This study evaluated the tyrosinase inhibitory activity of *A. mollis* leaf extracts and their phytochemicals. The ethanol extract (EET) exhibited significant activity (IC₅₀ = 1.21 µg/mL), and the kinetic study showed that two compounds present in EET, DIBOA (2,4-dihydroxy-1,4-benzoxazine-3-one) and verbascoside, contribute to tyrosinase inhibition through a non-competitive inhibitor-enzyme interaction. Furthermore, a synergistic effect on tyrosinase inhibition was observed in the binary combination of these compounds using external standards in the ratios 5:1 and 1:5 rather than 1:1 (µg/mL). Tyrosinase inhibitors are chemical agents capable of reducing enzymatic reactions such as the darkening of food and melanogenesis of human skin. They, therefore, have good commercial potential in the food processing, cosmetic and pharmaceutical industries.

P-051 Influence of Harvesting Season on Phytochemical Profile and its Correlation with the Antioxidant Properties of *Acanthus mollis*

Authors Patrícia Matos^{1, 2, 3}, Maria Teresa Batista^{3, 4}, Artur Figueirinha^{1, 2}

Institutes 1 Faculty of Pharmacy of the University of Coimbra, University of Coimbra, Coimbra, Portugal; 2 LAQV, REQUIMTE, Faculty of Pharmacy, University of Coimbra, Coimbra, Portugal; 3 Univ Coimbra, CIEPQPF, FCTUC, Department of Chemical Engineering, Coimbra, Portugal; 4 Center for Pharmaceutical Studies, Faculty of Pharmacy, University of Coimbra, Coimbra, Portugal

DOI 10.1055/s-0043-1773937

The biosynthesis of secondary metabolites is influenced by various external factors that change with the season and plant differentiation stage. *Acanthus mollis*, an important medicinal plant rich in bioactive compounds, treats several human diseases. In this study, the influence of the harvest season on the qualitative and quantitative profiles was evaluated by HPLC-PDA. A correlation between the concentration of the two majority compounds of ethanol extracts from *A. mollis* leaf, DIBOA (2,4-dihydroxy-1,4-benzoxazine-3-one) and verbascoside, with antioxidant activity was established.

Liquid chromatography (HPLC-PDA) analysis revealed significant changes in the concentration of compounds between samples harvested in different seasons. Verbascoside was significantly higher (18.8 g/100 g dry weight of extract) in the samples collected in autumn (November), decreasing in the remaining harvest seasons. Nevertheless, the amount of DIBOA was higher in the late winter (March), reducing significantly in late spring (May) after the plant is in flowering. In addition, leaves harvested in autumn had a significantly higher antioxidant activity than those gathered later. In conclusion, a direct correlation between the antioxidant properties of *A. mollis* leaves, and the biosynthesised verbascoside content was verified, with harvesting season having been decisive in obtaining maximum bioactivity.

P-052 Antiprotozoal activity of alkaloid fractions and isolation of a new megastigmane alkaloid from leaves of *Pachysandra terminalis*

Authors Lizanne Schäfer¹, Marcel Kaiser, Pascal Mäser, Thomas J. Schmidt¹

Institutes 1 Institute of Pharmaceutical Biology and Phytochemistry (IPBP), University of Münster, PharmaCampus, Münster, Germany; 2 Swiss Tropical and Public Health Institute, Allschwil, Switzerland

DOI 10.1055/s-0043-1773938

Trypanosoma brucei rhodesiense (Tbr) and *Plasmodium falciparum* (Pf) are protozoan parasites that cause severe diseases namely human African trypanosomiasis and Malaria. As there are limited treatment options and with occurring resistances there is the compelling need for new antiprotozoal compounds. Previous studies have already shown that plants belonging to the family of Buxaceae contain aminosteroids with high activities against these parasites.

The alkaloid enriched fraction of *Pachysandra terminalis* (Buxaceae) also showed prominent activity against Tbr. It is therefore promising to further examine the constituents of this plant and systematically isolate single compounds. An optimised extraction protocol was established to receive an alkaloid enriched fraction that was active against Tbr (IC₅₀ 1.84 µg/mL) and especially highly active against Pf (IC₅₀ 0.31 µg/mL). The alkaloid enriched fraction was separated into 18 subfractions using centrifugal partition chromatography (CPC). Each of these subfractions showed strong activity against Pf and some of them were also active against Tbr. From one of these fractions a megastigmane alkaloid (► **Fig. 1**) could be isolated, which, to the best of our knowledge, is a new natural product. The structure elucidation was accomplished by UHPLC/ + ESI-QqTOF-MS/MS, NMR and CD-Spectroscopy. This compound did not show a high activity against Tbr (IC₅₀ 6.22 µg/mL). Its activity against Pf was higher (IC₅₀ 0.93 µg/mL), but it is not mainly responsible for the high activity of the alkaloid fraction. Therefore, systematic search for and isolation of the compounds responsible for the activity of *P. terminalis* is now in progress.

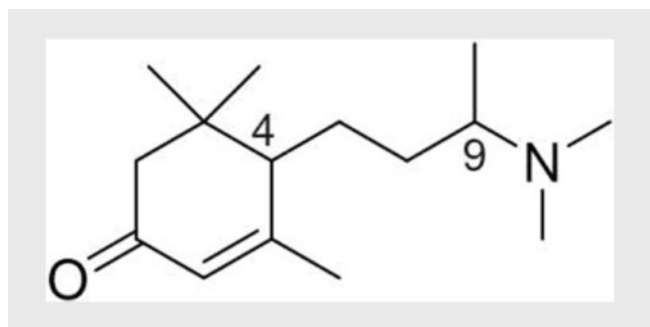

► **Fig. 1** Megastigmane alkaloid isolated from *Pachysandra terminalis*. The compound exists as a mixture of the R- and S-isomers at C-4. The configuration at C-9 is still under investigation.

P-053 Discovery of novel natural products from endophytic *Streptomyces* spp. isolated from *Leontopodium nivale* ssp. *alpinum*

Authors Fabian Malfent^{1, 2}, Valerie Niedermayr¹, Martina Oberhofer¹, Martin Zehl³, Petra Pjevac^{4, 5}, Sergey B. Zotchev¹
Institutes 1 University of Vienna, Department of Pharmaceutical Sciences, Division of Pharmacognosy, Vienna, Austria; 2 University of Vienna, Vienna Doctoral School of Pharmaceutical, Nutritional and Sport Sciences (PhaNuSpo), Vienna, Austria; 3 University of Vienna, Department of Analytical Chemistry, Faculty of Chemistry, Vienna, Austria; 4 University of Vienna, Division of Microbial Ecology, Centre for Microbiology and Environmental Systems Science, Vienna, Austria; 5 Joint Microbiome Facility of the Medical University of Vienna and the University of Vienna, Vienna, Austria
 DOI 10.1055/s-0043-1773939

In our lab, several *Streptomyces* spp. were isolated from the medicinal plant *Leontopodium nivale* ssp. *alpinum*, commonly known as Edelweiss. Bacteria of the genus *Streptomyces* are known to produce many secondary metabolites, some of which are of major importance for biotechnology, agriculture, and especially medicine because they represent about two-thirds of all naturally derived antibiotics in current clinical use [1]. Typically, only a few secondary metabolites are produced under standard laboratory conditions because the biosynthesis gene clusters (BGCs) responsible for their production are not or are only poorly expressed [2]. In this project, the genomes of 9 *Streptomyces* spp. from Edelweiss were sequenced. A total of 210 BGCs of which 42 are presumably unique, were identified by the bioinformatics tool antiSMASH 6.0 [3]. Genome mining approaches such as heterologous expression of biosynthesis

gene clusters, gene knock-outs and overexpression are being applied to these isolates to reveal their potential for bioactive secondary metabolite production [4]. Extracts from the generated recombinant strains are being analysed by HPLC and LC-MS in search of novel compounds. This project may lead to the discovery of novel natural products, including antibiotics against bacterial and fungal infections, as well as other diseases (e.g. cancer).

Conflict of Interest The authors declare no conflict of interest.

References

- [1] Barka E.A. et al. Taxonomy, Physiology, and Natural Products of Actinobacteria. Microbiol. Mol. Biol. Rev 80: 1–43 2016
- [2] Zerikly M., Challis G.L. Strategies for the discovery of new natural products by genome mining. ChemBioChem 2009; 10: 625–633
- [3] Blin K, Shaw S, Kloosterman AM. et al. antiSMASH 6.0: improving cluster detection and comparison capabilities Nucleic Acids Research 2021
- [4] Sekurova ON, Schneider O, Zotchev SB. Novel bioactive natural products from bacteria via bioprospecting, genome mining and metabolic engineering. Microb. Biotechnol. 2019; 12: 828–844

P-054 Sinulariaone A: A novel diterpenoid with a 13-membered carbocyclic skeleton from an octocoral *Sinularia* species

Authors Ping-Jyun Sung¹, Hsuan-Jung Tseng², Jui-Hsin Su¹
Institutes 1 National Museum of Marine Biology & Aquarium, Checheng, Taiwan; 2 National Dong Hwa University, Checheng, Taiwan
 DOI 10.1055/s-0043-1773940

Chemical composition screening of an octocoral identified as *Sinularia* species led to the isolation of a novel diterpenoid, sinulariaone A (**1**), featuring an unprecedented 13-membered carbocyclic skeleton. The structure of **1** was established by spectroscopic elucidation, computed calculation and X-ray diffraction analysis. It is to note that diterpenoid **1**, involving an uncommon 13-membered carbocyclic carbon system, with suggested biosynthesis from the common 14-membered carbocyclic cembrane analogues by ring contraction, is one of a kind. This is the first time to obtain a 13-membered carbocyclic cembranolid analogue featuring an acetyl group at C-3. Moreover, a single-crystal X-ray diffraction analysis of chlorofurancembranoid B (**2**), obtained in our previous study from the same octocoral species, was reported for the first time to demonstrate the absolute configuration. Diterpenoid **1** showed cytotoxicity towards human promyelocytic leukemia HL-60 cells, with an IC₅₀ value of 38.01 µM (► **Fig. 1**).

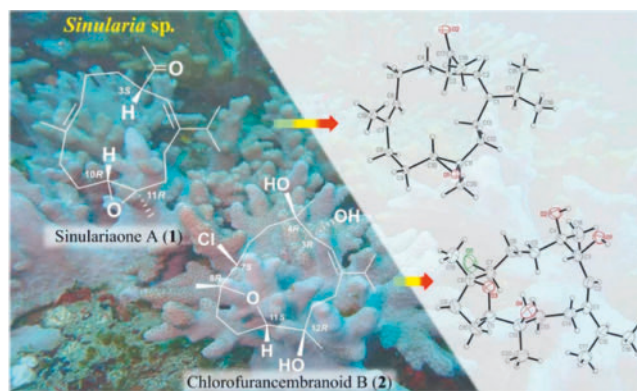

► **Fig. 1** Structures of Sinulariaone A (**1**) and Chlorofurancembranoid B (**2**)

P-055 Main Bioactive Components and their Biological Activities from Natural and Processed Rhizomes of *Anemarrhena asphodeloides*

Authors Yi-Cheng Chu^{1,2}, Chang-Syun Yang¹, Ming-Jen Cheng³, Shu-Ling Fu², Jih-Jung Chen^{1,2,4}

Institutes 1 Department of Pharmacy, School of Pharmaceutical Sciences, National Yang Ming Chiao Tung University, Taiwan; 2 Institute of Traditional Medicine, School of Medicine, National Yang Ming Chiao Tung University, Taiwan; 3 Department of Life Science, Fu Jen Catholic University, Taiwan; 4 Department of Medical Research, China Medical University Hospital, China Medical University, Taiwan
DOI 10.1055/s-0043-1773941

The rhizome of *Anemarrhena asphodeloides* Bunge is a famous and frequently used herbal drug in the traditional medicine of Asia, under the vernacular name “zhimu”. It has anti-inflammatory, antipyretic, anti-platelet aggregation, anti-depressant and anti-diabetic effects. We examined the antioxidant and anti- α -glucosidase activities of various solvent extracts and the main bioactive compounds from the rhizome of *A. asphodeloides*. The acetone extract exhibited comparatively high antioxidant activities measured by 2,2-diphenyl-1-(2,4,6-trinitrophenyl)hydrazyl (DPPH), 2,2'-azino-bis(3-ethylbenzothiazoline-6-sulfonic acid) (ABTS) radical scavenging and ferric-reducing antioxidant power (FRAP) assays. A water extract exhibited relatively strong antioxidant activity measured by superoxide radical scavenging test. Furthermore, dichloromethane, chloroform and n-hexane extracts showed significant anti- α -glucosidase activities. HPLC analysis was used to examine and compare various solvent extracts for their compositions of isolates. We isolated four major chemical constituents and analysed their antioxidant and anti- α -glucosidase inhibitory activities. The bioactivity assays showed that mangiferin displayed the most potential antioxidant activities via FRAP, ABTS, DPPH and superoxide assays and also exhibited the most effective anti- α -glucosidase activities among all the isolates. The present study suggests that *A. asphodeloides* and its active extracts and components are worth further investigation and might be expected to develop as a candidate drug for the treatment or prevention of oxidative stress-related diseases and hyperglycemia.

P-057 Phytochemicals from the Under-utilised fruit *Gnetum leptostachyum*

Authors Kamsirah Jim Shamsudin¹, Nurulfazlina Edayah Rasol¹, Nurunajah Ab Ghani¹, Monica Suleiman², Fatimah Salim¹, Nor Hadiani Ismail¹

Institutes 1 Atta-ur-Rahman Institute for Natural Product Discovery, Universiti Teknologi MARA, Bandar Puncak Alam, Malaysia; 2 Institute for Tropical Biology and Conservation, Universiti Malaysia Sabah, Kota Kinabalu, Malaysia
DOI 10.1055/s-0043-1773942

Borneo is one of the world's biodiversity hotspots, which offers a huge diversity of plants that are yet to be explored. *Gnetum leptostachyum* is a gymnosperm that shares several angiosperm morphologies, indigenous to Borneo. The red fruits are eaten by the native people. In order to investigate the potential health benefits of these underutilized fruits, we probed their underlying chemistry by means of high-resolution tandem LC-mass spectrometry analysis and isolated the chemical constituents using advanced chromatographic techniques. Mass-based molecular networking analysis revealed four main clusters, which are resveratrol monomer-based stilbenes, isoharpontigenin monomer-based stilbenes, alkaloids and flavonoids. Seven stilbenes were successfully purified utilizing recycling HPLC, including resveratrol, isoharpontigenin, gnetin C, gnetin E, gnetin J, gnetin M and gnetin B. The structures were confirmed using high-resolution NMR and accurate mass data. The isolated compounds were tested for α -glucosidase activity and all compounds exhibited promising activity with gnetin J and gnetin E possessing IC_{50} values of 0.31 μ g/mL and 0.32 μ g/mL, respectively. Acarbose was used as the positive control (IC_{50} of 2.2 mg/mL). This work presents for the first time the chemical constituents present in the fruit of *G. leptostachyum*, which we hope will form a basis for further investigation into its exploitation as a healthy food source.

P-058 Antioxidant, and Anti- α -glucosidase Activities of Various Solvent Extracts and Major Bioactive Components from *Ampelopsis japonica*

Authors Jih-Jung Chen^{1,2}, Jia-Hua Liang², Chang-Syun Yang¹, Yi-Cheng Chu^{1,2}, Chia-Ching Liaw³

Institutes 1 Department of Pharmacy, School of Pharmaceutical Sciences, National Yang Ming Chiao Tung University, Taipei, Taiwan; 2 Institute of Traditional Medicine, School of Medicine, National Yang Ming Chiao Tung University, Taipei, Taiwan; 3 National Research Institute of Chinese Medicine, Ministry of Health and Welfare, Taipei, Taiwan
DOI 10.1055/s-0043-1773943

The dried root of *Ampelopsis japonica* (Thunb.) Makino (*A. japonica*) is a traditional medicine used to treat fever, pain and wound healing. It exhibits anti-inflammatory, antitumour, anti-tyrosinase and anti-melanogenic activities. In this congress, we used different solvent extracts from the root of *A. japonica* to determine their antioxidant activity. Acetone extract showed relatively strong antioxidant properties by 2,2'-azino-bis(3-ethylbenzothiazoline-6-sulfonic acid) (ABTS), 2,2-diphenyl-1-(2,4,6-trinitrophenyl)hydrazyl (DPPH), superoxide radical scavenging activity and ferric reducing antioxidant power (FRAP) assays. In addition, these extracts also showed significant α -glucosidase inhibitory activities. Acetone extract significantly inhibited α -glucosidase with an IC_{50} value of 8.30 ± 0.78 μ g/mL. Using HPLC analysis and comparison with the chemical composition of various solvent extracts, we isolated seven active compounds and assessed their antioxidant and anti- α -glucosidase activities. Catechin (1), gallic acid (2), kaempferol (3), quercetin (4), resveratrol (6), and epicatechin (7) were the main antioxidant components in the root of *A. japonica*. According to the results of DPPH, ABTS and superoxide radical scavenging assays, these isolates showed stronger antioxidant capacity than butylated hydroxytoluene (BHT). Moreover, 1, 3, 4, euscaphic acid (5), 6 and 7 also expressed stronger anti- α -glucosidase activity than the positive control acarbose. This study indicates that *A. japonica* and its active extracts and components may be a promising source of natural antioxidants and α -glucosidase inhibitors.

P-059 New neo-clerodane diterpenes from *Teucrium polium* subsp. *capitatum*

Authors Morris Keller¹, Sarra Chabane², Ombeline Danton¹, Alessandro Prescimone³, Amel Boudjelal^{4,5}, Matthias Hamburger¹, Olivier Potterat¹

Institutes 1 Division of Pharmaceutical Biology, University of Basel, Basel, Switzerland; 2 Department of Life and Nature Science, Faculty of Sciences, Mohamed Boudiaf University, M'sila, Algeria; 3 Department of Chemistry, University of Basel, Basel, Switzerland; 4 Department of Microbiology and Biochemistry, Faculty of Sciences, Mohamed Boudiaf University, M'sila, Algeria; 5 Biology Laboratory: Applications in Health and Environment, Faculty of Sciences, Mohamed Boudiaf University, M'sila, Algeria
DOI 10.1055/s-0043-1773944

Teucrium polium subsp. *capitatum* (syn. *Teucrium capitatum*, Lamiaceae), popularly known as golden or felty germander, is a deciduous shrub that abundantly grows in Mediterranean regions of Europe, Northern Africa and Southwest Asia. The aerial parts are traditionally used in Algeria as a decoction or ointment in the treatment of hypertension, diabetes and wounds. In a previous study we reported the wound healing properties of a methanolic extract in a wound excision model in rabbits, and a comprehensive polyphenolic profile of this extract [1]. Further investigation of the methanolic extract focusing on the non-phenolic constituents afforded six furanoid neo-clerodane diterpenes, including 20-acetylauropolin and 6-acetylteucjaponin A, along with four previously undescribed congeners. The compounds were isolated by preparative HPLC-ESIMS after silica gel column chromatography. Their structures were established by extensive NMR analysis, HRESIMS, and by comparison with literature data of related compounds. The absolute configuration of 20-acetylauropolin was confirmed by single crystal X-ray crystallographic analysis. Some of the isolated diterpenes possess structural features uncommon in neo-clerodane

diterpenes, such as a rare C-20 hemiacetal function forming an oxepane ring to C-7 of the trans-decalin core structure in teupocapin C (► Fig. 1).

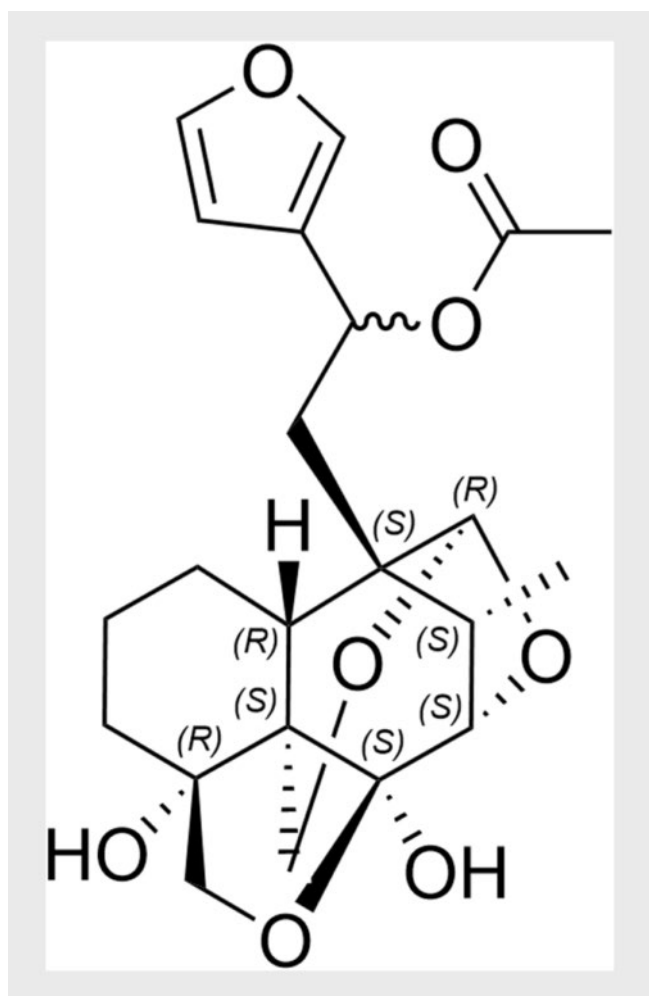

► Fig. 1 Structure of teupocapin C.

Conflict of Interest The authors declare no conflict of interest.

References

[1] Chabane S., Boudjelal A., Keller M., Doubakh S., Potterat O. Teucrium polium – wound healing potential, toxicity and polyphenolic profile, South African J. Bot. 2021; 137: 228–235. doi:10.1016/j.sajb.2020.10.017

P-060 Identification and profiling of flavonoids in ten samples of *Alliaria petiolata* aerial parts collected from Belgium.

Authors Alison Marotte¹, Cécile Nouet¹, Olivier Bonnet¹, Marc Hanikenne¹, Michel Frederich¹

Institute 1 University of Liege, Liege, Belgium

DOI 10.1055/s-0043-1773945

Alliaria petiolata, commonly known as garlic mustard, is a biennial ruderal herbaceous plant belonging to the Brassicaceae family. It is distributed in Europe, North Africa and West Asia, and has become invasive in North America. The plant is known to produce glucosinolates, which are responsible for its garlic odour and are mainly present in the seeds, and flavonoids have been cited as the plant's aerial parts main metabolites. Derivatives of isovitexin and isoorientin, are cited as the main metabolites present in the aerial parts of the plant. Described in the plant were Isovitexin-6''-O-beta-D-glucopyranoside, a sinapoyl derivative of 6''-O-beta-D-glucopyranoside and Isoorientin-6''-O-be-

ta-D-glucopyranoside. Some general texts, as well as internet sources, also indicate saponarin (Isovitexin-7-O-beta-D-glucopyranoside) as the main flavonoid of *Alliaria petiolata* but no recent reference could be found. This goes back to a publication of Keegan in 1911, where saponarin was described as the main flavonoid of *Alliaria petiolata* [4]. In our study, in ten samples collected in different locations in Belgium, saponarin or its glucoside was found as the main metabolite, and it was accompanied in different amounts, according to samples, by lutoarin, isoorientin, synapoyl-saponarin, hydroxyferuloyl-saponarin. The flavonoids were purified and identified by HR-MS and NMR, and profiled by HPLC-DAD.

Conflict of Interest The authors declare no conflict of interest.

P-061 Are plants of the *Strychnos* genus still a potential source of antiplasmodial metabolites after more than two centuries of study?

Authors Oliver Bonnet¹, Mehdi Benddir², Pierre Champy², Gilles Degotte¹, Lucia Mamede¹, Pauline Desdemoustier¹, Michel Frederich¹, Allison Ledoux¹, Alembert Tiabou Tchinda¹, Luc Angenot¹

Institutes 1 University of Liege, Liege, Belgium; 2 Université de Paris-Saclay, Paris, France

DOI 10.1055/s-0043-1773946

Malaria, caused by *Plasmodium* parasites, remains a significant public health concern due to the development of resistance to current treatments [1]. To address this issue, researchers have turned to plants, such as those of the *Strychnos* genus, as a potential source of new anti-malarial compounds. Over the course of two centuries, several antiplasmodial metabolites such as 3,4-dihydrosambarensine, isostrychnopentamine, sungucine and strychnogucine B have been identified from this genus [2, 3].

However, despite extensive research, there is still a possibility that the *Strychnos* genus harbours other promising antiplasmodial metabolites. To investigate this, methanolic extracts from 28 *Strychnos* species were tested against the artemisinin-sensitive strain 3D7 of *Plasmodium falciparum*. The extracts were also analysed using LC-MS/MS and molecular networking techniques. Three noteworthy clusters emerged: the usambarensine cluster and its derivatives, the sungucine and strychnogucine C cluster and the strychnofoline cluster. These clusters contained compounds structurally similar to the aforementioned metabolites, yet previously unknown. The confirmed antiplasmodial activities of certain known compounds within these clusters suggest that the unidentified metabolites may also possess anti-malarial properties due to their structural proximity.

Consequently, this study confirms the presence of untapped potential within the *Strychnos* genus. Further exploration of the phytochemical profile of *Strychnos* plants is warranted, as it is likely to yield additional promising antiplasmodial metabolites.

Conflict of Interest The authors declare no conflict of interest.

References

[1] WHO. World malaria report. Available at <https://www.who.int/publications/i/item/9789240064898> (Accessed 2023/03/21). 2022

[2] Frédéric M et al. Antimicrobial Agents and Chemotherapy 1999; 43: 2328–2331

[3] Philippe G et al. Phytochemistry 2003; 62: 623–629

P-062 Comparison of water-soluble vitamins in various vegetables and true retention by different cooking methods

Authors Jinju Park¹, Youngmin Choi¹, Eunji Park¹, Hye Kyung Han¹, Ah Hyun Kim¹, Arin Park¹

Institute 1 National Institute of Agricultural Sciences, Wanju-gun, South Korea

DOI 10.1055/s-0043-1773947

This study aimed to evaluate the content of moisture, water-soluble vitamins, vitamin B₅ and C, and the true retention of vitamins in cooked vegetables. Some

vegetables can be eaten fresh, and others are eaten cooked, such as by blanching, boiling, etc. Therefore, it is important to figure out the content of vitamins and true retention by cooking methods to calculate the nutritional intake. This study chose ten vegetables, aloe, bitter melon, chicory, etc., as the commonly used ones in South Korea. The moisture was determined by a dry oven (105°C). Vitamins B₅ and C were quantified by reverse-phase liquid chromatography using photodiode-array (PDA, 200 nm) and UV-visible detection (UVD, 471 nm). The moisture content ranged from 77.08 g/100g (Sseumbagwi, *Ixeridium dentatum*) to 99.17 g/100 g (aloe) in fresh vegetables. The raw endive had the highest vitamin B₅ content (0.827 mg/100 g) among the samples. And the true retention of vitamin B₅ ranged from 5.55% (bitter melon, boiling) to 62.41% (spaghetti squash pumpkin, boiling). The highest value of vitamin C was 67.046 mg/100 g in raw bitter melon, and the true retention ranged from 0.00% (spaghetti squash pumpkin, boiling) to 80.59% (Korean radish, blanching). These results indicate that water-soluble vitamins decreased after cooking. It can be used for basic data for planning meals and the food industry (► **Table 1**).

► **Table 1** Moisture, vitamin B₅ and C contents in raw and cooked vegetables.

Food Description	Scientific name	Moisture (g/100g)	Vitamin B ₅ (mg/100g)	Vitamin C (mg/100g)	
Bitter melon (Yooje), Raw	<i>Momordica charantia</i> L.	92.72 ± 0.12 ^a	0.771 ± 0.031	67.046 ± 0.116	
Bitter melon (Yooje), Raw, Blanching		93.76 ± 0.04	0.943 ± 0.001	53.499 ± 0.149	
Bitter melon (Yooje), Dried		10.67 ± 0.02	0.015 ± 0.000	17.342 ± 0.006	
Bitter melon (Yooje), Dried, Boiled		88.02 ± 0.21	0.079 ± 0.002	0.420 ± 0.000	
Bitter melon (Yooje), Dried, Boiled		98.19 ± 0.01	0.036 ± 0.000	0.000 ± 0.000	
Radish (Yoo-om), Young, Raw		94.64 ± 0.08	0.202 ± 0.006	28.340 ± 0.236	
Radish (Yoo-om), Young, Raw, Blanching		94.29 ± 1.32	0.049 ± 0.002	16.276 ± 0.022	
Radish, Korean radish (Joo-om-om), Root, Raw		92.71 ± 0.04	0.211 ± 0.003	19.367 ± 0.017	
Radish, Korean radish (Joo-om-om), Root, Raw, Blanching		92.62 ± 0.04	0.186 ± 0.009	15.608 ± 0.047	
Sseumbagwi, Raw		<i>Ixeridium dentatum</i>	77.08 ± 0.06	0.827 ± 0.001	3.627 ± 0.013
Sseumbagwi, Raw, Blanching	78.42 ± 0.02		0.000 ± 0.000	2.390 ± 0.017	
Pumpkin, Spaghetti squash, Raw	94.90 ± 0.09		0.428 ± 0.019	0.593 ± 0.013	
Pumpkin, Spaghetti squash, Raw, Boiled	96.58 ± 0.01		0.267 ± 0.007	0.000 ± 0.000	
Endive, Raw	<i>Cichorium endivia</i> L.		95.39 ± 0.06	0.827 ± 0.027	2.045 ± 0.035
Radishin, Raw	<i>Cichorium intybus</i> var. <i>edismum</i>		95.23 ± 0.03	0.779 ± 0.038	3.282 ± 0.012
Chicory, Leaf, Root, Raw	<i>Cichorium intybus</i> L.		92.79 ± 0.12	0.464 ± 0.008	12.021 ± 0.035
Kale, Tossans, Raw	<i>Brassica oleracea</i> L.		90.02 ± 0.02	0.245 ± 0.010	42.706 ± 0.107
Aloe, Fresh, Raw	<i>Aloe vera</i> (L.) <i>Burm. f.</i>		99.17 ± 0.07	0.260 ± 0.001	0.056 ± 0.002

^aAll values are mean±SD

P-063 Changes of antioxidant activity and bioactive compounds of *Acer tegmentosum* stem at different harvest time

Authors Youngki Park¹, Rhim Ryoo¹, Kyoung Tae Lee¹, Hyun Jun Kim², Gwang Hun Park²

Institutes 1 National Institute of Forest Science, Suwon, South Korea; 2 Forest Medicinal Resources Research Center, National Institute of Forest Science, Youngju, South Korea
DOI 10.1055/s-0043-1773948

We investigated the antioxidant activity, total phenolics, free sugar and bioactive compounds content in *Acer tegmentosum* stem at different harvest times. *A. tegmentosum* has been used as a traditional medicine in Asia. In general, the stem of *A. tegmentosum* is used for treating traumatic bleeding, and the leaves and stem were used to treat liver disease such as hepatitis, cirrhosis, liver cancer and diabetes. In our study, we used *A. tegmentosum* stem to measure the phenolic compounds, free sugars and antioxidant activity. We report changes in the overall antioxidant activity and phenolic compounds at different harvest times. We aim to increase the understanding and knowledge of these changes, which may be useful for optimal harvest timing. Using HPLC with a diode-array detector, three phenolic compounds including salidroside, (-)-catechin and (-)-epicatechin gallate were evaluated. *A. tegmentosum* stem samples used in this study were grown in Uljin, Korea, during May – September. The results findings were that the samples contained salidroside from 46.26 to 61.48 mg/g, (-)-catechin from 2.83 to 3.41 mg/g and (-)-epicatechin gallate from 0.75 to 1.10 mg/g. In our research, the free-radical scavenging activities of five samples (harvested from May to September) were 51.39, 51.43, 54.10, 57.15 and 70.08% at 40 µg/mL, respectively. Total phenolic

content in *A. tegmentosum* stem harvested at different times were 457.1, 446.4, 466.6, 468.1 and 482.6 mg/g, respectively. Glucose, raffinose, fructose and sucrose were the major sugar components of *A. tegmentosum* stem. We also observed that sucrose and raffinose content increased during May – September.

P-064 Analysis of pachymic acid and dehydropachymic acid of *Pachyma hoelen* collected in Korea

Authors Youngki Park¹, Rhim Ryoo¹, Kyoung Tae Lee¹, Hyo-rim Lee¹, Jongbeom Seo¹

Institute 1 National Institute of Forest Science, Suwon, South Korea
DOI 10.1055/s-0043-1773949

The sclerotia of *Pachyma hoelen* (Bokryeong) which belong to Polyporaceae, are one of the most important crude drugs in traditional medicine and health food in Korea. It is used for sedative, diuretic and tonic effects. Among the many compounds, pachymic acid (PA) and dehydropachymic acid (DPA) are the main triterpenes isolated from *P. hoelen*. Because PA and DPA are recognized as marker compounds of *P. hoelen*, we measured the contents of these two compounds for selecting superior ones. In this study, we evaluate the characteristics and measured the content of PA and DPA in the bark and inside skin of the sclerotia of *P. hoelen* collected in Korea. Using HPLC, two major triterpene acids including PA and DPA, in the sclerotia of *P. hoelen* were evaluated. The results findings were that the contents of PA and DPA in the bark and the inside skin of the sclerotia of *P. hoelen* collected from Hongchun were 2.82 ± 0.1 mg/g and 1.03 ± 0.1 mg/g for PA, and 7.37 ± 0.2 mg/g and 2.83 ± 0.1 mg/g for DPA, respectively. On the other hand, the contents of PA and DPA in the bark and the inside skin of the sclerotia of *P. hoelen* from Chungju were 2.75 ± 0.1 mg/g and 2.01 ± 0.1 mg/g for PA, and 8.55 ± 0.2 mg/g and 4.12 ± 0.1 mg/g for DPA, respectively. The content of PA and DPA in *P. hoelen* were in the range of 1.03 – 5.94 mg/g and 2.83 – 10.92 mg/g, respectively.

P-066 Qualitative analysis of extracts from *Eleutherococcus senticosus* roots with quantitative determination of eleutherosides B and E

Authors Katarzyna Kupniewska¹, Andrzej Patyra^{1,2,3}, Anna Kiss¹

Institutes 1 Department Of Pharmaceutical Biology, Medical University Of Warsaw, Warsaw, Poland; 2 Institut des Biomolécules Max Mousseron, Université de Montpellier, CNRS, ENSCM, Montpellier, France; 3 Doctoral School, Medical University of Warsaw, Warsaw, Poland
DOI 10.1055/s-0043-1773950

Eleutherococcus senticosus (Rupr. & Maxim.) Maxim. (Araliaceae) is a plant growing in Korea, China, Japan, and Russia. *E. senticosus*, also known as Siberian ginseng and Ciwujia, has a long history of use in Traditional Chinese Medicine. According to the European Medicines Agency, its root is recommended in cases of fatigue and weakness. The monograph of *Eleutherococcus radix* can be found in Ph. Eur. 11th.

The presented study aimed to analyse the phytochemical composition of *E. senticosus* root. Additionally, the quality of herbal products containing this plant material was evaluated.

Commercial samples of the root of *E. senticosus* or its ethanolic extract in the form of cut root, capsules, tablets and tinctures were purchased online. As described in Ph. Eur. 11th, the authenticity of the plant material was confirmed using microscopic anatomical analysis and TLC. Extracts were phytochemically characterised through LC-DAD-ESI-MS/MS method. The content of marker compounds syringin (eleutheroside B) and syringaresinol 4,4'-di-O-β-D-glucoside (eleutheroside E) was analyzed using HPLC.

Our analysis revealed different qualitative and quantitative profiles of tested products. In some samples, the sum of eleutherosides B and E did not exceed 0.08% required by Ph. Eur. 11th, nor did they contain labelled amounts of

eleutherosides. Moreover, eleutherosides were not detected in a few tested products.

These results indicate the importance of quality control and standardisation of plant material.

Funding This work was supported by “Studenckie koła naukowe tworzą innowacje” from the Ministry of Education and Science (SKN/SP/533710/2022).

Conflict of Interest The authors declare no conflict of interest.

P-067 Headspace Gas chromatography-tandem mass spectrometry for the identification and characterization of *Larix decidua* Mill. (Pinaceae) oleoresins

Authors Joao Vitor Da Costa Batista^{1,2}, Carla Holandino³, Jakob Maier¹, Jörg Huwyler², Stephan Baumgartner^{1,4,5}, Fabio Boylan⁶

Institutes 1 Society For Cancer Research, Hiscia Institute, Arlesheim, Switzerland; 2 University of Basel, Basel, Switzerland; 3 Departamento de Fármacos e Medicamentos, Faculdade de Farmácia, Universidade Federal do Rio de Janeiro, Rio de Janeiro, Brazil; 4 Institute of Complementary and Integrative Medicine, University of Bern, Bern, Switzerland; 5 Institute of Integrative Medicine, University of Witter/Herdecke, Witten, Germany; 6 School of Pharmacy and Pharmaceutical Sciences, Trinity Biomedical Sciences Institute, Trinity College Dublin, Dublin, Ireland

DOI 10.1055/s-0043-1773951

Differences in the headspace (HS) volatile profiles of oleoresins of *Larix decidua* Mill. were studied for the first-time using GC-MS (gas chromatography – mass spectrometry). This was done to investigate the possible differences between the HS volatiles from different provinces and compare them with the HS volatiles published for the sapwood and heartwood of *L. decidua*. The most dominant HS volatiles of all resins were monoterpenes. α -Pinene was the major volatile, representing more than 72% of the total volatiles. The following most abundant HS volatiles of the resins were β -pinene (> 6.30%), D-limonene (> 2.80%), δ -3-carene (> 0.03%), β -myrcene (> 1.50%), camphene (> 0.80%). These results contrast with the results published for *L. decidua* wood where α -pinene varied from 41.60% to 65.70% and β -pinene from 10.30% to 21.30% [1]. Oleoresins presented over 98% of monoterpenes while sapwood presents between 71–84% and heartwood between 81–90%. To obtain the exact concentration of each compound in the oleoresin, hydrodistillation was performed in triplicate, giving a yield of 7.8–19% of EO in the resins used. Although the composition and concentration of the EO themselves are very similar, when one looks at each individual component's yield in the resins, a variation can be seen. Also, taking into consideration the production time of each resin, their HS composition in EO is very stable. There are small variations when production factors such as geography and season of the year are considered.

References

[1] Wajs A et al. Journal of Essential Oil Research 2007; 19 (2): 125–133. doi:10.1080/10412905.2007.9699244

P-068 Comparative Investigation of Hydrated Fruits of *Prunella vulgaris* and Nepetoideae species

Authors Venelina Angelkova¹, Asen Stoyanov¹

Institute 1 Sofia University “St. Kliment Ohridski”, 1164 Sofia, 1 James Bourchier Blvd., Bulgaria

DOI 10.1055/s-0043-1773952

Hydrogels have become some of the most well-known and valued materials in the pharmaceutical and biomedical industry due to their unique rheological properties. The search for new polymers with desirable characteristics is ongoing

and also includes natural sources, such as medicinal plants [1]. *Prunella vulgaris* has a long history of use in both Bulgarian and Chinese traditional medicine.

The goal of this study was to determine the structural and functional characteristics of the hydrogel (resulting from mixocarp) and the mucilage production capabilities of *P. vulgaris* and compare it with 9 other taxa. Of those *Ocimum basilicum*, *P. vulgaris*, *Rosmarinus officinalis*, *Salvia hispanica*, and *Thymus vulgaris* formed a hydrogel capsule. We further compared their dissolution and swelling capabilities by using pure water, 50% ethanol and 10% sucrose solutions and measuring changes in the width of the polymer layer over time. Lastly SEM images of the mixocarp were taken and compared. *O. basilicum* formed the widest mucilage capsule, *P. vulgaris*, *S. hispanica* and *R. officinalis* had similar widths in water, while *T. vulgaris* had the smallest capsule. Results were similar for the other solvents used.

Fully defining the properties of these naturally occurring hydrogels (such as rehydration capabilities and impact on rheology in ionic solutions) requires more research.

Funding The authors are grateful for the financial support of Bulgarian NSF at the Ministry of Education and Science, 2901/KP-06-China/15/2020.

References

[1] Mohammadinejad R et al. Status and future scope of plant-based green hydrogels in biomedical engineering. Appl. Mater. Today 2019; 16: 213–246

P-069 The Versatile Uses of Lavender Herb

Authors Olha Mykhailenko^{1,2}, Viktoriia Hurina¹,

Liudas Ivanauskas³, Victoriya Georgiyants¹

Institutes 1 National University of Pharmacy, Kharkiv, Ukraine; 2 Pharmacognosy and Phytotherapy Group, UCL School of Pharmacy, London, UK;

3 Lithuanian University of Health Sciences, Kaunas, Lithuania

DOI 10.1055/s-0043-1773953

Lavandula genus plants (Lamiaceae) are widely used to obtain essential oil, which is known for its bactericidal, antipsoriatic, anti-inflammatory, sedative, anxiolytic, antiproliferative and insecticidal effects. The plant is used in the perfumery, decorative cosmetics, and folk and official medicine. In pharmaceutical practice, raw materials of the perennial herbaceous plant *Lavandula angustifolia* L. are mainly used. Currently, lavender flowers and inflorescences are included in the pharmacopeias of 16 countries. It should be noted that the complex processing of raw materials is the most ecologically beneficial, but a niche should be properly found for the proper use of these resources. Plant herbs or leaves contain phenolic compounds, amino acids and carboxylic acids. Therefore, the study of the chemical composition of the whole plant may have a perspective. The HPLC study of phenolic compounds in *Lavandula* herb grown in Ukraine made it possible to establish the presence of the following compounds: neochlorogenic acid (0.225 $\mu\text{g/g}$); vanillin (0.054 $\mu\text{g/g}$); rosmarinic acid (0.219 $\mu\text{g/g}$); salicylic acid (0.078 $\mu\text{g/g}$); hyperoside (13,568 $\mu\text{g/g}$); ononin (0.028 $\mu\text{g/g}$) and apigenin (0.058 $\mu\text{g/g}$). Lavender herbs have a diverse chemical composition and contain a sufficiently large amount of essential oil, the largest part of which is in the inflorescences. Determining the *Lavandula* herb chemical composition is a promising direction of research, because it will make it possible to establish other pharmacological effects of the plant compounds, and will allow the use of the whole plant in the industry, reducing the amount of waste.

P-070 *Erythrina* alkaloids as source of valuable chemicals

Authors Marcos Soto-Hernandez¹, Luis Díaz- Núñez¹, Rubén SanMiguel-Chávez¹, Cesáreo Rodríguez-Hernández²
Institutes 1 Colegio de Postgraduados, Campus Montecillo, Postgrado en Botánica, Texcoco, Mexico; 2 Colegio de Postgraduados, Campus Montecillo, Postgrado en Entomología, Texcoco, Mexico
DOI 10.1055/s-0043-1773954

The *Erythrina* genus of the Leguminosae family contains 115 species with morphological variation and great ecological diversity. Around the world, *Erythrina* species have been widely distributed in southern Mexico and Central America. The genus has been studied for its ornamental or culinary applications [1]. More recently the genus has been evaluated for its chemical composition and its ethnomedicinal applications. The genus contains different phytochemicals as flavonoids, isoflavonoids, alkaloids, or saponins distributed across different plant tissues [2]. The phytochemical composition of the stem bark, flowers and seeds of them have been extensively studied but the alkaloids and isoflavonoids have received special attention due to their structural variation and their biological applications in medicine or agriculture [3]. Herein we report an insecticidal activity of the alkaloid fractions and crude extracts of seeds of *Erythrina americana* Miller against *Trialeuroides vaporariorum*, a pest of many crops worldwide. It was observed that: the crude extract and fractions exhibited the same activity or repellence and mortality at 24 h, whereas the liberated alkaloid fraction at 0.1 % was the best treatment because the repellence, oviposition and mortality are effective for 6 days. These results validate the use of *Erythrina americana* Miller in the organic management of crops.

References

- [1] García-Mateos R, Soto-Hernández M., Vibrans H. *Erythrina americana* Mill (Colorin, Fabaceae) A versatile Resource from México 2011; 55: 391–400
- [2] Rasooli I. Bioactive Compounds in Phytomedicine. 1st ed. Rijeka, Croatia 2011; 163–184
- [3] Díaz-Núñez JL, Soto-Hernández RM, Rodríguez-Hernández C, SanMiguel-Chávez R. Repellence, mortality and oviposition of *Trialeuroides vaporariorum* (West) with alkaloids of *Erythrina americana* Mill. *Agrociencia* 2019; 53: 1071–1083

P-071 Morpho-anatomy and histochemistry of European mistletoe (*Viscum album* L. subsp. *album*), a semi-parasite growing on *Malus domestica*

Authors Valter Almeida¹, Irailson Monchak¹, João Batista¹, Mirio Grazi¹, Hartmut Ramm¹, Vijayasankar Raman¹, Stephan Baumgartner¹, Carla Holandino¹, Jane Manfron¹
Institute 1 Universidade Federal Do Rio de Janeiro, Av Prof Carlos Chagas S/n. Ilha Do Fundão. Rio de Janeiro, Brazil
DOI 10.1055/s-0043-1773955

This work provides detailed morpho-anatomical characteristics of the leaves, stems and berries of *Viscum album* L. subsp. *album* (Santalaceae) growing on the branches of *Malus domestica*. Additionally, microchemical analyses of all tissues and Energy Dispersive X-Ray Spectroscopy (EDS) analyses of the calcium oxalate crystals are provided for the first time. The plant grows as a semi-parasite on the branches of host trees and shrubs; it develops as dichasium with pseudo-dichotomous branching stems and well-developed green leaves with parallel veins; the dioecious inflorescences usually consist of three flowers, with female flowers generating white fleshy berries, in which a seed is embedded in the mucilaginous mesocarp, normally containing two embryos. The analysed leaves were isobilateral, amphistomatic and showed straight anticlinal epidermal cell walls, thick cuticles with epicuticular wax crystalloids and paracytic stomata. The midrib is flat on both sides and has a single vascular bundle, whereas the petiole is concave-convex in shape and contains five bundles. The stems show a primary structure with a ring of nine vascular bundles enclosing the pith. Calcium oxalate druses and cubic and quadrangular prisms were ob-

served in different parts of the plant. The microscopic features of the tissues and structures are illustrated with light and scanning electron micrographs.

P-072 Evaluation of effects of *Leea indica* leaf extracts and herbal formula on proliferation of breast and ovarian cancer cells

Authors Yen-Thong Loh¹, Xuan Li¹, Ronghui He¹, Keng-Ling Poh¹, Soek-Ying Neo¹, Matthew Koh², Liam Liu², Alex Liu², Susanna Ma², Hwee Ling Koh¹
Institutes 1 Department of Pharmacy, Faculty of Science, National University of Singapore, Singapore; 2 Natura Biotechnologies Pte Ltd, Singapore
DOI 10.1055/s-0043-1773956

Breast cancer is one of the top killers while ovarian cancer is often detected at late stages. Side effects, cancer relapse and refractory cancer are common challenges encountered. Despite medical advances, incidences of such cancer and associated deaths remain high. Some medicinal plants are traditionally used for treatment of cancer and are sources of anticancer drugs. *Leea indica* (Burm.f.) Merr. is a medicinal plant reported to have antiproliferative effects against various types of cancer. This study aims to evaluate the antiproliferative effects of *L. indica* leaves extracted with 70% methanol and water using Soxhlet extraction, ultrasonication and maceration in two human breast cancer and two ovarian cancer cell lines via WST-1 assays. Combination treatment with *L. indica* 70% methanol maceration crude extract and a breast herbal formula was also studied. Generally, 70% methanol maceration extract resulted in lower IC₅₀ values compared to other extracts while its ethyl acetate fraction obtained after liquid-liquid fractionation was generally more potent than the 70% methanol crude extract. The combination treatment with 70% methanol maceration extract and breast herbal formula significantly ($p < 0.01$) reduced cell viabilities of MDA-MB-231 and MCF-7 cells as compared to the single treatments alone. In conclusion, the antiproliferative effects of *L. indica* leaves have been successfully evaluated in breast and ovarian cancer cell lines. Addition of *L. indica* to an herbal formula shows promise in enhancing the antiproliferative effects against breast cancer cells. Further research to harness the potential benefits of medicinal plants is clearly warranted.

Conflict of Interest The authors declare no conflict of interest.

P-073 Invasive plants: problems and solutions

Authors Olha Mykhailenko^{1,2}, Zigmantas Gudžinskas³, Alla Kozurak⁴, Victoriya Georgiyants²
Institutes 1 National University of Pharmacy, Kharkiv, Ukraine; 2 UCL School of Pharmacy, London, UK; 3 Nature Research Centre, Institute of Botany, Vilnius, Lithuania; 4 Carpathian Biosphere Reserve, Rakhiv, Ukraine
DOI 10.1055/s-0043-1773957

Invasive plants pose a serious problem in Ukraine, in the European Union and globally, displacing native species, reducing biodiversity, negatively impacting agriculture and other industries, and threatening human health. In Ukraine, efforts are being made to control the spread of invasive plants, including monitoring and eradication programmes, public education and awareness raising and the development of policy and regulations aimed at preventing further introductions. The control of some invasive plants can lead to the exploitation of their raw material for industrial or pharmaceutical purposes. For example, *Paulownia tomentosa*, which is spreading in the central and southern parts of Ukraine, can also be used in the pharmaceutical industry. The spreading *Gleditsia triacanthos* contains the alkaloid triacanthine, which has strong antispasmodic properties. The plant is used in folk medicine to treat bronchial and intestinal spasms, chronic gastritis, gastrointestinal spasms, etc. Studies on the invasive *Epilobium ciliatum* in Europe have shown that its phenolic composition (oenothein B, hyperoside) is equal to, or even superior to, native and often sparse species of the genus *Epilobium*. The leaves and rhizomes of the alien *Iris x germanica* accumulate a high concentration of biologically active com-

pounds (germanaism B, irisolidon), thus allowing naturalised populations to be used for the preparation of raw materials without damaging the native populations. It is therefore important to investigate and assess the chemical composition of spreading invasive plants and to search for new bioactive compounds in order to maximise the economic benefit of the resulting biomass of invasive species to be controlled and eradicated.

P-074 Polyphenolic Compounds in Fruits and Leaves of *Hippophae rhamnoides*

Authors Ain Raal¹, Tõnu Püssa², Kelly Talvistu¹, Oleh Koshovyi^{1,3}

Institutes 1 University of Tartu, Tartu, Estonia; 2 Estonian University of Life Sciences, Tartu, Estonia; 3 National University of Pharmacy, Kharkiv, Ukraine

DOI 10.1055/s-0043-1773958

Fruits, seeds, and leaves of *Hippophae rhamnoides* L. (Elaeagnaceae) are widely used in folk medicine. Although the fruits are usually used, the leaves also need attention.

The aim of the study was to estimate the content of polyphenolic compounds in methanolic and water extracts of fresh fruits and fresh and dried leaves of *H. rhamnoides* using LC-MS/MS method.

Almost 2.5 times more total phenols and 1.7 times more total flavonols were found in methanolic extracts (24 h) of leaves than in their water extracts (10 min). The methanolic and water extracts contained almost 10 times more total phenolics from leaves than from fruits. Methanolic and water extracts from leaves contained also more flavonols than water extracts (1.7 and 24 times, respectively).

A total of 30 compounds were found in fruits and leaves of *H. rhamnoides*. The methanolic and water extracts of fruits contained significant amounts of isorhamnetin rutinoside (48.5 mg/100 g and 44.4 mg/100 g, respectively), isorhamnetin glycoside (21.6 mg/100 g and 23.3 mg/100 g) and quercetin rutinoside (both about 20 mg/100 g). The methanolic extract of dried leaves contained the most catechin dimer, which was higher in fresh leaves (36 and 55 mg/100 g). The dried leaves also contained more quercetin-3-O-glucoside-7-O-rhamnoside and its isomer than the fresh sample. Methanol extracted significantly more isorhamnetin rutinoside, isorhamnetin glucoside and isorhamnetin 3-O-glucoside-7-O-rhamnosides than water (~10, 5, and 4 times, respectively).

The leaves of *H. rhamnoides* deserve further attention due to their rich phenolic composition. This work was supported by the MSCA4Ukraine (1232466).

P-075 Phytochemical and pharmacological characteristics of an extract from *Eryngium planum* L. herb

Authors Oleh Koshovyi^{1,2}, Kseniia Gnatoyko³, Andriy Grytsyk³, Roman Hrytsky³, Ain Raal¹

Institutes 1 University Of Tartu, Tartu, Estonia; 2 National University of Pharmacy, Kharkiv, Ukraine; 3 Ivano-Frankivsk National Medical University, Ivano-Frankivsk, Ukraine

DOI 10.1055/s-0043-1773959

Medicinal plants are valuable sources of biologically active substances, which may show a positive therapeutic effect in various pathological processes. *Eryngium* species have been used in Ukrainian folk medicine for a long time. *E. planum* L. is mostly widespread in Ukraine.

The aim of the research was to study the phytochemical composition and pharmacological activity of an *E. planum* herb thick extract.

The extract was obtained with 70% ethanol by fractional maceration (3 times). The combined extracts were evaporated to a thick extract, which is the dark viscous mass with a specific smell. The yield of the extract was 22.1 ± 0.8%. In the extract, tannins (8.1 ± 0.23%), flavonoids (6.1 ± 0.13%) and total polyphenols (21.8 ± 0.97%) were established. Caffeic acid and rutin were identified by TLC.

Hepatoprotective activity of the extract was studied in the tetrachloromethane method in a rat model. The extract significantly reduces toxic effect in the case of acute toxic damage to the liver. Providing hepatoprotective activity is at the level of the reference drug – Silibor from *Silybum marianum*. The extract also has anti-inflammatory effect in the formalin edema model. At 1, 3, 5 h of the experiment the extract showed anti-exudative activity of 16.85%, 19.80%, 21.05%, respectively, which is close to the reference drug – diclofenac sodium. The possibility of implementation of *E. planum* herb and its extract as a medicinal plant material has been proven by conducting phytochemical and pharmacological research.

Funding This work was supported by the MSCA4Ukraine (1232466).

Conflict of Interest The authors declare no conflict of interest.

P-076 Phytochemical and Pharmacological Investigation of the Thick Extract of *Gentiana asclepiadea* Roots

Authors Oleh Koshovyi^{1,2}, Nataliya Hrytsky³,

Hanna Ersteniuk³, Lyubov Grytsyk³, Ain Raal¹

Institutes 1 University Of Tartu, Tartu, Estonia; 2 The National University of Pharmacy, Kharkiv, Ukraine; 3 Ivano-Frankivsk National Medical University, Ivano-Frankivsk, Ukraine

DOI 10.1055/s-0043-1773960

Plants of the genus *Gentiana* L. are widely used in medical practice in the treatment of gastrointestinal tract diseases. The pharmacological activity is provided by secoiridoids, xanthenes, flavonoids and other compounds. The study of *Gentiana asclepiadea* L. (family Gentianaceae), which is widely distributed in the Ukrainian Carpathians, is promising.

The aim was to study the acute toxicity and hepatoprotective activity of thick extract of the roots of *G. asclepiadea* (ERGA).

ERGA was obtained by the fractional maceration method, using 40% ethanol. The obtained extracts were evaporated to a residual humidity of no more than 25%. According to the results of chromatographic and spectrophotometric studies the flavonoids, hydroxycinnamic acids, polysaccharides in the extract were confirmed and the amount of polyphenols was determined.

Determination of acute toxicity showed that ERGA, when administered intragastrically at a dose of 6000 mg/kg, did not lead to the death of mice. Changes in integral, hematological, biochemical indicators and morphological structure of internal organs did not occur. The obtained results characterise the studied extract as practically non-toxic (toxicity class V).

The study of the hepatoprotective activity of ERGA in the tetrachloromethane hepatitis model showed that the most pronounced activity was established when using the extract at a dose of 25 mg/kg, which, according to the biochemical indicators of blood serum and liver homogenate, probably exceeded the referent-drug Silymarin from *Silybum marianum*.

The conducted research shows the expediency of further pharmacological studies of ERGA.

Funding This work was supported by the MSCA4Ukraine (1232466).

Conflict of Interest There authors declare no conflict of interest.

P-077 Detailed phytochemical and antioxidant profiling of extracts obtained from flower buds of *Magnolia × soulangeana* Soul.-Bod. var. 'Lennei'

Authors Aldona Adamska-Szewczyk¹, Tomasz Baj²,

Grażyna Zgórk²

Institutes 1 Bionorica Poland, Warsaw, Poland; 2 Department of Pharmacognosy with the Medicinal Plant Garden, Medical University of Lublin, Lublin, Poland

DOI 10.1055/s-0043-1773961

Magnolia × soulangeana Soul.-Bod. var. 'Lennei' (MSL) is known as one of the most famous ornamental species grown in many botanical gardens in Europe. In the present study, in-depth phytochemical profiling of aqueous-ethanolic

extracts obtained from MSL flower buds, previously collected at the UMCS Botanical Garden (Lublin, Poland), was performed using coupled chromatographic (RP-LC), spectroscopic (PDA) and mass spectrometric (QTOF/MS-MS) techniques. At the same time, the total phenolic content (TPC) and antiradical capacity of MSL extracts were evaluated using Folin-Ciocalteu and DPPH assays, respectively. To ensure the highest recovery of phenolic compounds from MSL flower buds, ultrasound-assisted extraction (UAE) was used with optimised extraction parameters (temperature, extraction time, composition of aqueous-ethanol extractants and solvent-to-solid ratio), controlled by a response surface methodology (RSM) protocol. As a result, the highest polyphenolic content of MSL extracts were determined for preparations obtained using an extraction solvent (ethanol) in the concentration range of 63 – 82% (optimum 66.82%, v/v), solvent/herbal substance ratio > 45 mL/g (optimum 46.82 mL/g), and UAE time of

55.2 min. Detailed phytochemical LC-MS studies revealed the presence of significant amounts of polyphenols (with different types of molecular structure) in MSL flower buds, namely hydroxybenzoic (protocatechuic, vanillic, p-hydroxybenzoic) and hydroxycinnamic (chlorogenic) acids, phenylethanoids (acteoside, echinacoside, yulanoside B), flavonoids (rutin, quercitrin, isoquercitrin, nicotiflorin, isorhamnetin 3-O-glucoside) and lignans (magnolin and fargesin derivatives). Simultaneous phytochemical and biological profiling confirmed that MSL flower buds could serve as a potential source of bioactive polyphenolic antioxidants with promising therapeutic effects.

Conflict of Interest The authors declare no conflict of interest.

P-078 Evaluation of Phenolic compounds in Perilla (*Perilla frutescens*) Germplasm from Korea

Authors Eunae Yoo¹, Jungsook Sung¹, Sojeong Hwang¹, Heon-Woong Kim², Sookyeong Lee¹, Weilan Li¹

Institutes 1 National Agrobiodiversity Center, National Institute of Agricultural Sciences, 370, Nongsaengmyeong-ro, Deokjin-gu, Jeonju-si, South Korea; 2 Food and Nutrition Division, National Institute of Agricultural Sciences, 166, Nongsaengmyeong-ro, Iseo-myeon, Wanju-gun, South Korea

DOI 10.1055/s-0043-1773962

Perilla (*Perilla frutescens*) is an annual herb plant and oil seed crop belonging to the Lamiaceae and is native to regions of Asia. The leaves of perilla (*P. frutescens* var. *frutescens*) are used as vegetables and pickles in Korea, whereas those of shiso (*P. frutescens* var. *crispa*) are more often used in China and Japan for medicine and food flavouring. The leaf of Perilla is a rich source of phenolic compounds, including rosmarinic acid and scutellarin, but there is still a lack of quantitative information concerning the contents of phenolic compounds. Rosmarinic acid is the most abundant phenolic compound, and scutellarin is the second most abundant in perilla. We investigated individual phenolic compounds using Ultra-High Performance Liquid Chromatography (UPLC) and evaluated major phenolic compounds in 115 perilla germplasm accessions collected from Korea. Wide variations in scutellarein-7-O-glucuronide (636.24 to 1933.62 mg/100 g), luteolin-7-O-glucuronide (73.88 to 664.23 mg/100g), apigenin-7-O-glucuronide (60.49 to 588.07 mg/100 g), caffeic acid (2.94 to 19.41 mg/100 g) and rosmarinic acid (1274.08 to 5189.86 mg/100 g) in perilla and scutellarein-7-O-glucuronide (356.07 to 1949.91 mg/100 g), luteolin-7-O-glucuronide (67.63 to 563.84 mg/100g), apigenin-7-O-glucuronide (46.32 to 404.23 mg/100g), caffeic acid (3.73 to 72.25 mg/100g) and rosmarinic acid (1609.47 to 5535.59 mg/100g) in shiso were observed but there needs to be another step in the analysis of the minor contents of these similar compounds. The data on higher concentrations of phenolic compounds can provide baseline information for evaluating the phytochemicals of perilla and improving varieties.

P-079 Unravelling the ecotype influence on metabolomics and toxicity of *Corema album* L.

Authors Eliana Fernandes¹, Riccardo Trentin Trentin²,

Maria João Rodrigues¹, Luís Custódio¹

Institutes 1 Centre of Marine Sciences (CCMAR), Campus de Gambelas, University of Algarve, 8005-139 Faro, Portugal; 2 Department of Biology, University of Padova, Via U. Bassi 58/B, 35131 Padova, Italy
DOI 10.1055/s-0043-1773963

Previous work showed relevant radical scavenging activities of ethanol and acetone extracts of *Corema album* [1]. This work expended upon that work by evaluating the ecotype influence on metabolomics and toxicity of methanol leaf extracts of *Corema album*. Leaves were collected from adult plants from populations located in two distinct areas: east (CAE) and west (CAW) coast of Southern Portugal. Extracts were evaluated for metabolomics by LC-ESI-HRMS/MS and toxicity towards murine RAW 264.7 macrophages, murine bone marrow stromal [S17], human embryonic kidney [HEK 293] and human hepatocellular carcinoma [HepG2] cells. Untargeted metabolomics revealed significant differences in the composition of the extracts; however pinocembrin was the major compound in both. Both extracts were toxic against tested cells. Our results suggest that *C. album* contains bioactive polyphenolic compounds with antioxidant and cytotoxic properties that could be further explored in the pharmaceutical area.

Funding This work received Portuguese national funds from FCT – Foundation for Science and Technology through projects UIDB/04326/2020, UIDP/04326/2020, and LA/P/0101/2020, the PhD grant (UI/BD/151301/2121: EF), FCT program contract (UIDP/04326/2020: MJR) and FCT Scientific Employment Stimulus (CEECIND/00425/2017: LC).

Conflict of Interest The authors declare no conflict of interest.

References

[1] Fernandes E., Correia H., Rodrigues M.J., Castañeda-Loaiza V., Pereira C., Custódio L. Exploring the biotechnological value of *Corema album* leaves. *Planta Medica* 2022; 88 (15): P-216

P-080 Medicinal Centauri Honey: a promising ingredient?

Authors Márcia Santos Filipe^{1,2}, Tânia C.S.P. Pires^{3,4}, Ricardo C. Calheta^{3,4}, Eva María Domínguez Martín^{1,2}, Ana María Díaz-Lanza², Miguel Vilas-Boas^{3,4}, Soraia Falcão^{3,4}, Patrícia Rijo^{1,5}

Institutes 1 CBIOS – Universidade Lusófona’s Research Center for Biosciences & Health Technologies, Campo Grande 376, 1749-024 Lisbon, Portugal; 2 Universidad de Alcalá de Henares. Facultad de Farmacia, Departamento de Ciencias Biomédicas (Área de Farmacología; Nuevos agentes antitumorales, Acción tóxica sobre células leucémicas. Ctra. Madrid-Barcelona km. 33,600 28805 Alcalá de Henares, Madrid, España; 3 Centro de Investigação de Montanha (CIMO), Instituto Politécnico de Bragança, Campus de Santa Apolónia, 5300-253 Bragança, Portugal; 4 Laboratório Associado para a Sustentabilidade e Tecnologia em Regiões de Montanha (SusTEC), Instituto Politécnico de Bragança, Campus de Santa Apolónia, 5300-253 Bragança, Portugal; 5 Instituto de Investigação do Medicamento (iMed.Ulisboa), Faculdade de Farmácia, Universidade de Lisboa, 1649-003 Lisbon, Portugal.
DOI 10.1055/s-0043-1773964

Honey is a natural product with antioxidant and antimicrobial properties, has been used as a medicinal substance for centuries. This natural product is mainly composed of a supersaturated solution of sugars, containing low water content and trace amounts of bioactive compounds. The flower source, climate, geographical origin, harvesting process and storage conditions are factors that influence the composition of the nectar, leading to significant changes in the chemical composition, physical properties, and bioactivity of honey¹. Centauri Honey is harvested from bee colonies located in the wild Alps of Turkey’s mountainous region, approximately 2,500 meters above the Black Sea. The

bees live in caves far from human settlements and other bees, and they have access to medicinal endemic blooms throughout the year.

The aim of this work was to investigate the quality, physicochemical, nutritional parameters, and bioactivity of honey. The quality and physicochemical parameters was analysed by colour, moisture content, conductivity, pH and acidity, 5-HMF (5-Hydroxymethylfurfural), diastase index and proline. The nutritional values were determined assessing ash, protein content, sugars, carbohydrates and energy. The biological activity was evaluated through the antioxidant, antimicrobial activity (broth microdilution method) and cytotoxicity in cell lines (AGS, CaCo-2, MCF-7, NCI-H460, PLP2, HFF-2, and HaCat), and anti-inflammatory activity (using RAW 264.7 macrophages).

Further studies are ongoing to scientifically validate the medicinal properties of Centauri Honey due to its exceptional chemical composition and thus to become an innovative Ingredient.

Conflict of Interest The authors declare no conflict of interest.

P-081 A study on the triterpenoid constituents in *Erica Erigena*

Authors Khadijah Jabal^{1, 2}, John Walsh¹

Institutes 1 School of Pharmacy and Pharmaceutical Science, Trinity College Dublin, Dublin 2, Ireland; 2 Department of Pharmacognosy, Faculty of Pharmacy, Umm Al-Qura University, Makkah, Saudi Arabia

DOI 10.1055/s-0043-1773965

E. erigena (Ericaceae), formerly known as 'Mediterranean heath' and as 'Irish heath', is an interesting plant with a limited geographical distribution [1]. As this plant is somewhat underexplored phytochemically, the present study focused on determination of the triterpene constituents in the ethyl acetate extract of *E. erigena* by GC-MS and NMR. The principal triterpenoids identified in free form were α -amyrin, β -amyrin, lupeol, oleanolic acid, micromeric acid and ursolic acid. The minor constituents present included α -amyrenone, β -amyrenone, lupenone, erythrodiol, uvaol, betulin, ursolic aldehyde, stigmasterol and β -sitosterol. Interestingly of those conjugated to fatty acids, determined after hydrolysis, β -amyrin was particularly dominant together with lupeol and α -amyrin. The same correlation was noted for the triterpenes conjugated to coumaric acid where these conjugates existed as a rapidly equilibrating mixture of cis/trans isomers. Quantification of the triterpenoids present in *E. erigena*, leaves and flowers, was conducted using reference standards, where available, and using lithocholic acid as internal standard. Coumaroyl triterpenes and micromeric acid have not been reported previously from plants in the Ericaceae family where in general, micromeric acid has shown a very limited distribution in the plant kingdom.

Conflict of Interest The authors declare no conflict of interest.

References

[1] Nelson EC. 905. *Erica erigena*. *Curtis's Botanical Magazine* 2019; 36 (1): 32–45

P-082 Reinvestigation of Phenolic Glycosides of *Solanum Glaucophyllum* Desf.

Authors Sabrina Autzen¹, Thomas Heymann², Marcus A. Glomb²

Institutes 1 Herbonis Animal Health, Augst, Switzerland; 2 Martin-Luther-University Halle-Wittenberg, Halle, Germany

DOI 10.1055/s-0043-1773966

The current study is primarily aimed at reinvestigating the flavonoid glycoside composition of *Solanum glaucophyllum* Desf. (SG). Only a few substances were described in the literature. The analysis of glycosidic compounds of SG is a focus of interest to improve the understanding of glycosylation patterns. Probably these results will help in isolation and determination of 1,25-dihydroxycholecalciferol (1,25(OH)₂D₃) derivatives. Up to now, only two glycosides of 1,25(OH)₂D₃ were discussed in the literature while a much more complex

situation is expected. We have discovered in SG via size-exclusion chromatography, up to more than 10 sugar units could be bound.

Acidic hydrolyses of a crude leaf extract (acetone/water) and subsequent analyses by HPLC-DAD revealed that almost solely quercetin derivatives were present in SG (>95%). Preparative reverse phase chromatography using water/methanol as mobile phase allowed isolation of 3 pure flavonoid-glycosides that were unequivocally identified as isoquercitrin (A), rutin (B) and quercetin-3-O-apiosylrutinoside (C) via HRMS and 1D-/2D-NMR. All structures were known from the literature and occurred in a ratio of 0.4/1.0/0.4 (A/B/C). Moreover, small amounts (<5% of total flavonoids at 350 nm) of more polar quercetin derivatives were observed. One of them is supposed to be quercetin-3-O-rutinoside-7-O-glucoside (D) which is described for the first time in SG (► Fig. 1).

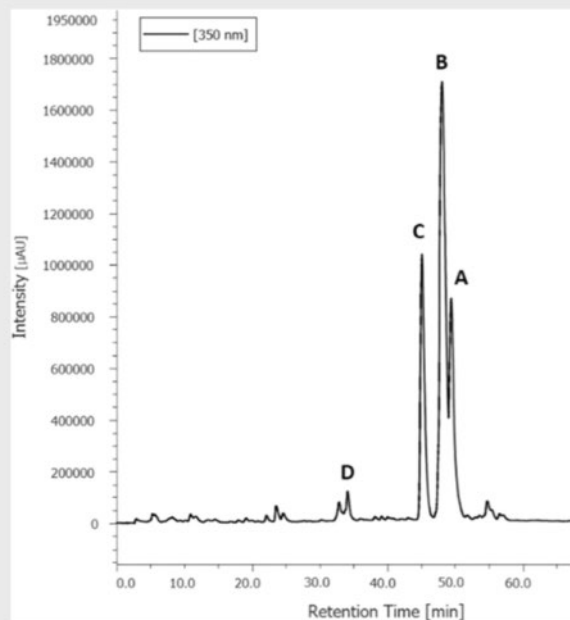

► **Fig. 1** HPLC-DAD chromatogram of *Solanum glaucophyllum* extract at 350 nm.

In summary, glycosylation of quercetin in SG is solely based on glucose, rhamnose and apiose. This finding will help in the determination of the more complex glycosidic pattern of 1,25(OH)₂D₃.

Conflict of Interest SA is an employee of Herbonis.

Funding This project was funded by Herbonis.

P-083 Flavonoids and a chromone from the twigs of *Cynometra cauliflora* Linn.

Authors Nik Nik Azmin^{1, 2}, Norizan Ahmat^{1, 2}, Aisyah Salihah Kamarozaman^{1, 2, 3}, M.Sulaiman M. Johari^{2, 3}, Noorzilina Adnan^{1, 2, 3}, Sabiha Hanim Saleh²

Institutes 1 Centre of Foundation Studies, Universiti Teknologi MARA, Cawangan Selangor, Kampus Dengkil, 43800 Dengkil, Malaysia; 2 Faculty of Applied Sciences, Universiti Teknologi MARA, 40450 Shah Alam, Malaysia; 3 Atta-ur-Rahman Institute for Natural Product Discovery, Universiti Teknologi MARA, Cawangan Selangor, Kampus Puncak Alam, 42300 Bandar Puncak Alam, Malaysia

DOI 10.1055/s-0043-1773967

Cynometra cauliflora Linn., a member of the bean family Fabaceae, with the vernacular name Nam-nam, was believed to be native to Malaysia and cultivated in Indonesia and India [1]. *C. cauliflora* is a small, much-branched perennial

tree growing up to 5m tall. It is a typical underutilized fruit tree. This plant was used as traditional folk medicine in treating several diseases and is also cultivated as an ornamental plant in villages [2]. This study focused on investigating the constituents from the twigs part of this plant. The extraction and isolation of the acetone extract of *C. cauliflora* Linn. twigs by a combination of a repetitive radial and preparative thin layer (pTLC) chromatographic techniques have successfully yielded nine pure compounds which consist of eight flavonoids; naringenin (1), eriodictyol (2), luteolin (3), luteolin-3',5-dimethyl ether (4), acacetin (5), 3',4',7-trihydroxyflavone (6), 4',7-dihydroxyflavone (7) and apigenin (8) and one chromone known as 5,7-dihydroxychromone (9) (► Fig. 1). The structures of these compounds were determined and confirmed on the basis of analysis of spectral evidence and comparison with the published data.

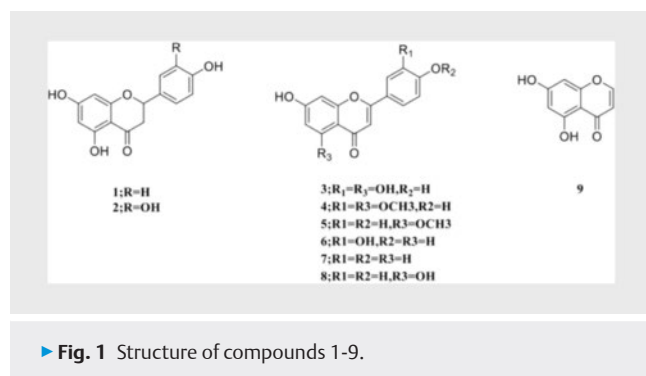

Compound 7 showed good PGE2 inhibitory activity with an IC₅₀ value of 3.39 μM as compared to standard indomethacin with an IC₅₀ of 1.29 μM.

Funding Fundamental Research Grant Scheme: FRGS/1/2021/STG04/UITM/01/1, Ministry of Higher Education, Malaysia.

Conflict of Interest The authors declare no conflict of interest.

References

- [1] Seidemann J. World spice plants. Springer; Berlin-Heidelberg: 2005 131:
- [2] Ikram E.H.K., Eng K.H., Jalil A.M.M., Ismail A., Idris S., Azlan A., Mokhtar R.A.M. Antioxidant capacity and total phenolic content of Malaysian underutilized fruits. Journal of Food Composition and Analysis 2009; 22 (5): 388–393

P-084 Stilbenoid compounds from the lianas of *Gnetum microcarpum*

Authors Nik Nik Azmin^{1,2}, Norizan Ahmat^{1,2}, Aisyah Salihah Kamarozaman^{1,2,3}, M.Sulaiman M. Johari^{2,3}, Noorazlina Adnan^{1,2,3}, Sabiha Hanim Saleh²

Institutes 1 Centre of Foundation Studies, Universiti Teknologi MARA, Cawangan Selangor, Kampus Dengkil, 43800, Dengkil, Malaysia; 2 Faculty of Applied Sciences, Universiti Teknologi MARA, 40450 Shah Alam, Malaysia; 3 Atta-ur-Rahman Institute for Natural Product Discovery, Universiti Teknologi MARA, Cawangan Selangor, Kampus Puncak Alam, 42300 Puncak Alam, Malaysia
DOI 10.1055/s-0043-1773968

The plants of Gnetaceae with its sole genus, *Gnetum*, are known to contain oligostilbenoids and have been ethnobotanically used in the folk treatment of arthritis, bronchitis and asthma. About 30 to 40 *Gnetum* species are found in the tropical lowlands of the world, from northeastern South America, tropical West Africa, and south China to Southeast Asia. Previously, many studies have been done on several species of *Gnetum* which revealed various stilbenes and oligostilbenes, some of which have multiple bioactivities such as antioxidant, anti-inflammatory, antitumour and so on. In our search for structurally and biologically interesting compounds from tropical plants found in Malaysia, the lianas of *Gnetum microcarpum* have been investigated. *Gnetum microcarpum*

Blume grows in Malaysia and the phytochemical investigation of this plant has never been reported. The acetone extract of the lianas of this plant, when subjected to various chromatographic techniques, has led to the isolation of five known stilbenes, which are; isorhapontigenin (1), cuspidan B (2), gnetifolin M (3), parvifolol D (4) and malaysianol D (5) as shown in ► Fig. 1. The structures were determined using spectroscopic techniques of 1D and 2D NMR, and MS and the known compounds were readily identified by comparison of physical and spectroscopic data with previous values from the literature.

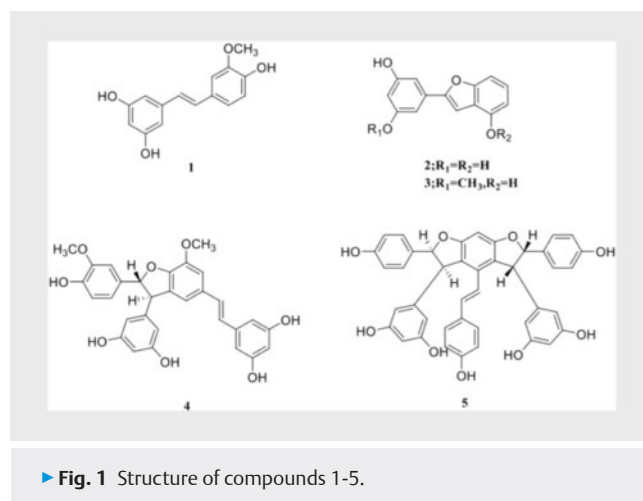

Funding Fundamental Research Grant Scheme: FRGS/1/2021/STG04/UITM/01/1, Ministry of Higher Education, Malaysia. Faculty of Applied Sciences and Atta-ur-Rahman Institute for Natural Product Discovery, Universiti Teknologi MARA for providing the research facilities.

Conflict of Interest The authors declare no conflict of interest.

P-085 Isolation and elucidation of flavonoid constituents from the twigs of *Bouea oppositifolia* (Roxb.) Meisn.

Authors Nik Fatini Nik Azmin^{1,2}, Norizan Ahmat^{1,2}, Noorazlina Adnan^{1,2,3}, Aisyah salihah Kamarozaman^{1,2,3}, M.Sulaiman M. Johari^{1,2,3}, Aiza Harun⁴

Institutes 1 Centre of Foundation Studies, Universiti Teknologi MARA, Cawangan Selangor, Kampus Dengkil, 43800 Dengkil, Malaysia; 2 Faculty of Applied Sciences, Universiti Teknologi MARA, 40450 Shah Alam, Malaysia; 3 Atta-ur-Rahman Institute for Natural Product Discovery, Universiti Teknologi MARA, Cawangan Selangor, Kampus Puncak Alam, 42300 Bandar Puncak Alam, Malaysia; 4 Faculty of Applied Sciences, Universiti Teknologi MARA, Cawangan Pahang, Lintasan Semarak, Bandar Tun Abdul Razak, 26400 Jengka, Malaysia
DOI 10.1055/s-0043-1773969

Bouea oppositifolia (Roxb.) Meisn., commonly known as Burmese or Marian plum from the family of Anacardiaceae, is an erect, evergreen, perennial tree which grows up to 32 m high with a trunk diameter of 75 cm and grey-green light brown to purple-brown fissured bark [1]. The species is indigenous to Southern China, Indochina, Myanmar, Thailand, Andaman Islands, the Malay Peninsula, Sumatra and Java; Borneo. The taxon of *B. oppositifolia*, is an extremely rare wild mango [2]. Traditionally, the leaf, root and fruit parts of this plant are used for their anticephalalgia, antifebrile and expectorant activities [3]. The investigation of the secondary metabolites from the twigs part of *B. oppositifolia* using vacuum liquid chromatography and repetitive radial chromatography techniques successfully led to the isolation of nine known flavonoid constituents

► **Fig. 1** which consist of four flavanones which are eriodictyol (**1**), naringenin (**2**), liquiritigenin (**3**) and butin (**4**), one chalcone, isoliquiritigenin (**5**), three flavanols, taxifolin (**6**), garbanzol (**7**), fustin (**8**) and one aurone, sulfuretin (**9**). The structures of the compounds were determined on the basis of analysis of spectral evidence and comparison with the published data. These compounds were isolated for the first time from this plant.

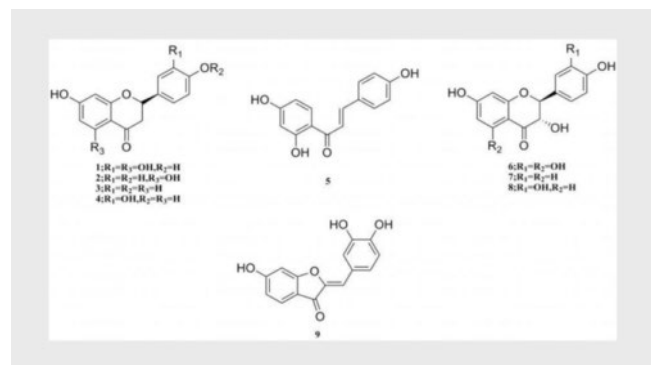

► **Fig. 1** Structure of compounds 1-9.

Funding Fundamental Research Grant Scheme: FRGS/1/2022/STG04/UITM/02/24, Ministry of Higher Education, Malaysia.

Conflict of Interest The authors declare no conflict of interest.

References

- [1] Seidemann J. World spice plants. Springer; Berlin-Heidelberg: 2005 131:
 [2] Ikram E.H.K., Eng K.H., Jalil A.M.M., Ismail A., Idris S., Azlan A., Mokhtar R.A.M. Antioxidant capacity and total phenolic content of Malaysian underutilized fruits. Journal of Food Composition and Analysis 2009; 22 (5): 388–393

P-086 Chemical Constituents from the Leaves of *Macaranga heynei* I.M. Johnson (Euphorbiaceae)

Authors Aisyah Salihah Kamarozaman^{1,2}, Norizan Ahmat¹, Noorzilina Adnan^{1,2,3}, Abu Zar Muhamad³, Muhammad Mohd Johari^{2,3}, Nik Nik Azmin³

Institutes 1 Centre of Foundation Studies, Universiti Teknologi MARA, Cawangan Selangor, Kampus Dengkil, 43800 Dengkil, Selangor, Malaysia; 2 Atta-ur-Rahman Institute for Natural Product Discovery, Universiti Teknologi MARA, Cawangan Selangor, Kampus Puncak Alam, 42300 Bandar Puncak Alam, Selangor, Malaysia; 3 Faculty of Applied Sciences, Universiti Teknologi MARA, 40450 Shah Alam, Selangor, Malaysia
 DOI 10.1055/s-0043-1773970

Prenylated flavonoids, stilbenoids and terpenoids are abundantly found in the genus of *Macaranga*, which belongs to the Euphorbiaceae family. This genus has been traditionally used to alleviate chest and hypochondrium pain. In 2018 and 2019, we have reported the discovery of four new compounds and three known compounds from *Macaranga heynei* which demonstrated significant activity on anticholinesterase and DPPH radical scavenging. Hence, an extensive investigation was carried out on this species to purify other chemical constituents with promising bioactivities. Two kilograms of *M. heynei* leaves were macerated in methanol for 24 hours at room temperature to obtain a crude methanolic extract (300 g). The crude extract was dissolved in 80% methanol:20% water, and partitioned with n-hexane and ethyl acetate. The crude ethyl acetate extract (150 g) was fractionated using vacuum liquid chromatography (VLC) with n-hexane:ethyl acetate gradient to give seven fractions (MH1-7). Fraction MH2 (360 mg) was subjected to column chromatography (CC) using the eluent chloroform:ethyl acetate in ascending polarity to afford a pure

compound (**1**) (54.7 mg). Two pure compounds, (**2**) (4.0 mg) and (**3**) (0.5 mg), were obtained from fraction MH3 (11 g) after fractionation and purification using VLC (n-hexane:ethyl acetate), sephadex, radial chromatography and CC (chloroform:ethyl acetate). Based on the spectroscopic analyses and comparison with the literature data, the compounds were elucidated as macarubiginosin B (**1**) and two new compounds Y (**2**) and Z (**3**) (► **Fig. 1**).

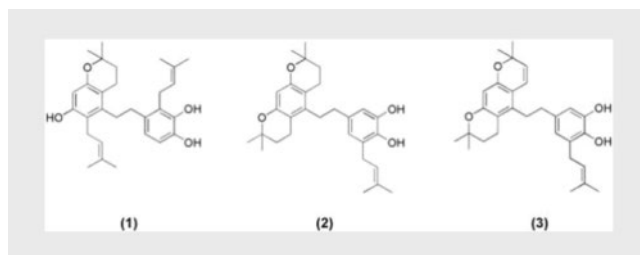

► **Fig. 1** Structure of compounds 1-3.

Funding This research is funded under Fundamental Research Grant Scheme (FRGS/1/2021/STG04/UITM/01/1).

Conflict of Interest The authors declare no conflict of interest.

P-087 Isolation of Phenolic Compounds from the Stem Bark of *Anisoptera laevis* (Dipterocarpaceae)

Authors Noorzilina Adnan^{1,2}, Aisyah Salihah Kamarozaman^{1,2}, Nurulfazlina Edayah Rasol^{2,3}, Norizan Ahmat¹, Siti Zakirah Azahar³, Muhammad Mohd Johari^{2,3}

Institutes 1 Centre of Foundation Studies, Universiti Teknologi MARA, Cawangan Selangor, Kampus Dengkil, 43800 Dengkil, Selangor, Malaysia; 2 Atta-ur-Rahman Institute for Natural Product Discovery, Universiti Teknologi MARA, Cawangan Selangor, Kampus Puncak Alam, 42300 Bandar Puncak Alam, Selangor, Malaysia; 3 Faculty of Applied Sciences, Universiti Teknologi MARA, 40450 Shah Alam, Selangor, Malaysia
 DOI 10.1055/s-0043-1773971

Anisoptera is a minor genus of Dipterocarpaceae, with 10 species that are extensively spread in Malaysia and Indonesia. The members of this genus contain rich sources of oligostilbenoids such as dimer and tetramer stilbenoids which were identified to have potential antiviral and antioxidant activities. Nevertheless, only four species of this genus have isolation reports. Herein, *A. laevis* was selected to be phytochemically investigated in order to develop a chemical profile of this species. The powder from the stem bark of *A. laevis* (900 g) was macerated in acetone at room temperature for 24 hours and repeated three times. The crude acetone extract (65 g) obtained was fractionated by vacuum liquid chromatography (VLC) with the eluent n-hexane-ethyl acetate in increasing polarity resulting in eight semi-purified fractions (AL1-8). Fraction AL2 (620 mg) was purified by column chromatography (CC) with the solvent system of n-hexane-ethyl acetate to afford a pure compound **1** (8.9 mg). Compound **2** (8.5 mg) was isolated from fraction AL3 (940 mg) using CC (chloroform:methanol). The purification of fraction AL4 (1 g) using CC (chloroform:methanol) yielded compound **3** (205 mg). Based on Nuclear Magnetic Resonance (NMR), Fourier Transform Infrared Spectroscopy (FTIR), Ultraviolet-Visible (UV-Vis) and comparison with literature data, the isolates were determined as pentadecyl ferulate (**1**), p-hydroxybenzaldehyde (**2**), and vaticanol B (**3**) (► **Fig. 1**).

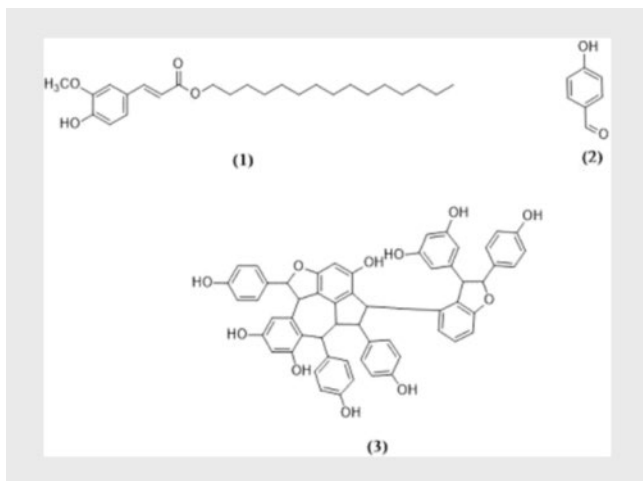

► Fig. 1 Structure of compounds 1-3.

Funding We would like to express our greatest appreciation to Universiti Teknologi MARA, Malaysia for the financial support [600-RMC/SRC/5/3(025/2020)].

Conflict of Interest The authors declare that there is no conflict of interest.

P-088 Phytochemical Study from *Hopea pubescens* Ridl. (Dipterocarpaceae)

Authors Muhammad Mohd Johari^{1,2}, Norizan Ahmat³, Fatimah Salim^{1,2}, Noorazlina Adnan^{1,2,3}, Nik Nik Azmin¹, Aisyah Salihah Kamarozaman^{2,3}

Institutes 1 Faculty of Applied Sciences, Universiti Teknologi MARA, 40450 Shah Alam, Selangor, Malaysia; 2 Atta-ur-Rahman Institute for Natural Product Discovery, Universiti Teknologi MARA, Cawangan Selangor, Kampus Puncak Alam, 42300 Bandar Puncak Alam, Selangor, Malaysia; 3 Centre of Foundation Studies, Universiti Teknologi MARA, Cawangan Selangor, Kampus Dengkil, 43800 Dengkil, Selangor, Malaysia

DOI 10.1055/s-0043-1773972

Hopea belongs to the Dipterocarpaceae family, which consists of 104 species. Peninsular Malaysia is home to the indigenous species *Hopea pubescens*, also referred to as Merawan Bunga. This genus is known for its potential as an antimicrobial, anti-inflammatory and therapeutic agent. The first study on *H. pubescens* resins has discovered four dammerane-type triterpenes. Thus, a phytochemical study of the stem bark of *H. pubescens* was carried out as part of the ongoing search for active components with medicinal potential in *Hopea*. The stem bark of *H. pubescens* was dried and ground into granules (2.25 kg). The granules were macerated in acetone at room temperature for 24 hours to yield crude acetone extract (25 g). Fractionation of the crude extract was executed using vacuum liquid chromatography with the mixture of n-hexane:ethyl acetate to give six fractions. Compound 1 (128 mg), a solid white precipitate, was obtained from the washing technique of fraction 1 (1.3 g) which displayed two distinct layers. Fraction 3 (4.5 g) was further purified using column chromatography with the eluent n-hexane:ethyl acetate to afford compound 2 (2 mg). The spectroscopic analyses and literature data revealed that the pure compounds are triterpene and ferulic acid derivatives, namely lupeol (1) and pentadecyl ferulate (2) respectively (► Fig. 1). These two constituents were the first to be isolated from this species.

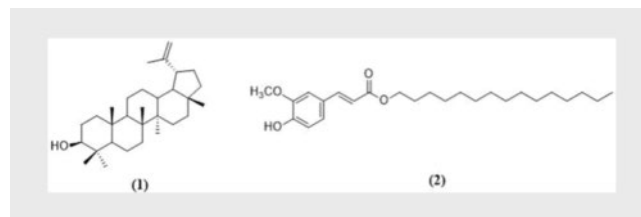

► Fig. 1 Structure of compounds 1-2.

Funding We would like to express our greatest appreciation to the Ministry of Higher Education, Malaysia, for the financial support (FRGS/1/2022/STG04/UITM/02/24).

Conflict of Interest The authors declare no conflict of interest.

P-089 Trimer Stilbenoids from *Shorea materialis* Ridl. (Dipterocarpaceae)

Authors Muhammad Mohd Johari^{1,2}, Norizan Ahmat³, Fatimah Salim^{1,2}, Noorazlina Adnan^{1,2,3}, Nik Nik Azmin¹, Aisyah Salihah Kamarozaman^{2,3}

Institutes 1 Faculty of Applied Sciences, Universiti Teknologi MARA, 40450 Shah Alam, Malaysia; 2 Atta-ur-Rahman Institute for Natural Product Discovery, Universiti Teknologi MARA, Cawangan Selangor, Kampus Puncak Alam, 42300 Bandar Puncak Alam, Malaysia; 3 Centre of Foundation Studies, Universiti Teknologi MARA, Cawangan Selangor, Kampus Dengkil, 43800 Dengkil, Malaysia

DOI 10.1055/s-0043-1773973

Shorea, a genus in the family of Dipterocarpaceae, is a notable source of oligostilbenoids with various degrees of polymerisation, including monomers, dimers, trimers and tetramers which possess significant biological actions. *Shorea materialis*, also known as Balau Pasir, grows primarily in swampy habitats in Pahang, Perak, Terengganu's coast and Johor. In continuing to discover active constituents with therapeutic potential from *Shorea*, a phytochemical study on the stem bark of *Shorea materialis* was conducted. The stem bark of *S. materialis* was dried and ground into powder (1 kg). The powder was macerated in acetone at room temperature for 24 hours to yield crude acetone extract (117 g). Using the eluent of n-hexane:ethyl acetate by vacuum liquid chromatography, eight fractions were produced from the fractionation of the crude extract. Fraction 5 (26 g) was fractionated twice, followed by purification using column chromatography (CC) with the eluent chloroform:methanol, which yielded compounds 1 (8 mg) and 2 (4 mg). Compound 3 (5 mg) was obtained from fraction 6 (568 mg) using CC with the same solvent system. The spectroscopic analyses and literature data revealed that the pure compounds are trimer stilbenoids, known as (+)-alpha-viniferin (1), hopeanolin (2) and davidiol A (3) (► Fig. 1). These compounds have been reported from other species for their antiproliferative, antioxidant and antibacterial properties. Notably, this is the first report of these chemical constituents in this species.

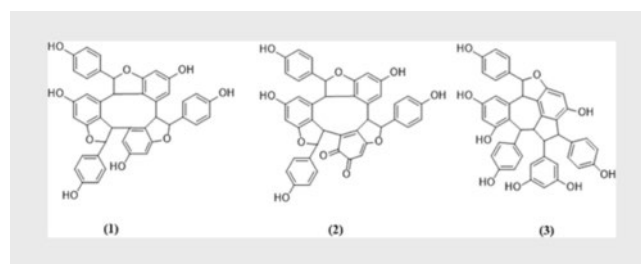

► Fig. 1 Structure of compounds 1-3.

Funding We appreciate the funding provided by University Teknologi MARA [600-UITMSEL (Pl. 5/4) (127/2022)].

Conflict of Interest The authors declare no conflict of interest.

P-090 Resveratrol Oligomers from the Twigs of *Neobalanocarpus heimii* (King) P.S. Ashton (Dipterocarpaceae)

Authors Nurul Shahira Zakaria¹, Norizan Ahmat², Noorazlina Adnan^{1,2,3}, Nik Nik Azmin¹, Farah Izzati Azman¹, NorulNazilah Ab'lah², Syafiqah Saidin⁴, Aisyah Salihah Kamarozaman^{2,3}

Institutes 1 Faculty of Applied Sciences, Universiti Teknologi MARA, 40450 Shah Alam, Malaysia; 2 Centre of Foundation Studies, Universiti Teknologi MARA, Cawangan Selangor, Kampus Dengkil, 43800 Dengkil, Malaysia; 3 Atta-ur-Rahman Institute for Natural Product Discovery, Universiti Teknologi MARA, Cawangan Selangor, Kampus Puncak Alam, 42300 Bandar Puncak Alam, Malaysia; 4 IJN-UTM Cardiovascular Engineering Centre, Institute for Human Centred Engineering, Universiti Teknologi Malaysia, 81310 UTM Johor Bahru, Malaysia

DOI 10.1055/s-0043-1773974

Neobalanocarpus heimii is a monotypic genus belonging to the Dipterocarpaceae family and mainly has native distribution in Peninsular Malaysia and southern Thailand. As the number one heavy hardwood in Malaysia, this plant is famous in the timber industry, furniture making, boat building and heavy construction. Previous studies reported that *N. heimii* has a rich source of resveratrol oligomers including dimers, trimers and tetramers. Additionally, its crude extract was found to have antimicrobial and antifungal properties. Due to its specialty, a phytochemical study on the twigs of *N. heimii* was conducted. The granulated twigs (500 g) from *N. heimii* were extracted in methanol for 24 hours at room temperature to yield crude methanolic extract (150 g). The crude extract was subjected to fractionation using vacuum liquid chromatography (VLC) with n-hexane:ethyl acetate eluent to give six fractions (NH1-6). Fraction NH2 (537 mg) was purified using column chromatography with the solvent system chloroform:methanol in increasing polarity, yielding two pure compounds, **1** (51 mg) and **2** (51 mg). In addition, the purification of fraction NH4 (1 g) using the same method afforded compound **3** (119 mg). Based on the spectra and comparison with the published data, the pure compounds were elucidated as resveratrol monomer, trans-resveratrol (**1**) as well as two resveratrol dimers, (-)-epi-lon-viniferin (**2**) and ampelopsin A (**3**) (► Fig. 1).

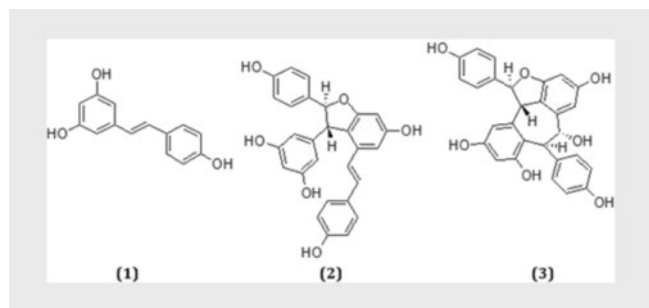

► Fig. 1 Structure of compounds 1-3.

Funding We would like to express our gratitude to Universiti Teknologi MARA, Malaysia for the financial support [600-UITMSEL (Pl. 5/4) (025/2022)].

Conflict of Interest The authors declare no conflict of interest.

P-091 Chemical Constituents from the Stem Bark of Malaysian *Shorea pauciflora* King (Dipterocarpaceae)

Authors Nik Nik Azmin¹, Aisyah Salihah Kamarozaman^{2,3}, Norizan Ahmat², Noorazlina Adnan^{1,2,3}, Muhammad Mohd Johari^{1,3}

Institutes 1 Faculty of Applied Sciences, Universiti Teknologi MARA, 40450 Shah Alam, Malaysia; 2 Centre of Foundation Studies, Universiti Teknologi MARA, Cawangan Selangor, Kampus Dengkil, 43800 Dengkil, Malaysia; 3 Atta-ur-Rahman Institute for Natural Product Discovery, Universiti Teknologi MARA, Cawangan Selangor, Kampus Puncak Alam, 42300 Bandar Puncak Alam, Malaysia

DOI 10.1055/s-0043-1773975

Shorea, also known as Meranti, is the largest genus in the Dipterocarpaceae family with over 150 species worldwide and is found throughout Malaysia, India, Indonesia and Philippines, mostly in Borneo, Sumatra, Peninsular Malaysia and Intermediate Island. *Shorea pauciflora*, a species in this genus known as dark red meranti or red lauan, was discovered in Sumatra, Peninsular Malaysia and Singapore. Thus far, no research has been conducted on its phytochemistry or biological activity. However, resveratrol oligomers isolated from *Shorea* species demonstrated anticancer, antimicrobial and antiviral activities. In this work,

1.4 kg of powdered stem bark from *S. pauciflora* was macerated in acetone at room temperature for 24 hours. The crude acetone extract (148 g) obtained was fractionated using vacuum liquid chromatography with n-hexane:ethyl acetate as the solvent system affording 10 fractions. Fraction 5 (423 mg) was further purified by column chromatography using a solvent system of chloroform:methanol to yield three compounds: trans-diptoindonesin B (**1**) (9.5 mg), viniferal (**2**) (11.2 mg) and 5,7-dihydroxycoumarin (**3**) (5.4 mg) (► Fig. 1). The structures of these compounds were elucidated by analysing spectrum evidence and comparing them to previously published data. To the best of our knowledge, this is the first report of viniferal (**2**) and 5,7-dihydroxycoumarin (**3**) in the Dipterocarpaceae family.

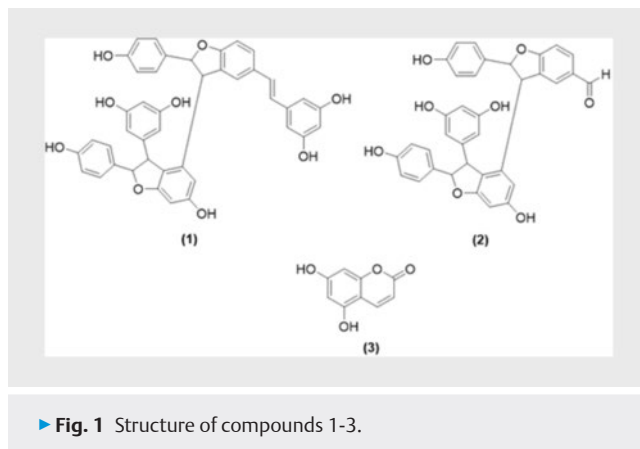

► Fig. 1 Structure of compounds 1-3.

Funding We would like to express our greatest appreciation to the Ministry of Higher Education, Malaysia for the financial support (FRGS/1/2022/STG04/UITM/02/24).

Conflict of Interest The authors declare no conflict of interest.

P-092 Investigation of different *Tripleurospermum* taxa from Greece: comparison by GC-MS and LC-HRMS

Authors Christodoulos Anagnostou¹, Eleni Mikropoulou¹, Sofia Mitakou¹, Maria Halabalaki¹, Eleftherios Kalpoutzakis¹

Institute 1 Division of Pharmacognosy and Natural Products Chemistry, Department of Pharmacy, National and Kapodistrian University of Athens, Athens, Greece

DOI 10.1055/s-0043-1773976

The genus *Tripleurospermum* (L.) Sch.Bip, Asteraceae, comprises 30 to 40 species and is distributed in the Northern Hemisphere, mainly in North America, Europe, temperate Asia and North Africa. In Greece, 7 taxa have been reported, with some of them only encountered in specific areas of the country. The current work describes the phytochemical investigation, using modern analytical techniques, of *T. rosellum* collected from two localities in Greece (Lesvos and Mt. Parnon) and *T. tempuskyanum*[1]. GC-MS was applied for the analysis of the nonpolar extracts and the essential oils, revealing significant similarities between the major constituents, specifically their high concentration in matri-caria ester. Digging further into the variation and distribution of minor volatile compounds, HCA analysis disclosed distinct compound-biomarkers attributed to each taxon. On the other hand, medium and high polarity extracts were analysed by means of UPLC- Orbitrap-HRMS/MS, whereby 290 compounds were determined and more than 200 tentatively identified, belonging mainly to the classes of hydroxycinnamates, flavonoids and fatty acids. Consequently, the data were subjected to multivariate analysis (MVA), to underline marker compounds distinct to each taxon. Despite the evident similarities in the extracts' phytochemical profiles, both qualitative and quantitative differences were observed for the studied species and localities.

Funding ERDF, "RESEARCH-CREATE-INNOVATE", CosmAGE (project code T2EAK-02583)

Conflict of Interest The authors declare no conflict of interest.

References

[1] Oberprieler C et al. Willdenowia 2007; 37: 89

P-093 Domestication and breeding of *Artemisia absinthium* strains: discriminating between genetics and environmental factors determining their thujone content

Authors Hendrick Vermeulen¹, Nicolas Delabays¹

Institute 1 Institute Earth-nature-environment, Hepia, University of Applied Sciences and Arts of Western Switzerland, CH-1254 Jussy, Switzerland

DOI 10.1055/s-0043-1773977

Wormwood (*Artemisia absinthium* L.) is a well-known medicinal and aromatic plant, used notably for the production of famous aperitif drinks. The chemical composition of the raw plant material, especially its content of α -thujone and β -thujone, is important in order to assure high quality standard of the final product, as well as to respect legal requirements. Therefore, the agricultural production of selected lines is justified. Today, the species is still at a very early stage of its domestication process, and the genetic and environmental parts of the variations observed in the phytochemical profile of plants from different origins are still poorly documented.

To discriminate between the effects of genetic and environmental factors on thujone content, explants from 2 genotypes, selected in two different populations, were produced by in vitro micropropagation. The two batches of genetically homogeneous plants thus obtained were planted in four stations with variable environmental conditions. Plants were harvested in mid-July and their α -thujone and β -thujone contents analysed by GC-MS (gas chromatography – mass spectrometry).

A two-way ANOVA applied to α -thujone and β -thujone contents show that α -thujone content appears to be partially influenced by genotype and also by environmental conditions, while β -thujone content seems to be mostly influenced by the genotype. Other trials carried out with other strains issued from seeds, planted in various geographic locations, gave similar results. A new campaign of harvesting and analysis of samples is planned in 2023 to investigate influences of these variables on more secondary metabolites.

Conflict of Interest The authors declare no conflict of interest.

P-094 Prenylated acylphloroglucinols from *Hypericum tetrapterum*

Authors Julia Brunner¹, Andrija Smelcerovic², Jörg Heilmann¹

Institutes 1 Department for Pharmaceutical Biology, University of Regensburg, 93053 Regensburg, Germany; **2** Department of Chemistry, Faculty of Medicine, University of Nis, 1800 Nis, Serbia

DOI 10.1055/s-0043-1773978

The genus *Hypericum* L. (Hypericaceae) comprises about 500 species and is almost spread worldwide, avoiding only zones of extreme aridity, temperature and/or salinity. Acylphloroglucinols are an abundant class of secondary metabolites with hyperforin being a prominent representative occurring in *H. perforatum* (► Fig. 1) L. and several other *Hypericum* species.

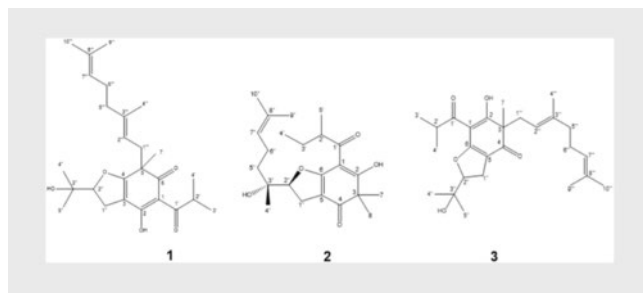

► Fig. 1 Structures of prenylated acylphloroglucinols from *Hypericum tetrapterum* Fr.

Besides their antibacterial effects, the extracts of *H. perforatum* show anti-depressive, antiviral, anti-inflammatory and anti-tumoural activity.

Hypericum tetrapterum Fr. is a perennial herb with a four-winged stem and a congested inflorescence of small yellow flowers. It is native to Europe, Western Asia and North Africa. To date, the chemical profile of the plant, particularly the composition of prenylated acylphloroglucinols is mostly unknown. For the isolation of acylphloroglucinols based on ¹H-NMR-guided fractionation a petroleum ether extract was obtained from the dried aerial parts of *H. tetrapterum*. The structures of three isolates were elucidated by ¹H-, ¹³C- and 2D NMR (HSQC, HMBC, NOESY, COSY) spectroscopy as well as on data derived from mass spectrometry. Optical characterisation was performed by polarimetry and circular dichroism. The compounds obtained are prenylated bicyclic acylphloroglucinols with furanone skeletons which are described here for the first time. The compounds will be evaluated for anti-bacterial, cytotoxic and anti-angiogenic activity. Isolation and structure elucidation of further acylphloroglucinols from *H. tetrapterum* Fr. is in progress.

P-095 Phytochemical study and biological evaluation of *Sideritis* species growing in Greece

Authors Marianna Vanioti¹, Aikaterini Argyropoulou¹, Nikos Adamopoulos², Alexios Leandros Skaltsounis³

Institutes 1 PharmaGnose S.A., 57th km Athens-Lamia National Road, 32011, Oinofyta, Greece; **2** Galenica SA, 14564, Kifisia, Greece; **3** Division of Pharmacognosy and Natural Products Chemistry, Department of Pharmacy, National and Kapodistrian University of Athens, Panepistimioupoli, Zografou, 15771, Athens, Greece

DOI 10.1055/s-0043-1773979

The need for healthy and effective products is nowadays accompanied with environmental awareness. This "green" approach drove a trend toward natural products (NPs). Greece, and especially the Southern part of the country, harvest the most diverse flora in Mediterranean [1, 2].

The current study investigates and highlights the unexploited richness and biodiversity of the Greek flora, focusing on species of the genus *Sideritis*. The chemical content of three *Sideritis* water extracts, specifically

S. scardica, *S. perfoliata* and *S. raeseri* was analysed and evaluated. The plant materials were dried, pulverised and water extracts were prepared. HPLC-DAD, HPTLC and LC-HRMS were used for analysis and chemical markers were identified. The extracts showed many similarities concerning their chemical profile and most differences were quantitative. Phenolic acids, like 5-caffeoylquinic acid and p-coumaric acid 4-O- glucoside and phenylethanoid glycosides, like forsythoside B and verbascoside were detected. The major metabolites of the extracts were acetylated flavonoid glycosides, such as isoscutellarein 7-O-[6'''-O-acetyl]-allosyl(1→2)glucoside, 4'-O-methylhypolaetin 7-O-[6'''-O-acetyl]-allosyl(1→2)glucoside and isoscutellarein 7-O-[6'''-O-acetyl]-allosyl(1→2)-[6'''-O-acetyl]-glucoside. The extracts were fractionated and purified with preparative column chromatography and prep-HPLC and the structures of the isolated compounds were identified with NMR. The extracts were evaluated for their antioxidant activity, showing IC₅₀ values in the DPPH assay less than 50 µg/ml. In conclusion, *Sideritis* species provide water extracts rich in bioactive constituents that can be used in the development of promising products.

Funding ESPA 2014-2022, SIDNEU, project code: ΣTEP1-0019461.

Conflict of Interest The authors declare no conflict of interest.

References

- [1] Sklirou A.D., Angelopoulou M.T., Argyropoulou A., Chaita E., Boka V.I., Cheimonidi C., Niforou K., Mavrogonatou E., Pratsinis H., Kalpoutzakis E., Aligiannis N., Kletsas D., Trougakos I.P., Skaltsounis A.L. *Antioxidants* 2021; 10: 1206
- [2] Aneva L., Zhelev P., Kozuharova E., Danova K., Nabavi S.F., Behzad S. *DARU J. Pharm. Sci* 2019; 27: 407–421

P-096 Pharmacological evaluation of *Cosmos sulphureus* Cav.

Authors Gabriela Avila-Villarreal^{1,2}, A. Berenice Aguilar-Guadarrama³, Samuel Estrada-Soto⁴, Irma-Martha Medina- Díaz¹

Institutes 1 Unidad Académica de Ciencias Químico Biológicas y Farmacéuticas, Universidad Autónoma de Nayarit, Tepic, México; 2 Centro Nayarita de Innovación y Transferencia de Tecnología “Unidad especializada en I+D+i en Calidad de Alimentos y Productos Naturales”, Universidad Autónoma de Nayarit, Tepic, México; 3 Centro de Investigaciones Químicas, IICBA, Universidad Autónoma del Estado de Morelos, Cuernavaca, Mexico; 4 Facultad de Farmacia, Universidad Autónoma del Estado de Morelos, Cuernavaca, Mexico

DOI 10.1055/s-0043-1773980

Plants are sources of potential bioactive compounds, in this context plants in the Asteraceae Family have been reported to contain a broad diversity of phenolic compounds, mostly flavonoids, which have a wide range of pharmacological activities. Edible flowers from *Cosmos sulphureus* Cav. have been used in some world regions due to its potential biological activities such as antioxidant, antidiabetic and anti-inflammatory activities [1]. Current work aimed to determine the phytochemical content of *C. sulphureus* and evaluate its pharmacological activity by in vitro and ex vivo models.

A hydroalcoholic extract (HE-Cs) from inflorescences was obtained by maceration. n-Hexane (Hxn), ethyl acetate (EtOAc) and butanol (BuOH) fractions were obtained by a liquid-liquid extraction from HE-Cs. Extract and fractions were evaluated in vitro for α-glucosidases inhibition, and vasorelaxant effect in an ex vivo model using isolated rat aortic rings precontracted with noradrenaline with and without endothelium. In vitro α-glucosidases inhibition assay showed significant inhibition for EtOAc (41 ± 0.6%) and BuOH (76.6 ± 1.03%) fractions contrasted with *Camelia sinensis* (96.3 ± 1.22%), a well characterised plant extract inhibitor of intestinal α-glucosidase enzymes.

As a result of the ex vivo evaluations, the EtOAc-Cs (E_{max} = 91.40%; EC₅₀ = 130.88 µg/mL) fractions showed the best vasorelaxant effect in a partially endothelium dependent manner (► Fig. 1). LC-MS chromatogram and mass spectrum analysis from EtOAc-Cs allowed us to tentatively identify apigenin, quercetin and chlorogenic acid. These results partially support the valuable potential attributed to *C. sulphureus*.

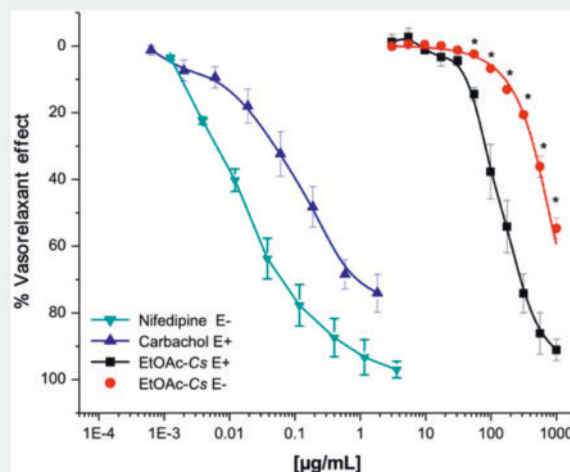

► **Fig. 1** The ex vivo vasorelaxant effect of the EtOAc-Cs extract of *C. sulphureus* inflorescences

References

- [1] Andrushchenko Olena The content of flavonoids in *Cosmos sulphureus*. *Plant Introduction* 2021; 83–88

P-097 Proanthocyanidines from EGb 761: pharmacological effect on learning and memory and oral bioavailability

Authors Markus Schmitt¹, Thomas Ganter¹, Gabriele Luderer¹, Sebastian Kraus¹, Heike Schneider¹, Simone Kaiser¹, Anna-Franziska Becker¹, Carla Sens-Albert¹, Sabrina Weisenburger¹, Žarko Kulić¹, D. Martin Lehner¹

Institute 1 Dr. Willmar Schwabe GmbH & Co. KG, Karlsruhe, Germany

DOI 10.1055/s-0043-1773981

EGb 761, a dry extract from *Ginkgo biloba* leaves, is used for the treatment of declining cognitive performance. The extract is adjusted to 22.0 – 27.0% flavonoids, 5.4 – 6.6% terpene lactones and contains 4.5 – 9.5% of proanthocyanidines (PAC) and less than 5 ppm ginkgolic acids. We recently reported first evidence of pharmacological activity of a PAC fraction isolated from EGb 761 [1]. In the present study, we aimed to further characterize the PAC fraction to identify PACs or associated metabolites linked to pharmacological activity. To this end, we assessed learning and memory in mice using the passive avoidance model. Metabolite profiles in plasma and brain of PAC-treated mice and from in-vitro gut microbiota experiments were examined by untargeted and targeted LC-(HR)-MS/MS. Our experiments revealed a dose-dependent amelioration of scopolamine induced amnesic effects by both EGb 761 and PAC. Whereas no (conjugated)-PAC monomers were detectable, we observed a dose-dependent increase in other metabolites in plasma and brain of PAC-treated animals. In addition, a potential relevance of gut microbiota for PAC metabolisation was suggested by formation of low molecular weight metabolites from the mostly polymeric PAC fraction in the in-vitro experiments.

In conclusion, a PAC fraction isolated from EGb 761 displays anti-amnesic effects in vivo that are probably mediated by strongly metabolised PAC rather than PAC monomers. Our results are consistent with the assumption that PACs contribute to the efficacy of EGb 761.

Conflict of Interest All authors are employees of Dr. Willmar Schwabe

References

- [1] Sens-Albert C. et al. *Planta Med* 2021; 87: PC5–1

P-098 Anti-osteoclastogenic activity of compounds from *Nelumbo nucifera* Gaertn.

Authors Ngoc Khanh Vu¹, Manh Tuan Ha¹, Jeong Ah Kim², Byung Sun Min¹

Institutes 1 Daegu Catholic University, Hayang-eup Hayang-ri, 13-13, Kyeongsan-si, South Korea; 2 College of Pharmacy, Research Institute of Pharmaceutical Sciences, Kyungpook National University, Daegu, South Korea

DOI 10.1055/s-0043-1773982

To obtain antiosteoclastogenic active compounds from the natural sources, 18 compounds were isolated from the leaves and stems of *Nelumbo nucifera* Gaertner (Nymphaeaceae). All the isolated compounds were examined for their antiosteoclastogenic activity. Preliminary results of the TRAP staining on RAW [1–2]

264.7 cells indicated that compounds **1** and **11** possess potential inhibitory effects on RANKL-induced osteoclast formation. Further bioassay investigation was carried out to reveal that compounds **1** and **11** suppressed RANKL-induced osteoclast formation in a concentration-dependent manner with inhibition up to 55% and 78% at concentrations of 10 μ M, respectively. The findings provided valuable insights for the discovery and structural modification of aporphine alkaloids as antiosteoclastogenic lead compounds (► **Fig. 1**).

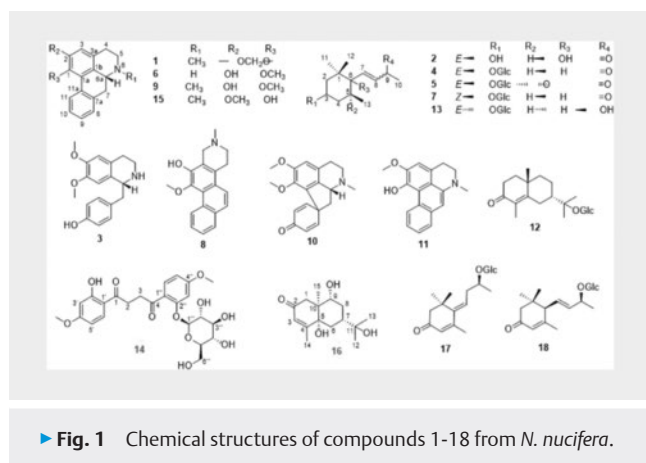

► **Fig. 1** Chemical structures of compounds 1–18 from *N. nucifera*.

References

- [1] Vu NK, Ha MT, Ha YJ, Kim CS., Gal M, Ngo QMT., Kim JA, Lee JH, Min BS. Structures and antiosteoclastogenic activity of compounds from edible lotus (*Nelumbo nucifera* Gaertn.) leaves and stems. *Fitoterapia* 2022; 162: 105294
- [2] Tran PT, Ngo TQM, Lee S, Kim O, Tran HNK, Hwangbo C, Min BS, Lee JH. Identification of anti-osteoclastogenic compounds from *Cleistanthus operculatus* flower buds and their effects on RANKL-induced osteoclastogenesis. *J. Funct. Foods.* 2019; 60: 103388

P-099 Immune-enhancing effect and mechanism of Insam paedok-san

Authors Ki Sung Kang¹, Su Nam Kim², Myoung-Sook Shin¹, Sullim Lee³, Seung Hyun Kim⁴, Young-Joo Kim²

Institutes 1 College of Korean Medicine, Gachon University, Seongnam, South Korea; 2 Korea Institute of Science and Technology, Gangneung, South Korea; 3 College of Bio-Nano Technology, Gachon University, Seongnam, South Korea; 4 Yonsei Institute of Pharmaceutical Science, Yonsei University, Incheon, South Korea

DOI 10.1055/s-0043-1773983

Insam paedok-san (IS), which consists of 10 herbs, is a traditional prescription for cold-related symptoms in Korea and China. We focused on clarifying the molecular mechanism underlying the immunomodulatory activity of IS in mac-

rophages in silico and in vitro. IS contains a number of active compounds whose pharmacological targets and mechanisms are complicated. Network pharmacology analysis was performed to predict the potential key components (scopoletin, neocnidilide, liquiritic acid, isoglabrolide, glabric acid, ferulic acid and erybin B), targets and mechanisms of IS as an immunomodulator. Then, the network pharmacology results were validated through chemical and molecular biological experiments. Seven key components were identified through HPLC-QTOF-MS. As predicted by the network pharmacology analysis, IS increased the mRNA expression of TNF and IL-6. Furthermore, IS increased the phosphorylation, nuclear translocation and transcriptional activity of the p65 subunit of the nuclear factor- κ B (NF- κ B) as well as the phosphorylation of MAPK signalling pathway. Therefore, IS is an immune activator that can elevate the production of NO, PGE2 and proinflammatory cytokines mediated by NF- κ B and the MAPK signalling pathway.

P-100 Isolation, identification and characterisation of a triterpenoid ROR γ inverse agonist

Authors Patrik Schwarz¹, Alexander F. Perhal¹, Martin M. Kraus¹, Johannes Kirchmair¹, Ulrike Grienke¹, Judith M. Rollinger¹, Verena M. Dirsch¹

Institute 1 Department of Pharmaceutical Sciences, University of Vienna, Austria

DOI 10.1055/s-0043-1773984

The nuclear receptor RAR-related orphan receptor gamma (ROR γ) plays a pivotal role in the differentiation of naïve CD4+ T cells towards pro-inflammatory T helper 17 (Th17) cells [1]. This distinct lineage of T helper cells are important host defenders but also contribute to various autoimmune diseases like rheumatoid arthritis, multiple sclerosis, psoriasis and severe neutrophilic asthma [2, 3]. To improve treatment of these ailments, new innovative therapeutic approaches like ROR γ inverse agonists are heavily sought after.

In this study, we have identified a triterpenoid ROR γ inverse agonist by luciferase assays. This natural product demonstrated potent (IC₅₀ = 119 nM) and selective inhibition of the ROR γ nuclear receptor over other nuclear receptors commonly modulated by triterpenes. To investigate the differences in binding mode between this new inverse agonist and weak ROR γ inverse agonists such as oleanolic acid (IC₅₀ = 9 μ M) [4], we conducted molecular docking, which revealed distinct binding modes. These results were further validated by using site-directed mutagenesis and luciferase assays. Furthermore, we conducted biological examinations on both gene (qPCR) and protein levels (flow cytometry): Upon treatment, we found a significant decrease in the expression of ROR γ target genes glucose-6-phosphatase [5] and interleukin-17 [1] and showed a reduction in Th17 differentiation, further corroborating the potential of this unprecedented natural product.

In conclusion, we have successfully identified and characterised a new potent and selective natural triterpenoid ROR γ inverse agonist, which could serve as a useful tool compound for future endeavours.

Conflict of Interest The authors declare no conflict of interest.

References

- [1] Ivanov I et al. The orphan nuclear receptor ROR γ directs the differentiation program of proinflammatory IL-17+ T helper cells. *Cell* 2006; 126 (6): 1121–33
- [2] Gege C. Retinoic acid-related orphan receptor gamma t (RoR γ) inverse agonists/antagonists for the treatment of inflammatory diseases – where are we presently? *Expert Opin Drug Discov* 2021; 1–19
- [3] Ramakrishnan R.K., Al Heialy S., Hamid Q. Role of IL-17 in asthma pathogenesis and its implications for the clinic. *Expert Rev Respir Med* 2019; 13 (11): 1057–1068
- [4] Kim S.H., Hong J.H., Lee Y.C. Oleanolic acid suppresses ovalbumin-induced airway inflammation and Th2-mediated allergic asthma by modulating the transcription factors T-bet, GATA-3, ROR γ and Foxp3 in asthmatic mice. *Int Immunopharmacol* 2014; 18 (2): 311–24
- [5] Takeda Y. et al. Retinoic acid-related orphan receptor gamma (RoR γ): a novel participant in the diurnal regulation of hepatic gluconeogenesis and insulin sensitivity. *PLoS Genet* 2014; 10 (5): e1004331

P-101 Therapeutic effects of *Acer palmatum* Thumb. leaf extract (KIOM-2015E) in a mouse Benzalkonium Chloride-induced dry eye model

Authors Nam-Hui Yim¹, Yeoun-Hee Kim², Won-Kyung Cho¹, Jin Yeul Ma¹

Institutes 1 Korea Institute of Oriental Medicine, Daegu, South Korea;

2 R&D Center, Etnova Therapeutics Corp., Suwon, South Korea

DOI 10.1055/s-0043-1773985

We confirmed the protective effects of *Acer palmatum* Thumb. leaf extract against the degeneration of rat retinal ganglion cells after ischemia/reperfusion (I/R) induced by midbrain cerebral artery occlusion (MCAO) in a previous study. Referring to the results of that, in this study, we determined the effects of two kinds of

A. palmatum Thumb. leaf extract (KIOM-2015E, hot water extract KIOM-2015EW and 25% ethanol extract KIOM-2015EE) in a benzalkonium chloride (BAC)-induced dry eye mouse model. Dry eye was induced by 0.2% BAC for 2 weeks, followed by treatment three times (eye drop) or once (oral administration) daily with KIOM-2015E for 2 weeks. Treatment with both KIOM-2015EE and KIOM-2015EW resulted in a marked increase in tear volume production for the 4 days of treatment. The Lissamine Green staining score, TUNEL-positive cells and inflammatory index were significantly decreased after 2 weeks. Topical KIOM-2015EE administration exhibited greater improvement in decreasing the ocular surface staining scores, inflammation, dead cells and increasing tear production in a dose-dependent manner compared with the other groups. Furthermore, KIOM-2015E significantly reduced the phosphorylation of NF- κ B, which was activated in the BAC-treated cornea. Topical administration was much more effective than oral administration for KIOM-2015E and KIOM-2015EE was more effective than KIOM-2015EW. Application of KIOM-2015E resulted in clinical improvement, including inhibiting the inflammatory response and alleviating signs of dry eye. Taken together, these results indicate that KIOM-2015E has potential as a therapeutic agent for the clinical treatment of dry eye.

P-102 Antibacterial and α -glucosidase inhibitory activity in vitro of *Bassia longifolia*, a traditional medicinal plant from Nepal

Authors Peter Bürkel¹, Meena Rajbhandari², Guido Jürgenliemk¹

Institutes 1 University of Regensburg, Regensburg, Germany; 2 Centre for Applied Science and Technology (RECAST), Kathmandu, Nepal

DOI 10.1055/s-0043-1773986

Bassia longifolia KOENIG (= *Madhuca longifolia* KOENIG, Sapotaceae) is an evergreen tree which grows about 20 m in height and is one of more than 1600 different plant species that are used for traditional phytomedicine in Nepal. The bark is used internally, as a decoction for diabetic patients. Externally, the bark paste can be applied on cuts and wounds to stop bleeding.

Phytochemical investigations for the bark revealed the occurrence of different flavan-3-ols including some with rare epiafzelechin-units. Regarding pharmacological studies, only a few for wound healing properties and none for the use in diabetes are reported. Therefore, fractions of the bark were tested for their antibacterial activity as a possible assisting effect in wound healing. Furthermore, an α -glucosidase assay was performed with the same fractions and with 15 flavan-3-ols isolated from the bark. As a result, only fractions enriched with oligomeric proanthocyanidins (PA) and polymeric PAs showed antibacterial activity. The effect increased with a higher concentration of polymeric PAs. Moreover, all tested substances and fractions showed high α -glucosidase inhibition. Again, fractions with a high content of polymeric PAs showed a stronger effect. The substances showed an increasing inhibition with a rising degree of polymerisation. The intramolecular linkage also affected the outcome. A 4 α -configuration and 4 \rightarrow 6 linkage caused a higher inhibition than 4 β \rightarrow 8 configured flavan-3-ols. In conclusion, for the traditional use of the bark of *B. longifolia*, the first evidence as an antidiabetic drug is given in this study (► Fig. 1).

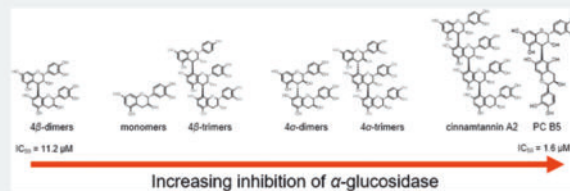

► **Fig. 1** In vitro inhibition of α -glucosidase by oligomeric and polymeric proanthocyanidins from the bark of *Bassia longifolia*

P-103 Investigating the Mechanism of Actions and Potential targets of Aryl Naphthalene Lignans with Dual Bioactivity Functions against Cancer and Viruses

Authors Abdullah Al Mamun¹, Zheng-Ming Liang¹, Wanfei Li¹, Chu Shing Lam¹, Nga Yi Tsang¹, Yi-Xuan Xia¹, Hong-jie Zhang¹

Institute 1 School of Chinese Medicine, Hong Kong Baptist University, Hong Kong SAR, China, Kowloon City, Hong Kong

DOI 10.1055/s-0043-1773987

The present study explored the mechanistic pathways of aryl naphthalene lignan (ANL) compounds for their therapeutic potential as both anticancer and antiviral agents.

We examined our synthetic ANL compound library for their cancer cell-killing and antiviral activities using our "One-Stone-Two-Birds" protocol. Some of the ANLs displayed potent cancer cell-killing activities, and others demonstrated antiviral activities with high selectivity indices. Flow cytometry analysis demonstrated that the ANL compound C27P2 significantly induced S-phase cell cycle arrest by decreasing CDK2 and Cyclin A2 while increasing p21 and p27 protein markers. Mechanistically, C27P2 treatment inhibited the activation of the PI3K/Akt/mTOR signalling pathway by significantly downregulating p-PI3K, p-AKT, mTOR and cyclin D1 in A375 and IGR1 cell lines.

Conversely, the time of addition assay results indicated that two other ANL compounds ZM-615 and ZM-621 inhibited the HIV/VSV and HIV/H5N1 reverse transcription step in the same manner as zidovudine. Moreover, we performed a pull-down assay to identify the potential targets for ANLs in cancer cells and viral infections. The results suggested that biotin-linked diphyllin may target several proteins including, Plectin, Myosin-9, and Myosin-10, which are associated with different viral infections and cancer developments. Overall, these findings suggest that ANL compounds could be structurally modified to serve as both antiviral and anticancer molecules for developing new drugs.

Funding This work is supported by the RGC of the HKSAR, China (Project No. HKBU12103021), the Innovation and Technology Commission of HKSAR, China (MHP/105/19), the Health and Medical Research Fund (COVID190214) of the Food and Health, and HKPFS.

Conflict of Interest The authors declare no conflict of interest.

P-104 Natural product discovery and development for targeting pyruvate dehydrogenase kinase 1 in EGFR-mutant NSCLC

Authors Wonyoung Park^{1,2}, Kibong Kim³, Sung-jin Bae⁴, Dongryeol Ryu⁵, Ki-Tae Ha^{1,2}, Shibo Wei

Institutes 1 Department of Korean Medical Science, School of Korean Medicine, Pusan National University, Yangsan, South Korea; 2 Korean Medical Research Center for Healthy Aging, Pusan National University, Yangsan, South Korea; 3 Department of Korean Pediatrics, School of Korean Medicine, Pusan National University, Yangsan, South Korea; 4 Department

of Molecular Biology and Immunology, Kosin University College of Medicine, Busan, South Korea; 5 Department of Biomedical Science and Engineering, Gwangju Institute of Science and Technology, Gwangju, South Korea

DOI 10.1055/s-0043-1773988

Natural products have diverse bioactive molecules with high therapeutic potential, better biocompatibility, and lower toxicity than synthetic compounds. Pyruvate dehydrogenase kinase 1 (PDK1) inhibitors, such as dichloroacetate (DCA), increase energy production and have potential therapeutic applications in cancer and metabolic disorders. Combining DCA with EGFR-TKIs overcomes EGFR-TKI resistance.

This study aimed to identify a most selective and potent PDK inhibitor from natural products and to overcome EGFR-TKI resistance.

We found that several natural product compounds, such as hemisteptin A, huzhangoside A, ilimaquinone, otobaphenol and leemanine, exhibited inhibitory effects against PDK1 activity. Through experiments with cell lines transfected with the always inactive form of PDHA1, we found that leelamine, derived from the nodal bark of pine trees, is the most effective and selective PDK1 inhibitor we have identified. Leelamine and the established PDK inhibitor, DCA, were found to enhance the sensitivity of NSCLC cells with the EGFR-TKI, such as gefitinib and osimertinib, in the cells expressing the resisting-mutant form of EGFR. The combination of PDK inhibitors and EGFR-TKI overcome the resistance to EGFR-TKI mediated by the EGFR mutation in both in vitro and in vivo experiments.

This study demonstrates the potential of natural products as a source of PDK inhibitors. The combination of PDK inhibitors with EGFR-TKIs could provide a promising therapeutic option for patients with EGFR-mutant NSCLC. These findings provide insights for further investigation and development of PDK inhibitors from natural products as a targeted therapy for cancer treatment.

Conflict of Interest The authors declare no conflict of interest.

P-105 Effect of hederagenin-type triterpene saponin mixture of *Sapindus saponaria* (Sapindaceae) on *Leishmania* spp. and its therapeutic potential in cutaneous leishmaniasis

Authors Sara M. Robledo¹, Yulieth A. Upegui², Fernando Torres³, Fernando Echeverri³

Institutes 1 PECET-Facultad de Medicina, Universidad de Antioquia, Antioquia, Colombia; 2 Departamento de Salud Pública, Facultad de Medicina, Universidad Nacional de Colombia, Bogotá D.C., Colombia; 3 Química Orgánica de Productos Naturales, Instituto de Química, Universidad de Antioquia, Medellín, Colombia

DOI 10.1055/s-0043-1773989

Cutaneous leishmaniasis (CL) causes skin lesions, mainly ulcers, on exposed parts of the body which can leave life-long scars and cause serious disability or stigma. Early diagnosis and treatment reduce the prevalence of the disease, reduce transmission and prevents disabilities and death. Nevertheless, there are very few effective anti-leishmanial medicines that are associated with high toxicity and adverse effects; therefore, more effective and safer drugs are urgently needed. Previously it was found saponins of *Sapindus saponaria* (Sapindaceae) pericarp had an inhibitory activity in *Leishmania panamensis*. This work aimed to determine the in vitro cytotoxicity and leishmanicidal activity of a mixture of hederagenin-type triterpene saponins of *S. saponaria*. The effects of SS on the parasite ultrastructure and on several parasite functions including energy metabolism, cellular stress, protease activity, re-infection capacity, production of reactive oxygen and nitrogen species and formation of lipid bodies were also evaluated. The SS was active against *L. braziliensis* and *L. panamensis* amastigotes at 20 µg/mL; nonetheless the cytotoxicity varied according to cell type and origin. Additionally, SS increased the parasite size and the number of electro-dense vacuoles. SS also affected the mitochondrial functioning modulating ROS production, $\Delta\Psi_m$ and ATP levels. Lastly, SS inhibited protease ac-

tivity in *Leishmania* and induced the production of nitric oxide in infected cells. In conclusion, SS destabilizes the energy metabolism, the redox balance and the infective capacity of the parasite. These results allow us to point out SS as a lead compound in the development of a drug to effectively treat CL (► Fig. 1).

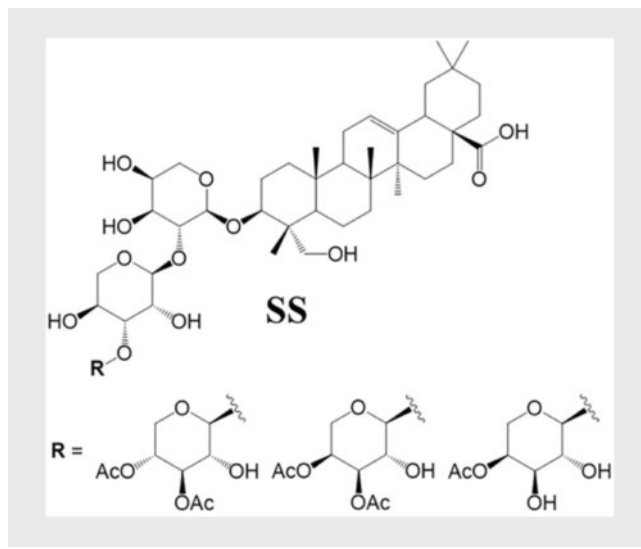

► Fig. 1 Chemical structures in the hederagenin-type triterpene saponin mixture.

P-107 Immunomodulatory activity in vitro of a mixture of hederagenin-type triterpene saponin from *Sapindus saponaria* and chroman hydrazone

Authors Sara M. Robledo¹, Julián Agudelo², Yulieth A. Upegui³, Winston Quiñones⁴, Fernando Torres⁴, Fernando Echeverri⁴

Institutes 1 PECET-Facultad de Medicina, Universidad de Antioquia, Medellín, Colombia; 2 Corporación de Innovación CIDEPRO, Medellín, Colombia; 3 Departamento de Salud Pública, Facultad de Medicina, Universidad Nacional de Colombia, Bogotá, Colombia; 4 Química Orgánica de Productos Naturales, Instituto de Química, Universidad de Antioquia, Medellín, Colombia

DOI 10.1055/s-0043-1773990

Only a few drugs are available to treat cutaneous leishmaniasis (CL), an infectious disease endemic in 98 countries in the tropical region. Moreover, toxicity, reduced adherence, and resistance to treatments against CL highlight the need for new therapeutic alternatives.

This work aimed to evaluate the in vitro immunomodulatory activity of a potential leishmanicidal agent containing a mixture of 2% hederagenin-type triterpene saponin from *Sapindus saponaria* (SS) with 2% chromane hydrazone derivative (TC2).

Nitric oxide (NO) and cytokine production by human macrophages derived from peripheral blood monocytes infected or not with *Leishmania braziliensis* and exposed or not to the combination of SS and TC2 was assessed by flow cytometry (for NO) and ELISA and RT-qPCR (for cytokines). Reduced production of IL-4 (anti-inflammatory cytokine), IL-1 β (proinflammatory cytokine), and increased MIP-1 α (proinflammatory) was observed in infected cells exposed to treatment with the mixture of SS and TC2 compared to the control group of untreated infected cells. In addition, there was an increase in NO production, the primary marker of macrophage microbicidal function, along with morphological changes such as cytoplasmic extensions in infected cells subjected to treatment (► Fig. 1).

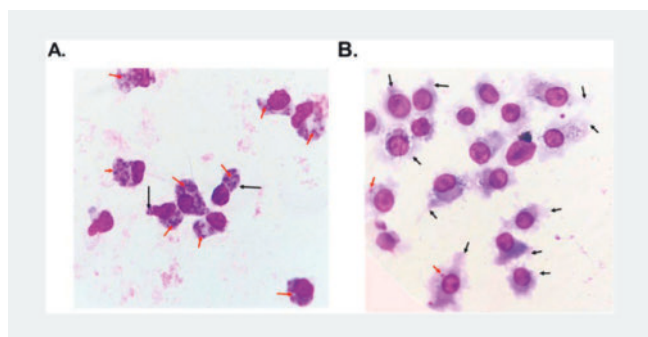

► Fig. 1 Human macrophages derived from peripheral monocytes (HuMDM) infected with *L. braziliensis*. The figure shows infected and non-exposed cells (A) and cells infected and exposed during 60 h to TC2: SS mixture (B). Black arrows are cytoplasmic prolongations (pseudopodia), and red arrows are intracellular amastigotes.

In conclusion, treating *L. braziliensis*-infected macrophages with the combination of SS and TC2 modulates the macrophage phenotype towards a proinflammatory response with the activation of the microbicidal response responsible for the subsequent elimination of the parasite load and resolution of the infection.

P-108 Natural Acetylcholinesterase Inhibitors from *Glycosmis parviflora* stems

Authors Thi Truc-Ly Duong^{1,2}, Tran Quoc-Dung Huynh¹, Ta-Wei Liu³, Yun-Han Wang¹, Ching-Kuo Lee^{1,3}

Institutes 1 Ph.D. Program in Clinical Drug Development of Herbal Medicine, College of Pharmacy, Taipei Medical University, Taipei 11031, Taiwan; 2 Can Tho University of Medicine and Pharmacy, Can Tho 90000, Vietnam; 3 School of Pharmacy, College of Pharmacy, Taipei Medical University, Taipei 11031, Taiwan

DOI 10.1055/s-0043-1773991

Discovering natural medicines for Alzheimer's disease (AD) with minimal side effects is an ongoing challenge. In this study, we investigated the inhibitory effect of extracts and fractions from *Glycosmis parviflora* stems collected in Vietnam on acetylcholinesterase (AChE), an enzyme responsible for the hydrolysis of the cholinergic neurotransmitter acetylcholine. Our results revealed that the ethyl acetate extract exhibited the strongest AChE inhibitory activity. Through a bioassay-guided isolation approach, we identified eleven compounds, including a novel alkaloid, eight known alkaloids, one flavonoid and one saponin steroid. These compounds were assessed for their inhibitory activity against AChE, and among the tested compounds, O-methylglycosolone (**6**), 3-dimethoxy-10-methyl-9-acridone (**1**), skimmianine (**4**), and arborine (**2**) showed inhibitory effects. Notably, O-methylglycosolone was the most potent, with an IC₅₀ value of 39.81 ± 1.76 μM.

Overall, our findings suggest that *G. parviflora* has the potential to protect neurotransmitters that have not been previously evaluated for AD. These results offer a promising direction for further investigation of *G. parviflora* and its compounds as potential natural medicines for AD.

Conflict of Interest The authors declare no conflict of interest.

P-109 In-vitro Antitrypanosomal Activities of the stem bark of *Entadrophragma angolense* (Meliaceae)

Authors Latif Adams^{1,2}, Siobhan Moane¹, Dorcas Obiri-Yeboah², Michelle Mckean-Bennett¹

Institutes 1 Technological University of Shannon: Midlands Midwest, Athlone, Ireland; 2 Department of Microbiology and Immunology, School

of Medical Sciences, College of Health and Allied Sciences, University of Cape Coast, Cape Coast, Ghana

DOI 10.1055/s-0043-1773992

In this study, we investigated the potential antitrypanosomal properties of *E. angolense* and its possible development as a therapeutic intervention for treating African trypanosomiasis or Sleeping Sickness. In-vitro effects of crude extracts and fractions of stem bark of *E. angolense* were tested against *Trypanosoma brucei* using Alamar blue assay. Additionally, the crude extract's antioxidant (FRAP and DPPH) and cytotoxicity activities were also determined. The phytochemical profiling of the crude extract was determined using LC-ESI-QTOF-MS to identify major bioactive compounds present. *E. angolense* crude extract and fractions (hexane, chloroform and ethyl acetate) exhibited potential anti-trypanosomal activities with IC₅₀ values of 17.55, 6.8, 6.1 and 22.92 μg/mL respectively. Moreover, the crude extracts were non-toxic against HepG2 and PNT2 cells, with CC₅₀ values of 235.4 ± 0.30 and 548.3 ± 0.09 μg/mL respectively. Antioxidant potential was observed in the crude extracts of *E. angolense*. LC-MS analysis revealed the presence of 32 bioactive compounds. Furthermore, the bioactive compounds identified were subjected to molecular docking studies to identify novel compounds against *Trypanosoma brucei*'s UDP-Galactose 4'-Epimerase (TbGalE). Seven (7) potential leads were identified after molecular docking with binding energies -11.4, -11.2, -10.3, -10.2, -10.1, -9.9, -9.3 and -9.1 kcal/mol respectively. Molecular Dynamics simulation and Molecular Mechanics-Poisson Boltzmann Surface Area calculation were performed to elucidate the stability and the binding free energy of the potential leads' complexes. These compounds will further be investigated experimentally to determine their potential efficacy and could serve as candidates for the design of novel anti-trypanosomal therapeutics.

P-110 Evodiamine causes mitotic catastrophe in PDGF-induced vascular smooth muscle cells

Authors Patricia Haiss¹, Rongxia Liu¹, Agnes Graf¹, Verena Dirsch¹, Tina Blažević¹

Institute 1 Division of Pharmacognosy, Department of Pharmaceutical Sciences, University of Vienna, Vienna, Austria

DOI 10.1055/s-0043-1773993

Proliferation of vascular smooth muscle cells (VSMC) is a key factor driving atherosclerosis and restenosis [1]. Evodiamine, an indoloquinazoline alkaloid found in fructus Evodiae [2], inhibits the proliferation of platelet derived growth factor (PDGF)-stimulated VSMC with an IC₅₀ of 0.67 μmol/L, as determined by a BrdU incorporation assay. Thus, it may serve as a therapeutic/preventive agent against atherosclerosis and restenosis. This study characterises evodiamine's anti-proliferative activity and the underlying molecular mechanisms in PDGF-stimulated VSMC.

In addition to a G2/M arrest, flow cytometry revealed an increase in polyploidy upon 3 μmol/L evodiamine treatment. This indicates mitotic catastrophe (MC), which is a state of improper cell cycle entry and progression that precedes cell death or slippage of irregularly divided cells into a new cell cycle [3]. Immunofluorescence confocal microscopy revealed an increased occurrence of round-shaped cells with irregular nuclei and micronuclei in response to evodiamine treatment, further corroborating MC as a mode of action. Whereas a minor increase in apoptotic cells was observed by Annexin V/PI staining, LDH release was unaffected upon evodiamine treatment. Apoptosis (caspase-3 and PARP-1 cleavage) and DNA-damage (γ-H2A.X) indicators were unaffected in western blot, compared to respective controls, staurosporine and etoposide. Western blot further demonstrated no effect on the signalling cascades downstream of PDGF receptor (AMPK, p38, JNK, STAT3) by evodiamine.

These findings indicate that apoptosis is not the main driving force of the anti-proliferative activity of evodiamine in VSMC, but rather a consequence of MC caused by a mechanism yet to be elucidated.

Conflict of Interest The authors declare no conflict of interest.

References

- [1] Basatemur GL, Jorgensen HF, Clarke MCH, Bennett MR, Mallat Z. Vascular smooth muscle cells in atherosclerosis. *Nat Rev Cardiol* 2019; 16 (12): 727–744
- [2] Sun Q, Xie L, Song J, Li X. Evodiamine: A review of its pharmacology, toxicity, pharmacokinetics and preparation researches. *JEthnopharmacol* 2020; 262: 113164
- [3] Vakifahmetoglu H, Olsson M, Zhivotovsky B. Death through a tragedy: mitotic catastrophe. *Cell Death Differ* 2008; 15 (7): 1153–62

P-111 Biological activity of 6,7-dehydroroyleanone derivatives from *Plectranthus aliciae*

Authors Marcia Filipe^{1,2}, Eva Dominguez^{1,2}, Vera Isca^{1,3}, Raquel Pereira¹, Filipa Mandim^{4,5}, Ricardo Calhelha^{4,5},

Ana-Maria Diaz-Lanza², Lillian Barros^{4,5}, Patrícia Rijo^{1,3}

Institutes 1 Universidade Lusófona, Lisbon, Portugal; 2 Universidad de Alcalá de Henares, Facultad de Farmacia, Departamento de Ciencias Biomédicas (Área de Farmacología; Nuevos agentes antitumorales, Acción tóxica sobre células leucémicas) Ctra. Madrid-Barcelona km. 33,600 28805 Alcalá de Henares, Alcalá, Spain; 3 Instituto de Investigação do Medicamento (iMed.Ulisboa), Lisbon, Portugal; 4 Centro de Investigação de Montanha (CI MO), Instituto Politécnico de Bragança, Campus de Santa Apolónia, 5300-253 Bragança, Portugal; 5 Laboratório Associado para a Sustentabilidade e Tecnologia em Regiões de Montanha (SusTEC), Instituto Politécnico de Bragança, Campus de Santa Apolónia, 5300-253 Bragança, Portugal
DOI 10.1055/s-0043-1773994

Plectranthus genus (Lamiaceae) is known to be rich in bioactive abietane royleanone-type diterpenes, such as 6,7-dehydroxyroyleanone (**1**, ► Fig. 1), which have been previously found in *P. madagascariensis* (var. *aliciae* Codd). This abietane royleanone presents moderate to significant cytotoxic activity against several cancer cell lines. Moreover, **1** has one hydroxyl group suitable for derivatization that can be explored to enhance the cytotoxic activity of lead compound **1**. Based on this, the aim of the present work is to explore the obtention of **1**, from *P. aliciae aliciae* (Codd) van Jaarsv. & T.J. Edwards., a subspecies of *P. madagascariensis* to be further used in the preparation of new derivatives with enhanced biological activities.

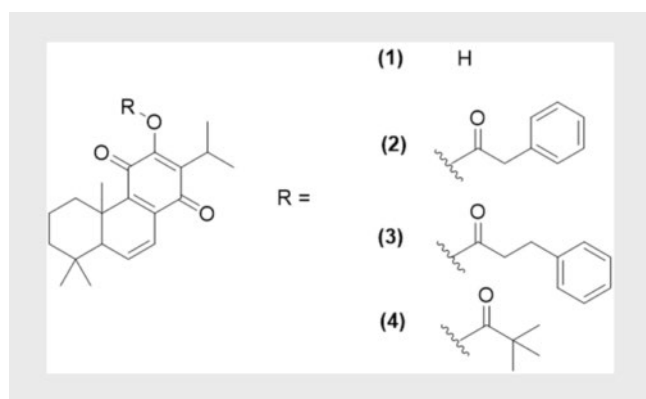

► **Fig. 1** Structure of 6,7-dehydroxyroyleanone (**1**) and semi-synthetic ester derivatives (**2**, **3** and **4**).

P. aliciae leaf hydrodistillation using Clevenger equipment was performed, affording the essential oil (EO). **1** was assessed as the major compound of the EO, by HPLC-DAD, which was isolated and used as a scaffold for esterification reactions. It was possible to obtain three new acyl derivatives (**2**–**4**, ► Fig. 1), with overall good yields (86–95%). Regarding the biological activity screening, the semi-synthetic derivatives (**2**–**4**) improved the antioxidant activity and the cytotoxic activity in MCF-7 and NCI-H460 cancer cell lines, when compared to **1**. Amazingly, the new esters (**2**–**4**) showed a promising anti-inflammatory

activity, in the range of 16 to 53 times more than **1**, and also higher than the one of the positive control (dexamethasone). Currently, the mechanism of action and security of the potential anti-inflammatory derivatives are under evaluation.

P-112 Investigation on the cytotoxic activity of the weed *Mikania micrantha* using bioassay-guided fractionation

Authors Grace Yue¹, Tao Zheng¹, Wai-Fung Lee¹, Julia Lee¹, Clara Bik-San Lau¹

Institute 1 The Chinese University of Hong Kong, Hong Kong

DOI 10.1055/s-0043-1776746

The weed *Mikania micrantha* Kunth (family Asteraceae) is a fast-growing, perennial herbaceous vine that originates from tropical South and Central America. Nevertheless, *M. micrantha* (MM) has been used as a medicinal plant in South America, with pharmacological activities such as anti-inflammatory, antioxidant, antiviral and cytotoxicity towards cancer cells. The present study aimed to investigate the cytotoxic activity of MM extract in human cancer cell lines and to identify the active fraction using bioassay-guided fractionation. The aerial parts of MM were extracted with 80% ethanol under reflux, followed by sequential partition with petroleum ether, ethyl acetate and n-butanol. The active fraction was then subjected to column chromatography to yield sub-fractions for cell viability testing in human cancer cells and normal fibroblasts Hs27 using MTT assay. Our results showed that the ethyl acetate fraction of MM extract could significantly decrease the cell viability of MDA-MB-231 (breast), HT-29 (colon) and EC-109 (esophageal) cancer cells (with IC₅₀s of 12.9, 21.5 and 46.9 µg/mL, respectively), but not Hs27 (IC₅₀ > 200 µg/mL) cells, suggesting its selective cytotoxic effects. Besides, the ethyl acetate fraction induced cell cycle arrest at G2 phase in MDA-MB-231 and HT-29 cells in a concentration dependent manner. The sub-fraction E2 maintained selective cytotoxic activity in MDA-MB-231 cells, with an IC₅₀ value of 46.8 µg/mL. The findings revealed the potential of this sub-fraction in inhibiting breast tumor growth and further in vivo investigations will be conducted in order to explore the new utility of this plant.

P-113 Omega-3 fatty acids intake in vegetarian diets

Authors Ruxandra Stefanescu¹, Amalia Puşcaş¹,

Amelia Tero-Vescan¹

Institute 1 George Emil Palade University of Medicine, Pharmacy, Science and Technology of Târgu Mureş, Romania

DOI 10.1055/s-0043-1773995

Vegetarian diets have an important role in reducing body mass index, ischemic heart disease mortality, lower prevalence of hypertension, type 2 diabetes, colon, and prostate cancer [1]. Vegetal food sources of omega 3 fatty acids (n-3PUFA) contain α-linolenic acid (C18: 3n-3) (ALA). The conversion of ALA to the active compounds, eicosapentaenoic acid (C20: 5n-3) (EPA) and docosahexaenoic acid (C22: 6n-3) (DHA) in the body involves desaturation and elongation. Food sources of n-3PUFA in an omnivorous diet are either ALA or by the direct consumption of fish or animal products, while in an ovo-lacto-vegetarian or vegan diet intake of n-3PUFA is limited to the bioconversion of ALA to EPA and DHA. The conversion of ALA to EPA and DHA has a low efficiency as an important part of ALA is used in mitochondrial β-oxidation. Another problem of ALA conversion is the competition between ALA and linoleic acid (C18: 2n-6) (LA), the precursor of omega 6 fatty acids (n-6PUFA), for Δ6 desaturase, a key enzyme in the PUFA metabolism, converting LA and ALA into γ-linolenic acid (C18:3n-6) (GLA) and (C18:4n-3), respectively, with a higher affinity for LA [2]. Following a vegetarian or vegan diet raises the issue of adequate supplementation with EPA and DHA, as important precursors of extremely active compounds obtained via cyclooxygenase or lipoxygenase pathway, or from the class of resolvins or neuroprotectins with complex physio pathological implications (► Fig. 1).

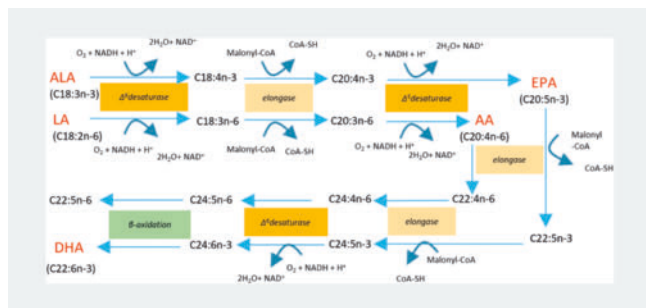

► **Fig. 1** Biosynthesis of EPA, DHA and AA (arachidonic acid) from precursors ALA and LA.

References

- [1] Tero-Vescan A et al. *Farmacia* 2015; 63 (4): 504–509
 [2] Saunders AV et al. *Med J Aust* 2013; 199 (S4): S22–26

P-114 Effect of *Caesalpinia spinosa* (Molina) Kuntze extract P2Et on the resolution of cutaneous leishmaniasis in hamsters infected with *Leishmania braziliensis*

Authors Sara M. Robledo¹, Javier Murillo², Natalia Arbeláez², Jorge Higueta-Castro², Ricardo Ballesteros-Ramírez^{3,4}, Susana Fiorentino^{3,4}
Institutes 1 PECET-Facultad de Medicina, Universidad de Antioquia, Medellín, Colombia; 2 Grupo de Estudios Preclínicos, Corporación de Innovación CIDEPRO., Medellín, Colombia; 3 DreemBio S.A.S., Bogotá, Colombia; 4 Grupo de Inmunobiología y Biología Celular, Facultad de Ciencias, Unidad de Investigación en Ciencias Biomédicas, Pontificia Universidad Javeriana., Bogotá, Colombia
 DOI 10.1055/s-0043-1773996

Cutaneous leishmaniasis is endemic in 18 countries in America, with 54,000 cases reported annually, 80% of them in Brazil, Colombia, Peru, Nicaragua, and Bolivia. Worldwide, leishmaniasis is among the top ten neglected tropical diseases, with more than 12 million people infected. The high toxicity of few available drugs is a barrier to access to treatment. Therefore, it is necessary to work on developing new therapeutic options. A previous work identified leishmanicidal potential of glycolic and ethanolic extracts from aereal parts of the *Caesalpinia spinosa* (Molina) Kuntze tree [1]. Now, this work validated the toxicity and leishmanicidal activity of a standarised extract obtained from pods and fruits, named P2Et, using *in vitro* and *in vivo* methods. The P2Et was active against *Leishmania braziliensis* amastigotes at an $EC_{50} = 22.8 \pm 3.4 \mu\text{g/mL}$, with no toxicity to U937, Caco-2, HepG2, and Vero cells ($LC_{50} > 200 \mu\text{g/mL}$). On the other hand, the cure rates in groups of hamsters ($n = 5$ each) treated with 5% P2Et formulated as solution, cream, or emulsion at a dose of 40 mg/day/60 days were 80%, 71.4%, and 100%, respectively. None of the formulations administered at single or repeated doses showed any signs of dermal toxicity. In conclusion, the 5% P2Et emulsion has the potential to become a therapeutic alternative for cutaneous leishmaniasis that warrants further validation in controlled clinical trials (► **Fig. 1**).



► **Fig. 1** Photographs of *Caesalpinia spinosa*. Photographs of A. Seed B. Pods C. Seeds and pods.

References

- [1] Robledo S et al. *Caesalpinia spinosa* (Molina) Kuntze: una nueva promesa para el tratamiento tóxico de la leishmaniasis cutánea. *Rev. Acad. Colomb. Cienc. Ex. Fis. Nat* 2020; 4 (173): 915–936

P-115 Design, synthesis and *in vitro* biological evaluation of novel Oleuropein derivatives as potential anti-leishmanial agents

Authors Panagiota Stamou¹, Panagiota Papakotsi³, Olga Koutsoni², Georgia Gogou², Eleni Dotsika², Maria Halabalaki⁴, Ioannis Kostakis¹, Alexios-Leandros Skaltsounis⁴

Institutes 1 Division of Pharmaceutical Chemistry, National and Kapodistrian University of Athens, Athens, Greece; 2 Laboratory of Cellular Immunology, Department of Microbiology, Hellenic Pasteur Institute, 127 Vas. Sofias av., 11521, Athens, Greece; 3 Pharmagnose S.A., 57km National Road Athinon-Lamia, 32011, Inofyta, Greece; 4 Division of Pharmacognosy and Natural Products Chemistry, Department of Pharmacy, National and Kapodistrian University of Athens, Panepistimiopolis Zografou, 15771, Athens, Greece
 DOI 10.1055/s-0043-1773997

Leishmaniasis is a complex disease caused by multiple subspecies of *Leishmania* intracellular protozoan parasites. It is the second most deadly vector-transmitted disease, affecting almost 12 million people, predominantly of low socio-economic status. Although it is considered as a neglected tropical disease, there is a global distribution and several factors have contributed to its expansion during the last years. The lack of safe and effective treatment renders imperative the development of new drugs, which will have a significant health impact along with economical ramifications. Our group has previously reported the promising anti-leishmanial activity of Oleuropein, one of the most important polyphenols of olive tree [1]. Clear epidemiological and biochemical evidence indicates that Oleuropein is endowed with leishmanicidal effects against *Leishmania spp.* minimising the parasite burden in infected BALB/c mice. Within this context, in the current work, 12 novel Oleuropein analogues were designed and synthesised via a convenient and facile procedure. The compounds were further evaluated *in vitro* for their potential anti-leishmanial activity using the resazurin cell viability assay, against both developmental stages of a viscerotropic and a dermatropic *Leishmania* strain. The obtained data produce scientific evidence of the promising anti-leishmanial properties of analogues, emerging from the initial structure of Oleuropein.

Funding ERDF, "RESEARCH-CREATE-INNOVATE", OliveFeed (project code T2EΔK-03891)

Conflict of Interest The authors declare no conflict of interest.

References

- [1] Kyriazis I. et al. *Parasites Vectors* 9: 441 2016

P-116 Src kinase inhibitory activity of black chokeberry and bilberry fruits

Authors Sanda Vladimír-Knežević¹, Biljana Blažeković¹, Maja Bival Štefan¹, Dubravko Jelić², Tea Petković¹, Marta Mandić⁴, Ekaterina Šprajc³, Sandy Lovković³

Institutes 1 University of Zagreb, Faculty of Pharmacy and Biochemistry, Zagreb, Croatia; 2 Selvita Ltd., Zagreb, Croatia; 3 Jamnica plus Ltd., Zagreb, Croatia; 4University of Mostar, Faculty of Pharmacy, Mostar, Bosnia and Herzegovina
 DOI 10.1055/s-0043-1773998

Edible berries such as the fruits of black chokeberry (*Aronia melanocarpa* (Michx.) Elliott.) and bilberry (*Vaccinium myrtillus* L.) are considered to be rich in polyphenols, which are nowadays attracting great interest due to their prom-

ising health benefits. The aim of our study was to investigate their inhibitory properties on Src kinase activity, as this enzyme plays an important role in multiple cellular processes and is activated in both cancer and inflammatory cells. In the hydroethanolic fruit extracts, 5.0 – 5.9% of total polyphenols were determined spectrophotometrically, including high amounts of hydroxycinnamic acid derivatives. HPLC analysis revealed that the black chokeberry and bilberry extracts contained 2.05 mg/g and 2.54 mg/g of chlorogenic acid, respectively. Using a time-resolved fluorescence resonance energy transfer (TR-FRET) assay, the extracts studied were found to have comparable inhibitory effects on Src kinase, with IC_{50} values of 366 μ g/mL and 369 μ g/mL, respectively. The results also indicated that chlorogenic acid contributes significantly to the observed effect (IC_{50} 122 μ g/mL). In addition, both fruit extracts exhibited antioxidant activity by scavenging NO radicals with IC_{50} values of 158 μ g/mL (black chokeberry) and 352 μ g/mL (bilberry). Our study demonstrated, for the first time, that black chokeberry and bilberry fruits are able to affect Src kinase activity, which could be beneficial in the prevention of cancer and inflammation-related diseases.

P-117 New pharmacological evidence for Chios mastic gum

Authors Eleni V. Mikropoulou¹, Zoi Evangelakou², Despoina Gianniou², Charalampia Amerikanou³, Andriana Kaliora³, George Dedoussis³, Ioannis Trougkos², Maria Halabalaki¹

Institutes 1 Division of Pharmacognosy and Natural Products Chemistry, Department of Pharmacy, National and Kapodistrian University of Athens, Panepistimiopolis Zografou, 15771, Athens, Greece; 2 Department of Cell Biology and Biophysics, Faculty of Biology, National and Kapodistrian University of Athens, Panepistimiopolis Zografou, 15784, Athens, Greece; 3 Department of Nutrition and Dietetics, School of Health Science and Education, Harokopio University of Athens, 17671, Athens, Greece

DOI 10.1055/s-0043-1773999

Chios mastic gum (CMG) is a highly valuable phytotherapeutic product of Greece, with broad applications in the food and supplements industries. Due to its complex chemical composition, studies involving the pharmacological investigation of its constituents remain scarce and fragmented. The last few years, thanks to mastic's recognition by the EMA, there has been a renewed interest by the scientific community about the possible beneficial effect of CMG on various pathologies, especially towards inflammatory conditions and those associated with metabolic syndrome [1]. In this framework, the current work summarises the results of several national and international cooperations, aiming to investigate the effect of CMG on different biological platforms. From human endothelial cell lines and the versatile model organism *Drosophila melanogaster*, to the complex pathophysiology of NAFLD/NASH in human patients, CMG's unexplored potential is only beginning to unravel. Additionally, with the use of state-of-the-art instrumentation such as LC-HRMS/MS and metabolomic approaches, the disclosure of the metabolic fate of CMG's bioactives through the tentative identification of several triterpenic acid biotransformation products in plasma and faecal samples of human patients was deemed possible. All compounds were products of Phase I and Phase II metabolic reactions, while the most common modifications were the hydroxylation and/or sulfation of the basic triterpenic skeleton. Overall, this information opens new opportunities in the therapeutic valorisation of this ancient product (► Fig. 1).

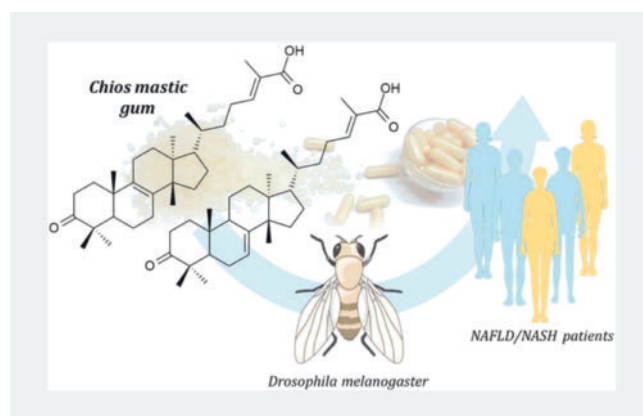

► **Fig. 1** Chios mastic gum – an ancient product with therapeutic valorisation opportunities

Funding ERDF, "RESEARCH-CREATE-INNOVATE", Hyper-Mastic (project code T2EAK-00547).

Conflict of Interest The authors declare no conflict of interest.

References

[1] Pachi V. et al. J Ethnopharmacol 2020; 254: 112485

P-118 Bioavailability and metabolism aspects of natural bioactive phenylalcohols and secoiridoids

Authors Theodora Nikou¹, Maria Eleni Sakavitsi¹, Olga S. Koutsoni², Christina Fytilli², Eleni Dotsika², Luc Pieters⁴, Nina Hermans⁴, Nikolaos Tentolouris³, Maria Halabalaki¹

Institutes 1 Division of Pharmacognosy and Natural Products Chemistry, Department of Pharmacy, National and Kapodistrian University of Athens, Panipistimioupoli, Zografou, 15771, Greece; 2 Laboratory of Cellular Immunology, Department of Microbiology, Hellenic Pasteur Institute, Greece; 3 First Department of Propaedeutic and Internal Medicine, Medical School, National and Kapodistrian University of Athens, Laiko General Hospital, 17 Agiou Thoma Street, 11527, Greece; 4 Natural Products & Food Research and Analysis (NatuRA), Department of Pharmaceutical Sciences, University of Antwerp, Antwerp, Belgium

DOI 10.1055/s-0043-1774000

The disclosure of the decisive role of the gut microbiome in disease onset, prevention, and health maintenance, repositioned active small molecules found in food products as a unique class of natural products with a high impact to human health [1]. Furthermore, scientific dialogs globally over comment on the correlation of biological and/or pharmacological functions of natural products with their in vivo bioavailability and metabolism, as well as highlight the lack of relevant information and solid data [2]. Amongst these lines there are limited and scattered data related to pharmacokinetics and especially metabolism of olive oil biophenols (OBs). The most characteristic chemical classes of OBs are phenylalcohols and secoiridoids widely known for their significant and beneficial health effects [3]. Aiming towards the exploration of OBs bioavailability aspects, a multi-arm workflow is established involving in vitro investigation [4], animal experiments as well as human studies [5]. LC-HRMS & HRMS/MS-based metabolite profiling and dereplication approaches with the aid of public and in-house databases framed this workflow in a holistic and interactive crosstalk. Several biomarkers and biotransformation patterns were revealed giving better insight into OBs biological mechanism of action.

Funding ERDF, "RESEARCH-CREATE-INNOVATE", OliveFeed (project code T2EAK-03891)

Conflict of Interest The authors declare no conflict of interest.

References

- [1] Sericov I. et al. *Physiol Rev* 90: 859–904 2010
 [2] Sakavitsi ME et al. *Nutrients* 14 (18): 3773 2022
 [3] Bulotta S. et al. *Journal of Translational Medicine. J Transl. Med.* 12: 219 2014
 [4] Sakavitsi M.E. et al. *Metabolites* 12: 391 2022
 [5] Fytli C. et al. *Nutrients* 14 (7): 1525 2022

P-119 Hyperuricemia induced by a high fructose diet – a consequence or a cause of oxidative stress?

Authors Amelia Tero-Vescan¹, Amalia Pușcaș¹, Ruxandra Stefanescu¹

Institute 1 George Emil Palade University of Medicine, Pharmacy, Science and Technology of Târgu Mureș, Romania

DOI 10.1055/s-0043-1774001

It is known that a high consumption of fructose from fruits, sucrose or sweeteners such as high fructose corn syrup is a cause of many diseases such as obesity, insulin resistance, non-alcoholic fatty liver disease or hyperuricemia. Furthermore, fructose-feeding is used for induction of type 2 diabetes in experimental animals [1]. Fructose is the only ketohexose found in superior plants, and it can be present as a free monosaccharide, complexed with glucose in sucrose and polymerised as fructans. Although fructose and fructans are related, they have different effects, and different metabolic pathways. The mechanisms responsible for hyperuricemia are not fully known, but it is considered that the depletion of ATP, a cofactor for ketohexokinase and triosokinase, enzymes involved in the metabolism of fructose, with the degradation of ADP and AMP to uric acid and the activation of AMP deaminase by fructose-1-phosphate would initiate the degradation pathways of purines to uric acid [2]. Paradoxically, some studies show that excess uric acid in the blood would be a protective factor against oxidative stress induced by excessive consumption of fructose and its aerobic metabolism in the mitochondria by oxidative phosphorylation with the generation of reactive oxygen species. Uric acid is absorbed inside the cells through special transporters like URAT1 and exerts prooxidant effects by activating NADPH oxidase (NOX), a synergic effect with fructose also an activator of NOX.

References

- [1] Ștefănescu R et al. *Plants* 2021; 10 (4):. doi:10.3390/plants10040744
 [2] Rho YH et al. *Semin Nephrol* 2011; 31 (5): 410–9. doi:10.1016/j.semnephrol.2011.08.004

P-120 A meta-analysis confirms the efficacy of ivy leaves dry extract EA 575 as treatment of acute cough in adults

Authors Lukas Uebbing¹, Ralph Mösges^{2,3}

Institutes 1 Engelhard Arzneimittel GmbH & Co KG, 61138 Niederdorfelden, Germany; 2 Institute of Medical Statistics and Computational Biology (IMSB), Medical Faculty, University at Cologne, Köln, Germany; 3 ClinCompetence Cologne GmbH, Köln, Germany

DOI 10.1055/s-0043-1774002

Meta-analyses are generally regarded as the highest possible level of clinical evidence (evidence grade Ia) [1, 2]. The presented meta-analysis aimed to evaluate all available double-blind, randomised, placebo-controlled studies (RCTs) investigating the effects of ivy leaf dry extract mono-preparations in the treatment of cough in acute respiratory tract infections (ARTIs) in adult patients. Two RCTs for ivy leaves dry extract EA 575 (Prospan cough liquid) met these inclusion criteria and previously had their low risk of bias attested in an independent review [3, 4]. In addition to the pooled efficacy quantification from the RCTs, the distribution of individual results from all 390 randomised patients was examined. This enabled further analyses, including the quantification of complete cough remission under EA 575 or placebo at treatment end.

The results from all tested parameters favoured EA 575 over placebo, confirming the significantly stronger improvement of key parameters such as the bronchitis severity score (BSS). The decrease of the BSS total score in patients treated with EA

575 was approximately one visit (3 days) ahead of that of patients who received placebo throughout the entire study period. At the follow-up visit, 12% of patients receiving treatment with EA 575 still showed continuous coughing, while 56% were completely cough-free. This was in contrast to the placebo group, where 41% of patients still showed distressing coughing (► Fig. 1).



► **Fig. 1** Cough frequency VRS at the end of follow-up. The EA 575 group included more than twice as many cough-free patients (56%) compared to the Placebo group (26%). Only 12% of patients receiving treatment with EA 575 still showed continuous coughing at the end of follow-up, compared to 41% of patients receiving placebo.

This meta-analysis increases the level of evidence for EA 575 in the treatment of cough in adults and represents a major step towards highest evidence based phytomedicine.

Potential conflicts of interest RM reports grants and personal fees from Engelhard Arzneimittel GmbH & Co. KG, the manufacturer of Prospan cough liquid, during the conduct of the study and is the director and the owner of Clinical Research International Ltd. and of ClinCompetence Cologne GmbH, two contract research organisations focusing on upper airways diseases. LU is an employee of Engelhard.

References

- [1] World Health Organization Programme on Traditional M. General guidelines for methodologies on research and evaluation of traditional medicine. In.. Geneva: World Health Organization; 2000
 [2] Shekelle PG, Woolf SH, Eccles M, Grimshaw J. Clinical guidelines: developing guidelines. *BMJ* 1999; 318: 593–596
 [3] Volp A, Schmitz J, Bulitta M, askopf E, Acikel C, Mosaes R. Ivy leaves extract EA 575 in the treatment of cough during acute respiratory tract infections: meta-analysis of double-blind, randomized, placebo-controlled trials. *Scientific Reports* 2022; 12: 20041
 [4] Sierocinski E, Holzinaer F, Chenot JF. Ivy leaf (*Hedera helix*) for acute upper respiratory tract infections: an updated systematic review. *Eur J Clin Pharmacol* 2021. doi:10.1007/s00228-021-03090-4

P-121 Treatment of rhinosinusitis with 1,8-cineole and nasal spray under real-world conditions: influence on the quality of life

Authors Lukas Uebbing¹, Simon Braun¹, Christoph Strehl¹, Antonia Claas², Ralph Mösges^{2,3}

Institutes 1 Engelhard Arzneimittel GmbH & Co KG, 61138 Niederdorfelden, Germany; 2 Institute of Medical Statistics and Computational Biology (IMSB), Medical Faculty, University at Cologne, Köln, Germany; 3 ClinCompetence Cologne GmbH, Köln, Germany

DOI 10.1055/s-0043-1774003

Rhinosinusitis is a highly prevalent inflammatory disease of the nose and paranasal sinuses. Typical symptoms, such as nasal obstruction and facial pressure can constitute a significant burden for individuals and therefore impair their quality of life (QoL) [1]. Consequently, patients often seek symptom-relief via over-the-counter medications. Two of these are systemic treatments with 1,8-cineole (the main constituent of eucalyptus essential oil) and topical decongesting nasal sprays. Systemic treatment with 1,8-cineole has previously demonstrated superior symptom improvement compared to a placebo in a controlled clinical trial setting [2].

Here, we present the results of a recent non-interventional study (ClinicalTrials.gov Identifier: NCT04703673) investigating the QoL in 350 patients suffering from rhinosinusitis during treatment with 1,8-cineole capsules (Sinolpan or Sinolpan forte) with or without a nasal decongestant under real-world conditions via an anonymous pharmacy-based survey. Additionally, a comparison was drawn to a group of 40 patients, who used a topical nasal decongestant but not 1,8-cineole. Evaluation of the QoL was assessed with the German version of the validated Rhinosinusitis Quality of Life (RhinQoL) questionnaire [3–5].

Significant improvements in the frequency, bothersomeness, and impact of rhinosinusitis symptoms were observed under treatment with 1,8-cineole. Notably, stronger improvements were made in the cineole group compared to the decongestant group (► Fig. 1).

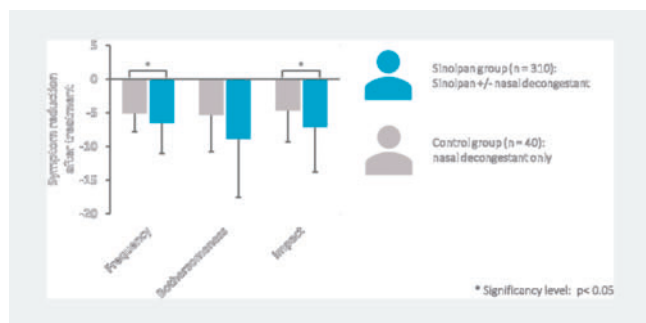

► Fig. 1 Decreases in frequency, bothersomeness, and impact of rhinosinusitis symptoms upon treatment with 1,8-cineole capsules or nasal spray. Data is presented as mean ± SD.

Overall, these results showed that 1,8-cineole treatment of rhinosinusitis was well tolerated and resulted in QoL improvements. The data revealed that the concomitant use of 1,8-cineole and decongesting nasal spray may provide therapeutic benefits such as stronger quality-of-life-improvements as compared to using decongesting nasal spray without 1,8-cineole.

Potential conflicts of interest This research was funded by Engelhard arzneimittel GmbH & Co. KG, the manufacturer of Sinolpan and Sinolpan forte. RM reports grants and personal fees from Engelhard, during the conduct of the study and is the director and the owner of Clinical Research International Ltd. and of ClinCompetence Cologne GmbH, two contract research organisations focusing on upper airways diseases. L, SB and CS are employees of Engelhard.

References

- [1] Desrosiers M. Diagnosis and Management of Acute Rhinosinusitis. *Postgraduate Medicine* 2009; 121: 83–89
- [2] Kehrl W, Sonnemann U, Dethlefsen U. Therapy for acute nonpurulent rhinosinusitis with cineole: results of a double-blind, randomized-placebo-controlled trial. *Laryngoscope* 2004; 114: 738–742
- [3] Atlas SJ, Gallagher PM, Wu YA, Singer DE, Gliklich RE, Metson RB, Fowler FJ Jr. Development and validation of a new health-related quality of life instrument for patients with sinusitis. *Qual Life Res* 2005; 14: 1375–1386
- [4] Atlas SJ, Metson RB, Singer DE, Wu YA, Gliklich RE. Validity of a new health-related quality of life instrument for patients with chronic sinusitis. *Laryngoscope* 2005; 115: 846–854
- [5] Petrat T. Validation of the German version of the RhinoQoL questionnaire for evaluation of the quality of life in acute rhinosinusitis. University of Cologne 2020

P-122 Ivy leaf dry extract EA 575 is the first phytotherapeutic drug known to mediate biased β_2 -receptor signaling

Authors Fabio Meurer¹, Janka Schulte-Michels¹, Lukas Uebbing², Hanns Häberlein¹, Sebastian Franken¹

Institutes 1 Institute of Biochemistry and Molecular Biology, Medical Faculty, University of Bonn, Bonn, Germany; 2 Engelhard Arzneimittel GmbH & Co KG, 61138 Niederdorfelden, Germany

DOI 10.1055/s-0043-1774004

Ivy leaf dry extract EA 575 belongs to the most extensively studied phytotherapeutics. In recent years, preclinical research on EA 575 has focused on the molecular mechanisms of action that might be responsible for its secretolytic, bronchodilatory, and anti-inflammatory effects.

β_2 -receptors relay their signals via both G proteins and β -arrestins. If one of these pathways is preferentially followed after stimulation, this is referred to as biased signalling. In respiratory diseases the effects caused by G protein signalling are desirable, whereas the β -arrestin effects are rather undesirable. A better understanding of the effects on biased signalling at β_2 -receptors may contribute to the development of more effective drugs with fewer side effects. Here, we present results using HEK wild-type and HEK β -arrestin knock-out cells investigating impacts of EA 575 on β_2 -adrenergic signalling. Under stimulating conditions, β_2 -adrenergic signalling was enhanced by EA 575 in wild-type cells, whereas in β -arrestin knock-out cells EA 575 was without effect as demonstrated in dynamic mass redistribution assays. EA 575 mediates biased Gsa/cAMP signalling which is supported by increased cAMP formation and inhibition of β -arrestin 2 recruitment. These findings can be explained by inhibition of GRK2-mediated phosphorylation of β_2 -receptors by the EA 575 constituent α -hederin.

In airway smooth muscle cells and type-II alveolar cells, this would mean a bias towards desired effects, such as secretolysis and bronchodilation, while undesired effects such as receptor internalisation and desensitisation towards β_2 -agonists would decrease. This marks the first time that biased β_2 -receptors signalling has been demonstrated for a phytotherapeutic.

P-123 Discovery of GS27, a novel, oleocanthal based inhibitor of ATP citrate lyase

Authors Georgia Sarikakaki², Panagiota Papakotsi³, Ioannis D. Kyriazis⁴, Demetrios Kouretas⁴, Dimitrios Iliopoulos⁵, Ioannis Kostakis¹, Alexios-Leandros Skaltsounis²

Institutes 1 Department of Medicinal Chemistry, Department of Pharmacy, National and Kapodistrian University of Athens, Panepistimiopolis Zografou, Athens, Greece; 2 Department of Pharmacognosy and Natural Products Chemistry, Department of Pharmacy, National and Kapodistrian University of Athens, Panepistimiopolis Zografou, Athens, Greece; 3 Pharmagnose S.A., 57km National Road Athinon-Lamia., Inofyta, Greece; 4 Department of Biochemistry and Biotechnology, University of Thessaly, Viopoulis, Mezourlo, Larissa, Greece; 5 Athos Therapeutics Inc., Los Angeles, USA

DOI 10.1055/s-0043-1774005

Oleocanthal, a key ingredient of EVOO, has attracted considerable scientific attention in recent years because of its biological activities and contribution to many aspects of human health. Prompted by the outstanding interest of this high-value natural compound, herein we describe the development of a concise and scalable procedure for the synthesis of various oleocanthal analogues. The synthesis is performed by a convenient biomimetic and stereo-controlled approach, starting from oleuropein, an abundant raw material in olive leaves [1]. All synthesized compounds were evaluated for their anticancer activity against nine cancer cell lines with interesting activities. One of them, namely GS27, displayed significant activity against all cancer cell lines, bearing appropriate ADME properties. GS27 altered the phosphorylation profile of ACLY, AMPK, and p70S6 in different cell types. ACLY is the “gate-keeping” enzyme that controls the de novo liposynthesis in cells, thus, targeting ACLY activity is a promising

strategy to tackle the needful glucose dependent lipid synthesis for the propagating cancer cells. Furthermore, since GS27 decreases the phosphorylation of both ACLY and p70S6, it is able to inhibit two major metabolic pathways like de novo liposynthesis and protein synthesis.

Funding This research has been co-financed by the European Union and Greek national funds through the Operational Program Competitiveness, Entrepreneurship and Innovation, under the call RESEARCH – CREATE – INNOVATE (project code: T2EDK-02423).

Conflict of Interest The authors declare no conflict of interest.

References

[1] Sarikaki G.et.al. Biomimetic Synthesis of Oleocanthal, Oleacein, and Their Analogues Starting from Oleuropein, A Major Compound of Olive Leaves. *J. Nat. Prod* 2020; 83 (6): 1735–1739

P-125 Crude plant extracts application in photodynamic therapy: making a case for *Ficus carica* L.

Authors Francesca Scotti¹, Elena Sarti², Linru Mou¹, Caroline Maake², Michael Heinrich¹

Institutes 1 UCL School of Pharmacy, London, United Kingdom; 2 UZH Department of Anatomy, Zurich, Switzerland

DOI 10.1055/s-0043-1774006

Photodynamic therapy (PDT) exploits the cellular effects of reactive oxygen species (ROS) generated by light-induced photosensitisers. *Ficus carica* leaf latex causes severe photodermatitis in the sunlight, indicating the presence of natural photoactive compounds. This project investigated whether crude extracts of *F. carica* may be suitable for simple and cheap PDT applications. UV/Vis spectrophotometry of the leaves' acetone extract revealed three main absorption peaks (330, 410, 666 nm) and two minor ones (538 and 612 nm). Assays for ROS showed a light-dependent synthesis of singlet oxygen and hydroxyl radicals. With microscopic methods, intracellular accumulation of fluorescence was visible within 2 – 4 hours of exposure of 4T1 and MRC-5 cells to the extract. Further in vitro studies in these cell lines indicated a strong reduction of viability after application of white light (10 minutes, 32 mW/cm²) together with an exposure to the extract at concentrations that were harmless in the dark. Preliminary results of FAM-FLICA assays indicated apoptosis may not be the main mode of cell death, while Seahorse XFe96 Mito Stress tests provided evidence for profound changes in mitochondrial respiration due to the treatment. In conclusion, *F. carica* leaves may contain photosensitisers with promising profiles for safe and efficient PDT. Our observation that a simple extraction in acetone suffices to achieve a product with the desired PDT activity opens up new avenues for the development of simple therapeutic interventions in remote areas and impoverished settings. Ongoing studies are investigating the potential of this crude extract to combat wound infections.

Conflict of Interest The authors declare no conflict of interest.

P-126 Chemical Constituents from an Oyster-derived Fungus *Westerdykella dispersa* Ca4-13

Authors Shu-Jung Huang¹, Li-Kwan Chang², Yi-Shan Lu², George Hsiao^{3,4}, Tzong-Huei Lee¹

Institutes 1 Institute of Fisheries Science, College of Life Science, National Taiwan University, Taipei, Taiwan; 2 Department of Biochemical Science and Technology, College of Life Science, National Taiwan University, Taipei, Taiwan; 3 Department of Pharmacology, School of Medicine, College of Medicine, Taipei Medical University, Taipei, Taiwan; 4 Graduate Institute of Medical Sciences, College of Medicine, Taipei Medical University, Taipei, Taiwan

DOI 10.1055/s-0043-1774007

Chromatographic separation of the liquid-state fermented products of the fungal strain *Westerdykella dispersa* Ca4-13 isolated from an edible oyster *Crassostrea angulata* collected from Yunlin, Taiwan has resulted in the isolation of compounds 1 – 6. The structures of compounds 1 – 6 were characterised by spectroscopic analysis to be westeroic acid A, westeroic acid B, auranticin A, auranticin B, pilobolusone C, and epi-radicinol (► Fig. 1), respectively.

Westeroic acid A, a rare C28 polyketide with a 6/6-spiro-linked δ -lactone moiety, and westeroic acid B, a C14 polyketide with a γ -lactone functionality, were previously unreported chemical entities. Of the compounds identified, 1, 2 and 6 exhibited anti-inflammatory activities with IC₅₀ values ranging from 9.5 to 14.7 μ M without any cytotoxicity, and compound 4 exhibited anti-Epstein-Barr virus (EBV) activity with an EC₅₀ value of 38.1 μ M. The aldehyde group of auranticin B (4) would play a vital role in its anti-EBV activity comparing the activity of 4 with those of its two analogues, auranticin A (3) and pilobolusone C (5).

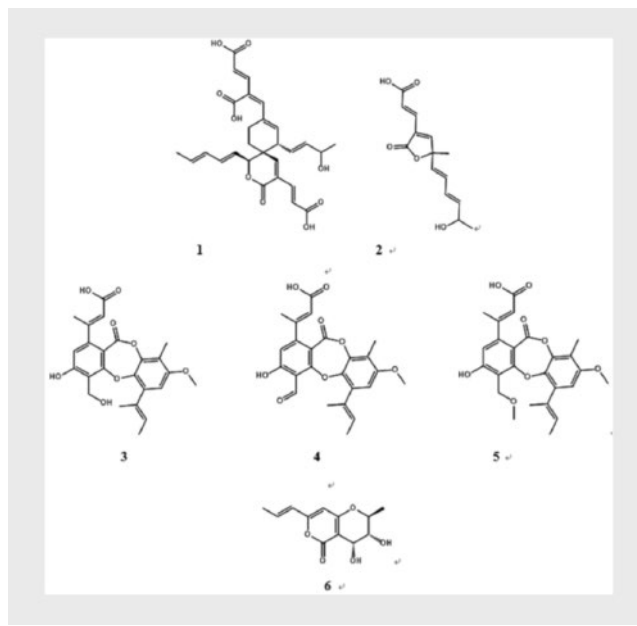

► Fig. 1 Chemical structures of compounds 1-6 identified in this study.

P-129 Antipruritic effects of the flower part of *Hypericum patulum*

Authors Hisae Oku¹, Kana Shimomura¹, Syui Aoki¹, Naoki Inoue¹

Institute 1 School of Pharmacy and Pharmaceutical Sciences, Mukogawa Women's University, 663-8179, Japan

DOI 10.1055/s-0043-1774008

The discovery of antipruritic substances is expected to help patients with chronic and severe pruritus, such as atopic dermatitis. We previously searched for natural products with antipruritic activity using in vivo assay systems, through evaluation of the inhibitory effect on scratching behaviour (itching-related reactions by degranulation of mast cell) induced by compound 48/80 (COM) in mice. In our continuing search for antipruritic substances from natural sources, we found the fresh flower of *Hypericum patulum*. We previously reported antipruritic triterpene of the petals of *H. patulum* and in this study, we evaluated the antipruritic effect of the flower part's methanol extract (HP) in which petals were removed.

The HP (100 mg/kg, p.o., 1 h before injection of COM) significantly inhibited COM-induced scratching behaviour. Bioassay-guided fractionation of HP led to the identification of quercetin (1), hyperin (2), and 3, 8"-biapigenin (3) as main compounds in AcOEt fractionation which have activity. The activity of compounds 1 and 2 was reported previously, so compound 3 was evaluated in the same assay. At 20 mg/kg of compound 3 significantly inhibited COM-induced scratching behaviour. Its activity was comparable to apigenin (20 mg/kg), and chlorpheniramine maleate (10 mg/kg) as a positive control. The sedative effect and mechanism of compound 3 are under investigation.

Our findings showed that the *H. patulum* may provide new leads for discovering antipruritic substances for the treatment of the itching sensation that accompanies allergic reactions.

Conflict of Interest The authors declare no conflict of interest.

P-130 The alleviative effects of *Sophora Flavescens* root on skin barrier dysfunction via suppressing thymic stromal lymphopoietin in atopic dermatitis-induced mice

Authors Soyeon Kim¹, Ji Hyo Ryu^{1,2}, Hyungwoo Kim¹

Institutes 1 Pusan national university, Yangsan, South Korea; 2 Korea Institute of Oriental Medicine, Naju, South Korea

DOI 10.1055/s-0043-1774009

The root of *Sophora flavescens* is a traditional herbal medicine with a bitter taste and 'cold' properties and can be used to reduce body moisture and heat, as well as treat eczema, hepatitis, indigestion, pruritus, and jaundice. Recently *S. flavescens* was reported to have anti-oxidative, anti-inflammatory, anti-cancer, anti-bacterial, and anti-allergic effects. Atopic dermatitis (AD) is a chronic inflammatory disease that begins in childhood and continues into adulthood. The cause of AD is unclear, but its aetiology involves a complex interaction between abnormal skin barrier function and abnormal immune regulation. Furthermore, it has been shown that skin barrier dysfunction, an early symptom of AD, is related to thymic stromal lymphopoietin (TSLP). For these reasons, this study was designed to confirm the efficacy of *S. flavescens* at alleviating the symptoms of AD. AD was induced by applying MC903 in the dorsal skins of balb/c mice. The effects of *S. flavescens* on moisture contents, histopathological abnormalities, and TSLP production were investigated, and weight changes were evaluated. In our results, EESF revealed significantly increased skin moisture levels. In addition, water-holding capacity of stratum corneum was greater in the EESF-treated group than in the control group. Furthermore, TSLP levels in skin tissues were suppressed by EESF treatment, which suggests *S. flavescens* ameliorates skin barrier dysfunction and is a potential treatment for AD. EESF ameliorated skin barrier dysfunction and symptoms of atopic dermatitis by inhibiting TSLP. These results indicate that EESF could be used as a therapeutic for patients with AD.

P-132 Marshmallow extract – a systematic review for use in irritable cough

Authors Olaf Kelber¹, Konstanze Bedal¹, Karen Nieber²

Institutes 1 Phytomedicines Supply and Development Center, Bayer Consumer Health, Steigerwald Arzneimittelwerk GmbH, Darmstadt, Germany; 2 Institute of Pharmacy, Leipzig University, Leipzig, Germany

DOI 10.1055/s-0043-1774010

Irritative cough is common during the cold season, and aqueous extracts of marshmallow root are used for the treatment of this condition since ancient times and is also described in several monographs. It therefore seems important to summarise the presently available data on its use in patients. For this purpose, a systematic literature search was conducted in medical-scientific databases, supplemented by cross referencing.

Regarding studies on therapeutic use, a placebo-controlled trial on patients with irritable cough induced by ACE inhibitors was identified [1], in which a significant effect was described. A herbal medicine containing an aqueous extract of marshmallow, STW 42, four non-interventional studies (NIS) were identified for use in cold-related irritable cough [2–5], including 599 and 313 children, respectively 822 and 126 patients of all age groups. Tolerability ranged from very good to good, as was the patients' assessments of the effect, with rapid onset of action, usually within a few minutes.

In summary, the real world evidence documented in the present NIS provides very good evidence of the high value of marshmallow extracts in the treatment of irritable cough.

Acknowledgements: Special thanks to Kooperation Phytopharmaka, Bonn and to Ralph Mösges, Esther Raskopf and Kija Shah Hosseini, Cologne as well as to Alexa Göpfert, Darmstadt, Germany.

References

- [1] Rouhi H, Ganji F, Pak J Nutr 2007; 6: 256–8
- [2] Bässler D. Steigerwald Arzneimittelwerk GmbH 2005

[3] Fasse M, Zieseniss E, Bässler D. Paed 2005; 11: 3–8

[4] Fink C et al. Complement Med Res 2018; 25 (5): 299–305

[5] Möller J et al. ZPT 2019; 40: S35–S36

P-134 Polyporenic acids N-R, novel lanostane triterpenes from the mushroom *Buglossoporus quercinus* exert efflux pump inhibitory activity on Colo 320 cells

Authors Kristof Felegyi¹, Zsafia Garadi^{1,3}, Balint Racz², Gabor Toth^{2,5}, Viktor Papp⁴, Imre Boldizsar^{1,6}, Andras Dancso³, Gabriella Spengler², Szabolcs Beni¹, Attila Vanyolos¹

Institutes 1 Department of Pharmacognosy, Semmelweis University, Budapest, Hungary; 2 Department of Medical Microbiology, University of Szeged, Szeged, Hungary; 3 Directorate of Drug Substance Development, Egis Pharmaceuticals, Budapest, Hungary; 4 Department of Botany, Hungarian University of Agriculture and Life Sciences, Budapest, Hungary; 5 ELKH-USZ Biologically Active Natural Products Research Group, University of Szeged, Szeged, Hungary; 6 Department of Plant Anatomy, Institute of Biology, Eötvös Loránd University, Budapest, Hungary

DOI 10.1055/s-0043-1774011

Polyporenic acids N-R (1 – 5), five new lanostane triterpenes besides seven known polyporenic acids (6 – 12) were identified from the sporocarps of *Buglossoporus quercinus*. The isolation of fungal metabolites 1 – 12 was carried out by combination of multistep flash chromatography and reverse phase HPLC. The structure determination was performed by spectroscopic analysis, including 1D and 2D NMR and HRESIMS methods. The isolated lanostane triterpenes were investigated for their antiproliferative activity in vitro by MTT assay on resistant Colo 320 human colon adenocarcinoma cell lines, expressing P-glycoprotein. The fungal metabolites demonstrated moderate antiproliferative activity with IC50 values in the range of 20.7 – 106.2 µM. A P-glycoprotein efflux pump modulatory test on resistant Colo 320 cells revealed that compounds 3, 5, 8, and 10 – 12 inhibit the efflux-pump activity of cancer cells. The drug interactions of triterpenes with doxorubicin were also investigated by the checkerboard method. Compounds 3 – 4, 7 – 8, and 12 interacted in a synergistic manner, moreover, compound 9 exerted a strong synergistic potency (CI = 0.276). Our study highlights that *B. quercinus* is an excellent source of fungal steroids with significant chemosensitising activity on cancer cells (► Fig. 1).

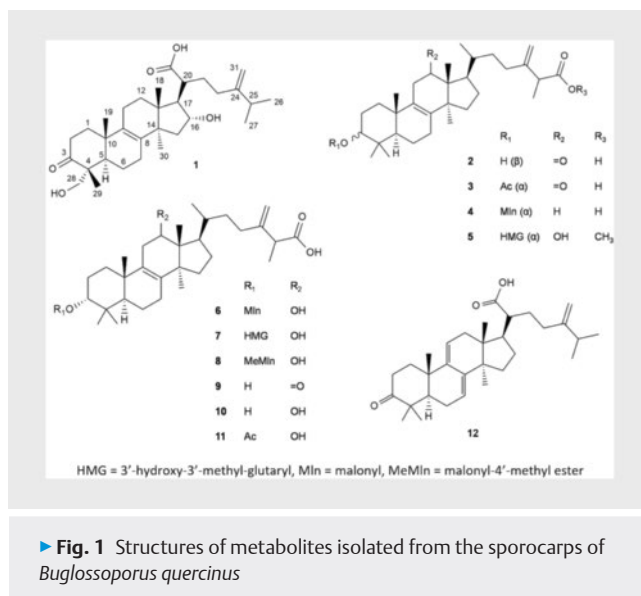

► Fig. 1 Structures of metabolites isolated from the sporocarps of *Buglossoporus quercinus*

P-135 Evaluation of cell viability by MTT and nitric oxide release after treatment of HepG2 cells with soursop and purple ipe

Authors Ana Catarina Valle^{1,2}, Aloisio Cunha Carvalho^{1,2}, Maria P.V. Valle^{2,3}, Hilana S. Brunel⁴, Rosangela V. Andrade³

Institutes 1 Doctor Izaao Soares Institute – IDIS, Ribeirao Preto, Brazil; 2 Natural Veterinary Medicine Institute – IMVN, Brasilia, Brazil; 3 Brasilia University, Brasilia, Brazil; 4 Biolnova, Brasilia, Brazil; 5 Catholic University, Brasilia, Brazil

DOI 10.1055/s-0043-1774012

Homeopathy has become increasingly known and used in various treatments, showing excellent clinical results. One of its most common indications is to help treat chronic diseases, directly improving patients' quality of life, especially those with cancer. Hepatocellular carcinoma is a disease that depends on different factors for its development and the success of its treatment. In this context, searching for new therapeutic tools is essential, and homeopathy seems promising. Therefore, *Annona muricata* (soursop/graviola) and *Handroanthus impetiginosus* (purple ipe) have been studied due to their action potential against tumour cells. This study aimed to evaluate the effect of these medicines combined in 1.1 mL ampoules, in homeopathic dilutions, on HepG2 (hepatocellular carcinoma) cells through in vitro tests. Treatment with the Soursop D5 (1×10^{-5}) + Purple Ipe D5 (1×10^{-5}) formulation resulted in decreased cell viability and increased nitric oxide production by these cells. These findings indicate that this medicine showed an antitumour effect and can be an ally in treating this type of pathology.

P-136 Healing activity of the *Viscum album* eye drops

Authors Ana Catarina Valle¹, Aloisio Cunha Carvalho¹, Maria P.V. Valle³, Hilana S. Brunel², Rosangela V. Andrade³

Institutes 1 Doctor Izaao Soares Institute – IDIS, Ribeirao Preto, Brazil; 2 Biolnova, Brasilia, Brazil; 3 Catholic University of Brasilia, Brasilia, Brazil

DOI 10.1055/s-0043-1774013

Extracts of the *Viscum album* (VA) plant gained several indications of use throughout history for the clinical improvement of patients. Among these indications is its healing activity, but the literature lacks reports about this feature. Fibroblasts and keratinocytes are directly involved in this context, and greater stimulation of these cells is beneficial to accelerate the healing of wounds. This work aims to verify the cell proliferation capacity of the *Viscum album* homeopathic eye drops at 6DH (1×10^{-6}) potency after a lesion that mimics the corneal groove.

HaCat keratinocyte cells were treated with the VA 6DH (1×10^{-6}) eye drops at an 8 $\mu\text{L}/\text{mL}$ concentration. The plates were opened, and after 24 hours, a scratch (► **Fig. 1: A and B**) was performed. Treatment was then added to each well. After 48 hours of incubation with the eye drops (► **Fig. 1: C and D**), the plates were analysed to define the percentage of healed area (► **Fig. 1: Table 1**) using the Image J software. Statistical analysis was performed using the Graph Prisma Version 9.5.0. Data were analysed for normality using the Shapiro-Wilk test. Subsequently, the Student's t-test was performed for comparison of results. After statistical analysis, data were considered normal (parametric) and demonstrated that the VA 6DH (1×10^{-6}) eye drops provided more significant healing of the area ($p=0.0071$) compared to the control treatment (► **Fig. 1: Bottom right**). The results indicate that the VA 6DH (1×10^{-6}) eye drops may assist in the treatment of eye injury.

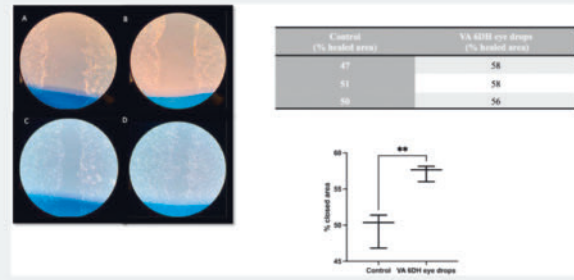

► **Fig. 1** Left – Scratch test. Day 0: At the moment the scratch was performed. A (control) and B (treated) – Plates with no treatment yet. Day 2 (after 48 h): C. Plate with no treatment (control); D. Plate treated with *Viscum album* eye drops. Top right – Table of percentage of healed area in controls and VA 6DH treatments. Bottom right – Graph of percentage of healed area in control and treated plates.

P-137 Exploring the pain-relieving potential of *Piper mollicomum*: combining traditional wisdom with scientific investigation

Authors Leticia Barbosa Santos¹, Felipe Pedroz Lima¹, Izabella Ribeiro¹, Rachel Oliveira Castilho¹

Institute 1 Faculty of Pharmacy, Department of Pharmaceutical Products – UFMG

DOI 10.1055/s-0043-1774014

The plant *Piper mollicomum*, commonly known as "aperta ruão," is widely distributed in Brazil. Despite the lack of clinical evidence, its traditional use for lumbar spine pain relief has prompted an investigation into its analgesic and anti-inflammatory properties [1]. In this study, the main objective was to conduct in vitro and in silico evaluations, along with chemical analysis of the aqueous extract prepared by decoction, replicating the traditional methods. Phenolic compounds, known for their potent antioxidant, anti-inflammatory, and analgesic effects, were identified through co-injection experiments with standards using ultra-performance liquid chromatography. The total phenolic content was determined according to the British Pharmacopoeia [2]. Phytochemical analysis confirmed the presence of caffeic acid and cinnamic acid, reported for the first time in this species and a high amount of total phenolic content, 9.64% w/v. The aqueous extract demonstrated significant antioxidant activity, with an EC50 value of 31.26 $\mu\text{g}/\text{mL}$ (DPPH assay). Molecular docking studies using AutodockTools were performed to evaluate the inhibitory activity against COX and LOX enzymes, which play crucial roles in the synthesis of inflammatory mediators. The binding energy for caffeic acid and cinnamic acid were DOX -5.63 and LOX -6.02 and, DOX -4.95 and LOX -5.84, respectively. The significant antioxidant effects observed in vitro, the substantial total phenolic content of the extract, and the in silico assay results for the identified compounds support the traditional medicinal use of *P. mollicomum* as pain reliever. Further studies are required to elucidate this action, the mechanism of action, determine appropriate dosage, and explore administration methods.

Funding This project was supported by Coordenação de Aperfeiçoamento de Pessoal de Nível Superior (CAPES).

Conflict of Interest The authors declare no conflict of interest.

References

- [1] Medeiros et al. (2004). 10.1590/S0102-33062004000200019.
- [2] British Pharmacopoeia (2020).

P-138 Therapeutic potential of *Rudgea viburnoides* as anti-rheumatic agent: an in vitro and in silico study

Authors [Leticia Barbosa Santos¹](#), [Felipe Pedroz Lima¹](#), [Rachel Oliveira Castilho¹](#)

Institute 1 Faculty of Pharmacy, Department of Pharmaceutical Products – UFMG

DOI [10.1055/s-0043-1774015](#)

Rudgea viburnoides, commonly known as "congonha," is a plant species of the Brazilian cerrado. Traditionally, its leaves have been used as a tea for rheumatism relief, despite the lack of clinical evidence supporting its efficacy [1]. To address the gap of scientific data, this study aimed to assess the potential of *R. viburnoides* as an anti-rheumatic agent by investigating its bioactive compounds. The aqueous extract was obtained by decocting the plant and mimicking its popular traditional usage. Phenolic compounds were identified by co-injection experiments with standards in ultra-performance liquid chromatography. The decoction's antioxidant activity was evaluated using the DPPH radical assay, considering the role of the radicals in the chronic inflammation in rheumatoid conditions and the anti-inflammatory properties of antioxidants [2]. An in silico analysis was also conducted to examine the interaction between the identified compounds and the target TNF- α , a key factor in rheumatoid inflammation [3]. The decoction exhibited significant antioxidant activity with an EC₅₀ value of 42.41 μ g/mL, indicating its substantial antioxidant potential. Phytochemical analysis confirmed the presence of chlorogenic acid and rutin in the decoction, with higher antioxidant activity, 1.85 and 6.57 μ g/mL, respectively. Molecular docking studies in BOLIVIADiscovery and AutodockTools software revealed that both compounds are able to bind to the active sites of TNF- α forming stable protein-ligand complexes. The antioxidant activity of congonha's extract and its compounds suggests their anti-inflammatory action in rheumatoid conditions. Results support *R. viburnoides*' traditional use as an anti-rheumatic remedy, emphasising its ethnopharmacological significance. Further research is required for safety profiling and drug development.

Funding This project was supported by Coordenação de Aperfeiçoamento de Pessoal de Nível Superior (CAPES).

Conflict of Interest The authors declare no conflict of interest.

References

- [1] Young et al. (1998). doi:/10.1021/np9704617.
- [2] Moriasi et. al. (2018). doi: 10.1016/j.heliyon.2021.e07145.
- [3] Kaloni et. al. (2020). doi: 10.1016/j.hermed.2020.100396.

P-139 Synergistic effect of *Panax ginseng* and *Inula japonica* formula on pulmonary fibrosis in MRC-5 cells

Authors [Nam-Hui Yim¹](#), [YeonGyun Jung²](#), [Jin Yeul Ma¹](#)

Institutes 1 Korea Institute Of Oriental Medicine, Daegu, South Korea; 2 Hallym University College of Medicine, Seoul, South Korea

DOI [10.1055/s-0043-1774016](#)

Panax ginseng Meyer and *Inula japonica* Thunb. have long been used as traditional medicines and have pharmacological activity in the treatment of various diseases, such as diabetes, asthma, and cancer. Although each extract of *P. ginseng* and *I. japonica* can alleviate pulmonary fibrosis (PF), their synergistic effect on PF remains unexplored. Therefore, this study explores this combined effect. MRC-5 cells were stimulated by TGF- β 1 and treated with a *P. ginseng* and *I. japonica* formula (ISE081) under noncytotoxic conditions to investigate fibroblast-to-myofibroblast transition (FMT). After harvesting the treated cells, mRNA levels were determined to evaluate the anti-inflammation activities of ISE081. Western blotting was used to assess the expressions of FMT-related marker proteins, including α -smooth muscle actin (α -SMA) and fibronectin, and Smad2/3 as a migration-associated protein. Furthermore, a wound healing assay was used to confirm the antimigration effect of ISE081. ISE081 significantly reduced the mRNA levels of IL-6, IL-8, α -SMA, and TGF- β 1 in MRC-5 cells and suppressed α -SMA and fibronectin expressions dose-dependently. Furthermore, ISE081 inhibited Smad2/3 phosphorylation and wound migration of

MRC-5 cells. Under the same conditions ISE081 inhibited the fibrosis-associated signals in TGF- β 1 stimulated MRC-5 cells, *P. ginseng* did not affect the expression of α -SMA, fibronectin and Smad2/3 phosphorylation, whereas *I. japonica* significantly inhibited them but with cytotoxicity. These findings suggest the combined use of *P. ginseng* and *I. japonica* can improve the antifibrotic activity of pulmonary fibroblast while reducing toxicity, which carries out the synergistic effect. Therefore, ISE081 has potential as a preventative and treatment herbal medicine for PF.

P-140 Management of acute bronchitis in Switzerland with *Pelargonium sidoides* extract EPS 7630 versus usual care: protocol of a randomized controlled trial

Authors [Angélique Bourqui¹](#), [Julie Dubois¹](#),

[Federico Bonofiglio¹](#), [Chantal Csajka²](#), [Pierre-Yves Rodondi¹](#)

Institutes 1 University of Fribourg, Switzerland; 2 University Hospital and University of Lausanne, Switzerland

DOI [10.1055/s-0043-1774017](#)

Pelargonium sidoides has been used for centuries for the treatment of coughs in South Africa. The root of this plant is well-known for its antiviral and immunomodulatory properties. A standardized extract of this plant, EPS7630, has been used for years in Europe, Asia and North America to treat acute bronchitis. This study aims to evaluate the effectiveness and feasibility of using this standardized extract of *Pelargonium sidoides* for the treatment of acute bronchitis in primary care settings.

The study will be a pragmatic randomized controlled trial carried out in primary care physicians' practices (PCPs) in Switzerland, with a pilot study planned for Spring 2023 and a confirmatory study in Winter 2023- 2024. A total of 412 patients diagnosed with acute bronchitis will be included and randomized into either the usual care group or the intervention group. At inclusion, symptoms will be assessed by PCPs in order to quantify the severity of five symptoms related to acute bronchitis, using the ABSS score. The patients will complete a daily diary to report their symptoms. The primary outcome will be determined by comparing the number of days needed to achieve a 50% reduction in symptom severity between the two groups. Secondary outcomes will measure the proportion of patients receiving antibiotics and the proportion of PCPs agreeing to participate and adhere to the study.

This study will contribute by providing insight into ways to reduce antibiotics overuse and improve the understanding of the facilitators and barriers to prescribing herbal medicine in primary care.

P-141 A possible shortcut in protecting animals against nematode infestations

Author [Jacobus Eloff¹](#)

Institute 1 University of Pretoria, Pretoria, South Africa

DOI [10.1055/s-0043-1774018](#)

Nematodes such as *Haemonchus contortus* limit the production of sheep in many parts of the world. The use of chemical anthelmintics such as albendazole has led to the development of resistance. Traditional use of plants against parasites has been used to investigate alternative treatments [1]. The assays used involve testing the effect of extracts on hatching or larval development of nematode eggs obtained from infected sheep. These assays are time consuming and require experience.

Benzimidazoles such as albendazole are active against nematodes and fungi. To determine the antifungal activity of plant extracts and to isolate the active compounds by column chromatography and bioautography is relatively easy. We determined the anthelmintic activity of 13 plants used traditionally [1]. I removed three species where the traditional uses for anthelmintic activity were not clear and determined the antifungal activity of acetone leaf extracts of these 10 species and the correlation of antifungal activity with ED₅₀ of egg hatch

and larval development assays. There was some correlation between egg hatching and antifungal activity ($R^2 = 0.458$), but a reasonably good correlation between larval development ED_{50} and antifungal activity ($R^2 = 0.819$).

This may mean that the compounds inhibiting larval development may also have antifungal activity. By investigating plants with high antifungal activity, extracts and compounds with high anthelmintic activity may be discovered.

Conflict of Interest The author declares no conflict of interest.

References

[1] Adamu et al. BMC Veterinary Research 2013, 9:38 <http://www.biomedcentral.com/1746-6148/9/38>

P-142 An Evaluation of *Sanicula europaea* L. for its Potential in the Treatment of Pulmonary Arterial Hypertension

Authors Mohamed Ahmed Elshorbagy^{1,2}, Talat Nasim¹, Colin Wright¹

Institutes 1 School of Pharmacy and Medical Sciences, University of Bradford, Bradford, United Kingdom; 2 Faculty of Pharmacy, Tanta University, Tanta, Egypt

DOI 10.1055/s-0043-1774019

Pulmonary arterial hypertension (PAH) is a damaging cardiovascular disease characterised by the narrowing of the small pulmonary blood vessels leading to right heart failure and pre-mature death. The treatment of PAH is limited and aimed to improve symptoms and hence there is an urgent need for new drugs. We hypothesised that the competing processes of bone morphogenetic protein (BMP) and TGF- β pathways are tightly regulated in PAH; agents that restore the balance between these two pathways may provide therapeutic intervention. *Sanicula europaea* L. is traditionally used for the treatment of wounds and respiratory disorders. Saponin glycosides and phenolic compounds, as major constituents, are responsible for antioxidant and antiproliferation activities that may have benefits in PAH.

S. europaea herb was extracted with 70% methanol and the concentrated extract partitioned with ethyl acetate and then with butanol. The dried butanol fraction was dissolved in methanol and dropped into diethyl ether to give crude glycosides. Biological evaluation of the ethyl acetate (E) and glycoside (G) fractions on BMP and TGF β pathways was carried out using reporter assays, western blot and RT-PCR.

Both fractions, (E and G) inhibited TGF- β responsive reporter activity whilst eliciting no effect on the BMP-mediated reporter activation. Fraction G promoted SMAD 1/5 protein phosphorylation and Id1 gene transcription and inhibited the expression of Pai1 transcripts. Taken together, TGF- β signalling is inhibited by both fractions while fraction (G) promotes BMP signalling suggesting that further investigation of *S. europaea* in PAH would be worthwhile.

Conflict of Interest The authors declare no conflict of interest.

P-143 Phyllobilins as promising bilirubin-like compounds to counter atherosclerosis

Authors Patricia Frei¹, Angelika M. Vollmar¹, Simone Moser¹

Institute 1 Lmu Munich, Munich, Germany

DOI 10.1055/s-0043-1774020

Phyllobilins, linear bilin-type tetrapyrroles, represent the degradation products of the ubiquitous pigment chlorophyll. Phyllobilins occur in high structural variety, and previous studies have shown promising bioactivities for these natural products, including anti-oxidative and anti-inflammatory properties, as well as activities against cancer cells. Catabolites derived from heme, the bilins, are structural relatives of the phyllobilins. For bilirubin, observational studies have shown that unconjugated bilirubin levels decrease the risk of oxidative-stress mediated diseases such as hypertension, type-2-diabetes mellitus, metabolic syndrome, obesity, cardiovascular disease, and cancer development. Recent studies have further shown that high serum bilirubin levels correlate with the prevention of atherosclerotic plaque formation. Moreover, bilirubin is

known to inhibit endothelial VCAM-1 and ICAM-1 signalling. We present here the investigation of phyllobilins as bilin-related compounds from plants in the prevention and treatment of atherosclerosis. In the frame of a Schwabe Phyto Innovation Challenge project, we aim at deciphering the anti-oxidative potential of phyllobilins in an atherosclerosis context, as well as their influence on adhesive proteins on the endothelium surface, such as VCAM-1 and ICAM-1, which mediate leukocyte migration and play a crucial step in atherosclerotic plaque formation.

P-144 Clickable Microcystins as payloads in Antibody-Drug Conjugates

Authors Laura Louisa Stock¹, Sabine Schuster¹, Heike Enke², Dan Enke², Timo H.J. Niedermeyer¹

Institutes 1 Martin-Luther Universität Halle-Wittenberg, Halle (Saale), Germany; 2 Cyanobiotec GmbH, Berlin, Germany

DOI 10.1055/s-0043-1774021

Freshwater cyanobacteria like *Microcystis* and *Planktothrix* often produce Microcystins (MCs). These well-studied cyanotoxins are nonribosomal cyclic heptapeptides and known for their inhibition of the eukaryotic serine/threonine protein phosphatases 1 and 2a with IC_{50} values in the pico- to nanomolar concentration range. Unlike many other cytotoxic agents that enter cells by passive diffusion, MCs are dependent on an active uptake via organic anion transporting polypeptides 1B1 and 1B3, which are expressed especially by liver cells. The transportability strongly depends on the structure of the MCs and can dramatically differ by the exchange of one single amino acid in the core structure.

Because of the high potency, the yet unexploited mode-of-action of MCs, the unlikely resistance development, and the prospect of lower side effects compared to known payloads of antibody-drug conjugates (ADCs), we strive to develop MC derivatives with optimized properties that can be used as payloads for ADCs. Here, we present the semi-synthesis of MC analogs bearing different properties and their in vitro characterization. Easily derivatizable, "clickable" MCs were produced in distinct *Microcystis* sp. strains by precursor-directed biosynthesis, followed by extraction of biomass and isolation of these unnatural MCs by chromatographic methods. The obtained MCs were modified with a library of small molecules with different properties using "click chemistry", and the structures of the derivatives were confirmed by HRMS2. Both cell viability studies as well as phosphatase inhibition assays have been performed to study structure-activity and structure-transportability relationships of the compounds.

Conflict of Interest The authors declare no conflict of interest.

P-145 One-pot semi-synthesis and neurogenic potential of pyranoflavonoids with different structural scaffolds

Authors Corinna Urmann^{1,2}, Lara Bieler^{3,4}, Michael Hackl², Olivia Chia-Leeson², Sebastien Couillard-Despres^{3,4}, Herbert Riepl^{1,2}

Institutes 1 Weihenstephan-Triesdorf University of Applied Sciences, Straubing, Germany; 2 Technical University Munich, TUM Campus for Biotechnology and Sustainability, Straubing, Germany; 3 Institute of Experimental Neuroregeneration and Spinal Cord Injury and Tissue Regeneration Center Salzburg, Salzburg, Austria; 4 Austrian Cluster for Tissue Regeneration, Vienna, Austria

DOI 10.1055/s-0043-1774022

Flavonoids and chalcones show a variety of effects in the central nervous system, such as anti-inflammatory and antidepressant effects, as well as promoting neuronal differentiation, neurite outgrowth and nerve regeneration [1]. Such neurogenic effects have been demonstrated for the class of pyranochalcones [2]. Our question was whether other flavonoid scaffolds with a pyrano-ring as a structural moiety would also have comparable neurogenic potential.

Starting from the prenylated chalcone xanthohumol isolated from hops, pyranoflavonoids with different scaffolds (flavanone, flavone, flavonol and au-

rone) were obtained using several semi-synthetic approaches. The yields of the semi-synthesis were improved by microwave irradiation and a less toxic reagent than usually applied for aurone synthesis could be used. The different semi-synthetic isomerisation reactions are well suited for further structure-activity studies of natural products as they are mostly simple one-pot, one-step reactions that provide a readily accessible source of different flavonoid scaffolds. Furthermore, using a reporter gene assay based on the promoter activity of doublecortin, an early neuronal marker, we identified the chalcone scaffold as the most active scaffold with pyrano-ring. Accordingly, pyranochalcones remain a promising class of compounds to develop a strategy for treating neurodegenerative diseases.

References

- [1] Spencer JP. The interactions of flavonoids within neuronal signalling pathways. *Genes Nutr* 2007; 2: 257–273
- [2] Oberbauer E, Urmann C, Steffenhagen C, Bieler L, Brunner D, Furtner T, Humpel C, Baumer B, Bandtlow C, Couillard-Despres S, Rivera FJ, Riepl H, Aigner L. Chroman-like cyclic prenylflavonoids promote neuronal differentiation and neurite outgrowth and are neuroprotective. *J Nutr Biochem* 2013; 24: 1953–1962

P-146 Antibacterial evaluation of natural oridonin and its chemically synthesised derivatives

Authors [Fatimah Qassadi](#)^{1,2}, [Tanya Monaghan](#)^{3,4},

[Dong-Hyun Kim](#)¹, [Rian Griffiths](#)¹, [Zheyang Zhu](#)¹

Institutes 1 University Of Nottingham, Nottingham, United Kingdom;

2 Department of Pharmacognosy, School of Pharmacy, Prince Sattam Bin Abdulaziz University, Central Region, Saudi Arabia; 3 NIHR Nottingham Biomedical Research Centre, University of Nottingham, Nottingham, United Kingdom; 4 Nottingham Digestive Disease Centre, College of Medicine, University of Nottingham, Nottingham, United Kingdom

DOI 10.1055/s-0043-1774023

Antimicrobial resistance has become one of the most important and pressing healthcare challenges of the present time [1]. Plant-derived natural antimicrobials have recently regained increased attention due to their great structural and chemical diversity [2, 3]. *Isodon rubescens* (Hemsl.) H.Hara is a perennial herb of the genus *Isodon* in the Labiatae family [4]. *Isodon* diterpenoids have attracted considerable attention as antibacterial, anti-inflammatory and anti-tumour agents. Oridonin, an ent-kaurane diterpenoid, has been attracting rising attention in recent years as the main bioactive chemical component of *I. rubescens*, and it is the material basis for its efficacy [5]. The aim of this study is to investigate the antibacterial activities of oridonin and four oridonin derivatives (X1, DCL-13, DCL-13p, C07-4BDXS) against *Escherichia coli*. Broth microdilution assay was used to determine the minimum inhibitory concentration (MIC) of each compound. Uptake of the fluorescent probe 1-N-phenyl-naphthylamine (NPN) was applied to determine the permeability changes in the cell membrane of *E. coli*. Oridonin and its derivatives (X1 and C07-4BDXS) permeabilise the outer membrane of *E. coli* MG655 and DH5a pUC19 with inhibitory activity between 100 μ M – 25 μ M. DCL-13 and DCL-13p have weaker antibacterial activity against *E. coli* growth, with MIC values \geq 200 μ M, suggesting a weaker bacteriostatic effect. Our results represent a first step towards the potential application of oridonin and its synthetic derivatives in the prevention and treatment of bacterial infections.

References

- [1] Khameneh B., Diab R., Ghazvini K, Fazly Bazzaz B.S. Breakthroughs in bacterial resistance mechanisms and the potential ways to combat them. *Microbial Pathogenesis* 2016; 95: 32–42
- [2] AlSheikh HMA, Sultan I, Kumar V, Rather IA, Al-Sheikh H, Tasleem Jan A, Haq QMR. Plant-Based Phytochemicals as Possible Alternative to Antibiotics in Combating Bacterial Drug Resistance. *Antibiotics* 2020; 9: 480
- [3] Cheesman M.J., Ilanko A, Blonk B., Cock I.E. Developing New Antimicrobial Therapies: Are Synergistic Combinations of Plant Extracts/Compounds with Conventional Antibiotics the Solution? *Pharmacogn Rev* 2017; 11: 57–72. doi:10.4103/phrev.phrev_21_17

[4] Li D, Han T, Xu S, Zhou T, Tian K, Hu X, Cheng K, Li Z, Hua H, Xu J. Antitumor and Antibacterial Derivatives of Oridonin: A Main Composition of Dong-Ling-Cao. *Molecules* 2016; 21: 575

[5] Xu S, Pei L, Li D, Yao H, Cai H, Yao H, Wu X, Xu J Synthesis and antimicrobial evaluation of natural oridonin and its enmein-type derivatives. *Fito-terapia* 2014; 99: 300–306

P-147 A clear and dilutable tea tree oil concentrate for medicinal immersion without uses of organic solvents or pharmaceutical excipients

Author [Zhijun Liu](#)¹

Institute 1 Louisiana State University, Baton Rouge, United States

DOI 10.1055/s-0043-1774024

Essential oils have shown a plethora of medicinal properties including anti-inflammatory, antioxidant and antimicrobial. Topical use of essential oils remains prevalent although aromatherapy is on the rise. Essential oils are composed of volatile isoprenyl small molecules that readily drift into the air but are not soluble in water. Dispersing essential oils in water would allow applications of immersion. Many dispersing techniques, especially co-solvency, have been used. However, we are using a natural steviol glycoside (SG) to act as the solubilizer.

This study aims to develop a method for dispersing tea tree oil in water to allow accurate dosing design and to achieve desired medicinal effects.

Tea tree oil separates from water. After being processed with SG into a water-soluble concentrate, it was clear and transparent without hints of haziness. The concentrate was dilutable freely in a water body fully and completely from 8% down to as low as 0.05%. All dilutions were stable for at least 24 hours.

A range of water solutions containing 0.05% to 8% tea tree oil are developed for immersion applications. The single use of SG to enable the dispersion of tea tree oil promises a clean label and 100% natural formulation because it does not include any organic solvents, surfactants or pharmaceutical excipients.

A joint faculty member of PBRC and member in a company that holds a license of Louisiana State University patent claiming the use of SG as a solubilizer.

P-148 Development of dissolution test for the capsule of *Thunbergia laurifolia*

Authors [Piyanuch Rojsanga](#)¹, [Thanapat Onsawang](#)¹,

[Naphat Chaiwipanon](#)¹, [Wanida Thongwat](#)¹, [Chutima Phechkrajang](#)¹, [Pongtip Sithisarn](#)²

Institutes 1 Department of Pharmaceutical Chemistry, Faculty of Pharmacy, Mahidol University, Bangkok, Thailand; 2 Department of Pharmacognosy, Faculty of Pharmacy, Mahidol University, Bangkok, Thailand

DOI 10.1055/s-0043-1774025

Thunbergia laurifolia Lindl. is a widely growing herb in Thailand. The leaves of *T. laurifolia* are indicated in the Thai national list of essential medicines 2018 for treating fever and relieving mouth ulcers. The dissolution method for evaluating caffeic acid and rosmarinic acid release from *T. laurifolia* leaf extract capsules was established in this study. The dissolution method was developed by testing the solubility of caffeic acid and rosmarinic acid from the leaf extract in 0.1 N HCl and water, as well as the influence of rotation speed. The dissolution method was then validated in accordance with the United States Pharmacopeia 2023. The results showed that the optimal dissolution for *T. laurifolia* capsules was achieved in 500 mL of 0.1 N HCl in water using apparatus 2 (a paddle) at a 100 rpm rotation speed at 37.0 ± 0.5 °C. Parameters including specificity, linearity, accuracy, precision and robustness were evaluated for the validation of the HPLC method, and the obtained results were acceptable according to the official criteria. The developed method was then used to evaluate the dissolution profiles of caffeic acid and rosmarinic acid released from the *T. laurifolia* extract capsule. The dissolutions of both chemical markers were higher than 85% at the 30-minute time point. The developed method could be useful for routine quality control of phytopharmaceutical products at the industrial level, especially for quality control of *T. laurifolia* leaf extract capsules in the future.

P-149 Rational Design of Dosage form of Medicinal Plant and Natural Product

Authors Zhijun Yang¹, Aiping Lyu¹

Institute 1 Hong Kong Baptist University, Kowloon Tong, Hong Kong

DOI 10.1055/s-0043-1774026

In China Mainland, the output value of medicinal plants product is about 2.8 million tons per year, which means each Chinese on average takes 2 kg of medicinal plant products. However, most content standards of the same API are different in crude drug pieces and decoction products. This phenomenon prompts there should be a big loss of the API during the process of preparing the products.

We analysed and compared the APIs in several marketed water extraction products and in the crude drug pieces, and the traditional dosage form of these marketed products was the powders of crude medicinal plants. The studies provide some exact clues for rationally designing dosage forms for medicinal plants and natural products, saving raw medicinal materials while preserving the ecological environment.

The results show that the total standard labelled ingredients by Pharmacopeia in the crude plant drugs may be extracted about 45 % once boiling for 30 minutes. However, the extracted total suspended solids is about 10 % of the plants of the formulation, while the content of the labelled ingredients in the extract is normally less than 15 %. After drying the extractions, more excipients will be added to form the dosage forms such as granules, capsules, etc. So the traditional dosage forms, powders of crude medicinal plants, are the most effective and economical.

Based on the results, we suggest the company, as much as possible, design, produce and sales promote the crude medicinal plant powder dosage forms for medicinal plant products.

P-150 Liberation of polyphenols of different agrimony extracts from topical preparations

Authors Pavel Mučaji¹, Martina Papadokos², Elena Kurin¹, Silvia Bittner Fialova¹, Emil Švajdlenka³, Milan Nagy¹, Peter Gál¹

Institutes 1 Comenius University Bratislava, Faculty of Pharmacy, Department of Pharmacognosy and Botany, Bratislava, Slovakia; 2 Comenius University Bratislava, Faculty of Pharmacy, Department of Galenic Pharmacy, Bratislava, Slovakia; 3 Comenius University Bratislava, Faculty of Pharmacy, Department of Chemical Theory of Drugs, Bratislava, Slovakia

DOI 10.1055/s-0043-1774027

Agrimony belongs to one of the most famous middle-European medicinal plants widely used in traditional medicine. The study aimed to formulate a topical preparation of the hydro-ointment type intended to treat minor skin inflammation and small, superficial wounds. Three gel-forming bases containing hydroxyethyl cellulose, carboxymethyl cellulose and Carbopol 940 were evaluated. MeOH, 50 % MeOH, and H₂O lyophilized extracts of agrimony served as active ingredients. The suitability of gel-forming bases was assessed based on total phenolic liberating capability. The liberation of extracts was performed in vitro through a semipermeable membrane using a vertical Franz diffusion cell system. The total polyphenolics quantity was determined spectrophotometrically by reaction with Folin-Ciocalteu's reagent. The cumulative amount of polyphenols released through the synthetic membrane from 1 % Carbopol gel was 61.3 % for H₂O, 67.3 % for MeOH and 55.4 % for 50 % MeOH extract within six hours. In comparison, 4 % carboxymethyl cellulose gel released 47.1 % (H₂O extract), 55 % (MeOH extract) and 39.3 % (50 % MeOH extract) of total polyphenolics. In a preliminary test of liberation, 5 % hydroxyethyl cellulose exhibited the lowest rate of released polyphenolics and was excluded from further experiments. The mutual HPLC comparison of lyophilized extract fingerprints and polyphenolic patterns of topical formulations after liberation exhibit differences in the content and profile of polyphenols. From the admin-

istration's viewpoint, the base with 1 % Carbopol and 4 % carboxymethyl cellulose proved most suitable.

Funding This work was supported by the Grants: VEGA 1/0226/22, and APVV-20-0017.

Conflict of Interest The authors declare no conflict of interest.

P-151 Preparation of natural product extracts of *Echinacea purpurea* (L.) Moench for drug product formulation using NADES

Authors Kate Tolan^{1,2,3,4}, Inshiya Kagalwala¹, Anne Marie Healy^{1,2,3,4}, Helen Sheridan^{1,2,3,4}

Institutes 1 School of Pharmacy and Pharmaceutical Sciences, Trinity College Dublin, Dublin, Ireland; 2 SSPC, the SFI Research Centre for Pharmaceuticals; 3 NatPro Centre for Natural Products Research, School of Pharmacy and Pharmaceutical Sciences, Trinity College Dublin, Dublin, Ireland; 4 EPSRC-SFI Centre for Doctoral Training in Transformative Pharmaceutical Technologies

DOI 10.1055/s-0043-1774028

Natural deep eutectic solvents (NADES) are gaining popularity as alternative green solvents to conventional organic solvents. NADES consist of solid, naturally occurring compounds, that when combined in a specific molar ratio, form a liquid, bound together by inter-molecular interactions, particularly hydrogen bonding. When used as extraction solvents NADES have been reported to extract significantly higher concentrations of phytochemicals from plants than traditionally used solvents, such as ethanol.

The plant of interest in this study is *Echinacea purpurea*, one of the top selling herbal medicines used to treat common cold symptoms and infections of the upper respiratory tract. Currently, all three liquid preparations of *E. purpurea* registered by the Health Products Regulatory Authority in Ireland use ethanol as the extraction solvent. Hence, this study investigated the use of NADES as a replacement for ethanol in the extraction of caffeic acid derivatives from *E. purpurea*. The extractability of cichoric acid, cynarin and caftaric acid in two NADES: betaine: citric acid (BeCa) and choline chloride: citric acid (CCCa), was examined. Both NADES extracted higher concentrations of all three caffeic acid derivatives when compared to an ethanol control. Impressively, the concentration of cichoric acid extracted using CCCa diluted with 20 % w/w water was 7 times that of an ethanol control. Solidification of the NADES and the NADES-plant extract by freeze drying was also examined and was found to be feasible. This was achieved by combining the NADES with a high glass transition temperature maltodextrin excipient to overcome issues associated with "stickiness" and a reduced powder yield.

Tuesday 4th July 2023 | Poster Session II

- Phytochemistry II – General (P-152 – P-177)
- Phytochemistry II – Antimicrobials; Cosmetics; Essential oils; Nutraceuticals; Biotechnology (P-178 – P-231)
- Ethnopharmacology/ Ethnobotany/Herbal Medicines (P-232 – P-239)
- Herbal Medicines/CAM – contemporary use (P-240–P-249)
- Regulatory (P-250 – P-251)
- Phytopharmacology II – Inflammation (P-252 – P-271)
- Phytopharmacology II – Metabolism; Diabetes; Obesity; Gut (P-272 – P-297)
- Macromolecules (P-298 – P-301)

P-152 Evaluation of antimicrobial and antioxidant potential of German mushrooms

Authors Christine Krüger¹, Manuela Wende¹, Michael Lalk¹

Institute 1 Institute of Biochemistry, University of Greifswald, Greifswald, Germany

DOI 10.1055/s-0043-1774029

Some mushroom species have been known for their medical properties for centuries and are now used mainly in Asian countries for their antioxidant, antimicrobial and antitumor potential among other things. The use of medicinal mushrooms is not very common in European countries and chemical, biological or pharmacological information is rare. This study investigates the biological activity of 20 selected wild mushrooms harvested from northern Germany. For this, dichloromethane, methanol and aqueous extracts of the dried fruiting bodies were obtained by Soxhlet extraction. The extracts were tested for their antimicrobial and antioxidant activities.

The antioxidant activity was evaluated by the DPPH method. A concentration-dependent increase in DPPH scavenging activity was found in all extracts, whereas methanol extracts possessed the most potent activity compared to those of the dichloromethane and aqueous extracts. The lowest effect was observed for aqueous extracts. The highest DPPH scavenging activity was found in the dichloromethane extract of *Boletus radicans* (31.25 µg/ml, 98.29%).

Antibacterial activity was screened by agar disk diffusion method against ES-KAPE pathogens. *Clitopilus prunulus* dichloromethane and methanol extracts showed the best antibacterial activity against *Staphylococcus aureus* with 27 mm and 22 mm inhibition zone respectively. The highest antibacterial activity was observed for dichloromethane extracts followed by methanol extracts. This study did not reveal any antibacterial activity for aqueous extracts against the six strains.

These findings show that mushroom extracts are a valuable source for natural antioxidants and antibacterial agents.

Conflict of Interest The authors declare no conflict of interest.

P-153 Extraction, isolation and identification of glucosinolates and their myrosinase derived metabolites from *Eruca sativa*

Authors [Varvara Papaioannou¹](#), [Marianna Vanioti²](#), [Dimitris Michailidis²](#), [Aikaterini Argyropoulou²](#), [Sofia Mitakou¹](#), [Maria Halabalaki¹](#)

Institutes 1 Division of Pharmacognosy and Natural Products Chemistry, Department of Pharmacy, National and Kapodistrian University of Athens, Panepistimioupoli, Zografos, 15771, Athens, Greece; 2 PharmaGnose S.A., 57th km Athens-Lamia National Road, Oinofyta, 32011, Greece
DOI 10.1055/s-0043-1774030

Eruca sativa (Brassicaceae), or arugula or rocket, contains various compounds that contribute to its nutritional and potential health benefits. Sulfur containing molecules (SCM), particularly glucosinolates and their myrosinase derived metabolites like isothiocyanates and epithionitriles, are of special research interest. These molecules are under investigation due to their potential anticancer [1], antihypertensive and vasodilator properties [2]. In parallel, their isolation from rocket involves many challenges due to their physicochemical properties. In this work, various extraction protocols including conventional extractions as well as “green” techniques, i.e. Supercritical Fluid Extraction (SFE) were tested and compared considering yield and SCM recovery. The investigated parameters were related to the pre-treatment of the plant material (freeze-drying, frozen -80 °C, fresh) as well as extraction temperature and the used methodology (stirring, sonication). The extracts were consequently characterised by LC-PDA-MS and LC-HRMS/MS optimised methods including ion-pair, reverse phase and hilic separations offering different selectivity and resolution. Moreover, fractionation techniques were applied such as adsorption resin chromatography (XAD-4, -16N, -7), column chromatography (normal phase, reverse phase and size exclusion), prep-HPLC-UV with columns of various stationary phases (RP-Amide, RP-C18, RP-C8), prepTLC and Centrifugal Partition Chromatography (CPC). Resin fractionation followed by reverse phase (C18) flash chromatography was proven more efficient for targeted fractionation and further isolation of aliphatic, indole, and dimeric glucosinolates.

Funding ERDF, “RESEARCH-CREATE-INNOVATE”, VEGNO + (project code T2EAK-00843)

Conflict of Interest The authors declare no conflict of interest.

References

- [1] Becker TM, Juvik JA. *Juvik. Diseases* 2016; 4: 22
- [2] Martelli A et al. *Br J Pharmacol* 2020; 177: 824–835

P-154 Exploring the phytochemical diversity and antiplasmodial potential of *Artemisia annua* and *A. afra* from different geographical locations in cameroon

Authors [Methodius Lahngong¹](#), [Allison Ledoux¹](#), [Benjamin Palmaerts²](#), [Kristiaan Demeyer³](#), [Jacob Souopgui⁶](#), [Stephen Ghogomu⁵](#), [Gisèle E. Loe⁴](#), [Eric Hallot²](#), [Michel Frédérick¹](#)

Institutes 1 Pharmacognosy Laboratory, Center of Interdisciplinary Research on Medicine (CIRM), Uliège, Liège, Belgium; 2 Remote Sensing and Geodata Unit, Institut Scientifique de Service Public (ISSeP), Liège, Belgique; 3 Laboratory of In Vitro Toxicology and Dermato-Cosmetology (IVTD), Department of Analytical, Applied Chemometrics and Molecular Modeling (FABI), Faculty of Medicine and Pharmacy, Vrije Universiteit of Brussel, Brussels, Belgium; 4 Laboratory of Pharmacochemical and natural pharmaceutical substances, Doctoral Training Unit in Health Sciences, Faculty of Medicine and Pharmaceutical Sciences, University of Douala, Douala, Cameroon; 5 Molecular and Cell Biology Laboratory (MCBL), Department of Biochemistry and Molecular Biology, Faculty of Science, University of Buea, Buea, Cameroon; 6 Embryology and Biotechnology Laboratory, Université Libre de Bruxelles, Brussels, Belgium
DOI 10.1055/s-0043-1774031

Malaria remains a global public health concern, and natural products have been investigated as potential treatments [1]. This study aimed to evaluate the potential of *Artemisia annua* and *A. afra* as both curative and preventative measures against malaria, and to analyse the phytochemical composition of ten *Artemisia* samples from different geographical locations in Cameroon. The plants were collected at the flowering stage from five regions during both the rainy and dry seasons, and the content of artemisinin and polyphenols in the samples was evaluated. Additionally, *ex-vivo* antiplasmodial activity was assessed. The results showed that the activity profiles of the samples were correlated with their environment, with distinct phytochemical compositions observed for each sample based on its geographical origin and the season of collection, as analysed using both geographical and multispectral remote sensing data. These findings suggest that the selection of a suitable *Artemisia* sample for use as a potential anti-malarial treatment should take into consideration its geographical origin, the period of collection, season, and remote sensing data. By understanding the environmental factors that influence the phytochemical composition of *Artemisia* samples using remote sensing data, this study may provide insight into how natural products can be effectively used as a preventative or curative measure against malaria.

References

- [1] Newman D.J., Cragg G.M. *Natural Products as Sources of New Drugs over the Nearly Four Decades from 01/1981 to 09/2019*. *J. Nat. Prod* 2020; 83: 770–803

P-156 Isolation, structure elucidation and anti-inflammatory testing of some sesquiterpene lactones and methoxylated flavonoids from *Achillea millefolium* L.

Authors [Carola Aumer¹](#), [Sabrina Zölch¹](#), [Sebastian Schwindl¹](#), [Jörg Heilmann¹](#)

Institute 1 University of Regensburg, 93053 Regensburg, Germany
DOI 10.1055/s-0043-1774032

Achillea millefolium L. is a medicinal plant with a long traditional use in a wide variety of cultures from Europe to Asia. Yarrow contains a broad range of secondary metabolites such as essential oil, sesquiterpene lactones, among them several proazulenes, as well as flavonoids and various other phenols. The herb

is mostly used for gastrointestinal problems, inflammations, hepatobiliary disorders, or wound healing. As the anti-inflammatory effects of yarrow are not completely understood, it was aimed to work on the isolation, structural elucidation and subsequent anti-inflammatory *in vitro* testing of *A. millefolium*. Fourteen isolates including one sesquiterpene, nine sesquiterpene lactones – all of them guaianolide type – and four methylated flavonoids were obtained using various chromatographic techniques such as CPC and preparative HPLC. Four guaianolides 1–4 were isolated for the first time (► Fig. 1). The isolated molecules were elucidated by NMR spectroscopy and mass spectrometry. Further characterisation was done by using polarimetry, UV- and CD-spectroscopy. Furthermore, ten selected compounds were tested in the Griess assay. Thereby, the LPS-induced nitric oxide release in a mouse macrophage cell line (RAW 264.7 cells) was significantly reduced in a concentration range from 0.5 – 75 μM by six isolates, namely 9-episintenin, 8 α -angloxyartabsin, 8-desacetyl-8-angeloyl-4-epi-matricin, artemetin, pectolarigenin, and centaureidin. Methylated flavonoids (0.5 – 75 μM) showed higher activity than sesquiterpene lactones (12.5 – 50 μM). In future, the anti-inflammatory activity of the molecules will be further investigated in the ICAM-1-assay using a human endothelial cell line (HMEC-1).

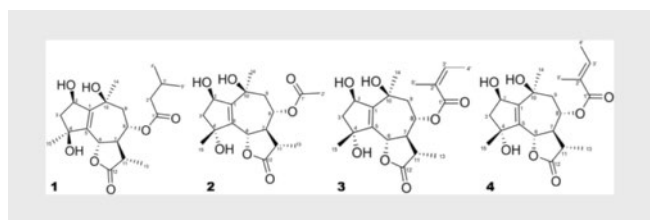

► Fig. 1 Structures 1–4 of isolated sesquiterpene lactones described for the first time.

P-157 Phytochemical investigation, isolation and structure elucidation of bioactive compounds of the roots of *Alkanna methanaea* Hausskn.

Authors Georgia Papazoglou¹, Christodoulos Anagnostou¹, Maria Eleni Sakavitsi¹, Eleftherios Kalpoutzakis¹, Maria Halabalaki¹

Institute 1 Division of Pharmacognosy and Natural Products Chemistry, Department of Pharmacy, National and Kapodistrian University of Athens, Panepistimioupolis, Zografou 15771, Greece

DOI 10.1055/s-0043-1774033

Alkanna methanaea Hausskn. is an endemic Greek species belonging to the Boraginaceae family. Although the genus *Alkanna* is mostly known for its lipophilic red pigments alkannins/shikonins and related isohexenylnaphthazarins found in the roots, it also contains a non-negligible amount of hepatotoxic pyrrolizidine alkaloids [1]. Thus, the aim of the present study was the extensive phytochemical investigation of *A. methanaea* cyclohexane and methanol root extracts. After the extraction, a qualitative investigation was performed using analytical techniques such as HPLC, UHPLC-ESI-HRMS/MS and GC-MS. Subsequent fractionation of the extracts with numerous preparative techniques such as FCPC, column chromatography, Sephadex gel chromatography and preparative HPLC led to the isolation of the secondary metabolites, for the final structure elucidation of which, 1 & 2D NMR were employed. Conclusively, the phytochemical study of the cyclohexane extract led to the identification of 22 non-polar compounds and isolation of 4 known alkannins' mixture, whereas 3 phenolic compounds, 1 nucleoside, 6 lignans the 3 of which were isolated for the first time in *Alkanna* genus. Moreover, 5 pyrrolizidine alkaloids among which 2 new natural products and 1 derivative which was isolated for the first time in

Boraginaceae family, were isolated and identified from the methanol extract. To our knowledge, this is the first time that *Alkanna methanaea* Hausskn. is being phytochemically investigated.

Funding ERDF, "RESEARCH-CREATE-INNOVATE", CosMAGE (project code T2EAK-02583)

Conflict of Interest The authors declare no conflict of interest.

References

[1] EA Abdel-Gelil O. et al. Journal of Food Science and Nutrition Research 2019; 2: 309–315

P-158 Oleanolic acid glycosides from *Scabiosa caucasica* and *Scabiosa ochroleuca*: Structural analysis and cytotoxicity

Authors Samvel Nazaryan^{1,2}, Antoine Bruguère¹, Nelli Hovhannisyantsyan², Loïc Briand¹, Anne-Claire Mitaine-Offer¹

Institutes 1 Centre des Sciences du Goût et de l'Alimentation, CNRS, INRAE, Institut Agro, Université de Bourgogne, Dijon, France; 2 Yerevan State University, Yerevan, Armenia

DOI 10.1055/s-0043-1774034

The *Scabiosa* genus includes therapeutic herbs recognised in traditional Armenian medicine for their ability to heal skin irritation and are also used predominantly as a tea to cure or prevent influenza. The objective of the study was to identify novel applications of certain species belonging to the *Scabiosa* genus in pharmaceutical and cosmetic industry. The phytochemical investigation of two Armenian plants, *Scabiosa caucasica* and *Scabiosa ochroleuca* allowed the discovery of five previously unreported oleanolic acid glycosides (compound 1–5, ► Fig. 1) in their roots. Extensive 1D and 2D NMR experiments, as well as mass spectrometry analysis, were used to identify them as triterpenoid glycosides, with the aglycon part identified as oleanolic acid with an oligosaccharidic chain attached to the C3 position through glycosylation, and a disaccharide chain identified as a gentiobiose unit attached to the C28 (except compound 3) position through esterification. These structures are similar to those isolated from some *Weigela* species, which belong to the Dipsacales order, Caprifoliaceae family and Diervilloideae subfamily. The *Scabiosa* genus belongs to the same order and family, but to the Dipsacoideae subfamily. The saponins from the two genera share the same 3-O- β -D-xylopyranosyl-(1 \rightarrow 3)- α -L-rhamnopyranosyl-(1 \rightarrow 2)- α -L-arabinopyranosyloleanolic acid sequence, which might be a chemotaxonomic marker of these two subfamilies. The cytotoxicity of all the isolated compounds against a mouse colon cancer cell line (MC-38) was evaluated by MTS assay. Compound 3 exhibits potent cytotoxicity on a mouse colon cancer cell line (MC-38), highlighting the key role of the lack or the presence of esterification at C-28 position.

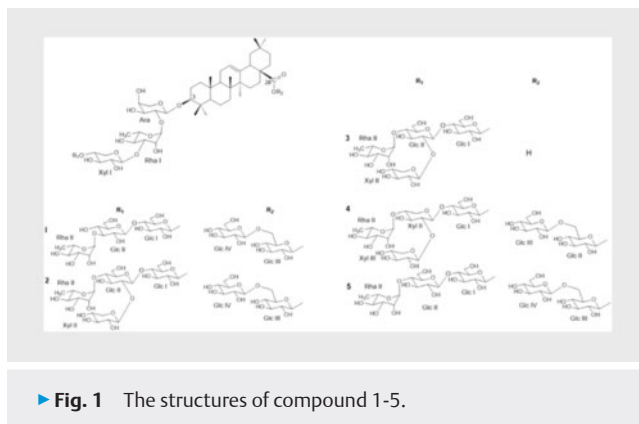

► Fig. 1 The structures of compound 1–5.

P-159 Structural prediction and mass-guided isolation of new potentially bioactive compounds from ammoniacum (*Ferula communis*)

Authors Capucine Braillon¹, Elora Aubert¹, Régine Janel-Bintz¹, Véronique Pitchon², M Pierre Fechter¹, Catherine Vonthron-Senecheau¹, M Sergio Ortiz¹

Institutes 1 LIT, Université de Strasbourg, Illkirch-Graffenstaden, France;

2 BSC, Université de Strasbourg, Illkirch-Graffenstaden, France

DOI 10.1055/s-0043-1774035

The recent proliferation and prevalence of antimicrobial multi-resistant infections has prompted the development of other strategies and alternatives to urgently combat this global threat. For this purpose, past mastering of remedies formulation appears as a wealth of resources for present research. In particular, Arab Medieval Pharmacopeias (AMP) were explored by our interdisciplinary team gathering researchers from biology, chemistry, humanities and informatics sciences. One remedy from the Ibn Al-Kindi Pharmacopeia (9th Century) which combines plant-based products and metal was reproduced and biological activity was tested. Ammoniacum, one of the five ingredients, showed antimicrobial activity against Gram-positive cutaneous bacteria. This present study aimed to further explore this gum-resin from *Ferula communis* using a molecular-networking-guided method for the accelerated discovery of new compounds. HPLC-PDA-HRMS/MS molecular-networking-based dereplication strategy highlighted the presence of known sesquiterpene coumarins (SC) among potential new derivatives by comparison of their MS/MS fragmentation spectra. By this approach, a new hydroxycinnamic-ferulenol (1) (► Fig. 1) derivative was predicted in the extract. Mass-guided isolation followed by structural characterisation allowed us to corroborate the predicted structure of this new SC compound. This targeted isolation led to a total of two known SC exhibiting antimicrobial activity (2, 3) and two new SC structures (1, 4). The results of the present study confirm the interest attached to *Ferula communis*' gum exploration in the discovery of new structures not described yet.

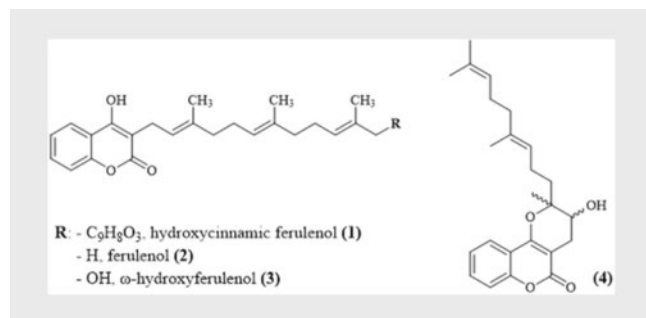

► Fig. 1 Structures of compounds 1-4.

P-160 Antioxidant activity from leaves of *Cochlospermum angolense*

Authors Lucia Silva^{1,2}, Nsevolu Samba^{2,3}, João Medeiros^{1,2}, José Mendes^{1,2}, Estela Leon⁴, Juan Moran-Pinzon⁴, Eily Mondolis⁴, Aldahir Diez-Rodriguez⁴, Abdy Morales-Barrios⁴, Jesus Rodilla^{1,2}, Arlindo Gomes^{1,2}, Joana Curto^{1,2}

Institutes 1 Universidade Da Beira Interior, Covilha, Portugal; 2 Fiber Materials and Environmental Technologies (FibEnTech-UBI), Universidade Da Beira Interior, Portugal; 3 Department of clinical analysis and Public Health, Kimpa Vita University, Angola; 4 Centro de Investigaciones Psicofarmacológicas, Facultad de Medicina, Panama

DOI 10.1055/s-0043-1774036

Cochlospermum angolense Welw. ex Oliv, commonly known as Borututu, is an endemic plant from Angola. This medicinal plant belongs to the Cochlospermeaceae family and is used in traditional medicine for treating malaria, diabetes and other diseases. This is a plant of biological interest and its antioxidant activity and chemical profile have been described in this study. Antioxidant activity of three extracts (hexane, acetone and ethanol) from leaves of *C. Angolenses*, were determined by three different methods: 1) DPPH radical scavenging activity; 2) *in vitro* evaluation of the superoxide anion trapping capacity in a non-enzymatic system; 3) nitric oxide radical scavenging activity. As shown in ► Table 1, the results suggest strong antioxidant activity for this species. The ethanol and acetone extracts of leaves developed antiradical activity against DPPH, obtaining an inhibition near 80%. These results are very similar to those obtained for quercetin standard. The ●O – radical scavenging activity of acetone and ethanol extracts presented inhibitory effects similar to quercetin. The hexane extract did not show activity indicating an inhibition of reactive oxygen species. Against the radical NO, the ethanol extract presents higher inhibitory activity comparing to the standards. Compounds with hydroxyl groups, from acetone and ethanol extracts, could explain this strong antioxidant activity.

► Table 1 Antioxidant activity from leaves of *C. angolense*.

	DPPH (%)	●O (%)	NO (%)
Hexane	26.4±7.1	6.9±9.8	-
Acetone	77.8±2.9	45.9±2.7	-
Ethanol	83±0.2	52.5±10.7	63.1±1.7
Quercetine	77.9±4.4	-	57.7±1.3
Curcumine	108.0±22.1	53.0±0.8	78.1±3.2

P-161 Structural characterisation of phenolic compounds from the bark of *Daphne mezereum* L.

Authors Hussain Shakeel Butt¹, Emilie Ulriksen², Marit Inngjerdigen², Kari Tvette Inngjerdigen¹, Helle Wangenstein¹
Institutes 1 Section for Pharmaceutical Chemistry, Department of Pharmacy, University of Oslo, Oslo, Norway; 2 Department of Pharmacology, Institute of Clinical Medicine, University of Oslo, Oslo, Norway
DOI 10.1055/s-0043-1774037

There is an urgent need for novel medicines in the treatment of infections and multi-drug resistance. For centuries, plants have been widely used in folk medicine for their medicinal benefits. Nature retains a large potential for novel compounds due to the vast diversity and complexity of chemical structures found in natural sources. Based on this, the overall aim of the project is isolation and structural characterisation of bioactive polysaccharides and phenolic compounds from Nordic medicinal plants.

One important traditional Norwegian medicinal plant is *Daphne mezereum* L. (Thymelaeaceae). Despite its well-known toxicity, *D. mezereum* was used to treat ailments and diseases such as diarrhea, fever, and tuberculosis. Both ethanol and hot water extract of *D. mezereum* have shown promising bioactivity, but little is known about the phytochemistry of the plant. Hence, the focus of the present study was isolation and structural characterisation of phenolic compounds from a hot water extract of the bark of *D. mezereum*. The compounds were isolated using reverse phase chromatography (Diaion HP-20 and Sephadex LH-20), in addition to C-18 flash chromatography and preparative HPLC, all with varying water:methanol ratio. The structures were elucidated using NMR and MS. Isolated compounds included coumarins and flavonoids.

Conflict of Interest The authors declare no conflicts of interest.

P-162 Investigation of the isomerisation reaction of MNA/IMNA triterpenic acids of natural origin

Authors Panagiotis Stathopoulos¹, Panagiota Stamou², Maria Halabalaki¹, Leandros Skaltsounis¹, Ioannis Kostakis²

Institutes 1 Division of Pharmacognosy and Natural Products Chemistry, Department of Pharmacy, National and Kapodistrian University of Athens, Panepistimioupoli, Zografou, 15771, Athens, Greece; 2 Division of Pharmaceutical Chemistry, Department of Pharmacy, National and Kapodistrian University of Athens, Panepistimioupoli, Zografou, 15771, Athens, Greece

DOI 10.1055/s-0043-1774038

Triterpenic acids are a populated class of bioactive natural products with an array of important biological properties. They are comprised of a versatile chemical scaffold to produce semi-synthetic derivatives. *Pistacia lentiscus* var. *chia*, (Anacardiaceae) and especially its natural resin or Chios mastic gum (CMG) is a rich source of triterpenic acids. The major triterpenic acids present in CMG are 24Z-masticadienonic acid (MNA) and 24Z-isomasticadienonic acid (IMNA), which are challenging to isolate as pure compounds and so far, not commercially available. Therefore, there is limited information available about their biological or pharmacological potential and no semi-synthetic derivatives thereof have been developed. Thus, the aim of this work was to establish an alternative approach for the production of MNA and/or IMNA. CMG was used as a starting material for their isolation using different chromatographic techniques (CPC and prep-HPLC-DAD) [1]. An equivalent of boron tribromide (BBr₃) solution was added to the isolated mixture of MNA/IMNA under argon at 0 °C for 15 minutes, to afford pure IMNA. Thus, it was confirmed that the isomerisation reaction occurs and pure IMNA can be obtained in high yield. When concentrated BBr₃ was added to the MNA/IMNA mixture, a non-previously described isomer of IMNA was isolated. Additionally, another new isomer was synthesised by the treatment of pure IMNA with potassium tert-butoxide. To conclude, the proposed approach could offer a potential procedure to obtain modified MNA/IMNA derivatives with possible optimised properties.

Funding ERDF, "RESEARCH-CREATE-INNOVATE", Hyper-Mastic (project code T2EΔK-00547).

Conflict of Interest The authors declare no conflict of interest.

P-163 Phytochemistry and biological activity of *Cistus monspeliensis* L.: does the sampling area have an impact?

Authors Eileen Mac Sweeney¹, Giulia Abate^{1,4}, Manuela Mandrone², Ilaria Chiochio², Cinzia Sanna³, Giuseppina Maccarinelli¹, Mariachiara Pucci¹, Emanuela Tirelli¹, Daniela Uberti^{1,4}, Maurizio Memo^{1,4}, Ferruccio Poli², Andrea Mastinu^{1,4}

Institutes 1 Department of Molecular and Translational Medicine, Division of Pharmacology, University of Brescia, 25123, Brescia, Italy; 2 Department of Pharmacy and Biotechnology (FaBiT), University of Bologna, 40126, Bologna, Italy; 3 Department of Life and Environmental Sciences, University of Cagliari, 09123, Cagliari, Italy; 4 NutriFun4Health, Centre for Research and Services on Nutraceuticals and Functional Food for Health, 25123, Brescia, Italy

DOI 10.1055/s-0043-1774039

Cistus monspeliensis L. belongs to the Cistaceae family and is the most common *Cistus* species distributed in the Mediterranean area. It was traditionally used in Sardinian folk medicine and contains mainly diterpenes, which have antimicrobial, anti-oxidant and anti-inflammatory properties [1, 2]. This study aims to correlate the secondary metabolites content and biological activity of *C. monspeliensis* plants grown in various areas of Sardinia. The phytochemical profiles of the aerial parts and root extracts of *C. monspeliensis* plants were investigated by means of ¹H-NMR analysis. The anti-inflammatory and antioxidant activities of each extract were evaluated using the RAW 264.7 and the

SH-SY5Y cell lines, respectively. The activity of phase I antioxidant enzymes and the expression of genes involved in the anti-inflammatory and anti-oxidant responses were also evaluated. According to the ¹H-NMR analysis, the metabolomic profiles of *C. monspeliensis* plants showed some differences and the main secondary compounds identified were labdane and clerodane analogues. The in vitro assay results showed that only some extracts were able to protect against lipopolysaccharide (LPS) and hydrogen peroxide (H₂O₂)-induced cytotoxicity. It is interesting to note that only the treatment with one extract significantly reduced the expression of IL-6 and IL-1β and was able to detoxify H₂O₂. This study demonstrates that metabolomic profile of *C. monspeliensis* could vary in response to plant location, which leads to differences in the plant's biological activity.

Conflict of Interest The authors declare no conflict of interest.

References

- [1] doi:10.3389/fchem.2014.00035.
- [2] doi:10.1016/j.phytochem.2020.112402.

P-164 Secretory tissues from *Heracleum sphondylium* L. fruits in different maturity stages

Authors Eszter Laczkó Zöld¹, Béla Darkó², Erzsébet Domokos³

Institutes 1 George Emil Palade University of Medicine, Pharmacy, Science, and Technology of Târgu Mureş, Târgu Mureş, Romania; 2 George Emil Palade University of Medicine, Pharmacy, Science, and Technology of Târgu Mureş, Department of Pharmaceutical Botany, Târgu Mureş, Romania; 3 Sapientia Hungarian University of Transylvania, Faculty of Technical and Human Sciences, Department of Horticulture, Târgu Mureş/Corunca, Romania

DOI 10.1055/s-0043-1774040

Heracleum sphondylium L., commonly known as hogweed, belongs to the Apiaceae family and is native to Romania. Traditionally it is used to manage several human ailments, mostly for the treatment of pathologies related to hormonal balance. These uses are based on empirical experience only. This microscopic study is the first step in a comprehensive work aimed for elucidating these effects. *Heracleum sphondylium* plants were collected from spontaneous flora in August 2022 (Simeria, Romania) and were identified by Erzsébet Domokos. Immature fruits and mature fruits were transversely sectioned in the middle area, and examined under light microscopy. The small secretory canals were associated with the three dorsal vascular bundles from the mesocarp and the dorsal vascular bundle from the lateral wings. The mature fruits presented four dorsal vittae and two commissural vittae with resin and volatile oil secreting epithelia. In the immature fruits the commissural vittae were not developed (► Fig. 1).

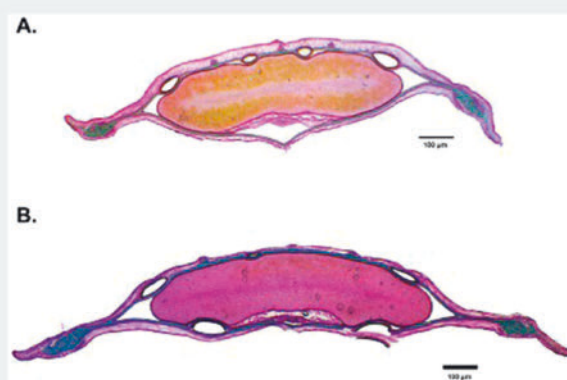

► Fig. 1 Transverse sections of the fruits of *Heracleum sphondylium*. Immature fruit (a), mature fruit (b).

Funding This work was supported by the University of Medicine, Pharmacy, Science, and Technology "George Emil Palade" of Târgu Mureş Research Grant number 164/17/10.01. 2023.

P-165 Determination of appropriate harvest time of *Cissus quadrangularis* for pharmaceutical use

Authors [Thanika Pathomwachaiwat¹](#), [Suriwipa Prueksa¹](#), [Chutima Phechkrajang²](#), [Sompop Prathanturarug¹](#)

Institutes **1** Department of Pharmaceutical Botany, Faculty of Pharmacy, Mahidol University, Bangkok, Thailand; **2** Department of Pharmaceutical Chemistry, Faculty of Pharmacy, Mahidol University, Bangkok, Thailand
DOI [10.1055/s-0043-1774041](#)

High-quality herbal raw material is the first step in producing a high-quality herbal product. Controlling the harvesting time, which is one of the crucial factors affecting the active compositions, is recommended to ensure the consistency of plant material quality. *Cissus quadrangularis* L. (CQ) has been highlighted as an alternative medicine for the prevention of bone loss in postmenopausal women. However, our previous study found that the chemical composition of CQ stem varied with ages between 6–18 months. Therefore, we determine the effect of harvesting time on the yield and bone-related chemical profiles of CQ stem. The CQ was planted under an insect-protected greenhouse in Prachinburi province, Thailand. It was divided into three groups using randomized complete block design (RCBD), viz., harvesting every 6, 12 and 18 months (n = 8 trellises/group, 2 plants/trellis). The CQ stem yields of the first 6 months, calculated as fresh and dried weights, rapidly increased at the first pruning at 6 months before significantly decreasing at the second harvesting. No difference in total yield compared between harvesting at 12 months old but a significantly higher yield was shown in harvesting at 18 months old when compared to harvesting every 6 months. Moreover, the chemical profiles which reflected the anti-osteoporotic activity and calcium contents were compared using principal component analysis (PCA). The results will be useful for appropriate planning to harvest CQ for pharmaceutical purposes.

P-166 Medicinal and aromatic plants for the control of lice and scabies following the Turkish earthquake

Authors [Ece Akman¹](#), [Fatma Zerrin Saltan²](#)

Institutes **1** Eskisehir Technical University, Department of Biotechnology, Eskisehir, Turkey; **2** Anadolu University, Department of Pharmacognosy, Eskisehir, Turkey

DOI [10.1055/s-0043-1774042](#)

Turkey encountered the most major earthquake called the disaster of the century on February 6, 2023. After the earthquake, diverse outbreaks caused by a lack of hygiene including outbreaks of scabies and lice appeared. In this study, some medicinal and aromatic plants that can be used as an alternative to synthetic chemicals such as permethrin and benzyl benzoate, have been compiled due to both fewer side effects and reduced cost. These are all used for treatment in these scabies and lice outbreaks.

The aims of this study are to determine whether medicinal and aromatic plants will be used for the new formulation of scabies and lice outbreaks after an earthquake, to identify herbs and active ingredients with ethnic uses and biological effects, and to review some herbal formulations on the market. In this review, approximately 50 medicinal and aromatic plants (*Pimpinella anisum*, *Clitoria ternatea*, etc.) including 30 families (Apiaceae, Fabaceae, and Solanaceae, etc.) were examined besides triterpenoids, flavonoids and diallylthiosulfonates have been used against these outbreaks.

Results have been reported as follows; (1) The scarcity of clinical studies against scabies and lice (2) The fact that the side effects of the herbs determined in the literature are few and can be eliminated (3) The low cost of herbal formulations compared to chemicals.

P-167 Chemical profile and biological activities of root oil from *Vetiveria zizanioides* (L.) Nash

Authors [Andreea David¹](#), [Sonia Ancuta Socaci^{1,2}](#)

Institutes **1** Faculty of Food Science and Technology, University of Agricultural Sciences and Veterinary Medicine Cluj-Napoca, 3-5 Calea Manastur, Cluj Napoca, Romania; **2** Institute of Life Sciences, University of Agricultural Sciences and Veterinary Medicine, Calea Manastur 3–5, Cluj Napoca, Romania

DOI [10.1055/s-0043-1774043](#)

Vetiveria zizanioides (L.) Nash (*Chrysopogon zizanioides* (L.) Roberty syn.), is a perennial plant of the family Poaceae (subfamily Panicoideae), native to India and widely found in Asia, Africa, Central and South America. Vetiver essential oil was described as a viscous liquid with low volatility, diverse colour from pale yellow to dark brown, as well as a deep and woody odour. Vetiver oil is commonly used as a main odour contributor in the perfumery industry, and also can be beneficial in the food industry as a flavouring agent. The root essential oil possesses various functional properties, such as antioxidant, antibacterial and anti-inflammatory properties, with applications in aromatherapy. Due to various properties, current studies have focused on the optimisation of vetiver oil extraction techniques in order to reduce production costs, solving problems related to environmental pollution, and the exhaustive characterisation of its chemical profile, using different chromatographic methods.

The aim of the project is to evaluate the bioactivities, especially antimicrobial, antioxidant and anti-inflammatory of vetiver oil obtained by different extraction techniques, to determine if the non-conventional extraction methods can have an impact on the extraction yield and biological properties of the oil. Moreover, it is necessary to use advanced and suitable analytical techniques, due to the fact that conventional chromatographic methods are no longer being used as the only chromatographic technique for vetiver essential oil because of its chemical complexity.

P-168 Intercropping the edible halophyte *Arthrocaulon macrostachyum* with commercial tomato to phytoremediate saline soils and obtain high added value products

Authors [Luísa Custódio¹](#), [Maria João Rodrigues¹](#), [Tiago Braga¹](#), [Aida Selmi²](#), [Karim Ben Hamed²](#)

Institutes **1** Centre of Marine Sciences (CCMAR), University of Algarve, Faculty of Sciences and Technology, Building 7, Campus of Gambelas, Faro, Portugal; **2** Laboratory of Extremophile Plants, Centre of Biotechnology of Borj Cedria, PB 901, Hammam-Lif, 2050, Tunisia

DOI [10.1055/s-0043-1774044](#)

This work evaluated the effect of intercropping a moderate salt-sensitive tomato cultivar with the edible halophyte *Arthrocaulon macrostachyum*, on the soil chemical properties, plant productivity, and biochemical properties of produced biomass. Cultivation occurred in an open field located in Tunisia, where conductivity of the irrigation water and soil reaches 3.64 and 3 dS/m, respectively. The experimental design comprised *Arthrocaulon* monoculture, *Arthrocaulon* and tomato intercropping, and tomato monoculture, under drip irrigation. Plants were evaluated for productivity, soil for chemical properties, and biomass was collected and used to prepare food grade extracts, that were appraised for bioactivities (phenolics, antioxidant and enzyme inhibitory properties), and metabolomics (LC-ESI-HRMS/MS). Intercropping allowed for a reduction in the soil salt levels, and increased tomato productivity. Produced biomass was rich in phenolics, and displayed antioxidant and enzyme inhibitory properties. Our results suggest that the tested system can phytoremediate the saline soil, increase the productivity of the commercial crop (tomato) and produce biomass enriched in biocompounds with high added value.

Funding This work received Portuguese national funds from FCT – Foundation for Science and Technology through projects UIDB/04326/2020, UIDP/04326/2020 and LA/P/0101/2020; FCT program contract (UIDP/04326/2020: MJR) and FCT Scientific Employment Stimulus (CECIND/00425/2017: LC). It was also funded by the project HaloFarMs (PRIMA/0002/2019), which is part of the Partnership on Research and Innovation in the Mediterranean Area (PRI-

MA) Program supported by the European Union and funded by the national funding bodies of Participating States (FCT in Portugal, MHESR in Tunisia).

Conflict of Interest The authors declare no conflict of interest.

P-169 Unlocking nature's pharmacy: a story of an Irish tormentil

Authors Cillian Jacques Gately¹, Ismael Obaidi¹, Maria Pigott¹, Özlem Erol², Shipra Nagar¹, Wirginia Kukuła-Koch³, Young Hae Choi², Helen Sheridan^{1,2}

Institutes 1 NatPro Centre, School of Pharmacy and Pharmaceutical Sciences, Trinity College Dublin, Dublin, Ireland; 2 Natural Products Laboratory, Institute of Biology, Leiden University, Sylviusweg 72, 2333BE, The Netherlands; 3 Department of Pharmacognosy, medical University of Lublin, Lublin, Poland

DOI 10.1055/s-0043-1774046

Potentilla erecta L. (Rosacea), commonly known as tormentil, is found on peat soil associated with Irish boglands and is widespread across Europe. The species is ethnopharmacologically significant, its roots traditionally used to treat oral cavity ulcerations, indigestion and wounds. Research into *P. erecta* has revealed anti-inflammatory properties which have been attributed to the total tannin content of the plant, but there is a gap in robust correlation studies between bioactivity and the constituent phytochemical(s) responsible (► Fig. 1).

Methanol extracts of tormentil aerial and root parts were tested for antiflammatory effects in vitro by measuring ability to suppress LPS-induced cytokine release in a phorbol 1y2r-imstate 13-acetate (PMA)-differentiated human leukemic THP-1 cell line. Cell viability and cytokine levels were measured using resazurin and ELISA techniques, respectively. LC-MS based separation and identification of constituents coupled with ¹H-NMR based metabolomics determined phytochemical distribution across plant morphology and correlated extract bioactivity with chemical profile. LC-MS results revealed the presence of agrimoniin and ellagic acid as two of the major components in aerial and root parts. A viability assay demonstrated that all extracts were non-toxic at the highest tested concentration of 100 µg/mL. Aerial and root extracts, and agrimoniin alone, suppressed IL-6, Rantes, TNF-α and IL-1β release post LPS treatment. Metabolomics analysis employing the OPLS and PLS-DA models found that anti-inflammatory activity correlated well with the chemical profile and could predict differences in phytochemical composition between plant parts, which was further supported by HPLC data. Overall, a better understanding of the relationship between biology and chemistry of *P. erecta* was achieved.

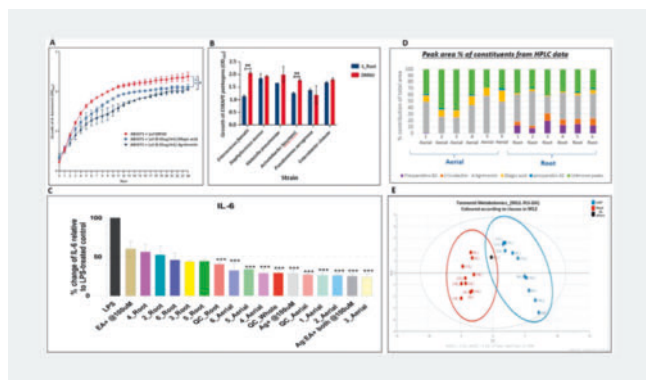

► **Fig. 1** *P. erecta* data from study. A: Agrimoniin and ellagic acid inhibition against cell growth of *A. baumannii*. B: Impact of *P. erecta* root extract against ESKAPE pathogens. C: IL-6 cytokine production of THP-1 cells when treated with aerial and root extracts. D: HPLC-PDA analysis of % contribution of analytes to the total peak area of methanol extracts. E: PLS-DA model obtained from ¹H-NMR spectra of *P. erecta* samples (blue: aerial cluster, red: root cluster).

P-170 Chemical characterisation, comprehensive antioxidant and antimicrobial capacity of fruits and seed oils of *Pistacia terebinthus* from Greece

Authors Elisavet-Foteini Varvouni¹, Prokopios Magiatis¹, Konstantia Graikou¹, Olga Gortzi², Ioanna Chinou¹

Institutes 1 National and Kapodistrian University of Athens, Dept of Pharmacy, Lab of Pharmacognosy, Athens, Greece; 2 Department of Agriculture Crop Production and Rural Environment, University of Thessaly, Volos, Greece

DOI 10.1055/s-0043-1774046

Pistacia terebinthus is a medicinal plant and part of the human diet [1]. In this study, we aimed to compare and evaluate the chemical profile of cold pressed terebinth fruit oil from trees growing wild on Chios Island, during three annual harvests (2019 – 2021). Considering the fatty acid composition of the oils, palmitic (24 – 30%), oleic (42 – 45%), and linoleic acids (19 – 22%) were the dominant saturated, mono-unsaturated, and poly-unsaturated fatty acids, respectively [2]. A high content of bioactive phenolic acids, expressed as anacardic acids [2], were measured in the oils (q-1H-NMR) (600 – 1000 mg/kg of oil). Fruit extracts showed high total phenolic content (TPC) (185.92 ± 2.61 mg GAE/g) and significant antioxidant capacity (DPPH), > 80% inhibition at 100 µg/mL which highly correlated with TPC. Agar dilution was used to determine the antimicrobial properties of terebinth extracts against selected human pathogenic bacteria and fungi, and interesting activity was noted. The results of this study confirmed that terebinth oil, which is comparable to olive oil, specifically its fruits exhibit strong antiradical and antimicrobial properties and show an important nutritional value. Both fruits and oils could be beneficial to human health due to a high ω-9 and ω-6 acid content, and promising antibacterial and antioxidant properties which could be further evaluated for potential pharmaceutical, cosmetic and food-industry applications.

References

- [1] Memet I.N.A.N. Not Bot Horti Agrobot Cluj Napoca 2021; 49 (1): 12171–12171
- [2] Hemshekhar M., Santhosh M., Kemparaju K., Girish K.S. Basic Clin Pharmacol Toxicol 2012; 110 (2): 122–132

P-171 Difference in the concentration of bioactive compounds between clones of *Pereskia aculeata* under different planting densities

Authors Maria Miranda Souza¹, Lucas Moreira Maia², Bianca Carvalho Reis², Thatiana Ferraz Ferreira², Maira Marques Fonseca¹, Cleide Ferreira Pinto³, Sérgio Lopes Donzeles¹, Thiago Oliveira Mendes²

Institutes 1 Agricultural Research Company of Minas Gerais – EPAMIG, Viçosa, Brazil; 2 Department of Biochemistry and Molecular Biology, Biological Sciences Center, Federal University of Viçosa, Viçosa, Brazil; 3 Brazilian Agricultural Research Corporation – EMBRAPA, Brasília, Brazil

DOI 10.1055/s-0043-1774047

Pereskia aculeata Miller, popularly known as ora-pro-nobis, belongs to the Cactaceae family. The contents of its active compounds may vary among different clones and genotypes and is a fundamental tool to assist in the selection of plants with desired nutraceutical activity. The aim here was to investigate the difference in the concentration of the main secondary metabolites and total soluble proteins present in clones V2 (with thorns) and V3 (without thorns) of *Pereskia aculeata* produced by EPAMIG Sudeste – MG, Brazil. Planting was done in randomised blocks, with four different densities (1, 4, 8 and 16 plants/m²) and quadruplicates. The concentration of bioactives in fresh leaf extracts was quantitatively determined by spectrophotometry. The antioxidant activity (DPPH method) of the leaves of clone V3 (79.2%) was significantly higher than the leaves of clone V2 (28.9%) at all analysed densities. Clones V2 and V3 grown in areas of 8 plants/m² showed higher total phenolic contents than the other densities. Both clones were shown to be a rich source of total soluble proteins, with the concentration of these proteins being more pronounced in V3, at an

average value of 173.27 mg/g of leaf in all densities. It was also observed that the leaves of clone V3 were more abundant in total carotenoids at densities of 1, 8 and 16 plants/m². The proportion of flavonoids and nitric oxide was similar for both clones, thus, clone V3 is a better source of antioxidant compounds, carotenoids and soluble proteins, in addition to the agronomic advantage of its collection due to the absence of thorns.

P-172 Content of bioactive compounds and soluble proteins in leaves of Ora- pro-nobis (*Pereskia aculeata* Miller) collected at different stages of growth

Authors Maria Miranda Souza¹, Bianca Carvalho Reis², Lucas Moreira Maia², Thatiana Ferraz Ferreira², Maira Marques Fonseca¹, Sérgio Lopes Donzeles¹, Cleide Ferreira Pinto³, Thiago Oliveira Mendes²
Institutes 1 Agricultural Research Company of Minas Gerais – Southeast Unit, Viçosa, Brazil; 2 Department of Biochemistry and Molecular Biology, Biological Sciences Center, Federal University of Viçosa, Minas Gerais, Viçosa, Brazil; 3 Brazilian Agricultural Research Corporation – EMBRAPA Vegetables Unit, Brasília, Brazil
DOI 10.1055/s-0043-1774048

Pereskia aculeata Miller (ora-pro-nobis) is considered in Brazil a Conventional Food Plant (PANC). Domestic consumption occurs mainly through the leaves in nature, that present a high level of proteins and other bioactive compounds. Therefore, the plant has a high potential for bioeconomy by development of new products for animal and human food. The protein content and the metabolite composition of the plant depends on cultivation features. Therefore, the composition analysis of the leaves in its different stages of development is important for knowledge of the quality of the product ingested by the consumer. We identified and quantified the bioactive compounds and total soluble proteins in extracts of fresh leaves of ora-pro-nobis (clone V1, maintained by EPAMIG Sudeste – MG, Brazil) at different maturation stages: fully developed and older, and the youngest i.e., those in development. Antioxidant activity measured by ABTS radical capture was greater than 80% in both types of leaves. In the DPPH radical scavenging assay, the antioxidant activity in both steps was around 49%. No difference was identified in the concentration of total phenolics between older and younger leaves. Younger leaves contained significantly more flavonoids (528 mg/100 g of leaf), total soluble proteins (140 mg/100 g of leaf) and nitric oxide (10 ng/100 g leaf) than older leaves. In contrast, carotenoid content was higher in older leaves (52 ug/100 g of leaf). Thus, the results indicate that the consumption of younger leaves has the potential for better use of nutrients than that of older leaves.

P-173 Effect of planting density on the production of bioactive compounds in *Pereskia aculeata*

Authors Maria Miranda Souza¹, Lucas Moreira Maia², Bianca Carvalho Reis², Thatiana Ferraz Ferreira², Maira Marques Fonseca¹, Cleide Ferreira Pinto³, Sérgio Lopes Donzeles¹, PH D Thiago Antônio de Oliveira Mendes²
Institutes 1 Agricultural Research Company of Minas Gerais – EPAMIG, Viçosa, Brazil; 2 Department of Biochemistry and Molecular Biology, Biological Sciences Center, Federal University of Viçosa, Viçosa, Brazil; 3 Brazilian Agricultural Research Corporation – EMBRAPA, Brasília, Brazil
DOI 10.1055/s-0043-1774049

Planting density is a practice that can add nutraceutical quality to many crops. Ora-pro-nobis (*Pereskia aculeata* Miller) is a plant with high productive and nutritional value, but there is limited research regarding its agronomic aspects. The aim of this study was to investigate the influence of planting density on the contents of bioactive compounds and total soluble proteins in leaves of ora-pro-nobis produced by EPAMIG Sudeste – MG, Brazil. Planting was done in randomised blocks, with four different densities (1, 4, 8 and 16 plants/m²), and four replicates of each group. The concentration of bioactives in fresh leaf was quantitatively determined by colorimetric methods. Leaves of the clone grown

at densities of 4 and 8 plants/m² showed a significant increase in carotenoid content (90 and 87 ug/100 g of leaves, respectively) in relation to those grown in areas of 1 plant/m² (51 ug/100 g of leaves). For all evaluated densities, the amount of total phenolics was higher in leaves grown under a density of 8 plants/m², reaching a content of 300 mg/100 g of leaves, which represents twice the concentration value found in leaves from other densities. The antioxidant activity (ABTS method) showed the best result, 41 %, in the planting of 16 plants/m², indicating variation in metabolite composition or concentration. Density had no significant effect on the contents of flavonoids, nitric oxide, hydrogen peroxide and total proteins. These results indicate that planting density affects the composition and concentration of metabolites of the plant and should be considered for the development of derivative products.

P-174 Unravelling the healing power of Irish bogland species

Authors Shipra Nagar¹, Maria Pigott¹, Ismael Obaidi¹, Cillian Jacques Gately¹, Shilong Chen¹, Sophie Whyms¹, Lee Sherlock¹, Özlem Erol², Kavita Gadar³, Young Hae Choi², Ronan R McCarthy³, Jandirk Sendker⁴, Wirginia Kukulá-Koch⁵, Michael Carty⁶, Gaia Scalabrino¹, Helen Sheridan¹
Institutes 1 NatPro Centre, School of Pharmacy and Pharmaceutical Sciences, Trinity College Dublin, Dublin, Ireland; 2 Natural Products Laboratory, Institute of Biology, Leiden University, Sylviusweg 72, 2333BE, the Netherlands; 3 Division of Biosciences, Department of Life Sciences, Centre of Inflammation Research and Translational Medicine, College of Health and Life Sciences, Brunel University London, Uxbridge, UB8 3PH, UK; 4 University of Münster, Institute of Pharmaceutical Biology and Phytochemistry, Corrensstraße 48, 48149, Germany; 5 Department of Pharmacognosy, Medical University of Lublin, 1 Chodzki street, 20-093, Poland; 6 Trinity Biomedical Sciences Institute, Trinity College Dublin, Dublin D02 PN40, Ireland
DOI 10.1055/s-0043-1774050

Boglands are ancient ecosystems, scattered across the Northern Hemisphere and are custodians of unique biodiversity which has adapted to survive in these nutrient deficient, stunningly beautiful environments. As part of the project 'Unlocking Nature's Pharmacy from Bogland Species (UNPBS)' we have focused on investigating the properties of species found in raised and blanket bogs across the island of Ireland. We have collected 64 unique plant and lichen species, encompassing 20 genera from different bogland locations and have segregated their different plant parts, where appropriate, to generate a repository of 393 samples. Ongoing screening and filtering of these samples via a range of bioassays has guided the isolation and characterisation of bioactive molecules. From the first 17 species, ten leads with potent immunomodulatory properties have been identified through in vitro cell-based assays of treatment effects on cell viability; and on production of the key cytokines-IFN- β , IL-6, IL-1 β , TNF- α and RANTES produced by in vitro iBMDM and THP-1 cell lines. Anti-bacterial and antibiofilm activities toward key ESKAPE pathogens have been evaluated for all species and lead extracts have been identified from a range of species, now undergoing phase 2 screening. Simultaneously, metabolic profiling has been prioritised for select species employing analytical (GC-MS, LC-MS, HPTLC, NMR) and chemometric approaches. Furthermore, metabolomics has been applied to correlate the difference in chemical profiles of extracts with respect to location. The lead species will undergo further advanced biological and phytochemical investigation. As well as this an accessible database for the chemistry and biology of Irish bogland species is under construction.

P-175 Fagomine occurrence in African honey

Authors David Katerere¹, Yana B. Penkova³, Robert J Nash⁴
Institutes 1 Tshwane University of Technology, South Africa; 2 TUT/CSIR Cannabis Research Hub, South Africa; 3 Phytoquest, Aberystwyth, UK; 4 Sugars for Health, Aberystwyth, UK
DOI 10.1055/s-0043-1774051

Iminosugars are polyhydroxyalkaloids in which the oxygen ring of the monosaccharide is replaced with a nitrogen. They have been isolated from many different natural sources including buckwheat, cucumber and potatoes. The stereochemical diversity of hydroxylation patterns gives them often potent pharmacological activity primarily as a result of enzyme inhibition which gives them potential for broad application in managing diabetes, cancer, osteoarthritis and other conditions. They can also interact with receptors for biological activities. In the recent past, African honey has been found to contain causerine and a proprietary version is being marketed as iminohoney to boost immune response and promote healthy aging in animals and humans.

In this study we set out to investigate the presence of iminosugars in honey samples collected in Kenya, South Africa and Zimbabwe. An iminosugar internal reference (castanospermine) was added into honey samples prior to cation exchange being used to remove the nitrogen-containing components from the sugars and most flavonoids. GC-MS was used to determine iminosugars in the cation exchange resin retained components. Of the 16 samples, the majority showed the presence of fagomine or fagomine glycosides and none had causerine. This is the first time that fagomine is being reported in honey. Further studies to formulate and test honey samples in in vivo diabetes and osteoarthritis models will be initiated to further understand efficacy of African honey.

P-176 New triterpene saponins of the aerial parts of *Sanicula europaea*

Authors Stefan Schwaiger¹, Franziska Drechsel¹, Hermann Stuppner¹

Institute 1 Universität Innsbruck, Institute of Pharmacy/Pharmacognosy, CMBI, Innsbruck, Austria

DOI 10.1055/s-0043-1774052

Sanicula europaea L. has been used in European traditional medicine for centuries and revealed up to now the presence of six triterpene saponins. Further representatives of this compound class were described incompletely after hydrolysis experiments. Therefore, the aim of this study was the investigation of the saponin fraction of the aerial plant parts of this species. Among the isolated components, the structure elucidation of four compounds was possible. Two compounds were identified as the known saponins Bonarienosid A and Bonarienosid B, known from *Hydrocotyle bonariensis* (Araliaceae), but are described here for the first time as constituents of *S. europaea*. The other two isolates were identified as 3-O- [glucopyranosyl-(1→2)]-arabinopyranosyl-(1→3)-glucuronopyranosyl-21-O-acetyl-22-O-seneciyl-R1-barrigenol as well as 3-O-glucopyranosyl-(1→2)-glucuronopyranosyl-21-O-acetyl-22-O-seneciyl-R1-barrigenol. Both compounds represent new natural products due to the presence of a senecioic acid unit in contrast to their more common angelic acid analogues Saniculasaponin II, isolated from *Sanicula elata* var. *chinesis* and 3-O-glucopyranosyl-(1→2)-glucuronopyranosyl-21-O-acetyl-22-O-angeloyl-R1-barrigenol isolated from the roots of *Eryngium planum*.

P-177 The impact of different extraction methods on the phytochemical profiles and antimicrobial activities of the extracts of *Cinnamomum* and *Illicium verum*

Authors Tao Zhang¹, Catriona McGearty¹, Daniela Maslovska¹, Louise Kearney¹

Institute 1 School of Food Science and Environmental Health, Technological University Dublin, Grangegorman, Dublin 7, Ireland.

DOI 10.1055/s-0043-1774053

A nutraceutical is defined as a food or substance present in food which can provide health benefits such as the prevention and the treatment of diseases, including cancer, heart disease, arthritis, diabetes and many more. Both *Cinnamomum* and *Illicium verum* have been traditionally used in Chinese medicine as well as being more often used in the culinary industry as a spice. The aim of this study was to evaluate possible impact of extraction methods, including

different parameters on the phytochemical and antimicrobial profiles of the extracts of *Cinnamomum* and *Illicium verum*. Extraction methods were chosen as follows: maceration, Soxhlet extraction; ultrasound-assisted extraction, microwave-assisted extraction and pressure-assisted extraction. Different parameters (temperatures, power and time) and solvents (water and methanol) were used. Extracts were subjected to phytochemical content analysis by thin-layer chromatography, and the percentage yield of extraction was determined and compared by high-performance liquid chromatography. This study also addressed the antimicrobial activity of *Cinnamomum* against *S. aureus* and *E. coli* by disc diffusion. *Cinnamomum* extracts 1-4 had inhibitory effects on *S. aureus* at 20% (ZOI 8.5 – 9.5 mm). However, the methanol extract produced a ZOI of 6 mm at 2% which indicates that a 20% concentration would have been superior to extraction methods 1-4. There was no antimicrobial activity against *E. coli*. *Illicium verum* extracts showed some antimicrobial activities against *C. albicans* compared to *S. enterica*, however overall inhibition activity was quiet low.

P-178 Chemical Composition and Cytotoxicity of *Litsea rubicunda* Essential Oil from Malaysia

Authors WanMohdNuzul Wan Salleh¹, Abubakar Siddiq Salihu², Nur Abdul Kadir¹, Nurunajah Ab Ghani^{3,4}, Nurulfazlina Edayah Rasol^{3,4}, Shamsul Khamis⁵

Institutes 1 Department of Chemistry, Faculty of Science and Mathematics, Universiti Pendidikan Sultan Idris, 35900 Tanjong Malim, Malaysia;

2 Department of Pure and Industrial Chemistry, Faculty of Natural and Applied Sciences, Umaru Musa Yar'adua University, Nigeria; 3 Atta-ur-Rahman Institute for Natural Product Discovery, Universiti Teknologi MARA, Puncak Alam Campus, 42300 Bandar Puncak Alam, Malaysia; 4 Faculty of Applied Sciences, Universiti Teknologi MARA, 40450 Shah Alam, Malaysia;

5 Department of Biological Sciences and Biotechnology, Faculty of Science and Technology, Universiti Kebangsaan Malaysia, 43600 Bangi, Malaysia

DOI 10.1055/s-0043-1774054

This work aimed to investigate, for the first time, the chemical composition and cytotoxicity of *Litsea rubicunda* Kosterm. essential oil. The essential oil was obtained through hydrodistillation, and its volatile components were analysed through gas chromatography (GC-FID) and gas chromatography-mass spectrometry (GC-MS) techniques. Twenty-eight components, constituting 90.2% of the oil content, were identified. The most prominent components were β -caryophyllene (29.5%), caryophyllene oxide (11.2%), α -humulene (8.5%) and germacrene D (8.0%). The cytotoxicity of the essential oil was evaluated using an MTT assay. The essential oil exhibited weak cytotoxicity against three cancer cell lines which are HepG2, MCF7 and A549 with the IC₅₀ values ranging from 59.5 – 62.4 μ g/mL. The present study highlights the potential of using a plant essential oil as an alternative for the development of chemopreventive or cosmetic agents for the pharmaceutical industry.

P-179 Essential Oil Constituents of Seeds of Two *Monodora* Species from Nigeria

Authors Christianah Elusiyan¹, Tiwalade Olugbade², Abiodun Ogundaini²

Institutes 1 Drug Research and Production Unit, Obafemi Awolowo University, Ile Ife, Nigeria; 2 Department of Pharmaceutical Chemistry, Obafemi Awolowo University, Ile Ife, Nigeria

DOI 10.1055/s-0043-1774055

The genus *Monodora* (Annonaceae) comprises many aromatic and economically important species, widely distributed across tropical Africa. They are sources of edible fruits, spices and medicines. *Monodora myristica* and *M. tenuifolia* are the prominent species in Southwest Nigeria. The fruit seeds of *M. myristica* are locally sold and generally used as spices and condiments in cuisines or as snuff flavour.

Differences exist largely in the oil content and composition of *M. myristica* seeds due to different processing techniques and handling, which could affect its quality. The study aimed at profiling the volatile oils of freshly collected seed for quality control. Seeds of mature ripe and unripe fruits of *M. myristica* and mature ripe fruits of *M. tenuifolia* were pulverised and subjected to hydrodistillation to extract the volatile oils. The oils were analysed using gas chromatography-mass spectrometry. The compounds were identified by their Kovats indices and comparison with literature values.

Both unripe and ripe seed oils of *M. myristica* consisted mainly of monoterpene hydrocarbons, with α -phellandrene as the major constituent, 74.60% and 70.86%, respectively. The seed oil of *M. tenuifolia* had mainly sesquiterpenes, with germacrene-D (24.43%) as the major constituent. The presence of the psychoactive compound, myristicin was highest in *M. tenuifolia* seed oil (1.88%) compared to *M. myristica* unripe (0.14%) and ripe (0.27%) seed oils.

The differences in composition observed are useful for quality control purposes and the implication of the myristicin content of the oils should be discussed.

Conflict of Interest The authors declare no conflict of interest.

P-180 Chemical Composition and Phytotoxic Activity of *Lippia organoides* Essential Oil

Authors Maira Fonseca^{1,2,3}, Patricia Pinheiro²

Institutes 1 Epamig, Viçosa, Brazil; 2 Federal University of Viçosa (UFV), Viçosa, Brazil; 3 Univiçosa, Viçosa, Brazil

DOI 10.1055/s-0043-1774056

Pepper rosemary (*Lippia organoides*) is a medicinal plant rich in essential oil, containing as main phenolic compounds thymol or carvacrol, which have potential herbicidal activity. The aim of this study was to extract, characterise and test the phytotoxic activity of the essential oil (EO) obtained from pepper rosemary leaves, with a view to its potential use as a bioherbicide. The EO was obtained using the hydrodistillation method, with an extraction time of 3 hours and an average yield of 2.24%. Analysis of the EO by GC-MS identified thymol (79.37%), *o*-cymene (9.73%), caryophyllene (3.78%) and caryophyllene oxide (2.61%) as the main compounds. The *in vitro* biological assay evaluated the effect of the EO on the root growth of *Lactuca sativa* and *Sorghum bicolor*. At all tested concentrations, *L. sativa* seed germination was completely inhibited, while inhibition was total at 1% and 81% at 0.25% in *S. bicolor* seeds. It is concluded that the EO had a phytotoxic effect, likely due to the presence of thymol as the main constituent, and that pepper rosemary EO holds promise for use in formulations as a bioherbicide.

Funding FAPEMIG, CNPq and CAPES for financial support

Conflict of Interest The authors declare no conflict of interest.

P-181 Insecticidal activity of *Varronia curassavica* (Boraginaceae) essential oil against the coffee berry borer

Authors Maira Fonseca^{1,2,3}, Fernanda Andrade^{1,2}, Nancy Sena^{1,2}, Elen Martins¹, Madelaine Venzon¹

Institutes 1 Epamig, Viçosa, Brazil; 2 Federal University of Viçosa (UFV), Viçosa, Brazil; 3 Univiçosa, Viçosa, Brazil

DOI 10.1055/s-0043-1774057

Varronia curassavica is a medicinal species native to Brazil and produces an essential oil with a range of biological activities. Essential oils have been studied worldwide as an environmentally safer alternative to biopesticides for pest control, due to several issues for the environment and humans related to these products. The coffee berry borer, *Hypothenemus hampei* Ferrari (Coleoptera: Curculionidae, Scolytinae) is considered the leading pest of coffee crops worldwide, reducing the quality and the economic value of the coffee grains, and its principal method of control is by the use of synthetic pesticides. This work aimed to evaluate the mortality activity of *V. curassavica* essential oil on *H. hampei*. In the test, we used five treatments (0.2, 0.4, 0.6, 0.8 and 1.0% essential oil concentration) and the control (distilled water and Tween 80 (0.05%)).

We applied the tested solutions in a filter paper disk placed in a Petri dish and left to dry at room temperature for five minutes. Afterward, we released five *H. hampei* females in the Petri dish and kept them there for two days, and then the number of dead insects was counted. All essential oil concentrations tested present mortality activity and mortality rates increased with increasing concentrations, reaching 100% mortality at the highest concentration. Therefore, *V. curassavica* essential oil could be a potential natural insecticide for *H. hampei* control.

Funding FAPEMIG, CNPq and CAPES for financial support

Conflict of Interest The authors declare no conflict of interest.

P-182 Volatile compounds from *Heracleum sphondylium* L. Leaves and Fruits as identified by GC/MS

Authors Eszter Laczkó Zöld¹, Erzsébet Domokos²,

Ruxandra Ștefănescu¹, Szende Vancea³

Institutes 1 George Emil Palade University of Medicine, Pharmacy, Science, and Technology of Târgu Mureș, Târgu Mureș, Romania; 2 Sapientia Hungarian University of Transylvania, Faculty of Technical and Human Sciences, Department of Horticulture, Târgu Mureș/Corunca, Romania; 3 Legal Medicine Service, Emergency County Hospital, Miercurea Ciuc, Romania

DOI 10.1055/s-0043-1774058

The genus *Heracleum* (Apiaceae) comprises mostly perennial, rarely biennial herbs. They are found throughout the temperate Northern Hemisphere, and most species of the genus are known to cause photo-dermatitis. Among the *Heracleum* species available in Romania, *Heracleum sphondylium* L. (hogweed) is used in folk medicine. Moreover, in the last decade, it has become very popular in local herbal medicine.

There is a wide range of dietary supplements recommended in various diseases related to hormone balance. From the comprehensive examination of *Heracleum sphondylium*, in this paper, we report the results of the examination of the essential oil. The essential oil from immature fruits, mature fruits and leaves of *Heracleum sphondylium* collected from Romania was isolated by hydrodistillation. A GC-MS analysis was carried out with a 7890B GC-5977A MSD system (Agilent Technologies). The identification of the constituents was achieved from their retention indices and comparison of their MS data with the computer library database and literature data. The immature fruit oil was found to contain octyl acetate, *n*-octanol, octyl hexanoate and vinyl cyclohexane as main constituents. The mature fruit oil was found to contain fewer compounds than the immature ones, with octyl acetate, *n*-octacosane and octyl hexanoate as main compounds. In the essential oil obtained from the leaves, seven compounds were identified with nonacosane and hexadecanoic acid as main constituents.

Funding This work was supported by the University of Medicine, Pharmacy, Science, and Technology “George Emil Palade” of Târgu Mureș Research Grant number 164/17/10.01. 2023.

P-183 Hydrodistillation by-products of Greek flora plants as possible sources of innovative commercial food supplements

Authors Dimitrios Michailidis¹, Aikaterini Argyropoulou¹, Nikolaos Adamopoulos², Athanasios Stergiopoulos⁴, Katerina Gioti⁴, Athena Stergiou⁴, Panagiota Binou⁴, Paraskevi Vasilakopoulou⁴, Antonia Chiou⁴, Vaios Karathanos⁴, Roxane Tenta⁴, Leandros-Alexios Skaltsounis³

Institutes 1 Pharmagnose Biotechnology SA, 57th km Athens-Lamia National Road, Oinofyta, Greece; 2 Galenica SA, Kifissia, Greece; 3 Division of Pharmacognosy and Natural Products Chemistry, Department of Pharmacy, NKUA, Panepistimiopolis Zografou, Athens, Greece; 4 Department of Nutrition & Dietetics, School of Health Sciences & Education, Harokopio University of Athens, 70 El. Venizelou Street, Athens, Greece

DOI 10.1055/s-0043-1774059

Cretan lama is a food supplement gaining increasing consumer acceptance that enhances the body's immune system and defense against seasonal infections. Its composition is based on aromatic plants of Greek flora (Greek dittany – *Origanum dictamnus*, thyme – *Coridothymus capitatus* and sage – *Salvia fruticosa*), known for their beneficial effects on health and plethora of strong bioactive agents. Interestingly, a significant part of these bioactives passes with the generated by-products (hydrosols, aqueous plant extracts, plant parts) of the production process, which can consequently be used as a pool of high added value constituents. State-of-the-art chromatographic and spectroscopic techniques (CPC, HPTLC, HPLC-DAD, LC-MS and NMR) were employed for the investigation of their chemical profiles and then selected extracts were forwarded for anti-inflammatory testing on cells. Moreover, extract cytotoxicity was evaluated based on MTT assay. Formulation experiments were finally employed using a freeze dryer. The encapsulation efficiency and the stability of the products were examined using spectroscopic and thermal analyses, aiming to evaluate their potential as commercial products [1–2].

Funding EPANek 2014-2020, Hydraroma, T2EAK-02951

Conflict of Interest The authors declare no conflict of interest.

References

- [1] Anastasaki M. et al., 2017. BMC Complement. Altern. Med., 17, Article number 466.
[2] Duijker G. et al. J. Ethnopharmacol. 2015; 163: 157–166

P-184 Antimicrobial activity of eleven essential oils against otitis-associated *Staphylococci* and *Streptococci* isolated from canine ears

Authors Doris Bismarck¹, Tom-Elvis Gärtner^{1,2}, Marie-Louise Hoffknecht¹, Anton Heusinger¹, Elisabeth Müller¹
Institutes 1 Laboklin GmbH und Co. KG, Bad Kissingen, Germany; 2 Coburg University of Applied Sciences and Arts, Coburg, Germany
DOI 10.1055/s-0043-1774060

Canine otitis externa is a common problem seen in small animal practice. It is caused by different factors and bacterial infections with *Staphylococci* or *Streptococci* can perpetuate this condition. Essential oils as natural plant products were successfully used for local treatment of canine otitis. Aim of this study was to analyse the antimicrobial *in vitro* activity of eleven *in vivo* compliant essential oils against *Staphylococcus pseudintermedius* (n = 10) and *Streptococcus canis* (n = 10). A microdilution of essential oils to determine the minimum inhibitory and bactericidal concentration (MIC and MBC) was performed. *Staphylococcus pseudintermedius* and *Streptococcus canis* were strongly inhibited by citronella (MIC: both 0.25%; MBC: 0.50% and 0.46%), thyme chemotype thymol (MIC both 0.50%; MBC: 1.00% and 0.50%), and oregano oil (MIC: 1.00% and 0.50%, MBC: 1.67% and 0.67%). Basil, tea tree, lavender and rosemary oil showed a moderate inhibitory effect against *Staphylococcus pseudintermedius* (MIC: 1.25%–2.50%; MBC: 2.50%–≥5.00) and a good inhibitory effect against *Streptococcus canis* (MIC: 0.50%–1.25%; MBC: 1.00%–1.67%). Bergamot, clary sage, lemon, and grapefruit oil showed no inhibitory effect in the analysed concentrations (≤5.00%). Generally, *Streptococcus canis* was more susceptible than *Staphylococcus pseudintermedius*. In conclusion, citronella, thyme, and oregano oil are first choice essential oils for local treatment of canine otitis externa. Ideally for therapy, an essential oil should be chosen depending on the result of the bacteriological examination and its *in vitro* activity, since individual bacteria show different susceptibility patterns (► Fig. 1).



► Fig. 1 Antimicrobial activity of essential oils against otitis-associated *Staphylococcus pseudintermedius* and *Streptococcus canis*

Conflict of Interest The authors declare no conflict of interest.

P-185 Comparison of the composition of volatile extracts from *Veronica beccabunga* L.

Authors Valerija Dunkić¹, Dario Kremer², Karla Akrap¹, Ivana Vrca¹, Marija Nazlić¹
Institutes 1 Faculty of Science, University of Split, Split, Croatia; 2 Faculty of Pharmacy and Biochemistry, University of Zagreb, Zagreb, Croatia
DOI 10.1055/s-0043-1774061

European speedwell is a widespread and well known species among the population. It is commonly known to be edible in the period before flowering. Therefore, the aim of this study was to compare the composition of free volatile compounds extracted in the lipophilic part and in the aqueous part (hydrosol) of the aerial parts of *Veronica beccabunga* L. (Plantaginaceae). This comparison is important for the selection of the extract for further biological studies. Two extraction methods were used: the classical one (hydrodistillation, HD) and a new technique (microwave-assisted water extraction, MAE). Gas chromatography-mass spectrometry was used to identify the volatile compounds in two phases of the two extractions, i.e., in four samples. The main components in the hydrosol HD sample are: piperitone (28.15%), benzene-acetaldehyde (13.23%) and trans-p-mentha-1(7),8-dien-2-ol (10.3%), while in the MAE hydrosol sample piperitone is the main compound with 79.86%. The oxygenated diterpene phytol (27.31%) and the two hydrocarbons, hexacosane (16.21%) and heptacosane (14.89%), are the predominant compounds in the lipophilic HD extract. Piperitone (29.28%) and phytol (34.54%) are the predominant compounds in the lipophilic MAE extract. Comparing these two extraction methods, the method MAE is more environmentally friendly due to the working conditions. From the obtained results, it is clear that hydrosols should not be classified as extraction waste, as they are a valuable source of bioactive compounds. Due to the richness of volatiles, *Veronica beccabunga* is important for further research. Considering the wide distribution of this plant, the material is easy accessible for research and application.

P-186 Phytochemical profiling of cosmetic African seed oils using comprehensive two-dimensional gas chromatography

Author [Baatile Komane¹](#)

Institute **1** Tshwane University Of Technology, Pretoria, South Africa

DOI [10.1055/s-0043-1774062](#)

African seed oils such as baobab, kalahari melon and marula, are popularly included in commercially available cosmetic products based on reported traditional uses. The fatty acid content of seed oils, are of significant value in cosmetic product formulations and are considered the most important quality parameter. In this study, comprehensive phytochemical profiling of seed oils was done using comprehensive two-dimensional gas chromatography analysis (GCxGC-ToF-MS) through the identification and relative quantification of the fatty acid methyl esters (FAMES). Twenty-four fatty acids were detected in baobab oil samples (n = 40), with linoleic (22.0 – 55.6%) and oleic acid (14.0 – 39.6%) as principal fatty acids. A total of twenty-one fatty acids were detected in kalahari melon oil samples (n = 22) with linoleic acid being the major fatty acid ranging from 48.8 – 72.5% and eighteen fatty acids were detected in marula seed oils (n = 45) with oleic acid identified as the major fatty acid (10.9 – 89.1%). Based on the latter outcome of the fatty acid analysis of these selected African seed oils, it is evident that there is great variation amongst the samples hence comprehensive two-dimensional chromatographic profiling is necessitated for quality control. It could therefore be suggested that the analysis of fatty acids using GCxGC-ToF-MS can provide important information for quality control and oil authentication. It has been noted that the GCxGC-ToF-MS is unique powerful and sensitive analytical system that can extrapolate diagnostic information from minor and major components of selected African seed oils.

P-187 Botanical identification of oregano from the European food market and determination of their essential oils' constituents utilizing μ -Raman and HS-GC/MS

Authors [Dimitrios Mertzani^{1,4}](#), [Alexandros Nakas^{2,4}](#),

[Elli Kampasakali³](#), [Andreana Assimopoulou^{2,4}](#), [Dimitrios Christofilos³](#),

[Emeritus Stella Kokkini^{1,4}](#)

Institutes **1** Aristotle University of Thessaloniki, School of Biology, Laboratory of Systematic Botany and Phytogeography, Thessaloniki, Greece;

2 Aristotle University of Thessaloniki, School of Chemical Engineering,

Laboratory of Organic Chemistry, Thessaloniki, Greece; **3** Aristotle

University of Thessaloniki, Faculty of Engineering, School of Chemical

Engineering & Physics Laboratory, Thessaloniki, Greece; **4** Center for

Interdisciplinary Research and Innovation, Aristotle University of Thessaloni-

ki, Natural Products Research Centre of Excellence (NatPro-AUTH),

Thessaloniki, Greece

DOI [10.1055/s-0043-1774063](#)

“Oregano” is a culinary herb, widely used in everyday cooking. According to a CBI survey market (2009) [1], “oregano” is one of the top traded herbs on the European food market. It is found in supermarkets, flea markets and traditional shops, mainly in dried (crushed or ground) form.

Aims of the present study were: i) the botanical identification of crushed oregano material from European markets and ii) the assessment of the yield and quality of their essential oils, utilizing both Raman spectroscopy and headspace gas chromatography – mass spectrometry (HS-GC/MS).

HS-GC/MS is a routinely applied technique for the analysis of essential oils [2], while Raman spectroscopy offers the advantage of time efficiency, no sample preparation and non-destructiveness. It is also environmentally friendly and cost effective [3]. Eighteen commercial oreganos' packages were purchased from 14 European countries. The botanical identification of the plant material was based on the major micro-morphological key characters. Essential oils were

isolated using a Clevenger type apparatus and analysed by both Raman and HS-GC/MS methods, as previously described [4]. Two taxa of the genus *Origanum*, viz. *O. onites* and *O. vulgare* subsp. *hirtum*, were found to be sold under the commercial name oregano on the European food market, with a wide range of yields (0.99% – 6.04% v/w). The relative abundances of the six most prominent constituents were also compared, with carvacrol and thymol being the main components in all cases. Raman and GC/MS results were in very good agreement, with a deviation of less than 10%.

Funding This research has been co-financed by the European Regional Development Fund of the European Union and Greek national funds through the Operational Program Competitiveness, Entrepreneurship, and Innovation, under the call RESEARCH – CREATE – INNOVATE (project code: T1EDK-04174).

References

[1] CBI Market Survey The Spices and the herbs in the European Union CBI Ministry of Foreign Affairs Market Intelligence 2009

[2] Napoli E, Govino A, Carrubba A, Siong VHY, Rinaldo C Nina O, Ruberto G. Variations of Essential Oil Constituents in Oregano (*Origanum vulgare* subsp. *viridulum* (= *O. heracleoticum*) over Cultivation Cycles. *Plants* 2020; 9: 1174

[3] Hanif MA, Nawaz H, Naz S, Mukhtar R, Rashid N, Bhatti IA, Saleem M. Raman spectroscopy for the characterization of different fractions of hemp essential oil extracted at 130 C using steam distillation method. *Spectrochim. Acta A* 2017; 182: 168–174

[4] Kampasakali E, Nakas A, Mertzani D, Kokkini S, Assimopoulou AN, Christofilos D. μ -Raman Determination of Essential Oils' Constituents from Distillates and Leaf Glands of *Origanum* Plants. *Molecules* 2023; 28: 1221

P-188 Mass spectrometry-driven exploration of volatile interactions in microbial consortia

Authors [Antonio Azzolini^{1,2,3}](#), [Barbara Sgorbini⁴](#),

[Nicole Lecoultr⁵](#), [Carlo Bicchi⁴](#), [Jean-Luc Wolfender^{1,2}](#), [Patrizia Rubiolo⁴](#),

[Katia Gindro⁵](#)

Institutes **1** School of Pharmaceutical Sciences, University of Geneva, 1211

Geneva, Switzerland; **2** Institute of Pharmaceutical Sciences of Western

Switzerland (ISPSO), University of Geneva, 1211 Geneva, Switzerland;

3 Department of Laboratory Medicine and Pathology, Lausanne University

Hospital (CHUV), 1011 Lausanne, Switzerland; **4** Department of Drug

Science and Technology, University of Turin, Turin, Italy; **5** Plant protection

Research department, Mycology group, 1260 Nyon, Switzerland

DOI [10.1055/s-0043-1774064](#)

Microbial co-cultivation has emerged as a promising approach to unravel interspecies communication at the molecular scale. Nonetheless, a significant hurdle in this research domain is highlighting the microbial origin of metabolites present in co-culture systems. Metabolites observed in co-cultures can be absent in their respective single cultures, rendering it impossible to determine the microorganisms responsible for their production. For non-volatile metabolites, imaging mass spectrometry can help address this challenge by localising the induced molecules within the co-cultivation sample. However, for volatile induced metabolites, this issue persists as an unresolved challenge that requires further investigation and development of appropriate methodologies. To address this challenge, a three head-to-head microbial co-culture strategy was devised, focusing on the investigation of volatile interactions through gas chromatography-mass spectrometry (GC-MS). This methodology was used to study the volatile molecular interactions among three microbial species: *Fusarium culmorum*, *Aspergillus amstelodami* and *Cladosporium cladosporioides*. The employed strategy enabled the detection of induced volatile molecules (terpenes) as well as the identification of the microorganism producing these metabolites. Additionally, the induced molecules underwent antimicrobial activity assessment to gain deeper insight into their potential contribution to the microbial interplay. These results illustrate that the developed three head-to-head microbial co-culture strategy can be employed to better investigate the inter-microbial molecular cross-talk and efficiently uncover metabolite induction specific to individual microorganisms.

Conflict of Interest The authors declare no conflict of interest.

P-189 Optimisation of *Helichrysum italicum* distillation process by studying the essential oil's chemical composition using headspace-GC-MS

Authors Alexandros Nakas^{1,2}, Georgia Giannarelli¹, Konstantinos Kontogiannopoulos^{1,2}, Artemis Tsiaprazi-Stamou³, Vasilios Varsamis³, Andrea Assimopoulou^{1,2}

Institutes 1 Aristotle University of Thessaloniki, School of Chemical Engineering, Laboratory of Organic Chemistry, Thessaloniki, Greece; 2 Center for Interdisciplinary Research and Innovation, Aristotle University of Thessaloniki, Natural Products Research Centre of Excellence (Nat-Pro-AUTH), Thessaloniki, Greece; 3 Vessel Essential Oils, Neo Rysio, Greece
DOI 10.1055/s-0043-1774065

Helichrysum italicum is a perennial subshrub of the Asteraceae family (Compositae), found in dry, sandy and stony areas of the Mediterranean region. *Helichrysum italicum* is known for its anti-inflammatory, anti-allergic and antimicrobial activity. Due to its characteristic scent, its essential oil (EO) – also known as immortelle – is very popular in the cosmetic and perfume industry [1, 2]. The aim of the present study was to discover the appropriate pilot scale distillation conditions that optimise the yield and pleasant fragrance of the EO of *Helichrysum italicum* cultivated in northern Greece.

Steam distillation was conducted at the industrial distillery “Vessel Essential Oils”. To optimise the yield and the relative abundance of neryl acetate and γ -curcumene, which are the two main constituents responsible for the distinctive aroma of *H. italicum*. A face-centred composite experimental design was implemented, assessing the process parameters of steam distillation: time, temperature and pressure. The EOs' composition was determined by headspace-gas chromatography-mass spectrometry (headspace-GC-MS). Prior to the final analyses, pre-treatment, sampling, chromatography and MS conditions were optimised.

With the applied GC-MS method, more than 60 volatile compounds were identified in the EOs of *H. italicum* and their relative percentages were recorded and compared. In all cases, α -pinene was the most prominent component, displaying a great variance among samples with different distillation conditions. The desired space was determined by applying a three-dimensional response surface analysis of the independent and dependent variables, selecting as optimisation criteria the EOs' yield, along with the relative abundance of neryl acetate and γ -curcumene.

Funding This research has been co-financed by the European Regional Development Fund of the European Union and Greek national funds through the Operational Program Competitiveness, Entrepreneurship, and Innovation, under the call RESEARCH – CREATE – INNOVATE (project code: T1EDK-04174).

References

- [1] Nostro A, Bisignano G, Cannatelli MA, Crisafi G, Germano MP, Alonzo V. Effects of *Helichrysum italicum* extract on growth and enzymatic activity of *Staphylococcus aureus*. *International Journal of Antimicrobial Agents* 2001; 17 (6): 517–520
- [2] Nincevic T, Grdisa M, Satovic Z, Jug-Dujakovic M. *Helichrysum italicum* (Roth) G. Don: Taxonomy, biological activity, biochemical and genetic diversity. *Industrial Crops and Products* 2019; 138: 111487

P-190 Essential oils and achene germination tests of *Stevia incognita* and *Stevia ovata* from Guatemala

Authors Juan Francisco Perez-Sabino¹, Bessie Evelyn Oliva-Hernández¹, Max Samuel Mérida-Reyes¹, Julio Enrique Guerra-López¹, José Vicente Martínez-Arévalo², Antonio Jorge Ribeiro da Silva³

Institutes 1 Facultad de Ciencias Químicas y Farmacia, Universidad De San Carlos De Guatemala, Guatemala; 2 Facultad de Agronomía, Universidad de San Carlos de Guatemala, Guatemala; 3 Instituto de Pesquisas de Produtos Naturais, Universidade Federal do Rio de Janeiro, Rio de Janeiro, Brasil
DOI 10.1055/s-0043-1774066

Guatemala is a megadiverse country as a consequence of its geographical location where species native to North and South America converge. Among plant species there is a large number whose phytochemistry has not been sufficiently studied. Among these species are several of the genus *Stevia*, which produce secondary metabolites with potential applications in health, as has been demonstrated for *Stevia serrata*. The objective of this research was to characterise the composition of the essential oils of *Stevia ovata* and *Stevia incognita*, as well as to evaluate their sexual propagation. The study species were found in western and eastern Guatemalan departments, where aerial parts were collected. The essential oils were extracted by hydrodistillation. The extraction yields of the essential oils were less than 0.2% for both species. The oils were analysed by gas chromatography-mass spectrometry, presenting mainly sesquiterpenes and sesquiterpenoids in percentages of up to 30%. Nerolidol (19.9%) and spathulenol (18.7%) were the major components in the oil of *S. ovata* and germacrene D (31.8%) for the *S. incognita* oil. In the achene germination tests, yields of 0.71% and 0.9% were obtained for *S. ovata* from Jutiapa and Sololá, and 0.48% for *S. incognita* from San Marco. Both in peat moss yields of 5% and 11.7% were obtained for *S. ovata* from Jutiapa and Sololá, respectively. In view of the high sesquiterpenoid composition of the oils, it is advisable to characterise the biological and antioxidant activity of the extracts and essential oils.

P-191 Antibacterial Compounds from Bacteria Isolated from Saudi Arabian Thermal Springs

Authors Omaish Alqahtani¹, Simon Gibbons²

Institutes 1 Department of Pharmacognosy, Najran University, Najran, Saudi Arabia; 2 Centre for Natural Products Discovery (CNPD), Liverpool John Moores University, Liverpool, United Kingdom
DOI 10.1055/s-0043-1774067

Recently, the emergence of antimicrobial-resistant bacterial infections has been considered one of the global health crises that threaten communities. The rise and dissemination of resistance within bacterial pathogens make the effectiveness of antibiotics decline gradually over time. As a result, the search for novel antibiotics from different natural sources has increased. Bacteria, for example, have the ability to yield antibiotics. One important habitat that has yet to be fully exploited for antibiotic-producing bacteria is geothermal springs. Hot springs have been used for spas as well as for treating dermatological infections.

The aim of this study is to discover antibacterial compounds from thermal springs. Seventeen water samples were collected from four different thermal springs in Saudi Arabia. Microbiological assays were used to assess the antibacterial activities of bacterial colonies against antibiotic-resistant and susceptible bacterial strains and 16S rRNA gene sequencing was used to identify the genus and species of these antibiotic-producing bacteria. Chromatographic and spectroscopic techniques were utilized to isolate the active compounds and aid their structural elucidation. Four compounds were isolated from bacteria; N-acetyl-tryptamine (1), isovaleric acid (2), ethyl-4-ethoxybenzoate (3) and phenylacetic acid (4). Compounds 1, 2 and 4 were isolated from *Bacillus pumilus* and 3 was from *Bacillus licheniformis*. The outcomes of the MIC assays showed that all isolates had mild antibacterial activities against Gram-positive pathogens (between 128 mg/L and 512 mg/L compared to the control) and compound 2 had mild activity against *E. coli*.

Conflict of Interest The authors declare no conflict of interest.

P-192 Investigation into the Synthesis and Antibacterial Activity of Curcumin Analogues against Gram-positive and Gram-negative Bacteria

Authors Hannah Denison¹, Alison Kelly¹, Sianne Schwickard¹, Mouhamad Khoder¹

Institute 1 Kingston University London, Kingston Upon Thames, United Kingdom
DOI 10.1055/s-0043-1774068

Bacteria cause important infectious diseases, and the rapid development of resistance is a serious concern. Therefore, investigating novel drugs from natural or synthetic sources with potent antibacterial activity against resistant strains is highly desirable. Curcumin is a natural phenolic compound isolated from turmeric; it possesses a wide range of pharmacological activities including antimicrobial effects. One challenge with curcumin is poor solubility/bioavailability; therefore it is of interest to investigate curcumin analogues (CAs) with potentially enhanced antibacterial activity and bioavailability. The aims were to synthesise CAs, establish their antibacterial activity, improve the solubility and assess their cytotoxicity.

A total of 22 CAs were synthesised via a Claisen-Schmidt condensation reaction and characterised prior to determining antibacterial activity against *Staphylococcus aureus*, *Staphylococcus epidermidis*, MRSA, MSSA, *Escherichia coli* and *Pseudomonas aeruginosa*. Initial activity was demonstrated by 15 CAs, with 7 active against all isolates. The cytotoxicity assessment against HeLa and HaCaT cells using a PrestoBlue assay showed no toxicity towards either cell line. However, to improve solubility, the CAs were combined with albumin using a solid dispersion technique which, although resulting in significantly enhanced solubility, did not improve nor reduce antibacterial activity when re-tested using the same bacteria and assays as previously mentioned.

In conclusion, the potential antibacterial action, improved solubility and lack of cytotoxicity shows that these CAs have the capacity to become new drugs with the aim to slow the emergence of resistance, but further testing is required to show their full potential.

Conflict of Interest The authors declare no conflict of interest.

P-193 More than a perfect 6: the fungi in Massa Medicata Fermentata

Authors [Kay Ling Ang¹](#), [Hung-Rong Yen¹](#)

Institute [1 China Medical University, Taichung, Taichung, Taiwan](#)

DOI [10.1055/s-0043-1774069](#)

Unlike most indigenous crude drugs of plants, animal or mineral sources in the East Asian ethnomedical practice, Massa medicata fermentata (MMF) stands out as a fermented mixture of six different botanical ingredients. Although MMF exerts a range of gut modulating effects attributed to the phytochemical properties of the individual botanical ingredients, this association requires further elucidation.

The individual botanical ingredients and fermenting process are reviewed for a more comprehensive understanding of its gut modulating effects.

A mixture of sweet wormwood (*Artemisia annua*), waterpepper (*Persicaria hydropiper*), cocklebur (*Xanthium sibiricum*), apricot kernel (*Prunus armeniaca*), red rice-bean (*Vigna umbellata*) and wheat flour and/or bran (*Triticum sativum*) is spontaneously fermented to produce MMF. During fermentation, the phytochemicals present in the individual botanical ingredients undergo rapid degradation. Simultaneously, bioactive metabolites are generated via microbial actions. The microorganisms, predominantly filamentous fungi, have been known to yield proteins, digestive enzymes and secondary metabolites that are distinctly different to those produced by yeast/bacteria. Depending on the species, some are known to produce mycotoxins with detrimental effects on humans and animals. Fungi are known to survive in varying environmental conditions. To ensure proper growth of desired fungi and suppression of pathogenic ones, standardised manufacturing conditions are necessary.

Medicinal effects of MMF are traditionally believed to be conferred by the botanical ingredients that go into its production. However, it is postulated here that filamentous fungal species is the crucial factor that determines the product quality and therapeutic effect of MMF, while the role of the six botanical ingredients are supplementary.

P-194 Massa medicata fermentata: gut modulation, holism, and human health

Authors [Kay Ling Ang¹](#), [Hung-Rong Yen¹](#)

Institute [1 China Medical University, Taichung, Taichung, Taiwan](#)

DOI [10.1055/s-0043-1774070](#)

A fermented mixture of different botanical ingredients, Massa medicata fermentata (MMF) has been in existence for centuries and is customarily used to address gastrointestinal disorders in East Asia. MMF is also one of the most widely-used substances in East Asian ethnomedical practice that highly values the holistic whole-person approach with an emphasis on its relationship with nature.

For a deeper understanding of its health effects, the gut modulating properties of MMF are reviewed, with discussions on its role in other aspects of human health.

Studies have shown that oral administration of MMF can positively influence gut motility, secretion and microbiota composition, which is attributed to its enzymatic and probiotic-like effects. MMF also acts as an inoculum for other fermented medicinals. From a macro level perspective, the impact of MMF on human health is multi-dimensional. In addition to its explicit medicinal use, MMF is commonly found in the husbandry practice as feed additives and alternative medicines for farmed animals. And since animal welfare is intrinsically linked to human health with environmental implications, MMF may offer a valuable ecocentric perspective on human health in the face of rising global health and environmental threats to humanity.

In the case of MMF, it may be the perfect example to showcase a holistic approach to human health from an ancient East Asian perspective. Viewed primarily to be a gut modulating ethnomedicine, the relevance of MMF has exceeded its medicinal purposes, and can be applied across different realms of human health.

P-195 Chemical constituents with senolytic activity from the stems of *Limacia scandens*

Authors [Keun Oh¹](#), [Hee Ju Lee²](#), [Ha-Thanh-Tung Pham³](#)

Institutes [1 Research Institute of Pharmaceutical Sciences, College of Pharmacy, Seoul National University, Seoul, South Korea;](#) [2 Natural Product Informatics Research Center, Gangneung, South Korea;](#) [3 Faculty of Pharmacy, PHENIKAA University, Hanoi, Vietnam](#)

DOI [10.1055/s-0043-1774071](#)

While screening senotherapeutics from natural products, seven undescribed chemicals (two syringylglycerol derivatives, two cyclopeptides, one tigliane analogue and two chromone derivatives), as well as six known compounds, were isolated from the stems of *Limacia scandens*. The structures of compounds were elucidated through spectroscopic data analysis, including 1D and 2D NMR, HRESIMS and CD data. All compounds were tested in replicative senescent human dermal fibroblasts (HDFs) to determine their potential as senotherapeutic agents to specifically target senescent cells. One tigliane and two chromone derivatives showed senolytic activity, indicating that senescent cells were selectively removed. Especially, 2-

[2-[(3'-O- β -D-glucopyranosyl)phenyl]ethyl]chromone is expected to be a potential senotherapeutic by inducing HDF death, inhibiting the activity of senescence-associated β -galactosidase (SA- β -gal) and expressing senescence-associated secretory phenotype (SASP) factors.

P-196 *Streptomyces* spp. from the rhizosphere of *Leontopodium nivale* subsp. *alpinum* – uncovering potential for the biosynthesis of secondary metabolites

Authors [Anna Vignolle¹](#), [Martin Zehl²](#), [Petra Pjevac³](#), [Sergey B. Zotchev¹](#)

Institutes **1** Department of Pharmaceutical Sciences, Division of Pharmacognosy, University of Vienna, 1090 Vienna, Austria; **2** Mass Spectrometry Centre, Faculty of Chemistry, University of Vienna, 1090 Vienna, Austria; **3** Joint Microbiome Facility, Medical University of Vienna and University of Vienna, 1030 Vienna, Austria

DOI [10.1055/s-0043-1774072](https://doi.org/10.1055/s-0043-1774072)

Actinomycetes, especially the genus *Streptomyces*, are prolific producers of natural products, from which many therapeutically valuable molecules have been isolated. With increasing rediscovery rates, the focus has shifted to *Streptomyces* from unique ecological niches for the discovery of new natural products. One such ecological niche is the plant rhizosphere, characterised by chemical interactions between the plant and the rhizobiome, which can elicit the production of antibiotics by *Streptomyces* [1].

Rhizosphere soil of the rare alpine plant *Leontopodium nivale* subsp. *alpinum* was used to isolate 77 actinomycetes [2] of which 20 strains belonging to the genus *Streptomyces* were chosen to characterise their secondary metabolite production potential and to discover novel natural products.

The genomes of the 20 *Streptomyces* spp. strains were sequenced and analysed with antiSMASHv6.0 software [3]. A total of 601 biosynthetic gene clusters were detected, 119 of which are possibly unique.

The 20 strains were cultivated in the fermentation media MYM, PM4 and SM17. Methanolic extracts were prepared from the fermentation broths and tested for antimicrobial activity against *Bacillus subtilis*, *Staphylococcus carnosus*, *Escherichia coli*, *Saccharomyces cerevisiae* and *Pseudomonas fluorescens*. Of the 60 tested extracts 37% displayed antimicrobial activity. LC-MS analysis of some methanolic extracts resulted in the detection of 19 known compounds, including nonactin, tambromycins and heronamides, and 3 potentially novel secondary metabolites. To facilitate genetic engineering aimed at eliciting expression of potentially novel clusters and hence production of their cognate secondary metabolites, we successfully established gene transfer systems for 11 strains.

Conflict of Interest The authors declare that they have no conflict of interest.

References

- [1] van Bergeijk DA, Terlouw BR, Medema MH, van Wezel GP. Ecology and genomics of Actinobacteria: new concepts for natural product discovery. *Nat Rev Microbiol* 2020; 18: 546–558
- [2] Oberhofer M, Hess J, Leutgeb M, Gossnitzer F, Rattei T, Wawrosch C, Zotchev SB. Exploring Actinobacteria Associated With Rhizosphere and Endosphere of the Native Alpine Medicinal Plant *Leontopodium nivale* Subspecies *alpinum*. *Front Microbiol* 2019; 10: 2531
- [3] Blin K, Shaw S, Kloosterman AM, Charlop-Powers Z, van Wezel GP, Medema MH, Weber T. antiSMASH 6.0: improving cluster detection and comparison capabilities. *Nucleic Acids Res* 2021; 49: W29–W35

P-197 Optimisation and Formulation of Synergistic Essential Oil Combinations for Effective Antimicrobial Activity against Respiratory Pathogens

Authors [Stephanie Leigh-de Rapper¹](#), [Alvaro Viljoen^{2,3}](#), [Sandy van Vuuren¹](#)

Institutes **1** Department of Pharmacy and Pharmacology, Faculty of Health Sciences, The University of the Witwatersrand, Johannesburg, South Africa; **2** Department of Pharmaceutical Sciences, Faculty of Sciences, Tshwane University of Technology, Pretoria, South Africa; **3** SAMRC Herbal Drugs Research Unit, Department of Pharmaceutical Sciences, Tshwane University of Technology, Pretoria, South Africa

DOI [10.1055/s-0043-1774073](https://doi.org/10.1055/s-0043-1774073)

An antimicrobial study was conducted on 369 essential oil combinations commonly indicated for respiratory infections. Based on the findings, five distinct combinations of essential oils held promise having antimicrobial synergy, anti-inflammatory effects and retaining cell viability between 80.4% and 99.6% against A549 cells. This study aimed to quantify and optimize the synergy of all five combinations and select the optimum combination for further nano-emulsion formulation ideal for respiratory inhalation formulation. The prediction tool, SynergyFinder was implemented to determine optimal synergy blends. According to the synergy maps derived, and by means of computational interpretation, the best essential oil combination comprised of essential oils from *Hyssopus officinalis* var. *angustifolius* in combination with *Salvia rosmarinus* var. *angustifolius*, with a blend representing 49.57% of *H. officinalis* to 50.43% of *S. rosmarinus*. This optimized blend was then formulated into a nanoemulsion, using the two-component, self-emulsification technique. The essential oil nanoemulsion showed strong in vitro antimicrobial activities against pathogens of the respiratory tract including; *Streptococcus pneumoniae* (ATCC 49619), *Haemophilus influenzae* (ATCC 19418), *Klebsiella pneumoniae* (ATCC 13883) and *Moraxella catarrhalis* (ATCC 23246) with an average six-fold improvement in antimicrobial effect when compared to the neat essential oils when tested in minimum inhibitory assays. The blended *H. officinalis* and *S. rosmarinus* essential oil nanoemulsion therefore holds potential to be developed as a natural antimicrobial agent for the management of respiratory tract infections.

P-198 Antimicrobial activity of Portuguese *Asphodelus* root extracts against multidrug-resistant bacteria

Authors [Maryam Malmir¹](#), [Katelene Lima¹](#), [Vera Manageiro^{2,3,4}](#), [Isabel da Silva¹](#), [Manuela Caniça^{2,3,4,5}](#), [Beatriz Silva Lima¹](#), [Olga Silva¹](#)

Institutes **1** Research Institute for Medicines (iMed.U LISBOA), Faculty of Pharmacy, Universidade de Lisboa, 1649-003, Lisbon, Portugal; **2** National Reference Laboratory of Antibiotic Resistances and Healthcare-Associated Infections, Department of Infectious Diseases, National Institute of Health Dr. Ricardo Jorge, 1649-016, Lisbon, Portugal; **3** Centre for the Studies of Animal Science, Institute of Agrarian and Agri-Food Sciences and Technologies, University of Porto, Porto, Portugal; **4** AL4AnimalS, Associate Laboratory for Animal and Veterinary Sciences, Portugal; **5** CIISA, Center for Interdisciplinary Research in Animal Health, Faculty of Veterinary Medicine, University of Lisbon, Lisbon, Portugal

DOI [10.1055/s-0043-1774074](https://doi.org/10.1055/s-0043-1774074)

Antimicrobial resistance (AMR) is a growing global health concern due to the loss of efficacy of first-line antibiotics and the development of multidrug-resistance in many pathogens. In this context, ethnomedical information plays an increasingly important role, since herbal medicines have shown high potential as anti-infective agents. Root tubers of the Portuguese endemism *Asphodelus bentorainhae* and its coexisting species *Asphodelus macrocarpus* have been traditionally used to treat skin diseases and infections, therefore the present study aims to detect and identify the potential secondary metabolites of antimicrobial markers using an in vitro bioguided procedure. The hydroethanolic (70%) extracts of both medicinal plants were subjected to liquid-liquid separation with solvents of increasing polarity, generating the diethyl ether, ethyl acetate and aqueous fractions. Phytochemical screening of the potential extracts was performed using TLC and LC-UV/DAD-ESI/MS chromatography techniques and broth microdilution method was used for in vitro evaluations of antimicrobial activity. The diethyl ether L-L fractions of both species showed the highest activity against all tested Gram-positive microorganisms (MIC: 16 to 1000 µg/mL). Chrysophanol derivatives have been identified as major marker compounds and have shown high antimicrobial activity, particularly against *Staphylococcus epidermidis* (MIC: 3.2 to 100 µg/mL). The studied *Asphodelus* species found to be a potential source of antimicrobial agents against multidrug-resistant pathogens and the obtained results contribute to the concrete validation of the use of these medicinal plants as future herbal products.

P-199 Time-kill kinetics and cell surface morphology of *Oroxylum indicum* extract against clinical strains *Staphylococcus aureus* and *Staphylococcus intermedius*

Authors Patchima Sithisarn¹, Pongtip Sithisarn², Piyanuch Rojsanga²

Institutes 1 Faculty of Veterinary Medicine, Kasetsart University city, Bangkok, Thailand; 2 Faculty of Pharmacy, Mahidol University, Bangkok, Thailand

DOI 10.1055/s-0043-1774075

The flavone-rich *Oroxylum indicum* young fruit extract has been reported to effectively inhibit five clinically important zoonotic bacteria including *Staphylococcus intermedius* and *Staphylococcus aureus*, and the minimum inhibitory concentrations (MIC) were identified. Mechanisms of the antibacterial activities were suggested to be chemical–pathogen interactions involved in cell wall or cell membrane dysfunction, direct damage to the cytoplasmic membrane or indirect damage through autolysis/weakening of the cell wall and osmotic lysis. The exploration of interactions between *S. intermedius*, *S. aureus*, and *O. indicum* young fruit extract at 2.5 mg/mL were performed compared to amoxicillin and cefotaxime using time-kill kinetic assays over 24 hours. High magnification scanning electron microscopy (SEM) for bacterial cellular surface morphological changes at MIC concentration was completed. The prominently affected *S. intermedius* and *S. aureus* were found shortly at 3-hour (h) post incubation. The bacterial cell number showed a 54.56-fold decrease in *S. intermedius* and a 32.74-fold decrease in *S. aureus*. The viable bacteria and the bacterial growth pattern were distinctly altered after 6-h post incubation. It reached 3.6 log cfu/mL in *S. intermedius* and 4.2 log₁₀ cfu/mL in *S. aureus* at 24-h post incubation. The bacterial particles were found smaller, less than one-half in size, and aggregated into large clumps. Irregular cellular surface with membrane morphological changes, cell membrane shrinkage, cell eruption with content leakage and cellular fusion were found. Further investigation is ongoing. This information will be beneficial for the formula development and clinical use of *O. indicum* to fit with the reality of the important zoonotic bacteria.

P-200 Antibacterial evaluation of natural oridonin and its chemically synthesized derivatives

Authors Fatimah Qassadi^{1,2}, Tanya Monaghan^{3,4}, Dong-Hyun Kim¹, Rian Griffiths¹, Zheyang Zhu¹

Institutes 1 School of Pharmacy, University of Nottingham, Nottingham, United Kingdom; 2 Department of Pharmacognosy, School of Pharmacy, Prince Sattam Bin Abdulaziz University, Central Region, Saudi Arabia; 3 NIHR Nottingham Biomedical Research Centre, University of Nottingham, Nottingham, United Kingdom; 4 Nottingham Digestive Disease Centre, College of Medicine, University of Nottingham, Nottingham, United Kingdom

DOI 10.1055/s-0043-1774076

Antimicrobial resistance has become one of the most important and pressing healthcare challenges of the present time. Plant-derived natural antimicrobials have recently regained increased attention due to their great structural and chemical diversity. *Isodon rubescens* (Hemsl.) H.Hara is a perennial herb of the genus *Isodon* in the Labiatae family. *Isodon* diterpenoids have attracted considerable attention as antibacterial, anti-inflammatory and anti-tumour agents. Oridonin, an ent-kaurane diterpenoid, has been attracting a rising attention in recent years as the main bioactive chemical component of *I. rubescens*, and it is the material basis for its efficacy. The aim of this study was to investigate the antibacterial activities of oridonin and four oridonin derivatives (X1, DCL-13, DCL-13p, C07-4BDXS) against *Escherichia coli*. Broth microdilution assay was used to determine the minimum inhibitory concentration (MIC) of each compound. Uptake of the fluorescent probe 1-N-phenyl-naphthylamine (NPN) was

applied to determine the permeability changes in the cell membrane of *E. coli*. Oridonin and its derivatives (X1 and C07-4BDXS) permeabilise the outer membrane of *E. coli* MG655 and DH5a pUC19 with inhibitory activities between 100 µM – 25 µM. DCL-13 and DCL-13p have weaker antibacterial activity against *E. coli* growth, with MIC values ≥ 200 µM, suggesting a weaker bacteriostatic effect. Our results represent a first step towards the potential application of oridonin and its synthetic derivatives in the prevention and treatment of bacterial infections.

P-201 The rhizomes of *Origanum vulgare* exhibit antioxidant and antimicrobial activity comparable to the leaves

Authors Silvia Bittner Fialova¹, Elena Kurin¹, Eva Trajčiková¹, Pavel Mučaji¹, Eva Drobná², Svetlana Dokupilová³, Livia Slobodníková⁴

Institutes 1 Comenius University Bratislava, Faculty of Pharmacy, Department of Pharmacognosy and Botany, Bratislava, Slovakia; 2 Comenius University Bratislava, Faculty of Pharmacy, Department of Biochemistry and Microbiology, Bratislava, Slovakia; 3 Comenius University Bratislava, Faculty of Pharmacy, Department of Pharmaceutical Analysis and Nuclear Pharmacy, Bratislava, Slovakia; 4 Comenius University Bratislava, Faculty of Medicine, Institute of Microbiology, Bratislava, Slovakia

DOI 10.1055/s-0043-1774077

Our study aimed to examine the antibacterial and antioxidant activity of *Origanum vulgare* underground parts (OvR) besides the leaves (OVI) that are used conventionally. Antioxidant activity was determined using the DPPH model as IC₅₀ of OVI 6.32 µg/mL and OvR 8.50 µg/mL. In ABTS assay, the IC₅₀ of OVI was 11.86 µg/mL and OvR 7.55 µg/mL. The determination of intracellular oxidative stress by DCFH-DA assay resulted in a reduction of ROS production in NIH/3T3 cells treated with H₂O₂ by OVI, IC₅₀ = 3.95 µg/mL, and OvR, IC₅₀ = 3.23 µg/mL. The antioxidant activity of rosmarinic acid (positive control) was slightly stronger in all assays (1.83 µg/mL, 3.27 µg/mL and 1.57 µg/mL, respectively). The antimicrobial activity of OVI and OvR was tested by broth microdilution assay. MICs and MBCs of OvR are 2.5 mg/mL for MSSA and MRSA. MIC and MBC of OVI against *P. mirabilis* is also 2.5 mg/mL, whereas MIC and MBC of OvR is 5 mg/mL. Both extracts also inhibited the growth of *E. faecalis* (MIC OVI = 10 mg/mL, MIC OvR = 2.5 mg/mL), but they did not act as bactericidals. *P. aeruginosa*, *E. coli*, *K. pneumoniae* and *C. albicans* were found to be resistant against both. LC-MS-DAD analysis revealed rosmarinic acid and oreganol A as major compounds. In conclusion, *O. vulgare* rhizomes showed significant antioxidant and antimicrobial action and might be intended as an alternative to the leaves.

Funding This work was supported by grants APVV-19-0056 and VEGA 1/0284/20.

Conflict of Interest The authors declare no conflict of interest.

P-202 Biological activity of halimane derivatives through diversity-oriented synthesis

Authors Florencia Z. Brauning¹, Gabrielle Bangay^{1,2}, Vera Isca^{1,3}, Carlos A.M. Afonso³, Ahmed A. Hussein⁴, Vânia André⁵, Patrícia Rijo¹

Institutes 1 Universidade Lusófona's Research Center for Biosciences and Health Technologies (CBIOS), Lisbon, Portugal; 2 Universidad de Alcalá de Henares, Facultad de Farmacia, Departamento de Ciencias Biomédicas (Área de Farmacología; Nuevos agentes antitumorales, Acción tóxica sobre células leucémicas), Ctra. Madrid-Barcelona km. 33,600 28805 Alcalá de Henares, Madrid, Alcala, Spain; 3 Instituto de Investigação do Medicamento (iMed. ULisboa), Faculdade de Farmácia, Universidade de Lisboa, 1649-003 Lisboa, Portugal; 4 Cape Peninsula University of Technology, Cape town, South Africa; 5 Centro de Química Estrutural, Institute of Molecular Sciences, Instituto Superior Técnico, Universidade de Lisboa, Avenida Rovisco Pais, 1049-001 Lisbon, Portugal

DOI 10.1055/s-0043-1774078

In recent times, the emergence of antibiotic-resistant bacteria and chemotherapeutic resistance has prompted the quest for bioactive compounds to develop new and more effective drugs. *Plectranthus* spp. (Lamiaceae) are known for their traditional medicinal properties, being a rich source of natural lead molecules with diverse structures and biological activities. *P. ornatus* Codd. has been used traditionally in Africa, Asia and Brazil for alleviating a wide range of ailments, including digestive tract (stomach and liver), diuretic, pain, fever, inflammation and infections. The halimane compound 11R⁺-acetoxyhalima-5,13E-dien-15-oic acid (HAL), the main constituent of *P. ornatus*' acetonitrile extract, revealed interesting biological activities, such as moderate anti-inflammatory effects, antimycobacterial and cytotoxicity. A previous study from our group, yielded promising results regarding the antimycobacterial activity of a HAL derivative, which inhibited bacterial growth almost to the same extent as a clinically used antitubercular drug. Based on this, the aim of the present work was to fully physicochemically characterize the HAL starting material for potential pharmaceutical use. HAL was characterized through SCXRD, FTIR, HSM (170 °C), DSC and TG. SCXRD results showed that HAL presents orthorhombic symmetry, crystallizing in the space group P212121, and that its carboxylic groups can form hydrogen bonds with the binding motif R₂² (8). Also, new HAL derivatives were prepared, functionalized using amines, with improved biological activity. HAL derivatives **1**, **2** and **3** (► Fig. 1) were successfully synthesized and their structural characterization confirmed by ¹H-, ¹³C-NMR and FTIR. Further physicochemical biological activity characterization of the analogues is on-going.

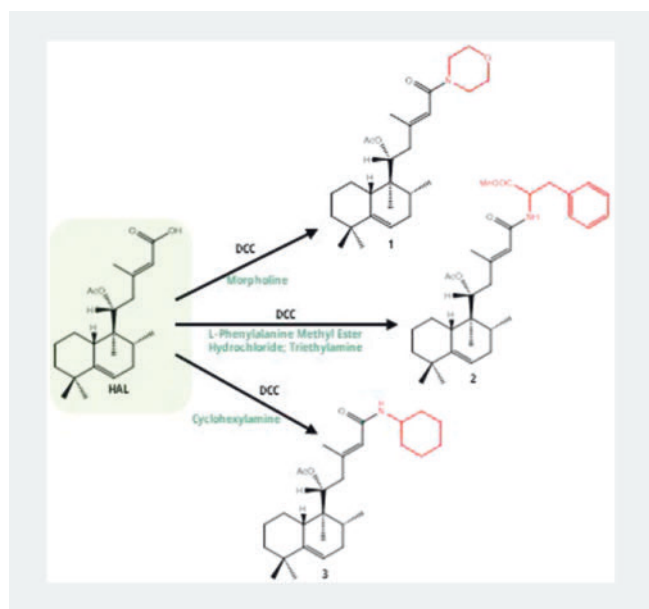

► Fig. 1 Structure of HAL and synthesized derivatives **1**, **2** and **3**

P-204 Effect of *Satureja montana* L. essential oil on quorum sensing-controlled virulence factors and biofilm production of *Pseudomonas aeruginosa*

Authors Gordana Maravić-Vlahoviček¹, Marija Kindl¹, Klara Andričević¹, Mateja Mervić¹, Verica Dragović-Uzelac², Sanda Vladimirović-Knežević¹

Institutes **1** University of Zagreb, Faculty of Pharmacy and Biochemistry, Zagreb, Croatia; **2** University of Zagreb, Faculty of Food Technology and Biotechnology, Zagreb, Croatia

DOI 10.1055/s-0043-1774079

Pseudomonas aeruginosa is one of the most common causes of nosocomial infections worldwide, associated with high morbidity and mortality rates. It is

one of the most difficult bacteria to treat because of its innate, acquired, and adaptive antibiotic resistance, which is controlled by a complex interplay of mechanisms. Adjuvant strategies targeting *P. aeruginosa* resistance mechanisms could rejuvenate conventional antibiotic therapy by increasing drug efficacy and slowing antibiotic resistance. Therefore, the aim of this study was to investigate, for the first time, the effect of *Satureja montana* L. essential oil and its major constituent thymol (56.5%) on quorum sensing controlled virulence factors and biofilm production of *P. aeruginosa* individually and in combination with tobramycin. Both essential oil and thymol at a concentration of 0.5 mg/mL inhibited the growth of planktonic *P. aeruginosa* PAO1 and acted synergistically with the reference antibiotic at subinhibitory concentrations. Furthermore, *S. montana* essential oil and thymol synergistically with tobramycin decreased the swarming and proteolytic activity of *P. aeruginosa* strains PAO1, PA14, and ATCC 27853. In contrast, they showed antagonistic effects in the same combination, resulting in increased pyocyanin production by *P. aeruginosa* PAO1. Despite the demonstrated inhibitory effect against planktonic *P. aeruginosa* ATCC 27853, their synergistic-antagonistic activity on biofilm production was highly variable and strongly dependent on a narrow concentration range. Our study contributed to a better understanding of the influence of essential oils on quorum sensing-controlled virulence and biofilm formation.

P-205 Antimicrobial activity of a grape marc polyphenolic extract on antibiotic resistant clinical isolates

Authors Trinidad de Miguel¹, Tamara Manso¹, Rosa Antía Villarino¹, Lorena G. Calvo¹, Marta Lores¹, José R. Rama¹

Institute **1** University of Santiago de Compostela, Santiago De Compostela, España

DOI 10.1055/s-0043-1774080

The problem of bacterial resistance is a global public threat, difficult to solve due to the lack of development of new antibiotics, which highlights the importance of the search for new alternatives to treat infections caused by resistant pathogens. The bioactive compounds of plants, such as polyphenols, could be a solution to this relevant problem as these molecules have antimicrobial properties. In this work we have studied the antimicrobial activity of a polyphenolic-rich extract from Galician white grapes against clinical strains, some of them presenting antibiotic resistance. For the polyphenolic extraction, a Medium-Scale Ambient Temperature (MSAT) system was employed, based on the principles of Green Chemistry, being respectful of the environment, as mild process conditions and solvents recognised as safe (GRAS) were used. As selected extracting mixture, ethyl lactate:water 50% is used. To estimate the polyphenol content of extract, total polyphenol index (TPI) was determined, while liquid chromatography with tandem mass spectrometry (LC-MS/MS) was used for detailed analytical characterisation of these compounds, obtaining their individualised polyphenol profile and their quantitative composition. The antimicrobial capacity of the extract was determined by calculating the minimum bactericidal concentration (MBC) and half the maximum inhibitory concentration (IC₅₀), using a range of concentrations of the extract between 0 and 20% (v/v). The bacterial strains used were collected from clinical samples. The values of IC₅₀ obtained ranged from about 0.4 to 8% (v/v). Our results showed that this grape extract is effective against the majority of the pathogenic bacteria studied.

P-206 Evaluation of the antimicrobial potential of several natural extracts obtained from Albarino grape marc

Authors Trinidad de Miguel¹, Carmen Melatti¹,

Rosa Antía Villarino¹, Lorena G. Calvo¹, Sandra Sanchez¹, Jose R. Rama¹

Institute **1** University of Santiago de Compostela, 15896- Santiago De Compostela, España

DOI 10.1055/s-0043-1774081

The antimicrobial activity of polyphenolic-rich plant extracts has been largely proved. In recent years, this feature has been gaining attention due to the need of new sources of environmental friendly antimicrobials that can help reduce the use of antibiotics. In this study we tested several extracts from Albarino grape marc against a collection of pathogenic and commensal bacteria, which includes *Staphylococcus aureus*, *Escherichia coli*, *Pseudomonas aeruginosa*, *Staphylococcus hyicus*, *Bacillus subtilis*, *Enterococcus faecalis*, *Aeromonas salmonicida* subsp. *salmonicida*, *Aeromonas hydrophila*, *Proteus mirabilis*, *Streptococcus suis*, *Citrobacter freundii* and *Streptococcus uberis*. The antimicrobial tests were performed according to the EUCAST recommendations, using the Alamar-Blue colorimetric/fluorometric method, and reading the plates by fluorometry. Although the results indicate that there is a wide range of susceptibility depending on both the nature of the extract and the bacterial strain, in general these extracts present good antimicrobial activity against most of the studied species, and in most cases with values of IC₅₀ was below 2%.

P-208 Investigating Irish bogland plants for antimicrobial activity and uncovering their mechanism of action

Authors [Kavita Gadar¹](#), [Cillian Jacques Gately²](#), [Ismael Obaidi²](#), [Maria Pigott²](#), [Helen Sheridan²](#), [Ronan McCarthy¹](#)

Institutes **1** Brunel University London, London, United Kingdom; **2** NatPro Centre, School of Pharmacy and Pharmaceutical Sciences, Trinity College Dublin, Dublin, Ireland

DOI [10.1055/s-0043-1774082](#)

The emergence of antibiotic resistance is currently a worldwide threat as it renders our reservoir of antibiotics as ineffective when treating bacterial infections. In 2019, 4.95 million people died with an antibiotic-resistant associated infection. One of the biggest threats contributing to this crisis is the bacteria *Acinetobacter baumannii*. *A. baumannii* is a Gram-negative multi-drug resistant pathogen that commonly causes bloodstream, wound, and urinary tract infections. Multi-drug resistant (MDR) *A. baumannii* is currently at the top of the World Health Organisation's list of priority pathogens and is in urgent need of novel therapeutic interventions. Fortunately, the natural environment serves as a vast and largely untapped resource for novel antibiotics, as plants have endured millennia of intensive selective pressure to prevent bacterial colonisation. Thus, the discovery of plant-derived antimicrobials are currently of great interest.

Using high throughput screening of Irish bogland plant extracts, we discovered an extract, derived from tormentil plants, that can inhibit the growth of *A. baumannii* in a dose-dependent manner. Through further analysis we were then able to identify the bioactive component of the MeOH extract, which was found to exhibit a more potent antibiotic effect against *A. baumannii* when used singularly. To determine the antimicrobial mechanism of action, we assessed the effect of this bioactive component on the bacteria's gene expression using transcriptomics. We then demonstrated a successful reversal of the treatment, which validated the identified mechanism of action. Overall, our findings have the potential to open up novel avenues for treating MDR *A. baumannii* infections.

Conflict of Interest The author declares no conflict of interests.

P-209 Recent updates on exploiting the Greek microbial diversity for the discovery and development of novel anti-aging molecules.

Authors [Konstantinos Gaitanis¹](#), [Nikolaos Tsafantakis¹](#), [Eirini Gkogkou²](#), [Despoina D. Gianniou²](#), [Stavroula Kaili³](#), [Paris Laskaris³](#), [Evangelia Tsiokanos¹](#), [Dimitris G. Hatzinikolaou³](#), [Ioannis P. Trougakos²](#), [Amalia D. Karagouni³](#), [Nikolas Fokialakis¹](#)

Institutes **1** Section of Pharmacognosy & Chemistry of Natural Products, Department of Pharmacy, National and Kapodistrian University of Athens,

Athens, Greece; **2** Section of Cell Biology and Biophysics, Department of Biology, Athens, Greece; **3** Section of Botany, Department of Biology, Athens, Greece

DOI [10.1055/s-0043-1774083](#)

Actinobacteria from Greek ecosystems are renowned for producing bioactive compounds. To this purpose, the "AntiAging" project sought to uncover new, promising natural compounds with anti-aging properties, which could be incorporated into cosmeceutical/nutraceutical formulations. Herein, 1000 isolates originating from the Greek natural environment and belonging to the ATHUBA collection (Athens University Bacterial & Archaea Culture Collection), were investigated. A unique library of ~2000 extracts (EtOAc and MeOH/H₂O) was generated, and the tyrosinase and elastase inhibition activity was evaluated via enzymatic assays. Out of the top 100 extracts with the highest inhibitory activity, 28 were found to be non-cytotoxic, when tested on cell-based assays. Those extracts were then analysed by HPLC-DAD-ELSD and UPLC-HRMS. The top 3 microbial strains, belonging to *Amycolatopsis* sp. and *Streptomyces* sp. families, combining a high production of secondary metabolites and bioactivity on both cell-free and cell-based assays, with inhibition rates ranging from 35–65% and 20–25%, respectively, were subsequently grown using four different cultivation media. The most promising cultures were subjected to a scale-up process (2 L) and fractionation, and their bioactivity was further assessed. A customised bio-guided workflow was then applied, combining a high-throughput dereplication and molecular networking method (UPLC-HRMS), along with the bioactivity of each fraction. Our ultimate goal is the targeted identification and isolation of bioactive compounds, which can be integrated into cosmeceutical formulations. The plethora of identified molecules highlights the significant potential for exploiting Greek microbial diversity in the realm of anti-aging research.

Funding This work was funded by the national EPAnEK project (Grant No T2EDK-01410).

P-210 A study on *Verbascum thapsus* using microbiological and phytochemical methodologies

Authors [Anna-Maria Keaveney¹](#), [Fiona Maher²](#), [Brigid Lucey¹](#), [Ambrose Furey²](#)

Institutes **1** Department of Biological Sciences, Munster Technological University, Rossa avenue, Ireland; **2** Department of Physical Sciences, Munster Technological University, Rossa Avenue, Ireland
DOI [10.1055/s-0043-1774084](#)

Increasing research on botanicals is not matched by standardised methods of preparation and analysis. For example, antibacterial activity has been reported for *Verbascum thapsus* studies with varied methods of plant extraction, antimicrobial-susceptibility-testing and media. Notably, conventional antimicrobial testing methods for commercial preparations of antibiotics as set out by EUCAST, the brand of M-H medium is not specified.

The aim of the current study was to characterise the impact of selected variables (growth area and post-harvesting processing), alone and in combination, on the demonstrable antibacterial efficacy of selected crude extracts of *V. Thapsus*. The results showed that one preparation of M-H media (Fluka) gave false negative activity which appeared to be associated with the agar element of the M-H media. Factors, extraction temperature (Room temperature and 50 °C) and solvent concentration (100%, 80%, 50%, 25% EtOH, 100% Water), have statistically significant main and interaction effects ($P < 0.001$). Factor combinations (Serbian origin, *V. thapsus* and room temperature (extraction) (► Fig. 1)) found that the most polar solvents (25% EtOH and 100% water) had statistically significant activity. No activity was observed for both these solvent concentrations with the GB and West Cork (WC) origin crude extracts. The phytochemical profile was consistent across repeat and replicate crude extracts.

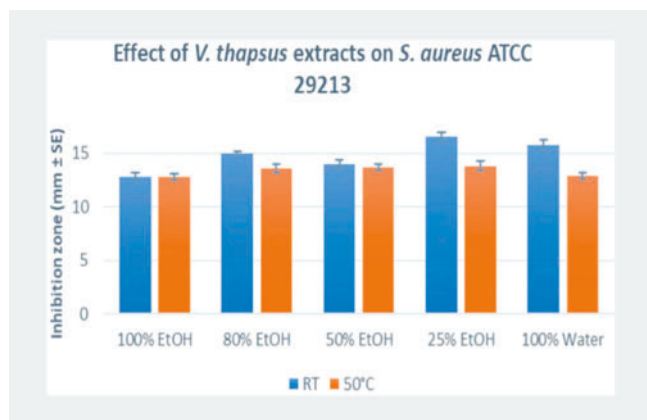

► **Fig. 1** Effect of *V. Thapsus* (Serbian origin) (100% – 25% EtOH and 100% water) at room temperature (RT) and 50°C based on the average diameter of inhibition zone (mm ± SE) against *S. aureus* ATCC 29213 on Acumedia brand of M-H agar (n = 27).

In conclusion, validated methods are required to undertake internationally standardised extraction and testing of antimicrobial effects of putative antimicrobial agents. As demonstrated in the current study an assumption of suitability of EUCAST methods for the testing of botanicals should definitely not be made.

Conflict of Interest The authors declare no conflict of interest.

P-211 Extremophilic marine microbiota as a source of siderophores and biosurfactants

Authors Nikola Milic¹, Nikolaos Tsafantakis¹, Evangelia Tsiokanos¹, Alba Arranz², Tania Antón Rodríguez², Carmen Vargas², Joaquín J. Nieto², Montserrat Argandoña Bertran², Nikolas Fokialakis¹
Institutes 1 Section of Pharmacognosy & Chemistry of Natural Products, Department of Pharmacy, National and Kapodistrian University of Athens, Athens, Greece; 2 Department of Microbiology and Parasitology, Faculty of Pharmacy, University of Sevilla, Seville, Spain
 DOI 10.1055/s-0043-1774085

Microorganisms are a prolific source of natural products and prospective micro-factories of bioactive compounds. Extremophilic microorganisms have recently gained prominence in natural products chemistry. Marine environments, characterised as such, harbour largely unknown microbiota, and possess great potential regarding the discovery of novel compounds with distinctive chemistry and bioactivity. A large and diverse group of marine-derived molecules are those known as biosurfactants and metallophores (chelators, mainly siderophores) have numerous applications across industries. A multifaceted study of several extremophilic bacterial strains from the genera *Chromohalobacter*, *Marinospirillum* and *Halomonas* (phylum: Pseudomonadota) was conducted as part of the ongoing SECRETed project. It included but was not limited to physiological investigations (optimal cultivation conditions), quantitative screening assays for detection of microbially-produced siderophores and biosurfactants and, protocol development for the extraction of biomasses and supernatants from liquid cultures, coupled with a high-throughput HPLC-HRMS dereplication method, reinforced by state-of-the-art cheminformatic approaches, aiming at detection of potentially novel compounds. Analyses of biomass extracts (obtained via a multi-step extraction using solvents of increasing polarity) and supernatant extracts (obtained via a multi-step XAD resins-assisted extraction) against specialised in-house libraries, demonstrated the presence of both groups in the rendered molecular networks, belonging to various chemical classes (e.g. lipopeptides and depsipeptides, fatty acid derivatives, pyra-

nones, naphthofurans, organosulfur compounds and glycosides). Interestingly, several clusters of biosurfactants and/or siderophores were found, including many unknown molecules sharing similar characteristics.

Funding SECRETed project was funded by the European Union's Horizon2020 Research and Innovation Programme (Grant Agreement No. 101000794).

P-212 Selected South African medicinal plants with a broad spectrum of antimicrobial effects

Authors Makosha Patience Mamabolo¹, Mathapelo Seopela², Xavier Siwe Noundou¹, Nontobeko Mncwangi¹
Institutes 1 Sefako Makgatho Health Sciences University, Pretoria, South Africa; 2 University of Johannesburg, Johannesburg, South Africa
 DOI 10.1055/s-0043-1774086

Lower respiratory tract infections are ranked as the fourth leading cause of mortality in the world with people in low-income countries more likely to die from communicable than non-communicable diseases. Different microbial species threaten modern medicine by developing resistance toward previously effective drugs. Scientists have discovered that nature can provide solutions to these challenges through medicinal plants.

Helichrysum caespitium (DC) Harv is a perennial herb traditionally used to alleviate broncho-pneumonia, sexually transmitted diseases, tuberculosis, headaches, and colds as well as a dressing for open wounds. *Carpobrotus edulis*, a sour fig, is used traditionally as medicine to treat TB, throat infections, digestive ailments, eczema, wounds, burns, toothaches and earaches as well as thrush. *Tulbaghia violacea* commonly known as wild garlic is traditionally used as a remedy for fever, colds, asthma, lung ulcers, sinusitis, TB and stomach problems as well as oesophagus cancer. The aim of the study was to investigate the bioactivity of the plants in a scientific setting.

Research has revealed that the extract possesses significant biological activity. *H. caespitium* extracts showed activities against different bacterial strains but were more pronounced on *Escherichia coli*, *Klebsiella pneumoniae* and *Enterococcus faecalis* with reference to the standards (streptomycin and nalidixic acid). Hexane extract showed good activity against all gonorrhoea strains under study. The isolated compound was further investigated for efficacy against six pathogens with MIC between 60 – 250 µg/L.

It can be concluded that plants have the potential to be good drug candidates against multi-drug-resistant pathogens. Furthermore, modification of the drug candidates may improve overall efficacy.

P-213 Identification of antiparasitic bioactive compounds from the *Psorospermum* genus (Hypericaceae).

Authors Sergio Ortiz¹, Bruno Lenta³, Marcel Kaiser³, Eric Deharo⁴, Nicolas Girard¹, Catherine Vonthron¹
Institutes 1 Université De Strasbourg, France; 2 University of Yaoundé, Cameroon; 3 Swiss Tropical and Public Health Institution, Switzerland; 4 Université Paul Sabatier, France
 DOI 10.1055/s-0043-1774087

Several plants from the *Psorospermum* genus are described to treat cutaneous disorders in different African traditional medicines. In addition, barks from *P. glaberrimum* are also described to treat severe cases of malaria. Previously, dichloromethane extracts from six species of the *Psorospermum* genus have shown significant in vitro antiparasitic activities against *Plasmodium falciparum* and *Leishmania donovani* parasites. Anthraquinones, flavonoids and terpenoids have been isolated from *Psorospermum* sp., reporting multiple anti-infectious activities (► Fig. 1).

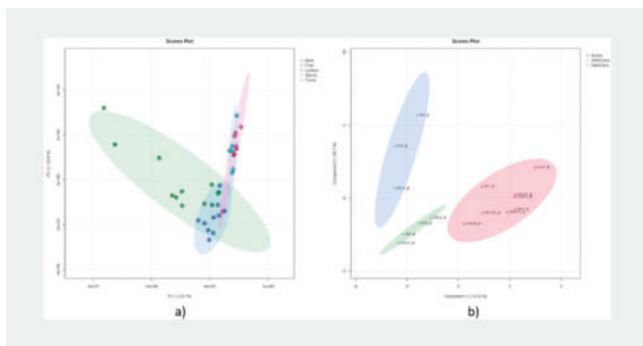

► **Fig. 1** Principal Component Analysis Score Plots

With the principal aim to identify a putative class of bioactive compounds from *Psorospermum* medicinal plants, we analysed by a metabolomic approach the correlation between in vitro antiplasmodial/antileishmanial activities and the chemical composition of ten *Psorospermum* species. A total of 39 extracts were obtained by classical maceration in dichloromethane from 10 *Psorospermum* species and their in vitro antiplasmodial activity was evaluated against the blood stages of *P. falciparum* (at 1 and 10 µg/mL). HPLC-PDA-HRMS/MS analysis was performed to evaluate the chemical constitutions of the extracts. Metabolomic analyses were performed on MetaboAnalyst 5.0 platform. Principal component analysis of the chemical constituents of the matrix, allowed us to discriminate between two groups of samples: firstly, trunks, barks and stems (BTS) and on the other hand, leaves and fruits (FFr) extracts. Specific analysis between BTS and FFr groups and their antiplasmodial activity, allowed us to identify three (*m/z* 325, 469 and 343) and five (*m/z* 545, 647, 357, 561 and 475) putative bioactive compounds respectively for their activity. Antileishmanial screening, dereplication and mass-guided isolation are in progress to confirm and explore the antiparasitic activities of these compounds.

P-214 Main flavonoids and antioxidant activity of varieties of two species of “jocote” (*Spondias purpurea* and *Spondias mombin*) from Guatemala.

Authors Juan Francisco Perez-Sabino¹, Pedro Molina Jauregui¹, Max Samuel Mérida-Reyes¹, José Vicente Martínez-Arévalo², Antonio Jorge Ribeiro da Silva³

Institutes 1 Facultad de Ciencias Químicas y Farmacia, Universidad De San Carlos De Guatemala, Guatemala; 2 Facultad de Agronomía, Universidad de San Carlos de Guatemala, Guatemala; 3 Instituto de Pesquisas de Produtos Naturais, Universidade Federal do Rio de Janeiro, Rio de Janeiro, Brasil
DOI 10.1055/s-0043-1774088

The fruit called “jocote” is an abundant fruit in Guatemala, with two species, *Spondias purpurea* and *Spondias mombin*, found in the country. In studies carried out in other countries, it has been found that the fruit has a high vitamin content and different phenolic compounds that can be beneficial for health. In the present study, the percentage of extraction yield was determined by maceration with alcohol, analysing the flavonoids, antioxidant activity and total phenolic content of extracts from 9 varieties of 2 species of *Spondias* spp. fruits collected in different regions of Guatemala. The antioxidant activity was evaluated using a method of the radical DPPH (2,2-diphenyl-1-picrylhydrazyl) extinction. The quantification of total phenolic content was carried out using the Folin-Ciocalteu reagent method. Flavonoids and other phenolic compounds were determined by high-performance liquid chromatography (HPLC) with a diode array detector (DAD). Considerably high antioxidant activity was found in extracts obtained from samples of the varieties, “corona”, “tronador” and “rax ux” of the species *Spondias purpurea* and varieties “jobo” and “quinín” of the species *Spondias mombin*. The flavonoids and phenolic compounds most frequently present in the different varieties of “jocote” were p-coumaric acid, rutin and

quercetin, found in 17 out of 19 samples analysed. In conclusion, *Spondias purpurea* and *Spondias mombin* fruits are a food rich in flavonoids and phenolic compounds, so they can be considered to have nutritional value and significance in the development of nutraceutical products.

P-215 Optimisation of the extraction process and cultivar selection as a key to obtaining a high-quality extract from elderberry (*Sambucus nigra*)

Authors Anna Gościński¹, Piotr Szulc², Judyta Cielecka-Piontek¹

Institutes 1 Department of Pharmacognosy and Biomaterials, Poznan University of Medical Sciences, Poznan, Poland; 2 Department of Agronomy, Poznan University of Life Sciences, Poznan, Poland
DOI 10.1055/s-0043-1774089

Choosing the most suitable extraction conditions and cultivar of raw material is crucial for obtaining an extract with the best health-promoting properties. The aim of this study was to optimise the extraction conditions for elderberries (*Sambucus nigra*) using the response surface methodology – the Box-Behnken design. The aim of the optimisation was to obtain an extract with the highest polyphenol content assessed by using Folin-Ciocalteu assay (TPC). The selected parameters yielded the richest extract in polyphenols. An optimised extraction method was used to obtain extracts from 12 elderberry cultivars. The obtained extracts were characterised in terms of antioxidant activity (DPPH, CUPRAC, FRAP, ABTS), TPC, and content of cyanidin 3-glucoside and cyanidin 3-sambubioside – determined by validated HPLC method. The study showed that the number of extraction cycles and the methanol content in the extraction mixture have a significant effect on the content of active compounds. Elderberry cultivars differ significantly in their content of active compounds, leading to significant differences in antioxidant activity.

Funding This research was funded by National Science Center, Poland, under the Preludium BIS grant (number 2020/39/O/NZ7/03441).

Conflict of Interest The authors declare no conflict of interest.

P-216 Sea lavender (*Limonium algarvense* Erben) seeds as a promising source of cosmetic ingredients

Authors Leonardo Lescano¹, Eliana Fernandes¹, Riccardo Trentin^{1,2}, Catarina Pereira¹, Luísa Custódio¹, Maria Rodrigues¹

Institutes 1 Center of Marine Sciences, Faro, Portugal; 2 Department of Biology, University of Padova, Padova, Italy
DOI 10.1055/s-0043-1774090

Sea lavender is a medicinal species endemic to the southwest of the Iberian Peninsula. Although its flowers and leaves have already been studied, the potential of its seeds as a source of bioactive components has never been studied. Thus, this work aimed to evaluate sea lavender seeds as a source of new cosmetic ingredients. Ultrasound-assisted extracts of water, ethanol, acetone, and ethyl acetate were evaluated for their antioxidant activity, metal chelation, inhibitory potential of enzymes related to cosmetic uses (lipase, elastase, tyrosinase) and cytotoxicity towards mammalian cell lines. The total contents of phenols, flavonoids and tannins were also determined. The most active extract was selected for metabolomic analysis by LC-MS. The aqueous extract was the most active in antioxidant (DPPH: EC₅₀ = 0.296 mg/mL; ABTS: EC₅₀ = 0.506 mg/mL; FRAP: EC₅₀ = 0.230 mg/mL), copper chelation (EC₅₀ = 0.678 mg/mL) and tyrosinase inhibition (EC₅₀ = 0.450 mg/mL), as well as containing the highest levels of phenols (96.5 mg/g DW GAE) and tannins (76.3 mg/g DW EC). Furthermore, the extracts were not cytotoxic to mammalian cell lines. LC-MS analysis identified choline, L-histidinol and L-isoleucine as the main bioactive compounds. This suggests that sea lavender seeds are a promising source of bioactive ingredients for cosmetic applications.

Funding Foundation for Science and Technology (FCT) and Portuguese National Budget (UIDB/04326/2020, UIDP/04326/2020, LA/P/0101/2020); Operational programmes CRES Algarve 2020 and COMPETE 2020 (EMBR.PT ALG-01-0145-FEDER-022121); MJR was supported by FCT program contract

(UIDP/04326/2020), LC by FCT Scientific Employment Stimulus (CEECIND/00425/2017), and EF by FCT PhD grant (UI/BD/151301/2121).

P-217 Impact of traditionally used plants from Nepal on skin cell viability and screening for antioxidant and antibacterial activity

Authors [Manuela Wende¹](#), [Ana Langel¹](#), [Martina Wurster¹](#), [Meena Rajbhandari²](#), [Michael Lalk¹](#)

Institutes **1** University of Greifswald, 17489 Greifswald, Germany;

2 Tribhuvan University, Kathmandu, Nepal

DOI 10.1055/s-0043-1774091

Ethnomedicinal drugs are an increasingly attractive biological treasure vault. Despite a well-established traditional use of many Nepalese plants, there is a severe lack of pharmacological information about most of them. Therefore, this study was conducted to scientifically validate the traditional use of fifteen medicinal plants common to Nepal.

Aqueous-methanolic extracts were evaluated for antioxidant and antimicrobial activity and impact on a human skin cell line. As evaluated by the DPPH assay, a concentration-dependent increase in oxidant scavenging activity was observed in all extracts. *Melastoma malabathricum*, *Ficus cunia* leaf, and *Cheilanthes bicolor* frond extracts showed the highest activity with EC₅₀ values of 70.6 µg/ml, 83.7 µg/ml, and 146 µg/ml respectively.

The antimicrobial activity was estimated by agar disk diffusion method against eight bacterial strains. Strongest impact on *Pseudomonas aeruginosa* was observed for *Drymaria diandra* whole plant extract and *Pogostemon benghalensis* flower extract with inhibition zones of 13.6 mm and 12.3 mm respectively. *Ficus cunia* leaf extract showed antimicrobial activity against six microbial strains with good activity against *Acinetobacter baumannii* and *Staphylococcus aureus*. The influence on cell viability was tested on human keratinocytes using the Alamar Blue Assay. Extracts of *Boehmeria macrophylla* and *Lonicera glabrata* increased cell metabolism. Eleven extracts showed a moderate reduction of cell metabolism with *Cheilanthes bicolor* frond extract showing the lowest IC₅₀ value of 53 µg/ml.

This study demonstrates the eligibility of traditional medicinal plant usage and might provide lead structures for potential new drugs.

Conflict of Interest The authors declare no conflict of interest.

P-218 Phytochemical and bioactivity profiling correlations of Greek flora towards the assessment of skin-health promoting properties

Authors [Gabriela Belen Lemus Ringele¹](#), [Aikaterini Argyropoulou^{1,3}](#), [Asimina Fotopoulou²](#), [Sentiljana Gumeni⁴](#), [Eirini Gkogkou⁴](#), [Georgios Stavropoulos⁵](#), [Konstantina Angeli⁵](#), [Anastasia Papachristodoulou¹](#), [Harris Pratsinis²](#), [Dimitris Kletsas²](#), [Dimitris Beis³](#), [Ioannis P. Trougakos⁴](#), [Eleftherios Kalpoutzakis¹](#), [Maria Halabalaki¹](#)

Institutes **1** Division of Pharmacognosy and Natural Products Chemistry, Department of Pharmacy, National and Kapodistrian University of Athens, Panepistimioupoli, Zografou, 15771, Athens, Greece; **2** Laboratory of Cell Proliferation and Ageing, Institute of Biosciences and Applications, NCSR "Demokritos", 15310, Athens, Greece; **3** PharmaGnose S.A., 57th km Athens-Lamia National Road, Oinofyta, 32011, Athens, Greece; **4** Department of Cell Biology and Biophysics, Faculty of Biology, National and Kapodistrian University of Athens, 15784, Athens, Greece; **5** Korres S.A. Natural Products, 57th Athens-Lamia National Road, Inofyta, 32011, Athens, Greece

DOI 10.1055/s-0043-1774092

Cosmeceuticals are considered skin care products that go beyond mere beautification and claim to have medicinal or drug-like benefits [1]. Natural ingredients used in cosmeceutical formulations originate from a variety of different

sources, as the possibilities are limitless when it comes to plant species. As Greece is one of the biodiversity hotspots, its endemic flora could be expected to provide new promising agents [2]. Thus, the aim of this study was the evaluation of different plant materials towards their cosmeceutical related properties. More than 50 plant species were collected and extracted using Accelerated Solvent Extraction (ASE) as well as Supercritical Fluid Extraction (SFE-CO₂). The derived extracts were subjected to phytochemical (LC-HRMS/MS and HPTLC) and biological screening. Specifically, they were evaluated for possible tyrosinase, elastase and collagenase inhibitory activity as well as cytotoxic and anti-ageing properties. Furthermore, the antioxidant and photoprotective properties in cellular models were assessed together with anti-melanogenesis profile in zebrafish model. Based on the responses to the different targets, the extracts were compared, prioritised and correlated with their chemical compositions. Amongst others *Juniperus turbinata*, *Achillea millefolium* and *Citrus medica* are rich in compounds such as gallotannins, flavonoid glycosides and phenolic acids, and revealed to be promising leads for cosmeceuticals development.

Conflict of Interest The authors declare no conflict of interest.

Funding ERDF, "RESEARCH-CREATE-INNOVATE", CosmAGE (project code T2EΔK-02583)

References

- [1] Draelos ZD. Cosmeceuticals: Efficacy and Influence on Skin Tone. *Dermatol Clin* 2014; 32: 137–143. doi:10.1016/j.det.2013.12.002
- [2] Sklirou AD, Angelopoulou MT, Argyropoulou A et al. Phytochemical study and in vitro screening focusing on the anti-aging features of various plants of the greek flora. *Antioxidants* 2021; 10: doi:10.3390/antiox10081206

P-219 Determination of the anti-aging and skin-protective potential of Greek plants

Authors [Ioannis Trougakos¹](#), [Sentiljana Gumeni¹](#), [Asimina Fotopoulou²](#), [Adamantia Agalou³](#), [Gabriela Lemus Ringele⁴](#), [Maria S. Manola¹](#), [Georgios Stavropoulos⁵](#), [Konstantina Karamanou²](#), [Zoi Evangelakou¹](#), [Antonia Theodoridi³](#), [Konstantina Angeli⁵](#), [Despoina D. Gianniou¹](#), [Xanthippi P. Louka¹](#), [Eirini Gkogkou¹](#), [Eleni Mavrogonatou²](#), [Aikaterini Argyropoulou^{4,6}](#), [Harris Pratsinis²](#), [Maria Halabalaki⁴](#), [Dimitris Beis³](#), [Dimitris Kletsas²](#)

Institutes **1** The National and Kapodistrian University of Athens, Faculty of Biology, Athens, Greece; **2** Laboratory of Cell Proliferation and Ageing, Institute of Biosciences and Applications, NCSR "Demokritos", Athens, Greece; **3** Biomedical Research Foundation Academy of Athens, Athens, Greece; **4** The National and Kapodistrian University of Athens, Faculty of Pharmacy, Athens, Greece; **5** Korres S.A, Natural Products, Inofyta, Greece; **6** PharmaGnose S.A., Oinofyta, Greece

DOI 10.1055/s-0043-1774093

Natural extracts are enriched repositories for identification of novel bioactive compounds or Natural Products (NPs) with cosmeceutical, pharmacological or disease treating properties. During the CosmAGE project we are performing an extensive high-throughput screening of extracts from various plants of the Greek flora, aiming to identify novel NPs with potential anti-aging and/or cosmeceutical properties. Specifically, 52 plant species and organs from different genus including *Abies sp.*, *Achillea sp.*, *Arbutus sp.*, *Cistus sp.*, *Epilobium sp.*, *Pistacia sp.*, and *Juniperus sp.*, were extracted (ASE and SFE-CO₂) and evaluated against different biological targets. In parallel LC-HRMS-based profiling was performed to reveal their chemical composition. Obtained extracts were screened in cell-free systems and in normal human skin cells for their antioxidant capacity and for their ability to activate cytoprotective modules of the proteostasis network, as well as for their potential skin protective effects as evidenced by effective inhibition of the skin aging-related enzymes, collagenase, elastase and tyrosinase. Further, they were tested in zebrafish embryos, which allow *in vivo* monitoring of complex cell behaviour and physiological

parameters, for their capacity to inhibit melanogenesis and/or promote wound healing. Our findings (on-going screening) have revealed promising extracts (IC₅₀ values in the range of 1-10 µg/mL) that could be a potential repository of novel NPs with anti-aging and/or skin-protective properties.

P-220 C^oa Valley's medicinal plants as potential cosmetic ingredients: cytotoxic and antioxidant screening

Authors Mário Pedro Marques^{1,2}, Euclides Landim^{1,2,3},

Carla Varela^{1,2,4}, Joana Marques⁵, Ricardo Costa⁵, Luis de Carvalho⁵,

Aida Carvalho^{6,7,8}, Paulo Oliveira^{2,9}, Célia Cabral^{1,2,3}

Institutes 1 University of Coimbra, Coimbra Institute for Clinical and Biomedical Research (iCIBR), Clinic Academic Center of Coimbra (CACC), Faculty of Medicine, 3000-548 Coimbra, Portugal; 2 University of Coimbra, Center for Innovative Biomedicine and Biotechnology (CIBB), 3000-548 Coimbra, Portugal; 3 Center for Functional Ecology, Department of Life Sciences, University of Coimbra, Calçada Martim de Freitas, 3000-456 Coimbra, Portugal; 4 University of Coimbra, CIEPQPF, Faculty of Medicine, Coimbra, Portugal; 5 University of Coimbra, Molecular Physical-Chemistry R&D Unit, Department of Chemistry, Rua Larga, 3004-535 Coimbra, Portugal; 6 Instituto Politécnico de Bragança, Campus Santa Apolónia, Bragança, Portugal; 7 Centro de Investigação, Desenvolvimento e Inovação em Turismo (CITUR), Pólo Guarda, Av. Dr. Francisco Sá Carneiro 50, 6300-559, Guarda, Portugal; 8 Fundação C^oa Parque, Rua do Museu, 5150-620, Vila Nova de Foz C^oa, Portugal; 9 CNC-Center for Neuroscience and Cell Biology, CIBB – Centre for Innovative Biomedicine and Biotechnology, University of Coimbra, 3004-504 Coimbra, Portugal
DOI 10.1055/s-0043-1774094

C^oa Valley is a Northeast region of Portugal, classified as a UNESCO World Heritage Site since 1998, and recognised as “the most important open-air Paleolithic rock art site”. So far, little is known about the natural endogenous resources of this territory, namely medicinal plants. According to a preliminary ethnobotanical survey in this region, several medicinal plants were mentioned to have skin-beneficial effects. However, many of them still lacking scientific validation. Taking into account the results gathered during the survey carried in the C^oaMedPlants project, the main goal of this investigation is to assess the cytotoxicity and antioxidant activity of selected species to incorporate them into scientific-validated plant-based cosmetic formulations and create an exclusive cosmetic brand for C^oa Valley. Therefore, nine species were selected and their hydroalcoholic extracts (EtOH 80%) were prepared. Their non-cytotoxic concentrations were determined in vitro using the Normal Human Dermal Fibroblasts (NHDF) cell line, by the evaluation of metabolic activity through the Alamar Blue assay, and cell mass estimation according to the sulforhodamine B (SRB) assay.

Most of the extracts revealed non-toxic concentrations ≤ 0.2 mg/mL using the NHDF cell model. Afterwards, non-cellular techniques were used to screen the antioxidant activity of these ethanolic extracts, through DPPH, ABTS, CUPRAC and FRAP assays. From the 9 species studied, the most promising so far are: *Arbutus unedo* L., *Cistus albidus* L., *Cistus salviifolius* L., *Lavandula pedunculata* (Mill.) Cav. and *Pistacia terebinthus* L., which will be further investigated in-depth, to characterise their antioxidant potential using in vitro cell models.

P-221 Evaluation of the skin beneficial properties of *Centaurea* species belonging to the Greek flora: phytochemical investigation of *Centaurea salonitana*

Authors Christina Koufali¹, Antigoni Cheilari¹, Nektarios Aliagiannis¹

Institute 1 Laboratory of Pharmacognosy and Natural Products Chemistry, Faculty of Pharmacy, National and Kapodistrian University of Athens, Panepistimiopolis Zografou, 15771, Athens, Greece
DOI 10.1055/s-0043-1774095

Plants of the genus *Centaurea*, one of the biggest genera of the Asteraceae family, have been used traditionally for hundreds of years as diuretics, to treat fever, diabetes, stomachic disorders as well as for their anti-inflammatory, antibacterial and wound healing properties [1]. The aim of the present study was to explore the phytochemical profile of *Centaurea* species belonging to the Greek flora, to evaluate their antioxidant properties and their ability to inhibit the enzymes tyrosinase and collagenase. Particularly, seven *Centaurea* species were successively extracted (dichloromethane, methanol, methanol:water, 1:1) by ultrasound-assisted extraction and the phytochemical profile of extracts was characterized by high-performance thin-layer chromatography (HPTLC), high-performance liquid chromatography (HPLC-DAD) and nuclear magnetic resonance (NMR) spectroscopy. Moreover, the total phenolic (TPC) and total flavonoid (TFC) content was determined. Finally, the DPPH scavenging capacity as well as the anti-tyrosinase and anti-collagenase activity of extracts was evaluated. The methanolic extract of *Centaurea salonitana* was selected for further investigation as it presented significant tyrosinase inhibition (IC₅₀ = 7.8 µg/mL). Fast centrifugal partition chromatography (FCPC) followed by various chromatographic techniques (Sephadex, semi-prep-HPLC, prep-TLC) facilitated the isolation of 15 compounds. Structure elucidation was performed with 1D & 2D NMR experiments and 8 flavonoids, 1 lignan, 1 lactone, 2 phenylpropanoids and 3 sesquiterpene lactones were identified. One flavonoid and one lactone were isolated from the genus *Centaurea* for the first time.

References

[1] Khammar A, Djeddi S. Pharmacological and Biological Properties of some *Centaurea* Species. Eur J Sci Res 2012; 84 (3): 398–416

P-222 Exploration of Serbian biodiversity for the discovery of bioactive natural products with skin beneficial effects.

Authors Maria Eleftheria Apostolopoulou¹, Ilinka Pećinar², Efthymia Eleni Tsioutsiou¹, Vaios Amountzias¹, Evanthia Dina¹, Antigoni Cheilari¹, Zora Dajić Stevanović², Nektarios Aliagiannis¹

Institutes 1 Laboratory of Pharmacognosy and Natural Products Chemistry, Faculty of Pharmacy, National and Kapodistrian University of Athens, Panepistimiopolis Zografou, 17551, Athens, Greece; 2 Faculty of Agriculture, University of Belgrade, Belgrade, Serbia
DOI 10.1055/s-0043-1774096

The Balkan Peninsula has a long tradition in folk medicine and a plethora of plant species are utilised in treating skin disorders [1]. Within the context of the EU project “EthnoHERBS”, the aim of this study was the phytochemical and biological investigation of Serbian plants that have been traditionally used in the treatment of skin ailments (hyperpigmentation, wound healing). Eighty-two plant species, selected based on ethnobotanical studies, were extracted successively with dichloromethane, methanol and methanol:water (1:1) and their chemical profile was investigated through high-performance thin-layer chromatography (HPTLC) and high-performance liquid chromatography (HPLC-DAD). The total phenolic (TPC) and total flavonoid content (TFC) were evaluated using the Folin-Ciocalteu and the aluminium chloride colorimetric method, respectively. The antioxidant capacity of extracts was determined through the DPPH assay (concentration of 200 µg/mL), and their anti-tyrosinase and anti-collagenase activity was tested at a concentration of 300 µg/mL and 100 µg/mL, respectively. Several secondary metabolites were detected in the extracts such as terpenes, flavonoids, tannins, etc. The highest antioxidant activity was found in the extracts of *Mentha longifolia*, *Hypericum perforatum* and *Cotinus coggyria*. The hydroalcoholic and the methanolic extracts of *Cotinus coggyria* demonstrated the best anti-tyrosinase (IC₅₀ = 36.27 µg/mL) and the best anti-collagenase (IC₅₀ = 18.13 µg/mL) activity, respectively. In conclusion, exploitation of traditional knowledge can provide valuable information for the development of natural products with beneficial skin effects.

References

[1] Tsoutsou EE et al. Medicinal Plants Used Traditionally for Skin Related Problems in the South Balkan and East Mediterranean Region-A Review. *Front Pharmacol* 2022; 13: 936047

P-223 Cosmeceutical activity of *Satureja montana* extracts prepared using hydroxypropyl- β -cyclodextrin-glycerol-assisted extraction

Authors [Marijana Zovko Koncic¹](#), [Lejsa Jakupović¹](#), [Marijan Marijan¹](#)

Institute 1 Department of Pharmacognosy, Faculty of Pharmacy and Biochemistry, University of Zagreb, Zagreb, Croatia

DOI [10.1055/s-0043-1774097](https://doi.org/10.1055/s-0043-1774097)

Satureja montana L., Lamiaceae (winter savory) is an aromatic plant widely distributed in the Mediterranean region. A previous study has demonstrated that *S. montana* extracts prepared using hydroxypropyl- β -cyclodextrin-glycerol assisted extraction were rich in various phenolic compounds and demonstrated notable anti-elastase and anti-hyaluronidase properties. The aim of this research was the further investigation of their cosmeceutical activity. Four extracts rich in total phenols (OPT-TP), flavonoids (OPT-TF), phenolic acids (especially rosmarinic acid) (OPT-TPA-RA), and luteolin 7-O-glucoside (OPT-LG) were prepared as previously described. Their antioxidant, anti-inflammatory, and depigmenting activities were tested. Biocompatibility (MTT assay) and wound-healing activity (scratch assay) of the extracts was established using HaCaT cells. The extracts were active in all the performed assays with the most prominent activities noted as follows: DPPH radical scavenging activity (OPT-LG IC₅₀ = 0.97 ± 0.01 μ L extract/mL), reducing power (OPT-TF EC_{0.5} = 6.07 ± 1.05 μ L extract/mL), β -carotene linoleic acid assay (OPT-TPA-RA IC₅₀ = 5.36 ± 0.37 μ L extract/mL), anti-lipoxygenase (OPT-TF IC₅₀ = 2.09 ± 0.08 μ L extract/mL), anti-heat-induced ovalbumin coagulation (OPT-TF IC₅₀ = 45.4 ± 1.7 μ L extract/mL) and anti-tyrosinase (OPT-LG IC₅₀ = 224.62 ± 6.56 μ L extract/mL) activity. Additionally, the extracts were able to absorb UVA and UVB radiation and showed the ability to promote wound healing. They were non-toxic to HaCaT cells in concentrations of up to 62.5 μ L extract/mL assuring their status as excellent candidates for cosmeceutical product development.

P-224 Functionalisation of goat cheese with sea fennel ingredients

Authors [Ana Paula Carvalho¹](#), [Catarina G. Pereira³](#), [Maria João Rodrigues³](#), [Viana Castañeda-Loaiza³](#), [Isabel Ratão^{1,2}](#), [Célia Quintas^{1,2}](#), [Luísa Custódio³](#)

Institutes 1 Instituto Superior de Engenharia, Universidade do Algarve, Faro, Portugal; 2 Mediterranean Institute for Agriculture, Environment and Development (MED), Universidade do Algarve, Faro, Portugal; 3 CCMAR – Algarve Centre of Marine Sciences, Faculdade de Ciências e Tecnologia, Universidade do Algarve, Faro, Portugal

DOI [10.1055/s-0043-1774098](https://doi.org/10.1055/s-0043-1774098)

Functional foods, i.e., foods promoting health positive effects in addition to nutritional purposes, are gaining prominence. Different organisms have been explored for bioactive ingredients to functionalise foods, but scarce research has targeted halophytes despite their recognized biological properties. In this study, the aromatic and medicinal halophyte *Crithmum maritimum* L. (sea fennel) was used to functionalise goat cheese (dried biomass, water extract), to obtain a dairy product with improved antioxidant, organoleptic, and microbiological properties. Sea fennel ingredients were added before/after cheese coagulation, and cheeses were evaluated for physicochemical, nutritional, and antioxidant properties. Adding sea fennel ingredients after coagulation reduced the cheese's yellow colour and lowered its pH. Fat content was higher in cheese with *C. maritimum* biomass added before coagulation (17 – 19%, versus 15.8 – 16% from addition after), oppositely to protein content that was higher when biomass was added after coagulation (30.96%, versus 24.20% from addition

before). Adding plant ingredients to cheese led to an increased microbial population, probably due to plants' microbiological contamination, but values were within the parameters required by guidelines. As for antioxidant activity, no significant results indicated that *C. maritimum* added this property to cheeses.

Funding This research received Portuguese national funds from FCT – Foundation for Science and Technology (projects UIDB/04326/2020, UIDP/04326/2020, LA/P/0101/2020, and PTDC/BAA-AGR/1391/2020) and Operational Programmes CRESC Algarve 2020 and COMPETE 2020 (project EMBRC.PT ALG-01-0145-FEDER- 022121). LC was supported by FCT Scientific Employment Stimulus (CEECIND/00425/2017), MJR by FCT program contract (UIDP/04326/2020), and VCL by FCT PhD grant (2020.04541.BD).

Conflict of Interest The authors declare no conflict of interest.

P-225 In vitro propagation of the aromatic edible halophyte *Inula crithmoides* L.

Authors [Maria Rodrigues¹](#), [Viana Castañeda-Loaiza¹](#), [Eliana Fernandes¹](#), [Luísa Custódio¹](#)

Institute 1 Center of Marine Sciences, Faro, Portugal

DOI [10.1055/s-0043-1774099](https://doi.org/10.1055/s-0043-1774099)

Inula crithmoides L. is an aromatic edible halophyte with nutritional and medicinal properties related to important metabolites (proteins, carotenoids, vitamins, minerals). Therefore, this study aimed to establish a micropropagation protocol to be used as a nursery for its standardized commercial cultivation. Nodal explants from greenhouse-grown plants were subjected to shoot multiplication treatments with various combinations of BAP and IAA, followed by rooting and acclimatization. BAP alone induced the highest shoot formation (7 – 7.8 shoots/explant), while IAA increased the shoot height (9.26 – 9.5 cm). The best set of shoot multiplication (7.8 shoots/explant) and highest shoot height (7.58 cm) was obtained with 0.25 mg/L BAP. All shoots rooted successfully, and multiplication treatments did not affect root length (7.8 – 9.7 cm/plantlet). After rooting, plantlets cultivated with 0.25 mg/L BAP had the highest shoot number (4.2 shoots/plantlet), whereas from 0.6 mg/L IAA + 1 mg/L BAP presented the highest shoot height (14.2 cm), likewise control plantlets (14.0 cm). The survival to ex-vitro acclimatization was low (9.8%), and assays aiming for its improvement are ongoing. Still, the in vitro multiplication of *I. crithmoides* can be used as a nursery method, allowing the development of this species as an alternative food and medicinal crop.

Funding Foundation for Science and Technology (FCT) and Portuguese National Budget (UIDB/04326/2020, UIDP/04326/2020, LA/P/0101/2020); Partnership on Research and Innovation in the Mediterranean Area (PRIMA) program supported by European Union (PRIMA/0002/2019); MJR was supported by FCT program contract (UIDP/04326/2020), LC by FCT Scientific Employment Stimulus (CEECIND/00425/2017), and VCL (2020.04541.BD) and EF (UI/BD/151301/2121) by FCT PhD grants.

P-226 The effect of different organic amendments on growth, secondary metabolites and antioxidant capacities of *Artemisia afra*

Authors [Sibusiso Xego¹](#), [Learnmore Kambizi¹](#), [Felix Nchu¹](#)

Institute 1 Cape Peninsula University of Technology, Bellville, South Africa
DOI [10.1055/s-0043-1774100](https://doi.org/10.1055/s-0043-1774100)

Traditional medicine is crucial in the treatment of various ailments and is frequently used as a primary intervention or as an alternate supplementary therapy. The increased demand for commonly used medicinal plants exerts pressure on wild populations and, in many cases, threatens their survival. During the first Covid-19 outbreak, people in most African countries including South Africa turned to *Artemisia afra* as one of the remedies, and as the demand increased, so did the plant's price and harvesting. In order to develop a sustainable growing method for this herb, this study compared the effects of various organic amendments on *A. afra* growth, secondary metabolites and antioxidant

properties such as FRAP, DPPH and TEAC. Four organic amendments were used: vermicompost, mushroom compost, poultry and kraal manure, with coarse river sand making up 70 % of the mixture and the remaining 30 % being the organic amendments. Dried plant materials (aerial parts) were sent to the Oxidative Stress Research Centre for secondary metabolite and antioxidant analysis. Plants that were exposed to poultry manure had significantly enhanced higher growth in all the measured parameters and yielded the highest concentration of secondary metabolites (polyphenols and flavonols) and antioxidant activity of *A. afra*. Moreover, there was a strong correlation between secondary metabolites and overall antioxidant activity, suggesting that the total activity of the plant was due to the presence of polyphenols and flavonols. In conclusion, the application of poultry manure influenced the growth, secondary metabolites and antioxidant activities of *A. afra*.

P-227 Enhancement of bergenin formation in cell suspension cultures of *Bergenia pacumbis* (Buch.-Ham. ex D.Don) C.Y.Wu & J.T.Pan by bacterial endophytes

Authors [Christoph Wawrosch](#)¹, [Stefan Steinbrecher](#)¹, [Martina Oberhofer](#)¹, [Sergey Zotchev](#)¹

Institute 1 University of Vienna, Dept. of Pharmaceutical Sciences, Division of Pharmacognosy, Vienna, Austria

DOI 10.1055/s-0043-1774101

Various species of the genus *Bergenia* (Saxifragaceae) are used as an Ayurvedic traditional remedy for the treatment of e.g. heart, lung, kidney, liver and bladder diseases, as well as tumours and ulcers [1]. The gallic acid derivative bergenin, a main compound of *Bergenia* species, exhibits many biological activities like hepatoprotective, anti-inflammatory, antioxidant, antitumour, or anti-virus [2]. Endophytes, microorganisms that live within plants without causing any visible disease symptoms, can, amongst other benefits for the host plant, influence the production of plant secondary metabolites [3]. In this study, cell suspension cultures of *Bergenia pacumbis* were established in order to investigate the effects of bacterial endophytes on bergenin formation in vitro. Cultures were treated with cells and culture filtrates of 5 bacterial strains (*Microbacterium* sp., *Micrococcus* sp., *Moraxella* sp., *Paracoccus* sp. and *Pseudomonas* sp.), which were earlier isolated from *B. pacumbis* and grown in two different media. Elicitation of *Bergenia* cell suspension cultures with cells of *Moraxella* sp. cultivated in LB medium, or with the culture filtrate of *Micrococcus* sp. cultivated in TSB medium, was most effective and resulted in ca. 2.7 fold increase in bergenin formation compared to the untreated control. Our results indicate that elicitation of plant suspension cultures with specific bacterial endophytes might be a promising strategy to increase in vitro secondary metabolite production.

Conflict of Interest The authors declare that they have no conflict of interest.

References

- [1] Khouli B, Kumar A, Yadav D, Jin J-O. *Bergenia* Genus: Traditional Uses, Phytochemistry and Pharmacology. *Molecules* 2020; 25: 5555
- [2] Xiang S, Chen K, Xu L, Wang T, Guo C. Bergenin Exerts Hepatoprotective Effects by Inhibiting the Release of Inflammatory Factors, Apoptosis and Autophagy via the PPAR- γ Pathway. *Drug Des Devel Ther* 2020; 14: 129–143
- [3] Khare E, Mishra J, Arora NK. Multifaceted Interactions Between Endophytes and Plant: Developments and Prospects. *Front Microbiol* 2018; 9: 2732

P-228 Effect of polyculture on the phenological and nutraceutical attributes of *Amaranthus*, *Cucurbita*, *Medicago*, *Ocimum* and *Salvia* species grown as microgreens

Authors [Claudia Espinosa Leal](#)^{1,2}, [Juan Celis Rodriguez](#)¹, [Abdala Coutiño Mijangos](#)¹, [Claudia García-Soto](#)¹, [Johana López Ramírez](#)¹, [Brandon Marroquín Rodríguez](#)¹, [Silverio García Lara](#)¹

Institutes 1 Centro de Biotecnología FEMSA, Escuela de Ingeniería y Ciencias, Tecnológico de Monterrey, Campus Monterrey, Eugenio Garza Sada 2501. Monterrey, Mexico; 2 Department of Chemical Engineering, Massachusetts Institute of Technology, 77 Massachusetts Avenue, Cambridge, USA

DOI 10.1055/s-0043-1774102

Production of microgreens; young plants with a central stem, and a pair of true leaves; has gained traction in the culinary world due to their flavor and aesthetic qualities. Microgreens are a source of nutraceutical compounds including terpenoids, polyphenols and carotenoids, while being cheaper and more sustainable to grow. Microgreens are cultivated as a monoculture. Here we investigate the potential value of five species *Amaranthus cruentus*, *Cucurbita ficifolia*, *Medicago sativa*, *Ocimum basilicum*, and *Salvia hispanica* with complementary nutraceutical profiles, grown separately and in polyculture, to assess their potential as a well-rounded source of nutraceuticals. Seeds were surface disinfected and sowed in containers with coco coir, for the monocultures 100 seeds per container for all species except *C. ficifolia* with 12 seeds, for the polycultures 4 seeds of *C. ficifolia* and 66 each of the rest of the species per container. Biophysical measurements were obtained, nutraceutical quantification included Total Ascorbic Acid, Total Phenolic Compound, Total Carotene Concentration, Total Tocopherol Determination and Antioxidant Capacity by ORAC. Biophysical properties remained the same or decreased for all the species except *A. cruentus* shoot length, *M. sativa*, *S. hispanica* and *C. ficifolia* root length. For the nutraceutical content (► **Table 1**) all components tended to increase or stay the same except for antioxidant capacity which decreased for all species. This study demonstrates that the use of polyculture in microgreens is an efficient method to raise nutraceutical components, more work needs to be done to limit the detrimental effect on yield.

► **Table 1** Nutraceutical content of plants grown in monoculture (M) and polyculture (P)

Parameter	Amaranthus cruentus		Cucurbita ficifolia		Medicago sativa		Ocimum basilicum		Salvia hispanica	
	M	P	M	P	M	P	M	P	M	P
Shoot length (mg/100g DW)	33.10 ± 0.42*	38.10 ± 0.42*	28.90 ± 0.42**	43.70 ± 0.33*	33.90 ± 0.42**	43.40 ± 0.42**	49.90 ± 0.42*	37.7 ± 0.42*	38.20 ± 0.42**	46.20 ± 0.42*
Total Phenolic Compound (mg/g DW)	8.87 ± 0.03*	4.52 ± 0.03*	4.20 ± 0.03*	5.30 ± 0.03*	4.50 ± 0.03*	5.10 ± 0.03*	5.10 ± 0.03*	6.00 ± 0.03*	6.00 ± 0.03*	6.00 ± 0.03*
Carotenoid concentration (mg/g DW)	290.42 ± 16.42*	434.20 ± 16.42*	488.2 ± 16.42*	487.2 ± 16.42*	588.20 ± 16.42*	588.20 ± 16.42*	588.20 ± 16.42*	588.20 ± 16.42*	588.20 ± 16.42*	588.20 ± 16.42*
Total Tocopherol (mg/100g DW)	6.80 ± 0.04*	6.10 ± 0.04*	6.10 ± 0.04*	10.10 ± 0.04*	7.00 ± 0.04*	6.80 ± 0.04*	7.00 ± 0.04*	6.80 ± 0.04*	6.80 ± 0.04*	6.80 ± 0.04*
Antioxidant Capacity (mg/g DW)	1.80 ± 0.03*	1.00 ± 0.03*	1.10 ± 0.03*	1.00 ± 0.03*	0.90 ± 0.03*	0.90 ± 0.03*	1.00 ± 0.03*	0.80 ± 0.03*	0.80 ± 0.03*	0.80 ± 0.03*

Different letters denote significant differences at $p < 0.05$ (ANOVA test, Tukey $\alpha = 5$).

Conflict of Interest The authors declare no conflict of interest.

P-229 Optimisation of Wormwood (*Artemisia absinthium* L.) in vitro micropropagation

Authors [Hendrick Vermeulen](#)¹, [Nicolas Delabays](#)¹

Institute 1 Institute Earth-nature-environment, HEPIA, University of Applied Sciences and Arts of Western Switzerland, CH-1254 Jussy, Switzerland

DOI 10.1055/s-0043-1774103

Wormwood (*Artemisia absinthium* L.) is a well-known medicinal and aromatic plant, used notably for the production of famous aperitif drinks. Today, a large-scale clonal production of selected genotypes, for genetics studies (p.e. heritability of phytochemical profiles) or breeding programs, is justified.

In order to readily provide researchers and producers with healthy and genetically homogeneous plants at rational cost, optimisation of in vitro culture parameters is necessary. Presently, the in vitro conservation and propagation of wormwood is partially documented, but a great disparity of methods, with very variable results – propagation rate, physiological problems, efficiency – are reported.

Today, we can propose an optimised protocol for the in vitro micropropagation of the species. Disinfecting explants with sodium hypochlorite (2%) for 10 min, followed by three rinses with ascorbic acid solution (1 g/L), gives the best dis-

infection/recovery ratio. Highest proliferation rates are obtained with medium containing BAP (6-Benzylaminopurine), Kinetin, NAA (1-Naphthaleneacetic acid) (0.5, 0.25 and 0.1 mg/L respectively) and a full dose of MS (Murashige and Skoog's medium). This media also reduces hyperhydricity problems by 50 % when the MS concentration is decreased by a quarter. The most efficient rooting medium is hormone-free and contains half a dose of MS. It allows us to obtain 96 % well rooted explants in 27 days. New bioassays are planned to investigate links between MS or (D+) -saccharose concentrations and hyperhydricity occurrence. GC-MS (Gas Chromatography – Mass Spectrometry) analysis is also planned in order to document secondary metabolite variations in vitro.

Conflict of Interest The authors declare no conflict of interest.

P-230 *Escherichia coli* biofactories as an alternative reservoir of human hydroxytyrosol metabolites

Authors Evangelos Kalampokis¹, Efthymia Panteli¹, Dimitris Michailidis^{1,4}, Emmanouil Trantas^{2,3}, Filippos Ververidis^{2,3}, Theodora Nikou¹, Maria Halabalaki¹

Institutes 1 Division of Pharmacognosy and Natural Products Chemistry, Department of Pharmacy, National and Kapodistrian University of Athens, Panepistimioupoli Zografou, 15771, Greece; 2 Plant Biochemistry and Biotechnology Group, Laboratory of Biological and Biotechnological Applications, Department of Agriculture, School of Agricultural Sciences, Hellenic Mediterranean University, Heraklion, Greece; 3 Institute of Agri-Food and Life Sciences, University Research Centre, Hellenic Mediterranean University, Heraklion, Greece; 4 PharmaGnose S.A., 57th km Athens-Lamia National Road, Oinofyta, 32011, Greece

DOI 10.1055/s-0043-1774104

Hydroxytyrosol (HT), one of the most potent natural scavengers, has been recognised for its impressive biological and pharmacological properties. Pharmacokinetics, especially biotransformations in human organism is critical for HT pharmacological properties and mechanism of action [1]. Despite the plethora of studies available, its metabolic pathways for the elucidation of its activity haven't been interpreted so far. Biotechnological approaches offer an attractive alternative strategy for HT production as well as diverse HT derivatives. Thus, the scope of the present work was to investigate *Escherichia coli* biofactories engineered to produce HT using L-tyrosine/L-DOPA [2] for the recovery and identification of possible new HT metabolites. Therefore, a novel methodology was developed and implemented based on ACE extraction hyphenated at-line with a stepwise gradient CPC fractionation and prep-HPLC-DAD for further purification. This process resulted in 20 compounds belonging to various classes and their structure was identified by LC-HRMS/MS and NMR techniques. Amongst them, several comprised previously described HT human metabolites as well as novel ones. The proposed workflow is the first reported method that describes the direct isolation of pure HT metabolites from *E. coli* and their unambiguous identification. Also, this approach could aid in the elucidation of the bioengineering process of the bacteria, but most importantly could comprise a reservoir for human HT metabolites.

Funding ERDF, "RESEARCH-CREATE-INNOVATE", OliveFeed (project code T2EΔK-03891).

Conflict of Interest The authors declare no conflict of interest.

References

- [1] Nikou T. et al. *Nutrients* 2022; 14: 3773
- [2] Trantas E. et al. *PLoS One* 2019; 14: 1–23

P-231 Nutritional value of *Sarcocornia perennis* sp. cultivated under an integrated multitrophic aquaculture (IMTA) system

Authors Eliana Fernandes¹, Viana Castañeda-Loaiza¹, Maria João Rodrigues¹, Nuno da Rosa Neng^{2,3}, Luísa Custódio¹

Institutes 1 Centre of Marine Sciences (CCMAR), Campus de Gambelas, University of Algarve, 8005-139 Faro, Portugal; 2 Centro de Química

Estrutural, Institute of Molecular Sciences, Departamento de Química e Bioquímica, Faculdade de Ciências, Universidade de Lisboa, Campo Grande, 1749-016 Lisboa, Portugal; 3 Laboratório de Ciências Forenses e Psicológicas Egas Moniz, Molecular Pathology and Forensic Biochemistry Laboratory, Centro de Investigação Interdisciplinar Egas Moniz, Egas Moniz School of Health and Science, Campus Universitário, Quinta da Granja, Monte de Caparica, 2829-511 Caparica, Portugal

DOI 10.1055/s-0043-1774105

The halophyte *Sarcocornia perennis* sp. is a perennial shrub growing in extreme salt conditions, has a good nutritional value and a very much appreciated salty taste and therefore, has a high potential as a fresh vegetable crop to be used in gourmet cuisine, similar to *Salicornia*. Cuttings of *S. perennis* sp. were cultivated in greenhouse conditions, in an IMTA system at different salinities. Aerial edible parts were harvested in summer, autumn and spring, and evaluated for proximate composition. Methanol extracts were prepared from dried biomass and profiled for antioxidant activity by the ABTS and DPPH assays, and for phenolic composition, by HPLC-DAD. Plant survival and productivity were also determined. Productivity decreased with the harvests and with increasing irrigation salinity. HPLC analysis identified 30 compounds mainly hydroxybenzoic acids (gallic and salicylic acids), hydroxycinnamic acids (chlorogenic and ferulic acids) and flavonoids (epicatechin). The radical scavenging activity on ABTS and DPPH were similar ($EC_{50} < 9$ mg/mL), and the proximate composition showed variable values with salinity and harvests. Our results suggest that *S. perennis* could be further explored as a source of nutrients and polyphenolic enriched extracts with antioxidant properties to be used in the food industry.

Funding This work received Portuguese national funds from FCT – Foundation for Science and Technology through projects UIDB/04326/2020, UIDP/04326/2020, UIDB/00100/2020 and UIDP/00100/2020, LA/P/0056/2020 and LA/P/0101/2020, the PhD grants (UI/BD/151301/2121: EF; 2020.04541. BD: VCL), FCT program contract (UIDP/04326/2020: MJR) and FCT Scientific Employment Stimulus (CEECIND/00425/2017: LC).

Conflict of Interest The authors declare no conflict of interest.

P-232 Bioprospecting the Ghanaian flora as a potential source of anti-schistosomal agents

Authors Evelyn Asante-Kwatia¹, Lord Gyimah¹, Arnold Forkuo Donkor², William Anyan³, Abraham Mensah Yeboah¹

Institutes 1 Department of Pharmacognosy, Kwame Nkrumah University of Science And Technology, Kumasi, Ghana; 2 Department of Pharmacology, Kwame Nkrumah University of Science And Technology, Kumasi, Ghana; 3 Noguchi Memorial Institute of Medical Research, University of Ghana, Accra, Ghana; 4 Department of Biomedical Sciences, School of Allied Health Sciences, College of Health and Allied Science, University of Cape Coast, Cape Coast, Ghana

DOI 10.1055/s-0043-1774106

Schistosomiasis affects more than 200 million people globally, with about 90 % of cases reported from sub-Saharan Africa. Interventions to eradicate schistosomiasis from developing countries like Ghana have been impeded by inequity of access to preventive chemotherapy and emergence of drug-resistant *Schistosoma* parasites. There is an increasing awareness of the potential of natural products as chemotherapeutic agents to combat parasitic infections. This study focused on documenting medicinal plants used for schistosomiasis treatment in an endemic area in Ghana, and evaluating their cercaricidal activity. Through semi-structured interview questionnaires, thirty plants distributed in 19 families, were reported to be used for schistosomiasis treatment by herbalists in Atwima-Nwabiagya district, Ghana. The families Apocynaceae and Euphorbiaceae recorded the highest number of plants (14 % each), followed by Asteraceae (10 %), Loranthaceae (7 %) and Rubiaceae (7 %). Nine plants were screened against the human *Schistosoma mansoni* parasite. All plants tested demonstrated time and concentration dependent cercaricidal activity. With lethality set at < 1000 µg/mL, for a duration of 240 min, the cercaricidal activity in order of decreasing potency was as follows: *W. somnifera* ($LC_{50} = 1.29$) > *B. aegyptiaca*

($LC_{50} = 7.1$) > *X. evansii* ($LC_{50} = 1.14$) > *J. multifida* ($LC_{50} = 12.9$) > *J. flava* ($LC_{50} = 22.9$) > *A. klaineana* ($LC_{50} = 182.81$) > *X. americana* ($LC_{50} = 194.98$) > *L. lecardii* ($LC_{50} = 223.87$) > *B. tenuifolia* ($LC_{50} = 309.03$) > *Z. zanthoxyloides* ($LC_{50} = 851.94$). The results of this study prove that the rich botanical knowledge on medicinal plants could provide an incredible starting point for the discovery of new anti-schistosomal drugs.

Conflict of Interest The authors declare no conflict of interest.

P-233 Exploring African traditional medicine: Insights from Northern Maputaland, KwaZulu- Natal, South Africa

Authors Sandy Van Vuuren¹, Helene de Wet²

Institutes 1 University of Witwatersrand, Johannesburg, South Africa;

2 University of Zululand, KwaDlangezwa, South Africa

DOI 10.1055/s-0043-1774107

Northern Maputaland has a diverse and novel source of ethnobotanical knowledge where indigenous communities rely on medicinal plants for the treatment of various diseases. This study aims to collate ethnobotanical survey studies undertaken over a 10-year period where our field work focused on traditional plant use for various infectious diseases involving the respiratory tract, gut, skin and sexually transmitted infections (STI). In addition, the concept of blood purification was explored, as well as ailments related to woman health and hypertension. This diverse set of medical conditions revealed a number of plant species that were documented for the first time and a quantitative analysis demonstrates common medicinal plants used across all medical conditions. Scientific validation studies were undertaken from plant species collected in situ and the antimicrobial model (minimum inhibitory concentration assays) was used to validate medicinal use for infectious diseases. *Ranunculus multifidus* for example was found to demonstrate excellent (MIC 20 µg/mL) STI activity. Brine shrimp lethality assays were used to evaluate toxicity. The plant species *Trichilia dregeana* was found to be highly toxic (75-92% mortality), and this correlated with the traditional use as an abortifacient. The most antimicrobially active plant species across all the studies will be presented together with combination studies based on traditional practices. One synergistic plant combination was *Acanthospermum glabratum* with *Krauseola mosambicina*, having fractional inhibitory concentrations between 0.01-0.30 against five diarrhoeal pathogens. These findings provide valuable ethnobotanical insight and strengthen the in vitro evidence of traditional plant knowledge in KwaZulu-Natal, South Africa.

P-234 Novel insights into the roots of an ancient medicinal plant: *Matricaria recutita* L.

Authors Lilo Mailänder^{1,2}, Peter Lorenz¹, Hannes Bitterling¹, Florian Stintzing¹, Rolf Daniels², Dietmar Kammerer¹

Institutes 1 WALA Heilmittel GmbH, Bad Boll, Germany; 2 Tübingen University, Tübingen, Germany

DOI 10.1055/s-0043-1774108

German chamomile is among the most widely known and applied medicinal plants. Its yellow-white flowers together with its blue essential oil have been shown to exhibit anti-inflammatory and spasmolytic properties [1]. Rather uncommon, however, is the use of chamomile roots in complementary medicine for their soothing and kidney-strengthening effects.

Since detailed information on chamomile roots was lacking, our study aimed at a detailed investigation of this mostly overlooked plant part. Firstly, root extracts obtained with solvents of different polarity were analysed using GC-MS and HPLC-MSn. Among the volatiles, sesquiterpenes were detected in addition to different polyacetylenic compounds previously described for chamomile flowers. However, the roots were devoid of matricin and bisabolol, which are typical of the essential flower oil. The polar fraction contained a variety of hydroxycinnamic acid derivatives. Additionally, coumarin glycosides and glyceroglycolipids of linoleic and linolenic acid were detected. Secondly, bioactivity

screening of the aforementioned extracts was performed. Interestingly, in the DPPH radical scavenging assay, ethyl acetate and butanol extracts of chamomile roots showed antioxidant activity comparable to that of chamomile flower extracts. Furthermore, distinct superoxide-scavenging activity was demonstrated using a hypoxanthin/xanthin oxidase system, and non-polar root extracts inhibited growth of the Gram-positive bacteria *S. aureus* and *B. subtilis* [2] (► Fig. 1).



► Fig. 1 *Matricaria recutita* L. root workflow

Based on these findings and marked emulsifying properties, chamomile root extracts may be incorporated as stabilizing and antioxidant components in various pharmaceutical, food and cosmetic products. This may also contribute to more sustainable chamomile cultivation, since the root material is usually not exploited so far.

References

- [1] Singh O, Khanam Z., Mira N, Srivastava M.K. Chamomile (*Matricaria chamomilla* L.): An overview. *Pharmacogn Rev* 2011; 5 (9): 82–95
- [2] Mailänder L.K., Lorenz P, Bitterling H, Stintzing F.C., Daniels R., Kammerer D.R. Phytochemical characterization of chamomile (*Matricaria recutita* L.) roots and evaluation of their antioxidant and antibacterial potential. *Molecules* 2022; 27 (23): 8508

P-235 Comparison of Herbal Substances (HS) Used in Traditional Bulgarian Medicine (TBM) and Traditional Chinese Medicine (TCM)

Authors Asen Stoyanov¹, Anely Nedelcheva¹

Institute 1 Sofia University "st. Kliment Ohridski", Sofia, Bulgaria

DOI 10.1055/s-0043-1774109

The use of herbal substances to improve one's health and quality of life is a deeply rooted therapeutic tradition among the Bulgarian people [1]. Multiple cultural and economic factors can influence this use.

A retrospective analysis of Bulgarian therapeutic traditions has been performed. HS used in both traditional systems of medicine were determined and compared. Concurrently HS were purchased and authenticated from several distributors in the Bulgarian market. Results from ethnobotanical sources and literature were compared to collected samples.

Of 544 taxa with a known ethnobotanical use in Bulgaria, 39 were found to be utilised by both systems, 16 – native to Bulgaria. Of 72 taxa comprising the collection, 20 were known to both traditional medicine systems. Discrepancies in indications and methods of administration were also determined.

More research must be done to ensure the responsible and rational integration of practices from TCM into TBM.

Funding The authors are grateful to the financial support of Bulgarian National Science Fund at the Ministry of Education and Science, Contract No 2901/KP-06-China/15/17.12.2020.

References

- [1] Nedelcheva A., Draganov S. Bulgarian Medical Ethnobotany: The Power of Plants in Pragmatic and Poetic Frames. In: Pieroni, A., Quave, C. (eds) *Ethnobotany and Biocultural Diversities in the Balkans*. Springer; New York, NY: 2014

P-237 Medicinal herbs: From past experience to new technologies

Authors [Ragazinskiene Ona](#)¹

Institute 1 Vytautas Magnus University, Botanical Garden, Kaunas, Lithuania

DOI [10.1055/s-0043-1774110](https://doi.org/10.1055/s-0043-1774110)

Medicinal (aromatic) plants (MAPs) are playing an important role for the solution to WHO problem 'Health for everyone in 21st Century'. The aim of study is to review the research in herbalism from archival material to recent research in Lithuania. The presentation will focus on recent and present research projects carried out [1, 2]. Currently, innovative technologies, programs and methodologies are being applied to the research. All the ongoing activities can be classified into fundamental and applied research. Fundamental research includes development of new separation and analysis methods, materials and apparatus [3]. Applied research includes downstream biotechnology and analytical method applications for revealing qualitative and quantitative composition of the MAPs and matrices, industrial, pharmaceutical and food products and investigation of applicability of plant extracts and their fractions for the suppression and control of viruses from animal environment. Several approaches to increase food safety and quality using medicinal plant-based biotechnologies will be presented.

The research has been carried out on the basis of various national and international projects and correspond to European and Lithuanian scientific research and experimental development priorities.

References

- [1] Balčiūnaitė G. et al. Identification of *Echinacea purpurea* (L.) Moench root lysM lectin with nephrotoxic properties//Toxins., 2020; Vol. 12, iss. 2, 1-18
- [2] Lelešius R. et al. *In vitro* antiviral activity of fifteen plant extracts against avian infectious bronchitis virus/. BMC Veterinary Research 2019; 15: 178. doi:10.1186/s12917-019-1925-6
- [3] Penkauskienė E, Rimkienė S. Ecological and biological characteristics of wild and cultivated sorts of officinal plants of Lithuania. Monograph. Vilnius 1991; 177

P-238 Anti-inflammatory activity of medicinal plants from the traditional medicine of Atacama People (Calama, Chile)

Authors [Lauriane Lenen](#)¹, [Adeline Knittel-Obrecht](#)², [Pascal Villa](#)², [Catherine Vonthron-Sénécheau](#)¹, [Sergio Ortiz](#)¹

Institutes 1 Université De Strasbourg, France; 2 PCBIS, Université de Strasbourg, France

DOI [10.1055/s-0043-1774111](https://doi.org/10.1055/s-0043-1774111)

With principal aims to better understand and search for new anti-inflammatory compounds, we investigated the antioxidant, anti-inflammatory and wound-healing properties of several medicinal plants from the Atacama People's traditional medicine. To begin, cytotoxic (cell viability) and anti-inflammatory (production of pro-inflammatory cytokines) activities were assessed of extracts obtained from classical maceration procedures from selected medicinal plants species. The less polar extracts from *Fabiana* sp. (*F. squamata* and *F. denudata*, Solanaceae) showed the more promising *in vitro* results, inhibiting the production of pro-inflammatory cytokines (82 % and 89 % for *F. squamata* and 61 % and 77 % for *F. denudata* of IL-1 β and IL-10 inhibition respectively at 50 μ g/mL, final concentration) by LPS-stimulated peripheral blood mononuclear cells (PBMC) with no effect on cell viability. Chemical characterisation of both extracts allowed us to identify flavonoids and bicyclic sesquiterpenes as the major compounds by HPLC-PAD- HRMS/MS and by molecular network approaches. Bio-guided isolation of bioactive compounds is ongoing in order to identify the responsible compounds of the anti-inflammatory activity of extracts.

P-239 The Kampo formulation Hainosankyuto as an antibacterial and immunomodulatory agent

Authors [Jana Seele](#)², [Corinna Duck](#)^{1, 2}, [Silke Cameron](#)³, [Roland Nau](#)², [Hans Rausch](#)⁴, [Erwin Bergmeier](#)¹, [Kenny Kuchta](#)¹

Institutes 1 Albrecht von Haller Institute of Plant Sciences, Georg August University Göttingen, 37073 Göttingen, Germany; 2 Department of Neuropathology, University Medical Center Göttingen, 37075 Göttingen, Germany; 3 Department of Gastroenterology and Gastrointestinal Oncology, University Medicine Göttingen, 37075 Göttingen, Germany; 4 Phytochem Referenzsubstanzen, 89231 Neu-Ulm, Germany

DOI [10.1055/s-0043-1774112](https://doi.org/10.1055/s-0043-1774112)

With growing antibiotic resistance, treatment of bacterial infections such as septic peritonitis becomes increasingly challenging. In Japan, the herbal prescription Hainosankyuto (HSK) is traditionally used for infections with abscess formation like appendicitis, diverticulitis and perianal abscesses. HSK consists of *Platycodon grandiflorus* root (4.0 g), *Glycyrrhiza uralensis* root (3.0 g), *Citrus reticulata* unripe fruit (3.0 g), *Paeonia lactiflora* root (3.0 g), *Ziziphus jujuba* fruit (3.0 g), and *Zingiber officinale* rhizome (1.0 g). The aim of the study was to elucidate its antibacterial activity against the Gram-negative and Gram-positive bacteria *Escherichia coli* K1 and *Streptococcus pneumoniae* D39 as well as its effect on phagocytosis (► Fig. 1).

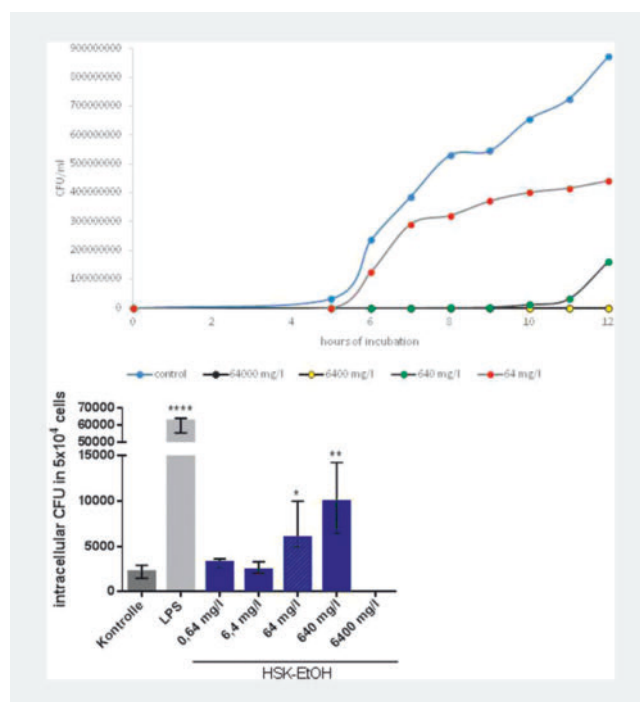

► **Fig. 1** Above: Growth curve of *S. pneumoniae* D39 with different concentrations of Hainosankyuto (n = 3). Below: Phagocytosis assay with THP1-blue-NF κ B-reporter-macrophages, stimulated with lipopolysaccharide (LPS) and different concentrations of Hainosankyuto (n = 9).

E. coli and *S. pneumoniae* were incubated with different concentrations of aqueous and ethanolic extracts. High concentrations of HSK (32000 mg/L) showed a moderate inhibitory effect on *E. coli* growth. A strong inhibitory effect (50 %) on *S. pneumoniae* growth was seen at a concentration of 64 mg/L. Assuming a volume of distribution of 1 L/kg this concentration can be reached *in vivo* in humans with appropriate doses. For complete inhibition of *S. pneumoniae* growth, 2560 mg/L of HSK was necessary. Stimulation of human macrophages (THP-1-Blue-NF- κ B) with 64 mg/L of HSK led to a significant increase of phago-

cytosis, associated with an activation of NFκB. Cytotoxic effects appeared at 6400 mg/L of HSK.

HSK has a strong bacteriostatic effect on *S. pneumoniae* with bactericidal effects at higher doses and a strong phagocytosis-promoting effect, which may support clearance of bacterial infections. This makes HSK a potentially beneficial anti-bacterial agent also in modern times, contributing to the prevention of the evolution of antibiotic resistance, and is worth further study.

P-240 Herbal Medicine Usage and Changes during the Covid-19 Pandemic: A representative Study in Germany

Authors Miriam Wolf¹, Agnes Emberger-Klein, Klaus Menrad
Institute 1 Weihenstephan-Triesdorf University of Applied Sciences/ Technical University of Munich Campus Straubing, Straubing, Germany
DOI 10.1055/s-0043-1774113

In recent years, restrictions in order to control the Covid-19-pandemic changed behaviour and consumption pattern in many areas of life. Little is known about herbal medicine (HM) usage and how it changed during the pandemic in Germany. The aim of this study was to examine HM usage behaviour, the prevalence of HM usage in popular indication fields as well as the aims of HM usage in comparison to the time before the pandemic started.

Therefore, a representative online study took place in Germany in April 2022. 1165 (of 1707) participants indicated HM usage within the previous 12 months. Compared to a study conducted in 2018, HM usage prevalence for influenza (46%) and cough (41%) decreased for example about 20%. 80% of users aimed to support or maintain their health (+9%) with HM. Illness prevention (55%; -6%) and the treatment or therapies of diseases or symptoms (73%; -20%) were less popular aims of HM usage during the Covid-19 pandemic. 46% of users took HM on demand and 21% daily. The majority indicated no change in the frequency of HM consumption (85%) since the beginning of the pandemic. Nevertheless, more users noticed an increased frequency of HM usage (11%) than a decreased frequency (4%). 18% of HM-users started using new HM, which they had not used before the pandemic.

The findings of this study can help health policymakers and pharmaceutical professionals to improve and optimise future pandemic-control strategies considering the potential of HM due to the consumption pattern.

P-241 Herbal medicinal products are well tolerated also in old age – data from the PhytoVIS study

Authors Olaf Kelber¹, Tamara Gramlinger¹, Karin Kraft²
Institutes 1 Phytomedicines Supply and Development Center, Bayer Consumer Health, Steigerwald Arzneimittelwerk GmbH, Darmstadt, Deutschland; 2 Rostock University Medical Center, Rostock, Germany
DOI 10.1055/s-0043-1774114

Herbal medicinal products are used especially also in the elderly. However, scientific data on their use are still scarce.

The PhytoVIS study generated data from over 20,000 patients who had taken HMPs, including patients over 65 years. The latter were evaluated using descriptive statistics. Parameters were analysed in two patient groups (66–75 years old (group 1, n = 1,865) and over 75 years old (group 2, n = 1,200).

Only few relevant differences were detected in comparison to the patients below 66 years (n = 17,805). The incidence of chronic diseases and complaints was much higher in both geriatric groups, e.g. memory impairment and arthralgia. Long-term use of the HMP was reported by 48% of the patients (group 1) and 56% (group 2), but only by 28% of the total population. The proportion of comorbidities was also significantly higher, i.e. 76.0% resp. 82.8% vs. 39.8%, as was the proportion of patients with co-medication. Most patients of both geriatric groups rated effectiveness as moderate to very good (CGI-E). The proportion of patients not noticing any impairment by side effects was slightly higher in group 1 (91.9%) and in group 2 (93.8%) as compared to the total population (91.2%).

PhytoVIS data confirm the age-dependent increase of multimorbidity and poly-medication. The geriatric age groups reported that the HMP was very well tolerated and had mostly no side effects. For an ageing population, HMPs are therefore an important and safe therapy option with a good efficacy-tolerability profile, also for the treatment of chronic diseases.

P-242 Herbal medicines used by Chilean adults – an online survey

Authors Katja Löbel¹, Sara Garfield¹, Javier Echeverría², Michael Heinrich¹
Institutes 1 UCL School of Pharmacy, London, United Kingdom; 2 Facultad de Química y Biología, Universidad de Santiago de Chile, Santiago, Chile
DOI 10.1055/s-0043-1774115

Herbal medicine has a long history of use worldwide, including in Chile, where indigenous Mapuche communities have relied on plant-based remedies for generations. Despite this rich tradition, there is limited documentation on the specific herbal medicines used and the health conditions used among the general population. In this study, we conducted an online survey (ethical approval N° 16697/001) to investigate and understand the use of herbal medicines in the adult population in Chile and repurposed the data to complete an online ethnobotanical assessment.

Our survey included 422 participants who reported having used 187 plant species. The most commonly used are shown in (► **Table 1**). Native plants accounted for only 18.8% of the total mentioned. The median number of herbal medicines used by participants was five species, with an interquartile range from three to seven. Participants also reported using herbal medicines, most commonly to aid the digestive system, for anxiety/stress, and to help with sleep. Interestingly, our results showed that over 70% of the participants learned about herbal medicines from their families and friends, while only 23% received recommendations from healthcare professionals.

► **Table 1** Most commonly used herbal Medicines mentioned by the respondents (N = 422).

Plant species	Vernacular name	Frequency of Citation (FC)	Relative Frequency of Citation (RFC)
<i>Matricaria chamomilla</i> L.	Manzanilla	279	0.66
<i>Mentha x piperita</i> L.	Menta	246	0.58
<i>Buddleja globosa</i> Hope	Matico	161	0.38
<i>Peumus boldus</i> Mol.	Boldo	156	0.37
<i>Melissa officinalis</i> L.	Toronjil/Melisa	149	0.35
<i>Aloysia citrodora</i> Paláu	Cedrón	95	0.23
<i>Ruta chalepensis</i> L.	Ruda	64	0.15
<i>Mentha pulegium</i> L.	Poleo/Menta poleo	63	0.15
<i>Salvia rosmarinus</i> Spenn.	Romero	59	0.14
<i>Origanum vulgare</i> L.	Orégano	56	0.13

Our study provides important insights into the diversity of herbal medicine used among Chilean adults from an ethnobotanical perspective. The findings suggest that traditional knowledge plays a significant role in using herbal medicines in Chile. By repurposing existing survey data, we were able to document the plant species used and the health concerns they were used for.

Conflict of Interest The authors declare no conflict of interest.

P-243 Clinical benefits of herbal medicinal products in gynecological complaints

Authors Alexandra Drebka¹, Olaf Kelber^{2,3}, E Raskopf^{4,5}, R Mösges⁵, Beatrice Bachmeier¹

Institutes 1 Institute of Pharmaceutical Biology, Goethe University Frankfurt, Germany, Frankfurt/Main, Germany; 2 R&D, Phytomedicines Supply and Development Center, Bayer Consumer Health, Steigerwald Arzneimittelwerk GmbH, Darmstadt, Germany; 3 Kooperation Phytopharma GbR, Bonn, Germany; 4 Institut für Medizinische Statistik und Bioinformatik, University Hospital Cologne, Cologne, Germany; 5 ClinNovis GmbH, Cologne, Germany

DOI 10.1055/s-0043-1774116

Herbal medicines have traditionally been used for a variety of diseases, but their use in recent therapeutic strategies is limited due to a lack of clinical evidence. The aim was to assess the clinical benefit of medicinal plants in gynecological complaints by evaluating patient-reported outcomes from PhytoVIS, a large pharmacoepidemiological database.

For data collection, patients were interviewed by an anonymous questionnaire about their personal experiences with herbal medicines. This included information on indication, gender, age, therapeutic benefit and side effects. After data cleaning, 1,405 data entries were descriptively analysed. The efficacy of herbal preparations was evaluated by Clinical Global Impression Scale-Efficacy (CGI-E).

In the data set, 228 women (12-65 years) use herbal medicines for menstrual complaints. For 99.4% of these patients a CGI-E of 1 or higher was observed. 31.6% of the population had the highest possible clinical benefits with a score of four. 306 women (31 years and older) described taking herbal medicines for menopausal symptoms. For 97.8% of these patients a CGI-E of at least 1 was observed, whereas 31.0% had the highest possible clinical benefits with a score of four. 851 female patients (12 years and older) use herbal medicines for the treatment of bladder and urinary tract symptoms, of which 98.5% had a CGI-E of 1 or higher. 45.4% of the population had the highest possible clinical benefits with a score of four.

For all three indications the therapeutic effect of herbal medicines was very high.

P-244 Investigation of the impact of inhalation aromatherapy on relaxation and wellbeing

Authors Fiona Hedigan^{1,2}, Helen Sheridan^{1,2}, Astrid Sasse^{1,2}

Institutes 1 School of Pharmacy & Pharmaceutical Sciences, The University of Dublin, Trinity College Dublin, Dublin 2, Ireland; 2 NatPro Centre, School of Pharmacy and Pharmaceutical Sciences, Trinity College Dublin, Dublin 2, Ireland

DOI 10.1055/s-0043-1774117

Aromatherapy is the systematic use of essential oils extracted from plants to support health and wellbeing. Recent clinical studies have shown that aromatherapy has potential benefits as a non-pharmacological approach to alleviate stress and anxiety. A double-blind, randomised placebo-controlled pilot study was conducted to investigate the benefit of using an aromatherapy room diffusion product to promote wellbeing and aid relaxation. The participants consisted of students from the School of Pharmacy and Pharmaceutical Sciences in Trinity College Dublin. The test product was a blend of five essential oils (100%) and the control, a different single essential oil (3%) in a base oil with a faint citrus aroma. The participants were asked to use the product every day for one hour over one week. The DASS-42 stress index questionnaire was the measurement tool used at baseline, before starting to use the product, and at the end of the one week of aromatherapy intervention. The results showed that participants in the test product group reported a more positive response for anxiety levels compared to the control group in 75% of the participants ($p = 0.09$), for depression in 87.5% ($p = 0.03$) and for stress in 87.5% of participants ($p = 0.024$). This was a small pilot study with a total of 17 participants

which limits statistical significance, but a clear trend was observed in favour of the test intervention.

Conflict of Interest Fiona Hedigan (postgraduate researcher) is employed by Fiona Hedigan & Associates Limited, the Enterprise Partner in a collaboration agreement with Trinity College Dublin.

P-245 The role of herbal medicines: a survey exploring healthcare professionals' perceptions across the UK

Authors Sobha Sharma¹, Sukvinder Bhamra¹, Michael Heinrich²

Institutes 1 Medway School of Pharmacy, University of Kent, Chatham, United Kingdom; 2 UCL School of Pharmacy, University of London, London, United Kingdom

DOI 10.1055/s-0043-1774118

Healthcare professionals (HCPs) have a key role in optimising patient care. As the use of Herbal Medicines (HM) is on the rise it is important that HCPs have knowledge of them, to help patients make informed decisions. The aim of the study was to explore UK based HCPs personal and professional views on HM.

An online questionnaire was distributed via various networks to recruit a large range of HCPs from across the UK.

A total of 1113 HCPs responses were analysed, 64% of HCPs confirmed that they regularly checked patients' use of HM as part of the clinical consultation. Most patient queries were regarding HM efficacy and interactions with conventional medicines; however, 67% of HCPs did not know where to access such information and 45% were not sure or were unaware of any herb-drug interactions.

HCPs (87%) identified insufficient education and training on HM which made them unable to advise patients on the safe and effective use of HMs. HCPs (37.52%) who used HM for their own health found them effective (68%) the most frequently used HMs were Turmeric, St John's wort and Echinacea. However, there was some uncertainty amongst HCPs around what herbal, homeopathic and nutritional supplements were.

HCPs have little knowledge of HM due to limited training thus lack the confidence to respond to patient queries. There is a need to therefore review the current HM training provision for HCPs and make improvements to facilitate informed consultations as HM could have a role in improving patient care.

P-246 Natural products in dermatology: exploring how skin conditions are managed using herbal remedies in the UK.

Authors Sukvinder Bhamra¹, Mariam Magid¹, Anu Siby¹

Institute 1 Medway School of Pharmacy, University of Kent, Chatham, United Kingdom

DOI 10.1055/s-0043-1774119

As natural products (NPs) become more accessible and desirable in a globalised world, there has been a rise in the demand for herbal remedies for skin care. This has resulted in more cosmetics being formulated and enriched with NPs. This study explored the current use of NPs for managing skin conditions in the UK comparing the perceived safety and efficacy of NPs and conventional medicines (CMs) for treating and managing skin conditions. An online survey was distributed via social media platforms and face-to-face data collection, utilising snowball and convenience sampling.

NPs were used by 53% of participants ($n = 210/400$) for skin conditions such as acne, dry skin and sunburn. Turmeric, aloe vera and honey were the most commonly cited NPs used by participants for a range of skin conditions. Of the 369 participants who identified as having a skin condition, 50% had used CMs (i.e. prescription and over-the-counter medicines) and 55% had tried NPs. NPs were deemed more effective for some skin conditions such as sunburn and minor wounds; however, CMs were perceived as more effective for other conditions such as steroids for itchy skin and antibiotics for more serious wounds. Overall,

67% of participants believed NPs were effective and 75% perceived NPs to be safe for skin conditions.

NPs have a pivotal role in managing acute and chronic skin conditions. As people seek holistic ways to manage their skin care, formulations based on natural products are becoming a preferred option.

Conflict of Interest The authors declare no conflict of interest.

P-247 Access to the complementary medicine – Challenges and opportunities in Cuba

Author [Diadelis Ramirez¹](#)

Institute **1** National Center For State Quality Control Of Drugs And Medical Devices, Havana City, Cuba

DOI [10.1055/s-0043-1774120](#)

Traditional and Complementary medicine (T&CM) is an important and often underestimated part of health care found in almost every country in the world and the demand for its services is increasing. Complementary medicine (CM) of proven quality, safety and efficacy, contributes to the goal of ensuring that all people have access to care.

The objectives were to show the importance of the T&CM access for people around the world, how to get the access, to explain World Health Organization (WHO) Strategy related with this subject, besides that, to illustrate Cuban experiences with the integration of T&CM in the health system taking into account the challenges and opportunities.

In order to explain the objectives, the factors involved for getting access will be shown, such as: policy and regulations, the knowledge about appropriate use, cost, among others. Moreover, the Cuban health system, which is for all the people, will be illustrated as an example. There are different levels of health care (primary, secondary and tertiary level), the regulations are based on risk approach, T&CM is included in the list of essential medicines, and Traditional Medicine is an official specialty. There are some challenges for rational use like, the fulfilment of agricultural and manufacturing practices for all the practitioners. In general, health systems around the world should take care about the use of T&CM based on the quality, safety and efficacy.

Conflict of Interest The author declares no conflict of interest.

P-248 The medicinal plant online encyclopaedia of Kooperation Phytopharmaka- proven knowledge on medicinal plants and their use

Authors [Olaf Kelber⁵](#), [Elisabeth Stahl-Biskup¹](#), [Robert Fürst²](#), [Björn Feistel³](#), [Karen Nieber⁴](#), [Jürgen Reichling⁶](#), [Stefan Siegmund⁷](#), [Cornelia Kern⁸](#)

Institutes **1** Universität Hamburg, Pharmazie, Abt. Pharmazeutische Biologie und Mikrobiologie, Hamburg, Germany; **2** Institut für Pharmazeutische Biologie, Goethe-Universität Frankfurt, Frankfurt, Germany; **3** Finzelberg GmbH & Co. KG, Andernach, Germany; **4** Universität Leipzig, Institut für Pharmazie, Leipzig, Germany; **5** R&D, PSDC, Bayer CH, Steigerwald Arzneimittelwerk GmbH, Darmstadt, Germany; **6** Institut für Pharmazie und Molekulare Biotechnologie (IPMB), Abt. Pharmazeutische Biologie, Universität Heidelberg, Heidelberg, Germany; **7** Convidia Clinical Research GmbH, Münster, Germany; **8** Kooperation Phytopharmaka GbR, Bonn, Germany

DOI [10.1055/s-0043-1774121](#)

The internet has developed as a fast and free source of information also in the field of medicinal plants. Not all information on the internet is based on solid sources and this poses risks and dangers for their use on patients. Following the definition of an encyclopaedia, alphabetically sorted according to German plant names and professionally prepared by experts for medicinal plants, the medicinal plant encyclopaedia of the Kooperation Phytopharmaka is available online for German-speaking countries (<https://arzneipflanzenlexikon.info>). Facts on medicinal plants and their history, origin and current use in herbal medicines are presented. For more than a decade, it has been an established

database on the internet and is continuously updated by Prof. Elisabeth Stahl-Biskup (Hamburg University, Germany) in collaboration with members of the Scientific Working Group of the Kooperation Phytopharmaka [1].

An essential part of all monographs are necessary warnings and information on side effects and interactions. The medicinal plant encyclopaedia currently includes about 180 plants. It is constantly being expanded and adapted to current requirements. An English language version of the monographs is currently being prepared in order to provide scientifically sound information on medicinal plants worldwide in the future. The medicinal plant encyclopaedia of the Kooperation Phytopharmaka is an example of how scientific facts can be successfully communicated to experts and laypersons.

References

[1] Schwöppe C et al. *Zeitschrift für Phytotherapie* 2015; 36: P23

P-249 Subgroup evaluation of pharmacoepidemiological data. PhytoVIS – a success story

Authors [Karen Nieber²](#), [Olaf Kelber¹](#)

Institutes **1** Phytomedicines Supply and Development Center, Bayer Consumer Health, Steigerwald Arzneimittelwerk GmbH, Darmstadt, Germany; **2** Institute for Pharmacy, Leipzig University, Leipzig, Germany
DOI [10.1055/s-0043-1774122](#)

Herbal medicinal products (HMPs) are effective drugs with few side effects and play an important role in self-medication and general medical practice. To generate data especially on susceptible groups such as the elderly, children and patients with concomitant diseases, the PhytoVIS database was developed [1]. Data were collected by means of a retrospective, anonymous, one-time survey in a standardised format in pharmacies and physicians' offices and analysed in an exploratory manner. A total of 24,056 patients were surveyed, 16,443 were female and 7,613 were male. Of these, 75% females and 77.5% males used HMPs for acute complaints, 15.6% females and 14.1% males for chronic complaints, and 7.1% females and 6.1% males for preventive measures. Different evaluations were performed, such as for geriatric (n = 365) and for paediatric (n = 2063) populations [2] and on the use of HMPs in pain management (n = 1,350). Overall, more than 90% of all patients in the studies reported good to excellent efficacy with no serious side effects.

The PhytoVIS database is accordingly, a good example of a "real life" study to provide data for medical care as well as regulatory purposes to support risk to benefit assessments.

Funding The study was supported by the Kooperation Phytopharmaka, Bonn.

Acknowledgement The authors thank the interns of Bayer Darmstadt and the staff of IMSIE, Cologne, Germany for the analysis of the data.

References

[1] Wegener T et al. *Pharmind* 2021; 83: 416–423

[2] Nieber K et al. *European Journal of Pediatrics* 2020; 179: 507–5

P-250 How can herbal medicine be well developed under the current regulatory system?

Author [Zhao-xiang Bian¹](#)

Institute **1** Hong Kong Baptist University, Hong Kong, China
DOI [10.1055/s-0043-1774123](#)

Herbal medicine has been used in Eastern Asia for more than three thousand years. Accumulated evidence, from classic literature to the scientific research, demonstrates the efficacy and safety of herbal medicine. The public is recognising the usefulness and its scientific value at the Age of Knowledge Explosion. The contradiction is becoming more and more obvious, especially between the increasing needs of herbal medicine and the tough regulation policy from different jurisdictions. There is an urgent need to find a solution to solve such contradiction practically thus to let the public get benefit from the traditional wisdom. Some considerations are listed herewith and wish to be considered by

regulatory agencies to go forward and help the public. Firstly, herbal medicine should be studied and the research can provide solid evidence to demonstrate the safety and efficacy for certain conditions/disease, from clinical, preclinical and basic research level. Evidence from rigorous process is a critical issue. Secondly, herbal medicine should start from the unmet medical needs to demonstrate their uniqueness, which includes but not limited to no cure conditions, conditions with treatment but with serious side effects, prevention and rehabilitation. Thirdly, new drug development is one of the key paths to let patients access the herbal medicine product. In order to facilitate the process, the agencies for drug approval in different regions need to work together to find a common path thus to speed up the evaluation process, although it is not easy to some extent. One world, one medicine.

P-251 Regulatory Framework of Traditional and Complementary Medicine – Focus on Cuba

Author Diadelis Ramirez¹

Institute 1 National Center for State Quality Control of Drugs and Medical Devices, Havana City, Cuba

DOI 10.1055/s-0043-1774124

In the last decade there has been a global upsurge in the use of traditional medicine and complementary and alternative medicine in both developed and developing countries. This is one of the main reasons for reinforcing the surveillance of the safety, efficacy and quality control of traditional medicine, complementary and alternative medicines.

This work describes the WHO strategy for the development of herbal medicinal products, as well as, global status of the regulations, use of pharmacopoeias, categories given to herbal medicines by WHO members and other important aspects related to the rational use of complementary medicine. On the other side, Cuba.

Regulatory Framework on this topic will be explained in detail; and some important considerations for investigation focused on marketing authorisation of natural products will be shown.

In conclusion, herbal medicines take special consideration in this moment, for its properties. Drug Regulatory Authorities should ensure the quality, safety and efficacy of traditional medicines.

Conflict of Interest The author declares no conflict of interest.

P-252 Effects of *Securinega suffruticosa* on atopic dermatitis-induced NC/Nga mice

Authors Mi-Sun Kim¹, Yoon-Young Sung¹, Heung Joo Yuk¹, Dong-Seon Kim¹

Institute 1 KM Science Research Division, Korea Institute of Oriental Medicine, Daejeon, Republic of Korea

DOI 10.1055/s-0043-1774125

Securinega suffruticosa (SS) is known to be associated with anti-oxidants, anti-vascular inflammatory effects and muscle relaxation. However, the relationship between SS and atopic dermatitis (AD) has not yet been reported. Therefore, this study investigates SS for the effects of atopic dermatitis in NC/Nga mice. The TNF- α /IFN- γ induced HaCaT cell line was studied for the effects on RANTES secretion by SS. Atopic dermatitis was induced by repeated treatment of *Dermatophagoides farinae* extract (DfE) on the ears and back skin of NC/Nga mice. In the AD mice model, SS attenuated DfE-induced AD-like symptoms, such as dermatitis score, epidermal thickness, scratching frequency and skin water loss. SS reduced the levels of immunoglobulin E (IgE) and thymic stromal lymphopoietin (TSLP) in the serum of DfE-induced AD mice. Histological analysis showed significantly reduced mast cells and eosinophil cells infiltration into the skin. SS decreased secretion of RANTES in the TNF- α /IFN- γ induced HaCaT cells. The findings indicate that SS attenuates atopic dermatitis and components in SS can be used as potential therapeutic candidates for AD.

P-253 The hydroethanolic extract from *Arnicae flos* demonstrated potent anti-inflammatory properties in vitro

Authors Johann Röhrli¹, Maria-Riera Piqué-Borràs¹, Gerald Künstle¹

Institute 1 Weleda AG, 4144 Arlesheim, Switzerland

DOI 10.1055/s-0043-1774126

Traditionally *Arnica montana* L. is indicated for treatment of blunt injuries like strains and bruises that are physiologically accompanied by local inflammation, including activation of the NF- κ B pathway and release of pro-inflammatory mediators such as leukotrienes and prostaglandins.

Here we aimed to evaluate the anti-inflammatory efficacy of a hydroethanolic extract from *Arnicae flos* (A. flos).

The dry extract from A. flos was prepared using liquid extracts from fresh flowers. NF- κ B activation was analysed in a reporter assay with the human Jurkat cell line. Stimulated human PMNLs or monocytes were used for analysis of 5-lipoxygenase (5-LO) product formation and cyclooxygenase-2 (COX-2)-mediated PGE₂ release. 5-LO and COX-2 gene expression was analysed in the human THP-1 cell line, stimulated with LPS.

A. flos concentration-dependently inhibited NF- κ B activation (IC₅₀: 52.5 μ g/mL), and PGE₂ release from monocytes (IC₅₀: 105.4 μ g/mL). In contrast, 5-lipoxygenase product formation in PMNLs was not inhibited by A. flos (IC₅₀: > 300 μ g/mL). In a cell-free enzyme inhibition assay, A. flos concentration-dependently inhibited both, 5-LO and COX-2 enzyme activity (IC₅₀: 47.8 μ g/mL and 33.1 μ g/mL). In addition, A. flos significantly inhibited 5-LO gene expression in a concentration-dependent manner.

In this experimental in vitro approach the complex mixture of active compounds contained in the Weleda A. flos extract demonstrated potent anti-inflammatory and pain-related activity (► Fig. 1). Additional studies are performed to further characterise therapeutic advantages of A. flos preparations.

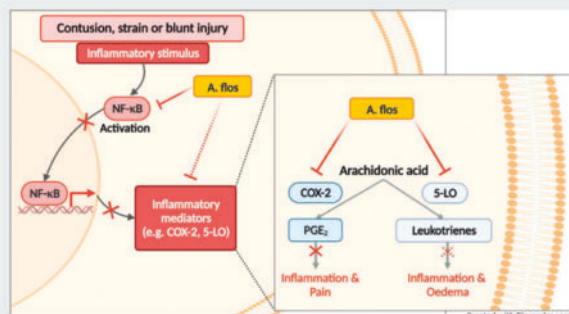

► Fig. 1 Summary of anti-inflammatory properties of the hydroethanolic A. flos extract.

P-254 Evaluation of the anti-inflammatory activity of sumac fruits (*Rhus coriaria* L.) in an in vivo model of skin inflammation

Authors Marco Fumagalli¹, Marco Pelin², Stefano Piazza¹, Nicole Maranta¹, Carola Pozzoli¹, Giulia Martinelli¹, Enrico Sangiovanni¹, Silvio Sosa², Mario Dell'Agli¹

Institutes 1 Department of Pharmacological and Biomolecular Sciences "Rodolfo Paoletti", Università Degli Studi di Milano, Milan, Italy; 2 Department of Life Sciences, University of Trieste, Trieste, Italy

DOI 10.1055/s-0043-1774127

The fruits of *Rhus coriaria* L. are traditionally used in southern Europe and the Middle East as a spice and for the treatment of various skin pathologies. There are several studies demonstrating different biological activities of this plant,

including antimicrobial [1] and anti-inflammatory [2] activity. In our previous study we demonstrated the anti-inflammatory activity of *Rhus coriaria* L. fruit extracts in human keratinocytes [3]. The aim of this work was to investigate the anti-inflammatory activity of two different extracts of the fruit of *Rhus coriaria* L., macerated ethanol and acetone extracts, in an in vivo model of skin inflammation.

The quantitative analysis, through HPLC-UV, of macerated ethanol showed: flavonoids (0.23%), tannins (4.33%) and anthocyanins (0.031%). The skin of CD-1 mice was co-treated with croton oil and the extracts at three doses (100–300–1000 µg/cm²) for 6 or 24 hours and compared with the untreated group. The extracts showed the ability to reduce the formation of edema and the infiltration of leukocytes induced by croton oil application; the effect was dose dependent after both treatment times. Acetone extract appeared more active than ethanolic in inhibiting the two parameters. The two extracts downregulated some pro-inflammatory genes, in the skin of animals treated at the dose of 1000 µg/cm², including VEGF and IL-6, after 6 hours treatment, while no genes were downregulated by the extracts at 24 hours treatment.

Our in vivo results confirmed the activity observed in human keratinocytes, thus making this plant promising against skin inflammation.

Conflict of Interest The authors declare no conflict of interest.

References

- [1] Vahid-Dastjerdi E., Sarmast Z., Abdolazimi Z., Mahboubi A., Amdjadi P., Kamalinejad M. Effect of *Rhus coriaria* L. Water Extract on Five Common Oral Bacteria and Bacterial Biofilm Formation on Orthodontic Wire. *Iran J. Microbiol* 2014; 6 (4): 269–275
- [2] Khalilpour S., Bchnammanesh G., Suede F., Ezzat M.O., Muniandy J., Tabana Y., Ahamed M.K., Tamayol A., Majid A.M.S., Sangiovanni E. Neuroprotective and Anti-Inflammatory Effects of *Rhus coriaria* Extract in a Mouse Model of Ischemic Optic Neuropathy. *Biomedicines* 2018; 6 (2): 48
- [3] Khalilpour S., Sangiovanni E., Piazza S., Fumagalli M., Beretta G., Dell'Agli M. In vitro evidences of the traditional use of *Rhus coriaria* L. fruits against skin inflammatory conditions. *J Ethnopharmacol* 2019; 28 (238): 111829

P-255 Euphrasia planta tota extract revealed potent anti-inflammatory properties

Authors Manuela Jaklin¹, Johann Röhrl¹, Maria-Riera Piqué-Borràs¹, Gerald Künstle¹

Institute 1 Weleda AG, 4144 Arlesheim, Switzerland

DOI 10.1055/s-0043-1774128

Euphrasia officinalis is used as traditional herbal medicine in the treatment of irritated eyes for indications like allergic or non-infectious conjunctivitis and catarrhal inflammation accompanied by symptoms such as redness, swelling, pain and increased lacrimation.

Detailed investigations of pharmaceutical mode of actions for *Euphrasia* are scarce. Here we present a variety of pathways, effectively targeted by the treatment of *Euphrasia planta tota* (EPT), demonstrating its anti-inflammatory properties in vitro.

Dry extracts from EPT were prepared according to V.3c HAB. Anti-oxidative effects were investigated by the ORAC radical scavenging assay. Activation of nuclear factor kappa B (NF-κB) was analysed in a reporter assay with the human Jurkat T-cell line. Cyclooxygenase-2 (COX-2) and 5-lipoxygenase (5-LO) were analysed by enzyme inhibition assays. Alpha1A adrenergic receptor activity was tested in a cell-based cAMP assay.

We investigated EPT, showing its preventive capability of tissue damage by reduction of oxidative radicals. EPT showed a concentration-dependent inhibition of NF-κB translocation (IC₅₀: 50.7 µg/mL), generally involved in regulation of immune response and inflammation. Furthermore, we demonstrated effective enzyme inhibition of the inflammatory mediators COX-2 (IC₅₀: 7.6 µg/mL) and 5-LO (IC₅₀: 27.9 µg/mL), which play a major role in pain and inflammation. We also revealed selective agonistic activity on the alpha1A adrenoceptor (EC₅₀: 102.8 µg/mL), which could support vasoconstriction by narrowing swollen blood vessels in the eyes to reduce eye redness.

Altogether, these mechanisms targeted by EPT are contributing to a general anti-inflammatory response and preventing oxidative damage, which ultimately promotes the healing process of the affected tissue in irritated eyes.

P-256 Arctigenin – an effective modulator of gene expression related to the TLR pathways

Authors Małgorzata Kołtun-Jasion¹, Małgorzata Wrzosek², Anna Karolina Kiss¹

Institutes 1 Department of Pharmaceutical Biology, Medical University of Warsaw, Warsaw, Poland; 2 Department of Biochemistry and Pharmacogenomics, Medical University of Warsaw, Warsaw, Poland

DOI 10.1055/s-0043-1774129

In recent years, much attention has been paid to the relationship between quality of life, health and a balanced diet rich in bioactive compounds and appropriate supplementation. An interesting class of bioactive substances are compounds from the lignan group, which are commonly found in food plants, including the genera *Linum*, *Forsythia* and *Sesamum*. An example of a structure representing the lignan group is arctigenin, which is also found in herbs, including *Arctium lappa* L. or *Forsythia suspensa* Vahl. Both arctigenin and its glycosidic form, arctiin, have shown various therapeutic properties, including antimicrobial and anticancer activity. Arctigenin, through its involvement in various molecular mechanisms and signalling pathways, has also been shown to exhibit broad potential for anti-inflammatory activity, which is still under investigation.

The aim of this study was to analyse the anti-inflammatory activity of arctigenin, in lipopolysaccharide (LPS)-stimulated, THP-1-derived macrophages, by assessing the expression profile of multiple genes related to the Toll – like (TLR) receptor signalling pathways.

Arctigenin reduced the LPS-induced inflammatory response by inhibiting the MyD88-dependent and MyD88-independent TLR receptor expression pathways (TLR3, TLR5, TLR8), leading to inhibition of the secretion of pro-inflammatory cytokines (TNF, IL-6, IL-1, IFN-α), and induction of apoptosis in this model. Inflammatory responses are an important component of various acute and chronic disease states. Our results lead to a better understanding of the mechanisms that allow arctigenin to act as a potent adjuvant and immunomodulatory agent.

Conflict of Interest The authors declare no conflict of interest.

P-257 Comparison of In vitro Anti-inflammatory, COX-1/COX-2 and LOX inhibitory activities of *Malva sylvestris* L. leaves and flowers extract

Authors Rengin Baydar¹, Sevde Nur Biltekin¹, Ayşe Esra Karadağ¹

Institute 1 İstanbul Medipol University, İstanbul, Turkey

DOI 10.1055/s-0043-1774130

Malva sylvestris L. was used traditionally for its anti-inflammatory, anti-ulcerogenic and wound-healing properties. The aim of this study was the evaluation of *M. sylvestris* leaf and flower extracts for their in vitro COX-1/COX-2 and LOX enzyme inhibitory activity. The extracts were separately prepared by maceration with 70% ethanol. *M. sylvestris* extracts (European Pharmacopoeial quality) were analysed by HPLC. MTT was used for in vitro cytotoxic effects using the HEK293/A549, MCF7 and PC3 cell lines. To evaluate the COX-1/COX-2 inhibition, they were studied with commercial assay test kits (20 µg/mL concentration). The major component of *M. sylvestris* flower extract was characterised as 0.19% malvin; components of leaf extract were characterised as 0.6% tiliroside and 2.5% rutin (► **Figs. 1** and ► **2**). The cytotoxicity result showed that there was not any cytotoxic effect on HEK293 cells and the results were statistically significant. The IC₅₀ results for COX-1 and COX-2 inhibition of the flower extract were 62.13 and 23.77 µg/mL, for the leaf extract the results were 47.90 and 28.13 µg/mL, respectively. The inhibition value of the flower extract on LOX was 73.17% and the value of the leaf extract on LOX was 71.3%. Overall, *M. sylvestris* extracts showed selective potential for COX-2 enzyme inhibition. The

extracts were tested against selected cancer cell lines for the first time to the best of our knowledge. Further in vivo tests are required to confirm the anti-inflammatory and anticancer potentials of the *M. sylvestris* extracts, also combination studies are worthwhile to screen.

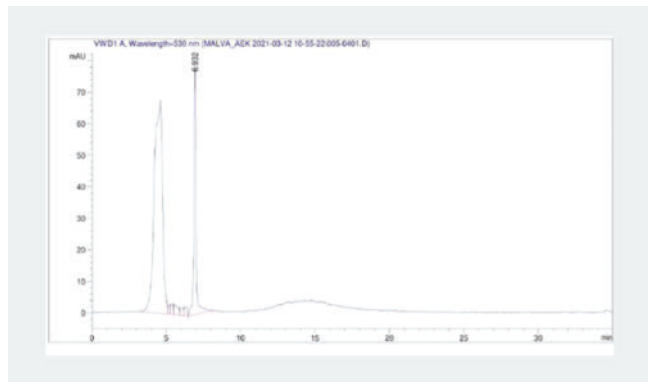

► **Fig. 1** HPLC chromatogram of the *M. sylvestris* flower extract (Malvin t_R : 6.932).

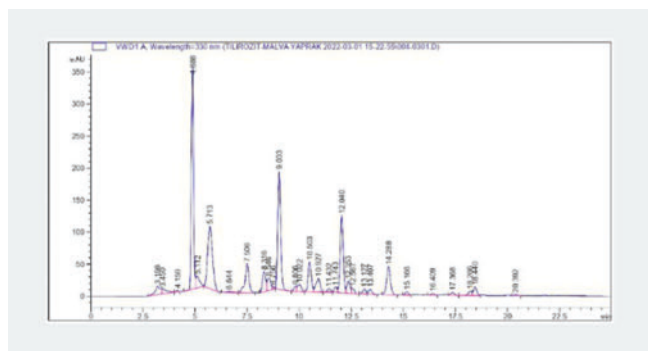

► **Fig. 2** HPLC chromatogram of the *M. sylvestris* leaf extract (t_R : 17.4 triliroside; t_R : 9.0 rutin).

Conflict of Interest The authors declare no conflict of interest.

P-258 In vitro study of antioxidant and anti-inflammatory effects of *Capparis cartilaginea* Decne. leaves

Authors Bashaer Alsharif^{1,2}, Maria Santos-Martinez^{1,3}, Fabio Boylan¹

Institutes 1 School of Pharmacy and Pharmaceutical Sciences and Trinity Biomedical Sciences Institute, Trinity College Dublin, Dublin 2, Ireland; 2 School of Pharmacy, Umm Al-Qura University, Makkah, Saudi Arabia; 3 School of Medicine, Trinity College Dublin, Dublin 2, Ireland
DOI 10.1055/s-0043-1774131

Capparis cartilaginea Decne. (*C. cartilaginea*) leaves are used in folk medicine as a decoction to alleviate inflammatory conditions such as rheumatism. However, the scientific basis for its anti-inflammatory indication remains to be proven. The present study aimed to examine the antioxidative and anti-inflammatory effects of *C. cartilaginea*. The extracts and tea of *C. cartilaginea* showed a high antioxidant profile as evidenced by the determination of total phenolics and flavonoid equivalent and the radical scavenging activity. The IC_{50} values of the extract and tea were, respectively: 24.0 ± 1.4 μ g/mL and 48.5 ± 4.4 μ g/mL in the DPPH assay; 46.5 ± 2.6 μ g/mL and 103.8 ± 1.8 μ g/mL, in the ABTS assay. To investigate their potential anti-inflammatory effect, murine (Raw 264.7) and human (THP-1) macrophages were stimulated with LPS (1 μ g/mL) in the presence or absence of *C. cartilaginea* tea, extract and oil at 50, 100 and 200 μ g/mL.

The main flavonoids isolated from the extract were tested at 50, 100 and 200 μ M. The pro-inflammatory cytokines (IL-6, IL-1 β and TNF- α) were evaluated by ELISA while the production of nitric oxide in macrophages was measured by the Griess method. Raw 264.7 and THP-1 macrophages treated with the tea, extract and flavonoids showed a decreased production of nitric oxide in a concentration-dependent manner and modulated the production of pro-inflammatory cytokines. These results support the traditional knowledge of *C. cartilaginea* tea as an anti-inflammatory agent.

P-259 Leaf extract and ellagitannins from Chestnut (*Castanea sativa* Mill.) counteract *Cutibacterium acnes*-induced inflammation in human keratinocytes

Authors Stefano Piazza¹, Giulia Martinelli¹, Carola Pozzoli¹, Nicole Maranta¹, Marco Fumagalli¹, Enrico Sangiovanni¹, Mario Dell'Agli¹

Institute 1 Dept. Pharmacological and Biomolecular Sciences "Rodolfo Paoletti", University of Milan, Milano, Italy
DOI 10.1055/s-0043-1774132

The pathogenesis of acne is characterised by dysregulated sebum production, dysbiosis, and skin inflammation. The latter is caused by the activation of the TLR-2/NF- κ B pathway, leading to chemokines release. A crucial role is attributed to the opportunistic gram-positive bacteria *Cutibacterium acnes*. However, the host response and virulence factors including biofilm formation, rather than bacterial proliferation, are correlated with the severity of disease. Ellagitannins were cited as topical candidates for skin disorders, but their role in acne is still unrevealed. Chestnut (*Castanea sativa* Mill.) leaf is a sustainable source of ellagitannins, such as castalagin, with potential anti-inflammatory and antibacterial properties (PMID: 36986236). We investigated a hydroalcoholic extract from chestnut leaf (0 – 50 μ g/mL) and castalagin (0 – 20 μ M) in human keratinocytes (HaCaT) infected with *C. acnes* (ATCC NCTC737 strain from facial acne).

Leaf extract inhibited the NF- κ B pathway, thus leading to the reduction of IL-8 and IL-6 release from HaCaT cells, with IC_{50} close to 20 μ g/mL. In parallel, castalagin impaired IL-8 release at low μ M level (IC_{50} = 3.7 μ M). Neither leaf extract nor castalagin inhibited the growth of *C. acnes*, but their addition to penicillin halved the antibiotic minimum inhibitory concentration, thus suggesting co-adjuvant effects. Of note, both leaf extract (100 μ g/mL) and castalagin (20 μ M) showed anti-biofilm activity (Crystal violet assay).

The present work underlines the anti-inflammatory and anti-biofilm effects of chestnut leaf extract, characterised by the ellagitannin content, thus supposing a novel natural candidate for the relief of acne.

Conflict of Interest The authors declare no conflict of interest.

P-260 Phytochemical characterisation and in vitro anti-inflammatory evaluation in immune cell models of *Eucommia ulmoides* Oliv. bark extracts

Authors Małgorzata Kołtun-Jasion¹, Agnieszka Sadowska¹, Anna Karolina Kiss¹

Institute 1 Department of Pharmaceutical Biology, Medical University of Warsaw, Warsaw, Poland
DOI 10.1055/s-0043-1774133

Inflammation is the body's natural defence mechanism to remove harmful stimuli and initiate a return to a state of homeostasis. Among leukocytes, neutrophils are the first line of cellular defence, giving a signal to monocytes/macrophages for further pro-inflammatory actions leading to the neutralisation of the threat. It seems crucial to search for compounds of natural origin that act comprehensively on different immune system elements to avoid the development of chronic inflammation. *Eucommia ulmoides* Oliv. cortex is a valued component of Traditional Chinese Medicine as a rich source of lignans, iridoids, flavonoids, steroids and terpenes. The wide range of secondary metabolites makes *E. ulmoides* a potential agent with anti-inflammatory, antioxidant and immunomodulatory properties.

The aim of the study was a detailed phytochemical analysis (HPLC-DAD-MS/MS) of the 60% ethanol extract and its subfractions of *E. ulmoides* cortex along with the determination of their effect on anti-inflammatory activity in Lipopolysaccharide – stimulated neutrophils and THP-1- derived macrophages.

The ethanol extract of the *Eucommiae* cortex shows a significant inhibitory effect on the secretion of pro-inflammatory cytokines (TNF- α , IL-6, IL-1 β , IL-8) in both research models. The phytochemical analysis of this raw material indicates a significant role of compounds from the group of lignans (liriodendrine, (+)- pinoresinol, di-O- β -D-glucopyranoside, (+)-syringaresinol) and iridoids (aucubin, geniposidic acid) potentially responsible for the pharmacological activity of *E. ulmoides* extracts.

The properties identified here may provide new insights to further define more precise mechanisms and applications for the *Eucommiae* cortex in therapy.

P-262 Myrrh sesquiterpenes of various scaffolds exhibit inhibitory activities on NO production in RAW 264.7 cells

Authors [Anna Unterholzner¹](#), [Katrin Kuck¹](#), [Bartosz Lipowicz²](#), [Jörg Heilmann¹](#)

Institutes **1** [Universität Regensburg, Regensburg, Germany](#); **2** [Repha GmbH Biologische Arzneimittel, Langenhagen, Germany](#)
DOI [10.1055/s-0043-1774134](#)

The oleo-gum resin of *Commiphora myrrha* (NEES) ENGL. (Burseraceae), known as myrrh, is traditionally used for a variety of diseases. Nowadays, it is well established in the treatment of ulcerative colitis in a combined herbal drug, which suggests further investigations to complete its chemical characterisation as well as revealing the molecular principles of action. Therefore, an ethanolic extract was prepared and mainly sesquiterpenes were isolated from it by chromatographic steps as previously described in parts. The sesquiterpenes elucidated using NMR and CD spectroscopy as well as HR-ESI-MS are representatives of six different structural types, one of which is reported here for the first time and represents a 4,8-cyclo-eudesmane scaffold (**1**, ► **Fig. 1**). Besides, the first lignan for *C. myrrha* was found (**2**, ► **Fig. 1**). To test anti-inflammatory activity, nine selected isolates (1,5,8-trihydroxy-4,8-cyclo-eudesma-2,7(11)Z-dien-12-al (**1**), 2 β -methoxyglychomanolide, 8-epi-2 β -methoxyglychomanolide, 2S-methoxy-8,12-epoxy-4S-furano-1(10)E-germacren-6-on, dehydrolindestrenolide, hydroxylindestrenolide, isohydroxylindestrenolide, 9-oxo-9,10- seco-isolindestrene, commiterpene E) and the reference furanoeudesma-1,3-diene were analysed for their effect on LPS-induced production of nitric oxide in a mouse macrophage cell line (RAW 264.7) including control of cell viability via an MTT assay. Seven substances, except 2 β -methoxyglychomanolide and hydroxylindestrenolide, showed a slight but significant up to 40% reduction in NO production in a concentration range of 5 to 70 μ M. Furanoeudesma-1,3-diene was the most active compound with an IC₅₀ value of 46.0 μ M. These compounds might therefore be a part of the multi-target molecular principle behind myrrh's efficacy in inflammatory diseases.

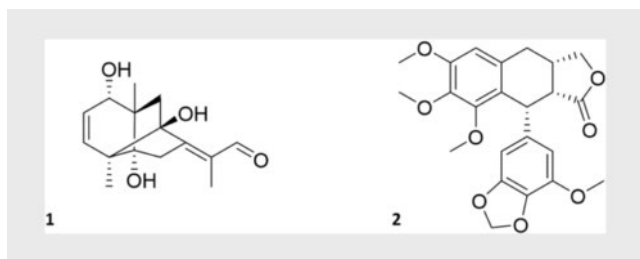

► **Fig. 1** Compound **1** represents the first described 4,8-cyclo-eudesmane type sesquiterpene and was isolated from myrrh. Compound **2** is the first lignan published for *C. myrrha*.

P-263 Evaluation of the anti-inflammatory potential of *Bergenia crassifolia* (L.) extracts

Authors [Anna Nickl¹](#), [Sanja Krstic¹](#), [Eva-Maria Pferschy-Wenzig¹](#), [Jelena S. Katanic Stankovic²](#), [Rudolf Bauer¹](#)

Institutes **1** [Institute of Pharmaceutical Sciences, Department of Pharmacognosy, University of Graz, Graz, Austria](#); **2** [Institute for Information Technologies Kragujevac, Department of Science, University of Kragujevac, Kragujevac, Serbia](#)

DOI [10.1055/s-0043-1774135](#)

Bergenia crassifolia (L.) Fritsch (Saxifragaceae) is commonly used in traditional medicine of various countries, most notably in Russia, Mongolia and China. Rhizomes, roots and leaves are utilised to treat a variety of diseases, like gastrointestinal disorders, fevers and gynaecological conditions [1, 2]. *Bergenia* extracts and infusions exhibit significant pharmacological activities, including antimicrobial, antihypertensive, adaptogenic and anti-inflammatory effects. The plant contains a multitude of bioactive constituents, such as arbutin, bergenin, tannins and flavonoids, which have been credited for some of the reported activities [1, 3].

One aim of the current study was to evaluate the anti-inflammatory properties of *B. crassifolia* leaf and root extracts by assessing inhibition of cyclooxygenase (COX-1 and COX-2) enzyme activity.

Bergenia extracts were obtained by accelerated solvent extraction (ASE) with methanol and subsequent fractionation by liquid-liquid distribution with solvents of various polarity.

The effect of *Bergenia* extracts on COX enzyme activity was assessed by using COX-1 from ram seminal vesicles and human recombinant COX-2 in a microtiter scale and by subsequently determining the level of PGE2 production via competitive ELISA. Root and leaf extracts showed high degree of COX-1 and -2 enzyme inhibition and similarly high levels of inhibition were observed in most fractions. Bergenin, arbutin and gallic acid were tested as well and displayed only moderate to no inhibitory potential on COX enzyme activity, compared to the positive controls (indomethacin for COX-1 and celecoxib for COX-2). Investigations regarding the phytochemical composition of the extracts and to identify the relevant active constituents are in progress.

Funding This project has been supported by OeAD within the funding program “Cooperation Development Research” and funded by the Austrian Federal Ministry of Education, Science and Research (BMBWF) (RS 23/2022).

Conflict of Interest The authors declare no conflict of interest.

References

- [1] Shikov AN, Pozharitskaya ON, Makarova MN, Makarov VG, Wagner H. *Bergenia crassifolia* (L.) Fritsch--pharmacology and phytochemistry. *Phyto-medicine* 2014; 21: 1534–1542. doi:10.1016/j.phymed.2014.06.009
- [2] Koul B, Kumar A, Yadav D, Jin J-O. *Bergenia* Genus: Traditional Uses, Phytochemistry and Pharmacology. *Molecules* 2020; 25: doi:10.3390/molecules25235555
- [3] Shikov AN, Pozharitskaya ON, Makarova MN, Damien Dorman HJ, Makarov VG, Hiltunen R, Galambosi B. Adaptogenic effect of black and fermented leaves of *Bergenia crassifolia* L. in mice. *Journal of Functional Foods* 2010; 2: 71–76. doi:10.1016/j.jff.2009.11.003

P-264 Development of inflammasome assays to assess novel therapeutics in immune cells related to multiple sclerosis pathogenesis

Authors [Almudena Otalora-Alcaraz¹](#), [Obianuju Ukponu¹](#), [Melody Cui-Sun¹](#), [Thomas Reilly¹](#), [Martin Sutton²](#), [Jack Prenderville²](#), [Eric J. Downer¹](#)

Institutes **1** [Trinity College Dublin, Dublin, Ireland](#); **2** [Transpharmation Ireland Ltd, Institute of Neuroscience, Trinity College Dublin, Dublin, Ireland](#)
DOI [10.1055/s-0043-1774136](#)

Multiple sclerosis (MS) is a chronic autoimmune disorder associated with sensory and motor impairments. In Ireland, MS currently afflicts over 9,000 people, with approximately 290 people diagnosed with MS in Ireland each year. A range of disease-modifying therapies (DMTs) are available for symptom management

in MS, nevertheless, most DMTs present with side-effects. There is a need for new therapeutic strategies in MS. Although MS is a complex disease, there is evidence indicating the role of neuroinflammation in MS pathogenesis. The NLRP3 inflammasome has a well-established function in innate immunity, and current evidence suggests that targeting the inflammasome is a key therapeutic target in the disease. Indeed, small molecule NLRP3 inhibitors are in pre-clinical development for MS. The goals of this project are to define the role of the inflammasome in MS and to identify novel inflammasome inhibitors that have efficacy in immune cells with relevance to MS. This study assessed the expression profile of inflammasome markers (IL-1 β /IL-18) in plasma samples from healthy control cases and people with MS. In addition, using a combination of human macrophage cell lines (THP-1), primary immune cell lines and whole blood assays, this project has established inflammasome assays. Cannabidiol (CBD) and tetrahydrocannabinol (THC) are protective in murine models of MS, and Sativex (a 1:1 combination of THC:CBD), is clinically available for symptom management in MS. Hence, this project is assessing the efficacy of THC/CBD as inflammasome inhibitors in immune cells with relevance to MS.

P-265 Anti-inflammatory activity and hepatotoxicity of four South African *Croton* species

Authors Guy Kamatou¹, Khumo Rampa¹, Maryna Van De Venter², Trevor Koekemoer², Bresler Swanepoel², Luanne Venables², Anna Hattingh², Alvaro Viljoen^{1,3}

Institutes 1 Department of Pharmaceutical Sciences, Tshwane University of Technology, Private Bag X680, Pretoria, South Africa; 2 Department of Biochemistry and Microbiology, Nelson Mandela University, PO Box 77000, Port Elizabeth, South Africa; 3 SAMRC Herbal Drugs Research Unit, Faculty of Science, Tshwane University of Technology, Private Bag X680, Pretoria, South Africa
DOI 10.1055/s-0043-1774137

The genus *Croton* encompasses about 1300 species worldwide and 26 species are on the African continent. Many species of this genus are traditionally used for the treatment of many diverse conditions such as diabetes, malaria, sexually transmitted diseases, cancer and inflammation. The objective of the study was to evaluate the potential of four South African *Croton* species extracts (*Croton gratissimus* Burch., *C. pseudopulchellus* Pax, *C. sylvaticus* Schltldl, and *C. steenkampianus* Gerstner) for anti-inflammatory activity and to evaluate the potential risk for hepatotoxicity. Leaves of the four species were extracted with methanol and chloroform (1:1, v/v). The anti-inflammatory activity was determined using lipopolysaccharide (LPS) induced nitric oxide production in RAW 264.7 macrophages, while the hepatotoxicity was evaluated using multi-parameter end point analysis in complement components (C3A). All four species attenuated nitric oxide production with negligible cytotoxicity. However, *C. gratissimus* yielded the most favourable profile. Cell density was significantly reduced in both C3A with the *C. gratissimus* extract providing a suitable toxicity profile. In general, the data suggested that some species possess anti-inflammatory potential. However, there is a risk for possible hepatotoxic side effects associated with the plants investigated.

P-266 Anti-inflammatory effects of *Artemisia argyi* and *A. princeps* extract in mice with contact dermatitis in vitro and in vivo

Authors Hyungwoo Kim¹

Institute 1 Pusan National University, Yangsan, South Korea
DOI 10.1055/s-0043-1774138

The leaves of *Artemisia argyi* Lev. et Vant. and *A. princeps* Pamp. are well known medicinal herbs used to treat patients in China, Japan and Korea with skin problems such as eczema and itching, as well as abdominal pain and dysmenorrhoea. We investigated the anti-inflammatory effects of *Artemisia* leaf extract (ALE) using contact dermatitis (CD) mice and RAW 264.7 cells. The effects of ALE on histopathological changes and cytokine production in ear tissues were assessed in mice with CD induced by 1-fluoro-2,4-dinitrobenzene (DNFB). Moreover,

the anti-inflammatory effects on production levels of prostaglandin E2 (PGE2) and nitric oxide (NO), and expression levels of cyclooxygenase 2 (COX-2) and inducible nitric oxide synthase (iNOS) were investigated in RAW 264.7 cells. Topical application of ALE effectively prevented ear swelling induced by repeated DNFB application. ALE prevented epidermal hyperplasia and infiltration of immune cells and lowered the production of interferon (IFN)-gamma, tumour necrosis factor (TNF)-alpha and interleukin(IL)-6 in inflamed tissues. In addition, ALE inhibited expression of COX-2 and iNOS and production of NO and PGE2 in RAW 264.7 cells. These results indicate that *Artemisia* leaf can be used as a therapeutic agent for inflammatory skin diseases, and that its anti-inflammatory effects are closely related to the inhibition of inflammatory mediator release from macrophages and inflammatory cytokine production in inflamed tissues.

P-268 Probing the anti-inflammatory activity of tormentil rhizome (*Potentilla erecta* (L.) Raeusch., rhizoma)

Authors Maria Pigott¹, Ismael Obaidi¹, Elaine Dempsey²,

Cillian Jacques Gately¹, Michael Carty³, Sinéad C. Corr², Helen Sheridan¹

Institutes 1 NatPro Centre, School of Pharmacy and Pharmaceutical Sciences, Trinity College Dublin, Dublin, Ireland; 2 Dept. of Microbiology, School of Genetics and Microbiology, Trinity College Dublin, Dublin, Ireland; 3 School of Biochemistry and Immunology, Trinity Biomedical Sciences Institute, Trinity College Dublin, Dublin, Ireland
DOI 10.1055/s-0043-1774139

Traditional herbal medicinal products of *Potentilla erecta* (L.) Raeusch., rhizoma (tormentil rhizome) are indicated for symptomatic treatment of mild diarrhoea or minor inflammations of the oral mucosa exclusively based upon long-standing use. Tormentil's utility is largely attributed to the astringent effects of the rhizome's high tannin content but there are also non-clinical reports of the antimicrobial, antioxidant, anti-inflammatory and immunostimulatory effects of tormentil that may contribute to its pharmacology. In this study, we probed the anti-inflammatory effects of tormentil rhizome in vitro and in a dextran sodium sulfate (DSS) mouse model of colitis. A methanolic extract was screened for effects on lipopolysaccharide induced cytokine release in human THP-1 cells and in murine immortalised bone marrow derived macrophages (iBMDMs). In phorbol 12-myristate 13-acetate differentiated THP-1 cells, tormentil reduced the production of TNF- α , IL-1 β , IL-6 and RANTES on stimulation. Somewhat contradictory results were found in murine iBMDMs, whereby treatment caused a dose dependent increase in TNF- α with no significant change in IL-6 or RANTES. In line with this, tormentil treatment in the DSS model increased TNF- α in the proximal colon tissue of the DSS group and also increased IL-1 β and IL-10 significantly. Despite these changes, a small but significant reduction in colitis severity, as demonstrated by the reduced Disease Activity Index, was observed on the last day of the experiment. Furthermore, tormentil treatment increased basal IL-10 in the proximal colon of healthy control animals. Taken together, these results support further work to unravel the mechanism underlying the immunomodulatory effects of tormentil rhizome extract.

P-269 A combination of *Zingiber officinale* root extract and cannabidiol exhibits potent anti-inflammatory effects and ameliorates clinical symptoms of atopic dermatitis

Authors Martin Kragl¹, Christine Neubauer¹, Kathrin Moritz¹, Ramona Ziegler¹, Nicole Mähler¹, Michael Soeberdt¹, Ehsan Bonyadirad², Theodor Braun³, Przemyslaw Filipek³, Thomas Jakschitz³, Andreas Koeberle², Günther Bonn³, Christoph Abels¹

Institutes 1 Bionorica SE, Neumarkt, Germany; 2 Michael Popp Institute, Innsbruck, Austria; 3 Austrian Drug Screening Institute (ADSI), Innsbruck, Austria

DOI 10.1055/s-0043-1774140

Potential anti-inflammatory and anti-oxidative activities of 24 plant extracts displaying different polarities were screened in various in vitro assays and applied to a principal component analysis. Cannabidiol (CBD) and a *Zingiber officinale* root (ginger) extract were found to be extraordinarily active.

In subsequent studies on TNF- α -stimulated NF- κ B activation [1], poly(I:C)-stimulated cytokine and chemokine secretion from human epithelial primary cells and cell lines, their anti-inflammatory activities were confirmed. Notably, the combination of CBD and ginger consistently enhanced the anti-inflammatory effects, accompanied by an increased release of the endocannabinoid anandamide. A positive modulation of the endocannabinoid system is relevant for effects regarding inflammation and pruritus [2, 3]. Subsequently, an O/W emulsion containing CBD and ginger was developed and investigated in a clinical trial including 44 subjects with history of atopic eczema and itching score of at least 1. Efficacy and tolerability were evaluated at baseline and after 5 days of product application. A statistically significant reduction of erythema, skin dryness and trans epidermal water loss was observed, whereas skin moisture increased significantly. Subjective evaluation of an itch using a numeric rating scale [4] showed a continuous decrease that was significantly reduced from day 2 onwards. The product was very well tolerated.

In summary, identification of CBD and *Zingiber officinale* root extracts with proven antioxidative and anti-inflammatory activities enabled the development of a new O/W emulsion which improved key symptoms of dry and eczema-prone skin clinically.

Funding This project was funded by Bionorica SE, Germany.

Conflict of Interest This study was supported by industrial research grants, and several of the authors (CA, CN, KM, MK, MS, NM, and RZ) are employees of the sponsor. CA and MS are named as inventors on a patent application for compositions containing cannabidiol and an extract from ginger.

References

- [1] Leitner PD, Jakschitz T, Gstir R, Stuppner S, Perkams S, Kruus M, Trockenbacher A, Griesbeck C, Bonn GK, Huber LA. Anti-Inflammatory Extract from Soil Algae *Chromochloris zofingiensis* Targeting TNFR/NF- κ B Signaling at Different Levels. *Cells* 2022; 11: 1407
- [2] Tóth KF, Ádám D, Bíró T, Oláh A. Cannabinoid Signaling in the Skin: Therapeutic Potential of the "C (ut)annabinoid" System. *Molecules* 2019; 24: 918
- [3] Oláh A, Ambrus L, Nicolussi S, Gertsch J, Tubak V, Kemeny L, Soeberdt M, Abels C, Biro T. Inhibition of fatty acid amide hydrolase exerts cutaneous anti-inflammatory effects both in vitro and in vivo. *Exp Dermatol* 2016; 25: 328–330
- [4] Yosipovitch G, Reaney M, Mastey V, Eckert L, Abbe A, Nelson L, Clark M, Williams N, Chen Z, Ardeleanu M. Peak Pruritus Numerical Rating Scale: psychometric validation and responder definition for assessing itch in moderate-to-severe atopic dermatitis. *British Journal of Dermatology* 2019; 181: 761–769

P-270 Evaluation of antioxidant, anti-inflammatory and neuroprotective activities and chemical contents of species used traditionally for inflammation in Turkey

Authors [Burcu Sen](#)¹, [Sukran-Kubra Ilhan](#)^{1,2}, [Buge Erel](#)^{3,4}, [Zulfiye Gul](#)³, [Timucin Avsar](#)⁵, [Hilal Bardakci](#)^{6,7}, [Alexandra K. Kierner](#)⁸, [Britta Diesel](#)⁸

Institutes 1 Istanbul University, Faculty of Pharmacy, Department of Pharmacognosy, 34116, Istanbul, Turkey; 2 Logo Pharmacy, 34510, Istanbul, Turkey; 3 Bahcesehir University, Faculty of Medicine, Department of Medical Pharmacology, 34734, Istanbul, Turkey; 4 Novartis Turkey, Business Excellence & Execution – Customer Strategy (CX) & Digital, 34805, Istanbul, Turkey; 5 Bahcesehir University, Faculty of Medicine, Department of Medical Biology, 34734, Istanbul, Turkey; 6 Acibadem Mehmet Ali Aydinlar University, Faculty of Pharmacy, Department of Pharmacognosy, 34684, Istanbul, Turkey; 7 Fenerbahce University, Faculty of Pharmacy, Department of Pharmacognosy, 34758, Istanbul, Turkey (current address); 8 Saarland University, Department of Pharmacy, Pharmaceutical Biology,

66123, Saarbrücken, Germany

DOI 10.1055/s-0043-1774141

The pathophysiology of Parkinson's disease (PD) is linked to accumulation of the cytoplasmic structures called Lewy bodies with their main constituent being α -synuclein oligomers. Recent studies showed that α -synuclein overexpression is associated with microglial activation, neuroinflammation, and neurodegeneration. In order to protect neurons and prevent disease progression, studies on agents that are effective on α -synuclein expression, whose oligomers cause cell damage by initiating neuroinflammation, and therefore anti-inflammatory and antioxidant agents, are increasingly important [1].

This study aimed to determine antioxidant, anti-inflammatory, and neuroprotective activities of various extracts of *Clematis vitalba*, *Ecballium elaterium* (EE), *Fraxinus ornus* subsp. *ornus* (FOO), *Paliurus spina-christi* and *Sambucus ebulus* (SE), which might indicate a therapeutic potential for treatment of inflammatory disorders like PD. FOO showed the highest antioxidant activity by DPPH method. FOO, SE and EE extracts exhibited higher anti-inflammatory potential since they reduced nitric oxide and TNF-production by Griess assay (using LPS-activated RAW 264.7 macrophages) and TNF bioassay (using L929 cells), and were found to be rich in flavonoid and phenolic compounds chromatographically. Therefore, their protective activities on the toxicity induced by rotenone and A-53T- α -synuclein plasmid were tested by analysis of the change in α -synuclein expression, its effect on the cell lines and cell viability analysis through xCELLigence. Only FOO cortex extract was protective and decreased the cell death. Our findings indicate that FOO has good anti-inflammatory and neuroprotective activity. Further studies are required to assess its potential applications in the treatment of inflammatory disorders like PD.

References

- [1] Forloni G. Alpha Synuclein: Neurodegeneration and Inflammation. *Int. J. Mol Sci* 2023; 24: 5914

P-271 Chalcones from *Melodorum fruticosum* inhibit microsomal prostaglandin E2 synthase-1 (mPGES-1) and 5-lipoxygenase (5-LO)

Authors [Birgit Waltenberger](#)¹, [S. Engels](#)^{1,2}, [Veronika Temml](#)³, [Loi Huynh](#)^{4,5}, [Hung Tran](#)⁴, [Oliver Werz](#)⁶, [Andreas Koehler](#)⁷

Institutes 1 Institute of Pharmacy/Pharmacognosy and Center for Molecular Biosciences Innsbruck (CMBI), University of Innsbruck, Innsbruck, Austria; 2 Department of Extract(ion) Research and Phytoanalytics, Bionorica research GmbH, Innsbruck, Austria; 3 Department of Pharmaceutical and Medicinal Chemistry, Paracelsus Medical University Salzburg, Salzburg, Austria; 4 Department of Pharmacognosy, Faculty of Pharmacy, University of Medicine and Pharmacy, Hô Chí Minh, Vietnam; 5 School of Medicine and Pharmacy, University of Danang, Da Nang, Vietnam; 6 Chair of Pharmaceutical/Medicinal Chemistry, Institute of Pharmacy, Friedrich-Schiller-University, Jena, Germany; 7 Michael Popp Institute and Center for Molecular Biosciences Innsbruck (CMBI), University of Innsbruck, Innsbruck, Austria

DOI 10.1055/s-0043-1774142

Melodorum fruticosum (Annonaceae) is used in traditional Vietnamese medicine to aid digestion and has previously been shown to inhibit interleukin-8 (IL-8) release in human neutrophils [1]. Herein, we report additional anti-inflammatory features of this medicinal plant. At 30 μ g/mL, the dichloromethane (DCM) extract of *M. fruticosum* leaves inhibited microsomal prostaglandin E₂ synthase-1 (mPGES-1), which catalyses the formation of prostaglandin E₂, to 11.5% residual activity. Moreover, at the same concentration, it also inhibited 5-lipoxygenase (5-LO), an enzyme catalysing the formation of leukotrienes (LT), to a residual activity of 19.4%. To identify the constituents which might be responsible for these anti-inflammatory activities, fifteen constituents isolated from the bioactive DCM extract of *M. fruticosum* were analysed for their inhibitory activities on mPGES-1 and 5-LO. The benzylated chalcone 2',4'-dihydroxy-4,6'-dimethoxy-3'(2''-hydroxybenzyl)chalcone and its corresponding dihydrochalcone, also known as MF-15, were most active against mPGES-1 with IC₅₀ values

of 2.6 and 1.8 μM , respectively. The benzylated dihydrochalcone MF-15 showed also the highest activity against 5-LO ($\text{IC}_{50} = 3.4 \mu\text{M}$), together with 2',4'-dihydroxy-4,6'-dimethoxychalcone, 2',4'-dihydroxy-4,6'-dimethoxydihydrochalcone, and 2',6'-dihydroxy-4'-methoxychalcone, inhibiting 5-LO with IC_{50} values between 9.6 and 12.2 μM . The obtained inhibitory activities against mPGES-1 and 5-LO were supported by docking studies which revealed putative binding modes of the bioactive natural products in the active sites of the enzymes. The findings of this study show that *M. fruticosum* possesses promising anti-inflammatory activity via multiple pathways and points of attack.

Conflict of Interest The authors declare no conflict of interest.

References

[1] Engels Waltenberger, Michalak Huynh, Tran Kiss, Stuppner Chem Biodivers 2018; 15 (11): e1800269

P-272 Effects of Iso-mukaadial acetate on glucose homeostasis, insulin secretion and haematological function in streptozotocin-induced diabetic rats

Authors Nontokozi Msomi¹, Murtala Isah², Mohammed Ibrahim³, Mthokozisi Simelane⁴

Institutes 1 University of KwaZulu Natal, Durban, South Africa; 2 Umaru Musa Yar'adua University, Katsina, Nigeria; 3 Ahmadu Bello University, Zaria, Nigeria; 4 University of Johannesburg, Johannesburg, South Africa
DOI 10.1055/s-0043-1774143

Diabetes is a chronic, progressive metabolic disorder which is becoming a global health risk, as its prevalence is increasing steadily worldwide. *Warburgia salutaris* (Bertol. f.) Chiov. [Canellaceae] is traditionally used to treat diabetes. The use of hypoglycaemic plants to manage this condition is a common practice in developing countries. In the present study, iso-mukaadial acetate (MA) from the ground stem bark of *W. salutaris* was evaluated for its effect on blood glucose, insulin level and haematological parameters in a streptozotocin (STZ) induced diabetic rat model. Male Sprague-Dawley rats were randomly divided into untreated and treated groups with MA (0.5, 1.5 and 2.5 mg/kg), acarbose (10 mg/kg) and crude extract (1.5 mg/kg). Diabetes was induced in the diabetic group and treatment was administered for five days (Days 8-12). Treatment with MA improved body weight, white blood cells, haemoglobin and eosinophil levels with a moderate decrease in neutrophils in comparison to the diabetic control animals. MA at its lowest dose (0.5 mg/kg) improved red blood cell production and significantly increased lymphocytes, with a marginal decrease in monocytes in comparison to the diabetic control animals. It was further observed that MA at its lowest dose decreased blood glucose concentration and slightly increased insulin level, compared to the highest doses of MA. The data of this study suggests that administration of iso-mukaadial acetate at its lowest concentration modulates diabetes-induced haematological changes. However, further experimental studies are required to substantiate its relevant therapeutic effects.

P-273 Anti-obesity effects of *Philadelphus tenuifolius* extract via improvement of lipid metabolism in high-fat diet-induced obese mice

Authors Yoon-Young Sung¹, Mi-Sun Kim¹, Heung Joo Yuk¹, Seung-Hyung Kim², Geung-Joo Lee³, Dong-Seon Kim¹

Institutes 1 KM Science Research Division, Korea Institute of Oriental Medicine, Daejeon 34054, Republic of Korea; 2 Institute of Traditional Medicine and Bioscience, Daejeon University, Daejeon 34520, Republic of Korea; 3 Department of Horticulture, Chungnam National University, Daejeon 34134, Republic of Korea
DOI 10.1055/s-0043-1774144

Philadelphus tenuifolius is a Korean native plant used for nerve tonic, diuretics and haemorrhoids. This study investigated the anti-obesity activities of an extract of the leaves of *Philadelphus tenuifolius* in high-fat diet-induced obese mice. *Philadelphus tenuifolius* treatment significantly reduced body weight, food

efficiency ratio, adipose tissue mass, adipocyte size, and serum triglyceride, glucose, total cholesterol, low density lipoprotein-cholesterol and leptin levels in obese mice relative to the high-fat diet-fed mice. Furthermore, *Philadelphus tenuifolius* suppressed the mRNA levels of sterol regulatory element-binding protein 1c, peroxisome proliferator-activated receptor γ , C/EBP α , adipocyte fatty acid-binding protein and fatty acid synthase in white adipose tissue with increased levels of uncoupling protein 1 in brown adipose tissue of obese mice. These results suggest that *Philadelphus tenuifolius* ameliorated high-fat diet-induced obesity by downregulating the expression of transcription factors and lipogenic enzymes involved in lipid metabolism. Therefore, *Philadelphus tenuifolius* could be useful for preventing and treating obesity and its related metabolic diseases [1–2].

Funding This work was supported by the KIOM of Korea (grant no. KSN1823312).

References

[1] Spiegelman B.M. et al. Cell 2001; 104: 531–543
[2] Lee Y.S. et al. Nutrients 2018; 10: 1204

P-274 Alpha-Glucosidase inhibitory activity of phenolic compounds from the stems of *Caesalpinia decapetala* var. *japonica*

Authors Thi Thanh Le¹, Manh Tuan Ha¹, Jeong Ah Kim², Byung Sun Min¹

Institutes 1 Daegu Catholic University, Hayang-eup Hayang-ri, 13-13, Kyeongsan-si, South Korea; 2 College of Pharmacy, Research Institute of Pharmaceutical Sciences, Kyungpook National University, Daegu, South Korea
DOI 10.1055/s-0043-1774145

To obtain antidiabetic active compounds from the natural sources, 14 compounds were isolated from the stems of *Caesalpinia decapetala* var. *japonica*. Their structures were elucidated based on a comparison of their physicochemical and spectral data with those of literature. To the best of our knowledge, this represents the first isolation of compounds **3**, **4**, **8**, **9**, and **10** from *C. decapetala* and compounds **13** and **14** from the *Caesalpinia* genus. All the isolated compounds were evaluated for their inhibitory effect against the α -glucosidase enzyme. Among them, two flavonols (**1** and **9**), one chalcone (**6**), and one homoisoflavanone (**7**) exhibited an inhibitory effect on α -glucosidase action with an IC_{50} range of 5.08 – 15.01 μM , stronger than that of the positive control (acarbose, $\text{IC}_{50} = 152.22 \mu\text{M}$). Kinetic analysis revealed that compounds **1** and **9** showed non-competitive α -glucosidase inhibition, while the inhibition type was mixed for compounds **6** and **7** (► Fig. 1) [1–2].

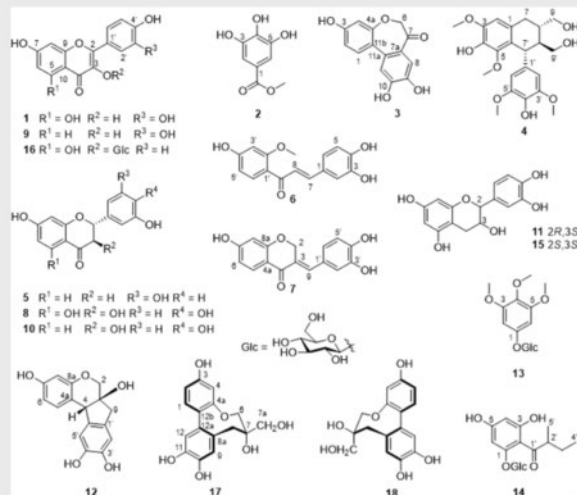

► Fig. 1 Chemical structures of compounds 1–14 from *C. decapetala* var. *japonica*.

References

- [1] Le TT, Ha MT, Hoang LM., Vu NK., Kim JA, Min BS. α -Glucosidase Inhibitory Activity of Phenolic Compounds Isolated from the Stems of *Caesalpinia decapetala* var. *japonica*. *Natural Product Sciences* 2022; 28 (3): 143–152
- [2] Van de Laar FA., Lucassen PIBJ., Akkermans RP., Van de Lisdonk EH., Rutten GEHM., Van Weel C. Alpha- glucosidase inhibitors for type 2 diabetes mellitus. *Cochrane Database Syst. Rev* 2005; CD003639

P-275 Oxindole and Benzoxazinone Alkaloids from the Seeds of *Persea americana* Mill. (Avocado) and their SIRT 1 Stimulatory Activity

Authors Won-Keun Oh¹, Thi-Phuong Doan¹, Mi Zhang¹

Institute 1 Research Institute of Pharmaceutical Sciences, College of Pharmacy, Seoul National University, Seoul, South Korea

DOI 10.1055/s-0043-1774146

Persea americana Mill. (Lauraceae), commonly known as avocado, is a well-known food because of its nutrition and health benefits. The seeds of avocado are major byproducts, and, thus their phytochemicals and bioactivities have been of interest for study. The chemical components in avocado seeds were investigated by using UPLC-qTOF-MS/MS-based molecular networking, resulting in the isolation of seven new oxindole alkaloids (**1**–**7**) and two new benzoxazinone alkaloids (**8** and **9**). The chemical structures of the isolated compounds were identified by NMR spectroscopy methods in combination with computational approaches, including NMR and ECD calculations. The activities of the isolated compounds towards silent information regulation 2 homolog-1 (SIRT1) in HEK293 cells were tested. The results showed that compound **1** had the most potent effect on SIRT1 activation with an elevated NAD⁺/NADH ratio and could be a promising candidate for further investigation as an anti-ageing agent.

P-276 Evaluation of antioxidant and antidiabetic activities of *Trigonella foenum-graecum* phytoestrogen-rich extracts

Authors Gabriela Paun¹, Elena Neagu¹, Camelia Albu¹,

Oana Teodora Apreutesei², Gabriel Lucian Radu¹

Institutes 1 National Institute For Research-Development Of Biological Sciences, Bucharest, Romania; 2 Centrul de Cercetare si Prelucrare a Plantelor Medicinale PLANTAVOREL S.A, Piatra Neamt, Romania

DOI 10.1055/s-0043-1774147

Trigonella foenum-graecum has long been used in traditional medicine for different diseases. Recent studies highlighted the antidiabetic activity of fenu-greek seeds linked to the presence of trigonelline alkaloid and galactomannan polysaccharides [1, 2]. In this study, *T. foenum-graecum* extract was obtained by accelerated solvent extraction (ASE), and processed by microfiltration and nanofiltration in a tangential module, using a membrane with MWCO 150-300 Da for concentrating the phytoestrogen compounds. Some of the most important phytoestrogens are flavonoids and isoflavonoids. Plant extracts were evaluated for phytochemical profile (phenolics, flavonoids, isoflavonoids), antioxidant (DPPH• and reducing power assays), α -amylase and α -glucosidase inhibition. The HPLC-MS analysis showed that the *T. foenum-graecum* phytoestrogen-rich extract contains mainly vitexin, rutin and isoquercitrin. The studied extract exhibited a high antioxidant capacity in DPPH inhibition (85.7 \pm 0.6%) and reducing power assay (94.7%). The *T. foenum-graecum* phytoestrogen-rich extract showed significant α -amylase (IC₅₀ = 9.71 μ g/mL) and α -glucosidase (IC₅₀ = 28.19 μ g/mL) inhibitory activities, compared to acarbose as control (IC₅₀ = 24.18 μ g/mL and 798.32 μ g/mL, respectively). Furthermore, combinations of isoflavones with other bioactive compounds from the concentrated extract could act synergistically and the *T. foenum-graecum* phytoestrogen-rich extract could be a feasible source of nutraceuticals.

Funding This work was supported by a grant of the Ministry of Research, Innovation and Digitization, CCCDI – UEFISCDI, project number PN-III-P2-2.1-PED-2021-1185, within PNCDI III.

References

- [1] Singh N., Yadav S.S., Kumar S., Narashiman B. *Food Biosci* 2022; 46: doi:10.1016/j.fbio.2022.101546
- [2] Srinivasa U.M., Naidu M.M. *Studies in Natural Products Chemistry* 2021; 71: 141–184

P-277 Inhibitory effect of *Cinnamomum cortex* extracts on PCSK9 expression in fructose induced HepG2

Authors Min Ho Cha¹, Kwang-Youn Kim¹, Song-Hee Kim¹

Institute 1 Korea Institute Of Oriental Medicine, Daegu, South Korea

DOI 10.1055/s-0043-1774148

Cinnamomum cortex (dried bark of *Cinnamomum verum*), which is a widely used herb in food ingredients and traditional medicine, contains many bioactive components such as cis-cinnamaldehyde, cinnamyl acetate etc. In this study, we elucidated that the water extract of *Cinnamomum cortex* (WCC) has a strong inhibitory effect on proprotein convertase subtilisin/kexin type 9 (PCSK9) expression, which plays a role in the regulation of low-density lipoprotein receptor (LDLR) degradation, in fructose induced HepG2 cells. We investigated the effect of WCC on PCSK9 expression using q-PCR and western blot, and predicted pathways affected by WCC on PCSK9 expression using chemical-protein interaction. WCC significantly inhibited PCSK9 expression, which is induced by fructose or lovastatin, in a dose dependent manner. Chemical-protein interaction using three databases, (Promo DB, TSMC DB and STICH DB) showed that WCC might affect the PPAR signalling pathway regulating lipid metabolism in the liver. PPAR/RXR expression, induced by fructose, was also attenuated by WCC. In conclusion, our results showed that WCC inhibits PCSK9 expression through regulating the MAPK/PPAR signalling pathway, and WCC could be used as a natural product for preventing hypercholesterolemia.

P-278 American Cranberry (*Oxycoccus macrocarpus*) Leaves Extract and Its Modified Arginine Preparation for the Management of Insulin Resistance

Authors Ain Raal¹, Inna Vlasova², Ganna Kravchenko²,

Oleh Koshoviy^{1, 2}

Institutes 1 University of Tartu, Tartu, Estonia; 2 National University of Pharmacy, Kharkiv, Ukraine

DOI 10.1055/s-0043-1774149

Metabolic syndrome is a cluster of abnormalities combining insulin resistance (IR), obesity, hypertension, and atherosclerotic hyperlipidemia suggested to be a pandemic by WHO experts. In Ukraine, bilberry leaves (*Vaccinium myrtillus*, Ericaceae) are widely used as a hypoglycemic agent. American cranberry (AC) could be of particular interest for IR prevention. During cultivating, AC bushes are pruned annually; leaves act as by-products and are interesting for supplements with hypoglycemic activity development.

The aim was to study the chemical composition and hypoglycemic activity of AC leaves extract and its arginine preparation.

AC leaves were macerated (1:10) twice with 50% ethanol at room temperature, evaporated to the dry extract (E1). The content of phenolic substances in the liquid extract was 1.04%, arginine was added at three times equimolar amount to them. E1 is a brown loose powder, its arginine preparation (E2) – a viscous mass.

In the extracts, quinic, 3-caffeoylquinic (chlorogenic), p-coumaroylquinic acids, quercetin 3-O-galactoside, quercetin-3-O-glucoside, quercetin-3-xyloside, quercetin-3-O-arabinopyranoside, quercetin-3-O-arabinofuranoside, quercetin 3-O-rhamnoside and quercetin-O-p-coumaroyl-hexoside-2 were identified by HPLC. Assay of phenolic compounds, flavonoids and hydroxycinnamic acids were determined by spectrophotometry. The oral glucose tolerance test with the extracts demonstrated positive dynamics in IR correction. E2 administration showed reducing glycemia by 22.6%. AC extracts restored insulin concentration

compared with metformin. They had positive effect on liver lipid content, reducing triacylglycerols, diacylglycerols and free fatty acids.

The studies revealed potential of AC leaves extracts in prevention of insulin-resistance, which can be additionally augmented by conjugation with L-arginine.

Funding This work was supported by the MSCA4Ukraine (1232466).

Conflict of Interest The authors declare no conflict of interest.

P-279 Triterpene-enriched natural extract modulates the expression of metabolic pathways in primary human adipocytes and mouse adipocyte cell lines.

Authors Sergio Acin^{1,2}, Alejandro Mejia¹, Geysson Fernandez¹, Luis Fernando Echeverri³, Norman Balcazar¹

Institutes 1 Universidad de Antioquia/GENMOL Group – Faculty of Natural and Exact Sciences, Medellin, Colombia; 2 Universidad de Antioquia, Faculty of Medicine, Department of Physiology and Biochemistry, Medellin, Colombia; 3 Universidad de Antioquia/Organic chemistry of natural products group – Faculty of Natural and Exact Sciences, Medellin, Colombia

DOI 10.1055/s-0043-1774150

Previous studies have shown that a triterpene-enriched extract of *Eucalyptus tereticornis* (OBE100), with ursolic acid (UA), oleanolic acid (OA) and ursolic acid lactone (UAL), reduces the expression of genes involved in lipogenesis and enhanced genes expression involved in catabolism in 3T3-L1 cells. The present work aims to analyse the effect of OBE100 and single triterpenes on gene expression in primary human adipocytes and mouse 3T3-L1 adipocyte cell lines. Differentiated cells were treated with OBE100, UA, OA, UAL or a triterpene mixture (M1). RNA was sequenced using the DNBseq platform and the EnrichR software to perform gene enrichment analysis using the Gene Ontology database, Kyoto Encyclopaedia of Genes and Genomes, and Reactome was used. To conduct clustering analysis, we standardised the normalised counts of each gene and applied k-means clustering.

When the expression pattern of differentiated human and mouse adipocytes was compared with the control, 933 differentially expressed genes (DEGs) were identified. When comparing the different treatments with the differentiated control, OBE100 generated the most significant change in DEGs. OBE100 generates a negative regulation of the PPAR pathway and metabolism of fatty acids, triglycerides, and ketone bodies. It increases the expression of extracellular matrix genes and the TGF-beta pathway.

These results suggest that the transcriptional effect of OBE100 treatment is higher, inhibiting the expression of genes involved in adipogenesis and extracellular matrix remodelling. On the other hand, it provides valuable information in determining potential action targets in adipocytes treated with a complex mixture of triterpenes.

P-280 New amorfrutins from *Glycyrrhiza foetida* and their profile of PPAR γ / α modulation

Authors Elena Serino¹, Francesca Masi¹, Hekmat Al-Hmadi^{2,3}, Saoussen Hammami², Fabio Arturo Iannotti⁴, Rosa Maria Vitale⁴, Orazio Tagliabue-Scafati¹

Institutes 1 Department of Pharmacy, School of Medicine and Surgery, University of Naples Federico II, Naples, Italy; 2 Research Unit LR21E504, Environmental and Clean Processes Chemistry Faculty of Sciences of Monastir, Monastir University, Monastir, Tunisia; 3 Department of Chemistry, College of Medicine, AL-Muthanna Univeristy, Samawah, Iraq; 4 Institute of Biomolecular Chemistry (ICB) – National Research Council (CNR), Pozzuoli, Italy

DOI 10.1055/s-0043-1774151

Amorfrutins are an intriguing class of secondary metabolites, described for the first time in *Amorpha fruticosa*, that are reported to be highly active as PPAR γ (peroxisome proliferator-activated receptor gamma) agonists. PPAR γ plays a crucial role in many biological pathways involved in type 2 diabetes mellitus and obesity, widespread pathological conditions in western world. The available drugs active on this target are thiazolidinediones (e.g. rosiglitazone), but their use is often associated with severe side effects. More recently, amorfrutins have been also found in *Glycyrrhiza foetida*, a less investigated species of the genus *Glycyrrhiza*, whose phytochemical properties, despite the attractive information mentioned in literature, have not been deepened yet (► Fig. 1).

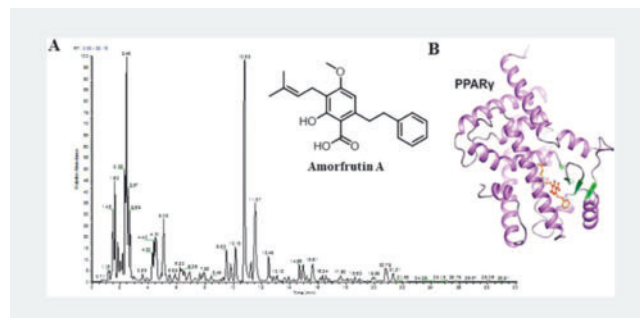

► Fig. 1 LC-MS profile of *G. foetida* aerial parts extract (a). Amorfrutin A bound to PPAR γ (b).

Thus, in the frame of our research activity in identifying natural compounds active on metabolic syndrome condition, we have focused our efforts on exploring the phytochemical space of *G. foetida* amorfrutins. After a preliminary LC-MS² analysis of aerial parts extract, 16 amorfrutins were isolated through repeated chromatographic separations. Ten amorfrutins, belonging both to the phenethyl and pentyl series, were unprecedented in literature, and were therefore fully characterised through HRMS and 2D NMR experiments. In this communication we will also report on the results of pharmacological tests on PPAR γ and PPAR α , and on the corresponding structure-target interaction relationships. Beside the expected activity of amorfrutin A on PPAR γ , we have found a new dual activator and a selective PPAR α agonist, thus expanding the biological space of this class of natural compounds.

P-281 Potential use of *Pterospartum tridentatum* as treatment of type-2 diabetes and its vascular complications

Authors Marcelo Queiroz¹, Artur Figueirinha², Raquel Seiça¹, Cristina Sena¹
Institutes 1 iCBR, Faculty of Medicine, University of Coimbra, Portugal, Coimbra, Portugal; 2 LAQV, REQUIMTE, Faculty of Pharmacy, University of Coimbra, Coimbra, Portugal

DOI 10.1055/s-0043-1774152

The growing incidence of type-2 diabetes (T2D) at a global scale, together with the low effectiveness of some of the first line treatments, presents a serious health problem. To solve this problem, we must search for new and more effective treatments that also need to be more sustainable.

In this work, we evaluated the potential use of *Pterospartum tridentatum* (L.) Willk. Infusions (PTI) in the treatment of type-2 diabetes and its vascular complications. PTI extract was chemically characterised by HPLC-PDA. Then a screening of the effects of PTI extract in the inhibition of enzymes related to T2D, namely α -glucosidase and pancreatic lipase was performed. Subsequently, we studied the effects of PTI on vascular and perivascular function in normal Wistar (W) rats and non-obese type 2 diabetic Goto-Kakizaki (GK) rats. We

studied the effects of cumulative concentrations of PTI and pre-incubation and with a fixed dose in endothelial function of aortas with PVAT (+) or without PVAT (-).

Pterospartum tridentatum infusion, mainly constituted of isoflavones, flavanones and flavonols, was able to significantly reduce the activities of α -glucosidase and pancreatic lipase enzymes. PTI also promoted endothelial vasorelaxation and was able to protect against contractile stimulation in aorta rings of W and GK rats.

In conclusion, PTI exhibited anti-diabetic potential significantly reducing the activity of enzymes related with the progression of T2D and exhibiting a protective effect in endothelial function of W and GK rats.

Conflict of Interest The authors declare no conflict of interest.

P-282 *In vivo* antihyperglycemic activity of *Periploca chevalieri* aerial parts

Authors [Katelene Lima¹](#), [Maryam Malmir¹](#), [Shabnam Sabiha¹](#), [Rui Pinto^{1,2}](#), [Samuel Gomes³](#), [Isabel Moreira da Silva¹](#), [Maria Figueira¹](#), [Paula Duarte⁴](#), [João Rocha¹](#), [Olga Silva¹](#)

Institutes 1 Research Institute for Medicines (iMed.Ulisboa), Faculty of Pharmacy, Universidade de Lisboa, Av. Professor Gama Pinto, 1649-003, Lisboa, Portugal; 2 Dr Joaquim Chaves Laboratório de Análises Clínicas, 2790-224, Lisboa, Portugal; 3 Instituto Nacional de Investigação e Desenvolvimento Agrário, CP 84, Santiago, Cabo Verde; 4 METRICS/NOVA School of Science and Technology, Universidade NOVA de Lisboa, 2829-516, Lisboa, Portugal

DOI [10.1055/s-0043-1774153](https://doi.org/10.1055/s-0043-1774153)

Periploca chevalieri Browicz dried aerial parts are used in Cabo Verde to treat diabetes. Considering our previously obtained results regarding the antioxidant activity and *in vitro* inhibition of α -amylase and α -glucosidase enzymes by this medicinal plant and in continuation of our efforts to investigate its antihyperglycemic activity, the present study aims to evaluate *in vivo* antihyperglycemic activity of a chemically characterised hydroethanolic (70%) extract of *P. chevalieri*. Oral Saccharose Tolerance Test (OSTT) was performed using different doses of the extract (40, 170, 300 mg/kg body weight) to treat mice with saccharose overload. A significant reduction in glycemia ($p < 0.05$) was observed in animals treated with the dose of 170 mg/kg after 30 minutes ($\approx 28\%$) and 60 minutes ($\approx 35\%$) compared to the hyperglycemic control. The results of the biochemical analysis of the blood of animals treated with the extracts showed minor relevant changes compared to the control group. Phenolic acids, flavonoids, and condensed tannins were the main classes of secondary metabolites identified in plant extract, and hyperoside was found to be the main marker compound. The obtained results suggest that while *P. chevalieri* possesses antihyperglycemic properties, it is not dose-dependent, as the reduction in glycemia was more pronounced at the lower dose (170 mg/kg). In conclusion, the *in vivo* antihyperglycemic activity may be related to the detected *in vitro* inhibition α -amylase and α -glucosidase enzymes, however, further investigation on the mechanisms of action of *P. chevalieri* extract is needed.

Conflict of Interest The authors declare no conflict of interest.

P-283 Anti-obesity effects of a standardised hydro-alcoholic extract of blackcurrant leaf in Wistar rat subjected to a high-fat diet

Authors [Breger Gwendoline^{1,2}](#), [Andre Agnès²](#), [Favre Claude¹](#), [Martignat Lionel²](#), [Hammaidi Abderrahim¹](#), [Mallem Yassine²](#), [Aline Amerand³](#)

Institutes 1 Wamine, Champtoceaux, France; 2 NP3, Nantes, France; 3 University of Brest, Brest, France

DOI [10.1055/s-0043-1774154](https://doi.org/10.1055/s-0043-1774154)

Blackcurrant extract (BCE) is reported to exert anti-obesity effects. However its effectiveness in alleviating obesity-related disorders caused by a high-fat

diet (HFD) intake remains insufficiently documented. Moreover, there are no reports on whether BCE with a composition close to the totum differentially affects obesity when compared to a one of its active compounds.

We evaluated the anti-obesity effects of a standardised hydro-alcoholic BCE of leaves in a HFD-induced obesity rat model, and compared its effects with one of its active compounds, quercetin at two doses, lower dose being the level of quercetin present in the extract.

Thirty-six, 11-week-old Wistar rats were randomly divided into six groups: control, untreated HFD rats, BCE (40 and 50 mg/BW)-treated HFD rats and quercetin (0.9 and 50 mg BW)-treated HFD rats. Rats received oral gavage daily with water or treatments for 12 weeks. Compared with the control group, HFD rats showed an increase in body weight (BW), abdominal circumference, and adiposity index. The BW gain was prevented only by the lower dose BCE and the higher dose of quercetin. The HFD decreased oral glucose tolerance which was attenuated by the lower dose of quercetin. Hepatic glutathione peroxidase activity was increased in the HFD group and only BCE treatment counteracted this change.

Those findings highlight the advantage of lower dose BCE (totum of the plant) over lower dose quercetin; but the beneficial anti-obesity effects of BCE seem to depend on the dose used. The significance of these results will be discussed.

P-284 Investigation into the metabolic health effects of *Leptadenia hastata* (Pers.) Decne

Authors [Kieron Edwards¹](#), [Aminu Chika²](#), [Shaibu O. Bello²](#), [Mohamed Zaibi³](#)

Institutes 1 Sibelius Limited, Abingdon, United Kingdom; 2 Department of Pharmacology and Therapeutics; College of Health Sciences, Usmanu Danfodiyo University, Sokoto, Nigeria; 3 The Faculty of Medicine and Health Sciences, the Institute for Biomedical and Bioscience Research, the University of Buckingham, Buckingham, United Kingdom

DOI [10.1055/s-0043-1774155](https://doi.org/10.1055/s-0043-1774155)

Leptadenia hastata (Pers.) Decne is a perennial plant of the Asclepiadaceae family that provides a drought-tolerant food source as well as having applications in traditional medicine in Africa. To investigate potential health benefits of the plant, *L. hastata* extracts were assessed for effects on lifespan in the model organism *Caenorhabditis elegans*. Methanolic extracts showed significant increases in *C. elegans* longevity, and assessment in DAF-16 mutant worms suggested that these effects were dependent on functional insulin/insulin-like growth factor signalling (IIS). Methanolic *L. hastata* extracts also showed amelioration of the developmental and reproductive toxic effects of high glucose conditions in *C. elegans*. Together with IIS-dependent lifespan effects, improved glucose tolerance in the worms suggests that *L. hastata* may have potential benefits towards metabolic health.

In agreement with the results in *C. elegans*, assessment of aqueous and methanolic *L. hastata* extracts in Diet Induced Obese (DIO) mice, and *ob/ob* mutant mice, showed significant improvements to glucose tolerance and insulin sensitivity, as well as significant reductions in food intake and bodyweight/fat mass, and significant increases in leptin sensitivity and energy expenditure.

The concurrent increases in the incidence of obesity and metabolic syndrome represents a global challenge, and treatments derived from natural products already play an important role in meeting this challenge. Our results suggest that *L. hastata* may have beneficial effects on metabolic health that can further contribute towards meeting this challenge and are therefore worthy of further investigation. Sibelius Limited develops science-backed natural product ingredients for application in the nutraceuticals industry.

P-285 Antihyperglycemic activity from *Castilleja arvensis* (Orobanchaceae)

Authors Mónica Aideé Díaz-Román^{1,2}, Berenice Aguilar-Guadarrama², Gabriela Ávila-Villarreal^{3,4}, Juan José Acevedo-Fernández⁵, Elizabeth Negrete-León⁵

Institutes 1 Facultad de Farmacia, Universidad Autónoma del Estado de Morelos, Cuernavaca, Mexico; 2 Centro de Investigaciones Químicas, Universidad Autónoma del Estado de Morelos, Cuernavaca, Mexico; 3 Centro Nayarita de Innovación y Transferencia de Tecnología A. C. "Unidad Especializada en I+D+i en Calidad de Alimentos y Productos Naturales", Tepic, Mexico; 4 Unidad Académica de Ciencias Químico Biológicas y Farmacéuticas, Universidad Autónoma de Nayarit, Tepic, Mexico; 5 Facultad de Medicina, Universidad Autónoma del Estado de Morelos, Cuernavaca, Mexico

DOI 10.1055/s-0043-1774156

Diabetes is a metabolic syndrome characterised by chronic hyperglycaemia, causing several complications including cardiovascular disease, both representing leading causes of death. A chronic inflammatory state has been identified to contribute to the development of diabetes and complications. Several *Castilleja* species are frequently used in the management of inflammation and some studies have demonstrated the potential anti-inflammatory activity of the genus. Inactivation of NF-κB has been proposed as one of the main mechanisms, suggesting additional therapeutic applications in inflammatory diseases such as diabetes. In this work, antihyperglycemic activity of *Castilleja arvensis* was evaluated. Hydroalcoholic extract (HECa) obtained from the maceration process of aerial parts of *C. arvensis*, collected in Tepic, Nayarit, Mexico was fractionated by liquid-liquid extraction obtaining dichloromethane (DF), ethyl acetate (EF), butanol fractions (BF) and aqueous residue (AR). Antihyperglycemic activity was determined through an oral glucose tolerance test in mice, using sucrose and glucose as substrates. As a result, when sucrose was used as substrate HECa, DF, EF and BF significantly prevented post-prandial hyperglycaemia. On the other side, when glucose was used as substrate, HECa significantly prevented post-prandial hyperglycaemia and maintained low glucose levels for 3 hours. Nevertheless, EF, BF and AR showed a similar effect to glibenclamide and hypoglycaemic effect (▶ **Table 1**). These observations suggest that *C. arvensis* has a potential antihyperglycemic function possibly by inhibiting intestinal enzymes; and a possible hypoglycaemic effect could be suggested.

▶ **Table 1** Antihyperglycemic activity from *C. arvensis*.

Oral glucose tolerance test (Substrate: Glucose)										
Plasmatic glucose levels (mg/dL)										
Treatments	0 min	15 min	30 min	45 min	60 min	90 min	120 min	180 min	180 min	AUC (mg/dL)
Vehicle	74 ± 2.5	148 ± 6.0	134 ± 6.5	121 ± 4.9	114 ± 3.9	105 ± 3.8	91 ± 2.5	76 ± 2.9	18650	
Glibenclamide	73 ± 0.7	111 ± 1.5	99 ± 2.4	89 ± 2.0	68 ± 1.6	62 ± 1.5	54 ± 1.3	46 ± 1.6	12267 (*)	
HECa	71 ± 1.1	124 ± 1.0	112 ± 1.5	99 ± 1.6	88 ± 1.8	80 ± 1.8	78 ± 1.5	70 ± 1.8	15554 (**)	
DF	70 ± 1.6	127 ± 2.5	114 ± 1.7	102 ± 1.0	98 ± 1.9	87 ± 1.2	78 ± 1.3	70 ± 1.2	14691 (**)	
EF	67 ± 2.0	95 ± 2.9	82 ± 3.4	75 ± 2.7	69 ± 3.5	68 ± 1.3	53 ± 0.8	43 ± 2.4	11547 (**)	
BF	63 ± 2.3	110 ± 1.8	103 ± 1.0	90 ± 2.1	82 ± 2.0	67 ± 2.8	55 ± 2.0	48 ± 2.6	12760 (**)	
AR	65 ± 0.7	86 ± 1.5	73 ± 1.0	64 ± 1.8	56 ± 0.7	56 ± 0.9	54 ± 1.4	43 ± 1.0	10503 (**)	
Oral glucose tolerance test (Substrate: Sucrose)										
Plasmatic glucose levels (mg/dL)										
Treatments	0 min	15 min	30 min	45 min	60 min	90 min	120 min	180 min	180 min	AUC (mg/dL)
Vehicle	74 ± 1.0	148 ± 1.4	132 ± 1.4	120 ± 2.0	113 ± 1.8	100 ± 2.1	85 ± 1.6	75 ± 1.9	18147	
Acarbose	75 ± 0.8	105 ± 2.2	96 ± 2.1	92 ± 1.6	82 ± 1.5	79 ± 1.5	74 ± 1.4	68 ± 1.2	14560 (**)	
HECa	75 ± 0.8	110 ± 1.0	92 ± 1.2	87 ± 1.7	79 ± 1.6	71 ± 1.2	69 ± 1.6	61 ± 1.3	13739 (**)	
DF	72 ± 0.8	110 ± 1.8	100 ± 2.3	88 ± 1.3	82 ± 1.5	76 ± 1.8	63 ± 1.0	56 ± 1.5	13659 (**)	
EF	66 ± 1.3	95 ± 1.1	87 ± 1.3	72 ± 1.6	69 ± 1.9	61 ± 1.9	56 ± 0.7	52 ± 1.3	11729 (**)	
BF	75 ± 1.1	116 ± 1.6	97 ± 1.9	84 ± 0.8	78 ± 1.7	69 ± 1.4	62 ± 1.5	53 ± 1.6	13163 (**)	
AR	75 ± 1.1	137 ± 1.1	131 ± 1.6	109 ± 1.5	82 ± 1.6	70 ± 1.4	61 ± 1.9	57 ± 1.4	14616 (**)	

Plasmatic glucose levels at 0, 15, 30, 45, 60, 90, 120 and 180 min after oral glucose/sucrose oral administration with different treatments (HECa, DF, EF and AR). AUC: Area under the curve of glucose (mg/dL/180 min). Each group represents the mean ± SEM of n=10. *p<0.05 vs vehicle, **p<0.05 vs glibenclamide/acarbose determined by One-way ANOVA followed by Tukey's test.

Conflict of Interest The authors declare no conflict of interest.

P-286 *Centaurea nicaeensis*: a rich source of sesquiterpene lactones and other constituents with hypoglycemic activity

Authors Elena Serino¹, Gökhan Zengin², Daniela Rigano¹, Mariano Stornaiuolo¹, Orazio Tagliatalata-Scafati¹, Carmen Formisano¹

Institutes 1 Department of Pharmacy, School of Medicine and Surgery, University of Naples Federico II, Via Montesano 49, 80131, Naples, Italy; 2 Department of Biology, Science Faculty, Selcuk University, 42250 Konya, Turkey

DOI 10.1055/s-0043-1774157

Genus *Centaurea* is one of the richest genera in Turkish flora and, at this moment, is constituted by 206 taxa. *Centaurea* sp. have been used in folk medicine to treat indigestion, headache, muscle pains, diarrhoea, infections and inflammations. Recently, the chemistry and the biological properties of genus *Centaurea* have been reviewed and, to continue our phytochemical examination of less studied species of this genus [1, 2], we have investigated the aerial parts of *C. nicaeensis*. A preliminary purification of *C. nicaeensis* apolar extract was performed through MPLC instrument with UV detector DAD. Afterwards, HPLC purifications were carried out in reverse phase, leading us to the isolation of 24 compounds. The main secondary metabolites of *C. nicaeensis* are sesquiterpenes belonging to different families. Through elemenes, we have isolated two known compounds and their derivatives decorated with a lateral side chain in position 8. This has resulted in a common substituent in the sesquiterpenes lactones of this plant. Moreover, through elemenes, we have characterised a new sesquiterpene lactone, an unreported methyl-ester derivative along with three unprecedented eudemanes. Moreover, in the extract characterised, were various monoterpenes, three lignans, alongside with other polyphenols. All the compounds were identified with NMR and HR-MS analysis and the new ones were further characterised with an extensive 2D NMR analysis. All pure compounds were tested for their activity on some of the major pathways involved in metabolic syndrome, such as glucose uptake.

References

- Formisano et al. Fitoterapia (2017).
- Serino et al. Phytochemistry (2022).

P-287 Effects of *Marantodes pumilum* on biochemical and histopathological changes on dyslipidemia rats model

Authors Roza Dianita¹, Ibrahim Jantan²

Institutes 1 Universiti Sains Malaysia, USM Pulau Pinang, Malaysia; 2 Universiti Kebangsaan Malaysia, UKM Bangi, Malaysia

DOI 10.1055/s-0043-1774158

Marantodes pumilum, also known as *Labisia pumila* or Kacip Fatimah by the local people, has been studied for its antioxidant, anti-inflammatory, phytoestrogenic and skin collagen synthesis promoting properties. Our previous study revealed the extracts provided potentially inhibited in vitro LDL oxidation and platelet aggregation. Our further study also revealed that the extracts had improved the in vivo antioxidant enzymes activity during isoproterenol-induced myocardial infraction events on rats. Thus, our present study aimed to evaluate the effects of *M. pumilum* extracts on reducing the atherosclerotic risks on high-cholesterol diet rats. The rats were induced to dyslipidemia status with a daily intake of 2% cholesterol for a duration of 8 weeks. Three different doses (100, 200 and 400 mg/kg) of the extracts were administered daily on the 4th week onwards. The rats were then sacrificed, and the blood was collected via abdominal aorta and, serum was separated by centrifugation for biochemical analysis. Part of the aorta tissues were excised immediately for histopathological examination. The results of treated rats showed significant reduction ($p \leq 0.05$) in serum aspartate aminotransferase (AST), alanine aminotransferase (ALT) and lactate dehydrogenase (LDH) levels and improved the antioxidant

enzymes. The histopathological examination of the abdominal aorta showed a decrease of atheroma lesions in treated rats and significantly improved ($p \leq 0.05$) in the lipid profile which eventually reduced the atherogenic indices in treated rats. The extracts of *M. pumilum* can reduce the risk of atherosclerosis on dyslipidaemia rats at the initial stage by improving the serum lipid profiles and modulating serum antioxidants.

P-289 *Pulsatilla* decoction suppressed intestinal inflammation by reducing infiltration of innate immune cells and increasing lactic acid in the colon

Authors [Ming-Kuem Lin](#)¹, [Ya-Ting Yang](#)^{2,3}, [Wei-Hsuan Yu](#)³, [Huan-Yuan Chen](#)²

Institutes 1 Department Of Chinese Pharmaceutical Sciences And Chinese Medicine Resources, China Medical University, Taichung, Taiwan; 2 Institute of Biomedical Sciences, Academia Sinica, Taiwan; 3 Institute of Biochemistry and Molecular Biology, College of Medicine, National Taiwan University, Taiwan

DOI [10.1055/s-0043-1774159](#)

Pulsatilla decoction (PD), a traditional Chinese medicine commonly used in Asian countries for ulcerative colitis (UC), has an unclear mechanism of action. In this study, the effects of PD were investigated in a mouse model of UC induced by dextran sulfate sodium (DSS). Histology and immunohistochemistry analyses were used to examine intestinal inflammation and leukocyte infiltration in colonic tissues. A Multi-Plex immunoassay was used to examine cytokine levels. Immunofluorescence double staining was employed to examine the expression of matrix metalloproteinase-7 (MMP-7) in immune cells. Our results showed that administration of PD in the DSS-induced colitis mouse model attenuated intestinal inflammation and markedly decreased colonic infiltration of innate immune cells. Immunohistochemical analyses revealed that PD inhibited MMP-7 expression in infiltrating leukocytes, including neutrophils and macrophages. PD increased the cytokine level of IL-6 in colonic tissues. PD exhibited a beneficial effect of probiotic microorganisms on the intestinal microbiome's balance as lactate was significantly increased in the colonic chyme. Importantly, lactic acid induction was confirmed by testing two lactobacteria. It is likely that polysaccharides of PD contributed to the benefits for lactobacteria in the colon. In conclusion, PD effectively suppressed intestinal inflammation in the DSS-induced colitis mouse model by reducing colonic infiltration of innate immune cells and increasing lactic acid in the colon. These findings shed light on the mechanism of action of PD in UC treatment and provide a basis for further research in this area.

P-290 Effect of *Atractylodes macrocephala* Koidzumi in a mouse model of Zymosan-induced irritable bowel syndrome

Authors [Na Ri Choi](#)¹, [Haejeong Jeong](#)¹, [Woo-Gyun Choi](#)¹, [Joo Han Woo](#)², [Byung Joo Kim](#)¹

Institutes 1 Pusan National University School of Korean Medicine, Yangsan, South Korea; 2 Dongguk University College of Medicine, Kyeongju, South Korea

DOI [10.1055/s-0043-1774160](#)

Irritable Bowel Syndrome (IBS) is a common functional gastrointestinal disorder that is associated with abdominal pain, discomfort and altered bowel movements. The cause of IBS, characterized by dysfunction without anatomical abnormalities in the colon, is not well known. *Atractylodes macrocephala* Koidzumi (AMK) is a traditional herbal medicine widely used in East Asia for the treatment of digestive system diseases. We investigated the effect and related mechanism of AMK in the treatment of IBS. First, we investigated the efficacy of AMK in the zymosan-induced IBS animal model. The IBS model was established by intracolonic administration of zymosan. Also, to investigate the rele-

vant mechanisms, we used electrophysiological methods to determine the modulation of transient receptor potential (TRP) and voltage-switched Na⁺ (NaV) ion channels. As a result, AMK oral administration showed increased colon length and decreased stool score and colon weight compared to the control group. In addition, AMK controlled weight loss without significantly affecting food intake. In the AMK administration group, mucosal thickness was reduced, similar to normal mice, and pain-related behaviour was significantly reduced. These effects were similar to those of sulfasalazine, an anti-inflammatory drug, and amitriptyline, an antidepressant. AMK inhibited TRPV1, NaV1.5 and NaV1.7 ion channels associated with IBS-mediated visceral hypersensitivity. These results suggest that AMK could be a potential therapeutic agent for IBS through its modulation of ion channels involved in pain and inflammation.

Conflict of Interest The authors declare no conflict of interest.

P-291 Effects of selected flavonoids isolated from *Cirsium palustre* on colon motility – an ex vivo study

Authors [Dominika Szadkowska](#)¹, [Magdalena Chłopecka](#)¹, [Jakub Strawa](#)², [Katarzyna Jakimiuk](#)², [Daniel Augustynowicz](#)², [Michał Tomczyk](#)², [Marta Mendel](#)¹

Institutes 1 Institute of Veterinary Medicine, Warsaw University Of Life Sciences, Warsaw, Poland; 2 Department of Pharmacognosy, Faculty of Pharmacy with the Division of Laboratory Medicine, Medical University of Białystok, Białystok, Poland

DOI [10.1055/s-0043-1774161](#)

Cirsium palustre (L.) Scop. (Asteraceae) is a species commonly found in Europe, Siberia, northern USA and Canada. Previous studies have proven the effect of extracts and fractions obtained from this plant on intestinal motility. The study presented herein was aimed to verify the usefulness of flavonoids apigenin (AP), luteolin (LUT), apigenin 7-O-glucuronide (APG), and chrysoeriol (CHRY) isolated from *C. palustre* to modify colon motility [1]. The experiment was performed on a porcine intestine model for future use in translational medicine. Colon specimens were incubated in modified Krebs-Henseleit solution under isometric conditions [2]. The effect of all analysed flavonoids on the spontaneous and acetylcholine (ACh)-provoked contractility of colon was verified. The results indicated that all the examined flavonoids are potent modifiers of colon motility. The spontaneous and ACh-induced activity was significantly enhanced in the presence of AP and APG. Contrariwise, LUT and CHRY caused spasmolytic effect in case of both spontaneous and ACh-evoked activity. Considering the complex pathophysiology of disorder of gut-brain interaction and the lack of fully satisfactory treatment methods, flavonoids when properly selected, seem to be an interesting solution in symptomatic treatment.

References

- [1] Nazaruk J. Flavonoid compounds from *Cirsium palustre* (L.) Scop. flower heads. *Biochem Syst Ecol* 2009; 37: 525
- [2] Mendel M., Chłopecka M., Latek U., Karlik W., Tomczyk M., Strawa J., Tomczyk M. Evaluation of the effects of *Bidens tripartita* extracts and their main constituents on intestinal motility – an ex vivo study. *J Ethnopharmacol* 2020; 259: 112982

P-292 Compatibility of a specific herbal multi-component medicine for digestive disorders with the growth of selected intestinal bacteria

Authors [Michael Maier](#)¹, [Maria-Riera Piqué-Borràs](#)², [Sebastian Schmelzer](#)¹, [Johann Röhrl](#)², [Lydia Nausch](#)¹

Institutes 1 Institute of Nutrition and Food Supply Management, University of Applied Sciences Weihenstephan-Triesdorf, 91746 Weidenbach, Germany; 2 Weleda AG, 4144 Arlesheim, Switzerland

DOI [10.1055/s-0043-1774162](#)

The multi-component herbal medicine Amara oral drops consists of nine different hydroethanolic herbal extracts, *Artemisia absinthium* (Aa), *Centaureum erythraea* (Ce), *Cichorium intybus* (Ci), *Gentiana lutea* (Gl), *Juniperus communis* (Jc), *Millefolii herba* (Mh), *Peucedanum ostruthium* (Po), *Salvia officinalis* (So) and *Taraxacum* (T). It is indicated for treatment of moderate digestive disorders like fullness, heartburn, nausea and disturbed gastrointestinal motility. A well functioning digestion is inevitably linked to a healthy intestinal microbiota. Thus, medication should not interfere with intestinal microbes.

We aimed to evaluate the antibacterial impact of the herbal extracts towards distinct bacterial strains using an in vitro approach.

Dry extracts were prepared from mother tinctures of extracts used for production of the final medicinal product Amara oral drops (Amara-Tropfen). Clove, a known antibacterial spice, was used as herbal reference compound. Bacterial strains were incubated in liquid culture under constant shaking at 37 °C for up to 7 h together with test samples or controls.

No extract contained in Amara revealed antibacterial effects towards the intestinal commensal bacterial strain *Escherichia coli* up to a concentration of 10 mg/mL. The growth of *Enterobacter cloacae* and *Bacillus subtilis* was differentially affected by some extracts at higher concentrations. The reference extract from cloves was strongly antibiotic towards all tested bacterial strains (► **Table 1**).

► **Table 1** Overview of differential effects of herbal extracts from Amara oral drops on growth of bacterial strains in vitro.

Table 1: Overview of differential effects of herbal extracts from Amara oral drops on growth of bacterial strains in vitro. ■ = growth promotion; □ = no effect; ■ = growth inhibition; ■ = growth promotion at low concentration (1–5 mg/ml), inhibition at high concentration (5–10 mg/ml).

	Amara extract mixture	<i>Artemisia absinthium</i>	<i>Centaureum erythraea</i>	<i>Cichorium intybus</i>	<i>Gentiana lutea</i>	<i>Juniperus communis</i>	<i>Millefolii herba</i>	<i>Peucedanum ostruthium</i>	<i>Salvia officinalis</i>	<i>Taraxacum</i>	Cloves
<i>E. coli</i>	□	■	□	■	■	■	■	■	■	■	■
<i>E. cloacae</i>	■	■	■	■	■	■	■	■	■	■	■
<i>B. subtilis</i>	■	■	■	■	■	■	■	■	■	■	■

These results indicate that Amara oral drops are predominantly compatible with the intestinal bacterial strains *E. coli* and *E. cloacae* and might be considered as microbiome-friendly.

Additional studies are required to further characterise the compatibility of Amara oral drops with intestinal microbiota.

P-293 *Castanea sativa* Mill. leaf extracts contain ellagitannins with antibacterial and anti-inflammatory activity in *H. pylori* infection

Authors Giulia Martinelli¹, Stefano Piazza¹, Marco Fumagalli¹, Nicole Maranta¹, Carola Pozzoli¹, Flavio Giavarini¹, Luca Colombo², Giovanna Nicotra³, Silvia Francesca Vicentini³, Francesca Genova¹, Emma De Fabiani¹, Enrico Sangiovanni¹, Mario Dell'Agli¹

Institutes 1 University of Milan – Department of Pharmacological and Biomolecular Sciences (DiSFeB) "Rodolfo Paoletti" Via Balzaretti 9, Milan, Italy; 2 Consorzio Castanicoltori di Brinzio, Orino e Castello Cabiaglio, Società Cooperativa Agricola- Varese, Varese, Italy; 3 Estratti Piante Officiali (E.P.O.) S.r.l., Milan, Italy

DOI 10.1055/s-0043-1774163

Helicobacter pylori (*H. pylori*) infection is associated with gastritis and elevated risk of gastric cancer. Virulent strains cause the activation of NF-κB and the

expression of IL-8 at mucosal level, leading to severe inflammation [1]. Polyphenols could adjuvate the pharmacological treatment through antibacterial and anti-inflammatory properties [2]. However, the role of ellagitannins in *H. pylori*-related gastritis has been poorly investigated.

The present research aimed at studying two genotyped varieties of *Castanea sativa* Mill. (Northern Italy), verdesa and venegon, in a human in vitro model of gastric epithelium (GES-1 cells) infected with *H. pylori*. The bioactivity was compared after in vitro simulated gastric digestion.

Ethanol:water (50:50) extracts were prepared from leaves and characterised for ellagitannin content. The high levels of polyphenols were partially maintained after gastric digestion (19–23%), similar to the ellagitannin castalagin (0.2–0.4% w/w of dry extract), measured by LC-MS analysis. In GES-1 cells infected by *H. pylori*, leaf extracts and castalagin inhibited IL-8 release (IC₅₀ ≈ 28 µg/mL and 11 µM, respectively). The anti-inflammatory mechanism was partly due to the impairment of NF-κB translocation (200 µg/mL), observed by immunofluorescence. Moreover, the extracts and pure compound reduced bacterial growth (MIC = 200 µg/mL and 25 µM, respectively) and adhesion to cells. NGS analysis showed that castalagin downregulated proinflammatory genes (NF-κB, AP-1, ERK) and cell migration (Rho GTPase).

This investigation supported for the first time the role of ellagitannins from *Castanea sativa* Mill. leaf against *H. pylori* infection [3].

Conflict of Interest The authors declare no conflict of interest.

References

- [1] McColl K.E. Clinical practice. *Helicobacter pylori* infection. N Engl J Med 2010; 362: 1597–1604
- [2] Guerra-Valle M. et al. Plant-Based Polyphenols: Anti-*Helicobacter pylori* Effect and Improvement of Gut Microbiota. Antioxidants 2022; 11 (1): 109
- [3] Martinelli G., Piazza S., Fumagalli M., Pozzoli C., Maranta N., Giavarini F., Colombo L., Nicotra G., Vicentini S.F., Genova F. et al. Ellagitannins from *Castanea sativa* Mill. Leaf Extracts Impair *H. pylori* Viability and Infection-Induced Inflammation in Human Gastric Epithelial Cells. Nutrients 2023; 15: 1504

P-294 A mixture of thymol and carvacrol mitigates inflammation and oxidative stress responses in intestinal epithelial cell models

Authors Delphine Gardan-Salmon¹, Arnaud Bruyère², Marisela Arturo-Schaan¹

Institutes 1 Deltavit (CCPA Group), 35150 Janzé, France; 2 Irset – Inserm UMR 1085, Université de Rennes, 35000 Rennes, France
DOI 10.1055/s-0043-1774164

With One Health approach, reducing the use of antibiotics in livestock animal feeds will benefit human and animal health. Among natural alternatives, phytochemicals have beneficial intestinal health promoting values. In vitro models can be employed to better evaluate the biological activities and mode of action of those alternatives prior to in vivo investigations.

Our study aimed at investigating the ability of a mixture of thymol and carvacrol essential oils (TC), the main components of *Origanum vulgare*, to modulate inflammation and oxidative stress in vitro in intestinal cell lines. Porcine IPEC-J2 cells were used to study cytokine gene expressions in a livestock cell model. Mechanisms underlying such effects were investigated with a human reference cell line (Caco-2) by cell imagery. Oxidative stress mitigation was measured using Caco-2 and CellRox technique by imagery.

In the IPEC-J2 cells, TC (5 to 100 µg/mL) alleviated inflammation by significantly reducing IL-8, TNFα and CCL20 gene expressions compared to the pro-inflammatory group (-4 to -21-fold depending on cytokines and doses; *P* < 0.001). In the Caco-2 cells, TC (5 µg/mL) alleviated inflammation by significantly reducing the % of NF-κB positive nuclei (-46%; *P* < 0.001; ► **Fig. 1**). TC reduced oxidative stress by reducing oxidised probe quantity (-15% with 10 µg/mL; *P* < 0.01).

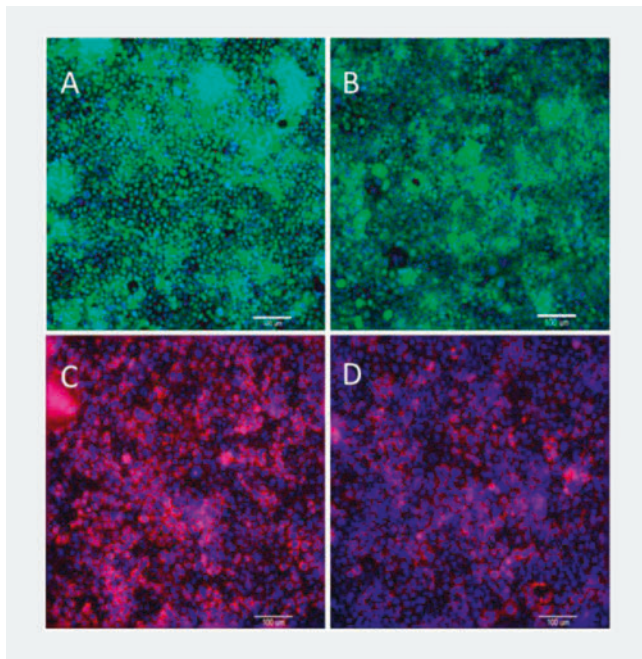

► **Fig. 1** Evaluation of biological properties of a mixture of thymol and carvacrol essential oils (TC) in Caco-2 cells by imagery. Inflammation was evaluated using NF- κ B immunocytochemical labeling in presence of IL-1 β at 100 ng/mL (a) or with a pre-incubation of 1h with TC (5 μ g/mL) and then co-incubation of 1h with IL-1 β and TC (b). The nuclei are shown in blue and NF- κ B in green. Oxidative stress was evaluated using Deep Red CellROX fluorescent probe after 1h incubation with menadione (50 μ M) (c) or after a pre-incubation of 1h with TC (10 μ g/mL) and then co-incubation of 1h with menadione and TC (d). Nuclei are shown in blue and Reactive oxygen species in red. The scale bar corresponds to 100 μ m.

Using cellular models, these results showed that TC can exert anti-inflammatory effects through the NF- κ B pathway and pro-inflammatory cytokine regulation, as well as antioxidant effects in enterocytes. This mixture of thymol and carvacrol is a promising candidate to develop a functional ingredient for livestock animals.

Conflict of Interest The authors declare no conflict of interest.

P-295 Leaf and fruit from Mediterranean Sicilian sumac (*Rhus coriaria* L.) show promising antioxidant and anti-inflammatory activities in gastrointestinal epithelial cells

Authors Stefano Piazza¹, Nicole Maranta¹, Rita Nasti², Elisabetta Grillo³, Carola Pozzoli¹, Giulia Martinelli¹, Marco Fumagalli¹, Giangiacomo Beretta², Enrico Sangiovanni¹, Mario Dell'Agli¹

Institutes 1 Dept. Pharmacological and Biomolecular Sciences "Rodolfo Paoletti", University of Milan, Milano, Italy; 2 Department of Environmental Science and Policy, University of Milan, Milano, Italy; 3 Redess S.r.l., Termini Imerese, Italy

DOI 10.1055/s-0043-1774165

Sumac (*Rhus coriaria* L.) is gaining attention as a rich source of polyphenols with health properties, including anti-inflammatory and antioxidants. Most of the available literature was generated on its traditional use in the Middle East, but the plant has also been historically propagated in the Mediterranean region. The fruit is consumed as spice, whereas both fruit and leaf are considered as empirical remedies for gastrointestinal disorders. Unexpectedly, the biological activity at this level is still poorly investigated. We previously reported that fruit

extracts from Iranian sumac may counteract *Helicobacter pylori* related gastritis (PMID: 35565724).

Here, we investigated the antioxidant and anti-inflammatory properties of fruit and leaf from Sicilian sumac (Sicily, Italy) in human gastric (GES-1) and intestinal (CaCo-2) cells.

Traditional methods of extraction, such as hot water infusion and hydroalcoholic maceration, allowed to obtain dry extracts rich in gallic acid, flavonoids and gallotannins (up to 73 % GA eq. in leaf). Polyphenols and antioxidant capacity (ORAC) remained elevated after simulated gastrointestinal digestion. Both fruit (1 – 60 μ g/mL) and leaf (0.01 – 20 μ g/mL) extracts inhibited the release of chemokines (IL-8 and MCP-1) in epithelial cells. The mechanism was related to the NF- κ B impairment in gastric cells. At same concentrations, fruit and leaf extracts reduced the level of ROS in intestinal, but not in gastric cells (► Fig. 1).

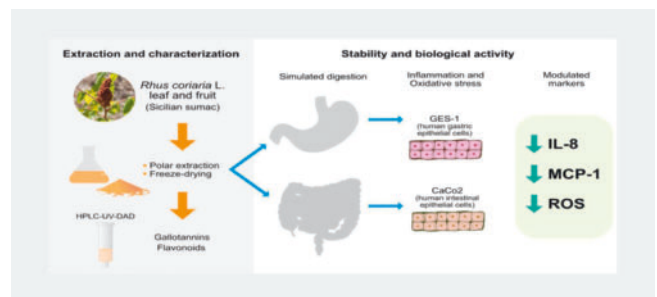

► **Fig. 1** *Rhus coriaria* L. workflow

The overall data valorise the potential role of Sicilian sumac in gut inflammation and oxidative stress, highlighting the properties of leaf extracts.

Conflict of Interest The authors declare no conflict of interest.

P-296 Mode of action of an herbal mixture preparation for improving gastric accommodation in functional dyspepsia patients

Authors Maria-Riera Piqué-Borràs¹, Johann Röhrli¹, Gerald Künstle¹

Institute 1 Weleda AG, 4144 Arlesheim, Switzerland

DOI 10.1055/s-0043-1774166

In functional dyspepsia, impaired gastric accommodation has been found in a significant proportion of cases, however, the underlying cause of this disorder is poorly understood. Amara oral drops is traditionally used for treatment of gastrointestinal dysmotility and contains an herbal mixture of nine hydroethanolic herbal extracts (*Artemisia abstinthium*, *Centaureum erythraea*, *Cichorium intybus*, *Gentiana lutea*, *Juniperus communis*, Millefolii herba, *Peucedanum ostruthium*, *Salvia officinalis* and *Taraxacum*). The study aim was to investigate the herbal mixture's mechanisms to improve gastrointestinal motility disorders such as gastric accommodation by identifying the specific targets.

We investigated the functional activity of several G-protein-coupled-receptors known to play a role in the pathogenesis of gastrointestinal disorders, i.e. muscarinic M3 and M2, opioid μ (OP1) and several serotonin receptors (5-HT1B, 5-HT1D, 5-HT3, 5-HT7 and 5-HT1A). The dry extracts were prepared from the commercial medicinal product Amara oral drops or from the ethanolic tinctures. The herbal mixture potentially impaired the activity of OP1 and M2 receptors, shown by inhibition of intracellular cAMP release (IC₅₀: 304 and 219 μ g/mL, respectively). Furthermore, *Juniperus*, *Salvia* and *Peucedanum* extracts impaired M2 receptors' activity (IC₅₀: 32, 20.1 and 20.8 μ g/mL, respectively), whereas *Gentiana*, *Artemisia*, *Cichorium* and *Juniperus* inhibited OP1 receptors' activity (IC₅₀: 41.7, 21.7, 104 and 24.6 μ g/mL, respectively). However, serotonin and M3 receptors' activity was not affected. These data suggest that the Amara herbal extract has an effect on central motility-regulating receptors involved in gastrointestinal disorders. Additionally, different activity profiles of

the individual extracts act together, resulting in an increase of the overall preparation's efficacy.

P-297 The mutual interactions of silymarin and colon microbiota

Authors Katerina Tomisova¹, Veronika Jarosova¹, Petr Marsik¹, Anna Mascellani¹, Lucie Hlinakova², Ondrej Cinek², Katerina Valentova³, Pavel Kloucek¹, Jaroslav Havlik¹

Institutes 1 Department of Food Science, Czech University of Life Sciences Prague, Prague, Czech Republic; 2 Department of Medical Microbiology, 2nd Faculty of Medicine, Charles University, Motol University Hospital, Prague, Czech Republic; 3 Laboratory of Biotransformation, Institute of Microbiology of the Czech Academy of Sciences, Prague, Czech Republic
DOI 10.1055/s-0043-1774167

A multi-omics approach was used to investigate interactions among silymarin (seed extract of *Silybum marianum*), colon microbiota and metabolic profiles. Gut metabolism and microbiota may play a role in the activity of many natural remedies.

Using an in vitro colon model batch incubations with faeces of 20 individuals (10 young adults under 45 years, 10 seniors above 70 years), we explored the effect of age and individuals' microbial profiles on the catabolism of silymarin (50 µg/mL), and the reverse effect on microbiota. Next-generation sequencing (NGS), liquid chromatography-mass spectrometry (LC-MS) and nuclear magnetic resonance spectrometry (¹H-NMR) were used, and the data from all three platforms were processed separately and by data fusion using PERMANOVA, lowest AIC model, linear models, and relevance network analysis.

Silymarin was catabolised into a few final products with m/z 469.113, suggesting demethylation of its main flavonolignans. Silymarin was found to suppress bacterial metabolism, as evidenced by a 2.8% decrease ($p < 0.01$) in the production of short-chain fatty acids (SCFAs), an 8.4% decrease ($p < 0.001$) in branched-chain fatty acids (BCFAs), and decreased utilisation of carbohydrates, and amino acids ($p < 0.05$). No effect on the microbiome composition itself was observed. Differences in the microbial profiles of both age groups were associated with differences in metabolism, with young adults showing more catabolites with m/z = 469.113 and m/z 471.129. Clear associations were found between the abundance of *Faecalibacterium* and other bacterial taxa, and the production of the most abundant transient metabolite with m/z 485.144.

Funding Supported by GA CR, projects 23-04655S and 21-00551S.

P-298 *Opuntia ficus-indica* polysaccharides protect against bile acid-induced esophageal cell irritation

Authors Martin D. Lehner¹, Ulrike Scheyhing¹

Institute 1 Preclinical R&D, Dr. Willmar Schwabe GmbH & Co. KG, 76227 Karlsruhe, Germany

DOI 10.1055/s-0043-1774168

A new treatment option containing mineral antacids in combination with a polysaccharide-enriched extract from prickly pear (*Opuntia ficus-indica*) cladodes has been recently developed for the treatment of heartburn. In vitro studies indicate the formation of viscous films of *Opuntia* mucilage polysaccharides and adhesion to the surface of gastrointestinal epithelial cells [1, 2]. This film formation is suggested to create a physically acting protective barrier to reflux of gastric content, but actual proof of protective activity has been missing. In the present study, we assessed the protective activity of an *Opuntia ficus-indica* cladode extract against bile acid-mediated esophageal cell irritation. Different concentrations of extract were added to esophageal epithelial cells (Colo 680N). Following a 30 min challenge with deoxycholic acid (DCA), cell irritation was assessed by measuring gene induction of interleukin-6 (IL-6) and IL-8 (qPCR) after 4 h and viability (ATP) and IL-6 concentration in supernatant (Bioplex) at 24 h post wash-out, respectively. We observed that *Opuntia* extract addition

at 0.1–3 mg/mL concentration-dependently reduced the DCA-mediated cytokine gene induction with maximal reductions of 63% and 70% for IL-6 and IL-8, respectively. At 24 h, extract addition was associated with attenuation of DCA-induced cytotoxicity and reduction of IL-6 production in supernatant. In conclusion, addition of an *Opuntia ficus-indica* polysaccharide-enriched extract to esophageal cells confers protection against bile acid-induced inflammation and cytotoxicity in vitro, compatible with the concept of formation of a physically acting barrier.

References

- [1] Cardenas A J Prof Assoc Cactus Dev 1998; 2: 152–9
- [2] Rizza L Int J Pharm 2012; 422 (1/2): 318–22

P-299 Oligosaccharide analysis of the backbone structure of the characteristic polysaccharide of *Dendrobium officinale*

Authors Lifeng Li¹, Tin-Long Wong¹, Xue-Ting Zhang¹, Quan-Wei Zhang¹, Hau-Yee Fung¹, Chu-Ying Huo¹, Hui-Yuan Cheng¹, Quan-Bin Han¹

Institute 1 Hong Kong Baptist University, Hong Kong, China

DOI 10.1055/s-0043-1774169

Natural polysaccharides occur as complex mixtures and are hardly isolated as a single molecule, challenging the current analytical methods. *Dendrobium officinale* polysaccharide, the characteristic active ingredient, is an example. The backbone of *Dendrobium officinale* polysaccharide (DOP) was reported to be glucomannan. But the dispute continues due to the limitations of conventional analysis methods (e.g. the overlapped NMR signals). Herein, we describe an oligosaccharide sequencing analysis that successfully corrects the backbone to mannan as shown in ► Fig. 1. This analysis involves producing oligosaccharide fragments from mild acid hydrolysis of DOP followed by p-aminobenzoic ethyl ester (ABEE) derivatisation. Then, a series of oligosaccharides with varied polymerisation degrees (DP = 2–10) were isolated and identified by LC-MS profiling, monosaccharide composition analysis, linkage analysis and 1D-/2D-NMR elucidation. Finally, we conclude that the backbone of DOP is a β-D-1,4-mannan which is confirmed by other analysis such as comparison with reference mannan. This oligosaccharide analysis is more straightforward and reliable by transforming the complicated polymers into oligomers which have more accurate and convincing MS and NMR data.



► **Fig. 1** Structural characterization of the backbone of *Dendrobium officinale* polysaccharide (DOP) using an oligosaccharide analysis strategy. With the aid of sugar sequence analysis by LC-MS profiling, monosaccharide composition, linkage analysis and NMR spectroscopy.

Conflict of Interest The authors declare no conflict of interest.

P-300 Characterisation of macrophage activation after treatment with polysaccharides from ginseng according to heat processing

Authors Sung Jin Kim¹, Noriko Yamabe¹, Myoung-sook Shin¹

Institute 1 Gachon University, Seongnam 13120, Kyonggi-do, South Korea
DOI 10.1055/s-0043-1774170

The worldwide persistence of infectious diseases is a significant public health issue. Consequently, studying immunomodulatory ingredients in natural products, such as ginseng, is important for developing new treatment options. Here, we extracted three different types of polysaccharides from white (P-WG), red (P-RG), and heat-processed (P-HPG) ginseng and analysed their chemical properties and immunostimulatory activity against RAW 264.7 murine macrophages. Carbohydrates were the main components of all three polysaccharide types, while uronic acid and protein levels were relatively low. Chemical analysis indicated that the content of carbohydrates (total sugar) increased with processing temperature, while that of uronic acid decreased. Treatment with P-WG, P-RG or P-HPG stimulated nitric oxide (NO) production and increased tumor necrosis factor- α (TNF- α) and interleukin (IL)-6 levels in RAW 264.7 macrophages, with P-WG showing the highest activity among the three polysaccharides. The expression of inducible NO synthase, which affects NO secretion, was highest in the macrophages treated with P-WG. Analysis of intracellular signalling pathways showed that mitogen-activated protein kinases (ERK, JNK, and p38) and NF- κ B p65 were strongly phosphorylated by P-WG in macrophages but were only moderately phosphorylated by P-RG and P-HPG. Collectively, these results suggest that the polysaccharides isolated from ginseng undergo different changes in response to heat processing and display different chemical compositions and immune-enhancing activities.

P-301 Immunomodulatory studies on selected plants from the Hallwyl "Kräuterbuch" – an influential recipe text from 16th century Switzerland

Authors Jonas Stehlin¹, Samuel Peter¹, Ina Albert², Nina Vahekeni¹, Evelyn Wolfram¹, Barbara Frei-Haller³, Andreas Lardos¹

Institutes 1 Zurich University of Applied Sciences: Section Phytopharmacy and Natural Products, 8820 Wädenswil, Switzerland; 2 Zurich University of Applied Sciences: Pharmaceutical Technology and Pharmacology, 8820 Wädenswil, Switzerland; 3 ETH: Department of Chemistry and Applied Biosciences, 8093 Zürich, Switzerland

DOI 10.1055/s-0043-1774171

An *ex vivo* screening effort using plants from the "Arzneibuch von Hallwyl" (ABvH), an influential recipe text from 16th-century Switzerland, was carried out with the goal of exploring the immunomodulatory potential of medicinal plants that have largely fallen out of use in modern practice.

An *ex vivo* screening model using a human whole blood assay (WBA) stimulated with LPS was chosen to measure perturbation of IL-6 release in 21 preparations, 5 of which were directly based on recipes from the ABvH. Candidates with promising activity were then to be tested in LPS-activated human PBMC for comparison with the results of the WBA. MTT assay was chosen to characterise the cytotoxic profile of active extracts.

Eight of the 21 tested samples showed heterogeneous effects on IL-6 release in the WBA. In the PBMC assay the 80% EtOH extract from the roots of *Vincetoxicum hirundinaria* Medik. (VHR) showed the strongest *ex vivo* inhibition with an IC₅₀ of 3.62 ± 0.47 µg/mL. Results of the MTT assay in NIH-3T3 fibroblasts suggest a minor cytotoxic potential of most samples.

The data gathered during this study points to promising *ex vivo* immunomodulatory activity exhibited by the active samples and rationalises further screening efforts based on plants from the ABvH.

Conflict of Interest The authors declare no conflict of interest.

Wednesday 5th July 2023 | Poster Session III

- Phytochemistry III – Ethnopharmacology; Ethnobotany II; Quality; Monographs; Safety; Stability (P-302 – P-316)
- Analytical Methods (P-317 – P-337)
- Molecular modelling/ Virtual screening/ Metabolomics/Molecular networking/ Chemometrics and profiling (P-339 – P-365)
- Phytopharmacology III
 - General; Cancer (P-382 – P-380)
 - Neuroscience; Neuroprotection; Cognitive health (P-401 – P-400)
 - Respiratory; antiviral (P-413 – P-412)
- Pharmaceuticals (P-414 – P-429)

P-302 Biomarkers for the quality control of Dangkwisoo-san

Authors Noriko Yamabe¹, Ji Hwan Lee¹, Myoung-Sook Shin¹

Institute 1 Gachon University, Seongnam, 대한민국

DOI 10.1055/s-0043-1774172

Dangkwisoo-san (DS) is a traditional Korean herbal medicine used to treat traumatic diseases, including pulmonary contusions, traumatic pneumothorax, bruising and ankle sprain. Quality control (QC) biomarkers for DS can help ensure its safety and efficacy. Although chemical quality assessments are performed to ensure consistent efficacy of DS, the identity and quantity of the compounds contained within a given natural product is a frequent complication. We conducted a literature review to identify biological assays that support the chemical QC of DS. The results of our investigation confirmed that *in vitro* experiments with aqueous and alcoholic extracts of DS exhibited positive effects on many aspects of treatment. With 80% EtOH extraction, a low concentration of DS (1 µg/ml) significantly diminished the expression of inflammatory factors, such as nitric oxide (NO), TNF- α , IL-1 β and IL-6, in the Raw264.7 cell line. MeOH extracts activated NRF2 and antioxidant activities in response to the inflammatory inducer LPS, and water extracts of DS remarkably reduced proinflammatory cytokine levels compared to dexamethasone and cyclosporin treatments. Aqueous extracts of DS at a moderate dose of 125 µg/mL supported bone regeneration, recovered ischemic injury in an eNOS-dependent manner, and prevented metabolic disorders (TRPM7 channel inhibition). Cytokines, NO, and immunoglobulins are potential biological QC biomarkers to assess the anti-inflammatory and immune response to DS.

P-305 Quality assessments of *Campylanthus glaber* aerial parts as an herbal medicine

Authors Katelene Lima¹, Maryam Malmir¹, Rita Serrano¹, Kamrul Hasan¹, Samuel Gomes², Isabel Moreira da Silva¹, Maria Eduardo Figueira¹, Paula Duarte³, Olga Silva¹

Institutes 1 Research Institute for Medicines (iMed.Ulisboa), Faculty of Pharmacy, Universidade de Lisboa, Av. Professor Gama Pinto, 1649-003, Lisboa, Portugal; 2 Instituto Nacional de Investigação e Desenvolvimento Agrário, CP 84, Santiago, Cabo Verde; 3 METRICs/Chemistry Department, Nova School of Science and Technology, Universidade Nova de Lisboa, 2829-516, Lisboa, Portugal

DOI 10.1055/s-0043-1774173

The dried aerial parts of *Campylanthus glaber* Benth. subsp. *glaber* is traditionally used in Cabo Verde as an herbal preparation in the form of decoction to treat fever and muscular pain. Considering the lack of data regarding the quality and efficacy of this medicinal plant, the present work aims to establish the botanical and chemical identification parameters required for pharmaceutical quality assessments. Additionally, *in vitro* antioxidant activity was determined using FRAP and DPPH methods. Microscopy of *C. glaber* leaf showed a unique

xeromorphic, isobilateral succulent leaf with a thick cuticle ($23 \pm 2.1 \mu\text{m}$), circular and thick-walled epidermal cells, anomocytic stomata, glandular trichomes ($110 \pm 9.8 \mu\text{m}$), and calcium oxalate crystals. Chemical screening of aqueous and 70 % ethanolic extracts of *C. glaber* revealed the presence of flavonoids, phenylethanoids and iridoids. Both extracts showed similar LC/UV-DAD profiles and DPPH scavenging activity ($\text{IC}_{50} = 130.9 \pm 1.4 \mu\text{g/mL}$; $134.3 \pm 3.1 \mu\text{g/mL}$, respectively). The results obtained are an important contribution to the monographic quality assessment of *C. glaber*. Further studies are underway to characterise the pre-clinical safety of this medicinal plant, and additional data is being collected on its mechanism of action as an anti-inflammatory agent.

Conflict of Interest The authors declare no conflict of interest.

P-306 New methodology for the authentication of raw materials adapted to herbal products.

Author Loic Loffredo²

Institutes 1 BotaniCERT, GRASSE, France; 2 University of Paris Saclay, Orsay, France

DOI 10.1055/s-0043-1774174

Natural herbal products are widely used in cosmetics, food supplements and pharmaceutical products. The market is constantly changing with many new references and each country provides guidelines for verifying the authenticity of plant raw materials: the pharmacopoeias. Faced with the explosion of the market, it is difficult to change these standards quickly enough. Today, many of these methods are outdated and can no longer guarantee adequate control. This is why, many falsifications are found on products on the market [1]. Fraud can be confusion of species, voluntary mixtures of other species, significant dilutions, or enrichments by synthetic substances. It is within this framework that BotaniCERT, a plant analysis laboratory, analyses many samples from the market to verify the authenticity of plant raw materials. Herein, the goal is to develop a unique simple methodology to detect and anticipate all types of fraud while verifying the botanical species with the highest level of confidence possible. In this way, it is necessary to consider the qualitative and semi-quantitative aspects of all detected substances. The first step of this project is to develop a methodology by UHPLC-DAD/MS with manual structural elucidation of more than 1000 secondary metabolites in more than 500 plant species in front of an automated methodology by UHPLC-DAD/Q-T with quick annotation of known metabolites by bioinformatics global approach [2] to highlight real discriminating differences between all studied plant species.

References

- [1] Gafner S et al. *Journal of Natural Products* 2023; 86: 460–472
- [2] Nothias-Scaglia L-F et al. *Spectra Analyse* 2015; 307: 65–70

P-307 Application of viscosity-enhanced NMR spectroscopy to complex mixtures such as essential oils

Authors Ritchy Leroy¹, Jean-Marc Nuzillard¹, Pedro Lameiras¹

Institute 1 Reims Institute of Molecular Chemistry, REIMS, France

DOI 10.1055/s-0043-1774175

Complex mixture investigations by liquid-NMR is a subject as old as NMR itself and for which only a few solutions have been developed, such as LC-NMR hyphenation, diffusion-ordered spectroscopy (DOSY), multi-quantum spectroscopy combined with broadband homonuclear decoupling, sparse sampling, ultrafast data acquisition, multiple selective excitation, or tensor decomposition methods. The recent use of viscous solvents has provided a promising approach called ViscY (Viscosity-enhanced spectroscopy) to investigate complex mixtures by slowing down the tumbling rate of mixed analytes [1–3]. As a result, the molecules present a negative NOE regime, and their resonances can be grouped in relation to their capability to exchange magnetisation through intramolecular spin diffusion. The 2D ¹H NOESY spectrum of a complex mixture shows correlations between all ¹H resonances of each compound when

recorded in spin diffusion conditions, thus giving access to the individual ¹H NMR spectra of the mixture components. In this context, we applied 1D & 2D ViscY NMR experiments (1D, 2D ¹H NOESY, 2D ¹H-¹³C-HSQC-NOESY, ¹H/¹³C NOAH BSCN) to complex mixtures such as essential oils: Vanilla, Lemon, Cummin, Niaouli and Lemon Eucalyptus, by considering viscous chlorotrifluoroethylene polymer. We assessed information gain compared to the usual non-viscous solvent CDCl₃ regarding the number of chemical shifts, NOEs and structures elucidated.

References

- [1] Pedinielli F., Nuzillard J.-M., Lameiras P. *Anal. Chem.* 2020; 92 (7): 5191–5199
- [2] Pedinielli F., Leroy R., Martinez A., Nuzillard J.M., Lameiras P. *Analyst.* 2021; 146: 5316–5325
- [3] Leroy R., Pedinielli F., Bourbon G., Nuzillard J.-M., Lameiras P. *Anal. Chem.* 2022; 94 (26): 9278–9286

P-308 Contributions to the elaboration of a monograph of Pogostemonis Herba for the European Pharmacopoeia

Authors Marlene Hribernig¹, Volker Wolkinger¹, Yu-Ling Ho², Hung-Rong Yen³, Lu-Hai Wang³, Yuan-Shiun Chang³, Rudolf Bauer¹

Institutes 1 Institute of Pharmaceutical Sciences, Section Pharmacognosy, University of Graz, Graz, Austria; 2 Department of Nursing, Hungkuang University, Taichung, Taiwan; 3 College of Chinese Medicine, China Medical University, Taichung, Taiwan

DOI 10.1055/s-0043-1774176

Pogostemonis Herba, the dried aerial parts of *Pogostemon cablin* (Blanco) Benth., Lamiaceae, are used in TCM to treat nausea, diarrhoea, headache, colds, and fever. For the development of a monograph of *Pogostemonis Herba* for the European Pharmacopoeia, various methods for quality control have been evaluated. The content of the essential oil is indicative of the age of the drug and of the content of the stems, with leaves containing five times more essential oil than stems. A limit of 0.6 % has been suggested, like in the Japanese Pharmacopoeia. The content of patchoulol and pogostone was determined in the essential oil by gas chromatography (GC). In all batches, patchoulol was the major constituent (average of 49.4 %). CP2020 requires ≥ 26 % of patchoulol in the essential oil. A batch, which consisted only of wooden stems, had the lowest patchoulol content (30.5 %), however, the content of pogostone was 10 times higher than in leaves, which shows that it is a marker for high stem content. An HPTLC method was developed which allows discrimination of *Pogostemonis Herba* and *Agastaches Herba* based on the constituents of the essential oil. *Agastaches Herba*, which is often confused for *Pogostemonis Herba*, was lacking pogostone and has a low patchoulol content. They can also be distinguished by the analysis of verbascoside, because *Agastaches Herba* is lacking it. The project has been supported by OeAD within the program “Cooperation Development Research” and funded by the Austrian Federal Ministry of Education, Science and Research (TW 01/2020) together with the funding support from Ministry of Education, Taiwan.

P-309 Evaluating the stability and quality of commercially available tinctures of *Scutellaria lateriflora* L.

Authors Cillian Gately¹, Rachel Scully¹, Zeeshan Anwar¹, Helen Sheridan¹

Institute 1 NatPro Centre, School of Pharmacy and Pharmaceutical Sciences, Trinity College Dublin, Dublin, Ireland

DOI 10.1055/s-0043-1774177

American skullcap, (*Scutellaria lateriflora* L.) belongs to the Lamiaceae family and is one of 300 *Scutellaria* species worldwide. It's been traditionally used by Native Americans for its sedative and diuretic properties. The anxiolytic properties of the *Scutellaria* species have been attributed to the flavonoids present.

The main constituents baicalin and baicalein bind to the benzodiaspine site of the GABAA receptor. While baicalin is considered the main active constituent within *S. lateriflora*, baicalein has shown higher affinity to the benzodiaspine site, exhibiting a stronger anxiolytic effect. *S. lateriflora* preparations are sold as commercial tinctures and hydroalcoholic solutions, for their practicality in storage and dosage. A key challenge is validating the stability and quality of herbal products, due to their complex nature. Source material, solvent to solute ratio, and type of extraction can dictate the quality, safety, and efficacy of the preparations. Key constituents, baicilin and baicalein, are pH and temperature sensitive which may cause change in composition over time.

In this study, a significant difference was found between commercial tinctures prepared with fresh and dried plant material of *S. lateriflora*. Comparatively, levels of baicalin were lower (48 – 58 %) in fresh plant tinctures, potentially due to hydrolysis by glucuronidases enzymes present in fresh plant tinctures. Additionally, fresh plant tinctures were placed under accelerated storage conditions (25°C/RH 45 %), resulting in an observable change over the 6-month period (► Fig. 1).

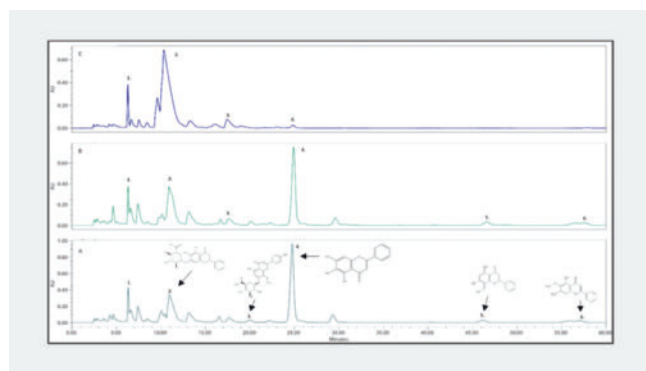

► Fig. 1 HPLC-PDA chromatograms of *S. lateriflora* tinctures. **a:** Fresh-plant tinctures at initial timepoint. **b:** Fresh-plant tinctures after 6 months. **c:** Dry-herb tinctures. 1-internal standard (4-hydroxybenzoate), 2-baicalin, 3-wogonoside, 4-baicalein, 5-wogonin, 6-oroxylin A.

P-310 Analysis of parameters influencing the overall quality of *Pinus halepensis* resin used in the vinification process of retsina

Authors Alexandros Nakas^{1, 5}, Eleni Kechri², Dionysia Samara², Christina Virgiliou^{3, 6}, Helen Gika^{4, 6}, Andreana Assimopoulou^{1, 5}

Institutes 1 Laboratory of Organic Chemistry, School of Chemical Engineering, Aristotle University of Thessaloniki, Thessaloniki, Greece; 2 Asty Wine, Thessaloniki, Greece; 3 Laboratory of Analytical Chemistry, School of Chemical Engineering, Aristotle University of Thessaloniki, Thessaloniki, Greece; 4 School of Medicine, Aristotle University of Thessaloniki, Thessaloniki, Greece; 5 Natural Products Research Centre of Excellence (NatPro-AUTH), Center for Interdisciplinary Research and Innovation, Aristotle University of Thessaloniki, Thessaloniki, Greece; 6 Center for Bioanalysis & Omics (BIOMIC_AUTH), Center for Interdisciplinary Research and Innovation, Aristotle University of Thessaloniki, Thessaloniki, Greece

DOI 10.1055/s-0043-1774178

Retsina is a Greek white or rosé wine produced by the traditional method of adding pine resin (*Pinus halepensis*) to the must. It is protected by the Greek and European legislation under the category "Traditional Appellation", which is exclusively used for wines produced according to traditional methods of a specific area or country [1]. This study focuses on the resin, and in particular how the altitude of the pine forest (microclimate), the collection practice and the contact time with the must affect the quality of the aromatic compounds

of the resin and resinated wine, as well. Several analytical techniques, such as HS-SPME GC-MS, HPLC-MS, ¹H NMR and ¹³C NMR were employed to identify aromatic, phenolic and terpenoid compounds extracted from the resin into the wine under 8 different vinification protocols. The results of the chemical analysis are correlated with the results of a sensory analysis, performed in parallel. Chemical and sensory analysis results confirm that all the examined parameters of the resin significantly influence the aromatic profile of the final product.

Funding This research has been co-financed by the European Union and Greek national funds through the Operational Program Competitiveness, Entrepreneurship and Innovation, under the call RESEARCH–CREATE–INNOVATE (project code: T2EDK-03382).

References

[1] Council Regulation (EC) No 479/2008, P.D. 514/1979 on production, control and protection of resinous wines.

P-311 *Anacardium occidentale* bark Monograph

Authors Sofia Encarnação¹, Katelene Lima¹, Olga Silva¹

Institute 1 Research Institute for Medicines (iMed.Ulisboa), Faculty of Pharmacy, Universidade de Lisboa, 1649-003, Lisboa, Portugal

DOI 10.1055/s-0043-1774179

Anacardium occidentale L., commonly known as the cashew tree and native to South America, plays an essential role in traditional medicine. The aim of this work is to update the ethnopharmacological data with regards to the validation of the concrete use of a traditional herbal preparation (THP) based on an aqueous extract of *A. occidentale* bark. This THP is used to treat diabetes and other inflammatory conditions in Portugal and African Portuguese-speaking countries. The results of the quality and preclinical safety and efficacy studies we have conducted are systematised and discussed using the available scientific data on this medicinal plant. In addition, a comprehensive monograph will be presented that can help consumers and healthcare professionals to better use this medicinal plant. Quality control parameters for identification (botanical and chemical), purity (total ash and loss on drying) and assay (e.g. total phenols) are established. The results of in vivo repeated dose toxicity and genotoxicity as well as the in vitro Ames test suggest the continued safe use of this *A. occidentale* bark THP. This extract was found to be a source of natural antioxidants and demonstrated significant anti-inflammatory activity and the potential to improve glucose tolerance in animal models when administered at a dose of 127 mg/kg/day.

A. occidentale bark THP is emerging as an interesting and promising therapeutic alternative for use in healthcare systems to treat and slow the progression of various pro-inflammatory diseases such as diabetes.

Conflict of Interest The authors declare no conflict of interest.

P-312 A small-scale in vitro digestion model to examine the stability of flavonoid C-glycosides, O-glycosides, and their aglycons

Authors Sabrina Zölch¹, Jörg Heilmann¹

Institute 1 University Regensburg, Regensburg, Germany

DOI 10.1055/s-0043-1774180

Flavonoids are widespread secondary plant metabolites and exhibit a broad range of biological activities, thus, they are of great interest for medical applications. In plants, flavonoids often occur as O- or C- glycosides since glycosylation improves their water solubility and stability. A small-scale in vitro digestion model modified according to Brodkorb et al. (2019) was applied to examine the impact of glycosylation on the stability of flavonoids upon oral application until resorption in the small intestine. The model consists of three different phases: oral, gastric, and intestinal digestion. In the oral phase, substances are incubated with simulated salivary fluid and 75 U/mL of α-amylase, followed by incubation with simulated gastric fluid and 2000 U/mL of pepsin. In the last step, the substances are incubated in simulated intestinal fluid and a mixture of different excretory digestive enzymes of the pancreas, such as li-

pases, amylases, and proteases (pancreatin). The amount of pancreatin added is based on the measured trypsin activity of 100 U/mL. The proportion of flavonoids stable against digestive fluids and enzymes was determined by subsequent HPLC-DAD analysis. As ► Fig. 1 illustrates, compared to apigenin 8-C- and 6-C-glycosylated derivatives (vitexin and isovitexin) showed greatly increased stability. In comparison to luteolin, only a slight increase in stability was observed for the 8-C- and 6-C-glycosides orientin and isoorientin. Moreover, no positive impact on stability was observed for the O-glycosides apigenin-7-glucoside and luteolin-7-glucoside. These differences in the stability of flavonoids against digestive fluids and enzymes must be considered in subsequent studies on resorption, and metabolism.

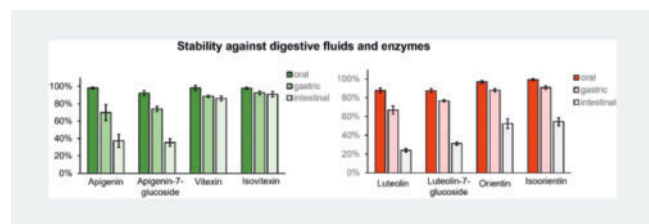

► Fig. 1 Stability of apigenin, luteolin, and their O- and C-glycosides in a small-scale *in vitro* digestion model. To investigate the stability of the flavonoids a small-scale *in vitro* digestion model was applied. The substances were incubated in three simulated digestion steps: oral, gastric, and intestinal phase, followed by HPLC-DAD analysis. The proportions of stable flavonoids are indicated as mean values of three independent measurements ($n = 3$) and the error bars declare the standard error of mean.

P-313 *Asphodelus bento-rainhae* and *Asphodelus macrocarpus* root extracts pre- clinical safety assessments

Authors Maryam Malmir¹, Katelene Lima¹, Sérgio Póvoas Camões¹, Paula Duarte², Joana Paiva Miranda¹, Manuela Caniça^{3, 4, 5, 6}, Beatriz Silva Lima¹, Olga Silva¹

Institutes 1 Research Institute for Medicines (iMed.Ulisboa), Faculty of Pharmacy, Universidade de Lisboa, 1649-003, Lisbon, Portugal; 2 METRICs/Chemistry Department, Nova School of Science and Technology, Universidade Nova de Lisboa, 2829- 516, Caparica, Portugal; 3 National Reference Laboratory of Antibiotic Resistances and Healthcare-Associated Infections, Department of Infectious Diseases, National Institute of Health Dr. Ricardo Jorge, 1649-016, Lisbon, Portugal; 4 Centre for the Studies of Animal Science, Institute of Agrarian and Agri-Food Sciences and Technologies, University of Porto, Porto, Portugal; 5 AL4AnimalS, Associate Laboratory for Animal and Veterinary Sciences, Portugal; 6 CIISA, Center for Interdisciplinary Research in Animal Health, Faculty of Veterinary Medicine, University of Lisbon, Portugal

DOI 10.1055/s-0043-1774181

Herbal medicines generally have minimal safety concerns compared to synthetic medicines; however, they are not free from toxicity or side effects. Due to the significant increase in global consumption, the safety of herbal medicines has been highlighted. *Asphodelus bento-rainhae* subsp. *bento-rainhae* and *Asphodelus macrocarpus* subsp. *macrocarpus* root tubers have been traditionally used in Portugal to treat inflammatory and infectious skin diseases. Given the lack of scientific evidence on the safety and efficacy of both *Asphodelus* medicinal plants, the present study aims to evaluate the toxicity of their hydroethanolic (70% and 96%) root extracts. Cytotoxicity was assessed by MTT assay using HepG2 and HaCaT cells and genotoxicity by bacterial reverse mutation assay (Ames test) with and without metabolic activation according to OECD guidelines. The obtained results showed no cytotoxic (up to 125 µg/mL) or genotoxic/mutagenic potential (up to 5000 µg/plate, with/without metabolic

activation) for the two extracts of both species. Although further studies are needed to complete the safety profile of these two medicinal plants, the obtained negative results provide relevant contributions to their toxicological profiles and important contributions to their future use as therapeutic resources.

P-314 Safety assessment of *Serjania triquetra*

Authors Guadalupe Yáñez-Ibarra², Berenice Aguilar-Guadarrama¹, Javier-German Rodríguez-Carpene³, Gabriela Ávila- Villarreal^{2, 3}

Institutes 1 Centro de Investigaciones Químicas, IICBA, Universidad Autónoma del Estado de Morelos, Cuernavaca, Mexico; 2 Centro Nayarita de Innovación y Transferencia de Tecnología A. C. "Unidad Especializada en I+D+i en Calidad de Alimentos y Productos Naturales", Universidad Autónoma de Nayarit, Mexico., Tepic, Mexico; 3 Unidad Académica de Ciencias Químico Biológicas y Farmacéuticas, Universidad Autónoma de Nayarit, Tepic, Mexico

DOI 10.1055/s-0043-1774182

Serjania triquetra is used in traditional medicine to treat kidney diseases and is found in various herbal products. However, with the increase in the sale of herbal products without proper validation, it is important to assess the safety and quality of herbal medicinal products to ensure the well-being of individuals using them. This can be achieved through a combination of *in vitro* and *in vivo* studies, including adherence to the OECD guidelines for toxicity testing. Safety of commercial *S. triquetra* products was evaluated by lethality assay in *Artemia salina* L. model and acute oral toxicity (AOT) *in vivo* (mouse) according to OECD Guide 420. Different concentrations of the hydroalcoholic extract from two commercial samples (HAES-I, HAES-II) and a reference (HAESr) were evaluated to determine its toxicity according to Meyer's and Clarkson's toxicity index. Results showed that the extracts analysed were classified as 'non-toxic' with values higher than 1000 µg/mL. The AOT of HAESr was evaluated by administering doses of 300 and 1000 mg/kg intragastrically and observing behaviour and weight variation for 14 days. Signs of toxicity were observed in the animals, including changes in breathing, piloerection and pain upon touch, but no weight variations were recorded. Necropsy revealed changes in organ coloration, whitish masses in the lungs, and decreased heart size. Based on these results, HAESr was classified as Category 4 "Harmful if ingested" according to the GHS, with an LD₅₀ of > 300 and ≤ 2000 mg/kg. According to the results, *S. triquetra* is classified as low hazard.

P-315 Genotoxicity evaluation of *Tagetes erecta* L.

Authors Daniela-Yusbizareth Rodríguez-Jiménez^{2, 3}, Aurora Elizabeth Rojas-García⁴, Irma Martha Medina-Díaz⁴, Javier German Rodríguez-Carpene³, Gabriela Ávila-Villarreal^{2, 3}, A. Berenice Aguilar-Guadarrama¹

Institutes 1 Centro de Investigaciones Químicas, IICBA, Universidad Autónoma del Estado de Morelos, Cuernavaca, Mexico; 2 Unidad Académica de Ciencias Químico Biológicas y Farmacéuticas, Universidad Autónoma de Nayarit, Tepic, Mexico; 3 Unidad Especializada en I+D+i en Calidad de Alimentos y Productos Naturales. Centro Nayarita de Innovación y Transferencia de Tecnología, Universidad Autónoma de Nayarit, Tepic, Mexico; 4 Laboratorio de Contaminación y Toxicología Ambiental, Universidad Autónoma de Nayarit, Tepic, Mexico

DOI 10.1055/s-0043-1774183

Tagetes erecta L. is an annual plant from the Asteraceae family widely consumed in gastronomy and Traditional Mexican Medicine (TMM) practices. This plant is rich in phenolic compounds such as flavonoids and coumarins. The present study aimed to evaluate the subtoxic concentrations of hydroalcoholic extract of *T. erecta* (HAETe) by cytokinesis blocking micronucleus technique (CBMN) to assess chromosomal aberrations in human lymphocytes. Five different concentrations of HAETe were evaluated, and a total of 1,000 binucleated (BN) cells were assessed to identify the presence of micronuclei (MNI), the frequency of MNI cells were calculated. DNA damage events were scored in BN cells and include MNI, a biomarker of chromosome breakage and/or whole chromosome

loss, nucleoplasmic bridges (NPBs), a biomarker of DNA misrepair and/or telomere end-fusions, and nuclear buds (NBUDs), a biomarker of elimination of amplified DNA and/or DNA repair complexes, determination [1].

The frequency of MNI has been widely recognized as a biomarker for chromosomal damage and has shown a significant correlation with the incidence of cancer. Preliminary results from this study did not show an increase in MNI occurrence in cells treated with HAETe compared to the control group. These findings provide initial evidence suggesting the lack of genotoxic activity of *T. erecta*. Given the widespread consumption in gastronomy and TMM, further investigation of its safety profile should be conducted.

References

[1] Fenech Michael "Cytokinesis-Block Micronucleus Cytome Assay." Nature Protocols 2007; 2 (5): 1084–1104

P-316 Planar umuC assay: a novel effect-directed analysis kit for screening of genotoxic potential of plant extracts

Authors Evelyn Wolfram^{1,2}, Matthias Graf¹, Ramona Schlicht, Stephan Schilling², Andreas Schönborn², Stefan Weiss²

Institutes 1 Zurich University of Applied Sciences (ZHAW) ICBT – Natural Products and Phytopharmacy, Wädenswil, Switzerland; 2 Planar4 GmbH, Stäfa, Switzerland

DOI 10.1055/s-0043-1774184

Botanical raw materials for phytopharmaceutical applications must comply with the current regulations for medicines in the EU or guidelines for herbal medicinal products in terms of quality, safety and effectiveness when placed on the market in Europe. In the EU, the legal requirements for active ingredients (API) and medicines (Herbal Medicinal Products for human use) as well as the guidelines and monographs of the Herbal Medicinal Product Committee (HMPC) as an expert committee for medicinal plant products within the EMA apply here. If extracts are used in the food sector, the safety regulations of the European Food Safety Agency (EFSA) must be considered. In both cases, genotoxicity testing is an important aspect of the safety assessment of plant extracts and their preparations.

So far, the Ames test has been mandatory. In recent years it has been shown that this established test has some disadvantages. In the field of ecotoxicology, which also deals with multi-component mixtures, the suitability of the more sensitive umuC test in addition to or even instead of the Ames test is already being discussed.

This poster demonstrates the application of the umuC test coupled to HPTLC (planar umuC) for assessing plant extracts and their leachables from their containers. The results of a validation study as well as S9 activation of metabolites prior to chromatography show the applicability of the novel effect directed analysis method for routine safety screening in R&D, quality control and regulatory compliance of plant derived natural health products.

P-317 Monoclonal antibody production against majonoside-R2, the major bioactive compound of Vietnamese ginseng

Authors Jiranan Chaingam¹, Le Van Huy², Gorawit Yusakul³, Kanta Noguchi¹, Satoshi Morimoto¹, Seiichi Sakamoto¹

Institutes 1 Department of Pharmacognosy, Graduate School of Pharmaceutical Sciences, Kyushu University; Department of Pharmacognosy, Graduate School of Pharmaceutical Sciences, Kyushu University, 3-1-1 Maidashi, Higashi-ku, Japan; 2 Research Institute for Biotechnology and Environment, Nong Lam University, Ho Chi Minh city; 3 School of Pharmacy, Walailak University, Nakhon Si Thammarat

DOI 10.1055/s-0043-1774185

Panax vietnamensis, or Vietnamese ginseng (VG), is a *Panax* sp. that was a plant discovered and proven to possess multifunctional biological activities. Chemical constituents of VG have been studied, and majonoside-R2 (MR2) has been

found as a major ocotillol-type saponin containing around 5.3% in addition to protopanaxadiol-type and protopanaxatriol-type saponins. As with other *Panax* spp., VG is used for numerous treatment indications, including immune system enhancement, inflammatory reduction, anti-cancer, memory loss protection, and aging prevention; furthermore, it has been reported as a dominant anti-myocardial ischemia. Therefore, MR2 became a consequential bioactive compound in VG that needs to be investigated. In previous studies, HPLC and HPLC/evaporative light scattering detector were the only methods performed in order to detect the ocotillol saponin. The difficulty in detecting this saponin-type was caused by the lack of appropriate chromophores for UV absorbance. Thus, immune-specific detection using monoclonal antibodies (mAb) was developed for the purpose of providing the analytical benefit of MR2 in VG. In this study, BALB/c mice were immunised with MR2-BSA conjugates prepared by oxidative amination using sodium periodate. After cell fusion of splenocytes with SP2/0 myeloma cells, three outstanding hybridoma candidates secreting anti-MR2 antibodies were screened on the basis of specificity. Finally, the best hybridoma cells secreting highly specific MR2 mAb was chosen for further expansion. In conclusion, MR2 mAb was successfully obtained as a useful tool for nanogram-level quantitative analysis detection for MR2 (3.90 – 125 ng/mL) using enzyme-linked immunosorbent assay.

Conflict of Interest The authors declare no conflict of interest.

P-318 Comparison of flavonoid contents in the red-stem and green-stem *Persicaria odorata* extracts analysed by HPLC method

Authors Pongtip Sithisam¹

Institute 1 Faculty of Pharmacy, Mahidol University, Bangkok, Thailand

DOI 10.1055/s-0043-1774186

There are two different types of *P. odorata* (Lour.) Sojak (Polygonaceae) found in Thailand, the red-stem and green-stem ones which our previous report suggested promote in vitro antioxidant activities with inhibitory effects against α -glucosidase and α -amylase enzymes. There is only report on essential oils analyses but no report on phytochemicals in their leaves and stems. Therefore, this study was conducted in order to quantitatively analyse the major chemical constituents in the leaf and stem extracts from the red-stem and green-stem *P. odorata* samples. A high performance liquid chromatographic (HPLC) method was optimised, validated and used. Phenolics and flavonoids including gallic acid, scutellarin, quercetin and kaempferol were major compounds in *P. odorata* extracts. Scutellarin was found in the highest amounts in the leaves (4.81 ± 0.05 and 1.59 ± 0.01 g in 100 g extract for red-stem and green-stem leaf extracts, respectively) while it was found in very low amounts in both coloured stems. In the green-stem stem extract, only gallic acid could be detected in a low amount (0.56 ± 0.00 g in 100 g extract). The red-stem *P. odorata* extracts significantly contained higher amounts of all phytochemicals than the extracts from green-stem samples while the leaf extracts contained higher amounts of all compounds than the stem extracts. The results suggest the leaves of red-stem *P. odorata* as raw materials with high amounts of phytochemicals that could be useful for further pharmaceutical and medicinal applications in the future.

P-319 Production of specific monoclonal antibody against marker compound, hesperidin, geniposide, and saikosaponin b₂ for the quality control of crude drugs

Authors Kanta Noguchi¹, Akihiro Ochi¹, Poomraphie Nuntawong¹, Shunsuke Fujii², Hiroyuki Tanaka³, Satoshi Morimoto¹, Seiichi Sakamoto¹

Institutes 1 Graduate School of Pharmaceutical Sciences, Kyushu University, Fukuoka, Japan; 2 Faculty of Health Management, Nagasaki International University, Japan; 3 Faculty of Pharmaceutical Sciences, Sanyo-Onoda City University, Japan

DOI 10.1055/s-0043-1774187

Quality control of crude drugs based on marker compound is crucial as the quality directly affects efficacy of the treatment. So far, we have focused on plant secondary metabolites, and developed immunoassays for the quality control of crude drugs because highly sensitive, selective and efficacy quantitative/qualitative analysis can be carried out with immunoassay even though the sample is plant-derived sample which contains abundant secondary metabolites as well as primary metabolites, such as carbohydrates, lipids and amino acids.

In this study, we have produced three monoclonal antibodies (mAbs) for hesperidin (HP), geniposide (GP), and saikosaponin b₂ (SSb₂) to develop quality assessment method for *Citrus unshiu* peel, *Gardenia* fruit, and *Bupleurum* root, respectively, which were used in Kampo medicines. The marker compounds, HP, GP and SSb₂ were individually conjugated with bovine serum albumin to elicit an immunogenicity. Hybridomas secreting mAb were generated by fusing splenocytes and mice myeloma cells, SP2/0, and specific mAb to each compound was screened by indirect competitive enzyme-linked immunosorbent assay (icELISA). Characterisation of three purified mAbs by icELISA revealed that they were specific to each marker compound with high sensitivity, in which the limit of detection for HP, GP and SSb₂ exhibited were 1.12 ng/mL 1.13 µg/mL, and 2.13 ng/mL, respectively. These results indicated that the mAbs can be applied to quality control for the crude drugs containing HP, GP and SSb₂.

Production and characterisation of three mAbs, and their application to icELISA, will be presented in this conference.

Conflict of Interest The authors declare no conflict of interest.

P-320 Development and optimization of extractive and analytical methods on *Humulus lupulus* L.

Authors Valentin Pichon^{1,2}, Lea Gibot-Leclerc¹, Emilie Pinault¹, Marylène Viana¹, Gilles Ducret², Lengo Mambu¹

Institutes 1 Limoges University, LABCIS, UR 22722; BISCEM, UAR 2015 US42, F-87000 Limoges, France; 2 Pharmaceutical laboratory, CentreLab, F-23000 Guéret, France

DOI 10.1055/s-0043-1774188

Humulus lupulus L. (cones) biosynthesises a specific variety of natural compounds with several applications in the food and pharmaceutical industries according to different access methods used.

This work focuses on the development of extractive methods with green solvents and transferable to other plant species on an industrial scale. All extractive techniques used were compared according to their yields, chemical composition such as total assays (polyphenol, flavonoid and chlorophyll), metabolite profile, LC-MS/MS quantification and molecular networks.

Classical extractive methods including maceration (SE) and ultrasound (UAE) were used along with alternative techniques using pressure (PLE) or microwaves (MAE), as well as other triphasic or combined extractions (SE + UAE). Ethanol was chosen as the reference solvent.

The use of ultrasound allowed increasing yield with reducing time in comparison with maceration. These results were clearly marked with PLE with 3 and 6-fold gains for yield and time.

The quantification of compounds showed that each extraction technique favours a type of products. The best content of α/β-bitter acids such as humulone and lupulone was obtained with PLE at 125 °C. The xanthohumol content obtained by maceration is multiplied by 3 in MAE or by 5 with ASE. The determination of flavonoids and polyphenols demonstrated that MAE provides higher contents than other methods.

The use of pressure, microwaves or coupling methods strongly improves the yields (mass and molecules of interest) and LC-MS/MS allows us to follow different concentrations of metabolites and to choose the appropriate technique.

Conflict of Interest The authors declare no conflict of interest.

P-321 Mass-spectrometric analysis of chlorophyll degradation products in medicinal plants during leaf senescence

Authors Lisa Marie Gorfer¹, Manuel Pramsohler¹, Peter Robatscher¹, Michael Oberhuber¹

Institute 1 Laimburg Research Centre, Ora, Italy

DOI 10.1055/s-0043-1774189

Chlorophyll is the most abundant pigment in the kingdom of higher plants. During leaf senescence, chlorophyll is released from the photosystems and degraded to linear tetrapyrroles, referred to as phyllobilins (PBs) in analogy to the bile pigments. Recently, pharmacological activities have been reported for a series of PBs.

The aim of this study was to investigate the appearance of PBs during leaf senescence in *Melissa officinalis*, *Mentha x piperita*, *Salvia officinalis*, *Alchemilla vulgaris* and *Malva sylvestris*. Senescence was induced, and chlorophyll contents of methanolic extracts were analyzed using UV/Vis-spectroscopy. Decrease in chlorophyll was moderate with 35% in mallow and sage, 40% in lemon balm. A more complete breakdown was observed in peppermint and lady's mantle, decreasing about 60–80%. Qualitative analysis of phyllobilins in *Lamiaceae* species was performed using high-resolution mass-spectrometry, applying a MS/MS-method with an inclusion-list containing 65 PBs. With decrease in chlorophyll, the number of phyllobilins increased in senescent mint (four to ten) and sage (three to seven). In yellow leaves of lemon balm, the number of phyllobilins increased from six to eight, showing a higher number already in the pre-senescence. Fourteen different PBs were identified in the three *Lamiaceae*, while four occurred in all three species. Such a pattern was suspected, as they belong to the same plant family (► Fig. 1).

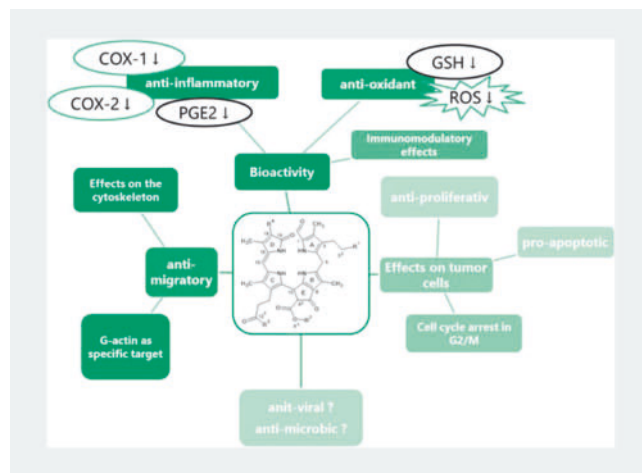

► Fig. 1 Phyllobilins act as bioactive phytochemicals.

In conclusion, this study shows that medicinal herbs contain phyllobilins already in green stages. PB content and diversity increase at the onset of senescence, highlighting the potential of these phytochemicals for medical applications.

Conflict of Interest The authors declare no conflict of interest.

P-322 Quantification of bitter compounds in (un) traditional preparations of *Gentiana purpurea* roots

Authors Håvard Hoel¹, Helle Wangenstein¹

Institute 1 Department of Pharmacy, University Of Oslo, Oslo, Norway

DOI 10.1055/s-0043-1774190

Gentiana purpurea L. was one of the most important medicinal plants in Norway in the 18th and 19th centuries. Indications were all kind of stomach diseases,

especially diarrhoea, but also chest diseases such as bronchitis, and to treat coughing and colds. The roots have an intensely bitter taste due to a high content of secoiridoids, with gentiopicrin as the major one. The roots were used as medicine both for humans and animals and prepared with boiling milk, beer or water, or macerated with liqueur. The aim of this study was to quantify the yield of the bitter compounds sweroside, gentiopicrin and amarogentin, and the degradation product erythrocentaurin in preparations of gentian root extracted with solvents used in traditional preparations of herbal drugs.

Dried gentian roots were extracted with beer, white wine, vinegar, ethanol, milk and water at different temperatures and time lengths, and the yield of the bitter compounds sweroside, gentiopicrin, amarogentin and erythrocentaurin were quantified with HPLC-DAD.

Maceration with 40% and 70% ethanol gave the highest yield of gentiopicrin, while boiling with beer, white wine, vinegar and milk gave a higher yield than with boiling water. Erythrocentaurin was only detected when the roots were added to cold water or low alcohol concentrations before heating. There were only small differences in the yields of sweroside and amarogentin.

We have for the first time described how traditional extraction solvents influence the yield of bitter compounds from *G. purpurea* roots.

P-323 Determination of selected biologically active substances in the adaptogenic herb *Rhaponticum carthamoides* using HPLC-MS/MS

Authors [Katerina Knizkova](#)^{1,2}, [Martin Kuchar](#)^{1,2}, [Petra Cihlarova](#)^{1,2}

Institutes 1 Forensic Laboratory of Biologically Active Substances, UCT Prague, Czech Republic; 2 The Department of Chemistry of Natural Compounds, UCT Prague, Czech Republic

DOI 10.1055/s-0043-1774191

Rhaponticum carthamoides (Willd.) Iljin, widely known as maral root, is an adaptogenic herb that has been used in traditional medicine for centuries. According to the presence of a large number of bioactive substances, the herb has significant beneficial effects on human health. Nowadays, maral root is sold on the market in many forms, such as dried root, milled plant, capsules, tinctures and seeds. This study aimed to develop new analytical methods for the determination of bioactive compounds in the plant itself and dietary supplements using high-performance liquid chromatography coupled with tandem mass spectrometry. For this purpose, a wide spectrum of supplements was purchased. Based on optimisation experiments, 60% ethanol and tert-butyl methyl ether were selected as extraction solvents. In plant ethanolic extracts, more than 20 polyphenolic compounds such as kaempferol, quercetin, naringenin, hesperetin and 2 ecdysteroids 20-hydroxyecdysone and polypodine B were quantified. To extract the remaining steroidal compounds, tert-butyl methyl ether was used. Due to insufficient ionisation of stigmaterol and β -sitosterol at the ion source, a derivatization method was required to be developed and optimised. The best result showed the derivatization agent 2-fluoro-1-methylpyridinium p-toluenesulfonate. Subsequently, an analysis of the obtained samples was performed. The abundance of compounds was quite diverse, while the most abundant one was 20-hydroxyecdysone. Variability may be caused by the quality of plant material, collection location, season, climate and other external conditions. Using the developed methods, selected bioactive compounds in *R. carthamoides* and dietary supplements were successfully quantified by HPLC-MS/MS analysis.

Conflict of Interest The authors declare no conflict of interest.

P-324 UHPLC-MS/MS determination of anthraquinone derivatives in food supplements containing Aloe vera

Authors [Petra Cihlarova](#)¹, [Simon Suda](#)¹, [Katerina Knizkova](#)¹, [Martin Kuchar](#)¹
Institute 1 University of Chemistry and Technology Prague, Prague, Czech Republic

DOI 10.1055/s-0043-1774192

Aloe vera, a monocotyledonous succulent plant, has been used in traditional medicine for centuries. It is widely used in dermatology and cosmetics as well as a part of beverages and food supplements marketed to support functions of the digestive system. Anthraquinone derivatives from aloe are used as laxatives. Due to the proven carcinogenic effects of anthraquinone derivatives, the FDA and EMA set limits of 1 ppm for these substances in food and food supplements. The aim of this study was to develop a method suitable for the determination of aloin A and B, aloin-emodin and emodin in capsules, tablets, and drinks containing Aloe vera. The first step was to optimise the extraction of analytes from complex matrices like various food supplements containing different amounts of aloe vera, as well as other components. The liquid-liquid extraction using ethyl acetate and solid phase extraction methods were used for sample processing. A UHPLC-MS/MS method was developed for the analysis, using a C18 column for the chromatographic separation of the analytes. The detection was performed on a triple-quadrupole mass spectrometer with negative mode electrospray ionisation. The developed method was used for the analysis of six beverages and four types of capsules containing Aloe vera. Aloin A and B were the most abundant anthraquinone derivatives detected in studied samples, with one product exceeding the set limit.

Conflict of Interest The authors declare no conflict of interest.

P-325 Targeted UHPLC-HRMS analysis of the ceramide and cerebroside profile of *Lonicera japonica* L.

Authors [Andrea Weihrich](#)¹, [Jürgen Hartler](#)², [Yu Ling Ho](#)³, [Yuan Shiun Chang](#)⁴, [Rudolf Bauer](#)¹, [Eva-Maria Pferschy-Wenzig](#)¹

Institutes 1 University of Graz, Institute of Pharmaceutical Sciences, Pharmacognosy, Beethovenstraße 8, 8010 Graz, Austria; 2 University of Graz, Institute of Pharmaceutical Sciences, Pharmaceutical Chemistry, Universitaetsplatz 1, 8010 Graz, Austria; 3 Department of Nursing, Hung Kung University, Taichung 43302, Taiwan; 4 Department of Chinese Pharmaceutical Sciences and Chinese Medicine Resources, College of Chinese Medicine China Medical University, Taichung 40402, Taiwan

DOI 10.1055/s-0043-1774193

Ceramides and cerebroside are sphingolipids consisting of a sphingoid base (SPB), a fatty acid, and in case of cerebroside, glucose as polar head group. They occur in all plant species, displaying high structural diversity [1]. Plant-derived ceramides and cerebroside have shown beneficial effects on skin hydration and the skin barrier, and preventive effects on intestinal impairments [2, 3]. *Lonicera japonica* L. (Caprifoliaceae) is an important TCM plant. The plant parts predominantly applied in pharmaceutical treatments are the flower buds, followed by stems. The plant is phytochemically well-characterised, with more than 300 isolated and identified constituents to date [4]. However, ceramides and cerebroside have only been occasionally reported from this species. Therefore, the aim of this study was a systematic ceramide and cerebroside profiling in the aerial parts of *L. japonica*.

Flower buds, bloomed flowers, stems and leaves from four different accessions in Taiwan were analysed by UHPLC-HRMS analysis, using inclusion lists for cer-

amide and cerebroside precursor ions. Compound annotation was performed by the software Lipid Data Analyzer [5].

77 different ceramides and 46 cerebrosides were annotated on the molecular species level, including several so far unreported species. Major ceramides consisted of a trihydroxylated 18:0 or a 18:1 SPB and a dihydroxylated fatty acid, and predominant cerebrosides contained trihydroxylated 18:1 SPBs and non-hydroxylated fatty acids. Ceramide and cerebroside levels were highest in flower buds, intermediate in bloomed flowers and leaves and lowest in stems. Variations were also observed between different accessions.

Funding The project has been funded by OeAD (TW 01/2020).

References

- [1] Haslam T, Feussner I. Diversity in sphingolipid metabolism across land plants. *J Exp Botany* 2022; 73: 2786–2798
- [2] Tessema E, Gebre-Mariam T, Neubert RHH, Wohlrab J. Potential applications of phyto-derived ceramides in improving epidermal barrier function. *Skin Pharmacol Physiol* 2017; 30: 115–138
- [3] Jiang C, Ge J, He B, Zeng B. Glycosphingolipids in filamentous fungi: Biological roles and potential applications in cosmetics and health foods. *Front Microbiol* 2021; 12: 690211
- [4] Li Y, Li W, Fu C, Song Y, Fu Q. *Lonicerae japonicae* flos and *Lonicerae flos*: a systematic review of ethnopharmacology, phytochemistry and pharmacology. *Phytochem Rev* 2020; 19: 1–61
- [5] Hartler J, Armando AM, Trotschmuller M, Dennis MA, Kofeler HC, Quehenberger O. Automated annotation of sphingolipids including accurate identification of hydroxylation sites using MSⁿ data. *Anal Chem* 2020; 92: 14054–14062

P-326 HPTLC fingerprinting for botanical origin assessment of Greek honeys

Authors Gabriela Lemus Ringele¹, Maria Pavlea¹, Stavros Beteinakis¹, Anastasia Papachristodoulou¹, Maria Halabalaki¹

Institute 1 Division of Pharmacognosy and Natural Products Chemistry, Department of Pharmacy, National and Kapodistrian University of Athens, Panepistimiopolis, Zografou, 15771, Athens, Greece
DOI 10.1055/s-0043-1774194

The composition of honey, an intricate matrix, depends on a plethora of endogenous and exogenous factors like bee species, harvesting conditions and climate among others. However, the most significant factor is on which flowers the bees feed, which directly affects its properties, its quality and, finally, the consumers [1]. The plants from which the nectar is gathered additionally influence its market value and often leads to adulteration practices, namely mixing with other lower-cost ingredients, and product mislabelling [2]. Consequently, new methods are required for authenticity assessment of honey as alternatives to more traditional ones, such as melissopalynological analysis. Thus, the aim of the present study was to develop an HPTLC fingerprinting method for the rapid determination of the botanical origin of honey. As a simple, easily handled, and cost-effective technique compared to other analytical platforms, e.g. HPLC-DAD, LC-MS or NMR, HPTLC is suitable for the analysis of large numbers of samples. Following collection and extraction, more than 250 samples from Greece were analysed. Numerous readouts were collected by using different wavelengths and derivatisation agents for monitoring purposes. Characteristic sets of bands typical for most of the analysed samples were detected, especially after derivatisation with sulfuric acid/vanillin reagent. In conclusion, it seems that HPTLC could offer a rapid alternative to conventional techniques for honey type characterisation and detection of adulteration.

Funding H.F.R.I. “Creation of national networks in value chains of honey – “Bee roads” 2018ΣΕ01300000

Conflict of Interest The authors declare no conflict of interest.

References

- [1] Lemus Ringele GB, Beteinakis S, Papachristodoulou A et al. NMR Metabolite Profiling in the Quality and Authentication Assessment of Greek Hon-

ey-Exploitation of STOCSY for Markers Identification. *Foods* 2022; 11: doi:10.3390/foods11182853

[2] Brar DS, Pant K, Krishnan R et al. A comprehensive review on unethical honey: Validation by emerging techniques. *Food Control* 2023; 145: doi:10.1016/j.foodcont.2022.109482

P-327 In vivo metabolism and analysis optimisation of oleocanthal

Authors Theodora Nikou¹, Kalliopi V. Karampetsou², Olga S. Koutsoni², Eleni Dotsika², Panagiotis Stathopoulos¹, Leandros A. Skaltsounis¹, Maria Halabalaki¹

Institutes 1 Division of Pharmacognosy and Natural Products Chemistry, Department of Pharmacy, National and Kapodistrian University of Athens, Athens, Greece; 2 Laboratory of Cellular Immunology, Department of Microbiology, Hellenic Pasteur Institute, Athens, Greece
DOI 10.1055/s-0043-1774195

Nature comprises a valuable source of therapeutic agents and natural products' (NPs) structural uniqueness still inspires drug discovery [1]. However, several bioactive NPs are complex or chemically labile. Furthermore, the exploration of their metabolic fate in vivo is commonly underestimated, mainly due to analytical and detection difficulties, despite being a hot point of discussion in today's pharmaceuticals development. A prominent example is the olive oil secoiridoid oleocanthal (Oleo), regarded as a strong anti-inflammatory agent, with significant antioxidant, anticancer and antimicrobial properties [2]. Despite, the long literature devoted to olive oil analysis, so far, there is not a sufficient methodology for the analysis of Oleo, while its pharmacokinetic properties (PK) have never been described. Thus, the aim of the current study was the development of an appropriate protocol for the detection and analysis of Oleo and then its metabolism in vivo. Several analytical methodologies were incorporated in parallel to specialised protocols for the optimisation of oleocanthal's chromatographic behaviour and detection efficiency. Then, a PK study was designed and oleocanthal (5 mg/kg) was supplemented in mice. Plasma samples were collected at appropriate time points and analysed via LC-HRMS/MS. The PK characteristics of Oleo and its metabolic derivatives were determined over time, along with their relative content. Novel biomarker compounds were revealed and associated over time with Oleo administration in vivo.

Funding ERDF, “RESEARCH–CREATE–INNOVATE”, Hyper-Mastic (project code T2EΔK-00547)

Conflict of Interest The authors declare no conflict of interest.

References

- [1] Atanasov AG. et. al. *Biotechnol. Adv.* 2015; 33 (8): 1582–1614
- [2] Pung K. et.al. *Nutrients.* 2018; 10 (5): 570

P-328 Seasonal variation effects and LC-HRMS/MS monitoring of key metabolites of *Pistacia lentiscus* L. leaves

Authors Theodora Nikou¹, Varvara Papaioannou¹, Aikaterini L Stefi², Dido Vassilakopoulou³, Nikolaos S Christodoulakis², Maria Halabalaki¹

Institutes 1 Division of Pharmacognosy and Natural Products Chemistry, Department of Pharmacy, National and Kapodistrian University of Athens, Athens, Greece; 2 Section of Botany, Department of Biology, Faculty of Sciences, National and Kapodistrian University of Athens, Athens, Greece; 3 Section of Biochemistry and Molecular Biology, Department of Biology, Faculty of Sciences, National and Kapodistrian University of Athens, Athens, Greece
DOI 10.1055/s-0043-1774196

Mastic tree (*Pistacia lentiscus* – Anacardiaceae), is a dioecious evergreen sclerophyllous shrub native to the Mediterranean Basin, mostly cultivated for its aromatic resin. The leaves of the shrub are considered as a valuable source of phenolic compounds, as plants of the Mediterranean-type climate, and produce increased amounts of secondary metabolites [1]. However, leaves are an un-

derestimated part of *P. lentiscus*, and limited literature data exist for their phytochemical profile. Thus, the aim of the current study was the phytochemical investigation of *P. lentiscus* leaves and the correlation of their metabolic profile to seasonal variations and thus temperature conditions. Seeds of *Pistacia lentiscus* were cultured in plant growth chambers for three months and separated into three groups. The first group was left to grow under normal Mediterranean conditions, as those recorded in spring. The other group was exposed to a five-day heat stress while the last one suffered a cold stress for five days as well. Leaves were successively extracted (DCM, MeOH, MeOH/H₂O 1/1) and then analysed via UPLC-qTOF MS for compound identification. Interesting correlations were revealed, indicating that summer and winter leaves (stressed plants) displayed similar qualitative profile, although with evident quantitative differences. Additionally, specialised protocols were developed for the quantitation of key-biosynthetic metabolites, verifying the observed qualitative variations, while indicating that plant exposure to specific temperatures shifts the secondary metabolic pathways and influences the biosynthesis of certain metabolites.

Funding ERDF, "RESEARCH-CREATE-INNOVATE", Hyper-Mastic (project code T2EAK-00547)

Conflict of Interest The authors declare no conflict of interest.

References

[1] Christodoulakis NS. *Environ Exp Bot* 1992; 32 (3): 295–305

P-329 Isolation and characterisation of several kratom alkaloids for subsequent HPLC-MS analysis of commercial products

Authors [Hana Walaska](#)^{1,2}, [Petra Cihlarova](#)^{1,2}, [Martin Kuchar](#)^{1,2}, [Magdalena Vagnerova](#)², [Lenka Kohoutova](#)¹

Institutes 1 Department of Chemistry of Natural Compounds, UCT Prague, Czech Republic; 2 Forensic Laboratory of Biologically Active Substances, UCT Prague, Czech Republic

DOI [10.1055/s-0043-1774197](https://doi.org/10.1055/s-0043-1774197)

Kratom (*Mitragyna speciosa* tree) has been traditionally used in Asia and Indochina to alleviate pain, reduce fatigue, or induce better mood. It contains more than 40 different bioactive alkaloids, with the major alkaloid mitragynine and its metabolite 7-hydroxymitragynine binding to opioid, serotonin and dopamine receptors. Due to its attractive neuroactive effects, in recent years, there has been increased interest in introducing new kratom products to western markets with regulatory uncertainty. Therefore, knowledge of the products composition, their possible contamination and their active substances profile, is important. Different kratom species have been observed to have varying effects, despite containing almost identical amounts of major alkaloids. This suggests that minor alkaloids may be responsible for the different effects. Consequently, it is crucial to investigate the alkaloid profile of the kratom products. However, analytical standards for many of these minor alkaloids are not easily available. The aim of this study was to design and optimise a method for the isolation of alkaloids from the dried leaves of the *Mitragyna speciosa* tree. In this work, we successfully isolated mitragynine and several other minor alkaloids. After purification and characterisation of the obtained substances, we used them as analytical standards for HPLC-MS qualitative and quantitative analysis of the alkaloid profile in the kratom products available on the Czech market. The results will be further used to investigate the dependence of the alkaloid profile and biological effect.

Conflict of Interest These authors declare no conflict of interest.

P-330 High Performance Thin Layer Chromatography (HPTLC) to profile lichen metabolites

Authors [Alice Brissoit](#)¹, [Léo Andruszkow](#)¹, [Enola Roussin](#)¹, [Françoise Lohéziec Le-Dévéhat](#)¹, [Marylène Chollet Krugler](#)¹, [Joël Boustie](#)¹

Institute 1 Iscr, Corint, Rennes, France

DOI [10.1055/s-0043-1774198](https://doi.org/10.1055/s-0043-1774198)

Lichens produce a large collection of secondary metabolites, mainly phenolic and terpene compounds. Since their discovery, they have been analysed by different techniques such as color tests, crystallisation, separative techniques, and informative physico-chemical techniques for structure elucidation. Thin Layer Chromatography is the most used approach by lichenologists and the current work aims at developing standardised methods for phenolic and terpene compounds analysis. We also compare analytical techniques, such as High Performance TLC (HPTLC) and High Performance Liquid Chromatography (HPLC) with regard to the qualitative and quantitative characterisation of secondary metabolites in lichen extracts. A variety of parameters have been optimised for HPTLC, monitored by a software in a semi-automatic mode. Thanks to pure available lichen compounds, databases were constituted in order to analyse complex lichen extracts.

HPTLC data is mainly based on R_f, absorbances (254 nm, 366 nm, white light), spot colors after derivatisation, KUV test (KOH 10%, 366 nm) and mass data (ESI- for phenols, APCI+ for terpenoids). For terpenoid compounds, HPLC data resulted from ELSD detector and an APCI ionisation mode because the major part of them was not visible in UV and show difficulties for ionisation (ESI+/-). Hence, these techniques can be compared and afford additional or complementary results for an accurate profiling of lichen extracts. Results are expected to be useful not only for chemotaxonomic approaches but also to identify new or valuable lichen compounds. With HPTLC, a rapid and convenient identification of bioactive compounds is expected as the technique is suitable for bioautographic assays (antibiotic screening).

P-331 Analysis of pollen in "handmade" honey samples from the central microregion of Romania by scanning electron microscopy

Authors [Eszter Laczkó Zöld](#)¹, [Beáta Koreh](#)¹, [László Jakab-Farkas](#)², [Erzsébet Domokos](#)³

Institutes 1 George Emil Palade University of Medicine, Pharmacy, Science, and Technology of Târgu Mureş, Târgu Mureş, Romania; 2 Sapientia Hungarian University of Transylvania, Faculty of Technical and Human Sciences, Department of Mechanical Engineering, Târgu Mureş/Corunca, Romania; 3 Sapientia Hungarian University of Transylvania, Faculty of Technical and Human Sciences, Department of Horticulture, Târgu Mureş/Corunca, Romania

DOI [10.1055/s-0043-1774199](https://doi.org/10.1055/s-0043-1774199)

Honey is considered a natural food supplement due to its valuable constituents. The composition and nutritional quality of honey depend on environmental conditions, plant source, geographic location, and bee species. Melissopalynological analyses examine pollen grains and their frequency in studied samples to determine the botanical origin of the honey. Scanning electron microscopy (SEM) can provide much more information, especially regarding pollen wall decoration, than the optical microscope. The purpose of this paper is to identify the plant species whose pollen is found in the analysed honey samples. Polyfloral honey, lime honey and rape honey samples from the central microregion of Romania were analysed. Samples were prepared by acetolysis. Titanium spray coating was obtained with a standard coating system. Pollen analysis was performed with a JSM-5200 type (JEOL) scanning electron microscope. Reference collections and databases (Illustrated pollen terminology 2020, Palynological database) were used to identify the samples. In linden honey, besides *Tilia cordata*, pollen of *Atriplex patula*, *Brassica napus*, *Helianthus tuberosus*, *Rosa gallica*, *Prunus spinosa*, *P. avium*, *Anemone nemorosa*, *Plantago lanceolata*, *Che-nopodium hybridum*, *Galium verum*, *Malva moschata*, and *Leontodon hispidus* species were identified. In rapeseed honey pollen of the following species was detected: *Prunus padus*, *P. spinosa*, *P. avium*, *P. domestica*, *Brassica napus*, *Ambrosia artemisiifolia*, and *Anemone nemorosa*. In the polyfloral honey from the alpine area, the pollen of *Mentha arvensis*, *Rosa gallica*, *Cruciata laevipes*, *Malus sylvestris*, and *Alyssum murale* was identified. In polyfloral honey from the lower region pollen from numerous species was identified (► **Fig. 1**).

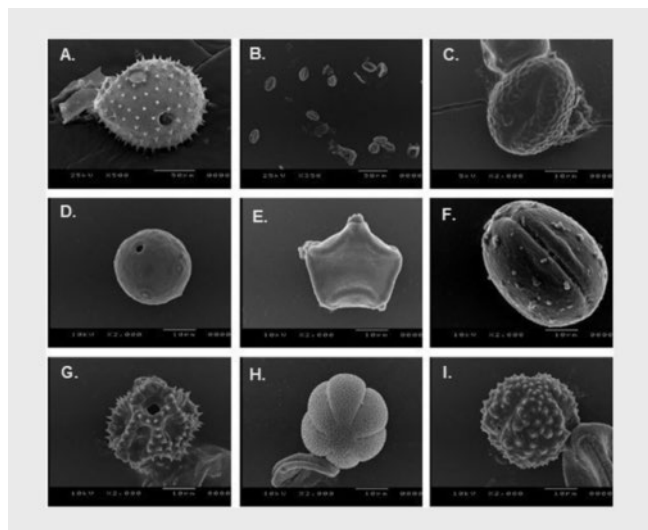

► **Fig. 1** Pollen types identified in polyfloral honey. *Abutilon theophrasti* (a), *Falcaria vulgaris* (b), *Ligustrum vulgare* (c), *Plantago argentea* (d), *Alnus glutinosa* (e), *Prunus spinosa* (f), *Chichorium intybus* (g), *Mentha arvensis* (h), *Arcitum lappa* (i).

P-332 LC-MS based metabolic profiling of *Cetraria islandica* and quantification of aliphatic secondary metabolites by LC-MS

Authors Eduardo Villicana Gonzalez¹, Stefan Schwaiger¹, I. R. Hermann Stuppner¹

Institute 1 Innsbruck Universität, Innsbruck, Austria

DOI 10.1055/s-0043-1774200

C. islandica is one of the most studied lichen species within the cetrarioid species and belongs to the Parmeliaceae family [1]. *C. islandica* is widely used in folk European medicine for the treatment of respiratory diseases and cough and has been listed in European pharmacopoeias since the 17th century. In addition, an HMPC monograph of the European Medicines Agency (EMA) is also available (EMA/HMPC/678891/2013) [2–4].

Lichens produce unique profiles of secondary metabolites due to the genetic diversity of the symbiotic partners and the interaction with their environment [4]. In the present project, LC-MS analysis was employed for metabolic profiling of petroleum ether extracts of seven *C. islandica* samples from different locations, but also including two batches, which were collected about 40 years ago. PCA analysis of the LC-MS data obtained in negative mode revealed paraconic acids as major discriminators in the investigated samples. Paraconic acids are a group of secondary metabolites mainly found in lichens and selected fungi. From *C. islandica*, compounds such as, lichesterinic, protolichesterinic, dihydroprotolichesterinic and roccellaric acids have shown antitumor, antiproliferative, antiviral and anti-inflammatory activities [5], which makes this compound class of special interest.

Consequently, LC-MS analysis was also employed for the quantification of the four major paraconic acids. Ricinoleic acid was used as an internal standard and lichesterinic acid, isolated by CPC [6], as a calibrator. Among the quantified compounds, lichesterinic acid is the most abundant in all samples ranging from 0.03 to 0.11 % w. The content of the major discriminator, protolichesterinic acid, ranges from 0.002 to 0.048 % w.

References

[1] Fernandez-Moriano C, Divakar PK, Crespo A et al. In vitro neuroprotective potential of lichen metabolite fumarprotocetraric acid via intracellular redox modulation. *Toxicol Appl Pharmacol* 2017; 316: 83–94. doi:10.1016/j.taap.2016.12.020

[2] Mitchell ME. Contentious Cures: The Rise and Decline of Lichens as European Materia Medica. *Pharm Hist* 2015; 57: 55–66. doi:10.26506/pharm-hist.57.3-4.0055

[3] , Crawford SD. Lichens Used in Traditional Medicine. In: Rankovic B, Hrsg. *Lichen Secondary Metabolites: Bioactive Properties and Pharmaceutical Potential*. Cham: Springer International Publishing; 2019:31-97.

[4] Xu M, Heidmarsson S, Olafsdottir ES, et al. Secondary metabolites from cetrarioid lichens: Chemotaxonomy, biological activities and pharmaceutical potential. *Phytomedicine* 2016; 23: 441-459. 10.1016/j.phymed.2016.02.012

[5] Fernandes RA, Chaudhari DA, Jha AK. Evolution of Strategies in Paraconic Acids Synthesis. *Asian. J Org Chem* 2020; 9: 1478–1501. doi:10.1002/ajoc.202000353

[6] Gonzalez EV, Schwaiger S, Stuppner H. Two-step isolation of the two major paraconic acids of *Cetraria islandica*. *J Sep Sci* 2023; 46: 2200805. doi:10.1002/jssc.202200805

P-333 UHPLC-ELSD determination of triterpenic acids in table olives

Authors Vasilis Zavrakoglou¹, Athanasios Arampatzis^{2,3}, Aggeliki Kalogeropoulou¹, Fani Mantzouridou^{1,3}, Andreana Assimopoulou^{2,3}, Nikolaos Nenadis^{1,3}

Institutes 1 Laboratory of Food Chemistry and Technology, School of Chemistry, Aristotle University of Thessaloniki, Thessaloniki, Greece;

2 Laboratory of Organic Chemistry, School of Chemical Engineering,

Aristotle University of Thessaloniki, Thessaloniki, Greece; 3 Natural

Products Research Center of Excellence (NatPro-AUTH), Center for

Interdisciplinary Research and Innovation (CIRI-AUTH), Thessaloniki, Greece

DOI 10.1055/s-0043-1774201

Table olives are fermented products widely consumed mainly in the Mediterranean basin. Lately, they are reconsidered from a nutritional/functional point of view due to their content in monounsaturated fats and different phytochemicals. The latter, except for known bioactive phenols, include health promoting triterpenic acids (maslinic and oleanolic) [1]. Their liquid chromatographic determination in table olives using a UV detector is economic but presents certain shortcomings [use of low wavelength (205 – 210 nm) for better sensitivity, leading to the limited and demanding choice of the mobile phase and other chromatographic parameters [2]. To overcome these, a validated UHPLC-ELSD (evaporative light scattering detector) method is proposed as a detector's response and is unaffected by the mobile phase composition and the optical properties of the analytes, granted that their volatility is below that of the mobile phase [3]. Using isocratic elution (92:8, v/v, methanol/acidified water), and in-line connected a DA detector (210 nm), linearity was observed for maslinic (MA) and oleanolic acid (OA) over the range 250 – 2000 ng and 125 – 1000 ng injected, after log conversion of concentration and signal values only for ELSD. The linearity was stronger in ELSD vs DAD considering the F, p and R2 values derived from ANOVA (MA:15542/1.2E – 37/0.9983 vs 9889/4E – 35/0.9973; OA: 9596/6.4E – 35/0.9972 vs 2340/1.21E – 24/0.9903). Additionally, the

LOD values were too low in ELSD vs DAD (1.2 and 1.1 ng injected for both acids vs 34.8 and 37.4 ng respectively) highlighting the potency of the proposed detection system for the target analytes determination in table olives.

References

[1] Boskou D. Table olives: a vehicle for the delivery of bioactive compounds. *J Exp Food Chem* 2017; 3: 123

[2] Vilkickyte G, Raudone L. Optimization, Validation and Application of HPLC-PDA Methods for Quantification of Triterpenoids in *Vaccinium vitis-idaea* L. *Molecules* 2021; 26: 1645

[3] Vaccalluzzo A, Pino A, Russo N, De Angelis M, Caggia C, Randazzo CL. FoodOmics as a new frontier to reveal microbial community and metabolic processes occurring on table olives fermentation. *Food Microbiol* 2020; 92: 103606

P-334 Analysis and isolation of luteolin and luteolin 7-O-glucoside from plants of the Greek biodiversity by UHPLC-PDA analysis

Authors Aspasia Pampori^{1,2}, Athanasios Arampatzis^{1,2}, Antigoni Koletti^{1,2}, Alexandros Nakas^{1,2}, Maria Laskari³, Paschalis Papakaloudis³, Andreas Michalitsis³, Elli Kampasakali⁴, George Menexes³, Lazaros Tsalikis⁵, Panagiotis Barmapalexis^{2,6}, Christos Dordas³, Dimitrios Christofilos⁴, Andreana Assimopoulou^{1,2}

Institutes 1 Aristotle University of Thessaloniki, School of Chemical Engineering, Thessaloniki, Greece; 2 Center for Interdisciplinary Research and Innovation of Aristotle University of Thessaloniki (CIRI-AUTH), Natural Products Research Center of Excellence (NatPro-AUTH), Thessaloniki, Greece; 3 Aristotle University of Thessaloniki, School of Agriculture, Thessaloniki, Greece; 4 Aristotle University of Thessaloniki, Faculty of Engineering, School of Chemical Engineering & Physics Laboratory, Thessaloniki, Greece; 5 Aristotle University of Thessaloniki, School of Dentistry, Thessaloniki, Greece; 6 Aristotle University of Thessaloniki, School of Pharmacy, Thessaloniki, Greece

DOI 10.1055/s-0043-1774202

Flavonoids are a group of bioactive molecules that are commonly found in numerous plants, fruits and vegetables. They have been extensively studied over the last decades, mainly due to their important pharmacological activities and their application for various diseases. Luteolin is a naturally occurring flavonoid that can be found in many medicinal plants and vegetables and possesses anti-microbial and anti-inflammatory properties among others. The aim of LuteoPaste project is to exploit Greek biodiversity for the isolation of luteolin and/or its derivatives, for the development of a formulation against periodontitis. In our previous work [1], several plants of the Greek flora (e.g., *Origanum vulgare*, *Thymus vulgaris*, *Salvia officinalis*, *Laurus nobilis*) were grown and analysed for their luteolin content. Herein, we expanded our analysis with cultivated plants of interest, as well as others (e.g., *Olea europea*, *Capsicum annuum*, *Cichorium intybus*, *Petroselinum crispum*). Moreover, we demonstrated the quantitation of luteolin and luteolin 7-O-glucoside, by means of UHPLC-PDA analysis (λ_{max} : 349 nm), in methanolic extracts of *O. europea* leaves and pits and *S. officinalis* leaves obtained by ultrasonication. Luteolin was detected in *O. europea* pits, whereas luteolin 7-O-glucoside in *O. europea* and *S. officinalis* leaves. Different extraction methods (e.g. soxhlet and accelerated solvent extraction) and solvents were used to define the optimum ones in terms of luteolin(s) content. In samples containing high amounts of 7-O-glucoside derivative, a UHPLC-preparative method was applied and enriched fractions of the derivative were isolated. These were identified by means of LC-DAD, LC-MS and Raman techniques.

Funding This research has been co-financed by the European Regional Development Fund of the European Union and Greek national funds through the Operational Program Competitiveness, Entrepreneurship, and Innovation, under the call RESEARCH – CREATE – INNOVATE (project code: T2EDK-01627)

References

[1] Arampatzis AS, Drousta E, Laskari M, Papakaloudis P, Menexes G, Dordas C, Tsalikis L, Assimopoulou AN. Hunting Luteolin in the Greek biodiversity for the treatment of periodontal diseases. *Planta Med* 2022; 88: 1435

P-335 Quantitative analysis of *Capparis spinosa* samples of different preservation process, from Aegean islands – bioactivities

Authors Eugenia Fotiadou¹, Konstantia Graikou¹, Ioanna Chinou¹

Institute 1 National and Kapodistrian University of Athens, Dept of Pharmacy, Lab of Pharmacognosy, Athens, Greece

DOI 10.1055/s-0043-1774203

C. spinosa is an edible plant with long history in the Mediterranean area since antiquity. Its flowers, buds and leaves are mostly consumed as salted or fermented (in vinegar) and rarely eaten raw or dried. Caper samples of different

preservation processes (dried, salted or/and pickled, desalted) were studied for the first time, foraged selected most producing them, Cycladic islands in Greece (Sifnos, Serifos, Tinos). Quantitative determination of the flavonoids rutin and quercetin was carried out (HPTLC), showing the abundance of rutin in buds and leaves (9.263 – 76.852 mg/g in dry extract), approximately four times the amount of rutin in comparison with dry flowers from Turkey [1], while only one sample of desalted buds from Serifos showed sufficient amount of quercetin (2.878 mg/g in dry extract). The determination of total phenolic content (TPC) showed a decrease during brine preservation (salted, 11 – 37 mg GAE/g extract), compared to air-dried samples (50 – 62 mg GAE/g extract). The DPPH analyses (10 – 35% inhibition in 200 μ g/mL) were fully correlated with the TPCs. All extracts showed stronger activity against Gram-positive bacteria and *C. glabrata*. The samples from Sifnos exerted better bioactivities, presenting air-drying as the best preservation process, in terms of antioxidant properties and phenolic content, and the only drawback being a more bitter taste. Due to its high economic value, capers hold high prospects for further exploitation to better establish and optimise processes in the food industry [2].

References

[1] Aksay O., Selli S., Kelebek H. *Food Chem* 2021; 337: 127959

[2] AL-Azawi A.H., Ghaima K.K., Salih H.H. *Biosci Res* 2018; 15: 2611–2618

P-336 Swiss herbs in climate change: HPTLC fingerprints of thyme, sage and horehound from Zermatt and a controlled green house

Authors Evelyn Wolfram^{1,2}, Leona Hölzel³

Institutes 1 Zurich University of Applied Sciences (zhaw), Switzerland;

2 Ricola Group AG, Laufen, Switzerland; 3 Kantonsschule Uetikon am See, Switzerland

DOI 10.1055/s-0043-1774204

Thymus vulgaris L., *Salvia officinalis* L. and *Marrubium vulgare* L. have been used traditionally in Switzerland for relieving symptoms in the upper respiratory tract. Ricola is a well-known producer of Swiss cough lozenges and herbal teas based on a traditional 13 herb mixture, which contains the aforementioned three herbs from the Lamiaceae family.

In order to assess the influence of climate change on the accumulation of secondary metabolites, a primary study which involved the cultivation of the seeds of Ricola varieties of thyme, sage and horehound compared to seedlings from a commercial nursery inside a climate controlled green house as well as outdoors at 450 m elevation, was carried out. In addition, the Ricola varieties were harvested from the Ricola herb garden in Zermatt, Blatten at 1740 m altitude. The morphologies of the plants were assessed until harvest. Dried plant samples were extracted with 50% MeOH (v/v) 1:20 15 min in an ultrasonic bath and a semiquantitative analysis using HPTLC fingerprints with Neu's reagent for flavonoids/phenolic acids in 366 nm was carried out, as well as DPPH in white light to compare radical scavenging activity of the same zones.

The results show that the effect of elevated temperature averaging from 7 – 9°C on growth, morphology and metabolites is plant and accession specific. Sage and horehound exhibited more and larger zones and stronger radical scavenging activities, whereas thyme did not exhibit notable differences. The results are a first indication of how chemodiversity is influenced by elevated temperatures. Further agro-phytochemical studies over several harvest seasons are needed to assess consequences of climate change on herbs.

P-337 A rapid methodology for the determination of anthocyanins in natural products

Authors Alexandra Svoraki¹, Nefeli Afentouli¹,

Stavros Beteinakis¹, Panagiotis Stathopoulos¹, Alexios-Leandros Skaltsounis¹

Institute 1 Division of Pharmacognosy and Natural Products Chemistry, Department of Pharmacy, National and Kapodistrian University of Athens, Panepistimiopolis, Zografou, 15771, Athens, Greece

DOI 10.1055/s-0043-1774205

Anthocyanins are natural pigments found in fruits and vegetables and are responsible for their characteristic bright red or purple colour. They have been studied extensively and have been proven to possess beneficial effects for plants, humans, and animals. Anthocyanins can act as antioxidants, phytoalexins and antibacterial agents. However, their determination has many difficulties, as there are more than 550 different anthocyanins in nature. Hydrolysis of anthocyanins and quantification of their aglycon forms is a fast and efficient methodology for their determination in natural products. Literature describes different conditions for the acidic hydrolysis of anthocyanins extracted from several food matrices. The aim of this study is the development of an easy and fast methodology, based on acid hydrolysis, for the determination of anthocyanins in natural products and the comparison of the proposed method with corresponding ones described in literature. Results of this study showed that direct hydrolysis of anthocyanins in initial material with sulfuric acid solution, heating at 90 °C for 2 hours, and then HPLC-DAD quantitative determination of their aglycon forms, cyanidin, delphinidin, malvidin, peonidin, petunidin, and pelargonidin, is an appropriate methodology for the determination of anthocyanins in natural products assessed with greater accuracy and efficiency compared to corresponding hydrolysis methods described in literature. Overall, this is the first time that an analytical methodology for the determination of anthocyanins in fruits and vegetables is described, where extraction and hydrolysis procedures are performed in one step.

Funding ERDF, “RESEARCH–CREATE–INNOVATE”, BLOODY BERRY (project code: T2EΔK-03427).

Conflict of Interest The authors declare no conflict of interest.

P-339 Design of Pharmacophore Models to identify β -Tubulin Colchicine-Binding Site Inhibitors for Antiparasitic Development

Authors [Mark James Horgan](#)¹, [Bianka Siewert](#)¹, [Lukas Zell](#)², [Hermann Stuppner](#)¹, [Veronika Temml](#)²

Institutes **1** Institute of Pharmacy/Pharmacognosy, Center for Chemistry and Biomedicine, University of Innsbruck, Innsbruck, Austria; **2** Department of Pharmaceutical and Medicinal Chemistry, Paracelsus Medical University Salzburg, Salzburg, Austria

DOI 10.1055/s-0043-1774206

Cytoskeleton microtubules have a critical role in mitosis, offering an established target for antiparasitic drug development. Despite toxicity, the natural product (NP) colchicine from *Colchicum autumnale*, is considered a classical antimitotic. Moreover, structural knowledge of the β -tubulin colchicine-binding site led to safer and successful therapeutics. Such information provides opportunity to establish in silico-in vitro workflows searching for new lead compounds. To discover potential tubulin inhibitors, a pharmacophore-based virtual screening approach was utilised in LigandScout and Discovery Studio programmes. Structure-based models were built on the PDB crystal information of β -tubulin/colchicine-binding domain. Additionally, ligand-based models were designed from known inhibitor NPs scaffolds. Model optimization was performed with datasets of known actives -including NPs- and corresponding decoy set. Virtual screening of vendor databank (SPECS) led to predicted hits prioritised for in vitro testing based on consensus overlap, fit scores, and drug-likeness. To validate virtual hits, 41 commercially available compounds were tested in a cell-free fluorescence-based tubulin polymerisation assay (Cytoskeleton). Test compounds (30 or 10 μ M) were initially discriminated as active/inactive. Inhibition observed across varying scaffolds led to a hit-rate of 26.83%. Dose-response experiments showed a benzimidazole derivative as most active (IC_{50} = 2.9 μ M) with potency in range of colchicine for other structural classes. Next, inhibitors could be screened in cytotoxicity or antiparasitic assays for biological activity. Validated models recognising NPs scaffolds can be used cross-functionally to identify bioactives in extracts. Results demonstrate this coupled in silico-in vitro approach offers an efficient tool to identify NPs and synthetic tubulin inhibitors [1–4].

Funding EUREGIO (Interregional Project Networks) (IPN 119) ‘HERBAL’.

Conflict of Interest The authors declare no conflict of interest.

References

- [1] Morgan U.M., Reynoldson J.A., Thompson R.C. Activities of several benzimidazoles and tubulin inhibitors against *Giardia* spp. in vitro. *Antimicrobial agents and chemotherapy* 1993; 37 (2): 328–331. doi:10.1128/AAC.37.2.328
- [2] Jordan M.A., Wilson L. Microtubules as a target for anticancer drugs. *Nature reviews. Cancer* 2004; 4 (4): 253–265. doi:10.1038/nrc1317
- [3] Liu J., Gao R., Gu X., Yu B., Wu Y., Li Q., Xiang P., Xu H. 2022; A New Insight into Toxicity of Colchicine Analogues by Molecular Docking Analysis Based on Intestinal Tight Junction Protein zO-1. *Molecules (Basel, Switzerland)* 27 (6): 1797. doi:10.3390/molecules27061797
- [4] McLoughlin E.C., O’Boyle N.M. 2020; Colchicine-Binding Site Inhibitors from Chemistry to Clinic: A Review. *Pharmaceuticals (Basel, Switzerland)* 13 (1): 8. doi:10.3390/ph13010008

P-340 Monoamine oxidase B template: useful for virtual screening

Authors [Sarocho Tomputsa](#)¹, [Pornthip Waiwut](#)²,

[Chantana Boonyarat](#)¹

Institutes **1** Faculty of Pharmaceutical Sciences, Khon Kaen University, Thailand; **2** Faculty of Pharmaceutical Sciences, Ubon Ratchathani University, Thailand

DOI 10.1055/s-0043-1774207

Monoamine oxidase B (MAO-B) is an outer mitochondrial membrane-bound enzyme that catalyses the oxidative deamination of arylalkylamine neurotransmitters. Activated MAO-B has a critical role in the pathogenesis of Alzheimer’s disease (AD), including the accumulation of amyloid plaques, formation of neurofibrillary tangles, and cognitive impairment via the destruction of cholinergic neurons. As such, MAO-B has been proposed as a potential target for AD drug design. To accelerate the development of new MAO-B inhibitors, MAO-B template based on the protein target of MAO-B inhibitors was developed in the present study which can be used for structure-based drug design or for virtual screening studies. Six crystallographic structures of MAO-B bound with the selective MAO-B inhibitor were selected and downloaded from RCSB Protein Data Bank which include 1OJA, 2BK4, 2V5Z, 2V60, 2V61 and 3PO7. The six MAO-B templates were constructed by using AutoDockTools suite program. The developed templates of MAO-B were cross-validated by redocking with native ligand, and by docking the other five MAO-B inhibitors by utilising AutoDock 4. The results indicated that all ligands showed the best match of the docked and the crystallographic binding orientation in the MAO-B template developed from 1OJA. The results showed the same configuration of each ligand bound to 1OJA template with average RMSD values less than 1.95 Å. The new MAO-B template reported here should prove to be a useful tool for structure-based drug design and virtual screening in searching for new MAO-B inhibitors.

P-342 Exploring New Dimensions: Single and Multi-Block Analysis of Essential Oils Using DBDI-MS and FT-IR for Enhanced Authenticity Control

Authors [Justine Raeber](#)¹, [Christian Steuer](#)¹

Institute **1** Department of Chemistry and Applied Biosciences, ETH Zurich, 8093 Zurich, Switzerland

DOI 10.1055/s-0043-1774208

Rose oil, extracted from *Rosa damascena* by distillation, is a valuable essential oil (EO) widely used as a flavouring, fragrance and medicinal agent in the food, perfume as well as pharmaceutical industry. Due to its high demand and lack of substitutes rose oil is a lucrative target for adulteration, which does not only deceive consumers, but can also have a severe impact on human health. Advances have been made in authenticity and origin verification of EOs by joining their chromatographic profiles with multivariate analysis in order to identify potential markers or fingerprints for genuineness. However, one-dimensional

analyses can be insufficient in capturing the intricacies of natural products and are furthermore destructive, time consuming and require trained personnel. Dielectric barrier discharge ionization mass spectrometry (DBDI-MS) is suitable as a high-throughput analytical method that generates large data arrays, which contain structural information about the analyte. Combining DBDI-MS and Fourier-transform infrared spectroscopy (FT-IR) allows for a multivariate as well as multi-model analysis, which can be tackled by multi-block chemometrics to gain a deeper understanding of the analyte's characteristics. We herein present a chemometric analysis of commercial rose oil samples using single and multi-block approaches with DBDI-MS and FT-IR. Data was analysed both in an unsupervised and supervised manner and the classification accuracy of chemometric tools (PCA, PLS-DA and SO-PLS-LDA) were compared against each other. DBDI-MS was found the most effective method for discriminating EO quality, indicating its potential as a powerful tool for EO authenticity control (► Fig. 1).

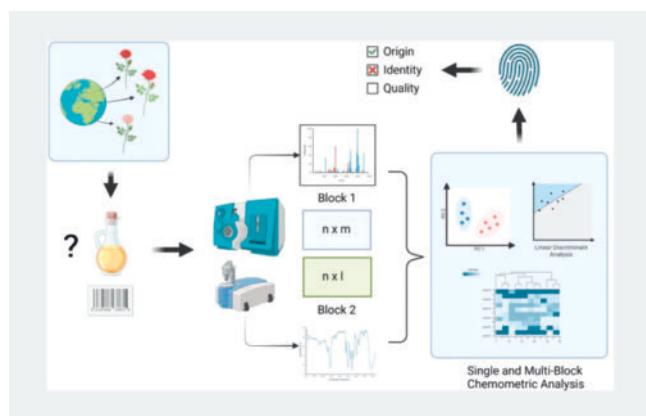

► Fig. 1 Workflow authenticity control of EOs using DBDI-MS and FT-IR. Created with BioRender.com.

Conflict of Interest The authors declare no conflict of interest.

P-343 Probing the Secondary Metabolites in *Brucea javanica* (L.) Merr. Root through Mass Spectroscopy with Molecular Networking for Dengue Antiviral Activity

Authors Nor Mohd Yousof^{1,2}, Adlin Afzan², Murizal Zainol², Syahrul Abu Bakar¹, Mohd Abd Razak², Nor Hadiani Ismail¹

Institutes 1 Atta-ur-Rahman Institute for Natural Product Discovery, Universiti Teknologi MARA, Bandar Puncak Alam, Malaysia; 2 Institute for Medical Research, National Health Institute, Setia Alam, Malaysia
DOI 10.1055/s-0043-1774209

Brucea javanica (L.) Merr. is a medicinal plant used traditionally for fever treatment in Malaysia. The dichloromethane roots extract was found to have good dengue antiviral activity with $EC_{50} = 0.3 \pm 0.08 \mu\text{g/mL}$ and $CC_{50} = 2.99 \pm 0.99 \mu\text{g/mL}$ (SI of 9.96) in adenosine triphosphate (ATP) assay and plaque assay. With the aim of identifying the dengue antiviral compounds, a comprehensive analysis of the chemical space in the root extract of *B. javanica* using a combination of untargeted LC-MS2 and molecular networking analysis was undertaken. MS data pre-processing using MZmine3 revealed 254 MS features in positive and 237 in negative ionisation mode, forming three distinct but chemotaxonomically related clusters, which are carboline alkaloids, indole alkaloids and quassinoids. Seven compounds were isolated from the roots, which are canthin-6-one, canthin-6-one-N-oxide, methoxycanthin-6-one, methoxyhydroxycanthin-6-one, brusatol, bruceolline J and bruceolline E. Among them, canthin-6-one and canthin-6-one-N-oxide showed good binding energies

(-17.8689 kcal/mol and -6.3425 kcal/mol, respectively) in molecular docking studies against DENV-2 NS5 RNA-dependent RNA polymerase (RdRp) protein. Both compounds also exhibited in vitro dengue antiviral activity, with canthin-6-one having an EC_{50} of 0.86 μM (SI = 63), and canthin-6-one-N-oxide an EC_{50} of 1.6 μM (SI = 46) in a plaque assay. These findings offer promising leads for further studies towards understanding the role of these natural products as dengue antivirals.

P-344 Quality evaluation and application of chemometrics in *Apis mellifera* honey from the dry arch of Panama

Authors Andrés Rivera-Mondragón^{1,2,3}, Maravi Marrone⁴, Gaspar Bruner-Montero⁵, Katerin Gaitan², Leticia De Núñez², Rolando Otero-Palacio⁶, Yostin Añino⁷, Sergio Martinez^{3,4}, Hermógenes Fernández Marín^{3,4,8}

Institutes 1 Departamento de Química Medicinal y Farmacognosia, Facultad de Farmacia, Universidad de Panamá, Ciudad de Panamá, Panamá; 2 Instituto Especializado de Análisis (IEA), Universidad de Panamá, Ciudad de Panamá, Panamá; 3 Sistema Nacional de Investigación, Senacyt, Ciudad de Panamá, Panamá; 4 Instituto de Investigaciones Científicas y Servicios de Alta Tecnología (INDICASAT-AIP), Edificio 208, Ciudad del Saber, Ciudad de Panamá, Panamá; 5 Estación Científica Coiba AIP, Coiba, Panamá; 6 Facultad de Agronomía, Universidad de Panamá, Ciudad de Panamá, Panamá; 7 Museo de Invertebrados G. B. Fairchild, Estafeta Universitaria Apartado 00017, Universidad de Panamá, Ciudad de Panamá, Panamá; 8 Smithsonian Tropical Research Institute, Ciudad de Panamá, Panamá
DOI 10.1055/s-0043-1774210

Parameters for assessing the quality of honeybee produced by *Apis mellifera* have been standardised worldwide, however, its physicochemical properties might vary extensively under the influence of several factors related to the origin of the honey such as (but not limited to) the geographical area of honey production and the season in which the honey was produced. Variation of these parameters between different harvest periods in tropical areas are scarcely reported in literature. The aim of this investigation was to provide scientific evidence of the variation in the physicochemical parameters of honey harvested during the dry season in the dry arc of Panama by analysis of sixteen physicochemical parameters from five beehives in February, March and April 2021. Our results indicated that potassium is the most abundant mineral in honey samples and its concentration increases among the harvest period from February to May; while the heavy metals analysed, cadmium and lead, were not detected in any sample. PCA analysis shown significant differences between samples collected during different harvest periods. Furthermore, it can be concluded that climatic conditions might play an important role in the quality of honey produced in the dry arc of Panama. The results obtained in this research might be useful for the establishment of quality parameters for honeybee produced in Panama and may also increase the commercial value of this product.

P-345 Untargeted metabolomics based on UPLC-MS coupled with a chemometrics approach to target α -glucosidase inhibitory activity of six Panamanian *Cecropia* species

Authors Aylin De Lora¹, Yuliana Christopher¹, Orlando Ortiz⁴, Yostin Añino⁵, Yancho Zarev⁶, Andrés Rivera-Mondragón^{1,2,3}

Institutes 1 Departamento de Química Medicinal y Farmacognosia, Facultad de Farmacia, Universidad de Panamá, Ciudad de Panamá, Panamá; 2 Instituto Especializado de Análisis (IEA), Universidad de Panamá, Ciudad de Panamá, Panamá; 3 Sistema Nacional de Investigación, Senacyt, Ciudad de Panamá, Panamá; 4 University of Munich, Germany; 5 Museo de Invertebrados G. B. Fairchild, Universidad de Panamá, Ciudad de Panamá,

Panamá; 6 Department of Pharmacognosy, Faculty of Pharmacy, Medical University of Sofia, 2 Dunav Str., 1000, Bulgaria

DOI 10.1055/s-0043-1774211

Guarumo leaf (*Cecropia* sp.) is a Latin American medicinal plant that has been traditionally used to treat diabetes mellitus. Due to the lack of comprehensive research, its antidiabetic mechanism has not yet been fully described. One of the therapeutic approaches in the management of type 2 diabetes is preventing a rise in postprandial glucose levels through the inhibition of intestinal α -glucosidase. In consequence, this work aimed to evaluate the potential α -glucosidase inhibitory activity of the leaf extracts of six *Cecropia* species collected in Panama and to characterise the chemical compounds related to such activity. Since the classical blinded-chemical investigation is a challenging process due to the highly complex chemical composition of medicinal plants, we used untargeted metabolomics-based ultra-high-performance liquid-chromatography–tandem mass spectrophotometry (UPLC–MS/MS) coupled with an orthogonal projection to latent structure (OPLS) for screening the most probable bioactive candidates. Out of all *Cecropia* species evaluated, *C. obtusifolia*, *C. hispidissima*, *C. longipes*, *C. peltata* (Cerro Azul), and *C. insignis* showed significant α -glucosidase inhibitory activity with IC_{50} values in the range of 9.0–44.0 mg/mL, compared to acarbose (4977.1 mg/mL) as a positive control. *C. heterochroma* and *C. peltata* (collected in Sta. Catalina) did not show any significant effect in this assay. Procyanidin B, ourateacatechin (4'-Methyl-epigallocatechin) and kaji-ichigoside F1 were correlated to be the strongest inhibitors of α -glucosidase via the OPLS model. Our results suggest that these *Cecropia* constituents are promising candidates for the development of an anti-hyperglycemic formulation to manage postprandial hyperglycemia incidence (► Fig. 1).

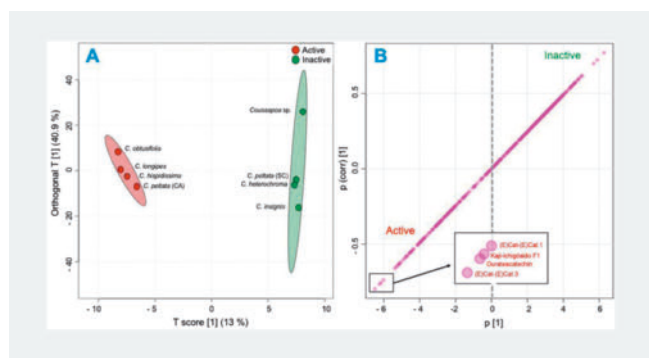

► Fig. 1 Metabolomics results.

P-346 Chemometric-Guided Exploration of Marine Anti-Neurofibroma Leads

Authors Lo-Yun Chen¹, Bo-Rong Peng^{1,2}, Jui-Hsin Su³, Ping-Jyun Sung³, Chung-Ping Liao⁴, Kuei-Hung Lai^{1,2}

Institutes 1 Graduate Institute of Pharmacognosy, College of Pharmacy, Taipei Medical University, Taipei, Taiwan; 2 PhD Program in Clinical Drug Development of Herbal Medicine, College of Pharmacy, Taipei Medical University, Taipei, Taiwan; 3 National Museum of Marine Biology & Aquarium, Pingtung, Taiwan; 4 Graduate Institute of Medical Sciences, College of Medicine, Taipei Medical University, Taipei, Taiwan
DOI 10.1055/s-0043-1774212

Neurofibroma is a common hereditary peripheral nervous system tumour for which treatment options are currently limited, necessitating the exploration of potential drugs for its treatment. The development of big data and mass spectroscopic technologies has led to the breakthrough development of new strategies for separation. Hence, we proposed an advanced spectroscopic approach in this study, called multi-information molecular networking (MIMN).

It is a visualised tool combined with chemical and biological information that assists lead compound investigation [1].

Our study focused on the chemical analysis and anti-neurofibroma activity assessment of the Taiwanese sponge *Lendenfeldia* sp. We mainly targeted the inhibitory activities of six chemokines, including CCL3, CCL4, CCL5, CXCL1, CXCL8 and CXCL10. MIMN revealed that the sponge is abundant in scalarane, which has anti-inflammatory potential. The most promising compound with the most significant anti-chemokine effect among the extracts of sponges, 24-methyl-12,24,25-trioxoscalar-16-en-22-oic acid [2] was subsequently isolated and annotated as the lead compound.

The results suggest that MIMN is a valuable tool for exploring potential drugs for neurofibroma. In conclusion, the MIMN strategy can be applied for future new drug discoveries.

References

- [1] Wang M, Carver JJ, Phelan VV et al. Sharing and community curation of mass spectrometry data with Global Natural Products Social Molecular Networking. *Nat biotechnol* 2016; 34: 828–837
- [2] Prada CE, Jousma E, Rizvi TA et al. Neurofibroma-associated macrophages play roles in tumor growth and response to pharmacological inhibition. *Acta Neuropathologica* 2012; 125: 159–168

P-347 Chemometric-Guided Chemical Marker Selection: A Case Study of the Herb *Scrophularia ningpoensis* Hemsl.

Authors Huong-Giang Le¹, Tsong-Long Hwang³, Kuei-Hung Lai^{1,2}

Institutes 1 PhD Program in Clinical Drug Development of Herbal Medicine, College of Pharmacy, Taipei Medical University, Taipei, Taiwan; 2 Graduate Institute of Pharmacognosy, College of Pharmacy, Taipei Medical University, Taipei, Taiwan; 3 Research Center for Chinese Herbal Medicine, College of Human Ecology, Chang Gung University of Science and Technology, Taoyuan, Taiwan

DOI 10.1055/s-0043-1774213

In the past, the chemical markers selection of herbal medicine took the bioactivity as the primary consideration, followed by referring to their content, stability and ease of availability. However, herbal medicines are valued by their complexes and joint pharmacological effects. Therefore, in order to systematically clarify the chemical-biological relationships of herbal medicines, and to improve the correctness of the chemical marker selections, the multi-informative molecular networking (MIMN) approach is employed to construct the bioactive metabolomic pattern of Traditional Chinese Medicines (TCMs). In the results, a MIMN profile of an herb, *Scrophularia ningpoensis* Hemsl. (*S. ningpoensis*), was established based on the MS2 fragmentation information and neutrophilic inhibition (anti-ROS generation). Among all *S. ningpoensis* metabolites, four chemical clusters showed relatively higher bioactive scores (BS) and were assumed to be potential anti-inflammatory chemical skeletons. Moreover, the GNPS and Reaxys databases assisted the putative annotations of nineteen metabolites from bioactive chemical clusters. Finally, the chemical marker validations of six commercially available compounds were carried out through the anti-inflammatory assessments in activated human neutrophils. A major carbohydrate conjugate, angoroside C, showed a dose-dependent anti-inflammatory effect with an IC_{50} of 0.34 μ M, suggesting its great potential to be selected as a chemical marker for *S. ningpoensis*. To sum up, in this study, the MIMN platform was applied to assist the chemical marker selection of *S. ningpoensis*. These results could serve as the basis for the selection of marker constituents, and provide reference for the compilation and revision of the herbal pharmacopeia (► Fig. 1).

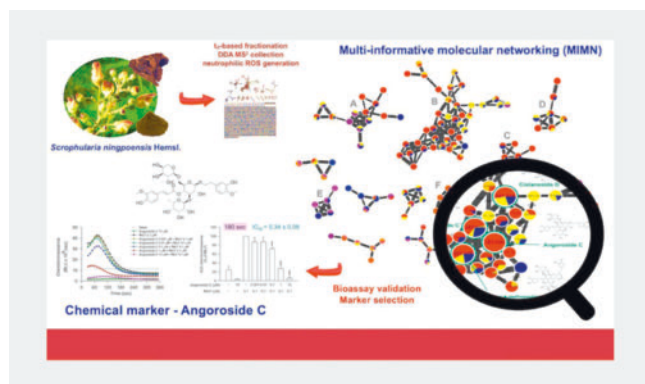

► **Fig. 1** Chemometric-Guided Chemical Marker Selection: A Case Study of the herb *Scrophularia ningpoensis* Hemsl.

P-348 Identification of anti-tuberculosis compounds from commercial essential oils using a biochemometrics approach

Authors [Maxleene Sandasi](#)^{1,2}, [Katyna J. Boussamba-Digombou](#)¹, [Guy Kamatou](#)¹, [Sandy van Vuuren](#)³, [Rafal Sawicki](#)⁴, [Alvaro Viljoen](#)^{1,2}

Institutes 1 Department of Pharmaceutical Sciences, Tshwane University of Technology, Pretoria, South Africa; 2 SAMRC Herbal Drugs Research Unit, Tshwane University of Technology, Pretoria, South Africa; 3 Department of Pharmacy and Pharmacology, University of Witwatersrand, Johannesburg, Pretoria; 4 Department of Biochemistry and Biotechnology, Faculty of Pharmacy, Medical University of Lublin, Lublin, Poland
DOI 10.1055/s-0043-1774214

Essential oils are a rich source of bioactive compounds with potential anti-infective properties that can be used against a range of pathogens including *Mycobacterium* strains. Drug-resistant Tuberculosis (TB), caused by *Mycobacterium tuberculosis*, has become prevalent, due to the emergence of *M. tuberculosis* resistant strains. The current study aimed to identify commercial EOs with anti-TB activity, as well as to predict the bioactive EO compounds using biochemometrics. The broth microdilution assay was used to determine the antimycobacterial activity of the EOs towards non-pathogenic *M. smegmatis*, *M. goodii* and *M. fortuitum*. In parallel, the antimycobacterial activity towards the pathogenic *M. tuberculosis* strain was determined using the Alamar blue assay. The chemical profiles of the EOs were obtained through gas chromatography-mass spectrometry (GC-MS) analysis and biochemometrics was performed using orthogonal projections to latent structures discriminant analysis (OPLS-DA). The EOs that displayed broad spectrum antimycobacterial activity towards all four pathogens were *Cinnamomum zeylanicum* (minimum inhibitory concentration (MIC) = 0.25, 0.50, 1.00 mg/mL and 8.00 µg/mL) and *Levisticum officinale* (MICs = 0.50, 0.5, 0.5 mg/mL and 4 µg/mL) towards *M. smegmatis*, *M. fortuitum*, *M. goodii* and *M. tuberculosis*, respectively. Biochemometrics analysis predicted the putative biomarkers to be cinnamaldehyde, thymol, eugenol, 5-heptylcyclohexa, 1,3-diene, geranyl butyrate and α-calacorene and cinnamaldehyde (MIC = 0.03 - 0.25 mg/mL) was the most active compounds towards *M. fortuitum*, *M. smegmatis* and *M. goodii*. This study successfully established the chemical correlation between EOs and their antimicrobial activity against *Mycobacterium* species through the application of biochemometrics.

P-349 Mass spectral molecular networking to profile the phytochemicals of *Cissampelos* species

Authors [Weiyang Chen](#)¹, [Efficient Ncube](#)¹, [Zimkhitha Sotenjwa](#)¹, [Alvaro Viljoen](#)^{1,2}

Institutes 1 Department of Pharmaceutical Sciences Tshwane University of Technology, Pretoria, South Africa; 2 SAMRC Herbal Drugs Research Unit, Tshwane University of Technology, Pretoria, South Africa
DOI 10.1055/s-0043-1774215

The genus *Cissampelos* belongs to the Menispermaceae family and is used to treat a wide variety of ailments. South Africa harbours four indigenous species, namely *Cissampelos capensis* L.f., *C. hirta* Klotzsch, *C. mucronata* A.Rich. and *C. torulosa* E.Mey. ex Harv. & Sond. Comprehensive phytochemical studies revealed the presence of a rich diversity of biologically active bisbenzylisoquinoline alkaloids. Previous studies have also reported that the chemical profiles of these four *Cissampelos* species were influenced by geographical origin. The knowledge of this variation would assist in the commercialisation of chemotypes with favourable profile. Molecular network is an in silico tool to summarise the most predominant chemical classes retrieved through library matching and structure annotation. In this study, high performance or ultra-performance liquid chromatography (UPLC) hyphenated with mass spectrometry (MS) was used to analyse 271 acid-base extract samples collected from different localities in South Africa. Molecular networking was used to explore the chemical profile of the leaves, stems and roots in these four *Cissampelos* species. The classes of compounds in the *Cissampelos* species revealed varying levels of organ heterocyclic compounds including alkaloids, indoles, quinolines, benzopyrans, benzimidazoles, imidazopyridines across the different species from different localities. The putatively annotated metabolites also varied in the leaves, stems and roots. This work demonstrates the ability of in silico tools such as molecular networking to profile the phytochemical space of *Cissampelos* and determine signature markers relevant for chemotaxonomy.

P-350 HPLC Analysis on Ginseng Root in Normal and Root Rot model

Authors [Minsik Choi](#)¹, [Geonha Park](#)², [Sejin Ku](#)¹, [Kyu Won Kim](#)¹, [Young Pyo Jang](#)^{1,2,3}

Institutes 1 Department of Biomedical and Pharmaceutical Sciences, Graduate School, Kyung Hee University, Seoul, South Korea; 2 Department of Life and Nanopharmaceutical Sciences, Graduate School, Kyung Hee University, Seoul, South Korea; 3 Department of Integrated Drug Development and Natural Products, College of Pharmacy, Kyung Hee University, Seoul, South Korea
DOI 10.1055/s-0043-1774216

Although ginseng is highly valued worldwide for its pharmacological benefits, its mass production is challenging due to its uneconomical production process. The growth of ginseng is heavily influenced by soil microbes and the environment, making it vulnerable to diseases such as root rot, which is a major obstacle to ginseng production. While methods to cope with this disease are being researched, there is currently a lack of metabolic research related to ginseng root rot. To address this issue, an experiment was designed to identify the molecular components of ginseng that are related to root rot disease by comparing normal and diseased ginseng extracts using HPLC-PDA. From multivariate analysis on the HPLC chromatograms, ten significant peaks were identified, and six substances with VIP scores over 1.0 were selected for further analysis: ginsenoside Rg₁, ginsenoside Re, ginsenoside Ra₁, ginsenoside Rc, notoginsenoside Fc, and panaxydol. By taking a metabolomics approach to understand ginseng root rot related metabolome change, it was discovered that these six substances are primarily responsible for the disease in continuously cropped ginseng. This finding will lay the foundation for future metabolomics research on ways to find efficient cultivation methods for the continuous cropping of ginseng.

Conflict of Interest The authors declare no conflict of interest.

P-351 Molecular Networking and Dereplication: Facilitating Natural Product Analysis of *Piper sarmentosum* Leaves

Authors Nursabrina Najwa Salmin^{1,2}, Nurulfazlina Edayah Rasol^{1,2}, Ling Sui Kiong³, Nor Hadiani Ismail^{1,2}

Institutes 1 Atta-ur-Rahman Institute for Natural Product Discovery (AuRIns), Universiti Teknologi MARA, Puncak Alam Campus, 42300 Bandar Puncak Alam, Malaysia; 2 Faculty of Applied Sciences, Universiti Teknologi Mara, 42450 Shah Alam, Malaysia; 3 Herbal Product Development Program, Natural Products Division, Forest Research Institute Malaysia, 52109 Kepong, Malaysia
DOI 10.1055/s-0043-1774217

Natural products are an important source of compounds for drug discovery and development but isolating a single pure compound from complex mixtures of phytochemicals can be a daunting task, especially in metabolomics studies. To address this issue, dereplication strategies are employed to quickly identify known phytochemicals prior to the isolation process. In our ongoing research, we have conducted a comprehensive phytochemical analysis of the methanol extract of *Piper sarmentosum* leaves using a mass-based dereplication strategy coupled with a molecular networking approach. The combination of mass spectrometry processing tools such as MZmine3, SIRIUS and GNPS revealed 28 clusters comprising of alkaloids, flavonoids, terpenoids, coumarins, lignans, monoacylglycerol and acid derivatives. We identified 61 constituents with piperidine alkaloids being the major components. The dereplicated compounds were validated using seven isolated compounds, which are 3-(4-methoxyphenyl)propanoic acid pyrrolidine (1), 3-phenylpropanoic acid pyrrolidine (2), cepharanone B (3), sarmentosine (4), isoasarone (5), trans-asarone (6) and magnosalin (7). The compounds were purified using preparative and recycling high-performance liquid chromatography. The comprehensive LCMS/MS profile hopefully will provide valuable insights into the phytochemical composition of *Piper sarmentosum* and demonstrate the effectiveness of the dereplication strategy in streamlining natural product analysis.

P-352 Mining Secondary Metabolites of *Rennellia borneensis* Baill. using SIRIUS and High-Resolution Mass Spectrometry Data

Authors Nur Ammar Rushdan^{1,2}, Nurunajah Ab Ghani^{1,2}, Nurulfazlina Edayah Rasol^{1,2}, Wan Wan Salleh³, Adlin Afzan⁴, Monica Suleiman⁵

Institutes 1 Atta-ur-Rahman Institute for Natural Product Discovery, Universiti Teknologi MARA, Puncak Alam Campus, 42300 Bandar Puncak Alam, Malaysia; 2 Faculty of Applied Sciences, Universiti Teknologi Mara, 42450 Shah Alam, Malaysia; 3 Department of Chemistry, Faculty of Science and Mathematics, Universiti Pendidikan Sultan Idris, Tanjong Malim, Malaysia; 4 Herbal Medicine Research Centre, Institute for Medical Research, National Institutes of Health, Ministry of Health Malaysia, Setia Alam, 40170 Shah Alam, Malaysia; 5 Institute for Tropical Biology & Conservation, Universiti Malaysia Sabah, 88400 Kota Kinabalu, Malaysia
DOI 10.1055/s-0043-1774218

Rennellia borneensis Baill. (Rubiaceae), also known as Borneo ginseng, is an endemic plant species of Sabah, growing in a few surrounding Imbak Canyon Conservation Area (ICCA). The plant's roots are sought after and collected for their medicinal properties to treat various illnesses, including cancer and poisoning. It is also used for anti-ageing, vitality and as an energy booster. Nevertheless, the scientific data such as secondary metabolites and biological properties are still unknown. Understanding the chemistry and biological potential of the species is vital for substantiating the traditional usage while ensuring its sustainability. Hence, this study was designed to examine, for the first time, the secondary metabolites of the roots (dichloromethane extract) of *Rennellia borneensis* growing in Borneo. The annotation of the secondary metabolites was achieved by comprehensive analysis of the data-dependent acquisition (DDA) LC-MS/MS using SIRIUS. The study identified 20 compounds from distinct tan-

dem MS data. De novo molecular formula annotations and predictions from SIRIUS suggested 4 major classes of compound classified as anthraquinones, flavonoids, isoflavonoids and triterpenoids. Based on the literature, anthraquinone plays as a marker compound from this genus. Based on our results, we advocate the MS-based approach as a useful starting method for the dereplication of compounds from the complex crude extracts of plants.

P-353 Metabolomics and bioinformatics strategies for the valorization of *Prunus domestica* L. Italian varieties with antiangiogenic activity

Authors Marinella De Leo^{1,2}, Emily Cioni³, Fabio Camangi³, Maria Paola Germanò⁴, Valeria D'Angelo⁴, Gianfranco Diretto⁵, Nunziatina De Tommasi⁶, Alessandra Braca^{1,2}

Institutes 1 Department Of Pharmacy University Of Pisa, Pisa, Italy; 2 CISUP, Centre for Instrumentation Sharing, Pisa, Italy; 3 Scuola Superiore Sant'Anna di Studi Universitari e di Perfezionamento, Pisa, Italy; 4 Dipartimento di Scienze Chimiche, Biologiche, Farmaceutiche e Ambientali, Università degli Studi di Messina, Messina, Italy; 5 Agenzia Nazionale per le Nuove Tecnologie, l'Energia e lo Sviluppo Economico Sostenibile (ENEA), Centro Ricerche "Casaccia", Laboratorio Biotecnologie, Roma; 6 Dipartimento di Farmacia, Università degli Studi di Salerno, Fisciano (SA)
DOI 10.1055/s-0043-1774219

Plant biodiversity means richness of earth life and its protection is a current hot topic worldwide. In Italy, numerous *Prunus domestica* L. (Rosaceae) varieties are produced, some of them having a local spread and being poorly studied. The aim of this work was the valorization of Italian plum varieties at risk of extinction provided by the natural reserve "National Park of the Tuscan Archipelago". Chemical quali-quantitative analyses by UHPLC-Orbitrap/ESI-HRMS and antiangiogenic tests joint with a bioinformatics approach for data processing were performed. The multidimensional chemical/biological datasets were compared with those of commercial and Mediterranean varieties. Thirty-two compounds (hydroxycinnamic acid derivatives, flavonoids and anthocyanins) were identified. The Rossa Casa Velasco (RCV) was the richest in flavonoid and anthocyanin content (76.9 ± 1.0 fresh fruit (FF) and 610.9 ± 13.2 mg/100g FF, respectively). Its rich phytocomplex determined a marked microvasculature reduction in the chick chorioallantoic membrane (CAM) model, in addition to a decrease of endogenous alkaline phosphatase (EAP) activity released by zebrafish embryos. Multivariate analyses (PCA) according to genotypes and metabolites allow for identifying RCV and anthocyanins, respectively, as the main components driving the overall variance, whereas hierarchical clustering demonstrated the presence of three groups (RCV and Marisa being the most distal) in terms of chemical profile similarity. Pearson correlation-based approach was exploited to the metabolites potentially most associated with the antiangiogenic bioactivity: three flavonoids (rutin, quercetin arabinoside and isorhamnetin) were found in common with CAM and zebrafish. In conclusion, Italian plum varieties showed a better antiangiogenic activity compared to the extensively consumed ones.

P-354 Phytochemical Identification from *Eleusine indica* Methanolic Extract through High-Performance Liquid Chromatography Tandem Mass Spectrometry Databases-driven Analysis

Authors Fatimah Salim^{1,2}, Nur Syahirah Mad Sukor², Zikry Md Zakri³, Nurulfazlina Edayah Rasol^{1,2}

Institutes 1 Atta-ur-Rahman Institute for Natural Product Discovery (AuRIns), Universiti Teknologi MARA Selangor Branch, Puncak Alam Campus, Puncak Alam, Malaysia; 2 Faculty of Applied Sciences, Universiti Teknologi MARA, Shah Alam, Malaysia; 3 Institute for Tropical Biology and Conservation, Universiti Malaysia Sabah, Jalan UMS, Kota Kinabalu, Malaysia
DOI 10.1055/s-0043-1774220

Eleusine indica (L.) Gaertn is a perennial herb belonging to the grass family, Poaceae. The plant, which is locally known as "rumput sambau", is the only species of

Eleusine found abundantly in Malaysia. It has been traditionally used to treat various ailments including pain relief from fever, vaginal bleeding, hastening the placenta delivery after childbirth, urinary infection and as a tonic for flu-related symptoms. A diverse array of biological activities have been reported for the plant, such as antipyretic, analgesic, anticonvulsant, antimicrobial, cytotoxic, anti-inflammatory and hepatoprotective actions. Despite many reports on the traditional uses and biological activities of *E. indica*, only a few phytochemicals have been isolated, thus limiting the plant's available chemical databases. This study aimed to identify the phytochemical constituents in the methanolic extract of *E. indica* through liquid chromatography high-performance tandem mass spectrometry databases-driven analysis technique using MZmine, GNPS, Compound Discoverer and SIRIUS platforms. This technique managed to identify a total of 65 phytochemicals in the extract, comprising primary and secondary metabolites and was verified by the isolation of one of its identified phytochemicals. The structural elucidation mainly using 1D and 2D NMR as well as comparison with the literature values confirms the isolated phytochemical to be a C-3 anomer of a known compound loliolide, which consequently increases the level of confidence in the applied technique. The research describes a useful technique for the fast and simultaneous identification of phytochemicals in *E. indica*, contributing to the chemical properties study of the genus and family (► Fig. 1).

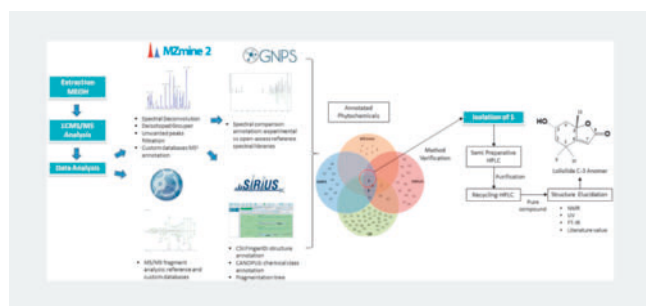

► Fig. 1 Phytochemical identification workflow for *Eleusine indica* methanolic extract

P-355 Dereplication of *Wrightia dubia* and *Wrightia pubescens* by UPLC-ESI- Orbitrap-MS/MS

Authors Hidayatul Atiqah Abdul Karim^{1,2}, Nor Hadiani Ismail^{1,2}, Nurulfazlina Edayah Rasol^{1,2}, Che Puteh Osman^{1,2}

Institutes 1 Atta-ur-Rahman Institute for Natural Product Discovery, Universiti Teknologi MARA, Cawangan Selangor, Kampus Puncak Alam, 42300 Bandar Puncak Alam, Malaysia; 2 Fakulti Sains Gunaan, Universiti Teknologi MARA, 40450 Shah Alam, Malaysia

DOI 10.1055/s-0043-1774221

Wrightia pubescens R.Br. subsp. *laniti* (Blanco) Ngan and *Wrightia dubia* (Sims) Spreng. belong to the Apocynaceae family. Several metabolites were identified from *W. pubescens*, and none reported from *W. dubia*. The limited knowledge about their metabolites hinders further pharmacological investigation of the plants. To address this issue, a dereplication approach was proposed to identify the known metabolites and guide the isolation work towards potential new metabolites. *W. pubescens* and *W. dubia* were collected in Pulau Tuba, Langkawi, Malaysia in November 2019. The plant materials were air-dried and extracted successively using hexane, dichloromethane and methanol. The dichloromethane extracts were pre-treated with a C-18 SPE and profiled using UHPLC, followed by UPLC-MS/MS analysis. Tryptanthrin was isolated from *W. dubia* stem bark following exhaustive purification using recycling preparative HPLC. Metabolite databases from the Apocynaceae family, genus *Wrightia*, *Wrightia pubescens* and *Wrightia dubia* were created using the Sirius software. The annotated metabolites were identified using molecular formula identification, zodiac, fingerprint prediction, structure database search and compound class prediction. The analysis revealed 21 compounds in *W. pubescens* twig and 20

compounds in *W. dubia* stem bark. The compounds belong to the coumarin, lignan, alkaloid, fatty acid, peptide and lactone classes. Both plants were found to contain tryptanthrin, an indole quinazoline alkaloid, and dipeptides namely asperphenamate, asperglauclide and aurantiamide. The dereplication strategy was validated using tryptanthrin. Future isolation studies will be directed towards unknown compounds and selected alkaloids for further pharmacological assessments (► Fig. 1).

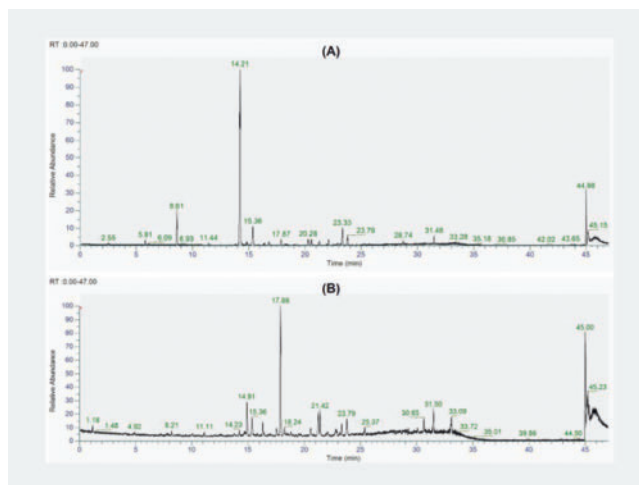

► Fig. 1 Total Ion Chromatogram of the twig extract of *Wrightia pubescens* (a) and stem bark extract of *Wrightia dubia* (b).

Conflict of Interest The authors declare no conflict of interest.

P-356 Metabolite profiling of “Eretto Liguria”, an Italian local ecotype of *Salvia rosmarinus*, and antimicrobial activity against *Pectobacterium carotovorum* subsp. *carotovorum*

Authors Valeria Iobbi¹, Giuliana Donadio², Anna Paola Lanteri³, Norbert Maggi⁴, Johannes Kirchmair⁵, Valentina Parisi², Giovanni Minuto³, Andrea Copetta⁶, Mauro Giacomini⁴, Angela Bisio¹, Nunziatina De Tommasi², Giuliana Drava¹

Institutes 1 Department of Pharmacy, University of Genova, Genova, Italy; 2 Department of Pharmacy, University of Salerno, Fisciano, Italy; 3 Centro di Sperimentazione e Assistenza Agricola (CeRSAA), Albenga, Italy; 4 Department of Informatics, Bioengineering, Robotics and System Science, University of Genova, Genova, Italy; 5 Department of Pharmaceutical Sciences, Division of Pharmaceutical Chemistry, University of Vienna, Vienna, Austria; 6 Centro di Ricerca Orticoltura e Florovivaismo (CREA), Sanremo, Italy

DOI 10.1055/s-0043-1774222

A targeted NMR metabolomic approach was used to characterise *Salvia rosmarinus* “Eretto Liguria” ecotype, commonly used in Northwest Italy by farmers for cuttings and for marketing, with a view to application and registration processes for designation of protected geographical indications. Qualitative NMR based investigation was performed by means of Chenomx (Chenomx NMR Suite 8.6, Chenomx Inc., Edmonton, 252 Canada) and NMRProcFlow tools, and was followed by multivariate data analysis. Self-organising maps (SOMs) showed that the accessions of “Eretto Liguria” appeared well characterised compared to the other commercial cultivars and ecotypes from the same geographical region, and had a good content in carnosic acid. Moreover, to evaluate the possibility of using the rosemary biomass, after the removal of cuttings or fronds marketable as flavouring, as a source of extracts and pure compounds with potential phytosanitary activity in organic farming, rosemary methanolic extracts and the pure abietane compounds were tested for their ability to re-

duce the pectolytic activity of the soft rotting *P. carotovorum* subsp. *carotovorum* on potato tissue. The in vitro assay on potato tuber slices showed the ability of rosemary methanolic extracts to reduce the pectolytic activity, and 7-O-methylrosmanol, carnosol and isorosmanol were showed to completely inhibit the pectolytic activity. In silico studies showed that these abietane diterpenoids may interact with *P. carotovorum* subsp. *carotovorum* pectinase enzymes (pectate lyase 1 and endopolygalacturonase), thus highlighting these rosemary components as starting points for the development of agents able to prevent soft rot progression in potato crops.

P-357 Comparison of phenolic composition of ten *Salix* species

Authors Thomas Olaf Gruber¹, Leonie Kayser¹, Jörg Heilmann¹, Gregor Aas², Guido Jürgenliemk¹

Institutes 1 Department of Pharmaceutical Biology, University of Regensburg, Universitaetsstr. 31, 93053 Regensburg, Germany; 2 Ecological-Botanical Gardens Bayreuth, University of Bayreuth, Universitaetsstr. 30, 95447 Bayreuth, Germany

DOI 10.1055/s-0043-1774223

Willow bark (*Salix cortex*, *Salix* sp., Salicaceae) is well known for its analgesic, antiphlogistic, and antipyretic efficacy. Besides salicylic alcohol derivatives, further phenolic components contribute to the pharmacological effects. Thus, knowledge about the phenolic composition of *Salix cortex* is of great interest. The present study was conducted to investigate the variations in the phytochemical composition of willow bark. Ten *Salix* species were analysed for their phenolic component profile during the growing season of 2017 (June–September). The investigated species were *Salix purpurea* (1), *S. daphnoides* (2), *S. fragilis* (3), *S. bicolor* (4), *S. hastata* (5), *S. caesia* (6), *S. aurita* (7), *S. viminalis* (8), *S. lapponum* (9), *S. x sepulcralis* (10). All individuals were localised at the Ecological-Botanical Gardens at the University of Bayreuth, Germany.

Methanolic extracts of the bark of these willow species were analysed by applying a UPLC-PDA method. To characterise the extracts, a spectral reference database for the automated assignment of UV spectra was created.

A principal component analysis (PCA) of the obtained data suggests dividing the studied species into three groups by their phenolic profile. One group is defined by its increased amounts of caffeic acid derivatives, as well as flavan-3-ols ((2), (3), (5), (6), (10)), the second group by flavanones (1), and the third by caffeic alcohol glycosides and partly flavanonols ((4), (7), (8), (9)). These results were compared to the plants relationship based on morphological characteristics, where differences, as well as similarities, were recognisable.

Conflict of Interest The authors declare no conflict of interest.

P-359 Dereplication of norlichexanthenes in lichen extracts: LC/MS vs NMR

Authors Solenn Ferron¹, Marylène Chollet-Krugler¹, Joël Boustie¹, Françoise Lohézic-Le Dévéhat¹, Philippe Uriac¹

Institute 1 Univ Rennes, CNRS, ISCR (Institut des Sciences Chimiques de Rennes), UMR 6226, 35042 Rennes, France

DOI 10.1055/s-0043-1774224

Xanthenes are secondary metabolites deriving from the 9H-xanthen-9-one scaffold produced by a wide range of plant, bacterial and fungal species. In lichens, they occur mostly as members of two classes: lichexanthenes and norlichexanthenes, differing by the methylation of positions 3 and 5 for lichexanthenes. Chlorination can occur on positions 2, 4, 5 and 7, resulting in a total of sixteen different norlichexanthenes for only five different exact masses. This high number of isomers makes them tedious to identify. High resolution tandem mass spectrometry is of no help without HPLC separation combined to standard compounds availability, and even NMR on pure compounds could be tricky, due to their high proton-deficiency.

However, they are of chemotaxonomic interest for lichenologists to identify crustaceous lichens with very similar morphology, such as some species of *Lecanora*.

We therefore constituted a library of the sixteen norlichexanthenes, which were obtained by a combined strategy of synthesis and isolation. An HPLC/MS method was set up to separate them efficiently by their m/z and retention times (► Fig. 1a). In parallel, we acquired NMR data to perform the dereplication of these compounds in lichen extracts, based on the HSQC correlations observed for the non-chlorinated positions (► Fig. 1b).

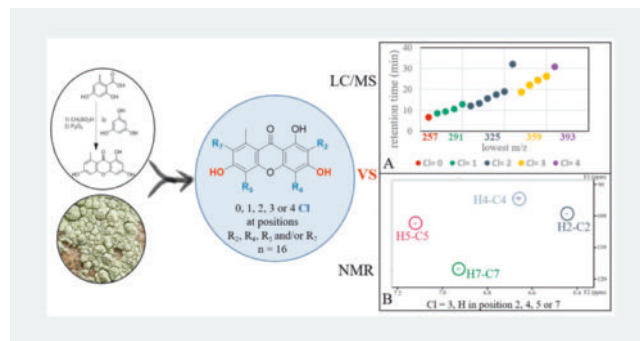

► **Fig. 1** Norlichexanthenes in lichens: two complementary dereplication strategies.

While LC/MS is sensitive and easy to interpret, NMR is robust and highly reproducible. A combination of both methods provides a good overview of the xanthone content in lichens.

P-360 *Vitis vinifera* canes and leaves of nine Greek varieties from Crete: Stilbene quantification, metabolomics and bioactivity assessment

Authors Eleni V. Mikropoulou¹, Vlasios Tsiounis¹, Adamantia Agalou², Emmanouil Kontaxakis³, Dimitris Beis², Maria Halabalaki¹

Institutes 1 Division of Pharmacognosy and Natural Products Chemistry, Department of Pharmacy, National and Kapodistrian University of Athens, Panepistimiopolis Zografou, 15771, Athens, Greece; 2 Center for Clinical, Experimental Surgery and Translational Research, Biomedical Research Foundation Academy of Athens, 11527, Athens, Greece; 3 Department of Agriculture, School of Agricultural Sciences, Hellenic Mediterranean University, 71410, Heraklion, Greece

DOI 10.1055/s-0043-1774225

Grape production is among the most long-lasting cultivations in the Mediterranean basin. Waste management in the vinification process is a pressing issue, while the valorisation of grape culture residues presents an appealing alternative for the manufacturing of high added value products. Among these by-products, grape canes and leaves constitute rich sources of bioactive compounds, including stilbenes and procyanidins [1]. In the present work, canes and leaves of nine unexplored Greek *Vitis vinifera* varieties from Crete were collected at different maturation stages. Following collection, the plant material was extracted with several solvent systems and the extracts were profiled by means of HPTLC and HPLC-PDA, while stilbenoid quantification was also carried out in cane samples. Additionally, a metabolomics approach with an LC-Orbitrap-HRMS platform was implemented to map the differences between different sample groups. After data preprocessing and multivariate analysis, biomarkers responsible for class differentiation were detected and annotated. Finally, extracts of grape canes were evaluated for their biological activity against melanogenesis in a zebrafish embryo model. In conclusion, the combination of different analytical techniques allows the in-depth investigation of grapevine's complex phytochemical profile, whose composition is highly affected by dynamic changes during the plant's life cycle. Overall, leaves have

higher levels of flavonoids compared to canes, while the latter exhibit increased levels of fatty acids during blooming and higher stilbenoid content during maturation.

Funding ERDF, “RESEARCH–CREATE–INNOVATE”, VitVin (project code T1EAK-04103)

Conflict of Interest The authors declare no conflict of interest.

References

[1] Drosou et al., *Ind Crops and Prod* 2015; 75: 141–149.

P-361 New insights into the metabolomic markers of azole-resistant *Aspergillus fumigatus* pathogenic fungus

Authors Rémy Marcellin-Gros¹, Nicole Lecoultré², Sylvain Schnee², Katia Gindro², Emerson Queiroz¹, Jean-Luc Wolfender¹

Institutes 1 University Of Geneva, Geneva, Switzerland; 2 Agroscope, Nyon, Switzerland

DOI 10.1055/s-0043-1774226

Aspergillus fumigatus is a saprophytic fungus, able to occasionally colonise living organisms ranging from plants to mammals. In human it is considered as the most common and life-threatening airborne opportunistic fungal pathogen, causing a broad spectrum of diseases, including the devastating invasive aspergillosis in patients with impaired immunity, such as transplant recipients or cancer. Extensive use of antifungal drugs (such as azoles) from crop to clinic, led to the progressive emergence of multi-drug resistant pathogenic strains and poses a considerable threat to disease control. The genetic basis of azole resistance is related to membrane modifications, but the changes occurring at the metabolic scale remain unexplored.

Here we investigated the metabolomic markers of the azole-resistance in *A. fumigatus* across 17 and 6 environmental and clinical strains respectively in comparison to 90 azole-susceptible environmental strains. All extracts were analysed by untargeted data dependant metabolite profiling UHPLC-HRMS/MS and processed by molecular networking (MN). Markers annotation was first conducted through experimental MS² spectra processing with the most advanced bioinformatic pipelines (SIRIUS and timar) (► Fig. 1).

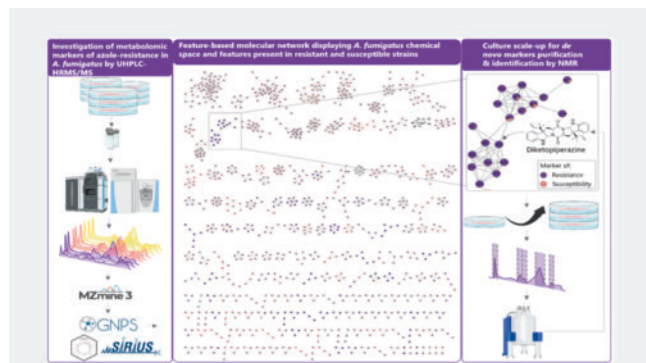

► Fig. 1 Workflow for investigation of metabolomic markers of azole-resistant *Aspergillus fumigatus*.

From this comparative analysis, five chaetoglobosins were annotated as markers of azole-resistance in the clinical strains, while markers of environmental azole-resistant strains were annotated as dimers of diketopiperazine derivatives. These markers are currently undergoing purification by high-resolution fractionation for full *de novo* NMR identification. The biosynthesis of these markers is subjected to activation of specific biosynthetic gene clusters (BGCs) suggesting that azole resistance may be accompanied by more profound metabolic changes than the ones involved in membrane remodelling.

P-362 A metabolomic approach to investigate metabolization of *Echinacea purpurea* extract in the upper gastrointestinal tract in vitro

Authors Maria-Eleni Grafakou¹, Eva-Maria Pferschy-Wenzig¹, Ramy M. Ammar², Olaf Kalber², Rudolf Bauer¹

Institutes 1 Institute of Pharmaceutical Sciences, Department of Pharmacognosy, University of Graz, Graz, Austria; 2 Phytomedicines Supply and Development Center, Bayer Consumer Health, Steigerwald Arzneimittelwerk GmbH, Darmstadt, Germany

DOI 10.1055/s-0043-1774227

Echinacea purpurea is frequently used to relieve the symptoms of upper respiratory tract infections [1]. An important first step to understand the pharmacological activity and the mechanism of action of medicinal plant extracts is the investigation of the complex metabolic processes within the human digestive tract. The effects of upper intestinal tract digestion on an *E. purpurea* pressed juice were assessed using the static in-vitro model Infogest 2.0 [2]. The pressed juice dried under gentle conditions was successively mixed 1:1 with simulated salivary fluid (no amylase, no incubation), simulated gastric fluid (pepsin, gastric lipase, 2h, pH 3, 37 °C) and simulated intestinal fluid (pancreatin, bile, 2h, pH 7, 37 °C).

Analysis and annotation of the constituents present in the native preparation and in the gastric and intestinal phases after in vitro digestion (after lyophilisation and protein precipitation) was accomplished by UHPLC-HRMS analysis. Individual compound analysis suggested the presence of compounds like malic, citric and tartaric acids, betaine, caftaric, fertaric, coutaric, coumaric acids and several alkamides. The overall chemical profile was highly impacted by the gastric phase, where the levels of numerous compounds were enhanced. These enhanced levels returned to basal levels or were decreased in the intestinal phase. Alkamides remained unaffected by in vitro digestion. Compounds remaining stable towards simulated upper intestinal tract digestion may reach the colon in unchanged form in vivo, unless they are absorbed in the upper intestinal tract.

Conflicts of Interest The investigations and MEG have been funded by, and RMA and OK are fully employed by Steigerwald Arzneimittelwerk GmbH.

References

[1] <https://www.ema.europa.eu/en/medicines/herbal/echinaceae-purpureae-herba>
[2] Brodtkorb A, Egger L, Alminger M, Alvito P, Assuncao R, Ballance S, Bohn T, Bourlieu-Lacanal C, Boutrou R, Carriere F et al. INFOGEST static in vitro simulation of gastrointestinal food digestion. *Nat Protoc* 2019; 14: 991–1014

P-363 Deep learning algorithm integrates multiomics data to identify unique functional molecules and diagnostic biomarkers from the human microbiome.

Authors Walaa Mousa¹, Tareq Abu-Izneid¹

Institutes 1 Al Ain University, Al Ain, United Arab Emirates; 2 Mansoura University, Mansoura, Egypt

DOI 10.1055/s-0043-1774228

We live in a deep symbiosis with trillions of microbes, together with their genes and secreted molecules it is referred to as the human microbiome. Mounting evidence suggests the crucial role of the microbiome in shaping human health or mediating diseases although the mechanistic underpinning is lacking. Discovery of functional genes or molecules from the microbiome holds a promise to develop unique therapeutics and diagnostic biomarkers for multiple diseases from metabolic disorders to inflammatory autoimmune diseases and malignancies. In this research we present a novel deep learning algorithm that integrates metabolomic and transcriptomic data to annotate the microbiome function ultimately unlocking its chemistry. The algorithm pinpoints functional molecules directly in the mass spectrometry data enabling downstream isolation, structural elucidation, and in-depth biological evaluation. Guided by the new tool we

identified and fully characterised a novel immune modulatory molecule, we named it limousine, encoded in a rare poorly understood human-associated microbe. Our data shows that this molecule is consistently correlated with the onset and progression of inflammatory bowel syndrome and could be a potential microbiome-based biomarker. We envision our tool to be a driving force to identify active molecules *in silico* and guide the downstream structural characterisation. The algorithm is applicable to all microbiome systems with potential application in all fields from agriculture to medicine.

Conflict of Interest The authors declare no conflict of interest.

P-365 Molecular networking and LOTUS-based *in silico* fragmentation spectral database dereplication for the chemical exploration of *Epicoccum nigrum*

Authors Antonio Azzollini^{1,2,3}, Pierre-Marie Allard^{1,2,4}, Sylvian Cretton^{1,2}, Adriano Rutz^{1,2}, Elettra Pinetti^{1,2}, Laurence Marcourt^{1,2}, Katia Gindro⁵, Jean-Luc Wolfender^{1,2}

Institutes 1 School of Pharmaceutical Sciences, University of Geneva, 1211 Geneva, Switzerland; 2 Institute of Pharmaceutical Sciences of Western Switzerland (ISPSO), University of Geneva, 1211 Geneva, Switzerland; 3 Department of Laboratory Medicine and Pathology, Lausanne University Hospital (CHUV), 1011 Lausanne, Switzerland; 4 Department of Biology, University of Fribourg, 1700 Fribourg, Switzerland; 5 Plant protection Research department, Mycology group, 1260 Nyon, Switzerland
DOI 10.1055/s-0043-1774229

The accurate and trustworthy identification of novel molecules in complex extracts (such as those derived from microorganisms) is a critical task of Natural Products (NPs) research. In this context, the integration of high-resolution mass spectrometry and molecular networking offers a powerful and effective approach for precise molecular annotation.

In this study, an integrated metabolomics strategy, including Feature Based Molecular Networking (FBMN) in combination with *in silico* fragmented spectral database dereplication (ISDB) was used to explore the metabolome of *Epicoccum nigrum*. In particular, the molecular annotation procedure was performed using the latest version of the ISDB which includes a comprehensive collection of molecular structures compiled in LOTUS together with the associated metadata documenting biological sources of the metabolites. This comprehensive metabolomics approach allowed for the mapping of the metabolome of *Epicoccum nigrum*, a saprotrophic fungal microorganism that plays a significant role in various ecological and biotechnological contexts. Interestingly, the detailed inspection of the FBMN and employed annotation procedure led to the identification of a molecular cluster related to isoindolin derivatives presenting two putatively new molecules. Moreover, the highlighted features were among the most intense of the metabolite profile and thus could be reasonably targeted for isolation and full structure NMR elucidation.

These results confirm the utility of FBMN, in combination with recently developed taxonomically informed metabolite annotation processes, in exploring microbial metabolomes and for prioritising the isolation of potential novel compounds.

Conflict of Interest The authors declare no conflict of interest.

P-366 Antimicrobial activity evaluation of three different medicinal plants against human pathogenic strains

Authors Sumeyye Elif Kahya^{1,3}, Sule Nur Karavus^{1,2}

Institutes 1 Istanbul Medipol University, Istanbul, Turkey; 2 Institute of Health Science, Istanbul University, Istanbul, Turkey; 3 Institute of Health Science, Anadolu University, Eskisehir, Turkey
DOI 10.1055/s-0043-1774230

The flora of the Mediterranean area includes many aromatic and medicinal species that have long been an integral part of the local culture, covering an extensive area with different environmental conditions. Both *Salvia* and *Cyno-*

glossum species are important medicinal and aromatic plants. In this present study, n-hexane, dichloromethane, and methanol extracts of *Salvia viridis* L., *Cynoglossum officinale* L., and *Cynoglossum creticum* Mill. were investigated. DPPH and ABTS assays were studied to evaluate the antioxidant activity of these extracts. The antimicrobial activity of the materials was tested using the *in vitro* broth microdilution assay towards three different pathogenic microorganisms, *Staphylococcus aureus*, *Escherichia coli* and *Streptococcus mutans*. The minimum inhibitory concentration (MIC) of the n-hexane, dichloromethane and methanol extracts of *S. viridis*, *C. officinale* and *C. creticum* towards *S. aureus*, *S. mutans*, and *E. coli* was calculated to be the range 1 – 0.25 mg/mL. For all extracts, moderate antioxidant activity was demonstrated. Further detailed studies and phytochemical analyses are ongoing to confirm the efficacy of the studied extracts.

Conflict of Interest The authors declare no conflict of interest

P-367 Antiproliferative activities of some selected Nigerian medicinal plants towards human breast, liver and cervical cancers

Author Olubusola Olaleye¹

Institute 1 University of Nottingham, Nottingham, United Kingdom
DOI 10.1055/s-0043-1774231

Due to their biological activity and structural diversity, natural products have historically been an important source of novel anticancer medicines, facilitating the development of chemical entities with established safety and efficacy. This study is aimed at investigating the anticancer activity of some selected Nigerian medicinal plants used in cancer treatment with a view to isolate bioactive compounds with cytotoxic potential. Ethanol extracts of *Dialium guineense* root (DGR), *Dialium guineense* leaves (DGL), *Jateorhiza macrantha* leaves (JML), *Musanga cecropioides* leaves (MCL), *Musanga cecropioides* stembark (MCSB), *Piptadeniastrum africanum* stembark (PASB), *Piptadeniastrum africanum* root (PAR), *Pupalia lappacea* flower tops (PLF), *Raphiostylis beninensis* root (RBR) and *Raphiostylis beninensis* (RBL) were selected being the most frequently used ethnomedicinally in tumour related problems.

The extract of PASB had the highest cytotoxicity (LC₅₀ = 1.58 µg/mL) on the brine shrimps compared to vincristine sulphate (LC₅₀ = 2.24 µg/mL). In the cell viability assay, all the extracts produced a significant (*p* < 0.05) growth inhibitory effect against all cell lines tested in a dose dependent manner. All extracts were selective to cancer cells at varying degrees. Worthy of mentioning are the extracts of MCL, DGR, RBR and PASB, which exhibited 14-, 7-, 6- and 2-fold selectivity toward MCF-7 cancer cells relative to normal lung fibroblasts (MRC-5), respectively. These four extracts also significantly inhibited cell migration and colony formation in MCF-7 treated cells in a dose-dependent manner. These findings advocate continued development of MCL, DGR, RBR and PASB as potential chemotherapeutic agents.

Conflict of Interest The authors declare no conflict of interest.

P-370 Sinulariolide, a Compound from Soft Corals, Suppresses TGFβ-Induced Interleukin-6 Secretion in Carcinoma Cells

Author Chun-Lin Chen¹

Institute 1 National Sun Yat-sen University, Kaohsiung, Taiwan
DOI 10.1055/s-0043-1774232

Sinulariolide is a natural product extracted from the soft coral *Sinularia flexibilis* and has anti-inflammatory, anti-proliferative and anti-migratory effects on several types of cancer cells. However, the underlying mechanism of its anti-inflammatory effects is not well understood. In this study, we focus on investigating the effects of sinulariolide on TGFβ-induced release of interleukin 6 (IL-6) in an *in vitro* cell culture model. We found that TGFβ stimulated the expression and secretion of IL-6 and was associated with increased transcription of IL-6 mRNA in A549 cells. Sinulariolide blocked TGFβ-induced IL-6 secretion without affecting the induction of fibronectin and plasminogen activator *in-*

hibitor-1 genes, indicating that it only interferes with a subset of TGF β activities. Moreover, sinulariolide inhibits TGF β -induced IL-6 by suppressing p38 MAPK signaling and subsequent NF- κ B and its nuclear translocation, while having no effect on the canonical Smad pathway or receptor turnover. Our data suggests that p38 is involved in the inhibition of sinulariolide-mediated IL-6 release, highlighting its potential in suppressing inflammation, EMT phenotype, and tumorigenesis.

Conflict of Interest The author declares no conflict of interest.

P-371 Cytotoxic activities of compounds from genera *Euphorbia rowlandii* R.A Dyer and *Euphorbia tirucalli* L. (Euphorbiaceae) against triple negative breast cells

Authors Jacqueline Tembu¹, Mmabatho Monica Dinala¹, Nthabiseng Prudence Mokwana¹, Wilma Augustyn¹, Molahleli Sonopo⁴, Lyndy McGaw², Getrude Nyemba³, Candance Davidson³, Jo De LaMare³, Xavier Siwe- Noundou⁵

Institutes 1 Department of Chemistry, Tshwane University of Technology, Private Bag x680, Pretoria, South Africa; 2 Department of Paraclinical Sciences, University of Pretoria, Private BagX20, Onderstepoort, 0110, South Africa; 3 Department of Biochemistry and Microbiology, Female Cancers Research at Rhodes University (FemCR2U), 6140, Makhanda, South Africa; 4 Radiochemistry, South African Nuclear Energy Corporation, R104, Pelindaba Brits, South Africa; 5 School of Pharmacy, Department of Pharmaceutical Science, Sefako Makgatho Health Sciences University, PO Box 218, South Africa

DOI 10.1055/s-0043-1774233

Triple-negative breast cancer cells (TNBC) are a heterogeneous group of malignancies that lack estrogen receptor (ER) and progesterone receptor (PR), and human epidermal growth factor receptor 2 (HER2) [1]. This subtype accounts for approximately 10 to 15% of diagnosed breast cancers worldwide and in Africa, more than 50% of women diagnosed with this type die [2]. Genus *Euphorbia* contains compounds with anticancer properties [3], hence exploring *Euphorbia rowlandii* R.A Dyer and *Euphorbia tirucalli* L. phytochemicals and cytotoxic effects.

E. rowlandii R.A Dyer afforded phorbol ester, 16-Hydroxy-12-deoxy-phorbol (1), a tentative phorbol ester (2), 3 β -hydroxy-5-glutinene (3), while *Euphorbia tirucalli* L. afforded hexyl ferulate (4), stigmaterol (5), euphol (6), jolkinolide A (7) and lupeol acetate (8). Structures were characterised using NMR, IR and MS. Extracts and compounds were tested for cytotoxicity using MTT against (MCF-7), (HCC70) and (MCF-12A) cells. Dichloromethane extract showed high toxicity against HCC70 and MCF-7 at 4.97 and 1.177 μ M while methanol extract showed selective index (SI) > 1. Compound 1 showed activity against HCC70 and MCF-7 with EC₅₀ values of 0.592 and 1.003 μ M respectively. Compound 2 showed moderate activity against HCC70 cells at 20.48 μ M, high toxicity against MCF-7 cells with a low value of (7.67 μ M) and good SI at 1.08. Compounds (4-8) showed good activity against MCF-7 at 1.397 μ M (4), 2.058 μ M (5), 0.760 μ M (6), 2.675 μ M (7) and 3.515 μ M (8).

References

- [1] Anyanwu SN. et al. *Expl Clin Cancer Res* 2008; 27: 17
- [2] Won KA et al. *Int. J. Oncol* 2020; 57: 1245–1261
- [3] Zolfaghari B et al. *Iran J Pharm Res* 2022; 21 (1): e127028

P-373 The effect of *Pouteria campechiana* fruit extracts on the inhibition of cancer cell proliferation

Authors Chantana Boonyarat¹, Churdphong Ubolban², Pornthip Waiwut²

Institutes 1 Faculty of Pharmaceutical Sciences, Khon Kaen University, Khon Kaen 40002, Mueang, Thailand; 2 Faculty of Pharmaceutical Sciences, Ubon Ratchathani University, Ubon Ratchathani 34190, Warin Chamrab, Thailand

DOI 10.1055/s-0043-1774234

This study aimed to test the effect of *Pouteria campechiana* fruit extracts on inhibiting the growth of cancer cells and to investigate the molecular mechanism of *Pouteria campechiana* fruit extract-induced apoptosis. The MTT assay was used to assess the cell viability of HT-29 cells inhibited by *Pouteria campechiana* fruit extracts compared with doxorubicin (positive control) and without *Pouteria campechiana* fruit extracts (negative control) and percentage of cell viability of FHC treated by *Pouteria campechiana* fruit extracts compared with doxorubicin (positive control) and without *Pouteria campechiana* fruit extracts (negative control). The MTT assay was determined using a UV spectrophotometer technique then converted into percentage of cell viability. Moreover, morphological change of HT-29 and FHC cells was observed by Phase contrast microscopy and the mechanism of *Pouteria campechiana* fruit extracts in inhibiting the growth of cancer cells was determined by Western blot. The MTT assay revealed that *Pouteria campechiana* fruit extracts significantly inhibited the cell viability of HT-29 cells in a concentration and time dependent manner. The cell viability of FHC normal cells treated with *Pouteria campechiana* fruit extracts at 24, 48 and 72 hours were more than 90% and not decreased with higher concentration. Phase contrast microscopy of HT-29 cells showed the morphology changes of cells treated with extract included shrinkage and fragmentation. Western blot analysis showed the change of apoptotic related proteins including caspase-3, PARP-1, survivin and Bid. This study indicated that *Pouteria campechiana* fruit extract inhibited HT-29 cell proliferation by apoptosis through apoptosis inducing proteins.

P-374 Evaluating the Inhibitory Potential of Phytochemicals on Species-specific Breast Cancer Resistance Protein Transport Activity

Authors Lerica Le Roux-Pullen¹, Noraly Jonis², Jeroen Van den Heuvel², Ilse Dubbelboer^{1,3}, Jan Koenderink², Frans Russel², Ronette Gehring¹

Institutes 1 Department Population Health Sciences, Faculty of Veterinary Medicine, Utrecht University, Utrecht, Netherlands; 2 Department of Pharmacology and Toxicology, Radboud University Medical Center, Nijmegen, Netherlands; 3 Department of Pharmaceutical Biosciences, Uppsala University, Uppsala, Sweden
DOI 10.1055/s-0043-1774235

Inhibition of ATP-binding cassette (ABC) transporters is a common mechanism underlying pharmacokinetic interactions between xenobiotics (for example, drug-herb, herb-herb and herb-nutrient interactions). ABCG2, or Breast Cancer Resistance Protein (BCRP), is an efflux transporter located on a variety of cells, playing a key role in maintaining the barrier function of organs. We determined the inhibitory potential of eight phytochemicals on BCRP activity, in vitro, using membrane vesicles engineered to express species-specific BCRP.

Phytochemicals were selected based on their relevance for both human and animal health. Membrane vesicles were isolated from transduced human embryonic kidney (HEK) 293 cells, overexpressing BCRP with a human, bovine, caprine or ovine gene sequence. The inhibitory potential of 200 microM allyl methyl sulfide (in garlic), anethole (in anise), apigenin (in camomile), berberine (in goldenseal), carvacrol (in oregano), kaempferol (in chicory), quercetin (abundant in green plants and fruits) and N-isobutyldodeca-2E,4E,8Z,10E/Z-tetraenamide (in *Echinacea angustifolia*), on the transport of the model BCRP-substrate [³H]-estrone-3-sulphate, was evaluated. Compounds were considered inhibitors when uptake was reduced by more than 30%. Five of the eight phytochemicals showed potential clinically relevant inhibition in all four species. These phytochemicals are now being compared for their inhibitory potency between species.

To our knowledge this is the first study where differences in the inhibitory potential of phytochemicals interacting with BCRP transport in human and dairy animals are being investigated. Our assay will give insight into the extrapolation of data between species and improve the ease of assessing safe and effective herbal use in humans and dairy animals.

P-375 Anti-proliferative activity of β -damascenone and related C13- norisoprenoids

Authors [Teresa Pirker¹](#), [Rudolf Bauer¹](#)

Institute 1 Institute of Pharmaceutical Sciences, Department of Pharmacognosy, University of Graz, Graz, Austria

DOI [10.1055/s-0043-1774236](#)

Damascenone and ionones are structurally related C13-norisoprenoids. Recent studies focused on the promising anti-proliferative activity of β -ionone and its analogs [1], but did not consider β -damascenone.

We could recently demonstrate that β -damascenone inhibits cell growth in various cancer cell lines, including human leukemia, melanoma and glioblastoma cells. In all cell lines, β -damascenone was more active than β -ionone, which showed only weak inhibition rates at concentrations below 100 μ M. Our experiments also showed that the toxicity of β -damascenone towards non-malignant cell lines was reduced compared to cancer cell lines, indicating a selective mechanism. Furthermore, the results indicated a link to caspase 3/7 induced apoptosis [2].

Also, the effect of various damascenone and ionone analogs on cancer cell lines was investigated. Among the tested compounds, β -damascenone was still the most effective, with IC_{50} values between 8 and 30 μ M.

References

- [1] Ansari M, Emami S. β -Ionone and its analogs as promising anticancer agents. *Eur J Med Chem* 2016; 123: 141–154. doi:10.1016/j.ejmech.2016.07.037
 [2] Pirker T, Bauer R. Comparison of anti-proliferative activity of β -damascenone and β -ionone. *Planta Medica* 2022; 88 (15): 1428. doi:10.1055/s-0042-1758979

P-376 Antitumour activity of a natural cardiac glycoside, periplocin, by regulating Nrf2-mediated signalling pathway in gemcitabine-resistant pancreatic cancer cells

Authors [Sang Kook Lee¹](#), [Eun Seo Bae¹](#), [Woong Sub Byun¹](#), [Chae Won Ock¹](#), [Won Kyung Kim¹](#), [Hyen Joo Park¹](#)

Institute 1 Seoul National University, Seoul, South Korea

DOI [10.1055/s-0043-1774237](#)

Although gemcitabine-based chemotherapy is common and effective for pancreatic cancer (PC), acquired drug resistance is one of the major reasons for treatment failure. Therefore, a novel therapeutic approach for gemcitabine-resistant PC is required. Nrf2 is an oxidative stress-responsive transcription factor regulating antioxidant responses and plays a crucial role in chemoresistance. In the present study, the antitumour activity of periplocin, a natural cardiac glycoside, was evaluated in an established gemcitabine-resistant PC cell line (PANC-GR). The antiproliferative activity of periplocin was highly associated with Nrf2 downregulation and Nrf2-mediated signaling pathways in PANC-GR cells. Periplocin also increased reactive oxygen species production inducing G0/G1 cell cycle arrest and apoptosis in PANC-GR cells. Periplocin and gemcitabine combined significantly inhibited tumor growth in a PANC-GR cells-implanted xenograft mouse model via Nrf2 downregulation. Overall, these findings suggest that periplocin might be a novel therapeutic agent against gemcitabine resistance, as it could recover sensitivity to gemcitabine by regulating Nrf2 mediated signalling pathways in gemcitabine-resistant PC cells.

P-377 Selective cytotoxicity against MDA-MB-231 and MCF7 breast cancer cells of preparations of *Hypericum calycinum* L. and *Artemisia alba* Turra

Authors [Elena Stoyanova¹](#), [Ina Aneva²](#), [Kalina Danova³](#)

Institutes 1 Institute of Biology and Immunology of Reproduction, Bulgarian Academy of Sciences, Sofia, Bulgaria; 2 Institute of Biodiversity and Ecosystem Research, Bulgarian Academy of Sciences, Sofia, Bulgaria; 3 Institute of Organic Chemistry with Centre of Phytochemistry, Bulgarian Academy of Sciences, Sofia, Bulgaria

DOI [10.1055/s-0043-1774238](#)

The hypericin non-producing *Hypericum calycinum* L. was collected from its wild habitat in the Strandzha mountain in Bulgaria and essential oil bearing *Artemisia alba* Turra, growing at the experimental field of the Institute of Biodiversity and Ecosystem Research – was kindly provided by Assoc. Prof Luba Evstatieva. Hexane, chloroform and methanol extracts of the two species were prepared by ultrasonic extraction at room temperature. The obtained plant preparations were tested in metastatic (MDA-MB-231) and non-metastatic (MCF7) breast cancer cells and non-tumorigenic epithelial breast cells (MCF10A) by the MTT colorimetric assay.

All three extract types from both plants showed markedly higher cytotoxicity against the tumorigenic MCF7 and MDA-MB-231 cell lines as compared with their activity against the non-tumorigenic MCF10A cell line, implying a trend to selectivity in the experimental conditions of the present study.

In addition, in *H. calycinum*, the hexane extract showed a high cytotoxic activity against both cancerous lines, while its chloroform extract was more active against the highly metastatic MDA-MB-231 cells. The reverse tendency was obtained for *A. alba* preparations, where the chloroform extract was more cytotoxic against the MCF7 line. The lack of cytotoxicity of the total methanol extract for both species could be attributed to the protecting instead of inhibitory effect of polyphenolics, characteristic of extracts obtained by higher polarity solvents.

Funding We are thankful to the National Scientific Fund, Bulgaria, Grant num. KP-06-H39/6.

P-378 Benzylated dihydrochalcones as a novel therapeutic approach for the treatment of hepatocellular and thyroid carcinoma

Authors [Petra Huber-Cantonati¹](#), [Veronika Temml²](#), [Larissa Meier¹](#), [Felix Schwitzer¹](#), [Theresa Mähr¹](#), [Guillaume Viault³](#), [Andrea Ghidini³](#), [J J Helesbeux³](#), [Daniela Schuster²](#), [Johanna Pachmayr¹](#)

Institutes 1 Paracelsus Medical Private University Salzburg, Institute of Pharmacy, Department of Pharmaceutical Biology and Clinical Pharmacy, Salzburg, Austria; 2 Paracelsus Medical Private University Salzburg, Institute of Pharmacy, Department of Pharmaceutical and Medicinal Chemistry, Salzburg, Austria; 3 Univ. Angers, Sonas, France

DOI [10.1055/s-0043-1774239](#)

Dihydrochalcones represent a class of natural flavonoids that are known for their anti-inflammatory and anti-cancer activities. In this context, the natural benzylated dihydrochalcone MF-15, found in *Melodorum fruticosum*, showed growth suppression of castration-resistant prostate cancer (CRPC) cells by occupying the DNA-binding domain (DBD) of the androgen receptor (AR). Moreover, it was shown that MF-15 interacts with inflammation-related proteins like 5-lipoxygenase (5-LOX) and 15-LOX. Therefore, the hypothesis is that MF-15 acts as a multi-target drug and thus leads to anti-inflammatory and anti-cancer effects in different cancer types. The aim of the underlying study is to evaluate the effect of MF-15 and derivatives on hepatocellular (HCC) and differentiated thyroid carcinoma (DTC) cell proliferation and cell death. Furthermore, potential synergistic effects of MF-15 and lenvatinib combination therapy on HCC and DTC cells are investigated.

The data so far indicated that MF-15 leads to a concentration-dependent inhibition of cell proliferation in HUH7 (IC_{50} = 12.3 μ M) and Hep3B (HCC, IC_{50} = 4.6 μ M) as well as in FTC-133, K1 and TPC-1 (DTC) cells. In addition, we demonstrated that slight modifications in the MF-15 structure lead to an 8-fold increase of activity in cell viability assays. We could also show that combination of MF-15 with lenvatinib in FTC-133 cells caused a synergistic proliferation reduction. Beyond that, caspase 3/7 activity measurements suggested that the tested substances caused apoptosis. To sum up, the results indicated that natural plant dihydrochalcones may be promising new lead compounds for the development of anti-cancer small molecules.

P-379 Antiproliferative activity of Amaryllidaceae alkaloids from *Leucojum aestivum* L. of Turkish origin

Authors Yasemin Bas¹, Bitir Entezari², Hande Güler Orhan², Buket Bozkurt¹, Nehir Unver Somer¹, Gulen Irem Kaya¹

Institutes 1 Ege University Faculty of Pharmacy Department of Pharmacognosy, Izmir, Turkey; 2 Ege University Faculty of Pharmacy Department of Toxicology, Izmir, Turkey

DOI 10.1055/s-0043-1774240

Plants of the Amaryllidaceae family are known to produce structurally diverse Amaryllidaceae alkaloids that have the potential to be used in different diseases depending on their wide spectrum of biological activities [1]. Among the Amaryllidaceae genera in Türkiye, *Leucojum aestivum* L., is the only naturally growing species of the genus *Leucojum* L. [2].

Aiming at finding antiproliferative compounds against breast cancer cells, isolation and structural elucidation studies were carried out on *L. aestivum* plant samples collected from the vicinity of Yenişarbademli in Isparta province during flowering period. The alkaloidal extract was prepared from total dried plant material and fractionated by column chromatography (CC). The fractions were further purified by using methods such as preparative CC, preparative thin layer chromatography and crystallisation. The structures of the purified compounds were identified by MS, 1D and 2D NMR spectroscopic analyses and by comparison with the previous literature data as galantamine, lycorine, tazettine and narwedine previously obtained from *Leucojum aestivum* [3], as well as hippamine, 11-deoxytazettine and 5,6-dihydrobicolorine which were isolated from this plant for the first time.

Antiproliferative activity of the isolated compounds was evaluated by MTT and LDH leakage assays on the estrogen-dependent breast cancer cell line MCF7 [4]. Among the isolated alkaloids, 5,6-dihydrobicolorine and lycorine were found to decrease cell viability statistically in a dose-dependent manner in MTT assay. Furthermore, all compounds caused statistically significant increase in LDH enzyme activity when compared to the control (0.1% DMSO). Hippamine induced highest increase in enzyme activity at all concentrations tested.

Funding This research was funded by Ege University Research Project TGA-2020-21193.

References

- [1] Cimmino A, Masi M, Evidente M, Superchi S, Evidente A. Chirality 2017; 29: 486–499
- [2] Mill RR *Leucojum* L. in: Davis (PH) Ed) Flora of Turkey and the East Aegean Islands. 1984; 8: 364–365
- [3] Berkov S, Codina C, Viladomat F, Bastida J. Bioorganic & Medicinal Chemistry Letters 2008; 18: 2263–2266
- [4] Abe K, Matsuki N. Neuroscience Research 2000; 38: 325–329

P-380 Cytotoxic and apoptotic activities of hydrosols from six *Veronica* species

Authors Ivana Vrca¹, Marija Marija¹, Mirela Lozić², Vedrana Čikeš Čulić², Dario Kremer³, Valerija Dunkić¹

Institutes 1 Faculty of Science, University of Split, Split, Croatia; 2 School of Medicine, University of Split, Split, Croatia; 3 Faculty of Pharmacy and Biochemistry, University of Zagreb, Zagreb, Croatia

DOI 10.1055/s-0043-1774241

The aim of this study was to identify the volatile compounds in hydrosols of different *Veronica* species (*Veronica cymbalaria*, *V. anagalloides-aquatica*, *V. agrestis*, *V. jacquini*, *V. officinalis*, and *V. beccabunga*) and to examine their cytotoxic and apoptotic activities on the bladder cancer cell line T24. Hydrosols were obtained by microwave-assisted extraction (MAE) using the Milestone ETHOS X apparatus for 30 min at 800 W (98 °C). The volatile compounds present in hydrosols were analysed by gas chromatography and mass spectrometry (GC-MS). Cell viability and proliferation were assessed by measuring cell metabolism using the MTT assay. Hydrosols were tested at different dilutions (50%, 40%, 30%, 20%, and 10%) for cytotoxic activity at 4, 24, 48, and 72 hours. For apop-

toxis, cells were treated with hydrosols for 48 hours. The FITC Annexin V Apoptosis Detection Kit with PI was used to detect cell apoptosis by flow cytometry. The major compounds in all investigated *Veronica* species were phenylacetaldehyde, caryophyllene oxide and hexadecanoic acid. The hydrosols of the analysed *Veronica* species showed inhibitory activity on the bladder cancer cell line T24. The results of the study show that *Veronica* species are an excellent source of volatile compounds with various biological activities and future research should focus on their hydrosols.

P-383 Mode of action and synergy analysis of LY-294002 and the natural product fucoxanthin in glioblastoma cells

Authors Lavinia-Lorena Pruteanu¹, Andreas Bender², David Stanley Bailey³

Institutes 1 Technical University Of Cluj-Napoca, Faculty Of Sciences, Department Of Chemistry And Biology, Baia Mare, Romania; 2 Centre for Molecular Informatics, Department of Chemistry, University of Cambridge, Lensfield Road, Cambridge, UK; 3 IOTA Pharmaceuticals Ltd, St Johns Innovation Centre, Cambridge, UK

DOI 10.1055/s-0043-1774242

Glioblastoma multiforme is the most common primary and aggressive malignant brain tumour in adults and current chemotherapy, together with surgery and radiotherapy, provide only minor patient benefit, there being a considerable need for the development of effective new therapies. In this work we aimed to elucidate the mode of action of fucoxanthin (a compound found in algae) alone and in combination with the prototypic PI3K inhibitor LY-294002 via transcriptomics analysis in glioblastoma U87MG cells, followed by pathway analysis. The results showed that no pro-apoptotic genes are up-regulated by either compound at any time point tested while a different spectrum of down-regulated apoptotic genes accompanies growth inhibition by fucoxanthin and that fucoxanthin modulates pathways including the retinoblastoma, DNA damage, DNA replication and cell cycle. We observed a strong divergence of gene induction and repression between the two compounds, with fucoxanthin influencing fewer genes that are differentially expressed between the two compounds, while LY-294002 influences a higher number of differentially expressed genes. We also observed synergy between the two compounds at 50 µM LY-294002 and 25 µM Fucoxanthin, suggesting complementarity in their molecular modes of action. Our work has implications for the field of glioblastoma, but also opens the way for the field of nutri-pharmaceuticals, in which drug and natural products are combined for cancer and other diseases (► Fig. 1).

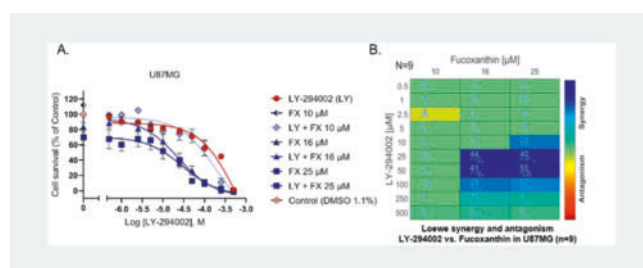

► Fig. 1 LY-294002 and Fucoxanthin are synergistic. a. Dose response curves of LY-294002 and Fucoxanthin using three concentrations of Fucoxanthin (10 µM, 16 µM and 25 µM) with 10 separate concentrations of LY-294002 b. Loewe synergy analysis. Doi: 10.1371/journal.pone.0239551.

Conflict of Interest The authors declare no conflict of interest.

P-384 A standardized extract of Greek Mountain Tea Concental positively modulates neurotransmitters: New evidence for cognitive performance improvements

Authors [Cynthia Gisela Suarez¹](#), [Andressa Blainski¹](#), [René Roth-Ehrang¹](#)

Institute 1 [Finzelberg GmbH & Co. KG, Andernach, Germany](#)

DOI [10.1055/s-0043-1774243](#)

Greek Mountain Tea (*Sideritis scardica* Griseb.) belongs to the Lamiaceae family and it is traditionally consumed as tea in the Balkans as a gastroprotective and to relieve common colds [1].

Finzelberg introduced a hydroethanolic extract from Greek Mountain Tea (Concental) for the improvement of cognitive performance. Actual research has revealed that dietary consumption of the standardised extract of Greek Mountain Tea as a polyphenol-containing supplement significantly improves cognitive capabilities and mood and increases cerebral blood flow [2]. Further investigations have demonstrated its potential to inhibit or delay the senescence process related neurodegenerative disorders including Alzheimer's disease [3]. The multilevel positive effect on the body appears to originate from the abundant occurrence of phenolic compounds in Greek Mountain Tea extracts, as p.e., acteoside, which is a phenylpropanoid with several biological activities and health benefits such as neuroprotective effects via antioxidant action against reactive oxygen and nitrogen species [4].

The present work aimed to explore the activities of acteoside, a phytochemical present in Greek Mountain Tea extract in comparison to the extract itself. Moreover, uptake and binding assays were performed to observe some effects on different neurotransmitters like noradrenaline and serotonin and GABA-A site binding.

The results revealed that Greek Mountain Tea extract showed a higher re-uptake inhibition of several neurotransmitters compared to the biomarker acteoside (► [Table 1](#)).

► **Table 1** Inhibition of neurotransmitters uptake and GABA-A site binding by Greek Mountain Tea extract and Acteoside.

	Inhibition of Neurotransmitter uptake		Receptor Binding
	IC ₅₀ [µg/ml]		IC ₅₀ [µg/ml]
	Noradrenaline	Serotonin	GABA-A site
Greek Mountain Tea extract	26.5 (0.37 µg/ml Acteoside)	212.0 (2.92 µg/ml Acteoside)	144.5 (2.0 µg/ml Acteoside)
Acteoside	2.8	36.8	499.6

These data confirm that Acteoside should be considered as one active biomarker in standardised extracts of Greek Mountain Tea. Moreover, it demonstrates the relevance of botanical extracts in health care.

Conflict of Interest The authors declare no conflict of interest.

P-385 Multifunctionality of *Clausena harmandiana* Extract and Its Active Constituents against Alzheimer's Disease

Authors [Chantana Boonyarat¹](#), [Pornthip Waiwut²](#)

Institutes 1 [Faculty of Pharmaceutical Sciences, Khon Kaen University, Khon Kaen 40002, Mueang, Thailand](#); 2 [Faculty of Pharmaceutical Sciences, Ubon Ratchathani University, Ubon Ratchathani 34190, Warinchamrab, Thailand](#)

DOI [10.1055/s-0043-1774244](#)

This study was designed to investigate the effects of the root-bark extract of *Clausena harmandiana* (CH) and its active constituents (nordentatin and 7-methoxyheptaphylline) on pharmacological activities regarding selected targets associated with AD, namely, its antioxidant activity, inhibition of Aβ aggregation, acetylcholinesterase (AChE) activity and neuroprotective effects. The effect of the CH extract on the cognitive impairment induced by scopolamine was also evaluated in mice. The effects of the CH extract and its active constituents on radical scavenging, Aβ aggregation and AChE activity were investigated with a 2,2'-azino-bis(3-ethylbenzthiazoline-6-sulfonic acid) (ABTS) assay, a thioflavin-T assay and Ellman's method. The neuroprotective effects of the extract against hydrogen-peroxide and Aβ toxicity were evaluated with a 3-(4,5-dimethylthiazol-2-yl)-2,5-diphenyl tetrazolium bromide (MTT) assay. In addition, the effects on cognitive impairment induced by scopolamine in mice were evaluated using Morris-water-maze and modified-Y-maze test models. The results of the present study demonstrate that the root-bark extract of CH shows multimodal actions relevant to the AD pathological cascade, including antioxidant effects, the inhibition of Aβ aggregation, the inhibition of AChE function and neuroprotection against oxidative stress and Aβ toxicity. The extracts could improve both the short- and long-term memory deficits induced by scopolamine in mice.

P-387 A human pilot dose-finding study of *Aloysia citriodora* extract for CNS activity

Authors [Cynthia Gisela Suarez¹](#), [Björn Feistel¹](#), [René Roth-Ehrang¹](#)

Institute 1 [Finzelberg GmbH & Co. KG, Andernach, Germany](#)

DOI [10.1055/s-0043-1774245](#)

Lemon verbena (*Aloysia citriodora*, Fam. Verbenaceae) is used to ease digestion, to reduce nervousness in adults and children and for sleep disorders. This clinical study aimed to find out what dose of an *Aloysia citriodora* dry extract can change brain electrical activity, using "EnkephaloVision" method.

Aloysia citriodora was extracted with ethanol 30% – final dry extract composition: 70% native extract, 30% Maltodextrin. This trial was a DBPC, 4-arm, cross-over study. Placebo and *Aloysia* extract: 400, 600 and 800 mg were tested in 10 women. Ninety minutes after intake the following measurements were performed: questionnaire, performance of psychometric tasks and quantitative recording of electrical activity. The Ethics Committee from the University of Giessen gave approval for the study (► [Fig. 1](#)).

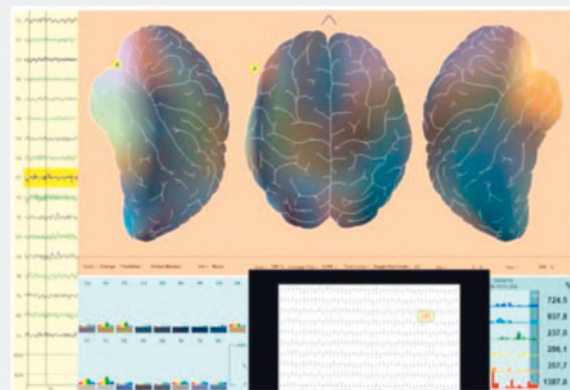

► **Fig. 1** Representative scene from the video clip "d2-Test".

The active ingredients of *Aloysia* extract cross the blood-brain barrier and show CNS activity within 90 minutes. EEG data clearly show a dose-dependent effect of the *Aloysia* extract: 400 mg has a threshold effect on delta and theta activity in the brain. A 600 mg dose increases delta and theta activity as well as alpha

activity, all statistically significant. An 800 mg dose results in statistically significant changes in all local brain areas.

Therefore, 600mg is the preferred dosage; it leads to mental activation when performing cognitive tasks. Alpha1 activity seems to be under the control of serotonin, while alpha2 waves indicate changes in dopaminergic activity. Both neurotransmitters play a key role in motivation and mood. In conclusion, *Aloysia citriodora* seems to have a specific influence on emotional brain processes.

P-388 Korean red ginseng enhances hippocampal neurogenesis in mice

Authors Hanul Lee¹, Ji Eun Seo¹, Chang-Hwan Bae¹, Hee-Young Kim¹, Seungtae Kim¹

Institute 1 Department of Korean Medical Science, School of Korean Medicine, Pusan National University, Yangsan, South Korea
DOI 10.1055/s-0043-1774246

Neurogenesis in the adult hippocampus plays a major role in cognitive ability of animals including learning and memory. We evaluated that Korean red ginseng (KRG) can promote cognitive function and enhance neurogenesis in the hippocampus. C57BL/6 mice (male, 8 weeks) received 50 mg/kg of 5-bromo-2'-deoxyuridine (BrdU) intraperitoneally and 100 mg/kg of KRG or vehicle orally once a day for 14 days. Pole, Rotarod and Morris water maze tests were performed and the brains were collected after the last behavioural test. KRG-treated mice came down the pole significantly faster and stood on the rotarod longer than vehicle-treated mice. The Morris water maze test showed that KRG administration enhanced learning and memory abilities. KRG also significantly increased BrdU- and BrdU/doublecortin-positive cells in the dentate gyrus as well as the proliferating cell nuclear antigen, cerebral dopamine neurotrophic factor and ciliary neurotrophic factor mRNA expression levels in the hippocampus compared to vehicle. Therefore, KRG promotes learning and memory abilities, possibly by enhancing hippocampal neurogenesis.

P-389 Effects of 4-Methoxycinnamic acid from *Scrophularia buergeriana* on post-traumatic stress disorder-like behaviors induced by single prolonged stress in mice

Authors Keontae Park¹, Mijin Jeon¹, Chang Hyoen Kong¹, Woo Chang Kang¹, Min Seo Kim¹, Seo Yun Jung¹, Jong Hoon Ryu¹

Institute 1 Kyung Hee University, Seoul, South Korea
DOI 10.1055/s-0043-1774247

Post-traumatic stress disorder (PTSD) is a severe mental illness that results from exposure to traumatic events, such as war, natural disasters, traffic accidents and sexual violence. These experiences cause permanent alterations in brain circuitry and lead to several symptoms including intrusive re-experience of the trauma, persistent avoidance behavior, arousal and negative alterations in cognition and mood, which manifest in PTSD patients. Despite the high severity and prevalence of PTSD, current treatments mainly focus on managing symptoms. Cheonwangbosimdan (CWBSD) is an herbal medicinal product approved by the Ministry of Food and Drug Safety of Korea for its anxiolytic and memory-enhancing effects. Previously, we found that CWBSD and one of its constituents, *Scrophularia buergeriana*, significantly improved reduced prepulse inhibition in the acoustic startle test, and we identified 4-methoxycinnamic acid (4-MCA) as the active ingredient responsible for this effect. This study aimed to investigate the therapeutic potential of 4-MCA for PTSD symptoms using a PTSD animal model induced by single-prolonged stress (SPS). Treatment with 4-MCA (10 mg/kg, p.o.) reduced anxiety-like behavior as measured by the elevated plus-maze test and the marble burying test, and alleviated depressive-like behavior as measured by the splash test and the tail suspension test. Moreover, 4-MCA treatment (10 mg/kg, p.o.) improved cognitive impairment observed in SPS mice, as demonstrated by the Y-maze test. These findings suggest that 4-MCA may ameliorate PTSD-like behaviours, including anxiety,

depression, anhedonia and cognitive dysfunction, and has the potential to be used as a treatment for PTSD.

P-390 A Systematic Effort Investigating the Synergistic Anti-Cholinergic Effect of *Salvia officinalis*

Authors Lukas Zell¹, Erik Koch¹, Veronika Temml¹, Daniela Schuster¹

Institute 1 Institute of Pharmacy, Department of Pharmaceutical and Medicinal Chemistry, Paracelsus Medical University, Salzburg, Austria
DOI 10.1055/s-0043-1774248

Alzheimer's Disease (AD) remains incurable, with cholinesterase inhibitors as one of the few FDA-approved drug classes slowing disease progress. Plant extracts with cholinesterase inhibitory activity like *Salvia officinalis* have been of medical interest for decades, especially because AD is associated with cholinergic deficiency. Like with many plant extracts, synergistic effects can be observed when comparing the extracts activity to that of individual, purified active constituents, such as rosmarinic acid (RA).

In this study, aqueous extracts of *Salvia officinalis* leaves were prepared and analysed quantitatively using HPLC and LC-MS setups focusing on its main components RA, caffeic acid (CA) and ferulic acid (FA). The activities of individual compounds, aqueous extract and "artificial extracts" (consisting of different combinations of RA, CA and FA) were evaluated to quantify potential synergistic effects. The inhibitory potency was measured in human plasma (including active butyrylcholine esterase (BChE)) utilizing Ellman's method. The individual compounds all exerted IC₅₀ values ≥ 1 mM. While aqueous extracts contain only 172.4, 55.99 and 36.8 μM (well below the determined IC₅₀ values) of RA, CA and FA, respectively, the extract showed inhibition of 12.5% (at 200 mg plant material per mL). Mixtures with these concentrations did not inhibit BChE activity. This very much indicates a synergistic effect of more constituents combined, other than the three investigated in this study. Systematic analysis of the synergism could further contribute to better understanding of the anti-cholinergic activity of *Salvia officinalis*.

P-391 Neuroprotective effect of *Salvia purpurea* on motor behavior in a model of Parkinson's disease

Authors Yoshajandith Aguirre Vidal¹, Brisia-Marlen Ortiz-Vargas^{2,3}, Dayana-Guadalupe Rafael Camacho^{2,3}, Itzi Fragosó-Martínez⁴, Randy Ortiz-Castro¹, Gabriela Ávila-Villarreal^{2,3}

Institutes 1 Red de Estudios Moleculares Avanzados, Instituto de Ecología A.C. (INECOL), Xalapa, Mexico; 2 Unidad Académica de Ciencias Químico Biológicas y Farmacéuticas, Universidad Autónoma de Nayarit, Tepic, Mexico; 3 Centro Nayarita de Innovación y Transferencia de Tecnología A. C. "Unidad Especializada en I+D+i en Calidad de Alimentos y Productos Naturales", Universidad Autónoma de Nayarit, Tepic, Mexico; 4 Flora de Veracruz, Secretaría Académica, Instituto de Ecología A.C. (INECOL), Xalapa, México

DOI 10.1055/s-0043-1774249

Parkinson's disease is the fastest growing neurological disorder in the world. It has traditionally been recognised clinically by a distinctive motor phenotype that includes bradykinesia (slowed movements), rigidity (increased muscle tone), tremor, and altered gait and postural reflexes. Pharmacological Parkinson's treatment is a challenge that requires new therapeutic options. *Salvia purpurea* is widely distributed in Mexico, belonging to the mint family (Lamiaceae). *Salvia* species are considered valuable due to their antiviral, anti-Alzheimer, anti-inflammatory, antidiarrheal and antispasmodic activities, amongst others. The aim of this work was to evaluate the neuroprotective effect of *S. purpurea* on motor behaviour in a rat model of Parkinson's induced by MPP+ neurotoxin. Aerial parts collected in Xalapa, Veracruz, Mexico and a hydroalcoholic extract 85:15 (HESp) was prepared. The Parkinson's model was performed as described previously [1]. To evaluate the effect of HESp on different levels of motor ability, such as: gross motor activity, motor asymmetry

and motor coordination and balance, open field, cylinder, and RotaRod tests were performed respectively. Results shows a decrease of the motor ability induced by the MPP + neurotoxin with respect to the control group, and the treatment with HESp (100 mg/kg for 14 days, v.o.) shows a tendency to prevent neurotoxin-induced motor damage in all tests performed. These results suggest that *S. purpurea* has a potential neuroprotective effect in the Parkinson's model.

References

[1] Aguirre-Vidal Y et al. Protection induced by estradiol benzoate in the MPP+ rat model of Parkinson's disease is associated with the regulation of the inflammatory cytokine profile in the nigro striatum. *J Neuroimmunol* 2020; 349: 577426

P-393 *Gelsemium* low doses protect against serum deprivation-induced stress on mitochondria in neuronal cells

Authors Imane Lejri^{1,2}, Amandine Grimm^{1,2}, Pascal Trempat³, Naoual Boujedaini³, Anne Eckert^{1,2}

Institutes 1 Research Platform Molecular & Cognitive Neuroscience, Neurobiology Laboratory for Brain Aging and Mental Health, University of Basel, Basel, Switzerland; 2 Psychiatric University Clinics, Basel, Switzerland; 3 Laboratoire Boiron, Messimy, France

DOI 10.1055/s-0043-1774250

Mitochondria play crucial roles in well-being, cell maintenance and survival. These paramount organelles represent the main producers of energy in the cells, but at the same time also the main source of reactive oxygen species. Especially, the brain is a high-energy consuming organ and the age-dependent dysregulation in cerebral bioenergetics and redox homeostasis could lead to the development of neurodegenerative disorders. Furthermore, sustained stress can damage the brain and makes neurons more vulnerable to insults. Previously, we demonstrated that low doses of *Gelsemium sempervirens* L. (*Gelsemium*) at centesimal dilutions promoted neurite outgrowth via the stimulation of mitochondrial bioenergetics and cell survival in vitro. In the present study, we investigated the neuroprotective effects of *Gelsemium* to counteract stress-induced mitochondrial deficits. Especially, we evaluated the effects of *Gelsemium* dilutions on reactive oxygen species generation, redox state, mitochondrial network and bioenergetics as well as cell survival under cellular stress induced through serum deprivation in human neuroblastoma cells. Our findings demonstrate that *Gelsemium* (3C and 5C) exerted neuroprotective effects by i) regulating specific levels of mitochondrial or total superoxide anion radicals and total nitric oxide levels, ii) ameliorating the mitochondrial redox environment and networks, iii) improving ATP production and mitochondrial respiration, thereby attenuating stress-induced decrease in viability evoked by serum withdrawal. These findings emphasise that *Gelsemium* dilution low doses 3C and 5C might exert neuroprotection in stress-associated brain disorders.

Conflict of Interest The authors declare no conflict of interest.

P-394 Effects of Tri-Kesornmas, a Thai traditional herbal formular, on improvement of memory deficit induced by scopolamine in mice

Authors Pornthip Waiwut¹, Supawadee Doadee², Yaowared Chulikhit², Orawan Monthakantirat², Charinya Khamphukdee², Chantana Boonyarat²

Institutes 1 Faculty Of Pharmaceutical Sciences, Ubon Ratchathani University, Warin Chamrap, Thailand; 2 Faculty of Pharmaceutical Sciences, Khon Kaen University, Muang, Thailand

DOI 10.1055/s-0043-1774251

Tri-Kesornmas formular (TKM) has been used as a traditional Thai medicine for a long time. It is composed of 3 herbal plants including *Jatropha multifida*, *Nelumbo nucifera* and *Aegle marmelos* which show diverse biological activities related to Alzheimer's disease (AD). Based on the activities of its components, TKM might have potential for AD treatment. Thus, the present study aimed to

investigate the effects of TKM formula on biological activities related pathology of AD and on the improvement of cognitive impairment induced by scopolamine in mice. Our *in vitro* results showed that the ethanol extracts of TKM possessed antioxidant, anti-butyrylcholinesterase, anti-beta-amyloid aggregation and neuroprotective activities. For the Morris water maze test which reflects in long-term memory, pretreatment of mice with TKM at the concentration of 250 and 500 mg/kg/day for 14 days significantly decreased escape latency time when compared with the only scopolamine treated mice. In addition, it significantly increased % alternation measured by the Y-maze test which was used as a measure of short-term memory. The *in vivo* results indicated that TKM could improve both short-term and long-term memory. Conclusively, TKM possesses multimode of action involved with AD pathology cascade and shows an ability to improve both short-term and long-term memory deficit induced by scopolamine.

P-395 Putative molecular mechanism of *Bryophyllum pinnatum* preparations used to treat a variety of hyperactive conditions

Authors Maria-Riera Piqué-Borràs¹, Johann Röhrl¹, Gerald Künstle¹

Institute 1 Weleda AG, 4144 Arlesheim, Switzerland
DOI 10.1055/s-0043-1774252

Bryophyllum pinnatum (BP, aka *Kalanchoe pinnata*) is a succulent plant native to Madagascar. Preparations from its leaves are traditionally used especially in complementary medicine, for a variety of hyperactive conditions such as restlessness, anxiety, attention deficit hyperactivity disorder (ADHD), preterm labor, hyperactive bladder, restless leg syndrome, and especially sleep disorders. GABA (gamma-aminobutyric acid) is a central inhibitory neurotransmitter in the mature mammalian central nervous system (CNS) and its principal role is reducing neuronal excitability. It inhibits CNS functions and reduces the body's muscle tone by binding and activating either the ionotropic GABA A receptor or the G-protein-coupled GABA B receptor, respectively.

Here we tested the ability of BP preparations (lyophilisates directly from leaves [BP-L] or from hydroethanolic leaf extract [BP-EtOH]) either to act on GABA receptors or to interfere with other G-protein-coupled-receptors known to play a role in the sleep-wake/activity regulation, i.e. adenosine A1 and A2 and prostaglandin D2-1 (DP1) receptors.

Investigations by patch clamp revealed that the extracts BP-L as well as BP-EtOH strongly activated GABA A in a concentration-dependent manner. Notably, the activation triggered by BP-EtOH was significantly stronger as compared to BP-L. Similar results were obtained for the GABA B receptor with IC₅₀ values of 11.5 µg/mL for BP-EtOH and 30.2 µg/mL for BP-L, respectively. All other receptors investigated were not affected by any of the BP preparations.

These data suggest that preparations from *Bryophyllum pinnatum* are beneficial in the treatment of a variety of hyperactive conditions due to their capability to activate GABA receptors.

P-396 Molecular mechanisms of two herbal mixture preparations in sleeping disorders

Authors Maria-Riera Piqué-Borràs¹, Johann Röhrl¹, Gerald Künstle¹

Institute 1 Weleda AG, 4144 Arlesheim, Switzerland
DOI 10.1055/s-0043-1774253

A good night's sleep is essential for our overall health and wellbeing. Lack of sleep can have a negative impact on our physical, emotional and cognitive functioning. There are several phytotherapeutic preparations available to improve sleep's quality. Calmedoron and Ansiodoron preparations are traditionally used to aid sleeping disorders promoting soothing sleep. Calmedoron contains a herbal mixture preparation of four hydroethanolic herbal extracts (*Avena sativa* (As), *Humulus lupulus* (Hu), *Passiflora incarnata* (Pn) and *Valeriana*

officinalis (Vo) whereas Ansiodoron contains only three (As, Vo and *Passiflora alata* (Pa)). The study goal is to understand the molecular mechanisms of both herbal mixture preparations and its single extracts to improve sleep quality and promote sleeping.

We investigated the functional activity of several G-protein-coupled-receptors known to play a role in sleep regulation: adenosine A1 and A2, GABA-B1a-B2 and prostaglandin D2-1 (DP1) receptors. The dry extracts were prepared from the commercial medicinal products or from the ethanolic tinctures. Both herbal mixtures potentially promoted the activity of A1 and GABA-B1a-B2 receptors but only Calmedoron herbal mixture extract activated A2 receptor, shown by intracellular cAMP release ($IC_{50} < 300 \mu\text{g/mL}$). However, DP1 receptor's activity was not affected. Single extracts triggered different receptors' activity: Pn and Vo inhibited A2 and GABA-B1a-B2; Vo also inhibited A1; As, Hu and Pa induced GABA-B1a-B2 activity ($IC_{50} < 180 \mu\text{g/mL}$). These data suggest that both herbal mixture extracts trigger distinct sleep receptors. Additionally, each individual extract's activity profile could complement each other, potentiating overall preparation's efficacy.

P-398 Unravelling an abietane diterpenoid with very promising chemotherapeutic potential against glioblastoma cells

Authors Mariana Magalhães^{1,2,3,4}, Eva Domínguez-Martín^{5,6}, Joana Jorge Jorge^{7,8}, Ana Cristina Gonçalves^{7,8}, Paulo Oliveira^{2,4}, Thomas Efferth⁹, Patrícia Rijo^{5,10}, Célia Cabral^{3,4,11}

Institutes 1 PhD Programme in Experimental Biology and Biomedicine, Institute for Interdisciplinary Research (IIIUC), University of Coimbra, Coimbra, Portugal; 2 CNC—Center for Neuroscience and Cell Biology, University of Coimbra, Coimbra, Portugal; 3 Coimbra Institute for Clinical and Biomedical Research (iCBR), Clinic Academic Center of Coimbra (CACC), Faculty of Medicine, University of Coimbra, Coimbra, Portugal; 4 Center for Innovative Biomedicine and Biotechnology (CIBB), University of Coimbra, Coimbra, Portugal; 5 CBIOS—Universidade Lusófona's Research Center for Biosciences & Health Technologies, Lisbon, Portugal; 6 Departamento de Ciencias Biomédicas, Facultad de Farmacia, Universidad de Alcalá de Henares, Madrid, Spain; 7 Laboratory of Oncobiology and Hematology, University Clinic of Hematology and Applied Molecular Biology, Faculty of Medicine, University of Coimbra, Coimbra, Portugal; 8 iCBR, Group of Environment Genetics and Oncobiology (CIMAGO)—Faculty of Medicine, University of Coimbra, Coimbra, Portugal; 9 Department of Pharmaceutical Biology, Institute of Pharmaceutical and Biomedical Sciences, Johannes Gutenberg University, Mainz, Germany; 10 Faculty of Pharmacy, Instituto de Investigação do Medicamento (iMed.U.Lisboa), University of Lisbon, Lisbon, Portugal; 11 Centre for Functional Ecology, Department of Life Sciences, University of Coimbra, Coimbra, Portugal

DOI 10.1055/s-0043-1774254

Glioblastoma (GB), the most frequent and deadly primary tumour of the central nervous system, has a survival rate of 6% due to the lack of efficient therapeutic approaches and poor prognosis. Concerning this, new treatment options based on drug leads from natural sources are an appealing starting point to further improve patients' well-being. Therefore, in this study, the potential antitumoral mechanism of the abietane diterpenoid 7 α -acetoxy-6 β -hydroxyroleanone (ROY), a drug lead isolated from the acetonic extract of *Plectranthus hadiensis* (Forssk.) Schweinf. ex Sprenger, was assessed in GB cell lines (A172, U87) and a neuroglioma cell line (H4). Briefly, Roy's cytotoxic/antiproliferative activity was evaluated by Alamar Blue assay and its impact on cell cycle regulation, as well as, on activation of cell death-related pathways was measured by flow cytometry and qPCR. This work evidenced that this natural compound was able to induce a strong cytotoxic/antiproliferative effect against tumour cells, being the half-inhibitory concentration (IC_{50}) for U87, A172 and H4 cells of 59.37, 84.60 and 46.82 μM , respectively. Moreover, Roy induced cell

cycle arrest at G2/M phase, mitochondrial membrane potentials decrease and caspase-dependent cell death in GB cells. An increase in the tumour suppressor genes PTEN and TP53 expression was also observed after treatment with Roy. In this regard, this study represents an initial step in the design of a more effective therapy for this malignant glioma, showing a potential approach to surpass the limitations associated with conventional therapeutics and suggesting Roy as a potential drug lead for future chemotherapeutic treatment in GB.

P-399 Ecdysteroids from an industrial *Cyanotis arachnoidea* extract as potent new blood-brain barrier protective agents

Authors Gábor Tóth², Dávid Laczkó^{1,3}, Árpád Kőnczöl³, En-Liang Chu⁷, Ching-Chia Chang⁴, Fang-Rong Chang⁴, Ana Santa Maria^{5,6}, Fruzsina R. Walter⁵, Mária A. Deli⁵, Attila Hunyadi¹

Institutes 1 Institute of Pharmacognosy, University of Szeged, Szeged, Hungary; 2 Department of Inorganic and Analytical Chemistry, NMR Group, Budapest University of Technology and Economics, Budapest, Hungary; 3 RotaChrom Technologies LLC, Kecskemét, Hungary; 4 Graduate Institute of Natural Products, Kaohsiung Medical University, Kaohsiung, Taiwan; 5 Institute of Biophysics, Biological Research Centre, Hungary; 6 Wyss Institute for Biologically Inspired Engineering at Harvard University, Boston, USA; 7 Division of Botany, Endemic Species Research Institute, National Chung Hsing University, Taipei, Taiwan

DOI 10.1055/s-0043-1774255

20-Hydroxyecdysone (20E), the insect moulting hormone, acts as a non-hormonal, "green" anabolic agent in mammals, and there is a large market of ecdysteroid-containing food supplements. These are typically extracted from the Far-East plant *Cyanotis arachnoidea*. Currently > 500 natural ecdysteroids are known. Still, since plants' ecdysteroid composition is usually dominated by a few compounds and others are present in significantly lower amounts, very little is known about the pharmacology of ecdysteroids other than 20E. In this work, our aim was to isolate minor ecdysteroids from industrial, commercially available *C. arachnoidea* extracts, and to study them as cytoprotective agents. Further, it was also our aim to evaluate the compounds' natural or artificial in origin by a comparative LC-MS/MS analysis with an authentic sample of *C. arachnoidea*.

Altogether, 25 ecdysteroids were isolated by a combination of various chromatographic methods of different selectivities. The compounds' structures were determined by comprehensive 1D- and 2D-NMR spectroscopic method. To this end, four compounds were evaluated for their capacity to protect human brain microvascular endothelial cells (hCMEC/D3) from oxidative stress and inflammation. Significant protective effect was found at 1 μM . The commercial extract demonstrated a much more complex LC-MS/MS fingerprint than the authentic plant material, suggesting that many of its constituents are present as artefacts. **Funding** NKFIH, Hungary K134704, TKP2021-EGA-32, and the Gedeon Richter PLC. Centenarial Foundation Research Grant.

P-400 Effects of STW3-VI (St. John's wort) on molecular mechanisms of depression in vitro

Authors Laura Much¹, Christiane Kolb², Heba Aziz-Kalbhenn², Olaf Kelber², Gabriel Alejandro Bonaterra¹, Ralf Kinscherf¹

Institutes 1 Philipps University of Marburg, Marburg, Germany; 2 PSDC, Bayer Consumer Health, Steigerwald Arzneimittelwerk GmbH, Darmstadt, Germany

DOI 10.1055/s-0043-1774256

Depression may be induced by chronic stress, affecting neuronal and microglia function. Microglia are involved in the plasticity of the hippocampus by synaptic remodelling, which is related to depression, development and healing [1]. However, the molecular mechanisms are not entirely understood. Extracts of *Hypericum perforatum* L., like STW3-VI, have been recommended to treat de-

pression [2]. Our investigation aimed to determine the effects of STW3-VI on the paracrine signalling between neurons and microglia in vitro. Co-cultures of mouse SIM-A9 microglia and hippocampal HT-22 neurons were treated with different concentrations of STW3-VI, hyperoside, an active component of *Hypericum perforatum* L., escitalopram and NGF as a positive control. BDNF and TNF- α releases were quantified by ELISA. Quantification of neurogenesis was performed by a neurite outgrowth staining kit. Incubation of HT-22 with STW3-VI, escitalopram, hyperoside, and NGF, with/without co-culture with SIM-A9 stimulated the neurite formation by 2 to 5-fold compared to the untreated control. However, co-incubation with SIM-A9 inhibited the neurite outgrowth in the untreated control by 2.4-fold ($p \leq 0.05$). Interestingly, the BDNF release of HT-22 neurons was significantly decreased with SIM-A9 microglia compared to without microglia. Incubation of SIM-A9 with STW3-VI, escitalopram, hyperoside, and NGF alone did not stimulate a pro-inflammatory TNF- α release. STW3-VI and hyperoside stimulate neurite formation in HT-22 neurons with/without microglia under non-inflammatory conditions. These effects on neuronal plasticity might contribute to the clinically proven antidepressant activity of STW3-VI.

Conflict of Interest C.K., H.A-K and O.K are employees of Steigerwald Arzneimittelwerk GmbH, Darmstadt.

Funding The study was supported by Steigerwald Arzneimittelwerk GmbH, Darmstadt.

References

- [1] Cornell J et al. *Neural. Regen. Res.* 2022; 17 (4): 705–716. doi:10.4103/1673-5374.322423
- [2] Bonaterra GA et al. *Front.Pharmacol.* 2020; 11: 603575. doi:10.3389/fphar.2020.603575

P-402 Exploring the potential of Traditional Chinese Medicines for antiviral therapy

Authors Kristi Leka^{1, 2}, Alexis Hoste^{2, 3}, Ruihua Xin^{2, 3}, Carla Hamann¹, Mutien Garigliany², Allison Ledoux¹

Institutes 1 University of Liege Faculty of medicine, CIRM, Building B36 Quartier Hôpital 4000, Liege, Belgium; 2 University of Liege Faculty of veterinary medicine, FARAH, Building B42 Quartier Vallée 2 Avenue de Cureghem 7A-7D 4000, Liege, Belgium; 3 University of Liege Faculty of Gembloux Agro-Bio Tech, Avenue de la Faculté d'Agronomie 2B 5030, Gembloux, Belgium

DOI 10.1055/s-0043-1774257

The SARS-CoV-2 virus has caused a devastating pandemic, resulting in the death of nearly 7 million people worldwide and causing significant socio-economic consequences. The pandemic has highlighted the need for effective antiviral drugs, as current treatments have proven insufficient. Traditional plant-based formulas have been integrated into the treatment protocols for COVID-19 in Chinese hospitals, and many of these have shown beneficial effects. Recent research by Newman and Cragg (2020) has shown that almost 50% of antiviral drugs are either derived from natural resources or have a natural pharmacophore.

Our preliminary study investigated the antiviral activity of plants commonly used in Chinese treatments, including *Paeonia suffruticosa*, *Glycyrrhiza uralensis*, *Cinnamomum ramulus*, and *Armeniacae amarum*. The results demonstrated significant antiviral activities with no signs of cytotoxicity on VERO E6 cells. In light of the recent findings, our research focuses specifically on *Paeonia suffruticosa* and its main constituents, such as paeonol, paeoniflorine and oxypaeoniflorine. Although these major constituents might contribute to the activity, a bioguided fractionation was accomplished to identify additional potential active compounds. The antiviral activity was observed through the RT-qPCR detection method which has become the gold standard test for the SARS-CoV-2 virus. Our results feature the phytochemical profile of *Paeonia suffruticosa* with an emphasis on the active molecules' antiviral activity, with the aim of inspiring the development of new antiviral drugs.

Conflict of Interest The authors declare no conflict of interest.

P-403 The antiviral effect of Broccoli leaves extract against Influenza A virus infection via inhibition of Hemagglutinin

Authors Won-kyung Cho¹, Nam-Hui Yim¹, Myong-Min Lee¹, Chang-Hoon Han², Jin Yeul Ma¹

Institutes 1 KM application Center, Korea Institute Of Oriental Medicine, Daegu, South Korea; 2 College of Veterinary Medicine, Jeju National University, Jeju, South Korea

DOI 10.1055/s-0043-1774258

Broccoli leaves are a byproduct of broccoli and could have use as a food ingredient. In this study, we examined the effect of ethanol extract of Broccoli leaves (EBL) on Influenza A virus infection using green fluorescent protein (GFP)-tagged Influenza A/PR/8/34 virus (PR8-GFP IAV). When EBL and PR8-GFP IAV were cotreated to RAW 264.7 cells, fluorescent microscopy and fluorescence-activated cell sorting (FACS) analysis showed that EBL significantly decreased the levels of GFP expression by influenza viral infection dose-dependently. Immunofluorescence (IF) analysis confirmed that EBL repressed the expression of Influenza viral proteins. Time-of-addition assays showed EBL exhibited a strong inhibitory effect on IAV binding on the cells and moderate virucidal impact. Consistently, EBL potently suppressed hemagglutination by IAV infection. These results indicate EBL prevents IAV attachment via the inhibition of HA upon viral infection. Finally, EBL could be used as a natural antiviral source to protect against viral influenza infection.

P-405 Mechanistic Evaluation of the Antiviral Potential of Two Commercial Herbal Products

Authors Ayse Esra Karadag¹, Fatih Demirci²

Institutes 1 İstanbul Medipol University, School of Pharmacy, İstanbul, Türkiye; 2 Anadolu University, Faculty of Pharmacy, Eskişehir, Türkiye

DOI 10.1055/s-0043-1774259

CarvenS (*Thymus vulgaris* & *Glycyrrhiza glabra* Extract Stevia Syrup) and Maxerin (*Mentha piperita* aetheroleum solution) are used both for cold and flu symptoms in Türkiye. In this present study, the in vitro ACE2, TMPRSS2 and neuraminidase (NA) enzyme inhibitory potentials of the preparations were evaluated experimentally. CarvenS contains standardised *Thymus vulgaris* and *Glycyrrhiza glabra* extracts in a stevia syrup form. Maxerin, on the other hand, is a topically applied medical device with *Mentha piperita* essential oil. In vitro enzyme inhibition assays were conducted using a fixed 20 $\mu\text{g}/\text{mL}$ concentration with commercially available "Angiotensin II Converting Enzyme (ACE2) Inhibitor Screening", "Neuraminidase Activity", and "TMPRSS2 Fluorogenic" Assay Kits by a microplate reader system in fluorescence mode. The ACE2 comparative data for CarvenS and Maxerin were measured as 81% and 76% inhibition, respectively. The in vitro TMPRSS2 inhibition of CarvenS and Maxerin was with 89% and 75% relatively high. Finally, the NA inhibition results for CarvenS and Maxerin were determined as 85% and 78%, respectively. Further detailed experimental studies are ongoing to confirm this effect of the preparations.

Funding This study was supported by EnaFarma Comp., İstanbul, Türkiye.

Conflict of Interest The authors declare commercial interest in this study with EnaFarma Co.

P-406 *Narcissus pseudonarcissus* L. and *Narcissus poeticus* L.: a source of antiviral compounds active against coronavirus

Authors Isabelle Ripoché¹, Maël Gainche¹, Marie Chastanet¹, Estelle Trouve¹, Pierre Chalard¹

Institute 1 UCA/ClermontAuvergneINP/ICCC, Clermont-Ferrand, France

DOI 10.1055/s-0043-1774260

The coronavirus disease 2019 (COVID-19) pandemic, for which the first cases were detected in China in 2019, has recently started its ninth pandemic wave. In a recent overview, the World Health Organization (WHO) estimated that this

disease, caused by the severe acute respiratory syndrome coronavirus 2 (SARS-CoV-2) has infected over 640 million people and killed more than 6 million people over the world. Plants are considered as inexhaustible sources of novel bioactive compounds and recent reviews demonstrated that plants are rich in antiviral active compounds and particularly active against coronavirus. In this context we investigated the antiviral activity of plants growing in Auvergne, a region of France possessing a diversified flora, and we evaluated the chemical profile and the antiviral potency of two plants. Our study described the isolation and characterisation of specific alkaloid derivatives from two plants of the amaryllidaceae family: *Narcissus pseudonarcissus* L. and *Narcissus poeticus* L. We isolated two major alkaloids from *N. pseudonarcissus* and four major compounds from *N. poeticus*. Among these six alkaloids, one was a new compound that has never been described and another one showed a similar antiviral activity on SARS-CoV-2 as Remdesivir, used as a control, with an IC₅₀ of around 1 µM. We also determined the selectivity index between cytotoxicity and antiviral activity which was around 4.7.

P-407 Exploring the antiviral activity of flavonoids from *Strychnos variabilis* leaves against SARS-CoV-2

Authors Allison Ledoux¹, Kristi Leka¹, Olivia Jansen¹, Olivier Bonnet¹, Carla Hamann¹, Luc Angenot¹, Mutien-Marie Garigliany², Michel Frédéric¹

Institutes 1 University of Liege Faculty of Medicine, CIRM, Building B36 Quartier Hôpital 4000, Liège, Belgium; 2 University of Liege Faculty of Veterinary Medicine, FARA, Building B42 Quartier Vallée 2 Avenue de Cureghem 7A-7D 4000, Liège, Belgium

DOI 10.1055/s-0043-1774261

Strychnos variabilis De Wild. is a small deciduous tree that is primarily distributed in and around Brazzaville and Kinshasa, located on both sides of the Congo River in Africa [1]. While the leaves have only trace amounts of indoline alkaloids (retuline series) [2, 3], our laboratory isolated numerous rare flavonoids, including flavonol glycosides, from the leaves over three decades ago [4–6]. Flavonoids are known for their antiviral activity, especially when in glycosidic form, which increases their solubility and effectiveness compared to their non-glycosidic forms [7, 8]. Therefore, our present study aims to investigate the potential antiviral activity of *S. variabilis* leaves against SARS-CoV-2. Our findings revealed that the total extract of *S. variabilis* exhibits significant antiviral activity with an IC₅₀ range of 12.5 to 6.25 µg/mL. Moreover, we tested two flavonoids, variabilosides C and D [5], which demonstrated even greater potency with an IC₅₀ range of 6.9 to 3.5 µM.

We suggest that the flavonoids present in *S. variabilis* leaves could provide a promising pathway for the development of a new herbal substrate used as an adjunctive therapeutic in the treatment of coronavirus disease. Further investigation into the pharmacological properties of these flavonoids is thus warranted to fully explore their potential as therapeutic agents against SARS-CoV-2.

References

- [1] Leeuwenberg AJ.M. The Loganiaceae of Africa VIII-Strychnos III. Meded. Landb. Hoogsch. Wageningen, Nederland 1969
- [2] Tits M., Angenot L.PI. Med. Phytother. 1980; 14: 213–217
- [3] Angenot L, Damas J., Tits M. Use of compounds of the retuline series as compounds with pharmaceutical activity Brevet (PCT) WO8905301 1989
- [4] Brasseur T., Angenot L. Phytochemistry 1986; 25: 563–564
- [5] Brasseur T., Angenot L. Phytochemistry 1987; 26: 3331–3334
- [6] Brasseur T., Angenot L. Phytochemistry 1988; 27: 1487–1490
- [7] Badshah S.L. et al. Biomedicine and Pharmacotherapy 2021; 140: 111596
- [8] Solmier J., Fladerer J.P. Phytochem. Rev 2021; 20: 773–795

P-408 Cheminformatic and biochemometric strategies for the discovery of natural products against SARS-CoV-2

Authors Benjamin Kirchwegger¹, Andreas Wasilewicz^{1,2}, Ulrike Grienke¹, Judith M. Rollinger¹

Institutes 1 Department of Pharmaceutical Sciences, Faculty of Life Sciences, University of Vienna, 1090 Vienna, Austria; 2 Vienna Doctoral School of Pharmaceutical, Nutritional, Sport Sciences, University of Vienna, 1090 Vienna, Austria
DOI 10.1055/s-0043-1774262

The global spread of SARS-CoV-2 viruses still asks for antiviral drugs to protect at-risk groups and to mitigate the incidence of post COVID-19 conditions. Already approved drugs are remarkable achievements. However, they partly lack efficacy and are constantly at risk of losing activity due to mutations in target proteins. Three years ago, we launched a project funded by the Austrian Science Fund (FWF) with the aim to discover natural products active against SARS-CoV-2 as potential drug leads. To achieve this goal, we used two orthogonal strategies:

- (1) A target-molecule directed approach, where an in silico – in vitro strategy was used to find natural compounds that inhibit viral proteases. We discovered that mulberry Diels–Alder-type adducts from *Morus alba* L. are potent inhibitors of the viral main protease which inhibit SARS-CoV-2 replication in a Calu-3 cell model [1].
- (2) A holistic-function directed approach, where 240 multi-component mixtures were tested in a phenotypic assay for their anti SARS-CoV-2 activity. Active extracts were then phytochemically followed up. An extract of *Pterocarpus santalinus* L.f. was fractionated and dereplicated with an MS2 molecular network. This led to the discovery of pterocarpan as new class of anti-SARS-CoV-2 natural products [2].

Results of both strategies are presented together with strengths, pitfalls and weaknesses. The timeline, the state of knowledge and possible perspectives for the two examples are discussed.

Conflict of Interest The authors declare no conflict of interest.

References

- [1] Wasilewicz A, Kirchwegger B, Bojkova D, Abi Saad MJ, Langeder J, Büttkofer M, Adelsberger S, Grienke U, Cinatl JJ, Petermann O, Scapozza L, Orts J, Kirchmair J, Rabenau HF, Rollinger JM. Identification of Natural Products Inhibiting SARS-CoV-2 by Targeting Viral Proteases: A Combined in Silico and in Vitro Approach. J Nat Prod 2023; 86 (2): 264–275
- [2] Wasilewicz A, Zwirchmayr J, Kirchwegger B, Bojkova D, Cinatl JJ, Rabenau HF, Rollinger JM, Beniddir MA, Grienke U. The Hitchhiker’s Guide to Multi-informative Molecular Networks: Discovery of Anti-SARS-CoV-2 Natural Compounds. Submitted 2023

P-409 Fufang Yuxingcao Heiji for the treatment of COVID-19: clinical observations of a traditional Chinese preparation

Authors Kenny Kuchta¹, Xiaomei Li², Songhua Li³, Zhuming Jin⁴, Ruwei Wang⁴, Silke Cameron⁵

Institutes 1 Albrecht von Haller Institute of Plant Sciences, Georg August University Göttingen, 37073 Göttingen, Germany; 2 Praxis Xiaomei Li, Traditionelle Chinesische Medizin, Stuntzstr. 2, 81677 München, Germany; 3 Izumo Clinic, Izumo-shi, Japan; 4 Zhejiang CONBA Pharmaceutical, China; 5 Department for Gastroenterology and General Internal Medicine, Clinic Hann. Münden, Germany
DOI 10.1055/s-0043-1774263

Traditional herbal prescriptions are well-established in the treatment of viral respiratory tract infections and have proven extremely valuable during the recent COVID-19 pandemic. In China, Fufang Yuxingcao Heiji (FYH; Forsythiae Fructus 0.6 g, Houttuyniae Herba 6 g, Isatidis Radix 1.5 g, Lonicerae flos 0.6 g, Scutellariae radix 1.5 g) is often prescribed [1]. For this prescription, we conducted an observation of COVID-19 positive patients in Germany. Symptoms were assessed via a questionnaire at the beginning and at the end of the treatment, when symptoms had disappeared. The present clinical observation included 23 COVID-19- positive patients (10 males, 13 females, aged 18 – 80

years). The primary symptoms were sore throat, stuffy or runny nose, cough with or without phlegm. Non-respiratory symptoms included fatigue and weakness, rarely fever. Other symptoms were changes in smell and taste, lack of appetite and thirst, headache, nausea, sweating and changes in stool habits such as bloating and diarrhoea. The duration of treatment was three to six days. FYH was well tolerated, and no side effects were observed, even in patients with tumours. All patients reported an improvement in their symptoms, which was also perceived by the treating physicians (XL, SC). FYH was also administered to COVID-negative health care workers with sore throats in a COVID-19 high-risk environment (COVID-ward). None of them were diagnosed with COVID-19 infection during the preventive treatment. Symptoms reported were resolved. Based on these preliminary observations and the above mentioned previous therapeutic experience in China, FYH appears to be safe and effective for treatment and prevention of COVID-19 and warrants further investigation (► Fig. 1).

復方魚腥草合劑 / ふくほうぎょせいそうこうざい / Fufang Yuxingcao Heiji				
Drug (Chin.)	Drug (Jap.)	Drug (Lat.)	Plant species	Daily dose
十葉	ショウヤク	<i>Houttuyniae herba</i>	<i>Houttuynia cordata</i>	6.0 g
板藍根	ハンランコン	<i>Isatis radix</i>	<i>Isatis indigogetica</i>	1.5 g
黃芩	オウゴン	<i>Scutellariae radix</i>	<i>Scutellaria baicalensis</i>	1.5 g
連翹	レンギョウ	<i>Forsythiae fructus</i>	<i>Forsythia suspensa</i>	0.6 g
金銀花	キンギンカ	<i>Lonicerae flos</i>	<i>Lonicera japonica</i>	0.6 g

► Fig. 1 The traditional herbal prescription Fufang Yuxingcao Heiji

References

[1] Kuchta K, Cameron S, Lee M, Cai SQ, Shoyama Y. Which East Asian herbal medicines can decrease viral infections? *Phytochem Rev* 2022; 21 (1): 219–237

P-410 Pharmacological profiling of Hanshiyi formula, a herbal mixture used for the treatment of COVID-19 in China

Authors Stefanie Tiefenbacher¹, Patrik Schwarz², Alexander Perhal², Teresa Pirker¹, Eva-Maria Pferschy-Wenzig¹, Chensi Yao³, Chuanxi Tian³, Weihao Wang⁴, Yanyan Zhou⁴, Hang Liu⁵, Min Li³, Verena Dirsch², Xiaolin Tong³, Rudolf Bauer¹

Institutes 1 Institute of Pharmaceutical Sciences, Division of Pharmacognosy, University of Graz, Graz, Austria; 2 Department of Pharmaceutical Sciences, Division of Pharmacognosy, University of Vienna, Vienna, Austria; 3 China Academy of Chinese Medical Sciences, Guang'anmen Hospital, Department of Endocrinology, Beijing, China; 4 China Academy of Chinese Medical Sciences, Institute of Chinese Materia Medica, Beijing, China; 5 Wuhan Institute of Virology, Chinese Academy of Sciences, Wuhan, China
DOI 10.1055/s-0043-1774264

During Covid-19 pandemic, the TCM formula Hanshiyi (HSYF) has been developed in China to treat patients with Covid-19. In a first retrospective cohort study, HSYF showed a significant reduction of severe cases in the treated group [1]. The formula contains 20 ingredients, 16 are derived from plant material. The other four originate from animals, mineral, fungi, or are a mixture of fermented material. Recently, we have established HPTLC and LC-MS-methods for the quality control of HSYF [2]. Now we present the results of pharmacological investigations of HSYF and its ingredients.

The cytotoxicity of HSYF in Vero E6 Cells was tested with a MTT-assay and an IC₅₀ value of 6.576 mg/mL was found. SARS-CoV-2 standard strains were propagated in Vero E6-cells and the viral titre of cell infection was detected by RT-qPCR-analysis to identify the antiviral activity of HSYF in vitro. Significant anti-viral effects were found at 1.0 and 2.0 mg/mL. In addition, the copy of viral genes was significantly reduced in cells which were incubated with HSYF before viral

infection. The HSYF-decoction and fractions of increasing polarity were tested in LPS and IFN- γ stimulated RAW macrophages [3]. The dichloromethane-fraction showed a reduction in NO-production, but did not exhibit any cytotoxicity in the XTT-assay.

Finally, the decoction and the fractions were tested for their anti-inflammatory-activity in RORY-Gal4 luciferase [4] and TGR5 CRE-luciferase assays [5]. Only the n-hexane-fraction and the ASE-dichloromethane extract showed activity.

Funding The project has been carried out within the framework of the Eurasia-Pacific Uninet, funded by the Austrian Federal Ministry of Education, Science and Research (BMBWF) (EPU 15/2020). CACMS has been supported by National Key projects for international cooperation on science, technology and innovation: International cooperation research on the mechanism of Hanshiyi Formula in the treatment of COVID-19 (2021YFE0201100).

Conflict of Interest The authors declare no conflict of interest.

References

[1] Tian J, Yan S, Wang H, Zhang Y, Zheng Y, Wu H, Li X, Gao Z, Ai Y, Gou X, Zhang L, He L, Lian F, Liu B, Tong X. Hanshiyi Formula, a medicine for Sars-Cov2 infection in China, reduced the proportion of mild and moderate COVID-19 patients turning to severe status: A cohort study, *Pharmacological research* 2020; 161 (105127):. doi:10.1016/j.phrs.2020.105127

[2] Tiefenbacher S, Zhou Y, Whang W, Chao Y, Li M, Tong X, Bauer R Development of HPTLC and UPLC methods for quality control of Hanshiyi formula. In: *Planta Medica: Planta Med.* Vol. 88. GeorgThieme Verlag KG; 2022: P-079

[3] Tran HT, Gao X, Kretschmer N, Pferschy-Wenzig E-M, Raab P, Pirker T, Temml V, Schuster D, Kunert O, Huynh L, Bauer R. Anti-inflammatory and antiproliferative compounds from *Sphaeranthus africanus*. *Phytomedicine: international journal of phytotherapy and phytopharmacology* 2019; 62: 152951. doi:10.1016/j.phymed.2019.152951

[4] Schwarz PE, Perhal AF, Schoberl LN, Kraus MM, Kirchmair J, Dirsch VM. Identification of the Natural Steroid Sapogenin Diosgenin as a Direct Dual-Specific ROR α / γ Inverse Agonist. *Biomedicines* 2022; 10:.. doi:10.3390/biomedicines10092076

[5] Ladurner A, Zehl M, Grienke U, Hofstadler C, Faur N, Pereira FC, Berry D, Dirsch VM, Rollinger JM. Allspice and Clove As Source of Triterpene Acids Activating the G Protein-Coupled Bile Acid Receptor TGR5. *Front Pharmacol* 2017; 8: 468. doi:10.3389/fphar.2017.00468

P-411 Historical herbal texts from Switzerland: a potential source for plant- derived natural products against SARS-CoV-2

Authors Nina Vahekeni¹, Corinna Urmann^{2,3}, Jonas Stehlin¹, Niklas Hofer^{2,3}, Yvonne Gmach^{2,3}, Evelyn Wolfram¹, Andreas Lardos¹

Institutes 1 Zurich University Of Applied Sciences (ZHAW) – ICBT – Natural Products and Phytopharmacy, Wädenswil, Switzerland; 2 Weihe-Stephan-Triesdorf University of Applied Sciences, Organic-analytical Chemistry, Straubing, Germany; 3 TUM Campus Straubing for Biotechnology and Sustainability, Technical University of Munich, Straubing, Germany
DOI 10.1055/s-0043-1774265

In search for more effective prophylactic and curative therapeutics against SARS-CoV-2, an ethnopharmacological approach was used to select 20 plants described in the “Arzneibuch von Hallwyl” (ABvH), an influential recipe text from 16th century Switzerland. Plants were selected based on specific historical uses possibly linked with the treatment of microbial or viral infections as well as inflammatory conditions. For each plant candidate, aqueous and hydroethanolic extracts have been produced, respectively. The prophylactic activity of extracts against SARS-CoV-2 was assessed using the CellTiter-Glo Luminescent Cell Viability Assay upon viral infection in vitro. Four plants showed promising activity; among them *Sambucus nigra* L. (leaves) and *Artemisia vulgaris* L. (aerial parts) showed an anti-SARS-CoV-2 potential both with an activity of $\leq 33.3 \mu\text{g/mL}$ for their hydroethanolic extract.

The findings confirm the historical traditional use in the area of infectious diseases. Accordingly, this study shows supportive evidence that an ethnopharmacological approach combined with robust in vitro methods effectively enables to screen for promising antiviral plant extracts against SARS-CoV-2.

P-412 Anti-viral and anti-inflammatory activity of phenolics from *Helianthemum lippii*

Authors Michal Korinek¹, Yen Chi Loo¹, Yuan-Bin Cheng², Mohamed El-Shazly³, Ahmed K. Osman⁴, Thiyagarajan Raviraj¹, Chung-Fan Hsieh⁵, Olha Mykhailenko⁶, Tsong-Long Hwang⁷, Jim-Tong Horng⁸, Bing-Hung Chen⁹, Attila Hunyadi¹⁰, Fang-Rong Chang¹

Institutes 1 Graduate Institute of Natural Products, College of Pharmacy, Kaohsiung Medical University, Kaohsiung, Taiwan; 2 Department of Marine Biotechnology and Resources, National Sun Yat-sen University, Kaohsiung, Taiwan; 3 Department of Pharmacognosy and Natural Products Chemistry, Faculty of Pharmacy, Ain-Shams University, Cairo, Egypt; 4 Department of Botany and Microbiology, Faculty of Science, South Valley University, Qena, Egypt; 5 Research Center for Emerging Viral Infections, College of Medicine, Chang Gung University, Kweishan, Taoyuan, Taiwan; 6 Department of Pharmaceutical Chemistry, National University of Pharmacy of Ministry of Health of Ukraine, Kharkiv, Ukraine; 7 Graduate Institute of Natural Products, College of Medicine, Chang Gung University, Taoyuan, Taiwan; 8 Department of Biochemistry and Molecular Biology, College of Medicine, Chang Gung University, Kweishan, Taoyuan, Taiwan; 9 Department of Biotechnology, College of Life Science, Kaohsiung Medical University, Kaohsiung, Taiwan; 10 Institute of Pharmacognosy, Interdisciplinary Excellence Centre, University of Szeged, Szeged, Hungary
DOI 10.1055/s-0043-1774266

Influenza and enteroviruses cause severe threats to human health which leads to huge economic losses. Due to emerging resistance towards traditional drugs, the development of novel therapeutic strategies is needed. The *Helianthemum* genus (Cistaceae) is comprised of plant species that widely grow in Mediterranean regions. *Helianthemum lippii* (HL) is a rare and threatened psammophyte from the Saudi Arabia desert. Traditionally, it was used to treat skin rashes and gastrointestinal disorders. In this study, the constituents of HL and their anti-enterovirus, anti-influenza and anti-inflammatory activities were explored. The crude extracts, partitioned fractions and subfractions were evaluated for protective effects against influenza H1N1 and enterovirus D68 in vitro, and anti-inflammatory activity in human neutrophils. The results revealed potent activities for methanol partitioned layer and its subfractions. Further, bioactivity-guided fractionation resulted in the isolation of two major flavonoid glycosides, namely kaempferol 3-O-(6"-O-p-coumaroyl)- β -D-glucopyranoside (tiliroside) and kaempferol 3-O-(3"-6"-di-O-p-coumaroyl)- β -D-glucopyranoside, together with three phenolic acids, namely 4-hydroxybenzoic acid, vanillic acid, and 4-methoxycinnamic acid. The isolated compounds were identified using 1D and 2D NMR, and mass spectroscopy. Currently, the two major flavonoid glycosides are being quantified using HPLC and evaluated also for the target activities. The anti-viral and anti-inflammatory potency of this rare plant and its bioactive compounds may be further utilised in the development of drug or health food products for the treatment of influenza and enteritis and may be useful to suppress associated inflammatory complications. However, the preservation of this endangered species remains as a concern before its utilisation (► Fig. 1).

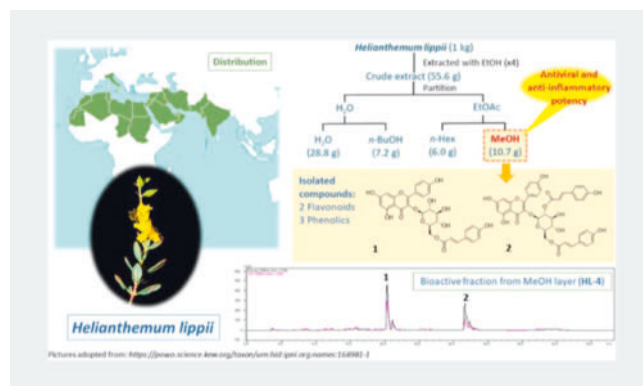

► Fig. 1 Workflow of the investigation of the antiviral and anti-inflammatory activities of *Helianthemum lippii*.

P-414 3D-printing of novel pharmaceutical delivery systems for eucalypt extract

Authors Oleh Koshovyi^{1, 2}, Jyrki Heinämäki¹, Mykola Komisarenko², Ain Raal¹

Institutes 1 University of Tartu, Tartu, Estonia; 2 The National University of Pharmacy, Kharkiv, Ukraine
DOI 10.1055/s-0043-1774267

3D-printing is considered as a promising technology for fabricating patient-specific drug delivery systems (DDSs). *Staphylococcal* infections are challenging for global healthcare. The main drawback in their pharmacotherapy is the resistance to antimicrobial drugs. One promising approach in the battle against antibiotic-resistant strains is the use of plant-origin medicines. The aim was to develop aqueous gels for semi-solid extrusion (SSE) 3D-printing of eucalypt extract (EE), to design novel 3D-printed DDSs with antimicrobial activity.

A modified EE was used for preparing water-soluble 3D-printable nanoemulsions. A total of 35 substances were identified in a modified EE by GC. The dominant ones were α -phellandrene, 1,8-cineole, aromadendrene, ledene and globulol. The EE and its nanoemulsions showed antimicrobial activity against *S. aureus*, *B. subtilis*. Polyethylene oxide (PEO) and gelatin were investigated as carrier polymers for 3D-printing. The viscosity of the gels ranged from 229000 to 633000 cP, and the injection force measured was within 20.2 – 63.2 N. Full squares (lattices) and small round discs were 3D-printed. The area ratio of full squares (3D-printed lattice area vs theoretical area) ranged from 1.24-1.87. The aqueous PEO gels loaded with EE (nanoemulsion) were applicable in pharmaceutical SSE 3D-printing. The most feasible PEO-EE gel for 3D-printing consisted of EE 10 mg/mL, eumulgin 30 mg/mL, ascorbic acid 20 mg/mL in 20% PEO gel. The present 3D-printed antibacterial delivery systems could have potential medicinal uses in the treatment of oral cavity infections and in wound healing applications.

Funding This work was supported by the Estonian Research Council grant (PRG1903) and MSCA4Ukraine (1232466).

Conflict of Interest The authors declare no conflict of interest.

P-415 Semi-solid extrusion 3D-printing of pharmaceutical forms with rosmarinic acid

Authors Ain Raal¹, Oleh Koshovyi^{1, 2}, Jyrki Heinämäki¹

Institutes 1 University of Tartu, Tartu, Estonia; 2 National University of Pharmacy, Kharkiv, Ukraine
DOI 10.1055/s-0043-1774268

The “one size fits all” conception is still common in medicine, but the new paradigm of personalised medicine is becoming more popular. One important “pharmaceutical tool” for fostering the implementation of personalised med-

icine is 3D printing. To date, there is very limited research in 3D-printing of plant-origin substances.

Rosmarinic acid (RA), first isolated from *Rosmarinus officinalis*, is a well-known plant-origin substance. The therapeutic efficacy of RA is dose dependent. The in-vivo studies with rats have shown that RA has anti-oxidative (2 mg/kg), hypoglycemic (120–200 mg/kg), antiviral (20 mg/kg), neuroprotective (50 mg/kg) and hepatoprotective (10 mg/kg) effects. RA is sparingly soluble in water, which limits its bioavailability.

The aim of this study was to develop aqueous gels for semi-solid extrusion (SSE) 3D-printing, and to design novel 3D-printed delivery systems for RA.

Polyethylene oxide (PEO) and gelatin were investigated as carrier polymers for 3D-printing. The gels with a RA concentration up to 20% were well printable. Some gels were unprintable after a short-term storage because of the high oxidative activity of RA. The viscosity of the gels was in the range of 256700–345100 cP. The injection force ranged from 26.1 N to 36.2 N. The RA-loaded gels were 3D-printed to full squares (lattices) and round discs. The lattice area ratio (printed vs theoretical) was 1.34–1.72.

In conclusion, the present aqueous PEO gels loaded with the RA are feasible in pharmaceutical SSE 3D-printing.

Funding This work was supported by the Estonian Research Council grant (PRG1903) MSCA4Ukraine (1232466).

P-416 Preclinical evaluation of oral nanoformulation based on natural extract as a potential treatment for type 2 diabetes mellitus: preliminary data.

Authors Elkin Escobar^{1,2}, Natalia Arbelaez³, Adriana Restrepo³, Diana Lorena Munoz⁵, Luis Fernando Echeverri⁴, Jahir Orozco², Norman Balcazar^{1,5}

Institutes 1 GENMOL Group, Universidad de Antioquia, Medellín, Colombia; 2 Max Planck Tandem Group in Nanobioengineering, University of Antioquia, Medellín, Colombia; 3 PECET Group, Faculty of Medicine, Universidad de Antioquia, Medellín, Colombia; 4 Organic chemistry of natural products group, Faculty of Natural and Exact Sciences, Medellín, Colombia; 5 Department of Physiology and Biochemistry, Faculty of Medicine, Medellín, Colombia

DOI 10.1055/s-0043-1774269

Previous studies have shown that an oral nanoformulation (ONF) based on natural extracts, ursolic acid (104.3 µM), oleanolic acid (30.8 µM) and ursolic acid lactone (35.8 µM) obtained by hexane: methanol: water 4:3:1 (v/v) extraction from *Eucalyptus tereticornis* leaves reduces metabolic alterations in a diet-induced obese (DIO) mouse model. The present work aims to develop preclinical safety and biological efficacy tests for the ONF, following the recommendations established by the Organization for Economic Cooperation and Development guidelines.

The ONF was scaled up from the previously described protocol characterised, and carbohydrate metabolism was evaluated in the DIO mouse model. Three groups were established: ONF, empty nanoparticles (NPs) and vehicle.

Acute oral toxicity: Three Wistar rats were given a single dose of 2000 mg/kg of ONF. The animals were monitored daily for 14 days. Repeated dose oral toxicity for 28 days: Five male and five female Swiss mice were treated daily for 28 days with one dose of 218 µg/kg (ONF). In the end, they remained under observation for two weeks. At the endpoint, blood samples for hemogram and blood chemistry were taken. A necropsy was also performed, and samples of the internal organs were taken for histopathological analysis.

There were no clinical signs of disease or signs suggestive of toxicity and weight gain remained stable; no organ abnormalities were observed. Renal and liver function tests, ionogram and haem-leukogram were within normal ranges.

The preliminary results show that ONF with anti-obesogenic activity and potential anti-diabetic activity is biologically effective and safe in experimental animals.

P-417 New formulations with royleanone derivatives from *Plectranthus* spp. to inhibit P-glycoprotein activity

Authors Gabrielle Bangay^{1,2}, Vera Isca^{1,3}, Eva María Domínguez-Martín^{1,2}, Daniel J.V.A. Santos¹, Ana María Díaz-Lanza², Lucília Saraiva⁴, Carlos A.M. Afonso³, Mirna Jovanovic⁵, Milica Pesic⁵, Patrícia Rijo^{1,3}

Institutes 1 CBIOS – Research Center for Biosciences & Health Technologies, Universidade Lusófona De Humanidades e Tecnologias, Campo Grande 376, 1749-024, Lisbon, Portugal; 2 Universidad de Alcalá de Henares, Facultad de Farmacia, Departamento de Ciencias Biomédicas (Área de Farmacología); Nuevos agentes antitumorales, Acción tóxica sobre células leucémicas. Ctra. Madrid-Barcelona km. 33,600. 28805, Alcalá de Henares, Spain; 3 Instituto de Investigação do Medicamento (iMed.Ulisboa), Faculdade de Farmácia, Universidade de Lisboa 1649-003, Lisbon, Portugal; 4 LAQV/REQUIMTE, Laboratório de Microbiologia, Departamento de Ciências Biológicas, Faculdade de Farmácia, Universidade do Porto 4050-313, Porto, Portugal; 5 Institute for Biological Research “Siniša Stanković” – National Institute of Republic of Serbia University of Belgrade. Bulevar despota Stefana 142, 11060, Belgrade, Serbia

DOI 10.1055/s-0043-1774270

Multidrug resistant (MDR) cancer cases continue to increase, such that the search for novel and more effective anti-cancer therapeutics is of high priority. In some MDR cancers, the overexpression of membrane transport proteins, like P-glycoprotein (P-gp), continues to be a major impediment to successful therapy. *Plectranthus* genus (Lamiaceae), known for their medicinal and therapeutic properties, is a well-known source of bioactive diterpenoids, such as 7 α -acetoxy-6 β -hydroxyroyleanone (Roy) and 6,7-dehydroroyleanone (DeRoy). Based on in silico molecular docking studies, a small library of semi-synthetic derivatives was prepared. The antitumoural activity of the compounds was assessed in resistant human cancer cell lines NCI-H460/R and DLD1-TxR. Cell viability was assessed using MTT assay and cell death induction by Annexin V/PI. Overall, it was demonstrated that three of the abietane diterpenoid analogues induced P-gp inhibition in MDR cancer cell lines, presenting novel selective compounds for the possible treatment of lung and colon cancer. Moreover, Roy and DeRoy nano-formulations were successfully prepared. DeRoy hybrid nanoparticles significantly increased the efficacy of DeRoy in NCI-H460 and NCI-H460/R. Roy, conjugated with oleic acid afforded self-assembly nanoparticles, to improve aqueous solubility and bioavailability of Roy. This new nano formulation did not decrease cell viability of Vero-E6 cells when compared to Roy with potential as a pro-drug delivery system. Currently, top hit derivatives are being prepared into nano-formulations for prospective pharmaceutical use as P-gp modulators.

Conflict of Interest The authors declare no conflict of interest.

P-418 Biodegradable *Cannabis sativa* L. and *Ageratum conyzoides* L. essential oils Drug Delivery System (DDS) for dermic applications

Authors João Medeiros^{1,2}, José Mendes^{1,2}, Nsevolo Samba^{2,3}, Paulo Fiadeiro², Lucia Silva^{1,2}, Joana Curto^{1,2}

Institutes 1 Departamento de Química, Universidade Da Beira Interior, Portugal; 2 Fiber Materials and Environmental Technologies (FibEn-Tech-UBI), Universidade Da Beira Interior, Portugal; 3 Department of clinical analysis and Public Health, Kimpa Vita University, Angola

DOI 10.1055/s-0043-1774271

There is a growing demand for research into fully biodegradable dermic Drug Delivery Systems (DDS) for retention and controlled delivery of cannabis active molecules, for dermic applications. Following the trend in several countries toward legalisation of cannabis for medicinal purposes, the development of dermic drug delivery, with applications from pharmaceuticals to cosmetic, in which it is fundamental to control the ability to retain and release of the active molecules such as terpenes, and other volatile compounds present in this plant, will be a welcoming innovation in this sector. The goal is to obtain, characterise

and capture the oil and volatile compounds from *Cannabis sativa* L. combined with the *Ageratum conyzoides* L. and assess the compatibility and potential of these two plants in a single product, incorporating the main active molecules into an environmentally friendly DDS. The essential oil was obtained from hydrodistillation and analysed by GC-MS. More than 60 compounds were present in the essential oil, among them Caryophyllene (14.3%), α -Terpinolene (10.8%) and α -Humulene (8.1%). The volatile constituents present in the hydrolate were extracted through Headspace solid-phase microextraction (HS-SPME). The analysis identified Citronella (10.3%) and β -Citronellol (8.9%) as well as other volatile compounds that were incorporated in the cellulose-based DDS. The development of a cellulose-based matrix with optimisation of the porosity using computational simulation was used to predict the retention and release of the active molecules along a certain period, contributing to the replacement of non-biodegradable DDS medical devices and improving their ecologic footprint.

P-419 Hydrosols of *Veronica* species with antioxidant activity

Authors [Marija Nazlič¹](#), [Karla Akrap¹](#), [Dario Kremer²](#), [Ivana Vrca¹](#), [Valerija Dunkić¹](#)

Institutes **1** Faculty of Science, University of Split, Croatia; **2** Faculty of Pharmacy and Biochemistry, University of Zagreb, Zagreb, Croatia
DOI [10.1055/s-0043-1774272](#)

Composition of volatile compounds and antioxidant activity of hydrosols of five *Veronica* species is presented in this research: *V. acinifolia*, *V. anagallis-aquatica*, *V. anagalloides*, *V. catenata* and *V. arvensis*. Hydrodistillation (HD) and microwave-assisted extraction (MAE) were methods used for the extraction of free volatile compounds (FVCs) in hydrosols of the chosen species. These extraction methods yielded two layers, the lipophilic layer or essential oil and the aqueous layer – hydrosols. In general, research on the aroma profiles of hydrosols and their biological efficacy is limited but in the last decade, hydrosols have been increasingly explored due to higher acceptance towards using natural products in daily life.

The compounds β -ionone and benzene acetaldehyde were detected in all five species regardless of the extraction method. Except these two compounds, (E)- β -damascenone was detected in all HD hydrosols and caryophyllene oxide in all MAE hydrosols. Hydrosols from both extraction techniques, were tested by two methods: ORAC and DPPH. Comparing the antioxidant activity of all hydrosols, it can be concluded that *V. anagallis-aquatica* HD hydrosol and *V. anagalloides* HD hydrosol showed highest but similar antioxidant activity in ORAC method. For DPPH method, *V. arvensis* HD hydrosol showed highest antioxidant activity. Both *V. anagalloides* HD and *V. anagallis-aquatica* HD hydrosols had benzene acetaldehyde in high percentages. *Veronica arvensis* HD extract also had benzene acetaldehyde together with (E)- β -damascenone as a major compound so these compounds could be responsible for the shown antioxidant activity of these extracts.

P-420 Gel transition temperature optimisation for a new pilocarpine formulation using design of experiments methodology

Authors [Afroditi Kapourani¹](#), [Katerina Kirimkiroglou¹](#), [Maria Koromili¹](#), [Alexandros Nakas^{2,3}](#), [Antigoni Koletti^{2,3}](#), [Andreana Assimopoulou^{2,3}](#), [Panagiotis Barmapalexis^{1,3}](#)

Institutes **1** Laboratory of Pharmaceutical Technology, Division of Pharmaceutical Technology, School of Pharmacy, Faculty of Health Sciences, Aristotle University of Thessaloniki, Thessaloniki, Greece; **2** Laboratory of Organic Chemistry, School of Chemical Engineering, Aristotle University of Thessaloniki, Thessaloniki, Greece; **3** Natural Products Research Centre of Excellence- AUTH (NatPro-AUTH), Center for Interdisciplinary Research and Innovation (CIRI-AUTH), Thessaloniki, Greece
DOI [10.1055/s-0043-1774273](#)

Pilocarpine (PIL) is a parasymphathomimetic active pharmaceutical ingredient (API) with weak beta- adrenergic action that predominantly functions as a non-specific muscarinic acetylcholine receptor agonist. It is a naturally occurring compound (tertiary alkaloid) extracted from the leaves of *Pilocarpus microphyllus* and *Pilocarpus jaborandi*. PIL's systematic administration in the form of film-coated tablets is approved against dry mouth and xerostomia from both FDA and EMA. However, despite its high efficacy and acceptance, the systematic administration of PIL results in significant adverse events (including nausea, sweating, diarrhoea, headache, chest pain, etc.) [1]. Therefore, the preparation of a novel, buccally administrated, PIL formulation may be a significant step in an effort to lessen these side effects and increase patient compliance. Hence, the aim of the present study was to evaluate the gel transition properties of an in situ thermo-responsive PIL gel formulation using design of experiments (DoE) methodology. Specifically, a Box-Behnken experimental design was employed for evaluating the effect of three formulation factors, namely poloxamer 407 (P407), poloxamer 188 (P188) and xanthan gum (XG), on the sol-gel transition temperature (Tsol-gel) of the in situ forming PIL hydrogels. Results showed that P407 had the most significant impact in the changes induced on the sol-gel transition temperature, P188 showed a synergistic effect, whereas XG an antagonistic effect. DoE optimization suggested the use of P407, P188 and XG at concentrations of 17.95, 1.88 and 0.09% w/w, respectively, as the optimum factors' levels for the buccally administrated PIL sol-gel formulation.

Funding This research has been co-financed by the European Regional Development Fund of the European Union and Greek national funds through the Operational Program Competitiveness, Entrepreneurship and Innovation, under the call RESEARCH – CREATE – INNOVATE (project code: T2EDK-00842).

References

[1] Farag A.M., Holliday C., Cimmino J., Roomian T., Papas A. Comparing the effectiveness and adverse effects of pilocarpine and cevimeline in patients with hyposalivation. *Oral diseases* 25 (8): 2019; 1937–1944

P-421 Enhancement of luteolin solubility in carriers and drug delivery systems and formulation of a toothpaste with luteolin for periodontal diseases

Authors [Athanasios Arampatzis^{1,2}](#), [Elli Kampasakali³](#), [Afroditi Kapourani⁴](#), [Ioannis Tsvintzelis⁵](#), [Lazaros Tsalikis⁶](#), [Dimitrios Christofilos³](#), [Panagiotis Barmapalexis^{2,4}](#), [Spyros Papageorgiou⁷](#), [Katerina Argyriou⁸](#), [Angelina Tsouna⁸](#), [Andreana Assimopoulou^{1,2}](#)

Institutes **1** Aristotle University of Thessaloniki, School of Chemical Engineering, Laboratory of Organic Chemistry, Thessaloniki, Greece; **2** Center for Interdisciplinary Research and Innovation of Aristotle University of Thessaloniki, Natural Products Research Center of Excellence (NatPro-AUTH), Thessaloniki, Greece; **3** Aristotle University of Thessaloniki, Faculty of Engineering, School of Chemical Engineering & Physics Laboratory, Thessaloniki, Greece; **4** Aristotle University of Thessaloniki, School of Pharmacy, Laboratory of Pharmaceutical Technology, Thessaloniki, Greece; **5** Aristotle University of Thessaloniki, School of Chemical Engineering, Laboratory of Physical Chemistry, Thessaloniki, Greece; **6** Aristotle University of Thessaloniki, School of Dentistry, Thessaloniki, Greece; **7** University of West Attica, Research Laboratory of Chemistry, Biochemistry and Cosmetic Science, Athens, Greece; **8** Frezyderm SA, Tatoiou Av. 4, Metamorfossi, Athens, Greece
DOI [10.1055/s-0043-1774274](#)

Luteolin (LUT) is a naturally derived bioactive flavonoid with significant anti-microbial and anti-inflammatory properties. The physicochemical properties of luteolin, such as its very high melting point (601 – 614 K) and its very low solubility in water, are mainly due to the strong intermolecular forces. LUT shows significant formulation problems due to its poor aqueous solubility and water stability [1]. In order to use LUT as an active ingredient in gels/toothpastes for periodontal applications, we aimed, in the frame of the project LuteoPaste, to initially enhance solubility of LUT in several carriers and overcome such limitations for product development and subsequently to incorporate that in the final formulation.

Specifically, solubilisation of LUT in lipophilic flavours used in toothpastes and gels, as well as in micelles by the use of non-ionic surfactants, such as PEG derivatives, was examined. Furthermore, drug delivery systems (DDS) of varying concentrations of LUT were prepared, such as liposomes, complexes with cyclodextrins and chitosan. Following the successful solubilisation of LUT into several carriers and DDS, different combinations of excipients (gelling agent, thickener, dispersing agent, humectant, polishing agent, opacifier etc.) at varying concentrations, were utilized to formulate a toothpaste for periodontitis with LUT as active ingredient, that will be used for further in vivo studies in dogs. Stability of the developed toothpastes/gels was examined and scale up characteristics have been defined.

Funding This research has been co-financed by the European Regional Development Fund of the European Union and Greek national funds through the Operational Program Competitiveness, Entrepreneurship and Innovation, under the call RESEARCH – CREATE – INNOVATE (project code: T2EDK-01627).

References

[1] Peng B, Yan W. Solubility of luteolin in ethanol + water mixed solvents at different temperatures. *J Chem Eng Data* 2010; 55: 583–585

P-422 Physicochemical evaluation of buccally administrated pilocarpine nanoparticles used against xerostomia

Authors Vassiliki Valkanioti¹, Afroditi Kapourani¹, Melina Chatzitheodoridou¹, Evangelos Tzimpilis², Andreana Assimopoulou^{3,4}, Panagiotis Barmapalexis^{1,4}

Institutes 1 Laboratory of Pharmaceutical Technology, Division of Pharmaceutical Technology, School of Pharmacy, Faculty of Health Sciences, Aristotle University of Thessaloniki, Thessaloniki, Greece; 2 Laboratory of Physical Chemistry, School of Chemical Engineering, Aristotle University of Thessaloniki, Thessaloniki, Greece; 3 Laboratory of Organic Chemistry, School of Chemical Engineering, Aristotle University of Thessaloniki, Thessaloniki, Greece; 4 Natural Products Research Centre of Excellence-AUTH (NatPro-AUTH), Center for Interdisciplinary Research and Innovation (CIRI-AUTH), Thessaloniki, Greece

DOI 10.1055/s-0043-1774275

Hyposalivation (also referred to as xerostomia or dry mouth) causes a feeling of oral dryness and has an enormous impact on patients' quality of life. Xerostomia treatment includes salivary substitutes and stimulants, the use of acids, and the administration of parasympathomimetic drugs, such as pilocarpine (PIL) [1, 2]. PIL is a naturally derived active pharmaceutical ingredient (API) that has extensive and pervasive effects on exocrine and smooth muscle tissues, by directly stimulating muscarinic receptors. Despite its clinical efficacy, the systematic administration of PIL (in the form of film-coated tablets) results in significant adverse events [3]. To overcome these side effects [4], local administration of the API in the buccal cavity is proposed. The aim of the present study was to evaluate the physicochemical properties of a new nanoparticulate (NP) formulation designed for the effective buccal administration of PIL.

Specifically, PIL-loaded NPs were fabricated using the double-emulsification process. Poly (lactic-co-glycolic acid) was used as a biodegradable matrix/carrier, while Carbopol-974P (CRB) as a coating and mucoadhesive agent. The physicochemical properties of the resulting NPs were evaluated by DSC, TGA, ATR-FTIR and pXRD. Results showed significant changes in the physicochemical properties of the NPs upon addition of the API and the coating agent (CRB). TGA showed that the prepared NPs were stable up to approximately 200 °C, while pXRD diffractogram analysis revealed that, in all cases, the API was amorphously dispersed within the PLGA matrix/carrier. ATR-FTIR analysis confirmed the successful coating of CBR on the PIL-loaded PLGA NPs.

Funding This research has been co-financed by the European Regional Development Fund of the European Union and Greek national funds through the Operational Program Competitiveness, Entrepreneurship and Innovation, under the call RESEARCH – CREATE – INNOVATE (project code: T2EDK-00842).

References

- [1] Quilici D., Zech K.N. Prevention and treatment options for medication-induced xerostomia. *General dentistry* 2019; 67 (4): 52–57
 [2] Turner M.D. Hyposalivation and Xerostomia: Etiology, Complications, and Medical Management. *Dental clinics of North America* 2016; 60 (2): 435–43
 [3] Barbe A.G. Medication-Induced Xerostomia and Hyposalivation in the Elderly: Culprits, Complications, and Management. *Drugs & aging* 2018; 35 (10): 877–885
 [4] Malallah O.S., Garcia C.M.A., Proctor G.B., Forbes B., Royall P.G. Buccal drug delivery technologies for patient-centred treatment of radiation-induced xerostomia (dry mouth). *International Journal of Pharmaceutics* 2018; 541 (1): 157–16

P-423 Modelling the solubility of luteolin in liquid solvents with the NRHB equation of state model

Authors Ioannis Tsivintzelis¹, Panagiotis Barmapalexis^{2,3}, Evangelos Tzimpilis¹, Andreana Assimopoulou^{1,3}

Institutes 1 Aristotle University of Thessaloniki, School of Chemical Engineering, Thessaloniki, Greece; 2 Aristotle University of Thessaloniki, School of Pharmacy, Laboratory of Pharmaceutical Technology, Thessaloniki, Greece; 3 Center for Interdisciplinary Research and Innovation of Aristotle University of Thessaloniki, Natural Products Research Center of Excellence (NatPro-AUTH), Thessaloniki, Greece

DOI 10.1055/s-0043-1774276

Luteolin is a bioactive flavonoid of natural origin with significant anti-microbial and anti-inflammatory properties. The physicochemical properties of luteolin, such as its very high melting point (601 – 614 K) and its very low solubility in water, are mainly affected by the strong specific intermolecular interactions, such as hydrogen bonding [1]. In this study, the solubility of luteolin in several solvents, such as water, alcohols, low and high molecular weight glycols and various other organic solvents, was modelled using the Non-Random Hydrogen-Bonding theory, which is a statistical thermodynamic equation of state model that is based on lattice theory [2]. Due to the severe effect of hydrogen bonding in the crystalline structure and the dissolution behaviour of luteolin, all potential intermolecular hydrogen bonds were explicitly accounted for using literature values for the hydrogen bonding enthalpy and entropy. In this way, and by adjusting one binary interaction parameter to the solubility experimental data, the model successfully correlates the solubility of luteolin in water and the investigated organic solvents, showing an average absolute deviation of 3.3%. Such an approach allows the prediction of the dissolution behaviour both in cases of extremely low solubility (e.g. in water, in which the solubility value is of the order of 1E-06 in mole fraction) and in cases of relatively higher solubility (e.g., in PEG-400, in which the solubility value is of the order of 1E-01 in mole fraction) (► Fig. 1).

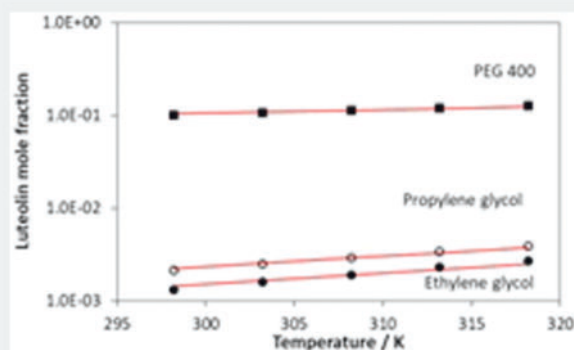

► Fig. 1 Solubility of luteolin in low molecular weight glycols and poly(ethylene glycol) with average molecular weight of 400 g mol⁻¹. Experimental data (symbols) [3] and NRHB calculations (lines).

Funding This research has been co-financed by the European Regional Development Fund of the European Union and Greek national funds through the Operational Program Competitiveness, Entrepreneurship and Innovation, under the call RESEARCH – CREATE – INNOVATE (project code: T2EDK-01627).

References

- [1] Peng B, Zi J, Yan W. Measurement and Correlation of Solubilities of Luteolin in Organic Solvents at Different Temperatures. *J Chem Eng Data* 2006; 51: 2038–2040
- [2] Panayiotou C Tsvintzelis I, Economou IG, Nonrandom hydrogen-bonding model of fluids and their mixtures. 2. Multicomponent mixtures, *Ind Eng Chem Res* 2007; 46: 2628–2636
- [3] Shakeel F, Haq N, Alshehri S, Ibrahim MA, Elzayat EM, Altamimi MA, Mohsin K., Alanazi FK, Alsarra IA. Solubility, thermodynamic properties and solute-solvent molecular interactions of luteolin in various pure solvents. *J Molecular Liquids* 2018; 255: 43–50

P-424 Three-dimensional printed gelatin methacrylate bioscaffolds containing alkannin/shikonin derivatives for skin wound healing applications

Authors [Elisavet Aslanidou](#)¹, [Konstantinos Theodoridis](#)¹, [Athanasios Arampatzis](#)^{1,2}, [Vassilios Papageorgiou](#)³, [Andreana Assimopoulou](#)^{1,2}

Institutes 1 Aristotle University of Thessaloniki, School of Chemical Engineering, Laboratory of Organic Chemistry, Thessaloniki, Greece; 2 Center for Interdisciplinary Research and Innovation of Aristotle University of Thessaloniki, Natural Products Research Center of Excellence (NatPro-AUTH), Thessaloniki, Greece; 3 IATRON HELLAS, Fragkini 9, Thessaloniki, Greece

DOI [10.1055/s-0043-1774277](https://doi.org/10.1055/s-0043-1774277)

Patients suffering from chronic wounds are facing prolonged treatments and major complications, ranging from major bacterial infections to severe disabilities [1]. Wound treatment primarily aims at promoting healing and restoration of the damaged tissue. Wound dressings are often used to cover the wound, protect it from external pathogens and preserve moisture. While traditional dressings, such as gauzes and bandages provide protection, they do not actively contribute to the healing process. In contrast, advanced dressings play a pivotal role in the healing process, either by utilising bioactive materials and/or by acting as carriers for drug molecules. Three-dimensional (3D) printing can be used to provide sophisticated and engineered wound dressings, with precise geometry and porosity, enabling them to resemble the physiology and anatomy of the damaged tissue, and thus serve as supportive scaffolds for cells [2].

The aim of the present study was to fabricate 3D-printed biocompatible and biodegradable hydrogel scaffolds loaded with the well-established wound healing agents, alkannins/shikonins (A/S), for wound healing applications. In this respect, we have successfully synthesised and fabricated 3D-printed gelatin methacrylate (GelMA) hydrogel scaffolds with a mixture of alkannins/shikonins. A/S are naturally-occurring molecules, capable of modulating both the inflammatory and proliferative phases of wound healing, as well as exhibiting strong antimicrobial and regenerative properties [3]. The produced scaffolds were evaluated in terms of their physicochemical characteristics, drug entrapment efficiency and release kinetics. Additionally, A/S loaded 3D-printed hydrogels were seeded with dermal fibroblasts, and their biocompatibility and ability to induce cell proliferation and new extracellular matrix formation was assessed.

References

- [1] Lazarus GS, Cooper DM, Knighton DR, Margolis DJ, Percoraro RE, Rodeheaver G, Robson MC. Definitions and guidelines for assessment of wounds and evaluation of healing. *Wound Repair Regen* 1994; 2: 165–170
- [2] Tottoli EM, Dorati R, Genta I, Chiesa E, Pisani S, Conti B. Skin wound healing process and new emerging technologies for skin wound care and regeneration. *Pharmaceutics* 2020; 12: 1–30
- [3] Papageorgiou VP, Assimopoulou AN, Ballis AC. Alkannins and shikonins: a new class of wound healing agents. *Curr Med Chem* 2008; 15: 3248–3267

P-425 Comparison of poly(ϵ -caprolactone) and poly(lactic acid) three-dimensional printed scaffolds loaded with curcumin for periodontitis treatment

Authors [Georgia Liasi](#)¹, [Christiana Pliakou](#)¹, [Konstantinos Theodoridis](#)¹, [Athanasios Arampatzis](#)^{1,2}, [Evangelos Kyrilas](#)³, [Elli Kampasakali](#)³, [Ioannis Tsvintzelis](#)⁴, [Lazaros Tsalikis](#)⁵, [Panagiotis Barmpalexis](#)^{2,6}, [Dimitrios Christofilos](#)³, [Andreana Assimopoulou](#)^{1,2}

Institutes 1 Aristotle University of Thessaloniki, School of Chemical Engineering, Laboratory of Organic Chemistry, Thessaloniki, Greece; 2 Center for Interdisciplinary Research and Innovation of Aristotle University of Thessaloniki, Natural Products Research Center of Excellence (NatPro-AUTH), Thessaloniki, Greece; 3 Aristotle University of Thessaloniki, Faculty of Engineering, School of Chemical Engineering & Physics Laboratory, Thessaloniki, Greece; 4 Aristotle University of Thessaloniki, School of Chemical Engineering, Laboratory of Physical Chemistry, Thessaloniki, Greece; 5 Aristotle University of Thessaloniki, School of Dentistry, Thessaloniki, Greece; 6 Aristotle University of Thessaloniki, School of Pharmacy, Laboratory of Pharmaceutical Technology, Thessaloniki, Greece

DOI [10.1055/s-0043-1774278](https://doi.org/10.1055/s-0043-1774278)

Periodontitis is a chronic inflammatory disease, affecting the supporting tissues of the teeth, leading to tooth loss if left untreated. Current treatments aim to eliminate the bacteria responsible for the disease and in more severe cases to replace a significant amount of alveolar bone that has been destroyed. However, with the above treatments side effects are often observed, such as post-operative inflammation or the recurrence of bacterial infection that could potentially harm the remaining healthy alveolar bone [1]. Thus, alternative strategies are being explored, such as the utilisation of multi-layered porous and biocompatible scaffolds, that can be fabricated with three-dimensional (3D) printing technology. These constructs serve as the basis for regenerating bone tissue at the defect area. On top of that, incorporating a bioactive agent inside the scaffold exerts a therapeutic effect towards the inhibition of bacterial recurrence and the healing of the damaged tissue accompanying the regeneration of alveolar bone.

In this context, the present study aimed to expand our previous work [2] by fabricating poly(ϵ -caprolactone) (PCL) and poly(lactic acid) (PLA) 3D-printed scaffolds, loaded with the naturally-occurring bioactive molecule curcumin and *Curcuma longa* extract (10 wt.% based on polymer weight), which possess anti-inflammatory, anti-microbial, anti-oxidant and anti-septic properties [3]. Neat and drug-loaded 3D printed scaffolds were fabricated using a bioprinter (BIO X, Cellink, Sweden) and were subsequently characterised in terms of their morphology (optical microscopy, SEM), physicochemical properties (DSC, TGA, FTIR, Raman), drug entrapment efficiency and release kinetics.

Funding This research has been co-financed by the European Regional Development Fund of the European Union and Greek national funds through the Operational Program Competitiveness, Entrepreneurship and Innovation, under the call RESEARCH – CREATE – INNOVATE (project code: T2EDK-01641).

References

- [1] Pihlstrom B, Michalowicz B, Johnson N. Periodontal disease. *Lancet* 2005; 366: 1809–1820
- [2] Arampatzis A, Karra A, Kyrilas E, Kampasakali E, Tsalikis L, Barmpalexis P, Christofilos D, Assimopoulou A. Bioactive 3D printed scaffolds for the treatment of periodontal diseases. *Planta Med* 2022; 88: 1577
- [3] Ahangari N, Kargozar S, Ghayour-Mobarhan M, Baino F, Pasdar A, Sahebkar A, Ferns G, Kim H, Mozafari M. Curcumin in tissue engineering: A traditional remedy for modern medicine. *BioFactors* 2019; 45: 135–151

P-426 Advanced three-dimensional printed scaffolds loaded with ibuprofen for periodontitis management

Authors [Georgia Liasi](#)¹, [Konstantinos Theodoridis](#)¹, [Athanasios Arampatzis](#)^{1,2}, [Evangelos Kyriakos](#)³, [Elli Kampasakali](#)³, [Ioannis Tsivintzelis](#)⁴, [Lazaros Tsalikis](#)⁵, [Panagiotis Barmapalexis](#)^{2,6}, [Dimitrios Christofilos](#)³, [Andreana Assimopoulou](#)^{1,2}

Institutes **1** Aristotle University of Thessaloniki, School of Chemical Engineering, Laboratory of Organic Chemistry, Thessaloniki, Greece; **2** Center for Interdisciplinary Research and Innovation of Aristotle University of Thessaloniki, Natural Products Research Center of Excellence (NatPro-AUTH), Thessaloniki, Greece; **3** Aristotle University of Thessaloniki, Faculty of Engineering, School of Chemical Engineering & Physics Laboratory, Thessaloniki, Greece; **4** Aristotle University of Thessaloniki, School of Chemical Engineering, Laboratory of Physical Chemistry, Thessaloniki, Greece; **5** Aristotle University of Thessaloniki, School of Dentistry, Thessaloniki, Greece; **6** Aristotle University of Thessaloniki, School of Pharmacy, Laboratory of Pharmaceutical Technology, Thessaloniki, Greece

DOI [10.1055/s-0043-1774279](#)

Periodontal diseases involve a group of inflammatory conditions, with the mildest form being gingivitis and the more severe one being periodontitis. These diseases are mainly caused by anaerobic bacteria, as a result of the disturbance of the oral cavity microflora. Given the severity of the disease, existing treatment methods are based on either the administration of antibiotics and/or surgery [1]. A promising treatment strategy is the use of three dimensional printed (3D-printed) scaffolds using biodegradable synthetic polymers. Poly(ϵ -caprolactone) (PCL) and poly(lactic acid) (PLA) are two well-established, biocompatible synthetic polymers that are widely used as biomaterials for the fabrication of 3D scaffolds in tissue regeneration applications. Additionally, these scaffolds can be loaded with pharmaceutical compounds to address any possible inflammatory reactions and promote bone regeneration. Ibuprofen is an approved non-steroidal, anti-inflammatory drug, possessing excellent analgesic and anti-inflammatory properties. Previous studies have shown that polycaprolactone fibre mats containing ibuprofen demonstrated the augmentation of mechanical properties of the defect periodontal tissue and alleviation of inflammation [2]. Therefore, in this work we sought to develop drug-loaded 3D scaffolds by combining PCL or PLA polymers with ibuprofen (10 wt. % based on polymer weight). Neat and drug-loaded 3D printed scaffolds were fabricated using a bioprinter (BIO X, Cellink, Sweden). All scaffolds were examined for their morphological characteristics under a scanning electron microscope (SEM), while their physicochemical properties were also assessed by differential scanning calorimetry (DSC), thermogravimetric analysis (TGA), Fourier transform infrared (FT-IR) spectroscopy and Raman analysis.

Funding This research has been co-financed by the European Regional Development Fund of the European Union and Greek national funds through the Operational Program Competitiveness, Entrepreneurship and Innovation, under the call RESEARCH – CREATE – INNOVATE (project code: T2EDK-01641).

References

- [1] Jain N, Jain G, Javed S, Iqbal Z, Talegaonkar S, Ahmad F, Khar R. Recent approaches for the treatment of periodontitis. *Drug Discov Today* 2008; 13: 932–943
- [2] Batool F, Morand D, Thomas L, Bugueno I, Aragon J, Irusta S, Keller L, Benkirane-Jessel N, Tenenbaum H, Huck O. Synthesis of a novel electrospun polycaprolactone scaffold functionalized with ibuprofen for periodontal regeneration: An in vitro and in vivo study. *Materials* 2018; 11: 580

P-427 Poly(3-hydroxybutyrate)-based composite 3D printed scaffolds for tissue engineering applications

Authors [Vasileios Manouras](#)¹, [Konstantinos Theodoridis](#)¹, [Athanasios Arampatzis](#)^{1,2}, [Evangelos Kyriakos](#)³, [Elli Kampasakali](#)³, [Ioannis Tsivintzelis](#)⁴, [Lazaros Tsalikis](#)⁵, [Christina Papanikolaou](#)⁶, [Christos Chatzidoukas](#)⁶, [Panagiotis Barmapalexis](#)^{2,7}, [Dimitrios Christofilos](#)³, [Andreana Assimopoulou](#)^{1,2}

Institutes **1** Aristotle University of Thessaloniki, School of Chemical Engineering, Laboratory of Organic Chemistry, Thessaloniki, Greece; **2** Center for Interdisciplinary Research and Innovation of Aristotle University of Thessaloniki, Natural Products Research Center of Excellence (NatPro-AUTH), Thessaloniki, Greece; **3** Aristotle University of Thessaloniki, Faculty of Engineering, School of Chemical Engineering & Physics Laboratory, Thessaloniki, Greece; **4** Aristotle University of Thessaloniki, School of Chemical Engineering, Laboratory of Physical Chemistry, Thessaloniki, Greece; **5** Aristotle University of Thessaloniki, School of Dentistry, Thessaloniki, Greece; **6** Aristotle University of Thessaloniki, School of Chemical Engineering, Laboratory of Biochemical and Biotechnological Processes, Thessaloniki, Greece; **7** Aristotle University of Thessaloniki, School of Pharmacy, Laboratory of Pharmaceutical Technology, Thessaloniki, Greece

DOI [10.1055/s-0043-1774280](#)

Poly(hydroxybutyrate) or PHB is a natural bio-based aliphatic polyester, which is degradable by numerous microorganisms (bacteria, fungi and algae) [1]. PHB can be produced from bacterial fermentation under nutrient-limiting conditions. Poly(3-hydroxy-butyrate) is considered a non-toxic, highly biodegradable and biocompatible material making it very attractive for various biomedical applications [2]. It is a versatile natural polymer that can be extruded, moulded, spun into fibres or processed into films. However, high production costs, thermal instability, and disputable mechanical properties limit its desirable applications. Copolymers or blends with other polymers can broaden its clinical applications, with enhanced characteristics on demand [3]. PHB alone or with various combinations, has been recently used to create porous structures with a sol-gel approach, suitable for bone tissue engineering scaffolds [4]. In order to improve printability of the PHB material, we have synthesised several blends of PHB with other biocompatible polyesters, namely poly(ϵ -caprolactone) (PCL) and poly(lactic acid) (PLA). Each polymer was diluted in chloroform and their solutions were mixed in appropriate ratios. The composite materials were successfully fabricated as 3D-printed bioscaffolds with the BIO-X 3D-bioprinter (CELLINK, Sweden) using a thermoplastic head. Morphological characteristics of these scaffolds were examined by Scanning Electron Microscopy (SEM), and their physicochemical properties were assessed with Differential Scanning Calorimetry (DSC), Thermogravimetric Analysis (TGA), Fourier Transform Infrared Spectroscopy (FT-IR) and Raman spectroscopy. This work focuses on the exploitation of composite materials based on the natural-based PHB to fabricate 3D printed bioscaffolds for replacing damaged bone tissues or tissues that cannot self-regenerate, such as cartilage tissue.

P-428 Agronomic performance and nutritional properties of *Sarcocornia* Ecotypes grown in an integrated multi-trophic aquaculture (IMTA) system

Authors [Viana Castañeda-Loaiza](#)¹, [Maria João Rodrigues](#)¹, [Eliana Fernandes](#)¹, [Luísa Custódio](#)¹

Institute **1** Centre of Marine Sciences (CCMAR), University of Algarve, Faculty of Sciences and Technology, Building 7, Campus of Gambelas, Faro, Portugal

DOI [10.1055/s-0043-1774281](#)

Sarcocornia A. J. Scott is an edible halophyte with a high economic value due to its nutritional, organoleptic, and medicinal properties. This work determined the influence of different cultivation systems, applied to three *S. perennis* ecotypes collected in the Southern Portugal (SP1, Tavira; SP2, Faro; and SP3, Portimão) on its productivity and nutritional properties. Plants were cultivated in a greenhouse, in an IMTA system, in hydroponics, semi-hydroponics (coco-peat) and conventional cultivation (peat, coco peat and perlite (2:2:1) and irrigated with diluted aquaculture effluents at different salinities (35 mS/cm for SP1 and SP3; 30 mS/cm for SP2). The nutritional load of the used effluent was evaluated, along with the growth, survival, and nutritional profile of the cultivated plants. Cultivation of the ecotypes in the semi-hydroponics and conventional systems reduced the nitrate and nitrite content of the irrigation water. SP2 plants cultivated in the conventional cultivation system exhibited the highest productivity. The protein and ash levels were higher in plants cultivated in the hydroponics and conventional cultivation system, respectively. Our results suggest that cultivation of *Sarcocornia* ecotypes in an IMTA system is possible, and that results in terms of productivity and nutritional profile depend on the ecotype and cultivation system used.

Funding This work was funded by FCT – Foundation for Science and Technology through projects UIDB/04326/2020, UIDP/04326/2020, LA/P/0101/2020, and PT-IL/0003/2019; PhD grants (2020.04541.BD: V C-L) and UI/BD/151301/2121: EF); FCT program contract (UIDP/04326/2020: MJR) and FCT Scientific Employment Stimulus (CEECIND/00425/2017: LC).

Conflict of Interest The authors declare no conflict of interest.

P-429 Medical herbarium of the Faculty of Medicine, University of Coimbra: from a 19th century collection to 21st century health literacy

Authors [Laura Mendonça^{1,2,3}](#), [Ana Castanheira^{1,2}](#), [Carla Varela^{1,2,4}](#), [Henrique Girão^{1,2}](#), [Helena Freitas³](#), [Célia Cabral^{1,2,3}](#)

Institutes **1** University of Coimbra, Coimbra Institute for Clinical and Biomedical Research (ICBR), Clinic Academic Center of Coimbra (CACC),

Faculty of Medicine, 3000-548 Coimbra, Portugal; **2** University of Coimbra, Center for Innovative Biomedicine and Biotechnology (CIBB), 3000-548 Coimbra, Portugal; **3** Center for Functional Ecology, Department of Life Sciences, University of Coimbra, Calçada Martim de Freitas, 3000-456 Coimbra, Portugal; **4** University of Coimbra, CIEPQPF, Faculty of Medicine, Coimbra, Portugal

DOI [10.1055/s-0043-1774282](https://doi.org/10.1055/s-0043-1774282)

In modern pharmacopeia, 25% of herbal drugs are plant-based while several synthetic drugs are inspired by chemical compounds isolated from plants [1]. In the 19th century, Júlio Sacadura Botte, professor at the Faculty of Medicine, University of Coimbra, felt the need to materialise his theoretical explanations. So, to present to his students from which plants the medicines came from, he asked Júlio Henriques, the Director of the Botanical Garden, to compile a herbarium of medicinal plants organised after their medicinal properties. This idea gave inspiration to use this collection in the 21st century and raise awareness for the importance of medicinal plants as potential sources of medicines. Our aim is to preserve this collection, a very important heritage, by digitising, databasing and restoring the 998 specimens. We also will promote health literacy and awareness in the field of medicinal plants, by linking the plants, their active compounds, and the medicines in the market nowadays. These 19th century medicinal uses can inspire new investigations from those species and test them in various incurable pathologies or with less effective treatment available and demonstrate that the preservation of medicinal plants is an investment in human health. Plants have unique molecules that we don't know yet the mechanisms of action in human diseases and have the potential to become new sources of molecules that could be translated in health solutions [2].

References

- [1] Evans. Trease and Evans – Pharmacognosy, 16th Edition. Saunders, Elsevier, UK, 2009; 603. ISBN: 9780702029332
- [2] Howes. The Lancet Oncology 2018; 19 (3): 293–294. doi:10.1016/S1470-2045(18)30136-0

Notice

This article was changed according to the erratum on January 15, 2024.

Erratum

In the above-mentioned article, the authors name Soufiyan Omhmed was misspelled, which is now corrected.

Authors' Index

A

Aas Gregor 1410
 Abate Giulia 1352
 Abderrahim Hammadi 1387
 Abdul Karim Hidayatul Atiqah 1409
 Abels Christoph 1382
 Ab'lah NorulNazilah 1330
 Abu-Ghannam Nissreen 1292
 Abu-Izneid Tareq 1411
 Acevedo- Fernández Juan José 1388
 Acin Sergio 1386
 Adamopoulos Nikolaos 1357
 Adamopoulos Nikos 1331
 Adamska-Szewczyk Aldona 1324
 Adams Latif 1336
 Adelsberger Sigrid 1278
 Adnan Noorzlina 1326, 1327, 1328, 1329, 1330
 Afentouli Nefeli 1403
 Afonso Carlos A.M. 1363, 1424
 Afzan Adlin 1405, 1408
 Agalou Adamantia 1368, 1410
 Agnès Andre 1387
 Agudelo Julián 1335
 Aguilar-Guadarrama Berenice 1388, 1396
 Agyare Christian 1291
 Ahmat Norizan 1326, 1327, 1328, 1329, 1330
 Akinboye Ayodele 1307
 Akman Ece 1353
 Akrap Karla 1358, 1425
 Albert Ina 1393
 Albu Camelia 1385
 Alcaraz Almudena Otorola 1316
 Al-Hmadi Hekmat 1386
 Aligiannis Nektarios 1369
 Alilou Mostafa 1289
 Allard Pierre-Marie 1289, 1412
 Almeida Valter 1323
 Alqahtani Omaish 1360
 Alsharif Bashaer 1380
 Amerand Aline 1387
 Amerikanou Charalampia 1339
 Amiteye Daniel 1301
 Ammar Ramy M. 1301, 1411
 Amountzias Vaios 1369
 Anagnostou Christodoulos 1279, 1330, 1350
 Andrade Fernanda 1357
 Andrade Rosangela V. 1344
 André Vânia 1363
 Andričević Klara 1364
 Andruszkow Léo 1401
 Aneva Ina 1414
 Angeli Konstantina 1368
 Angelkova Venelina 1322
 Angenot Luc 1320, 1421
 Ang Kay Ling 1361
 Añino Yostin 1405
 Anwar Zeeshan 1394
 Anyan William 1372
 Aoki Syui 1342
 Apostolopoulou Maria Eleftheria 1369
 Appendino Giovanni 1282
 Apreutesei Oana Teodora 1385
 Arampatzis Athanasios 1402, 1403, 1425, 1427, 1428
 Arbelaez Natalia 1424
 Arbeláez Natalia 1338
 Argandoña Bertran Montserrat 1366
 Argyriou Katerina 1425
 Argyropoulou Aikaterini 1331, 1349, 1357, 1368
 Arnason John Thor 1283
 Arranz Alba 1366
 Arturo-Schaan Marisela 1390
 Asante-Kwatia Evelyn 1372

Aslanidou Elisavet 1427
 Assimopoulou Andreana 1313, 1359, 1360, 1395, 1402, 1403, 1425, 1426, 1427, 1428
 Aubert Dominique 1276
 Aubert Elora 1351
 Augustynowicz Daniel 1389
 Augustyn Wilma 1413
 Aumer Carola 1349
 Autzen Sabrina 1326
 Avila-Villarreal Gabriela 1332
 Ávila- Villarreal Gabriela 1396
 Ávila-Villarreal Gabriela 1388, 1396, 1417
 Avsar Timucin 1383
 Azahar Siti Zakirah 1328
 Aziz-Kalbhenn Heba 1419
 Azman Farah Izzati 1330
 Azmin Nik Nik 1326, 1327, 1328, 1329, 1330
 Azzollini Antonio 1359, 1412

B

Bachmeier Beatrice 1376
 Bacova Kristina 1280
 Bada Lucia 1295
 Bae Chang-Hwan 1417
 Bae Eun Seo 1414
 Baek Nam-In 1276
 Bae Sung-Jin 1334
 Bafort MFrançoise 1315
 Bahij Rime 1314
 Bailey David Stanley 1415
 Baj Tomasz 1324
 Bakar Syahrul Abu 1405
 Baker Charlotte 1294
 Balcazar Norman 1386, 1424
 Ballesteros-Ramírez Ricardo 1338
 Bangay Gabrielle 1363, 1424
 Bardakci Hilal 1383
 Bardot Valérie 1311
 Barmpalexis Panagiotis 1403, 1425, 1426, 1427, 1428
 Barros Lillian 1337
 Bas Yasemin 1415
 Bateman Rebecca 1316
 Batista João 1323
 Batista Maria Teresa 1317
 Baud Stéphanie 1276
 Bauer Rudolf 1301, 1381, 1394, 1399, 1411, 1414, 1422
 Baumgartner Stephan 1322, 1323
 Baydar Rengin 1379
 Becker Anna-Franziska 1332
 Bedal Konstanze 1343
 Beis Dimitris 1368, 1410
 Bekoe Emelia Oppong 1291
 Belen Lemus Ringle Gabriela 1368
 Belga François Ngnodandi 1291
 Bello Shaibu O. 1387
 Benarbia Mohammed Amine 1305, 1308
 Benarbia Mohammed el Amine 1281
 Benddir Mehdi 1320
 Bender Andreas 1291, 1415
 Beniddir Mehdi Ahmed 1288
 Beni Szabolcs 1343
 Berenice Aguilar-Guadarrama A. 1332, 1396
 Beretta Giangiacomo 1391
 Bergmeier Erwin 1374
 Beteinakis Stavros 1279, 1312, 1400, 1403
 Beukes Natasha 1314
 Bhamra Sukvinder 1376
 Bian Zhao-xiang 1377
 Bicchi Carlo 1359
 Biegel Ulrike 1306
 Bieler Lara 1346

Bigler Laurent 1279
 Biltekin Sevde Nur 1379
 Binou Panagiota 1357
 Bisio Angela 1409
 Bismarck Doris 1358
 Bitterling Hannes 1373
 Bival Štefan Maja 1338
 Blainski Andressa 1416
 Blažeković Biljana 1338
 Blažević Tina 1336
 Bojkova Denisa 1288
 Boldizar Imre 1343
 Bonaterra Gabriel Alejandro 1419
 Bonnet Oliver 1320
 Bonnet Olivier 1320, 1421
 Bonnet Sylvestre 1292
 Bonn Günther 1382
 Bonofiglio Federico 1345
 Bonyadirad Ehsan 1382
 Booker Anthony 1310
 Boonyarat Chantana 1404, 1413, 1416, 1418
 Booth Zelna 1290
 Boppré Michael 1282
 Bory Alexandre 1289
 Bösking Julian 1292
 Bot Maxime Le 1305
 Boudjelal Amel 1319
 Boujedaini Naoual 1418
 Bourqui Angélique 1345
 Boussamba-Digombou Katyna J. 1407
 Boustie Joël 1401, 1410
 Boutefnouchet Sabrina 1299
 Boylan Fabio 1322, 1380
 Bozkurt Buket 1415
 Braca Alessandra 1408
 Braga Tiago 1353
 Braillon Capucine 1351
 Brauning Florencia Z. 1363
 Braun Simon 1340
 Braun Theodor 1382
 Briand Loïc 1350
 Brissoit Alice 1401
 Bruguière Antoine 1350
 Brunel Hilana S. 1344
 Bruner-Montero Gaspar 1405
 Brunner Julia 1331
 Bruyère Arnaud 1390
 Bui Hoa 1281
 Bürkel Peter 1334
 Butterer Andreas 1303
 Byun Woong Sub 1414

C

Cabral Célia 1303, 1369, 1419, 1429
 Caddeo Carla 1309
 Caldwell Maeve 1316
 Calhelha Ricardo 1337
 Calhelha Ricardo C. 1325
 Cal Victor 1283
 Calvo Lorena G. 1364
 Camangi Fabiano 1408
 Cameron Silke 1374, 1421
 Camões Sérgio Póvoas 1396
 Caniça Manuela 1362, 1396
 Carty Michael 1355, 1382
 Carvalho Aida 1369
 Carvalho Aloisio Cunha 1344
 Carvalho Ana Paula 1370
 Carvalho Luis de 1369
 Cassidy Aedin 1287
 Castañeda-Loaiza Viana 1370, 1372, 1428
 Castanheira Ana 1429
 Castilho Rachel Oliveira 1344, 1345

- Cavalheiro Alberto José 1311
 Čavara Lucija 1310
 Čavar Marina 1310
 Celeiro Maria 1308
 Chabane Sarra 1319
 Chaingam Jiranan 1397
 Chaiwipanon Naphat 1347
 Chalard Pierre 1420
 Cha Min Ho 1385
 Champy Pierre 1320
 Chandra Sona 1291
 Chang Ching-Chia 1419
 Chang Fang-Rong 1419, 1423
 Chang Li-Kwan 1342
 Chang Yuan Shiun 1399
 Chang Yuan-Shiun 1394
 Chastanet Marie 1420
 Chatzidoukas Christos 1428
 Chatzitheodoridou Melina 1426
 Cheilari Antigoni 1369
 Chen Bing-Hung 1423
 Chen Chun-Lin 1412
 Cheng Huiyuan 1301
 Cheng Hui-Yuan 1392
 Cheng Ming-Jen 1319
 Cheng Yuan-Bin 1423
 Chen Huan-Yuan 1389
 Chen Jih-Jung 1319
 Chen Lo-Yun 1406
 Chen Shilong 1355
 Chen Weiyang 1407
 Chia-Leeson Olivia 1346
 Chianese Giuseppina 1290
 Chika Aminu 1387
 Chinova Ioanna 1284, 1298, 1354, 1403
 Chiocchio Ilaria 1352
 Chiou Antonia 1357
 Chlopecka Magdalena 1292, 1389
 Choi Minsik 1407
 Choi Na Ri 1389
 Choi Woo-Gyun 1389
 Choi Young Hae 1286, 1355
 Choi Youngmin 1320
 Chollet-Krugler Marylène 1410
 Cho Won-kyung 1420
 Cho Won-Kyung 1334
 Christodoulakis Nikolaos S 1400
 Christofilos Dimitrios 1313, 1359, 1403, 1425, 1427, 1428
 Christopher Yuliana 1405
 Chu En-Liang 1419
 Chulikhit Yaowared 1418
 Chu Yi-Cheng 1319
 Cielecka-Piontek Judyta 1367
 Cihlarova Petra 1399, 1401
 Cinatl Jindrich 1288
 Cinek Ondrej 1392
 Cioni Emily 1408
 Cisse Sekhou 1308
 Cisternas-Olmedo Marisol 1277
 Claas Antonia 1340
 Claude Faivre 1387
 Colombo Luca 1390
 Copetta Andrea 1409
 Cordonnier Julien 1276
 Correia Lilian Cherubin 1311
 Corr Sinéad C. 1382
 Corson Timothy 1294, 1316
 Corthay Alexandre 1301
 Costa António da 1314
 Costa Maria Céu 1314
 Costa Ricardo 1369
 Couillard-Despres Sebastien 1346
 Cousseau Camille 1310
 Coutinho Isabel Duarte 1311
 Cretton Sylvian 1412
 Csajka Chantal 1345
 Cuendet Muriel 1296
 Cuerrier Alain 1283
 Cui-Sun Melody 1381
 Čulić Vedrana Čikeš 1415
 Cunha Carvalho Aloisio 1344
 Curto Joana 1351, 1424
 Custódio Luís 1325
 Custódio Luísa 1295, 1308, 1353, 1367, 1370, 1372, 1428
- D**
- Da Costa Batista Joao Vitor 1322
 Dailey Lea Ann 1278, 1286
 Dancso Andras 1343
 D'Angelo Valeria 1408
 Daniels Rolf 1373
 Danova Kalina 1414
 Danton Ombeline 1319
 Darkó Béla 1352
 Darne Pierre 1276
 da Rosa Neng Nuno 1372
 da Silva Isabel Moreira 1393
 Dassou Hospice 1281
 David Andreea 1353
 Davidson Candance 1413
 Dedoussis George 1339
 Degotte Gilles 1320
 Deharo Eric 1366
 Delabays Nicolas 1331, 1371
 de la Harpe Amy 1314
 De Leo Marinella 1408
 Deli Mária A. 1419
 Dell'Agli Mario 1378, 1380, 1390, 1391
 Delporte Carla 1277
 Delporte Norberta 1312
 Demeyer Kristiaan 1349
 de Miguel Trinidad 1308, 1364
 Demirci Fatih 1420
 De Moor Cornelia H 1295
 Dempsey Elaine 1382
 Denison Hannah 1360
 De Núñez Leticia 1405
 De Petrocellis Luciano 1290
 Desdemoustier Pauline 1320
 De Tommasi Nunziatina 1309, 1408
 de Wet Helene 1373
 Dianita Roza 1388
 Diaz-Lanza Ana-Maria 1337
 Diaz- Lanza Ana María 1303
 Díaz-Lanza Ana María 1325, 1424
 Díaz- Núñez Luis 1323
 Díaz-Román Mónica Aideé 1388
 Diesel Britta 1383
 Diez-Rodriguez Aldahir 1351
 Diken Dilara 1308
 Dimitrova Mila 1305
 Dina Evanthia 1369
 Dinala Mmabatho Monica 1413
 Diretto Gianfranco 1408
 Dirsch Verena 1336, 1422
 Dirsch Verena M. 1333
 Doadee Supawadee 1418
 Doan Thi-Phuong 1385
 Doering Kristin 1298
 Dokupilová Svetlana 1363
 Dominguez Eva 1337
 Domínguez-Martín Eva 1419
 Domínguez Martín Eva María 1325
 Domínguez-Martín Eva María 1303, 1424
 Domokos Erzsébet 1352, 1357, 1401
 Donadio Giuliana 1409
 Donzeles Sérgio Lopes 1354, 1355
 Dordas Christos 1403
 Do Tiên 1298
 Dotsika Eleni 1338, 1339, 1400
 Douglas Kinghorn A. 1287
 Downer Eric 1304, 1316
 Downer Eric J. 1316, 1381
 Dragović-Uzelac Verica 1364
 Drava Giuliana 1409
 Dreбка Alexandra 1376
 Drechsel Franziska 1356
 Driscoll Daniel 1294
 Drobná Eva 1363
 Duarte Paula 1387, 1393, 1396
 Dubbelboer Ilse 1413
 Dubois Julie 1345
 Dubost Jean Marc 1281
 Duck Corinna 1374
 Ducret Gilles 1398
 Dunkić Valerija 1358, 1415, 1425
 Duong Thi Truc-Ly 1336
 Dzoyem Jean Paul 1307
- E**
- Echeverría Javier 1375
 Echeverri Fernando 1335
 Echeverri Luis Fernando 1424
 Eckert Anne 1418
 Edayah Rasol Nurulfazlina 1356, 1409
 Edwards Kieron 1387
 Efferth Thomas 1303, 1419
 Eleni Sakavitsi Maria 1339
 Elgorashi Esameldin 1307
 Eloff Jacobus 1345
 Elsbroek Leonardo 1301
 El-Shazly Mohamed 1423
 Elshorbagy Mohamed Ahmed 1346
 Elusiyan Christianah 1356
 Emberger-Klein Agnes 1375
 Embrey Michelle 1298
 Embry M. R. 1297
 Encarnação Sofia 1395
 Engels S. 1383
 Engler Paul 1305
 Enke Dan 1346
 Enke Heike 1346
 Entezari Bitá 1415
 Erel Buge 1383
 Erhabor Rosemary 1307
 Erol Özlem 1286, 1354, 1355
 Erritoe David 1284
 Ersteniuk Hanna 1324
 Escobar Elkin 1424
 Escotte Sandie 1276
 Essack Sabiha 1290
 Estrada-Soto Samuel 1332
 Evangelakou Zoi 1339, 1368
- F**
- Fabiani Emma De 1390
 Falcão Soraia 1325
 Famuyide Ibukun 1307
 Famuyide Ibukun Michael 1284
 Fechter Pierre 1299
 Feistel Björn 1377, 1416
 Felegyi Kristof 1343
 Fernandes Eliana 1308, 1325, 1367, 1370, 1372, 1428
 Fernandes Hocelayne Paulino 1286
 Fernández-Alegre Estela 1306
 Fernández Estíbaliz Lacalle 1306
 Fernandez Geysson 1386
 Fernández Marín Hermógenes 1405
 Fernando Echeverri Luis 1386
 Ferreira Thátiana Ferraz 1354, 1355
 Ferrier Jon 1283
 Ferro Ms Angelica 1296
 Ferron Solenn 1410
 Fiadeiro Paulo 1424
 Fiala Johannes 1292
 Fialova Silvia Bittner 1348, 1363
 Figueira Maria 1387
 Figueira Maria Eduardo 1393
 Figueirinha Artur 1317
 Figueirinha Artur 1386
 Filipek Przemyslaw 1382

- Filipe Marcia 1337
 Filipe Márcia Santos 1325
 Fiorentino Susana 1338
 Fitzgerald Martin 1310
 Fokialakis Nikolas 1365, 1366
 Fonseca Maira 1357
 Fonseca Maira Marques 1354, 1355
 Forkuo Donkor Arnold 1372
 Formisano Carmen 1388
 Fotiadou Eugenia 1403
 Fotopoulou Asimina 1368
 Fragoso- Martínez Itzi 1417
 Franken Sebastian 1341
 Frank Éva 1278
 Frederich Michel 1320
 Frédéric Michel 1315, 1349, 1421
 Frei-Haller Barbara 1393
 Frei Patricia 1346
 Freitas Helena 1429
 Frost Carminita 1313, 1314
 Fuhrmann Gregor 1313
 Fujii Shunsuke 1397
 Fumagalli Marco 1378, 1380, 1390, 1391
 Funari Cristiano S. 1309
 Fung Hau-Yee 1392
 Furey Ambrose 1365
 Fürnkranz Ursula 1289
 Fürst Robert 1377
 Fu Shu-Ling 1319
 Fytili Christina 1339
- G**
- Gadar Kavita 1355, 1365
 Gafner S. 1297
 Gafner Stefan 1297
 Gainche Maël 1312, 1420
 Gaitanis Konstantinos 1365
 Gaitan Katerin 1405
 Gál Peter 1348
 Gantert Thomas 1332
 Garadi Zsofia 1343
 García-Lara Silverio 1294
 García-Soto Claudia 1371
 Gardan-Salmon Delphine 1390
 Garfield Sara 1375
 Gargiulo Ernesto 1290
 Garigliany Mutien 1420
 Garigliany Mutien-Marie 1421
 Gärtner Tom-Elvis 1358
 Gately Cillian 1394
 Gately Cillian Jacques 1355, 1382
 Gauvin François 1299
 Gehring Ronette 1413
 Genova Francesca 1390
 Georgiyants Victoriya 1322, 1323
 Gerber Luc 1292
 Germanò Maria Paola 1408
 Gertsch Jürg 1285
 Ghani Nurunajah Ab 1319, 1356, 1408
 Ghidini Andrea 1414
 Ghogomu Stephen 1349
 Giacomini Mauro 1409
 Giannarelli Georgia 1360
 Gianniu Despoina 1339
 Gianniu Despoina D. 1365, 1368
 Giavarini Flavio 1390
 Gibbons Simon 1360
 Gibot-Leclerc Lea 1398
 Gika Helen 1395
 Gil-Longo Jose 1295
 Gindro Katia 1285, 1289, 1359, 1411, 1412
 Gioti Katerina 1357
 Girão Henrique 1429
 Girard Nicolas 1366
 Girst Gábor 1278
 Gkiouvetidis Petros 1400
 Gkogkou Eirini 1365, 1368
 Glavac Nina Kocevar 1311
 Glomb Marcus A. 1326
 Gmach Yvonne 1422
- Gnatoyko Kseniia 1324
 Gogou Georgia 1338
 Gomes Arlindo 1351
 Gomes Samuel 1387, 1393
 Gómez Ana M. 1303
 Gonçalves Ana Cristina 1419
 Gonzalez Eduardo Villicana 1402
 Gorfer Lisa Marie 1398
 Gortzi Olga 1354
 Gościński Anna 1367
 Graf Agnes 1336
 Grafakou Maria-Eleni 1301, 1411
 Graf Matthias 1397
 Graf-Schiller Sandra 1292
 Graikou Konstantia 1354, 1403
 Gramlinger Tamara 1291, 1375
 Grazi Mirio 1323
 Greif Arne 1313
 Greiffer Luise 1291
 Grienke Ulrike 1278, 1288, 1298, 1333, 1421
 Griffin Elisha 1294
 Griffiths Rian 1347, 1363
 Grillo Elisabetta 1391
 Grimm Amandine 1418
 Grondin Antonio 1289
 Grougnet Raphaël 1299
 Gruber Thomas Olaf 1410
 Grytsyk Andriy 1324
 Grytsyk Lyubov 1324
 Gsaller Fabio 1289
 Gudžinskas Zigmantas 1323
 Guerra-López Julio Enrique 1360
 Guerrero-Analco José A. 1283
 Guichard Roxane 1305
 Guilet David 1305
 Gul Zulfiye 1383
 Gumeni Sentiljana 1368
 Gunatilaka Leslie 1296
 Gürer Orhan Hande 1415
 Gwendoline Breger 1387
 Gyimah Lord 1372
- H**
- Haas Hubertus 1289
 Häberlein Hanns 1341
 Hackl Michael 1346
 Haddad Pierre 1283
 Hadiani Ismail Nor 1409
 Hädrich Gabriela 1278
 Hae Choi Young 1354
 Hafeez Abdul 1295
 Haiss Patricia 1336
 Ha Ki-Tae 1334
 Halabalaki Maria 1279, 1296, 1312, 1330, 1338, 1339, 1349, 1350, 1352, 1368, 1372, 1400, 1410
 Hallot Eric 1349
 Ha Manh Tuan 1333, 1384
 Hamann Carla 1315, 1420, 1421
 Hamburger Matthias 1319
 Hamed Karim Ben 1353
 Hammami Saoussen 1386
 Hammerle Fabian 1292
 Han Chang-Hoon 1420
 Han Hye Kyung 1320
 Hanikenne Marc 1320
 Hanna Nabil 1289
 Han Quanbin 1284, 1300, 1301
 Han Quan-Bin 1392
 Hansen Immo 1293, 1294
 Harris Cory 1283
 Hartler Jürgen 1399
 Harun Aiza 1327
 Hasan Kamrul 1393
 Hattingh Anna 1382
 Hatzinikolaou Dimitris G. 1365
 Havlik Jaroslav 1392
 Healy Anne Marie 1348
 Hedigan Fiona 1376
 Heilmann Jörg 1331, 1349, 1381, 1395, 1410
- Heinämäki Jyrki 1423
 Heinrich Michael 1299, 1310, 1342, 1375, 1376
 Helesbeux JJ 1414
 Hensel Andreas 1291
 Hermann Stuppner I. R. 1402
 Hermans Nina 1339
 He Ronghui 1323
 Herrmann Fabian 1291, 1301, 1312
 Herrmann Fabian Christopher 1287
 Heusinger Anton 1358
 Heymann Thomas 1326
 Higuaita-Castro Jorge 1338
 Hirsbrunner Gaby 1292
 Hlinakova Lucie 1392
 Hoel Hävard 1301, 1398
 Hofer Niklas 1422
 Hoffknecht Marie-Louise 1358
 Holandino Carla 1322, 1323
 Holinger Mirjam 1292
 Hölzel Leona 1403
 Horgan Mark James 1404
 Horng Jim-Tong 1423
 Hoste Alexis 1420
 Hovhannysyan Nelli 1350
 Ho Yu Ling 1399
 Ho Yu-Ling 1394
 Hribernik Marlene 1394
 Hrytsyk Nataliya 1324
 Hrytsyk Roman 1324
 Hsiao George 1342
 Hsieh Chung-Fan 1423
 Huang Shu-Jung 1342
 Huber-Cantonati Petra 1414
 Huber Robin 1285
 Huffman Michael A 1282
 Hunyadi Attila 1278, 1419, 1423
 Huo Chuying 1300
 Huo Chu-Ying 1392
 Hurina Viktoriia 1322
 Hussein Ahmed A. 1363
 Huwyler Jörg 1322
 Huynh Loi 1383
 Huynh Tran Quoc-Dung 1336
 Hwang Sojeong 1325
 Hwang Tsong-Long 1406, 1423
- I**
- Iannotti Fabio Arturo 1386
 Ibrahim Mohammed 1384
 Ilhan Sukran-Kubra 1383
 Iliopoulos Dimitrios 1341
 Imiolek Magdalena 1316
 Ingalalli Vijay 1291
 Inngjerdigen Kari 1301
 Inngjerdigen Kari Tvete 1295
 Inngjerdigen Marit 1351
 Inoue Naoki 1342
 Iobbi Valeria 1409
 Irem Kaya Gulen 1415
 Isah Murtala 1384
 Isca Vera 1337, 1363, 1424
 Isca Vera M.S. 1314
 Ismail Nor Hadiani 1319, 1405, 1408
 Ivanauskas Liudas 1322
- J**
- Jabal Khadijah 1326
 Jablan Jasna 1310
 Jacques Gately Cillian 1354, 1365
 Jagu Elodie 1312
 Jakab-Farkas László 1401
 Jakimiuk Katarzyna 1389
 Jaklin Manuela 1379
 Jakschitz Thomas 1382
 Jakupović Lejsa 1370
 Jalil Banaz 1299
 Jambwa Prosper 1284
 Janeckova Lucie 1303
 Janel-Bintz Régine 1299, 1351
 Jang Young Pyo 1286, 1407

Jansen Olivia 1315, 1421
Jantan Ibrahim 1388
Jarosova Veronika 1392
Jato Jonathan 1291
Jauregui Pedro Molina 1367
Jeang Jin Woo 1276
Jefford Hannah 1316
Jelić Dubravko 1338
Jeong Haejeong 1389
Jeon Mijin 1417
Jin Zhuming 1421
João Rodrigues Maria 1370, 1372
Johari M.Sulaiman M. 1326, 1327
Johari Muhammad Mohd 1328, 1329, 1330
Johnson H. 1297
Jonis Noraly 1413
Joo Yuk Heung 1384
Jordan Paul 1288
Jorge Joana Jorge 1419
Jovanovic Mirna 1424
Jullien Kateline 1315
Jung Seo Yun 1417
Jung YeonGyun 1345
Jürgenliemk Guido 1334, 1410

K

Kadir Nur Abdul 1356
Kagalwala Inshiya 1348
Kahya Sumeyye Elif 1412
Kaili Stavroula 1365
Kaiser Marcel 1317, 1366
Kaiser Simone 1332
Kalampokis Evangelos 1372
Kalber Olaf 1411
Kaliora Andriana 1339
Kalogeropoulou Aggeliki 1402
Kalpoutzakis Eleftherios 1330, 1350, 1368
Kamarozaman Aisyah Salihah 1326, 1327, 1328, 1329, 1330
Kamatou Guy 1382, 1407
Kambizi Learnmore 1370
Kammerer Dietmar 1304, 1373
Kampasakali Elli 1313, 1359, 1403, 1425, 1427, 1428
Kang Ki Sung 1333
Kang Se Chan 1276
Kang Woo Chang 1417
Kapourani Afroditi 1425, 1426
Karadag Ayse Esra 1420
Karadağ Ayşe Esra 1379
Karagouni Amalia D. 1365
Karamanou Konstantina 1368
Karampetsou Kalliopi V. 1400
Karathanos Vaios 1357
Karavus Sule Nur 1412
Karlik Wojciech 1292
Katanić Stanković Jelena S. 1381
Katerere David 1355
Kayser Leonie 1410
Kearney Louise 1356
Keaveney Anna-Maria 1365
Kechri Eleni 1395
Kelber O. 1297
Kelber Olaf 1291, 1301, 1343, 1375, 1376, 1377, 1419
Keller Morris 1319
Kelly Alison 1360
Kern Cornelia 1377
Khamis Shamsul 1356
Khamphukdee Charinya 1418
Khederlarian Lila 1291
Khoder Mouhamad 1360
Kierner Alexandra K. 1383
Kim Ah Hyun 1320
Kim Byung Joo 1389
Kim Dong-Hyun 1347, 1363
Kim Dong-Seon 1378, 1384
Kim Hee-Young 1417
Kim Heon-Woong 1325
Kim Hye Kyong 1286
Kim Hyungwoo 1343, 1382
Kim Hyun Jun 1321
Kim Jeong Ah 1333, 1384
Kim Kibong 1334
Kim Kwang-Youn 1385
Kim Kyu Won 1407
Kim Min Seo 1417
Kim Mi-Sun 1378, 1384
Kim Seung Hyun 1333
Kim Seung-Hyung 1384
Kim Seungtae 1417
Kim Song-Hee 1385
Kim Soyeon 1343
Kim Su Nam 1333
Kim Sung Jin 1393
Kim Won Kyung 1414
Kim Yeoun-Hee 1334
Kim Young-Joo 1333
Kindl Marija 1364
Kinscherf Ralf 1419
Kiong Ling Sui 1408
Kirchhoffer Olivier 1289
Kirchmair Johannes 1333, 1409
Kirchweger Benjamin 1288, 1421
Kirimkirogrou Katerina 1425
Kiss Anna 1321
Kiss Anna Karolina 1278, 1379, 1380
Kleef Regina van 1298
Klenner Alena 1293
Kletsas Dimitris 1368
Kloucek Pavel 1392
Knittel-Obrecht Adeline 1374
Knizkova Katerina 1399
Knöss Werner 1315
Knubben-Schweizer Gabriela 1281
Koch Erik 1417
Koeberle Andreas 1382, 1383
Koekemoer Trevor 1382
Koenderink Jan 1413
Koh Hwee Ling 1323
Köhler Thilo 1289
Koh Matthew 1323
Kohoutova Lenka 1401
Kok Kin Aik 1293
Kokkini Emeritus Stella 1359
Kolb Christiane 1419
Koletti Antigoni 1403, 1425
Koltun-Jasion Małgorzata 1379, 1380
Komane Baatile 1359
Komisarenko Mykola 1423
Koncic Marijana Zovko 1370
Končić Marijana Zovko 1310
Könczöl Árpád 1419
Kong Chang Hyeon 1417
Kontaxakis Emmanouil 1410
Kontogiannopoulos Konstantinos 1360
Koreh Beáta 1401
Korinek Michal 1423
Koromili Maria 1425
Koshovyi Oleh 1324, 1385, 1423
Kosney Pauline 1313
Kostakis Ioannis 1338, 1341, 1352
Kostakis Ioannis K. 1302
Koufali Christina 1369
Kouretas Demetrios 1341
Koutsioni Olga 1338
Koutsioni Olga S. 1339, 1400
Kozurak Alla 1323
Kraft Karin 1291, 1375
Kragl Martin 1382
Kraus Martin M. 1333
Kraus Sebastian 1332
Kravchenko Ganna 1385
Kremer Dario 1358, 1415, 1425
Kristofova Radoslava 1280
Krstic Sanja 1381

Krüger Christine 1348
Krugler Marylène Chollet 1401
Kuchar Martin 1303, 1315, 1399, 1401
Kuchta Kenny 1302, 1374, 1421
Kuck Katrin 1381
Kukula-Koch Wirginia 1286
Kukula-Koch Wirginia 1354, 1355
Kulić Žarko 1303, 1332
Kunert Olaf 1293
Künstle Gerald 1378, 1379, 1391, 1418
Kupniewska Katarzyna 1321
Kurin Elena 1348, 1363
Ku Sejin 1407
Kwon Jeong Eun 1276
Kyriazis Ioannis D. 1341
Kyrilas Evangelos 1313, 1427, 1428

L

Lackner Michaela 1292
Laczkó Dávid 1419
Laenger Lisa 1293
Lahngong Methodius 1349
Lai Kuei-Hung 1406
Lalk Michael 1348, 1368
LaMare Jo De 1413
Lam Chu Shing 1334
Lameiras Pedro 1312, 1394
Landim Euclides 1369
Langat Linda 1294
Langat Moses 1294, 1316
Langeder Julia 1298
Langel Ana 1368
Lanteri Anna Paola 1409
Lara Silverio Garcia 1371
Lardos Andreas 1393, 1422
Laskari Maria 1403
Laskaris Paris 1365
Latek Urszula 1292
Lau Clara Bik-San 1285, 1337
Lawrence Steven 1295
Leal Claudia Espinosa 1371
Leandros Skaltsounis Alexios 1331
Lebeloane Moipone 1307
Lecoultre Nicole 1359, 1411
Ledderhose Cindy 1315
Le-Dévêhat Françoise Lohézic 1401
Ledoux Allison 1315, 1320, 1349, 1420, 1421
Lee Ching-Kuo 1336
Lee Geung-Joo 1384
Lee Hanul 1417
Lee Hee Ju 1361
Lee Hyo-rim 1321
Lee Ji Hwan 1393
Lee Julia 1337
Lee Kyoung Tae 1321
Lee Myong-Min 1420
Lee Sang Kook 1414
Lee Sookyeong 1325
Lee Sullim 1333
Lee Tzong-Huei 1342
Lee Yeong-Geun 1276
Legouin Béatrice 1310
Lehner Martin D. 1392
Le Huong-Giang 1406
Lei Feiyi 1279
Lejri Imane 1418
Leka Kristi 1315, 1420, 1421
Lenen Lauriane 1299, 1374
Le Ngoc-Thao-Hien 1277
Lenta Bruno 1366
Leon Estela 1351
Leroy Ritchy 1394
Lescano Leonardo 1367
Le Thi Thanh 1384
Liang Jia-Hua 1319
Liang Zheng-Ming 1334
Liao Chung-Ping 1406
Liasi Georgia 1427, 1428

- Liaw Chia-Ching 1319
 Libault Arthur 1315
 Liebau Eva 1291
 Li Lifeng 1301, 1392
 Lima Beatriz Silva 1362, 1396
 Lima Felipe Pedroz 1344, 1345
 Lima Katelene 1362, 1387, 1393, 1395, 1396
 Limanton Emmanuelle 1310
 Li Min 1422
 Lin Jialiang 1295
 Lin Ming-Kuem 1389
 Lionel Martignat 1387
 Lipowicz Bartosz 1381
 Li Songhua 1421
 Liu Alex 1323
 Liu Hang 1422
 Liu Liam 1323
 Liu Rongxia 1336
 Liu Ta-Wei 1336
 Liu Zhijun 1347
 Li Wanfei 1334
 Li Weilan 1325
 Li Xiaomei 1421
 Li Xuan 1323
 Lobb Kevin 1313
 Löbel Katja 1375
 Loe Gisèle E. 1349
 Loffredo Loic 1394
 Lohéziec-Le Dévéhat Françoise 1410
 Loh Yen-Thong 1323
 Loo Yen Chi 1423
 Lopez April 1293
 Lora Aylin De 1405
 Lorenz Peter 1304, 1373
 Lores Marta 1308, 1364
 Louka Xanthippi P. 1368
 Lovković Sandy 1338
 Lozić Mirela 1415
 Lucey Brigid 1365
 Luderer Gabriele 1332
 Luker Hailey 1293, 1294
 Luscher Alexandre 1289
 Lussot-Kervern Isabelle 1280
 Lu Yi-Shan 1342
 Lyu Aiping 1284, 1348
- M**
- Maake Caroline 1342
 Maccarinelli Giuseppina 1352
 Mad Sukor Nur Syahirah 1408
 Maeschli Ariane 1281
 Magalhães Mariana 1303, 1419
 Maggi Norbert 1409
 Magiatis Prokopios 1354
 Magid Mariam 1376
 Maher Fiona 1365
 Mähler Nicole 1382
 Mähr Theresa 1414
 Maia Lucas Moreira 1354, 1355
 Maier Jakob 1322
 Maier Michael 1389
 Mailänder Lilo 1304, 1373
 Ma Jin Yeul 1334, 1345, 1420
 Mak Herng 1300
 Malfent Fabian 1318
 Malmir Maryam 1362, 1387, 1393, 1396
 Mamabolo Makosha Patience 1366
 Mambu Lengo 1398
 Mamede Lucia 1320
 Mamun Abdullah Al 1334
 Manageiro Vera 1362
 Mandić Marta 1338
 Mandim Filipa 1337
 Mandrone Manuela 1352
 Manfron Jane 1323
 Manola Maria S. 1368
 Manouras Vasileios 1428
 Manso Tamara 1364
- Mantzouridou Fani 1402
 Maranta Nicole 1378, 1380, 1390, 1391
 Maravič-Vlahoviček Gordana 1364
 Marcellin-Gros Rémy 1411
 Marcourt Laurence 1285, 1289, 1412
 Maria Ana Santa 1419
 Marija Marija 1415
 Marijan Marijan 1370
 Marotte Alison 1315, 1320
 Marques Joana 1369
 Marques Mário Pedro 1369
 Marrone Maravi 1405
 Marsik Petr 1392
 Marsman D. S. 1297
 Martinelli Giulia 1378, 1380, 1390, 1391
 Martínez-Arévalo José Vicente 1360, 1367
 Martínez-Martínez Sonia 1306
 Martínez-Pastor Felipe 1306
 Martinez Sergio 1405
 Martín-Fernández Beatriz 1306
 Martin Lehner D. 1332
 Martins Elen 1357
 Mascellani Anna 1392
 Mäser Pascal 1317
 Masi Francesca 1386
 Maslovska Daniela 1356
 Mastinu Andrea 1352
 Ma Susanna 1323
 Matope Gift 1284
 Matos Patrícia 1317
 Mavreas Konstantinos F. 1302
 Mavrogonatou Eleni 1368
 Mayer Philipp 1292
 McCarthy Ronan 1365
 McCarthy Ronan R. 1355
 McComish Sarah 1316
 McGaw Lyndy 1307, 1413
 McGaw Lyndy Joy 1284
 McGearthy Catriona 1356
 Mckee-Bennett Michelle 1336
 Medeiros João 1351, 1424
 Medina-Díaz Irma Martha 1396
 Medina-Díaz Irma-Martha 1332
 Meier Larissa 1414
 Mejia Alejandro 1386
 Melatti Carmen 1364
 Memo Maurizio 1352
 Mendel Marta 1292, 1308, 1389
 Mendes José 1351, 1424
 Mendes Thiago Oliveira 1354, 1355
 Mendonça Laura 1429
 Meneses George 1403
 Menoud Valérie 1292
 Menrad Klaus 1375
 Mensah Yeboah Abraham 1372
 Mérida-Reyes Max Samuel 1360, 1367
 Mertzaniotis Dimitrios 1359
 Mervić Mateja 1364
 Meurer Fabio 1341
 Michailidis Dimitrios 1357
 Michailidis Dimitris 1349, 1372
 Michalitsis Andreas 1403
 Michelin Clément 1312
 Mijangos Abdala Coutiño 1371
 Mikropoulou Eleni 1330
 Mikropoulou Eleni V. 1296, 1339, 1410
 Mikros Emmanuel 1312
 Milella Luigi 1309
 Milic Nikola 1366
 Min Byung Sun 1333, 1384
 Minorics Renáta 1278
 Minuto Giovanni 1409
 Miranda Joana Paiva 1396
 Misakyan Micaela Freitas 1296
 Mitaine-Offer Anne-Claire 1350
 Mitakou Sofia 1330, 1349
 Mitchell C. A. 1297
 Mitchell Connie 1298
- Mkabayi Lithalethu 1313
 Mncwangi Nontobeko 1366
 Moane Siobhan 1336
 Mohnl Michaela 1304
 Mokwana Nthabiseng Prudence 1413
 Molnár Barnabás 1278
 Monaghan Tanya 1347, 1363
 Monchak Irailson 1323
 Mondolis Eily 1351
 Mondragón Andrés Rivera- 1405
 Monthakantirat Orawan 1418
 Morales-Barrios Abdy 1351
 Moran-Pinzo Juan 1351
 Moreira da Silva Isabel 1387
 Mori Emiliano 1282
 Morimoto Satoshi 1397
 Morineau Denis 1310
 Moritz Kathrin 1382
 Moser Simone 1276, 1346
 Mösges R. 1376
 Mösges Ralph 1340
 Mottaghishah Javad 1289
 Mou Linru 1342
 Mousa Walaa 1411
 Msomi Nontokozi 1384
 Mučaji Pavel 1348, 1363
 Much Laura 1419
 Muhamad Abu Zar 1328
 Mulholland Dulcie 1294, 1316
 Müller Elisabeth 1358
 Munkert Jennifer 1313
 Munoz Diana Lorena 1424
 Murillo Javier 1338
 Mykhailenko Olha 1304, 1322, 1323, 1423
- N**
- Nagar Shipra 1293, 1354, 1355
 Nagy Milan 1348
 Nakas Alexandros 1359, 1360, 1395, 1403, 1425
 Nash Robert J. 1355
 Nasim Talat 1346
 Nasti Rita 1391
 Nau Roland 1374
 Nausch Lydia 1389
 Nazaryan Samvel 1350
 Nazlić Marija 1358, 1425
 Nchu Felix 1370
 Ncube Efficient 1407
 Ndjonka Dieudonné 1291
 Neagu Elena 1309, 1385
 Neasta Jérémie 1278
 Nedelcheva Anely 1305, 1373
 Negrete-León Elizabeth 1388
 Nemeskalova Alzbeta 1315
 Nenadis Nikolaos 1402
 Neng Nuno 1295
 Neo Soek-Ying 1323
 Neubauer Christine 1382
 Nickl Anna 1381
 Nicotra Giovanna 1390
 Nieber Karen 1343, 1377
 Niedermayr Valerie 1318
 Niedermeyer Timo H.J. 1346
 Nieto Joaquín J. 1366
 Nik Azmin Nik Fatini 1327
 Nikou Theodora 1279, 1296, 1339, 1372, 1400
 Nisticò Antonio 1309
 Nitschke Jahn 1289
 Noel Olga 1305
 Noguchi Kanta 1397
 Nogueira Professor José 1295
 Nothias Louis-Félix 1289
 Nouet Cécile 1320
 Noundou Xavier Siwe 1366
 Noundou Xavier Siwe- 1413
 Nuntawong Poomraphie 1397
 Nuzillard Jean-Marc 1394
 Nyemba Getrude 1413

Nyffeler Reto 1279

O

Obaidi Ismael 1354, 1355, 1365, 1382
Oberhofer Martina 1318, 1371
Oberhuber Michael 1398
Obiri-Yeboah Dorcas 1336
Ocelova Vladimira 1304, 1307
Ochi Akihiro 1397
Ock Chae Won 1414
Ogundaini Abiodun 1356
Oh Keun 1361
Oh Won-Keun 1385
Oiry Catherine 1278
Oketch-Rabah H. A. 1297
Oku Hisae 1342
Olalaye Olubusola 1412
Olawuwo Olasunkanmi Stephen 1284
Oliva-Hernández Bessie Evelyn 1360
Oliveira Paulo 1369, 1419
Olugbade Tiwalade 1356
Omhmmed Soufayan 1278
Ona Ragazinskiene 1374
Onsawang Thanapat 1347
Orman Emmanuel 1291
Orozco Jahir 1424
Ortiz-Castro Randy 1417
Ortiz Orlando 1405
Ortiz Sergio 1299, 1366, 1374
Ortiz-Vargas Brisia-Marlen 1417
Osman Ahmed K. 1423
Otalora-Alcaraz Almudena 1381
Otero-Palacio Rolando 1405

P

Pachi Vasiliki K. 1312
Pachmayr Johanna 1414
Palenicek Tomas 1303
Palmaerts Benjamin 1349
Pampori Aspasia 1403
Pannwitz Andrea 1292
Panteli Efthymia 1372
Papachristodoulou Anastasia 1279, 1368, 1400
Papadakis Martina 1348
Papageorgiou Spyros 1425
Papageorgiou Vassilios 1427
Papaiconomou Nicolas 1310
Papaioannou Varvara 1349, 1400
Papakaloudis Paschalis 1403
Papakotsi Panagiota 1302, 1338, 1341
Papanikolaou Christina 1428
Papazoglou Georgia 1350
Papp Viktor 1343
Paquin Ludovic 1310
Paranhos António 1317
Parisi Valentina 1309, 1409
Park Arin 1320
Park Eunji 1320
Park Geonha 1407
Park Gwang Hun 1321
Park Hyen Joo 1414
Park Jinju 1320
Park Keontae 1417
Park Wonyoung 1334
Park Youngki 1321
Pathomwachaiwat Thanika 1353
Patyra Andrzej 1278, 1321
Paun Gabriela 1309, 1385
Pavlea Maria 1400
Pečínar Ilinka 1369
Peintner Ursula 1289, 1292
Pelín Marco 1378
Peltner Lukas 1288
Peng Bo-Rong 1406
Penkova Yana B. 1355
Péraldi-Roux Sylvie 1278
Pereira Alana Kelyene 1286
Pereira Catarina 1367

Pereira Catarina G. 1295, 1370
Pereira Raquel 1314, 1337
Perez-Sabino Juan Francisco 1360, 1367
Perhal Alexander 1422
Perhal Alexander F. 1333
Pesek Todd 1283
Pestic Milica 1424
Peter Samuel 1393
Petković Tea 1338
Petzger Inge-Marie 1307
Pferschy-Wenzig Eva-Maria 1293, 1301, 1381, 1399, 1411, 1422
Pham Ha-Thanh-Tung 1361
Phechkrajang Chutima 1347, 1353
Piazza Stefano 1378, 1380, 1390, 1391
Pichon Valentin 1398
Pierre Fechter M 1351
Pieters Luc 1277, 1339
Pigott Maria 1293, 1354, 1355, 1365, 1382
Pillinger Manuela 1307
Pinault Emilie 1398
Pinetti Elettra 1412
Pinheiro Patricia 1357
Pinto Cleide Ferreira 1354, 1355
Pinto Rui 1387
Piqué-Borràs Maria-Riera 1378, 1379, 1389, 1391, 1418
Pires Tânia C.S.P. 1325
Pirker Teresa 1414, 1422
Pitchon Véronique 1351
Piwowarski Jakub 1280
Pjevac Petra 1318, 1362
Placha Iveta 1280
Pletschke Brett 1313
Pliakou Christiana 1427
Poh Keng-Ling 1323
Polak Joanna 1306
Poli Ferruccio 1352
Posluszny Martyna 1308
Possart Katharina 1287
Potterat Olivier 1319
Pozzoli Carola 1378, 1380, 1390, 1391
Pramsohler Manuel 1398
Prathantarug Sompop 1353
Pratsinis Harris 1368
Prenderville Jack 1381
Prescimone Alessandro 1319
Pristouschek Christof 1307
Prueksa Suriwipa 1353
Pruteanu Lavinia-Lorena 1415
Pucci Mariachiara 1352
Puenta-Garza César Armando 1294
Puşças Amalia 1337, 1340
Püssa Tõnu 1324
Puteh Osman Che 1409

Q

Qassadi Fatimah 1347, 1363
Queiroz Emerson 1411
Queiroz Emerson Ferreira 1285, 1289
Queiroz Marcelo 1386
Quezada Elías 1295
Quignard Jean-François 1278
Quiñones Winston 1335
Quintas Célia 1370

R

Raal Ain 1324, 1385, 1423
Rabenau Holger Friedrich 1288
Racz Balint 1343
Radhi Masar 1295
Radu Gabriel Lucian 1309, 1385
Raeber Justine 1404
Rafael Camacho Dayana-Guadalupe 1417
Rajbhandari Meena 1334, 1368
Rama Jose R. 1364
Rama José R. 1364
Raman Vijayasankar 1323

Ramírez Johana López 1371
Ramm Hartmut 1323
Rampa Khumo 1382
Rapisarda Samuel 1292
Rapper Stephanie Leigh-de 1296, 1362
Raskopf E 1376
Rasol Nurulfazlina Edayah 1319, 1328, 1408
Ratão Isabel 1370
Raulf Marie-Kristin 1291
Rausch Hans 1374
Raviraj Thiagarajan 1423
Razak Mohd Abd 1405
Redl Martina 1311
Reich Eike 1298
Reichling Jürgen 1377
Reilly Thomas 1381
Reis Bianca Carvalho 1354, 1355
Remirez Diadelis 1377, 1378
Remy Simon 1276
Renault Jean-Hugues 1276
Restrepo Adriana 1424
Rianika Mustafa Natali 1286
Ribeiro da Silva Antonio Jorge 1360, 1367
Ribeiro Izabella 1344
Rider C. V. 1297
Riepl Herbert 1346
Rigano Daniela 1388
Rijo Patrícia 1314, 1337, 1363, 1419
Rijo Patrícia 1303, 1325, 1424
Ringle Gabriela Lemus 1368, 1400
Ripoche Isabelle 1420
Rivera-Mondragón Andrés 1405
Robatscher Peter 1398
Robledo Sara M. 1335, 1338
Rocha João 1387
Röck Birgit 1303
Rodilla Jesus 1351
Rodondi Pierre-Yves 1345
Rodrigues Maria 1308, 1367, 1370
Rodrigues Maria João 1325, 1353, 1428
Rodríguez Brandon Marroquín 1371
Rodríguez-Carpena Javier German 1396
Rodríguez-Carpena Javier-German 1396
Rodríguez-de La Garza Enrique 1294
Rodríguez-Hernández Cesáreo 1323
Rodríguez-Jimenez Daniela-Yusbizareth 1396
Rodríguez Juan Celis 1371
Rodríguez Tania Antón 1366
Röhl Johann 1378, 1379, 1389, 1391, 1418
Rojas-García Aurora Elizabeth 1396
Rojsanga Piyanch 1347, 1363
Rollinger Judith M. 1278, 1333, 1421
Rollinger Judith Maria 1288, 1298, 1311
Roth-Ehrang René 1416
Roussin Enola 1401
Roux-Pullen Lerica Le 1413
Rubiolo Patrizia 1359
Rushdan Nur Ammar 1408
Russel Frans 1413
Russo Daniela 1309
Rutz Adriano 1283, 1412
Ryoo Rhim 1321
Ryu Dongryeol 1334
Ryu Ji Hyo 1343
Ryu Jong Hoon 1417

S

Sabiha Shabnam 1387
Sadowska Agnieszka 1380
Saidin Syafiqah 1330
Sakamoto Seiichi 1397
Sakavitsi Maria Eleni 1350
Saldanha Luiz Leonardo 1279
Saleh Sabiha Hanim 1326, 1327
salihah Kamarozaman Aisyah 1327
Salihu Abubakar Siddiq 1356
Salim Fatimah 1319, 1329, 1408
Salleh WanMohdNuzul Wan 1356

- Salleh Wan Wan 1408
 Salmin Nursabrina Najwa 1408
 Saltan Fatma Zerrin 1353
 Samara Dionysia 1395
 Samba Nsevolo 1351, 1424
 Sanchez Sandra 1364
 Sandasi Maxleene 1407
 Sangiovanni Enrico 1378, 1380, 1390, 1391
 SanMiguel-Chávez Rubén 1323
 Sanna Cinzia 1352
 Santoro Valentina 1309
 Santos Daniel J.V.A. 1424
 Santos Leticia Barbosa 1344, 1345
 Santos-Martinez Maria 1380
 Saraiva Lucília 1424
 Sarikakaki Georgia 1341
 Sarti Elena 1342
 Sasse Astrid 1376
 Sawicki Rafal 1407
 Scafati Orazio Tagliatalata 1290
 Scalabrino Gaia 1355
 Schäfer Lizanne 1317
 Schärer Hans-Jakob 1294
 Scheyhing Ulrike 1392
 Schilling Stephan 1397
 Schlicht Ramona 1397
 Schlittenlacher Theresa 1281
 Schmelzer Sebastian 1389
 Schmidtke Michaela 1298
 Schmidt Thomas J. 1317
 Schmidt Thomas Jürgen 1287
 Schmietendorf Hannes 1298
 Schmitt Markus 1332
 Schnee Sylvain 1285, 1289, 1411
 Schneider Heike 1332
 Schönborn Andreas 1397
 Schoss Katja 1311
 Schreiber Sebastian 1301
 Schüler Vincent 1303
 Schulte-Michels Janka 1341
 Schuster Daniela 1288, 1414, 1417
 Schuster Sabine 1346
 Schwaiger Stefan 1356, 1402
 Schwarzinger Jacqueline 1278
 Schwarz Patrik 1333, 1422
 Schwikkard Sianne 1294, 1360
 Schwindl Sebastian 1349
 Schwitzer Felix 1414
 Scotti Francesca 1342
 Scully Rachel 1394
 Seele Jana 1374
 Seiça Raquel 1386
 Selmi Aida 1353
 Sena Cristina 1386
 Sena Nancy 1357
 Sen Burcu 1383
 Sendker Jandirk 1355
 Sens-Albert Carla 1332
 Seo Ji Eun 1417
 Seo Jongbeom 1321
 Seopela Mathapelo 1366
 Sergio Ortiz M 1351
 Serino Elena 1386, 1388
 Serrano Rita 1393
 Sgorbini Barbara 1359
 Shakeel Butt Hussain 1351
 Shamsudin Kamsirah Jim 1319
 Sharma Sobha 1376
 Sheridan Helen 1293, 1348, 1354, 1355, 1365, 1376, 1382, 1394
 Sherlock Lee 1355
 Shimomura Kana 1342
 Shin Myoung-sook 1393
 Shin Myoung-Sook 1333, 1393
 Siby Anu 1376
 Sichova Klara 1303
 Siegmund Stefan 1377
 Siewert Bianca 1292, 1404
 Silva Isabel da 1362
 Silva Lucia 1351, 1424
 Silva Olga 1362, 1387, 1393, 1395, 1396
 Simelane Mthokozisi 1384
 Sita Dragos Dan 1315
 Sitarek Przemysław 1303
 Sithisarn Patchima 1363
 Sithisarn Pongtip 1347, 1363, 1397
 Skaltsounis Alexios L. 1302
 Skaltsounis Alexios-Leandros 1338, 1341, 1403
 Skaltsounis Leandros 1352
 Skaltsounis Leandros A. 1400
 Skaltsounis Leandros-Alexios 1357
 Slobodniková Lúvia 1363
 Smelcerovic Andrija 1331
 Socaci Sonia Ancuta 1353
 Soeberdt Michael 1382
 Soldati Thierry 1289
 Sonopo Molahleli 1413
 Sosa Silvio 1378
 Sotenjwa Zimkhitha 1407
 Soto-Hernandez Marcos 1323
 Souopgui Jacob 1349
 Souza Maria Miranda 1354, 1355
 Spengler Gabriella 1343
 Spiegel Verena 1291, 1309
 Šprajc Ekaterina 1338
 Stahl-Biskup Elisabeth 1377
 Stamou Panagiota 1338, 1352
 Stathopoulos Panagiotis 1352, 1400, 1403
 Stavropoulos Georgios 1368
 Ștefănescu Ruxandra 1315, 1337, 1340
 Ștefănescu Ruxandra 1357
 Stefi Aikaterini L 1400
 Stehlin Jonas 1393, 1422
 Steinbrecher Stefan 1371
 Stephens Kevin 1294
 Stergiopoulos Athanasios 1357
 Stergiou Athena 1357
 Steuer Christian 1404
 Stevanović Zora Dajić 1369
 Stintzing Florian 1304, 1373
 Stock Laura Louisa 1346
 Stornaiuolo Mariano 1388
 Stoyanova Elena 1414
 Stoyanov Asen 1305, 1322, 1373
 Strawa Jakub 1389
 Strehl Christoph 1340
 Strube Christina 1291
 Stuppner Hermann 1356, 1404
 Suarez Cynthia Gisela 1416
 Suda Simon 1399
 Sudberg E. 1297
 Su Jui-Hsin 1317, 1318, 1406
 Suleiman Monica 1319, 1408
 Sung Jungsook 1325
 Sung Ping-Jyun 1317, 1318, 1406
 Sung Yoon-Young 1378, 1384
 Sun Melody Cui 1316
 Suor-Cherer Sorphon 1281, 1308
 Sutton Martin 1381
 Švajdenka Emil 1348
 Svouraki Alexandra 1403
 Swanepoel Bresler 1382
 Sweeney Eileen Mac 1352
 Syed Basharat 1304
 Sykora David 1315
 Szadkowska Dominika 1389
 Szulc Piotr 1367
- T**
 Tache Andrea 1309
 Tagliatalata-Scafati Orazio 1386, 1388
 Talvistu Kelly 1324
 Tamm Lucius 1294
 Tanaka Hiroyuki 1397
 Tchinda Alembert Tiabou 1320
 Teichmann Klaus 1307
 Tembu Jacqueline 1413
 Temml Veronika 1288, 1383, 1404, 1414, 1417
 Tenta Roxane 1357
 Tentoulouris Nikolaos 1339
 Tero-Vescan Amelia 1337, 1340
 Theodoridi Antonia 1368
 Theodoridis Konstantinos 1427, 1428
 Thiago Antônio de Oliveira Mendes PH D 1355
 Thongwat Wanida 1347
 Thuerig Barbara 1294
 Tian Chuanxi 1422
 Tiefenbacher Stefanie 1422
 Tirelli Emanuela 1352
 Tolan Kate 1348
 Toma Camelia 1315
 Tomczyk Michał 1389
 Tomisova Katerina 1392
 Tommasi Nunziatina De 1409
 Tomputsa Sarocha 1404
 Tong Xiaolin 1422
 Torres Fernando 1335
 Toth Gabor 1343
 Tóth Gábor 1419
 Trabelssi Nidhal 1311
 Trajčíková Eva 1363
 Tran Hung 1383
 Trantas Emmanouil 1372
 Trempat Pascal 1418
 Trentin Riccardo 1367
 Trentin Riccardo Trentin 1325
 Trougakos Ioannis 1339, 1368
 Trougakos Ioannis P. 1365, 1368
 Trouve Estelle 1420
 Tsafantakis Nikolaos 1365, 1366
 Tsakos Michail 1302
 Tsalikis Lazaros 1403, 1425, 1427, 1428
 Tsang Nga Yi 1334
 Tseng Hsuan-Jung 1318
 Tsiaprazi-Stamou Artemis 1360
 Tsiokanos Evangelia 1365, 1366
 Tsiounis Vlasios 1410
 Tsioutsiou Efthymia Eleni 1369
 Tsvintzelis Ioannis 1425, 1426, 1427, 1428
 Tsouna Angelina 1425
 Tuenter Emmy 1277
 Tvete Inngjerdingen Kari 1351
 Tzimpilis Evangelos 1426
- U**
 Uberti Daniela 1352
 Ubolban Churdphong 1413
 Uebbing Lukas 1340, 1341
 Ukponu Obianuju 1381
 Ulriksen Emilie 1351
 Ungureanu Oana 1309
 Unterholzner Anna 1381
 Unver Somer Nehir 1415
 Upegui Yulieth A. 1335
 Urbain Aurélie 1311
 Uriac Philippe 1410
 Urmann Corinna 1346, 1422
- V**
 Vagnerova Magdalena 1315, 1401
 Vahekeni Nina 1393, 1422
 Vaillé Justine 1278
 Valentova Katerina 1392
 Valkanioti Vassiliki 1426
 Valle Ana Catarina 1344
 Valle Maria P.V. 1344
 Vancea Szende 1357
 Van den Heuvel Jeroen 1413
 Van De Venter Maryna 1382
 Van Huy Le 1397
 Vanioti Marianna 1331, 1349
 van Vuuren Sandy 1362
 Vanyolos Attila 1343
 Varela Carla 1369, 1429

Vargas Carmen 1366
Varsamis Vasilios 1360
Varvouni Elisavet-Foteini 1354
Vasilakopoulou Paraskevi 1357
Vassilakopoulou Dido 1400
Venables Luanne 1382
Venzon Madelaine 1357
Vérièpe-Salerno Julie 1296
Vermeulen Hendrick 1331, 1371
Verpoorte Robert 1286
Ververidis Filippou 1372
Viana Marylène 1398
Viault Guillaume 1414
Vicentini Silvia Francesca 1390
Vidal Rene 1277
Vidal Yoshajandith Aguirre 1417
Vignolle Anna 1362
Vilas-Boas Miguel 1325
Viljoen Alvaro 1290
Viljoen Alvaro 1296, 1362, 1382, 1407
Viljoen Zenobia 1313
Villa Pascal 1374
Villarino Rosa Antia 1364
Villarino Rosa Antía 1364
Villena Isabelle 1276
Viña Dolores 1295
Vinhas Iva 1314
Virgiliou Christina 1395
Vitale Rosa M. 1290
Vitale Rosa Maria 1386
Viviano Andrea 1282
Vladimir-Knežević Sanda 1338, 1364
Vlad Robert-Alexandru 1315
Vlasova Inna 1385
Vollmar Angelika M. 1346
Vollstedt Sabine 1280
Vonhron Catherine 1366
Vonhron-Senecheau Catherine 1351
Vonhron-Sénécheau Catherine 1374
Vonhron-Sénécheau Catherine 1299
Vougogiannopoulou Konstantina 1302
Vrabi Pamela 1292
Vrca Ivana 1358, 1415, 1425
Vu Ngoc Khanh 1333
Vuuren Sandy van 1290, 1296, 1407
Vuuren Sandy Van 1373

W

Wai-Fung Lee 1337
Waindok Patrick 1291
Waiwut Pornthip 1404, 1413, 1416, 1418
Walaska Hana 1315, 1401
Walkenhorst Michael 1281, 1292
Walsh John 1300, 1326
Waltenberger Birgit 1383
Walter Fruzsina R. 1419
Wangensteen Helle 1295, 1351, 1398
Wang Hui-Chun 1278
Wang Lu-Hai 1394
Wang Ruwei 1421
Wang Weihao 1422
Wang Yun-Han 1336
Wasilewicz Andreas 1288, 1421
Wawrosch Christoph 1371
Weckerle Caroline 1279
Wehrich Andrea 1399
Weisenburger Sabrina 1332
Wei Shibo 1334
Weiss Stefan 1397
Welch C. 1297
Wende Manuela 1348, 1368
Weng Jing-Ru 1317
Werz Oliver 1288, 1383
Westerink Remco 1298
Whyms Sophie 1293, 1355
Wilhelm Elke 1303
Wold Christian W. 1301
Wolfender Jean-Luc 1285, 1289, 1359, 1411, 1412
Wolff Jürgen 1303
Wolf Miriam 1375
Wolfram Evelyn 1393, 1397, 1403, 1422
Wolkinger Volker 1394
Wong Tin-Long 1392
Woo Joo Han 1389
Wright Colin 1346
Wrzosek Małgorzata 1379
Wurster Martina 1368

X

Xego Sibusiso 1370
Xia Yi-Xuan 1299, 1334
Xie Wen-Jian 1299
Xin Ruihua 1420

Y

Yamabe Noriko 1393
Yáñez-Ibarra Guadalupe 1396
Yang Chang-Syun 1319
Yang Ya-Ting 1389
Yang Zhijun 1348
Yao Chensi 1422
Yassine Mallem 1387
Yen Hung-Rong 1361, 1394
Yim Nam-Hui 1334, 1345, 1420
Yoo Eunae 1325
Yusuf Nor Mohd 1405
Yuan Jui-Hung 1291
Yue Grace 1337
Yuk Heung Joo 1378
Yusakul Gorawit 1397
Yu Wei-Hsuan 1389

Z

Zaibi Mohamed 1387
Zainol Murizal 1405
Zakaria Nurul Shahira 1330
Zakri Zikry Md 1408
Zarev Yancho 1405
Zavragoglou Vasilis 1402
Zehl Martin 1318, 1362
Zell Lukas 1404, 1417
Zengin Gökhan 1388
Zgórka Grażyna 1324
Zhang Hongjie 1299
Zhang Hong-jie 1334
Zhang Mi 1385
Zhang Quan-Wei 1392
Zhang Tao 1293, 1356
Zhang Xue-Ting 1392
Zheng Tao 1337
Zhou Yanyan 1422
Zhu Zheyang 1347, 1363
Ziegler Ramona 1382
Zölch Sabrina 1349, 1395
Zöld Eszter Laczkó 1315, 1352, 1357, 1401
Zotchev Sergey 1371
Zotchev Sergey B. 1318, 1362
Zupkó István 1278
Zwirchmayr Julia 1288