

*thinklogical*<sup>®</sup>

# TLX VIDEO & KVM EXTENSION

**UNCOMPRESSED 4K**



Full 4K-30 Hz & 60Hz Video and KVM CATx  
Extension Solutions

**TLX10 and TLX20 CATx Extender Products Manual**  
High Reliability CATx Video & KVM Extension Solutions



**NABSHOW**  
Where Content Comes to Life

Thinklogical, LLC<sup>®</sup>  
100 Washington Street  
Milford, Connecticut 06460 U.S.A.  
Telephone: 1-203-647-8700  
Fax: 1-203-783-9949  
[www.thinklogical.com](http://www.thinklogical.com)

# thinklogical®

## Copyright Notice

Copyright © 2016. All rights reserved. Printed in the U.S.A.

Thinklogical, LLC®  
100 Washington Street  
Milford, Connecticut 06460 U.S.A.  
Telephone: 1-203-647-8700

*All trademarks and service marks are property of their respective owners.*



thinklogical®



TLX 10G

**Subject:** TLX10 and TLX20 CATx Extender Products Manual  
**Revision:** B, August, 2016



Website: [www.thinklogical.com](http://www.thinklogical.com)  
Facebook: [www.facebook.com/ThinklogicalUSA](http://www.facebook.com/ThinklogicalUSA)  
LinkedIn: [www.linkedin.com/company/thinklogical](http://www.linkedin.com/company/thinklogical)  
Google+: <http://plus.google.com/u/0/109273605590791763795/about>  
YouTube: [www.youtube.com/user/thinklogicalNA](http://www.youtube.com/user/thinklogicalNA)  
Twitter: [@thinklogical](https://twitter.com/thinklogical)

# Table of Contents

<b>PREFACE</b>	<b>3</b>
About Thinklogical	3
Note and Warning Symbols	4
The Scope of This Document	4
<b>INTRODUCTION</b>	<b>5</b>
Features of the TLX Extension & Matrix Switch System	5
<b>PRODUCT OVERVIEW</b>	<b>6</b>
DisplayPort and HDMI Connector	6
Form Factor	7
Operating Features	9
Interface Configurations	10
Status Indicator LEDs	12
Supplied Cables	13
TLX10 and TLX20 CATx Cable Configurations	15
FPGA and Firmware Upgrade Applications	15
TLX10 and TLX20 Extender Technical Specifications	16
TLX10 and TLX20 Extender Audio Specifications	17
<b>REGULATORY &amp; SAFETY COMPLIANCE</b>	<b>17</b>
Safety Requirements	17
Symbols Found on the Product	17
Regulatory Compliance	17
North America	17
Australia & New Zealand	18
European Union	18
Standards with which Our Products Comply	18
Supplementary Information	19
Product Serial Number	19
Connection to the Product	19
<b>THINKLOGICAL SUPPORT</b>	<b>19</b>
Customer Support	19
Website	19
Email	20
Telephone	20
Fax	21
Product Support	20
Warranty	20
Return Authorization	21
Our Addresses	21
<b>APPENDIX A: Quick Start Guide</b>	<b>22</b>
<b>APPENDIX B: RJ45 to DB9 Adapter Pin-outs</b>	<b>23</b>
<b>APPENDIX C: FPGA Program Code Update Procedure</b>	<b>24</b>
<b>APPENDIX D: EDID and DDC for TLX Modules</b>	<b>25</b>
How to Change DDC Modes	26
How to Change the IP Address of a CATx Extender	29
How to Configure a PC with a Static Address	31



## PREFACE

### About Thinklogical



**We, the Thinklogical team, are committed to understanding and exceeding our customers' requirements, the first time and every time.**

Thinklogical is the leading manufacturer and provider of fiber optic and CATx KVM, video, audio, and peripheral extension and switching solutions used in video-rich, big-data computing environments.

Thinklogical offers the only fiber-optic KVM matrix switches in the world that are accredited to the Common Criteria EAL4, TEMPEST Level B, and NATO NIAPC Evaluation Scheme: GREEN information assurance standards. And Thinklogical Velocity products are the first system with both KVM and video matrix switching capabilities to be placed on the Unified Capabilities Approved Product List (UC APL) under the Video Distribution System (VDS) category.

Governments, entertainment, scientific and industrial customers worldwide rely on Thinklogical's products and solutions for security, high performance, continuous operation and ease of integration. Thinklogical products are designed and manufactured in the USA and are certified to the ISO 9001-2008 standard.

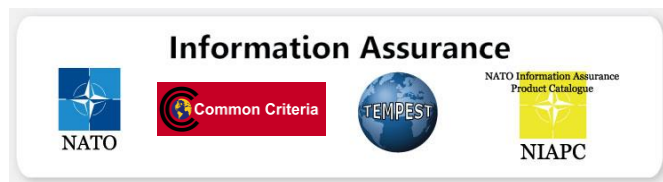

Thinklogical is headquartered in Milford, Connecticut and is privately held by Riverside Partners, LLC, Boston, MA (<http://www.riversidepartners.com>). For more information about Thinklogical products and services, please visit [www.thinklogical.com](http://www.thinklogical.com).

Follow Thinklogical on LinkedIn at <http://www.linkedin.com/company/thinklogical> and on Facebook at <http://www.facebook.com/ThinklogicalUSA>



## Note and Warning Symbols

Throughout this manual you will notice certain symbols that bring your attention to important information. These are **Notes** and **Warnings**. Examples are shown below.



**Note:** Important Notes appear in blue text preceded by a yellow exclamation point symbol, as shown here.

A note is meant to call the reader's attention to **helpful** information at a point in the text that is relevant to the subject being discussed.



**Warning!** All Warnings appear in red text, followed by blue text, and preceded by a red stop sign, as shown here.

A warning is meant to call the reader's attention to **critical** information at a point in the text that is relevant to the subject being discussed.

**BEFORE STARTING ANY PROCEDURE, IT IS RECOMMENDED THAT YOU READ THE INSTRUCTIONS THOROUGHLY!**

## The Scope of This Document

This Product Manual is intended to provide customers with a full overview of the features, functions, usage and support for Thinklogical's **TLX10 CATx Extender Transmitter** (TLX-TCF-U00D10) and **Receiver** (TLX-RCF-U00D10), capable of extending a single Video Display and Data at a rate of **4096x2160 @ 30Hz** for up to 100m over a **single** CAT6a 23 AWG Cable...

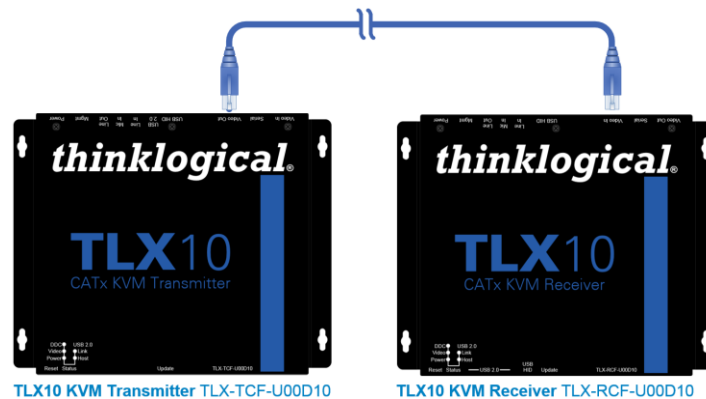

...and for Thinklogical's **TLX20 CATx Extender Transmitter** (TLX-TCF-U00D20) and **Receiver** (TLX-RCF-U00D20), capable of extending a single Video Display and Data at a rate of **4096x2160 @ 60Hz** for up to 100m over a **pair** of CAT6a 23 AWG Cables.



## Introduction

*Introducing Thinklogical's newest family of switching and extension solutions, for uncompressed, high resolution video and KVM systems over fewer cables.*

## UNCOMPRESSED 4K



## Features of the TLX Extension & Matrix Switch System

**Offering a higher bandwidth solution, the TLX product line provides 10Gbps bandwidth per port to preserve signal integrity and provide uncompressed, high resolution video with no artifacts, latency or lost frames.**

The TLX Product Family offers these features to enhance ease of integration:

- Hybrid switching solutions (fiber and CATx) start at 12 ports and scale up to 640 ports.
- Offers a higher bandwidth solution to address new video resolutions and prepare for future protocols.
- The TLX system reduces cabling by half through higher bandwidth.
- Extend and switch:

**Single display up to 4096x2160 @ 30Hz with full 4:4:4 color depth, over a single fiber or CATx cable**

(or dual displays up to 1920x1200 @ 60Hz with full 4:4:4 color depth)

**Single display up to 4096x2160 @ 60Hz with full 4:4:4 color depth, over two fibers or CATx cables**

(or dual displays up to 4096x2160 @ 30Hz with full 4:4:4 color depth)

**Dual displays up to 4096x2160 @ 60Hz with full 4:4:4 color depth, over four fibers.**

Dual connectors on TLX Extenders, offering support for both HDMI and DisplayPort, **reduces the number of extenders and converter cables required** and enables users to future-proof system designs.

**DisplayPort 1.2 up to 4K @ 60Hz**

**HDMI 1.4 up to 4K @ 30Hz**



*Connector installed on every Video and KVM extender module.*



*TLX-TCF-U00D20 60Hz Display Transmitter with USB HID, USB 2.0, RS-232 & Audio*

## Product Overview

- All TLX Extenders are compatible with each other, **but not backwards compatible with Velocity 6.25 Gbps transport.**

### TLX Video and KVM Extension Systems

- Video connector supports both **HDMI 1.4** (4K @ 30Hz) and **DisplayPort 1.2** (4K @ 60Hz) cables
- 10Gbps bandwidth per port
- Extension of up to 100 meters over CAT6a cables, 23 AWG solid S/FTP
- Support for a single display up to 4096x2160 @ 30Hz over a single CATx cable
- Support for a single display up to 4096x2160 @ 60Hz (DisplayPort only) over two CATx cables
- Supports HDCP content
- Ethernet port for configuration, management and updates
- Supports embedded audio, with ability to de-embed at the Receiver
- Supports unbalanced analog audio and serial RS-232
- Options include USB HID (1.5 Mbps) and USB 2.0 (480 Mbps)

## DisplayPort & HDMI Connector

**Thinklogical includes an innovative connector on its TLX Extenders.** The connector can receive either HDMI 1.4 or DisplayPort 1.2 cables, reducing the number of extenders needed and, eliminating the need for an external adapter or dongle to convert from DisplayPort to HDMI/DVI. It also allows the customer to upgrade from HDMI to DisplayPort with no change in equipment. When combined with a Thinklogical TLX Matrix Switch, it's easy to combine and connect HDMI/DVI and DisplayPort sources and displays.



**Note:** **DisplayPort 1.2 Video Cables** support up to 4K @ 60Hz. **HDMI 1.4 Video Cables** support up to 4K @ 30Hz. Install *either* DisplayPort or HDMI cables at both the Transmitter and Receiver.

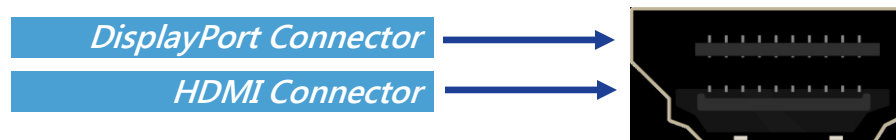

## Form Factor

TLX CATx Extension Systems are available in a compact, desk top form factor. The chassis includes a pair of mounting brackets that can be removed or installed to mount the unit above or below a bench, desk or shelf.



**Height:** 1.25" (31.75mm)  
**Depth:** 7.1875" (182.56mm)  
**Width:** 7.625" (193.68mm)  
**Width (w/ brackets):** 8.875" (225.43mm)

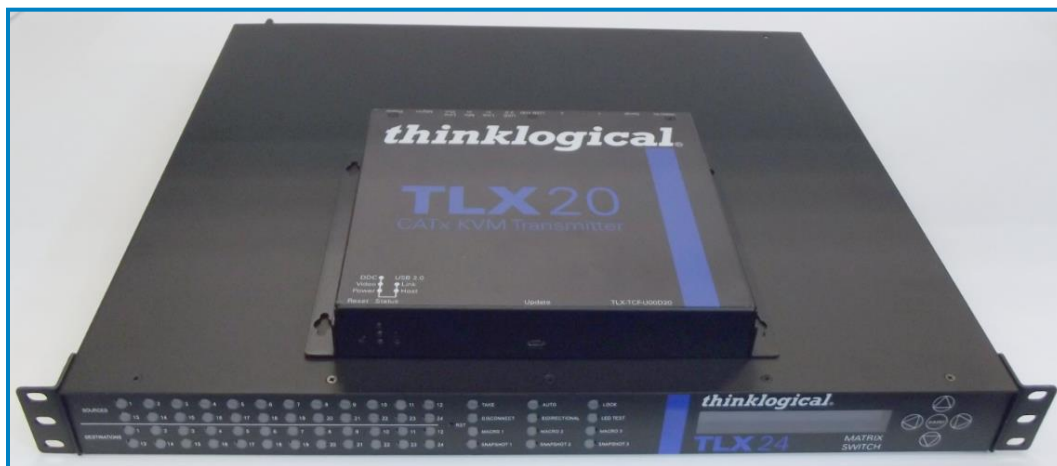

The TLX20 Extender and the 19" rack-mountable TLX24 Matrix Switch



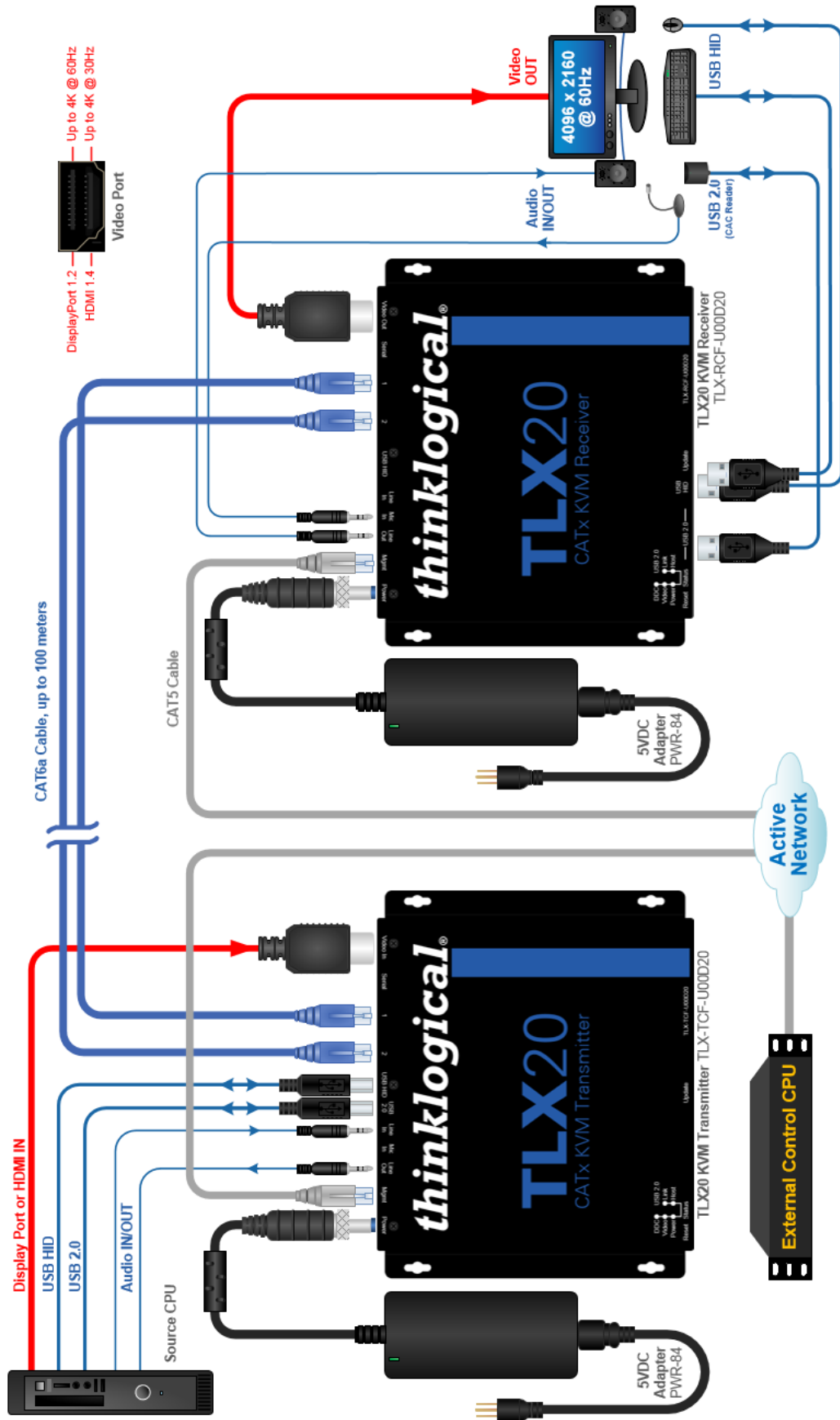

Typical TLX CATx Application

## Operating Features

- DisplayPort 1.2 Video Head
- HDMI 1.4 Video Head



**Note:** Install either DisplayPort or HDMI cables at both the Transmitter and Receiver.

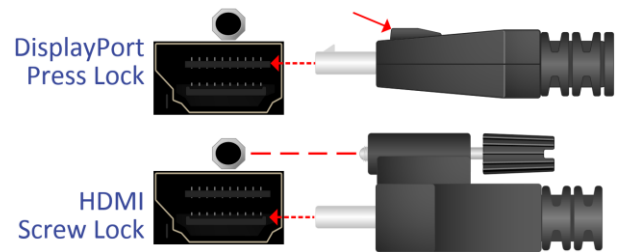

- **Mechanical lock for DisplayPort and HDMI connectors**
- HDCP Compliant
- 10.3125G Copper Interface (CATx)
- Audio Option
  - Supports standard L/R Audio; Line/Mic In, Line Out on both TX and RX (pg. 17).
- RS-232 Serial Port Extension Option (includes a CAT5 cable and RJ45 to DB9 Adapters)
- The Management (MGMT) Port
  - For module status and software updates
  - In-band System Management Interface
  - Ethernet on module (i.e. Wiznet)
- Bi-color indicator LEDs
- EDID Table DDC Modes: Static, Dynamic, Remote Acquire, Load Custom

### Supported Tables:

- 1024x768 @ 60Hz
- 1920x1080 @ 60Hz
- 1920x1200 @ 60Hz
- 2560x1440 @ 60Hz
- 3840x2160 @ 30Hz
- 3840x2160 @ 60Hz (DisplayPort only)
- 4096x2180 @ 24Hz
- 4096x2160 @ 60Hz (DisplayPort only)
- Temperature sensor
- TLX Chassis Interface compliant (physical and protocol)
- Power: 5V @ 7A Max.
- Remote Upgrade of S/W and Firmware
- FPGA Configuration supports 'Golden Boot Image' as backup for failed upgrade.
- Audio De-embedding in Receiver Module
  - Line Out User Selectable between TLX Line In or De-embedded Audio
- HDMI 1.4 or DisplayPort 1.2 cables included, as applicable.

**TLX20 TX Rear Panel**  
TLX-TCF-U00D20



**TLX20 RX Rear Panel**  
TLX-RCF-U00D20



**TLX20 TX Front Panel**



**TLX20 RX Front Panel**



## Interface Configurations

All physical connections to the product use industry-standard connectors. Non-supplied cables that may be needed are commercially available.

### TLX10 and TLX20 CATx Extender Configurations- USB & Serial

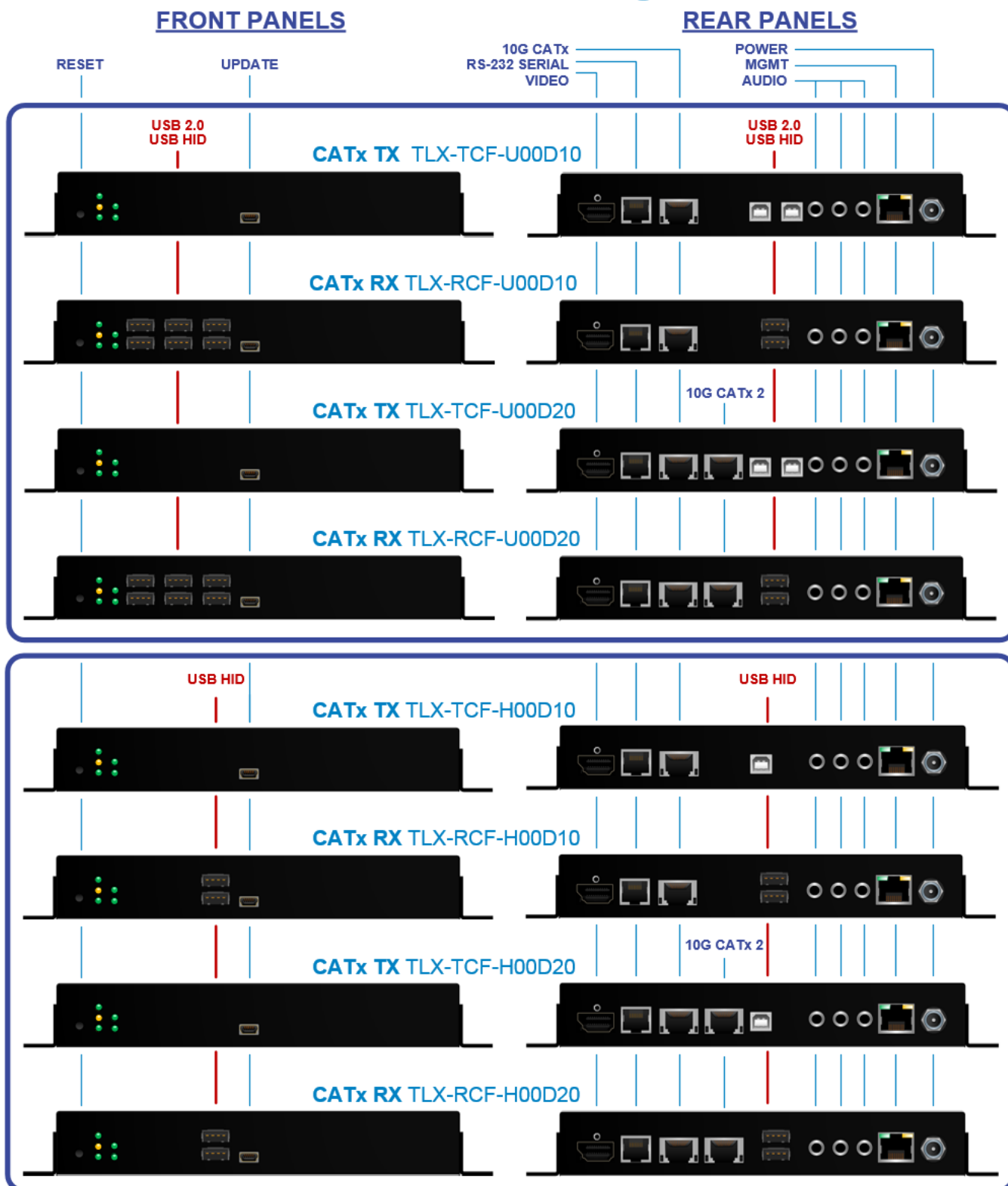

## TLX10 and TLX20 CATx Extender Configurations- Serial only

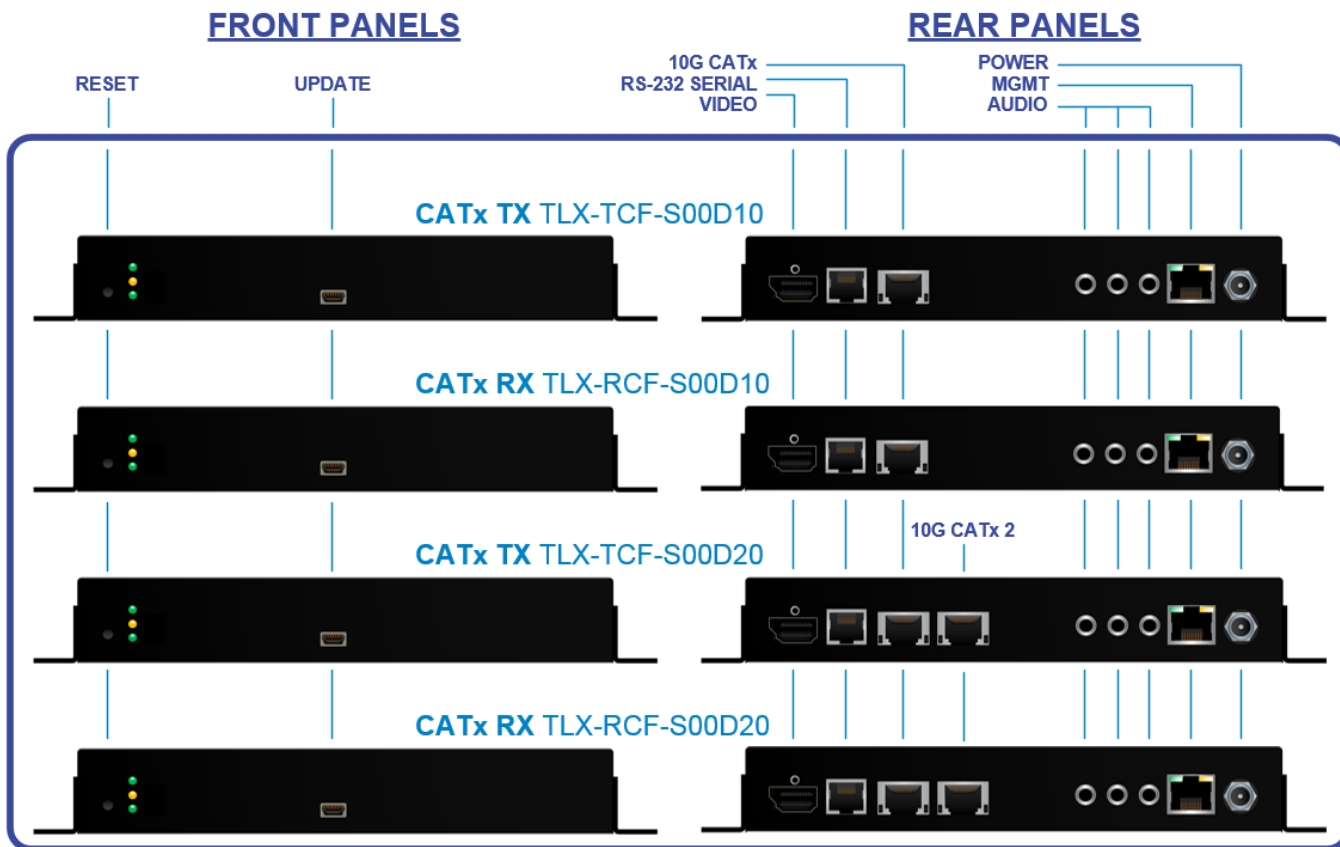

All Transmitters and Receivers are connected to each other via CATx cables (page 15). The transmitter connects to the CPU with supplied video, audio, serial and network cables. (USB A-B cables are supplied with applicable models.) The receiver provides an interface to the monitor, audio, serial and network devices (and USB 2.0 and USB HID devices in applicable models).

### CATx Cables

There are currently several versions of CATx (category 5/5e/6/6a/etc.) cables with RJ-45 connectors on the market. **Thinklogical recommends CAT6a 23 AWG Solid, Shielded and foiled (S/FTP- Shielded/ Foiled Twisted Pair) Cabling for TLX applications, which can operate over channel lengths of up to 100 meters.** Assume a 30% derating for 26 AWG CAT6a cabling.

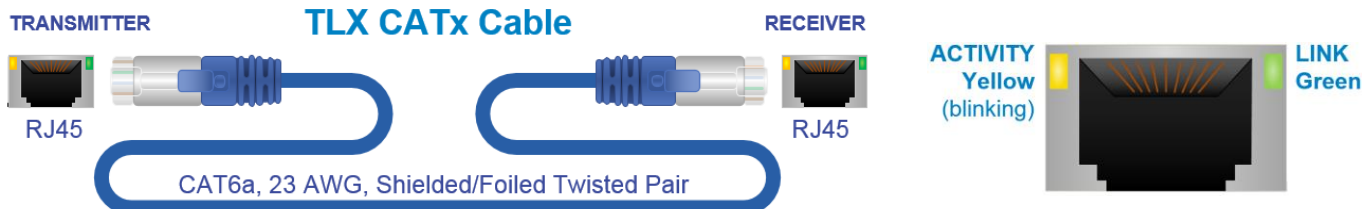

## Video Cables

**DisplayPort 1.2 Video Cables** support up to 4K @ 60Hz and are supplied with TLX20 Transmitters. **HDMI 1.4 Video Cables** support up to 4K @ 30Hz and are supplied with TLX10 Transmitters. Both feature a locking mechanism.

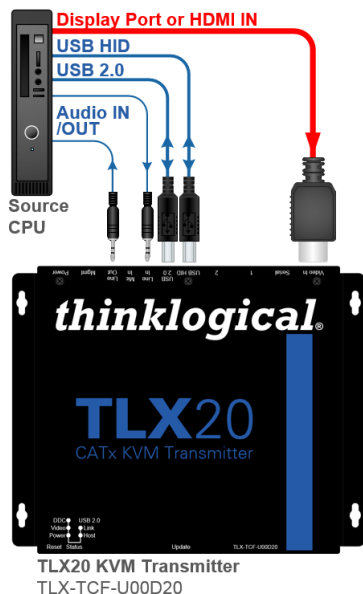
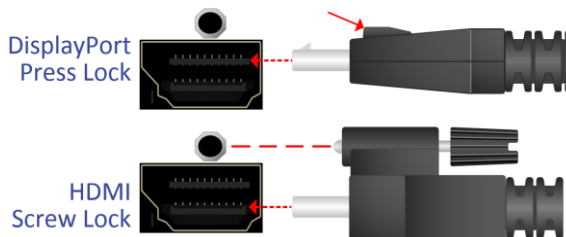

### Transmitter

A transmitter chassis connects to the CPU/peripheral sources through standard copper cables. The available connector configurations of the TLX Transmitters can be viewed in detail on pages 10 and 11.

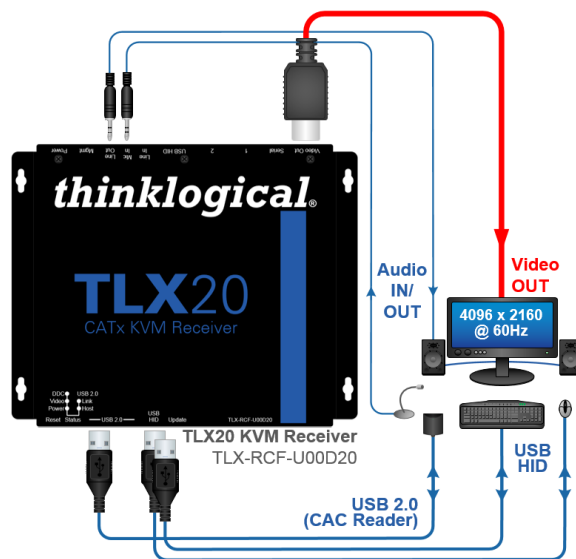

### Receiver

A receiver chassis connects to a viewing device (monitor, projector, etc.) and audio devices with their own standard cables. The available connector configurations of the TLX Receivers can be viewed in detail on pages 10 and 11.

## Status Indicator LEDs

The status indicator LEDs on the TLX CATx Extenders are provided as a visual reference for the various states the device may be in during normal operation.

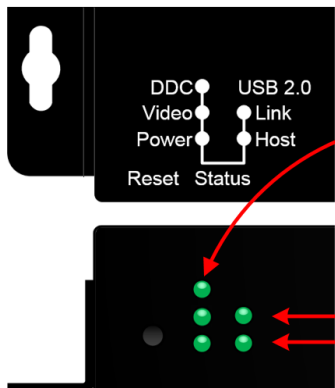

- DDC: Solid **GREEN** when receiving DDC information
- Video: **OFF** = No active video signal, no CATx cable (Tx & Rx)
- Flashing Green** = Active video signal, link between Tx and Rx (Tx & Rx)
- Solid Green** = Active video signal, no CATx cable (Tx only)
- Yellow** = CATx cable connection, no active signal
- Power: Solid **GREEN** when power is ON.
- USB 2.0 Link: (Through CATx Cable) Solid **GREEN** for proper Tx to Rx connection.
- USB 2.0 Host: (Through USB 2.0 Cable) Solid **GREEN** when an active USB device is detected at the Rx.

## Supplied Cables

All **TLX10** Models will be supplied with an **HDMI 1.4** (supports 4K @ 30Hz) **cable** and all **TLX20** Models will be supplied with a **DisplayPort 1.2** (supports 4K @ 60Hz) **cable**. Transmitters will also be supplied with **Audio** and **USB A-B** cables (2 each). Transmitters and Receivers will both be supplied with a **CAT5** cable and **RJ45 to DB9 Adapters** as described below.

<u>MODEL</u>	<u>QTY</u>	<u>CABLE TYPE</u>
<b>TLX-TMM-U00D10</b>		
ADP-000025-R	1	RJ-45 to DB-9F
CBL000001-002MR	1	CAT5, 2 Meters
CBL000015-006FR	2	USB A-B, 6 ft.
CBL000016-006FR	2	3.5mm to 3.5mm plug, M/M, 6 ft.
CBL000103-002MR	1	HDMI 1.4 to HDMI 1.4, 2 Meters
<b>TLX-RMM-U00D10</b>		
ADP-000019-R	1	RJ-45 to DB-9M
CBL000001-002MR	1	CAT5, 2 Meters
<b>TLX-TMM-U00D20</b>		
ADP-000025-R	1	RJ-45 to DB-9F
CBL000001-002MR	1	CAT5, 2 Meters
CBL000015-006FR	2	USB A-B, 6 ft.
CBL000016-006FR	2	3.5mm to 3.5mm plug, M/M, 6 ft.
CBL000104-002MR	1	Display Port 1.2 to Display Port 1.2
<b>TLX-RMM-U00D20</b>		
ADP-000019-R	1	RJ-45 to DB-9M
CBL000001-002MR	1	CAT5, 2 Meters

### Supplied with all TLX10 Transmitters:

#### HDMI 1.4 to HDMI 1.4-locking (CBL000103-002MR)



### Supplied with all TLX20 Transmitters:

#### DisplayPort 1.2 to DisplayPort 1.2, locking (CBL000104-002MR)



**Supplied with all Transmitters:**

**3.5mm to 3.5mm Audio Cable, 6 Feet (CBL000016-006FR) – 2 each**

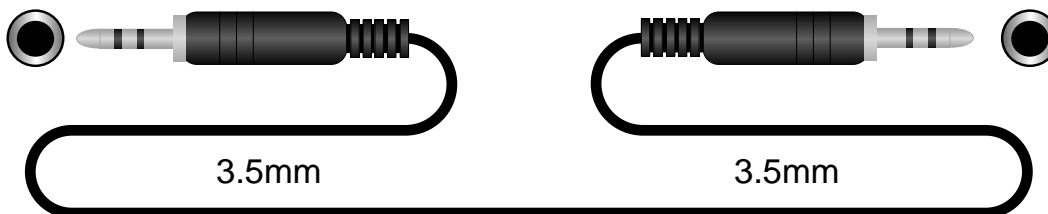

**USB A-B Cable, 6 Feet (CBL000015-006FR) – 2 each**



**Supplied with all Transmitters and Receivers:**

**CAT5 Serial Cable, 6 Feet (CBL000001-006FR) – 1 each**



**RJ45 to DB9 F & M Adapters (ADP-000025, ADP-000019)\***

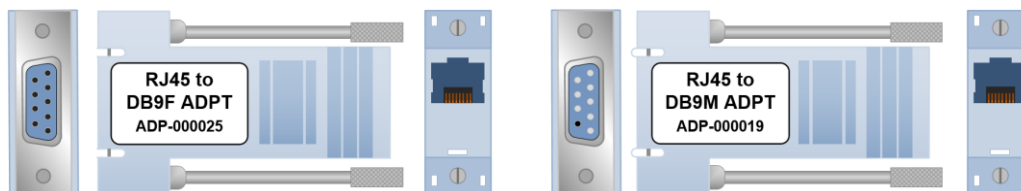

\*See pin-outs in Appendix B, pg. 23

## TLX10 and TLX20 CATx Cable Configurations

There are currently several versions of CATx (category 5/5e/6/6a/etc.) cables with RJ-45 connectors on the market. **Thinklogical recommends CAT6a 23 AWG Solid, Shielded and foiled (SFTP-Shielded/Foiled Twisted Pair) Cabling for TLX applications, which can operate over channel lengths of up to 100 meters.** Assume a 30% derating for 26 AWG CAT6a cabling.

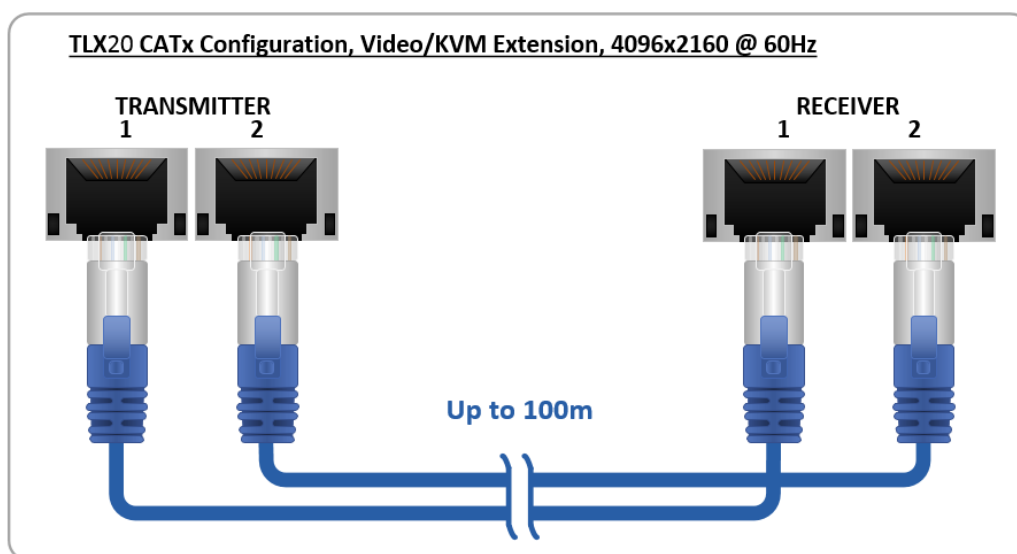
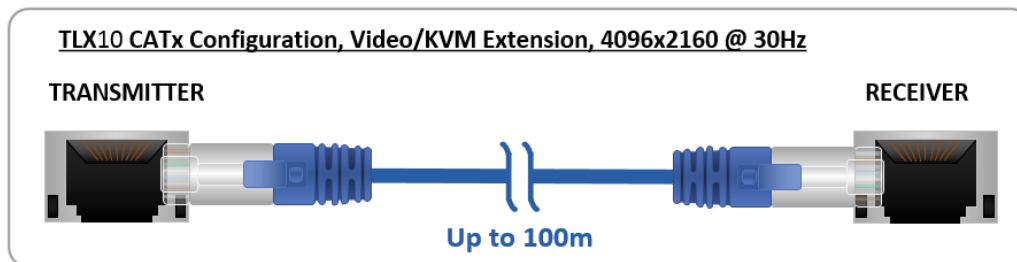

## FPGA and Firmware Upgrade Applications

*FPGA and Firmware Upgrade Applications are available through Thinklogical's® Technical Assistance Department. Please call us at 1-203-647-8700 and we'll be happy to provide you with all the assistance you'll need to keep your system up and running at its optimum performance level.*

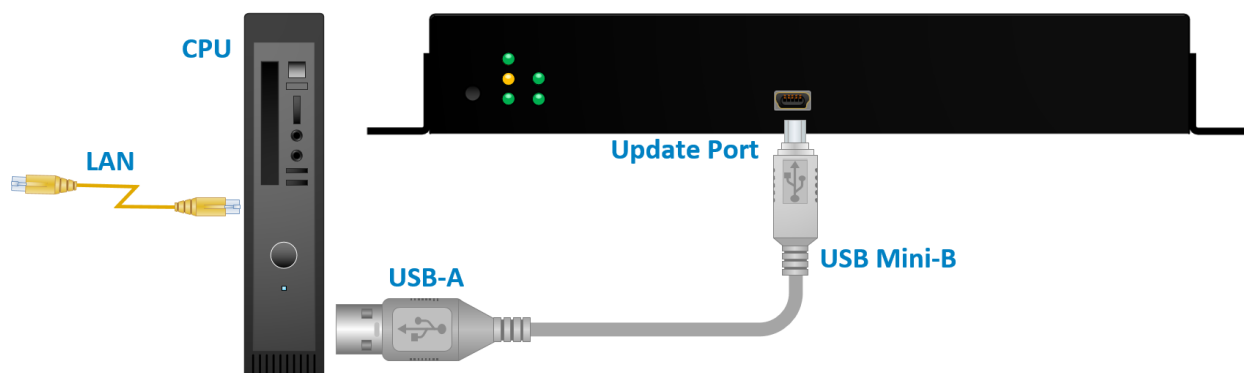



## TLX10 and TLX20 Extender Technical Specifications

<b>Power Consumption</b>	TLX10: Rx; 31 W @100 meters, Tx; 28 W @100 meters TLX20: Rx; 33 W @100 meters, Tx; 31 W @100 meters																																												
<b>TLX10 Tx &amp; TLX10 Rx TLX20 Tx &amp; TLX20 Rx</b>	<u>Dimensions:</u> Height: 1.25" (31.75mm) Depth: 7.1875" (182.56mm) Width: 7.625" (193.68mm) Width (w/ brackets): 8.875" (225.43mm)																																												
<b>Supplied Cables</b>	<p><b>TLX-TMM-U00D10</b></p> <table border="0"> <tr> <td>ADP-000025-R</td> <td>1</td> <td>RJ-45 to DB-9F</td> </tr> <tr> <td>CBL000001-002MR</td> <td>1</td> <td>CAT5, 2 Meters</td> </tr> <tr> <td>CBL000015-006FR</td> <td>2</td> <td>USB A-B, 6 ft.</td> </tr> <tr> <td>CBL000016-006FR</td> <td>2</td> <td>3.5mm to 3.5mm plug, M/M, 6 ft.</td> </tr> <tr> <td>CBL000103-002MR</td> <td>1</td> <td>HDMI 1.4 / HDMI 1.4</td> </tr> </table> <p><b>TLX-RMM-U00D10</b></p> <table border="0"> <tr> <td>ADP-000019-R</td> <td>1</td> <td>RJ-45 to DB-9M</td> </tr> <tr> <td>CBL000001-002MR</td> <td>1</td> <td>CAT5, 2 Meters</td> </tr> </table> <p><b>TLX-TMM-U00D20</b></p> <table border="0"> <tr> <td>ADP-000025-R</td> <td>1</td> <td>RJ-45 to DB-9F</td> </tr> <tr> <td>CBL000001-002MR</td> <td>1</td> <td>CAT5, 2 Meters</td> </tr> <tr> <td>CBL000015-006FR</td> <td>2</td> <td>USB A-B, 6 ft.</td> </tr> <tr> <td>CBL000016-006FR</td> <td>2</td> <td>3.5mm to 3.5mm plug, M/M, 6 ft.</td> </tr> <tr> <td>CBL000104-002MR</td> <td>1</td> <td>DisplayPort 1.2 / DisplayPort 1.2</td> </tr> </table> <p><b>TLX-RMM-U00D20</b></p> <table border="0"> <tr> <td>ADP-000019-R</td> <td>1</td> <td>RJ-45 to DB-9M</td> </tr> <tr> <td>CBL000001-002MR</td> <td>1</td> <td>CAT5, 2 Meters</td> </tr> </table>			ADP-000025-R	1	RJ-45 to DB-9F	CBL000001-002MR	1	CAT5, 2 Meters	CBL000015-006FR	2	USB A-B, 6 ft.	CBL000016-006FR	2	3.5mm to 3.5mm plug, M/M, 6 ft.	CBL000103-002MR	1	HDMI 1.4 / HDMI 1.4	ADP-000019-R	1	RJ-45 to DB-9M	CBL000001-002MR	1	CAT5, 2 Meters	ADP-000025-R	1	RJ-45 to DB-9F	CBL000001-002MR	1	CAT5, 2 Meters	CBL000015-006FR	2	USB A-B, 6 ft.	CBL000016-006FR	2	3.5mm to 3.5mm plug, M/M, 6 ft.	CBL000104-002MR	1	DisplayPort 1.2 / DisplayPort 1.2	ADP-000019-R	1	RJ-45 to DB-9M	CBL000001-002MR	1	CAT5, 2 Meters
ADP-000025-R	1	RJ-45 to DB-9F																																											
CBL000001-002MR	1	CAT5, 2 Meters																																											
CBL000015-006FR	2	USB A-B, 6 ft.																																											
CBL000016-006FR	2	3.5mm to 3.5mm plug, M/M, 6 ft.																																											
CBL000103-002MR	1	HDMI 1.4 / HDMI 1.4																																											
ADP-000019-R	1	RJ-45 to DB-9M																																											
CBL000001-002MR	1	CAT5, 2 Meters																																											
ADP-000025-R	1	RJ-45 to DB-9F																																											
CBL000001-002MR	1	CAT5, 2 Meters																																											
CBL000015-006FR	2	USB A-B, 6 ft.																																											
CBL000016-006FR	2	3.5mm to 3.5mm plug, M/M, 6 ft.																																											
CBL000104-002MR	1	DisplayPort 1.2 / DisplayPort 1.2																																											
ADP-000019-R	1	RJ-45 to DB-9M																																											
CBL000001-002MR	1	CAT5, 2 Meters																																											
<b>CATx Cable Distance</b>	CAT6a 23 AWG: Up to 100 meters CAT6a 26 AWG: Up to 70 meters																																												
<b>External Supply Voltage</b>	100-240 VAC, 47-63 Hz, Universal AC. DC power supply, 5VDC/7A																																												
<b>Operating Temp and Humidity</b>	0° to 50°C (32° to 122 °F), 5% to 95% RH, non-condensing																																												
<b>Compliance</b>	Approvals for US, Canada, and European Union																																												
<b>Warranty</b>	12 months from date of shipment. Extended warranties available.																																												

## TLX10 and TLX20 Extender Audio Specifications

<b>Line</b>	Line In Voltage (max): 3.15 V p/p (1.11 Vrms, 3.15 dBu) Line Out Voltage (max) into 1K $\Omega$ : 3.50 V p/p (1.24 Vrms, 4.10 dBu) Frequency Response: 20-20kHz Line In Impedance: 6.8K $\Omega$ Line Out Impedance: 470 $\Omega$
<b>Mic</b>	Frequency Response: 20-20kHz Mic In Voltage (max): 105 mV p/p (0.037 Vrms, -26.40 dBu) Mic In Impedance: 60K $\Omega$

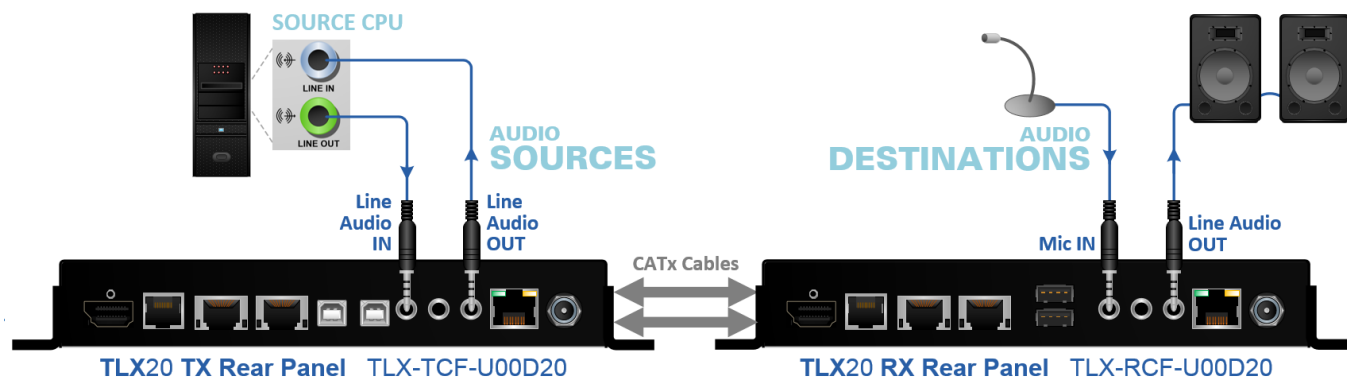

*Standard TLX Extender Audio Line In/Out Configuration*

## Regulatory & Safety Compliance

### Safety Requirements

#### Symbols Found on Our Products

Markings and labels on the product follow industry-standard conventions. Regulatory markings found on the products comply with domestic and many international requirements.

#### Regulatory Compliance

Thinklogical's® products are designed and made in the U.S.A. Our products have been tested by a certified testing laboratory and found to be compliant with the following standards (both domestic USA and many international locations):

#### North America

##### Safety

ANSI/UL60950-1: 1<sup>st</sup> Edition (2003)  
 CAN/CSA C22.2 No. 60950-1-03

##### LASER Safety

CDRH 21CFR 1040.10  
 Class 1 LASER Product



**Electromagnetic Interference**

US: FCC CFR47, Part 15, Class A

Canada: Industry Canada ICES-003 Issue 2, Revision 1

Europe: EN55022 Class A

**Australia & New Zealand**

This is a Class A product. In a domestic environment this product may cause radio interference, in which case the user may be required to take adequate measures.

**European Union****Declaration of Conformity**

Manufacturer's Name & Address: **Thinklogical, LLC®**  
**100 Washington Street**  
**Milford, Connecticut 06460 USA**

These products comply with the requirements of the Low Voltage Directive 72/23/EEC and the EMC Directive 89/336/EEC.

**Standards with Which Our Products Comply****Safety**CENELEC IEC 600950-1 2<sup>nd</sup> Ed. 2005**LASER Safety**

IEC60825:2001 Parts 1 and 2

Class 1 LASER Product

**Electromagnetic Emissions**

EN55022: 1994 (IEC/CSP1R22: 1993)

EN61000-3-2/A14: 2000

EN61000-3-3: 1994

**Electromagnetic Immunity**

EN55024: 1998 Information Technology Equipment-Immunity Characteristics

EN61000-4-2: 1995 Electro-Static Discharge Test

EN61000-4-3: 1996 Radiated Immunity Field Test

EN61000-4-4: 1995 Electrical Fast Transient Test

EN61000-4-5: 1995 Power Supply Surge Test

EN61000-4-6: 1996 Conducted Immunity Test

EN61000-4-8: 1993 Magnetic Field Test

EN61000-4-11: 1994 Voltage Dips &amp; Interrupts Test

**Supplementary Information**

The following statements may be appropriate for certain geographical regions and might not apply to your location.

This Class A digital apparatus meets all requirements of the Canadian Interference-Causing Equipment Regulations.

*Cet appareil numérique de la classe A respecte toutes les exigences du Règlement sur le matériel brouilleur du Canada.*



**Warning!** This is a Class A product. In a domestic environment, this product may cause radio interference, in which case the user may be required to take corrective measures.



**Note:** This equipment has been tested and found to comply with the limits for a Class A digital device, pursuant to part 15 of the FCC Rules. These limits are designed to provide reasonable protection against harmful interference when the equipment is operated in a

commercial environment. This equipment generates, uses and can radiate radio frequency energy and, if not installed and used in accordance with the instruction manual, may cause harmful interference to radio communications in which case the user may be required to take adequate corrective measures at their own expense.



**Note:** This Class A digital apparatus complies with Canadian ICES-003 and has been verified as being compliant within the Class A limits of the FCC Radio Frequency Device Rules (FCC Title 47, Part 15, Subpart B CLASS A), measured to CISPR 22: 1993 limits and methods of measurement of Radio Disturbance Characteristics of Information Technology Equipment.



**Note:** The user may notice degraded audio performance in the presence of electromagnetic fields.



**Note:** If using a keyboard that is noise susceptible, a ferrite ring on the keyboard cable may be needed to comply with Immunity Requirements

### Product Serial Number

Thinklogical products have a unique serial number, which includes a date-code, printed on an adhesive label that is affixed to the unit. The format for the date-code is 2 digits for the month, dash, 2 digits for the year, plus at least four digits for a unique unit number. For example, **05-160127** indicates the unit was built in the 5<sup>th</sup> month of 2016, and is unit number **127**.

### Connection to the Product

Connections and installation hardware for our products use industry-standard devices and methods. All wiring connections to the customer equipment are designed to minimize proprietary or customized connectors and cabling. Power connections are made with regionally appropriate power cords and approved methods.

## Thinklogical Support

### Customer Support

**Thank you for choosing Thinklogical® products for your application.**

*We appreciate your business and are dedicated to helping you successfully use our products.*

***thinklogical® is always here to help you.***

*To contact us, please use the following telephone numbers and internet-based methods:*

Thinklogical® is an engineering company and we will always do our best to ensure that you receive any assistance you need directly from our most knowledgeable engineers.

*We believe that the first line of support comes from the design engineers that developed each particular product.*

Therefore, your questions or issues will be handled promptly by our in-house engineers who are most familiar with your products. **We won't be satisfied until you are satisfied.**

## Website

Check out our website for current product offerings, support information and general information about all of the products we offer.

Our internet website offers product information on all current systems, including technical specification sheets and installation guides (for viewing online or for download), product diagrams showing physical connections and other information you might need.

Internet: [www.thinklogical.com](http://www.thinklogical.com)



**Note: Most online documents are stored as Adobe Acrobat “PDF” files. If you do not have the Adobe Acrobat reader needed to view PDF files, visit [www.adobe.com](http://www.adobe.com) for a download.**

## Email

Thinklogical® is staffed **Monday through Friday from 8:30am to 5:00pm**, Eastern Time Zone. We will always do our best to respond to your email inquiries promptly. Please use one of the following email addresses:

[info@thinklogical.com](mailto:info@thinklogical.com) – Information on Thinklogical® and our products.

[sales@thinklogical.com](mailto:sales@thinklogical.com) – Sales Department - orders, questions or issues.

[support@thinklogical.com](mailto:support@thinklogical.com) – Product support, technical issues or questions, product repairs and request for Return Authorization.

## Telephone

<b>Thinklogical Operator</b>	<b>1-203-647-8700</b>
<b>Product &amp; Customer Support:</b>	<b>1-203-647-8798</b>
<b>US Commercial &amp; Canada Sales:</b>	<b>1-203-647-8715</b>
<b>US Federal Government Sales:</b>	<b>1-203-647-8716</b>
<b>Toll Free in the Continental US:</b>	<b>1-800-291-3211</b>
<b>International Sales (Europe, Middle East, Africa):</b>	<b>1-203-647-8704</b>
<b>International Sales (Asia Pacific, Central &amp; Latin America):</b>	<b>1-203-647-8734</b>

Please contact our expert sales staff in Milford, CT. We are here Monday through Friday from 8:30am to 5:00pm, Eastern Time Zone. We'll provide a representative's direct dial phone number when you call.

If leaving a voice message, please provide a preferred time to call back so we may reach you at your convenience.

Our switchboard attendant will direct your call during regular business hours. We have an automated attendant answering our main telephone switchboard after regular business hours and holidays. You can leave voice messages for individuals at any time.

## Fax

Our company facsimile number is **1-203-783-9949**. Please indicate the nature of the fax on your cover sheet and provide return contact information.

## Product Support

Thinklogical's® support personnel are available **Monday through Friday from 8:30am to 5:00pm**, Eastern Time Zone. If your application requires assistance at some time outside of our normal business hours, please contact us beforehand and we will do our best to make arrangements to help you with your Thinklogical® products. **1-203-647-8798**.

## Warranty

Thinklogical, LLC® warrants this product against defects in materials and workmanship for a period of one year from the date of delivery. Thinklogical, LLC® and its suppliers disclaim any and all other warranties.



**Note:** Thinklogical, LLC® products carry a one year warranty, with longer term available at time of purchase on most products. Please refer to your product invoice for your product's Warranty Terms & Conditions.

Defect remedy shall be the repair or replacement of the product, provided that the defective product is returned to the authorized dealer *within a year from the date of delivery*.

If you wish to return your device, contact the Thinklogical, LLC® authorized dealer where you purchased the device, or if you purchased directly, call Thinklogical, LLC at **1-800-291-3211** (USA).

## Return Authorization

In the event you must return a product to Thinklogical® directly, please contact **Customer Support** at: **1-800-291-3211** or **1-203-647-8700**.

If you need to return your Thinklogical® product to us for any reason, please get a **Return Merchandise Authorization Number (RMA#)** from Thinklogical's **Product Support Department (1-203-647-8798)** before sending the unit in.

Customer Support will ask you to describe the problem and will issue you a **Return Merchandise Authorization** number (RMA#). Pack the device in its original box, if possible, and return it with the RMA# printed on the outside of the box.



**Note:** **DO NOT** return a product to Thinklogical® without a **Return Merchandise Authorization**.

## Our Addresses

If you have any product issues or questions or need technical assistance with your Thinklogical® system, please call us at **1-800-291-3211 (USA only)** or **1-203-647-8700** and let us help. If you need to write us or return a product, please use the following address:

Return address for products with Return Merchandise Authorization:

**Thinklogical, LLC®**  
**Attn: RMA#**  
**100 Washington Street**  
**Milford, CT 06460 USA**

**PHONE: 1-203-647-8700**



Website: [www.thinklogical.com](http://www.thinklogical.com)  
 Facebook: [www.facebook.com/ThinklogicalUSA](http://www.facebook.com/ThinklogicalUSA)  
 LinkedIn: [www.linkedin.com/company/thinklogical](http://www.linkedin.com/company/thinklogical)  
 Google+: <http://plus.google.com/u/0/109273605590791763795/about>  
 YouTube: [www.youtube.com/user/thinklogicalNA](http://www.youtube.com/user/thinklogicalNA)  
 Twitter: [@thinklogical](https://twitter.com/thinklogical)



# Appendix A: TLX CATx Video & KVM Quick Start Guide

## thinklogical® QUICK-START GUIDE

## thinklogical's® TLX CATx VIDEO & KVM Extension System

With TLX CATx Video & KVM Transmitters & Receivers

Full 60Hz 4K Video and  
KVM Extension Solutions  
over two CATx Cables

### Complete Steps 1 through 6 to connect your TLX CATx Extenders:

**STEP 1:** Connect the TLX20 Transmitters to the TLX20 Receivers using CATx cables.

For a **single 4K @ 30Hz DisplayPort or HDMI video and KMASS data**, only one CATx cable is required (Port 1).

For a **single 4K @ 60Hz DisplayPort video and KMASS data**, two CATx cables are required (Ports 1 and 2).

**STEPS 2:** Connect the PWR-84 5VDC @ 7A Adapter to the Receiver's Power port. Be sure to secure the connection with the built-in screw lock.

**STEP 3:** Connect an HDMI (for 4K @ 30Hz) or DisplayPort (for 4K @ 60Hz) Cable from the Receiver to the display device. (Use either HDMI or DisplayPort at both the Transmitter and Receiver.)

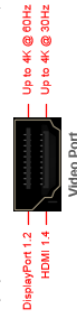

Depending on your configuration, connect your peripheral devices (audio, USB, etc.) to the Receivers using standard copper cables as shown right. Turn all the devices ON.

**STEP 4:** Connect the PWR-84 5VDC @ 7A Adapter to the Transmitter's Power port. Be sure to secure the connection with the built-in screw lock.

**STEP 5:** Connect the HDMI (for 4K @ 30Hz) or DisplayPort (for 4K @ 60Hz) Cable from the source CPU to the Transmitter's Video In port. (Use either HDMI or DisplayPort at both the Transmitter and Receiver.) Connect the peripheral device sources (audio, USB, etc.) to the Transmitter using standard copper cables. Ensure the CPU is turned ON.

**STEP 6:** Connect the Mgmt Ports to an Ethernet switch, if applicable. (CATx Extender default IP address: 192.168.1.101)

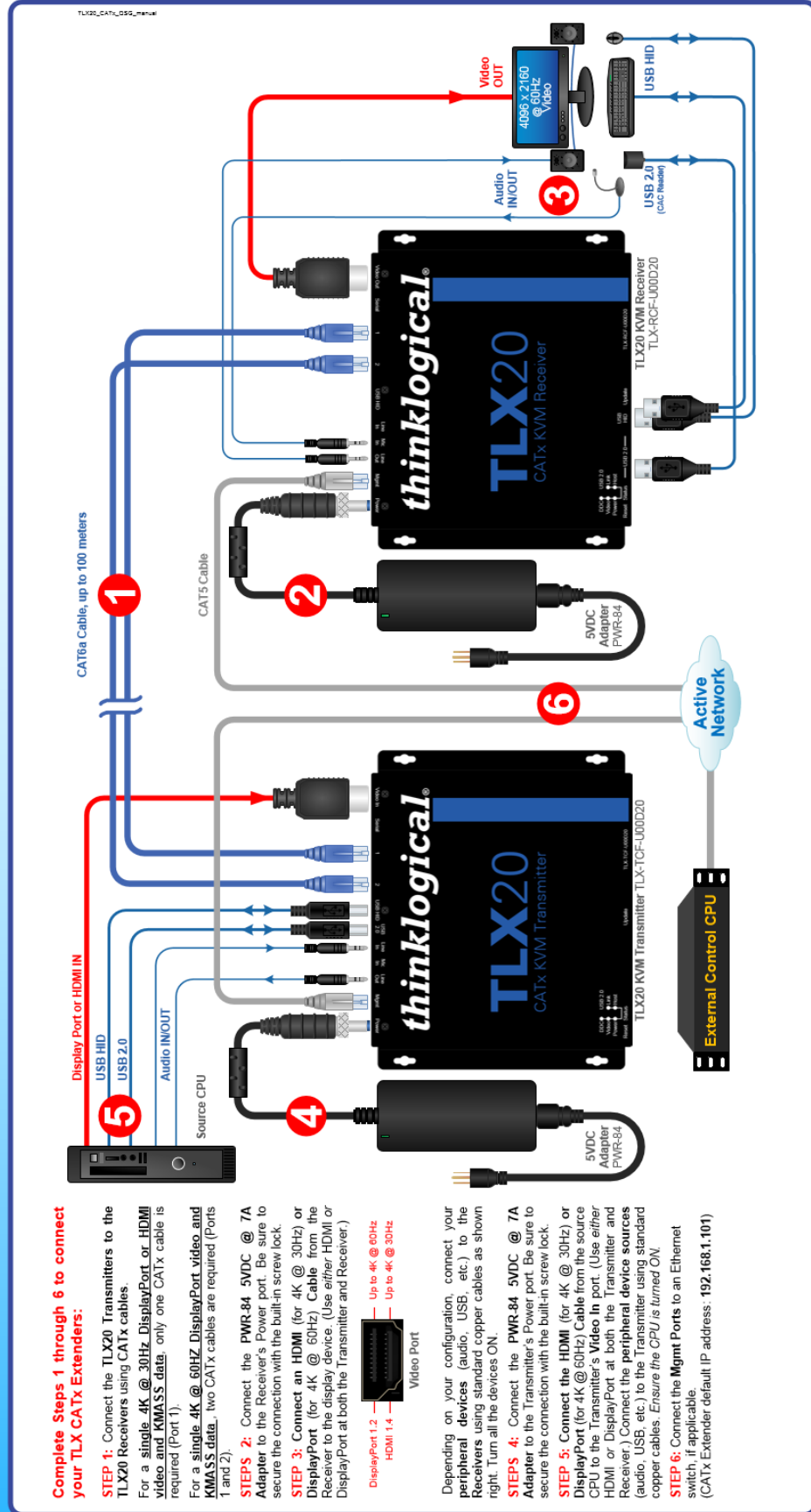

## Appendix B: RJ45 to DB9 Adapter Pin-outs

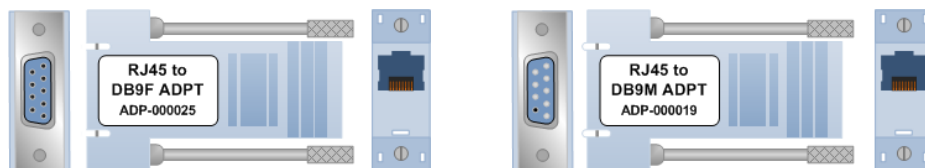
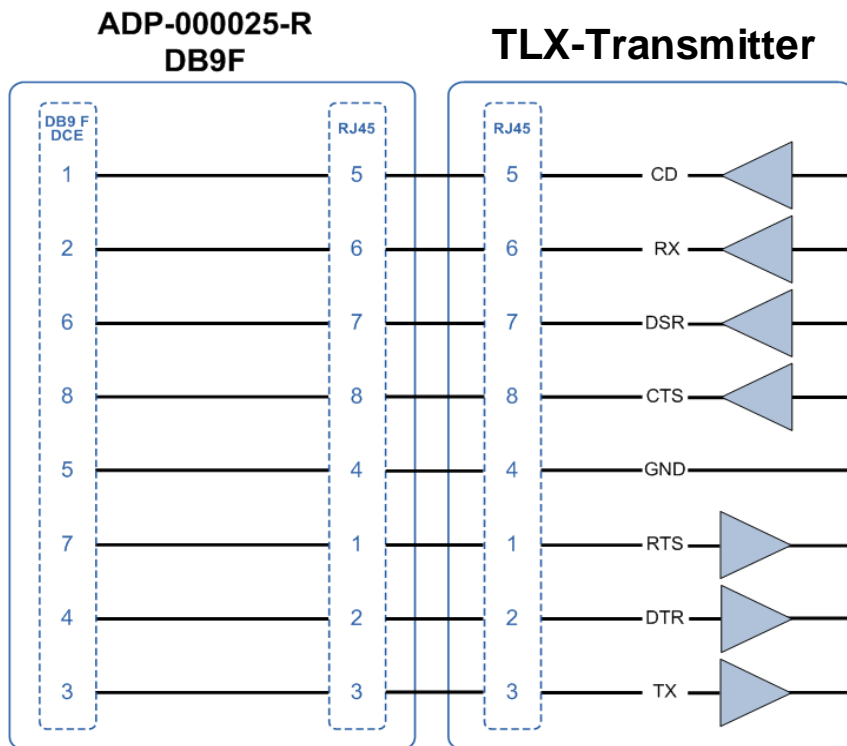
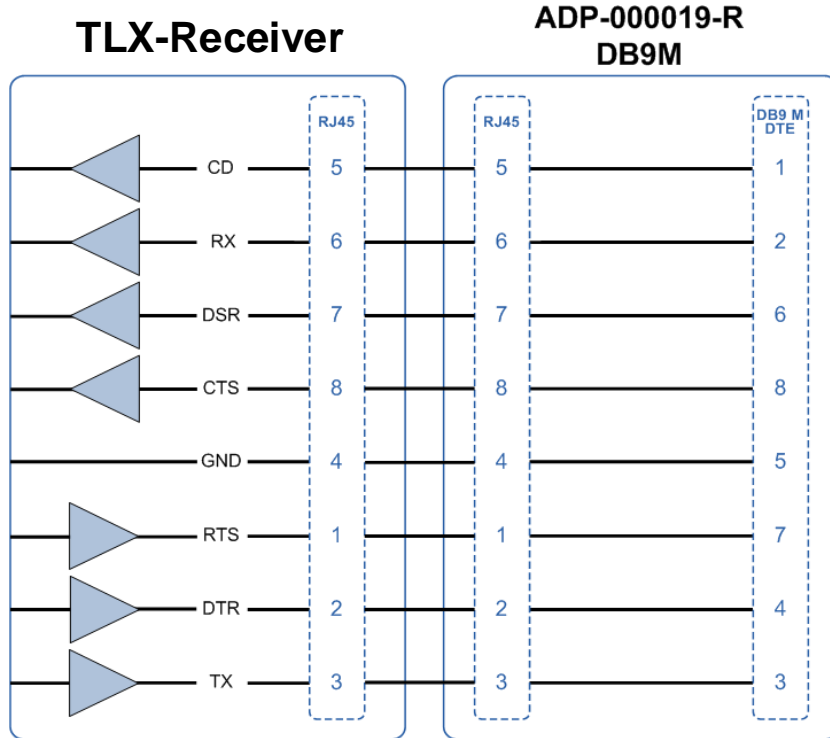



# Appendix C: FPGA Program Code Update Procedure

## thinklogical® TLX CATx Extender FPGA Program Code Update Procedure

The following procedure documents the process for updating the FPGA Program Code, using a Windows-based computer, for TLX10 and TLX20 CATx Extenders Modules

- 1** **STEP 1:** FPGA Update Preparation: Please contact your *thinklogical* Sales Representative or Customer Service (1-203-647-8700) for access to the FPGA Download Update application and firmware.
- 2** **STEP 2:** Install the provided FPGA Download Update application on the system's CPU.
- 3** **STEP 3:** Save the FPGA program code update file provided by Thinklogical to a known location on the CPU. The program code update file will have a file extension of ".lbf". This is the file that will be retrieved in Step 9.
- 4** **STEP 4:** Connect a USB mini-B cable from the Update Port of the TLX10 or TLX20 chassis to the CPU. (When connecting Thinklogical equipment to your PC for the first time, it may take a few moments for Windows to correctly install the required drivers.) Open the Windows Device Manager to check that all drivers are installed correctly.

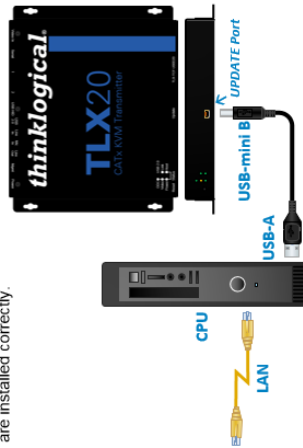

**5** **STEP 5:** This Device Manager window will appear. When completed successfully, The Universal Serial Bus controllers section will contain USB Serial Converter A and USB Serial Converter B at the bottom of the list.

**6** **STEP 6:** Once the drivers are installed, go to the Start menu and choose: Start → All Programs → FPGA\_Download → FPGA\_Download. The window above will appear. Select *Identify Product*.

**7** **STEP 7:** If you do not see CATX.TX, call Thinklogical for assistance. Otherwise, select *Open File*.

**8** **STEP 8:** A window similar to this will open. As shown, there is only one firmware option for each of the CATX Extender Transmitters. To upgrade the Tx, select the file and click OK, as shown above.

**9** **STEP 9:** A dialog box similar to this will appear. Navigate to the folder with the unzipped firmware files from Step 3 (i.e. catx\_tx\_fpga\_sw - lbf). The dialog box will already be populated with the correct file name. Click *Open*. This will take approximately 10 minutes. The Upgrade window will open again.

**10** **STEP 10:** Select *Open File* and repeat the previous steps to update the RX modules. Be sure to move the USB cable to the Receiver's Update Port.

- 11** **STEP 11:** To make the new firmware active, cycle power to the unit by momentarily removing and reinstalling the power cord.
- if you have any problems or questions, please call thinklogical for help: 203-647-8700**

ISO 9001:2008 CERTIFIED  
2016 NABSHOW  
thinklogical  
TLX\_CATx\_Extender\_FPGA\_Update\_Procedure\_manual

## Appendix D: EDID and DDC for TLX Modules

**Extended Display Identification Data (EDID)** is a data structure provided by a digital display to describe its identity (*manufacturer's name, product type, serial number, etc.*) and capabilities (*native timing, frequency range, video and audio formats, etc.*) to a video source.

**EDID is what enables a modern personal computer to know what kind of monitor is connected.**

With this information the CPU and video card can determine what resolutions the monitor is capable of. EDID is defined by a standard published by the Video Electronics Standards Association (VESA). The EDID also includes such information as the phosphor or filter type, timings supported by the display, display size, luminance data and pixel mapping data for digital displays.

**Display Data Channel (DDC)** is a VESA standard transport medium between a CPU's graphics adapter and monitor used to pass EDID.

### Default DDC Modes:

#### Remote Dynamic Mode

The unit acts as a direct connection between the RX and TX. In this mode DDC data is read at the RX and sent to the TX. Once verified at the TX the information is written into a PROM on the TX and provided to the CPU video card. The RX will not send DDC data to the TX unless a different display is connected to the RX.

**Advantage:** Allows CPU video card to boot when there is no fiber connection to the RX.

**Limitations:** No communication link from the CPU to the display. Remote Dynamic prevents the use of HDCP or monitor configuration /color tuning.

#### Remote Static Mode

Remote Static Mode is a subset of Dynamic Mode in that once a transfer from the RX to the TX is completed successfully, no other transfer will be made unless specifically requested. The DDC data stored in the TX PROM will not change regardless of display changes.

**Advantage:** Allows the user to acquire and use an EDID table regardless of changes in connection at the RX.

**Limitations:** No communication link from the CPU to the display. Remote Static prevents the use of HDCP or monitor configuration/color tuning. This may result in no video if a display with lower resolution capability is subsequently connected.

#### Default EDID Table

Multiple EDID Tables are present to support most common default resolutions. i.e. 1920x1200, 3840x2160, etc..

**Advantage:** Sends a valid EDID table to the CPU to boot the graphics adapter.

**Limitations:** Default EDID table may not support required resolutions.



**Note:** Most graphics adapters will not boot if a valid EDID table is not received at power up.

TLX Modules EDID Table			
Feature	Remote Dynamic	Remote Static	Load Default
Supports HDCP	Yes	Yes	Yes
Supports Monitor calibration	No	No	No
Monitor on Rx side required to boot video	No	No	No
EDID table loaded from Rx	Yes	Yes	No
EDID table loaded from Tx	No	No	No
EDID table stored in non-volatile memory	Yes	Yes	Yes

## How to Change DDC Modes

*The TLX10 and TLX20 have no LCD or Navigation buttons, therefore the MGMT Port must be used to change DDC modes.*

1. Connect an active **Ethernet cable** to the module's **MGMT Port**.



2. Open a Telnet session to the CATx Extender using **PuTTY** (an SSH and Telnet Client available for Linux and Windows). PuTTY is an open source program, downloaded for free at [www.putty.org](http://www.putty.org).

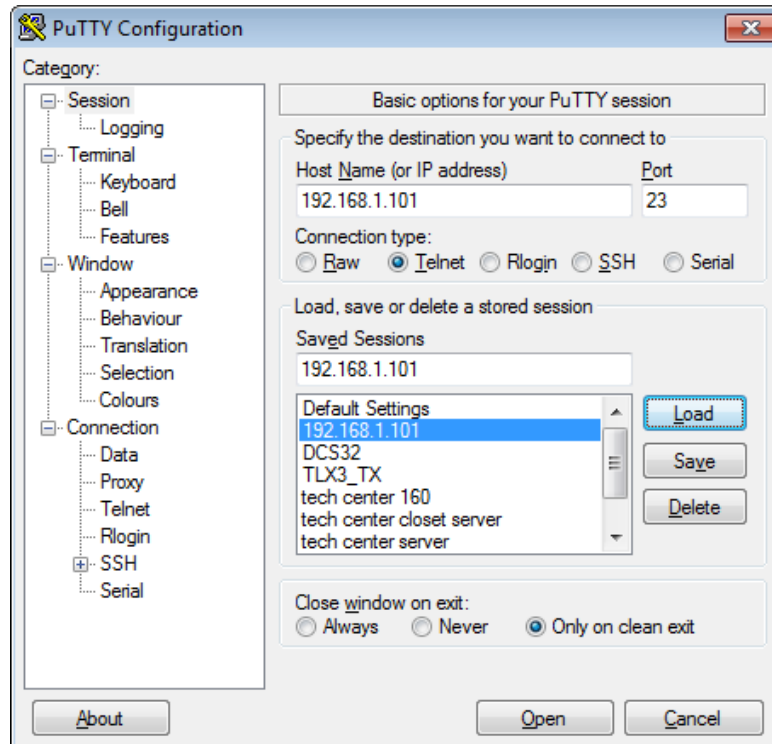

3. The login ID and Password are both **admin**

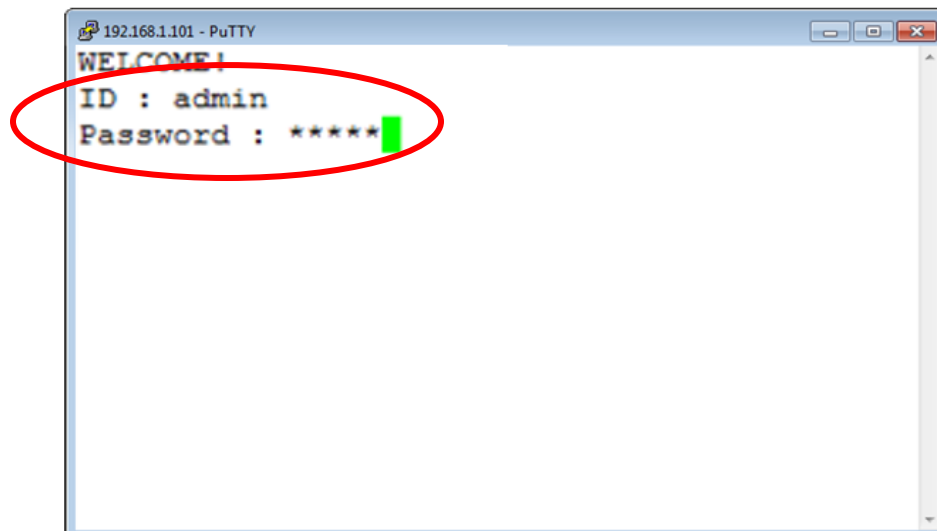

4. The **Main Menu** will appear.

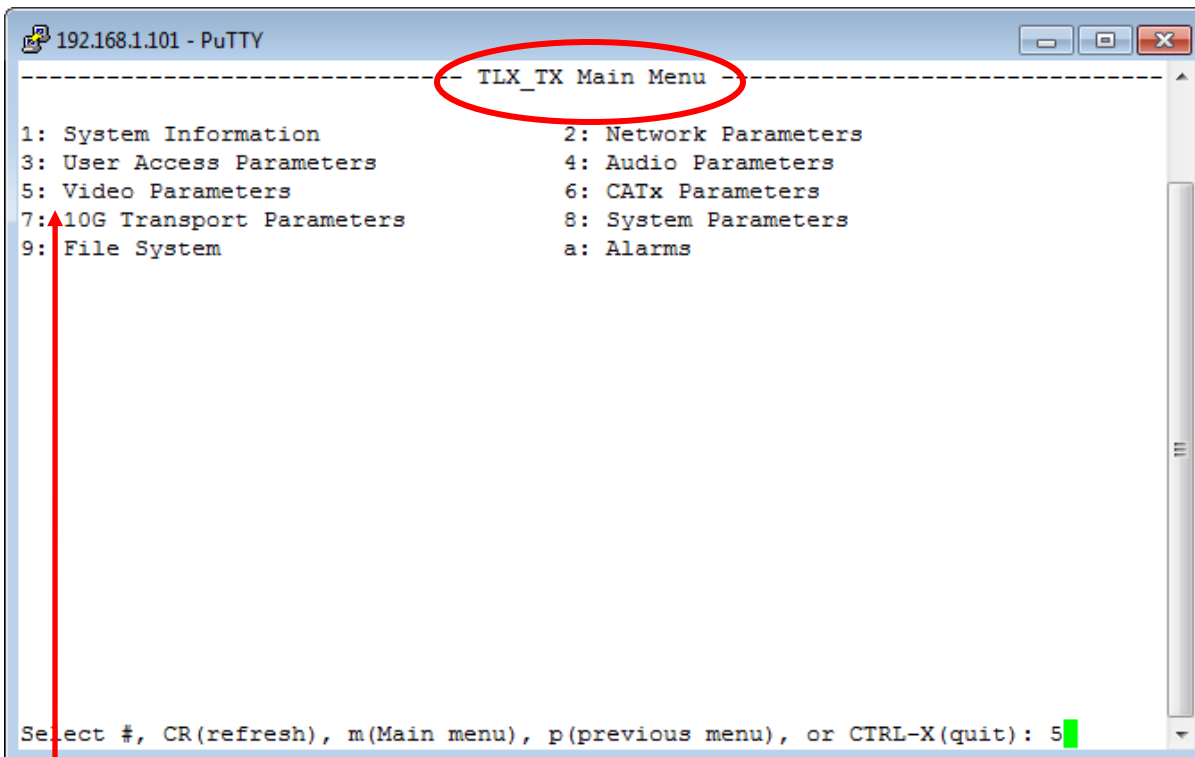

```
192.168.1.101 - PuTTY
----- TLX_TX Main Menu -----
1: System Information                2: Network Parameters
3: User Access Parameters           4: Audio Parameters
5: Video Parameters                 6: CATx Parameters
7: 10G Transport Parameters         8: System Parameters
9: File System                      a: Alarms

Select #, CR(refresh), m(Main menu), p(previous menu), or CTRL-X(quit): 5
```

5. Type **5** and <ENTER> to access the **Video Parameters**

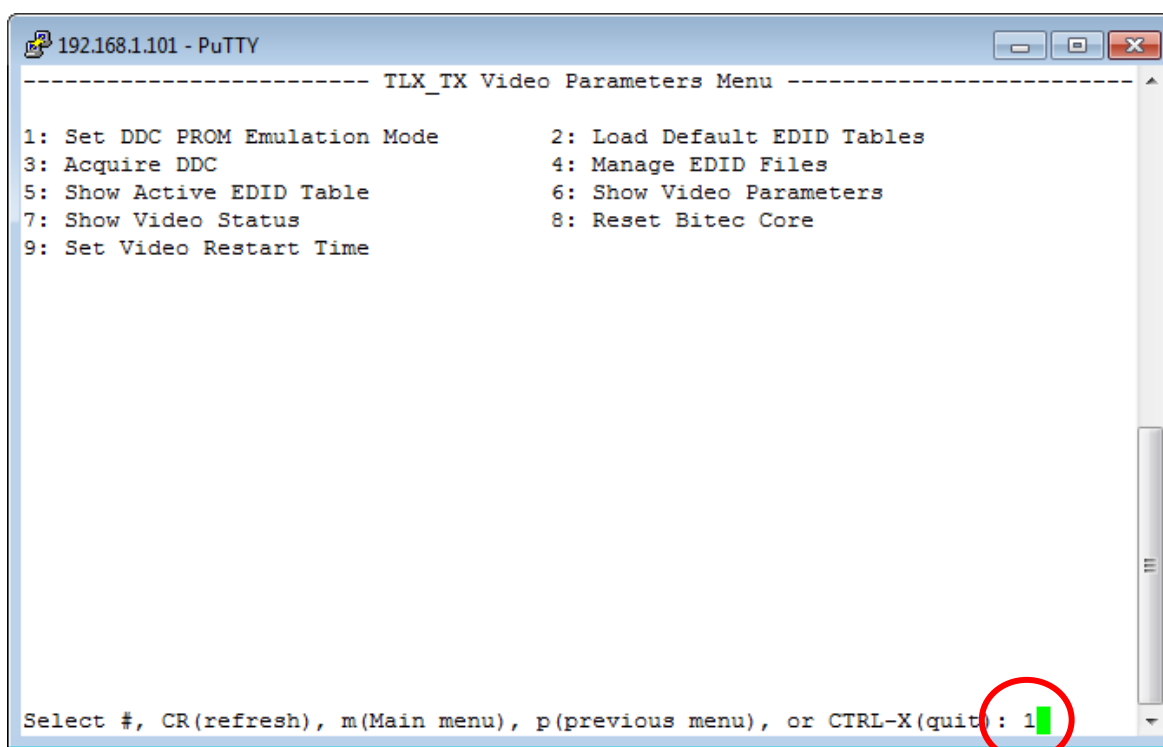

```
192.168.1.101 - PuTTY
----- TLX_TX Video Parameters Menu -----
1: Set DDC PROM Emulation Mode      2: Load Default EDID Tables
3: Acquire DDC                      4: Manage EDID Files
5: Show Active EDID Table           6: Show Video Parameters
7: Show Video Status                8: Reset Bitec Core
9: Set Video Restart Time

Select #, CR(refresh), m(Main menu), p(previous menu), or CTRL-X(quit): 1
```

6. The **Video Parameters** window will open (above). Select **1: Set DDC PROM Emulation Mode**.

```

----- TLX_TX Video Parameters Menu -----

1: Set DDC PROM Emulation Mode           2: Load Default EDID Tables
3: Acquire DDC                           4: Manage EDID Files
5: Show Active EDID Table                 6: Show Video Parameters
7: Show Video Status                       8: Reset Bitec Core
9: Set Video Restart Time

DDC PROM Emulation Mode is Dynamic Change? (Y/N): y

```

7. The default DDC Mode is **Dynamic**. To change modes, type **y** and <ENTER>.

```

----- TLX_TX Video Parameters Menu -----

1: Set DDC PROM Emulation Mode           2: Load Default EDID Tables
3: Acquire DDC                           4: Manage EDID Files
5: Show Active EDID Table                 6: Show Video Parameters
7: Show Video Status                       8: Reset Bitec Core
9: Set Video Restart Time

Select <1> for Dynamic, <2> for Static, or <3> for Local Static: 2

```

8. To change the DDC Mode to **Static**, for example, type **2**, then <ENTER>

9. The DDC Mode has now been changed to **Static**.

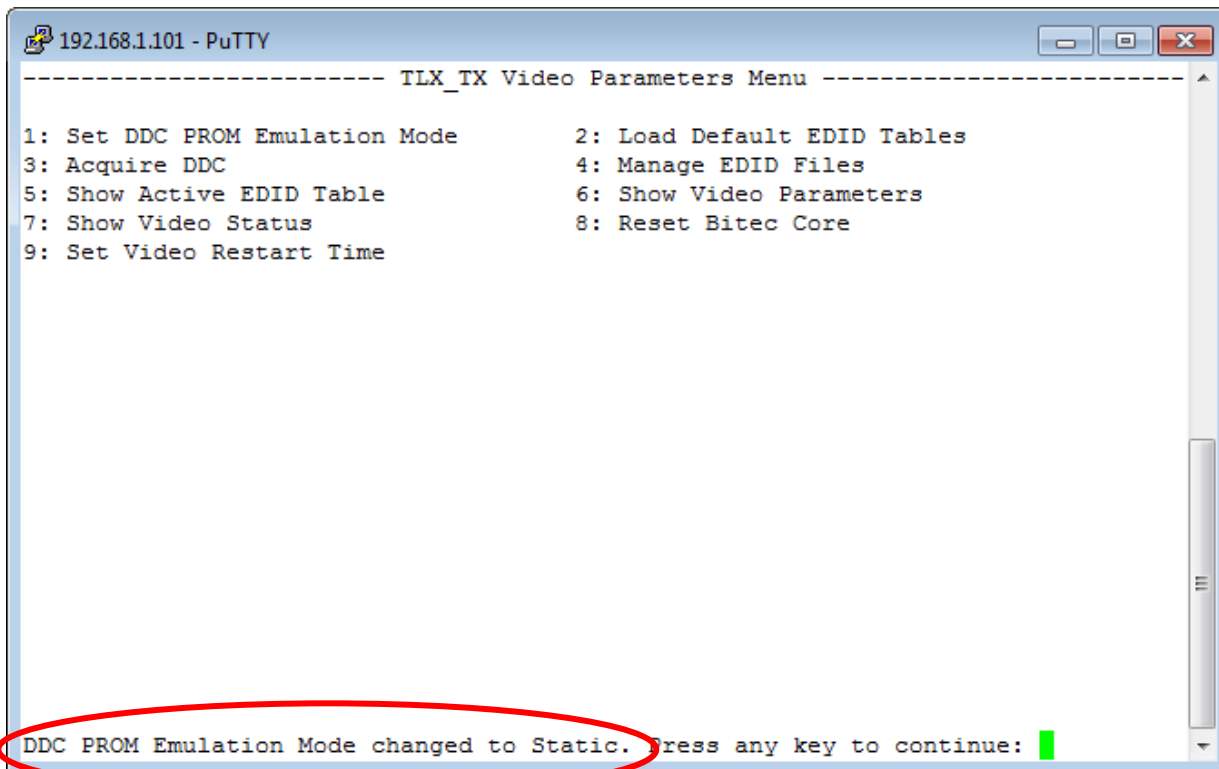

## How to Change the IP Address of a CATx Extender

1. Connect an **Ethernet cable** to the module's **MGMT port**.
2. Open a Telnet session to the CATx Extender using **PuTTY** (an SSH and Telnet Client available for Linux and Windows). PuTTY is an open source program, downloaded for free at [www.putty.org](http://www.putty.org).

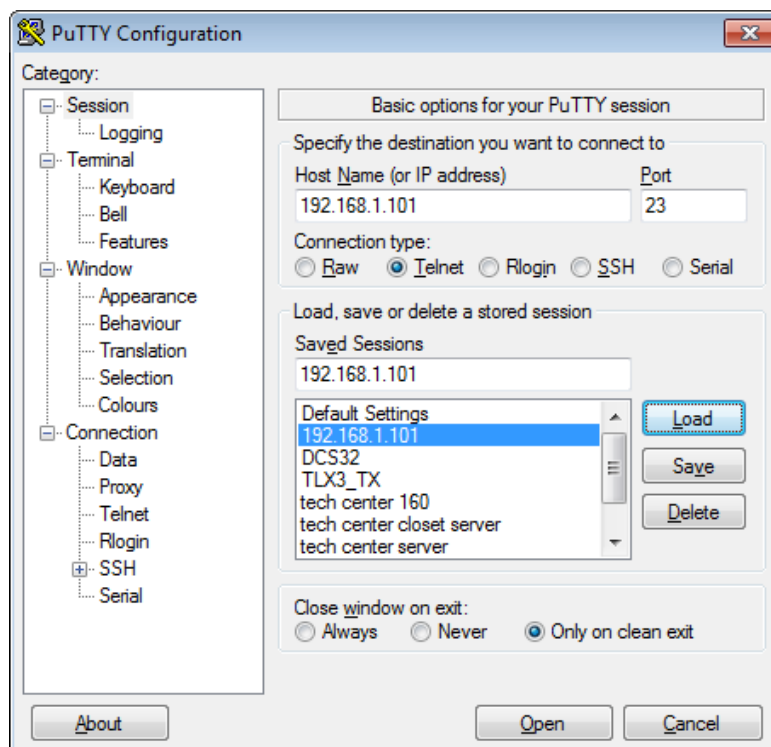

- Once connected via MGMT Port, the address can be changed to the user's preference using Option 2 (**2: Network Parameters**) on the Main Menu.

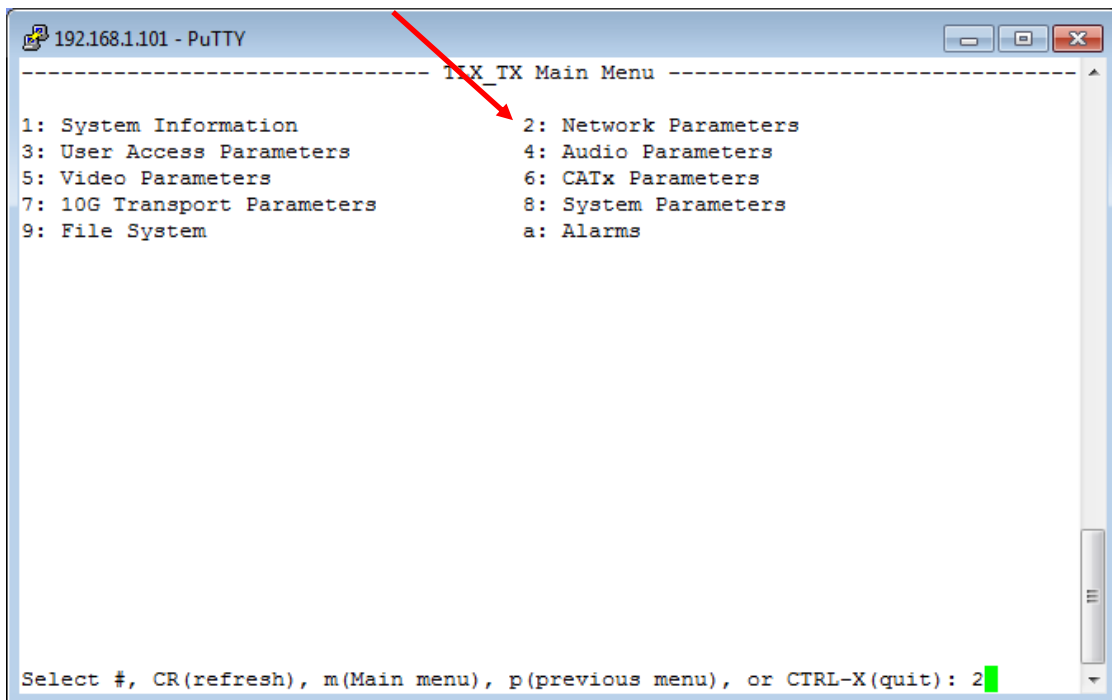

```
192.168.1.101 - PuTTY
----- TLX_TX Main Menu -----
1: System Information
3: User Access Parameters
5: Video Parameters
7: 10G Transport Parameters
9: File System
2: Network Parameters
4: Audio Parameters
6: CATx Parameters
8: System Parameters
a: Alarms

Select #, CR(refresh), m(Main menu), p(previous menu), or CTRL-X(quit): 2
```

- The extender can be configured with a new static IP address or configured using DHCP. **By default, the extender has a static IP address of 192.168.1.101.**

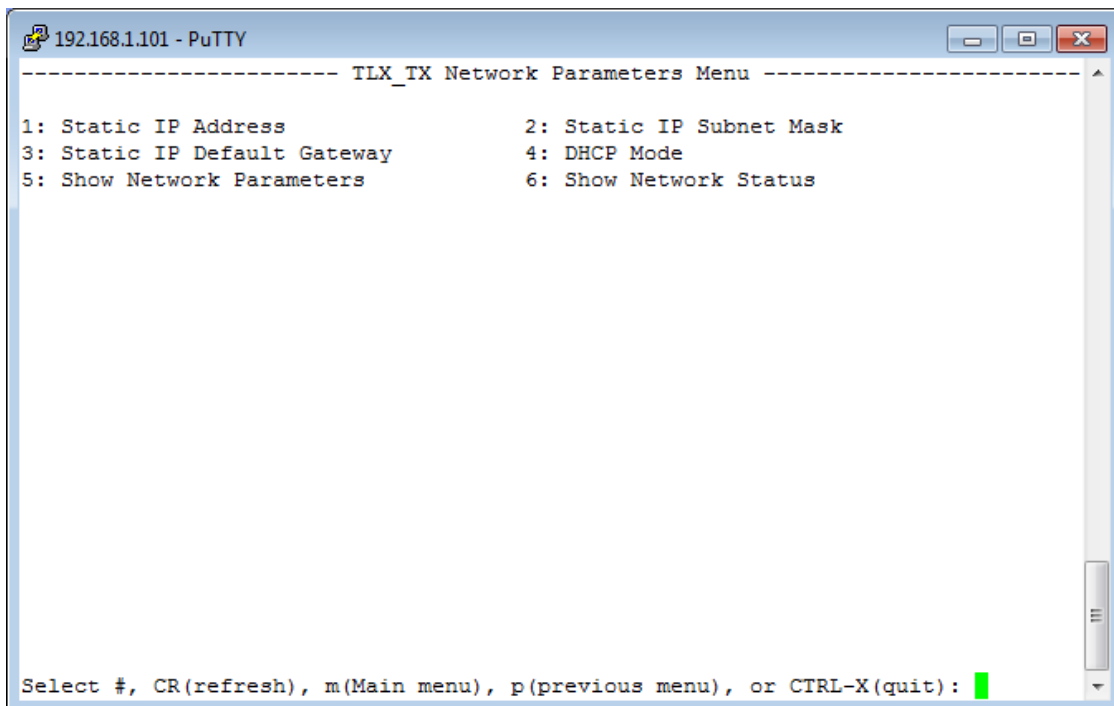

```
192.168.1.101 - PuTTY
----- TLX_TX Network Parameters Menu -----
1: Static IP Address
3: Static IP Default Gateway
5: Show Network Parameters
2: Static IP Subnet Mask
4: DHCP Mode
6: Show Network Status

Select #, CR(refresh), m(Main menu), p(previous menu), or CTRL-X(quit):
```

## How to Configure a PC with a Static IP Address

1. On the PC monitor's bottom tool bar, click on the Network icon (below).

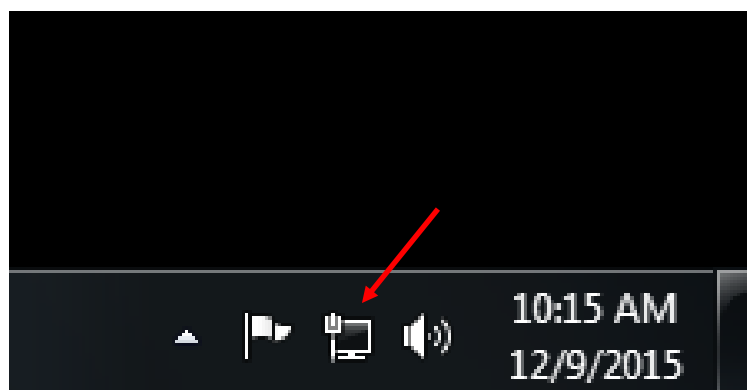

2. Click on [Open Network and Sharing Center](#) (below).

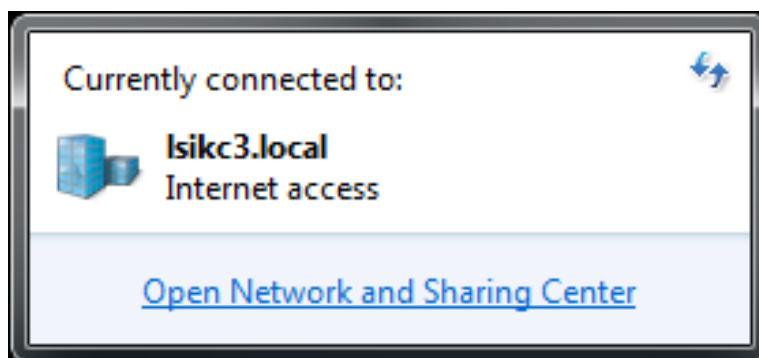

3. Click on **Change adapter settings**

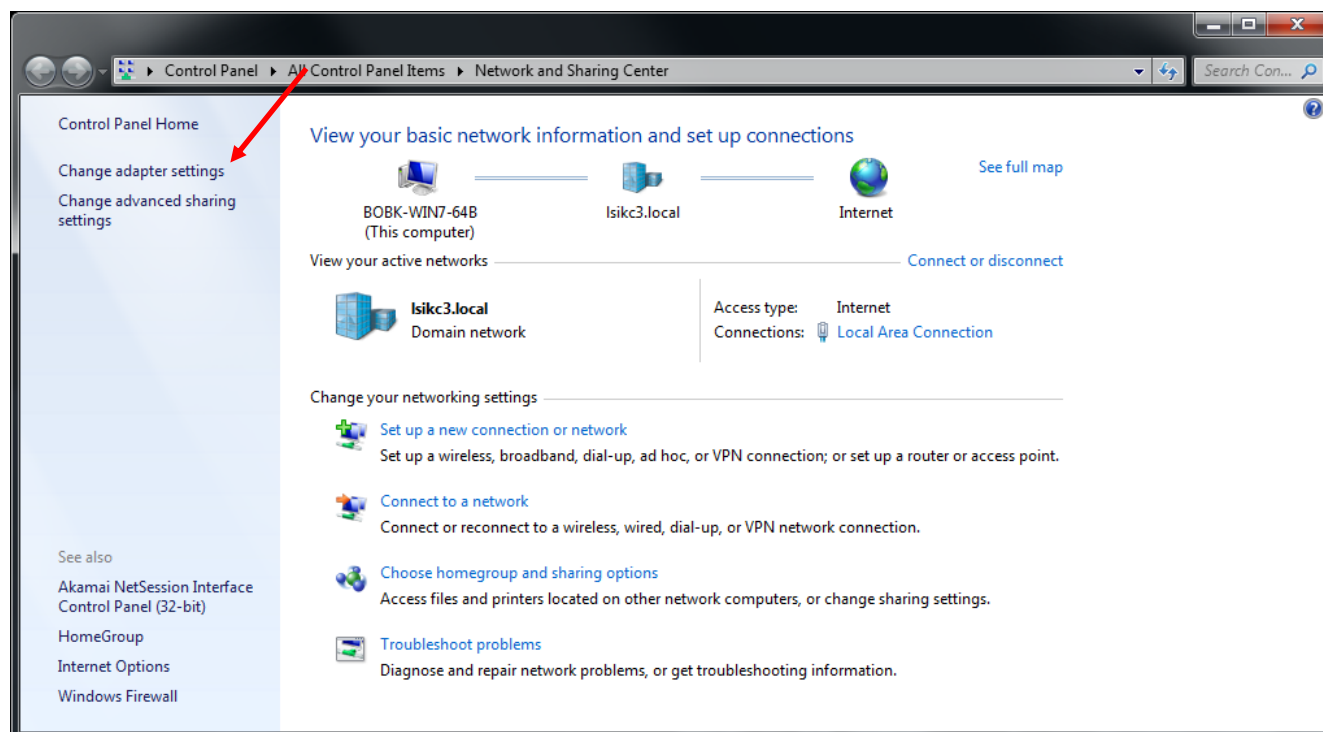



- Right click on the adapter to be configured (**Local Area Connection** in this example) and select **Properties**.

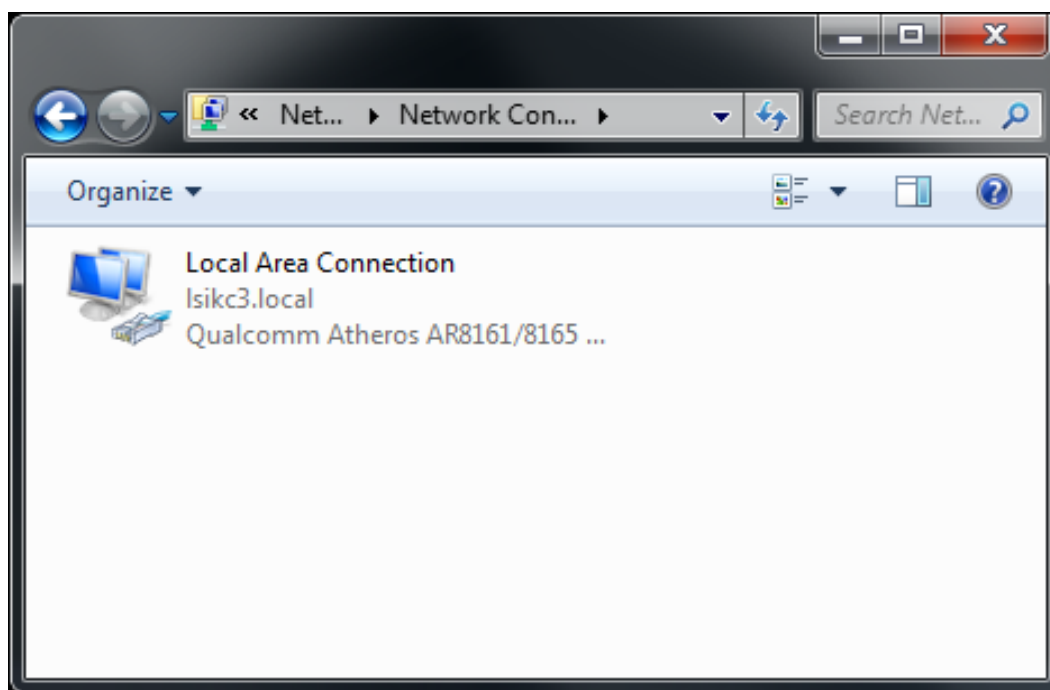

- Select **Internet Protocol Version 4 (TCP/IPv4)**, then click on **Properties**.

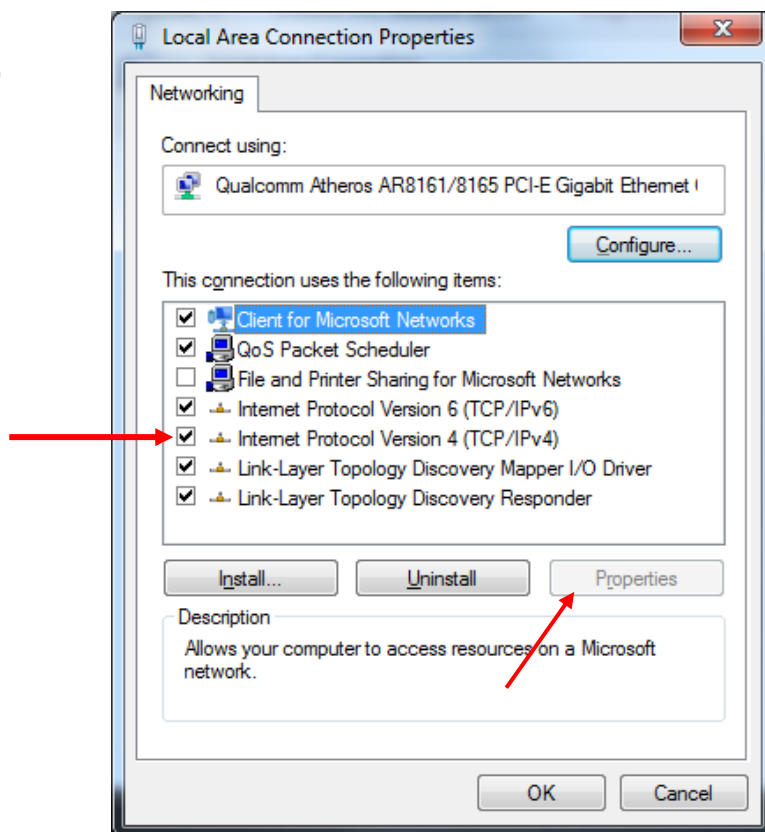

6. Click on the **Use the Following IP address** button.

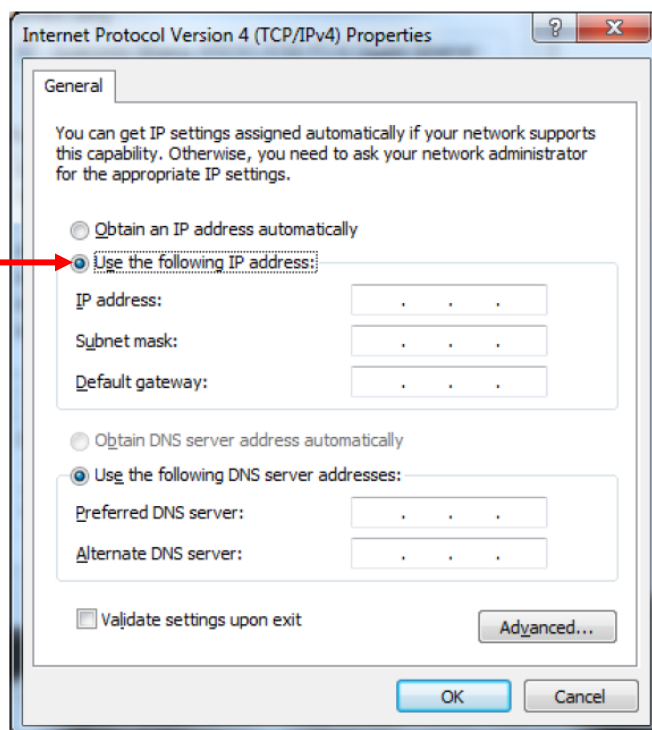

7. Enter a **Network address** (192.168.1 in this example) and a **Host address** (43 in this example) in the **IP address:** box as shown below.
8. Click on **Subnet mask:** The default address will appear automatically.
9. Enter the **Default gateway address** (the Network address 192.168.75 and 1 for the Host address).
10. Click **OK** to complete the process.

