

Timbecon

Everything
to **get wood
working**

2018/19

Product Catalogue



FRONT COVER

Featured on the front cover this year is furniture maker Alexandra Pontonio. Check out her amazing work at www.alexsandrapontonio.com

Check out our new and improved website at timbecon.com.au



Welcome to our 2018/19 catalogue

A yearly catalogue has become a necessity at Timbecon because of the big changes that our range has been going through. Very few products have fallen from the range and below is a list of the best new brands you'll find in this catalogue when you browse through it –

- **Armor Tool**
- **Bow Products**
- **CMT Router Bits**
- **Easy Wood Tools**
- **iVac**
- **Micro Jig**
- **Next Wave Automation**
- **SawStop**
- **Whittle Waxes**

This doesn't include the product additions from our existing stable of brands – with new products from virtually all of them. And we continue to revitalize the Sherwood range with the addition of router tables, an overhaul of our planers completed and the new Sherwood Bandsaw range landing in the second half of 2018.

And now we are also releasing products that are unique to Australia as well as globally under the Torquata brand. We think you'll be impressed with what you find contained in our ever-growing range and catalogue. We're very proud to bring this new catalogue to you and hope you find it a valuable reference.

Have you seen our popular YouTube channel?



Contents

Extraction & Safety	5-13	Sanding & Scraping	108-113	Carving & Chisels	162-170
Measuring & Marking	14-24	Drilling	114-121	Woodturning	171-186
Sawing	25-41	Joinery	122-135	Wooden Parts & Inlays	187-189
Site & Shop Accessories	42-58	Clamps & Vices	136-146	Cabinet Fittings	190-202
Routing	59-97	Finishing	147-152		
Planing	98-107	Sharpening	153-161		

Keep tabs on all things Timbecon



Keep up with the latest news on promotions, product arrivals and general interest woodworking topics.

The Timbecon Rewards Program is designed to give back to you for supporting us.

It is a simple system where you will always earn one point for every dollar that you spend with us (excluding discounts over and above advertised specials). When you reach 500 points we will give you a \$20 voucher that is valid for four months and

can be redeemed on any purchase of your choice.

Your points will never expire, so it doesn't matter how long it takes for you to reach the threshold.

- For every voucher we issue, you will also receive a Timbecon Status point and when you get to 10 Timbecon Status

points, you will receive a lifetime member 5% discount on all purchases that you make with us forever.

- When you get 20 Timbecon Status points you will get a lifetime membership discount of 10% on all purchases.
- A limited number of exclusions may apply.



Gift Vouchers

Gift vouchers are a great gift-giving option and at Timbecon we can provide Gift Vouchers to any value. Vouchers don't have to be used all at once either – you can use partial values multiple times until the full value has been redeemed.

We post Gift Vouchers anywhere in Australia via standard Australia Post envelope free-of-charge so if you can't make it in-store, call us to arrange a voucher over the phone.

If you've left it to the last minute, don't worry, we can post Gift Vouchers for a small extra charge by Express Post too.

Store Locations

We have retail showrooms in Perth & Melbourne that are open Monday-Friday and Saturday mornings. Customer service and shipping in WA is handled from the Perth store, with customer service and shipping for the remainder of the country being handled by our Melbourne store.

If you're in the area, we'd love to see you in-store!

Melbourne Store

P: 1300 880 996
Local: 03 9448 8300
Fax: 08 6161 1176
U6/3b Newlands Road
Reservoir VIC 3073
E: melbourne.shop@timbecon.com.au

Perth Store

P: 1300 880 996
Local: 08 6161 0392
Fax: 08 6161 1176
31 Canvale Road
Canning Vale WA 6155
E: perth.shop@timbecon.com.au



WARRANTY

All goods sold by Timbecon Pty Ltd will carry a minimum two-year warranty, regardless of the manufacturer's warranty. Timbecon will cover any gap between the manufacturer's warranty up to and including this two-year period.

Sherwood is covered by a five-year warranty and Torquata with a lifetime warranty against manufacturing defects from date of purchase.

The warranty does not cover willful misuse of the product from what it was originally designed for, nor does it cover user neglect of the product. The warranty specifically covers manufacturing defects and/or inability to perform the task as advertised by Timbecon when used correctly.

Warranties may be granted without returning the product if you are able to provide clear photographs showing the nature of the defect. If this is not possible, then you must pay the freight to have the goods returned to us or to an authorized repairer/distributor to confirm warranty.

If the item is not deemed to be warranty, then the cost of freight to and from the nominated return address is to be payable by you. If the item needs to be repaired/replaced under warranty, we will cover the return freight to you and refund your freight cost to send it to us.

PRICES

While we attempt to get all prices correct in this catalogue there may be errors. We will also attempt to maintain pricing for as long as possible but cannot foresee changes in our costs that may result in a change in our retail price. Always check in-store, online or on the phone for the current price.

We cannot be bound by the advertised price shown in this catalogue and are free to change it as necessary. We will honour all prices shown in-store and/or on the website at the time of placing an order.

RETURNS

If you change your mind and no longer wish to own any product that has been bought from Timbecon, the goods may be returned within three months from date of purchase. You are responsible for the cost of returning it. The item must not be used and be returned in original packaging to get a full refund of the value of goods.

Items returned which have been used and/or are not in the original packaging and cannot be re-sold as new will not be accepted. Once we have received the product from you, we will issue you with a credit on your account or a full refund. The choice is yours.

CREDIT CARD PAYMENTS

The Timbecon website processes all credit card payments using the SecurePay gateway processing system. Your account is debited at the time of placing the order for the full order value as seen in the checkout.

If a refund needs to be performed by Timbecon for an online order, this will either be processed directly through SecurePay's online portal or we will perform a direct deposit to your nominated bank account. We do not receive the full credit card details for your online purchases.

If you order over the phone, Timbecon enters your credit card details directly into our processing system where the payment will be processed immediately and no credit

card details will be kept on file. If we need to perform a refund for a phone order, we will contact you at the time of processing the refund and enter your credit card details immediately so that we do not to store your card details.

OTHER METHODS OF PAYMENT

We also accept Paypal and direct deposit payments online. In-store we accept cash and payment by debit (savings or cheque) cards as well as Visa & Mastercard credit card payments. We cannot accept Amex and will not accept personal cheques without prior arrangement.

DISPATCH TIMING

We aim to dispatch your order with 1-2 business days of receiving it. If we are unable to do this, we will contact you as soon as we know that we are unable to meet this commitment and advise of any delay. You can expect a turnaround time of less than 24 hours (excluding weekends) for order dispatch.

FREIGHT & DELIVERY

All prices advertised exclude freight delivery costs. Before you commit to any order from Timbecon we will show the full price including freight (and optional insurance). Confirming any order means that you accept the freight cost as shown. If you decide quickly after ordering that you wish to cancel the order, please contact us immediately and if we haven't dispatched the order, we will refund the full value of the order.

We have a variety of carrier options – including Australia Post, Startrack Express Priority and Border Express road freight options. More information on the freight options are shown on the website and you can choose whichever option you prefer when ordering either by phone or on the website.

INSURANCE - COVERING LOSS/DAMAGE IN TRANSIT

All freight companies used by Timbecon are general carriers and therefore do not cover damage or loss of goods in transit. Timbecon offers a simple insurance option, that is calculated at 2% of the value of goods, your order will be insured against loss and/or damage.

If you do not accept the insurance charge, you will do so at your own risk and any damage and/or loss is your responsibility. In all cases we recommend the optional protection of insurance.

BACKORDERS

If we are out of stock of any item, we will calculate the total weight of your order as if it was shipped together with other items and charge you the freight cost calculated. This means that the cost of shipping your backorder will be covered in only one payment to us.

You can choose to cancel your backorder any time before we ship it to you.

AVAILABILITY

Generally all items that are advertised in the catalogue and on the website are either in stock or able to be sourced within a short period of time (1-2 working days). Check the website or contact us directly to confirm product availability at any given time.

WEIGHTS

All weights shown in any advertising by Timbecon may not be the true product

weights but are a value shown to calculate freight costs. In some cases products can occupy a large volume relative to weight and therefore the true product weight may be overstated. If you wish to know the actual weight of any item, please contact us.

SPECIFICATIONS

Measurements and specifications are supplied as an approximate guide. We take all care to ensure that information is accurate and if it is found that we have made a material mistake that stops you from being able to use it as advertised, we will pay the return freight and offer a full refund for the goods and freight cost to ship that item to you.

All items shown in pictures or illustrations with the main product are deemed to be accessories or props and are not included in the sale price of the main item unless expressly stated.

SUITABILITY

You must satisfy yourself that the suitability of the product for its intended use prior to purchasing any product. While Timbecon can offer advice and show how a product is used, it is ultimately your responsibility to ensure that the product is used correctly.

Timbecon cannot be held liable for any damage or loss to any persons and/or property from the lack of training necessary to use any product. It is up to the user to ensure that they are capable and have the necessary skill to use any products sold by Timbecon.

It is also the customer's responsibility to ensure they have an adequate and properly connected electrical supply capable of running the machine(s) they wish to buy. Any warranty claim will be denied in all cases where extension cords and/or powerboards are deemed to have contributed to the failure of any electrical or electronic component of the machine. The same exclusion will apply where the machine is connected to the incorrect voltage and/or amperage designated for the machine and/or if the machine is used for anything other than what it was designed and built to do.

WARNING

Woodworking machines and tools are potentially dangerous. The user of the products should take every precaution while using the products to avoid personal injury and/or property damage. This includes, but is not limited to, the use of personal protective equipment, electrical safety precautions, inhaling dust particles. Items are used at your own risk.

DANGEROUS GOODS

Dangerous goods cannot be sent by any freight companies that we use and for that reason we will advertise them but do not provide the option for them to be shipped. We list them for research/information purposes only and can only be bought in-store. If you wish to purchase these to be shipped, you can arrange for your own freight to collect from our stores in Perth and Melbourne.

GOVERNMENT TAXES

All prices on this website include the 10% Australian Goods and Services tax. All customer orders shipped within Australia include GST and a tax invoice matching the ATO's requirements are provided.

Timbecon's ABN is 80 601 953 682.

\$725⁰⁰
2HP Industrial Dust Extractor

SHERWOOD
 DC-1750 | 125kg

- Motor** 1500W (2HP)
- Air Flow** 1750CFM
- Static Pressure** 13.0"/H2O
- Inlet Diameter** 1 x 6in
- Bag Diameter** 500mm
- Bag Capacity** 180L
- Overall Size** 2350 x 950 x 630mm



Running your extractor all day, every day? With the same motor input as the FM-300, this unit will flow 30% more air – meaning you can run two machines generating a large volume of waste with ease.

This is done by a computer-model enhanced impeller design along with a more efficient motor mating to increase the capacity. Perfect for school, industrial or a demanding home user. Comes on castors to be moved around easily.

\$1099⁰⁰
3HP Industrial Dust Extractor

SHERWOOD
 DC-2900 | 170kg

- Motor** 2250W (3HP)
- Air Flow** 2900CFM
- Static Pressure** 22.5"/H2O
- Inlet Diameter** 1 x 8in
- Bag Diameter** 500mm
- Bag Capacity** 400L (Combined)
- Overall Size** 2600 x 1570 x 710mm



This unit will flow a massive 52% more air than the FM-400 with the same size motor– meaning you can run three or even four machines with ease. Perfect for school and industry or a demanding home user with enough space. Comes on castors to be moved if necessary.

\$399⁰⁰
Air Filter Room Cleaner

SHERWOOD
 TDF-1000 | 35kg

- Air Flow** 1000CFM
- Efficient Workshop Size** Up to 200m³
- Motor Size** 190W (1/4HP)
- Unit Size** 610 x 750 x 310mm
- Weight** 35kg



Protect your health with a room cleaner. For best results, it should be mounted to the roof of your workshop where most of the ambient dust is generated.

Comes with a remote to control the seven-speed settings and built-in timer that can be set for 2, 4 and 8 hours. There is still dust in your workshop air after you leave so its recommended to set the timer for two hours once you leave to ensure all air has been cleaned

and recycled, not settling over your machines and benches.

The first outer filter removes particles down to 10 microns and the second internal fine filter cleans dust down to a maximum of 1 micron.

Both filters are easily accessible, replaceable and cleanable.

For a workshop larger than 200m³ we recommend setting up two room cleaners to zone the air filtration.

Prod Code	Product	Weight	Price
TDF-1000-OF	Replacement Outer Filter	4kg	\$35.00
TDF-1000-IF	Replacement Inner Filter	6kg	\$65.00

\$299⁰⁰
Room Cleaning Air Filter

RECORD POWER
 AC-400 | 22kg



- Air Flow** 409CFM
- Efficient Workshop Size** Up to 112m³
- Motor Size** 95W (1/8HP)
- Unit Size** 515 x 430 x 260mm
- Weight** 22kg
- Noise Level** 69dB

Useful for reducing nuisance dust, particularly in small workshops, this room cleaner has two-stage filtration with pocket filters to provide filtration down to 1 micron. With 3 speeds and a timer function you can leave the unit to run for a period after you have finished in the workshop. Both of which can be applied by remote control, which is included with the machine. Also supplied with mounting hooks and chains.

Prod Code	Product	Weight	Price
AC-400-26	Room Cleaner Air Filter - Inner Filter	3kg	\$37.90
AC-400-27	Room Cleaner Air Filter - Outer Filter	4kg	\$27.90

“Measuring Extraction Efficiency – Air Flow and Static Pressure Explained”.

There are two measurements of extractor efficiency – air flow which we measure in in cubic feet/minute (CFM) and the other lesser known measurement is static pressure that we measure in inches of water (in/H2O).

Most woodworkers buy on CFM, but this is only a measurement of the extractor flow when no hose is attached and at the head of the extractor – not a common real-world measure. On the other hand, static pressure measures the resistance once hose has been attached. Make sure you get and check both measurements before buying.

EXTRACTION & SAFETY

Extraction & Safety
 Measuring & Marking
 Sawing
 Site & Shop Accessories
 Routing
 Planing
 Sanding & Scraping
 Drilling
 Joinery
 Clamps & Vices
 Finishing
 Sharpening
 Carving & Chisels
 Woodturning
 Wooden Parts
 Cabinet Fittings

\$369.00 2HP Dust Extractor

Shown with optional Pleated Filter Cartridge (PFC) fitted



SHERWOOD
FM-300 | 70kg

Motor 1500W (2HP)
Air Flow 1200CFM
Static Pressure 8.0"/H2O
Inlet Diameter 2 x 4in or 1 x 5in
Bag Diameter 500mm
Bag Capacity 153L
Overall Size 1950 x 875 x 540mm

A great value-for-money extractor for home workshop use. It has a larger motor for extra capacity and with a impeller measuring 300mm, it is generally suitable for extraction of two low dust generating machines at

any one time.

It is generally recommended for large-volume extraction (like planing or heavy-duty routing) to block off one of the inlets for maximum suction through one path.

\$219.00 1HP Dust Extractor

Shown with optional Pleated Filter Cartridge (PFC) fitted



SHERWOOD
FM-230 | 30kg

Motor 750W (1HP)
Air Flow 600CFM
Static Pressure 4.0"/H2O
Inlet Diameter 1 x 4in
Bag Diameter 370mm
Bag Capacity 57L
Assembled Size 1575 x 650 x 425mm

An economical extractor for small home workshop use. It has a 230mm-diameter impeller that is capable of removing dust from a single machine at any one time.

It comes standard on a base with castors for easy portability, as well as a needle felt filter and plastic collector bag.

\$499.00 3HP Dust Extractor



SHERWOOD
FM-400 | 84kg

Motor 2250W (3HP)
Air Flow 1900CFM
Static Pressure 14.0"/H2O
Inlet Diameter 3 x 4in or 1 x 6in
Bag Diameter 500mm
Bag Capacity 307L (Combined)
Overall Size 1950 x 1450 x 540mm

A great low-cost option for a workshop extracting dust from one or two machines in a trade environment generating large volumes of shavings. It has a rubber-sealed metal connection for

travel from inlet to bags resulting in a better seal and more suction. It also comes on castors for movement around a workshop if necessary, though most users leave it stationed in one place.

\$179.00 Compact Dust Extractor

SHERWOOD
DC-50 | 30kg



Motor 1100W 240V
 112CFM (53L/Second)
Features Handle for easy moving
Noise Level 85dB (A)
Dimensions 400 (D) x 700mm (WxH)
Empty Wght 12kg approx.

Perfect for small woodworking machines such as router tables, table saws, benchtop thicknessers etc. Comes standard with 2m of 4in dust hose. The twin filtration

system cleans down to 0.5micron and the steel 50L collection drum is easily emptied via a single-action quick release barrel clamp when getting full.

Prod Code	Product	Weight	Price
DC-50-FB-5	Filter Bag	100g	\$11.90
DC-50-MF	Main Filter	700g	\$16.50

from \$219.00 Pleated Filter Cartridges

SHERWOOD



These filters will clean the air cycling through down to 1 micron. The pleated filter increases the filtering surface area up to seven times than a standard bag ensuring there is no loss of efficiency that

comes with finer filtration. A built-in handle at the top turns an internal brush that knocks the trapped fine particles down into the collection bag underneath.

Prod Code	Product	Weight	Price
PFC-1610	Suits 1HP units 370x610mm	23kg	\$219.00
PFC-2610	Suits 2HP units 500x610mm	50kg	\$229.00
PFC-21220	Suits 2 or 3HP units 500x1220mm	95kg	\$339.00

iVac Pro Dust Control System

Time is money and safety is paramount these days. One of the major issues around dust extraction systems is having to turn them on when needed and then turning them off, or moving around opening and closing blast gates. Sometimes you're just going to do one quick cut and can't be bothered with it all. So the dust creeps back in. We're all guilty of it!

Or you're in a shared workshop – where multiple machines are being used – who's opening and closing the blast gates and turning the extractor on and off?

What if there was a better way? What if you could have an integrated system that you can program once and then it will control the system for you?

That is the iVac Pro Dust Control System – a system that integrates with your existing extraction system to automate it – with the full system you will only ever have to touch the extractor to empty it.

And it has been engineered to work in the toughest workshop environments, where it is expected to work, maintenance free for years and years and years.

It comes with all necessary regulatory approvals so you can install it with the peace of mind that it is up to code at home, at your business, your school – anywhere!

Its made up of four components.

iVac Pro MSC –

The “brain” of the system that controls the extractor being turned on and off as well as communicating with the rest of the parts of the system for complete control.

iVac Pro Tool Plus –

connects to your power tool's power cord and will know when it turns on and off to make any configuration changes to the system as necessary.

Automated Blast Gates –

will open and close when the signal is received from the Pro MSC

iVac Pro Remote –

turn your extractor on or off no matter where you are in and out of the workshop.



Pro MSC Controller

The iVAC Pro Switch is at the heart of the iVAC automated dust control system. It automatically turns on your dust collector when you turn on a tool that is connected to the iVAC system via an iVAC Pro Tool Plus automatic sensor.

Each iVAC Pro Switch can accept signals from up to 8 different tools to form a system – more than enough for the typical workshop. And up to 4 iVAC Pro systems can operate independently in the same workshop. Tools can be stationary, such as a cabinet saw, or hand held, such as a sander or router. In fact any tool that has a dust

collection port can be used with an iVAC system.

The iVac Pro MSC (Magnetic Switch Controller) has been specifically designed to work with magnetic switches typically found on dust extractors in Australia. It is rated for all single and three-phase dust collectors found here.

It is recommended that if you have a standard (KJD12-style) switch to purchase the full NVR magnetic switch to wire in conjunction with the Pro MSC for minimal extra cost – providing an extra layer of protection on the system in the event of power loss.

Features -

Variable Turn Off time can be set to 5 seconds, 15 seconds, or 45 seconds. Allows surface debris to be cleared once the tool is turned off by leaving the collector on.

Minimum Run Time can be set for up to 5 minutes so the induction motor of dust collectors isn't damaged by constant turning off and on with short rest intervals

Turn On Delay of 1.5 seconds to avoid power surges and tripped breakers.



Prod Code	Product	Price
MSC-01	iVac Pro MSC	\$169.00
BCT-01	NVR Magnetic Switch	\$30.00
R-11S240	iVac Pro Remote	\$54.90

\$109.00 Pro Tool Plus



The iVAC Pro Tool Plus is a dust collector auto sensor that automatically detects when your power tool is turned on by sensing the magnetic field around the power cord. When the power tool is turned on or off, the presence of that field is detected by the sensor and a wireless signal is sent to the iVAC Pro Switch to turn on the dust collector.

There's no need to accommodate different types of electrical circuits or power requirements, as is often the case with workshop power tools.



Installation is effortless. iVAC Pro Tool Plus dust collector auto sensor is attached to the electrical cord of the power tool using the supplied clamp, and the unit is powered by an AC adaptor, which is also included.

\$189.00 4in Automated Blast Gate



The iVAC Pro Automated Blast Gates let you control vacuum flows precisely and automatically. All are electrically driven and programmable. There are three methods of controlling an iVAC Pro Blast Gate:

Fully Automatic: when the power tool is turned on, the iVAC Tool Interface sends a wireless signal instructing the iVAC Pro Switch to turn on the Dust Collector, and this same signal is used to instruct the blast gate to open and close.

iVAC Pro Remote: in this mode an iVAC Pro Remote is used to send the Open and Close commands to the pro blast gate.

Remotely from a wired cable: a toggle switch on a wired cable will instruct the blast gate to open or close. This means it can be used independently of the iVac system for remote blast gate control.

Never worry about whether the blast gate is open or closed ever again – iVac lets you create a system of effortless dust control.



EXTRACTION & SAFETY

from \$6.00

Blast Gate Connectors **SHERWOOD**

When installing two dust lines on an extractor, it is recommended to install blast gates as well. If only one machine is in use, the other line can be closed off to provide more suction along one path.

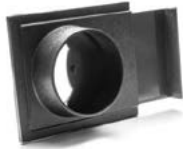

Code	Product	Wgt	Price
YW-1030	2½in (63mm)	100g	\$6.00
YW-1006	3in (76mm)	150g	\$7.00
YW-1007	4in (102mm)	210g	\$8.00
YW-1008	5in (127mm)	330g	\$12.00
YW-1009	6in (152mm)	400g	\$17.00

from \$29.90

Flexible Dust Hose **SHERWOOD**

This grey industrial extraction hose has a unique mix of flexibility and elasticity so that it can be compressed to virtually nothing or expand out to full length with ease.



The reinforcing banding also has steel wire so it can be exposed and earth the hose to prevent static electricity build-up. The PVC is strength-rated for industrial use.

Prod Code	Product	Weight	Price
DH-200-M-3	2in (51mm) x 3m length	1kg	\$29.90
DH-200-M-15	2in (51mm) x 15m roll	7.5kg	\$129.00
DH-250-M-2	2½in (63mm) x 2m length	800g	\$22.90
DH-250-M-3	2½in (63mm) x 3m length	1.1kg	\$31.90
DH-250-M-6	2½in (63mm) x 6m length	3.6kg	\$59.90
DH-250-M-15	2½in (63mm) x 15m roll	10.5kg	\$139.00
DH-300-M-3	3in (76mm) x 3m length	1.3kg	\$34.90
DH-400-M-2	4in (102mm) x 2m length	2kg	\$29.90
DH-400-M-3	4in (102mm) x 3m length	3kg	\$39.90
DH-400-M-6	4in (102mm) x 6m length	8.1kg	\$69.90
DH-400-M-15	4in (102mm) x 15m roll	22kg	\$159.00
DH-500-M-3	5in (127mm) x 3m length	3.3kg	\$49.90
DH-500-M-6	5in (127mm) x 6m length	11kg	\$99.00
DH-500-M-15	5in (127mm) x 15m roll	37kg	\$219.00
DH-600-M-3	6in (152mm) x 3m length	4.4kg	\$84.90
DH-600-M-6	6in (152mm) x 6m length	15kg	\$149.00
DH-600-M-15	6in (152mm) x 15m roll	46kg	\$339.00

from \$2.20

Flexible Dust Hose Clamps **SHERWOOD**

Automotive grade clamps will connect your hose to the inlet



securely without any slippage or stretching.

Prod Code	Product	Weight	Price	Bulk Price
HC-50	2in (51mm) Each	30g	\$2.20	\$16.50 x10
HC-75	3in (76mm) Each	50g	\$3.30	\$26.50 x10
HC-125	5in (127mm) Each	70g	\$3.90	\$29.90 x10
HC-150	6in (152mm) Each	90g	\$4.50	\$34.90 x10

from \$3.50

Tool-Free Dust Hose Clamps **SHERWOOD**

Now, rather than reaching for your screwdriver to use with these clamps, they feature an easy winder



handle so you can clamp or loosen without any other tools necessary.

Prod Code	Product	Weight	Price	Bulk Price
HC-63	2½in (63mm) Each	20g	\$3.50	\$29.90 x10
HC-102	4in (102mm) Each	30g	\$4.00	\$34.90 x10

from \$10.00

Wall Mount Blast Gates **SHERWOOD**

Easily the biggest and best upgrade to the humble plastic blast gates we've ever seen!

✓ A wall or bracket mounting foot has been moulded into the side for quick fixed installation anywhere on a flat surface.

✓ Self-cleaning ejection flutes clear out the waste while opening or



closing the gates, preventing jamming.

✓ Available to either attach hose on both ends as per normal or now available with one end to fit standard 4in hose while the other side will go over a 4in dust outlet on a machine or another ID 4in hose fitting.

Prod Code	Product	Weight	Price
YW-1128	4in for Hose	260g	\$10.00
YW-1129	4in Hose --> Connector	260g	\$10.00

\$125.00

Dust Picker Stand and Hood **SHERWOOD**

Locate the base on the floor, wall or roof using the steel base plate, then extend and rotate the (included) dust hood just about anywhere you need. Main post telescopes 700 – 1140mm, with the 720mm-long first fixed arm that can rotate 360°



arm pivots, telescopes 620 – 900mm long and rotates 360° to position the hood in exactly the right place.

The 250 x 110mm hood is popular in its own right and is available separately. It can be attached to common 4in hose.

Prod Code	Product	Weight	Price
DP-100	Dust Picker Stand and Hood	5kg	\$125.00
YW-1068	Dust Hood Only	340g	\$15.00

\$20.00

Big Gulp Dust Hood **SHERWOOD**

This hood has an amazing 420 x 320mm opening to collect shavings from a large area and funnel it down to a 4in outlet.



It has a lip around the edge of the inlet so it can be pre-drilled and screwed into place.

\$12.00

Cowling Dust Hood **SHERWOOD**

Perfect for making your own dust collection cowlings, it is 340 x 184mm with ledges on either side and a large flat inlet on the long

range of different applications. The 4in outlet on the back has a grating to prevent large offcuts from going into the hose - handy if using as a cowling behind mitre saws etc.



YW-1083	420g
---------	------

\$110.00 Dust Extractor Fitting Starter Kit



SHERWOOD

DCK-2 | 33kg

Not sure what you need setting up a home workshop? For not much more than the cost of the hose you get a range of accessories and fittings to start an effective extraction system.

- ✓ 2x 3m lengths of 4in hose
- ✓ 1x 310x310mm 4in exhaust hood
- ✓ 10x 4in (102mm) hose clamps
- ✓ 1x 210x210mm 4in exhaust hood
- ✓ 4x 4in blast gates
- ✓ 1x 155x155mm 4in exhaust hood
- ✓ 1x 4in Y-Piece connector
- ✓ 1x 610x170mm 4in floor sweep

\$159.00 Wall Mounted Extractor Kits



SHERWOOD

YW-1000 | 13kg

Want to setup a wall mounted dust collection system in your home workshop? These kits will certainly help to get you started with a range of connectors and fittings that can be used in conjunction with the widest possible range of other fittings as both kits are now available in the most common 2 1/2in and 4in sizes to get you started.

2 1/2in Kit Contains

- ✓ 8x 914mm-long clear tubing (great to quickly see any potential blockages developing)
- ✓ 5x 63mm blast gates
- ✓ 4x 63mm t-connectors
- ✓ 3x 63mm 45° elbows
- ✓ 2x 63mm 90° elbows
- ✓ 16x 63mm dust hose clamps
- ✓ 10x 63mm tubing hanger straps
- ✓ 1x 100mm --> 63mm reducers

4in Kit Contains

- ✓ 8 x 914mm clear tubing
- ✓ 3 x 100mm Blast Gates
- ✓ 2 x 100mm Y-connectors
- ✓ 2 x 100mm 60° bends
- ✓ 2x 100mm 90° Bends
- ✓ 16 x Joiners and Mounting hardware
- ✓ 10 x 100mm tubing hanger straps

Prod Code	Product	Weight	Price
YW-1000	2 1/2in (63mm) Kit	13kg	\$159.00
YW-2000	4in (102mm) Kit	36kg	\$275.00



from
\$24.90

Hold Tite Hose Extraction Kits

SHERWOOD

These kits are a convenient system for collecting waste material produced by a range of workshop activities.

- ✓ Rectangular nozzle can be positioned to capture airborne dust from scroll or band saws and sanders
- ✓ Tapered nozzle can be positioned to capture wood chips from routers and drill presses
- ✓ Rigid flex dust collection hose expandable to 900mm in length
- ✓ Includes: rectangular nozzle, tapered nozzle, two hose end fittings and rigid flex dust hose
- ✓ 63mm (2 1/2in) hose end fittings mate with most shop vacuums and accessories with 57mm (2 1/4in) I.D.
- ✓ 100mm (4in) hose end fittings mate with most dust collector inlet ports and other dust collection fittings

Prod Code	Product	Weight	Price
HTK-63	2 1/2in (63mm) Kit	1kg	\$24.90
HTK-100	4in (102mm) Kit	2kg	\$37.90

from
\$1.50

Hose Hanger Strap

SHERWOOD



Need to fix your hose up against the wall or roof? This simple strap can hold all your flexible hosing in place to maximize its effectiveness whilst minimizing its hassles.

Prod Code	Product	Weight	Price
YW-1100	4in (102mm) Each	30g	\$1.50
YW-1100-K-10	4in (102mm) Pack 10	300g	\$11.50

from
\$24.90

Needle Felt Filter Bags

SHERWOOD



If you still have an old cloth bag this is a cheap and easy upgrade to get better filtration on your extractor or as a replacement if you've just worn out or damaged your current one.

Prod Code	Product	Weight	Price
NFB-230	370mm Diameter - FM-230	500g	\$24.90
NFB-300	500mm Diameter - FM-300 & FM-400	500g	\$34.90

from
\$18.00

Plastic 10-Pack Collection Bags

SHERWOOD



If you don't enjoy emptying your plastic collection bag (which should always be done with a respirator being worn) or damage it, it's always handy to have these on hand to keep on sucking.

Prod Code	Product	Weight	Price
PBAG-110	370mm Diameter - FM-230	1.5kg	\$18.00
PBAG-210	500mm Diameter - FM-300 & FM-400	1.5kg	\$25.00
PBAG-410	500mm Diameter - DC-1750 & DC-2900	3kg	\$35.00
FM-230-34	Bag Clamp - 370mm Diameter	500g	\$15.00
FM-300-34	Bag Clamp - 500mm Diameter	500g	\$15.00

EXTRACTION & SAFETY

Extraction & Safety
 Measuring & Marking
 Sawing
 Site & Shop Accessories
 Routing
 Planing
 Sanding & Scraping
 Drilling
 Joinery
 Clamps & Vices
 Finishing
 Sharpening
 Carving & Chisels
 Woodturning
 Wooden Parts
 Cabinet Fittings

\$89.00 Vacuum Mini Dust Cyclone Kit



SHERWOOD
 MDCK-100 | 17kg

Ruining the house vacuum cleaner with sawdust? Or your workshop vacuum's filter keeps getting clogged up and emptying the drum is a pain? Hook up the included 1m length of 63mm hose to your vacuum and the other 1m length of 63mm hose to your existing

vacuum hose and/or directly on to your machines and let the cyclone kit capture all the coarse and fine shavings in the 15L drum. Comes on four castors, plus 4in --> 2 1/2in and 2 1/2in --> 1 1/2in reducers to adapt to popular workshop sizes.

\$10.00 Machine Angled Outlet



SHERWOOD
 YW-1061 | 130g

With a big 4in outlet but small 190 x 110mm footprint, this angled outlet was originally designed and most commonly used as an outlet

underneath bandsaw tables and can be adapted for a variety of other applications.

from \$8.50 Router Table Dust Outlets



SHERWOOD

After regular requests from customers, we have made the clear 2 1/2in dust outlet found on the back of Sherwood router fences and the 4in flanged outlet on the

back of the dust collection box a catalogue item.

The 2 1/2in hose connecting the fence outlet to the box outlet is not included.

Prod Code	Product	Weight	Price
RTFNC-32	2 1/2in Fence Outlet	100g	\$8.50
RTDCB-19	Dust Box Plastic Outlet	200g	\$15.00

\$6.00 Router Fence Outlet



SHERWOOD
 YW-1079 | 500g

Need a dust outlet on a router table, drill press or other types of fences? This connector measures 65mm from the apex x 170mm long. The large collection mouth area

measures a tad under 135mm long x 63mm for optimal clearance of the extraction area, leaving 16mm ledges on both sides to pre-drill for mounting holes to suit.

\$249.00 Dust Extractor Dust Cyclone Kit



SHERWOOD
 MDCK-200 | 45kg

Cyclones work by using vortex separation to get the coarse and fine particles to collect in a separate container from your extractor, meaning more free air is flowing through the system and therefore improving the overall extraction efficiency of your system.

This kit comes with all the basics

plus a few extra's to get you going. The cyclone lid sits atop the included 100L collection drum and can connect to your existing extraction system using the included 2x 3m lengths of hose. Also included in the kit is the vacuum wand kit that allows you to clean up your workshop floor.

\$79.00 Extractor Floor Vacuum Kit



SHERWOOD
 YW-1106 | 13kg

Harness the high volume suction power of your extractor to get rid of all the waste off the floor quickly. Includes an adjustable wand handle, clear lengths of rigid tubing to create the wand, a quick connect blast gate, floor sweep intake as

shown on the cyclone kit above, plus an additional dust wand with bristles on the end as shown here, for cleaning benches and hard to reach places. Works with standard size 4in dust hose.

\$9.00 Floor Sweep



SHERWOOD
 YW-1003 | 360g

Attach your hose and run around the workshop floor to pick up large shavings or fine dust that may have fallen on the ground when

in use. Measuring 610 x 170mm, combining this with your extractor will make light work of even the biggest messes.

\$4.00 Flanged Extraction Inlet



SHERWOOD
 YW-1112 | 200g

Part of the new popular, 2 1/2in fitting range, this inlet measures approximately 95mm diameter with an 11mm ledge and four pre-drilled mounting holes cast for quick and easy mounting. The fitting measures 63mm long overall

and tapers down to easily attach standard 2 1/2in flexible hose to the end.

Perfect for making your own dust cowl and attaching to make it easy to connect your hose to your system.

from \$4.00

Connector Couplings

SHERWOOD

Need to connect two extractor fittings together (such as a Y-piece to a blast gate)? Most of the time you would have to use a small piece



of hose and two clamps to do this but this coupling provides a strong, airtight joint between the fittings quickly.

Code	Product	Weight	Price
YW-1112	2 1/2in (63mm)	30g	\$4.00
YW-1070	4in (102mm)	120g	\$8.00

N

\$19.90

Triple Y-Connector

SHERWOOD

YW-1134 | 700g

Add more tools to your dust collection system by branching off your main line with this 3-way



Dust Collection Junction. All ends are 4in to suit the attachment of flexible hose.

from \$6.00

90° Elbow Fittings

SHERWOOD

Using rigid ducting or want a permanent 90° bend in your flexible hose installation? This is the connector for you!



Code	Product	Weight	Price
YW-1123	2 1/2in (63mm)	100g	\$6.00
YW-1017	4in (102mm)	1.21kg	\$9.00

from \$8.00

Y-Connectors

SHERWOOD

For splitting off a single line into two separate lines at some point in your extraction system.



Code	Product	Wght	Price
YW-1050	2 1/2in (63mm)	200g	\$8.00
YW-1015	4in (102mm)	400g	\$12.00
YW-1049	5in (127mm)	660g	\$15.00

\$16.00

Ball Joint Connector

SHERWOOD

YW-1087

Great for repositioning rigid extraction ducting as required or to provide more articulation on flexible dust hose. It is made of durable, hard



plastic that can withstand heavy knocks. It has a 360° articulation with inlets and outlets to suit 4in flexible hose.

\$12.00

Reducing Y-Connector

SHERWOOD

YW-1076 | 340g

Want to split off a 2 1/2in hose line from a 4in duct? Connect 4in hose to both straight ends and then connect your 2 1/2in hose to



the Y-reducer coming off the side - perfect for the burgeoning range of extractor fittings available in the new 2 1/2in common size.

from \$8.00

Machine Exhaust Hoods

SHERWOOD

A range of hoods that can be built into bases and shop-made chute



systems to extract from machines any number of machines.

Prod Code	Product	Weight	Price
YW-1001	210 x 210mm	150g	\$8.00
YW-1004	305 x 305mm	360g	\$13.00

\$12.00

Twin Reducing Y-Connector

SHERWOOD

YW-1136 | 340g

Adapt from a single 102mm (4in) hose outlet to twin 63mm (2 1/2in) hose outlets. Especially handy



for separating a line to two small machines located close together in a workshop.

\$8.00

T-Connector

SHERWOOD

YW-1051 | 200g

Included in the wall-mounted kit and also available separately is this T-piece which suits the connection



of hose or 2 1/2in tubing on all three sides.

EXTRACTION & SAFETY

\$7.00 Reducing Quick Connector

SHERWOOD
YW-1105 | 110g

The small end will accept 2 1/2in hose on the outside while the ID suits most 2 1/4in hose end fittings like Shop Vacs etc. The big end is a tapered and will fit over most 4in dust outlets found on



machines etc. Rather than being rigid plastic, it is rugged resin construction that flexes rather than cracking - great for being moved around regularly.

from \$17.90 Dust Hood SawStaches

FastCap



The SawStache allows you to soup up your saw and efficiently contain dust and leave you with a cleaner work environment. The flexible bristles provide zero resistance to

your work piece passing through but create an effective barrier to keep the dust contained for extraction.

Prod Code	Product	Weight	Price
FC-02061	51mm High 300mm Increments	250g	\$17.90
FC-02062	102mm High 300mm Increments	400g	\$19.90

\$10.00 Threaded Splice Quick Connector

SHERWOOD
YW-1127 | 130g

Move your connector quickly from one machine to the next. The thread allows you to "turn" the hose on to one end and the other end is



tapered larger than 4in outlets on machines to provide a snug fit but quick removal to move around as required in the workshop.

from \$3.00 Hose Reducers/Connectors

SHERWOOD



All connectors suit the size of hose listed - therefore are the male-size connection.

Prod Code	Product	Weight	Price
YW-1077	2 1/2in --> 1 1/2in	40g	\$3.00
YW-1032	4in --> 2in	100g	\$6.00
YW-1026	4in --> 2 1/2in	100g	\$7.00
YW-1011	4in --> 3in	100g	\$7.00
YW-1019	4in --> 4in	200g	\$8.00
YW-1027	5in --> 4in	500g	\$8.00
YW-1073	6in --> 4in	500g	\$10.00

\$5.00 2 1/2in Quick Connect Threaded Splice

SHERWOOD
YW-1088 | 80g

After popular request - this part has been made available from the hold-tite kit. Thread standard or hold-tite



63mm (2 1/2in) hose on one end and fit the end over standard 63mm (2 1/2in) fittings.

from \$10.00 Hose Stepped Reducers

SHERWOOD



An economical way of adapting two different hose sizes.

Small reducer stepped sizes - 2 1/2in to 1 1/2in, 1 1/4in, 1in
Large reducer stepped sizes - 6in to 5in, 4in, 3in, 2in, 1in

Prod Code	Product	Weight	Price
YW-1039	Large	280g	\$11.00
YW-1054	Small	130g	\$10.00

from \$12.00 Flex Cuff Connectors

SHERWOOD

Flex Cuffs connect two dust fittings of similar port (OD) size. Two hose clamps form a semi-rigid connection, a reusable alternative to permanent screws or messy tape.



Flexible rubber construction conforms to narrow range of sized ports and clamps nest in moulded grooves for ease of installation.

Prod Code	Product	Weight	Price
YW-1125	2 1/2in (63mm)	400g	\$12.00
YW-1126	4in (102mm)	600g	\$18.00

\$49.00 Y-Connector Fitting

SHERWOOD



Designed for the industrial dust collectors with one inlet going to dual outlets. Folded and spot welded galvanized steel for long life.

Prod Code	Product	Weight	Price
YW-1201	8 --> 6 x 6in	500g	\$49.90
YW-1202	6 --> 4 x 4in	720g	\$49.90

\$29.90

Black Shield Disposable Gloves



- ✓ Extra heavy-duty nitrile gloves
- ✓ Amazing dexterity and feeling
- ✓ High Puncture Resistance
- ✓ Super-comfortable for extended periods of wear



Prod Code	Product	Price
GNB-218-M	Medium Box 100	\$29.90
GNB-218-L	Large Box 100	\$29.90
GNB-218-XL	X-Large Box 100	\$29.90
GNB-218-XXL	XX-Large Box 100	\$29.90

\$9.90

Safety Glasses - Portland



- ✓ Ultra Lightweight and frameless design with curved temple arm to fit most face profiles
- ✓ The 9-base lense design provides distortion free coverage, with 180° field of vision



EP-0312 | 30g

\$19.90

Safety Glasses - Bi-Focal



- ✓ The integrated magnifying panels provide visual assistance and protection
- ✓ Ultra lightweight construction & comfort
- ✓ Medium Impact, anti-scratch lens
- ✓ 99.9% UV protection



Prod Code	Product	Price
EPS-46620	2x Magnification	\$19.90
EPS-46630	3x Magnification	\$19.90

\$129.00

Half-Face Powered Dust Mask Kit



A common criticism of a full-face respirator is the stifling and isolating effect it has on people. Full-face respirators also have a price tag many struggle to invest in. This simple but effective mask overcomes both criticisms while still performing well.

The 4x AA battery pack clips on to the belt and then plugs into the standard-shape half-face respirator where it can run the cooling fan for up to 6 – 10 hours. It has the two-speed setting built into the battery pack.

Combining the main and pre-filters means that filtration is rated down to 0.4microns – removing all hazardous wood dust from the air you're breathing.

Code	Product	Wgt	Price
SA-201	Complete Dusk Mask Kit	800g	\$129.00
SFN-800	Replacement P2 Filters	40g	\$19.00
SFN-900	Replacement Carbon Filters	40g	\$19.00
SNA-201	Pre-Filters Pk 10	10g	\$12.00

\$59.90

Ear Muffs - Professional 32dB



HRE-661 | 330g

- ✓ Class 5 protection with SLC80 rating of 32dB
- ✓ Unique Elastex™ sweat reducing ear cushions
- ✓ Super low headband tension for extended use
- ✓ Replaceable cushioned headband
- ✓ Two-point suspension for simple height adjustment



\$54.90

Ear Muffs - Neck Mount 25dB



HRE-663 | 330g

- ✓ Class 4 protection with SLC80 rating of 25dB
- ✓ Unique Elastex™ sweat reducing ear cushions
- ✓ Super low headband tension for extended use
- ✓ Stainless steel spring wire system provides constant clamp pressure



\$19.90

Ear Muffs - Economy



HBE-635 | 280g

- ✓ Class 5, 28dB according to AS/NZS 1270
- ✓ Shock resistant and durable construction
- ✓ Slide and swivel cup enhances comfort and fit
- ✓ Soft foam cushions for comfort and secure fit



\$44.90

Disposable Dust Masks - P2 Pk 20



RES-503 | 330g

- ✓ Unique pre-moulded respirator fits a wide variety of face profiles
- ✓ P2 rating offers protection against mechanically and thermally generated particles such as wood dust
- ✓ Twin straps offer firm comfortable fit



\$34.90

Disposable Dust Masks - P2 Valved Pk 10



RES-504 | 250g

- ✓ Exhalation valve provides increased air flow and comfort
- ✓ Pre-formed nose-bridge minimizes the risk of leaks



\$49.90

Disposable Dust Masks - Carbon Pk 10



RES-505 | 280g

- ✓ Active carbon filter protects against nuisance level organic vapours
- ✓ Suitable for medical, soldering, welding, grinding, sanding and dusty environments



\$599.00

Airshield Respirator Kit



AIRSHIELD | 2kg



- ✓ Combination face-seal and hood improve face protection
- ✓ Motor positioned away from the sensitive forehead area to reduce noise and irritation
- ✓ Strategic component distribution ensure optimum centre of gravity is achieved for balance and comfort
- ✓ Twin filters with efficiency of 98%, more than double the MK I Airshield
- ✓ Audible low battery warning.
- ✓ Removable 8 hour Ni-MH battery.
- ✓ Suitable for use when machining MDF

Prod Code	Product	Price
AIRSHIELD	Respirator Kit Complete	\$599.00
AIRP-1	Replacement Filter Pack	\$79.00
AIRP-3-C	Clear Visor Overlay Pk 10	\$59.00

Extraction & Safety
Measuring & Marking
Sawing
Site & Shop Accessories
Routing
Planing
Sanding & Scraping
Drilling
Joinery
Clamps & Vices
Finishing
Sharpening
Carving & Chisels
Woodturning
Wooden Parts
Cabinet Fittings

MEASURING & MARKING

\$27.00
Layout Saddles



Veritas®
05-N-5601 | 20g

Square Saddles allow you to scribe two perpendicular surfaces at a time. More important, it allows you to pick up on a line already scribed, and accurately transfer it to another face perpendicular to it. With 31.8 x 57.2mm inside legs, they can be used to wrap a line around workpieces up to almost double this. Made of anodized aluminum, 51mm wide, with both end faces machined square to within 1/4°.

Dovetail Saddles markers are precision machined with the same size ledges as the square with 1:6 and 1:8 angles, traditional angles for softwood and hardwood dovetails respectively. The 14° marker is designed when working in thinner stock, as it not only provides stronger material interlock than traditional ratio angles but produces an exaggerated dovetail joint many find attractive.

Prod Code	Product	Weight	Price
05-N-5601	Square Saddle	20g	\$27.00
05-N-6104	1:6 Ratio Dovetail Saddle	70g	\$26.00
05-N-6105	1:8 Ratio Dovetail Saddle	70g	\$26.00
05-N-6108	14° Angle Dovetail Saddle	70g	\$26.00

\$27.00
Mitre Layout Saddle



Veritas®
05-N-5615 | 20g

When working on small items such as picture frames, a large combination square or try square can often be cumbersome. Not so with this mitre saddle. The relatively small size makes it easy to use.

Made from anodized aluminum, this marker is light and durable, and will never mark your work. Both angles are 45°.

from **\$14.00**
Dovetail Markers

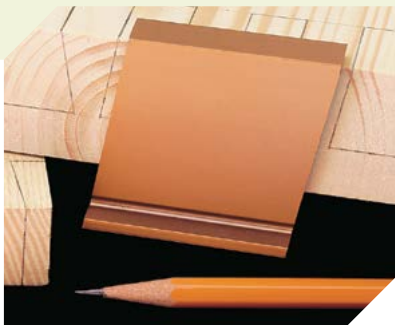

Veritas®

With riding ledges on both sides, these 50.8mm markers can be flipped over to mark both slopes of the dovetail. They are designed so that the entire ledge is riding on the reference face, even when marking

edge dovetails. The relieved corners at the join of the body and the riding ledges ensure perfect seating even on saw whiskers. Pack of two includes 1:6 & 1:8 ratios.

Prod Code	Product	Weight	Price
05-N-1011	Pack Of Two	70g	\$22.00
05-N-1013	14° Angle Only	30g	\$14.00

from **\$39.90**
Layout Transfer Devices

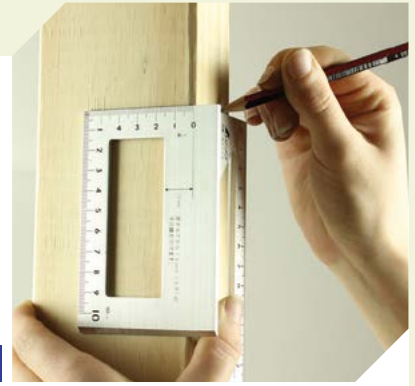

Shinwa

Shinwa are a leading manufacturer of measuring tools in Japan and these transfer devices are built to superb quality standards. Extruded as

2.9mm-thick aluminium, each transfer device is precision ground and measurements are clearly marked in black on the silver anodized finish.

Prod Code	Product	Weight	Price
S-62113	90/90° & 90/45° Range	120g	\$39.90
S-62114	LH & RH 45° Angles	140g	\$44.90

\$6.90
Centre Finder



BALADONI

MJ-831 | 80g

So simple and yet probably the most popular design of centre finder found in the world!

Woodturners use it to find the centre of work pieces to turn but of

course it can be used to find centre on any square, round, hexagonal or octagonal stock up to 8in (203mm) square or round.

\$44.00
Centre Marker



Veritas®

05-N-1501 | 250g

Made from die-cast aluminum (pre-drilled for mounting near your lathe), it uses a knife-edged steel blade to score the end of a work piece. You set a square or cylinder (up to 152mm across) in the marker, tap it with a mallet, turn the wood approximately 90° and tap it again.

The result is two score lines that intersect at the exact center of the wood. In softwoods the lines are deep enough to hold the drive center directly; you won't need to make additional intersecting saw cuts in the drive end of your work piece.



Search **Timbecon** to watch all of our instructional videos.

from **\$17.90**
Precision Measuring Rule



Inkra scores again with its precision steel rule. Select the proper slot or hole, insert a 0.5mm mechanical pencil, and mark the measurement with dead-on accuracy.

These Marking Rules are precisely what's needed for accuracy by offering marking holes at every 1/4mm! This is unmatched in the industry of marking rules.

Prod Code	Product	Weight	Price
IRR-150	150mm Long Metric	30g	\$17.90
IRR-300	300mm Long Metric	50g	\$29.90
IRR-250	250mm Long Metric/Imperial	50g	\$29.90
IRPENCIL	Inkra Pencil Only	20g	\$2.00

from **\$34.90**
Precision T-Rules

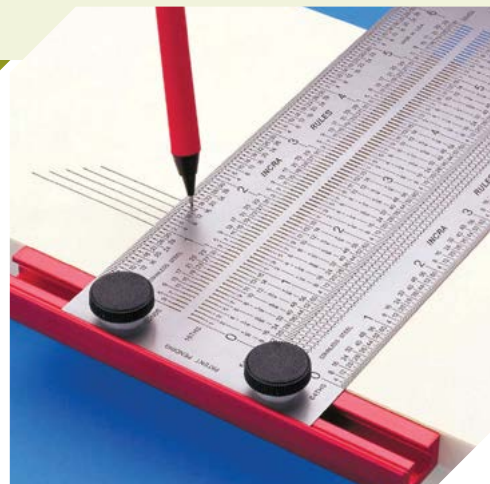

With the addition of a fence you can now quickly and accurately mark anything from a work piece edge, as well as use the T-rule as an accurate layout square. Slide the fence along the work piece

with 0.5mm mechanical pencil or scribe in place to use as a marking/mortice gauge too. The end has height marking slots 50mm high to expand its usefulness even more.

Prod Code	Product	Weight	Price
IRT-150	150mm Long Metric	110g	\$34.90
IRT-300	300mm Long Metric	140g	\$54.90
IRD-150	150mm Long Metric/Imperial	120g	\$42.90
IRD-300	300mm Long Metric/Imperial	150g	\$57.90

from **\$34.90**
Precision Centring Rule

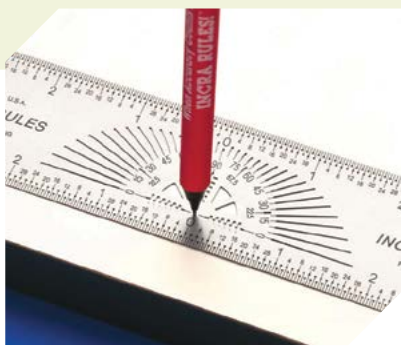

Find the exact centre of any work piece up to 300mm wide. In addition to top and bottom micro-fine marking holes at every 1mm

it also has a built-in protractor with guide slots at every 45°, 30°, 22.5°, and 5° interval.

from **\$29.90**
Precision Bend Rules

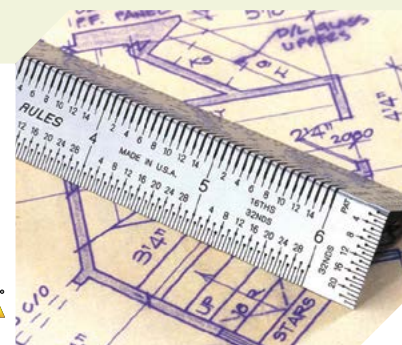

Inkra Bend Rules make dual-surface layouts a snap using the corner slots. It also provides zero-parallax measuring on any flat surface. Micro-fine marking holes at every 1/4mm instantly locate your sharp pencil point exactly on target with zero uncertainty and no

eye-strain! The 90° shape holds it snugly in place and there are even two vertical end scales for drawing precision parallel lines relative to the edge of your work.

Prod Code	Product	Weight	Price
IRB-150	150mm Long	30g	\$29.90
IRB-300	300mm Long	50g	\$34.90

from **\$3.50**
Stainless Rule & Stop



Not sure what you need setting up a home workshop? For not much more than the cost of the hose you get a

range of accessories and fittings to start an effective extraction system.

Prod Code	Product	Weight	Price
IG-34012-N	300mm Rule Only	80g	\$3.50
IG-34-ST-12	Rule Stop Only	20g	\$8.90

from **\$17.90**
1m Stainless Rule



RUS-1000 | 200g



A good quality stainless 1000mm/40in rule, it measures 33mm wide and 1.2mm thick. Graduated in 1mm & 1/16in on

one face while the other contains a handy conversion table. Graduations are acid-etched and painted black.

from **\$6.90**
Self-Adhesive Measuring Tapes

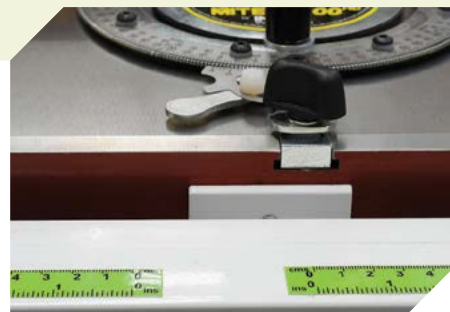

At 18mm wide x 1400mm long these can be easily adhered to standard 19mm wide timber with clear, quality metric and imperial graduations. Without the backing removed it can be used as a flexible ruler too.

Available in both Left - Right and Right - Left orientation so you can go both ways from centre.

Prod Code	Product	Weight	Price
AMLR-1400	L-R	40g	\$6.90
AMRL-1400	R-L	40g	\$6.90

Extraction & Safety
 Measuring & Marking
 Sawing
 Site & Shop Accessories
 Routing
 Planing
 Sanding & Scraping
 Drilling
 Joinery
 Clamps & Vices
 Finishing
 Sharpening
 Carving & Chisels
 Woodturning
 Wooden Parts
 Cabinet Fittings

MEASURING & MARKING

\$49.90 EZCal Digital Vernier Calipers



iGaging EZCal digital vernier calipers are almost without equal in quality. Accurate to 0.038mm with a repeatability 0.0127mm and reading accuracy of 0.01mm on both internal and external measures. Most verniers are only accurate on external measures so be sure to check this before buying another set.

The super large LCD display is easy to read and can measure in metric, decimalised and fractional imperial in 1/128th graduations with a quick measuring speed of 120" per second. All iGaging EZCal verniers are IP54-splash water, oil and dust resistant and individually serialized. Produced from hardened stainless with a precision lapped smooth finish.

\$14.90 Vernier Caliper Depth Base

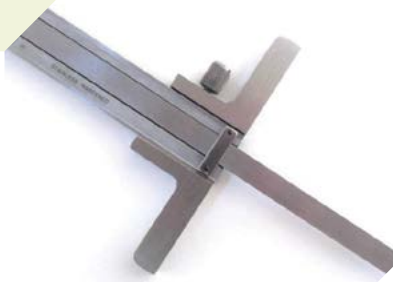

Convert a standard 5/8in or 16mm bar width standard vernier caliper into a stable depth gauge. It saddles the bottom end of gauge secured in

place with a small stainless thumb screw. When used with an iGaging vernier caliper you can get fantastic digital accuracy.

\$24.90 Spring Dividers & Calipers



Manufactured from select carbon steel, dividers have hardened steel points making them perfect for scribing circles and arcs on timber, steel and many other materials.

The speed nut can disengage from the thread to allow for fast adjustments when required making them easier to use.

Inside calipers are used for checking and transferring internal sizes, or measuring when used in conjunction with a micrometer or vernier.

Outside calipers work for external measurements. Very popular with woodturners.

Prod Code	Product	Weight	Price
G-01453	200mm Spring Divider	220g	\$24.90
G-01433	200mm Inside Caliper	220g	\$24.90
G-01443	200mm Outside Caliper	220g	\$24.90

from \$89.00 OriginCal Vernier Calipers



- It knows zero and therefore always has 100% hyper-accurate read-out
- Unlimited measuring speed to instantly show the accurate read-out
- Advanced encoding technology
- Meets super-stringent DIN 862 standard
- IP54 water, drop and dust resistant

- Individually serialized and checked before leaving the factory
- Accurate to 0.0254mm/0.001in over 200mm/8in range or 0.0381mm/0.0015in over 300mm/12in range
- Repeatable to 0.0127mm/0.0005in
- Reading accuracy to 0.0127mm/0.0005in
- Battery is standard 3V CR2032

These verniers sit in the same class as any engineering vernier caliper manufactured anywhere in the world. What sets them apart is that the 6in version is less than \$100 and less than half the price of any competitors.

Prod Code	Product	Weight	Price
IG-1007006	150mm 6in Long	450g	\$89.00
IG-1007008	200mm 8in Long	600g	\$119.00
IG-10070012	300mm 12in Long	950g	\$139.00

\$54.90 Digital Thickness Gauge



Take exact measurements of your woodturning and many other work pieces. The spring-loaded jaws are accurate to 0.254mm. The large digital display reads measurements in metric, as well as decimalised

and fractional imperial in 1/128th graduations. The thumbscrew tightens to lock blade in place to maintain any position and easy-grip handle offers additional control when in use.

from \$18.90 Woodturners Calipers



Designed specifically for woodturners, these calipers are stamped from durable 2.0mm

plate steel and zinc-plated for long workshop life (able to last many years in sometime damp sheds).

Prod Code	Product	Weight	Price
CAL-205	205mm Double-Ended	130g	\$18.90
CAL-350	350mm Double-Ended	270g	\$25.90
CAL-305	305mm Combination	140g	\$19.90

\$69.90

Third-Generation AngleCube

iGAGING
IG-352269 | 200g

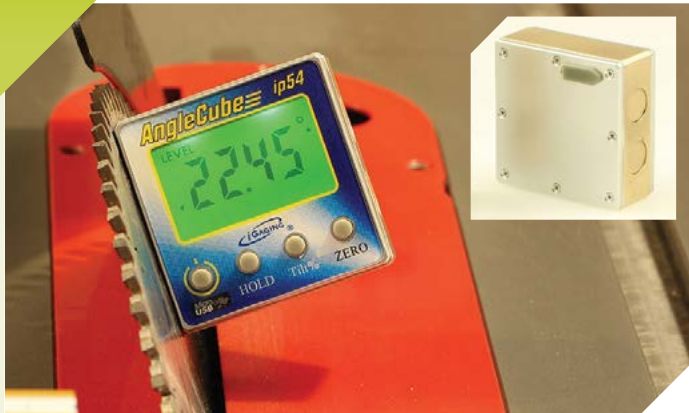

The new precision digital sensor virtually adjust bevels in real time. With two rare-earth magnets on all three sides, it stays put on saw blades and more. Powered by a Li-Ion rechargeable battery, the new recharge input allows the case to be more effectively sealed against dust and moisture and achieves an IP-54 rating for a more durable lifetime in the workshop.

The large crystal LCF readout is backlit but don't worry about recharging it regularly - an

auto-off function will preserve power if left on for too long. The military-grade anodized alloy body will take punishment and some accidental drops without affecting performance.

- ✓ Tilt range - 0-90°
- ✓ Resolution - 0.05°
- ✓ Accuracy - 0.2°
- ✓ Repeatability - 0.1°
- ✓ Size - 54 x 54 x 23mm
- ✓ Weight - 80g

from \$39.90

Engineers Straight Edges

iGAGING



When you need to setup a machine, mark accurate layouts, do some drafting or checking straightness of your work piece for warping, this precision straight edge is the essential tool. The 5.00mm hardened steel blades are meticulously ground and

lapped for straightness and parallelism. They have a beveled knife edge with metric 1mm scales, which means they can be used as precision rulers. For storage they have a hanging hole as well as a protective case if you prefer to store them in a drawer.

Prod Code	Product	Weight	Price
IG-36012-M	305mm 12in Long	520g	\$39.90
IG-36024-M	610mm 24in Long	940g	\$69.90
IG-36036-M	914mm 36in Long	1.36kg	\$129.90

\$3.00

Measuring Tape SpeedClip

FastCap
FC-98035 | 40g



Never have torn pants from your tape measure again. With the SpeedClip, securing your tape measure is a

breeze. It easily clips over your pants or belt, plus it even holds your pencil and has a built-in sharpener.

\$49.90

Precision Aluminium Straight Edge

BALADONA
ASE-968 | 900g



An 11mm-wide lapped flat sole on one edge means it easily stands upright leaving both hands free to work. The 3mm-wide edge is tapered to make it easier to line up by eye against fences etc.

Both edges are accurate to the British Standard - 0.075mm over its 965mm length - with metric scales on sides. Approximately 47mm tall with a comfortable-to-grip shape.

from \$14.90

Tape Measures

FastCap



Flatback

True32 Reverse

PMS16 Autolock



Flatback and True32



PMS16 Autolock

Common features of all FastCap tape measures

- ✓ Lever action belt clip
- ✓ Pencil sharpener
- ✓ Durable dual-locking system
- ✓ Erasable notepad
- ✓ Heavy-duty 25mm blades
- ✓ High contrast tapes
- ✓ Rugged compact design

PMS16 Autolock - When you pull the blade out, it stays in place then

push the release button to retract the blade.

Flatback - Not all surfaces are flat! A flexible tape for measuring curves and flat panels with precision and ease. Works well in layouts as it lays flat on boards making it easier to mark. Definitely our pick!

True32 Reverse - Standard-style shallow U-Shape tape with metric on both sides to work either way with ease.

Prod Code	Product	Weight	Price
FC-80507	PMS16 Autolock	300g	\$18.90
FC-99944	Flatback	300g	\$14.90
FC-99953	True32 Reverse	300g	\$14.90

from \$55.00

Aluminium Straight Edges

Veritas



Economical alternatives to steel straightedges, these anodized aluminum straightedges are extremely useful for setting up machines such as planers and

jointers, and they will not rust. They are 44.5 x 11.1mm, and the reference edge is machined flat to within 0.076mm over the entire length.

Prod Code	Product	Weight	Price
05-N-6301	610mm 24in Long	500g	\$55.00
05-N-6303	965mm 38in Long	900g	\$72.00

Extraction & Safety
Measuring & Marking
Sawing
Site & Shop Accessories
Routing
Planing
Sanding & Scraping
Drilling
Joinery
Clamps & Vices
Finishing
Sharpening
Carving & Chisels
Woodturning
Wooden Parts
Cabinet Fittings

MEASURING & MARKING

\$39.90 200mm Digital Protractor



IG-35408 | 240g

Two overlapping stainless blades with clear metric and imperial graduations are paired with a digital protractor angle sensor to measure and show the entire 360° range that is accurate to +/-0.2°.

A great improvement for setting angles when laying out or for getting an accurate angle on an existing work piece to transfer. The reverse button flips the reading direction of the display on the large, clear LCD display.

\$44.90 150mm Digital Protractor & T-Rule



IG-35407-T | 230g

While the 1.15mm thick stainless blades with clear metric and imperial graduations arms are shorter than the standard digital protractor (blade length 180mm vs. 275mm), the addition of the 280mm long chrome-

finished aluminium-alloy fence turns this protractor into a highly accurate, easy-to-use digital sliding bevel. The additional base means you will find it much easier to use due to the increased stability of the fence.

\$11.90 Stainless Small Protractor



PRO-1195 | 90g

A small, simple protractor for occasional layout work at various angles. Produced from stainless steel with acid-etched graduations, it is simple and easy to use but can

be difficult to set accurately due to the simplicity of its design. Perfect for transferring angles. Overall length is 195mm.

\$16.90 125mm Plastic Profile Gauge



PCG-908 | 260g

Produced with taller relief pins than the metal gauge for more accurate registration against the work piece it is marked in both metric and imperial graduations on the body. You can remove the end block to

going multiple gauges together for longer profiles.

Perfect for transferring shapes for woodturnings, fitting tiles, carpets, joinery work, car body repairs and a whole range of other applications.

from
\$32.90

Traditional Sliding Bevels



Miniature Sliding Bevel

Small in size but definitely not a toy, it has a 0.8mm thick 100mm long blued tool steel blade, with a 75mm-long rosewood and brass handle. The solid brass wing nut secures the blade in place.

Standard Beech Handle Bevel

The handle stock is lacquered beech with a 28 x 19mm cross-sectional dimension, approximately 145mm long. The 1.0mm-thick blued tool steel blade is 230mm long and secured in place with a solid brass bolt and wing nut. The 3mm-thick brass plate caps protect the business end from damage in use.

Standard Rosewood Handle Bevel

The same size handle and blade as the beech bevel but with the handle made from more durable and stable lacquered Rosewood.

Bespoke Brass Bevel

Simply gorgeous to look at, hold and use, the handle is the same size and construction as above. The major upgrade is the bespoke 3.0mm solid brass blade. The overall weight of the bevel increases from about 160g to 260g and it feels well weighted in the hand. Being solid brass it will never rust and naturally reduces friction when used with marking knives, pencils etc. An extra relief is routed into the front and back of the handle making it easier to grip.

Prod Code	Product	Weight	Price
115-MW	Mini Rosewood Handle	50g	\$32.90
116-BW	Standard Beech Handle	150g	\$29.90
116-W	Standard Rosewood Handle	160g	\$44.90
116-XW	Standard Brass Blade	260g	\$89.00

\$81.00 Optical Centre Punch

veritas®
05-N-5901 | 400g



To keep a twist drill from skating on metal (and leaving you with a hole in the wrong place) you should always use a center punch, especially when using small flexible bits. The dimple created by the punch holds the bit point true.

The Veritas optical centre punch simplifies the procedure at the same time as it substantially increases accuracy. Even with wood there is an advantage to using a center punch; it creates a small crater that readily centers a brad-point drill.

Keep tabs on Timbecon



Like us on Facebook ([fb.com/timbecon](https://www.facebook.com/timbecon)) to keep up with the latest news on promotions, product arrivals and general interest woodworking topics.



\$60.00
Angle Poly Gauge

Veritas®
05-N-1401 | 460g

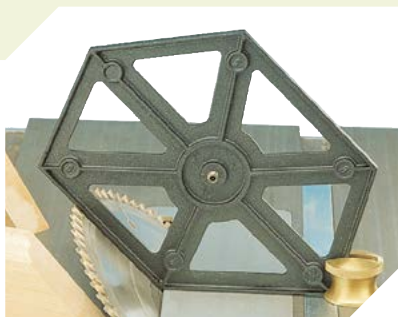

This gauge, which is accurate to ±5 arc minutes (1/12°) on every angle, can be used to set table saws, jointers, radial arm saws, bandsaws, drill presses, or similar machines. Used flat, the gauge is ideal for setting mitre fences or

for layout work. Used vertically, the slotted knob becomes a stabilizing base that holds the gauge erect so that you have both hands free for adjusting and locking a fence or blade.

\$54.90
160mm Precision Protractor

INCRA®
IRP-100 | 150g



Incra have reinvented the protractor by putting extra long guide slots at every 45°, 30°, 22.5°, 5°, 1° and 0.5° interval to plot any angle with ease and absolute accuracy.

If you take a few seconds to remove the T-bar you will also have an excellent 160mm rule with micro-fine marking holes at every 1mm.

\$32.90
Graduated Try Square

Paladina
SQ-01250 | 620g



Produced to the US Standard (0.02mm tolerance), this square is perfect for general-purpose work. Stainless acid-etched graduated blade – metric one side, imperial the other – with a massive hardened

chrome finish 17.5mm thick steel base. While we like using the engineer's square for setting up machines etc. we've found this is THE go-to square for general layout work.

\$17.90
Exactor

MILESCRAFT
MC-8406 | 120g



One tool does it all:

- ✓ Lay out mitred corners
- ✓ Set 5mm reveals for trim and casing
- ✓ Transfer measurements
- ✓ Align and square projects

- ✓ Set bit and blade heights
- ✓ Lay out wall studs
- ✓ Use as a basic rule
- ✓ Use as a story stick
- ✓ Create markings for layouts
- ✓ Serves as a simple level

from **\$54.90**
Cast Combination Square System

iGAGING®



The iGaging set is machinist-shop quality to the US standard with accuracy over the blade of +/- 0.1 degree. All heads are heavy stabilized cast-iron and machined to standard. We doubt you will

find another set with this kind of quality at this price. The 2.18mm satin ground blades are graduated in metric on both sides. Both sets come with sturdy storage cases and will get a lot of use in your workshop.

Prod Code	Product	Weight	Price
IG-342122-M	Two Piece Set	820g	\$54.90
IG-342124-M	Four Piece Set	1.4kg	\$119.00
IG-34212-B	300mm Rule Only	120g	\$13.90

from **\$24.90**
Engineers Squares

iGAGING®



Produced to German DIN 875-1 Standard, these squ 0.005mm and straightness tolerance of 0.0127mm. The 4in square has a 2.18mm blade with 11.18mm base,

while the 6in square has a heavy 2.4mm blade and 15.4mm base. Perfect weight in the hand – great to use and accuracy you can rely on.

Prod Code	Product	Weight	Price
IG-34-S-04	100mm 4in Long	220g	\$24.90
IG-34-S-06	150mm 6in Long	470g	\$29.90

from **\$23.90**
Double Squares

iGAGING®



Produced to the US standard (0.02mm tolerance), these handy squares have cast-iron machined bases with satin ground blades. The handle can be positioned anywhere along the blade to use as a layout tool as well as a precision

square. The blades are graduated in metric on both sides. The square with the 4in-long blade has a handle with a usable inside height of 49mm and the cross-sectional size of it is 28 x 14mm.

Prod Code	Product	Weight	Price
IG-34244-M	100mm 4in Long	160g	\$23.90
IG-34266-M	150mm 6in Long	420g	\$39.90
IG-344466-M	Set of Two	580g	\$49.90

Extraction & Safety
Measuring & Marking
Sawing
Site & Shop Accessories
Routing
Planing
Sanding & Scraping
Drilling
Joinery
Clamps & Vices
Finishing
Sharpening
Carving & Chisels
Woodturning
Wooden Parts
Cabinet Fittings

MEASURING & MARKING

\$24.⁹⁰ Traditional Beech Try Square

C-121 | 240g

A traditional carpenter's try square for woodworking. The handle is made from European Beech with a 1.5mm solid brass protective strip



installed on the working face. The 225mm-long blue tool steel blade is attached to the handle via three brass rivets.

\$49.⁹⁰ Traditional Rosewood Try Square

C-131 | 280g

A better long-term traditional try square over the Beech handled unit, it has a more stable Rosewood handle with a thicker 3mm brass strip on the front to maintain squareness. The 1.0mm thick blue tool steel blade measures 71mm to the brass face or 102mm overall and



a 45° relief cut into it so it can be used as a mitre square as well. The 225mm-long blue tool steel blade is attached to the handle via three brass rivets.

\$74.⁹⁰ Adjustable Try Square

124-XW | 220g

If you've been woodworking for a while you will appreciate this beautiful square. The 1.5mm-thick solid brass blade can mark up to 105mm from the face of the handle. It is held to the 75 x 38mm



Rosewood handle with one fixed brass pin and can be adjusted square with the two lead screws running through the handle by adjusting them in the base of the handle.

\$37.⁹⁰ Miniature Try Square

133-MW | 80g

The Rosewood handle measures 67 x 32 x 15mm with a thick 3mm solid brass strip on the front to maintain squareness. The 1.0mm thick blue tool steel blade measures 71mm to the brass face or 102mm overall and



is manufactured to the BS3322 standard (accuracy better than 0.01mm per 10mm blade length). A great little feature is the relief at the top of the handle set at 45° so it can be used as both a try (90°) and mitre square.

\$42.⁰⁰ Carpenter's Square Fence

Veritas®
05-N-5401 | 250g

A carpenter's square is frequently needed just because of its size. The key disadvantage of such a square (its lack of a supporting fence ledge) can now be eliminated using a Veritas square fence. The 203mm long anodized aluminum extrusion can be readily



attached to either the stock or blade of your square (depending upon intended use) with the two integral brass screws. The face of the square fence aligns with the edge of the work piece while the weight of the framing square rests on the material.

\$16.⁹⁰ Stair Gauges

SG-01 | 80g

Produced in solid brass, attach these handy gauges to your carpenter's square to mark out



identical angles for staircase risers, rafter angles or a variety of other uses.

from \$14.⁹⁰ Carpenters Framing Square

MILESCRAFT



- Every 10mm has a locating hole for quick mark-outs with a pencil
- Built-in retractable edge guide to reference the square against edge of work piece quickly
- Square can be anchored to use as a simple circle or arc scribe
- Includes euro style hinge mounting hole markers
- Has three quick angle finders for 30°, 45° and 60° angles
- Great for laying out shelf-pins and rafter connectors

Prod Code	Product	Weight	Price
MC-8454	FramingSquare300	400g	\$14.90
MC-8455	FramingSquare500	600g	\$19.90

\$24.⁹⁰ Carpenter's Square

ECLIPSE
EG-6040 | 750g

A typical steel carpenter's square with a reasonable price tag. 2mm steel with a black anodized finish for long life the graduations are marked in white for easy reading in 1mm graduations.

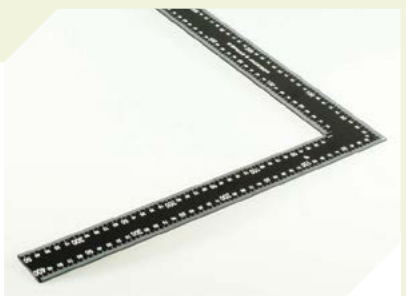

Internal dimensions marked from the inside corner and outside dimensions from the outside corner for easy measuring along the 600 x 400mm arms (outside dimensions).



Gift Vouchers

A great gift-giving option. Any value, sent anywhere in Australia.

Extraction & Safety
Measuring & Marking
Sawing
Site & Shop Accessories
Routing
Planing
Sanding & Scraping
Drilling
Joinery
Clamps & Vices
Finishing
Sharpening
Carving & Chisels
Woodturning
Wooden Parts
Cabinet Fittings

\$49.⁹⁰
Point 2 Point
MK 2



MP-20045 | 290g

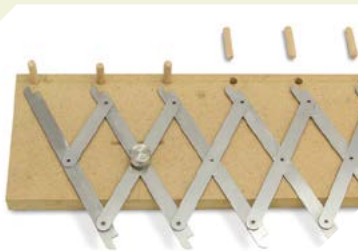

Take the hassle out of marking out jobs that need equal spacings, saving time with a calculator, tape measure and note pad. Instead find the perfect sequence and spacings for a row of coat hooks, screws,

nails, dowels, or shirt buttons as easy as an equally divided piece of cake. It has seven accurate marking points on boards up to 760mm in width.

\$49.⁹⁰
Lie Flat
Trammel Set



MP-20041 | 230g



Clip the two Trammel Scribe heads onto any length of steel rule. Choose the pencil or the (included) hyper fine cutting blade and strike that arc.

- ✓ Hands Free Stability.
- ✓ Flat Lying positioning for low centre of gravity.

- ✓ Self supporting assembly.
- ✓ Quick setting "Lock and release".
- ✓ Virtually unlimited radii.
- ✓ Work as a deep range marking gauge or mortice gauge.
- ✓ Work to a Pencil line or a hyper fine cut-line.

\$39.⁹⁰
Mini Magnetic
Square



FC-80569 | 200g



Square up your table saw, band saw or any piece of equipment effortlessly! It sticks firmly to cast iron tables and allows hands free

adjustment of spindles, blades and fences with imperial and metric graduations up to 100mm (4in) long.

\$65.⁰⁰
Taper Gauge



05-N-3803 | 140g



A tapered gauge effectively stretches any scale for accurate reading. These stretch the standard scale by a factor of seven. When a thickness difference of 0.2mm is stretched over 22mm of the scale, small

differences in thickness can easily be measured with fine accuracy. The aluminum gauges can be used many ways – for setting fences, router bits and drill-press stops, as well as measuring gaps when you repair work.

\$44.⁰⁰
Carpenters
Gauge



05-N-3601 | 180g



Specifically designed to be carried in an apron or pocket, this is both a direct-reading compass and a marking gauge, two things that carpenters frequently need but find hard to carry. It has a rotatable

head, which locks vertically for use and horizontally for storage and tip protection. It is direct reading, for both radius and diameter, in inches and centimetres.

\$49.⁰⁰
Wheel Marking
Gauge



LMG-001 | 350g



Turned from solid brass with a hardwood infill, this is one damn beautiful and superbly accurate marking gauge with around twice the weight of comparable tools giving it real heft to tackle marking

jobs with relative ease. The 182mm long stainless steel bar with accurate etched graduations makes what engineers would describe as a 'close sliding fit' within the body of the gauge.

\$27.⁰⁰
Bar Gauge
Heads



05-N-3101 | 40g



Simple bar gauges are among the most useful tools in a shop. Much like cabinet scrapers, once you have used them, you wonder how you got along without them.

They have two primary purposes, comparing measurements (such as ensuring equal diagonals in drawers or carcasses to guarantee squareness) and transferring measurements.

\$95.⁰⁰
Wheel Mortice
Gauge



LMG-002 | 450g



This superb solid brass twin stem mortice gauge has a couple of very useful features.

The bridle clamp at the back is designed to hold the setting

of the cutters relative to each other while the fence is adjusted independently, or vice versa if you want to adjust one rod but leave everything else set.



Search **Timbecon** to watch all of our instructional videos.

Extraction & Safety
 Measuring & Marking
 Sawing
 Site & Shop Accessories
 Routing
 Planing
 Sanding & Scraping
 Drilling
 Joinery
 Clamps & Vices
 Finishing
 Sharpening
 Carving & Chisels
 Woodturning
 Wooden Parts
 Cabinet Fittings

MEASURING & MARKING

\$21.90 Traditional Beech Marking Gauge



136-W | 190g

A single steel pin for marking along the grain and the faces are reinforced with brass strips to minimize wear and movements of the timber over time. Maximum



capacity is 145mm from the edge of work piece with the head measuring 66 x 56mm. The plastic thumb screw prevents marking on the 18.5mm² arm.

from \$54.90 Traditional Marking & Mortice Gauges



Produced from rosewood with a solid 3.5mm-thick solid brass wear strip running across its length. The heavy 2.5mm pin reduces chatter and will work across softwood grains with ease. There are 3mm brass wear strips installed in the solid 65 x 56 x 28mm fence and a knurled brass knob locks the fence in place.



6.0 - 140mm apart via the second adjustable pin that runs on a 4.75 x 5.50mm t-profile brass strip or it works up to 135mm from the edge when using the single marking gauge pin. It has the same high-quality brass and rosewood as listed in the marking gauge.

Code	Product	Wgt	Price
138-W	Rosewood Marking	280g	\$54.90
153-W	Rosewood Mortice	280g	\$69.90

The mortice pins can be positioned

\$59.90 Traditional Cutting Gauge



143-W | 280g

A solid cutting gauge to last a lifetime. It is produced from rosewood with a hefty 18.5mm main bar measuring 203mm long and a solid 3.5mm-thick solid brass wear strip running across its length. The razor-sharp knife cutter is held in place with an attractive solid



brass wedge and is perfect for use when marking across and along end-grain in all hardwoods. There are extra 3mm brass wear strips installed in the face solid 65 x 56 x 28mm fence and a knurled brass knob locks the fence in place.

from \$24.90 Miniature Marking & Mortice Gauges



Great little gauges that suits smaller hands or finer detail work. Produced solely from rosewood and brass, the main bar measures approximate 12mm square and 165mm long.



The 2.5mm heavy steel pin can be positioned up to the 120mm from the 45 x 43 x 19mm fence.

Code	Product	Wght	Price
138-MW	Rosewood Marking	80g	\$24.90
152-MW	Rosewood Mortice	80g	\$39.90

\$93.00 Wheel Mortice Head Gauge

Veritas®
05-N-7001 | 330g



The hardened steel wheel cutters scribe perfectly at any point of their circumference. Since they cut wood fibers rather than tear, marks are clean, even on cross grain. The cutting wheels are oriented with opposing bevels, ensuring that you can always set the bevel in the waste side of a cut. One rod has its cutting edge at the extreme end of the rod, making it useful for

transferring dimensions such as tenon shoulder and mortise depth. Each cutter can be retracted into the brass face for safe storage or to permit use with a single cutter. The eccentric placement of the rods ensures a large reference face and helps the gauge resist rolling on a surface. Aluminum housing with brass face and stainless-steel rods. 184mm overall length.

\$69.00 Wheel Micro- Adjustable Marking Gauge

Veritas®



There are two main problems with a typical marking gauge: you have to tilt it just right to avoid pin chatter and, even then, the pin tends to

follow the wood grain, throwing off your line. Wheel marking gauges solve both problems.

Prod Code	Product	Weight	Price
05-N-3510	Marking Gauge	180g	\$69.00
05-N-3511	Replacement Cutter	10g	\$9.00

\$22.00 Mortice Gauge Head

Veritas®
15-N-0101 | 30g



The hardened steel wheel cutter scribes perfectly at any point of its circumference. Since it cuts wood fibres rather than tears, it marks cleanly, even on cross grain. The wheel's single-sided bevel also pulls the gauge face against the stock, maintaining accuracy. Its cutting edge is at the extreme end of the rod,

useful for transferring dimensions such as tenon shoulder and mortise depth. The wheel retracts into the face of the gauge for storage and protection. The gauges are very easy to set, since each has an internal O-ring to keep light but constant friction on the rod.

\$51.00 Brass Marking Gauge

Veritas®
05-N-6501 | 100g



This elegant marking gauge is really three tools in one – a wheel gauge, a pin gauge, and a cutting gauge.

The unique swiveling pin/blade that locks in place (after extension is

set) using a set screw in the end of the 115mm gauge stem. The cutting blade can be set for either right- or left-handed use. The opposite end of the stem is tapped to accept a 9.5mm diameter wheel cutter.

\$79.⁹⁰ Digital 3-in-1 Mortice Gauge



IG-35777 | 350g



This gauge has a heavy-duty pin for chatter-free marking along, across and on end grain. It also contains a secondary pin attachment to use as a mortice gauge. It has another pin that replaces the 4.90mm thick machined flat gauge face so it can be used as a divider/compass. Just like the digital wheel marking

gauge, this gauge is made to same high quality standards as all iGAGING products with an accuracy of up to 0.0254mm over the 150mm range. Due to its 3-in-1 functionality we recommend this gauge over the wheel marking gauge but you will be happy with either depending on personal preference.

\$39.⁹⁰ Striking Knife



N-822302 | 20g



Easily one of the best striking knives around, it is light and very comfortable in the hand with a 100mm handle and a fine Manganese-Vanadium steel blade

measuring approximately 30mm long and 1.5mm thick. It cuts wood fibres with a very fine line perfect for registering a chisel or saw to for fine, accurate detail work.

\$69.⁹⁰ Digital Wheel Marking Gauge



IG-35780 | 350g



Wheel marking gauges are a massive leap forward as the wheel cutter can mark both with and across the grain. The wheel on this gauge is beveled on one side

naturally creating a force that pulls the face of the gauge against your work piece for straight, accurate marking.

\$15.⁹⁰ Traditional Marking Knives



The knife measures approximately 152mm long with the 19.0 x 1.4mm blade exposed by approximately 57mm. The 95mm Rosewood handle cheeks sit comfortably in the hand and make it easy to use for

extended periods of time. Bevelled either for predominantly right or left-handed people, you can flip it upside and use the point when you occasionally work on your non-preferred side.

Prod Code	Product	Weight	Price
112-W	Right-Hand	80g	\$15.90
112-AW	Left-Hand	80g	\$15.90

\$44.⁹⁰ Wheel Mortice Gauge



IG-34708 | 180g



- ✓ Metric graduations 0 - 150mm with 0.5mm increments
- ✓ Imperial graduations 0 - 6in in 1/32in increments
- ✓ Hardened steel wheels make clean cuts even against grain

- ✓ Two reversible cutters allow precise mortice and tenon layout
- ✓ Included stop collar keeps rod steady when working
- ✓ Your chisel can be used to set the width of the steel cutting wheels

\$29.⁹⁰ Scratch Awl



114-RW | 80g



Used to scribe a line to be followed by a hand saw or chisel when making woodworking joints and other operations, it is also handy when marking a centre point for starting a screw or locating a spur

on say a brad point or forstner bit for more accurate drilling. It has a 125mm long tempered tool steel spike with a comfortable 70mm turned rosewood handle is fixed in place using a brass ferrule.

\$8.⁹⁰ Automatic Centre Punch



MJ-845 | 70g



The 98mm long knurled brass handle fits comfortably in the hand and 25mm long hardened steel point makes marking centre points quick and easy. The point will press easily into softwoods but by

pushing down on the handle the snap spring will mark a deep point in the hardest materials quickly and accurately. Sharpen the point to use as a scratch awl as well.

\$14.⁹⁰ Marking Knife



IG-34360 | 20g



When marking accuracy is paramount, this marking knife will cut a line about 1/10th as wide as a sharp pencil line for greater accuracy. The blade is 38mm long with a comfortable handle that is

125mm long. It is flat on one side and beveled on the other, allowing you to draw the flat side across the reference piece to perfectly mark the edge. It is 100% reversible so is ideal for left or right-handed users.

MEASURING & MARKING

\$39.90

Japanese Height Gauge



S-62081 | 220g



This height gauge can be used for setting the height of saw blades, router bits and many other items by eye at both the 90° maximum of 100mm and 45° maximum of

80mm. The thick 5 x 15mm base is precision ground so it can be taken into account when measuring from the edge of a work piece if used as a saddle layout square.

\$49.90

Perfect Butt Profile Scriber



MP-20043 | 260g



A simple and elegant solution to the age-old problem of accurate profile copying and offsetting. Curved or straight, it gives you a perfect

profile, and a perfect butt joint, every time. With 5 different wheel sizes it can cope with almost every profiling situation.

\$17.90

MiniScribe



FC-02060 | 130g



Get a consistent scribe in those tight and difficult areas, staying parallel to the object surface every time. The Turning-Cam allows

you to adjust the measurement on either side of the Mini Scribe, making it easy to get up close measurements every time.

\$29.90

AccuScribe Pro



FC-98036 | 130g



The AccuScribe Pro makes it easy to maintain a consistent scribe offset, staying parallel to the object surface every time. It is ideal for scribing trim on kitchen cabinets,

architectural moldings, counter tops, splash guards, tile and even flooring. Fits a standard pencil or Sharpie.

\$19.90

Trim45 Carpenter's Aid



MC-8401 | 140g



The Trim45™ is the handiest tool in the toolbox when it comes to installing door and window casement trim as well as trim on fireplaces or book shelves. This unique device eliminates fumbling with tape

measures when determining the length of finish trim. Unique to the Trim45™ is an adjustable reveal setting ranging from 1/8in to 1/2in in 1/8in increments allowing it to be used on any project.

\$39.90

Digital Woodworker's Snap Check Gauge



IG-350907 | 350g



SNAP-CHECK makes machine setups a snap! Dialing in truly accurate machine setups on your jointer, table saw and router table can be a fussy, frustrating pain in the neck. The new SNAP-CHECK from iGaging makes tedious trial-and-error nightmares a thing of the

past. You'll be amazed at the shop time you'll save setting up your equipment.

- ✓ 3Way Reading: 0.1mm, 0.0005in, 1/64in
- ✓ Accuracy: ±0.001in / 1in
- ✓ Battery: 3V CR2032 included

\$29.90

Digital 3-in-1 Multi Gauge



IG-350906 | 200g



The large LCD display measures heights and depths accurately up to 150mm in three planes – horizontally, vertically and at 45° in metric, decimalized and fractional imperial in 1/128th graduations!

The heavy-duty polycarbonate frame can be used freestanding on flat surfaces so you can use both hands elsewhere. Comes with a flat and pointed hardened steel anvil points. It can also be locked for extra accuracy.

\$99.00

Digital MiniMag Height Gauge



IG-35628 | 960g



Get engineering accuracy with the MiniMag Height Gauge. The powerful magnetic base clamps to any ferrous metal surface for precise measuring of saw blades, router bits or any other application. It has a very large, clear LCD display

that reads in metric, decimalized and fractional imperial in 1/128th graduations. It is IP54-splash water, oil and dust resistant with accuracy over the whole 150mm length of 0.0254mm!

\$10.90

Depth Gauge



MC-8601 | 120g



- ✓ Durable metal scale measures in inches or millimeters
- ✓ Thumb lever for easy lock and release of scale
- ✓ Wide base with large feet
- ✓ Straddles most table saw throats for measuring while adjusting

- ✓ Self-standing - Allows a depth to be set while bringing the blade or bit up to the desired level
- ✓ Large scale markers and view finder - Easy for accurate adjustments

\$34.⁹⁰
Flush Cut Saw



187-FW | 150g



The 158mm-long traditional high-carbon Sheffield steel blade has teeth that cut on the pull stroke. The blade is just 0.4mm thick with 20tpi and a set on one side

only - so it will not scratch your finest finish and won't mar adjacent surfaces. Brass ferruled with a beautiful Rosewood handle that fits comfortably in hand.

\$149.⁰⁰
12in Tennon Saw



195-W | 800g



A coarser 13tpi blade makes light work of larger stock, ideal for cutting tenon shoulders and dado's, with maximum 76mm depth of cut to the solid brass back.

Traditionally made, the blade is filed and set for crosscutting both hard and softwoods equally well while outperforming cheaper competitors. It is designed to last a lifetime.

\$44.⁹⁰
Model Makers Saw



187-JSW | 180g



Perfectly sized for detail and miniature work. The blade is 152mm long with 20tpi and a 25mm depth of cut.

The traditionally filed and set high carbon steel blade is just 0.25mm thick and draws a very fine kerf.

\$139.⁰⁰
8in Dovetail Saw



188-W | 600g



Great for cutting box joints, dovetails and other general joinery work. The blade is 20tpi and cut up to a maximum 57mm deep to the

solid brass back. Like the tennon saw above, it has a comfortable stained beech handle with solid brass ferrules.

from **\$36.⁹⁰**
Traditional Gents Saws



A Gents saws is a small dovetailing saw with a straight turned handle. The name colloquially comes from the term that a gent (hobbyist) would use a saw of this nature.

It is a fine traditional ground tooth saw suitable for making joints in very small woodwork such as dovetailing, musical instruments, model-making etc.

Prod Code	Product	Weight	Price
187-MW	100mm 25TPI	150g	\$36.90
187-W	200mm 17TPI	210g	\$39.90

\$44.⁹⁰
Veneer Inlay Saw



187-VRW | 140g



The Veneer Inlay Saw has a 76mm-long 20tpi super thin curved blade specially crafted for the

finest veneer work and furniture repair without danger of damaging adjacent areas.

\$44.⁹⁰
Veneer Cutting Saw



187-VW | 120g



It has a lacquered beech handle with a 15tpi high-carbon steel blade. Blade length is 76mm and has resharpenable teeth on both sides that will cut on both the push

and pull strokes. Great for cutting veneers plus a range of other tasks in a traditional cabinetmakers workshop.

\$54.⁹⁰
Reversible Gents Saw



187-RSW | 350g



Best suited for cutting close to flat surfaces without interference from the saw back or your hand, such as when trimming a dowels or tenons flush with the surface. The 250mm-long 15tpi high carbon-steel

re-sharpenable blade is reversible for both right handed and left handed cuts, measuring just 0.5mm thick. Teeth are traditionally set and filed sharp.

\$99.⁰⁰
Tennon Saw



9550-B | 700g



- ✓ Universal teeth for along and cross-grain cutting
- ✓ Brass spine for maximum rigidity, control and accuracy
- ✓ 300mm x 15pt blade

- ✓ Resharpenable precision ground tooth high carbon steel blade
- ✓ Comfortable Beech handle fixed with brass rivets

Extraction & Safety
 Measuring & Marking
 Sawing
 Site & Shop Accessories
 Routing
 Planing
 Sanding & Scraping
 Drilling
 Joinery
 Clamps & Vices
 Finishing
 Sharpening
 Carving & Chisels
 Woodturning
 Wooden Parts
 Cabinet Fittings

SAWING

Extraction & Safety
Measuring & Marking

Sawing
Site & Shop Accessories

Routing

Planing

Sanding & Scraping

Drilling

Joinery

Clamps & Vices

Finishing

Sharpening

Carving & Chisels

Woodturning

Wooden Parts

Cabinet Fittings

\$131.00 Carcass Saws



Veritas®

Typically used to cut joints in drawer runners, dividers, and stretchers (the framework or carcass of a piece), they are well balanced,

maneuverable, and scaled for smaller work than a tenon saw. Blade size is 280 x 0.51mm.

Prod Code	Product	Weight	Price
05-T-0705	Ripping-12TPI	300g	\$131.00
05-T-0701	Crosscut-14TPI	300g	\$131.00

\$193.00 Rip & Crosscut Tenon Saws



Veritas®

Weighing just under 700g with a 406mm blade, these are the largest saws in the Veritas line. Available in 9tpi rip pattern with 14° rake angle or 12tpi crosscut pattern with 15° rake angle, severing wood fibres rather than tearing them.

The blades are made from 0.61mm thick high-carbon steel with 0.08mm of set per side and a cut depth of nearly 102mm.

Code	Product	Wgt	Price
05-T-1401	Rip-9TPI	800g	\$193.00
05-T-1405	Cross-12TPI	800g	\$193.00

\$125.00 Dovetail & Crosscut Saws



Veritas®

These dovetail and crosscut saws are an innovative blend of tradition and technology, incorporating the critical characteristics of a classic fine joinery saw but made using modern production processes and state-of-the-art materials.

The blades of the dovetail saws have 14 or 20 rip-cut teeth per inch. The 14 tpi model is most efficient on stock thicker than 13mm; the less aggressive cut of the 20 tpi version is best for stock under 13mm thick. The teeth, set

0.075mm per side, have a rake angle of 14° and an included angle of 60°.

Used for cutting across or perpendicular to the grain, the 16 tpi crosscut saw blade has teeth filed with alternating bevel angles so it severs rather than tears wood fibers; it tracks better and leaves a smoother finish than a rip-cut blade. The teeth are filed with 15° rake and bevel angles and have 0.075mm of set per side. Blade size is 235 x 0.51mm.

Prod Code	Product	Weight	Price
05-T-0501	Standard Dovetail - 14TPI	700g	\$125.00
05-T-0505	Finecut Dovetail - 20TPI	700g	\$125.00
05-T-0601	Small Crosscut - 16TPI	700g	\$125.00

from \$51.00 Magnetic Saw Guides



Veritas®

These anodized aluminium guides help keep a saw square to a workpiece. Held against a workpiece by hand or secured with (not included) clamps, it provides a registration surface, about 32mm tall, to help maintain accuracy throughout the cut. The machined reference face has three embedded

13mm rare-earth magnets and covered with a strip of low-friction UHMW tape. The bottom of the guide has two high-friction strips to resist slipping on a surface.

Code	Product	Wgt	Price
05-T-2001	200mm Guide	630g	\$51.00
05-T-2004	356mm Guide	630	\$55.00

\$72.00 Magnetic Saw Guide



Veritas®

After receiving many requests from customers for a 90° version of the dovetail saw guide, Veritas developed a right-angle saw guide for making finger joints, cutting tenons or on-

the-spot trimming of small items. It is also ideal for beginners or children learning to make perfectly square perpendicular cuts on board ends.

For dovetail saw guides see p. 86

Prod Code	Product	Weight	Price
05-T-0401	Straight Saw Guide Only	110g	\$72.00
05-T-0203	Saw Suits Guide Only	300g	\$44.00

\$93.00 Gents Saws



Veritas®

These gents saws have a 200mm long high-carbon steel blade that is just 0.38mm thick with 0.075mm of teeth set per side. The 20 tpi rip saw has teeth with a 14° rake angle and a 60° included angle.

The teeth on the 22 tpi crosscut saw have a rake angle of 15°, an included angle of 60° and have been filed with alternating 15° bevel angles so that they sever rather than tear wood fibers.

Prod Code	Product	Weight	Price
05-T-1001	Ripping - 20TPI	300g	\$93.00
05-T-1005	Crosscut - 22TPI	300g	\$93.00

\$44.00 Flush Cut Saw



Veritas®
05-K-3410 | 90g

Traditionally used for the rapid trimming of plugs and dowels flush with a surface, Veritas flush-cutting saws can be used where you want to cut off a projection without damaging the surrounding or adjoining face. This is possible because the teeth are set one way only.

The 22tpi Japanese tooth-pattern blade cuts aggressively (on the pull stroke), but does not mark the surface that it is cutting next to. The thin blade is flexible and can be pressed flush to any surface, yet is rigid enough for good control.

Japanese Saws

The most striking advantage of the pull stroke saw is the ability to cut accurately with less effort. There is less binding, buckling and breaking of the blade because the blade is under tension on the pull cutting stroke rather than under compression as in Western style saws. The ability of a saw to accurate cut along a line i.e. cutting control, is directly related to the saw's ease of cutting. Invariably, the saws that cut the most efficiently are the easiest to control.

Because Japanese saws cut on the pull stroke, it permits the use of thinner, harder steel, and the blade can be much sharper. This will allow the blade's to have thinner kerfs, which reduces the effort of cutting because you are sawing a smaller amount of material compared to a Western-style saw, which means more smooth and accurate cuts.

In 1969 the company marketing the RAZORSAW brand invented the system with the thinnest

blade ever for the most efficient cutting. The introduction of this new disposable saw amazed the Japanese woodworking industry and its success has proved that this method of manufacturing Japanese saws has taken the world by storm.

RAZORSAW are continuously looking ahead. Development in the future will bring further benefits as they continue a history of combining human wisdom with technological innovation.

Each blade is impulse hardened. Impulse hardening is a new technique of heating for 1/1000 second by impulse energy at an extra high frequency resulting in hard and tenacious steel that gives remarkable durability. It is recommended you pull the saw towards you with a slight power keeping the edge at a 15-degree angle. Then push softly and repeat. Once you have used a RAZORSAW you will wonder how anything else in the workshop did the job.

Japanese Saws - Miniature

from \$39.00

RAZORSAW ORIKOMI Series



The only difference between these saws and their larger brothers is in the blade and handle length. Each has a 180mm-long blade with

0.5mm blade thickness and 16TPI tooth set for cross and end-grain cutting. Perfect for trialing Japanese saws or getting into a tight space.

Prod Code	Product	Weight	Price
RS-290	Dozuki Style	150g	\$39.00
RS-291	Ryoba Style	150g	\$44.90
RS-293	Kabata Style	140g	\$39.90
RSS-290	Replacement Blade for RS-290	30g	\$29.90
RSS-291	Replacement Blade for RS-291	50g	\$29.90
RSS-293	Replacement Blade for RS-293	50g	\$29.90

Double Sided Flush Cutting Saws

\$34.90

RAZORSAW ORIKOMI Series

RS-1151 | 70g



Double-sided so it can cut plugs and other timber extrusions flush with the surface around it without damage in both directions. The blade thickness is 0.3mm

with a 1.0mm pitch on one edge and 1.3mm on the other for a finer cut on end-grain. Blade length is 125mm with a comfortable raw timber handle.

Dozuki Japanese Saws

from \$54.90

RAZORSAW ORIKOMI Series



Dozuki Japanese Saws are the most popular in the range as they can be used as a tennon, backsaw or dovetail saw. The addition of the spine means the blades are

manufactured wafer thin with a kerf of just 0.3mm. The tooth configuration is designed primarily for cross and end-grain cutting leaving a fine and smooth surface finish.

Prod	Product	Weight	Price
RS-202	270 x 0.3mm 16TPI DOC = 60mm	270g	\$69.90
RS-300	240 x 0.3mm 16TPI DOC = 42mm	230g	\$54.90
RS-301	240 x 0.3mm 16TPI EVA-GRIP	260g	\$59.90
RS-370	240 x 0.3mm 25TPI DOC = 51mm	270g	\$74.90
RS-371	240 x 0.3mm 25TPI DOC = 60mm	280g	\$79.90
RSS-202	Replacement Blade for RS-202	100g	\$39.90
RSS-300	Replacement Blade for RS-300/301	90g	\$34.90
RSS-370	Replacement Blade for RS-370	100g	\$49.90
RSS-371	Replacement Blade for RS-371	110g	\$54.90

DOC = Depth of Cut

Kabata Japanese Saws

from \$44.90

RAZORSAW ORIKOMI Series



Popular for general cabinet work, Kabata saws have a flexible spineless blade so you can crosscut and perform fine ripping applications to any depth.

The blade slightly tapers close to the spine to reduce friction when performing deep cuts from the 0.6mm kerf that all these blades have. All blade lengths are 240mm.

Prod Code	Product	Weight	Price
RS-400	240 x 0.6mm 13TPI	220g	\$44.90
RS-410	240 x 0.6mm 16TPI	220g	\$44.90
RS-412	240 x 0.6mm 16TPI EVA-GRIP	250g	\$49.90
RSS-400	Replacement Blade for RS-400	120g	\$27.90
RSS-410	Replacement Blade for RS-410/412	130g	\$27.90

Ryoba Japanese Saws

from \$44.90

RAZORSAW ORIKOMI Series



Ryoba saws have a double-edged blade – with one side for cross and end-grain cutting and the other for ripping along the grain. This makes for a very useful saw for general-

purpose traditional woodwork. They are all slightly thinner in the middle of the saw to reduce friction when cutting through thick work pieces.

Prod Code	Product	Weight	Price
RS-605	210 x 0.45mm 8/16TPI	210g	\$44.90
RS-611	240 x 0.45mm 10/19TPI	240g	\$54.90
RS-615	270 x 0.6mm 5/10TPI	310g	\$59.90
RSS-605	Replacement Blade for RS-605	90g	\$34.90
RSS-611	Replacement Blade for RS-611	100g	\$39.90
RSS-615	Replacement Blade for RS-615	130g	\$44.90

SAWING

\$849.00
14in Bandsaw



A single-piece steel body has been laser cut, precision folded and welded to form a sturdy frame. The alloy wheels are computer balanced and each machine is assembled and checked prior to shipping.

The speed can be varied for cutting wood and metal using a simple speed change mechanism. At the base of the machine is a 4in dust outlet.

Specifications

Blade Guides	Sealed Edge Facing Bearings
Blade Length	2490mm
Blade Widths	6 - 19mm
Blade Speed	390 & 800m/min
Blade Release	Fine adjustment knob
Cutting Height 90°	200mm
Throat (Cutting Width)	345mm
Table Size	400 x 548mm
Table Tilt	0 - 45°
Dust Port Diameter	4in (102mm)
Motor Input/Output	1000W/750W (4-Pole)
Wheel Material	Alloy
Included Extras	Stand Rip Fence Mitre Guide
Shipping Weight	70kg

\$1,499.00
14in Deluxe Bandsaw



- ✓ Upgraded Deep Rip Capacity to 330mm
- ✓ Upgraded Motor Output
- ✓ Upgraded polished steel adjustment wheels
- ✓ Heavy-duty reinforced single-piece steel body laser cut, precision folded and welded with extra gussets for improved frame strength
- ✓ Quick-release blade tension system with suggested indicator for different widths to speed up and more accurately tension blades
- ✓ Height winder for top blade guide assembly and blade cover



- ✓ Micro-adjustable top and bottom bearing blade guides
- ✓ Trunnion winder system for table angle adjustments
- ✓ Heavy-duty industrial-style resawing fence
- ✓ Heavy-duty cabinet-style base
- ✓ Flexible arm working light to illuminate work table

Specifications

Blade Guides	Sealed Edge Facing Bearings
Blade Length	2630mm
Blade Widths	6 - 19mm
Blade Speed	390 & 800m/min
Blade Release	Quick-Release Lever
Cutting Height 90°	330mm
Throat (Cutting Width)	345mm
Table Size	400 x 548mm
Table Tilt	0 - 45°
Dust Port Diameter	4in (102mm)
Motor Input/Output	2000W/1500W (2-pole)
Wheel Material	Alloy
Included Extras	Cabinet Base Resaw Fence Mitre Guide
Shipping Weight	110kg

\$129.00
Bandsaw Rip Fence Attachment

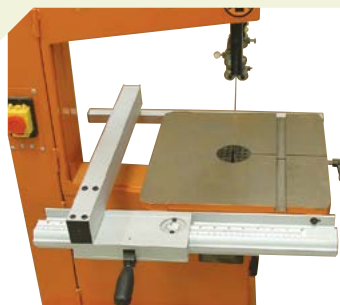

The front rail has an oval extruded shape that pulls the fence in square with the fence when the camlock lever locks it into place. The fence arm itself measures 60mm high and 430mm from the clamping arm, so it should reach across the distance of most tables. The rear rail is there to support the back ledge of the

fence arm, so table width is not critical.

The front rail is graduated in both imperial and metric sizes. The viewing lens on the fence arm is magnified, which makes it easier to line the fence accurately against the graduations.

\$119.00
Bandsaw Blade Deluxe Guide Set



This blade guide set replaces the standard block guides completely and offers a significant quality upgrade over the traditional standard design. The benefit of the bearings is that they do not wear down over time and provide reduced friction

and heat build-up on the blade prolonging its life. The top and bottom guides are micro-adjustable for perfect placement against the blade and are produced from heavy-duty industrial aluminium casting so should last the lifetime of the machine.

\$2,599.00
18in Bandsaw



SHERWOOD

SBS-470 | 200kg



Main Features

- ✓ Reinforced tapered single-piece steel body laser cut, precision folded and welded with extra gussets for improved frame strength for resawing and deep ripping applications
- ✓ Upgraded 4-pole (1400rpm) motor that has twice the torque of standard 2-pole motors (2800rpm) that effortlessly copes with any resawing
- ✓ Computer balanced heavy-duty cast-iron wheels
- ✓ Rack and pinion height winder for top blade guide assembly/ blade cover
- ✓ Quick-release blade tension system with suggested indicator for different widths to speed up and more accurately tension blades
- ✓ Heavy-duty trunnion winder system for table angle adjustments
- ✓ Heavy-duty industrial-style resawing fence
- ✓ Quick access knobs for top and bottom blade covers with micro-switches built in to automatically cut power when covers are open

Specifications

Blade Guides	Dual Sealed Edge Facing Bearings
Blade Length	3610mm
Blade Widths	6 - 32mm
Blade Speed	380 & 800m/min
Blade Release	Quick-Release Lever
Cutting Height 90°	345mm
Throat (Cutting Width)	470mm
Table Size	630 x 485mm
Table Tilt	0 - 45°
Dust Port Diameter	2x 4in (102mm)
Motor Input/Output	2000W/1500W (4-Pole)
Wheel Material	Cast-Iron
Included Extras	Mitre Guide
Shipping Weight	200kg

Sherwood Industrial Bandsaws



In the second half of 2018, the Sherwood Industrial Bandsaw range will be launched.

Featuring heavy-duty welded steel frames, along with massive cast-iron wheels, patented blade guide systems and unparalleled levels of detail, fit and finish, some of these features have never been seen in the Australian market on bandsaws before.

These ensure complete ease of use – from the effortless cutting performance to easier machine adjustments – all combining to make the machine a joy to operate and all importantly improving cutting performance.

Keep a look out for these in 2018!

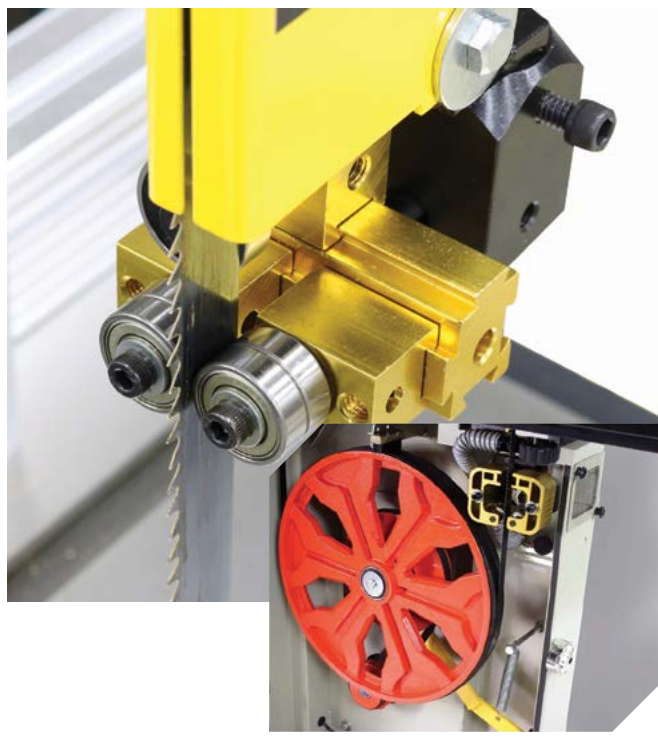

SpaceAge Ceramic GuideBlocks



How does this work on a bandsaw?

SpaceAge Ceramic Guideblocks & Thrust Bearings are made of baked aluminum-oxide, the same material used to make the ceramic tiles found on NASA space craft. They work by drawing out and absorbing the heat created in the environment around it and store it within the block. It means the temperature inside the block can be astronomical whilst still cool to touch on the outside.

The blocks draw the heat out of the blade as it passes past the guides, virtually eliminating the expansion of the blade created from normal friction build-up as well as not changing the temper of the hardened steel teeth – both of these characteristics combine to ensure the blade tracks better, run smoother and quieter and will increase blade life by 40%!

They also practically never wear out. An absolute necessity for resawing.

Prod Code	Weight	Price
BAS-350-CGB	400g	\$129.00
BAS-415-CGB	500g	\$199.00



Gift Vouchers

A great gift-giving option. Any value, sent anywhere in Australia.

At Timbecon we can provide Gift Vouchers to any value. Vouchers don't have to be used all at once either – you can use partial values multiple times until the full value has been redeemed.

Extraction & Safety
Measuring & Marking
Sawing
Site & Shop Accessories
Routing
Planing
Sanding & Scraping
Drilling
Joinery
Clamps & Vices
Finishing
Sharpening
Carving & Chisels
Woodturning
Wooden Parts
Cabinet Fittings

SAWING

\$349.⁰⁰ 9in Hobby Bandsaw

RECORD POWER
RP-65002 | 17kg

Specifications

Blade Guides	Steel Bar
Blade Length	1575mm
Blade Widths	3 - 10mm
Blade Speed	770m/min
Blade Release	Cam-Action Tensioner
Cutting Height 90°	92mm
Throat (Cutting Width)	228mm
Table Size	300 x 300mm
Table Tilt	0 - 45°
Dust Port Diameter	2in (51mm)
Motor Output	200W
Wheel Material	Cast Iron
Shipping Weight	25kg

Ideal for users in a compact workshop who require a robust, reliable and powerful machine for smaller scale work. It gives exceptional performance and capacities for a bandsaw of its size

and is designed for consistently effective cutting and longevity.

The band wheels are dynamically balanced and are heavily built for a machine of this size, providing impressive torque and power.



\$479.⁰⁰ 10in Bandsaw

RECORD POWER

Specifications

Blade Guides	Sealed Edge Facing Bearings
Blade Length	1790mm
Blade Widths	6 - 13mm
Blade Speed	740m/min
Blade Release	Fine Adjustment Knob
Cutting Height 90°	120mm
Throat (Cutting Width)	240mm
Table Size	315 x 350mm
Table Tilt	0 - 45°
Dust Port Diameter	2 1/2in (58mm)
Motor Output	375W
Wheel Material	Alloy
Shipping Weight	30kg

With a cast iron table at the heart of this compact machine it is designed to offer those with limited space or budgets a real bandsaw with sensible capacity and performance, as an alternative to lightweight

hobby machines.

The machine can be bench mounted or fitted to the optional stand and wheel kit, providing great flexibility in a tight space.



Prod Code	Product	Weight	Price
BS-250	10in Bandsaw	33kg	\$479.00
BS-250-AW	Stand & Wheel Kit	11kg	\$175.00

Bandsaw Blades

SHERWOOD

- Each tooth on the blade is hardened to Rockwell Rc80 – making it resistant to heat build-up, increasing blade life and strength
- Unique heat line on the back of the blade – the blade does not buckle in use giving you a straighter cut.
- Tooth shaped with a chip-breaker – removing waste more efficiently, reducing heat build-up, improving and extending cutting performance.
- Increased hook angle – cuts more aggressively but still leaves a smooth finish, making the cuts faster and easier to control.
- Thin gauge (kerf) – Just like thin kerf circular saw blades, it takes less power to drive, with less waste, so deeper cuts are quicker & easier than before.
- Increased set of tooth – standard tooth set does not affect hardwood cutting but can affect cutting resinous timbers such as Pine. With a greater set, these blades handle a wider range of material.
- Made in Germany – the blade stock is manufactured in the world's centre of modern engineering. Expect excellent, consistent blade quality every time.
- Butt welded: the strongest method of welding. We guarantee these blades will never break on the weld – ever.

Bandsaw Blades - Suits MJ-3435-W

Prod Code	Product	Weight	Price
BS-23650310	3mm x 10TPI	1kg	\$23.00
BS-23650604	6mm x 4TPI	1kg	\$23.00
BS-23650606	6mm x 6TPI	1kg	\$23.00
BS-23650610	6mm x 10TPI	1kg	\$23.00
BS-23651003	10mm x 3TPI	1kg	\$23.00
BS-23651006	10mm x 6TPI	1kg	\$23.00
BS-23651303	13mm x 3TPI	1kg	\$24.00
BS-23651306	13mm x 6TPI	1kg	\$24.00
BS-23651603	16mm x 3TPI	1kg	\$31.00

Bandsaw Blades - Suits BAS-350

Prod Code	Product	Weight	Price
BS-24900604	6mm x 4TPI	1kg	\$23.00
BS-24900606	6mm x 6TPI	1kg	\$23.00
BS-24900610	6mm x 10TPI	1kg	\$23.00
BS-24901003	10mm x 3TPI	1kg	\$23.00
BS-24901006	10mm x 6TPI	1kg	\$23.00
BS-24901303	13mm x 3TPI	1kg	\$24.00
BS-24901306	13mm x 6TPI	1kg	\$24.00
BS-24901603	16mm x 3TPI	1kg	\$31.00
BS-2490250114	25mm x 1 1/4TPI	1kg	\$50.00
BS-24902503	25mm x 3TPI	1kg	\$45.00

Bandsaw Blades - Suits BAS-350-B

Prod Code	Product	Weight	Price
BS-26300604	6mm x 4TPI	1kg	\$24.00
BS-26300606	6mm x 6TPI	1kg	\$24.00
BS-26300610	6mm x 10TPI	1kg	\$24.00
BS-26301003	10mm x 3TPI	1kg	\$24.00
BS-26301006	10mm x 6TPI	1kg	\$24.00
BS-26301303	13mm x 3TPI	1kg	\$27.50
BS-26301306	13mm x 6TPI	1kg	\$27.50
BS-26301603	16mm x 3TPI	1kg	\$32.00
BS-2630250114	25mm x 1 1/4TPI	1kg	\$50.00
BS-26302503	25mm x 3TPI	1.5kg	\$45.00

Bandsaw Blades - Suits BAS-415

Prod Code	Product	Weight	Price
BS-33800604	6mm x 4TPI	1.5kg	\$29.00
BS-33800606	6mm x 6TPI	1.5kg	\$29.00
BS-33800610	6mm x 10TPI	1.5kg	\$30.00
BS-33801003	10mm x 3TPI	1.5kg	\$30.00
BS-33801006	10mm x 6TPI	1.5kg	\$30.00
BS-33801303	13mm x 3TPI	1.5kg	\$34.00
BS-33801306	13mm x 6TPI	1.5kg	\$34.00
BS-33801603	16mm x 3TPI	1.5kg	\$41.00
BS-3380250114	25mm x 1 1/4TPI	1.5kg	\$65.00
BS-33802503	25mm x 3TPI	1.5kg	\$55.00
BS-3380320114	32mm x 1 1/4TPI	1.5kg	\$85.00

Bandsaw Blades - Suits BAS-470

Prod Code	Product	Weight	Price
BS-36100604	6mm x 4TPI	2kg	\$30.00
BS-36100606	6mm x 6TPI	2kg	\$30.00
BS-36100610	6mm x 10TPI	2kg	\$30.00
BS-36101003	10mm x 3TPI	2kg	\$31.00
BS-36101006	10mm x 6TPI	2kg	\$31.00
BS-36101303	13mm x 3TPI	2kg	\$35.00
BS-36101306	13mm x 6TPI	2kg	\$35.00
BS-36101603	16mm x 3TPI	2kg	\$40.00
BS-3610250114	25mm x 1 1/4TPI	2kg	\$65.00
BS-36102503	25mm x 3TPI	2kg	\$55.00
BS-3610320114	32mm x 1 1/4TPI	2kg	\$90.00

\$19.90 Scroll Saw Dual Blade System



ACCS-16 | 240g



Have a scroll saw that will only accept pinned-end blades? This handy kit swaps the existing brackets out for the black clamping blocks that will accept pinned-end

blades by hooking them over the front gusset or pinless blades by placing the end in the split block and tightening the allen bolt located on the side. Available in packs of 12.

\$9.90 Pinned End Scroll Saw Blades - 6pk

OLSON



Standard tooth configuration for machines that require 5in pinned-end blades.

Prod Code	TPI	Width x Thickness	Weight	Price
FR-41001	7TPI	2.54 x 0.45	20g	\$9.90
FR-42003	9TPI	2.54 x 0.45	20g	\$9.90
SC-41101	15TPI	2.54 x 0.45	20g	\$9.90
FR-42401	18.5TPI	1.77 x 0.25	20g	\$9.90
SC-40501	18.5TPI	2.54 x 0.45	20g	\$9.90

\$9.90 Spiral Scroll Saw Blades

OLSON



Spiral Tooth blades saw in all directions with 360° cutting capability.

Prod Code	TPI	Thickness	Universal no.	Wgt	Price
SP-46500	36TPI	1.04	4	20g	\$9.90
SP-46300	41TPI	0.88	2	20g	\$9.90
SP-46100	46TPI	0.81	0	20g	\$9.90

\$9.90 PGT Scroll Saw Blades - 12pk

OLSON



Razor sharp teeth cut faster and more accurately in straight and radius cuts.

Prod Code	TPI	Width x Thickness	Weight	Price
PG-45902	Reverse Skip 8/6TPI	1.21 x 0.45	20g	\$9.90
PG-45702	Reverse Skip 10/7TPI	1.16 x 0.45	20g	\$9.90
PG-45502	Reverse Skip 12/9TPI	1.11 x 0.45	20g	\$9.90
PG-49902	Double Reverse 9/6TPI	1.24 x 0.45	20g	\$9.90
PG-49702	Double Reverse 10.5/8TPI	1.19 x 0.45	20g	\$9.90
PG-49502	Double Reverse 12.5/8TPI	1.14 x 0.45	20g	\$9.90

\$11.90 Mach Speed Scroll Saw Blades - 12pk

OLSON



Widely spaced gullets minimize burning and provide rapid chip removal.

Prod Code	Product	Weight	Price
FR-64902	8/6TPI Thick	20g	\$11.90
FR-64702	8/6TPI Thin	20g	\$11.90
FR-64502	13/7TPI Thick	20g	\$11.90
FR-64302	13/7TPI Thin	20g	\$11.90

\$8.90 Skiptoath Scroll Saw Blades - 12pk

OLSON



Skip tooth blades are available in a range from the finest to coarser sizes for sawing of thicker materials.

Prod Code	TPI	Width x Thickness	Universal no.	Weight	Price
FR-45300	9.5TPI	1.57 x 0.60	12	20g	\$8.90
FR-44600	12.5TPI	0.96 x 0.40	5	20g	\$8.90
FR-44500	15TPI	0.88 x 0.38	4	20g	\$8.90
FR-44300	20TPI	0.73 x 0.30	2	20g	\$8.90
FR-44000	28TPI	0.55 x 0.25	2/0	20g	\$8.90
FR-40000	33TPI	0.55 x 0.20	3/0	20g	\$8.90

\$9.90 Reverse Skip Scroll Saw Blades - 12pk

OLSON



Excellent blade for eliminating tear-out on birch and maple plywood.

Prod Code	TPI	Width x Thickness	Universal no.	Wgt	Price
FR-45302	9.5TPI	1.57 x 0.60	12R	20g	\$9.90
FR-44602	12.5TPI	0.96 x 0.40	5R	20g	\$9.90
FR-44302	20TPI	0.73 x 0.30	2R	20g	\$9.90
FR-44002	28TPI	0.66 x 0.27	2/OR	20g	\$9.90

\$8.90 Double Tooth Scroll Saw Blades - 12pk

OLSON



Double tooth blades cut fast, leaving clean edges in wood and plastic.

Prod Code	TPI	Width x Thickness	Universal no.	Wgt	Price
DT-43900	10TPI	1.54 x 0.55	12	20g	\$8.90
DT-43700	13TPI	1.11 x 0.45	7	20g	\$8.90
DT-43600	16TPI	0.96 x 0.4	5	20g	\$8.90
DT-43500	23TPI	0.81 x 0.35	3	20g	\$8.90
DT-43400	30TPI	0.66 x 0.33	1	20g	\$8.90

From \$8.90 Crown Tooth Scroll Saw Blades - 12pk

OLSON



Unique tooth design allows the blade to cut on both the up and down stroke.

Prod Code	TPI	Width x Thickness	Universal no.	Wgt	Price
CT-63200	6TPI	1.65 x 0.6	12	20g	\$11.90
CT-62700	11TPI	1.14 x 0.43	7	20g	\$11.90
CT-62500	16TPI	0.96 x 0.4	5	20g	\$11.90
CT-62000	20TPI	0.6 x 0.27	2/0	20g	\$11.90
DT-43400	30TPI	0.66 x 0.33	1	20g	\$8.90

\$11.90 Metal Cutting Scroll Saw Blades - 12pk

OLSON



These blades are for use in hand-held frames due to their inherent brittleness.

Prod Code	TPI	Width x Thickness	Universal no.	Weight	Price
MC-49000	20TPI	1.77 x 0.58	12	20g	\$11.90
MC-48700	25TPI	1.24 x 0.55	9	20g	\$11.90
MC-48500	30TPI	1.04 x 0.48	7	20g	\$11.90

SAWING

\$399.00

12in Slide Compound Mitre Saw

Stand and Vacuum Sold Separately

Engineered from the ground up, jam packed with features that are usually only seen on \$1,000+ saws.

At the core of this 305mm saw is a powerful 2000W belt-driven motor, meticulously designed for maximum durability.

It performs both bevel and mitre cuts up to 45° to the left and right, giving it world class cutting efficiency with included preset click-locks, allowing you to lock the base in place at the most common mitre angles.



SWARTS TOOLS
SW-1045 | 65kg

- ✓ Adjustable depth stop
- ✓ Front mount clamp
- ✓ High rear fence
- ✓ 45 degree bevel left or right
- ✓ Standard 25.4m (1") bore
- ✓ 100T TCT Saw Blade with standard 25.4mm (1in) bore
- ✓ Integrated carry handle

\$129.90

Mitre Saw Stand

SWARTS TOOLS
SS-1001 | 22kg

- ✓ Sets up in only 30 seconds and packs down in 20 seconds
- ✓ Quick release clamps remove saw from the stand in 3 seconds without tools
- ✓ Solid right angle stops support work piece when doing multiple precise identical cuts.
- ✓ Single knob release adjustable roller & stop arms between 89 and 190cm extension
- ✓ Folds up to a minimal 99 x 27 x 25cm for easy storage
- ✓ Sturdy Steel Frame
- ✓ Includes wheels for extra mobility when packed down

\$26.90

10 Million Dollar Stick

FastCap
FC-04247 | 750g



Make dangerous cuts on a mitre saw safe for your fingers with the 10 Million Dollar Stick. The ergonomic design and rubberized traction foot gives you a safer, and

more precise cut. How valuable are your fingers to you? Do yourself a favour – anyone who has used these will tell you to get one!

\$9.90

Zero Clearance Tape

FastCap
FC-05432 | 1kg



Zero Clearance Tape brings a whole new level of precision to your mitre saw. Simply apply over the throat of your saw to eliminate chip out and

create an exact reference for line up. Made from durable PVC, they will last for many jobs.

\$109.00

DigiAlign

I GAGING
IG-350928 | 520g



Designed for completing numerous tests in your workshop, this digital alignment tool will allow you to test your table saw alignment, fence alignment; saw, router and drill press arbor run-out; set jointer knives, saw blade run-out and much more. Get accurate measurements on any steel (cast iron) machine with a standard mitre slot (19.0 x 9.5mm). The magnetic mitre bar holds the tool tight against the

edge of the mitre slot, while still allowing for sliding movement up and down the mitre slot to check fence-alignment-to-mitre-slot or saw-blade-to-mitre-slot. The easy-to-read, 3-way digital indicator gives you readings in metric, inch or fractional increments. It has a 25mm range, will read to within 0.01mm/0.0005in and features both an ABS-Hold function and a data output for your computer.

\$199.00

16in Variable Speed Scroll Saw

RECORD POWER
SS-16-V | 16kg



A real benefit of the SS16V is the variable speed which gives the versatility to cut a range of different materials. Slower speeds can be used for the cutting of plastic and non-ferrous metals, while faster

speeds can be used for cutting wood up to 50mm thick. Importantly, the blade can be quickly and easily changed to minimise interruptions to work-flow, particularly when cutting intricate pieces.

Throat size	405mm	Table tilt	0 - 45°
Motor size	75W brush-type	Dust port diameter	35mm
Variable speed control	400 - 1600rpm	Adjustable LED work light	
Table size	250 x 410mm	Dual-blade system to suit pinned-end and pinless blades	
Maximum depth of cut	50mm		

\$17.90

Coping Saw

ECLIPSE



Coping saws are great for cutting and shaping curved timber work pieces. You can also drill a small hole and pass the blade through

for cutting out internal shapes. The blade can be positioned at any angle to the frame to expand its usefulness.

Prod Code	Product	Weight	Price
SJ-7-CP	Coping Saw	300g	\$17.90
CP-7-R	Replacement Blades Pk 10	70g	\$16.90

\$49.90

Fret Saw

ECLIPSE
FS-1-RSF | 525g



Fret saws are well known as a fine cutting saw on thin materials such as timber, bone, plastic and many other materials – perfect for model

makers or fine detail work. You can also drill a tiny hole to pass the blade through for cutting out internal shapes.

from **\$269.00**
Precision Dado Sets



CMT thoroughly researched the shortcomings of standard dado sets and learned what cabinet makers required most from an ideal dado. The result was the superior CMT Precision Dado Set; designed with the following features -

- ✓ Anti-kickback design to reduce the possibility of overfeeding that



can occur when cutting mass material

- ✓ Splinter resistant cuts in veneer plywood; melamine and hard and soft woods
- ✓ Shim sets included for cuts between 6.4mm (1/4in) and 23mm (29/32in).

Prod Code	Product	Weight	Price
23052006	152mm Diameter 15.9mm Bore	450g	\$269.00
23052408	203mm Diameter 15.9mm Bore	1.2kg	\$369.00
23052408-M	203mm Diameter 30.0mm Bore	1.2kg	\$369.00

\$189.00
Dado Saw Blade



Designed for cutting trenches smoothly and efficiently on a table saw on cross grain as well as along the grain. For ply and veneered board crosscuts we recommend the Precision Dado Sets.

The 203mm (8in) diameter set comes with two 12-tooth blades stack to cut 6.4mm dadoes and have the following 2-tooth chippers included -

- ✓ 1 x 3.2mm
- ✓ 4 x 6.4mm

With the following shim sizes included -

- ✓ 4 x 0.1mm
- ✓ 2 x 0.2mm
- ✓ 1 x 0.3mm
- ✓ 1 x 0.5mm

With the included shim sizes you can stack this set to cut dadoes in 0.1mm increments from 6.4 - 20.6mm. Available with 5/8in bore to suit most common table saws. Great value-for-money performance.

\$119.00
250mm Non-Ferrous Metal Saw Blade



29708010-M | 960g



Provides high-quality performance cutting non-ferrous metals (such as aluminium and brass). Key features include high impact strength teeth made from a special formulation carbide and a triple chip grind to extend blade longevity.

The -6° hook angle provides controlled cutting for a smooth finish without collapsing channel or storm window frames. Its special gullet design allows for efficient chip evacuation. Ideal for mitre, radial arm and table saws.

\$299.00
Metric Precision Dado Set



A world-first development – a METRIC width dado stacking set!

Up until now, you've had to buy an imperial dado and work out the metric conversions and make up the difference with shims with yet more calculations.

The Torquata Precision Dado eliminates all of this. Measuring 203mm (8in) with a 15.9mm bore (5/8in) to suit most Australian table saws that take dado's.

The two 24-tooth blades stack to make a 5.9mm width groove for undersize 6mm boards that can be shimmed to exactly 6.0mm with an included 0.1mm metric shim.

The set includes six 4-Tooth chippers for improved cutting performance and finish on cross and end grain as well as along the

grain. They can stack to increase the width by –

- ✓ 1 x 1.5mm
- ✓ 1 x 2.5mm
- ✓ 3 x 3.0mm
- ✓ 1 x 3.5mm

It also includes 9 precision stainless shims measuring the following thicknesses –

- ✓ 2x 0.05mm
- ✓ 3x 0.10mm
- ✓ 2x 0.20mm
- ✓ 2x 0.30mm

Combining the blades, chippers and shims means you can build your dado from 5.9 – 23.5mm wide – in 0.05mm increments without having to do any more conversions.

\$119.00
Flat Top Dado Saw Blades



Make clean crosscuts with perfectly flat bottoms. Offered in either metric 6.0mm or imperial 1/4in (6.4mm) kerf, each blade has 24 flat-top ground carbide teeth with special side clearance for an ultra-smooth finish when cutting hardwood, softwood, laminates and veneered ply.

Both blades are only supplied with 15.9mm (5/8in) bores because, due to the thickness of the body plate, cannot be bushed like conventional blades.

Perfect for box joints or for use with the MicroJig Dado Stop Pro on p.40.

Prod Code	Product	Weight	Price
SBFT-20324-MET	6.0mm Kerf	1.1kg	\$119.00
SBFT-20324-IMP	6.4mm (1/4in) Kerf	1.1kg	\$119.00

Extraction & Safety
 Measuring & Marking
 Sawing
 Site & Shop Accessories
 Routing
 Planing
 Sanding & Scraping
 Drilling
 Joinery
 Clamps & Vices
 Finishing
 Sharpening
 Carving & Chisels
 Woodturning
 Wooden Parts
 Cabinet Fittings

SAWING

Orange Chrome Technology



Orange Chrome Technology starts with special Industrial Chromium Micrograin Carbide (0.5µm) that reduces cutting edge abrasion; while improving cut quality and extending the tool life. Combined with Mirror Finish Sharpening, which features less than 0.25µm Rmax edge roughness; it guarantees extra-clean cuts and extended tool life.

They are also a Low-Noise Saw Blade - slots are filled with orange polyurethane that reduces vibration

and noise (<86 dB); whilst improving the cutting quality and extending the tool's lifetime.

Other benefits of Orange Chrome are:

- ✓ Protects from overheating
- ✓ Protects against corrosion and rust
- ✓ Reduces resin build-ups
- ✓ Improves chip ejection
- ✓ Improves performance and cutting life

from **\$59.00**

Ripping Circular Saw Blades

Featuring alternate top bevel ground teeth; a low number of teeth and a 20° hook angle; ideal for glue line

rips in hard and soft woods. Ideal for automatic and manual feeding with low feed rate force.

Prod Code	Product	Weight	Price
29025024-M	250 x 2.8mm Kerf 30mm Bore 24 Teeth	960g	\$59.00
29302412-M	300 x 3.2mm Kerf 30mm Bore 24 Teeth	1.3kg	\$79.00

\$44.00

250mm Thin Kerf Ripping Blade

27125024-M | 650g



The blade considerably reduces material waste thanks to the 2.4mm thin-kerf design (15% thinner than the standard rip blade) with the

Orange Shield Coating it is a high-performance rip blade able to work for prolonged periods at high speed feed rates. 24-Tooth Blade.

from **\$109.00**

Crosscutting Saw Blades

Extra number of teeth reduces performance ripping timber but has

excellent performance crosscutting soft and hardwoods as well plywood.

Prod Code	Product	Weight	Price
28566010-M	250 x 3.2mm Kerf 30mm Bore 60 Teeth	960g	\$109.00
28567212-M	300 x 3.2mm Kerf 30mm Bore 72 Teeth	1.3kg	\$139.00

from **\$59.00**

Thin Kerf General-Purpose Blades

Up to 25% thinner and designed optimal performance trading off between ripping and crosscutting in soft and hardwoods, the Orange

Shield Coating means it can work for prolonged periods at high speed feed rates

Prod Code	Product	Weight	Price
27125042-M	250 x 2.4mm Kerf 30mm Bore 42 Teeth	800g	\$59.00
27130048-M	300 x 2.6mm Kerf 30mm Bore 48 Teeth	1.1kg	\$69.00

from **\$139.00**

Fine Cut Off Saw Blades

Built to guarantee the best results in high-use where a fine end finish is required.

Perfect for crosscutting hard and soft woods; plywood; chipboard, MDF and even melamine.

Prod Code	Product	Weight	Price
28368010-M	250 x 3.2mm Kerf 30mm Bore 80 Teeth	960g	\$139.00
28369612-M	300 x 3.2mm Kerf 30mm Bore 96 Teeth	1.3kg	\$159.00

from **\$89.00**

General-Purpose Saw Blades

Designed for optimal performance trading off between ripping and

crosscutting in soft and hardwoods plus wood-based panels.

Prod Code	Product	Weight	Price
28564010-M	250 x 3.2mm Kerf 30mm Bore 40 Teeth	960g	\$89.00
28564812-M	300 x 3.2mm Kerf 30mm Bore 48 Teeth	1.3kg	\$119.00

from **\$139.00**

Melamine & Fine-Cut Off Saw Blades

For the finest in finish blades. CMT puts a 40° top tooth angle on its blades to provide flawless finishing

on single and double laminates; melamine and hard and soft woods.

Prod Code	Product	Weight	Price
28568010-M	250 x 3.2mm Kerf 30mm Bore 80 Teeth	960g	\$139.00
28569612-M	300 x 3.2mm Kerf 30mm Bore 96 Teeth	1.3kg	\$169.00

from **\$139.00**

Melamine & Chipboard Saw Blades

Will crosscut timber with splinter-free results but mainly designed and will

last longest when cutting through laminates/melamine, chipboard.

Prod Code	Product	Weight	Price
28168010-M	250 x 3.2mm Kerf 30mm Bore 80 Teeth	960g	\$149.00
28167212-M	300 x 3.2mm Kerf 30mm Bore 72 Teeth	1.3kg	\$139.00
28169612-M	300 x 3.2mm Kerf 30mm Bore 96 Teeth	1.3kg	\$179.00

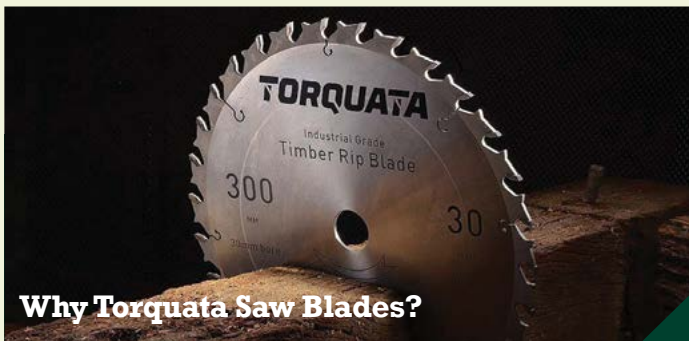

Why Torquata Saw Blades?

- ✓ Hardened steel plate body laser cut and pre-tensioned for reduced vibration and fatigue
- ✓ Engineered expansions slots reduces blade noise
- ✓ Anti-kickback design improves working safety and prevents overfeeding
- ✓ Industrial high silver/copper brazing – guaranteed to never delaminate over lifetime of blade
- ✓ Oversize carbide tip thickness reduces cutting vibration and increases blade life for multiple resharpens
- ✓ All come with standard 30mm bore

from **\$89.00**

Fine Cut-Off Circular Saw Blades

TORQUATA

Designed specifically for ultra-smooth fine crosscuts on timber and ply when used in your table

Prod Code	Product	Weight	Price
SBFC-25080	250mm 80 Teeth	1kg	\$89.00
SBFC-30096	300mm 96 Teeth	1.5kg	\$109.00



saw. Thicker steel body virtually eliminates blade vibration.

from **\$34.90**

Ripping Circular Saw Blades

TORQUATA

Designed for ripping along the grain in both hard and soft woods. The aggressive hook angle and flat tooth configuration leaves a

smooth finish and greatly increases the useful life of the blade between sharpens.

Prod Code	Product	Weight	Price
SBRI-18420	184mm 20 Teeth	600g	\$34.90
SBRI-23524	235mm 24 Teeth	850g	\$44.90
SBRI-25024	250mm 24 Teeth	1kg	\$44.90
SBRI-30030	300mm 30 Teeth	1.8kg	\$69.90

from **\$89.90**

Laminate/Wood Circular Saw Blades

TORQUATA

The special triple chip tooth grind is specifically designed to reduce chip-out on melamine and veneered boards along the upward-facing side of the board. To eliminate chip-out on the underside a table saw

with scorer is required. It also works well in timber and ply crosscuts but prolonged use of this material can shorten the life span of this blade between sharpens.

Prod Code	Product	Weight	Price
SBLW-25080	250mm 80 Teeth	1kg	\$89.90
SBLW-30096	300mm 96 Teeth	1.5kg	\$119.00



from **\$39.90**

General Purpose Circular Saw Blades

TORQUATA

Designed for industrial life cross-cutting all timbers as well as being able to perform long-grain ripping as required. A perfect general-purpose blade for table saws that do a little bit of everything and only have one blade needed.

Prod Code	Product	Weight	Price
SBGP-18430	184mm 30 Teeth	600g	\$39.90
SBGP-23536	235mm 36 Teeth	900g	\$54.90
SBGP-25040	250mm 40 Teeth	1kg	\$69.90
SBGP-30048	300mm 48 Teeth	1.5kg	\$99.00



from **\$49.90**

Mitre Saw Circular Saw Blades

TORQUATA

These blades are specifically designed for use in drop or sliding compound mitre saws. The -5° hook angle provides better cutting control

and less chance of grabbing. The reduced kerf places less load on the motor.

Prod Code	Product	Weight	Price
SBCM-21048	210mm 48 Teeth	650g	\$49.90
SBCM-25060	250mm 60 Teeth	1kg	\$59.90
SBCM-30072	300mm 72 Teeth	1.5kg	\$89.90



from **\$44.90**

Crosscut Circular Saw Blade

TORQUATA

Designed for cross cutting solid timber and ply as well as leaving a smooth finish on MDF and particleboard in hand and table saws.

Prod Code	Product	Weight	Price
SBCC-21048	210mm 48 Teeth	650g	\$44.90
SBCC-23554	235mm 54 Teeth	850g	\$57.90
SBCC-25060	250mm 60 Teeth	1kg	\$59.90
SBCC-30072	300mm 72 Teeth	1.5kg	\$89.90



from **\$5.00**

Saw Blade Bushes

LINBIDE
Quality Precision Tools

Sourced from Linbide in New Zealand these bushes have found their way into thousands of blades over the years keeping the

performance and balance of your saw blade perfectly in line with the manufacturer's design.

Prod Code	Product	Weight	Price
CSBB-222159	Saw Blade Bush 22.2mm ---> 15.9mm	10g	\$5.00
CSBB-254159	Saw Blade Bush 25.4mm ---> 15.9mm	10g	\$5.00
CSBB-300159	Saw Blade Bush 30.0mm ---> 15.9mm	10g	\$5.00
CSBB-300254	Saw Blade Bush 30.0mm ---> 25.4mm	10g	\$5.00

Check out the full range of sizes on our website



from **\$899.00**

LS Table Saw Fence System

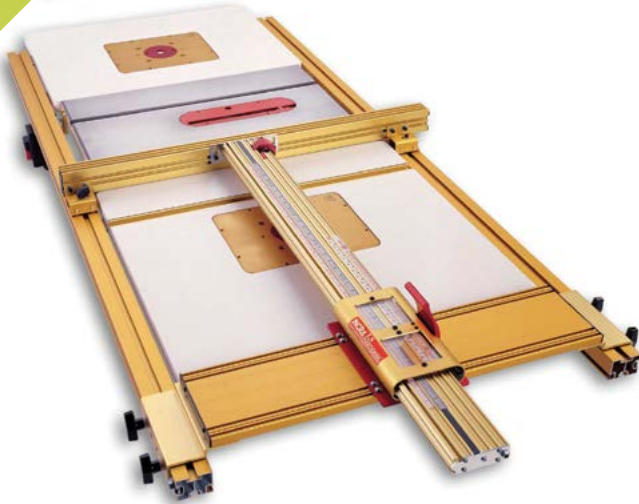

Extension wings and mounting plates shown are not included

The INCR TS-LS offers the one thing that every table saw fence should have, Automatic Positioning Control. All other saws depend on a tape measure and your eyesight to position your work. That's why users are resigned to the fact that a good cut requires long set-up times and endless trial and error.

The TS-LS completely eliminates this need by using INCR'S patented lead screw technology to position your work instantly and automatically to within 0.05mm.

Spend more time cutting, less time tapping and measuring!

If you want to repeat a cut, you can return to any former position in less than 5 seconds with ZERO repeatability error. The centrally placed carriage, and optimized side mounted clamping system, virtually welds itself together into one solid block of steel and aluminium when locked in place.

The large micro-adjust knob turns the lead screw against the mating threads, shifting in incremental steps with 0.025mm resolution.

✓ The 810mm version is based on 1830mm rail length,

✓ The 1320mm-version system uses 2335mm rails

Both use the same 810mm Positioner, quick-release knobs allow the base assembly to be shifted on the 1320mm system's longer rails to achieve the greater capacity. Support legs are standard equipment on the 1320mm System.

Do you already own a router table that you want to incorporate into your saw?

The TS-LS Joinery System consists of the TS-LS Rip Fence PLUS the WonderFence routing fence attachment and accessories to use it as a dovetail & box joint jig.

Prod Code	Product	Weight	Price
TSL5-32	810mm Table Saw Fence System	29kg	\$899.00
TSL5-52	1320mm Table Saw Fence System	35kg	\$1,199.00
TSL5-32-WF	TSL5-32 Joinery System	35kg	\$1,349.00
TSL5-52-WF	TSL5-52 Joinery System	45kg	\$1,599.00
TSL5XLUG	XL Table Size Upgrade Kit	5kg	\$169.00

\$1,299.00

10in Contractors Saw

SWCS-1254 | 148kg



This saw is feature-packed and includes virtually everything you need in a basic home workshop saw along with peace-of-mind Sherwood quality, induction motor with single belt drive.

- ✓ 2300W (3hp) induction motor with single belt drive
- ✓ Sturdy 510 x 685mm cast-iron top with 2x 254mm pressed steel extension wings to create a large 1020mm working surface
- ✓ 254mm (10in) blade capacity with standard-size 5/8in arbor (blade included)
- ✓ 76mm/50mm depth of cut at 90°/45° tilt
- ✓ Left tilting bevel for safer bevel ripping
- ✓ Smooth and comfortable cast-iron rack and pinion height and tilt adjustment
- ✓ Strong 70mm-high alloy fence which locks parallel to the blade at both ends of table
- ✓ Maximum rip capacity with fence of 760mm to right and 330mm to left of blade
- ✓ Industry-standard 3/4x in mitre slot so all standard jigs and fixtures can be used



\$1,999.00

10in Hybrid Cabinet Saw

**SHERWOOD**

TS-250-HL | 171kg

While named a hybrid - the cast-iron saw carriage is mounted directly to the cabinet, providing better inherent machine strength, reducing vibration and improving cutting performance over a normal contractor's or hybrid saw. A smooth 45° LH tilting bevel and height adjustment system.

Other features of this saw include -

- ✓ 1500W (2HP) induction motor
- ✓ Poly-V ribbed drive belt maximizes power transfer to standard 5/8in (15.9mm) arbor
- ✓ 80mm depth of cut
- ✓ Built-in spindle lock for easy blade changes
- ✓ 4in dust outlet built into rear of cabinet base
- ✓ Overhead guard with integral dust outlet
- ✓ Low profile splitter included to use in quick-release riving knife system

- ✓ Precision ground cast-iron table measures 1120 x 685mm when assembled
- ✓ Standard 3/4 x 3/8in T-mitre slots, mitre guide included
- ✓ 60 x 40mm steel tube fence rails with RH capacity 760mm and LH capacity 200mm
- ✓ Rigid extruded aluminium 840mm-long fence arm
- ✓ Clear magnified fence cursor to accurately align against scale
- ✓ Heavy-duty No-Volt Release (NVR) switch conveniently located

Available as an upgrade, sold separately, is the solid, well-built fence from saw. Because of its mounting system, holes can be drilled into the front and rear lip of most standard cast-iron-top table saws to adapt it to suit.

Prod Code	Product	Weight	Price
TSF-2	Saw Fence Upgrade Kit	21kg	\$279.00

\$2,599.00

10in Standard Cabinet Saw

**SHERWOOD**

TS-250-SL-30-F | 170kg

While the features list closely mirror the 10in hybrid saw there are three main improvements this saw has that creates a positive real-world performance improvement -

1. Development was only been completed late 2016 using the latest in table saw design thinking. Developed from the ground up with mass and directional force stresses in mind to reduce vibration running the full 45 - 90° left-hand tilt range, load-tested for deep rip applications with maximum power transfer to reduce motor load and improve cutting speed and performance.
2. The fit and finish of the saw is unsurpassed at this price point. Multiple CNC grinds on the precision-machined and polished table tops, run-out calibration checked and signed off on each unit prior to shipping, straight out of the box the

quality of manufacturing is palpable in ease of assembly and fitment.

3. Upgraded rigid 870 x 60mm-long solid steel tubular steel welded fence arm with 910mm long 19mm thick UHMW glide strips.

Upgraded features of this saw include -

- ✓ Heavy-duty 7.6A (1800W) induction motor
- ✓ 4in cabinet dust outlet with 2 1/2in sub-inlet to attach hose (not included) for extraction above and below blade
- ✓ Precision ground cast-iron table measures 1025 x 685mm when assembled
- ✓ Solid 60 x 40mm steel tube fence rails with capacity 785mm to right and 300mm to left of blade

\$3,499.00

10in Full Width Cabinet Saw

**SHERWOOD**

TS-250-CH-30-F | 210kg

Finishing development has late 2016, it displays the latest and best in cabinet saw development and design. The carriage is a massive hulking network of ductile iron castings stretching the full width of the cabinet, all designed to cope with the extra power from the huge 14.5A (maximum 3,500W peak power output) motor and the 40% wider poly v-ribbed belt transfers that power to create one of the smoothest cutting saws available today.

The castings work to deaden vibration and cope with the directional forces of sawing even the thickest, hardest timbers out there with relative ease running at 90° through to the full 45° range of left-hand tilt.

Upgraded features of this saw over and above the 10in Standard Cabinet Saw include -

- ✓ Heavy-duty 14.5A (3500W) induction motor
- ✓ Precision-ground cast-iron table measuring 1070 x 740mm when fully assembled
- ✓ Solid 75 x 50mm steel tube fence rails with capacity 785mm to right and 300mm to left of blade
- ✓ Rigid 900 x 75mm-long solid steel tubular steel welded fence arm with 950mm-long 19mm thick UHMW glide strips
- ✓ Heavy-duty magnetic no-volt-release (NVR) switch

SAWING

SawStop Saws

What if you could stop a saw blade and prevent a serious injury? That sounds like a really good idea.

Today, that idea is protecting woodworkers in tens of thousands of SawStop table saws around the globe. SawStop are proud to say that it was their idea, but are most proud of the fact that woodworking is now safer.

SawStop make table saws. SawStop saws, besides being the highest quality and best featured saws in their market segments, feature the ability to detect contact with skin and stop the blade in less than 5 milliseconds.

In 2004 the first SawStop Table Saw was sold. In the years between then and now, SawStop saws have saved thousands of fingers. The combination of safety, unparalleled design and craftsmanship has made SawStop the #1 cabinet saw in North America.

\$1,999.00
Jobsite Saw

JSS-15-AU | 140kg



The SawStop Jobsite Saw unites SawStop safety and pioneering innovation with compact portability. For the first time, the promise of SawStop safety, quality and peace of mind can travel with you wherever you go. The Quick Tilt Blade Adjustment means you can raise or lower the blade in one revolution of the wheel. Storage is provided for all accessories so nothing should ever be lost.

Motor	2100W
Blade Dia.	10in (250-254mm)
Arbor Dia.	5/8in (15.9mm)
Max. Cut At 90°	79mm
Blade Guard	Low Profile Blade Guard
Blade Tilt	Left
Dust Port	2-1/2in (63mm)
Maximum Rip Capacity	648mm
Table Size	794mm x 575mm (retracted)

from **\$2,549.00**
Contractors Saws

CNS-30-STD | 140kg



Contractors Saw shown with Standard 30in Fence

Features & Benefits

- Open cabinet with outboard motor & table-mounted trunnion
- Lightest weight, most affordable cast-iron SawStop Saw

Motor	1.3kW (1.75HP) Induction, 10A plug	Dust Port	4in (102mm)
Blade Dia.	10in (250-254mm)	Maximum Rip 30in Std Fence	770mm
Arbor Dia.	5/8in (15.9mm)	Maximum Rip 36in T-Glide Fence	925mm
Max. Cut At 90°	76mm (Using 254mm Blade)	Maximum Rip 52in T-Glide Fence	1435mm
Blade Guard	Clear, Tilting - Rise & Fall	Table Size	1120mm x 686mm
Blade Tilt	Left		

Prod Code	Product	Weight	Price
CNS-30-STD	Saw with 30in Standard Fence	140kg	\$2,549.00
CNS-36-TGLIDE	Saw with 36in T-Glide Fence	165kg	\$2,799.00
CNS-52-TGLIDE	Saw with 52in T-Glide Fence	190kg	\$2,999.00
CNS-175-AU	Saw with No Fence System	120kg	\$2,300.00
MBCNS-000	Saw Mobile Base Only	13kg	\$259.00
CNCSIWA	Cast-Iron Wing Set	36kg	\$419.00

from **\$59.00**
Table Inserts



- Precision machined from a high-quality, ultra strong phenolic core material that is covered on top and bottom with a low-friction, wear-resistant melamine surface
- Positioning screws ensure a solid and precise fit in the table
- Pre-formed clearance slots for SawStop blade guard and riving knife
- Dual metal wear plates for anti-kickback pawls
- Positive locking latch allows for tool-free operation

Prod Code	Product	Weight	Price
TSIDL	Table Saw Blade Insert Dado	800g	\$59.00
TSISLD	Table Saw Blade Insert Standard	800g	\$59.00

from **\$99.00**
Brake Cartridges



- Revolutionary SawStop protection
- Standard cartridge compatible with all standard 10in blades
- Dado cartridge compatible with all standard 8in dado sets up to 20.6mm thick
- Compatible with all woods and other non-conductive materials

Prod Code	Product	Weight	Price
TSBC-10-R-2	Standard Blade Replacement Cartridge	800g	\$99.00
TSDC-8-R-2	Dado Blade Replacement Cartridge	800g	\$139.00

from **\$4,399.00**

Professional Cabinet Saws

PCS-30-PREM | 220kg



Professional Saw shown with Optional 36in T-Glide Fence

Features & Benefits

- ✓ Closed cabinet saw with inboard motor & cabinet-mounted trunnion for better accuracy
- ✓ 3hp motor
- ✓ Heavy weight + excellent engineering = reduced vibration

The integrated mobile base is designed to be installed into the base of the saw. This allows the saw to rest on the floor when the mobile base is not engaged rather than sitting on the mobile base itself - making it far more stable than standard mobile base designs.

Motor	2.2kW (3.0HP) Induction, 15A plug	Maximum Rip 30in Std Fence	760mm
Blade Dia.	10in (250-254mm)	Maximum Rip 36in T-Glide Fence	914mm
Arbor Dia.	5/8in (15.9mm)	Maximum Rip 52in T-Glide Fence	1320mm
Max. Cut At 90°	76mm (Using 254mm Blade)	Riving Knife Style	Quick Release
Blade Guard	Clear, Tilting - Rise & Fall	Table Size	1120mm x 686mm
Blade Tilt	Left		
Dust Port	4in (102mm)		

Prod Code	Product	Weight	Price
PCS-30-PREM	Saw with 30in Standard Fence	220kg	\$4,399.00
PCS-36-TGLIDE	Saw with 36in T-Glide Fence	250kg	\$4,599.00
PCS-52-TGLIDE	Saw with 52in T-Glide Fence	275kg	\$4,799.00
PCS-31230	Saw with No Fence System	180kg	\$4,100.00
MBPCS-000	Saw Mobile Base Only	9kg	\$329.00

from **\$34.90**

Industrial Cabinet Saws

ICS-36-TGLIDE | 315kg



Industrial Saw shown with Optional Overarm Dust Collection and Mobile Base

The Industrial Cabinet Saw is engineered for heavy duty cycle environments. It comprises a thicker cast iron table for added stability and precision as well as thicker gauge steel in the cabinet, rails, tube and fence, compared to the Contractor and Professional models. It also has larger hand wheels for easy adjustment and two large access doors for quick access and maintenance are also some additional features.

SawStop's Mobile Bases uniquely allow the saw to rest on the floor rather than the wheels like other mobile bases. This unit has a weight rating of 453kg and is engineered just like the Industrial Saw - it will NOT disappoint.

Motor - Single Phase	2.2kW (3.0HP) Induction, 15A plug
Motor - Three Phase	3.7kW (5.0HP) Induction, NO PLUG
Blade Diameter	10in (250-254mm)
Arbor Diameter	5/8in (15.9mm)
Maximum Cut At 90°	76mm (Using 254mm Blade)
Blade Guard	Clear, Tilting - Rise & Fall
Blade Tilt	Left
Dust Port	4in (102mm)
Maximum Rip 36in T-Glide Fence	914mm
Maximum Rip 52in T-Glide Fence	1320mm
Riving Knife Style	Quick Release
Table Size	1120mm x 765mm

Prod Code	Product	Weight	Price
ICS-36-TGLIDE	Saw with 36in T-Glide Fence - Single Phase	315kg	\$5,899.00
ICS-36-TGLIDE-3-PH	Saw with 36in T-Glide Fence - Three Phase	315kg	\$6,399.00
ICS-52-TGLIDE	Saw with 52in T-Glide Fence - Single Phase	350kg	\$6,099.00
ICS-52-TGLIDE-3-PH	Saw with 52in T-Glide Fence - Three Phase	350kg	\$6,599.00
ICS-31240	Saw with No Fence System - Single Phase	270kg	\$5,200.00
ICS-53415-3-PH	Saw with No Fence System - Three Phase	270kg	\$5,700.00
MBICS-000	Saw Mobile Base Only	35kg	\$459.00

from **\$1,899.00**
Sliding Panel Attachment



TSASA-48 | 49kg

Enjoy the finest crosscut experience available with the SawStop Sliding Crosscut Table. This meticulously-engineered table features multiple large bearings for smooth travel under load. Micro-adjust the tracks for smoothness and parallelism. Measure +/- 60° with the oversize

miter gauge. Easily adjust fence/blade proximity. Choose to mount traditionally for a full 1220mm capacity, or flush-mount the sliding table with the saw's front rail, keeping a full 914mm crosscut capacity.

from **\$219.00**

Dust Collection Accessories



The SawStop Overarm Dust Collector removes dust up and out of the way and is compatible with all cast iron SawStop saws. Pair the Overarm Dust Collection

with the SawStop Dust Collection Blade Guard for easy, reliable dust management (included on Professional and Industrial Saws).

Prod Code	Product	Weight	Price
TSAODC	Overarm Dust Collection System	28kg	\$309.00
TSGDC	Dust Collection Blade Guard	4kg	\$219.00

SAWING

\$229.00 MicroDial Taper Jig



MICROJIG
TJ-5000 | 2.2kg

Set angles by rise over run or degree – easily with the ColorMatch dials.

Use the Rise Over Run ColorMatch dial to set your taper between 0 - 51mm (0 - 2in) with 1.6mm (1/16in) intervals. We provide a simple step-by-step taper formula so you can eliminate the guesswork.

Use the Degree Scale ColorMatch dial to set exact angles as low as 1/8th of degree, and expands from 0 - 10° with the simple turn of the dial. Measurement markings are color-coded and lock in place, so you get the exact angle you want, quickly.

\$27.90 Taper Cutting Jig



BALADONA
7726-TCJ | 600g

A simple and effective device for cutting tapers on your table saw without any major modification to the fence. Simply hook the foot of the 610mm-long taper jig to the end of your work piece and run it along your existing fence to cut the taper.

The built-in gauge shows the 0-15° taper angle to be cut which also has

a simple conversion of removing 1/4in (6.4mm) width of material for every degree – so a maximum width of material to be removed is 3in (76.2mm).

Made of anodized aluminium and steel for long life with a single plastic handle included to keep fingers away from the blade.

\$109.00 Dado Stop Pro

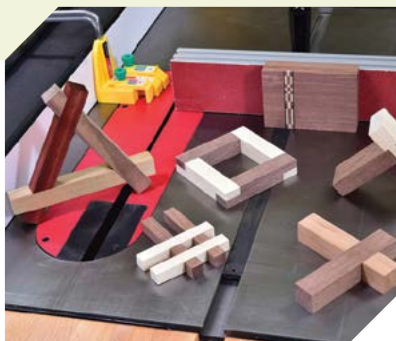

MICROJIG

Perfectly-fitted dados, joinery, and inlays without measuring, marking, or test cuts.

Simple and easy to use, the MatchFit Dado Stop sets the

shoulders of your cross dado using the actual part that will be fitted in the dado for a perfect fit without measuring or test cuts. No hassles, no tricky measurements, just perfect-fitting dado cuts.

Prod Code	Product	Weight	Price
MF-1004	Dado Stop Pro Kit	1.2kg	\$109.00
DS-333	Dado Stop Pro Jig Only	510g	\$44.90
SG-133	Dado Stop Setup Gauge	650g	\$29.90

from **\$45.00** MJ Splitters

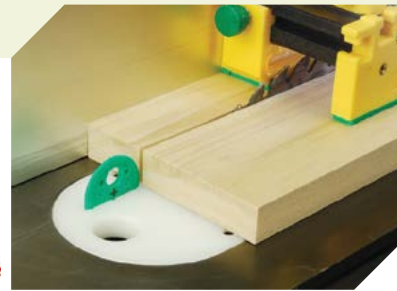

MICROJIG

The Micro Jig MJ Splitters do the work of a mini-ripping knife to help prevent kickback on your table saw- designed to mount to your Zero Clearance throat plates and behave like a mini-ripping knife when ripping 90° cuts. An included template drill guide and bit let you drill precise holes into your zero clearance throat plate to accept the mounting pins on the splitters. Once installed, the MJ Splitters remove and remount in seconds. They also act as mini feather boards on the

exit side of the saw blade that help to bear your keeper piece against the fence.

Available in two kerf sizes – thin (2-28 – 2.99mm) and standard (3.2mm) in both standard Splitter Kits as well as SteelPro Splitters. The SteelPros have an ABS polymer shell reinforced with a solid stainless steel core. It's able to take on the stress caused by many solid woods, greatly reduce the chance of kickback on your table saw, and virtually eliminate burning.

Prod Code	Product	Weight	Price
SP-0100-TK	Thin Kerf Splitter (Yellow)	450g	\$45.00
SP-0125	Std Kerf Splitter (Green)	450g	\$45.00
SP-2-TK	Thin Kerf SteelPro (Orange)	510g	\$75.00
SP-2	Std Kerf SteelPro (Blue)	510g	\$75.00

\$49.90 Thin Ripping Jig



BALADONA
TRP-01 | 650g

Rip thin strips on the left side of the blade, eliminating the danger of pushing narrow strips between the saw and fence. Since the strip is not trapped between the blade and fence, there is also less risk of binding and kickback. It's simple to use; a single knob locks the

jig into the mitre track and locks your setting at the same time. Ball bearing guide keeps your workpiece firmly against the fence for perfect repeatability. Use the graduated scale to fine-tune for extremely thin strips.

\$299.00 I-Box Jointing Jig

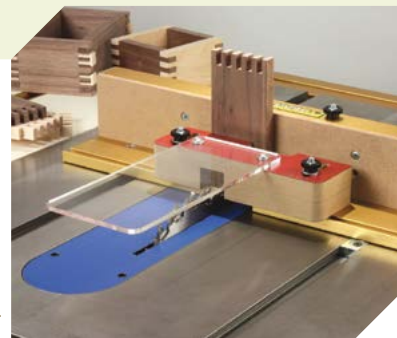

INCRA
IBOX | 3.3kg

The new Inkra I-Box is the most advanced tool ever produced for creating a stunning variety of box & finger joints. Its revolutionary design allows faster setup, greater versatility, and improved user safety compared to traditional jigs. At the same time, it's easy to use and the

included 1-hour instructional DVD covers everything from basic setup to advanced decorative joinery.

This versatile design works on both table saws and router tables, and it's available to fit standard 19.0 x 9.5mm standard mitre slots.

(See page 34 for more info)

\$19.90
TriGrips



MILESCRAFT
MC-1600 | 530g

The special foam impregnated non-slip skin holds any type of material in place, allowing you to rout, sand, drill, carve and paint without clamps. Holding the work piece 30mm above

the bench top allows full access to work on the material's edges. Set on edge, TriGrips™ raise the work piece 76mm above the bench offering single-duty painting supports.

\$14.90
Non Slip Mat



BALADONA
RM-120640 | 530g

The synthetic rubber of our non-slip mat is one of the stickiest around and can hold work pieces while being sanded, routed or just about anything! Also great for boots of

cars to stop shopping sliding around or under furniture etc. Cheap and easy to throw around, wash, clean and use again. Generous 1200x600mm size.

\$29.90
Magnetic Tool Holder

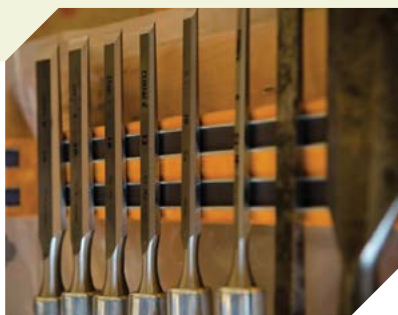

BALADONA
MTH-24 | 850g

The magnetic tool holder is a great way of laying your hands on your favourite tools quickly and easily when working in one area. With two magnetic strips it will hold virtually

anything securely in place – even standard size hand planes! Measuring 610 x 48mm, you can screw in place just about anywhere!

\$69.00
Woodrack Storage System



triton
WRA-001 | 500g

Provides generous storage capacity for timber, pipes and other long items. For internal or external mounting applications in workshops,

garages, sheds, on fences and walls etc. 6 levels of storage – holding up to 50kg per level. Made from 25.4mm (1in) steel - easy to install.

\$159.00
400kg Deluxe Mobile Base

BALADONA
MBDEL-400 | 18kg

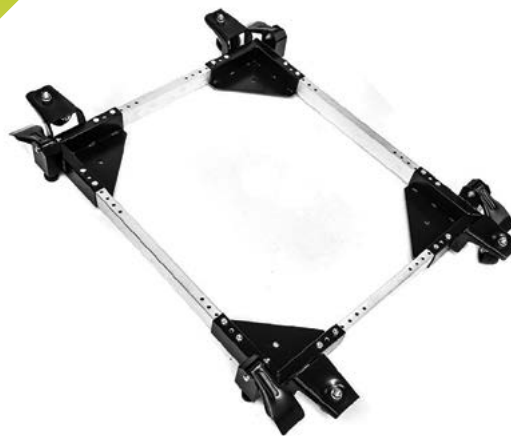

A slight flaw with the design of the standard 400kg base below is that when the feet are engaged so it cannot move, the base is on a slight angle, meaning your machines are too. This deluxe kit replaces the

fixed castor brackets so all four corners have the swivelling castors with adjustable feet to fix it in place, keeping the base and machine level. All other specs match with the base below.

\$139.00
400kg Mobile Machine Base

BALADONA
MB-400 | 14.2kg



This base makes relatively light work of moving even the heaviest machine around the workshop – a person of average fitness and strength would be able to use this

to move around machines weighing up to 400kg (or 900lb)!!! Can be used on machines 460 x 620mm up to 720 x 850mm

\$99.00
150kg Mobile Machine Base

BALADONA
MB-150 | 8kg



Our lighter mobile machine base has two fixed and two swivelling castors – with the swivelling castors engaging to move the machine by pushing down on two sturdy steel foot levers. It can accept machines

with a base size from a minimum 300x300mm to a maximum 900x900mm square or rectangle of 1300x500mm and a maximum weight capacity of 150kg (330lb).

Extraction & Safety
Measuring & Marking
Sawing
Site & Shop Accessories
Routing
Planing
Sanding & Scraping
Drilling
Joinery
Clamps & Vices
Finishing
Sharpening
Carving & Chisels
Woodturning
Wooden Parts
Cabinet Fittings

SITE & SHOP ACCESSORIES

Extraction & Safety
 Measuring & Marking
 Sawing
Site & Shop Accessories
 Routing
 Planing
 Sanding & Scraping
 Drilling
 Joinery
 Clamps & Vices
 Finishing
 Sharpening
 Carving & Chisels
 Woodturning
 Wooden Parts
 Cabinet Fittings

\$19.90 Sub-Fence Clamp Brackets



Perfect for when you need to attach a sacrificial fence to your table saw, router table, bandsaw or mitre saw's current fence. They stay completely

out of your way when running your work piece across the sacrificial fence, so you'll never get caught up in the middle of the cut.

\$95.00 Deluxe Roller/ Ball Stand



S-5008 | 8.5kg



It has a maximum load capacity of 100kg (220lb) capacity that comes from its heavy-duty 38mm square tube all-steel welded construction. The working height is 760 -

1195mm (30 - 47in) with a unique tapered safety support design to prevent the roller from accidentally dropping during adjustment.

\$29.90 Roller Transfer Balls



AN-25 | 300g



Want to make your own work piece transfer station? Buy these transfer balls and simply screw or bolt down to whatever surface you are working on – whether it's a shop-made stand or larger feed table setup.

Made in Taiwan, these balls are fantastic quality and very reliable. Each 25mm transfer ball base measures 53x70mm and can handle up to 34kg each, so all six can handle over 200kg in total. Sold as a pack of six only.

\$39.90 Simple Roller Support Stand



5000-R | 5.2kg



While you can get ever cheaper roller stands elsewhere, this one is well-made and designed for long-term use in workshops. The footprint measures 535 x

425mm and can work on heights 685 – 1090mm. The roller itself is 300mm wide with a diameter of 50mm and can handle loads up to 50kg each.

\$149.00 Mitre Guide & Fence



MG-450 | 3.1kg

The mitre bar fits standard 19.0 x 9.5mm T-slots, with four reversible ball-ended grub screws. Reversible so you can screw them from either side to remove any play in the slot as well as square the bar against the working face of the machine.

The 5mm-steel plate protractor is powdercoated CNC-machined positive stops at 0°, 22.5°, 30°, 45°, 60°, 67.5° and 90°. The spring-loaded pin engages the countersunk holes so the

protractor aligns perfectly, taking any guesswork out and providing accurate mitre cuts. Any angle in between the stops can be set manually between 0-90° as required.

Includes the 450mm-long tall anodised alloy fence, fitted with an (included) adjustable flip-over length stop. It is repositionable for maximum support or capacity depending on the application. Great for making repeatable cuts.

\$20.00 Router Bit Cleaner Formula 2050



CMT-2050 | 520g



- ✓ Formula 2050 is safe, completely non-toxic and certified biodegradable
- ✓ Penetrates the microscopic cracks in the resin and attacks the bond between it and the carbide steel surfaces
- ✓ The resin releases its grip and you simply wipe it off

- ✓ Do not rinse after cleaning – Formula 2050 provides protection from rust and corrosion
- ✓ Also good to use as a protective coating on cast-iron tables to prevent rust

from \$38.00 SilverGlide



Mainly used to protect cast iron tops from rust. It can also provide lubrication for highly resinous timbers while machining them on

table saws, jointers, etc. Simply apply with a rag to a clean, grease-free surface.

Prod Code	Product	Weight	Price
SILVER-250	250g Tin	250g	\$38.00
SILVER-010	1 Litre Tin	1.2kg	\$87.00

\$109.00
V27 Miter Guide

INCRA
IMV-27 | 1.3kg



Engineered to provide a high performance, yet low cost upgrade for any machine with a 3/4in mitre track slot that's in need of a better mitre guide. The V27 delivers extreme mitre cutting accuracy through the advanced combination of INCRA's exclusive AngleLOCK indexing system and its patented Adjustable

GlideLOCK Mitre Bar.

The AngleLOCK precision angle indexing teeth are laser cut in solid steel to lock in 27 of the most popular positive angle stops over a full +/- 90° range in 5° increments, including the popular 22 1/2° angle for eight-sided projects.



Patented AngleLOCK indexing system



Easy-to-adjust GlideLOCK expansion slots

\$135.90
V120 Miter Guide

INCRA
IMV-120 | 1.6kg



An incredible 120 AngleLOCK stops are laser cut into the steel protractor, with a stop available for

every whole degree and two special stops at 22.5° for cutting eight-sided frames and mouldings.

\$299.00
1000 HD Metric Mitre Guide

INCRA
IM-1000-MHD | 4.3kg

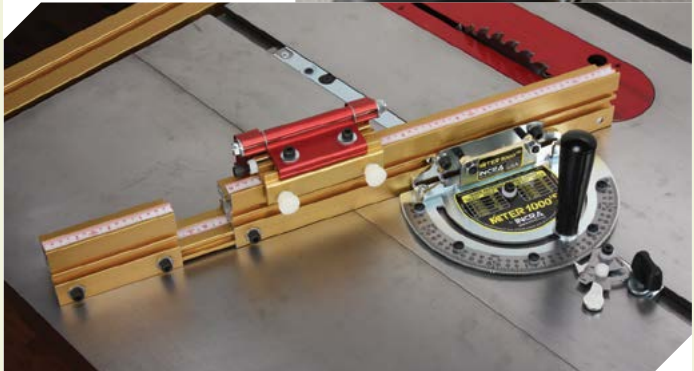

The HD stands for High Definition, because the protractor plate's exclusive AngleLOCK Indexing System has a whopping 180 can't-miss angle stops in 1° increments with special stops located at 22-1/2°.

Combine that high-resolution

protractor with the industry's smoothest adjustable mitre bar, the 18-31in telescoping IncraLOCK Cut-off Fence & Flip Shop Stop, and a steel vernier scale that reads to 1/10°, and you've got a winner that will improve the quality of any project.

\$259.00
Miter Express Universal Sled System

INCRA
IME-1 | 9kg



The fast "Dock and Lock" system securely locks your own mitre guide in just seconds. It eliminates all side play with the patented mitre channel expansion technology. Even the least expensive mitre guides will experience a tremendous

performance boost when docked on top of the Miter Express.

Doubles any mitre gauge's crosscut capacity to 610mm and securely holds even the smallest workpieces for safe accurate cuts.

from **\$95.00**
Mitre Guide Flip Fences & Stop

INCRA

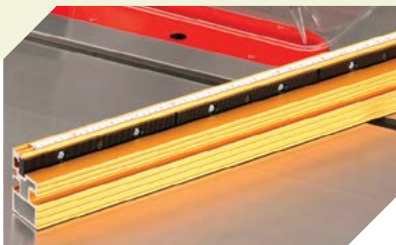

The INCRA Flip Fence is designed to give you outstanding fence performance and rigidity. Manufactured by Incra from

aircraft grade aluminum extrusions, this fence profile is designed to coordinate perfectly with the FlipShopStop.

\$269.00
1000 Special Edition Metric Mitre Guide

INCRA
IM-1000-MSE | 4.1kg

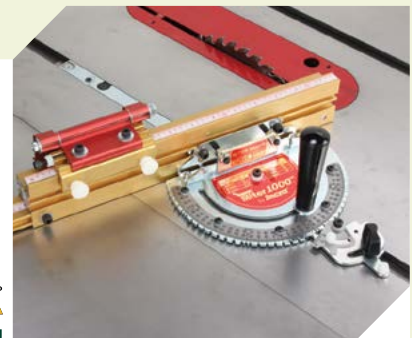

The AngleLOCK Indexing System delivers 41 lock solid angle stops in 5° increments over a full 180° range. Combine this with the GlideLOCK Mitre Bar, 18-31in Telescoping IncraLOCK Cut-off Fence and the Incra FlipShopStop, and you'll easily achieve mitering

accuracy that you never thought possible. Whether it's your basic 90° cut-off, simple picture frames, or a 20-sided object, the Miter1000SE by Incra delivers perfect, repeatable accuracy. First time, Every time, Any angle.

Prod Code	Product	Weight	Price
FLIPFNC-1831	457 - 787mm (18 - 31in) Range	1.4kg	\$95.00
FLIPFNC-2749	685 - 1245mm (27 - 49in) Range	1.8kg	\$119.00
ISM-3	FlipShopStop	910g	\$89.00

Extraction & Safety
Measuring & Marking
Sawing
Site & Shop Accessories
Routing
Planing
Sanding & Scraping
Drilling
Joinery
Clamps & Vices
Finishing
Sharpening
Carving & Chisels
Woodturning
Wooden Parts
Cabinet Fittings

SITE & SHOP ACCESSORIES

Extraction & Safety
 Measuring & Marking
 Sawing
Site & Shop Accessories
 Routing
 Planing
 Sanding & Scraping
 Drilling
 Joinery
 Clamps & Vices
 Finishing
 Sharpening
 Carving & Chisels
 Woodturning
 Wooden Parts
 Cabinet Fittings

from **\$17.90**
Universal Featherboards



The horizontal boards come standard with hardware to mount in 3/4in T-mitre slots that are common on most machines available in Australia. With the extended arms, they are able to be positioned up to 155mm from the track to the edge of the fingers.

The vertical boards have a reduced reach of 85mm from the track to the edge of the featherboard and come with mounting hardware to work in standard 5/16in t-track slots. Both featherboards measure 190mm long with the fingers of the board measuring 110mm long.

Prod Code	Product	Weight	Price
RTFBV	Vertical Featherboard	320g	\$17.90
RTFBH	Horizontal Featherboard	420g	\$29.90
RTFBSET	Set of 2 Vertical & 2 Horizontal	1.5kg	\$85.00

\$14.90
Horizontal Featherboard Risers

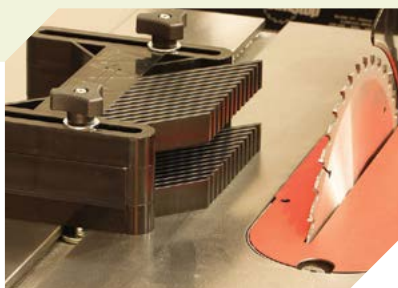

This riser kit includes two riser blocks plus longer bolts that fit in standard 3/4in t-mitre slots. The standard featherboard thickness is

22mm and the riser increases this by 22mm so the double-stacked assembly will measure 66mm height.

from **\$36.00**
True-FLEX™ Featherboards

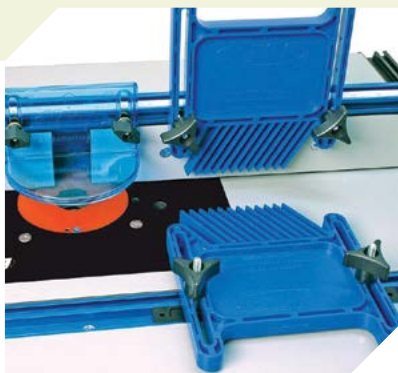

True-FLEX™ gets its name from the careful engineering that provides a consistent and optimum pressure on your work piece. Made from extremely durable plastic composite body with the Wedge-Lock™ System that allows the featherboard to be secured to a variety of shop tools without the need for additional hardware.

Wedge-Lock™ self-adjusts for use in for use in standard 3/4 x 3/8in (19.0 x 9.5mm) mitre slots and lets you work with confidence. Reversible so can be used either horizontally or vertically these featherboards are very versatile to have in the work shop.

Prod Code	Product	Weight	Price
PRS-3010	Feather Board True Flex Single	300g	\$36.00
PRS-3020	Feather Board True Flex Twin Pack	600g	\$67.00

\$39.90
Resaw Fence Attachment



The Magswitch Resaw Guide attachment is designed for use with the Magswitch Workholding System. It mounts to the Universal Mounting Base with MagJigs (each sold separately).

Magswitch including fast, strong set up anywhere on a steel table or cast iron fence. The roller bearing support provides for firm yet smooth gliding of wood through a blade – while the angled infeed/outfeed allows for blade drift adjustment.

\$49.90
Dual Roller Fence Attachment



The Magswitch Dual Roller Guide tool attachment is for use with the Magswitch Workholding System. It mounts to the Universal Mounting Base with MagJigs (each sold separately).

The dual set of roller bearing supports a firm, yet smooth glide of wood through a blade and includes micro adjustment for fine-tuning to 90 degrees.

\$39.90
Thin Hold-Down Attachment



The Ultimate Thin Stock Hold Down/ Rip Guide attachment is for use with the Magswitch Workholding System. It mounts to the Universal Mounting Base with MagJigs (each sold separately).

industry! Three tools in one! The Ultimate Thin Stock Rip Guide features a fixed roller bearing and extends forward for accurate repetitive ripping of your thin stock and is ideal as a thin stock hold down on the infeed/outfeed of your table saw.

\$17.90
Magnetic Featherboard Risers



Available separately are the Magswitch Featherboard Risers that can be used in conjunction with the Reversible Featherboard Attachment as well as the Table

Featherboard to create stackable/ tandem featherboards that improve workholding of thick or tall work pieces.

\$115.00
Magnetic Table Featherboard



Three featherboards in one. This powerful Featherboard adds to your safety and quality of cut. It accepts the Magswitch Vertical Attachment with Risers for holding down your work piece down

vertically as well as in to the fence. The Magswitch Pro Featherboard also acts as the base of an adjustable stackable featherboard for tall pieces. Features two powerful 30mm Magswitches.

\$149.00
Magnetic Featherboard Starter Kit



The Perfect entry into the Magswitch Work Holding System. The Starter Kit comes complete with the Reversible Featherboard Attachment, the Universal Mounting

Base and two MagJig 150's. Once you have this kit, get all the other great Magswitch attachments and simply mount to the base as needed.

\$115.00
Magnetic Fence Featherboard



- ✓ Fast, precise positioning
- ✓ Perfect for infeed/outfeed applications
- ✓ Keeps work firmly in place
- ✓ Powerful Control

- ✓ Can be used with a table saw on the right side of the blade
- ✓ Features two 30mm Magswitches
- ✓ Easy On/Off Operation
- ✓ Versatile Cast-Iron Fence Support

\$29.90
Vertical Attachment Kit



The Vertical Featherboard Attachment Kit can be used with the Magswitch Reversible Featherboard Attachment, Universal Mounting Base and the Pro Table Featherboard. It will add a new dimension to dual plane workholding.

When attached to the Pro Table Featherboard, or Reversible Featherboard, the Vertical Featherboard Attachment can be mounted in a vertical position from the top for pressure down on the material at the same time as the horizontal featherboard is holding the material against the fence.

\$79.00
Magnetic Universal Featherboard



- ✓ Versatile – no mitre slot limitation
- ✓ Perfect for infeed/outfeed applications
- ✓ Can be used on the left or right side of the blade

- ✓ Precise, fast setup
- ✓ The most versatile Featherboard ever
- ✓ Easy On/Off Operation

\$31.90
Universal Base



The Magswitch Universal Mounting Base is the centerpiece of the Magswitch Workholding System. The low profile design enables use on small surfaces including fences and small table-tops. It has the provision to take either two MagJig

95's or MagJig 150's and a myriad of the Magswitch attachments can be mounted to the base to enhance workshop safety as well as improve your output and reduce errors, saving time and money.

from **\$44.90**
Magnetic Featherboard MagJigs



At the core of the Magswitch Workholding System are the MagJigs themselves. Simply turn the knob on the top of the MagJig to engage or dis-engage the

magnetic field that securely holds the Magswitch Workholding System range in place on any cast-iron or steel surface.

\$27.90
Reversible Attachment



The Magswitch Reversible Featherboard Attachment is for use with the Magswitch Workholding System. It mounts to the Universal Mounting Base and MagJigs (each sold separately).

Features core advantages of Magswitch including fast, strong set up anywhere on a steel table or cast Iron fence where you're not limited by the mitre slot. The featherboard is reversible for left and right hand feeds.

Prod Code	Product	Weight	Price
MSMJ-95	MagJig 95 20mm	170g	\$44.90
MSMJ-150	MagJig 150 30mm	270g	\$64.90

Extraction & Safety
Measuring & Marking
Sawing
Site & Shop Accessories
Routing
Planing
Sanding & Scraping
Drilling
Joinery
Clamps & Vices
Finishing
Sharpening
Carving & Chisels
Woodturning
Wooden Parts
Cabinet Fittings

SITE & SHOP ACCESSORIES

from **\$17.50**

UHMW Polyethylene Sheets



You can attach to saw or router table fences to reduce glide friction, or make zero-clearance insert plates, you could cut up and use in mitre and t-track slots for sliders, rout it once bits have been setup to keep

as a setup block, plus a whole range of other uses. These polyethylene sheets are Ultra-High Molecular Weight (UHMW) and are great for a range of applications.

Prod Code	Product	Weight	Price
PES-03-MM	3mm Thick	180g	\$17.50
PES-06-MM	6mm Thick	360g	\$25.00
PES-12-MM	12mm Thick	730g	\$55.00
PES-19-MM	19mm Thick	1.14kg	\$80.00

\$29.90

Aluminium Mitre Slides



IM-10 | 200g



Stop spending precious time trial-and-error fitting wooden or plastic runners, INCRA'S Mitre Sliders are the greatest shortcut ever invented for getting a sled or other fixture

tracking perfectly through a mitre slot. Rigid and installed quickly, with adjustment in seconds for a perfect, play-free fit.

\$49.90

Steel Mitre Slides



IMS-10 | 700g



When you need to build super-accurate sliding jigs and fixtures, the new INCRA Miter Slider SE combines the time savings of the original aluminum Miter Slider with the unique performance and feel

of the adjustable GlideLOCK Miter Bar used on INCRA Miter Gauges. These beefy miter slot runners are perfect for the most demanding jig applications!

from **\$49.90**

Aluminium Fence Tracks



Locate ANY cut on ANY machine EXACTLY where you want it. The INCRA Track works with the ShopStop (sold separately) and is equipped with the patented incremental rack system for

outstanding stop positioning accuracy and 1/1000in repeatability to give your jigs, fixtures, and fence system cutting precision not available anywhere else.

Prod Code	Product	Weight	Price
TRACK-18	457mm 18in Long	750g	\$49.90
TRACK-36	914mm 36in Long	1.5kg	\$79.00
TRACK-52	1320mm 52in Long	2.3kg	\$99.00
ISM-2	Metric ShopStop	250g	\$59.90

from **\$17.90**

Aluminium Mitre Tracks & Bars



Making your own table-top and need to install mitre track? It comes with a silver anodized finish in 1220mm lengths, with ribbed sides to ensure a tight fit and improved gluing surface area for installation. The outside profile measures 30.5 x 12.7mm and can accept t-slot as well as standard 3/4x in mitre bars. Also available is 450mm-long silver

anodized mitre slider for making your own jigs to suit all standard 3/4x in mitre slots, including most cast-iron table saws. It has three mounting holes along the length of the bar to adapt for most jigs easily. Four nylon screws in the side of the bar expand the overall width of the bar to remove any side play as well as reducing friction.

Prod Code	Product	Weight	Price
AMT-148	1220mm Long Mitre Track	690g	\$31.90
AMB-118	457mm Long Mitre Bar	220g	\$19.90
AMB-124	Mitre Slider Aluminium 610mm 24in	300g	\$24.90

\$3.50

Mitre Track Bolt



MTB-57 | 10g



This bolt with an over-size head fits perfectly into a 3/4in t-mitre slots commonly found. It measures 57mm long and has an M8 thread.

It comes with the washer and three-point star knob as a complete set. Sold individually.

\$11.00

Mitre Track Nuts



TTN-01 | 50g



Designed to fit into t-slots in standard 3/4in mitre tracks. The 5/16in thread is found in the

Baladonia t-track system range to adapt fixtures and fittings to mitre tracks. Sold as a pack of 10.

from **\$29.90**

Zero-Play Mitre Sliders



Create perfectly square crosscut jigs fast. The ZeroPlay Mitre Bar System takes miter bars and table saw sleds to the next level of

precision. By using the One-Touch Calibration, you instantly fill the full width of the miter slot for no side-to-side play.

Prod Code	Product	Weight	Price
ZP-9-B-1	Single Zero-Play Mitre Slide	200g	\$29.90
ZP-9-B-2-S-2	Twin Zero-Play Slide Pack	300g	\$59.90
ZP-9-S-1	Zero-Play Mitre Stop	-	\$13.90

Build-It T-Slot Panel Connectors

See description below

from **\$199.00**

Build-It System Starter Kit

INCRA
BKITSTART | 4.5kg

The Build-It System Starter Kit provides all of the components you'll need to produce any of 5 different very beneficial jigs you need in the work shop with the possibility of producing many more!

This highly versatile collection of Jig and Fixture "building blocks", along with the included plans, will change the way you approach these and many other jig designs, making it possible to produce in minutes what used to take hours or even days.

from **\$26.50**

Build-It T-Slot Panel Connectors

INCRA

Makes adding and positioning your jig accessories and hold down clamps a snap! Now you can build hundreds of your own custom jigs and fixtures in minutes with just a

screwdriver and your imagination using Inkra's Build-It Panels or your own 16mm MDF board. Adds strength, rigidity and a rock solid T-slot.

Prod Code	Product	Weight	Price
BCONNECT-18	18" T-Slot Panel Connector	400g	\$26.50
BCONNECT-24	24" T-Slot Panel Connector	500g	\$34.90

\$16.90 Build-It Bracket Kit

INCRA
BBRACKET-1 | 150g

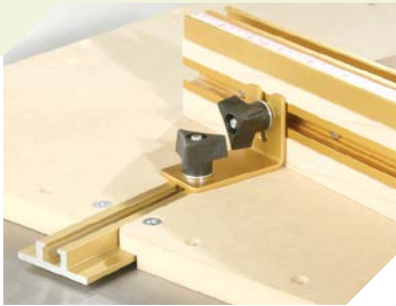

Works with any T-Track and Build-It T-Slot Panel Connector to interconnect any two T-Slot components. Great for attaching fences and other jig accessories.

Includes 2x brackets, 4x knobs, 4x bolts and 4x washers.

\$15.90 Build-It Knobs

INCRA
BKNOBS-1 | 180g



Easily attach user made stops and accessories to the T-Slots Connector on your Build-It

assemblies. Fasteners suit material up to 25mm thick. Includes 8 each bolts, knobs and flat washers.

from **\$16.50**

Regular T-Track

INCRA



Large T-Slot accepts standard 1/4in-20TPI Hex Bolts and Nuts PLUS 5/16in t-track hardware found on following page

Mount easily with pre-drilled holes and included fasteners
Hard anodized aluminium for durability

Prod Code	Product	Weight	Price
INTTR-610	24" INCRA T-Track, Single Track	300g	\$16.50
INTTR-914	36" INCRA T-Track, Single Track	400g	\$19.90
INTTR-1220	48" INCRA T-Track, Single Track	500g	\$26.90

from **\$19.90**

T-Track Plus

INCRA



The only T-Track with an included adjustable scale. Can be cut to fit your jig exactly.

Adjustable Lexan® Scale
Available with Metric scales
Mount easily with pre-drilled holes and included fasteners
Hard anodized aluminium for durability

Large T-Slot accepts standard 1/4in-20TPI Hex Bolts and Nuts PLUS 5/16in t-track hardware found on following page

Prod Code	Product	Weight	Price
INTPT-610	610mm Metric INCRA T-Track PLUS	400g	\$19.90
INTPT-914	914mm Metric INCRA T-Track PLUS	600g	\$23.90
INTPT-1220	1219mm Metric INCRA T-Track PLUS	750g	\$31.90

\$18.90

Build-It Hold-Down Clamp

INCRA
BCLAMP-1 | 250g



The perfect accessory to the Build-It System family of tools. Locks your workpiece in place for consistent,

safe cutting results. Exclusive captured pivot design for hassle free clamping.

\$31.90

Aluminium Mitre Track

INCRA
INMT-148 | 600g



Works with INCRA Mitre Sliders and INCRA Mitre Gauges or any standard 19.0 x 9.5mm mitre bar. T-Slot design for hold down capability. Mounts easily with pre-drilled holes and included

fasteners. Cut a 28.6 x 12.7mm groove for mounting in a channel.



Extraction & Safety
Measuring & Marking
Sawing
Site & Shop Accessories
Routing
Planing
Sanding & Scraping
Drilling
Joinery
Clamps & Vices
Finishing
Sharpening
Carving & Chisels
Woodturning
Wooden Parts
Cabinet Fittings

SITE & SHOP ACCESSORIES

from **\$11^{.50}**

T-Tracks



T-track is a versatile product that has many great uses around the shop. It can be attached to the fence of a mitre saw, drill press or router table to provide a quick, secure place to attach feather boards, stops and hold-downs. It's also a great addition to jigs and fixtures with parts that need to be adjustable or easily removed like table saw sleds and so much more.

The Baladonia system uses 5/16in t-bolts and matching nuts, knobs etc. and will also accept 1/4in or M6 hexhead bolts and nuts. It is available in a variety of configurations to suit many different applications.

- ✓ **A.** Rout 19mm wide x 9.5mm deep channels or rebates to install this standard track. It comes undrilled so you can choose where you want your own mounting holes (use 3/16in twist drill bit to create screw holes quickly and easily). Ribbed on the outside to grip the walls of the timber around it and anodized silver for long life.
- ✓ **B.** Need a t-track with a scale for more accurate jig setups? This anodized silver aluminium t-track measures 31.5 x 12.7mm overall. Only available in 915mm lengths, it already comes predrilled, but if necessary, use 3/16in twist drill bit to create more screw holes.
- ✓ **C.** It comes packed standard with one self-adhesive metric scale to be attached once the track is installed for easy calibration. Metric and imperial scales are available separately as required.
- ✓ **C.** A specialty track with the 17.5mm-wide ledge designed to be drilled and screwed to the underside of 18mm board (MDF or ply) so the top of the track is flush with the top of the board board to create a very strong and durable edge t-track. It can also be rebated in for thicker table-tops if necessary.
- ✓ **D.** The track is standard width for use with 5/16in hardware but measures a little deeper so threaded bolts have extra clearance for ease-of-use. Also has a standard 5/16in t-track moulded into the front to provide a track that can be used on the vertical axis. Can be used in a myriad of applications on benches or as parts of fences. Available in 915mm lengths only.
- ✓ **D.** Three lengths of 5/16in threaded t-bolts are available in packs of 10 as shown in the tracks above. All produced from high-quality mild steel and then zinc-plated for long workshop life.
- ✓ **E.** Also available is a 5/16in thread t-nut suitable for use in all the above t-track slots. Sold as a pack of 10.

Prod Code	Product	Weight	Price
TT-1610	Std T-Track 610mm Long	520g	\$11.50
TT-1914	Std T-Track 914mm Long	530g	\$15.00
TT-11220	Std T-Track 1220mm Long	530g	\$20.00
TT-2914	T-Track Plus 914mm Long	520g	\$15.00
TT-2-MT	Spare Tape - Metric	10g	\$2.90
TT-2-IT	Spare Tape - Imperial	10g	\$2.90
TTE-4914	Edge T-Track 914mm Long	900g	\$29.90
TTB-38	T-Bolts 38mm Long Pk 10	160g	\$11.00
TTB-63	T-Bolts 63mm Long Pk	230g	\$12.00
TTB-88	T-Bolts 88mm Long Pk 10	300g	\$13.00
TTN-02	T-Nuts Pk 10	90g	\$8.00

from **\$1^{.50}**

T-Track Knobs



A large variety of knobs and handles to clamp fences and jigs in place. All knobs use 5/16in thread size.

- ✓ Diameter is measured at widest point.
- ✓ TTK-10 & TTK-11 handles are repositionable on the main shaft knuckle.
- ✓ Length DOES NOT include external thread length, only knob

length, thread length for external threads is shown in the Thread Configuration/Length column below.

- ✓ Where the bolt can pass through the handle length completely, thread length is marked as Through, otherwise where it is a blind nut the depth of the hole is shown in the Thread Configuration/Length column below.

Prod Code	Thread Config/Length	Length	Diameter	Weight	Price
TTK-01	Internal/Through	20.5mm	25.0mm	20g	\$1.50
TTK-02	Internal/Through	26.0mm	38.3mm	30g	\$3.00
TTK-03	Internal/17.0mm	29.3mm	50.5mm	40g	\$3.00
TTK-04	Internal/Through	29.3mm	50.5mm	40g	\$1.50
TTK-05	Internal/Through	24.1mm	54.5mm	70g	\$3.00
TTK-06	Internal/19.1mm	39.5mm	50.0mm	80g	\$6.00
TTK-07	Internal/56.9mm	62.5mm	40.5mm	60g	\$6.00
TTK-08	Internal/25.9mm	98.5mm	26.4mm	230g	\$4.50
TTK-09	Internal/25.5mm	98.5mm	26.4mm	250g	\$4.50
TTK-10	Internal/19.5mm	43.0mm	75.1mm	110g	\$6.00
TTK-11	Internal/25.3mm	43.0mm	75.1mm	120g	\$7.00
TTK-12	Internal/75.0mm	111.1mm	55.9mm	80g	\$5.00
TTK-14	Internal/98.0mm	117.9mm	33.5mm	120g	\$5.00

\$19^{.90}

T-Track Intersection Kit



TTINT-1 | 100g



When you need to have two standard t-tracks intersect continuously, these kits are perfect

to match with the long lengths of standard t-track. Comes with required eight mounting screws.

\$19^{.90}

T-Track Cam Clamps



TTCAM-1 | 80g



Cam Clamps clamps give you quick release for clamping jigs and fixtures. Simply thread the cross dowel on to the 5/16in t-track bolts in the Baladonia range and then lever down to clamp completely. Great for jigs where repeated clamping pressure is required on

the same thickness material - like fences etc. Quickly tension and release by flipping up and pushing back down.

Each pack contains two clamps, two 5/16in cross dowels and four rubber washers so the work piece is not marked.

\$39.90 T-Track Fence System



A thick-walled, heavy-duty aluminium extrusion measuring close to 59 x 22mm with t-slots top and bottom. Only available in 610mm length at this stage.

Also available separately is the heavy-duty aluminium flip stop that's

self-squaring in the track. The stop itself measures 19,5mm wide and protrudes 10mm from the fence face, finishing flush with the bottom of the fence. Strong 5/16in flip bolt assembly has no lateral flex to stand up to years of regular workshop use. Stop also fits in standard t-tracks.

Prod Code	Product	Weight	Price
TTF-3610	T-Track Fence Only 610mm 24in Long	1kg	\$39.90
TTSTOP-6	T-Track Stop Flip Fence Aluminium HD	160g	\$19.90

\$11.90 T-Track Fence Mount Bracket



TTSTOP-5 | 120g



Available separately and sold individually to suit the T-Track Fence above is the fence bracket. Measuring 29mm x 76mm x 53mm (H x W x D). The holes allow you to adapt your own sub-fences

(including shop-made curved fences) as required, so handy for speciality fixturing work. Can also be used as a broad t-track stop in a table. Mount a simple strip of t-track to use as a simple floating long stop.

\$9.00 Simple T-Track Stop



TTSTOP-1 | 90g

Produced from 8.5mm thick PE UHMW with the groove pre-routed to self-square in track. Measures 30 x 40mm and finishes flush on one

edge of t-track so can be cut down if full 40mm height is not required. Comes with mounting hardware and knurled knob.

\$17.90 Low Profile T-Track Flip Stops

TTSTOP-3 | 90g

A flip stop perfectly suited to the Baladonia t-track with scale. The stop self-squares in the track slot and the 3mm zinc-plated steel flips out of the way when in use as necessary.



When flipped down in the place, the size of the stop measures 12.7mm high x 20mm deep. All alloy, steel and brass construction. Sold as a pack of two.

\$14.90 Low Profile Brass T-Track Stop

TTSTOP-4 | 120g

This stop is only 6mm thin and produced in solid brass, allowing access to work thin work pieces without obstruction. The head pivots to accommodate round or irregularly shaped workpieces; its two flat



faces are sloped inward by 2° to help hold wood securely. Comes with mounting hardware to use in t-track or mitre track. Overall 30 x 19mm with flat edge approximately 23mm long.

from \$13.00 T-Track Hold-Down Clamps



Works but creating clamping pivot pressure – a quick, easily adjustable way to hold work pieces down without marring as each end has a PVC rubber boot. Made from 6 x 25mm plate steel, the smaller hold-down comes with a 63mm bolt

and measures 110mm long while the large hold-down comes with an 88mm bolt and measures 150mm long. Includes knob and washer to adapt mounting bolt to 3/4in t-mitre slot. Sold individually.

Prod Code	Product	Weight	Price
TTHDC-1	T-Track Hold-Down Clamp Small Each	190g	\$13.00
TTHDC-2	T-Track Hold-Down Clamp Large Each	260g	\$14.00

from \$59.90 Universal Tracks



Attaches to Magswitch Universal Mounting Base (sold separately) to take advantage of Magswitch's placement technology or mounts to mitre gauges and fences as well as accepting all standard mounting hardware. One side accepts

standard 1/4in T and hex bolts. The other side accepts standard 5/16in T and hex bolts as well as Kreg® clamps. Also includes micro adjustable brackets for fine tuning to 90°. Measures a massive 27mm thick x 104mm tall.

Prod Code	Product	Weight	Price
MSWUT-18	457mm 18in Long	1.92kg	\$59.90
MSWUT-36	914mm 36in Long	3.89kg	\$109.00

Extraction & Safety
Measuring & Marking
Sawing
Site & Shop Accessories
Routing
Planing
Sanding & Scraping
Drilling
Joinery
Clamps & Vices
Finishing
Sharpening
Carving & Chisels
Woodturning
Wooden Parts
Cabinet Fittings

SITE & SHOP ACCESSORIES

Extraction & Safety
 Measuring & Marking
 Sawing
Site & Shop Accessories
 Routing
 Planing
 Sanding & Scraping
 Drilling
 Joinery
 Clamps & Vices
 Finishing
 Sharpening
 Carving & Chisels
 Woodturning
 Wooden Parts
 Cabinet Fittings

\$109.00 GRR-Ripper 100



MICROJIG
GR-100 | 950g

Precision, control and safety has never been so smart. The GRR-Ripper acts as a Moving-Blade-Guard™ for total hand protection. The Adjustable Centre Leg grips the off cut piece and prevents wood

burn. The 6.4mm (1/4) Leg controls the keeper piece. Balance Support stabilizes small and narrow work pieces. Fully adjustable to allow for a limitless amount of uses.

\$139.00 GRR-Ripper 200



MICROJIG

The GRR-Ripper Advanced Model is packaged with the Stabilizing Plate and the Adjustable Spacer. These accessories are also sold separately as the GR-100 Upgrade Kit. The Stabilizing Plate provides 250% more stabilizing surface

area. Like a featherboard, it keeps wood locked against the fence for a smooth cut – virtually eliminating binding. Fully adjustable, it's great to use as a router table guide for bullnose routing and eliminating snipe from your full-profile cuts.

Prod Code	Product	Weight	Price
GR-200	GRR-Ripper 200	1.2kg	\$139.00
GRAK-404	GRR-Ripper 100-200 Upgrade Kit	380g	\$49.90

\$449.00 GRR-Ripper Complete System



MICROJIG
GR-562 | 4.5kg

This kit contains two GRR-Ripper Push Blocks along with two of all the accessories to get the most from the system. The twin pack includes the following items, saving you up to 15% off RRP

- ✓ 2x GRR-Ripper 3D Pushblock (GR-100)
- ✓ 2x Stabilizing Plates & Adjustable Spacers (GRAK-404)
- ✓ 2x 3.2mm (1/8") Legs (GRP-11-G)
- ✓ 2x Gravity Heel Kits (GRGH-040)
- ✓ 2x Handle Bridge Kits (GRHB-010)
- ✓ 2x Deflector/Connectors (GRDC-020)
- ✓ 1x GRR-Ripper 3D Pushblock Manual
- ✓ 1x Advanced Techniques DVD

\$29.90 GRR-Ripper Thin Rip Leg



MICROJIG
GRP-11-G | 180g

Make rip cuts as thin as 3.2mm (1/8") without breaking a sweat. Before the GRR-Ripper 1/8" Leg, thin rip cuts were extremely dangerous when manually feeding. Traditional push sticks are

dangerous and unstable. Now, repeatable, clean, safe and controlled 3mm rip cuts are a reality for woodworkers worldwide. Fits all GRR-Ripper models.

Need a spare part for your Micro Jig product? Check out the full range of spares and accessories on timbecon.com.au

from \$54.90 GRR-Rip Block



MICROJIG
GB-1 | 550g

Harness the ultimate control that comes from combining our Green GRR-Rip High Friction Material with Smart Hooks. Smart hooks grab the tail end of the board to give you complete control and confidence to finish the cut. Smart Hooks

automatically drop down when you need them, and instantly retract mid-board. They can also be locked into the retracted position. There when you need them – out of the way when you don't.

\$24.90 Clear Deflector/Connector



MICROJIG
GRDC-020 | 350g

Acts as a chip deflector preventing material from flying towards you when freehand routing. It can also bridge two GRR-Rippers to tackle longer or wider stock. Quickly

connects to the Handle Bridge Kit for fast, easy and safe use. Handle Bridge Kit required for use with GRR-Ripper, mounts directly to GRR-Rip Block models.

\$29.90 Gravity Heel Kit



MICROJIG

Attach to your GRR-Ripper to hook the tail end of your work piece and automatically retracts mid-board. Provides extra leverage to help

push through the cut and prevent blow out. For use with table saws, bandsaws, jointers and router tables.

Prod Code	Product	Weight	Price
GRGH-040	GRR-Ripper Adjustable Gravity Heel Kit	200g	\$29.90
GRGH-045	Replacement Heels	-	\$29.90

\$27.90 Handle Bridge Set



MICROJIG
GRHB-010 | 400g

Unique arch design gives the handle four points of contact to evenly distribute the downward pressure. Also allows you to angle the handle for more ergonomic

comfort. Bonus trailing hook is included - a handy and simple addition that works similarly to the more advanced Gravity Heel Kit. Fits all existing GRR-Ripper models.

from **\$3.50**
Push Sticks



A simple and cost-effective way to keep your fingers away from the work piece. More comfortable than a home-made version and produced from safety orange plastic so that

it's easy to find. Now available with two rare-earth magnets installed in side of push stick for easy placement/storage on machine to keep close at hand.

Prod Code	Product	Weight	Price
PS-1	Push Stick Simple Each	110g	\$3.50
PS-3	Push Stick Simple With Magnetic Handle	120g	\$7.50

\$9.90
Deluxe Push Block



PS-4 | 280g

When you need to stay on top of the work piece (using a jointer or router), a set of these are perfect to keep the (vertical) pressure on. Produced from resin-filled, easy-to-find safety orange ABS and a high-quality

non-slip large grip pad, we find they are very comfortable across the full hand size range.

Prod Code	Product	Price
PS-4 - K-2	Sets of Two	\$16.90

\$17.90
The Grabber Push Block



MC-3403 | 350g

Ideal for use on router tables, table saws, jointers and even band saws. Provides superior control and maximum grip, while keeping your hands angled away from the cutting tool with a large and

comfortable handle grip for hands of all sizes. The massive 203 x 80mm Diamond Grip Rubber Bottom provides maximum strength to safely hold your work piece in place.

\$17.90
Universal Push Stick



MC-3404 | 300g

The extra tall handle is tilted inward, away from the saw blade, automatically moving it further from potential danger. The low profile rear foot hooks over back

of material and the bottom of the PushStick is covered in a soft, high-traction polymer coating that prevents slipping and scratching the surface.

from **\$49.00**
FeatherPro Safety System

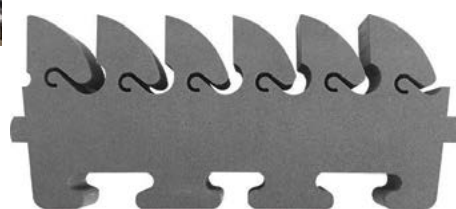

The FeatherPro Featherboard developed by Bow Products is a game changer in woodworking tools. You might think that sounds like a lot of hype, but they've got the stats and the features to prove it. Take a look at some of the features this featherboard provides - and watch the videos showing it in action.

Currently the FeatherPro fits any table with a standard 19.0 x 9.5mm (3/4in x 3/8in) mitre slot.

Prod Code	Product	Weight	Price
BFP-1	FeatherPRO Single Pack	750g	\$49.00
BFP-3	FeatherDUO Twin Pack	1.3kg	\$95.00
FPS-2	Standard Replacement Feathers	300g	\$24.90
FPU-2	UltraLight Replacement Feathers	300g	\$24.90

The FeatherPro includes one board body, standard feather and necessary mounting hardware, while the FeatherDuo includes two board bodies, two each of both the standard and UltraLight feathers as well as riser blocks and all necessary mounting hardware so they can either be used in stackable or tandem configuration.

All replacement feather packs are sold as packs of two.

\$17.90
11th Finger Push Stick



FC-02051 | 100g



Keep your fingers safely away from the saw blade with the 11th Finger. Made from durable polyethylene to prevent damage to your saw blade. Two powerful neodymium magnets keep the push stick

perfectly positioned for safety and efficiency on your table saw or any other cast-iron machine. Design by woodworking teacher to guarantee his students keep all 10 fingers by the end of class.

Extraction & Safety
Measuring & Marking
Sawing
Site & Shop Accessories
Routing
Planing
Sanding & Scraping
Drilling
Joinery
Clamps & Vices
Finishing
Sharpening
Carving & Chisels
Woodturning
Wooden Parts
Cabinet Fittings

SITE & SHOP ACCESSORIES

from **\$64.⁹⁰**

EZ-View Plus DRO's



- ✓ New-generation sensor and processor provides close to real-time read-outs of adjustments on the display.
- ✓ Massive new crystal-clear readout display much easier to read with integrated magnets in the back - easy to place on machines.
- ✓ Reads in 0.05mm increments as well as decimalized and fractional imperial in 1/64in increments.
- ✓ The sensor connects to read-out with a 1300mm cord that can be disconnected for easy installation/access.
- ✓ Ability for (user-supplied) 3V power supply adapter to be plugged in so batteries are no longer needed to run it.
- ✓ Includes wall-mount bracket to setup display permanently.
- ✓ IP-54 water/dust resistant rated.
- ✓ Hardened stainless steel body for long life.
- ✓ Comes with brackets to be adapted to any number of metalworking or woodworking machines such as router lifts or fences, planers, table saws.

Prod Code	Product	Weight	Price
IG-35706-EZ	150mm 6in Capacity	700g	\$64.90
IG-35712-EZ	305mm 12in Capacity	800g	\$69.90
IG-35724-EZ	610mm 24in Capacity	900g	\$89.90
IG-35736-EZ	914mm 36in Capacity	1kg	\$109.90

\$59.⁹⁰

Router Table Switch



BALADONA
RTSW-10

Available separately to use on your own table is the router table switchbox only. It doesn't come with any mounting brackets, however, you can remove the front face and fix through the box using the four mounting holes at the back of the case. Rated up to 10 amps this remote switch is a must for anyone looking to build their own table.

\$34.⁹⁰

Mag Shim Set



FastCap
FC-04151 | 110g

Mag Shims are the easiest way to set your blade height and fence spacing on your table saw, router or any other woodworking tool. Simply stick the magnetic shims together to get a perfect setup in seconds! Also great for setting the depth on drill presses. You get 6x 2mm shims and 2x 1mm spacers so you can setup anything from 0-14mm in seconds.

\$34.⁹⁰

Magnetic Worklight

BALADONA
L-40 | 2.5kg



- A fantastic accessory for your just about every machine in your workshop. It attaches to your steel machines via its strong, magnetic
- ✓ Rotary on/off switch
 - ✓ 370mm flexible arm
 - ✓ 70mm dia. magnet in the base

- base. It also has screw holes in the base for dual mounting on a bench top or wall. Light bulb not included.
- ✓ Easy to install
 - ✓ Easy to move
 - ✓ 2m power lead

\$149.⁰⁰

Flexible LED Worklight

BALADONA
L-80 | 1.3kg



- ✓ Full worklight assembly and LED's manufactured in Taiwan
- ✓ Strong magnetic base securely holds lamp on horizontal and vertical planes
- ✓ 410mm-long arm to position anywhere over work piece

- ✓ Head designed to remain cool to accidental touches after operating for long periods
- ✓ 4x 6W LED's brightly illuminates work space with clear white light
- ✓ Rated at 260 lumens

\$49.⁹⁰

ZoomFlex LED Light Kit

iGAGING
IG-341480-Z | 450g



The perfect workshop or worksite companion, this rugged and durable kit comes with a powerful single LED light torch that runs for hours on just 3x AAA batteries (included). Clip it into the strong adjustable arm

and the powerful magnetic base will clip on to any steel or iron surface horizontally or vertically to shine the torch just about anywhere so you can see what you're doing.

\$79.⁰⁰

Magnetic Base LED Magnifier

iGAGING
IG-36-LED-58 | 930g



The 83mm-diameter optical grade 4x magnifying lens has a small 20mm-diameter 8x zoom section and, when necessary, 12 bright small LED's can be turned on in the surrounding lens casing to illuminate the area with a nice

bright white light to see extra details. The 250mm-long metal flexible arm can position the head in virtually any position and is held in place using the strong rare-earth magnetic base.

What Is The Third Hand?

The Third Hand family is built with the same core construction, the only difference being the height capacity. From the 420-580mm Capacity Little Hand through to the Original Third Hand shown below, you're sure to find the right size to help you in a myriad of ways at the workshop and onsite.



- ✓ Easy and powerful ratchet system for fine height adjustments
- ✓ Telescoping steel red poles provide great working capacity range
- ✓ Ball detents quickly snap in position to adjust telescoping height quickly
- ✓ Every size has a maximum working capacity of 65kg per pole
- ✓ Designed to be maintenance free and has lifetime warranty against defects
- ✓ Interchangeable feet to adapt to any situation
- ✓ Cheaper than an apprentice or a mate!



\$329⁰⁰ LJ4 LaserJamb Pro Kit

FastCap
FC-02146 | 12kg



Make the process of leveling anything from a cabinet to a picture frame fast, easy and accurate. This allows you to use any (not included) laser and position it from the floor to the ceiling with ease. No longer do you have to create a reference line and measure off of it.

Simply position the laser exactly where the work is. This eliminates pencil line, chalk line and a level and allows both of your hands to be free so you can work more efficiently and accurately. Includes everything you need except the laser itself.

from \$149⁰⁰ The Original Third Hand

FastCap

The Original Third Hand has a working range of 1525 – 3660mm and can be used for virtually anything including hanging wall cabinets, holding crown mouldings, light fittings, fans or roofing panels in place whilst installing plus many more!

- ✓ When bought as a twin-pack, it includes two 3x3in articulating feet and a dust barrier foot per pole.
- ✓ Buy the two-piece system to get the same three feet per pole, plus a heavy-duty carry bag and four 6x6in universal feet.
- ✓ The contractor's pack doubles everything included in the two-piece system – four poles with 2 of the 3x3in & 6x6in and 1 of the dust barrier feet per pole.



Prod Code	Product	Wgt	Price
FC-80473	Twin-Pack	6.4kg	\$149.00
FC-80672	Two-Piece System	10kg	\$249.00
FC-98039	Contractor's Pack	16.5kg	\$399.00

\$49⁹⁰ Magnetic Lasermount Kit

FastCap
FC-80085 | 360g



Our Magnetic LaserMount utilizes powerful neodymium magnets to securely attach your laser to the Third Hand.

The laserline becomes the actual line you work from, eliminating the need for chalk lines. Position any laser exactly where you want it.

\$9⁹⁰ Hook & Hang

FastCap
FC-09982 | 190g



A sturdy steel accessory that attaches quickly and easily to any Third Hand main pole to hang lights

or any other accessories on it. Use one on two different Third Hands as a door rotisserie!

Extraction & Safety
Measuring & Marking
Sawing
Site & Shop Accessories
Routing
Planing
Sanding & Scraping
Drilling
Joinery
Clamps & Vices
Finishing
Sharpening
Carving & Chisels
Woodturning
Wooden Parts
Cabinet Fittings

SITE & SHOP ACCESSORIES

Extraction & Safety
 Measuring & Marking
 Sawing
Site & Shop Accessories
 Routing
 Planing
 Sanding & Scraping
 Drilling
 Joinery
 Clamps & Vices
 Finishing
 Sharpening
 Carving & Chisels
 Woodturning
 Wooden Parts
 Cabinet Fittings

\$169.00

The Upper Hand



Problem



Solution

Designed for use in the 715 – 1525mm range. The Upper Hand is useful when installing upper cabinets when the base cabinets are not in yet as well as a range of

other uses. Available as a two-piece system with two Upper Hands, four 6x6in feet and carry bag.

\$149.00

Little Hands



Because of its height range, the Little Hand does not have telescopic poles. It is the same in every other way to the Third Hand so is still rated to 68kg (150lb) per Hand. Great for supporting upper cabinet installation off base

cabinets as well as general lifting and spreading work.

The standard pack has a 420-480mm height range while the popular XL System covers a 600 – 965mm range.

Prod Code	Product	Weight	Price
FC-80673	Two-Piece Standard Pack	3.1kg	\$149.00
FC-09829	Two-Piece XL System	3.1kg	\$149.00

from **\$39.90**

Upper Hand Accessories



Extend the use of the Upper Hand with the tripod stand (which can be used on all Third Hand products to improve stability) and the roller stand top.

The Roller Stand Pack includes all the items shown in the image above plus 2x 152mm² feet so the Upper Hand can be used as a support.

Prod Code	Product	Weight	Price
FC-07263	Roller Support Stand Kit	4.3kg	\$149.00
FC-01049	Roller Only	1.15kg	\$39.90
FC-09994	Tripod Only	1.05kg	\$39.90

Dust Barrier Door Kit



One of the most exciting applications of the Third Hand family is the ability to create instant dust barriers. To call these barriers makeshift is wrong because you can create fully-sealed enclosures with the Third Hand Dust Barriers that are quick and easy to setup, easy to use and will keep your customers, wife or husband happy

from making a mess in the rest of the house.

The magnetic dust barrier door measures 1090 x 2160mm so it will suit most standard and oversized single width doors. Simply walk through the door and let the magnets snap the door shut behind you to keep the dust from spreading outside your workspace.

from **\$2.50**

Replacement Feet



If you damage, or want to carve up a wrong kit and need more of the right feet, they are available separately.

Prod Code	Product	Weight	Price
FC-80062	Dust Barrier Fee	50g	\$6.50
FC-99939	76 x 76mm Feet	50g	\$2.50
FC-98044	152 x 152mm Feet	250g	\$8.00

Handle On Demand



The perfect way to get a handle on items big and small to move them around. The suction cups engage and make it easy to pick up large furniture, panels and anything else

you can think of without doing your back in. Maximum holding capacity of 90kg each.

\$74.⁹⁰
Jack Of All Trades



FC-98021 | 1.5kg



The new & improved Jack of All Trades is great for lifting base cabinets to install shims or adjust leg levelers. It can also be used as a clamp, for lifting and installing entry doors, or use it horizontally to

pull flooring joints together. Spread up to 635mm apart, clamp up to 450mm thick or lift up to 450mm high with a new, massive maximum load capacity of 90kg (200lb).

\$99.⁰⁰
Door Jaw

TDJ | 3.5kg



A complete breakthrough for people, the DoorJaw provides safe, convenient clamping of doors and other constructions materials during the fitting preparation process.

Use it in three simple and easy set up steps:

- Turn the bottom stabiliser bar of the DoorJaw at 90 degrees to the frame, and place onto a level floor area ready for use.

- Place the door between the jaw and lower until the door is held firm. Place a wooden block at the other end of the object to keep it level.

- Once work is complete, lift and remove the door. The jaws will automatically open ready for use again.

\$49.⁹⁰
Speed Skate



FC-09822 | 600g



The Speed Skate allows you to move large & heavy materials around the job or shop by yourself. It easily supports 8 x 4ft (2400x1200mm) sheets of material

up to 45mm thick. Large wheels and ball bearings allow you to move boards without struggle. Has a massive 225kg capacity.

\$39.⁹⁰
DoorMortiseKit

MILESCRAFT
 MC-1213 | 900g



Rout matching mortises for hinges, as well as strike and latch plates into the door and jamb quickly and easily. Featuring an easy to use drop-in template design with a sturdy steel frame, this kit comes with everything you need for virtually all hinges on 35mm and 45mm doors and jamba.

Templates for square and rounded corner butt hinge sizes – 63mm, 76mm, 88-90mm, 100-102mm, 115mm

Templates for strike plate mortises – 28 x 70mm, 38 x 63mm, 38 x 70mm

Templates for latch plate mortises – 25 x 63mm, 28 x 63mm, 28 x 70mm

Prod Code	Product	Weight	Price
MC-1213	DoorMortiseKit	900g	\$39.90
MC-2216	Replacement Router Bit	30g	\$14.90

\$17.⁹⁰
Bowtie Clamps



FC-02161 | 150g



The quickest and easiest way to secure any irregularly shaped object for assembly or storage. Simply run the rope around whatever you want to clamp or bundle up, clip

into the clamp and do a half turn (or more) to create tension then lock it off quickly and easily. Each clamp comes with 1m of nylon rope to suit most jobs. Sold as a pack of four.

from **\$14.⁹⁰**
Workholding Adapters



Your 3rd Hand just got better! Introducing the Pipe Adapter and Panel Adapter. These little adapters will allow you to support stock wherever you need it! It simply attaches on to the end of your 3rd

Hand System giving you the extra help on those difficult installs.

Code	Product	Wgt	Price
FC-04251	Panel Adapter	60g	\$14.90
FC-04279	Pipe Adapter	60g	\$14.90

\$27.⁹⁰
Fatboy Pencil Kit



Never break your lead again with the FatBoy Pencil. It combines the utility of a mechanical pencil with the strength of a carpenter pencil. Easily sharpens in a standard pencil sharpener and this unbreakable 5.5mm lead stays sharp longer.

Replacement refills are now available, all as packs of 5:

- Standard HB2 leads for timber
- Red crayons for tiles and concrete
- White soapstone for metals

Prod Code	Product	Weight	Price
FC-80768	Fatboy Pencil Kit	80g	\$27.90
FC-01018	Standard Refills Pk 5	30g	\$7.50
FC-08881	Red Refills Pk 5	30g	\$7.50
FC-02782	White Refills Pk 5	30g	\$7.50

Extraction & Safety
 Measuring & Marking
 Sawing
 Site & Shop Accessories
 Routing
 Planing
 Sanding & Scraping
 Drilling
 Joinery
 Clamps & Vices
 Finishing
 Sharpening
 Carving & Chisels
 Woodturning
 Wooden Parts
 Cabinet Fittings

SITE & SHOP ACCESSORIES

Flush Cut Trimmers



The Flush Cut Trimmer series of innovative trimmers will help you stop the struggle, saving you time and money. They are the first tools you will

pull out of your bag every time! There are six models to choose from for your specific need.

\$27.90

Macro Flush Cut Trimmers



w | 300g

Work great with wood and PVC edge banding with standard thicknesses of 0.45 - 0.64mm.

\$37.90

HD Flush Cut Trimmers



FC-80550 | 340g

Cut nails flush! These things ROCK and once you use them you will throw your other cutters out!

Includes two PowerMags to catch metal debris whilst in use.

\$19.90

Micro Flush Cut Trimmers

FC-80551 | 100g



These have a rounded flush side cutting surface. This design allows you to get into tight spots when removing brad nails or small slivers.

Gently pull the nail out by rolling the Micro Flush Cut Pliers without marring or denting the wood.

from **\$27.90**

Nippers



The End Nippers have a flush 25mm (1in) wide head that can be used for cutting metal protrusions like fret wires, small brads, edge banding up to 3mm thick as well as so many other numerous items in a workshop or on a jobsite.

An all-new fret nipper, designed by a luthier. With a hardened blade and compounding mechanical leverage you'll get a beautiful flush trim on your frets every time. (Perfect for use with stainless steel, nickel, copper & brass frets).

Prod Code	Product	Weight	Price
FC-80563	End Nippers	300g	\$27.90
FC-05067	Fret Nippers	220g	\$27.90

\$27.90

PowerShears



FC-80549 | 140g



Whether you are cutting wood veneer, laminate or lace, the Power Shears are the most incredible

scissors you will ever use. Small and compact, yet razor sharp to cut through the toughest material.

\$37.90

Quad Edge Trimmer



Trimming edge banding quickly and easily! With a comfortable and ergonomic design, it trims both sides forwards and backwards in just one pass. Unlike spring-loaded versions, this is pneumatically set – so it provides better control

and is easier to use, creating a better result as you don't have to continually hold the two sides together when trimming. Will work on edgebanding up to 0.5mm thick. Made in USA.

Prod Code	Product	Weight	Price
FC-80077	Quad Edge Trimmer	140g	\$37.90
FC-80083	Replacement Carbon Steel Blades	140g	\$19.90
FC-80084	Replacement Tungsten Blades	140g	\$49.90

\$9.90

Laminate Trimmer



MC-8403 | 50g



A simple yet effective tool for trimming up laminate edges once edge banding has been applied. Simply hold the laminate trimmer at

a comfortable angle and pull towards you to shave the edging from the board for a clean, neat edge that is finished and ready to go.

\$13.90

FastBreak Sander



FC-80076 | 180g



The FastBreak sander allows you to uniformly break the edge on sharp melamine material in just one pass. The FastBreak dramatically

increases the speed, efficiency and ease to break sharp and chipped edges. Made in USA.

\$29.90

FastBreak XL



FC-80467 | 280g



While the standard FastBreak works up to standard 19mm material, the XL is designed for use on 19 – 65mm materials – making it perfect for use on custom thick bench-tops or on the edge of doors. Made in USA.

\$54.90

SpeedRoller Pro



FC-98038 | 660g



The SpeedRollerPRO is an ergonomic laminate roller that can be used for any PSA application. Two rollers in continuous contact ensure no bubbling and even

pressure across your edging. It includes 2 sets of interchangeable wheels – steel and rubber – for all rolling uses. Made in USA.

from **\$115.00**
**Custom Colour
 Punch Kits**



Need one cap and not 1,000? Take any standard edgbanding or veneer, apply SpeedTape, punch your cap out and you are done. It works well with edgbanding up to 0.5mm thick and includes heads

to punch out 9.5mm, 14.3mm and 18mm heads. The Deluxe Kit includes a 9/16in Flush Mount Carbide Countersinking Bit.

Code	Product	Weight	Price
FC-80056	Basic Kit	1.3kg	\$115.00
FC-80057	Deluxe Kit	1.8kg	\$189.00

PVC FastCaps & FastEdge

FastCaps are 14.3mm self-adhesive screw cover caps, made with ultra-bond high performance PSA adhesive which increases in strength as it cures. They are fast and easy to install and are made with quality materials to ensure a long-lasting finish to any project



FastEdge is the same material in rolls 19mm wide x 15m long for peel and stick edgbanding onsite.



Just replace the ** at the end of the code with the following colour codes –

WH	White (Standard Ripple)
SWH	Smooth White
AW	Antique White
BL	Black
AL	Almond
LG	Folkstone (Light) Grey
DG	Dove Grey

Prod Code	Product	Price
FCMB-916-**	Pk of 265	\$13.90
FCSP-916-**	Pk of 1,060	\$44.90
FCBULK-916-**	Pk of 20,000	\$799.00
FESP-151650-**	FastEdge	\$34.90

from **\$17.90**
Kaizen Foam



Achieve maximum organisation and visual control in your workspace! Kaizen Foam separates between the layers creating a perfect fit for all your tools in drawers and on walls.

The custom-cut recesses keep things firmly in place—no more tools rattling around as a drawer is opened and closed. Available dark grey, Kaizen Foam is one of the most innovative storage ideas released globally.

Available in 1220 x 610mm sheets, the foam is easy to use. Made of thin 3mm layers, you just excavate a bit at a time as needed. Trace the tools and then cut through one layer using a utility knife, remove the waste, and check the fit. Keep cutting until the recess is deep enough to hold the tool securely but shallow enough to grab easily.

Also available is the Kaizen Knife. While you can use a standard trimmer this inexpensive knife has triple-edge blade that is 50% sharper than standard blades, with a comfortable moulded rubber grip, a double-tooth steel track for a positive lock and auto blade lock.

Prod Code	Size	Weight	Price
FC-01107	20mm Thick	6kg	\$19.90
FC-01113	30mm Thick	8kg	\$24.90
FC-01117	57mm Thick	14kg	\$44.90
FC-09654	Kaizen Knife	50g	\$4.90

\$19.90
Fastedge Clamp

FC-80811 | 270g



Applying edgbanding to 18-19mm shelves can be a real pain. Stop the struggle with the FastEdge Clamp. It securely holds your shelf in place

allowing you to use both hands to install your peel and stick FastEdge banding. Sold as a pair with 28mm screws included to fix down.

\$14.90
**Kaizen
 Foam Frame**



FC-02152 | 600g



The Kaizen Foam Frame comes with a single 1245mm extruded panel that allows you to customize your frame. It has a high-performance peel-and-stick adhesive on the back, making it fast and easy to mount on any wall.

The back lip allows you to screw the panels into the wall for added support. This product is great for organizing workplace, inventory, and hardware areas. It takes 3 Kaizen Frame pieces to frame a full 1220 x 610mm sheet of Kaizen Foam.

from **\$12.90**
**SpeedTape FastEdge
 Applicator**



With the SpeedTape Applicator you can have peel and stick cover caps and edgbanding "just in time". Simply load up your roll of SpeedTape and edgbanding, align the two rolls and then get your edgbanding assembled in no time for sticking straight on the job.

You can also apply SpeedTape to almost anything you want to stick in place. as an ultra-high performance double sided tape.

Prod Code	Product	Wght	Price
FC-02783	Applicator	2.25kg	\$115.90
FC-80714	19mm x 15m	100g	\$12.90
FC-99958	51mm x 15m Roll	280g	\$37.90

\$9.90
**Long Nose
 Pattern Markers**

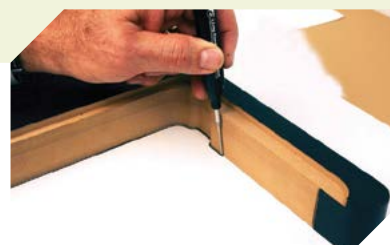

The Long Nose Pattern Marker solves all your tricky layout problems. It has a 28.5mm long fine point tip for marking inside holes and along walls while the other end has a wide tip for general use.

Permanent & waterproof, it will be your go-to marker for any job. Available in silver and black.

Prod Code	Product	Wght	Price
FC-80553	Black Colour	50g	\$9.90
FC-04250	Silver Colour	50g	\$9.90

Extraction & Safety
 Measuring & Marking
 Sawing
 Site & Shop Accessories
 Routing
 Planing
 Sanding & Scraping
 Drilling
 Joinery
 Clamps & Vices
 Finishing
 Sharpening
 Carving & Chisels
 Woodturning
 Wooden Parts
 Cabinet Fittings

SITE & SHOP ACCESSORIES

Extraction & Safety
Measuring & Marking
Sawing
Site & Shop Accessories
Routing
Planing
Sanding & Scraping
Drilling
Joinery
Clamps & Vices
Finishing
Sharpening
Carving & Chisels
Woodturning
Wooden Parts
Cabinet Fittings

from **\$34.90**
Power Tool Guide Rails

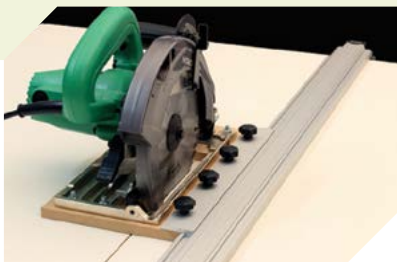

Don't muck around with a straight edge and two clamps, wasting time making sure its fixed in place only for the clamps to get in the way anyway! This power tool guide is low-profile, with a built-in cam

clamp that sits under the board and out of the way. The jaws automatically pull the guide close to square and can be quickly clamped in place and removed within seconds.

Prod Code	Product	Weight	Price
PTG-24	24in 610mm Long	1.7kg	\$34.90
PTG-50	50in 1270mm Long	2.4kg	\$57.90

from **\$89.90**
Power Tool Guide Extension Kit



If you need to go longer than 50in (1270mm), look no further than this cost-effective extension kit. Remove the included clamps on your guide rails and replace with the centre connector and two sliding toggle clamp heads in less than

two minutes. Two 50in guides with the extension kit allows you to rip 2440mm-long boards.

Also available separately is the connector if you want to join more than one rail so you can go longer than 2440mm-long boards.

Prod Code	Product	Weight	Price
PTGEXTN	Guide Rail Extension Kit	1.4kg	\$89.90
PTGCONN	Guide Rail Connector Only	350g	\$39.90

from **\$14.90**
Power Tool Guide Traveller + Stop



If you want to make sure the cut is accurate, square and repeatable make the small investment in the 300mm guide traveller. Cut and drill a 12mm MDF base to bolt your power tool in place and then mount to the traveller using the included bolts and knobs.

Then run the traveller in the captive groove for maximum accuracy.

For repeated stopped cuts get the position stop - a simple way of stopping in the same place on multiple boards.

Prod Code	Product	Weight	Price
PTGTR	PowerTool Guide Traveller	200g	\$14.90
PTGPS	PowerTool Guide Position Stop	60g	\$8.50

from **\$185.00**
100in Power Tool Guide Kits



Standard 2440mm Capacity Kit Includes:

- ✓ 2x 50in Guide Rails
- ✓ 1x Extension Kit
- ✓ 1x Guide Traveller

Super Guide Rail Kit Includes:

- ✓ 2x 50in Guide Rails
- ✓ 1x Extension Kit
- ✓ 2x Guide Travellers
- ✓ 2x Position Stops

Prod Code	Product	Weight	Price
PTG-100-K	Standard 100in Kit	6.7kg	\$185.00
PTG-100-RSK	Super Guide Rail Kit	7kg	\$209.00

from **\$44.90**
Power Tool Guide Protractor Attachment



The protractor head is fixed to a steel base that has a lip which references it against the edge of the work piece. It can be secured more rigidly if you use a clamp to hold the black steel base down to the work piece than if it was just held by hand if necessary.

secures the protractor head to the top channel in the power tool guide and then swivels the guide to the correct position in a +/- 60° range (120° overall range). Then all you need to do is run your saw against the guide or use your traveller to prevent any accidental movement if necessary.

An extruded aluminium bracket



100in Power Tool Guide Kits PTG-100-K Standard 100in Kit

from **\$17.90**
Universal SawGuide



MILESCRAFT
MC-1400 | 470g

The innovative tooth-gear design allows tool-less exchange of bars which come in four sizes of varying widths to suit virtually all circular and jig saws available on the market

today. With the inclusion of special holding clips it permits easy setup and attachment to be used as both a circle and edge guide.



Search **Timbecon** on Instagram to keep updated with all our promotions.

\$419.00 Benchtop Router Table



PRS-2100 | 14kg



610 x 406mm table top made from an edgebanded, vibration- and noise-resistant MDF, it features the Easy-Slide™ Micro-Dot skin.

The phenolic Precision Router Table Insert Plate measures 9.5mm x 235 x 298mm to support even the biggest routers, and comes with a set of Kreg's Precision Insert Levelers.

The aluminium fence has quick adjustment and locks confidently. Independent sliding faces increase work piece support and, with the use of the included jointing rods, allow the table to be used as a vertical jointer. A bit guard and a dust-collection port are also included.

\$44.90 Phenolic Router Insert Plates



RTPMP-1 |



Produced from high quality phenolic ensures perfect mating with the aluminium mounting plate to be perfectly flat.

Blank insert rings are available so you can drill whatever size you need

or raise the bit through the ring to create a perfect zero-clearance insert.

Also available as a set of four rings that are pre-drilled with 6.75, 12.9, 30.0 & 38.2mm holes.

\$75.00 Rip-Cut Saw Guide



KMA-2685 | 1.25kg



Turn Your Circular Saw Into A Precision Cutting Tool!

- ✓ Connects to most circular saws – right or left blade
- ✓ Reversible guide arm for right – or left-handed use
- ✓ Cut materials up to 610mm wide
- ✓ No need for measuring, marking, or layout lines

- ✓ 100% guide-support through the entire cut
- ✓ Quick and accurate adjustments – no tools required
- ✓ Lightweight, sturdy design for use on the jobsite
- ✓ Saw sled is 165 x 210mm platform

\$149.00 Router Extension Wing



REW-1 | 14kg

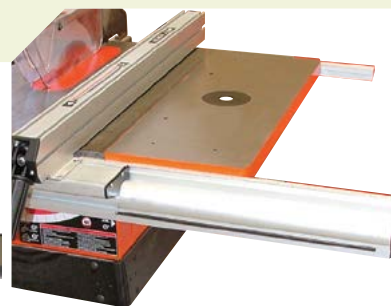

Suits table saws with a 685mm-long mitre slot. Three pre-drilled holes exist, but if they don't line up on your saw, it can be drilled out with a standard twist drill bit.

T-channels run underneath to work with the included set of clamps holding any standard plunge-base router in place. Hole diameter is 90mm, with 30mm and 60mm insert rings included.

\$149.00 Accu-cut Track Saw Kit



Straight, accurate, splinter-free cuts made easy

- ✓ Rip, cross cut, and make angled cuts up to 1220mm long in plywood, MDF, and panels
- ✓ Simply align the Guide Track with your marks to make accurate cuts
- ✓ Hold track in place without clamps thanks to anti-slip guide strips
- ✓ Prevent splintering with anti-chip strips that support material during the cut
- ✓ Begin cuts easily with a Starting Block that the supports saw and allows normal blade guard operation
- ✓ Mount almost any circular saw—left or right blade—to the Universal Sled
- ✓ Universal Sled is compatible with the Kreg Rip-Cut™
- ✓ Take your saw to the material instead of having to take your material to the saw

\$59.90 Mitre Guide Only



RTMG | 1kg



Available separately now is the simple, solid mitre guide show above. Standard mitre bar size 3/4 x 3/8in. The extruded aluminium sub-fence that measures 330 x 25

x 72mm which easily attaches to the mitre guide protractor and can slide close to the cutting edge providing maximum support to the work piece and improving shop safety.

\$59.90 Router Table Switch Sold Separately



RTSW-10

See pages 64 and 65 to see mounted on Router Tables.

The router table switchbox is available separately on its own. It doesn't come with any mounting brackets, however the front face of the switch can be removed to gain access to the four mounting holes located in the back of the box. Rated up to 10 amps with a direct contact switch mechanism. It also has a removable locking key so you can prevent accidental turning on by removing the key and taking it with you.

Prod Code	Product	Price
KMA-2700	Accu-Cut Track Guide System	\$149.00
KMA-2699	Replacement Guide Strips	\$15.90
KMA-7520	Track Clamps Set of 2	\$29.00

Extraction & Safety
Measuring & Marking
Sawing
Site & Shop Accessories
Routing
Planing
Sanding & Scraping
Drilling
Joinery
Clamps & Vices
Finishing
Sharpening
Carving & Chisels
Woodturning
Wooden Parts
Cabinet Fittings

Inkra LS Positioners

Inkra's LS positioners are the world's most versatile and accurate movable fence for your router table. They are designed to meet the needs of the most serious woodworker yet easy enough for even a beginner to use. The LS stands for Lead Screw and the patented technology makes

this unit the leader in precision positioners for woodworking.

The LS positioner's accuracy is +/- 0.05mm on the lead screw's 1.0mm increments across its entire range, so it's essentially perfect even

without the built-in micro adjust. The large micro-adjust knob turns the lead screw against the mating threads, allowing the fence to be shifted in 0.025mm steps to tweak the width of a groove or zero the fence against a router bit.



from **\$599.00**

Inkra LS Joinery System

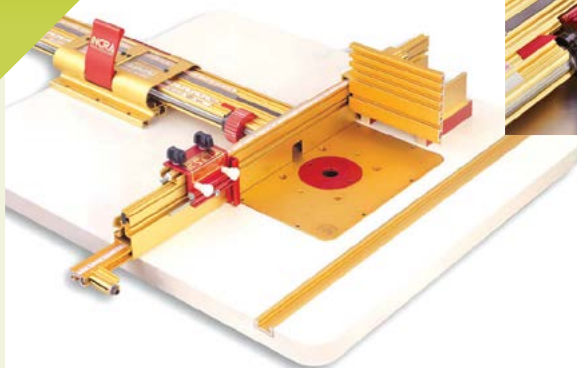

The LS Joinery System gives you one of the most versatile, unique, accurate and easy-to-use joinery systems. Five channels on the top of the LS positioner are where you slide one of the included joinery reference templates to cut just about any dovetail and box joint that you can think of.

You can do a massive range of box joints and standard dovetails as well as the joints unique to the Incra system – double and double-double dovetails plus so much more.

Included in each LS Joinery System are the following components;

- ✓ Incra LS carriage
- ✓ 710mm Pro-II Joinery Fence
- ✓ 330mm Extender Bar & Stop
- ✓ ShopStop
- ✓ Jumbo Right-Angle Fixture
- ✓ Master Reference & Template Library
- ✓ 82-minute Instructional DVD

What else do you get when you buy from Timbecon that you won't get anywhere else?

8 Piece Router Bit Set and Incra Projects & Techniques Book valued at \$39.90 included free.

Prod Code	Product	Weight	Price
LS-17-MSYS	430mm Capacity	10kg	\$599.00
LS-25-MSYS	635mm Capacity	11kg	\$649.00
LSWFUG	WonderFence Upgrade Kit	5kg	\$369.00



from **\$849.00**

LS WonderFence Super Systems

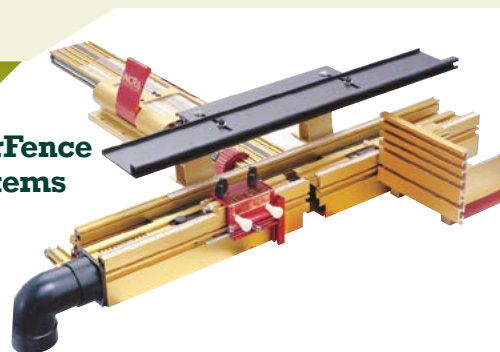

Need to do more with your router table than joinery work? Then the ultimate package is the INCRA LS Super System. It contains all of the components of the LS Joinery System with the addition of the Incra WonderFence.

The WonderFence slides into the front T-slot of the Pro-II Joinery Fence, and it adds adjustability to accept any size router bit, as well as accommodate zero-clearance

sub-fences. The WonderFence also adds the ability to very precisely offset the in-feed and out-feed fence halves for edge jointing rough timber or setting up for complex moulding jobs like reversible glue joints.

Not just for dovetail and box jointing, this system is the absolute best routing fence available anywhere in the world.

Prod Code	Product	Weight	Price
LS-17-MWF	430mm Capacity	15kg	\$849.00
LS-25-MWF	635mm Capacity	16kg	\$899.00



from **\$99.00**

Original Incra Jig

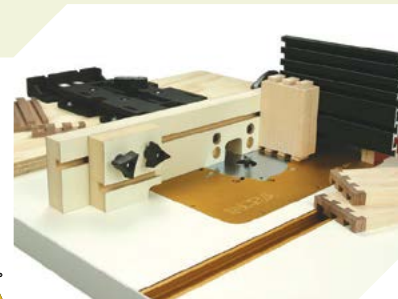

The Original Incra Jig has been reissued, and the same qualities that made it such a knockout are still relevant in workshops today.

The only two moving parts are the locking knob and the single-piece upper carriage and it indexes on 1.0mm increments with 0.025mm positioning accuracy and repeatability.

The rigid, glass-reinforced resin body provides 200mm of solid fence travel. The patented incremental racks are installed where the halves of the jig meet and when the clamping knob is

tightened, the teeth mesh, causing the fence and carriage to instantly "centre up" on the perfect multiples of 1.0mm increments far more precisely than working by eye alone.

By adding the Incra Jig Fence System, 3/8in box joint and 1/2in dovetails can also be produced equally spaced or variably spaced. The dovetail template can be made half-blind, through, sliding, or corner-post.

For even more variety check out the Incra Master Reference Guide overleaf.

Prod Code	Product	Weight	Price
IJ-32-M	Original Incra Jig Only	1.6kg	\$99.00
IJ-32-FNC	Fence, Stop & Right Angle Fixture	1.6kg	\$99.00
IJ-32-MSET	Incra Jig & Fence System	3.3kg	\$195.00



\$149.00

Wooden HingeCrafter Jig



IHCM-1 | 1.2kg

Combine your INCRA Positioner with the HingeCrafter drill guide and you will have beautiful wooden hinges ready to glue right into your project with four different diameter hinges using Incra's famous incremental accuracy.

It easily works with extra-length hinges. With the four diameters you have hundreds of options for your next hinge based project. The only limit is twice the length of your drill bit. The included bit will make hinges over 250mm long!

from
\$1,999.00

INCRA

LS Super System Table Combo's



We now have complete routing table packages available that matches Incra's legendary LS Positioner quality.

- ✓ Reinforced rigid open-leg stand featuring solid tubular steel legs bolted with four extra braces to create a stable platform for the offset tables.
- ✓ The remote switchbox and mounting bracket is included
- ✓ Australian CNC-machined table-tops manufactured from 32mm High Moisture Resistant melamine MDF with 2mm PVC edging.
- ✓ Extruded, anodized 3/4in aluminium mitre and 5/16in t-track are supplied for installation by the user

Prod Code	Product	Weight	Price
LSWFKIT-2	Super System Combo #2	67kg	\$1,999.00
LSWFKIT-4	Super System Combo #4	72kg	\$2,099.00
LSWFKIT-2-CNC	Combo #2 with CNC Spindle	77kg	\$2,999.00
LSWFKIT-4-CNC	Combo #4 with CNC Spindle	82kg	\$3,099.00

For more info on the CNC Spindle please go to p.63

Super System Combo #2 Includes -

430mm Incra LS Super System
1170 x 684mm table top
Stand and remote switch
RLIFT-3 Router Lift System
RTDCB Dust Collection Box

Super System Combo #4 Includes -

635mm Incra LS Super System
1370 x 684mm table top
Stand and remote switch
RLIFT-3 Router Lift System
RTDCB Dust Collection Box

from
\$1,149.00

INCRA

LS Joinery Table Combo's

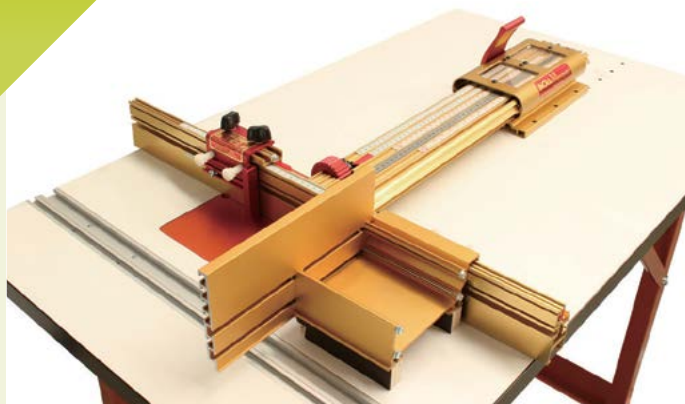

Buy the Incra LS Joinery System in a combo for a turn-key solution to your new LS Positioner Joinery System.

Joinery Combo #1 Includes -
430mm LS Joinery System
1170 x 684mm table top
Stand and remote switch
RTAMP-2 router mounting plate

Joinery Combo #3 Includes -
635mm LS Joinery System
1370 x 684mm table top
Stand and remote switch
RTAMP-2 router mounting plate

Prod Code	Product	Weight	Price
LSJKIT-1	Joinery Combo #1	49kg	\$1,149.00
LSJKIT-3	Joinery Combo #3	54kg	\$1,199.00

Table Components

Prod Code	Product	Weight	Price
RT-2746-MT	Table Top Only - 430mm Jigs	17kg	\$249.00
RT-2754-MT	Table Top Only - 635mm Jigs	19kg	\$279.00
RT-2336-ST	Stand & Switch Only	20kg	\$299.00



\$39.90

Projects & Techniques Book

INCRA
IP-4 | 520g

The definitive work on using INCRA Tools. This 148 page book contains detailed plans with over 400 illustrations and photos to build 14 of Perry McDaniel's intriguing original projects.



Also included are 11 Techniques sections that will turn any woodworker into a real INCRA pro, plus complete instructions for making four exclusive new INCRA joints.

\$49.90

Master Reference Guide & Template Library

INCRA
IMM-3 | 520g

This complete guide contains clear, step-by-step instructions for making Box Joints, Half Blind and Through Dovetails, and INCRA's trademark Double and Double-Double Joints. Over 200 detailed illustrations and



photos, plus numerous handy tips help guarantee success.

This book is included with the INCRA LS Joinery and Super Systems.

\$59.90

Metric ShopStop

INCRA
ISM-2 | 250g

The Incra ShopStop is their most versatile stop. The vertical stop bar is adjustable up and down, it can be reversed, and it has a screw-based micro adjustment. The ShopStop is also expandable - the top section can be slid into a second channel



on the base section to make the interior wide enough to span an Incra fence and a wooden sub fence up to 19.0mm thick.

INCRA's patented positioning mechanics make it deadly accurate and completely repeatable.

Shark CNCs

The All New CNC Shark range features a new heavy duty gantry reinforced with plate aluminium to allow heavier routing applications and a rigid interlocking aluminium table. It comes with a Color Pendant Controller and CNC Shark's Exclusive Auto Alignment.

It has anti-backlash, wear-compensated high precision lead screws on all 3 axis and is built to handle large round-body 1/2in routers popular in the North American market and can be supplied with water-cooled spindles (sold separately) here in Australia.

Simply supply a PC computer with USB 2.0 port, connect the USB cable to the controller box and load the software. All Sharks come with a DVD to install fully-featured licenced Vectric VCarve Desktop V9 Design software, Vector Art 3D Sampler Pack, and CNC Shark Control Software - all integrated to work straight out of the box.

XYZ travel:

- ✓ Shark II - 330 x 625 x 175mm (13 x 25 x 7in)
- ✓ Shark HD4 - 635 x 635 x 175mm (25 x 25 x 7in)
- ✓ HD4 Extended - 635 x 1270 x 175mm (25 x 50 x 7in)

Overall dimensions:

- ✓ Shark II - 615 x 914 x 620mm (W x L x H)
- ✓ Shark HD4 - 920 x 914 x 620mm (W x L x H)
- ✓ HD4 Extended - 920 x 1600 x 620mm (W x L x H)

Prod Code	Product	Price
NW-10020	Shark II	\$5,299.00
NW-10018	Shark HD4	\$6,799.00
NW-10019	HD4 Extended	\$8,599.00
NW-20006	Dust Boot	\$149.00



Next Wave Automation

Piranha CNCs

Although featuring an entry level price, the CNC Piranha FX® is every bit as capable as its large CNC Shark cousins.

Its compact table size makes it perfect for smaller-scale projects from wood, soft metals, or plastics, all at a fraction of the price of a full-sized CNC. With its 3D carving capability, including a 3D models library, you can carve with incredible accuracy, you can even engrave custom circuit boards with it.

XYZ travel:

- ✓ Piranha FX - 305 x 330 x 76mm (12 x 13 x 3in)
- ✓ Piranha XL - 305 x 610 x 102mm (12 x 13 x 4in)

Overall dimensions:

- ✓ Piranha FX - 495 x 520 x 457mm (19-1/2 x 20-1/2 x 18in - W x L x H)
- ✓ Piranha XL - 495 x 775 x 610mm (19-1/2 x 30-1/2 x 24in - W x L x H)

Includes VCarve Desktop V8 Design software now incorporating Cut 3D functionality and Vector Art 3D Sampler Pack

- ✓ Color touch screen pendant controller system
- ✓ Requires a PC computer with USB 2.0 port (not included)
- ✓ Requires a Dewalt, Makita, Bosch or similar style 1/4in router trimmer (sold separately)
- ✓ Ships fully assembled and Made in USA

Code	Product	Price
NW-10001	Piranha FX	\$2,699.00
NW-10014	Piranha XL	\$3,849.00
NW-20015	Dust Boot	\$149.00
NW-20012	Laser Module	\$1,249.00



Next Wave Automation

Ready2Rout

Shown mounted on Kreg Router Table and Stand (sold separately)

Next Wave Automation



The Ready2Rout Router Table System adapts to virtually any router table and provides the user with the accuracy of a CNC router. In addition to being able to adjust either the fence or lift to measurements to as little as 0.025mm or 0.001in (!!!) the Ready2Rout Router Table System also has a suite of built in joinery apps that takes the guesswork out of once complicated setups and allows repeatability virtually unmatched with any other system.

The Router Table System comes with a router lift that is designed to mount large round-body 1/2in routers popular in the North American market and can be supplied with water-cooled spindles (sold separately) here in Australia.

It also includes the Ready2Rout fence that is controlled in conjunction with the Router2Rout Lift from the one colour touch-screen pendant. In other words, the pendant gives you fence movement accuracy AND router bit height accuracy, both to within 0.025mm, which of course is repeatable and completely foolproof.

from
\$525.00

Router Lift Kit



The top mounting plates are milled and CNC-machined from 6mm-thick aluminium plate. This lift has a four pillar design - all threaded so that when the cradle is adjusted - they all act in unison to keep the cradle perfectly parallel to the top plate.

The pitch has been set so a full revolution of the winder handle results in exactly 2.00mm of height adjustment - a quarter turn is exactly 0.5mm and even the positive action of one graduation is as fine as 0.05mm. There is minimal backlash so you have

certainty that you can make these fine adjustments and rely on their accuracy.

The cradle is a huge piece of cast aluminium. Vibration is absorbed through this massive reinforced cradle. All the important parts are machined multiple times so that the mounting system mates perfectly square with the mounting plate above it.

There are two mounting options -

1. Base plate mount for standard plunge routers
2. Sleeve mount for fixed-base (round body) motors

Prod Code	Product	Weight	Price
RLIFT-2	305 x 230mm Base Plate Mount	7kg	\$525.00
RLIFT-3	298 x 235mm Base Plate Mount	7kg	\$525.00
RLIFT-4	298 x 235mm Sleeve Mount	8kg	\$599.00
RLIFT-4-CNC	Includes CNC Spindle Kit	17kg	\$1499.00

\$999.00

CNC Water-Cooled Spindle & Inverter Kit

Includes all the components necessary to mount to your CNC machine or router table lift (Ready2Rout or Sherwood Router Lift) - just supply your own water receptacle.

The benefits of pairing a Sherwood water-cooled CNC spindle are many.

1. All brush-type routers have a normal 1,000 working hour lifespan. CNC spindles have a 10,000 hour lifespan - ten times a router!
2. CNC spindles run whisper quiet. The most noise is generated only when the bit engages with the work piece.
3. It comes standard with an external inverter - you can turn it on and off and adjust the speed remotely as standard.
4. The inverter converts standard single-phase 240V to three-phase 415V 2.2kW power - to handle ANY routing cut.
5. The electronic inverter maintains maximum torque literally from 0 - 24,000rpm.
6. The spindle uses industry-standard ER20 collets, so with a full collet set, you can run any bit with a shank size 2 - 13mm. The spindle comes standard with 12-13mm collet to run normal 1/2in shank bits.
7. The spindle is water-cooled - meaning it can run all-day, every day without variation, regardless of ambient temperature.
8. The collet sits a comfortable distance to ensure above-table bit changes when used in a router table straight out of the box.

Prod Code	Product	Price
CNC-2200-KIT	CNC Water-Cooled Spindle Kit	\$999.00
ER-20-KIT	ER20 Collet Kit 1 - 13mm Range	\$219.00

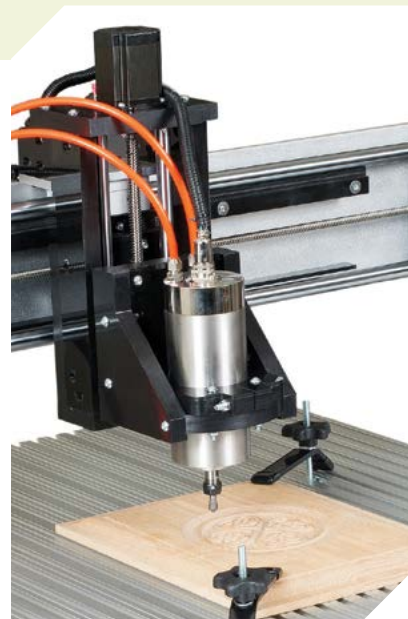

from
\$159.00

Router Raizer Height Winder Kits

Router Technologies



The fastest most versatile height adjustment system available for your plunge router!! It does not require a special insert or re-machining your table to fit, just use any standard table or insert 4.8 - 12.7mm thick and all the parts that come with the kit will fit and function perfectly.

The two kits fit 18 different models of routers from 9 different manufacturers.

By replacing the original height adjustment system it becomes an integral part of the router and makes both above and below table fine adjustments so easy. An absolute joy to use and so simple! RZ100 suits DeWalt, Hitachi, 3612* Makita models PLUS MORE

RZ200 suits Bosch 16", Triton RP/ RF Makita models PLUS MORE

Prod Code	Product	Weight	Price
RZ-100	RZ100 Kit	550g	\$159.00
RZ-200	RZ200 Kit	450g	\$159.00

\$95.00

Aluminium Mounting Plate

SHERWOOD

The Sherwood aluminium router mounting plate is precision-milled and CNC-machined from 6mm-thick aluminium plate. Anodized in Sherwood orange and then checked for flatness. Where necessary, each plate is adjusted for flatness for a perfect smooth surface closest to the bit - where it matters most.

There are six grub screws installed along the edges of the mount plate to ensure a perfectly level fit on the lip of the router table. The centre hole is 92.2mm diameter and includes one phenolic twist-lock insert ring that has a 38.1mm aperture.

Prod Code	Product	Weight	Price
RTAMP-2	305 x 230mm size	1.3kg	\$95.00
RTAMP-3	298 x 235mm size	1.3kg	\$95.00



ROUTING

Extraction & Safety
Measuring & Marking
Sawing
Site & Shop Accessories
Routing
Planing
Sanding & Scraping
Drilling
Joinery
Clamps & Vices
Finishing
Sharpening
Carving & Chisels
Woodturning
Wooden Parts
Cabinet Fittings

\$699.00

MDF/Phenolic Portable Router Table



SHERWOOD
RT-610-K5

For more information on the individual components please check the individual product descriptions in the catalogue or our website for even more info.

This kit contains the following items:

✓ 610 x 406mm Router Table
MDF/Phenolic Top

- ✓ Benchtop Router Stand – including remote switch & mitre guide
- ✓ 600-700mm Super-Flat Router Fence
- ✓ 298 x 235mm Aluminium Mounting Plate

\$649.00

MDF/Phenolic Deluxe Benchtop Table



SHERWOOD
RT-610-K6

For more information on the individual components please check the individual product descriptions in the catalogue or our website for even more info.

This kit contains the following items:

✓ 610 x 406mm Router Table
MDF/Phenolic Top

✓ Benchtop Router Stand – including remote switch & mitre guide

- ✓ 600 – 700mm Super-Flat Router Fence
- ✓ Super-Flat Fence Fine Adjustment Kit
- ✓ Super-Flat Fence Flip Stop
- ✓ 2x universal table feather boards
- ✓ 2x universal fence feather boards
- ✓ Router table dust collection system
- ✓ 298 x 235mm plunge router lift

\$799.00

Cast-Iron Benchtop Router Table



SHERWOOD
RT-685-K3

Includes all the components of the MDF/Phenolic Portable Router

Table, replacing the table top with the 685 x 406mm cast-iron version.

from **\$1,599.00**

Cast-Iron Industrial Benchtop Tables

SHERWOOD
RT-685-K4



Includes all the components of the MDF/Phenolic Deluxe Benchtop

Table, replacing the table top with the 685 x 406mm cast-iron version.

from **\$699.00**

Cast-Iron Industrial Router Extension Wings



For more information on the individual components please check the individual product descriptions in the catalogue or our website for even more info.

The Basic Kit contains the following items –

- ✓ 685 x 406mm Router Table Cast-Iron Top
- ✓ 600 – 700mm Super-Flat Router Fence
- ✓ 298 x 235mm Aluminium Mounting Plate
- ✓ Remote Switchbox and Mount Bracket
- ✓ Most necessary mounting hardware*

The Deluxe Kit contains all of the above plus –

- ✓ Router Table Dust Collection System
- ✓ 298 x 235mm plunge router lift
- ✓ Option of body mount lift & CNC Spindle Kit

*Please Note - some hardware is included but may not suit your table saw so some may need to be user-provided to complete installation

Prod Code	Product	Weight	Price
RT-685-K10	Basic Kit	34kg	\$699.00
RT-685-K12	Deluxe Kit	47kg	\$1,299.00
RT-685-K12-CNC	Deluxe Kit with CNC Spindle	55kg	\$2,299.00

\$879.00

MDF/Phenolic Full-Size Router Table

SHERWOOD
RT-810-K5



For more information on the individual components please check the individual product descriptions in the catalogue or our website for even more info. This kit contains the following items—

- ✓ 810 x 610mm Router Table MDF/Phenolic Top
- ✓ Full-Size Router Stand – including remote switch & mitre guide
- ✓ 810mm Super-Flat Router Fence
- ✓ 298 x 235mm Aluminium Mounting Plate

\$1,199.00

Cast-Iron Full-Size Router Table

SHERWOOD
RT-810-K3



Includes all the components of the MDF/Phenolic Full-Size Router Table, replacing the table top with the 810 x 610mm cast-iron version.

from
\$1,599.00

MDF/Phenolic Deluxe Router Tables

SHERWOOD
RT-810-K6



For more information on the individual components please check the individual product descriptions in the catalogue or our website for even more info.

This kit contains the following items –

- ✓ 810 x 610mm Router Table MDF/Phenolic Top
- ✓ Full-Size Router Stand – including remote switch & mitre guide
- ✓ 810mm Super-Flat Router Fence
- ✓ Super-Flat Fence Fine Adjustment Kit
- ✓ Super-Flat Fence Flip Stop
- ✓ 2x universal table feather boards
- ✓ 2x universal fence feather boards
- ✓ Router table dust collection system
- ✓ Your choice of –
 - ✓ 298 x 235mm plunge router lift
 - ✓ 298 x 235mm fixed base router lift with Industrial Water-Cooled Spindle Kit

Prod Code	Product	Weight	Price
RT-810-K6	Deluxe Router Table	62kg	\$1599.00
RT-810-K6-CNC	Includes CNC Spindle Kit	72kg	\$2,599.00

from
\$1,899.00

Cast-Iron Industrial Router Tables

SHERWOOD
RT-810-K4



Shown with optional CNC spindle installed

Includes all the components of the MDF/Phenolic Full-Size Router Table, replacing the table top with the 810 x 610mm cast-iron version.

Prod Code	Product	Weight	Price
RT-810-K4	Industrial Router Table	62kg	\$1899.00
RT-810-K4-CNC	Includes CNC Spindle Kit	72kg	\$2,899.00

\$149.00

Dust Collection Box

SHERWOOD

As shown on Deluxe Kits

Designed to bolt or screw to the underside of router tables. The included 2 1/2in hose can be hooked up to the dust outlet on the back of the Super-Flat Router Fences and then connect it to the 4in dust outlet at the rear of the box to extract dust from both locations straight to your dust collector for a solution that removes around 99.5% of all dust (ensuring that there is suitable access to the bit at the fence).

Extraction & Safety
Measuring & Marking
Sawing
Site & Shop Accessories
Routing
Planing
Sanding & Scraping
Drilling
Joinery
Clamps & Vices
Finishing
Sharpening
Carving & Chisels
Woodturning
Wooden Parts
Cabinet Fittings

ROUTING

from **\$169.00**

MDF/Phenolic Tables Tops



While cast-iron table tops are the ideal choice when it comes to your router table, there is one flaw with cast-iron that means you need another option - weight.

- Produced from 30mm-thick HMR (High Moisture Resistant) MDF.
- Vacuum-pressed phenolic top and bottom - a durable and long-lasting polymer with reduced friction.
- Sealed on all four sides with 2mm-thick black PVC edgebanding.
- Weight saving of the bench router table top compared to cast-iron is 13kg.
- Weight saving of the full-size router table top compared to cast-iron is 28kg.
- Aluminium extrusion containing 19.0 x 9.5mm (3/4 x 3/8in) t-mitre guide and full-size 5/16in t-track slot pre-installed.

Prod Code	Product	Weight	Price
RT-610-PT	610 x 405mm	7kg	\$169.00
RT-810-PT	810 x 610mm	14kg	\$249.00

from **\$189.00**

Super-Flat Router Fences

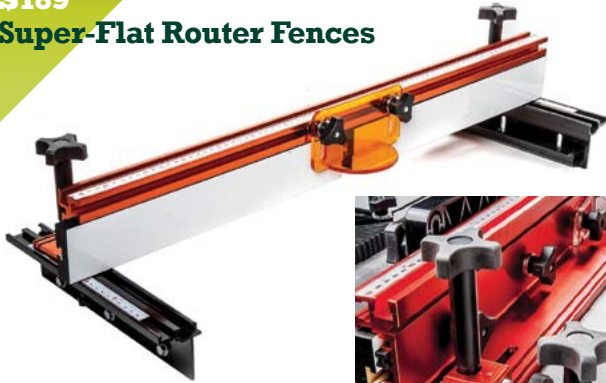

- Independent Clamping System - mount brackets included to take the pressure off the table.
- Recalibratable Scales - reset to zero from a reference point to reduce calculation errors when adjusting fence.
- Heavy-Duty Engineered Fence - extruded from aircraft-grade aluminium and then CNC-milled to length
- Two Sizes Available just two variables - fence length and mounting bracket length. All other dimensions remain the same.
- Full size 5/16in T-tracks are moulded into the top and front
- of the fence for attaching stops, feather boards or other custom fixtures.
- Sacrificial sub-fences are UHMW polyethylene coated for a smooth surface glide of your work piece. Replacements available.
- Clear 2 1/2in dust outlet and safety orange polycarbonate bit cover included.
- Offset Routing - H-pattern spacers provide either a 1mm or 2mm to offset on the outfeed fence for use as a planer.
- Quality hardware used throughout the whole fence system.

Also available is a fine adjustment assembly that you can retrofit where you lock the main handle, then perform fine adjustment then lock the fence in place when perfectly located - no more tapping and trial and error required to get it right first time, every time.

Prod Code	Product	Price
RT-2716-FNC	Fence suits 590-685mm Long Tables	\$189.00
RT-3224-FNC	Fence suits 700-810mm Long Tables	\$215.00
RT-2716-FNC-9	Replacement Sub-Fence Pack of 2	\$31.00
RT-3224-FNC-9	Replacement Sub-Fence Set of 2	\$33.00
RTFNCFAS	Fine Adjustment Assembly	\$69.90

from **\$349.00**

Cast Iron Table Tops



One of the most important parts of a router table is the flatness and support provided by the table top. You need one of the Sherwood Cast-Iron Router Table Tops.

- Four-step machining process so it is flat straight out of the box
- Huge 38mm edge casting with maximum casting support around the aperture
- Designed to take industry-standard 298 x 235mm mounting plates.
- 19.0 x 9.5mm (3/4 x 3/8in) t-mitre guide and full-size 5/16in t-track slot precision machined into the table top

Unlike other brands, the only difference between the smaller and large table top is the external footprint dimensions.

Prod Code	Product	Weight	Price
RT-685-CIT	685 x 405mm	27kg	\$349.00
RT-810-CIT	810 x 610mm	42kg	\$599.00

from **\$249.00**

Router Table Stands



Like all Sherwood router table components - the stands are built to the same stringent specifications, with the only difference being the footprint. Both include the mitre guides and remote switches mounted as shown, as well as the brackets for storing the mitre guide and router lift winder.

Full-Size Stand

The full-size stand has straight square-tube legs which provide four pillars of strength. Cross-braced with 2mm-thick folded steel plate frames, threads are cut directly into the legs, ensuring fast assembly and creating a square frame straight out of the box. Designed to take both 810 x 610mm table tops.

Benchtop Stand

Designed to be accept the heavy-duty 685 x 405mm cast-iron router table top and smaller, lighter 610 x 406mm top. Not a single corner has been cut with the benchtop stand - all produced from folded 2mm, metallic powdercoated steel plate for maximum reinforcement and zero flex - a rock solid base for a benchtop router table.

Prod Code	Product	Price
RT-685-ST	Benchtop Stand	\$249.00
RT-810-ST	Full Size Stand	\$349.00

\$149.00 Router Table Extension Frame

SHERWOOD
RT-3224-SE | 5kg



Working with end-grain or panel product regularly? This is a great accessory to have. Suits the 810mm tables and either bolts directly to the underside of the cast-iron top or screws to the

underside of the MDF/phenolic tops. It extends support of the work piece by up to 500mm from the edge of the table - taking the centre point of work piece up to 800mm from the bit.

\$259.00 Deluxe Coping Sled



The new Baladonia Deluxe Coping Sled is the router table accessory you need to make rail & style doors, tenons, lap joints and any other tricky end grain cuts. It has been engineered to provide the very best in control, safety and repeatability.

This sled easily outperforms home-made jigs and works in a standard 3/4 x 3/8in mitre slot. Four-sided clamping pressure and precision milled high-grade materials ensures perfect repeatability and accuracy every time.

\$39.90 Fence Flip Stop

SHERWOOD
RTFNCFS | 280g



A heavy-duty flip stop that mounts into the t-track on the top of the Super-Flat Fences. Finished in gloss black for excellent contrast on the white fence face. Measuring 35mm thick and protruding 40mm

from the fence it is rock solid. A large and secure pivot point with zero side play means it can be relied on for many years of service, just like the rest of the range.

\$159.00 Fence Right- Angle Fixture

SHERWOOD
RTRAF | 1.6kg

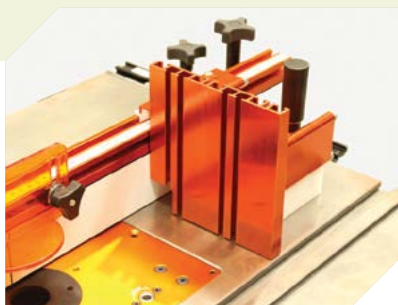

Doing a lot of fine, vertical routing work using a Baladonia Router Table Fence? This right-angle fixture runs in the t-slot on the top of the fence via a matching precision-milled UHMW t-profile. Produced from heavy-duty extruded aluminium the face measures 165 x 165mm with a 32 x 32mm cut-out

to clear the router bit. Due to the ingenious design, it locks in square to the fence automatically and only requires one low-friction UHMW support leg to glide across the router table top. In-built grip handle makes it comfortable to use with 3x nylon screws to fine-tune the glide on the fence.

\$34.90 TurnLock Baseplate Kit

MILESCRAFT



- TurnLock™ concept turns changing guide bushings, and installing router attachments, into a simple matter of a 1/4 twist.
- Align the TurnLock™ bushing inside the TurnLock™ base, and twist to lock in place
- Simply reverse the simple process to remove the bushing
- TurnLock™ Base Plate is made from clear resin, greatly increasing the user's visibility of the work area

- The TurnLock™ base attaches to any of the Milescraft® router attachments via the same principle...align and twist.
- The Kit includes the BasePlate, centering pin and 8 guide bushings - 5/16in
 - 3/8in
 - 7/16in
 - 1/2in
 - 2x 5/8in (one standard length and one long)
 - 51/64in

Prod Code	Product	Weight	Price
MC-1201	BasePlate Kit	525g	\$34.90
MC-1216	Guide Bushing Set	150g	\$19.90

\$49.90 Brass Template Guide Set

BALADONIA
BTGK-01 | 400g



Based on the popular Porter Cable bushing design that many adapters are made for to go on a variety of routers now, this set includes 5/16in, 11/32in, 3/8in, 7/16in 1/2in, 9/16in, and 5/8in

OD templates and two lock nuts. Precision machined solid brass in a case. The TurnLock BasePlate Kit above includes a top-hat adapter to accept these template guides.

from \$69.00 Lock Mitre Setup Jigs

INFINITY
CUTTING TOOLS



The Infinity Lock Mitre Master jig is a simple, yet precisely machined, setup-aid for use with lock mitre router bits (in table mounted routers only). Unlike other setup jigs or blocks, it's easy to use and opens up new locking mitre joint possibilities. It requires zero math calculations and virtually no trial and error cuts. With these jigs you can quickly and easily set the proper bit height AND

fence position for precise-fitting standard and special case lock miter joints. They attach securely to your router bit with rare earth magnets and are precision milled with engraved reference lines that make it easy to set-up flawless standard lock miter joints as well as a variety of special lock miter joints only possible with the Lock Miter Master.

Prod Code	Product	Weight	Price
LMM-002	Jig Suits Baby Lock Mitre Bits	10g	\$69.00
LMM-003	Jig Suits Std Lock Mitre Bits	10g	\$69.00
LMMSET	Set of Two Setup Jigs	20g	\$129.00

ROUTING

\$99.00

SignPro Signmaking Kit

MILESCRAFT



- ✓ Create professional timber signs up to 36in long at one time
- ✓ All hardware included for sign-making – just supply your own router and timber
- ✓ The durable plastic character templates are self-spacing so there is no measuring required
- ✓ Milescraft TurnLock BasePlate and required size template guides included
- ✓ The template frame and hold-down clamps are inside the box
- ✓ 1/2in shank round-nose router bits to suit different size letters
- ✓ SignPro comes with two sets of 1 1/2in (38mm) AND 2 1/2in (63mm) letter and numbers so you can create words that use two of the same letter at the same time for each letter height (ENTRANCE for instance – that has two E's & N's)
- ✓ SignPro comes with two sets of 1 1/2in (38mm) AND 2 1/2in (63mm) letter and numbers
- ✓ SignPro includes vertical number sets for routing mailboxes etc.

Prod Code	Product	Weight	Price
MC-1212	SignPro Kit	3.6kg	\$99.00
MC-2202	Replacement 38mm Template Set	230g	\$17.90
MC-2201	Replacement 63mm Template Set	320g	\$17.90
MC-2211	Replacement 1/4in Round Nose Bit	30g	\$15.00
MC-2212	Replacement 3/8in Round Nose Bit	30g	\$16.00
MC-2213	Optional 1/2in Round Nose Bit	30g	\$17.00

\$89.90

Pantograph Pro Kit

MILESCRAFT
MC-1221 | 3.2kg



- ✓ Trace along any letter stencil or line drawing, while your router makes the same cut at a 50 percent reduction
- ✓ Easily controlled fingertip stylus
- ✓ Comes with two font stencils, Modern & Old English
- ✓ Attaches easily to most routers
- ✓ using the included TurnLock™ BasePlate
- ✓ Develop your own stencils using other sources such as a computer, colouring book or any other type of downloaded art
- ✓ Includes 3 different router bits
- ✓ Minimal assembly is required

\$69.90

Circle Router Guide Kit

MILESCRAFT

MC-1269

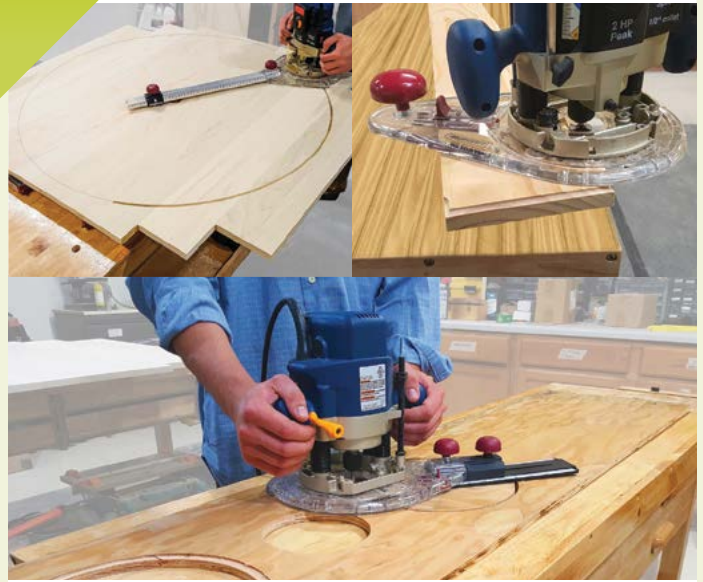

Cut small and large circles with the CircleGuideKit. With the included TurnLock™ base plate, this product is compatible with almost all plunge-base routers. No longer a need for that homemade circle cutting jig, the CircleGuideKit does it all for you straight out of the box and includes everything you need to start straight away.

The small circle jig cuts 38 – 305mm circles with the large circle jig overlapping and cutting 254 – 1320mm circles. Changing over from each jig takes seconds with the patented TurnLock™ technology. The included bonus 330mm offset base provides added stability when finishing the edges on your work piece using your router handheld.

\$79.90

Decorative Design/Inlay Kit

MILESCRAFT
MC-1207 | 1.15kg

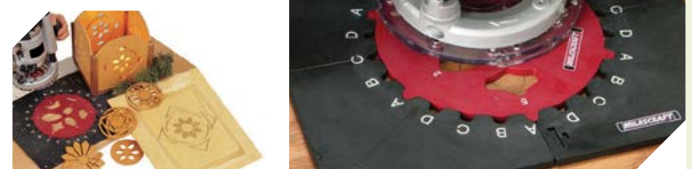

- ✓ The core of the Design/Inlay Kit is the indexing ring and four template patterns that fall into place in-line with the 16-position indexing marks
- ✓ This allows you to create multiple patterns at various precise intersections from the centre starting point
- ✓ User manual contains 25 design ideas, plus instructions on the best way to create your own designs
- ✓ Multiple sizes of common inlay shapes are also included.
- ✓ Pencil guide and pencil duplicate the cutting path of the router allowing you to practice your designs before cutting the project material.
- ✓ Kit includes everything you need (even router bits) so just supply your own router and wood and get started

\$49.90

Edge & Mortise Guide

MILESCRAFT
MC-1224



Get more from your router with this innovative new base from Milescraft. The offset base provides better support for edge routing, with the included fence you can cut mortises and rabbets all the way to the end of your work piece.

Flip the fence over and use it as a guide to rout grooves around the edge of circular pieces. And fit the included pins in the base plate to provide guidance when mortising on narrow work piece edges and ends with ease.

from
\$189.90

Mk 3 CRB7 Router Base Kit

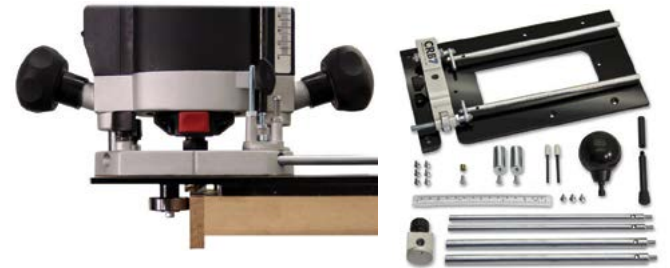

- Set up with speed and ease to any router that has 2 through-rod drillings in the base.

- The CRB7 can be fitted/removed in no time. No fiddly screws or special fitting plates required.

- Indexed Micro Adjuster: Allows precise control over the router cutter position. Knurled and indexed for ease of use.

- 2in Bakelite Ball Handle: Ergonomic design, comfortable to the touch, allows for easy hours of consecutive use.

- Indexed self-adhesive Imperial/Metric rule to ensure quick visual indication of the router cutter position.

- Two Part Anti Tilt Leg: Supports and stabilizes the router when edge routing.

- Professional Grade Build: Made in the United Kingdom to the highest standards.

Tool Functions

- Small Circle Compass: Rout precision circles and holes 38 - 450mm diameter

- Large Circle Compass: Cut circles over 1220mm

- Adjustable Mortising: Allows "centred and off centred mortises.

- Anti Tilt Leg supports the router eliminating router tilt.

- Adjustable Clamp Guide: Accurately rout parallel dado's along the length or width of your work piece.

- Off Set Base Plate: Increases overall router stability while reducing errors.

- Adjustable false panel dado copier: Provides a simple, quick way of accurately repeating a moulded dado.

\$109.00

CRB7 Mortice Hinge & Lock Jig



MP-20075 | 920g



Expand the usefulness of your CRB7 Router Base Kit by purchasing the Mortice Hinge & Lock Jig accessory.

Functions:

- Work mortice length with uninterrupted sight lines
- Cut centred and off centred mortises with minimal setup
- Cut hinge and lock rebates with ease
- Repeat cut sets of flutes instantly
- Edge mould with best-in-class stability
- Parallel edge groove or channelling

Features:

- Quick to fit and easy to set up.
- Creates genuine stability when routing into an edge.
- Twin micro adjustable quick lock jaws.
- Highly adjustable range of stock widths 13 - 175mm wide.
- Mounting points and Fixings included for auxiliary cheeks.
- Machined in anodized aluminium and highly durable Nylon.

This is a deluxe version of the Edge Guide Kit that would no longer be required once this is purchased.

\$2.50

Router Bit Tidies



Great for organizing all the bits lying around your workshop or in a tool bag. The 1/2in organizer holds up to eight bits and the 1/4in organizer can hold up to 40. Dovetail locking system means you can join as many

together as you need and mix and match sizes.

Prod Code	Product	Weight	Price
RBORG-14	For 1/4in Bits	20g	\$2.50
RBORG-12	For 1/2in Bits	20g	\$2.50

Edging & Dowel Trim Kit

Quick-fit the Trim Kit Riser Pad, to flush trim hardwood lippings and dowels in one routing pass.

Edge Guide Kit

Allows parallel dado's up to an impressive 190mm in from the board edge. (a greater range than a regular edge guide offers). Or edge mould decorative panels. Machined in solid clear Perspex with mounting points for a false face piece.

Prod Code	Product	Weight	Price
MP-20005	Mk 3 CRB7 Router Base Kit	1.7kg	\$189.00
MP-20003	Dowel & Edge Trim Kit	580g	\$49.90
MP-20001	Edge Guide Kit	270g	\$34.90
MP-20005-KIT	All Three Above Together	2.6kg	\$249.00

Who Makes Torquata Router Bits?



Torquata router bits have been made in the same factory for over fifteen years and every year they invest in improving the production process as well as expanding capacity to meet increasing global demand.

We believe they are the best value-for-money router bits found in Australia.

Value-for-money means that the mix of the quality and the price are outstanding. It DOES NOT mean they are produced to the cheapest cost; in fact this manufacturer (located in China) is more expensive than many other Asian manufacturers located in countries better-known for quality.

We put our name behind this range because you will not find better value-for-money bits anywhere else.

Tungsten Carbide Selection

Torquata router bits use a unique micro-grain compressed Tungsten-Cobalt formula. The uniform ultra-fine granules are chemically bonded so the tips are consistently manufactured – generally to 92Rc hardness, however this varies by design, depending on the application of the bit.

The factory produces its own carbide tips - only virgin (not recycled) tungsten material is used and that maintains consistency.

All batches of tungsten are quality-control tested before production so every bit you get will work the same every time and you will get multiple sharpens from them.

Tip Brazing

All Torquata router bits either use tungsten-carbide tips or are milled from solid carbide.

The induction brazing process ensures lower temperature and better control so it doesn't affect the chemical composition of the bit body or tips.

The copper-silver braze improves fluidity at reduced brazing temperatures. Each bit's temperature is then reduced in normalizing ovens to relieve any stress from the brazing process.

All tips are CNC-machine brazed to ensure that there is no variation between the bits and the tips are perfectly balanced on the body of the bit.

We guarantee that no Torquata router bit will ever delaminate. We put a lifetime guarantee on it.

Steel Body

The body of the bits are milled on CNC lathes from solid steel bar. Each batch is chemically tested to ensure that it meets the stringent standards required to absorb the high levels of fatigue and abrasion that face all router bits. The shank will never slip in the collet and will stand up to the most punishing cuts.

Cutter Optimisation

Each Torquata router bit has been individually designed to cut as efficiently as possible. Most Torquata router bits feature anti-kickback body designs.

A full body shape is milled with clearance for optimal chip ejection, improving safety and reducing abrasion caused by waste on the tips, extending cutting life.

On many larger bits, a downshear angle (7 - 15°) has been used so rather than chipping at the work piece, it planes the material away by keep the tip in contact with the work piece for longer – producing a smoother finish and more efficient cut – therefore extending cutting life.

Superior Finishing

All Torquata bits are coated with Liquid Black non-stick PTFE coating. This slippery finish reduces friction and therefore heat build-up, plus it has a high temperature resistance for long life.

All Torquata bits are ground on 3-axis CNC machines for razor-sharp long-life edges and if necessary, fully sealed bearings (for long life) are attached, then packaged and sent, ready for you to start using.

Industrial Solid Carbide Spiral Bits



Torquata solid carbide spiral bits begin life as extra-hard C4 micro grain carbide, ground using sophisticated 6-Axis C.N.C. to grind their spiral geometry. The precision of the spiral and hardness of carbide allows for a very sharp edge and typically longer edge sharpness. A straight bit can't compete with that. The geometry and top point allow you to plunge into your work like a drill, using a constant shearing action when making the cuts.

Used handheld, upcut bits eject the waste up towards the shank with a smoother edge on the bottom of the cut, while downcut bits ejects the waste down with a smoother top edge where plunged. Used in a table, upcut bits eject waste under the table with a smoother top edge, and downcut bits eject waste upward with a smoother bottom edge.

Also available are the same spiral bits with double-bearing top guides so they can be used as the cleanest, smoothest flush trim bits.

Spiral bits work perfectly on all forms of solid timber, along, across and on end-grain and leave razor-sharp edges on melamine, veneered boards, ply, MDF and chipboard.



Downcut Spiral Bits

Product Code	Shank Size	Cutting Diameter		Cutting Height		Overall Length	Weight	RRP
		Metric	Imp'l	Metric	Imp'l			
SCD-032-Q	1/4in	3.2	1/8in	12.7	1/2in	50.8	50g	\$28.00
SCD-040-Q	1/4in	4.0	5/32in	12.7	1/2in	50.8	50g	\$28.00
SCD-048-Q	1/4in	4.8	3/16in	19.0	3/4in	50.8	50g	\$28.00
SCD-064-Q	1/4in	6.4	1/4in	19.0	3/4in	50.8	50g	\$28.00
SCD-064-XQ	1/4in	6.4	1/4in	25.4	1in	63.5	50g	\$30.00
SCD-080-H	1/2in	8.0	N/A	25.4	1in	76.1	80g	\$89.00
SCD-095-H	1/2in	9.5	3/8in	31.7	1 1/4in	76.1	80g	\$89.00
SCD-127-H	1/2in	12.7	1/2in	31.7	1 1/4in	76.1	220g	\$89.00
SCD-127-LH	1/2in	12.7	1/2in	38.1	1 1/2in	88.9	220g	\$95.00
SCD-127-XH	1/2in	12.7	1/2in	50.8	2in	102	220g	\$105.00

Upcut Spiral Bits

Product Code	Shank Size	Cutting Diameter		Cutting Height		Overall Length	Weight	RRP
		Metric	Imp'l	Metric	Imp'l			
SCU-032-Q	1/4in	3.2	1/8in	12.7	1/2in	50.8	50g	\$28.00
SCU-040-Q	1/4in	4.0	5/32in	12.7	1/2in	50.8	50g	\$28.00
SCU-048-Q	1/4in	4.8	3/16in	19.0	3/4in	50.8	50g	\$28.00
SCU-064-Q	1/4in	6.4	1/4in	19.0	3/4in	50.8	50g	\$28.00
SCU-064-XQ	1/4in	6.4	1/4in	25.4	1in	63.5	50g	\$30.00
SCU-080-H	1/2in	8.0	N/A	25.4	1in	76.1	80g	\$89.00
SCU-095-H	1/2in	9.5	3/8in	31.7	1 1/4in	76.1	80g	\$89.00
SCU-127-H	1/2in	12.7	1/2in	31.7	1 1/4in	76.1	220g	\$89.00
SCU-127-LH	1/2in	12.7	1/2in	38.1	1 1/2in	88.9	220g	\$95.00
SCU-127-XH	1/2in	12.7	1/2in	50.8	2in	102	220g	\$105.00

Flush Trim Spiral Bits

Product Code	Shank Size	Cutting Diameter		Cutting Height		Overall Length	Weight	RRP
		Metric	Imp'l	Metric	Imp'l			
SCU-127-BH	1/2in	12.7	1/2in	31.7	1 1/2in	76.1	220g	\$99.00
SCU-127-XBH	1/2in	12.7	1/2in	50.8	2in	102	240g	\$119.00
SCD-127-BH	1/2in	12.7	1/2in	31.7	1 1/2in	76.1	220g	\$99.00
SCD-127-XBH	1/2in	12.7	1/2in	50.8	2in	102	240g	\$119.00

\$19.00

Solid Carbide Straight Bits

TORQUATA

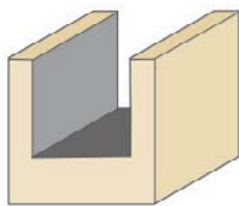

All Torquata straight bits below 6.0mm diameter are solid carbide to improve cutting performance. Due to carbide's brittle nature it is recommended that feed rates are significantly reduced.

Solid Carbide Bits are not

automatically covered by Torquata's normal Five-Year Warranty against breakage.

TurnLock™ concept turns changing guide bushings, and installing router attachments, into a simple matter of a 1/4 twist.

Product Code	Shank Size	Cutting Diameter		Cutting Height		Overall Length	Weight	RRP
		Metric	Imp'l	Metric	Imp'l			
SB-016-Q	1/4in	1.6	1/16in	5.2	13/64in	44.5	30g	\$19.00
SB-020-Q	1/4in	2.0	5/64in	6.0	15/64in	48.0	30g	\$19.00
SB-024-Q	1/4in	2.4	3/32in	7.5	19/64in	50.8	30g	\$19.00
SB-030-Q	1/4in	3.0		6.4	1/4in	49.0	30g	\$19.00
SB-032-Q	1/4in	3.2	1/8in	11.1	7/16in	54.0	30g	\$19.00
SB-040-Q	1/4in	4.0	5/32in	12.7	1/2in	63.5	30g	\$19.00
SB-048-Q	1/4in	4.8	3/16in	12.7	1/2in	57.2	30g	\$19.00

from **\$15.00**

Twin-Flute Carbide Tipped Straight Bits

TORQUATA

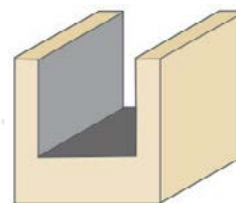

Straight bits are the most versatile and can be used for trenching, grooving, trimming and rebating either hand-held with a guide or in a

router table.

All Torquata straight bits are twin-fluted for a better-finished edge.

Product Code	Shank Size	Cutting Diameter		Cutting Height		Overall Length	Weight	RRP
		Metric	Imp'l	Metric	Imp'l			
SB-060-Q	1/4in	6.0	15/64in	25.0		57.0	30g	\$15.00
SB-064-Q	1/4in	6.4	1/4in	25.4	1in	57.2	30g	\$15.00
SB-070-Q	1/4in	7.0		25.4	1in	57.2	30g	\$15.00
SB-079-Q	1/4in	7.9	5/16in	25.4	1in	57.2	30g	\$15.00
SB-080-Q	1/4in	8.0		25.0		57.0	30g	\$15.00
SB-095-Q	1/4in	9.5	3/8in	25.4	1in	57.2	30g	\$15.00
SB-100-Q	1/4in	10.0		25.0		57.0	35g	\$15.00
SB-100-XQ	1/4in	10.0		31.8	1 1/4in	63.5	40g	\$16.50
SB-111-Q	1/4in	11.1	7/16in	25.4	1in	57.2	35g	\$15.00
SB-120-Q	1/4in	12.0		25.0		57.0	35g	\$15.00
SB-120-XQ	1/4in	12.0		31.8	1 1/4in	63.5	40g	\$17.00
SB-127-Q	1/4in	12.7	1/2in	25.4	1in	57.2	40g	\$15.00
SB-130-Q	1/4in	13.0		25.0		57.0	40g	\$17.00
SB-143-Q	1/4in	14.3	9/16in	25.4	1in	57.2	45g	\$17.00
SB-150-Q	1/4in	15.0		25.0		57.0	45g	\$17.00
SB-159-Q	1/4in	15.9	5/8in	25.4	1in	57.2	45g	\$17.00
SB-160-Q	1/4in	16.0		25.0		57.0	45g	\$20.00
SB-160-XQ	1/4in	16.0		31.8	1 1/4in	63.5	60g	\$23.00
SB-170-Q	1/4in	17.0		25.0		57.0	50g	\$20.00
SB-180-Q	1/4in	18.0		25.0		57.0	55g	\$20.00
SB-190-Q	1/4in	19.0	3/4in	25.0		57.0	60g	\$20.00
SB-060-H	1/2in	6.0	15/64in	25.0		67.0	55g	\$15.00
SB-064-H	1/2in	6.4	1/4in	25.4	1in	67.9	55g	\$15.00
SB-079-H	1/2in	7.9	5/16in	25.4	1in	67.9	65g	\$15.00
SB-095-H	1/2in	9.5	3/8in	25.4	1in	67.9	65g	\$15.00
SB-100-H	1/2in	10.0		32.0		73.0	65g	\$15.00
SB-120-H	1/2in	12.0		32.0		73.0	70g	\$17.00
SB-127-H	1/2in	12.7	1/2in	31.8	1 1/4in	63.5	70g	\$17.00
SB-127-XH	1/2in	12.7	1/2in	38.1	1 1/2in	76.2	95g	\$22.00
SB-130-H	1/2in	13.0		32.0		73.0	75g	\$20.00
SB-130-XH	1/2in	13.0		51.0		81.0	90g	\$26.00
SB-143-H	1/2in	14.3	9/16in	31.8	1 1/4in	63.5	70g	\$20.00
SB-150-H	1/2in	15.0		32.0		73.0	80g	\$20.00
SB-159-H	1/2in	15.9	5/8in	31.8	1 1/4in	63.5	70g	\$20.00
SB-160-H	1/2in	16.0		32.0		73.0	85g	\$20.00
SB-160-XH	1/2in	16.0		51.0		89.0	110g	\$29.00
SB-170-H	1/2in	17.0		32.0		73.0	90g	\$20.00
SB-180-H	1/2in	18.0		32.0		73.0	100g	\$20.00
SB-180-XH	1/2in	18.0		51.0		89.0	120g	\$29.00
SB-190-H	1/2in	19.0	3/4in	32.0		73.0	100g	\$20.00
SB-190-XH	1/2in	19.0	3/4in	51.0		89.0	130g	\$29.00
SB-222-H	1/2in	22.2	7/8in	31.8	1 1/4in	73.0	120g	\$25.00
SB-254-H	1/2in	25.4	1in	31.8	1 1/4in	73.0	150g	\$28.00
SB-350-H	1/2in	35.0		31.8		73.0	250g	\$39.00

from **\$20.00**

End/Bottom Cutting Straight Bits

TORQUATA

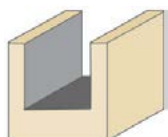

If you plunge with straight bits regularly you'll know that performance can be improved by the addition of a third flute across the end of the bit.

These bits offer that improved

performance for only a small extra cost. 16.0mm diameter bits and above have a downshear angle for improved chip injection and smooth finish cut.

Product Code	Shank Size	Cutting Diameter		Cutting Height		Overall Length	Weight	RRP
		Metric	Imp'l	Metric	Imp'l			
SE-060-Q	1/4in	6.0	15/64in	25.0		57.0	30g	\$20.00
SE-095-Q	1/4in	9.5	3/8in	25.4	1in	57.2	30g	\$20.00
SE-100-Q	1/4in	10.0		25.0		57.0	35g	\$20.00
SE-120-H	1/2in	12.0		32.0		73.0	70g	\$22.00
SE-127-H	1/2in	12.7	1/2in	31.8	1 1/4in	73.5	70g	\$22.00
SE-160-H	1/2in	16.0		32.0		73.0	80g	\$25.00
SE-190-H	1/2in	19.0	3/4in	31.8	1 1/4in	73.5	100g	\$25.00
SE-250-H	1/2in	25.0		32.0		73.0	150g	\$33.00

from **\$31.00**

Stair Tread Bits

TORQUATA



Stair tread bits are designed to remove large amounts of material in either planing, grooving or rebating

operations with cutting blades running along the entire top edge of the bit and large cutaways for chip ejection.

Product Code	Shank Size	Cutting Diameter		Cutting Height		Overall Length	Weight	RRP
		Metric	Imp'l	Metric	Imp'l			
ST-318-H	1/2in	31.8	1 1/4in	11.9	15/32in	63.5	120g	\$31.00
ST-350-H	1/2in	35.0		12.7	1/2in	57.0	130g	\$33.00
ST-381-H	1/2in	38.1	1 1/2in	15.9	5/8in	68.0	140g	\$35.00
ST-450-H	1/2in	45.0		15.9	5/8in	60.0	170g	\$46.00

ROUTING

from **\$17.00**
Mortising Bits

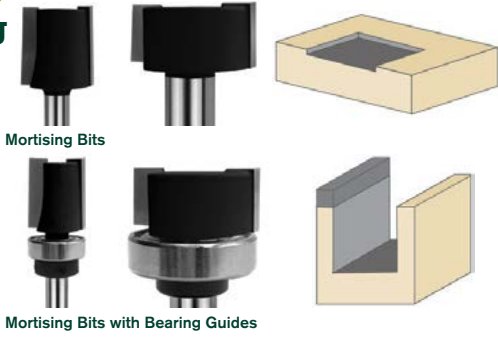

Mortising bits are designed specifically for routing out recesses. With profiles designed for maximum stock removal and chip injection they are very handy for clearing out material.

Pairing up a mortising bit with bearing guide improves repeatability by allowing you to follow a template – perfect for mortising multiple hinges or any other recess.

Product Code	Shank Size	Cutting Diameter		Cutting Height		Overall Length	Weight	RRP
		Metric	Imp'l	Metric	Imp'l			
MO-127-Q	1/4in	12.7	1/2in	12.7	1/2in	44.5	35g	\$17.00
MO-159-Q	1/4in	15.9	5/8in	19.0	3/4in	50.8	40g	\$20.00
MO-190-Q	1/4in	19.0	3/4in	19.0	3/4in	50.8	60g	\$22.00
MO-127-H	1/2in	12.7	1/2in	19.0	3/4in	60.3	60g	\$20.00
MO-190-H	1/2in	19.0	3/4in	19.0	3/4in	60.3	90g	\$22.00
MO-318-H	1/2in	31.8	1 1/4in	13.9	35/64in	54.0	120g	\$25.00
MO-127-BQ	1/4in	12.7	1/2in	12.7	1/2in	44.5	50g	\$23.00
MO-159-BQ	1/4in	15.9	5/8in	19.0	3/4in	50.8	50g	\$26.00
MO-190-BQ	1/4in	19.0	3/4in	19.0	3/4in	50.8	70g	\$28.00
MO-190-BH	1/2in	19.0	3/4in	19.0	3/4in	60.3	110g	\$28.00
MO-318-BH	1/2in	31.8	1 1/4in	13.9	35/64in	54.0	150g	\$39.00

from **\$15.00**
Panel Pilot Bits

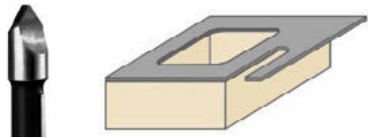

The v-shaped pilot quickly drills through any material with the smooth face that runs along the material beneath to act as the template for cutting the material above it. Perfect for sink, window cut-outs etc. in a variety of materials such as plywood, plasterboard etc.

1/4in shank bit is single-fluted for faster stock material removal.

Product Code	Shank Size	Cutting Diameter		Cutting Height		Overall Length	Weight	RRP
		Metric	Imp'l	Metric	Imp'l			
PP-064-Q	1/2in	6.4	1/4in	19.0	3/4in	76.2	30g	\$15.00
PP-064-H	1/2in	6.4	1/4in	19.0	3/4in	76.2	30g	\$15.00
PP-127-H	1/2in	12.7	1/2in	31.8	1 1/4in	92.1	70g	\$20.00

\$17.00
Solid Carbide Trimmer Bits

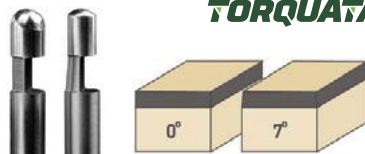

Single-fluted solid carbide trimmer bits with in-built guide are perfect for trimming laminates and veneers from substrate. Available with either a straight flush or popular 7° edge.

Product Code	Shank Size	Angle	Cutting Diameter		Cutting Height	Overall Length	Weight	RRP	
			Metric	Imp'l					Metric
CT-0640-Q	1/4in	0°	6.4	1/4in	6.4	1/4in	39.7	30g	\$17.00
CT-0647-Q	1/4in	7°	6.4	1/4in	6.4	1/4in	39.7	30g	\$17.00

TORQUATA

\$75.00
Surface Planing Bit



Timber slab planing with a router is popular due to size limitations and/or cost of large-capacity thicknessers.

This bit is specifically designed for timber removal of Australian hardwoods with six shallow cutters and maximum chip ejection.

Product Code	Shank Size	Cutting Diameter		Cutting Height		Overall Length	Weight	RRP
		Metric	Imp'l	Metric	Imp'l			
SP-500-H	1/2in	50.8	2in	9.50	3/8in	63.5	130g	\$75.00

TORQUATA

\$15.00
Combination Trimmer Bits

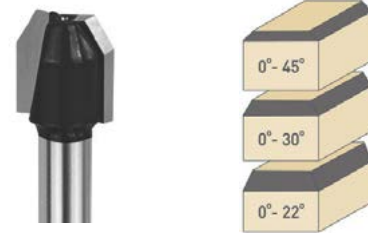

These bits make fast work of trimming up laminate edges in hand-held trimmers and can either

be used to trim square or, when set to the correct depth, with a small chamfer to eliminate sharp edges.

Product Code	Shank Size	Angle	Cutting Diameter		Cutting Height		Overall Length	Weight	RRP
			Metric	Imp'l	Metric	Imp'l			
CT-022-Q	1/4in	22°	11.9	15/32in	12.7	1/2in	47.6	40g	\$15.00
CT-030-Q	1/4in	30°	11.9	15/32in	12.7	1/2in	47.6	40g	\$15.00
CT-045-Q	1/4in	45°	11.9	15/32in	12.7	1/2in	47.6	40g	\$15.00

from **\$27.00**
Dish Cutting Bit

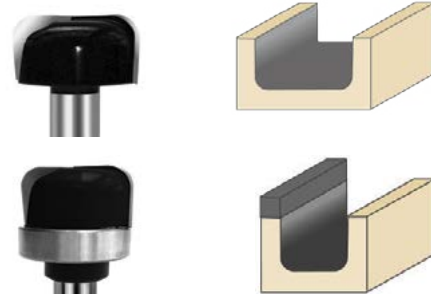

Both dish cutting bits are available with bearing guides to run against

templates or straight edges for a more accurate cut.

Product Code	Shank Size	Cutting Diameter		Cutting Height		Overall Length	Weight	RRP
		Metric	Imp'l	Metric	Imp'l			
DC-190-H	1/2in	19.0	3/4in	15.9mm	5/8in	54.0	60g	\$27.00
DC-318-H	1/2in	31.8	1 1/4in	15.9mm	5/8in	60.3	120g	\$32.00
DC-190-BH	1/2in	19.0	3/4in	15.9mm	5/8in	54.0	100g	\$33.00
DC-318-BH	1/2in	31.8	1 1/4in	15.9mm	5/8in	60.3	140g	\$45.00

TORQUATA

TORQUATA



from **\$50⁰⁰**

Ultimate Flush Trimming Router Bits

The world's first triple-blade downshear flush trim bit. Coming in at 22.2mm diameter it is designed to provide the ultimate finish on all materials with minimal chatter due to the bit body absorbing most vibration.

Due to the extra blade, there are 50% more cuts per inch, creating the smoother, cleaner result as well as staying sharper for 50% longer than standard flush trim bits. As the blades are downshear, one blade stays in contact with the work piece for virtually the whole time.

Only available with 1/2in shank.



Product Code	Product	Weight	Price
FTHD-22-H	Cutting Length 25.4mm (1in)	100g	\$50.00
FTHD-22-XH	Cutting Length 50.8mm (2in)	120g	\$65.00
FTHD-22-BH	1in High Dual Bearing Bit	150g	\$59.00
FTHD-22-XBH	2in High Dual Bearing Bit	160g	\$75.00

TORQUATA



from **\$17⁰⁰**

Flush Trimming Bits

Flush trim bits are perfect for removing excess material once timber or laminates have been jointed or for duplicating the same pattern when used in conjunction with a master template across multiple work pieces.



Product Code	Shank Size	Cutting Diameter		Cutting Height		Overall Length	Weight	RRP
		Metric	Imp'l	Metric	Imp'l			
FT-079-Q	1/4in	7.90	5/16in	12.7	1/2in	52.4	40g	\$17.00
FT-127-Q	1/4in	12.7	1/2in	25.4	1in	67.9	50g	\$21.00
FT-127-H	1/2in	12.7	1/2in	31.8	1 1/4in	84.1	80g	\$21.00
FT-127-XH	1/2in	12.7	1/2in	50.8	2in	75.0	90g	\$26.00
FT-222-H	1/2in	22.2	7/8in	25.4	1in	84.0	170g	\$25.00

TORQUATA



from **\$29⁰⁰**

Heavy Duty Flush Trimming Bits

The heavy-duty trimming bits are larger diameter and use thicker carbide tips to remove more material quickly.

With a negative shear on the blade they provide a smoother finish on timber edges than standard trimming bits.

Also available is the heavy-duty flush trimming bits with bottom as well as top bearing guides that make it easier to use in just about any trimming application, whether you need to locate your template top or bottom on the work piece.



Product Code	Shank Size	Cutting Diameter		Cutting Height		Overall Length	Weight	RRP
		Metric	Imp'l	Metric	Imp'l			
FTHD-19-Q	1/4in	19.0	3/4in	25.4	1in	69.9	70g	\$29.00
FTHD-19-H	1/2in	19.0	3/4in	25.4	1in	69.9	100g	\$29.00
FTHD-19-XH	1/2in	19.0	3/4in	50.8	2in	101.6	140g	\$35.00
FTHD-19-BQ	1/4in	19.0	3/4in	25.4	1in	69.9	70g	\$35.00
FTHD-19-BH	1/2in	19.0	3/4in	25.4	1in	69.9	100g	\$35.00
FTHD-19-XBH	1/2in	19.0	3/4in	50.8	2in	101.6	140g	\$40.00

TORQUATA



from **\$24⁰⁰**

V-Groove Flush Trimming Bits

When you need to hide a joint that's less than perfect, use the v-groove flush trim bit to cut a V recess over

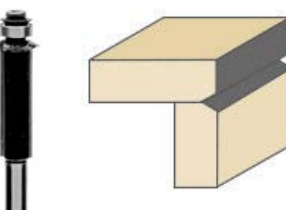

the jointed edge. Also great for adding a sharp detail close to the edge of work pieces.

Product Code	Shank Size	Cutting Diameter		Cutting Height		Cutting Depth		Overall Length	Wgt	RRP
		Metric	Imp'l	Metric	Imp'l	Metric	Imp'l			
VF-127-BQ	1/4in	12.7	1/2in	31.8	1 1/4in	2.0	5/64in	85.3	80g	\$27.00
VF-190-BH	1/2in	19.0	3/4in	25.4	1 1/4in	2.0	5/64in	82.6	110g	\$29.00

TORQUATA

\$44⁰⁰

Laserpoint Bit

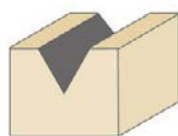

Designed specifically for fine decorative detail routing, this bit is made of solid-carbide with multiple

ejection flutes to create perfect engraving patterns on timber.

Product Code	Shank Size	Angle	Cutting Diameter		Cutting Height		Overall Length	Weight	RRP
			Metric	Imp'l	Metric	Imp'l			
LP-151-Q	1/4in	60°	15.1	19/32in	13.1	33/64in	68.3	60g	\$44.00

TORQUATA



from **\$17⁰⁰**

Pattern Following Bits

Perfect for following patterns when used in a hand-held router application where the template is located at the top of the timber.

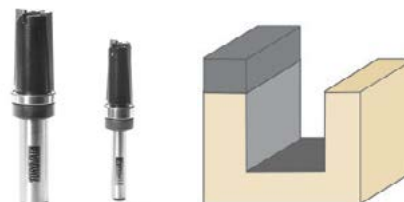

PLEASE NOTE all bits with the prefix SE- have flutes to improve the ability to plunge cut.

Product Code	Shank Size	Cutting Diameter		Bearing Size	Cutting Height		Overall Length	Wgt	RRP
		Metric	Imp'l		Metric	Imp'l			
PF-064-BQ	1/4in	6.4	1/4in	1/2in	25.4	1in	63.5	40g	\$21.00
SE-127-BQ	1/4in	12.7	1/2in	1/2in	25.4	1in	66.7	50g	\$26.00
SE-159-BQ	1/4in	15.9	5/8in	5/8in	25.4	1in	66.7	60g	\$26.00
SE-190-BH	1/2in	19.0	3/4in	3/4in	38.1	1 1/2in	84.1	100g	\$30.00
PF-286-BH	1/2in	28.6	1 1/8in	1 1/8in	38.1	1 1/2in	84.1	150g	\$45.00
PFHD-22-BH	1/2in	19.0	7/8in	3/4in	38.1	1 1/2in	84.1	140g	\$40.00

TORQUATA

ROUTING

from \$20.00 Rebate Moulding Bits



TORQUATA

With a guide bearing that automatically sets the cutting depth,

these bits are easy to use for creating an accurate rebate depth consistently.

Product Code	Shank Size	Cutting Depth		Cutting Height		Overall Length	Weight	RRP
		Metric	Imp'l	Metric	Imp'l			
RB-032-BQ	1/4in	3.2	1/8in	6.4	1/4in	49.2	70g	\$20.00
RB-064-BQ	1/4in	6.4	1/4in	12.7	1/2in	54.0	70g	\$21.00
RB-095-BQ	1/4in	9.5	3/8in	12.7	1/2in	54.0	80g	\$22.00
RB-095-BH	1/2in	9.5	3/8in	12.7	1/2in	63.5	110g	\$22.00
RB-127-BH	1/2in	12.7	1/2in	12.7	1/2in	63.5	140g	\$29.00
RB-159-BH	1/2in	15.9	5/8in	12.7	1/2in	63.5	160g	\$33.00
RB-190-BH	1/2in	19.00	3/4in	19.00	3/4in	68.3	240g	\$65.00

\$65.00 Rebate Moulding Set



TORQUATA

Rather than buying multiple bits, buy this set once, change bearings and get the following rebate depths:

4.8mm, 6.4mm, 8.0mm, 9.5mm, 11.1mm and 12.7mm. Cutting height is max 12.7mm

Product Code	Shank Size	Weight	RRP
RBSET-6-H	1/2in	540g	\$65.00

from \$15.00 Keyhole Bits



TORQUATA

Plunge and groove into the workpiece to create a recess for hanging hooks or run a groove through the workpiece to create a

trench that can be used to capture either 4mm or 6mm nuts or bolt heads (when using KH095Q or KH127Q bits respectively).

Product Code	Shank Size	Cutting Dia 1		Cutting Dia 2		Overall Length	Weight	RRP
		Metric	Metric	Metric	Metric			
KH-095-Q	1/4in	9.5	4.8	4.8	4.8	44.5	30g	\$15.00
KH-127-Q	1/4in	12.7	4.8	6.4	4.8	50.8	30g	\$15.00
KH-143-H*	1/2in	14.3	4.0	8.5	5.5	50.8	50g	\$18.00

* Now available is a keyhole bit specifically designed to replicate the groove size of the Torquata T-Track

Rails so it can be used with all available hardware found on p. 40.

from \$18.00 Chamfer Moulding Bits



TORQUATA

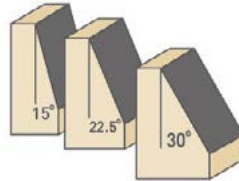

Finish the edge of your work with an edge at a variety of angles from 15 – 45°. Adjust the bit height to change the size of the chamfer on your work piece up to 32mm.

The bits can also create either 4, 6, 8 or 12-sided shapes.

The CH3245BH should only be used in a router table.

Product Code	Shank Size	Angle	Cutting Depth		Cutting Height		Overall Length	Weight	RRP
			M	Imp'l	M	Imp'l			
CH-0945-BQ	1/4in	45°	6.4	1/4in	9.1	23/64in	50.8	60g	\$18.00
CH-1645-BQ	1/4in	45°	11.1	7/16in	15.9	5/8in	58.7	80g	\$22.00
CH-1645-BH	1/2in	45°	11.1	7/16in	15.9	5/8in	65.1	110g	\$22.00
CH-2545-BH	1/2in	45°	14.3	9/16in	19.0	3/4in	65.1	200g	\$35.00
CH-3245-BH	1/2in	45°	22.2	7/8in	31.8	1 1/4in	79.4	320g	\$49.00
CH-2215-BH	1/2in	15°	6.4	1/4in	22.2	7/8in	71.5	100g	\$22.00
CH-2222-BH	1/2in	22°	9.5	3/8in	22.2	7/8in	71.5	110g	\$25.00
CH-2230-BH	1/2in	30°	12.7	1/2in	22.2	7/8in	71.5	120g	\$28.00

from \$15.00 V-Groove Plunge Bits



TORQUATA

Designed to either cut grooves with 45° walls or, when used in conjunction with a router table and fence, they can also trim chamfered edges.

Some V-groove bits are available with bearing guides to run against templates or straight edges for a more accurate cut.

Product Code	Shank Size	Cutting Depth		Cutting Height		Overall Length	Weight	RRP
		Metric	Imp'l	Metric	Imp'l			
VG-064-Q	1/4in	6.4	1/4in	7.9	5/16in	39.7	30g	\$15.00
VG-095-Q	1/4in	9.5	3/8in	12.7	1/2in	44.5	30g	\$17.00
VG-127-Q	1/4in	12.7	1/2in	12.7	1/2in	44.5	30g	\$18.00
VG-190-Q	1/4in	19.0	3/4in	15.9	5/8in	47.6	40g	\$20.00
VG-254-H	1/2in	25.4	1in	19.0	3/4in	60.3	95g	\$28.00
VG-318-Q	1/4in	31.8	1 1/4in	25.4	1in	57.2	80g	\$32.00
VG-318-H	1/2in	31.8	1 1/4in	25.4	1in	63.5	110g	\$32.00
VG-127-BQ	1/4in	12.7	1/2in	12.7	1/2in	44.5	40g	\$24.00
VG-190-BQ	1/4in	19.0	3/4in	15.9	5/8in	47.6	50g	\$26.00
VG-254-BH	1/2in	25.4	1in	19.0	3/4in	60.3	110g	\$40.00
VG-318-BH	1/2in	31.8	1 1/4in	25.4	1in	63.5	110g	\$45.00

\$33.00 Slatwall Groove Forming Bit



TORQUATA

Slatwall is a popular method of fitting out showrooms and now you can run your own slot in any board

to fit the aluminium profile and custom-build your own shop fittings.

Product Code	Shank Size	Cutting Dia 1	Cutting Height 1	Cutting Dia 2	Cutting Height 2	Overall Length	Weight	RRP
SW-296-H	1/2in	29.6	10.0	4.3	4.3	57.2	130g	\$33.00

from **\$14.00**

Round Nose Plunge Bits

TORQUATA



These bits are used to cut radiused grooves in timber for a variety of applications or edge trimming a

cove when used in conjunction with a guide hand-held or in a router table.

Product Code	Shank Size	Cutting Radius		Cutting Diameter		Cutting Height		Overall Length	Wgt	RRP
		M	Imp'l	M	Imp'l	M	Imp'l			
RN-064-Q	1/4in	3.2	1/8in	6.4	1/4in	6.4	1/4in	38.1	30g	\$14.00
RN-095-Q	1/4in	4.8	3/16in	9.5	3/8in	9.5	3/8in	39.7	30g	\$14.00
RN-127-Q	1/4in	6.4	1/4in	12.7	1/2in	9.5	3/8in	39.7	30g	\$16.00
RN-159-Q	1/4in	7.9	5/16in	15.9	5/8in	12.7	1/2in	44.5	40g	\$17.00
RN-190-Q	1/4in	19.0	3/4in	12.7	1/2in			50.8	70g	\$18.00
RN-254-Q	1/4in	25.4	1in	15.9	5/8in			57.2	70g	\$21.00
RN-095-H	1/2in	4.8	3/16in	9.5	3/8in	19.0	3/4in	57.2	50g	\$20.00
RN-127-H	1/2in	6.4	1/4in	12.7	1/2in	25.4	1in	63.5	70g	\$22.00
RN-159-H	1/2in	7.9	5/16in	15.9	5/8in	25.4	1in	63.5	60g	\$31.00
RN-190-H	1/2in	9.5	3/8in	19.0	3/4in	38.1	1 1/2in	80.2	70g	\$33.00
RN-254-H	1/2in	12.7	1/2in	25.4	1/2in	38.1	1 1/2in	76.2	140g	\$50.00
RN-127-BQ	1/4in	6.4	1/4in	12.7	1/2in	9.5	3/8in	39.7	30g	\$22.00
RN-159-BQ	1/4in	7.9	5/16in	15.9	5/8in	12.7	1/2in	44.5	40g	\$23.00
RN-190-BH	1/2in	9.5	3/8in	19.0	3/4in	38.1	1 1/2in	80.2	60g	\$39.00
RN-254-BH	1/2in	12.7	1/2in	25.4	1/2in	38.1	1 1/2in	76.2	140g	\$65.00

Some round nose bits are available with bearing guides to run against templates or straight edges for a more accurate cut.

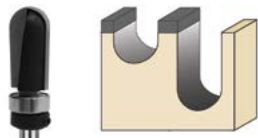

from **\$29.00**

Bullnose Moulding Bits

TORQUATA



Rather than running a roundover bit twice to create the perfect half-circle edge on a work piece, this bit allows you to do the cut in one pass

with no extra machining required for the four most common timber thicknesses.

Product Code	Shank Size	Cutting Radius		Cutting Depth		Cutting Height		Overall Weight	RRP	
		M	Imp'l	M	Imp'l	M	Imp'l			M
BN-095-Q	1/4in	4.8	3/16in	9.5	3/8in	22.2	7/8in	54.0	70g	\$29.00
BN-127-Q	1/4in	6.4	1/4in	12.7	1/2in	25.4	1in	57.2	90g	\$31.00
BN-159-H	1/2in	7.9	5/16in	15.9	5/8in	31.8	1 1/4	67	150g	\$39.00
BN-190-H	1/2in	9.5	3/8in	19.0	3/4in	34.9	1 3/8in	76.2	180g	\$43.00
BN-318-H	1/2in	15.9	5/8in	31.8	1 1/4in	44.5	1 3/8in	85.7	330g	\$72.00

\$65.00

Adjustable Round-Over Bit



ARO-380-BH | 150g **TORQUATA**

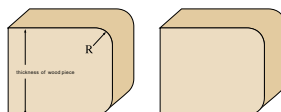

Round over two edges in one pass with the most common 4.8 or 6.4mm radius. Change the radius by flipping the cutters over.

Change the stack of spacers to cut on material 9.5 – 38.0mm thick. 1/2in shank only available.

from **\$20.00**

Rounding Over Bits

TORQUATA

Extra bearing included to cut straight and filleted profile for no extra cost



Easily the most popular and timeless edge trimming option for almost every timber project. Use a small radius in a hand-held trimmer to remove sharp edges on a

well-planned table or use in conjunction with the same radius cove moulding bit and you can fit together panels on a drop-side table.

Product Code	Shank Size	Cutting Radius		Cutting Diameter		Cutting Height		Overall Length	Wgt	RRP
		M	Imp'l	M	Imp'l	M	Imp'l			
RO-016-BQ	1/4in	1.6	1/16in	1.6	1/16in	6.0	15/64in	47.6	40g	\$20
RO-020-BQ	1/4in	2	1/16in	1.6	1/16in	6.0	15/64in	47.6	40g	\$20
RO-032-BQ	1/4in	3.2	1/8in	3.2	1/8in	10.3	13/32in	54.0	40g	\$20
RO-048-BQ	1/4in	4.8	3/16in	4.8	3/16in	12.7	1/2in	55.6	50g	\$21
RO-064-BQ	1/4in	6.4	1/4in	6.4	1/4in	13.5	17/32in	57.2	60g	\$22
RO-079-BQ	1/4in	7.9	5/16in	7.9	5/16in	14.3	9/16in	57.2	60g	\$25
RO-095-BQ	1/4in	9.5	3/8in	9.5	3/8in	16.7	21/32in	58.7	70g	\$28
RO-127-BQ	1/4in	12.7	1/2in	12.7	1/2in	19.0	3/4in	61.9	70g	\$32
RO-064-BH	1/2in	6.4	1/4in	6.4	1/4in	13.5	17/32in	57.2	60g	\$23
RO-079-BH	1/2in	7.9	5/16in	7.9	5/16in	14.3	9/16in	57.2	60g	\$26
RO-095-BH	1/2in	9.5	3/8in	9.5	3/8in	16.7	21/32in	68.3	100g	\$29
RO-127-BH	1/2in	12.7	1/2in	12.7	1/2in	19.0	3/4in	68.3	120g	\$33
RO-159-BH	1/2in	15.9	5/8in	15.9	5/8in	22.2	7/8in	73.0	140g	\$39
RO-190-BH	1/2in	19.0	3/4in	19.0	3/4in	25.4	1in	76.2	190g	\$46
RO-254-BH	1/2in	25.4	1in	25.4	1in	31.8	1 1/4in	84.1	250g	\$65
RO-318-BH	1/2in	31.8	1 1/4in	31.8	1 1/4in	38.1	1 1/2in	87.3	320g	\$85

from **\$18.00**

Cove Moulding Bits

TORQUATA



Cove bits cut perfect quarter-radius shapes with the bearing offering instant repeatability every time for a

simple but attractive edge finish on tables, desks etc.

Product Code	Shank Size	Cutting Radius		Cutting Depth		Cutting Height		Overall Weight	RRP	
		M	Imp'l	M	Imp'l	M	Imp'l			M
CO-032-BQ	1/4in	3.2	1/8in	3.2	1/8in	9.5	3/8in	44.5	60g	\$18.00
CO-064-BQ	1/4in	6.4	1/4in	6.4	1/4in	12.7	1/2in	55.6	60g	\$18.00
CO-095-BQ	1/4in	9.5	3/8in	9.5	3/8in	14.3	9/16in	55.6	80g	\$22.00
CO-127-BH	1/2in	12.7	1/2in	12.7	1/2in	15.9	5/8in	65.1	140g	\$27.00
CO-190-BH	1/2in	19.0	3/4in	19.0	3/4in	22.2	7/8in	73.0	260g	\$42.00

ROUTING

from \$22.00

Plunging Classical Bits

TORQUATA

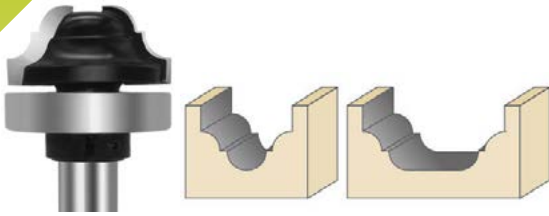

CL349BH

Either used to plunge-cut grooves to make dummy raised panel doors or in conjunction with a fence to cut the decorative classical edge pattern. The bits with B in the suffix come with a shank-mounted

bearing for following a fence or template edge. Some Plunging Classical Bits bits are available with bearing guides to run against templates or straight edges for a more accurate cut.

Product Code	Shank Size	Cutting Radius		Cutting Diameter		Cutting Height		Overall Length	Wgt	RRP
		M	Imp'l	M	Imp'l	M	Imp'l			
CP-127-Q	1/4in	2.4	3/32in	12.7	1/2in	9.5	3/8in	42.1	30g	\$22.00
CP-190-H	1/2in	4.0	5/32in	19.0	3/4in	12.7	1/2in	50.8	70g	\$28.00
CP-254-H	1/2in	5.6	7/32in	25.4	1in	15.9	5/8in	54.0	80g	\$32.00
CP-222-BQ	1/4in	3.2	1/8in	22.2	7/8in	12.7	1/2in	54.0	80g	\$34.00
CP-349-BH	1/2in	5.6	7/32in	34.9	1 3/4in	15.9	5/8in	69.1	140g	\$51.00

from \$29.00

Ogee Moulding Bits

TORQUATA



Extra bearing included to cut straight and filleted profile for no extra cost

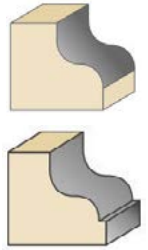

Ogee profiles have been used since ancient times and these bits are perfect for creating a traditional edge profile to suit a variety of timber thicknesses.

Product Code	Shank Size	Cutting Radius		Cutting Depth		Cutting Height		Overall Length	Wgt	RRP
		M	Imp'l	M	Imp'l	M	Imp'l			
OG-127-BQ	1/4in	4.8	3/16in	9.5	3/8in	12.7	1/2in	55.6	70g	\$29.00
OG-159-BQ	1/4in	6.4	1/4in	12.7	1/2in	15.9	5/8in	58.7	90g	\$32.00
OG-127-BH	1/2in	4.8	3/16in	9.5	3/8in	12.7	1/2in	61.9	100g	\$30.00
OG-159-BH	1/2in	6.4	1/4in	12.7	1/2in	15.9	5/8in	68.3	120g	\$33.00
OG-222-BH	1/2in	9.5	3/8in	19.0	3/4in	22.2	7/8in	73.0	200g	\$55.00

from \$29.00

Classical Moulding Bits

TORQUATA

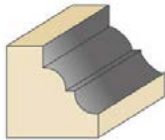

Extra bearing included to cut straight and filleted profile for no extra cost

Cut the timeless, classical edge pattern to a consistent, repeatable depth using this bit with the

included guide bearing either hand-held or without needing a fence on a router table.

Product Code	Shank Size	Cutting Radius		Cutting Depth		Cutting Height		Overall Length	Wgt	RRP
		M	Imp'l	M	Imp'l	M	Imp'l			
CL-127-BQ	1/4in	3.2	1/8in	7.9	5/16in	12.7	1/2in	54.0	70g	\$29.00
CL-159-BQ	1/4in	4.8	3/16in	11.1	7/16in	15.9	5/8in	58.7	90g	\$32.00
CL-127-BH	1/2in	3.2	1/8in	7.9	5/16in	12.7	1/2in	63.5	100g	\$30.00
CL-159-BH	1/2in	4.8	3/16in	11.1	7/16in	15.9	5/8in	65.1	120g	\$33.00
CL-190-BH	1/2in	6.4	1/4in	15.1	19/32in	19.0	3/4in	69.8	160g	\$39.00

from \$29.00

Roman Ogee Moulding Bit

TORQUATA



Extra bearing included to cut straight and filleted profile for no extra cost

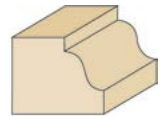

This profile is the inverse of the ogee profile and a bead can be created by adjusting the depth of cut on the bit.

Product Code	Shank Size	Cutting Radius		Cutting Depth		Cutting Height		Overall Length	Wgt	RRP
		M	Imp'l	M	Imp'l	M	Imp'l			
ROG-127-BQ	1/4in	4.0	5/32in	7.9	5/16in	12.7	1/2in	55.1	80g	\$29.00
ROG-175-BQ	1/4in	6.4	1/4in	12.7	1/2in	17.5	11/16in	60.3	180g	\$32.00
ROG-127-BH	1/2in	4.0	5/32in	7.9	5/16in	12.7	1/2in	63.5	80g	\$30.00
ROG-175-BH	1/2in	6.4	1/4in	12.7	1/2in	17.5	11/16in	66.3	190g	\$33.00

\$32.00

Full Bead Moulding Bit

TORQUATA

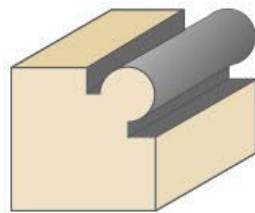

Designed to be used hand-held, this bit can be used to make a decorative edge trim or when

run multiple times, it can create a unique, delicate edge bead on your work piece.

Product Code	Shank Size	Cutting Radius		Cutting Depth		Cutting Height		Overall Length	Weight	RRP
		M	Imp'l	M	Imp'l	M	Imp'l			
FB-048-BQ	1/4in	4.8	3/16in	25.4	1in	12.7	1/2in	60.3	60g	\$32.00

from \$16.00

Groove & Beadforming Bits

TORQUATA



Great for cutting fine grooves in timber or when used with a fence, it can be setup to create multiple beads across the timber in two different, common bead sizes.

All groove & beadforming bits are available with bearing guides to run against templates or straight edges for a more accurate cut.

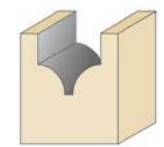

Product Code	Shank Size	Cutting Radius		Cutting Diameter		Cutting Height		Overall Length	Wgt	RRP
		M	Imp'l	M	Imp'l	M	Imp'l			
GF-048-Q	1/4in	4.0	5/32in	9.5	3/8in	7.9	5/16in	38.1	30g	\$16.00
GF-079-Q	1/4in	7.9	5/16in	15.9	5/8in	12.7	1/2in	50.8	50g	\$20.00
GF-095-H	1/2in	9.5	3/8in	22.2	7/8in	14.3	9/16in	53.2	70g	\$23.00
GF-079-BQ	1/4in	7.9	5/16in	15.9	5/8in	12.7	1/2in	50.8	60g	\$26.00
GF-095-BH	1/2in	9.5	3/8in	22.2	7/8in	14.3	9/16in	53.2	80g	\$29.00

from **\$32.00**

Table Edge Moulding Bits

TORQUATA

TE-01-BH



TE-02-BH

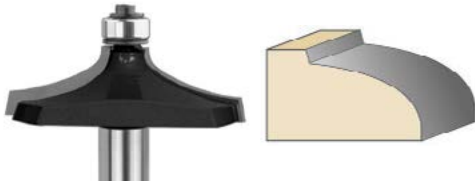

TE-03-BH



TE-04-BH

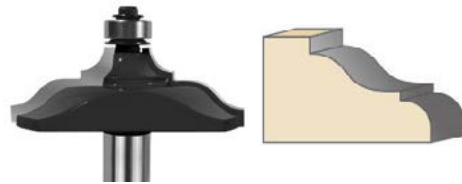

Kitchen and dining tables usually have large, sweeping flat surfaces and these bits have been designed

to complement this surface by creating a range of large, sweeping curved edges to suit.

Product Code	Shank Size	Cutting Depth		Cutting Height		Overall Length	Wgt	RRP
		Metric	Imp'l	Metric	Imp'l			
TE-01-BH	1/2in	12.7	1/2in	15.9	5/8in	63.5	100g	\$32.00
TE-02-BH	1/2in	25.4	1in	19.0	3/4in	71.8	200g	\$72.00
TE-03-BH	1/2in	25.4	1in	19.0	3/4in	71.8	200g	\$72.00
TE-04-BH	1/2in	27.4	1 5/64in	19.0	3/4in	67.5	210g	\$72.00

from **\$44.00**

Face Moulding Bits

TORQUATA

FM-01-BH

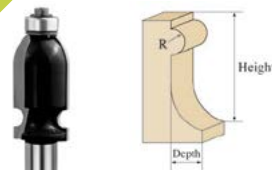

FM-02-BH



FM-03-BH

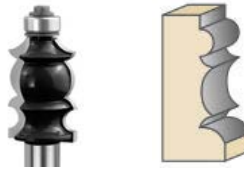

FM-04-BH

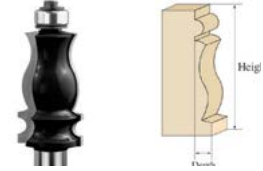

FM-05-BH

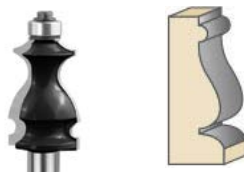

FM-06-BH

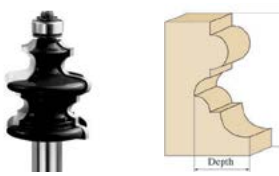

FM-08-BH

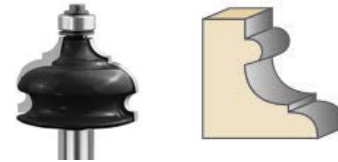

Face-moulding bits create the most common and attractive architrave and door frame edge shapes used in carpentry. They are also handy for

creating picture frame profiles and a multitude of other applications where a shallow but long decorative profile would be suitable.

Product Code	Shank Size	Cutting Depth		Cutting Height		Overall Length	Wgt	RRP
		Metric	Imp'l	Metric	Imp'l			
FM-01-BH	1/2in	4.8	3/16in	41.3	1 5/8in	90.5	180g	\$44.00
FM-02-BH	1/2in	4.8	3/16in	41.3	1 5/8in	90.5	120g	\$50.00
FM-03-BH	1/2in	4.8	3/16in	34.9	1 3/8in	85.7	130g	\$50.00
FM-04-BH	1/2in	6.4	1/4in	44.5	1 3/4in	90.5	220g	\$50.00
FM-05-BH	1/2in	7.9	5/16in	38.1	1 1/2in	87.3	150g	\$50.00
FM-06-BH	1/2in	12.7	1/2in	38.1	1 1/2in	87.7	270g	\$58.00
FM-08-BH	1/2in	15.9	5/8in	28.6	1 1/8in	53.6	230g	\$58.00

\$33.00

Triple Bead Moulding Bit

TORQUATA

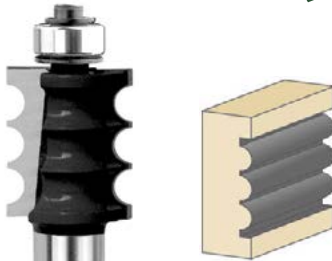

Make your own reeded decking or finely fluted furniture using this versatile bit.

Adjust the height to cut one, two or all three flutes in one pass.

Product Code	Shank Size	Cutting Radius		Cutting Depth		Cutting Height		Overall Length	Wgt	RRP
		M	Imp'l	M	Imp'l	M	Imp'l			
TB-032-BH	1/2in	3.2	1/8in	4.8	3/16in	25.4	1in	73.8	100g	\$33.00

\$249.00

Face Moulding Set

TORQUATA

FMSET-07-H | 1.6kg



If you are serious about getting a wide range of face moulding profiles this set is the way to go.

Get three extra profiles not normally available in a handy wooden storage case.

ROUTING

\$79.00

Crown Moulding Bits

TORQUATA

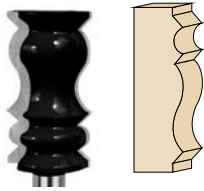

CM-55-H

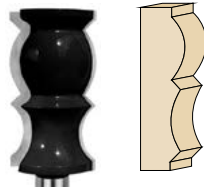

CM-56-H

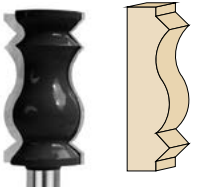

CM-57-H

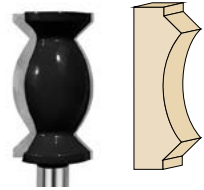

CM-58-H

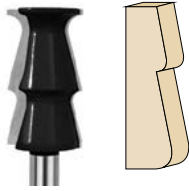

CM-59-H

Create your own timber crown moulds for cornices, architraves, as decorative trim on fire places or on a grandfather clock.

Product Code	Shank Size	Cutting Diameter		Cutting Height		Overall Length	Wgt	RRP
		Metric	Imp'l	Metric	Imp'l			
CM-55-H	1/2in	31.8	1 1/4in	57.2	2 1/4in	95.2	240g	\$79.00
CM-56-H	1/2in	31.8	1 1/4in	57.2	2 1/4in	95.2	240g	\$79.00
CM-57-H	1/2in	31.8	1 1/4in	57.2	2 1/4in	95.2	240g	\$79.00
CM-58-H	1/2in	31.8	1 1/4in	57.2	2 1/4in	95.2	240g	\$79.00
CM-59-H	1/2in	31.8	1 1/4in	57.2	2 1/4in	95.2	240g	\$79.00

from \$54.00

Multi-Profile Moulding Bit

TORQUATA

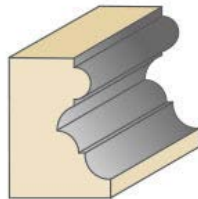

Adjust the bit height and run multiple passes on your workpiece to create over 40 different profile options. Must be used in a router table due to the bit diameter.

options. Must be used in a router table due to the bit diameter.

Product Code	Shank Size	Cutting Depth		Cutting Diameter		Cutting Height		Overall Length	Wgt	RRP
		M	Imp'l	M	Imp'l	M	Imp'l			
MF-349-BQ	1/4in	11.1	7/16in	34.9	1 3/8in	25.4	1in	49.00	240g	\$54.00
MF-571-BH	1/2in	22.2	7/8in	57.2	2 1/4in	47.6	1 7/8in	59.00	340g	\$85.00

from \$35.00

Finger Pull Router Bits

TORQUATA



Gaining significantly in popularity in recent times, finger pull bits provide two options for keeping grabs in line with the doors being produced. The first option is to cut a recessed pull directly on to the door, whether by running a pull all the way along the top or bottom of the drawer or cutting out an inset in the middle or edge of the doors.

of timber and run it past the the router bit on both sides, then cut the handle to length and fix it to the door as a feature.

Please note the cutter height is the overall height of the cutter with the rebated section closest to the shank. The Pull Recess Height refers to the useable height that stops at the start of this rebate which would be the depth used when cutting the pull in material.

The second option popular in European furniture is to get a matching or offset-colour piece

Product Code	Shank Size	Cutting Diameter	Narrow Diameter	Cutter Height	Pull Recess Height	Overall Length
FP-190-H	1/2in	19.0	9.5	19.0	14.0	57.2
FP-381-H	1/2in	38.1	17.0	20.7	18.0	61.8
FP-476-H	1/2in	47.6	24.0	28.5	22.0	66.6

from \$45.00

Finger Pull & Window Sill Router Bits

TORQUATA



Originally intended for shaping window sill edges, these bits are also used for creating finger pulls on your doors and drawer edges. When used horizontally they provide a smooth, flowing sill edge profile,

but running the work piece vertically will provide a smooth, flowing but grip-able door pull edge that softens otherwise straight edge doors.

Product Code	Shank Size	Cutter Diameter	Cutter Height	Overall Length
WF-318-H	1/2in	31.8	25.4	73.0
WF-381-H	1/2in	38.1	35.0	85.8

from \$39.00

Edge Bead Moulding Bits

TORQUATA



These bits are great for running a decorative bead along the edge of the timber and can create a full

bead by turning the work piece 90° after the first pass.

Product Code	Shank Size	Cutting Radius		Cutting Depth		Cutting Height		Overall Length	Wgt	RRP
		M	Imp'l	M	Imp'l	M	Imp'l			
EB-095-BQ	1/4in	9.5	3/8in	19.0	3/4in	28.6	1 1/8in	80.2	90g	\$39.00
EB-127-BH	1/2in	12.7	1/2in	25.4	1in	34.9	1 3/8in	86.1	160g	\$43.00
EB-190-BH	1/2in	19.0	3/4in	38.1	1 1/2in	50.8	2in	101.6	300g	\$60.00

\$85.00

Tongue & Groove Jointing Sets



Make tongue and groove joints without the complicated process of taking apart and reassembling

combination bits. This set gives you one grooving and one tonging bit for a perfectly matched set.

Product Code	Shank Size	Cutting Height		Overall Length		Weight	RRP
		Metric	Imp'l	Metric	Imp'l		
TGSET-120-BH	1/2in	9-12mm		71.0		190g	\$85.00
TGSET-190-BH	1/2in	13-19mm		71.0		190g	\$85.00

\$99.00

Tongue & V-Groove Jointing Bit



Traditional tongue and groove boards have a chamfered edge profile on one side so you can choose to either use it as a feature or reverse it to hide the chamfer. Using this bit and changing the

cutter pattern will allow you cut both the tongue and groove profile on any board of your choosing.

**This bit must be used in a router table with fence.

Product Code	Shank Size	Cutting Height		Overall Length		Weight	RRP
		Metric	Imp'l	Metric	Imp'l		
TG-238-BH	1/2in	18 - 24mm		82.6		230g	\$99.00

from **\$24.00**

Slot Cutter Router Bits

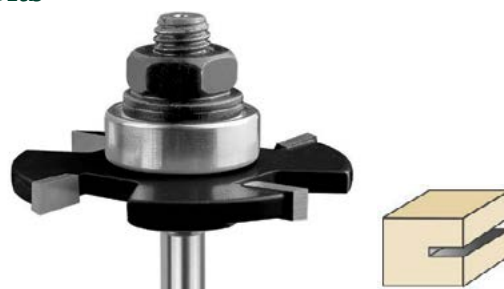

Use slot cutters for cutting grooves, trenches and shallow rebates quickly and easily into the edge or face of timber for a variety of applications. You can stack multiple slot cutters on top of each other to increase the cutting height. Biscuit jointing is a simple, effective and strong method of joining two boards. Simply cut a slot in the timber 4mm thick, squirt some glue

and put the biscuit in on one side and you can quickly and effectively locate two work pieces when jointing. The bearing is designed to cut to the depth of the popular #20 Lamello biscuit size.

Slot cutter blades are available separately so you can create your own stacked sizes as required or even a special size of a tongue and groove cutter.

Product Code	Shank Size	Cutting Depth		Cutting Height		Overall Length	Weight	RRP
		Metric	Imp'l	Metric	Imp'l			
SC-020	-	2.0	-	51.0	-	-	40g	\$22.00
SC-020-BQ	1/4in	12.7	1/2in	2.0	5/64in	56.4	170g	\$35.00
SC-020-BH	1/2in	12.7	1/2in	2.0	5/64in	66.7	170g	\$37.00
SC-030	-	3.0	-	51.0	-	-	50g	\$22.00
SC-030-BQ	1/4in	12.7	1/2in	3.0	-	56.4	160g	\$35.00
SC-030-BH	1/2in	12.7	1/2in	3.0	-	66.7	180g	\$37.00
SC-032	-	3.2	1/8in	50.8	2in	-	50g	\$22.00
SC-032-BQ	1/4in	12.7	1/2in	3.2	1/8in	56.4	160g	\$35.00
SC-032-BH	1/2in	12.7	1/2in	3.2	1/8in	66.7	180g	\$37.00
SC-040	-	4.0	5/32in	51.0	-	-	60g	\$23.00
SC-040-BQ	1/4in	12.7	1/2in	4.0	5/32in	56.4	170g	\$36.00
SC-040-BH	1/2in	12.7	1/2in	4.0	5/32in	66.7	180g	\$38.00
SC-048	-	4.8	3/16in	50.8	2in	-	60g	\$23.00
SC-050	-	6.0	-	51.0	-	-	60g	\$23.00
SC-050-BQ	1/4in	12.7	1/2in	5.0	-	56.4	180g	\$36.00
SC-050-BH	1/2in	12.7	1/2in	5.0	-	66.7	190g	\$38.00
SC-060	-	6.0	-	51.0	-	-	70g	\$26.00
SC-060-BQ	1/4in	12.7	1/2in	6.0	15/64in	56.4	190g	\$40.00
SC-060-BH	1/2in	12.7	1/2in	6.0	15/64in	66.7	200g	\$41.00
SC-064	-	6.4	1/4in	50.8	2in	-	70g	\$26.00
SC-064-BQ	1/4in	12.7	1/2in	6.4	1/4in	56.4	190g	\$40.00
SC-064-BH	1/2in	12.7	1/2in	6.4	1/4in	66.7	200g	\$41.00

from **\$14.00**

Slot Cutter Arbors



Designed to be used with Torquata and most popular slot cutters on the market, all Torquata arbors are CNC

machined and balanced for smooth operation in routers. Includes BEAR-10 Bearing.

Product Code	Shank Size	Cutting Depth		Cutting Height		Overall Length	Weight	RRP
		Metric	Imp'l	Metric	Imp'l			
ARB-1-BQ	1/4in	17.5	11/16in	7.9	5/16in	56.4	60g	\$14.00
ARB-1-BH	1/2in	23.8	15/16in	7.9	5/16in	66.7	90g	\$15.00
ARB-2-BH	1/2in	31.8	1 1/4in	7.9	5/16in	76.2	90g	\$15.00

\$99.00

Slot Cutter Set

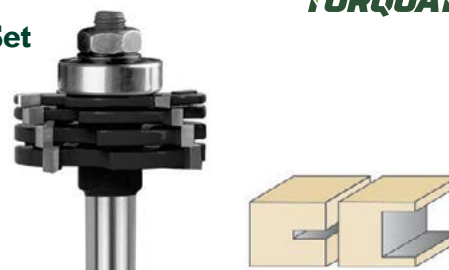

Save money and buy this slot cutter set, which includes the SC032, SC040, SC048, and SC064 blade on the one long arbor.

You can use each individually or stack to cut grooves or rebates 3.2 - 18.4mm high with standard 12.7mm cutting depth.

Product Code	Shank Size	Cutting Depth		Overall Length	Weight	RRP
		Metric	Imp'l			
SCSET-4H	1/2in	12.7	1/2in	76.2	330g	\$99.00

Extraction & Safety
Measuring & Marking
Sawing
Site & Shop Accessories
Routing
Planing
Sanding & Scraping
Drilling
Joinery
Clamps & Vices
Finishing
Sharpening
Carving & Chisels
Woodturning
Wooden Parts
Cabinet Fittings

ROUTING

\$109.00

Finger Joint Bit

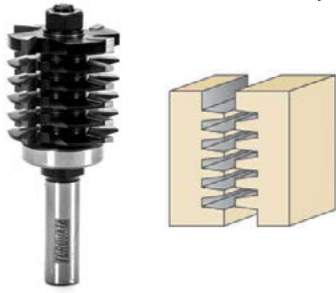

TORQUATA

Finger joints are the strongest method of butt jointing when using a router bit to cut the profile. The tapered fingers interlock and create a joint that is stronger than the

timber and make it simpler and easier to assemble the work pieces when gluing.

**This bit must be used in a router table with fence.

Product Code	Shank Size	Cutting Height		Overall Length	RRP	Weight
		Metric	Imp'l			
FJ-380-BH	1/2in	13 - 38mm		100.0	\$109.00	280g

\$109.00

Box Joint Router Bit



TORQUATA

This router bit allows you to carry out accurate and functional finger joints in a much easier way. Because the fingers aren't tapered and finish flush and square with the slot and finger the same size, you can work with timbers of different thicknesses without any adjustment. Just run the two work pieces face down on the same reference face and get a flush joint every time.

You can also run work pieces through on their ends and cut decorative box joints for fast assembly. Because the cutter height is 40mm, you can set the height of the bit exactly half the height of a work piece up to 80mm and run through on both sides to do the full height.

The bearing provides a 9.5mm (3/8in) depth of cut. For deeper cuts a fence will need to be used.

Product Code	Shank Size	Cutting Height		Cutter Diameter	Overall Length
		Metric	Imp'l		
BJ-400-BH	1/2in	12 - 40mm		47.6	97.3

\$65.00

Flute & Bead Router Bit Set



TORQUATA

This perfectly mated set is ideal for making canoe slats, hot tubs or even beautiful, curved trays

and platters as demonstrated in the video above. The set includes both bits.

Product Code	Shank Size	Cutting Diameter		Cutting Height		Overall Diameter
		Metric	Imp'l	Metric	Imperial	
FBSET-064-H	1/2in	3.2mm	1/8in	6.4mm	1/4in	38.0

\$55.00

Birdsmouth Jointing Bits

TORQUATA

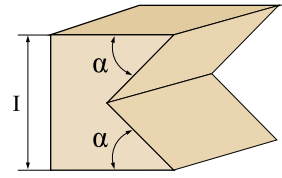

BM-2222-H

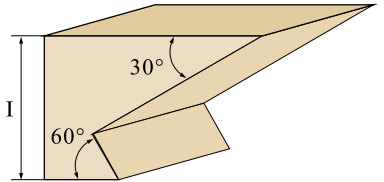

BM-2230-H

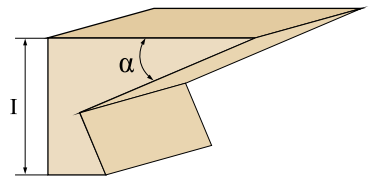

BM-2245-H

Produce multi-sided, nested, interlocking vessels. Traditionally used to make hollow sea-masts they can be used for virtually any

multi-sided application, short or long. Maximum material thickness is 22.2mm. Larger timber will require planning after assembly.

Product Code	Shank Size	Cutting Diameter		Joint Angle	# Sides	Weight	RRP
		Metric	Imp'l				
BM-2222-H	1/2in	38.1	1 1/2in	22.5°	16	200g	\$55.00
BM-2230-H	1/2in	41.3	1 5/8in	30.0°	6 or 12	200g	\$55.00
BM-2245-H	1/2in	38.1	1 1/2in	45.0°	8	200g	\$55.00

\$50.00

Butterfly Key Spline Bit

TORQUATA

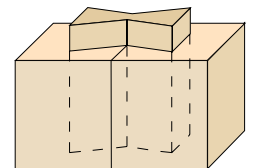
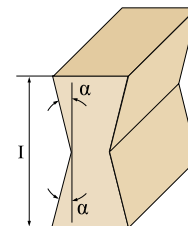

Create strong loose tenon joints using this bit in conjunction with a corresponding 14° dovetail bit. Run a dovetailed trench in two work pieces then run the mating loosen

tenon piece using the butterfly key spline bit to pull both work pieces together. Great for decorative edge joints. 1/2in shank only available.

Product Code	Cutting Diameter	Cutting Height		Weight	RRP
		Metric	Imp'l		
BKS-286-H	28.6	1 1/8in	12 - 45mm	200g	\$50.00

from \$60⁰⁰

Lock Mitre Jointing Router Bits

TORQUATA



LM280H LM190H LM120H

Lock mitre bits are designed to create corner joints at a 90° angle where the apex of the joint is barely visible. This joint makes it easier to assemble boxes and larger

carcass work pieces together and significantly increases joint strength. **These bits must be used in a router table with fence.

Product Code	Shank Size	Cutting Height Metric	Overall Length Metric	Weight	RRP
LM-120-Q	1/4in	9 - 12mm	56.0	90g	\$60.00
LM-120-H	1/2in	9 - 12mm	56.0	100g	\$60.00
LM-190-H	1/2in	10.5 - 19mm	59.1	120g	\$75.00
LM-280-H	1/2in	16 - 28mm	75.0	350g	\$95.00

\$129⁰⁰

Edge Banding Set

TORQUATA



Simply centre and run the groove cutter along the edge of your MDF or ply board to cut the 60° profile and then centre and run the tongue

cutter along your timber edging of choice to create a snug, strong and attractive joint. Suits material 12.7 - 25.4mm thick.

Product Code	Shank Size	Cutting Height Metric	Overall Length Metric	Weight	RRP
EBSET-254-H	1/2in	12.7-25.4mm	76.2	630g	\$129.00

from \$39⁰⁰

Glue Joint Bits

TORQUATA



GJ430BH
GJ410H

Glue joint bits are simple and easy to setup and use to create strong butt joints in timber, as well as making it easier to assemble when applying glue and clamping. The tapered profile allows the timber

to be clamped even when slightly out of square and significantly increases joint strength.

**These bits must be used in a router table with fence.

Product Code	Shank Size	Cutting Height Metric	Overall Length Metric	Weight	RRP
GJ-250-Q	1/4in	12 - 25 mm	57.2	80g	\$39.00
GJ-410-H	1/2in	12 - 41mm	76.2	250g	\$55.00
GJ-430-BH	1/2in	14 - 43mm	94.1	130g	\$55.00

\$75⁰⁰

Combination Window Sash Jointing Bit

TORQUATA

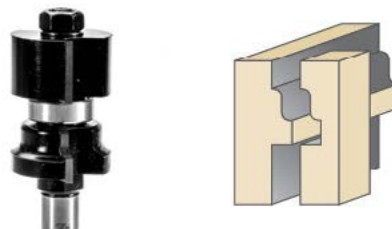

Create your own sash windows! You can choose and use your own timber as well as creating unique window sizes. The main bit creates the window frame with a common

ogee profile as well as cutting the rebate to bead your glass into the frame without any further machining required.

Product Code	Shank Size	Cutting Height Metric	Overall Length Metric	Weight	RRP
WS-450-BH	1/2in	42 - 45mm	96.8	310g	\$75.00

\$115⁰⁰

Two-Piece Window Sash Jointing Set

TORQUATA

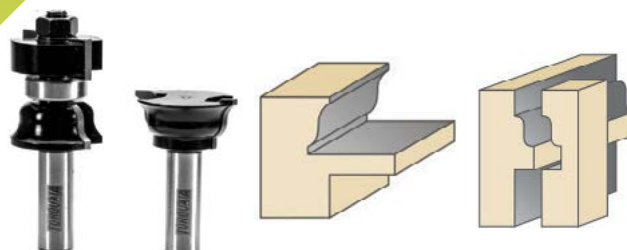

While the combination bit will make simple frames, if you want to go the traditional route and make through mortise and tenon joints in the

corner of the frame you'll need this set as the second cutter cuts the profile rebate the full length of a through tenon.

Product Code	Shank Size	Cutting Height Metric	Overall Length 1 Metric	Overall Length 2 Metric	Weight	RRP
WS3-80-SET	1/2in	35 - 38mm	84.1	55.6	510g	\$115.00

\$50⁰⁰

Drawer Lock Joint Bit

TORQUATA

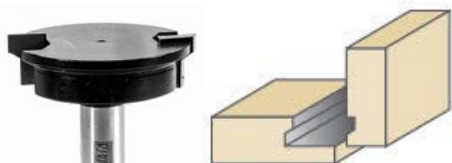

Drawer lock bits are designed to speed up the alignment of flush fitting 90° angle joints to improve joint strength and ease of assembly when making drawer frames. There are two sizes available for

different timber thicknesses. The larger of the two (DL-131-h) will make simple lap joints in thinner material down to 12mm whilst making full size drawer lock joints in materials 16mm and up.

Product Code	Shank Size	Cutter Diameter Metric	Max Joint Thickness	Overall Length Metric
DL-127-Q	1/4in	31.7	10.0 - 12.7mm	44.5
DL-131-H	1/2in	50.8	12.0 - 19.0mm	50.8

ROUTING

\$85.00

Combination Stile & Rail Jointing Bits

TORQUATA

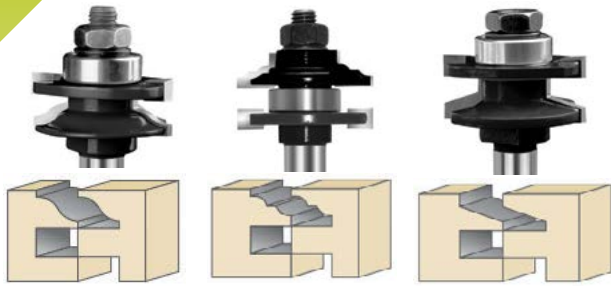

SR-011-BH

SR-021-BH

SR-031-BH

Make a small number of your own unique raised kitchen door frames by purchasing this bit and running the long edge profile, then change the stack of cutters to run the

short-edge profile to joint all pieces together.

**These bits must be used in a router table with fence.

Product Code	Shank Size	Style	Cutting Depth		Cutting Height		Overall Wgt Length	RRP
			M	Imp'l	M	Imp'l		
SR-011-BH	1/2in	Ogee	9.5	3/8in	17.5	22.2	11/16 - 7/8in	74.6 170g \$85.00
SR-021-BH	1/2in	Classical	9.5	3/8in	17.5	22.2	11/16 - 7/8in	74.6 170g \$85.00
SR-031-BH	1/2in	Chamfer	9.5	3/8in	17.5	22.2	11/16 - 7/8in	74.6 170g \$85.00

\$55.00

Vertical Panel Raising Moulding Bits

TORQUATA

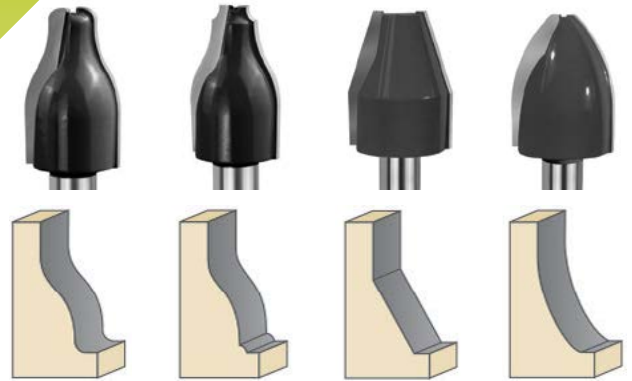

VPR-01-H

VPR-02-H

VPR-03-H

VPR-04-H

Standard panel raising bits are at least 79mm diameter and are usually daunting for novice furniture makers. Vertical panel raising bits are significantly smaller diameter with the only difference that you run the work piece vertically in a router table. The only drawback of these bits is that they can only machine

rectangular frames.

For a modern kitchen door simply cut the profile of these bits on MDF panels and finish them either in clear coat or high-gloss paint minus the rail and stile frame.

**These bits must be used in a router table with fence.

Product Code	Shank Size	Style	Cutting Depth		Cutting Height		Overall Wgt Length	RRP
			M	Imp'l	M	Imp'l		
VPR-01-H	1/2in	Ogee	41.3	1 5/8in	6.4	1/4in	81.0 140g \$55.00	
VPR-02-H	1/2in	Ogee w Bead	41.3	1 5/8in	6.4	1/4in	81.0 140g \$55.00	
VPR-03-H	1/2in	Chamfer	41.3	1 5/8in	9.5	3/8in	81.0 190g \$55.00	
VPR-04-H	1/2in	Cove	41.3	1 5/8in	9.5	3/8in	81.0 180g \$55.00	

\$109.00

Dedicated Stile & Rail Jointing Bits

TORQUATA

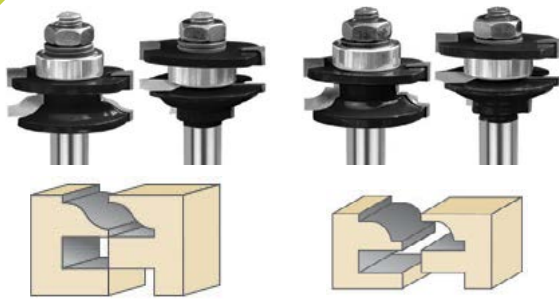

SR-012-BH

SR-042-BH

Get the results of a professional by using the two-piece set for running both profiles to create perfectly matched kitchen door frames. These two bits are matched to

minimize setup time when changing between the two necessary profiles to create your own door frame panels.

**These bits must be used in a router table with fence.

Product Code	Shank Size	Style	Cutting Depth		Cutting Height		Overall Wgt Length	RRP
			M	Imp'l	M	Imp'l		
SR-012-BH	1/2in	Ogee	9.5	3/8in	17.5-23.0	11/16-29/32in	73.8 320g \$109.00	
SR-042-BH	1/2in	Beading	9.5	3/8in	17.5-23.0	11/16-29/32in	73.8 320g \$109.00	

from \$99.00

Horizontal Panel Raising Moulding Bits

TORQUATA

Horizontal Panel Raising Moulding Bits – When using horizontal panel raising bits, you should usually machine the timber in two passes and you must run the router on its lowest speed setting (a maximum of 12,000rpm). Bits with the back

relief cutter are perfect for 19mm panels as this will cut a rebate that allows the panel to sit flush with the door frame.

**These bits must be used in a router table with fence.

Product Code	Shank Size	Style	Cutting Depth		Cutting Height		Overall Length	Wgt	RRP
			M	Imp'l	M	Imp'l			
BPR-01-BH	1/2in	Ogee	31.8	1 1/4in	19.0	3/4in	84.1	370g \$109.00	
BPR-03-BH	1/2in	Chamfer	31.8	1 1/4in	19.0	3/4in	84.1	370g \$109.00	
BPR-04-BH	1/2in	Cove	31.8	1 1/4in	19.0	3/4in	84.1	370g \$109.00	
HPR-01-BH	1/2in	Ogee	38.1	1 1/2in	15.9	5/8in	79.4	330g \$99.00	
HPR-03-BH	1/2in	Chamfer	38.1	1 1/2in	15.9	5/8in	79.4	330g \$99.00	
HPR-04-BH	1/2in	Cove	38.1	1 1/2in	15.9	5/8in	79.4	330g \$99.00	

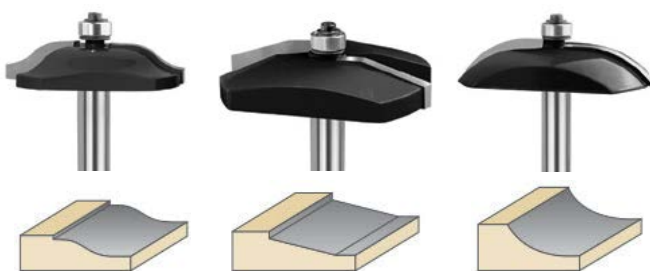

HPR01BH

HPR03BH

HPR04BH

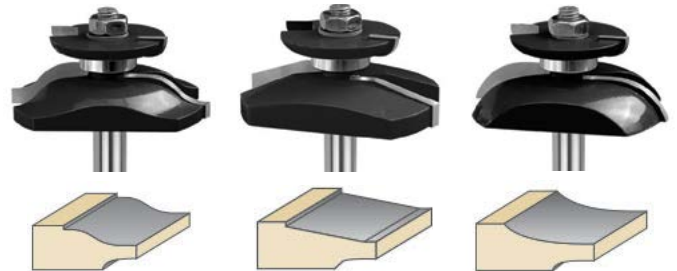

BPR01BH

BPR03BH

BPR04BH

from **\$165⁰⁰**

Router Bit Sets

TORQUATA



Not sure which bit is right for you? The Torquata router bit sets are a selection of common plunge, trim and moulding bits.

Unlike some brands, all bits in the set are identical in quality to the individual bits so are a cost-effective way of getting started.

Product Code	Shank Size	Weight	RRP
RBSET-15-Q	1/4in	1.2kg	\$165.00
RBSET-15-H	1/2in	1.9kg	\$175.00

\$64⁹⁰

Router Collet Extension

TORQUATA

Get a longer reach from your router when mounted in a table by using this collet extension. It will add as much as 45mm to the shaft length of your existing bit making it easier to access when changing over and setting up.

*Not recommended for running router bits greater than 50mm diameter.



Code	Product	RRP	Weight
RCE-127	1/2in Shank 1/2in Collet	\$64.90	160g
RCE-1264	1/2in Shank 1/4in Collet	\$64.90	160g

\$9⁰⁰

Router Collet Sleeve

TORQUATA

RCS-12764 | 120g

Need a collet reducer to fit 1/4in bits in your 1/2in router? Each collet reducer is machined and tested before shipping to ensure minimal run-out in use.



from **\$16⁰⁰**

Dovetail Jointing Bits

TORQUATA



Dovetail bits are primarily used in conjunction with a range of dovetail jigs commonly available. They can also be used for cutting a trench

and matching profile on timber to create sliding shelves in carcass construction.

Product Code	Shank Size	Angle	Cutting Diameter		Cutting Height		Overall Length	Wgt	RRP
			Met	Imp'l	Met	Imp'l			
DT-064-Q	1/4in	75°	6.4	1/4in	7.9	5/16in	63.5	30g	\$18.00
DT-079-Q	1/4in	9°	7.9	5/16in	9.5	3/8in	63.5	30g	\$18.00
DT-095-Q	1/4in	9°	9.5	3/8in	9.5	3/8in	39.7	30g	\$18.00
DT-127-Q	1/4in	14°	12.7	1/2in	12.7	1/2in	44.5	30g	\$18.00
DT-143-Q	1/4in	14°	14.3	9/16in	12.7	1/2in	44.5	30g	\$18.00
DT-159-Q	1/4in	7°	15.9	5/7in	22.2	7/8in	54.0	40g	\$22.00
DT-190-Q	1/4in	7°	19.0	3/4in	22.2	7/8in	54.0	50g	\$24.00
DT-064-H	1/2in	75°	6.4	1/4in	7.9	5/16in	54.0	50g	\$20.00
DT-079-H	1/2in	9°	7.9	5/16in	9.5	3/8in	54.0	50g	\$20.00
DT-095-H	1/2in	9°	9.5	3/8in	9.5	3/8in	54.0	50g	\$20.00
DT-127-H	1/2in	14°	12.7	1/2in	12.7	1/2in	54.0	60g	\$20.00
DT-143-H	1/2in	14°	14.3	9/16in	12.7	1/2in	54.0	50g	\$20.00
DT-159-H	1/2in	7°	15.9	5/8in	22.2	7/8in	63.5	70g	\$23.00
DT-190-SH	1/2in	14°	19.0	3/4in	19.0	3/4in	63.5	70g	\$25.00
DT-190-H	1/2in	7°	19.0	3/4in	22.2	7/8in	63.5	80g	\$25.00
DT-254-H	1/2in	14°	25.4	1in	22.2	7/8in	63.5	90g	\$28.00
DT-127-BQ	1/4in	14	12.7	1/2in	12.7	1/2in	44.5	30g	\$24.00
DT-143-BQ	1/4in	14°	14.3	9/16in	12.7	1/2in	44.5	40g	\$24.00
DT-159-BQ	1/4in	7°	15.9	5/8in	22.2	7/8in	54.0	40g	\$28.00
DT-190-BQ	1/4in	7°	19.0	3/4in	22.2	7/8in	54.0	50g	\$30.00
DT-190-BSH	1/2in	14°	19	3/4in	19	3/4in	63.5	80g	\$31.00
DT-190-BH	1/2in	7°	19.0	2/4in	22.2	7/8in	63.5	80g	\$32.00
DT-254-BH	1/2in	14°	25.4	1in	22.2	7/8in	63.5	90g	\$40.00

from **\$6⁰⁰**

Router Bit Replacement Bearings

TORQUATA

All Torquata router bit bearings are made in Japan and fully-sealed for long life. Be sure not to soak your

bit in solvents as it will dissolve the lubricant within the seals.

Product Code	Outside Diameter		Inside Diameter		Bearing Height	Wgt	RRP
	Metric	Imp'l	Metric	Imp'l			
BEAR-01	9.5	3/8in	4.8	3/16in	3.2	10g	\$6.00
BEAR-02	12.7	1/2in	4.8	3/16in	5.0	10g	\$6.00
BEAR-03	16.0	N/A	5.0	N/A	5.0	20g	\$6.00
BEAR-04	19.0	3/4in	5.0	N/A	6.0	20g	\$6.00
BEAR-06	12.7	1/2in	6.4	1/4in	4.8	10g	\$6.00
BEAR-07	15.9	5/8in	6.4	1/4in	5.0	10g	\$6.00
BEAR-08	19.0	3/4in	6.4	1/4in	7.1	20g	\$6.00
BEAR-09	22.2	7/8in	6.4	1/4in	6.4	20g	\$10.00
BEAR-10	24.0	N/A	8.0	N/A	8.0	20g	\$6.00
BEAR-11	19.0	3/4in	12.7	1/2in	4.0	20g	\$6.00
BEAR-12	25.4	1in	12.7	1/2in	8.0	20g	\$13.00
BEAR-13	28.6	1 1/8in	12.7	1/2in	8.0	20g	\$13.00
BEAR-14	31.8	1 1/4in	12.7	1/2in	8.0	20g	\$13.00
BEAR-15	34.9	1 3/8in	12.7	1/2in	7.9	20g	\$16.50
BEAR-16	22.2	7/8in	8.0	N/A	8.0	20g	\$13.00
BEAR-17	29.2	1 3/16in	8.0	N/A	8.0	20g	\$13.00
BEAR-18	22.2	7/8in	12.7	1/2in	8.0	20g	\$10.00

from **\$2⁰⁰**

Router Bearing Lock Rings, Screws and Washers

TORQUATA



You should always keep spares of common components for router bits on hand in case you lose or

break anything. Below is the list of common parts found on Torquata Router Bits

Prod Code	Product	Weight	Price
LR1263505	Lock Ring for 1/4in Shank Bits	10g	\$3.50
LR1812705	Lock Ring for 1/2in Shank Bits	10g	\$3.50
SC-02508	Bearing Screw 2.5 x 8.0mm	5g	\$2.00
SC-03008	Bearing Screw 3.0 x 8.0mm	5g	\$2.00
SC-03010	Bearing Screw 3.0 x 10.0mm	5g	\$2.00
SC-04010	Bearing Screw 4.0 x 10.0mm	5g	\$2.00
SC-04015	Bearing Screw 4.0 x 15.0mm	5g	\$2.00
W-3108	Bearing Washer 8.5 x 3.1 x 1.4mm	5g	\$2.00
W-4912	Bearing Washer 12.0 x 4.9 x 1.4mm	5g	\$2.00
W-6418	Bearing Washer 18.0 x 6.4 x 1.0mm	5g	\$2.00

ROUTING

from \$119.00

Compression Spiral Bits

Designed with both up and downcut chip ejection, providing an excellent finish on both the upper and the lower side of the workpiece.



Product Code	Shank Size	Cutting Diameter		Cutting Height		Overall Length	RRP	Weight
		Metric	Imp'l	Metric	Imp'l			
19050511	1/2in	12.7	1/2in	25.4	1in	76.2	\$149.00	60g
19050611	1/2in	12.7	1/2in	28.6	1 1/8in	76.2	\$169.00	60g
19050811	1/2in	12.7	1/2in	41.3	1 5/8in	101.6	\$189.00	60g
19051311	3/8in	9.5	3/8in	22.2	7/8in	76.2	\$119.00	60g
19051511	1/2in	12.7	1/2in	22.2	7/8in	76.2	\$149.00	60g
19051711	1/2in	12.7	1/2in	34.9	1 3/8in	88.9	\$179.00	60g

from \$37.00

Upcut Spiral Bits

So-called because when used handheld, have upward chip ejection providing an excellent finish on the lower side of the workpiece. When used in a router this action is reversed, the waste is ejected under the table with an excellent finish on the upper side of the work piece.



Product Code	Shank Size	Cutting Diameter		Cutting Height		Overall Length	RRP	Weight
		Metric	Imp'l	Metric	Imp'l			
19100111	1/4in	3.2	1/8in	12.7	1/2in	50.8	\$39.00	60g
19100311	1/4in	4.0	5/32in	12.7	1/2in	50.8	\$39.00	60g
19100511	1/4in	4.8	3/16in	19.0	3/4in	50.8	\$39.00	60g
19100711	1/4in	6.4	1/4in	19.0	3/4in	50.8	\$36.00	60g
19100811	1/4in	6.4	1/4in	25.4	1in	63.5	\$37.00	60g
19150111	1/2in	7.9	5/16in	25.4	1in	76.2	\$119.00	60g
19150311	1/2in	9.5	3/8in	31.8	1 1/4in	76.2	\$119.00	60g
19150511	1/2in	12.7	1/2in	31.8	1 1/4in	76.2	\$119.00	60g
19150611	1/2in	12.7	1/2in	38.1	1 1/2in	88.9	\$139.00	60g
19150711	1/2in	12.7	1/2in	50.8	2in	101.6	\$149.00	60g

from \$37.00

Downcut Spiral Bits

When used handheld have downward chip ejection providing an excellent finish on the upper side of the workpiece. When used in a table this action is reversed, the waste is ejected above the table and bit with an excellent finish on the lower side of the work piece. To note that when used for trenching operations, this can cause the router/work piece to lift due to the waste collecting in the bottom of the trench.



Product Code	Shank Size	Cutting Diameter		Cutting Height		Overall Length	RRP	Weight
		Metric	Imp'l	Metric	Imp'l			
19200111	1/4in	3.2	1/8in	12.7	1/2in	50.8	\$39.00	50g
19200311	1/4in	4.0	5/32in	12.7	1/2in	50.8	\$39.00	60g
19200511	1/4in	4.8	3/16in	19.0	3/4in	50.8	\$39.00	60g
19200711	1/4in	6.4	1/4in	19.0	3/4in	50.8	\$36.00	60g
19200811	1/4in	6.4	1/4in	25.4	1in	63.5	\$37.00	60g
19250111	1/2in	7.9	5/16in	25.4	1in	76.2	\$119.00	60g
19250311	1/2in	9.5	3/8in	31.8	1 1/4in	76.2	\$119.00	60g
19250511	1/2in	12.7	1/2in	31.8	1 1/4in	76.2	\$119.00	60g
19250611	1/2in	12.7	1/2in	38.1	1 1/2in	88.9	\$139.00	60g
19250711	1/2in	12.7	1/2in	50.8	2in	101.6	\$149.00	60g

from \$32.00

Straight Bits

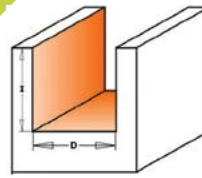

Straight bits are the essential multipurpose router bits you can't do without. Used for trimming, mortising and tenoning, tongue and groove forming and rabbeting. Available in various cutting diameters and lengths to suit your application. CMT's 812 series straight bits provide extra cutting length.

Product Code	Shank Size	Cutting Diameter		Cutting Height		Overall Length	RRP	Weight
		Metric	Imp'l	Metric	Imp'l			
81102011	1/4in	2.0		4.0	5/32in	45.0	\$32.00	50g
81103011	1/4in	3.0		8.0	5/16in	45.0	\$32.00	550g
81103211	1/4in	3.2	1/8in	9.5	3/8in	45.0	\$32.00	550g
81203211	1/4in	3.2	1/8in	12.7	1/2in	50.8	\$36.00	60g
81104011	1/4in	4.0	5/32in	10.0		45.0	\$32.00	550g
81104711	1/4in	4.8	3/16in	12.7	1/2in	50.8	\$33.00	550g
81105011	1/4in	5.0		12.0		50.0	\$33.00	600g
81106011	1/4in	6.0		16.0		50.0	\$33.00	600g
81206011	1/4in	6.0		25.4	1in	60.0	\$36.00	60g
81106411	1/4in	6.4	1/4in	19.0	3/4in	50.8	\$33.00	600g
81106511	1/4in	6.4	1/4in	19.0	3/4in	57.2	\$35.00	600g
81206411	1/4in	6.4	1/4in	25.4	1in	60.0	\$36.00	60g
81107011	1/4in	7.0		18.0		49.0	\$38.00	600g
81108011	1/4in	8.0		20.0		50.0	\$38.00	600g
81108111	1/4in	8.0		25.4	1in	70.0	\$46.00	600g
81208011	1/4in	8.0		31.7	1 1/4in	60.0	\$42.00	60g
81109511	1/4in	9.5	3/8in	19.0	3/4in	50.8	\$35.00	600g
81109611	1/4in	9.5	3/8in	25.4	1in	63.5	\$36.00	600g
81209511	1/4in	9.5	3/8in	31.7	1 1/4in	63.5	\$39.00	60g
81110011	1/4in	10.0		20.0		48.0	\$35.00	600g
81210011	1/4in	10.0		31.7	1 1/4in	60.0	\$39.00	60g
81112011	1/4in	12.0		20.0		50.0	\$35.00	600g
81212011	1/4in	12.0		31.7	1 1/4in	60.0	\$39.00	60g
81112311	1/4in	12.3		25.4	1in	57.2	\$39.00	600g
81112711	1/4in	12.7	1/2in	19.0	3/4in	57.2	\$35.00	600g
81212711	1/4in	12.7	1/2in	31.7	1 1/4in	70.0	\$39.00	60g
81114011	1/4in	14.0		20.0		50.0	\$35.00	600g
81214011	1/4in	14.0		31.7	1 1/4in	60.0	\$41.00	70g
81114211	1/4in	14.2	9/16in	14.2	9/16in	57.2	\$39.00	600g
81115011	1/4in	15.0		20.0		57.2	\$37.00	650g
81215011	1/4in	15.0		31.7	1 1/4in	66.0	\$41.00	70g
81215811	1/4in	15.9	5/8in	31.7	1 1/4in	70.0	\$41.00	70g
81116011	1/4in	16.0		20.0		57.2	\$37.00	650g
81216011	1/4in	16.0		31.7	1 1/4in	66.0	\$41.00	70g
81118011	1/4in	18.0		20.0		50.0	\$39.00	650g
81118211	1/4in	18.2	23/32in	25.4	1in	57.2	\$41.00	700g
81119111	1/4in	19.0	3/4in	20.0		57.2	\$41.00	700g
81120011	1/4in	20.0		20.0		50.0	\$41.00	700g
81122011	1/4in	22.0		20.0		57.2	\$43.00	800g
81125411	1/4in	25.4	1in	19.0	3/4in	50.8	\$47.00	800g
81156011	1/2in	6.0		19.0	3/4in	63.5	\$40.00	850g
81156411	1/2in	6.4	1/4in	19.0	3/4in	63.5	\$42.00	800g
81159511	1/2in	9.5	3/8in	25.4	1in	66.7	\$38.00	850g
81259511	1/2in	9.5	3/8in	31.7	1 1/4in	73.0	\$39.00	80g
81160011	1/2in	10.0		25.4	1in	63.5	\$38.00	800g
81260011	1/2in	10.0		31.7	1 1/4in	70.0	\$39.00	80g
81261111	1/2in	11.1	7/16in	31.7	1 1/4in	82.5	\$42.00	80g
81162011	1/2in	12.0		25.4	1in	63.5	\$39.00	850g
81262011	1/2in	12.0		31.7	1 1/4in	70.0	\$39.00	90g
81162311	1/2in	12.3		25.4	1in	63.5	\$39.00	850g
81162711	1/2in	12.7	1/2in	25.4	1in	66.7	\$39.00	900g
81162811	1/2in	12.7	1/2in	31.7	1 1/4in	82.5	\$40.00	1.05kg
81262711	1/2in	12.7	1/2in	38.1	1 1/2in	95.0	\$40.00	150g
81262811	1/2in	12.7	1/2in	50.8	2in	108.0	\$59.00	150g
81166011	1/2in	15.9	5/8in	25.4	1in	63.5	\$39.00	950g
81166111	1/2in	16.0		25.4	1in	63.5	\$39.00	950g
81266011	1/2in	16.0		31.7	1 1/4in	70.0	\$41.00	100g
81168211	1/2in	18.2	23/32in	25.4	1in	63.5	\$40.00	1kg
81169011	1/2in	19.0	3/4in	25.4	1in	63.5	\$40.00	1kg
81269011	1/2in	19.0	3/4in	38.1	1 1/2in	82.5	\$49.00	120g
81175411	1/2in	25.4	1in	31.7	1 1/4in	76.2	\$48.00	1.55kg

from \$25.00 Mortising Bits

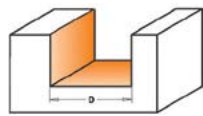

80181711-B

Equipped with thick carbide tips and a negative shear angle design to guarantee you a flawless performance with no splintered edges or rough bottoms. Suffix -B have guide bearings pre-installed on the shaft the same as the cutting diameter.

Product Code	Shank Size	Cutting Diameter		Cutting Height		Overall Length	RRP	Weight
		Metric	Imp'l	Metric	Imp'l			
80112811	1/4in	12.7	1/2in	6.4	1/4in	41.0	\$25.00	50g
80112711	1/4in	12.7	1/2in	19.0	3/4in	54.0	\$27.00	60g
80115811	1/4in	15.9	5/8in	19.0	3/4in	57.0	\$30.00	60g
80119011	1/4in	19.0	3/4in	19.0	3/4in	54.0	\$30.00	70g
80131711	1/4in	31.7	1 1/4in	12.7	1/2in	48.0	\$39.00	90g
80162711	1/2in	12.7	1/2in	19.0	3/4in	60.0	\$27.00	60g
80169011	1/2in	19.0	3/4in	19.0	3/4in	57.0	\$30.00	70g
80181811	1/2in	31.7	1 1/4in	5.7	7/32in	63.0	\$34.00	110g
80181711	1/2in	31.7	1 1/4in	12.7	1/2in	54.0	\$39.00	90g
80112811-B	1/4in	12.7	1/2in	6.4	1/4in	41.0	\$36.00	70g
80112711-B	1/4in	12.7	1/2in	19.0	3/4in	54.0	\$37.00	60g
80115811-B	1/4in	15.9	5/8in	19.0	3/4in	57.0	\$42.00	70g
80119011-B	1/4in	19.0	3/4in	19.0	3/4in	54.0	\$42.00	160g
80181711-B	1/2in	31.7	1 1/4in	5.7	7/32in	63.0	\$59.00	160g
80181811-B	1/2in	31.7	1 1/4in	12.7	1/2in	54.0	\$48.00	160g

from \$46.00 Pattern Following Bits

Pair up these double fluted straight bits with your choice of template to produce cabinet and furniture pieces, signs etc.

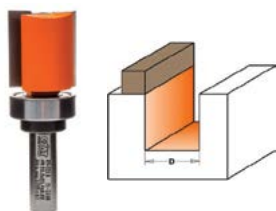

Product Code	Shank Size	Cutting Diameter		Bearing Size	Cutting Height		Overall Length	RRP	Wgt
		Metric	Imp'l		Metric	Imp'l			
81108111-B	1/4in	8.0	1/2in	1/2in	25.4	1in	70.0	\$59.00	70g
81112711-B	1/4in	12.7	1/2in	1/2in	19.0	3/4in	57.2	\$46.00	70g
81212711-B	1/4in	12.7	1/2in	1/2in	31.7	1 1/4in	70.0	\$48.00	70g
81114211-B	1/4in	14.2	9/16in	9/16in	14.2	9/16in	57.2	\$49.00	70g
81115911-B	1/4in	15.9	5/8in	5/8in	12.7	1/2in	58.0	\$46.00	70g
81115811-B	1/4in	15.9	5/8in	5/8in	19.0	3/4in	66.7	\$59.00	70g
81215811-B	1/4in	15.9	5/8in	5/8in	31.7	1 1/4in	70.0	\$59.00	70g
81119111-B	1/4in	19.0	3/4in	3/4in	20.0		57.2	\$49.00	100g
81122211-B	3/8in	22.2	7/8in	7/8in	25.4	1in	66.7	\$59.00	150g
81169011-B	1/2in	19.0	3/4in	3/4in	25.4	1in	63.5	\$59.00	110g
81269011-B	1/2in	19.0	3/4in	3/4in	38.1	1 1/2in	82.5	\$69.00	110g
81269111-B	1/2in	19.0	3/4in	3/4in	50.8	2in	92.0	\$69.00	130g

\$119.00 Flush Trim Set

A convenient set that contains the following three bits in a foam and hard plastic storage case - 80609511, 8060961 & 80619111.



80600111 | 350g

from \$35.00 Flush Trimming Bits

CMT have designed a series of truly indispensable bits available in a wide range of sizes for all your trimming needs and for your most difficult projects. Ideal for precision work on laminates or quick template work with excellent finishing.



Product Code	Shank Size	Cutting Diameter		Cutting Height		Overall Length	RRP	Weight
		Metric	Imp'l	Metric	Imp'l			
80606411	1/4in	6.4	1/4in	25.4	1in	63.5	\$48.00	60g
80609611	1/4in	9.5	3/8in	12.7	1/2in	55.5	\$35.00	60g
80609511	1/4in	9.5	3/8in	25.4	1in	68.2	\$38.00	60g
80612811	1/4in	12.7	1/2in	12.7	1/2in	57.8	\$35.00	60g
80612711	1/4in	12.7	1/2in	25.4	1in	70.7	\$38.00	100g
80662811	1/2in	12.7	1/2in	12.7	1/2in	70.6	\$39.00	60g
80662711	1/2in	12.7	1/2in	25.4	1in	86.6	\$39.00	100g
80662911	1/2in	12.7	1/2in	38.1	1 1/2in	94.0	\$59.00	150g
80663011	1/2in	12.7	1/2in	50.8	2in	104.0	\$59.00	150g

from \$59.00 Heavy-Duty Flush Trimming Bits

With a downshear angle, thicker carbide tips and larger diameter for heavy-duty trimming work in all timber and wood composite materials.



Product Code	Shank Size	Cutting Diameter		Cutting Height		Overall Length	RRP	Weight
		Metric	Imp'l	Metric	Imp'l			
80619111	1/4in	19.0	3/4in	25.4	1in	73.9	\$59.00	950g
80669111	1/2in	19.0	3/4in	25.4	1in	86.5	\$59.00	90g
80669011	1/2in	19.0	3/4in	50.8	2in	109.5	\$69.00	200g

from \$139.00 Spiral Flush Trimming Bits

Aspecial super-micrograin formulation with increased hardness, combined with the spiral cutting angle allows the cabinet maker to shear all materials cleanly, providing more efficient chip ejection than standard flush trim bits.



Product Code	Spiral	Shank Size	Cutting Diameter		Cutting Height		Overall Length	RRP	Wgt
			Met	Imp'l	Met	Imp'l			
19150511-B	Upcut	1/2in	12.7	1/2in	31.7	1 1/4in	89.0	\$139.00	130g
19150711-B	Upcut	1/2in	12.7	1/2in	50.8	2in	114.0	\$169.00	130g
19250511-B	Downcut	1/2in	12.7	1/2in	31.7	1 1/4in	89.0	\$139.00	130g
19250711-B	Downcut	1/2in	12.7	1/2in	50.8	2in	114.0	\$169.00	130g

from \$139.00 V-Groove Flush Trimming Bits

The added V-cutter makes a decorative groove along the hinge joint to hide the seam if the joint is not perfect as well as creating an interesting decorative relief line.



Product Code	Shank Size	Trimmer Diameter	Overall Diameter		Cutting Diameter		Overall Length	RRP	Wgt
			Met	Imp'l	Met	Imp'l			
85300111	1/4in	12.7	19.0	3/4in	25.4	1in	63.5	\$59.00	70g
85350111	1/2in	12.7	19.0	3/4in	25.4	1in	63.5	\$59.00	70g

Extraction & Safety
Measuring & Marking
Sawing
Site & Shop Accessories
Routing
Planing
Sanding & Scraping
Drilling
Joinery
Clamps & Vices
Finishing
Sharpening
Carving & Chisels
Woodturning
Wooden Parts
Cabinet Fittings

ROUTING

\$189.00

DP Flush Trim Bit for Laminates

The ultimate in CMT flush trim bits - lasting 40 times longer than conventional carbide-tipped flush trim bits. Ideal for trimming laminates and timbers in high-volume, repetitive industrial applications.



CMT ORANGE TOOLS
80612861 | 60g



from \$28.00

Panel Pilot Bits

The point plunges smoothly and easily and the carbide edges trim clean and fast. Great for trimming Formica®, veneer and other laminates that need a blind hole cut-out like sinks etc.



CMT ORANGE TOOLS



Product Code	Shank Size	Cutting Diameter		Cutting Height		Overall Length	RRP	Weight
		Metric	Imp'l	Metric	Imp'l			
81606411	1/4in	6.4	1/4in	19.0	3/4in	64.0	\$28.00	50g
81662711	1/2in	12.7	1/2in	31.7	1 1/4in	102.0	\$47.00	150g

from \$42.00

3-in-1 Laminate Flush Trim Bit

The Delrin® triangular bearings solve 3 of the most common problems that occur in flush trimming in cabinet shops.

1. The anti-stick properties of Delrin® reduces the likelihood of the bearing freezing from glue.
2. The extended guide surface of matches the work surface without scratching like steel bearings do and improves maximum stability.
3. The shear angle cutting edge reduces the need for filing - ideal on plastic as well as aluminium laminates!

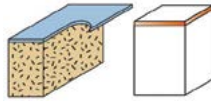

Product Code	Shank Size	Cutting Diameter		Cutting Height		Overall Length	RRP	Weight
		Metric	Imp'l	Metric	Imp'l			
80712811	1/4in	12.7	1/2in	12.7	1/2in	54.2	\$42.00	500g
80719011	1/4in	19.0	3/4in	15.9	5/8in	59.2	\$59.00	600g
80769011	1/2in	19.0	3/4in	15.9	5/8in	65.7	\$59.00	600g

\$59.00

Weatherseal Bit

Make your house more energy efficient by insulating old doors and windows. A CMT Weatherseal Bit is the perfect bit to re-groove door and window frames to accommodate wind blocking inserts.



CMT ORANGE TOOLS

81300111 | 50g

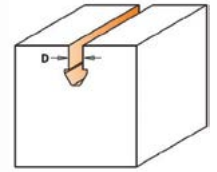

\$59.00

Screw Pilot Bits

Any large panel or table top should be secured in a way that allows it to expand or contract without splitting. These create screw slots so panels are held in place but able to slide back and forth without splitting the wood or breaking the securing screw.



CMT ORANGE TOOLS

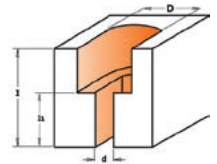

Product Code	Shank Size	Cutting Diameter		Cutting Height		Overall Length	RRP	Weight
		Overall	Slot	Overall	Slot			
81370111	1/2in	11.1	4.4	20.6	12.7	63.5	\$59.00	60g
81360111	1/2in	12.7	4.4	24.2	13.9	63.5	\$59.00	60g

from \$21.00

Combination Trimmer Bits

Cut, trim and bevel all laminates without changing the bits. Achieve great results in straight or angled cuts on both soft and hardwood.

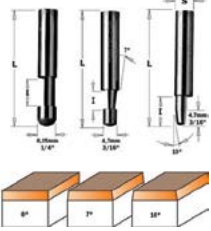

Product Code	Shank Size	Trimmer Angle	Cutting Diameter		Cutting Height		Overall Length	RRP	Wgt
			Met	Imp'l	Met	Imp'l			
84209511	1/4in	0°	6.4	1/4in	9.5	3/8in	38.1	\$21.00	50g
84306311	1/4in	7°	4.8 - 6.4	5/16-1/4in	6.4	1/4in	38.1	\$24.00	50g
84306411	1/4in	0-10°	6.4	1/4in	9.5	3/8in	38.1	\$21.00	50g

from \$37.00

Round Nose Plunge Bits

Suffix -B part numbers have guide bearings pre-installed on the shaft the same as the cutting diameter.



CMT ORANGE TOOLS

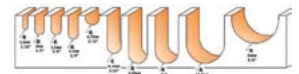

Product Code	Shank Size	Cutting Diameter		Cutting Height		Overall Length	RRP	Wgt
		Metric	Imp'l	Metric	Imp'l			
81403211	1/4in	3.2	1/8in	9.5	3/8in	50.8	\$37.00	50g
81406411	1/4in	6.4	1/4in	12.7	1/2in	50.8	\$37.00	60g
81409511	1/4in	9.5	3/8in	6.4	1/4in	50.8	\$34.00	50g
81412711	1/4in	12.7	1/2in	9.5	3/8in	50.8	\$35.00	50g
81416011	1/4in	15.9	5/8in	9.5	3/8in	50.8	\$39.00	50g
81419011	1/4in	19.0	3/4in	11.3	7/16in	50.8	\$42.00	60g
81456411	1/2in	6.4	1/4in	15.9	5/8in	63.5	\$59.00	90g
81462711	1/2in	12.7	1/2in	31.7	1 1/4in	73.0	\$59.00	90g
81466011	1/2in	15.9	5/8in	31.7	1 1/4in	73.0	\$69.00	100g
81469011	1/2in	19.0	3/4in	31.7	1 1/4in	73.0	\$69.00	110g
81475411	1/2in	25.4	1/2in	31.7	1 1/4in	73.0	\$89.00	140g
81412711-B	1/4in	12.7	1/2in	9.5	3/8in	50.8	\$46.00	60g
81416011-B	1/4in	15.9	5/8in	9.5	3/8in	50.8	\$59.00	60g
81419011-B	1/4in	19.0	3/4in	11.3	7/16in	50.8	\$59.00	120g
81469011-B	1/2in	19.0	3/4in	31.7	1 1/4in	73.0	\$89.00	120g

from \$32.00

Combination Trimmer Bits

Produced from solid carbide, both the 0° and 7° bits have an included rounded end that can be used as a guide to trim laminates, veneer etc. with ease.



CMT ORANGE TOOLS



Product Code	Shank Size	Trimmer Angle	Cutting Diameter		Cutting Height		Overall Length	RRP	Weight
			Metric	Metric	Metric	Imp'l			
82102211	1/4in	0-22°	12.0	12.7	1/2in	44.5	\$32.00	50g	
82103011	1/4in	0-30°	12.0	12.7	1/2in	44.5	\$32.00	50g	
82104511	1/4in	0-45°	12.0	12.7	1/2in	44.5	\$32.00	50g	

from **\$35.00**

V-Groove Plunge Bits

The included angle of the point is 90° - each wall is 45° from both x and y axes'. Suffix -B part numbers have guide bearings pre-installed on the shaft the same as the cutting diameter.



Product Code	Shank Size	Cutting Diameter		Cutting Height		Overall Length	RRP	Weight
		Metric	Imp'l	Metric	Imp'l			
81506411	1/4in	6.4	1/4in	8.0	5/16in	38.1	\$35.00	50g
81509511	1/4in	9.5	3/8in	12.7	1/2in	44.5	\$37.00	50g
81512711	1/4in	12.7	1/2in	12.7	1/2in	44.5	\$34.00	50g
81566011	1/2in	15.9	5/8in	12.7	1/2in	63.5	\$44.00	100g
81569011	1/2in	19.0	3/4in	15.9	5/8in	63.5	\$46.00	100g
81512711-B	1/4in	12.7	1/2in	12.7	1/2in	44.5	\$44.00	60g
81569011-B	1/2in	19.0	3/4in	15.9	5/8in	63.5	\$69.00	110g

from **\$46.00**

Keyhole Bits

You can make holes that keep your frames, plaques or any wall hanging perfectly straight and attached to the wall. The perfect way to securely mount wall hangings on screws and nails.

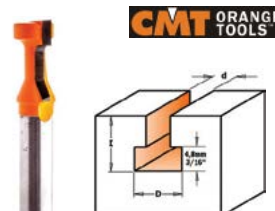

Product Code	Shank Size	Lrg Dia.	Lrg Cut Hgt.	Sml Dia.	Sml Cut Hgt.	Overall Cut Hgt.	Overall Lgth.	RRP	Wgt
85050111	1/2in	9.5	5.0	4.8	6.0	11.0	54.0	\$59.00	60g

\$59.00

60° Lettering Bits

A 60° curved profile with 3.2mm radius and a flattened bottom means relief letter-making is easy and accurate. Allows you to efficiently level off the area and bevel the letter edges to eliminate splintering. Suffix -B part numbers have guide bearings pre-installed on the shaft the same as the cutting diameter.



Product Code	Shank Size	Cutting Diameter		Cutting Height		Overall Length	RRP	Weight
		Metric	Imp'l	Metric	Imp'l			
84900111	1/4in	25.4	1in	19.0	3/4in	50.8	\$59.00	70g
84950111	1/2in	28.5	1 1/8in	19.0	3/4in	63.5	\$59.00	110g
84950111-B	1/2in	28.5	1 1/8in	19.0	3/4in	63.5	\$69.00	140g

from **\$79.00**

Slatwall/T-Slot Bits

Can be used to run t-slots in panel product like melamine etc. to create slatwall - available with either a square profile to install hooks/brackets directly into slot or angled profile so aluminium slatwall stripping can be installed.



Product Code	Shank Size	Lrg Dia.	Lrg Cut Hgt.	Sml Dia.	Sml Cut Hgt.	Overall Cut Hgt.	Overall Lgth.	RRP	Wgt
85060211	1/2in	34.9	9.5	12.7	12.7	22.2	63.5	\$89.00	160g

from **\$49.00**

Rebate Moulding Bits

You can quickly produce inset doors and drawer fronts, make strong rabbet joints, mill perfect tongue and groove joints or any number of other jobs that before were time consuming and difficult.



Product Code	Shank Size	Cutting Depth		Cutting Height		Overall Length	RRP	Weight
		Metric	Imp'l	Metric	Imp'l			
83531711	1/4in	9.5	3/8in	12.7	1/2in	58.4	\$49.00	130g
83535011	1/4in	12.7	1/2in	12.7	1/2in	59.4	\$59.00	160g
83581711	1/2in	9.5	3/8in	12.7	1/2in	61.2	\$49.00	130g
83585011	1/2in	12.7	1/2in	12.7	1/2in	59.4	\$59.00	160g
83585111	1/2in	12.7	1/2in	19.0	3/4in	65.8	\$59.00	190g
83599011	1/2in	15.9	5/8in	22.2	7/8in	77.8	\$89.00	350g

from **\$49.00**

Bowl & Tray/Dish Bits

Ideal for making bowls, trays, boxes, cutting boards or any other specialty or craft item. The round corner of the bit shapes the inner radius while the sides and bottom create the smooth flat surfaces. Suffix -B part numbers have guide bearings pre-installed on the shaft the same as the cutting diameter.



Product Code	Shank Size	Cutting Diameter		Cutting Height		Overall Length	RRP	Weight
		Metric	Imp'l	Metric	Imp'l			
85100111	1/4in	11.1	7/16in	12.7	1/2in	45.5	\$49.00	50g
85100211	1/4in	19.0	3/4in	16.0	5/8in	54.0	\$59.00	60g
85150111	1/2in	19.0	3/4in	16.0	5/8in	60.4	\$59.00	60g
85150211	1/2in	31.7	1 1/4in	16.0	5/8in	60.4	\$69.00	150g
85100211-B	1/4in	19.0	3/4in	16.0	5/8in	54.0	\$69.00	80g
85150111-B	1/2in	19.0	3/4in	16.0	5/8in	60.4	\$79.00	80g
85150211-B	1/2in	31.7	1 1/4in	16.0	5/8in	60.4	\$79.00	200g

from **\$109.00**

Rebate Moulding Sets

The seven included bearings allow you to cut the following rebate depths - 0mm (for use as a flush trim bit), 3.2mm, 6.4mm, 8.0mm, 9.5mm, 11.1mm and 12.7mm.

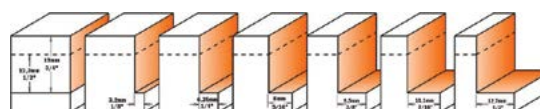

Product Code	Shank Size	Cutting Depth		Cutting Height		Overall Length	RRP	Weight
		Metric	Imp'l	Metric	Imp'l			
83500111	1/4in	0-12.7	0-1/2in	12.7	1/2in	59.4	\$109.00	400g
83550111	1/2in	0-12.7	0-1/2in	12.7	1/2in	59.4	\$109.00	400g
83550211	1/2in	0-12.7	0-1/2in	19.0	3/4in	65.8	\$119.00	0

\$46.00

Laserpoint Bit

The 3-flute solid carbide bit makes delicate grooves and incisions with laser precision with a 60° bevel. Perfectly balanced to give you a superior accuracy with no risk of burning.



Product Code	Shank Size	Angle	Cutting Diameter		Cutting Height		Overall Length	RRP	Weight
			Metric	Imp'l	Metric	Metric			
85800111	1/4in	60°	12.7	1/2in	11.0	57.2	\$46.00	70g	

Extraction & Safety
Measuring & Marking
Sawing
Site & Shop Accessories
Routing
Planing
Sanding & Scraping
Drilling
Joinery
Clamps & Vices
Finishing
Sharpening
Carving & Chisels
Woodturning
Wooden Parts
Cabinet Fittings

ROUTING

\$249.00

Grand Rabbet Set

The set includes the massive 835.990.11 rebate bit with a 22.2mm (7/8") cutting height, all organised with 17 bearing sleeves to achieve almost every needed cutting depth in a sturdy moulded case.



CMT ORANGE TOOLS
83550311 | 1.5kg

from **\$28.00**

Slot Cutter Blades

CMT slot cutters are available as a blade only in a massive range of sizes listed below.

823 series has a countersunk recess for end mount arbors.



CMT ORANGE TOOLS

Product Code	Cutting Height		Cutter Diameter		RRP	Weight
	Metric	Imp'l	Metric	Imp'l		
82231511	1.5		47.6	1 7/8in	\$28.00	50g
82231611	1.6	1/16in	47.6	1 7/8in	\$28.00	50g
82231811	1.8		47.6	1 7/8in	\$28.00	50g
82232011	2.0	5/64in	47.6	1 7/8in	\$28.00	50g
82232211	2.2		47.6	1 7/8in	\$28.00	50g
82232411	2.4	3/32in	47.6	1 7/8in	\$28.00	50g
82232511	2.5		47.6	1 7/8in	\$28.00	50g
82232811	2.8	7/64in	47.6	1 7/8in	\$28.00	50g
82233011	3.0		47.6	1 7/8in	\$28.00	50g
82233211	3.2	1/8in	47.6	1 7/8in	\$28.00	50g
82233511	3.5	9/64in	47.6	1 7/8in	\$28.00	50g
82234011	4.0	5/32in	47.6	1 7/8in	\$28.00	50g
82234811	4.8	3/16in	47.6	1 7/8in	\$29.00	50g
82235011	5.0	13/64in	47.6	1 7/8in	\$29.00	50g
82236011	6.0	15/64in	47.6	1 7/8in	\$31.00	50g
82236411	6.4	1/4in	47.6	1 7/8in	\$31.00	50g
82333011	3.0		47.6	1 7/8in	\$32.00	50g
82333211	3.2	1/8in	47.6	1 7/8in	\$33.00	50g
82334011	4.0	5/32in	47.6	1 7/8in	\$33.00	50g
82335011	5.0	13/64in	47.6	1 7/8in	\$34.00	50g
82336411	6.4	1/4in	47.6	1 7/8in	\$35.00	50g

\$109.00

Variable Slot Cutter Set

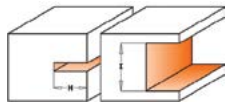

CMT ORANGE TOOLS
80050611 | 350g

Create slots, grooves and rabbets in materials 3.2 - 18mm thick by using the adjustable CMT three wing slot cutter set. Includes 3.2mm, 4.0mm, 4.8mm, 6.4mm slot cutters on 1/2in arbor.

\$359.00

Deluxe Slot Cutter Set

Ideal for milling just about any shape and size - includes four bearings for different cutting depths, seven slot cutters ranging 1.6 - 6.4mm thick and four different types of arbors.



CMT ORANGE TOOLS
82300111 | 1.3kg

from **\$18.00**

Slot Cutter Arbors

Pair CMT's slot cutters with the widest range of arbors available to get the most from your slot cutter blades.



CMT ORANGE TOOLS

Product Code	Shank Size	Bearing Diameter	Arbor Height	Cutter Mount	Overall Length	RRP	Weight
82406400	1/4in	N/A	26.0	Standard	61.0	\$18.00	40g
82406410	1/4in	22.2	26.0	Standard	61.0	\$24.00	100g
82412700	1/2in	N/A	26.0	Standard	67.5	\$18.00	80g
82412710	1/2in	22.2	26.0	Standard	67.5	\$24.00	100g
82406110	1/4in	22.2	1.5 - 6.4	End	55.0	\$24.00	100g
82412110	1/2in	22.2	1.5 - 6.4	End	55	\$24.00	70g
82412200	1/2in	N/A	1.5 - 6.4	End	61	\$18.00	50g
82412210	1/2in	22.2	1.5 - 6.4	End	61	\$24.00	70g

from **\$49.00**

Slot Cutter Router Bits



CMT ORANGE TOOLS

Every cutter features anti-kickback design, micrograin carbide tips and orange CMT trademark non-stick PTFE coating.

Product Code	Shank Size	Cutting Depth		Cutting Height		Overall Length	RRP	Weight
		Metric	Imp'l	Metric	Imp'l			
82231611-A	1/4in	12.7	1/2in	1.6	1/16in	61.0	\$49.00	150g
82232011-A	1/4in	12.7	1/2in	2.0	5/64in	61.0	\$49.00	150g
82232411-A	1/4in	12.7	1/2in	2.4	3/32in	61.0	\$49.00	150g
82233211-A	1/4in	12.7	1/2in	3.2	1/8in	61.0	\$50.00	150g
82234011-A	1/4in	12.7	1/2in	4.0	5/32in	61.0	\$50.00	150g
82236011-A	1/4in	12.7	1/2in	6.0	15/64in	61.0	\$59.00	170g
82236411-A	1/4in	12.7	1/2in	6.4	1/4in	61.0	\$59.00	180g
82231611-B	1/2in	12.7	1/2in	1.6	1/16in	67.5	\$49.00	150g
82232011-B	1/2in	12.7	1/2in	2.0	5/64in	67.5	\$49.00	150g
82232411-B	1/2in	12.7	1/2in	2.4	3/32in	67.5	\$49.00	150g
82233211-B	1/2in	12.7	1/2in	3.2	1/8in	67.5	\$50.00	150g
82234011-B	1/2in	12.7	1/2in	4.0	5/32in	67.5	\$50.00	150g
82234811-B	1/2in	12.7	1/2in	4.8	3/16in	67.5	\$59.00	150g
82236011-B	1/2in	12.7	1/2in	6.0	15/64in	67.5	\$59.00	170g
82236411-B	1/2in	12.7	1/2in	6.4	1/4in	67.5	\$59.00	180g

from **\$41.00**

Chamfer Moulding Bits

CMT chamfer bits cut clean, accurate bevels and chamfers, great for edge work or for making perfectly aligned multi-sided containers and boxes.



CMT ORANGE TOOLS

Product Code	Shank Size	Angle	Cutting Depth	Cutting Height	Overall Length	RRP	Weight
83613011	1/4in	15°	3.8	11.5	54.9	\$41.00	60g
83619011	1/4in	25°	4.8	10.0	54.9	\$42.00	60g
83628011	1/4in	45°	9.5	9.5	53.0	\$45.00	70g
83642011	1/4in	45°	15.9	18.0	60.2	\$59.00	160g
83692011	1/2in	45°	15.9	18.0	66.5	\$59.00	160g
83695011	1/2in	45°	26.1	26.0	76.7	\$109.00	380g
85750411	1/2in	11.25°	4.4	21.5	71.1	\$59.00	100g
85750311	1/2in	15°	5.9	24.5	71.1	\$59.00	110g
85750211	1/2in	22.5°	9.2	31.5	71.1	\$69.00	120g
85750111	1/2in	30°	12.9	38.5	71.1	\$69.00	170g

from **\$44.00**

Rounding Over Bits



CMT ORANGE TOOLS

All bits are made of Fatigue Proof® steel and have CMT's unique micro-grain carbide-tipped cutting edges - suitable for industrial applications.

Up to 25.4mm radii bits have a 12.7mm diameter guide bearing that can be interchanged with 9.5mm diameter bearing, creating an extra decorative lip.

Product Code	Shank Size	Cutting Radius		Cutting Depth		Cutting Height	RRP	Weight
		Metric	Imp'l	Metric	Imp'l			
83816011	1/4in	1.6	1/16in	1.6	1/16in	12.7	\$44.00	60g
83819011	1/4in	3.2	1/8in	3.2	1/8in	12.7	\$48.00	60g
83822211	1/4in	4.8	3/16in	4.8	3/16in	12.7	\$49.00	70g
83825411	1/4in	6.4	1/4in	6.4	1/4in	12.7	\$59.00	150g
83828511	1/4in	7.9	5/16in	7.9	5/16in	12.7	\$59.00	70g
83831711	1/4in	9.5	3/8in	9.5	3/8in	15.9	\$59.00	150g
83838011	1/4in	12.7	1/2in	12.7	1/2in	19.0	\$69.00	150g
83844511	1/4in	15.9	5/8in	15.9	5/8in	22.2	\$89.00	170g
83875411	1/2in	6.4	1/4in	6.4	1/4in	12.7	\$59.00	150g
83881711	1/2in	7.9	5/16in	7.9	5/16in	12.7	\$59.00	150g
83888011	1/2in	9.5	3/8in	9.5	3/8in	15.9	\$69.00	150g
83894511	1/2in	12.7	1/2in	12.7	1/2in	19.0	\$89.00	170g
83899011	1/2in	15.9	5/8in	15.9	5/8in	22.2	\$89.00	180g
83899111	1/2in	19.0	3/4in	19.0	3/4in	25.4	\$129.00	310g
83899211	1/2in	25.4	1in	25.4	1in	33.3	\$139.00	360g
83899311	1/2in	28.6	1 1/8in	28.6	1 1/8in	38.1	\$169.00	510g
83899411	1/2in	31.7	1 1/4in	31.7	1 1/4in	44.5	\$199.00	600g

from **\$45.00**

Cove Moulding Bits

Make simple or elegant furniture, doors and drawer fronts by adding a final touch with CMT cove bits.



CMT ORANGE TOOLS

Product Code	Shank Size	Cutting Radius		Cutting Height		Overall Length	RRP	Weight
		Metric	Imp'l	Metric	Imp'l			
83719011	1/4in	4.8	3/16in	12.7	1/2in	54.9	\$45.00	100g
83722211	1/4in	6.4	1/4in	12.7	1/2in	54.9	\$46.00	110g
83725411	1/4in	7.9	5/16in	12.7	1/2in	54.9	\$59.00	110g
83728611	1/4in	9.5	3/8in	12.7	1/2in	54.9	\$59.00	120g
83735011	1/4in	12.7	1/2in	15.5	5/8in	57.7	\$69.00	170g
83769011	1/2in	4.8	3/16in	12.7	1/2in	61.2	\$46.00	100g
83772211	1/2in	6.4	1/4in	12.7	1/2in	61.2	\$48.00	110g
83775411	1/2in	7.9	5/16in	12.7	1/2in	60.5	\$59.00	110g
83778611	1/2in	9.5	3/8in	12.7	1/2in	60.5	\$59.00	120g
83785011	1/2in	12.7	1/2in	15.5	5/8in	64.0	\$69.00	170g
83795011	1/2in	15.9	5/8in	18.5	47/64in	67.0	\$79.00	210g
83795111	1/2in	19.0	3/4in	22.2	7/8in	70.7	\$99.00	260g
83795511	1/2in	14.3 - 35.0	9/16 - 3/8	12.7	1/2in	61.2	\$99.00	220g

\$159.00

Cove Moulding Set

A convenient set that contains the following three 1/2in shank bits in a foam and hard plastic storage case - 83772211, 83778611 & 83785011. The anti-kickback design and thick carbide tips provide long lasting performance.



CMT ORANGE TOOLS

83750111 | 350g0g



from **\$47.00**

Beading Bits

Identical to the roundover bits except that they have a 9.5mm diameter guide bearing, creating an extra decorative lip.



CMT ORANGE TOOLS

Product Code	Shank Size	Cutting Radius		Cutting Depth		Cutting Height	RRP	Weight
		Metric	Imp'l	Metric	Imp'l			
83916011	1/4in	1.6	1/16in	1.6	1/16in	12.7	\$47.00	60g
83919011	1/4in	3.2	1/8in	3.2	1/8in	12.7	\$48.00	60g
83922211	1/4in	4.8	3/16in	4.8	3/16in	12.7	\$59.00	70g
83925411	1/4in	6.4	1/4in	6.4	1/4in	12.7	\$59.00	100g
83928511	1/4in	7.9	5/16in	7.9	5/16in	12.7	\$59.00	70g
83931711	1/4in	9.5	3/8in	9.5	3/8in	15.9	\$59.00	100g
83938011	1/4in	12.7	1/2in	12.7	1/2in	19.0	\$69.00	150g
83944511	1/4in	15.9	5/8in	15.9	5/8in	22.2	\$89.00	170g
83975411	1/2in	6.4	1/4in	6.4	1/4in	12.7	\$59.00	100g
83981711	1/2in	7.9	5/16in	7.9	5/16in	12.7	\$69.00	100g
83988011	1/2in	9.5	3/8in	9.5	3/8in	15.9	\$69.00	150g
83994511	1/2in	12.7	1/2in	12.7	1/2in	19.0	\$89.00	170g
83999011	1/2in	15.9	5/8in	15.9	5/8in	22.2	\$99.00	180g
83999111	1/2in	19.0	3/4in	19.0	3/4in	25.4	\$129.00	200g
83999211	1/2in	25.4	1in	25.4	1in	33.3	\$139.00	250g

\$169.00

Roundover Set

A convenient set that contains the following three 1/2in shank bits in a foam and hard plastic storage case - 83875411, 83881711 & 83888011.

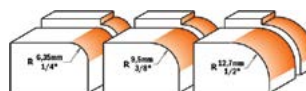

CMT ORANGE TOOLS

83850111 | 350g

from **\$42.00**

Ovolo Bits



CMT ORANGE TOOLS

The work capacity of several different bits all in one - ovolo bits allow you to make beautiful beadwork, edgework and veins. Use on CNCs or with a fence to produce a wide variety of single and double bead profiles and round overs simply adjusting the height or depth of the cut.

Product Code	Shank Size	Cutting Radius		Cutting Diameter		Cutting Height		Overall Lgth	RRP	Wgt
		Met	Imp'l	Met	Imp'l	Met	Imp'l			
82705011	1/4in	5.0		21.0		12.0		43.8	\$42.00	60g
82706011	1/4in	6.0		23.0		12.0		43.8	\$45.00	80g
82709511	1/4in	9.5	3/8in	31.7	1 1/4in	15.9	5/8in	47.6	\$50.00	100g
82712711	1/4in	12.7	1/2in	38.1	1 1/2in	19.0	3/4in	50.8	\$59.00	140g
82756011	1/2in	6.0		23.0		12.0		50.8	\$45.00	80g
82759511	1/2in	9.5	3/8in	31.7	1 1/4in	15.9	5/8in	54.0	\$50.00	100g
82762711	1/2in	12.7	1/2in	38.1	1 1/2in	19.0	3/4in	57.1	\$59.00	140g
82766011	1/2in	16.0	5/8in	44.5	1 3/4in	22.2	7/8in	60.3	\$79.00	110g
82769011	1/2in	19.0	3/4in	50.8	2in	25.4	1in	63.5	\$89.00	250
82772211	1/2in	22.2	7/8in	57.1	2 1/4in	28.6	1 1/2in	66.6	\$109.00	300g
82775411	1/2in	25.4	1in	63.5	2 1/2in	33.5	1 5/8in	71.4	\$129.00	350g

ROUTING

from \$47.00

Bullnose Moulding Bits

CMT bull nose bits create beautifully finished edges on stair treads, window sills and shelves in a single pass.



Product Code	Shank Size	Cutting Radius		Cutter Diameter		Cutting Height		Overall Length	RRP	Wgt
		Met	Imp'l	Met	Imp'l	Met	Imp'l			
85400211	1/4in	3.2	1/8in	6.4	1/4in	19.0	3/4in	50.8	\$47.00	70g
85400311	1/4in	4.8	3/16in	9.5	3/8in	22.0	7/8in	54.0	\$59.00	90g
85400411	1/2in	6.4	1/4in	12.7	1/2in	25.5	1in	57.1	\$59.00	120g
85450211	1/2in	3.2	1/8in	6.4	1/4in	19.0	3/4in	57.1	\$48.00	70g
85450311	1/2in	4.8	3/16in	9.5	3/8in	22.0	7/8in	60.3	\$59.00	90g
85450411	1/2in	6.4	1/4in	12.7	1/2in	25.5	1in	63.5	\$59.00	120g
85450711	1/2in	9.5	3/8in	19.0	3/4in	35.0	1 3/8in	73.0	\$89.00	190g
85450911	1/2in	12.7	1/2in	25.4	1in	41.0	1 5/8in	79.4	\$109.00	270g

from \$59.00

Roman Ogee Moulding Bits

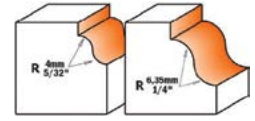

Product Code	Shank Size	Cutting Radius		Cutting Diameter		Cutting Height		RRP	Weight
		Met	Imp'l	Met	Imp'l	Met	Imp'l		
84027011	1/4in	4.0	5/32in	28.7	1 1/8in	11.5	29/64in	\$59.00	130g
84035011	1/4in	6.4	1/4in	38.1	1 1/2in	17.3	11/16in	\$69.00	160g
84077011	1/2in	4.0	5/32in	28.7	1 1/8in	11.5	29/64in	\$59.00	130g
84085011	1/2in	6.4	1/4in	38.1	1 1/2in	17.3	11/16in	\$69.00	160g

from \$59.00

Edge Bead Moulding Bits

Make beautiful traditional and edge beads or turn old beads into new mouldings. Run the bit twice to form a complete corner bead; they provide excellent results.



Product Code	Shank Size	Cutting Radius		Cutter Diameter		Cutting Height		Overall Length	RRP	Wgt
		Met	Imp'l	Met	Imp'l	Met	Imp'l			
86103211	1/4in	3.2	1/8in	6.4	1/4in	15.0	19/32in	57.7	\$59.00	100g
86104811	1/4in	4.8	3/16in	9.5	3/8in	18.6		61.2	\$59.00	100g
86106411	1/4in	6.4	1/4in	12.7	1/2in	22.2	7/8in	64.8	\$69.00	110g
86153211	1/2in	3.2	1/8in	6.4	1/4in	15.0	19/32in	64	\$59.00	100g
86154811	1/2in	4.8	3/16in	9.5	3/8in	18.6		67.6	\$59.00	110g
86156411	1/2in	6.4	1/4in	12.7	1/2in	22.2	7/8in	71.7	\$69.00	110g

from \$69.00

Classical Edge Moulding Bits

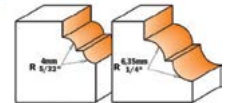

Product Code	Shank Size	Cutting Radius		Cutting Diameter		Cutting Height	RRP	Weight
		Met	Imp'l	Met	Imp'l			
84128511	1/4in	4.0	5/32in	33.4	1 5/16in	13.0	\$69.00	180g
84138011	1/4in	6.4	1/4in	42.8	1 11/16in	18.5	\$79.00	180g
84178511	1/2in	4.0	5/32in	33.4	1 5/16in	13.0	\$69.00	180g
84188011	1/2in	6.4	1/4in	42.8	1 11/16in	18.5	\$79.00	180g

\$69.00

Wainscot Paneling Bit

Designed for 19mm stock, perfect for creating wainscots and panels on your walls. Perfect for cabinets, bookcase backings, ceiling and wall panelling.



Product Code	Shank Size	Cutting Radius	Cutting Diameter	Cutting Height	Overall Length	RRP	Weight
86160111	1/2in	4.0	23.8	19.0	67.7	\$69.00	110g

from \$69.00

Classical Ogee Moulding Bits

844 series have a 1/2in diameter guide bearing, 845 series have a 3/8in diameter bearing to create an extra decorative lip.

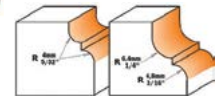

Product Code	Shank Size	Cutting Radius		Cutting Diameter		Cutting Height	RRP	Weight
		Metric	Imp'l	Metric	Imp'l			
84428711	1/4in	4.0	5/32in	28.7	1 1/8in	13.0	\$69.00	160g
84435011	1/4in	6.4-4.8	1/4in	35.0	1 3/8in	18.5	\$79.00	160g
84478711	1/2in	4.0	5/32in	28.7	1 1/8in	13.0	\$69.00	160g
84485011	1/2in	6.4-4.8	1/4in	35.0	1 3/8in	18.5	\$79.00	160g
84528711	1/4in	4.0	5/32in	28.7	1 1/8in	13.0	\$69.00	160g
84535011	1/4in	6.4-4.8	1/4in	35.0	1 3/8in	18.5	\$79.00	160g
84578711	1/2in	4.0	5/32in	28.7	1 1/8in	13.0	\$69.00	160g

from \$59.00

Ogee Moulding Bits

859 series have a 1/2in diameter guide bearing, 860 series have a 3/8in diameter bearing to create an extra decorative lip.

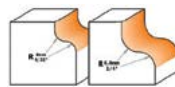

Product Code	Shank Size	Cutting Radius		Cutting Diameter		Cutting Height	RRP	Weight
		Metric	Imp'l	Metric	Imp'l			
85904011	1/4in	4.0	5/32in	28.7	1 1/8in	13.0	\$59.00	110g
85906411	1/4in	6.4	1/4in	38.1	1 1/2in	18.5	\$69.00	160g
85954011	1/2in	4.0	5/32in	28.7	1 1/8in	13.0	\$69.00	110g
85956411	1/2in	6.4	1/4in	38.1	1 1/2in	18.5	\$69.00	160g
86004011	1/4in	4.0	5/32in	28.7	1 1/8in	13.0	\$69.00	100g
86006411	1/4in	6.4	1/4in	38.1	1 1/2in	18.5	\$79.00	160g
86054011	1/2in	4.0	5/32in	28.7	1 1/8in	13.0	\$69.00	100g
86056411	1/2in	6.4	1/4in	38.1	1 1/2in	18.5	\$79.00	160g

\$69.00

Ogee Fillet Moulding Bits

846 series have a 1/2in diameter guide bearing, 847 series have a 3/8in diameter bearing to create an extra decorative lip.

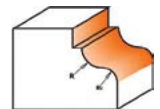

Product Code	Shank Size	Cutting Radius		Cutting Diameter		Cutting Height	RRP	Weight
		Metric	Imp'l	Metric	Imp'l			
84632511	1/4in	4.8-3.6	3/16in	34.2	1 11/32in	13.0	\$69.00	140g
84682511	1/2in	4.8-3.6	3/16in	34.2	1 11/32in	13.0	\$69.00	140g
84732511	1/4in	4.8-3.6	3/16in	34.2	1 11/32in	13.0	\$69.00	140g
84782511	1/2in	4.8-3.6	3/16in	34.2	1 11/32in	13.0	\$69.00	140g

from **\$59.00**

Cavetto Moulding Bits



CMT ORANGE TOOLS

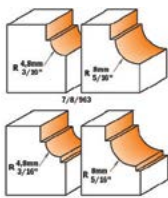

Product Code	Shank Size	Cutting Radius		Cutting Diameter		Cutting Height	RRP	Weight
		Metric	Imp'l	Metric	Imp'l			
86304811	1/4in	4.8	3/16in	25.4	1.0	11.5	\$59.00	100g
86308011	1/4in	8.0	5/16in	31.8	1 1/4in	14.3	\$69.00	110g
86354811	1/2in	4.8	3/16in	25.4	1.0	11.5	\$59.00	100g
86358011	1/2in	8.0	5/16in	31.8	1 1/4in	14.3	\$69.00	110g
86404811	1/4in	4.8	3/16in	25.4	1.0	11.5	\$59.00	100g
86408011	1/4in	8.0	5/16in	31.8	1 1/4in	14.3	\$69.00	110g
86454811	1/2in	4.8	3/16in	25.4	1.0	11.5	\$59.00	100g
86458011	1/2in	8.0	5/16in	31.8	1 1/4in	14.3	\$69.00	110g

from **\$69.00**

Classical Bead Plunge Bits



CMT ORANGE TOOLS

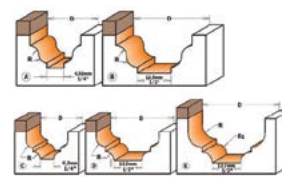

The bit design gives a wide flat bottom cut and a longer shank allows for a greater depth in the detail of the profile.

Product Code	Shank Size	Cutting Radius		Cutting Diameter	Cutting Height	Overall Length	RRP	Weight
		Metric	Metric					
86520111-B	1/4in	3.2	19.0	12.3	54	\$69.00	70g	
86530111-B	1/4in	3.2	19.0	12.3	54	\$69.00	70g	
86570211-B	1/2in	4.0	28.6	14.3	58.8	\$59.00	130g	
86580211-B	1/2in	4.0	28.6	13.3	58	\$59.00	130g	

\$59.00

Ogee Plunge Bits



CMT ORANGE TOOLS

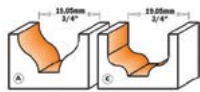

Product Code	Shank Size	Cutting Radius	Cutting Diameter	Cutting Height	Overall Length	RRP	Weight
86500111	1/4in	6.4	19.0	11.0	50.8	\$59.00	90g
86550111	1/2in	6.4	19.0	11.0	50.8	\$59.00	50g

from **\$59.00**

Plunging Classical Bits

Suffix -B part numbers have guide bearings pre-installed on the shaft the same as the cutting diameter.



CMT ORANGE TOOLS



Product Code	Shank Size	Cutting Radius		Cutting Diameter		Cutting Height	Overall Length	RRP	Wgt
		Met	Imp'l	Met	Imp'l				
84819011	1/4in	4.0	5/32in	19.0	3/4in	13.0	51.1	\$59.00	60g
84819111	1/4in	2.4	3/32in	19.0	3/4in	12.0	53.0	\$59.00	70g
84881711	1/2in	4.0	5/32in	31.8	1 1/4in	13.0	58.0	\$59.00	110g
84819011-B	1/4in	4.0	5/32in	19.0	3/4in	13.0	51.1	\$69.00	70g
84819111-B	1/4in	2.4	3/32in	19.0	3/4in	12.0	53.0	\$69.00	70g
84881711-B	1/2in	4.0	5/32in	31.8	1 1/4in	13.0	58.0	\$79.00	170g

from **\$44.00**

Decorative Ogee Plunge Bits



CMT ORANGE TOOLS

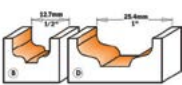

Product Code	Shank Size	Cutting Radius	Cutting Diameter	Cutting Height	Overall Length	RRP	Weight
86510111	1/4in	1.2	12.7	12.7	50.8	\$44.00	50g
86510211	1/4in	2.4	19.0	11.0	50.8	\$48.00	60g

from **\$99.00**

Face Moulding Bits



CMT ORANGE TOOLS

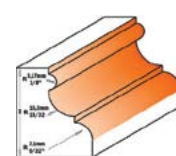
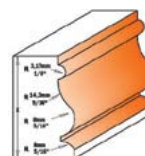
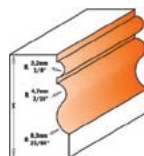

Product Code	Shank Size	Cutting Depth		Cutting Height		Overall Length	RRP	Weight
		Metric	Imp'l	Metric	Imp'l			
85590111	1/2in	5.5	7/32in	35.0	1 3/8in	83.8	\$99.00	200g
85590211	1/2in	7.1	9/32in	41.0	1 39/64in	90.2	\$99.00	200g
85650111	1/2in	17.5	11/16in	28.5	1 1/8in	77.4	\$109.00	260g

\$139.00

Flute & Bead Set



CMT ORANGE TOOLS

85570111 | 150g

This perfectly mated set is ideal for making canoe slats, hot tubs or any kind of curved, thin work piece such as a tray. Set includes the two bits, producing 6.4mm (1/4") slats

Product Code	Shank Size	Cutting Height		Cutting Diameter		Overall Length	RRP	Weight	
		Met	Imp'l	Met	Imp'l				Met
85570111	1/2in	6.4	1/4in	38.1	1 1/2in	44.5	1 3/4in	\$139.00	150g

Extraction & Safety
Measuring & Marking
Sawing
Site & Shop Accessories
Routing
Planing
Sanding & Scraping
Drilling
Joinery
Clamps & Vices
Finishing
Sharpening
Carving & Chisels
Woodturning
Wooden Parts
Cabinet Fittings

ROUTING

from \$109.00

Handrail Moulding Bits



Gives you well-proportioned smooth curves for elegant eye-catching work on your tables or in two passes will cut the curvature of the top of a handrail. Pair with two popular handrail grip options - adding a touch of class to your architectural settings.



Product Code	Shank Size	Cutting Depth		Cutting Height		Overall Length	RRP	Weight
		Metric	Imp'l	Metric	Imp'l			
85660111	1/2in	25.4	1in	19.0	3/4in	67.9	\$129.00	300g
85670111	1/2in	11.0	7/16in	38.1	1 1/2in	87.0	\$109.00	210g
85670211	1/2in	9.5	3/8in	38.1	1 1/2in	87.0	\$109.00	210g

from \$89.00

Window Sill / Finger Pull Bits



Originally intended for shaping window sill edges, these bits are also used for creating finger pulls on your door and drawer edges. Suffix -B part numbers have guide bearings pre-installed on the shaft the same as the cutting diameter.



Product Code	Shank Size	Cutting Height		Cutting Diameter		Cutting Height		RRP	Wgt
		Met	Imp'l	Met	Imp'l	Met	Imp'l		
85580411	1/2in	25.4	1in	31.8	1 1/4in	73.0	2 7/8in	\$89.00	150g
85580511	1/2in	35.0	1 3/8in	38.1	1 1/2in	85.8	3 3/8in	\$109.00	230g
85580411-B	1/2in	25.4	1in	31.8	1 1/4in	73.0	2 7/8in	\$119.00	200g
85580511-B	1/2in	35.0	1 3/8in	38.1	1 1/2in	85.8	3 3/8in	\$119.00	290g

from \$109.00

Multi-Profile Bits



Create endless profiles with CMT Multi Profile bits. Simply adjust the height of the bit to create classic profiles in one single pass, or make more complex decorative effects in multiple passes. The bits super-strength steel body can withstand long-lasting cutting operations.



Product Code	Shank Size	Cutting Depth		Cutting Height		Overall Length	RRP	Weight
		Metric	Imp'l	Metric	Imp'l			
85680111	1/2in	12.7	1/2in	28.0	1 1/8in	77.5	\$109.00	180g
85680211	1/2in	21.5	27/32in	47.0	1 27/32in	96.4	\$159.00	470g

\$149.00

Finger Joint Bit



80060611 | 800g

Finger joints are incredibly strong for side-to-side or end-to-end joints in timber and wood composites. The tightness and accuracy of the cut joint coupled with the maximum glue surface create a joint that is stronger than an unworked piece of wood. Features two-flute design, carbide teeth and six removable cutters.



Product Code	Shank Size	Material Thickness	Cutter Diameter	Overall Length	RRP	Weight
		Metric	Metric	Metric		
80060611	1/2in	12.7 - 36mm	47.6	100.0	\$149.00	800g

from \$69.00

Finger Pull Bits



Why interrupt the subtle linearity of an all-wood drawer front or cabinet door with a metal knob or handle? Use a CMT finger pull bit and make a harmonious wooden handle. Choose your preference - a template profile made directly in the wood or a European-style hardwood pull.



Product Code	Shank Size	Cutting Height		Cutting Diameter		Overall Length	RRP	Weight
		Metric	Metric	Imp'l	Imp'l			
85560211	1/2in	14.0	19.0	3/4in	57.2	2 1/4in	\$69.00	90g
85560111	1/2in	22.0	47.6	1 7/8in	66.6	2 5/8in	\$109.00	260g

\$129.00

Box Joint Bit



80061611 | 600g

This router bit allows you to carry out accurate and functional finger joints in a much easier way. Without any adjustment you will be able to work with timbers of different thicknesses by simply running both work pieces on the same reference face.



Product Code	Shank Size	Material Thickness	Cutter Diameter	Overall Length	RRP	Weight
		Metric	Metric	Metric		
80061611	1/2in	12 - 40mm	47.6	97.0	\$129.00	600g

\$109.00

Tongue & Groove Set

Make tongue and groove joints without the complicated process of taking apart and reassembling bits. The CMT tongue and groove set gives you one bit to groove the slot and a separate bit to mill the tongue. Or use your imagination and put them to work individually on other projects.

Product Code	Shank Size	Material Thickness	Cutter Depth	Overall Length	RRP	Weight
		Metric	Metric	Metric		
80062611	1/2in	19.0	12.5	71.0	\$109.00	700g



80062611 | 700g

\$239.00

V-Tongue & Groove Joint Set

This unique set will produce beautiful tongue and groove panelling or flooring with an attractive 45° V pattern. Bits are carefully matched, so it is easy to change them to make the male and female cuts.



CMT ORANGE TOOLS
85550611 | 400g

\$309.00

8-Piece Joinery Bit Set

This set has been specifically developed to cover all the router bits that are used with the Inkra Dovetail Jigs. It includes six dovetail and two straight bits in all the necessary configurations to cover the requirements of this innovative jig.

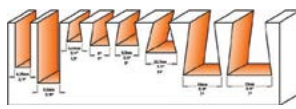

CMT ORANGE TOOLS
80050111 | 1.5kg

\$179.00

3-Piece Tongue & Groove Cabinetmaking Set

This set includes a matched set that produce a 6,4mm2 tongue. The feature of this set that sets it apart from other tongue and groove joints is that the tongue is offset to one side of the joint, ensuring that it is easier to assemble flush with each other.

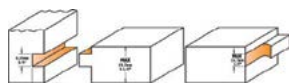

CMT ORANGE TOOLS
80052611 | 1.2kg

\$349.00

13-Piece Joinery Bit Set

This set has been specifically developed to cover all the router bits that are used with the Leigh D4 Joinery Jig System. It includes ten dovetail and three straight bits in all the necessary configurations to cover the requirements of this innovative jig.

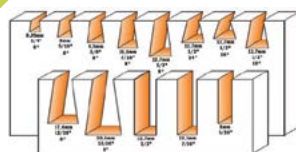

CMT ORANGE TOOLS
80051911 | 1.4kg

from **\$34.00**

Dovetail Joint Bits

The beautifully crafted dovetail joint is a classic that appeals to both professionals and novices alike. Admired for its attractiveness in box and exposed joint projects, the dovetail is remarkably strong and functional.

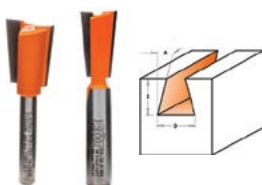

CMT ORANGE TOOLS

from **\$59.00**

Drawer Lock Joint Bits

You can make strong, perfectly fitting joints quickly and easily. Mill the drawer front with the inside face-down on the work table. Mill the sides of the drawer with the inside face placed vertical to the bit and fence, and perpendicular to the table then assemble square and flush.

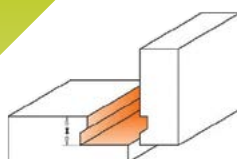

CMT ORANGE TOOLS

Product Code	Shank Size	Angle	Cutting Diameter		Cutting Height		Overall Length		RRP	Wgt
			Met	Imp'l	Met	Imp'l	Met	Imp'l		
81806411	1/4in	75°	6.4	1/4in	8.3	5/16in	63.5	2 1/2in	\$38.00	60g
81806511	1/4in	8°	6.4	1/4in	6.4	1/4in	50.8	2in	\$35.00	90g
81807911	1/4in	9°	8.0		6.0		43.0		\$44.00	50g
81808011	1/4in	9°	8.0		9.5	3/8in	52.5	2 1/8in	\$42.00	50g
81808111	1/4in	8°	8.0		9.5	3/8in	54.0	1 1/8in	\$42.00	50g
81809711	1/4in	8°	9.5	3/8in	12.7	1/2in	60.3	2 3/8in	\$44.00	60g
81809811	1/4in	14°	9.5	3/8in	9.5	3/8in	60.3	2 3/8in	\$42.00	60g
81811111	1/4in	8°	11.1	7/16in	15.9	5/8in	60.3	2 3/8in	\$42.00	60g
81812811	1/4in	14°	12.7	1/2in	12.7	1/2in	52.5	2 1/8in	\$34.00	50g
81812911	1/4in	8°	12.7	1/2in	20.6	13/16in	69.8	2 3/4in	\$35.00	60g
81813011	1/4in	14°	12.7	1/2in	12.7	1/2in	62.0	2 7/16in	\$34.00	60g
81813211	1/4in	18°	12.7	1/2in	10.3	13/32in	60.3	2 3/8in	\$35.00	60g
81813311	1/4in	10°	12.7	1/2in	15.9	5/8in	60.3	2 3/8in	\$37.00	60g
81814211	1/4in	14°	14.3	9/16in	9.5	3/8in	50.8	2in	\$34.00	60g
81814211-B	1/4in	14°	14.3	9/16in	9.5	3/8in	50.8	2in	\$44.00	120g
81815811	1/4in	7°	15.9	5/8in	22.2	7/8in	60.3	2 3/8in	\$46.00	60g
81819011	1/4in	7°	19.0	3/4in	22.2	7/8in	60.3	2 3/8in	\$59.00	60g
81819111	1/4in	14°	19.0	3/4in	22.2	7/8in	60.3	2 3/8in	\$59.00	60g
81856411	1/2in	75°	6.4	1/4in	8.3	5/16in	63.5	2 1/2in	\$38.00	60g
81858011	1/2in	9°	8.0		9.5	3/8in	63.5	2 1/2in	\$59.00	90g
81859611	1/2in	9°	9.5	3/8in	9.5	3/8in	63.5	2 1/2in	\$49.00	90g
81862811	1/2in	14°	12.7	1/2in	12.7	1/2in	63.5	2 1/2in	\$34.00	90g
81865811	1/2in	7°	15.9	5/8in	22.2	7/8in	66.7	2 5/8in	\$46.00	60g
81867411	1/2in	8°	17.4	11/16in	25.4	1in	77.6		\$48.00	90g
81869011	1/2in	7°	19.0	3/4in	22.2	7/8in	66.7	2 5/8in	\$59.00	100g
81869111	1/2in	14°	19.0	3/4in	22.2	7/8in	77.6		\$50.00	100g
81870611	1/2in	8°	20.6	13/16in	31.8	1 1/4in	84.1		\$59.00	100g

Product Code	Shank Size	Material Thickness	Cutter Diameter		Overall Length		RRP	Weight
			Metric	Metric	Imp'l	Metric		
85500211	1/4in	6.0 - 12.0	31.8	1 1/4in	44.5	1 3/4in	\$59.00	80g
85550211	1/2in	6.0 - 12.0	50.8	2in	50.8	2in	\$99.00	210g

from **\$79.00**

CMT Moulding System

If the standard selection of mouldings you find in today's timber yards or hardware stores isn't satisfactory to your woodworking tastes, then look to CMT's Moulding System instead.



Product Code	Shank Size	Cutting Height		Cutting Diameter		Overall Length	RRP	Weight
		Metric	Imp'l	Metric	Imp'l			
85685111	1/2in	23.0	29/32in	31.8	1 1/4in	61.1	\$79.00	350g
85685211	1/2in	19.0	3/4in	31.8	1 1/4in	57.2	\$89.00	350g

Extraction & Safety
Measuring & Marking
Sawing
Site & Shop Accessories
Routing
Planing
Sanding & Scraping
Drilling
Joinery
Clamps & Vices
Finishing
Sharpening
Carving & Chisels
Woodturning
Wooden Parts
Cabinet Fittings

ROUTING

\$109.00 Glue Joint Bit

CMT ORANGE TOOLS
85550111 | 300g

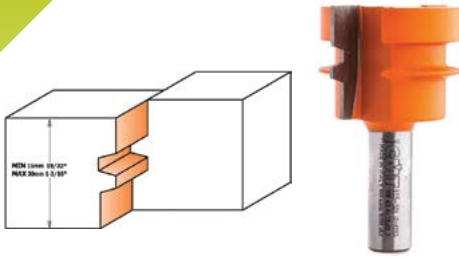

Produce an almost indestructible glue joint quickly and without error. Ideal for routing wide dimension panels, doors and furniture pieces. Simply run one edge of the panel, turn the panel over, and then run the opposite edge - you will produce perfectly harmonized reverse cuts that match up to make flawless joints.

Product Code	Shank Size	Material Thickness		Cutter Diameter		Overall Length	RRP	Weight
		Metric	Imp'l	Metric	Imp'l			
85550111	1/2in	15.0	30.0	44.5	1 3/4in	70.1	2 3/4in	\$109.00 300g

\$179.00 Edge Banding Joinery Set

CMT ORANGE TOOLS
85551011 | 300g



This is a great set to create economical but attractive and durable edge banding to your cabinet doors. Use 12,7 - 25.4mm thick panels of ply or MDF and create your own edge banding from the wood of your choice. Just centre each cutter on the stock and make the cut; glue together the two pieces and flush trim it after assembly if necessary.

Product Code	Shank Size	Material Thickness		Cutter Diameter	Overall Length	RRP	Weight
		Metric	Metric				
85551011	1/2in	9.5	25.4	40.0	74.5	\$179.00	300g

from \$119.00 45° Lock Mitre Bits

CMT ORANGE TOOLS

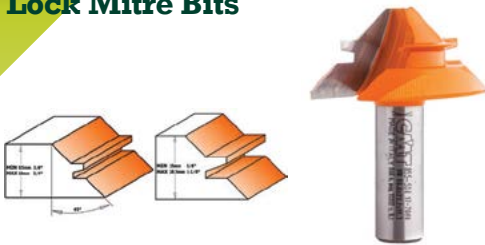

Ideal for milling perfect 90° mitre joints to accurately create boxes, stretcher bars, frames and any assortment of right angle or parallel joint projects.

Product Code	Shank Size	Material Thickness	Cutting Diameter		Overall Length	RRP	Weight
			Metric	Imp'l			
85550411	1/2in	9.5 - 19.0	50.8	2in	60.3	2 3/8in	\$119.00 180g
85550311	1/2in	15.0 - 28.5	70.0	2 3/4in	69.9	2 3/4in	\$159.00 420g

\$199.00 Sash Window Joinery Set

CMT ORANGE TOOLS
85580111 | 450g



CMT designed this set so you can create window sashes that are as beautiful as they are functional. It will also mill perfectly joining 35mm rail and stile parts for custom made doors.

Product Code	Shank Size	Material Thickness	Dia. Bit 1	Dia. Bit 2	Overall Lgth 1	Overall Lgth 2	RRP	Wgt
85580111	1/2in	35.0	35.0	38.0	84.0	56.0	\$199.00	450g

\$189.00 22 1/2° Lock Mitre Bit Set

CMT ORANGE TOOLS
85550511 | 350g

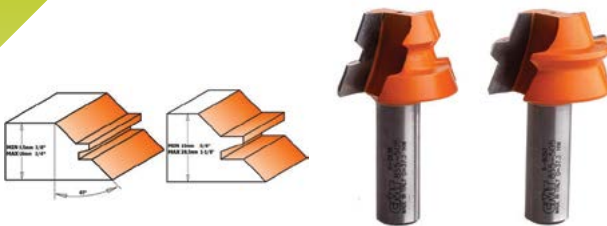

Now you don't have to fight with those awkward clamps on your 22,5° projects. Use this pair of bits to produce octagonal shaped boxes and popular corner cabinetry like corner cabinets for kitchens, entertainment centres, kitchen islands and corner hutches. CMT's matched pair of cutters makes set-up easy.

Height adjustment is not critical with this matched pair; simply adjust your fence so the top edge of the work piece intersects the angle of the bit where it meets the fence. After your joints are machined they can be glued and assembled and simply clamped by using strapping tape.

Product Code	Shank Size	Material Thickness	Cutter Diameter	Overall Length		RRP	Weight
				Metric	Imp'l		
85550511	1/2in	9.5 - 19.0	37.3	60.3	2 3/8in	\$189.00	350g

\$229.00 Rail & Stile Joinery Bit Sets

CMT ORANGE TOOLS

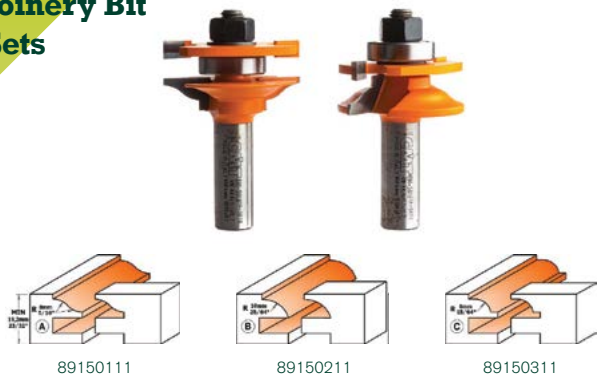

A well-constructed door will bear the mark of a perfect joint - clean, exact and well-crafted for strength. For this project, the CMT male-female rail and stile sets are the perfect pair as they match exactly.

Product Code	Shank Size	Style	Cutting Depth	Cutter Dia.	Material Thickness	Overall Length	RRP	Weight
89150111	1/2in	Roman Ogee	9.5	44.5	18.0-22.0	71.0	\$229.00	450g
89150211	1/2in	Roundover	9.5	44.5	18.0-22.0	71.0	\$229.00	300g
89150311	1/2in	Beaded	9.5	44.5	18.0-22.0	71.0	\$229.00	300g

\$179.00

Rail & Stile Combination Bit

CMT ORANGE TOOLS
89152111 | 300g

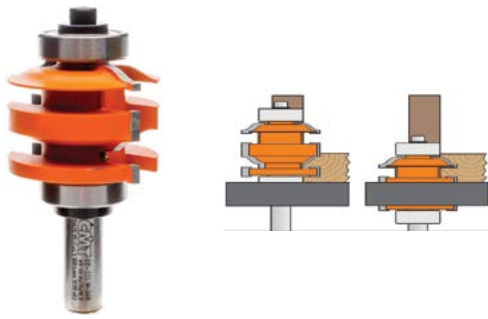

The most innovative bit for the construction of doors and drawers. Two cutters are embodied in a unique bit to allow you to cut two perfectly joining profiles efficiently and effectively, and also to reduce costs by investing in a single CMT bit rather than multiple cutters.

Product Code	Shank Size	Style	Cutting Depth	Cutter Dia.	Material Thickness	Overall Length	RRP	Weight
			Metric	Metric	Metric	Metric		
89152111	1/2in	Roman Ogee	9.5	50.8	18.0-22.0	96.0	\$179.00	300g

from \$269.00

3-Piece Doormaking Sets

CMT ORANGE TOOLS

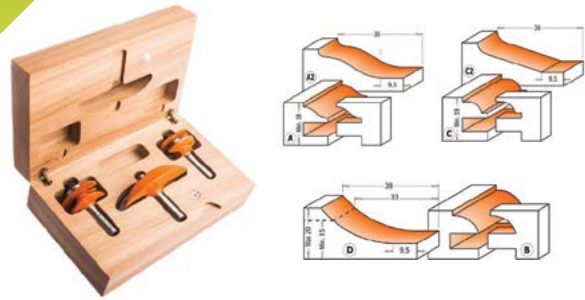

Get a rail & stile set along with a matching profile raised panel bit, all in an attractive hardwood storage case. The matrix below lists the part numbers of the bits included in the sets to match up your preferred profile and material thicknesses.

Product Code	Shank Size	Rail & Stile Set	Style	Material Thk	Panel Raising Bit	Style	Material Thk	RRP	Wght
80051311	1/2in	89150111	Roman Ogee	18.0-22.0	89050411	Roman Ogee	18.0-20.0	\$269.00	1.5kg
80051411	1/2in	89150211	Round-over	18.0-22.0	89050611	Soft Chamfer	18.0-20.0	\$269.00	1.5kg
80051611	1/2in	89150311	Beaded	18.0-22.0	89050711	Cove	15.0-20.0	\$269.00	1.5kg
80052111	1/2in	89150111	Roman Ogee	18.0-22.0	89052411	Roman Ogee	19.0-20.6	\$319.00	1.4kg
80051711	1/2in	89150111	Roman Ogee	18.0-22.0	89052711	Cove	19.0-20.6	\$319.00	1.4kg
80052211	1/2in	89151711	Ogee	11.0-17.4	89053411	Roman Ogee	15.0-18.0	\$299.00	1.2kg
80051811	1/2in	89151711	Ogee	11.0-17.4	89053711	Cove	15.0-18.0	\$299.00	1.2kg

\$179.00

Thumbnail Rail & Stile Set

CMT ORANGE TOOLS
89151211 | 400g

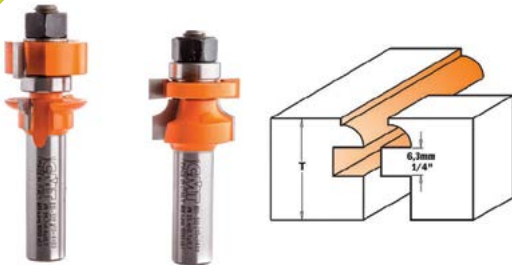

Designed for fine furniture construction, these bits mill a delicate 4,8mm thumbnail profile in stock from 15,9mm - 22,2mm thick.

Product Code	Shank Size	Style	Cutting Depth	Cutter Dia.	Material Thickness	Overall Length	RRP	Weight
			Metric	Metric	Metric	Metric		
89151211	1/2in	Roundover	6.4	28.7	16.0-22.0	79.2	\$179.00	400g

from \$399.00

5-Piece Complete Kitchen Sets

CMT ORANGE TOOLS

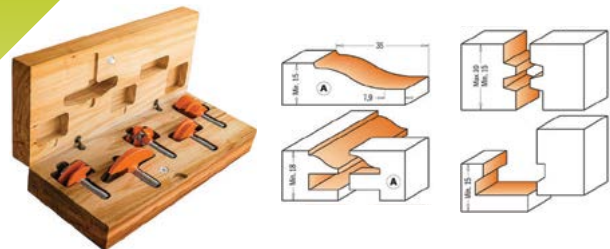

Get the most popular matching rail & stile sets and panel raising bits as well as the very popular 85550111 reversible glue joint and 85550211 drawer lock bits, all in an attractive hardwood storage case.

Product Code	Description	RRP	Weight
80050911	5 Piece Set with A + A Profile Bits	\$399.00	2kg
80051011	5 Piece Set with B + B Profile Bits	\$399.00	2kg

\$199.00

Junior Ogee Rail & Stile Set

CMT ORANGE TOOLS
89151711 | 300g

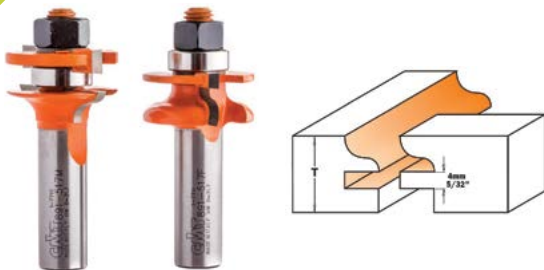

These bits are designed for projects that require smaller panel door with stock from 11mm - 17,4mm thick, and build doors as small as 70mm square.

Product Code	Shank Size	Style	Cutting Depth	Cutter Dia.	Material Thickness	Overall Length	RRP	Weight
			Metric	Metric	Metric	Metric		
89151711	1/2in	Ogee	7.9	31.8	11.0 - 17.4	67.0	\$199.00	300g

\$469.00

6-Piece Cabinetmaking Set

CMT ORANGE TOOLS
80051511 | 2.4kg



This set features six router bits for making arched raised panel doors and professional drawer fronts, including the 89150111 rail & stile set, 89052711 raised panel bit, 80669011 HD flush trim bit, 83795511 cove bit and 8595611 ogee moulding bit.

ROUTING

\$199.00

Small Arch Doormaking Set

CMT ORANGE TOOLS
80052411 | 1.2kg

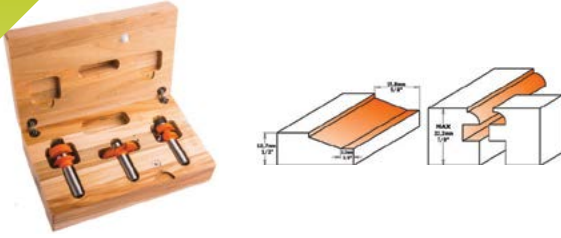

This 3-piece set will produce beautiful raised panel doors with a classic, diminutive bevelled profile. Designed for use in fine furniture making, these sets include two matched cope and stick bits for producing frames from 15,9mm - 19mm thick.

\$149.00

Divided Light Doormaking Set

CMT ORANGE TOOLS
80052511 | 1.2kg

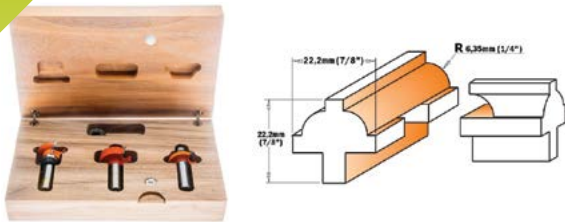

Build authentic divided light doors for fine furniture and cabinets with this 3-piece set. Includes a bit to cut the decorative ovolo profile on frame edges, a cope to shape the mating profile on the ends of the stock, and a rabbeting bit to cut the recess for the glass. Thanks to the guide bearings, you can also create arches on curved frames

from \$69.00

Ovolo Sash Bits

CMT ORANGE TOOLS

These bits allow you to make true divided light doors for fine furniture and cabinets as well as sash bar windows, and stile and rail constructions. The glazing bar ovolo bit (855.308.11F) is bearing-guided to enable curved frames to be moulded. Cove bits can be used to produce easy-to-pull drawer handles.



Product Code	Shank Size	Cutter Diameter	Material Thickness	Overall Length	RRP	Weight
		Metric	Metric	Metric		
85530711-M	1/4in	25.0	19.0	50.8	\$69.00	60g
85530711-F	1/4in	22.0	19.0	50.8	\$69.00	60g
85530811-F	1/4in	28.0	19.0	61.2	\$89.00	60g

\$239.00

Glass Panel Doormaking Set

CMT ORANGE TOOLS
85580311 | 1.1kg

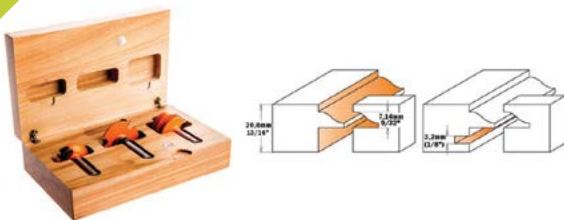

CMT's unique stile and rail router bit sets allow you to produce glass panel doors by using a rubber panel retainer to secure the glass in a 3,2mm slot cut into the frames. These bits work the same as other CMT stile and rail sets, but they leave you with a square rabbet on the inside of your door for installing the glass panel.

from \$429.00

Interior & Entry Doormaking Set

CMT ORANGE TOOLS
80052711 | 1.3kg

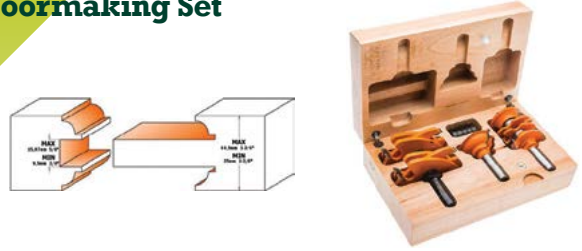

This is a multifunctional set for door and furniture makers building entry or passage doors and any furniture tenons. The included tenon cutter produces a beefy 27mm-long tenon. Coupled with the cope cutter, you can produce long and strong tenons with minimal setup. As an extra bonus the tenon cutter can be used for furniture making requiring any tenon from 4,8mm - 16mm thick.

from \$49.00

Stile & Panel Plunge Moulding Bits

CMT ORANGE TOOLS

These bits can be used for decorative work on solid wood panels and MDF materials. Use the panel bits in one pass or in combination with the MDF stile bits for complex and intricate profiles. A simple approach for an elegant appearance.



Product Code	Shank Size	Cutter Dia.	Flat Btm Section	Cutting Depth	Radius/ Angle	Overall Length	RRP	Weight
		Metric	Metric	Metric		Metric		
87010111	1/2in	25.0	6.0	8.0	12.0	39.8	\$49.00	80g
87050111	1/2in	50.0	16.0	14.0	12.0	52.1	\$99.00	230g
87050211	1/2in	50.0	16.0	17.0	10°	55.1	\$99.00	230g
87050311	1/2in	45.0	34.0	13.5	3.2 - 6.4	51.6	\$99.00	180g
87050411	1/2in	35.0	12.5	9.5	3.2	47.6	\$59.00	150g

Solid Surface Router Bits

CMT ORANGE TOOLS

Solid surface material, most commonly known as Corian (the inventing brand name behind the material) requires specialized bits used in normal routers to cut, shape and trim the material. CMT do these bits better than most. Where necessary, a special non-marring Delrin® bearing is installed to protect the finished edges. The special angled Delrin® sleeve lets you work without leaving marks on the workpiece.

from \$59.00

Solid Surface Rounding Over Bits

CMT ORANGE TOOLS



Product Code	Shank Size	Cutting Radius	Cutting Depth	Cutting Height	Overall Length	RRP	Weight
		Metric	Metric	Metric	Metric		
88050111	1/2in	3.2	3.2	12.7	59.5	\$59.00	90g
88050211	1/2in	6.4	6.4	12.7	59.5	\$69.00	90g
88050311	1/2in	9.5	9.5	14.0	61.0	\$69.00	100g
88050411	1/2in	12.7	12.7	19.0	66.0	\$89.00	150g

\$59.00

Solid Surface Decorative Edge Bit

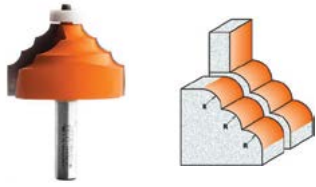

Product Code	Shank Size	Cutting Radius	Cutter Dia.	Cutting Height	Overall Length	RRP	Weight
88052111	1/2in	Metric 8.00	Metric 66.7	Metric 41.3	Metric 89.80	\$59.00	630g

\$69.00

Solid Surface Beveling Bit

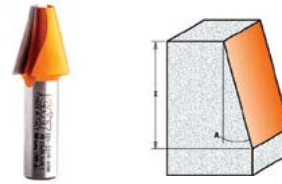

Product Code	Shank Size	Cutter Dia.	Cutting Angle	Cutting Height	Overall Length	RRP	Weight
88152111	1/2in	Metric 23.0	Metric 15°	Metric 25.4	Metric 63.5	\$69.00	100g

\$129.00

Solid Surface Rounding Over Bowl Bit

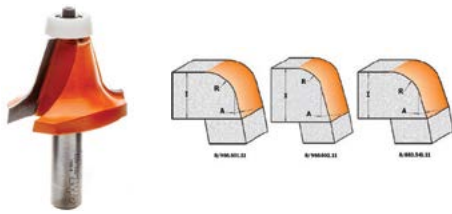

Product Code	Shank Size	Cutting Radius	Cutting Angle	Cutting Height	Overall Length	RRP	Weight
86660211	1/2in	Metric 12.7	Metric 15°	Metric 25.4	Metric 74.9	\$129.00	210g

from \$59.00

Solid Surface No Drip Edge Bits



These bits are designed to create "no-drip" edges on kitchen and vanity counter tops in a single pass. The one bit will cut both the outer and inner profiles creating a slightly raised edge that controls spilled liquids.



Product Code	Shank Size	Cutter Dia.	Guide Bearing	Cutting Height	Overall Length	RRP	Weight
88150111	1/2in	Metric 25.4	No	Metric 12.7	Metric 63.5	\$59.00	110g
88053111	1/2in	Metric 25.4	Yes	Metric 22	Metric 77.0	\$79.00	120g

\$129.00

Solid Surface Ogee Profile Bit



Product Code	Shank Size	Cutting Radius	Cutter Dia.	Cutting Height	Overall Length	RRP	Weight
88054211	1/2in	Metric 6.4-12.7	Metric 54	Metric 25.4	Metric 77.6	\$129.00	260g

from \$46.00

Solid Surface Drainboard Bits

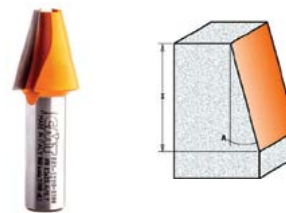

Product Code	Shank Size	Cutter Dia.	Cutter Radius	Cutting Height	Overall Length	RRP	Weight
88151111	1/2in	Metric 15.9	Metric 3.2	Metric 12.7	Metric 63.5	\$46.00	90g
88151211	1/2in	Metric 25.4	Metric 3.2	Metric 12.7	Metric 69.8	\$59.00	120g

\$99.00

Solid Surface Bevel Bowl Bit

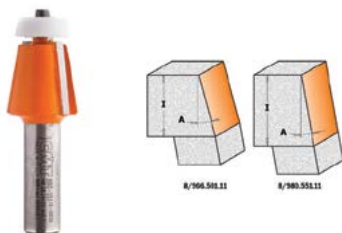

Product Code	Shank Size	Cutter Dia.	Cutting Angle	Cutting Height	Overall Length	RRP	Weight
88055111	1/2in	Metric 28.5	Metric 10°	Metric 25.4	Metric 77.0	\$99.00	140g

\$59.00

Solid Surface Inlay Bits

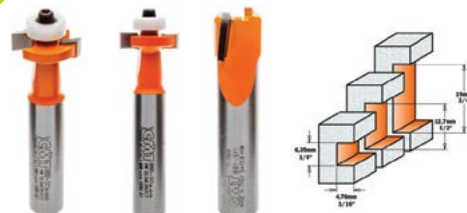

Product Code	Shank Size	Cutter Dia.	Cutter Depth	Cutting Height	Overall Length	RRP	Weight
88051111	1/2in	Metric 22.2	Metric 4.8	Metric 6.4	Metric 77.0	\$59.00	100g
88051211	1/2in	Metric 22.2	Metric 4.8	Metric 12.7	Metric 90.0	\$59.00	130g
88051311	1/2in	Metric 22.2	Metric 4.8	Metric 19.0	Metric 90.0	\$59.00	140g

Extraction & Safety
Measuring & Marking
Sawing
Site & Shop Accessories
Routing
Planing
Sanding & Scraping
Drilling
Joinery
Clamps & Vices
Finishing
Sharpening
Carving & Chisels
Woodturning
Wooden Parts
Cabinet Fittings

PLANING

from **\$199.00**
Bench Planes

LUBAN®



LBP-040



LBP-060



The design of these high-performance bench planes are based on the famous Stanley Bedrock series (regarded as one of the very best designs of all time) with a fully machined frog and body seating pad. The Bedrock design ensures the blade is held with absolute rigidity thereby preventing

chatter. The sole of the planes are heavy, stress-relieved ductile iron castings that are machined and lapped smooth to tight tolerances so little tuning needs to be done to get them working immediately.

Features you can expect to enjoy when buying a Luban plane are –

- ✓ 3.2mm-thick high-carbon tool steel blade
- ✓ 3.2mm cap-iron mated to the blade for improved rigidity and reduced chatter
- ✓ Precision cast and machined stainless steel cap
- ✓ Large solid brass blade adjustment hand wheel and screw
- ✓ Smooth bubinga front and rear knobs
- ✓ Heavy-duty steel lateral-adjustment lever

Product Code	Product	Weight	RRP
LBP-040	#4 - 251 x 62mm Sole	2.3kg	\$199.00
LBP-050	#5 - 352 x 62mm Sole	3.2kg	\$229.00
LBP-060	#6 - 451 x 73mm Sole	3.4kg	\$279.00
LBP-070	#7 - 559 x 73mm Sole	4.75kg	\$299.00
LBP-040-BL	50mm Plane Iron Suits #4 & #5	240g	\$40.00
LBP-60-BL	60mm Plane Iron Suits #6 & #7	240g	\$40.00
LBP-040-CI	50mm Cap Iron Suits #4 & #5	180g	\$27.50
LBP-060-CI	60mm Cap Iron Suits #6 & #7	w180g	\$27.50
LBP-040-LV	50mm Lever Suits #4 & #5	200g	\$40.00
LBP-060-LV	60mm Lever Suits #6 & #7	200g	\$40.00



Check out the ingenious Veritas Planing Stop on page 119 to help with holding your work piece in place while planing

\$249.00
Low-Angle Jack Plane

LUBAN®



Based on the original Stanley #62 – it was originally designed for heavy stock removal across the grain, however it now has found a popular place in hand plane

ranges around the world to be used for shooting mitres, working on end-grain and initial smoothing on figured timbers, minimizing tear-out.

- ✓ 62 x 355mm sole with 51mm-wide blade
- ✓ 12° bed angle with 25° blade angle
- ✓ High-Carbon steel blade (Mn65)
- ✓ Adjustable mouth by loosening front knob and turned solid brass lever
- ✓ Precision ground and lapped sole and wings
- ✓ Approximately 2.1kg in the hand – similar to a #4 smoothing plane
- ✓ Polished Bubinga front and rear handles

Product Code	Product	Weight	RRP
LLAJ-001	Jack Plane	3.2kg	\$249.00
LLAJ-001-BL	Replacement 25° Plane Iron	120g	\$40.00
LLAJ-001-BL-38	Optional 38° Plane Iron	120g	\$40.00
LLAJ-001-BL-50	Optional 50° Plane Iron	120g	\$40.00

from **\$99.00**
Block Planes

LUBAN®



Knuckle Cap Block Planes –

Unique to Bronze Apron Planes –

- ✓ 51 x 178mm sole with 41mm-wide blade
- ✓ 3.2mm-thick T10 carbon steel blade hardened to Rc60-63, ground with 25° bevel
- ✓ Stress relieved ductile iron castings precision machined and lapped smooth and square
- ✓ Solid cast bronze knuckle cap
- ✓ Simple and easy adjustment of the blades using the rear knob
- ✓ Adjustable mouth is smooth to operate and allows for coarse to ultra-fine shavings

- ✓ 35 x 137mm sole with 32mm-wide blade
- ✓ Solid cast bronze body precision machined and lapped smooth
- ✓ Available with standard 20° or low 12 1/2° bed angle

Rabbit Block Plane –

Similar to specs as the block planes with a 165 x 44mm body and 44mm blade to be able to reach into an internal corner. Comes with low 12 1/2° bed angle.

Product Code	Product	Weight	RRP
LBP-120	Block 12 1/2° Angle	1kg	\$119.00
LBP-200	Block 20° Bed Angle	1kg	\$119.00
LBP-102	Bronze Apron 12 1/2° Bed Angle	580g	\$109.00
LBP-103	Bronze Apron 20° Bed Angle	580g	\$109.00
LRP-120	Rabbit Block Plane	900g	\$109.00
LBP-120-BL	Plane Iron Suits Block	100g	\$27.50
LBP-102-BL	Plane Iron Suits Apron	100g	\$20.00
LRP-120-BL	Plane Iron Suits Rabbit	100g	\$27.50

\$115.00
#1 Chisel Plane



LCP-001 | 120g



A real luxury – it is effectively just an elegant 44.5mm wide chisel blade with a comfortable body that provides extra mass for clean-up jobs like removing excess glue, trimming plug heads etc.

The cast stainless steel body measures 114mm long with a bubinga rear knob and is precision-machined flat and smooth on the sole and sides. The meaty 4.3mm thick blade is high-carbon (Mn65) tool-steel.



\$139.00
#1 Shoulder Plane



Even at this small scale the design of this plane works astonishingly well. At 135 x 13mm, weighing in at around 350g, it is equally easy to use with one hand or two. The long lever extends beyond the adjuster, preventing inadvertent alterations to the blade setting in use, and the deep swoop at the front provides a nice positive rest for the thumb or forefinger.

An adjustable mouth and a clever twin thread adjustment mechanism provide fine control of the blade position. The body is cast in unbreakable CR40, with a T10 blade and all other components cast or machined from stainless steel. Another refinement is that the lever is captive at low tensions, so the plane won't disassemble itself while you are making adjustments.

Product Code	Product	Weight	RRP
LSP-001	Shoulder Plane	380g	\$139.00
LSP-001-BL	Replacement Plane Iron	40g	\$20.00

\$229.00
#73 Scraping Plane



One step beyond a high angle smoothing plane, scraping planes take a very light cut and produce a clean surface with no concerns about grain direction and no tear-out.

a hook is burnished that does the cutting. Depth of cut is fine tuned by leaning the blade forward or back via the opposed thumbwheels. Sole dimensions: 238mm x 88mm. Blade: 1.6mm thick 73mm, from T10 carbon steel hardened to RC59.

The blade is sharpened square or very lightly cambered at 45°, then

Product Code	Product	Weight	RRP
LSC-001	Scraping Plane	2kg	\$229.00
LSC-001-BL	Replacement Plane Iron	80g	\$20.00

\$159.00
#2 Shoulder Plane



The most common size shoulder plane measuring out at approximately 180 x 20mm and weighing in at 950g, it has all the

features of its smaller cousin but in a more substantial package for standard cabinetmaking.

Product Code	Product	Weight	RRP
LSP-002	Shoulder Plane	1.1kg	\$159.00
LSP-002-BL	Replacement Plane Iron	60g	\$20.00

\$99.00
Small Router Plane



LRP-001 | 300g



Really useful for cleaning up the bottom of housings and trenches or truing and levelling tenon cheeks with remarkable accuracy. 100 x 50mm cast stainless steel body, is broad enough to give support on a

trench up to 40mm wide and the open design offers excellent visibility and shaving clearance.

Three included cutters are - 2.5mm straight plus 2.5mm & 6mm V-point.

\$229.00
#3 Shoulder Plane



Tipping the scales at just over 1.8kg with a sole measuring 210 x 25.4mm, this behemoth is great for large-scale solid timber

woodworking. The additional mass provides excellent registration to the batten, corresponding joint surface or planing block.

Product Code	Product	Weight	RRP
LSP-003	Shoulder Plane	1.8kg	\$229.00
LSP-003-BL	Replacement Plane Iron	70g	\$27.50

\$109.00
Side Rabbet Plane



LSR-001 | 550g



Incorporates two manually adjusted blades with a reversible, adjustable depth stop. Perfect for cleaning up rebates and grooves, ensuring a proper fit. The body is precisely

machined from 40Cr tool steel and the T10 steel blades are hardened to RC59-63. The front is easily removable for conversion to a bull nose configuration for corners.

Extraction & Safety
Measuring & Marking
Sawing
Site & Shop Accessories
Routing
Planing
Sanding & Scraping
Drilling
Joinery
Clamps & Vices
Finishing
Sharpening
Carving & Chisels
Woodturning
Wooden Parts
Cabinet Fittings

PLANING

\$291.00 Scraping Plane



Veritas®
05-P-2901 | 2kg

The ideal tool for final smoothing — especially when you have to deal with highly figured wood or reversing grain. With a well-sharpened blade and light cuts

you can achieve excellent results on any wood. Tear-out is virtually eliminated with the cutting action of the included scraping blade.

Prod Code	Product	Weight	RRP
05-P-2901	Scraping Plane	2kg	\$291.00
05-P-2902	1.4mm Replacement Blade	80g	\$24.00
05-P-2903	3.2mm Replacement Blade	100g	\$50.00

\$258.00 Router Plane



Veritas®
05-P-3801 | 350g

An invaluable tool for work on stopped or through dados and grooves. It includes two high-carbon steel cutters: a two-piece 12.7mm

straight blade, and a two-piece 12.7mm spear-point blade (for final smoothing). A blade sharpening jig is also included.

Prod Code	Product	Weight	RRP
05-P-3801	Router Plane Only	1.2kg	\$258.00
05-P-3807	Fence Attachment	350g	\$38.00

\$546.00 Shooting Plane



Veritas®
05-P-5471 | 3.8kg

The mass of this plane, combined with its long base and low centre of gravity, makes it both stable and effective for shooting end grains. At 3.5kg and just under 405mm long,

it is a substantial plane; you will appreciate the authority it provides when shooting. Available in left-handed version upon request.

\$323.00 17.5mm Shoulder Plane



Veritas®
05-P-4101 | 1kg

The ultimate tool for trimming a joint to a perfect fit. The Veritas medium shoulder plane is proportioned for versatility; it measures 178mm long by 175mm

wide and weighs 900g. The ductile cast iron body is accurately machined and ground so that the sole and sides are flat and square.

Prod Code	Product	Weight	RRP
05-P-4101	17.5mm Shoulder Plane	1kg	\$323.00
05-P-4172	PMV-11 Plane Iron	100g	\$73.00

\$374.00 32mm Shoulder Plane



Veritas®
05-P-4301 | 1.8kg

This specialized rabbet plane is the largest in the Veritas line of shoulder planes. Its size and mass make it perfect for trimming breadboard tenons, adjusting

shoulders, or even paring down tenon cheeks. At 210mm long and 31.8mm wide, and weighing 1.7kg, it brings both authority and precision to larger work.

\$291.00 25mm Bullnose Plane



Veritas®
05-P-4201 | 1.2kg

The Veritas bullnose plane, perfect for cleaning up machine-cut joints, is one of the most useful hand joinery tools you can own. Designed for maximum versatility, it performs as either a bullnose or a chisel

plane as required. Simply loosen the brass toe locking knob to remove the toe piece for chisel plane configuration, and you can work right up to a blind corner.

\$119.00 Cabinetmaker's Scraper



Veritas®
05-P-3205 | 1kg

Used in place of a much heavier belt sander, this can clean a dirty workbench top, remove dried glue and smooth a panel or tricky grain tabletop efficiently, leaving behind a surface free of tear-out, digs or gouges. This tool has been designed with

several improvements over the old #80 cabinet scraper. To apply pressure directly in line with the cutting edge and prevent the blade catching when the scraper runs off the end, the sole is longer and the handles have been placed further back and slightly lower.

from
\$348.00

Bench Planes



All Veritas bench planes incorporate a frog that extends all the way to the sole. This unique design provides complete blade support, reducing chatter and allows quick mouth adjustment. It can be closed to a narrow slit for fine shavings and minimum tear-out, or opened for heavier cuts, all without removing the lever cap or other parts; just loosen two screws and set the opening with the thumb wheel. The bodies are

fully stress-relieved ductile cast iron, surface-ground flat and square to the sides, with extra-large side wings for stable shooting. The bubinga front knob and rear tote provide excellent control and comfort. A combined feed and lateral adjustment mechanism make blade setting easy and accurate. The lapped blades are a full 3.2mm thick, made in A2 tool steel.

Sizes listed below are sole length x blade width.

Prod Code	Product	Size	Weight	RRP
05-P-2601	#4 Plane	241 x 50.8mm	2.3kg	\$348.00
05-P-2301	#4 1/2 Plane	254 x 60.3mm	2.5kg	\$390.00
05-P-2401	#5 1/4 Plane	305 x 50.8mm	3.2kg	\$390.00
05-P-2801	#6 Plane	457 x 60.3mm	3.4kg	\$428.00

from
\$17.00

Plane Socks

Veritas®



Made from a silicone-treated knit cotton that resists moisture, these socks are ideal for plane storage. Designed much like a tube sock with a drawstring closure, they keep dust

and dirt off planes and help deter rust. A tag on the outside of the sack lets you label the contents. Branded Veritas, they can be used for all brands of planes.

Prod Code	Product	Weight	RRP
05-P-6107	For Block & Other Small Planes	80g	\$17.00
05-P-6112	For Smoothing, Scraping, Router Planes	90g	\$18.00
05-P-6116	For Jack (inc. Low Angle) Planes	100g	\$19.00
05-P-6125	For #6 - #8 Planes	110g	\$21.00

\$85.00

Bullnose Chisel Plane

Veritas®
05-P-2101 | 170g



Rabbit planes used to be widely available, but are now being discontinued by manufacturers.

Veritas developed this specialized plane to convert a chisel into a rabbit plane.

from
\$390.00

Low Angle Jack Plane

Veritas®



Low-angle jack planes are ideal for shooting mitres, working end grain, and initial smoothing. This has been designated as a #62-1/2 because of its generous size and weight, low center of gravity, and radically set-back mouth. This is a bevel-up plane, with a 12° bed angle similar to a low-angle block plane.

Measuring 380 x 70mm with a 63mm blade it weighs 2.6kg. Sides are machined square to the sole, with a specially shaped lever cap and machined thumb recess on either side of the body, it provides both comfort and excellent control when shooting. The adjustable mouth can be closed to a narrow slit for fine shavings with minimum tear-out or opened for heavier cuts with ease.

Prod Code	Product	Weight	RRP
05-P-3401	Plane with A2 Steel Blade	3kg	\$390.00
05-P-3471	Plane with PM-V11 Blade	3kg	\$409.00
05-P-3472	PM-V11 Plane Iron Only 25°	400g	\$86.00
05-P-3473	PM-V11 Plane Iron Only 38°	400g	\$86.00
05-P-3474	PM-V11 Plane Iron Only 50°	400g	\$86.00

\$345.00

Low Angle Smoothing Plane

Veritas®
05-P-2501 | 2.7kg



A low-angle smoothing plane is used to smooth surfaces and, with its generous side wings, is ideal for shooting mitres. Its low cutting angle of 37° minimizes fiber tearing, making it ideal for end-grain work.

With a bed angle of 12°, this is a bevel-up plane. It features an adjustable mouth with a unique stop-screw, a combined feed and lateral adjustment knob for blade setting, and a bubinga front knob and rear handle.

\$323.00

Small Bevel Up Plane

Veritas®
05-P-3901 | 1.4kg



With a size comparable to a #3 bench plane (230 x 58mm), this is smaller and lighter than a full-size smoother, so easier to manoeuvre and is less fatiguing to use for extended periods. Further, since the blade is narrower, at 44.5mm wide, cuts are easier to push through.

Like the full-size versions, it is useful for final finishing of surfaces, end-grain work and for shooting mitres. The machined and surface ground ductile cast iron body has a 12° bed angle and a movable toe fully enclosed by the body casting.

PLANING

\$252.00 Block Planes



Veritas®

- Combined feed and lateral adjusting screw for better blade placement
- Higher side wings (ideal for shooting) with multiple finger grips in each side
- 152mm by 50.8mm wide body made from ductile iron
- Accurately milled sides and sole are surface ground to almost perfect finish
- For working difficult wood, 38° and 50° bevel blades are available
- Toothed blade (38° bevel) works the most difficult grain, especially knots

Prod Code	Product	Weight	RRP
05-P-2201	Low 12 1/2° Bed Angle Plane	1kg	\$252.00
05-P-2230	Standard 20° Bed Angle Plane	1kg	\$252.00
05-P-2272	PM-V11 Plane Iron Only 25°	200g	\$69.00
05-P-2277	PM-V11 Plane Iron Only 38°	200g	\$68.00
05-P-2278	PM-V11 Plane Iron Only 50°	200g	\$68.00
05-P-2206	Toothed Plane Iron Only 38°	200g	\$62.00

\$42.00 Low-Angle Block Plane Chamfer Guide



Veritas®
05-P-2210 | 120g

You can convert the Veritas block plane into a chamfer plane in seconds with this cunning new guide. Easy to install – you first set the chamfer width on the guide, then

install the guide by unscrewing the front knob of the plane, replacing the toe piece with the chamfer guide and tightening the knob again. It is ready to go.

\$158.00 Apron Plane



Veritas®
05-P-2702 | 160g

This small, low-angle block plane is ideal for trim carpentry. At around 400g it is half the weight of a standard block plane, a big plus if

you carry it in your apron all day. Plane size is 140 x 45mm with an A2 Steel 32mm-wide blade.

from \$19.00 Low-Angle Block Plane Handles



Veritas®

- Inexpensive hardwood grips adapt the low-angle block plane into a small bevel-up smoothing plane
- Choose from small or large rear handles according to hand size
- Matching front knob available separately to complete set
- All grips are made of Bubinga wood

Prod Code	Product	Weight	RRP
05-P-2204	Front Knob	100g	\$19.00
05-P-2215	Rear Handle Large	270g	\$51.00
05-P-2217	Rear Handle Small	270g	\$51.00

\$193.00 Iron Edge Trimming Plane



Veritas®
05-P-0301 | 700g

Edge-trimming planes work end grain or give final trimming cuts on jointed boards, for smooth edges exactly 90° to the face. This plane is cast in durable ductile iron for everyday use, and is available in

right- and left-hand models. They have a 12° bed angle and 30° blade skew. The 31.8 x 3.2mm wide blades in A2 steel work wood up to 25mm wide. Each plane weighs 525g.

from \$69.00 Miniature Planes



Made of Rosewood and solid brass, these miniature planes are a model or violin maker's dream. Made to an impeccable quality level, they are a pleasure to own and use on delicate and intricate work. All measuring 76mm long with the block and scraper 19mm and the bullnose 12.5mm wide for a variety of applications.

Prod Code	Product	Weight	RRP
MPBW	Block	130g	\$69.00
MPSW	Scraper	130g	\$89.00
MPBNW	Bullnose	130g	\$89.00

\$210.00 Cabinetmaker's Trimming Chisel Plane



Veritas®
05-P-7401 | 600g

Commonly called a chisel plane, this 165 x 45mm plane has an exposed full-width blade that lets you work up to adjacent surfaces. It excels at making paring cuts in places where a chisel would be awkward or impossible to use, making short

work of cleaning up corners and joints inside carcasses. Because the blade can be set level with the sole, you can also trim plugs or small inlays flush without marring the surrounding wood. Plane weight is 545g.

\$101.00 Variable Plane Fence

Veritas®
05-P-3004 | 500g



Don't limit yourself to right angles – get accurate and consistent planing of any angle from 45° - 135°. Angles are set using a square or angle gauge, or directly on an angle you wish to match. Through-holes in the 280mm aluminium fence allow

the attachment of extensions or spacers. Mounts with stainless-steel thumbscrews to the Veritas custom bench planes, shooting plane, bevel-up jointer plane and jack rabbet plane.

\$77.00 Hand Plane Fence

Veritas®
05-P-3001 | 350g



Planing a square edge on a board requires a jointer fence, whether you are using an electric jointer or a hand plane. The Veritas jointer fence allows you to shoot accurate and consistent square or bevelled edges with

most* iron or steel bench planes. The integral rare-earth magnets make it quick and easy to attach or remove the 279mm long anodized aluminum fence from either side of all sizes of bench planes, from a smooth plane (#4) to a jointer (#8).

\$57.00 Cornering Tool Kit

Veritas®
05-K-5030 | 150g



A cornering tool is actually a small molding plane. It cuts a fixed-radius curve on an edge. These cornering tools have a different radius cutter at either end. One tool cuts a 1.6mm and a 3.2mm radius and the other cuts a 4.8mm

and a 6.4mm radius. They are ground with two fixed fences that stop the tool from cutting past the fixed radius. Made in England from tool steel hardened to Rc48-52, they hold an excellent edge.

\$68.00 Flush Plane

Veritas®
05-P-2001 | 300g



Ideal for flush trimming projections such as glue lines, laminate edges, and plugs. It can also be used for cleaning out inside corners (e.g., hinge gains, tenons, half-laps). The purposeful shape provides a comfortable, secure grip and is designed so that the blade can easily be reversed for safe storage and edge protection.

At only 230g, it is easily carried around. A powerful 25mm diameter rare-earth magnet holds the 50.8mm wide blade in place. A steel pin molded into the tough ABS body takes thrust loads. The included blade, with a 25° bevel angle, is readily removed for honing in the usual way.

Prod Code	Product	Price
05-P-2002	Replacement blade	\$44.00

from \$65.00 Flat Sole Spokeshaves

LUBAN®



Spokeshaves are, in essence, very short soled planes for working curved surfaces. Used for refining convex, biconvex, slightly concave, and concave/convex surfaces after initial shaping with the bandsaw and rasps.

This delightful 265mm flat sole spokeshave has a 50mm wide T10 cutting iron hardened to RC60-63. Either made from a cast-iron or rust-free bronze body with comfortable bubinga handles.

Prod Code	Product	Weight	RRP
LSSF-001	Flat Sole	400g	\$65.00
LSSF-002	Bronze Body	400g	\$75.00
LSSF-001-BL	Replacement Blade	50g	\$20.00

\$117.00 Low Angle Spokeshave

Veritas®
05-P-3201 | 400g



This spokeshave uses a basic traditional shape, not of the spokeshaves of the last century, but of the century before. Until about 1900, the vast majority of spokeshaves were low-angle spokeshaves with wooden bodies. The blades were hand forged with

upturned tangs that fitted into holes pierced in the body of the shave. Wedged in position, they were adjusted by tapping the ends of the tangs or the base of the blade, as required.

Prod Code	Product	Price
05-P-3202	Replacement blade	\$30.00

from \$177.00 Premium Spokeshaves

Veritas®



The 3.2mm thick A2 tool steel blade, machined lever cap, and blade bed achieves chatter-free cutting in virtually all conditions.

cut depth and skew, and shims let you adjust the mouth opening as needed.

The ductile cast iron body is fitted with Bubinga handles, shaped for comfort and control. The toe serves as a thumb rest, allowing the user to choke up on the body to attain exceptional control for fine work. Twin adjustment wheels quickly and accurately control

The flat and round spokeshaves have 54mm wide blades with the round shave sole having a 44.5mm radius, whereas the concave spokeshave has a 45° bed angle, a sole radius of 33.3mm and 38mm wide blade.

Each spokeshave weighs about 345g and 267mm long overall.

Product Code	Product	Weight	RRP
05-P-3301	Flat Sole	410g	\$177.00
05-P-3303	Rounded Sole	410g	\$177.00
05-P-3311	Concave	410g	\$185.00
05-P-3305	Replacement Blade for Flat/Rounded	80g	\$39.00

PLANING

\$569.00 13in Standard Thicknesser



- ✓ Cutterhead parallelism maintained by four precision ground steel posts
- ✓ In-built dust chute and dust port with three sizes built into one outlet (2, 2 1/2 & 4in)
- ✓ Easy-access changeable brushes
- ✓ Built-in depth-of-cut gauge to ensure you're taking off the correct amount in each pass
- ✓ Magnified cursor to make height adjustment easier to see accurately
- ✓ Quick-set reversible knives for fast blade change-overs in less than 5 minutes
- ✓ No-Volt Release switch won't restart after power cuts
- ✓ Sherwood-exclusive drive and auto-feed system lasts longer

Motor Size	1500W (2HP)	Max Planing Capacity	330 x 152mm
Motor Type	Brush-Type	Min Stock Thickness	2.8mm
# of Belts	1	Planer Bed Size	330 x 240mm
Cutterhead Speed	9,500rpm	Extension Table Size	340 x 195mm
# of Blades	2	Planer Feed Speed	7m/min
Blade Type	Replaceable	Machine Footprint	550 x 640 x 490mm
Cutterhead Lock	No		

Product Code	Product	Weight	RRP
MB-1932	Thicknesser	35kg	\$569.00
MB-1932-BL	Replacement Blade Set	100g	\$59.00

\$899.00 13in Spiral-head Thicknesser



The fundamental upgrade to this unit is the segmented spiral cutterhead. The segmented spiral head uses a 27mm-wide two-sided solid tungsten knife arranged in a straight pattern and are designed to shear cut the work piece rather than planing the full width at the same time. It requires less horsepower, makes smaller chips and less noise than standard full-width blade types of cutterheads.

- ✓ A solid granite base instead of a stainless sheet over an alloy base.
- ✓ A built-in depth-of-cut stop - set the depth of cut to the common 3.2mm, 6.4mm, 12.7mm, 19.0mm, 25.4mm and 31.8mm thicknesses to maintain a consistent thickness
- ✓ Bigger infeed and outfeed tables to support the work piece more effectively.

All specifications match MB-1932 except -

Number of Blades	26
Blade Type	Segmented Spiral
Extension Table Size	332 x 230mm
Machine Footprint	540 x 710 x 485mm



Prod Code	Product	Weight	Price
MB-1935	13in Spiral-head Thicknesser	35kg	\$899.00
MB-1935-TBL	Replacement Knives Pk 6	70g	\$55.00

\$479.00 6in Bench Top Jointer



This jointer is suitable for use in a small workshop or on a jobsite. Whilst this machine is small, it is not small on features. The body is made of solid cast iron, which makes it less portable but it is better suited to handle heavier planing operations.

It also has a large brush-type motor, which will handle all jobs thrown at it. Because the cutterhead only has two knives, it is compensated by increased cutterhead speed, allowing as smooth a finish as found on most floor-standing 6in jointers.

Motor Size	1500W (2HP)	Fence Dimensions	580 x 110mm
# of Belts	1	Max Planing Capacity	155 x 2.0mm
Cutterhead Speed	10,000rpm	Rebating Capacity	N/A
# of Blades	2	Bed Height	205mm
Blade Type	Replaceable	Dust Port Diameter	63mm (2 1/2in)
Table Dimensions	725 x 160mm		

Prod Code	Product	Weight	RRP
TB-6	Jointer	45kg	\$479.00
TB-6-BL	Replacement Blade Set	100g	\$40.00

\$49.00 Jointer Blade Setting Jig



BSJ-01 | 650g

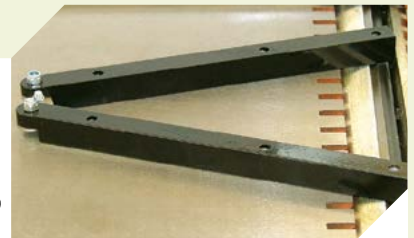

A simple but very effective tool for setting jointer knives. Six rare-earth magnets are mounted in twin arms. Simply put your planer knives in the cutterhead, place the jig on the

outfeed table and engage two of the magnets with the planer knives and tighten. Rotate the cutterhead and repeat.

\$69.00 Planer Blade Setting Jig



BSJ-02 | 600g



Suitable for all types of jointers and thicknessers. Simply adjust the jigs for the correct diameter cutterhead and length of extrusion of the blade from the cutterhead. Put your planer knives into the cutterhead and set the jig over the planer blade.

Two rare-earth magnets hold the jig onto the cutterhead whilst pressure is being applied to the knives for tightening the clamping bar. Allows perfect setting of blades on any type of cutterhead.

\$679.00

6in Standard Jointer

SHERWOOD



A substantial cast-iron fence mechanism locks in place solidly and provides a great platform for accurate planing. The fence can also be tilted up to 45° with a built-in stop to return it back to 0° again quickly as needed.

An integral dust port is built in for safer woodworking. The outfeed table has a fine-adjustment handwheel adjustment whereas the infeed table has a quick-adjusting handle for cutting depth.

Motor Size	750W (1HP)
Motor Type	Induction
# of Belts	1
Cutterhead Speed	4800rpm
# of Blades	3
Blade Type	Resharpenable
Table Dimensions	1210 x 190mm
Fence Dimensions	740 x 100mm
Max Planing Capacity	155 x 3.2mm
Rebating Capacity	13 x 13mm
Bed Height	845mm
Dust Port Diameter	102mm (4in)

Prod Code	Product	Weight	RRP
TBJ-6-C	Jointer	118kg	\$679.00
TBJSC-6-C	Spiral Head Jointer	125kg	\$1,299.00
TBJ-6-BL	Replacement Blade Set	150g	\$40.00

\$849.00

6in Deluxe Jointer

TBS-6-D | 120kg



Great bang for your buck over the standard 6in jointer, this has a few extra features that makes it a joy to use in the workshop.

1. A welded cabinet stand that creates a more solid base for the main jointer body to sit on. The integral 4in dust port works better at controlling the dust in the enclosure as well.

2. The switch is conveniently located at about elbow height with a quick-stop paddle that makes it easy to turn off even with your hands full.

3. The table adjustment handwheels are located at the front of the machine. Rather than fumbling under the tables, its far easier to adjust both table heights precisely from a comfortable position.

Motor Size	750W (1HP)	Table Dimensions	1210 x 190mm
Motor Type	Induction	Fence Dimensions	890 x 125mm
# of Belts	1	Max Planing Capacity	155 x 3.2mm
Cutterhead Speed	4800rpm	Rebating Capacity	16 x 13mm
# of Blades	3	Bed Height	880mm
Blade Type	Resharpenable	Dust Port Diameter	102mm (4in)

\$1,349.00

8in Jointer

SHERWOOD



It has larger width capacity as well as long tables for straightening longer pieces of timber. The fence is higher to support work pieces more effectively when planing edges, as well as a mechanism that allows for reliable placement over the cutterhead.

It comes on a sturdy cabinet stand with an integral 4in dust outlet that helps keep your workshop clean and a mobile wheel kit to move it around as needed. New for 2018 is the movement of the hand wheel adjustments to the front of the machine, making it easier to accurately adjust both the in and outfeed tables without having to fumble underneath.

Motor Size	1500W (2HP)	Table Dimensions	1800 x 235mm
Motor Type	Induction	Fence Dimensions	890 x 125mm
# of Belts	1 - Poly V	Max Planing Capacity	203 x 3.2mm
Cutterhead Speed	5000rpm	Rebating Capacity	19 x 16mm
# of Blades	4	Bed Height	820mm
Blade Type	Resharpenable	Dust Port Diameter	102mm (4in)

Prod Code	Product	Weight	RRP
TBJ-8-N	Jointer	230kg	\$1,349.00
TBJSC-8-N	Spiral Head Jointer	240kg	\$2,149.00
TBJ-8-BL	Replacement Blade Set	220g	\$60.00

Extraction & Safety
Measuring & Marking
Sawing
Site & Shop Accessories
Routing
Planing
Sanding & Scraping
Drilling
Joinery
Clamps & Vices
Finishing
Sharpening
Carving & Chisels
Woodturning
Wooden Parts
Cabinet Fittings

PLANING

from **\$2,799.00**

20in Industrial Thicknesser

SHERWOOD



All Sherwood Industrial Thicknessers come standard with –

- Japanese SKF cutterhead bearings & housings
- Triple belt drive

- Two feed-speed gearbox
- Built-in mobile base
- Cast-iron in & outfeed tables
- Cutterhead lock
- Heavy-duty NVR switches

Motor Size	2200W (240V) 3800W (415V)	Max Planing Capacity	508 x 203mm
Motor Type	Induction	Min Stock Thickness	3.2mm
# of Belts	3	Planer Bed Size	490 x 655mm
Cutterhead Speed	5000rpm	Extension Table Size	530 x 390mm
# of Blades	4	Planer Feed Speed	4.8 & 6m/min
Blade Type	Resharpenable	Dust Port Diameter	102mm (4in)
Cutterhead Lock	Yes	Machine Footprint	1055 x 1430 x 990mm

Prod Code	Product	Weight	RRP
TBW-5081	Straight Knife Single Phase - 240V	375kg	\$2,799.00
TBW-5083	Straight Knife Three Phase - 415V	375kg	\$2,799.00
THUSC-5081	Spiral Head Single Phase - 240V	390kg	\$4,599.00
THUSC-5083	Spiral Head Three Phase - 415V	390kg	\$4,599.00
TBW-508-BL	Replacement Straight Blade Set	1.1kg	\$160.00

from **\$1,999.00**

16in Industrial Thicknesser

SHERWOOD



Motor Size	2200W (3HP)	Min Stock Thickness	1.1mm
Motor Type	Induction	Planer Bed Size	390 x 450mm
# of Belts	3	Extension Table Size	373 x 305mm
Cutterhead Speed	5000rpm	Planer Feed Speed	4.8 & 6m/min
# of Blades	3	Dust Port Diameter	102mm (4in)
Blade Type	Resharpenable	Machine Footprint	850 x 1070 x 1060mm
Cutterhead Lock	Yes		
Max Planing Capacity	406 x 203mm		

Prod Code	Product	Weight	RRP
THU-4061	Straight Knife Single Phase - 240V	280kg	\$1,999.00
THU-4063	Straight Knife Three Phase - 415V	280kg	\$1,999.00
THUSC-4061	Spiral Head Single Phase - 240V	290kg	\$3,199.00
THUSC-4063	Spiral Head Three Phase - 415V	290kg	\$3,199.00
TBW-406-BL	Replacement Straight Blade Set	700g	\$100.00

from **\$1,649.00**

15in Heavy-Duty Thicknesser



SHERWOOD



New for 2018 – the 15in thicknesser now comes stripped back minus stand and feed tables so it can be used as a heavy-duty "portable" unit. Still weighing in at

195kg means you'll need a few people to move it but means you will have the option to mount it as necessary in a workshop or on a worksite.

Motor Size	2200W (3HP) -240V	Min Stock Thickness	1.1mm
Motor Type	Induction	Planer Bed Size	365 x 505mm
# of Belts	3	Extension Table Size	373 x 305mm
Cutterhead Speed	5000rpm	Planer Feed Speed	4.8 & 6m/min
# of Blades	3	Dust Port Diameter	102mm (4in)
Blade Type	Resharpenable	Machine Footprint	660 x 700 x 600mm
Cutterhead Lock	Yes		
Max Planing Capacity	380 x 152mm		

Prod Code	Product	Weight	RRP
THO-3851	Straight Knife Head Thicknesser	200kg	\$1,649.00
THOSC-3851	Spiral Head Thicknesser	275g	\$2,799.00
TBV-380-BL	Replacement Straight Blade Set	650g	\$90.00
THO-385-ST	Cabinet Stand	20kg	\$89.00
THO-385-CIT	Cast-Iron Tables	20kg	\$89.00

\$2,799.00 12in Combination Planer



Motor Size	2400W (3HP)	Planer Feed Speed	7m/min
Motor Type	Induction	Min Stock Thickness	6mm
Cutterhead Speed	5300rpm	Jointer Table	1410 x
# of Blades	3	Dimensions	310mm
Blade Type	Resharpenable	Bed Height	855mm
Thickening Capacity	305 x 230mm	Max Planing Capacity	3mm
Planer Table Length	545mm	Dust Port Diameter	102mm (4in)
Prod Code	Product	Weight	RRP
PTX-310	Straight Knife Head Planer	254kg	\$2,799.00
PTXSC-310	Spiral Head Planer	265kg	\$3,699.00
PTX-310-BL	Replacement Straight Blade Set	550g	\$100.00

\$1,899.00 10in Lift-Up Combination Planer

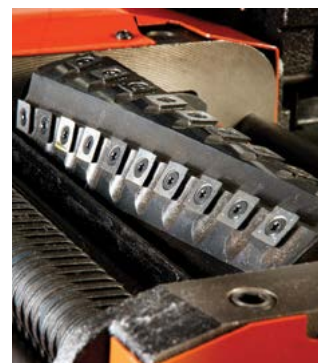

Shown with optional MB-230 Base

The parallel lift-up table mechanism makes it much easier to re-set up for use as a jointer after thickening. The powerful motor is capable of planing to full width capacity with ease, while the solid fence stay in position when changing modes. The simple easy-to-read micro-

adjustable thickening read-out makes height adjustment easy to use in environments with all types of lighting.

The dust port flips over and covers the cutterhead and the micro-switch will ensure it can't run by accident without proper safety guarding.

Motor Size	2200W (2.9HP)	Planer Feed Speed	5.5m/min
Motor Type	Induction	Min Stock Thickness	3mm
Cutterhead Speed	5500rpm	Jointer Table	1125 x
# of Blades	3	Dimensions	260mm
Blade Type	Resharpenable	Fence Dimensions	700 x 120mm
Thickening Capacity	260 x 230mm	Bed Height	825mm
Planer Table Length	545mm	Max Planing Capacity	3mm
Dust Port Diameter	102mm (4in)	Dust Port Diameter	102mm (4in)
Prod Code	Product	Weight	RRP
PTX-260	Straight Knife Head Planer	195kg	\$1,899.00
PTXSC-260	Spiral Head Planer	195kg	\$2,699.00

from \$599.00 Helical Spiral Cutterheads for Thickeners



Helical spiral cutterheads are designed with a true shear cut. It requires less horsepower, makes smaller chips and less noise than other types of cutterheads. Unlike conventional single straight knives you do not need to replace the knife if it becomes damaged or dull.

Instead, if one knife edge is damaged or needs sharpening simply turn it to another edge in seconds. You will only need to replace the TCT inserts when four edges are dull giving you more life than speed steel knives. Your initial investment is paid back in no time.



Prod Code	Product	Weight	RRP
TBJ-6-SC	Suits Sherwood 6in Jointers	8kg	\$599.00
TBJ-8-SC	Suits Sherwood 8in Jointer	8kg	\$799.00
ML-392-SC	Suits Sherwood ML-392 10in Combo	10.5kg	\$699.00
PTX-310-SC	Suits Sherwood 12in Combo	10.5kg	\$899.00
TBV-380-SC	Suits Sherwood 15in Thickener	12kg	\$999.00
TBW-406-SC	Suits Sherwood 16in Thickener	13kg	\$1,199.00
TBW-508-SC	Suits Sherwood 20in Thickener	18.5kg	\$1,799.00
SCK-10-T	Replacement Pack 10 Tungsten Knives	80g	\$85.00

SANDING & SCRAPING

\$229.00 4 x 6in Belt/Disc Sander

SHERWOOD
BDS-46-Q | 22kg



Motor Size 375W (½ HP)
Motor Speed 2800RPM
Belt Size 914 x 100mm
Working Length 320mm
Disc Diameter 152mm (6in)
Disc Table Size 225 x 160mm

While there are many different versions of this size sander, some at wildly cheaper prices, the Sherwood is the best quality 4 x 6in sander found in the Australian market. It has a powerful motor that runs a ribbed poly belt for excellent power transfer, machine balanced drums and disc for vibration-free sanding and a solid cast-iron body with a

60mm dust outlet built in to be used with extractors for a clean working environment.

The alloy disc table can be tilted up to 45° and the belt platen can be tilted upwards at any angle for improved usability. Belt changing is a cinch as it has a quick-release belt system. A great performer at a realistic price.

\$449.00 6 x 9in Belt/Disc Sander

SHERWOOD
BDS-69-D | 45kg



Motor Size 900W (1 1/5HP)
Motor Speed 1400RPM
Belt Size 1220 x 150mm
Working Length 435mm
Disc Diameter 230mm (9in)
Disc Table Size 315 x 155mm

This traditionally design of combination sander has been around for a long time and is a reliable performer at a reasonable price. We have sourced a new, upgraded model with improved fit and finish over the previous model with the major upgrade being the 900W aluminium-bodied motor so it can cruise through all work

with ease. It now has an A-frame open-sided stand so it can be setup without taking up valuable bench space.

It has separate, 2in dust collection outlets for both the belt and disc that operate effectively. The table can be positioned either in front of the disc or the belt as well - improving its real-world usability.

\$649.00 6 x 9in Heavy-Duty Belt/Disc Sander



SHERWOOD
BDS-69-HD | 56kg



An upgraded version of the most popular size combo sander. At the core is the industrial 4-pole, direct-drive 1100W motor mounted on the solid cast-iron base. Also included is the pressed steel stand if it needs to be freestanding and can't be mounted to the bench.

There are tables specifically for both the belt and the disc and can be tilted up to 45° as necessary with integral dust extraction. This machine runs very smoothly and quietly and can be loaded up for very aggressive sanding operations.

Motor Size 1100W (1 ½ HP)
Motor Speed 1400RPM
Belt Size 1220 x 150mm
Working Length 405mm
Disc Diameter 230mm (9in)
Disc Table Size 300 x 190mm
Belt Table Size 150 x 145mm
Dust Port Size B - 60mm, D - 35mm

from \$8.50 Sandpaper Cleaning Sticks

ABR/SIFLEX



This rubber is run back and forth across a moving belt and will flick out dust embedded in the pores of the abrasive, restoring it to near original condition and extending abrasive life. It can be used on any sandpaper, particularly the belts and pads used on stationary machinery.

For a small outlay, this item will pay for itself many times over by improving the performance of your abrasives.

Especially important with the industrial-grade abrasives we sell as they will get clogged many times before wearing out.

Prod Code	Product	Weight	RRP
RR-86100	200 x 32 x 32mm	200g	\$8.50
RR-86101	200 x 50 x 50mm	300g	\$14.90

from \$10.90 Velcro Disc Backing Pads



We only sell and recommend genuine Velcro® sanding disc backing pads as we have found that most machine manufacturer's hook & loop backing pads are quickly worn out with regular disc changes.

While this means a higher upfront cost as it is not included with the machine price, you will buy this backing pad once and are unlikely to ever need to replace it for the lifetime of the machine.

Prod Code	Product	Weight	RRP
VDM-150	150mm 6in Diameter	20g	\$10.90
VDM-230	230mm 9in Diameter	30g	\$24.90
VDM-305	305mm 12in Diameter	50g	\$39.90

\$369.00 12in Disc Sander



RECORD POWER

DS-300 | 35kg

A real workhorse that will provide years of reliable service in the workshop. Featuring a cast iron body, disc and table, this machine is more than capable of withstanding heavy sanding tasks. The powerful motor provides plenty of power and torque to easily handle large sections of timber and the dynamically balanced disc ensures smooth operation. This machine is in a different league to other disc

sanders. When seen in action, the build quality and performance speak for themselves.

Motor Size	750W (1HP)
Motor Speed	1400RPM
Disc Diameter	305mm (12in)
Working Table Size	435 x 165mm
Overall Size	400 x 510 x 450mm
Dust Port Size	60mm

\$549.00 Oscillating Spindle Sander



SHERWOOD

Motor Size	375W (½ HP)
Motor Speed	1400RPM
Working Height	110mm
Vertical Travel	24mm
Oscillations p/min	60 OPM
Working Table Size	370 x 370mm

This solid little sander is great for sanding around curves of just about any size. While there are other benchtop units with a higher power rating - this unit has a 1/2HP 4-pole motor that runs at the more optimal sanding speed of 1400rpm so will work equally well both along

the grain and on endgrain. 4-pole motors also have twice as much torque as 2-pole motors (that run at 2,800RPM). The housing is sturdy folded steel so it absorbs vibration providing a smoother finished edge. Includes 19, 35 & 50mm spindles

\$39.90 Mini Long Drum Sanding Set



An economical mini drum sanding set for use in hand and drill presses. It includes four drums with two sets of fine and two sets of coarse

abrasive drums. It has the following diameter sanding drums - all in 63.5mm (2 ½in) lengths - 12.7mm, 19.0mm, 25.4mm & 38.1mm.

Prod Code	Product	Weight	RRP
DS-20	Drum Sanding Set	850g	\$39.90
DSS-8	Replacement Sleeves	120g	\$19.90

Prod Code	Product	Weight	RRP
OS-100	Spindle Sander	38kg	\$549.00
OS-19060	19mm 60 Grit Sleeves	30g	\$9.00
OS-19080	19mm 80 Grit Sleeves	30g	\$9.00
OS-19120	19mm 120 Grit Sleeves	30g	\$9.00
OS-35060	35mm 60 Grit Sleeves	50g	\$11.00
OS-35080	35mm 80 Grit Sleeves	50g	\$11.00
OS-35120	38mm 120 Grit Sleeves	50g	\$11.00
OS-50060	50mm 60 Grit Sleeves	60g	\$14.00
OS-50080	50mm 80 Grit Sleeves	60g	\$14.00
OS-50120	50mm 120 Grit Sleeves	60g	\$14.00

\$339.00 Bench Oscillating Spindle Sander



Large 370 x 295mm cast iron table for stability and enhanced material support. Rotating and oscillating action for increased speed and efficiency and precise finishing of intricate work. Includes 6 x 80-grit sanding sleeves 13-76mm dia, with matching rubber drums and table inserts. On-board storage for all accessories. Dust port for connection to extraction system.

No Load Speed	2000R
Power	450W
Product Height	450mm
Product Length	390mm
Product Width	330mm
Product Weight	12.9kg
Sleeve Height	115mm
Oscillations p/min	58 OPM

from \$22.00 Sleeveless Drum Sanders



Sleeveless drum sanders are great as you're not committed to buy replacement drums from the source, just use commonly available 75mm-wide or cut down 100mm-wide cloth-backed abrasives - opening

up a much larger range of grits available to suit any task. Simply wrap the strips around the drums, feed the ends into the slot and turn the eccentric post that clamps the material securely in place.

Prod Code	Product	Weight	RRP
DS-1	25.4mm 1in Diameter	180g	\$20.00
DS-2	50.8mm 2in Diameter	300g	\$22.00
DS-2-H	63.5mm 2 1/2in Diameter	360g	\$24.00
DS-3	76.1mm 3in Diameter	440g	\$27.00
DS-4	Sleeveless Drum Sander Set	2.3kg	\$99.00

Prod Code	Product	Weight	RRP
TSPS-450	Spindle Sander	17kg	\$339.00
TSS-80-G	80 Grit Replacement Sleeves	170g	\$30.00
TSS-100-G	100 Grit Replacement Sleeves	150g	\$30.00
TSS-150-G	150 Grit Replacement Sleeves	150g	\$30.00
TSS-240-G	240 Grit Replacement Sleeves	150g	\$30.00

Extraction & Safety
Measuring & Marking
Sawing
Site & Shop Accessories
Routing
Planing
Sanding & Scraping
Drilling
Joinery
Clamps & Vices
Finishing
Sharpening
Carving & Chisels
Woodturning
Wooden Parts
Cabinet Fittings

SANDING & SCRAPING

Extraction & Safety
Measuring & Marking
Sawing
Site & Shop Accessories
Routing
Planing
Sanding & Scraping
Drilling
Joinery
Clamps & Vices
Finishing
Sharpening
Carving & Chisels
Woodturning
Wooden Parts
Cabinet Fittings

\$999.00

16in Wide Drum Sander

SHERWOOD

WDS-400-A | 84kg

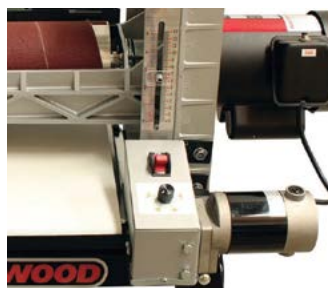

Wide drum sanders are valuable in cabinetmaking as they get the finest of finishes on flat surfaces in shortest period of time.

An industry-standard model and has a 1HP (750W) direct-drive

- ✓ Open sided configuration means it can sand surfaces up to 32in (812mm) wide by flipping the work piece around
- ✓ Capable of sanding exceptionally thin material - 3.2 - 127mm thick
- ✓ Heavy-duty rubberized variable speed platen can be adjusted to run at 570 - 2700mm/min
- ✓ 2 1/2in diameter dust outlet built into overhead drum guard

1,400rpm motor along with a compact and powerful 95W (1/8HP) DC motor that has variable speed so you can adjust the feed speed to suit the abrasive and material.

- ✓ Rugged aluminium tower and drum frame absorbs vibration
- ✓ Conveyor belt tracking easy to adjust
- ✓ Drum diameter 5in accepts standard 100mm-wide clothed back abrasives
- ✓ Includes stand

\$2,799.00

25in Twin-Head Drum Sander

SHERWOOD

WDS-635-TW | 210kg



Two dynamically-balanced 635mm (25in) wide drums are twin-belt driven from a 3HP single-phase (15-Amp) motor so it will handle all sanding in home and small trade/school workshops with ease.

- ✓ 2250W (3HP) 4-pole (1,400rpm) high-torque induction motor
- ✓ 125W (1/6HP) DC variable feed motor
- ✓ Twin-belt drive system to dynamically balanced 5in sanding drum
- ✓ Accepts standard 100mm-wide clothed back abrasives

The benefit of the twin-head design is that by winding two different grit abrasives on the two drums you can effectively run two passes in one feed through the machine.

- ✓ Will sand work piece thicknesses 6.4 - 127mm
- ✓ Conveyor feed speeds 0.9 - 6m/min
- ✓ Twin 4in dust outlets ducted into sanding drum cover for max extraction



Search **Timbecon** to watch all of our instructional videos.

Keep tabs on Timbecon



Like us on Facebook (fb.com/timbecon) to keep up with the latest news on promotions, product arrivals and general interest woodworking topics.



from \$2.50

100mm Paper Backed Roll



Code	Product	Weight	Price	50m
ANR-80	80 Grit	70g	\$2.50	\$100.00
ANR-120	120 Grit	60g	\$2.50	\$100.00
ANR-180	180 Grit	50g	\$2.50	\$100.00
ANR-240	240 Grit	50g	\$2.50	\$100.00
ANR-320	320 Grit	50g	\$2.50	\$100.00
ANR-400	400 Grit	50g	\$2.50	\$100.00

\$6.75 per m

100mm Cloth Backed Roll



Prod Code	Product	Weight	Price	50m
ACR-60	60 Grit	50g	\$6.75	\$270.00
ACR-80	80 Grit	50g	\$6.75	\$270.00
ACR-120	120 Grit	50g	\$6.75	\$270.00
ACR-180	180 Grit	50g	\$6.75	\$270.00
ACR-240	240 Grit	50g	\$6.75	\$270.00
ACR-320	320 Grit	50g	\$6.75	\$270.00
ACR-400	400 Grit	50g	\$6.75	\$270.00

from \$1.30

280 x 230mm Abrasive Sheets

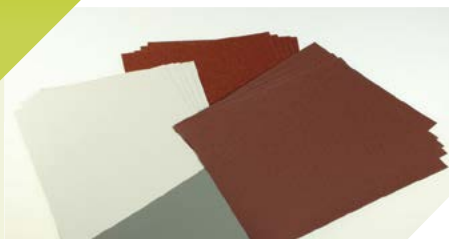

Code	Product	Weight	Price	Pk 50
APS-40	40 Grit	40g	\$2.60	\$105.00
APS-60	60 Grit	30g	\$2.30	\$90.00
APS-80	80 Grit	30g	\$1.60	\$60.00
APS-120	120 Grit	20g	\$1.60	\$60.00
APS-180	180 Grit	20g	\$1.60	\$60.00
APS-240	240 Grit	20g	\$1.60	\$60.00
APS-320	320 Grit	20g	\$1.80	\$70.00
APS-400	400 Grit	20g	\$1.80	\$70.00
APS-600	600 Grit	20g	\$2.00	\$80.00
APS-800	800 Grit	20g	\$2.00	\$80.00
APS-1000	1000 Grit	20g	\$2.00	\$80.00
APS-1200	1200 Grit	20g	\$2.00	\$80.00
APS-1500	1500 Grit	20g	\$2.00	\$80.00
APS-2000	2000 Grit (1/2 Sht)	10g	\$1.30	\$50.00
APS-2500	2500 Grit (1/2 Sht)	10g	\$1.30	\$50.00

from \$1.40

150mm Hook & Loop Sanding Discs



Prod Code	Product	Weight	Price	Pk 50
VD-150040	40 Grit	160g	\$2.30	\$85.00
VD-150060	60 Grit	20g	\$2.00	\$75.00
VD-150080	80 Grit	20g	\$2.00	\$55.00
VD-150120	120 Grit	20g	\$1.40	\$55.00
VD-150180	180 Grit	20g	\$1.40	\$55.00
VD-150240	240 Grit	10g	\$1.40	\$55.00
VD-150320	320 Grit	10g	\$1.40	\$55.00
VD-150400	400 Grit	10g	\$1.40	\$55.00
VD-150600	600 Grit	10g	\$1.50	\$57.50
VD-150800	800 Grit	10g	\$1.50	\$57.50
VD-1501200	1200 Grit	10g	\$1.50	\$57.50
VD-1501500	1500 Grit	10g	\$1.50	\$57.50
VD-1502000	2000 Grit	10g	\$1.50	\$57.50

from \$6.00

230mm Hook & Loop Sanding Discs



Prod Code	Product	Weight	Price
VD-230040	40 Grit	210g	\$7.50
VD-230060	60 Grit	210g	\$6.50
VD-230080	80 Grit	170g	\$6.50
VD-230120	120 Grit	130g	\$6.00
VD-230180	180 Grit	130g	\$6.00
VD-230240	240 Grit	130g	\$6.00
VD-230320	320 Grit	130g	\$6.00

from \$8.50

300mm Hook & Loop Sanding Discs



Prod Code	Product	Weight	Price
VD-300040	40 Grit	280g	\$9.00
VD-300060	60 Grit	280g	\$9.00
VD-300080	80 Grit	230g	\$8.50
VD-300120	120 Grit	170g	\$8.50
VD-300180	180 Grit	170g	\$8.50
VD-300240	240 Grit	170g	\$8.50
VD-300320	320 Grit	170g	\$8.50

from \$15.90

Finishing Steel Wool



- ✓ For ultra fine finishing
- ✓ Ideal for cutting back finishes to produce ultra smooth surfaces
- ✓ Obtaining matt or satin finishes, removing wax polish, even cleaning brass and polishing metal
- ✓ The finest grade 0000 Steel Wools available in Australia

Code	Product	Weight	Price
STW-0000	#0000 Grade	250g	\$16.90
STW-00000	#0000+ Grade	250g	\$18.50

from \$11.50

914 x 100mm Sanding Belts



Prod Code	Product	Weight	Price
9-H-040	40 Grit	120g	\$12.00
9-H-060	60 Grit	120g	\$11.50
9-H-080	80 Grit	90g	\$11.50
9-H-100	100 Grit	90g	\$11.50
9-H-120	120 Grit	70g	\$11.50

from \$20.00

1220 x 150mm Sanding Belts



Prod Code	Product	Weight	Price
10-H-040	40 Grit	290g	\$21.00
10-H-060	60 Grit	260g	\$20.50
10-H-080	80 Grit	180g	\$20.00
10-H-100	100 Grit	170g	\$20.00
10-H-120	120 Grit	160g	\$20.00

\$6.50 pk 5

Punched 125mm Hook & Loop Discs



Prod Code	Product	Weight	Price
BD-067	40 Grit	60g	\$6.50
BD-068	60 Grit	50g	\$6.50
BD-069	80 Grit	50g	\$6.50
BD-071	120 Grit	50g	\$6.50
BD-072	180 Grit	50g	\$6.50
BD-073	240 Grit	50g	\$6.50
BD-074	320 Grit	50g	\$6.50
BD-075	400 Grit	50g	\$6.50

\$7.90 pk 5

Punched 150mm Hook & Loop Discs



Prod Code	Product	Weight	Price
BD-085	40 Grit	110g	\$7.90
BD-086	60 Grit	110g	\$7.90
BD-087	80 Grit	110g	\$7.90
BD-089	120 Grit	110g	\$7.90
BD-090	180 Grit	110g	\$7.90
BD-091	240 Grit	110g	\$7.90
BD-092	320 Grit	110g	\$7.90
BD-093	400 Grit	110g	\$7.90

\$3.50

Scotchbrite Abrasive Pads



The fast yet forgiving cut and consistent performance of Scotch-Brite™ abrasives allows you to improve surfaces without significantly changing the shape of dimension or the workpiece – and helps prevent undercutting and gouging. Scotch-Brite products make it easier to produce a consistent finish, part after part.

Code	Product	Weight	Price
SBPC	Coarse (White)	10g	\$4.00
SBPM	Medium (Green)	10g	\$4.00
SBPF	Fine (Maroon)	10g	\$4.00
SBPSF	Superfine (Grey)	10g	\$4.00

SANDING & SCRAPING

Extraction & Safety
Measuring & Marking
Sawing
Site & Shop Accessories
Routing
Planing
Sanding & Scraping
Drilling
Joinery
Clamps & Vices
Finishing
Sharpening
Carving & Chisels
Woodturning
Wooden Parts
Cabinet Fittings

from
\$20.90

Mini Sanding Pads for Drills



Tim Skilton has been making his sanding pads in Adelaide for as long as we can remember and is the industry-standard when it comes to flexible sanding pads for use in a drill. Made from neoprene, which can deal with the inevitable heat build-up, it provides maximum durability and flexibility. They are sharply tapered to allow maximum flex for accessing difficult areas such as the inside of lipped bowls.

The 1/4in hexagonal shanks grip tightly in drill chucks and we have

never known of the metal shank assembly delaminating from the pad - we are happy to offer a lifetime warranty on this product and we know Tim is too!

The hook & loop pads are attached with high-temperature adhesive and can eventually wear out so replacements are available.

Also available are premium Australian lambswool buffs that will contour to any shape and provide a mirror finish.

Description	Prefix	30mm (-30)	50mm (-50)	75mm (-75)
Starter Kit	SK-*	\$29.90	\$44.90	\$49.90
Sanding Pad Only	VD-*	\$20.90	\$26.90	\$31.90
60 Grit Discs Pack 25	VD-060	\$6.90	\$10.90	\$21.90
80 Grit Discs Pack 25	VD-080	\$6.90	\$10.90	\$21.90
120 Grit Discs Pack 25	VD-120	\$6.90	\$10.90	\$21.90
180 Grit Discs Pack 25	VD-180	\$6.90	\$10.90	\$21.90
240 Grit Discs Pack 25	VD-240	\$6.90	\$10.90	\$21.90
320 Grit Discs Pack 25	VD-320	\$6.90	\$10.90	\$21.90
500 Grit Discs Pack 25	VD-500	\$6.90	\$10.90	\$21.90
Replacement Velcro	VERF-*	\$2.50	\$4.90	\$7.90

from
\$24.90

Skilton Hand Sander System



Leave your work piece on the lathe and turn at a high speed. The opposing directions of the work piece turning against the head of the sander makes the sanding more

aggressive reducing the time taken yet provides a smoother finish as the multi-directional action results in an orbital sanding effect being created.

Prod Code	Product	Weight	RRP
SSH	Skilton Sander Handle Only	120g	\$29.90
SS-50	Skilton Sander Pad 50mm	40g	\$26.90
SS-75	Skilton Sander Pad 75mm	70g	\$31.90

\$3.50

Cork Sanding Block



AM-228044 | 70g



Everyone needs a simple, humble boring old sanding block!!!

This is the perfect size to be used with 100mm wide abrasives.

\$28.00

Scraper Joiner/Edger



Veritas®

05-M-0701 | 350g

To be used on cabinet scrapers, scraper plane blades, and handsaws. It has a 45° jointing capability as well as the standard 90°. With a comfortable, ergonomic shape it is invaluable for jointing

scrapers and handsaws; the fence is relieved next to the file to accommodate tooth set. Anodized aluminium with solid brass screws. Use with a 150mm or 200mm mill file (not included).

\$24.90

SandDevil 3.0



MILESCRAFT

MC-1605 | 380g

A Valuable Addition To Every Tool Box! Multiple sanding surfaces for hard to reach spaces, providing precision sanding results with a

flawless finish. The clever lever is self-tightening, providing tool-free exchange of standard 533 x 75mm sanding belts.

\$9.90

Small Sanding Block



UH-432 | 90g



When you have a small set of hands this block is the way to go. It has a small comfortable ball grip and the pad size is a useful 125 x 75mm. We recommend cutting down

125mm hook & loop abrasive discs to use for this pad. The plasticized foam backing is moulded to fit in the hand and is great for fine finishing work.

\$10.90

Medium Sanding Block



UH-632-E | 100g



We recommend this sanding block as the perfect all-purpose unit. It is shaped to accept standard 150mm hook & loop abrasive discs with the base measuring 152 x 85mm. The

edges of the disc wrap up the sides of the block which makes it great for sanding up against a ledge into corners as the side of the pad can sand in conjunction as the main base.

\$35.00 Square Cabinet Scraper Set

Veritas®
05-K-3010 | 230g

- These scrapers are hardened to Rc48-52 and hold an edge longer
- Edges are carefully milled to a square, sharp 90° ready for immediate use on fine work
- A hook must be burnished onto them for heavy-duty use
- The 0.4mm & 0.6mm scrapers are 152 x 51mm
- The 0.8mm & 1.0mm scrapers measure 152 x 60mm
- All four come with edge guards and sharpening instructions



from \$10.90 Traditional Cabinet Scrapers



These Sheffield manufactured scrapers are 0.9mm and made from tempered carbon steel. When used in conjunction with the Crown Burnisher to create a perfect hook angle – they work perfectly to scrape away excess material, glue lines and any other



finishing tasks needed when making fine furniture. Available either as a single rectangular size (measuring 152 x 63mm) or a set of three with the most common rectangle, convex and gooseneck scrapers to be used on any shape moulding.

Prod Code	Product	Weight	Price
C-375	Single Rectangular Scraper	120g	\$10.90
C-376	Set of 3 Scrapers	350g	\$27.90

from \$27.00 Tri Burnisher & Curved Cabinet Scrapers

Veritas®



The concave/convex ends of the flat scraper are excellent for bowl or spindle work, while the flat edges are for general purpose work. The French curve shape handles various sizes of concave surfaces. The gently cambered surfaces of the third style are perfect for stripping glue lines or precisely controlled localized scraping. The 0.6mm set is for regular scraping, the 0.4mm set is for finer work.

Shown here with the Tri Burnisher which is designed to perform all the functions of round, triangular and oval burnishers, it has a mirror finish to guarantee smoothly formed hooks on cabinet scrapers. The unique shape lets you apply just the right amount of pressure at each stage of the burnishing process on scrapers of all shapes. The superior surface finish is particularly important to avoid galling and hook tearing.

Prod Code	Product	Weight	Price
05-K-2010	Scrapers Thickness 0.6mm	110g	\$27.00
05-K-2020	Scrapers Thickness 0.4mm	70g	\$27.00
05-K-3201	Tri Burnisher	120g	\$58.00

\$27.90 Mini Cabinet Scraper Set of 4



C-376-M | 20g



A unique set of scrapers - you can see by reference of a standard size pen these miniature cabinet

scrapers are tiny and will work perfectly in extremely fine detail work. Measuring 0.3mm thick.

\$72.00 Cabinet Scraper Holder

Veritas®
05-K-3301 | 250g



There is no tool handier in the shop than a cabinet scraper, and this holder lets you use it to maximum advantage. The light, strong, glass-filled nylon body, with all-brass

fittings, is kind to a sharp hook. You can slip any thickness of scraper (6in/152mm long) into it, clamp it in position, and set the amount of bow with the screw-actuated center pad.

\$29.90 Traditional Round Burnisher



C-377-W | 120g



This burnisher creates a hook on your rectangular cabinet scrapers. Hold at the correct angle and simply roll the burnisher down the edge a few times to create the hook.

The 152mm-long bar is made of high-speed steel and hardened to 70Rc, which is harder than the scraper so it will last forever.

\$58.00 Variable Burnisher

Veritas®
05-K-3701 | 220g



The unique Variable Burnisher eliminates guesswork and makes burnishing easy. It has a carbide rod fixed in a brass hub at an angle. A knob on the face of the body lets you set any angle 0 - 15°. You

rotate the hub to the chosen angle and then lock it into position with the brass thumbscrew. Because the burnisher body is slotted, you burnish a scraper with confidence that the angle is being maintained.

\$22.00 Mini Carbide Burnisher

Veritas®
05-K-2030 | 40g



Veritas made this carbide burnisher specifically for curved scrapers and fine detail scrapers where you need to use a sort of paring-knife action to roll an edge – your thumb on the

scraper and four fingers drawing the burnisher along. A perfect companion to the mini Crown scraper set for instance.

Extraction & Safety
Measuring & Marking
Sawing
Site & Shop Accessories
Routing
Planing
Sanding & Scraping
Drilling
Joinery
Clamps & Vices
Finishing
Sharpening
Carving & Chisels
Woodturning
Wooden Parts
Cabinet Fittings

DRILLING

\$299.00

Light-Duty Bench Drill Press

SHERWOOD
DPB-400 | 32kg



Motor Size	400W (1/2HP)
# of Speeds	5
Speed Range	500-2500rpm
Spindle Travel	60mm
Swing	200mm
Chuck Capacity	1 - 13mm
Quill Size	60mm
Base - Chuck Height	340mm
Post Diameter	60mm
Table Size	198 x 215mm
Base Size	350 x 215mm
Height when assembled	850mm
Machine Weight	30kg

\$499.00

Standard Bench Drill Press

SHERWOOD
DPB-600 | 58kg



Upgraded features above and beyond the competition are -

- ✓ 4-Pole 1,400rpm motor produces double the torque of standard motors
- ✓ Standard bayonet-style light fitting mounted in the drill head creates improved lighting on the drill press table
- ✓ One-piece drive spindle drive design
- ✓ Industrial keyless chuck included as standard equipment
- ✓ Micro-switch built into pulley cover for improved safety

\$535.00

Standard Floor Drill Press

SHERWOOD
DPF-600 | 64kg



\$84.90

Drill Press Easy Riser Kit

TORQUATA
ERK-100 | 4.4kg

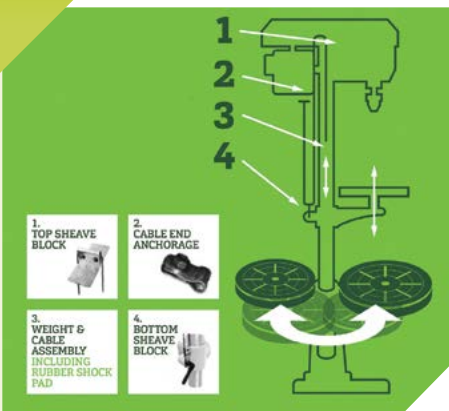

Ever been frustrated by the slow and tedious winding of your drill press table?

The answer is finally here and its so simple its amazing no one has ever thought of it before! Remove your rack and experience the freedom of adjusting your table freehand and it never catching when swinging it out of the way.

You install the counter-weight down the post of your drill press and install the two pulleys (one in the head, the other on the table), anchor it back to your motor mount and it allows for smooth, quick and easy adjustment vertically as well as positioning laterally without the rack getting in the way. Then just clamp it in position like you normally would.

It works on virtually any fixed head drill press with minimal modification.

\$149.00

Drill Press Stand

RECORD POWER
ESTABLISHED 1909
DS-19 | 8kg



The DS19 drill stand offers a premium quality entry-level stand. The DS-19 features a precision manufactured rack and pinion rise and fall, with a solid precision ground column to provide steady, smooth and accurate movement.

- ✓ The headstock is cast aluminium with a 43mm collar to accept most hand held drills and some small routers. For milling work with a router the head can be tilted to increase functionality.
- ✓ Precision manufactured rack and pinion rise and fall, with a solid precision ground solid steel column to provide steady, smooth and accurate movement.



Sherwood's standard bench and floor drills are identical in all but post height. That means they both have ample power to do almost all drilling operations including mortising, drum sanding and using larger size forstner-style bits. Solid construction reduces vibration and improves drilling performance.

Motor Size	600W (4/5HP)
# of Speeds	16
Speed Range	180-2740rpm
Spindle Travel	80mm
Swing	380mm
Chuck Capacity	1 - 16mm
Quill Size	60mm
Base - Chuck Height	700mm (Bench Model = 400mm)
Post Diameter	73mm
Table Size	305 x 305mm
Machine Weight	60kg (Bench Model = 55kg)

\$749.00

Heavy Duty Floor Drill Press

SHERWOOD
DPF-1100 | 81kg



Now our most popular model - this machine is ample for all woodworkers and also allows for heavy-duty metalworking drilling applications as well. The heavy, stable base, large vibration-absorbing head and decent size working table all combine to make it great for all jobs and is finding itself in many satisfied workshops.

Motor Size	1100W (11/2HP)
# of Speeds	16
Speed Range	160 - 3000rpm
Spindle Travel	80mm
Swing	430mm
Chuck Capacity	1 - 16mm
Quill Size	75mm
Base - Chuck Height	640mm
Post Diameter	80mm
Table Size	356 x 356mm
Machine Weight	79kg

\$535.00

Radial Floor Drill Press

SHERWOOD
RDF-600 | 62kg



The ability to drill in the centre of larger sheets. Drilling a series of holes in line without moving the work. Or what about drilling on an angle while the work piece remains flat and easier to handle?

Combined with the use of forstner-style bits this becomes so easy. Think of the compound angles or the addition of various attachments to take advantage of the adjustable head - such as drum sanders or the mortice attachment kit. Radial drill presses are recommended for woodworkers for all of these reasons and can make your work easier and more accurate.

Motor Size	600W (4/5HP)
# of Speeds	5
Speed Range	500 - 2500rpm
Spindle Travel	80mm
Swing	100 - 420mm
Chuck Capacity	1 - 16mm
Quill Size	55mm
Base - Chuck Height	610mm
Post Diameter	72mm
Table Size	300mm Round
Machine Weight	58kg

\$99.00

Cross Slide Vice

BALADONA
CSV-4 | 10kg



Solid cast iron construction with accurate sliding mechanism. The vice slides on two dovetailed channels to ensure the vice remains parallel and stable when being adjusted. It can hold pieces up to 100mm wide and is great for fine adjustment when making mortice joints and accurately positioning work for drilling.

\$49.90

13mm Keyed Drill Chuck

BALADONA
DCA-132 | 890g



This chuck has a range of 1.0 - 13.0mm. It includes the common #2MT arbor (and chuck key), to ensure that ordering and fitment is as easy as possible to suit 90% of requests we receive. It comes from the industrial range of one of the biggest OE manufacturers of drill chucks in the world so quality is assured.

\$69.90

16mm Keyless Drill Chuck

BALADONA
DCAK-162 | 1.1kg



Heavy-duty keyless chucks are fast becoming a popular choice for drilling due to their ease of use. A chuck key (that often gets mis-placed or sometimes even lost) is no longer required to tighten these chucks properly and hold your drill bits securely. 1-16mm range with #2MT arbor included.

DRILLING

\$14.00

Adjustable Stop Collar Set

Veritas®
86-K-6501 | 40g



This pair of stops fits all drill bits from 1.5mm to 12.7mm. The smaller one takes bits from 1.5 - 6.4mm, and the larger takes 6.4 - 12.7mm bits.

Designed with double-ended collets inside threaded sleeves, they lock in position with a quick twist. They are handy, versatile stops for the shop or toolbox.

from **\$3.50**

Brad Point Drill Bits

BALADONA



Brad point bits are true wood boring bits. They are designed with a centre spur to locate the centre of the hole easily, with perimeter cutters to cut the outside of the hole and horizontal scrapers to remove the wood which can peel upwards through the steep spiral to quickly clear the hole. They give a clean, accurate hole and tend to track true rather than follow the grain.

This new range of brad point drill bits has been hand selected from a

world renowned drill manufacturer. Each bit is manufactured from M2 High-Speed Steel for superior heat absorption characteristics as well as excellent edge-holding capabilities, increasing bit life. Each bit also features large chip ejection channels to reduce boring time.

Drill bit length ranges from 61mm for the 3.0mm bit to 161mm for the 16.0mm bit. All bits over 10mm have a reduced shaft diameter of 3/8in (9.5mm) so they can be used in all size hand drills.

Prod Code	Product	Weight	Price
BPD-30	3.0mm	10g	\$3.50
BPD-40	4.0mm	10g	\$3.50
BPD-50	5.0mm	10g	\$3.50
BPD-60	6.0mm	10g	\$4.50
BPD-70	7.0mm	20g	\$4.50
BPD-80	8.0mm	30g	\$4.50
BPD-100	10.0mm	50g	\$5.50
BPD-120	12.0mm	60g	\$5.90
BPD-160	16.0mm	110g	\$9.50
BPD-32	1/8in 3.2mm	10g	\$3.50
BPD-64	1/4in 6.4mm	20g	\$3.50
BPD-79	5/16in 7.9mm	30g	\$4.50
BPD-95	3/8in 9.5mm	50g	\$5.50
BPD-111	7/16in 11.1mm	60g	\$5.90
BPD-127	1/2in 12.7mm	90g	\$8.50
BPD-159	5/8in 15.9mm	110g	\$9.50

\$19.90

8 Piece Brad Point Drill Set

BALADONA
BPDS-8 | 220g



Save by buying a complete set. Get more than 35% off buying them on their own. The set includes 8 bits in the following diameters - 3mm, 4mm, 5mm, 6mm, 7mm, 8mm, 9mm & 10mm. Lengths range from 61mm to 132mm depending on the bit size (see above for more info).

from **\$18.50**

Forstner Style Tungsten Boring Bits

TORQUATA



For drilling large diameter holes in timber you cannot beat a tungsten boring bit.

Each bit has thick 3mm TCT cutting tips and flutes, which dramatically improves performance and durability staying sharper far longer than regular carbon-steel forstner-style bits. Not only will these bits out-drill the number of holes compared to carbon-steel bits by a factor of 10-to-1 or more, they are

designed to be run in a drill as fast as possible meaning boring speeds far outstrip carbon steel bits.

The finish left is very smooth, with minimal burning or tear-out and works equally well along or on end-grain or in difficult materials such as ply etc.

Overall length of the bit is 91mm with boring capacity approximately 65-70mm.

Code	Product	Weight	Price	Code	Product	Weight	Price
THSB-12	12.0mm	50g	\$18.50	THSB-28	28.0mm	100g	\$23.90
THSB-13	13.0mm	50g	\$18.50	THSB-30	30.0mm	100g	\$23.90
THSB-14	14.0mm	50g	\$18.50	THSB-32	32.0mm	110g	\$24.90
THSB-15	15.0mm	60g	\$18.50	THSB-35	35.0mm	140g	\$26.50
THSB-16	16.0mm	60g	\$18.50	THSB-38	38.0mm	140g	\$41.90
THSB-18	18.0mm	70g	\$18.50	THSB-40	40.0mm	160g	\$42.90
THSB-19	19.0mm	70g	\$19.90	THSB-45	45.0mm	180g	\$43.90
THSB-20	20.0mm	80g	\$19.90	THSB-50	50.0mm	200g	\$49.90
THSB-22	22.0mm	90g	\$19.90	THSB-54	54.0mm	370g	\$52.90
THSB-23	23.0mm	90g	\$21.90	THSB-57	57.0mm	380g	\$57.90
THSB-24	24.0mm	90g	\$21.90	THSB-60	60.0mm	390g	\$59.90
THSB-25	25.0mm	90g	\$21.90	THSB-63	63.0mm	400g	\$62.50
THSB-26	26.0mm	90g	\$23.90	THSB-67	67.0mm	410g	\$69.00

\$24.90

Forstner Bit Extension

BALADONA
EXTN-1 | 320g



Allows you to extend the shaft of your forstner or sawtooth bit for deep drillings operations. It is 160mm long, 18mm in diameter and suits all Torquata metric and imperial

forstner style and sawtooth bits that are 19mm diameter or more. If required, they can be joined as shown to drill to greater depths.



Search **Timbecon** to watch all of our instructional videos.

from
\$7^{.-50}

Forstner & Sawtooth Bits



Forstner bits are superior bits for drilling wood because they are guided by the rim and not a centre point. Hence they are not deflected easily by the natural differences in hardness found in timber such as knots or strong grain patterns. They can be used to be bore in any direction and are extremely useful for boring holes on an angle or to true up and increase the size of an existing hole or timber imperfection.

The design permits large chip clearance easily and this combined with their ability to track truly makes them especially suited for drilling deep or extra large diameter holes. Extension bars are available for this purpose.

All bits up to 7/8in or 24mm are forstner-style (continuous edge) with all bits 1in or 25mm and larger having a sawtooth design. A sawtooth design makes them able to cut more easily when drilling with the grain (such as through end-grain). They still retain clean cutting characteristics when used drilling across the grain, just not as clean as a true forstner bit - although acceptable for virtually all wood boring.

All bits up to 2 1/8in (54mm) size are 90mm long and all sawtooth bits 2 1/4in or larger are 160mm long.

Imperial

Prod Code	Product	Weight	Price
FSB-34	3/4in 19.0mm	N/A	See FSBM-19 below
FSB-78	7/8in 22.2mm	70g	\$8.50
FSB-1	1in 25.4mm	80g	\$9.90
FSB-118	1 1/8in 28.6mm	100g	\$9.90
FSB-114	1 1/4in 31.8mm	100g	\$10.90
FSB-138	1 3/8in 34.9mm	130g	\$11.90
FSB-112	1 1/2in 38.1mm	160g	\$12.90
FSB-158	1 5/8in 41.3mm	170g	\$14.90
FSB-134	1 3/4in 44.5mm	190g	\$16.90
FSB-178	1 7/8in 48.6mm	190g	\$18.50
FSB-2	2in 50.8mm	190g	\$19.90
FSB-218	2 1/8in 54.0mm	200g	\$21.90
FSB-214	2 1/4in 57.1mm	370g	\$28.90
FSB-238	2 3/8in 60.3mm	470g	\$29.90
FSB-212	2 1/2in 63.5mm	500g	\$31.90
FSB-258	2 5/8in 66.7mm	470g	\$37.90
FSB-234	2 3/4in 69.9mm	500g	\$38.90
FSB-278	2 7/8in 73.0mm	470g	\$39.90
FSB-3	3in 76.2mm	500g	\$42.90
FSB-318	3 1/8in 79.4mm	560g	\$44.90
FSB-314	3 1/4in 82.6mm	640g	\$48.90
FSB-312	3 1/2in 88.9mm	850g	\$52.90
FSB-4	4in 102.1mm	990g	\$58.90

Metric

Code	Product	Weight	Price	Code	Product	Weight	Price
FSBM-14	14.0mm	60g	\$7.50	FSBM-26	26.0mm	100g	\$11.50
FSBM-15	15.0mm	60g	\$7.50	FSBM-28	28.0mm	100g	\$11.50
FSBM-18	18.0mm	60g	\$8.50	FSBM-30	30.0mm	100g	\$12.50
FSBM-19	19.0mm	70g	\$8.50	FSBM-32	32.0mm	120g	\$12.50
FSBM-20	20.0mm	70g	\$8.50	FSBM-34	34.0mm	140g	\$13.90
FSBM-22	22.0mm	70g	\$8.50	FSBM-35	35.0mm	140g	\$13.90
FSBM-23	23.0mm	80g	\$9.90	FSBM-36	36.0mm	140g	\$14.90
FSBM-24	24.0mm	80g	\$9.90	FSBM-38	38.0mm	160g	\$14.90
FSBM-25	25.0mm	80g	\$9.90	FSBM-40	40.0mm	180g	\$16.90
				FSBM-45	45.0mm	190g	\$16.90
				FSBM-50	50.0mm	210g	\$19.90

\$109⁰⁰

15 Piece Metric Forstner Bit Set

BALADONA
FSB-15 | 2.5kg



We have selected the fifteen most popular metric sizes - make sure you compare the sizes before buying. Buying all bits individually is more than \$158 - saving you 30%!

Sizes included in this set are - 10mm, 12mm, 13mm, 16mm, 19mm, 22mm, 25mm, 28mm, 30mm, 32mm, 35mm, 38mm, 40mm, 45mm and 50mm in an attractive and durable wooden case.

\$125⁰⁰

16 Piece Imperial Forstner Bit Set

BALADONA
FSB-16 | 2.6kg



Buying all bits individually is more than \$187 - saving you more than 35%!

Sizes included in this set are - 1/4in, 3/8in, 1/2in, 5/8in, 3/4in,

7/8in, 1in, 1 1/8in, 1 1/4in, 1 3/8in, 1 1/2in, 1 5/8in, 1 3/4in, 1 7/8in, 2in & 2 1/8in in an attractive and durable wooden case.

\$299⁰⁰

24 Piece Metric Forstner Bit Set

BALADONA
FSBQ-24 | 7.7kg



Buying all bits individually is more than \$450.00 - so buying this set is fantastic value-for-money!

Sizes include in this set are - 10mm, 13mm, 16mm, 19mm, 22mm, 25mm, 30mm, 32mm,

35mm, 38mm, 41mm, 45mm, 48mm, 50mm, 55mm, 57mm, 60mm, 63mm, 65mm, 67mm, 70mm, 73mm, 75mm and 80mm in an attractive and durable wooden case.

DRILLING

from \$9.90

Counterbore Bits



- ✓ Tapered drill with widened flutes for drilling fast, clean pilot holes.
- ✓ Adjustable four-cutter counterbore cuts and clears chips quicker for fast, smooth countersinking.
- ✓ Counterbore attaches to flats on shank with two hex screws for a secure fit, and can be adjusted for controlled pilot hole depth.
- ✓ 1/4in quick-change shank reduces slipping in standard chucks and is compatible with all 1/4in quick-change chucks, including impact drills.

Prod Code	Product	Weight	Price
IR-1882630	4-Gauge Screws	40g	\$9.90
IR-1882781	6-Gauge Screws	40g	\$10.90
IR-1882782	8-Gauge Screws	40g	\$11.90
IR-1882783	10-Gauge Screws	40g	\$12.50
IR-1882784	12-Gauge Screws	50g	\$13.50
IR-1882785	14-Gauge Screws	50g	\$14.90

\$34.90

Counterbore Bit Set of 3



IR-1882793 | 120g



This set includes bits for the three most common size screws in cabinet-making - #6, #8 and #10 gauge screws along with adjustable depth stop and allen key.

\$64.90

Counterbore Bit Set of 6



IR-1882792 | 250g



This set includes all six counterboring bits for #4, #6, #8, #10, #12 and #14 gauge screws along with two adjustable depth stops to suit all sizes and allen key.

\$15.90

Screw Pilot Bit Set



MC-5341 | 70g



Allowing you to simultaneously countersink or counterbore screw pilot holes.

- ✓ Simultaneously countersink or counterbore screw pilot holes with this handy little drill set.
- ✓ Four piece set includes bits for drilling pilot holes for screw sizes #6, #8, #10, and #12
- ✓ Special designed steel sleeve countersinks or counterbores pilot hole
- ✓ Adjustable counter sleeve depth with allen key wrench
- ✓ Standard 1/4in hex shank is quick change compatible
- ✓ TiN coated brad point pilot drill bits (#6 bit is not brad point)

Snappy Tools



Founded in 1962 Snappy are a family-owned company, operating out of Texas, USA. They manufacture premium drilling accessories for use in power drills, impact drivers and drill presses.

The 1/4in hex power bit shaft found on Snappy Tools has become an industry standard, being accepted in quick change chucks and impact drivers everywhere. Their namesake is the "snap" that's heard when a drill bit, driver bit or other tool is pushed into their patented quick change chuck. By utilizing the quick-change system, craftsmen and hobbyists can easily transition from pre-drilling to driving screws.

Whether for daily use on the job or personal use around the house, professionals and hobby woodworkers both demand the most out of their power tools and accessories. By using superior materials, cutting-edge machinery and patented technology, Snappy deliver industrial quality tools at an affordable price.

Proudly Made in the USA.

from \$23.90

Gold Screw Countersinks



- ✓ Combination countersink - Drill pilot and counterbore screw head below surface in one step.
- ✓ Large 1/4in hardened set screw - Easily adjust length of drill bit for correct depth of pilot hole, will securely hold drill bit to prevent slippage.
- ✓ 82° countersink angle - Set screw heads tight and flush to the surface.
- ✓ Use standard wood plugs or cut your own (matching) plugs to cover screw.
- ✓ Alloy steel - Through-hardened to Rc 60 for long cutting life can be resharpened.
- ✓ 1/4in standard hex shank - Fits all quick change chucks or any standard drill chuck.
- ✓ Milled flats on shaft prevent slippage in standard chucks.
- ✓ Supplied with standard point HSS drill bits - normal jobber drills can be used for replacement drill bits.

Prod Code	Product	Weight	Price
SN-43005	2.0mm #4-Gauge Hardwood	30g	\$23.90
SN-43006	2.4mm #6-Gauge Softwood	30g	\$23.90
SN-43007	2.8mm #6-Gauge Hard/8-Gauge Softwood	30g	\$23.90
SN-43008	3.2mm #8-Gauge Hard/10-Gauge Softwood	40g	\$23.90
SN-43009	3.6mm #10-Gauge Hard/12-Gauge Softwood	40g	\$23.90
SN-43010	4.0mm Clearance Hole 7-Gauge	40g	\$26.90
SN-43011	4.4mm Clearance Hole 8-Gauge	40g	\$26.90
SN-43012	4.8mm Clearance Hole 10-Gauge	40g	\$26.90

\$89.90

Countersink and Chuck Set



SN-43400 | 200g



Get started with Snappy Countersinks with this popular set! Includes the standard Quick Change Chuck (SN-40011) plus three most popular Gold Screw Countersinks - SN-43007, SN-43008 & SN-43009.

from **\$47.90**

Tungsten Carbide Countersinks



Tungsten Carbide Tipped cutters provide superior wear resistance and cut a clean countersink or counterbore even in the toughest materials. TiN coated twist drills have parabolic flutes for more chip

clearance. Perfect for laminate countertops, melamine, exotic hardwoods and other tough materials – or if you just wanted the best, longest lasting countersinks in the world.

Prod Code	Product	Weight	Price
SN-46335	2.0mm #4-Gauge Hardwood	40g	\$47.90
SN-46336	2.4mm #6-Gauge Softwood	40g	\$47.90
SN-46337	2.8mm #6-Gauge Hard/8-Gauge Softwood	50g	\$47.90
SN-46338	3.2mm #8-Gauge Hard/10-Gauge Softwood	50g	\$47.90
SN-46309	3.6mm #10-Gauge Hard/12-Gauge Softwood	60g	\$47.90
SN-46330	4.0mm Clearance Hole 7&8-Gauge	50g	\$55.00
SN-46332	4.8mm Clearance Hole 10-Gauge	50g	\$59.90

\$39.90

Countersink Set



CS-7 | 400g



This popular countersinking set features seven bits for 5, 6, 7, 8, 9, 10 & 12 gauge screws. All drill bits are tapered for extra strength when screwing and single fluted for fast

boring. Each counterbore has four high speed steel blades. Very handy to prevent splitting of your timber when screwing. Adjustable stops and tapered drills to set the depth.

\$199.00

Tungsten Countersink Set



SN-46030 | 250g



Get all the world's best tungsten countersinks in one complete set. It includes the series of five

countersinks listed above – SN-46335 to 46309.

\$17.90

Adjustable TCT Countersink

TORQUATA

ACB-160 | 30g



Designed to cut an 82° bevel in wood or plastic for wood screw heads ranging from #4 to #10. Attach to a drill with two set screws, adjustable up and down the drill for

any length screw – only limited by the drill bit length. For use with 2.4 - 6.4mm (3/32 - 1/4in) diameter drills, maximum countersinking diameter is 16mm.

\$95.00

Gold Screw Countersink Set



SN-40030 | 150g



Already got a Quick Change Chuck and just need one of the best countersink sets? Easy! This set

contains the five most common countersinks listed above – SN-43005 to 43009.

\$129.90

Cabinetmakers Countersinking Set



SN-43572 | 250g



This set gives you all the most common bits a cabinetmaker would reach for in the workshop or out on site in one convenient pouch. The kit includes four Gold Screw

Countersinks to suit #6, #8, #10 & #12-gauge screws plus vix bits for #6 & #8-gauge screws and a #2 100mm long square screwdriver.

\$44.90

Offline Driver



SNAPOFLD | 200g



Use your drill next to walls or in any other tight spaces. The outer sleeve rotates, allowing secure positioning and the shaft swivels up to a 15°

angle. Accepts both insert and direct drive bits. Includes No.2 Pozi 50mm screwdriver bit.

\$165.00

Belt Clip Kit



SN-48010 | 250g



Get the four Gold Screw Countersinks to suit #4, #6, #8 & #10-gauge screws plus the evergreen 3/8in plug cutter, #2

Phillips and #2 square driver with the quick change chuck all in a convenient belt-clip pouch so you'll never misplace them.

DRILLING

\$32.90

Quick Change Chuck



SN-40011 | 100g



The patented Snappy quick change chuck accepts all tools with a 1/4in hex power bit shaft, allowing fast changes between drilling and driving. Durable all steel construction, heat-treated for excellent wear resistance

and strength. Simply pushing the bit in will lock it firmly into the drive channel with a hardened chrome ball bearing. Pulling back the knurled sleeve allows the tool to be quickly removed with just one hand.

from **\$16.50**

Metric Drills & Adapters



Produced by Snappy for Trend in the UK, these drill bit adapters suit common metric sizes and come with TiN coated twist drill bits. When necessary, drill bits can be replaced with standard jobber or brad point

drill bits. Allows use of common drill bits with Snappy Quick Change Chucks.

Also available is a set of seven including - 1.5mm, 2.0mm, 2.5mm, 3.0mm, 4.0mm, 5.0mm, 6.0mm.

Prod Code	Product	Weight	Price
SNAPD-2-MM	2.0mm Diameter	30g	\$16.50
SNAPD-3-MM	3.0mm Diameter	30g	\$16.50
SNAPD-4-MM	4.0mm Diameter	40g	\$16.50
SNAPD-5-MM	5.0mm Diameter	50g	\$17.50
SNAPD-6-MM	6.0mm Diameter	50g	\$18.90
SNAPD-2-SET	Set of 7	250g	\$99.00



from **\$31.90**

Original Vix Bits



Use the original Snappy Vix self-centring hinge bits to accurately drill pilot holes in hinges, handles, drawer slides and other hardware. Ensures screws will be straight and flush for proper mounting of hardware.

The hardened nose bushing centres itself in the hardware for a perfectly centred pilot screw hole while the spring-loaded HSS drill bit makes light work of creating pilot holes.

Prod Code	Product	Weight	Price
SN-45105	Suits 4G Screws	50g	\$31.90
SN-45107	Suits 6G Screws	50g	\$31.90
SN-45109	Suits 8-10G Screws	60g	\$34.90
SN-45111	Suits 12G Screws	70g	\$62.90
SN-49105	Replacement Drill - 4G Screws	20g	\$10.50
SN-49107	Replacement Drill - 6G Screws	20g	\$10.50
SN-49109	Replacement Drill - 8-10G Screws	20g	\$10.50
SN-49111	Replacement Drill - 12G Screws	20g	\$18.90

\$110.00

Quick Change Vix Bit Kit



SN-45400 | 300g



Get the three most popular size Vix Bits to suit #4, #6 & #8-10-gauge screws as well as the Snappy Quick Change Chuck all in the one handy kit.

from **\$29.90**

Stubby Drill Bit Sets



These durable short drill bits (ranging from 33 - 58mm in length) are precision ground from one piece of M2 High Speed Steel. StubbyBits™ let you drill in confined spaces and around tight corners. The shank is 1/4in hex shaft that works with standard quick change chucks. Use

with the Drive90™ to get into really tight spaces.

- ✓ The 6-Piece Wood Set includes - 2.0mm, 3.0mm, 4.0mm, 6.0mm, 8.0mm and 10.0mm diameters.
- ✓ The 6-Piece Metal Set includes - 2.0mm, 3.0mm, 4.0mm, 5.0mm, 6.0mm and 8.0mm diameters.

Prod Code	Product	Weight	Price
MC-2350	Wood Stubby Set	100g	\$32.90
MC-2370	Metal Stubby Set	80g	\$29.90

\$249.00

The Ultimate Snappy Kit - Set of 25



SN-48025 | 400g



Get almost all of it in one no-rip nylon Velcro-closure pouch. Includes the following -

- 1x Quick Change Chuck / 5x Gold Screw Countersinks SN-43005 to 43009 / 2x Countersink Stop Collars / 7x Drill Bit Adapters -

- SN-42004, 42006, 42008, 42010, 42012, 42014, 42016 / 3x Phillips Driver Bits (#1, #2, #3) / 3x Square Driver Bits(#1, #2, #3) / 1x Hex Shank Socket / 2x Hex Keys

\$17.90

Hinge Screw Pilot Vix Bit Set



MILESCRAFT
MC-2317 | 150g

There is almost nothing more frustrating when installing fitted hardware (such as hinges) than having your pilot hole accidentally run off center. The screw itself

then tends to be drawn off center, spoiling the perfection you are striving for. Set of 3 for 4, 6 & 8 gauge screws.

\$37.90

Drive90 Plus



MC-1303 | 230g

- ✓ Makes it even easier to use in close quarter drilling
- ✓ Design provides maximum comfort and control when drilling
- ✓ Flat back handle to assist with perpendicular drilling
- ✓ Impact Ready

- ✓ New, improved gears for enhanced durability and longer life
- ✓ Only 38mm wide, for maximum reach into those tight spaces
- ✓ Magnetic 1/4" Hex Socket accepts most standard hex accessories



\$49.⁹⁰ Hand Drill Attach AccuDrillMate

MILESCRAFT
MC-1318 | 2kg



Everyone knows that the success of many DIY projects depends on drilling straight and accurate holes. Now you can add a whole new level of accuracy to drilling holes with your standard hand drill.

The AccuDrillMate by Milescraft is just the tool to provide you the precision and ease of drilling straight holes all of the time. You will get the precision of a drill press with the ease of a hand drill.

\$12.⁹⁰ DrillBlock Drilling Guides

MILESCRAFT



DrillBlock™ allows you to drill straight holes every time. The inserted solid metal guide offers the six common drill diameters: 3mm, 4mm, 6mm, 8mm, 10mm, and 12mm on the metric version or

1/8in, 3/16in, 1/4in, 5/16in, 3/8in, and 1/2in on the imperial version. It is held at a tight tolerance and allows you to drill a hole 90 degrees to any surface.

Prod Code	Product	Weight	Price
MC-1362	Metric Version	130g	\$12.90
MC-1312	Imperial Version	130g	\$12.90

\$37.⁹⁰ Drill90 Plus

MILESCRAFT
MC-1304 | 620g

The Milescraft Drill90 Plus is perfect for drilling those hard to reach wall studs and floor joists, as well as a host of other applications. Ideal for plumbers, electricians, HVAC installers and homeowners needing to navigate tight spaces. With a head size of only 103mm, it is compact and lightweight for prolonged use giving you increased productivity and versatility. For use with most drills – corded or cordless. Comes with 10mm keyless chuck.



from \$33.⁹⁰ Tapered Plug Cutters



Use Snappy tapered plug cutters to cut your own plugs to conceal screws and other fasteners. Use scraps to match wood grain, making the plug nearly invisible or, for a decorative look; use a contrasting wood. Snappy plug cutters produce a tapered plug, so you get a tight fit

with no glue needed. The chamfered nose makes it easy to get the plug started into the bore. Four precision-milled angles on each of the four flutes ensure a smooth cut and a tight-fitting, consistent taper. Heat-treated to provide excellent wear resistance and a long cutting life.

Prod Code	Product	Weight	Price
SN-40316	6.4mm 1/4in	30g	\$33.90
SN-40324	9.5mm 3/8in	50g	\$37.90
SN-40332	12.7mm 1/2in	60g	\$44.00
SN-40340	15.9mm 5/8in	70g	\$49.90
SN-40348	19.0mm 3/4in	80g	\$72.90
SN-40364	25.4mm 1in	120g	\$93.50

\$105.⁰⁰ Tapered Plug Cutter Set



SN-43300 | 120g

The three most popular sizes of quality plug cutters in one set – get the 1/4in, 3/8in and 1/2in sizes

– of course all compatible with the Snappy Quick Change Chucks.

from \$30.⁰⁰ Snug Plug Cutters

veritas



It is always difficult to fit plugs perfectly; any slight run-out in your drill press quill can make the holes oversize. Unfortunately, this run-out will also make plugs undersize. The combination leads to ill-fitting plugs

that are very noticeable in your finished work. Snug-Plug® cutters are designed to cut slightly tapered plugs; the first 3.2mm of the plug is the stated size and then flares out at a 3° included angle.

Prod Code	Product	Weight	Price
05-J-0531	6mm	30g	\$30.00
05-J-0533	8mm	40g	\$31.00
05-J-0535	10mm	50g	\$32.00
05-J-0550	Set of 3 - 6, 8 & 10mm	90g	\$79.00
05-J-0510	Set of 3 - 1/4, 3/8 & 1/2in	100g	\$81.00

\$24.⁹⁰ Plug Cutter Set of 3 Imperial

MILESCRAFT
MC-5340 | 70g



Produce tapered plugs from the same stock for superior grain matching or for removing small blemishes. Includes a bit for drilling scrap project material to produce tapered plugs to cover screws or

hide blemishes. By using the same species wood fasteners virtually disappear or use contrasting material to create a unique visual effect.

JOINERY

\$219.00 K5 Pocket Hole Jig Kit

Kreg
KRK-5 | 2.5kg

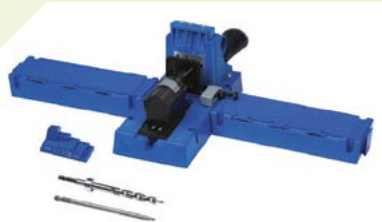

The Kreg Jig® K5 incorporates the best features of every Kreg Jig® that came before, with innovative upgrades you've never seen. Starting with a clamping mechanism that you can quickly adjust, without

tools or adjusting nuts, to match your workpiece thickness. Just slide the clamp into place, "click" the large front-mounted clamp handle, and your jig is set to hold your workpiece tight every time.

- ✓ Front-mounted handle makes clamping easy
- ✓ Ratcheting clamp mechanism adjusts without tools
- ✓ Storage wings provide built-in storage for bits and accessories
- ✓ Swiveling dust collection port accepts any standard vacuum hose
- ✓ Adjustable workpiece stop mounts on either side for easy repeat drilling
- ✓ Stop-collar setting block makes drill bit setup easy
- ✓ Quick-release pin holds drill block securely in place

\$279.00 K5 Pocket Hole Master System

Kreg
KRK-5-MS | 2.5kg

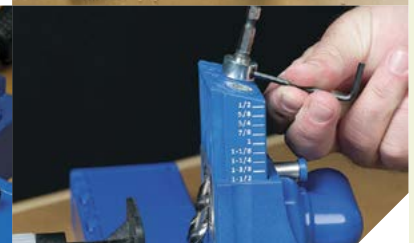

The Kreg Jig® K5 Master System combines the Kreg Jig® K5 with premium accessories to make it even easier to get started building with Kreg Joinery. Accessories include the –

- ✓ 76mm Automaxx® Wood Project Clamp
- ✓ A Portable Base for building on the go
- ✓ Downloadable plans for six great projects

\$229.00 K4 Pocket Hole Master System

Kreg
KRK-4-MS | 3.2kg



With its solid clamp, large clamping recess, dust collection attachment, material support stop, and removable 3-hole drill guide, this jig truly has it all. The Master System includes a Kreg Jig® K4, plus;



- ✓ Standard face frame clamp
- ✓ Portable base
- ✓ Drill guide spacer
- ✓ Material support stop
- ✓ Dust-collection attachment
- ✓ Starter Kreg® Screw set
- ✓ Starter pocket-hole plug set

Looking for face frame clamps for your pocket hole jig?
Go to p. 141 for the full range of Kreg Face Frame Clamps.

\$629.00 The Foreman Pocket Hole Machine

Kreg



Professional-Grade Pocket Hole Machine at a Consumer-Friendly Price

- ✓ One pull of the handle starts the motor, clamps your workpiece, and drills perfect pocket holes
- ✓ Powerful 240V motor
- ✓ Comes with 9.5mm (3/8in) hex-shank drill bit
- ✓ Works with materials from 12 - 38mm thick (1/2 - 1 1/2in)
- ✓ Adjustable fence to position workpiece for precise pocket depth
- ✓ Two spring-loaded stops for repeatable accuracy
- ✓ Clear markings in the table that make it easy to position the fence



- ✓ Compatible with the Micro-Pocket™ Bit and Heavy-Duty Bit
- ✓ Built-in storage tray and dust collection attachment

\$149.00 K4 Pocket Hole Jig Kit

Kreg
KRK-4 | 2kg



Whether you're building your first set of garage storage shelves or making simple repairs around the house, the Kreg Jig® K4 can help you finish the job in less time, and with far less effort than you ever thought possible.

Its simple design gives you the confidence you need to get started, and you'll have your project finished in no time with joints as easy as "Drill. Drive. Done!"

- ✓ Perfect for do-it-yourselfers and anyone new to Kreg Joinery™
- ✓ Removable Drill Guide for benchtop and portable use
- ✓ Drill Guide includes 3-hole xed spacing
- ✓ For use with materials from 1/2" to 1 1/2" thick (12-38mm)
- ✓ Hardened-steel Kreg® drill guides feature a lifetime warranty
- ✓ Removable Drill Guide is great for making home repairs
- ✓ Wood-chip relief holes keep the drill bit clear of excess wood chips
- ✓ Includes everything you need to start building

Prod Code	Product	Weight	Price
DB-210	Foreman Pocket Hole Machine	14kg	\$629.00
DB-210-MBB	Micro Bit & Bushing	190g	\$45.00
DB-210-HDBB	Heavy-Duty Bit & Bushing	230g	\$59.00
DB-210-HDB	Heavy-Duty Replacement Bit	120g	\$39.00

Extraction & Safety
Measuring & Marking
Sawing
Site & Shop Accessories
Routing
Planing
Sanding & Scraping
Drilling
Joinery
Clamps & Vices
Finishing
Sharpening
Carving & Chisels
Woodturning
Wooden Parts
Cabinet Fittings

from **\$89.00**
Heavy-Duty Pocket Hole Jig Kit



Efficient Design and Hardened-Steel Drill Guides - Designed with the same tried-and-true efficient design and hardened-steel drill guides as the original Kreg Jig®, the Kreg Jig® HD lets you create joints in 38mm and thicker materials that are an amazing 50% stronger than

- ✓ Creates joints 50% stronger than standard Kreg Joints™
- ✓ Optimized for large outdoor projects
- ✓ For use with materials 38mm and thicker
- ✓ Works with the Kreg Jig® K3, K4, K4MS, and K5

traditional Kreg Joints™. If you are framing walls, building deck railings, outdoor furniture, or any other large project, you always want the strongest joint possible; and this is where the Kreg Jig® HD excels—strength.

- ✓ Stop Block provides easy, repeatable registration to work piece
- ✓ Face Clamp locks into Kreg Jig HD for secure drilling
- ✓ Hex-Shank HD Drill Bit is Quick-Change compatible

Prod Code	Product	Weight	Price
KJHD	Heavy-Duty Kit	650g	\$89.00
KRBS-127	Replacement Drill Bit	170g	\$35.00
D-6-HD	Replacement Driver	50g	\$9.00

\$79.00
Micro Drill Guide Kit



Create more Compact Pocket Holes in the same Kreg Joinery applications.

- ✓ 25% smaller pocket-hole diameter
- ✓ Great for smaller projects, thinner stock, and repair applications
- ✓ Compatible with the Kreg Jig® K3, K4, K4MS, and K5
- ✓ Features black color to differentiate from standard Kreg Drill Guide
- ✓ Works with 12mm thickness and narrow stock, down to 25mm wide
- ✓ Works with Kreg Pan-Head Pocket-Hole Screws (SPS)

Prod Code	Product	Weight	Price
KJMICRODGB	Drill Guide Kit	440g	\$79.00
KJDMICROBIT	Replacement Micro Drill Bit	50g	\$29.00

\$109.00
Custom Plug Cutter Kit



Take your Kreg Joinery projects to the next level by creating custom plugs from any wood species.

- ✓ Fits into any Kreg K3, K4, or K5 Jig® longer bit life
- ✓ Hardened-steel drill guides provide reliable drilling and feature a lifetime warranty
- ✓ Bit tip shears wood fibres cleanly to create a smooth, consistent plug
- ✓ Special fluting reduces heat and friction for better plugs and longer bit life
- ✓ Open design ensures easy plug release
- ✓ Standard Plug Cutting Bit for standard size pocket holes included
- ✓ Plug cutters available to suit pocket holes created by HD and Micro Bits (sold separately)

Prod Code	Product	Weight	Price
KPCS	Custom Plug Cutter Kit	550g	\$109.00
KPC-1020	Standard Plug Cutter Bit	160g	\$65.00
KPC-1040	Micro Plug Cutter Bit	160g	\$65.00
KPC-1060	Heavy-Duty Plug Cutter Bit	60g	\$65.00

\$60.00
R3 Pocket Hole Jig Kit



KRR-3 | 600g



With the Kreg Jig® R3, you can build bookcases, shelves, and storage projects for your home. It's also great for creating custom built-ins, and

- ✓ Easily join materials from 1/2 in to 1 1/2 in thick (12-38mm) in 1/8 in (3mm) increments
- ✓ Positioning sliders allow you to easily adjust within 9 depth settings
- ✓ Dual wood-chip holes keep your drill bit clear of excess wood chips
- ✓ Two hardened-steel Kreg® drill bit guides feature a lifetime warranty

countless other home improvement projects. Plus, the Kreg Jig® R3 can be used portably to make lasting repairs around your home.

- ✓ Comes with Kreg® accessories organized in a durable carrying case
- ✓ Depth-collar gauge is molded into the case for handy reference
- ✓ Durable jig body made from heavy-duty, glass-reinforced nylon
- ✓ Easily attaches to any Kreg® Face Clamp, bar clamp, or C-clamp

\$15.00
Pocket Hole Plugs



- ✓ Hide or decoratively accent exposed pocket holes
- ✓ Plastic plugs are great for painted or laminated-type surfaces
- ✓ Plastic plugs available in five distinct colors
- ✓ Highly-quality, trimmable, solid-wood plugs
- ✓ For use with 12- to 38mm thick material
- ✓ Solid-wood plugs available in the two most common wood species

Prod Code	Product	Weight	Price
PHJPP1-50	Wood Pine Pk 50	80g	\$15.00
PHJPAO-50	Wood Am Oak Pk 50	80g	\$15.00
PHJPDW-50	Plastic White Pk 50	80g	\$15.00
PHJPAL-50	Plastic Almond Pk 50	80g	\$15.00
PHJPLB-50	Plastic L-Brown Pk 50	80g	\$15.00
PHJPBR-50	Plastic Brown Pk 50	80g	\$15.00
PHJPBL-50	Plastic Black Pk 50	80g	\$15.00

\$38.00
Mini Pocket Hole Jig Kit



KRMKJKIT | 170g

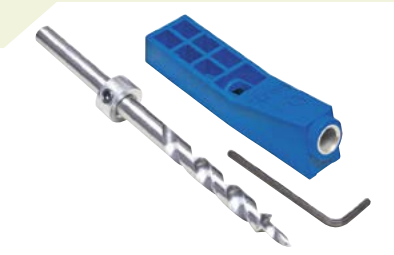

The Kreg Jig® Mini is good for very specific applications where the smallest jig possible is required. The simplistic design includes the hardened-steel drill guide of the

other jigs, but does not include a reference fence, so material thickness adjustments must be made manually.

Extraction & Safety
 Measuring & Marking
 Sawing
 Site & Shop Accessories
 Routing
 Planing
 Sanding & Scraping
 Drilling
 Joinery
 Clamps & Vices
 Finishing
 Sharpening
 Carving & Chisels
 Woodturning
 Wooden Parts
 Cabinet Fittings

So, what's so special about a Kreg Screws?



Coarse-threads are for softwoods, plywood, particle board, MDF and Melamine etc. The deep, aggressive threads will bite into the soft fibres. Red Coded screws have coarse threads.

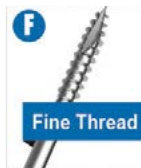

Hardwoods are too hard and dense for coarse-thread screws. The aggressive threads tend to tear the wood fibres, resulting in splits in your wood. For hardwoods, choose Fine Kreg Screws. Blue Coded screws have fine threads.



The original and most-popular screwhead is Maxi-Loc. Features a washer-style head that seats firmly in the pocket hole to draw the joint tight. SML prefix screws have this style of head.



Panhead Screws feature a smaller-diameter head, as well as a smaller-diameter screw shank. Great for use in tight spaces, as well as with extremely hard woods. SPS prefix screws have this style of thread.

Zinc Pocket Hole Screws

A good choice indoor projects with limited exposure to the elements and adequate interior rust protection.

Prod Code	Product	Weight	Price
SPSC-1100	25mm Pk 100	340g	\$ 8.00
SPSC-1250	25mm Pk 250	470g	\$18.00
SPSC-1500	25mm Pk 500	940g	\$29.00
SPSC-11200	25mm Pk 1200	1.9kg	\$51.00
SPSF-075100	19mm Pk 100	200g	\$ 7.00
SPSF-075500	19mm Pk 500	920g	\$ 27.00
SPSF-0751200	19mm Pk 1200	1.9kg	\$51.00
SPSF-1100	25mm Pk 100	200g	\$ 8.00
SPSF-1500	25mm Pk 500	950g	\$29.00
SPSF-11200	25mm Pk 1200	1.9kg	\$51.00
SPSF-125100	31mm Pk 100	340g	\$ 8.00
SPSF-125500	31mm Pk 500	90g	\$30.00
SPSF-1251200	31mm Pk 1200	2.2kg	\$53.00
SPSF-150100	37mm Pk 100	260g	\$ 9.00
SPSF-150500	37mm Pk 500	1.3kg	\$33.00
SPSF-1501200	37mm Pk 1200	2.5kg	\$60.00
SMLC-1100	25mm Pk 100	220g	\$ 7.00
SMLC-1500	25mm Pk 500	1.1kg	\$29.00
SMLC-11200	25mm Pk 1200	2kg	\$51.00
SMLC-125100	31mm Pk 100	340g	\$ 8.00
SMLC-125250	31mm Pk 250	470g	\$18.00
SMLC-125500	31mm Pk 500	1.3kg	\$30.00

SMLC-1251200	31mm Pk 1200	2.4kg	\$53.00
SMLC-150100	37mm Pk 100	340g	\$ 9.00
SMLC-150250	37mm Pk 250	470g	\$20.00
SMLC-150500	37mm Pk 500	1.4kg	\$33.00
SMLC-1501200	37mm Pk 1200	2.8kg	\$60.00
SMLC-250	50mm Pk 50	200g	\$ 6.00
SMLC-2250	50mm Pk 250	870g	\$23.00
SMLC-25050	63mm Pk 50	220g	\$ 9.00
SMLC-250125	63mm Pk 125	470g	\$20.00
SMLC-250250	63mm Pk 250	1kg	\$30.00
SMLF-125100	31mm Pk 100	340g	\$ 8.00
SMLF-125250	31mm Pk 250	470g	\$18.00
SMLF-125500	31mm Pk 500	1.3kg	\$30.00
SMLF-1251200	31mm Pk 1200	2.5kg	\$ 53.00
SMLF-150100	37mm Pk 100	290g	\$ 9.00
SMLF-150500	37mm Pk 500	1.4kg	\$33.00
SMLF-1501200	37mm Pk 1200	2.8kg	\$60.00

Blue Kote Pocket Hole Screws

Blue-Kote™ feature three anti-corrosion layers, making them the perfect choice for a wide variety of indoor and outdoor projects.

Prod Code	Product	Weight	Price
SMLC-125-B-100	31mm Pk 100	250g	\$11.00
SMLC-125-B-1200	31mm Pk 1200	2.4kg	\$75.00
SMLC-150-B-100	37mm Pk 100	280g	\$12.00
SMLC-150-B-1200	37mm Pk 1200	2.7kg	\$ 82.00
SMLC-2-B-50	50mm Pk 50	190g	\$ 8.00

SMLC-2-B-250	50mm Pk 250	68g	\$28.00
SMLC-250-B-50	63mm Pk 50	340g	\$ 9.00
SMLC-250-B-125	63mm Pk 125	470g	\$23.00
SMLC-250-B-250	63mm Pk 250	1.1kg	\$33.00

Stainless Pocket Hole Screws

Specially designed for maritime applications, excessive exposure to water, and other exceedingly corrosive environments, such as ACQ-treated lumber.

Prod Code	Product	Weight	Price
SMLC-125-S-5100	31mm Pk 100	250g	\$32.00
SMLC-150-S-5100	37mm Pk 100	2.4kg	\$35.00
SMLC-250-S-50	63mm Pk 50	280g	\$42.00
SMLC-250-S-250	63mm Pk 250	2.7kg	\$171.00
SMLF-125-S-5100	31mm Pk 100	190g	\$33.00

Steel Pocket Hole Screws for HD Jig

- ✓ Optimized for use with the Kreg Jig® HD
- ✓ 14-gauge hardened-steel 63mm long
- ✓ Provides incredible shear-resistance
- ✓ Protec-Kote™ finish
- ✓ Requires #3 square driver

Prod Code	Product	Weight	Price
SMLC-2-X-25030	Pack of 30	340g	\$ 9.00
SMLC-2-X-250125	Pack of 125	1.2kg	\$33.00

\$53.00 Quik Change Drill Kit



- ✓ Compatible with all manual Kreg Jigs®
- ✓ 3/8" (9.5mm) hex shank stepped drill bit snaps directly into quick-change chuck
- ✓ Eliminates the need for a bit adapter
- ✓ Industrial design eliminates slippage and optimizes drilling power
- ✓ Includes 6" (152mm) #2 driver - the most versatile length for Kreg Joinery™
- ✓ Includes Allen wrench and depth collar

from \$5.00 Pocket Hole Jig Drill Accessories



Need replacements for any standard Kreg Jigs? Available separately is the 3/8in stepped drill bit, the stop collar and the two-piece square drive screw drivers found in the K4, K5 and R3 kits.



Prod Code	Product	Weight	Price
KRBS-095	3/8in Stepped Drill Bit	70g	\$30.00
KJSCD	3/8in Stop Collar	40g	\$ 5.00
KRDDS	Square Driver Set of 2	60g	\$ 8.00

from \$7.80 Face Frame Wood Screws

The fine thread and smaller seated head makes these ideal for all hardwoods. Requires #2 square driver.

Prod Code	Product	Weight	Price
SQD-0737-F	7G x 37mm	250g	\$8.50
SQD-0637-F	6G x 37mm	210g	\$ 8.00
SQD-0731-F	7G x 31mm	230g	\$7.80

Go to p. 135 for more information on the Robertson Range of screws

from \$7.00 Round Washer Head Wood Screws



The coarse thread and large round-washer head makes these perfect for softwoods, cabinet timbers and sheet goods: Pine, Cedar, Plywood, Particle Board, MDF, Melamine.



Prod Code	Product	Weight	Price
SQD-0825-RZ	25mm Pk 100	240g	\$ 7.00
SQD-0825-RW-5	25mm Pk 500	1.3kg	\$30.00
SQD-0828-RZ	28mm Pk 100	270g	\$ 7.00
SQD-0828-RW-5	28mm Pk 500	1.45kg	\$31.50
SQD-0831-R	31mm Pk 100	280g	\$ 7.30
SQD-0831-RW-5	31mm Pk 500	1.5kg	\$32.50
SQD-0837-R	37mm Pk 100	320g	\$ 7.80
SQD-0837-RW-5	37mm Pk 500	1.7kg	\$35.00
SQD-0844-RZ	44mm Pk 100	310g	\$ 9.00
SQD-0844-RW-5	44mm Pk 500	1.85kg	\$40.00
SQD-0850-RZ	50mm Pk 100	400g	\$ 9.50
SQD-0850-RW-4	50mm Pk 400	1.85kg	\$37.00

\$24.⁹⁰ Mini Pocket Hole Jig Kit

MILESCRAFT
MC-1321 | 200g



The PocketJig100 allows you to connect your work pieces in a quick and timely manner or do repairs around your house. Small, compact design allows you to do applications where a small jig is required. Single pocket hole guide for repairs & getting into tight spots

- ✔ Settings for common board thicknesses – 12, 19, 27 & 38mm
- ✔ Easy reference marks to mark your board thickness and set

- your jig
- ✔ Magnet built-in to secure jig with any metal jaw clamp
 - ✔ Comes with stepped drill bit and stop collar
 - ✔ Hardened steel bushing for precise pocket holes every time
 - ✔ No fence and the small design allows you to get into some of the smallest places to make repairs to many joints

\$49.⁹⁰ Portable Pocket Hole Jig Kit

MILESCRAFT
MC-1323 | 800g



Whether you want to build storage projects, cabinets, shelves or bookcases, this kit does it all. Allowing you to create corner joints, T-Joints, framing joints, mitre joints and do repairs. With built-in board thicknesses, there is no need to manually measure. Just set this jig to your desired setting, set the depth of your bit and start drilling. Includes everything you need to get started with your first pocket holes including the stepped drill bit, quick-change connector and two length drivers (also available separately)

- ✔ The built-in scales allow you to easily measure the thickness of your work piece
- ✔ There are four common board thickness settings built into the jig: 1/2", 3/4" 1" and 1-1/2" (12, 19, 27, 38mm)
- ✔ Easy read out arrow to help define your board thickness setting
- ✔ Easy adjust to your board thickness setting with the single sled design and locking cam lever

from \$5.⁹⁰ Pocket Hole Jig Connector Kit

MILESCRAFT



The ConnectorKit allows you to quickly change from drilling to driving and is compatible with any drill/driver that accepts 1/4" Hex Shaft.

The chuck accepts all 1/4in hex-shank bits and also includes the

popular HSS 3/8in stepped drill bit with a 150mm-long Magnetic T20 Star Driver. Replacement stepped drill bits as well as a set of two 1/4in hex-shank drivers – one 75mm and the other 150mm long are available separately to suit the Milescraft kits.

Code	Product	Weight	Price
MC-1322	Pocket Hole Jig Connector Kit	160g	\$24.90
MC-2307	Replacement Stepped Drill Bit	90g	\$16.90
MC-2308	Set of 2 Drivers	60g	\$5.90

from \$4.⁵⁰ T20 Star Pocket Hole Screws

MILESCRAFT



Self-tapping, zinc coated T20 Star screws are perfect for joining your work pieces together, ensuring a secure hold.

The 700-Piece Introductory Pack includes

- ✔ 150x 25mm coarse-thread pocket screws
- ✔ 150x 31mm fine-thread pocket screws
- ✔ 150x 31mm coarse-thread pocket screws
- ✔ 100x 37mm coarse-thread pocket screws
- ✔ 75x 50mm coarse-thread pocket screws
- ✔ 75x 63mm coarse-thread pocket screws

Prod Code	Product	Weight	Price
MC-5200	700-Piece Introductory Pack	2.1kg	\$37.90
MC-5201	Coarse 8Gx25mm Pk 100	200g	\$5.00
MC-5202	Coarse 8Gx31mm Pk 100	200g	\$6.00
MC-5203	Fine 8Gx31mm Pk 100	200g	\$6.00
MC-5204	Coarse 8Gx37mm Pk 100	200g	\$6.00
MC-5205	Coarse 8Gx50mm Pk 50	200g	\$4.50
MC-5206	Coarse 8Gx63mm Pk 50	200g	\$5.00

Looking for face frame clamps for your pocket hole jig?
Go to p. 141 for the full range of Milescraft Face Frame Clamps.

\$129.⁰⁰ Decking Jig Kit

MILESCRAFT

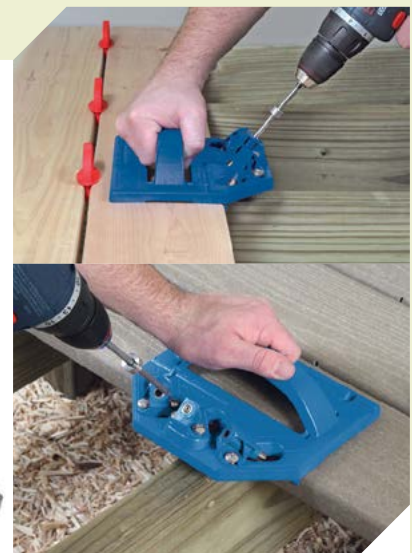

Whether you're building a new deck or refinishing an old one, you want to do the job right. With the Kreg Deck Jig™, and a few simple tools you already own, you can create a beautiful and functional deck surface that is completely free of exposed fasteners and painful splinters. Traditional concealed-decking systems utilise awkward

steel fasteners or thin plastic clips to hold your deck boards in place. The Kreg Deck Jig™ utilises a more straightforward approach, creating an incredibly strong wood-to-wood bond through precisely-placed self-tapping screws. Comes with everything you need, except the screws in a handy storage case.

Prod Code	Product	Weight	Price
KJDECKSYS	Decking Jig Kit	1.8kg	\$129.00
KJDECKBIT	Replacement Drill Bit	60g	\$29.00
SDKC-2-W-100	Screws - Protec Kote 50mm Pk 100	350g	\$12.00
SDKC-2-W-700	Screws - Protec Kote 50mm Pk 700	2.5kg	\$82.00
SDKC-262-W-100	Screws - Protec Kote 63mm Pk 100	460g	\$20.00
SDKC-262-W-525	Screws - Protec Kote 63mm Pk 525	2.5kg	\$97.00
SDKC-2-SS-100	Screws - Stainless 50mm Pk 100	350g	\$30.00
SDKC-2-SS-700	Screws - Stainless 50mm Pk 700	2.4kg	\$179.00

Extraction & Safety
Measuring & Marking
Sawing
Site & Shop Accessories
Routing
Planing
Sanding & Scraping
Drilling
Joinery
Clamps & Vices
Finishing
Sharpening
Carving & Chisels
Woodturning
Wooden Parts
Cabinet Fittings

JOINERY

\$139.⁹⁰ 12in Dovetail Jig



DJ-12 | 9.8kg



Dovetail joints are as traditional to woodworking as you can get. Years ago, cabinetmakers would saw these by hand and clean them with a chisel but with modern technology comes a much quicker and easier way to create dovetails.

While dovetails are quite specialized and only generally used for ornamental purposes these days, you can create simple but stunning boxes of many shapes and sizes using the Baladonia Dovetail System.

\$39.⁹⁰ 12in Dovetail Jig Half-Blind Templates



The Baladonia Dovetail System comes standard with the 1/2in half-blind template so if you damage it and it needs replacing you can buy this separately. Another other option is the small 5/16in comb

to be used on small, fine decorative work. The template is suitable for use up to 12mm timber in conjunction with the DT-079-Q router bit, available separately.



Prod Code	Product	Weight	Price
DJ-12-TA-516	5/16in Half-Blind Comb	450g	\$39.90
DJ-12-TA-012	1/2in Replacement Comb	450g	\$39.90

\$39.⁹⁰ 12in Dovetail Jig Box Joint Templates

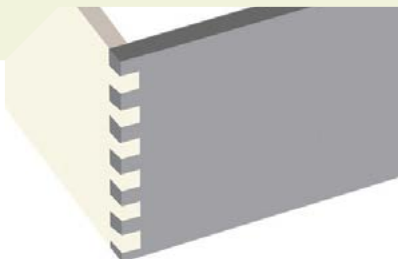

Box joint templates are a clean, simple and popular decorative method of jointing. The fingers are visible from both sides of the timber and provide a simple, elegant joint appearance.

The box joint templates come in three popular sizes - 1/4in, 3/8in and 1/2in width combs. The combs can be used up to the maximum clamping thickness of the jig - approximately 35mm.

Prod Code	Product	Weight	Price
DJ-12-TB-014	1/4in 6.4mm	510g	\$39.90
DJ-12-TB-038	3/8in 9.5mm	410g	\$39.90
DJ-12-TB-012	1/2in 12.7mm	380g	\$39.90

\$69.⁹⁰ 12in Dovetail Jig Through Template



DJ-12-TC-012 | 870g



Through dovetails are visible from both sides of the workpiece and are an ideal choice when visible craftsmanship is the preferred option - such as on jewellery and other decorative boxes. This template will machine most common timber thicknesses ranging

from 9 - 19mm. The bits required for machining the work pieces are an SB079Q straight bit and DT127Q dovetail bit. Both require the use of a 7/16in template guide to work with the comb.

\$299.⁰⁰ I-Box Jointing Jig



IBOX | 3.3kg

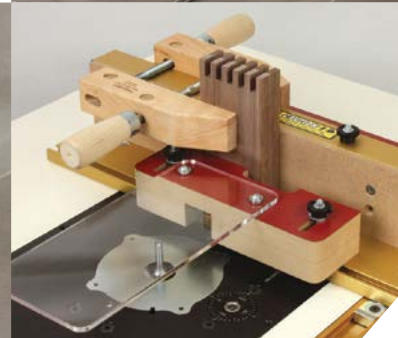

The new Inkra I-Box is the most advanced tool ever produced for creating a stunning variety of box & finger joints. Its revolutionary design allows faster setup, greater versatility, and improved user safety compared to traditional jigs. At the same time, it's easy to use and the included 1-hour instructional DVD covers everything from basic setup to advanced decorative joinery.

This versatile design works on both table saws and router tables, and it's available to fit standard 19.0 x 9.5mm standard mitre slots.

The I-Box is an evolutionary leap forward from conventional box joint methods and the I-Box's dual pitch lead screw mechanics easily micro-adjust joint tightness & provide a massive 3.2 - 19.0mm range of pin widths. It's capable of making good fitting box joints using any width cutter within that range into timber from 6.4 - 25.4mm thick. If you've been looking to improve your shop's joinery capabilities with a fast, versatile, and easy to use method for producing box joints of all descriptions, the INCR A I-Box is what you've been waiting for.

from \$44.⁰⁰ Magnetic Dovetail Saw Guide System



Hand-cut dovetails remain the mark of the skilled cabinetmaker and a feature that buyers look for in high-end furniture. Veritas has developed a guide and saw system that lets amateurs achieve professional results. The system also allows the seasoned expert to produce dovetail joints more quickly and with less effort.

The Veritas dovetail guides, which clamp in position, hold the

saw at the correct place and the correct angle for a perfect cut. 19mm rare-earth magnets embedded in the anodized aluminum guide are covered with a layer of low-friction UHMW plastic keep the saw perfectly aligned as you cut. You still have to chop out waste from the tails and pins, but the detailed instructions give you tips on how to do this quickly and accurately.

Prod Code	Product	Weight	Price
05-T-0211	1:6 Ratio	300g	\$89.00
05-T-0212	1:8 Ratio	300g	\$89.00
05-T-0205	14° Degree	300g	\$81.00
05-T-0401	Straight Saw Guide Only	110g	\$72.00
05-T-0203	Saw to Suit Guides	300g	\$44.00

\$37.90 Dowel Jig Kit

MILESCRAFT
MC-1359 | 850g

Build or repair furniture and more!
Includes everything you need to

- ✓ Powerful magnetic base holds gauge securely to steel/iron surfaces
- ✓ Precise measurement in metric, decimalized and fractional imperial up to 0.01mm/1/128th graduations
- ✓ Large and clear digital display makes it easy-to-read
- ✓ Lapped smooth stainless bar and cursor
- ✓ Accurate to 0.0254mm across 150mm capacity



get started creating strong and accurate doweled joints.

from \$13.90 Simple Dowelling Kit

HARON

If you just need to fix up a couple of broken dowel joints or need to do a one-off job using dowels then this simple kit is a great way to get everything you need. Each kit contains the following items;

- ✓ 1x Brad point drill bit
- ✓ 1x Stop collar to suit above drill bit
- ✓ 4x dowel centre points
- ✓ 20x dowel joiners



Prod Code	Product	Weight	Price
H-5406	6mm Kit	70g	\$13.90
H-5408	8mm Kit	130g	\$15.90
H-5410	10mm Kit	150g	\$16.90

\$109.00 JointPro Dowelling Jig

MILESCRAFT
MC-1361 | 1.8kg

JointPro™ quickly and accurately creates strong doweled joints. The interchangeable hardened steel bushing blocks allow you to drill up to six matching holes per set-up for each common dowel size - 6mm,



8mm and 10mm. The self-clamping jig securely holds work pieces in place. Works for butt, corner and floating joints. Quick and easy to setup and use.

from \$4.50 Dowel Centre Points

HARON

Use these centre points to mark aligned pilot holes on two work pieces. Drill the common dowel size hole (6mm, 8mm or 10mm) in the first work piece and insert the centre point into the hole on the first work piece. Then press the two work pieces together a point is marked in the correct position

for drilling matching holes on the second piece of wood.

All sizes are supplied in packs of 4.

Set of 6 Drill stops - built around the three common dowelling sizes of 6, 8, & 10mm as well as helpful and not commonly available sizes such as 5, 12 and 16mm.



Prod Code	Product	Weight	Price
H-5418	For 6mm Dowels	20g	\$4.50
H-5420	For 8mm Dowels	20g	\$4.50
H-5422	For 10mm Dowels	30g	\$4.50
H-710	Drill Stop Set	40g	\$8.90

from \$8.90 Biscuit Joiners

BALADON



Biscuit joining is a simple, quick and effective method of locating two work pieces for joining timber that was developed by Lamello in Switzerland. You simply put the work pieces together, mark a common point on both and use that as a reference to cut a 4mm slot approximately halfway down the side of the timber, most commonly using either a router bit slot cutter or a dedicated biscuit joining machine. Squirt glue into the slots on both

work pieces, pop a biscuit in and run glue along the remainder of the edge of the joint then clamp it together. The biscuit absorbs the glue, swelling and locking the work pieces in together tight. For thicker materials, you can use two biscuits in the same location at differing heights increasing the joint strength even more.

It is a very simple, quick and effective method of assembly that is used commonly in the joinery industry.

Prod Code	Product	Weight	Price
LB-20100	Size #20 Bag of 100	320g	\$8.90
LB-20300	Size #20 Bag of 300	710g	\$21.50
LB-201000	Size #20 Box of 1000	2.6kg	\$59.90
LB-10100	Size #10 Bag of 100	280g	\$8.90
LB-10300	Size #10 Bag of 300	650g	\$19.90
LB-101000	Size #10 Box of 1000	1.7kg	\$59.90
LB-00100	Size #0 Bag of 100	280g	\$8.90
LB-001000	Size #0 Box of 1000	1.35kg	\$59.90

from \$4.50 Dowel Joiners

HARON

When doweling you can use standard lengths of dowel from local hardware stores or purchase specific dowel joiners. These dowel joiners make life a little easier by having tapered ends making them quicker and easier to insert, plus

are fluted allow the glue to spread and fill in the gaps, providing better bonding strength.

The timber is specifically chosen to swell making your dowel joints as tight as they can be.



Prod Code	Product	Weight	Price
H-5412	6 x 32mm Pk 60	50g	\$4.50
H-5426	6 x 32mm Pk 150	80g	\$7.90
H-5432	6 x 32mm Pk 1000	130g	\$42.90
H-5414	8 x 38mm Pk 50	110g	\$4.50
H-5428	8 x 38mm Pk 125	190g	\$8.50
H-5433	8 x 38mm Pk 1000	270g	\$54.90
H-5417	10 x 50mm Pk 40	600g	\$6.50
H-5431	10 x 50mm Pk 100	1.5kg	\$14.90
H-5439	10 x 50mm Pk 1000	2.75kg	\$99.00

JOINERY

Extraction & Safety
Measuring & Marking
Sawing
Site & Shop Accessories
Routing
Planing
Sanding & Scraping
Drilling
Joinery
Clamps & Vices
Finishing
Sharpening
Carving & Chisels
Woodturning
Wooden Parts
Cabinet Fittings

\$85.00 Basic Picture Framing Kit



PFK-100 | 2.2kg



This complete kit contains everything you need to make picture frames and is perfect for the occasional picture framer that will only be making frames

occasionally. The quality of this unit is great and has all the items needed to get a professional-looking frame in no time.



\$379.00 Hand Mitre Trimmer



If you're picture framing a lot you need this mitre trimmer. It has SUPER sharp blades that are designed to shave 1-2mm from your mitred picture frames to leave you with a smooth, close-grained face that doesn't require any planing, sanding and has no tear-out - ready to join together for flush, invisible join lines.



Top Trim Attachment

This simple attachment makes it easier to cut perfect miters on hollow, round or outside edge mouldings. Ideal for making picture frames when measuring and marking on the inside of the rabbet.



Prod Code	Product	Weight	Price
CTMT	Mitre Trimmer Only	13.6kg	\$379.00
FTA-01	Trimmer Fence	2kg	\$75.00
FTA-02	Top Trim Attachment	-	\$49.90

\$129.00 Ezy Measuring System



For improved performance of any sawing system the FrameCo Ezy - Measuring System makes cutting of picture frame moulding quick and easy.



Prod Code	Product	Weight	Price
F-10125	Ezy Measuring System	2kg	\$129.00
F-10127	Extension Kit	1.5kg	\$79.00

\$69.00 Small Hand Mitre Saw



CPT-350 | 1.7kg

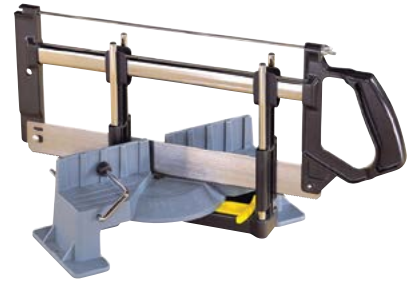

The blow-moulded plastic saw carriage swings right and left up to 45° for simple mitre cuts with stops built in at the popular 15°, 22.5°, 30°, 36°, 45° and 90°. It includes a two-way clamp for holding the material in place securely

with an integral length stop to ensure uniform work piece length, maintaining parallel squareness of the frame. Quality Taiwanese construction for smooth cutting and long life.

Prod Code	Product	Weight	Price
CPT-35018-TPI	Replacement Blade 18TPI	250g	\$18.00

\$79.00 Large Hand Mitre Saw

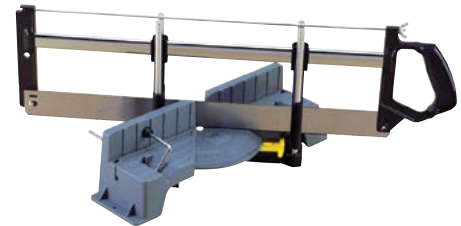

The blow-moulded plastic saw carriage swings right and left up to 45° for simple mitre cuts with stops built in at the popular 15°, 22.5°, 30°, 36°, 45° and 90°. It includes a two-way clamp for holding the material in place securely

with an integral length stop to ensure uniform work piece length, maintaining parallel squareness of the frame. Quality Taiwanese construction for smooth cutting and long life.

Prod Code	Product	Weight	Price
CPT-550	Hand Mitre Saw	2.7kg	\$79.00
CPT-55018-TPI	Replacement Blade 18TPI	250g	\$21.00
CPT-55024-TPI	Replacement Blade 24TPI	250g	\$24.00

\$109.00 Compound Hand Mitre Saw



The blow-moulded plastic saw carriage swings right and left up to 45° for simple mitre cuts with stops built in at the popular 15°, 22.5°, 30°, 36°, 45° and 90°.

The blade also tilts right and left for 45° compound mitre cuts with stops set at 15°, 22.5°, 30°, 36°, 45° and 90° as well.

Prod Code	Product	Weight	Price
CPTC-600	Hand Mitre Saw	4.2kg	\$109.00
CPTC-60014-TPI	Replacement Blade 14TPI	250g	\$28.00
CPTC-60018-TPI	Replacement Blade 18TPI	250g	\$28.00
CPTC-60024-TPI	Replacement Blade 24TPI	250g	\$31.00

\$44.00 EzyFramer V Nailer Kit



F-14747 | 450g



The Ezy-Framer will insert all sizes of V-Nails and backing nails to hold the art work into the frame. Ezy-Framer combined with a cord clamp make an ideal start-up option for the home framer who wants to join a few picture frames. Kit includes 140 V-Nails and instructions.

\$92.50 PushMaster V Nailer Kit



The PushMaster inserts V-Nails which are used to join the frame corners. V-Nailing is the preferred method of joining used by professional framers, and is now available to amateur framers.



Prod Code	Product	Weight	Price
F-14730	PushMaster Kit	600g	\$92.50
F-70004	Replacement Magnetic Tip	20g	\$12.50
F-14404	Replacement Spring	20g	\$3.90

from \$180.00 BenchMaster V Nailing Kit



BenchMaster is ideal for the serious home framer, photographer or artist, who want to do their own framing. The powerful cam action of the handle combined with the size of the PushMaster drives V-Nails into the hardest of timbers. Strap Clamp sold separately.

Prod Code	Product	Weight	Price
F-14729	Bench & Push Master Kit	3.3kg	\$250.00
F-14728	BenchMaster Frame Only	2.9kg	\$180.00

\$26.00 Corner Jack



F-15610 | 550g



- Prevents the corner from opening whilst joining
- Fully adjustable to suit small, and reverse shaped profiles
- Supports the frame corner when driving v-nails in with a mallet into hard timbers.

from \$19.90 Mat Cutter System



A simple and effective tool for cutting matboard. The mat cutter has two blade, one set at 45° and the other at 90° to the mat being cut so you can either cut it square or

with a mitred face which creates the impression of the photo being inset in the mat. The mat cutter is packed with three spare cutters.

Prod Code	Product	Weight	Price
MC-4590-SET	Mat Cutter & Rule	120g	\$34.90
MC-4590	Mat Cutter Only	120g	\$19.90
MC-4590-RU	600mm Rule	600g	\$19.90
MC-4590-BL	Replacement blades Pk 5	40g	\$7.90

\$39.90 Glass Cutter



F-13220 | 300g



FrameCo manufacturers a large range of mat cutters to suit the home framer. With the innovative FrameCo cutters, you can now cut your own mounts just like a

professional. Whether it be for your needlework, photos, paper tole or other artwork, we have a mat cutter just right for you.

from \$63.50 MatMaster Board Cutters



FrameCo manufacturers a large range of mat cutters to suit the home framer. With the innovative FrameCo cutters, you can now cut your own mounts just like a

professional. Whether it be for your needlework, photos, paper tole or other artwork, we have a mat cutter just right for you.

Prod Code	Product	Price
F-14209	Rule Only 660mm 26in Long	\$63.50
F-14210	Rule Only 810mm 32in Long	\$95.00
F-14211	Rule Only 1010mm 40in Long	\$125.00
F-14212	Rule Only 1500mm 60in Long	\$169.00
F-14201-R	#201 Bevel Cutter RH	\$63.50
F-14250	Replacement Blades Pk20	\$21.90

from \$119.00 Strap Clamps



Ideal for picture framing. The spring steel band is 5m long (will hold a 1.2x1.2m frame) or 9m long (will hold a 2.2x2.2m frame). The plastic corners are specially made so that

they will not slip off the frame plus the corner pieces are flexible so that they can clamp at any angle. Extra corners are supplied so that you can join 4, 6, 8 and 10 sided frames.

Prod Code	Product	Weight	Price
F-10106	5m 16ft Long	520g	\$119.00
F-10107	9m 29ft Long	540g	\$139.00
F-10108	Strap Only 5m	160g	\$24.00
F-10109	Strap Only 9m	300g	\$33.00

Extraction & Safety
Measuring & Marking
Sawing
Site & Shop Accessories
Routing
Planing
Sanding & Scraping
Drilling
Joinery
Clamps & Vices
Finishing
Sharpening
Carving & Chisels
Woodturning
Wooden Parts
Cabinet Fittings

JOINERY

Extraction & Safety
Measuring & Marking
Sawing
Site & Shop Accessories
Routing
Planing
Sanding & Scraping
Drilling
Joinery
Clamps & Vices
Finishing
Sharpening
Carving & Chisels
Woodturning
Wooden Parts
Cabinet Fittings

\$449.00 Bench Top Morticing Machine



SHERWOOD

TBM-160 | 46kg

Motor Size	375W (1/2 HP) induction-type
Chuck size	5/8in (16mm)
Mortice bit max.	5/8in (16mm) recommended
Downward travel	130mm
Table size	200 x 120mm (width x depth)
Clamp cap.	0 - 100mm
Table side adj.	180mm (max)
Fore/aft adj.	90mm (max)



This new model fills a niche in the market between simple hobby and industrial mortice machines. It has all the features of industrial machines, but in a compact and well-priced bench top unit. The most significant feature that has been added to this unit is the adjustable working table. This table, which measures 200 x 120mm has an integral clamp built into it that can hold work pieces up to 100mm wide or complete removed for

bigger material.

The alloy-bodied motor has been chosen so that the outside body of it does not heat up excessively and cause accidental burning when you come into contact with it. It is able to drive a maximum diameter 5/8in mortice bit easily. It has a standard 3/4in collar to hold the square bit in place so almost all mortice bits available on the market today will suit this machine.

\$99.00 Drill Press Mortice Kit

BALADONA
MAS-1 | 6.3kg



Convert your drill press into a morticer. Will attach to most standard bench or floor drill presses with a quill (collar) size of 55-65mm. A range of shims are included in the kit to bush to the correct size. Also included in the kit are four standard sized mortice bits - 6.4mm (1/4in), 7.9mm (5/16in), 9.5mm (3/8in) & 12.7mm (1/2in).

It comes with a fence which has integral horizontal and vertical clamps to ensure minimal movement of the work piece. The included blow-moulded carry case is handy to store the attachment when not in use.

For occasional morticing where you don't need a dedicated machine this is a great option.

from \$16.90 Mortice Chisels & Bits

BALADONA



A range of mortice bits suitable for working on all types of timber. This range has been specifically chosen because of the quality of the chisels. 98% of all mortice bits are now manufactured in Asia and this manufacturer was chosen due to their outstanding quality. They supply many OE manufacturers of mortice

machines that are world renowned. Collar size is 19mm. Maximum cutting depth recommended is 60mm.

Code	Product	Weight	Price
MCB-14	1/4in 6.4mm	300g	\$16.90
MCB-516	5/16in 7.9mm	300g	\$17.90
MCB-38	3/8in 9.5mm	310g	\$17.90
MCB-12	1/2in 12.7mm	310g	\$17.90
MCB-58	5/8in 15.9mm	450g	\$24.90
MCB-34	3/4in 19mm	520g	\$39.90

\$15.90 Mortice Chisel Bit Handle

BALADONA
MCBHANDLE | 170g



Take any standard 3/4in collared square mortice chisel used on morticing machines and convert the square mortice cutter into a hand tool - cutting clean, square mortises by hand.

The wooden handle and machined steel collar is approximately 130mm long with a steel strike plate

installed in the top of the handle to take hammer blows with ease. Perfect for cutting clean, precise mortises where morticing machines can't access the work piece or when you just have a few to do and don't want to buy or set up your mortice machine. Chisels shown not included.

from \$4.50 Turn Buttons



Turn buttons are very handy to hold the backing cards in on pictures when they will need to be removed semi-regularly or where the backing

material is installed flush with the surrounding frame as they pivot on the fixing screw rather than be driven as a wedge like flexipoints are.

Prod Code	Product	Weight	Price
TBB-10	Electro Brass - Pk 10	10g	\$4.50
TBB-100	Electro Brass - Pk 100	60g	\$33.00
TBB-1000	Electro Brass - Pk 1000	600g	\$265.00

from \$2.50 Picture Framing Fixings

Frameco
Of Picture Framing Tools



V-Nails are uniquely shaped wedges used to join the mitred joint. When the V-Nail enters the timber the V shape is deflected outwards to open

it out slightly. As the V-Nail tries to come back to its original shape, the joint is pulled tightly together.

Prod Code	Product	Weight	Price
F-10410	V Nails Pk 400 - 7mm	150g	\$15.90
F-10412	V Nails Pk 400 - 10mm	160g	\$15.90
F-10414	V Nails Pk 400 - 12mm	160g	\$15.90
F-10416	V Nails Pk 400 - 15mm	200g	\$15.90
F-14736	Flexipoints Pk 300	50g	\$6.90
F-14737	Backing Nails Pk 300	30g	\$2.50

\$3.90
TiteBrush

Titebond®
TB-516330 | 30g



Titebond Titebrush is a durable glue brush with 100% silicone bristles and a plastic handle with a paddle on the end built to last. It's ideal for use with most woodworking and polyurethane glues eliminating the need for disposable brushes, fingers and other spreading tools.

When finished let glue dry and simply peel or ruffle the bristles for easy cleanup. Brush: Ideal for edge and face gluing, as well as general applications.

Paddle: Ideal for finer detail work, such as mortise and tenon, dovetail and finger joints, as well as moldings.

\$8.50
TiteWrap

Titebond®
TB-516310 | 50g



Titebond Titewrap eliminates the need for traditional clamps and secures your project while the glue dries! This self-adhering wrap sticks only to itself and won't damage

the wood surface. It is perfect for irregular joints or pieces that are difficult to clamp. When finished, simply cut the wrap away! Measures 19mm wide x 2.25m long.

\$13.90
Liquid Hide Glue

Titebond®
TBL-0237 | 350g



Titebond Liquid Hide Glue is the first hide glue to be offered in a liquid, ready-to-use form. It requires no mixing, heating or stirring. Professional woodworkers use Titebond Liquid Hide for its long assembly time, exceptional strength and unique cracking effect on wood. 237mL bottle.

from **\$14.50**
Pearl Animal Hide Glue



Most modern glues are not able to re-bond to other glues or for that matter to themselves so clean timber to timber contact is a must, especially when working on the restoration of furniture.

Hide glue on the other hand will reglue to old hide glue and form a good strong bond to boot.

This doesn't mean that you need not clean out the joint before regluing, but you do not have to put in quite as much work as the old glue can be mostly removed with hot water and a rag without damage to the joint. The new glue will then bond to the residue that remains in the joint and is already keyed into the timber.

Code	Product	Weight	Price
PAG-500	Glue Pearl Animal Hide 500g	520g	\$14.90
PAG-010	Glue Pearl Animal Hide 1kg	1.05kg	\$29.90
PAG-0025	Glue Pearl Animal Hide 25kg Sack	27.5kg	\$525.00

from **\$8.50**
GluBot Dispenser System

FastCap®



The GluBot from FastCap is the only glue bottle that will not drip or spill. You never have to clean up glue spills or drips again. The easy-squeeze GluBot will put the glue where you want it... and only where you want it.

Designed with a 2-chamber system that pushes glue from the bottom up through the secondary side chamber which ensures fresh glue every time.

- ✓ Replaceable tips & cap storage
- ✓ Dispenses glue from the bottom first keeping it fresh
- ✓ 1 blade tip, 1 yorker tip & 1 red cap included
- ✓ Easy fill wide mouth
- ✓ New lanyard to keep the redcap close

Available in two sizes –
GluBot capacity is 448ml
BabeBot capacity is 112ml

Prod Code	Product	Weight	Price
FC-98201	GluBot Each	80g	\$12.90
FC-98201-K-5	GluBot 5-Pack	400g	\$59.90
FC-98201-K-10	GluBot 10-Pack	800g	\$115.00
FC-98212	Yorker Tip Pack of 5	10g	\$2.50
FC-98213	Blade Tip Pack of 5	10g	\$2.50
FC-98215	Replacement Cap Pack of 5	10g	\$2.50
FC-98211	BabeBot Each	40g	\$8.50
FC-98211-K-5	BabeBot 5-Pack	200g	\$39.90
FC-98211-K-10	BabeBot 10-Pack	400g	\$75.00
FC-98216	Yorker Tip Pack of 5	10g	\$2.50
FC-98217	Blade Tip Pack of 5	10g	\$2.50
FC-98219	Replacement Cap Pack of 5	10g	\$2.50

\$4.90
Glue Syringe & Needle Set

GSN-201838 | 100g



Using glue in a syringe is a great way of filling fine cracks with glue on finished work pieces or awkward places that otherwise could end up being a mess by applying normally. Available as a

pack of five disposable syringe and needle sets - the syringe itself holds up to 10mL of liquid and the blunt needles measure 18-gauge x 38mm long.

from **\$69.90**
Structural Epoxy Adhesive

Techniglu is a solvent free, epoxy resin, specifically formulated for use with Techniglu hardeners to cure at room temperature, and produce high-strength, waterproof bonds.

Prod Code	Product	Weight	Price
TECHNIFAST-750	750mL Kit	1kg	\$69.90
TECHNIFAST-015	1.5L Kit	2kg	\$109.90



Extraction & Safety
Measuring & Marking
Sawing
Site & Shop Accessories
Routing
Planing
Sanding & Scraping
Drilling
Joinery
Clamps & Vices
Finishing
Sharpening
Carving & Chisels
Woodturning
Wooden Parts
Cabinet Fittings

JOINERY

from **\$5.50**

Original Woodworking Glue

Titebond

- ✓ Fast set - Shortens clamp time
- ✓ Bonds stronger than wood
- ✓ Solvent-resistant
- ✓ Excellent sandability
- ✓ Unaffected by finishes
- ✓ Easy cleanup with water

Prod Code	Product	Wgt	Price
TB-10237	237mL	300g	\$5.50
TB-10473	473mL	600g	\$8.90
TB-10946	946mL	1.2kg	\$13.90
TB-13785	3.785L	4.4kg	\$37.90
TB-510324	20L	25kg	\$149.00



from **\$8.90**

Ultimate III Woodworking Glue

Titebond

Titebond III Ultimate Wood Glue is the first one-part, water cleanup wood glue ever offered that is proven waterproof. The waterproof formula passes the ANSI/HPVA

Type I water-resistance specification and offers superior bond strength, longer open assembly time and lower application temperature.

Prod Code	Product	Weight	Price
TB-30237	237mL Bottle	300g	\$8.90
TB-30473	473mL Bottle	600g	\$13.90
TB-30946	946mL Bottle	1.2kg	\$22.90
TB-33785	3.785L Bottle	4.4kg	\$52.90
TB-511417	20L Drum	25kg	\$225.00

from **\$6.90**

Premium II Woodworking Glue

Titebond

- ✓ First one-part wood glue to pass ANSI Type II water-resistance
- ✓ Designed for exterior use
- ✓ Excellent sandability
- ✓ Unaffected by finishes
- ✓ FDA approved for indirect food contact
- ✓ Ideal for radio frequency (R-F) and hot press gluing systems
- ✓ Easy cleanup with water

Prod Code	Product	Weight	Price
TB-20237	237mL Bottle	300g	\$6.90
TB-20473	473mL Bottle	600g	\$11.90
TB-20473-EXT	473mL Extend	600g	\$11.90
TB-20946	946mL Bottle	1.2kg	\$16.90
TB-23785	3.785L Bottle	4.4kg	\$39.90
TB-510332	20L Drum	25kg	\$155.00



\$15.90

No Drip No Run Glue

Titebond
TB-512404 | 550g

Titebond No-Run, No-Drip Wood Glue is the thickest, fastest-drying glue available for use with porous and semi-porous materials. It is ideal for finish trim, crown molding, baseboards, window casings and other applications requiring a professional, no-run wood glue. 473mL bottle.



\$21.90

Polyurethane Glue

Titebond
TBP-0355 | 500g

Titebond Polyurethane glue is a breakthrough in adhesive technology. It is the only polyurethane glue to combine a long 20 minute working time with a short 45 minute clamp

time. It is a versatile, professional-strength glue specifically formulated for multi-purpose applications. In addition to its superior wood-to-wood performance. 355mL bottle.



\$44.90

Cold Press Veneering Glue

Titebond
TB-515176 | 4.2kg

Titebond Cold Press for Veneer is a high-quality, economical alternative to contact cement for large-scale bonding of veneers to flat surfaces. It is specifically formulated for cold press laminating of wood to solid woods, particleboard, MDF, plywood and other porous materials.

Titebond Cold Press offers a moderate speed of set, a translucent glue line and contains none of the harmful or corrosive fumes typical of most contact cements. It also prevents bleed-through on open-grained and unbacked wood veneers. 3.785L bottle.



from **\$15.90**

Melamine Bonding Glue

Titebond

Titebond Melamine Glue is designed for bonding wood, particleboard, MDF and other porous substrates to synthetic materials such as melamine, vinyl

and HPL as well as metals. It offers a fast initial tack, yet has a longer open time that allows for the accurate alignment of working materials.

Prod Code	Product	Weight	Price
TBM-0473	473mL Bottle	600g	\$15.90
TBM-3785	3.785L Bottle	4.4kg	\$69.90



\$10.00

Quick & Thick Glue

Titebond
TB-512403 | 350g

Titebond Quick & Thick Multi-Surface Glue is the thickest, fastest-drying water-based glue available for use with porous and semi-porous materials. It is ideal for wood, pottery, ceramic, stone, glass, fabrics, leather and most craft-type materials. It provides a strong initial tack and fast speed of set, yet allows realignment of working pieces. It also develops a bond stronger than the wood itself, dries clear and is unaffected by finishes. Brilliant!



About West System Epoxies

WEST SYSTEM epoxy cures to a high-strength plastic solid at room temperatures, by mixing specific proportions of liquid epoxy resin and hardener. This highly moisture-resistant plastic adheres to a wide range of materials, making it ideal for projects that require water and chemical resistance, and strong

physical properties for structural bonding. Select from a range of hardeners and additives that allow you to tailor the mixture's handling characteristics and the physical properties of the cured epoxy to suit your working conditions and specific coating or bonding application.



from **\$26.50**

Epoxy Resin Super Clear Hardener

207 Special Coating Hardener provides an extremely clear finish in coating applications and also excellent adhesion for bonding applications. It contains an ultraviolet inhibitor to protect the mix against sunlight. However, the cured epoxy surface still requires long-term UV protection with a quality marine paint or a UV filtered two part varnish.

When combined with 105 Resin it is a 3:1 ratio

Pot Life at 25°C: 20 to 30 minutes

Cure to a solid state: 9 to 12 hours

Cure to maximum strength: 5 to 7 days

Minimum recommended temperature: 16°C



Prod Code	Product	Weight	Price
HA-207	106mL Hardener	130g	\$26.50
HB-207	330mL Hardener	380g	\$43.90
HC-207	800mL Hardener	1.75kg	\$139.00

from **\$36.50**

Epoxy Resin Part A



105 Epoxy Resin is the base material on which all West System 105 System epoxy compounds are built. The resin is a clear, pale yellow, low-viscosity liquid. It can be cured in a wide temperature range to form a high-strength solid with excellent moisture resistance.

It is formulated without volatile solvents and does not shrink after curing. It has a relatively high flash point and no strong solvent odour,

making it safer to work with than polyester resins.

Designed specifically to wet out and bond with wood fibre, fibreglass, reinforcing fabrics and a variety of metals it is an excellent adhesive that will bridge gaps and fill voids. It can be sanded and shaped when cured. With roller applications, it has excellent thin-film characteristics to flow out and self-level.

Prod Code	Product	Weight	Price
RA-105	500mL Resin	620g	\$36.50
RB-105	1L Resin	1.2kg	\$52.90
RC-105	4L Resin	4.5kg	\$155.00

from **\$39.90**

Epoxy Resin Pump Set

301 Mini Pumps are designed for convenient and accurate metering of all 5.1 ratio

WEST SYSTEM resin and hardeners. They eliminate the mess involved with measuring by hand.



Code	Product	Weight	Price
B-301	For 1.2L Kits	100g	\$39.90
C-301	For 4.8L Kits	250g	\$59.00

from **\$14.90**

Resin Microfibre Blend

413 Microfibres, a fine fibre blend, is used as a thickening additive with resin/hardener to create a multi-purpose adhesive, especially for bonding wood. Epoxy thickened with

microfibres has good gap-filling qualities while retaining excellent wetting/penetrating capability. One pack suits 1L of West System epoxy mixture.



from **\$22.90**

Black Pigment (Epoxy Resins)

This product is recommended for mixing with the epoxy to fill in gum veins with a black epoxy which is popular in modern furniture. Pigments should be added at a rate of approximately 3-5 % by weight (so a

125mL bottle can be mixed with up to 4L of epoxy) and should only be added to the final coat because the increased viscosity of the mix will impair the ability of the epoxy to penetrate and seal surfaces.



Code	Product	Weight	Price
A-502	125mL	260g	\$22.90
B-502	250mL	500g	\$39.90

from **\$13.90**

Epoxy Resin Slow Hardener

A low-viscosity curing agent when extended working and cure time is needed. When combined with 105 Resin it is a 5:1 ratio, the cured resin/hardener mixture yields a rigid, high-strength, moisture-resistant solid with excellent bonding and coating properties. Can be used for interior clear coating

(filling gum resin veins etc.).

Pot life at 22°C: 20 to 25 minutes

Cure to a solid state: 10 to 15 hours

Cure to maximum strength: 1 to 4 days

Minimum recommended temperature: 16°C

Prod Code	Product	Weight	Price
HA-206	100mL Hardener	130g	\$13.90
HB-206	200mL Hardener	240g	\$19.90
HC-206	800mL Hardener	800g	\$55.00

from **\$13.90**

Epoxy Resin Fast Hardener

A medium-viscosity epoxy curing agent used in a majority of situations at lower temperatures and to produce a rapid cure. When combined with 105 Resin it is a 5:1 ratio, the cured resin/hardener mixture yields a rigid, high-strength, moisture-resistant solid with excellent bonding and coating

properties. Not intended for clear coating as it dries opaque yellow so best suited for gluing applications.

Pot Life at 22°C: 9 to 12 minutes

Cure to a solid state: 6 to 8 hours

Cure to maximum strength: 1 to 4 days

Minimum recommended temperature: 4°C

Prod Code	Product	Weight	Price
HA-205	100mL Hardener	130g	\$13.90
HB-205	200mL Hardener	240g	\$19.90
HC-205	800mL Hardener	800g	\$55.00



Extraction & Safety
Measuring & Marking
Sawing
Site & Shop Accessories
Routing
Planing
Sanding & Scraping
Drilling
Joinery
Clamps & Vices
Finishing
Sharpening
Carving & Chisels
Woodturning
Wooden Parts
Cabinet Fittings

JOINERY

Extraction & Safety
Measuring & Marking
Sawing
Site & Shop Accessories
Routing
Planing
Sanding & Scraping
Drilling
Joinery
Clamps & Vices
Finishing
Sharpening
Carving & Chisels
Woodturning
Wooden Parts
Cabinet Fittings

from **\$10⁹⁰**

Cyanoacrylate (CA) Super Glue



Cyanoacrylate glues are a fast-acting adhesive that can bond just about anything.

Thin CA - Super-thin penetrating formula. Works great on most materials, especially Balsa and other soft woods. Bonds in 1 to 5 seconds.

Medium CA - Fills gaps. Works well on harder woods such as Tasmanian Oak etc, even works on oily surfaces! Allows 7 to 10 seconds for positioning.

Thick CA - Thick and strong for

high-stress areas. Works well on hardwoods such as Maple, Oak or equivalent Eucalypts. Allows 30 seconds for positioning. ZAP-RT (Rubber Toughened) - formulated for numerous hobby and craft applications in wood, plastic, composites, rubber, etc. ZAP ZIP Kicker (Accelerator) - Forces immediate cure of CA glue, expands gap filling capacity, solves most tough to bond material combinations.

Prod Code	Product	Weight	Price
PT-07	Thin	80g	\$19.90
PT-01	Medium	80g	\$19.90
PT-33	Thick	80g	\$21.00
PT-44	Thick RT	50g	\$12.90
PT-15-P	Accelerator	90g	\$9.90

from **\$22⁹⁰**

Epoxy Resin Kits



Z-POXY is a premium two part epoxy adhesive that dries clear so it can be used as a strong adhesive as well as a clear gap filler. Vibration resistant and fuel proof, this epoxy is perfect for all types of crafts and is excellent for furniture. It does not

get brittle with age and because it is a 1-to-1 ratio, it makes it easy to mix - just combine equal parts by volume. Durable and sand-able, it comes as a fast setting 30-minute or super-fast 5-minute mix so using this won't slow you down.

Prod Code	Product	Weight	Price
PT-37	5-Minute 112g Kit	50g	\$19.90
PT-38	5-Minute 224g Kit	250g	\$29.90
PT-39	30-Minute 224g Kit	250g	\$29.90

\$26⁰⁰

Chair Doctor Glue

Veritas®
05-K-9904 | 170g



If a chair has a loose rung, an injection of Chair Doctor glue will first swell the rung and then bond it in position. It will soak into the end grain of wood, swell the wood and

then freeze the wood in the swollen state as it cures. A film of dry glue lines the wood cells, preventing contraction. The glue can penetrate the narrowest of cracks.

from **\$2⁸⁰**

Power Screwdriver Bits



The hex head suits all common cordless drill and electric screwdrivers.

Prod Code	Product	Weight	Price
SQD-0002-DY	#0 50mm Yellow	20g	\$2.80
SQD-0102-DG	#1 50mm Green	20g	\$2.80
SQD-0104-DG	#1 100mm Green	30g	\$5.00
SQD-0201-DR	#2 25mm Red	20g	\$2.80
SQD-0202-DR	#2 50mm Red	20g	\$2.80
SQD-0203-DR	#2 75mm Red	20g	\$4.00
SQD-0203-HD	#2 75mm Red	50g	\$4.00
SQD-0204-DR	#2 100mm Red	30g	\$5.00
SQD-0206-DR	#2 150mm Red	50g	\$6.50
SQD-0302-DB	#3 50mm Black	20g	\$2.80
SQD-0303-DB	#3 75mm Black	20g	\$4.00

from **\$8⁰⁰**

Hand Screwdriver Bits



Comfortable rubberised, colour coded hand grip for traditional woodworkers.

Prod Code	Product	Weight	Price
SQD-0060-HD	#00 170mm Orange	100g	\$8.00
SQD-0075-HD	#0 190mm Yellow	120g	\$8.00
SQD-0103-HD	#1 75mm Green	40g	\$8.50
SQD-0175-HD	#1 190mm Green	80g	\$8.50
SQD-0203-HD	#2 75mm Red	50g	\$8.50
SQD-0210-HD	#2 250mm Red	150g	\$9.00
SQD-0310-HD	#3 250mm Black	170g	\$9.00

from **\$5⁵⁰**

Screw Cap Covers



Cover countersunk screws in timber and melamine with these easy-to-apply screw caps. Available for most common colours and suits 8G & 10G screws.

Code	Product	Weight	Price
SQD-02-CW	White Pk 100	20g	\$5.50
SQD-02-CT	Light Brown Pk 100	20g	\$5.50
SQD-02-CC	Dark Brown Pk 100	20g	\$5.50
SQD-02-CB	Black Pk 100	20g	\$5.50
SQD-02-CM	Mixed Pk 100	20g	\$5.50

from **\$7⁹⁰**

Screw Washers



The Wood Washers are a great new product from FastCap that is designed with a 14.3mm (9/16in) or 25.4mm (1in) head diameter and a recess that allows your screw to sit flush in the washer when extra holding power is needed. Sold as a pack of 30.

Prod Code	Product	Weight	Price
FC-08729	14.3mm Diameter	200g	\$7.90
FC-09581	25.4mm Diameter	200g	\$7.90

Square Drive Screws

Screws are one of the most commonly used and cursed items bought from local hardware stores. For years we thought it was just something you had to put up with as the driver heads would slip and sometimes strip the screw head, starting a frustrating period of fixing the problem - wasted down time because of a poorly designed product. You could get a positive drive on the screws every once in a while but it was a pretty frustrating experience when you didn't. That was until we started using square drive screws. We never thought we'd get excited about screws, yet here we are talking up such a simple, but crucial part

of just about everything you assemble. These are now the only one's we enjoy using, and considering the size of the range, it means we never have to go back to the old phillips or slotted screws. We think once you start using them you'll find it hard to go back too. The secret is in the driver bit that locks deep and positively with the screw head, meaning that you get a positive driving action when running the screw into the timber. The rotational torque that is exerted on the screw is amazing and allows you to drive into even the hardest recycled timbers without having to pre-drill. We have chosen the Robertson brand

of screws because the quality of the Robertson screw is so high that you don't chew out the head of the screw, and the screws are re-useable a number of times and work every time. Most of the time we use a screw once, pull it back out when it's not a permanent fixing and chuck them out. But when you pull a Robertson screw out of the work piece, just put it aside and it will work just as well the second, third even fourth time you need it. We do recommend drilling countersink holes for countersunk head screws and using cordless drills or screwdrivers to maintain correct driving speeds for long driver and screw life.

from **\$4.00**

Steel & Zinc Countersunk Wood Screws



Finish is clear (silver) zinc plating; moderately corrosion resistant, but is primarily decorative so should only be used in sheltered exterior applications. This finish is denoted by the -Z shown at the end of the product code.

Where zinc is not available, steel "lube" finish is offered, a bronze/grey colour that comes from heat treatment after which a dry wax is applied to prevent corrosion and ease driving. If no suffix on product code, this is the screw finish.

Prod Code	Product	Wgt	Price
SQD-0410-Z	4Gx10mm Pk 100	50g	\$4.00
SQD-0415	4G x 15mm Pk 100	80g	\$4.50
SQD-0425-Z	4Gx25mm Pk 100	120g	\$4.50
SQD-0610	6G x 10mm Pk 100	90g	\$4.30
SQD-0612	6G x 12mm Pk 100	90g	\$4.50
SQD-0615-Z	6Gx15mm Pk 100	110g	\$5.00
SQD-0619-Z	6Gx19mm Pk 100	130g	\$5.00
SQD-0625-Z	6Gx25mm Pk 100	130g	\$5.80
SQD-0631-Z	6Gx31mm Pk 100	160g	\$6.30
SQD-0637-Z	6Gx37mm Pk 100	200g	\$7.00
SQD-0644	6Gx44mm Pk 100	220g	\$6.50
SQD-0815-Z	8Gx15mm Pk 100	140g	\$5.00
SQD-0819-Z	8Gx19mm Pk 100	160g	\$5.30
SQD-0825-Z	8Gx25mm Pk 100	200g	\$6.30
SQD-0828	8Gx28mm Pk 100	270g	\$6.00
SQD-0831-Z	8Gx31mm Pk 100	230g	\$6.50
SQD-0837-Z	8Gx37mm Pk 100	280g	\$7.80
SQD-0844-Z	8Gx44mm Pk 100	310g	\$8.80
SQD-0850-Z	8Gx50mm Pk 100	350g	\$9.00
SQD-0856	8Gx56mm Pk 50	390g	\$4.80
SQD-0875	8Gx75mm Pk 50	510g	\$6.30
SQD-0899	8G x 99mm Pk 50	750g	\$10.50
SQD-0862-Z	8Gx62mm Pk 50	440g	\$5.80
SQD-1025-Z	10Gx25mm Pk 100	250g	\$7.80
SQD-1031	10Gx31mm Pk 100	300g	\$8.30
SQD-1037	10G x 37mm Pk 100	360g	\$9.00
SQD-1044-Z	10Gx44mm Pk 100	420g	\$10.00
SQD-1050-Z	10Gx50mm Pk 100	470g	\$11.30
SQD-1056	10Gx50mm Pk 50	520g	\$5.80
SQD-1062-Z	10Gx62mm Pk 50	560g	\$7.00
SQD-1075-Z	10Gx75mm Pk 50	660g	\$8.30
SQD-1099-Z	10Gx99mm Pk 50	950g	\$13.00
SQD-1219-Z	12Gx19mm Pk 100	290g	\$9.50
SQD-1225	12G x 25mm Pk 100	370g	\$10.50
SQD-1231-Z	12Gx31mm Pk 100	440g	\$11.00
SQD-1237-Z	12Gx37mm Pk 100	520g	\$12.50
SQD-1244	12Gx44mm Pk 100	590g	\$13.80
SQD-1250	12Gx50mm Pk 100	670g	\$14.30
SQD-1262	12Gx62mm Pk 50	830g	\$8.00
SQD-1275	12Gx75mm Pk 50	950g	\$9.50
SQD-1288-Z	12Gx88mm Pk 50	1.2kg	\$10.80
SQD-1299	12Gx99mm Pk 50	1.3kg	\$13.50

from **\$3.80**

Truss & Panhead Screws



Panhead screws have a large flat bearing area under the head and a rounded profile which protrudes above the surface. Denoted with a -T, the Trusshead screw has a larger diameter head, but a lower profile and are preferred for short length screws to seat against the work piece better.

Prod Code	Product	Wgt	Price
SQD-0410-PZ	4G x 10mm Zinc	70g	\$5.30
SQD-0412-PZ	4G x 12mm Zinc	80g	\$5.30
SQD-0419-PZ	4G x 19mm Zinc	100g	\$6.30
SQD-0610-T	6G x 10mm Steel	90g	\$3.80
SQD-0612-T	6G x 12mm Steel	90g	\$4.80
SQD-0615-TZ	6G x 15mm Zinc	120g	\$5.00
SQD-0619-TZ	6G x 19mm Zinc	140g	\$5.80
SQD-0625-PZ	6G x 25mm Zinc	180g	\$5.80
SQD-0631-PZ	6G x 31mm Zinc	200g	\$6.30
SQD-0637-PZ	6G x 37mm Zinc	250g	\$7.00
SQD-0810-TZ	8G x 10mm Zinc	150g	\$5.80
SQD-0812-TZ	8G x 12mm Zinc	160g	\$6.00
SQD-0815-TZ	8G x 15mm Zinc	200g	\$6.80
SQD-0819-TZ	8G x 19mm Zinc	210g	\$7.50
SQD-0825-PZ	8G x 25mm Zinc	240g	\$7.00
SQD-0825-TZ	8G x 25mm Zinc	240g	\$7.50
SQD-0831-PZ	8G x 31mm Zinc	290g	\$7.50
SQD-0837-PZ	8G x 37mm Zinc	340g	\$8.00
SQD-0850-PZ	8G x 50mm Zinc	420g	\$9.80
SQD-1019-PZ	10G x 19mm Zinc	270g	\$7.80
SQD-1025-PZ	10G x 25mm Zinc	340g	\$8.50
SQD-1037-PZ	10G x 37mm Zinc	450g	\$10.50
SQD-1050-PZ	10G x 50mm Zinc	540g	\$13.00

from **\$11.00**

Stainless Countersunk Wood Screws

Made for all exterior applications except continuous exposure to seawater, these screws are the best quality you will find anywhere and are suitable for architectural applications. Produced from 18-8 grade Stainless Steel as it offers the best blend of strength and corrosion resistance without brittleness.

Prod Code	Product	Wgt	Price
SQD-0612-S	6G x 12mm Pk 100	80g	\$11.00
SQD-0619-S	6G x 19mm Pk 100	120g	\$13.00
SQD-0625-S	6G x 25mm Pk 100	150g	\$16.50
SQD-0631-S	6G x 31mm Pk 100	200g	\$19.00
SQD-0815-S	8G x 15mm Pk 100	150g	\$16.50
SQD-0819-S	8G x 19mm Pk 100	180g	\$17.50
SQD-0825-S	8G x 25mm Pk 100	210g	\$19.00
SQD-0831-S	8G x 31mm Pk 100	230g	\$21.00
SQD-0837-S	8G x 37mm Pk 100	320g	\$26.00
SQD-0850-S	8G x 50mm Pk 100	340g	\$31.50

from **\$5.30**

Particleboard Screws

Similar to steel countersunk screws but with four lugs under the head so the screw doesn't crack the surface of the board.

Prod Code	Product	Wgt	Price
SQD-0825-C	8G x 25mm Pk 100	200g	\$6.00
SQD-0831-C	8G x 31mm Pk 100	200g	\$6.30
SQD-0837-C	8G x 37mm Pk 100	230g	\$7.00
SQD-0844-C	8G x 44mm Pk 100	270g	\$7.50
SQD-0850-C	8G x 50mm Pk 100	300g	\$8.30
SQD-0862-C	8G x 62mm Pk 50	370g	\$5.30
SQD-0875-C	8G x 75mm Pk 50	450g	\$6.30

from **\$7.30**

Treated Pine Screws

Coated in MAGNIGARD - these screws are finished to ensure excellent corrosion resistance - especially in treated pine. In addition, they have sharp thread angles and points which allow them to penetrate easily.

Prod Code	Product	Wgt	Price
SQD-0831-DG	8Gx31mm Pk 100	220g	\$7.30
SQD-0837-DG	8Gx37mm Pk 100	250g	\$8.50
SQD-0844-DG	8Gx44mm Pk 100	290g	\$9.50
SQD-0850-DG	8Gx50mm Pk 100	320g	\$10.80
SQD-0862-DG	8Gx62mm Pk 50	390g	\$6.00
SQD-0875-DG	8Gx75mm Pk 50	460g	\$7.80

from **\$7.50**

Countersunk Square Drive Solid Brass Screws

Made from brass, these screws are designed for use alongside brass fittings and hinges. Being made from brass, they are quite soft and therefore great care needs to be taken when being installed.

Prod Code	Product	Wgt	Price
SQD-0210-B	2G x 10mm	30g	\$7.50
SQD-0412-B	4G x 12mm	70g	\$7.50
SQD-0419-B	4G x 19mm	90g	\$7.50
SQD-0619-B	6G x 19mm	120g	\$18.00
SQD-0625-B	6G x 25mm	160g	\$20.00
SQD-0631-B	6G x 31mm	200g	\$28.50

from **\$17.50**

Stainless Panhead Wood Screws

Prod Code	Product	Wgt	Price
SQD-0619-PS	6G x 19mm	150g	\$17.50
SQD-0625-PS	6G x 25mm	160g	\$21.00
SQD-0631-PS	6G x 31mm	180g	\$24.50
SQD-0815-PS	6G x 15mm	130g	\$16.00
SQD-0819-PS	8G x 19mm	230g	\$21.00
SQD-0825-PS	8G x 25mm	250g	\$23.50
SQD-0831-PS	8G x 31mm	270g	\$26.00
SQD-0837-PS	8G x 37mm	320g	\$31.50
SQD-0850-PS	8G x 50mm	420g	\$41.50

CLAMPS & VICES

from **\$33.00**

Quick Action F-Clamps



- Clamping force up to 6,000Nm
- High-quality 2-component plastic handle
- Pressure plates can be replaced by hand – no tools required
- Protective caps for non-marring on clamping surfaces
- Stable, high quality profiled rail with serrations on six faces
- Integrated BESSEY anti-slip system
- Reinforced malleable iron
- The original F-clamp made in Germany #1 for quality

Prod Code	Product	Weight	Price
TG-162-K	160mm Capacity 100mm Throat	660g	\$33.00
TG-252-K	250mm Capacity 100mm Throat	1.54kg	\$45.00
TG-30-S-122K	300mm Capacity 120mm Throat	1.63kg	\$47.00
TG-40-S-122K	400mm Capacity 120mm Throat	1.78kg	\$61.00
TG-60-S-122K	600mm Capacity 120mm Throat	2.13kg	\$71.00

from **\$32.00**

DuoKlamps



- Clamping force up to 1,200 N
- Change from clamping to spreading by turn a knob to switch, no need to convert!
- Handle with pump lever parallel to the rail makes it easier and safer to use
- Convenient one-handed operation, with little effort required
- Rapidly-adjustable release lever – a press of a button is all it takes
- All-round clamping – in front of, behind and at the side of the rail
- Large jaw faces made from impact- and fracture-resistant reinforced polyamide are exactly parallel.
- Perfect for gentle clamping of a very wide range of different shapes.

Prod Code	Product	Weight	Price
DUO-168	160mm Capacity	660g	\$32.00
DUO-308	300mm Capacity	720g	\$33.00
DUO-458	450mm Capacity	830g	\$35.00
DUO-658	650mm Capacity	1.13kg	\$39.00

from **\$42.00**

KliKlamps



- Clamping force up to 1,200 N
- Feather light yet ultra strong - upper and lower sections made from sturdy magnesium
- Multi-stage ratchet mechanism is easy to operate, vibration-resistant, easy to control, and can be released quickly
- The fixed arm with the crossed v-grooves holds round, pointed or angular components firmly in place
- Ergonomically shaped clamping arm made from fibreglass-reinforced polyamide is breakproof and fits snugly in the hand

Prod Code	Product	Weight	Price
KLI-16	160mm Capacity	290g	\$43.00
KLI-25	250mm Capacity	350g	\$47.00
KLI-30	300mm Capacity	450g	\$49.00

from **\$17.90**

Quick-Action Clamps

TORQUATA



- Ergonomic soft grip handle is larger, creating higher clamping pressure with less effort
- I-beam bar design eliminates flexing and bowing in high-pressure clamping
- Zinc-plated drawn bar and rolled steel screw for long service life
- Malleable cast-iron heads will not crack under pressure
- Precision cast heads ensures significantly improves parallelism between the posts
- Choose from smaller 80mm throat with lighter bar for easier handling or
- Heavy-duty 120mm throat and heavier bar for maximum clamping pressure

Prod Code	Product	Weight	Price	Per Box
QA-080200	200mm Cap 80mm Thr	820g	\$17.90	8x\$115.00
QA-080300	300mm Cap 80mm Thr	900g	\$19.90	8x\$129.00
QA-120300	300mm Cap 120mm Thr	1.600kg	\$29.90	4x \$109.00
QA-120400	400mm Cap 120mm Thr	1.800kg	\$31.90	4x \$115.00
QA-120600	600mm Cap 120mm Thr	2.100kg	\$37.90	4x \$135.00

from **\$34.90**

Quick-Lever Clamps

TORQUATA



- Die-cast aluminium alloy body with forged steel locking components
- Drawn I-beam will not flex
- TPR grip pads increase friction to hold it in place when tensioning clamp and will not mark work
- Jaw depth of 90mm
- Maximum clamping pressure up to 440lbs (200kg)
- Unique lever makes it easy to apply maximum clamping pressure
- Locking mechanism makes it quick to clamp and easy to release

Prod Code	Product	Weight	Price	Kit of 4
QLA-150	150mm Capacity	600g	\$34.90	\$119.00
QLA-300	300mm Capacity	700g	\$39.90	\$135.00

from **\$75.00**

K-Body Evolution Clamps



The large, perfectly parallel jaw faces are characteristic of the BESSEY K Body Evolution Clamps. It allows for easy clamping and spreading with the extra large jaws that always remain exactly parallel

- ✓ Clamping force up to 8,000 N (up from 7,000 N in the REVO Clamps)
- ✓ The new formed 2-component handle with hexagon socket end means extra clamping force can be comfortably applied
- ✓ Very large 95 x 20 x 20mm parallel clamping surface
- ✓ Glass fibre reinforced polyamide jaw cover pressure caps protect

to each other. With a new design that has the following features (including the upgrades of the Evolution series), you can rely on Bessey for any clamping job.

- delicate surfaces that are also repellent to glue, and also resistant to paint and grease solvents
- ✓ Can be converted to spreading function with no need for tools
- ✓ Profiled serrated rail - Two brakes on the sliding jaws incorporates an anti-gravity slide braking system, guaranteeing safe, non-slip clamping

Prod Code	Product	Weight	Price
KRE-302-K	300mm Capacity	1.83kg	\$75.00
KRE-602-K	600mm Capacity	2.76kg	\$89.00
KRE-802-K	800mm Capacity	3.10kg	\$100.00
KRE-1002-K	1000mm Capacity	3.45kg	\$112.00
KRE-1252-K	1200mm Capacity	3.87kg	\$125.00
KRE-1502-K	1500mm Capacity	4.28kg	\$137.00
KRE-2002-K	2000mm Capacity	5.09kg	\$162.00
KRE-2502-K	2500mm Capacity	6.05kg	\$192.00

\$42.00

K-Body Clamp Extender



KBX-20 | 750g

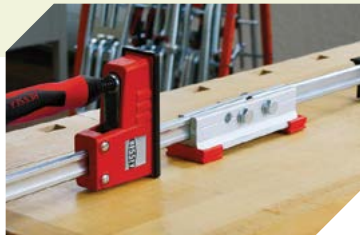

- ✓ Connect any two K-Body REVO's to increase the clamping capacity.
- ✓ The connector is made of robust aluminium and comes with two red adaptors.

from **\$123.00**

Vario K-Body Clamps



Vario K-Body Clamps build on the features & benefits of the original K-Body REVO with the opportunity to adjust both jaws to optimise clamping preparation.

With the push of a button the 'fixed' jaw can be moved to where you want it - eliminating a great deal of workpiece balancing before glue is applied.

Prod Code	Product	Weight	Price
KREV-1002-K	1000mm Capacity	3.85kg	\$123.00
KREV-1502-K	1500mm Capacity	4.25kg	\$149.00



from **\$49.90**

Parallel Clamps

TORQUATA

Parallel clamps completely change the game in high-performance clamping. Their name comes from the ability of the jaws to remain parallel to each other and stay at 90°, ensuring it pulls your work piece in square every time without needing to check.

Their design makes them much lighter and easier to handle than standard sash clamps but still apply massive 400kg of clamping force.

These clamps feature –

- ✓ Drawn steel I-beam bar will not flex while reducing clamp weight
- ✓ Easy conversion into spreader without needing tools
- ✓ Durable die cast aluminium body with all steel clamp fittings
- ✓ Jaw depth of 100mm
- ✓ Powdercoated finish with non-marring TPR jaw pads
- ✓ Two non-marring clip-on work piece supports included

Prod Code	Product	Weight	Price	Per Kit of 6
PC-300	305mm Long	1.6kg	\$49.90	\$249.00
PC-610	610mm Long	1.9kg	\$54.90	\$275.00
PC-915	914mm Long	2.2kg	\$59.90	\$299.00

\$65.00

K-Body Clamp Frame Set



KRKP | 550g



- ✓ Set the K-Body REVO's (sold separately) into a framed clamping system (from 30cm to 250cm) with four 90° KP Blocks

- ✓ Separately adjustable clamping force with 2 inserted clamps per corner
- ✓ Lightweight / easy to assemble

\$23.00

Tilting Clamp Adaptor



KRAS | 260g



- ✓ Adapter with tilting clamping jaws with a tilt range of -15° to +15°
- ✓ Clamping on sloping and parallel surfaces

- ✓ Sold as a set of two jaws to suit one K-Body REVO clamp

Extraction & Safety
Measuring & Marking
Sawing
Site & Shop Accessories
Routing
Planing
Sanding & Scraping
Drilling
Joinery
Clamps & Vices
Finishing
Sharpening
Carving & Chisels
Woodturning
Wooden Parts
Cabinet Fittings

CLAMPS & VICES

\$69.00

Match Fit Dovetail Clamps

MICROJIG
DVC-525-K-2 | 700g



The MatchFit Dovetail Clamp is a versatile approach to achieving clamping pressure in hard to reach places or set-ups. By routing a dovetail groove using the popular 1/2in 14° Dovetail Bit, you can create your own dovetail channels virtually anywhere you need clamping pressure. The clamp head is contained within the track and does not interfere with the operation.

Breakthrough dovetail clamp arm design gives you the freedom to

create your own track grooves allowing you to clamp virtually anywhere

- Build tall, stable fences and infeed tables for your table saw
- Create a versatile dovetail clamp table with dog holes and many other workbench extensions
- Make the 2-in-1 Straight Edge Guide to square ends of boards quickly and easily
- Plus wherever you can cut a dovetail groove!

\$14.90

Maxi-5 Spring Clamp

TORQUATA
SQM-015 | 390g



Innovative five-adjustable jaw angles with a maximum 0 - 254mm (10in) opening

Patented ratchet mechanism with easy release trigger exerts clamping pressure more easily

Ratcheting mechanism removes standard spring clamp spring making it easier to open and

position against work piece before clamping

Durable main nylon body with ThermoPlastic Rubber (TPR) soft-grip handles and non-marring adjustable grip pads

Manufactured in Taiwan to OE specifications for lifetime of enjoyable use

\$9.90

3-Way Edge Clamp

FastCap
FC-02094 | 200g



FastCap have combined the usual spring clamp with an additional spring that applies a third direction of pressure. With approximately

14kg of clamping pressure, the 3-Way Clamp can provide a better bond than tape alone on edge banding.

from \$16.00

Wooden Hand Screw Clamps



A classic design that lets you offset and/or angle the jaws however you need to keep parts from shifting.

All feature solid steel clamping elements and hardwood jaws and handles.

Prod Code	Product	Weight	Price
HSC-4	50mm Throat 55mm Wide	200g	\$16.00
HSC-6	75mm Throat 75mm Wide	450g	\$21.00
HSC-8	100mm Throat 115mm Wide	860g	\$25.00
HSC-10	125mm Throat 150mm Wide	1kg	\$29.00

\$44.90

Spring Mitre Clamp Set



The quickest and easiest way to clamp mitred corners! Great for mouldings, trim and a variety of frames. Simply choose the appropriate size spring clamp and use the spreader to open and

position the clamp. A light sand and fill of the pits left behind takes no time. Kit includes the spreader and 4 each of 19 -35mm, 29 - 51mm, 51 - 80mm, and 57 - 88mm spring clamps in a form fitted case.

Prod Code	Product	Weight	Price
SPC-1-K	Spring Mitre Clamp Set	820g	\$44.90
SPC-35	Replacement Springs 35mm Pk 8	80g	\$12.90
SPC-51	Replacement Springs 51mm Pk 8	100g	\$14.90
SPC-80	Replacement Springs 80mm Pk 8	200g	\$16.90
SPC-88	Replacement Springs 88mm Pk 8	230g	\$17.90

from \$3.90

Clippix Spring Clamps



Bessey's spring clamps lie perfectly in the hand, guaranteeing ease of handling. Even with large opening widths, powerful, constant one-handed clamping is always

possible. And the infinitely variable adjustment and protective caps mean that even the most delicate workpieces receive effective protection.

Prod Code	Product	Weight	Price
XC-2	25mm Opening 30mm Throat	-	\$3.90
XC-5	50mm Opening 50mm Throat	-	\$8.90
XC-7	75mm Opening 70mm Throat	-	\$11.50

from \$21.00

Edge Clamps



Practical accessory for clamping edges and difficult to reach areas

Suitable for conventional screw clamps with a maximum rail thickness of 13mm

Prod Code	Product	Weight	Price
KT-51-CP	Single Spindle	350g	\$21.00
KT-52	Double Spindle	580g	\$36.00

\$49.⁹⁰ Steel Band Clamp



BC-001 | 1.4kg



The Baladonia steel band clamp is a US patented design and has four, heavy-duty but light cast alloy removable corners that can clamp either a triangle or rectangle using three or four corners. By removing all but the base corner, you can clamp

virtually any sided shape you wish. The steel band can clamp work pieces up to 3.6m outside diameter (600x1200 or 900x900mm for example) and is kept neat in a retractable band reel to keep it out of the way when working.

\$65.⁰⁰ Speed Frame Clamp



05-F-0120 | 1.3kg



The fastest-adjusting frame clamp on the market. Completely knurled for good grip, the speed-clamping nuts are designed to let you make fast adjustments, yet hold securely when you tighten them. The speed clamp includes four corners (strong, glass-filled nylon with brass inserts), four speed-clamping nuts and four

1/4in x 20TPI threaded rods that will clamp up to 584mm square. To increase clamping capacity to 1,115mm square or 1650 x 584mm rectangle, an extension set is available; it includes four 1/4-20 threaded rods and four coupling nuts. The rods and coupling nuts have a black-oxide finish.

\$39.⁹⁰ Heavy-Duty Mitre Clamp



TV-276 | 1.3kg



This alloy mitre corner clamp is great for oversize carcass clamping - doing one corner at a time - making it easy to use for complex glue-ups. The adjustable jaw pivots on its knuckle so it can clamp two work pieces of different thicknesses whilst still maintaining a 90-degree join - improving accuracy and the outcome.

Maximum material thickness is 75mm - ample for most applications. The base and jaw is produced from high-quality aluminium alloy with the clamping screw, handle and knuckle produced from bright steel for long-life. It has holes cast in the base so it can be fixed down to bench or worktable as needed.

\$29.⁹⁰ Quick-Release Mitre Clamps



ZFZD-65 | 1.3kg

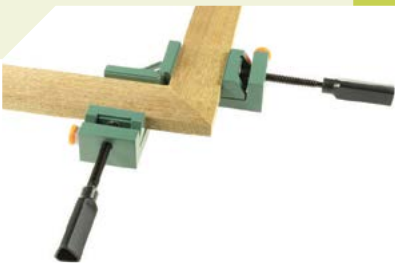

A convenient, quick-action mitre clamp with a light, easy-to-handle alloy body. Jaw width and clamping capacity is 65mm. The inside corner has a gap which allows for

saw cuts to be made. The thumb operated quick action button and triangular profiled handle makes operation easy with the ability to get considerable purchase tension.

\$60.⁰⁰ Canvas Band Clamp



Difficulty clamping curves, and other odd angles are a thing of the past. Secured by an automatic locking system that ensures even tractive forces on all sides, you can clamp up to 7m around the work piece. The included four vario corners adapt to the angle at hand and

even pressure is exerted on mitre joints. The crank handle can be relocated for right and left-handed users. Corners can be purchased separately too. Maximize clamping pressure by dialing in the handle screw.

Prod Code	Product	Weight	Price
VAS-23	Band Clamp with 4 Corners	730g	\$60.00
KRBVE	Vario Corner Set of 6	100g	\$34.00

\$60.⁰⁰ Alloy Mitre Clamp

WS-3 | 1Kg



- ✓ Automatic adjustment to variously-sized workpieces up to 55mm thick
- ✓ Quick clamping action with a single spindle

- ✓ Stable and durable aluminium body light and easy to handle
- ✓ Can be attached to table with TK-6 clamps (available separately)

\$53.⁰⁰ Handy Vise Kit

S-10-ST | 830g



- ✓ Ideal for parallel clamping with guide rods left mounted in
- ✓ When used without guide rods can also clamp at an angle (up to 25°)
- ✓ Two clips included for quick and

- simple attachment to a table edge.
- ✓ Light weight makes it easy to use
- ✓ Jaw width 90mm with maximum clamping capacity 100mm

CLAMPS & VICES

from **\$24.90**

Pipe Clamp



Clutched pipe clamps are a cost-effective and lighter option to traditional T-bar sash clamps that have a fair heft to them. This pipe clamp follows the popular modern design in having taller feet with a cast crank handle, thereby saving your knuckles from being caught under the handle when tensioning the work piece. It works with standard 3/4in pipe, which you

can also purchase as a kit as listed below - or supply your own pipe.

The head and foot are produced from ductile cast-iron with the thread bright steel bar and the thread rolled into it to ensure it does not slip even when fully tightened. The thread on the head is cut all the way through so it can be mounted as a spreader as well as clamp.

Prod Code	Product	Weight	Price
CPC-2	Pipe Clamp Only	1.3kg	\$24.90
CPC-2900	Clamp & 900m Pipe Kit	4.05kg	\$39.90
CPC-21200	Clamp & 1200m Pipe Kit	4.30kg	\$40.90
CPC-21500	Clamp & 1800m Pipe Kit	4.80kg	\$42.90
CPC-21800	Clamp & 1800m Pipe Kit	5.3kg	\$44.90
CPC-22100	Clamp & 2100m Pipe Kit	5.7kg	\$46.90

Pipe - Suits 3/4in Pipe Clamps

Galvanized pipe, threaded on one end to suit all common brands of 3/4in pipe clamps - including Baladonia, Irwin, Bessey, Pony etc.

Prod Code	Product	Weight	Price
PP-900	900mm Long	2.25kg	\$18.50
PP-1200	1200mm Long	3kg	\$19.90
PP-1500	1500mm Long	3.5kg	\$21.90
PP-1800	1800mm Long	4kg	\$24.90
PP-2100	2100mm Long	4.4kg	\$25.90

\$55.00

Pipe Clamping Set



BPCH-34 | 1.3kg



- ✓ Suitable for steel pipes DN20/ R3/4in (outer diameter 26.9mm)
- ✓ Infinitely-adjustable clamping width determined by pipe length

- ✓ With stand feet so handle clears table
- ✓ Includes non-marring plastic pads to prevent work piece damage

\$52.90

Double Clutched Pipe Clamping Kit



IR-224134 | 1.6kg



- ✓ Innovative clutch system eliminates the need for threaded pipe.
- ✓ Larger feet offer more stability and clearance between handle and worktop.
- ✓ Longer, larger, more ergonomic handle offers easier clamping

- with reduced hand fatigue, and no more skinned knuckles.
- ✓ Larger clutch plates allow for easier release and increased durability and dependability.
- ✓ Works with 3/4-inch pipe (not included)

\$49.90

Panel Clamp Kit



The system works by applying equal pressure from all four directions: top, bottom, and both sides all at the same time.

Setup begins by attaching the mounting brackets to the 38 x 38mm timber bottom bar and attaching the clamp ends so that the heads applying lateral clamping pressure are in place. We recommend running masking tape along the wooden clamp bars before loading in the boards so

that when the glue is squeezed out the boards, they don't bond to the clamping bars. Load all your boards into the clamp and then slide the top bar into place and wind up the clamp handle as per normal to exert clamping pressure. The rear strip is 310mm long with 12 notches in it so it is adjustable within a range to ensure that you can quickly and easily adjust the overall width of the clamping range so it gets done before the glue dries.

Prod Code	Product	Weight	Price
YF-00101	Single Clamp Kit	1.95kg	\$49.90
YF-00101-K-2	Twin Clamp Kit (as shown)	3.90kg	\$89.00
YF-00101-K-4	Four Clamp Kits	7.80kg	\$159.00

\$81.00

Panel Clamp



05-G-1601 | 720g



Bowed panels can be a thing of the past. This Veritas® product is the most effective panel clamp available. It is easy to use, tightens by hand, and is stackable for production work. Best of all, you can make double clamp bars of any length to suit your own needs.

The specially serrated posts grip

the bars, keeping a panel flat under any pressure load without allowing the bars to lift. Bars can be made by drilling 19mm (3/4in) diameter holes in straight stock. 50 x 50mm material is fine, but 100 x 500mm bars let you stack panels, since there is room for the top of one post and the bottom of another in the same hole.

from **\$42.90**

Auto-PRO Multi-Purpose Clamps



With Auto Adjust technology the jaws automatically adjust to and grip different size objects quickly without manually fine tuning the adjustment. Set the desired clamping pressure (25 - 400 lb range), and the jaws apply that pressure to the different

sizes of material. No continuous adjustment needed. Features a Swivel Tip with removable soft-grip pads that cover steel jaws. Ideal for jiggling, timber clamping and metal fabrication.

Prod Code	Product	Weight	Price
3-MPC-70	76mm Reach 76mm Thickness	500g	\$42.90
6-MPC-70	152mm Reach 115mm Thickness	700g	\$49.90

from
\$54.90

T-Bar Sash Clamps



We have stocked just about every brand of T-Bar sash clamp available in Australia over the years, from the bad to the very best and up until now have never imported our own as we couldn't find one that had the right mix of quality and price. We have finally found it in these one's and will now only stock this range of heavy-duty sash clamps as they are the same quality as clamps costing twice as much or even more. They are a pleasure to use and will offer a lifetime of use.

These clamps have the following features;

- ✓ Drawn and rolled t-bar profile that will never bend or distort
- ✓ Ductile cast-iron clamp head and foot
- ✓ Drawn steel bar with fine rolled thread adjustment that will never slip
- ✓ Drawn steel handle that will never bend under normal use

Code	Product	Weight	Price	Per Box
TBAR-3	914mm Long 750mm Capacity	4.75kg	\$54.90	\$189.00
TBAR-4	1220mm Long 1050mm Capacity	5.75kg	\$64.90	\$219.00
TBAR-5	1535mm Long 1360mm Capacity	6.25kg	\$74.90	\$249.00
TBAR-6	1830mm Long 1670mm Capacity	7kg	\$84.90	\$289.00

from
\$42.90

Auto-PRO Face Frame Clamps



Auto-PRO Face Frame Clamps feature technology that enables the jaws to automatically adjust to and grip different size objects quickly without manually fine tuning the adjustment. Set the desired

clamping pressure, and the jaws apply that pressure to the different sizes of material with no continuous adjustment needed - providing unprecedented convenience.

Prod Code	Product	Weight	Price
3-FC-70	76mm Reach 76mm Thickness	500g	\$42.90
6-FC-70	152mm Reach 115mm Thickness	700g	\$49.90

\$39.90

Right Angle Face Frame Clamp



MC-4004 | 900g



A right-angle face frame clamp is designed to make alignment and assembly of large work pieces that you are pocket hole jointing a simple and easy process. The

thumbscrew mechanism allows for quick and easy adjustment of jaw capacity whilst also maintaining consistent clamping pressure in use.

from
\$17.90

Face Frame Clamp



The FaceClamps are perfect for pocket hole joinery, project construction, general clamping, and more. The versatile clamps help create a flush joint during

pocket hole assembly. The thumb screw allows for quick and easy adjustment of jaw capacity, as well as clamping strength.

Prod Code	Product	Weight	Price
MC-4000	60mm Reach 51mm Thickness	330g	\$17.90
MC-4001	80mm Reach 76mm Thickness	720g	\$26.90
MC-4002	150mm Reach 150mm Thickness	850g	\$39.90
MC-4003	190mm Reach 200mm Thickness	1.1kg	\$49.90

from
\$45.00

Automaxx Face Frame Clamps



- ✓ Auto-Adjust technology automatically adjusts to any thickness
- ✓ Available in two sizes -

- ✓ Easy-to-regulate clamping pressure using a simple thumbscrew
- ✓ Extra-large clamp faces spread clamp pressure evenly

Prod Code	Product	Weight	Price
KHC-3	76mm Reach 76mm Capacity	650g	\$45.00
KHC-6	152mm Reach 127mm Capacity	720g	\$60.00

\$26.00

Micro Face Frame Clamp



KHCMICRO | 650g



- ✓ 51mm reach; clamps materials up to 57mm thick
- ✓ Compact size fits easily into tight spaces
- ✓ Compatible with Kreg Jig® R3's Portable Clamp Adapter
- ✓ Ergonomic padded grip for comfort and ease of use

\$53.00

Right-Angle Face Frame Clamp



KHCRAC | 900g



Makes projects with 90° joints faster and easier - just slip the pin into a pocket hole, close the clamp, and it draws the mating pieces tightly together.

Thanks to Automaxx® Technology, it matches the material automatically with a simple squeeze of the handles - making it even easier to use.

Extraction & Safety
Measuring & Marking
Sawing
Site & Shop Accessories
Routing
Planing
Sanding & Scraping
Drilling
Joinery
Clamps & Vices
Finishing
Sharpening
Carving & Chisels
Woodturning
Wooden Parts
Cabinet Fittings

CLAMPS & VICES

Extraction & Safety
Measuring & Marking
Sawing
Site & Shop Accessories
Routing
Planing
Sanding & Scraping
Drilling
Joinery
Clamps & Vices
Finishing
Sharpening
Carving & Chisels
Woodturning
Wooden Parts
Cabinet Fittings

from \$42.90 Auto-PRO Hold-Downs



Simply set the desired clamping pressure, and the jaws apply that pressure to the different sizes of material with no more continuous adjustment needed, providing unprecedented convenience. The one-hand clamping operation frees up your other hand to hold material for fast, easy setups.

Features a swivel tip with removable

soft-grip pads that covers the large steel face pad and soft-grip handles for comfortable use. The large eyebolt is included as standard for mounting on to drill press as well as being able to remove this and using the included bolt for use in standard 5/16in t-track.

Code	Product	Price
3-DP-70	76mm 3in Clamp	\$42.90
6-DP-70	152mm 6in Clamp	\$49.90

from \$34.90 Drill Press Hold-Downs



Great for repetitive clamping work in a variety of applications. The integral wheel at the end of the handle adjusts the clamping pressure and thickness so it can be dialed in quickly to set the necessary force on the work piece

- working effectively from very thin, delicate pieces all the way to thick and high-pressure applications.

Code	Product	Price
MC-4006	Std 76mm 3in	\$34.90
MC-4007	Std 152mm 6in	\$39.90

from \$53.00 Automaxx Bench Clamps



- Adjusts automatically to match material thickness
- Easy-to-regulate pressure with a simple thumbscrew
- Large clamp faces spread pressure evenly

- Ergonomic padded grips prevent hand fatigue
- Compatible with the Clamp Plate as shown (sold separately)

Prod Code	Product	Weight	Price
KBC-3	76mm Reach 83mm Capacity	820g	\$53.00
KBC-6	152mm Reach 127mm Capacity	900g	\$60.00
KBKIP	Bench Clamp Mount Plate	220g	\$23.00

\$299.00 Mobile Project Centre



Make any place your workspace. Work on projects wherever, whenever, and however you need to!

- Tables provide large 27³/₄in x 31¹/₂in (700 x 800mm) work surface and 360° access
- Locking table supports with easy-release tabs
- Hole pattern on tables accept Kreg Bench Dogs and other accessories
- Included Kreg Bench Clamp with

- Automaxx® clamps vertically and horizontally
- Heavy-gauge steel legs provide a solid foundation
- Folds down in seconds for work on the go and easy storage
- Expandable by pairing with a second Mobile Project Centre

\$47.90 Auto-PRO T-Track Clamps



With the same construction as the Dog Hole clamps on the following page with one small exception – the mounting system. Rather than having the dog-hole posts, the base of these clamps is designed for t-track with the following features –

- Fitted with a 5/16in T-Bolt that inserts into a standard 5/16in T-Track.
- Versatile clamp has the ability to rotate 360°, allowing for a wide range of clamping applications.
- Includes pins to keep it captive at

90° and 45° angles to the track for faster setups

- In the clamped position, the lever is horizontal
- Automatic and infinitely variable adjustment of the clamping reach up to 90mm
- Clamping force is variable up to 700lb depending on the adjustment of the set screw in the cantilevered joint
- Sturdy, tempered metal sheets for a long service life

Prod Code	Product	Weight	Price
B-5-HH	T-Track Hold-Down	700g	\$47.90
B-7-IL	T-Track Inline Clamp	800g	\$44.90

\$39.90 Auto-PRO Inline Toggle Clamp



- In the clamped position, the lever is horizontal
- Moving the handle moves the push-pull rod a maximum travel of 35mm
- Automatic and infinitely variable adjustment of the clamping distance up to 19mm while clamping force remains unchanged

- Adjustable clamping force up to 700lb, based on the adjusting screw in the joint
- Sturdy, tempered metal sheets for a long service life
- Base plate hole pattern suitable for metric and imperial

from \$36.90 Auto-PRO Toggle Clamps



Automatically Adjustable to variations in workpiece dimensions while maintaining consistent

clamping pressure. It replaces the need for multiple sizes, eliminating the need for constant adjustments

Opening Size	STCHH-20	STCHH-50	STCHH-70
Clamping Force	0 – 30.0mm	0 – 39.5mm	0 – 60.0mm
Holding Capacity	25 – 250lbs	25 – 550lbs	25 – 550lbs
Approx. Weight	450lbs	700lbs	700lbs
	275g	500g	545g
Prod Code	Product	Weight	Price
STCHH-20	Auto Adjust Small Horizontal Mount	300g	\$36.90
STCHH-50	Auto Adjust Medium Horizontal Mount	500g	\$38.90
STCHH-70	Auto Adjust Large Horizontal Mount	500g	\$39.90

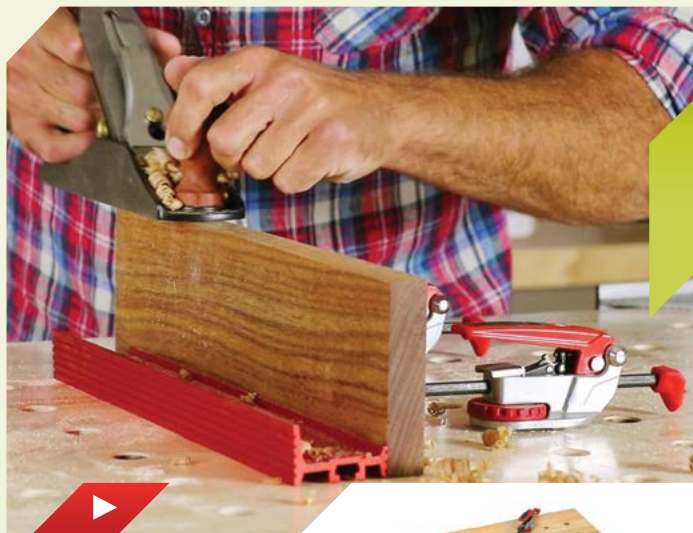

\$54.90

Auto-PRO Bench Dog Holddown Clamp

ARMOR
TOOL
P-7-HH | 1.3kg

The first truly revolutionary hold-down clamp to have been released in the 21st century.

Armor Tool have taken one of their Auto-PRO™ Horizontal Toggle Clamps and rather than securing it with a mounting plate, they supply it with a serrated 19mm (3/4in) bench dog post which grips into the dog hole very securely - allowing

greater clamping pressure to be applied without slipping.

The benefit of this over any other type of toggle clamp is that it provides fast placement in a 360° radius around the dog hole over a massive height range from as 0 - 175mm (7in) along with the fast setup times of Armor Tool's Auto-PRO™ technology!!!



from \$499.00

Auto-PRO Workbench System

ARMOR
TOOL



The Core of the Armor Tool Clamping Workbench Revolution

Sometimes the most elegant solutions are the simplest. Armor Tool had the Hold-down and Inline Clamps, plus the Dog Fences - but the missing link was a table that turned these great clamps into a fantastic system. So the Auto-PRO™ Workbenches came into being.

For the Australian market* these are supplied as 30mm-thick A/A face-grade Birch ply which are incredibly dense and durable. The 19mm dog holes are CNC machined precisely 3in apart so that the fences and inline clamps can be set at guaranteed 90° or 45° angles to make setting up and clamping quick and easy.

Prod Code	Product	Weight	Price
TTS-3625-KIT	900 x 600mm Complete Kit	40kg	\$499.00
TTS-5425-KIT	1200 x 600mm Complete Kit	53kg	\$599.00
PTT-3625	900 x 600mm Tabletop Only	17.5kg	\$239.00
PTT-5425	1200 x 600mm Tabletop Only	26.5kg	\$339.00
TS-3625	900 x 600mm Stand Only	18.7kg	\$219.00
TS-5425	1200 x 600mm Stand Only	22kg	\$229.00
TC-10	Braked Castor Set of 4	3.6kg	\$65.00

\$49.90

Auto-PRO Bench Dog Inline Clamp

ARMOR
TOOL
P-7-IL | 600g

A Major Part of the Armor Tool Workbench Clamping Revolution. Not all work piece clamping on a bench works by holding the piece down - clamping from the side means the top of your workpiece is unobstructed for easy machining and sanding.

The clamp pivots 360°, allowing you to locate it near the workpiece edge to minimize obstructions. It also have a shallow V relief cut into the face, allowing for gripping the corners of boxes and/or on curved work pieces - further expanding its usefulness.



\$295.00

Auto-PRO Bench Dog Clamp Kit

ARMOR
TOOL
TTsCKIT-1 | 5kg



If you're looking at buying the Auto-PRO™ Workbench System or making a version of your own, this is a great kit to consider as you can get the most popular clamps and accessories by placing an order for just the kit for one great low price.

This kit contains the following items -

- ✓ 2x Auto-PRO™ Hold-down Clamps
- ✓ 2x Auto-PRO™ Inline Clamps
- ✓ 1x Auto-PRO™ 8in Dog Fence
- ✓ 1x Auto-PRO™ 14in Dog Fence

from \$22.90

Auto-PRO Bench Dog Fences

ARMOR
TOOL

Armor Auto-PRO™ Peg Fences easily slide into the table and allow you to position and brace materials or set up corners. Dog Fences are reversible with a high side and a low side to accommodate variations in work thickness and length for sanding and routing. Comes with two 76mm tall, 19mm (3/4in)

diameter dogs that grip securely into standard traditional dog holes. The Dogs fit into a track under the Dog Fence and spacing can be easily adjusted. The Dog Fence height is 32mm on tall side, and 16mm on short side which should suit most applications.



Prod Code	Product	Weight	Price
PF-4	102mm 4in Long	250g	\$22.90
PF-8	203mm 8in Long	330g	\$29.90
PF-14	355mm 14in Long	550g	\$34.90

CLAMPS & VICES

Extraction & Safety
Measuring & Marking
Sawing
Site & Shop Accessories
Routing
Planing
Sanding & Scraping
Drilling
Joinery
Clamps & Vices
Finishing
Sharpening
Carving & Chisels
Woodturning
Wooden Parts
Cabinet Fittings



\$29.⁹⁰ Bench Holdfast

TORQUATA
BDC-01 | 960g



The large, ergonomic grip is made from two-component plastic and yields high clamping pressure with just a few turns. The 44mm-diameter rubber pressure plate ensures non-marring clamping of the workpiece while the serrated (fluted) shaft securely fits into any 19 mm (3/4in) hole. Galvanized, with an overall length of 155mm,

maximum working height is 115mm and throat capacity is 125mm. A real benefit is that it can be used by either exerting increasing pressure using the screw mechanism or used traditionally by quickly knocking it into and out of place with the tap on the arm with a mallet.

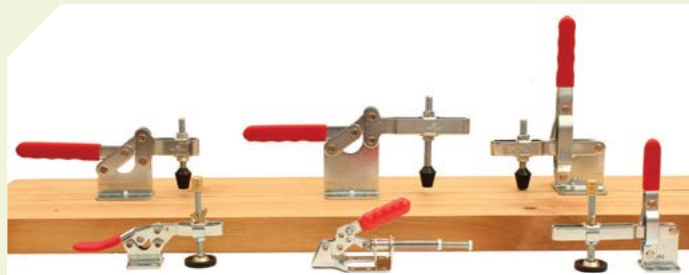

For repetitive clamping in both woodworking and metalworking applications, toggle clamps are the go-to accessory. Available in a

range of sizes and configurations to suit practically all situations. The larger the overall size of the clamp, the greater the clamping strength.

from \$15.⁹⁰ Horizontal Toggle Clamps



Named horizontal because when locked down the handle locks in parallel to the body of the clamp. Most common configuration used.

Code	Reach	Height Closed	Max. Clamping Thickness	Weight	Price
TCH-01	67mm	48mm	33mm	270g	\$15.90
TCH-02	60mm	87mm	56mm	580g	\$18.90
TCH-03	110mm	110mm	77mm	950g	\$22.90

\$15.⁹⁰ Toggle Clamp Pads



TCACP | 160g



Coming as a pack of two - the heads are 35mm diameter with the force distributed around the perimeter of the pad, rather than in the centre like standard bullet heads. A brass wing-nut provides

quick shaft release and a knurled brass knob on the end fine tunes clamping pressure. Suitable for use with the smaller TCH-01 and TCV-01.

\$19.⁹⁰ Vertical Fixing Toggle Clamp



TCH-04 | 440g



Rather than being fixed flat on the work surface being clamped, can be fixed at a 90° degree angle to the surface, perfect for use on

adjustable fences. Reach is 98mm, height closed 76mm and maximum clamping thickness is 63mm.

from \$18.⁹⁰ Vertical Toggle Clamps



Named vertical because when locked, the handle runs perpendicular to the body of the

clamp. Comfortable when working with the clamp pointing towards instead of away from you.

\$9.⁹⁰ Plastic Bench Dogs



PBD-4-Q | 80g



This set of four plastic bench dogs are designed to suit the common 19mm (3/4in) round bench dog holes. They have an extra low profile of 13mm and will not damage your plane iron if accidentally hit.

\$22.⁹⁰ Piston-Type Toggle Clamp



TCP-01 | 320g



For repetitive clamping in both woodworking and metalworking applications, toggle clamps are the go-to accessory to hold work pieces in place when working on them. This particular clamp works

by holding material from the side on the same plane that its mounted on. The total horizontal reach of this clamp is 78mm and when fully extended has a maximum height of 80mm.

from
\$99.00

Quick Action Bench Vices



We have sold this range of woodworking vices from the same factory for a number of years because they are such a reliable vice and are in use in thousands of home, school and trade workshops around the country.

Each vice has two solid steel guide bars which are 23mm diameter, with another deep-cut thread screw bar to ensure high clamping pressure is maintained without any slippage.

They have fully ductile cast iron jaws that are tapered to allow clamping of slightly out of square stock. Both jaw have holes pre-cast so you can attach your own wooden

sub-faces to prevent timber being clamped from marking or you can make jigs and fix them easily to hold odd-shape material.

The quick action release mechanism is all steel and cast-iron construction for long life and superior clamping strength. The handles are made of solid 17mm solid steel bar so they will never bend over the lifetime of the vice.

A height-adjustable peg is built into the face of the vice so you can use it in conjunction with bench dogs to clamp work pieces above the bench top.

Code	Product	Weight	Price
RV-77	175mm Wide 175mm Capacity	11kg	\$99.00
RV-99	230mm Wide 230mm Capacity	16kg	\$139.00
RV-1010	265mm Wide 265mm Capacity	20kg	\$169.00

\$109.00

Quick Action Front Vice Screw



TBFQA-2 | 10.5kg



A common issue with standard front vice screws is the time taken to wind it in and out when moving between two work pieces of significantly different dimension - leading to frustration. This quick-action vice front vice screw overcomes that problem by being able to slide the front jaw in and

out for big adjustments and then re-engage the screw to clamp the work piece.

A half turn outward ingeniously disengages the screw, slide it in and out close to where you need it to be and then a half turn to clamp re-engages the screw again.

from **\$49.90**

Front Vice Screws



Front vices are the most common type of woodworking vice. A solid cast iron plate mounts underneath the bench with the edge of the bench acting as one clamping face and another jaw is mounted on the

front of the vice. The non-marring properties of timber make it a great choice for clamp jaws. Three posts (two guide posts and a screw) allow for smooth adjustment and positive, even clamping pressure.

Code	Product	Weight	Price
TBFV-1	Small Front Vice Screw	4.7kg	\$49.90
TBFV-2	Large Front Vice Screw	9.3kg	\$99.00

\$39.90

Shoulder Vice Screw



TBSV-1 | 2.1kg



Create an L-shaped shoulder vice commonly found on Scandinavian-style benches. A pivoting jaw mount is located on a ball-end to provide flexibility for the jaw to move when

clamping out-of-square work pieces. 28.6mm diameter screw and can clamp up to 175mm less the thickness of the jaws. Produced from cast-iron and bright steel.

\$79.00

Tail Vice & Mount



TBTSL-1 | 2.6kg



Tail vice screws are commonly available in Australia but lack the extra mounting brackets to prevent sagging over time when just the screw is installed. This vice and mount kit beefs up the installation and prevents sagging once installed. The 4.75mm steel mount plate is mounted to the side of the

bench with the vice screw knuckle installed. The 2x 10mm reinforcing steel plates are then installed in the vice jaw cavity along with the screw. When the vice screw is wound, the reinforcing steel plates slide along the mount plate and because of the weight of the material will prevent the vice sagging down over time.

\$44.00

Planing Stop



05-G-2301 | 280g



This low-profile work stop presents a broad bearing surface. Particularly useful with thin or narrow workpieces, it is 31.8mm wide anodized aluminum rail projects just a tad over 5.5mm above the bench top, allowing materials as thin as 6.4mm (1/4in) to be worked

or planed without obstruction. It also provides a reliable registration surface for materials too narrow to span two adjacent bench dogs. The two 19.0mm (3/4in) steel posts slide along a T-track on the underside of the 247.5mm-long rail.

\$44.90

Tail Vice Screw



TBTV-1 | 3.9kg



Tail vices are very handy when installed on a workbench as they can allow for the clamping of long and wide work pieces. It is best to mount with the vice assembly in the bench and an L-section extending to the edge of the bench so that the

screw doesn't get in the way. This vice screw has a working size of 330mm jaw opening and allows for jaw size of at least 73mm thickness (please note that this allows for two jaw thicknesses of at least 36mm).

Extraction & Safety
Measuring & Marking
Sawing
Site & Shop Accessories
Routing
Planing
Sanding & Scraping
Drilling
Joinery
Clamps & Vices
Finishing
Sharpening
Carving & Chisels
Woodturning
Wooden Parts
Cabinet Fittings

CLAMPS & VICES

Extraction & Safety
Measuring & Marking
Sawing
Site & Shop Accessories
Routing
Planing
Sanding & Scraping
Drilling
Joinery
Clamps & Vices
Finishing
Sharpening
Carving & Chisels
Woodturning
Wooden Parts
Cabinet Fittings

from **\$63.00**

Wonder Dogs & Pups



Veritas®

Wonder Dog® clamps? Well, you have to wonder why nobody thought of them before and then wonder if you can get along without them.

At 165mm long, the versatile Wonder Dog clamp can be used anywhere you can drill a 19mm

(3/4in) hole. It makes it easy to clamp curved work and irregular shapes. Since the dog head has two screw holes, any shape of tip can be cut with a scroll saw and quickly attached for specialized work, giving good control without marring work.

Prod Code	Product	Weight	Price
05-G-1001	Wonder Dog Each	640g	\$69.00
05-G-1002	Wonder Pup Each	400g	\$63.00

Bench Dog & Pup Muzzles

For clamping a finished piece without marking it, these slip-resistant muzzles slide over the Veritas Bench Dogs (or Bench Pups - both sold separately) to give you a non-marring surface. They have a hard, spring-grip, plastic body with six face ribs.

Prod Code	Product	Weight	Price
05-G-0406	Bench Pup Muzzles	10g	\$9.00
05-G-0410	Bench Dog Muzzles	10g	\$12.00

from **\$44.00**

Bench Dogs & Pups



Veritas®

The round bench dogs are made from solid brass rod and can be installed in any bench by drilling a 19mm (3/4in) hole. Brass dogs are non-corroding and kind to your tools. The combined crosshatching

and 2° inward slope of the face hold wood securely. The side spring lets the dog slide smoothly, but holds it well at any desired projection.

Prod Code	Product	Weight	Price
05-G-0402	Bench Dogs Pack of 2	510g	\$52.00
05-G-0404	Bench Pups Pack of 2	290g	\$44.00

\$29.90

Workbench Assembly Bolts



WBB-01 | 1kg



The solid brass nuts on these bench bolts slide into a pre-drilled hole in the stretcher, and distribute pressure to prevent breakout.

A bench can be made very rigid (without complex joinery) by using a wide stretcher, since the stretcher is bolted into position.

\$148.00

Traditional Hold-Down



Veritas®
05-G-1401 | 1.4kg

With the arm free to pivot independently all levered forces are exerted downward, without any losses due to horizontal slippage from the canting action of the hold-down post.

The fine barb-shaped grooves on the post resist upward forces, yet still allow easy entry into a hole. The long, low profile arm is unobstructed at the clamping end, allowing good

access to work from all sides.

The 255mm hold-down post gives you 203mm (8in) of clamping capacity, matching the 203mm (8in) throat capacity. Used vertically in the top of a bench, or horizontally in a side skirt. Clamping forces are infinitely variable by tightening the clamping knob (machined brass) to any degree.

\$48.00

Prairie Dog



Veritas®
05-G-1022 | 220g

This is a clever bench dog. Whenever you need a stop, simply press the top and the dog pops up and locks in its raised position (about 8mm projection), ready for

use. When you're done, just press down on the top again to recess the stop into the hole, where it conveniently remains at the ready.

\$126.00

Surface Clamp



Veritas®
05-G-1901 | 600g

This fast-acting surface clamp can be used anywhere you can drill a 19mm (3/4in) diameter hole. The post has a wedging mechanism that anchors it firmly (horizontally

or vertically) in material as thin as 16mm (depending on the strength of the material), making it ideal for use in jigs and fixtures, e.g., sliding tables for saws.

\$36.00

Bench Blade



Veritas®
05-G-2210 | 200g

This is essentially a low-profile bench dog with a quick-release sliding jaw for holding work. Dubbed a "blade" due to its flat design, it projects just 6.4mm (1/4in) above a work surface to permit maximum

access to a work piece. Used much like a toggle clamp, it has a thumb-operated eccentric cam lever to control the sliding jaw, so you can quickly secure or release work.

from **\$27.90**

Hard Burnishing Oil

Based on genuine Tung Oil this fine-friction-on-application provides sealing capacity, very efficient drying/curing, and 'handling' durability of the finished item. Used alone in multiple applications and lathe workings results in a high matt sheen finish that is geared for minimal darkening/yellowing whilst still providing natural colour and character enhancement of all timbers.



Code	Product	Weight	Price
HBO-500	500mL	560g	\$27.90
HBO-010	1L	1.2kg	\$44.90
HBO-020	2L	2.1kg	\$79.00
HBO-040	4L	4.8kg	\$130.00

from **\$44.90**

Pure Tung Oil

Can be used as a timber finish and is widely used as a drier in varnishes and paints. Pure Tung Oil is also a most Effective seal for concrete bench-tops, floors, slate/ stone, terracotta, mud brick (adobe) and other similar constructions.



The finish is more suited for interior or exterior/protected use than fully exposed exterior, due to lack of UV resistance.

Code	Product	Weight	Price
OTO-010	1L	1kg	\$44.90
OTO-040	4L	4kg	\$149.00

from **\$29.90**

Danish Oil

A tung oil based traditional blend with linseed, pinewood and citrus oils to give a rich, heavy oil for which Danish oil is renowned. It will nourish and preserve timber used internally for furniture, doors/windows and panelling. Sold in 500mL tins.



Code	Product	Weight	Price
ODO-500	500mL	570g	\$29.90
ODO-010	1L	1.2kg	\$47.90
ODO-040	4L	4.8kg	\$130.00

from **\$42.90**

Woodsheen Fine Buffing Oil

A pure non-toxic timber finish formulated from highly refined natural plant and wood oils. Used as a final light buffing oil over other oil finishes to provide a quality satin patina or on its own for a softer, paler finish.



Code	Product	Weight	Price
WSO-010	1L	530g	\$42.90
WSO-020	2L	2.1kg	\$70.00
WSO-040	4L	4.8kg	\$119.00

from **\$19.90**

Danish Oil

An oil finish, suitable for all types of wood. It differs from Teak Oil in that it contains special ingredients, which prevent it drying to a gloss. It is an easy to use wipe on finish, which brings out the beauty of the timber and gives a natural, open grained, soft lustrous finish. Ideal for all woods and is excellent on turned woodwork. Danish Oil is a unique formulation developed by Rustins.



Code	Product	Weight	Price
RDO-250	250mL	250g	\$19.90
RDO-500	500mL	500g	\$29.90
RDO-010	1L	1kg	\$52.50
RDO-050	5L	5kg	\$169.00

from **\$24.90**

Garden Furniture Oil

A unique clear finishing oil that penetrates, nourishes and seals timbers, whilst enhancing the natural hues with a rich wet look. Combining the technical component oils from decking oil with the 'hard oil' qualities of tung oil in a clear base enables the finished result to be as natural as the timber used.



Prod Code	Product	Weight	Price
GFO-500	500mL	530g	\$24.90
GFO-010	1L	1.2kg	\$39.90
GFO-020	2L	2.1kg	\$69.00

\$29.90

Wax Polish

It is a highly refined Beeswax & Citrus Oil polish, with pleasant aromatics and emulsified into a soft, ready-to-use paste. It is environmentally friendly, will not harden once opened, is excellent for woodworking projects, upkeep of French-polished/lacquered items and also great for leather. Available in 500ml bottle.



WP-500 | 300g

\$16.90

Wood Wipe

The new product by Organoil has been developed to be used on wooden kitchenware. It is a blend of citrus and nut oils and can be used on chopping boards, wooden bowls and wooden serving utensils. Just ensure the timber is clean and dry, wipe the oil on, leave for thirty seconds and wipe off again. Once dry it will protect the basic integrity of the timber. Available in 250mL bottles.



WW-250 | 270g

Extraction & Safety
Measuring & Marking
Sawing
Site & Shop Accessories
Routing
Planing
Sanding & Scraping
Drilling
Joinery
Clamps & Vices
Finishing
Sharpening
Carving & Chisels
Woodturning
Wooden Parts
Cabinet Fittings

FINISHING

from **\$35.90**

Shellawax Glow

The polish that has revolutionised the way woodturners finish their work. Ideal for use on small turned work, pens, knife handles, small lidded containers etc. but can also be used on larger work. Creates a brilliant shine on turned work in seconds, is water resistant, non-toxic, dries instantly, is food safe and can be handled immediately after use.



Prod Code	Product	Weight	Price
FO-250	250mL	260g	\$35.90
FO-500	500mL	550g	\$52.90

\$52.90

Shellawax Glow

FOG-500 | 550g

Works the same as Shellawax. It is designed to enhance highly figured timber, giving more depth and clarity to the finish. Only available in 500mL bottles.



\$18.50

Woodturners WaxTik

WSPK | 100g



Non-toxic, food safe and foolproof. Works on raw timber, over Shellawax, shellac, oils and most other finishes. For a magnificent fully waxed finish, use Waxtik over EEE-Ultra Shine. Long lasting and extremely economical.

from **\$14.90**

100% IMS Ethanol

Industrial-grade, 100% pure ethanol with no impurities (such as water or methanol) – perfect for mixing with shellac flakes for perfectly clear finish.



Code	Product	Weight	Price
PMS-010	1L	1.1kg	\$14.90
PMS-002	20L	22kg	\$189.00

\$27.90

EEE Ultra Shine

EEE-250 | 320g



A cut and polish paste designed to be used in conjunction with Shellawax specifically for the use of woodturners. Can also be used for restoration, french polishing and over most other finishes to give a smoother and brighter finish. Available in 250ml tub.

\$18.50

Traditional Wax

UBTN-250 | 300g



Polishes to a brilliant lustre but unlike most other waxes will not show finger marks or attract dust etc. Use as a finish in its own right or for restoration and upkeep of pre-polished surfaces. Available in 250ml tub.

\$34.90

Aussie Fine Buffing Oil

UBAO-250 | 250g

This product is designed to be hand rubbed on to raw timber, giving a finish with a hard, bright, high gloss. It will bring out amazing depth and brilliance to most timbers making the grain pop and become opalescent, vibrant, shimmering and alive. Especially when used on a fine grained, highly gure timber.

250ml bottle.



\$11.50

Foodsafe + Oil

UBFS-250 | 250g

Mineral Oil is food safe for use on chopping boards, bread boards, salad bowls, and all wooden food utensils where you want a natural and safe finish for raw timber. Its water absorption prevention and lack of flavour and odour make this food grade mineral oil an ideal preservative for wooden utensils and boards.

250ml bottle.



\$39.90

White Shellac Polish

UBWS-500 | 500g

Dewaxed White Shellac is used the same way as any of the other varieties of shellac. This shellac is a bit harder and shines a bit brighter than other shellacs. It is completely free from wax and will not change the natural, wet colour of wood. Suited for application over brightly dyed or stained timbers and is fantastic for use in decorative finishes where a clear glaze is required. 500ml bottle.



\$45.90

Hard Shellac Polish

UBHS-500 | 500g

Ever wished you had a finish that was as easy to use as shellac but with the durability of polyurethane? Well wish no more, because here it is.

This unique Hardened Shellac creates a film with a high resistance to heat, water and alcohol, yet it is used in exactly the same way as any normal shellac. It can be applied with a rubber as French polish, brushed, sprayed and dipped. 500ml bottle.



from **\$34.090**

Golden Glory Shellac Flakes

Golden Glory Shellac Flakes are drawn out over fire to remove impurities and mixed with methylated spirits to create traditional French Polish – better suited for darker timbers.



Code	Product	Weight	Price
SFG-220	200g Container	280g	\$34.90
SFG-010	1kg Bag	1.1kg	\$73.90

from **\$32.90**

Blonde Dewaxed Shellac Flakes

Blonde Shellac Flakes are more refined than Golden Glory with more impurities removed resulting in a paler and clearer finish – suitable for all timbers or applying over stains. Mix with methylated spirits to create White Polish.



Code	Product	Weight	Price
SFB-250	250g Bag	250g	\$32.90
SFB-500	500g Bag	500g	\$59.90

\$20.90

French Polish Sanding Sealer

This sanding sealer is designed to raise the nap of the grain, making it stand up and become brittle. It can then be sanded off with fine grit abrasive paper, giving a silky smooth base for you to apply your finish with no fear of the nap raising again. 500mL bottle.



UBSS-500 | 500g

\$59.90

Pine Brush

PB-105 | 280g



A top-quality synthetic hair-brush specifically developed for Timbecon to create heat and friction to polish all oils and wax finishes on timber. It speeds up the buffing process, whilst evenly spreading and applying the finish to any flat and shaped surfaces creating a buffed, smooth finish. Virtually no maintenance required for lifetime of use.

\$18.90

Wood Dye Stains



WOOD DYE - For use on bare wood prior to finishing with any of Rustin's wood finishes. Quick drying penetrating stain, does not raise the grain. Supplied in 11 shades, which may be intermixed to make an infinite variety of natural wood shades. Suitable for interior and exterior use.

Code	Product	Weight	Price
WAP-250	Antique Pine	250g	\$18.90
WLO-250	Light Oak	250g	\$18.90
WMO-250	Medium Oak	250g	\$18.90
WDO-250	Dark Oak	250g	\$18.90
WLT-250	Light Teak	250g	\$18.90
WDT-250	Dark Teak	250g	\$18.90
WRM-250	Red Mahogany	250g	\$18.90
WBM-250	Brown Mahogany	250g	\$18.90
WDW-250	Walnut	250g	\$18.90
WDE-250	Ebony	250g	\$18.90

\$13.90

Talc Powder

Super fine Talcum Powder (unscented), is an ultra fine abrasive and filler.

Also used to make gesso for gilding and for use as a base for many decorative finishes.

Mix with Shellac as a grain filling sanding sealer.

Comes in a convenient 300g shaker pack.



UBTP-300 | 320g

from **\$33.50**

Swansdown Polishing Mops



These genuine Swansdown mops are made right here in Australia and are one of the best ways we have found to put a brilliant wax finish onto timber especially if you are using EEE-Ultra Shine, Traditional Wax or both. They also work extremely well with Shellawax and Shellawax Cream.

Code	Product	Weight	Price
SD-50	100mm x 50 fold	80g	\$33.50
SD-75	150mm x 75 fold	230g	\$45.00
SD-100	150mm x 100 fold	300g	\$67.00

\$18.50

Tripoli Powder

Tripoli Powder AFC (Air Float Cream) is a super fine abrasive powder used as a final buffing compound for French Polishing and over many other finishes.

It can bring up a mirror finish on most surfaces.

Comes in a convenient 400g powder shaker pack.



UBTP-400 | 430g

\$39.90

Non Toxic Water Dyes



The dyes are concentrated and can be diluted up to 10 times their volume in water and still have extremely strong dyeing capabilities. Also possible to obtain very subtle pastel shades by adding full strength dye to 100 or even 1,000 times its volume of water. The dyes are all made from colourings approved for use in kindergartens and foodstuffs and are therefore NON-TOXIC making them safe for use on bowls, food utensils, children's toys, babies rattles, etc.

UBWD | 470g

from **\$16.90**

Finishing Steel Wool



For ultra fine finishing. Ideal for cutting back finishes to produce ultra smooth surfaces. Obtaining matt or satin finishes, removing wax polish, even cleaning brass and polishing metal.

Prod Code	Product	Weight	Price
STW-0000	#0000 Grade	250g	\$16.90
STW-00000	#0000+ Grade	250g	\$18.50

\$39.90

Restor-A-Finish



With a simple wipe-on, wipe-off process, most finished wood surfaces that seem to need a complete refinishing job can be restored in a few minutes. White heat rings, and water marks, sun fade, smoke damage and most other blemishes can be quickly eliminated. Before you go to the extreme of stripping it, try restoring it.

- ✓ Eliminates white heat rings and water marks
- ✓ Blends out scratches and blemishes
- ✓ Restores colour and lustre to faded finishes
- ✓ Will NOT dissolve existing finish

Code	Product	Weight	Price
HRN	Neutral	470g	\$39.90
HRMP	Maple-Pine	470g	\$39.90
HRGO	Golden Oak	470g	\$39.90
HRDO	Dark Oak	470g	\$39.90
HRC	Cherry	470g	\$39.90
HRM	Mahogany	470g	\$39.90
HRW	Walnut	470g	\$39.90
HRDW	Dark Walnut	470g	\$39.90
HREB	Ebony Brown	470g	\$39.90

Extraction & Safety
Measuring & Marking
Sawing
Site & Shop Accessories
Routing
Planing
Sanding & Scraping
Drilling
Joinery
Clamps & Vices
Finishing
Sharpening
Carving & Chisels
Woodturning
Wooden Parts
Cabinet Fittings

FINISHING

\$16.90

GS-70400 | 100g

Beeswax Filler Sticks

These coloured sticks are used for repairing cracks and small holes in most wood surfaces. Can be buffed to a fine finish and coated with most materials. This pack consists of 6 sticks – one each of pale brown, orange/brown, mid brown, red/brown, dark brown and black.



from \$49.90

Evolution Hardwax Oil

Hardwax Oils are the 21st century finish of choice among more and more woodworkers. Starting off as an innovative hardwood flooring finish, it consists of 3 layers of wax oil produced from natural components. Hardwax Oil is an oxidative finish and it dries out on open air. Hardwax Oil soaks in and lightly colours the wood to form a protective film on the surface of the wood. It provides a more natural wood finish while also creating a protective layer – tough enough for flooring, leaving the natural beauty of timber for fine furniture.



It is easy to apply with minimal sanding and application of two coats that can be brushed, rolled or rubbed on. With the hardness of a polyurethane and the natural beauty of natural oils, Evolution Hardwax Oil is a unique formulation made for the Australian market with German technology. It will give your project the finish it deserves – lasting up to seven years on flooring and even more on furniture.

Size	Matt	Satin	Classic	Gloss	Price
500mL	TEM-30279	TES-30285	TEC-30282	TEG-30288	\$49.90
1L	TEM-30280	TES-30286	TEC-30283	TEG-30289	\$86.50
2.5L	TEM-30281	TES-30287	TEC-30284	TEG-30290	\$205.00
10L	TEM-30282	TES-30288	TEC-30285	TEG-30291	\$785.00

from \$11.00

Water-Based Filler



Prep Wood Filler is a water-based interior wood filler suitable for all types of timber types. It can fill cracks, holes, end grain and edges. once set, it can be sanded, screwed, stained and nailed. It dries quickly and cleans up in water.

Available in the following colours - Natural (NAT), Oak (OAK), Pine (PIN), Teak (TEA), Jarrah (JAR), Mahogany (MAH), Maple (MAP), Walnu (WAL), White (WHI), Cedar (CED), Rimu (RIM), Hardwood (HAR), Ebony (EBO) and Brushbox (BRU).

Code	Product	Price
WF***-250	250g Tubs	\$11.00
WF***-550	550g Tubs	\$17.00
WF***-020	2kg Tubs	\$39.00

Replace *** with colour code listed above

from \$92.50

Raw Stains



Whittle Wax Raw is a preparatory treatment that counteracts the darkening effect of finish application. Designed specifically for use with the Evolution Hardwax Oils, one light coat of WW Raw prior to oiling will maintain the effect and look of freshly sanded timber, keeping it looking raw after being completely finished.



Size	Light	Red	Dark	Price
750mL	PNZ-30237	PNZ-30322	PNZ-30331	\$92.50
2.5L	PNZ-30238	PNZ-30329	PNZ-30332	\$285.00

from \$34.90

Pre-Cat Lacquer



Solvent-based nitrocellulose lacquer is the dominant finish used by commercial furniture and instrument makers for its relatively low-cost coverage, ease of application, incredibly fast drying time and hardness when dry. This particular pre-catalysed lacquer is ready to spray once thinned down and is manufactured by Protec - a major chemical finishes manufacturer



Code	Product	Price	Code	Product	Price
PLS-010	1L Satin	\$37.90	PLSG-040	4L Semi	\$85.00
PLS-040	4L Satin	\$85.00	PLG-010	1L Gloss	\$37.90
PLSG-010	1L Semi	\$37.90	PLG-040	4L Gloss	\$85.00

from \$34.90



Lacquer Sanding Sealer



Before spraying nitrocellulose lacquer directly on to open-grained, spongy timbers you should use sanding sealer. Zinc stearate is added to lacquer, creating a sanding sealer that quickly builds up a layer sealing timber quickly and sands easily. It can be painted or preferably thinned down and sprayed.

Code	Product	Weight	Price
PSS-010	1L	1kg	\$37.90
PSS-040	4L	4kg	\$85.00

from \$24.90

Lacquer Thinners



This particular nitrocellulose thinner works specifically with the lacquers and sanding sealers found on this page. We cannot recommend if these thinners will work with any other finish, just the Protec range we stock.

Code	Product	Price
PLT-010	1L	\$27.90
PLT-040	4L	\$75.00

\$159.00 KITS

Two-Pack Lacquer



So called because the hardener needs to be mixed to activate the lacquer, it is a better quality, more durable finish with the hardness and viscosity able to be controlled with slight variations in the lacquer/hardener mix. Must be thinned down with lacquer thinners once activated to spray finish.

Code	Product	Price
PL-2-S-036	3.6L Satin	\$116.50
PL-2-G-036	3.6L Gloss	\$116.50
PLHD-400	400mL Hardener	\$42.50

from **\$48.90**
Bio Wax



Bio Hard Floor Wax is a blend of four natural waxes and plant oils to produce a transparent, matt finish designed to preserve the natural timber colour. This eco-friendly wax seals the pores, producing a durable, antistatic effect for your timber surfaces making it dirt and water resistant. A great alternative for lacquers and varnishes.

Code	Product	Weight	Price
PNZ-07300	500mL Tin	500g	\$48.90
PNZ-07301	2.5L Tin	3.2kg	\$162.50

\$12.90
Pure Beeswax

GS-70416 | 250g



A 200g block of pure Australian food-grade beeswax, unadulterated and 100% natural.

\$19.90
Liquid Beeswax Oil

GS-70415 | 100g



Easy-to-use, it nourishes timber, protecting from dryness and enhancing its natural grain. Rich in Western Australian pure beeswax, it can be used on finished or unfinished surfaces and is even suitable for use on a lathe. Enjoy the pleasant fragrance as you polish, knowing it is food safe.

from **\$19.90**
Carnauba Wax Flakes



Type 1 Filtered Prime Yellow Carnauba Wax Flakes sourced from the Copernica Cerifera tree in Brazil. The hardest naturally-occurring timber finish wax, available separately to be blended with other oils and waxes to make your own finishes.

Code	Product	Weight	Price
GS-70417	100g Bag	100g	\$19.90
GS-70418	250g Bag	250g	\$37.90

\$14.50 GS-70404 | 100g
Cabinetmakers Wax



Cabinet Maker's Wax is a traditional type of beeswax polish with the addition of carnauba wax. It gives an added sheen and harder finish and is excellent for filling small holes, defects and hairline cracks. Cabinet Maker's Wax is marvellous on oak, jarrah and other woods that have no specific finish.

\$14.50 GS-70405 | 100g
Carnauba Wax Polish



Carnauba Polish is high sheen finishing polish, excellent for tabletops and other surfaces prone to 'fingering'. Made with beeswax and a high proportion of carnauba wax, it is very good on modern finishes. Carnauba Polish brings up a lovely finish on marble, tortoiseshell and is good for preventing tarnish of metal. Carnauba Polish is excellent for decoupage.

\$15.00
New Timber & Restoring Polish



Ideal for restoration and new timber work, this wax will nourish and enhance the natural grain of your timber. Gilly Stephenson's Restoring and New Timber Polish is also effective on dark or brown leather, creating a great all rounder for restoring moisture to your dry or faded furniture.

Code	Product	Weight	Price
GS-70402	Clear	100g	\$15.00
GS-70403	Dark	100g	\$15.00

\$19.90
Cream Polish



Gilly Stephenson's Cream Polish is made with the finest West Australian beeswax to an old English recipe. The Cream Polish is emulsified, making it easy to apply, whilst giving the furniture the goodness it requires. The Cream Polish is recommended for general maintenance and the best polish for French polished furniture.

Code	Product	Weight	Price
GS-70407	Lavender	230g	\$19.90
GS-70408	Lemon	230g	\$19.90
GS-70409	Rose	230g	\$19.90

\$14.90
Chopping Board Oil



Rejuvenate and protect your chopping boards with our trio of citrus-based Chopping Board Oils. Easy to use, with a delightful fragrance and have the added benefit of mould-resistance.

Code	Product	Weight	Price
GS-70411	Orange 100mL	110g	\$14.90
GS-70412	Lemon 100mL	110g	\$14.90
GS-70413	Citrus & Beeswax 100mL	110g	\$14.90

\$19.90 GS-70414 | 250g
Food Safe Wax



A rich, soft wax perfect for a natural finish on a variety of raw timber surfaces, including children's furniture, chopping boards and food serving utensils. Easy to apply and penetrates deeply into the fibres to nourish and protect. Imparts a matt sheen.

\$19.90 GS-70410 | 300g
Orange Oil

Not all 'Orange Oil' is the same; many are diluted with cheap petro-chemical derived solvents. Gilly Stephenson's contains the highest percentage of pure orange oil of all of its competitors. Perfect for using as a cleaning and rejuvenating oil over the top of any finished surface - whether it was oiled, varnished or lacquered, Orange Oil will lift out dirt and grease as well as re-invigorate the finish. Best results occur when used cleaning furniture regularly.



from **\$19.90**
Feed-N-Wax

- ✓ Enhance the natural beauty and depth of grain in finished and unfinished wood.
- ✓ Prevent drying and deterioration of all wood finishes.
- ✓ Polish all wood surfaces to a soft lustre and protect with a coating of natural waxes.



Code	Product	Weight	Price
HFW-236	236mL	250g	\$19.90
HFW-480	480mL	250g	\$29.90

Extraction & Safety
Measuring & Marking
Sawing
Site & Shop Accessories
Routing
Planing
Sanding & Scraping
Drilling
Joinery
Clamps & Vices
Finishing
Sharpening
Carving & Chisels
Woodturning
Wooden Parts
Cabinet Fittings

Flocking

Most woodcraft surfaces are finished in clear varnish to bring out the grain and colour of beautiful timber, but there are some places where a finish which hides the timber is preferable. For example the bottom of a small box can be made of ply if both the inside of the box and the bottom are coated. But what coat do you use? Paint is OK but wears and does not enhance a work of art.

Years ago, people used "contact suede" similar to the surface of a billiard table. Now flocking powder is available. It gives you the same suede finish but is a lot easier to apply and makes it easier for you to get a professional finish. It comes in two separate parts. One is a tin of glue, the other is a bag of flocking powder. These both need to be the same colour. For instance, royal blue powder is always used with royal blue glue.

It is easy to work with. Firstly paint the glue onto the area to be covered. It is a good idea to apply sanding sealer before the glue to reduce absorption of the glue into the wood and make the glue go further. Apply the glue carefully and neatly to get the flocking to stick.

Simply shake the flocking powder over the glued surface. Ensure the fibres are broken up as much as possible and we recommend using a fine cooking sieve for this to get a thin even application. Make sure it is well-coated because any powder that is not required will not adhere and can be brushed off and stored for future use.

An 85g powder and 250mL glue pack will cover an area approximately 1.5m².

from **\$21.90**

Emerald Green Flocking

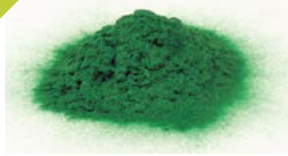

Code	Product	Weight	Price
FPEG-85	Powder 85g	80g	\$21.90
FPEG-450	Powder 450g	490g	\$99.00
FGEG-200	Glue 200mL	320g	\$13.90
FGEG-010	Glue 1L	1.1kg	\$39.90

from **\$21.90**

Red Flocking



Code	Product	Weight	Price
FPRD-85	Powder 85g	80g	\$21.90
FPRD-450	Powder 450g	490g	\$99.00
FGRD-200	Glue 200mL	320g	\$13.90
FGRD-010	Glue 1L	1.1kg	\$39.90

from **\$21.90**

Royal Blue Flocking



Code	Product	Weight	Price
FPRB-85	Powder 85g	80g	\$21.90
FPRB-450	Powder 450g	490g	\$99.00
FGRB-200	Glue 200mL	320g	\$13.90
FGRB-010	Glue 1L	1.1kg	\$39.90

from **\$21.90**

Burgundy Flocking



Code	Product	Weight	Price
FPBY-85	Powder 85g	90g	\$21.90
FPBY-450	Powder 450g	490g	\$99.00
FGBY-200	Glue 200mL	320g	\$13.90
FGBY-010	Glue 1L	1.1kg	\$39.90

from **\$21.90**

Black Flocking



Code	Product	Weight	Price
FPBL-85	Powder 85g	80g	\$21.90
FPBL-450	Powder 450g	490g	\$99.00
FGBL-200	Glue 200mL	320g	\$13.90
FGBL-010	Glue 1L	1.1kg	\$39.90

from **\$26.90**

Glasscoat



Glass Coat provides a clear pour-on glass-life finish to wood, metal, ceramics, tiled and slate floors, terracotta – in fact almost any non-porous surface will achieve a stunning affect with the application of Glass Coat.

The finished surface is heat-resistant and completely water-proof when cured and is equal to many coats of polyurethane or any traditional varnish. Its easy to apply, safe to use and virtually odourless (no resin smell at all).

Code	Product	Price
GCOAT-250	250mL Kit	\$26.90
GCOAT-500	500mL Kit	\$44.90
GCOAT-010	1L Kit	\$79.00
GCOAT-020	2L Kit	\$145.00
GCOAT-001	10L Kit	\$599.00
GCC-250	250mL Cleaner	\$9.90
GCC-500	500mL Cleaner	\$14.00

from **\$14.90**

End Check Wax Sealer



End Check is a cost-effective liquid wax sealer that should be painted on green sawn timber immediately after being milled. Coating the end grain where moisture evaporates most quickly, it slows down the drying process and reducing splits whilst it is air drying. Paint the end grain and a minimum 100mm section on all sides immediately from the end grain for greatest effectiveness.

Code	Product	Weight	Price
EC-010	1 litre	1.1kg	\$14.90
EC-020	2 Litre	2.5kg	\$24.90
EC-002	20 Litre	25kg	\$195.00

from **\$19.90**

Leather Care Wax

GS-70419 | 250g



The ideal way to care for your leather goods from furniture to saddlery and bags to shoes. Containing beeswax and orange oil it is easy to use and nourishes the leather leaving it supple and therefore more resistant to dirt and staining. Non-toxic, water resistant and non-staining.

from **\$21.90**

Beige Flocking



Code	Product	Weight	Price
FPBE-85	Powder 85g	80g	\$21.90
FPBE-450	Powder 450g	490g	\$99.00
FGBE-200	Glue 200mL	320g	\$13.90
FGBE-010	Glue 1L	1.1kg	\$39.90

from **\$21.90**

Charcoal Grey Flocking



Code	Product	Weight	Price
FPCG-85	Powder 85g	90g	\$21.90
FPCG-450	Powder 450g	490g	\$99.00
FGCG-200	Glue 200mL	320g	\$13.90
FGCG-010	Glue 1L	1.1kg	\$39.90

from **\$21.90**

Rust Flocking



Code	Product	Weight	Price
FPRU-85	Powder 85g	90g	\$21.90
FPRU-450	Powder 450g	490g	\$99.00
FGRU-200	Glue 200mL	320g	\$13.90
FGRU-010	Glue 1L	1.1kg	\$39.90

\$199.00 Slow-Speed 8in Bench Grinder



SHERWOOD

MDN-200-SL | 19kg

Sherwood bench grinders have been coming from the same factory since 1999 and this latest model covers virtually every need a woodworker has in a bench grinder. Heat is the enemy of woodworking steel and this bench grinder runs at 1,400RPM so heat build-up is reduced when sharpening your woodworking tools. The 375W 4-pole motor has twice the torque of 2,800RPM 2-pole motors so while the motor output is lower, it will still perform well when grinding tool steel. It comes mounted a cast-iron base to absorb vibration and has the following specifications –



- ✓ 375W (1/2HP) 1400RPM induction motor designed for continuous running
- ✓ Aluminium oxide 60-grit 250 x 25mm wheel for shaping grinds and has an adjustable 70 x 40mm toolrest
- ✓ Aluminium oxide 120-grit 250 x 40mm wheel for finer grinding and has an adjustable adjustable 85 x 40mm toolrest
- ✓ Crystal clear perspex eye-guards for better viewing of grinding when in use

\$49.90 Bench Grinder Toolrest



This accessory suits 6in and 8in bench grinders and is capable of a wide range of angles, making it versatile for sharpening virtually all woodworking tools.

- ✓ Massive 190 x 85mm working surface
- ✓ Maximum height of table when positioned flat is 150mm
- ✓ Includes straight grinding guide for use when sharpening square edge blades
- ✓ Spring loaded clamping handles lock the table in place securely and stay out of the way
- ✓ Creates a hollow ground bevel which, when honed, creates a razor sharp edge



Code	Product	Weight	Price
CJ-05	Toolrest Kit	900g	\$49.90
CJ-05-WT	Woodturners Toolrest	250g	\$19.90

from \$99.00 Bench Grinders



RECORD POWER

Record Power Grinders have a long and established reputation for robustness and long lasting performance.

Both have a 40mm wide white stone ideal for giving a fine finish, particularly to HSS turning tools, while the more coarse grey stone

for rougher grinding and shaping. The bodies are cast iron to reduce vibration and give the smooth operation that is essential for successful, accurate sharpening. Rubber feet also dampen vibration whilst ensuring the grinder does not move during use.

Code	Product	Weight	Price
RP-71002	6in Wheel 350W	10kg	\$99.00
RP-71502	8in Wheel 400W	14kg	\$139.00

from \$51.00 Bench Grinder Toolrest

veritas®

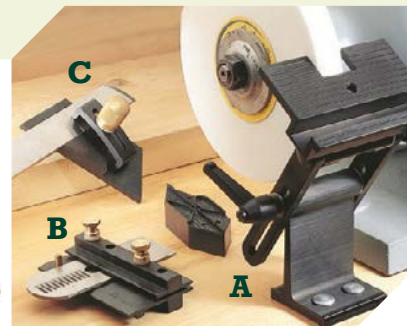

A. Can be used with 150–200mm bench grinders, mounts directly to the bench as well as be folded out of the way for freehand grinding. Slotted arms allow a wide range of angular and height adjustments.

The 102mm-wide table straddles wheels up to 26mm wide, grooved for sliding jigs and centre drilled for rotating jigs.

Included is an angle-setting gauge to set the table to the common bevel angles of 20°, 25°, 30° and 35°.

B. Put a tool in and slide it against the alignment pin and one clamping thumbscrew to square it, adjust the blade projection for bevel angle, and tighten in place. The tool is now held squarely in the jig at the chosen bevel angle.

The brass clamping bolts have nylon washers to prevent galling;

Code	Product	Weight	Price
05-M-2301	Toolrest	510g	\$86.00
05-M-0601	Straight Grinding Jig	160g	\$44.00
05-N-1301	Skew Grinding Jig	180g	\$51.00

other parts are made from hard aluminum, further hardened by anodizing to prevent wear.

High-friction pads ensure solid clamping without inadvertent misalignment.

C. To prevent digs, this jig allows you to grind a slight radius rather than a straight 20° skew. All you need to do is drill a 6.4mm hole in a tool rest to hold the base pin, or use the hole pre-drilled in the Veritas Tool Rest.

The radius of the grind is determined by the amount the skew projects from the jig.



\$19.90 Diamond Wheel Dressing Stick



DTBAR-1 | 1.5kg

Trues, dresses and cleans all types of bench grinder wheels. The 45 x 13mm impregnated industrial diamond head makes quick work of dressing the stone to expose new grit. Always recommended when you

first use the bench grinder to ensure the grinder wheel is balanced on the shaft. Simple 105mm-long solid steel knurled handle is comfortable to grip in use.



Extraction & Safety
Measuring & Marking
Sawing
Site & Shop Accessories
Routing
Planing
Sanding & Scraping
Drilling
Joinery
Clamps & Vices
Finishing
Sharpening
Carving & Chisels
Woodturning
Wooden Parts
Cabinet Fittings

SHARPENING

from **\$29.90**

ABRASIFLEX

Aluminium Oxide Grinder Wheels

Aluminium oxide grinding wheels are the woodworker's choice for bench grinding wheels as they provide a cool yet maximum cutting rate on hardened tool and high-speed steel commonly found in woodworking tools.

The grit refers to the density of the crystalline structure of the plate – the higher the density the slower the material stock removal – therefore acting as a “finer grit” but this also can lead to increased heat build-up with the chance of changing the structure of the cutting edge or “burning” the edge.



We generally recommend a 46 or 60 “Grit” wheel for most woodworking applications.

Each wheel contains nested bushings to accommodate a wide variety of standard arbor sizes

Code	Product	Weight	Price
AOW-150-X	150x25mm 46grit	950g	\$29.90
AOW-150-C	150x25mm 60Grit	950g	\$29.90
AOW-150-F	150x25mm 120Grit	950g	\$29.90
AOW-20025-X	200-25mm 46Grit	1.2kg	\$44.90
AOW-20025-C	200-25mm 60Grit	1.2kg	\$44.90
AOW-20025-F	200x25mm 120Grit	1.2kg	\$44.90
AOW-20040-X	200x40mm 46Grit	1.5kg	\$69.90
AOW-20040-C	200x40mm 60Grit	1.5kg	\$69.90
AOW-20040-M	200x40mm 80Grit	1.5kg	\$69.90

\$8.50

Carborundum Wheel Dressing Stick

ABRASIFLEX
86095-CS | 200g



A simple method of dressing grinder wheels – the coarse grit is harder than aluminium oxide and

will slowly but effectively true up the plate and expose new a cutting face on bench grinder wheels.

From **\$49.00**

Felt Buffing Wheels

Veritas



The finest edge you can get on any tool is with a strop or a buffing wheel. A hard felt wheel is best for straight edge blades.

When the wheel is dressed with the Veritas blade honing compound, the edge obtained is comparable to most razor blades.

Code	Product	Weight	Price
08-M-4103	Hard Felt 150 x 19mm	950g	\$62.00
08-M-4105	Hard Felt 150 x 25mm	950g	\$74.00
08-M-4003	Medium Felt 150 x 19mm	950g	\$49.00
08-M-4105	Medium Felt 150 x 25mm	1.2kg	\$65.00
08-M-4203	Shaped Felt	1.2kg	\$114.00

\$179.00

HGK-01 | 2.1kg

HeliGrind Sharpening System



The HeliGrind Sharpening System is the only jig on the market that will sharpen gouges on the helical path – the ideal way to sharpen all your woodturning gouges. This type of grind is known as either a fingernail or sidegrind and is recommended but virtually impossible to grind accurately freehand.



The HeliGrind is a versatile jig that is fixed in front of your bench grinder and has several attachments to simplify and make more accurate sharpening grinds of a range of different tools.

1. Woodturning bowl and spindle gouges – the gouge is clamped into an inner cylinder that can be easily rotated via a fully-sealed guide bearing seated against the outer solid, cast bronze holder. This patented system was designed to follow the correct path for producing the best type of grind on your gouges.

It means that every time you re-grind, you remove a tiny and constant thickness of steel, extending the life of both your tools and grinding wheels. It also means that the geometry of the tip won't change, allowing your tools to display the same properties every time you use them.

The nose of the gouge is pushed up the wheel along the helical path to produce the optimum shape without having to constantly reset the jig as you grind the wheel down.

2. The HeliGrind System also allows you to sharpen skew chisels by attached the preset holder to grind at the popular 20° angle.

It produces hollow ground edges, which provides a superb two-point bearing that makes the grinding self-jigging.

3. There is also a conventional toolrest in the kit, which can be quickly attached to provide a flat plate in front of the wheel – perfect for scrapers and other chisels.

Extraction & Safety
Measuring & Marking
Sawing
Site & Shop Accessories
Routing
Planing
Sanding & Scraping
Drilling
Joinery
Clamps & Vices
Finishing
Sharpening
Carving & Chisels
Woodturning
Wooden Parts
Cabinet Fittings

\$349.00

10in Wetstone Grinder

The basis of the Sherwood Wetstone Grinding System is the grinder itself. Well specified with the below features, the cool running wet grinding system will allow you to sharpen a range of edges to a razor-sharp finish in a cost-effective package.

- ✓ Powerful 180W induction motor provides quiet & efficient operation
- ✓ High-grade 220 grit stone sharpens woodworking tools efficiently
- ✓ Water trough keeps the stone wet & the grinding surface cool, preventing overheating
- ✓ Leather honing wheel creates razor-sharp, polished edges in one compact machine

- ✓ Horizontal mounts for support arms maintain the correct angle for honing the blade
- ✓ Vertical mounts for support arm for perfect positioning of the blade for sharpening
- ✓ Standardized 12mm mounting bar system suits wide range of sharpening jig brands
- ✓ Rubber feet keep the machine steady & minimise vibration

Shown here with the Grinder Setup Kit that includes all the accessories shown in the image that you can purchase in one neat package to get started. And then simply pick the jigs you are going to use to complete the system.

SHERWOOD



Code	Product	Weight	Price
SWG-1001	10in Wetstone Grinder	17kg	\$349.00
SWGAKIT-1	Grinder Setup Kit	900g	\$39.90
SWGA-03	Angle Set-Up Jig	60g	\$9.90
SWGA-04	Metal Polish	150g	\$14.90
SWGA-05	Stone Grader	500g	\$8.90
SWGA-08	Wetstone Grinder Machine Cover	175g	\$34.90

\$21.90

Tool Rest

Creates a large, 88 x 107mm stable platform for sharpening a variety of tools. Especially good for larger bevel angles



SWGA-17 | 300g

\$39.90

Short Knife Jig

Use for short kitchen knives to create a razor-sharp edge.



SWGA-09 | 200g

\$29.90

Straight Edge Jig

Suits chisels, plane irons etc. up to 40mm wide.



SWGA-13 | 225g

\$17.90

Support Arm Extension

Provides simultaneous tool support above the grindstone and honing wheels.



SWGA-02 | 600g

\$44.90

Long Knife Jig

Use for long or thin flexible filleting knives. Broad clamping head holds blade securely.



SWGA-10 | 260g

\$59.90

Plane Camber Jig

Suits all standard plane irons. Puts an even, slight radius onto the edge. Camber creates improved shearing action.



SWGA-14 | 450g

\$49.90

Diamond Truing Tool

Easy to setup for quick restoration of the grinding surface than standard stone grader. The back bar controls rate of material removal.



SWGA-06 | 200g

\$57.90

Scissor Jig

Restores sharp edge to blunt scissors and can be used on garden shears. Twin clamps to completely secure blades.



SWGA-11 | 500g

\$39.90

Turning Gouge Jig

Controlled, accurate sharpening of all types of woodturning gouges, including fingernail grind.



SWGA-15 | 175g

\$74.90

Profiled Leather Honing Wheel

Gets inside turning chisels and carving gouges plus V-parting tools. Produced from solid tanned leather.



SWGA-07 | 300g

\$29.90

Axe Jig

Holds hatchet and axe heads securely for efficient repeatable sharpening to keen edge.



SWGA-12 | 200g

\$19.90

Carving Tool Jig

For accurate sharpening of carving tools and other short tools. Clamps narrow and butt chisels firmly. Internal 'V' shape automatically centres the tool. Will also clamp power tool carving blades.



SWGA-16 | 160g

SHARPENING

Extraction & Safety
Measuring & Marking
Sawing
Site & Shop Accessories
Routing
Planing
Sanding & Scraping
Drilling
Joinery
Clamps & Vices
Finishing
Sharpening
Carving & Chisels
Woodturning
Wooden Parts
Cabinet Fittings

\$479.00

24in Planer Blade Sharpener



This grinder is purpose-built to sharpen jointer and planer blades up to 24in long. It works by running the 6in aluminium oxide wheel horizontally with a 375W (1/2HP) motor running at 2800RPM, and the blade carriage passing across the face of the stone.

Solid cast-iron body construction with included cast-iron base for extra stability when in use. This

unique machine will quickly save time and hassle by moving your sharpening service in-house. Comes with attached for sharpening chisels and plane irons as well as a twist drill bit sharpening attachment.

Code	Product	Weight	Price
YF-624	24in Planer Blade Sharpener	38kg	\$479.00
YFG-6100	Replacement 6in Stone	1.5kg	\$44.90

\$26.00

Leather Strop

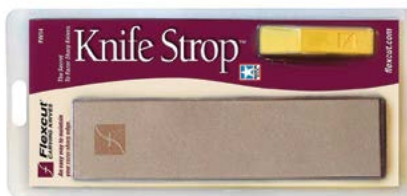

With a 203 x 51mm leather stropping surface, designed to keep your knife blades razor sharp. Simply strop your knife blade away from the cutting edge on both sides

to maintain your factory edge. Flat and sturdy construction. Includes a 28g bar of Flexcut Gold Polishing Compound.

\$24.00

Blade Honing Compound



This honing compound, which took over two years to develop, is the most effective on the market.

It is a blend of both chromium and aluminum oxide to give the best combination of cutting speed and fine finish. The bonding is formulated for ease of charging. It will adhere equally well to felt, leather or wood.

Cuts quickly but it leaves a mirror finish with a light wax film. The average size of scratch pattern it leaves behind is 0.5 microns or



0.00002in. Ideal for carving tools and firmer gouges, it can be used for final honing of almost any tool. Used with a felt wheel or leather belt for power honing or with a leather strop for hand honing.

\$11.50

Strop Honing Compound



KIR-0375 | 30g



A traditional German strop honing compound used for generations to get razor-sharp edges on tools. Two

7.5g blocks are included in each package.

\$379.00

Circular Saw Blade Sharpener



A simple yet effective benchtop machine so you can sharpen your own circular saw blades when you need to! As it is a manual sharpening machine it will take a short bit of experience to get efficient at sharpening your blades but practice will quickly improve sharpening times. It is easy to setup and use straight out of the box.

- Efficient 250W motor drives

125mm diamond coated grinding wheel

- Wheel can be tilted +/- 20° to suit alternate-tooth bevel (ATB) blades
- Cradle can be swiveled to suit all positive and negative-rake blades
- Can sharpen blades 160 - 500mm diameter
- Heavy-duty cast-iron base for extra stability

\$163.00

Grey Iron Lapping Plate



Measuring 305 x 105 x 29mm high and weighing approximately 6.35kg, this is one substantial lapping plate! Made from an iron chosen for its dimensional stability and material consistency, the bottom and sides are machined, and the top is ground flat to within 0.025mm over the entire surface. The unique channel design is, optimized for a figure-eight lapping pattern. For fingertip safety, the channels have been chamfered to eliminate sharp edges and corners. Not intended for heavy



material removal, it is designed to condition or smooth previously ground surfaces and is used with light mineral or honing oil and Abrasive lapping grits.

\$44.00

Steel Lapping Plate



Precision-ground to a flatness tolerance of 0.13mm over the entire surface, this honing plate is an excellent substrate for diamond paste. Made of dimensionally stable low-carbon steel, it will retain its flatness over a lifetime of ordinary use; unlike sharpening stones, it will never need truing. It measures 203 x 76 x 10mm and weighs just under 1.1kg.



\$24.⁹⁰
Deluxe Honing Guide



MJ-847 | 300g

This guide will clamp blades and chisels anywhere from 0 – 63mm by sandwiching the blade between the base and clamp. The brass nuts and nylon washers make it easy to have good clamping pressure without over-tightening and



damaging your tool or the guide. The 40mm-wide brass roller provides stability when rolling on the stone. This can be removed to expose a ledge that can then be run against your bench grinder tool rest to use as a straight grinding jig.

\$117.⁰⁰
MK II Sharpening System



05-M-0901 | 820g

The key to consistent and fast honing is repeatability – and this guide delivers it in spades. Whether you're a sharpening veteran or just starting out, this versatile guide lets you concentrate on sharpening without worrying about controlling blade angle at the same time.



This makes your honing reliable, accurate and consistent.

This standard set includes both Standard Honing Guide (with straight roller base) as well as the Angle Registration jig. The Standard Honing Guide accepts blades ranging 12 – 73mm wide.

\$14.⁹⁰
Alloy Honing Guide



MJ-817 | 260g

A simple universal design that has been around for years and still "does the job". This one is manufactured in Taiwan so has clean, accurate castings and is well



assembled. Will clamp any blades 3.2 – 76.1mm wide and runs on a simple alloy wheel on the stone. Great value-for-money.

\$57.⁰⁰
Skew Registration Jig



05-M-0903 | 600g

Veritas Skew Registration Jig locks into the MkII honing guide to make quick work of setting both skew and bevel angles (left- or right-hand) of chisel and plane blades. The jig's machined aluminum base provides skew angle markings



that are laser etched for accuracy and legibility. The skew angle graduations cover the range of 10° to 45° in 5° increments, and there are additional marks (18°, 22°, 28°) to cover the angles of popular skew plane blades.

\$30.⁰⁰
**Lubricant/
 Rust Inhibitor
 Camellia Oil**

CO-240 | 250g

Japanese craftsmen have used this oil for generations as an effective rust inhibitor. It can also be used a



liquid lubricant when sharpening if water is not suitable.

\$44.⁰⁰
**Camber Roller
 Only**



05-M-0905 | 600g

The included straight roller hones straight edges. At 50.8mm wide, it provides a stable base for even the narrowest of blades. The barrel-shaped camber roller



(available separately) lets you rock the guide slightly to hone a slight curve or camber into a blade edge, eliminating blade tracks when planing.

\$15.⁰⁰
**Brass Bevel
 Angle Gauge**



50-K-0901 | 40g

Half the secret of sharpening is the control of blade geometry. Nothing is handier than a bevel gauge for quickly checking the grind angle of chisels, plane blades, turning tools, etc. A quick check confirms the angle last used for grinding or



honing so that the edge geometry can be maintained. The slots on the gauge are about 19mm deep for good registration. The pocket-sized disc is 63mm in diameter with a center hole for hanging it on a nail.

\$86.⁰⁰
**Narrow Blade
 Head Only**



05-M-0909 | 200g

The narrow blade head replaces the standard head and clamps blades 3.2 - 38mm wide using parallel jaws to ensure blades stay square to



the jig. Whether they have bevelled or square edges, blades are kept centered and tight to the reference face of the jig by the canted jaws.

SHARPENING

\$100.00
Stone Pond

Veritas®
05-M-2006 | 3.5kg



The Stone Pond is a complete system to store, use and maintain water stones up to 305mm long. Stones can be stored, ready for use, in a stand that also clamps them and provides a base for lapping. The twin-clamping system holds

both coarse and fine stones at the same time and the quick-acting cam clamps are fully adjustable. There is ample space for three or more bench stones. Stones are kept clean and evaporation is minimized.

from **\$10.00**
Abrasive Lapping Grits

Veritas®



Silicon carbide is ideal for flattening oil and water stones or lapping plane bottoms and blades. Just sprinkle the grit on a piece of glass or a steel lapping plate, add a shot of oil or water (as required), and lap the item flat.

90x is used for most applications, while the finer grits are used to put a silky finish on plane bottoms or blades. Grits are available individually or as a set of five 2 oz containers.

Code	Product	Weight	Price
05-M-0101	Five-Grit Kit	450g	\$44.00
05-M-2007	90X Grit	200g	\$10.00
05-M-0104	180X Grit	200g	\$10.00
05-M-0105	280X Grit	200g	\$10.00
05-M-0106	400X Grit	200g	\$12.00
05-M-0107	600X Grit	200g	\$13.00

\$38.00
Waterstone Flattening Plate

KING

WSF-150 | 450g



Ceramic formed stone with reliefs cut in designed to be used to flatten ceramic water stones only once they have become dishd from

prolonged use. Measures 150 x 50 x 27mm. Will not work with oil stones.

from **\$25.90**

Natural Belgian Crumb Stone



A traditional natural-occurring honing stone quarried from, yep Belgium! Will provide an extra-fine honed edge on your tools – especially suited for carving chisels. Natural shape varies with stone size.

Code	Product	Price
KIR-370203	20cm ²	\$25.90
KIR-370205	30cm ²	\$46.90
KIR-370206	35cm ²	\$63.50

\$79.90
Sharpening Set of 3



KIR-3703 | 340g



Includes two Arkansas sharpening stones – soft for quick sharpening and hard for creating a fine edge as well as a bottle of honing oil. Great kit for cabinet and carving chisel sharpening.

\$49.90
Set of 4 Arkansas Slip Stones



KIR-3704 | 90g



- ✓ Cut from natural Arkansas Stone
- ✓ Use with honing oil shown below
- ✓ 4 different shaped stones for all

carving chisel shapes
Supplied in cardboard display box

\$76.50
100 x 50mm Arkansas Stone

KIR-3706 | 250g



Cut from natural Arkansas stone, to be used with honing oil below, it comes in a handy storage wooden box and is perfect for getting a very sharpe edge on cabinet and other straight edge chisels.

\$17.90
Stone Honing Oil



KIR-3708 | 140g



Lubricates oil stones and prevents metal particles from glazing on the surface. Supplied as 120mL bottle.



Search **Timbecon** on Instagram to keep updated with all our promotions.

\$37.⁹⁰ Coarse Bench Waterstones



King is the major producer of manufactured ceramic waterstones in Japan and for good reason – they produce the best low-cost manufactured stones in the country and generally regarded as the industry-standard waterstone, not only in Japan but also Australia. The 300grit stone can be used for reshaping tools and/or for use on coarse steels like gardening

tools etc. The 800grit stone is for repairing major nicks in your woodworking blades and chisels or for your general household sharpening. The 1200grit stones are perfect for giving your tools a quick touch-up if you sharpen regularly before moving on to your finer grit stones.

These stones should be stored in water when not being used.

Code	Product	Weight	Price
WS-300	300 Grit	1.2kg	\$37.90
WS-800	800 Grit	1.1kg	\$37.90
WS-1200	1200 Grit	970g	\$37.90

from \$39.⁹⁰ Fine Bench Waterstones



Used for the final sharpening process – simply sprinkle a few drops of water on for lubrication and put that razor-sharp edge on

your tools. The 4000 grit stone is good value-for-money whilst 6000 grit will provide a very fine edge for a few more bucks.

Code	Product	Weight	Price
WS-4000	4000 Grit	450g	\$39.90
WS-6000	6000 Grit	450g	\$44.90

\$139.⁹⁰ Superfine Bench Waterstone



For the ultimate edge on your tools you can't go past this stone. A very generous size for all chisels and plane blades (210 x 73 x 22mm), this stone comes on its own stand. The abrasive

used in the manufacture of this stone is of the highest purity, ensuring that you receive a top-quality man-made stone. Comes with its own cleaning stone.

WS-8000 | 1kg

from \$34.⁹⁰ Combination Bench Waterstone & Holder



Combination Bench Waterstone
A cost-effective method of buying two stones-in-one. Supplied as a reversible 1000/6000grit combination, this stone will suit most woodworkers as the 1000grit side can be used for preparing and dressing the tool, whilst the 6000grit stone can be used to finish the sharpening process.

Bench Stone Holder
Stop your water stone sliding all over the bench. Made in Taiwan of quality stainless steel and non-slip rubber so that it can be used to suspend in your water bath when not in use, this will hold stones of any width and thickness and a length of 180-230mm.

Code	Product	Weight	Price
WS-16000	Waterstone 1000/6000grit 210x66x36mm	980g	\$75.00
BSH-100	Stone Holder Suits Bench Stone	300g	\$34.90

From \$49.⁰⁰ Multi-Form Water Slip Stones



These Japanese manufactured products have a series of concave forms, ideal for honing carving

chisels. Also included is one double-sided convex slip stone for inside the gouge.

Code	Product	Weight	Price
PWS-1000	1000 Grit	300g	\$59.00
PWS-4000	4000 Grit	300g	\$49.00

\$18.⁰⁰ Nagura Stone Cleaner



NGS-1 | 40g

Cleans ingrained surface scum on water stones. Simply run the stone multiple times over the surface to lift filings and other waste from the stone to freshen the sharpening

surface. It will also create a slurry of water and stone particles on the face of your water stone, providing an excellent sharpening surface.

from \$26.⁰⁰ Water Slip Stones



These slip stones are made to a specified hardness to best combine cutting speed and durability. Widely used for sharpening firmer gouges; scribing gouges; carving tools and radiused blades; these stones

can be used on nearly any curved cutting edge of simple or compound shape. The coarsest slip (1000x) is the fastest cutting and is used for establishing a basic edge. Also available in 4000x and 8000x.

Code	Product	Weight	Price
60-M-9001	1000 Grit		\$26.00
60-M-9002	4000 Grit		\$30.00
60-M-9003	8000 Grit		\$49.00

Extraction & Safety
Measuring & Marking
Sawing
Site & Shop Accessories
Routing
Planing
Sanding & Scraping
Drilling
Joinery
Clamps & Vices
Finishing
Sharpening
Carving & Chisels
Woodturning
Wooden Parts
Cabinet Fittings

SHARPENING

Extraction & Safety

Measuring & Marking

Sawing

Site & Shop Accessories

Routing

Planing

Sanding & Scraping

Drilling

Joinery

Clamps & Vices

Finishing

Sharpening

Carving & Chisels

Woodturning

Wooden Parts

Cabinet Fittings

from \$59.90

Single-Sided Diamond Plates



Ezelap diamond plates have been manufactured in the US since the 1970s and use a unique process and modern technology to produce the highest quality diamond plates. The continuous diamond plates cut the fastest and most efficiently, with the best edge produced of any diamond plate worldwide. The high-quality industrial-grade diamonds are bonded on to a 1/4in thick steel plate substrate to

ensure perfect flatness and long-life durability. Once coated the plates are approximately 6.5mm thick. Unlike cheap Asian diamond plates, as the diamond surface wears down, more and more diamonds are exposed and the sharpener cuts faster. When more pressure the plate will cut even faster. With care these sharpeners can last a lifetime.

Code	Size	Product	Weight	Price
61-F	150 x 50mm	600 Grit	420g	\$59.90
61-SF	150 x 50mm	1200 Grit	420g	\$59.90
81-F	200 x 75mm	600 Grit	800g	\$115.00
81-SF	200 x 75mm	1200 Grit	800g	\$115.00

from \$99.00

Double Sided Diamond Plates



Most woodworkers need two grits to sharpen their tools – a medium or fine grit to touch up edges and super-fine to finish off. These double-sided plates offer great value-for-money as you can get both in one compact package.

Each sharpener is approximately 2.7mm thick and uses the same high-quality industrial diamonds as all Ezelap products and the two plates are set into a durable plastic cradle that maintains long-term durability and plate flatness.

Code	Size	Product	Weight	Price
DD-6-FC	150 x 50mm	250/600 Grit	700g	\$99.00
DD-6-SFF	150 x 50mm	600/1200 Grit	700g	\$99.00
DD-6-SFM	150 x 50mm	400/1200 Grit	700g	\$99.00
DD-8-FC	200 x 75mm	250/600 Grit	800g	\$159.00
DD-8-SFF	200 x 75mm	600/1200 Grit	800g	\$159.00
DD-8-SFM	200 x 75mm	400/1200 Grit	800g	\$159.00

\$19.90

75 x 25mm Diamond Plate



26-F | 1kg



These diamond plates are perfect for hunting and fishing knives, woodworking tools, blades, axes and industrial use. No oil or water is

necessary, the surface will remain true and flat. Includes a groove for fish hooks and comes with durable leather pouch for storage.

\$23.90

80 x 50mm Diamond Plates



A great economy option to the bigger and heavier diamond plates. The high-quality industrial-grade diamonds are bonded to a thin flat

steel plate substrate and are great for small woodworking tools and other items needing a keen edge. Approximate thickness is 1.35mm.

Prod Code	Product	Weight	Price
201-F	600 Grit	40g	\$23.90
200-SF	1200 Grit	40g	\$23.90

from \$14.90

Diamond Hand Laps



These hand laps are the versatile little sharpeners that can. On a durable 100x19mm plastic handle, the diamond plate measures 50 x 20mm and they are great for sharpening virtually anything – scissors, spade bits, knives, fish

hooks or anything else you can think of. Available in a wide range of grits or as two different kits.

LP-3 kit includes popular 400, 600 & 1200 grits.

LP-5 kit includes full range 110, 250, 400, 600 & 1200 grits.

Code	Product	Weight	Price
LC	250 Grit	20g	\$24.90
LM	400 Grit	20g	\$19.90
LF	600 Grit	20g	\$14.90
LSF	1200 Grit	20g	\$14.90
LP-3	Set of 3	90g	\$44.90
LP-5	Set of 5	100g	\$79.90

\$34.90

Diamond/Ceramic Double-Sided Stone

CD-4 | 80g



This double-sided plate is a super-fine diamond/ceramic combination finishing stone to give you the finest edge possible on all tools.

No need to strop once you have used one of these. Comes with a durable quality leather pouch.

\$59.90

Dual Grit Foldable Hand Lap



510 | 150g



EZE-Fold models have a carrying case that unfolds into a handle. When closed the case protects the diamond surface and when open, the case becomes a functional handle.

Get two popular grits – 400 and 1200-Grit in the one unit. The diamond plate areas measure 102 x 19mm each.

\$44.90

Oval Foldable Hand Lap



591 | 100g



EZE-Fold models have a carrying case that unfolds into a handle. When closed the case protects the diamond surface and when open, the case becomes a functional handle.

A great shape for a variety of applications including the sharpening of kitchen knives plus other long sharp edges. Available in the most popular 600-Grit (fine) model.

\$149.00

Double-Sided Bench Stone



New interlocking magnetic nitrile rubber stone holders safely hold your bench stone steady on a work surface. They can also hold a range of other regular diamond stones including the smaller tricky to hold credit card size stones. Stone holders also available separately.

At its core is a precision ground, tool steel plate that provides the first building block of an ultra-flat diamond surface

Monocrystalline diamond plates are made of high quality rust-proof stainless steel

Laminated is then pressure bonded together using a high specification 3M adhesive

Every stone is flatness checked to 0.045mm or less over entire length

Double Sided 300-1000 Grit for fast stock removal plus fine honing and finishing in one package

Supplied with cleaning block and well-made canvas storage wallet with a Velcro strip fastener is included

Code	Product	Weight	Price
MP-20019	Double-Sided Bench Stone	980g	\$149.00
MP-20021	Diamond Stone Holders	90g	\$19.90

\$39.90

Twin Handle Diamond Lap



Inspired by the traditional spoke shave, the Twin Handle File has been developed to enable the user to employ both hands when sharpening using the double-sided 125 x 25mm diamond plates.

100/300# Combo - The 100# is extra coarse and has the highest

abrasion rate helping to remove blade nicks more quickly with the 300# preparing or even finishing the blade edge of a mower.

300/600# Combo - The 300# would prepare an Axe or Shears edge; Allowing the 600# to hone and finish it.

Code	Product	Weight	Price
MP-20015	100/300grit	130g	\$39.90
MP-20013	300/600grit	120g	\$39.90

\$39.90

80 x 50mm Dual Sided Stone



MP-20011 | 80g



The credit card diamond stone is a handy little sharpener, successfully used for years by woodworkers, crafters through to other groups

such as fishermen and gardeners. Now comes with handle to make it easier to use. 300/600 grit combination for general purpose use.

\$36.90

Single Handle Diamond Lap



MP-20017 | 110g



A sturdy "general purpose" file. As with the rest of the Diamond Cross file range, they have a single solid piece of 1/16th Stainless Steel at their core which runs right through under the handle providing

a comfortably robust feeling. Can be used for sharpening any number of different tools found in the kitchen, workshop or garden shed. 300/600 grit combination for general purpose use.

from **\$135.00**

Fasttrack Sharpening System



Buy the Basic Fasttrack Sharpening System and get the standard 220grit and 450grit plates. The Complete Fasttrack System builds on this to include the deburring plate, remaining three different grit plates and storage pouch all in one low price!

- Safe - Simple - Quick to use.
- No set up time and no experience needed!
- Unique lateral sharpening action ensures a razor sharp edge with a flat ground finish.
- The blade remains stationary when sharpening - so it's very safe.
- Sharpens square edge chisels and plane irons from 3 - 64mm

(1/8 - 2 1/2in).

- Change the grade of Diamond Cross stone instantly via magnetic lock
- Change the sharpening angle from 25° primary to 30° secondary in seconds.
- Lift slightly to hone fine micro-bevel
- Built to last - Machined in solid aluminium and finished in a hard wearing anodize.
- Sharpening system carriage runs on Nylon 66 slip rails for a smooth action.
- Deburring plate installs in Fasttrack to remove burr when removing sharpened edge all in one motion

Code	Product	Weight	Price
MP-20027	Basic Fasttrack Sharpening System	1.10kg	\$135.00
MP-20023	Deburring Plate	22g	\$19.90
MP-20025	Extra Coarse (100 Grit) Plate	40g	\$22.90
MP-20037	Preparation (220 Grit) Plate	40g	\$22.90
MP-20035	Standard Finish (450 Grit) Plate	40g	\$22.90
MP-20033	Fine Finishing (600 Grit) Plate	40g	\$22.90
MP-20039	Super Fine (1000 Grit) Plate	40g	\$22.90
MP-20031	Storage Pouch	150g	\$22.90
MP-20027-KIT	Complete Fasttrack Sharpening System	1.25kg	\$225.00

\$34.90

Router Bit Sharpener



MP-20009 | 80g



The Diamond Cross Router Bit Sharpener was created directly from prototype tester's feedback to reduce the stone's width and have the handle closer to the point of

contact with either router bit edge or TCT saw blades. The 300-grit side prepares and the fine 600-grit side hones the primary edge.

Extraction & Safety
Measuring & Marking
Sawing
Site & Shop Accessories
Routing
Planing
Sanding & Scraping
Drilling
Joinery
Clamps & Vices
Finishing
Sharpening
Carving & Chisels
Woodturning
Wooden Parts
Cabinet Fittings

CARVING & CHISELS

Extraction & Safety
Measuring & Marking
Sawing
Site & Shop Accessories
Routing
Planing
Sanding & Scraping
Drilling
Joinery
Clamps & Vices
Finishing
Sharpening
Carving & Chisels
Woodturning
Wooden Parts
Cabinet Fittings



Kutzall discs are manufactured by Oliver Carbide in the USA. The company specializes in tungsten carbide coatings on a range of tools including these woodworking tools listed below.

The Kutzall Extreme discs listed below are simply the best power carving disc for an angle grinder found anywhere in the world. The Extreme pattern is more open than the Original coating, making them resistant to loading up even on softwoods and are easily cleaned with a blow torch (yes seriously! They are that tough!) when you've finished using them.

Because of their design they can be used multi-directionally without grabbing, making them easier to control and therefore providing a better, faster and most importantly, safer result.

To use on most 4in angle grinders, simply purchase CSBB-222159 bush - RRP \$5.00.

\$129.00 Extreme Dished Carving Discs



When it comes to freehand carving on your larger projects, no other tool gets the job done better than a Kutzall Dish Wheel. Paired with a quality angle grinder, these Dish Wheels have helped skilled craftsman

create truly remarkable things. The pronounced carving radius on 4 1/2in Dish Wheels is perfect for effortless contour sculpting, and adding extra levels of dimension to your creations.

Code	Product	Weight	Price
DW-412120	Coarse (Black)	300g	\$129.00
DW-41290	Medium (Blue)	300g	\$129.00
DW-41270	Fine (Green)	300g	\$129.00

\$129.00 Extreme Flat Sanding Discs



When compared to the fully-rounded Dish Wheels, the Sanding Discs have a semi-flat surface, which allows you to effortlessly level high spots,

or adjust uneven surfaces. Despite their relatively flat shape, the slight curvature will allow for controlled free-hand, flat, or convex shaping.

Code	Product	Weight	Price
SD-412120	Coarse (Black)	300g	\$129.00
SD-41290	Medium (Blue)	300g	\$129.00
SD-41270	Fine (Green)	300g	\$129.00

\$19.00 Economy Tungsten Carving Disc



D-100 | 120g

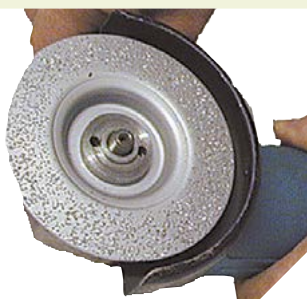

Got a one-off job or occasional need for wood sculpting with an angle grinder? This economical tungsten impregnated steel disc

fits virtually any 4in or 4 1/2in angle grinder and is great for general stock removal on virtually any timber.

\$173.00 Industrial Woodcarver Kit



(Angle Grinder Not Included)

- ✓ Freehand Power Carving in hard and soft wood
- ✓ Replaceable carbide teeth with long blade life
- ✓ Fast wood removal in sculpting
- ✓ Excellent control

Code	Product	Weight	Price
IND-200	Industrial Shaper Kit	500g	\$173.00
IND-100	Industrial blade	240g	\$156.90
IND-012	Replacement Teeth Set 3	10g	\$60.00
IND-030	Replacement Screws Set 3	10g	\$37.50
IND-040	Replace. fixing key	20g	\$46.50
ACC-100	Replacement Pro-Guard Only	280g	\$41.90
ACC-010	Replacement Nylon Washers	30g	\$9.90

\$109.00 Angle Grinder Turbo Shaft Kit



IND-500 | 240g



The TURBOShaft provides detailed freehand carving to perfectly combine efficiency and exceptional control. Fitted with replaceable carbide teeth for excellent performance and durability even in

the hardest timbers. The adjustable depth gauge makes it easy to quickly set your cutting depth. Perfect for deep and narrow profiles, detailed sculpting, letterwork, template work and more.

\$159.00 Turbo Plane Blade



IND-400 | 250g



- ✓ Freehand power carving in hard and soft wood
- ✓ Wide cutting edge per tooth leaves a smooth finish requiring minimal sanding.
- ✓ Rapid sculpting, planing and trimming
- ✓ Durable carbide teeth ensuring long blade life even in hard woods; easy to sharpen
- ✓ Ideal for free formed convex and concave shapes

\$79.00 Trade Blade



IND-115 | 400g



- ✓ Very controllable
- ✓ Easy to sharpen tungsten carbide teeth
- ✓ Use for a large variety of applications including straight cuts
- ✓ Great for carving aluminium
- ✓ Cuts most materials
- ✓ Ideal for removing old floorboards and decking with nails, cutting PVC pipes, cutting any sheet material.

\$139.00 Mini-TURBO Carving Attachment

ARBORTECH
MIN-500 | 280g



- ✓ Suitable for use with Arbortech Mini-Grinder
- ✓ Attaches to standard 100mm (4in) and 115mm (4 1/2in) angle grinders (using the supplied extension adapter)
- ✓ Replaceable/Resharpenable carbide teeth
- ✓ Extend life of carbide teeth by rotating to new sharp edge
- ✓ Can be used with guides and templates for accuracy

\$89.00 Contour Random Sander

ARBORTECH
SAN-200 | 300g

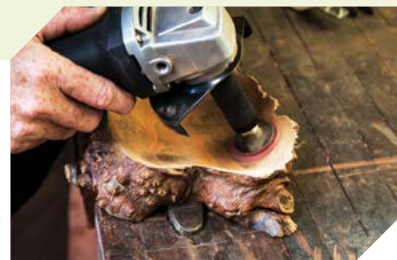

- ✓ Moulds to shape for effective sanding of shaped and sculpted forms
- ✓ Powerful random sanding action
- ✓ Does not burn or dig in at edges
- ✓ Fits to any standard angle grinder

\$249.00 Mini-Grinder

ARBORTECH



The Mini Grinder is so easy to use and lets you do everything from rough shaping to the finest details and even sanding. This tool's unique shape allows you excellent visibility and access to your work piece.

Code	Product	Weight	Price
MIN-300	Mini Carver Grinder Kit	2.6kg	\$249.00
MIN-001	Replace. blades pk2	30g	\$20.90
MIN-003	Mini pulley belt	30g	\$28.50

from \$249.00 Power Chisel

ARBORTECH

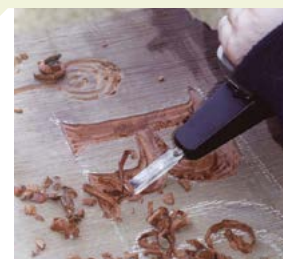

The Power Chisel is the ultimate woodworker's sidekick. You simply let the motor do the work and guide the chisel in whichever direction you prefer. The Power Chisel does everything that a traditional hammer

and chisel will, only easier and faster. The Power Chisel is so safe and easy to use that it is suitable for anyone to use, from kids to the professional woodworker.

Code	Product	Weight	Price
PCH-300	Power Chisel	2.6kg	\$249.00
PCH-050	Service Kit	100g	\$20.90
PCH-055	Oil Kit	100g	\$20.90

from \$25.90 Mini-Grinder Blades

ARBORTECH



Find that you're using your Mini Grinder a lot? Or do you need to do some fine cut-off work similar to the larger Industrial Woodcarver blade?

The tungsten carbide teeth on this Mini Industrial Blade has a 10mm depth and 4mm width (kerf) of cut.

Code	Product	Weight	Price
MIN-012	Industrial Blade	30g	\$32.50
MIN-016	Diamond Blade	30g	\$25.90

\$129.90 Power Chisel Starter Chisel Kit

ARBORTECH
PCH-030 | 210g



- ✓ Contains chisels to give maximum flexibility in usage
- ✓ Manufactured from high strength carbon steel
- ✓ Heat treated for optimum hardness

This kit includes

- ✓ 1x 60° V-Profile 8mm Gouge
- ✓ 1x Profile #11 7mm Gouge
- ✓ 1x Profile #8 7mm Gouge
- ✓ 1x Profile #9 20mm Gouge
- ✓ 1x 90° V-Profile 18mm Gouge

from \$15.90 Mini-Grinder Sanding Pads

ARBORTECH



Great for finishing off your work once you have shaped it with the Mini-Grinder, the sanding pads

screw directly on to the Mini Grinder's end to get into tight spots.

Code	Product	Weight	Price
MIN-008	40 Grit	40g	\$15.90
MIN-009	60 Grit	40g	\$15.90
MIN-010	80 Grit	40g	\$15.90
MIN-011	120 Grit	40g	\$15.90

\$89.00 Power Chisel Carver's Chisel Kit

ARBORTECH
PCH-032 | 210g



- ✓ Chisels selected to suit the basic needs of Woodcarvers and Sculptors
- ✓ Manufactured from high strength carbon steel
- ✓ Heat treated for optimum

hardness

This kit includes

- ✓ 1x Profile #9 20mm Gouge
- ✓ 1x Profile #8 7mm Gouge
- ✓ 1x 90° V-Profile 18mm Gouge

CARVING & CHISELS

Extraction & Safety
 Measuring & Marking
 Sawing
 Site & Shop Accessories
 Routing
 Planing
 Sanding & Scraping
 Drilling
 Joinery
 Clamps & Vices
 Finishing
 Sharpening
 Carving & Chisels
 Woodturning
 Wooden Parts
 Cabinet Fittings

from
\$19.90

Cabinet Bevel Edge Chisels



Produced in the Czech Republic, these cabinet chisels are forged from highly alloyed chrome-manganese steel, and heat-treatment hardened to Rc59. The blades are accurately ground and fully sharpened so are virtually ready for use out of the box and meet the German DIN 5139 standard.

The classic design bevel-edge has a narrow land on each side, providing excellent clearance when chiselling

into an angled corner such as in dovetail work, as well as reducing sidewall friction when working in tight recesses.

The clear varnished beech handles are an ergonomic oval shape that sits comfortably in the hand and resists rolling around on a bench. Reinforced with steel hoops and ferrules for strength the chisel length varies from about 250 - 300mm.

Code	Product	Weight	Price
N-810103	3mm Wide	120g	\$19.90
N-810106	6mm Wide	120g	\$19.90
N-810108	8mm Wide	120g	\$19.90
N-810110	10mm Wide	140g	\$19.90
N-810112	12mm Wide	140g	\$19.90
N-810114	14mm Wide	160g	\$19.90
N-810116	16mm Wide	160g	\$19.90
N-810118	18mm Wide	180g	\$19.90
N-810120	20mm Wide	180g	\$20.90
N-810122	22mm Wide	200g	\$22.90
N-810126	26mm Wide	220g	\$22.90
N-810130	30mm Wide	240g	\$29.90
N-810132	32mm Wide	320g	\$29.90
N-810140	40mm Wide	360g	\$32.90
N-810150	50mm Wide	400g	\$44.90

\$74.90

Cabinet Chisel Set of 4



N-863010 | 700g

This beginner's set includes the following chisel sizes - 6mm, 12mm, 20mm & 26mm.

Produced in the Czech Republic, these cabinet chisels are forged from highly alloyed chrome-manganese

steel, and heat-treatment hardened to Rc59. The blades are accurately ground and fully sharpened so are virtually ready for use out of the box and meet the German DIN 5139 standard.

from
\$29.90

Cabinet Mortice Chisels



The traditional mortice chisel design has relieved edges and taper from tip to shoulder for sidewall clearance with a significantly thicker cross-sectional shape to be able to chisel and lever out large quantities of material in deep recesses whilst

still maintaining its shape.

The stained, waxed beech handles are reinforced with steel hoops and ferrules for strength. Blade length is approximately 145-150mm with the overall length generally around 300mm long.

Code	Product	Weight	Price
N-811204	4mm Wide	200g	\$29.90
N-811206	6mm Wide	200g	\$29.90
N-811208	8mm Wide	220g	\$29.90
N-811210	10mm Wide	220g	\$29.90
N-811212	12mm Wide	240g	\$31.90
N-811214	14mm Wide	260g	\$34.90
N-811216	16mm Wide	280g	\$34.90

\$139.00

Cabinet Chisel Set of 6 Blocked



N-877601 | 2kg

This set includes the most commonly used chisel sizes - 6mm, 12mm, 16mm, 20mm, 26mm & 32mm (not commonly found in most sets) and comes in a wooden

block - a unique storage option for woodworking chisels as it can be positioned so all sizes are in easy reach on a workbench or mounted on a pedestal.

\$139.00

Cabinet Chisel Set of 6 Cased



N-853055 | 1.5kg

This set includes the most popular chisel sizes - 6mm, 10mm, 12mm, 16mm, 20mm & 26mm and comes in a well-made and attractive wooden case, making it perfect for users on the move or needing to pack up their tools after use. A great gift choice too.

The classic design bevel-edge has a narrow land on each side, providing excellent clearance when chiselling into an angled corner such as in dovetail work, as well as reducing sidewall friction when working in tight recesses.

\$29.90

Cabinet Firmer Chisels



Traditional firmer chisels are special tools designed for rough carpentry work. The blade tapers in width and lengthwise from tip to shoulder for sidewall clearance and is great for removing large chunks of material.

Unfinished hornbeam wood handles sit comfortably in the hand. A brass ferrule secures the tang to the handle with a blade length of approximately 135mm from tip to bolster and an overall length of around 280mm long.

Code	Product	Weight	Price
N-811520	20mm Wide	200g	\$29.90
N-811526	26mm Wide	220g	\$29.90

from **\$24^{.90}**

Cabinet Butt Chisels



Butt chisels were named for their use in installing butt hinges but now find wider acceptance with woodworkers as an easy to

control, shorter chisel that fits more comfortably in smaller hands and are primarily used for cutting and paring tasks.

Code	Product	Weight	Price
N-811056	6mm Wide	80g	\$24.90
N-811062	12mm Wide	100g	\$24.90
N-811070	20mm Wide	120g	\$24.90
N-811076	26mm Wide	140g	\$27.90

from **\$54^{.90}**

Paring Chisels



Among Narex's finest chisels - they feature bright brass ferrules, sturdy handles and Narex's longest (245mm) blades - perfect for reaching into deeply housed joints. The thick blades, which taper from

5.55mm at the handle to 7.15mm just before the bevel, provide maximum control without flexing. The handles are stained and waxed hornbeam.

Code	Product	Weight	Price
N-813207	6.4mm 1/4in Wide	300g	\$54.90
N-813213	12.7mm 1/2in Wide	300g	\$54.90
N-813219	19.0mm 3/4in Wide	300g	\$57.90
N-813225	25.4mm 1in Wide	300g	\$59.90

from **\$39^{.90}**

Cranked Paring Chisels



Though often overlooked, cranked-neck chisels are valuable. Able to work in areas a regular chisel can't as well as easily clean out trenches. The blades are short (95 - 102mm) for maneuverability, and the offset handles provide clearance when fitting housed joints or working into

restricted recesses. Also lets you register the blade face on the work when flush-trimming projections for better control and reduced risk of digging in. The unfinished hornbeam handles are fitted with brass-plated ferrules and measure about 260 - 305mm long overall.

Code	Product	Weight	Price
N-813307	6.4mm 1/4in Wide	120g	\$39.90
N-813313	12.7mm 1/2in Wide	140g	\$41.90
N-813319	19.0mm 3/4in Wide	160g	\$44.90

\$59^{.90}

Cabinet Corner Cleaning Chisel



N-813410 | 180g



Enables the smooth and precise squaring of corners at a 90° angle, after a mortise has been cut out. The square section size is 10 x 10mm so can handle cutting square corners in all material. The unfinished hornbeam wood handle

sits comfortably in the hand. A brass ferrule secures the tang to the handle with a working depth of approximately 60mm. The blade length is approximately 120mm from tip to bolster with an overall length of around 265mm long.

Narex Rasp Range

The blades of all Narex rasps are manufactured from European tool steel. After they are CNC stitched, they are hardened to HRc 45 and finished with comfortable Hornbeam handles and brass ferrules. CNC stitching ensures

that the pattern is uniform and each tooth is raised to the same height. The result is a rasp that exhibits a steady rate of removal and produces an even finish on the work piece.

from **\$29^{.90}**

Flat Rasps



While not as versatile as the half-round rasps, the square edges of the rasp get into tight corners and work very well cleaning up mortices and tenons.

Code	Product	Weight	Price
N-872501	150 x 16mm Bastard	300g	\$29.90
N-872502	200 x 20mm Bastard	300g	\$33.90
N-872552	200 x 20mm 2nd Cut	300g	\$37.90

from **\$35^{.90}**

Half Round Rasps



The most popular shape with a nice wide flat section plus a large radius on the back for working inside convex shapes.

Code	Product	Weight	Price
N-872521	150 x 6mm Bastard	300g	\$35.90
N-872522	200 x 8mm Bastard	300g	\$41.90
N-872572	200 x 8mm 2nd Cut	300g	\$47.90

from **\$26^{.90}**

Full Round Rasps



Perfect where minimal surface contact is required or cleaning out drilled holes.

Code	Product	Weight	Price
N-872511	150 x 6mm Bastard	300g	\$26.90
N-872512	200 x 8mm Bastard	300g	\$27.90
N-872562	200 x 8mm 2nd Cut	300g	\$31.90

\$85^{.00}

Skewed Paring Chisel Sets



Skew chisels are made for reaching into corners to finish a joint or lift squeeze-out, scribing or deepening layout lines, paring next to perpendicular surfaces & making slicing cuts to trim end grain flush. The blades are accurately ground to 32° and fully sharpened so are

virtually ready for use out of the (included wooden) box and meet the German DIN 5139 standard. Finished with hornbeam handles and solid brass ferrules, each size is sold as a set of two (left and right hand skews).

Code	Product	Weight	Price
N-851656	6mm Wide	600g	\$85.00
N-851662	12mm Wide	600g	\$85.00
N-851670	20mm Wide	600g	\$85.00

CARVING & CHISELS

Extraction & Safety
 Measuring & Marking
 Sawing
 Site & Shop Accessories
 Routing
 Planing
 Sanding & Scraping
 Drilling
 Joinery
 Clamps & Vices
 Finishing
 Sharpening
 Carving & Chisels
 Woodturning
 Wooden Parts
 Cabinet Fittings

\$24.90

Spring-Loaded Corner Chisel



TCC-01 | 120g

Squaring off the round edges of mortises can be fussy work. Not anymore! One quick chop, and this corner chisel cuts a neat 90° corner that is perfectly aligned with the

hinge gain. The chisel is razor sharp and spring-loaded, so it immediately returns to a ready position for the next hinge corner.



from **\$92.50**

Carpenters Curved Drawknives



A traditional woodworking hand tool traditionally, expect it to last a lifetime if well maintained. used to shape wood by removing shavings.

Code	Product	Price
KIR-4002140	140mm Blade	\$97.50
KIR-4002250	250mm Blade	\$92.50

\$69.00

Magnetic Corner Cleaning Chisel



50-S-0101 | 300g

Two embedded rare-earth magnets hold the chisel squarely in place, while the outside faces of the block register

against the routed pocket. A tap on the chisel cuts the corner square, and the outside faces of the block register flush with the routed edges.



from **\$58.90**

Carpenters Straight Drawknives



Similar to the curved drawknives but with a complete straight blade that is better to create flat or square finished pieces more than rounded finished work which the curved drawknives are more suitable for.

Code	Product	Price
KIR-4000225	225mm Blade	\$58.90
KIR-4000300	300mm Blade	\$99.00

\$125.00

102mm Curved Drawknife



An ordinary drawknife is too large for most carving — the Veritas is designed for ease of use with maximum control.

The teardrop-shaped handles are

cocked at 45° to the blade and nestle comfortably in your hands. The polished 102mm x 3.2mm x 19mm blade is ground and honed to a perfect edge, and is supplied with a blade guard.



Code	Product	Weight	Price
17-U-0630	102mm Curved Drawknife	800g	\$125.00
17-U-0618	Leather Case Only	200g	\$22.00

\$159.00

Traditional Drawknife



An absolute beast of a drawknife, the 279mm blade is straight and suitable for general roughing and shaping work in green and dry timber. Overall length including stained Beech handles is 457mm.

The blade is forged and ground high-carbon Sheffield tool steel that is heat treated to last a lifetime of faithful service. It measures a meaty 6mm thick and 55mm with a 20° bevel ground on the edge.

\$109.00

Scorp



KIR-4018 | 350g

Tightly curved blade with single handle designed for quick hollow stock removal in carving, green

woodworking or traditional furniture making. Approximately 170mm long.



\$159.00

Traditional Drawknife



The beast's brother, the 279mm blade is curved and overall length including stained Beech handles is 565mm. Handles are parallel

to the line of the cutting blade as per traditional hand woodworking curved blade drawknives.

from
\$39.90

Spoon Carving Knives

MORAKNIL



Mora woodcarving knives are well known and appreciated hand-made precision tools that are used by wood carvers all over the world, including places like Nusnäs where one of Sweden's most recognized national symbols – the Dala Horse is carved.

There are five green spoon carving knives available, all with birchwood handles (from left-to-right).

WARNING These knives are extremely sharp out of the sheath and need to be handled with care.

Code	Product	Weight	Price
MORA-106	#106 Straight Long*	80g	\$39.90
MORA-120	#120 Straight Short	80g	\$39.90
MORA-162	#162 Hook*	60g	\$59.90
MORA-163	#163 Hook*	70g	\$59.90
MORA-164	#164 Hook*	60g	\$49.90
MORASET-4	Set of Four	270g	\$199.00
MORASET-5	Set of Five	360g	\$235.00

*Contained in the Set of Four. Set of Five includes all knives.



\$69.00

Cabinetmakers Mallet

veritas

05-E-1501 | 700g



Wooden mallets are well suited to shop work such as driving chisels or larger carving tools. Although they tend to be bulky, the wooden striking faces are much kinder to tool handles than steel-face hammers. This mallet has the best features of both wood and metal and is a

direct substitute for a carpenter's mallet. The cast brass head has the mass and small size typical of a metal hammer. The 38mm diameter hardwood inserts provide wooden striking faces so you can strike chisels without mushrooming the handles.

\$29.90

Carpenter's Mallet



C-106 | 450g



A handy general mallet for cabinetry work using chisels and other hand tools. The handle length is 290mm with a 115mm block head - both

made from premium European beech and unfinished. The handle is shaped for comfortable use.

from
\$39.90

Microfibre Chisel Rolls



Produced from heavy-duty microfibre with pockets for plenty of chisels, its quick and easy to roll up and clip together with the buckle clasp, taking no time to unroll it

again. Highly recommended as a way to organize, store and protect your expensive cabinet and carving chisels!

Code	Product	Weight	Price
KIR-3565	12-Place	240g	\$39.90
KIR-3566	18-Place	370g	\$51.50
KIR-3567	24-Place	450g	\$53.90
KIR-3568	32-Place	500g	\$62.90

\$93.50

Leather Chisel Roll



KIR-3571 | 300g



Beautifully made from genuine suede leather with a full leather strap and traditional buckle to hold

it together. The cut-resistant clear plastic pouches make it easy to see what is contained with the pouches.

from
\$27.00

Canvas Chisel Rolls

veritas



Available with 9 or 12 pockets, these rolls are specially designed for cabinetmakers' chisels and larger gouges. The flap folds down over the blades to protect them

when the tools are rolled up. This is the best way to store and protect your fine chisels and gouges. All are fully bound, made of heavy-duty canvas with a sturdy cloth tie.

Code	Product	Weight	Price
67-E-0102	9-Place	150g	\$27.00
67-E-0103	12-Place	200g	\$34.00

\$24.90

Safety Gloves - Hi-Cut Plus



Carving or using other sharp hand tools? These gloves are super comfortable for long periods of use and will either prevent or

greatly reduce other potentially catastrophic injuries. Pretty good value when they've saved your skin just once!

Code	Product	Weight	Price
GKH-196-M	Medium	100g	\$24.90
GKH-196-L	Large	100g	\$24.90
GKH-196-XL	Extra Large	100g	\$24.90

CARVING & CHISELS

from \$29.90

Kirschen Two Cherries Carving Chisels



Two Cherries Tools are still largely made the same way in which they were made decades ago, still produced in the factory in Remscheid Germany since 1858! The finest steel is used throughout the product line, and skilled craftsmen work with diligence to bring you a tool that you will be proud to own and love to work with. Take care of these tools, your children and grandchildren will thank you.

Carefully forged blades are skillfully heat treated in a salt immersion bath to achieve a Rockwell Hardness of 61C.

This means that sharpening the chisels may take an extra few minutes, but they will hold an edge significantly longer than just about any other brand on the market. After heat treating, the blades are polished to a rich finish that makes them a joy to use. Fitting size-appropriate handles made from European Hardwood is the final step in producing these highest quality German Chisels.

The short pattern range listed below have hornbeam handles, approximately 110mm long with 60mm blades.



#3201 Series #1 Profile Straight

Stich Cut	Code	Product	Price
1	KIR-320102	2mm Wide	\$29.90
2 1/2	KIR-320104	4mm Wide	\$29.90
3	KIR-320106	6mm Wide	\$29.90
4	KIR-320108	8mm Wide	\$29.90
6	KIR-320110	10mm Wide	\$29.90



#3215 Series #6 Profile Long Bent Shape

Stich Cut	Code	Product	Price
6	KIR-321502	2mm Wide	\$46.90
2	KIR-321504	4mm Wide	\$46.90
3	KIR-321506	6mm Wide	\$46.90
4	KIR-321508	8mm Wide	\$46.90
8	KIR-321510	10mm Wide	\$46.90



#3202 Series #1 Profile Skew

Stich Cut	Code	Product	Price
1	KIR-320202	2mm Wide	\$29.90
2 1/2	KIR-320204	4mm Wide	\$29.90
3	KIR-320206	6mm Wide	\$29.90
4	KIR-320208	8mm Wide	\$29.90
6	KIR-320210	10mm Wide	\$29.90

#3217 Series #8 Profile Long Bent Shape

Code	Product	Price
KIR-321702	2mm Wide	\$46.90
KIR-321704	4mm Wide	\$46.90
KIR-321706	6mm Wide	\$46.90
KIR-321708	8mm Wide	\$46.90
KIR-321710	10mm Wide	\$46.90



#3221 Series #1 Profile Short Bent Shape

Code	Product	Price
KIR-322102	2mm Wide	\$36.50
KIR-322104	4mm Wide	\$36.50
KIR-322106	6mm Wide	\$36.50
KIR-322108	8mm Wide	\$36.50
KIR-322110	10mm Wide	\$36.50

#3219 Series #10 Profile Long Bent Shape

Stich Cut	Code	Product	Price
10	KIR-321902	2mm Wide	\$56.90
2 1/2	KIR-321904	4mm Wide	\$56.90
3	KIR-321906	6mm Wide	\$56.90
4	KIR-321908	8mm Wide	\$56.90
8	KIR-321910	10mm Wide	\$56.90



#3206 Series #6 Profile Straight

Code	Product	Price
KIR-320602	2mm Wide	\$38.50
KIR-320604	4mm Wide	\$38.50
KIR-320606	6mm Wide	\$38.50
KIR-320608	8mm Wide	\$38.50
KIR-320610	10mm Wide	\$38.50

#3227 Series #6 Profile Short Bent Shape

Stich Cut	Code	Product	Price
6	KIR-322702	2mm Wide	\$48.50
2	KIR-322704	4mm Wide	\$48.50
3	KIR-322706	6mm Wide	\$48.50
4	KIR-322608	8mm Wide	\$48.50
6	KIR-322710	10mm Wide	\$48.50

#3229 Series #8 Profile Short Bent Shape

Stich Cut	Code	Product	Price
8	KIR-322902	2mm Wide	\$48.50
2 1/2	KIR-322904	4mm Wide	\$48.50
3	KIR-322906	6mm Wide	\$48.50
4	KIR-322908	8mm Wide	\$48.50
6	KIR-322910	10mm Wide	\$48.50

#3208 Series #8 Profile Straight

Stich Cut	Code	Product	Price
8	KIR-320802	2mm Wide	\$38.50
2 1/2	KIR-320804	4mm Wide	\$38.50
3	KIR-320806	6mm Wide	\$38.50
4	KIR-320808	8mm Wide	\$38.50
6	KIR-320810	10mm Wide	\$38.50

#3208 Series #10 Profile Straight

Stich Cut	Code	Product	Price
10	KIR-321002	2mm Wide	\$46.90
2 1/2	KIR-321004	4mm Wide	\$46.90
3	KIR-321006	6mm Wide	\$46.90
4	KIR-321008	8mm Wide	\$46.90
6	KIR-321010	10mm Wide	\$46.90

#3231 Series #10 Profile Short Bent Shape

Code	Product	Price
KIR-323102	2mm Wide	\$59.90
KIR-323104	4mm Wide	\$59.90
KIR-323106	6mm Wide	\$59.90
KIR-323108	8mm Wide	\$59.90
KIR-323110	10mm Wide	\$59.90

#3239 Series #39 Profile 75°-V Straight Shape



Code	Product	Price
KIR-323902	2mm Wide	\$4790
KIR-323904	4mm Wide	\$4790
KIR-323906	6mm Wide	\$4790
KIR-323908	8mm Wide	\$4790
KIR-323910	10mm Wide	\$4790

#3240 Series #39 Profile 75°-V Long Bent Shape



Code	Product	Price
KIR-324002	2mm Wide	\$5790
KIR-324004	4mm Wide	\$5790
KIR-324006	6mm Wide	\$5790
KIR-324008	8mm Wide	\$5790
KIR-324010	10mm Wide	\$5790

#3243 Series #39 Profile 75°-V Short Bent Shape



Code	Product	Price
KIR-324302	2mm Wide	\$59.90
KIR-324304	4mm Wide	\$59.90
KIR-324306	6mm Wide	\$59.90
KIR-324308	8mm Wide	\$59.90
KIR-324310	10mm Wide	\$59.90

#3247 Series #11 Profile Straight

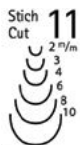

Code	Product	Price
KIR-324702	2mm Wide	\$46.90
KIR-324704	4mm Wide	\$46.90
KIR-324706	6mm Wide	\$46.90
KIR-324808	8mm Wide	\$46.90
KIR-324710	10mm Wide	\$46.90

\$19.90 Chip Carving Knives



Traditional chip carving knives are short-bladed and used to make triangular shaped cuts to create intricate designs in wood. Designs carved in this fashion are cut into the wood or incised, not relieved. Kirschen offer a popular range of shapes and sizes to suit every application. Handles are made from hornbeam and blade lengths vary 35 – 55mm.

Code	Product	Price
KIR-3351	Profile #1	\$19.90
KIR-3352	Profile #2	\$19.90
KIR-3353	Profile #3	\$28.90
KIR-3354	Profile #4	\$19.90
KIR-3356	Profile #6	\$17.90
KIR-3357	Profile #7	\$20.90
KIR-3358	Profile #8	\$22.90
KIR-3360	Profile #10	\$28.90
KIR-3361	Profile #11	\$28.90
KIR-3362	Profile #12	\$24.90
KIR-3363	Profile #13	\$22.90

\$92.50 Inshave



KIR-4017 | 780g

- ✓ Deeply curved blade
- ✓ Designed for carving hollows such as in seats or bowls
- ✓ 2 turned wooden handles
- ✓ Traditionally made to typical German quality standards

\$68.50 Carving Knife Set



KIR-3303 | 150g

Get the three most popular chip carving knives in one set – includes

the #1, #3 and #6 profiles in a display box.

CARVING & CHISELS

\$149.00

Beginners Carving Set of 12

RECORD POWER
ESTABLISHED 1991

RPCV-12 | 1.5kg



This unique woodcarving package of 12 carving tool profiles plus bonus DVD and booklet represents incredible value.

Ideal for woodworkers of all skill levels from the complete novice to the seasoned professional.

\$89.90

Carver's Vice

RECORD POWER
ESTABLISHED 1991

RPCV-130 | 3.4kg



- Access from any angle - The rotation of the arm and faceplate allows access from all around the work piece.
- 360° Rotation - The faceplate revolves 360° for easy access all around the workpiece.

- Pivoting Support Arm - This provides further flexibility of positioning.
- Secure Clamping - The cast iron clamp jaws provide more than enough holding power for heavy use.

from **\$40.90**

Carving Mallets



Two-piece design feels more comfortable and balanced in the hand – the handle is produced from Ash and the head is durable hornbeam so will stand up to pounding chisel heads for years. Available in three head diameters, small for more control and finer

detail work right up to the massive 120mm head for big knocks on large chisels.

Code	Product	Price
KIR-3500080	80mm Dia.	\$40.90
KIR-3500100	100mm Dia.	\$51.90
KIR-3500120	120mm Dia.	\$67.90

\$355.00

Carving Set of 10+1



KIR-3441 | 1.2kg



Includes six chisels (KIR-320108, 320210, 320806, 320808, 323906 and 324702) plus #1, #3, #6 and #8 chip carving knives along

with an 80x30mm sharpening stone all in an attractive wooden storage case.

\$125.00

Carving Set of 4



KIR-3424 | 250g



Great simple starter set with three chisels (KIR-320108, 320208 and

323906) plus #2 chip carving knife in a display box.

\$175.00

Carving Set of 6+1



KIR-3427 | 400g



More complete set to get started with, it includes the #1, #3 and #6 chip carving knives as well as the three basic chisels (KIR-320108,

320208 and 323906) and an 80x30mm sharpening stone in a display box.

\$56.00

Bronze Mallet

Veritas®

05-E-1401 | 650g



This mallet can be used with a traditional grip or it can be nestled in the palm of your hand to exactly control the force used. The brass head has a blind threaded connection giving it the same feel and force to the 41mm diameter

top as the sides. The final turning of the handle is done after the handle is mounted, ensuring a perfectly smooth transition between brass head and cherry wood handle. 570g with an overall length of 152mm.

from
\$85.00

Roughing Gouges



Traditionally made hot forged gouges are ground and finished by hand. A very steep 170° scrapes away large sections of stock, minimising dig-in with a large flute for fast stock removal. All are tested before leaving the factory at the tang to ensure shock absorption

without danger of snapping.
Blade length: 185mm
Handle Length: 320 – 445mm

Code	Product	Wgt	Price
230-W	19mm Wide	380g	\$85.00
231-W	32mm Wide	650g	\$119.00
231-XW	44mm Wide	890g	\$219.00

from
\$52.00

Spindle Gouges



Spindle gouges are used along the edge of the grain. They are typified as being a standard length chisel as they generally don't have to reach too far from the tool rest whilst turning (compared to bowl gouges) and provide close cutting control as a result. The edge is often ground at a 45 degree angle and generally

have more of a pointed tip ground so that finer smaller turning is possible. Blade length: 185mm, Handle Length: 320mm

Code	Product	Wgt	Price
235-W	6mm Wide	200g	\$52.00
236-W	10mm Wide	250g	\$57.00
237-W	13mm Wide	290g	\$70.00
238-W	19mm Wide	320g	\$90.00

\$125.00

Side Grind Ellsworth-Style Bowl Gouge



242-SGW | 750g



This deep fluted bowl gouge comes sharpened with a specialized side grind, offering exceptional versatility in bowl turning. Powerful roughing to delicate shearing cuts are

made with ease, making this tool a favorite for turning bowls. Blade length: 260mm
Handle Length: 350mm

\$65.00

Skewchigouge



236-SKW | 300g



Designed by English turner Alan Beecham, this tool will work as a skew chisel and gouge, thus the name Skewchigouge. With equal ease you can cut beads, pummels, balls, birds' beaks, plane, v-grooves, and more. Virtually catch-proof,

this amazing tool has become a favourite for any spindle work. Don't let its odd looks fool you, this tool is one you'll find more uses for every time you try it. Blade length: 190mm, Handle Length: 320mm

from
\$69.00

Bowl Gouges



Bowl gouges are used for turning along the grain and also for turning on end grain. This is exemplified by the relatively straight profile of the tip of the gouge so that it scrapes rather than peels the timber off, to provide a smoother finish on end grain. The flute is deeper on bowl gouges so that the cutting edge is supported and large quantities of waste can be removed easily.

Blade Length: 260mm
Handle Length: 350mm
except 19mm: 406mm & 10mm Short: 215mm

Code	Product	Wgt	Price
240-W	6mm Wide	530g	\$69.00
241-SW	10mm Short	600g	\$79.00
241-W	10mm Wide	600g	\$89.00
242-W	13mm Wide	670g	\$115.00
243-W	19mm Wide	950g	\$189.00

\$59.00

Thin Parting Tool



244-AW | 120g



The ultimate in small parting tools. Constructed with a 1.6 x 32mm blade, it is so delicate, the handle has been made one-handed to ensure that not too much force is

placed on the chisel when in use. Creates the perfect small part on any timber. Blade length: 130mm
Handle length: 105mm

from
\$62.00

Detail Gouges



Detail gouges have a shallow flute and thicker cross-section compared with standard spindle gouges, resulting in less vibration and providing a smoother cut. This is due to there being more metal under the flute, supporting the cutting tip. They can also hang off the toolrest more than a traditional spindle gouge so

are great for cleaning up the sides of deep vessels etc. the longer the bevel angle, the sharper the edge, the further it can reach tight spaces. Blade length: 185mm, Handle Length: 320mm

Code	Product	Wgt	Price
236-DW	10mm Wide	430g	\$62.00
237-DW	13mm Wide	630g	\$79.00

\$75.00

Firmager Parting Tool



244-AFW | 160g



Melvin Firmager is known for making turnings that have many thin parting cuts in green wood that warp during drying to give a flower effect. He also uses it as a brilliant shear scraper.

The tool is identical to the thin parting tool above except it has a 175mm-long blade and special grind on the end. Comes with instructions for use/sharpening.

Extraction & Safety
Measuring & Marking
Sawing
Site & Shop Accessories
Routing
Planing
Sanding & Scraping
Drilling
Joinery
Clamps & Vices
Finishing
Sharpening
Carving & Chisels
Woodturning
Wooden Parts
Cabinet Fittings

WOODTURNING

Extraction & Safety
 Measuring & Marking
 Sawing
 Site & Shop Accessories
 Routing
 Planing
 Sanding & Scraping
 Drilling
 Joinery
 Clamps & Vices
 Finishing
 Sharpening
 Carving & Chisels
Woodturning
 Wooden Parts
 Cabinet Fittings

\$69.00

Parting Tools



Parting tools cut parallel-sided grooves into your work piece. They are suitable for use in marking beads on the work piece, or separating a work piece from its waste mounted in the chuck to make removal easier once removed from the lathe.

Handle Length: 320mm,
 Blade Length of 3mm: 150mm
 Blade Length of 6mm: 165mm

Code	Product	Wgt	Price
244-W	3 x 13mm Blade	330g	\$69.00
245-W	6 x 19mm Blade	420g	\$69.00

from **\$65.00**

Round Nose Scrapers



Scrapers are used to finish work pieces or to plane a piece that would be difficult to access with a standard chisel (timbers that are otherwise difficult to turn - i.e. Radiata pine). All scrapers are suitable for use along the grain or on end-grain work. They are perfect for achieving a smooth finish after

shaping has been completed by other tools.

Blade Length: 165mm,
 Handle Length: 320mm
 Except 38mm: 350mm

Code	Product	Wgt	Price
260-W	13 x 6.4mm Blade	400g	\$65.00
261-W	19 x 6.4mm Blade	450g	\$69.00
262-W	25 x 6.4mm Blade	510g	\$85.00
2561-W	38 x 10mm Blade	840g	\$155.00

from **\$79.00**

Diamond Parting Tools



Diamond parting tools are a relatively recent development. The diamond shape provides a dramatically reduced chance of the parting tool jamming when in use as the full edge is not in contact with the timber, allowing movement.

Handle Length: 320mm,
 Blade Length of 3mm: 150mm,
 Blade Length of 6mm: 165mm

Code	Product	Wgt	Price
246-XW	3 x 13mm Blade	330g	\$79.00
246-W	5 x 19mm Blade	420g	\$89.00

\$155.00

Domed Nose Scraper



2562-W | 840g

A specialized heavy-duty scraper with a fuller radius than the standard 38mm round nose scraper.

Blade Size: 38 x 10mm,
 Blade Length: 165mm,
 Handle Length: 350mm

from **\$67.00**

Bead & Parting Tools



These tools have symmetrical bevels formed on a body having a square cross section. They are widely used for forming tenons with a peeling cut and rolling beads on a spindle. This name comes from the motion of the tool while shaping a bead. You can use the tool to cut

a pair of convex surfaces back-to-back, which constitutes a bead if done correctly.
 Blade length: 185mm
 Handle Length: 320mm

Code	Product	Wgt	Price
247-AW	6 x 6mm Blade	350g	\$67.00
247-W	10 x 10mm Blade	420g	\$72.00

\$129.00

Bowl Finishing Scraper



2565-W | 700g

As the name suggests – this has a special grind so most of the 25 x 13mm blade is behind the scraping edge, providing better support to the cutting edge and a smoother

finishing scrape on the inside edge of bowls when inboard turning.

Blade Length: 200mm,
 Handle Length: 350mm

\$72.00

Dovetail Scraper



267-W | 530g

This tool is specifically designed for making accurate recesses to accommodate the jaws of an expanding scroll chuck with dovetailed jaws.

Blade Length: 165mm,
 Handle Length: 320mm

\$99.00

Hook Nose Scraper



265-XW | 700g

The grind allows this scraper to get into hard-to-reach places – like undercut lips on bowls – to scrape smooth the work piece before finishing.

Blade Section: 25 x 6.4mm,
 Blade Length: 185mm,
 Handle Length: 350mm

from **\$65.00**

Square End Scrapers



Great for scraping flat sections or grinding your own unique scraper shape for specific tasks.

Blade Length: 165mm,
Handle Length: 320mm
Except 38mm: 350mm

Code	Product	Wgt	Price
253-W	13x6.4mm Blade	340g	\$65.00
254-W	19x6.4mm Blade	400g	\$69.00
255-W	25x6.4mm Blade	500g	\$85.00
256-W	38x10mm Blade	840g	\$149.00

from **\$54.00**

Round Skew Chisels



Skew chisels can catch on the work piece and dig into the timber and tool rest. Standard skew chisels have sharp edges and therefore little nicks on it. By using a round skew chisel on small turnings, it doesn't damage the tool rest when a dig

in occurs. The round profile also makes it easier to control for the fine work these are used for.

Blade Length: 165mm,
Handle Length: 320mm

Code	Product	Wgt	Price
271-EW	10mm Diameter	480g	\$54.00
271-CW	13mm Handled	530g	\$65.00

\$159.00 Multi-Tip Scrapers



268-W | 700g



Developed to offer a full range of scraper shapes on one handle for a relatively low cost it comes with the standard round, square tips as well as a teardrop-shaped cutter that can be used on flat work and the

outside of bowls then rotated to suit the inside of bowls for shear scraping.

Blade Length: 185mm,
Handle Length: 320mm

from **\$65.00**

Rolled Edge Skew Chisels



Rolled edge skews are perhaps the best type of skew chisel available. Still manufactured from flat bar for a large mass on turnings, the edges are radiused so if a dig-in occurs, the tool rest is not damaged,

so it won't have to be re-adjusted as there is no nick to get in the way. It also provides better control.

Blade length = 165mm,
Handle length = 320mm

Code	Product	Weight	Price
270-RESW	13 x 6.4mm Blade	390g	\$65.00
270-ARESW	19 x 6.4mm Blade	420g	\$80.00
271-RESW	25 x 6.4mm Blade	500g	\$99.00
271-ARESW	32 x 6.4mm Blade	760g	\$135.00

\$75.00 Side Cutting Scrapers



Scrapers used to finish work pieces or to plane a piece that would be difficult to access with a standard scraper. Ground to work either

with surround curved (rounded) or straight (diamond) surfaces.

Blade Length: 165mm,
Handle Length: 320mm

Code	Product	Weight	Price
265-W	Rounded 19 x 6.4mm	530g	\$75.00
266-W	Diamond 19 x 6.4mm	530g	\$75.00

\$90.00

Radius Grind Skew Chisel



270-ARSW | 420g



Probably the best design of skew coming straight out of a factory. It has rolled edges, making it easier to maneuver as well as being kinder to tool rests. It has a radius edge grind, greatly reducing the chance of a dig-in because the surface-area of the cutting edge is reduced when

working at all angles. All skews can be ground with this profile by using the Veritas Skew Grinding Jig found on p. 153.

Blade Width: 19mm
Blade Length: 165mm
Handle length: 320mm

\$169.00 Long Hole Drills



Made from high-speed steel rod along the full length to maintain their strength over a lifetime. The shell tip is designed for end-grain

drilling with a single, short flute, the strength is unparalleled.

Blade Length: 605mm,
Handle Length: 160mm

Code	Product	Weight	Price
279-SSW	9.5mm 3/8in Diameter	550g	\$169.00

from **\$55.00**

Three-Point Tools



A round bar ground on the end with a three-sided pyramid – it is one that you may find among the most useful you own. It cuts small beads, skews across long grain work, makes decorative "V" cuts on bowls, and trims up end grain on the

shoulder of boxes. Especially good on dense, hard timber.

Blade Length: 100mm,
Handle Length: 165mm

Code	Product	Wgt	Price
271-DAW	10mm Diameter	480g	\$55.00
271-DW	13mm Handled	530g	\$67.00

Extraction & Safety
Measuring & Marking
Sawing
Site & Shop Accessories
Routing
Planing
Sanding & Scraping
Drilling
Joinery
Clamps & Vices
Finishing
Sharpening
Carving & Chisels
Woodturning
Wooden Parts
Cabinet Fittings

WOODTURNING

\$62.00 Beadforming Tools



The perfect tool for cutting accurate beads exactly the same width every time. Use in conjunction with the captive ring tools as it will cut a perfect bead that can then be "freed" from the stem using the captive ring tool.

Blade Length: 165mm,
Handle Length: 320mm

Code	Product	Wgt	Price
276-W	6mm Wide	370g	\$62.00
276-AW	10mm Wide	390g	\$62.00

from \$69.00 Captive Ring Tools



These tools are made specifically for producing rings that are captured by the work piece. The Crown chisels feature a double bevel which results in only one tool being necessary to complete the ring by allowing the user to cut in from both

the left and right-hand side.
Blade Length: 165mm,
Handle Length: 320mm

Code	Product	Wgt	Price
277-W	6mm Wide	380g	\$69.00
278-W	10mm Wide	410g	\$75.00
278-AW	13mm Wide	430g	\$79.00

\$299.00 Chinese Ball Tool Set



DSW | 600g



These are the tools you need to turn beautiful separated balls like those found in the book Woodturning Wizardry (available separately - \$29.99). The set consists of one Profile tool for cutting holes and one internal circle-cutting tool with

four cutters. They can be used to produce many intriguing pieces such as cubes in spheres, spiked stars in spheres, and lidded boxes containing spheres. General instructions by David Springett are included with the set of tools.

\$149.00 Thread Chasing Tools



The thread chasing tool comes as a matched set of two chisels to produce 18TPI threads in timber. One tool is used for cutting external threads while the other is for internal threads. They feature a unique enhanced helix angle specifically designed for cutting wood. The Recess Tool is used to make

a recess when chasing internal threads that are stopped.
Blade Length: 100mm,
Handle Length: 165mm

Code	Product	Wgt	Price
TC-18-W	Thread Chaser 18TPI	350g	\$149.00
TCRTN	Recessing Tool	100g	\$40.00

\$269.00 Standard Spiralling/Texturing System



ST-1-W | 1.25kg



Add visual interest to your turnings such as whorls, orange peel, striations and other effects. The tool can be used to create some stunning effects that can alter the tactile and visual appearance of your turning.

It includes the texturing wheel, an indexing sleeve and two types of spiralling cutter. For repeatable effects the angle of presentation can be locked in position by using the indexing sleeve. Full instructions included.

\$119.00 Mini Spiralling System



Create miniature left and right hand spirals and barley twists with ease. Can also be used as miniature texturing tool with optional texturing wheel listed below. The set includes

the Miniature Spiralling Tool & 17 Tooth & 27 Tooth Spiralling Wheels.

Code	Product	Price
ST-2-W	Spiralling System	\$119.00
ST-17-TW	17 Tooth Texturing Wheel	\$52.00

\$115.00 Cryogenic Hollowing Tools



HTC-1



The Cryo Hollower from Crown is a great tool for small and medium size hollowing. It comes complete with 2 hollowing probes, 1 shear scraping

tip and an egg cutter for those heavier cuts. All tips are cryogenically treated for vastly improved wear resistance.

from \$32.00 Revolution Cutting Tips



While the full Revolution System comes with five popular cutting tips for added flexibility, the Midi and Mini tools only come with the standard Super Ring cutter and one more tip. These cutters are all cryogenically treated for excellent edge retention and expand the usefulness of the Revolution System.

Code	Product	Wgt	Price
REV-11	Super Ring Cutter	20g	\$49.00
REV-12	Reg Heart Scraper	50g	\$35.00
REV-13	Reg Egg Scraper	10g	\$32.00
REV-14	Lg Egg Scraper	20g	\$37.00
REV-15	Flat Key Cutter	50g	\$39.00
REV-17	Lrg Heart Scraper	50g	\$49.00
REV-18	Pear Scrape	50g	\$45.00
REV-19	Key Cutter	20g	\$32.00

\$449.00 Revolution Deep Hollowing System



REV-01-U-58 | 1.75kg

Crown's Revolution is a completely new hollowing system. The modular articulated design provides the freedom and flexibility to configure the tool for any situation. From straight vases to heavily undercut hollow forms, the Revolution has it covered. At the heart of it is the new fully depth adjustable Super Ring that allows for ultra efficient wood removal without clogging. The revolutionary modular articulation design ensures clean, efficient wood removal at all times. It comes standard with 5 different cutting tips for unrivaled flexibility.



Shown here with optional shafts and handles sold separately

All collars and collets beautifully machined from solid marine grade brass billet. High performance cryogenically treated cutting tips for vastly improved wear resistance.

\$179.00 Midi Revolution Deep Hollower



MIDIREV | 700g

The Midi Revolution Deep Hollower is a great way to get into the Revolution System with a much lower entry price. It has a fixed 360mm wooden handle and blade length of 220mm and includes the revolutionary Super Ring cutter

with integral, adjustable brass limiter, plus one shaped scraper cutter should the surface require further refinement. All cutters are cryogenically treated steel for excellent edge retention.

\$145.00 Mini Revolution Deep Hollower



MINIREV-01-U | 450g

For detailed hollowing work, this tool is perfect. It is the same design as the Midi Hollowing Tool but comes

with a shorter 250mm handle and 180mm blade length.

About Cryogenic High-Speed Woodturning Tools

The Crown Cryogenic range are high quality turning tools with a difference. Using cryogenically treated tools means that now you can turn more and sharpen less often. The tools are made from M2 Steel that are heat treated normally then taken down to temperatures as low as -185°C which changes the molecular structure of the steel.

The two main crystals in tooling steel are the larger and softer austenite and the smaller, more stable martensite. Normal heat treatment seeks to transform the austenite to martensite to produce steel with good wear characteristics and an amount of ductile properties.

The cryogenic process greatly enhances and accelerates the

austenitic transformation. Another benefit is that at these extreme temperatures, fine 'eta' carbides are formed within the carbon structure. Growing very slowly and only at these very low temperatures, 'eta' carbides are extremely small and act as a 'filler' between the other crystals in the metal.

The combined effect of heat treatment and cryogenic processing is to produce a refined crystal structure in your hand tool that will give a lifetime's service by producing a blade that will retain its edge longer and give a superior 'feel' in use.

All Crown Cryogenic Turning Tools are finished with beautiful black Ash handles.

Code	Product	Weight	Price
230-KW	Roughing Gouge 19mm	380g	\$119.00
231-KW	Roughing Gouge 32mm	650g	\$149.00
240-KW	Bowl Gouge 6mm	530g	\$99.00
241-SKW	Bowl Gouge 10mm Short	520g	\$105.00
241-KW	Bowl Gouge 10mm	600g	\$109.00
242-KW	Bowl Gouge 13mm	670g	\$129.00
242-SGKW	Sidegrind Gouge 13mm	750g	\$145.00
235-KW	Spindle Gouge 6mm	300g	\$65.00
236-KW	Spindle Gouge 10mm	430g	\$69.00
237-KW	Spindle Gouge 13mm	630g	\$85.00



Code	Product	Weight	Price
236-DKW	Detail Gouge 10mm	430g	\$85.00
237-DKW	Detail Gouge 13mm	630g	\$105.00
236-KSKW	Skewchigouge	300g	\$85.00
244-KW	Std Parting Tool 3mm	330g	\$79.00
245-KW	Std Parting Tool 6mm	420g	\$79.00
246-KXW	Diamond Parting Tool 3mm	330g	\$99.00
246-KW	Diamond Parting Tool 5mm	420g	\$109.00
247-AKW	Bead & Part Tool 6mm	350g	\$89.00
247-KW	Bead & Part Tool 10mm	420g	\$95.00
265-KW	Round Sidecut Scraper	530g	\$105.00
260-KW	Round Nose Scraper 13mm	400g	\$85.00
261-KW	Round Nose Scraper 19mm	450g	\$89.00
262-KW	Round Nose Scraper 25mm	510g	\$99.00
2561-KW	Round Nose Scraper 38mm	840g	\$199.00
2565-KW	Bowl Finish Scraper	700g	\$159.00
265-XKW	Hook Nose Scraper	700g	\$135.00
270-KRESW	Rolled Skew Chisel 13mm	390g	\$85.00
270-KARESW	Rolled Skew Chisel 19mm	420g	\$105.00
271-KRESW	Rolled Skew Chisel 25mm	500g	\$129.00
280-K	5-Piece Chisel Set	2KG	\$449.00

Extraction & Safety
Measuring & Marking
Sawing
Site & Shop Accessories
Routing
Planing
Sanding & Scraping
Drilling
Joinery
Clamps & Vices
Finishing
Sharpening
Carving & Chisels
Woodturning
Wooden Parts
Cabinet Fittings

Extraction & Safety
 Measuring & Marking
 Sawing
 Site & Shop Accessories
 Routing
 Planing
 Sanding & Scraping
 Drilling
 Joinery
 Clamps & Vices
 Finishing
 Sharpening
 Carving & Chisels
Woodturning
 Wooden Parts
 Cabinet Fittings

\$249.00 Standard Turning Tool Set



C-280 | 2kg

A beginners set for the discerning woodturner it contains the five most common chisels -

- ✓ 19mm roughing gouge
- ✓ 10mm spindle gouge
- ✓ 6mm parting tool
- ✓ 13mm round nose scraper
- ✓ 13mm skew chisel



About Easy Wood Tools

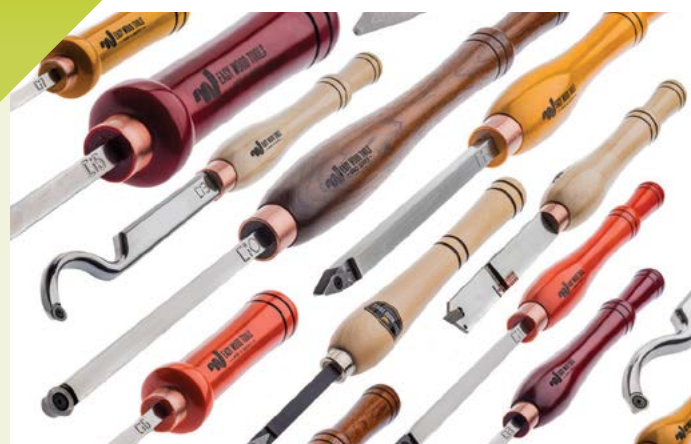

Easy Wood Tools offers a series of replaceable carbide cutter woodturning tools that address fatigue, safety and efficiency like no other tools. They are designed to effortlessly remove massive amounts of material on any woodturning project without the need for sharpening. Rotate the cutter when one side gets dull and when you've used all the sides, just replace with a new cutter.

The tools are designed with support directly beneath the cutting edge transferring the cutting pressure downward allowing the lathe to take the pressure that normally would go to your hands and body when roughing. Because the pressure goes into the tool rest, your body doesn't get tired as quickly which equals more turning time.

Other benefits include;

- ✓ The reduced likelihood of kick-back and catches - due to the neutral cutting angles, the tool is easy to use.
- ✓ There are no bevels to learn - Easy Wood Tools are held flat on the tool rest and parallel to the floor. Cut left, right or straight in within minutes of picking it up.

So why pick Easy Wood Tools over the other carbide cutter turning tools found on the market? They only specialize in carbide turning tools and have put a huge investment into making them the best. While other companies are trying to imitate, Easy Wood continue to innovate and are at the forefront of this new evolution in turning tools.

\$219.00 Micro Turning Tool Set



C-299 | 300g



Developed from an idea from a French woodturner, these unique tools are the smallest commercially available with 51mm blades and 114mm Rosewood handles. It contains -

- ✓ 2.4mm gouge
- ✓ 4.8mm gouge
- ✓ 2.4mm parting tool
- ✓ 4mm oval skew chisel
- ✓ 4mm round nose scraper

Grade, Grind and Geometry

These are the 3G's of the perfect carbide cutter. Easy Wood have invested thousands of man hours finding the perfect combination of these variables and it shows in the quality of the cutters, the sharpness of the edge and the life you get from each one. Made solely by Easy Wood in Kentucky, the secret formulation of these attributes means you will never find a better performing carbide edge than genuine EWT Carbide.

Combined with the best quality

materials to complete the manufacturing process of producing these tools - you can be sure to buy an Easy Wood Tool and for it to last a lifetime, with just the cutters needing replacement.

The handles are produced from American Rock Maple and stained so are easily identified as each type of tool, with copper rather than brass ferrules and the laser-cut stainless-steel bar means that you never have to worry about your tools rusting ever again.

\$199.00 Mini Turning Tool Set



C-295 | 850g



A very popular set of miniature tools with 95mm blades and 150mm Rosewood handles. It contains -

- ✓ 3mm gouge
- ✓ 6mm gouge
- ✓ 1.6mm parting tool
- ✓ 6mm skew chisel
- ✓ 6mm round nose scraper



You Tube

Search **Timbecon** to see them in action



from **\$135.00**
The Easy Detailer



These tools are designed primarily for small, intricate work and cutting final details on your projects. These would include such things as small coves and beads on both spindle and bowl work. They are also very handy for cutting inside reverse angle cuts for inside chucking bowls with dovetail jaws. You may also find they work very well for hogging your green wood projects too.

The Easy Detailer tools are engineered with a reduced relief angle to the long cuttings edges making the long edges less

aggressive when held in contact with the wood as the nose of the tool is cutting. In use, the long edge is intended to perform as a "control surface" and serve to be in contact with the wood just behind the cut - much like a bevel is being rubbed. For safety reasons, avoid plunging the tool so deep into the work at once to the depth you would have both sides of the cutter in contact with the wood too greatly at the same time. This could cause too much force and lead to binding of the tool in the groove.

Code	Size	Product	Weight	Price
EWT-12011	Micro	82mm Blade 150mm Handle	230g	\$135.00
EWT-6200	Mini	102mm Blade 305mm Handle	380g	\$149.00
EWT-6300	Midi	175mm Blade 355mm Handle	600g	\$179.00
EWT-4200	Full	215mm Blade 405mm Handle	930g	\$209.00
EWT-3400	Pro	215mm Blade 510mm Handle	1.1kg	\$235.00



from **\$135.00**
The Easy Rougher



The Easy Rougher is a carbide turning tool that addresses fatigue, safety, and efficiency like no other type of tool on the market. Designed to be kept flat on the tool rest and level to the floor, the Easy Rougher will effortlessly hog away massive amounts of material for any woodturning process - without the need for sharpening.

- ✓ Cuts left, right and straight in without changing approach angle
- ✓ Truly deeper cuts - up to 25mm off the diameter in one pass with the Full Size Rougher.
- ✓ Requires very little physical

strength or exertion

- ✓ Your feet and hips stay in nearly the same position for the blank roughing process.
- ✓ Very minimal handle bouncing on irregular shaped blanks
- ✓ Reduced kick-back or sucking into work piece
- ✓ Available Chip Deflector keeps most projectiles away from the face and neck
- ✓ No intimidating cutting angles to learn and remember
- ✓ No bevels to ride, no fear of a dangerous catch

Code	Size	Product	Weight	Price
EWT-12006	Micro	82mm Blade 150mm Handle	230g	\$135.00
EWT-5200	Mini	102mm Blade 305mm Handle	380g	\$149.00
EWT-2200	Midi	175mm Blade 355mm Handle	600g	\$179.00
EWT-1200	Full	215mm Blade 405mm Handle	930g	\$199.00
EWT-3200	Pro	215mm Blade 510mm Handle	1.1kg	\$235.00

from **\$135.00**
The Easy Finisher



The Easy Finisher has a round carbide cutter perfect for inside work on smaller bowls and larger coves on spindle work. The carbide inserts are manufactured in the USA. There are no complicated approach angles, or bevels to ride.

The design of this tool allows the Easy Finisher to effortlessly cut from the centre of a bowl out to the rim OR from the rim to the centre! All without changing any angles whatsoever. You just stand in one spot and cut - coming and going until you get to the shape you want.

Code	Size	Product	Weight	Price
EWT-12011	Micro	82mm Blade 150mm Handle	230g	\$135.00
EWT-6200	Mini	102mm Blade 305mm Handle	380g	\$149.00
EWT-6300	Midi	175mm Blade 355mm Handle	600g	\$179.00
EWT-4200	Full	215mm Blade 405mm Handle	930g	\$209.00
EWT-3400	Pro	215mm Blade 510mm Handle	1.1kg	\$235.00



from **\$209.00**
Easy Hollowing Tools



The Easy Hollowers were designed to offer a revolutionary new approach to turning hollow forms. These patented tools allow any skill level to achieve professional results for hollowing work with minimum effort and worry.

- ✓ Choose a Hollower for undercutting the rim of hollow forms
- ✓ Utilizes the proven round carbide cutters
- ✓ The True Curve Neck is designed

to access the most difficult hollow form shapes

- ✓ The proprietary Super Wide Tool Bar provides stable tool rest contact and offers support in line with the cutting edge eliminating all rotational forces

The Hollower tools are 100% CNC machined on all surfaces, except the bottom, from solid stainless steel plate (not bent round bar) and come with clear lacquered Rock Maple handles ergonomically shaped for comfort.

Code	Size	Product	Wgt	Price
EWT-6601	Midi Straight	215mm Blade 355mm Handle	730g	\$209.00
EWT-6602	Midi Shallow Swan	190mm Blade 355mm Handle	730g	\$229.00
EWT-6603	Midi Deep Swan	190mm Blade 355mm Handle	730g	\$229.00
EWT-6305	Full Deep Swan	240mm Blade 405mm Handle	1.1kg	\$239.00
EWT-3505	Pro Deep Swan	240mm Blade 515mm Handle	1.1kg	\$269.00

Extraction & Safety
 Measuring & Marking
 Sawing
 Site & Shop Accessories
 Routing
 Planing
 Sanding & Scraping
 Drilling
 Joinery
 Clamps & Vices
 Finishing
 Sharpening
 Carving & Chisels
 Woodturning
 Wooden Parts
 Cabinet Fittings

WOODTURNING

Extraction & Safety
 Measuring & Marking
 Sawing
 Site & Shop Accessories
 Routing
 Planing
 Sanding & Scraping
 Drilling
 Joinery
 Clamps & Vices
 Finishing
 Sharpening
 Carving & Chisels
Woodturning
 Wooden Parts
 Cabinet Fittings

\$189.00 Easy Parting Tool



EWTPT-125 | 660g



Quite simply - this is the easiest, safest and most versatile parting tool you will ever use! With perfect geometrics built right into the replaceable cutter, you will never need to concern yourself with all the fuss of sharpening.

Exclusive Features

- ✓ First ever replaceable carbide insert parting tool for woodturners
- ✓ Used flat and level like all Easy Wood Tools (you can also rub the bevel if you wish)
- ✓ Genuine EWT Carbide Cutters cut wood much cleaner and stays sharp longer than HSS tools

- ✓ No uncomfortable sharp edges on the tool bar

Specifications

- ✓ Handle - 355mm Hard Maple
- ✓ Cut Width - 3.2mm (1/8in)
- ✓ Blade/Cutting Depth - 2.4 x 76mm
- ✓ Tool Bar Length - 152mm
- ✓ Max Part Off Diameter - 51mm

from **\$6.50** Easy Start Tools



These tools are new to the Easy Wood range and combine the genuine American-made quality and super-sharp EWT carbide cutters for a low start-up cost.

They have economical 230mm-long hard Maple handles combined with 88mm-long black oxide steel tool bars with 9.5mm (3/8in) carbide cutters - perfect for beginners, schools and smaller projects.

Code	Product	Weight	Price
EWT-9520	Easy Start Rougher	300g	\$99.00
EWT-9620	Easy Start Finisher	300g	\$99.00
EWT-9720	Easy Start Detailer	300g	\$99.00

\$6.50 Easy Tool Level



EWT-8202 | 50g



The Easy Level is a small removeable guide that helps you use your Easy Wood Tools. For best cutting results, you need to keep all Easy Wood Turning Tools level and this is a simple and easy-to-use attachment to assist with this.

For the Easy Hollowing Tools, never use with the handle below the level of the tool rest - so when using Easy Hollowing Tools, keep the bubble on the back of the line by slightly raising the handle.

\$399.00 Easy Micro Tool Set



EWT-12021 | 160g



Easy Micro Turning Tools brings a whole new level of creativity and capabilities to carbide turning. Precision feel and the ability to achieve finer detailing bring more control when turning small, detailed projects.

Turning ornaments and finials has never been more satisfying and fun. Easy Micro Tools have 82mm blades with comfortably shaped 150mm handles. Includes bonus Ci6-R1 carbide cutter.

\$44.90 Easy Chip Deflectors



The Easy Rougher is capable of plunge cuts similar to using a giant parting tool. This type of cut sends massive amounts of material straight back at the operator. You will not regret having this deflector in place for those cuts.

- ✓ Not a substitute for proper eye protection.
- ✓ Deflector was designed to be looked over rather than through.

- ✓ Available in two sizes - 3/8in for the Micro, Mini and Midi tools, 1/2in for the Full and Pro Sizes.

Code	Product	Wgt	Price
EWT-2700	3/8in Deflectors	70g	\$44.90
EWT-1700	1/2in Deflectors	70g	\$44.90

from **\$19.90** Easy Tool Carbide Cutters



Part No.	Description	Tools That Require Tip/Cutter	Price
EWT-4400	Ci0 - Round	EWT-3400 Easy Finisher Pro	\$29.90
EWT-6400	Ci3 - Round	EWT-4200 Easy Finisher Full Size	\$24.90
		EWT-6300 Easy Finisher Midi	
		EWT-6200 Easy Finisher Mini	
EWT-6604	Ci5 - Round	EWT-9620 Easy Start Finisher	\$24.90
		EWT-6305 Easy Hollower Full Size	
		EWT-3505 Easy Hollower Pro	
EWT-1500	Ci1-SQ - Square	EWT-12011 Easy Finisher Micro	\$19.90
		EWT-6601 Easy Hollower Midi #1	
		EWT-6602 Easy Hollower Midi #2	
EWT-1600	Ci1-R2 - 2in Radius	EWT-6603 Easy Hollower Midi #3	\$19.90
		EWT-3200 Easy Rougher Pro	
		EWT-1200 Easy Rougher Full Size	
EWT-1400	Ci1-R4 - 4in Radius	EWT-3200 Easy Rougher Pro	\$19.90
		EWT-1200 Easy Rougher Full Size	
		EWT-2200 Easy Rougher Midi	
EWT-2500	Ci2-SQ - Square	EWT-5200 Easy Rougher Mini	\$19.90
		EWT-9520 Easy Start Rougher	
		EWT-2200 Easy Rougher Midi	
EWT-2600	Ci2 R2 - 2in Radius	EWT-5200 Easy Rougher Mini	\$19.90
		EWT-9520 Easy Start Rougher	
		EWT-12006 Easy Rougher Micro	
EWT-12406	Ci6-SQ - Square	EWT-12006 Easy Rougher Micro	\$24.90
EWT-12411	Ci6-R1 - 1in Radius	EWT-12006 Easy Rougher Micro	\$24.90
EWT-7400	Ci4 - Diamond	EWT-3700 Easy Detailer Pro	\$29.90
		EWT-7500 Easy Detailer Full Size	\$24.90
		EWT-7300 Easy Detailer Midi	
		EWT-7200 Easy Detailer Mini	
EWT-12407	Ci7 - Diamond	EWT-9720 Easy Start Detailer	\$24.90
EWTPI-126	pi1 - 1/8in Part	EWT-12007 Easy Detailer Micro	
		EWTPI-125 Easy Parting Tool	\$24.90



\$1,799.00

Coronet Herald Lathe

RECORD POWER
ESTABLISHED 1905



This brand new lathe from Record Power represents the culmination of many decades of expertise in the manufacture and supply of superior woodturning lathes. Thanks to a number of innovative design solutions the capabilities, features and performance of the Herald far exceed anything a machine of this size has been capable of before - It brings top-end professional

performance at a fraction of the size and cost of comparable heavy-duty machines.

As well as looking great, the Herald feels great - the excellence of engineering, ergonomics and quality manufacturing can be felt throughout, making the lathe a pleasure to use whilst delivering rock solid performance.

Motor Size	1000W (1 1/3HP)	Max. diameter bowl (over bed)	14in (355mm)
Spindle speeds	95-3890rpm	Max. diameter bowl (swivelled)	21in (533mm)
Headstock type	Swivelling	Distance between centres	22in (508mm)
Thread size	33mm x 3.5TPI	Distance between centres with bed extension:	36in (915mm)
Morse taper size	2MT		
Code	Product	Weight	Price
RP-16007	Woodlathe Only	48kg	\$1,799.00
RP-16015	Leg Stand Set	-	\$289.00
RP-16011	Bed Extension	-	\$345.00
RP-16012	Bench Feet	-	\$135.00
RP-16013	Cast-Iron Outtrigger	-	\$95.00

\$949.00

550 x 320mm Woodlathe

SHERWOOD



Motor Size	550W (3/4HP)	Thread Size	30mm x 3.5TPI
Spindle Speeds on Belt Setting 1	250-750rpm	Morse Taper Size	2MT
Spindle Speeds on Belt Setting 2	550-1650rpm	Max. Diameter Bowl (over bed)	13in (320mm)
Spindle Speeds on Belt Setting 3	1300-3850rpm	Distance Between Centres	22in (550mm)
Headstock Type	Fixed	Distance Between Centres with Bed Extension	48in (1220mm)

While this lathe falls into the midi lathe category, its short bed hides what is the best lathe under \$1k in Australia now. That's a big call and we stick by it. The spec's on their own sound good but seeing this lathe in action is when you understand how well-built it is, which will mean a lifetime of enjoyable use.

The 3/4HP DC motor goes to the electronic variable speed control box, located at the tailstock end to

keep the electronics away from the dust generated at the headstock end.

The bed section itself is actually a bigger and heavier cross-section than all MC series (except the MCVF-1847) and the tool rest holder is full sized 1in with industry-standard thread and morse taper sizes.

An absolute pleasure to use we would highly recommend this unit to anyone looking for an entry-level lathe doing all spindle and most standard-size bowl work.

Prod Code	Product	Weight	Price
M-320	Woodlathe Only	57kg	\$949.00
M-320-BE	Bed Extension	19kg	\$199.00
M-320-ST	Stand For Lathe	18kg	\$179.00
M-320-BEST	Bed Extn Stand	11kg	\$119.00
M-320-K-1	Woodlathe & Stand Kit	76kg	\$1,049.00
M-320-K-2	Woodlathe & Bed Extn Kit	76kg	\$1,099.00
M-320-K-3	Lathe, Extn & Stands Kit	105kg	\$1,379.00



\$569.00

Midi Lathe



Motor Size	375W (1/2HP)	Max. diameter bowl (over bed)	12in (305mm)
Spindle speeds	350, 670, 1025, 1500, 2225, 3250rpm	Distance between centres	15in (380mm)
Headstock type	Fixed	Distance between centres with bed extension:	39in (990mm)
Thread size	33mm x 3.5TPI		
Morse taper size	2MT		

The DML305 cast iron lathe represents a new benchmark in high quality midi lathes and is perfect for the user with minimal space or as a second lathe for demonstrations and shows. The bed is made from finely ground cast iron for weight and rigidity and fitted with cam locking tool rests that

clamp easily and solidly to the bed with one handed operation.

This lathe is extremely well finished with polished metal handles, spindle locks with indexing and graduated markings on the tailstock barrels. Many of these features are normally only found on expensive professional lathes.

Code	Product	Weight	Price
DML-305-M-33	Woodlathe Only	52kg	\$569.00
DML-305-BE	Bed Extension	18kg	\$169.00

WOODTURNING

\$399.00
450 x 300mm
Woodlathe



SHERWOOD

Motor Size	550W (3/4HP)
Spindle Speeds	650, 1000, 1450, 2000, 3000RPM
Headstock Type	Fixed
Thread Size	30mm x 3.5TPI
Morse Taper Size	2MT
Max. Diameter Bowl (over bed)	12in (305mm)
Distance Between Centres	18in (450mm)

A great little performer at an even better price! It is built on a small scale but is by no means lightweight with industry-standard morse tapers and threads so it is great for performing to its maximum capacity. Perfect for a woodturner that needs to move the lathe around or has a serious space restrictions. It has a punchy motor and with the fixed head design performs smoothly when either bowl or spindle turning.



Code	Product	Weight	Price
MC-1218	Woodlathe Only	40kg	\$399.00
MC-1218-BE	Bed Extension	10kg	\$99.00

\$599.00
900 x 300mm
Woodlathe



SHERWOOD

MC-1236 | 85kg

Now the most popular lathe on the Australian market - and with good reason. At an extremely affordable price this lathe has all the features most woodturners want. It has a solid cast-iron bed; suitable for absorbing vibration and comes with

the stand, 150mm face plate, spur drive, live centre and knockout bar as standard. The headstock can be swivelled for outboard turning with and with the included bed extension, the tool rest can be mounted to reach the work piece.

Motor Size	550W (3/4HP)	Morse Taper Size	2MT
Spindle Speeds	500-2000rpm	Max. Diameter Bowl (over bed)	12in (305mm)
Headstock Type	Swivelling	Distance Between Centres	36in (900mm)
Thread Size	30mm x 3.5TPI		

\$1,099.00
1100 x 400mm
Woodlathe



SHERWOOD

Motor Size	1100W (1 1/2 HP)
Spindle Speeds	500-2000RPM
Headstock Type	Swivel sliding
Thread Size	30mm x 3.5TPI
Morse Taper Size	2MT
Max. Diameter Bowl (over bed)	16in (406mm)
Distance Between Centres	43in (1100mm)

This lathe sits at the top of the entry-level lathe range with the largest capacity of all mechanical speed lathes. Due to the motor power and size increasing on this unit, it is now mounted on the outboard side of the headstock. The major upgrade of this unit is swapping out the pressed steel bolt-together stand for two cast-iron legs.

Code	Product	Weight	Price
MC-1643	1100 x 400mm Woodlathe	182kg	\$1,099.00



\$699.00
1100 x 350mm
Woodlathe



SHERWOOD

MC-1443 | 97kg

Motor Size	750W (1HP)
Spindle Speeds	500-2000RPM
Headstock Type	Swivel sliding
Thread Size	30mm x 3.5TPI
Morse Taper Size	2MT
Max. Diameter Bowl (over bed)	14in (352mm)
Distance Between Centres	43in (1100mm)

The bigger brother of the MC-1236, it is a great intermediate lathe that you won't outgrow quickly. It has all the features the MC-1443 has, but has several upgraded features such as motor size, swing over the bed and increased distance between centres for heavier turning. The stand also features a tray to store your tools. An important distinction between the two lathes is that the headstock can slide anywhere along the bed for increased stability when turning large bowls.



\$159.⁰⁰ Turning Tool Set of 6



WTS-6 | 3.9kg



The blades are good quality high-speed-steel that hold their edge well and are easy to grind to shape. Great to practice on to get your grinds how you like them once experienced.

The Ash handles are lacquered and they come in a wooden storage box. The selection of profiles in the set gives you a comprehensive range of chisels to do both spindle and faceplate (bowl) turning and

we specified these as they are the most common standard sizes of each chisel to maximize usability.

The set includes;

- ✓ 10mm spindle gouge
- ✓ 13mm bowl gouge
- ✓ 22mm roughing gouge
- ✓ 19mm round nose scraper
- ✓ 5 x 20mm diamond parting tool
- ✓ 25mm oval skew chisel

from \$17.⁹⁰ Steel Face Plates



Need a simple, steel face plate? Look no further! Available in a range of three sizes, they're machine-spun and perfectly balanced and

produced from bright steel so will last. M30x3.5TPI direct threads only.

Code	Product	Weight	Price
FP-75-M-30	75mm Diameter	1kg	\$17.90
FP-100-M-30	100mm Diameter	1.2kg	\$19.90

\$74.⁹⁰ Standard Toolrest Kit



TRKSTD-1 | 2.4kg

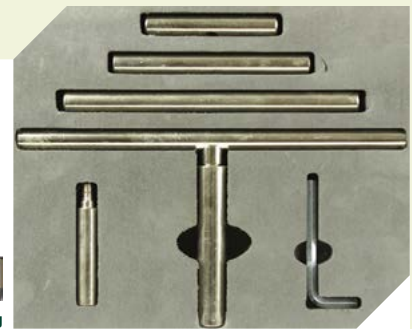

Not sure what tool rest size you need? This modular kit solves the problem with eight different tool rest size combinations. Two shaft sizes of 5/8in and 25mm with four post lengths.

Simply grip the crossbar and

unscrew shaft from the crossbar using the included allen key then remount the shaft on to the other required crossbar. Each crossbar is produced solid, round hardened 18mm bright steel and comes in 100mm, 150mm, 225mm and 300mm lengths.

\$44.⁹⁰ Turning Tool Set of 3 - Mini



WTSM-3 | 480g



A neat set of small gouges suitable for miniature turning work such as pen turning etc. The set contains a 2mm parting tool, 13mm skew chisel and 8mm gouge. The tools have good quality high speed

steel blades measuring 110mm long, with a raw finish Ash handle 145mm long (overall length of 255mm) and a brass ferrule holding the blade in place.

\$299.⁰⁰ Lathe Copy Attachment

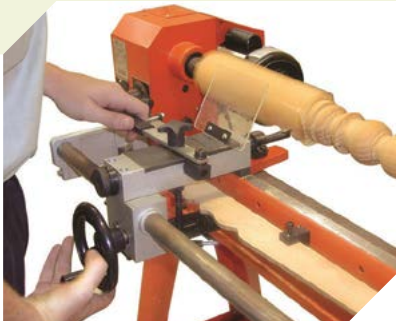

Designed to fit any twin bar or cast bed lathe with a centre height of 125-300mm with a maximum capacity bed length of 1100mm. It easily adapts to fit shorter bed lengths without modification required. It comes with all parts to mount directly to the bed in the kit.

The cutterhead is moved laterally by the handwheel as the spring-loaded

stylus and cutter follow either an original piece or a pattern whilst cutting. The handle on the side is to release the pressure so that you can cut away the stock in a few passes, which will give you a very smooth result.

Now standard with diamond-shaped solid tungsten carbide cutter for long life and use.

Code	Product	Weight	Price
SCA-1100	Lathe copy attachment	20kg	\$299.00
SCA-9002	Replacement TCT Tip	20g	\$29.90

\$79.⁹⁰ Bowl Turner's Toolrest Kit



TRKBT-1 | 3.5kg



Reach far into the interior of bowls with ease with these 4 invaluable tool rests. The comfortable, ergonomically designed tool rests will provide you with all-day turning support.

With the unique concave design, your fingers will fit snugly on the rest and let you get closer to your

work. The ultra smooth, round hardened steel top will let you effortlessly glide your lathe tool for superior results. All rests have hardened rods (that will not nick or scratch giving it a long life) welded over 16mm curved bar stock for long life and superior support when turning. Shaft size is 25.4mm (1in).

Extraction & Safety
Measuring & Marking
Sawing
Site & Shop Accessories
Routing
Planing
Sanding & Scraping
Drilling
Joinery
Clamps & Vices
Finishing
Sharpening
Carving & Chisels
Woodturning
Wooden Parts
Cabinet Fittings

\$215.00 KIT

Torquata Scroll Chuck System



Code	Product	Price
TSC-100	Scroll Chuck Only	\$199.00

Select insert from list below

Code	Product	Price
TSCI-3035	M30 x 3.5TPI	\$16.00
TSCI-110	1in x 10TPI	\$16.00
TSCI-108	1in x 8TPI	\$16.00
TSCI-3416	3/4in x 16TPI	\$16.00
TSCI-580	5/8in Unthreaded	\$16.00

If you look at the comparison you will see that the Torquata Chuck is bigger than its major rivals in the market. Most chucks are known as 3 1/2in or 90mm chucks – Torquata uses a full-size 100mm chuck body.

Why does this matter?

1. The internals of this chuck are bigger and stronger, which translates to stronger, more secure work holding on larger work pieces up to 700mm (28in) diameter when appropriate jaws are used.
2. The jaw slides are bigger and work over a larger range inside the chuck body – meaning you get bigger ranges when the jaws are mounted.



Torquata 100mm Chuck Body

Competitor's 90mm Chuck Body

TORQUATA

TSC-100 | 3.3kg

Scroll chucks are indispensable for woodturner's work-holding. They need to be durable, accurately manufactured to provide a smooth scrolling action and positively locking jaws to ensure the work piece is held securely when being machined.

Main Features

- ✓ 100mm bright steel precision-machined chuck body
- ✓ Fully enclosed scrolling gear wheel means it doesn't get clogged with shavings
- ✓ Indexing plate built into side of enclosing plate
- ✓ Hardened steel jaw slides
- ✓ Large and comfortable single T-Handle for single-handed chuck adjustment
- ✓ Includes woodworm screw for extra work holding if necessary
- ✓ Includes standard 60mm dovetail jaws to grip in expanding and contracting mode
- ✓ Standard jaws recommended for work pieces up to 350mm (14in) diameter

- ✓ Jaw Travel Contracting 45–73mm
- ✓ Jaw Travel Expanding 60–88mm
- ✓ Chuck body recommended for work pieces up to 700mm (28in) diameter

The Torquata System Saving

The Scroll Chuck is the first of what is a multi-stage investment when you need more accessory jaws. How much do the spare jaws cost? Look at the comparison below

	Torquata	Record Power
Large Jaws	\$49.90	\$79.90
Pin Jaws	\$44.90	\$79.90
Cole Jaws	\$64.90	\$115.00
Pen Jaws	\$42.90	\$49.90
PowerGrip Jaws	\$64.90	\$79.90
Total	\$268.50	\$404.50

That's a saving of \$136.00 or 33%!

The Torquata Chuck delivers on features, quality and value. Every time.

\$44.90

Scroll Chuck Pin Jaws

TORQUATA

TSCPJ-100 | 550g



Pin jaws are for small work and have several uses: Used in expansion mode for internal holding within a dovetail recess. The dovetail is set away from the flat jaw surface by about 25mm. This gives you better access to the bottom of the bowl for easier tool

work while your bowl is on the lathe. The straight side can be used to hold the inside of a small box body. In compression mode, they can grip a small part like a finial, or pen mandrel.

Jaw Travel Contracting 11 – 42mm
Jaw Travel Expanding 30 – 58mm

\$64.90

Scroll Chuck Cole Jaws

TORQUATA

TSCFJ-100 | 2.7kg



Flat cole jaws are designed to grip bowls and other large diameter work pieces so that the underside of the vessel can be sanded and finished. These jaws specifically suit the Torquata Scroll Chuck and come with the necessary TPR (Thermo-

Plastic Rubber) buffers to the hold the work piece in place in either expanding or contracting mode over a broad range of diameters.

Jaw Travel Contracting 49–236mm
Jaw Travel Expanding 97–287mm

\$49.90

Scroll Chuck Large Jaws

TORQUATA

TSLJ-100 | 820g



These large dovetail jaws are one of the largest capacity dovetail jaws readily available for woodturning chucks. They are designed for turning large bowls on a full size lathe only. They can be used in

contracting mode for gripping a tenon or expansion mode for internal holding within a dovetail recess.

Jaw Travel Expanding 110–138mm
Jaw Travel Contracting 92– 20mm

\$47.90

Scroll Chuck SuperGrip Jaws

TORQUATA



The SuperGrip Jaws are designed for holding long work pieces securely. Both will hold work pieces up to 500mm (20in) from the jaws in two different size ranges.

The small also has a special cut-away in the jaw to more securely hold square stock in the chuck.

Small Jaw Capacity

Jaw Travel Contracting 29–59mm
Jaw Travel Expanding 37–77mm

Large Jaw Capacity

Jaw Travel Contracting 60–93mm
Jaw Travel Expanding 80–110mm

Code	Product	Wgt	Price
TSCSGS-100	Small	540g	\$47.90
TSCSGL-100	Large	540g	\$47.90

from **\$42^{.90}**

Scroll Chuck Pen Plus Jaws

TORQUATA

TSCPP-100 | 440g

Pen Plus Jaws easily convert your Torquata Chuck into a fast and accurate pen blank drilling facility. The big jaw profile provides a vibration free, solid grip for all sizes of pen blanks and an accurate centred hole every time. Being able to finely control the drill feed on the



lathe is a big advantage to prevent break out on those delicate pen walls. Also perfect for squaring up the pen blank ends after gluing in the pen kit tubes.

Jaw Travel Contracting 14x14 - 35x35mm

Jaw Travel Expanding 43 - 75mm

\$64^{.90}

Scroll Chuck Power Grip Jaws

TORQUATA

TSCPG-100 | 650g

PowerGrip Jaws are designed to expand the range and capacity of your Torquata Chuck for specific projects and applications. It's the most powerful jaw available in the Torquata range for large spigot/hollow form turning - a great multipurpose jaw for bowl and hollow form turners.



With a massive 35mm depth and a special serrated tooth form, it grips firmly in the contraction mode, providing high tear out strength. In expansion mode, a special dovetail profile is designed for maximum strength and holding without crushing wood fibres.

Jaw Travel Contracting 75-101mm
Jaw Travel Expanding 93-125mm

from **\$52^{.90}**

Scroll Chuck Spigot Jaws

TORQUATA

Spigot jaws are heavy section jaws with a powerful grip for spigot (tenon) turning.

With 30mm depth and a special serrated tooth form, it grips firmly in the contraction mode, providing high tear out strength. These jaws really hang on to your workpiece where a long overhang is needed or hollowing into end grain, these jaws provide superior gripping power. In expansion mode, a special dovetail



profile is designed for maximum strength and holding without crushing wood fibres.

35mm Jaws

Jaw Travel Contracting 30 - 58mm
Jaw Travel Expanding 51 - 81mm

45mm Jaws

Jaw Travel Contracting 41 - 68mm
Jaw Travel Expanding 52 - 83mm

Code	Product	Wgt	Price
TSCSP-35	35mm Jaw Set	450g	\$52.90
TSCSP-45	45mm Jaw Set	450g	\$54.90

\$34^{.90}

Scroll Chuck Soft-Grip Jaws

TORQUATA

TSCSJ-100 | 300g

Made from soft nylon so that the user can cut, mould and customise to their requirements for special work holding. These provide markless holding - the

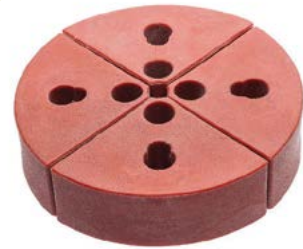

nylon material holds most woods without marring. The thick jaw body provides flexibility of design. Comes with 4 jaw segments of soft nylon.

\$69^{.90}

Scroll Chuck Long Nose Jaws

TORQUATA

TSLN-100 | 620g

The Long Nose Jaws feature a 51mm rise above their base which means a very long reach, deep inside bowls. This is a very versatile jaw with tremendous holding power externally and internally.



An ideal set for green wood turning. The internal features dovetail grip for holding footed bowls and other footed work pieces.

Jaw Travel Contracting 45 - 73mm
Jaw Travel Expanding 55 - 87mm

from **\$24^{.90}**

Scroll Chuck Face Plate Rings

TORQUATA

Designed to expand your range and capacity of your Scroll Chuck for specific projects and applications. Available in three sizes to fit on to various Torquata Chuck Jaws as listed below to provide a strong and



fast method for mounting of bowl blanks, offering a secure mounting of a faceplate with the quick convenience and power of a chuck. Strong mounting even with irregular sized wood and rough cut surfaces.

Code	Product	Weight	Price
TSCFP-050	Suits Standard Jaws	300g	\$24.90
TSCFP-100	Suits PowerGrip Jaws	690g	\$44.90
TSCFP-130	Suits Large Jaws	1.4kg	\$59.90

\$49^{.90}

Scroll Chuck Heavy Duty Bowl Jaws

TORQUATA

TSCBJ-100 | 740g

Perfect for bowl and spigot projects. Designed for expanded dovetail and reverse dovetail holds, for gripping footed bowls. The walls of the jaw are 3x the thickness standard jaws for heavy-duty bowl turning.



Screws go right through the wall section to add more securing force where it's needed most.

Jaw Travel Contracting 44 - 72mm
Jaw Travel Expanding 80 - 110mm

from **\$27^{.90}**

Scroll Chuck Spur Centres

TORQUATA

Need to use a spur centre but don't want the hassle of removing your chuck? Simply expand your standard jaws, insert the spur centre and tighten the jaws on the spur centre for occasional spindle turning.

Spring-loaded centre pin With 4 solid prongs to dig into wood. Available in two diameters.

Code	Product	Weight	Price
TSCSC-19	19mm Diameter	100g	\$27.90
TSCSC-25	25mm Diameter.	130g	\$29.90



WOODTURNING

\$218.⁹⁰ KIT SC4 Scroll Chuck Kit



RECORD POWER
ESTABLISHED 1908

Perfect for the demanding wood turner, being capable of holding large work pieces yet possessing the precision and compactness to handle more delicate work. With full indexing plate and pinions driven by a long ball-ended hex key to make access easy, even when large work pieces are mounted.

Supplied complete with the woodworm screw, 50 mm standard jaws, 51 mm face plate, choose the insert from the list below.

Expansion Mode: 52 - 72 mm
Contraction Mode: 42 - 61 mm

Code	Product	Weight	Price
RP-62063	Kit Does Not Include Insert	3.2kg	\$189.00
RP-62134	Insert 5/8in Plain Bore	350g	\$29.90
RP-62128	Insert 3/4inx16TPI	350g	\$29.90
RP-62133	Insert 1x8TPI	350g	\$29.90
RP-62129	Insert 1x10TPI	350g	\$29.90
RP-62127	Insert 1 1/8x 8TPI	350g	\$29.90
RP-62130	Insert M30x3.5TPI	350g	\$29.90
RP-62125	Insert M33x3.5TPI	350g	\$29.90

\$79.⁹⁰ 130mm Dovetail Jaws



RECORD POWER
ESTABLISHED 1908
RP-62317 | 900g

Featuring a specialised dovetail profile, these jaws are ideal for turning up to 760mm bowls. They also feature a reverse dovetail for a contracting grip on large spigots.

Expansion Mode: 125 - 145 mm
Contraction Mode: 104 - 123 mm

\$79.⁹⁰ Mini Cole Jaws



RECORD POWER
ESTABLISHED 1908
RP-62356 | 1.2kg

Remounting jaws are incredibly popular due to their flexibility. They work in both contraction and expansion modes and can be fitted behind other jaw sets to create bespoke setups to make turning more efficient. The soft stoppers

are designed to hold without causing damage, making them ideal for remounting finished or partly finished objects for further work.
Expansion Mode: 95 - 215 mm
Contraction Mode: 59 - 170 mm

\$179.⁰⁰ SC3 Scroll Chuck



RECORD POWER
ESTABLISHED 1908

The SC3 chuck is lighter and more compact than the SC4, making it ideal for use on any lathe, particularly small to medium sized machines and is still compatible with the full jaw range. The compact design reduces load on the lathe

spindles and bearings and gives good access to smaller work pieces. Supplied complete with the woodworm screw, 50 mm standard jaws and 51 mm face plate this package offers unrivalled value.

Code	Product	Weight	Price
RP-61064	Direct Thread 3/4in x 16TPI	2.6kg	\$179.00
RP-61062	Direct Thread 1in x 8TPI	2.5kg	\$179.00
RP-61069	Direct Thread 1in x 10TPI	2.6kg	\$179.00
RP-61060	Direct Thread M30 x 3.5TPI	2.6kg	\$179.00
RP-61065	Direct Thread M33 x 3.5TPI	3.1kg	\$179.00

\$115.⁰⁰ Mega Cole Jaws



RECORD POWER
ESTABLISHED 1908

A bigger version of the above jaws they hold up to 275 mm diameter

bowls in contraction mode.

Code	Product	Weight	Price
RP-62377	Mega Cole Jaws	1.35kg	\$115.00
RP-62838	Replacement Buffer Kit	170g	\$39.90

\$54.⁹⁰ 35mm Standard Jaws

RECORD POWER
ESTABLISHED 1908

RP-62321 | 300g



A smaller version of the standard 50 mm jaws, featuring the same dovetail profile in expansion and the superb grip of the hawk beak design on contraction.

Designed specifically for smaller spigots and recesses.
Expansion Mode: 38 - 58 mm
Contraction Mode: 28 - 47 mm

from 25.⁹⁰ Woodworm Screws

RECORD POWER
ESTABLISHED 1908



The SC3 and SC4 are supplied with the standard woodworm screw. Ideal for mounting bowl blanks, it is held in the jaws of the chuck,

giving exceptional holding power. Also available is a longer version for even more exceptional holding power for large work pieces.

Code	Product	Weight	Price
RP-62833	Standard Length	90g	\$25.90
RP-62832	Long Series	125g	\$29.90

\$89.90

Long Nose Jaws

RECORD POWER
ESTABLISHED 1908

RP-62323 | 680g



Extremely flexible jaws that feature internal and external dovetails for bowl work. The deep internal grip is versatile but main benefit of these jaws is to project the work away from the chuck, allowing good tool access to the base of the timber for cleaning and shaping.

Expansion Mode: 54 - 74 mm
Contraction Mode: 38 - 58 mm

\$69.90

Mini Spigot Jaws

RECORD POWER
ESTABLISHED 1908

RP-62336 | 350g



A complement to the new pin jaws, performing many of the same tasks in expansion and the extra screw hole profiles and added teeth to the outside provide tremendous grip when this area will not be visible in the finished work piece. The 13mm internal diameter makes it ideal for turning strong spigots on knobs and handles, again adding to their versatility.

Expansion Mode: 26 - 46 mm
Contraction Mode: 13 - 33 mm

\$29.90

Soft Plastic Jaws

RECORD POWER
ESTABLISHED 1908

RP-62378 | 400g

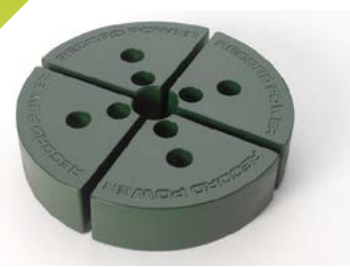

Designed specifically to be cut with standard turning tools. They can be easily shaped to create bespoke jaws to fulfil exacting requirements and offer excellent grip without marking the work piece.

Diameter: 118 - 140 mm
Depth: 26 mm

\$84.90

75mm Heavy Bowl Gripper Jaws

RECORD POWER
ESTABLISHED 1908

RP-62322 | 950g



Ideal for heavy bowls and vases. The wide front face provides a good register for the base of the bowl or vase and the deep toothed body provides strong grip on the spigot. The internal gripper can also be used on smaller rough green timber. Also featuring an external dovetail in expansion, they can be used for large platters.

Expansion Mode: 81 - 102 mm
Contraction Mode: 46 - 65 mm

\$79.90

9mm Pin Jaws

RECORD POWER
ESTABLISHED 1908

RP-62327 | 400g



Improved by squaring the external shoulder to allow workpieces to properly register against the back of the jaws - ideal for use in expansion, to grip tubes in work pieces such as pepper or salt grinders. Internal diameter is reduced to 9 mm, making it ideal for making finials or lace bobbins. Ideal for miniature turning and to grip workpieces internally without excessive damage or marking.

Expansion Mode: 25 - 45 mm
Contraction Mode: 9 - 28 mm

from
\$45.00

Face Plate Rings

RECORD POWER
ESTABLISHED 1908



Faceplate rings are ideal for bowl blanks and due to its strong hold is also suitable for more out of balance timber. Both are held to the chuck using the standard 50mm jaw set which comes complete with all Record Power chuck packages.

Code	Product	Weight	Price
RP-62572	87mm Diameter	500g	\$45.00
RP-62574	126mm Diameter	1.1kg	\$59.90

\$79.90

100mm Powergrip Jaws

RECORD POWER
ESTABLISHED 1908

RP-62329 | 1kg



Ideal for turning large bowls, and hollow vessels. The outer dovetail jaws are ideal for large bowls or platters, particularly when gripping onto a spigot and the deep internal toothed body is ideal for large spigots of large hollow vessels.

Expansion Mode: 94 - 114 mm
Contraction Mode: 76 - 95 mm

\$49.90

Pen Jaws

RECORD POWER
ESTABLISHED 1908

RP-62337 | 400g



Fantastically effective for drilling pen blanks, eliminating the need for a drill press. They offer more accurate results and the deep grip to all four sides ensures incredible holding power. Also useful for working on small finials and similar projects as in addition to their strong grip, the work piece is moved forward from the chuck, allowing greater access.

Contraction Square: 10 - 26 mm
Contraction Spigot: 11 - 20 mm
Expansion Mode: 35 - 64 mm

\$33.00

Scroll Chuck Spur Centre

RECORD POWER
ESTABLISHED 1908

RP-62811 | 130g



You won't need to remove the chuck!

This useful centre is held in the chuck with the 50 mm standard jaws to give a quick-mount solution for spindle turning, meaning the chuck need not be removed from the lathe.

Extraction & Safety
Measuring & Marking
Sawing
Site & Shop Accessories
Routing
Planing
Sanding & Scraping
Drilling
Joinery
Clamps & Vices
Finishing
Sharpening
Carving & Chisels
Woodturning
Wooden Parts
Cabinet Fittings

WOODTURNING

from **\$14.90**

16mm Spur Centres



Featuring a large and sturdy tapered retractable centre pin, with four spurs, each spur has a score taken out of the middle to greatly improve the grip when turning over standard smooth spurred centres.

Code	Product	Weight	Price
TSC-0116	#1MT	80g	\$14.90
TSC-0216	#2MT	80g	\$17.90

\$34.90

Crown Spur Drive Centres



Get a better bite on your spindle with the crown drive centre. More teeth give a better grip while providing equal pressure and a positive drive. There is no need to hammer your drive center into the work piece and risk splitting your work.

Code	Product	Weight	Price
TDC-0216	#2MT 16mm	180g	\$34.90
TDC-0225	#2MT 25mm	180g	\$34.90

\$39.90

Faceshield - Standard



- ✓ Ratchet adjustable head gear
- ✓ Replaceable polycarbonate visor and chinguard
- ✓ Full range of replaceable parts and visors available
- ✓ Quick lock clips for quick and easy visor replacement
- ✓ Protection from fluid splash, particles & dust

Code	Product	Price
EBF-457-A	Faceshield Assembly	\$39.90
EBC-459	Replacement Visor	\$16.90

\$19.90

25mm Spur Centre

TSC-0225 | 220g



Featuring a large and sturdy tapered retractable centre pin with four spurs. Each spur has a score taken out of the middle to greatly improve the grip when turning over standard smooth spurred centres.

Only available in #2MT.

\$49.90

Crown Revolving Live Centre

TLRC-0219 | 400g



This multi-tooth live tailstock center provides a great grip with less stress and avoids splitting your wood. It has sealed bearings and spring loaded point for easy positioning and wood removal.

The head measures 19mm for use on small to medium size work pieces. Only available to suit industry-standard #2 morse tapers.

\$57.90

Faceshield - High Impact



- ✓ High impact visor with integrated chin protection is perfect for woodturners that don't want to cop one in the face
- ✓ Tested, rated and complies with AS/NZS 1337 standard

Code	Product	Price
EBF-454	Faceshield Assembly	\$57.90
EHV-434	Replacement Visor	\$29.90

\$19.90

Live Cup Centres



Large and heavy duty standard live cup centre with a 60° point and full-sealed ball bearing precision for long centre life. The head diameter measures 33mm and is available in both standard #1 and #2 morse tapers.

Code	Product	Weight	Price
TLCC-0133	#1MT	180g	\$19.90
TLCC-0233	#2MT	180g	\$19.90

\$49.90

Live Cup Boring Centre

TLBC-0235 | 220g



The same spec's as the #2MT live cup centre listed to the left but with this one you can pop the centre pin out and you have a hollow revolving cup boring centre. Designed to work with the 3/8in long hole drill auger available in the Crown (and most of other ranges), you can turn your work piece using the live centre, remove the centre pin and easily remount the work exactly where it was and complete your deep hole drilling.

Search **Timbecon** on Instagram to keep updated with all our promotions.



Extraction & Safety
Measuring & Marking
Sawing
Site & Shop Accessories
Routing
Planing
Sanding & Scraping
Drilling
Joinery
Clamps & Vices
Finishing
Sharpening
Carving & Chisels
Woodturning

Wooden Parts
Cabinet Fittings

from
\$0.20

Mini Toy Wheels



All toy wheels are manufactured in USA and produced from high-quality Birch. The MW-0750 measures 19.0 x 4.8mm and uses the AP-0900 axle peg. The MW-0875 measures 22.2 x 6.3mm and uses the AP-0900 axle peg. Axle pegs are not included and are bought separately.

Prod Code	Product	Weight	Price	Bulk Price
MW-0750	19mm Diameter	10g	\$0.25	\$20.00 x100
MW-0875	22mm Diameter	10g	\$0.30	\$24.00 x100

from
\$0.50

Treaded Toy Wheels



Very popular with toy trucks in presents for loved ones where the attention to detail is more important than the cost of the components. They are superbly produced and all use either the AP-3000 or AP-3500 axle pegs, except TWT-150 that uses AP-1010.

Prod Code	Size	Weight	Price	Bulk Price
TWT-150	38.1 x 12.7mm	20g	\$0.70	\$56.00 x100
TWT-200	50.8 x 19.0mm	30g	\$1.40	\$112.00 x100
TWT-250	63.5 x 19.0mm	40g	\$2.50	\$100.00 x50
TWT-300	76.2 x 25.4mm	60g	\$5.50	\$220.00 x50

from
\$3.50

Spoked Toy Wheels



Featuring an eight-spoke hub and wooden "tyre", these spoked wheels are the best you can get and suit fine toy cars. The axle pegs are included in the price. Both wheels are 16.7mm wide at the hub and 11mm and 14mm at the "tyre" respectively on the 51mm & 63mm diameter wheels. The 5mm axle, once installed has a maximum of 20.5mm protruding for installation.

Prod Code	Product	Weight	Price	Bulk Price
SW-2000	51mm Diameter	20g	\$3.50	\$202.00 x72
SW-2500	63mm Diameter	40g	\$6.00	\$345.00 x72

from
\$0.30

Standard Toy Wheels



All toy wheels are manufactured in USA and produced from high-quality Birch. Axle pegs are not included and are bought separately if required.

Prod Code	Size	Weight	Price	Bulk Price
TW-1000	25.4 x 9.5mm	10g	\$0.35	\$28.00 x100
TW-1250	31.8 x 11.1mm	10g	\$0.45	\$36.00 x100
TW-1500	38.1 x 12.7mm	10g	\$0.50	\$40.00 x100
TW-1750	44.5 x 12.7mm	20g	\$1.00	\$80.00 x100

All wheels listed above use the AP-1010 axle peg. All wheels listed below are 19mm wide and use either AP-3000 or AP-3500 axle pegs.

Prod Code	Size	Weight	Price	Bulk Price
TW-2000	50.8 x 19.0mm	30g	\$1.40	\$112.00 x100
TW-2250	57.1 x 19.0mm	35g	\$2.00	\$80.00 x50
TW-2500	63.5 x 19.0mm	40g	\$2.60	\$104.00 x50
TW-3000	76.2 x 19.0mm	50g	\$4.00	\$160.00 x50

from
\$0.20

Solid Round Balls



These solid timber round balls are machined from solid birch and available in a variety of sizes for a variety of applications. The size listed is nominal and subject to slight variations in both diameter and concentricity.

Prod Code	Product	Weight	Price	Bulk Price
RB-0500	12.7mm Diameter	10g	\$0.25	\$20.00 x100
RB-0750	19.0mm Diameter	10g	\$0.35	\$28.00 x100
RB-1000	25.4mm Diameter	10g	\$0.60	\$48.00 x100
RB-1250	31.8mm Diameter	10g	\$0.90	\$72.00 x100
RB-1500	38.1mm Diameter	20g	\$1.25	\$100.00 x100
RB-1750	44.5mm Diameter	30g	\$2.25	\$180.00 x100
RB-2000	50.8mm Diameter	50g	\$3.50	\$140.00 x50
RB-2250	57.1mm Diameter	65g	\$8.50	\$340.00 x50
RB-2500	63.5mm Diameter	80g	\$10.00	\$400.00 x50

from
\$0.15

Axle Pegs



Produced from matching Birch to go with all wheels, they match perfectly and look more professional than using standard dowel.

Prod Code	Product	Weight	Price	Bulk Price
AP-0900	4 x 21mm	10g	\$0.20	\$16.00 x100
AP-1010	6 x 35mm	10g	\$0.25	\$20.00 x100
AP-3000	8.7 x 46mm	10g	\$0.45	\$36.00 x100
AP-3500	8.7 x 65mm	10g	\$0.60	\$48.00 x100

from
\$0.30

Shaker Pegs



Originally used to hang chairs on walls in Shaker households, these can be used for anything as a decorative peg in many craft projects.

Prod Code	Product	Weight	Price	Bulk Price
SP-45	45mm Long	10g	\$0.35	\$28.00 x100
SP-62	62mm Long	10g	\$0.75	\$60.00 x100
SP-89	89mm Long	10g	\$0.90	\$72.00 x100

from
\$26.90

Handcarved Timber Corbels

TRADCO HARDWARE

Handcarved from Mahogany, these corbels jut out from the wall to support shelves on mantles and traditional furniture. Part of the massive range of timber cabinet fittings you can see on our website now!

	T-1-M	60 x 205 x 50mm	\$27.50		T-2-M	60 x 245 x 60mm	\$29.90		T-5-M	60 x 220 x 45mm	\$27.50
	T-14-M	100 x 335 x 80mm	\$49.90		T-16-M	100 x 320 x 75mm	\$49.90		T-28-M	120 x 375 x 95mm	\$61.50



















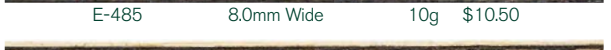

Extraction & Safety
Measuring & Marking
Sawing
Site & Shop Accessories
Routing
Planing
Sanding & Scraping
Drilling
Joinery
Clamps & Vices
Finishing
Sharpening
Carving & Chisels
Woodturning
Wooden Parts
Cabinet Fittings

WOODEN PARTS

Inlay Strips

Classic real wood decorative inlay banding to lift that special box, desk, or reproduction furniture project. Strips are uniform in thickness and come in 1.2m lengths.

	A-2176	3.0mm Wide	10g	\$8.00
	A-2040	4.5mm Wide Economy	10g	\$4.50
	C-1803	5.0mm Wide	10g	\$8.00
	C-505	5.0mm Wide	10g	\$8.00
	D-1002	5.0mm Wide	10g	\$7.50
	DS-38-M	5.0mm Wide	10g	\$7.50
	E-313	5.0mm Wide Economy	10g	\$4.50
	A-2175	5.5mm Wide	10g	\$8.00
	A-2183	5.6mm Wide	10g	\$8.00
	C-533	6.0mm Wide	10g	\$8.00
	C-830	6.0mm Wide	10g	\$8.00
	D-938	6.0mm Wide	10g	\$7.50
	A-2020	6.0mm Wide Economy	10g	\$4.50
	A-2023	6.0mm Wide Economy	10g	\$4.50
	A-2031	6.0mm Wide Economy	10g	\$4.50
	A-2043	6.0mm Wide Economy	10g	\$4.50
	C-1602	6.0mm Wide Economy	10g	\$4.50
	C-532	6.0mm Wide Economy	10g	\$4.50
	ES-47	6.3mm Wide	10g	\$8.00
	E-480	6.5mm Wide	10g	\$7.50
	A-2072	6.5mm Wide Economy	10g	\$4.50
	C-1001	7.0mm Wide	10g	\$8.00

	D-928	7.0mm Wide	10g	\$7.50
	E-109	7.0mm Wide	10g	\$7.50
	D-311	7.5mm Wide	10g	\$7.50
	F-1128	7.5mm Wide	10g	\$10.50
	F-2401	7.5mm Wide	10g	\$10.50
	A-2069	7.5mm Wide Economy	10g	\$4.50
	A-2074	7.5mm Wide Economy	10g	\$4.50
	A-2181	8.0mm Wide	10g	\$8.00
	C-725	8.0mm Wide	10g	\$8.00
	DS-20-M	8.0mm Wide	10g	\$7.50
	E-485	8.0mm Wide	10g	\$10.50
	EL-07	8.0mm Wide	10g	\$13.00
	F-1116	8.0mm Wide	10g	\$10.50
	D-2406	8.0mm Wide Economy	10g	\$4.50
	A-2182	8.0mm Wide	10g	\$10.00
	E-688	8.5mm Wide	10g	\$13.00
	F-807	8.5mm Wide	10g	\$10.50
	F-818	8.5mm Wide	10g	\$10.50
	K-001	8.5mm Wide	10g	\$14.00
	E-2807	9.0mm Wide	10g	\$7.50
	A-2185	9.3mm Wide	10g	\$11.00

Extraction & Safety
 Measuring & Marking
 Sawing
 Site & Shop Accessories
 Routing
 Planing
 Sanding & Scraping
 Drilling
 Joinery
 Clamps & Vices
 Finishing
 Sharpening
 Carving & Chisels
 Woodturning
Wooden Parts
 Cabinet Fittings

Inlay Motifs

Let one of these into the surface of your project for that spectacular lift out of the ordinary. Classic designs in real wood.



A-2178 9.5mm Wide 10g \$11.00



C-2007 10.0mm Wide 10g \$11.00



F-279 10.0mm Wide 10g \$10.50



A-2184 10.0mm Wide 10g \$10.50



E-1523 10.5mm Wide 10g \$13.00



G-213 10.5mm Wide 10g \$16.00



G-561 10.5mm Wide 10g \$14.00



A-2125 12.0mm Wide 10g \$9.90



A-2180 12.0mm Wide 10g \$13.00



A-2186 12.0mm Wide 10g \$13.00



G-1136 12.0mm Wide 10g \$14.00



FS-08 14.0mm Wide 10g \$17.00

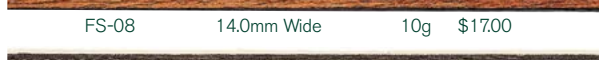

H-1107 14.0mm Wide 10g \$17.00



H-1202 14.0mm Wide 10g \$17.00



F-955 15.0mm Wide 20g \$17.00



F-955 15.0mm Wide 20g \$17.00



H-708 26.0mm Wide 30g \$32.50



H-708 26.0mm Wide 30g \$32.50



K-1109 26.0mm Wide 30g \$32.50



K-1109 26.0mm Wide 30g \$32.50



C-3013 28 x 28mm 10g \$8.00



D-3862 50 x 50mm 10g \$10.00



D-3861 50 x 50mm 10g \$10.00



D-3812 50mm Dia. 20g \$10.50



D-3821 50mm Dia. 20g \$10.50



E-3003 51 x 51mm 10g \$13.50



D-3802 55mm Dia. 20g \$10.50



D-3804 61mm Dia. 20g \$10.50



D-3832 67mm Dia. 20g \$12.00



E-4002 70 x 70mm 20g \$11.00



D-3102 73 x 30mm 10g \$7.50



D-3852 80mm Dia. 20g \$16.00



D-3851 80mm Dia. 20g \$16.00



D-3842 105 x 63mm 20g \$16.00



D-3902 105 x 75mm 20g \$14.50



F-5042 120 x 120mm 20g \$18.00



D-3913 142 x 53mm 20g \$16.00

CABINET FITTINGS

from \$2.90

Jewellery Box Pin Fix Hinges



Simple stamped steel and electro-plated finish brass. Fix in place using escutcheon pins.

Prod Code	Product	Weight	Price
802-PR	15 x 9mm Pk 2	10g	\$2.90
802-PT	15 x 9mm Pk 10	10g	\$9.90
802-PC	15 x 9mm Pk 100	100g	\$86.00
813-PR	20 x 12mm Pk 2	10g	\$3.30
813-PT	20 x 12mm Pk 10	20g	\$11.90
813-PC	20 x 12mm Pk 100	200g	\$104.00

from \$4.90

Jewellery Box Screw Fix Hinges



Simple stamped steel and electro-plated finish brass. Fix in place using 2-gauge brass screws.

Prod Code	Product	Weight	Price
2942-PR	20 x 12mm Pk 2	10g	\$4.90
2942-PT	20 x 12mm Pk 10	10g	\$17.90
2942-PC	20 x 12mm Pk 100	100g	\$154.00
2165-PR	25 x 12mm Pk 2	10g	\$5.50
2165-PT	25 x 12mm Pk 10	20g	\$17.90
2165-PC	25 x 12mm Pk 100	200g	\$159.00
643-PR	25 x 17mm Pk 2	10g	\$5.50
643-PT	25 x 17mm Pk 10	50g	\$18.90
643-PC	25 x 17mm Pk 100	500g	\$170.00
2497-PR	35 x 12mm Pk 2	10g	\$5.50
2497-PT	35 x 12mm Pk 10	50g	\$18.90
2497-PC	35 x 12mm Pk 100	500g	\$170.00

from \$3.50

Jewellery Box Engraved Hinges



Simple stamped steel and electro-plated finish brass. Fix in place using escutcheon pins.

Code	Product	Weight	Price
684-PR	20 x 12mm Pk 2	10g	\$3.50
684-PT	20 x 12mm Pk 10	40g	\$12.90
684-PC	20 x 12mm Pk 100	400g	\$113.00
684-SPR	Pk 2 w/110° stop	10g	\$3.50
684-SPT	Pk 10 w/110° stop	40g	\$12.90
684-SPC	Pk 100 w/110° stop	400g	\$113.00
2439-PR	25 x 16mm Pk 2	10g	\$5.50
2439-PT	25 x 16mm Pk 10	50g	\$17.90
2439-PC	25 x 16mm Pk 100	500g	\$159.00

\$11.50

C-5252 | 30g

Jewellery Box Piano Hinge

300mm length x overall width of 12mm. Steel with an electroplated brass finish, use 2-gauge brass countersunk screws.



from \$9.90

Concealed 180° Barrel Hinges

Drill a hole same diameter as hinge in both work pieces, drop in and install by tightening integral screw for expansion fit.



Prod Code	Product	Weight	Price
CH-508-PR	8mm Pk 2	20g	\$9.90
CH-508-PT	8mm Pk 10	90g	\$44.90
CH-508-PC	8mm Pk 100	900g	\$418.00
CH-510-PR	10mm Pk 2	20g	\$11.00
CH-510-PT	10mm Pk 10	90g	\$49.90
CH-510-PC	10mm Pk 100	900g	\$462.00
CH-512-PR	12mm Pk 2	30g	\$13.50
CH-512-PT	12mm Pk 12	110g	\$60.00
CH-512-PC	12mm Pk 120	1.1kg	\$550.00
CH-514-PR	14mm Pk 2	40g	\$17.90
CH-516-PR	16mm Pk 2	50g	\$20.50

from \$3.00

Concealed Barrel Hinges



To mount, cut a chamfer off the two joining edges so there is clearance for the lid swing open. Drill 5mm diameter hole and glue them in. Its that simple. Available in electro-plated brass or chrome finish.

Code	Product	Wght	Price
CH-5-SPR	5 x 14mm Pk 2	10g	\$3.00
CH-5-SPT	5 x 14mm Pk 10	30g	\$11.00
CH-5-SPC	5 x 14mm Pk 100	200g	\$106.00
CH-10	5 x 14mm Pk 4 Chrome	10g	\$9.90
CH-11	5 x 14mm Pk 20 Chrome	50g	\$49.00
CH-5-LPR	5 x 19mm Pk 2	10g	\$3.50
CH-5-LPT	5 x 19mm Pk 10	30g	\$11.50
CH-5-LPC	5 x 19mm Pk 100	200g	\$110.00

from \$3.50

Jewellery Box Decorative Hinges

Simple stamped steel and electro-plated finish brass. Fix in place using escutcheon pins.



Prod Code	Product	Weight	Price
1623-HPR	16 x 23mm Pk 2	10g	\$3.50
1623-HPT	16 x 23mm Pk 10	40g	\$16.50
1623-HPC	16 x 23mm Pk 100	400g	\$139.00
1645-HPR	16 x 45mm Pk 2	20g	\$5.50
1645-HPT	16 x 45mm Pk 10	50g	\$24.00
1645-HPC	16 x 45mm Pk 100	500g	\$199.00

from \$7.90

Jewellery Box Butterfly Hinges



The smallest size is solid brass and will open up to 180°, the two larger sizes are steel and electro-plated brass with 105° stops built in.

Prod Code	Product	Weight	Price
BFH-02	18mm Pk 10	10g	\$7.90
PBH-01	25mm Pk 10	30g	\$16.50
PBH-03	32mm Pk 10	40g	\$19.90

from \$2.50

Jewellery Box Slotted Hinges



Cut a 1/16in thick slot into the box and lid and then knock these hinges lightly into place.

Prod Code	Product	Weight	Price
2315-KPR	Pk 2	10g	\$2.50
2315-KPT	Pk 10	30g	\$10.90
2315-KPC	Pk 100	300g	\$97.00

from \$6.50

Jewellery Box Quadrant Hinges



The L-shaped hinge needs to be recessed into the corner of a box base and lid, with a mortice cut in the base and top to allow for free movement of the integral stay.

Available in three finishes - solid brass, gold-plated and chrome-plated.

Prod Code	Product	Wght	Price
BOH-3221-PR	30x32x7mm Brass Pk2	10g	\$6.50
BOH-3221-PT	30x32x7mm Brass Pk10	50g	\$24.50
GOH-3221-PR	30x32x7mm Gold Pk2	10g	\$13.50
GOH-3221-PT	30x32x7mm Gold Pk10	50g	\$60.00
GOH-4841-PR	48x41x7mm Gold Pk2	30g	\$17.50
GOH-4841-PT	48x41x7mm Gold Pk10	150g	\$79.00
COH-4040-PR	40x40x7mm Chrome Pk2	30g	\$13.90
COH-4040-PT	40x40x7mm Chrome Pk10	150g	\$69.00

from \$7.90

Jewellery Box Strap Hinges



Strap hinges are similar to quadrant hinges but are easier to install. The strap of the hinge measures 6 x 35mm and needs to be recessed on one side of the box with a small mortice drilled out for clearance of the integral stay on the V-5160-B. The V-5260 has an integral 105° stop built-in, not requiring the separate stay.

Prod Code	Product	Weight	Price
V-5160-B	Pk 2 With Stay	10g	\$45.00
V-5260-PR	Pk 2 No Stay	10g	\$7.90
V-5260-PT	Pk 10 No Stay	50g	\$34.90

from **\$17.90**

Stopped Solid Brass Butt Hinges

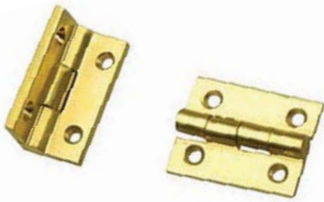

25 x 25mm when open, the leaf has a built-in stop at 90° to hold lids open without needing a stay.

Prod Code	Product	Weight	Price
SBB-259001	25mm Pk 2	10g	\$17.90
SBB-259002	25mm Pk 10	50g	\$89.00



\$19.90 each

Décor Jewellery Box Brass Feet

Vintage 1960's look solid brass box foot.



VIOLA
V-5015 | 30g

\$16.50 each

Classic Jewellery Box Brass Feet

A classic, clean shape solid brass foot which can be used to lift the base of anything from a jewellery box to a bespoke small cabinet or mantle clock.



VIOLA
V-5006 | 30g

\$16.50 each

Lion's Jewellery Box Brass Feet

A classic, bespoke lion's paw solid brass foot.



VIOLA
V-5031 | 30g

from **\$4.90**

Decorative Box Clasps



Made from pressed steel with an electro-plated brass finish. Sizes listed are the width of the clasp.

Prod Code	Product	Weight	Price
562-PR	20mm Pk 2	10g	\$4.90
562-PT	20mm Pk 10	20g	\$15.90
562-PC	20mm Pk 100	200g	\$141.00
1399-PR	25mm Pk 2	10g	\$5.50
1399-PT	25mm Pk 10	20g	\$16.90
1399-PC	25mm Pk 100	200g	\$155.00
560-PR	32mm Pk 2	10g	\$5.50
560-PT	32mm Pk 10	20g	\$17.50
560-PC	32mm Pk 100	200g	\$163.00

from **\$5.90**

Box Hasp & Staples

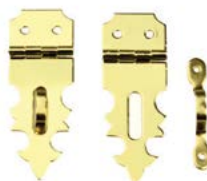

Well-made from pressed steel with an electro-plated brass finish.

Measures 47x15mm

Prod Code	Product	Weight	Price
1645-HSPR	Pk 2	10g	\$5.90
1645-HSPT	Pk 10	80g	\$24.90
1645-HSPC	Pk 100	750g	\$219.00

from **\$5.50**

Box Canteen Clasps

Made from pressed steel with an electro-plated brass finish.

The size listed is width x installed height.



Prod Code	Product	Weight	Price
1788-PR	20 x 16mm Pk 2	10g	\$5.50
1788-PT	20 x 16mm Pk 10	30g	\$17.50
1788-PC	20 x 16mm Pk 100	250g	\$163.00
1789-PR	30 x 20mm Pk 2	10g	\$5.90
1789-PT	30 x 20mm Pk 10	30g	\$18.50
1789-PC	30 x 20mm Pk 100	250g	\$174.00

from **\$3.30**

Jewellery Box Stays

A quick and simple solution to keeping jewellery box lids open. The measurement listed is the overall length of the stay.



Prod Code	Product	Weight	Price
423-PR	55 x 5mm Pk 2	10g	\$3.30
423-PT	55 x 5mm Pk 10	20g	\$12.00
423-PC	55 x 5mm Pk 100	200g	\$110.00
2682-PR	67 x 9mm Pk 2	10g	\$3.50
2682-PT	67 x 9mm Pk 10	40g	\$12.90
2682-PC	67 x 9mm Pk 100	400g	\$117.00

from **\$8.90**

Jewellery Box Brass Corners

Solid brass corners folded into shape.

Measuring 20mm on all three axes.



Prod Code	Product	Weight	Price
2895-PQ	Pk 4	10g	\$8.90
2895-PD	Pk 12	40g	\$19.90
2895-PC	Pk 100	400g	\$205.00

from **\$7.50**

Box Snap Catches

Simply drill a 5mm hole into the top of the side of your box and the lid, glue these ends in and you have a simple and barely visible fastener to hold the lid of your box down.



Prod Code	Product	Weight	Price
3003-PR	Pk 2	10g	\$7.50
3003-PT	Pk 10	20g	\$35.90
3003-PC	Pk 100	150g	\$285.00

from **\$12.50**

Solid Brass Box Catches

Screwed to the face of the box, it has a tongue to ensure that the lid aligns exactly with the body of the box.



Prod Code	Product	Weight	Price
C-058-PR	Pk 2	20g	\$12.50
C-058-PT	Pk 10	200g	\$52.90
C-058-PC	Pk 100	2kg	\$465.00



\$7.90

Decorative Solid Brass Box Hinges

VIOLA
V-499017 | 30g



Solid brass hinge measures 38.7mm across finials, flap size 24.6 x 10 x 1.5mm, 24.8mm wide when fully open.

Sold as a pair.

from **\$8.90**

Box Swing Catches



A decorative swing pin catch to finish jewellery boxes. It is made from pressed steel with a bright electro-plated brass finish. Installation screws are also included. The size once installed is 29mm wide x 34mm high.

Prod Code	Product	Weight	Price
CATCH-03	Each	20g	\$8.90
CATCH-04	Pk 5	70g	\$44.90

\$12.50

CHAIN-01 | 40g

Jewellery Box Chain



A fine 1m length of electro-plated brass chain to use as a stay in jewellery boxes. It comes with the fittings and joiners to make up to six lengths from the one pack of chain.

Extraction & Safety
Measuring & Marking
Sawing
Site & Shop Accessories
Routing
Planing
Sanding & Scraping
Drilling
Joinery
Clamps & Vices
Finishing
Sharpening
Carving & Chisels
Woodturning
Wooden Parts
Cabinet Fittings

CABINET FITTINGS

from \$6.50

Solid Miniature Brass Knobs



Very, very, very small brass knobs! They are produced from 100% polished brass and include the matching backing screw to hold it in place. Sold in packs of two.

Prod Code	Product	Weight	Price
BK-01	4mm Diameter	10g	\$6.50
BK-02	5mm Diameter	10g	\$8.00
BK-03	6mm Diameter	10g	\$11.00

from \$6.00

Solid Brass Knobs

VIOLA

Small, decorative polished 100% solid (not hollow brass) knobs which can dress up many small cabinets and boxes. The securing screw is included with each knob. Sold individually.



Code	Product	Weight	Price
V-498011	12mm Diameter	30g	\$6.00
V-498001	16mm Diameter	10g	\$6.00
V-498012	19mm Diameter	20g	\$9.00

\$6.00

Nickel Plated Solid Brass Knobs

VIOLA



Identical to solid brass knobs with premium polished nickel plated finish.

Code	Product	Weight	Price
V-498011-NP	12mm Diameter	10g	\$6.00
V-498001-NP	16mm Diameter	20g	\$6.00

\$6.00

Flat Top Solid Brass Knob

VIOLA

V-1051 | 10g

13mm diameter x 10mm deep when installed. Screw is 10mm long x 2.9mm diameter.



\$4.90

Latch Trap Solid Brass Knob

VIOLA

V-498013 | 10g

Traps a thickness of 6mm with sliding pin and shoulder pressing into correct size hole for friction fit door latch. Knob is 10 x 10mm when installed.



N

from \$7.90

Brass Push Button Catches



Perfect for use with jewellery boxes, the barrel measures only 6mm.

Code	Product	Weight	Price
3005-PE	Each	10g	\$7.90
3005-PT	Pack 10	100g	\$68.00

from \$5.90

Surface Bolts



Polished 100% solid brass barrel surface bolts. Perfect for marine applications or decorative cabinetry work. All come with a strike plate and brass screws. Sold individually - the size listed is the length of the surface bolt installed on one work piece.

Prod Code	Product	Weight	Price
BB-01	51mm Wide	50g	\$5.90
BB-03	63mm Wide	60g	\$6.90
BB-05	76mm Wide	70g	\$7.90
BB-07	102mm Wide	80g	\$9.90
BB-09	152mm Wide	120g	\$12.90

from \$6.50

Brass Plated Escutcheon Pins

A range of electro-plated brass escutcheon pins for fixing use in fine furniture. An economical option or good for matching with other electro-plated brass fittings.



Prod Code	Product	Weight	Price
C-09025	9mm 25g Bag	30g	\$13.90
C-09250	9mm 250g Bag	530g	\$99.00
C-11025	11mm 25g Bag	30g	\$13.90
C-11250	11mm 250g Bag	530g	\$99.00
EP-10	13mm Pk 100	20g	\$6.50
EP-13	16mm Pk 100	30g	\$8.50
EP-16	19mm Pk 100	30g	\$11.00

from \$5.90

Chrome Plated Escutcheon Pins

A range of steel, chrome-plated escutcheon pins for fixing use in fine furniture in conjunction with modern chrome or zinc-plated fittings.



Prod Code	Product	Weight	Price
CPEP-01	8mm Pk 100	20g	\$5.90
CPEP-03	10mm Pk 100	20g	\$6.50

\$6.00

MES-209 | 30g

Screws 9mm Pk 50 Phillips

2-Gauge gold-plated screws to match the quadrant hinges found on p. 164 and any other small gold-plated cabinet fittings.



from \$9.00

Solid Brass Escutcheon Pins

A range of solid brass escutcheon pins for fixing use in fine furniture. These match perfectly and age gracefully with time and will never rust.

Prod Code	Product	Weight	Price
SBEP-01	8 x 1mm Pk 100	40g	\$9.00
SBEP-03	12 x 1.2mm Pk 100	40g	\$11.00
SBEP-07	15 x 1.5mm Pk 100	40g	\$12.50

from \$20.00

Countersunk Slotted Solid Brass Screws

One of the most complete ranges of solid brass countersunk slotted brass screws available in Australia.

Prod Code	Product	Weight	Price
SBWS-01	0G x 6mm	20g	\$20.00
SBWS-06	0G x 10mm	20g	\$24.00
SBWS-13	0G x 13mm	30g	\$28.00
SBWS-02	1G x 6mm	20g	\$20.00
SBWS-07	1G x 10mm	20g	\$24.00
SBWS-14	1G x 13mm	30g	\$28.00
SBWS-03	2G x 6mm	30g	\$20.00
SBWS-08	2G x 10mm	30g	\$24.00
SBWS-15	2G x 13mm	30g	\$28.00
SBWS-04	3G x 6mm	40g	\$20.00
SBWS-09	3G x 10mm	30g	\$24.00
SBWS-16	3G x 13mm	40g	\$28.00
SBWS-42	3G x 19mm	60g	\$32.00
SBWS-05	4G x 6mm	40g	\$20.00
SBWS-10	4G x 10mm	50g	\$24.00
SBWS-17	4G x 13mm	70g	\$28.00
SBWS-43	4G x 19mm	80g	\$32.00
SBWS-12	6G x 10mm	70g	\$24.00
SBWS-19	6G x 13mm	90g	\$28.00
SBWS-46	6G x 25mm	180g	\$42.00
SBWS-47	6G x 32mm	200g	\$45.00
SBWS-48	6G x 38mm	230g	\$49.00

from \$7.50

Roundhead Slotted Solid Brass Screws

One of the most complete ranges of solid brass roundhead slotted brass screws available in Australia.

Prod Code	Product	Weight	Price
SBWS-21	0G x 6mm	20g	\$20.00
SBWS-26	0G x 10mm	20g	\$24.00
SBWS-33	0G x 13mm	20g	\$28.00
SBWS-22	1G x 6mm	20g	\$20.00
SBWS-27	1G x 10mm	20g	\$24.00
SBWS-34	1G x 13mm	30g	\$28.00
SBWS-23	2G x 6mm	20g	\$20.00
SBWS-28	2G x 10mm	30g	\$24.00
SBWS-35	2G x 13mm	40g	\$28.00
SBWS-24	3G x 6mm	30g	\$20.00
SBWS-29	3G x 10mm	40g	\$24.00
SBWS-36	3G x 13mm	50g	\$28.00
SBWS-25	4G x 6mm	50g	\$20.00
SBWS-30	4G x 10mm	50g	\$24.00
SBWS-37	4G x 13mm	70g	\$28.00
SBWS-32	6G x 10mm	90g	\$24.00
SBWS-39	6G x 13mm	100g	\$28.00
SBWS-61	6G x 19mm	130g	\$38.90
SBWS-62	6G x 25mm	170g	\$41.90

from **\$16.90**

Pin Type Brass Box Locks



Locking against a pin, this box lock measures 45 x 21mm and 7.9mm thick. Comes with brass plated pin striker plate, key and 13.3mm diameter escutcheon that needs a 7/16in hole drilled to seat plus screws.

Also available separately, the solid brass escutcheon, 20mm diameter to be installed by drilling a 19mm hole.

Prod Code	Product	Weight	Price
WE-8-PE	Each	20g	\$16.90
WE-8-PT	Pk 10	180g	\$145.00
EBR-20	Each	10g	\$3.90
EBR-20-PT	Pk 10	100g	\$31.90

from **\$14.90**

Hook Type Brass Box Locks



Slightly bigger at 56 x 19 x 8.8mm thick, this hook-type lock includes both striker plates, key, screws and decorative flat 28 x 20mm escutcheon plate.

Prod Code	Product	Weight	Price
WE-9-PE	Each	20g	\$14.90
WE-9-PT	Pk 10	180g	\$125.00

from **\$21.90**

French Box Locks



Made in France to perfecting standards – great for larger sizes of boxes measuring 65 x 30mm. Includes all mounting hardware.

Prod Code	Product	Price
WE-7-PE	Each	\$21.90
WE-7-PT	Pk 10	\$185.00

\$5.50

19mm Polished Solid Brass Escutcheon Plates



t tradco
3804-PB | 10g

from **\$14.90**

Solid Brass Drawer Locks

Solid brass and designed to be installed with the longest part horizontal in the top of a drawer.



Prod Code	Product	Weight	Price
4004-SB	38 x 32mm	50g	\$14.90
4005-SB	51 x 38mm	70g	\$16.00
4006-SB	63 x 48mm	100g	\$18.00
4007-SB	76 x 48mm	110g	\$20.00

from **\$14.90**

Solid Brass Cupboard Locks

These solid brass cupboard locks have a black key and the flat tongue passes all the way through the body so it can be used for left-hand or right-hand locking applications.



Prod Code	Product	Weight	Price
4000-SB	38 x 20mm	30g	\$14.90
4001-SB	51 x 26mm	50g	\$16.00
4002-SB	63 x 32mm	70g	\$18.00
4003-SB	76 x 37mm	90g	\$20.00

\$5.00

Cupboard Lock



EB-57063 | 70g

A cost-effective cupboard lock, it is produced from pressed steel with an electro-plated brass finish. The tongue slides through the body and therefore can be used in right or left-handed installations.

from **\$5.50**

23mm Solid Brass Escutcheon Plate



Prod Code	Product	Weight	Price
3818-PB	Polished Brass	10g	\$5.50
3829-AB	Antique Bronze	10g	\$6.50
3828-AC	Antique Copper	10g	\$6.50

from **\$2.90**

28 x 16mm Escutcheon Plate



Prod Code	Product	Weight	Price
3819-PB	Polished Brass	10g	\$2.90
3812-AB	Antique Bronze	10g	\$3.50
3813-AC	Antique Copper	10g	\$3.50

from **\$0.90**

No-Mortise Butt Hinges

Don't worry about morticing your hinges - just screw one flap to the jamb and the other to the door to get your installations done quicker.



Prod Code	Product	Wght	Price
HEB-51	Electro-Brass 51mm	30g	\$0.90
HEB-64	Electro-Brass 64mm	40g	\$1.10
HFB-51	Florentine Bronze 51mm	30g	\$0.90
HZB-51	Zinc Plate 51mm	30g	\$1.10

\$13.50/pair

No-Mortise Overlay Hinges

VIOLA
V-499014 | 50g



Perfect where the door is set inside the carcass frame as it automatically has an offset flap built into it so the door clears the frame.

N

from **\$8.90/pair**

Lift-Off Solid Brass Barrel Hinges

VIOLA



Threaded adjustment and press fit mounting, the symmetrical design allows for use as left or right opening of doors.

Prod Code	Product	Price
V-499005	52 x 6mm Pk 2	\$8.90
V-499006	76 x 8mm Pk 2	\$19.90

N

\$29.90 88mm Bent Flap Lift-Off Hinges

VIOLA



Opens more than 270°, bent flap creates clearance of the carcass while opening the door.

Prod Code	Product	Price
V-499013-L	Left-Hand Open	\$29.90
V-499013-R	Right-Hand Open	\$29.90

Extraction & Safety
Measuring & Marking
Sawing
Site & Shop Accessories
Routing
Planing
Sanding & Scraping
Drilling
Joinery
Clamps & Vices
Finishing
Sharpening
Carving & Chisels
Woodturning
Wooden Parts
Cabinet Fittings

CABINET FITTINGS

Tradco Hardware

Tradco are Australia's leading solid timber cabinet hardware distributor and Timbecon has partnered with Tradco to bring their full range to you. Shown on the following pages is just a small part of their total range which is now listed on Timbecon's website.

All items are available in at least one of 14 different surface finishes and are made to true premium quality standards so you can be sure when you get a Tradco product, it will finish the final item perfectly.

While we will be stocking the most popular items for immediate dispatch, because of the massive size of their range, some items will be marked as special order with full details listed on the website on how this is handled.

The full list of finishes are –

- ✓ PB – Polished Brass
- ✓ PM – Polished Metal
- ✓ AB – Antique Brass
- ✓ MB – Matt Black
- ✓ AC – Antique Copper
- ✓ AF – Antique Finish
- ✓ CP – Chrome Plated
- ✓ MP – Metallic Finish
- ✓ SC – Satin Chrome
- ✓ CA – Aged Copper
- ✓ PN – Polished Nickel
- ✓ AN – Aged Nickel
- ✓ SN – Satin Nickel
- ✓ RN – Rumbled Nickel

Check The Full Range of over 2,000 products Online Now!



\$6.50 / each

75 x 50mm Polished Brass



tradco
3756-PB

\$7.50 / each

70 x 50mm Polished Brass



tradco
3757-PB

from \$6.50 / each

Polished Brass (PB) Finish



tradco

Code	Product	Price
3765-PB	41 x 29mm	\$6.50
3766-PB	53 x 38mm	\$7.90

Butt Hinges /each

Antique Brass

Code	Product	Price
9726-AB	25 x 22mm	\$1.90
9727-AB	38 x 22mm	\$2.30
9728-AB	50 x 28mm	\$3.60
9729-AB	63 x 35mm	\$5.00
9730-AB	76 x 41mm	\$9.00



Matt Black

Code	Product	Price
9694-MB	25 x 22mm	\$1.90
9695-MB	38 x 22mm	\$2.30
9696-MB	50 x 28mm	\$3.60
9697-MB	63 x 35mm	\$5.00
9698-MB	76 x 41mm	\$9.00



Chrome Plated

Code	Product	Price
3110-CP	25 x 22mm	\$1.90
3111-CP	38 x 22mm	\$2.30
3112-CP	50 x 28mm	\$3.60
3113-CP	63 x 35mm	\$5.00
3114-CP	76 x 41mm	\$9.00



Satin Chrome

Code	Product	Price
3120-SC	25 x 22mm	\$1.90
3121-SC	38 x 22mm	\$2.30
3122-SC	50 x 28mm	\$3.60
3123-SC	63 x 35mm	\$5.00
3124-SC	76 x 41mm	\$9.00



Polished Brass

Code	Product	Price
3750-PB	25 x 22mm	\$1.60
3751-PB	38 x 22mm	\$1.90
3752-PB	50 x 28mm	\$3.00
3753-PB	63 x 35mm	\$4.20
3754-PB	76 x 41mm	\$7.90



Aged Copper

Code	Product	Price
2440-AGC	100 x 125mm	\$44.50
2441-AGC	100 x 150mm	\$54.50
2442-AGC	100 x 175mm	\$65.50
2443-AGC	100 x 200mm	\$75.50



Antique Copper

Code	Product	Price
3743-AC	25 x 22mm	\$1.90
3744-AC	38 x 22mm	\$2.30
3792-AC	50 x 28mm	\$3.60
3793-AC	63 x 35mm	\$5.00
3743-AC	76 x 41mm	\$9.00



Matt Black Broad

Code	Product	Price
2990-MB	100 x 125mm	\$41.00
2991-MB	100 x 150mm	\$50.50
2992-MB	100 x 175mm	\$60.50
2993-MB	100 x 200mm	\$69.90



Finial Hinges /each

Antique Brass

Code	Product	Price
9731-AB	50 x 28mm	\$4.90
9732-AB	63 x 35mm	\$6.50
9733-AB	76 x 41mm	\$10.50



Polished Brass

Code	Product	Price
3762-PB	50 x 28mm	\$4.30
3763-PB	63 x 35mm	\$6.00
3764-PB	76 x 41mm	\$9.50



Chrome Plated

Code	Product	Price
3115-CP	50 x 28mm	\$4.60
3116-CP	63 x 35mm	\$6.30
3117-CP	76 x 41mm	\$10.50



Matt Black

Code	Product	Price
9699-MB	50 x 28mm	\$4.60
9700-MB	63 x 35mm	\$6.30
9701-MB	76 x 41mm	\$10.50



Parliament Hinges /each

Antique Copper

Code	Product	Price
2580-AC	100 x 100mm	\$31.50
2581-AC	100 x 125mm	\$38.50
2582-AC	100 x 150mm	\$42.50
2583-AC	100 x 175mm	\$54.90
2584-AC	100 x 200mm	\$63.50



Chrome Plated

Code	Product	Price
2680-AC	100 x 100mm	\$31.50
2681-AC	100 x 125mm	\$38.50
2682-AC	100 x 150mm	\$42.50
2683-AC	100 x 175mm	\$54.90
2684-AC	100 x 200mm	\$63.50



Extraction & Safety
 Measuring & Marking
 Sawing
 Site & Shop Accessories
 Routing
 Planing
 Sanding & Scraping
 Drilling
 Joinery
 Clamps & Vices
 Finishing
 Sharpening
 Carving & Chisels
 Woodturning
 Wooden Parts
Cabinet Fittings



D13mm P11mm
Polished Brass
(PB) Finish

Code	Price
3710-PB	\$2.20
3715-AB	\$2.50



D16mm P12mm
Antique Bronze
(AB) Finish

Code	Price
3711-PB	\$2.40
3716-AB	\$2.90



D19mm P14mm
Polished Brass
(PB) Finish

Code	Price
3712-PB	\$3.00
3717-AB	\$3.50



D19mm P19mm
Chrome Plated
(CP) Finish

Code	Price
3650-PB	\$5.30
3250-AB	\$6.50
3654-AC	\$6.50
3658-CP	\$6.50
3150-SC	\$6.50
3142-PN	\$6.90
3146-SN	\$6.90



D25mm P27mm
Satin Chrome
(SC) Finish

Code	Price
3651-PB	\$6.50
3251-AB	\$7.90
3655-AC	\$7.90
3659-CP	\$7.90
3151-SC	\$7.90
3143-PN	\$8.50
3147-SN	\$8.50



D32mm P28mm
Polished Nickel (PN)
Finish

Code	Price
3652-PB	\$7.50
3252-AB	\$9.00
3656-AC	\$9.00
3660-CP	\$9.00
3152-SC	\$9.00
3144-PN	\$9.90
3148-SN	\$9.90



D38mm P35mm
Antique Nickel
(AN) Finish

Code	Price
3653-PB	\$8.50
3253-AB	\$10.50
3657-AC	\$10.50
3661-CP	\$10.50
3153-SC	\$10.50
3145-PN	\$11.50
3149-SN	\$11.50



25mm Antique Bronze
(AB) Finish

Code	Price
3662-PB	\$6.50
3050-AB	\$7.90
3685-AC	\$7.90
3053-CP	\$7.90
3056-SC	\$7.90



32mm Antique Copper
(AC) Finish

Code	Price
3677-PB	\$8.00
3051-AB	\$9.90
3678-AC	\$9.90
3054-CP	\$9.90
3057-SC	\$9.90



38mm Satin Chrome
(SC) Finish

Code	Price
3663-PB	\$10.90
3052-AB	\$13.00
3686-AC	\$13.00
3055-CP	\$13.00
3058-SC	\$13.00



D25mm P20mm
Polished Brass (PB)
Finish

Code	Price
3679-PB	\$6.00
3036-AB	\$7.50
3037-AC	\$7.50
3038-CP	\$7.50
3039-SC	\$7.50



D32mm P23mm
Antique Bronze
(AB) Finish

Code	Price
3680-PB	\$8.00
3046-AB	\$9.90
3047-AC	\$9.90
3048-CP	\$9.90
3049-SC	\$9.90



35mm Chrome Plated
(CP) Finish

Code	Price
3675-PB	\$8.00
3043-AB	\$9.90
3676-AC	\$9.90
3044-CP	\$9.90
3045-SC	\$9.90



25mm Satin
Chrome (SC)
Finish

Code	Price
4116-PB	\$2.20
4119-AB	\$2.60
4122-AC	\$2.60
4125-CP	\$2.60
4128-SC	\$2.60



32mm Chrome
Plated (CP)
Finish

Code	Price
4117-PB	\$2.70
4120-AB	\$3.20
4123-AC	\$3.20
4126-CP	\$3.20
4129-SC	\$3.20



38mm Antique
Bronze (AB)
Finish

Code	Price
4118-PB	\$3.30
4121-AB	\$4.00
4124-AC	\$4.00
4127-CP	\$4.00
4130-SC	\$4.00



97 x 40mm
Antique
Bronze (AB) Finish

Code	Price
3551-PB	\$6.50
3261-AB	\$7.90
3561-AC	\$7.90
3581-CP	\$7.90
3141-SC	\$7.90
3137-PN	\$8.50
3139-SN	\$8.50



97 x 40mm
Antique
Copper (AC) Finish

Code	Price
3550-PB	\$6.70
3260-AB	\$8.00
3560-AC	\$8.00
3580-CP	\$8.00
3140-SC	\$8.00
3136-PN	\$8.90
3138-SN	\$8.90



100 x 40mm
Chrome
Plated (CP) Finish

Code	Price
3558-PB	\$9.00
3262-AB	\$10.90
3568-AC	\$10.90
3569-CP	\$10.90
3570-SC	\$10.90
4080-MB	\$6.90
4090-PM	\$7.50



105 x 40mm
Antique
Copper (AC) Finish

Code	Price
3554-PB	\$8.90
3564-AC	\$10.50
3574-AF	\$6.50
3584-PM	\$6.90



110 x 35mm
Matt
Black (MB) Finish

Code	Price
3552-PB	\$8.90
3562-AC	\$10.50
3572-MB	\$6.50
3582-PM	\$6.90



100 x 40mm
Antique
Finish (AF)

Code	Price
3553-PB	\$8.90
3573-AF	\$6.50
3583-PM	\$6.90



85 x 32mm
Polished
Metal (PM) Finish

Code	Price
3555-PB	\$8.90
3565-AC	\$10.50
3575-MB	\$6.50
3585-PM	\$6.90



95 x 50mm
Polished
Brass (PB) Finish

Code	Price
3559-PB	\$8.90
3571-AF	\$6.50
3589-PM	\$6.90

CABINET FITTINGS

from **\$9.90**

Traditional Brass Shelf Support System

The traditional and attractive brass shelf support system. The solid brass shelf pins require a 6.4mm diameter hole drilled 8mm deep into the carcass to seat it.



Prod Code	Product	Wgt	Price
SSPSB-20	Shelf Pins Pk 20	30g	\$9.90
SSPSB-200	Shelf Pins Pk 200	300g	\$60.00
SSBSB-20	Shelf Sockets Pk 20	10g	\$4.00
SSBSB-400	Shelf Sockets Pk 400	400g	\$54.00

from **\$16.90**

Traditional Zinc Finish Shelf Supports

Similar to the brass shelf support pins - these suit more modern furniture and are shaped similarly but have are produced from steel with a nickel-plate finish.



Prod Code	Product	Weight	Price
SSPNP-100	Pk 100	130g	\$16.90
SSPNP-1000	1000	1.3kg	\$135.00

from **\$4.90**

Plastic Shelf Supports

A modern shelf support produced from durable urethane plastic, this support is clear or white. Drill 5mm holes for the steel peg, the support area is 10x10mm with an approximate overall height of 20mm.



Prod Code	Product	Weight	Price
SSPCL-50	Clear Pack of 50	50g	\$4.90
SSPCL-1000	Clear Pack of 1000	1kg	\$45.00
SSPWH-50	White Pack of 50	50g	\$4.90
SSPWH-1000	White Pack of 1000	1kg	\$45.00

from **\$13.90**

Steel Bracket Shelf Supports

A heavy-duty shelf support with a wide, flat platform for extra stability holding the shelf in place. The support is 18x12mm and the bracket is approximately 1.4mm thick.



Prod Code	Product	Weight	Price
SSPBZP-50	Pk 50	340g	\$13.90
SSPBZP-500	Pk 500	3.4kg	\$85.00

from **\$13.90**

Steel Bracket Shelf Supports

A modern shelf support - produced from steel and nickel plated. Drill 5mm holes for the steel peg.



Prod Code	Product	Weight	Price
SSPFZP-100	Pk 100	120g	\$13.90
SSPFZP-1000	Pk 1000	1.2kg	\$90.00



from **\$6.00**

Light-Duty Side Mount Runners



- Bottom mounted - with tabs
- Fold tabs up for side mount
- Detachable for ease of installation
- 15kg load rating
- Extension = full length of runner
- Black powdercoated finish
- 1 Set = 1 Drawer

Prod Code	Product	Price
LDDRS-300	300mm capacity	\$6.00
LDDRS-350	350mm capacity	\$6.50
LDDRS-400	400mm capacity	\$7.00
LDDRS-450	450mm capacity	\$7.50

from **\$3.00**

Drawer Runners - Standard



- Bottom mounted
- Self closing
- 25kg Load rating
- 1 Set = 1 Drawer
- White powder-coated finish
- Extension = 50mm less than runner length

Code	Product	Weight	Price
DRS-300	300mm 25kg capacity	490g	\$3.00
DRS-350	350mm 25kg capacity	530g	\$3.50
DRS-400	400mm 25kg capacity	590g	\$3.80
DRS-450	450mm 25kg capacity	700g	\$4.25
DRS-500	500mm 25kg capacity	720g	\$4.50
DRS-550	550mm 25kg capacity	740g	\$5.00
DRS-600	600mm 25kg capacity	850g	\$5.50



from **\$9.00**

Heavy-Duty Drawer Runners



- Don't get fooled by big box stores - compare the load rating of cheaper runners!
- Side mounted
 - Detachable for ease of installation
 - 45kg load rating
 - Extension = full length of runner
 - Zinc plated finish
 - 1 Set = 1 Drawer

Code	Product	Weight	Price
HDDRS-300	300mm 45kg cap.	1.8kg	\$9.00
HDDRS-350	350mm 45kg cap.	2.0kg	\$10.00
HDDRS-400	400mm 45kg cap.	2.3kg	\$11.00
HDDRS-450	450mm 45kg cap.	2.6kg	\$12.00
HDDRS-500	500mm 45kg cap.	2.9kg	\$13.00
HDDRS-550	550mm 45kg cap.	3.2kg	\$14.50
HDDRS-600	600mm 45kg cap.	3.5kg	\$16.00

from **\$25.00**

Soft-Close Drawer Runners



- 50,000 life cycle guaranteed under correct installation and normal usage
- Drawer profile features easy-to-operate drawer removal lever
- Side mounted System 32 compatible hole locations
- Load capacity: 40kg per pair

Code	Product	Weight	Price
SCDRS-300	300mm 40kg cap.	1.8kg	\$25.00
SCDRS-350	350mm 40kg cap.	2.0kg	\$25.50
SCDRS-400	400mm 40kg cap.	2.3kg	\$26.50
SCDRS-450	450mm 40kg cap.	2.6kg	\$28.00
SCDRS-500	500mm 40kg cap.	2.9kg	\$29.50
SCDRS-550	550mm 40kg cap.	3.2kg	\$31.00
SCDRS-600	600mm 40kg cap.	3.5kg	\$33.00



from **\$31.00**

Undermount Soft Close Runners



- Under mount with full extension travel length
- Optimized lengths for standard cabinet depths
- To suit 16mm thick drawer sides
- Ultra smooth gliding motion with high

Code	Product	Price
USCDR-350	350mm Capacity	\$31.00
USCDR-400	400mm Capacity	\$33.00
USCDR-450	450mm Capacity	\$35.00
USCDR-500	500mm Capacity	\$36.50
USCDR-550	550mm Capacity	\$39.00



from **\$125.00**

Extra Heavy Duty Runners



- Side mounted
- Full ball bearing slides
- Non-detachable design
- Heavy duty 75-113kg load rating
- Extension = full length of runner
- Zinc plated finish
- 1 Set = 1 Drawer

Code	Product	Price
XHDDR-550	555mm 113kg Cap.	\$125.00
XHDDR-750	760mm 102kg Cap.	\$139.00
XHDDR-1000	1015mm 87kg Cap.	\$155.00
XHDDR-1200	1215mm 75kg Cap.	\$179.00

Extraction & Safety
Measuring & Marking
Sawing
Site & Shop Accessories
Routing
Planing
Sanding & Scraping
Drilling
Joinery
Clamps & Vices
Finishing
Sharpening
Carving & Chisels
Woodturning
Wooden Parts
Cabinet Fittings

\$159⁰⁰
The SlidePro



The Slide Pro is a fast, hands free installation system for any drawer slide. Install a whole set of slides at once, instead of one at a time! Not only that but you can work on one side and then when you go to

the other it will match exactly, no measuring, no adjustments - just time-saving installs that are level with the base every time.

Maximum height for installation of slides is 680mm.

\$45⁰⁰
Drawer Slide Installation Jig



Install drawer slides the fast, easy way that fits perfectly and slides smoothly every time.

- ✓ Accurate slide positioning with built-in indexing tabs
- ✓ Repeatable results without measuring and marking

- ✓ Versatile for use in cabinets, cases, and more
- ✓ Reversible to mount slides to cabinet and drawer box
- ✓ Secure for holding slides in place as you work
- ✓ Strong, lightweight materials for easy handling

\$34⁹⁰
Shelf Pin Drill Jig



- ✓ 3mm-thick clear perspex body makes it easy to see your work
- ✓ Rigid steel tube fence reversible for both sides of carcass
- ✓ 1/4in hex shank retractable bit self-centres over guide hole
- ✓ High-quality 5mm diameter M2 HSS brad point bit
- ✓ Drilling depth is adjustable via the grub screw

- ✓ Industry-standard 32mm hole centres.
- ✓ Drill either 37 or 63mm from the edge
- ✓ Locating pin holes so you can continue to drill past the 11 built into the jig body.
- ✓ 1/4in bit also available separately is the for older-style shelf pins.

Code	Products	Weight	Price
SPD-01	Jig with 5mm Bit	640g	\$34.90
SPDB-050	Replacement 5mm Bit	60g	\$16.90
SPDB-064	Optional 1/4in Bit	60g	\$16.90

\$45⁰⁰
Drawer Pull Drilling Jig



Install knobs and pulls with easy, repeatable accuracy.

- ✓ Adjustable guides for accurate hole placement
- ✓ Built-in measuring scales for repeatable results
- ✓ Versatile for mounting single and multi-hole knobs

- ✓ Adjustable edge guide for easy positioning
- ✓ Strong, lightweight materials for easy handling
- ✓ Durable hardened-steel drill guides

\$60⁰⁰
Shelf Pin Drilling Jig



Add shelf pin holes to existing furniture or build custom shelves from scratch.

- ✓ Six hardened-steel drill guides
- ✓ Removable, dual-position fence
- ✓ Standard 32mm hole spacing
- ✓ Optional 1/4in drill bit available separately

- ✓ Includes 5mm drill bit
- ✓ Included locating pin for fast, accurate registration
- ✓ Built-in storage for locating pin, drill bit, and depth collar
- ✓ Kreg drill guides guaranteed for life

Code	Products	Wght	Price
KMA-3220	Jig w 5mm Bit	300g	\$60.00
KMA-3210	Sep. 1/4in Bit	50g	\$20.00

\$16⁹⁰
Drill-Rite Drawer Pull Jig



DPJ-01 | 200g

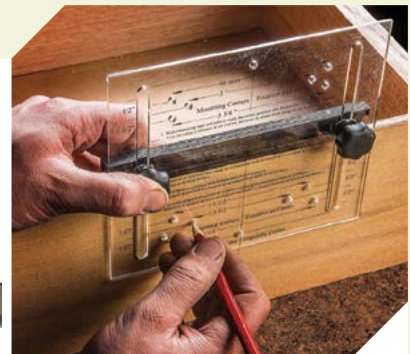

1. Mark the centre position of a drawer pull on the first drawer.
2. Choose the hole pair on the template that matches your pull mounting centres - 63.5mm, 76.1mm, 88.1mm, 95.0mm, 96.0mm or 101.6mm (2 1/2in, 3in, 3 1/2in, 3 3/4in or 4in)
3. Loosen and re-tighten the handle locking knobs with the hole pair centred and at the correct distance

4. Mark the hole positions with a sharp pencil, awl or automatic centre punch.
5. Move the template from drawer to drawer to repeat the process for consistent results.

Extraction & Safety
 Measuring & Marking
 Sawing
 Site & Shop Accessories
 Routing
 Planing
 Sanding & Scraping
 Drilling
 Joinery
 Clamps & Vices
 Finishing
 Sharpening
 Carving & Chisels
 Woodturning
 Wooden Parts
 Cabinet Fittings

CABINET FITTINGS

\$3.50 each

SCH-511102 | 70g

Full Overlay Soft-Closing Hinge



This economical range of commercial-grade soft-closing European Cabinet Hinges are made to a high-standard for long life and well-priced for discerning cabinetmaking applications.

\$3.75 each

SCH-511103 | 70g

Half Overlay Soft-Closing Hinge



Known as half overlay, which means when the door is closed it covers half the thickness of the carcass its attached to. This makes it ideal where two doors are being attached to the same carcass.

\$4.00 each

SCH-511104 | 70g

No Overlay Soft-Closing Hinge



When the door is closed it can sit completely within the edge of the carcass so is perfect where there is no space for the door to swing open.

\$0.30 each

SCH-522710 | 10g

Soft-Closing Hinge Mount Plate



This mount plate suits the standard range of soft-closing European cabinet door hinges. One is required for each hinge.

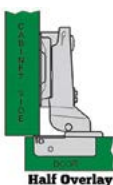

\$45.00

Concealed Hinge Jig

Kreg
KHIHINGE | 500g



Make cabinet door installation easy! Get drill press accuracy with any hand drill.

- ✓ Accurate hinge positioning with built-in indexing tabs
- ✓ Repeatable results with built-in measuring scales
- ✓ Reliable drilling with bit guide and stop collar
- ✓ Simple to use with any drill—no special tools needed
- ✓ Adjustable cams ensure proper hinge offset
- ✓ Durable 35mm carbide-tipped drill bit included for standard European cup hinges
- ✓ Strong, lightweight materials for easy handling

\$99.00

Drawer Front Installation Clamps

FastCap
FC-02254 | 1kg



The Drawer Front Clamp will give you an accurate drawer front install every time. These well engineered clamps make it quick and easy to align and install with no struggle. The dual clamping allows any user to easily adjust a drawer front in seconds. Simply place the Drawer Front Clamps on the drawers, clamp, and adjust for the perfect alignment. Sold as a pair of clamps - produced from high-quality materials that will last on a worksite for years.



from \$6.00

Dually Cabling Grommets



The Dually Grommet snaps together to give holes a finished look in seconds! Perfect to finish ducting holes for cables, dishwasher plumbing or just about anything in carcass installations!

Length Range: 19 - 63.5mm (3/4 to 2-1/2in)

Outside Diameter: 63.5mm (2-1/2in)

Inside Diameter: 57mm (2-1/4in)

Flange Diameter: 82.5mm (3-1/4in)

Prod Code	Product	Weight	Price
FC-01142	White Each	40g	\$6.00
FC-01073	Black Each	40g	\$6.00
FC-01145	White Box 25	4.5kg	\$120.00
FC-09948	Black Box 25	4.5kg	\$120.00



from \$2.00 ea

Standard Bench Top Connectors

ZIPBOLT



Drill two 35mm holes at least 20mm deep to the underside of your two benchtops, along with routing a channel at least 7mm wide to accept the rod, drop the bench top connector and use a 5mm hex bit (or allen key) to pull together. Available in three shaft lengths to suit all spans.

Code	Product	Price
ZB-10500	80mm	\$2.00
ZB-10600	114mm	\$2.20
ZB-10700	165mm	\$2.60

from **\$1.50** each

Plastic Adjustable Feet



Zinc plated 3/8 inch threads.

Prod Code	Product	Weight	Price
ADJF-29	29mm Diameter	30g	\$1.50
ADJF-35	35mm Diameter	30g	\$1.50
ADJF-43	43mm Diameter	40g	\$2.50

from **\$2.00** ea

Metal Hooded Adjustable Feet



More attractive adjustable foot, the metal hood is black on the smaller 25mm diameter foot or silver on the larger 35mm foot.

Prod Code	Product	Weight	Price
ADJF-25-A	25mm Diameter	40g	\$2.00
ADJF-35-A	35mm Diameter	40g	\$2.75

from **\$2.50** ea

Spigot Fixing Furniture Hooded Castors



Prod Code	Product	Weight	Price
CPHS-50	Standard Castor	80g	\$2.50
CPHBS-50	Braked Castor	100g	\$4.00
CPHSGN	Castor Socket Only	30g	\$0.50

from **\$2.50** ea

Plate Fixing Furniture Castors



Has a 42mm square steel plate with four holes for screwing to the underside of furniture.

Prod Code	Product	Weight	Price
CPHP-50	Standard Castor	90g	\$2.50
CPHPB-50	Braked Castor	100g	\$4.00

from **\$2.50** ea

Threaded Furniture Castors



Has a 9.5 (3/8in) x 20mm thread can be used in conjunction with 3/8in teenuts (available separately) for blind installations.

Prod Code	Product	Weight	Price
CPHT-50	Standard Castor	90g	\$2.50
CPHBT-50	Braked Castor	100g	\$4.00

from **\$1.50**

Double Ball Catches



Double ball catches are attractive and sturdy for holding cabinet doors closed.

Prod Code	Product	Weight	Price
DBC-38	38mm Wide	40g	\$1.50
DBC-49	49mm Wide	50g	\$2.00
DBC-60	60mm Wide	70g	\$3.50

\$2.00 ea

Plastic Cable Entry Caps



Drill a 60mm hole and pass your cables through the swivelling outlet.

Prod Code	Product	Weight	Price
CEC-60-WH	White	30g	\$2.00
CEC-60-BE	Beige	30g	\$2.00
CEC-60-BL	Black	30g	\$2.00

from **\$13.50**

Aluminium Cable Entry Caps



Drill a 60mm or 76mm hole and pass your cables through solid cast-and-polished aluminium cable outlet. A perfect piece of hardware to finish off a well-built workstation.

Prod Code	Product	Weight	Price
CEC-60-AL	60mm Diameter	110g	\$13.50
CEC-76-AL	76mm Diameter	160g	\$16.00

\$9.00

CCL-13565 | 70g

Cable Tidy Clamp



With six separate trunks to keep various types of wiring separate and sorted it measures 300 x 135 x 65mm and can be screwed or glued in place just about anywhere.



Search **Timbecon** to watch all of our instructional videos.

from **\$15.90**

Rare Earth Magnets



Rare earth magnets are the strongest type of permanent magnets made, producing significantly stronger magnetic fields than other types. All rare earth magnets have a silver finish on them and the range of sizes available make them perfect for a variety of applications - most commonly in woodworking by gluing them in place so they can be used as a clasp or latching mechanism on doors.

Magnets are also handy to have in a workshop environment or on a jobsite for a whole range of reasons - get creative with them!

All sold as packs of 10 - the pulling strengths listed below are not laboratory tested but reflect approximate magnetic strength.

3 x 2mm - 375g	12 x 2mm - 1.5kg
6 x 2mm - 750g	14 x 3mm - 3.0kg
10 x 2mm - 1.2kg	19 x 6mm - 6.5kg

Code	Product	Price
REM-0302	3 x 2mm Pk 10	\$7.90
REM-0602	6 x 2mm Pk 10	\$9.90
REM-1002	10 x 2mm Pk 10	\$11.90
REM-1202	12 x 2mm Pk 10	\$14.90
REM-1403	14 x 3mm Pk 10	\$18.90
REM-1906	19 x 6mm Pk 10	\$39.90

\$1.50 each

Magnetic Cupboard Catches



A simple and cost-effective magnetic door catch that is easy to install and works well as the semi-floating magnets securely locate on to the striker plate every time.

Prod Code	Product	Weight	Price
MGC-06-B	Brown	30g	\$1.50
MGC-06-W	White	30g	\$1.50

\$9.00 ea

MGC-06-M | 30g

Metal Magnetic Cupboard Catches



A simple and cost-effective magnetic door catch that is easy to install and works well as the semi-floating magnets securely locate on to the striker plate every time.

CABINET FITTINGS

from **\$0.40** each

Knockdown Demon Bolts & Cap Nut

The M6 cabinet knock-down fitting system is well-known and widely used as it is a simple, yet effective way of assembling furniture.



Prod Code	Product	Weight	Price
KDC-25	25mm Long	10g	\$0.40
KDC-35	35mm Long	10g	\$0.40
KDC-40	40mm Long	20g	\$0.40
KDC-50	50mm Long	20g	\$0.40
KDC-60	60mm Long	20g	\$0.40
KDC-70	70mm Long	20g	\$0.50
KDC-80	80mm Long	30g	\$0.50
KDC-90	90mm Long	30g	\$0.50
KDC-100	100mm Long	40g	\$0.55
KDC-115	115mm Long	40g	\$0.60
KDCN-6	Cap Nut Only	10g	\$0.40

from **\$0.60** ea

Knockdown Cross Dowel Nuts

The cross dowel nuts will work with the M6 knock-down demon bolts as well as any standard M6 threaded bolt.



Prod Code	Product	Weight	Price
KDCD-14	14mm Long	10g	\$0.60
KDCD-20	20mm Long	10g	\$0.80

from **\$0.30** ea

Knockdown Insert Nuts

The insert nuts will work with the M6 knock-down demon bolts as well as any standard M6 threaded bolt for blind installations.



Prod Code	Product	Weight	Price
KDSN-13	13mm Long	10g	\$0.30
KDSN-20	20mm Long	10g	\$0.40
KDSNF-13	13mm Long Flanged	10g	\$0.35
KDSNF-20	20mm Long Flanged	10g	\$0.40

from **\$0.30** ea

Lag Screws & T-Nuts

Machine thread on one end and wood screw thread on the other. The wood screw is driven into the timber then you have an exposed machine thread for attaching permanent or temporary items to your timber basework. One way of doing this is using t-nuts with the matching size machine thread.



Prod Code	Product	Weight	Price
LS-14	6.4mm x 50mm Long	10g	\$0.30
LS-516	7.9mm x 75mm Long	20g	\$0.40
LS-38	9.5mm x 75mm Long	20g	\$0.60
LSN-14	6.4mm T-Nut	10g	\$0.25
LSN-516	7.9mm T-Nut	10g	\$0.35
LSN-38	9.5mm T-Nut	10g	\$0.40

\$7.00 each

Cheval Mirror Mounting Brackets

A heavy duty mirror fitting to facilitate tilting even the largest wooden-frame Cheval Mirror. The name comes from the traditional oval-shaped full-length mirrors made from the early 19th century onwards.



CFM-02 | 80g

from **\$0.80** ea

Bench Top Traditional Connectors

Drill a 35mm blind hole into each panel on the underside of your benchtop material and rout a lateral hole or groove for the threaded bolt, butt up the two panels, fit the nut to the threaded bolt and tighten.



Prod Code	Product	Weight	Price
MJC-65	65mm Long	50g	\$0.80
MJC-150	150mm Long	60g	\$2.00

\$2.00 each

Table Leg Brace

Hold two rails to a leg securely in place using this table leg bracket.

The centre hole is oval to allow for adjustment in installation. The bracket measures 125 x 55mm and is folded and stamped so will not deform.



TLB-127 | 120g

\$0.30 each

Z-Type Table Clip

These clips are used to fit table tops to the supporting rail. Cut a 4mm slot into the inside of the rail about 20-25mm from the top of the rail, insert one end of the clip into the slot & screw the clip to the underside of the table top.

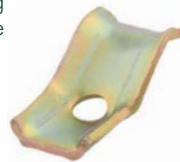

TCZ | 30g

\$0.25 each

Figure 8 Table Clip

These are used to fit table or bench tops to the supporting rail. Cut a recess the thickness of the clip (2mm) into the top of the rail. Screw the clip into the top of the rail, then screw the other hole in the clip to the under side of the table or bench top.



TC-8 | 10g

\$13.90 /set

Standard Bed Brackets

MDBB-2 | 700g



These bed-brackets measure 85mm high and require two (included) M5 allen key bolts to fix the rail plate to the head or foot mount. Produced from solid 3mm-thick steel that is zinc-plated for long life they are suitable for solid single, double and queen beds.

\$17.90 /set

Heavy-Duty Bed Brackets

HDBB-2 | 1kg



These ultra heavy-duty bed-brackets measure 120mm high and require three M5 allen key bolts to fix the rail plate to the head or foot mount. Produced from solid 4mm-thick folded steel plate that is zinc-plated for long life they are suitable for any queen and king-size beds.

\$2.90 each

Bed Bracket Centre Rail Mount

CRBB-1 | 80g



When making a queen or king wooden slatwall-base bed it is recommended to use a strengthening centre rail. To quickly assemble and dis-assemble along with matching bed brackets use this centre rail bracket.

\$49.90

Cot Fitting Bracket Set

HVP-62-NP | 1.5kg



If you're making your own dropside cot for a loved one you'll need the brackets to suit. This is one of few (possibly even the only) the bracket set available in Australia to suit drop-side cots. As long as all other requirements are followed, these brackets will allow you to pass Australian standards.

Extraction & Safety
Measuring & Marking
Sawing
Site & Shop Accessories
Routing
Planing
Sanding & Scraping
Drilling
Joinery
Clamps & Vices
Finishing
Sharpening
Carving & Chisels
Woodturning
Wooden Parts
Cabinet Fittings

from **\$6^{.50}**

Clear Plastic Bumpers

Handy for a range of applications like feet under wooden boxes, as dampers on the inside of drawer fronts to prevent slamming, etc.



Prod Code	Product	Weight	Price
PB-1510100	10 x 1.5mm Pk 100	40g	\$6.50
PB-1510500	10 x 1.5mm Pk 500	200g	\$25.00
PB-3010100	10 x 3.0mm Pk 100	40g	\$6.50
PB-3010500	10 x 3.0mm Pk 500	200g	\$26.00

from **\$4^{.90}**

Traction Dots

Apply to anything you want to stay put and not damage furniture or delicate surfaces. The rubber is flexible with tiny treads on the surface for super grip on the smoothest materials.



Prod Code	Product	Weight	Price
FC-08165	Sheet of 56	40g	\$4.90
FC-08166	Box of 280	140g	\$22.90



from **\$10^{.00}**

Aluminium Lazy Susan Bearings



These lazy susan bearing are made from cast aluminium with a 12mm thickness and are available in a variety of diameters from small (120mm) to the largest commercially available (450mm).

The load rating for all bearings is listed below and a 2mm offset between the inner and outer ring allows the bearing to spin freely alleviating rubbing.

120-250mm = 50kg	350mm = 180kg
300mm = 150kg	400-450mm = 300kg

All bearings come with clear suction stoppers to attach glass to it easily in the traditional way. They can be removed so the 5mm countersunk holes can be used to screw in place.

Prod Code	Product	Weight	Price
LS-120	120mm Round	100g	\$10.00
LS-140	140mm Round	250g	\$10.50
LS-200	200mm Round	420g	\$14.90
LS-250	250mm Round	530g	\$15.90
LS-300	300mm Round	630g	\$17.90
LS-350	350mm Round	770g	\$19.90
LS-400	400mm Round	1kg	\$27.90
LS-450	450mm Round	1.4kg	\$39.90

\$0^{.30} each

FLW-10520 | 10g

Furniture Levelling Wedges



Measures 105 x 20mm and has 8 height options. Simply slide under the offending leg and when it is stable, snap off the overhanging levels so the furniture to lose the wobble.

\$2^{.50} /pair

CHG-0504-BL | 60g

Glass Door Pivot Hinges

A simple hinge for installing glass doors. The black powdercoated steel hinge straddles standard 5mm glass.



\$2^{.50} /pair

CHT-0505-BL | 40g

Wooden Door Pivot Hinges

A simple hinge for installing timber doors - same as the glass door pivot hinges. The black powdercoated steel hinge has a lip that can be screwed on to the door.



\$6^{.90} pk 100

Glass Clips

Hold glass in place securely using the clear swivel clips. Simply install around the edge of the frame and swivel to hold in place, then swivel again to remove the glass or mirror as necessary.



Prod Code	Product	Weight	Price
GC-3100	Suits 3mm Glass	30g	\$6.90
GC-4100	Suits 4mm Glass	30g	\$6.90

\$1^{.00} each

KH-04 | 50g

Escutcheon Plate Hanger

Stamped with an offset key hole shape from 2mm thick steel plate, it is then zinc-plated for long life. Measuring 45 x 16mm with two countersunk holes to screw to the work piece.



\$2^{.00} each

MGDC-1 | 30g

Single Magnetic Glass Door Catches

The single-barrel magnetic push catch is suitable for most standard-size glass doors. It is used in conjunction with a steel strike plate.



\$3^{.50} each

MGDC-2 | 50g

Double Magnetic Glass Door Catches

The double-barrel magnetic push catch has stronger holding properties and needs to be used in conjunction with a steel strike plate.



\$2^{.00}

Sawtooth Hangers



Get adjustment when hanging up work pieces. Install close to the centre of weight distribution and move along the teeth to find the sweet spot where they will hang well. Sold as packs of 10 - installation nails need to be supplied separately (backing nails are suitable).

Prod Code	Product	Weight	Price
STH-4710	Small Pk 10	20g	\$2.00
STH-7410	Large Pk 10	90g	\$2.00

\$1^{.00} each

MGDCPBL | 10g

Magnetic Glass Door Catch Strike Plate

A simple, steel black powdercoat finish strike plate that straddles standard 6mm thick glass doors. To be used with the single or double barrel magnetic push catches.



from **\$4^{.90}**

Steel Lazy Susan Bearings



Each lazy susan is solid pressed steel plate construction with heavy-duty ball-bearing swivel mechanisms. Available in a number of sizes to suit most furniture projects - the 76 - 152mm sizes are all square while the 230mm and 305mm diameter are round in shape and have a large access hole to enable an access hole to be drilled in the bottom (invisible) piece so you can screw up into the top work piece.

Prod Code	Product	Weight	Price
L-33	76mm Square	100g	\$4.90
L-44	102mm Square	140g	\$6.90
L-66	152mm Square	240g	\$9.90
L-90	230mm Round	500g	\$13.90
L-120	305mm Round	720g	\$26.90

Search **Timbecon** to watch all of our instructional videos.



Extraction & Safety
Measuring & Marking
Sawing
Site & Shop Accessories
Routing
Planing
Sanding & Scraping
Drilling
Joinery
Clamps & Vices
Finishing
Sharpening
Carving & Chisels
Woodturning
Wooden Parts
Cabinet Fittings

CABINET FITTINGS



Why Use Striplox when Glues & Screws Will Do?

- It allows simple, safe and efficient assembly, without complex methods, processes or multiple parts.
- It delivers a uniformly loaded joint by spreading the loads and forces evenly across the entire joint.
- Traditional, time consuming, labour intensive joining methods such as nuts, bolts, screws, welding and adhesives are no longer needed.
- It can simultaneously reduce failure risks and costs and enables the easier adoption of high-strength, state-of-the-art composite materials.
- In most cases only a single one-step process will complete the join.
- It can join traditionally incompatible materials as well as objects that have complex curved edges.
- It provides simple self-alignment of joint components.



from
\$14.50
90D



Quickly and easily connect any right-angle joints. Ideal for mitre, butt, square, frame, flush and T joints. Installed height 98mm.

Prod Code	Product	Price
SL-098203-BP	2-Set Pack White	\$14.50
SL-098103-BP	2-Set Pack Black	\$14.50
SL-098203-BX	50-Set Box - White	\$245.00
SL-098103-BX	50-Set Box - Black	\$245.00

\$14.50
Pro 23



Literally hundreds of uses such as installing modern timber battens, hanging cabinets, floating shelves, bookcases, artwork frames, mirrors and feature panels. Achieves these results with its narrow profile for tidy concealment. 83 x 28 x 9mm installed with load capacity up to 160kg per bracket.

Prod Code	Product	Price
SL-023103-BP	4-Set Pack	\$14.50
SL-023303	Locating Jig	\$12.00

from
\$10.50
180D



Incredibly strong and easy to use in one action joining two horizontal boards like kitchen and benchtop tables, workstations, retail fixtures etc.

Prod Code	Product	Price
SL-114103	Single Set	\$10.50
SL-114103-BX	20-Set Box	\$210.00

\$14.50
Mini 60



An invisible joiner that creates a tight, neat, fully concealed solution that can be a permanent or fully reusable joint every time. Requires 60 x 10 x 7mm slots in both work pieces. Maximum 100kg load capacity. Sold as a 10-Set Pack.

from
\$14.50
Pro 55



Same design as the Pro 23 but with larger 126 x 45 x 13mm size and 200kg load capacity per bracket.

Prod Code	Product	Price
SL-055103-BP	2-Set Pack	\$14.50
SL-055103-BX	50-Set Box	\$245.00
SL-055303	Locating Jig	\$12.00

from
\$6.00
Megalox



Has a load capacity of up to 300kg per bracket across its 254 x 19 x 9.5mm length – making it ideal for custom designed kitchen benches and waterfalls Perfect solution for office, bathroom, furniture and toilet partitions.

Prod Code	Product	Price
SL-241103	Single Set	\$6.00
SL-241103-BX	50-Set Box	\$290.00

from
\$14.50
Mini 120



Just like the Mini 60 but with increased load capacity of up to 200kg per bracket. Installation size on each work piece is 125 x 10 x 7mm.

Prod Code	Product	Price
SL-120103-BP	4-Set Pack	\$14.50
SL-120103-BX	100-Set Box	\$245.00

\$14.50
Clip 50



Measures 45 x 50 x 9.5mm with some smaller applications in mind, it offers an advantage when being used on a less than perfectly square wall as the locking key can swivel for easy positioning.

Prod Code	Product	Price
SL-050103-BP	4-Set Pack	\$14.50
SL-050303	Locating Jig	\$12.00

\$20.90
Striplox Template



Speeds up the manufacturing processes by enabling the easy fitments of the Striplox range of joining solutions.

from
\$0.40



Griplox #20 Biscuit



Like the simplicity of biscuits but hate the glue and clamps? Just cut the same #20 size slot, hammer to knock in the Griplox biscuit and push both pieces together so the innovative gripping spikes secure your project in place, providing a superior result every time.

Prod Code	Product	Price
SL-060100	Each	\$0.40
SL-060100-BX	200-Biscuit Box	\$77.00

Extraction & Safety
Measuring & Marking
Sawing
Site & Shop Accessories
Routing
Planing
Sanding & Scraping
Drilling
Joinery
Clamps & Vices
Finishing
Sharpening
Carving & Chisels
Woodturning
Wooden Parts
Cabinet Fittings

INDEX

A

ABRASIVES 111
ADHESIVES 131-134
ANGLE DRIVER 121
ANGLE FINDER 14
ANGLE GAUGE 17, 19
ARBORTECH 162, 163
AXLE PEGS 187

B

BALLS, WOODEN 187
BAND CLAMPS 129, 139
BAND CLAMPS 141
BANDSAWS 28-30
BED BRACKETS 200
BELT SANDER 108
BENCH DOGS 144, 145
BENCH DOGS 146
BENCH GRINDER 153
BENCH STOPS 49, 58
BENCH TOP
CONNECTORS 199, 200
BENCHMASTER 129
BEVEL EDGE CHISEL 164, 165
BISCUITS 127
BIT, DRILL 116
BIT, ROUTER 70-97
BLADE, CIRCULAR SAW 35
BLADES, BANDSAW 30
BLADES, SCROLL SAW 31
BLAST GATE 8
BLOCK PLANE 102
BOBBIN SANDER 109
BORING BIT 116
BOWL GOUGE 171, 175
BRAD POINT BIT 116
BRASS SCREWS 192
BURNISHER 113
BURNISHING BRUSH 149
BUTT CHISELS 165

C

CABINET CHISEL 164, 165
CABINET SAW 37-39
CABINET SCRAPER 100
CALIPERS 16
CAMELLIA OIL 157
CARD SCRAPER 113
CARPENTERS SQUARE 20
CARVING CHISELS 168-170
CASE CATCH, CORNERS 191
CASTORS, FURNITURE 199
CATCHES 191, 199
CENTRE FINDER 14
CENTRE PUNCHES 18, 23
CENTRE, WOODTURNING 186
CHIP CARVING KNIFE 169
CHISEL SETS 164, 170
CHOPPING BOARD OIL 148, 151
CHUCK, DRILL 115
CHUCK, SCROLL 186, 188
CIRCLE CUTTING JIG 68
CIRCLE MARKER 21
CIRCULAR SAW BLADE 34-35
CIRCULAR SAW GUIDE 58, 59
CLASPS 191
CNC MACHINES 62
COMBINATION SQUARE 19
CONTOUR GAUGE 18
CONTRACTORS SAW 36, 38
COPING SAW 32
COPING SLED 67
COPY ATTACHMENT 181
CORNER CHISEL 166
COT FITTINGS 200
COUNTERBORES 118, 119
COUNTERSINKING BIT 118, 119
CRACK FILLING 133, 134
CROWN CENTRE 186
CUTTING GAUGE 22

D

DADO BLADE 33
DANISH OIL 147
DADO BLADE 33

DANISH OIL 147
DECKING JIG 125
DEPTH GAUGES 24
DIAMOND STONE 160, 161
DIGITAL PROTRACTOR 18
DIGITAL SCALE 52
DISC SANDER 109
DIVIDER 16
DOOR SUPPORT 55
DOVETAIL JIG 126
DOVETAIL JIGS 60-61, 126
DOVETAIL MARKERS 14
DOVETAIL SAW GUIDE 126
DOVETAIL SAWS 25
DOVETAIL SQUARE 14
DOWEL CENTRES 127
DOWEL JIGS 127
DOWELLING JIG 127
DOWELS 127
DRAWER PULL JIGS 197
DRAWER RUNNERS 196
DRAWER SLIDE JIGS 197
DRAWKNIFE 166
DRILL BIT 116
DRILL CHUCK 115
DRILL PRESS 114-115
DRILL PRESS VICE 115
DRILL SANDERS 109
DRILL STAND 114
DRILL STOPS 120, 127
DRILLING GUIDE 123
DRO 52
DRUM SANDER 109, 110
DUST BARRIER 54
DUST COLLECTOR 5, 6, 10
DUST FILTER 5, 6
DUST HOSE 8
DUST MASK 13

H

HAMMERS 167
HAND SANDER 112
HANDLES 148

HANDPLANES 98-103
HANDSAW 25-27
HARDWAX OIL 150
HEIGHT GAUGES 24
HELIGRIND 154
HIDE GLUE 131
HINGE MORTICING KIT 55
HINGECRAFTER 60
HINGES 190, 191, 193, 194, 198
HOLD DOWNS 47, 49, 146
HOLDDOWNS 142, 143, 146
HOLLOWING TOOL 174, 175, 177
HONING COMPOUND 156
HONING GUIDE 157
HOSE, DUST 8

I

I-BOX 40, 126
INCRA JIG 60, 61
INCRA MITRE GUIDE 43
INCRA RULE 15
INLAY MOTIFS 189
INLAY STRIPS 188, 189

J

JAPANESE SAWS 27
JIG FIXTURES 47-49
JOINTER 104, 105

K

K BODY CLAMPS 137
KAIZEN FOAM 57
KNIVES 167, 169
KNOBS 192, 195
KNOCKDOWN HARDWARE 200, 202
KREG JIGS 124, 125

L

LACQUER 150
LAG SCREWS 200
LAMINATE TRIMMERS 56
LAPPING PLATE 156
LATHES 179, 180
LAZY SUSAN BEARINGS 201
LIVE CENTRE 186
LOCK MITRE BITS 81, 94
LOCK MITRE SETUP JIG 67
LOCKS 193
LOW ANGLE PLANES 98, 101, 102

M

MACHINE MOBILE BASE 41
MACHINE SWITCH 52
MAG BASE LIGHT 52
MAGNIFYING GLASS 52
MAGSWITCH 44, 45
MALLET 167
MARKING GAUGE, MAT CUTTER 23
MAT CUTTER 128
MEASURING TAPE 17
MICRO JIG 50
MITRE BARS 46
MITRE CLAMPS 139
MITRE GAUGE 42, 43, 59
MITRE GUIDE 43
MITRE SAW 32, 128
MITRE TRACK 46
MITRE TRIMMER 129
MOBILE BASE 41
MORTICE BIT 130
MORTICE CHISEL 130, 164
MORTICE GAUGE 22, 23
MORTICE KIT 55
MORTICE MACHINE 130
MORTICING JIG 55

N

NON-SLIP MATS 41

O

OILSTONE 158

ORANGE OIL 151
ORGANOIL 147

P

PANEL ATTACHMENT 39
PANEL CLAMPS 140
PANTOGRAPH 68
PARALLEL CLAMPS 137
PARING CHISELS 165
PARTING TOOL 171, 172, 175, 178
PEG, WOODEN
PICTURE FRAMING 128-129
PINE BRUSH 149
PIPE CLAMPS 140
PLANER 108-111
PLANNER BLADE SHARPENER 156
PLANES 98-103
PLEATED FILTER 6
PLUG CUTTERS 121
POCKET HOLE JIGS 122-126
POWER TOOL GUIDES 58
PROFILE GAUGE 18
PROTRACTOR 18, 19
PUSH STICKS 50, 51
PUSHMASTER 129
PUTTY 150
PVA GLUE 132

Q

QUICK ACTION CLAMPS 136

R

RASP 165
REMOTE SWITCH 59
RESPIRATOR 13
RESTORING FINISH 149
REVEAL TRIM 24
RIGHT ANGLE DRIVER 120, 121
ROLLER STAND 42, 54
ROOM CLEANER 5
ROUGHING GOUGE 171, 175
ROUND NOSE SCRAPER 172, 175
ROUND OVER BITS 75, 89
ROUTER 63
ROUTER BIT SHARPENER 161
ROUTER EDGE GUIDE 68, 69
ROUTER FENCE 66
ROUTER LIFT 63
ROUTER MAT 41
ROUTER TABLES 59, 61, 64-67
RULERS 15
RUSTINS 147, 149

S

SADDLES, MEASURING 14
SAFETY GLASSES 13
SANDING BLOCK 116
SANDING PADS 111, 112
SANDING SEALER 149
SANDPAPER 113
SASH CLAMPS 141
SAW BLADE SHARPENER 156
SAW PROTRACTOR 58
SAW TABLE 37-39
SAWSTOP 38, 39
SAWTOOTH BIT 117
SCOTCHBRITE PADS 111
SCRAPER 113
SCRAPER, WOODTURNING 172, 175
SCRAPING PLANE 100
SCREW PILOT BIT 118, 119
SCREWS 124, 134, 135
SCRIBER 24
SCROLL CHUCK 186, 188
SCROLL SAWING 32
SHAKER PEGS 187
SHARPENING MACHINE 155, 156
SHARPENING STONE 158-161
SHARPENING SYSTEM 155, 157
SHELF PIN JIGS 197
SHELF SUPPORT PINS 196
SHELLAC 148
SHELLAWAX 148
SHOULDER PLANE 99

SHOULDER VICE 145
SIGNMAKING KIT 68
SKEW CHISEL 173, 175
SKEWCHIGOUGE 171, 175
SLIDING BEVEL 18
SLIDING COMPOUND SAW 32
SLIP STONE 158, 159
SPADE BIT 116, 117
SPINDLE GOUGE 171, 175
SPIRAL BITS 70, 84
SPIRAL CUTTERHEAD 107
SPIRALLING TOOL 174
SPOKESHAVES 193
SPOON CARVING KNIFE 167
SPRAY LACQUER, VARNISH 149
SPRING CALIPER 16
SPRING CLAMPS 138
SPUR CENTRE 183, 185, 186
SQUARE DRIVE SCREWS 124, 134, 135
SQUARE END SCRAPER 173, 175
SQUARES 19-21
STAINS 149
STEEL WOOL 149
STRAIGHT EDGE 17
STRIPOX 202
SUPER GLUE 134

T

T-BAR CLAMPS 141
T-TRACK 47-49
TABLE SAW 37-39
TABLE SAW FENCE 37
TAIL VICE 145
TAPER JIG 40
TEMPLATE GUIDES 67
TENNON SAW 25, 26
THICKNESS GAUGE 16
THICKNESSER 104, 106
THIRD HAND 53-55
TOGGLE CLAMPS 142, 144
TOOL RESTS
TOOL ROLLS 167
TRAMMEL HEADS 21
TRANSFER BALLS 42
TRY SQUARE 20
TUNGSTEN TURNING TOOLS 176-178
TURNING SETS 176, 185
TURNING TOOL SHARPENER 154

U

U BEAUT 148-149

V

V NAILER 129
VACUUM 10
VARNISH 149
VENEER ROLLER 56
VENEER TRIMMERS 56
VERNIER CALIPERS 16
VICES 145
VICES, CARVING 170
VIX BIT 124

W

WATER STAINS 149
WATERSTONE 159
WAXES 151
WETSTONE GRINDER 155
WHEEL MARKING GAUGE 21, 22
WOOD FILLER 150
WOODEN CLAMPS 138
WOODEN WHEELS 187
WOODLATHES 181
WOODRACK 41
WOODTURNING CHUCK 186, 188
WORK SUPPORT STAND 42, 54
WORKLIGHT 52

XYZ

ZIPBOLT 202



A World First Development - A **Metric** width Dado Stacking Set!

The blades, chippers and shims stack in 0.05mm increments from 5.9 – 23.5mm wide – no more calculations or conversions from imperial. You will see more of these kinds of unique world-exclusive developments being released from Torquata in coming years. Stay tuned!

TORQUATA

WHEN IT JUST WORKS

Plenty more where that came from.

Our range is still too big to fit it all in this catalogue and it keeps growing as we continuously search for more of the best value products to add to our shelves.

So go online or visit in-store to get the whole picture.

1300 880 996
www.timbecon.com.au
sales@timbecon.com.au

Melbourne Store
P: 1300 880 996
Local: 03 9448 8300
Fax: 08 6161 1176
U6/3b Newlands Road
Reservoir VIC 3073
E: melbourne.shop@timbecon.com.au

Perth Store
P: 1300 880 996
Local: 08 6161 0392
Fax: 08 6161 1176
31 Canvale Road
Canning Vale WA 6155
E: perth.shop@timbecon.com.au