

VENDOR CONTRACT

Between ILS INC/INTERNATIONAL LASER and
(Company Name) SYSTEMS

THE INTERLOCAL PURCHASING SYSTEM (TIPS)

For

OFFICE AND SCHOOL SUPPLIES

#03062515

General Information

The vendor contract shall include the contract, the terms and conditions, special terms and conditions, any agreed upon amendments, as well as all of the sections of the solicitation and the awarded vendor's proposal. Once signed, if an awarded vendor's proposal varies or is unclear in any way from the TIPS contract, TIPS, at its sole discretion, will decide which provision will prevail. Other documents to be included are the awarded vendor's proposals, task orders, purchase orders and any adjustments which have been issued.

The following pages will constitute the contract between the successful vendors(s) and TIPS. Bidders shall state, in a separate writing, and include with their proposal response, any required exceptions or deviations from these terms, conditions, and specifications. If agreed to by TIPS, they will be incorporated into the final contract.

The Vendor Contract ("Contract") made and entered into by and between The Interlocal Purchasing System (hereinafter referred to as "TIPS" respectfully) a government cooperative purchasing program authorized by the Region VIII Education Service Center, having its principal place of business at 4845 US Hwy 271 North, Pittsburg, Texas 75686. This contract consists of the provisions set forth below, including provisions of all Attachments referenced herein. In the event of a conflict between the provisions set forth below and those contained in any Attachment, the provisions set forth shall control.

Definitions

PURCHASE ORDER is the TIPS member's approval providing the authority to proceed with the negotiated delivery order under the contract. Special terms and conditions as agreed to between the vendor and TIPS member will be added as addendums to the PO. Items such as certificate of insurance, bonding requirements, small or disadvantaged business goals are some of the addendums possible.

Contract – OFFICE AND SCHOOL SUPPLIES

The Interlocal Purchasing System (TIPS)
Page 1 of 12

Lead Agency – Region VIII Education Service Center

Scanned by CamScanner

PREMIUM HOURS are defined as those hours not included in regular hours or recognized holidays. Premium hours are to be approved by the TIPS member for each delivery order and noted in the delivery order proposal as a line item during negotiations.

REGULAR HOURS are defined as those hours between the hours of 7 AM and 6 PM Monday thru Friday.

Terms and Conditions

Freight

All deliveries shall be freight prepaid, F.O.B. destination and shall be included in all pricing offered unless otherwise clearly stated in writing.

Warranty Conditions

All supplies equipment and services shall include manufacturer's minimum standard warranty unless otherwise agreed to in writing. Vendor shall be an authorized dealer, distributor or manufacturer for all products. All equipment proposed shall be new unless clearly stated in writing.

Customer Support

The Vendor shall provide timely and accurate customer support to TIPS members. Vendors shall respond to such requests within one (1) working day after receipt of the request. Vendor shall provide training regarding products and services supplied by the Vendor unless otherwise clearly stated in writing at the time of purchase. (Unless training is a line item sold or packaged and must be purchased with product.)

Contracts

All contracts and agreements between Vendors and TIPS Members shall strictly adhere to the statutes that are set forth in the Uniform Commercial Code as most recently revised.

Contracts for purchase will normally be put into effect by means of a purchase order(s) executed by authorized agents of the participating government entities.

Davis Bacon Act requirements will be met when Federal Funds are used for construction and/or repair of buildings.

Tax exempt status

A taxable item sold, leased, rented to, stored, used, or consumed by any of the following governmental entities is exempted from the taxes imposed by this chapter:(1) the United States; (2) an unincorporated instrumentality of the United States; (3) a corporation that is an agency or instrumentality of the United States and is wholly owned by the United States or by another corporation wholly owned by the United States;(4) the State of Texas; (5) a Texas county, city, special district, or other political subdivision; or (6) a state, or a governmental unit of a state that borders Texas, but only to the extent that the other state or governmental unit

Contract – OFFICE AND SCHOOL SUPPLIES

exempts or does not impose a tax on similar sales of items to this state or a political subdivision of this state. Texas Tax Code § 151.309.

Assignments of contracts

No assignment of contract may be made without the prior written approval of TIPS. Payment can only be made to the awarded Vendor or vendor assigned dealer.

Disclosures

1. Vendor affirms that he/she has not given, offered to give, nor intends to give at any time hereafter any economic opportunity, future employment, gift, loan, gratuity, special discount, trip, favor or service to a public servant in connection with this contract.
2. Vendor shall attach, in writing, a complete description of any and all relationships that might be considered a conflict of interest in doing business with participants in the TIPS program.
3. The vendor affirms that, to the best of his/her knowledge, the offer has been arrived at independently, and is submitted without collusion with anyone to obtain information or gain any favoritism that would in any way limit competition or give an unfair advantage over other vendors in the award of this contract.

Renewal of Contracts

The OFFICE AND SCHOOL SUPPLIES contract is for one (1) year with an option for renewal for 2 consecutive years. Total term of contract can be up to 3 years if sales are reported through the contract and both parties agree.

Shipments

The Vendor shall ship ordered products within five (5) working days after the receipt of the order. If a product cannot be shipped within that time, the Vendor shall notify TIPS and the requesting entity as to why the product has not shipped and shall provide an estimated shipping date, if applicable. TIPS or the requesting entity may cancel the order if estimated shipping time is not acceptable.

Invoices

The Vendor or vendor assigned dealer shall submit invoices, to the TIPS participant. Each invoice shall include the TIPS participant's purchase order number. The shipment tracking number or pertinent information for verification of TIPS participant receipt shall be made available upon request. The Vendor or vendor assigned dealer shall not invoice for partial shipments unless agreed to in writing in advance by TIPS and the TIPS participant.

Payments

The TIPS participant will make payments directly to the Vendor or vendor assigned dealer at net 30 days after receiving invoice.

Pricing

The Vendor contracts to provide pricing to TIPS and its participating governmental entities that is the lowest pricing available to like cooperative purchasing customers and the pricing shall remain so throughout the duration of the contract.

The Vendor agrees to promptly lower the cost of any product purchased through TIPS following a reduction in the manufacturer or publisher's direct cost to the Vendor. Price increases will be honored. However, the Vendor shall honor previous prices for thirty (30) days after written notification to TIPS of an increase.

All pricing submitted to TIPS shall include the One Percent (1%) participation fee to be remitted to TIPS by the Vendor. Vendor will not show adding the 1% to the invoice presented to customer.

Participation Fees

Vendor or vendor assigned dealer contracts to pay 1% of all sales to TIPS on a monthly scheduled report. TIPS will email a Monthly Submission Report to each vendor. The Vendor or vendor assigned dealer is responsible for keeping record of all sales that go through the TIPS contract. Report may be sent to TIPS electronically while check for 1% is mailed. Failure to pay 1% participation fee will result in termination of contract.

Indemnity

- 1. Indemnity for Personality Contracts.** Vendor agrees to indemnify and hold harmless and defend TIPS, TIPS member(s), officers and employees, from and against all claims and suits for damages, injuries to persons (including death), property damages, losses, and expenses including court costs and attorney's fees, arising out of, or resulting from, Vendor's performance of this contract, including all such causes of action based upon common, constitutional, or statutory law, or based in whole or in part, upon allegations of negligent or intentional acts on the part of the Vendor, its officers, employees, agents, subcontractors, licensees, invitees, whether or not such claims are based in whole or in part upon the negligent acts or omissions of the TIPS, TIPS member(s), officers, employees, or agents.
- 2. Indemnity for Performance Contracts.** The Vendor agrees to indemnify and hold harmless and defend TIPS, TIPS member(s), officers and employees from and against all claims and suits for damages, injuries to persons (including death), property damages, losses, and expenses including court costs and attorney's fees, arising out of, or resulting from, Vendor's work under this contract, including all such causes of action based upon common, constitutional, or statutory law, or based in whole or in part, upon allegations

of negligent or intentional acts on the part of the Vendor, its officers, employees, agents, subcontractors, licensees, or invitees. Vendor further agrees to indemnify and hold harmless and defend TIPS, TIPS member(s), officers and employees, from and against all claims and suits for injuries (including death) to an officer, employee, agent, subcontractor, supplier or equipment lessee of the Vendor, arising out of, or resulting from, Vendor's work under this contract whether or not such claims are based in whole or in part upon the negligent acts or omissions of the TIPS, TIPS member(s), officers, employees, or agents.

Attorney's Fees--Texas Local Government Code § 271.159 is expressly referenced.

Pursuant to §271.159, TEXAS LOC. GOV'T CODE, in the event that any one of the Parties is required to obtain the services of an attorney to enforce this Agreement, the prevailing party, in addition to other remedies available, shall be entitled to recover reasonable attorney's fees and costs of court.

Multiple Vendor Awards

TIPS reserves the right to award multiple vendor contracts for categories when deemed in the best interest of the TIPS membership. Bidders scoring 80% or above will be considered for an award. Categories are established at the discretion of TIPS.

State of Texas Franchise Tax

By signature hereon, the bidder hereby certifies that he/she is not currently delinquent in the payment of any franchise taxes owed the State of Texas under Chapter 171, Tax Code.

Miscellaneous

The Vendor acknowledges and agrees that continued participation in TIPS is subject to TIPS sole discretion and that any Vendor may be removed from the participation in the Program at any time with or without cause. Nothing in the contract or in any other communication between TIPS and the Vendor may be construed as a guarantee that TIPS participants will submit any orders at any time. TIPS reserves the right to request additional proposals for items already on contract at any time.

Purchase Order Pricing/Product Deviation

If a deviation of pricing/product on a purchase order occurs, TIPS is to be notified within 24 hours of receipt of order.

Cancellation for non-performance or contract deficiency

TIPS may terminate any contract if TIPS Members have not used the contract, or if purchase volume is determined to be "low volume" in any 12-month period. TIPS reserves the right to cancel the whole or any part of this contract due to failure by awarded vendor to carry out any

obligation, term or condition of the contract. TIPS may issue a written deficiency notice to awarded vendor for acting or failing to act in any of the following:

- Providing material that does not meet the specifications of the contract;
- Providing work and/or material that was not awarded under the contract;
- Failing to adequately perform the services set forth in the scope of work and specifications;
- Failing to complete required work or furnish required materials within a reasonable amount of time;
- Failing to make progress in performance of the contract and/or giving TIPS reason to believe that awarded vendor will not or cannot perform the requirements of the contract; and/or
- Performing work or providing services under the contract prior to receiving a TIPS reviewed purchase order for such work.

Upon receipt of the written deficiency, awarded vendor shall have ten (10) days to provide a satisfactory response to TIPS. Failure to adequately address all issues of concern may result in contract cancellation. Upon cancellation under this paragraph, all goods, materials, work, documents, data and reports prepared by awarded vendor under this contract shall become the property of the TIPS Member on demand.

TIPS Member Purchasing Procedures

Purchase orders are issued by participating TIPS member to the awarded vendor indicating on the PO "Contract Number 03062515". Purchase Order is emailed to TIPS at tipspo@tips-usa.com.

- Awarded vendor delivers goods/services directly to the participating member.
- Awarded vendor invoices the participating TIPS member directly.
- Awarded vendor receives payment directly from the participating member.
- Awarded vendor reports sales monthly to TIPS (unless prior arrangements have been made with TIPS to report monthly).

Form of Contract

The form of contract for this solicitation shall be the Request for Proposal, the awarded proposal(s) and best and final offer(s), and properly issued and reviewed purchase orders referencing the requirements of the Request for Proposals. If a vendor submitting an offer requires TIPS and/or TIPS Member to sign an additional agreement, a copy of the proposed agreement must be included with the proposal.

Vendor contract documents: TIPS will review proposed vendor contract documents. Vendor's contract document shall not become part of TIPS's contract with vendor unless and until an authorized representative of TIPS reviews and approves it.

Licenses

Awarded vendor shall maintain in current status all federal, state and local licenses, bonds and permits required for the operation of the business conducted by awarded vendor. Awarded vendor shall remain fully informed of and in compliance with all ordinances and regulations pertaining to the lawful provision of services under the contract. TIPS reserves the right to stop work and/or cancel contract of any awarded vendor whose license(s) expire, lapse, are suspended or terminated.

Novation

If awarded vendor sells or transfers all assets or the entire portion of the assets used to perform this contract, a successor in interest must guarantee to perform all obligations under this contract. TIPS reserves the right to accept or reject any new party. A simple change of name agreement will not change the contractual obligations of awarded vendor.

Site Requirements (when applicable to service or job)

Cleanup: Awarded vendor shall clean up and remove all debris and rubbish resulting from their work as required or directed by TIPS Member. Upon completion of work, the premises shall be left in good repair and an orderly, neat, clean and unobstructed condition.

Preparation: Awarded vendor shall not begin a project for which TIPS Member has not prepared the site, unless awarded vendor does the preparation work at no cost, or until TIPS Member includes the cost of site preparation in a purchase order.

Site preparation includes, but is not limited to: moving furniture, installing wiring for networks or power, and similar pre-installation requirements.

Registered sex offender restrictions: For work to be performed at schools, awarded vendor agrees that no employee of a sub-contractor who has been adjudicated to be a registered sex offender will perform work at any time when students are or reasonably expected to be present. Awarded vendor agrees that a violation of this condition shall be considered a material breach and may result in the cancellation of the purchase order at the TIPS Member's discretion.

Awarded vendor must identify any additional costs associated with compliance of this term. If no costs are specified, compliance with this term will be provided at no additional charge.

Safety measures: Awarded vendor shall take all reasonable precautions for the safety of employees on the worksite, and shall erect and properly maintain all necessary safeguards for protection of workers and the public. Awarded vendor shall post warning signs against all hazards created by the operation and work in progress. Proper precautions shall be taken pursuant to state law and standard practices to protect workers, general public and existing structures from injury or damage.

Smoking

Persons working under contract shall adhere to local smoking policies. Smoking will only be permitted in posted areas or off premises.

Invoices

The awarded vendor shall submit invoices to the participating entity clearly stating "Per TIPS Contract". The shipment tracking number or pertinent information for verification shall be made available upon request.

Marketing

Awarded vendor agrees to allow TIPS to use their name and logo within website, marketing materials and advertisement. Any use of TIPS name and logo or any form of publicity, inclusive of press release, regarding this contract by awarded vendor must have prior approval from TIPS.

Supplemental agreements

The entity participating in the TIPS contract and awarded vendor may enter into a separate supplemental agreement to further define the level of service requirements over and above the minimum defined in this contract i.e. invoice requirements, ordering requirements, specialized delivery, etc. Any supplemental agreement developed as a result of this contract is exclusively between the participating entity and awarded vendor. TIPS, its agents, TIPS members and employees shall not be made party to any claim for breach of such agreement.

Legal obligations

It is the responding vendor's responsibility to be aware of and comply with all local, state and federal laws governing the sale of products/services identified in this RFP and any awarded contract thereof. Applicable laws and regulations must be followed even if not specifically identified herein.

Audit rights

Awarded Vendor shall, at their sole expense, maintain appropriate due diligence of all purchases made by TIPS Member that utilizes this Contract. TIPS and Region 8 ESC each reserve the right to audit the accounting for a period of three (3) years from the time such purchases are made. This audit right shall survive termination of this Agreement for a period of one (1) year from the effective date of termination. TIPS shall have authority to conduct random audits of Awarded Vendor's pricing that is offered to TIPS Members. Notwithstanding the foregoing, in the event that TIPS is made aware of any pricing being offered to eligible entities that is materially inconsistent with the pricing under this agreement, TIPS shall have the ability to conduct the audit internally or may engage a third-party auditing firm. In the event of an audit, the requested materials shall be provided in the format and at the location designated by Region 8 ESC or TIPS.

Force Majeure

If by reason of Force Majeure, either party hereto shall be rendered unable wholly or in part to carry out its obligations under this Agreement then such party shall give notice and fully particulars of Force Majeure in writing to the other party within a reasonable time after

occurrence of the event or cause relied upon, and the obligation of the party giving such notice, so far as it is affected by such Force Majeure, shall be suspended during the continuance of the inability then claimed, except as hereinafter provided, but for no longer period, and such party shall endeavor to remove or overcome such inability with all reasonable dispatch.

Services

When applicable, performance bonds will be required on construction or labor required jobs over \$100,000 and payment bonds on jobs over \$25,000 or awarded vendor will meet the TIPS member's local and state purchasing requirements. Awarded vendors may need to provide additional capacity as jobs increase. Bonds will not require that a fee be paid to TIPS. The actual cost of the bond will be a pass through to the TIPS member and added to the purchase order.

Scope of Services

The specific scope of work for each job shall be determined in advance and in writing between TIPS Member and Awarded vendor. It is okay if the TIPS member provides a general scope, but the awarded vendor should provide a written scope of work to the TIPS member as part of the proposal. Once the scope of the job is agreed to, the TIPS member will issue a PO with the estimate referenced as an attachment along with bond and any other special provisions agreed to for the TIPS member. If special terms and conditions other than those covered within this solicitation and awarded contracts are required, they will be attached to the PO and shall take precedence over those in the base contract.

Project Delivery Order Procedures

The TIPS member having approved and signed an interlocal agreement, or other TIPS membership document, may make a request of the awarded vendor under this contract when the TIPS member has services that need to be undertaken. Notification may occur via phone, the web, email, fax, or in person.

Upon notification of a pending request, the awarded vendor shall make contact with the TIPS member as soon as possible, but must make contact with the TIPS member within two working days.

Scheduling of Projects

Scheduling of projects (if applicable) will be accomplished when the TIPS member issues a purchase order that will serve as "the notice to proceed". The period for the delivery order will include the mobilization, materials purchase, installation and delivery, design, weather, and site cleanup and inspection. No additional claims may be made for delays as a result of these items. When the tasks have been completed the awarded vendor shall notify the client and have the TIPS member inspect the work for acceptance under the scope and terms in the PO. The TIPS member will issue in writing any corrective actions that are required. Upon completion of these items, the TIPS member will issue a completion notice and final payment will be issued.

Support Requirements

If there is a dispute between the awarded vendor and TIPS member, TIPS or its representatives will assist in conflict resolution or third party (mandatory mediation), if requested by either party. TIPS, or its representatives, reserves the right to inspect any project and audit the awarded vendors TIPS project files, documentation and correspondence.

Special Terms and Conditions

It is the intent of TIPS to contract with a reliable, high performance vendor to supply products and services to government and educational agencies. It is the experience of TIPS that the following procedures provide TIPS, the Vendor, and the participating agency the necessary support to facilitate a mutually beneficial relationship. The specific procedures will be negotiated with the successful vendor.

- **Contracts:** All vendor purchase orders must be emailed to TIPS at tipspo@tips-usa.com. Should an agency send an order direct to vendor, it is the vendor's responsibility to forward the order to TIPS at the email above within 24 business hours and confirm its receipt with TIPS.
 - **Promotion of Contract:** It is agreed that Vendor will encourage all eligible entities to purchase from the TIPS Program. Encouraging entities to purchase directly from the Vendor and not through TIPS contract is not acceptable to the terms and conditions of this contract and will result in removal of Vendor from Program. Vendor is expected to use marketing funds for the marketing and promotion of this contract.
 - **Daily Order Confirmation:** All contract purchase orders will be approved daily by TIPS and sent to vendor. The vendor must confirm receipt of orders to the TIPS member (customer) within 24 business hours.
 - **Vendor custom website for TIPS:** If Vendor is hosting a custom TIPS website, then updated pricing must be posted by 1st of each month.
 - **Back Ordered Products:** If product is not expected to ship within 3 business days, customer is to be notified within 24 hours and appropriate action taken based on customer request.
-

Check one of the following responses to the General Terms and Special Terms and Conditions:

We take no exceptions/deviations to the general and/or special terms and conditions.

(Note: If none are listed below, it is understood that no exceptions/deviations are taken.)

We take the following exceptions/deviations to the general and/or special terms and conditions. All exceptions/deviations must be clearly explained. Reference the corresponding general or special terms and conditions that you are taking exceptions/deviations to. The proposer must clearly state if you are adding additional terms and conditions to the general or special terms and conditions. Provide details on your exceptions/deviations below:

Contract – OFFICE AND SCHOOL SUPPLIES

The Interlocal Purchasing System (TIPS)

Lead Agency – Region VIII Education Service Center

Page 11 of 12

Scanned by CamScanner

The Interlocal Purchasing System (TIPS Cooperative) Supplier Response

| Bid Information | | Contact Information | | Ship to Information |
|-----------------|-------------------------------------|---------------------|---|---------------------|
| Bid Creator | Mr. David Mabe National Coordinator | Address | Region VIII Education Service Center 4845 US Highway 271 North Pittsburg, TX 75686 | Address |
| Email | david.mabe@tips-usa.com | Contact | Mrs. Kim Thompson Coordinator of Office Operations | Contact |
| Phone | +1 (903) 243-4759 | Department | | Department |
| Fax | +1 (866) 749-6674 | Building | | Building |
| Bid Number | 03062515 Addendum 1 | Floor/Room | | Floor/Room |
| Title | Office and School Supplies | Telephone | +1 (866) 839-8477 | Telephone |
| Bid Type | RFP | Fax | +1 (866) 929-4402 | Fax |
| Issue Date | 04/02/2015 | Email | bids@tips-usa.com | Email |
| Close Date | 5/15/2015 3:00:00 PM CT | | | |
| Need by Date | | | | |

Supplier Information

Company ILS Inc./ International Laser Systems
 Address 3929 Fondren Rd.
 Houston, TX 77063
 Contact
 Department
 Building
 Floor/Room
 Telephone 1 (713) 7897272
 Fax 1 (713) 7893436
 Email
 Submitted 4/20/2015 2:01:43 PM CT
 Total \$0.00

Signature Ray Ahmadi

Email rahmadi@ilscorp.us.com

Supplier Notes

Bid Notes

Bid Activities

Bid Messages

Please review the following and respond where necessary

| # | Name | Note | Response |
|----|---------------------------|---|------------------------|
| 1 | Yes - No | Disadvantaged/Minority/Women Business Enterprise - D/M/WBE (Required by some participating governmental entities) Vendor certifies that their firm is a D/M/WBE? Vendor must upload proof of certification to the "Response Attachments" D/M/WBE CERTIFICATES section. | No |
| 2 | Yes - No | Highly Underutilized Business - HUB (Required by some participating governmental entities) Vendor certifies that their firm is a HUB? Vendor must upload proof of certification to the "Response Attachments" HUB CERTIFICATES section. | No |
| 3 | Yes - No | Certification of Residency (Required by the State of Texas) Company submitting bid is a Texas resident bidder? | Yes |
| 4 | Company Residence (City) | Vendor's principal place of business is in the city of? | Houston |
| 5 | Company Residence (State) | Vendor's principal place of business is in the state of? | Texas |
| 6 | Felony Conviction Notice: | (Required by the State of Texas) My firm is, as outlined on PAGE 5 in the Instructions to Bidders document: (Questions 7 - 9) | (No Response Required) |
| 7 | Yes - No | A publicly held corporation; therefore, this reporting requirement is not applicable? | No |
| 8 | Yes - No | Is not owned or operated by anyone who has been convicted of a felony? | No |
| 9 | Yes - No | Is owned or operated by individual(s) who has/have been convicted of a felony? If answer is YES, a detailed explanation of the name(s) and conviction(s) must be uploaded to the "Response Attachments" FELONY CONVICTION section. | No |
| 10 | Pricing Information: | Pricing information section. (Questions 11 - 14) | (No Response Required) |
| 11 | Yes - No | In addition to the typical unit pricing furnished herein, the Vendor agrees to furnish all current and future products at prices that are proportionate to Dealer Pricing. If answer is NO, include a statement detailing how pricing for TIPS participants would be calculated in the PRICING document that is uploaded to the "Response Attachments" PRICING section. | Yes |
| 12 | Yes - No | Pricing submitted includes the 1% TIPS participation fee? | Yes |
| 13 | Yes - No | Vendor agrees to remit to TIPS the required 1% participation fee? | Yes |
| 14 | Yes - No | Additional discounts to TIPS members for bulk quantities? | Yes |
| 15 | Start Time | Average start time after receipt of customer order is ____ working days? | 5 |
| 16 | Years Experience | Company years experience in this category? | 25 |
| 17 | Yes - No | The Vendor can provide services and/or products to all 50 US States? | Yes |
| 18 | States Served: | If answer is NO to question #17, please list which states can be served. (Example: AR, OK, TX) | |

| | | | |
|----|-------------------------------------|--|--|
| 19 | Company and/or Product Description: | This information will appear on the TIPS website in the company profile section, if awarded a TIPS contract. (Limit 750 characters.) | For over 25 years, International Laser Systems holds a leading position as a distributor of quality imaging products from many leading OEM suppliers as well as high quality compatible imaging supplies. With established ranges that include laser toner cartridges, inkjet cartridges, copier toners, thermal fax rolls & cartridges and POS & Printer ribbons, as well as office machines such as printer, fax, copier, shredder, and parts. |
| 20 | Resellers: | Does the vendor have resellers that it will name under this contract? (If applicable, vendor should download the Reseller/Dealers spreadsheet from the Attachments section, fill out the form and submit the document in the "Response Attachments" RESELLERS section. | No |
| 21 | Primary Contact Name | Primary Contact Name | Ray Ahmadi |
| 22 | Primary Contact Title | Primary Contact Title | Dir. Technical and sales management |
| 23 | Primary Contact Email | Primary Contact Email | rahmadi@ilscorp.us.com |
| 24 | Primary Contact Phone | Primary Contact Phone - Format (xxx) xxx-xxxx | 713-789-7272 |
| 25 | Primary Contact Fax | Primary Contact Fax - Format (xxx) xxx-xxxx | 713-789-3436 |
| 26 | Primary Contact Mobile | Primary Contact Mobile- Format (xxx) xxx-xxxx | 713-515-6149 |
| 27 | Secondary Contact Name | Secondary Contact Name | Lalhe Ghaderifard |
| 28 | Secondary Contact Title | Secondary Contact Title | Customer Services |
| 29 | Secondary Contact Email | Secondary Contact Email | lalhe.ghaderifard@ilscorp.us.com |
| 30 | Secondary Contact Phone | Secondary Contact Phone - Format (xxx) xxx-xxxx | 713-789-7272 |
| 31 | Secondary Contact Fax | Secondary Contact Fax - Format (xxx) xxx-xxxx | 713-789-3436 |
| 32 | Secondary Contact Mobile | Secondary Contact Mobile - Format (xxx) xxx-xxxx | |
| 33 | 2% Contact Name | 2% Contact Name | sales |
| 34 | 2% Contact Email | 2% Contact Email | sales@ilscorp.us.com |
| 35 | 2% Contact Phone | 2% Contact Phone - Format (xxx) xxx-xxxx | 713-789-7272 |
| 36 | Purchase Order Contact: | This person is responsible for receiving Purchase Orders from TIPS. (Questions 37 - 39) | (No Response Required) |
| 37 | Purchase Order Contact Name | Purchase Order Contact Name | Ray Ahmadi |
| 38 | Purchase Order Contact Email | Purchase Order Contact Email | sales@ilscorp.us.com |
| 39 | Purchase Order Contact Phone | Purchase Order Contact Phone - Format (xxx) xxx-xxxx | 713-789-7272 |
| 40 | Company Website | Company Website | www.ilscorp.us.com |
| 41 | Federal ID Number: | Federal ID Number also known as the Employer Identification Number. | 760474633 |
| 42 | Primary Address | Primary Address | 3929 Fondren Rd. |

| | | |
|--------------------------|--|---|
| 43 Primary Address City | Primary Address City | Houston |
| 44 Primary Address State | Primary Address State | Texas |
| 45 Primary Address Zip | Primary Address Zip | 77063 |
| 46 Search Words: | <p>Please list search words to be posted in the TIPS database about your company that TIPS website users might search. Words may be product names, manufacturers, or other words associated with the category of award. YOU MAY NOT LIST NON-CATEGORY ITEMS. (Limit 500 words) (Format: product, paper, construction, manufacturer name, etc.)</p> | <p>Office supplies, toner, ink, parts, office machines, printer, fax, scanner, copier, mfp, hp, canon,dell, xerox, ricoh,ibm,toshiba, lexmark, samsung, konica minolta, brother, okidata, epson,panasonic,sharp,nec, oce imagistics, zenith</p> |
| 47 Yes - No | <p>Do you wish to be eligible to participate in a TIPS contract in which a TIPS member utilizes federal funds on contracts exceeding \$100,000? (Non-Construction) (If YES, vendor should download the Federal Funds Over \$100,000 Certification document from the Attachments section, fill out the form and submit the document in the "Response Attachments" FEDERAL FUNDS section.) (Vendor must also download the Suspension or Debarment Certificate document from the Attachments section, fill out the form and submit the document in the "Response Attachments" SUSPENSION OR DEBARMENT section.)</p> | No |

Line Items

Response Total: \$0.00

Provisions for purchase with federal funds for contracts exceeding \$100,000

These forms are for non-construction contracts

Many TIPS members (grantees and sub-grantees) purchase goods and services with federal funds. When a member engages a contract exceeding \$100,000 and paid with federal funds, provisions are triggered by various Code of Federal Regulations requirements. Primarily 34 CFR 80.36 from the Department of Education and 7 CFR 3015 & 3016 from the Department of Agriculture for School Lunch Program. There may be other Federal programs from time to time that are not enumerated above that may fund certain projects using outside vendors. These are not optional for the contracting entity and in order to spend the federal funds certain provision and certifications must be in place to ensure legal compliance.

If your company wishes to be eligible to participate in a TIPS contract in which a member utilizes federal funds on contracts exceeding \$100,000, you must complete the following forms can provide the certifications as required on the subsequent pages.

Do you wish to be eligible to participate in a TIPS contract in which a member utilizes federal funds on contracts exceeding \$100,000?

Check your response?

YES NO



4/17/15

Signature of Authorized Company Official

Date

RAY AHMADI

Printed Name of Authorized Company Official

ILS INC / INTERNATIONAL LASER SYSTEMS

Company Name

Attach to this page a current W-9 form

Please complete the forms below

Legal Compliance

It is the proposing company's duty and responsibility to have knowledge of and be responsible for the compliance with all applicable laws, rules and regulations as they apply to this procurement process and any subsequent award. The vendor agrees to comply, in all relevant respects, with all Federal, State, and Local laws, rules and regulations related to the performance of services or supply of goods to TIPS or TIPS members?

Does vendor agree? YES _____ Initial of Authorized Company Official

Non-Collusive Bidding Certificate

By submitting a proposal in response to a Request for Proposals or other procurement device containing this clause, you certify that you are authorized to certify to the following:

- 1) This bid or proposal has been independently arrived at without collusion with any other Bidder or with any Competitor;
- 2) This bid or proposal has not been knowingly disclosed and will not be knowingly disclosed, prior to the opening of bids, or proposals for this project, to any other Bidder, Competitor or potential competitor;
- 3) No attempt has been or will be made to induce any other person, partnership or corporation to submit or not to submit a bid or proposal;
- 4) The person signing this bid or proposal certifies that he has fully informed himself regarding the accuracy of the statements contained in this certification, and under the penalties being applicable to the Bidder as well as to the person signing in its behalf.

The vendor complied with #1 through 4 above? YES _____ Initial of Authorized Company Official

SUSPENSION OR DEBARMENT CERTIFICATE

Non-Federal entities are prohibited from contracting with or making sub-awards under covered transactions to parties that are suspended or debarred or whose principals are suspended or debarred. Covered transactions include procurement for goods or services equal to or in excess of \$100,000.00. Contractors receiving individual awards for \$25,000.00 or more and all sub-recipients must certify that the organization and its principals are not suspended or debarred.

You certify that no suspension or disbarment is in place, which would preclude receiving a federally funded contract under the Federal OMB, A-102, common rules

The vendor has not been debarred? YES _____ Initial of Authorized Company Official

Certification Regarding Lobbying

Applicable to Grants, Subgrants, Cooperative Agreements, and Contracts Exceeding \$100,000 in Federal Funds

Submission of this certification is a prerequisite for making or entering into this transaction and is imposed by section 1352, Title 31, U.S. Code. This certification is a material representation of fact upon which reliance was placed when this transaction was made or entered into. Any person who fails to file the required certification shall be subject to a civil penalty of not less than

\$10,000 and not more than \$100,000 for each such failure.

The undersigned certifies, to the best of his or her knowledge and belief, that:

- (1) No Federal appropriated funds have been paid or will be paid by or on behalf of the undersigned, to any person for influencing or attempting to influence an officer or employee of any agency, a Member of Congress, an officer or employee of congress, or an employee of a Member of Congress in connection with the awarding of a Federal contract, the making of a Federal grant, the making of a Federal loan, the entering into a cooperative agreement, and the extension, continuation, renewal, amendment, or modification of a Federal contract, grant, loan, or cooperative agreement.
- (2) If any funds other than Federal appropriated funds have been paid or will be paid to any person for influencing or attempting to influence an officer or employee of any agency, a Member of Congress, an officer or employee of congress, or an employee of a Member of Congress in connection with this Federal grant or cooperative agreement, the undersigned shall complete and submit Standard Form-LLL, "disclosure Form to Report Lobbying," in accordance with its instructions.
- (3) The undersigned shall require that the language of this certification be included in the award documents for all covered subawards exceeding \$100,000 in Federal funds at all appropriate tiers and that all subrecipients shall certify and disclose accordingly.

ILS INC / INTERNATIONAL LASER SYSTEMS

Name of Organization

3929 FONDREN ROAD, HOUSTON, TX, 77063

Address of Organization

RAY AHMADI / DIR. TECHNICAL SALES MGMT

Name / Title of Submitting Official

Signature of Submitting Official

4/17/15

Signature Date

Federal Rule (1) Administrative, contractual, or legal remedies in instances where contractors violate or breach contract terms, and provide for such sanctions and penalties as may be appropriate. (Contracts more than the simplified acquisition threshold)

Notice: Pursuant to Federal Rule (1) above, when federal funds are expended by TIPS Member, TIPS Member reserves all rights and privileges under the applicable laws and regulations with respect to this procurement in the event of breach of contract by either party.

Does vendor agree? YES _____ Initial of Authorized Company Official

Federal Rule (2) Termination for cause and for convenience by the grantee or subgrantee including the manner by which it will be effected and the basis for settlement. (All contracts in excess of \$10,000)

Pursuant to Federal Rule (2) above, when federal funds are expended by TIPS Member, TIPS Member reserves the right to terminate any agreement in excess of \$10,000 resulting from this procurement process for cause after giving the vendor an appropriate opportunity and up to 30 days, to cure the causal breach of terms and conditions. TIPS Member reserves the right to terminate any agreement in excess of \$10,000 resulting from this procurement process for convenience with 30 days notice in writing to the awarded vendor. Any award under this procurement process is not exclusive and the District reserves the right to purchase goods and services from other vendors when it is in the best interest of the District.

Does vendor agree? YES _____ Initial of Authorized Company Official

Federal Rule (7) Notice of awarding agency requirements and regulations pertaining to reporting.

Pursuant to Federal Rule (7) above, when federal funds are expended by TIPS Member, TIPS Member requires that the proposer certify that during the term of an award by the TIPS Member resulting from this procurement process the vendor will provide reports and documentation required by all applicable law and state and federal regulations upon request by the TIPS Member or any relevant state or federal agency.

Does vendor agree? YES _____ Initial of Authorized Company Official

Federal Rule (8) Notice of awarding agency requirements and regulations pertaining to patent rights with respect to any discovery or invention which arises or is developed in the course of or under such contract.

Provisions for purchase with federal funds for contracts exceeding \$100,000

Pursuant to Federal Rule (8) above, when federal funds are expended by TIPS Member, TIPS Member shall address any requirements and regulations pertaining to patent rights with respect to any discovery or invention which arises or is developed in the course of or under such contract in the contract document and absent language to the contrary or if the contract silent on the subject, the District retains all rights thereto.

Does vendor agree? YES _____ Initial of Authorized Company Official

Federal Rule (9) Awarding agency requirements and regulations pertaining to copyrights and rights in data.

Pursuant to Federal Rule (9) above, when federal funds are expended by TIPS Member, TIPS Member requires the proposer certify that during the term of an award by the TIPS Member resulting for this procurement process the vendor will surrender upon request any copyrighted materials owned by the TIPS Member but used in the awarded contract performance unless otherwise agreed in a written document by the parties. TIPS Member reserves the rights to all data created or provided to the vendor for the purpose of contract performance resulting for this procurement process and the vendor will surrender such data upon request unless otherwise agreed in a written document by the parties. If the contract is silent or not dispositive on the subject matter data or copyrights TIPS Member retains all rights in the data developed or gathered during the contract term.

Does vendor agree? YES _____ Initial of Authorized Company Official

Federal Rule (10) Access by the grantee, the subgrantee, the Federal grantor agency, the Comptroller General of the United States, or any of their duly authorized representatives to any books, documents, papers, and records of the contractor which are directly pertinent to that specific contract for the purpose of making audit, examination, excerpts, and transcriptions.

Pursuant to Federal Rule (9) above, when federal funds are expended by TIPS Member, TIPS Member requires the proposer certify that during the term and after the awarded term of an award by the TIPS Member resulting for this procurement process the vendor will grant access by the grantee, the subgrantee, the Federal grantor agency, the Comptroller General of the United States, or any of their duly authorized representatives to any books, documents, papers, and records of the contractor which are directly pertinent to that specific contract for the purpose of making audit, examination, excerpts, and transcriptions.

Does vendor agree? YES _____ Initial of Authorized Company Official

Provisions for purchase with federal funds for contracts exceeding \$100,000

Federal Rule (11) Retention of all required records for three years after grantees or subgrantees make final payments and all other pending matters are closed.

Pursuant to Federal Rule (11) above, when federal funds are expended by TIPS Member, TIPS Member requires the proposer certify that the awarded vendor retain of all required records for three years after grantees or subgrantees make final payments and all other pending matters are closed.

Does vendor agree? YES _____ Initial of Authorized Company Official

Federal Rule (12) Compliance with all applicable standards, orders, or requirements issued under section 306 of the Clean Air Act (42 U.S.C. 1857(h)), section 508 of the Clean Water Act (33 U.S.C. 1368), Executive Order 11738, and Environmental Protection Agency regulations (40 CFR part 15). (Contracts, subcontracts, and subgrants of amounts in excess of \$100,000)

Pursuant to Federal Rule (12) above, when federal funds are expended by TIPS Member, TIPS Member requires the proposer certify that in performance of the contracts, subcontracts, and subgrants of amounts in excess of \$100,000, the vendor will be in compliance with all applicable standards, orders, or requirements issued under section 306 of the Clean Air Act (42 U.S.C. 1857(h)), section 508 of the Clean Water Act (33 U.S.C. 1368), Executive Order 11738, and Environmental Protection Agency regulations (40 CFR part 15).

Does vendor agree? YES _____ Initial of Authorized Company Official

Federal Rule (13) Mandatory standards and policies relating to energy efficiency which are contained in the state energy conservation plan issued in compliance with the Energy Policy and Conservation Act (Pub. L. 94-163, 89 Stat. 871).

Pursuant to Federal Rule (13) above, when federal funds are expended by TIPS Member, TIPS Member requires proposer certify that during the term of an award by the TIPS Member resulting for this procurement process the vendor will be in compliance with mandatory standards and policies relating to energy efficiency which are contained in the state energy conservation plan issued in compliance with the Energy Policy and Conservation Act (Pub. L. 94-163, 89 Stat. 871).

Does vendor agree? YES _____ Initial of Authorized Company Official

SUSPENSION OR DEBARMENT CERTIFICATE

Non-Federal entities are prohibited from contracting with or making sub-awards under covered transactions to parties that are suspended or debarred or whose principals are suspended or debarred. Covered transactions include procurement for goods or services equal to or in excess of \$100,000.00. Contractors receiving individual awards for \$25,000.00 or more and all sub-recipients must certify that the organization and its principals are not suspended or debarred.

You certify that no suspension or disbarment is in place, which would preclude receiving a federally funded contract under the Federal OMB, A-102, common rules

Information may be found at <https://www.sam.gov/index.html>

Has the vendor been debarred form participation in Federal funds contracts?

NO AR Initial of Authorized Company Official

YES ___ Initial of Authorized Company Official

Company Official: ANTONE RAD

Company: ILS INC / INTERNATIONAL LASER
SYSTEMS

CONTRACT Signature Form

The undersigned hereby proposes and agrees to furnish goods and/or services in compliance with the terms, specifications and conditions at the prices quoted unless noted in writing. The undersigned further certifies that he or she is an authorized agent of the company and has authority to negotiate and contract for the company named below.

Company Name: ILS INC/INTERNATIONAL LASER SYSTEMS

Mailing Address: 3929 FONDREN ROAD

City: HOUSTON

State: TX

Zip: 77063

Telephone Number: 713-789-7272

Fax Number: 713-789-3436

Email Address: SALES@ILSCORP.US.COM

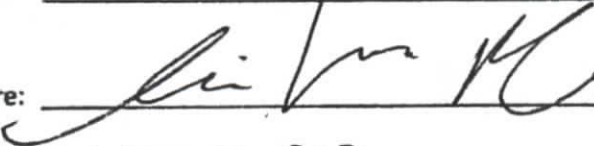
Authorized Signature: 

Printed Name: ANTOINE RAD

Position: OWNER

This contract is for a total TERM of one year with the option of two additional years. Vendors shall honor the participation fee for any sales made based on the TIPS contract. Failure to pay the fee will be grounds for termination of contract and will affect the award of future contracts.

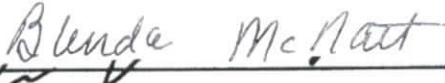
 6-25-15
TIPS Authorized Signature Date

 6-25-15
Approved by Region VIII ESC Date

Lorena Narvaez
Cudd Energy Services
2828 Technology Forest Blvd.
The Woodlands, TX 77381
O: 832-295-5555
F: 713-849-3861
E: lnarvaez@cudd.com

Veronica Ramirez
Patterson Services Inc.
2828 Technology Forest Blvd.
The Woodlands, TX 77381
O: 713-751-0066
E: vramirez@pattersonservices.com

Nunzi Pritchett
The Leukemia & Lymphoma Society
5433 Westheimer, Ste. 300
Houston, TX 77056
O: 713-840-8534 ext. 1682
F: 713-877-8534
E: nunzi.pritchett@lls.org

Ava Haywood
Key Energy Services, Inc.
1301 McKinney St., Ste. 1800
Houston, TX 77010
O: 713-651-4539
F: 713-652-4005
E: ahaywood@keyenergy.com

Lisa Hailey
Patterson Tubular Services
P.O. Box 117
539 S. Sheldon
Channelview, TX 77530
O: 281-247-7946
F: 281-452-7410
E: lhailey13760@pattersonstubular.com

WARRANTY

All products purchased from International Laser Systems are warranted to be free from manufacturing and material defects for a period of 90 days from the date of purchase and one year directly thru manufacture. If, at any time, International Laser Systems products fail to perform according to the aforementioned, International Laser Systems will replace the item or credit the full purchase price. International Laser Systems warranty coverage does not include freight related damages, improper installation, storage, or abuse of the products. International Laser Systems liability to the purchase price of the product that is sold. International Laser Systems will not be held liable for incidental or consequential damages of any kind. Buyer accepts full responsibility for use of said products.

PRODUCT RETURNS

Prior to returning any merchandise (defective or otherwise), customers must contact International Laser Systems to obtain a Return Authorization Number and shipping instructions. All non-defective returns must be in resalable condition and in the original packaging. Please do not mark, write address or Return Authorization Number on the outside of the original packaging. A 15% restocking fee will apply for all non-defective returns. Non-defective returns are only accepted within 30 days of the original invoice date. Return Authorization Number are valid for 30 days from date of issue. All returns are subject to inspection by International Laser Systems on the resell condition, and credit will be issued after the product have been received and inspected. All returns freight shipping charges will be the responsibility of the customer, unless the error was due to International Laser Systems.

DEFECTIVE MERCHANDISE RETURNS

All defective returns must be pre-authorized by International Laser Systems and have a Return Authorization Number. Returns without an RA number will be refused. Contact your sales representative or our customer service team to request an RA number. International Laser Systems will credit or exchange the defective product after receipt and inspection of the merchandise.

SHORTAGES & DAMAGED SHIPMENTS

All shortages and damages from FedEx, UPS, or other freight carriers must be reported to International Laser Systems within 48 hours of delivery. All trucking company freight shortages or damages must be filed at the receiving site with the trucking carrier. If you receive product that has been damaged in transit, please refuse the delivery. If you notice a shortage or damage after the carrier has left your premise, you must file a claim with the carrier according to their policies.

INTERNATIONAL LASER SYSTEMS

3929 Fondren Rd. Houston, Texas 77063

FAX: 713-789-3436 | Email: sales@ilscorp.us.com



INTERNATIONAL LASER SYSTEMS

1H15 TECHNOLOGY SUPPLIES



DELIVERING AN
**EXCEPTIONAL
EXPERIENCE**

to our customers

(713) 789-7272 | www.ilscorp.us.com



OEM PRINT SUPPLIES & PARTS



COMPATIBLE PRINT SUPPLIES & PARTS



PRINT MEDIA



DATA STORAGE



IMAGING EQUIPMENT

AMT*Datasouth* _____ 8

AVERY® _____ 188

brother
at your side _____ 8-17, 188-193, 211-217

Canon _____ 17-23, 217-220

CLOVER
Innovative Environmental Solutions _____ 123-140

Copystar
Kyocera Technology _____ 23

DATAPRODUCTS® _____ 141

DELL
The power to do more _____ 23-28

digital _____ 28

ecoPost _____ 141, 142

EPSON
EXCEED YOUR VISION _____ 28-32, 193

GENICOM _____ 32, 107

Gestetner _____ 33

hp _____ 33-53, 175-184, 193-195,
200-202, 221-231

HSM _____ 206-211

imagistics _____ 53

imation _____ 202-203

RICOH
InfoPrint Solutions _____ 53-56

A Katun Brand
mediaSciences®
Imaging the World in Color™ _____ 142-151

KONICA MINOLTA _____ 56, 58

KYOCERA
mita _____ 58, 59

LANIER _____ 59, 60

LEXMARK™ _____ 60-87, 184-186, 231-240

MACO® _____ 195-197

maxell
Data Storage Group _____ 203

memorex™ _____ 203, 204

WISE Choose Quality™ _____ 151-157

muratec _____ 87

NEC _____ 87

NuPost® _____ 157

OKI
PRINTING SOLUTIONS _____ 87-95, 240-243

 **OUTPUT TECHNOLOGY** _____ 95
High Performance Business Process, June 2007

 _____ 4, 5

Panasonic _____ 95, 96

PRES-a-ply[®] _____ 97, 98

Primera _____ 96

 _____ 253-256

PRINTRONIX _____ 96

RICOH
imagine. change. _____ 96-100, 243-245

RISOGRAPH _____ 100

 _____ 101-105

savin _____ 105

SHARP _____ 105, 106

 **SourceTechnologies**[®] _____ 106, 246

 **TallyGenicom** _____ 107

 **TDK**
Life on Record _____ 204

 **TEXAS INSTRUMENTS** _____ 107

TOSHIBA _____ 107-109

 **TROY** _____ 109-111, 246-249

 **Verbatim** _____ 204

 **West Point Products**
QUALITY IMAGING SOLUTIONS _____ 157-163

XANTÉ _____ 111

xerox  _____ 111-121, 163-168, 186, 249-253

500 SERIES _____ 168-174



Delicious PapaNicholas coffee in a variety of bagged and single-serve blends.



All catalog content is subject to change.

PAPANICHOLAS COFFEE

| Product Type | OEM # | Description | |
|-----------------------------------|---|---|--|
| PapaNicholas Premium Single-Serve | 03241BX | Breakfast Blend Single-Serve Coffee Cups (24 Cups/Box) | |
| | 03242BX | Hawaiian Islands Blend Single-Serve Coffee Cups (24 Cups/Box) | |
| | 03243BX | Italian Espresso Single-Serve Coffee Cups (24 Cups/Box) | |
| | 03244BX | French Roast Single-Serve Coffee Cups (24 Cups/Box) | |
| | 03245BX | 5-Star Restaurant Blend Single-Serve Coffee Cups (24 Cups/Box) | |
| | 03246BX | Hazelnut Creme Single-Serve Coffee Cups (24 Cups/Box) | |
| | 03247 | Decaf French Roast Single-Serve Coffee Cups (24 Cups/Box) | |
| | 03248 | Black and Tan Single-Serve Coffee Cups (24 Cups/Box) | |
| | 03249 | Colombian Supremo Single-Serve Coffee Cups (24 Cups/Box) | |
| | 03250 | Special House Blend Single-Serve Coffee Cups (24 Cups/Box) | |
| | 03251 | Donut Blend Single-Serve Coffee Cups (24 Cups/Box) | |
| | 03252 | Costa Rican Single-Serve Coffee Cups (24 Cups/Box) | |
| | 03253 | French Vanilla Single-Serve Coffee Cups (24 Cups/Box) | |
| | 03254 | Cinnamon Bun Single-Serve Coffee Cups (24 Cups/Box) | |
| | 03401 | French Vanilla Cappuccino Single-Serve Cups (24 Cups/Box) | |
| | 03404 | Apple Cider Single-Serve Cups (24 Cups/Box) | |
| | 03405 | Cocoa Single-Serve Cups (24 Cups/Box) | |
| | 03406 | French Vanilla Cappuccino Single-Serve Cups (24 Cups/Box) | |
| | PapaNicholas Premium Bag | 25181 | Hawaiian Islands Blend Ground Coffee, Light Roast, 2.5-oz. Bag (18 Bags/Box) |
| | | 25182 | Colombian Supremo Ground Coffee, Light Roast, 2.5-oz. Bag (18 Bags/Box) |
| 25183 | | French Roast Ground Coffee, Medium Dark Roast, 2.5-oz. Bag (18 Bags/Box) | |
| 25184 | | Breakfast Blend Ground Coffee, Medium Roast, 2.5-oz. Bag (18 Bags/Box) | |
| 25185 | | Special House Blend Ground Coffee, Light Roast, 2.5-oz. Bag (18 Bags/Box) | |
| 25186 | | Decaffeinated French Roast Coffee, Medium Dark Roast, 2.5-oz. Bag (18 Bags/Box) | |
| 25187 | | Hazelnut Creme Ground Coffee, Light Roast, 2.5-oz. Bag (18 Bags/Box) | |
| 25188 | | French Vanilla Ground Coffee, Light Roast, 2.5-oz. Bag (18 Bags/Box) | |
| 32003 | | Hawaiian Islands Blend Whole Bean Coffee, Light Roast, 2-lb. Bag (6 Bags/Box) | |
| 32006 | | Breakfast Blend Whole Bean Coffee, Medium Roast, 2-lb. Bag (6 Bags/Box) | |
| Day to Day Single Serve | 79224 | Dutch Chocolate Cocoa, 1.25-oz. Bag (24 Bags/Box) | |
| | 79424 | Chocolate Peppermint Cocoa, 1.25-oz. Bag (24 Bags/Box) | |
| | 03601 | Colombian Supreme Single-Serve Cups (24 Cups/Box) | |
| | 03602 | Original Blend Single-Serve Cups (24 Cups/Box) | |
| | 03605 | Donut Blend Single-Serve Cups (24 Cups/Box) | |
| | 03606 | Dark Roast Single-Serve Cups (24 Cups/Box) | |
| | 03607 | Vanilla Creme Single-Serve Cups (24 Cups/Box) | |
| | 03608 | House Blend Single-Serve Cups (24 Cups/Box) | |
| | 03609 | Morning Blend Single-Serve Cups (24 Cups/Box) | |
| | 03610 | Breakfast Blend Ground Coffee Single-Serve Cups (24 Cups/Box) | |
| Day to Day Ground Bag | 38017 | French Vanilla Cappuccino Single-Serve Cups (24 Cups/Box) | |
| | 23001 | Colombian Blend Ground Coffee, Light Roast, 1.5-oz. Bag (42 Bags/Box) | |
| | 23002 | Kona Blend Ground Coffee, Light Roast, 1.5-oz. Bag (42 Bags/Box) | |
| | 23003 | Breakfast Blend Ground Coffee, Medium Roast, 1.5-oz. Bag (42 Bags/Box) | |
| | 23004 | Decaffeinated Ground Coffee, Medium Roast, 1.5-oz. Bag (42 Bags/Box) | |
| 33100 | House Blend Ground Coffee, Light Roast, 33-oz. Bag (6 Bags/Box) | | |

* All coffee SKUs are non-returnable.

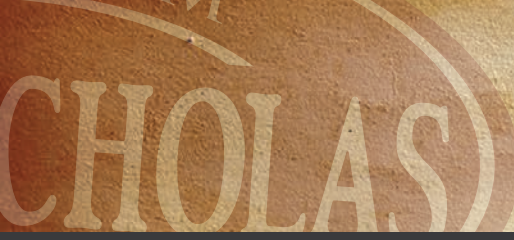

All catalog content is subject to change.

PAPANICHOLAS COFFEE

NEW single-serve flavors now available!

- Over 20 blends to choose from
- 24-count boxes
- Compatible with commercial Keurig® K-cup® brewers
- No special equipment or authorization required



The PapaNicholas philosophy on coffee is pretty simple...**GREAT** beans make **GREAT** coffee.

Now You Can Have Great Taste and Great Price!

Day to Day is a premium tasting coffee made with only the freshest coffee beans from around the world.

Using the expertise of PapaNicholas Coffee Company, we are able to provide you a low cost coffee while not sacrificing taste.





OEM PRINT SUPPLIES & PARTS
10-121



COMPATIBLE PRINT SUPPLIES & PARTS
122-186



PRINT MEDIA
187-198



DATA STORAGE
199-204

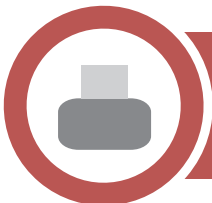

IMAGING EQUIPMENT
205-256

Indexes

Brand Name Index _____ 2-3
 Manufacturer # Index _____ 283-300
 Product Category Index _____ 6

Sections

OEM Print Supplies & Parts ____ 7-121
 Compatible Print Supplies & Parts ____
 _____ 122-186
 Print Media _____ 187-198
 Data Storage _____ 199-204
 Imaging Equipment _____ 205-256

Reference Guides

Brother Labeling _____ 190-191
 HP Cross Reference _____ 257-282



..... **OEM** PRINT SUPPLIES & PARTS

We Work With Over 70+ Manufacturers to bring you the best products, prices and promotions on OEM supplies.



QUALITY AND RELIABILITY.

| MFG# | Product Description | Part# | UOM | Retail |
|--|--|--------|-----|---------|
| AMT DATASOUTH SUPPLIES | | | | |
| AMT Datasouth Ribbons | | | | |
| 844110-001 | Accel-535/635/5350/6310/6350 Black Ribbon (5M Characters) | 1610 | RBN | \$16.00 |
| 130074 | Accel-7350/7450 Black Ribbon Cartridge | 105330 | RBN | \$40.00 |
| AAB-105453 | CX3400/CX5400/DS400/DS440/TX5400/XL400 Black Ribbon | 91077 | RBN | \$28.00 |
| AAB-104443 | Documax Ribbon (Fits All Documax Machines) | 94667 | RBN | \$23.00 |
| BROTHER SUPPLIES | | | | |
| Brother AX Series/GX Series/Correctronic Series/EM-30/31/31-11/ML-100/300/500/SX-14/16/23/4000 Correction Ribbon | | | | |
| 1030 | Black Correctable Ribbon | 91709 | RBN | \$8.49 |
| 1230 | Black Correctable Ribbon 2-Pack | 12329 | PK | \$14.49 |
| 3015 | Lift-Off Correction Tape (6 Tapes/Pack) | 90594 | PK | \$18.49 |
| Brother CE-25/35/40/45/50/50XL/58/60/65/68/70/333/CX-80/90/95/PRO-400/420/440/460/EM-401/411/430/450/530/550/630/WP-55/200/500/510+/650 Correction Ribbon | | | | |
| 7020 | Correctable Ribbon | 90043 | RBN | \$8.49 |
| Brother FAX 575 Thermal Supplies | | | | |
| PC501 | Print Cartridge (150 Yield) | 6127 | CTG | \$23.49 |
| Brother MFC-660MC Thermal Supplies | | | | |
| PC401 | Print Cartridge (150 Yield) | 106807 | CTG | \$23.49 |
| Brother MFC-970MC Thermal Supplies | | | | |
| PC301 | Print Cartridge (250 Yield) | 101348 | CTG | \$25.99 |
| PC302RF | PC301 Refill Kit (250 Yield/Roll) (2 RI/Pkg) | 101349 | PK | \$39.99 |
| Brother MFC-1750/1850MC/1950MC/1950+ Thermal Supplies | | | | |
| PC101 | Print Cartridge (750 Yield) | 94801 | CTG | \$47.99 |
| Brother MFC-1770/1780/1870MC/1970MC Thermal Supplies | | | | |
| PC201 | Print Cartridge (450 Yield) | 98127 | CTG | \$32.99 |
| PC202RF | PC201 Refill Kit (450 Yield/Roll) (2 RI/Pkg) | 98665 | PK | \$57.99 |
| Brother PPF-560/565/580MC Thermal Supplies | | | | |
| PC401 | Print Cartridge (150 Yield) | 106807 | CTG | \$23.49 |
| Brother PPF-750/770/775/870MC/885MC Thermal Supplies | | | | |
| PC301 | Print Cartridge (250 Yield) | 101348 | CTG | \$25.99 |
| PC302RF | PC301 Refill Kit (250 Yield/Roll) (2 RI/Pkg) | 101349 | PK | \$39.99 |
| Brother PPF-1150/1250/1350M/1450MC/1550MC Thermal Supplies | | | | |
| PC101 | Print Cartridge (750 Yield) | 94801 | CTG | \$47.99 |
| Brother PPF-1170/1270/1270e/1570MC/1575MC Thermal Supplies | | | | |
| PC201 | Print Cartridge (450 Yield) | 98127 | CTG | \$32.99 |
| PC202RF | PC201 Refill Kit (450 Yield/Roll) (2 RI/Pkg) | 98665 | PK | \$57.99 |
| Brother DCP-110C/120C Ink Supplies | | | | |
| LC41BK | Black Ink (500 Yield) | 5482 | CTG | \$28.99 |
| LC41HYBK | High Yield Black Ink (900 Yield) | 5483 | CTG | \$40.49 |
| LC41C | Cyan Ink (400 Yield) | 5484 | CTG | \$15.99 |
| LC41M | Magenta Ink (400 Yield) | 5485 | CTG | \$15.99 |
| LC41Y | Yellow Ink (400 Yield) | 5486 | CTG | \$15.99 |
| LC41BK2PKS | Black Ink Twin Pack (2 Pack of OEM# LC41BK) (2 x 500 Yield) | 102533 | PK | \$56.99 |
| LC413PKS | C/M/Y Ink Combo Pack (Includes OEM# LC41C, LC41M, LC41Y) (3 x 400 Yield) | 102534 | PK | \$46.99 |
| Brother DCP-130/330C/350C Ink Supplies | | | | |
| LC51BK | Black Ink (500 Yield) | 15087 | CTG | \$27.99 |
| LC51C | Cyan Ink (400 Yield) | 15089 | CTG | \$15.49 |
| LC51M | Magenta Ink (400 Yield) | 15090 | CTG | \$15.49 |
| LC51Y | Yellow Ink (400 Yield) | 15091 | CTG | \$15.49 |
| LC512PKS | Black Ink Twin Pack (2 Pack of OEM# LC51BK) (2 x 500 Yield) | 102535 | PK | \$56.99 |
| LC513PKS | C/M/Y Ink Combo Pack (Includes OEM# LC51C, LC51M, LC51Y) (3 x 400 Yield) | 102536 | PK | \$47.49 |
| Brother DCP-J125/165C Ink Supplies (Continued on next page) | | | | |
| LC61BK | Black Ink (450 Yield) | 901404 | CTG | \$25.99 |
| LC61C | Cyan Ink (325 Yield) | 901405 | CTG | \$10.99 |
| LC61M | Magenta Ink (325 Yield) | 901406 | CTG | \$10.99 |

| MFG# | Product Description | Part# | UOM | Retail |
|--|--|--------|-----|---------|
| BROTHER SUPPLIES | | | | |
| Brother DCP-J125/165C Ink Supplies (Continued) | | | | |
| LC61Y | Yellow Ink (325 Yield) | 901407 | CTG | \$10.99 |
| LC612PKS | Black Ink Twin Pack (2 Pack of OEM# LC61BK) (2 x 450 Yield) | 901412 | PK | \$47.49 |
| LC613PKS | C/M/Y Ink Combo Pack (Includes OEM# LC61C, LC61M, LC61Y) (3 x 325 Yield) | 901413 | PK | \$30.49 |
| Brother DCP-J152W Ink Supplies | | | | |
| LC101BK | Black Ink (300 Yield) | 914469 | CTG | \$14.99 |
| LC103BK | High Yield Black Ink (600 Yield) | 908751 | CTG | \$24.99 |
| LC101C | Cyan Ink (300 Yield) | 914470 | CTG | \$9.99 |
| LC101M | Magenta Ink (300 Yield) | 914471 | CTG | \$9.99 |
| LC101Y | Yellow Ink (300 Yield) | 914472 | CTG | \$9.99 |
| LC1032PKS | High Yield Black Ink Twin Pack (2 Pack of OEM# LC103BK) (2 x 600 Yield) | 914473 | PK | \$45.99 |
| LC1013PKS | C/M/Y Ink Combo Pack (Includes OEM# LC101C, LC101M, LC101Y) (3 x 300 Yield) | 914468 | PK | \$27.49 |
| Brother FAX 1840C/1940CN/2440C Ink Supplies | | | | |
| LC41BK | Black Ink (500 Yield) | 5482 | CTG | \$28.99 |
| LC41HYBK | High Yield Black Ink (900 Yield) | 5483 | CTG | \$40.49 |
| LC41C | Cyan Ink (400 Yield) | 5484 | CTG | \$15.99 |
| LC41M | Magenta Ink (400 Yield) | 5485 | CTG | \$15.99 |
| LC41Y | Yellow Ink (400 Yield) | 5486 | CTG | \$15.99 |
| LC41BK2PKS | Black Ink Twin Pack (2 Pack of OEM# LC41BK) (2 x 500 Yield) | 102533 | PK | \$56.99 |
| LC413PKS | C/M/Y Ink Combo Pack (Includes OEM# LC41C, LC41M, LC41Y) (3 x 400 Yield) | 102534 | PK | \$46.99 |
| Brother FAX 1860/1960C/2480C/2580C Ink Supplies | | | | |
| LC51BK | Black Ink (500 Yield) | 15087 | CTG | \$27.99 |
| LC51C | Cyan Ink (400 Yield) | 15089 | CTG | \$15.49 |
| LC51M | Magenta Ink (400 Yield) | 15090 | CTG | \$15.49 |
| LC51Y | Yellow Ink (400 Yield) | 15091 | CTG | \$15.49 |
| LC512PKS | Black Ink Twin Pack (2 Pack of OEM# LC51BK) (2 x 500 Yield) | 102535 | PK | \$56.99 |
| LC513PKS | C/M/Y Ink Combo Pack (Includes OEM# LC51C, LC51M, LC51Y) (3 x 400 Yield) | 102536 | PK | \$47.49 |
| Brother MFC-210C/420CN/620CN/3240C/3340CN/5440CN/5840CN Ink Supplies | | | | |
| LC41BK | Black Ink (500 Yield) | 5482 | CTG | \$28.99 |
| LC41HYBK | High Yield Black Ink (900 Yield) | 5483 | CTG | \$40.49 |
| LC41C | Cyan Ink (400 Yield) | 5484 | CTG | \$15.99 |
| LC41M | Magenta Ink (400 Yield) | 5485 | CTG | \$15.99 |
| LC41Y | Yellow Ink (400 Yield) | 5486 | CTG | \$15.99 |
| LC41BK2PKS | Black Ink Twin Pack (2 Pack of OEM# LC41BK) (2 x 500 Yield) | 102533 | PK | \$56.99 |
| LC413PKS | C/M/Y Ink Combo Pack (Includes OEM# LC41C, LC41M, LC41Y) (3 x 400 Yield) | 102534 | PK | \$46.99 |
| Brother MFC-230C/240C/440CN/465CN/665CW/685CW/845CW/885CW/3360C/5460CN/5860CN Ink Supplies | | | | |
| LC51BK | Black Ink (500 Yield) | 15087 | CTG | \$27.99 |
| LC51HYBK | High Yield Black Ink (900 Yield) (For Use in 5460CN/5860CN Models Only) | 15088 | CTG | \$40.49 |
| LC51C | Cyan Ink (400 Yield) | 15089 | CTG | \$15.49 |
| LC51M | Magenta Ink (400 Yield) | 15090 | CTG | \$15.49 |
| LC51Y | Yellow Ink (400 Yield) | 15091 | CTG | \$15.49 |
| LC512PKS | Black Ink Twin Pack (2 Pack of OEM# LC51BK) (2 x 500 Yield) | 102535 | PK | \$56.99 |
| LC513PKS | C/M/Y Ink Combo Pack (Includes OEM# LC51C, LC51M, LC51Y) (3 x 400 Yield) | 102536 | PK | \$47.49 |
| Brother MFC-5890CN/5895CW/6490CW/6890CDW Ink Supplies | | | | |
| LC65HYBK | High Yield Black Ink (900 Yield) | 901408 | CTG | \$32.99 |
| LC65HYC | High Yield Cyan Ink (750 Yield) | 901409 | CTG | \$17.99 |
| LC65HYM | High Yield Magenta Ink (750 Yield) | 901410 | CTG | \$17.99 |
| LC65HYY | High Yield Yellow Ink (750 Yield) | 901411 | CTG | \$17.99 |
| LC652PKS | Black Ink Twin Pack (2 Pack of OEM# LC65HYBK) (2 x 900 Yield) | 901414 | PK | \$54.99 |
| LC653PKS | C/M/Y Ink Combo Pack (Includes OEM# LC65HYC, LC65HYM, LC65HYY) (3 x 750 Yield) | 901415 | PK | \$43.99 |
| Brother MFC-J220/J265W/J270W/290C/J410W/J415W/490CW/J615W/790CW/990CW Ink Supplies | | | | |
| LC61BK | Black Ink (450 Yield) | 901404 | CTG | \$25.99 |
| LC61C | Cyan Ink (325 Yield) | 901405 | CTG | \$10.99 |
| LC61M | Magenta Ink (325 Yield) | 901406 | CTG | \$10.99 |
| LC61Y | Yellow Ink (325 Yield) | 901407 | CTG | \$10.99 |
| LC612PKS | Black Ink Twin Pack (2 Pack of OEM# LC61BK) (2 x 450 Yield) | 901412 | PK | \$47.49 |
| LC613PKS | C/M/Y Ink Combo Pack (Includes OEM# LC61C, LC61M, LC61Y) (3 x 325 Yield) | 901413 | PK | \$30.49 |
| Brother MFC-J245/J285DW/J450DW/J470DW/J475DW/J650DW/J870DW/J875DW Ink Supplies (Continued on next page) | | | | |
| LC101BK | Black Ink (300 Yield) | 914469 | CTG | \$14.99 |

| MFG# | Product Description | Part# | UOM | Retail |
|---|--|--------|-----|---------|
| BROTHER SUPPLIES | | | | |
| Brother MFC-J245/J285DW/J450DW/J470DW/J475DW/J650DW/J870DW/J875DW Ink Supplies (Continued) | | | | |
| LC103BK | High Yield Black Ink (600 Yield) | 908751 | CTG | \$24.99 |
| LC101C | Cyan Ink (300 Yield) | 914470 | CTG | \$9.99 |
| LC101M | Magenta Ink (300 Yield) | 914471 | CTG | \$9.99 |
| LC101Y | Yellow Ink (300 Yield) | 914472 | CTG | \$9.99 |
| LC1032PKS | High Yield Black Ink Dual Pack (2 Pack of OEM# LC103BK) (2 x 600 Yield) | 914473 | PK | \$45.99 |
| LC1013PKS | C/M/Y Ink Combo Pack (Includes OEM# LC101C, LC101M, LC101Y) (3 x 300 Yield) | 914468 | PK | \$27.49 |
| Brother MFC-J280W/J425W/J430W/J435W/J625DW/J825DW/J835DW Ink Supplies | | | | |
| LC71BK | Black Ink (400 Yield) | 500070 | CTG | \$14.99 |
| LC71C | Cyan Ink (300 Yield) | 500095 | CTG | \$9.99 |
| LC71M | Magenta Ink (300 Yield) | 500101 | CTG | \$9.99 |
| LC71Y | Yellow Ink (300 Yield) | 500107 | CTG | \$9.99 |
| LC713PKS | C/M/Y Ink Combo Pack (Includes OEM# LC71C, LC71M, LC71Y) (3 x 300 Yield) | 500108 | PK | \$27.49 |
| LC75BK | High Yield Black Ink (600 Yield) | 93953 | CTG | \$24.99 |
| LC75C | High Yield Cyan Ink (600 Yield) | 93954 | CTG | \$14.99 |
| LC75M | High Yield Magenta Ink (600 Yield) | 93957 | CTG | \$14.99 |
| LC75Y | High Yield Yellow Ink (600 Yield) | 93958 | CTG | \$14.99 |
| LC752PKS | High Yield Black Ink Twin Pack (2 Pack of OEM# LC75BK) (2 x 600 Yield) | 500042 | PK | \$45.99 |
| LC753PKS | High Yield C/M/Y Ink Combo Pack (Includes OEM# LC75C, LC75M, LC75Y) (3 x 600 Yield) | 500045 | PK | \$41.49 |
| Brother MFC-J4310DW/J4410DW/J4510DW/J4610DW/J4710DW Ink Supplies | | | | |
| LC103BK | High Yield Black Ink (600 Yield) | 908751 | CTG | \$24.99 |
| LC103C | High Yield Cyan Ink (600 Yield) | 908752 | CTG | \$14.99 |
| LC103M | High Yield Magenta Ink (600 Yield) | 908753 | CTG | \$14.99 |
| LC103Y | High Yield Yellow Ink (600 Yield) | 908754 | CTG | \$14.99 |
| LC1032PKS | High Yield Black Ink Dual Pack (2 Pack of OEM# LC103BK) (2 x 600 Yield) | 914473 | PK | \$45.99 |
| LC1033PKS | High Yield C/M/Y Ink Combo Pack (Includes OEM# LC103C, LC103M, LC103Y) (3 x 600 Yield) | 908750 | PK | \$41.49 |
| LC107BK | Super High Yield Black Ink (1,200 Yield) | 908760 | CTG | \$29.99 |
| LC105C | Super High Yield Cyan Ink (1,200 Yield) | 908756 | CTG | \$22.99 |
| LC105M | Super High Yield Magenta Ink (1,200 Yield) | 908757 | CTG | \$22.99 |
| LC105Y | Super High Yield Yellow Ink (1,200 Yield) | 908758 | CTG | \$22.99 |
| LC1072PKS | Super High Yield Black Ink Dual Pack (2 Pack of OEM# LC107BK) (2 x 1,200 Yield) | 908759 | PK | \$54.99 |
| LC1053PKS | Super High Yield C/M/Y Ink Combo Pack (Includes OEM# LC105C, LC105M, LC105Y) (3 x 1,200 Yield) | 908755 | PK | \$63.49 |
| Brother MFC-J4320DW/J4420DW/J4620DW Ink Supplies | | | | |
| LC203BK | High Yield Black Ink (550 Yield) | 922979 | CTG | \$24.49 |
| LC203C | High Yield Cyan Ink (550 Yield) | 922980 | CTG | \$14.49 |
| LC203M | High Yield Magenta Ink (550 Yield) | 922981 | CTG | \$14.49 |
| LC203Y | High Yield Yellow Ink (550 Yield) | 922982 | CTG | \$14.49 |
| LC207BK | Super High Yield Black Ink (1,200 Yield) | 922988 | CTG | \$29.99 |
| LC205C | Super High Yield Cyan Ink (1,200 Yield) | 922984 | CTG | \$22.99 |
| LC205M | Super High Yield Magenta Ink (1,200 Yield) | 922985 | CTG | \$22.99 |
| LC205Y | Super High Yield Yellow Ink (1,200 Yield) | 922986 | CTG | \$22.99 |
| LC2072PKS | Super High Yield Black Ink Dual Pack (2 Pack of OEM# LC207BK) (2 x 1,200 Yield) | 922987 | PK | \$54.99 |
| LC2033PKS | High Yield C/M/Y Ink Combo Pack (Includes OEM# LC203C, LC203M, LC203Y) (3 x 550 Yield) | 922978 | PK | \$39.99 |
| LC2053PKS | Super High Yield C/M/Y Ink Combo Pack (Includes OEM# LC205C, LC205M, LC205Y) (3 x 1,200 Yield) | 922983 | PK | \$63.49 |
| Brother MFC-J5520DW/J5720DW Ink Supplies | | | | |
| LC203BK | High Yield Black Ink (550 Yield) | 922979 | CTG | \$24.49 |
| LC203C | High Yield Cyan Ink (550 Yield) | 922980 | CTG | \$14.49 |
| LC203M | High Yield Magenta Ink (550 Yield) | 922981 | CTG | \$14.49 |
| LC203Y | High Yield Yellow Ink (550 Yield) | 922982 | CTG | \$14.49 |
| LC2033PKS | High Yield C/M/Y Ink Combo Pack (Includes OEM# LC203C, LC203M, LC203Y) (3 x 550 Yield) | 922978 | PK | \$39.99 |
| LC209BK | Super High Yield Black Ink (2,400 Yield) | 922989 | CTG | \$39.99 |
| LC205C | Super High Yield Cyan Ink (1,200 Yield) | 922984 | CTG | \$22.99 |
| LC205M | Super High Yield Magenta Ink (1,200 Yield) | 922985 | CTG | \$22.99 |
| LC205Y | Super High Yield Yellow Ink (1,200 Yield) | 922986 | CTG | \$22.99 |
| LC2053PKS | Super High Yield C/M/Y Ink Combo Pack (Includes OEM# LC205C, LC205M, LC205Y) (3 x 1,200 Yield) | 922983 | PK | \$63.49 |
| Brother MFC-J5910DW/J6510DW/J6710DW/J6910DW Ink Supplies (Continued on next page) | | | | |
| LC75BK | High Yield Black Ink (600 Yield) | 93953 | CTG | \$24.99 |
| LC75C | High Yield Cyan Ink (600 Yield) | 93954 | CTG | \$14.99 |



Some things should never be separated
Brother™ Genuine Supplies & Our Quality Products.



All of our products and their supplies are designed as
integrated systems to achieve optimum performance and superior output.

Some things are just better together.



brother®
at your side

© 2014 Brother International Corporation. All Rights Reserved.

| MFG# | Product Description | Part# | UOM | Retail |
|---|--|--------|-----|----------|
| BROTHER SUPPLIES | | | | |
| Brother MFC-J5910DW/J6510DW/J6710DW/J6910DW Ink Supplies (Continued) | | | | |
| LC75M | High Yield Magenta Ink (600 Yield) | 93957 | CTG | \$14.99 |
| LC75Y | High Yield Yellow Ink (600 Yield) | 93958 | CTG | \$14.99 |
| LC752PKS | High Yield Black Ink Twin Pack (2 Pack of OEM# LC75BK) (2 x 600 Yield) | 500042 | PK | \$45.99 |
| LC753PKS | High Yield C/M/Y Ink Combo Pack (Includes OEM# LC75C, LC75M, LC75Y) (3 x 600 Yield) | 500045 | PK | \$41.49 |
| LC79BK | Super High Yield Black Ink (2,400 Yield) | 93959 | CTG | \$39.99 |
| LC79C | Super High Yield Cyan Ink (1,200 Yield) | 93960 | CTG | \$22.99 |
| LC79M | Super High Yield Magenta Ink (1,200 Yield) | 93961 | CTG | \$22.99 |
| LC79Y | Super High Yield Yellow Ink (1,200 Yield) | 93962 | CTG | \$22.99 |
| LC793PKS | Super High Yield C/M/Y Ink Combo Pack (Includes OEM# LC79C, LC79M, LC79Y) (3 x 1,200 Yield) | 500055 | PK | \$63.49 |
| Brother MFC-J6520DW/J6720DW/J6920DW Ink Supplies | | | | |
| LC103BK | High Yield Black Ink (600 Yield) | 908751 | CTG | \$24.99 |
| LC1032PKS | High Yield Black Ink Dual Pack (2 Pack of OEM# LC103BK) (2 x 600 Yield) | 914473 | PK | \$45.99 |
| LC103C | High Yield Cyan Ink (600 Yield) | 908752 | CTG | \$14.99 |
| LC103M | High Yield Magenta Ink (600 Yield) | 908753 | CTG | \$14.99 |
| LC103Y | High Yield Yellow Ink (600 Yield) | 908754 | CTG | \$14.99 |
| LC1033PKS | High Yield C/M/Y Ink Combo Pack (Includes OEM# LC103C, LC103M, LC103Y) (3 x 600 Yield) | 908750 | PK | \$41.49 |
| LC105C | Super High Yield Cyan Ink (1,200 Yield) | 908756 | CTG | \$22.99 |
| LC105M | Super High Yield Magenta Ink (1,200 Yield) | 908757 | CTG | \$22.99 |
| LC105Y | Super High Yield Yellow Ink (1,200 Yield) | 908758 | CTG | \$22.99 |
| LC1053PKS | Super High Yield C/M/Y Ink Combo Pack (Includes OEM# LC105C, LC105M, LC105Y) (3 x 1,200 Yield) | 908755 | PK | \$63.49 |
| LC109BK | Ultra High Yield Black Ink (2,400 Yield) | 914691 | CTG | \$39.99 |
| Brother FAX 2820/2920 Laser Supplies | | | | |
| TN350 | Toner (2,500 Yield) | 6103 | CTG | \$72.99 |
| DR350 | Replacement Drum Unit (12,000 Yield) | 6104 | EA | \$139.99 |
| Brother FAX 2840/2940 Laser Supplies | | | | |
| TN420 | Toner (1,200 Yield) | 93825 | CTG | \$44.99 |
| TN450 | High Yield Toner (2,600 Yield) | 93826 | CTG | \$68.49 |
| Brother FAX-4100e Laser Supplies | | | | |
| TN430 | Toner (3,000 Yield) | 105031 | CTG | \$69.49 |
| TN460 | High Yield Toner (6,000 Yield) | 105032 | CTG | \$100.49 |
| DR400 | Replacement Drum Unit (20,000 Yield) | 105072 | EA | \$208.49 |
| Brother DCP-1000 Laser Supplies | | | | |
| TN250 | Toner (2,200 Yield) | 4581 | CTG | \$43.99 |
| DR250 | Replacement Drum Unit (12,000 Yield) | 4580 | EA | \$244.99 |
| Brother DCP-1200/1400 Laser Supplies | | | | |
| TN430 | Toner (3,000 Yield) | 105031 | CTG | \$69.49 |
| TN460 | High Yield Toner (6,000 Yield) | 105032 | CTG | \$100.49 |
| DR400 | Replacement Drum Unit (20,000 Yield) | 105072 | EA | \$208.49 |
| Brother DCP-7020 Laser Supplies | | | | |
| TN350 | Toner (2,500 Yield) | 6103 | CTG | \$72.99 |
| DR350 | Replacement Drum Unit (12,000 Yield) | 6104 | EA | \$139.99 |
| Brother DCP-7030/7040 Laser Supplies | | | | |
| TN330 | Toner (1,500 Yield) | 101567 | CTG | \$49.99 |
| TN360 | High Yield Toner (2,600 Yield) | 101568 | CTG | \$71.99 |
| DR360 | Replacement Drum Unit (12,000 Yield) | 101569 | EA | \$110.49 |
| Brother DCP-7060/7065 Laser Supplies | | | | |
| TN420 | Toner (1,200 Yield) | 93825 | CTG | \$44.99 |
| TN450 | High Yield Toner (2,600 Yield) | 93826 | CTG | \$68.49 |
| Brother DCP-8020/8025D Laser Supplies | | | | |
| TN530 | Toner (3,300 Yield) | 1568 | CTG | \$84.49 |
| TN560 | High Yield Toner (6,500 Yield) | 107828 | CTG | \$114.99 |
| DR500 | Replacement Drum Unit (20,000 Yield) | 107829 | EA | \$228.49 |
| Brother DCP-8040/8045D Laser Supplies (Continued on next page) | | | | |
| TN540 | Toner (3,500 Yield) | 5137 | CTG | \$89.49 |

| MFG# | Product Description | Part# | UOM | Retail |
|--|--------------------------------------|--------|-----|----------|
| BROTHER SUPPLIES | | | | |
| Brother DCP-8040/8045D Laser Supplies <i>(Continued)</i> | | | | |
| TN570 | High Yield Toner (6,700 Yield) | 5138 | CTG | \$117.49 |
| DR510 | Replacement Drum Unit (20,000 Yield) | 5139 | EA | \$228.49 |
| Brother DCP-8060/8065DN Laser Supplies | | | | |
| TN550 | Toner (3,500 Yield) | 11848 | CTG | \$89.49 |
| TN580 | High Yield Toner (7,000 Yield) | 11849 | CTG | \$120.99 |
| DR520 | Replacement Drum Unit (25,000 Yield) | 11850 | EA | \$228.49 |
| Brother DCP-8080DN/8085DN Laser Supplies | | | | |
| TN620 | Toner (3,000 Yield) | 905106 | CTG | \$74.99 |
| TN650 | High Yield Toner (8,000 Yield) | 905107 | CTG | \$119.99 |
| DR620 | Replacement Drum Unit (25,000 Yield) | 905105 | EA | \$149.99 |
| Brother DCP-8110DN/8150DN/8155DN Laser Supplies | | | | |
| TN720 | Toner (3,000 Yield) | 906794 | CTG | \$76.99 |
| TN750 | High Yield Toner (8,000 Yield) | 906795 | CTG | \$124.99 |
| DR720 | Replacement Drum Unit (30,000 Yield) | 906793 | EA | \$159.99 |
| Brother DCP-L2520DW/L2540DW Laser Supplies | | | | |
| TN630 | Toner (1,200 Yield) | 922999 | CTG | \$44.99 |
| TN660 | High Yield Toner (2,600 Yield) | 923000 | CTG | \$68.48 |
| DR630 | Drum Unit (12,000 Yield) | 922998 | EA | \$104.99 |
| Brother HL-720/730+/730DX/760/760+/760DX/760DX+ Laser Supplies | | | | |
| TN200HL | Toner (2,200 Yield) | 95932 | CTG | \$37.99 |
| DR200 | Replacement Drum Unit (20,000 Yield) | 95934 | EA | \$244.99 |
| Brother HL-1230/1240/1250/1270N/1435/1440/1450/1470N Laser Supplies | | | | |
| TN430 | Toner (3,000 Yield) | 105031 | CTG | \$69.49 |
| TN460 | High Yield Toner (6,000 Yield) | 105032 | CTG | \$100.49 |
| DR400 | Replacement Drum Unit (20,000 Yield) | 105072 | EA | \$208.49 |
| Brother HL-1650/1670N/1850/1870N/5040/5050/5070N Laser Supplies | | | | |
| TN530 | Toner (3,300 Yield) | 1568 | CTG | \$84.49 |
| TN560 | High Yield Toner (6,500 Yield) | 107828 | CTG | \$114.99 |
| DR500 | Replacement Drum Unit (20,000 Yield) | 107829 | EA | \$228.49 |
| Brother HL-2040/2070N Laser Supplies | | | | |
| TN350 | Toner (2,500 Yield) | 6103 | CTG | \$72.99 |
| DR350 | Replacement Drum Unit (12,000 Yield) | 6104 | EA | \$139.99 |
| Brother HL-2140/2170W Laser Supplies | | | | |
| TN330 | Toner (1,500 Yield) | 101567 | CTG | \$49.99 |
| TN360 | High Yield Toner (2,600 Yield) | 101568 | CTG | \$71.99 |
| DR360 | Replacement Drum Unit (12,000 Yield) | 101569 | EA | \$110.49 |
| Brother HL-2220/2230/2240/2240D/2270DW/2280DW Laser Supplies | | | | |
| TN420 | Toner (1,200 Yield) | 93825 | CTG | \$44.99 |
| TN450 | High Yield Toner (2,600 Yield) | 93826 | CTG | \$68.49 |
| DR420 | Replacement Drum Unit (12,000 Yield) | 93963 | EA | \$104.99 |
| Brother HL-5140/5150D/5150DLT/5170DN/5170DLT Laser Supplies | | | | |
| TN540 | Toner (3,500 Yield) | 5137 | CTG | \$89.49 |
| TN570 | High Yield Toner (6,700 Yield) | 5138 | CTG | \$117.49 |
| DR510 | Replacement Drum Unit (20,000 Yield) | 5139 | EA | \$228.49 |
| Brother HL-5240/5250DN/5250DNT/5280DW Laser Supplies | | | | |
| TN550 | Toner (3,500 Yield) | 11848 | CTG | \$89.49 |
| TN580 | High Yield Toner (7,000 Yield) | 11849 | CTG | \$120.99 |
| DR520 | Replacement Drum Unit (25,000 Yield) | 11850 | EA | \$228.49 |
| Brother HL-5340D/5350DN/5370DW/5370DWT Laser Supplies | | | | |
| TN620 | Toner (3,000 Yield) | 905106 | CTG | \$74.99 |
| TN650 | High Yield Toner (8,000 Yield) | 905107 | CTG | \$119.99 |
| DR620 | Replacement Drum Unit (25,000 Yield) | 905105 | EA | \$149.99 |

| MFG# | Product Description | Part# | UOM | Retail |
|--|--------------------------------------|--------|-----|----------|
| BROTHER SUPPLIES | | | | |
| Brother HL-5440D/5450D/5470DW/5470DWT/6180DW/6180DWT Laser Supplies | | | | |
| TN720 | Toner (3,000 Yield) | 906794 | CTG | \$76.99 |
| TN750 | High Yield Toner (8,000 Yield) | 906795 | CTG | \$124.99 |
| DR720 | Replacement Drum Unit (30,000 Yield) | 906793 | EA | \$159.99 |
| Brother HL-6050D/6050DN Laser Supplies | | | | |
| TN670 | High Yield Toner (7,500 Yield) | 1115 | CTG | \$121.99 |
| DR600 | Replacement Drum (30,000 Yield) | 1116 | EA | \$182.99 |
| Brother HL-7050/7050N Laser Supplies | | | | |
| TN700 | Toner (12,000 Yield) | 1244 | CTG | \$134.49 |
| DR700 | Replacement Drum Unit (40,000 Yield) | 1230 | EA | \$145.99 |
| Brother HL-L2300D/L2340DW/L2380DW Laser Supplies | | | | |
| TN630 | Toner (1,200 Yield) | 922999 | CTG | \$44.99 |
| TN660 | High Yield Toner (2,600 Yield) | 923000 | CTG | \$68.48 |
| DR630 | Drum Unit (12,000 Yield) | 922998 | EA | \$104.99 |
| Brother PPF-2600/2750/3550/3650/3750 Laser Supplies | | | | |
| TN5000PF | Toner (2,200 Yield) | 95933 | CTG | \$43.99 |
| DR200 | Replacement Drum Unit (20,000 Yield) | 95934 | EA | \$244.99 |
| Brother PPF-2800/2900/3800 Laser Supplies | | | | |
| TN250 | Toner (2,200 Yield) | 4581 | CTG | \$43.99 |
| DR250 | Replacement Drum Unit (12,000 Yield) | 4580 | EA | \$244.99 |
| Brother PPF-4100/4750/4750E/5750/5750E Laser Supplies | | | | |
| TN430 | Toner (3,000 Yield) | 105031 | CTG | \$69.49 |
| TN460 | High Yield Toner (6,000 Yield) | 105032 | CTG | \$100.49 |
| DR400 | Replacement Drum Unit (20,000 Yield) | 105072 | EA | \$208.49 |
| Brother MFC-P2500/8300/8500/8600/8700/9600/9700/9800 Laser Supplies | | | | |
| TN430 | Toner (3,000 Yield) | 105031 | CTG | \$69.49 |
| TN460 | High Yield Toner (6,000 Yield) | 105032 | CTG | \$100.49 |
| DR400 | Replacement Drum Unit (20,000 Yield) | 105072 | EA | \$208.49 |
| Brother MFC-4300/4350/4450/4550/4550+/4600/4650/6550MC/6650MC/7550MC/7650MC/7750 Laser Supplies | | | | |
| TN5000PF | Toner (2,200 Yield) | 95933 | CTG | \$43.99 |
| DR200 | Replacement Drum Unit (20,000 Yield) | 95934 | EA | \$244.99 |
| Brother MFC-4800/6800 Laser Supplies | | | | |
| TN250 | Toner (2,200 Yield) | 4581 | CTG | \$43.99 |
| DR250 | Replacement Drum Unit (12,000 Yield) | 4580 | EA | \$244.99 |
| Brother MFC-7220/7225N/7420/7820N Laser Supplies | | | | |
| TN350 | Toner (2,500 Yield) | 6103 | CTG | \$72.99 |
| DR350 | Replacement Drum Unit (12,000 Yield) | 6104 | EA | \$139.99 |
| Brother MFC-7340/7345N/7440N/7840W Laser Supplies | | | | |
| TN330 | Toner (1,500 Yield) | 101567 | CTG | \$49.99 |
| TN360 | High Yield Toner (2,600 Yield) | 101568 | CTG | \$71.99 |
| DR360 | Replacement Drum Unit (12,000 Yield) | 101569 | EA | \$110.49 |
| Brother MFC-7360/7460/7860 Laser Supplies | | | | |
| TN420 | Toner (1,200 Yield) | 93825 | CTG | \$44.99 |
| TN450 | High Yield Toner (2,600 Yield) | 93826 | CTG | \$68.49 |
| Brother MFC-8220/8440/8640D/8840D/8840DN Laser Supplies | | | | |
| TN540 | Toner (3,500 Yield) | 5137 | CTG | \$89.49 |
| TN570 | High Yield Toner (6,700 Yield) | 5138 | CTG | \$117.49 |
| DR510 | Replacement Drum Unit (20,000 Yield) | 5139 | EA | \$228.49 |
| Brother MFC-8420/8820D/8820DN Laser Supplies | | | | |
| TN530 | Toner (3,300 Yield) | 1568 | CTG | \$84.49 |
| TN560 | High Yield Toner (6,500 Yield) | 107828 | CTG | \$114.99 |
| DR500 | Replacement Drum Unit (20,000 Yield) | 107829 | EA | \$228.49 |

| MFG# | Product Description | Part# | UOM | Retail |
|---|--|--------|-----|----------|
| BROTHER SUPPLIES | | | | |
| Brother MFC-8460N/8660DN/8670DN/8860DN/8870DW Laser Supplies | | | | |
| TN550 | Toner (3,500 Yield) | 11848 | CTG | \$89.49 |
| TN580 | High Yield Toner (7,000 Yield) | 11849 | CTG | \$120.99 |
| DR520 | Replacement Drum Unit (25,000 Yield) | 11850 | EA | \$228.49 |
| Brother MFC-8480DN/8680DN/8890DW Laser Supplies | | | | |
| TN620 | Toner (3,000 Yield) | 905106 | CTG | \$74.99 |
| TN650 | High Yield Toner (8,000 Yield) | 905107 | CTG | \$119.99 |
| DR620 | Replacement Drum Unit (25,000 Yield) | 905105 | EA | \$149.99 |
| Brother MFC-8710DW/8910DW Laser Supplies | | | | |
| TN720 | Toner (3,000 Yield) | 906794 | CTG | \$76.99 |
| TN750 | High Yield Toner (8,000 Yield) | 906795 | CTG | \$124.99 |
| DR720 | Replacement Drum Unit (30,000 Yield) | 906793 | EA | \$159.99 |
| Brother MFC-8950DW/8950DWT Laser Supplies | | | | |
| TN780 | Super High Yield Toner Cartridge (12,000 Yield) | 908472 | CTG | \$149.99 |
| DR720 | Replacement Drum Unit (30,000 Yield) | 906793 | EA | \$159.99 |
| Brother MFC-L2700DW/L2720DW/L2740DW Laser Supplies | | | | |
| TN630 | Toner (1,200 Yield) | 922999 | CTG | \$44.99 |
| TN660 | High Yield Toner (2,600 Yield) | 923000 | CTG | \$68.48 |
| DR630 | Drum Unit (12,000 Yield) | 922998 | EA | \$104.99 |
| Brother DCP-9040CN/9045CDN Color Laser Supplies | | | | |
| TN110BK | Black Toner (2,500 Yield) | 94707 | CTG | \$66.49 |
| TN110C | Cyan Toner (1,500 Yield) | 94708 | CTG | \$77.49 |
| TN110M | Magenta Toner (1,500 Yield) | 94709 | CTG | \$77.49 |
| TN110Y | Yellow Toner (1,500 Yield) | 94711 | CTG | \$77.49 |
| TN115BK | High Yield Black Toner (5,000 Yield) | 94713 | CTG | \$102.49 |
| TN115C | High Yield Cyan Toner (4,000 Yield) | 94714 | CTG | \$143.49 |
| TN115M | High Yield Magenta Toner (4,000 Yield) | 94715 | CTG | \$143.49 |
| TN115Y | High Yield Yellow Toner (4,000 Yield) | 94716 | CTG | \$143.49 |
| DR110CL | Replacement Drum Unit (17,000 Yield) | 94717 | EA | \$220.49 |
| WT100CL | Waste Toner Container (20,000 Yield) | 94719 | EA | \$27.99 |
| Brother HL-3040CN/3045CN/3070CW/3075CW Color Laser Supplies | | | | |
| TN210BK | Black Toner (2,200 Yield) | 17539 | CTG | \$74.99 |
| TN210C | Cyan Toner (1,400 Yield) | 17540 | CTG | \$69.99 |
| TN210M | Magenta Toner (1,400 Yield) | 17541 | CTG | \$69.99 |
| TN210Y | Yellow Toner (1,400 Yield) | 17542 | CTG | \$69.99 |
| DR210CL | Replacement Drum Unit Set (15,000 Yield) | 19524 | EA | \$149.99 |
| BU200CL | Belt Unit (50,000 Yield) | 17544 | EA | \$129.99 |
| Brother HL-3140CW/3170CDW Color Laser Supplies | | | | |
| TN221BK | Black Toner (2,500 Yield) | 912990 | CTG | \$84.99 |
| TN221C | Cyan Toner (1,400 Yield) | 912991 | CTG | \$69.99 |
| TN221M | Magenta Toner (1,400 Yield) | 912992 | CTG | \$69.99 |
| TN221Y | Yellow Toner (1,400 Yield) | 912993 | CTG | \$69.99 |
| TN225C | High Yield Cyan Toner (2,200 Yield) | 912994 | CTG | \$98.99 |
| TN225M | High Yield Magenta Toner (2,200 Yield) | 912995 | CTG | \$98.99 |
| TN225Y | High Yield Yellow Toner (2,200 Yield) | 912996 | CTG | \$98.99 |
| WT220CL | Waste Toner Box (50,000 Yield) | 914690 | EA | \$29.99 |
| DR221CL | Replacement Drum Set (4 Piece Drum Set) (15,000 Yield) | 913206 | EA | \$149.99 |
| BU220CL | Belt Unit (50,000 Yield) | 916084 | EA | \$129.99 |



Brother printers offer low total cost of ownership as well as low acquisition costs and have been winning awards for years. There is a Brother solution for every opportunity. Designed for use in every setting, the full line of Brother printers includes something for everyone.

brother
at your side

| MFG# | Product Description | Part# | UOM | Retail |
|--|--|--------|-----|----------|
| BROTHER SUPPLIES | | | | |
| Brother HL-4040CDN/4070CDW Color Laser Supplies | | | | |
| TN110BK | Black Toner (2,500 Yield) | 94707 | CTG | \$66.49 |
| TN110C | Cyan Toner (1,500 Yield) | 94708 | CTG | \$77.49 |
| TN110M | Magenta Toner (1,500 Yield) | 94709 | CTG | \$77.49 |
| TN110Y | Yellow Toner (1,500 Yield) | 94711 | CTG | \$77.49 |
| TN115BK | High Yield Black Toner (5,000 Yield) | 94713 | CTG | \$102.49 |
| TN115C | High Yield Cyan Toner (4,000 Yield) | 94714 | CTG | \$143.49 |
| TN115M | High Yield Magenta Toner (4,000 Yield) | 94715 | CTG | \$143.49 |
| TN115Y | High Yield Yellow Toner (4,000 Yield) | 94716 | CTG | \$143.49 |
| DR110CL | Replacement Drum Unit (17,000 Yield) | 94717 | EA | \$220.49 |
| WT100CL | Waste Toner Container (20,000 Yield) | 94719 | EA | \$27.99 |
| BU100CL | Belt Unit (50,000 Yield) | 94718 | EA | \$143.49 |
| Brother HL-4150CDN/4570CDW/4570CDWT Color Laser Supplies | | | | |
| TN310BK | Black Toner (2,500 Yield) | 91931 | CTG | \$62.99 |
| TN310C | Cyan Toner (1,500 Yield) | 91932 | CTG | \$69.99 |
| TN310M | Magenta Toner (1,500 Yield) | 91933 | CTG | \$69.99 |
| TN310Y | Yellow Toner (1,500 Yield) | 91935 | CTG | \$69.99 |
| TN315BK | High Yield Black Toner (6,000 Yield) | 91936 | CTG | \$116.99 |
| TN315C | High Yield Cyan Toner (3,500 Yield) | 91937 | CTG | \$124.99 |
| TN315M | High Yield Magenta Toner (3,500 Yield) | 91938 | CTG | \$124.99 |
| TN315Y | High Yield Yellow Toner (3,500 Yield) | 91939 | CTG | \$124.99 |
| DR310CL | Replacement Drum Unit (25,000 Yield) | 91941 | EA | \$179.99 |
| Brother HL-L8250CDN/L8350CDW/L8350CDWT Color Laser Supplies | | | | |
| TN331BK | Black Toner (2,500 Yield) | 922254 | CTG | \$62.99 |
| TN331C | Cyan Toner (1,500 Yield) | 922255 | CTG | \$69.99 |
| TN331M | Magenta Toner (1,500 Yield) | 922256 | CTG | \$69.99 |
| TN331Y | Yellow Toner (1,500 Yield) | 922257 | CTG | \$69.99 |
| TN336BK | High Yield Black Toner (4,000 Yield) | 922258 | CTG | \$77.99 |
| TN336C | High Yield Cyan Toner (3,500 Yield) | 922259 | CTG | \$124.99 |
| TN336M | High Yield Magenta Toner (3,500 Yield) | 922260 | CTG | \$124.99 |
| TN336Y | High Yield Yellow Toner (3,500 Yield) | 922261 | CTG | \$124.99 |
| DR331CL | Replacement Drum Unit (25,000 Yield) | 922253 | EA | \$179.99 |
| WT320CL | Waste Toner Box (50,000 Yield) | 922262 | EA | \$26.49 |
| BU320CL | Belt Unit (50,000 Yield) | 922252 | EA | \$136.49 |
| Brother MFC-9010CN/9120CN/9125CN/9320CW/9325CW Color Laser Supplies | | | | |
| TN210BK | Black Toner (2,200 Yield) | 17539 | CTG | \$74.99 |
| TN210C | Cyan Toner (1,400 Yield) | 17540 | CTG | \$69.99 |
| TN210M | Magenta Toner (1,400 Yield) | 17541 | CTG | \$69.99 |
| TN210Y | Yellow Toner (1,400 Yield) | 17542 | CTG | \$69.99 |
| DR210CL | Replacement Drum Unit Set (15,000 Yield) | 19524 | EA | \$149.99 |
| BU200CL | Belt Unit (50,000 Yield) | 17544 | EA | \$129.99 |
| Brother MFC-9130CW/9330CDW Color Laser Supplies | | | | |
| TN221BK | Black Toner (2,500 Yield) | 912990 | CTG | \$84.99 |
| TN221C | Cyan Toner (1,400 Yield) | 912991 | CTG | \$69.99 |
| TN221M | Magenta Toner (1,400 Yield) | 912992 | CTG | \$69.99 |
| TN221Y | Yellow Toner (1,400 Yield) | 912993 | CTG | \$69.99 |
| TN225C | High Yield Cyan Toner (2,200 Yield) | 912994 | CTG | \$98.99 |
| TN225M | High Yield Magenta Toner (2,200 Yield) | 912995 | CTG | \$98.99 |
| TN225Y | High Yield Yellow Toner (2,200 Yield) | 912996 | CTG | \$98.99 |
| WT220CL | Waste Toner Box (50,000 Yield) | 914690 | EA | \$29.99 |
| DR221CL | Replacement Drum Set (4 Piece Drum Set) (15,000 Yield) | 913206 | EA | \$149.99 |
| BU220CL | Belt Unit (50,000 Yield) | 916084 | EA | \$129.99 |
| Brother MFC-9440CN/9840CDW Color Laser Supplies | | | | |
| TN110BK | Black Toner (2,500 Yield) | 94707 | CTG | \$66.49 |
| TN110C | Cyan Toner (1,500 Yield) | 94708 | CTG | \$77.49 |
| TN110M | Magenta Toner (1,500 Yield) | 94709 | CTG | \$77.49 |
| TN110Y | Yellow Toner (1,500 Yield) | 94711 | CTG | \$77.49 |
| TN115BK | High Yield Black Toner (5,000 Yield) | 94713 | CTG | \$102.49 |
| TN115C | High Yield Cyan Toner (4,000 Yield) | 94714 | CTG | \$143.49 |
| TN115M | High Yield Magenta Toner (4,000 Yield) | 94715 | CTG | \$143.49 |
| TN115Y | High Yield Yellow Toner (4,000 Yield) | 94716 | CTG | \$143.49 |
| WT100CL | Waste Toner Container (20,000 Yield) | 94719 | EA | \$27.99 |
| DR110CL | Replacement Drum Unit (17,000 Yield) | 94717 | EA | \$220.49 |
| BU100CL | Belt Unit (50,000 Yield) | 94718 | EA | \$143.49 |

| MFG# | Product Description | Part# | UOM | Retail |
|---|--|--------|-----|----------|
| BROTHER SUPPLIES | | | | |
| Brother MFC-9460CDN/9560CDW Color Laser Supplies | | | | |
| TN310BK | Black Toner (2,500 Yield) | 91931 | CTG | \$62.99 |
| TN310C | Cyan Toner (1,500 Yield) | 91932 | CTG | \$69.99 |
| TN310M | Magenta Toner (1,500 Yield) | 91933 | CTG | \$69.99 |
| TN310Y | Yellow Toner (1,500 Yield) | 91935 | CTG | \$69.99 |
| TN315BK | High Yield Black Toner (6,000 Yield) | 91936 | CTG | \$116.99 |
| TN315C | High Yield Cyan Toner (3,500 Yield) | 91937 | CTG | \$124.99 |
| TN315M | High Yield Magenta Toner (3,500 Yield) | 91938 | CTG | \$124.99 |
| TN315Y | High Yield Yellow Toner (3,500 Yield) | 91939 | CTG | \$124.99 |
| WT300CL | Waste Toner Container | 502141 | CTG | \$26.49 |
| DR310CL | Replacement Drum Unit (25,000 Yield) | 91941 | EA | \$179.99 |
| BU300CL | Belt Unit (50,000 Yield) | 91940 | EA | \$136.49 |

| CANON SUPPLIES | | | | |
|---|--|--------|-----|---------|
| Canon Inkjet Supplies (Continued on next page) | | | | |
| 4479A003 | (BCI-3eBk) BJC 3000/6000/6100/6200/6500/i560/iP3000/iP4000/iP4000R/iP5000/S400/S450/S500/S520/S530D/S600/S630/S750/i550/i850/i860/MP C100/400/600F/700/730/750/755/760/780/F30/F50/LR1 Enhanced Black Ink Tank | 4577 | EA | \$15.99 |
| 4479A271 | (BCI-3eBk) BJC 3000/6000/i450/i550/i560/i850/i860/iP3000/iP4000/iP4000R/iP5000/S400/S450/S500/S520/S530D/S600/S630/S630N/S750/MP 700/730/750/760/780/C755/F30/F50/F60/F80 Black Ink Tank Twin Pack (2 Pack of OEM# 4479A003) (2 x 500 Yield) | 23208 | PK | \$28.99 |
| 4479A230 | (BCI-3eBk/C/M/Y) BJC 3000/6000/i550/i850/S500/S520/S530D/S600/S630/S750/MP 700/730/F30/F50/F60/F80 Ink Tank Multipack (Includes 1 Each of OEM# 4479A003, 4480A003, 4481A003, 4482A003) | 23196 | PK | \$49.99 |
| 4705A003 | (BCI-6Bk) BJC 8200/i860/i900D/i950/i960/i9100/i9900/iP4000/iP4000R/iP5000/iP6000D/iP8500/S800/S820/S820D/S830D/S900/S9000/MP 750/760/780 Black Ink Tank | 4567 | EA | \$13.99 |
| 4706A003 | (BCI-6C) BJC 8200/i560/i860/i900D/i950/i960/i9100/i9900/iP3000/iP4000/iP4000R/iP5000/iP6000D/iP8500/S800/S820/S820D/S830D/S900/S9000/MP 750/760/780 Cyan Ink Tank | 4566 | EA | \$13.99 |
| 4707A003 | (BCI-6M) BJC 8200/i560/i860/i900D/i950/i960/i9100/i9900/iP3000/iP4000/iP4000R/iP5000/iP6000D/iP8500/S800/S820/S820D/S830D/S900/S9000/MP 750/760/780 Magenta Ink Tank | 4565 | EA | \$13.99 |
| 4708A003 | (BCI-6Y) BJC 8200/i560/i860/i900D/i950/i960/i9100/i9900/iP3000/iP4000/iP4000R/iP5000/iP6000D/iP8500/S800/S820/S820D/S830D/S900/S9000/MP 750/760/780 Yellow Ink Tank | 4562 | EA | \$13.99 |
| 4709A003 | (BCI-6PC) BJC 8200/i900D/i950/i960/i9100/i9900/iP6000D/iP8500/S800/S820/S820D/S830D/S900/S9000 Photo Cyan Ink Tank | 4564 | EA | \$13.99 |
| 4710A003 | (BCI-6PM) BJC 8200/i900D/i950/i960/i9100/i9900/iP6000D/iP8500/S800/S820/S820D/S830D/S900/S9000 Photo Magenta Ink Tank | 4563 | EA | \$13.99 |
| 9473A003 | (BCI-6G) i9900/iP8500 Green Ink Tank | 5470 | EA | \$13.99 |
| 8891A003 | (BCI-6R) i9900/iP8500 Red Ink Tank | 5469 | EA | \$13.99 |
| 8190A003 | (BCI-15Bk) i70/i80/iP90 Black Ink Tank Twin Pack | 1915 | PK | \$14.99 |
| 8191A003 | (BCI-15CLR) i70/i80 Color Ink Tank Twin Pack | 1913 | PK | \$24.49 |
| 9818A003 | (BCI-16) Selphy DS700/DS810/iP90 Color Ink Tank Twin Pack | 6018 | PK | \$25.99 |
| 1900B002 | (CL-31) iP1800 Color Ink | 93409 | CTG | \$20.99 |
| 0617B002 | (CL-41) iP1600/iP1700/iP2600/iP6210D/iP6220D/iP6310D/MP 150/160/170/450/460 Color Ink | 10891 | CTG | \$26.99 |
| 0618B002 | (CL-51) iP6210D/iP6220D/iP6310D/MP 150/160/170/450/460 High Yield Color Ink | 12141 | CTG | \$41.99 |
| 0619B002 | (CL-52) iP6210D/iP6220D/iP6310D Photo Ink | 12142 | CTG | \$29.99 |
| 2975B001 | (CL-21 1XL) PIXMA MP240/MP250/MP270/MP480/MP490/MX330/MX340/MX350/MX410/MX420 Extra Large Capacity Color Ink | 904834 | CTG | \$26.99 |
| 5208B001 | (CL-24 1XL) PIXMA MG2120/MG2220/MG3120/MG3220/MG3520/MG4120/MG4220/MX372/MX392/MX432/MX452/MX472/MX512/MX522/MX532 High Yield Color Ink (400 Yield) | 501447 | CTG | \$29.99 |
| 8280B001 | (CL-246XL) PIXMA iP2820/MG2420/MG2924 High Yield Color Ink (300 Yield) | 914726 | CTG | \$27.99 |
| 0620B002 | (CLI-8BK) iP4200/iP4300/iP4500/iP5200/iP5200R/iP6600D/iP6700D/MP 500/530/600/610/800/800R/810/830/850/950/960/970/PIXMA Pro9000/Pro9000 Mark II Black Ink Tank | 10893 | EA | \$15.99 |
| 0621B002 | (CLI-8C) iP3300/3500/4200/4300/4500/5200/5200R/6600D/6700D/MP 500/510/520/530/600/610/800/800R/810/830/950/960/970/MX 700/850/PIXMA Pro9000/Pro9000 Mark II Cyan Ink Tank | 10894 | EA | \$15.99 |
| 0622B002 | (CLI-8M) iP3300/3500/4200/4300/4500/5200/5200R/6600D/6700D/MP 500/510/520/530/600/610/800/800R/810/830/950/960/970/MX 700/850/PIXMA Pro9000/Pro9000 Mark II Magenta Ink Tank | 10895 | EA | \$15.99 |
| 0623B002 | (CLI-8Y) iP3300/3500/4200/4300/4500/5200/5200R/6600D/6700D/MP 500/510/520/530/600/610/800/800R/810/830/950/960/970/MX 700/850/PIXMA Pro9000/Pro9000 Mark II Yellow Ink Tank | 10896 | EA | \$15.99 |
| 0624B002 | (CLI-8PC) iP4200/iP6600D/iP6700D/MP 500/530/950/PIXMA Pro9000/Pro9000 Mark II Photo Cyan Ink Tank | 12131 | EA | \$15.99 |
| 0625B002 | (CLI-8PM) iP4200/iP6600D/iP6700D/MP 500/530/950/PIXMA Pro9000/Pro9000 Mark II Photo Magenta Ink Tank | 12132 | EA | \$15.99 |

| MFG# | Product Description | Part# | UOM | Retail |
|---|--|--------|-----|----------|
| CANON SUPPLIES | | | | |
| Canon Inkjet Supplies (Continued on next page) | | | | |
| 0626B002 | (CLI-8R) iP4200/iP4300/iP5200/iP5200R/MP 500/510/530/600/800/810/830/950/PIXMA Pro9000/Pro9000 Mark II Red Ink Tank | 92014 | EA | \$15.99 |
| 0627B002 | (CLI-8G) iP4200/iP4300/iP5200/iP5200R/MP 500/510/530/600/800/810/830/950/PIXMA Pro9000/Pro9000 Mark II Green Ink Tank | 92015 | EA | \$15.99 |
| 0621B016 | (CLI-8) iP4200/iP4300/iP5200/iP5200R/iP6600D/iP6700D/MP 500/510/530/600/800/800R/810/830/950/PIXMA Pro9000/Pro9000 Mark II Color Ink Tank Combo Pack (Includes 1 Each of OEM# 0621B002, 0622B002, 0623B002) | 100770 | PK | \$43.99 |
| 0620B010 | (CLI-8) iP4200/iP4300/iP4500/iP5200/iP5200R/iP6600D/iP6700D/MP 500/530/600/610/800/800R/810/830/850/950/960/970/PIXMA Pro9000/Pro9000 Mark II C/M/Y/K Ink Tank Combo Pack (Includes 1 Each of OEM# 0620B002, 0621B002, 0622B002, 0623B002) | 30421 | PK | \$56.99 |
| 0620B015 | (CLI-8) PIXMA Pro9000/Pro9000 Mark II Color Ink Combo Pack (Includes 1 Each of OEM# 0620B002, 0621B002, 0622B002, 0623B002, 0624B002, 0625B002, 0626B002, 0627B002) | 29132 | PK | \$109.99 |
| 1511B002 | (CLI-36) iP100/PIXMA mini260/320 Color Ink Tank | 29510 | CTG | \$18.99 |
| 2946B001 | (CLI-221BK) iP3600/iP4600/iP4700/MP540/MP550/MP560/MP620/MP630/MP640/MP980/MP990/MX860/MX870 Black Ink Tank | 903105 | EA | \$12.99 |
| 2947B001 | (CLI-221C) iP3600/iP4600/iP4700/MP540/MP550/MP560/MP620/MP630/MP640/MP980/MP990/MX860/MX870 Cyan Ink Tank | 903106 | EA | \$12.99 |
| 2948B001 | (CLI-221M) iP3600/iP4600/iP4700/MP540/MP550/MP560/MP620/MP630/MP640/MP980/MP990/MX860/MX870 Magenta Ink Tank | 903107 | EA | \$12.99 |
| 2949B001 | (CLI-221Y) iP3600/iP4600/iP4700/MP540/MP550/MP560/MP620/MP630/MP640/MP980/MP990/MX860/MX870 Yellow Ink Tank | 903108 | EA | \$12.99 |
| 2950B001 | (CLI-221GY) MP980/MP990 Gray Ink Tank | 903109 | EA | \$12.99 |
| 2946B004 | (CLI-221) iP3600/iP4600/iP4700/MP540/MP550/MP560/MP620/MP630/MP640/MP980/MP990/MX860/MX870 C/M/Y/K Color Ink Combo Pack (Includes 1 Each of OEM# 2946B001, 2947B001, 2948B001, 2949B001) | 903111 | PK | \$47.99 |
| 4546B001 | (CLI-226BK) iP4820/MG5120/MG5220/MG6120/MG8120/MX882/MX892/iX6520/iP4920/MG5320 Black Dye-based Ink Tank | 93518 | EA | \$13.99 |
| 4547B001 | (CLI-226C) iP4820/MG5120/MG5220/MG6120/MG8120/MX882/MX892/iX6520/iP4920/MG5320 Cyan Ink Tank | 93519 | EA | \$13.99 |
| 4548B001 | (CLI-226M) iP4820/MG5120/MG5220/MG6120/MG8120/MX882/MX892/iX6520/iP4920/MG5320 Magenta Ink Tank | 93520 | EA | \$13.99 |
| 4549B001 | (CLI-226Y) iP4820/MG5120/MG5220/MG6120/MG8120/MX882/MX892/iX6520/iP4920/MG5320 Yellow Ink Tank | 93521 | EA | \$13.99 |
| 4550B001 | (CLI-226) MG6120/MG8120 Gray Ink Tank | 94895 | EA | \$13.99 |
| 4547B005 | (CLI-226) iP4820/MG5120/MG5220/MG6120/MG8120/MX882/MX892/iX6520/iP4920/MG5320 C/M/Y Combo Pack (Includes OEM# 4547B001, 4548B001, 4549B001) | 908504 | PK | \$39.99 |
| 4546B007 | (CLI-226) iP4820/MG5220/MG5120/MG6120/MG8120/MX882/MX892/iX6520/iP4920/MG5320 Photo Color Ink Tank Multipack with 50 Sheets of Photo Paper (Includes 1 Each of OEM# 4546B001, 4547B001, 4548B001, 4549B001) | 105268 | PK | \$55.99 |
| 6513B001 | (CLI-251) PIXMA iP7220/iP8720/iX6820/iX8720/MG5420/MG5520/MG5620/MG6320/MG6420/MG6620/MG7120/MG7520/MX922 Black Ink Tank | 910681 | CTG | \$11.99 |
| 6514B001 | (CLI-251) PIXMA iP7220/iP8720/iX6820/iX8720/MG5420/MG5520/MG5620/MG6320/MG6420/MG6620/MG7120/MG7520/MX922 Cyan Ink Tank | 910682 | CTG | \$11.99 |
| 6515B001 | (CLI-251) PIXMA iP7220/iP8720/iX6820/iX8720/MG5420/MG5520/MG5620/MG6320/MG6420/MG6620/MG7120/MG7520/MX922 Magenta Ink Tank | 910683 | CTG | \$11.99 |
| 6516B001 | (CLI-251) PIXMA iP7220/iP8720/iX6820/iX8720/MG5420/MG5520/MG5620/MG6320/MG6420/MG6620/MG7120/MG7520/MX922 Yellow Ink Tank | 910684 | CTG | \$11.99 |
| 6513B004 | (CLI-251) PIXMA iP7220/iP8720/iX6820/iX8720/MG5420/MG5520/MG5620/MG6320/MG6420/MG6620/MG7120/MG7520/MX922 Black/Cyan/Magenta/Yellow Ink Combo Pack (Includes 1 Each of OEM# 6513B001, 6514B001, 6515B001, 6516B001) | 923201 | PK | \$44.99 |
| 6448B001 | (CLI-251XL) PIXMA iP7220/iP8720/iX6820/iX8720/MG5420/MG5520/MG5620/MG6320/MG6420/MG6620/MG7120/MG7520/MX922 High Yield Black Ink Tank | 910675 | CTG | \$17.99 |
| 6449B001 | (CLI-251XL) PIXMA iP7220/iP8720/iX6820/iX8720/MG5420/MG5520/MG5620/MG6320/MG6420/MG6620/MG7120/MG7520/MX922 High Yield Cyan Ink Tank | 910676 | CTG | \$17.99 |
| 6450B001 | (CLI-251XL) PIXMA iP7220/iP8720/iX6820/iX8720/MG5420/MG5520/MG5620/MG6320/MG6420/MG6620/MG7120/MG7520/MX922 High Yield Magenta Ink Tank | 910677 | CTG | \$17.99 |
| 6451B001 | (CLI-251XL) PIXMA iP7220/iP8720/iX6820/iX8720/MG5420/MG5520/MG5620/MG6320/MG6420/MG6620/MG7120/MG7520/MX922 High Yield Yellow Ink Tank | 910678 | CTG | \$17.99 |
| 1899B002 | (PG-30) iP1800 Black Ink | 93408 | CTG | \$16.99 |
| 0615B002 | (PG-40) iP1600/iP1700/iP2600/MP 150/160/170/400/450 Black Ink | 10890 | CTG | \$22.99 |
| 0615B013 | (PG-40) iP1600/iP1700/iP2600/MP 150/160/170/400/450 Black Ink Twin Pack (2 Pack of OEM# 0615B002) | 29546 | PK | \$41.99 |
| 0616B002 | (PG-50) iP6210/MP 150/160/170/450/460/MX 300/310/JX 200/210P High Yield Black Ink | 12140 | CTG | \$37.99 |
| 2973B001 | (PG-210XL) PIXMA MP240/MP250/MP270/MP480/MP490/MX330/MX340/MX350/MX410/MX420 Extra Large Capacity Black Ink (401 Yield) | 904833 | CTG | \$21.99 |
| 5206B001 | (PG-240XL) PIXMA MG2120/MG2220/MG3120/MG3220/MG3520/MG4120/MG4220/MX372/MX392/MX432/MX452/MX472/MX512/MX522/MX532 High Yield Black Ink (300 Yield) | 501443 | CTG | \$20.99 |

| MFG# | Product Description | Part# | UOM | Retail |
|--|---|--------|-----|----------|
| CANON SUPPLIES | | | | |
| Canon Inkjet Supplies (Continued) | | | | |
| 5206B005 | (PG-240XL/CL-241XL) PIXMA MG2120/MG2220/MG3120/MG3220/MG3520/MG4120/MG4220/MX372/MX392/MX432/MX452/MX472/MX512/MX522/MX532 High Yield Black and Color Ink Combo Pack (Includes 1 Each of OEM# 5206B001, 5208B001, 50 Sheets Photo Paper) (300 Yield Black, 400 Yield Color) | 923199 | PK | \$49.99 |
| 5204B001 | (PG-240XXL) PIXMA MG2120/MG2220/MG3120/MG3220/MG3520/MG4120/MG4220/MX372/MX392/MX432/MX452/MX472/MX512/MX522/MX532 Extra High Yield Black Ink (600 Yield) | 501433 | CTG | \$37.99 |
| 8278B001 | (PG-245XL) PIXMA iP2820/MG2420/MG2924 High Yield Black Ink (300 Yield) | 914724 | CTG | \$23.99 |
| 0628B002 | (PGI-5BK) iP3300/3500/4200/4300/4500/5200/5200R/MP500/510/520/530/600/610/800/800R/810/830/950/960/970/MX700/850 Black Ink Tank | 10897 | EA | \$18.49 |
| 0628B009 | (PGI-5BK) iP3300/3500/4200/4300/4500/5200/5200R/MP500/510/520/530/600/610/780/800/800R/810/830/950/960/970/MX700/850 Black Ink Tank Dual Pack (2 Pack of OEM# 0628B002) | 20405 | PK | \$33.99 |
| 1033B002 | (PGI-9MBK) PIXMA Pro9500/Pro9500 Mark II Matte Black Ink | 93412 | CTG | \$15.99 |
| 1034B002 | (PGI-9PBK) PIXMA Pro9500/Pro9500 Mark II/MX7600 Photo Black Ink | 93421 | CTG | \$15.99 |
| 1035B002 | (PGI-9C) PIXMA Pro9500/Pro9500 Mark II/iX7000/MX7600 Cyan Ink | 93414 | CTG | \$15.99 |
| 1036B002 | (PGI-9M) PIXMA Pro9500/Pro9500 Mark II/iX7000/MX7600 Magenta Ink | 93415 | CTG | \$15.99 |
| 1037B002 | (PGI-9Y) PIXMA Pro9500/Pro9500 Mark II/iX7000/MX7600 Yellow Ink | 93416 | CTG | \$15.99 |
| 1038B002 | (PGI-9PC) PIXMA Pro9500/Pro9500 Mark II Photo Cyan Ink | 93426 | CTG | \$15.99 |
| 1039B002 | (PGI-9PM) PIXMA Pro9500/Pro9500 Mark II Photo Magenta Ink | 93428 | CTG | \$15.99 |
| 1040B002 | (PGI-9R) PIXMA Pro9500/Pro9500 Mark II Red Ink | 93417 | CTG | \$15.99 |
| 1041B002 | (PGI-9G) PIXMA Pro9500/Pro9500 Mark II Green Ink | 93419 | CTG | \$15.99 |
| 1042B002 | (PGI-9GR) PIXMA Pro9500/Pro9500 Mark II Gray Ink | 93420 | CTG | \$15.99 |
| 1033B005 | (PGI-9) PIXMA Pro9500/Pro9500 Mark II Color Ink Combo Pack (Includes 1 Each of OEM# 1033B002, 1034B002, 1035B002, 1036B002, 1037B002, 1038B002, 1039B002, 1040B002, 1041B002, 1042B002) | 93429 | PK | \$145.99 |
| 1509B002 | (PGI-35) iP100 Black Ink Tank | 900948 | EA | \$14.99 |
| 1509B007 | (PGI-35/CLI-36) iP100 Black/Color Ink Combo Pack (Includes 2 of OEM# 1509B002, 1 of OEM# 1511B002) | 900949 | PK | \$41.99 |
| 2945B001 | (PGI-220) iP3600/iP4600/MP620/MP980/MX870 Pigment Black Ink Tank | 903104 | EA | \$14.99 |
| 2945B004 | (PGI-220) iP3600/iP4600/MP620/MP980 Pigment Black Ink Multipack (3 Pack of OEM# 2945B001) | 903110 | PK | \$41.99 |
| 4530B001 | (PGI-225) iP4820/MG5120/MG5220/MG6120/MG8120/MX882/MX892/iX6520/iP4920/MG5320 Pigment Black Ink Tank | 93517 | EA | \$15.99 |
| 4530B007 | (PGI-225) iP4820/MG5220/MG5120/MG6120/MG8120/MX882/MX892/iX6520/iP4920/MG5320 Pigment Black Ink Tank Twin Pack (2 Pack of OEM# 4530B001) | 105251 | PK | \$29.99 |
| 4530B008 | (PGI-225/CLI226) iP4820/MG5220/MG5120/MG6120/MG8120/MX882/MX892/iX6520/iP4920/MG5320 Photo Color Ink Tank Multipack (1 Each of OEM# 4530B001, 4547B001, 4548B001, 4549B001) | 105260 | PK | \$53.99 |
| 6497B001 | (PGI-250) PIXMA iP7220/iP8720/iX6820/iX8720/MG5420/MG5520/MG5620/MG6320/MG6420/MG6620/MG7120/MG7520/MX922 Pigment Black Ink Tank | 910680 | CTG | \$14.99 |
| 6497B004 | (PGI-250 PGBK/CLI-251 C/M/Y) PIXMA iP7220/iP8720/iX6820/iX8720/MG5420/MG5520/MG5620/MG6320/MG6420/MG6620/MG7120/MG7520/MX922 Pigment Black/Cyan/Magenta/Yellow Ink Combo Pack (Includes 1 Each OEM# 6497B001, 6514B001, 6515B001, 6516B001, 50 Sheets Photo Paper) | 923202 | PK | \$52.99 |
| 6432B001 | (PGI-250XL) PIXMA iP7220/iP8720/iX6820/iX8720/MG5420/MG5520/MG5620/MG6320/MG6420/MG6620/MG7120/MG7520/MX922 High Yield Pigment Black Ink | 910674 | CTG | \$22.99 |
| 6432B004 | (PGI-250XL) PIXMA iP7220/iP8720/iX6820/iX8720/MG5420/MG5520/MG5620/MG6320/MG6420/MG6620/MG7120/MG7520/MX922 High Yield Pigment Black Ink Twin Pack (Includes 2 of OEM# 6432B001) | 923200 | PK | \$42.99 |
| 8050B001 | (PGI-255XXL) PIXMA iX6820/MX922 Extra High Yield Pigment Black Ink | 911003 | CTG | \$34.99 |
| 0894B001AA | (PFI-102MBK) iPF 500/600/605/610/700/710/720/750/755 Matte Black Ink Tank | 30097 | EA | \$79.00 |
| 0895B001AA | (PFI-102BK) iPF 500/600/605/610/700/710/720/750/755 Black Ink Tank | 30099 | EA | \$79.00 |
| 0896B001AA | (PFI-102C) iPF 500/600/605/610/700/710/720/750/755 Cyan Ink Tank | 30100 | EA | \$79.00 |
| 0897B001AA | (PFI-102M) iPF 500/510/600/605/610/700/710/720 Magenta Ink Tank | 30101 | EA | \$79.00 |
| 0898B001AA | (PFI-102Y) iPF 500/600/605/610/700/710/720/750/755 Yellow Ink Tank | 30102 | EA | \$79.00 |
| 6680B001AA | (PFI-706) imagePROGRAF iPF8300/8400/9400 Matte Black Ink (700 ml) | 912949 | CTG | \$323.00 |
| 6681B001AA | (PFI-706) imagePROGRAF iPF8300/8400/9400 Black Ink (700 ml) | 912950 | CTG | \$294.00 |
| 6682B001AA | (PFI-706) imagePROGRAF iPF8300/8400/9400 Cyan Ink (700 ml) | 912951 | CTG | \$294.00 |
| 6683B001AA | (PFI-706) imagePROGRAF iPF8300/8400/9400 Magenta Ink (700 ml) | 912952 | CTG | \$323.00 |
| 6684B001AA | (PFI-706) imagePROGRAF iPF8300/8400/9400 Yellow Ink (700 ml) | 912953 | CTG | \$323.00 |
| 6685B001AA | (PFI-706) imagePROGRAF iPF8300/8400/9400 Photo Cyan Ink (700 ml) | 912954 | CTG | \$294.00 |
| 6686B001AA | (PFI-706) imagePROGRAF iPF8300/8400/9400 Photo Magenta Ink (700 ml) | 912955 | CTG | \$294.00 |
| 6687B001AA | (PFI-706) imagePROGRAF iPF8300/8400/9400 Red Ink (700 ml) | 912956 | CTG | \$294.00 |
| 6688B001AA | (PFI-706) imagePROGRAF iPF8300/8400/9400 Green Ink (700 ml) | 912957 | CTG | \$294.00 |
| 6689B001AA | (PFI-706) imagePROGRAF iPF8300/8400/9400 Blue Ink (700 ml) | 912958 | CTG | \$294.00 |
| 6690B001AA | (PFI-706) imagePROGRAF iPF8300/8400/9400 Gray Ink (700 ml) | 912959 | CTG | \$294.00 |
| 6691B001AA | (PFI-706) imagePROGRAF iPF8300/8400/9400 Photo Gray Ink (700 ml) | 912960 | CTG | \$294.00 |

| MFG# | Product Description | Part# | UOM | Retail |
|--|--|--------|-----|----------|
| CANON SUPPLIES | | | | |
| Canon imageCLASS 2300/2300n Digital Copier Supplies | | | | |
| 7138A002AA | (P Cartridge) Toner (10,000 Yield) | 1725 | CTG | \$233.00 |
| Canon imageCLASS D530/D550/MF4450/MF4570dn/MF4570dw/MF4770n/MF4880dw/MF4890dw/Faxphone L100/L190 Laser Supplies | | | | |
| 3500B001AA | (CRG-128) Toner (2,100 Yield) | 95416 | CTG | \$114.00 |
| Canon imageCLASS D1120/D1150/D1170/D1180/D1320/D1350/D1370 Multifunction Laser Supplies | | | | |
| 2617B001AA | (CRG-120) Toner (5,000 Yield) | 15270 | CTG | \$219.00 |
| Canon imageCLASS LBP6000/LBP6030w/MF3010 Laser Supplies | | | | |
| 3484B001AA | (CRG-125) Toner (1,600 Yield) | 906921 | CTG | \$92.00 |
| Canon imageCLASS LBP6200d/6230dw Laser Supplies | | | | |
| 3483B001AA | (CRG-126) Toner (2,100 Yield) | 926564 | CTG | \$114.00 |
| Canon imageCLASS LBP6300dn/6650dn/6670dn Laser Supplies | | | | |
| 3479B001AA | (CRG-119) Toner (2,100 Yield) | 607705 | CTG | \$122.00 |
| 3480B001AA | (CRG-119II) High Yield Toner (6,400 Yield) | 607739 | CTG | \$236.00 |
| Canon imageCLASS LBP6780dn Laser Supplies | | | | |
| 3482B013AA | (CRG-324II) High Yield Toner (12,500 Yield) | 911705 | CTG | \$295.00 |
| Canon imageCLASS LBP7780Cdn Color Laser Supplies | | | | |
| 6264B012AA | (CRG-332II BK) Black Toner (12,000 Yield) | 911706 | CTG | \$280.00 |
| 6262B012AA | (CRG-332C) Cyan Toner (6,400 Yield) | 911707 | CTG | \$310.00 |
| 6261B012AA | (CRG-332M) Magenta Toner (6,400 Yield) | 911708 | CTG | \$310.00 |
| 6260B012AA | (CRG-332Y) Yellow Toner (6,400 Yield) | 911709 | CTG | \$310.00 |
| Canon imageCLASS MF212w/216n/227dw/229dw Laser Supplies | | | | |
| 9435B001AA | (CRG-137) Toner (2,400 Yield) | 930343 | CTG | \$111.00 |
| Canon imageCLASS MF5850dn/MF5880dn/MF5950dw/MF5960dn/MF6160dw/MF6180dw Laser Supplies | | | | |
| 3479B001AA | (CRG-119) Toner (2,100 Yield) | 607705 | CTG | \$122.00 |
| 3480B001AA | (CRG-119II) High Yield Toner (6,400 Yield) | 607739 | CTG | \$236.00 |
| Canon imageCLASS MF8050Cn/MF8080Cw Color Multifunction Laser Supplies | | | | |
| 1980B001AA | (CRG-116BK) Black Toner (2,300 Yield) | 33193 | CTG | \$104.00 |
| 1979B001AA | (CRG-116C) Cyan Toner (1,500 Yield) | 33194 | CTG | \$98.00 |
| 1978B001AA | (CRG-116M) Magenta Toner (1,500 Yield) | 33195 | CTG | \$98.00 |
| 1977B001AA | (CRG-116Y) Yellow Toner (1,500 Yield) | 33196 | CTG | \$98.00 |
| Canon imageCLASS MF8170C/MF8180C Color Multifunction Laser Supplies | | | | |
| 7433A005BA | (EP-87) Black Toner (5,000 Yield) | 10071 | CTG | \$122.00 |
| 7432A005BA | (EP-87) Cyan Toner (4,000 Yield) | 10072 | CTG | \$148.00 |
| 7431A005BA | (EP-87) Magenta Toner (4,000 Yield) | 10073 | CTG | \$148.00 |
| 7430A005BA | (EP-87) Yellow Toner (4,000 Yield) | 10075 | CTG | \$148.00 |
| 7429A005BA | (EP-87) Drum (20,000 Yield) | 10076 | EA | \$247.00 |
| Canon imageCLASS MF8280Cw/LBP7110Cw Color Multifunction Laser Supplies | | | | |
| 6272B001AA | (CRG-131BK) Black Toner (1,400 Yield) | 912420 | CTG | \$91.00 |
| 6273B001AA | (CRG-131BK H) High Yield Black Toner (2,400 Yield) | 912421 | CTG | \$113.00 |
| 6271B001AA | (CRG-131C) Cyan Toner (1,500 Yield) | 912424 | CTG | \$112.00 |
| 6270B001AA | (CRG-131M) Magenta Toner (1,500 Yield) | 912423 | CTG | \$112.00 |
| 6269B001AA | (CRG-131Y) Yellow Toner (1,500 Yield) | 912422 | CTG | \$112.00 |



Canon's imageCLASS is a line of color and black-and-white laser printers that deliver high-quality results necessary for business printing. A must-have for any business. Premier Partners have access to an extensive line of imageCLASS products, along with sales and marketing support.

Canon

| MFG# | Product Description | Part# | UOM | Retail |
|--|--|--------|-----|----------|
| CANON SUPPLIES | | | | |
| Canon imageCLASS MF8350Cdn/MF8380Cdw/MF8580Cdw/LBP7200Cdn/LBP7660Cdn Color Multifunction Laser Supplies | | | | |
| 2662B001AA | (CRG-118BK) Black Toner (3,400 Yield) | 20424 | CTG | \$164.00 |
| 2661B001AA | (CRG-118C) Cyan Toner (2,900 Yield) | 20436 | CTG | \$155.00 |
| 2660B001AA | (CRG-118M) Magenta Toner (2,900 Yield) | 20438 | CTG | \$155.00 |
| 2659B001AA | (CRG-118Y) Yellow Toner (2,900 Yield) | 20437 | CTG | \$155.00 |
| Canon imageCLASS MF8450C Color Multifunction Laser Supplies | | | | |
| 2578B001BA | (CRG-117BK) Black Toner (6,000 Yield) | 15271 | CTG | \$170.00 |
| 2577B001BA | (CRG-117C) Cyan Toner (4,000 Yield) | 15274 | CTG | \$166.00 |
| 2576B001BA | (CRG-117M) Magenta Toner (4,000 Yield) | 15273 | CTG | \$166.00 |
| 2575B001BA | (CRG-117Y) Yellow Toner (4,000 Yield) | 15272 | CTG | \$166.00 |
| Canon imageCLASS MF9150C/MF9170C/MF9220Cdn/MF9280Cdn Color Multifunction Laser Supplies | | | | |
| 1660B001BA | (CRG-111BK) Black Toner (6,000 Yield) | 95072 | CTG | \$165.24 |
| 1659B001BA | (CRG-111C) Cyan Toner (6,000 Yield) | 95073 | CTG | \$212.67 |
| 1658B001BA | (CRG-111M) Magenta Toner (6,000 Yield) | 95074 | CTG | \$212.67 |
| 1657B001BA | (CRG-111Y) Yellow Toner (6,000 Yield) | 95075 | CTG | \$212.67 |
| Canon imagePRESS 1110S/1110P/1125P/1135P Copier Supplies | | | | |
| 2784B003AA | (IPQ-4) Toner (69,000 Yield) | 16607 | EA | \$73.00 |
| Canon imageRUNNER 1730/1740/1750 Series Copier Supplies | | | | |
| 2787B003AA | (GPR-39) Toner (15,100 Yield) | 906226 | CTG | \$72.42 |
| Canon imageRUNNER C1022/C1022i Color Copier Supplies | | | | |
| 1660B004BA | (GPR-28) Black Toner (6,000 Yield) | 35584 | CTG | \$162.00 |
| 1659B004AA | (GPR-28) Cyan Toner (6,000 Yield) | 903593 | CTG | \$208.50 |
| 1658B004AA | (GPR-28) Magenta Toner (6,000 Yield) | 903594 | CTG | \$208.50 |
| 1657B004AA | (GPR-28) Yellow Toner (6,000 Yield) | 903595 | CTG | \$208.50 |
| Canon imageRUNNER C2550/C2880/C2880i/C3080/C3080i/C3380/C3380i/C3480/C3480i Color Copier Supplies | | | | |
| 0452B003AA | (GPR-23) Black Toner (26,000 Yield) | 30570 | BTL | \$70.50 |
| 0453B003AA | (GPR-23) Cyan Toner (14,000 Yield) | 30571 | BTL | \$175.00 |
| 0454B003AA | (GPR-23) Magenta Toner (14,000 Yield) | 30572 | BTL | \$175.00 |
| 0455B003AA | (GPR-23) Yellow Toner (14,000 Yield) | 30573 | BTL | \$175.00 |
| Canon imageRUNNER C2620/C3200/C3220 Color Copier Supplies | | | | |
| 7629A001AA | (GPR-11) Black Toner (25,000 Yield) | 1362 | BTL | \$105.00 |
| 7628A001AA | (GPR-11) Cyan Toner (25,000 Yield) | 1361 | BTL | \$167.00 |
| 7627A001AA | (GPR-11) Magenta Toner (25,000 Yield) | 1360 | BTL | \$167.00 |
| 7626A001AA | (GPR-11) Yellow Toner (25,000 Yield) | 1359 | BTL | \$167.00 |
| Canon imageRUNNER C4080/C4580 Color Copier Supplies | | | | |
| 0262B001AA | (GPR-21) Black Toner (26,000 Yield) | 30556 | BTL | \$100.00 |
| 0261B001AA | (GPR-21) Cyan Toner (30,000 Yield) | 30557 | BTL | \$175.00 |
| 0260B001AA | (GPR-21) Magenta Toner (30,000 Yield) | 30558 | BTL | \$175.00 |
| 0259B001AA | (GPR-21) Yellow Toner (30,000 Yield) | 30559 | BTL | \$175.00 |
| Canon imageRUNNER C5180/C5185/C5185i Color Copier Supplies | | | | |
| 1069B001AA | (GPR-20) Black Toner (27,000 Yield) | 29620 | BTL | \$102.00 |
| 1068B001AA | (GPR-20) Cyan Toner (36,000 Yield) | 29621 | BTL | \$175.00 |
| 1067B001AA | (GPR-20) Magenta Toner (36,000 Yield) | 29623 | BTL | \$175.00 |
| 1066B001AA | (GPR-20) Yellow Toner (36,000 Yield) | 29624 | BTL | \$175.00 |
| Canon imageRUNNER LBP3470 Laser Supplies | | | | |
| 3480B005AA | (GPR-41) Toner (6,400 Yield) | 94019 | CTG | \$155.00 |
| Canon imageRUNNER LBP5360 Color Copier Supplies | | | | |
| 1660B001BA | (CRG-111BK) Black Toner (6,000 Yield) | 95072 | CTG | \$165.24 |
| 1659B001BA | (CRG-111C) Cyan Toner (6,000 Yield) | 95073 | CTG | \$212.67 |
| 1658B001BA | (CRG-111M) Magenta Toner (6,000 Yield) | 95074 | CTG | \$212.67 |
| 1657B001BA | (CRG-111Y) Yellow Toner (6,000 Yield) | 95075 | CTG | \$212.67 |
| Canon imageRUNNER MF2535/2545 Multifunction Copier Supplies | | | | |
| 2786B003AA | (GPR-34) Toner (19,400 Yield) | 94021 | CTG | \$67.50 |

| MFG# | Product Description | Part# | UOM | Retail |
|--|--|--------|-----|----------|
| CANON SUPPLIES | | | | |
| Canon imageRUNNER Advance 6055/6065/6075 Copier Supplies | | | | |
| 3766B003AA | (GPR-38) Toner (56,000 Yield) | 94024 | CTG | \$112.00 |
| Canon imageRUNNER Advance C5030/C5035 Color Copier Supplies | | | | |
| 2790B003AB | (GPR-31) Black Toner (36,000 Yield) | 94354 | CTG | \$90.00 |
| 2794B003AB | (GPR-31) Cyan Toner (27,000 Yield) | 94355 | CTG | \$160.00 |
| 2798B003AB | (GPR-31) Magenta Toner (27,000 Yield) | 105289 | CTG | \$160.00 |
| 2802B003AA | (GPR-31) Yellow Toner (27,000 Yield) | 94358 | CTG | \$160.00 |
| FM4-8400-010 | Waste Toner Case Assembly | 910290 | EA | \$84.99 |
| Canon imageRUNNER Advance C5045/C5051 Color Copier Supplies | | | | |
| 2789B003AA | (GPR-30) Black Toner (44,000 Yield) | 34581 | CTG | \$114.50 |
| 2793B003AA | (GPR-30) Cyan Toner (38,000 Yield) | 34582 | CTG | \$184.50 |
| 2797B003AA | (GPR-30) Magenta Toner (38,000 Yield) | 34583 | CTG | \$184.50 |
| 2801B003AA | (GPR-30) Yellow Toner (38,000 Yield) | 34584 | CTG | \$184.50 |
| 2776B004BA | (GPR-30) Black Drum (171,000 Yield) | 911251 | EA | \$396.78 |
| 2777B004BA | (GPR-30) Color Drum (85,000 Yield) | 911252 | EA | \$349.35 |
| Canon Analog Copier Supplies | | | | |
| 1382A005AA | C120/C122/122F/C130/C130F Toner (5,000 Yield) | 3952 | CTG | \$41.00 |
| 1337A003AA | (NPG-11) C122/C122F/C130/130F/NP 6012/6012F/C120/C120F/6412/6412F/7130/ 7130F Drum (30,000 Yield) | 4424 | EA | \$185.00 |
| 1382A003AA | (NPG-11) NP 6012/6012F/6412/6412F/7130/7130F Toner (1-280 gm. Ctg/Ctn) (5,000 Yield) | 4373 | CTG | \$44.00 |
| Canon Networked Office System Copier/Printer Supplies | | | | |
| 1390A003AA | (GPR-1) imageRUNNER 60/550/600/7200/8070/8500 Toner (3-1650 gm. Ctgs/Ctn) (99,000 Yield) | 4368 | CTN | \$212.00 |
| 1389A004AA | (GPR-2) imageRUNNER 330N/330S/400N/400S/400V Toner (1-530 gm. Ctg/Ctn) (10,600 Yield) | 4359 | CTG | \$34.00 |
| 4234A003AA | (GPR-4) imageRUNNER 5000E/5000EN/5000V/5000i/5020/6000/6020 Toner (1-1650 gm. Ctg/Ctn) (33,000 Yield) | 4358 | CTG | \$84.00 |
| 6647A003AA | (GPR-6) imageRUNNER 2200/2200N/2220i/2800/3300/3300E/3300EN/3300i/3320N/ 3320i Toner (1-795 gm. Ctg/Ctn) (15,000 Yield) | 4308 | CTG | \$48.10 |
| 6748A003AA | (GPR-7) imageRUNNER 105/8500 Toner (2-1650 gm. Ctgs/Ctn) (73,200 Yield) | 4980 | CTN | \$135.30 |
| 6836A003AA | (GPR-8) imageRUNNER 1600/2000/2010F Toner (1-440 gm. Ctg/Ctn) (7,850 Yield) | 2923 | CTG | \$30.00 |
| 7814A003AA | (GPR-10) imageRUNNER 1300/1310/1330/1370/1630/1670F Toner (1-300 gm. Ctg/Ctn) (5,300 Yield) | 2495 | CTG | \$32.00 |
| 9629A003AA | (GPR-15) imageRUNNER 2230/2270/2830/2870/3025/3030/3225/3230 Toner (21,000 Yield) | 6444 | CTG | \$64.00 |
| 9634A003AA | (GPR-16) imageRUNNER 3035/3045/3235/3235i/3245/3245i/3530/3570/4570 Toner (24,000 Yield) | 6410 | CTG | \$69.50 |
| 0279B003AA | (GPR-17) imageRUNNER 5070/5570/6570 Toner (45,000 Yield) | 12576 | CTG | \$94.50 |
| 0384B003AA | (GPR-18) imageRUNNER 2016/2016i/2018/2018i/2020/2020i/2022/2022i/2025/2030i Toner (1-460 gm. Ctg/Box) (8,300 Yield) | 12577 | CTG | \$38.47 |
| 0387B003AA | (GPR-19) imageRUNNER 7105/7095/7086 Toner (1-2000 gm. Ctg/Box) | 15108 | CTG | \$75.70 |
| 0386B003AA | (GPR-22) imageRUNNER 1023/1023N/1023iF/1025/1025N/1025iF Toner (8,400 Yield) | 30568 | CTG | \$48.00 |
| 0388B003AA | (GPR-22) imageRUNNER 1023/1025 Drum (26,900 Yield) | 30569 | EA | \$133.00 |
| 1872B003AA | (GPR-24) imageRUNNER 5050/5050N/5055/5065/5075 Toner (48,000 Yield) | 95078 | CTG | \$100.70 |
| 2785B003AA | (GPR-35) imageRUNNER 2525/2530 Toner (14,600 Yield) | 35654 | CTG | \$53.50 |
| 0985B004AA | (CRG-110) imageRUNNER LBP 3460 Toner (6,000 Yield) | 95077 | CTG | \$153.50 |
| 0986B004AA | (CRG-110) imageRUNNER LBP 3460 High Yield Toner (12,000 Yield) | 901867 | CTG | \$257.00 |
| Canon Personal Copier Supplies | | | | |
| 0263B001BA | (104) Faxphone L90/L120/imageCLASS D420/D480/MF4100/MF4120/MF4150/ MF4270/MF4350/MF4370/MF4690 Toner | 11929 | CTG | \$104.00 |
| 0265B001AA | (105) imageCLASS MF7280/7460/7470/7480 Toner (10,000 Yield) | 13057 | CTG | \$233.00 |
| 0264B001AA | (106) imageCLASS MF6530/6540/6550/6560/6560cx/6580/6580cx Toner (5,000 Yield) | 15086 | CTG | \$219.00 |
| 1474A002AA | (A30) PC 1/2/2Lx/3/5/5L/5L(I)/6/6RE/7/8/11/11RE/12/65 Toner (3,000 Yield) | 4455 | CTG | \$169.00 |
| 1492A002CA | (E20) PC 140/150/300/310/320/325/400/420/430/530/550/940 Toner (2,000 Yield) | 4456 | CTG | \$122.00 |
| 1491A002AC | (E40) PC 140/150/160/170/300/310/320/325/330/400/420/425/428/430/530/550/710/ 720/730/735/740/745/770/775/785/790/795/860/880/890/920/921/940/941/950/980/ 981 Toner (4,000 Yield) | 4454 | CTG | \$188.00 |
| 6812A001AA | (L50) PC 1060/1061/1080F/imageCLASS D660/661/680/760/761/780/860/861/880 Toner (5,000 Yield) | 3542 | CTG | \$219.00 |
| 7138A002AA | (P Cartridge) imageCLASS 2300/2300n Toner (10,000 Yield) | 1725 | CTG | \$233.00 |
| 7833A001AA | (S35) imageCLASS D320/D340; Faxphone L170 Toner (3,500 Yield) | 1780 | CTG | \$172.00 |
| 8489A001BA | (X25) imageCLASS MF3110/3111/3240/5530/5550/5700/5730/5770 Toner (2,500 Yield) | 1374 | CTG | \$114.00 |

| MFG# | Product Description | Part# | UOM | Retail |
|--|--|--------|-----|----------|
| CANON SUPPLIES | | | | |
| Canon Copier Staples | | | | |
| 6788A001AA | G1 Staples (5,000/Ctg, 3 Ctgs/Box) | 3957 | BOX | \$115.00 |
| Canon Micrographic Toner | | | | |
| 3708A007AA | (MP20 N01) MP 50/55/60/90 Negative Toner (3,000 Yield) (Import Version) | 5799 | CTG | \$157.00 |
| 3711A001AA | File Print 400/DMP400/450 Toner (10,000 Yield) | 2220 | CTG | \$220.00 |
| Canon Business Facsimile Supplies | | | | |
| 1557A002BA | (FX3) CFX-LC2050/2060/L3500/L4000/L4500/L75/Faxphone L80/imageCLASS 1100/MP L6000 Toner (2,700 Yield) | 4417 | CTG | \$101.20 |
| 1558A002AA | (FX4) LaserCLASS 8500/9000/9000L/9000MS/9000S/9500/9500MS/9500S Toner (4,000 Yield) | 4415 | CTG | \$108.90 |
| 1559A002AA | (FX6) LaserCLASS 3170/3175 Toner (5,000 Yield) | 4412 | CTG | \$134.20 |
| 7621A001AA | (FX7) LaserCLASS 710/720i/730i Toner (4,500 Yield) | 2368 | CTG | \$117.70 |
| 8955A001AA | (FX8) LaserCLASS 310/510 Toner (3,500 Yield) | 1502 | CTG | \$143.99 |
| 1153B001AA | (FX11) LaserCLASS LC810/830 Toner (4,500 Yield) | 100297 | CTG | \$129.47 |
| COPYSTAR SUPPLIES | | | | |
| Copystar Copier Supplies **NOT Interchangeable with Mita Copiers!** | | | | |
| 370QB012 | (TK-18CS) CS-1500/1815/1820 Toner (6,000 Yield) | 6011 | CTG | \$129.00 |
| 37029015 | CS-1505/1510/1810 Toner (Includes Waste Bottle) (300 gm/Ctg) (7,000 Yield) | 2968 | CTG | \$67.87 |
| 37028015 | CS-1530/2030 Toner (11,000 Yield) | 3592 | CTG | \$42.00 |
| 370AM016 | (TK-413) CS-1620/1650/2020/2050 Toner (15,000 Yield) | 5686 | CTG | \$79.00 |
| TK-677 | CS2540/CS2560/CS3040/CS3060 Toner (20,000 Yield) | 15726 | EA | \$85.88 |
| TK-423 | CS-2550 Toner (15,000 Yield) | 6158 | CTG | \$90.00 |
| TK719 | CS3050/4050/5050 Toner (34,000 Yield) | 900621 | CTG | \$250.00 |
| DELL SUPPLIES | | | | |
| Dell Inkjet Supplies (Continued on next page) | | | | |
| FN172 | (Series 1) A920 Standard Resolution Black Ink (OEM# 310-4142, 310-5508, 330-0044) | 24669 | CTG | \$37.43 |
| FN178 | (Series 1) A920 Standard Resolution Color Ink (OEM# 310-4143, 310-5509, 330-0045) | 17532 | CTG | \$42.11 |
| 7Y743 | (Series 2) A940 Standard Resolution Black Ink (OEM# 310-3540, 310-4631, 330-0047) | 14649 | EA | \$42.11 |
| 7Y745 | (Series 2) A940 Standard Resolution Color Ink (OEM# 310-3541, 310-4633, 330-0048) | 14650 | EA | \$47.96 |
| J5566 | (Series 5) 922/924/942/944/946/962/964 Black Ink (OEM# 310-5372, 310-6273, 310-6965, 310-5883, 310-6970, 310-8342, 310-7161, 330-0053) | 14669 | CTG | \$31.58 |
| J5567 | (Series 5) 922/924/942/944/946/632/964/962 Color Ink (OEM# 310-5375, 310-6274, 310-6966, 310-5884, 310-6971, 310-8236, 310-7162, 330-0052) | 14670 | CTG | \$36.26 |
| M4640 | (Series 5) 922/924/942/944/946/962/964 High Capacity Black Ink (OEM# 310-7159, 310-5368, 310-6963, 310-5881, 310-6968, 310-6271, 330-9542) (483 Yield) | 14678 | CTG | \$39.77 |
| M4646 | (Series 5) 922/924/942/944/946/962/964 High Capacity Color Ink (OEM# 310-5371, 310-7160, 310-6964, 310-5882, 310-6969, 310-8235, 310-6272, 330-8387) | 14679 | EA | \$52.64 |
| UU255 | (Series 6) 725/810 Black/Color Ink (OEM# 310-7853, 310-7518, 330-0046) | 14672 | EA | \$29.24 |
| DH828 | (Series 7) 966/968 Black Ink (OEM# 310-8376, 330-0055) | 14697 | EA | \$28.07 |
| DH829 | (Series 7) 966/968 Color Ink (OEM# 310-8375, 330-0056) | 14698 | EA | \$33.92 |
| GR274 | (Series 7) 966/968 High Capacity Black Ink (OEM# 310-8373, 330-0022, 330-9538) | 14651 | EA | \$32.39 |
| GR277 | (Series 7) 966/968 High Capacity Color Ink (OEM# 310-8374, 330-0023, 330-9539) | 14652 | EA | \$45.59 |
| MJ264 | (Series 8) 946 High Capacity Black Ink (OEM# 310-8234, 330-9551) | 16259 | CTG | \$34.79 |
| DX506 | (Series 9) 926 Color Ink (OEM# 310-8389, 330-0971, 330-0032) | 95849 | CTG | \$25.73 |
| MK992 | (Series 9) 926/V305 High Capacity Black Ink (OEM# 310-8386, 330-0971, 330-9540) (285 Yield) | 14724 | CTG | \$25.73 |
| MK993 | (Series 9) 926/V305 High Capacity Color Ink (OEM# 310-8387, 330-0972, 330-9541) (285 Yield) | 14725 | CTG | \$33.92 |
| DX516 | (Series 11) 948/V505 Color Ink (OEM# 310-9684, 330-2091, 330-0041) | 16185 | EA | \$26.90 |
| KX701 | (Series 11) 948/V505 High Capacity Black Ink (OEM# 310-9682, 330-2092, 330-9549) | 14673 | EA | \$34.79 |
| KX703 | (Series 11) 948/V505 High Capacity Color Ink (OEM# 310-9683, 330-2093, 330-9550) | 14674 | EA | \$38.39 |
| WP322 | (Series 15) V105 Black Ink (OEM# 330-0868, 330-1123) (177 Yield) | 34564 | CTG | \$23.39 |
| UK852 | (Series 15) V105 Color Ink (OEM# 330-0867, 330-1124) (158 Yield) | 34563 | CTG | \$25.73 |
| DW905 | (Series 20) P703w Black Ink (OEM# 330-2117, 330-2397) (375 Yield) | 14701 | CTG | \$22.22 |
| DW906 | (Series 20) P703w Color Ink (OEM# 330-2116, 330-2396) (338 Yield) | 14700 | CTG | \$29.24 |
| U313R | (Series 21) P513w/P713w/V313/V313w/V515w/V715w Single Use Black Ink (OEM# 330-5275, 330-5890, 330-5264, 330-5261) (180 Yield) | 90844 | CTG | \$19.88 |
| XG8R3 | (Series 21) P513w/P713w/V313/V313w/V515w/V715w Single Use Color Ink (OEM# 330-5274, 330-5891, 330-5262, 330-5263) | 90843 | CTG | \$24.56 |
| T9FFK | (Series 33) V525w/V725w Single Use Extra High Capacity Black Ink (OEM# 331-7377) (750 Yield) | 906787 | CTG | \$33.60 |
| 8DNKH | (Series 33) V525w/V725w Single Use Extra High Capacity Cyan Ink (OEM# 331-7378) (700 Yield) | 906788 | CTG | \$33.60 |
| 6M6FG | (Series 33) V525w/V725w Single Use Extra High Capacity Magenta Ink (OEM# 331-7379) (700 Yield) | 906789 | CTG | \$33.60 |

| MFG# | Product Description | Part# | UOM | Retail |
|---|---|--------|-----|----------|
| DELL SUPPLIES | | | | |
| Dell Inkjet Supplies (Continued) | | | | |
| GRW63 | (Series 33) V525w/V725w Single Use Extra High Capacity Yellow Ink (OEM# 331-7380) (700 Yield) | 906790 | CTG | \$33.60 |
| Dell 1100/1110 Laser Supplies | | | | |
| J9833 | Toner (OEM# 310-6640, 310-7660) (2,000 Yield) | 14711 | EA | \$98.27 |
| Dell 1125 Laser Supplies | | | | |
| XP092 | Toner (OEM# 310-9318) (1,000 Yield) | 14758 | CTG | \$70.19 |
| XP407 | High Yield Toner (OEM# 310-9319) (2,000 Yield) | 14759 | EA | \$93.59 |
| MY323 | Drum (OEM# 310-9320) (20,000 Yield) | 14726 | EA | \$74.12 |
| Dell 1130/1135 Series Laser Supplies | | | | |
| 2MMJP | High Yield Toner (OEM# 330-9523) (2,500 Yield) | 93790 | CTG | \$105.29 |
| Dell 1230C/1235CN Color Laser Supplies | | | | |
| Y924J | Black Toner (OEM# 330-3578, 330-3012) (1,500 Yield) | 15718 | CTG | \$74.87 |
| C815K | Cyan Toner (OEM# 330-3581, 330-3015) (1,000 Yield) | 15720 | CTG | \$66.68 |
| D593K | Magenta Toner (OEM# 330-3580, 330-3014) (1,000 Yield) | 15719 | CTG | \$66.68 |
| F479K | Yellow Toner (OEM# 330-3579, 330-3013) (1,000 Yield) | 15721 | CTG | \$66.68 |
| F562K | Toner Waste Container (OEM# 330-3582, 330-3016) (12,500 Yield) | 32010 | EA | \$22.22 |
| C920K | Drum Kit (OEM# 330-3583, 330-3017) (24,000 Black/6,000 Color Yield) | 32011 | EA | \$128.69 |
| Dell 1250C/1350CNW/1355CN/1355CNW Color Laser Supplies | | | | |
| XKP2P | Black Toner (OEM# 332-0403) (700 Yield) | 911077 | CTG | \$58.49 |
| YX24V | Cyan Toner (OEM# 332-0405) (700 Yield) | 911079 | CTG | \$65.51 |
| MHT79 | Magenta Toner (OEM# 332-0404) (700 Yield) | 911078 | CTG | \$65.51 |
| J95NM | Yellow Toner (OEM# 332-0406) (700 Yield) | 911080 | CTG | \$65.51 |
| 810WH | High Yield Black Toner (OEM# 332-0407, 331-0778) (2,000 Yield) | 910120 | CTG | \$69.99 |
| C5GC3 | High Yield Cyan Toner (OEM# 332-0410, 331-0777) (1,400 Yield) | 910122 | CTG | \$69.99 |
| XXM5D | High Yield Magenta Toner (OEM# 332-0409, 331-0780) (1,400 Yield) | 910131 | CTG | \$69.99 |
| WM2JC | High Yield Yellow Toner (OEM# 332-0408, 331-0779) (1,400 Yield) | 910129 | CTG | \$69.99 |
| Dell 1320C Color Laser Supplies | | | | |
| P237C | Black Toner (OEM# 310-9059, 330-1416) (1,000 Yield) | 14746 | CTG | \$70.19 |
| P238C | Cyan Toner (OEM# 310-9061, 330-1386, 330-1417) (1,000 Yield) | 14743 | CTG | \$81.89 |
| P240C | Magenta Toner (OEM# 310-9065, 330-1388, 330-1419) (1,000 Yield) | 14744 | CTG | \$81.89 |
| P239C | Yellow Toner (OEM# 310-9063, 330-1418) (1,000 Yield) | 14745 | CTG | \$81.89 |
| DT615 | High Yield Black Toner (OEM# 310-9058) (2,000 Yield) | 14699 | CTG | \$87.74 |
| KU051 | High Yield Cyan Toner (OEM# 310-9060) (2,000 Yield) | 14719 | CTG | \$112.31 |
| WM138 | High Yield Magenta Toner (OEM# 310-9064) (2,000 Yield) | 14755 | CTG | \$112.31 |
| PN124 | High Yield Yellow Toner (OEM# 310-9062) (2,000 Yield) | 14738 | CTG | \$112.31 |
| Dell 1600N Laser Supplies | | | | |
| P4210 | High Yield Toner (OEM# 310-5417) (5,000 Yield) | 14731 | CTG | \$128.69 |
| Dell 1700/1700N/1710/1710N Laser Supplies | | | | |
| N3769 | Toner (OEM# 310-7040, 310-5401, 310-7023) (3,000 Yield) | 14681 | CTG | \$152.09 |
| J3815 | Use and Return Toner (OEM# 310-5399, 310-7038, 310-7020) (3,000 Yield) | 14667 | CTG | \$128.69 |
| H3730 | High Yield Toner (OEM# 310-5402, 310-7041, 310-7025) (6,000 Yield) | 14664 | CTG | \$222.29 |
| K3756 | High Yield Use and Return Toner (OEM# 310-5400, 310-7039, 310-7022) (6,000 Yield) | 14675 | CTG | \$157.94 |
| D4283 | Drum (OEM # 310-7021; 310-7042; 310-5404) (30,000 Yield) | 14696 | EA | \$69.02 |
| Dell 1720/1720DN Laser Supplies | | | | |
| PY408 | Use and Return Toner (OEM# 310-8699, 310-8706) (3,000 Yield) | 14682 | CTG | \$116.99 |
| MW558 | High Yield Use and Return Toner (OEM# 310-8700, 310-8707) (6,000 Yield) | 14680 | CTG | \$146.24 |
| TJ987 | Imaging Drum Kit (OEM# 310-8703, 310-8710) (30,000 Yield) | 14751 | EA | \$67.85 |
| Dell 1815DN Laser Supplies | | | | |
| NF485 | Toner (OEM# 310-7943) (3,000 Yield) | 14727 | EA | \$116.99 |
| RF223 | High Yield Toner (OEM# 310-7945) (5,000 Yield) | 14742 | CTG | \$122.84 |
| Dell 2130CN/2135CN Color Laser Supplies (Continued on next page) | | | | |
| P237C | Black Toner (OEM# 310-9059, 330-1416) (1,000 Yield) | 14746 | CTG | \$70.19 |
| P238C | Cyan Toner (OEM# 310-9061, 330-1386, 330-1417) (1,000 Yield) | 14743 | CTG | \$81.89 |
| P240C | Magenta Toner (OEM# 310-9065, 330-1388, 330-1419) (1,000 Yield) | 14744 | CTG | \$81.89 |
| P239C | Yellow Toner (OEM# 310-9063, 330-1418) (1,000 Yield) | 14745 | CTG | \$81.89 |
| FM064 | High Yield Black Toner (OEM# 330-1389, 330-1436) (2,500 Yield) | 14653 | CTG | \$105.29 |
| FM065 | High Yield Cyan Toner (OEM# 330-1390, 330-1437) (2,500 Yield) | 14654 | CTG | \$134.54 |

| MFG# | Product Description | Part# | UOM | Retail |
|---|---|--------|-----|----------|
| DELL SUPPLIES | | | | |
| Dell 2130CN/2135CN Color Laser Supplies (Continued) | | | | |
| FM067 | High Yield Magenta Toner (OEM# 330-1392, 330-1433) (2,500 Yield) | 14656 | CTG | \$134.54 |
| FM066 | High Yield Yellow Toner (OEM# 330-1391, 330-1438) (2,500 Yield) | 14655 | CTG | \$134.54 |
| KGR81 | Imaging Drum Kit (OEM# 331-0711, 330-1435, 310-9230, 330-3108) (24,000 Yield) | 103389 | EA | \$114.00 |
| Dell 2145CN Color Laser Supplies | | | | |
| T272J | Black Toner (OEM# 330-3785) (2,500 Yield) | 17909 | CTG | \$105.29 |
| P586K | Cyan Toner (OEM# 330-3788) (2,000 Yield) | 17911 | CTG | \$111.14 |
| K756K | Magenta Toner (OEM# 330-3787) (2,000 Yield) | 17913 | CTG | \$111.14 |
| M802K | Yellow Toner (OEM# 330-3786) (2,000 Yield) | 17915 | CTG | \$111.14 |
| Dell 2150CN/2150CDN/2155CN/2155CDN Color Laser Supplies | | | | |
| 2FV35 | Black Toner (OEM# 331-0712) (1,200 Yield) | 95900 | CTG | \$65.99 |
| WHPFG | Cyan Toner (OEM# 331-0713) (1,200 Yield) | 95913 | CTG | \$87.99 |
| 9M2WC | Magenta Toner (OEM# 331-0714) (1,200 Yield) | 95911 | CTG | \$87.99 |
| NT6X2 | Yellow Toner (OEM# 331-0715) (1,200 Yield) | 95901 | CTG | \$87.99 |
| N51XP | High Yield Black Toner (OEM# 331-0719) (3,000 Yield) | 95899 | CTG | \$109.99 |
| 769T5 | High Yield Cyan Toner (OEM# 331-0716) (2,500 Yield) | 95893 | CTG | \$108.89 |
| 8WNV5 | High Yield Magenta Toner (OEM# 331-0717) (2,500 Yield) | 95898 | CTG | \$108.89 |
| NPDYG | High Yield Yellow Toner (OEM# 331-0718) (2,500 Yield) | 95897 | CTG | \$108.89 |
| KGR81 | Imaging Drum Kit (OEM# 331-0711, 330-1435, 310-9230, 330-3108) (24,000 Yield) | 103389 | EA | \$114.00 |
| Dell 2230D Laser Supplies | | | | |
| M795K | Toner (OEM# 330-4130) (3,500 Yield) | 17958 | CTG | \$167.99 |
| M797K | Use and Return Toner (OEM# 330-4131) (3,500 Yield) | 32009 | CTG | \$133.18 |
| Dell 2330/2350 Laser Supplies | | | | |
| DM254 | Toner (OEM# 330-2664, 330-2647) (2,000 Yield) | 30821 | CTG | \$134.00 |
| PK492 | Use and Return Toner (OEM# 330-2648, 330-2665) (2,000 Yield) | 24213 | CTG | \$76.04 |
| PK937 | High Yield Toner (OEM# 330-2666) (6,000 Yield) | 919277 | CTG | \$187.19 |
| PK941 | High Yield Use and Return Toner (OEM# 330-2650, 330-2667) (6,000 Yield) | 14737 | CTG | \$140.39 |
| PK496 | Drum Kit (OEM# 330-8988, 330-4133, 330-2663, 330-5208, 330-2646) (30,000 Yield) | 19653 | EA | \$46.79 |
| Dell 2335DN Laser Supplies | | | | |
| CR963 | Toner (OEM# 330-2208) (3,000 Yield) | 99244 | CTG | \$89.99 |
| HX756 | High Yield Toner (OEM# 330-2209) (6,000 Yield) | 14709 | CTG | \$131.99 |
| Dell 2355DN Laser Supplies | | | | |
| CR963 | Toner (OEM# 330-2208) (3,000 Yield) | 99244 | CTG | \$89.99 |
| YTVTC | High Yield Toner (OEM# 331-0611) (10,000 Yield) | 99243 | CTG | \$189.99 |
| Dell 3000CN Color Laser Supplies | | | | |
| K4971 | Black Toner (OEM# 310-5726, 310-6874) (4,000 Yield) | 14714 | CTG | \$81.89 |
| T6412 | Cyan Toner (OEM# 310-5739) (2,000 Yield) | 14749 | CTG | \$85.19 |
| M6935 | Magenta Toner (OEM# 310-5738) (2,000 Yield) | 14721 | CTG | \$85.19 |
| P6731 | Yellow Toner (OEM# 310-5737) (2,000 Yield) | 14733 | CTG | \$85.19 |
| P4866 | Imaging Drum Kit (OEM# 310-5732, 310-8075) (42,000 Yield - 10,500 per Color) | 14732 | KIT | \$235.16 |
| Dell 3010CN Color Laser Supplies | | | | |
| JH565 | Black Toner (OEM# 341-3568) (2,000 Yield) | 14713 | CTG | \$70.19 |
| TH204 | Cyan Toner (OEM# 341-3571) (2,000 Yield) | 14750 | CTG | \$111.14 |
| XH005 | Magenta Toner (OEM# 341-3570) (2,000 Yield) | 14757 | CTG | \$111.14 |
| WH006 | Yellow Toner (OEM# 341-3569) (2,000 Yield) | 14754 | CTG | \$111.14 |
| P4866 | Imaging Drum Kit (OEM# 310-5732, 310-8075) (42,000 Yield - 10,500 per Color) | 14732 | KIT | \$235.16 |
| Dell 3100CN Color Laser Supplies | | | | |
| K4971 | Black Toner (OEM# 310-5726, 310-6874) (4,000 Yield) | 14714 | CTG | \$81.89 |
| T6412 | Cyan Toner (OEM# 310-5739) (2,000 Yield) | 14749 | CTG | \$85.19 |
| M6935 | Magenta Toner (OEM# 310-5738) (2,000 Yield) | 14721 | CTG | \$85.19 |
| P6731 | Yellow Toner (OEM# 310-5737) (2,000 Yield) | 14733 | CTG | \$85.19 |
| K4973 | High Yield Cyan Toner (OEM# 310-5731) (4,000 Yield) | 14716 | CTG | \$163.79 |
| K4972 | High Yield Magenta Toner (OEM# 310-5730) (4,000 Yield) | 14715 | CTG | \$163.79 |
| K4974 | High Yield Yellow Toner (OEM# 310-5729) (4,000 Yield) | 14717 | CTG | \$163.79 |
| P4866 | Imaging Drum Kit (OEM# 310-5732, 310-8075) (42,000 Yield - 10,500 per Color) | 14732 | KIT | \$235.16 |
| Dell 3110CN/3115CN Color Laser Supplies (Continued on next page) | | | | |
| PF028 | Black Toner (OEM# 310-8093, 310-8396) (5,000 Yield) | 14734 | EA | \$111.14 |
| RF012 | Cyan Toner (OEM# 310-8095, 310-8398) (4,000 Yield) | 14740 | EA | \$160.28 |
| MF790 | Magenta Toner (OEM# 310-8097, 310-8400) (4,000 Yield) | 14723 | EA | \$160.28 |
| NF555 | Yellow Toner (OEM# 310-8099, 310-8402) (4,000 Yield) | 14728 | EA | \$160.28 |

| MFG# | Product Description | Part# | UOM | Retail |
|--|---|--------|-----|----------|
| DELL SUPPLIES | | | | |
| Dell 3110CN/3115CN Color Laser Supplies (Continued) | | | | |
| PF030 | High Yield Black Toner (OEM# 310-8092, 310-8395) (8,000 Yield) | 14736 | CTG | \$157.94 |
| PF029 | High Yield Cyan Toner (OEM# 310-8094, 310-8397) (8,000 Yield) | 14735 | CTG | \$292.49 |
| RF013 | High Yield Magenta Toner (OEM# 310-8096, 310-8399) (8,000 Yield) | 14741 | CTG | \$292.49 |
| NF556 | High Yield Yellow Toner (OEM# 310-8098, 310-8401) (8,000 Yield) | 14729 | CTG | \$292.49 |
| UG190 | Fuser Maintenance Kit (Includes Fuser, Roller, Transfer Belt) (OEM# 310-8730) (100,000 Yield) | 14756 | EA | \$274.80 |
| Dell 3130CN Color Laser Supplies | | | | |
| G910C | Black Toner (OEM# 330-1197) (4,000 Yield) | 14660 | EA | \$95.93 |
| G907C | Cyan Toner (OEM# 330-1194) (3,000 Yield) | 14657 | EA | \$125.99 |
| G908C | Magenta Toner (OEM# 330-1195) (3,000 Yield) | 14658 | EA | \$125.99 |
| G909C | Yellow Toner (OEM# 330-1196) (3,000 Yield) | 14659 | EA | \$125.99 |
| H516C | High Yield Black Toner (OEM# 330-1198) (9,000 Yield) | 18015 | CTG | \$163.79 |
| H513C | High Yield Cyan Toner (OEM# 330-1199) (9,000 Yield) | 18016 | CTG | \$304.19 |
| H514C | High Yield Magenta Toner (OEM# 330-1200) (9,000 Yield) | 18017 | CTG | \$304.19 |
| H515C | High Yield Yellow Toner (OEM# 330-1204) (9,000 Yield) | 18018 | CTG | \$304.19 |
| K247F | Fuser Maintenance Kit (115V) (Includes Fuser, Roller, Transfer Belt) (OEM# 330-1209) | 906918 | EA | \$310.00 |
| Dell 3330DN Laser Supplies | | | | |
| P976R | Use and Return Toner (OEM# 330-5210) (7,000 Yield) | 24792 | CTG | \$191.99 |
| C233R | High Yield Use and Return Toner (OEM# 330-5207) (14,000 Yield) | 24791 | CTG | \$257.99 |
| PK496 | Drum Kit (OEM# 330-8988, 330-4133, 330-2663, 330-5208, 330-2646) (30,000 Yield) | 19653 | EA | \$46.79 |
| Dell 3333DN/3335DN Laser Supplies | | | | |
| G7D0Y | High Yield Use and Return Toner (OEM# 330-8984, 330-8985) (14,000 Yield) | 50208 | CTG | \$257.99 |
| Dell 5100CN Color Laser Supplies | | | | |
| GG577 | Black Toner (OEM# 310-5807) (9,000 Yield) | 14704 | CTG | \$93.59 |
| GG579 | Cyan Toner (OEM# 310-5810) (8,000 Yield) | 14706 | CTG | \$269.09 |
| GG578 | Magenta Toner (OEM# 310-5809) (8,000 Yield) | 14705 | CTG | \$269.09 |
| HG308 | Yellow Toner (OEM# 310-5808) (8,000 Yield) | 14708 | CTG | \$269.09 |
| UF100 | Imaging Drum Kit (Transfer Roller Included) (OEM# 310-7899) (35,000 Yield) | 14752 | KIT | \$218.78 |
| HY723 | Fuser Kit (120V) (Includes Fuser, Roller) (OEM# 310-8727) (100,000 Yield) | 14710 | EA | \$238.80 |
| J6343 | Transfer Roll (OEM# 310-5814) (35,000 Yield) | 18597 | EA | \$35.99 |
| Dell 5110CN Color Laser Supplies | | | | |
| JD746 | Black Toner (OEM# 310-7890) (10,000 Yield) | 14671 | CTG | \$93.59 |
| GD907 | Cyan Toner (OEM# 310-7892) (8,000 Yield) | 14662 | CTG | \$245.69 |
| KD566 | Magenta Toner (OEM# 310-7894) (8,000 Yield) | 14676 | CTG | \$245.69 |
| GD908 | Yellow Toner (OEM# 310-7896) (8,000 Yield) | 14663 | CTG | \$245.69 |
| GD898 | High Yield Black Toner (OEM# 310-7889) (18,000 Yield) | 14702 | CTG | \$152.09 |
| GD900 | High Yield Cyan Toner (OEM# 310-7891) (12,000 Yield) | 14703 | CTG | \$327.59 |
| KD557 | High Yield Magenta Toner (OEM# 310-7893) (12,000 Yield) | 14718 | CTG | \$327.59 |
| JD750 | High Yield Yellow Toner (OEM# 310-7895) (12,000 Yield) | 14712 | CTG | \$327.59 |
| UF100 | Imaging Drum Kit (Transfer Roller Included) (OEM# 310-7899) (35,000 Yield) | 14752 | KIT | \$218.78 |
| KX494 | Fuser Kit (Includes Fuser, Roller) (OEM# 310-8729) (100,000 Yield) | 14720 | EA | \$239.99 |
| Dell 5130CDN Color Laser Supplies | | | | |
| U157N | Black Toner (OEM# 330-5851) (9,000 Yield) | 29186 | CTG | \$128.39 |
| X942N | Cyan Toner (OEM# 330-5848) (6,000 Yield) | 29184 | CTG | \$233.99 |
| P615N | Magenta Toner (OEM# 330-5845) (6,000 Yield) | 29183 | CTG | \$233.99 |
| R273N | Yellow Toner (OEM# 330-5839) (6,000 Yield) | 29185 | CTG | \$233.99 |
| N848N | High Yield Black Toner (OEM# 330-5846) (18,000 Yield) | 35083 | CTG | \$164.39 |
| P614N | High Yield Cyan Toner (OEM# 330-5850) (12,000 Yield) | 35080 | CTG | \$293.99 |
| R272N | High Yield Magenta Toner (OEM# 330-5843) (12,000 Yield) | 35082 | CTG | \$293.99 |
| T222N | High Yield Yellow Toner (OEM# 330-5852) (12,000 Yield) | 35081 | CTG | \$293.99 |
| P623N | Black Imaging Drum (OEM# 330-5849) (50,000 Yield) | 31267 | EA | \$107.99 |
| U163N | Cyan Imaging Drum (OEM# 330-5847) (50,000 Yield) | 31268 | EA | \$107.99 |
| T229N | Magenta Imaging Drum (OEM# 330-5855) (50,000 Yield) | 31270 | EA | \$107.99 |
| X951N | Yellow Imaging Drum (OEM# 330-5853) (50,000 Yield) | 31269 | EA | \$107.99 |
| N856N | Fuser Kit (110V) (OEM# 330-5840) (100,000 Yield) | 101887 | EA | \$195.00 |
| U162N | Toner Waste Container (OEM# 330-5844) (25,000 Yield) | 31266 | EA | \$30.88 |
| Dell 5210N/5310N Laser Supplies | | | | |
| GD531 | Use and Return Toner (OEM# 341-2918, 310-7236) (10,000 Yield) | 14661 | CTG | \$198.89 |
| HD767 | High Yield Use and Return Toner (OEM# 341-2919, 310-7237) (20,000 Yield) | 14665 | CTG | \$315.89 |
| UD314 | Extra High Yield Use and Return Toner (OEM# 310-7238) (30,000 Yield) (For Use in Model 5310N) | 14685 | CTG | \$421.19 |

| MFG# | Product Description | Part# | UOM | Retail |
|--|---|--------|-----|----------|
| DELL SUPPLIES | | | | |
| Dell 5230N/5230DN/5350DN Laser Supplies | | | | |
| F361T | Toner (OEM# 330-6990) (7,000 Yield) | 35805 | CTG | \$239.99 |
| D524T | Use and Return Toner (OEM# 330-6989) (7,000 Yield) | 91371 | CTG | \$167.99 |
| F362T | High Yield Use and Return Toner (OEM# 330-6968) (21,000 Yield) | 35764 | CTG | \$359.99 |
| Dell 5330DN Laser Supplies | | | | |
| NY312 | Toner (OEM# 330-2044) (10,000 Yield) | 35709 | CTG | \$199.18 |
| NY313 | High Yield Toner (OEM# 330-2045) (20,000 Yield) | 14730 | CTG | \$247.19 |
| HW679 | Fuser Kit 110V (OEM# 311-9572) | 25608 | EA | \$239.99 |
| Dell 5530DN/5535DN Laser Supplies | | | | |
| MPXDF | Use and Return Toner (OEM# 330-9786) (7,000 Yield) | 99501 | CTG | \$149.99 |
| 9GPVM | High Yield Use and Return Toner (OEM# 330-9787, 330-9788) (25,000 Yield) | 99503 | CTG | \$320.99 |
| Dell 7130CDN Color Laser Supplies | | | | |
| 3GDT0 | High Yield Black Toner (OEM# 330-6135) (19,000 Yield) | 35737 | CTG | \$299.99 |
| 05C8C | Cyan Toner (OEM# 330-6142) (11,000 Yield) | 35735 | CTG | \$431.99 |
| Y7NPH | Magenta Toner (OEM# 330-6143) (11,000 Yield) | 35734 | CTG | \$431.99 |
| 3DRPP | Yellow Toner (OEM# 330-6144) (11,000 Yield) | 35736 | CTG | \$431.99 |
| RPFY9 | Drum (OEM# 330-6137) (80,000 Yield) | 507033 | EA | \$219.00 |
| 1HKN6 | Toner Waste Container (OEM# 330-6136) (20,000 Yield) | 105189 | EA | \$32.00 |
| Dell 7330DN Laser Supplies | | | | |
| X730H | Toner (OEM# 330-3110) (35,000 Yield) | 14686 | CTG | \$163.79 |
| D625J | Imaging Drum Kit (OEM# 330-3111) | 101507 | EA | \$295.00 |
| G447J | Fuser Maintenance Kit (120V) (Includes Fuser, Roller) (OEM# 330-3112) (300,000 Yield) | 101509 | EA | \$630.00 |
| Dell B1160/B1160W Laser Supplies | | | | |
| YK1PM | Toner (OEM# 331-7335) (1,500 Yield) | 907635 | EA | \$63.99 |
| Dell B1260DN/B1265DNF Laser Supplies | | | | |
| DRYXV | High Yield Toner (OEM# 331-7328) (2,500 Yield) | 907636 | EA | \$87.99 |
| Dell B2360D/B2360DN Laser Supplies | | | | |
| M11XH | Use and Return Toner (OEM# 331-9805) (8,500 Yield) | 910126 | CTG | \$169.99 |
| KVK63 | Use and Return Imaging Drum (OEM# 331-9811) (60,000 Yield) | 910133 | EA | \$35.09 |
| Dell B2375DN/B2375DFW Laser Supplies | | | | |
| C7D6F | Toner (OEM# 593-BBBJ) (10,000 Yield) | 919294 | CTG | \$215.27 |
| Dell B3460DN Laser Supplies | | | | |
| M11XH | Use and Return Toner (OEM# 331-9805) (8,500 Yield) | 910126 | CTG | \$169.99 |
| 9GG2G | High Yield Use and Return Toner (OEM# 331-9807) (20,000 Yield) | 910121 | CTG | \$299.99 |
| KVK63 | Use and Return Imaging Drum (OEM# 331-9811) (60,000 Yield) | 910133 | EA | \$35.09 |
| Dell B3465DN/B3465DNF Laser Supplies | | | | |
| M11XH | Use and Return Toner (OEM# 331-9805) (8,500 Yield) | 910126 | CTG | \$169.99 |
| DJMKY | High Yield Use and Return Toner (OEM# 332-0373) (20,000 Yield) | 910123 | CTG | \$299.99 |
| KVK63 | Use and Return Imaging Drum (OEM# 331-9811) (60,000 Yield) | 910133 | EA | \$35.09 |
| Dell B5460DN Laser Supplies | | | | |
| T6J1J | Use and Return Toner (OEM# 331-9797) (6,000 Yield) | 920089 | CTG | \$116.99 |
| X5GDJ | High Yield Use and Return Toner (OEM# 331-9756) (25,000 Yield) | 910130 | CTG | \$329.46 |
| 03YNJ | Ultra High Yield Use and Return Toner (OEM# 332-0131) (45,000 Yield) | 910118 | CTG | \$409.99 |
| 9PN5P | Use and Return Imaging Drum (OEM# 331-9754) (100,000 Yield) | 910132 | EA | \$97.10 |
| Dell B5465DNF Laser Supplies | | | | |
| T6J1J | Use and Return Toner (OEM# 331-9797) (6,000 Yield) | 920089 | CTG | \$116.99 |
| X5GDJ | High Yield Use and Return Toner (OEM# 331-9756) (25,000 Yield) | 910130 | CTG | \$329.46 |
| 9PN5P | Use and Return Imaging Drum (OEM# 331-9754) (100,000 Yield) | 910132 | EA | \$97.10 |
| Dell C1660W Color Laser Supplies | | | | |
| 4G9HP | Black Toner (OEM# 332-0399) (1,250 Yield) | 910119 | CTG | \$58.49 |
| DWGCP | Cyan Toner (OEM# 332-0400) (1,000 Yield) | 910124 | CTG | \$65.51 |
| V3W4C | Magenta Toner (OEM# 332-0401) (1,000 Yield) | 910127 | CTG | \$65.51 |
| V53F6 | Yellow Toner (OEM# 332-0402) (1,000 Yield) | 910128 | CTG | \$55.99 |
| Dell C1760NW/C1765NF/C1765NFW Color Laser Supplies (Continued on next page) | | | | |
| XKP2P | Black Toner (OEM# 332-0403) (700 Yield) | 911077 | CTG | \$58.49 |

| MFG# | Product Description | Part# | UOM | Retail |
|--|--|--------|-----|----------|
| DELL SUPPLIES | | | | |
| Dell C1760NW/C1765NF/C1765NFW Color Laser Supplies <i>(Continued)</i> | | | | |
| YX24V | Cyan Toner (OEM# 332-0405) (700 Yield) | 911079 | CTG | \$65.51 |
| MHT79 | Magenta Toner (OEM# 332-0404) (700 Yield) | 911078 | CTG | \$65.51 |
| J95NM | Yellow Toner (OEM# 332-0406) (700 Yield) | 911080 | CTG | \$65.51 |
| 810WH | High Yield Black Toner (OEM# 332-0407, 331-0778) (2,000 Yield) | 910120 | CTG | \$69.99 |
| C5GC3 | High Yield Cyan Toner (OEM# 332-0410, 331-0777) (1,400 Yield) | 910122 | CTG | \$69.99 |
| XXM5D | High Yield Magenta Toner (OEM# 332-0409, 331-0780) (1,400 Yield) | 910131 | CTG | \$69.99 |
| WM2JC | High Yield Yellow Toner (OEM# 332-0408, 331-0779) (1,400 Yield) | 910129 | CTG | \$69.99 |
| Dell C2660DN/C2665DNF Color Laser Supplies | | | | |
| HD47M | Black Toner (OEM# 593-BBBM) (1,200 Yield) | 919296 | CTG | \$79.55 |
| V1620 | Cyan Toner (OEM# 593-BBBN) (1,200 Yield) | 919299 | CTG | \$90.08 |
| GP3M4 | Magenta Toner (OEM# 593-BBBP) (1,200 Yield) | 919295 | CTG | \$90.08 |
| R9PYX | Yellow Toner (OEM# 593-BBBO) (1,200 Yield) | 919298 | CTG | \$90.08 |
| 3070F | High Yield Black Toner (OEM# 593-BBBQ) (3,000 Yield) | 919301 | CTG | \$116.99 |
| TW3NN | High Yield Cyan Toner (OEM# 593-BBBT) (4,000 Yield) | 919293 | CTG | \$164.96 |
| V4TG6 | High Yield Magenta Toner (OEM# 593-BBBS) (4,000 Yield) | 919300 | CTG | \$165.96 |
| 2K1VC | High Yield Yellow Toner (OEM# 593-BBBR) (4,000 Yield) | 919302 | CTG | \$164.85 |
| 67H2T | Extra High Yield Black Toner (OEM# 593-BBBU) (6,000 Yield) | 919297 | CTG | \$158.64 |
| Dell C3760n/C3760dn/C3765dnf Color Laser Supplies | | | | |
| W8D60 | Extra High Yield Black Toner (OEM# 331-8429) (11,000 Yield) | 907640 | CTG | \$142.99 |
| 1M4KP | Extra High Yield Cyan Toner (OEM# 331-8432) (9,000 Yield) | 907641 | CTG | \$269.99 |
| XKGFP | Extra High Yield Magenta Toner (OEM# 331-8431) (9,000 Yield) | 907642 | CTG | \$269.99 |
| MD8G4 | Extra High Yield Yellow Toner (OEM# 331-8430) (9,000 Yield) | 907643 | CTG | \$269.99 |
| Dell M5200N Laser Supplies | | | | |
| K2885 | High Yield Use and Return Toner (OEM# 310-4131, 310-4549) (18,000 Yield) | 14760 | CTG | \$327.59 |
| Dell W5300N Laser Supplies | | | | |
| M2925 | Extra High Yield Use and Return Toner (OEM# 310-4585) (27,000 Yield) | 14677 | CTG | \$409.49 |

DIGITAL IMPACT SUPPLIES

Digital Impact Ribbons

| | | | | |
|----------------|---|-------|-----|---------|
| 44A507014-G08B | 4410/4440/4500 Black Fabric Ribbon with Weld Sensor Hole (50M Characters) (Interchangeable with Digital LG31) | 29009 | RBN | \$86.00 |
| LA30R-KA | LA30N/LA36N Black Fabric Cartridge (2M Characters) | 96885 | RBN | \$20.54 |
| LA40R-KA | LA400 Black Fabric Cartridge (15M Characters) (Interchangeable with Compaq 126336-B21 or Genicom 1A3000B02) | 97070 | RBN | \$66.00 |

EPSON SUPPLIES

Epson Inkjet Supplies *(Continued on next page)*

| | | | | |
|---------|--|-------|-----|---------|
| T044120 | (44) Stylus C64/C66/C84/C86/CX4600/CX6400/CX6600 DURABrite Black Ink (540 Yield) | 1443 | CTG | \$28.59 |
| T044220 | (44) Stylus C64/C66/C84/C86/CX4600/CX6400/CX6600 DURABrite Cyan Ink (400 Yield) | 1441 | CTG | \$15.39 |
| T044320 | (44) Stylus C64/C66/C84/C86/CX4600/CX6400/CX6600 DURABrite Magenta Ink (400 Yield) | 1440 | CTG | \$15.39 |
| T044420 | (44) Stylus C64/C66/C84/C86/CX4600/CX6400/CX6600 DURABrite Yellow Ink (400 Yield) | 1439 | CTG | \$15.39 |
| T048120 | (48) Stylus Photo R200/R220/R300/R300M/R320/R340/RX500/RX600/RX620 Black Ink (630 Yield) | 1437 | CTG | \$19.99 |
| T048220 | (48) Stylus Photo R200/R220/R300/R300M/R320/R340/RX500/RX600/RX620 Cyan Ink (430 Yield) | 1436 | CTG | \$15.39 |
| T048320 | (48) Stylus Photo R200/R220/R300/R300M/R320/R340/RX500/RX600/RX620 Magenta Ink (430 Yield) | 1435 | CTG | \$15.39 |
| T048420 | (48) Stylus Photo R200/R220/R300/R300M/R320/R340/RX500/RX600/RX620 Yellow Ink (430 Yield) | 1432 | CTG | \$15.39 |
| T048520 | (48) Stylus Photo R200/R220/R300/R300M/R320/R340/RX500/RX600/RX620 Light Cyan Ink (430 Yield) | 1431 | CTG | \$15.39 |
| T048620 | (48) Stylus Photo R200/R220/R300/R300M/R320/R340/RX500/RX600/RX620 Light Magenta Ink (430 Yield) | 1428 | CTG | \$15.39 |
| T060120 | (60) Stylus C68/C88/C88+/CX3800/CX3810/CX4200/CX4800/CX5800F/CX7800 Black Ink (400 Yield) | 11364 | CTG | \$22.49 |
| T060220 | (60) Stylus C68/C88/C88+/CX3800/CX3810/CX4200/CX4800/CX5800F/CX7800 Cyan Ink (600 Yield) | 11365 | CTG | \$15.39 |
| T060320 | (60) Stylus C68/C88/C88+/CX3800/CX3810/CX4200/CX4800/CX5800F/CX7800 Magenta Ink (600 Yield) | 11368 | CTG | \$15.39 |
| T060420 | (60) Stylus C68/C88/C88+/CX3800/CX3810/CX4200/CX4800/CX5800F/CX7800 Yellow Ink (600 Yield) | 11372 | CTG | \$15.39 |
| T060520 | (60) Stylus C68/C88/C88+/CX3800/CX3810/CX4200/CX4800/CX5800F/CX7800 Color Ink Combo Pack (Includes 1 Each of OEM# T060220, T060320, T060420) (3 x 600 Yield) | 11376 | PK | \$45.99 |

| MFG# | Product Description | Part# | UOM | Retail |
|---|---|--------|-----|---------|
| EPSON SUPPLIES | | | | |
| Epson Inkjet Supplies (Continued on next page) | | | | |
| T068120-D2 | (68) Stylus C120/CX5000/CX6000/CX7000F/CX8400/CX9400Fax/CX9475Fax/NX215/NX300/NX305/NX400/NX415/NX510/NX515/WorkForce 30/40/310/315/500/600/610/615/1100 DURABrite Ultra High Capacity Black Ink Twin Pack (2 x 370 Yield) | 11063 | PK | \$40.99 |
| T068520 | (68) Stylus NX215/NX300/NX400/NX415/NX510/NX515/C120/CX5000/CX6000/CX7000F/CX8400/CX9400/Workforce 30/40/310/500/600 DURABrite Ultra High Capacity C/M/Y Ink Cartridge Multipack (Includes 1 Each of OEM# T068220, T068320, T068420) (3 x 500 Yield) | 18534 | PK | \$55.49 |
| T069120 | (69) Stylus CX5000/CX6000/CX7000F/CX7400/CX7450/CX8400/CX9400Fax/CX9475Fax/NX100/NX105/NX110/NX115/NX200/NX215/NX300/NX305/NX400/NX415/NX510/NX515/WorkForce 30/40/310/315/500/600/610/615/1100 DURABrite Ultra Black Ink (245 Yield) | 26086 | CTG | \$18.19 |
| T069220 | (69) Stylus C120/CX5000/CX6000/CX7000F/CX7400/CX7450/CX8400/CX9400Fax/CX9475Fax/N11/NX100/NX105/NX110/NX115/NX200/NX215/NX300/NX305/NX400/NX415/NX510/NX515/WorkForce 30/40/310/315/500/600/610/615/1100 DURABrite Ultra Cyan Ink (380 Yield) | 26088 | CTG | \$15.29 |
| T069320 | (69) Stylus C120/CX5000/CX6000/CX7000F/CX7400/CX7450/CX8400/CX9400Fax/CX9475Fax/N11/NX100/NX105/NX110/NX115/NX200/NX215/NX300/NX305/NX400/NX410/Nx415/NX510/NX515/WorkForce 30/40/310/315/500/600/610/615/1100 DURABrite Ultra Magenta Ink (380 Yield) | 26089 | CTG | \$15.29 |
| T069420 | (69) Stylus C120/CX5000/CX6000/CX7000F/CX7400/CX7450/CX8400/CX9400Fax/CX9475Fax/N11/NX100/NX105/NX110/NX115/NX200/NX215/NX300/NX305/NX400/NX410/NX415/NX510/NX515/WorkForce 30/40/310/315/500/515/600/610/615/1100 DURABrite Ultra Yellow Ink (380 Yield) | 26095 | CTG | \$15.29 |
| T069520 | (69) Stylus C120/CX5000/CX6000/CX7000F/CX7400/CX7450/CX8400/CX9400Fax/CX9475Fax/N11/NX100/NX105/NX110/NX115/NX215/NX200/NX300/NX305/NX400/NX410/NX415/NX510/NX515 WorkForce 30/40/310/315/500/600/610/615/1100 DURABrite Ultra Color Ink Combo Pack (Includes 1 Each of OEM# T069220, T069320, T069420) (3 x 380 Yield) | 26099 | PK | \$41.99 |
| T078120 | (78) Stylus Photo R260/R280/R380/RX580/RX595/RX680 Artisan 50 Claria Hi-Definition Black Ink (330 Yield) | 26105 | CTG | \$16.99 |
| T078220 | (78) Stylus Photo R260/R280/R380/RX580/RX595/RX680 Artisan 50 Claria Hi-Definition Cyan Ink (525 Yield) | 26109 | CTG | \$14.29 |
| T078320 | (78) Stylus Photo R260/R280/R380/RX580/RX595/RX680 Artisan 50 Claria Hi-Definition Magenta Ink (525 Yield) | 26113 | CTG | \$14.29 |
| T078420 | (78) Stylus Photo R260/R280/R380/RX580/RX595/RX680 Artisan 50 Claria Hi-Definition Yellow Ink (525 Yield) | 26124 | CTG | \$14.29 |
| T078520 | (78) Stylus Photo R260/R280/R380/RX580/RX595/RX680 Artisan 50 Claria Hi-Definition Light Cyan Ink (525 Yield) | 26125 | CTG | \$14.29 |
| T078620 | (78) Stylus Photo R260/R280/R380/RX580/RX595/RX680 Artisan 50 Claria Hi-Definition Light Magenta Ink (525 Yield) | 26132 | CTG | \$14.29 |
| T078920 | (78) Stylus Photo R260/R280/R380/RX580/RX595/RX680 Artisan 50 Claria Hi-Definition C/M/Y/LC/LM Ink Combo Pack (Includes 1 Each of OEM# T078220, T078320, T078420, T078520, T078620) (5 x 525 Yield) | 26149 | PK | \$64.99 |
| T079120 | (79) Stylus Photo 1400/Artisan 1430 Claria High Capacity Black Ink (470 Yield) | 90889 | CTG | \$19.99 |
| T079220 | (79) Stylus Photo 1400/Artisan 1430 Claria High Capacity Cyan Ink (800 Yield) | 90890 | CTG | \$21.99 |
| T079320 | (79) Stylus Photo 1400/Artisan 1430 Claria High Capacity Magenta Ink (800 Yield) | 90891 | CTG | \$21.99 |
| T079420 | (79) Stylus Photo 1400/Artisan 1430 Claria High Capacity Yellow Ink (800 Yield) | 90892 | CTG | \$21.99 |
| T079520 | (79) Stylus Photo 1400/Artisan 1430 Claria High Capacity Light Cyan Ink (800 Yield) | 90893 | CTG | \$21.99 |
| T079620 | (79) Stylus Photo 1400/Artisan 1430 Claria High Capacity Light Magenta Ink (800 Yield) | 90894 | CTG | \$21.99 |
| T087120 | (87) Stylus Photo R1900 Photo Black Ink (5,630 Yield) | 104477 | CTG | \$13.99 |
| T087220 | (87) Stylus Photo R1900 Cyan Ink (915 Yield) | 104479 | CTG | \$13.99 |
| T087320 | (87) Stylus Photo R1900 Magenta Ink (915 Yield) | 104480 | CTG | \$13.99 |
| T087420 | (87) Stylus Photo R1900 Yellow Ink (915 Yield) | 104484 | CTG | \$13.99 |
| T087720 | (87) Stylus Photo R1900 Red Ink | 104485 | CTG | \$13.99 |
| T087820 | (87) Stylus Photo R1900 Matte Black Ink | 104489 | CTG | \$13.99 |
| T087920 | (87) Stylus Photo R1900 Orange Ink | 104490 | CTG | \$13.99 |
| T087020 | (87) Stylus Photo R1900 Gloss Optimizer Cartridge (3,615 Yield) (4/Pk) | 104494 | PK | \$13.99 |
| T088120 | (88) Stylus CX4400/CX4450/CX7400/CX7450/N11/NX100/NX105/NX110/NX115/NX200/NX215/NX300/NX305/NX400/NX415 DURABrite Ultra Moderate Capacity Black Ink | 95868 | CTG | \$13.99 |
| T088220 | (88) Stylus CX4400/CX4450/CX7400/CX7450/N11/NX100/NX105/NX110/NX115/NX200/NX215/NX300/NX305/NX400/NX415 DURABrite Ultra Moderate Capacity Cyan Ink | 95869 | CTG | \$9.89 |
| T088320 | (88) Stylus CX4400/CX4450/CX7400/CX7450/N11/NX100/NX105/NX110/NX115/NX200/NX215/NX300/NX305/NX400/NX415 DURABrite Ultra Moderate Capacity Magenta Ink | 95871 | CTG | \$9.89 |
| T088420 | (88) Stylus CX4400/CX4450/CX7400/CX7450/N11/NX100/NX105/NX110/NX115/NX200/NX215/NX300/NX305/NX400/NX415 DURABrite Ultra Moderate Capacity Yellow Ink | 95872 | CTG | \$9.89 |
| T088520 | (88) Stylus CX4400/CX4450/CX7400/CX7450/N11/NX100/NX105/NX110/NX115/NX200/Nx215/NX300/NX305/NX400/NX415 DURABrite Color Ink Cartridge Combo Pack (Includes 1 Each of OEM# T088220, T088320, T088420) | 95873 | PK | \$29.49 |

| MFG# | Product Description | Part# | UOM | Retail |
|---|--|--------|-----|---------|
| EPSON SUPPLIES | | | | |
| Epson Inkjet Supplies (Continued on next page) | | | | |
| T096120 | (96) Stylus Photo R2880 Photo Black Ink Cartridge | 901158 | CTG | \$13.99 |
| T096220 | (96) Stylus Photo R2880 Cyan Ink Cartridge | 901159 | CTG | \$13.99 |
| T096320 | (96) Stylus Photo R2880 Vivid Magenta Ink Cartridge | 901160 | CTG | \$13.99 |
| T096420 | (96) Stylus Photo R2880 Yellow Ink Cartridge | 901161 | CTG | \$13.99 |
| T096520 | (96) Stylus Photo R2880 Light Cyan Ink Cartridge | 901162 | CTG | \$13.99 |
| T096620 | (96) Stylus Photo R2880 Vivid Light Magenta Ink Cartridge | 901163 | CTG | \$13.99 |
| T096720 | (96) Stylus Photo R2880 Light Black Ink Cartridge | 901164 | CTG | \$13.99 |
| T096820 | (96) Stylus Photo R2880 Matte Black Ink Cartridge | 901165 | CTG | \$13.99 |
| T096920 | (96) Stylus Photo R2880 Light Light Black Ink Cartridge | 901166 | CTG | \$13.99 |
| T097120 | (97) Stylus NX510/515/WorkForce 40/600/610/615 DURABrite Ultra Extra High Capacity Black Ink (900 Yield) | 902463 | CTG | \$29.99 |
| T098120 | (98) Artisan 700/710/725/730/800/810/835/837 Claria Hi-Definition High Capacity Black Ink (550 Yield) | 902456 | CTG | \$18.99 |
| T099220 | (99) Artisan 700/710/725/730/800/810/835/837 Claria Hi-Definition Cyan Ink | 902457 | CTG | \$12.09 |
| T099320 | (99) Artisan 700/710/725/730/800/810/835/837 Claria Hi-Definition Magenta Ink | 902458 | CTG | \$12.09 |
| T099420 | (99) Artisan 700/710/725/730/800/810/835/837 Claria Hi-Definition Yellow Ink | 902459 | CTG | \$12.09 |
| T099520 | (99) Artisan 700/710/725/730/800/810/835/837 Claria Hi-Definition Light Cyan Ink | 902460 | CTG | \$12.09 |
| T099620 | (99) Artisan 700/710/725/730/800/810/835/837 Claria Hi-Definition Light Magenta Ink | 902461 | CTG | \$12.09 |
| T099920 | (99) Artisan 700/710/725/730/800/810/835/837 Claria Ultra Hi-Definition Color Ink Combo Pack (Includes 1 Each of OEM# T099220, T099320, T099420, T099520, T099620) | 902462 | PK | \$54.99 |
| T124120 | (124) Stylus NX125/127/130/230/330/420/430/Workforce 320/323/325/435 Moderate Capacity Black Ink (200 Yield) | 90907 | CTG | \$12.99 |
| T124220 | (124) Stylus NX125/127/130/230/330/420/430/Workforce 320/323/325/435 Moderate Capacity Cyan Ink (200 Yield) | 90908 | CTG | \$8.99 |
| T124320 | (124) Stylus NX125/127/130/230/330/420/430/Workforce 320/323/325/435 Moderate Capacity Magenta Ink (200 Yield) | 90910 | CTG | \$8.99 |
| T124420 | (124) Stylus NX125/127/130/230/330/420/430/Workforce 320/323/325/435 Moderate Capacity Yellow Ink (200 Yield) | 90911 | CTG | \$8.99 |
| T125120 | (125) Stylus NX125/127/130/230/420/530/625/Workforce 320/323/325/520 DURABrite Ultra Black Ink (445 Yield) | 34509 | CTG | \$15.99 |
| T125220 | (125) Stylus NX125/127/130/230/420/530/625/Workforce 320/323/325/520 DURABrite Ultra Cyan Ink (335 Yield) | 90923 | CTG | \$13.19 |
| T125320 | (125) Stylus NX125/127/130/230/420/530/625/Workforce 320/323/325/520 DURABrite Ultra Magenta Ink (335 Yield) | 90912 | CTG | \$13.19 |
| T125420 | (125) Stylus NX125/127/130/230/420/530/625/Workforce 320/323/325/520 DURABrite Ultra Yellow Ink (335 Yield) | 90913 | CTG | \$13.19 |
| T125520 | (125) Stylus NX125/127/130/230/420/530/625/Workforce 320/323/325/520 DURABrite Ultra Color Ink Combo Pack (Includes 1 each of OEM# T125220, T125320, T125420) (3 x 335 Yield) | 34513 | PK | \$35.99 |
| T126120 | (126) Stylus NX330/430/Workforce 60/435/520/545/630/633/635/645/840/845/3520/3540/7010/7510/7520 DURABrite Ultra High Capacity Black Ink (385 Yield) | 93965 | CTG | \$18.99 |
| T126220 | (126) Stylus NX330/430/Workforce 60/435/520/545/630/633/635/645/840/845/3520/3540/7010/7510/7520 DURABrite Ultra High Capacity Cyan Ink (470 Yield) | 93966 | CTG | \$17.59 |
| T126320 | (126) Stylus NX330/430/Workforce 60/435/520/545/630/633/635/645/840/845/3520/3540/7010/7510/7520 DURABrite Ultra High Capacity Magenta Ink (470 Yield) | 93967 | CTG | \$17.59 |
| T126420 | (126) Stylus NX330/430/Workforce 60/435/520/545/630/633/635/645/840/845/3520/3540/7010/7510/7520 DURABrite Ultra High Capacity Yellow Ink (470 Yield) | 93969 | CTG | \$17.59 |
| T126520 | (126) Stylus NX330/430/Workforce 60/435/520/545/630/633/635/645/840/845/3520/3540/7010/7510/7520 DURABrite Ultra High Capacity Color Ink Multipack (Includes 1 Each of OEM# T126220, T126320, T126420) (3 x 470 Yield) | 93973 | CTG | \$47.99 |
| T127120 | (127) Stylus NX530/NX625 Workforce 60/545/630/633/635/645/840/845/3520/3540/7010/7510/7520 DURABrite Ultra Extra High Capacity Black Ink (945 Yield) | 93974 | CTG | \$29.99 |
| T127120-D2 | (127) Stylus NX530/NX625 Workforce 60/545/630/633/635/645/840/845/3520/3540/7010/7510/7520 DURABrite Ultra Extra High Capacity Black Ink Twin Pack (2 Pack of OEM# T127120) (2 x 945 Yield) | 800738 | PK | \$59.95 |
| T127220 | (127) Stylus NX530/NX625 Workforce 60/545/630/633/635/645/840/845/3520/3540/7010/7510/7520 DURABrite Ultra Extra High Capacity Cyan Ink (755 Yield) | 93975 | CTG | \$20.89 |
| T127320 | (127) Stylus NX530/NX625 Workforce 60/545/630/633/635/645/840/845/3520/3540/7010/7510/7520 DURABrite Ultra Extra High Capacity Magenta Ink (755 Yield) | 93976 | CTG | \$20.89 |
| T127420 | (127) Stylus NX530/NX625 Workforce 60/545/630/633/635/645/840/845/3520/3540/7010/7510/7520 DURABrite Ultra Extra High Capacity Yellow Ink (755 Yield) | 93977 | CTG | \$20.89 |
| T127520 | (127) Stylus NX530/NX625 Workforce 60/545/630/633/635/645/840/845/3520/3540/7010/7510/7520/ DURABrite Ultra Extra High Capacity Color Ink Combo Pack (Includes 1 Each of OEM# T127220, T127320, T127420) (3 x 755 Yield) | 93978 | CTG | \$56.99 |
| T157120 | (157) Stylus Photo R3000 Photo Black UltraChrome K3 Ink Cartridge | 96603 | CTG | \$31.99 |
| T157220 | (157) Stylus Photo R3000 Cyan UltraChrome K3 Ink Cartridge | 96604 | CTG | \$31.99 |
| T157320 | (157) Stylus Photo R3000 Vivid Magenta UltraChrome K3 Ink Cartridge | 96609 | CTG | \$31.99 |
| T157420 | (157) Stylus Photo R3000 Yellow UltraChrome K3 Ink Cartridge | 96610 | CTG | \$31.99 |
| T157520 | (157) Stylus Photo R3000 Light Cyan UltraChrome K3 Ink Cartridge | 96611 | CTG | \$31.99 |

| MFG# | Product Description | Part# | UOM | Retail |
|---|--|--------|-----|---------|
| EPSON SUPPLIES | | | | |
| Epson Inkjet Supplies (Continued on next page) | | | | |
| T157620 | (157) Stylus Photo R3000 Vivid Light Magenta UltraChrome K3 Ink Cartridge | 96612 | CTG | \$31.99 |
| T157720 | (157) Stylus Photo R3000 Light Black UltraChrome K3 Ink Cartridge | 96613 | CTG | \$31.99 |
| T157820 | (157) Stylus Photo R3000 Photo Matte Black UltraChrome K3 Ink Cartridge | 96614 | CTG | \$31.99 |
| T157920 | (157) Stylus Photo R3000 Light Light Black UltraChrome K3 Ink Cartridge | 96616 | CTG | \$31.99 |
| T159020 | (159) Stylus Photo R2000 UltraChrome Hi-Gloss 2 Gloss Optimizer | 800379 | CTG | \$21.99 |
| T159120 | (159) Stylus Photo R2000 UltraChrome Hi-Gloss 2 Photo Black Ink Cartridge | 800380 | CTG | \$21.99 |
| T159220 | (159) Stylus Photo R2000 UltraChrome Hi-Gloss 2 Photo Cyan Ink Cartridge | 800381 | CTG | \$21.99 |
| T159320 | (159) Stylus Photo R2000 UltraChrome Hi-Gloss 2 Photo Magenta Ink Cartridge | 800382 | CTG | \$21.99 |
| T159420 | (159) Stylus Photo R2000 UltraChrome Hi-Gloss 2 Photo Yellow Ink Cartridge | 800383 | CTG | \$21.99 |
| T159720 | (159) Stylus Photo R2000 UltraChrome Hi-Gloss 2 Photo Red Ink Cartridge | 800384 | CTG | \$21.99 |
| T159820 | (159) Stylus Photo R2000 UltraChrome Hi-Gloss 2 Matte Black Ink Cartridge | 800385 | CTG | \$21.99 |
| T159920 | (159) Stylus Photo R2000 UltraChrome Hi-Gloss 2 Photo Orange Ink Cartridge | 800386 | CTG | \$21.99 |
| T200120 | (200) Home XP-400/200/WorkForce WF-2530/2540 DURABrite Ultra Black Ink | 906804 | CTG | \$12.99 |
| T200220 | (200) Home XP-400/200/WorkForce WF-2530/2540 DURABrite Ultra Cyan Ink | 906805 | CTG | \$8.99 |
| T200320 | (200) Home XP-400/200/WorkForce WF-2530/2540 DURABrite Ultra Magenta Ink | 906806 | CTG | \$8.99 |
| T200420 | (200) Home XP-400/200/WorkForce WF-2530/2540 DURABrite Ultra Yellow Ink | 906807 | CTG | \$8.99 |
| T200520 | (200) Home XP-400/200/WorkForce WF-2530/2540 DURABrite Ultra Ink Combo Pack (Includes 1 Each of OEM# T200220, T200320, T200420) | 906808 | PK | \$24.99 |
| T252120 | (252) WorkForce WF-3620/3640/5190/5620/5690/7110/7610/7620 DURABrite Ultra Black Ink (350 Yield) | 927365 | CTG | \$19.99 |
| T252220 | (252) WorkForce WF-3620/3640/5190/5620/5690/7110/7610/7620 DURABrite Ultra Cyan Ink (300 Yield) | 927366 | CTG | \$12.99 |
| T252320 | (252) WorkForce WF-3620/3640/5190/5620/5690/7110/7610/7620 DURABrite Ultra Magenta Ink (300 Yield) | 927367 | CTG | \$12.99 |
| T252420 | (252) WorkForce WF-3620/3640/5190/5620/5690/7110/7610/7620 DURABrite Ultra Yellow Ink (300 Yield) | 927368 | CTG | \$12.99 |
| T252520 | (252) WorkForce WF-3620/3640/5190/5620/5690/7110/7610/7620 DURABrite Ultra Cyan/Magenta/Yellow Ink Multipack (3 x 300 Yield) | 927369 | CTG | \$36.19 |
| T273020 | (273) Expression Premium XP-600/XP-800 Small-in-One Black Ink | 908994 | CTG | \$12.99 |
| T273120 | (273) Expression Premium XP-600/XP-800 Small-in-One Photo Black Ink | 908995 | CTG | \$12.99 |
| T273220 | (273) Expression Premium XP-600/XP-800 Small-in-One Cyan Ink | 908996 | CTG | \$12.99 |
| T273320 | (273) Expression Premium XP-600/XP-800 Small-in-One Magenta Ink | 908997 | CTG | \$12.99 |
| T273420 | (273) Expression Premium XP-600/XP-800 Small-in-One Yellow Ink | 908998 | CTG | \$12.99 |
| T676XL120 | (676XL) Workforce Pro 4010/4020/4023/4090/4520/4530/4533/4540/4590 DURABrite Ultra Black Ink (2,400 Yield) | 107902 | CTG | \$41.99 |
| T676XL220 | (676XL) Workforce Pro 4010/4020/4023/4090/4520/4530/4533/4540/4590 DURABrite Ultra Cyan Ink (1,200 Yield) | 107907 | CTG | \$26.99 |
| T676XL320 | (676XL) Workforce Pro 4010/4020/4023/4090/4520/4530/4533/4540/4590 DURABrite Ultra Magenta Ink (1,200 Yield) | 107925 | CTG | \$26.99 |
| T676XL420 | (676XL) Workforce Pro 4010/4020/4023/4090/4520/4530/4533/4540/4590 DURABrite Ultra Yellow Ink (1,200 Yield) | 107948 | CTG | \$26.99 |
| T786120 | (786) WorkForce WF-4630/4640/5110/5190/5620/5690 DURABrite Ultra Black Ink (900 Yield) | 933254 | CTG | \$22.99 |
| T786220 | (786) WorkForce WF-4630/4640/5110/5190/5620/5690 DURABrite Ultra Cyan Ink (800 Yield) | 933255 | CTG | \$22.99 |
| T786320 | (786) WorkForce WF-4630/4640/5110/5190/5620/5690 DURABrite Ultra Magenta Ink (800 Yield) | 933256 | CTG | \$22.99 |
| T786420 | (786) WorkForce WF-4630/4640/5110/5190/5620/5690 DURABrite Ultra Yellow Ink (800 Yield) | 933257 | CTG | \$22.99 |
| T786520 | (786) WorkForce WF-4630/4640/5110/5190/5620/5690 DURABrite Ultra Cyan/Magenta/Yellow Ink Combo Pack (Includes 1 Each of OEM# T786220, T786320, T786420) (3 x 800 Yield) | 933258 | EA | \$64.09 |
| T5570 | PictureMate Photo/500/Deluxe/Express Print Pack (Contains 1 Photo Ink Cartridge, 100 Sheets of Glossy 4" x 6" Photo Paper) | 5788 | PK | \$29.99 |
| T5846 | PictureMate Pal/Snap/Flash/Charm/Dash/Show/Zoom Print Pack (Contains 1 Photo Ink Cartridge, 150 Sheets of Glossy 4" x 6" Photo Paper) | 29547 | PK | \$39.99 |
| T043120 | Stylus C84/C84N/C84WN/C86/CX6400/CX6600 High Capacity DURABrite Black Ink (950 Yield) | 1442 | CTG | \$39.59 |
| S187093 | Stylus Color 400/440/500/600/640/660/670/Stylus Photo 700/750/1200/Ex Black Ink (370 Yield) | 1426 | CTG | \$28.59 |
| S191089 | Stylus Color 400/440/600/640/660/670/740/740i/760/800/850/850N/850Ne/860/1160/1520/Stylus Scan 2000/2500 Pro Color Ink (300 Yield) | 1422 | CTG | \$34.09 |
| S189108 | Stylus Color 740/740i/760/800/850/850N/850Ne/860/1160/1520/Stylus Scan 2000/2500 Pro Black Ink | 1425 | CTG | \$34.09 |
| T019201 | Stylus Color 880/880i/83 Black Ink (630 Yield) | 107202 | CTG | \$34.09 |
| T020201 | Stylus Color 880/880i/83 Color Ink (360 Yield) | 107203 | CTG | \$28.59 |
| S020118 | Stylus Color 3000/Pro 5000 Black Ink (3,800 Yield) | 98672 | CTG | \$87.00 |
| S020130 | Stylus Color 3000 Cyan Ink (2,100 Yield) | 98675 | CTG | \$87.00 |
| S020126 | Stylus Color 3000 Magenta Ink (2,100 Yield) | 98674 | CTG | \$87.00 |

| MFG# | Product Description | Part# | UOM | Retail |
|---|--|--------|-----|----------|
| EPSON SUPPLIES | | | | |
| Epson Inkjet Supplies (Continued on next page) | | | | |
| S020122 | Stylus Color 3000/Pro 5000 Yellow Ink (2,100 Yield) | 98673 | CTG | \$87.00 |
| T007201 | Stylus Photo 780/785EPX/825/870/875DC/875DCS/890/900/1270/1280 Black Ink (370 Yield) | 105953 | CTG | \$28.59 |
| T008201 | Stylus Photo 780/785EPX/825/870/875DC/875DCS/890 Color Ink (220 Yield) | 105955 | CTG | \$23.09 |
| T026201 | Stylus Photo 820/925 Black Ink (370 Yield) | 4294 | CTG | \$30.79 |
| T027201 | Stylus Photo 820/925 Color Ink (220 Yield) | 4293 | CTG | \$26.39 |
| T009201 | Stylus Photo 1270/1280/900 Color Ink (330 Yield) | 105954 | CTG | \$34.09 |
| T034120 | Stylus Photo 2200 Photo Black Ink (628 Yield) | 2993 | CTG | \$14.99 |
| T034220 | Stylus Photo 2200 Cyan Ink (440 Yield) | 2992 | CTG | \$14.99 |
| T034320 | Stylus Photo 2200 Magenta Ink (440 Yield) | 2991 | CTG | \$14.99 |
| T034420 | Stylus Photo 2200 Yellow Ink (440 Yield) | 2990 | CTG | \$14.99 |
| T034520 | Stylus Photo 2200 Light Cyan Ink (440 Yield) | 2989 | CTG | \$14.99 |
| T034620 | Stylus Photo 2200 Light Magenta Ink (440 Yield) | 2988 | CTG | \$14.99 |
| T034720 | Stylus Photo 2200 Light Black Ink (440 Yield) | 2987 | CTG | \$14.99 |
| T034820 | Stylus Photo 2200 Matte Black Ink (440 Yield) | 2986 | CTG | \$14.99 |
| T054120 | Stylus Photo R800/R1800 Photo Black UltraChrome Hi-Gloss Ink (400 Yield) | 5128 | CTG | \$17.99 |
| T054220 | Stylus Photo R800/R1800 Cyan UltraChrome Hi-Gloss Ink (400 Yield) | 5129 | CTG | \$17.99 |
| T054320 | Stylus Photo R800/R1800 Magenta UltraChrome Hi-Gloss Ink (400 Yield) | 5130 | CTG | \$17.99 |
| T054420 | Stylus Photo R800/R1800 Yellow UltraChrome Hi-Gloss Ink (400 Yield) | 5131 | CTG | \$17.99 |
| T054720 | Stylus Photo R800/R1800 Red UltraChrome Hi-Gloss Ink (400 Yield) | 5132 | CTG | \$17.99 |
| T054820 | Stylus Photo R800/R1800 Matte Black UltraChrome Hi-Gloss Ink (400 Yield) | 5133 | CTG | \$17.99 |
| T054920 | Stylus Photo R800/R1800 Blue UltraChrome Hi-Gloss Ink (400 Yield) | 5134 | CTG | \$17.99 |
| T054020 | Stylus Photo R800/R1800 Gloss Optimizer Cartridge (400 Yield) (2/Pkg) | 5136 | PK | \$17.99 |
| T059120 | Stylus Photo R2400 Photo Black UltraChrome K3 Ink | 10469 | CTG | \$17.99 |
| T059220 | Stylus Photo R2400 Cyan UltraChrome K3 Ink | 10470 | CTG | \$17.99 |
| T059320 | Stylus Photo R2400 Magenta UltraChrome K3 Ink | 10471 | CTG | \$17.99 |
| T059420 | Stylus Photo R2400 Yellow UltraChrome K3 Ink | 10472 | CTG | \$17.99 |
| T059520 | Stylus Photo R2400 Light Cyan UltraChrome K3 Ink | 10474 | CTG | \$17.99 |
| T059620 | Stylus Photo R2400 Light Magenta UltraChrome K3 Ink | 10475 | CTG | \$17.99 |
| T059720 | Stylus Photo R2400 Light Black UltraChrome K3 Ink | 10473 | CTG | \$17.99 |
| T059920 | Stylus Photo R2400 Light Light Black UltraChrome K3 Ink | 10476 | CTG | \$17.99 |
| Epson Ribbons | | | | |
| 8766 | DFX 5000/5000+/8000/8500 Black Fabric Ribbon (15M Characters) | 90419 | RBN | \$33.00 |
| S015384 | DFX 9000 Black Ribbon (15M Characters) | 10693 | RBN | \$32.99 |
| 8750 | FX 80/80+/85/86e/850/870/880/880+T/LX0800/810/300/300+/300+II/MX 70/80/RX 80 Black Fabric Ribbon (5M Characters) | 90100 | RBN | \$6.00 |
| S015329 | FX 890 Black Ribbon (7.5M Characters) | 1167 | RBN | \$8.99 |
| S015091 | FX 980 Black Ribbon (7M Characters) | 104349 | RBN | \$25.99 |
| S015335 | FX 2190/LQ 2090 Black Ribbon (12M Characters) | 5125 | RBN | \$26.99 |
| 7753 | LQ 200/300/500/510/570/570+/570e/800/850/870/LP 1000/AP 3000/4000/5000/5000+ Black Fabric Ribbon (2M Characters) | 90551 | RBN | \$7.00 |
| S015337 | LQ 590 Black Ribbon (5M Characters) | 5480 | RBN | \$15.49 |
| 7762L | LQ 670/680/680PRO/860/2500/2550 Black Fabric Ribbon (2M Characters) | 90588 | RBN | \$11.00 |
| S015086 | LQ 2070/2080/2170/FX 2170/2180 Black Fabric Ribbon (12M Characters) | 97604 | RBN | \$27.00 |
| Epson ERC Ribbon Cassettes | | | | |
| ERC-03B | M-210V/220/240 Black Ribbon (2M Yield) | 98509 | RBN | \$6.80 |
| ERC-09B | M-160/163/164/180/181/182/183/190/191/192 Black Ribbon (200K Characters) | 90598 | RBN | \$3.20 |
| ERC-23B | M-250/255/260/264/265/RP-265/267 Series/TM-270 Black Ribbon (1.5M Characters) (1/Pkg) | 100870 | RBN | \$2.30 |
| ERC-23BR | M-252/257/262/267/RP-267 Series/TM-267, A-D Black/Red Ribbon (750K Characters) | 3286 | RBN | \$2.30 |
| ERC-27B | CTM-290/M-290/TM-290/290II/295 Black Ribbon (1M Characters) | 100873 | RBN | \$3.10 |
| ERC-38B | TM-U200D/300A/300B/300C/300D/U370/U375/IT-U375 Black Ribbon (3M Characters) | 97912 | RBN | \$2.30 |
| ERC-38BR | TM-U370/5/U200/300/IT-U375 Black/Red Ribbon (1.5M/750K Characters) | 95956 | RBN | \$2.30 |
| GENICOM SUPPLIES | | | | |
| Genicom Branded Ribbons | | | | |
| 3A0100B02 | 3800/3900 Series Black Fabric Ribbon (15M Characters) | 29032 | RBN | \$56.00 |
| 3A1600B21 | 3860/3880 Black Fabric Ribbon (15M Characters) | 1986 | RBN | \$56.00 |
| 3A1600B22 | 3860/3880 Black Fabric Long Life Ribbon with Re-Inker (25M Characters) | 1985 | RBN | \$72.00 |
| 44A507014-G08B | 4410/4440/4500 Black Fabric Ribbon with Weld Sensor Hole (50M Characters) (Interchangeable with Digital LG31) | 29009 | RBN | \$86.00 |
| 44A509160-G03 | 4470/4490/4570/4590/5180 Black Fabric Ribbon Cartridge (50M Characters) | 29037 | RBN | \$123.00 |
| 4A0040B02 | 4800/4810/4810+/4840/4840+/4842/4900/4910/4910+/4912/4940/4940+/4942/5050/5100 Series Black Fabric Ribbon Cartridge with Re-Inker (50M Characters) | 29058 | RBN | \$55.00 |
| 4A0040B05 | 4800/4810/4810+/4840/4840+/4842/4900/4910/4910+/4912/4940/4940+/4942/5050/5100 Series Black Fabric Ribbon Cartridge with Re-Inker (75M Characters) | 29057 | RBN | \$71.00 |
| 4A0040B13 | 4800/4810/4810+/4840/4840+/4842/4900/4910/4910+/4912/4940/4940+/4942/5050/5100 Series Black Fabric Ribbon Cartridge (25M Characters) | 4824 | RBN | \$47.00 |

| MFG# | Product Description | Part# | UOM | Retail |
|---|--|--------|-----|----------|
| GESTETNER SUPPLIES | | | | |
| Gestetner C7425dn/C7526dn/C7531DN Color Laser Supplies | | | | |
| 888308 | High Yield Black Toner (15,000 Yield) (Type 145) | 10456 | CTG | \$97.34 |
| 888311 | High Yield Cyan Toner (15,000 Yield) (Type 145) | 10459 | CTG | \$225.75 |
| 888310 | High Yield Magenta Toner (15,000 Yield) (Type 145) | 10458 | CTG | \$225.75 |
| 888309 | High Yield Yellow Toner (15,000 Yield) (Type 145) | 10457 | CTG | \$225.75 |
| Gestetner C7528 Color Laser Supplies | | | | |
| 888442 | Black Toner (24,000 Yield) (Type 160) | 13127 | CTG | \$64.89 |
| 888445 | Cyan Toner (10,000 Yield) (Type 160) | 13130 | CTG | \$144.92 |
| 888444 | Magenta Toner (10,000 Yield) (Type 160) | 13129 | CTG | \$144.92 |
| 888443 | Yellow Toner (10,000 Yield) (Type 160) | 13128 | CTG | \$144.92 |
| Gestetner DSc428/DSc435/DSc445 Color Laser Supplies | | | | |
| 888340 | Black Toner (24,000 Yield) (Type R1) | 91800 | CTG | \$55.50 |
| 888343 | Cyan Toner (10,000 Yield) (Type R1) | 91804 | CTG | \$176.50 |
| 888342 | Magenta Toner (10,000 Yield) (Type R1) | 91803 | CTG | \$176.50 |
| 888341 | Yellow Toner (10,000 Yield) (Type R1) | 91802 | CTG | \$176.50 |
| Gestetner DSc460/CS555 Color Laser Supplies | | | | |
| 841333 | Black Toner (910 gm. Ctg) (36,000 Yield) (Type S1) | 19326 | CTG | \$67.00 |
| 841336 | Cyan Toner (530 gm. Ctg) (18,000 Yield) (Type S1) | 19329 | CTG | \$224.50 |
| 841335 | Magenta Toner (530 gm. Ctg) (18,000 Yield) (Type S1) | 19328 | CTG | \$224.50 |
| 841334 | Yellow Toner (530 gm. Ctg) (18,000 Yield) (Type S1) | 19327 | CTG | \$224.50 |
| Gestetner DSc535/DSc545 Color Laser Supplies | | | | |
| 841342 | Black Toner (23,000 Yield) | 16144 | CTG | \$72.00 |
| 841345 | Cyan Toner (17,000 Yield) | 16147 | CTG | \$215.00 |
| 841344 | Magenta Toner (17,000 Yield) | 16148 | CTG | \$215.00 |
| 841343 | Yellow Toner (17,000 Yield) | 16149 | CTG | \$215.00 |
| Gestetner Copier Supplies | | | | |
| 89846 | 3222/3227/P7027/P7032 Toner (365 gm. Ctg) (11,000 Yield) (Type ST27) | 107124 | CTG | \$39.58 |
| 841718 | DSm415/416 Toner (7,000 Yield) (Type 1170D/1270D) | 510024 | BTL | \$35.99 |
| 411844 | DSm415/416 Photoconductor (Type 1515) | 50105 | EA | \$214.00 |
| 841337 | DSm622/627/725/730 Toner (66,000 Yield) (Type 2212) | 19378 | BTL | \$65.00 |
| Gestetner Facsimile Supplies | | | | |
| 89839 | DSm516pf/F250/F270 Toner (AIO) (3,500 Yield) (Type 1175) | 6222 | CTG | \$108.00 |
| 89875 | F104/F9103 Toner (5,000 Yield) (Type 1160) | 2145 | CTG | \$81.00 |
| 413460 | F411 Black Toner (4,000 Yield) (Type SP 1000A) | 95191 | CTG | \$127.72 |

HP SUPPLIES

HP CROSS REFERENCE GUIDE CAN BE FOUND ON PAGES 257-282.

HP Inkjet Supplies - Multi Unit Packs *(Continued on next page)*

| | | | | |
|---------|---|--------|----|---------|
| C9500FN | HP 02 2-Pack Black Original Ink Cartridges (2 Pack of OEM# C8721WN) (2 x 660 Yield) | 100289 | PK | \$53.92 |
| CC604FN | HP 02 5-Pack Cyan/Magenta/Yellow/Light Cyan/Light Magenta Original Ink Cartridges (Includes 1 Each of OEM# C8771WN, C8772WN, C8773WN, C8774WN, C8775WN) (400 Cyan/370 Magenta/500 Yellow/220 Light Cyan/230 Light Magenta Yield) | 104408 | PK | \$74.52 |
| Q7964AN | HP 02 Black/Cyan/Magenta/Yellow/Light Cyan/Light Magenta Original Ink Cartridges Photo Value Pack (Includes 1 Each of OEM# C8721WN, C8771WN, C8772WN, C8773WN, C8774WN, C8775WN, 150 Sheets of 4" x 6" HP Advanced Photo Paper, Glossy) | 95120 | PK | \$64.55 |
| C9508FN | HP 21 2-Pack Black Original Ink Cartridges (2 Pack of OEM# C9351AN) (2 x 190 Yield) | 90089 | PK | \$39.12 |
| C9509FN | HP 21 Black/22 Tri-Color 2-Pack Original Ink Cartridges (Includes 1 Each of OEM# C9351AN, C9352AN) (190 Black, 165 Tri-Color Yield) | 104403 | PK | \$48.27 |
| D8J23FN | HP 60 Black/Tri-Color Original Ink Cartridges Creative Combo Pack (Includes 1 Each of OEM# CC640WN, CC643WN, 15 Sheets of 5" x 7" Advanced Photo Paper, 5 5" x 7" Envelopes) (200 Black, 165 Tri-Color Yield) | 913208 | PK | \$46.57 |
| CR259FN | HP 61 2-Pack Black/Tri-Color Original Ink Cartridges (Includes 1 Each of OEM# CH561WN, CH562WN) (190 Black, 165 Tri-Color Yield) | 90980 | PK | \$44.64 |
| F6U00FN | HP 62 Black/Tri-Color Original Ink Cartridges Content Value Pack (Includes 1 Each of OEM# C2P04AN, C2P06A, 10 Sheets 5" x 7" Photo Paper, 5 Sheets 4" x 6" Photo Paper, 5 TwoSmiles Envelopes) (200 Black, 165 Color Yield) | 925985 | PK | \$41.44 |
| CC659FN | HP 74 Black/75 Tri-Color 2-Pack Original Ink Cartridges (Includes 1 Each of OEM# CB335WN, CB337WN) (200 Black, 170 Tri-Color Yield) | 95304 | PK | \$46.81 |
| C9513FN | HP 92 Black/93 Tri-Color 2-Pack Original Ink Cartridges (Includes 1 Each of OEM# C9362WN C9361WN) (2 x 220 Yield) | 95121 | PK | \$52.42 |
| C9354FN | HP 94 Black/95 Tri-Color 2-Pack Original Ink Cartridges (Includes 1 Each of OEM# C8765WN, C8766WN) (480 Black, 330 Tri-Color Yield) | 104401 | PK | \$74.03 |
| CB327FN | HP 98 Black/95 Tri-Color 2-Pack Original Ink Cartridges (Includes 1 Each of OEM# C8766WN, C9364WN) (420 Black, 330 Tri-Color Yield) | 104406 | PK | \$74.01 |

| MFG# | Product Description | Part# | UOM | Retail |
|--|--|--------|-----|----------|
| HP SUPPLIES | | | | |
| <i>HP CROSS REFERENCE GUIDE CAN BE FOUND ON PAGES 257-282.</i> | | | | |
| HP Inkjet Supplies - Multi Unit Packs (Continued) | | | | |
| C9348FN | HP 96 2-Pack Black Original Ink Cartridges (2 Pack of OEM# C8767WN) (2 x 860 Yield) | 90108 | PK | \$92.81 |
| C9353FN | HP 96 Black/97 Tri-Color 2-Pack Original Ink Cartridges (Includes 1 Each of OEM# C8767WN, C9363WN) (860 Black, 560 Tri-Color Yield) | 104400 | PK | \$104.14 |
| C9514FN | HP 98 2-Pack Black Original Ink Cartridges (2 Pack of OEM# C9364WN) (2 x 420 Yield) | 90077 | PK | \$65.23 |
| C2P51FN | HP 564 2-Pack Black Original Ink Cartridges (2 Pack of OEM# CB316WN) (2 x 250 Yield) | 910542 | PK | \$31.56 |
| B3B33FN | HP 564 Cyan/Magenta/Yellow Original Ink Cartridges Creative Combo Pack (Includes 1 Each of OEM# CB318WN, CB319WN, CB320WN, 15 Sheets 5" x 7" HP Advanced Photo Paper, 5 5" x 7" Envelopes) (3 x 300 Yield) | 908272 | PK | \$41.25 |
| CZ134A | HP 711 3-Pack Cyan Original Ink Cartridges (3 Pack of OEM# CZ130A) (3 x 29 ml) | 909107 | PK | \$66.99 |
| CZ135A | HP 711 3-Pack Magenta Original Ink Cartridges (3 Pack of OEM# CZ131A) (3 x 29 ml) | 909108 | PK | \$66.99 |
| CZ136A | HP 711 3-Pack Yellow Original Ink Cartridges (3 Pack of OEM# CZ132A) (3 x 29 ml) | 909109 | PK | \$66.99 |
| CZ075FN | HP 901 2-Pack Black Original Ink Cartridges (2 Pack of OEM# CC653AN) (2 x 200 Yield) | 920098 | PK | \$36.61 |
| CN069FN | HP 901 2-Pack Black/Tri-Color Original Ink Cartridges (Includes 1 Each of OEM# CC653AN, CC656AN) (200 Black, 360 Tri-Color Yield) | 16332 | PK | \$54.84 |
| B3B30FN | HP 920 Cyan/Magenta/Yellow Original Ink Cartridges Creative Combo Pack (Includes 1 Each of OEM# CH634AN, CH635AN, CH636AN, 15 Sheets 5" x 7" HP Advanced Photo Paper, 5 5" x 7" Envelopes) (3 x 300 Yield) | 908273 | PK | \$34.55 |
| B3B32FN | HP 933 Cyan/Magenta/Yellow Original Ink Cartridges Creative Combo Pack (Includes 1 Each of OEM# CN058AN, CN059AN, CN060AN, 15 Sheets 5" x 7" HP Advanced Photo Paper, 5 5" x 7" Envelopes) (3 x 330 Yield) | 908274 | PK | \$38.25 |
| F6U03FN | HP 935 Cyan/Magenta/Yellow Original Ink Cartridges Content Value Pack (Includes 1 Each of OEM# C2P20A, C2P21A, C2P22A, 10 Sheets 5" x 7" Photo Paper, 5 Sheets 4" x 6" Photo Paper, 5 TwoSmiles Envelopes) (3 x 400 Yield) | 926203 | PK | \$46.24 |
| CN065FN | HP 940 3-Pack Cyan/Magenta/Yellow Original Ink Cartridges (Includes 1 Each of OEM# C4903AN, C4904AN, C4905AN) (3 x 900 Yield) | 16333 | PK | \$74.04 |
| CR314FN | HP 951 3-Pack Cyan/Magenta/Yellow Original Ink Cartridges (Includes 1 each of OEM# CN050AN, CN051AN, CN052AN) (3 x 700 Yield) | 108021 | PK | \$70.35 |
| HP Inkjet Supplies (Continued on next page) | | | | |
| C6602A | HP Black Original Thermal Ink Cartridge (7M Characters) | 1958 | CTG | \$21.95 |
| C6602R | HP Red Original Thermal Ink Cartridge (7M Characters) | 1956 | CTG | \$21.95 |
| 51604A | HP Black Original Thermal Ink Cartridge | 20255 | CTG | \$17.48 |
| 51605R | HP Red Original Thermal Ink Cartridge | 4301 | CTG | \$17.88 |
| C8721WN | HP 02 Black Original Ink Cartridge (660 Yield) | 10576 | CTG | \$28.67 |
| C8771WN | HP 02 Cyan Original Ink Cartridge (400 Yield) | 10577 | CTG | \$14.73 |
| C8772WN | HP 02 Magenta Original Ink Cartridge (370 Yield) | 10578 | CTG | \$14.73 |
| C8773WN | HP 02 Yellow Original Ink Cartridge (500 Yield) | 10581 | CTG | \$14.73 |
| C8774WN | HP 02 Light Cyan Original Ink Cartridge (220 Yield - 4" x 6" Prints) | 10585 | CTG | \$14.73 |
| C8775WN | HP 02 Light Magenta Original Ink Cartridge (230 Yield - 4" x 6" Prints) | 10590 | CTG | \$14.73 |
| C8730WN | HP 02XL High Yield Cyan Original Ink Cartridge (600 Yield) | 16580 | CTG | \$20.97 |
| C8731WN | HP 02XL High Yield Magenta Original Ink Cartridge (555 Yield) | 16581 | CTG | \$20.97 |
| C8732WN | HP 02XL High Yield Yellow Original Ink Cartridge (750 Yield) | 16582 | CTG | \$20.97 |
| C4844A | HP 10 Black Original Ink Cartridge (2,200 Yield) | 101114 | CTG | \$52.40 |
| C4836A | HP 11 Cyan Original Ink Cartridge (2,350 Yield) | 106998 | CTG | \$52.40 |
| C4837A | HP 11 Magenta Original Ink Cartridge (2,000 Yield) | 106999 | CTG | \$52.40 |
| C4838A | HP 11 Yellow Original Ink Cartridge (2,550 Yield) | 107000 | CTG | \$52.40 |
| C4810A | HP 11 Black Printhead | 106993 | EA | \$53.74 |
| C4811A | HP 11 Cyan Printhead | 106995 | EA | \$53.74 |
| C4812A | HP 11 Magenta Printhead | 106996 | EA | \$53.74 |
| C4813A | HP 11 Yellow Printhead | 106997 | EA | \$53.74 |
| C4814A | HP 13 Black Original Ink Cartridge (920 Yield) | 10417 | CTG | \$33.09 |
| C4815A | HP 13 Cyan Original Ink Cartridge (1,200 Yield) | 10418 | CTG | \$33.09 |
| C4816A | HP 13 Magenta Original Ink Cartridge (1,020 Yield) | 10419 | CTG | \$33.09 |
| C4817A | HP 13 Yellow Original Ink Cartridge (1,260 Yield) | 10420 | CTG | \$33.09 |
| C6615DN | HP 15 Black Original Ink Cartridge (500 Yield) | 105739 | CTG | \$47.31 |
| C6625A | HP 17 Tri-Color Original Ink Cartridge (480 Yield) | 105788 | CTG | \$51.20 |
| C6614D | HP 20 Black Original Ink Cartridge (500 Yield) | 105740 | CTG | \$50.78 |
| C9351AN | HP 21 Black Original Ink Cartridge (190 Yield) | 10354 | CTG | \$20.82 |
| C9352AN | HP 22 Tri-Color Original Ink Cartridge (165 Yield) | 10355 | CTG | \$28.02 |
| C1823D | HP 23 Tri-Color Original Ink Cartridge (620 Yield) | 103765 | CTG | \$61.45 |
| 51626A | HP 26 Black Original Ink Cartridge (790 Yield) | 20336 | CTG | \$49.60 |
| C8727AN | HP 27 Black Original Ink Cartridge (280 Yield) | 3352 | CTG | \$29.21 |
| C8728AN | HP 28 Tri-Color Original Ink Cartridge (240 Yield) | 3351 | CTG | \$36.19 |
| 51629A | HP 29 Black Original Ink Cartridge (720 Yield) | 20652 | CTG | \$49.41 |
| C9412A | HP 38 Matte Black Original Pigment Ink Cartridge (3,200 Yield - 4" x 6" Prints) | 15135 | CTG | \$41.53 |
| C9413A | HP 38 Photo Black Original Pigment Ink Cartridge (1,340 Yield - 4" x 6" Prints) | 15136 | CTG | \$41.53 |
| C9415A | HP 38 Cyan Original Pigment Ink Cartridge (4,500 Yield - 4" x 6" Prints) | 15137 | CTG | \$41.53 |
| C9416A | HP 38 Magenta Original Pigment Ink Cartridge (5,000 Yield - 4" x 6" Prints) | 15138 | CTG | \$41.53 |
| C9417A | HP 38 Yellow Original Pigment Ink Cartridge (800 Yield - 4" x 6" Prints) | 15139 | CTG | \$41.53 |

| MFG# | Product Description | Part# | UOM | Retail |
|--|---|--------|-----|----------|
| HP SUPPLIES | | | | |
| <i>HP CROSS REFERENCE GUIDE CAN BE FOUND ON PAGES 257-282.</i> | | | | |
| HP Inkjet Supplies (Continued on next page) | | | | |
| C9418A | HP 38 Light Cyan Original Pigment Ink Cartridge (1,080 Yield - 4" x 6" Prints) | 15140 | CTG | \$41.53 |
| C9419A | HP 38 Light Magenta Original Pigment Ink Cartridge (440 Yield - 4" x 6" Prints) | 15141 | CTG | \$41.53 |
| C9414A | HP 38 Light Gray Original Pigment Ink Cartridge (320 Yield - 4" x 6" Prints) | 15143 | CTG | \$41.53 |
| 51640A | HP 40 Black Original Ink Cartridge (1,100 Yield) | 20577 | CTG | \$46.56 |
| 51644C | HP 44 Cyan Original Ink Cartridge (42 ml) | 20671 | CTG | \$63.33 |
| 51644M | HP 44 Magenta Original Ink Cartridge (42 ml) | 20672 | CTG | \$63.33 |
| 51644Y | HP 44 Yellow Original Ink Cartridge (42 ml) | 20673 | CTG | \$63.33 |
| 51645A | HP 45 Black Original Ink Cartridge (930 Yield) | 20663 | CTG | \$50.06 |
| 51649A | HP 49 Tri-Color Original Ink Cartridge (350 Yield) | 20653 | CTG | \$51.34 |
| C6656AN | HP 56 Black Original Ink Cartridge (520 Yield) | 3356 | CTG | \$34.63 |
| C6657AN | HP 57 Tri-Color Original Ink Cartridge (500 Yield) | 3820 | CTG | \$54.48 |
| C6658AN | HP 58 Photo Original Ink Cartridge (140 Yield - 4" x 6" Prints) | 3355 | CTG | \$40.81 |
| CC640WN | HP 60 Black Original Ink Cartridge (200 Yield) | 104370 | CTG | \$22.06 |
| CC643WN | HP 60 Tri-Color Original Ink Cartridge (165 Yield) | 104376 | CTG | \$26.85 |
| CC641WN | HP 60XL High Yield Black Original Ink Cartridge (600 Yield) | 104375 | CTG | \$51.42 |
| CC644WN | HP 60XL High Yield Tri-Color Original Ink Cartridge (440 Yield) | 104377 | CTG | \$58.38 |
| CH561WN | HP 61 Black Original Ink Cartridge (190 Yield) | 32233 | CTG | \$19.61 |
| CH562WN | HP 61 Tri-Color Original Ink Cartridge (165 Yield) | 32234 | CTG | \$25.83 |
| CH563WN | HP 61XL High Yield Black Original Ink Cartridge (480 Yield) | 33018 | CTG | \$40.41 |
| CH564WN | HP 61XL High Yield Tri-Color Original Ink Cartridge (330 Yield) | 33042 | CTG | \$42.50 |
| C2P04AN | HP 62 Black Original Ink Cartridge (200 Yield) | 925981 | CTG | \$18.45 |
| C2P06AN | HP 62 Tri-Color Original Ink Cartridge (165 Yield) | 925983 | CTG | \$23.43 |
| C2P05AN | HP 62XL High Yield Black Original Ink Cartridge (600 Yield) | 925982 | CTG | \$44.18 |
| C2P07AN | HP 62XL High Yield Tri-Color Original Ink Cartridge (415 Yield) | 925984 | CTG | \$48.74 |
| C9448A | HP 70 Matte Black Original Ink Cartridge (130 ml) | 21809 | CTG | \$91.51 |
| C9449A | HP 70 Photo Black Original Ink Cartridge (130 ml) | 21813 | CTG | \$91.51 |
| C9452A | HP 70 Cyan Original Ink Cartridge (130 ml) | 21816 | CTG | \$91.51 |
| C9453A | HP 70 Magenta Original Ink Cartridge (130 ml) | 21819 | CTG | \$91.51 |
| C9454A | HP 70 Yellow Original Ink Cartridge (130 ml) | 21877 | CTG | \$91.51 |
| C9450A | HP 70 Gray Original Ink Cartridge (130 ml) | 21879 | CTG | \$91.51 |
| C9456A | HP 70 Red Original Ink Cartridge (130 ml) | 21926 | CTG | \$91.51 |
| C9457A | HP 70 Green Original Ink Cartridge (130 ml) | 21927 | CTG | \$91.51 |
| C9458A | HP 70 Blue Original Ink Cartridge (130 ml) | 21928 | CTG | \$91.51 |
| C9390A | HP 70 Light Cyan Original Ink Cartridge (130 ml) | 21929 | CTG | \$91.51 |
| C9455A | HP 70 Light Magenta Original Ink Cartridge (130 ml) | 21930 | CTG | \$91.51 |
| C9451A | HP 70 Light Gray Original Ink Cartridge (130 ml) | 21931 | CTG | \$91.51 |
| C9459A | HP 70 Gloss Enhancer Original Ink Cartridge (130 ml) | 21932 | CTG | \$68.36 |
| C9404A | HP 70 Matte Black/Cyan Printhead | 25028 | EA | \$77.55 |
| C9405A | HP 70 Light Cyan/Light Magenta Printhead | 25515 | EA | \$77.55 |
| C9406A | HP 70 Magenta/Yellow Printhead | 25502 | EA | \$77.55 |
| C9407A | HP 70 Photo Black/Light Gray Printhead | 25517 | EA | \$77.55 |
| C9408A | HP 70 Blue/Green Printhead | 25514 | EA | \$77.55 |
| C9409A | HP 70 Matte Black/Red Printhead | 25503 | EA | \$77.55 |
| C9410A | HP 70 Gray/Gloss Enhancer Printhead | 25518 | EA | \$77.55 |
| C9403A | HP 72 Matte Black Original Ink Cartridge (130 ml) | 92644 | CTG | \$80.49 |
| C9370A | HP 72 Photo Black Original Ink Cartridge (130 ml) | 92647 | CTG | \$80.49 |
| C9371A | HP 72 Cyan Original Ink Cartridge (130 ml) | 92648 | CTG | \$80.49 |
| C9372A | HP 72 Magenta Original Ink Cartridge (130 ml) | 92654 | CTG | \$80.49 |
| C9373A | HP 72 Yellow Original Ink Cartridge (130 ml) | 92655 | CTG | \$80.49 |
| C9374A | HP 72 Gray Original Ink Cartridge (130 ml) | 92656 | CTG | \$80.49 |
| C9397A | HP 72 Photo Black Original Ink Cartridge (69 ml) | 92657 | CTG | \$55.13 |
| C9398A | HP 72 Cyan Original Ink Cartridge (69 ml) | 92658 | CTG | \$55.13 |
| C9399A | HP 72 Magenta Original Ink Cartridge (69 ml) | 92659 | CTG | \$55.13 |
| C9400A | HP 72 Yellow Original Ink Cartridge (69 ml) | 92649 | CTG | \$55.13 |
| C9401A | HP 72 Gray Original Ink Cartridge (69 ml) | 92650 | CTG | \$55.13 |
| C9380A | HP 72 Gray/Photo Black Printhead | 92651 | EA | \$78.28 |
| C9383A | HP 72 Cyan/Magenta Printhead | 92652 | EA | \$78.28 |
| C9384A | HP 72 Matte Black/Yellow Printhead | 92653 | EA | \$78.28 |
| CB335WN | HP 74 Black Original Ink Cartridge (200 Yield) | 90212 | CTG | \$20.82 |
| CB336WN | HP 74XL High Yield Black Original Ink Cartridge (750 Yield) | 90215 | CTG | \$56.43 |
| CB337WN | HP 75 Tri-Color Original Ink Cartridge (170 Yield) | 90216 | CTG | \$26.85 |
| CB338WN | HP 75XL High Yield Tri-Color Original Ink Cartridge (520 Yield) | 90217 | CTG | \$67.06 |
| C6578DN | HP 78 Tri-Color Original Ink Cartridge (560 Yield) | 104674 | CTG | \$52.20 |
| C6578AN | HP 78XL High Yield Tri-Color Original Ink Cartridge (1,200 Yield) | 105332 | CTG | \$90.79 |
| C4871A | HP 80 Black Original Ink Cartridge (350 ml) | 103652 | CTG | \$208.39 |
| C4846A | HP 80 Cyan Original Ink Cartridge (350 ml) | 103653 | CTG | \$208.39 |
| C4847A | HP 80 Magenta Original Ink Cartridge (350 ml) | 103654 | CTG | \$208.39 |
| C4848A | HP 80 Yellow Original Ink Cartridge (350 ml) | 103655 | CTG | \$208.39 |
| C4872A | HP 80 Cyan Original Ink Cartridge (175 ml) | 103656 | CTG | \$127.72 |

Mobilize printing. Maximize security.

The MFP. Redefined by HP. New mobile-enabled HP LaserJet MFPs now let everyone in the office print from their tablet or smartphone with the security of a peer-to-peer connection. HP wireless direct and touch-to-print technology¹ make them easy to use, easy to manage, and keep mobile devices off your corporate network. Giving everyone freedom to print, it matters.



Make it matter.



HP MFP Mobile Printing Features

- Use optional wireless direct printing to simply discover and connect your mobile device to your MFP
- Walk up and touch-to-print—your NFC-enabled smartphone or tablet automatically discovers the printer for you

HP Color LaserJet Enterprise flow M880z+ NFC/Wireless direct MFP



- Comes standard with wireless direct and touch-to-print technology
- 3,500-sheet high-capacity input tray supports media up to size A3/11 x 17 inches

HP LaserJet Enterprise 700 color MFP M775f



- Save and print files directly at the printer with an easy-access USB port
- Bold text and smooth color with Pantone® matching

HP LaserJet Enterprise color flow MFP M575c



- Advanced scanning streamlines paper and digital workflows
- Secure encryption protects documents and data in transit

¹ For wireless direct printing, mobile device may require an app or print software. Wireless performance is dependent on physical environment and distance from the printer. For touch-to-print capability, the mobile device must support near field communications-enabled printing.

| MFG# | Product Description | Part# | UOM | Retail |
|--|--|--------|-----|----------|
| HP SUPPLIES | | | | |
| <i>HP CROSS REFERENCE GUIDE CAN BE FOUND ON PAGES 257-282.</i> | | | | |
| HP Inkjet Supplies <i>(Continued on next page)</i> | | | | |
| C4874A | HP 80 Magenta Original Ink Cartridge (175 ml) | 103657 | CTG | \$127.72 |
| C4873A | HP 80 Yellow Original Ink Cartridge (175 ml) | 103658 | CTG | \$127.72 |
| C4820A | HP 80 Black Printhead/Printhead Cleaner (Ink Not Included) | 103659 | EA | \$228.91 |
| C4821A | HP 80 Cyan Printhead/Printhead Cleaner (Ink Not Included) | 103660 | EA | \$228.91 |
| C4822A | HP 80 Magenta Printhead/Printhead Cleaner (Ink Not Included) | 103661 | EA | \$228.91 |
| C4823A | HP 80 Yellow Printhead/Printhead Cleaner (Ink Not Included) | 103662 | EA | \$228.91 |
| C4930A | HP 81 Black Original Dye Ink Cartridge (680 ml) (1,000 Yield) | 107214 | CTG | \$299.79 |
| C4931A | HP 81 Cyan Original Dye Ink Cartridge (680 ml) (1,000 Yield) | 107215 | CTG | \$299.79 |
| C4932A | HP 81 Magenta Original Dye Ink Cartridge (680 ml) (1,000 Yield) | 107216 | CTG | \$299.79 |
| C4933A | HP 81 Yellow Original Dye Ink Cartridge (680 ml) (1,000 Yield) | 107217 | CTG | \$299.79 |
| C4934A | HP 81 Light Cyan Original Dye Ink Cartridge (680 ml) (1,000 Yield) | 107218 | CTG | \$299.79 |
| C4935A | HP 81 Light Magenta Original Dye Ink Cartridge (680 ml) (1,000 Yield) | 107219 | CTG | \$299.79 |
| C4950A | HP 81 Black Dye Printhead/Printhead Cleaner (Ink Not Included) | 107220 | EA | \$218.51 |
| C4951A | HP 81 Cyan Dye Printhead/Printhead Cleaner (Ink Not Included) | 107221 | EA | \$218.51 |
| C4952A | HP 81 Magenta Dye Printhead/Printhead Cleaner (Ink Not Included) | 107222 | EA | \$218.51 |
| C4953A | HP 81 Yellow Dye Printhead/Printhead Cleaner (Ink Not Included) | 107223 | EA | \$218.51 |
| C4954A | HP 81 Light Cyan Dye Printhead/Printhead Cleaner (Ink Not Included) | 107224 | EA | \$218.51 |
| C4955A | HP 81 Light Magenta Dye Printhead/Printhead Cleaner (Ink Not Included) | 107225 | EA | \$218.51 |
| CH565A | HP 82 Black Original Ink Cartridge (69 ml) | 903990 | CTG | \$49.97 |
| C4911A | HP 82 Cyan Original Ink Cartridge (69 ml) | 107232 | CTG | \$55.09 |
| C4912A | HP 82 Magenta Original Ink Cartridge (69 ml) | 107233 | CTG | \$55.09 |
| C4913A | HP 82 Yellow Original Ink Cartridge (69 ml) | 107234 | CTG | \$55.09 |
| CH566A | HP 82 Cyan Original Ink Cartridge (28 ml) | 903991 | CTG | \$34.61 |
| CH567A | HP 82 Magenta Original Ink Cartridge (28 ml) | 903992 | CTG | \$34.61 |
| CH568A | HP 82 Yellow Original Ink Cartridge (28 ml) | 903993 | CTG | \$34.61 |
| C4940A | HP 83 Black Original UV Ink Cartridge (680 ml) | 20984 | CTG | \$374.74 |
| C4941A | HP 83 Cyan Original UV Ink Cartridge (680 ml) | 20985 | CTG | \$374.74 |
| C4942A | HP 83 Magenta Original UV Ink Cartridge (680 ml) | 20986 | CTG | \$374.74 |
| C4943A | HP 83 Yellow Original UV Ink Cartridge (680 ml) | 20987 | CTG | \$374.74 |
| C4944A | HP 83 Light Cyan Original UV Ink Cartridge (680 ml) | 20988 | CTG | \$374.74 |
| C4945A | HP 83 Light Magenta Original UV Ink Cartridge (680 ml) | 20989 | CTG | \$374.74 |
| C4960A | HP 83 Black UV Printhead/Printhead Cleaner (Ink Not Included) | 20990 | EA | \$218.51 |
| C4961A | HP 83 Cyan UV Printhead/Printhead Cleaner (Ink Not Included) | 20991 | EA | \$218.51 |
| C4962A | HP 83 Magenta UV Printhead/Printhead Cleaner (Ink Not Included) | 20993 | EA | \$218.51 |
| C4963A | HP 83 Yellow UV Printhead/Printhead Cleaner (Ink Not Included) | 20995 | EA | \$218.51 |
| C4964A | HP 83 Light Cyan UV Printhead/Printhead Cleaner (Ink Not Included) | 20996 | EA | \$218.51 |
| C4965A | HP 83 Light Magenta UV Printhead/Printhead Cleaner (Ink Not Included) | 20997 | EA | \$218.51 |
| C5016A | HP 84 Black Original Ink Cartridge (69 ml) | 4531 | CTG | \$54.96 |
| C5017A | HP 84 Light Cyan Original Ink Cartridge (69 ml) | 4529 | CTG | \$54.96 |
| C5018A | HP 84 Light Magenta Original Ink Cartridge (69 ml) | 4527 | CTG | \$54.96 |
| C5019A | HP 84 Black Printhead | 4526 | EA | \$50.45 |
| C9425A | HP 85 Cyan Original Ink Cartridge (28 ml) | 5514 | CTG | \$49.97 |
| C9426A | HP 85 Magenta Original Ink Cartridge (28 ml) | 5521 | CTG | \$49.97 |
| C9427A | HP 85 Yellow Original Ink Cartridge (69 ml) | 5522 | CTG | \$56.21 |
| C9428A | HP 85 Light Cyan Original Ink Cartridge (69 ml) | 5523 | CTG | \$56.21 |
| C9429A | HP 85 Light Magenta Original Ink Cartridge (69 ml) | 5524 | CTG | \$56.21 |
| C9420A | HP 85 Cyan Printhead | 5503 | EA | \$55.04 |
| C9421A | HP 85 Magenta Printhead | 5504 | EA | \$55.04 |
| C9422A | HP 85 Yellow Printhead | 5505 | EA | \$55.04 |
| C9423A | HP 85 Light Cyan Printhead | 5507 | EA | \$55.04 |
| C9424A | HP 85 Light Magenta Printhead | 5513 | EA | \$55.04 |
| C9385AN | HP 88 Black Original Ink Cartridge (850 Yield) | 11989 | CTG | \$30.66 |
| C9386AN | HP 88 Cyan Original Ink Cartridge (860 Yield) | 11990 | CTG | \$22.73 |
| C9387AN | HP 88 Magenta Original Ink Cartridge (1,000 Yield) | 11993 | CTG | \$22.73 |
| C9388AN | HP 88 Yellow Original Ink Cartridge (860 Yield) | 11994 | CTG | \$22.73 |
| C9396AN | HP 88XL High Yield Black Original Ink Cartridge (2,450 Yield) | 11995 | CTG | \$62.39 |
| C9391AN | HP 88XL High Yield Cyan Original Ink Cartridge (1,700 Yield) | 11996 | CTG | \$35.41 |
| C9392AN | HP 88XL High Yield Magenta Original Ink Cartridge (1,980 Yield) | 11997 | CTG | \$35.41 |
| C9393AN | HP 88XL High Yield Yellow Original Ink Cartridge (1,540 Yield) | 11998 | CTG | \$35.41 |
| C9381A | HP 88 Black/Yellow Printhead | 11987 | EA | \$97.77 |
| C9382A | HP 88 Cyan/Magenta Printhead | 11988 | EA | \$97.77 |
| C5058A | HP 90 Black Original Ink Cartridge (400 ml) | 6141 | CTG | \$208.67 |
| C5059A | HP 90 Black Original Ink Cartridge (775 ml) | 6148 | CTG | \$357.71 |
| C5061A | HP 90 Cyan Original Ink Cartridge (400 ml) | 6143 | CTG | \$232.51 |
| C5063A | HP 90 Magenta Original Ink Cartridge (400 ml) | 6144 | CTG | \$232.51 |
| C5065A | HP 90 Yellow Original Ink Cartridge (400 ml) | 6145 | CTG | \$232.51 |
| C5054A | HP 90 Black Printhead/Printhead Cleaner (Ink Not Included) | 6137 | EA | \$208.11 |
| C5055A | HP 90 Cyan Printhead/Printhead Cleaner (Ink Not Included) | 6138 | EA | \$208.11 |
| C5056A | HP 90 Magenta Printhead/Printhead Cleaner (Ink Not Included) | 6139 | EA | \$208.11 |

| MFG# | Product Description | Part# | UOM | Retail |
|--|---|--------|-----|----------|
| HP SUPPLIES | | | | |
| <i>HP CROSS REFERENCE GUIDE CAN BE FOUND ON PAGES 257-282.</i> | | | | |
| HP Inkjet Supplies (Continued on next page) | | | | |
| C5057A | HP 90 Yellow Printhead/Printhead Cleaner (Ink Not Included) | 6140 | EA | \$208.11 |
| C9464A | HP 91 Matte Black Original Pigment Ink Cartridge (775 ml) | 92467 | CTG | \$335.27 |
| C9465A | HP 91 Photo Black Original Pigment Ink Cartridge (775 ml) | 92469 | CTG | \$335.27 |
| C9467A | HP 91 Cyan Original Pigment Ink Cartridge (775 ml) | 92472 | CTG | \$335.27 |
| C9468A | HP 91 Magenta Original Pigment Ink Cartridge (775 ml) | 92473 | CTG | \$335.27 |
| C9469A | HP 91 Yellow Original Pigment Ink Cartridge (775 ml) | 92474 | CTG | \$335.27 |
| C9470A | HP 91 Light Cyan Original Pigment Ink Cartridge (775 ml) | 92476 | CTG | \$335.27 |
| C9471A | HP 91 Light Magenta Original Pigment Ink Cartridge (775 ml) | 92478 | CTG | \$335.27 |
| C9466A | HP 91 Light Gray Original Pigment Ink Cartridge (775 ml) | 92479 | CTG | \$335.27 |
| C9460A | HP 91 Matte Black/Cyan Printhead | 92491 | EA | \$180.18 |
| C9461A | HP 91 Magenta/Yellow Printhead | 92516 | EA | \$180.18 |
| C9462A | HP 91 Light Magenta/Light Cyan Printhead | 92517 | EA | \$180.18 |
| C9463A | HP 91 Photo Black/Light Gray Printhead | 92518 | EA | \$180.18 |
| C9518A | HP 91 Maintenance Cartridge | 92519 | CTG | \$92.82 |
| C9362WN | HP 92 Black Original Ink Cartridge (220 Yield) | 10481 | CTG | \$20.82 |
| C9361WN | HP 93 Tri-Color Original Ink Cartridge (220 Yield) | 10482 | CTG | \$33.85 |
| C8765WN | HP 94 Black Original Ink Cartridge (480 Yield) | 5774 | CTG | \$34.63 |
| C8766WN | HP 95 Tri-Color Original Ink Cartridge (330 Yield) | 5778 | CTG | \$39.70 |
| C8767WN | HP 96 Black Original Ink Cartridge (860 Yield) | 5779 | CTG | \$48.93 |
| C9363WN | HP 97 Tri-Color Original Ink Cartridge (560 Yield) | 5780 | CTG | \$54.48 |
| C9364WN | HP 98 Black Original Ink Cartridge (420 Yield) | 10969 | CTG | \$34.63 |
| C9369WN | HP 99 Photo Original Ink Cartridge (130 Yield - 4" x 6" Prints) | 5782 | CTG | \$40.81 |
| CB304AN | HP 110 Tri-Color Original Ink Cartridge (55 Yield - 4" x 6" Prints) | 15175 | CTG | \$31.79 |
| CB316WN | HP 564 Black Original Ink Cartridge (250 Yield) | 900679 | CTG | \$16.68 |
| CB317WN | HP 564 Photo Original Ink Cartridge (130 Yield - 4" x 6" Photos) | 900680 | CTG | \$13.69 |
| CB318WN | HP 564 Cyan Original Ink Cartridge (300 Yield) | 900681 | CTG | \$13.69 |
| CB319WN | HP 564 Magenta Original Ink Cartridge (300 Yield) | 900682 | CTG | \$13.69 |
| CB320WN | HP 564 Yellow Original Ink Cartridge (300 Yield) | 900683 | CTG | \$13.69 |
| CN684WN | HP 564XL High Yield Black Original Ink Cartridge (550 Yield) | 95614 | CTG | \$31.35 |
| CB322WN | HP 564XL High Yield Photo Original Ink Cartridge (290 Yield - 4" x 6" Photos) | 900685 | CTG | \$26.09 |
| CB323WN | HP 564XL High Yield Cyan Original Ink Cartridge (750 Yield) | 900686 | CTG | \$26.09 |
| CB324WN | HP 564XL High Yield Magenta Original Ink Cartridge (750 Yield) | 900687 | CTG | \$26.09 |
| CB325WN | HP 564XL High Yield Yellow Original Ink Cartridge (750 Yield) | 900688 | CTG | \$26.09 |
| CC635A | HP 701 Black Original Ink Cartridge (895 Yield) | 93506 | CTG | \$48.86 |
| CZ129A | HP 711 Black Original Ink Cartridge (38 ml) | 909102 | CTG | \$38.00 |
| CZ133A | HP 711 Black Original Ink Cartridge (80 ml) | 909106 | CTG | \$61.60 |
| CZ130A | HP 711 Cyan Original Ink Cartridge (29 ml) | 909103 | CTG | \$31.61 |
| CZ131A | HP 711 Magenta Original Ink Cartridge (29 ml) | 909104 | CTG | \$31.61 |
| CZ132A | HP 711 Yellow Original Ink Cartridge (29 ml) | 909105 | CTG | \$31.61 |
| CH575A | HP 726 Matte Black Original Ink Cartridge (300 ml) | 19039 | CTG | \$178.50 |
| B3P19A | HP 727 Cyan Original Ink Cartridge (130 ml) | 913606 | CTG | \$80.49 |
| B3P20A | HP 727 Magenta Original Ink Cartridge (130 ml) | 913607 | CTG | \$80.49 |
| B3P21A | HP 727 Yellow Original Ink Cartridge (130 ml) | 913608 | CTG | \$80.49 |
| B3P23A | HP 727 Photo Black Original Ink Cartridge (130 ml) | 913610 | CTG | \$80.49 |
| B3P24A | HP 727 Gray Original Ink Cartridge (130 ml) | 913611 | CTG | \$80.49 |
| C1Q12A | HP 727 Matte Black Original Ink Cartridge (300 ml) | 915005 | CTG | \$178.50 |
| CM991A | HP 761 Matte Black Original Ink Cartridge (400 ml) | 93356 | CTG | \$183.75 |
| CM997A | HP 761 Matte Black Original Ink Cartridge (775 ml) | 93368 | CTG | \$315.00 |
| CM994A | HP 761 Cyan Original Ink Cartridge (400 ml) | 93360 | CTG | \$204.75 |
| CM993A | HP 761 Magenta Original Ink Cartridge (400 ml) | 93359 | CTG | \$204.75 |
| CM992A | HP 761 Yellow Original Ink Cartridge (400 ml) | 93357 | CTG | \$204.75 |
| CM995A | HP 761 Gray Original Ink Cartridge (400 ml) | 93366 | CTG | \$204.75 |
| CM996A | HP 761 Dark Gray Original Ink Cartridge (400 ml) | 93367 | CTG | \$204.75 |
| CH648A | HP 761 Matte Black/Matte Black Printhead | 93380 | EA | \$173.25 |
| CH646A | HP 761 Magenta/Cyan Printhead | 93370 | EA | \$173.25 |
| CH645A | HP 761 Yellow Printhead | 93369 | EA | \$173.25 |
| CH647A | HP 761 Gray/Dark Gray Printhead | 93371 | EA | \$173.25 |
| CH649A | HP 761 Maintenance Cartridge | 93381 | EA | \$89.25 |
| CE017A | HP 771 Matte Black/Chromatic Red Printhead | 93443 | EA | \$173.25 |
| CE018A | HP 771 Magenta/Yellow Printhead | 93444 | EA | \$173.25 |
| CE019A | HP 771 Light Magenta/Light Cyan Printhead | 93445 | EA | \$173.25 |
| CE020A | HP 771 Photo Black/Light Gray Printhead | 93446 | EA | \$173.25 |
| B6Y15A | HP 771A Matte Black Original Ink Cartridge (775 ml) | 913425 | CTG | \$374.33 |
| B6Y16A | HP 771A Chromatic Red Original Ink Cartridge (775 ml) | 913426 | CTG | \$374.33 |
| B6Y17A | HP 771A Magenta Original Ink Cartridge (775 ml) | 913427 | CTG | \$374.33 |
| B6Y18A | HP 771A Yellow Original Ink Cartridge (775 ml) | 913428 | CTG | \$374.33 |
| B6Y19A | HP 771A Light Magenta Original Ink Cartridge (775 ml) | 913429 | CTG | \$374.33 |
| B6Y20A | HP 771A Light Cyan Original Ink Cartridge (775 ml) | 913430 | CTG | \$374.33 |
| B6Y21A | HP 771A Photo Black Original Ink Cartridge (775 ml) | 913431 | CTG | \$374.33 |

| MFG# | Product Description | Part# | UOM | Retail |
|--|--|--------|-----|----------|
| HP SUPPLIES | | | | |
| <i>HP CROSS REFERENCE GUIDE CAN BE FOUND ON PAGES 257-282.</i> | | | | |
| HP Inkjet Supplies (Continued on next page) | | | | |
| B6Y22A | HP 771A Light Gray Original Ink Cartridge (775 ml) | 913432 | CTG | \$374.33 |
| CH644A | HP 771 Maintenance Cartridge | 93447 | EA | \$89.25 |
| CN635A | HP 772 Matte Black Original Ink Cartridge (300 ml) | 31207 | CTG | \$154.00 |
| CN633A | HP 772 Photo Black Original Ink Cartridge (300 ml) | 31205 | CTG | \$154.00 |
| CN636A | HP 772 Cyan Original Ink Cartridge (300 ml) | 31208 | CTG | \$154.00 |
| CN629A | HP 772 Magenta Original Ink Cartridge (300 ml) | 31201 | CTG | \$154.00 |
| CN630A | HP 772 Yellow Original Ink Cartridge (300 ml) | 31202 | CTG | \$154.00 |
| CN632A | HP 772 Light Cyan Original Ink Cartridge (300 ml) | 31204 | CTG | \$154.00 |
| CN631A | HP 772 Light Magenta Original Ink Cartridge (300 ml) | 31203 | CTG | \$154.00 |
| CN634A | HP 772 Light Gray Original Ink Cartridge (300 ml) | 31209 | CTG | \$154.00 |
| C1Q20A | HP 773 Matte Black/Cyan Printhead | 923160 | EA | \$173.00 |
| CC653AN | HP 901 Black Original Ink Cartridge (200 Yield) | 104378 | CTG | \$19.60 |
| CC656AN | HP 901 Tri-Color Original Ink Cartridge (360 Yield) | 104381 | CTG | \$35.00 |
| CC654AN | HP 901XL High Yield Black Original Ink Cartridge (700 Yield) | 104379 | CTG | \$48.91 |
| CD971AN | HP 920 Black Original Ink Cartridge (420 Yield) | 904726 | CTG | \$25.85 |
| CH634AN | HP 920 Cyan Original Ink Cartridge (300 Yield) | 904727 | CTG | \$11.70 |
| CH635AN | HP 920 Magenta Original Ink Cartridge (300 Yield) | 904728 | CTG | \$11.70 |
| CH636AN | HP 920 Yellow Original Ink Cartridge (300 Yield) | 904729 | CTG | \$11.70 |
| CD975AN | HP 920XL High Yield Black Original Ink Cartridge (1,200 Yield) | 904730 | CTG | \$44.19 |
| CD972AN | HP 920XL High Yield Cyan Original Ink Cartridge (700 Yield) | 904731 | CTG | \$19.98 |
| CD973AN | HP 920XL High Yield Magenta Original Ink Cartridge (700 Yield) | 904732 | CTG | \$19.98 |
| CD974AN | HP 920XL High Yield Yellow Original Ink Cartridge (700 Yield) | 904733 | CTG | \$19.98 |
| CN057AN | HP 932 Black Original Ink Cartridge (400 Yield) | 800650 | CTG | \$24.61 |
| CN053AN | HP 932XL High Yield Black Original Ink Cartridge (1,000 Yield) | 800655 | CTG | \$40.39 |
| CN058AN | HP 933 Cyan Original Ink Cartridge (330 Yield) | 800651 | CTG | \$12.88 |
| CN059AN | HP 933 Magenta Original Ink Cartridge (330 Yield) | 800652 | CTG | \$12.88 |
| CN060AN | HP 933 Yellow Original Ink Cartridge (330 Yield) | 800653 | CTG | \$12.88 |
| CN054AN | HP 933XL High Yield Cyan Original Ink Cartridge (825 Yield) | 800656 | CTG | \$19.99 |
| CN055AN | HP 933XL High Yield Magenta Original Ink Cartridge (825 Yield) | 800657 | CTG | \$19.99 |
| CN056AN | HP 933XL High Yield Yellow Original Ink Cartridge (825 Yield) | 800658 | CTG | \$19.99 |
| C2P19AN | HP 934 Black Original Ink Cartridge (400 Yield) | 926195 | CTG | \$20.92 |
| C2P23AN | HP 934XL High Yield Black Original Ink Cartridge (1,000 Yield) | 926199 | CTG | \$37.87 |
| C2P20AN | HP 935 Cyan Original Ink Cartridge (400 Yield) | 926196 | CTG | \$15.32 |
| C2P21AN | HP 935 Magenta Original Ink Cartridge (400 Yield) | 926197 | CTG | \$15.32 |
| C2P22AN | HP 935 Yellow Original Ink Cartridge (400 Yield) | 926198 | CTG | \$15.32 |
| C2P24AN | HP 935XL High Yield Cyan Original Ink Cartridge (825 Yield) | 926200 | CTG | \$23.74 |
| C2P25AN | HP 935XL High Yield Magenta Original Ink Cartridge (825 Yield) | 926201 | CTG | \$23.74 |
| C2P26AN | HP 935XL High Yield Yellow Original Ink Cartridge (825 Yield) | 926202 | CTG | \$23.74 |
| C4902AN | HP 940 Black Original Ink Cartridge (1,000 Yield) | 904734 | CTG | \$32.35 |
| C4903AN | HP 940 Cyan Original Ink Cartridge (900 Yield) | 904739 | CTG | \$23.94 |
| C4904AN | HP 940 Magenta Original Ink Cartridge (900 Yield) | 904740 | CTG | \$23.94 |
| C4905AN | HP 940 Yellow Original Ink Cartridge (900 Yield) | 904741 | CTG | \$23.94 |
| C4906AN | HP 940XL High Yield Black Original Ink Cartridge (2,200 Yield) | 904735 | CTG | \$49.24 |
| C4907AN | HP 940XL High Yield Cyan Original Ink Cartridge (1,400 Yield) | 904736 | CTG | \$32.81 |
| C4908AN | HP 940XL High Yield Magenta Original Ink Cartridge (1,400 Yield) | 904737 | CTG | \$32.81 |
| C4909AN | HP 940XL High Yield Yellow Original Ink Cartridge (1,400 Yield) | 904738 | CTG | \$32.81 |
| C4900A | HP 940 Black/Yellow Printhead | 904742 | EA | \$74.74 |
| C4901A | HP 940 Cyan/Magenta Printhead | 904743 | EA | \$74.74 |
| CN049AN | HP 950 Black Original Ink Cartridge (1,000 Yield) | 107967 | CTG | \$32.37 |
| CN045AN | HP 950XL High Yield Black Original Ink Cartridge (2,300 Yield) | 108022 | CTG | \$46.70 |
| CN050AN | HP 951 Cyan Original Ink Cartridge (700 Yield) | 107968 | CTG | \$22.80 |
| CN051AN | HP 951 Magenta Original Ink Cartridge, (700 Yield) | 107981 | CTG | \$22.80 |
| CN052AN | HP 951 Yellow Original Ink Cartridge (700 Yield) | 108020 | CTG | \$22.80 |
| CN046AN | HP 951XL High Yield Cyan Original Ink Cartridge (1,500 Yield) | 108023 | CTG | \$34.99 |
| CN047AN | HP 951XL High Yield Magenta Original Ink Cartridge (1,500 Yield) | 108024 | CTG | \$34.99 |
| CN048AN | HP 951XL High Yield Yellow Original Ink Cartridge (1,500 Yield) | 108025 | CTG | \$34.99 |
| CN621AM | HP 970 Black Original Ink Cartridge (3,000 Yield) | 910947 | CTG | \$90.54 |
| CN625AM | HP 970XL High Yield Black Original Ink Cartridge (9,200 Yield) | 910951 | CTG | \$144.87 |
| CN625AM#201 | HP 970XL High Yield Black Original Ink Cartridge for US Government (9,200 Yield) (TAA Compliant Version of CN625AM) | 930135 | CTG | \$144.87 |
| CN622AM | HP 971 Cyan Original Ink Cartridge (2,500 Yield) | 910948 | CTG | \$94.42 |
| CN623AM | HP 971 Magenta Original Ink Cartridge (2,500 Yield) | 910949 | CTG | \$94.42 |
| CN624AM | HP 971 Yellow Original Ink Cartridge (2,500 Yield) | 910950 | CTG | \$94.42 |
| CN626AM | HP 971XL High Yield Cyan Original Ink Cartridge (6,600 Yield) | 910952 | CTG | \$143.43 |
| CN627AM | HP 971XL High Yield Magenta Original Ink Cartridge (6,600 Yield) | 910953 | CTG | \$143.43 |
| CN628AM | HP 971XL High Yield Yellow Original Ink Cartridge (6,600 Yield) | 910954 | CTG | \$143.43 |
| CN626AM#201 | HP 971XL High Yield Cyan Original Ink Cartridge for US Government (6,600 Yield) (TAA Compliant Version of CN626AM) | 930136 | CTG | \$143.43 |

| MFG# | Product Description | Part# | UOM | Retail |
|---|---|--------|-----|----------|
| HP SUPPLIES | | | | |
| <i>HP CROSS REFERENCE GUIDE CAN BE FOUND ON PAGES 257-282.</i> | | | | |
| HP Inkjet Supplies (Continued) | | | | |
| CN627AM#201 | HP 971XL High Yield Magenta Original Ink Cartridge for US Government (6,600 Yield) (TAA Compliant Version of CN627AM) | 930137 | CTG | \$143.43 |
| CN628AM#201 | HP 971XL High Yield Yellow Original Ink Cartridge for US Government (6,600 Yield) (TAA Compliant Version of CN628AM) | 930138 | CTG | \$143.43 |
| D8J10A | HP 980 Black Original Ink Cartridge (10,000 Yield) | 920251 | CTG | \$148.50 |
| D8J07A | HP 980 Cyan Original Ink Cartridge (6,600 Yield) | 920248 | CTG | \$127.30 |
| D8J08A | HP 980 Magenta Original Ink Cartridge (6,600 Yield) | 920249 | CTG | \$127.30 |
| D8J09A | HP 980 Yellow Original Ink Cartridge (6,600 Yield) | 920250 | CTG | \$127.30 |
| D8J10AG | HP 980 Black Original Ink Cartridge for US Government (10,000 Yield) (TAA Compliant Version of D8J10A) | 928708 | CTG | \$148.50 |
| D8J07AG | HP 980 Cyan Original Ink Cartridge for US Government (6,600 Yield) (TAA Compliant Version of D8J07A) | 928705 | CTG | \$127.30 |
| D8J08AG | HP 980 Magenta Original Ink Cartridge for US Government (6,600 Yield) (TAA Compliant Version of D8J08A) | 928706 | CTG | \$127.30 |
| D8J09AG | HP 980 Yellow Original Ink Cartridge for US Government (6,600 Yield) (TAA Compliant Version of D8J09A) | 928707 | CTG | \$127.30 |
| HP Specialty Print Services Inkjet Supplies | | | | |
| C6602B | HP Addmaster IJ 6000 Blue Original Ink Cartridge (7M Characters) | 1957 | CTG | \$21.95 |
| C6602G | HP Addmaster IJ 6000 Green Original Ink Cartridge (7M Characters) | 1955 | CTG | \$21.95 |
| C6195A | (TIJ 2.5) HP 51645A Disposable Fast Dry Print Cartridge, Black (Generic Packaged) | 15768 | CTG | \$35.27 |
| C6168A | (TIJ 2.5) HP 51645A Disposable Spot Color Print Cartridge, Red (Generic Packaged) | 15764 | CTG | \$40.48 |
| C6170A | (TIJ 2.5) HP 51645A Disposable Spot Color Print Cartridge, Blue (Generic Packaged) | 15766 | CTG | \$33.44 |
| C6173A | (TIJ 2.5) HP 51645A Disposable Spot Color Print Cartridge, Yellow (Generic Packaged) | 15767 | CTG | \$40.48 |
| C8842A | (TIJ 2.5) HP 51645A Versatile Print Cartridge, Black (Generic Packaged) | 15779 | CTG | \$35.27 |
| C6119A | (TIJ 2.5/TIJ 2.5 Hybrid) HP 51645A Bulk Inkjet System, Black (Generic Packaged) | 15759 | CTG | \$129.93 |
| Q2344A | (TIJ 2.5) HP 1918 Dye Print Cartridge, Black | 15848 | CTG | \$35.27 |
| Q2392A | (TIJ 2.5) HP 2560 Pigment Ink, Black (40 ml) | 100177 | CTG | \$41.34 |
| Q7457A | (TIJ 2.5 Hybrid) HP 4500 Pigment Bulk Ink Supply, Black (350 ml) | 15854 | CTG | \$78.21 |
| Q2321A | (TIJ 2.5 Hybrid) HP Versatile Bulk Ink Cartridge, Black (350 ml) | 15843 | CTG | \$78.21 |
| CQ849A | (TIJ 2.5) HP Durable Ink Cartridge, Black (40 ml) | 93235 | CTG | \$38.82 |
| C6128A | (TIJ 2.5) HP Print Cartridge, Non-Fluorescent Red | 15847 | CTG | \$33.44 |
| HP LaserJet 4/4+/4M/4M+/5/5M/5N/5se Series Supplies | | | | |
| 92298A | HP 98A Black Original LaserJet Toner Cartridge (6,800 Yield) (EX) | 20106 | CTG | \$213.63 |
| HP LaserJet 5P/5MP/6MP/6P/6P se/6Pxi Series Supplies | | | | |
| C3903A | HP 03A Black Original LaserJet Toner Cartridge (4,000 Yield) (VX) | 20649 | CTG | \$165.31 |
| HP LaserJet 1000/1200/1220/3300 MFP/3310/3320 MFP/3330 MFP/3380 Series Supplies | | | | |
| C7115A | HP 15A Black Original LaserJet Toner Cartridge (2,500 Yield) | 107935 | CTG | \$119.00 |
| C7115X | HP 15X High Yield Black Original LaserJet Toner Cartridge (3,500 Yield) (For Use In Models 1200/1220/3300/3310/3320/3330/3380) | 108157 | CTG | \$129.79 |
| C7115AG | HP 15A Black Original LaserJet Toner Cartridge for US Government (2,500 Yield) (TAA Compliant Version of C7115A) | 103494 | CTG | \$112.26 |
| RM1-0550 | HP Transfer Roller | 7621 | EA | \$13.70 |
| HP LaserJet 1012/1018/1020/1022/3015/3020/3030/3050/3052/3055/M1319f MFP Series Supplies | | | | |
| Q2612A | HP 12A Black Original LaserJet Toner Cartridge (2,000 Yield) | 1309 | CTG | \$107.95 |
| Q2612AG | HP 12A Black Original LaserJet Toner Cartridge for US Government (2,000 Yield) (TAA Compliant Version of Q2612A) | 33249 | CTG | \$101.84 |
| Q2612D | HP 12A 2-Pack Black Original LaserJet Toner Cartridges (2 Pack of OEM# Q2612A) (2 x 2,000 Yield) | 100001 | PK | \$193.23 |
| RM1-2049 | HP Fusing Assembly (110-127V) (For Use in Model 1022) | 100458 | EA | \$104.50 |
| RM1-0865 | HP Fusing Assembly (110-127V) (For Use in Models 3015/3020/3030) | 7657 | EA | \$125.23 |
| RM1-3044 | HP Fusing Assembly (110-127V) (For Use in Models 3050/3052/3055) | 7658 | EA | \$114.95 |
| HP LaserJet 1100/3200 Series Supplies | | | | |
| C4092A | HP 92A Black Original LaserJet Toner Cartridge (2,500 Yield) | 102512 | CTG | \$120.58 |
| RG5-4589 | HP Fuser Assembly (100-127V) | 97913 | EA | \$59.00 |
| HP LaserJet 1150 Supplies | | | | |
| Q2624A | HP 24A Black Original LaserJet Toner Cartridge (2,500 Yield) | 1835 | CTG | \$120.99 |
| RM1-0550 | HP Transfer Roller | 7621 | EA | \$13.70 |

| MFG# | Product Description | Part# | UOM | Retail |
|--|--|--------|-----|----------|
| HP SUPPLIES | | | | |
| <i>HP CROSS REFERENCE GUIDE CAN BE FOUND ON PAGES 257-282.</i> | | | | |
| HP LaserJet 1160/1320/3390 AIO Series Supplies | | | | |
| Q5949A | HP 49A Black Original LaserJet Toner Cartridge (2,500 Yield) | 5825 | CTG | \$139.56 |
| Q5949AG | HP 49A Black Original LaserJet Toner Cartridge for US Government (2,500 Yield) (TAA Compliant Version of Q5949A) | 904892 | CTG | \$131.66 |
| Q5949X | HP 49X High Yield Black Original LaserJet Toner Cartridge (6,000 Yield) (For Use in Models 1320/3390) | 5826 | CTG | \$255.33 |
| Q5949XG | HP 49X High Yield Black Original LaserJet Toner Cartridge for US Government (6,000 Yield) (For Use in Models 1320/3390) (TAA Compliant Version of Q5949X) | 904893 | CTG | \$240.88 |
| Q5949XD | HP 49X 2-Pack High Yield Black Original LaserJet Toner Cartridges (2 Pack of OEM# Q5949X) (2 x 6,000 Yield) (For Use in Models 1320/3390) | 92268 | PK | \$460.57 |
| RM1-1289 | HP Fusing Assembly (110-127V) | 96330 | EA | \$123.50 |
| RM1-1471 | HP Transfer Roller Assembly | 905164 | EA | \$18.08 |
| HP LaserJet 1300 Series Supplies | | | | |
| Q2613A | HP 13A Black Original LaserJet Toner Cartridge (2,500 Yield) | 2160 | CTG | \$139.56 |
| Q2613X | HP 13X High Yield Black Original LaserJet Toner Cartridge (4,000 Yield) | 2159 | CTG | \$172.80 |
| Q2613XG | HP 13X High Yield Black Original LaserJet Toner Cartridge for US Government (4,000 Yield) (TAA Compliant Version of Q2613X) | 33251 | CTG | \$163.02 |
| RM1-0550 | HP Transfer Roller | 7621 | EA | \$13.70 |
| HP LaserJet 2100/2200 Series Supplies | | | | |
| C4096A | HP 96A Black Original LaserJet Toner Cartridge (5,000 Yield) | 103504 | CTG | \$195.63 |
| RG5-5581 | HP Transfer Roller Assembly (Includes Left Side Bushing) (For Use in Model 2200) | 901795 | EA | \$19.50 |
| HP LaserJet 2300 Series Supplies | | | | |
| Q2610A | HP 10A Black Original LaserJet Toner Cartridge (6,000 Yield) | 2158 | CTG | \$235.08 |
| Q2610D | HP 10A 2-Pack Black Original LaserJet Toner Cartridges (2 Pack of OEM# Q2610A) (2 x 6,000 Yield) | 1286 | PK | \$420.81 |
| RM1-0354 | HP Fusing Roller Assembly (110V) | 97904 | EA | \$317.30 |
| HP LaserJet 2420/2430 Series Supplies | | | | |
| Q6511A | HP 11A Black Original LaserJet Toner Cartridge (6,000 Yield) | 5830 | CTG | \$210.13 |
| Q6511X | HP 11X High Yield Black Original LaserJet Toner Cartridge (12,000 Yield) | 5831 | CTG | \$352.85 |
| H3980 | HP Maintenance Kit (110V) (Includes Fusing Roller, Transfer Roller, Tray 1 Pickup Roller, Tray 2 Separation Pad and Pickup Roller, Gloves) | 24526 | KIT | \$308.60 |
| RM1-1535 | HP Fuser Assembly (110V) | 96323 | EA | \$344.85 |
| RM1-1508 | HP Transfer Roller Assembly (Includes Right Side Bushing and Tension Spring) | 905156 | EA | \$22.00 |
| HP LaserJet 4000/4050 Series Supplies | | | | |
| C4127X | HP 27X High Yield Black Original LaserJet Toner Cartridge (10,000 Yield) | 99467 | CTG | \$248.79 |
| C4118 | HP Maintenance Kit (110V) (Includes Fuser Assembly, Transfer Roller, 6 Pickup/Separation Rollers, MP Tray/Tray 1 Pickup Roller, Vinyl Gloves, Instruction Manual) (200,000 Yield) | 107603 | KIT | \$332.50 |
| RG5-4283 | HP Transfer Roller Assembly | 901735 | EA | \$37.05 |
| HP LaserJet 4100/4100 MFP Series Supplies | | | | |
| C8061X | HP 61X High Yield Black Original LaserJet Toner Cartridge (10,000 Yield) | 107934 | CTG | \$248.79 |
| C8057A | HP Maintenance Kit (110V) (Contains Fusing Assembly, Transfer Roller, Tool To Remove Transfer Roller, Tray 1 Pickup Roller, 3 Feed Rollers, 3 Separation Rollers) (200,000 Yield) | 4744 | KIT | \$391.25 |
| RG5-5063 | HP Fusing Assembly (110V) | 1728 | EA | \$259.35 |
| RG5-5068 | HP Fusing Roller (110V) (Includes Heating Element and Film Sleeve) | 901800 | EA | \$144.40 |
| RG5-5295 | HP Transfer Roller Assembly | 901794 | EA | \$23.75 |
| C9148-67909 | HP ADF Preventative Maintenance Kit | 15044 | KIT | \$125.00 |
| HP LaserJet 4200 Series Supplies | | | | |
| Q1338A | HP 38A Black Original LaserJet Toner Cartridge (12,000 Yield) | 2694 | CTG | \$260.62 |
| Q1338AG | HP 38A Black Original LaserJet Toner Cartridge for US Government (12,000 Yield) (TAA Compliant Version of Q1338A) | 90112 | CTG | \$223.52 |
| Q1338D | HP 38A 2-Pack Black Original LaserJet Toner Cartridges (2 Pack of OEM# Q1338A) (2 x 12,000 Yield) | 11922 | PK | \$468.70 |
| Q3216A | HP Staple Cartridge (1,000 Yield) | 2130 | EA | \$27.72 |
| Q2429 | HP Maintenance Kit (120V) (Includes Fusing Assembly, Separation Roller, Transfer Roller, Feed Roller for Tray 1, Two Feed Rollers for 500 Sheet Tray, Feed Roller for 1,500 Sheet Tray, Installation Instructions) | 901704 | KIT | \$276.00 |
| RM1-0013 | HP Fuser Assembly (110V) (200,000 Yield) | 5639 | EA | \$282.15 |
| HP LaserJet 4240n/4250/4350 Series Supplies <i>(Continued on next page)</i> | | | | |
| Q5942A | HP 42A Black Original LaserJet Toner Cartridge (10,000 Yield) | 5828 | CTG | \$252.75 |
| Q5942X | HP 42X High Yield Black Original LaserJet Toner Cartridge (20,000 Yield) (For Use in Models 4250/4350) | 5829 | CTG | \$382.45 |

| MFG# | Product Description | Part# | UOM | Retail |
|--|---|--------|-----|----------|
| HP SUPPLIES | | | | |
| <i>HP CROSS REFERENCE GUIDE CAN BE FOUND ON PAGES 257-282.</i> | | | | |
| HP LaserJet 4240n/4250/4350 Series Supplies (Continued) | | | | |
| Q5942XD | HP 42X 2-Pack High Yield Black Original LaserJet Toner Cartridges (2 Pack of OEM# Q5942X) (2 x 20,000 Yield) (For Use in Models 4250/4350) | 92267 | PK | \$688.97 |
| Q5421 | HP Maintenance Kit (110V) (Includes Fuser Assembly, Separation Roller, Transfer Roller, Feed Roller and Pickup Roller for Tray 1, Two Feed Rollers for 500-Sheet Tray, Installation Instructions, Gloves) (225,000 Yield) | 901707 | KIT | \$382.80 |
| RM1-1082 | HP Fusing Assembly (110V) | 97911 | EA | \$333.45 |
| RM1-1110 | HP Transfer Roller Assembly | 901806 | EA | \$33.25 |
| HP LaserJet 4300 Series Supplies | | | | |
| Q1339A | HP 39A Black Original LaserJet Toner Cartridge (18,000 Yield) | 2695 | CTG | \$345.08 |
| Q1339AG | HP 39A Black Original LaserJet Toner Cartridge for US Government (18,000 Yield) (TAA Compliant Version of Q1339A) | 90113 | CTG | \$295.95 |
| Q3216A | HP Staple Cartridge (1,000 Yield) | 2130 | EA | \$27.72 |
| Q2436A | HP LaserJet Maintenance Kit (110V) (Contains Fusing Assembly, Separation Roller, Transfer Roller, Feed Roller for Tray 1, 2 Feed Rollers for 500-Sheet Tray, 1 Feed Roller for 1,500-Sheet Tray, Instructions) (200,000 Yield) | 2565 | KIT | \$412.43 |
| RM1-0101-300CN | HP Fuser Assembly (110V) | 97906 | EA | \$340.00 |
| HP LaserJet 4345 MFP/M4345 MFP Series Supplies | | | | |
| Q5945A | HP 45A Black Original LaserJet Toner Cartridge (18,000 Yield) | 6025 | CTG | \$345.08 |
| Q5945AG | HP 45A Black Original LaserJet Toner Cartridge for US Government (18,000 Yield) (TAA Compliant Version of Q5945A) | 90114 | CTG | \$295.95 |
| Q5998 | HP Maintenance Kit (110V) (Includes Fusing Assembly, Separation Rollers, Transfer Roller, Paper Feed Rollers, Pickup Roller, Gloves, Instruction Manual) (225,000 Yield) | 15105 | KIT | \$332.16 |
| Q5997-67901 | HP ADF Maintenance Kit (Includes ADF Paper Pickup Roller Assembly, Separation Pad Assembly, 3 Clear Mylar Replacement Strips) | 30624 | KIT | \$96.30 |
| RM1-1043 | HP Fusing Assembly (100-127V) | 900843 | EA | \$343.90 |
| RM1-1110 | HP Transfer Roller Assembly | 901806 | EA | \$33.25 |
| PF2288K050NI | HP ADF Mylar Replacement Kit (Includes 3 Clear Mylar Replacement Strips for the ADF Guide) | 20060 | KIT | \$26.00 |
| HP LaserJet 5000/5100 Series Supplies | | | | |
| C4129X | HP 29X High Yield Black Original LaserJet Toner Cartridge (10,000 Yield) | 100136 | CTG | \$319.01 |
| Q1860 | HP Maintenance Kit (110V) (Includes Fusing Roller, Transfer Roller, Tray 1 Separation Pad and Pickup Roller, 500 Sheet Tray Separation/Feed and Pickup Roller, Cleaning Brush, Gloves, Installation Guide) (For Use in Model 5100) | 1847 | KIT | \$430.35 |
| HP LaserJet 5200 Series Supplies | | | | |
| Q7516A | HP 16A Black Original LaserJet Toner Cartridge (12,000 Yield) | 15103 | CTG | \$280.55 |
| Q7516AG | HP 16A Black Original LaserJet Toner Cartridge for US Government (12,000 Yield) (TAA Compliant Version of Q7516A) | 33261 | CTG | \$264.67 |
| RM1-2522 | HP Fusing Assembly (110-120V) | 900844 | EA | \$351.50 |
| HP LaserJet 8100/8150/Mopier 320 Series Supplies | | | | |
| C4182X | HP 82X High Yield Black Original LaserJet Toner Cartridge (20,000 Yield) | 102537 | CTG | \$367.86 |
| C4182XG | HP 82X High Yield Black Original LaserJet Toner Cartridge for US Government (20,000 Yield) (TAA Compliant Version of C4182X) | 33232 | CTG | \$347.04 |
| C3914A | HP Maintenance Kit (110V) (Contains Fuser Assembly, Transfer Roller Assembly, 8 Feed Separation Rollers) (350,000 Yield) | 20954 | KIT | \$527.00 |
| RG5-6532 | HP Fusing Assembly (110V) | 3146 | EA | \$416.00 |
| RG9-1361 | HP Transfer Roller Assembly (Includes Transfer Roller with Attached Gear Only) | 901801 | EA | \$57.62 |
| HP LaserJet 9000/9040/9050/M9040 MFP/M9050 MFP Series Supplies | | | | |
| C8543X | HP 43X High Yield Black Original LaserJet Toner Cartridge (30,000 Yield) (Yield is 38,000 in Models 9040/9050/M9040/M9050) | 108103 | CTG | \$424.81 |
| C9152A | HP Maintenance Kit (120V) (Includes Fuser Assembly, 7 Feed/Separation Rollers, 2 Pickup Rollers, Transfer Roller Assembly) (350,000 Yield) (For Use in Models 9000/9040/9050) | 4064 | KIT | \$857.09 |
| RF5-3319 | HP Transfer Roller (Includes Long Black Spongy Roller, Roller Shaft, Drive Gear) | 901715 | EA | \$45.80 |
| HP LaserJet Pro 400 Printer M401/400 MFP M425dn Series Supplies | | | | |
| CF280A | HP 80A Black Original LaserJet Toner Cartridge (2,700 Yield) | 906175 | CTG | \$142.07 |
| CF280X | HP 80X High Yield Black Original LaserJet Toner Cartridge (6,900 Yield) | 906176 | CTG | \$244.60 |
| CF280XD | HP 80X 2-Pack High Yield Black Original LaserJet Toner Cartridges (2 Pack of OEM# CF280X) (2 x 6,900 Yield) | 908287 | PK | \$440.43 |
| RM1-8808 | HP Fusing Assembly (110-127V) | 910105 | EA | \$197.65 |
| RM1-9175 | HP Transfer Roller Assembly | 910106 | EA | \$15.57 |

Original HP Toner. Now up to 35% less.¹

Buy Original HP Toner and save. Rely on unsurpassed, professional-quality printing at a savings—up to 35% with toner cartridge multipacks and high-capacity toner cartridges. Only Original HP Toner works right the first time, every time.² Keeping up your business momentum, it matters.



Make it matter.



HP 05X Black Dual Pack



HP 43X Black Single Pack



HP 126A Cyan/Magenta/Yellow

¹Cost-per-page calculation based on ISO/IEC 19752 yield and web-based SRP for HP's (X) cartridges versus their standard (A) cartridge counterparts. Does not cover (X) cartridges that do not have an (A) equivalent. Prices may vary. ²A SpencerLab 2014 Color and a 2013 Monochrome Reliability studies for North America, both commissioned by HP. The color study compared Original HP color LaserJet cartridges with 5 brands of non-HP cartridges for the HP LaserJet Enterprise 500 color M551, CE400A/X, CE401A/02A/03A cartridges. For details, see spencerlab.com/reports/HP-CLR-Reliability-NA-2014.pdf. The monochrome study compared Original HP LaserJet cartridges with 10 brands of non-HP cartridges for the HP LaserJet P2035 and P1102 printers, HP 05A and 85A cartridges. For details, see spencerlab.com/reports/HP-Reliability-NA-2013.pdf.

| MFG# | Product Description | Part# | UOM | Retail |
|---|---|--------|-----|----------|
| HP SUPPLIES | | | | |
| <i>HP CROSS REFERENCE GUIDE CAN BE FOUND ON PAGES 257-282.</i> | | | | |
| HP LaserJet Enterprise M806/flow M830z Series Supplies | | | | |
| CF325X | HP 25X High Yield Black Original LaserJet Toner Cartridge (34,500 Yield) (For the Ent flow MFP M830z Only) (40,000 Yield) | 914754 | CTG | \$398.56 |
| C2H67A | HP Maintenance/Fuser Kit (110V) (200,000 Yield) | 916053 | KIT | \$431.40 |
| C2H57A | HP Maintenance/Fuser Kit (220V) (200,000 Yield) | 916052 | KIT | \$431.40 |
| HP LaserJet Enterprise MFP M630/Flow MFP M630 Series Supplies | | | | |
| CF281A | HP 81A Black Original LaserJet Toner Cartridge (10,500 Yield) | 927495 | CTG | \$236.37 |
| CF281X | HP 81X High Yield Black Original LaserJet Toner Cartridge (25,000 Yield) | 927497 | CTG | \$391.13 |
| B3M77A | HP 110V Maintenance Kit | 932721 | EA | \$369.60 |
| HP LaserJet Enterprise M4555 MFP Series Supplies | | | | |
| CE390A | HP 90A Black Original LaserJet Toner Cartridge (10,000 Yield) | 98125 | CTG | \$238.50 |
| CE390X | HP 90X High Yield Black Original LaserJet Toner Cartridge (24,000 Yield) | 98126 | CTG | \$398.56 |
| CE390XD | HP 90X 2-Pack High Yield Black Original LaserJet Toner Cartridges (2 Pack of OEM# CE390X) (2 x 24,000 Yield) | 906174 | PK | \$717.62 |
| CE390XG | HP 90X High Yield Black Original LaserJet Toner Cartridge for US Government (24,000 Yield) (TAA Compliant Version of CE390X) | 103496 | CTG | \$376.00 |
| CE731A | HP Maintenance Kit (110V) (225,000 Yield) | 103110 | EA | \$364.00 |
| CE248A | HP ADF Maintenance Kit (90,000 Yield) | 103029 | EA | \$112.00 |
| HP LaserJet Enterprise 500 MFP M525/Flow MFP M525c Series Supplies | | | | |
| CE255A | HP 55A Black Original LaserJet Toner Cartridge (6,000 Yield) | 14286 | CTG | \$202.46 |
| CE255AG | HP 55A Black Original LaserJet Toner Cartridge for US Government (6,000 Yield) (TAA Compliant Version of CE255A) | 913628 | CTG | \$191.00 |
| CE255X | HP 55X High Yield Black Original LaserJet Toner Cartridge (12,500 Yield) (Yield is 13,500 for Model M525) | 14287 | CTG | \$314.82 |
| CE255XD | HP 55X 2-Pack High Yield Black Original LaserJet Toner Cartridges (2 Pack of OEM# CE255X) (2 x 12,500 Yield) (Yield is 2 x 13,500 for Model M525) | 94020 | PK | \$566.57 |
| CE525-67901 | HP Maintenance Kit (110V) (Includes Transfer Roller, Fuser, Separation Pad for 500-Sheet Cassette, Tray 1 Pickup Roller, Tray 1 Separation Pad, Pickup and Feed Rollers for 500-Sheet Cassette) | 99958 | EA | \$414.20 |
| HP LaserJet Enterprise 600 Printer M601/M602/M603 Series Supplies | | | | |
| CE390A | HP 90A Black Original LaserJet Toner Cartridge (10,000 Yield) | 98125 | CTG | \$238.50 |
| CE390X | HP 90X High Yield Black Original LaserJet Toner Cartridge (24,000 Yield) (Not Compatible with M601) | 98126 | CTG | \$398.56 |
| CE390XD | HP 90X 2-Pack High Yield Black Original LaserJet Toner Cartridge (2 x 24,000 Yield) (2 Pack of CE290X) (Not Compatible with M601) | 906174 | PK | \$717.62 |
| CF064A | HP Maintenance Kit (110V) (225,000 Yield) | 503717 | KIT | \$383.00 |
| HP LaserJet Enterprise 700 MFP M725/700 Printer M712 Series Supplies | | | | |
| CF214A | HP 14A Black Original LaserJet Toner Cartridge (10,000 Yield) | 908798 | CTG | \$279.84 |
| CF214X | HP 14X High Yield Black Original LaserJet Toner Cartridge (17,500 Yield) | 908799 | CTG | \$308.46 |
| CF249A | HP Maintenance Kit (110V) (200,000 Yield) (For Use in M712 Models Only) | 910498 | KIT | \$444.00 |
| HP LaserJet M1522 MFP/P1505 Series Supplies | | | | |
| CB436A | HP 36A Black Original LaserJet Toner Cartridge (2,000 Yield) | 97851 | CTG | \$107.95 |
| CB436D | HP 36A 2-Pack Black Original LaserJet Toner Cartridges (2 Pack of OEM# CB436A) (2 x 2,000 Yield) | 6531 | PK | \$194.31 |
| RM1-8072 | HP Fusing Assembly (110V) | 906407 | EA | \$140.58 |
| HP LaserJet M2727nf MFP/P2015 Series Supplies | | | | |
| Q7553A | HP 53A Black Original LaserJet Toner Cartridge (3,000 Yield) | 30005 | CTG | \$136.42 |
| Q7553X | HP 53X High Yield Black Original LaserJet Toner Cartridge (7,000 Yield) | 30079 | CTG | \$251.83 |
| Q7553XD | HP 53X 2-Pack High Yield Black Original LaserJet Toner Cartridges (2 Pack of OEM# Q7553X) (2 x 7,000 Yield) | 900694 | PK | \$451.16 |
| RM1-4247 | HP Fusing Assembly (110-127V) | 905159 | EA | \$150.10 |
| RM1-4279 | HP Transfer Charge Roller | 7633 | EA | \$11.75 |
| HP LaserJet M3027 MFP/P3005 Series Supplies | | | | |
| Q7551A | HP 51A Black Original LaserJet Toner Cartridge (6,500 Yield) | 27032 | CTG | \$199.84 |
| Q7551X | HP 51X High Yield Black Original LaserJet Toner Cartridge (13,000 Yield) | 27033 | CTG | \$334.81 |
| Q7551XD | HP 51X 2-Pack High Yield Black Original LaserJet Toner Cartridges (2 Pack of OEM# Q7551X) (2 x 13,000 Yield) | 900693 | PK | \$601.45 |
| RM1-3717 | HP Fusing Assembly (110-127V) | 23338 | EA | \$316.35 |
| RM1-1508 | HP Transfer Roller Assembly (Includes Right Side Bushing and Tension Spring) | 905156 | EA | \$22.00 |

| MFG# | Product Description | Part# | UOM | Retail |
|--|---|--------|-----|----------|
| HP SUPPLIES | | | | |
| <i>HP CROSS REFERENCE GUIDE CAN BE FOUND ON PAGES 257-282.</i> | | | | |
| HP LaserJet M3035 MFP Series Supplies | | | | |
| Q7551A | HP 51A Black Original LaserJet Toner Cartridge (6,500 Yield) | 27032 | CTG | \$199.84 |
| Q7551X | HP 51X High Yield Black Original LaserJet Toner Cartridge (13,000 Yield) | 27033 | CTG | \$334.81 |
| Q7551XD | HP 51X 2-Pack High Yield Black Original LaserJet Toner Cartridges (2 Pack of OEM# Q7551X) (2 x 13,000 Yield) | 900693 | PK | \$601.45 |
| RM1-3717 | HP Fusing Assembly (110-127V) | 23338 | EA | \$316.35 |
| RM1-1508 | HP Transfer Roller Assembly (Includes Right Side Bushing and Tension Spring) | 905156 | EA | \$22.00 |
| Q7432-67001 | Staple Cartridge Dual Pack (2 x 1,500 Staples) | 91419 | PK | \$37.46 |
| HP LaserJet M5025 MFP/M5035 MFP Series Supplies | | | | |
| Q7570A | HP 70A Black Original LaserJet Toner Cartridge (15,000 Yield) | 27030 | CTG | \$292.19 |
| Q7832-67901 | HP Maintenance Kit (110V) (Includes Separation Pad, Pickup Rollers, Pickup and Feed Rollers, Transfer Roller, Fuser, Gloves, Tool (Hook), Instruction Guide) | 7684 | KIT | \$349.00 |
| RM1-3007 | HP Fusing Assembly (110V) | 7662 | EA | \$388.55 |
| Q7829-67928 | HP Transfer Roller Assembly | 7635 | EA | \$20.00 |
| HP LaserJet P1005/P1006 Series Supplies | | | | |
| CB435A | HP 35A Black Original LaserJet Toner Cartridge (1,500 Yield) | 97849 | CTG | \$93.92 |
| CB435D | HP 35A 2-Pack Black Original LaserJet Toner Cartridges (2 Pack of OEM# CB435A) (2 x 1,500 Yield) | 2465 | PK | \$169.05 |
| RM1-4023 | HP Transfer Roller Assembly | 7636 | EA | \$22.07 |
| HP LaserJet P2035/P2055 Series Supplies | | | | |
| CE505A | HP 05A Black Original LaserJet Toner Cartridge (2,300 Yield) | 902377 | CTG | \$122.73 |
| CE505D | HP 05A 2-Pack Black Original LaserJet Toner Cartridges (2 Pack of OEM# CE505A) (2 x 2,300 Yield) | 103097 | PK | \$221.54 |
| CE505X | HP 05X High Yield Black Original LaserJet Toner Cartridge (6,500 Yield) (For Use in Model P2055) | 902378 | CTG | \$225.14 |
| CE505XD | HP 05X 2-Pack High Yield Black Original LaserJet Toner Cartridges (2 Pack of OEM# CE505X) (2 x 6,500 Yield) (For Use in Model P2055) | 24807 | PK | \$406.51 |
| RM1-6405 | HP Fusing Assembly (110-127V) | 7663 | EA | \$248.77 |
| RM1-6450 | HP Transfer Roller Assembly | 7637 | EA | \$18.85 |
| HP LaserJet P3015 Series Supplies | | | | |
| CE255A | HP 55A Black Original LaserJet Toner Cartridge (6,000 Yield) | 14286 | CTG | \$202.46 |
| CE255AG | HP 55A Black Original LaserJet Toner Cartridge for US Government (6,000 Yield) (TAA Compliant Version of CE255A) | 913628 | CTG | \$191.00 |
| CE255X | HP 55X High Yield Black Original LaserJet Toner Cartridge (12,500 Yield) | 14287 | CTG | \$314.82 |
| CE255XD | HP 55X 2-Pack High Yield Black Original LaserJet Toner Cartridges (2 Pack of OEM# CE255X) (2 x 12,500 Yield) | 94020 | PK | \$566.57 |
| CE525-67901 | HP Maintenance Kit (110V) (Includes Transfer Roller, Fuser, Separation Pad for 500-Sheet Cassette, Tray 1 Pickup Roller, Tray 1 Separation Pad, Pickup and Feed Rollers for 500-Sheet Cassette) | 99958 | EA | \$414.20 |
| HP LaserJet P4014/P4015/P4515 Series Supplies | | | | |
| CC364A | HP 64A Black Original LaserJet Toner Cartridge (10,000 Yield) | 105569 | CTG | \$238.60 |
| CC364AG | HP 64A Black Original LaserJet Toner Cartridge for US Government (10,000 Yield) (TAA Compliant Version of CC364A) | 33242 | CTG | \$225.09 |
| CC364X | HP 64X High Yield Black Original LaserJet Toner Cartridge (24,000 Yield) (For Use in Models P4015/P4515) | 105572 | CTG | \$424.51 |
| CC364XD | HP 64X 2-Pack High Yield Black Original LaserJet Toner Cartridges (2 Pack of OEM# CC364X) (2 x 24,000 Yield) (For Use in Models P4015/P4515) | 17550 | PK | \$764.11 |
| CB388A | HP Maintenance Kit (110V) (Includes Fuser Assembly, Transfer Roller, Gloves) (225,000 Yield) | 900955 | KIT | \$384.12 |
| CB506-67901 | HP Fusing Assembly (110V) | 7664 | EA | \$486.00 |
| CB506-67903 | HP Transfer Roller Assembly | 7638 | EA | \$33.87 |



Simple and easy to use, HP printers and MFPs are great for you and your customer. With fast, reliable and affordable devices spanning from small inkjets to large format—HP has a product for every need.



| MFG# | Product Description | Part# | UOM | Retail |
|--|---|--------|-----|----------|
| HP SUPPLIES | | | | |
| <i>HP CROSS REFERENCE GUIDE CAN BE FOUND ON PAGES 257-282.</i> | | | | |
| HP LaserJet Pro MFP M127 Series Supplies | | | | |
| CF283A | HP 83A Black Original LaserJet Toner Cartridge (1,500 Yield) | 915876 | CTG | \$88.62 |
| HP LaserJet Pro M201dw/MFP M225 Series Supplies | | | | |
| CF283A | HP 83A Black Original LaserJet Toner Cartridge (1,500 Yield) | 915876 | CTG | \$88.62 |
| CF283X | HP 83X High Yield Black Original LaserJet Toner Cartridge (2,200 Yield) | 930330 | CTG | \$110.24 |
| HP LaserJet Pro M521dn Supplies | | | | |
| CE255A | HP 55A Black Original LaserJet Toner Cartridge (6,000 Yield) | 14286 | CTG | \$202.46 |
| CE255AG | HP 55A Black Original LaserJet Toner Cartridge for US Government (6,000 Yield) (TAA Compliant Version of CE255A) | 913628 | CTG | \$191.00 |
| CE255X | HP 55X High Yield Black Original LaserJet Toner Cartridge (12,500 Yield) (Yield is 13,500 for Model M525) | 14287 | CTG | \$314.82 |
| CE255XD | HP 55X 2-Pack High Yield Black Original LaserJet Toner Cartridges (2 Pack of OEM# CE255X) (2 x 12,500 Yield) (Yield is 2 x 13,500 for Model M525) | 94020 | PK | \$566.57 |
| HP LaserJet Pro M1212nf MFP/M1217nf MFP/P1102w Series Supplies | | | | |
| CE285A | HP 85A Black Original LaserJet Toner Cartridge (1,600 Yield) | 23307 | CTG | \$94.87 |
| CE285D | HP 85A 2-Pack Black Original LaserJet Toner Cartridges (2 Pack of OEM# CE285A) (2 x 1,600 Yield) | 502986 | PK | \$170.13 |
| HP LaserJet Pro M1536dnf MFP/P1606n Series Supplies | | | | |
| CE278A | HP 78A Black Original LaserJet Toner Cartridge (2,100 Yield) | 23310 | CTG | \$108.65 |
| CE278D | HP 78A 2-Pack Black Original LaserJet Toner Cartridges (2 Pack of OEM# CE278A) (2 x 2,100 Yield) | 502985 | PK | \$195.04 |
| HP Color LaserJet 1600/2600n/2605/CM1015 MFP/CM1017 MFP Series Supplies | | | | |
| Q6000A | HP 124A Black Original LaserJet Toner Cartridge (2,500 Yield) | 10390 | CTG | \$128.21 |
| Q6001A | HP 124A Cyan Original LaserJet Toner Cartridge (2,000 Yield) | 10391 | CTG | \$139.94 |
| Q6003A | HP 124A Magenta Original LaserJet Toner Cartridge (2,000 Yield) | 10392 | CTG | \$139.94 |
| Q6002A | HP 124A Yellow Original LaserJet Toner Cartridge (2,000 Yield) | 10393 | CTG | \$139.94 |
| Q6000AD | HP 124A 2-Pack Black Original LaserJet Toner Cartridges (2 Pack of OEM# Q6000A) (2 x 2,500 Yield) | 900695 | PK | \$230.15 |
| CE257A | HP 124A 3-Pack Cyan/Magenta/Yellow Original LaserJet Toner Cartridges (Includes 1 Each of OEM# Q6001A, Q6002A, Q6003A) (3 x 2,000 Yield) | 900696 | PK | \$377.04 |
| RM1-1820 | HP Fusing Assembly (110-127V) (For Use in Models 1600/2600) | 903853 | EA | \$148.20 |
| RM1-1828 | HP Fusing Assembly (110-127V) (For Use in 2605 - Simplex Model Only) | 7665 | EA | \$117.80 |
| RM1-4310 | HP Fusing Assembly (110V) (For Use in Models CM1015/CM1017) | 7667 | EA | \$138.75 |
| RM1-1885 | HP (ETB) Electrostatic Transfer Belt (Includes Assembly Structure, ETB Belt, Drive Roller, 4 Transfer Rollers) (For Use in Models 1600/2600/CM1015/CM1017) | 7668 | EA | \$178.21 |
| RM1-1891 | HP (ETB) Electrostatic Transfer Belt (Includes Assembly Structure, ETB Belt, Drive Roller, 4 Transfer Rollers) (For Use in 2605 - Simplex Model Only) | 7669 | EA | \$157.70 |
| RM1-1892 | HP (ETB) Electrostatic Transfer Belt (Includes Assembly Structure, ETB Belt, Drive Roller, 4 Transfer Rollers) (For Use in 2605 - Duplex Model Only) | 7670 | EA | \$187.15 |
| HP Color LaserJet 2550/2820/2830/2840 Series Supplies | | | | |
| Q3960A | HP 122A Black Original LaserJet Toner Cartridge (5,000 Yield) | 5531 | CTG | \$139.94 |
| Q3961A | HP 122A Cyan Original LaserJet Toner Cartridge (4,000 Yield) | 5532 | CTG | \$168.82 |
| Q3963A | HP 122A Magenta Original LaserJet Toner Cartridge (4,000 Yield) | 5535 | CTG | \$168.82 |
| Q3962A | HP 122A Yellow Original LaserJet Toner Cartridge (4,000 Yield) | 5533 | CTG | \$168.82 |
| Q3964A | HP 122A Original LaserJet Image Drum (Black 20,000/Color 5,000 Yield) | 5536 | EA | \$253.76 |
| RG5-7572 | HP Fusing Assembly (110-127V) (For Use in Model 2550) | 12826 | EA | \$317.30 |
| RG5-7162 | HP Fusing Film Assembly (110-127V) (For Use in Models 2820/2840) (Includes Heater Assembly, Fusing Film Tube) | 7671 | EA | \$132.93 |
| RG5-7602 | HP Fusing Assembly (110-127V) (Includes Fusing Mechanism, Lower Rear Cover with 2 Locking Levers and Rear Cover/Face-Up Output Tray) (For Use in Models 2820/2840) | 95169 | EA | \$320.32 |
| RF5-4067 | HP Transfer Roller Assembly (For Use in Models 2550/2820/2840) | 7640 | EA | \$16.15 |
| HP Color LaserJet 3500/3550 Series Supplies | | | | |
| Q2670A | HP 308A Black Original LaserJet Toner Cartridge (6,000 Yield) | 5017 | CTG | \$224.30 |
| Q2671A | HP 309A Cyan Original LaserJet Toner Cartridge (4,000 Yield) | 5018 | CTG | \$223.54 |
| Q2673A | HP 309A Magenta Original LaserJet Toner Cartridge (4,000 Yield) | 5020 | CTG | \$223.54 |
| Q2672A | HP 309A Yellow Original LaserJet Toner Cartridge (4,000 Yield) | 5019 | CTG | \$223.54 |
| Q3655A | HP Fusing Assembly Kit (110-127V) (Includes Image Fusing Assembly, Installation Guide) (60,000 Yield) | 5172 | KIT | \$134.53 |
| Q3658A | HP Image Transfer Kit (Includes Support Frame, Image Transfer Belt, Rollers, Covers, Drive Gears) (60,000 Yield) | 5214 | KIT | \$151.35 |

| MFG# | Product Description | Part# | UOM | Retail |
|--|---|-------|-----|----------|
| HP SUPPLIES | | | | |
| <i>HP CROSS REFERENCE GUIDE CAN BE FOUND ON PAGES 257-282.</i> | | | | |
| HP Color LaserJet 3600 Series Supplies | | | | |
| Q6470A | HP 501A Black Original LaserJet Toner Cartridge (6,000 Yield) | 11976 | CTG | \$224.30 |
| Q6471A | HP 502A Cyan Original LaserJet Toner Cartridge (4,000 Yield) | 11977 | CTG | \$223.54 |
| Q6473A | HP 502A Magenta Original LaserJet Toner Cartridge (4,000 Yield) | 11978 | CTG | \$223.54 |
| Q6472A | HP 502A Yellow Original LaserJet Toner Cartridge (4,000 Yield) | 11979 | CTG | \$223.54 |
| Q6470AG | HP 501A Black Original LaserJet Toner Cartridge for US Government (6,000 Yield) (TAA Compliant Version of Q6470A) | 33257 | CTG | \$211.60 |
| Q6471AG | HP 502A Cyan Original LaserJet Toner Cartridge for US Government (4,000 Yield) (TAA Compliant Version of Q6471A) | 33258 | CTG | \$210.89 |
| Q6473AG | HP 502A Magenta Original LaserJet Toner Cartridge for US Government (4,000 Yield) (TAA Compliant Version of Q6473A) | 33260 | CTG | \$210.89 |
| Q6472AG | HP 502A Yellow Original LaserJet Toner Cartridge for US Government (4,000 Yield) (TAA Compliant Version of Q6472A) | 33259 | CTG | \$210.89 |
| RM1-2763 | HP Fuser Assembly (110V) | 7772 | EA | \$294.46 |
| RM1-2759 | HP (ETB) Electrostatic Transfer Belt Assembly (Includes Assembly Structure, ETB Belt, Drive Roller, Drive Motor M5) (Simplex Model Only) | 30552 | EA | \$279.30 |
| RM1-2752 | HP (ETB) Electrostatic Transfer Belt Assembly (Includes Assembly Structure, ETB Belt, Drive Roller, Drive Motor M5) (Duplex Model Only) | 95118 | EA | \$294.73 |
| HP Color LaserJet 3700 Series Supplies | | | | |
| Q2670A | HP 308A Black Original LaserJet Toner Cartridge (6,000 Yield) | 5017 | CTG | \$224.30 |
| Q2681A | HP 311A Cyan Original LaserJet Toner Cartridge (6,000 Yield) | 5021 | CTG | \$288.48 |
| Q2683A | HP 311A Magenta Original LaserJet Toner Cartridge (6,000 Yield) | 5023 | CTG | \$288.48 |
| Q2682A | HP 311A Yellow Original LaserJet Toner Cartridge (6,000 Yield) | 5022 | CTG | \$288.48 |
| Q3655A | HP Fusing Assembly Kit (110-127V) (Includes Image Fusing Assembly, Installation Guide) (60,000 Yield) | 5172 | KIT | \$134.53 |
| Q3658A | HP Image Transfer Kit (Includes Support Frame, Image Transfer Belt, Rollers, Covers, Drive Gears) (60,000 Yield) | 5214 | KIT | \$151.35 |
| HP Color LaserJet 3800/CP3505 Series Supplies | | | | |
| Q6470A | HP 501A Black Original LaserJet Toner Cartridge (6,000 Yield) | 11976 | CTG | \$224.30 |
| Q7581A | HP 503A Cyan Original LaserJet Toner Cartridge (6,000 Yield) | 11980 | CTG | \$288.48 |
| Q7583A | HP 503A Magenta Original LaserJet Toner Cartridge (6,000 Yield) | 11981 | CTG | \$288.48 |
| Q7582A | HP 503A Yellow Original LaserJet Toner Cartridge (6,000 Yield) | 11982 | CTG | \$288.48 |
| Q6470AG | HP 501A Black Original LaserJet Toner Cartridge for US Government (6,000 Yield) (TAA Compliant Version of Q6470A) | 33257 | CTG | \$211.60 |
| Q7581AG | HP 503A Cyan Original LaserJet Toner Cartridge for US Government (6,000 Yield) (TAA Compliant Version of Q7581A) | 33262 | CTG | \$272.15 |
| Q7583AG | HP 503A Magenta Original LaserJet Toner Cartridge for US Government (6,000 Yield) (TAA Compliant Version of Q7583A) | 33264 | CTG | \$272.15 |
| Q7582AG | HP 503A Yellow Original LaserJet Toner Cartridge for US Government (6,000 Yield) (TAA Compliant Version of Q7582A) | 33263 | CTG | \$272.15 |
| RM1-2763 | HP Fuser Assembly (110V) | 7772 | EA | \$294.46 |
| RM1-2759 | HP (ETB) Electrostatic Transfer Belt Assembly (Includes Assembly Structure, ETB Belt, Drive Roller, Drive Motor M5) (Simplex Model Only) | 30552 | EA | \$279.30 |
| RM1-2752 | HP (ETB) Electrostatic Transfer Belt Assembly (Includes Assembly Structure, ETB Belt, Drive Roller, Drive Motor M5) (Duplex Model Only) | 95118 | EA | \$294.73 |
| HP Color LaserJet 4600/4610/4650 Series Supplies | | | | |
| C9720A | HP 641A Black Original LaserJet Toner Cartridge (9,000 Yield) | 3601 | CTG | \$301.90 |
| C9721A | HP 641A Cyan Original LaserJet Toner Cartridge (8,000 Yield) | 3600 | CTG | \$409.04 |
| C9723A | HP 641A Magenta Original LaserJet Toner Cartridge (8,000 Yield) | 3598 | CTG | \$409.04 |
| C9722A | HP 641A Yellow Original LaserJet Toner Cartridge (8,000 Yield) | 3599 | CTG | \$409.04 |
| C9725A | HP Fusing Assembly (100-127V) (For Use in Model 4600) | 3546 | EA | \$414.33 |
| Q3676A | HP Fusing Assembly Kit (110V) (Includes Fusing Assembly, Installation Instructions) (For Use in Models 4610/4650) | 6039 | KIT | \$414.33 |
| RG5-7455 | HP Electrostatic Transfer Belt Assembly (120,000 Yield) (Same as OEM# Q3675A, C9660-69004) | 98415 | EA | \$355.30 |
| HP Color LaserJet 4700 Series Supplies | | | | |
| Q5950A | HP 643A Black Original LaserJet Toner Cartridge (11,000 Yield) | 11962 | CTG | \$301.33 |
| Q5951A | HP 643A Cyan Original LaserJet Toner Cartridge (10,000 Yield) | 11963 | CTG | \$428.47 |
| Q5953A | HP 643A Magenta Original LaserJet Toner Cartridge (10,000 Yield) | 11964 | CTG | \$428.47 |
| Q5952A | HP 643A Yellow Original LaserJet Toner Cartridge (10,000 Yield) | 11965 | CTG | \$428.47 |
| RM1-3131 | HP Fusing Assembly (100-127V) (Same as OEM# Q7502A) | 7680 | EA | \$378.10 |
| RM1-3161 | HP Electrostatic Transfer Belt Assembly (Same as OEM# Q7504A) | 7645 | KIT | \$325.00 |
| HP Color LaserJet 4730 MFP/CM4730 MFP Series Supplies <i>(Continued on next page)</i> | | | | |
| Q6460A | HP 644A Black Original LaserJet Toner Cartridge (12,000 Yield) | 11865 | CTG | \$237.81 |
| Q6461A | HP 644A Cyan Original LaserJet Toner Cartridge (12,000 Yield) | 11866 | CTG | \$512.49 |

| MFG# | Product Description | Part# | UOM | Retail |
|---|---|--------|-----|----------|
| HP SUPPLIES | | | | |
| <i>HP CROSS REFERENCE GUIDE CAN BE FOUND ON PAGES 257-282.</i> | | | | |
| HP Color LaserJet 4730 MFP/CM4730 MFP Series Supplies (Continued) | | | | |
| Q6463A | HP 644A Magenta Original LaserJet Toner Cartridge (12,000 Yield) | 11868 | CTG | \$512.49 |
| Q6462A | HP 644A Yellow Original LaserJet Toner Cartridge (12,000 Yield) | 11867 | CTG | \$512.49 |
| Q6460AG | HP 644A Black Original LaserJet Toner Cartridge for US Government (12,000 Yield) (TAA Compliant Version of Q6460A) | 107689 | CTG | \$224.35 |
| Q6461AG | HP 644A Cyan Original LaserJet Toner Cartridge for US Government (12,000 Yield) (TAA Compliant Version of Q6461A) | 107690 | CTG | \$483.48 |
| Q6463AG | HP 644A Magenta Original LaserJet Toner Cartridge for US Government (12,000 Yield) (TAA Compliant Version of Q6463A) | 107692 | CTG | \$483.48 |
| Q6462AG | HP 644A Yellow Original LaserJet Toner Cartridge for US Government (12,000 Yield) (TAA Compliant Version of Q6462A) | 107691 | CTG | \$483.48 |
| RM1-3131 | HP Fusing Assembly (100-127V) (Same as OEM# Q7502A) | 7680 | EA | \$378.10 |
| RM1-3161 | HP Electrostatic Transfer Belt Assembly (Same as OEM# Q7504A) | 7645 | KIT | \$325.00 |
| Q5997-67901 | HP ADF Maintenance Kit (Includes ADF Paper Pickup Roller Assembly, Separation Pad Assembly, 3 Clear Mylar Replacement Strips) | 30624 | KIT | \$96.30 |
| C8091A | HP Staple Cartridge Refill for Stapler/Stacker (5,000 Yield) | 25505 | EA | \$41.00 |
| HP Color LaserJet 5500/5550 Series Supplies | | | | |
| C9730A | HP 645A Black Original LaserJet Toner Cartridge (13,000 Yield) | 3054 | CTG | \$418.59 |
| C9731A | HP 645A Cyan Original LaserJet Toner Cartridge (12,000 Yield) | 3053 | CTG | \$587.01 |
| C9733A | HP 645A Magenta Original LaserJet Toner Cartridge (12,000 Yield) | 3051 | CTG | \$587.01 |
| C9732A | HP 645A Yellow Original LaserJet Toner Cartridge (12,000 Yield) | 3052 | CTG | \$587.01 |
| C9735A | HP Fusing Assembly Kit (100-127V) (Includes Fusing Assembly, Instruction Guide) (150,000 Yield) (For Use in Model 5500) | 3049 | KIT | \$446.06 |
| Q3984A | Fuser Assembly (110V) (For Use in Model 5550) | 20059 | EA | \$469.54 |
| C9734-67901 | HP Image Transfer Kit (Includes Electrostatic Transfer Belt Assembly) (120,000 Yield) (Same as OEM# C9734B) | 7938 | KIT | \$426.00 |
| HP Color LaserJet 9500/9500 MFP Series Supplies | | | | |
| C8550A | HP 822A Black Original LaserJet Toner Cartridge (25,000 Yield) | 1484 | CTG | \$242.84 |
| C8551A | HP 822A Cyan Original LaserJet Toner Cartridge (25,000 Yield) | 1483 | CTG | \$494.97 |
| C8553A | HP 822A Magenta Original LaserJet Toner Cartridge (25,000 Yield) | 1481 | CTG | \$494.97 |
| C8552A | HP 822A Yellow Original LaserJet Toner Cartridge (25,000 Yield) | 1482 | CTG | \$494.97 |
| C8560A | HP 822A Black Original LaserJet Imaging Drum (40,000 Yield) | 1480 | EA | \$474.80 |
| C8561A | HP 822A Cyan Original LaserJet Imaging Drum (40,000 Yield) | 1479 | EA | \$738.86 |
| C8563A | HP 822A Magenta Original LaserJet Imaging Drum (40,000 Yield) | 1477 | EA | \$738.86 |
| C8562A | HP 822A Yellow Original LaserJet Imaging Drum (40,000 Yield) | 1478 | EA | \$738.86 |
| C8554A | HP 822A Image Cleaning Kit (50,000 Yield) | 1476 | KIT | \$65.10 |
| C8556A | HP 822A Image Fuser Kit (110V/220V) (100,000 Yield) | 1474 | KIT | \$368.55 |
| C8555A | HP 822A Image Transfer Kit (Includes Transfer Belt, Transfer Roller, 2 Small Tray Rollers, 7 Large Tray Rollers, Charcoal Filter, Toner Wipe) (200,000 Yield) | 1475 | KIT | \$491.40 |
| HP Color LaserJet CM1312nfi MFP/CP1215/CP1515n/CP1518ni Series Supplies | | | | |
| CB540A | HP 125A Black Original LaserJet Toner Cartridge (2,200 Yield) | 105555 | CTG | \$109.15 |
| CB541A | HP 125A Cyan Original LaserJet Toner Cartridge (1,400 Yield) | 105556 | CTG | \$100.32 |
| CB543A | HP 125A Magenta Original LaserJet Toner Cartridge (1,400 Yield) | 105563 | CTG | \$100.32 |
| CB542A | HP 125A Yellow Original LaserJet Toner Cartridge (1,400 Yield) | 105558 | CTG | \$100.32 |
| CB540AD | HP 125A 2-Pack Black Original LaserJet Toner Cartridges (2 Pack of OEM# CB540A) (2 x 2,200 Yield) | 17548 | PK | \$196.10 |
| CE259A | HP 125A 3-Pack Cyan/Magenta/Yellow Original LaserJet Toner Cartridges (Includes 1 Each of OEM# CB541A, CB542A, CB543A) (3 x 1,400 Yield) | 18806 | PK | \$270.30 |
| RM1-4430 | HP Fusing Assembly (110-127V) | 7682 | EA | \$132.05 |
| RM1-4436 | HP Intermediate Transfer Belt (ITB) Assembly | 7673 | EA | \$251.75 |
| HP Color LaserJet CM2320 MFP/CP2025 Series Supplies (Continued on next page) | | | | |
| CC530A | HP 304A Black Original LaserJet Toner Cartridge (3,500 Yield) | 902182 | CTG | \$170.79 |
| CC531A | HP 304A Cyan Original LaserJet Toner Cartridge (2,800 Yield) | 902183 | CTG | \$168.34 |
| CC533A | HP 304A Magenta Original LaserJet Toner Cartridge (2,800 Yield) | 902185 | CTG | \$168.34 |
| CC532A | HP 304A Yellow Original LaserJet Toner Cartridge (2,800 Yield) | 902184 | CTG | \$168.34 |
| CF340A | HP 304A 3-Pack Cyan/Magenta/Yellow Original LaserJet Toner Cartridges (Includes 1 Each of OEM# CC531A, CC532A, CC533A) (3 x 2,800 Yield) | 502997 | PK | \$453.68 |
| CC530AG | HP 304A Black Original LaserJet Toner Cartridge for US Government (3,500 Yield) (TAA Compliant Version of CC530A) | 33243 | CTG | \$161.12 |
| CC531AG | HP 304A Cyan Original LaserJet Toner Cartridge for US Government (2,800 Yield) (TAA Compliant Version of CC531A) | 93795 | CTG | \$158.81 |
| CC533AG | HP 304A Magenta Original LaserJet Toner Cartridge for US Government (2,800 Yield) (TAA Compliant Version of CC533A) | 93797 | CTG | \$158.81 |
| CC532AG | HP 304A Yellow Original LaserJet Toner Cartridge for US Government (2,800 Yield) (TAA Compliant Version of CC532A) | 93796 | CTG | \$158.81 |

| MFG# | Product Description | Part# | UOM | Retail |
|---|---|--------|-----|----------|
| HP SUPPLIES | | | | |
| <i>HP CROSS REFERENCE GUIDE CAN BE FOUND ON PAGES 257-282.</i> | | | | |
| HP Color LaserJet CM2320 MFP/CP2025 Series Supplies <i>(Continued)</i> | | | | |
| CC530AD | HP 304A 2-Pack Black Original LaserJet Toner Cartridge (2 Pack of OEM# CC530A) (2 x 3,500 Yield) | 903191 | PK | \$244.61 |
| RM1-6740 | HP Fusing Assembly (110-127V) (For Use in Model CM2320) | 7674 | EA | \$279.86 |
| RM1-4852 | HP Intermediate Transfer Belt Assembly | 7676 | EA | \$317.74 |
| HP Color LaserJet CM3530 MFP Series Supplies | | | | |
| CE250A | HP 504A Black Original LaserJet Toner Cartridge (5,000 Yield) | 902197 | CTG | \$187.04 |
| CE251A | HP 504A Cyan Original LaserJet Toner Cartridge (7,000 Yield) | 902199 | CTG | \$367.24 |
| CE253A | HP 504A Magenta Original LaserJet Toner Cartridge (7,000 Yield) | 902201 | CTG | \$367.24 |
| CE252A | HP 504A Yellow Original LaserJet Toner Cartridge (7,000 Yield) | 902200 | CTG | \$367.24 |
| CE250X | HP 504X High Yield Black Original LaserJet Toner Cartridge (10,500 Yield) | 902198 | CTG | \$271.38 |
| CE250AG | HP 504A Black Original LaserJet Toner Cartridge for US Government (5,000 Yield) (TAA Compliant Version of CE250A) | 93798 | CTG | \$176.45 |
| CE251AG | HP 504A Cyan Original LaserJet Toner Cartridge for US Government (7,000 Yield) (TAA Compliant Version of CE251A) | 33244 | CTG | \$346.45 |
| CE253AG | HP 504A Magenta Original LaserJet Toner Cartridge for US Government (7,000 Yield) (TAA Compliant Version of CE253A) | 33247 | CTG | \$346.45 |
| CE252AG | HP 504A Yellow Original LaserJet Toner Cartridge for US Government (7,000 Yield) (TAA Compliant Version of CE252A) | 33245 | CTG | \$346.45 |
| CE254A | HP Toner Collection Unit (36,000 Yield) | 902622 | EA | \$15.00 |
| CE484A | HP Fuser Maintenance Kit (110V) (150,000 Yield) | 21357 | EA | \$234.37 |
| CC468-67927 | HP (ITB) Intermediate Transfer Belt Service Kit (150,000 Yield) | 20155 | EA | \$605.31 |
| HP Color LaserJet CM4540 MFP Series Supplies | | | | |
| CE260A | HP 647A Black Original LaserJet Toner Cartridge (8,500 Yield) | 18825 | CTG | \$220.48 |
| CE260AG | HP 647A Black Original LaserJet Toner Cartridge for US Government (8,500 Yield) (TAA Compliant Version of CE260A) | 103488 | CTG | \$208.00 |
| CE264X | HP 646X High Yield Black Original LaserJet Toner Cartridge (17,000 Yield) | 91539 | CTG | \$280.90 |
| CF031A | HP 646A Cyan Original LaserJet Toner Cartridge (12,500 Yield) | 91540 | CTG | \$350.86 |
| CF033A | HP 646A Magenta Original LaserJet Toner Cartridge (12,500 Yield) | 91555 | CTG | \$350.86 |
| CF032A | HP 646A Yellow Original LaserJet Toner Cartridge (12,500 Yield) | 91541 | CTG | \$350.86 |
| CE265A | HP 648A Toner Collection Unit (36,000 Yield) | 18830 | EA | \$21.60 |
| CE248A | HP ADF Maintenance Kit (90,000 Yield) | 103029 | EA | \$112.00 |
| C8091A | HP Staple Cartridge Refill for Stapler/Stacker (5,000 Yield) | 25505 | EA | \$41.00 |
| HP Color LaserJet CM6030 MFP/CM6040 MFP/CP6015 Series Supplies | | | | |
| CB390A | HP 825A Black Original LaserJet Toner Cartridge (19,500 Yield) (For Use in Models CM6030 MFP/CM6040 MFP) | 104344 | CTG | \$88.31 |
| CB380A | HP 823A Black Original LaserJet Toner Cartridge (16,500 Yield) (For Use in Model CP6015) | 104343 | CTG | \$313.87 |
| CB381A | HP 824A Cyan Original LaserJet Toner Cartridge (21,000 Yield) | 104345 | CTG | \$491.34 |
| CB383A | HP 824A Magenta Original LaserJet Toner Cartridge (21,000 Yield) | 104348 | CTG | \$491.34 |
| CB382A | HP 824A Yellow Original LaserJet Toner Cartridge (21,000 Yield) | 104346 | CTG | \$491.34 |
| CB384A | HP 824A Black Original LaserJet Image Drum (23,000 Yield) | 104350 | EA | \$181.23 |
| CB385A | HP 824A Cyan Original LaserJet Image Drum (23,000 Yield) | 104354 | EA | \$510.44 |
| CB387A | HP 824A Magenta Original LaserJet Image Drum (23,000 Yield) | 104360 | EA | \$510.44 |
| CB386A | HP 824A Yellow Original LaserJet Image Drum (23,000 Yield) | 104359 | EA | \$510.44 |
| CB457A | HP Fuser Kit (110V) | 900327 | KIT | \$249.99 |
| CB463A | HP Transfer Kit (150,000 Yield) | 900329 | KIT | \$292.00 |
| CB459A | HP Image Roller Kit (150,000 Yield) | 900328 | KIT | \$44.00 |
| Q3938-67969 | HP ADF Roller Maintenance Kit (Includes ADF Paper Pickup Roller Assembly, Separation Pad Assembly) (60,000 Yield) | 7655 | EA | \$109.25 |
| HP Color LaserJet CP3525 Series Supplies | | | | |
| CE250A | HP 504A Black Original LaserJet Toner Cartridge (5,000 Yield) | 902197 | CTG | \$187.04 |
| CE251A | HP 504A Cyan Original LaserJet Toner Cartridge (7,000 Yield) | 902199 | CTG | \$367.24 |
| CE253A | HP 504A Magenta Original LaserJet Toner Cartridge (7,000 Yield) | 902201 | CTG | \$367.24 |
| CE252A | HP 504A Yellow Original LaserJet Toner Cartridge (7,000 Yield) | 902200 | CTG | \$367.24 |
| CE250X | HP 504X High Yield Black Original LaserJet Toner Cartridge (10,500 Yield) | 902198 | CTG | \$271.38 |
| CE250AG | HP 504A Black Original LaserJet Toner Cartridge for US Government (5,000 Yield) (TAA Compliant Version of CE250A) | 93798 | CTG | \$176.45 |
| CE251AG | HP 504A Cyan Original LaserJet Toner Cartridge for US Government (7,000 Yield) (TAA Compliant Version of CE251A) | 33244 | CTG | \$346.45 |
| CE253AG | HP 504A Magenta Original LaserJet Toner Cartridge for US Government (7,000 Yield) (TAA Compliant Version of CE253A) | 33247 | CTG | \$346.45 |
| CE252AG | HP 504A Yellow Original LaserJet Toner Cartridge for US Government (7,000 Yield) (TAA Compliant Version of CE252A) | 33245 | CTG | \$346.45 |
| CE254A | HP Toner Collection Unit (36,000 Yield) | 902622 | EA | \$15.00 |
| CE484A | HP Fuser Maintenance Kit (110V) (150,000 Yield) | 21357 | EA | \$234.37 |
| CC468-67927 | HP (ITB) Intermediate Transfer Belt Service Kit (150,000 Yield) | 20155 | EA | \$605.31 |

| MFG# | Product Description | Part# | UOM | Retail |
|--|---|--------|-----|----------|
| HP SUPPLIES | | | | |
| <i>HP CROSS REFERENCE GUIDE CAN BE FOUND ON PAGES 257-282.</i> | | | | |
| HP Color LaserJet CP4005 Series Supplies | | | | |
| CB400A | HP 642A Black Original LaserJet Toner Cartridge (7,500 Yield) | 29021 | CTG | \$274.15 |
| CB401A | HP 642A Cyan Original LaserJet Toner Cartridge (7,500 Yield) | 29038 | CTG | \$407.88 |
| CB403A | HP 642A Magenta Original LaserJet Toner Cartridge (7,500 Yield) | 29041 | CTG | \$407.88 |
| CB402A | HP 642A Yellow Original LaserJet Toner Cartridge (7,500 Yield) | 29042 | CTG | \$407.88 |
| CB400AG | HP 642A Black Original LaserJet Toner Cartridge for US Government (7,500 Yield) (TAA Compliant Version of CB400A) | 95376 | CTG | \$258.63 |
| CB401AG | HP 642A Cyan Original LaserJet Toner Cartridge for US Government (7,500 Yield) (TAA Compliant Version of CB401A) | 95377 | CTG | \$384.79 |
| CB403AG | HP 642A Magenta Original LaserJet Toner Cartridge for US Government (7,500 Yield) (TAA Compliant Version of CB403A) | 95383 | CTG | \$384.79 |
| CB402AG | HP 642A Yellow Original LaserJet Toner Cartridge for US Government (7,500 Yield) (TAA Compliant Version of CB402A) | 95382 | CTG | \$384.79 |
| RM1-3131 | HP Fusing Assembly (100-127V) (Same as OEM# Q7502A) | 7680 | EA | \$378.10 |
| RM1-3161 | HP Electrostatic Transfer Belt Assembly (Same as OEM# Q7504A) | 7645 | KIT | \$325.00 |
| HP Color LaserJet CP4025/CP4525 Series Supplies | | | | |
| CE260A | HP 647A Black Original LaserJet Toner Cartridge (8,500 Yield) | 18825 | CTG | \$220.48 |
| CE261A | HP 648A Cyan Original LaserJet Toner Cartridge (11,000 Yield) | 18827 | CTG | \$399.62 |
| CE263A | HP 648A Magenta Original LaserJet Toner Cartridge (11,000 Yield) | 18829 | CTG | \$399.62 |
| CE262A | HP 648A Yellow Original LaserJet Toner Cartridge (11,000 Yield) | 18828 | CTG | \$399.62 |
| CE260AG | HP 647A Black Original LaserJet Toner Cartridge for US Government (8,500 Yield) (TAA Compliant Version of CE260A) | 103488 | CTG | \$208.00 |
| CE261AG | HP 648A Cyan Original LaserJet Toner Cartridge for US Government (11,000 Yield) (TAA Compliant Version of CE261A) | 103489 | CTG | \$377.00 |
| CE263AG | HP 648A Magenta Original LaserJet Toner Cartridge for US Government (11,000 Yield) (TAA Compliant Version of CE263A) | 103491 | CTG | \$377.00 |
| CE262AG | HP 648A Yellow Original LaserJet Toner Cartridge for US Government (11,000 Yield) (TAA Compliant Version of CE262A) | 103490 | CTG | \$377.00 |
| CE260X | HP 649X High Yield Black Original LaserJet Toner Cartridge (17,000 Yield) (For Use in Model CP4525) | 18826 | CTG | \$348.74 |
| CE265A | HP 648A Toner Collection Unit (36,000 Yield) | 18830 | EA | \$21.60 |
| CE246A | HP Fuser Kit (110V) | 19862 | KIT | \$334.00 |
| CE249A | HP Transfer Kit | 19863 | KIT | \$385.92 |
| HP Color LaserJet Enterprise CP5525/M750 Series Supplies | | | | |
| CE270A | HP 650A Black Original LaserJet Toner Cartridge (13,500 Yield) | 91431 | CTG | \$341.32 |
| CE271A | HP 650A Cyan Original LaserJet Toner Cartridge (15,000 Yield) | 91433 | CTG | \$555.44 |
| CE273A | HP 650A Magenta Original LaserJet Toner Cartridge (15,000 Yield) | 91438 | CTG | \$555.44 |
| CE272A | HP 650A Yellow Original LaserJet Toner Cartridge (15,000 Yield) | 91437 | CTG | \$555.44 |
| CE980A | HP Toner Collection Unit (150,000 Yield) | 911943 | EA | \$30.00 |
| CE977A | HP Fuser Kit (110V) | 100054 | KIT | \$361.67 |
| CE516A | HP Intermediate Transfer Belt Maintenance Kit (150,000 Yield) | 910500 | KIT | \$516.00 |
| HP Color LaserJet Enterprise M651 Series Supplies | | | | |
| CF320A | HP 652A Black Original LaserJet Toner Cartridge (11,500 Yield) | 920234 | CTG | \$269.00 |
| CF330X | HP 654X High Yield Black Original LaserJet Toner Cartridge (20,500 Yield) | 920239 | CTG | \$353.50 |
| CF331A | HP 654A Cyan Original LaserJet Toner Cartridge (15,000 Yield) | 920240 | CTG | \$493.00 |
| CF333A | HP 654A Magenta Original LaserJet Toner Cartridge (15,000 Yield) | 920242 | CTG | \$493.00 |
| CF332A | HP 654A Yellow Original LaserJet Toner Cartridge (15,000 Yield) | 920241 | CTG | \$493.00 |
| CE265A | HP 648A Toner Collection Unit (36,000 Yield) | 18830 | EA | \$21.60 |
| HP Color LaserJet Enterprise MFP M680/flow M680z Series Supplies | | | | |
| CF320A | HP 652A Black Original LaserJet Toner Cartridge (11,500 Yield) | 920234 | CTG | \$269.00 |
| CF320X | HP 653X High Yield Black Original LaserJet Toner Cartridge (21,000 Yield) | 920235 | CTG | \$324.50 |
| CF321A | HP 653A Cyan Original LaserJet Toner Cartridge (16,500 Yield) | 920236 | CTG | \$437.00 |
| CF323A | HP 653A Magenta Original LaserJet Toner Cartridge (16,500 Yield) | 920238 | CTG | \$437.00 |
| CF322A | HP 653A Yellow Original LaserJet Toner Cartridge (16,500 Yield) | 920237 | CTG | \$437.00 |
| CE265A | HP 648A Toner Collection Unit (36,000 Yield) | 18830 | EA | \$21.60 |
| CE246A | HP Fuser Kit (110V) | 19862 | KIT | \$334.00 |
| CE249A | HP Transfer Kit | 19863 | KIT | \$385.92 |
| HP Color LaserJet Enterprise M855 Series Supplies <i>(Continued on next page)</i> | | | | |
| CF310A | HP 826A Black Original LaserJet Toner Cartridge (29,000 Yield) | 916026 | CTG | \$405.00 |
| CF311A | HP 826A Cyan Original LaserJet Toner Cartridge (31,500 Yield) | 916027 | CTG | \$665.00 |
| CF313A | HP 826A Magenta Original LaserJet Toner Cartridge (31,500 Yield) | 916029 | CTG | \$665.00 |
| CF312A | HP 826A Yellow Original LaserJet Toner Cartridge (31,500 Yield) | 916028 | CTG | \$665.00 |
| CF358A | HP 828A Black Original LaserJet Image Drum (30,000 Yield) | 916030 | EA | \$120.00 |
| CF359A | HP 828A Cyan Original LaserJet Image Drum (30,000 Yield) | 916031 | EA | \$332.00 |
| CF365A | HP 828A Magenta Original LaserJet Image Drum (30,000 Yield) | 916033 | EA | \$332.00 |

| MFG# | Product Description | Part# | UOM | Retail |
|---|--|--------|-----|----------|
| HP SUPPLIES | | | | |
| <i>HP CROSS REFERENCE GUIDE CAN BE FOUND ON PAGES 257-282.</i> | | | | |
| HP Color LaserJet Enterprise M855 Series Supplies <i>(Continued)</i> | | | | |
| CF364A | HP 828A Yellow Original LaserJet Image Drum (30,000 Yield) | 916032 | EA | \$332.00 |
| C1N54A | HP Fuser Maintenance Kit (110V) | 917898 | EA | \$344.88 |
| D7H14A | HP Transfer and Roller Kit | 933674 | EA | \$431.40 |
| HP Color LaserJet Enterprise flow M880z MFP Supplies | | | | |
| CF300A | HP 827A Black Original LaserJet Toner Cartridge (29,500 Yield) | 916034 | CTG | \$138.00 |
| CF301A | HP 827A Cyan Original LaserJet Toner Cartridge (32,000 Yield) | 916035 | CTG | \$615.00 |
| CF303A | HP 827A Magenta Original LaserJet Toner Cartridge (32,000 Yield) | 916037 | CTG | \$615.00 |
| CF302A | HP 827A Yellow Original LaserJet Toner Cartridge (32,000 Yield) | 916036 | CTG | \$615.00 |
| CF358A | HP 828A Black Original LaserJet Image Drum (30,000 Yield) | 916030 | EA | \$120.00 |
| CF359A | HP 828A Cyan Original LaserJet Image Drum (30,000 Yield) | 916031 | EA | \$332.00 |
| CF365A | HP 828A Magenta Original LaserJet Image Drum (30,000 Yield) | 916033 | EA | \$332.00 |
| CF364A | HP 828A Yellow Original LaserJet Image Drum (30,000 Yield) | 916032 | EA | \$332.00 |
| C1N54A | HP Fuser Maintenance Kit (110V) | 917898 | EA | \$344.88 |
| D7H14A | HP Transfer and Roller Kit | 933674 | EA | \$431.40 |
| HP Color LaserJet Professional CP5225 Series Supplies | | | | |
| CE740A | HP 307A Black Original LaserJet Toner Cartridge (7,000 Yield) | 91440 | CTG | \$208.82 |
| CE741A | HP 307A Cyan Original LaserJet Toner Cartridge (7,300 Yield) | 91441 | CTG | \$367.82 |
| CE743A | HP 307A Magenta Original LaserJet Toner Cartridge (7,300 Yield) | 91444 | CTG | \$367.82 |
| CE742A | HP 307A Yellow Original LaserJet Toner Cartridge (7,300 Yield) | 91443 | CTG | \$367.82 |
| HP Color LaserJet Pro MFP M176/M177 Series Supplies | | | | |
| CF350A | HP 130A Black Original LaserJet Toner Cartridge (1,300 Yield) | 916042 | CTG | \$77.91 |
| CF351A | HP 130A Cyan Original LaserJet Toner Cartridge (1,000 Yield) | 916043 | CTG | \$80.35 |
| CF353A | HP 130A Magenta Original LaserJet Toner Cartridge (1,000 Yield) | 916045 | CTG | \$80.35 |
| CF352A | HP 130A Yellow Original LaserJet Toner Cartridge (1,000 Yield) | 916044 | CTG | \$80.35 |

Committed to memory



Verbatim develops and markets innovative, high-quality products for storing, moving and using digital content. Our product range includes the ultra-fast USB 3.0 interface in USB drives and hard drives, a vast assortment of Premium memory cards and SSDs, innovative mice and keyboards as well as the most compatible optical media in the market. Buy Verbatim and you get innovation, security and reliability - and that means peace of mind.



All catalog content is subject to change.

| MFG# | Product Description | Part# | UOM | Retail |
|---|---|--------|-----|------------|
| HP SUPPLIES | | | | |
| <i>HP CROSS REFERENCE GUIDE CAN BE FOUND ON PAGES 257-282.</i> | | | | |
| HP Color LaserJet Pro MFP M476 Series Supplies | | | | |
| CF380A | HP 312A Black Original LaserJet Toner Cartridge (2,400 Yield) | 920243 | CTG | \$126.67 |
| CF380X | HP 312X High Yield Black Original LaserJet Toner Cartridge (4,400 Yield) | 920244 | CTG | \$153.70 |
| CF381A | HP 312A Cyan Original LaserJet Toner Cartridge (2,700 Yield) | 920245 | CTG | \$169.60 |
| CF383A | HP 312A Magenta Original LaserJet Toner Cartridge (2,700 Yield) | 920247 | CTG | \$169.60 |
| CF382A | HP 312A Yellow Original LaserJet Toner Cartridge (2,700 Yield) | 920246 | CTG | \$169.60 |
| HP LaserJet Enterprise 500 Color MFP M575/500 Color Printer M551/Color Flow MFP M575c Series Supplies | | | | |
| CE400A | HP 507A Black Original LaserJet Toner Cartridge (5,500 Yield) | 107885 | CTG | \$205.64 |
| CE400X | HP 507X High Yield Black Original LaserJet Toner Cartridge (11,000 Yield) | 107886 | CTG | \$276.66 |
| CE401A | HP 507A Cyan Original LaserJet Toner Cartridge (6,000 Yield) | 107887 | CTG | \$306.34 |
| CE403A | HP 507A Magenta Original LaserJet Toner Cartridge (6,000 Yield) | 107889 | CTG | \$306.34 |
| CE402A | HP 507A Yellow Original LaserJet Toner Cartridge (6,000 Yield) | 107888 | CTG | \$306.34 |
| CE400AG | HP 507A Black Original LaserJet Toner Cartridge for US Government (5,500 Yield) (TAA Compliant Version of CE400A) | 913629 | CTG | \$194.00 |
| CE401AG | HP 507A Cyan Original LaserJet Toner Cartridge for US Government (6,000 Yield) (TAA Compliant Version of CE401A) | 913630 | CTG | \$289.00 |
| CE403AG | HP 507A Magenta Original LaserJet Toner Cartridge for US Government (6,000 Yield) (TAA Compliant Version of CE403A) | 913632 | CTG | \$289.00 |
| CE402AG | HP 507A Yellow Original LaserJet Toner Cartridge for US Government (6,000 Yield) (TAA Compliant Version of CE402A) | 913631 | CTG | \$289.00 |
| CD644-67908 | HP Intermediate Transfer Belt Assembly (For Use in M575 Only) | 910100 | EA | \$1,161.52 |
| CE254A | HP Toner Collection Unit (36,000 Yield) | 902622 | EA | \$15.00 |
| HP LaserJet Enterprise 700 Color MFP M775 Series Supplies | | | | |
| CE340A | HP 651A Black Original LaserJet Toner Cartridge (13,500 Yield) | 908800 | CTG | \$237.44 |
| CE341A | HP 651A Cyan Original LaserJet Toner Cartridge (16,000 Yield) | 908801 | CTG | \$597.84 |
| CE343A | HP 651A Magenta Original LaserJet Toner Cartridge (16,000 Yield) | 908803 | CTG | \$597.84 |
| CE342A | HP 651A Yellow Original LaserJet Toner Cartridge (16,000 Yield) | 908802 | CTG | \$597.84 |
| CE980A | HP Toner Collection Unit (150,000 Yield) | 911943 | EA | \$30.00 |
| CE514A | HP Maintenance Kit (110V) (150,000 Yield) | 910499 | KIT | \$346.00 |
| CE516A | HP Intermediate Transfer Belt Maintenance Kit (150,000 Yield) | 910500 | KIT | \$516.00 |
| HP LaserJet Pro 100 Color MFP M175nw/Pro 200 Color MFP M275/CP1025nw Series Supplies | | | | |
| CE310A | HP 126A Black Original LaserJet Toner Cartridge (1,200 Yield) | 92948 | CTG | \$71.02 |
| CE311A | HP 126A Cyan Original LaserJet Toner Cartridge (1,000 Yield) | 92971 | CTG | \$78.97 |
| CE313A | HP 126A Magenta Original LaserJet Toner Cartridge (1,000 Yield) | 92992 | CTG | \$78.97 |
| CE312A | HP 126A Yellow Original LaserJet Toner Cartridge (1,000 Yield) | 92972 | CTG | \$78.97 |
| CE310AD | HP 126A 2-Pack Black Original LaserJet Toner Cartridges (2 Pack of OEM# CE310A) (2 x 1,200 Yield) | 800645 | CTG | \$127.73 |
| CF341A | HP 126A 3-Pack Cyan/Magenta/Yellow Original LaserJet Toner Cartridges (Includes 1 Each of OEM# CE311A, CE312A, CE313A) (3 x 1,000 Yield) | 800646 | CTG | \$213.06 |
| CE314A | HP 126A Original LaserJet Imaging Drum (Black 14,000/Color 7,000 Yield) | 93003 | EA | \$112.36 |
| HP LaserJet Pro 200 Color M251nw/200 Color MFP M276nw Series Supplies | | | | |
| CF210A | HP 131A Black Original LaserJet Toner Cartridge (1,600 Yield) | 908267 | CTG | \$94.34 |
| CF210X | HP 131X High Yield Black Original LaserJet Toner Cartridge (2,400 Yield) | 908268 | CTG | \$119.78 |
| CF211A | HP 131A Cyan Original LaserJet Toner Cartridge (1,800 Yield) | 908269 | CTG | \$118.19 |
| CF213A | HP 131A Magenta Original LaserJet Toner Cartridge (1,800 Yield) | 908271 | CTG | \$118.19 |
| CF212A | HP 131A Yellow Original LaserJet Toner Cartridge (1,800 Yield) | 908270 | CTG | \$118.19 |
| HP LaserJet Pro 300 Color MFP M375nw/400 Color Printer M451/400 Color MFP M475 Series Supplies <i>(Continued on next page)</i> | | | | |
| CE410A | HP 305A Black Original LaserJet Toner Cartridge (2,200 Yield) | 507813 | CTG | \$116.07 |
| CE410X | HP 305X High Yield Black Original LaserJet Toner Cartridge (4,000 Yield) | 507814 | CTG | \$142.57 |
| CE410XD | HP 305X 2-Pack High Yield Black Original LaserJet Toner Cartridges (2 Pack of OEM# CE410X) (2 x 4,000 Yield) | 912442 | PK | \$256.52 |
| CE411A | HP 305A Cyan Original LaserJet Toner Cartridge (2,600 Yield) | 507823 | CTG | \$165.36 |
| CE413A | HP 305A Magenta Original LaserJet Toner Cartridge (2,600 Yield) | 507827 | CTG | \$165.36 |
| CE412A | HP 305A Yellow Original LaserJet Toner Cartridge (2,600 Yield) | 507824 | CTG | \$165.36 |
| CF370AM | HP 305A 3-Pack Cyan/Magenta/Yellow Original LaserJet Toner Cartridges (Includes OEM# CE411A, CE412A, CE413A) (3 x 2,600 Yield) | 912443 | PK | \$446.26 |
| CE410AG | HP 305A Black Original LaserJet Toner Cartridge for US Government (2,200 Yield) (TAA Compliant Version of CE410A) | 913633 | CTG | \$109.50 |
| CE411AG | HP 305A Cyan Original LaserJet Toner Cartridge for US Government (2,600 Yield) (TAA Compliant Version of CE411A) | 913635 | CTG | \$156.00 |
| CE413AG | HP 305A Magenta Original LaserJet Toner Cartridge for US Government (2,600 Yield) (TAA Compliant Version of CE413A) | 913637 | CTG | \$156.00 |

| MFG# | Product Description | Part# | UOM | Retail |
|---|--|--------|-----|----------|
| HP SUPPLIES | | | | |
| <i>HP CROSS REFERENCE GUIDE CAN BE FOUND ON PAGES 257-282.</i> | | | | |
| HP LaserJet Pro 300 Color MFP M375nw/400 Color Printer M451/400 Color MFP M475 Series Supplies (Continued) | | | | |
| CE412AG | HP 305A Yellow Original LaserJet Toner Cartridge for US Government (2,600 Yield) (TAA Compliant Version of CE412A) | 913636 | CTG | \$156.00 |
| RM1-8061-000CN | HP Fusing Assembly (110V) (For Use with M375/M475 Models) | 906371 | EA | \$284.29 |
| RM2-5177 | HP Fusing Assembly (110V) (For Use in Model M451) | 923161 | EA | \$290.89 |
| RM1-4852 | HP Intermediate Transfer Belt Assembly | 7676 | EA | \$317.74 |
| HP LaserJet Pro 500 Color MFP M570dn Series Supplies | | | | |
| CE400A | HP 507A Black Original LaserJet Toner Cartridge (5,500 Yield) | 107885 | CTG | \$205.64 |
| CE400X | HP 507X High Yield Black Original LaserJet Toner Cartridge (11,000 Yield) | 107886 | CTG | \$276.66 |
| CE401A | HP 507A Cyan Original LaserJet Toner Cartridge (6,000 Yield) | 107887 | CTG | \$306.34 |
| CE403A | HP 507A Magenta Original LaserJet Toner Cartridge (6,000 Yield) | 107889 | CTG | \$306.34 |
| CE402A | HP 507A Yellow Original LaserJet Toner Cartridge (6,000 Yield) | 107888 | CTG | \$306.34 |
| CE400AG | HP 507A Black Original LaserJet Toner Cartridge for US Government (5,500 Yield) (TAA Compliant Version of CE400A) | 913629 | CTG | \$194.00 |
| CE401AG | HP 507A Cyan Original LaserJet Toner Cartridge for US Government (6,000 Yield) (TAA Compliant Version of CE401A) | 913630 | CTG | \$289.00 |
| CE403AG | HP 507A Magenta Original LaserJet Toner Cartridge for US Government (6,000 Yield) (TAA Compliant Version of CE403A) | 913632 | CTG | \$289.00 |
| CE402AG | HP 507A Yellow Original LaserJet Toner Cartridge for US Government (6,000 Yield) (TAA Compliant Version of CE402A) | 913631 | CTG | \$289.00 |
| CE254A | HP Toner Collection Unit (36,000 Yield) | 902622 | EA | \$15.00 |
| HP LaserJet Pro CM1415fnw MFP/CP1525nw Series Supplies | | | | |
| CE320A | HP 128A Black Original LaserJet Toner Cartridge (2,000 Yield) | 35513 | CTG | \$98.05 |
| CE321A | HP 128A Cyan Original LaserJet Toner Cartridge (1,300 Yield) | 35514 | CTG | \$93.28 |
| CE323A | HP 128A Magenta Original LaserJet Toner Cartridge (1,300 Yield) | 35538 | CTG | \$93.28 |
| CE322A | HP 128A Yellow Original LaserJet Toner Cartridge (1,300 Yield) | 35521 | CTG | \$93.28 |
| CE320AD | HP 128A 2-Pack Black Original LaserJet Toner Cartridges (2 Pack of OEM# CE320A) (2 x 2,000 Yield) | 800647 | CTG | \$176.49 |
| CF371AM | HP 128A 3-Pack Cyan/Magenta/Yellow Original LaserJet Toner Cartridges (Includes 1 Each of OEM# CE321A, CE322A, CE323A) (3 x 1,300 Yield) | 911084 | PK | \$252.28 |
| RM1-4430 | HP Fusing Assembly (110-127V) | 7682 | EA | \$132.05 |
| RM1-4436 | HP Intermediate Transfer Belt (ITB) Assembly | 7673 | EA | \$251.75 |

IMAGISTICS SUPPLIES

| | | | | |
|--|--|--------|-----|----------|
| Imagistics Copier Supplies | | | | |
| 460-4 | DF200/270/370/DL200/270/370 Toner (413 gm. Ctg) (11,000 Yield) | 1908 | CTG | \$67.00 |
| 666-5 | im2020/2520/2520f/3520 Toner (14,000 Yield) | 6458 | CTG | \$70.00 |
| 794-3 | im3510/3511/4510/4511 Toner (25,000 Yield) | 5391 | CTG | \$150.00 |
| 485-5 | FX-3000 Toner (7,500 Yield) | 90170 | CTG | \$134.75 |
| Imagistics Plain Paper Facsimile Supplies | | | | |
| 817-5 | 1500/1630/1640/2500/ix2600 Toner (10,000 Yield) | 106673 | CTG | \$295.00 |
| 816-8 | 1530 Toner (7,500 Yield) | 106715 | CTG | \$185.00 |
| 473-8 | fx2080/fx2081 Toner (16,000 Yield) | 30035 | CTG | \$307.50 |
| 484-5 | ix2700/2701/fx2100/sX2100/mx2100 Toner (6,500 Yield) | 5182 | CTG | \$199.00 |
| 473-0 | sx1480/sx1481 Toner (7,500 Yield) | 23308 | CTG | \$250.00 |
| 473-7 | sx1480/sx1481 Drum (20,000 Yield) | 30039 | CTG | \$180.00 |
| Imagistics/Oce VarioLink 3200x Supplies | | | | |
| 485-7 | Toner (8,000 Yield) | 94967 | CTG | \$141.00 |
| 485-3 | Drum (25,000 Yield) | 100169 | EA | \$199.00 |

INFOPRINT SUPPLIES

| | | | | |
|---|---|--------|-----|----------|
| InfoPrint Impact Printer Ribbons | | | | |
| 1053685 | 4247 Black Ribbon (15M Characters) | 30407 | RBN | \$38.50 |
| 41U2235 | 4247 LO3 Ribbon (15M Characters) | 96498 | RBN | \$38.50 |
| 57P1743 | 4247 V03/X03 Series Ribbon (20M Characters) | 2593 | RBN | \$41.00 |
| 57P2308 | 6400 i Series Premium 30 Ribbon (30M Characters) (6 Rbn/Box) | 2591 | BOX | \$188.00 |
| 44D7762 | 6400 i Series Premium 2000 Ribbon (60M Characters) (12 Rbn/Box) (For Use in Models 020/i20) | 101620 | BOX | \$464.00 |
| 41U1680 | 6500 V Series Ultra Capacity Ribbon (50M Characters) (6 Rbn/Box) | 31059 | BOX | \$254.00 |
| 45U3891 | 6500 V5P/V05/V10/V1P/V15/V20 Series Standard Ribbon (17,000 Yield) | 35163 | RBN | \$59.00 |
| 45U3895 | 6500 V10/V1P/V15/V20 Series Extended Life Ribbon (4 x 30,000 Yield) (4 Rbn/Box) (Special Order) | 35165 | BOX | \$258.00 |

| MFG# | Product Description | Part# | UOM | Retail |
|---|--|--------|-----|------------|
| INFOPRINT SUPPLIES | | | | |
| InfoPrint 1130/1140 Workgroup Laser Supplies | | | | |
| 28P2010 | High Yield Return Program Toner (30,000 Yield) | 4655 | CTG | \$525.00 |
| 28p2012 | LV Usage Kit (120V) (Includes Fuser, Charge Roll, Transfer Roll) (300,000 Yield) (For Use in Model 1130) | 4721 | KIT | \$500.00 |
| 28P2625 | LV Usage Kit (120V) (300,000 Yield) (For Use in Model 1140) | 4696 | KIT | \$528.00 |
| InfoPrint 1145 Workgroup Laser Supplies | | | | |
| 28P1882 | Toner (30,000 Yield) | 4713 | CTG | \$416.00 |
| 28P1883 | LV Usage Kit (120V) (300,000 Yield) | 4712 | KIT | \$964.00 |
| InfoPrint 1332/1352/1372 Workgroup Laser Supplies | | | | |
| 75P4301 | Return Program Toner (5,000 Yield) | 1814 | CTG | \$165.00 |
| 75P4303 | High Yield Return Program Toner (21,000 Yield) | 1812 | CTG | \$465.00 |
| 39V2634 | LV Usage Kit (120V) (300,000 Yield) (For Use in Models 1332/1352) | 107607 | KIT | \$414.00 |
| 39V2640 | LV Usage Kit (120V) (Includes Fuser, Charge Roll, Transfer Roll, Pick Rollers) (300,000 Yield) (For Use in Model 1372) | 107616 | KIT | \$601.00 |
| InfoPrint 1412/1512 Workgroup Laser Supplies | | | | |
| 75P5709 | Return Program Toner (2,500 Yield) | 5655 | CTG | \$108.00 |
| 75P5711 | High Yield Return Program Toner (6,000 Yield) | 5657 | CTG | \$167.00 |
| 75P5712 | Photoconductor Kit (30,000 Yield) | 5658 | KIT | \$91.00 |
| InfoPrint 1532/1552/1572 Workgroup Laser Supplies | | | | |
| 75P6959 | Return Program Toner (6,000 Yield) | 10875 | CTG | \$188.00 |
| 75P6961 | High Yield Return Program Toner (21,000 Yield) | 10877 | CTG | \$468.00 |
| 75P6963 | Extra High Yield Return Program Toner (32,000 Yield) (For Use in Model 1572) | 10879 | CTG | \$506.00 |
| 39V2598 | LV Maintenance Kit (110V) (300,000 Yield) | 107558 | KIT | \$390.00 |
| InfoPrint 1540MFP/1560MFP/1580MFP Multifunction Laser Supplies | | | | |
| 39V0529 | Toner (30,000 Yield) | 13026 | CTG | \$160.00 |
| 39V0530 | Photoconductor Cartridge (Models 001, 002 - 48,000 Yield/ Models 101, 102 - 60,000 Yield/ Models 201, 202 - 70,000 Yield) | 13028 | CTG | \$151.00 |
| InfoPrint 1570MFP/1572MFP/1650MFP Multifunction Laser Supplies | | | | |
| 39V0542 | Return Program Toner (10,000 Yield) | 13032 | CTG | \$313.00 |
| 39V1063 | Special Label Toner (Includes 2 Wipers) | 105542 | CTG | \$482.00 |
| 39V2598 | LV Maintenance Kit (110V) (300,000 Yield) | 107558 | KIT | \$390.00 |
| 39V2600 | LV Fuser Unit (110V) (300,000 Yield) | 107561 | EA | \$352.00 |
| InfoPrint 1585 Workgroup Laser Supplies | | | | |
| 75P6877 | Toner (30,000 Yield) | 11851 | CTG | \$275.00 |
| 75P6878 | Photoconductor Cartridge (60,000 Yield) | 11852 | CTG | \$231.00 |
| 39V2603 | LV Maintenance Kit (300,000 Yield) | 107568 | KIT | \$1,219.00 |
| InfoPrint 1612 Workgroup Laser Supplies | | | | |
| 39V1638 | Return Program Toner (3,500 Yield) | 30152 | CTG | \$133.00 |
| 39V1642 | High Yield Return Program Toner (9,000 Yield) | 30153 | CTG | \$261.00 |
| 39V1645 | Photoconductor Kit (30,000 Yield) | 30156 | KIT | \$50.00 |
| InfoPrint 1622 Workgroup Laser Supplies | | | | |
| 39V1644 | High Yield Return Program Toner (11,000 Yield) | 30155 | CTG | \$240.00 |
| 39V1645 | Photoconductor Kit (30,000 Yield) | 30156 | KIT | \$50.00 |
| InfoPrint 1811/1812/1822/1823 Workgroup Laser Supplies | | | | |
| 39V3204 | High Yield Return Program Toner (9,000 Yield) | 903631 | CTG | \$243.00 |
| 39V3207 | Photoconductor Kit (30,000 Yield) | 903633 | KIT | \$33.00 |
| 39V3525 | LV Maintenance Kit (110V) (Includes Fuser, ACM Pick Tires, Transfer Roll Assembly) (120,000 Yield) | 903634 | KIT | \$249.00 |
| InfoPrint 1832/1852/1872/1892 Workgroup Laser Supplies | | | | |
| 39V2511 | Return Program Toner (7,000 Yield) | 903648 | CTG | \$185.00 |
| 39V3394 | Government High Yield Return Program Toner (25,000 Yield) (For Use in Model 1832/1852/1872) | 27155 | CTG | \$445.00 |
| 39V2515 | Extra High Yield Return Program Toner (36,000 Yield) (For Use in Model 1872/1892) | 903650 | CTG | \$548.00 |
| 39V3590 | LV Maintenance Kit (110V) (Includes Fuser, Transfer Roll, Charge Roll, 3 Sets of 2 Pick Rolls) (300,000 Yield) | 903651 | KIT | \$479.00 |

| MFG# | Product Description | Part# | UOM | Retail |
|---|--|--------|-----|----------|
| INFOPRINT SUPPLIES | | | | |
| InfoPrint 1850MFP/1860MFP/1870MFP/1880MFP Multifunction Laser Supplies | | | | |
| 39V2969 | High Yield Return Program Toner (25,000 Yield) | 903660 | CTG | \$514.00 |
| 39V2971 | Extra High Yield Return Program Toner (36,000 Yield) (For Use in Models 1870MFP/1880MFP) | 903661 | CTG | \$548.00 |
| 39V3590 | LV Maintenance Kit (110V) (Includes Fuser, Transfer Roll, Charge Roll, 3 Sets of 2 Pick Rolls) (300,000 Yield) | 903651 | KIT | \$479.00 |
| 39V3600 | LV Fuser Assembly (110V) (300,000 Yield) | 903655 | EA | \$416.00 |
| InfoPrint 1930/1940 MFP Workgroup Laser Supplies | | | | |
| 39V3717 | Extra High Yield Return Program Toner (15,000 Yield) | 6546 | CTG | \$316.00 |
| 39V3207 | Photoconductor Kit (30,000 Yield) | 903633 | KIT | \$33.00 |
| 39V3525 | LV Maintenance Kit (110V) (Includes Fuser, ACM Pick Tires, Transfer Roll Assembly) (120,000 Yield) | 903634 | KIT | \$249.00 |
| InfoPrint 1985 Workgroup Laser Supplies | | | | |
| 39V3628 | Toner (35,000 Yield) | 20085 | CTG | \$297.00 |
| 39V3629 | Photoconductor Kit (60,000 Yield) | 20087 | KIT | \$218.00 |
| InfoPrint 3900/4000 Production Laser Supplies | | | | |
| 1402822 | Toner (8 x 42,000 Yield) (8 Btls/Ctn) | 2120 | CTN | \$380.56 |
| 1402823 | Developer (2 x 1,400,000 Yield) (2 Btls/Ctn) | 2105 | CTN | \$639.68 |
| 57P1888 | Enhanced Toner Cassette (8 x 55,000 Yield) (8 Btls/Ctn) | 1829 | CTN | \$543.92 |
| InfoPrint 4100 Production Laser Supplies | | | | |
| 69G7377 | Toner Cassette, Version 2 (TD1/TD2/TS1/HD1/HD2/HD5/HD6/HS3/MD1/MD2/MS1) (4 x 85,500 Yield) (4/Ctn) | 2104 | CTN | \$400.71 |
| 69G7370 | Developer, Version 2 (HD1/HD2/HD5/HD6/HS3/MD1/MD2/MS1/TD1/TD2/TS1) (2 x 1,600,000 Yield) (2 Btls/Ctn) | 2103 | CTN | \$656.95 |
| 56Y2500 | Toner Cassette, Version 5 (HS2/HD3/HD4) (4 x 110,000 Yield) (4/Ctn) | 50148 | CTN | \$546.53 |
| 56Y2501 | Developer, Version 5 (HS2/HD3/HD4) (2 x 2,000,000 Yield) (2 Btls/Ctn) | 50149 | CTN | \$815.61 |
| 719110 | Toner Cassette, Version 8 (4 x 110,000 Yield) (4/Ctn) | 932960 | CTN | \$546.53 |
| 719111 | Developer, Version 8 (2 x 1,600,000 Yield) (2 Btls/Ctn) | 932961 | CTN | \$894.56 |
| InfoPrint Color 1534/1634 Workgroup Color Laser Supplies | | | | |
| 39V0314 | High Yield Black Return Program Toner (8,000 Yield) | 12267 | CTG | \$227.00 |
| 39V0311 | High Yield Cyan Return Program Toner (5,000 Yield) | 12268 | CTG | \$228.00 |
| 39V0312 | High Yield Magenta Return Program Toner (5,000 Yield) | 12269 | CTG | \$228.00 |
| 39V0313 | High Yield Yellow Return Program Toner (5,000 Yield) | 12270 | CTG | \$228.00 |
| 39V1635 | Photoconductor (20,000 Yield) | 30144 | EA | \$46.00 |
| 39V2617 | LV Fuser (110V) (120,000 Yield) | 107680 | EA | \$316.00 |
| 39V0384 | Waste Toner Container (30,000 Yield) | 12274 | EA | \$12.00 |
| InfoPrint Color 1754/1764 Workgroup Color Laser Supplies | | | | |
| 39V1919 | High Yield Black Return Program Toner (10,000 Yield) | 94474 | CTG | \$220.00 |
| 39V1920 | High Yield Cyan Return Program Toner (10,000 Yield) | 94475 | CTG | \$412.00 |
| 39V1921 | High Yield Magenta Return Program Toner (10,000 Yield) | 94476 | CTG | \$412.00 |
| 39V1922 | High Yield Yellow Return Program Toner (10,000 Yield) | 94477 | CTG | \$412.00 |
| 39V1923 | Extra High Yield Black Return Program Toner (15,000 Yield) (For Use in Model 1764 Only) | 94483 | CTG | \$242.00 |
| 39V2318 | ITU Maintenance Kit (Includes 2nd Transfer Roll) (120,000 Yield) | 107527 | KIT | \$847.00 |
| 39V2313 | LV Fuser Unit (115V) (200,000 Yield) | 94488 | EA | \$608.00 |
| 53P9372 | Toner Waste Container (Black 180,000/Color 50,000 Yield) | 3899 | EA | \$15.00 |
| InfoPrint Color 1824/1826 Color Multifunction Laser Supplies | | | | |
| 39V2430 | Extra High Yield Black Return Program Toner (6,000 Yield) | 903636 | CTG | \$152.00 |
| 39V2431 | Extra High Yield Cyan Return Program Toner (4,000 Yield) | 903637 | CTG | \$149.00 |
| 39V2432 | Extra High Yield Magenta Return Program Toner (4,000 Yield) | 903638 | CTG | \$149.00 |
| 39V2433 | Extra High Yield Yellow Return Program Toner (4,000 Yield) | 903639 | CTG | \$149.00 |
| 39V3352 | Black/Color Imaging Kit (Includes 4 Photoconductors, 4 Developers) (8 x 30,000 Yield) | 903641 | KIT | \$269.00 |
| 39V3354 | Photoconductor Kit (30,000 Yield) | 903643 | KIT | \$145.00 |
| 39V2773 | Waste Toner Container (30,000 Mono/18,000 Color Yield) | 903640 | EA | \$11.00 |
| InfoPrint Color 1834/1854 Workgroup Color Laser Supplies | | | | |
| 39V2441 | Black Return Program Toner (8,000 Yield) | 12721 | CTG | \$163.00 |
| 39V2438 | Cyan Return Program Toner (6,000 Yield) | 12702 | CTG | \$259.00 |
| 39V2439 | Magenta Return Program Toner (6,000 Yield) | 12703 | CTG | \$259.00 |
| 39V2440 | Yellow Return Program Toner (6,000 Yield) | 12720 | CTG | \$259.00 |
| 39V2695 | Photoconductor Unit (20,000 Yield) | 12733 | EA | \$39.00 |
| 39V3412 | Fuser Maintenance Kit (115V) (120,000 Yield) | 12736 | KIT | \$365.00 |
| 39V2699 | Waste Toner Container (25,000 Yield) | 12734 | EA | \$10.00 |

| MFG# | Product Description | Part# | UOM | Retail |
|---|---|--------|-----|----------|
| INFOPRINT SUPPLIES | | | | |
| InfoPrint Color 1846MFP/1856MFP/1866MFP Color Multifunction Laser Supplies | | | | |
| 39V2449 | High Yield Black Return Program Toner (12,000 Yield) | 12729 | CTG | \$232.00 |
| 39V2446 | High Yield Cyan Return Program Toner (10,000 Yield) | 12722 | CTG | \$404.00 |
| 39V2447 | High Yield Magenta Return Program Toner (10,000 Yield) | 12727 | CTG | \$404.00 |
| 39V2448 | High Yield Yellow Return Program Toner (10,000 Yield) | 12728 | CTG | \$404.00 |
| 39V2695 | Photoconductor Unit (20,000 Yield) | 12733 | EA | \$39.00 |
| 39V3412 | Fuser Maintenance Kit (115V) (120,000 Yield) | 12736 | KIT | \$365.00 |
| 39V2699 | Waste Toner Container (25,000 Yield) | 12734 | EA | \$10.00 |
| InfoPrint C2047 Color Laser Supplies | | | | |
| 39V4055 | Extra High Yield Black Return Program Toner (20,000 Yield) | 99566 | CTG | \$359.00 |
| 39V4052 | Extra High Yield Cyan Return Program Toner (20,000 Yield) | 99562 | CTG | \$622.00 |
| 39V4053 | Extra High Yield Magenta Return Program Toner (20,000 Yield) | 99563 | CTG | \$622.00 |
| 39V4054 | Extra High Yield Yellow Return Program Toner (20,000 Yield) | 99565 | CTG | \$622.00 |
| KONICA MINOLTA SUPPLIES | | | | |
| KONICA MINOLTA Monochrome Copier Supplies | | | | |
| 950246 | 7022/7130/7222/7228 Toner (30,000 Yield) | 2852 | CTG | \$120.92 |
| 950564 | 7155/7165/7255/7272/FORCE 65 Toner (47,500 Yield) (TN601K) | 3221 | BTL | \$125.00 |
| A32W011 | bizhub 20/20P Toner (TNP24) (8,000 Yield) | 93176 | CTG | \$129.99 |
| 4518-605 | bizhub 160/161/Di1610 Series Toner (TN113) (5,000 Yield) | 6017 | CTG | \$79.00 |
| 8937-782 | bizhub 162/162F/163/180/181/210/ 211/7516/7521/Di152/Di152F/Di183/di183F Toner (11,000 Yield) (2-413 gm. Btl/Ctn) | 15165 | CTN | \$80.00 |
| 8938-413 | bizhub 200/222/250/282 Toner (17,500 Yield) (TN211) | 12798 | BTL | \$71.26 |
| TN217 | bizhub 223/283 Toner (25,000 Yield) | 906855 | CTG | \$59.50 |
| 8938-402 | bizhub 350/362 Toner (17,500 Yield) (TN311) | 30487 | CTG | \$63.21 |
| 024E | bizhub 360/361/420/421/500/501 Toner (TN511) (32,200 Yield) | 90655 | CTG | \$79.99 |
| A202030 | bizhub 363/423 Toner (25,000 Yield) (TN414) | 800659 | CTG | \$57.95 |
| 02XJ | bizhub 600/750 Toner (55,000 Yield) | 94677 | EA | \$87.85 |
| 8936-402 | Dialta Di200/200f/250/250f/251/251f/350/350f/351/351f Toner (2 x 11,000 Yield) (2-413 gm. Btls/Ctn) (Type 302A) | 104054 | CTN | \$81.00 |
| 8937-753 | Dialta Di2010/2510 Toner (28,000 Yield) (2 Ctg/Ctn) (Type 205A) | 1145 | CTN | \$125.00 |
| 8937-747 | Dialta Di3010/3010f/3510/3510f Toner (2 x 14,000 Yield) (2 Ctg/Ctn) (Type 303A) | 1146 | CTN | \$125.00 |
| 8935-802 | EP1030/1030F/1031/1031F Toner (1,500 Yield) (Type 103A) | 100090 | CTG | \$15.24 |
| 8935-202 | EP 1083/2010 Toner (2-350 gm. Btls/Ctn) (12,000 Yield) (Type 102A) | 98660 | CTN | \$76.00 |
| KONICA MINOLTA bizhub C250 Color Copier Supplies | | | | |
| 8938-505 | Black Toner (20,000 Yield) | 15121 | CTG | \$45.00 |
| 8938-508 | Cyan Toner (12,000 Yield) | 15124 | CTG | \$95.00 |
| 8938-507 | Magenta Toner (12,000 Yield) | 15123 | CTG | \$95.00 |
| 8938-506 | Yellow Toner (12,000 Yield) | 15122 | CTG | \$95.00 |
| KONICA MINOLTA bizhub C350/C351/C450 Color Copier Supplies | | | | |
| 4053-401 | Black Toner (11,500 Yield) | 6218 | CTG | \$30.00 |
| 4053-701 | Cyan Toner (11,500 Yield) | 6221 | CTG | \$65.50 |
| 4053-601 | Magenta Toner (11,500 Yield) | 6220 | CTG | \$65.50 |
| 4053-501 | Yellow Toner (11,500 Yield) | 6219 | CTG | \$65.50 |
| KONICA MINOLTA bizhub C654/C654e/C754/C754e Color Copier Supplies | | | | |
| A3VU130 | Black Toner (47,200 Yield) | 912811 | CTG | \$98.00 |
| A3VU430 | Cyan Toner (31,500 Yield) | 912814 | CTG | \$91.42 |
| A3VU330 | Magenta Toner (31,500 Yield) | 912813 | CTG | \$91.42 |
| A3VU230 | Yellow Toner (31,500 Yield) | 912812 | CTG | \$91.42 |
| KONICA MINOLTA magicolor 1600/1650/1680/1690 Color Laser Supplies | | | | |
| A0V30GF | Cyan Toner (1,500 Yield) | 16155 | CTG | \$88.00 |
| A0V30AF | Magenta Toner (1,500 Yield) | 16154 | CTG | \$88.00 |
| A0V305F | Yellow Toner (1,500 Yield) | 16153 | CTG | \$88.00 |
| A0V301F | High Capacity Black Toner (2,500 Yield) | 16156 | CTG | \$72.00 |
| A0V30HF | High Capacity Cyan Toner (2,500 Yield) | 16159 | CTG | \$109.00 |
| A0V30CF | High Capacity Magenta Toner (2,500 Yield) | 16158 | CTG | \$109.00 |
| A0V306F | High Capacity Yellow Toner (2,500 Yield) | 16157 | CTG | \$109.00 |
| A0VU011 | Imaging Unit (Mono 45,000/Color 11,250 Yield) | 16160 | EA | \$99.00 |
| KONICA MINOLTA magicolor 2400/2430/2450/2480/2490/2500/2530/2550/2590 Color Laser Supplies <i>(Continued on next page)</i> | | | | |
| 1710587-004 | High Capacity Black Toner (4,500 Yield) | 6334 | CTG | \$92.00 |
| 1710587-003 | Cyan Toner (1,500 Yield) | 6331 | CTG | \$76.00 |
| 1710587-002 | Magenta Toner (1,500 Yield) | 6332 | CTG | \$76.00 |

| MFG# | Product Description | Part# | UOM | Retail |
|---|--|--------|-----|----------|
| KONICA MINOLTA SUPPLIES | | | | |
| KONICA MINOLTA magicolor 2400/2430/2450/2480/2490/2500/2530/2550/2590 Color Laser Supplies (Continued) | | | | |
| 1710587-001 | Yellow Toner (1,500 Yield) | 6333 | CTG | \$76.00 |
| 1710591-001 | Drum (Mono 45,000/Color 11,250 Yield) | 6339 | EA | \$162.00 |
| KONICA MINOLTA magicolor 4650/4690 Color Laser Supplies | | | | |
| A0DK132 | High Capacity Black Toner (8,000 Yield) | 101069 | CTG | \$109.00 |
| A0DK432 | High Capacity Cyan Toner (8,000 Yield) | 101070 | CTG | \$177.00 |
| A0DK332 | High Capacity Magenta Toner (8,000 Yield) | 101071 | CTG | \$177.00 |
| A0DK232 | High Capacity Yellow Toner (8,000 Yield) | 101072 | CTG | \$177.00 |
| A0DKJ32 | High Capacity C/M/Y Toner Value Kit (Includes 1 Each of OEM# A0DK232, A0DK332, A0DK432) | 101073 | KIT | \$482.00 |
| A03100F | Black Imaging Unit (30,000 Yield) | 50119 | EA | \$156.00 |
| A0310NF | C/M/Y Imaging Unit Value Kit (Includes 1 Each of OEM# A03105F, A0310AF, A0310GF) | 50123 | KIT | \$597.00 |
| A06X010 | Waste Toner Container (2-Piece Pack) (36,000 Yield Mono/9,000 Yield Color) | 101068 | PK | \$44.00 |
| KONICA MINOLTA magicolor 4750 Color Laser Supplies | | | | |
| A0X5130 | High Capacity Black Toner (6,000 Yield) | 102001 | CTG | \$97.00 |
| A0X5430 | High Capacity Cyan Toner (6,000 Yield) | 102004 | CTG | \$141.00 |
| A0X5330 | High Capacity Magenta Toner (6,000 Yield) | 102003 | CTG | \$141.00 |
| A0X5230 | High Capacity Yellow Toner (6,000 Yield) | 102002 | CTG | \$141.00 |
| A0WG03F | Black Imaging Unit (30,000 Yield) | 102005 | EA | \$140.00 |
| A0WG0KF | Cyan Imaging Unit (30,000 Yield) | 102011 | EA | \$185.25 |
| A0WG0EF | Magenta Imaging Unit (30,000 Yield) | 102010 | EA | \$185.25 |
| A0WG08F | Yellow Imaging Unit (30,000 Yield) | 102009 | EA | \$185.25 |
| A1AU0Y1 | Waste Toner Box (20,000 Yield) | 95158 | EA | \$20.00 |
| KONICA MINOLTA magicolor 5430/5440/5450 Color Laser Supplies | | | | |
| 1710580-001 | Black Toner (6,000 Yield) | 5871 | CTG | \$130.00 |
| 1710580-004 | Cyan Toner (6,000 Yield) | 5874 | CTG | \$216.00 |
| 1710580-003 | Magenta Toner (6,000 Yield) | 5873 | CTG | \$216.00 |
| 1710580-002 | Yellow Toner (6,000 Yield) | 5872 | CTG | \$216.00 |
| 1710584-001 | Waste Toner Container (5430: Mono 32,000/Color 8,000 Yield) (5440/5450: Mono 40,000/Color 10,000 Yield) | 5875 | EA | \$29.99 |
| KONICA MINOLTA magicolor 5550/5570/5650/5670 Color Laser Supplies | | | | |
| A06V132 | Black Toner (6,000 Yield) | 50108 | CTG | \$92.00 |
| A06V432 | Cyan Toner (6,000 Yield) | 50109 | CTG | \$164.00 |
| A06V332 | Magenta Toner (6,000 Yield) | 50110 | CTG | \$164.00 |
| A06V232 | Yellow Toner (6,000 Yield) | 50111 | CTG | \$164.00 |
| A06V133 | High Capacity Black Toner (12,000 Yield) | 50113 | CTG | \$104.00 |
| A06V433 | High Capacity Cyan Toner (12,000 Yield) | 50114 | CTG | \$233.00 |
| A06V333 | High Capacity Magenta Toner (12,000 Yield) | 50115 | CTG | \$233.00 |
| A06V233 | High Capacity Yellow Toner (12,000 Yield) | 50116 | CTG | \$233.00 |
| A06VJ33 | High Capacity C/M/Y Toner Value Kit (Includes 1 Each of OEM# A06V233, A06V333, A06V433) (3 x 12,000 Yield) | 50118 | KIT | \$629.00 |
| A0310NF | C/M/Y Imaging Unit Value Kit (Includes 1 Each of OEM# A03105F, A0310AF, A0310GF) | 50123 | KIT | \$597.00 |
| KONICA MINOLTA PagePro 1300/1350 Laser Supplies | | | | |
| 1710566-001 | Toner (3,000 Yield) | 5040 | CTG | \$87.00 |
| 1710568-001 | Drum Unit (20,000 Yield) | 5041 | EA | \$113.00 |
| KONICA MINOLTA PagePro 4650 Laser Supplies | | | | |
| A0FN012 | High Capacity Toner (18,000 Yield) | 101061 | CTG | \$261.00 |
| KONICA MINOLTA PagePro 5650 Laser Supplies | | | | |
| A0FP012 | High Capacity Toner (19,000 Yield) | 101063 | CTG | \$235.00 |



Konica Minolta offers a wide range of printing solutions for any size business, giving you the document solution that best fits your needs. Replace legacy desktop devices with fast, cost-efficient, network-ready Konica Minolta printers that speed your output, improve your image quality and help you stay ahead of rising workloads.



| MFG# | Product Description | Part# | UOM | Retail |
|--|--|--------|-----|----------|
| KONICA MINOLTA SUPPLIES | | | | |
| KONICA MINOLTA Plain Paper Facsimile Supplies | | | | |
| 4152-611 | 1600/2600/2800/3600/3800 Toner (6,000 Yield) | 104052 | CTG | \$142.00 |
| 4518-826 | 2900/3900 Toner (TN110) (6,000 Yield) | 6439 | EA | \$156.00 |
| KONICA MINOLTA Micrographics Reader Supplies | | | | |
| 8910-203 | RP605Z/606Z Positive Toner (4 x 70-gm. Ctgs/Ctn) (2,000 Yield) | 100444 | CTN | \$108.10 |
| 8910-204 | RP605Z/606Z Negative Toner (4 x 70-gm. Ctgs/Ctn) (2,000 Yield) | 100089 | CTN | \$106.10 |
| 4161-106 | SP2000/3000/6000 Toner (10,000 Yield) | 105575 | CTG | \$363.50 |
| KYOCERA MITA SUPPLIES | | | | |
| Kyocera Mita Monochrome Laser Supplies | | | | |
| TS300 | F300/F305/F315/MFX-1330/1350D Toner (5,000 Yield) | 14263 | CTG | \$176.00 |
| TK17 | FS-1000+/1010 Toner (6,000 Yield) | 4783 | CTG | \$78.00 |
| KM-TK18 | FS-1020D/KM-1500/1815/1820 Toner (7,200 Yield) | 5336 | CTG | \$86.00 |
| TK122 | FS-1030D Toner (7,200 Yield) | 12824 | CTG | \$120.00 |
| TK-132 | FS-1028MFP/1128MFP/1300D/1300DN/1350DN Toner (7,200 Yield) | 902450 | CTG | \$89.00 |
| MK-132 | FS-1028MFP/1128MFP/1350DN Maintenance Kit (100,000 Yield) | 90870 | EA | \$175.00 |
| TK-142 | FS-1100 Toner (4,000 Yield) | 902484 | CTG | \$101.00 |
| TK-162 | FS-1120D Toner (2,400 Yield) | 27101 | CTG | \$62.00 |
| TK-1142 | FS-1035MFP/FS-1135MFP/M2035dn/M2535dn Toner (7,200 Yield) | 800635 | CTG | \$79.99 |
| TK-172 | FS-1320D/FS-1370DN/P2135 Toner (7,200 Yield) | 27102 | CTG | \$105.00 |
| TK60 | FS-1800/1800N/3800/3800N Toner (Includes Waste Bottle) (20,000 Yield) | 107718 | CTG | \$99.00 |
| TK50H | FS-1900 Toner (15,000 Yield) | 2157 | CTG | \$109.00 |
| TK57 | FS-1920 Toner (Includes Waste Bottle) (15,000 Yield) | 6156 | CTG | \$99.00 |
| TK312 | FS-2000D Toner Kit (12,000 Yield) | 29614 | CTG | \$93.21 |
| TK-342 | FS-2020D/2020DN Toner (12,000 Yield) | 12742 | CTG | \$79.20 |
| TK67 | FS-3820N/3830N Toner (20,000 Yield) | 6157 | CTG | \$99.00 |
| TK322 | FS-3900DN Toner (15,000 Yield) | 21937 | CTG | \$81.00 |
| TK-352 | FS-3040MFP/3140MFP/3540MFP/3640MFP/3920DN Toner (15,000 Yield) | 12748 | CTG | \$81.00 |
| TK332 | FS-4000DN Toner (20,000 Yield) | 26059 | CTG | \$92.00 |
| TK-362 | FS-4020DN Toner (20,000 Yield) | 12753 | CTG | \$84.00 |
| MK-360 | FS-4020D Maintenance Kit (300,000 Yield) | 90863 | EA | \$268.00 |
| TK-3112 | FS-4100DN Toner (15,500 Yield) | 911117 | CTG | \$88.20 |
| TK-3122 | FS-4200DN Toner (21,000 Yield) | 911088 | CTG | \$88.20 |
| TK-3132 | FS-4300DN Toner (25,000 Yield) | 911740 | CTG | \$90.00 |
| TK70 | FS-9100/9100DN/9120DN/9500DN/9520DN Toner (Includes Waste Bottle) (40,000 Yield) | 3814 | CTG | \$199.00 |
| TK712 | FS-9130DN/9530DN Toner (40,000 Yield) | 31508 | EA | \$173.25 |
| TK40 | KM-F650 AIO Toner (9,000 Yield) | 2150 | CTG | \$200.00 |
| TK45 | KM-F1050 AIO Toner (12,000 Yield) | 2151 | CTG | \$250.00 |
| TD-47 | KM-F1060 Toner (5,000 Yield) | 90364 | EA | \$178.06 |
| TK717 | TASKalfa 420i/520i/KM 3050/4050/5050 Toner (34,000 Yield) | 14537 | CTG | \$199.00 |
| Kyocera Mita FS-C1020 Color Laser Supplies | | | | |
| TK152K | Black Toner (6,500 Yield) | 14895 | CTG | \$132.00 |
| TK152C | Cyan Toner (6,000 Yield) | 14896 | CTG | \$200.00 |
| TK152M | Magenta Toner (6,000 Yield) | 14897 | CTG | \$200.00 |
| TK152Y | Yellow Toner (6,000 Yield) | 14898 | CTG | \$200.00 |
| Kyocera Mita FS-C2026/C2126/C2526/C2626/C5250 Color Laser Supplies | | | | |
| TK-592K | Black Toner (7,000 Yield) | 91533 | CTG | \$90.00 |
| TK-592C | Cyan Toner (5,000 Yield) | 91534 | CTG | \$95.00 |
| TK-592M | Magenta Toner (5,000 Yield) | 91535 | CTG | \$95.00 |
| TK-592Y | Yellow Toner (5,000 Yield) | 91536 | CTG | \$95.00 |
| Kyocera Mita FS-C5010N Color Laser Supplies | | | | |
| TK-522K | Black Toner (6,000 Yield) | 900501 | CTG | \$175.79 |
| TK-522C | Cyan Toner (4,000 Yield) | 900502 | CTG | \$171.68 |
| TK-522M | Magenta Toner (4,000 Yield) | 900503 | CTG | \$171.68 |
| TK-522Y | Yellow Toner (4,000 Yield) | 900504 | CTG | \$171.68 |
| Kyocera Mita FS-C5020N/C5030N Color Laser Supplies | | | | |
| TK512K | Black Toner (8,000 Yield) | 10830 | CTG | \$59.99 |
| TK512C | Cyan Toner (8,000 Yield) | 10831 | CTG | \$225.00 |
| TK512M | Magenta Toner (8,000 Yield) | 10832 | CTG | \$225.00 |
| TK512Y | Yellow Toner (8,000 Yield) | 10833 | CTG | \$225.00 |
| Kyocera Mita FS-C5100DN Color Laser Supplies (Continued on next page) | | | | |
| TK542K | Black Toner (5,000 Yield) | 11209 | CTG | \$197.89 |
| TK542C | Cyan Toner (4,000 Yield) | 11221 | CTG | \$264.71 |

| MFG# | Product Description | Part# | UOM | Retail |
|---|---|--------|-----|----------|
| KYOCERA MITA SUPPLIES | | | | |
| Kyocera Mita FS-C5100DN Color Laser Supplies (Continued) | | | | |
| TK542M | Magenta Toner (4,000 Yield) | 11228 | CTG | \$264.71 |
| TK542Y | Yellow Toner (4,000 Yield) | 11246 | CTG | \$264.71 |
| Kyocera Mita FS-C5150DN Color Laser Supplies | | | | |
| TK582K | Black Toner (3,500 Yield) | 105813 | CTG | \$99.95 |
| TK582C | Cyan Toner (2,800 Yield) | 105814 | CTG | \$110.95 |
| TK582M | Magenta Toner (2,800 Yield) | 105816 | CTG | \$110.95 |
| TK582Y | Yellow Toner (2,800 Yield) | 105815 | CTG | \$110.95 |
| Kyocera Mita FS-C5200DN Color Laser Supplies | | | | |
| TK552K | Black Toner (7,000 Yield) | 11086 | CTG | \$213.31 |
| TK552C | Cyan Toner (6,000 Yield) | 11094 | CTG | \$244.15 |
| TK552M | Magenta Toner (6,000 Yield) | 11099 | CTG | \$244.15 |
| TK552Y | Yellow Toner (6,000 Yield) | 11165 | CTG | \$244.15 |
| Kyocera Mita FS-C5300DN Color Laser Supplies | | | | |
| TK562K | Black Toner (12,000 Yield) | 11166 | CTG | \$218.45 |
| TK562C | Cyan Toner (10,000 Yield) | 11167 | CTG | \$312.26 |
| TK562M | Magenta Toner (10,000 Yield) | 11172 | CTG | \$312.26 |
| TK562Y | Yellow Toner (10,000 Yield) | 11196 | CTG | \$312.26 |
| Kyocera Mita FS-C5400DN Color Laser Supplies | | | | |
| TK-572K | Black Toner (16,000 Yield) | 15353 | CTG | \$128.00 |
| TK-572C | Cyan Toner (12,000 Yield) | 15354 | CTG | \$168.00 |
| TK-572M | Magenta Toner (12,000 Yield) | 15355 | CTG | \$168.00 |
| TK-572Y | Yellow Toner (12,000 Yield) | 15356 | CTG | \$168.00 |
| Kyocera Mita TASKalfa Monochrome Laser Supplies | | | | |
| TK-677 | TASKalfa 620/820 Toner (20,000 Yield) | 15726 | EA | \$85.88 |
| Kyocera Mita TASKalfa 250ci/300ci Color Laser Supplies | | | | |
| TK-867K | Black Toner (25,000 Yield) | 93681 | CTG | \$105.00 |
| TK-867C | Cyan Toner (25,000 Yield) | 93684 | CTG | \$110.00 |
| TK-867M | Magenta Toner (25,000 Yield) | 93691 | CTG | \$110.00 |
| TK-867Y | Yellow Toner (25,000 Yield) | 93695 | CTG | \$110.00 |
| Kyocera Mita Copier Supplies | | | | |
| 37029011 | KM 1510/1810 Toner (1-300 gm. Ctg, Waste Bottle) (7,000 Yield) | 3295 | CTG | \$66.20 |
| 37028011 | KM 1525/1530/2030 Toner (450 gm. Ctg) (11,000 Yield) | 107899 | CTG | \$68.00 |
| 370AM011 | (TK-411) KM 1620/1635/1650/2020/2050 Toner (Includes Toner Cartridge, 2 Waste Toner Bottles, 2 Waste Toner Bags, Grid Cleaner) (15,000 Yield) | 6159 | CTG | \$85.00 |
| 370AB011 | KM 2530/3035/3530/4030/4035/5035 Toner (1900 gm. Ctg) (34,000 Yield) | 2856 | CTG | \$222.00 |
| TK-677 | KM 2540/2560/3040/3060 Toner (20,000 Yield) | 15726 | EA | \$85.88 |
| 370AR011 | (TK-421) KM 2550 Toner (15,000 Yield) | 6160 | CTG | \$85.00 |
| 370AE011 | (TK-601) KM 4530/5530/6330/7530 Toner (30,000 Yield) | 1948 | CTG | \$80.00 |
| LANIER SUPPLIES | | | | |
| Lanier Digital Copier Supplies | | | | |
| 828080 | Lanier Pro 907/1107/1357/1357EX Toner (60,000 Yield) | 910277 | CTG | \$109.95 |
| Lanier 160c Color Laser Supplies | | | | |
| 841333 | Black Toner (910 gm. Ctg) (36,000 Yield) (Type S1) | 19326 | CTG | \$67.00 |
| 841336 | Cyan Toner (530 gm. Ctg) (18,000 Yield) (Type S1) | 19329 | CTG | \$224.50 |
| 841335 | Magenta Toner (530 gm. Ctg) (18,000 Yield) (Type S1) | 19328 | CTG | \$224.50 |
| 841334 | Yellow Toner (530 gm. Ctg) (18,000 Yield) (Type S1) | 19327 | CTG | \$224.50 |
| Lanier LC435c/LD445c Color Laser Supplies | | | | |
| 841342 | Black Toner (23,000 Yield) | 16144 | CTG | \$72.00 |
| 841345 | Cyan Toner (17,000 Yield) | 16147 | CTG | \$215.00 |
| 841344 | Magenta Toner (17,000 Yield) | 16148 | CTG | \$215.00 |
| 841343 | Yellow Toner (17,000 Yield) | 16149 | CTG | \$215.00 |
| Lanier LD328C/LD335C/LD345C Color Laser Supplies | | | | |
| 888340 | Black Toner (24,000 Yield) (Type R1) | 91800 | CTG | \$55.50 |
| 888343 | Cyan Toner (10,000 Yield) (Type R1) | 91804 | CTG | \$176.50 |
| 888342 | Magenta Toner (10,000 Yield) (Type R1) | 91803 | CTG | \$176.50 |
| 888341 | Yellow Toner (10,000 Yield) (Type R1) | 91802 | CTG | \$176.50 |

| MFG# | Product Description | Part# | UOM | Retail |
|--|--|--------|-----|----------|
| LANIER SUPPLIES | | | | |
| Lanier LP125cx/126cn/LP226cn/LP231cn Color Laser Supplies | | | | |
| 888308 | High Yield Black Toner (15,000 Yield) (Type 145) | 10456 | CTG | \$97.34 |
| 888311 | High Yield Cyan Toner (15,000 Yield) (Type 145) | 10459 | CTG | \$225.75 |
| 888310 | High Yield Magenta Toner (15,000 Yield) (Type 145) | 10458 | CTG | \$225.75 |
| 888309 | High Yield Yellow Toner (15,000 Yield) (Type 145) | 10457 | CTG | \$225.75 |
| Lanier Plain Paper Facsimile Supplies | | | | |
| 480-0032 | 5222/5227 Toner (12,000 Yield) | 106833 | BTL | \$40.00 |
| 480-0198 | LD115/118/118D Toner (9,000 Yield) | 6012 | CTG | \$79.00 |
| LEXMARK SUPPLIES | | | | |
| Lexmark Systems Printer Ribbons for IBM Printers | | | | |
| 3070166 | 2300/2400/2500 Series Re-Inking Printer Ribbon (4M Characters) | 906559 | RBN | \$19.48 |
| 3070169 | 2400/2500 Series High Yield Re-Inking Printer Ribbon (8M Characters) | 906562 | RBN | \$34.96 |
| 13L0034 | 4227 Plus Ribbon (15M Characters) | 104629 | RBN | \$66.25 |
| 1040990 | 6400 Models 050/P50/010/P10/015/6404/6405/6408 Ribbon (20M Characters) (6/Box) | 30349 | BOX | \$141.30 |
| 1040993 | 6400 Models 050/P50/010/P10/015/6408 High Contrast Ribbon (20M Characters, OCR/Bar Code) (6/Box) | 30372 | BOX | \$141.30 |
| 1040995 | 6400 Models 050/P50/010/P10/015/6412 Ribbon (30M Characters) (6/Box) | 30365 | BOX | \$239.88 |
| 1040998 | 6400 Models 050/P50/010/P10/015/6412 High Contrast Ribbon (30M Characters, OCR/Bar Code) (6/Box) | 30391 | BOX | \$239.88 |
| Lexmark Personal Printer Inkjet Supplies - Multi Unit Packs | | | | |
| 18C2239 | (#14/#15) Z3200/X2600/X2670 Black/Color Return Program Ink Combo Pack (Includes 1 Each of OEM# 18C2090, 18C2110) (175, 150 Yield) | 901882 | PK | \$58.21 |
| 10N0202 | (#16/#26) Z13/Z23/Z25/Z33/Z35/Z515/Z605/Z611/Z616/Z645/Z75/X1150/X1185/X1270 Black/Color Ink Combo Pack (Includes 1 Each of OEM# 10N0016, 10N0026) (335, 290 Yield) | 5509 | PK | \$89.55 |
| 18C1571 | (#23/#24) X3550/X4550/Z1420 Black/Color Ink Combo Pack (Includes 1 Each of OEM# 18C1523, 18C1524) | 93810 | PK | \$63.81 |
| 18C2229 | (#36/#37) X3500/X3600/X4600/X5650/X6650/X6675 Black/Color Return Program Ink Combo Pack (Includes 1 Each of OEM# 18C2130, 18C2140) (175, 150 Yield) | 901879 | PK | \$59.33 |
| 18C2249 | (#36XL/#37XL) X3500/X3600/X4600/X5650/X6650/X6675 High Yield Black/Color Return Program Ink Combo Pack (Includes 1 Each of OEM# 18C2170, 18C2180) (2 x 500 Yield) | 901881 | PK | \$82.84 |
| 18C0533 | (#32) P915/P4350/P6250/X3350/X5250/X5270/X5470/X7170/X7350/X8350/Z816 Black Ink Dual Pack (2 Pack of OEM# 18C0032) (2 x 200 Yield) | 5474 | PK | \$62.69 |
| 14N0683 | (#100XL) S305/S405/S505/S605/S815/Pro205/Pro705/Pro805/Pro905 High Yield Black Return Program Ink Dual Pack (2 Pack of OEM# 14N1068) (2 x 510 Yield) | 19670 | PK | \$69.40 |
| 14N0685 | (#100C/M/Y) S305/S405/S505/S605/S815/Pro205/Pro705/Pro805/Pro905 Color Return Program Ink Combo Pack (Includes 1 Each of OEM# 14N0900, 14N0901, 14N0902) (3 x 200 Yield) | 19673 | PK | \$43.66 |
| 14N0684 | (#100C/M/Y XL) S305/S405/S505/S605/S815/Pro205/Pro705/Pro805/Pro905 High Yield Color Return Program Ink Combo Pack (Includes 1 Each of OEM# 14N1069, 14N1070, 14N1071) (3 x 600 Yield) | 19674 | PK | \$73.88 |
| 14N0843 | (#105XL) Pro805/Pro905/Pro901 High Yield Black Return Program Ink Multipack (4 Pack of OEM# 14N0822) (4 x 510 Yield) | 19672 | PK | \$26.87 |
| 14N1835 | (#150 CMY) Pro715/Pro915 Color Return Program Ink Combo Ink (Includes 1 Each of OEM# 14N1608, 14N1609, 14N1610) (3 x 200 Yield) | 506662 | PK | \$50.45 |
| 14N1837 | (#155XL) Pro715/Pro915 High Yield Black Return Program Ink Dual Pack (2 Pack of OEM# 14N1619) (2 x 750 Yield) | 506663 | PK | \$41.64 |
| 14L0268 | (#200C/M/Y) OfficeEdge Pro 4000/4000C/5500/5500T Return Program Ink Combo Pack (Includes 1 Each of OEM# 14L0086, 14L0087, 14L0088) (3 x 500 Yield) | 701370 | CTG | \$77.24 |
| 14L0269 | (#200C/M/Y XL) OfficeEdge Pro 4000/4000C/5500/5500T High Yield Return Program Ink Combo Pack (Includes 1 Each of OEM# 14L0175, 14L0176, 14L0177) (3 x 1,600 Yield) | 701371 | PK | \$122.39 |
| Lexmark Personal Printer Inkjet Supplies (Continued on next page) | | | | |
| 18C2090 | (#14) Z2300/X2600/X2670 Black Return Program Ink (175 Yield) | 901869 | CTG | \$30.22 |
| 18C2080 | (#14A) Z2300/X2600/X2670 Black Ink (175 Yield) | 901871 | CTG | \$36.27 |
| 18C2110 | (#15) Z2300/X2600/X2670 Color Return Program Ink (150 Yield) | 901870 | CTG | \$33.58 |
| 18C2100 | (#15A) Z2300/X2600/X2670 Color Ink (150 Yield) | 901872 | CTG | \$40.30 |
| 10N0016 | (#16) Z23/Z25/Z33/Z35/X75/Z605/Z515/Z611/Z615/X2250/X1185/X1270/X2470/X3470/Z645 Black Ink (335 Yield) | 108252 | CTG | \$48.13 |
| 18C1523 | (#23) X3550/X4550/Z1420 Black Return Program Print Cartridge | 93802 | CTG | \$33.06 |
| 18C1524 | (#24) X3430/X3550/X4550/Z1420 Color Return Program Print Cartridge | 93805 | CTG | \$38.06 |
| 10N0026 | (#26) Z23/Z25/Z33/Z35/X75/Z605/Z515/Z611/Z615/X2250/X1185/X1270/X2470/X3470/Z645 Color Ink (290 Yield) | 108253 | CTG | \$51.49 |
| 18C1428 | (#28) Z845/Z1300/X2500,X5070/X5075/X5495 Black Return Program Ink (175 Yield) | 25581 | CTG | \$30.22 |
| 18C1528 | (#28A) Z845/Z1300/X2500,X5070/X5075/X5495 Black Ink (175 Yield) | 25576 | CTG | \$36.27 |
| 18C1429 | (#29) Z845/Z1300/X2500,X5070/X5075/X5495 Color Return Program Ink | 25582 | CTG | \$31.87 |

| MFG# | Product Description | Part# | UOM | Retail |
|--|--|--------|-----|----------|
| LEXMARK SUPPLIES | | | | |
| Lexmark Personal Printer Inkjet Supplies <i>(Continued)</i> | | | | |
| 18C1529 | (#29A) Z845/Z1300/X2500,X5070/X5075/X5495 Color Ink (150 Yield) | 25577 | CTG | \$38.21 |
| 18C0034 | (#34) P915/P4350/P6250/X2500/X3350/X3550/X4550/X5250/X5270/X5470/X7170/ X7300/X7350/X8350/Z816/Z1300/Z1420 High Yield Black Ink (550 Yield) | 5567 | CTG | \$41.42 |
| 18C2130 | (#36) X3650/X4650/X5650/X6650/X6675/Z2420 Black Return Program Ink (175 Yield) | 901874 | CTG | \$30.22 |
| 18C2150 | (#36A) X3650/X4650/X5650/X6650/X6675/Z2420 Black Ink (175 Yield) | 901876 | CTG | \$36.27 |
| 18C2170 | (#36XL) X3650/X4650/X5650/X6650/X6675/Z2420 High Yield Black Return Program Ink (500 Yield) | 901883 | CTG | \$41.42 |
| 18C2190 | (#36XLA) X3650/X4650/X5650/X6650/X6675/Z2420 High Yield Black Ink (500 Yield) | 901885 | CTG | \$49.70 |
| 18C2140 | (#37) X3650/X4650/X5650/X6650/X6675/Z2420 Color Return Program Ink (150 Yield) | 901875 | CTG | \$33.58 |
| 18C2160 | (#37A) X3650/X4650/X5650/X6650/X6675/Z2420 Color Ink (150 Yield) | 901877 | CTG | \$40.30 |
| 18C2180 | (#37XL) X3650/X4650/X5650/X6650/X6675/Z2420 High Yield Color Return Program Ink (500 Yield) | 901884 | CTG | \$50.37 |
| 18C2200 | (#37XLA) X3650/X4650/X5650/X6650/X6675/Z2420 High Yield Color Ink (500 Yield) | 901878 | CTG | \$60.45 |
| 18Y0144 | (#44XL) X4850/X6570/X7550/X9350/X9575 High Yield Black Ink | 30464 | EA | \$41.42 |
| 14N0820 | (#100) S305/S405/S505/S605/S815/Pro205/Pro705/Pro805/Pro901/Pro905 Black Return Program Ink (170 Yield) | 19661 | CTG | \$24.63 |
| 14N0900 | (#100C) S305/S405/S505/S605/S815/Pro205/Pro705/Pro805/Pro901/Pro905 Cyan Return Program Ink (200 Yield) | 19664 | CTG | \$16.19 |
| 14N0901 | (#100M) S305/S405/S505/S605/S815/Pro205/Pro705/Pro805/Pro901/Pro905 Magenta Return Program Ink (200 Yield) | 19666 | CTG | \$16.19 |
| 14N0902 | (#100Y) S305/S405/S505/S605/S815/Pro205/Pro705/Pro805/Pro901/Pro905 Yellow Return Program Ink (200 Yield) | 19668 | CTG | \$16.19 |
| 14N1068 | (#100XL) S305/S405/S505/S605/S815/Pro205/Pro705/Pro805/Pro901/Pro905 High Yield Black Return Program Ink (510 Yield) | 19662 | CTG | \$39.18 |
| 14N1069 | (#100C XL) S305/S405/S505/S605/S815/Pro205/Pro705/Pro805/Pro901/Pro905 High Yield Cyan Return Program Ink (600 Yield) | 19665 | CTG | \$27.46 |
| 14N1070 | (#100M XL) S305/S405/S505/S605/S815/Pro205/Pro705/Pro805/Pro901/Pro905 High Yield Magenta Return Program Ink (600 Yield) | 19667 | CTG | \$27.46 |
| 14N1071 | (#100Y XL) S305/S405/S505/S605/S815/Pro205/Pro705/Pro805/Pro901/Pro905 High Yield Yellow Return Program Ink (600 Yield) | 19669 | CTG | \$27.46 |
| 14N0822 | (#105XL) Pro805/Pro905/Pro901 High Yield Black Return Program Ink (510 Yield) | 19663 | CTG | \$6.72 |
| 14N1607 | (#150) Pro715/Pro915/S315/S415/S515 Black Return Program Ink (200 Yield) | 506624 | CTG | \$12.91 |
| 14N1608 | (#150) Pro715/Pro915/S315/S415/S515 Cyan Return Program Ink (200 Yield) | 506626 | CTG | \$20.15 |
| 14N1609 | (#150) Pro715/Pro915/S315/S415/S515 Magenta Return Program Ink (200 Yield) | 506638 | CTG | \$20.15 |
| 14N1610 | (#150) Pro715/Pro915/S315/S415/S515 Yellow Return Program Ink (200 Yield) | 506639 | CTG | \$20.15 |
| 14N1614 | (#150XL) Pro715/Pro915/S315/S415/S515 High Yield Black Return Program Ink (750 Yield) | 506640 | CTG | \$38.06 |
| 14N1615 | (#150XL) Pro715/Pro915/S315/S415/S515 High Yield Cyan Return Program Ink (700 Yield) | 506654 | CTG | \$40.30 |
| 14N1616 | (#150XL) Pro715/Pro915/S315/S415/S515 High Yield Magenta Return Program Ink (700 Yield) | 506655 | CTG | \$40.30 |
| 14N1618 | (#150XL) Pro715/Pro915/S315/S415/S515 High Yield Yellow Return Program Ink (700 Yield) | 506656 | CTG | \$40.30 |
| 14N1619 | (#155XL) Pro715/Pro915 High Yield Black Return Program Ink (750 Yield) | 506657 | CTG | \$23.51 |
| 14L0173 | (#200) OfficeEdge Pro 4000/4000C/5500/5500T Black Return Program Ink (625 Yield) | 701358 | CTG | \$34.70 |
| 14L0086 | (#200) OfficeEdge Pro 4000/4000C/5500/5500T Cyan Return Program Ink (500 Yield) | 701359 | CTG | \$28.36 |
| 14L0087 | (#200) OfficeEdge Pro 4000/4000C/5500/5500T Magenta Return Program Ink (500 Yield) | 701360 | CTG | \$28.36 |
| 14L0088 | (#200) OfficeEdge Pro 4000/4000C/5500/5500T Yellow Return Program Ink (500 Yield) | 701361 | CTG | \$28.36 |
| 14L0174 | (#200XL) OfficeEdge Pro 4000/4000C/5500/5500T High Yield Black Return Program Ink (2,500 Yield) | 701362 | CTG | \$48.13 |
| 14L0175 | (#200XL) OfficeEdge Pro 4000/4000C/5500/5500T High Yield Cyan Return Program Ink (1,600 Yield) | 701363 | CTG | \$44.78 |
| 14L0176 | (#200XL) OfficeEdge Pro 4000/4000C/5500/5500T High Yield Magenta Return Program Ink (1,600 Yield) | 701364 | CTG | \$44.78 |
| 14L0177 | (#200XL) OfficeEdge Pro 4000/4000C/5500/5500T High Yield Yellow Return Program Ink (1,600 Yield) | 701365 | CTG | \$44.78 |
| Lexmark E120 Laser Supplies | | | | |
| 12035SA | Toner (2,000 Yield) | 12948 | CTG | \$137.90 |
| 12015SA | Return Program Toner (2,000 Yield) | 12947 | CTG | \$113.31 |
| 12026XW | Photoconductor Kit (25,000 Yield) | 12949 | KIT | \$61.27 |
| 40X1276 | Fuser Assembly (110V) | 17836 | EA | \$79.02 |
| 40X1287 | Transfer Roll Assembly | 17837 | EA | \$12.17 |
| Lexmark E230/E232/E234/E240 Laser Supplies | | | | |
| 24035SA | Toner (2,500 Yield) | 12210 | EA | \$147.24 |
| 24015SA | Return Program Toner (2,500 Yield) | 12208 | EA | \$122.75 |
| 24060SW | Government Return Program Toner (2,500 Yield) (TAA Compliant Version of 24015SA) | 20034 | CTG | \$122.75 |
| 12A8302 | Photoconductor Kit (30,000 Yield) | 5586 | KIT | \$105.57 |
| GSA8302 | Government Photoconductor Kit (30,000 Yield) (TAA Compliant Version of 12A8302) | 6200 | KIT | \$105.57 |
| 40X4194 | Fuser Assembly (110V) | 33580 | EA | \$134.41 |
| 40X1322 | Transfer Roller (Includes Bearings, Gear, Spring) | 902620 | KIT | \$19.07 |

| MFG# | Product Description | Part# | UOM | Retail |
|---|---|--------|-----|----------|
| LEXMARK SUPPLIES | | | | |
| Lexmark E238 Laser Supplies | | | | |
| 23800SW | Return Program Toner (2,000 Yield) | 12401 | CTG | \$112.89 |
| 12A8302 | Photoconductor Kit (30,000 Yield) | 5586 | KIT | \$105.57 |
| GSA8302 | Government Photoconductor Kit (30,000 Yield) (TAA Compliant Version of 12A8302) | 6200 | KIT | \$105.57 |
| 40X4194 | Fuser Assembly (110V) | 33580 | EA | \$134.41 |
| 40X1322 | Transfer Roller (Includes Bearings, Gear, Spring) | 902620 | KIT | \$19.07 |
| Lexmark E250 Laser Supplies | | | | |
| E250A21A | Toner (3,500 Yield) | 30064 | EA | \$183.48 |
| E250A11A | Return Program Toner (3,500 Yield) | 30062 | EA | \$154.23 |
| E250A41G | Government Return Program Toner (3,500 Yield) (TAA Compliant Version of E250A11A) | 90373 | EA | \$154.23 |
| E250X22G | Photoconductor Kit (30,000 Yield) | 30077 | EA | \$57.88 |
| E250X42G | Government Photoconductor Kit (30,000 Yield) (TAA Compliant Version of E250X22G) | 90412 | EA | \$57.88 |
| 40X2847 | Maintenance Kit (110-127V) (Kit Includes Fuser, Exit Guide, Tray 1 Feed Tires, Transfer Roller) (120,000 Yield) | 17816 | KIT | \$200.84 |
| 40X2800 | Fuser Assembly (110-127V) | 17817 | EA | \$167.44 |
| 40X2822 | Transfer Roll Assembly | 17824 | EA | \$13.05 |
| Lexmark E260 Laser Supplies | | | | |
| E260A21A | Toner (3,500 Yield) | 903773 | CTG | \$186.42 |
| E260A11A | Return Program Toner (3,500 Yield) | 903774 | CTG | \$144.33 |
| E260A41G | Government Return Program Toner (3,500 Yield) (TAA Compliant Version of E260A11A) | 904051 | CTG | \$144.33 |
| E260X22G | Photoconductor Kit (30,000 Yield) | 903779 | KIT | \$39.07 |
| E260X42G | Government Photoconductor Kit (30,000 Yield) (TAA Compliant Version of E260X22G) | 904052 | KIT | \$39.07 |
| 40X5400 | Maintenance Kit (110-127V) (Kit Includes Fuser, Tray 1 Feed Tires, Transfer Roller) (120,000 Yield) | 17818 | KIT | \$185.73 |
| 40X5344 | Fuser Assembly (110-120V) (120,000 Yield) | 6760 | EA | \$154.91 |
| 40X5364 | Transfer Roll Assembly | 6761 | EA | \$12.77 |
| Lexmark E320/E322 Laser Supplies | | | | |
| 08A0477 | High Yield Toner (6,000 Yield) | 4222 | CTG | \$239.24 |
| 08A0478 | High Yield Return Program Toner (6,000 Yield) | 4220 | CTG | \$214.76 |
| 99A1017 | Charge Roll Replacement Kit | 105321 | KIT | \$44.09 |
| Lexmark E321/E323 Laser Supplies | | | | |
| 12A7400 | Return Program Toner (3,000 Yield) | 1837 | CTG | \$143.53 |
| 12A7305 | High Yield Toner (6,000 Yield) | 1838 | CTG | \$240.51 |
| 12A7405 | High Yield Return Program Toner (6,000 Yield) | 1836 | CTG | \$215.93 |
| GSA7405 | Government High Yield Return Program Toner (6,000 Yield) (TAA Compliant Version of 12A7405) | 10442 | CTG | \$215.93 |
| 99A1017 | Charge Roll Replacement Kit | 105321 | KIT | \$44.09 |
| Lexmark E330/E332/E340/E342 Laser Supplies | | | | |
| 24035SA | Toner (2,500 Yield) | 12210 | EA | \$147.24 |
| 24015SA | Return Program Toner (2,500 Yield) | 12208 | EA | \$122.75 |
| 24060SW | Government Return Program Toner (2,500 Yield) (TAA Compliant Version of 24015SA) | 20034 | CTG | \$122.75 |
| 34035HA | High Yield Toner (6,000 Yield) | 12211 | EA | \$219.73 |
| 34015HA | High Yield Return Program Toner (6,000 Yield) | 12359 | CTG | \$195.15 |
| 34060HW | Government High Yield Return Program Toner (6,000 Yield) (TAA Compliant Version of 34015HA) | 20035 | CTG | \$195.15 |
| 12A8302 | Photoconductor Kit (30,000 Yield) | 5586 | KIT | \$105.57 |
| GSA8302 | Government Photoconductor Kit (30,000 Yield) (TAA Compliant Version of 12A8302) | 6200 | KIT | \$105.57 |
| 40X4194 | Fuser Assembly (110V) | 33580 | EA | \$134.41 |
| 40X1322 | Transfer Roller (Includes Bearings, Gear, Spring) | 902620 | KIT | \$19.07 |
| Lexmark E350/E352 Laser Supplies | | | | |
| E250A21A | Toner (3,500 Yield) | 30064 | EA | \$183.48 |
| E250A11A | Return Program Toner (3,500 Yield) | 30062 | EA | \$154.23 |
| E250A41G | Government Return Program Toner (3,500 Yield) (TAA Compliant Version of E250A11A) | 90373 | EA | \$154.23 |
| E352H21A | High Yield Toner (9,000 Yield) | 30067 | EA | \$331.68 |
| E352H11A | High Yield Return Program Toner (9,000 Yield) | 30066 | EA | \$300.50 |
| E352H41G | Government High Yield Return Program Toner (9,000 Yield) (TAA Compliant Version of E352H11A) | 90378 | EA | \$300.50 |
| E250X22G | Photoconductor Kit (30,000 Yield) | 30077 | EA | \$57.88 |
| E250X42G | Government Photoconductor Kit (30,000 Yield) (TAA Compliant Version of E250X22G) | 90412 | EA | \$57.88 |
| 40X2847 | Maintenance Kit (110-127V) (Kit Includes Fuser, Exit Guide, Tray 1 Feed Tires, Transfer Roller) (120,000 Yield) | 17816 | KIT | \$200.84 |
| 40X2800 | Fuser Assembly (110-127V) | 17817 | EA | \$167.44 |
| 40X2822 | Transfer Roll Assembly | 17824 | EA | \$13.05 |

| MFG# | Product Description | Part# | UOM | Retail |
|---|---|--------|-----|----------|
| LEXMARK SUPPLIES | | | | |
| Lexmark E360 Laser Supplies | | | | |
| E260A21A | Toner (3,500 Yield) | 903773 | CTG | \$186.42 |
| E260A11A | Return Program Toner (3,500 Yield) | 903774 | CTG | \$144.33 |
| E260A41G | Government Return Program Toner (3,500 Yield) (TAA Compliant Version of E260A11A) | 904051 | CTG | \$144.33 |
| E360H21A | High Yield Toner (9,000 Yield) | 903775 | CTG | \$321.87 |
| E360H11A | High Yield Return Program Toner (9,000 Yield) | 903776 | CTG | \$279.52 |
| E360H41G | Government High Yield Return Program Toner (9,000 Yield) (TAA Compliant Version of E360H11A) | 904053 | CTG | \$279.52 |
| E260X22G | Photoconductor Kit (30,000 Yield) | 903779 | KIT | \$39.07 |
| E260X42G | Government Photoconductor Kit (30,000 Yield) (TAA Compliant Version of E260X22G) | 904052 | KIT | \$39.07 |
| 40X5400 | Maintenance Kit (110-127V) (Kit Includes Fuser, Tray 1 Feed Tires, Transfer Roller) (120,000 Yield) | 17818 | KIT | \$185.73 |
| 40X5344 | Fuser Assembly (110-120V) (120,000 Yield) | 6760 | EA | \$154.91 |
| 40X5364 | Transfer Roll Assembly | 6761 | EA | \$12.77 |
| Lexmark E450 Laser Supplies | | | | |
| E450A11A | Return Program Toner (6,000 Yield) | 30069 | EA | \$182.32 |
| E450H21A | High Yield Toner (11,000 Yield) | 30076 | EA | \$305.70 |
| E450H11A | High Yield Return Program Toner (11,000 Yield) | 30075 | EA | \$276.35 |
| E450H41G | Government High Yield Return Program Toner (11,000 Yield) (TAA Compliant Version of E450H11A) | 90456 | CTG | \$276.35 |
| E250X22G | Photoconductor Kit (30,000 Yield) | 30077 | EA | \$57.88 |
| E250X42G | Government Photoconductor Kit (30,000 Yield) (TAA Compliant Version of E250X22G) | 90412 | EA | \$57.88 |
| 40X2847 | Maintenance Kit (110-127V) (Kit Includes Fuser, Exit Guide, Tray 1 Feed Tires, Transfer Roller) (120,000 Yield) | 17816 | KIT | \$200.84 |
| 40X2800 | Fuser Assembly (110-127V) | 17817 | EA | \$167.44 |
| 40X2822 | Transfer Roll Assembly | 17824 | EA | \$13.05 |
| Lexmark E460 Laser Supplies | | | | |
| E260A21A | Toner (3,500 Yield) | 903773 | CTG | \$186.42 |
| E260A11A | Return Program Toner (3,500 Yield) | 903774 | CTG | \$144.33 |
| E260A41G | Government Return Program Toner (3,500 Yield) (TAA Compliant Version of E260A11A) | 904051 | CTG | \$144.33 |
| E360H21A | High Yield Toner (9,000 Yield) | 903775 | CTG | \$321.87 |
| E360H11A | High Yield Return Program Toner (9,000 Yield) | 903776 | CTG | \$279.52 |
| E360H41G | Government High Yield Return Program Toner (9,000 Yield) (TAA Compliant Version of E360H11A) | 904053 | CTG | \$279.52 |
| E460X21A | Extra High Yield Toner (15,000 Yield) | 903777 | CTG | \$405.08 |
| E460X11A | Extra High Yield Return Program Toner (15,000 Yield) | 903778 | CTG | \$362.92 |
| E460X41G | Government Extra High Yield Return Program Toner (15,000 Yield) (TAA Compliant Version of E460X11A) | 904054 | CTG | \$362.92 |
| E260X22G | Photoconductor Kit (30,000 Yield) | 903779 | KIT | \$39.07 |
| E260X42G | Government Photoconductor Kit (30,000 Yield) (TAA Compliant Version of E260X22G) | 904052 | KIT | \$39.07 |
| 40X5400 | Maintenance Kit (110-127V) (Kit Includes Fuser, Tray 1 Feed Tires, Transfer Roller) (120,000 Yield) | 17818 | KIT | \$185.73 |
| 40X5344 | Fuser Assembly (110-120V) (120,000 Yield) | 6760 | EA | \$154.91 |
| 40X5364 | Transfer Roll Assembly | 6761 | EA | \$12.77 |
| Lexmark E462 Laser Supplies | | | | |
| E260A21A | Toner (3,500 Yield) | 903773 | CTG | \$186.42 |
| E260A11A | Return Program Toner (3,500 Yield) | 903774 | CTG | \$144.33 |
| E260A41G | Government Return Program Toner (3,500 Yield) (TAA Compliant Version of E260A11A) | 904051 | CTG | \$144.33 |
| E360H21A | High Yield Toner (9,000 Yield) | 903775 | CTG | \$321.87 |
| E360H11A | High Yield Return Program Toner (9,000 Yield) | 903776 | CTG | \$279.52 |
| E360H41G | Government High Yield Return Program Toner (9,000 Yield) (TAA Compliant Version of E360H11A) | 904053 | CTG | \$279.52 |
| E462U11A | Extra High Yield Return Program Toner (18,000 Yield) | 19420 | CTG | \$402.27 |
| E462U41G | Government Extra High Yield Return Program Toner (18,000 Yield) (TAA Compliant Version of E462U11A) | 20008 | CTG | \$402.27 |
| E260X22G | Photoconductor Kit (30,000 Yield) | 903779 | KIT | \$39.07 |
| E260X42G | Government Photoconductor Kit (30,000 Yield) (TAA Compliant Version of E260X22G) | 904052 | KIT | \$39.07 |
| 40X5400 | Maintenance Kit (110-127V) (Kit Includes Fuser, Tray 1 Feed Tires, Transfer Roller) (120,000 Yield) | 17818 | KIT | \$185.73 |
| 40X5344 | Fuser Assembly (110-120V) (120,000 Yield) | 6760 | EA | \$154.91 |
| 40X5364 | Transfer Roll Assembly | 6761 | EA | \$12.77 |
| Lexmark MS310 Series Laser Supplies (Continued on next page) | | | | |
| 50F1000 | (501) Return Program Toner (1,500 Yield) | 908918 | CTG | \$86.21 |
| 50F000G | (500G) Government Return Program Toner (1,500 Yield) (TAA Compliant Version of 50F1000) | 913374 | CTG | \$86.21 |

| MFG# | Product Description | Part# | UOM | Retail |
|---|---|--------|-----|----------|
| LEXMARK SUPPLIES | | | | |
| Lexmark MS310 Series Laser Supplies (Continued) | | | | |
| 50F0HA0 | (500HA) High Yield Toner (5,000 Yield) | 908913 | CTG | \$258.90 |
| 50F0H0G | (500HG) Government High Yield Return Program Toner (5,000 Yield) (TAA Compliant Version of 50F0HA0) | 913375 | CTG | \$198.55 |
| 50F1H00 | (501H) High Yield Return Program Toner (5,000 Yield) | 908919 | CTG | \$198.55 |
| 50F0ZA0 | (500ZA) Imaging Unit (60,000 Yield) | 908917 | EA | \$93.21 |
| 50F0Z00 | (500Z) Return Program Imaging Unit (60,000 Yield) | 908916 | EA | \$58.72 |
| 50F0Z0G | (500ZG) Government Return Program Imaging Unit (60,000 Yield) (TAA Compliant Version of 50F0Z00) | 913378 | EA | \$58.72 |
| 40X8023 | Fuser (110-120V) (200,000 Yield) | 911344 | EA | \$215.07 |
| 40X8393 | Transfer Roll (200,000 Yield) | 911345 | EA | \$13.00 |
| Lexmark MS410 Series Laser Supplies | | | | |
| 50F1000 | (501) Return Program Toner (1,500 Yield) | 908918 | CTG | \$86.21 |
| 50F000G | (500G) Government Return Program Toner (1,500 Yield) (TAA Compliant Version of 50F1000) | 913374 | CTG | \$86.21 |
| 50F1H00 | (501H) High Yield Return Program Toner (5,000 Yield) | 908919 | CTG | \$198.55 |
| 50FOXA0 | (500XA) Extra High Yield Toner (10,000 Yield) | 908915 | CTG | \$359.17 |
| 50F1X00 | (501X) Extra High Yield Return Program Toner (10,000 Yield) | 908921 | CTG | \$298.83 |
| 50FOZA0 | (500ZA) Imaging Unit (60,000 Yield) | 908917 | EA | \$93.21 |
| 50FOZ00 | (500Z) Return Program Imaging Unit (60,000 Yield) | 908916 | EA | \$58.72 |
| 50FOZ0G | (500ZG) Government Return Program Imaging Unit (60,000 Yield) (TAA Compliant Version of 50FOZ00) | 913378 | EA | \$58.72 |
| 40X8023 | Fuser (110-120V) (200,000 Yield) | 911344 | EA | \$215.07 |
| 40X8393 | Transfer Roll (200,000 Yield) | 911345 | EA | \$13.00 |
| Lexmark MS510/MS610 Series Laser Supplies | | | | |
| 50F1000 | (501) Return Program Toner (1,500 Yield) | 908918 | CTG | \$86.21 |
| 50F000G | (500G) Government Return Program Toner (1,500 Yield) (TAA Compliant Version of 50F1000) | 913374 | CTG | \$86.21 |
| 50F1H00 | (501H) High Yield Return Program Toner (5,000 Yield) | 908919 | CTG | \$198.55 |
| 50F1X00 | (501X) Extra High Yield Return Program Toner (10,000 Yield) | 908921 | CTG | \$298.83 |
| 50FOUA0 | (500UA) Ultra High Yield Toner (20,000 Yield) | 908914 | CTG | \$498.53 |
| 50F1U00 | (501U) Ultra High Yield Return Program Toner (20,000 Yield) | 908920 | CTG | \$438.19 |
| 50FOZA0 | (500ZA) Imaging Unit (60,000 Yield) | 908917 | EA | \$93.21 |
| 50FOZ00 | (500Z) Return Program Imaging Unit (60,000 Yield) | 908916 | EA | \$58.72 |
| 50FOZ0G | (500ZG) Government Return Program Imaging Unit (60,000 Yield) (TAA Compliant Version of 50FOZ00) | 913378 | EA | \$58.72 |
| 40X8023 | Fuser (110-120V) (200,000 Yield) | 911344 | EA | \$215.07 |
| Lexmark MS710 Series Laser Supplies | | | | |
| 52D1000 | (521) Return Program Toner (6,000 Yield) | 908926 | CTG | \$187.60 |
| 52D1H00 | (521H) High Yield Return Program Toner (25,000 Yield) | 908927 | CTG | \$556.50 |
| 52D0HA0 | (520HA) High Yield Toner (25,000 Yield) | 908922 | CTG | \$659.95 |
| 52D0H0G | (520HG) Government High Yield Return Program Toner (25,000 Yield) (TAA Compliant Version of 52D0HA0) | 913380 | CTG | \$556.50 |
| 52D1H0L | (521HL) High Yield Return Program Toner for Label Applications (25,000 Yield) | 910958 | CTG | \$556.50 |
| 52D1X0L | (521XL) Extra High Yield Return Program Toner for Label Applications (45,000 Yield) | 910959 | CTG | \$689.02 |
| 52D0ZA0 | (520ZA) Imaging Unit (100,000 Yield) | 908925 | EA | \$97.29 |
| 52D0Z00 | (520Z) Return Program Imaging Unit (100,000 Yield) | 908924 | EA | \$62.81 |
| 52D0Z0G | (520ZG) Government Return Program Imaging Unit (100,000 Yield) (TAA Compliant Version of 52D0Z00) | 913382 | EA | \$62.81 |
| 25A0013 | Staple Cartridges (5,000 Staples/Ctg) (EA=Box of 3 Ctgs) | 29550 | EA | \$137.49 |
| 40X8530 | Return Program Fuser Maintenance Kit (110-120V) (Type 11) (Kit Includes Fuser, 3 Media Pick Rollers, Transfer Roller, 3 Separation Rollers) (200,000 Yield) | 910982 | KIT | \$332.22 |
| 40X8531 | Return Program Fuser Maintenance Kit (220-240V) (Type 13) (Kit Includes Fuser, 3 Media Pick Rollers, Transfer Roller, 3 Separation Rollers) (200,000 Yield) | 910983 | KIT | \$398.66 |
| 40X8532 | Return Program Fuser Maintenance Kit (100V) (Type 15) (Kit Includes Fuser, 3 Media Pick Rollers, Transfer Roller, 3 Separation Rollers) (200,000 Yield) | 910984 | KIT | \$332.22 |
| 40X8533 | Fuser Maintenance Kit (110-120V) (Type 17) (Kit Includes Fuser, 3 Media Pick Rollers, Transfer Roller, 3 Separation Rollers) (200,000 Yield) | 910985 | KIT | \$415.28 |
| 40X8534 | Fuser Maintenance Kit (220-240V) (Type 19) (Kit Includes Fuser, 3 Media Pick Rollers, Transfer Roller, 3 Separation Rollers) (200,000 Yield) | 910986 | KIT | \$498.34 |
| 40X8535 | Fuser Maintenance Kit (100V) (Type 21) (Kit Includes Fuser, 3 Media Pick Rollers, Transfer Roller, 3 Separation Rollers) (200,000 Yield) | 910987 | KIT | \$415.28 |
| Lexmark MS711 Series Laser Supplies (Continued on next page) | | | | |
| 52D1000 | (521) Return Program Toner (6,000 Yield) | 908926 | CTG | \$187.60 |
| 52D1H00 | (521H) High Yield Return Program Toner (25,000 Yield) | 908927 | CTG | \$556.50 |
| 52D1X00 | (521X) Extra High Yield Return Program Toner (45,000 Yield) | 908928 | CTG | \$689.02 |

| MFG# | Product Description | Part# | UOM | Retail |
|---|---|--------|-----|------------|
| LEXMARK SUPPLIES | | | | |
| Lexmark MS711 Series Laser Supplies (Continued) | | | | |
| 52D0XA0 | (520XA) Extra High Yield Toner (45,000 Yield) | 908923 | CTG | \$792.47 |
| 52D0Z00 | (520Z) Return Program Imaging Unit (100,000 Yield) | 908924 | EA | \$62.81 |
| 52D0Z0G | (520ZG) Government Return Program Imaging Unit (100,000 Yield) (TAA Compliant Version of 52D0Z00) | 913382 | EA | \$62.81 |
| 52D0ZA0 | (520ZA) Imaging Unit (100,000 Yield) | 908925 | EA | \$97.29 |
| 40X8532 | Return Program Fuser Maintenance Kit (100V) (Type 15) (Kit Includes Fuser, 3 Media Pick Rollers, Transfer Roller, 3 Separation Rollers) (200,000 Yield) | 910984 | KIT | \$332.22 |
| 40X8530 | Return Program Fuser Maintenance Kit (110-120V) (Type 11) (Kit Includes Fuser, 3 Media Pick Rollers, Transfer Roller, 3 Separation Rollers) (200,000 Yield) | 910982 | KIT | \$332.22 |
| 40X8535 | Fuser Maintenance Kit (100V) (Type 21) (Kit Includes Fuser, 3 Media Pick Rollers, Transfer Roller, 3 Separation Rollers) (200,000 Yield) | 910987 | KIT | \$415.28 |
| 40X8533 | Fuser Maintenance Kit (110-120V) (Type 17) (Kit Includes Fuser, 3 Media Pick Rollers, Transfer Roller, 3 Separation Rollers) (200,000 Yield) | 910985 | KIT | \$415.28 |
| 25A0013 | Staple Cartridges (5,000 Staples/Ctg) (EA=Box of 3 Ctg) | 29550 | EA | \$137.49 |
| Lexmark MS810 Series Laser Supplies | | | | |
| 52D1000 | (521) Return Program Toner (6,000 Yield) | 908926 | CTG | \$187.60 |
| 52D0HA0 | (520HA) High Yield Toner (25,000 Yield) | 908922 | CTG | \$659.95 |
| 52D0H0G | (520HG) Government High Yield Return Program Toner (25,000 Yield) (TAA Compliant Version of 52D0HA0) | 913380 | CTG | \$556.50 |
| 52D1H00 | (521H) High Yield Return Program Toner (25,000 Yield) | 908927 | CTG | \$556.50 |
| 52D0ZA0 | (520ZA) Imaging Unit (100,000 Yield) | 908925 | EA | \$97.29 |
| 52D0Z00 | (520Z) Return Program Imaging Unit (100,000 Yield) | 908924 | EA | \$62.81 |
| 52D0Z0G | (520ZG) Government Return Program Imaging Unit (100,000 Yield) (TAA Compliant Version of 52D0Z00) | 913382 | EA | \$62.81 |
| 40X8420 | Return Program Fuser Maintenance Kit (Type 00) (Includes 110-120V Letter Fuser Kit, 3 Media Pick Rollers, Transfer Roller, 3 Separation Rollers) (200,000 Yield) | 910211 | KIT | \$332.22 |
| Lexmark MS811/MS812 Series Laser Supplies | | | | |
| 52D1000 | (521) Return Program Toner (6,000 Yield) | 908926 | CTG | \$187.60 |
| 52D1H00 | (521H) High Yield Return Program Toner (25,000 Yield) | 908927 | CTG | \$556.50 |
| 52D0XA0 | (520XA) Extra High Yield Toner (45,000 Yield) | 908923 | CTG | \$792.47 |
| 52D1X00 | (521X) Extra High Yield Return Program Toner (45,000 Yield) | 908928 | CTG | \$689.02 |
| 52D0ZA0 | (520ZA) Imaging Unit (100,000 Yield) | 908925 | EA | \$97.29 |
| 52D0Z00 | (520Z) Return Program Imaging Unit (100,000 Yield) | 908924 | EA | \$62.81 |
| 52D0Z0G | (520ZG) Government Return Program Imaging Unit (100,000 Yield) (TAA Compliant Version of 52D0Z00) | 913382 | EA | \$62.81 |
| 40X8420 | Return Program Fuser Maintenance Kit (Type 00) (Includes 110-120V Letter Fuser Kit, 3 Media Pick Rollers, Transfer Roller, 3 Separation Rollers) (200,000 Yield) | 910211 | KIT | \$332.22 |
| Lexmark MS911 Series Laser Supplies | | | | |
| 54G0H00 | High Yield Toner (32,500 Yield) | 926132 | CTG | \$326.29 |
| 54G0P00 | Photoconductor Unit (125,000 Yield) | 926136 | EA | \$82.93 |
| 40X9936 | Developer Unit (600,000 Yield) | 926555 | EA | \$410.14 |
| 54G0W00 | Waste Toner Bottle (90,000 Yield) | 926137 | EA | \$34.48 |
| 40X9046 | Fuser (Universal 110V/220V) (720,000 Yield) | 926544 | EA | \$1,123.04 |
| 40X9669 | ITB Maintenance Kit (Includes Transfer Belt, Transfer Roller, 2 Pick Rollers, 4 Separator Rollers, Exhaust Filter, Ozone Filter, Printhead Cleaner) (300,000 Yield) | 926548 | EA | \$431.38 |
| 40X9010 | Transfer Roller | 926543 | EA | \$227.03 |
| 40X9704 | Imaging Transfer Kit (Includes Transfer Belt, Transfer Roller, Exhaust Filter, Ozone Filter, Printhead Cleaner) (300,000 Yield) | 926553 | EA | \$460.79 |
| Lexmark MX310/MX410 Series Laser Supplies | | | | |
| 60F1000 | (601) Return Program Toner (2,500 Yield) | 908931 | CTG | \$119.10 |
| 60F000G | (601G) Return Program Toner (2,500 Yield) (TAA Compliant Version of 60F1000) | 927346 | CTG | \$119.10 |
| 60F0HA0 | (600HA) High Yield Toner (10,000 Yield) | 908929 | CTG | \$388.48 |
| 60F1H00 | (601H) High Yield Return Program Toner (10,000 Yield) | 908932 | CTG | \$298.83 |
| 50F0ZA0 | (500ZA) Imaging Unit (60,000 Yield) | 908917 | EA | \$93.21 |
| 50F0Z00 | (500Z) Return Program Imaging Unit (60,000 Yield) | 908916 | EA | \$58.72 |
| 50F0Z0G | (500ZG) Government Return Program Imaging Unit (60,000 Yield) (TAA Compliant Version of 50F0Z00) | 913378 | EA | \$58.72 |
| 40X8023 | Fuser (110-120V) (200,000 Yield) | 911344 | EA | \$215.07 |
| 40X8393 | Transfer Roll (200,000 Yield) | 911345 | EA | \$13.00 |
| 40X9135 | Maintenance Kit (110V) (Includes Fuser, Redrive Roller Assembly, Pick Roller, Transfer Roll, Tray Separator Roller Assembly, Pick Roller and Separator Pad) (200,000 Yield) | 910230 | KIT | \$327.76 |
| Lexmark MX510/MX511/MX610/MX611 Series Laser Supplies (Continued on next page) | | | | |
| 60F1000 | (601) Return Program Toner (2,500 Yield) | 908931 | CTG | \$119.10 |
| 60F000G | (601G) Return Program Toner (2,500 Yield) (TAA Compliant Version of 60F1000) | 927346 | CTG | \$119.10 |

| MFG# | Product Description | Part# | UOM | Retail |
|---|--|--------|-----|------------|
| LEXMARK SUPPLIES | | | | |
| Lexmark MX510/MX511/MX610/MX611 Series Laser Supplies <i>(Continued)</i> | | | | |
| 60F1H00 | (601H) High Yield Return Program Toner (10,000 Yield) | 908932 | CTG | \$298.83 |
| 60F1X00 | (601X) Extra High Yield Return Program Toner (20,000 Yield) | 908933 | CTG | \$438.19 |
| 60F0X0G | (601X) Government Extra High Yield Return Program Toner (20,000 Yield) | 926820 | CTG | \$438.20 |
| 50F0ZA0 | (500ZA) Imaging Unit (60,000 Yield) | 908917 | EA | \$93.21 |
| 50F0Z00 | (500Z) Return Program Imaging Unit (60,000 Yield) | 908916 | EA | \$58.72 |
| 50F0Z0G | (500ZG) Government Return Program Imaging Unit (60,000 Yield) (TAA Compliant Version of 50F0Z00) | 913378 | EA | \$58.72 |
| 40X8023 | Fuser (110-120V) (200,000 Yield) | 911344 | EA | \$215.07 |
| 40X8393 | Transfer Roll (200,000 Yield) | 911345 | EA | \$13.00 |
| 40X9135 | Maintenance Kit (110V) (Includes Fuser, Redrive Roller Assembly, Pick Roller, Transfer Roll, Tray Separator Roller Assembly, Pick Roller and Separator Pad) (200,000 Yield) (For Use in MX510/MX511 Models) | 910230 | KIT | \$327.76 |
| 40X9137 | Maintenance Kit (110V) (Includes Fuser, Redrive Roller Assembly, Pick Roller, Transfer Roll, Tray Separator Roller Assembly, MPF Pick Roller and Separator Pad) (200,000 Yield) (For Use in Models MX610/MX611) | 910232 | KIT | \$327.76 |
| 35S8500 | Staple Cartridges (1,000 Staples/Ctg) (5 Ctgs/Box) (For Use in Models MX610/MX611) | 908912 | BOX | \$51.48 |
| Lexmark MX710/MX711/MX810/MX811/MX812 Series Laser Supplies | | | | |
| 62D1000 | (621) Return Program Toner (6,000 Yield) | 908936 | CTG | \$187.61 |
| 62D000G | (620G) Government Return Program Toner (6,000 Yield) (TAA Compliant Version of 62D1000) | 913383 | CTG | \$187.61 |
| 62D1H00 | (621H) High Yield Return Program Toner (25,000 Yield) | 908937 | CTG | \$440.52 |
| 62D0HA0 | (620HA) High Yield Toner (25,000 Yield) (For Use in Model MX710) | 908934 | CTG | \$543.97 |
| 62D0XA0 | (620XA) Extra High Yield Toner (45,000 Yield) (For Use in Models MX711/MX810/MX811/MX812) | 908935 | CTG | \$792.47 |
| 62D1X00 | (621X) Extra High Yield Return Program Toner (45,000 Yield) (For Use in Models MX711/MX810/MX811/MX812) | 908938 | CTG | \$689.02 |
| 62D0X0G | (620XG) Government Extra High Yield Return Program Toner (45,000 Yield) (TAA Compliant Version of 62D0XA0) (For Use in Models MX711/MX810/MX811/MX812) | 913385 | CTG | \$689.02 |
| 52D0ZA0 | (520ZA) Imaging Unit (100,000 Yield) | 908925 | EA | \$97.29 |
| 52D0Z00 | (520Z) Return Program Imaging Unit (100,000 Yield) | 908924 | EA | \$62.81 |
| 52D0Z0G | (520ZG) Government Return Program Imaging Unit (100,000 Yield) (TAA Compliant Version of 52D0Z00) | 913382 | EA | \$62.81 |
| 40X8420 | Return Program Fuser Maintenance Kit (Type 00) (Includes 110-120V Letter Fuser Kit, 3 Media Pick Rollers, Transfer Roller, 3 Separation Rollers) (200,000 Yield) | 910211 | KIT | \$332.22 |
| Lexmark MX910/MX911/MX912 Series Laser Supplies | | | | |
| 64G0H00 | High Yield Toner (32,500 Yield) | 926131 | CTG | \$231.93 |
| 54G0P00 | Photoconductor Unit (125,000 Yield) | 926136 | EA | \$82.93 |
| 40X9936 | Developer Unit (600,000 Yield) | 926555 | EA | \$410.14 |
| 54G0W00 | Waste Toner Bottle (90,000 Yield) | 926137 | EA | \$34.48 |
| 40X9046 | Fuser (Universal 110V/220V) (720,000 Yield) | 926544 | EA | \$1,123.04 |
| 40X9669 | ITB Maintenance Kit (Includes Transfer Belt, Transfer Roller, 2 Pick Rollers, 4 Separator Rollers, Exhaust Filter, Ozone Filter, Printhead Cleaner) (300,000 Yield) | 926548 | EA | \$431.38 |
| 40X9010 | Transfer Roller | 926543 | EA | \$227.03 |
| 40X9704 | Imaging Transfer Kit (Includes Transfer Belt, Transfer Roller, Exhaust Filter, Ozone Filter, Printhead Cleaner) (300,000 Yield) | 926553 | EA | \$460.79 |
| Lexmark Optra S 1250/1255 Laser Supplies | | | | |
| 1382925 | High Yield Return Program Toner (17,600 Yield) | 98365 | CTG | \$363.48 |
| 12A6591 | Government High Yield Return Program Toner (17,600 Yield) (TAA Compliant Version of 1382925) | 3449 | CTG | \$363.48 |
| 1382625 | High Yield Return Program Toner for Label Applications (17,600 Yield) | 98370 | CTG | \$402.49 |
| 1382929 | High Yield Return Program Toner for Special Label Applications (17,600 Yield) | 98369 | CTG | \$363.48 |
| 99A0179 | Transfer Roll Assembly (250,000 Yield) | 105561 | EA | \$53.73 |
| 99A1017 | Charge Roll Replacement Kit | 105321 | KIT | \$44.09 |



With a set of innovative features and forward-thinking functionality, the Lexmark family of printers and MFPs create solutions made for simplicity, productivity, reliability and affordability.

LEXMARK[™]

| MFG# | Product Description | Part# | UOM | Retail |
|---|--|--------|-----|----------|
| LEXMARK SUPPLIES | | | | |
| Lexmark Optra S 1620/1625/1650/1855 Laser Supplies | | | | |
| 1382625 | High Yield Return Program Toner for Label Applications (17,600 Yield) | 98370 | CTG | \$402.49 |
| 1382925 | High Yield Return Program Toner (17,600 Yield) | 98365 | CTG | \$363.48 |
| 12A6591 | Government High Yield Return Program Toner (17,600 Yield) (TAA Compliant Version of 1382925) | 3449 | CTG | \$363.48 |
| 1382929 | High Yield Return Program Toner for Special Label Applications (17,600 Yield) | 98369 | CTG | \$363.48 |
| 99A0967 | Fuser Maintenance Kit (110-120V) (Kit Includes Transfer Roller, Charge Roll Replacement Kit, Fuser, Pick Rollers) | 2069 | EA | \$445.94 |
| 99A0966 | Fuser (110-120V) (250,000 Yield) | 3953 | EA | \$421.91 |
| 99A0179 | Transfer Roll Assembly (250,000 Yield) | 105561 | EA | \$53.73 |
| 99A1017 | Charge Roll Replacement Kit | 105321 | KIT | \$44.09 |
| Lexmark Optra S 2420/2450/2455 Laser Supplies | | | | |
| 1382925 | High Yield Return Program Toner (17,600 Yield) | 98365 | CTG | \$363.48 |
| 12A6591 | Government High Yield Return Program Toner (17,600 Yield) (TAA Compliant Version of 1382925) | 3449 | CTG | \$363.48 |
| 1382625 | High Yield Return Program Toner for Label Applications (17,600 Yield) | 98370 | CTG | \$402.49 |
| 1382929 | High Yield Return Program Toner for Special Label Applications (17,600 Yield) | 98369 | CTG | \$363.48 |
| 99A1195 | Maintenance Kit (110V) (Kit Includes Transfer Roller, Charge Roll Replacement, Fuser, Pick Roll Assembly) (250,000 Yield) | 3962 | KIT | \$595.35 |
| 99A1190 | Fuser (110V) (250,000 Yield) | 3421 | EA | \$397.52 |
| 99A0179 | Transfer Roll Assembly (250,000 Yield) | 105561 | EA | \$53.73 |
| 99A1017 | Charge Roll Replacement Kit | 105321 | KIT | \$44.09 |
| Lexmark T420 Laser Supplies | | | | |
| 12A7410 | Return Program Toner (5,500 Yield) | 2180 | CTG | \$172.99 |
| 12A7315 | High Yield Toner (10,000 Yield) | 2178 | CTG | \$342.37 |
| 12A7415 | High Yield Return Program Toner (10,000 Yield) | 2179 | CTG | \$306.76 |
| 56P2036 | Maintenance Kit (110-127V) (Includes Charge Roll, Transfer Roller, Fuser Assembly, Paper Feed Roller) (200,000 Yield) | 17819 | KIT | \$303.30 |
| 56P0648 | Fuser Assembly (110V) | 900807 | EA | \$215.31 |
| 56P0643 | Transfer Roll Assembly | 17827 | EA | \$43.45 |
| Lexmark T430 Laser Supplies | | | | |
| 12A8420 | Return Program Toner (6,000 Yield) | 6058 | CTG | \$211.58 |
| 12A8325 | High Yield Toner (12,000 Yield) | 6059 | CTG | \$373.12 |
| 12A8425 | High Yield Return Program Toner (12,000 Yield) | 6060 | CTG | \$336.54 |
| 12A7775 | Government High Yield Return Program Toner (12,000 Yield) (TAA Compliant Version of 12A8425) | 10443 | CTG | \$336.54 |
| 56P2333 | Fuser Maintenance Kit (110-120V) (Kit Includes Charge Roll, Rear Cover Assembly, Lower MPF Housing Assembly, Transfer Roll, Fuser Assembly, Paper Feed Roll) (200,000 Yield) | 94847 | KIT | \$470.40 |
| 56P2364 | Maintenance Kit Parts | 6764 | EA | \$52.15 |
| 56P2330 | Fuser Assembly (110-127V) | 900821 | EA | \$297.48 |
| 56P2329 | Transfer Roll | 6763 | EA | \$52.69 |
| Lexmark T520/T522/X520/X522 Laser Supplies | | | | |
| 12A6735 | High Yield Toner (20,000 Yield) | 4867 | CTG | \$574.94 |
| 12A6835 | High Yield Return Program Toner (20,000 Yield) | 4865 | CTG | \$516.54 |
| 12A5361 | Government High Yield Return Program Toner (20,000 Yield) (TAA Compliant Version of 12A6835) | 3445 | CTG | \$516.54 |
| 12A6839 | High Yield Return Program Toner for Special Label Applications (20,000 Yield) | 4864 | CTG | \$516.54 |
| 11K3188 | Staple Cartridge (3,000 Staples/Ctg) (3 Ctgs/Box) | 6002 | BOX | \$55.23 |
| 99A2420 | Maintenance Kit (110V) (Kit Includes Transfer Roll Assembly, Charge Roll Replacement Kit, Fuser Assembly, Pick Roll Assembly) (250,000 Yield) | 2961 | KIT | \$472.38 |
| 99A2423 | Fuser Assembly (115V) | 900808 | EA | \$361.25 |
| 99A1015 | Transfer Roll Assembly | 5534 | EA | \$59.77 |
| 99A1017 | Charge Roll Replacement Kit | 105321 | KIT | \$44.09 |
| Lexmark T610/T612 Laser Supplies <i>(Continued on next page)</i> | | | | |
| 12A5840 | Return Program Toner (10,000 Yield) | 105104 | CTG | \$326.37 |
| 24B1429 | Government Return Program Toner (10,000 Yield) (TAA Compliant Version of 12A5840) | 90425 | CTG | \$326.37 |
| 12A5745 | High Yield Toner (25,000 Yield) | 105105 | CTG | \$562.01 |
| 12A5845 | High Yield Return Program Toner (25,000 Yield) | 105106 | CTG | \$505.51 |
| 12A6592 | Government High Yield Return Program Toner (25,000 Yield) (TAA Compliant Version of 12A5845) | 3446 | CTG | \$505.51 |
| 12A5849 | High Yield Return Program Toner for Special Label Applications (25,000 Yield) | 105107 | CTG | \$505.51 |
| 99A1970 | Fuser Maintenance Kit (110-120V) (Kit Includes Transfer Roll Assembly, Charge Roll Replacement Kit, Fuser, Pick Roll Assembly) (300,000 Yield) | 3048 | KIT | \$439.93 |
| 99A1969 | Fuser (115V) (300,000 Yield) | 3396 | EA | \$332.84 |

| MFG# | Product Description | Part# | UOM | Retail |
|--|---|--------|-----|----------|
| LEXMARK SUPPLIES | | | | |
| Lexmark T610/T612 Laser Supplies (Continued) | | | | |
| 99A1015 | Transfer Roll Assembly | 5534 | EA | \$59.77 |
| 99A1017 | Charge Roll Replacement Kit | 105321 | KIT | \$44.09 |
| Lexmark T614/T616 Laser Supplies | | | | |
| 12A5840 | Return Program Toner (10,000 Yield) | 105104 | CTG | \$326.37 |
| 24B1429 | Government Return Program Toner (10,000 Yield) (TAA Compliant Version of 12A5840) | 90425 | CTG | \$326.37 |
| 12A5745 | High Yield Toner (25,000 Yield) | 105105 | CTG | \$562.01 |
| 12A5845 | High Yield Return Program Toner (25,000 Yield) | 105106 | CTG | \$505.51 |
| 12A6592 | Government High Yield Return Program Toner (25,000 Yield) (TAA Compliant Version of 12A5845) | 3446 | CTG | \$505.51 |
| 12A5849 | High Yield Return Program Toner for Special Label Applications (25,000 Yield) | 105107 | CTG | \$505.51 |
| 99A1978 | Fuser Maintenance Kit (110V) (Kit Includes Transfer Roll Assembly, Charge Roll Replacement Kit, Fuser Assembly, Pick Roll Assembly) (300,000 Yield) | 3419 | KIT | \$445.62 |
| 99A1977 | Fuser Assembly (115V) (300,000 Yield) | 3420 | EA | \$402.33 |
| 99A1015 | Transfer Roll Assembly | 5534 | EA | \$59.77 |
| 99A1017 | Charge Roll Replacement Kit | 105321 | KIT | \$44.09 |
| Lexmark T620/X620 Laser Supplies | | | | |
| 12A6860 | Return Program Toner (10,000 Yield) | 4859 | CTG | \$290.97 |
| 24B1434 | Government Return Program Toner (10,000 Yield) (TAA Compliant Version of 12A6860) | 90426 | CTG | \$290.97 |
| 12A6765 | High Yield Toner (30,000 Yield) | 4860 | CTG | \$670.77 |
| 12A6865 | High Yield Return Program Toner (30,000 Yield) | 4858 | CTG | \$609.82 |
| 12A9684 | Government High Yield Return Program Toner (30,000 Yield) (TAA Compliant Version of 12A6865) | 20030 | CTG | \$609.82 |
| 12A6869 | High Yield Return Program Toner for Special Label Applications (30,000 Yield) | 4692 | CTG | \$609.82 |
| 11K3188 | Staple Cartridge (3,000 Staples/Ctg) (3 Ctgs/Box) | 6002 | BOX | \$55.23 |
| 99A2408 | Maintenance Kit (110V) (Kit Includes Transfer Roll Assembly, Charge Roll Replacement Kit, Fuser Assembly, Pick Roll Assembly) (300,000 Yield) | 3661 | KIT | \$429.92 |
| 99A2402 | Fuser Assembly (110-127V) | 6765 | EA | \$327.93 |
| 99A1015 | Transfer Roll Assembly | 5534 | EA | \$59.77 |
| 99A1017 | Charge Roll Replacement Kit | 105321 | KIT | \$44.09 |
| Lexmark T622 Laser Supplies | | | | |
| 12A6860 | Return Program Toner (10,000 Yield) | 4859 | CTG | \$290.97 |
| 24B1434 | Government Return Program Toner (10,000 Yield) (TAA Compliant Version of 12A6860) | 90426 | CTG | \$290.97 |
| 12A6765 | High Yield Toner (30,000 Yield) | 4860 | CTG | \$670.77 |
| 12A6865 | High Yield Return Program Toner (30,000 Yield) | 4858 | CTG | \$609.82 |
| 12A9684 | Government High Yield Return Program Toner (30,000 Yield) (TAA Compliant Version of 12A6865) | 20030 | CTG | \$609.82 |
| 12A6869 | High Yield Return Program Toner for Special Label Applications (30,000 Yield) | 4692 | CTG | \$609.82 |
| 11K3188 | Staple Cartridge (3,000 Staples/Ctg) (3 Ctgs/Box) | 6002 | BOX | \$55.23 |
| 99A2411 | Maintenance Kit (110V) (Kit Includes Transfer Roller, Charge Roll Replacement Kit, Fuser Assembly, Pick Roll Assembly) (300,000 Yield) | 3399 | KIT | \$452.64 |
| 99A2405 | Fuser Assembly (115V) | 12860 | EA | \$321.92 |
| 99A1015 | Transfer Roll Assembly | 5534 | EA | \$59.77 |
| 99A1017 | Charge Roll Replacement Kit | 105321 | KIT | \$44.09 |
| Lexmark T630/X630 Laser Supplies | | | | |
| 12A7460 | Return Program Toner (5,000 Yield) | 1843 | CTG | \$193.88 |
| 24B1439 | Government Return Program Toner (5,000 Yield) (TAA Compliant Version of 12A7460) | 90429 | CTG | \$193.88 |
| 12A7362 | High Yield Toner (21,000 Yield) | 1845 | CTG | \$603.78 |
| 12A7462 | High Yield Return Program Toner (21,000 Yield) | 1842 | CTG | \$542.41 |
| 12A9685 | Government High Yield Return Program Toner (21,000 Yield) (TAA Compliant Version of 12A7462) | 20031 | CTG | \$542.41 |
| 12A7468 | High Yield Return Program Toner for Special Label Applications (21,000 Yield) | 1840 | CTG | \$542.41 |
| 11K3188 | Staple Cartridge (3,000 Staples/Ctg) (3 Ctgs/Box) | 6002 | BOX | \$55.23 |
| 56P1409 | Fuser Maintenance Kit (110-120V) (Kit Includes Fuser Assembly, Transfer Roll Assembly, Charge Roll Replacement Kit, Pick Roll Assembly) (300,000 Yield) | 1808 | KIT | \$399.91 |
| 56P2542 | Fuser Assembly (115V) | 900809 | EA | \$331.74 |
| 99A0179 | Transfer Roll Assembly (250,000 Yield) | 105561 | EA | \$53.73 |
| 99A1017 | Charge Roll Replacement Kit | 105321 | KIT | \$44.09 |
| Lexmark T632/X632 Laser Supplies (Continued on next page) | | | | |
| 12A7460 | Return Program Toner (5,000 Yield) | 1843 | CTG | \$193.88 |
| 24B1439 | Government Return Program Toner (5,000 Yield) (TAA Compliant Version of 12A7460) | 90429 | CTG | \$193.88 |
| 12A7362 | High Yield Toner (21,000 Yield) | 1845 | CTG | \$603.78 |
| 12A7462 | High Yield Return Program Toner (21,000 Yield) | 1842 | CTG | \$542.41 |

| MFG# | Product Description | Part# | UOM | Retail |
|---|---|--------|-----|----------|
| LEXMARK SUPPLIES | | | | |
| Lexmark T632/X632 Laser Supplies (Continued) | | | | |
| 12A9685 | Government High Yield Return Program Toner (21,000 Yield) (TAA Compliant Version of 12A7462) | 20031 | CTG | \$542.41 |
| 12A7468 | High Yield Return Program Toner for Special Label Applications (21,000 Yield) | 1840 | CTG | \$542.41 |
| 12A7365 | Extra High Yield Toner (32,000 Yield) | 1844 | CTG | \$646.70 |
| 12A7465 | Extra High Yield Return Program Toner (32,000 Yield) | 1841 | CTG | \$585.33 |
| 12A9686 | Government Extra High Yield Return Program Toner (32,000 Yield) (TAA Compliant Version of 12A7465) | 20032 | CTG | \$585.33 |
| 12A7469 | Extra High Yield Return Program Toner for Special Label Applications (32,000 Yield) | 1839 | CTG | \$585.33 |
| 11K3188 | Staple Cartridge (3,000 Staples/Ctg) (3 Ctgs/Box) | 6002 | BOX | \$55.23 |
| 56P1409 | Fuser Maintenance Kit (110-120V) (Kit Includes Fuser Assembly, Transfer Roll Assembly, Charge Roll Replacement Kit, Pick Roll Assembly) (300,000 Yield) | 1808 | KIT | \$399.91 |
| 56P2542 | Fuser Assembly (115V) | 900809 | EA | \$331.74 |
| 99A0179 | Transfer Roll Assembly (250,000 Yield) | 105561 | EA | \$53.73 |
| 99A1017 | Charge Roll Replacement Kit | 105321 | KIT | \$44.09 |
| Lexmark T634/X634 Laser Supplies | | | | |
| 12A7460 | Return Program Toner (5,000 Yield) | 1843 | CTG | \$193.88 |
| 24B1439 | Government Return Program Toner (5,000 Yield) (TAA Compliant Version of 12A7460) | 90429 | CTG | \$193.88 |
| 12A7362 | High Yield Toner (21,000 Yield) | 1845 | CTG | \$603.78 |
| 12A7462 | High Yield Return Program Toner (21,000 Yield) | 1842 | CTG | \$542.41 |
| 12A9685 | Government High Yield Return Program Toner (21,000 Yield) (TAA Compliant Version of 12A7462) | 20031 | CTG | \$542.41 |
| 12A7468 | High Yield Return Program Toner for Special Label Applications (21,000 Yield) | 1840 | CTG | \$542.41 |
| 12A7365 | Extra High Yield Toner (32,000 Yield) | 1844 | CTG | \$646.70 |
| 12A7465 | Extra High Yield Return Program Toner (32,000 Yield) | 1841 | CTG | \$585.33 |
| 12A9686 | Government Extra High Yield Return Program Toner (32,000 Yield) (TAA Compliant Version of 12A7465) | 20032 | CTG | \$585.33 |
| 12A7469 | Extra High Yield Return Program Toner for Special Label Applications (32,000 Yield) | 1839 | CTG | \$585.33 |
| 11K3188 | Staple Cartridge (3,000 Staples/Ctg) (3 Ctgs/Box) | 6002 | BOX | \$55.23 |
| 56P1855 | Fuser Maintenance Kit (110-120V) (Kit Includes Fuser Assembly, Transfer Roll Assembly, Charge Roll Replacement Kit, Pick Roll Assembly) (300,000 Yield) | 6061 | KIT | \$419.49 |
| 56P2545 | Fuser Assembly (115V) | 900810 | EA | \$317.78 |
| 99A0179 | Transfer Roll Assembly (250,000 Yield) | 105561 | EA | \$53.73 |
| 99A1017 | Charge Roll Replacement Kit | 105321 | KIT | \$44.09 |
| Lexmark T640 Laser Supplies | | | | |
| 64015SA | Return Program Toner (6,000 Yield) | 10822 | CTG | \$215.92 |
| 64075SW | Government Return Program Toner (6,000 Yield) (TAA Compliant Version of 64015SA) | 90453 | CTG | \$215.92 |
| 64035HA | High Yield Toner (21,000 Yield) | 10827 | CTG | \$601.45 |
| 64015HA | High Yield Return Program Toner (21,000 Yield) | 10823 | CTG | \$542.61 |
| 64075HA | Government High Yield Return Program Toner for Label Applications (21,000 Yield) (TAA Compliant Version of 64004HA) | 12150 | CTG | \$542.61 |
| 64004HA | High Yield Return Program Toner for Label Applications (21,000 Yield) | 10825 | CTG | \$542.61 |
| 11K3188 | Staple Cartridge (3,000 Staples/Ctg) (3 Ctgs/Box) | 6002 | BOX | \$55.23 |
| 40X0100 | Fuser Maintenance Kit (110V) (Includes Charge Roll Replacement Kit, Transfer Roll Assembly, Fuser Assembly) (300,000 Yield) | 10880 | KIT | \$348.55 |
| 40X2592 | Fuser Assembly (115V) | 96168 | EA | \$262.98 |
| 40x2665 | Oil Fuser Wiper (Black Housing) | 901959 | EA | \$21.06 |
| 40X0127 | Charge Roller Kit (300,000 Yield) | 10884 | KIT | \$43.04 |
| 40X0130 | Transfer Roll Assembly (300,000 Yield) | 10885 | KIT | \$24.95 |
| 40X0076 | Pick Roll Assembly | 6753 | EA | \$2.77 |
| Lexmark T642 Laser Supplies | | | | |
| 64015SA | Return Program Toner (6,000 Yield) | 10822 | CTG | \$215.92 |
| 64075SW | Government Return Program Toner (6,000 Yield) (TAA Compliant Version of 64015SA) | 90453 | CTG | \$215.92 |
| 64035HA | High Yield Toner (21,000 Yield) | 10827 | CTG | \$601.45 |
| 64015HA | High Yield Return Program Toner (21,000 Yield) | 10823 | CTG | \$542.61 |
| 64075HA | Government High Yield Return Program Toner for Label Applications (21,000 Yield) (TAA Compliant Version of 64004HA) | 12150 | CTG | \$542.61 |
| 64004HA | High Yield Return Program Toner for Label Applications (21,000 Yield) | 10825 | CTG | \$542.61 |
| 11K3188 | Staple Cartridge (3,000 Staples/Ctg) (3 Ctgs/Box) | 6002 | BOX | \$55.23 |
| 40X0100 | Fuser Maintenance Kit (110V) (Includes Charge Roll Replacement Kit, Transfer Roll Assembly, Fuser Assembly) (300,000 Yield) | 10880 | KIT | \$348.55 |
| 40X2592 | Fuser Assembly (115V) | 96168 | EA | \$262.98 |
| 40x2665 | Oil Fuser Wiper (Black Housing) | 901959 | EA | \$21.06 |
| 40X0127 | Charge Roller Kit (300,000 Yield) | 10884 | KIT | \$43.04 |
| 40X0130 | Transfer Roll Assembly (300,000 Yield) | 10885 | KIT | \$24.95 |
| 40X0076 | Pick Roll Assembly | 6753 | EA | \$2.77 |
| 40X2540 | Pick Roller | 19552 | EA | \$34.26 |

| MFG# | Product Description | Part# | UOM | Retail |
|---|---|--------|-----|----------|
| LEXMARK SUPPLIES | | | | |
| Lexmark T644 Laser Supplies | | | | |
| 64015SA | Return Program Toner (6,000 Yield) | 10822 | CTG | \$215.92 |
| 64075SW | Government Return Program Toner (6,000 Yield) (TAA Compliant Version of 64015SA) | 90453 | CTG | \$215.92 |
| 64035HA | High Yield Toner (21,000 Yield) | 10827 | CTG | \$601.45 |
| 64015HA | High Yield Return Program Toner (21,000 Yield) | 10823 | CTG | \$542.61 |
| 64004HA | High Yield Return Program Toner for Label Applications (21,000 Yield) | 10825 | CTG | \$542.61 |
| 64075HA | Government High Yield Return Program Toner for Label Applications (21,000 Yield) (TAA Compliant Version of 64004HA) | 12150 | CTG | \$542.61 |
| 64435XA | Extra High Yield Toner (32,000 Yield) | 10828 | CTG | \$644.58 |
| 64415XA | Extra High Yield Return Program Toner (32,000 Yield) | 10824 | CTG | \$583.74 |
| 64475XA | Government Extra High Yield Return Program Toner (32,000 Yield) (TAA Compliant Version of 64415XA) | 11869 | CTG | \$583.74 |
| 64404XA | Extra High Yield Return Program Toner for Label Applications (32,000 Yield) | 10826 | CTG | \$583.74 |
| 11K3188 | Staple Cartridge (3,000 Staples/Ctg) (3 Ctg/Box) | 6002 | BOX | \$55.23 |
| 40X0100 | Fuser Maintenance Kit (110V) (Includes Charge Roll Replacement Kit, Transfer Roll Assembly, Fuser Assembly) (300,000 Yield) | 10880 | KIT | \$348.55 |
| 40X2592 | Fuser Assembly (115V) | 96168 | EA | \$262.98 |
| 40x2665 | Oil Fuser Wiper (Black Housing) | 901959 | EA | \$21.06 |
| 40X0127 | Charge Roller Kit (300,000 Yield) | 10884 | KIT | \$43.04 |
| 40X0130 | Transfer Roll Assembly (300,000 Yield) | 10885 | KIT | \$24.95 |
| 40X0076 | Pick Roll Assembly | 6753 | EA | \$2.77 |
| 40X2540 | Pick Roller | 19552 | EA | \$34.26 |
| Lexmark T650/T652 Laser Supplies | | | | |
| T650A21A | Toner (7,000 Yield) | 903780 | CTG | \$276.57 |
| T650A11A | Return Program Toner (7,000 Yield) | 903781 | CTG | \$219.43 |
| T650A41G | Government Return Program Toner (7,000 Yield) (TAA Compliant Version of T650A11A) | 904055 | CTG | \$219.43 |
| T650H21A | High Yield Toner (25,000 Yield) | 903782 | CTG | \$668.33 |
| T650H11A | High Yield Return Program Toner (25,000 Yield) | 903784 | CTG | \$611.19 |
| T650H41G | Government High Yield Return Program Toner (25,000 Yield) (TAA Compliant Version of T650H11A) | 904056 | CTG | \$611.19 |
| T650H04A | High Yield Return Program Toner for Label Applications (25,000 Yield) | 903783 | CTG | \$611.19 |
| 25A0013 | Staple Cartridges (5,000 Staples/Ctg) (EA=Box of 3 Ctg) | 29550 | EA | \$137.49 |
| 40X4724 | Type 1 Maintenance Kit (110-120V) (Includes Transfer Roll Assembly, Fuser Assembly, Charge Roll Replacement Kit, Pick Roll Assembly) (300,000 Yield) | 14153 | KIT | \$357.13 |
| 40X4767 | Type 2 Maintenance Kit (110-127V) (Kit Includes Transfer Roll Assembly, Charge Roll Replacement Kit, Fuser Assembly, Pick Roll Assembly) (Special Applications) (150,000 Yield) | 17820 | KIT | \$357.13 |
| 40X4418 | Type 1 Fuser Assembly (110-120V) (300,000 Yield) | 14155 | EA | \$310.30 |
| 40X5854 | Type 2 Fuser Assembly (110-127V) (150,000 Yield) | 17829 | EA | \$310.30 |
| 40x2665 | Oil Fuser Wiper (Black Housing) | 901959 | EA | \$21.06 |
| 40X1886 | Transfer Roll Assembly (with Tool) | 14157 | EA | \$29.34 |
| Lexmark T654/T656 Laser Supplies | | | | |
| T650A21A | Toner (7,000 Yield) | 903780 | CTG | \$276.57 |
| T650A11A | Return Program Toner (7,000 Yield) | 903781 | CTG | \$219.43 |
| T650A41G | Government Return Program Toner (7,000 Yield) (TAA Compliant Version of T650A11A) | 904055 | CTG | \$219.43 |
| T650H21A | High Yield Toner (25,000 Yield) | 903782 | CTG | \$668.33 |
| T650H11A | High Yield Return Program Toner (25,000 Yield) | 903784 | CTG | \$611.19 |
| T650H41G | Government High Yield Return Program Toner (25,000 Yield) (TAA Compliant Version of T650H11A) | 904056 | CTG | \$611.19 |
| T650H04A | High Yield Return Program Toner for Label Applications (25,000 Yield) | 903783 | CTG | \$611.19 |
| T654X11A | Extra High Yield Return Program Toner (36,000 Yield) | 903787 | CTG | \$650.94 |
| T654X41G | Government Extra High Yield Return Program Toner (36,000 Yield) (TAA Compliant Version of T654X11A) | 14540 | CTG | \$650.94 |
| T654X04A | Extra High Yield Toner for Label Applications (36,000 Yield) | 903786 | CTG | \$650.94 |
| 25A0013 | Staple Cartridges (5,000 Staples/Ctg) (EA=Box of 3 Ctg) | 29550 | EA | \$137.49 |
| 40X4724 | Type 1 Maintenance Kit (110-120V) (Includes Transfer Roll Assembly, Fuser Assembly, Charge Roll Replacement Kit, Pick Roll Assembly) (300,000 Yield) | 14153 | KIT | \$357.13 |
| 40X4767 | Type 2 Maintenance Kit (110-127V) (Kit Includes Transfer Roll Assembly, Charge Roll Replacement Kit, Fuser Assembly, Pick Roll Assembly) (Special Applications) (150,000 Yield) | 17820 | KIT | \$357.13 |
| 40X4418 | Type 1 Fuser Assembly (110-120V) (300,000 Yield) | 14155 | EA | \$310.30 |
| 40X5854 | Type 2 Fuser Assembly (110-127V) (150,000 Yield) | 17829 | EA | \$310.30 |
| 40x2665 | Oil Fuser Wiper (Black Housing) | 901959 | EA | \$21.06 |
| 40X1886 | Transfer Roll Assembly (with Tool) | 14157 | EA | \$29.34 |
| Lexmark W840 Laser Supplies (Continued on next page) | | | | |
| W84020H | Toner (30,000 Yield) | 10801 | CTG | \$306.13 |
| W84030H | Photoconductor Kit (60,000 Yield) | 10808 | CTG | \$257.16 |

| MFG# | Product Description | Part# | UOM | Retail |
|---|---|--------|-----|----------|
| LEXMARK SUPPLIES | | | | |
| Lexmark W840 Laser Supplies (Continued) | | | | |
| 25A0013 | Staple Cartridges (5,000 Staples/Ctg) (EA=Box of 3 Ctg) | 29550 | EA | \$137.49 |
| 40X0956 | Maintenance Kit (110-127V) (Includes Transfer Roll Assembly, Fuser Assembly, Feed Unit Roll Kit) (300,000 Yield) | 11853 | KIT | \$937.50 |
| 40X0647 | Fuser Assembly (110V) | 900811 | EA | \$535.78 |
| 40X0616 | Transfer Roll Assembly | 6754 | EA | \$89.88 |
| Lexmark W850 Laser Supplies | | | | |
| W850H21G | High Yield Toner (35,000 Yield) | 20776 | CTG | \$321.33 |
| W850H22G | High Yield Photoconductor Kit (60,000 Yield) | 20778 | KIT | \$235.67 |
| 25A0013 | Staple Cartridges (5,000 Staples/Ctg) (EA=Box of 3 Ctg) | 29550 | EA | \$137.49 |
| 40X0956 | Maintenance Kit (110-127V) (Includes Transfer Roll Assembly, Fuser Assembly, Feed Unit Roll Kit) (300,000 Yield) | 11853 | KIT | \$937.50 |
| 40X0647 | Fuser Assembly (110V) | 900811 | EA | \$535.78 |
| 40X0616 | Transfer Roll Assembly | 6754 | EA | \$89.88 |
| Lexmark X203/X204 Laser Supplies | | | | |
| X203A21G | Toner (2,500 Yield) | 14308 | CTG | \$146.09 |
| X203A11G | Return Program Toner (2,500 Yield) | 14307 | CTG | \$124.47 |
| X203H22G | Photoconductor Kit (25,000 Yield) | 14309 | KIT | \$93.52 |
| 40X4194 | Fuser Assembly (110V) | 33580 | EA | \$134.41 |
| 40X2822 | Transfer Roll Assembly | 17824 | EA | \$13.05 |
| Lexmark X264/X363/X364 Laser Supplies | | | | |
| X264A11G | Return Program Toner (3,500 Yield) | 6649 | CTG | \$144.97 |
| X264A41G | Government Return Program Toner (3,500 Yield) (TAA Compliant Version of X264A11G) | 608218 | CTG | \$134.00 |
| X264H11G | High Yield Return Program Toner (9,000 Yield) | 6650 | CTG | \$278.95 |
| E260X22G | Photoconductor Kit (30,000 Yield) | 903779 | KIT | \$39.07 |
| 40X5344 | Fuser Assembly (110-120V) (120,000 Yield) | 6760 | EA | \$154.91 |
| 40X5364 | Transfer Roll Assembly | 6761 | EA | \$12.77 |
| 40X5807 | ADF Maintenance Kit (Includes Separator Roller, Separator Pad) | 6762 | EA | \$54.88 |
| Lexmark X340 Laser Supplies | | | | |
| X340A21G | Toner (2,500 Yield) | 20144 | CTG | \$182.00 |
| X340A11G | Return Program Toner (2,500 Yield) | 20142 | CTG | \$158.89 |
| X340H22G | Photoconductor Kit (30,000 Yield) | 20147 | CTG | \$96.25 |
| 40X4194 | Fuser Assembly (110V) | 33580 | EA | \$134.41 |
| 40X2822 | Transfer Roll Assembly | 17824 | EA | \$13.05 |
| Lexmark X342 Laser Supplies | | | | |
| X340A21G | Toner (2,500 Yield) | 20144 | CTG | \$182.00 |
| X340A11G | Return Program Toner (2,500 Yield) | 20142 | CTG | \$158.89 |
| X340H11G | High Yield Return Program Toner (6,000 Yield) | 20145 | CTG | \$217.40 |
| X340H41G | Government High Yield Return Program Toner (6,000 Yield) (TAA Compliant Version of X340H11G) | 90413 | EA | \$217.40 |
| X340H22G | Photoconductor Kit (30,000 Yield) | 20147 | CTG | \$96.25 |
| 40X4194 | Fuser Assembly (110V) | 33580 | EA | \$134.41 |
| 40X2822 | Transfer Roll Assembly | 17824 | EA | \$13.05 |
| Lexmark X422 Laser Supplies | | | | |
| 12A4715 | High Yield Return Program Toner (12,000 Yield) | 5149 | CTG | \$368.13 |
| 56P2036 | Maintenance Kit (110-127V) (Includes Charge Roll, Transfer Roller, Fuser Assembly, Paper Feed Roller) (200,000 Yield) | 17819 | KIT | \$303.30 |
| 56P0648 | Fuser Assembly (110V) | 900807 | EA | \$215.31 |
| 56P0643 | Transfer Roll Assembly | 17827 | EA | \$43.45 |
| Lexmark X463/X464/X466 Laser Supplies (Continued on next page) | | | | |
| X463A11G | Return Program Toner (3,500 Yield) | 6652 | CTG | \$144.97 |
| X463A41G | Government Return Program Toner (3,500 Yield) (TAA Compliant Version of X463A11G) | 608215 | CTG | \$134.00 |
| X463H11G | High Yield Return Program Toner (9,000 Yield) | 6653 | CTG | \$278.95 |
| X463H41G | Government High Yield Return Program Toner (9,000 Yield) (TAA Compliant Version of X463H11G) | 608212 | CTG | \$258.00 |
| X463X11G | Extra High Yield Return Program Toner (15,000 Yield) | 6655 | CTG | \$362.35 |
| X463X41G | Government Extra High Yield Return Program Toner (15,000 Yield) (TAA Compliant Version of X463X11G) | 14542 | CTG | \$362.35 |
| E260X22G | Photoconductor Kit (30,000 Yield) | 903779 | KIT | \$39.07 |
| 40X5400 | Maintenance Kit (110-127V) (Kit Includes Fuser, Tray 1 Feed Tires, Transfer Roller) (120,000 Yield) | 17818 | KIT | \$185.73 |
| 40X5344 | Fuser Assembly (110-120V) (120,000 Yield) | 6760 | EA | \$154.91 |

| MFG# | Product Description | Part# | UOM | Retail |
|---|---|--------|-----|------------|
| LEXMARK SUPPLIES | | | | |
| Lexmark X463/X464/X466 Laser Supplies (Continued) | | | | |
| 40X5364 | Transfer Roll Assembly | 6761 | EA | \$12.77 |
| 40X5807 | ADF Maintenance Kit (Includes Separator Roller, Separator Pad) | 6762 | EA | \$54.88 |
| Lexmark X642 Laser Supplies | | | | |
| X644A21A | Toner (10,000 Yield) | 12955 | CTG | \$424.64 |
| X644A11A | Return Program Toner (10,000 Yield) | 12950 | CTG | \$363.04 |
| X644H11A | High Yield Return Program Toner (21,000 Yield) | 12951 | CTG | \$542.61 |
| X644H41G | Government High Yield Return Program Toner (21,000 Yield) (TAA Compliant Version of X644H11A) | 20020 | CTG | \$542.61 |
| X644H01A | High Yield Return Program Toner for Special Label Applications (21,000 Yield) | 12953 | CTG | \$542.61 |
| 40X0100 | Fuser Maintenance Kit (110V) (Includes Charge Roll Replacement Kit, Transfer Roll Assembly, Fuser Assembly) (300,000 Yield) | 10880 | KIT | \$348.55 |
| 40X2592 | Fuser Assembly (115V) | 96168 | EA | \$262.98 |
| 40x2665 | Oil Fuser Wiper (Black Housing) | 901959 | EA | \$21.06 |
| 40X0127 | Charge Roller Kit (300,000 Yield) | 10884 | KIT | \$43.04 |
| 40X0130 | Transfer Roll Assembly (300,000 Yield) | 10885 | KIT | \$24.95 |
| 40X0076 | Pick Roll Assembly | 6753 | EA | \$2.77 |
| 40X0450 | ADF Maintenance Kit (120,000 Yield) | 21403 | KIT | \$1,147.59 |
| Lexmark X644/X646 Laser Supplies | | | | |
| X644A21A | Toner (10,000 Yield) | 12955 | CTG | \$424.64 |
| X644A11A | Return Program Toner (10,000 Yield) | 12950 | CTG | \$363.04 |
| X644H11A | High Yield Return Program Toner (21,000 Yield) | 12951 | CTG | \$542.61 |
| X644H41G | Government High Yield Return Program Toner (21,000 Yield) (TAA Compliant Version of X644H11A) | 20020 | CTG | \$542.61 |
| X644H01A | High Yield Return Program Toner for Special Label Applications (21,000 Yield) | 12953 | CTG | \$542.61 |
| X644X11A | Extra High Yield Return Program Toner (32,000 Yield) | 12952 | CTG | \$583.74 |
| X644X41G | Government Extra High Yield Return Program Toner (32,000 Yield) (TAA Compliant Version of X644X11A) | 20033 | CTG | \$583.74 |
| 40X0100 | Fuser Maintenance Kit (110V) (Includes Charge Roll Replacement Kit, Transfer Roll Assembly, Fuser Assembly) (300,000 Yield) | 10880 | KIT | \$348.55 |
| 40X2592 | Fuser Assembly (115V) | 96168 | EA | \$262.98 |
| 40x2665 | Oil Fuser Wiper (Black Housing) | 901959 | EA | \$21.06 |
| 40X0127 | Charge Roller Kit (300,000 Yield) | 10884 | KIT | \$43.04 |
| 40X0130 | Transfer Roll Assembly (300,000 Yield) | 10885 | KIT | \$24.95 |
| 40X0076 | Pick Roll Assembly | 6753 | EA | \$2.77 |
| 40X0450 | ADF Maintenance Kit (120,000 Yield) | 21403 | KIT | \$1,147.59 |
| Lexmark X651/X652 Laser Supplies | | | | |
| X651A21A | Toner (7,000 Yield) | 903788 | CTG | \$276.57 |
| X651A11A | Return Program Toner (7,000 Yield) | 903789 | CTG | \$219.43 |
| X651A41G | Government Return Program Toner (7,000 Yield) (TAA Compliant Version of X651A11A) | 904057 | CTG | \$219.43 |
| X651H21A | High Yield Toner (25,000 Yield) | 903790 | CTG | \$668.33 |
| X651H11A | High Yield Return Program Toner (25,000 Yield) | 903791 | CTG | \$611.19 |
| X651H41G | Government High Yield Return Program Toner (25,000 Yield) (TAA Compliant Version of X651H11A) | 904058 | CTG | \$611.19 |
| X651H04A | High Yield Return Program Toner for Label Applications (25,000 Yield) | 903792 | CTG | \$611.19 |
| 25A0013 | Staple Cartridges (5,000 Staples/Ctg) (EA=Box of 3 Ctgs) | 29550 | EA | \$137.49 |
| 40X4724 | Type 1 Maintenance Kit (110-120V) (Includes Transfer Roll Assembly, Fuser Assembly, Charge Roll Replacement Kit, Pick Roll Assembly) (300,000 Yield) | 14153 | KIT | \$357.13 |
| 40X4767 | Type 2 Maintenance Kit (110-127V) (Kit Includes Transfer Roll Assembly, Charge Roll Replacement Kit, Fuser Assembly, Pick Roll Assembly) (Special Applications) (150,000 Yield) | 17820 | KIT | \$357.13 |
| 40X4418 | Type 1 Fuser Assembly (110-120V) (300,000 Yield) | 14155 | EA | \$310.30 |
| 40x2665 | Oil Fuser Wiper (Black Housing) | 901959 | EA | \$21.06 |
| 40X1886 | Transfer Roll Assembly (with Tool) | 14157 | EA | \$29.34 |
| 40X4769 | ADF Maintenance Kit (Includes Feed/Pick Roll Assembly, Separator Roll/Guide) | 17830 | KIT | \$107.13 |
| Lexmark X654/X656/X658 Laser Supplies (Continued on next page) | | | | |
| X651A21A | Toner (7,000 Yield) | 903788 | CTG | \$276.57 |
| X651A11A | Return Program Toner (7,000 Yield) | 903789 | CTG | \$219.43 |
| X651A41G | Government Return Program Toner (7,000 Yield) (TAA Compliant Version of X651A11A) | 904057 | CTG | \$219.43 |
| X651H21A | High Yield Toner (25,000 Yield) | 903790 | CTG | \$668.33 |
| X651H11A | High Yield Return Program Toner (25,000 Yield) | 903791 | CTG | \$611.19 |
| X651H41G | Government High Yield Return Program Toner (25,000 Yield) (TAA Compliant Version of X651H11A) | 904058 | CTG | \$611.19 |
| X651H04A | High Yield Return Program Toner for Label Applications (25,000 Yield) | 903792 | CTG | \$611.19 |
| X654X21A | Extra High Yield Toner (36,000 Yield) | 903794 | CTG | \$707.99 |
| X654X11A | Extra High Yield Return Program Toner (36,000 Yield) | 903793 | CTG | \$650.94 |

| MFG# | Product Description | Part# | UOM | Retail |
|---|---|--------|-----|----------|
| LEXMARK SUPPLIES | | | | |
| Lexmark X654/X656/X658 Laser Supplies (Continued) | | | | |
| X654X41G | Government Extra High Yield Toner (36,000 Yield) (TAA Compliant Version of X654X11A) | 904059 | CTG | \$650.94 |
| X654X04A | Extra High Yield Return Program Toner for Label Applications (36,000 Yield) | 903795 | CTG | \$650.94 |
| 25A0013 | Staple Cartridges (5,000 Staples/Ctg) (EA=Box of 3 Ctgs) | 29550 | EA | \$137.49 |
| 40X4724 | Type 1 Maintenance Kit (110-120V) (Includes Transfer Roll Assembly, Fuser Assembly, Charge Roll Replacement Kit, Pick Roll Assembly) (300,000 Yield) | 14153 | KIT | \$357.13 |
| 40X4767 | Type 2 Maintenance Kit (110-127V) (Kit Includes Transfer Roll Assembly, Charge Roll Replacement Kit, Fuser Assembly, Pick Roll Assembly) (Special Applications) (150,000 Yield) | 17820 | KIT | \$357.13 |
| 40X4418 | Type 1 Fuser Assembly (110-120V) (300,000 Yield) | 14155 | EA | \$310.30 |
| 40X5854 | Type 2 Fuser Assembly (110-127V) (150,000 Yield) | 17829 | EA | \$310.30 |
| 40x2665 | Oil Fuser Wiper (Black Housing) | 901959 | EA | \$21.06 |
| 40X1886 | Transfer Roll Assembly (with Tool) | 14157 | EA | \$29.34 |
| 40X4769 | ADF Maintenance Kit (Includes Feed/Pick Roll Assembly, Separator Roll/Guide) | 17830 | KIT | \$107.13 |
| Lexmark X850/X852/X854 Laser Supplies | | | | |
| X850H21G | High Yield Toner (30,000 Yield) | 15166 | CTG | \$187.08 |
| X850H22G | High Yield Photoconductor Kit (70,000 Yield) | 15167 | KIT | \$176.28 |
| 25A0013 | Staple Cartridges (5,000 Staples/Ctg) (EA=Box of 3 Ctgs) | 29550 | EA | \$137.49 |
| 40X0394 | Maintenance Kit (110-127V) (Includes Transfer Roll Assembly, Fuser Assembly, Feed Rolls, Pick Rolls, Separation Rolls) (300,000 Yield) | 12683 | KIT | \$366.67 |
| 40X2503 | Fuser Assembly (110-127V) | 19533 | EA | \$290.00 |
| 40X0616 | Transfer Roll Assembly | 6754 | EA | \$89.88 |
| 40X2734 | ADF Maintenance Kit (Includes Separation Roll Guide Assembly, Feed/Pick Roll Assembly) | 17754 | KIT | \$154.36 |
| Lexmark X860/X862/X864 Laser Supplies | | | | |
| X860H21G | High Yield Toner (35,000 Yield) | 19418 | CTG | \$208.22 |
| X860H22G | Photoconductor Drum | 19419 | CTG | \$166.31 |
| 25A0013 | Staple Cartridges (5,000 Staples/Ctg) (EA=Box of 3 Ctgs) | 29550 | EA | \$137.49 |
| 40X0394 | Maintenance Kit (110-127V) (Includes Transfer Roll Assembly, Fuser Assembly, Feed Rolls, Pick Rolls, Separation Rolls) (300,000 Yield) | 12683 | KIT | \$366.67 |
| 40X2503 | Fuser Assembly (110-127V) | 19533 | EA | \$290.00 |
| 40X0616 | Transfer Roll Assembly | 6754 | EA | \$89.88 |
| 40X2734 | ADF Maintenance Kit (Includes Separation Roll Guide Assembly, Feed/Pick Roll Assembly) | 17754 | KIT | \$154.36 |
| Lexmark C500/X500/X502 Color Laser Supplies | | | | |
| C500H2KG | High Yield Black Toner (5,000 Yield) | 20073 | CTG | \$230.23 |
| C500H2CG | High Yield Cyan Toner (3,000 Yield) | 20066 | CTG | \$203.31 |
| C500H2MG | High Yield Magenta Toner (3,000 Yield) | 20070 | CTG | \$203.31 |
| C500H2YG | High Yield Yellow Toner (3,000 Yield) | 20071 | CTG | \$203.31 |
| C500X28G | LV Fuser Unit (60,000 Yield) | 20076 | EA | \$391.45 |
| 40X3418 | Transfer Roller Assembly | 17849 | EA | \$88.71 |
| Lexmark C510 Color Laser Supplies | | | | |
| 20K0503 | Black Toner (5,000 Yield) | 5271 | CTG | \$146.07 |
| 20K0500 | Cyan Toner (3,000 Yield) | 5268 | CTG | \$167.16 |
| 20K0501 | Magenta Toner (3,000 Yield) | 5269 | CTG | \$167.16 |
| 20K0502 | Yellow Toner (3,000 Yield) | 5270 | CTG | \$167.16 |
| 20K1403 | High Yield Black Toner (10,000 Yield) | 5275 | CTG | \$250.05 |
| 20K1400 | High Yield Cyan Toner (6,600 Yield) | 5272 | CTG | \$331.89 |
| 20K1401 | High Yield Magenta Toner (6,600 Yield) | 5273 | CTG | \$331.89 |
| 20K1402 | High Yield Yellow Toner (6,600 Yield) | 5274 | CTG | \$331.89 |
| 20K1440 | Government High Yield Black Toner (10,000 Yield) (TAA Compliant Version of 20K1403) | 10900 | CTG | \$250.05 |
| 20K1441 | Government High Yield Cyan Toner (6,600 Yield) (TAA Compliant Version of 12K1400) | 10901 | CTG | \$331.89 |
| 20K1442 | Government High Yield Magenta Toner (6,600 Yield) (TAA Compliant Version of 20K1401) | 10902 | CTG | \$331.89 |
| 20K1443 | Government High Yield Yellow Toner (6,600 Yield) (TAA Compliant Version of 20K1402) | 10903 | CTG | \$331.89 |
| 20K0504 | Color Photodeveloper (40,000 Yield) | 5276 | EA | \$312.07 |
| 20K1452 | Government Color Photodeveloper (40,000 Yield) (TAA Compliant Version of 20K0504) | 10904 | EA | \$312.07 |
| 20K0505 | Waste Toner Bottle (12,000 Yield) | 5277 | EA | \$8.48 |
| C500X28G | LV Fuser Unit (60,000 Yield) | 20076 | EA | \$391.45 |
| 40X3418 | Transfer Roller Assembly | 17849 | EA | \$88.71 |
| Lexmark C520 Color Laser Supplies (Continued on next page) | | | | |
| C5200KS | Black Return Program Toner (1,500 Yield) | 20077 | CTG | \$130.92 |
| C5200CS | Cyan Return Program Toner (1,500 Yield) | 20078 | CTG | \$130.92 |
| C5200MS | Magenta Return Program Toner (1,500 Yield) | 20079 | CTG | \$130.92 |
| C5200YS | Yellow Return Program Toner (1,500 Yield) | 20086 | CTG | \$130.92 |
| C53030X | Photoconductor (20,000 Yield) (Single Pack) (For Use in Cyan, Magenta, Yellow or Black) | 92952 | EA | \$44.41 |

| MFG# | Product Description | Part# | UOM | Retail |
|--|---|-------|-----|----------|
| LEXMARK SUPPLIES | | | | |
| Lexmark C520 Color Laser Supplies <i>(Continued)</i> | | | | |
| C53034X | Photoconductor Multipack (For Use in Cyan, Magenta, Yellow or Black) (4 Pack of OEM# C53030X) (4 x 20,000 Yield) | 90321 | PK | \$169.49 |
| C53074X | Government Photoconductor Multipack (4 x 20,000 Yield) (TAA Compliant Version of OEM# C53034X) | 90424 | PK | \$169.49 |
| 40X3569 | Fuser Maintenance Kit (110-127V) (120,000 Yield) | 30150 | EA | \$245.49 |
| 40X1401 | Transfer Belt (120,000 Yield) | 12275 | EA | \$303.44 |
| C52025X | Waste Toner Bottle | 12234 | EA | \$12.29 |
| Lexmark C522 Color Laser Supplies | | | | |
| C5222KS | Black Toner (4,000 Yield) | 12213 | CTG | \$181.58 |
| C5222CS | Cyan Toner (3,000 Yield) | 12214 | CTG | \$201.29 |
| C5222MS | Magenta Toner (3,000 Yield) | 12215 | CTG | \$201.29 |
| C5222YS | Yellow Toner (3,000 Yield) | 12216 | CTG | \$201.29 |
| C5220KS | Black Return Program Toner (4,000 Yield) | 12217 | CTG | \$150.74 |
| C5220CS | Cyan Return Program Toner (3,000 Yield) | 12218 | CTG | \$170.66 |
| C5220MS | Magenta Return Program Toner (3,000 Yield) | 12219 | CTG | \$170.66 |
| C5220YS | Yellow Return Program Toner (3,000 Yield) | 12221 | CTG | \$170.66 |
| C5226KS | Government Black Return Program Toner (4,000 Yield) (TAA Compliant Version of C5220KS) | 20039 | CTG | \$150.74 |
| C5226CS | Government Cyan Return Program Toner (3,000 Yield) (TAA Compliant Version of C5220CS) | 20036 | CTG | \$170.66 |
| C5226MS | Government Magenta Return Program Toner (3,000 Yield) (TAA Compliant Version of C5220MS) | 20037 | CTG | \$170.66 |
| C5226YS | Government Yellow Return Program Toner (3,000 Yield) (TAA Compliant Version of C5220YS) | 20038 | CTG | \$170.66 |
| C53030X | Photoconductor (20,000 Yield) (Single Pack) (For Use in Cyan, Magenta, Yellow or Black) | 92952 | EA | \$44.41 |
| C53034X | Photoconductor Multipack (For Use in Cyan, Magenta, Yellow or Black) (4 Pack of OEM# C53030X) (4 x 20,000 Yield) | 90321 | PK | \$169.49 |
| C53074X | Government Photoconductor Multipack (4 x 20,000 Yield) (TAA Compliant Version of OEM# C53034X) | 90424 | PK | \$169.49 |
| 40X3569 | Fuser Maintenance Kit (110-127V) (120,000 Yield) | 30150 | EA | \$245.49 |
| 40X1401 | Transfer Belt (120,000 Yield) | 12275 | EA | \$303.44 |
| C52025X | Waste Toner Bottle | 12234 | EA | \$12.29 |
| Lexmark C524 Color Laser Supplies | | | | |
| C5222KS | Black Toner (4,000 Yield) | 12213 | CTG | \$181.58 |
| C5222CS | Cyan Toner (3,000 Yield) | 12214 | CTG | \$201.29 |
| C5222MS | Magenta Toner (3,000 Yield) | 12215 | CTG | \$201.29 |
| C5222YS | Yellow Toner (3,000 Yield) | 12216 | CTG | \$201.29 |
| C5220KS | Black Return Program Toner (4,000 Yield) | 12217 | CTG | \$150.74 |
| C5220CS | Cyan Return Program Toner (3,000 Yield) | 12218 | CTG | \$170.66 |
| C5220MS | Magenta Return Program Toner (3,000 Yield) | 12219 | CTG | \$170.66 |
| C5220YS | Yellow Return Program Toner (3,000 Yield) | 12221 | CTG | \$170.66 |
| C5226KS | Government Black Return Program Toner (4,000 Yield) (TAA Compliant Version of C5220KS) | 20039 | CTG | \$150.74 |
| C5226CS | Government Cyan Return Program Toner (3,000 Yield) (TAA Compliant Version of C5220CS) | 20036 | CTG | \$170.66 |
| C5226MS | Government Magenta Return Program Toner (3,000 Yield) (TAA Compliant Version of C5220MS) | 20037 | CTG | \$170.66 |
| C5226YS | Government Yellow Return Program Toner (3,000 Yield) (TAA Compliant Version of C5220YS) | 20038 | CTG | \$170.66 |
| C5240KH | High Yield Black Return Program Toner (8,000 Yield) | 12228 | CTG | \$227.90 |
| C5240CH | High Yield Cyan Return Program Toner (5,000 Yield) | 12229 | CTG | \$227.89 |
| C5240MH | High Yield Magenta Return Program Toner (5,000 Yield) | 12230 | CTG | \$227.89 |
| C5240YH | High Yield Yellow Return Program Toner (5,000 Yield) | 12231 | CTG | \$227.89 |
| C53030X | Photoconductor (20,000 Yield) (Single Pack) (For Use in Cyan, Magenta, Yellow or Black) | 92952 | EA | \$44.41 |
| C53034X | Photoconductor Multipack (For Use in Cyan, Magenta, Yellow or Black) (4 Pack of OEM# C53030X) (4 x 20,000 Yield) | 90321 | PK | \$169.49 |
| C53074X | Government Photoconductor Multipack (4 x 20,000 Yield) (TAA Compliant Version of OEM# C53034X) | 90424 | PK | \$169.49 |
| 40X3569 | Fuser Maintenance Kit (110-127V) (120,000 Yield) | 30150 | EA | \$245.49 |
| 40X1401 | Transfer Belt (120,000 Yield) | 12275 | EA | \$303.44 |
| C52025X | Waste Toner Bottle | 12234 | EA | \$12.29 |
| Lexmark C530 Color Laser Supplies <i>(Continued on next page)</i> | | | | |
| C5200KS | Black Return Program Toner (1,500 Yield) | 20077 | CTG | \$130.92 |
| C5200CS | Cyan Return Program Toner (1,500 Yield) | 20078 | CTG | \$130.92 |
| C5200MS | Magenta Return Program Toner (1,500 Yield) | 20079 | CTG | \$130.92 |
| C5200YS | Yellow Return Program Toner (1,500 Yield) | 20086 | CTG | \$130.92 |

| MFG# | Product Description | Part# | UOM | Retail |
|--|---|-------|-----|----------|
| LEXMARK SUPPLIES | | | | |
| Lexmark C530 Color Laser Supplies <i>(Continued)</i> | | | | |
| C5222KS | Black Toner (4,000 Yield) | 12213 | CTG | \$181.58 |
| C5222CS | Cyan Toner (3,000 Yield) | 12214 | CTG | \$201.29 |
| C5222MS | Magenta Toner (3,000 Yield) | 12215 | CTG | \$201.29 |
| C5222YS | Yellow Toner (3,000 Yield) | 12216 | CTG | \$201.29 |
| C5220KS | Black Return Program Toner (4,000 Yield) | 12217 | CTG | \$150.74 |
| C5220CS | Cyan Return Program Toner (3,000 Yield) | 12218 | CTG | \$170.66 |
| C5220MS | Magenta Return Program Toner (3,000 Yield) | 12219 | CTG | \$170.66 |
| C5220YS | Yellow Return Program Toner (3,000 Yield) | 12221 | CTG | \$170.66 |
| C5226KS | Government Black Return Program Toner (4,000 Yield) (TAA Compliant Version of C5220KS) | 20039 | CTG | \$150.74 |
| C5226CS | Government Cyan Return Program Toner (3,000 Yield) (TAA Compliant Version of C5220CS) | 20036 | CTG | \$170.66 |
| C5226MS | Government Magenta Return Program Toner (3,000 Yield) (TAA Compliant Version of C5220MS) | 20037 | CTG | \$170.66 |
| C5226YS | Government Yellow Return Program Toner (3,000 Yield) (TAA Compliant Version of C5220YS) | 20038 | CTG | \$170.66 |
| C53030X | Photoconductor (20,000 Yield) (Single Pack) (For Use in Cyan, Magenta, Yellow or Black) | 92952 | EA | \$44.41 |
| C53034X | Photoconductor Multipack (For Use in Cyan, Magenta, Yellow or Black) (4 Pack of OEM# C53030X) (4 x 20,000 Yield) | 90321 | PK | \$169.49 |
| C53074X | Government Photoconductor Multipack (4 x 20,000 Yield) (TAA Compliant Version of OEM# C53034X) | 90424 | PK | \$169.49 |
| 40X3569 | Fuser Maintenance Kit (110-127V) (120,000 Yield) | 30150 | EA | \$245.49 |
| 40X3572 | Transfer Belt Assembly (120,000 Yield) | 30146 | EA | \$264.85 |
| C52025X | Waste Toner Bottle | 12234 | EA | \$12.29 |
| Lexmark C532 Color Laser Supplies | | | | |
| C5222KS | Black Toner (4,000 Yield) | 12213 | CTG | \$181.58 |
| C5222CS | Cyan Toner (3,000 Yield) | 12214 | CTG | \$201.29 |
| C5222MS | Magenta Toner (3,000 Yield) | 12215 | CTG | \$201.29 |
| C5222YS | Yellow Toner (3,000 Yield) | 12216 | CTG | \$201.29 |
| C5220KS | Black Return Program Toner (4,000 Yield) | 12217 | CTG | \$150.74 |
| C5220CS | Cyan Return Program Toner (3,000 Yield) | 12218 | CTG | \$170.66 |
| C5220MS | Magenta Return Program Toner (3,000 Yield) | 12219 | CTG | \$170.66 |
| C5220YS | Yellow Return Program Toner (3,000 Yield) | 12221 | CTG | \$170.66 |
| C5226KS | Government Black Return Program Toner (4,000 Yield) (TAA Compliant Version of C5220KS) | 20039 | CTG | \$150.74 |
| C5226CS | Government Cyan Return Program Toner (3,000 Yield) (TAA Compliant Version of C5220CS) | 20036 | CTG | \$170.66 |
| C5226MS | Government Magenta Return Program Toner (3,000 Yield) (TAA Compliant Version of C5220MS) | 20037 | CTG | \$170.66 |
| C5226YS | Government Yellow Return Program Toner (3,000 Yield) (TAA Compliant Version of C5220YS) | 20038 | CTG | \$170.66 |
| C5240CH | High Yield Cyan Return Program Toner (5,000 Yield) | 12229 | CTG | \$227.89 |
| C5240MH | High Yield Magenta Return Program Toner (5,000 Yield) | 12230 | CTG | \$227.89 |
| C5240YH | High Yield Yellow Return Program Toner (5,000 Yield) | 12231 | CTG | \$227.89 |
| C5246CH | Government High Yield Cyan Return Program Toner (5,000 Yield) (TAA Compliant Version of C5240CH) | 20040 | CTG | \$227.89 |
| C5246MH | Government High Yield Magenta Return Program Toner (5,000 Yield) (TAA Compliant Version of C5240MH) | 20026 | CTG | \$227.89 |
| C5246YH | Government High Yield Yellow Return Program Toner (5,000 Yield) (TAA Compliant Version of C5240YH) | 20027 | CTG | \$227.89 |
| C53030X | Photoconductor (20,000 Yield) (Single Pack) (For Use in Cyan, Magenta, Yellow or Black) | 92952 | EA | \$44.41 |
| C53034X | Photoconductor Multipack (For Use in Cyan, Magenta, Yellow or Black) (4 Pack of OEM# C53030X) (4 x 20,000 Yield) | 90321 | PK | \$169.49 |
| C53074X | Government Photoconductor Multipack (4 x 20,000 Yield) (TAA Compliant Version of OEM# C53034X) | 90424 | PK | \$169.49 |
| 40X3569 | Fuser Maintenance Kit (110-127V) (120,000 Yield) | 30150 | EA | \$245.49 |
| 40X3572 | Transfer Belt Assembly (120,000 Yield) | 30146 | EA | \$264.85 |
| C52025X | Waste Toner Bottle | 12234 | EA | \$12.29 |
| Lexmark C534 Color Laser Supplies <i>(Continued on next page)</i> | | | | |
| C5222KS | Black Toner (4,000 Yield) | 12213 | CTG | \$181.58 |
| C5222CS | Cyan Toner (3,000 Yield) | 12214 | CTG | \$201.29 |
| C5222MS | Magenta Toner (3,000 Yield) | 12215 | CTG | \$201.29 |
| C5222YS | Yellow Toner (3,000 Yield) | 12216 | CTG | \$201.29 |
| C5220KS | Black Return Program Toner (4,000 Yield) | 12217 | CTG | \$150.74 |
| C5220CS | Cyan Return Program Toner (3,000 Yield) | 12218 | CTG | \$170.66 |
| C5220MS | Magenta Return Program Toner (3,000 Yield) | 12219 | CTG | \$170.66 |
| C5220YS | Yellow Return Program Toner (3,000 Yield) | 12221 | CTG | \$170.66 |

| MFG# | Product Description | Part# | UOM | Retail |
|--|--|--------|-----|----------|
| LEXMARK SUPPLIES | | | | |
| Lexmark C534 Color Laser Supplies (Continued) | | | | |
| C5226KS | Government Black Return Program Toner (4,000 Yield) (TAA Compliant Version of C5220KS) | 20039 | CTG | \$150.74 |
| C5226CS | Government Cyan Return Program Toner (3,000 Yield) (TAA Compliant Version of C5220CS) | 20036 | CTG | \$170.66 |
| C5226MS | Government Magenta Return Program Toner (3,000 Yield) (TAA Compliant Version of C5220MS) | 20037 | CTG | \$170.66 |
| C5226YS | Government Yellow Return Program Toner (3,000 Yield) (TAA Compliant Version of C5220YS) | 20038 | CTG | \$170.66 |
| C5240KH | High Yield Black Return Program Toner (8,000 Yield) | 12228 | CTG | \$227.90 |
| C5240CH | High Yield Cyan Return Program Toner (5,000 Yield) | 12229 | CTG | \$227.89 |
| C5240MH | High Yield Magenta Return Program Toner (5,000 Yield) | 12230 | CTG | \$227.89 |
| C5240YH | High Yield Yellow Return Program Toner (5,000 Yield) | 12231 | CTG | \$227.89 |
| C5340CX | Extra High Yield Cyan Return Program Toner (7,000 Yield) | 30047 | EA | \$262.98 |
| C5340MX | Extra High Yield Magenta Return Program Toner (7,000 Yield) | 30049 | EA | \$262.98 |
| C5340YX | Extra High Yield Yellow Return Program Toner (7,000 Yield) | 30054 | EA | \$262.98 |
| C5346CX | Government Extra High Yield Cyan Return Program Toner (7,000 Yield) (TAA Compliant Version of C5342CX) | 90415 | EA | \$262.98 |
| C5346MX | Government Extra High Yield Magenta Return Program Toner (7,000 Yield) (TAA Compliant Version of C5342MX) | 90417 | EA | \$262.98 |
| C5346YX | Government Extra High Yield Yellow Return Program Toner (7,000 Yield) (TAA Compliant Version of C5342YX) | 90420 | EA | \$262.98 |
| C53030X | Photoconductor (20,000 Yield) (Single Pack) (For Use in Cyan, Magenta, Yellow or Black) | 92952 | EA | \$44.41 |
| C53034X | Photoconductor Multipack (For Use in Cyan, Magenta, Yellow or Black) (4 Pack of OEM# C53030X) (4 x 20,000 Yield) | 90321 | PK | \$169.49 |
| C53074X | Government Photoconductor Multipack (4 x 20,000 Yield) (TAA Compliant Version of OEM# C53034X) | 90424 | PK | \$169.49 |
| 40X3569 | Fuser Maintenance Kit (110-127V) (120,000 Yield) | 30150 | EA | \$245.49 |
| 40X3572 | Transfer Belt Assembly (120,000 Yield) | 30146 | EA | \$264.85 |
| C52025X | Waste Toner Bottle | 12234 | EA | \$12.29 |
| Lexmark C540/C543/X543 Color Laser Supplies | | | | |
| C540A1KG | Black Return Program Toner (1,000 Yield) | 901626 | CTG | \$53.00 |
| C540A1CG | Cyan Return Program Toner (1,000 Yield) | 903750 | CTG | \$69.00 |
| C540A1MG | Magenta Return Program Toner (1,000 Yield) | 903751 | CTG | \$69.00 |
| C540A1YG | Yellow Return Program Toner (1,000 Yield) | 903752 | CTG | \$69.00 |
| C540A4KG | Government Black Return Program Toner (1,000 Yield) (TAA Compliant Version of C540A1KG) | 904039 | CTG | \$53.00 |
| C540A4CG | Government Cyan Return Program Toner (1,000 Yield) (TAA Compliant Version of C540A1CG) | 904038 | CTG | \$69.00 |
| C540A4MG | Government Magenta Return Program Toner (1,000 Yield) (TAA Compliant Version of C540A1MG) | 904040 | CTG | \$69.00 |
| C540A4YG | Government Yellow Return Program Toner (1,000 Yield) (TAA Compliant Version of C540A1YG) | 904041 | CTG | \$69.00 |
| C540H2KG | High Yield Black Toner (2,500 Yield) | 903753 | CTG | \$131.00 |
| C540H2CG | High Yield Cyan Toner (2,000 Yield) | 903754 | CTG | \$146.00 |
| C540H2MG | High Yield Magenta Toner (2,000 Yield) | 901628 | CTG | \$146.00 |
| C540H2YG | High Yield Yellow Toner (2,000 Yield) | 903755 | CTG | \$146.00 |
| C540H1KG | High Yield Black Return Program Toner (2,500 Yield) | 903756 | CTG | \$81.00 |
| C540H1CG | High Yield Cyan Return Program Toner (2,000 Yield) | 901627 | CTG | \$96.00 |
| C540H1MG | High Yield Magenta Return Program Toner (2,000 Yield) | 903757 | CTG | \$96.00 |
| C540H1YG | High Yield Yellow Return Program Toner (2,000 Yield) | 903758 | CTG | \$96.00 |
| C540H4KG | Government High Yield Black Return Program Toner (2,500 Yield) (TAA Compliant Version of C540H1KG) | 904043 | CTG | \$81.00 |
| C540H4CG | Government High Yield Cyan Return Program Toner (2,000 Yield) (TAA Compliant Version of C540H1CG) | 904042 | CTG | \$96.00 |
| C540H4MG | Government High Yield Magenta Return Program Toner (2,000 Yield) (TAA Compliant Version of C540H1MG) | 904044 | CTG | \$96.00 |
| C540H4YG | Government High Yield Yellow Return Program Toner (2,000 Yield) (TAA Compliant Version of C540H1YG) | 904045 | CTG | \$96.00 |
| C540X71G | Black Imaging Kit (Includes Black Developer & Photoconductor Unit) (30,000 Yield) | 901630 | KIT | \$210.00 |
| C540X74G | Black & Color Imaging Kit (30,000 Yield) | 903766 | KIT | \$291.00 |
| C540X31G | Black Developer Unit (30,000 Yield) | 903768 | EA | \$52.00 |
| C540X32G | Cyan Developer Unit (30,000 Yield) | 903769 | EA | \$52.00 |
| C540X33G | Magenta Developer Unit (30,000 Yield) | 903770 | EA | \$52.00 |
| C540X34G | Yellow Developer Unit (30,000 Yield) | 903771 | EA | \$52.00 |
| C540X35G | Photoconductor (30,000 Yield) | 903767 | EA | \$157.00 |
| 40X2254 | Maintenance Kit (110-127V) (Includes Image Transfer Unit (ITU) Assembly, Fuser Assembly, Duplex Reference Edge Guide) (60,000 Yield) | 19414 | KIT | \$330.75 |
| 40X5403 | Image Transfer Unit (ITU) Assembly | 17851 | EA | \$165.45 |
| C540X75G | Waste Toner Bottle (18,000 Yield Color/36,000 Yield Black) | 903772 | EA | \$12.00 |

| MFG# | Product Description | Part# | UOM | Retail |
|--|--|--------|-----|----------|
| LEXMARK SUPPLIES | | | | |
| Lexmark C544/X544 Color Laser Supplies | | | | |
| C540A1KG | Black Return Program Toner (1,000 Yield) | 901626 | CTG | \$53.00 |
| C540A1CG | Cyan Return Program Toner (1,000 Yield) | 903750 | CTG | \$69.00 |
| C540A1MG | Magenta Return Program Toner (1,000 Yield) | 903751 | CTG | \$69.00 |
| C540A1YG | Yellow Return Program Toner (1,000 Yield) | 903752 | CTG | \$69.00 |
| C540A4KG | Government Black Return Program Toner (1,000 Yield) (TAA Compliant Version of C540A1KG) | 904039 | CTG | \$53.00 |
| C540A4CG | Government Cyan Return Program Toner (1,000 Yield) (TAA Compliant Version of C540A1CG) | 904038 | CTG | \$69.00 |
| C540A4MG | Government Magenta Return Program Toner (1,000 Yield) (TAA Compliant Version of C540A1MG) | 904040 | CTG | \$69.00 |
| C540A4YG | Government Yellow Return Program Toner (1,000 Yield) (TAA Compliant Version of C540A1YG) | 904041 | CTG | \$69.00 |
| C540H2KG | High Yield Black Toner (2,500 Yield) | 903753 | CTG | \$131.00 |
| C540H2CG | High Yield Cyan Toner (2,000 Yield) | 903754 | CTG | \$146.00 |
| C540H2MG | High Yield Magenta Toner (2,000 Yield) | 901628 | CTG | \$146.00 |
| C540H2YG | High Yield Yellow Toner (2,000 Yield) | 903755 | CTG | \$146.00 |
| C540H1KG | High Yield Black Return Program Toner (2,500 Yield) | 903756 | CTG | \$81.00 |
| C540H1CG | High Yield Cyan Return Program Toner (2,000 Yield) | 901627 | CTG | \$96.00 |
| C540H1MG | High Yield Magenta Return Program Toner (2,000 Yield) | 903757 | CTG | \$96.00 |
| C540H1YG | High Yield Yellow Return Program Toner (2,000 Yield) | 903758 | CTG | \$96.00 |
| C540H4KG | Government High Yield Black Return Program Toner (2,500 Yield) (TAA Compliant Version of C540H1KG) | 904043 | CTG | \$81.00 |
| C540H4CG | Government High Yield Cyan Return Program Toner (2,000 Yield) (TAA Compliant Version of C540H1CG) | 904042 | CTG | \$96.00 |
| C540H4MG | Government High Yield Magenta Return Program Toner (2,000 Yield) (TAA Compliant Version of C540H1MG) | 904044 | CTG | \$96.00 |
| C540H4YG | Government High Yield Yellow Return Program Toner (2,000 Yield) (TAA Compliant Version of C540H1YG) | 904045 | CTG | \$96.00 |
| C544X2KG | Extra High Yield Black Toner (6,000 Yield) | 903759 | CTG | \$215.00 |
| C544X2CG | Extra High Yield Cyan Toner (4,000 Yield) | 903760 | CTG | \$212.00 |
| C544X2MG | Extra High Yield Magenta Toner (4,000 Yield) | 903761 | CTG | \$212.00 |
| C544X2YG | Extra High Yield Yellow Toner (4,000 Yield) | 901629 | CTG | \$212.00 |
| C544X1KG | Extra High Yield Black Return Program Toner (6,000 Yield) | 903762 | CTG | \$165.00 |
| C544X1CG | Extra High Yield Cyan Return Program Toner (4,000 Yield) | 903763 | CTG | \$162.00 |
| C544X1MG | Extra High Yield Magenta Return Program Toner (4,000 Yield) | 903764 | CTG | \$162.00 |
| C544X1YG | Extra High Yield Yellow Return Program Toner (4,000 Yield) | 903765 | CTG | \$162.00 |
| C544X4KG | Government Extra High Yield Black Return Program Toner (6,000 Yield) (TAA Compliant Version of C544X1KG) | 904048 | CTG | \$165.00 |
| C544X4CG | Government Extra High Yield Cyan Return Program Toner (4,000 Yield) (TAA Compliant Version of C544X1CG) | 904047 | CTG | \$162.00 |
| C544X4MG | Government Extra High Yield Magenta Return Program Toner (4,000 Yield) (TAA Compliant Version of C544X1MG) | 904049 | CTG | \$162.00 |
| C544X4YG | Government Extra High Yield Yellow Return Program Toner (4,000 Yield) (TAA Compliant Version of C544X1YG) | 904050 | CTG | \$162.00 |
| C540X71G | Black Imaging Kit (Includes Black Developer & Photoconductor Unit) (30,000 Yield) | 901630 | KIT | \$210.00 |
| C540X74G | Black & Color Imaging Kit (30,000 Yield) | 903766 | KIT | \$291.00 |
| C540X31G | Black Developer Unit (30,000 Yield) | 903768 | EA | \$52.00 |
| C540X32G | Cyan Developer Unit (30,000 Yield) | 903769 | EA | \$52.00 |
| C540X33G | Magenta Developer Unit (30,000 Yield) | 903770 | EA | \$52.00 |
| C540X34G | Yellow Developer Unit (30,000 Yield) | 903771 | EA | \$52.00 |
| C540X35G | Photoconductor (30,000 Yield) | 903767 | EA | \$157.00 |
| 40X2254 | Maintenance Kit (110-127V) (Includes Image Transfer Unit (ITU) Assembly, Fuser Assembly, Duplex Reference Edge Guide) (60,000 Yield) | 19414 | KIT | \$330.75 |
| 40X5403 | Image Transfer Unit (ITU) Assembly | 17851 | EA | \$165.45 |
| C540X75G | Waste Toner Bottle (18,000 Yield Color/36,000 Yield Black) | 903772 | EA | \$12.00 |
| Lexmark C546/X546 Color Laser Supplies (Continued on next page) | | | | |
| C540A1KG | Black Return Program Toner (1,000 Yield) | 901626 | CTG | \$53.00 |
| C540A1CG | Cyan Return Program Toner (1,000 Yield) | 903750 | CTG | \$69.00 |
| C540A1MG | Magenta Return Program Toner (1,000 Yield) | 903751 | CTG | \$69.00 |
| C540A1YG | Yellow Return Program Toner (1,000 Yield) | 903752 | CTG | \$69.00 |
| C540H2KG | High Yield Black Toner (2,500 Yield) | 903753 | CTG | \$131.00 |
| C540H2CG | High Yield Cyan Toner (2,000 Yield) | 903754 | CTG | \$146.00 |
| C540H2MG | High Yield Magenta Toner (2,000 Yield) | 901628 | CTG | \$146.00 |
| C540H2YG | High Yield Yellow Toner (2,000 Yield) | 903755 | CTG | \$146.00 |
| C540H1KG | High Yield Black Return Program Toner (2,500 Yield) | 903756 | CTG | \$81.00 |
| C540H1CG | High Yield Cyan Return Program Toner (2,000 Yield) | 901627 | CTG | \$96.00 |
| C540H1MG | High Yield Magenta Return Program Toner (2,000 Yield) | 903757 | CTG | \$96.00 |
| C540H1YG | High Yield Yellow Return Program Toner (2,000 Yield) | 903758 | CTG | \$96.00 |

| MFG# | Product Description | Part# | UOM | Retail |
|--|--|--------|-----|----------|
| LEXMARK SUPPLIES | | | | |
| Lexmark C546/X546 Color Laser Supplies <i>(Continued)</i> | | | | |
| C546U2KG | Extra High Yield Black Toner (8,000 Yield) | 19417 | KIT | \$206.00 |
| C544X2CG | Extra High Yield Cyan Toner (4,000 Yield) | 903760 | CTG | \$212.00 |
| C544X2MG | Extra High Yield Magenta Toner (4,000 Yield) | 903761 | CTG | \$212.00 |
| C544X2YG | Extra High Yield Yellow Toner (4,000 Yield) | 901629 | CTG | \$212.00 |
| C546U1KG | Extra High Yield Black Return Program Toner (8,000 Yield) | 19416 | CTG | \$156.00 |
| C544X1CG | Extra High Yield Cyan Return Program Toner (4,000 Yield) | 903763 | CTG | \$162.00 |
| C544X1MG | Extra High Yield Magenta Return Program Toner (4,000 Yield) | 903764 | CTG | \$162.00 |
| C544X1YG | Extra High Yield Yellow Return Program Toner (4,000 Yield) | 903765 | CTG | \$162.00 |
| C546U4KG | Government Extra High Yield Black Return Program Toner (8,000 Yield) (TAA Compliant Version of C546U1KG) | 19895 | CTG | \$156.00 |
| C544X4CG | Government Extra High Yield Cyan Return Program Toner (4,000 Yield) (TAA Compliant Version of C544X1CG) | 904047 | CTG | \$162.00 |
| C544X4MG | Government Extra High Yield Magenta Return Program Toner (4,000 Yield) (TAA Compliant Version of C544X1MG) | 904049 | CTG | \$162.00 |
| C544X4YG | Government Extra High Yield Yellow Return Program Toner (4,000 Yield) (TAA Compliant Version of C544X1YG) | 904050 | CTG | \$162.00 |
| C540X71G | Black Imaging Kit (Includes Black Developer & Photoconductor Unit) (30,000 Yield) | 901630 | KIT | \$210.00 |
| C540X74G | Black & Color Imaging Kit (30,000 Yield) | 903766 | KIT | \$291.00 |
| C540X31G | Black Developer Unit (30,000 Yield) | 903768 | EA | \$52.00 |
| C540X32G | Cyan Developer Unit (30,000 Yield) | 903769 | EA | \$52.00 |
| C540X33G | Magenta Developer Unit (30,000 Yield) | 903770 | EA | \$52.00 |
| C540X34G | Yellow Developer Unit (30,000 Yield) | 903771 | EA | \$52.00 |
| C540X35G | Photoconductor (30,000 Yield) | 903767 | EA | \$157.00 |
| 40X2254 | Maintenance Kit (110-127V) (Includes Image Transfer Unit (ITU) Assembly, Fuser Assembly, Duplex Reference Edge Guide) (60,000 Yield) | 19414 | KIT | \$330.75 |
| 40X5403 | Image Transfer Unit (ITU) Assembly | 17851 | EA | \$165.45 |
| C540X75G | Waste Toner Bottle (18,000 Yield Color/36,000 Yield Black) | 903772 | EA | \$12.00 |
| Lexmark C734/X734 Color Laser Supplies | | | | |
| C734A1KG | Black Return Program Toner (8,000 Yield) | 14296 | CTG | \$168.71 |
| C734A1CG | Cyan Return Program Toner (6,000 Yield) | 14297 | CTG | \$267.13 |
| C734A1MG | Magenta Return Program Toner (6,000 Yield) | 14298 | CTG | \$267.13 |
| C734A1YG | Yellow Return Program Toner (6,000 Yield) | 14299 | CTG | \$267.13 |
| C734A4KG | Government Black Return Program Toner (8,000 Yield) (TAA Compliant Version of C734A1KG) | 15408 | CTG | \$168.71 |
| C734A4CG | Government Cyan Return Program Toner (6,000 Yield) (TAA Compliant Version of C734A1CG) | 15407 | CTG | \$267.13 |
| C734A4MG | Government Magenta Return Program Toner (6,000 Yield) (TAA Compliant Version of C734A1MG) | 15409 | CTG | \$267.13 |
| C734A4YG | Government Yellow Return Program Toner (6,000 Yield) (TAA Compliant Version of C734A1YG) | 15410 | CTG | \$267.13 |
| C734X77G | Waste Toner Container (25,000 Yield) | 14306 | EA | \$10.65 |
| C734X20G | Photoconductor (20,000 Yield) (For Use in Cyan, Magenta, Yellow or Black) | 14304 | EA | \$38.38 |
| C734X24G | Photoconductor Multipack (For Use in Cyan, Magenta, Yellow or Black) (4 Pack of OEM# C734X20G) (4 x 20,000 Yield) | 14305 | KIT | \$149.30 |
| C734X44G | Government Photoconductor Multipack (4 Pack) (4 x 20,000 Yield) (TAA Compliant Version of OEM# C734X24G) | 19415 | KIT | \$149.30 |
| 40X8110 | Fuser Assembly (110-120V) | 908812 | EA | \$279.34 |
| 40X6401 | Transfer Module (120,000 Yield) | 50253 | EA | \$250.00 |
| Lexmark C736/X736/X738 Color Laser Supplies <i>(Continued on next page)</i> | | | | |
| C734A1KG | Black Return Program Toner (8,000 Yield) | 14296 | CTG | \$168.71 |
| C734A1CG | Cyan Return Program Toner (6,000 Yield) | 14297 | CTG | \$267.13 |
| C734A1MG | Magenta Return Program Toner (6,000 Yield) | 14298 | CTG | \$267.13 |
| C734A1YG | Yellow Return Program Toner (6,000 Yield) | 14299 | CTG | \$267.13 |
| C734A4KG | Government Black Return Program Toner (8,000 Yield) (TAA Compliant Version of C734A1KG) | 15408 | CTG | \$168.71 |
| C734A4CG | Government Cyan Return Program Toner (6,000 Yield) (TAA Compliant Version of C734A1CG) | 15407 | CTG | \$267.13 |
| C734A4MG | Government Magenta Return Program Toner (6,000 Yield) (TAA Compliant Version of C734A1MG) | 15409 | CTG | \$267.13 |
| C734A4YG | Government Yellow Return Program Toner (6,000 Yield) (TAA Compliant Version of C734A1YG) | 15410 | CTG | \$267.13 |
| C736H2KG | High Yield Black Toner (12,000 Yield) | 14292 | CTG | \$267.10 |
| C736H2CG | High Yield Cyan Toner (10,000 Yield) | 14293 | CTG | \$443.38 |
| C736H2MG | High Yield Magenta Toner (10,000 Yield) | 14294 | CTG | \$443.38 |
| C736H2YG | High Yield Yellow Toner (10,000 Yield) | 14295 | CTG | \$443.38 |
| C736H1KG | High Yield Black Return Program Toner (12,000 Yield) | 14288 | CTG | \$239.03 |
| C736H1CG | High Yield Cyan Return Program Toner (10,000 Yield) | 14289 | CTG | \$416.35 |

| MFG# | Product Description | Part# | UOM | Retail |
|--|--|--------|-----|----------|
| LEXMARK SUPPLIES | | | | |
| Lexmark C736/X736/X738 Color Laser Supplies (Continued) | | | | |
| C736H1MG | High Yield Magenta Return Program Toner (10,000 Yield) | 14290 | CTG | \$416.35 |
| C736H1YG | High Yield Yellow Return Program Toner (10,000 Yield) | 14291 | CTG | \$416.35 |
| C736H4KG | Government High Yield Black Return Program Toner (12,000 Yield) (TAA Compliant Version of C736H1KG) | 15412 | CTG | \$239.03 |
| C736H4CG | Government High Yield Cyan Return Program Toner (10,000 Yield) (TAA Compliant Version of C736H1CG) | 15411 | CTG | \$416.35 |
| C736H4MG | Government High Yield Magenta Return Program Toner (10,000 Yield) (TAA Compliant Version of C736H1MG) | 15413 | CTG | \$416.35 |
| C736H4YG | Government High Yield Yellow Return Program Toner (10,000 Yield) (TAA Compliant Version of C736H1YG) | 15414 | CTG | \$416.35 |
| C734X77G | Waste Toner Container (25,000 Yield) | 14306 | EA | \$10.65 |
| C734X20G | Photoconductor (20,000 Yield) (For Use in Cyan, Magenta, Yellow or Black) | 14304 | EA | \$38.38 |
| C734X24G | Photoconductor Multipack (For Use in Cyan, Magenta, Yellow or Black) (4 Pack of OEM# C734X20G) (4 x 20,000 Yield) | 14305 | KIT | \$149.30 |
| C734X44G | Government Photoconductor Multipack (4 Pack) (4 x 20,000 Yield) (TAA Compliant Version of OEM# C734X24G) | 19415 | KIT | \$149.30 |
| 40X8110 | Fuser Assembly (110-120V) | 908812 | EA | \$279.34 |
| 40X6401 | Transfer Module (120,000 Yield) | 50253 | EA | \$250.00 |
| Lexmark C746/C748 Color Laser Supplies | | | | |
| C746H1KG | High Yield Black Return Program Toner (12,000 Yield) | 905328 | CTG | \$228.51 |
| C746A1CG | Cyan Return Program Toner (7,000 Yield) (For Use in Model C746/C748) | 905325 | CTG | \$284.78 |
| C746A1MG | Magenta Return Program Toner (7,000 Yield) (For Use in Model C746/C748) | 905326 | CTG | \$284.78 |
| C746A1YG | Yellow Return Program Toner (7,000 Yield) (For Use in Model C746/C748) | 905327 | CTG | \$284.78 |
| C746H4KG | Government High Yield Black Return Program Toner (12,000 Yield) (TAA Compliant Version of C746H1KG) | 906771 | CTG | \$228.51 |
| C746A4CG | Government Cyan Return Program Toner (7,000 Yield) (TAA Compliant Version of C746A1CG) | 906768 | CTG | \$284.78 |
| C746A4MG | Government Magenta Return Program Toner (7,000 Yield) (TAA Compliant Version of C746A1MG) | 906769 | CTG | \$284.78 |
| C746A4YG | Government Yellow Return Program Toner (7,000 Yield) (TAA Compliant Version of C746A1YG) | 906770 | CTG | \$284.78 |
| C748H1CG | High Yield Cyan Return Program Toner (10,000 Yield) (For Use in Model C748) | 905333 | CTG | \$287.16 |
| C748H1MG | High Yield Magenta Return Program Toner (10,000 Yield) (For Use in Model C748) | 905334 | CTG | \$287.16 |
| C748H1YG | High Yield Yellow Return Program Toner (10,000 Yield) (For Use in Model C748) | 905335 | CTG | \$287.16 |
| C748H4CG | Government High Yield Cyan Return Program Toner (10,000 Yield) (For Use in Model C748) (TAA Compliant Version of C748H1CG) | 906772 | CTG | \$287.16 |
| C748H4MG | Government High Yield Magenta Return Program Toner (10,000 Yield) (For Use in Model C748) (TAA Compliant Version of C748H1MG) | 906773 | CTG | \$287.16 |
| C748H4YG | Government High Yield Yellow Return Program Toner (10,000 Yield) (For Use in Model C748) (TAA Compliant Version of C748H1YG) | 906774 | CTG | \$287.16 |
| C734X20G | Photoconductor (20,000 Yield) (For Use in Cyan, Magenta, Yellow or Black) | 14304 | EA | \$38.38 |
| C734X24G | Photoconductor Multipack (For Use in Cyan, Magenta, Yellow or Black) (4 Pack of OEM# C734X20G) (4 x 20,000 Yield) | 14305 | KIT | \$149.30 |
| C734X77G | Waste Toner Container (25,000 Yield) | 14306 | EA | \$10.65 |
| 40X8110 | Fuser Assembly (110-120V) | 908812 | EA | \$279.34 |
| 40X6401 | Transfer Module (120,000 Yield) | 50253 | EA | \$250.00 |
| Lexmark C752/X752 Color Laser Supplies (Continued on next page) | | | | |
| 15G031K | Black Toner (6,000 Yield) | 5151 | CTG | \$211.05 |
| 15G031C | Cyan Toner (6,000 Yield) | 5150 | CTG | \$366.86 |
| 15G031M | Magenta Toner (6,000 Yield) | 5152 | CTG | \$366.86 |
| 15G031Y | Yellow Toner (6,000 Yield) | 5153 | CTG | \$366.86 |
| 15G041K | Black Return Program Toner (6,000 Yield) | 10043 | CTG | \$178.82 |
| 15G041C | Cyan Return Program Toner (6,000 Yield) | 10029 | CTG | \$293.30 |
| 15G041M | Magenta Return Program Toner (6,000 Yield) | 10051 | CTG | \$293.30 |
| 15G041Y | Yellow Return Program Toner (6,000 Yield) | 10053 | CTG | \$293.30 |
| 15G032K | High Yield Black Toner (15,000 Yield) | 10047 | CTG | \$282.27 |
| 15G032C | High Yield Cyan Toner (15,000 Yield) | 10055 | CTG | \$660.16 |
| 15G032M | High Yield Magenta Toner (15,000 Yield) | 1000 | CTG | \$660.16 |
| 15G032Y | High Yield Yellow Toner (15,000 Yield) | 1001 | CTG | \$660.16 |
| 15G042K | High Yield Black Return Program Toner (15,000 Yield) | 10024 | CTG | \$248.89 |
| 15G042C | High Yield Cyan Return Program Toner (15,000 Yield) | 10005 | CTG | \$586.70 |
| 15G042M | High Yield Magenta Return Program Toner (15,000 Yield) | 10049 | CTG | \$586.70 |
| 15G042Y | High Yield Yellow Return Program Toner (15,000 Yield) | 10050 | CTG | \$586.70 |
| 15G642K | Government High Yield Black Return Program Toner (15,000 Yield) (TAA Compliant Version of 15G042K) | 5594 | CTG | \$248.89 |
| 15G642C | Government High Yield Cyan Return Program Toner (15,000 Yield) (TAA Compliant Version of 15G042C) | 5595 | CTG | \$586.70 |

| MFG# | Product Description | Part# | UOM | Retail |
|---|--|--------|-----|----------|
| LEXMARK SUPPLIES | | | | |
| Lexmark C752/X752 Color Laser Supplies (Continued) | | | | |
| 15G642M | Government High Yield Magenta Return Program Toner (15,000 Yield) (TAA Compliant Version of 15G042M) | 5596 | CTG | \$586.70 |
| 15G642Y | Government High Yield Yellow Return Program Toner (15,000 Yield) (TAA Compliant Version of 15G042Y) | 5597 | CTG | \$586.70 |
| 11K3188 | Staple Cartridge (3,000 Staples/Ctg) (3 Ctgs/Box) | 6002 | BOX | \$55.23 |
| 12G6496 | Fuser Maintenance Kit (110-1205V) (150,000 Yield) | 5960 | KIT | \$409.46 |
| 12G6301 | Fuser (110-120V) (150,000 Yield) | 5959 | EA | \$432.99 |
| 56P2848 | Image Transfer Unit (ITU) Maintenance Kit & Transfer Roller (120,000 Yield) | 6134 | KIT | \$715.61 |
| 12G6303 | Transfer Roller | 903488 | EA | \$82.17 |
| 10B3100 | Waste Toner Container (Black 180,000/Color 50,000 Yield) | 4195 | EA | \$18.66 |
| Lexmark C760 Color Laser Supplies | | | | |
| 15G031K | Black Toner (6,000 Yield) | 5151 | CTG | \$211.05 |
| 15G031C | Cyan Toner (6,000 Yield) | 5150 | CTG | \$366.86 |
| 15G031M | Magenta Toner (6,000 Yield) | 5152 | CTG | \$366.86 |
| 15G031Y | Yellow Toner (6,000 Yield) | 5153 | CTG | \$366.86 |
| 15G041K | Black Return Program Toner (6,000 Yield) | 10043 | CTG | \$178.82 |
| 15G041C | Cyan Return Program Toner (6,000 Yield) | 10029 | CTG | \$293.30 |
| 15G041M | Magenta Return Program Toner (6,000 Yield) | 10051 | CTG | \$293.30 |
| 15G041Y | Yellow Return Program Toner (6,000 Yield) | 10053 | CTG | \$293.30 |
| 11K3188 | Staple Cartridge (3,000 Staples/Ctg) (3 Ctgs/Box) | 6002 | BOX | \$55.23 |
| 56P2910 | Maintenance Kit (110-127V) (200,000 Yield) | 6135 | KIT | \$450.99 |
| 56P2851 | Fuser Assembly (115V) | 900814 | EA | \$472.87 |
| 56P2848 | Image Transfer Unit (ITU) Maintenance Kit & Transfer Roller (120,000 Yield) | 6134 | KIT | \$715.61 |
| 12G6303 | Transfer Roller | 903488 | EA | \$82.17 |
| 10B3100 | Waste Toner Container (Black 180,000/Color 50,000 Yield) | 4195 | EA | \$18.66 |
| Lexmark C762/X762 Color Laser Supplies | | | | |
| 15G031K | Black Toner (6,000 Yield) | 5151 | CTG | \$211.05 |
| 15G031C | Cyan Toner (6,000 Yield) | 5150 | CTG | \$366.86 |
| 15G031M | Magenta Toner (6,000 Yield) | 5152 | CTG | \$366.86 |
| 15G031Y | Yellow Toner (6,000 Yield) | 5153 | CTG | \$366.86 |
| 15G041K | Black Return Program Toner (6,000 Yield) | 10043 | CTG | \$178.82 |
| 15G041C | Cyan Return Program Toner (6,000 Yield) | 10029 | CTG | \$293.30 |
| 15G041M | Magenta Return Program Toner (6,000 Yield) | 10051 | CTG | \$293.30 |
| 15G041Y | Yellow Return Program Toner (6,000 Yield) | 10053 | CTG | \$293.30 |
| 15G032K | High Yield Black Toner (15,000 Yield) | 10047 | CTG | \$282.27 |
| 15G032C | High Yield Cyan Toner (15,000 Yield) | 10055 | CTG | \$660.16 |
| 15G032M | High Yield Magenta Toner (15,000 Yield) | 1000 | CTG | \$660.16 |
| 15G032Y | High Yield Yellow Toner (15,000 Yield) | 1001 | CTG | \$660.16 |
| 15G042K | High Yield Black Return Program Toner (15,000 Yield) | 10024 | CTG | \$248.89 |
| 15G042C | High Yield Cyan Return Program Toner (15,000 Yield) | 10005 | CTG | \$586.70 |
| 15G042M | High Yield Magenta Return Program Toner (15,000 Yield) | 10049 | CTG | \$586.70 |
| 15G042Y | High Yield Yellow Return Program Toner (15,000 Yield) | 10050 | CTG | \$586.70 |
| 15G642K | Government High Yield Black Return Program Toner (15,000 Yield) (TAA Compliant Version of 15G042K) | 5594 | CTG | \$248.89 |
| 15G642C | Government High Yield Cyan Return Program Toner (15,000 Yield) (TAA Compliant Version of 15G042C) | 5595 | CTG | \$586.70 |
| 15G642M | Government High Yield Magenta Return Program Toner (15,000 Yield) (TAA Compliant Version of 15G042M) | 5596 | CTG | \$586.70 |
| 15G642Y | Government High Yield Yellow Return Program Toner (15,000 Yield) (TAA Compliant Version of 15G042Y) | 5597 | CTG | \$586.70 |
| 11K3188 | Staple Cartridge (3,000 Staples/Ctg) (3 Ctgs/Box) | 6002 | BOX | \$55.23 |
| 56P2910 | Maintenance Kit (110-127V) (200,000 Yield) | 6135 | KIT | \$450.99 |
| 56P2851 | Fuser Assembly (115V) | 900814 | EA | \$472.87 |
| 56P2848 | Image Transfer Unit (ITU) Maintenance Kit & Transfer Roller (120,000 Yield) | 6134 | KIT | \$715.61 |
| 12G6303 | Transfer Roller | 903488 | EA | \$82.17 |
| 10B3100 | Waste Toner Container (Black 180,000/Color 50,000 Yield) | 4195 | EA | \$18.66 |
| Lexmark C770 Color Laser Supplies (Continued on next page) | | | | |
| C7702KS | Black Toner (6,000 Yield) | 21003 | CTG | \$211.05 |
| C7702CS | Cyan Toner (6,000 Yield) | 21004 | CTG | \$367.61 |
| C7702MS | Magenta Toner (6,000 Yield) | 21006 | CTG | \$367.61 |
| C7702YS | Yellow Toner (6,000 Yield) | 21007 | CTG | \$367.61 |
| C7700KS | Black Return Program Toner (6,000 Yield) | 20881 | CTG | \$178.82 |
| C7700CS | Cyan Return Program Toner (6,000 Yield) | 20890 | CTG | \$293.30 |
| C7700MS | Magenta Return Program Toner (6,000 Yield) | 20952 | CTG | \$293.30 |
| C7700YS | Yellow Return Program Toner (6,000 Yield) | 20962 | CTG | \$293.30 |
| C7702KH | High Yield Black Toner (10,000 Yield) | 20994 | CTG | \$258.96 |

| MFG# | Product Description | Part# | UOM | Retail |
|---|--|--------|-----|----------|
| LEXMARK SUPPLIES | | | | |
| Lexmark C770 Color Laser Supplies (Continued) | | | | |
| C7702CH | High Yield Cyan Toner (10,000 Yield) | 21000 | CTG | \$497.88 |
| C7702MH | High Yield Magenta Toner (10,000 Yield) | 21001 | CTG | \$497.88 |
| C7702YH | High Yield Yellow Toner (10,000 Yield) | 21002 | CTG | \$497.88 |
| C7700KH | High Yield Black Return Program Toner (10,000 Yield) | 20873 | CTG | \$227.90 |
| C7700CH | High Yield Cyan Return Program Toner (10,000 Yield) | 20874 | CTG | \$423.90 |
| C7700MH | High Yield Magenta Return Program Toner (10,000 Yield) | 20878 | CTG | \$423.90 |
| C7700YH | High Yield Yellow Return Program Toner (10,000 Yield) | 20880 | CTG | \$423.90 |
| C7706KH | Government High Yield Black Return Program Toner (10,000 Yield) (TAA Compliant Version of C7700KH) | 90449 | CTG | \$227.90 |
| C7706CH | Government High Yield Cyan Return Program Toner (10,000 Yield) (TAA Compliant Version of C7700CH) | 90450 | CTG | \$423.90 |
| C7706MH | Government High Yield Magenta Return Program Toner (10,000 Yield) (TAA Compliant Version of C7700MH) | 90451 | CTG | \$423.90 |
| C7706YH | Government High Yield Yellow Return Program Toner (10,000 Yield) (TAA Compliant Version of C7700YH) | 90452 | CTG | \$423.90 |
| 11K3188 | Staple Cartridge (3,000 Staples/Ctg) (3 Ctgs/Box) | 6002 | BOX | \$55.23 |
| 40X1831 | Fuser Maintenance Kit (110-120V) (120,000 Yield) | 900824 | KIT | \$462.81 |
| 40X0342 | Image Transfer Unit (ITU) Maintenance Kit (Includes Transfer Roller & Transfer Belt) (120,000 Yield) | 19704 | EA | \$681.16 |
| 40X1958 | Transfer Belt | 19705 | EA | \$623.09 |
| 10B3100 | Waste Toner Container (Black 180,000/Color 50,000 Yield) | 4195 | EA | \$18.66 |
| Lexmark C772/X772 Color Laser Supplies | | | | |
| C7702KS | Black Toner (6,000 Yield) | 21003 | CTG | \$211.05 |
| C7702CS | Cyan Toner (6,000 Yield) | 21004 | CTG | \$367.61 |
| C7702MS | Magenta Toner (6,000 Yield) | 21006 | CTG | \$367.61 |
| C7702YS | Yellow Toner (6,000 Yield) | 21007 | CTG | \$367.61 |
| C7700KS | Black Return Program Toner (6,000 Yield) | 20881 | CTG | \$178.82 |
| C7700CS | Cyan Return Program Toner (6,000 Yield) | 20890 | CTG | \$293.30 |
| C7700MS | Magenta Return Program Toner (6,000 Yield) | 20952 | CTG | \$293.30 |
| C7700YS | Yellow Return Program Toner (6,000 Yield) | 20962 | CTG | \$293.30 |
| C7702KH | High Yield Black Toner (10,000 Yield) | 20994 | CTG | \$258.96 |
| C7702CH | High Yield Cyan Toner (10,000 Yield) | 21000 | CTG | \$497.88 |
| C7702MH | High Yield Magenta Toner (10,000 Yield) | 21001 | CTG | \$497.88 |
| C7702YH | High Yield Yellow Toner (10,000 Yield) | 21002 | CTG | \$497.88 |
| C7700KH | High Yield Black Return Program Toner (10,000 Yield) | 20873 | CTG | \$227.90 |
| C7700CH | High Yield Cyan Return Program Toner (10,000 Yield) | 20874 | CTG | \$423.90 |
| C7700MH | High Yield Magenta Return Program Toner (10,000 Yield) | 20878 | CTG | \$423.90 |
| C7700YH | High Yield Yellow Return Program Toner (10,000 Yield) | 20880 | CTG | \$423.90 |
| C7706KH | Government High Yield Black Return Program Toner (10,000 Yield) (TAA Compliant Version of C7700KH) | 90449 | CTG | \$227.90 |
| C7706CH | Government High Yield Cyan Return Program Toner (10,000 Yield) (TAA Compliant Version of C7700CH) | 90450 | CTG | \$423.90 |
| C7706MH | Government High Yield Magenta Return Program Toner (10,000 Yield) (TAA Compliant Version of C7700MH) | 90451 | CTG | \$423.90 |
| C7706YH | Government High Yield Yellow Return Program Toner (10,000 Yield) (TAA Compliant Version of C7700YH) | 90452 | CTG | \$423.90 |
| C7720KX | Extra High Yield Black Return Program Toner (15,000 Yield) | 20865 | CTG | \$249.00 |
| C7720CX | Extra High Yield Cyan Return Program Toner (15,000 Yield) | 20868 | CTG | \$559.99 |
| C7720MX | Extra High Yield Magenta Return Program Toner (15,000 Yield) | 20870 | CTG | \$559.99 |
| C7720YX | Extra High Yield Yellow Return Program Toner (15,000 Yield) | 20872 | CTG | \$559.99 |
| 11K3188 | Staple Cartridge (3,000 Staples/Ctg) (3 Ctgs/Box) | 6002 | BOX | \$55.23 |
| 40X1831 | Fuser Maintenance Kit (110-120V) (120,000 Yield) | 900824 | KIT | \$462.81 |
| 40X0342 | Image Transfer Unit (ITU) Maintenance Kit (Includes Transfer Roller & Transfer Belt) (120,000 Yield) | 19704 | EA | \$681.16 |
| 40X1958 | Transfer Belt | 19705 | EA | \$623.09 |
| 40X2540 | Pick Roller | 19552 | EA | \$34.26 |
| 10B3100 | Waste Toner Container (Black 180,000/Color 50,000 Yield) | 4195 | EA | \$18.66 |
| Lexmark C780 Color Laser Supplies (Continued on next page) | | | | |
| C780A2KG | Black Toner (6,000 Yield) | 93775 | CTG | \$211.05 |
| C780A2CG | Cyan Toner (6,000 Yield) | 93776 | CTG | \$366.86 |
| C780A2MG | Magenta Toner (6,000 Yield) | 93778 | CTG | \$366.86 |
| C780A2YG | Yellow Toner (6,000 Yield) | 93779 | CTG | \$366.86 |
| C780A1KG | Black Return Program Toner (6,000 Yield) | 93748 | CTG | \$178.82 |
| C780A1CG | Cyan Return Program Toner (6,000 Yield) | 93749 | CTG | \$293.30 |
| C780A1MG | Magenta Return Program Toner (6,000 Yield) | 93751 | CTG | \$293.30 |
| C780A1YG | Yellow Return Program Toner (6,000 Yield) | 93752 | CTG | \$293.30 |
| C780H2KG | High Yield Black Toner (10,000 Yield) | 93764 | CTG | \$258.96 |

| MFG# | Product Description | Part# | UOM | Retail |
|--|--|--------|-----|----------|
| LEXMARK SUPPLIES | | | | |
| Lexmark C780 Color Laser Supplies (Continued) | | | | |
| C780H2CG | High Yield Cyan Toner (10,000 Yield) | 93766 | CTG | \$498.41 |
| C780H2MG | High Yield Magenta Toner (10,000 Yield) | 93768 | CTG | \$498.41 |
| C780H2YG | High Yield Yellow Toner (10,000 Yield) | 93772 | CTG | \$498.41 |
| C780H1KG | High Yield Black Return Program Toner (10,000 Yield) | 93737 | CTG | \$227.90 |
| C780H1CG | High Yield Cyan Return Program Toner (10,000 Yield) | 93740 | CTG | \$424.32 |
| C780H1MG | High Yield Magenta Return Program Toner (10,000 Yield) | 93741 | CTG | \$424.32 |
| C780H1YG | High Yield Yellow Return Program Toner (10,000 Yield) | 93746 | CTG | \$424.32 |
| C780H4KG | Government High Yield Black Return Program Toner (10,000 Yield) (TAA Compliant Version of C780H1KG) | 99465 | CTG | \$227.90 |
| C780H4CG | Government High Yield Cyan Return Program Toner (10,000 Yield) (TAA Compliant Version of C780H1CG) | 99471 | CTG | \$424.32 |
| C780H4MG | Government High Yield Magenta Return Program Toner (10,000 Yield) (TAA Compliant Version of C780H1MG) | 99473 | CTG | \$424.32 |
| C780H4YG | Government High Yield Yellow Return Program Toner (10,000 Yield) (TAA Compliant Version of C780H1YG) | 99474 | CTG | \$424.32 |
| 40X1831 | Fuser Maintenance Kit (110-120V) (120,000 Yield) | 900824 | KIT | \$462.81 |
| 40X0343 | Image Transfer Unit (ITU) Maintenance Kit (Includes Transfer Belt, Transfer Roller) (120,000 Yield) | 12619 | KIT | \$689.86 |
| 40X1958 | Transfer Belt | 19705 | EA | \$623.09 |
| 10B3100 | Waste Toner Container (Black 180,000/Color 50,000 Yield) | 4195 | EA | \$18.66 |
| Lexmark C782/X782 Color Laser Supplies (Continued on next page) | | | | |
| C780A2KG | Black Toner (6,000 Yield) | 93775 | CTG | \$211.05 |
| C780A2CG | Cyan Toner (6,000 Yield) | 93776 | CTG | \$366.86 |
| C780A2MG | Magenta Toner (6,000 Yield) | 93778 | CTG | \$366.86 |
| C780A2YG | Yellow Toner (6,000 Yield) | 93779 | CTG | \$366.86 |
| C780A1KG | Black Return Program Toner (6,000 Yield) | 93748 | CTG | \$178.82 |
| C780A1CG | Cyan Return Program Toner (6,000 Yield) | 93749 | CTG | \$293.30 |
| C780A1MG | Magenta Return Program Toner (6,000 Yield) | 93751 | CTG | \$293.30 |
| C780A1YG | Yellow Return Program Toner (6,000 Yield) | 93752 | CTG | \$293.30 |
| C780H2KG | High Yield Black Toner (10,000 Yield) | 93764 | CTG | \$258.96 |
| C780H2CG | High Yield Cyan Toner (10,000 Yield) | 93766 | CTG | \$498.41 |
| C780H2MG | High Yield Magenta Toner (10,000 Yield) | 93768 | CTG | \$498.41 |
| C780H2YG | High Yield Yellow Toner (10,000 Yield) | 93772 | CTG | \$498.41 |
| C780H1KG | High Yield Black Return Program Toner (10,000 Yield) | 93737 | CTG | \$227.90 |
| C780H1CG | High Yield Cyan Return Program Toner (10,000 Yield) | 93740 | CTG | \$424.32 |
| C780H1MG | High Yield Magenta Return Program Toner (10,000 Yield) | 93741 | CTG | \$424.32 |
| C780H1YG | High Yield Yellow Return Program Toner (10,000 Yield) | 93746 | CTG | \$424.32 |
| C780H4KG | Government High Yield Black Return Program Toner (10,000 Yield) (TAA Compliant Version of C780H1KG) | 99465 | CTG | \$227.90 |
| C780H4CG | Government High Yield Cyan Return Program Toner (10,000 Yield) (TAA Compliant Version of C780H1CG) | 99471 | CTG | \$424.32 |
| C780H4MG | Government High Yield Magenta Return Program Toner (10,000 Yield) (TAA Compliant Version of C780H1MG) | 99473 | CTG | \$424.32 |
| C780H4YG | Government High Yield Yellow Return Program Toner (10,000 Yield) (TAA Compliant Version of C780H1YG) | 99474 | CTG | \$424.32 |
| C782X1KG | Extra High Yield Black Return Program Toner (15,000 Yield) | 93733 | CTG | \$249.00 |
| C782X1CG | Extra High Yield Cyan Return Program Toner (15,000 Yield) | 93734 | CTG | \$559.99 |
| C782X1MG | Extra High Yield Magenta Return Program Toner (15,000 Yield) | 93735 | CTG | \$559.99 |
| C782X1YG | Extra High Yield Yellow Return Program Toner (15,000 Yield) | 93736 | CTG | \$559.99 |
| C782X4KG | Government Extra High Yield Black Return Program Toner (15,000 Yield) (TAA Compliant Version of C782X1KG) | 99480 | CTG | \$249.00 |
| C782X4CG | Government Extra High Yield Cyan Return Program Toner (15,000 Yield) (TAA Compliant Version of C782X1CG) | 99481 | CTG | \$559.99 |
| C782X4MG | Government Extra High Yield Magenta Return Program Toner (15,000 Yield) (TAA Compliant Version of C782X1MG) | 99482 | CTG | \$559.99 |
| C782X4YG | Government Extra High Yield Yellow Return Program Toner (15,000 Yield) (TAA Compliant Version of C782X1YG) | 99483 | CTG | \$559.99 |
| C782U1KG | XL Extra High Yield Black Return Program Toner (16,500 Yield) (For Use in Model C782 XL/X782e XL) | 903950 | CTG | \$260.45 |
| C782U1CG | XL Extra High Yield Cyan Return Program Toner (16,500 Yield) (For Use in Model C782 XL/X782e XL) | 903951 | CTG | \$260.45 |
| C782U1MG | XL Extra High Yield Magenta Return Program Toner (16,500 Yield) (For Use in Model C782 XL/X782e XL) | 903952 | CTG | \$260.45 |
| C782U1YG | XL Extra High Yield Yellow Return Program Toner (16,500 Yield) (For Use in Model C782 XL/X782e XL) | 903953 | CTG | \$260.45 |
| C782U4KG | Government XL Extra High Yield Black Return Program Toner (For Use in Model C782XL) (TAA Compliant Version of C782U1KG) | 904888 | CTG | \$260.45 |

| MFG# | Product Description | Part# | UOM | Retail |
|--|--|--------|-----|----------|
| LEXMARK SUPPLIES | | | | |
| Lexmark C782/X782 Color Laser Supplies <i>(Continued)</i> | | | | |
| C782U4CG | Government XL Extra High Yield Cyan Return Program Toner (For Use in Model C782XL) (TAA Compliant Version of C782U1CG) | 904887 | CTG | \$260.45 |
| C782U4MG | Government XL Extra High Yield Magenta Return Program Toner (For Use in Model C782XL) (TAA Compliant Version of C782U1MG) | 904889 | CTG | \$260.45 |
| C782U4YG | Government XL Extra High Yield Yellow Return Program Toner (For Use in Model C782XL) (TAA Compliant Version of C782U1YG) | 904890 | CTG | \$260.45 |
| 11K3188 | Staple Cartridge (3,000 Staples/Ctg) (3 Ctgs/Box) | 6002 | BOX | \$55.23 |
| 40X1831 | Fuser Maintenance Kit (110-120V) (120,000 Yield) | 900824 | KIT | \$462.81 |
| 40X0343 | Image Transfer Unit (ITU) Maintenance Kit (Includes Transfer Belt, Transfer Roller) (120,000 Yield) | 12619 | KIT | \$689.86 |
| 40X1958 | Transfer Belt | 19705 | EA | \$623.09 |
| 40X2540 | Pick Roller | 19552 | EA | \$34.26 |
| 10B3100 | Waste Toner Container (Black 180,000/Color 50,000 Yield) | 4195 | EA | \$18.66 |
| Lexmark C792/X792 Color Laser Supplies | | | | |
| C792A1KG | Black Return Program Toner (6,000 Yield) | 94085 | CTG | \$220.75 |
| C792A1CG | Cyan Return Program Toner (6,000 Yield) | 94082 | CTG | \$334.93 |
| C792A1MG | Magenta Return Program Toner (6,000 Yield) | 94083 | CTG | \$334.93 |
| C792A1YG | Yellow Return Program Toner (6,000 Yield) | 94084 | CTG | \$334.93 |
| C792A4KG | Government Return Program Black Toner (6,000 Yield) (TAA Compliant Version of C792A1KG) | 608243 | CTG | \$220.75 |
| C792A4CG | Government Return Program Cyan Toner (6,000 Yield) (TAA Compliant Version of C792A1CG) | 608221 | CTG | \$334.93 |
| C792A4MG | Government Return Program Magenta Toner (6,000 Yield) (TAA Compliant Version of C792A1MG) | 608250 | CTG | \$334.93 |
| C792A4YG | Government Return Program Yellow Toner (6,000 Yield) (TAA Compliant Version of C792A1YG) | 608251 | CTG | \$334.93 |
| C792X1KG | Extra High Yield Black Return Program Toner (20,000 Yield) (For Use in Model C792/CS796) | 94101 | CTG | \$348.36 |
| C792X1CG | Extra High Yield Cyan Return Program Toner (20,000 Yield) (For Use in Model C792/CS796) | 94089 | CTG | \$603.43 |
| C792X1MG | Extra High Yield Magenta Return Program Toner (20,000 Yield) (For Use in Model C792/CS796) | 94096 | CTG | \$603.43 |
| C792X1YG | Extra High Yield Yellow Return Program Toner (20,000 Yield) (For Use in Model C792/CS796) | 94099 | CTG | \$603.43 |
| C792X4KG | Government Extra High Yield Black Return Program Toner (20,000 Yield) (TAA Compliant Version of C792X1KG) | 608587 | CTG | \$348.36 |
| C792X4CG | Government Extra High Yield Cyan Return Program Toner (20,000 Yield) (TAA Compliant Version of C792X1CG) | 608270 | CTG | \$603.43 |
| C792X4MG | Government Extra High Yield Magenta Return Program Toner (20,000 Yield) (TAA Compliant Version of C792X1MG) | 608605 | CTG | \$603.43 |
| C792X4YG | Government Extra High Yield Yellow Return Program Toner (20,000 Yield) (TAA Compliant Version of C792X1YG) | 608668 | CTG | \$603.43 |
| X792X1KG | Extra High Yield Black Return Program Toner (20,000 Yield) (For Use in Model X792/XS796) | 94111 | CTG | \$281.49 |
| X792X1CG | Extra High Yield Cyan Return Program Toner (20,000 Yield) (For Use in Model X792/XS796) | 94107 | CTG | \$465.97 |
| X792X1MG | Extra High Yield Magenta Return Program Toner (20,000 Yield) (For Use in Model X792/XS796) | 94108 | CTG | \$465.97 |
| X792X1YG | Extra High Yield Yellow Return Program Toner (20,000 Yield) (For Use in Model X792/XS796) | 94109 | CTG | \$465.97 |
| X792X4KG | Government Extra High Yield Black Return Program Toner (20,000 Yield) (TAA Compliant Version of X792X1KG) (For Use in Model X792) | 608847 | CTG | \$281.49 |
| X792X4CG | Government Extra High Yield Cyan Return Program Toner (20,000 Yield) (TAA Compliant Version of X792X1CG) (For Use in Model X792) | 608707 | CTG | \$465.97 |
| X792X4MG | Government Extra High Yield Magenta Return Program Toner (20,000 Yield) (TAA Compliant Version of X792X1MG) (For Use in Model X792) | 608708 | CTG | \$465.97 |
| X792X4YG | Government Extra High Yield Yellow Return Program Toner (20,000 Yield) (TAA Compliant Version of X792X1YG) (For Use in Model X792) | 608778 | CTG | \$465.97 |
| C792X77G | Waste Toner Bottle (Black 180,000/Color 50,000 Yield) | 94121 | CTG | \$16.12 |
| 40X7100 | Fuser Maintenance Kit (110-127V) (150,000 Yield) | 94761 | EA | \$292.94 |
| 40X7103 | Transfer Module Maintenance Kit (200,000 Yield) | 94762 | EA | \$312.15 |
| Lexmark C910/C912/X912 Color Laser Supplies <i>(Continued on next page)</i> | | | | |
| 12N0771 | Black Toner (Includes Oil Coating Roller) (14,000 Yield) | 4192 | CTG | \$304.33 |
| 12N0768 | Cyan Toner (14,000 Yield) | 4191 | CTG | \$482.19 |
| 12N0769 | Magenta Toner (14,000 Yield) | 4190 | CTG | \$482.19 |
| 12N0770 | Yellow Toner (14,000 Yield) | 4189 | CTG | \$482.19 |
| 12N0773 | Black Photodeveloper (28,000 Yield) | 4187 | EA | \$79.71 |

| MFG# | Product Description | Part# | UOM | Retail |
|---|--|--------|-----|------------|
| LEXMARK SUPPLIES | | | | |
| Lexmark C910/C912/X912 Color Laser Supplies (Continued) | | | | |
| 12N0772 | Color Photodeveloper Set (28,000 Yield per Color - C/M/Y) | 4188 | EA | \$272.42 |
| 56P9900 | Fuser Maintenance Kit (110-120V) (105,000 Yield) | 1662 | EA | \$637.76 |
| 56P9751 | Fuser (120V) (105,000 Yield) | 3887 | EA | \$701.07 |
| 56P9903 | Transfer Belt Maintenance Kit | 1661 | EA | \$712.31 |
| Lexmark C920 Color Laser Supplies | | | | |
| C9202KH | Black Toner (15,000 Yield) | 10815 | CTG | \$321.50 |
| C9202CH | Cyan Toner (14,000 Yield) | 10819 | CTG | \$468.73 |
| C9202MH | Magenta Toner (14,000 Yield) | 10820 | CTG | \$468.73 |
| C9202YH | Yellow Toner (14,000 Yield) | 10821 | CTG | \$468.73 |
| C9206KH | Government Black Toner (15,000 Yield) (TAA Compliant Version of C9202KH) | 12136 | CTG | \$321.50 |
| C9206CH | Government Cyan Toner (14,000 Yield) (TAA Compliant Version of C9202CH) | 12137 | CTG | \$468.73 |
| C9206MH | Government Magenta Toner (14,000 Yield) (TAA Compliant Version of C9202MH) | 12138 | CTG | \$468.73 |
| C9206YH | Government Yellow Toner (14,000 Yield) (TAA Compliant Version of C9202YH) | 12139 | CTG | \$468.73 |
| 12N0773 | Black Photodeveloper (28,000 Yield) | 4187 | EA | \$79.71 |
| 12N0772 | Color Photodeveloper Set (28,000 Yield per Color - C/M/Y) | 4188 | EA | \$272.42 |
| 11K3188 | Staple Cartridge (3,000 Staples/Ctg) (3 Ctg/Box) | 6002 | BOX | \$55.23 |
| 40X1249 | Fuser Maintenance Kit (110-120V) (105,000 Yield) | 10913 | EA | \$835.10 |
| 40X1056 | Fuser (120V) | 17855 | EA | \$877.02 |
| C92035X | Oil Coating Roller (15,000 Yield) | 11917 | EA | \$71.13 |
| Lexmark C925/X925 Color Laser Supplies | | | | |
| C925H2KG | High Yield Black Toner (8,500 Yield) (For Use in Model C925) | 94751 | CTG | \$178.21 |
| C925H2CG | High Yield Cyan Toner (7,500 Yield) (For Use in Model C925) | 94752 | CTG | \$286.72 |
| C925H2MG | High Yield Magenta Toner (7,500 Yield) (For Use in Model C925) | 94753 | CTG | \$286.72 |
| C925H2YG | High Yield Yellow Toner (7,500 Yield) (For Use in Model C925) | 94754 | CTG | \$286.72 |
| X925H2KG | High Yield Black Toner (8,500 Yield) (For Use in Model X925) | 94757 | CTG | \$148.06 |
| X925H2CG | High Yield Cyan Toner (7,500 Yield) (For Use in Model X925) | 94758 | CTG | \$219.25 |
| X925H2MG | High Yield Magenta Toner (7,500 Yield) (For Use in Model X925) | 94759 | CTG | \$219.25 |
| X925H2YG | High Yield Yellow Toner (7,500 Yield) (For Use in Model X925) | 94760 | CTG | \$219.25 |
| C925X72G | Black Imaging Unit (30,000 Yield) | 98017 | EA | \$99.70 |
| C925X73G | Cyan Imaging Unit (30,000 Yield) | 98032 | EA | \$112.09 |
| C925X74G | Magenta Imaging Unit (30,000 Yield) | 98033 | EA | \$112.09 |
| C925X75G | Yellow Imaging Unit (30,000 Yield) | 98034 | EA | \$112.09 |
| C925X76G | Waste Toner Bottle (30,000 Yield) | 98035 | CTG | \$15.97 |
| 40X6013 | Fuser Maintenance Kit (110-127V) (120,000 Yield) | 94763 | EA | \$635.06 |
| 40X6011 | Transfer Module Maintenance Kit (100,000 Yield) | 94766 | EA | \$545.72 |
| Lexmark C935 Color Laser Supplies | | | | |
| C930H2KG | High Yield Black Toner (38,000 Yield) | 93781 | CTG | \$505.83 |
| C930H2CG | High Yield Cyan Toner (24,000 Yield) | 93782 | CTG | \$631.44 |
| C930H2MG | High Yield Magenta Toner (24,000 Yield) | 93783 | CTG | \$631.44 |
| C930H2YG | High Yield Yellow Toner (24,000 Yield) | 93784 | CTG | \$631.44 |
| C930X72G | Photoconductor (53,000 Yield) (For Use in Cyan, Magenta, Yellow or Black) | 93785 | KIT | \$387.33 |
| C930X73G | Photoconductor Multipack (For Use in Cyan, Magenta, Yellow or Black) (3 Pack of OEM# C930X72G) (3 x 53,000 Yield) | 93786 | KIT | \$1,159.74 |
| C930X82G | Government Photoconductor Kit (53,000 Yield) (TAA Compliant Version of C930X72G) | 99486 | KIT | \$387.33 |
| C930X83G | Government Photoconductor Kit (53,000 x 3 Yield) (For Use in Cyan, Magenta, Yellow or Black) (TAA Compliant Version of C930X73G) | 99485 | KIT | \$1,159.74 |
| 25A0013 | Staple Cartridges (5,000 Staples/Ctg) (EA=Box of 3 Ctg) | 29550 | EA | \$137.49 |
| 40X4032 | Maintenance Kit (110V) (Includes Transfer Belt Unit Assembly, Black Developer Carrier, Yellow Developer Carrier, Magenta Developer Carrier, Cyan Developer Carrier, Developer Unit Assembly) (600,000 Yield) | 101942 | KIT | \$2,447.95 |
| 40x4031 | Maintenance Kit (110-120V) (Includes Feed Unit Roller Kit, Transfer Roll Assembly, Transfer Belt Cleaner Assembly, Fuser) (100,000 Yield) | 101898 | KIT | \$1,079.66 |
| 40X3747 | Fuser (110-127V) | 6758 | EA | \$685.30 |
| 40X3732 | Transfer Belt Unit Assembly | 6757 | EA | \$1,346.89 |
| 40X3698 | 2nd Transfer Roll Assembly | 6756 | EA | \$286.00 |
| C930X76G | Waste Toner Container (30,000 Yield) | 93732 | EA | \$42.30 |
| Lexmark C950 Color Laser Supplies (Continued on next page) | | | | |
| C950X2KG | High Yield Black Toner (32,000 Yield) | 101892 | CTG | \$519.85 |
| C950X2CG | High Yield Cyan Toner (22,000 Yield) | 101888 | CTG | \$638.66 |
| C950X2MG | High Yield Magenta Toner (22,000 Yield) | 101893 | CTG | \$638.66 |
| C950X2YG | High Yield Yellow Toner (22,000 Yield) | 101894 | CTG | \$638.66 |
| C950X71G | Black Photoconductor Kit (115,000 Yield) | 101900 | KIT | \$302.98 |
| C950X73G | Color Photoconductor Kit (3 Pack) (115,000 Yield) | 101901 | KIT | \$908.95 |

| MFG# | Product Description | Part# | UOM | Retail |
|---|---|--------|-----|----------|
| LEXMARK SUPPLIES | | | | |
| Lexmark C950 Color Laser Supplies (Continued) | | | | |
| C950X76G | Waste Container (30,000 Yield) | 101902 | CTG | \$36.57 |
| 40X7550 | Fuser Maintenance Kit (110-120V) (Includes Fuser Unit Assembly, Transfer Belt Cleaner Assembly, 2nd Transfer Roll Assembly, Suction Filter, 4 Feed Rolls, 4 Pick Rolls, 4 Separation Rolls) (320,000 Yield) | 910074 | KIT | \$801.12 |
| Lexmark CS310/CS410 Series Color Laser Supplies | | | | |
| 70C10K0 | (701K) Black Return Program Toner (1,000 Yield) | 908954 | CTG | \$52.24 |
| 70C10C0 | (701C) Cyan Return Program Toner (1,000 Yield) | 908953 | CTG | \$68.66 |
| 70C10M0 | (701M) Magenta Return Program Toner (1,000 Yield) | 908955 | CTG | \$68.66 |
| 70C10Y0 | (701Y) Yellow Return Program Toner (1,000 Yield) | 908956 | CTG | \$68.66 |
| 70C0H10 | (700H1) High Yield Black Toner (4,000 Yield) | 908943 | CTG | \$191.79 |
| 70C0H20 | (700H2) High Yield Cyan Toner (3,000 Yield) | 908944 | CTG | \$232.76 |
| 70C0H30 | (700H3) High Yield Magenta Toner (3,000 Yield) | 908945 | CTG | \$232.76 |
| 70C0H40 | (700H4) High Yield Yellow Toner (3,000 Yield) | 908946 | CTG | \$232.76 |
| 70C1HK0 | (701HK) High Yield Black Return Program Toner (4,000 Yield) | 908958 | CTG | \$117.16 |
| 70C1HC0 | (701HC) High Yield Cyan Return Program Toner (3,000 Yield) | 908957 | CTG | \$158.13 |
| 70C1HM0 | (701HM) High Yield Magenta Return Program Toner (3,000 Yield) | 908959 | CTG | \$158.13 |
| 70C1HY0 | (701HY) High Yield Yellow Return Program Toner (3,000 Yield) | 908960 | CTG | \$158.13 |
| 70C0Z50 | (700Z5) Black and Color Imaging Kit (40,000 Yield) | 908952 | EA | \$289.55 |
| 70C0Z10 | (700Z1) Black Imaging Kit (40,000 Yield) | 910795 | KIT | \$208.96 |
| 70C0P00 | (700P) Photoconductor Unit (40,000 Yield) | 908947 | EA | \$156.72 |
| 40X7622 | Fuser Assembly (110-120V) | 917941 | EA | \$165.67 |
| 40X7610 | Transfer Module Assembly | 917940 | EA | \$179.21 |
| Lexmark CS510 Series Color Laser Supplies | | | | |
| 70C10K0 | (701K) Black Return Program Toner (1,000 Yield) | 908954 | CTG | \$52.24 |
| 70C10C0 | (701C) Cyan Return Program Toner (1,000 Yield) | 908953 | CTG | \$68.66 |
| 70C10M0 | (701M) Magenta Return Program Toner (1,000 Yield) | 908955 | CTG | \$68.66 |
| 70C10Y0 | (701Y) Yellow Return Program Toner (1,000 Yield) | 908956 | CTG | \$68.66 |
| 70C1HK0 | (701HK) High Yield Black Return Program Toner (4,000 Yield) | 908958 | CTG | \$117.16 |
| 70C1HC0 | (701HC) High Yield Cyan Return Program Toner (3,000 Yield) | 908957 | CTG | \$158.13 |
| 70C1HM0 | (701HM) High Yield Magenta Return Program Toner (3,000 Yield) | 908959 | CTG | \$158.13 |
| 70C1HY0 | (701HY) High Yield Yellow Return Program Toner (3,000 Yield) | 908960 | CTG | \$158.13 |
| 70C0X10 | (700X1) Extra High Yield Black Toner (8,000 Yield) | 908948 | CTG | \$238.81 |
| 70C0X20 | (700X2) Extra High Yield Cyan Toner (4,000 Yield) | 908949 | CTG | \$243.88 |
| 70C0X30 | (700X3) Extra High Yield Magenta Toner (4,000 Yield) | 908950 | CTG | \$243.88 |
| 70C0X40 | (700X4) Extra High Yield Yellow Toner (4,000 Yield) | 908951 | CTG | \$243.88 |
| 70C1XK0 | (701XK) Extra High Yield Black Return Program Toner (8,000 Yield) | 908962 | CTG | \$164.18 |
| 70C1XC0 | (701XC) Extra High Yield Cyan Return Program Toner (4,000 Yield) | 908961 | CTG | \$169.25 |
| 70C1XM0 | (701XM) Extra High Yield Magenta Return Program Toner (4,000 Yield) | 908963 | CTG | \$169.25 |
| 70C1XY0 | (701XY) Extra High Yield Yellow Return Program Toner (4,000 Yield) | 908964 | CTG | \$169.25 |
| 70C0Z50 | (700Z5) Black and Color Imaging Kit (40,000 Yield) | 908952 | EA | \$289.55 |
| 70C0Z10 | (700Z1) Black Imaging Kit (40,000 Yield) | 910795 | KIT | \$208.96 |
| 70C0P00 | (700P) Photoconductor Unit (40,000 Yield) | 908947 | EA | \$156.72 |
| 40X7622 | Fuser Assembly (110-120V) | 917941 | EA | \$165.67 |
| 40X7610 | Transfer Module Assembly | 917940 | EA | \$179.21 |
| Lexmark CX310 Series Color Laser Supplies | | | | |
| 80C10K0 | (801K) Black Return Program Toner (1,000 Yield) | 908978 | CTG | \$52.24 |
| 80C10C0 | (801C) Cyan Return Program Toner (1,000 Yield) | 908977 | CTG | \$68.66 |
| 80C10M0 | (801M) Magenta Return Program Toner (1,000 Yield) | 908979 | CTG | \$68.66 |
| 80C10Y0 | (801Y) Yellow Return Program Toner (1,000 Yield) | 908980 | CTG | \$68.66 |
| 80C1SK0 | (801SK) Black Return Program Toner (2,500 Yield) | 908986 | CTG | \$73.21 |
| 80C1SC0 | (801SC) Cyan Return Program Toner (2,000 Yield) | 908985 | CTG | \$105.45 |
| 80C1SM0 | (801SM) Magenta Return Program Toner (2,000 Yield) | 908987 | CTG | \$105.45 |
| 80C1SY0 | (801SY) Yellow Return Program Toner (2,000 Yield) | 908988 | CTG | \$105.45 |
| 70C0Z50 | (700Z5) Black and Color Imaging Kit (40,000 Yield) | 908952 | EA | \$289.55 |
| 70C0Z10 | (700Z1) Black Imaging Kit (40,000 Yield) | 910795 | KIT | \$208.96 |
| 70C0P00 | (700P) Photoconductor Unit (40,000 Yield) | 908947 | EA | \$156.72 |
| 40X7622 | Fuser Assembly (110-120V) | 917941 | EA | \$165.67 |
| 40X7610 | Transfer Module Assembly | 917940 | EA | \$179.21 |
| Lexmark CX410 Series Color Laser Supplies (Continued on next page) | | | | |
| 80C10K0 | (801K) Black Return Program Toner (1,000 Yield) | 908978 | CTG | \$52.24 |
| 80C10C0 | (801C) Cyan Return Program Toner (1,000 Yield) | 908977 | CTG | \$68.66 |
| 80C10M0 | (801M) Magenta Return Program Toner (1,000 Yield) | 908979 | CTG | \$68.66 |
| 80C10Y0 | (801Y) Yellow Return Program Toner (1,000 Yield) | 908980 | CTG | \$68.66 |
| 80C1SK0 | (801SK) Black Return Program Toner (2,500 Yield) | 908986 | CTG | \$73.21 |
| 80C1SC0 | (801SC) Cyan Return Program Toner (2,000 Yield) | 908985 | CTG | \$105.45 |

| MFG# | Product Description | Part# | UOM | Retail |
|--|--|--------|-----|----------|
| LEXMARK SUPPLIES | | | | |
| Lexmark CX410 Series Color Laser Supplies (Continued) | | | | |
| 80C1SM0 | (801SM) Magenta Return Program Toner (2,000 Yield) | 908987 | CTG | \$105.45 |
| 80C1SY0 | (801SY) Yellow Return Program Toner (2,000 Yield) | 908988 | CTG | \$105.45 |
| 80C1HK0 | (801HK) High Yield Black Return Program Toner (4,000 Yield) | 908982 | CTG | \$109.70 |
| 80C1HCO | (801HC) High Yield Cyan Return Program Toner (3,000 Yield) | 908981 | CTG | \$121.79 |
| 80C1HM0 | (801HM) High Yield Magenta Return Program Toner (3,000 Yield) | 908983 | CTG | \$121.79 |
| 80C1HY0 | (801HY) High Yield Yellow Return Program Toner (3,000 Yield) | 908984 | CTG | \$121.79 |
| 70C0Z50 | (700Z5) Black and Color Imaging Kit (40,000 Yield) | 908952 | EA | \$289.55 |
| 70C0Z10 | (700Z1) Black Imaging Kit (40,000 Yield) | 910795 | KIT | \$208.96 |
| 70C0P00 | (700P) Photoconductor Unit (40,000 Yield) | 908947 | EA | \$156.72 |
| 40X7622 | Fuser Assembly (110-120V) | 917941 | EA | \$165.67 |
| 40X7610 | Transfer Module Assembly | 917940 | EA | \$179.21 |
| Lexmark CX510 Series Color Laser Supplies | | | | |
| 80C10K0 | (801K) Black Return Program Toner (1,000 Yield) | 908978 | CTG | \$52.24 |
| 80C10C0 | (801C) Cyan Return Program Toner (1,000 Yield) | 908977 | CTG | \$68.66 |
| 80C10M0 | (801M) Magenta Return Program Toner (1,000 Yield) | 908979 | CTG | \$68.66 |
| 80C10Y0 | (801Y) Yellow Return Program Toner (1,000 Yield) | 908980 | CTG | \$68.66 |
| 80C1SK0 | (801SK) Black Return Program Toner (2,500 Yield) | 908986 | CTG | \$73.21 |
| 80C1SC0 | (801SC) Cyan Return Program Toner (2,000 Yield) | 908985 | CTG | \$105.45 |
| 80C1SM0 | (801SM) Magenta Return Program Toner (2,000 Yield) | 908987 | CTG | \$105.45 |
| 80C1SY0 | (801SY) Yellow Return Program Toner (2,000 Yield) | 908988 | CTG | \$105.45 |
| 80C1HK0 | (801HK) High Yield Black Return Program Toner (4,000 Yield) | 908982 | CTG | \$109.70 |
| 80C1HCO | (801HC) High Yield Cyan Return Program Toner (3,000 Yield) | 908981 | CTG | \$121.79 |
| 80C1HM0 | (801HM) High Yield Magenta Return Program Toner (3,000 Yield) | 908983 | CTG | \$121.79 |
| 80C1HY0 | (801HY) High Yield Yellow Return Program Toner (3,000 Yield) | 908984 | CTG | \$121.79 |
| 80C1XK0 | (801XK) Extra High Yield Black Return Program Toner (8,000 Yield) | 908990 | CTG | \$156.27 |
| 80C1XC0 | (801XC) Extra High Yield Cyan Return Program Toner (4,000 Yield) | 908989 | CTG | \$142.24 |
| 80C1XM0 | (801XM) Extra High Yield Magenta Return Program Toner (4,000 Yield) | 908991 | CTG | \$142.24 |
| 80C1XY0 | (801XY) Extra High Yield Yellow Return Program Toner (4,000 Yield) | 908992 | CTG | \$142.24 |
| 70C0Z50 | (700Z5) Black and Color Imaging Kit (40,000 Yield) | 908952 | EA | \$289.55 |
| 70C0Z10 | (700Z1) Black Imaging Kit (40,000 Yield) | 910795 | KIT | \$208.96 |
| 70C0P00 | (700P) Photoconductor Unit (40,000 Yield) | 908947 | EA | \$156.72 |
| 40X7622 | Fuser Assembly (110-120V) | 917941 | EA | \$165.67 |
| 40X7610 | Transfer Module Assembly | 917940 | EA | \$179.21 |
| Lexmark X560 Color Laser Supplies | | | | |
| X560H2KG | High Yield Black Toner (10,000 Yield) | 103956 | CTG | \$309.74 |
| X560H2CG | High Yield Cyan Toner (10,000 Yield) | 103958 | CTG | \$459.30 |
| X560H2MG | High Yield Magenta Toner (10,000 Yield) | 103959 | CTG | \$459.30 |
| X560H2YG | High Yield Yellow Toner (10,000 Yield) | 103964 | CTG | \$459.30 |
| 40X4860 | Fuser (110-127V) (100,000 Yield) | 17815 | KIT | \$276.64 |
| 40X4868 | Transfer Belt (100,000 Yield) | 17856 | EA | \$250.00 |
| 40X4924 | ADF Maintenance Kit (120,000 Yield) | 17822 | KIT | \$118.71 |
| Lexmark X746/X748 Color Laser Supplies | | | | |
| X746H1KG | High Yield Black Return Program Toner (12,000 Yield) (For Use in Model X746/X748) | 905339 | CTG | \$212.39 |
| X746A1CG | Cyan Return Program Toner (7,000 Yield) (For Use in Model X746/X748) | 905341 | CTG | \$237.46 |
| X746A1MG | Magenta Return Program Toner (7,000 Yield) (For Use in Model X746/X748) | 905342 | CTG | \$237.46 |
| X746A1YG | Yellow Return Program Toner (7,000 Yield) (For Use in Model X746/X748) | 905343 | CTG | \$237.46 |
| X746H4KG | Government High Yield Black Return Program Toner (12,000 Yield) (TAA Compliant Version of X746H1KG) | 906778 | CTG | \$212.39 |
| X746A4CG | Government Cyan Return Program Toner (7,000 Yield) (TAA Compliant Version of X746A1CG) | 906775 | CTG | \$237.46 |
| X746A4MG | Government Magenta Return Program Toner (7,000 Yield) (TAA Compliant Version of X746A1MG) | 906776 | CTG | \$237.46 |
| X746A4YG | Government Yellow Return Program Toner (7,000 Yield) (TAA Compliant Version of X746A1YG) | 906777 | CTG | \$237.46 |
| X748H1CG | High Yield Cyan Return Program Toner (10,000 Yield) (For Use in Model X748) | 905347 | CTG | \$287.16 |
| X748H1MG | High Yield Magenta Return Program Toner (10,000 Yield) (For Use in Model X748) | 905348 | CTG | \$287.16 |
| X748H1YG | High Yield Yellow Return Program Toner (10,000 Yield) (For Use in Model X748) | 905349 | CTG | \$287.16 |
| C734X20G | Photoconductor (20,000 Yield) (For Use in Cyan, Magenta, Yellow or Black) | 14304 | EA | \$38.38 |
| C734X24G | Photoconductor Multipack (For Use in Cyan, Magenta, Yellow or Black) (4 Pack of OEM# C734X20G) (4 x 20,000 Yield) | 14305 | KIT | \$149.30 |
| C734X77G | Waste Toner Container (25,000 Yield) | 14306 | EA | \$10.65 |
| 40X8110 | Fuser Assembly (110-120V) | 908812 | EA | \$279.34 |
| 40X6401 | Transfer Module (120,000 Yield) | 50253 | EA | \$250.00 |
| Lexmark X940/X945 Color Laser Supplies (Continued on next page) | | | | |
| X945X2KG | High Yield Black Toner (36,000 Yield) | 94539 | CTG | \$210.41 |

| MFG# | Product Description | Part# | UOM | Retail |
|---|--|--------|-----|------------|
| LEXMARK SUPPLIES | | | | |
| Lexmark X940/X945 Color Laser Supplies (Continued) | | | | |
| X945X2CG | High Yield Cyan Toner (22,000 Yield) | 94540 | CTG | \$537.00 |
| X945X2MG | High Yield Magenta Toner (22,000 Yield) | 94541 | CTG | \$537.00 |
| X945X2YG | High Yield Yellow Toner (22,000 Yield) | 94545 | CTG | \$537.00 |
| C930X72G | Photoconductor (53,000 Yield) (For Use in Cyan, Magenta, Yellow or Black) | 93785 | KIT | \$387.33 |
| C930X82G | Government Photoconductor Kit (53,000 Yield) (TAA Compliant Version of C930X72G) | 99486 | KIT | \$387.33 |
| C930X73G | Photoconductor Multipack (For Use in Cyan, Magenta, Yellow or Black) (3 Pack of OEM# C930X72G) (3 x 53,000 Yield) | 93786 | KIT | \$1,159.74 |
| C930X83G | Government Photoconductor Kit (53,000 x 3 Yield) (For Use in Cyan, Magenta, Yellow or Black) (TAA Compliant Version of C930X73G) | 99485 | KIT | \$1,159.74 |
| 25A0013 | Staple Cartridges (5,000 Staples/Ctg) (EA=Box of 3 Ctgs) | 29550 | EA | \$137.49 |
| 40x4031 | Maintenance Kit (110-120V) (Includes Feed Unit Roller Kit, Transfer Roll Assembly, Transfer Belt Cleaner Assembly, Fuser) (100,000 Yield) | 101898 | KIT | \$1,079.66 |
| 40X4032 | Maintenance Kit (110V) (Kit Includes Transfer Belt Unit Assembly, Black Developer Carrier, Yellow Developer Carrier, Magenta Developer Carrier, Cyan Developer Carrier, Developer Unit Assembly) (600,000 Yield) | 101942 | KIT | \$2,447.95 |
| 40X3747 | Fuser (110-127V) | 6758 | EA | \$685.30 |
| 40X3732 | Transfer Belt Unit Assembly | 6757 | EA | \$1,346.89 |
| 40X3698 | 2nd Transfer Roll Assembly | 6756 | EA | \$286.00 |
| 40x4033 | ADF Maintenance Kit (Includes 1 Each of 40X2273, 40X3887) (150,000 Yield) | 101956 | KIT | \$138.94 |
| 40X3887 | ADF Feed/Pick Roll Assembly | 6759 | EA | \$60.34 |
| C930X76G | Waste Toner Container (30,000 Yield) | 93732 | EA | \$42.30 |
| Lexmark X950/X952/X954 Color Laser Supplies | | | | |
| X950X2KG | High Yield Black Toner (32,000 Yield) | 101896 | CTG | \$135.07 |
| X950X2CG | High Yield Cyan Toner (22,000 Yield) | 101895 | CTG | \$638.66 |
| X950X2MG | High Yield Magenta Toner (22,000 Yield) | 101897 | CTG | \$638.66 |
| X950X2YG | High Yield Yellow Toner (22,000 Yield) | 101899 | CTG | \$638.66 |
| C950X71G | Black Photoconductor Kit (115,000 Yield) | 101900 | KIT | \$302.98 |
| C950X73G | Color Photoconductor Kit (3 Pack) (115,000 Yield) | 101901 | KIT | \$908.95 |
| 25A0013 | Staple Cartridges (5,000 Staples/Ctg) (EA=Box of 3 Ctgs) | 29550 | EA | \$137.49 |
| C950X76G | Waste Container (30,000 Yield) | 101902 | CTG | \$36.57 |
| 40X7550 | Fuser Maintenance Kit (110-120V) (Includes Fuser Unit Assembly, Transfer Belt Cleaner Assembly, 2nd Transfer Roll Assembly, Suction Filter, 4 Feed Rolls, 4 Pick Rolls, 4 Separation Rolls) (320,000 Yield) | 910074 | KIT | \$801.12 |

MURATEC SUPPLIES**Muratec Plain Paper Facsimile Supplies**

| | | | | |
|---------|--|--------|-----|----------|
| PF155 | F60/F65/M4500/M4700 Donor Film (2 Rolls/Ctn) (700 Yield) | 94197 | CTN | \$66.00 |
| TS120 | F95/F98/F100/F120/F150/F160 Toner (5,500 Yield) | 97846 | CTG | \$125.00 |
| TS40360 | F320/F360/MFX 1200/MFX1600 Toner (11,500 Yield) | 4062 | CTG | \$336.42 |
| TS560 | F520/560 Toner (15,000 Yield) | 904024 | CTG | \$310.97 |
| TS565 | F525/565 Toner (15,000 Yield) | 903995 | CTG | \$372.65 |
| DK40360 | MFX 1200/1300/1600/1700 Drum (20,000 Yield) | 103979 | EA | \$174.76 |
| TS2030 | MFX 1430/1450//1950/2030/2050 High Yield Toner (16,000 Yield) | 902163 | CTG | \$189.57 |
| DK2550 | F-300/305/520/525/560/565/MFX-1330/1350/1430/1450/2030/2050/2570 Fax Drum (30,000 Yield) | 101577 | EA | \$129.95 |

NEC SUPPLIES**NEC Plain Paper Facsimile Supplies**

| | | | | |
|-------|---------------------------------------|-------|-----|----------|
| S2518 | Nefax 721/790/791 Toner (5,000 Yield) | 96396 | CTG | \$140.00 |
| S3518 | Nefax 721/790/791 Drum (18,000 Yield) | 96397 | EA | \$150.00 |

OKI SUPPLIES**OKI Impact Printer Ribbons**

| | | | | |
|----------|--|--------|-----|---------|
| 52102001 | Microline 100 Series/320/320T/321/321T Black Fabric Ribbon (3M Characters) | 91087 | RBN | \$14.00 |
| 52104001 | Microline 380/390/390 Turbo/391/391Turbo Black Fabric Ribbon (2M Characters) | 91692 | RBN | \$16.00 |
| 52103601 | Microline 393/393C/393+/393C+/395/395C Black Fabric Ribbon (5M Characters) | 91218 | RBN | \$46.00 |
| 42377801 | Microline 420/421/490/491 Self-Inking Black Ribbon (4M Characters) | 2445 | RBN | \$19.00 |
| 52107001 | Microline 520/521 Black Fabric Ribbon (4M Characters) | 92407 | RBN | \$22.00 |
| 52106001 | Microline 590/591 Black Fabric Ribbon (4M Characters) | 91810 | RBN | \$22.00 |
| 44173403 | Microline 620/690 Ribbon (8M Characters) | 99671 | RBN | \$25.80 |
| 44173404 | Microline 621/691 Ribbon (13M Characters) | 99673 | RBN | \$49.80 |
| 52105801 | Pacemark 3410 Black Fabric Ribbon (7.5M Characters) | 90319 | RBN | \$54.00 |
| 40629302 | Pacemark 4410 Black Ribbon (15M Characters) | 103651 | RBN | \$51.00 |

| MFG# | Product Description | Part# | UOM | Retail |
|--|--|--------|-----|----------|
| OKI SUPPLIES | | | | |
| OKI B410 Series Laser Supplies | | | | |
| 43979101 | Toner (3,500 Yield) | 904799 | CTG | \$92.00 |
| 43979001 | Image Drum (25,000 Yield) | 904802 | EA | \$200.00 |
| OKI B411/B431 Series Laser Supplies | | | | |
| 44574701 | Toner (4,000 Yield) | 35797 | CTG | \$100.90 |
| 44574901 | High Yield Toner (10,000 Yield) (For Use in Model B431) | 35798 | CTG | \$170.00 |
| 44574301 | Image Drum (30,000 Yield) | 35799 | EA | \$195.70 |
| OKI B420 Series Laser Supplies | | | | |
| 43979101 | Toner (3,500 Yield) | 904799 | CTG | \$92.00 |
| 43979201 | High Yield Toner (7,000 Yield) | 904800 | CTG | \$135.00 |
| 43979215 | Extra High Yield Toner (12,000 Yield) | 20484 | CTG | \$185.00 |
| 43979001 | Image Drum (25,000 Yield) | 904802 | EA | \$200.00 |
| OKI B430 Series Laser Supplies | | | | |
| 43979101 | Toner (3,500 Yield) | 904799 | CTG | \$92.00 |
| 43979201 | High Yield Toner (7,000 Yield) | 904800 | CTG | \$135.00 |
| 43979001 | Image Drum (25,000 Yield) | 904802 | EA | \$200.00 |
| OKI B710 Series Laser Supplies | | | | |
| 52123601 | Toner (15,000 Yield) | 105888 | CTG | \$301.00 |
| OKI B720 Series Laser Supplies | | | | |
| 52123602 | High Yield Toner (20,000 Yield) | 105346 | CTG | \$335.00 |
| OKI B721/B731 Series Laser Supplies | | | | |
| 45488801 | Toner (18,000 Yield) | 916556 | CTG | \$360.00 |
| 45488901 | High Yield Toner (25,000 Yield) | 916557 | CTG | \$417.00 |
| 45439001 | Extra High Yield Toner (36,000 Yield) (For Use in Model B731) | 916558 | CTG | \$481.00 |
| OKI B730 Series Laser Supplies | | | | |
| 52123601 | Toner (15,000 Yield) | 105888 | CTG | \$301.00 |
| OKI B2500 MFP/B2520 MFP/B2540 MFP Series Laser Supplies | | | | |
| 56120401 | Toner (4,000 Yield) | 96416 | CTG | \$167.00 |
| OKI B4100/B4200/B4250/B4300/B4350 Series Laser Supplies | | | | |
| 42103001 | Toner (3,000 Yield) | 2053 | CTG | \$42.00 |
| 42102901 | High Yield Toner (6,000 Yield) (For Use in Models B4300/B4350) | 2033 | CTG | \$75.00 |
| 42102801 | Image Drum (25,000 Yield) | 2034 | EA | \$230.00 |
| OKI B4400/B4500/B4550/B4600 Series Laser Supplies | | | | |
| 43502301 | Toner (3,000 Yield) | 91250 | CTG | \$54.00 |
| 43502001 | High Yield Toner (7,000 Yield) (For Use in Model B4600) | 91251 | CTG | \$98.00 |
| 43501901 | Image Drum (25,000 Yield) | 91252 | EA | \$219.00 |
| OKI B4545 MFP Series Laser Supplies | | | | |
| 52116101 | Toner (6,000 Yield) | 33030 | CTG | \$177.00 |
| OKI B6200/B6300 Series Laser Supplies | | | | |
| 52114501 | Toner (11,000 Yield) | 5579 | CTG | \$260.00 |
| 52114502 | High Yield Toner (18,000 Yield) (For Use in Model B6300) | 5580 | CTG | \$278.00 |
| OKI B6500 Series Laser Supplies | | | | |
| 52116002 | High Yield Toner (18,000 Yield) | 33029 | CTG | \$287.00 |
| OKI B8300 Series Laser Supplies | | | | |
| 56115001 | Toner (27,000 Yield) | 2627 | CTG | \$268.00 |
| 57100101 | Developer (100,000 Yield) | 2626 | EA | \$205.00 |
| OKI MB260/MB280/MB290 MFP Series Laser Supplies | | | | |
| 56123402 | High Yield Toner (5,500 Yield) | 17732 | CTG | \$196.00 |
| OKI MB451w Laser Supplies | | | | |
| 44992405 | Toner (1,500 Yield) | 910071 | CTG | \$41.40 |
| 44574309 | Drum (25,000 Yield) | 910072 | EA | \$103.00 |

| MFG# | Product Description | Part# | UOM | Retail |
|--|---|--------|-----|----------|
| OKI SUPPLIES | | | | |
| OKI MB460 Series Laser Supplies | | | | |
| 43979101 | Toner (3,500 Yield) | 904799 | CTG | \$92.00 |
| 43979001 | Image Drum (25,000 Yield) | 904802 | EA | \$200.00 |
| OKI MB461/MB471 Series Laser Supplies | | | | |
| 44574701 | Toner (4,000 Yield) | 35797 | CTG | \$100.90 |
| 44574901 | High Yield Toner (10,000 Yield) | 35798 | CTG | \$170.00 |
| 44574301 | Image Drum (30,000 Yield) | 35799 | EA | \$195.70 |
| OKI MB470 Series Laser Supplies | | | | |
| 43979101 | Toner (3,500 Yield) | 904799 | CTG | \$92.00 |
| 43979201 | High Yield Toner (7,000 Yield) | 904800 | CTG | \$135.00 |
| 43979001 | Image Drum (25,000 Yield) | 904802 | EA | \$200.00 |
| OKI MB480 Series Laser Supplies | | | | |
| 43979101 | Toner (3,500 Yield) | 904799 | CTG | \$92.00 |
| 43979201 | High Yield Toner (7,000 Yield) | 904800 | CTG | \$135.00 |
| 43979215 | Extra High Yield Toner (12,000 Yield) | 20484 | CTG | \$185.00 |
| 43979001 | Image Drum (25,000 Yield) | 904802 | EA | \$200.00 |
| OKI MB491 Series Laser Supplies | | | | |
| 44574701 | Toner (4,000 Yield) | 35797 | CTG | \$100.90 |
| 44917601 | High Yield Toner (12,000 Yield) | 910073 | CTG | \$176.00 |
| 44574301 | Image Drum (30,000 Yield) | 35799 | EA | \$195.70 |
| OKI MB760/MB770 MFP Series Laser Supplies | | | | |
| 45460508 | Print Cartridge (18,000 Yield) | 916581 | CTG | \$303.00 |
| 45460509 | High Yield Print Cartridge (25,000 Yield) | 916582 | CTG | \$338.00 |
| 45460510 | Extra High Yield Print Cartridge (36,000 Yield) | 916583 | CTG | \$366.00 |
| 45456305 | Image Drum (72,000 Yield) | 916580 | EA | \$216.00 |
| OKI MC160 MFP Series Color Laser Supplies | | | | |
| 44250716 | High Yield Black Toner (2,500 Yield) | 32121 | CTG | \$92.00 |
| 44250715 | High Yield Cyan Toner (2,500 Yield) | 32120 | CTG | \$121.00 |
| 44250714 | High Yield Magenta Toner (2,500 Yield) | 32119 | CTG | \$121.00 |
| 44250713 | High Yield Yellow Toner (2,500 Yield) | 32118 | CTG | \$121.00 |
| 44250801 | Image Drum (20,800 Mono/9,600 Color Yield) (Type D1) | 32122 | EA | \$138.00 |
| OKI MC361/MC561 Series Color Laser Supplies | | | | |
| 44469801 | Black Toner (3,500 Yield) | 50133 | CTG | \$97.60 |
| 44469703 | Cyan Toner (3,000 Yield) | 35804 | CTG | \$146.30 |
| 44469702 | Magenta Toner (3,000 Yield) | 35803 | CTG | \$146.30 |
| 44469701 | Yellow Toner (3,000 Yield) | 35802 | CTG | \$146.30 |
| 44469802 | High Yield Black Toner (5,500 Yield) (For Use in Model MC561) | 50144 | EA | \$105.00 |
| 44469721 | High Yield Cyan Toner (5,000 Yield) (For Use in Model MC561) | 50139 | EA | \$212.00 |
| 44469720 | High Yield Magenta Toner (5,000 Yield) (For Use in Model MC561) | 50138 | EA | \$212.00 |
| 44469719 | High Yield Yellow Toner (5,000 Yield) (For Use in Model MC561) | 50137 | EA | \$212.00 |
| 44494201 | Image Drum (20,000 Yield) | 50145 | EA | \$166.00 |
| OKI MC560 MFP Series Color Laser Supplies | | | | |
| 43865720 | Black Toner (8,000 Yield) | 901426 | CTG | \$129.00 |
| 43865719 | Cyan Toner (6,000 Yield) | 901427 | CTG | \$194.00 |
| 43865718 | Magenta Toner (6,000 Yield) | 901428 | CTG | \$194.00 |
| 43865717 | Yellow Toner (6,000 Yield) | 901429 | CTG | \$194.00 |
| 43381720 | Black Image Drum (20,000 Yield) | 18687 | EA | \$82.00 |
| 43381719 | Cyan Image Drum (20,000 Yield) | 18688 | EA | \$87.00 |
| 43381718 | Magenta Image Drum (20,000 Yield) | 18689 | EA | \$87.00 |
| 43381717 | Yellow Image Drum (20,000 Yield) | 18690 | EA | \$87.00 |
| 43853101 | Fuser Unit (120V) (60,000 Yield) | 19719 | EA | \$208.77 |
| OKI MC770/MC780 MFP Series Color Laser Supplies | | | | |
| 45396212 | Black Toner (15,000 Yield) | 916578 | CTG | \$145.00 |
| 45396211 | Cyan Toner (11,500 Yield) | 916577 | CTG | \$263.00 |
| 45396210 | Magenta Toner (11,500 Yield) | 916576 | CTG | \$263.00 |
| 45396209 | Yellow Toner (11,500 Yield) | 916575 | CTG | \$263.00 |
| 45395712 | Black Image Drum (30,000 Yield) | 916574 | EA | \$131.00 |
| 45395711 | Cyan Image Drum (30,000 Yield) | 916573 | EA | \$163.00 |
| 45395710 | Magenta Image Drum (30,000 Yield) | 916572 | EA | \$163.00 |
| 45395709 | Yellow Image Drum (30,000 Yield) | 916571 | EA | \$163.00 |

| MFG# | Product Description | Part# | UOM | Retail |
|---|--|--------|-----|----------|
| OKI SUPPLIES | | | | |
| OKI MC860 MFP Series Color Laser Supplies | | | | |
| 44059216 | Black Toner (9,500 Yield) | 904708 | CTG | \$96.10 |
| 44059215 | Cyan Toner (10,000 Yield) | 904707 | CTG | \$220.00 |
| 44059214 | Magenta Toner (10,000 Yield) | 904706 | CTG | \$220.00 |
| 44059213 | Yellow Toner (10,000 Yield) | 904705 | CTG | \$220.00 |
| 44064016 | Black Image Drum (20,000 Yield) | 904620 | EA | \$130.00 |
| 44064015 | Cyan Image Drum (20,000 Yield) | 904621 | EA | \$130.00 |
| 44064014 | Magenta Image Drum (20,000 Yield) | 904622 | EA | \$130.00 |
| 44064013 | Yellow Image Drum (20,000 Yield) | 904623 | EA | \$130.00 |
| OKI MPS Series Monochrome Laser Supplies | | | | |
| 43979222 | MPS420b/MPS480mb Toner (12,000 Yield) | 95172 | CTG | \$60.00 |
| 43979009 | MPS420b/MPS480mb Drum (25,000 Yield) | 95173 | EA | \$198.00 |
| 52124803 | MPS730b Toner (26,000 Yield) | 95199 | EA | \$256.00 |
| OKI MPS710c Series Color Laser Supplies | | | | |
| 43866144 | Black Toner (11,000 Yield) | 95296 | CTG | \$68.00 |
| 43866143 | Cyan Toner (11,500 Yield) | 95297 | CTG | \$240.00 |
| 43866142 | Magenta Toner (11,500 Yield) | 95298 | CTG | \$240.00 |
| 43866141 | Yellow Toner (11,500 Yield) | 95299 | CTG | \$240.00 |
| 43913836 | Black Drum (30,000 Yield) | 95300 | EA | \$82.00 |
| 43913835 | Cyan Drum (30,000 Yield) | 95301 | EA | \$250.00 |
| 43913834 | Magenta Drum (30,000 Yield) | 95302 | EA | \$250.00 |
| 43913833 | Yellow Drum (30,000 Yield) | 95303 | EA | \$250.00 |
| 57106001 | Fuser (60,000 Yield) | 95308 | EA | \$180.00 |
| 57106301 | Transfer Belt (60,000 Yield) | 95307 | EA | \$150.00 |
| OKI MPS711c Series Color Laser Supplies | | | | |
| 52123804 | Black Toner (11,000 Yield) | 95243 | CTG | \$68.00 |
| 52123803 | Cyan Toner (11,500 Yield) | 95246 | CTG | \$240.00 |
| 52123802 | Magenta Toner (11,500 Yield) | 95247 | CTG | \$240.00 |
| 52123801 | Yellow Toner (11,500 Yield) | 95248 | CTG | \$240.00 |
| 56125804 | Black Drum (20,000 Yield) | 95249 | EA | \$82.00 |
| 56125803 | Cyan Drum (20,000 Yield) | 95250 | EA | \$250.00 |
| 56125802 | Magenta Drum (20,000 Yield) | 95251 | EA | \$250.00 |
| 56125801 | Yellow Drum (20,000 Yield) | 95252 | EA | \$250.00 |
| 57106002 | Fuser (60,000 Yield) | 95239 | EA | \$140.00 |
| 57106302 | Transfer Belt (60,000 Yield) | 95238 | EA | \$140.00 |
| OKI OKIFAX 1000/1050/2200/2350/2400/2450/2600/5050/5250/5300/5400/5600/5650/5680 Series Laser Supplies | | | | |
| 52106701 | Toner (2,500 Yield) | 93738 | CTG | \$51.00 |
| 56116901 | Image Drum (20,000 Yield) | 93739 | EA | \$274.00 |
| OKI C330 Series Color Laser Supplies | | | | |
| 44469801 | Black Toner (3,500 Yield) | 50133 | CTG | \$97.60 |
| 44469703 | Cyan Toner (3,000 Yield) | 35804 | CTG | \$146.30 |
| 44469702 | Magenta Toner (3,000 Yield) | 35803 | CTG | \$146.30 |
| 44469701 | Yellow Toner (3,000 Yield) | 35802 | CTG | \$146.30 |
| 44494201 | Image Drum (20,000 Yield) | 50145 | EA | \$166.00 |
| OKI C530 Series Color Laser Supplies | | | | |
| 44469801 | Black Toner (3,500 Yield) | 50133 | CTG | \$97.60 |
| 44469703 | Cyan Toner (3,000 Yield) | 35804 | CTG | \$146.30 |
| 44469702 | Magenta Toner (3,000 Yield) | 35803 | CTG | \$146.30 |
| 44469701 | Yellow Toner (3,000 Yield) | 35802 | CTG | \$146.30 |
| 44469802 | High Yield Black Toner (5,500 Yield) | 50144 | EA | \$105.00 |
| 44469721 | High Yield Cyan Toner (5,000 Yield) | 50139 | EA | \$212.00 |
| 44469720 | High Yield Magenta Toner (5,000 Yield) | 50138 | EA | \$212.00 |
| 44469719 | High Yield Yellow Toner (5,000 Yield) | 50137 | EA | \$212.00 |
| 44494201 | Image Drum (20,000 Yield) | 50145 | EA | \$166.00 |
| OKI C610 Series Color Laser Supplies (Continued on next page) | | | | |
| 44315304 | Black Toner (8,000 Yield) | 34595 | CTG | \$123.00 |
| 44315303 | Cyan Toner (6,000 Yield) | 34594 | CTG | \$204.00 |
| 44315302 | Magenta Toner (6,000 Yield) | 34593 | CTG | \$204.00 |
| 44315301 | Yellow Toner (6,000 Yield) | 34592 | CTG | \$204.00 |
| 44315104 | Black Image Drum (20,000 Yield) | 35007 | EA | \$78.00 |
| 44315103 | Cyan Image Drum (20,000 Yield) | 35005 | EA | \$83.00 |

| MFG# | Product Description | Part# | UOM | Retail |
|--|--|--------|-----|----------|
| OKI SUPPLIES | | | | |
| OKI C610 Series Color Laser Supplies <i>(Continued)</i> | | | | |
| 44315102 | Magenta Image Drum (20,000 Yield) | 35002 | EA | \$83.00 |
| 44315101 | Yellow Image Drum (20,000 Yield) | 34596 | EA | \$83.00 |
| OKI C710 Series Color Laser Supplies | | | | |
| 43866104 | Black Toner (11,000 Yield) | 901418 | CTG | \$124.00 |
| 43866103 | Cyan Toner (11,500 Yield) | 901419 | CTG | \$318.00 |
| 43866102 | Magenta Toner (11,500 Yield) | 901420 | CTG | \$318.00 |
| 43866101 | Yellow Toner (11,500 Yield) | 901421 | CTG | \$318.00 |
| 43913804 | Black Image Drum (30,000 Yield) | 901422 | EA | \$151.00 |
| 43913803 | Cyan Image Drum (30,000 Yield) | 901423 | EA | \$221.00 |
| 43913802 | Magenta Image Drum (30,000 Yield) | 901424 | EA | \$221.00 |
| 43913801 | Yellow Image Drum (30,000 Yield) | 901425 | EA | \$221.00 |
| 43854901 | Fuser Unit (120V) (60,000 Yield) | 19720 | EA | \$210.16 |
| 43363421 | Transfer Belt (60,000 Yield) | 7857 | EA | \$212.72 |
| OKI C711 Series Color Laser Supplies | | | | |
| 44318604 | Black Toner (11,000 Yield) | 31569 | CTG | \$124.00 |
| 44318603 | Cyan Toner (11,500 Yield) | 31566 | CTG | \$263.00 |
| 44318602 | Magenta Toner (11,500 Yield) | 31564 | CTG | \$263.00 |
| 44318601 | Yellow Toner (11,500 Yield) | 31556 | CTG | \$263.00 |
| 44318504 | Black Image Drum (20,000 Yield) | 31578 | EA | \$107.00 |
| 44318503 | Cyan Image Drum (20,000 Yield) | 31577 | EA | \$135.00 |
| 44318502 | Magenta Image Drum (20,000 Yield) | 31576 | EA | \$135.00 |
| 44318501 | Yellow Image Drum (20,000 Yield) | 31574 | EA | \$135.00 |
| OKI C830 Series Color Laser Supplies | | | | |
| 44059112 | Black Toner (8,000 Yield) (Type C14) | 904616 | CTG | \$137.00 |
| 44059111 | Cyan Toner (8,000 Yield) (Type C14) | 904617 | CTG | \$204.00 |
| 44059110 | Magenta Toner (8,000 Yield) (Type C14) | 904618 | CTG | \$204.00 |
| 44059109 | Yellow Toner (8,000 Yield) (Type C14) | 904619 | CTG | \$204.00 |
| 44064016 | Black Image Drum (20,000 Yield) | 904620 | EA | \$130.00 |
| 44064015 | Cyan Image Drum (20,000 Yield) | 904621 | EA | \$130.00 |
| 44064014 | Magenta Image Drum (20,000 Yield) | 904622 | EA | \$130.00 |
| 44064013 | Yellow Image Drum (20,000 Yield) | 904623 | EA | \$130.00 |
| 43529404 | Fuser Unit (120V) (60,000 Yield) | 19718 | EA | \$281.49 |
| OKI C831 Series Color Laser Supplies | | | | |
| 44844512 | Black Toner (10,000 Yield) | 916570 | CTG | \$163.30 |
| 44844511 | Cyan Toner (10,000 Yield) | 916569 | CTG | \$243.00 |
| 44844510 | Magenta Toner (10,000 Yield) | 916568 | CTG | \$243.00 |
| 44844509 | Yellow Toner (10,000 Yield) | 916567 | CTG | \$243.00 |
| 44844416 | Black Image Drum | 916566 | EA | \$185.00 |
| 44844415 | Cyan Image Drum | 916565 | EA | \$185.00 |
| 44844414 | Magenta Image Drum | 916564 | EA | \$185.00 |
| 44844413 | Yellow Image Drum | 916563 | EA | \$185.00 |
| OKI C3200 Series Color Laser Supplies | | | | |
| 43034804 | Black Toner (1,500 Yield) | 12897 | CTG | \$43.00 |
| 43034803 | Cyan Toner (1,500 Yield) | 12898 | CTG | \$81.00 |
| 43034802 | Magenta Toner (1,500 Yield) | 12899 | CTG | \$81.00 |
| 43034801 | Yellow Toner (1,500 Yield) | 12900 | CTG | \$81.00 |
| 42126661 | Black Image Drum (15,000 Yield) (Ships with 1,000 Yield Toner) | 12901 | EA | \$127.00 |
| 42126660 | Cyan Image Drum (15,000 Yield) (Ships with 1,000 Yield Toner) | 12902 | EA | \$154.00 |
| 42126659 | Magenta Image Drum (15,000 Yield) (Ships with 1,000 Yield Toner) | 12903 | EA | \$154.00 |
| 42126658 | Yellow Image Drum (15,000 Yield) (Ships with 1,000 Yield Toner) | 12904 | EA | \$154.00 |
| 42625501 | Fuser Unit (120V) (45,000 Yield) | 5511 | EA | \$162.00 |
| 42158711 | Transfer Belt (50,000 Yield) | 5512 | EA | \$230.00 |
| OKI C3400/C3530 MFP/C3600/MC360 MFP Series Color Laser Supplies <i>(Continued on next page)</i> | | | | |
| 43459404 | Black Toner (1,500 Yield) | 27505 | CTG | \$60.00 |
| 43459403 | Cyan Toner (1,000 Yield) | 27506 | CTG | \$69.00 |
| 43459402 | Magenta Toner (1,000 Yield) | 27510 | CTG | \$69.00 |
| 43459401 | Yellow Toner (1,000 Yield) | 27512 | CTG | \$69.00 |
| 43459304 | High Yield Black Toner (2,500 Yield) | 27514 | CTG | \$81.00 |
| 43459303 | High Yield Cyan Toner (2,000 Yield) | 27515 | CTG | \$116.00 |
| 43459302 | High Yield Magenta Toner (2,000 Yield) | 27519 | CTG | \$116.00 |
| 43459301 | High Yield Yellow Toner (2,000 Yield) | 27521 | CTG | \$116.00 |
| 43460204 | Black Image Drum (15,000 Yield) (Ships with 1,000 Yield Toner) | 29545 | EA | \$58.00 |

| MFG# | Product Description | Part# | UOM | Retail |
|---|--|--------|-----|----------|
| OKI SUPPLIES | | | | |
| OKI C3400/C3530 MFP/C3600/MC360 MFP Series Color Laser Supplies <i>(Continued)</i> | | | | |
| 43460203 | Cyan Image Drum (15,000 Yield) (Ships with 1,000 Yield Toner) | 27545 | EA | \$69.00 |
| 43460202 | Magenta Image Drum (15,000 Yield) (Ships with 1,000 Yield Toner) | 27557 | EA | \$69.00 |
| 43460201 | Yellow Image Drum (15,000 Yield) (Ships with 1,000 Yield Toner) | 27558 | EA | \$69.00 |
| 43377001 | Fuser Unit (120V) (For Use in Models C3400/C3530) | 904680 | EA | \$211.89 |
| 43378001 | Transfer Belt (For Use in Models C3400/C3530) | 105884 | EA | \$158.93 |
| OKI C5100/C5300 Series Color Laser Supplies | | | | |
| 42804504 | Black Toner (3,000 Yield) | 5807 | CTG | \$54.00 |
| 42804503 | Cyan Toner (3,000 Yield) | 5808 | CTG | \$144.00 |
| 42804502 | Magenta Toner (3,000 Yield) | 5809 | CTG | \$144.00 |
| 42804501 | Yellow Toner (3,000 Yield) | 5810 | CTG | \$144.00 |
| 42127404 | High Yield Black Toner (5,000 Yield) | 2044 | CTG | \$71.00 |
| 42127403 | High Yield Cyan Toner (5,000 Yield) | 2043 | CTG | \$166.00 |
| 42127402 | High Yield Magenta Toner (5,000 Yield) | 2042 | CTG | \$166.00 |
| 42127401 | High Yield Yellow Toner (5,000 Yield) | 2041 | CTG | \$166.00 |
| 42126604 | Black Image Drum (15,000 Yield) | 2040 | EA | \$101.00 |
| 42126603 | Cyan Image Drum (15,000 Yield) | 2039 | EA | \$110.00 |
| 42126602 | Magenta Image Drum (15,000 Yield) | 2038 | EA | \$110.00 |
| 42126601 | Yellow Image Drum (15,000 Yield) | 2037 | EA | \$110.00 |
| 42158601 | Fuser Unit (120V) (45,000 Yield) | 2035 | EA | \$138.00 |
| 42158711 | Transfer Belt (50,000 Yield) | 5512 | EA | \$230.00 |
| OKI C5150/C5200/C5400 Series Color Laser Supplies | | | | |
| 42804504 | Black Toner (3,000 Yield) | 5807 | CTG | \$54.00 |
| 42804503 | Cyan Toner (3,000 Yield) | 5808 | CTG | \$144.00 |
| 42804502 | Magenta Toner (3,000 Yield) | 5809 | CTG | \$144.00 |
| 42804501 | Yellow Toner (3,000 Yield) | 5810 | CTG | \$144.00 |
| 42127404 | High Yield Black Toner (5,000 Yield) | 2044 | CTG | \$71.00 |
| 42127403 | High Yield Cyan Toner (5,000 Yield) | 2043 | CTG | \$166.00 |
| 42127402 | High Yield Magenta Toner (5,000 Yield) | 2042 | CTG | \$166.00 |
| 42127401 | High Yield Yellow Toner (5,000 Yield) | 2041 | CTG | \$166.00 |
| 42126604 | Black Image Drum (15,000 Yield) | 2040 | EA | \$101.00 |
| 42126603 | Cyan Image Drum (15,000 Yield) | 2039 | EA | \$110.00 |
| 42126602 | Magenta Image Drum (15,000 Yield) | 2038 | EA | \$110.00 |
| 42126601 | Yellow Image Drum (15,000 Yield) | 2037 | EA | \$110.00 |
| 42158711 | Transfer Belt (50,000 Yield) | 5512 | EA | \$230.00 |
| 42625501 | Fuser Unit (120V) (45,000 Yield) | 5511 | EA | \$162.00 |
| OKI C5500/C5800 Series Color Laser Supplies | | | | |
| 43381904 | Black Toner (2,000 Yield) | 13181 | CTG | \$65.00 |
| 43381903 | Cyan Toner (2,000 Yield) | 13182 | CTG | \$96.00 |
| 43381902 | Magenta Toner (2,000 Yield) | 13183 | CTG | \$96.00 |
| 43381901 | Yellow Toner (2,000 Yield) | 13184 | CTG | \$96.00 |
| 43324404 | High Yield Black Toner (5,000 Yield) | 13185 | CTG | \$125.00 |
| 43324403 | High Yield Cyan Toner (5,000 Yield) | 13186 | CTG | \$191.00 |
| 43324402 | High Yield Magenta Toner (5,000 Yield) | 13187 | CTG | \$191.00 |
| 43324401 | High Yield Yellow Toner (5,000 Yield) | 13188 | CTG | \$191.00 |
| 43381704 | Black Drum (20,000 Yield) | 13189 | EA | \$79.00 |
| 43381703 | Cyan Drum (20,000 Yield) | 13190 | EA | \$86.00 |
| 43381702 | Magenta Drum (20,000 Yield) | 13191 | EA | \$86.00 |
| 43381701 | Yellow Drum (20,000 Yield) | 13192 | EA | \$86.00 |
| 43363201 | Fuser Unit (120V) (60,000 Yield) | 100906 | EA | \$210.40 |
| 43363421 | Transfer Belt (60,000 Yield) | 7857 | EA | \$212.72 |
| OKI C5510 MFP Series Color Multifunction Laser Supplies | | | | |
| 42804504 | Black Toner (3,000 Yield) | 5807 | CTG | \$54.00 |
| 42804503 | Cyan Toner (3,000 Yield) | 5808 | CTG | \$144.00 |
| 42804502 | Magenta Toner (3,000 Yield) | 5809 | CTG | \$144.00 |
| 42804501 | Yellow Toner (3,000 Yield) | 5810 | CTG | \$144.00 |
| 42127404 | High Yield Black Toner (5,000 Yield) | 2044 | CTG | \$71.00 |
| 42127403 | High Yield Cyan Toner (5,000 Yield) | 2043 | CTG | \$166.00 |
| 42127402 | High Yield Magenta Toner (5,000 Yield) | 2042 | CTG | \$166.00 |
| 42127401 | High Yield Yellow Toner (5,000 Yield) | 2041 | CTG | \$166.00 |
| 42126604 | Black Image Drum (15,000 Yield) | 2040 | EA | \$101.00 |
| 42126603 | Cyan Image Drum (15,000 Yield) | 2039 | EA | \$110.00 |
| 42126602 | Magenta Image Drum (15,000 Yield) | 2038 | EA | \$110.00 |
| 42126601 | Yellow Image Drum (15,000 Yield) | 2037 | EA | \$110.00 |
| 42625501 | Fuser Unit (120V) (45,000 Yield) | 5511 | EA | \$162.00 |

| MFG# | Product Description | Part# | UOM | Retail |
|--|--|--------|-----|----------|
| OKI SUPPLIES | | | | |
| OKI C5550 MFP Series Color Multifunction Laser Supplies | | | | |
| 43324420 | Black Toner (6,000 Yield) | 18683 | CTG | \$105.00 |
| 43324419 | Cyan Toner (5,000 Yield) | 18684 | CTG | \$161.00 |
| 43324418 | Magenta Toner (5,000 Yield) | 18685 | CTG | \$161.00 |
| 43324417 | Yellow Toner (5,000 Yield) | 18686 | CTG | \$161.00 |
| 43381720 | Black Image Drum (20,000 Yield) | 18687 | EA | \$82.00 |
| 43381719 | Cyan Image Drum (20,000 Yield) | 18688 | EA | \$87.00 |
| 43381718 | Magenta Image Drum (20,000 Yield) | 18689 | EA | \$87.00 |
| 43381717 | Yellow Image Drum (20,000 Yield) | 18690 | EA | \$87.00 |
| 43363201 | Fuser Unit (120V) (60,000 Yield) | 100906 | EA | \$210.40 |
| OKI C5650 Series Color Laser Supplies | | | | |
| 43381904 | Black Toner (2,000 Yield) | 13181 | CTG | \$65.00 |
| 43381903 | Cyan Toner (2,000 Yield) | 13182 | CTG | \$96.00 |
| 43381902 | Magenta Toner (2,000 Yield) | 13183 | CTG | \$96.00 |
| 43381901 | Yellow Toner (2,000 Yield) | 13184 | CTG | \$96.00 |
| 43324404 | High Yield Black Toner (5,000 Yield) | 13185 | CTG | \$125.00 |
| 43324403 | High Yield Cyan Toner (5,000 Yield) | 13186 | CTG | \$191.00 |
| 43324402 | High Yield Magenta Toner (5,000 Yield) | 13187 | CTG | \$191.00 |
| 43324401 | High Yield Yellow Toner (5,000 Yield) | 13188 | CTG | \$191.00 |
| 43381704 | Black Drum (20,000 Yield) | 13189 | EA | \$79.00 |
| 43381703 | Cyan Drum (20,000 Yield) | 13190 | EA | \$86.00 |
| 43381702 | Magenta Drum (20,000 Yield) | 13191 | EA | \$86.00 |
| 43381701 | Yellow Drum (20,000 Yield) | 13192 | EA | \$86.00 |
| 43363421 | Transfer Belt (60,000 Yield) | 7857 | EA | \$212.72 |
| OKI C6000/C6050 Series Color Laser Supplies | | | | |
| 43324469 | Black Toner (5,000 Yield) | 91196 | CTG | \$87.00 |
| 43324468 | Cyan Toner (4,000 Yield) | 91197 | CTG | \$135.00 |
| 43324467 | Magenta Toner (4,000 Yield) | 91198 | CTG | \$135.00 |
| 43324466 | Yellow Toner (4,000 Yield) | 91199 | CTG | \$135.00 |
| 43363421 | Transfer Belt (60,000 Yield) | 7857 | EA | \$212.72 |
| OKI C6100 Series Color Laser Supplies | | | | |
| 43324420 | Black Toner (6,000 Yield) | 18683 | CTG | \$105.00 |
| 43324419 | Cyan Toner (5,000 Yield) | 18684 | CTG | \$161.00 |
| 43324418 | Magenta Toner (5,000 Yield) | 18685 | CTG | \$161.00 |
| 43324417 | Yellow Toner (5,000 Yield) | 18686 | CTG | \$161.00 |
| 43381720 | Black Image Drum (20,000 Yield) | 18687 | EA | \$82.00 |
| 43381719 | Cyan Image Drum (20,000 Yield) | 18688 | EA | \$87.00 |
| 43381718 | Magenta Image Drum (20,000 Yield) | 18689 | EA | \$87.00 |
| 43381717 | Yellow Image Drum (20,000 Yield) | 18690 | EA | \$87.00 |
| 43363201 | Fuser Unit (120V) (60,000 Yield) | 100906 | EA | \$210.40 |
| 43363421 | Transfer Belt (60,000 Yield) | 7857 | EA | \$212.72 |
| OKI C6150 Series Color Laser Supplies | | | | |
| 43865720 | Black Toner (8,000 Yield) | 901426 | CTG | \$129.00 |
| 43865719 | Cyan Toner (6,000 Yield) | 901427 | CTG | \$194.00 |
| 43865718 | Magenta Toner (6,000 Yield) | 901428 | CTG | \$194.00 |
| 43865717 | Yellow Toner (6,000 Yield) | 901429 | CTG | \$194.00 |
| 43381720 | Black Image Drum (20,000 Yield) | 18687 | EA | \$82.00 |
| 43381719 | Cyan Image Drum (20,000 Yield) | 18688 | EA | \$87.00 |
| 43381718 | Magenta Image Drum (20,000 Yield) | 18689 | EA | \$87.00 |
| 43381717 | Yellow Image Drum (20,000 Yield) | 18690 | EA | \$87.00 |
| 43853101 | Fuser Unit (120V) (60,000 Yield) | 19719 | EA | \$208.77 |
| 43363421 | Transfer Belt (60,000 Yield) | 7857 | EA | \$212.72 |



OKI offers high-quality printers, MFPs and innovative printing solutions to meet the needs of every office configuration – from SMBs to enterprise businesses. They are designed to achieve the highest levels of efficiency and productivity while delivering a low total printer cost of ownership.

OKI
PRINTING SOLUTIONS

| MFG# | Product Description | Part# | UOM | Retail |
|--|--|--------|-----|----------|
| OKI SUPPLIES | | | | |
| OKI C7100/C7300/C7350/C7500/C7550 Series Color Laser Supplies | | | | |
| 41963004 | Black Toner (10,000 Yield) | 2651 | CTG | \$129.00 |
| 41963003 | Cyan Toner (10,000 Yield) | 2650 | CTG | \$221.00 |
| 41963002 | Magenta Toner (10,000 Yield) | 2649 | CTG | \$221.00 |
| 41963001 | Yellow Toner (10,000 Yield) | 2648 | CTG | \$221.00 |
| 41962804 | Black Image Drum (30,000 Yield) | 2647 | EA | \$172.00 |
| 41962803 | Cyan Image Drum (30,000 Yield) | 2646 | EA | \$185.00 |
| 41962802 | Magenta Image Drum (30,000 Yield) | 2645 | EA | \$185.00 |
| 41962801 | Yellow Image Drum (30,000 Yield) | 2644 | EA | \$185.00 |
| 41945601 | Fuser Unit (120V) (60,000 Yield) | 2640 | EA | \$272.00 |
| 41945521 | Transfer Belt (60,000 Yield) | 11251 | EA | \$332.00 |
| OKI C8800 Series Color Laser Supplies | | | | |
| 43487736 | Black Toner (6,000 Yield) | 95357 | CTG | \$105.00 |
| 43487735 | Cyan Toner (6,000 Yield) | 95358 | CTG | \$149.00 |
| 43487734 | Magenta Toner (6,000 Yield) | 95359 | CTG | \$149.00 |
| 43487733 | Yellow Toner (6,000 Yield) | 95360 | CTG | \$149.00 |
| 43529404 | Fuser Unit (120V) (60,000 Yield) | 19718 | EA | \$281.49 |
| OKI C9300/C9500 Series Color Laser Supplies | | | | |
| 41963604 | Black Toner (15,000 Yield) | 2639 | CTG | \$142.00 |
| 41963603 | Cyan Toner (15,000 Yield) | 2638 | CTG | \$357.00 |
| 41963602 | Magenta Toner (15,000 Yield) | 2637 | CTG | \$357.00 |
| 41963601 | Yellow Toner (15,000 Yield) | 2636 | CTG | \$357.00 |
| 41963404 | Black Image Drum (39,000 Yield) | 2635 | EA | \$201.00 |
| 41963403 | Cyan Image Drum (39,000 Yield) | 2634 | EA | \$237.00 |
| 41963402 | Magenta Image Drum (39,000 Yield) | 2633 | EA | \$237.00 |
| 41963401 | Yellow Image Drum (39,000 Yield) | 2632 | EA | \$237.00 |
| 41946101 | Fuser Unit (120V) (80,000 Yield) | 2630 | EA | \$248.00 |
| 41946021 | Transfer Belt (80,000 Yield) | 12574 | EA | \$302.00 |
| OKI C9600/C9800 Series Color Laser Supplies | | | | |
| 42918904 | Black Toner (15,000 Yield) | 10916 | CTG | \$128.00 |
| 42918903 | Cyan Toner (15,000 Yield) | 10917 | CTG | \$440.00 |
| 42918902 | Magenta Toner (15,000 Yield) | 10918 | CTG | \$440.00 |
| 42918901 | Yellow Toner (15,000 Yield) | 10919 | CTG | \$440.00 |
| 42918104 | Black Image Drum (42,000 Yield) | 10920 | EA | \$176.00 |
| 42918103 | Cyan Image Drum (42,000 Yield) | 10921 | EA | \$235.00 |
| 42918102 | Magenta Image Drum (42,000 Yield) | 10922 | EA | \$235.00 |
| 42918101 | Yellow Image Drum (42,000 Yield) | 10923 | EA | \$235.00 |
| 42869401 | Waste Toner Container | 10924 | EA | \$15.00 |
| 42931701 | Fuser Unit (120V) (100,000 Yield) | 10927 | EA | \$207.00 |
| 42931602 | Transfer Belt (100,000 Yield) | 11562 | EA | \$255.00 |
| OKI C9650 Series Color Laser Supplies | | | | |
| 42918984 | Black Toner (18,500 Yield) | 100710 | CTG | \$173.00 |
| 42918983 | Cyan Toner (16,500 Yield) | 100709 | CTG | \$565.00 |
| 42918982 | Magenta Toner (16,500 Yield) | 100702 | CTG | \$565.00 |
| 42918981 | Yellow Toner (16,500 Yield) | 100697 | CTG | \$565.00 |
| 42918104 | Black Image Drum (42,000 Yield) | 10920 | EA | \$176.00 |
| 42918103 | Cyan Image Drum (42,000 Yield) | 10921 | EA | \$235.00 |
| 42918102 | Magenta Image Drum (42,000 Yield) | 10922 | EA | \$235.00 |
| 42918101 | Yellow Image Drum (42,000 Yield) | 10923 | EA | \$235.00 |
| 42931701 | Fuser Unit (120V) (100,000 Yield) | 10927 | EA | \$207.00 |
| 42869401 | Waste Toner Container | 10924 | EA | \$15.00 |
| OKI CX2033 Series Color Multifunction Laser Supplies | | | | |
| 43865768 | Black Toner (8,000 Yield) (Type C11) | 32047 | CTG | \$86.00 |
| 43865767 | Cyan Toner (6,000 Yield) (Type C11) | 32045 | CTG | \$204.00 |
| 43865766 | Magenta Toner (6,000 Yield) (Type C11) | 32044 | CTG | \$204.00 |
| 43865765 | Yellow Toner (6,000 Yield) (Type C11) | 32043 | CTG | \$204.00 |
| OKI CX2731 Series Color Multifunction Laser Supplies | | | | |
| 44469813 | Black Toner (5,000 Yield) (Type C17) | 906962 | CTG | \$38.60 |
| 44469739 | Cyan Toner (5,000 Yield) (Type C17) | 906963 | CTG | \$140.00 |
| 44469738 | Magenta Toner (5,000 Yield) (Type C17) | 906964 | CTG | \$140.00 |
| 44469737 | Yellow Toner (5,000 Yield) (Type C17) | 906965 | CTG | \$140.00 |
| 44494207 | Drum Unit (20,000 Yield) (Type C17) | 906966 | EA | \$128.00 |

| MFG# | Product Description | Part# | UOM | Retail |
|--|--|--------|-----|----------|
| OKI SUPPLIES | | | | |
| OKI CX3535/CX4545 Series Color Multifunction Laser Supplies | | | | |
| 44947308 | Black Toner (Type D2) (34,200 Yield) | 917974 | CTG | \$114.00 |
| 44947307 | Cyan Toner (Type D2) (26,800 Yield) | 917972 | CTG | \$336.00 |
| 44947306 | Magenta Toner (Type D2) (26,800 Yield) | 917973 | CTG | \$336.00 |
| 44947305 | Yellow Toner (Type D2) (26,800 Yield) | 917975 | CTG | \$336.00 |
| OUTPUT TECHNOLOGY SUPPLIES | | | | |
| Output Technology Impact Printer Ribbons | | | | |
| 8XXC100 | 7XX/8XX/4100/OTC850/1050/1450 DuraLine Series Ribbon (3/Box) | 90165 | BOX | \$68.75 |
| PANASONIC SUPPLIES | | | | |
| Panasonic Impact Printer Ribbons | | | | |
| KX-P145 | KX-P1123/1124/1124i/2023 Black Fabric Ribbon | 24002 | RBN | \$21.00 |
| KX-P180 | KX-P1131/3200 Black Ribbon | 24079 | RBN | \$22.00 |
| KX-P115 | KX-P1150/1180/1180i/1191/1695 Black Fabric Ribbon | 24048 | RBN | \$21.00 |
| KX-P150 | KX-P2123/2124/2180/3123/3124 Black Fabric Ribbon | 24003 | RBN | \$19.00 |
| KX-P190 | KX-P3196 Black Nylon Ribbon (12M Characters) | 24099 | RBN | \$30.00 |
| KX-P170 | KX-P3626/3696 Dot Matrix Printer Ribbon | 24067 | RBN | \$28.00 |
| UG6001 | UB-5315/5815/7325/8325 Replacement Film Roll (2/Box) | 5145 | BOX | \$39.00 |
| Panasonic Monochrome Laser Supplies | | | | |
| KX-FA87 | KX-FLB801 Toner (5,000 Yield) | 15382 | CTG | \$64.37 |
| KX-FAT461 | KX-MB2000/MB2030 Toner (2,000 Yield) | 94273 | CTG | \$56.95 |
| KX-FAD462 | KX-MB2000/MB2030 Drum Cartridge (6,000 Yield) | 94274 | EA | \$109.95 |
| Panasonic Monochrome Digital/Multifunction Copier Supplies | | | | |
| DQ-UG15A | Workio DP-150/150A/150PA/150FX Toner (5,000 Yield) | 107623 | CTG | \$138.00 |
| DQ-UG27H | Workio DP-190 Toner (6,000 Yield) | 22531 | CTG | \$132.00 |
| DQ-UH35H | Workio DP-190 Drum (20,000 Yield) | 12000 | EA | \$95.00 |
| DQ-TU10J | Workio DP-1520/1820P/1820E Toner (10,000 Yield) | 12962 | CTG | \$69.95 |
| DQ-TU15E | Workio DP-2310/2330/3010/3030 Toner (Includes Waste Bottle) (15,000 Yield) | 5587 | BTL | \$85.00 |
| DQ-TU24D | Workio DP-3510/4510 Toner (24,000 Yield) | 2012 | BTL | \$105.00 |
| DQ-TU38R | Workio DP-8035/8045/8060 Toner (38,000 Yield) | 902154 | CTG | \$89.00 |
| DQ-TU33G | Workio DP-3530/4530/4530H Toner (33,000 Yield) | 13164 | BTL | \$144.00 |
| DQ-TCB008D | Workio DP-MB350 Toner (2 Ctg/Ctn) (8,000 Yield) | 90969 | CTN | \$210.00 |
| Panasonic Workio DP-C262/C322 Multifunction Color Copier Supplies | | | | |
| DQ-TUN28K | Black Toner (28,000 Yield) | 12056 | CTG | \$89.00 |
| DQ-TUN20C | Cyan Toner (20,000 Yield) | 12057 | CTG | \$349.00 |
| DQ-TUN20M | Magenta Toner (20,000 Yield) | 12058 | CTG | \$349.00 |
| DQ-TUN20Y | Yellow Toner (20,000 Yield) | 12059 | CTG | \$349.00 |
| DQ-BFN45 | Waste Toner Container (28,000 Yield) | 14176 | EA | \$28.91 |
| DQ-UHN30 | Color Drum Unit (36,000 Yield) | 12060 | EA | \$210.00 |
| DQ-UHN36K | Black Drum Unit (39,000 Yield) | 25051 | EA | \$95.00 |
| Panasonic Workio DP-C263/C264/C323/C354 Multifunction Color Copier Supplies | | | | |
| DQ-TUS28K | Black Toner (28,000 Yield) | 95089 | CTG | \$79.00 |
| DQ-TUS20C | Cyan Toner (20,000 Yield) | 95093 | CTG | \$225.00 |
| DQ-TUS20M | Magenta Toner (20,000 Yield) | 95090 | CTG | \$225.00 |
| DQ-TUS20Y | Yellow Toner (20,000 Yield) | 95095 | CTG | \$225.00 |
| DQ-UHS36K | Black Drum Unit (39,000 Yield) | 20595 | EA | \$95.00 |
| DQ-UHS30 | Color Drum Unit (30,000 Yield) | 29081 | EA | \$225.00 |
| Panasonic Workio DP-C265/C266/C305/C306/C405/C406 Multifunction Color Copier Supplies | | | | |
| DQ-TUV28K | Black Toner (28,000 Yield) (For Use in Models C265/C266/C305/C306) | 12592 | CTG | \$75.00 |
| DQ-TUW28K | Black Toner (28,000 Yield) (For Use in Models C405/C406) | 12575 | CTG | \$65.00 |
| DQ-TUV20C | Cyan Toner (20,000 Yield) | 12593 | CTG | \$195.00 |
| DQ-TUV20M | Magenta Toner (20,000 Yield) | 12601 | CTG | \$195.00 |
| DQ-TUV20Y | Yellow Toner (20,000 Yield) | 12606 | CTG | \$195.00 |
| Panasonic Plain Paper Facsimile Supplies (Continued on next page) | | | | |
| KX-FA133 | KX-F1000/1020/1050/1070/1100/1150/1200 Film Refill (1 Roll) (650 Yield) | 95390 | EA | \$49.95 |
| KX-FA93 | KX-FHD331/332/351 Fax Film (225 Yield) | 3550 | EA | \$29.95 |
| KX-FA83 | KX-FL511/541/611 Toner (2,500 Yield) | 1324 | CTG | \$34.95 |
| KX-FA84 | KX-FL511/541 Drum (10,000 Yield) | 1323 | EA | \$98.00 |
| KX-FA65 | KX-FP101/105/121/KX-FPM 106/KX-FPW 111/KX-FPC135/141/FHD301 Film Cartridge (330 Yield) | 103827 | CTG | \$34.00 |

| MFG# | Product Description | Part# | UOM | Retail |
|---|--|--------|-----|----------|
| PANASONIC SUPPLIES | | | | |
| Panasonic Plain Paper Facsimile Supplies (Continued) | | | | |
| KX-FA135 | KX-FP195/200/205/210/220/230/245/250/260/270/280/KXFM 220/230 Film Cartridge | 98595 | CTG | \$39.95 |
| KX-FA136 | KX-FP195/200/205/210/220/230/245/250/260/270/280/KXFM 220/230 Refill Ribbons (2/Box) (330 Yield) | 98596 | BOX | \$49.95 |
| KX-FA92 | KX-FP145/FPG376/377/381/391 Fax Film (210 Pages/Roll) (2 Rolls/Box) | 5039 | BOX | \$24.95 |
| KX-FAT92 | KX-MB261/262CX/263/271/771/772CX/773/781/783 Toner (2,000 Yield) | 901525 | CTG | \$65.00 |
| UG3221 | UF-490/4000 Toner (6,000 Yield) | 4158 | CTG | \$80.00 |
| UG3220 | UF-490/4000 Drum (20,000 Yield) | 4159 | EA | \$130.00 |
| UG3313 | UF-550/560/770/880/885/895/DF-1100/DX-1000/DX-2000 Toner (10,000 Yield) | 96324 | CTG | \$225.00 |
| UG3350 | UF-585/595 Toner (7,500 Yield) | 104361 | CTG | \$200.00 |
| UG5510 | UF-780/790/6000/DX-800 Toner (9,000 Yield) | 4117 | CTG | \$200.00 |
| UG5591 | UF-4500/5500 Toner (3,000 Yield) | 106490 | EA | \$89.95 |
| UG5590 | UF-4500/5500 Drum Unit (6,000 Yield) | 106489 | EA | \$129.95 |
| UG5520 | UF-890/990 Toner (12,000 Yield) | 4078 | CTG | \$250.00 |
| UG5580 | UF-6200 Toner (9,000 Yield) | 7498 | CTG | \$210.00 |
| UG5550 | UF-6950/7950 Toner (10,000 Yield) | 97870 | CTG | \$244.00 |
| UG5540 | UF-7000/8000/9000 Toner (10,000 Yield) | 19547 | CTG | \$195.00 |
| UG5570 | UF-7200/8200 Toner (10,000 Yield) | 1989 | CTG | \$210.00 |

PRIMERA SUPPLIES**Primera Inkjet Supplies**

| | | | | |
|-------|---|--------|----|---------|
| 53330 | Bravo/Bravo II/Bravo XR/Bravo XR-Blu Disc Publisher/OptiVault Appliance Tri-Color Ink Cartridge | 105535 | EA | \$60.20 |
| 53331 | Bravo/Bravo II/Bravo XR/Bravo XR-Blu Disc Publisher/OptiVault Appliance Black Ink Cartridge | 105534 | EA | \$47.95 |
| 53332 | Bravo SE/Bravo SE Blu Disc Publisher/Bravo SE AutoPrinter Tri-Color Ink Cartridge | 95150 | EA | \$56.95 |
| 53336 | Bravo Pro/Bravo XRP/Bravo XRP-Blu Disc Publisher/Bravo Pro AutoPrinter Black Ink Cartridge | 901599 | EA | \$49.95 |
| 53335 | Bravo Pro AutoPrinter Tri-Color Ink Cartridge | 901596 | EA | \$70.14 |

PRINTRONIX SUPPLIES**Printronix Impact Printer Ribbons**

| | | | | |
|------------|---|--------|-----|----------|
| 107675-001 | P4280/P5005/P5008/P5009/P5010/P5015/P5205/P5208/P5210/P5215/P5220s/P9212 Extended Life Text Ribbon (30M Characters) (6 Rbn/Box) | 95861 | BOX | \$119.00 |
| 107675-005 | P4280/P5005/P5008/P5009/P5010/P5015/P5205/P5208/P5210/P5215/P5220s/P9212 Extended Bar Code Ribbon (30M Characters) (6 Rbn/Box) | 95853 | BOX | \$128.00 |
| 107675-007 | P4280/P5205/P5208/P5210/P5215/P5220s/P9212 Extended Life Text Ribbon (50M Characters) (6 Rbn/Box) | 98167 | BOX | \$140.00 |
| 107675-008 | P4280/P5205/P5208/P5210/P5215/P5220s/P9212 Extended Bar Code Ribbon (50M Characters) (6 Rbn/Box) | 103582 | BOX | \$140.00 |
| 172293-001 | P4280/P5005/P5008/P5009/P5010/P5015/P5205/P5208/P5210/P5215/P5220s/P9212 Gold Series 30 Ribbon (30M Characters) (6 Rbn/Box) | 4481 | BOX | \$128.00 |
| 175006-001 | P4280/P5005/P5008/P5009/P5010/P5015/P5205/P5208/P5210/P5215/P5220s/P9212 Gold Series 50 Ribbon (50M Characters) (6 Rbn/Box) | 107830 | BOX | \$153.00 |
| 179006-001 | P4280/P5205/P5208/P5210/P5215/P5220s/P9212 Gold Series 90 Ribbon (90M Characters) (6 Rbn/Box) | 107831 | BOX | \$277.00 |
| P5000U | P5000 Series Black Text Ribbon (Also Fits IBM/Lexmark 6400/DEC/LG/HP C3200/Decision Data 6600/6800 Series) (OEM# 107675-001, 107675-005, 1040990) (30M Characters) (6 Rbn/Box) | 916154 | BOX | \$76.80 |
| 175220-001 | P5220D/P5224 Gold Series 2000 Ribbon (60M Characters) (12 Rbn/Box) | 4685 | BOX | \$388.00 |
| 179499-001 | P7000/P7005/P7010/P7015/P7205/P7210/P7215/P7220 Spool Printer Series Ultra Capacity Ribbon (90M Characters) (6 Rbn/Box) | 10856 | BOX | \$241.00 |
| 250269-005 | L150/MVP/P300/P600/P3000/P6000/P6040/P6080/P9005/P9008/P9012 General Purpose (Text/OCR) Legacy Printer Ribbon (30M Characters) (6 Rbn/Box) | 23096 | BOX | \$128.00 |
| 255048-402 | P7000/P7010/P7015/P7210/P7215/P7220/P8000/P8010/P8210/P8215/P8220 Extended Capacity Cartridge Ribbon (4 x 30,000 Yield) (4 Rbn/Box) (Not available in the P7005, P7205, P8005 or P8205) | 95340 | BOX | \$238.00 |
| 255049-102 | P7000/P7005/P7010/P7015/P7205/P7210/P7215/P7220/P8000/P8005/P8010/P8205/P8210/P8215/P8220 Series Standard Capacity Cartridge Ribbon (17,000 Yield) | 95338 | RBN | \$54.00 |
| 255163-001 | P7000/P7005/P7010/P7015/P7205/P7210/P7215/P7220 Spool Printer Series Standard Capacity Ribbon (53M Characters) | 20231 | RBN | \$29.00 |
| 255661-102 | 6600/6800/6x05/6x10/6x15/6x20 Series Standard Capacity Ribbon (17,000 Yield) | 105334 | RBN | \$54.00 |
| 255670-102 | 6600/6800/6x10/6x15/6x20 Series Extended Capacity Ribbon (30,000 Yield) | 105336 | CTG | \$67.00 |

RICOH SUPPLIES**Ricoh Monochrome Laser Printer Supplies (Continued on next page)**

| | | | | |
|--------|--|-------|-----|----------|
| 402455 | Aficio BP 20/20N Toner (5,000 Yield) (Type BP20) | 90140 | EA | \$144.19 |
| 841331 | Aficio MP 1100/1350/9000 Toner (1,650g Btl) (60,000 Yield) | 33197 | CTG | \$105.00 |

| MFG# | Product Description | Part# | UOM | Retail |
|--|---|--------|-----|----------|
| RICOH SUPPLIES | | | | |
| Ricoh Monochrome Laser Printer Supplies (Continued) | | | | |
| 841346 | Aficio MP 3500/4000/4001/4002/4500/5000/5001 Toner (30,000 Yield) (630g Btl) (Type 4500A) | 15232 | BTL | \$105.95 |
| 413460 | Aficio SP 1000SF/Fax 1140L/1180L Black Toner (4,000 Yield) (Type SP 1000A) | 95191 | CTG | \$127.72 |
| 407259 | Aficio SP 201Nw/204SN Toner (1,500 Yield) (Type SP 201LA) | 914996 | CTG | \$63.36 |
| 402888 | Aficio SP 3200SF Toner (8,000 Yield) | 105130 | CTG | \$230.00 |
| 406464 | Aficio SP 3400/3410/3500/3510 Series Toner (2,500 Yield) | 91947 | CTG | \$85.75 |
| 406465 | Aficio SP 3400/3410SF Series High Yield Toner (5,000 Yield) | 91948 | CTG | \$114.85 |
| 406989 | Aficio SP 3500/3510 Series High Yield Toner (6,400 Yield) | 914645 | CTG | \$138.00 |
| 406997 | Aficio SP 4100N/4100N-KP/4110N/4110N-KP/4210N/4310N Toner (15,000 Yield) | 908651 | CTG | \$243.35 |
| 407010 | Aficio SP 4100NL Toner (7,500 Yield) | 908652 | CTG | \$161.69 |
| 406642 | Aficio SP 4100N/4100NL/4110N/4210N/4310N Maintenance Kit (Includes Fuser Assembly, Transfer Roller, Separation Pad, Feed Rollers) (90,000 Yield) (Type 120) | 91192 | KIT | \$213.32 |
| 406978 | Aficio SP 4410SF Use and Return Program Toner (18,000 Yield) | 908649 | CTG | \$299.00 |
| 407169 | Aficio SP 5100N Toner (20,000 Yield) | 913699 | CTG | \$292.01 |
| 406683 | Aficio SP 5200DN/5200S/5200SHT/5200SHW/5210DN/5210DNHT/5210DNHW/5210SF/5210SFHT/5210SFHW/5210SR Toner (25,000 Yield) | 905445 | CTG | \$169.99 |
| 406686 | Aficio SP 5200DN/5200S/5210DN/5210SF/5210SR Maintenance Kit (Includes Fusing Unit, Transfer Roller, 5 Feed Rollers, 5 Friction Pads) (120,000 Yield) | 908643 | EA | \$167.50 |
| 406628 | Aficio SP 6330N Toner (20,000 Yield) | 620508 | CTG | \$284.97 |
| 412660 | AC205 Toner (5,000 Yield) (Type 2185) | 90118 | CTG | \$151.20 |
| 407000 | AP400/400N/410/410N Toner (15,000 Yield) (Type 120) | 901089 | CTG | \$199.20 |
| 400759 | AP600/610/2600/2600N/2610/2610N Toner (20,000 Yield) (Type 115) | 1987 | CTG | \$269.84 |
| 406713 | AP610N Maintenance Kit (Includes Fuser and Transfer Unit) (90,000 Yield) | 91013 | KIT | \$213.32 |
| Ricoh Analog Copier Supplies | | | | |
| 887718 | FT 4022/4027/4127/4522/4527/4622/4822/5035/5135/5535/5632/5732/5832/5840 Toner (17,000 Yield) (Type 450) | 97296 | BTL | \$53.65 |
| 410801 | SR790/SR840 Staples (5,000 Staples/Ctg) (1 Ctg/Box) (Type K) | 3285 | BOX | \$42.00 |
| 410802 | SR760/SR770/SR790 Staple Cartridge Refill (5,000 Staples/Ctg) (3 Ctgs/Ctn) (Type K) | 5688 | CTN | \$79.83 |
| Ricoh Digital Multifunction Copier Supplies | | | | |
| 888029 | Aficio 240W/470W/480W/MPW2400/MPW3600/FW240 Toner | 5908 | CTG | \$199.00 |
| 885235 | Aficio 551/700/1055 Toner (43,000 Yield) (Type 5105D) | 3961 | CTG | \$105.74 |
| 885527 | Aficio 1013/1013F Toner (7,000 Yield) (230 gm. Btl) (Type 1150D) | 94363 | BTL | \$28.17 |
| 888086 | Aficio 1015/1018 Toner (9,000 Yield) (260 gm. Btl) (Type 1140D) | 4342 | BTL | \$36.00 |
| 885208 | Aficio 220/270/AP2700/3200 Toner (66,000 Yield) (365 gm. Btl) (Type 2110D) | 107704 | BTL | \$40.80 |
| 841337 | Aficio 1022/1027/2022/2027/3025/3030; MP 2510/2550/2851/3010/3350/3351 Toner (66,000 Yield) (Type 2212) | 19378 | BTL | \$65.00 |
| 411018 | Aficio 1022/1027/1032/2022/2027 Drum (Type 1027) | 100007 | CTN | \$249.00 |
| 885247 | Aficio 1035/1045/AP4510 Toner (23,000 Yield) (Type 3105D) | 2808 | BTL | \$87.90 |
| 841332 | Aficio 1060/1075/2051/2051SP/2060/2060SP/2075; MP 5500/6000/6001/6002/6500/7000/7001/7500/8000/8001/9001 Toner (43,000 Yield) (Type 6110D/6075) | 17530 | BTL | \$105.00 |
| 888215 | Aficio 2015/2016/2018/2018D/2020/2020D; MP 1600/2000 Toner (9,000 Yield) (Type 1130D) | 6041 | BTL | \$36.00 |
| 888181 | Aficio 2035/2045/3035/3045 Toner (30,000 Yield) (Type 3110D) | 1515 | BTL | \$120.00 |
| 828080 | Pro 907EX/1107EX/1357EX Toner (60,000 Yield) | 910277 | CTG | \$109.95 |
| Ricoh Aficio 2228/2232C/2238C Digital Color Copier Supplies | | | | |
| 884900 | Black Toner (19,000 Yield) (Type P1) | 15163 | CTG | \$43.00 |
| 884903 | Cyan Toner (10,000 Yield) (Type P1) | 15161 | CTG | \$249.29 |
| 884902 | Magenta Toner (10,000 Yield) (Type P1) | 15160 | CTG | \$249.29 |
| 884901 | Yellow Toner (10,000 Yield) (Type P1) | 15162 | CTG | \$249.29 |
| Ricoh Aficio 3228C/3235C/3245C Multifunction Color Laser Supplies | | | | |
| 888340 | Black Toner (24,000 Yield) (Type R1) | 91800 | CTG | \$55.50 |
| 888343 | Cyan Toner (10,000 Yield) (Type R1) | 91804 | CTG | \$176.50 |
| 888342 | Magenta Toner (10,000 Yield) (Type R1) | 91803 | CTG | \$176.50 |
| 888341 | Yellow Toner (10,000 Yield) (Type R1) | 91802 | CTG | \$176.50 |



Ricoh offers a complete line of network-capable printers for every application. Plus, the Ricoh line of MFPs offer scanning, fax and copier options as well as advanced finishing capabilities. Ricoh printers enhance your productivity from individual to multi-user offices!

RICOH
imagine. change.

| MFG# | Product Description | Part# | UOM | Retail |
|---|--|--------|-----|----------|
| RICOH SUPPLIES | | | | |
| Ricoh Aficio 3260C/5560C Multifunction Color Copier Supplies | | | | |
| 841333 | Black Toner (910 gm. Ctg) (36,000 Yield) (Type S1) | 19326 | CTG | \$67.00 |
| 841336 | Cyan Toner (530 gm. Ctg) (18,000 Yield) (Type S1) | 19329 | CTG | \$224.50 |
| 841335 | Magenta Toner (530 gm. Ctg) (18,000 Yield) (Type S1) | 19328 | CTG | \$224.50 |
| 841334 | Yellow Toner (530 gm. Ctg) (18,000 Yield) (Type S1) | 19327 | CTG | \$224.50 |
| Ricoh Aficio CL2000/CL2000N/CL3000 Color Laser Supplies | | | | |
| 400963 | Black Toner (5,000 Yield) (Type 125) | 1256 | CTG | \$36.77 |
| 400969 | Cyan Toner (5,000 Yield) (Type 125) | 1255 | CTG | \$96.25 |
| 400975 | Magenta Toner (5,000 Yield) (Type 125) | 1254 | CTG | \$96.25 |
| 400981 | Yellow Toner (5,000 Yield) (Type 125) | 1253 | CTG | \$96.25 |
| 420131 | Waste Container (Type 155) | 11897 | EA | \$24.15 |
| Ricoh Aficio CL3500N Color Laser Supplies | | | | |
| 402552 | Black Toner (7,000 Yield) (Type 165) | 29525 | CTG | \$61.65 |
| 402553 | Cyan Toner (6,000 Yield) (Type 165) | 29526 | CTG | \$131.19 |
| 402554 | Magenta Toner (6,000 Yield) (Type 165) | 29527 | CTG | \$131.19 |
| 402555 | Yellow Toner (6,000 Yield) (Type 165) | 29528 | CTG | \$131.19 |
| 402448 | Black Photoconductor Unit (15,000 Yield) (Type 165) | 96811 | EA | \$139.51 |
| 402449 | Color Photoconductor Unit (15,000 Yield) (Type 165) | 96813 | EA | \$387.18 |
| 402450 | Waste Toner Bottle (56,000 Impression Yield) (Type 165) | 23341 | BTL | \$32.45 |
| 402452 | Transfer Belt (Type 165) | 90144 | EA | \$151.41 |
| Ricoh Aficio CL4000DN/SPC410DN/SPC411DN/SPC420DN Color Laser Supplies | | | | |
| 888308 | High Yield Black Toner (15,000 Yield) (Type 145) | 10456 | CTG | \$97.34 |
| 888311 | High Yield Cyan Toner (15,000 Yield) (Type 145) | 10459 | CTG | \$225.75 |
| 888310 | High Yield Magenta Toner (15,000 Yield) (Type 145) | 10458 | CTG | \$225.75 |
| 888309 | High Yield Yellow Toner (15,000 Yield) (Type 145) | 10457 | CTG | \$225.75 |
| 402319 | Black Photoconductor Unit (50,000 Yield) (Type 145) | 14079 | EA | \$173.25 |
| 402320 | Color Photoconductor Unit (50,000 Yield) (Type 145) | 14078 | EA | \$514.50 |
| 402321 | Fuser Unit Maintenance Kit (100,000 Yield) (Not For Use in Models SPC411DN/SPC420DN) | 24101 | KIT | \$204.75 |
| 402323 | Intermediate Transfer Unit (100,000 Yield) (Type 145) | 14080 | EA | \$147.00 |
| 402324 | Waste Toner Bottle (125,000 Yield) (Type 145) | 24100 | BTL | \$47.25 |
| Ricoh Aficio CL7200/CL7300 Color Laser Supplies | | | | |
| 888442 | Black Toner (24,000 Yield) (Type 160) | 13127 | CTG | \$64.89 |
| 888445 | Cyan Toner (10,000 Yield) (Type 160) | 13130 | CTG | \$144.92 |
| 888444 | Magenta Toner (10,000 Yield) (Type 160) | 13129 | CTG | \$144.92 |
| 888443 | Yellow Toner (10,000 Yield) (Type 160) | 13128 | CTG | \$144.92 |
| 402305 | Color Image Drum (40,000 Yield) | 13146 | EA | \$445.00 |
| 402307 | Fuser Unit Maintenance Kit (80,000 Yield) | 33056 | KIT | \$483.00 |
| Ricoh Aficio MP C2050/C2550 Color Laser Supplies | | | | |
| 841280 | Black Toner (10,000 Yield) | 904835 | CTG | \$65.53 |
| 841281 | Cyan Toner (5,500 Yield) | 904836 | CTG | \$157.41 |
| 841282 | Magenta Toner (5,500 Yield) | 904837 | CTG | \$157.41 |
| 841283 | Yellow Toner (5,500 Yield) | 904838 | CTG | \$157.41 |
| Ricoh Aficio MP C2500/C3000 Color Laser Supplies | | | | |
| 841338 | Black Toner (20,000 Yield) | 16143 | CTG | \$199.18 |
| 841341 | Cyan Toner (15,000 Yield) | 16181 | CTG | \$262.14 |
| 841340 | Magenta Toner (15,000 Yield) | 16180 | CTG | \$262.14 |
| 841339 | Yellow Toner (15,000 Yield) | 16179 | CTG | \$262.14 |
| Ricoh Aficio MP C2800/C3300 Color Laser Supplies | | | | |
| 841276 | Black Toner (20,000 Yield) | 4813 | CTG | \$83.00 |
| 841423 | Cyan Toner (16,000 Yield) | 98076 | CTG | \$185.00 |
| 841422 | Magenta Toner (16,000 Yield) | 98069 | CTG | \$185.00 |
| 841421 | Yellow Toner (16,000 Yield) | 98066 | CTG | \$185.00 |
| Ricoh Aficio MP C3001/C3501 Color Laser Supplies | | | | |
| 841578 | Black Toner (22,500 Yield) | 800648 | CTG | \$108.00 |
| 841423 | Cyan Toner (16,000 Yield) | 98076 | CTG | \$185.00 |
| 841422 | Magenta Toner (16,000 Yield) | 98069 | CTG | \$185.00 |
| 841421 | Yellow Toner (16,000 Yield) | 98066 | CTG | \$185.00 |
| Ricoh Aficio MP C3002/C3502 Color Laser Supplies <i>(Continued on next page)</i> | | | | |
| 841735 | Black Toner (28,000 Yield) | 911914 | CTG | \$129.95 |
| 841738 | Cyan Toner (18,000 Yield) | 911917 | CTG | \$199.95 |

| MFG# | Product Description | Part# | UOM | Retail |
|---|--|--------|-----|----------|
| RICOH SUPPLIES | | | | |
| Ricoh Aficio MP C3002/C3502 Color Laser Supplies (Continued) | | | | |
| 841737 | Magenta Toner (18,000 Yield) | 911916 | CTG | \$199.95 |
| 841736 | Yellow Toner (18,000 Yield) | 911915 | CTG | \$199.95 |
| Ricoh Aficio MP C3500/C4500A Color Laser Supplies | | | | |
| 841342 | Black Toner (23,000 Yield) | 16144 | CTG | \$72.00 |
| 841345 | Cyan Toner (17,000 Yield) | 16147 | CTG | \$215.00 |
| 841344 | Magenta Toner (17,000 Yield) | 16148 | CTG | \$215.00 |
| 841343 | Yellow Toner (17,000 Yield) | 16149 | CTG | \$215.00 |
| Ricoh Aficio MP C4000/C5000 Color Laser Supplies | | | | |
| 841284 | Black Toner (23,000 Yield) | 904325 | CTG | \$105.37 |
| 841455 | Cyan Toner (16,000 Yield) | 98091 | CTG | \$199.50 |
| 841454 | Magenta Toner (16,000 Yield) | 98086 | CTG | \$199.50 |
| 841453 | Yellow Toner (16,000 Yield) | 98080 | CTG | \$199.50 |
| Ricoh Aficio MP C4501/C5501 Color Laser Supplies | | | | |
| 841582 | Black Toner (25,500 Yield) | 701357 | CTG | \$99.99 |
| 841455 | Cyan Toner (16,000 Yield) | 98091 | CTG | \$199.50 |
| 841454 | Magenta Toner (16,000 Yield) | 98086 | CTG | \$199.50 |
| 841453 | Yellow Toner (16,000 Yield) | 98080 | CTG | \$199.50 |
| Ricoh SP C220/C221/C222 Color Laser Supplies | | | | |
| 406046 | Black Toner (2,000 Yield) | 903101 | CTG | \$60.03 |
| 406047 | Cyan Toner (2,000 Yield) | 15418 | CTG | \$107.61 |
| 406048 | Magenta Toner (2,000 Yield) | 15419 | CTG | \$107.61 |
| 406044 | Yellow Toner (2,000 Yield) | 15420 | CTG | \$107.61 |
| 406043 | Waste Toner Bottle (25,000 Yield) (Type 220) | 104633 | EA | \$23.36 |
| Ricoh SP C231N/C232DN/C242DN/C242SF/C311N/C312DN/C320DN Color Laser Supplies | | | | |
| 406344 | Black Toner (2,500 Yield) (Type SPC310A) | 15470 | CTG | \$86.01 |
| 406345 | Cyan Toner (2,500 Yield) (Type SPC310A) | 15471 | CTG | \$111.76 |
| 406346 | Magenta Toner (2,500 Yield) (Type SPC310A) | 15472 | CTG | \$111.76 |
| 406347 | Yellow Toner (2,500 Yield) (Type SPC310A) | 15473 | CTG | \$111.76 |
| 406475 | High Yield Black Toner (6,500 Yield) (Type SPC310HA) | 15474 | CTG | \$129.01 |
| 406476 | High Yield Cyan Toner (6,500 Yield) (Type SPC310HA) | 15475 | CTG | \$167.63 |
| 406477 | High Yield Magenta Toner (6,500 Yield) (Type SPC310HA) | 15476 | CTG | \$167.63 |
| 406478 | High Yield Yellow Toner (6,500 Yield) (Type SPC310HA) | 15477 | CTG | \$167.63 |
| Ricoh SP C252DN/SP C252SF Color Laser Supplies | | | | |
| 407653 | Black Toner (6,500 Yield) | 927135 | CTG | \$114.00 |
| 407654 | Cyan Toner (6,000 Yield) | 927136 | CTG | \$142.00 |
| 407655 | Magenta Toner (6,000 Yield) | 927137 | CTG | \$142.00 |
| 407656 | Yellow Toner (6,000 Yield) | 927138 | CTG | \$142.00 |
| 406043 | Waste Toner Bottle (25,000 Yield) (Type 220) | 104633 | EA | \$23.36 |
| Ricoh SP C430DN/C431DN/C431DN-HS Color Laser Supplies | | | | |
| 821105 | Black Toner (24,000 Yield) | 908842 | CTG | \$103.82 |
| 821108 | Cyan Toner (21,000 Yield) | 908845 | CTG | \$271.92 |
| 821107 | Magenta Toner (21,000 Yield) | 908844 | CTG | \$271.92 |
| 821106 | Yellow Toner (21,000 Yield) | 908843 | CTG | \$271.92 |
| 407018 | Black Photoconductor (13,000 Yield) | 701628 | EA | \$161.71 |
| 407019 | Color Drum Unit (Includes 1 Drum for Each C/M/Y) (50,000 Yield) | 908653 | EA | \$484.10 |
| 406666 | Fusing Unit (Includes 3 Dust Filters) (120,000 Yield) | 908642 | EA | \$233.81 |
| 406664 | Transfer Unit (Includes Image Transfer Belt Unit, Paper Transfer Roller) (100,000 Yield) | 908640 | EA | \$147.29 |
| 406665 | Waste Toner Bottle (50,000 Yield) | 908641 | BTL | \$24.72 |
| Ricoh SP C820/C821 Series Color Laser Supplies | | | | |
| 821026 | Black Toner (20,000 Yield) | 19435 | CTG | \$67.21 |
| 821029 | Cyan Toner (15,000 Yield) | 19438 | CTG | \$206.00 |
| 821028 | Magenta Toner (15,000 Yield) | 19437 | CTG | \$206.00 |
| 821027 | Yellow Toner (15,000 Yield) | 19436 | CTG | \$206.00 |
| 403115 | Black Drum Unit (40,000 Yield) (Type SP C820DN) | 908620 | EA | \$185.66 |
| 403116 | Color Drum Unit (Includes 3 PCUs, 1 Each for C/M/Y) (40,000 Yield) (Type SP C820DN) | 908621 | EA | \$556.20 |
| 403118 | Fusing Unit (160,000 Yield) (Type SP C820DN) | 908623 | EA | \$412.00 |
| 403117 | Transfer Unit (200,000 Yield) (Type SP C820DN) | 908622 | EA | \$278.10 |

| MFG# | Product Description | Part# | UOM | Retail |
|--|--|--------|-----|----------|
| RICOH SUPPLIES | | | | |
| Ricoh SP C830DN/C831DN Color Laser Supplies | | | | |
| 821181 | Black Toner (23,500 Yield) | 913082 | CTG | \$67.21 |
| 821184 | Cyan Toner (27,000 Yield) | 913085 | CTG | \$216.72 |
| 821183 | Magenta Toner (27,000 Yield) | 913084 | CTG | \$216.72 |
| 821182 | Yellow Toner (27,000 Yield) | 913083 | CTG | \$216.72 |
| 407095 | Black Drum Unit (60,000 Yield) | 910749 | EA | \$298.29 |
| 407096 | Color Drum Unit (Includes 3 PCUs, 1 Each For C/M/Y) (60,000 Yield) | 910750 | EA | \$894.23 |
| 407097 | Transfer Unit (200,000 Yield) | 910751 | EA | \$298.08 |
| 407098 | Fusing Unit (160,000 Yield) | 910752 | EA | \$441.60 |
| 407100 | Waste Toner Bottle (40,000 Yield) | 910753 | EA | \$21.34 |

| | | | | |
|--|------------------------------------|--------|-----|---------|
| Ricoh Aficio SG 3100SNw/3110DN/3110DNw/3110SFNw/7100DN Ink Supplies | | | | |
| 405761 | Black Ink (GC 41K) (2,500 Yield) | 908629 | CTG | \$41.00 |
| 405762 | Cyan Ink (GC 41C) (2,200 Yield) | 908630 | CTG | \$39.00 |
| 405763 | Magenta Ink (GC 41M) (2,200 Yield) | 908631 | CTG | \$39.00 |
| 405764 | Yellow Ink (GC 41Y) (2,200 Yield) | 908632 | CTG | \$39.00 |

| | | | | |
|---|---------------------------|-------|-----|---------|
| Ricoh Gelsprinter GX 2500/3000/3000S/3000SF/3050N/3050SFN/5050N/7000 Color GelJet Supplies | | | | |
| 405532 | Black Ink (1,500 Yield) | 30006 | CTG | \$42.83 |
| 405533 | Cyan Ink (1,000 Yield) | 30007 | CTG | \$46.72 |
| 405534 | Magenta Ink (1,000 Yield) | 30008 | CTG | \$46.72 |
| 405535 | Yellow Ink (1,000 Yield) | 30009 | CTG | \$46.72 |

| | | | | |
|---|---------------------------|--------|-----|---------|
| Ricoh Gelsprinter GX e3300N/e3350N Color GelJet Supplies | | | | |
| 405688 | Black Ink (1,920 Yield) | 905441 | CTG | \$42.83 |
| 405689 | Cyan Ink (1,920 Yield) | 905442 | CTG | \$46.72 |
| 405690 | Magenta Ink (1,560 Yield) | 905443 | CTG | \$46.72 |
| 405691 | Yellow Ink (1,750 Yield) | 905444 | CTG | \$46.72 |

| | | | | |
|---|--|--------|-----|---------|
| Ricoh Gelsprinter GX e5550N/e7700N Color GelJet Supplies | | | | |
| 405688 | Black Ink (1,920 Yield) | 905441 | CTG | \$42.83 |
| 405689 | Cyan Ink (1,920 Yield) | 905442 | CTG | \$46.72 |
| 405690 | Magenta Ink (1,560 Yield) | 905443 | CTG | \$46.72 |
| 405691 | Yellow Ink (1,750 Yield) | 905444 | CTG | \$46.72 |
| 405701 | High Yield Black Ink (4,230 Yield) | 905447 | CTG | \$83.12 |
| 405702 | High Yield Cyan Ink (4,890 Yield) | 905448 | CTG | \$85.91 |
| 405703 | High Yield Magenta Ink (4,000 Yield) | 905449 | CTG | \$85.91 |
| 405704 | High Yield Yellow Ink (4,000 Yield) | 905450 | CTG | \$85.91 |
| 405714 | Ink Collector Unit (28,000 Yield) (Type GX e5500) (For Use in Model GX e5500N) | 908628 | EA | \$28.07 |

| | | | | |
|---------------------------------|---|--------|-----|----------|
| Ricoh Facsimile Supplies | | | | |
| 430222 | 1900L/2000L/2900L/3900L/3900NF/SFX-2000M/3900M Toner (4,500 Yield) (Type 1135) | 103433 | CTG | \$114.45 |
| 412672 | AC104/LF215/FAX1170L/2210L Toner (3,500 Yield) (Type 1175) | 13195 | CTG | \$111.24 |
| 411113 | Aficio 1013/1013F/120/Fax 3310L/3320L/4410L/4410NF/4420L/4420NF Drum (45,000 Yield) (Type 1013) | 3114 | EA | \$213.52 |
| 413460 | Aficio SP 1000SF/Fax 1140L/1180L Toner (4,000 Yield) (Type SP 1000A) | 95191 | CTG | \$127.72 |
| 431007 | Fax 1190L Toner (2,500 Yield) (Type 1190) | 913302 | CTG | \$109.95 |
| 430347 | FAX3310L/3320L/4410L/4410NF/4420L/4420NF/4430L/4430NF Toner (5,000 Yield) (Type 1160) | 2903 | CTG | \$85.05 |
| 430208 | Fax 5510L AIO Toner (10,000 Yield) (Type 5110) | 106022 | CTG | \$245.00 |

| RISOGRAPH SUPPLIES | | | | |
|---|---|--------|-----|----------|
| RISOGRAPH Monochrome Copier Supplies | | | | |
| S-4254 | EZ220/RZ220/220UI/220U/390/MZ790 Black Ink (2 Ctgs/Ctn) | 6493 | CTN | \$72.00 |
| S-4250 | EZ220/RZ220 Masters (2 Rolls/Ctn) | 6492 | CTN | \$95.00 |
| S-4202 | FR2950/3910/3950 FP3500UI/3505UI Black Ink (2 Ctgs/Ctn) (10,000 Yield) | 1079 | CTN | \$62.00 |
| S-539 | GR1700/1750/2710/2750/3710/3700/3750 Black Ink (2 x 1,000 cc. Ctgs/Ctn) (10,000 Yield) | 12586 | CTN | \$62.00 |
| S-549LA | GR1700/1750/2710/2750 Masters (227 mm x 100 mm) (2 Rolls/Ctn) | 106441 | CTN | \$114.00 |
| S-132 | GR3750 Master (11" x 17") (2 Ea/Ctn) | 6282 | CTN | \$132.00 |
| S-2314 | GR3770 Black Ink (2 x 1,000 cc. Ctgs/Ctn) (20,000 Yield) | 101565 | CTN | \$92.00 |
| S-569 | RA4200/5900/RC4000/4500/4900/5600/5800/6300 Black Ink (2 x 1,000 cc. Ctgs/Ctn) (20,000 Yield) | 6285 | CTN | \$62.00 |
| S-4206 | RN2000UI/2030UI/2130UI/2235UI/2530UI Black Ink (2 x 1,000 cc. Ctgs/Ctn) (20,000 Yield) | 1472 | CTN | \$58.00 |
| S-3192 | RN2030UI/2130UI/2235UI/2530UI Master (215 Sheets/Roll) (2 Rolls/Ctn) | 3348 | CTN | \$85.20 |
| S-4386 | RP3100UI/3700UI Black Ink (2-1,000 cc. Ctgs/Ctn) | 6170 | CTN | \$96.00 |
| S-952 | TR1510 Black Ink (800 cc. Ctg) (10,000 Yield) | 100371 | CTG | \$24.30 |
| S-2488 | TR1610/CR1610/CR1630 Black Ink (2 Ctgs/Ctn) (20,000 Yield) | 104184 | CTN | \$48.60 |
| S-2500 | TR1510/CR1610/CR1630/CR2500 Master (2/Ctn) (400 Yield) | 6287 | CTN | \$83.80 |

| MFG# | Product Description | Part# | UOM | Retail |
|---|---|--------|-----|----------|
| SAMSUNG SUPPLIES | | | | |
| Samsung M2625D/M2825DW/M2875FD/M2875FW Laser Supplies | | | | |
| MLT-D116S | Toner (1,200 Yield) | 913580 | CTG | \$45.99 |
| MLT-D116L | High Yield Toner (3,000 Yield) | 913581 | CTG | \$85.99 |
| MLT-R116 | Imaging Unit (9,000 Yield) | 913582 | EA | \$73.99 |
| Samsung M4583FX Laser Supplies | | | | |
| MLT-D304S | Toner (7,000 Yield) | 930436 | CTG | \$190.99 |
| MLT-D304L | High Yield Toner (20,000 Yield) | 930435 | CTG | \$305.99 |
| MLT-D304E | Extra High Yield Toner (40,000 Yield) | 930434 | CTG | \$491.99 |
| MLT-R304 | Drum (100,000 Yield) | 930437 | EA | \$274.99 |
| Samsung ML-1610/2010/2510/2570/2571/SCX-4521 Series Laser Supplies | | | | |
| MLT-D119S | Toner (2,000 Yield) | 913583 | CTG | \$85.99 |
| Samsung ML-1630 Series Laser Supplies | | | | |
| ML-D1630A | Toner (2,000 Yield) | 902019 | CTG | \$94.99 |
| Samsung ML-1640/2240 Series Laser Supplies | | | | |
| MLT-D108S | Toner (1,500 Yield) | 4806 | CTG | \$88.99 |
| Samsung ML-1665/1865W Series Laser Supplies | | | | |
| MLT-D104X | Toner (700 Yield) | 930432 | CTG | \$62.99 |
| MLT-D104S | Toner (1,500 Yield) | 99857 | CTG | \$82.99 |
| Samsung ML-1710/1740/1750 Series Laser Supplies | | | | |
| ML-1710D3 | Toner (3,000 Yield) | 1750 | CTG | \$114.99 |
| Samsung ML-1910/1915/2525/2545/2580 Series Laser Supplies | | | | |
| MLT-D105S | Toner (1,500 Yield) | 19412 | CTG | \$86.99 |
| MLT-D105L | High Yield Toner (2,500 Yield) | 19411 | CTG | \$102.99 |
| MLT-P105A | High Yield Toner Dual Pack (2 Pack of OEM# MLT-D105L) (2 x 2,500 Yield) | 908540 | PK | \$174.99 |
| Samsung ML-2165/SCX-3405/SF-760 Series Laser Supplies | | | | |
| MLT-D101S | Toner (1,500 Yield) | 507828 | CTG | \$82.99 |
| Samsung ML-2250/2251/2252 Series Laser Supplies | | | | |
| ML-2250D5 | Toner (5,000 Yield) | 6010 | CTG | \$141.99 |
| Samsung ML-2851 Series Laser Supplies | | | | |
| ML-D2850A | Toner (2,000 Yield) | 100523 | CTG | \$81.99 |
| ML-D2850B | High Yield Toner (5,000 Yield) | 100524 | CTG | \$136.99 |
| Samsung ML-2855 Series Laser Supplies | | | | |
| MLT-D209S | Toner (2,000 Yield) | 903095 | CTG | \$92.99 |
| MLT-D209L | High Yield Toner (5,000 Yield) | 903096 | CTG | \$132.99 |
| MLT-D209L-TAA | High Yield Toner (5,000 Yield) (TAA Compliant Version of MLT-D209L) | 17895 | CTG | \$132.99 |
| Samsung ML-2955 Series Laser Supplies | | | | |
| MLT-D103S | Toner (1,500 Yield) | 107883 | CTG | \$81.99 |
| MLT-D103L | High Yield Toner (2,500 Yield) | 107882 | CTG | \$97.99 |
| Samsung ML-3051 Series Laser Supplies | | | | |
| ML-D3050A | Toner (4,000 Yield) | 21787 | CTG | \$144.99 |
| ML-D3050B | High Yield Toner (8,000 Yield) | 21796 | CTG | \$174.99 |
| Samsung ML-3312/3712/3712/SCX-4835/5639/5739 Series Laser Supplies | | | | |
| MLT-D205S | Toner (2,000 Yield) | 101281 | CTG | \$87.99 |
| MLT-D205L | High Yield Toner (5,000 Yield) | 101279 | CTG | \$162.99 |
| MLT-D205E | Extra High Yield Toner (10,000 Yield) (For Use in Models SCX-5639/5739) | 101278 | CTG | \$249.99 |
| Samsung ML-3471 Series Laser Supplies | | | | |
| ML-D3470B | Toner (10,000 Yield) | 100217 | CTG | \$247.99 |
| Samsung ML-4050/4551 Series Laser Supplies | | | | |
| ML-D4550B | Toner (20,000 Yield) | 90407 | CTG | \$279.99 |

| MFG# | Product Description | Part# | UOM | Retail |
|---|---|--------|-----|----------|
| SAMSUNG SUPPLIES | | | | |
| Samsung ML-4512ND/5012ND/5017ND Series Laser Supplies | | | | |
| MLT-D307S | Toner (7,000 Yield) | 500837 | CTG | \$181.99 |
| MLT-D307L | High Yield Toner (15,000 Yield) | 500836 | CTG | \$248.99 |
| MLT-R307 | Imaging Unit (60,000 Yield) | 902830 | EA | \$166.99 |
| Samsung ML-5512/6512 Series Laser Supplies | | | | |
| MLT-D309L | High Yield Toner (30,000 Yield) | 101283 | CTG | \$337.99 |
| Samsung ProXpress M2020/M2070 Series Laser Supplies | | | | |
| MLT-D111S | Toner (1,000 Yield) | 923074 | CTG | \$92.99 |
| Samsung ProXpress M3320/3370/3820/3870/4020/4070 Series Laser Supplies | | | | |
| MLT-D203S | Toner (3,000 Yield) | 914543 | CTG | \$98.99 |
| MLT-D203L | High Yield Toner (5,000 Yield) | 914542 | CTG | \$146.99 |
| MLT-D203U | Ultra High Yield Toner (15,000 Yield) (For Use in Models M4020/M4070) | 930433 | CTG | \$271.99 |
| Samsung SCX-4016/4116/4216 Series Multifunction Laser Supplies | | | | |
| SCX-4216D3 | Toner (3,000 Yield) | 1742 | CTG | \$119.99 |
| Samsung SCX-4200 Series Multifunction Laser Supplies | | | | |
| SCX-D4200A | Toner (3,000 Yield) | 20398 | CTG | \$127.99 |
| Samsung SCX-4300 Series Multifunction Laser Supplies | | | | |
| MLT-D109S | Toner (2,000 Yield) | 902020 | CTG | \$98.99 |
| Samsung SCX-4500 Series Multifunction Laser Supplies | | | | |
| ML-D1630A | Toner (2,000 Yield) | 902019 | CTG | \$94.99 |
| Samsung SCX-4600/4623 Series Multifunction Laser Supplies | | | | |
| MLT-D105S | Toner (1,500 Yield) | 19412 | CTG | \$86.99 |
| MLT-D105L | High Yield Toner (2,500 Yield) | 19411 | CTG | \$102.99 |
| MLT-P105A | High Yield Toner Dual Pack (2 Pack of OEM# MLT-D105L) (2 x 2,500 Yield) | 908540 | PK | \$174.99 |
| Samsung SCX-4720 Series Multifunction Laser Supplies | | | | |
| SCX-4720D5 | High Yield Toner (5,000 Yield) | 6364 | CTG | \$141.99 |
| Samsung SCX-4725 Series Multifunction Laser Supplies | | | | |
| SCX-D4725A | Toner (3,000 Yield) | 90408 | CTG | \$119.99 |
| Samsung SCX-4729 Series Multifunction Laser Supplies | | | | |
| MLT-D103S | Toner (1,500 Yield) | 107883 | CTG | \$81.99 |
| MLT-D103L | High Yield Toner (2,500 Yield) | 107882 | CTG | \$97.99 |
| Samsung SCX-4826/4828 Series Multifunction Laser Supplies | | | | |
| MLT-D209S | Toner (2,000 Yield) | 903095 | CTG | \$92.99 |
| MLT-D209L | High Yield Toner (5,000 Yield) | 903096 | CTG | \$132.99 |
| MLT-D209L-TAA | High Yield Toner (5,000 Yield) (TAA Compliant Version of MLT-D209L) | 17895 | CTG | \$132.99 |
| Samsung SCX-5112/5115/5312/5315 Series Multifunction Laser Supplies | | | | |
| SCX-5312D6 | Toner (6,000 Yield) | 2784 | CTG | \$177.99 |
| SCX-5315R2 | Imaging Unit (15,000 Yield) | 1319 | EA | \$198.99 |
| Samsung SCX-5530 Series Multifunction Laser Supplies | | | | |
| SCX-D5530B | High Yield Toner (8,000 Yield) | 21757 | CTG | \$179.99 |
| Samsung SCX-5635/5835 Series Multifunction Laser Supplies | | | | |
| MLT-D208S | Toner (4,000 Yield) | 904790 | CTG | \$108.99 |
| MLT-D208L | High Yield Toner (10,000 Yield) | 904791 | CTG | \$219.99 |
| MLT-P208A | Toner Dual Pack (2 Pack of OEM# MLT-D208L) (2 x 10,000 Yield) | 12696 | PK | \$324.99 |
| Samsung SCX-5935FN Series Multifunction Laser Supplies | | | | |
| MLT-D206L | Toner (10,000 Yield) | 903541 | CTG | \$156.99 |
| MLT-P206A | Toner Dual Pack (2 Pack of OEM# MLT-D206L) (2 x 10,000 Yield) | 30612 | PK | \$199.99 |
| Samsung SCX-6122/6220/6320/6322 Series Multifunction Laser Supplies | | | | |
| SCX-6320D8 | Toner (8,000 Yield) | 10430 | CTG | \$79.99 |
| SCX-6320R2 | Imaging Unit (20,000 Yield) | 10455 | EA | \$73.99 |

| MFG# | Product Description | Part# | UOM | Retail |
|---|---|--------|-----|----------|
| SAMSUNG SUPPLIES | | | | |
| Samsung SCX-6345 Series Multifunction Laser Supplies | | | | |
| SCX-D6345A | Toner (20,000 Yield) | 102126 | CTG | \$95.99 |
| SCX-R6345A | Imaging Unit (60,000 Yield) | 31464 | EA | \$183.99 |
| Samsung SCX-6545/6555 Series Multifunction Laser Supplies | | | | |
| SCX-D6555A | Toner (25,000 Yield) | 31466 | CTG | \$87.99 |
| SCX-R6555A | Imaging Unit (80,000 Yield) | 31465 | EA | \$191.99 |
| Samsung SF-550P/555P Series Multifunction Laser Supplies | | | | |
| SF-550D3 | Toner (3,000 Yield) | 1743 | CTG | \$109.99 |
| Samsung SF-560/565 Series Multifunction Laser Supplies | | | | |
| SCX-4216D3 | Toner (3,000 Yield) | 1742 | CTG | \$119.99 |
| Samsung SF-560R/565PR Series Multifunction Laser Supplies | | | | |
| SF-D560RA | Toner (3,000 Yield) (Must Not Be Used In SF-560/SF-565P Models) | 100240 | CTG | \$119.99 |
| Samsung SF-650 Series Multifunction Laser Supplies | | | | |
| MLT-D105S | Toner (1,500 Yield) | 19412 | CTG | \$86.99 |
| MLT-D105L | High Yield Toner (2,500 Yield) | 19411 | CTG | \$102.99 |
| MLT-P105A | High Yield Toner Dual Pack (2 Pack of OEM# MLT-D105L) (2 x 2,500 Yield) | 908540 | PK | \$174.99 |
| Samsung SF-830/835 Series Multifunction Laser Supplies | | | | |
| SCX-5312D6 | Toner (6,000 Yield) | 2784 | CTG | \$177.99 |
| SCX-5315R2 | Imaging Unit (15,000 Yield) | 1319 | EA | \$198.99 |
| Samsung C2620DW/C2670FW Color Laser Supplies | | | | |
| CLT-K505L | Black Toner (6,000 Yield) | 930429 | CTG | \$135.99 |
| CLT-C505L | Cyan Toner (3,500 Yield) | 930428 | CTG | \$126.99 |
| CLT-M505L | Magenta Toner (3,500 Yield) | 930430 | CTG | \$126.99 |
| CLT-Y505L | Yellow Toner (3,500 Yield) | 930431 | CTG | \$126.99 |
| Samsung CLP-310/315 Series Color Laser Supplies | | | | |
| CLT-K409S | Black Toner (1,500 Yield) | 902013 | CTG | \$71.99 |
| CLT-C409S | Cyan Toner (1,000 Yield) | 902014 | CTG | \$63.99 |
| CLT-M409S | Magenta Toner (1,000 Yield) | 902015 | CTG | \$63.99 |
| CLT-Y409S | Yellow Toner (1,000 Yield) | 902016 | CTG | \$63.99 |
| CLT-P409B | Black Toner Dual Pack (2 Pack of OEM# CLT-K409S) (2 x 1,500 Yield) | 6542 | PK | \$126.99 |
| CLT-P409A | C/M/Y Toner Combo Pack (Includes 1 Each of OEM# CLT-C409S, CLT-M409S, CLT-Y409S) (3 x 1,000 Yield) | 6541 | PK | \$171.99 |
| CLT-P409C | C/M/Y/K Toner Combo Pack (Includes 1 Each of OEM# CLT-K409S, CLT-C409S, CLT-M409S, CLT-Y409S) (1,500 Yield Black/3 x 1,000 Yield Color) | 19277 | PK | \$223.99 |
| CLT-R409 | Imaging Unit (24,000 Yield Mono/6,000 Yield Color) | 902017 | EA | \$187.99 |
| CLT-W409 | Waste Toner Container | 902018 | EA | \$16.99 |
| Samsung CLP-325/CLX-3185 Series Color Laser Supplies | | | | |
| CLT-K407S | Black Toner (1,500 Yield) | 101292 | CTG | \$71.99 |
| CLT-C407S | Cyan Toner (1,000 Yield) | 101289 | CTG | \$63.99 |
| CLT-M407S | Magenta Toner (1,000 Yield) | 101290 | CTG | \$63.99 |
| CLT-Y407S | Yellow Toner (1,000 Yield) | 101291 | CTG | \$63.99 |
| CLT-P407C | C/M/Y/K Toner Combo Pack (Includes 1 Each of OEM# CLT-C407S, CLT-M407S, CLT-Y407S, CLT-K407S) (1,500 Yield Black/3 x 1,000 Yield Color) | 108344 | PK | \$223.99 |
| CLT-R407 | Imaging Unit (24,000 Yield Black/6,000 Yield Color) | 101306 | EA | \$187.99 |
| Samsung CLP-365/CLX-3305/Xpress C410W/C460FW Series Color Laser Supplies | | | | |
| CLT-K406S | Black Toner (1,500 Yield) | 907039 | CTG | \$68.99 |
| CLT-C406S | Cyan Toner (1,000 Yield) | 907038 | CTG | \$68.99 |
| CLT-M406S | Magenta Toner (1,000 Yield) | 907040 | CTG | \$68.99 |
| CLT-Y406S | Yellow Toner (1,000 Yield) | 907041 | CTG | \$68.99 |
| CLT-R406 | Imaging Unit (16,000 Black/4,000 Color Yield) | 907042 | EA | \$122.99 |
| CLT-W406 | Waste Toner Bottle (7,000 Yield Black/1,750 Yield Color) | 907043 | EA | \$16.99 |
| Samsung CLP-415/CLX-4195 Series Color Laser Supplies | | | | |
| CLT-K504S | Black Toner (2,500 Yield) | 907045 | CTG | \$109.99 |
| CLT-C504S | Cyan Toner (1,800 Yield) | 907044 | CTG | \$114.99 |
| CLT-M504S | Magenta Toner (1,800 Yield) | 907046 | CTG | \$114.99 |
| CLT-Y504S | Yellow Toner (1,800 Yield) | 907047 | CTG | \$114.99 |

| MFG# | Product Description | Part# | UOM | Retail |
|---|---|--------|-----|----------|
| SAMSUNG SUPPLIES | | | | |
| Samsung CLP-610/660 Series Color Laser Supplies | | | | |
| CLP-K660A | Black Toner (2,500 Yield) | 100503 | CTG | \$101.99 |
| CLP-C660A | Cyan Toner (2,000 Yield) | 100504 | CTG | \$122.99 |
| CLP-M660A | Magenta Toner (2,000 Yield) | 100505 | CTG | \$122.99 |
| CLP-Y660A | Yellow Toner (2,000 Yield) | 100506 | CTG | \$122.99 |
| CLP-K660B | High Yield Black Toner (5,500 Yield) | 100513 | CTG | \$153.99 |
| CLP-C660B | High Yield Cyan Toner (5,000 Yield) | 100515 | CTG | \$182.99 |
| CLP-M660B | High Yield Magenta Toner (5,000 Yield) | 100521 | CTG | \$182.99 |
| CLP-Y660B | High Yield Yellow Toner (5,000 Yield) | 100522 | CTG | \$182.99 |
| CLP-T660B | Transfer Belt (50,000 Yield) | 102350 | EA | \$249.99 |
| Samsung CLP-620/670 Color Laser Supplies | | | | |
| CLT-K508S | Black Toner (2,500 Yield) | 20090 | CTG | \$112.49 |
| CLT-C508S | Cyan Toner (2,000 Yield) | 20092 | CTG | \$123.99 |
| CLT-M508S | Magenta Toner (2,000 Yield) | 20094 | CTG | \$123.99 |
| CLT-Y508S | Yellow Toner (2,000 Yield) | 20096 | CTG | \$123.99 |
| CLT-K508L | High Yield Black Toner (5,000 Yield) | 20091 | CTG | \$149.99 |
| CLT-C508L | High Yield Cyan Toner (4,000 Yield) | 20093 | CTG | \$174.99 |
| CLT-M508L | High Yield Magenta Toner (4,000 Yield) | 20095 | CTG | \$174.99 |
| CLT-Y508L | High Yield Yellow Toner (4,000 Yield) | 20097 | CTG | \$174.99 |
| CLT-T508 | Transfer Belt (50,000 Yield) | 20098 | EA | \$248.99 |
| Samsung CLP-680/CLX-6260 Series Color Laser Supplies | | | | |
| CLT-K506S | Black Toner (3,000 Yield) | 907057 | EA | \$79.99 |
| CLT-C506S | Cyan Toner (1,500 Yield) | 907056 | EA | \$98.99 |
| CLT-M506S | Magenta Toner (1,500 Yield) | 907058 | EA | \$98.99 |
| CLT-Y506S | Yellow Toner (1,500 Yield) | 907059 | EA | \$98.99 |
| CLT-K506L | High Yield Black Toner (6,000 Yield) | 907052 | EA | \$176.99 |
| CLT-C506L | High Yield Cyan Toner (3,500 Yield) | 907051 | EA | \$164.99 |
| CLT-M506L | High Yield Magenta Toner (3,500 Yield) | 907053 | EA | \$164.99 |
| CLT-Y506L | High Yield Yellow Toner (3,500 Yield) | 907054 | EA | \$164.99 |
| Samsung CLP-770 Series Color Laser Supplies | | | | |
| CLT-K609S | Black Toner (7,000 Yield) | 12684 | CTG | \$156.99 |
| CLT-C609S | Cyan Toner (7,000 Yield) | 12688 | CTG | \$227.99 |
| CLT-M609S | Magenta Toner (7,000 Yield) | 12692 | CTG | \$227.99 |
| CLT-Y609S | Yellow Toner (7,000 Yield) | 12693 | CTG | \$227.99 |
| CLT-T609 | Transfer Belt (50,000 Yield) | 12694 | EA | \$349.99 |
| Samsung CLX-3170/3175 Series Color Multifunction Laser Supplies | | | | |
| CLT-K409S | Black Toner (1,500 Yield) | 902013 | CTG | \$71.99 |
| CLT-C409S | Cyan Toner (1,000 Yield) | 902014 | CTG | \$63.99 |
| CLT-M409S | Magenta Toner (1,000 Yield) | 902015 | CTG | \$63.99 |
| CLT-Y409S | Yellow Toner (1,000 Yield) | 902016 | CTG | \$63.99 |
| CLT-P409B | Black Toner Dual Pack (2 Pack of OEM# CLT-K409S) (2 x 1,500 Yield) | 6542 | PK | \$126.99 |
| CLT-P409A | C/M/Y Toner Combo Pack (Includes 1 Each of OEM# CLT-C409S, CLT-M409S, CLT-Y409S) (3 x 1,000 Yield) | 6541 | PK | \$171.99 |
| CLT-P409C | C/M/Y/K Toner Combo Pack (Includes 1 Each of OEM# CLT-K409S, CLT-C409S, CLT-M409S, CLT-Y409S) (1,500 Yield Black/3 x 1,000 Yield Color) | 19277 | PK | \$223.99 |
| CLT-R409 | Imaging Unit (24,000 Yield Mono/6,000 Yield Color) | 902017 | EA | \$187.99 |
| CLT-W409 | Waste Toner Container | 902018 | EA | \$16.99 |
| Samsung CLX-6200/6210/6240 Series Color Multifunction Laser Supplies | | | | |
| CLP-K660A | Black Toner (2,500 Yield) | 100503 | CTG | \$101.99 |
| CLP-C660A | Cyan Toner (2,000 Yield) | 100504 | CTG | \$122.99 |
| CLP-M660A | Magenta Toner (2,000 Yield) | 100505 | CTG | \$122.99 |
| CLP-Y660A | Yellow Toner (2,000 Yield) | 100506 | CTG | \$122.99 |
| CLP-K660B | High Yield Black Toner (5,500 Yield) | 100513 | CTG | \$153.99 |
| CLP-C660B | High Yield Cyan Toner (5,000 Yield) | 100515 | CTG | \$182.99 |
| CLP-M660B | High Yield Magenta Toner (5,000 Yield) | 100521 | CTG | \$182.99 |
| CLP-Y660B | High Yield Yellow Toner (5,000 Yield) | 100522 | CTG | \$182.99 |
| CLP-T660B | Transfer Belt (50,000 Yield) | 102350 | EA | \$249.99 |
| Samsung CLX-6220/6250 Series Color Multifunction Laser Supplies | | | | |
| <i>(Continued on next page)</i> | | | | |
| CLT-K508S | Black Toner (2,500 Yield) | 20090 | CTG | \$112.49 |
| CLT-C508S | Cyan Toner (2,000 Yield) | 20092 | CTG | \$123.99 |
| CLT-M508S | Magenta Toner (2,000 Yield) | 20094 | CTG | \$123.99 |
| CLT-Y508S | Yellow Toner (2,000 Yield) | 20096 | CTG | \$123.99 |
| CLT-K508L | High Yield Black Toner (5,000 Yield) | 20091 | CTG | \$149.99 |

| MFG# | Product Description | Part# | UOM | Retail |
|--|--|--------|-----|----------|
| SAMSUNG SUPPLIES | | | | |
| Samsung CLX-6220/6250 Series Color Multifunction Laser Supplies (Continued) | | | | |
| CLT-C508L | High Yield Cyan Toner (4,000 Yield) | 20093 | CTG | \$174.99 |
| CLT-M508L | High Yield Magenta Toner (4,000 Yield) | 20095 | CTG | \$174.99 |
| CLT-Y508L | High Yield Yellow Toner (4,000 Yield) | 20097 | CTG | \$174.99 |
| CLT-T508 | Transfer Belt (50,000 Yield) | 20098 | EA | \$248.99 |
| Samsung CLX-8540 Series Color Multifunction Laser Supplies | | | | |
| CLX-K8540A | Black Toner (20,000 Yield) | 31456 | CTG | \$41.99 |
| CLX-C8540A | Cyan Toner (15,000 Yield) | 31457 | CTG | \$187.99 |
| CLX-M8540A | Magenta Toner (15,000 Yield) | 31458 | CTG | \$187.99 |
| CLX-Y8540A | Yellow Toner (15,000 Yield) | 31459 | CTG | \$187.99 |
| SAVIN SUPPLIES | | | | |
| Savin MLP25/MLP25N/MLP28N Monochrome Laser Supplies | | | | |
| 9894 | Toner (15,000 Yield) (Type 2503) | 5209 | CTG | \$229.76 |
| Savin C2824/C3528/C4535 Color Laser Supplies | | | | |
| 888340 | Black Toner (24,000 Yield) (Type R1) | 91800 | CTG | \$55.50 |
| 888343 | Cyan Toner (10,000 Yield) (Type R1) | 91804 | CTG | \$176.50 |
| 888342 | Magenta Toner (10,000 Yield) (Type R1) | 91803 | CTG | \$176.50 |
| 888341 | Yellow Toner (10,000 Yield) (Type R1) | 91802 | CTG | \$176.50 |
| Savin C3535/C4540 Color Laser Supplies | | | | |
| 841342 | Black Toner (23,000 Yield) | 16144 | CTG | \$72.00 |
| 841345 | Cyan Toner (17,000 Yield) | 16147 | CTG | \$215.00 |
| 841344 | Magenta Toner (17,000 Yield) | 16148 | CTG | \$215.00 |
| 841343 | Yellow Toner (17,000 Yield) | 16149 | CTG | \$215.00 |
| Savin Digital Copier Supplies | | | | |
| 9845 | 2015DP/9918DP Toner (12,000 Yield) (Type AIO-18) | 105942 | CTG | \$199.00 |
| 841332 | 2560/2575/4051/4051SP/4060/4060SP/4075/4075SP/8055/8055SP/8060/8060SP/8065/8065SP/8070/8070SP/8075/8075SP/8080/8080SP/9060/9060SP/9070/9070SP/9080/9080SP/9090/9090SP/MLP175N Toner (43,000 Yield) (Type 6110D/6075) | 17530 | BTL | \$105.00 |
| 828080 | Savin Pro 907EX/1107EX/1357EX Toner (60,000 Yield) | 910277 | CTG | \$109.95 |
| Savin Plain Paper Facsimile Supplies | | | | |
| 430223 | 3651/3687/3705/3720/3740/3740nf AIO Toner (4,500 Yield) (Type 135) | 104630 | CTG | \$109.00 |
| 9851 | 3699/3799/3799nf AIO Toner (10,000 Yield) (Type 500) | 105974 | CTG | \$210.00 |
| 9875 | 3725/3725e/3730/3750/3750nf/3760/3760nf/3770/3770nf Toner (5,000 Yield) (Type 116) | 3117 | CTG | \$85.05 |
| 9839 | 3810/3820 AIO Toner (3,500 Yield) (Type 1175) | 6123 | CTG | \$108.00 |
| 413460 | 3815/SP1000 Toner (4,000 Yield) (Type SP 1000A) | 95191 | CTG | \$127.72 |
| SHARP SUPPLIES | | | | |
| Sharp AR Digital Monochrome Imager Supplies | | | | |
| AR156NT | AR-151/151E/156/F152 Toner (6,500 Yield) | 98459 | CTG | \$74.00 |
| AR202NT | AR-162/163/164/201/207/M160/M162/M205/M207 Toner (13,000 Yield) | 1391 | CTG | \$112.00 |
| AR168NT | AR-168S/168D/153E/157E Toner (8,000 Yield) | 98460 | CTG | \$74.00 |
| AR208NT | AR-208S/208D Toner (8,000 Yield) | 901484 | CTG | \$95.62 |
| AR310NT | AR-235/236/257/275/M208/M237/M277/M317 Toner (25,000 Yield) | 94125 | CTG | \$155.00 |
| ARSC1 | AR-235/275 Staples (3,000 Staples/Ctg) (3 Ctgs/Box) | 2678 | BOX | \$55.00 |
| AR450MT | AR-M280N/M350/M450/P350/P450 Toner (27,000 Yield) | 4080 | CTG | \$119.20 |
| AR-621NTA | AR-M550/M620/M700 Toner (83,000 Yield) | 100569 | CTG | \$123.50 |
| AR455MT | AR-M355N/M355U/M455N/M455U/DM-3551/4551 Toner (35,000 Yield) | 12396 | CTG | \$119.20 |
| Sharp MX-2300N/2700N/3500N/3501N/4501N Color Copier Supplies | | | | |
| MX-27NTBA | Black Toner (18,000 Yield) (For Use in MX-2300/2700/3500 Models) | 20414 | CTG | \$74.00 |
| MX-45NTBA | High Yield Black Toner (36,000 Yield) (For Use in MX-3501/4501 Models) | 93530 | CTG | \$145.00 |
| MX-27NTCA | Cyan Toner (15,000 Yield) | 20417 | CTG | \$145.00 |
| MX-27NTMA | Magenta Toner (15,000 Yield) | 20419 | CTG | \$145.00 |
| MX-27NTYA | Yellow Toner (15,000 Yield) | 20420 | CTG | \$145.00 |
| Sharp MX-2600N/3100N Color Copier Supplies | | | | |
| MX-31NTBA | Black Toner (18,000 Yield) | 904034 | CTG | \$113.08 |
| MX-31NTCA | Cyan Toner (15,000 Yield) | 904035 | CTG | \$223.59 |
| MX-31NTMA | Magenta Toner (15,000 Yield) | 904036 | CTG | \$223.59 |
| MX-31NTYA | Yellow Toner (15,000 Yield) | 904037 | CTG | \$223.59 |

| MFG# | Product Description | Part# | UOM | Retail |
|---|---|--------|-----|----------|
| SHARP SUPPLIES | | | | |
| Sharp MX-4100N/4101N/5000N/5001N Color Copier Supplies | | | | |
| MX-50NTBA | Black Toner (36,000 Yield) | 50135 | CTG | \$85.00 |
| MX-31NTCA | Cyan Toner (15,000 Yield) | 904035 | CTG | \$223.59 |
| MX-31NTMA | Magenta Toner (15,000 Yield) | 904036 | CTG | \$223.59 |
| MX-31NTYA | Yellow Toner (15,000 Yield) | 904037 | CTG | \$223.59 |
| Sharp MX-C311/C400P/C401 Color Copier Supplies | | | | |
| MX-C40NTB | Black Toner (10,000 Yield) | 14224 | CTG | \$38.70 |
| MX-C40NTC | Cyan Toner (10,000 Yield) | 14225 | CTG | \$100.37 |
| MX-C40NTM | Magenta Toner (10,000 Yield) | 14227 | CTG | \$100.37 |
| MX-C40NTY | Yellow Toner (10,000 Yield) | 14226 | CTG | \$100.37 |
| Sharp Monochrome Copier Supplies | | | | |
| MX-206NT | MX-M200D Toner (16,000 Yield) | 99737 | CTG | \$112.00 |
| MX-312NT | MX-M260/264/310/314/354 Toner (25,000 Yield) | 93452 | CTG | \$100.00 |
| MX-312NR | MX-M260/264/310/314/354 Drum (75,000 Yield) | 93453 | EA | \$50.00 |
| MX-500NT | MX-M283N/MX-M363N/MX-M363U/MX-M453N/MX-M453U/MX-M503N/MX-M503U Toner (40,000 Yield) | 34571 | CTG | \$105.00 |
| MX-753NT | MX-M623/753 Toner (83,000 Yield) | 94402 | CTG | \$115.00 |
| MX-B40NT1 | MX-B400P/MX-B401 Toner (10,000 Yield) | 7773 | CTG | \$40.00 |
| Sharp Copier Staples | | | | |
| SFSC11 | SD-2260/SF-2275/4085/AR-280/285/405 Staple Cartridge (5,000 Staples/Ctg, 3 Ctg/Box) | 6165 | BOX | \$62.01 |
| Sharp Personal Fax Supplies | | | | |
| UX15CR | UX-500/510/600M/1000/1100/1300/1400 Imaging Film (500 Yield) | 99419 | EA | \$49.00 |
| Sharp Plain Paper Facsimile Supplies | | | | |
| FO55ND | FO-2080/FO-DC550 Toner (6,000 Yield) | 6093 | CTG | \$134.00 |
| FO55DR | FO-2080/FO-2081/FO-DC550 Drum (20,000 Yield) | 6094 | EA | \$116.48 |
| FO56ND | FO-2081 Toner/Developer (6,000 Yield) | 907013 | CTG | \$132.95 |
| FO29DR | FO-2950M/2970M/3150/3800M Drum (20,000 Yield) | 106503 | EA | \$117.00 |
| FO45ND | FO-4500/5500/5600/6500/6550/6600 Toner/Developer (5,600 Yield) | 97161 | CTG | \$116.00 |
| FO47ND | FO-4650/4700/4970/5550/5700/5800/6700 Toner/Developer (6,000 Yield) | 105253 | CTG | \$134.00 |
| FO47DR | FO-4400/4450/4470/4650/4700/4970/5550/5700/5800/6700/FO-DC500/525/535/600/635 Drum (20,000 Yield) | 105737 | EA | \$103.00 |
| FO50ND | FO-DC500/525/535/600/635/4400/4450/4470 Toner (6,000 Yield) | 1803 | CTG | \$134.00 |
| FO25ND | FO-IS125N Toner (3,000 Yield) | 103305 | CTG | \$97.00 |

SOURCE TECHNOLOGIES SUPPLIES

| | | | | |
|--|---|--------|-----|----------|
| Source Technologies MICR Toner Supplies | | | | |
| STI-204060 | ST9325 MICR Toner (14,000 Yield) | 5398 | CTG | \$399.00 |
| STI-204511 | ST9410/9510 MICR Toner (4,700 Yield) | 30245 | CTG | \$206.00 |
| STI-204512 | ST9512N MICR Toner (5,000 Yield) | 95954 | CTG | \$210.00 |
| STI-24B1423 | ST9512 Photoconductor Kit (20,000 Yield) | 19756 | KIT | \$50.00 |
| STI-204063H | ST9530 MICR Toner (15,000 Yield) | 29600 | CTG | \$399.00 |
| STI-204513 | ST9612/9620/9622 MICR Toner (3,000 Yield) | 27137 | CTG | \$165.00 |
| LEX-24B1080 | ST9612/ST9620 Photoconductor Kit | 90339 | EA | \$67.00 |
| STI-204513H | ST9620/9622 MICR Toner (10,000 Yield) | 27140 | CTG | \$300.00 |
| STI-204064 | ST9630/9650/9652 MICR Toner (8,000 Yield) | 27138 | CTG | \$280.00 |
| STI-204064H | ST9630/9650 MICR Toner (15,000 Yield) | 17952 | CTG | \$400.00 |
| STI-204514 | ST9712/ST9715/ST9717/ST9720/ST9722 MICR Toner (Drum Not Included) (5,000 Yield) | 913036 | CTG | \$275.00 |
| STI-204514H | ST9720/ST9722 High Yield MICR Toner (Drum Not Included) (12,000 Yield) | 913040 | CTG | \$360.00 |
| STI-24B6237 | ST9712/ST9715/ST9717/9720/9722 Imaging Unit (40,000 Yield) | 913073 | CTG | \$57.00 |
| STI-204065H | ST9730 High Yield MICR Toner (Drum Not Included) (17,000 Yield) | 913041 | CTG | \$432.00 |
| STI-24B6238 | ST9730 Imaging Unit (70,000 Yield) | 913074 | CTG | \$75.00 |



Cutting-edge security features and magnetic ink character recognition (MICR) printers from Source Technologies are engineered specifically to print checks and negotiable documents. Banish costly pre-printed stock and offer the greatest protection from fraud.



| MFG# | Product Description | Part# | UOM | Retail |
|--|--|-------|-----|----------|
| TALLY GENICOM SUPPLIES | | | | |
| Genicom Branded Ribbons | | | | |
| 3A0100B02 | 3800/3900 Series Black Fabric Ribbon (15M Characters) | 29032 | RBN | \$56.00 |
| 3A1600B21 | 3860/3880 Black Fabric Ribbon (15M Characters) | 1986 | RBN | \$56.00 |
| 3A1600B22 | 3860/3880 Black Fabric Long Life Ribbon with Re-Inker (25M Characters) | 1985 | RBN | \$72.00 |
| 44A507014-G08B | 4410/4440/4500 Black Fabric Ribbon with Weld Sensor Hole (50M Characters) (Interchangeable with Digital LG31) | 29009 | RBN | \$86.00 |
| 44A509160-G03 | 4470/4490/4570/4590/5180 Black Fabric Ribbon Cartridge (50M Characters) | 29037 | RBN | \$123.00 |
| 4A0040B02 | 4800/4810/4810+/4840/4840+/4842/4900/4910/4910+/4912/4940/4940+/4942/5050/ 5100 Series Black Fabric Ribbon Cartridge with Re-Inker (50M Characters) | 29058 | RBN | \$55.00 |
| 4A0040B05 | 4800/4810/4810+/4840/4840+/4842/4900/4910/4910+/4912/4940/4940+/4942/5050/ 5100 Series Black Fabric Ribbon Cartridge with Re-Inker (75M Characters) | 29057 | RBN | \$71.00 |
| 4A0040B13 | 4800/4810/4810+/4840/4840+/4842/4900/4910/4910+/4912/4940/4940+/4942/5050/ 5100 Series Black Fabric Ribbon Cartridge (25M Characters) | 4824 | RBN | \$47.00 |
| Tally/TallyGenicom Branded Impact Printer Ribbons | | | | |
| 062471 | 2265+/2280+/2365/2380/7265/7265+ Black Ribbon (Includes Ribbon Motion Sensor) (20M Characters) | 15151 | RBN | \$43.10 |
| 1A3000B01 | 3460/3470/3480/3570/3850 Black Fabric Ribbon (Interchangeable with Compaq 126336-B21 or Digital LA4OR-KA) (9M Characters) | 29056 | RBN | \$76.00 |
| 086039 | 6306/6312/LGe06/LGe12/LGi12/LGi15/LGL06/LGL12/LOGi18 Black Ribbon (40M Characters) | 6080 | RBN | \$72.00 |
| 086041 | 6312/LGe12/LGi12/LGi1500/LGi1800/LGL12 Black Smart Ribbon (60M Characters) | 6081 | RBN | \$89.00 |
| 086043 | 6312/LGe12/LGi12/LGi1500/LGi1800/LGL12 Black Smart Ribbon (250M Characters) | 6459 | RBN | \$212.00 |
| 082727 | LGi12/LGi15/LGi18/T6212/T6215/T6218 Black Ribbon (40M Characters) | 30644 | RBN | \$72.00 |
| 083683 | LGi12/LGi15/LGi18/T6212/T6215/T6218 Black Smart Ribbon (60M Characters) (4/Box) | 30643 | BOX | \$404.00 |
| 082725 | LGi12/LGi15/LGi18/T6212/T6215/T6218 Black Smart Ribbon (250M Characters) (4/Box) | 13535 | BOX | \$728.00 |
| 060097 | MT230/MT330/MT340/MT350/MT360/MT380/MT400/T2045/T2060/T2155/T2170/ T2265/T2280 Black Ribbon (20M Characters) | 30625 | RBN | \$45.76 |
| 080294 | MT600/MT645/MT660/MT661/MT681/MT690/MT691/T6045/T6082/T6090/T6091/T6092/ T6140/T6142/T6050/T6065/T6100/T6101 Black Ribbon (25M Characters) (4/Box) | 30626 | BOX | \$196.00 |
| 044829 | T2030/T2240 Black Ribbon (4M Characters) (6 Rbn/Box) | 30578 | BOX | \$142.68 |
| 060426 | T2040/T2145/T2150 Black Ribbon (3.6M Characters) | 21471 | RBN | \$23.50 |
| 044830 | T2130/T2340 Black Ribbon (4M Characters) | 30661 | RBN | \$27.03 |
| 060425 | T2140/T2245/T2250 Black Ribbon (5M Characters) | 30601 | RBN | \$27.00 |
| Tally/TallyGenicom Branded Laser Supplies | | | | |
| 043849 | 9045N Standard Yield Toner (13,000 Yield) | 94988 | CTG | \$245.00 |

TEXAS INSTRUMENTS SUPPLIES**Texas Instruments Ribbons**

| | | | | |
|--------------|--|-------|-----|---------|
| 2246601-0003 | 810/820/880/885 40-Yard Black Ribbon (7M Characters) | 34525 | RBN | \$8.93 |
| 1A3066B01 | 8920/8930 33-Yard Black Ribbon (15M Characters) | 6112 | RBN | \$33.49 |

TOSHIBA SUPPLIES**Toshiba Monochrome Copier Supplies** *(Continued on next page)*

| | | | | |
|--------|---|--------|-----|----------|
| T1350 | BD 1340/1350/1360/1370 Toner (4,300 Yield) (4 x 180-gm. Ctgs/Ctn) | 94190 | CTN | \$148.00 |
| T2060 | BD 2060/2860/2870 Toner (7,500 Yield) | 913461 | CTG | \$19.29 |
| T1600 | e-STUDIO16/160 Toner (5,000 Yield) (2 x 335-gm. Ctgs/Ctn) | 4274 | CTN | \$90.00 |
| T2500 | e-STUDIO20/25/200/250 Toner (7,500 Yield) (2 x 0.5-lb. Ctgs/Ctn) | 4099 | CTN | \$83.75 |
| T3500 | e-STUDIO28/35/45 Toner (13,500 Yield) (4 Ctgs/Ctn) | 4985 | CTN | \$145.05 |
| ZT500F | e-STUDIO50F Toner (6,000 Yield) | 5388 | CTG | \$99.00 |
| T1200E | e-STUDIO120/150/162/162D Toner (8,000 Yield) (1 Ctg/Ctn) | 1846 | CTN | \$75.00 |
| T-1910 | e-STUDIO191F Toner (10,000 Yield) | 905452 | CTG | \$149.99 |
| T2450 | e-STUDIO195/223/225/243/245 Toner (24,000 Yield) | 913482 | CTG | \$105.05 |
| T2340 | e-STUDIO202L/232/282 Toner (23,000 Yield) (4 Ctgs/Ctn) | 900367 | CTN | \$340.00 |
| T2021 | e-STUDIO202S/203S/203SD Toner (8,000 Yield) | 99864 | CTG | \$59.39 |
| T4530 | e-STUDIO205L/205SE/255/255SE/305/305SE/355/455 Toner (30,000 Yield) | 93719 | CTG | \$75.00 |
| T4590 | e-STUDIO206L/256/306/356/456/506 Toner (36,600 Yield) | 912230 | CTG | \$125.99 |
| T5070U | e-STUDIO207L/257/307/357/457/507 Toner (36,600 Yield) | 926821 | CTG | \$99.00 |
| T2320 | e-STUDIO230/280 Toner (22,000 Yield) (4 Ctg/Ctn) | 11984 | CTN | \$320.00 |
| T2840 | e-STUDIO203L/233/283 Toner (23,000 Yield) | 905093 | CTG | \$86.40 |
| T3520 | e-STUDIO350/450 Toner (72,000 Yield) (4 Ctgs/Ctn) | 5816 | CTN | \$189.00 |
| T4520 | e-STUDIO353/453 Toner (21,000 Yield) (4 Ctgs/Ctn) | 902879 | CTN | \$230.38 |
| TB3520 | e-STUDIO350/352/353/450/452/453 Waste Toner Bags (4 Bags/Ctn) | 12192 | CTN | \$25.00 |
| T4710U | e-STUDIO477s/527s Toner (36,000 Yield) | 914888 | CTG | \$201.25 |
| T8550 | e-STUDIO555/655/755/855 Toner (62,400 Yield) | 93720 | CTG | \$97.00 |
| T8560 | e-STUDIO556/656/756/856 Toner (73,900 Yield) | 901128 | CTG | \$159.99 |
| T8570U | e-STUDIO557/657/757/857 Toner (73,900 Yield) | 926827 | CTG | \$159.00 |

| MFG# | Product Description | Part# | UOM | Retail |
|--|---|--------|-----|----------|
| TOSHIBA SUPPLIES | | | | |
| Toshiba Monochrome Copier Supplies (Continued) | | | | |
| T2507U | e-STUDIO2306 Toner (10,000 Yield) | 914886 | CTG | \$43.75 |
| T2505U | e-STUDIO2505f/2505h Toner (10,000 Yield) | 914885 | CTG | \$59.50 |
| Toshiba e-STUDIO170F Copier Supplies | | | | |
| ZT170F | Toner (6,000 Yield) | 10496 | CTG | \$160.00 |
| OD170F | Drum (20,000 Yield) | 10864 | EA | \$150.00 |
| Toshiba e-STUDIO281c/351c/451c Color Copier Supplies | | | | |
| T281CK | Black Toner (27,000 Yield) | 913487 | CTG | \$44.67 |
| T281CC | Cyan Toner (10,000 Yield) | 913486 | CTG | \$81.89 |
| T281CM | Magenta Toner (10,000 Yield) | 913488 | CTG | \$81.89 |
| T281CY | Yellow Toner (10,000 Yield) | 913489 | CTG | \$81.89 |
| Toshiba e-STUDIO287cs/347cs/407cs Color Copier Supplies | | | | |
| TFC34UK | Black Toner (15,000 Yield) (1 Btl/Ctn) | 912978 | CTN | \$102.00 |
| TFC34UC | Cyan Toner (11,500 Yield) (1 Btl/Ctn) | 912979 | CTN | \$185.00 |
| TFC34UM | Magenta Toner (11,500 Yield) (1 Btl/Ctn) | 912980 | CTN | \$185.00 |
| TFC34UY | Yellow Toner (11,500 Yield) (1 Btl/Ctn) | 912981 | CTN | \$185.00 |
| ODFC34K | Black Drum (30,000 Yield) | 912982 | EA | \$175.00 |
| ODFC34C | Cyan Drum (30,000 Yield) | 912983 | EA | \$175.00 |
| ODFC34M | Magenta Drum (30,000 Yield) | 912984 | EA | \$175.00 |
| ODFC34Y | Yellow Drum (30,000 Yield) | 912985 | EA | \$175.00 |
| Toshiba e-STUDIO2040c/2540c/3040c/3540c/4540c Color Copier Supplies | | | | |
| TFC25K | Black Toner (34,200 Yield) | 500038 | CTG | \$79.99 |
| TFC25C | Cyan Toner (26,800 Yield) | 506981 | CTG | \$229.00 |
| TFC25M | Magenta Toner (26,800 Yield) | 506996 | CTG | \$229.00 |
| TFC25Y | Yellow Toner (26,800 Yield) | 507009 | CTG | \$229.00 |
| Toshiba e-STUDIO2050c/2051c/2550c/2551c Color Copier Supplies | | | | |
| TFC30UK | Black Toner (32,000 Yield) | 913476 | CTG | \$85.50 |
| TFC30UC | Cyan Toner (28,000 Yield) | 912231 | CTG | \$229.00 |
| TFC30UM | Magenta Toner (28,000 Yield) | 912232 | CTG | \$229.00 |
| TFC30UY | Yellow Toner (28,000 Yield) | 912233 | CTG | \$229.00 |
| Toshiba e-STUDIO2330c/2830c/3530c/4520c Color Copier Supplies | | | | |
| TFC28K | Black Toner (29,000 Yield) | 902595 | EA | \$102.03 |
| TFC28C | Cyan Toner (24,000 Yield) | 902596 | EA | \$260.29 |
| TFC28M | Magenta Toner (24,000 Yield) | 902597 | EA | \$260.29 |
| TFC28Y | Yellow Toner (24,000 Yield) | 902598 | EA | \$260.29 |
| TBFC28 | Waste Toner Bottle (112,000 Yield Black/30,000 Yield Color) | 93743 | BTL | \$80.00 |
| Toshiba e-STUDIO2500c/3500c/3510c Color Copier Supplies | | | | |
| TFC35K | Black Toner (24,000 Yield) | 94114 | CTG | \$98.95 |
| TFC35C | Cyan Toner (21,000 Yield) | 94115 | CTG | \$259.95 |
| TFC35M | Magenta Toner (21,000 Yield) | 94116 | CTG | \$259.95 |
| TFC35Y | Yellow Toner (21,000 Yield) | 94117 | CTG | \$259.95 |
| TBFC35 | Waste Toner Bottle | 12508 | EA | \$99.00 |
| Toshiba e-STUDIO2555c/3055c/3555c/4555c/5055c Color Copier Supplies | | | | |
| TFC50UK | Black Toner (32,000 Yield) | 914892 | CTG | \$78.75 |
| TFC50UC | Cyan Toner (28,000 Yield) | 914891 | CTG | \$173.25 |
| TFC50UM | Magenta Toner (28,000 Yield) | 914893 | CTG | \$173.25 |
| TFC50UY | Yellow Toner (28,000 Yield) | 914894 | CTG | \$173.25 |
| Toshiba e-STUDIO5520c/6520c/6530c Color Copier Supplies | | | | |
| TFC55K | Black Toner (73,000 Yield) | 93721 | CTG | \$165.00 |
| TFC55C | Cyan Toner (26,500 Yield) | 93722 | CTG | \$240.00 |
| TFC55M | Magenta Toner (26,500 Yield) | 93728 | CTG | \$240.00 |
| TFC55Y | Yellow Toner (26,500 Yield) | 93730 | CTG | \$240.00 |
| TBFC55 | Waste Toner Bottle (120,000 Yield Black/30,000 Yield Color) | 93745 | BTL | \$60.00 |
| Toshiba e-STUDIO5540c/6540c/6550c Color Copier Supplies | | | | |
| TFC65K | Black Toner (77,400 Yield) | 901133 | EA | \$199.99 |
| TFC65C | Cyan Toner (29,500 Yield) | 901130 | EA | \$275.99 |
| TFC65M | Magenta Toner (29,500 Yield) | 901131 | EA | \$275.99 |
| TFC65Y | Yellow Toner (29,500 Yield) | 901132 | EA | \$275.99 |

| MFG# | Product Description | Part# | UOM | Retail |
|---|--|--------|-----|----------|
| TOSHIBA SUPPLIES | | | | |
| Toshiba Plain Paper Facsimile Supplies | | | | |
| TK-18 | DP80F/DP85F Toner (6,000 Yield) | 106912 | CTG | \$150.00 |
| DK-18 | DP80F/DP85F Drum (20,000 Yield) | 106913 | EA | \$90.00 |
| TK-15 | DP120F/DP125F Toner (3,800 Yield) | 107107 | CTG | \$34.50 |
| DK-15 | DP120F/DP125F Drum (10,000 Yield) | 107108 | EA | \$186.50 |
| ZT170F | e-STUDIO170F Toner (6,000 Yield) | 10496 | CTG | \$160.00 |
| T1900 | e-STUDIO190F Toner/Drum/Developer Cartridge (10,000 Yield) | 94263 | CTG | \$356.59 |

| TROY SUPPLIES | | | | |
|---|--|--------|-----|----------|
| TROY MICR Toner (Continued on next page) | | | | |
| 02-81550-001 | 401 MICR Toner Secure Cartridge (2,700 Yield) (Compatible with HP LaserJet Pro 400 M401 Printers, HP Toner OEM# CF280A) | 906925 | CTG | \$184.00 |
| 02-81551-001 | 401 High Yield MICR Toner Secure Cartridge (6,800 Yield) (Compatible with HP LaserJet Pro 400 M401 Printers, HP Toner OEM# CF280X) | 906926 | CTG | \$275.00 |
| 02-81350-001 | 601/602/603 Series MICR Toner Secure Cartridge (10,000 Yield) (Compatible with HP LaserJet M601/M602/M603 Series Printers, HP Toner OEM# CE390A) | 506704 | CTG | \$342.00 |
| 02-81351-001 | 602/603 High Yield MICR Toner Secure Cartridge (24,000 Yield) (Compatible with HP LaserJet M602/M603 Series Printers, HP Toner OEM# CE390X) | 506705 | CTG | \$550.00 |
| 02-18944-001 | 617/4000/4050 High Yield MICR Toner Secure Cartridge (10,000 Yield) (Compatible with HP LaserJet 4000/4050 Printers, HP Toner OEM# C4127X) | 107838 | CTG | \$265.00 |
| 02-81128-001 | 1300 MICR Toner (3,000 Yield) (Compatible with HP LaserJet 1300 Printer, HP Toner OEM# Q2613A) | 1455 | CTG | \$162.00 |
| 02-81036-001 | 1320 MICR Toner Secure Cartridge (2,500 Yield) (Compatible with HP LaserJet 1160/1320 Printers, HP Toner OEM# Q5949A) | 6436 | CTG | \$139.00 |
| 02-81037-001 | 1320 High Yield MICR Toner Secure Cartridge (6,000 Yield) (Compatible with HP LaserJet 1320 Printer, HP Toner OEM# Q5949X) | 6437 | CTG | \$239.00 |
| 02-82000-001 | 1606 MICR Toner Secure Cartridge (2,100 Yield) (Compatible with HP LaserJet Pro P1606 Printer, HP Toner OEM# CE278A) | 35742 | CTG | \$164.00 |
| 02-81212-001 | 2015 MICR Toner Secure Cartridge (3,000 Yield) (Compatible with HP LaserJet P2015 Printers, HP Toner OEM# Q7553A) | 91596 | CTG | \$166.00 |
| 02-81213-001 | 2015 High Yield MICR Toner Secure Cartridge (7,000 Yield) (Compatible with HP LaserJet P2015 Printers, HP Toner OEM# Q7553X) | 93475 | CTG | \$276.00 |
| 02-81500-001 | 2035/2055 MICR Toner Secure Cartridge (2,300 Yield) (Compatible with HP LaserJet P2035/P2055 Printers, HP Toner OEM# CE505A) | 904228 | CTG | \$170.00 |
| 02-81501-001 | 2055 High Yield MICR Toner Secure Cartridge (6,500 Yield) (Compatible with HP LaserJet P2055 Printers, HP Toner OEM# CE505X) | 904229 | CTG | \$265.00 |
| 02-81038-001 | 2100/2200 MICR Toner (5,000 Yield) (Compatible with HP LaserJet 2100/2200 Printers, HP Toner OEM# C4096A) | 104101 | CTG | \$210.00 |
| 02-81127-001 | 2300 MICR Toner Secure Cartridge (6,000 Yield) (Compatible with HP LaserJet 2300 Printer, HP Toner OEM# Q2610A) | 1654 | CTG | \$252.00 |
| 02-81133-001 | 2420/2430 MICR Toner Secure Cartridge (6,000 Yield) (Compatible with HP LaserJet 2420/2430 Printers, HP Toner OEM# Q6511A) | 23330 | CTG | \$225.00 |
| 02-81134-001 | 2420/2430 High Yield MICR Toner Secure Cartridge (12,000 Yield) (Compatible with HP LaserJet 2420/2430 Printers, HP Toner OEM# Q6511X) | 6202 | CTG | \$385.00 |
| 02-81201-001 | 3005 MICR Toner Secure Cartridge (6,500 Yield) (Compatible with HP LaserJet M3027 MFP/M3035 MFP/P3005 Printer, HP Toner OEM# Q7551A) | 30360 | CTG | \$248.00 |
| 02-81200-001 | 3005 High Yield MICR Toner Secure Cartridge (13,000 Yield) (Compatible with HP LaserJet M3027 MFP/M3035 MFP/P3005 Printer, HP Toner OEM# Q7551X) | 92953 | CTG | \$416.00 |
| 02-81300-001 | 4014/4015/4515 MICR Toner Secure Cartridge (10,000 Yield) (Compatible with HP P4014/P4015/P4515 Printers, HP Toner OEM# CC364A) | 900741 | CTG | \$342.00 |
| 02-81301-001 | 4015/4515 High Yield MICR Toner Secure Cartridge (24,000 Yield) (Compatible with HP P4015/P4515 Printers, HP Toner OEM# CC364X) | 900744 | CTG | \$575.00 |
| 02-81078-001 | 4100 High Yield MICR Toner Secure Cartridge (10,000 Yield) (Compatible with HP 4100 Printer, HP Toner OEM# C8061X) | 108155 | CTG | \$270.00 |
| 02-81118-001 | 4200 MICR Toner Secure Cartridge (13,500 Yield) (Compatible with HP LaserJet 4200 Printer, HP Toner OEM# Q1338A) | 2216 | CTG | \$325.00 |



Based on the renowned HP LaserJet technology, TROY MICR and security printing deliver the ultimate level of security for all applications. TROY offers breakthrough innovations in fraud-deterrent security, unsurpassed quality and operational controls, and flexible integration.



ARE YOU AT RISK?

Many important documents used every day are targets for fraud. Identity documents, legal contracts, education transcripts, inspection certificates, insurance documents, vehicle registrations, and titles are just a few of the documents which can be at risk for forgery.

TROY offers multiple toner options for enhancing the security of valuable printed documents. From patented Security Toner to guard against alteration to SecureUV and UV Toner to provide an easy method for authentication, TROY Solutions help guard your organization against the costs of document fraud.

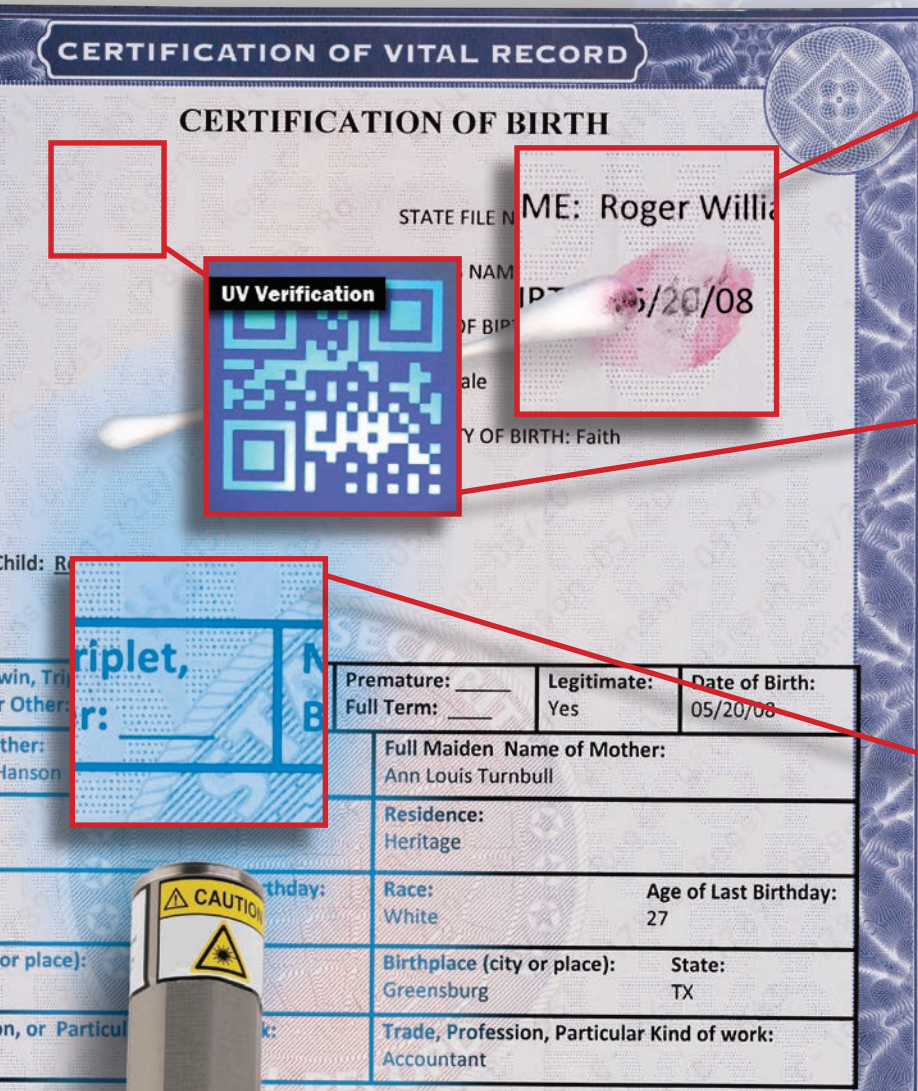

TROY Security Toner

Patented anti-fraud technology forces a red stain to appear on a document if fraudulent alteration of personal information is attempted using solvents.

TROY SecureUV

Prints invisible security features which are only visible under UV light. Any combination of barcodes, text, or graphics can be printed in invisible UV at the same time as the normal black print portions of any document.

TROY UV Toner

Special UV toner available for document authentication and MICR applications. Appears as normal black print but fluoresces blue under UV verification light.

Business Partner



TROY®

| MFG# | Product Description | Part# | UOM | Retail |
|--|---|--------|-----|----------|
| TROY SUPPLIES | | | | |
| TROY MICR Toner (Continued) | | | | |
| 02-81136-001 | 4250/4350 High Yield MICR Toner Secure Cartridge (20,000 Yield) (Compatible with HP LaserJet 4250/4350 Printers, HP Toner OEM# Q5942X) | 6201 | CTG | \$450.00 |
| 02-81119-001 | 4300 MICR Toner (19,500 Yield) (Compatible with HP LJ 4300 Printer, HP Toner OEM# Q1339A) | 2165 | CTG | \$445.00 |
| 02-81023-001 | 8100/8150 MICR Toner Secure Cartridge (25,000 Yield) (Compatible with HP LaserJet 8100/8150 Printers, HP Toner OEM# C4182X) | 104094 | CTG | \$450.00 |
| 02-81081-001 | 9000/9050 MICR Toner Secure Series Advance Formula Cartridge (35,000 Yield) (Compatible with HP LaserJet 9000/9040/9050 Printers, HP Toner OEM# C8543X) | 4686 | CTG | \$599.00 |
| 02-81600-001 | M525/P3015 MICR Toner Secure Cartridge (6,000 Yield) (Compatible with HP LaserJet P3015 Printer, HP Toner OEM# CE255A) | 17738 | CTG | \$245.00 |
| 02-81601-001 | M525/P3015 High Yield MICR Toner Secure Cartridge (12,500 Yield) (Compatible with HP LaserJet P3015 Printer, HP Toner OEM# CE255X) | 17739 | CTG | \$400.00 |
| 02-72344-001P | ST9530/ST9550 MICR Toner (OEM# STI-204063H) (15,000 Yield) (Compatible with ST9550 Printer) | 910112 | CTG | \$344.62 |
| 02-72339-001P | ST9630/ST9650 MICR Toner (OEM# STI-204064H) (15,000 Yield) (Compatible with ST9630/ST9650 Printers) | 910110 | CTG | \$366.15 |
| 02-72361-001P | T64x Series MICR Toner (OEM# 64037HR) (15,000 Yield) (Compatible with Lexmark T64x Series) | 910116 | CTG | \$247.69 |
| 02-72360-001P | T650 Series MICR Toner (OEM# T650A21P) (15,000 Yield) (Compatible with Lexmark T650 Series) | 910115 | CTG | \$344.62 |
| TROY Tamper-Evident Security Toner | | | | |
| 02-81350-700 | 601/602/603 Series Security Toner (10,000 Yield) (Compatible with HP LJ M601/M602/M603 Series, HP Toner OEM# CE390A) | 910490 | CTG | \$226.00 |
| 02-81351-700 | 602/603 Series High Yield Security Toner (24,000 Yield) (Compatible with HP LJ M602/M603 Series, HP Toner OEM# CE390X) | 910491 | CTG | \$363.00 |
| XANTE SUPPLIES | | | | |
| Xante Laser Supplies | | | | |
| 200-100041 | Accel-a-Writer 3/3G/3N/4G/4N/Platemaker 4/Screen Writer 4 Toner (14,000 Yield) | 103539 | CTG | \$300.00 |
| XEROX SUPPLIES | | | | |
| Genuine Xerox Phaser® 3040/WorkCentre® 3045 Laser Supplies | | | | |
| 106R02180 | Toner (1,000 Yield) | 916549 | CTG | \$61.68 |
| Genuine Xerox Phaser® 3100MFP Laser Supplies | | | | |
| 106R01378 | Toner (2,200 Yield) | 900786 | CTG | \$141.00 |
| 106R01379 | High Capacity Toner (4,000 Yield) | 900787 | CTG | \$194.00 |
| Genuine Xerox Phaser® 3117/3122/3124/3125 Laser Supplies | | | | |
| 106R01159 | Toner (3,000 Yield) | 90431 | CTG | \$139.00 |
| Genuine Xerox Phaser® 3150 Laser Supplies | | | | |
| 109R00746 | Toner (3,500 Yield) | 6068 | CTG | \$139.00 |
| 109R00747 | High Capacity Toner (5,000 Yield) | 6069 | CTG | \$161.00 |
| Genuine Xerox Phaser® 3200MFP Laser Supplies | | | | |
| 113R00730 | High Capacity Toner (3,000 Yield) | 94678 | CTG | \$146.09 |
| Genuine Xerox Phaser® 3250 Laser Supplies | | | | |
| 106R01373 | Toner (3,500 Yield) | 900784 | CTG | \$140.70 |
| 106R01374 | High Capacity Toner (5,000 Yield) | 900785 | CTG | \$155.00 |
| Genuine Xerox Phaser® 3260/WorkCentre® 3215/3225 Laser Supplies | | | | |
| 106R02775 | Toner (1,500 Yield) | 930622 | CTG | \$71.00 |
| 106R02777 | High Capacity Toner (3,000 Yield) | 930623 | CTG | \$112.00 |
| 101R00474 | Drum Cartridge (10,000 Yield) | 930620 | EA | \$88.00 |
| Genuine Xerox Phaser® 3300MFP Laser Supplies | | | | |
| 106R01411 | Toner (4,000 Yield) | 903138 | CTG | \$153.92 |
| 106R01412 | High Capacity Toner (8,000 Yield) | 903139 | CTG | \$234.33 |
| Genuine Xerox Phaser® 3320 Laser Supplies | | | | |
| 106R02305 | Toner (5,000 Yield) | 906415 | CTG | \$221.00 |
| 106R02307 | High Capacity Toner (11,000 Yield) | 906416 | CTG | \$339.00 |

| MFG# | Product Description | Part# | UOM | Retail |
|---|---|--------|-----|----------|
| XEROX SUPPLIES | | | | |
| Genuine Xerox Phaser® 3450 Laser Supplies | | | | |
| 106R00688 | High Capacity Toner (10,000 Yield) | 1444 | CTG | \$314.00 |
| Genuine Xerox Phaser® 3500 Laser Supplies | | | | |
| 106R01148 | Toner (6,000 Yield) | 11945 | CTG | \$219.00 |
| 106R01149 | High Capacity Toner (12,000 Yield) | 11946 | CTG | \$328.00 |
| Genuine Xerox Phaser® 3600 Laser Supplies | | | | |
| 106R01370 | Toner (7,000 Yield) | 900782 | CTG | \$245.26 |
| 106R01371 | High Capacity Toner (14,000 Yield) | 900783 | CTG | \$360.00 |
| 106R02639 | High Capacity Toner (14,000 Yield) (TAA Compliant Version of OEM# 106R01371) | 908682 | CTG | \$360.00 |
| Genuine Xerox Phaser® 3610/WorkCentre® 3615 Laser Supplies | | | | |
| 106R02720 | Toner (5,900 Yield) | 915009 | CTG | \$215.00 |
| 106R02722 | High Capacity Toner (14,100 Yield) | 915008 | CTG | \$400.00 |
| 106R02731 | Extra High Capacity Toner (25,300 Yield) | 915007 | CTG | \$541.00 |
| 113R00773 | Drum (85,000 Yield) | 915024 | EA | \$107.00 |
| 115R00084 | Fuser Maintenance Kit (110V) (Includes Fuser, Bias Transfer Roller) (200,000 Yield) | 915025 | KIT | \$400.00 |
| Genuine Xerox Phaser® 3635MFP Laser Supplies | | | | |
| 108R00793 | Toner (5,000 Yield) | 900779 | CTG | \$171.00 |
| 108R00795 | High Capacity Toner (10,000 Yield) | 900780 | CTG | \$237.00 |
| Genuine Xerox Phaser® 4400 Laser Supplies | | | | |
| 113R00628 | High Capacity Toner (15,000 Yield) | 2930 | CTG | \$318.00 |
| 108R00497 | Maintenance Kit (110V) (200,000 Yield) | 2929 | KIT | \$444.00 |
| Genuine Xerox Phaser® 4500 Laser Supplies | | | | |
| 113R00656 | Toner (10,000 Yield) | 5068 | CTG | \$272.68 |
| 113R00657 | High Capacity Toner (18,000 Yield) | 5069 | CTG | \$381.00 |
| 108R00600 | Maintenance Kit (110V) (200,000 Yield) | 5070 | KIT | \$423.00 |
| Genuine Xerox Phaser® 4510 Laser Supplies | | | | |
| 113R00711 | Toner (10,000 Yield) | 92007 | CTG | \$267.44 |
| 113R00712 | High Capacity Toner (19,000 Yield) | 92008 | CTG | \$360.00 |
| 108R00717 | Maintenance Kit (110V) (200,000 Yield) | 92009 | KIT | \$408.00 |
| Genuine Xerox Phaser® 4600/4620/4622 Laser Supplies | | | | |
| 106R01533 | Toner (13,000 Yield) | 99897 | CTG | \$293.00 |
| 106R01535 | High Capacity Toner (30,000 Yield) | 99899 | CTG | \$468.00 |
| 106R02638 | High Capacity Toner (30,000 Yield) (TAA Compliant Version of OEM# 106R01535) | 908686 | CTG | \$468.00 |
| 113R00762 | Drum (80,000 Yield) | 99905 | EA | \$293.00 |
| 113R00769 | Drum (80,000 Yield) (TAA Compliant Version of OEM# 113R00762) | 908687 | EA | \$293.00 |
| 115R00069 | Maintenance Kit (110V) (150,000 Yield) | 99906 | KIT | \$212.00 |
| Genuine Xerox Phaser® 5500 Laser Supplies | | | | |
| 113R00668 | Toner (30,000 Yield) | 6070 | CTG | \$202.67 |
| 113R00670 | Drum (60,000 Yield) | 6071 | EA | \$468.32 |
| 109R00731 | Maintenance Kit (110V) (Includes Fuser, Transfer Roller, 15 Feed Rollers) (300,000 Yield) | 6072 | KIT | \$712.38 |
| 008R12941 | Staple Refill Pack (3 x 5,000 Yield) | 13047 | PK | \$168.85 |
| Genuine Xerox Phaser® 5550 Laser Supplies | | | | |
| 106R01294 | Toner (35,000 Yield) | 900778 | CTG | \$194.00 |
| 113R00670 | Drum (60,000 Yield) | 6071 | EA | \$468.32 |
| 109R00731 | Maintenance Kit (110V) (Includes Fuser, Transfer Roller, 15 Feed Rollers) (300,000 Yield) | 6072 | KIT | \$712.38 |
| 008R12941 | Staple Refill Pack (3 x 5,000 Yield) | 13047 | PK | \$168.85 |
| Genuine Xerox Phaser® 6000/6010/WorkCentre® 6015 Color Laser Supplies | | | | |
| 106R01630 | Black Toner (2,000 Yield) | 97729 | CTG | \$96.48 |
| 106R01627 | Cyan Toner (1,000 Yield) | 97723 | CTG | \$82.70 |
| 106R01628 | Magenta Toner (1,000 Yield) | 97724 | CTG | \$82.70 |
| 106R01629 | Yellow Toner (1,000 Yield) | 97728 | CTG | \$82.70 |
| Genuine Xerox Phaser® 6120 Color Laser Supplies (Continued on next page) | | | | |
| 113R00692 | High Capacity Black Toner (4,500 Yield) | 12240 | CTG | \$164.00 |
| 113R00693 | High Capacity Cyan Toner (4,500 Yield) | 12241 | CTG | \$253.00 |
| 113R00695 | High Capacity Magenta Toner (4,500 Yield) | 12242 | CTG | \$253.00 |

| MFG# | Product Description | Part# | UOM | Retail |
|--|---|--------|-----|----------|
| XEROX SUPPLIES | | | | |
| Genuine Xerox Phaser® 6120 Color Laser Supplies <i>(Continued)</i> | | | | |
| 113R00694 | High Capacity Yellow Toner (4,500 Yield) | 12243 | CTG | \$253.00 |
| 108R00691 | Imaging Unit (Mono 20,000/Color 10,000 Yield) | 12245 | EA | \$277.00 |
| Genuine Xerox Phaser® 6125 Color Laser Supplies | | | | |
| 106R01334 | Black Toner (2,000 Yield) | 104235 | CTG | \$91.00 |
| 106R01331 | Cyan Toner (1,000 Yield) | 104217 | CTG | \$78.00 |
| 106R01332 | Magenta Toner (1,000 Yield) | 104218 | CTG | \$78.00 |
| 106R01333 | Yellow Toner (1,000 Yield) | 104219 | CTG | \$78.00 |
| 676K05360 | Imaging Unit | 500369 | EA | \$276.75 |
| 675K65655 | Fuser (110V) | 500423 | EA | \$109.34 |
| Genuine Xerox Phaser® 6128MFP Color Laser Supplies | | | | |
| 106R01455 | Black Toner (3,100 Yield) | 904789 | CTG | \$146.00 |
| 106R01452 | Cyan Toner (2,500 Yield) | 904786 | CTG | \$164.00 |
| 106R01453 | Magenta Toner (2,500 Yield) | 904787 | CTG | \$164.00 |
| 106R01454 | Yellow Toner (2,500 Yield) | 904788 | CTG | \$164.00 |
| 676K05360 | Imaging Unit | 500369 | EA | \$276.75 |
| Genuine Xerox Phaser® 6130 Color Laser Supplies | | | | |
| 106R01281 | Black Toner (2,500 Yield) | 100002 | CTG | \$131.00 |
| 106R01278 | Cyan Toner (1,900 Yield) | 100003 | CTG | \$137.00 |
| 106R01279 | Magenta Toner (1,900 Yield) | 100004 | CTG | \$137.00 |
| 106R01280 | Yellow Toner (1,900 Yield) | 100008 | CTG | \$137.00 |
| 676K05360 | Imaging Unit | 500369 | EA | \$276.75 |
| 675K65655 | Fuser (110V) | 500423 | EA | \$109.34 |
| Genuine Xerox Phaser® 6140 Color Laser Supplies | | | | |
| 106R01480 | Black Toner (2,600 Yield) | 18786 | CTG | \$133.00 |
| 106R01477 | Cyan Toner (2,000 Yield) | 18787 | CTG | \$133.00 |
| 106R01478 | Magenta Toner (2,000 Yield) | 18788 | CTG | \$133.00 |
| 106R01479 | Yellow Toner (2,000 Yield) | 18789 | CTG | \$133.00 |
| 676K05360 | Imaging Unit | 500369 | EA | \$276.75 |
| Genuine Xerox Phaser® 6180 Color Laser Supplies | | | | |
| 113R00722 | Black Toner (3,000 Yield) | 90262 | CTG | \$158.33 |
| 113R00719 | Cyan Toner (2,000 Yield) | 90263 | CTG | \$164.32 |
| 113R00720 | Magenta Toner (2,000 Yield) | 90264 | CTG | \$164.32 |
| 113R00721 | Yellow Toner (2,000 Yield) | 90265 | CTG | \$164.32 |
| 113R00726 | High Capacity Black Toner (8,000 Yield) | 90266 | CTG | \$307.69 |
| 113R00723 | High Capacity Cyan Toner (6,000 Yield) | 90267 | CTG | \$337.62 |
| 113R00724 | High Capacity Magenta Toner (6,000 Yield) | 90268 | CTG | \$337.62 |
| 113R00725 | High Capacity Yellow Toner (6,000 Yield) | 90269 | CTG | \$337.62 |
| 675K47089 | Transfer Belt | 926639 | EA | \$202.49 |
| 675K92002 | Fuser (110V) | 923217 | EA | \$202.49 |
| Genuine Xerox Phaser® 6250 Color Laser Supplies | | | | |
| 106R00675 | High Capacity Black Toner (8,000 Yield) | 1451 | CTG | \$111.00 |
| 106R00672 | High Capacity Cyan Toner (8,000 Yield) | 1454 | CTG | \$338.00 |
| 106R00673 | High Capacity Magenta Toner (8,000 Yield) | 1453 | CTG | \$338.00 |
| 106R00674 | High Capacity Yellow Toner (8,000 Yield) | 1452 | CTG | \$338.00 |
| 108R00591 | Imaging Unit (30,000 Yield) | 1450 | EA | \$449.00 |
| 108R00592 | Transfer Roller (15,000 Yield) | 1448 | EA | \$78.00 |
| 115R00029 | Fuser (110V) (100,000 Yield) | 1447 | EA | \$330.00 |
| Genuine Xerox Phaser® 6280 Color Laser Supplies | | | | |
| 106R01391 | Black Toner (3,000 Yield) | 904781 | CTG | \$168.48 |
| 106R01388 | Cyan Toner (2,200 Yield) | 904778 | CTG | \$180.44 |
| 106R01389 | Magenta Toner (2,200 Yield) | 904779 | CTG | \$180.44 |
| 106R01390 | Yellow Toner (2,200 Yield) | 904780 | CTG | \$180.44 |
| 106R01395 | High Capacity Black Toner (7,000 Yield) | 904785 | CTG | \$308.57 |
| 106R01392 | High Capacity Cyan Toner (5,900 Yield) | 904782 | CTG | \$352.65 |
| 106R01393 | High Capacity Magenta Toner (5,900 Yield) | 904783 | CTG | \$352.65 |
| 106R01394 | High Capacity Yellow Toner (5,900 Yield) | 904784 | CTG | \$352.65 |
| 675K70596 | Fuser (110V) | 926262 | EA | \$202.49 |
| Genuine Xerox Phaser® 6300 Color Laser Supplies <i>(Continued on next page)</i> | | | | |
| 106R01076 | Black Toner (4,000 Yield) | 10524 | CTG | \$112.95 |
| 106R01073 | Cyan Toner (4,000 Yield) | 10525 | CTG | \$266.39 |
| 106R01074 | Magenta Toner (4,000 Yield) | 10528 | CTG | \$266.39 |

| MFG# | Product Description | Part# | UOM | Retail |
|---|--|--------|-----|----------|
| XEROX SUPPLIES | | | | |
| Genuine Xerox Phaser® 6300 Color Laser Supplies (Continued) | | | | |
| 106R01075 | Yellow Toner (4,000 Yield) | 10529 | CTG | \$266.39 |
| 106R01085 | High Capacity Black Toner (7,000 Yield) | 10530 | CTG | \$137.00 |
| 106R01082 | High Capacity Cyan Toner (7,000 Yield) | 10532 | CTG | \$335.00 |
| 106R01083 | High Capacity Magenta Toner (7,000 Yield) | 10534 | CTG | \$335.00 |
| 106R01084 | High Capacity Yellow Toner (7,000 Yield) | 10535 | CTG | \$335.00 |
| 108R00645 | Imaging Unit (35,000 Yield) | 10542 | EA | \$379.54 |
| 115R00035 | Fuser (110V) (100,000 Yield) | 10550 | EA | \$239.00 |
| 108R00646 | Transfer Roller (35,000 Yield) | 10549 | EA | \$112.24 |
| Genuine Xerox Phaser® 6350 Color Laser Supplies | | | | |
| 106R01076 | Black Toner (4,000 Yield) | 10524 | CTG | \$112.95 |
| 106R01073 | Cyan Toner (4,000 Yield) | 10525 | CTG | \$266.39 |
| 106R01074 | Magenta Toner (4,000 Yield) | 10528 | CTG | \$266.39 |
| 106R01075 | Yellow Toner (4,000 Yield) | 10529 | CTG | \$266.39 |
| 106R01147 | High Capacity Black Toner (10,000 Yield) | 10537 | CTG | \$175.76 |
| 106R01144 | High Capacity Cyan Toner (10,000 Yield) | 10538 | CTG | \$433.33 |
| 106R01145 | High Capacity Magenta Toner (10,000 Yield) | 10539 | CTG | \$433.33 |
| 106R01146 | High Capacity Yellow Toner (10,000 Yield) | 10540 | CTG | \$433.33 |
| 108R00645 | Imaging Unit (35,000 Yield) | 10542 | EA | \$379.54 |
| 115R00035 | Fuser (110V) (100,000 Yield) | 10550 | EA | \$239.00 |
| 108R00646 | Transfer Roller (35,000 Yield) | 10549 | EA | \$112.24 |
| Genuine Xerox Phaser® 6360 Color Laser Supplies | | | | |
| 106R01217 | Black Toner (9,000 Yield) | 90295 | CTG | \$224.85 |
| 106R01214 | Cyan Toner (5,000 Yield) | 90296 | CTG | \$300.80 |
| 106R01215 | Magenta Toner (5,000 Yield) | 90298 | CTG | \$300.80 |
| 106R01216 | Yellow Toner (5,000 Yield) | 90299 | CTG | \$300.80 |
| 106R01221 | High Capacity Black Toner (18,000 Yield) | 90302 | CTG | \$277.61 |
| 106R01218 | High Capacity Cyan Toner (12,000 Yield) | 90307 | CTG | \$464.27 |
| 106R01219 | High Capacity Magenta Toner (12,000 Yield) | 90308 | CTG | \$464.27 |
| 106R01220 | High Capacity Yellow Toner (12,000 Yield) | 90309 | CTG | \$464.27 |
| 108R00645 | Imaging Unit (35,000 Yield) | 10542 | EA | \$379.54 |
| 115R00055 | Fuser (110V) (100,000 Yield) | 90310 | EA | \$226.47 |
| 108R00646 | Transfer Roller (35,000 Yield) | 10549 | EA | \$112.24 |
| Genuine Xerox Phaser® 6500/WorkCentre® 6505 Color Laser Supplies | | | | |
| 106R01591 | Cyan Toner (1,000 Yield) | 97730 | EA | \$92.00 |
| 106R01592 | Magenta Toner (1,000 Yield) | 97731 | EA | \$92.00 |
| 106R01593 | Yellow Toner (1,000 Yield) | 97732 | EA | \$92.00 |
| 106R01597 | High Capacity Black Toner (3,000 Yield) | 97743 | EA | \$150.00 |
| 106R01594 | High Capacity Cyan Toner (2,500 Yield) | 97733 | EA | \$155.00 |
| 106R01595 | High Capacity Magenta Toner (2,500 Yield) | 97741 | EA | \$155.00 |
| 106R01596 | High Capacity Yellow Toner (2,500 Yield) | 97742 | EA | \$155.00 |
| 676K05360 | Imaging Unit | 500369 | EA | \$276.75 |
| 604K64582 | Fuser (110V) | 500422 | EA | \$121.49 |
| Genuine Xerox Phaser® 6600/WorkCentre® 6605 Color Laser Supplies | | | | |
| 106R02244 | Black Toner (3,000 Yield) | 908825 | CTG | \$133.86 |
| 106R02241 | Cyan Toner (2,000 Yield) | 908822 | CTG | \$147.24 |
| 106R02242 | Magenta Toner (2,000 Yield) | 908823 | CTG | \$147.24 |
| 106R02243 | Yellow Toner (2,000 Yield) | 908824 | CTG | \$147.24 |
| 106R02228 | High Capacity Black Toner (8,000 Yield) | 908821 | CTG | \$254.34 |
| 106R02225 | High Capacity Cyan Toner (6,000 Yield) | 908818 | CTG | \$334.66 |
| 106R02226 | High Capacity Magenta Toner (6,000 Yield) | 908819 | CTG | \$334.66 |
| 106R02227 | High Capacity Yellow Toner (6,000 Yield) | 908820 | CTG | \$334.66 |
| 108R01124 | Waste Cartridge (30,000 Yield) | 908835 | CTG | \$33.45 |
| 108R01121 | Imaging Unit Kit (60,000 Yield) | 908834 | EA | \$321.28 |
| Genuine Xerox Phaser® 6700 Color Laser Supplies (Continued on next page) | | | | |
| 106R01506 | Black Toner (7,100 Yield) | 502211 | CTG | \$187.41 |
| 106R01503 | Cyan Toner (5,000 Yield) | 502148 | CTG | \$240.95 |
| 106R01504 | Magenta Toner (5,000 Yield) | 502169 | CTG | \$240.95 |
| 106R01505 | Yellow Toner (5,000 Yield) | 502207 | CTG | \$240.95 |
| 106R01510 | High Capacity Black Toner (18,000 Yield) | 502237 | CTG | \$289.15 |
| 106R01507 | High Capacity Cyan Toner (12,000 Yield) | 502216 | CTG | \$394.91 |
| 106R01508 | High Capacity Magenta Toner (12,000 Yield) | 502218 | CTG | \$394.91 |
| 106R01509 | High Capacity Yellow Toner (12,000 Yield) | 502236 | CTG | \$394.91 |
| 108R00974 | Black Imaging Unit (50,000 Yield) | 502263 | EA | \$107.10 |
| 108R00971 | Cyan Imaging Unit (50,000 Yield) | 502238 | EA | \$133.86 |
| 108R00972 | Magenta Imaging Unit (50,000 Yield) | 502240 | EA | \$133.86 |
| 108R00973 | Yellow Imaging Unit (50,000 Yield) | 502241 | EA | \$133.86 |

| MFG# | Product Description | Part# | UOM | Retail |
|---|--|--------|-----|----------|
| XEROX SUPPLIES | | | | |
| Genuine Xerox Phaser® 6700 Color Laser Supplies <i>(Continued)</i> | | | | |
| 108R00975 | Waste Container (25,000 Yield) | 502264 | EA | \$40.16 |
| 008R12964 | Staples (5,000 Staples/Ctg, 1 Ctg/Ctn) | 14070 | CTG | \$175.00 |
| 126K32220 | Fuser (110V) | 502265 | EA | \$266.40 |
| 604K73140 | Maintenance Kit | 502268 | EA | \$333.34 |
| Genuine Xerox Phaser® 7100 Color Laser Supplies | | | | |
| 106R02599 | Cyan Toner (4,500 Yield) | 908826 | CTG | \$254.34 |
| 106R02600 | Magenta Toner (4,500 Yield) | 908827 | CTG | \$254.34 |
| 106R02601 | Yellow Toner (4,500 Yield) | 908828 | CTG | \$254.34 |
| 106R02605 | Black Toner Dual Pack (2 x 5,000 Yield) | 908832 | PK | \$246.31 |
| 106R02602 | Cyan Toner Dual Pack (2 Pack of OEM# 106R02599) (2 x 4,500 Yield) | 908829 | PK | \$401.60 |
| 106R02603 | Magenta Toner Dual Pack (2 Pack of OEM# 106R02600) (2 x 4,500 Yield) | 908830 | PK | \$401.60 |
| 106R02604 | Yellow Toner Dual Pack (2 Pack of OEM# 106R02601) (2 x 4,500 Yield) | 908831 | PK | \$401.60 |
| 108R01148 | Imaging Unit (Unit is Color-Neutral Until Installed) (24,000 Yield) | 908836 | EA | \$107.08 |
| 106R02624 | Waste Cartridge (24,000 Yield) | 908833 | CTG | \$40.15 |
| Genuine Xerox Phaser® 7400 Tabloid Color Laser Supplies | | | | |
| 106R01150 | Cyan Toner (9,000 Yield) | 12108 | CTG | \$395.85 |
| 106R01151 | Magenta Toner (9,000 Yield) | 12109 | CTG | \$395.85 |
| 106R01152 | Yellow Toner (9,000 Yield) | 12110 | CTG | \$395.85 |
| 106R01080 | High Capacity Black Toner (15,000 Yield) | 12111 | CTG | \$248.43 |
| 106R01077 | High Capacity Cyan Toner (18,000 Yield) | 12112 | CTG | \$571.16 |
| 106R01078 | High Capacity Magenta Toner (18,000 Yield) | 12113 | CTG | \$571.16 |
| 106R01079 | High Capacity Yellow Toner (18,000 Yield) | 12114 | CTG | \$571.16 |
| 108R00650 | Black Imaging Unit (30,000 Yield) | 12115 | EA | \$249.11 |
| 108R00647 | Cyan Imaging Unit (30,000 Yield) | 12116 | EA | \$350.10 |
| 108R00648 | Magenta Imaging Unit (30,000 Yield) | 12117 | EA | \$350.10 |
| 108R00649 | Yellow Imaging Unit (30,000 Yield) | 12118 | EA | \$350.10 |
| 108R00697 | Color Imaging Unit Kit (Includes 1 Each of 108R00647, 108R00648, 108R00649) (30,000 x 3 Yield) | 12127 | KIT | \$924.24 |
| 106R01081 | Waste Container (30,000 Yield) | 12120 | EA | \$44.00 |
| 115R00037 | Fuser (110V) (100,000 Yield) | 12122 | EA | \$331.76 |
| 101R00421 | Transfer Unit (100,000 Yield) | 12121 | EA | \$387.37 |
| Genuine Xerox Phaser® 7500 Color Laser Supplies | | | | |
| 106R01433 | Cyan Toner (9,600 Yield) | 7761 | CTG | \$450.00 |
| 106R01434 | Magenta Toner (9,600 Yield) | 7762 | CTG | \$450.00 |
| 106R01435 | Yellow Toner (9,600 Yield) | 7763 | CTG | \$450.00 |
| 106R01439 | High Capacity Black Toner (19,800 Yield) | 7764 | CTG | \$467.00 |
| 106R01436 | High Capacity Cyan Toner (17,800 Yield) | 7765 | CTG | \$684.00 |
| 106R01437 | High Capacity Magenta Toner (17,800 Yield) | 7766 | CTG | \$684.00 |
| 106R01438 | High Capacity Yellow Toner (17,800 Yield) | 7767 | CTG | \$684.00 |
| 108R00861 | Imaging Unit (80,000 Yield) | 7768 | EA | \$143.00 |
| 108R00865 | Waste Container (20,000 Yield) | 7769 | EA | \$55.00 |
| 115R00061 | Fuser (110V) (100,000 Yield) | 7770 | EA | \$245.00 |
| Genuine Xerox Phaser® 7750 Color Laser Supplies | | | | |
| 106R00652 | Black Toner (32,000 Yield) | 5059 | CTG | \$253.00 |
| 106R00653 | Cyan Toner (22,000 Yield) | 5060 | CTG | \$463.00 |
| 106R00654 | Magenta Toner (22,000 Yield) | 5061 | CTG | \$463.00 |
| 106R00655 | Yellow Toner (22,000 Yield) | 5062 | CTG | \$463.00 |
| 108R00581 | Imaging Unit (32,000 Yield) | 5065 | EA | \$517.00 |
| 108R00575 | Waste Container (27,000 Yield) | 5067 | EA | \$37.00 |
| 115R00025 | Fuser (110V) (60,000 Yield) | 5063 | EA | \$310.00 |
| 108R00579 | Transfer Roller | 5066 | EA | \$232.00 |
| 108R00580 | Belt Cleaner Assembly | 5064 | EA | \$165.00 |



Xerox offers printers with a range of features and flexible office printing solutions, including award-winning Phaser printers and eco-friendly solid ink printers. Ask about trade-in programs and promotions.

xerox 

| MFG# | Product Description | Part# | UOM | Retail |
|--|--|--------|-----|----------|
| XEROX SUPPLIES | | | | |
| Genuine Xerox Phaser® 7760 Color Laser Supplies | | | | |
| 106R01163 | Black Toner (32,000 Yield) | 15079 | CTG | \$216.56 |
| 106R01160 | Cyan Toner (25,000 Yield) | 15080 | CTG | \$572.31 |
| 106R01161 | Magenta Toner (25,000 Yield) | 15081 | CTG | \$572.31 |
| 106R01162 | Yellow Toner (25,000 Yield) | 15082 | CTG | \$572.31 |
| 108R00713 | Imaging Unit (35,000 Yield) | 15083 | EA | \$546.33 |
| 108R00575 | Waste Container (27,000 Yield) | 5067 | EA | \$37.00 |
| 115R00049 | Fuser (110V) (100,000 Yield) | 15084 | EA | \$421.16 |
| 108R00579 | Transfer Roller | 5066 | EA | \$232.00 |
| 108R00580 | Belt Cleaner Assembly | 5064 | EA | \$165.00 |
| 008R12941 | Staple Refill Pack (3 x 5,000 Yield) | 13047 | PK | \$168.85 |
| Genuine Xerox Phaser® 7800 Color Laser Supplies | | | | |
| 106R01563 | Cyan Toner (6,000 Yield) | 502276 | CTG | \$266.12 |
| 106R01564 | Magenta Toner (6,000 Yield) | 502321 | CTG | \$266.12 |
| 106R01565 | Yellow Toner (6,000 Yield) | 502322 | CTG | \$266.12 |
| 106R01569 | High Capacity Black Toner (24,000 Yield) | 502401 | CTG | \$479.02 |
| 106R01566 | High Capacity Cyan Toner (17,200 Yield) | 502323 | CTG | \$586.80 |
| 106R01567 | High Capacity Magenta Toner (17,200 Yield) | 502335 | CTG | \$586.80 |
| 106R01568 | High Capacity Yellow Toner (17,200 Yield) | 502372 | CTG | \$586.80 |
| 106R01582 | Imaging Unit (Color-Neutral Until Installed - 145,000 Yield) | 502420 | CTG | \$291.40 |
| 108R00982 | Waste Container | 502422 | EA | \$65.20 |
| 008R12964 | Staples (5,000 Staples/Ctg, 1 Ctg/Ctn) | 14070 | CTG | \$175.00 |
| 115R00073 | Fuser Assembly (110V) | 502439 | EA | \$632.06 |
| 108R01053 | Transfer Roller | 502410 | CTG | \$145.04 |
| 108R01036 | IBT Cleaner Unit (160,000 Yield) | 502412 | CTG | \$105.12 |
| Genuine Xerox Phaser® 8400 Solid Ink Color Supplies | | | | |
| 108R00604 | Black Solid Ink (3 Sticks/Box) (Total Box Yield 3,400) | 5051 | BOX | \$112.00 |
| 108R00608 | Black Solid Ink (6 Sticks/Box) (Total Box Yield 6,800) | 5055 | BOX | \$165.00 |
| 108R00605 | Cyan Solid Ink (3 Sticks/Box) (Total Box Yield 3,400) | 5052 | BOX | \$165.00 |
| 108R00606 | Magenta Solid Ink (3 Sticks/Box) (Total Box Yield 3,400) | 5053 | BOX | \$165.00 |
| 108R00607 | Yellow Solid Ink (3 Sticks/Box) (Total Box Yield 3,400) | 5054 | BOX | \$165.00 |
| 108R00603 | Extended Capacity Maintenance Kit (30,000 Yield) | 5057 | KIT | \$236.00 |
| Genuine Xerox Phaser® 8500/8550 Solid Ink Color Supplies | | | | |
| 108R00668 | Black Solid Ink (3 Sticks/Box) (Total Box Yield 3,000) | 10554 | BOX | \$93.00 |
| 108R00669 | Cyan Solid Ink (3 Sticks/Box) (Total Box Yield 3,000) | 10556 | BOX | \$157.29 |
| 108R00670 | Magenta Solid Ink (3 Sticks/Box) (Total Box Yield 3,000) | 10562 | BOX | \$157.29 |
| 108R00671 | Yellow Solid Ink (3 Sticks/Box) (Total Box Yield 3,000) | 10563 | BOX | \$157.29 |
| 108R00672 | Black Solid Ink (6 Sticks/Box) (Total Box Yield 6,000) | 10552 | BOX | \$146.00 |
| 108R00675 | Maintenance Kit (10,000 Yield) | 10566 | KIT | \$167.44 |
| 108R00676 | Extended Capacity Maintenance Kit (30,000 Yield) | 10567 | KIT | \$231.43 |
| Genuine Xerox Phaser® 8560/8560MFP Solid Ink Color Supplies | | | | |
| 108R00726 | Black ColorStix Ink (3 Sticks/Box) (Total Box Yield 3,400) | 90278 | BOX | \$112.63 |
| 108R00723 | Cyan ColorStix Ink (3 Sticks/Box) (Total Box Yield 3,400) | 90290 | BOX | \$175.76 |
| 108R00724 | Magenta ColorStix Ink (3 Sticks/Box) (Total Box Yield 3,400) | 90291 | BOX | \$175.76 |
| 108R00725 | Yellow ColorStix Ink (3 Sticks/Box) (Total Box Yield 3,400) | 90292 | BOX | \$175.76 |
| 108R00727 | Black ColorStix Ink (6 Sticks/Box) (Total Box Yield 6,800) | 90277 | BOX | \$171.60 |
| 108R00675 | Maintenance Kit (10,000 Yield) | 10566 | KIT | \$167.44 |
| 108R00676 | Extended Capacity Maintenance Kit (30,000 Yield) | 10567 | KIT | \$231.43 |
| Genuine Xerox Phaser® 8860/8860MFP Solid Ink Color Supplies | | | | |
| 108R00749 | Black Solid Ink (6 Sticks/Box) (Total Box Yield 14,000) | 97989 | BOX | \$302.00 |
| 108R00746 | Cyan Solid Ink (6 Sticks/Box) (Total Box Yield 14,000) | 97990 | BOX | \$101.00 |
| 108R00747 | Magenta Solid Ink (6 Sticks/Box) (Total Box Yield 14,000) | 97991 | BOX | \$101.00 |
| 108R00748 | Yellow Solid Ink (6 Sticks/Box) (Total Box Yield 14,000) | 97992 | BOX | \$101.00 |
| 113R00736 | Extended Capacity Maintenance Kit (30,000 Yield) | 97996 | BOX | \$140.00 |
| Genuine Xerox ColorQube® 8570/8580 Solid Ink Color Supplies | | | | |
| 108R00929 | Black Solid Ink (2 Sticks/Box) (Total Box Yield 4,300) | 93329 | BOX | \$137.00 |
| 108R00926 | Cyan Solid Ink (2 Sticks/Box) (Total Box Yield 4,400) | 93325 | BOX | \$206.00 |
| 108R00927 | Magenta Solid Ink (2 Sticks/Box) (Total Box Yield 4,400) | 93327 | BOX | \$206.00 |
| 108R00928 | Yellow Solid Ink (2 Sticks/Box) (Total Box Yield 4,400) | 93328 | BOX | \$206.00 |
| 108R00930 | Black Solid Ink (4 Sticks/Box) (Total Box Yield 8,600) | 93336 | BOX | \$206.00 |
| 109R00784 | Maintenance Kit (10,000 Yield) | 93338 | KIT | \$81.00 |
| 109R00783 | Extended Capacity Maintenance Kit (Includes Lubricated Roller Part) (30,000 Yield) | 93339 | KIT | \$134.00 |

| MFG# | Product Description | Part# | UOM | Retail |
|---|--|--------|-----|----------|
| XEROX SUPPLIES | | | | |
| Genuine Xerox ColorQube® 8700 Solid Ink Color Supplies | | | | |
| 108R00993 | Black Solid Ink (2 Sticks/Box) (Total Box Yield 4,500) | 906098 | BOX | \$147.00 |
| 108R00990 | Cyan Solid Ink (2 Sticks/Box) (Total Box Yield 4,200) | 906095 | BOX | \$214.00 |
| 108R00991 | Magenta Solid Ink (2 Sticks/Box) (Total Box Yield 4,200) | 906096 | BOX | \$214.00 |
| 108R00992 | Yellow Solid Ink (2 Sticks/Box) (Total Box Yield 4,200) | 906097 | BOX | \$214.00 |
| 108R00994 | Black Solid Ink (4 Sticks/Box) (Total Box Yield 9,000) | 906099 | BOX | \$214.00 |
| 109R00784 | Maintenance Kit (10,000 Yield) | 93338 | KIT | \$81.00 |
| 109R00783 | Extended Capacity Maintenance Kit (Includes Lubricated Roller Part) (30,000 Yield) | 93339 | KIT | \$134.00 |
| 008R12964 | Staples (5,000 Staples/Ctg, 1 Ctg/Ctn) | 14070 | CTG | \$175.00 |
| Genuine Xerox ColorQube® 8870/8880 Solid Ink Color Supplies | | | | |
| 108R00953 | Black Solid Ink (6 Sticks/Box) (Total Box Yield 16,700) | 93355 | BOX | \$356.00 |
| 108R00950 | Cyan Solid Ink (6 Sticks/Box) (Total Box Yield 17,300) | 93350 | BOX | \$124.00 |
| 108R00951 | Magenta Solid Ink (6 Sticks/Box) (Total Box Yield 17,300) | 93351 | BOX | \$124.00 |
| 108R00952 | Yellow Solid Ink (6 Sticks/Box) (Total Box Yield 17,300) | 93352 | BOX | \$124.00 |
| 109R00784 | Maintenance Kit (10,000 Yield) | 93338 | KIT | \$81.00 |
| 109R00783 | Extended Capacity Maintenance Kit (Includes Lubricated Roller Part) (30,000 Yield) | 93339 | KIT | \$134.00 |
| Genuine Xerox ColorQube® 8900 Solid Ink Color Supplies | | | | |
| 108R01017 | Black Solid Ink (6 Sticks/Box) (Total Box Yield 18,000) | 906103 | BOX | \$373.99 |
| 108R01014 | Cyan Solid Ink (6 Sticks/Box) (Total Box Yield 16,900) | 906100 | BOX | \$114.99 |
| 108R01015 | Magenta Solid Ink (6 Sticks/Box) (Total Box Yield 16,900) | 906101 | BOX | \$114.99 |
| 108R01016 | Yellow Solid Ink (6 Sticks/Box) (Total Box Yield 16,900) | 906102 | BOX | \$114.99 |
| 109R00784 | Maintenance Kit (10,000 Yield) | 93338 | KIT | \$81.00 |
| 109R00783 | Extended Capacity Maintenance Kit (Includes Lubricated Roller Part) (30,000 Yield) | 93339 | KIT | \$134.00 |
| 008R12964 | Staples (5,000 Staples/Ctg, 1 Ctg/Ctn) | 14070 | CTG | \$175.00 |
| Xerox 4110/4112/4127/4590/4595 Supplies | | | | |
| 006R01583 | Toner (72,000 Yield) | 930073 | CTG | \$251.00 |
| Xerox 700/700i/770 Digital Color Press Supplies | | | | |
| 006R01383 | Black Toner (20,000 Yield) | 916436 | CTG | \$206.85 |
| 006R01384 | Cyan Toner (22,000 Yield) | 916437 | CTG | \$294.00 |
| 006R01385 | Magenta Toner (21,000 Yield) | 916438 | CTG | \$294.00 |
| 006R01386 | Yellow Toner (22,000 Yield) | 916439 | CTG | \$294.00 |
| 008R12990 | Waste Toner Cartridge (50,000 Yield) | 100190 | CTG | \$40.00 |
| Xerox Color 560/570 Supplies | | | | |
| 006R01525 | Black Toner (30,000 Yield) | 916440 | CTG | \$232.00 |
| 006R01528 | Cyan Toner (32,000 Yield) | 916443 | CTG | \$465.00 |
| 006R01527 | Magenta Toner (32,000 Yield) | 916442 | CTG | \$465.00 |
| 006R01526 | Yellow Toner (32,000 Yield) | 916441 | CTG | \$465.00 |
| 013R00663 | Black Drum Unit (190,000 Yield) | 927360 | EA | \$362.00 |
| 013R00664 | Color Drum Unit (85,000 Yield) | 927361 | EA | \$366.00 |
| Xerox CopyCentre® C20 Copier Supplies | | | | |
| 106R01047 | Toner (8,000 Yield) | 5441 | CTG | \$118.00 |
| 113R00671 | Drum (20,000 Yield) | 5442 | EA | \$134.00 |
| Xerox CopyCentre® C35/C45/C55 Copier Supplies | | | | |
| 006R01046 | Toner (64,000 Yield) (2 Ctgs + Waste Bottle/Ctn) | 1674 | CTN | \$307.60 |
| 108R00493 | Staple Cartridges (3 x 5,000 Staple Ctgs/Ctn) | 1166 | CTN | \$141.51 |
| Xerox CopyCentre® C118 Copier Supplies | | | | |
| 006R01179 | Toner (11,000 Yield) | 10077 | CTG | \$103.00 |
| 013R00589 | Drum (60,000 Yield) | 10079 | EA | \$281.40 |
| Xerox CopyCentre® C123/C128 Copier Supplies | | | | |
| 006R01184 | Toner (30,000 Yield) | 10839 | CTG | \$211.05 |
| 013R00589 | Drum (60,000 Yield) | 10079 | EA | \$281.40 |
| 008R12915 | Staple Cartridges (5,000 Staples/Ctg) (3 Ctgs/Box) | 10840 | BOX | \$124.95 |
| Xerox CopyCentre® C165/C175 Copier Supplies | | | | |
| 006R01146 | Toner (90,000 Yield) (2 Ctgs/Ctn) | 14090 | CTN | \$356.11 |
| Xerox CopyCentre® C2128/C2636/C3545 Color Copier Supplies (Continued on next page) | | | | |
| 006R01175 | Black Toner (26,000 Yield) | 6161 | CTG | \$224.40 |
| 006R01176 | Cyan Toner (16,000 Yield) | 6162 | CTG | \$305.80 |
| 006R01177 | Magenta Toner (16,000 Yield) | 6163 | CTG | \$305.80 |

| MFG# | Product Description | Part# | UOM | Retail |
|--|--|--------|-----|----------|
| XEROX SUPPLIES | | | | |
| Xerox CopyCentre® C2128/C2636/C3545 Color Copier Supplies (Continued) | | | | |
| 006R01178 | Yellow Toner (16,000 Yield) | 6164 | CTG | \$305.80 |
| 008R12903 | Waste Toner Bottle (25,000 Yield) | 28539 | EA | \$38.00 |
| 008R12915 | Staple Cartridges (5,000 Staples/Ctg) (3 Ctgs/Box) | 10840 | BOX | \$124.95 |
| Xerox DocuColor® 240/242/250/252/260 Color Laser Supplies | | | | |
| 006R01219 | Black Toner (30,000 Yield) | 106666 | CTG | \$317.18 |
| 006R01222 | Cyan Toner (34,000 Yield) | 106667 | CTG | \$635.47 |
| 006R01221 | Magenta Toner (34,000 Yield) | 106668 | CTG | \$635.47 |
| 006R01220 | Yellow Toner (34,000 Yield) | 106669 | CTG | \$635.47 |
| 008R13041 | Staple Cartridge and Waste Container for Light Production Finisher | 915470 | EA | \$182.00 |
| 008R12988 | Fuser Unit | 100189 | EA | \$450.00 |
| Xerox DocuColor® 2045/2060 Color Laser Supplies | | | | |
| 006R00975 | Black Toner (25,000 Yield) | 106569 | CTG | \$295.00 |
| 006R00976 | Cyan Toner (39,000 Yield) | 4907 | CTG | \$350.00 |
| 006R00977 | Magenta Toner (39,000 Yield) | 4906 | CTG | \$350.00 |
| 006R00978 | Yellow Toner (39,000 Yield) | 4905 | CTG | \$350.00 |
| Xerox Document Centre® 535/545/555 Supplies | | | | |
| 006R01046 | Toner (64,000 Yield) (2 Ctgs + Waste Bottle/Ctn) | 1674 | CTN | \$307.60 |
| Xerox DocuPrint® N4525 Laser Supplies | | | | |
| 113R00195 | Toner (30,000 Yield) | 107984 | CTG | \$454.00 |
| 109R00048 | Maintenance Kit (300,000 Yield) | 107983 | KIT | \$823.00 |
| Xerox FaxCentre® 2121 Fax Supplies | | | | |
| 006R01297 | Toner (6,000 Yield) | 90311 | CTG | \$146.00 |
| 006R01298 | Toner Dual Pack (2 Pack of OEM# 006R01297) (2 x 6,000 Yield) | 90312 | PK | \$271.00 |
| 013R00628 | Drum (20,000 Yield) | 90313 | CTG | \$188.00 |
| Xerox FaxCentre® 2218 Fax Supplies | | | | |
| 006R01278 | Toner (8,000 Yield) | 20173 | CTG | \$153.00 |
| Xerox FaxCentre® F12 Fax Supplies | | | | |
| 106R00584 | Toner (6,000 Yield) | 3585 | CTG | \$108.00 |
| 113R00663 | Drum (15,000 Yield) | 1520 | EA | \$139.00 |
| Xerox FaxCentre® F116/F116L Fax Supplies | | | | |
| 006R01218 | Toner (6,000 Yield) | 6073 | CTG | \$146.00 |
| 006R01236 | Toner Dual Pack (2 Pack of OEM# 006R01218) (2 x 6,000 Yield) | 6075 | PK | \$271.00 |
| 113R00655 | Drum (20,000 Yield) | 6076 | EA | \$188.00 |
| Xerox WorkCentre® 665/685/765/785 Supplies | | | | |
| 106R00404 | Toner (3,000 Yield) | 106391 | CTG | \$104.30 |
| 113R00459 | Drum (10,000 Yield) | 106547 | EA | \$287.75 |
| Xerox WorkCentre® 3210/3220 Supplies | | | | |
| 106R01485 | Toner (2,000 Yield) | 14312 | CTG | \$108.00 |
| 106R01486 | High Capacity Toner (4,100 Yield) | 14313 | CTG | \$140.00 |
| Xerox WorkCentre® 3315 Supplies | | | | |
| 106R02309 | Toner (2,300 Yield) | 906413 | CTG | \$119.74 |
| 106R02311 | High Capacity Toner (5,000 Yield) | 906414 | EA | \$192.93 |
| Xerox WorkCentre® 3325 Supplies | | | | |
| 106R02313 | High Capacity Toner (11,000 Yield) | 906412 | CTG | \$332.65 |
| Xerox WorkCentre® 3550 Supplies | | | | |
| 106R01528 | Toner (5,000 Yield) | 35751 | CTG | \$179.64 |
| 106R01530 | High Capacity Toner (11,000 Yield) | 35752 | CTG | \$266.65 |
| Xerox WorkCentre® 3655 Supplies | | | | |
| 106R02736 | Toner (6,100 Yield) | 930240 | CTG | \$212.00 |
| 106R02738 | High Capacity Toner (14,400 Yield) | 930241 | CTG | \$384.00 |
| 106R02740 | Extra High Capacity Toner (25,900 Yield) | 930242 | CTG | \$516.00 |

| MFG# | Product Description | Part# | UOM | Retail |
|---|---|--------|-----|----------|
| XEROX SUPPLIES | | | | |
| Xerox WorkCentre® 4118x Supplies | | | | |
| 006R01278 | Toner (8,000 Yield) | 20173 | CTG | \$153.00 |
| 113R00671 | Drum (20,000 Yield) | 5442 | EA | \$134.00 |
| Xerox WorkCentre® 4150 Supplies | | | | |
| 006R01275 | Toner (20,000 Yield) | 23241 | CTG | \$213.56 |
| 013R00623 | Drum (55,000 Yield) | 23248 | CTG | \$479.94 |
| 008R12941 | Staple Refill Pack (3 x 5,000 Yield) | 13047 | PK | \$168.85 |
| Xerox WorkCentre® 4250MFP/4260MFP Supplies | | | | |
| 106R01409 | Toner (25,000 Yield) | 903136 | CTG | \$223.00 |
| 113R00755 | Drum (80,000 Yield) | 903137 | EA | \$539.00 |
| 115R00063 | Maintenance Kit (110V) (200,000 Yield) | 16563 | KIT | \$448.00 |
| 106R02650 | Toner (25,000 Yield) (TAA Compliant Version of OEM# 106R01409) | 908684 | CTG | \$223.00 |
| 113R00770 | Smart Kit Drum Cartridge (80,000 Yield) (TAA Compliant Version of 113R00755) | 908685 | EA | \$539.00 |
| 008R12941 | Staple Refill Pack (3 x 5,000 Yield) | 13047 | PK | \$168.85 |
| Xerox WorkCentre® 4265 Supplies | | | | |
| 106R03104 | Toner (10,000 Yield) | 930625 | CTG | \$252.00 |
| 106R02734 | High Capacity Toner (25,000 Yield) | 930621 | CTG | \$397.00 |
| 106R03102 | Extra High Capacity Toner Dual Pack (2 x 25,000 Yield) | 930624 | EA | \$635.00 |
| 113R00776 | Drum Cartridge (100,000 Yield) | 930628 | EA | \$239.00 |
| 115R00086 | 110V Maintenance Kit | 930629 | EA | \$239.00 |
| 108R01266 | Bias Transfer Roll Maintenance Kit | 930626 | EA | \$27.00 |
| 108R01267 | Feed Roll Maintenance Kit | 930627 | EA | \$40.00 |
| Xerox WorkCentre® 5222/5225/5230 Supplies | | | | |
| 106R01306 | Toner (30,000 Yield) | 903310 | CTG | \$220.00 |
| 101R00435 | High Capacity Drum (80,000 Yield) | 97860 | EA | \$375.00 |
| 008R12897 | Staple Cartridges for Office LX Booklet Maker Option (2,000 Staples/Ctg, 8 Ctgs/EA) | 915464 | EA | \$170.10 |
| Xerox WorkCentre® 5325/5330/5335 Supplies | | | | |
| 006R01159 | Toner (30,000 Yield) | 800631 | CTG | \$202.40 |
| 013R00591 | Drum (96,000 Yield) | 913537 | EA | \$325.00 |
| 008R12964 | Staples (5,000 Staples/Ctg) | 14070 | CTG | \$175.00 |
| 008R12897 | Staple Cartridges for Office LX Booklet Maker Option (2,000 Staples/Ctg, 8 Ctgs/EA) | 915464 | EA | \$170.10 |
| Xerox WorkCentre® 5845/5855 Supplies | | | | |
| 006R01551 | Toner (Includes 2 Per Box) (76,000 Yield) | 915432 | BOX | \$299.00 |
| 008R12964 | Staples (5,000 Staples/Ctg) | 14070 | CTG | \$175.00 |
| 008R12897 | Staple Cartridges for Office LX Booklet Maker Option (2,000 Staples/Ctg, 8 Ctgs/EA) | 915464 | EA | \$170.10 |
| Xerox WorkCentre® 5865/5875/5890 Supplies | | | | |
| 006R01552 | Toner (2 x 55,000 Yield) (2 Ctgs/Ctn) | 913536 | CTN | \$439.00 |
| 108R00535 | Staple Cartridge Refills for Basic Office Finisher (3,000 Staples/Ctg) (3 Ctg/EA) | 915474 | EA | \$58.80 |
| Xerox WorkCentre® 6400 Color Supplies | | | | |
| 106R01316 | Black Toner (12,000 Yield) | 7744 | CTG | \$134.00 |
| 106R01320 | Cyan Toner (8,000 Yield) | 7745 | CTG | \$280.00 |
| 106R01321 | Magenta Toner (8,000 Yield) | 7746 | CTG | \$280.00 |
| 106R01322 | Yellow Toner (8,000 Yield) | 7747 | CTG | \$280.00 |
| 106R01317 | High Capacity Cyan Toner (16,500 Yield) | 7748 | CTG | \$473.00 |
| 106R01318 | High Capacity Magenta Toner (16,500 Yield) | 7749 | CTG | \$473.00 |
| 106R01319 | High Capacity Yellow Toner (16,500 Yield) | 7750 | CTG | \$473.00 |
| 108R00774 | Black Imaging Unit (30,000 Yield) | 7751 | CTG | \$134.00 |
| 108R00775 | Cyan Imaging Unit (30,000 Yield) | 7752 | EA | \$213.00 |
| 108R00776 | Magenta Imaging Unit (30,000 Yield) | 7753 | EA | \$213.00 |
| 108R00777 | Yellow Imaging Unit (30,000 Yield) | 7754 | EA | \$213.00 |
| 106R01368 | Waste Container (22,000 x 2 Yield) | 7755 | EA | \$73.00 |
| 115R00059 | Fuser (110V) (150,000 Yield) | 7757 | EA | \$320.00 |
| Xerox WorkCentre® 6655 Color Supplies | | | | |
| 106R02747 | High Capacity Black Toner (12,000 Yield) | 930246 | CTG | \$268.00 |
| 106R02744 | High Capacity Cyan Toner (7,500 Yield) | 930243 | CTG | \$349.00 |
| 106R02745 | High Capacity Magenta Toner (7,500 Yield) | 930244 | CTG | \$349.00 |
| 106R02746 | High Capacity Yellow Toner (7,500 Yield) | 930245 | CTG | \$349.00 |
| 115R00088 | Fuser (110V) (100,000 Yield) | 930247 | EA | \$268.00 |

| MFG# | Product Description | Part# | UOM | Retail |
|--|---|--------|-----|----------|
| XEROX SUPPLIES | | | | |
| Xerox WorkCentre® 7120/7125 Color Supplies | | | | |
| 006R01457 | Black Toner (22,000 Yield) | 100962 | CTG | \$129.15 |
| 006R01460 | Cyan Toner (15,000 Yield) | 100965 | CTG | \$210.00 |
| 006R01459 | Magenta Toner (15,000 Yield) | 100964 | CTG | \$210.00 |
| 006R01458 | Yellow Toner (15,000 Yield) | 100963 | CTG | \$210.00 |
| 013R00657 | Black Drum Cartridge (67,000 Yield) | 915437 | EA | \$340.00 |
| 013R00660 | Cyan Drum Cartridge (51,000 Yield) | 915440 | EA | \$320.00 |
| 013R00659 | Magenta Drum Cartridge (51,000 Yield) | 915439 | EA | \$320.00 |
| 013R00658 | Yellow Drum Cartridge (51,000 Yield) | 915438 | EA | \$320.00 |
| 008R13089 | Waste Toner Container | 910493 | EA | \$40.00 |
| 008R12964 | Staples (5,000 Staples/Ctg, 1 Ctg/Ctn) | 14070 | CTG | \$175.00 |
| 008R12897 | Staple Cartridges for Office LX Booklet Maker Option (2,000 Staples/Ctg, 8 Ctgs/EA) | 915464 | EA | \$170.10 |
| Xerox WorkCentre® 7132/7232/7242 Color Supplies | | | | |
| 006R01318 | Black Toner (24,300 Yield) (Replaces 6R1266) | 100793 | CTG | \$168.30 |
| 006R01269 | Cyan Toner (8,000 Yield) | 96450 | CTG | \$213.40 |
| 006R01268 | Magenta Toner (8,000 Yield) | 96461 | CTG | \$213.40 |
| 006R01267 | Yellow Toner (8,000 Yield) | 96476 | CTG | \$213.40 |
| 013R00636 | Black/Color Drum Cartridge (80,000 Yield) | 906457 | EA | \$385.00 |
| 008R13021 | Waste Toner Bottle (31,000 Yield) | 30823 | EA | \$49.00 |
| Xerox WorkCentre® 7425/7428/7435 Color Supplies | | | | |
| 006R01395 | Black Toner (26,000 Yield) | 25621 | CTG | \$176.00 |
| 006R01398 | Cyan Toner (15,000 Yield) | 25624 | CTG | \$243.10 |
| 006R01397 | Magenta Toner (15,000 Yield) | 25623 | CTG | \$243.10 |
| 006R01396 | Yellow Toner (15,000 Yield) | 25622 | CTG | \$243.10 |
| 008R13061 | Waste Toner Container (43,000 Yield) | 97772 | EA | \$40.00 |
| 008R13064 | Transfer Roller (200,000 Yield) | 915434 | EA | \$308.00 |
| 008R12897 | Staple Cartridges for Office LX Booklet Maker Option (2,000 Staples/Ctg, 8 Ctgs/EA) | 915464 | EA | \$170.10 |
| Xerox WorkCentre® 7525/7530/7535/7545/7556 Color Supplies | | | | |
| 006R01513 | Black Toner (26,000 Yield) | 100951 | CTG | \$183.75 |
| 006R01516 | Cyan Toner (15,000 Yield) | 100954 | CTG | \$193.00 |
| 006R01515 | Magenta Toner (15,000 Yield) | 100953 | CTG | \$193.00 |
| 006R01514 | Yellow Toner (15,000 Yield) | 100952 | CTG | \$193.00 |
| 013R00662 | Drum Unit (125,000 Yield) | 912322 | EA | \$450.00 |
| 008R12964 | Staples (5,000 Staples/Ctg) | 14070 | CTG | \$175.00 |
| 008R12897 | Staple Cartridges for Office LX Booklet Maker Option (2,000 Staples/Ctg, 8 Ctgs/EA) | 915464 | EA | \$170.10 |
| 008R13064 | Transfer Roller (200,000 Yield) | 915434 | EA | \$308.00 |
| 001R00613 | Transfer Belt Cleaner (160,000 Yield) | 915431 | EA | \$60.00 |
| Xerox WorkCentre® 7655/7665/7675 Color Supplies | | | | |
| 006R01219 | Black Toner (30,000 Yield) | 106666 | CTG | \$317.18 |
| 006R01222 | Cyan Toner (34,000 Yield) | 106667 | CTG | \$635.47 |
| 006R01221 | Magenta Toner (34,000 Yield) | 106668 | CTG | \$635.47 |
| 006R01220 | Yellow Toner (34,000 Yield) | 106669 | CTG | \$635.47 |
| 013R00603 | Color Drum (100,000 Yield) | 100192 | EA | \$412.00 |
| 008R12988 | Fuser Unit | 100189 | EA | \$450.00 |
| Xerox WorkCentre® C2424 Solid Ink Supplies | | | | |
| 108R00663 | Black Solid Ink (3 Sticks/Box) (Total Box Yield 3,400) | 10082 | BOX | \$103.00 |
| 108R00664 | Black Solid Ink (6 Sticks/Box) (Total Box Yield 6,800) | 10080 | BOX | \$154.00 |
| 108R00660 | Cyan Solid Ink (3 Sticks/Box) (Total Box Yield 3,400) | 10089 | BOX | \$154.00 |
| 108R00661 | Magenta Solid Ink (3 Sticks/Box) (Total Box Yield 3,400) | 10096 | BOX | \$154.00 |
| 108R00662 | Yellow Solid Ink (3 Sticks/Box) (Total Box Yield 3,400) | 10106 | BOX | \$154.00 |
| Xerox WorkCentre® M15/M15i Supplies | | | | |
| 106R00584 | Toner (6,000 Yield) | 3585 | CTG | \$108.00 |
| 113R00663 | Drum (15,000 Yield) | 1520 | EA | \$139.00 |
| Xerox WorkCentre® M20/M20i Supplies | | | | |
| 106R01047 | Toner (8,000 Yield) | 5441 | CTG | \$118.00 |
| 113R00671 | Drum (20,000 Yield) | 5442 | EA | \$134.00 |
| Xerox WorkCentre® M35/M45/M55/WorkCentre® Pro 35/45/55 Supplies | | | | |
| 006R01046 | Toner (64,000 Yield) (2 Ctgs + Waste Bottle/Ctn) | 1674 | CTN | \$307.60 |
| Xerox WorkCentre® M118/M118i Supplies | | | | |
| 006R01179 | Toner (11,000 Yield) | 10077 | CTG | \$103.00 |
| 013R00589 | Drum (60,000 Yield) | 10079 | EA | \$281.40 |

| MFG# | Product Description | Part# | UOM | Retail |
|---|---|--------|-----|----------|
| XEROX SUPPLIES | | | | |
| Xerox WorkCentre® M123/128/Pro M123/128 Supplies | | | | |
| 006R01184 | Toner (30,000 Yield) | 10839 | CTG | \$211.05 |
| 013R00589 | Drum (60,000 Yield) | 10079 | EA | \$281.40 |
| 008R12915 | Staple Cartridges (5,000 Staples/Ctg) (3 Ctgs/Box) | 10840 | BOX | \$124.95 |
| Xerox WorkCentre® M165/M175/Pro 265/275/5665 Supplies | | | | |
| 006R01146 | Toner (90,000 Yield) (2 Ctgs/Ctn) | 14090 | CTN | \$356.11 |
| Xerox WorkCentre® PE16 Supplies | | | | |
| 113R00667 | Toner (3,500 Yield) | 1347 | CTG | \$139.00 |
| Xerox WorkCentre® PE120/PE120i Supplies | | | | |
| 013R00601 | Toner (3,500 Yield) | 6078 | CTG | \$133.00 |
| 013R00606 | High Capacity Toner (5,000 Yield) | 6079 | CTG | \$142.00 |
| Xerox WorkCentre® PE220 Supplies | | | | |
| 013R00621 | Smart Kit Toner (3,000 Yield) | 12323 | CTG | \$135.00 |
| Xerox WorkCentre® Pro 412 Supplies | | | | |
| 106R00584 | Toner (6,000 Yield) | 3585 | CTG | \$108.00 |
| 113R00663 | Drum (15,000 Yield) | 1520 | EA | \$139.00 |
| Xerox WorkCentre® Pro 423/428 Supplies | | | | |
| 113R00634 | Toner (28,800 Yield) | 10158 | CTG | \$190.00 |
| 108R00535 | Staple Cartridge Refills for Basic Office Finisher (3,000 Staples/Ctg) (3 Ctg/EA) | 915474 | EA | \$58.80 |
| Xerox WorkCentre® Pro 555/575 Supplies | | | | |
| 106R00402 | Toner (6,000 Yield) | 106550 | CTG | \$259.53 |
| 113R00457 | Drum (20,000 Yield) | 106551 | EA | \$276.73 |
| Xerox WorkCentre® Pro 7328/7335/7345/7346 Color Supplies | | | | |
| 006R01175 | Black Toner (26,000 Yield) | 6161 | CTG | \$224.40 |
| 006R01176 | Cyan Toner (16,000 Yield) | 6162 | CTG | \$305.80 |
| 006R01177 | Magenta Toner (16,000 Yield) | 6163 | CTG | \$305.80 |
| 006R01178 | Yellow Toner (16,000 Yield) | 6164 | CTG | \$305.80 |
| 008R13055 | Fuser Unit (120V) | 915472 | EA | \$615.00 |
| 008R12903 | Waste Toner Bottle (25,000 Yield) | 28539 | EA | \$38.00 |
| Xerox WorkCentre® Pro C2128/C2636/C3545 Color Supplies | | | | |
| 006R01175 | Black Toner (26,000 Yield) | 6161 | CTG | \$224.40 |
| 006R01176 | Cyan Toner (16,000 Yield) | 6162 | CTG | \$305.80 |
| 006R01177 | Magenta Toner (16,000 Yield) | 6163 | CTG | \$305.80 |
| 006R01178 | Yellow Toner (16,000 Yield) | 6164 | CTG | \$305.80 |
| 008R12903 | Waste Toner Bottle (25,000 Yield) | 28539 | EA | \$38.00 |
| 008R12915 | Staple Cartridges (5,000 Staples/Ctg) (3 Ctgs/Box) | 10840 | BOX | \$124.95 |



COMPATIBLE PRINT SUPPLIES & PARTS

Quality and reliability are key when choosing OEM alternatives. We can help educate you on the best remanufactured products to fit your needs.

QUALITY AND RELIABILITY.

| MFG# | Product Description | Part# | UOM | Retail |
|--|--|--------|-----|----------|
| CTG COMPATIBLES | | | | |
| CTG - Brother DCP-130C/330C/350C; IntelliFax 1360/1860C/1960C/2480C/2580C; MFC-230C/240C/440CN/465CN/665CW/685CW/845CW/885CW/3360C/5460CN/5860CN Ink Supplies | | | | |
| CTGLC51B | Black Ink (OEM# LC51BK) (500 Yield) | 15387 | CTG | \$23.75 |
| CTGLC51C | Cyan Ink (OEM# LC51C) (400 Yield) | 15388 | CTG | \$13.15 |
| CTGLC51M | Magenta Ink (OEM# LC51M) (400 Yield) | 15389 | CTG | \$13.15 |
| CTGLC51Y | Yellow Ink (OEM# LC51Y) (400 Yield) | 15390 | CTG | \$13.15 |
| CTG - Brother DCP-165C/375CW/385C/395CW/585CW; MFC-250C/255CW/290C/295CN/490CW/495CW/5490CN/5890CN/6490CW/6890CDW/790CW/795CW/990CW/J220/J265w/J415w/J615w/J630w Ink Supplies | | | | |
| CTGLC61B | Black Ink (OEM# LC61BK) (865 Yield) | 95923 | CTG | \$22.05 |
| CTGLC65B | High Yield Black Ink (OEM# LC65HYBK) (1,250 Yield) (For MFC-5490CN/5890CN/5895CW/6490CW/6890CDW Models Only) | 95936 | CTG | \$28.00 |
| CTGLC65C | High Yield Cyan Ink (OEM# LC65HYC) (745 Yield) | 95937 | CTG | \$15.25 |
| CTGLC65M | High Yield Magenta Ink (OEM# LC65HYM) (745 Yield) | 95940 | CTG | \$15.25 |
| CTGLC65Y | High Yield Yellow Ink (OEM# LC65HY) (730 Yield) | 95947 | CTG | \$15.25 |
| CTG - Brother MFC-J280W/J425W/J430W/J435W/J625W/J825DW/J835DW/J5910DW/J6510DW/J6710DW/J6910DW Ink Supplies | | | | |
| CTGLC75B | High Yield Black Ink (OEM# LC71BK, LC75BK) (600 Yield) | 908377 | CTG | \$21.20 |
| CTGLC75C | High Yield Cyan Ink (OEM# LC71C, LC75C) (600 Yield) | 908378 | CTG | \$12.70 |
| CTGLC75M | High Yield Magenta Ink (OEM# LC71M, LC75M) (600 Yield) | 908379 | CTG | \$12.70 |
| CTGLC75Y | High Yield Yellow Ink (OEM# LC71Y, LC75Y) (600 Yield) | 908380 | CTG | \$12.70 |
| CTG - Brother MFC-J6510DW/J6710DW/J6910DW/J825DW/J835DW Ink Supplies | | | | |
| CTGLC79B | Extra High Yield Black Ink (OEM# LC79BK) (2,400 Yield) | 923322 | CTG | \$33.95 |
| CTGLC79C | Extra High Yield Cyan Ink (OEM# LC79C) (1,200 Yield) | 923323 | CTG | \$19.50 |
| CTGLC79M | Extra High Yield Magenta Ink (OEM# LC79M) (1,200 Yield) | 923324 | CTG | \$19.50 |
| CTGLC79Y | Extra High Yield Yellow Ink (OEM# LC79Y) (1,200 Yield) | 923325 | CTG | \$19.50 |
| CTG - Brother Facsimile Supplies | | | | |
| CTGPC201 | (PC201) IntelliFax 1170/1270e/1570MC/1575MC; MFC-1770/1780/1870MC/1970MC Toner (OEM# PC201) (450 Yield) | 101475 | CTG | \$28.00 |
| CTG202RF | (PC201) IntelliFax 1170/1270e/1570MC/1575MC; MFC-1770/1780/1870MC/1970MC Refill Kit (2/Ctn) (OEM# PC202RF) (450 Yield) | 108284 | CTN | \$49.25 |
| CTGPC301 | (PC301) IntelliFax 750/770/775/870MC/875MC/885MC; MFC-970MC Toner (OEM# PC301) (250 Yield) | 900142 | CTG | \$22.05 |
| CTG302RF | (PC301) IntelliFax 750/770/775/870MC/875MC/885MC; MFC-970MC Refill Kit (2/Ctn) (OEM# PC302RF) (250 Yield) | 101628 | CTN | \$33.95 |
| CTGPC401 | (PC401) IntelliFax 560/565/580MC; MFC-660MC Toner (OEM# PC401) (150 Yield) | 900134 | CTG | \$19.95 |
| CTG402RF | (PC401/PC501) IntelliFax 560/565/575/580MC; MFC-660MC Refill Kit (2/Box) (OEM# PC402RF) (150 Yield) | 108272 | BOX | \$28.00 |
| CTGPC501 | (PC501) IntelliFax 575 Toner (OEM# PC501) (150 Yield) | 900135 | CTG | \$19.95 |
| CTG - Brother DCP-7020; FAX 2820/2920; HL-2040/2070N; MFC-7220/7225N/7420/7820N Mono Laser Supplies | | | | |
| CTGTN350 | Toner (OEM# TN350) (2,500 Yield) | 900124 | CTG | \$62.00 |
| CTGDR350 | Drum (OEM# DR350) (12,000 Yield) | 903387 | CTG | \$118.95 |
| CTG - Brother DCP-7030/7040; HL-2140/2170W; MFC-7340/7345N/7440N/7840W Mono Laser Supplies | | | | |
| CTGTN330 | Toner (OEM# TN330) (1,500 Yield) | 7540 | CTG | \$42.45 |
| CTGTN360 | High Yield Toner (OEM# TN360) (2,600 Yield) | 7541 | CTG | \$61.15 |
| CTGDR360 | Drum Unit (OEM# DR360) (12,000 Yield) | 23462 | EA | \$93.90 |
| CTG - Brother DCP-1200/1400; HL-1030/1230/1240/1250/1270N/1435/1440/1450/1470N; MFC-8300/8500/8600/8700/9600/9700/9800/P2500; PPF-4100/4750/5750 Mono Laser Supplies | | | | |
| CTGTN430 | Toner (OEM# TN430) (3,000 Yield) | 900171 | CTG | \$59.05 |
| CTGTN460 | High Yield Toner (OEM# TN460) (6,000 Yield) | 900172 | CTG | \$85.40 |
| CTGDR400 | Drum (OEM# DR400) (20,000 Yield) | 900175 | CTG | \$177.20 |
| CTG - Brother DCP-8040/8045D; HL-5140/5150/ 5170DN; MFC-8120/8220/8440/8640D/8840 Mono Laser Supplies | | | | |
| CTGTN540 | Toner (OEM# TN540) (3,500 Yield) | 101501 | CTG | \$76.05 |
| CTGTN570 | Toner (OEM# TN570) (6,700 Yield) | 101502 | CTG | \$99.85 |
| CTGDR510 | Drum (OEM# DR510) (20,000 Yield) | 900166 | CTG | \$194.20 |

| MFG# | Product Description | Part# | UOM | Retail |
|---|---|--------|-----|----------|
| CTG COMPATIBLES | | | | |
| CTG - Brother DCP-8060/8065DN; HL-5240/5250/5280DW; MFC-8460N/8660/8670DN/8860DN/8870DW Mono Laser Supplies | | | | |
| CTGTN550 | Toner (OEM# TN550) (3,500 Yield) | 900126 | CTG | \$76.05 |
| CTGTN580 | High Yield Toner (OEM# TN580) (7,000 Yield) | 900128 | CTG | \$102.80 |
| CTGDR520 | Drum (OEM# DR520) (25,000 Yield) | 903424 | CTG | \$194.20 |
| CTG - Brother DCP-8080DN/8085DN; HL-5340D/5350DN/5370/5380DN; MFC-8480DN/8680DN/8690DW/8880DN/8890DW Mono Laser Supplies | | | | |
| CTGTN620 | Toner (OEM# TN620) (3,000 Yield) | 31142 | CTG | \$63.70 |
| CTGTN650 | High Yield Toner (OEM# TN650) (8,000 Yield) | 31139 | CTG | \$101.95 |
| CTGDR620 | Drum Unit (OEM# DR620) (25,000 Yield) | 106112 | CTG | \$127.45 |
| CTG - Brother DCP-8110DN/8150DN/8155DN; HL-5440D/5450/5470/6180; MFC-8510DN/8710/8910DW/8950 Mono Laser Supplies | | | | |
| CTGTN720 | Toner (OEM# TN720) (3,000 Yield) | 916683 | CTG | \$61.59 |
| CTGTN750 | High Yield Toner (OEM# TN750) (8,000 Yield) | 916684 | CTG | \$99.99 |
| CTGDR720 | Drum Unit (OEM# DR720) (30,000 Yield) | 916679 | EA | \$127.99 |
| CTG - Brother Monochrome Laser Supplies | | | | |
| CTGTN450 | DCP-7060/7065; FAX 2840/2940; HL-2230/2240D/2270DW/2280; MFC-7240/7360N/7460/7860 High Yield Toner (OEM# TN450) (2,600 Yield) | 503792 | CTG | \$58.20 |
| CTGTN670 | HL-6050 Toner (OEM# TN670) (7,500 Yield) | 7542 | CTG | \$103.65 |
| CTGTN780 | HL-6180; MFC-8950 Extra High Yield Toner (OEM# TN780) (12,000 Yield) | 922660 | CTG | \$127.45 |
| CTG - Brother HL-4040; MFC-9440/9840 Color Laser Supplies | | | | |
| CTGTN115B | High Yield Black Toner (OEM# TN115BK) (6,600 Yield) | 7536 | CTG | \$87.10 |
| CTGTN115C | High Yield Cyan Toner (OEM# TN115C) (6,600 Yield) | 7537 | CTG | \$121.95 |
| CTGTN115M | High Yield Magenta Toner (OEM# TN115M) (6,600 Yield) | 7538 | CTG | \$121.95 |
| CTGTN115Y | High Yield Yellow Toner (OEM# TN115Y) (6,600 Yield) | 7539 | CTG | \$121.95 |
| CTG - Canon Inkjet Supplies (Continued on next page) | | | | |
| CTGBC20 | (BC-20) BJC 2000/2010/2100/2110/2115/4000/4100/4200/4300/4400/4550/4650/5500 MultiPASS C2500/C3000/C3500/C5000/C530/C545/C5500/C555/C560/C635 Black Ink (OEM# 0895A003) (900 Yield) | 101445 | CTG | \$33.95 |
| CTGBX3 | (BX-3) Fax B45/B540/B550/B640/B95/MULTIPASS 800 Black Ink (OEM# 0884A003) (2,000 Yield) | 701190 | CTG | \$36.50 |
| CTGCL31 | (CL-31) PIXMA iP1800/iP2600/MP140/MP190/MP210/MP470/MX300/MX310 Tri-Color Ink (OEM# 1900B002) (405 Yield) | 106117 | CTG | \$17.80 |
| CTGCLI36 | (CLI-36) PIXMA iP100/PIXMA mini260/PIXMA mini320 Color Ink Tank (OEM# 1511B002) (275 Yield) | 106116 | CTG | \$16.10 |
| CTGCL41 | (CL-31) (CL-41) iP1600/iP2600/iP6210D/iP6220D/MP150/MP170/MP450 Tri-Color Ink (OEM# 0617B002) (325 Yield) | 701191 | CTG | \$22.90 |
| CTGCL241XL | (CL-241XL) MG2120/MG2220/MG3120/MG3220/MG3520/MG4120/MG4220/MX372/MX392/MX432/MX439/MX452/MX512/MX522 High Yield Color Ink (OEM# 5208B001) (400 Yield) | 916676 | CTG | \$23.99 |
| CTGCLI8BK | (CLI-8BK) PIXMA iP4200/iP4300/iP4500/iP5200/iP5200R/iP6600D/iP6700D; MP500/MP530/MP600/MP610/MP800/MP800R/MP810/MP830/MP950/MP960/MP970/MX850/Pro9000 Black Ink (OEM# 0620B002) (190 Yield) | 31146 | CTG | \$13.55 |
| CTGCLI8C | (CLI-8C) PIXMA iP3300/iP3500/iP4200/iP4300/iP4500/iP5200/iP5200R/iP6600D/iP6700D/MP500/MP510/MP520/MP530/MP600/MP610/MP800/MP800R/MP810/MP830/MP950/MP960/MP970/MX700/MX850/Pro9000 Cyan Ink (OEM# 0621B002) (350 Yield) | 31147 | CTG | \$13.55 |
| CTGCLI8M | (CLI-8M) PIXMA iP3300/iP3500/iP4200/iP4300/iP4500/iP5200/iP5200R/iP6600D/iP6700D/MP500/MP510/MP520/MP530/MP600/MP610/MP800/MP800R/MP810/MP830/MP950/MP960/MP970/MX700/MX850/Pro9000 Magenta Ink (OEM# 0622B002) (260 Yield) | 31148 | CTG | \$13.55 |
| CTGCLI8Y | (CLI-8Y) PIXMA iP3300/iP3500/iP4200/iP4300/iP4500/iP5200/iP5200R/iP6600D/iP6700D/MP500/MP510/MP520/MP530/MP600/MP610/MP800/MP800R/MP810/MP830/MP950/MP960/MP970/MX700/MX850/Pro9000 Yellow Ink (OEM# 0623B002) (360 Yield) | 31149 | CTG | \$13.55 |
| CTGCLI8PC | (CLI-8PC) PIXMA iP6600D/iP6700D/MP950/MP960/MP970/Pro9000 Photo Cyan Ink (OEM# 0624B002) (870 Yield) | 31150 | CTG | \$13.55 |
| CTGCLI8PM | (CLI-8PM) PIXMA iP6600D/iP6700D/MP950/MP960/MP970/Pro9000 Photo Magenta Ink (OEM# 0625B002) (870 Yield) | 31151 | CTG | \$13.55 |
| CTGCL211 | (CL-211) PIXMA MP240/MP250/MP480/MP490/MX300/MX320/MX330/IP 2702 Tri-Color Ink (OEM# 2976B001) (290 Yield) | 106140 | CTG | \$17.80 |
| CTGCL211XL | (CL-211XL) PIXMA MP240/MP250/MP480/MP490/MX300/MX320/MX330/IP 2702 High Yield Tri-Color Ink (OEM# 2975B001) (410 Yield) | 106130 | CTG | \$22.90 |
| CTGCLI221B | (CLI-221) PIXMA MP560/MP620/MP620B/MP640/MP640R/MP980/MP990/MX860/MX870/iP3600/iP4600/iP4700 Black Ink Tank (OEM# 2946B001) (750 Yield) | 94290 | CTG | \$11.00 |
| CTGCLI221C | (CLI-221) PIXMA MP560/MP620/MP620B/MP640/MP640R/MP980/MP990/MX860/MX870/iP3600/iP4600/iP4700 Cyan Ink Tank (OEM# 2947B001) (775 Yield) | 94291 | CTG | \$11.00 |

| MFG# | Product Description | Part# | UOM | Retail |
|--|--|--------|-----|----------|
| CTG COMPATIBLES | | | | |
| CTG - Canon Inkjet Supplies (Continued) | | | | |
| CTGCLI221M | (CLI-221) PIXMA MP560/MP620/MP620B/MP640/MP640R/MP980/MP990/MX860/MX870/iP3600/iP4600/iP4700 Magenta Ink Tank (OEM# 2948B001) (775 Yield) | 94292 | CTG | \$11.00 |
| CTGCLI221Y | (CLI-221) PIXMA MP560/MP620/MP620B/MP640/MP640R/MP980/MP990/MX860/MX870/iP3600/iP4600/iP4700 Yellow Ink Tank (OEM# 2949B001) (775 Yield) | 94293 | CTG | \$11.00 |
| CTGCLI226B | (CLI-226) PIXMA iP4820/iX6520/MG5120/MG5220/MG5320/MG6120/MG8120/MX882 Black Ink (OEM# 4546B001) | 908319 | CTG | \$11.85 |
| CTGCLI226C | (CLI-226) PIXMA iP4820/iX6520/MG5120/MG5220/MG5320/MG6120/MG8120/MX882 Cyan Ink (OEM# 4547B001) | 908320 | CTG | \$11.85 |
| CTGCLI226M | (CLI-226) PIXMA iP4820/iX6520/MG5120/MG5220/MG5320/MG6120/MG8120/MX882 Magenta Ink (OEM# 4548B001) | 908321 | CTG | \$11.85 |
| CTGCLI226Y | (CLI-226) PIXMA iP4820/iX6520/MG5120/MG5220/MG5320/MG6120/MG8120/MX882 Yellow Ink (OEM# 4549B001) | 908322 | CTG | \$11.85 |
| CTGCL51 | (CL-51) PIXMA iP6210D/iP6220D/iP6310D/MP150/MP160/MP170/MP180/MP450/MP460/MX300/MX310 High Yield Tri-Color Ink (OEM# 0618B002) (600 Yield) | 901452 | CTG | \$35.65 |
| CTGPGI35 | (PGI-35) PIXMA iP100 Black Ink (OEM# 1509B002) (235 Yield) | 106113 | CTG | \$12.70 |
| CTGPG40 | (PG-30) (PG-40) iP1600/iP2600/MP 150/170/450 Black Ink (OEM# 0615B002) (335 Yield) | 900143 | CTG | \$19.50 |
| CTGPG50 | (PG-50) PIMXA MP150/MP160/MP180/MP450/MP460/MX300/MX310 Fax JX200 High Yield Black Ink (OEM# 0616B002) (615 Yield) | 901451 | CTG | \$32.25 |
| CTGPGI5BK | (PGI-5BK) PIXMA iP3300/iP3500/iP4200/iP4300/iP4500/iP5200/iP5200R/MP500/MP510/MP520/MP530/MP600/MP610/MP800/MP800R/MP810/MP830/MP950/MP960/MP970/MX700/MX850 Black Ink (OEM# 0628B002) (370 Yield) | 31152 | CTG | \$15.70 |
| CTGPG210 | (PG-210) PIXMA MP240/MP250/MP480/MP490/MX300/MX320/MX330/IP 2702 Black Inkjet (OEM# 2974B001) (300 Yield) | 106123 | CTG | \$13.55 |
| CTGPG210XL | (PG-210XL) PIXMA MP240/MP250/MP480/MP490/MX300/MX320/MX330/IP 2702 High Yield Black Ink (OEM# 2973B001) (510 Yield) | 106120 | CTG | \$18.65 |
| CTGPG240XL | (PG-240XL) MG2120/MG2220/MG3120/MG3220/MG3520/MG4120/MG4220/MX372/MX392/MX432/MX439/MX452/MX512/MX522 High Yield Black Ink (OEM# 5206B001) (300 Yield) | 916681 | CTG | \$16.79 |
| CTGPGI220B | (PGI-220) PIXMA MP560/MP620/MP620B/MP640/MP640R/MP980/MP990/MX860/MX870/iP3600/iP4600/iP4700 Black Ink (OEM# 2945B001) (420 Yield) | 94275 | CTG | \$12.70 |
| CTGPGI225B | (PGI-225) PIXMA iP4820/iX6520/MG5120/MG5220/MG5320/MG6120/MG8120/MX882 Black Ink (OEM# 4530B001) | 908336 | CTG | \$13.55 |
| CTG - Canon Copier Supplies | | | | |
| CTG0264 | (106) imageCLASS MF6530/MF6550/MF6560/MF6560CX/MF6580/MF6580CX Toner (OEM# 0264B001AA) (5,000 Yield) | 7544 | CTG | \$186.15 |
| CTGE20 | (E20) FC200/204/220/310/330/336/ PC 140/150/160/300/310/320/325/330/330L/400/420/425/428/430/530/550/710/730/735/740/760/770/775/785/790/795/860/880/890/920/921/940/941/950/981 Toner (OEM# 1492A002AA) (2,000 Yield) | 900167 | CTG | \$103.70 |
| CTGE40 | (E40) FC200/204/220310/336/ PC 140/150/160/300/310/320/325/330/330L/400/420/425/428/430/530/550/710/720/730/735/740/745/760/770/775/785/790/795/860/880/890/920/921/940/941/950/980/981 High Yield Toner (OEM# 1491A002AA) (4,000 Yield) | 900168 | CTG | \$159.80 |
| CTGL50P | (L50) imageCLASS D660/D661/D680/Digital MFP/D760/Digital/D761/D780/D860/D861/D880, PC1060/1061/1080F Toner (OEM# 6812A001AA) (5,000 Yield) | 900116 | CTG | \$186.15 |
| CTGS35 | (S35) imageCLASS D320 Digital MFP/D340 Digital MFP/Fax L400/L170/LC 310 MFP/510/PC D320 Toner (OEM# 7833A001AA) (3,500 Yield) | 900144 | CTG | \$146.20 |
| CTG128 | (CRG-128) imageCLASS D530/D550/MF4412/MF4420/MF4450/MF4550/MF4570dn/MF4570dw/MF4580/MF4770n/MF4880dw/MF4890dw/Faxphone L100/L190 Toner (OEM# 3500B001AA) (2,100 Yield) | 911430 | CTG | \$96.90 |
| CTG2617 | (120) imageCLASS D1120/D1150/D1170/D1180 Toner (OEM# 2617B001AA, 1423A003AA) (5,000 Yield) | 94503 | CTG | \$177.65 |
| CTGX25 | (X25) imageCLASS MF3110/5530/5550/5730/5770 Toner (OEM# 8489A001AA) (2,500 Yield) | 900173 | CTG | \$96.90 |
| CTG - Canon Facsimile Supplies (Continued on next page) | | | | |
| CTGFX2P | (FX2) LaserCLASS 5000/5500/7000/7100/7500/7700 Toner (OEM# 1556A002BA) (4,000 Yield) | 101449 | CTG | \$84.15 |
| CTGFX3P | (FX3) Laser Fax FFX-LC2050/2060/L3500/L4000/L4500/L75/Faxphone L80/imageCLASS 1100/Multipass L6000 Toner (OEM# 1557A002BA) (2,700 Yield) | 101450 | CTG | \$86.00 |
| CTGFX4P | (FX4) LaserCLASS 8500/9000/9000L/9000MS/9000S/9500/9500MS/9500S Toner (OEM# 1558A002AA) (4,000 Yield) | 900109 | CTG | \$92.55 |
| CTGFX6P | (FX6) L1000/LaserCLASS 3170 MFP/3175MFP/3175MS MFP Toner (OEM# 1559A002AA) (5,000 Yield) | 101451 | CTG | \$114.05 |
| CTGFX7P | (FX7) L2000/L2000 IP/LaserCLASS 710/720i/730i Toner (OEM# 7621A001AA) (4,500 Yield) | 101452 | CTG | \$100.00 |
| CTGFX8P | (FX8) L400/FAXPHONE L170/imageCLASS D320/D340 Digital MFP/LaserCLASS 510/Copier PC-D320/PC-D340 Toner (OEM# 8955A001AA) (3,500 Yield) | 21786 | CTG | \$122.35 |
| CTG0263 | (FX9) (FX10) (104) FAXPHONE L120/imageCLASS MF4150 Toner (OEM# 0263B001BA) (2,000 Yield) | 7683 | CTG | \$88.40 |

| MFG# | Product Description | Part# | UOM | Retail |
|--|--|--------|-----|----------|
| CTG COMPATIBLES | | | | |
| CTG - Canon Facsimile Supplies (Continued) | | | | |
| CTGFX11P | (FX11) LaserCLASS LC810/830 Toner (OEM# 1153B001AA) (4,500 Yield) | 7545 | CTG | \$110.00 |
| CTG - Dell Inkjet Supplies | | | | |
| CTGD5878B | 720/A920 Black Ink (OEM# T0529) (410 Yield) | 900161 | CTG | \$35.15 |
| CTGD5882C | 720/A920 Color Ink (OEM# T0530) (275 Yield) | 900174 | CTG | \$38.00 |
| CTGM4640 | 922/924/942/944/946/962/964 Black Ink (OEM# M4640) (315 Yield) | 903372 | CTG | \$33.80 |
| CTGM4646 | 922/924/942/944/962/964 Tri-Color Ink (OEM# M4646) (225 Yield) | 903373 | CTG | \$44.70 |
| CTGD7Y745C | A940/A960 Color Ink (OEM# 7Y745, 310-3541) (450 Yield) | 903945 | CTG | \$47.55 |
| CTGDH828 | (Series 7) 966/968/968w Black Ink (OEM# CH883, DH828) (600 Yield) | 31160 | CTG | \$27.50 |
| CTGDH829 | (Series 7) 966/968/968w Color Ink (OEM# CH884, DH829) (475 Yield) | 31144 | CTG | \$38.75 |
| CTGMK990 | (Series 9) 926/Photo V305/V305x Black Ink (OEM# MK990, MK992) (775 Yield) | 19742 | CTG | \$21.85 |
| CTGMK991 | (Series 9) 926/Photo V305/V305x Color Ink (OEM# MK991, MK993) (510 Yield) | 19741 | CTG | \$28.80 |
| CTGD451 | (Series 11) 948/V505/V505w Black Ink (OEM# KX701, JP451) (500 Yield) | 31161 | CTG | \$29.55 |
| CTGD453 | (Series 11) 948/V505/V505w Color Ink (OEM# KX703, JP453) (375 Yield) | 31159 | CTG | \$32.60 |
| CTGD22BXLS | (Series 21XL/22XL) P513w/P713w/P715w/V313/V313w/V515w High Yield Black Ink (OEM# T095N, X739N) (980 Yield) | 908524 | CTG | \$23.45 |
| CTGD22CXLS | (Series 21XL/22XL) P513w/P713w/P715w/V313/V313w/V515w High Yield Tri-Color Ink (OEM# X740N) (850 Yield) | 908523 | CTG | \$27.50 |
| CTGD33XLB | (Series 33) V525w/V725w High Yield Black Ink (OEM# T9FKK, 331-7377) (750 Yield) | 932686 | CTG | \$28.55 |
| CTGD33XLC | (Series 33) V525w/V725w Cyan Ink (OEM# 8DNKH, 331-7378) (700 Yield) | 932687 | CTG | \$28.55 |
| CTGD33XLM | (Series 33) V525w/V725w Magenta Ink (OEM# 6M6FG, 331-7379) (700 Yield) | 932688 | CTG | \$28.55 |
| CTGD33XLY | (Series 33) V525w/V725w Yellow Ink (OEM# GRW63, 331-7380) (700 Yield) | 932689 | CTG | \$28.55 |
| CTG - Dell Monochrome Laser Supplies | | | | |
| CTGD6640 | 1100 Toner (OEM# 310-6640) (2,000 Yield) | 900162 | CTG | \$74.55 |
| CTGD1125 | 1125 High Yield Toner (OEM# 310-9319, TX300, 310-9318, UW919) (2,000 Yield) | 908327 | CTG | \$75.55 |
| CTGD1130 | 1130/1130n/1133/1135n High Yield Toner (OEM# 330-9523, 2MMJP, 7H53W, 330-9524, P9H7G) (2,500 Yield) | 908328 | CTG | \$89.75 |
| CTGD5417 | 1600n MFP High Yield Toner (OEM# 310-5417) (5,000 Yield) | 900160 | CTG | \$103.40 |
| CTGD5007 | 1700/1700n/1710 High Yield Toner (OEM# 310-5402) (6,000 Yield) | 900152 | CTG | \$169.05 |
| CTGD1720 | 1720/1720dn High Yield Toner (OEM# 310-8707/310-8706) (6,000 Yield) | 904526 | CTG | \$122.35 |
| CTGE450DR | 1720/1720dn Drum Unit (OEM# 310-8710, 39V1645, OD3500) (30,000 Yield) | 106143 | CTG | \$57.65 |
| CTGD1815 | 1815dn High Yield Toner (OEM# 310-7945, RF223) (5,000 Yield) | 904525 | CTG | \$96.40 |
| CTGD2230 | 2230d Toner (OEM# 330-4130, 330-4131) (3,500 Yield) | 916677 | CTG | \$110.12 |
| CTGD2330 | 2330d/2330dn/2350d/2350dn High Yield Toner (OEM# 330-2666) (6,000 Yield) | 503797 | CTG | \$129.15 |
| CTGD2335 | 2335dn High Yield Toner (OEM# 330-2209, HX756) (6,000 Yield) | 33163 | CTG | \$112.15 |
| CTGD2355 | 2355dn Toner (OEM# 331-0611, R2W64) (10,000 Yield) | 908329 | CTG | \$161.45 |
| CTGD3330 | 3330dn High Yield Toner (OEM# 330-5206, 330-5207, C233R) (14,000 Yield) | 908330 | CTG | \$254.95 |
| CTGD3333 | 3333dn/3335dn Toner (OEM# N27GW, YYOJN) (8,000 Yield) | 901454 | CTG | \$195.45 |
| CTGD3335 | 3333dn/3335dn High Yield Toner (OEM# 330-8985, 330-8987) (14,000 Yield) | 913017 | CTG | \$236.25 |
| CTGD5210 | 5210n/5310n High Yield Toner (OEM# 341-2916, 341-2939) (20,000 Yield) | 904528 | CTG | \$253.55 |
| CTGD5230 | 5230n/5230dn/5350dn High Yield Toner (OEM# 330-6968, F362T) (21,000 Yield) | 503798 | CTG | \$356.95 |
| CTGD5310 | 5210n/5310n Ultra High Yield Toner (OEM# 341-2939, 341-2916) (30,000 Yield) | 904527 | CTG | \$337.10 |
| CTGD5330 | 5330dn High Yield Toner (OEM# 330-2045, NY313) (20,000 Yield) | 916678 | CTG | \$161.14 |
| CTGD5535 | 5530dn/5535dn High Yield Toner (OEM# 330-9787, 330-9788) (25,000 Yield) | 913018 | CTG | \$377.35 |
| CTGD1260 | B1260dn/B1265dnf/B1265dfw High Yield Toner (OEM# 331-7328, DRYXV) (2,500 Yield) | 933819 | CTG | \$74.75 |
| CTGD2360 | B2360d/B2360dn/B3460dn/B3465dn/B3465dnf Toner (OEM# 331-9805) (2,500 Yield) | 923319 | CTG | \$97.70 |
| CTGD3460 | B2360d/B2360dn/B3460dn/B3465dn/B3465dnf High Yield Toner (OEM# 331-9805) (8,500 Yield) | 923320 | CTG | \$195.45 |
| CTGD3460X | B3460dn Extra High Yield Toner (OEM# 331-9807, 9GG2G) (20,000 Yield) | 933824 | CTG | \$459.95 |
| CTGD5460 | B5460dn/B5465dnf Toner (OEM# 331-9797, 331-9756) (6,000 Yield) | 923321 | CTG | \$138.20 |
| CTGD5460X | B5460dn/B5465dnf High Yield Toner (OEM# 331-9756, X5GDJ) (25,000 Yield) | 933825 | CTG | \$280.00 |
| CTGD2046 | M5200n/W5300n High Yield Toner (OEM# 310-4133, J2925) (18,000 Yield) | 701169 | CTG | \$215.00 |
| CTGD0893 | P1500 High Yield Toner (OEM# 310-3543) (6,000 Yield) | 701168 | CTG | \$149.15 |
| CTGD0887 | S2500/S2500n High Yield Toner (OEM# 310-3547, 310-3674) (10,000 Yield) | 701167 | CTG | \$244.90 |
| CTGD4587 | W5300n Extra High Yield Toner (OEM# 310-4587) (32,000 Yield) | 900151 | CTG | \$280.45 |
| CTG - Dell 1230c/1235cn Color Laser Supplies | | | | |
| CTGD1230B | Black Toner (OEM# 330-3578) (1,500 Yield) | 503793 | CTG | \$63.60 |
| CTGD1230C | Cyan Toner (OEM# 330-3581) (1,000 Yield) | 503796 | CTG | \$56.65 |
| CTGD1230M | Magenta Toner (OEM# 330-3580) (1,000 Yield) | 503795 | CTG | \$56.65 |
| CTGD1230Y | Yellow Toner (OEM# 330-3579) (1,000 Yield) | 503794 | CTG | \$56.65 |
| CTG - Dell 1250c/1350cnw/1355cn/1355cnw/C1760nw/C1765nf/C1765nfw Color Laser Supplies | | | | |
| CTGD1250B | High Yield Black Toner (OEM# 331-0778, 810WH, 332-0407, DC9NW) (2,000 Yield) | 933815 | CTG | \$59.45 |
| CTGD1250C | High Yield Cyan Toner (OEM# 331-0777, C5GC3, 332-0410, 79K5P) (1,400 Yield) | 933816 | CTG | \$59.45 |
| CTGD1250M | High Yield Magenta Toner (OEM# 331-0780, XMX5D, 332-0409, 4DV2W) (1,400 Yield) | 933817 | CTG | \$59.45 |
| CTGD1250Y | High Yield Yellow Toner (OEM# 331-0779, WM2JC, 332-0408, W8X8P) (1,400 Yield) | 933818 | CTG | \$59.45 |

| MFG# | Product Description | Part# | UOM | Retail |
|--|--|--------|-----|----------|
| CTG COMPATIBLES | | | | |
| CTG - Dell 1320c Color Laser Supplies | | | | |
| CTGD1320B | High Yield Black Toner (OEM# 310-9058, KU052, 310-9059, TP112) (2,000 Yield) | 7546 | CTG | \$72.55 |
| CTGD1320C | High Yield Cyan Toner (OEM# 310-9060, KU053, 310-9061, TP113) (2,000 Yield) | 7547 | CTG | \$95.45 |
| CTGD1320M | High Yield Magenta Toner (OEM# 310-9064, KU055, 310-9065, TP115) (2,000 Yield) | 7549 | CTG | \$95.45 |
| CTGD1320Y | High Yield Yellow Toner (OEM# 310-9062, KU054, 310-9063, TP114) (2,000 Yield) | 7548 | CTG | \$95.45 |
| CTG - Dell 2130cn/2135cn Color Laser Supplies | | | | |
| CTGD2130B | High Yield Black Toner (OEM# 330-1389, 330-1436, FM064) (2,500 Yield) | 7550 | CTG | \$98.55 |
| CTGD2130C | High Yield Cyan Toner (OEM# 330-1390, 330-1437, FM065) (2,500 Yield) | 7551 | CTG | \$132.55 |
| CTGD2130M | High Yield Magenta Toner (OEM# 330-1392, 330-1433, FM067) (2,500 Yield) | 7553 | CTG | \$132.55 |
| CTGD2130Y | High Yield Yellow Toner (OEM# 330-1391, 330-1438, FM066) (2,500 Yield) | 7552 | CTG | \$132.55 |
| CTG - Dell 2145cn Color Laser Supplies | | | | |
| CTGD2145B | High Yield Black Toner (OEM# R717J, 330-3789) (5,500 Yield) | 909960 | CTG | \$152.95 |
| CTGD2145C | High Yield Cyan Toner (OEM# P587K, 330-3792) (5,000 Yield) | 909961 | CTG | \$173.35 |
| CTGD2145M | High Yield Magenta Toner (OEM# K757K, 330-3791) (5,000 Yield) | 909962 | CTG | \$173.35 |
| CTGD2145Y | High Yield Yellow Toner (OEM# M803K, 330-3790) (5,000 Yield) | 909963 | CTG | \$173.35 |
| CTG - Dell 2150cn/2150cdn/2155cn/2155cdn Color Laser Supplies | | | | |
| CTGD2150B | High Yield Black Toner (OEM# 331-0719, N51XP) (3,000 Yield) | 933820 | CTG | \$93.45 |
| CTGD2150C | High Yield Cyan Toner (OEM# 331-0716, 769T5) (2,500 Yield) | 933821 | CTG | \$92.55 |
| CTGD2150M | High Yield Magenta Toner (OEM# 331-0717, 8WNV5) (2,500 Yield) | 933822 | CTG | \$92.55 |
| CTGD2150Y | High Yield Yellow Toner (OEM# 331-0718, NPDYG) (2,500 Yield) | 933823 | CTG | \$92.55 |
| CTG - Dell 3000cn/3100cn Color Laser Supplies | | | | |
| CTGD3100B | High Yield Black Toner (OEM# 310-5726) (4,000 Yield) | 900147 | CTG | \$49.95 |
| CTGD3100C | High Yield Cyan Toner (OEM# 310-5731, 310-5739) (4,000 Yield) | 900148 | CTG | \$144.80 |
| CTGD3100M | High Yield Magenta Toner (OEM# 310-5730, 310-5738) (4,000 Yield) | 900149 | CTG | \$144.80 |
| CTGD3100Y | High Yield Yellow Toner (OEM# 310-5729, 310-5737) (4,000 Yield) | 900150 | CTG | \$144.80 |
| CTG - Dell 3110/3115 Color Laser Supplies | | | | |
| CTGD3115B | High Yield Black Toner (OEM# 310-8395, 310-8396, 310-8092, 310-8093, PF030) (8,000 Yield) | 17900 | CTG | \$132.25 |
| CTGD3115C | High Yield Cyan Toner (OEM# 310-8397, 310-8398, 310-8094, 310-8095, XG722, XG726) (8,000 Yield) | 17901 | CTG | \$244.60 |
| CTGD3115M | High Yield Magenta Toner (OEM# 310-8399, 310-8400, 310-8096, 310-8097, XG723, XG727) (8,000 Yield) | 17902 | CTG | \$244.60 |
| CTGD3115Y | High Yield Yellow Toner (OEM# 310-8401, 310-8402, 310-8098, 310-8099, XG724, XG728) (8,000 Yield) | 17903 | CTG | \$244.60 |
| CTG - Dell 3130cn Color Laser Supplies | | | | |
| CTGD3130B | High Yield Black Toner (OEM# H516C, 330-1198) (9,000 Yield) | 908519 | CTG | \$141.75 |
| CTGD3130C | High Yield Cyan Toner (OEM# H513C, 330-1199) (9,000 Yield) | 908520 | CTG | \$258.05 |
| CTGD3130M | High Yield Magenta Toner (OEM# H514C, 330-1200) (9,000 Yield) | 908521 | CTG | \$258.05 |
| CTGD3130Y | High Yield Yellow Toner (OEM# H515C, 330-1204) (9,000 Yield) | 908522 | CTG | \$258.05 |
| CTG - Dell 5100cn Color Laser Supplies | | | | |
| CTGD5100B | High Yield Black Toner (OEM# 310-5807) (9,000 Yield) | 900153 | CTG | \$62.60 |
| CTGD5100C | High Yield Cyan Toner (OEM# 310-5810) (8,000 Yield) | 900154 | CTG | \$214.80 |
| CTGD5100M | High Yield Magenta Toner (OEM# 310-5809) (8,000 Yield) | 900155 | CTG | \$214.80 |
| CTGD5100Y | High Yield Yellow Toner (OEM# 310-5808) (8,000 Yield) | 900156 | CTG | \$214.80 |
| CTG - Dell 5110cn Color Laser Supplies | | | | |
| CTGD5110B | Black Toner (OEM# 310-7889, GD898) (18,000 Yield) | 900200 | CTG | \$109.35 |
| CTGD5110C | Cyan Toner (OEM# 310-7891, GD900) (12,000 Yield) | 900157 | CTG | \$277.45 |
| CTGD5110M | Magenta Toner (OEM# 310-7893, KD557) (12,000 Yield) | 900158 | CTG | \$277.45 |
| CTGD5110Y | Yellow Toner (OEM# 310-7895, JD750) (12,000 Yield) | 900159 | CTG | \$277.45 |
| CTG - Epson Inkjet Supplies (Continued on next page) | | | | |
| EPC48120 | Epson Stylus Photo R200/R220/R300/R300M/R320/R340/RX500/RX600/RX620 Black Inkjet Cartridge (OEM# T048120) (600 Yield) | 108057 | CTG | \$16.10 |
| EPC48220 | Epson Stylus Photo R200/R220/R300/R300M/R320/R340/RX500/RX600/RX620 Cyan Inkjet Cartridge (OEM# T048220) (1,250 Yield) | 108063 | CTG | \$11.85 |
| EPC48320 | Epson Stylus Photo R200/R220/R300/R300M/R320/R340/RX500/RX600/RX620 Magenta Inkjet Cartridge (OEM# T048320) (700 Yield) | 108064 | CTG | \$11.85 |
| EPC48420 | Epson Stylus Photo R200/R220/R300/R300M/R320/R340/RX500/RX600/RX620 Yellow Inkjet Cartridge (OEM# T048420) (700 Yield) | 108065 | CTG | \$11.85 |
| EPC48520 | Epson Stylus Photo R200/R220/R300/R300M/R320/R340/RX500/RX600/RX620 Light Cyan Inkjet Cartridge (OEM# T048520) (650 Yield) | 108066 | CTG | \$11.85 |

| MFG# | Product Description | Part# | UOM | Retail |
|---|---|--------|-----|---------|
| CTG COMPATIBLES | | | | |
| CTG - Epson Inkjet Supplies <i>(Continued)</i> | | | | |
| EPC48620 | Epson Stylus Photo R200/R220/R300/R300M/R320/R340/RX500/RX600/RX620 Light Magenta Inkjet Cartridge (OEM# T048620) (800 Yield) | 108069 | CTG | \$11.85 |
| EPC60120 | Epson Stylus C68/C88/C88+/CX3800/CX3810/CX4200/CX4800/CX5800F/CX7800 Black Ink (OEM# T060120) (400 Yield) | 108071 | CTG | \$17.80 |
| EPC60220 | Epson Stylus C68/C88/C88+/CX3800/CX3810/CX4200/CX4800/CX5800F/CX7800 Cyan Ink (OEM# T060220) (700 Yield) | 108072 | CTG | \$13.05 |
| EPC60320 | Epson Stylus C68/C88/C88+/CX3800/CX3810/CX4200/CX4800/CX5800F/CX7800 Magenta Ink (OEM# T060320) (650 Yield) | 108077 | CTG | \$13.05 |
| EPC60420 | Epson Stylus C68/C88/C88+/CX3800/CX3810/CX4200/CX4800/CX5800F/CX7800 Yellow Ink (OEM# T060420) (750 Yield) | 108083 | CTG | \$13.05 |
| EPC24120 | Epson Stylus NX125/NX127/NX130/NX230/NX330/NX420/NX430; Workforce 320/323/325/435 Black Ink (Remanufactured) (OEM# T124120) (260 Yield) | 908343 | CTG | \$11.00 |
| EPC24220 | Epson Stylus NX125/NX127/NX130/NX230/NX330/NX420/NX430; Workforce 320/323/325/435 Cyan Ink (Remanufactured) (OEM# T124220) (320 Yield) | 908344 | CTG | \$7.60 |
| EPC24320 | Epson Stylus NX125/NX127/NX130/NX230/NX330/NX420/NX430; Workforce 320/323/325/435 Magenta Ink (Remanufactured) (OEM# T124320) (235 Yield) | 908345 | CTG | \$7.60 |
| EPC24420 | Epson Stylus NX125/NX127/NX130/NX230/NX330/NX420/NX430; Workforce 320/323/325/435 Yellow Ink (Remanufactured) (OEM# T124420) (270 Yield) | 908346 | CTG | \$7.60 |
| EPC26120 | Epson Stylus NX330/NX430; Workforce 60/435/520/545/630/633/635/645/840/845 High Yield Black Ink (Remanufactured) (OEM# T126120) (645 Yield) | 908351 | CTG | \$16.10 |
| EPC26220 | Epson Stylus NX330/NX430; Workforce 60/435/520/545/630/633/635/645/840/845 High Yield Cyan Ink (Remanufactured) (OEM# T126220) (470 Yield) | 908352 | CTG | \$14.95 |
| EPC26320 | Epson Stylus NX330/NX430; Workforce 60/435/520/545/630/633/635/645/840/845 High Yield Magenta Ink (Remanufactured) (OEM# T126320) (375 Yield) | 908353 | CTG | \$14.95 |
| EPC26420 | Epson Stylus NX330/NX430; Workforce 60/435/520/545/630/633/635/645/840/845 High Yield Yellow Ink (Remanufactured) (OEM# T126420) (525 Yield) | 908354 | CTG | \$14.95 |
| EPC27120 | Epson Stylus NX530/NX625; Workforce 60/545/630/633/635/645/840/845/WF-3540/WF-7520 Extra High Capacity Black Ink Cartridge (Remanufactured) (OEM# T127120) (945 Yield) | 923328 | CTG | \$25.45 |
| EPC27220 | Epson Stylus NX530/NX625; Workforce 60/545/630/633/635/840/845 High Yield Cyan Ink Cartridge (Remanufactured) (OEM# T127220) (755 Yield) | 908355 | CTG | \$17.75 |
| EPC27320 | Epson Stylus NX530/NX625; Workforce 60/545/630/633/635/840/845 High Yield Magenta Ink Cartridge (Remanufactured) (OEM# T127320) (755 Yield) | 908356 | CTG | \$17.75 |
| EPC27420 | Epson Stylus NX530/NX625; Workforce 60/545/630/633/635/840/845 High Yield Yellow Ink Cartridge (Remanufactured) (OEM# T127420) (755 Yield) | 908357 | CTG | \$17.75 |
| CTG - Gestetner Copier Supplies | | | | |
| CTG5288 | 2212/2712/DSM627SP Toner (OEM# 841337) (11,000 Yield) | 19744 | BTL | \$35.70 |
| CTG5208 | 3222/3227/P7027/P7032 Toner (OEM# 89846) (11,000 Yield) (Type ST27) | 101395 | BTL | \$33.60 |
| CTG5400 | 6002/7502 Toner (OEM# 841332) (43,000 Yield) | 19743 | BTL | \$94.50 |
| CTG - HP Inkjet Supplies <i>(Continued on next page)</i> | | | | |
| CTG844A | Business Inkjet 1100dtn/2200/2230/2280/2600/CP1700/ Designjet 100/100 Plus/ Designjet Color PRO GA/CAD/K850 Black Ink (OEM# C4844A) (1,750 Yield) | 701148 | CTG | \$40.65 |
| CTG836A | Business Inkjet 1000/1100d/2200/2230/2280/2600/CP1700/ Designjet 10PS/20PS/ 50PS/Officejet 9110/9120/9130/K850 Cyan Ink (OEM# C4836AN) (1,750 Yield) | 701145 | CTG | \$40.65 |
| CTG837A | Business Inkjet 1000/1100d/2200/2230/2280/2600/CP1700/ Designjet 10PS/20PS/ 50PS/Officejet 9110/9120/9130/K850 Magenta Ink (OEM# C4837AN) (1,750 Yield) | 701146 | CTG | \$40.65 |
| CTG838A | Business Inkjet 1000/1100d/2200/2230/2280/2600/CP1700/ Designjet 10PS/20PS/ 50PS/Officejet 9110/9120/9130/K850 Yellow Ink (OEM# C4838AN) (1,750 Yield) | 701147 | CTG | \$40.65 |
| CTG561WN | Deskjet 1000/1050/1055/2050/3000/3050/3050A/3052A/3054A Black Ink (OEM# CH561WN) (190 Yield) | 908525 | CTG | \$15.60 |
| CTG562WN | Deskjet 1000/1050/1055/2050/3000/3050/3050A/3052A/3054A Tri-Color Ink (OEM# CH562WN) (185 Yield) | 908526 | CTG | \$19.95 |
| CTG563WN | Deskjet 1000/1050/1055/2050/3000/3050/3050A/3052A/3054A High Yield Black Ink (OEM# CH563WN) (590 Yield) | 908527 | CTG | \$30.00 |
| CTG564WN | Deskjet 1000/1050/1055/2050/3000/3050/3050A/3052A/3054A High Yield Tri-Color Ink (OEM# CH564WN) (375 Yield) | 908528 | CTG | \$31.85 |
| CTG49A | Deskjet 350C/350CBI/600/600C/610C/610CL/612C/630C/648C/656C/660C/670C/ 672C/680C/682C/690C/692C/693C/694C/695C/697C/ DeskWriter 600/660C/680C/ 694C/ Officejet 500/520/570/580/590/600/610/630/700/710/720 Tri-Color Ink (OEM# 51649A) (315 Yield) | 101683 | CTG | \$39.35 |
| CTG57A | Deskjet 400/5150/5500/5650/5650v/5850/PhotoSmart 7150/7260/7350/7450/7550/ 7660/7755/7760/7960/PSC 1110/1209/1210/1311/1315/1350/2175/2210/2410/2510/ Officejet 4110/4215/5505 Tri-Color Ink (OEM# C6657AN) (390 Yield) | 101677 | CTG | \$42.40 |
| CTG56A | Deskjet 450cbi/450ci/450wbt/5150/5150w/5160/5550/5650/5650v/5850/5850w/ PhotoSmart 7150/7260/7350/7450/7550/7660/7755/7760/7960/PSC 1110/1209/ 1210/1311/1315/1350/2175/2410/2510/Officejet 4110/4215/5505 Black Ink (OEM# C6656AN) (450 Yield) | 101676 | CTG | \$26.35 |

| MFG# | Product Description | Part# | UOM | Retail |
|--|--|--------|-----|---------|
| CTG COMPATIBLES | | | | |
| CTG - HP Inkjet Supplies (Continued on next page) | | | | |
| CTG63WN | Deskjet 460c/5740/5743/5745/5748/5940/6520/6540/6830v/6840/6940/6980/9800/Officejet 6210/7210/7310/7410/ PhotoSmart 2610PSC Tri-Color Ink (OEM# C9363WN) (450 Yield) | 101398 | CTG | \$42.40 |
| CTG65WN | Deskjet 460/5740/6520/6540/6620/6830v/6840/9800 Black Ink (OEM# C8765WN) (450 Yield) | 101410 | CTG | \$26.35 |
| CTG29A | Deskjet 682C/690C/692C/693C/694C/695C/697C, DeskWriter 600/660C/680C/694C/Fax 910/920/Officejet 500MFP/520MFP/570MFP/580MFP/590MPF/600MFP/610MFP/630MFP/635MFP/700MFP/710MFP/720MFP Black Ink (OEM# 51629A) (650 Yield) | 900205 | CTG | \$37.55 |
| CTG14DN | Deskjet 610C/610CL/612C/630C/632C/640/642C/648C/656C/Fax 925xi/1010/1010xi/1020/1020xi/1040/1040xi/1050/Apollo P-2100U/P-2150U/P-2200U/P-2250U/P-2300U/P-2350U/P-2500P/P-2500U/P-2550P/P-2600P/P-2600U/P-2650P Black Ink (OEM# C6614DN) (455 Yield) | 101385 | CTG | \$38.95 |
| CTG23D | Deskjet 710C/712C/720C/722C/810C/815C/830C/832C/880C/882C/890C/895Cse/1120C/1125C, Color Copier 140/145/150/155/160/170/260/270, Officejet T45/T65 Series R40/R60/R80/1170C/1175C/PSC 500 Tri-Color Ink (OEM# C1823D) (690 Yield) | 101681 | CTG | \$47.45 |
| CTG45A | Deskjet 710C/712C/720C/722C/820C/830C/832C/850C/855C/870Cxi/880C/882C/890C/895Cse/930C/932C/935CC/950C/952C/960C/970Cse/990Cse/995C/1000Cse/1000C/1100C/1120C/1125C/1220C/1600C/Designjet 700/750C/750C Plus/755CM Black Ink (OEM# 51645A) (835 Yield) | 900207 | CTG | \$38.55 |
| CTG15DN | Deskjet 810C/812C/825C/840C/841C/842C/843C/845C/920C/940C/3810/3816/3820/Officejet V40/V40xi/5110/5110xi/5100V/Fax 1230/1230xi/PSC 500/500xi/750/750xi/950/950xi Black Ink (OEM# C6615DN) (600 Yield) | 108282 | CTG | \$36.45 |
| CTG41A | Deskjet 820Cse/820Cxi/850C/855C/ 855Cse/855Cxi/870Cse/870Cxi/Officejet Pro 1150C/1150Cse Tri-Color Ink (OEM# 51641A) (460 Yield) | 900206 | CTG | \$39.70 |
| CTG25AN | Deskjet 825C/840C/842C/845C Tri-Color Ink (OEM# C6625AN) (410 Yield) | 101391 | CTG | \$39.70 |
| CTG78DN | Deskjet 920C/932C/935C/940C/950C/952C/960C/970Cse/990Cse/995C/1220C/3820/Officejet K60/K80/G55/G85/G95/V40/Color Copier 190/290/PhotoSmart P1000/P1100/P1115/P1215/P1218/ Tri-Color Ink (OEM# C6578DN) (450 Yield) | 101443 | CTG | \$40.50 |
| CTG727A | Deskjet 3320/3322/3420/3425/3450/3520/3620/3650/3653/3740/3740v/3745v/3843/3845/3845xi/PSC 1310/1311/1315/1317/2105/2108/2150/2210/Fax 1240/Officejet 5610 Black Ink (OEM# C8727AN) (220 Yield) | 101417 | CTG | \$22.75 |
| CTG728A | Deskjet 3320/3322/3420/3425/3450/3520/3550/3620/3650/3653/3740/3740v/3745/3745v/3843/3845/3845xi/Fax 1240/Officejet 4215 Tri-Color Ink (OEM# C8728AN) (190 Yield) | 101429 | CTG | \$27.75 |
| CTG58A | Deskjet 3620/3650/3653/3843/3845/3845xi/450cbi/450ci/450wbv/5150/5550/5650/5850/Digital Copier 410/Officejet 4215/4215xi/5605/5608/5610/5610v/5610xi/6110/6110xi/PhotoSmart 7150/7260/7350/7450/7550/7660/7755/7760 Photo Ink (OEM# C6658AN) (125 Yield) | 101680 | CTG | \$31.70 |
| CTG52AN | Deskjet 3910/3915/3918/3920/3930/3930v/3938/3940/3940v/Officejet 4312/4314/4315/4315v/4315xi/4317/4319/4352/4353/4355/4357/4359/5605/5608/5609/5610/5610v/5610xi/PSC 1401/1402/1403/1406/1408/1410/1410v/1410xi/1415/1417 Tri-Color Ink (OEM# C9352AN) (140 Yield) | 900209 | CTG | \$21.80 |
| CTG51AN | Deskjet 3910/3915/3920/3930/3930v/3940/3940v/Officejet 4311/4312/4314/4315/4315v/4315xi/4317/4319/4352/4353/4355/4357/4359/PSC1401/1402/1403/1406/1408/1410/1410v/1410xi/1415/1417 Black Ink (OEM# C9351AN) (200 Yield) | 900208 | CTG | \$16.65 |
| CTG62WN | Deskjet 5440/5440v/5440xi/Officejet 6310AIO/ PhotoSmart 7850/C3180 AIO/PSC 1507/1510/1510v/1510xi Black Ink (OEM# C9362WN) (210 Yield) | 101397 | CTG | \$16.65 |
| CTG61WN | Deskjet 5440/5440v/5440xi/Officejet 6310AIO/PhotoSmart 7850/C3180 AIO/PSC 1507/1510/1510v/1510xi Tri-Color Ink (OEM# C9361WN) (175 Yield) | 701177 | CTG | \$25.75 |
| CTG67WN | Deskjet 5740/5743/5940/5940xi/6520/6540/6830v/6840/6940/6980/9800/Officejet 7210/7310/7410/PhotoSmart 2610/2710/2710xi/8050 Black Ink (OEM# C8767WN) (860 Yield) | 101414 | CTG | \$37.50 |
| CTG66WN | Deskjet 5740/6520/6540 Tri-Color Ink (OEM# C8766WN) (260 Yield) | 101411 | CTG | \$30.80 |
| CTG64WN | Deskjet 5940/PhotoSmart 2575/8050/C4180 AIO Black Ink (OEM# C9364WN) (400 Yield) | 900210 | CTG | \$26.35 |
| CTG640WN | Deskjet D2530/D2545/D2560/D2660/D5560/F4200 Series/F4440/F4480/ PhotoSmart All-In-One C4640/C4650/C4680/C4795 Black Ink (OEM# CC640WN) (200 Yield) | 21941 | CTG | \$15.60 |
| CTG641WN | Deskjet D2530/D2545/D2560/D2660/D5560/F4200 Series/ F4440/ F4480/ PhotoSmart C4640/C4650/C4680/C4795 Black Ink (OEM# CC641WN) (600 Yield) | 31573 | CTG | \$37.30 |
| CTG643WN | Deskjet D2530/D2545/D2560/D2660/D5560/F4200 Series/F4440/F4480/ PhotoSmart All-In-One C4640/C4650/C4680/C4795 Tri-Color Ink (OEM# CC643WN) (165 Yield) | 21942 | CTG | \$19.80 |
| CTG644WN | Deskjet D2530/D2545/D2560/D2660/D5560/F4200 Series/ F4440/ F4480/ PhotoSmart C4640/C4650/C4680/C4795 Tri-Color Ink (OEM# CC644WN) (440 Yield) | 31575 | CTG | \$43.25 |
| CTG69WN | Deskjet D4160/PhotoSmart 2575/8050/C4180 AIO Tri-Color Ink (OEM# C9369WN) (130 Yield) | 701180 | CTG | \$31.70 |
| CTG75XL | Deskjet D4360/ Officejet J6480 AIO/PhotoSmart C4280/C4340/C4385/C4480/C4500/C4385/C5280/D5360/D5363/D5368 Tri-Color Ink (OEM# CB338WN) (520 Yield) | 7559 | CTG | \$47.50 |
| CTG26A | Deskjet Plus 400/420C/500500C/510/520/540/550C/560C/DeskWriter 400/510/520/540C/550C/560C/Designjet Plotter 200/220/600/Fax 200/300/310/700/750/900/950/Officejet LX/300/330/350 Black Ink (OEM# 51626A) (795 Yield) | 900236 | CTG | \$38.10 |

| MFG# | Product Description | Part# | UOM | Retail |
|--|--|--------|-----|---------|
| CTG COMPATIBLES | | | | |
| CTG - HP Inkjet Supplies (Continued on next page) | | | | |
| CTG74BK | Deskjet D4360/Officejet J6480/PhotoSmart C4280/C5280/D5360 Black Ink (OEM# CB335WN) (200 Yield) | 903938 | CTG | \$16.65 |
| CTG75CLR | Deskjet D4360/Officejet J6480 AIO/PhotoSmart C4280/C4340/C4385/C4480/C4500/C4385/C5280/D5360/D5363/D5368 Tri-Color Ink (OEM# CB337WN) (170 Yield) | 903380 | CTG | \$20.80 |
| CTG74XL | Deskjet D4360/ Officejet J6480 AIO/ PhotoSmart C4280/C4340/C4385/C4480/C4500/C4385/C5280/D5360/D5363/D5368 Black Ink (OEM# CB336WN) (750 Yield) | 7558 | CTG | \$40.50 |
| CTGC653AN | Officejet J4525/J4535/J4540/J4550/J4580/J4585/J4660/J4680/J4680c Black Ink (OEM# CC653AN) (200 Yield) | 106169 | CTG | \$16.65 |
| CTGC654AN | Officejet J4525/J4535/J4540/J4550/J4580/J4585/J4660/J4680/J4680c High Yield Black Ink (OEM# CC654AN) (770 Yield) | 106170 | CTG | \$37.30 |
| CTGC656AN | Officejet J4525/J4535/J4540/J4550/J4580/J4585/J4660/J4680/J4680c Tri-Color Ink (OEM# CC656AN) (360 Yield) | 106171 | CTG | \$29.75 |
| CTG88B | Officejet Pro K550/K550dtn/K550dtn/K5400/K5400dn/K5400dtn/K5400n/K5400tn/K8600/K8600dn/L7480/L7550/L7555/L7580/L7590/L7650/L7680/L7750/L7780 Black Ink (OEM# C9385AN) (1,170 Yield) | 106168 | CTG | \$24.10 |
| CTG88BXL | Officejet K8600/Pro K5400/L7580/L7680/L7780/L7480/L7550/L7555/L7590/L7750 High Yield Black Ink (OEM# C9396AN) (2,900 Yield) | 7557 | CTG | \$43.35 |
| CTG88CXL | Officejet K8600/Pro K5400/L7580/L7680/L7780/L7480/L7550/L7555/L7590/L7750 High Yield Cyan Ink (OEM# C9391AN) (2,500 Yield) | 7554 | CTG | \$27.15 |
| CTG88MXL | Officejet K8600/Pro K5400/L7580/L7680/L7780/L7480/L7550/L7555/L7590/L7750 High Yield Magenta Ink (OEM# C9392AN) (2,700 Yield) | 7555 | CTG | \$27.15 |
| CTG88YXL | Officejet K8600/Pro K5400/L7580/L7680/L7780/L7480/L7550/L7555/L7590/L7750 High Yield Yellow Ink (OEM# C9393AN) (2,300 Yield) | 7556 | CTG | \$27.15 |
| CTGWC920B | Officejet 6000/6000 Wireless/6500/6500 Wireless: Officejet Wide Format 7000; Officejet Pro 6000/6400A Plus/6500Ae/6500A Plus/7500A Black Ink, Chipped (Ink Monitoring Technology) (OEM# CD971AN) (500 Yield) | 908580 | CTG | \$20.90 |
| CTGWC920XLB | Officejet 6000/6000 Wireless/6500/6500 Wireless/6500A Plus; Officejet Wide Format 7000/7500A High Yield Black Ink, Chipped (Ink Monitoring Technology) (OEM# CD975AN) (1,365 Yield) | 908584 | CTG | \$34.30 |
| CTGWC920XLC | Officejet 6000/6000 Wireless/6500/6500 Wireless/6500A Plus; Officejet Wide Format 7000/7500A High Yield Cyan Ink, Chipped (Ink Monitoring Technology) (OEM# CD972AN) (895 Yield) | 908581 | CTG | \$15.90 |
| CTGWC920XLM | Officejet 6000/6000 Wireless/6500/6500 Wireless/6500A Plus; Officejet Wide Format 7000/7500A High Yield Magenta Ink, Chipped (Ink Monitoring Technology) (OEM# CD973AN) (695 Yield) | 908582 | CTG | \$15.90 |
| CTGWC920XLY | Officejet 6000/6000 Wireless/6500/6500 Wireless/6500A Plus; Officejet Wide Format 7000/7500A High Yield Yellow Ink, Chipped (Ink Monitoring Technology) (OEM# CD974AN) (925 Yield) | 908583 | CTG | \$15.90 |
| CTG057A | Officejet 6100/6600/6700/7610/7710 Black Ink (OEM# CN057AN) (400 Yield) | 916667 | CTG | \$20.90 |
| CTG058A | Officejet 6100/6600/6700/7610/7710 Cyan Ink (OEM# CN058AN) (330 Yield) | 916668 | CTG | \$14.90 |
| CTG059A | Officejet 6100/6600/6700/7610/7710 Magenta Ink (OEM# CN059AN) (330 Yield) | 916669 | CTG | \$14.90 |
| CTG060A | Officejet 6100/6600/6700/7610/7710 Yellow Ink (OEM# CN060AN) (330 Yield) | 916670 | CTG | \$14.90 |
| CTG053A | Officejet 6100/6600/6700/7610/7710 High Yield Black Ink (OEM# CN053AN) (1,000 Yield) | 916663 | CTG | \$34.30 |
| CTG054A | Officejet 6100/6600/6700/7610/7710 High Yield Cyan Ink (OEM# CN054AN) (825 Yield) | 916664 | CTG | \$19.95 |
| CTG055A | Officejet 6100/6600/6700/7610/7710 High Yield Magenta Ink (OEM# CN055AN) (825 Yield) | 916665 | CTG | \$19.95 |
| CTG056A | Officejet 6100/6600/6700/7610/7710 High Yield Yellow Ink (OEM# CN056AN) (825 Yield) | 916666 | CTG | \$19.95 |
| CTG11DN | Officejet 7110/7110xi/7130/7130xi/7140xi/d125xi/d135/d135xi/d145/d155xi/cp1160/cp1160tn/Copier 610 Black Ink (OEM# C5011DN) (800 Yield) | 108005 | CTG | \$25.35 |
| CTG10DN | Officejet 7110/7110xi/7130/7130xi/7140xi/d125xi/d135/d145/d155xi/7115/7135/cp1160/cp1160tn/Copier 610 Tri-Color Ink (OEM# C5010DN) (470 Yield) | 101376 | CTG | \$34.15 |
| CTG045AN | Officejet Pro 251dw/276dw/8100/8600 High Yield Black Ink (OEM# CN045AN) (2,300 Yield) | 916655 | CTG | \$39.65 |
| CTG046AN | Officejet Pro 251dw/276dw/8100/8600 High Yield Cyan Ink (OEM# CN046AN) (1,500 Yield) | 916656 | CTG | \$29.70 |
| CTG047AN | Officejet Pro 251dw/276dw/8100/8600 High Yield Magenta Ink (OEM# CN047AN) (1,500 Yield) | 916657 | CTG | \$29.70 |
| CTG048AN | Officejet Pro 251dw/276dw/8100/8600 High Yield Yellow Ink (OEM# CN048AN) (1,500 Yield) | 916658 | CTG | \$29.70 |
| CTGWC940XLB | Officejet Pro 8000/8000 Wireless/8500/8500 Premier/8500 Wireless/8500A/8500A Premium; Officejet Plus 8500A High Yield Black Ink, Chipped (Ink Monitoring Technology) (OEM# C4906AN) (2,605 Yield) | 908585 | CTG | \$41.85 |
| CTGWC940XLC | Officejet Pro 8000/8000 Wireless/8500/8500 Premier/8500 Wireless/8500A/8500A Premium; Officejet Plus 8500A High Yield Cyan Ink, Chipped (Ink Monitoring Technology) (OEM# C4907AN) (2,500 Yield) | 908586 | CTG | \$27.85 |
| CTGWC940XLM | Officejet Pro 8000/8000 Wireless/8500/8500 Premier/8500 Wireless/8500A/8500A Premium; Officejet Plus 8500A High Yield Magenta Ink, Chipped (Ink Monitoring Technology) (OEM# C4908AN) (1,750 Yield) | 908587 | CTG | \$27.85 |
| CTGWC940XLY | Officejet Pro 8000/8000 Wireless/8500/8500 Premier/8500 Wireless/8500A/8500A Premium; Officejet Plus 8500A High Yield Yellow Ink, Chipped (Ink Monitoring Technology) (OEM# C4909AN) (1,550 Yield) | 908588 | CTG | \$27.85 |

All catalog content is subject to change.

| MFG# | Product Description | Part# | UOM | Retail |
|--|--|--------|-----|----------|
| CTG COMPATIBLES | | | | |
| CTG - HP Inkjet Supplies (Continued) | | | | |
| CTG21WN | PhotoSmart 3110/3210/3310/8250/D7160/D7360 High Yield Black Ink (OEM# C8721WN) (850 Yield) | 108036 | CTG | \$22.30 |
| CTG71WN | PhotoSmart 3110/3210/3310/8250/D7160/D7360 High Yield Cyan Ink (OEM# C8771WN) (425 Yield) | 701181 | CTG | \$11.55 |
| CTG74WN | PhotoSmart 3110/3210/3310/8250/D7160/D7360 High Yield Light Cyan Ink (OEM# C8774WN) (400 Yield) | 701139 | CTG | \$11.55 |
| CTG75WN | PhotoSmart 3110/3210/3310/8250/D7160/D7360 High Yield Light Magenta Ink (OEM# C8775WN) (230 Yield) | 701141 | CTG | \$11.55 |
| CTG72WN | PhotoSmart 3110/3210/3310/8250/D7160/D7360 High Yield Magenta Ink (OEM# C8772WN) (400 Yield) | 701182 | CTG | \$11.55 |
| CTG73WN | PhotoSmart 3110/3210/3310/8250/D7160/D7360 High Yield Yellow Ink (OEM# C8773WN) (530 Yield) | 701137 | CTG | \$11.55 |
| CTGWC564XLPB | PhotoSmart 5510/5512/5514/6510/7510/B8550/B8553/B8558/D5460/D7560; Photosmart All-In-One C6340/C6350/C6380/C6383; Photosmart Plus B209A/B209B/B209C/B210A; Premium Touchsmart C309/C309n/C310; Photosmart Premium Fax All-In-One C410a; Photosmart E-Station, Photosmart E-Station All-In-One C510a; Photosmart Premium High Yield Photo Black Ink, Chipped (Ink Monitoring Technology) (OEM# CB322WN) (300 Yield) | 908576 | CTG | \$19.00 |
| CTGWC564XLB | PhotoSmart 5510/5512/5514/6510/7510/B8550/B8553/B8558/D5460/D7560; Photosmart All-In-One C6340/C6350/C6380/C6383; Photosmart Plus B209A/B209B/B209C/B210A; Premium Touchsmart C309/C309n/C310; Photosmart Premium Fax All-In-One C410a; Photosmart E-Station, Photosmart E-Station All-In-One C510a; Photosmart Premium High Yield Black Ink, Chipped (Ink Monitoring Technology) (OEM# CN684WN) (910 Yield) | 908575 | CTG | \$24.50 |
| CTGWC564XLC | PhotoSmart 5510/5512/5514/6510/7510/B8550/B8553/B8558/D5460/D7560; Photosmart All-In-One C6340/C6350/C6380/C6383; Photosmart Plus B209A/B209B/B209C/B210A; Premium Touchsmart C309/C309n/C310; Photosmart Premium Fax All-In-One C410a; Photosmart E-Station, Photosmart E-Station All-In-One C510a; Photosmart Premium High Yield Cyan Ink, Chipped (Ink Monitoring Technology) (OEM# CB323WN) (860 Yield) | 908577 | CTG | \$19.00 |
| CTGWC564XLM | PhotoSmart 5510/5512/5514/6510/7510/B8550/B8553/B8558/D5460/D7560; Photosmart All-In-One C6340/C6350/C6380/C6383; Photosmart Plus B209A/B209B/B209C/B210A; Premium Touchsmart C309/C309n/C310; Photosmart Premium Fax All-In-One C410a; Photosmart E-Station, Photosmart E-Station All-In-One C510a; Photosmart Premium High Yield Magenta Ink, Chipped (Ink Monitoring Technology) (OEM# CB324WN) (1,020 Yield) | 908578 | CTG | \$19.00 |
| CTGWC564XLY | PhotoSmart 5510/5512/5514/6510/7510/B8550/B8553/B8558/D5460/D7560; Photosmart All-In-One C6340/C6350/C6380/C6383; Photosmart Plus B209A/B209B/B209C/B210A; Premium Touchsmart C309/C309n/C310; Photosmart Premium Fax All-In-One C410a; Photosmart E-Station, Photosmart E-Station All-In-One C510a; Photosmart Premium High Yield Yellow Ink, Chipped (Ink Monitoring Technology) (OEM# CB325WN) (895 Yield) | 908579 | CTG | \$19.00 |
| CTG304A | PhotoSmart A314/A316/A320/A432/A433/A434/A436/A440/A444/A445/A446/A510/A512/A516/A522/A522xi/A526/A528/A610/A612/A616/A617/A618/A620/A622/A626/A627/A628/A712/A716/A717/A717/A717/A826/A827/A828 Tri-Color Ink (OEM# CB304A) (55 Yield) | 31157 | CTG | \$25.05 |
| CTGC635A | Fax 640/2140 Black Ink (OEM# CC635A) (500 Yield) | 908318 | CTG | \$37.45 |
| CTG - HP LJ 4V/4MV Mono Laser Supplies | | | | |
| CTG00P | Toner (OEM# C3900A) (8,100 Yield) | 107898 | CTG | \$194.55 |
| CTG - HP LJ 4L/4ML/4P/4MP Mono Laser Supplies | | | | |
| CTG74P | Toner (OEM# 92274A) (3,350 Yield) | 701138 | CTG | \$139.10 |
| CTG - HP LJ 4/4M/4+/4M+/5/5M/5N/5Se Mono Laser Supplies | | | | |
| CTG98P | Toner (OEM# 92298A) (6,800 Yield) | 701157 | CTG | \$165.05 |
| CTG98X | High Yield Toner (OEM# 92298X) (8,800 Yield) | 701158 | CTG | \$242.75 |
| CTG98TM | MICR Toner (OEM# 92298A) (6,800 Yield) | 101444 | CTG | \$157.25 |
| CTG - HP LJ 5L/6LXI/6LSF/3100/3150 Mono Laser Supplies | | | | |
| CTG06P | Toner (OEM# C3906A) (2,500 Yield) | 107940 | CTG | \$107.30 |



MPS Ready brand by PrintersDirect is designed with the MPS environment in mind, offering a premium-condition, high-margin alternative to OEM hardware.

- Market-proven, rugged late models remanufactured as new
- 12-month warranty
- Up to 50% savings when compared to the equivalent new model
- Lower service costs and improved performance

| MFG# | Product Description | Part# | UOM | Retail |
|--|--|--------|-----|----------|
| CTG COMPATIBLES | | | | |
| CTG - HP LJ 5P/5MP/6P/6MP/6PXI/6PSE/6RE Mono Laser Supplies | | | | |
| CTG03P | Toner (OEM# C3903A) (4,000 Yield) | 107922 | CTG | \$140.50 |
| CTG - HP LJ 5si/8000 Mono Laser Supplies | | | | |
| CTG09P | Toner (OEM# C3909A) (15,000 Yield) | 107953 | CTG | \$302.75 |
| CTG09X | Jumbo Toner (OEM# C3909X) (17,100 Yield) | 107970 | CTG | \$363.35 |
| CTG09ATM | MICR Toner (OEM# C3909A) (12,600 Yield) | 903407 | CTG | \$361.25 |
| CTG - HP LJ 1000/1200/1220/3300/3310/3320/3330/3380 Mono Laser Supplies | | | | |
| CTG15AP | Toner (OEM# C7115A) (2,500 Yield) | 108035 | CTG | \$91.90 |
| CTG15XP | High Yield Toner (OEM# C7115X) (3,500 Yield) | 108283 | CTG | \$100.25 |
| CTG15JP | Jumbo Toner (OEM# C7115X) (6,700 Yield) | 94344 | CTG | \$275.80 |
| CTG - HP LJ 1010/1012/1015/1018/1020/1022/3015/3020/3030/3050/3052/3055/ M1319f Mono Laser Supplies | | | | |
| CTG12AP | Toner (OEM# Q2612A) (2,000 Yield) | 108010 | CTG | \$91.75 |
| CTG12XP | High Yield Toner (OEM# Q2612X) (4,000 Yield) | 903489 | CTG | \$183.50 |
| CTG12M | MICR Toner (OEM# Q2612A) (2,000 Yield) | 108015 | CTG | \$126.65 |
| CTG - HP LJ 1100/1100A/3200 Mono Laser Supplies | | | | |
| CTG92P | Toner (OEM# C4092A) (2,500 Yield) | 701154 | CTG | \$93.15 |
| CTG - HP LJ 1150 Mono Laser Supplies | | | | |
| CTG24AP | Toner (OEM# Q2624A) (2,500 Yield) | 108109 | CTG | \$93.45 |
| CTG24XP | High Yield Toner (OEM# Q2624X) (4,000 Yield) | 108111 | CTG | \$149.55 |
| CTG - HP LJ 1160/1320/3390/3392 Mono Laser Supplies | | | | |
| CTG49AP | Toner (OEM# Q5949A) (2,500 Yield) | 900132 | CTG | \$107.80 |
| CTG49AM | MICR Toner (OEM# Q5949A) (2,500 Yield) | 701170 | CTG | \$118.15 |
| CTG - HP LJ 1300 Mono Laser Supplies | | | | |
| CTG13AN | Toner (OEM# Q2613A) (2,500 Yield) | 108016 | CTG | \$107.80 |
| CTG13XN | High Yield Toner (OEM# Q2613X) (4,000 Yield) | 108018 | CTG | \$133.50 |
| CTG13TM | MICR Toner (OEM# Q2613A) (2,500 Yield) | 903419 | CTG | \$137.70 |
| CTG - HP LJ 1320/3390/3392 Mono Laser Supplies | | | | |
| CTG49XP | Toner (OEM# Q5949X) (6,000 Yield) | 900133 | CTG | \$197.30 |
| CTG49JP | Jumbo Toner (OEM# Q5949X) (10,000 Yield) | 94345 | CTG | \$328.80 |
| CTG - HP LJ 2100/2200 Mono Laser Supplies | | | | |
| CTG96P | Toner (OEM# C4096A) (5,000 Yield) | 701156 | CTG | \$151.15 |
| CTG96X | Jumbo Toner (OEM# C4096X) (8,500 Yield) | 903941 | CTG | \$272.10 |
| CTG96TM | MICR Toner (OEM# C4096A) (5,000 Yield) | 101643 | CTG | \$178.50 |
| CTG - HP LJ 2300 Mono Laser Supplies | | | | |
| CTG10AP | Toner (OEM# Q2610A) (6,000 Yield) | 107972 | CTG | \$181.65 |
| CTG10X | Jumbo Toner (OEM# Q2610X) (10,000 Yield) | 903942 | CTG | \$302.75 |
| CTG10TM | MICR Toner (OEM# Q2610A) (6,000 Yield) | 101377 | CTG | \$214.20 |
| CTG - HP LJ 2400/2410/2420/2430 Mono Laser Supplies | | | | |
| CTG11AP | Toner (OEM# Q6511A) (6,000 Yield) | 107986 | CTG | \$162.35 |
| CTG11XP | High Yield Toner (OEM# Q6511X) (12,000 Yield) | 108008 | CTG | \$272.65 |
| CTG11JP | Jumbo Toner (OEM# Q6511X) (18,000 Yield) | 94341 | CTG | \$408.95 |
| CTG11AM | MICR Toner (OEM# Q6511A) (6,000 Yield) | 107973 | CTG | \$191.25 |
| CTG - HP LJ 4000/4050 Mono Laser Supplies | | | | |
| CTG27AP | Toner (OEM# C4127A) (6,000 Yield) | 108147 | CTG | \$100.70 |
| CTG27P | High Yield Toner (OEM# C4127X) (10,000 Yield) | 108149 | CTG | \$192.20 |
| CTG27JP | Jumbo Toner (OEM# C4127X) (14,000 Yield) | 18037 | CTG | \$251.75 |
| CTG27TM | High Yield MICR Toner (OEM# C4127X) (10,000 Yield) | 903388 | CTG | \$225.25 |
| CTG - HP LJ 4100 Mono Laser Supplies | | | | |
| CTG61AP | Toner (OEM# C8061A) (6,000 Yield) | 701176 | CTG | \$115.30 |
| CTG61XP | High Yield Toner (OEM# C8061X) (10,000 Yield) | 701178 | CTG | \$192.20 |
| CTG61JP | Jumbo Toner (OEM# C8061X) (14,000 Yield) | 18038 | CTG | \$288.35 |
| CTG61TM | High Yield MICR Toner (OEM# C8061X) (10,000 Yield) | 903385 | CTG | \$229.50 |

| MFG# | Product Description | Part# | UOM | Retail |
|--|---|--------|-----|----------|
| CTG COMPATIBLES | | | | |
| CTG - HP LJ 4200 Mono Laser Supplies | | | | |
| CTG38AP | Toner (OEM# Q1338A) (12,000 Yield) | 108237 | CTG | \$201.35 |
| CTG42JUP | Jumbo Universal Toner (OEM# Q5942X, Q1338A, Q1339A, Q5945A) (24,000 Yield) | 18040 | CTG | \$488.25 |
| CTG38TM | MICR Toner (OEM# Q1338A) (12,000 Yield) | 108240 | CTG | \$276.25 |
| CTG - HP LJ 4240/4250/4350 Mono Laser Supplies | | | | |
| CTG42AP | Toner (OEM# Q5942A) (10,000 Yield) | 108275 | CTG | \$195.30 |
| CTG42XP | High Yield Toner (OEM# Q5942X) (20,000 Yield) (For Use in 4250/4350 Models Only) | 108276 | CTG | \$295.50 |
| CTG42JUP | Jumbo Universal Toner (OEM# Q5942X, Q1338A, Q1339A, Q5945A) (24,000 Yield) (For Use in 4250/4350 Models Only) | 18040 | CTG | \$488.25 |
| CTG42AM | MICR Toner (OEM# Q5942A) (10,000 Yield) | 108274 | CTG | \$255.00 |
| CTG42XM | High Yield MICR Toner (OEM# Q5942X) (20,000 Yield) (For Use in 4250/4350 Models Only) | 903389 | CTG | \$382.50 |
| CTG - HP LJ 4300 Mono Laser Supplies | | | | |
| CTG39AP | Toner (OEM# Q1339A) (18,000 Yield) | 108241 | CTG | \$266.65 |
| CTG42JUP | Jumbo Universal Toner (OEM# Q5942X, Q1338A, Q1339A, Q5945A) (24,000 Yield) | 18040 | CTG | \$488.25 |
| CTG39TM | MICR Toner (OEM# Q1339A) (18,000 Yield) | 903394 | CTG | \$378.25 |
| CTG - HP LJ 4345/M4345 MFP Mono Laser Supplies | | | | |
| CTG45AP | Toner (OEM# Q5945A) (18,000 Yield) | 700135 | CTG | \$276.70 |
| CTG42JUP | Jumbo Universal Toner (OEM# Q5942X, Q1338A, Q1339A, Q5945A) (24,000 Yield) | 18040 | CTG | \$488.25 |
| CTG - HP LJ 5000/5100 Mono Laser Supplies | | | | |
| CTG29P | High Yield Toner (OEM# C4129X) (10,000 Yield) | 108150 | CTG | \$246.50 |
| CTG - HP LJ 5200 Mono Laser Supplies | | | | |
| CTG16AP | Toner (OEM# Q7516A) (12,000 Yield) | 903414 | CTG | \$238.45 |
| CTG - HP LJ 8100/8150 Mono Laser Supplies | | | | |
| CTG82P | High Yield Toner (OEM# C4182X) (22,000 Yield) | 701144 | CTG | \$284.25 |
| CTG82TM | High Yield MICR Toner (OEM# C4182X) (22,000 Yield) | 903386 | CTG | \$382.50 |
| CTG - HP LJ 9000/9040/9050/M9040/M9050 Mono Laser Supplies | | | | |
| CTG43P | High Yield Toner (OEM# C8543X) (30,000 Yield) | 701193 | CTG | \$361.05 |
| CTG43JP | Jumbo Toner (OEM# C8543X) (40,000 Yield) | 505005 | CTG | \$481.40 |
| CTG43TM | High Yield MICR Toner (OEM# C8543X) (30,000 Yield) | 903402 | CTG | \$509.15 |
| CTG - HP LJ M521/M525/P3010/P3015 Mono Laser Supplies | | | | |
| CTG55AP | Toner (OEM# CE255A) (6,000 Yield) | 90884 | CTG | \$172.05 |
| CTG55XP | High Yield Toner (OEM# CE255X) (12,500 Yield) | 90885 | CTG | \$267.55 |
| CTG55JP | Ultra High Yield Toner (OEM# CE255X) (20,000 Yield) | 908315 | CTG | \$428.15 |
| CTG55AM | MICR Toner (OEM# CE255A) (6,000 Yield) | 913019 | CTG | \$208.25 |
| CTG55XM | High Yield MICR Toner (OEM# CE255X) (12,500 Yield) | 908365 | CTG | \$340.00 |
| CTG - HP LJ M601/M602/M603/M4555 MFP Mono Laser Supplies | | | | |
| CTG90AP | Toner (OEM# CE390A) (10,000 Yield) | 908375 | CTG | \$202.70 |
| CTG90AJP | Extended Yield Toner (OEM# CE390A) (18,000 Yield) | 923318 | CTG | \$365.65 |
| CTG90XP | High Yield Toner (OEM# CE390X) (24,000 Yield) (For Use in M602/M603/M4555 Models Only) | 908376 | CTG | \$338.75 |
| CTG90JP | Ultra High Yield Toner (OEM# CE390X) (35,000 Yield) (For Use in M602/M603/M4555 Models Only) | 910694 | CTG | \$465.80 |
| CTG90AM | MICR Toner (OEM# CE390A) (10,000 Yield) | 909958 | CTG | \$260.35 |
| CTG90XM | High Yield MICR Toner (OEM# CE390X) (24,000 Yield) (For Use in M602/M603/M4555 Models Only) | 909959 | CTG | \$488.75 |
| CTG - HP LJ Enterprise M806/MFP flow M830 Mono Laser Supplies | | | | |
| CTG25XP | High Yield Toner (OEM# CF325X) (34,500 Yield) | 932680 | CTG | \$338.75 |
| CTG25XM | High Yield MICR Toner (OEM# CF325X) (34,500 Yield) | 933810 | CTG | \$518.30 |
| CTG - HP LJ M1120/M1522/P1505 Mono Laser Supplies | | | | |
| CTG36JP | Jumbo Toner (OEM# CB436A) (3,000 Yield) | 94336 | CTG | \$137.60 |
| CTG36AM | MICR Toner (OEM# CB436A) (2,000 Yield) | 31141 | CTG | \$105.00 |
| CTG - HP LJ M1130/M1132/M1134/M1136/M1137/M1138/M1139/M1210/M1212/M1213/M1214/M1216/M1217/M1219/P1100/P1102 Mono Laser Supplies | | | | |
| CTG85AP | Toner (OEM# CE285A) (1,600 Yield) | 106180 | CTG | \$80.60 |
| CTG85JP | Ultra High Yield Toner (OEM# CE285A) (2,300 Yield) | 908374 | CTG | \$115.90 |
| CTG85AM | MICR Toner (OEM# CE285A) (1,600 Yield) | 909957 | CTG | \$120.65 |

| MFG# | Product Description | Part# | UOM | Retail |
|--|---|--------|-----|----------|
| CTG COMPATIBLES | | | | |
| CTG - HP LJ M1522/P1505 Mono Laser Supplies | | | | |
| CTG36AP | Toner (OEM# CB436A) (2,000 Yield) | 7561 | CTG | \$91.75 |
| CTG - HP LJ M1536/P1566/P1606 Mono Laser Supplies | | | | |
| CTG78AP | Toner (OEM# CE278A) (2,100 Yield) | 106179 | CTG | \$92.35 |
| CTG78JP | Ultra High Yield Toner (OEM# CE278A) (3,000 Yield) | 908316 | CTG | \$131.90 |
| CTG78AM | MICR Toner (OEM# CE278A) (2,100 Yield) | 909956 | CTG | \$122.35 |
| CTG - HP LJ M2727/P2010/P2014/P2015 Mono Laser Supplies | | | | |
| CTG53JP | Jumbo Toner (OEM# Q7553X) (10,000 Yield) | 94349 | CTG | \$278.00 |
| CTG53TM | MICR Toner (OEM# Q7553A) (3,000 Yield) | 903423 | CTG | \$141.10 |
| CTG - HP LJ M3027/M3035/P3005 Mono Laser Supplies | | | | |
| CTG51AP | Toner (OEM# Q7551A) (6,500 Yield) | 701171 | CTG | \$169.85 |
| CTG51XP | High Yield Toner (OEM# Q7551X) (13,000 Yield) | 900234 | CTG | \$284.55 |
| CTG51JP | Jumbo Toner (OEM# Q7551X) (18,000 Yield) | 94346 | CTG | \$437.80 |
| CTG51TM | MICR Toner (OEM# Q7551A) (6,500 Yield) | 903422 | CTG | \$210.80 |
| CTG - HP LJ M5025/M5035 Mono Laser Supplies | | | | |
| CTG70AP | Toner (OEM# Q7570A) (15,000 Yield) | 903943 | CTG | \$225.75 |
| CTG - HP LJ P1002/P1003/P1004/P1005/P1006/P1009 Mono Laser Supplies | | | | |
| CTG35AP | Toner (OEM# CB435A) (1,500 Yield) | 7560 | CTG | \$79.80 |
| CTG35JP | Jumbo Toner (OEM# CB435A) (2,200 Yield) | 94335 | CTG | \$117.05 |
| CTG35AM | MICR Toner (OEM# CB435A) (1,500 Yield) | 31137 | CTG | \$101.75 |
| CTG - HP LJ P2014/P2015/M2727 Mono Laser Supplies | | | | |
| CTG53AP | Toner (OEM# Q7553A) (3,000 Yield) | 701172 | CTG | \$105.40 |
| CTG53XP | High Yield Toner (OEM# Q7553X) (7,000 Yield) | 701173 | CTG | \$194.55 |
| CTG - HP LJ P2035/P2055 Mono Laser Supplies | | | | |
| CTG05AP | Toner (OEM# CE505A) (2,300 Yield) | 23457 | CTG | \$104.30 |
| CTG05XP | High Yield Toner (OEM# CE505X) (6,500 Yield) (For Use in P2055 Only) | 23458 | CTG | \$191.35 |
| CTG05JP | Ultra High Yield Toner (OEM# CE505X) (8,000 Yield) (For Use in P2055 Only) | 908364 | CTG | \$235.50 |
| CTG05AM | MICR Toner (OEM# CE505A) (2,300 Yield) | 504992 | CTG | \$144.50 |
| CTG05XM | High Yield MICR Toner (OEM# CE505X) (6,500 Yield) (For Use in P2055 Only) | 505006 | CTG | \$225.25 |
| CTG - HP LJ P4014/P4015/P4515 Mono Laser Supplies | | | | |
| CTG64AP | Toner (OEM# CC364A) (10,000 Yield) | 20485 | CTG | \$202.80 |
| CTG64AJP | Extended Yield Toner (OEM# CC364A) (18,000 Yield) | 923317 | CTG | \$343.55 |
| CTG64XP | High Yield Toner (OEM# CC364X) (24,000 Yield) (For Use in Models P4015/P4515 Only) | 20486 | CTG | \$360.80 |
| CTG64JP | Jumbo Yield Toner (OEM# CC364X) (30,000 Yield) (For Use in Models P4015/P4515 Only) | 94350 | CTG | \$495.85 |
| CTG64AM | MICR Toner (OEM# CC364A) (10,000 Yield) | 31136 | CTG | \$290.70 |
| CTG64XM | High Yield MICR Toner (OEM# CC364X) (24,000 Yield) (For Use in Models P4015/P4515 Only) | 504942 | CTG | \$488.75 |
| CTG - HP LJ Pro 400 M401/MFP M425 Mono Laser Supplies | | | | |
| CTG80AP | Toner (OEM# CF280A) (2,700 Yield) | 910692 | CTG | \$120.75 |
| CTG80XP | High Yield Toner (OEM# CF280X) (6,900 Yield) | 910693 | CTG | \$207.90 |
| CTG80JP | Ultra High Yield Toner (OEM# CF280X) (8,000 Yield) | 911432 | CTG | \$199.00 |
| CTG80AM | MICR Toner (OEM# CF280A) (2,700 Yield) | 911433 | CTG | \$209.95 |
| CTG80XM | High Yield MICR Toner (OEM# CF280X) (6,900 Yield) | 911434 | CTG | \$232.20 |
| CTG - HP LJ M125/M127/M201/M225 Mono Laser Supplies | | | | |
| CTG83AP | Toner (OEM# CF283A) (1,500 Yield) | 933812 | CTG | \$127.50 |
| CTG83AM | MICR Toner (OEM# CF283A) (1,500 Yield) | 933811 | CTG | \$115.21 |
| CTG - HP LJ Enterprise 700 M712/MFP M725 Mono Laser Supplies | | | | |
| CTG14AP | Toner (OEM# CF214A) (10,000 Yield) | 914911 | CTG | \$224.40 |
| CTG14XP | High Yield Toner (OEM# CF214X) (17,500 Yield) | 914912 | CTG | \$247.35 |
| CTG - HP Color LJ 1500/2500/2550/2820/2840 Laser Supplies | | | | |
| CTG2500B | Black Toner (OEM# C9700A, Q3960A) (5,000 Yield) | 108116 | CTG | \$108.10 |
| CTG2500C | Cyan Toner (OEM# C9701A, Q3961A) (4,000 Yield) | 108143 | CTG | \$130.40 |
| CTG2500M | Magenta Toner (OEM# C9703A, Q3963A) (4,000 Yield) | 900212 | CTG | \$130.40 |
| CTG2500Y | Yellow Toner (OEM# C9702A, Q3962A) (4,000 Yield) | 900213 | CTG | \$130.40 |

| MFG# | Product Description | Part# | UOM | Retail |
|--|--|--------|-----|----------|
| CTG COMPATIBLES | | | | |
| CTG - HP Color LJ 1600/2600/CM1015/CM1017 Laser Supplies | | | | |
| CTG2600B | Black Toner (OEM# Q6000A) (2,500 Yield) | 900214 | CTG | \$99.05 |
| CTG2600C | Cyan Toner (OEM# Q6001A) (2,000 Yield) | 900215 | CTG | \$108.10 |
| CTG2600M | Magenta Toner (OEM# Q6003A) (2,000 Yield) | 900216 | CTG | \$108.10 |
| CTG2600Y | Yellow Toner (OEM# Q6002A) (2,000 Yield) | 900217 | CTG | \$108.10 |
| CTG - HP Color LJ 2700/3000 Laser Supplies | | | | |
| CTG3000B | Black Toner (OEM# Q7560A) (6,500 Yield) | 20490 | CTG | \$176.00 |
| CTG3000C | Cyan Toner (OEM# Q7561A) (3,500 Yield) | 20491 | CTG | \$168.80 |
| CTG3000M | Magenta Toner (OEM# Q7563A) (3,500 Yield) | 20493 | CTG | \$168.80 |
| CTG3000Y | Yellow Toner (OEM# Q7562A) (3,500 Yield) | 20492 | CTG | \$168.80 |
| CTG - HP Color LJ 3500/3550 Laser Supplies | | | | |
| CTG353700B | Black Toner (OEM# Q2670A) (6,000 Yield) | 900218 | CTG | \$173.30 |
| CTG3500C | Cyan Toner (OEM# Q2671A) (4,000 Yield) | 108217 | CTG | \$172.70 |
| CTG3500M | Magenta Toner (OEM# Q2673A) (4,000 Yield) | 108219 | CTG | \$172.70 |
| CTG3500Y | Yellow Toner (OEM# Q2672A) (4,000 Yield) | 108277 | CTG | \$172.70 |
| CTG - HP Color LJ 3600 Laser Supplies | | | | |
| CTG363800B | Black Toner (OEM# Q6470A) (6,000 Yield) | 108278 | CTG | \$173.30 |
| CTG3600C | Cyan Toner (OEM# Q6471A) (4,000 Yield) | 900219 | CTG | \$172.70 |
| CTG3600M | Magenta Toner (OEM# Q6473A) (4,000 Yield) | 900220 | CTG | \$172.70 |
| CTG3600Y | Yellow Toner (OEM# Q6472A) (4,000 Yield) | 900221 | CTG | \$172.70 |
| CTG - HP Color LJ 3700 Laser Supplies | | | | |
| CTG353700B | Black Toner (OEM# Q2670A) (6,000 Yield) | 900218 | CTG | \$173.30 |
| CTG3700C | Cyan Toner (OEM# Q2681A) (6,000 Yield) | 108279 | CTG | \$222.90 |
| CTG3700M | Magenta Toner (OEM# Q2683A) (6,000 Yield) | 108280 | CTG | \$222.90 |
| CTG3700Y | Yellow Toner (OEM# Q2682A) (6,000 Yield) | 108281 | CTG | \$222.90 |
| CTG - HP Color LJ 3800/CP3505 Laser Supplies | | | | |
| CTG363800B | Black Toner (OEM# Q6470A) (6,000 Yield) | 108278 | CTG | \$173.30 |
| CTG3800C | Cyan Toner (OEM# Q7581A) (6,000 Yield) | 900222 | CTG | \$222.90 |
| CTG3800M | Magenta Toner (OEM# Q7583A) (6,000 Yield) | 900223 | CTG | \$222.90 |
| CTG3800Y | Yellow Toner (OEM# Q7582A) (6,000 Yield) | 900224 | CTG | \$222.90 |
| CTG - HP Color LJ 4600 Laser Supplies | | | | |
| CTG4600B | Black Toner (OEM# C9720A) (9,000 Yield) | 700154 | CTG | \$233.25 |
| CTG4600C | Cyan Toner (OEM# C9721A) (8,000 Yield) | 700172 | CTG | \$316.05 |
| CTG4600M | Magenta Toner (OEM# C9723A) (8,000 Yield) | 701135 | CTG | \$316.05 |
| CTG4600Y | Yellow Toner (OEM# C9722A) (8,000 Yield) | 701136 | CTG | \$316.05 |
| CTG - HP Color LJ 4700 Laser Supplies | | | | |
| CTG4700B | Black Toner (OEM# Q5950A) (11,000 Yield) | 900225 | CTG | \$232.80 |
| CTG4700C | Cyan Toner (OEM# Q5951A) (10,000 Yield) | 900226 | CTG | \$331.05 |
| CTG4700M | Magenta Toner (OEM# Q5953A) (10,000 Yield) | 900227 | CTG | \$331.05 |
| CTG4700Y | Yellow Toner (OEM# Q5952A) (10,000 Yield) | 900228 | CTG | \$331.05 |
| CTG - HP Color LJ 4730 Laser Supplies | | | | |
| CTG4730B | Black Toner (OEM# Q6460A) (12,000 Yield) | 903398 | CTG | \$183.75 |
| CTG4730C | Cyan Toner (OEM# Q6461A) (12,000 Yield) | 903403 | CTG | \$396.00 |
| CTG4730M | Magenta Toner (OEM# Q6463A) (12,000 Yield) | 903404 | CTG | \$396.00 |
| CTG4730Y | Yellow Toner (OEM# Q6462A) (12,000 Yield) | 903405 | CTG | \$396.00 |
| CTG - HP Color LJ 5500/5550 Laser Supplies | | | | |
| CTG5500B | Black Toner (OEM# C9730A) (13,000 Yield) (Contains Chip) | 701174 | CTG | \$323.45 |
| CTG5500C | Cyan Toner (OEM# C9731A) (12,000 Yield) (Contains Chip) | 900229 | CTG | \$453.60 |
| CTG5500M | Magenta Toner (OEM# C9733A) (12,000 Yield) (Contains Chip) | 900230 | CTG | \$453.60 |
| CTG5500Y | Yellow Toner (OEM# C9732A) (12,000 Yield) (Contains Chip) | 900231 | CTG | \$453.60 |
| CTG - HP Color LJ CM1312 MFP/CP1215/CP1518 Laser Supplies | | | | |
| CTG1215B | Black Toner (OEM# CB540A) (2,200 Yield) | 30492 | CTG | \$88.40 |
| CTG1215C | Cyan Toner (OEM# CB541A) (1,400 Yield) | 30493 | CTG | \$83.30 |
| CTG1215M | Magenta Toner (OEM# CB543A) (1,400 Yield) | 30503 | CTG | \$83.30 |
| CTG1215Y | Yellow Toner (OEM# CB542A) (1,400 Yield) | 30500 | CTG | \$83.30 |
| CTG - HP Color LJ Pro CM1415/CP1525nw Laser Supplies | | | | |
| CTG1415B | Black Toner (OEM# CE320A) (2,000 Yield) | 901455 | CTG | \$83.30 |
| CTG1415C | Cyan Toner (OEM# CE321A) (1,300 Yield) | 901456 | CTG | \$79.25 |
| CTG1415M | Magenta Toner (OEM# CE323A) (1,300 Yield) | 901458 | CTG | \$79.25 |
| CTG1415Y | Yellow Toner (OEM# CE322A) (1,300 Yield) | 901457 | CTG | \$79.25 |

| MFG# | Product Description | Part# | UOM | Retail |
|---|---|--------|-----|----------|
| CTG COMPATIBLES | | | | |
| CTG - HP Color LJ CM2320 MFP/CP2025 Laser Supplies | | | | |
| CTG2025B | Black Toner (OEM# CC530A) (3,500 Yield) | 33164 | CTG | \$145.15 |
| CTG2025C | Cyan Toner (OEM# CC531A) (2,800 Yield) | 33165 | CTG | \$143.05 |
| CTG2025M | Magenta Toner (OEM# CC533A) (2,800 Yield) | 33167 | CTG | \$143.05 |
| CTG2025Y | Yellow Toner (OEM# CC532A) (2,800 Yield) | 33166 | CTG | \$143.05 |
| CTG - HP Color LJ CM3530/CP3525 Laser Supplies | | | | |
| CTG3525B | Black Toner (OEM# CE250A) (5,000 Yield) | 90896 | CTG | \$158.95 |
| CTG3525BX | High Yield Black Toner (OEM# CE250X) (10,500 Yield) | 106149 | CTG | \$230.65 |
| CTG3525C | Cyan Toner (OEM# CE251A) (7,000 Yield) | 90897 | CTG | \$312.15 |
| CTG3525M | Magenta Toner (OEM# CE253A) (7,000 Yield) | 90898 | CTG | \$312.15 |
| CTG3525Y | Yellow Toner (OEM# CE252A) (7,000 Yield) | 90899 | CTG | \$312.15 |
| CTG - HP Color LJ CM4540 Laser Supplies | | | | |
| CTG4025B | Black Toner (OEM# CE260A) (8,500 Yield) | 504132 | CTG | \$187.40 |
| CTG4540BX | High Yield Black Toner (OEM# CE264X) (17,000 Yield) | 909943 | CTG | \$238.75 |
| CTG4540C | Cyan Toner (OEM# CF031A) (12,500 Yield) | 909944 | CTG | \$298.20 |
| CTG4540M | Magenta Toner (OEM# CF033A) (12,500 Yield) | 909945 | CTG | \$298.20 |
| CTG4540Y | Yellow Toner (OEM# CF032A) (12,500 Yield) | 909946 | CTG | \$298.20 |
| CTG - HP Color LJ CM6030/CM6040 Laser Supplies | | | | |
| CTG6015C | Cyan Toner (OEM# CB381A) (21,000 Yield) | 504129 | CTG | \$417.60 |
| CTG6015M | Magenta Toner (OEM# CB383A) (21,000 Yield) | 504131 | CTG | \$417.60 |
| CTG6015Y | Yellow Toner (OEM# CB382A) (21,000 Yield) | 504130 | CTG | \$417.60 |
| CTG - HP Color LJ CP1020/CP1025nw; Pro 100 MFP M175nw; Pro 200 MFP M275nw Laser Supplies | | | | |
| CTG1025B | Black Toner (OEM# CE310A) (1,200 Yield) | 916671 | CTG | \$60.35 |
| CTG1025C | Cyan Toner (OEM# CE311A) (1,000 Yield) | 916672 | CTG | \$67.10 |
| CTG1025M | Magenta Toner (OEM# CE313A) (1,000 Yield) | 916673 | CTG | \$67.10 |
| CTG1025Y | Yellow Toner (OEM# CE312A) (1,000 Yield) | 916674 | CTG | \$67.10 |
| CTG - HP Color LJ CP4005 Laser Supplies | | | | |
| CTG4005B | Black Toner (OEM# CB400A) (7,500 Yield) | 903400 | CTG | \$211.80 |
| CTG4005C | Cyan Toner (OEM# CB401A) (7,500 Yield) | 903410 | CTG | \$315.15 |
| CTG4005M | Magenta Toner (OEM# CB403A) (7,500 Yield) | 903401 | CTG | \$315.15 |
| CTG4005Y | Yellow Toner (OEM# CB402A) (7,500 Yield) | 903406 | CTG | \$315.15 |
| CTG - HP Color LJ CP4025 Laser Supplies | | | | |
| CTG4025B | Black Toner (OEM# CE260A) (8,500 Yield) | 504132 | CTG | \$187.40 |
| CTG4025C | Cyan Toner (OEM# CE261A) (11,000 Yield) | 504207 | CTG | \$339.65 |
| CTG4025M | Magenta Toner (OEM# CE263A) (11,000 Yield) | 504392 | CTG | \$339.65 |
| CTG4025Y | Yellow Toner (OEM# CE262A) (11,000 Yield) | 504208 | CTG | \$339.65 |
| CTG - HP Color LJ CP4525 Laser Supplies | | | | |
| CTG4025B | Black Toner (OEM# CE260A) (8,500 Yield) | 504132 | CTG | \$187.40 |
| CTG4525BX | High Yield Black Toner (OEM# CE260X) (17,000 Yield) | 701619 | CTG | \$296.40 |
| CTG4025C | Cyan Toner (OEM# CE261A) (11,000 Yield) | 504207 | CTG | \$339.65 |
| CTG4025M | Magenta Toner (OEM# CE263A) (11,000 Yield) | 504392 | CTG | \$339.65 |
| CTG4025Y | Yellow Toner (OEM# CE262A) (11,000 Yield) | 504208 | CTG | \$339.65 |
| CTG - HP Color LJ CP5225 Laser Supplies | | | | |
| CTG5220B | Black Toner (OEM# CE740A) (7,000 Yield) | 909947 | CTG | \$177.45 |
| CTG5220C | Cyan Toner (OEM# CE741A) (7,300 Yield) | 909948 | CTG | \$312.60 |
| CTG5220M | Magenta Toner (OEM# CE743A) (7,300 Yield) | 909949 | CTG | \$312.60 |
| CTG5220Y | Yellow Toner (OEM# CE742A) (7,300 Yield) | 909950 | CTG | \$312.60 |
| CTG - HP Color LJ CP5525/Enterprise M750 Laser Supplies | | | | |
| CTG5525B | Black Toner (OEM# CE270A) (13,500 Yield) | 909951 | CTG | \$290.10 |
| CTG5525C | Cyan Toner (OEM# CE271A) (15,000 Yield) | 909952 | CTG | \$472.10 |
| CTG5525M | Magenta Toner (OEM# CE273A) (15,000 Yield) | 909953 | CTG | \$472.10 |
| CTG5525Y | Yellow Toner (OEM# CE272A) (15,000 Yield) | 909954 | CTG | \$472.10 |
| CTG - HP Color LJ CP6015 Laser Supplies | | | | |
| CTG6015B | Black Toner (OEM# CB380A) (16,500 Yield) | 504033 | CTG | \$266.75 |
| CTG6015C | Cyan Toner (OEM# CB381A) (21,000 Yield) | 504129 | CTG | \$417.60 |
| CTG6015M | Magenta Toner (OEM# CB383A) (21,000 Yield) | 504131 | CTG | \$417.60 |
| CTG6015Y | Yellow Toner (OEM# CB382A) (21,000 Yield) | 504130 | CTG | \$417.60 |

All catalog content is subject to change.

| MFG# | Product Description | Part# | UOM | Retail |
|--|---|--------|-----|----------|
| CTG COMPATIBLES | | | | |
| CTG - HP Color LJ Pro 200 Color M251nw/MFP M276nw Laser Supplies | | | | |
| CTGM251B | Black Toner (OEM# CF210A) (1,600 Yield) | 922652 | CTG | \$80.15 |
| CTGM251BX | High Yield Black Toner (OEM# CF210X) (2,400 Yield) | 922653 | CTG | \$101.80 |
| CTGM251C | Cyan Toner (OEM# CF211A) (1,800 Yield) | 922654 | CTG | \$100.45 |
| CTGM251M | Magenta Toner (OEM# CF213A) (1,800 Yield) | 922655 | CTG | \$100.45 |
| CTGM251Y | Yellow Toner (OEM# CF212A) (1,800 Yield) | 922656 | CTG | \$100.45 |
| CTG - HP Color LJ M375/M451/M475 Laser Supplies | | | | |
| CTGM451B | Black Toner (OEM# CE410A) (2,200 Yield) | 909966 | CTG | \$71.35 |
| CTGM451BX | High Yield Black Toner (OEM# CE410X) (4,000 Yield) | 909967 | CTG | \$88.35 |
| CTGM451C | Cyan Toner (OEM# CE411A) (2,600 Yield) | 909968 | CTG | \$101.95 |
| CTGM451M | Magenta Toner (OEM# CE413A) (2,600 Yield) | 909969 | CTG | \$101.95 |
| CTGM451Y | Yellow Toner (OEM# CE412A) (2,600 Yield) | 909970 | CTG | \$101.95 |
| CTG - HP Color LJ M551/M570/M575 Laser Supplies | | | | |
| CTGM551B | Black Toner (OEM# CE400A) (5,500 Yield) | 909971 | CTG | \$174.75 |
| CTGM551BX | High Yield Black Toner (OEM# CE400X) (11,000 Yield) | 909972 | CTG | \$235.15 |
| CTGM551C | Cyan Toner (OEM# CE401A) (6,000 Yield) | 909973 | CTG | \$235.15 |
| CTGM551M | Magenta Toner (OEM# CE403A) (6,000 Yield) | 909974 | CTG | \$260.35 |
| CTGM551Y | Yellow Toner (OEM# CE402A) (6,000 Yield) | 909975 | CTG | \$260.35 |
| CTG - Imagistics Facsimile Supplies | | | | |
| CTGPB99 | 9900 Fax Toner (OEM# 815-7) (10,000 Yield) | 900140 | CTG | \$424.15 |
| CTGPB21C | fx2100/ix2700/ix2701/mx2101/sx2101 Toner (OEM# 484-5) (6,500 Yield) | 24126 | CTG | \$169.15 |
| CTGPB21DC | fx2100/ix2700/ix2701/mx2101/sx2101 Drum Unit (OEM# 484-4) (20,000 Yield) | 24127 | CTG | \$135.15 |
| CTG - InfoPrint Monochrome Laser Supplies | | | | |
| CTGI1882 | 1145 Toner (OEM# 28P1882) (30,000 Yield) | 903411 | CTG | \$353.60 |
| CTGI4303 | 1332/1352/1372 High Yield Toner (OEM# 75P4301, 75P4303) (21,000 Yield) | 901479 | CTG | \$472.60 |
| CTGI6960 | 1532/1552/1572 High Yield Toner (OEM# 75P6960, 75P6961) (21,000 Yield) | 903384 | CTG | \$476.00 |
| CTGI2514 | 1832/1852/1872 High Yield Toner (OEM# 39V2513) (25,000 Yield) | 908333 | CTG | \$507.45 |
| CTG - Kodak Inkjet Supplies | | | | |
| CTG1467 | 5100/5300/5500/ ESP 3/5/7/9/3250/5210/5250/5520/7250/9250/ ESP Office 6150/ Hero 6.1/9.1 (10XL) High Yield Black Ink (OEM# 8237216) (770 Yield) | 909942 | CTG | \$16.95 |
| CTG5766 | 5100/5300/5500/ ESP 3/5/7/9/3250/5210/5250/5520/7250/9250/ ESP Office 6150/ Hero 6.1/9.1 (10) Color Ink (OEM# 8946501, 1935766) (420 Yield) | 909955 | CTG | \$16.95 |
| CTGK30BXL | ESP C110/C310/C315/ ESP Office 2150/2170/ ESP C and Office 2100 Series/ Hero 3.1/5.1 (30XL) High Yield Black Ink (OEM# 1550532) (670 Yield) | 909964 | CTG | \$16.95 |
| CTGK30CXL | ESP C110/C310/C315/ ESP Office 2150/2170/ ESP C and Office 2100 Series/ Hero 3.1/5.1 (30XL) High Yield Color Ink (OEM# 1341080) (550 Yield) | 909965 | CTG | \$30.55 |
| CTG - Kyocera Mono Laser Supplies | | | | |
| CTGTK312 | FS-2000D/2000DN Toner (OEM# TK-312) (12,000 Yield) | 932692 | CTG | \$79.20 |
| CTGTK322 | FS-3900DN Toner (OEM# TK-322) (15,000 Yield) | 932693 | CTG | \$68.85 |
| CTGTK332 | FS-4000DN Toner (OEM# TK-332) (20,000 Yield) | 932694 | CTG | \$78.20 |
| CTGTK342 | FS-2020/2020D/2020DN Toner (OEM# TK-342) (12,000 Yield) | 932695 | CTG | \$67.30 |
| CTGTK352 | FS-3040MFP/3140MFP/3540MFP/3640MFP/3920DN Toner (OEM# TK-352) (15,000 Yield) | 932696 | CTG | \$68.85 |
| CTGTK362 | FS-4020DN Toner (OEM# TK-362) (20,000 Yield) | 932697 | CTG | \$71.40 |
| CTG - Lanier Copier Supplies | | | | |
| CTG5208 | 5222/5227 Toner (OEM# 480-0032) (11,000 Yield) | 101395 | BTL | \$33.60 |
| CTG - Lexmark Genesis S815/S816; Impact S301/S305; Interpret S405; Interact S605; Intuition S505; Pinnacle PRO901; Platinum PRO905; Prestige PRO805; Prevail PRO705; Prospect PRO205 Ink Supplies | | | | |
| CTG100BXL | High Yield Black Inkjet Cartridge (OEM# 14N1068, 14N1092) (510 Yield) | 908529 | CTG | \$29.45 |
| CTG100CXL | High Yield Cyan Inkjet Cartridge (OEM# 14N1069, 14N1093) (600 Yield) | 908530 | CTG | \$20.90 |
| CTG100MXL | High Yield Magenta Inkjet Cartridge (OEM# 14N1070, 14N1094) (600 Yield) | 908531 | CTG | \$20.90 |
| CTG100YXL | High Yield Yellow Inkjet Cartridge (OEM# 14N1071, 14N1095) (600 Yield) | 908532 | CTG | \$20.90 |
| CTG - Lexmark Pro715/Pro915/S315/S415/S515 Ink Supplies | | | | |
| CTG150XLB | High Yield Black Inkjet Cartridge (OEM# 14N1614, 14N1636) (750 Yield) | 923313 | CTG | \$32.85 |
| CTG150XLC | High Yield Cyan Inkjet Cartridge (OEM# 14N1615, 14N1642) (700 Yield) | 923314 | CTG | \$34.65 |
| CTG150XLM | High Yield Magenta Inkjet Cartridge (OEM# 14N1616, 14N1646) (700 Yield) | 923315 | CTG | \$34.65 |
| CTG150XLY | High Yield Yellow Inkjet Cartridge (OEM# 14N1618, 14N1650) (700 Yield) | 923316 | CTG | \$26.05 |

| MFG# | Product Description | Part# | UOM | Retail |
|---|---|--------|-----|----------|
| CTG COMPATIBLES | | | | |
| CTG - Lexmark Inkjet Supplies | | | | |
| CTG0034 | (#28) (#34) P915/P4350/P4330/P6250/X2500/X2530/X2550/X3350/X3530/X3550/X4530/X4550/X5070/X5250/X5270/X5320/X5450/X5470/X5495/X7170/X7350/X8350/Z816/Z845/Z1300/Z1310/Z1320/Z1420 Black Ink (OEM# 18C0034, 18C1528) (475 Yield) | 107891 | CTG | \$31.35 |
| CTGC0032 | (#32) P915/P4350/P6250/X3350/X5250/X5270/X7170/X7350/X8350/Z816 Black Ink (OEM# 18C0032) (200 Yield) | 903374 | CTG | \$28.50 |
| CTG0035CLR | (#29) (#35) P315/P450/P915/P4330/P4350/P6250/P6350/X2500/X2530/X2550/X3350/X3550/X4530/X4550/X5070/X5075/X5250/X5270/X5320/X5450/X5470/X5495/X7170/X7350/X8350/Z816/Z845/Z1300/Z1310/Z1320/Z1420 High Yield Color Ink (OEM# 18C0035, 18C1529) (450 Yield) | 101371 | CTG | \$39.00 |
| CTG0033 | (#33) P315/P450/P915/P4330/P4350/P6250/P6350/X3350/X5250/X5270/X5400/X5450/X5470/X7170/X7350/X8350/Z816 Color Ink (OEM# 18C0033) (190 Yield) | 903371 | CTG | \$30.40 |
| CTG1970 | (#50) (#70) 3200/5700/5770/7000/7200/7200V/X63/X73/X83/X85/Z11/Z31/Z42/Z43/Z45/Z45se/Z51/Z52/Z53/Z82 Black Ink (OEM# 12A1970, 17G0050) (600 Yield) | 101386 | CTG | \$41.85 |
| CTG1980 | (#60) (#80) 3200/5700/5770/7000/7200/7200V/Z11/Z31 Color Ink (OEM# 12A1980, 17G0060) (275 Yield) | 101387 | CTG | \$45.65 |
| CTG0781 | X2300/AIO X2350/X2400/X2470/X3400/X3470/Color Jetprinter Z730/Z735 Tri-Color Ink (OEM# 18C0781) (245 Yield) | 31145 | CTG | \$28.50 |
| CTG0143 | Z1520/AIO X4850/X4875/X4950/X4975/4975ve/X6570/X6575/X7550/X7675/X9350/X9575/Photo Jetprinter P250/P350 High Yield Color Ink (OEM# 18Y0143) (480 Yield) | 31156 | CTG | \$39.00 |
| CTG0144 | Z1520/AIO X4850/X4875/X4950/X4975/4975ve/X6570/X6575/X7550/X7675/X9350/X9575 High Yield Black Ink (OEM# 18Y0144) (480 Yield) | 31143 | CTG | \$31.35 |
| CTG - Lexmark Monochrome Laser Supplies (Continued on next page) | | | | |
| CTGE120 | E120n Toner (OEM# 120155A) (2,000 Yield) (Compliant) | 913020 | CTG | \$110.55 |
| CTGE210 | E210 Toner (OEM# 10S0150) (2,000 Yield) | 101447 | CTG | \$95.40 |
| CTGE240 | E230/E232/E234/E240/E330/E332/E340/E342 Toner (OEM# 240155A, 240355A, 240605W) (2,500 Yield) (Compliant) | 933826 | CTG | \$118.05 |
| CTGE330 | E230/E232/E234/E238/E240/E242/E330/E332/E340/E342 High Yield Toner (OEM# 34015HA, 34035HA) (6,000 Yield) (Compliant) | 903391 | CTG | \$176.20 |
| CTGE250 | E250 Toner (OEM# E250A21A, E250A11A) (3,500 Yield) | 7562 | CTG | \$147.10 |
| CTGE260 | E260/E360/E460/E462/X463/X464/X466 Toner (OEM# E260A21A, E260A80G, E260A11A) (3,500 Yield) (Compliant) | 908892 | CTG | \$149.45 |
| CTGE260X | E260/E360/E460/E462 High Yield Toner (OEM# E260A11A, E260A21A) (9,000 Yield) (Compliant) | 915859 | CTG | \$267.81 |
| CTGE330DR | E230/E232/E234/E238/E240/E242/E330/E332N/E340/E342N Drum Unit (OEM# 12A8302) (33,000 Yield) | 31134 | CTG | \$84.65 |
| CTGE310 | Optra E310/E312/E312L High Yield Toner (OEM# 13T0101) (6,000 Yield) | 900105 | CTG | \$191.15 |
| CTGE320 | E320/E322 High Yield Toner (OEM# 08A0477) (6,000 Yield) (Compliant) | 101448 | CTG | \$191.80 |
| CTGE321 | E321/E323 Toner (OEM# 12A7405, 12A7305) (6,000 Yield) (Compliant) | 900106 | CTG | \$192.85 |
| CTGE350 | E350/E352 High Yield Toner (OEM# E352H21A, E352H11A) (9,000 Yield) (Compliant) | 7563 | CTG | \$265.95 |
| CTGE360 | E360/E460/E462/X463/X464/X466 High Yield Toner (OEM# E360H21A, E360H80G, E360H11A, X463H11G, X463H21G) (9,000 Yield) (Compliant) | 908893 | CTG | \$258.10 |
| CTGE450 | E450 Toner (OEM# E450A21A, E450A11A) (6,000 Yield) | 7564 | CTG | \$132.80 |
| CTGE450X | E450 Toner (OEM# E450A11A, E450H80G, E450A21A) (11,000 Yield) (Compliant) | 908894 | CTG | \$305.90 |
| CTGE460 | E460/X463/X464/X466/XS463 Extra High Yield Toner (OEM# E460X21A, E460X80G, E460X11A, X463X11G, X463X21G) (15,000 Yield) (Compliant) | 908895 | CTG | \$324.80 |
| CTGM410 | Optra M410/M412 High Yield Toner (OEM# 17G0152, 17G0154, 4K00199) (15,000 Yield) (Compliant) | 903396 | CTG | \$370.90 |
| CTG59P | Optra S 1250/1255/1620/1625/1650/1855/2420/2450/2455/4059 High Yield Toner (OEM# 1382625, 1382920, 1382925, 1382929) (17,600 Yield) (Compliant) | 701175 | CTG | \$322.70 |
| CTG69P | Optra T610/T612/T614/T616 High Yield Toner (OEM# 12A5745, 12A5840, 12A5845, 12A5849) (25,000 Yield) (Compliant) (Includes Label App Wand) | 701179 | CTG | \$450.65 |
| CTGT430 | T430 High Yield Toner (OEM# 12A8325, 12A8420, 12A8425) (12,000 Yield) (Compliant) | 31135 | CTG | \$299.20 |
| CTGT650 | T650/T652/T654/T656/X651/X652 High Yield Toner (OEM# T650A41G, T650H21A, T650H11A, T650H04A) (25,000 Yield) (Compliant) (Includes Label App Wand) | 106647 | CTG | \$535.90 |
| CTGT520NS | T520/T522/X520/X522 High Yield Toner (OEM# 12A6735, 12A3160, 12A6835) (20,000 Yield) (Compliant) | 900122 | CTG | \$461.00 |
| CTGT620NS | T620/T622 High Yield Toner (OEM# 12A6765, 12A6860, 12A6865, 12A6869) (30,000 Yield) (Compliant) (Includes Label App Wand) | 900123 | CTG | \$537.85 |
| CTGT630 | T630 High Yield Toner (OEM# 12A7362, 12A7460, 12A7462, 12A7468) (21,000 Yield) (Compliant) (Includes Label App Wand) | 101496 | CTG | \$484.15 |
| CTGT632 | T632/T634 Extra High Yield Toner (OEM# 12A7365, 12A7465) (32,000 Yield) (Compliant) | 900170 | CTG | \$518.55 |
| CTGT640 | T640/T642/T644/X642/X644/X646 High Yield Toner (OEM# 640155A, 64015HA, 64035HA, 64004HA) (21,000 Yield) (Compliant) (Includes Label App Wand) | 101497 | CTG | \$482.25 |
| CTGT644 | T644/X644/X646 Extra High Yield Toner (OEM# 64435XA, 64415XA, 64404XA) (32,000 Yield) (Compliant) (Includes Label App Wand) | 103384 | CTG | \$516.85 |

| MFG# | Product Description | Part# | UOM | Retail |
|---|---|--------|-----|----------|
| CTG COMPATIBLES | | | | |
| CTG - Lexmark Monochrome Laser Supplies <i>(Continued)</i> | | | | |
| CTGT654 | T654/T656/X654/X656/X658 Toner (OEM# T654X21A, T654X80G, T654X11A, X654X21A, X654X11A) (36,000 Yield) (Compliant) | 908896 | CTG | \$567.70 |
| CTGW820 | W820/X820 Toner (OEM# 12B0090) (30,000 Yield) (Compliant) | 923326 | CTG | \$366.00 |
| CTGX203 | X203N/X204N Toner (OEM# X203A11G, X203A21G) (2,500 Yield) (Compliant) | 911692 | CTG | \$117.10 |
| CTGX204 | X203N/X204N High Yield Toner (OEM# X203A11G, X203A21G) (6,000 Yield) | 914916 | CTG | \$199.35 |
| CTGX215 | X215 Toner (OEM# 18S0090) (3,200 Yield) (Compliant) | 923327 | CTG | \$92.45 |
| CTGX264 | X264/X363/X364 Toner (OEM# X264A11G, X264A41G) (3,500 Yield) (Compliant) | 913021 | CTG | \$223.65 |
| CTGX364 | X264/X364 High Yield Toner (OEM# X264H11G, X264H21G) (9,000 Yield) (Compliant) | 908897 | CTG | \$259.30 |
| CTGLX3402 | X340/X342 High Yield Toner (OEM# X340A11G, X340H11G) (6,000 Yield) (Compliant) | 7565 | CTG | \$194.05 |
| CTG - Lexmark MICR Supplies | | | | |
| CTGE260M | E260/E360/E460/E462 MICR Toner (OEM# E260A21A, E260A80G, E260A11A) (3,500 Yield) (Compliant) | 922691 | CTG | \$216.70 |
| CTGT640M | T640/T642/T644/T646/X642/X644/X646 High Yield MICR Toner (OEM# 64035HA, 640155A) (21,000 Yield) | 30518 | CTG | \$485.95 |
| CTG - OKI Monochrome Laser Supplies | | | | |
| CTG400E | 1000/1050/2200/2350/2400/2450/2600/5050/5250/5300/5300+/5400/5600/5600+/5650 Toner (OEM# 52106701, 52107201) (2,500 Yield) | 101634 | CTG | \$38.25 |
| CTGB410 | B410/B420/B430/MB460/MB470/MB480 Toner (OEM# 43979101) (3,500 Yield) | 933813 | CTG | \$74.80 |
| CTGB411 | B411/B431/MB461/MB471/MB491 Toner (OEM# 44574701) (4,000 Yield) | 933814 | CTG | \$85.75 |
| CTGB4300 | B4100/B4200/B4250/B4300/B4350 Toner (OEM# 42103001) (3,000 Yield) | 701185 | CTG | \$34.00 |
| CTGB4600 | B4400/B4400N/B4600/B4600N Toner (OEM# 43502301) (3,000 Yield) | 31140 | CTG | \$45.90 |
| CTGB6300 | B6300/B6300N High Yield Toner (OEM# 52114502) (17,000 Yield) | 31138 | CTG | \$225.25 |
| CTG - OKI C5100/C5150/C5200/C5250/C5300/C5400/C5450/C5540 MFP Color Laser Supplies | | | | |
| CTG5100B | High Yield Black Toner (OEM# 42127404) (5,000 Yield) | 14278 | CTG | \$57.80 |
| CTG5100C | High Yield Cyan Toner (OEM# 42127403) (5,000 Yield) | 14279 | CTG | \$134.30 |
| CTG5100M | High Yield Magenta Toner (OEM# 42127402) (5,000 Yield) | 14280 | CTG | \$134.30 |
| CTG5100Y | High Yield Yellow Toner (OEM# 42127401) (5,000 Yield) | 14281 | CTG | \$134.30 |
| CTG - OKI C5550 MFP/C6100 Color Laser Supplies | | | | |
| CTGC6100B | Black Toner (OEM# 43324420) (6,000 Yield) | 24122 | CTG | \$85.00 |
| CTGC6100C | Cyan Toner (OEM# 43324419) (5,000 Yield) | 24123 | CTG | \$130.05 |
| CTGC6100M | Magenta Toner (OEM# 43324418) (5,000 Yield) | 24124 | CTG | \$130.05 |
| CTGC6100Y | Yellow Toner (OEM# 43324417) (5,000 Yield) | 24125 | CTG | \$130.05 |
| CTG - Panasonic Facsimile Supplies | | | | |
| CTGKX83 | KX-FL511/FL541 Toner (OEM# KX-FA83) (2,500 Yield) | 903397 | CTG | \$29.70 |
| CTGKX136 | KX-FP200/KX-FP205/KX-FP250/KX-FP280/KX-FM210/KX-FM 215/KX-FM220/KX-FMC230/195/KX-FA135 Refill Kit (OEM# KX-FA136) (330 Yield) (2/Box) | 900112 | BOX | \$42.45 |
| CTGP13P | UF-550/560/770/880/885/895/DF-1100/DX-1000/DX-2000 Toner (OEM# UG3313) (10,000 Yield) | 900136 | CTG | \$191.25 |
| CTGP50P | UF-585/595 Toner (OEM# UG3350) (7,500 Yield) | 900138 | CTG | \$170.00 |
| CTGP10 | UF-780/790/6000/DX-800 Toner (OEM# UG5510) (9,000 Yield) | 900120 | CTG | \$170.00 |
| CTGP20 | UF-890/990 Toner (OEM# UG5520) (12,000 Yield) | 101455 | CTG | \$212.50 |
| CTGP30/40 | UF-7000/8000/9000 High Yield Toner (OEM# UG5530, UG5540) (10,000 Yield) | 900137 | CTG | \$165.75 |
| CTG - Ricoh Copier Supplies | | | | |
| CTG430222C | 1900L Fax Toner (OEM# 430222) (4,500 Yield) | 701192 | CTG | \$97.25 |
| CTG - Samsung Monochrome Laser Supplies <i>(Continued on next page)</i> | | | | |
| CTGML1210 | ML-1210/1250/1430 Toner (OEM# ML1210D3) (3,000 Yield) | 903416 | CTG | \$97.70 |
| CTGML6060 | ML-1440/1450/6060 Toner (OEM# ML6060D6) (6,000 Yield) | 903409 | CTG | \$138.50 |
| CTGML1610 | ML-1610 Toner (OEM# ML1610D2) (2,000 Yield) | 903417 | CTG | \$87.50 |
| CTGMLT108 | ML-1640/2240 Toner (OEM# MLT-D108S) (1,500 Yield) | 914914 | CTG | \$75.60 |
| CTGML1710 | ML-1710/1740/1750/1755/1500/1510/1520/SF-560/565P/755P; SCX-4016/4116/4216F Toner (OEM# ML1710D3, SCX4216D3) (3,000 Yield) | 900117 | CTG | \$97.70 |
| CTGMLT105 | ML-1910/1915/2525/2525W/2580N; SCX-4600/4623F/4623FN/4623FW/SF-650; SF-650/650P High Yield Toner (OEM# MLT-D105L) (2,500 Yield) | 908547 | CTG | \$87.50 |
| CTGML2010 | ML-2010/2510/2570/2571N; SCX-4521F/4521FG Toner (OEM# ML2010D3, SCX4521D3) (3,000 Yield) | 900118 | CTG | \$97.70 |
| CTGML2150 | ML-2150/2151N/2152W Toner (OEM# ML2150D8) (8,000 Yield) | 900119 | CTG | \$172.50 |
| CTGML2250 | ML-2250/2251N/2251NP/2252W; SCX-4720F/4720FN Toner (OEM# ML2250D5, SCX4720D5) (5,000 Yield) | 903421 | CTG | \$120.65 |
| CTGML2850 | ML-2450/2850/2851ND High Yield Toner (OEM# ML-2850B) (5,000 Yield) | 94353 | CTG | \$116.40 |
| CTGMLT209 | ML-2855ND; SCX-4826FN/4828FN High Yield Toner (OEM# MLT-D209L) (5,000 Yield) | 910669 | CTG | \$127.99 |

All catalog content is subject to change.

| MFG# | Product Description | Part# | UOM | Retail |
|---|---|--------|-----|----------|
| CTG COMPATIBLES | | | | |
| CTG - Samsung Monochrome Laser Supplies <i>(Continued)</i> | | | | |
| CTGMLT205 | ML-3312ND/3712DW/3712ND; SCX-4833FD/4835FR/4835FD/5637FR/5639FR/5737FR/5737FW/5739FW Toner (OEM# MLT-D205L) (5,000 Yield) | 914915 | CTG | \$138.50 |
| CTGMLT205X | ML-3310ND/3312ND/3710ND/3712DW/3712ND; SCX-4833FD/4835FR/4835FD/5637FR/5639FR/5737FR/5737FW/5739FW Extra High Yield Toner (OEM# MLT-D205L) (10,000 Yield) | 922657 | CTG | \$212.45 |
| CTGMLT206 | SCX-5935FN Toner (OEM# MLT-D206L) (10,000 Yield) | 911437 | CTG | \$95.00 |
| CTGMLT208 | SCX-5635FN/5835FN High Yield Toner (OEM# MLT-D208L, MLT-D208S) (10,000 Yield) | 505025 | CTG | \$186.95 |
| CTG - Samsung CLP-310/CLP-315/CLX-3170/CLX-3175 Color Laser Supplies | | | | |
| CTGCLP315B | Black Toner (OEM# CLT-K409S) (1,500 Yield) | 505015 | CTG | \$52.65 |
| CTGCLP315C | Cyan Toner (OEM# CLT-C409S) (1,000 Yield) | 505010 | CTG | \$46.70 |
| CTGCLP315M | Magenta Toner (OEM# CLT-M409S) (1,000 Yield) | 505017 | CTG | \$46.70 |
| CTGCLP315Y | Yellow Toner (OEM# CLT-Y409S) (1,000 Yield) | 505018 | CTG | \$46.70 |
| CTG - Samsung CLP-320/CLP-325/CLX-3185 Color Laser Supplies | | | | |
| CTGCLP320B | Black Toner (OEM# CLT-K407S) (1,500 Yield) | 922648 | CTG | \$47.45 |
| CTGCLP320C | Cyan Toner (OEM# CLT-C407S) (1,000 Yield) | 922649 | CTG | \$44.00 |
| CTGCLP320M | Magenta Toner (OEM# CLT-M407S) (1,000 Yield) | 922650 | CTG | \$44.00 |
| CTGCLP320Y | Yellow Toner (OEM# CLT-Y407S) (1,000 Yield) | 922651 | CTG | \$44.00 |
| CTG - Sharp Copier Supplies | | | | |
| CTGAL100TD | AL100TD/AL1000/AL1010/AL1020/AL1041/AL1200/AL1220/AL1250/AL1521/AL1631/AL1641CS/AL1651CS/AL1655CS/AL1661CS/AL1680 Toner (OEM# AL100TD) (6,000 Yield) | 701184 | CTG | \$231.15 |
| CTGAL110TD | AL110TD/AL1340/AL1351/AL1451/AL1530/AL1540/AL1551 Toner (OEM# AL110TD) (4,000 Yield) | 900232 | CTG | \$197.95 |
| CTGAL100DR | AL1000/AL1010/AL1020/AL1041/AL1200/AL1220/AL1250/AL1340/AL1451/AL1521/AL1540/AL1551/AL1631/AL1641CS/AL1651CS/AL1661CS Drum (OEM# AL100DR) (18,000 Yield) | 701183 | CTG | \$229.45 |
| CTG - Sharp Facsimile Supplies | | | | |
| CTGFO50ND | FO-4400/4450/4470 Toner (OEM# FO50ND) (6,000 Yield) | 900169 | CTG | \$113.90 |
| CTGFO47ND | FO-4650/4700/4970/5550/5700/5800/6700 Toner (OEM# FO47ND) (6,000 Yield) | 900107 | CTG | \$113.90 |
| CTG - Xerox Monochrome Laser Supplies | | | | |
| CTGR374 | Phaser 3250 High Yield Toner (OEM# 106R01373, 106R01374) (5,000 Yield) | 504993 | CTG | \$131.75 |
| CTGR412 | Phaser 3300MFP High Yield Toner (OEM# 106R01412, 106R01411) (8,000 Yield) | 504998 | CTG | \$188.70 |
| CTGR371 | Phaser 3600 High Yield Toner (OEM# 106R01371) (14,000 Yield) | 916682 | CTG | \$189.96 |
| CTGR795 | Phaser 3635MFP High Yield Toner (OEM# 108R00795, 108R00793) (10,000 Yield) | 505003 | CTG | \$201.45 |
| CTGX657 | Phaser 4500 High Yield Toner (OEM# 113R00656, 113R00657) (18,000 Yield) | 903418 | CTG | \$221.00 |
| CTGR712 | Phaser 4510 High Yield Toner (OEM# 113R00712, 113R00711) (19,000 Yield) | 907155 | CTG | \$306.00 |
| CTGR486 | WorkCentre 3210/3220 Toner (OEM# 106R01485, 106R01486) (4,100 Yield) | 101815 | CTG | \$119.00 |
| CTGR311 | WorkCentre 3315DN/3325DNI High Yield Toner (OEM# 106R02311) (5,000 Yield) | 932691 | CTG | \$163.95 |
| CTGR530 | WorkCentre 3550 High Yield Toner (OEM# 106R01530) (11,000 Yield) | 908337 | CTG | \$226.65 |
| CTGR402 | WorkCentre Pro 555/575 Toner (OEM# 106R402) (6,000 Yield) | 101494 | CTG | \$127.50 |
| CTGR404 | WorkCentre Pro 665/685/765/785 Toner (OEM# 106R404) (3,000 Yield) | 903382 | CTG | \$49.30 |
| CTG6R914 | XD100/102/103F/105F/120F/125/130DF/155F/155DF Toner (OEM# 6R914) (6,000 Yield) | 903420 | CTG | \$201.60 |
| CTG - Xerox Phaser 6125 Color Laser Supplies | | | | |
| CTG6125B | Black Toner (OEM# 106R01334) (2,000 Yield) | 7566 | CTG | \$73.95 |
| CTG6125C | Cyan Toner (OEM# 106R01331) (1,000 Yield) | 7567 | CTG | \$62.90 |
| CTG6125M | Magenta Toner (OEM# 106R01332) (1,000 Yield) | 7568 | CTG | \$62.90 |
| CTG6125Y | Yellow Toner (OEM# 106R01333) (1,000 Yield) | 7569 | CTG | \$62.90 |
| CTG - Xerox Phaser 6180 Color Laser Supplies | | | | |
| CTG6180B | High Yield Black Toner (OEM# 113R00726) (8,000 Yield) | 99839 | CTG | \$245.65 |
| CTG6180C | High Yield Cyan Toner (OEM# 113R00723) (6,000 Yield) | 99840 | CTG | \$270.30 |
| CTG6180M | High Yield Magenta Toner (OEM# 113R00724) (6,000 Yield) | 99841 | CTG | \$270.30 |
| CTG6180Y | High Yield Yellow Toner (OEM# 113R00725) (6,000 Yield) | 99842 | CTG | \$270.30 |
| CTG - Xerox Phaser 6360 Color Laser Supplies | | | | |
| CTG6360B | High Yield Black Toner (OEM# 106R01217, 106R01221) (18,000 Yield) | 31104 | CTG | \$224.40 |
| CTG6360C | High Yield Cyan Toner (OEM# 106R01214, 106R01218) (12,000 Yield) | 31101 | CTG | \$372.30 |
| CTG6360M | High Yield Magenta Toner (OEM# 106R01215, 106R01219) (12,000 Yield) | 31102 | CTG | \$372.30 |
| CTG6360Y | High Yield Yellow Toner (OEM# 106R01216, 106R01220) (12,000 Yield) | 31103 | CTG | \$372.30 |

All catalog content is subject to change.

| MFG# | Product Description | Part# | UOM | Retail |
|---|--|--------|-----|----------|
| DATAPRODUCTS COMPATIBLES | | | | |
| Dataproducts - Brother Ribbons | | | | |
| R1420 | Brother AX-10 Black Correctable Typewriter Ribbon (OEM# 1230) | 31499 | RBN | \$5.00 |
| Dataproducts - Casio Ribbons | | | | |
| R1427 | Red/Black Calculator Ink Roll (OEM# IR-40T) | 101504 | RBN | \$3.80 |
| Dataproducts - Digital Ribbons | | | | |
| P34126 | LA 30/36 Nylon Plastic Spool (OEM# LA36R12) (6 Ea/Box) | 92731 | BOX | \$17.46 |
| Dataproducts - Epson Ribbons | | | | |
| R4000 | DFX5000/DFX8000 Black Ribbon (OEM# 8766) | 903445 | RBN | \$25.40 |
| E2110 | ERC 30/34/38 Matrix Black Ribbon (OEM# ERC-30B) (6 Rbn/Ctn) | 31383 | CTN | \$22.20 |
| E2117 | ERC-30 Red/Black Ribbon (OEM# ERC-38RB) (6 Rbn/Box) | 903433 | BOX | \$22.20 |
| Dataproducts - Fujitsu Ribbons | | | | |
| P3460 | DL-3700/3800/ LA-30R-KA Black Nylon Ribbon (OEM# CA02374-C104) (6 Rbn/Box) | 92797 | BOX | \$75.00 |
| Dataproducts - IBM Ribbons | | | | |
| R5020 | 4224 Matrix Black Ribbon (OEM# 1040440) | 31505 | RBN | \$14.75 |
| P5020 | 4224 Black Ribbon (4 Rbn/Pk) | 903431 | PK | \$43.20 |
| P1877 | 4227 Black Nylon Ribbon (OEM# 13L0034) | 92900 | RBN | \$12.75 |
| P5030 | 4234 Model 1-2 Nylon Ribbon (OEM# 6295158) (2 Rbn/Box) | 92881 | BOX | \$100.00 |
| P5040 | 4234 Model 11/12/13 High Yield Ribbon (OEM# 1040282) (2 Rbn/Box) | 92882 | BOX | \$138.00 |
| R5190 | 2380/2381/2390/2391/2480/2481/2490/2580/2581/2590/2591 Matrix Black Ribbon (OEM# 1040930, 11A3540) | 31509 | RBN | \$10.99 |
| P5190 | Proprietary 2380/2381/2390/2391/2480/2490/Lexmark 2380/2390 Matrix Black Ribbon (OEM# 1040930) (6 Rbn/Ctn) | 31496 | CTN | \$34.80 |
| R5110 | Wheelwriter Black Correctable Ribbon (OEM# 1299845) | 903427 | RBN | \$6.75 |
| Dataproducts - OKI Ribbons | | | | |
| P6010 | ML182/192/193/320/321 Nylon Ribbon (OEM# 52102001) (6 Rbn/Box) | 97845 | BOX | \$26.40 |
| P6070 | ML520/521/590/591 Black Nylon Ribbon (OEM# 52106001) (6 Rbn/Box) | 903438 | BOX | \$36.00 |
| R6010 | ML182/192/320/321/380/390/391 Matrix Black Ribbon (OEM# 52104001) | 31510 | RBN | \$8.50 |
| R6041 | ML393/393C Matrix Black Ribbon (OEM# 52103601) | 31379 | RBN | \$23.95 |
| R6070 | ML590/590 Plus/591M/591 Plus Matrix Black Ribbon (OEM# 52106001) | 31511 | RBN | \$11.90 |
| P1634 | Pacemark 3410 Ribbon (OEM# 52105801) | 92771 | RBN | \$27.50 |
| Dataproducts - Panasonic Ribbons | | | | |
| R6405 | KX-P 1090/P1150/P1695 Matrix Black Ribbon (OEM# KX-P145) | 31384 | RBN | \$10.90 |
| R1420 | KX-R Black Correctable Typewriter Ribbon (OEM# 1230) | 31499 | RBN | \$5.00 |
| Dataproducts - Printek Ribbons | | | | |
| P6600 | 4000/4500 Magnet Black Ribbon (OEM# 90316) | 31367 | RBN | \$15.20 |
| Dataproducts - TallyGenicom Ribbons | | | | |
| P1334 | 330 Nylon Ribbon High Density (OEM# 060097) | 92732 | RBN | \$27.00 |
| R4640 | 3800 Nylon Ribbon (OEM# 3A0100B02) | 92755 | RBN | \$28.00 |
| R5470 | Mannesmann Tally MT660/691/6045 Matrix Black Ribbon (25M Characters) (OEM# 78749) | 31369 | RBN | \$27.50 |
| Dataproducts - Texas Instruments Ribbons | | | | |
| R8210 | TI8920/8930 Matrix Black Ribbon (OEM# 2551152-0011) | 31373 | RBN | \$18.85 |
| Dataproducts - Toshiba Ribbons | | | | |
| P1412 | 351C Nylon Ribbon (OEM# E20351CBLKS) (6 Rbn/Box) | 92735 | BOX | \$72.00 |
| Dataproducts - Unisys Ribbons | | | | |
| R3027 | Universal Calculator Spool, C Wind, Black/Red Nylon Ribbon (OEM# 19-2076-891) | 903440 | RBN | \$3.10 |
| E3027 | Universal Calculator Spool, C Wind, Black/Red Nylon Ribbon (OEM# 19-2076-891) (12 Rbn/Box) | 92734 | BOX | \$36.00 |

ECOPOST COMPATIBLES

| | | | | |
|--|---|--------|-----|----------|
| ecoPost Postage Supplies (Continued on next page) | | | | |
| ECO25RED | Neopost IJ 25/IJX 25/MSL 250 Postage Meter Red Ink Cartridge (OEM# 3300028D) (2,500 Yield) | 106185 | CTG | \$81.60 |
| ECO4560 | Neopost AS 73/223/225/226/268/700/710/830/930/940/960/980/990/3630/3640; IJ 35/40/50/60; Portosprinter 35/45; Hasler WJ 60/65/90/95/110 Postage Meter Red Ink Cartridge (OEM# IJINK3456H, 4105243U, WJ69INK, 4124705S) (17,000 Yield) | 93622 | CTG | \$178.50 |

All catalog content is subject to change.

| MFG# | Product Description | Part# | UOM | Retail |
|---|--|--------|-----|----------|
| ECOPOST COMPATIBLES | | | | |
| ecoPost Postage Supplies (Continued) | | | | |
| ECO85185 | Neopost IJ 65/70/75/80/85; Hasler WJ 135/150/180/185/215 Postage Meter Red Ink Cartridge (OEM# IJINK678H, 4102910P, WJINK-1, 4124703Q) (31,500 Yield) | 93623 | CTG | \$196.35 |
| ECO280 | Neopost IS 280; Hasler IM 280 Postage Meter Red Ink Cartridge (OEM# ISINK2) (2,500 Yield) | 919456 | CTG | \$81.60 |
| ECO34 | Neopost IS 330/350/420/440/460/480; Hasler IM 330/350/420/440/460/480 Postage Meter Red Ink Cartridge (OEM# ISINK34, IMINK34, 4135554T, ININK67) | 907672 | CTG | \$117.30 |
| ECO4HC | Neopost IS 420/430/440/460; Hasler IM 420/440/460 High Yield Postage Meter Red Ink Cartridge (OEM# ISINK4HC, IMINK4HC, 4145711Y, ININK67HC) (19,500 Yield) | 907673 | CTG | \$164.05 |
| ECO20 | Hasler WJ 20 Postage Meter Red Ink Cartridge (OEM# 33000262X, WJ20INK) (2,500 Yield) | 106184 | CTG | \$81.60 |

| | | | | |
|--|--|--------|-----|----------|
| KATUN COMPATIBLES | | | | |
| Katun Performance - Canon Copier Supplies | | | | |
| KP19630 | CFX-L3500IF; imageCLASS 1100; L75/L3500/L4000/L4500; LC1060P/LC2050/LC2060P (FX-3) Toner (OEM# 1557A002BA) (2,700 Yield) | 926167 | CTG | \$45.00 |
| KP26707 | Faxphone L170; imageCLASS D320/D340; L400; LaserClass 310/510; PC D320/D340 (FX-8) Toner (OEM# 7833A001AA) (3,500 Yield) | 926169 | CTG | \$70.00 |
| KP22529 | (GPR-2) imageRUNNER 330/330S/400/400S/GP200/GP210 Toner (OEM# 1389A004AA, 1388A003AA) (10,600 Yield) | 99428 | CTG | \$38.28 |
| KP21556 | (GPR-6) imageRUNNER 2200/2800/3300/3320 Toner (OEM# 6647A003AA) (15,000 Yield) | 99336 | CTG | \$44.65 |
| KP23649 | (GPR-10) imageRUNNER 1310/1330/1370/1630/1670 Toner (OEM# 7814A003AA) (5,300 Yield) | 99388 | CTG | \$33.44 |
| KP43598 | (GPR-15) imageRUNNER 2230/2270/2830/2870/3025/3030/3225/3230 Toner (OEM# 9629A003AA) (21,000 Yield) | 926175 | CTG | \$72.00 |
| Katun Performance - HP LJ 4/4M/4+/4M+/5/5M/5N/5Se Mono Laser Supplies | | | | |
| KP19632 | Toner (OEM# 92298A) (6,800 Yield) | 926168 | CTG | \$45.00 |
| Katun Performance - HP LJ 1010/1012/1015/1018/1020/1022/3015/3020/3030/3050/3052/3055/M1319 Mono Laser Supplies | | | | |
| KP32176 | Toner (OEM# Q2612A) (2,000 Yield) | 101446 | CTG | \$89.06 |
| Katun Performance - HP LJ 1100/3200 Mono Laser Supplies | | | | |
| KP32235 | Toner (OEM# C4092A) (2,500 Yield) | 914902 | CTG | \$59.00 |
| Katun Performance - HP LJ 1160/1320/3390 Mono Laser Supplies | | | | |
| KP32261 | Toner (OEM# Q5949A) (2,500 Yield) | 101465 | CTG | \$90.99 |
| Katun Performance - HP LJ 1200/1220/3300/3320/3330/3380 Mono Laser Supplies | | | | |
| KP39013 | Toner (OEM# C7115X) (3,500 Yield) | 91881 | CTG | \$97.68 |
| Katun Performance - HP LJ 1300 Mono Laser Supplies | | | | |
| KP32233 | Toner (OEM# Q2613A) (2,500 Yield) | 926170 | CTG | \$58.00 |
| KP39104 | High Yield Toner (OEM# Q2613X) (4,000 Yield) | 926172 | CTG | \$59.00 |
| Katun Performance - HP LJ 2300 Mono Laser Supplies | | | | |
| KP39107 | Toner (OEM# Q2610A) (6,000 Yield) | 926173 | CTG | \$65.00 |
| Katun Performance - HP LJ 4000/4050 Mono Laser Supplies | | | | |
| KP32239 | Toner (OEM# C4127X) (10,000 Yield) | 908289 | CTG | \$162.80 |
| Katun Performance - HP LJ 4200/4240/4250/4300/4350 Mono Laser Supplies | | | | |
| KP32259 | Toner (OEM# Q5942A) (10,000 Yield) (For Use in 4240/4250/4350 Models Only) | 101438 | CTG | \$189.73 |
| KP43795 | Toner (OEM# Q1338A, Q1339A, Q5942X) (20,000 Yield) (For Use in 4200/4250/4300/4350 Models Only) | 926184 | CTG | \$110.00 |
| Katun Performance - HP LJ 8100/8150/Mopier 320 Mono Laser Supplies | | | | |
| KP18335 | High Yield Toner (OEM# C4182X) (20,000 Yield) | 926166 | CTG | \$102.00 |
| Katun Performance - HP LJ 9000/9040/9050/M9040/M9050 Mono Laser Supplies | | | | |
| KP33207 | High Yield Toner (OEM# C8543X) (30,000 Yield) | 914903 | CTG | \$259.60 |
| Katun Performance - HP LJ M1120/M1522/P1505 Mono Laser Supplies | | | | |
| KP37086 | Toner (OEM# CB436A) (2,000 Yield) | 912285 | CTG | \$95.00 |
| Katun Performance - HP LJ M2727/P2014/P2015 Mono Laser Supplies | | | | |
| KP37316 | Toner (OEM# Q7553X) (7,000 Yield) | 906621 | CTG | \$184.48 |

All catalog content is subject to change.

| MFG# | Product Description | Part# | UOM | Retail |
|--|---|--------|-----|----------|
| KATUN COMPATIBLES | | | | |
| Katun Performance - HP LJ M3027/M3035/P3005 Mono Laser Supplies | | | | |
| KP37318 | Toner (OEM# Q7551X) (13,000 Yield) | 908291 | CTG | \$270.57 |
| Katun Performance - HP LJ P1005/P1006 Mono Laser Supplies | | | | |
| KP37085 | Toner (OEM# CB435A) (1,500 Yield) | 912284 | CTG | \$82.65 |
| Katun Performance - HP LJ P4014/P4015/P4515 Mono Laser Supplies | | | | |
| KP37489 | Toner (OEM# CC364A) (10,000 Yield) | 91903 | CTG | \$202.81 |
| KP39111 | High Yield Toner (OEM# CC364X) (24,000 Yield) | 915874 | CTG | \$299.00 |
| Katun Performance - HP Color LJ 1500/2500/2820/2840 Laser Supplies | | | | |
| KP32177 | Black Toner (OEM# C9700A, Q3960A) (5,000 Yield) | 91872 | CTG | \$95.92 |
| KP32213 | Cyan Toner (OEM# C9701A, Q3961A) (4,000 Yield) | 91873 | CTG | \$115.54 |
| KP32215 | Magenta Toner (OEM# C9703A, Q3963A) (4,000 Yield) | 91875 | CTG | \$115.54 |
| KP32214 | Yellow Toner (OEM# C9702A, Q3962A) (4,000 Yield) | 91874 | CTG | \$115.54 |
| KP32296 | Drum (OEM# C9704A, Q3964A) (20,000 Yield) | 91876 | CTG | \$200.64 |
| Katun Performance - HP Color LJ 1600/2600/2605/CM1015 MFP/CM1017 MFP Laser Supplies | | | | |
| KP37309 | Black Toner (OEM# Q6000A) (2,500 Yield) | 91797 | CTG | \$94.15 |
| KP37310 | Cyan Toner (OEM# Q6001A) (2,000 Yield) | 91799 | CTG | \$101.68 |
| KP37311 | Magenta Toner (OEM# Q6003A) (2,000 Yield) | 91839 | CTG | \$101.68 |
| KP37312 | Yellow Toner (OEM# Q6002A) (2,000 Yield) | 91838 | CTG | \$101.68 |
| Katun Performance - HP Color LJ 3000 Laser Supplies | | | | |
| KP35842 | Black Toner (OEM# Q7560A) (6,500 Yield) | 100693 | CTG | \$167.45 |
| KP35843 | Cyan Toner (OEM# Q7561A) (3,500 Yield) | 100694 | CTG | \$160.83 |
| KP35844 | Magenta Toner (OEM# Q7563A) (3,500 Yield) | 100699 | CTG | \$160.83 |
| KP35845 | Yellow Toner (OEM# Q7562A) (3,500 Yield) | 100700 | CTG | \$160.83 |
| Katun Performance - HP Color LJ 3500 Laser Supplies | | | | |
| KP32271 | Black Toner (OEM# Q7560A) (6,500 Yield) | 100681 | CTG | \$161.92 |
| KP32265 | Cyan Toner (OEM# Q7561A) (3,500 Yield) | 100671 | CTG | \$161.04 |
| KP32266 | Magenta Toner (OEM# Q7563A) (3,500 Yield) | 100673 | CTG | \$161.04 |
| KP32267 | Yellow Toner (OEM# Q7562A) (3,500 Yield) | 100677 | CTG | \$161.04 |
| Katun Performance - HP Color LJ 3525/3530 Laser Supplies | | | | |
| KP37480 | Black Toner (OEM# CE250A) (5,000 Yield) | 100712 | CTG | \$158.98 |
| KP37826 | High Yield Black Toner (OEM# CE250X) (10,500 Yield) | 100724 | CTG | \$164.04 |
| KP37481 | Cyan Toner (OEM# CE251A) (7,000 Yield) | 100713 | CTG | \$312.15 |
| KP37482 | Magenta Toner (OEM# CE253A) (7,000 Yield) | 100714 | CTG | \$312.15 |
| KP37483 | Yellow Toner (OEM# CE252A) (7,000 Yield) | 100721 | CTG | \$312.15 |
| Katun Performance - HP Color LJ 3600 Laser Supplies | | | | |
| KP33957 | Black Toner (OEM# Q6470A) (6,000 Yield) | 91848 | CTG | \$156.77 |
| KP33958 | Cyan Toner (OEM# Q6471A) (4,000 Yield) | 91849 | CTG | \$155.87 |
| KP33960 | Magenta Toner (OEM# Q6473A) (4,000 Yield) | 91851 | CTG | \$155.87 |
| KP33959 | Yellow Toner (OEM# Q6472A) (4,000 Yield) | 91850 | CTG | \$155.87 |
| Katun Performance - HP Color LJ 3700 Laser Supplies | | | | |
| KP32271 | Black Toner (OEM# Q2670A) (6,000 Yield) | 100681 | CTG | \$161.92 |
| KP32268 | Cyan Toner (OEM# Q2681A) (6,000 Yield) | 100678 | CTG | \$170.72 |
| KP32269 | Magenta Toner (OEM# Q2683A) (6,000 Yield) | 100679 | CTG | \$170.72 |
| KP32270 | Yellow Toner (OEM# Q2682A) (6,000 Yield) | 100680 | CTG | \$170.72 |
| Katun Performance - HP Color LJ 3800/CP3505 Laser Supplies | | | | |
| KP33957 | Black Toner (OEM# Q6470A) (6,000 Yield) | 91848 | CTG | \$156.77 |
| KP33961 | Cyan Toner (OEM# Q7581A) (6,000 Yield) | 91852 | CTG | \$201.82 |
| KP33963 | Magenta Toner (OEM# Q7583A) (6,000 Yield) | 91854 | CTG | \$201.82 |
| KP33962 | Yellow Toner (OEM# Q7582A) (6,000 Yield) | 91853 | CTG | \$201.82 |
| Katun Performance - HP Color LJ 4600 Laser Supplies | | | | |
| KP26093 | Black Toner (OEM# C9720A) (9,000 Yield) | 91856 | CTG | \$179.52 |
| KP26094 | Cyan Toner (OEM# C9721A) (8,000 Yield) | 91857 | CTG | \$242.88 |
| KP26096 | Magenta Toner (OEM# C9723A) (8,000 Yield) | 91859 | CTG | \$242.88 |
| KP26095 | Yellow Toner (OEM# C9722A) (8,000 Yield) | 91858 | CTG | \$242.88 |

| MFG# | Product Description | Part# | UOM | Retail |
|--|---|--------|-----|----------|
| KATUN COMPATIBLES | | | | |
| Katun Performance - HP Color LJ 4700 Laser Supplies | | | | |
| KP33964 | Black Toner (OEM# Q5950A) (11,000 Yield) | 91860 | CTG | \$221.34 |
| KP33965 | Cyan Toner (OEM# Q5951A) (10,000 Yield) | 91861 | CTG | \$314.16 |
| KP33967 | Magenta Toner (OEM# Q5953A) (10,000 Yield) | 91867 | CTG | \$314.16 |
| KP33966 | Yellow Toner (OEM# Q5952A) (10,000 Yield) | 91866 | CTG | \$314.16 |
| Katun Performance - HP Color LJ 5500 Laser Supplies | | | | |
| KP27325 | Black Toner (OEM# C9730A) (13,000 Yield) | 91868 | CTG | \$259.60 |
| KP27326 | Cyan Toner (OEM# C9731A) (12,000 Yield) | 91869 | CTG | \$364.32 |
| KP27328 | Magenta Toner (OEM# C9733A) (12,000 Yield) | 91871 | CTG | \$364.32 |
| KP27327 | Yellow Toner (OEM# C9732A) (12,000 Yield) | 91870 | CTG | \$364.32 |
| Katun Performance - HP Color LJ CM1312 MFP/CP1215/CP1518 Laser Supplies | | | | |
| KP36680 | Black Toner (OEM# CB540A) (2,200 Yield) | 91840 | CTG | \$92.78 |
| KP36681 | Cyan Toner (OEM# CB541A) (1,400 Yield) | 91841 | CTG | \$85.27 |
| KP36682 | Magenta Toner (OEM# CB543A) (1,400 Yield) | 91843 | CTG | \$85.27 |
| KP36683 | Yellow Toner (OEM# CB542A) (1,400 Yield) | 91842 | CTG | \$85.27 |
| Katun Performance - HP Color LJ CM2320 MFP/CP2025 Laser Supplies | | | | |
| KP37409 | Black Toner (OEM# CC530A) (3,500 Yield) | 91844 | CTG | \$145.17 |
| KP37410 | Cyan Toner (OEM# CC531A) (2,800 Yield) | 91845 | CTG | \$136.23 |
| KP37411 | Magenta Toner (OEM# CC533A) (2,800 Yield) | 91846 | CTG | \$136.23 |
| KP37412 | Yellow Toner (OEM# CC532A) (2,800 Yield) | 91847 | CTG | \$136.23 |
| Katun Performance - HP Color LJ CM4540/CP4025/CP4525 Laser Supplies | | | | |
| KP39272 | Black Toner (OEM# CE260A) (8,500 Yield) | 507758 | CTG | \$161.14 |
| KP39276 | High Yield Black Toner (OEM# CE260X) (17,000 Yield) | 507759 | CTG | \$296.43 |
| KP39273 | Cyan Toner (OEM# CE261A) (11,000 Yield) | 507770 | CTG | \$299.99 |
| KP39274 | Magenta Toner (OEM# CE263A) (11,000 Yield) | 507780 | CTG | \$299.99 |
| KP39275 | Yellow Toner (OEM# CE262A) (11,000 Yield) | 507782 | CTG | \$299.99 |

Your Most Trusted Source

for Printer and Copier Toner - Katun® & Media Sciences®!

- ▶ High Quality Color and Monochrome Toners
- ▶ OEM-Equivalent Yields
- ▶ Brilliant Color
- ▶ Consistently Reliable Performance
- ▶ Excellent Image Quality
- ▶ Industry Leading Warranties
- ▶ More than One Trillion Pages Produced

Increase Your Margins - **BIG** Savings vs. OEM Toners

Now Available!

Media Sciences® Toner for Dozens of HP Printers.



KATUN®

| MFG# | Product Description | Part# | UOM | Retail |
|---|---|--------|-----|----------|
| KATUN COMPATIBLES | | | | |
| Katun Performance - HP Color LJ CM4730 Laser Supplies | | | | |
| KP34169 | Black Toner (OEM# Q6460A) (12,000 Yield) | 91877 | CTG | \$162.80 |
| KP34170 | Cyan Toner (OEM# Q6461A) (12,000 Yield) | 91878 | CTG | \$350.24 |
| KP34171 | Magenta Toner (OEM# Q6463A) (12,000 Yield) | 91880 | CTG | \$350.24 |
| KP34172 | Yellow Toner (OEM# Q6462A) (12,000 Yield) | 91879 | CTG | \$350.24 |
| Katun Performance - HP Color LJ CM6030/CM6040 Laser Supplies | | | | |
| KP39423 | Black Toner (OEM# CB390A) (19,500 Yield) | 912301 | CTG | \$67.99 |
| KP39420 | Cyan Toner (OEM# CB381A) (21,000 Yield) | 912298 | CTG | \$251.99 |
| KP39421 | Magenta Toner (OEM# CB383A) (21,000 Yield) | 912299 | CTG | \$251.99 |
| KP39422 | Yellow Toner (OEM# CB382A) (21,000 Yield) | 912300 | CTG | \$251.99 |
| Katun Performance - HP Color LJ CP4005 Laser Supplies | | | | |
| KP35838 | Black Toner (OEM# CB400A) (7,500 Yield) | 100682 | CTG | \$201.51 |
| KP35839 | Cyan Toner (OEM# CB401A) (7,500 Yield) | 100684 | CTG | \$299.42 |
| KP35840 | Magenta Toner (OEM# CB403A) (7,500 Yield) | 100689 | CTG | \$299.42 |
| KP35841 | Yellow Toner (OEM# CB402A) (7,500 Yield) | 100692 | CTG | \$299.42 |
| Katun Performance - HP Color LJ CP6015 Laser Supplies | | | | |
| KP39419 | Black Toner (OEM# CB380A) (16,500 Yield) | 912297 | CTG | \$162.39 |
| KP39420 | Cyan Toner (OEM# CB381A) (21,000 Yield) | 912298 | CTG | \$251.99 |
| KP39421 | Magenta Toner (OEM# CB383A) (21,000 Yield) | 912299 | CTG | \$251.99 |
| KP39422 | Yellow Toner (OEM# CB382A) (21,000 Yield) | 912300 | CTG | \$251.99 |
| Katun Performance - Konica Minolta Copier Supplies | | | | |
| KP37020 | bizhub 200/222/250/282 Black Toner (OEM# 8938-413) (17,500 Yield) | 91978 | CTG | \$42.71 |
| KP39083 | bizhub 360/361/420/421/500/501 Black Toner (OEM# 024E) (32,200 Yield) | 107308 | CTG | \$59.25 |
| KP31991 | bizhub 600/601/750/751 Black Toner (OEM# 02XJ) (55,000 Yield) | 91959 | CTG | \$63.31 |
| KP37767 | bizhub C203/C253 Black Toner (OEM# A0D7132) (24,500 Yield) | 906942 | CTG | \$47.08 |
| KP37768 | bizhub C203/C253 Cyan Toner (OEM# A0D7432) (19,000 Yield) | 906943 | CTG | \$94.15 |
| KP37769 | bizhub C203/C253 Magenta Toner (OEM# A0D7332) (19,000 Yield) | 906944 | CTG | \$94.15 |
| KP37770 | bizhub C203/C253 Yellow Toner (OEM# A0D7232) (19,000 Yield) | 906945 | CTG | \$94.15 |
| KP27353 | bizhub C350/C351/C450 Black Toner (OEM# 4053-401) (11,500 Yield) | 106159 | CTG | \$20.52 |
| KP27354 | bizhub C350/C351/C450 Cyan Toner (OEM# 4053-701) (11,500 Yield) | 106165 | CTG | \$45.88 |
| KP27355 | bizhub C350/C351/C450 Magenta Toner (OEM# 4053-601) (11,500 Yield) | 106166 | CTG | \$45.88 |
| KP27356 | bizhub C350/C351/C450 Yellow Toner (OEM# 4053-501) (11,500 Yield) | 106167 | CTG | \$45.88 |
| KP22085 | Di450/470/550 Toner (1-1,100 gm Ctg/Ctn) (OEM# 8936-902) (33,300 Yield) (Type 502A) | 99430 | CTN | \$101.20 |
| Katun Performance - Kyocera Mita Copier Supplies | | | | |
| KP39565 | FS-1320D/FS-1370DN Toner (OEM# TK-172) (7,200 Yield) | 912303 | CTG | \$114.22 |
| KP36706 | FS-3900DN Toner (OEM# 1T02F9OUSO, TK-322) (15,000 Yield) | 91983 | CTG | \$52.00 |
| KP38880 | FS-3920DN Toner (OEM# TK-352) (15,000 Yield) | 701394 | CTG | \$109.65 |
| KP36704 | FS-4000 Toner (OEM# 1T02GAOUSO, TK-332) (20,000 Yield) | 91984 | CTG | \$64.00 |
| KP26014 | KM 1620/1635/1650/2020/2050 Toner Kit (Includes Toner Cartridge, 2 Waste Toner Bottles, 2 Waste Bags, Corona Grid Cleaner) (OEM# TK-411, 370AM011) (15,000 Yield) | 92004 | CTG | \$56.69 |
| KP36973 | KM 1815/1820/FS 1018 MFP/1020D Toner (OEM# TK-18) (6,000 Yield) | 90989 | CTG | \$110.00 |
| KP28526 | KM 2530/3035/3530/4030/4035/5035 Toner (1,900 gm. Ctg and Waste Container) (OEM# 370AB011) (34,000 Yield) | 99404 | CTG | \$171.60 |
| Katun Performance - Sharp Copier Supplies | | | | |
| KP36922 | AR-235/275/M208/M236/M237/M257/M276/M277/M317/N275 Toner (OEM# AR-270NT, AR-270MT, AR-310NT, AR-310MT) (25,000 Yield) | 91953 | CTG | \$131.75 |
| KP39347 | AR-M355N/355U/455N/455U/MX-M350N/350U/450N/450U Toner (OEM# AR-455NT) (35,000 Yield) | 906810 | CTG | \$105.66 |
| Katun Performance - Toshiba Copier Supplies | | | | |
| KP25627 | e-STUDIO350/450 Toner (OEM# T3520) (21,000 Yield) | 91950 | CTG | \$44.00 |
| KP26032 | e-STUDIO202/232/282 Toner (OEM# T2320, T2340) (22,000 Yield) | 91961 | CTG | \$40.49 |
| Katun Performance - Xerox Phaser 8500/8550 Solid Ink Supplies | | | | |
| KP37986 | Black Solid Ink Sticks (OEM# 108R00668) (3,000 Yield) (3 EA/Box) | 502671 | BOX | \$83.71 |
| KP39391 | Black Solid Ink Sticks (OEM# 108R00672) (6,000 Yield) (6 EA/Box) | 907624 | BOX | \$133.42 |
| KP37983 | Cyan Solid Ink Sticks (OEM# 108R00669) (3,000 Yield) (3 EA/Box) | 502672 | BOX | \$133.42 |
| KP37984 | Magenta Solid Ink Sticks (OEM# 108R00670) (3,000 Yield) (3 EA/Box) | 502674 | BOX | \$133.42 |
| KP37985 | Yellow Solid Ink Sticks (OEM# 108R00671) (3,000 Yield) (3 EA/Box) | 502676 | BOX | \$133.42 |
| Katun Performance - Xerox Phaser 8560/8560MFP Solid Ink Supplies | | | | |
| <i>(Continued on next page)</i> | | | | |
| KP37994 | Black Solid Ink Sticks (OEM# 108R00726) (3,400 Yield) (3 EA/Box) | 502684 | BOX | \$94.82 |

| MFG# | Product Description | Part# | UOM | Retail |
|---|--|--------|-----|----------|
| KATUN COMPATIBLES | | | | |
| Katun Performance - Xerox Phaser 8560/8560MFP Solid Ink Supplies <i>(Continued)</i> | | | | |
| KP39393 | Black Solid Ink Sticks (OEM# 108R00727) (6,800 Yield) (6 EA/Box) | 906387 | BOX | \$145.02 |
| KP37991 | Cyan Solid Ink Sticks (OEM# 108R00723) (3,400 Yield) (3 EA/Box) | 502678 | BOX | \$145.02 |
| KP37992 | Magenta Solid Ink Sticks (OEM# 108R00724) (3,400 Yield) (3 EA/Box) | 502680 | BOX | \$145.02 |
| KP37993 | Yellow Solid Ink Sticks (OEM# 108R00725) (3,400 Yield) (3 EA/Box) | 502682 | BOX | \$145.02 |
| Katun Performance - Xerox ColorQube 8570 Solid Ink Supplies | | | | |
| KP39401 | Black Solid Ink Sticks (OEM# 108R00929) (4,300 Yield) (2 EA/Box) | 910281 | BOX | \$119.69 |
| KP39403 | Black Solid Ink Sticks (OEM# 108R00930) (8,600 Yield) (4 EA/Box) | 910282 | BOX | \$179.54 |
| KP39395 | Cyan Solid Ink Sticks (OEM# 108R00926) (4,400 Yield) (2 EA/Box) | 910278 | BOX | \$179.54 |
| KP39397 | Magenta Solid Ink Sticks (OEM# 108R00927) (4,400 Yield) (2 EA/Box) | 910279 | BOX | \$179.54 |
| KP39399 | Yellow Solid Ink Sticks (OEM# 108R00928) (4,400 Yield) (2 EA/Box) | 910280 | BOX | \$179.54 |
| MEDIA SCIENCES COMPATIBLES | | | | |
| Media Sciences - Dell 1250c/1350cnw/1355cn/1355cnw/C1760nw/C1765nf/C1765nfw Color Laser Supplies | | | | |
| 41085 | High Yield Black Toner (OEM# 810WH, 331-0778) (2,000 Yield) | 915019 | CTG | \$73.99 |
| 41086 | High Yield Cyan Toner (OEM# C5GC3, 331-0777) (1,400 Yield) | 915020 | CTG | \$73.99 |
| 41087 | High Yield Magenta Toner (OEM# XMX5D, 331-0780) (1,400 Yield) | 915021 | CTG | \$73.99 |
| 41088 | High Yield Yellow Toner (OEM# WM2JC, 331-0779) (1,400 Yield) | 915022 | CTG | \$73.99 |
| Media Sciences - Dell 1320c Color Laser Supplies | | | | |
| 40069 | High Yield Black Toner (OEM# 310-9058) (2,000 Yield) | 30652 | CTG | \$65.99 |
| 40066 | High Yield Cyan Toner (OEM# 310-9060) (2,000 Yield) | 30631 | CTG | \$86.99 |
| 40067 | High Yield Magenta Toner (OEM # 310-9064) (2,000 Yield) | 30632 | CTG | \$86.99 |
| 40068 | High Yield Yellow Toner (OEM# 310-9062) (2,000 Yield) | 30647 | CTG | \$86.99 |
| Media Sciences - Dell 2130cn/2135cn Color Laser Supplies | | | | |
| 40093 | High Yield Black Toner (OEM# 330-1436, 330-1389) (2,500 Yield) | 30674 | CTG | \$72.99 |
| 40090 | High Yield Cyan Toner (OEM# 330-1437, 330-1390, FM065) (2,500 Yield) | 30671 | CTG | \$99.99 |
| 40091 | High Yield Magenta Toner (OEM# 330-1433, 330-1392) (2,500 Yield) | 30672 | CTG | \$99.99 |
| 40092 | High Yield Yellow Toner (OEM# 330-1438, 330-1391) (2,500 Yield) | 30673 | CTG | \$99.99 |
| Media Sciences - Dell 2150cn/2150cdn/2155cn/2155cdn Color Laser Supplies | | | | |
| 41077 | High Yield Black Toner (OEM# 331-0719, N51XP) (3,000 Yield) | 912012 | CTG | \$104.99 |
| 41078 | High Yield Cyan Toner (OEM# 331-0716, 769T5) (2,500 Yield) | 912017 | CTG | \$103.94 |
| 41079 | High Yield Magenta Toner (OEM# 331-0717, 8WNV5) (2,500 Yield) | 912019 | CTG | \$103.94 |
| 41080 | High Yield Yellow Toner (OEM# 331-0718, NPDXG) (2,500 Yield) | 912020 | CTG | \$103.94 |
| Media Sciences - Dell 3000cn/3100cn Color Laser Supplies | | | | |
| MS3031K-HC | High Yield Black Toner (OEM# 310-5726) (4,000 Yield) | 30711 | CTG | \$48.99 |
| MS3031C-HC | High Yield Cyan Toner (OEM# 310-5739) (4,000 Yield) | 30709 | CTG | \$104.99 |
| MS3031M-HC | High Yield Magenta Toner (OEM# 310-5738) (4,000 Yield) | 30712 | CTG | \$104.99 |
| MS3031Y-HC | High Yield Yellow Toner (OEM# 310-5737) (4,000 Yield) | 30714 | CTG | \$104.99 |
| Media Sciences - Dell 3110cn/3115cn Color Laser Supplies | | | | |
| MS44641 | Extended Yield Black Toner (OEM# 310-8092, PF030) (8,000 Yield) | 933533 | CTG | \$89.99 |
| MS44642 | Extended Yield Cyan Toner (OEM# 310-8094) (8,000 Yield) | 933534 | CTG | \$99.99 |
| MS44643 | Extended Yield Magenta Toner (OEM# 310-8096) (8,000 Yield) | 933535 | CTG | \$99.99 |
| MS44644 | Extended Yield Yellow Toner (OEM# 310-8098) (8,000 Yield) | 933536 | CTG | \$99.99 |
| Media Sciences - Dell 3130cn Color Laser Supplies | | | | |
| MS44645 | High Yield Black Toner (OEM# 330-1197) (9,000 Yield) | 933537 | CTG | \$120.00 |
| MS44646 | High Yield Cyan Toner (OEM# 330-1194) (9,000 Yield) | 933538 | CTG | \$162.50 |
| MS44647 | High Yield Magenta Toner (OEM# 330-1195) (9,000 Yield) | 933528 | CTG | \$162.50 |
| MS44648 | High Yield Yellow Toner (OEM# 330-1196) (9,000 Yield) | 933539 | CTG | \$162.50 |
| Media Sciences - Dell 5100cn Color Laser Supplies | | | | |
| MS510K | Black Toner (OEM# 310-5807) (9,000 Yield) | 30737 | CTG | \$54.99 |
| MS510C | Cyan Toner (OEM# 310-5810) (8,000 Yield) | 30736 | CTG | \$187.99 |
| MS510M | Magenta Toner (OEM# 310-5809) (8,000 Yield) | 30738 | CTG | \$187.99 |
| MS510Y | Yellow Toner (OEM# 310-5808) (8,000 Yield) | 30739 | CTG | \$187.99 |
| Media Sciences - Dell 5110cn Color Laser Supplies | | | | |
| MS511K-HC | High Yield Black Toner (OEM# 310-7889) (18,000 Yield) | 30742 | CTG | \$99.99 |
| MS511C-HC | High Yield Cyan Toner (OEM# 310-7891) (12,000 Yield) | 30740 | CTG | \$253.99 |
| MS511M-HC | High Yield Magenta Toner (OEM# 310-7893) (12,000 Yield) | 30744 | CTG | \$253.99 |
| MS511Y-HC | High Yield Yellow Toner (OEM# 310-7895) (12,000 Yield) | 30746 | CTG | \$253.99 |

| MFG# | Product Description | Part# | UOM | Retail |
|---|---|--------|-----|----------|
| MEDIA SCIENCES COMPATIBLES | | | | |
| Media Sciences - Dell 7130cdn Color Laser Supplies | | | | |
| 41116 | High Yield Black Toner (OEM# 330-6135) (19,000 Yield) | 916156 | CTG | \$297.49 |
| 41117 | High Yield Cyan Toner (OEM# 330-6138) (20,000 Yield) | 916157 | CTG | \$437.74 |
| 41118 | High Yield Magenta Toner (OEM# 330-6141) (20,000 Yield) | 916158 | CTG | \$437.74 |
| 41119 | High Yield Yellow Toner (OEM# 330-6139) (20,000 Yield) | 916159 | CTG | \$437.74 |
| Media Sciences - HP Mono Laser Supplies | | | | |
| MS43736 | LJ 1320/3390/3392 High Yield Toner (OEM# Q5949X) (6,000 Yield) | 926181 | CTG | \$65.00 |
| MS43752 | LJ Pro 400 M401/400 MFP M425 High Yield Toner (OEM# CF280X) (6,900 Yield) | 926183 | CTG | \$95.00 |
| 43749 | LJ M521/M525/P3010/P3015 Toner (OEM# CE255X) (12,500 Yield) | 926208 | CTG | \$110.54 |
| 43744 | LJ Pro P1566/P1606dn Toner (OEM# CE278A) (2,100 Yield) | 926207 | CTG | \$52.81 |
| MS43747 | LJ P2055 High Yield Toner (OEM# CE505X) (6,500 Yield) | 926182 | CTG | \$99.00 |
| Media Sciences - HP Color LJ 3600 Laser Supplies | | | | |
| MS40966 | Black Toner (OEM# Q6470A) (6,000 Yield) | 911401 | CTG | \$156.77 |
| MS40967 | Cyan Toner (OEM# Q6471A) (4,000 Yield) | 911402 | CTG | \$155.87 |
| MS40968 | Magenta Toner (OEM# Q6473A) (4,000 Yield) | 911403 | CTG | \$155.87 |
| MS40969 | Yellow Toner (OEM# Q6472A) (4,000 Yield) | 911404 | CTG | \$155.87 |
| Media Sciences - HP Color LJ 3800/CP3505 Laser Supplies | | | | |
| MS40966 | Black Toner (OEM# Q6470A) (6,000 Yield) | 911401 | CTG | \$156.77 |
| MS40970 | Cyan Toner (OEM# Q7581A) (6,000 Yield) | 911405 | CTG | \$201.82 |
| MS40971 | Magenta Toner (OEM# Q7583A) (6,000 Yield) | 911406 | CTG | \$201.82 |
| MS40972 | Yellow Toner (OEM# Q7582A) (6,000 Yield) | 911407 | CTG | \$201.82 |
| Media Sciences - HP Color LJ CM1312 MFP/CP1215/CP1515/CP1518 Laser Supplies | | | | |
| MS40928 | Black Toner (OEM# CB540A) (2,200 Yield) | 911386 | CTG | \$92.78 |
| MS40929 | Cyan Toner (OEM# CB541A) (1,400 Yield) | 911387 | CTG | \$85.27 |
| MS40930 | Magenta Toner (OEM# CB543A) (1,400 Yield) | 911388 | CTG | \$85.27 |
| MS40931 | Yellow Toner (OEM# CB542A) (1,400 Yield) | 911389 | CTG | \$85.27 |
| Media Sciences - HP Color LJ CM2320/CP2025 Laser Supplies | | | | |
| MS40912 | Black Toner (OEM# CC530A) (3,500 Yield) | 911378 | CTG | \$145.17 |
| MS40913 | Cyan Toner (OEM# CC531A) (2,800 Yield) | 911379 | CTG | \$136.23 |
| MS40914 | Magenta Toner (OEM# CC533A) (2,800 Yield) | 911380 | CTG | \$136.23 |
| MS40915 | Yellow Toner (OEM# CC532A) (2,800 Yield) | 911381 | CTG | \$136.23 |
| Media Sciences - HP Color LJ CM3530 MFP/CP3525 Laser Supplies | | | | |
| MS40920 | Black Toner (OEM# CE250A) (5,000 Yield) | 911382 | CTG | \$158.98 |
| MS40921 | Cyan Toner (OEM# CE251A) (7,000 Yield) | 911383 | CTG | \$312.15 |
| MS40922 | Magenta Toner (OEM# CE253A) (7,000 Yield) | 911384 | CTG | \$312.15 |
| MS40923 | Yellow Toner (OEM# CE252A) (7,000 Yield) | 911385 | CTG | \$312.15 |
| Media Sciences - HP Color LJ M551/Enterprise 500 MFP M570/M575 Laser Supplies | | | | |
| MS43713 | High Yield Black Toner (OEM# CE400X) (11,000 Yield) | 933806 | CTG | \$130.00 |
| MS43714 | Cyan Toner (OEM# CE401A) (6,000 Yield) | 933807 | CTG | \$270.00 |
| MS43715 | Magenta Toner (OEM# CE403A) (6,000 Yield) | 933808 | CTG | \$270.00 |
| MS43716 | Yellow Toner (OEM# CE402A) (6,000 Yield) | 933809 | CTG | \$270.00 |
| Media Sciences - HP Color LJ Pro 300 MFP M375nw/Pro 400 M451/Pro 400 MFP M475 Laser Supplies | | | | |
| MS43709 | High Yield Black Toner (OEM# CE410X) (4,000 Yield) | 926176 | CTG | \$75.00 |
| MS43710 | Cyan Toner (OEM# CE411A) (2,600 Yield) | 926177 | CTG | \$80.00 |
| MS43711 | Magenta Toner (OEM# CE413A) (2,600 Yield) | 926178 | CTG | \$80.00 |
| MS43712 | Yellow Toner (OEM# CE412A) (2,600 Yield) | 926179 | CTG | \$80.00 |
| Media Sciences - HP Color LJ Pro CM1415/CP1525 Laser Supplies | | | | |
| MS39825 | Black Toner (OEM# CE320A) (2,000 Yield) | 911360 | CTG | \$95.00 |
| MS39826 | Cyan Toner (OEM# CE321A) (1,300 Yield) | 911361 | CTG | \$93.00 |
| MS39827 | Magenta Toner (OEM# CE323A) (1,300 Yield) | 911362 | CTG | \$93.00 |
| MS39828 | Yellow Toner (OEM# CE322A) (1,300 Yield) | 911363 | CTG | \$93.00 |
| Media Sciences - OKI C3400n/C3530MFP/C3600 Color Laser Supplies | | | | |
| 40003 | High Yield Black Toner (OEM# 43459304) (2,500 Yield) | 30616 | CTG | \$59.99 |
| 40000 | High Yield Cyan Toner (OEM# 43459303) (2,000 Yield) | 30613 | CTG | \$94.99 |
| 40001 | High Yield Magenta Toner (OEM# 43459302) (2,000 Yield) | 30614 | CTG | \$94.99 |
| 40002 | High Yield Yellow Toner (OEM# 43459301) (2,000 Yield) | 30615 | CTG | \$94.99 |



Choose Quality

MPS ENGINEERED

UP TO 100% MORE YIELD



MSE's Extended Yield Color for HP CP3525



INTELLIGENT RE-ENGINEERING®



The Only True Alternative To OEM Cartridges



ENGINEERED® EXTENDED YIELD CARTRIDGES

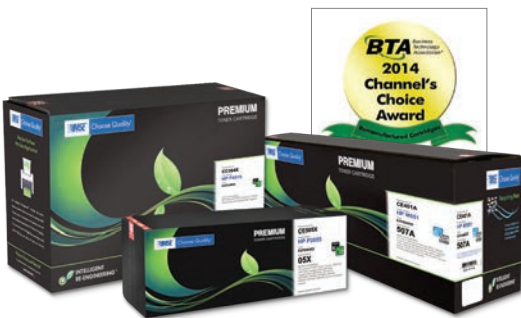

- ✓ MSE provides quality consumables to some of the largest independent dealers/**MPS** providers in the USA
- ✓ MSE's patented technologies and rigid test protocols allow greater color penetration in **MPS**
- ✓ MSE offers extensive marketing support to foster color growth and OEM conversion
- ✓ MSE's award-winning product is the vehicle to ensure profitable **MPS** engagements

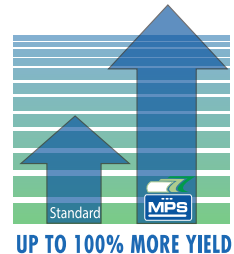

Learn more



[www.mse.com]

8201 Woodley Ave. Van Nuys, CA 91406 • MSE Corporate Headquarters: 800.673.4968 | 818.407.7500
MSE East Coast: 800.418.4968 • MSE EMEA: +31.36.522.2601 • e-mail: info@mse.com



Now is the Time for PROVEN ALTERNATIVES

Price changes and changes in channel strategy are squeezing your margins and reducing your profits. You would like to provide a quality alternative, but *who can you trust?*

MSE is the **ONLY TRUE** OEM Alternative!

MSE gives you a premium product with **REAL Differentiators** and full sales training on how to position and sell against the competition. IT WORKS. WE PROVED IT.



- ❖ Patented Technologies
- ❖ Quality Certifications
- ❖ Green Certifications
- ❖ Marketing Support
- ❖ Monogram Labeling
- ❖ 3-year Warranty

Learn more



[www.mse.com]

8201 Woodley Ave. Van Nuys, CA 91406 • MSE Corporate Headquarters: 800.673.4968 | 818.407.7500
MSE East Coast: 800.418.4968 • MSE EMEA: +31.36.522.2601 • e-mail: info@mse.com

| MFG# | Product Description | Part# | UOM | Retail |
|---|---|--------|-----|----------|
| MEDIA SCIENCES COMPATIBLES | | | | |
| Media Sciences - OKI C5100/C5150/C5200/C5300/C5400/C5510MFP Color Laser Supplies | | | | |
| MS5000K | High Yield Black Toner (OEM# 42127404) (5,000 Yield) | 10862 | CTG | \$55.99 |
| MS5000C | High Yield Cyan Toner (OEM# 42127403) (5,000 Yield) | 10859 | CTG | \$129.99 |
| MS5000M | High Yield Magenta Toner (OEM# 42127402) (5,000 Yield) | 10860 | CTG | \$129.99 |
| MS5000Y | High Yield Yellow Toner (OEM# 42127401) (5,000 Yield) | 10861 | CTG | \$129.99 |
| Media Sciences - OKI C5500/C5650/C5800 Color Laser Supplies | | | | |
| MSOK5855K-HC-NA | High Yield Black Toner (OEM# 43324404) (5,000 Yield) | 30790 | CTG | \$89.99 |
| MSOK5855C-HC-NA | High Yield Cyan Toner (OEM# 43324403) (5,000 Yield) | 30788 | CTG | \$149.99 |
| MSOK5855M-HC-NA | High Yield Magenta Toner (OEM# 43324402) (5,000 Yield) | 30792 | CTG | \$149.99 |
| MSOK5855Y-HC-NA | High Yield Yellow Toner (OEM# 43324401) (5,000 Yield) | 30794 | CTG | \$149.99 |
| Media Sciences - OKI C5550MFP/C6100/C6150/MC560MFP Color Laser Supplies | | | | |
| 40037 | Black Toner (OEM# 43865720) (8,000 Yield) | 30630 | CTG | \$89.99 |
| 40034 | Cyan Toner (OEM# 43865719) (6,000 Yield) | 30621 | CTG | \$156.99 |
| 40035 | Magenta Toner (OEM# 43865718) (6,000 Yield) | 30622 | CTG | \$156.99 |
| 40036 | Yellow Toner (OEM# 43865717) (6,000 Yield) | 30623 | CTG | \$156.99 |
| Media Sciences - OKI C9600/C9650/C9800 Color Laser Supplies | | | | |
| MSOK96K-HCNA | High Yield Black Toner (OEM# 42918904, 42918984) (18,500 Yield) | 30801 | CTG | \$101.99 |
| MSOK96C-HCNA | High Yield Cyan Toner (OEM# 42918903, 42918983) (16,500 Yield) | 30800 | CTG | \$293.99 |
| MSOK96M-HCNA | High Yield Magenta Toner (OEM# 42918902, 42918982) (16,500 Yield) | 30802 | CTG | \$293.99 |
| MSOK96Y-HCNA | High Yield Yellow Toner (OEM# 42918901, 42918981) (16,500 Yield) | 30803 | CTG | \$293.99 |
| Media Sciences - Xerox Phaser 6125 Color Laser Supplies | | | | |
| 40077 | Black Toner (OEM# 106R01334) (2,000 Yield) | 30664 | CTG | \$62.99 |
| 40074 | Cyan Toner (OEM# 106R01331) (1,000 Yield) | 30654 | CTG | \$52.99 |
| 40075 | Magenta Toner (OEM# 106R01332) (1,000 Yield) | 30657 | CTG | \$52.99 |
| 40076 | Yellow Toner (OEM# 106R01333) (1,000 Yield) | 30663 | CTG | \$52.99 |
| Media Sciences - Xerox Phaser 6128 MFP Color Laser Supplies | | | | |
| 40129 | Black Toner (OEM# 106R01455) (3,100 Yield) | 30686 | CTG | \$99.99 |
| 40126 | Cyan Toner (OEM# 106R01452) (2,500 Yield) | 30683 | CTG | \$109.99 |
| 40127 | Magenta Toner (OEM# 106R01453) (2,500 Yield) | 30684 | CTG | \$109.99 |
| 40128 | Yellow Toner (OEM# 106R01454) (2,500 Yield) | 30685 | CTG | \$109.99 |
| Media Sciences - Xerox Phaser 6130 Color Laser Supplies | | | | |
| 40085 | Black Toner (OEM# 106R01281) (2,500 Yield) | 30670 | CTG | \$78.99 |
| 40082 | Cyan Toner (OEM# 106R01278) (1,900 Yield) | 30667 | CTG | \$82.99 |
| 40083 | Magenta Toner (OEM# 106R01279) (1,900 Yield) | 30668 | CTG | \$82.99 |
| 40084 | Yellow Toner (OEM# 106R01280) (1,900 Yield) | 30669 | CTG | \$82.99 |
| Media Sciences - Xerox Phaser 6140 Color Laser Supplies | | | | |
| 40179 | Black Toner (OEM# 106R01480) (2,600 Yield) | 912308 | CTG | \$101.15 |
| 40176 | Cyan Toner (OEM# 106R01477) (2,000 Yield) | 912305 | CTG | \$101.15 |
| 40177 | Magenta Toner (OEM# 106R01478) (2,000 Yield) | 912306 | CTG | \$101.15 |
| 40178 | Yellow Toner (OEM# 106R01479) (2,000 Yield) | 912307 | CTG | \$101.15 |
| Media Sciences - Xerox Phaser 6180 Color Laser Supplies | | | | |
| MS44649 | High Yield Black Toner (OEM# 113R00726) (8,000 Yield) | 933540 | CTG | \$149.99 |
| MS44650 | High Yield Cyan Toner (OEM# 113R00723) (6,000 Yield) | 933541 | CTG | \$154.99 |
| MS44651 | High Yield Magenta Toner (OEM# 113R00724) (6,000 Yield) | 933542 | CTG | \$154.99 |
| MS44652 | High Yield Yellow Toner (OEM# 113R00725) (6,000 Yield) | 933543 | CTG | \$154.99 |
| Media Sciences - Xerox Phaser 6280 Color Laser Supplies | | | | |
| MS44653 | High Yield Black Toner (OEM# 106R01395) (7,000 Yield) | 933529 | CTG | \$166.00 |
| MS44654 | High Yield Cyan Toner (OEM# 106R01392) (5,900 Yield) | 933530 | CTG | \$183.00 |
| MS44655 | High Yield Magenta Toner (OEM# 106R01393) (5,900 Yield) | 933531 | CTG | \$183.00 |
| MS44656 | High Yield Yellow Toner (OEM# 106R01394) (5,900 Yield) | 933532 | CTG | \$183.00 |
| Media Sciences - Xerox Phaser 6300 Color Laser Supplies | | | | |
| MS630K | High Yield Black Toner (OEM# 106R01085) (7,000 Yield) | 30765 | CTG | \$84.99 |
| MS630C | High Yield Cyan Toner (OEM# 106R01082) (7,000 Yield) | 30764 | CTG | \$209.99 |
| MS630M | High Yield Magenta Toner (OEM# 106R01083) (7,000 Yield) | 30766 | CTG | \$209.99 |
| MS630Y | High Yield Yellow Toner (OEM# 106R01084) (7,000 Yield) | 30767 | CTG | \$209.99 |
| Media Sciences - Xerox Phaser 6360 Color Laser Supplies (Continued on next page) | | | | |
| MS636K-HC | High Yield Black Toner (OEM# 106R01221) (18,000 Yield) | 30774 | CTG | \$193.99 |
| MS636C-HC | High Yield Cyan Toner (OEM# 106R01218) (12,000 Yield) | 30772 | CTG | \$321.99 |

| MFG# | Product Description | Part# | UOM | Retail |
|--|---|--------|-----|----------|
| MEDIA SCIENCES COMPATIBLES | | | | |
| Media Sciences - Xerox Phaser 6360 Color Laser Supplies <i>(Continued)</i> | | | | |
| MS636M-HC | High Yield Magenta Toner (OEM# 106R01219) (12,000 Yield) | 30776 | CTG | \$321.99 |
| MS636Y-HC | High Yield Yellow Toner (OEM# 106R01220) (12,000 Yield) | 30778 | CTG | \$321.99 |
| Media Sciences - Xerox Phaser 6500; WorkCentre 6505 Color Laser Supplies | | | | |
| 41081 | High Yield Black Toner (OEM# 106R01597) (3,000 Yield) | 912022 | CTG | \$115.49 |
| 41082 | High Yield Cyan Toner (OEM# 106R01594) (2,500 Yield) | 912023 | CTG | \$120.74 |
| 41083 | High Yield Magenta Toner (OEM# 106R01595) (2,500 Yield) | 912024 | CTG | \$120.74 |
| 41084 | High Yield Yellow Toner (OEM# 106R01596) (2,500 Yield) | 912025 | CTG | \$120.74 |
| Media Sciences - Xerox Phaser 7400 Color Laser Supplies | | | | |
| MSX74K-HC | High Yield Black Toner (OEM# 106R01080) (15,000 Yield) | 30806 | CTG | \$144.99 |
| MSX74C-HC | High Yield Cyan Toner (OEM# 106R01077) (18,000 Yield) | 30804 | CTG | \$349.99 |
| MSX74M-HC | High Yield Magenta Toner (OEM# 106R01078) (18,000 Yield) | 30807 | CTG | \$349.99 |
| MSX74Y-HC | High Yield Yellow Toner (OEM# 106R01079) (18,000 Yield) | 30809 | CTG | \$349.99 |
| Media Sciences - Xerox Phaser 7500 Color Laser Supplies | | | | |
| 41093 | High Yield Black Toner (OEM# 106R01439) (19,800 Yield) | 916150 | CTG | \$297.49 |
| 41094 | High Yield Cyan Toner (OEM# 106R01436) (17,800 Yield) | 916151 | CTG | \$437.74 |
| 41095 | High Yield Magenta Toner (OEM# 106R01437) (17,800 Yield) | 916153 | CTG | \$437.74 |
| 41096 | High Yield Yellow Toner (OEM# 106R01438) (17,800 Yield) | 916155 | CTG | \$437.74 |
| MSE COMPATIBLES | | | | |
| MSE - Brother DCP-7020; FAX 2820/2920; HL 2040/2070N; MFC-7220/7225N/7420/7820N Mono Laser Supplies | | | | |
| 02-03-3514 | Toner (OEM# TN350) (2,500 Yield) | 17428 | CTG | \$55.00 |
| 58-03-3514 | Drum Unit (OEM# DR350) (12,000 Yield) | 502869 | EA | \$95.00 |
| MSE - Brother DCP-7030/7040; HL 2140/2170W; MFC-7340/7345N/7440N/7840W Mono Laser Supplies | | | | |
| 02-03-3616 | High Yield Toner (OEM# TN360) (2,600 Yield) | 31439 | CTG | \$51.00 |
| 58-03-3614 | Drum Unit (12,000 Yield) | 911061 | EA | \$75.00 |
| MSE - Brother DCP-1200/1400; Fax 4100/4750/5750; HL-1030/1230/1240/1250/1270N/1435/1440/1450/1470N; MFC-8300/8500/8600/8700/9600/9800/P2500 Mono Laser Supplies | | | | |
| 02-03-4616 | Toner (OEM# TN460) (6,000 Yield) | 10211 | CTG | \$69.00 |
| 58-03-4014 | Drum (OEM# DR400) (20,000 Yield) | 502753 | EA | \$175.00 |
| MSE - Brother DCP-8080DN/8085DN; HL-5340D/5350DN/5370/5380DN; MFC-8480DN/8680DN/8690DW/8880DN/8890DW Mono Laser Supplies | | | | |
| 02-03-6516 | High Yield Toner (OEM# TN650) (8,000 Yield) | 500949 | CTG | \$85.00 |
| 58-03-6216 | Drum Unit (OEM# DR620) (25,000 Yield) | 103039 | EA | \$89.00 |
| MSE - Brother DCP-9040CN/9045CDN/HL-4040CN/4040CDN/4070CDW/ MFC-9440CN/9450CDN/9840CDW Color Laser Supplies | | | | |
| 02-03-40016 | High Yield Black Toner (OEM# TN115BK) (5,000 Yield) | 901090 | CTG | \$70.00 |
| 02-03-40116 | High Yield Cyan Toner (OEM# TN115C) (4,000 Yield) | 901091 | CTG | \$99.75 |
| 02-03-40316 | High Yield Magenta Toner (OEM# TN115M) (4,000 Yield) | 901095 | CTG | \$99.75 |
| 02-03-40216 | High Yield Yellow Toner (OEM# TN115Y) (4,000 Yield) | 901092 | CTG | \$99.75 |
| MSE - Brother Monochrome Laser Supplies | | | | |
| 02-03-4516 | DCP-7060/7065; FAX 2840/2940; HL-2230/2240D/2270DW/2280; MFC-7240/7360N/7460/7860 High Yield Toner (OEM# TN450) (2,600 Yield) | 501921 | CTG | \$49.99 |
| 02-03-5716 | DCP-8040/8045D; HL-5140/5150/5170DN; MFC-8120/8220/8440/8640D/8840DN Toner (OEM# TN570) (6,700 Yield) | 19740 | CTG | \$79.00 |
| 02-03-5816 | DCP-8060/8065DN; HL-5240/5250/5280DW; MFC-8460N/8660/8670DN/8860DN/8870DW Toner (OEM# TN580) (7,000 Yield) | 502727 | CTG | \$65.00 |
| 02-03-7516 | DCP-8110DN/8150DN/8155DN; HL-5440D/5450/5470/6180; MFC-8510DN/8710/8910DW/8950 High Yield Toner (OEM# TN750) (8,000 Yield) | 924090 | CTG | \$77.25 |
| MSE - Canon Laser & Facsimile Supplies <i>(Continued on next page)</i> | | | | |
| 02-06-2814 | imageCLASS D530/D550/MF4412/MF4420/MF4450/MF4550/MF4570/MF4580/MF4770/MF4880/MF4890; Faxphone L100/L190 (CRG-128) Toner (OEM# 3500B001AA) (2,100 Yield) (Contains Chip) | 926633 | CTG | \$109.00 |
| 06-06-3116 | (E40, E31) PC 300/310/320/325/330/530/550/710/720/730/740/770/790/795/920/921/950/980 Toner (OEM# 1491A002AA) (4,000 Yield) | 10344 | CTG | \$95.00 |
| 04-06-0714 | (FX7) LaserCLASS 710/720i/730i Toner (OEM# 7621A001AA) (4,500 Yield) | 10335 | CTG | \$82.00 |
| 04-06-0814 | (FX8) LaserCLASS 510 Toner (OEM# 8955A001AA) (3,500 Yield) | 10336 | CTG | \$79.00 |

All catalog content is subject to change.

| MFG# | Product Description | Part# | UOM | Retail |
|--|---|--------|-----|----------|
| MSE COMPATIBLES | | | | |
| MSE - Canon Laser & Facsimile Supplies <i>(Continued)</i> | | | | |
| 06-06-1014 | (FX10) Faxphone L120/imageCLASS MF4150 Toner (104) (OEM# 0263B001BA) (2,000 Yield) | 911693 | CTG | \$89.00 |
| MSE - Dell Monochrome Laser Supplies | | | | |
| 02-25-3316 | 1700/1700n Toner (OEM# 310-5402) (6,000 Yield) (Contains Chip) | 908729 | CTG | \$75.00 |
| 02-24-3514 | 1720/1720dn Toner (OEM# 310-8700, 310-8707) (6,000 Yield) | 105876 | CTG | \$99.00 |
| 02-24-3516 | 1720/1720dn High Yield Toner (OEM# MW558, 310-8700, 310-8707) (9,000 Yield) (Contains Chip) | 911438 | CTG | \$139.00 |
| 02-24-35162 | 1720/1720dn Extended Yield Toner (OEM# 310-8709, 310-8702) (11,000 Yield) (Contains Chip) | 908903 | CTG | \$169.00 |
| 02-70-2214 | 2230d Toner (OEM# 330-4130, 330-4131) (3,500 Yield) | 906400 | CTG | \$84.75 |
| 02-70-2316 | 2330d/2330dn/2350d/2350dn Toner (OEM# 330-2650, 330-2666, 330-2667, PK941) (6,000 Yield) | 906398 | CTG | \$98.00 |
| 02-70-0616 | 2355dn Toner (OEM# 331-0611) (10,000 Yield) (Contains Chip) | 924091 | CTG | \$199.00 |
| 02-70-0916 | 2335dn High Yield Toner (OEM# 330-2209, HX756) (6,000 Yield) (Contains Chip) | 924092 | CTG | \$131.25 |
| 02-70-5316 | 5230n/5230dn/5350dn High Yield Toner (OEM# 330-6968, F362T) (21,000 Yield) | 906910 | CTG | \$225.00 |
| 02-24-15162 | 5310 Extra High Yield Toner (OEM# 341-2938) (32,000 Yield) | 900950 | CTG | \$299.00 |
| 02-70-2016 | 5330dn High Yield Toner (OEM# 330-2045, NY313) (20,000 Yield) (Contains Chip) | 926632 | CTG | \$89.00 |
| MSE - HP LJ 4/4M/4+/4M+/5/5N/5M/5se Mono Laser Supplies | | | | |
| 02-21-9814 | Toner (OEM# 92298A) (6,800 Yield) | 10270 | CTG | \$85.00 |
| 02-21-9816 | High Yield Toner (OEM# 92298X) (11,000 Yield) | 10271 | CTG | \$105.00 |
| MSE - HP LJ 5P/5MP/6P/6MP/6PSi/6PSE Mono Laser Supplies | | | | |
| 02-21-0314 | Toner (VX) (OEM# C3903A) (4,000 Yield) | 10216 | CTG | \$59.00 |
| MSE - HP LJ 5Si/8000 Mono Laser Supplies | | | | |
| 02-21-0914 | Toner (WX) (OEM# C3909A) (15,000 Yield) | 10218 | CTG | \$175.00 |
| 02-21-0916 | Extended Yield Toner (OEM# C3909X) (25,000 Yield) | 105689 | CTG | \$250.00 |
| MSE - HP LJ 1000/1200/1220/3300 Mono Laser Supplies | | | | |
| 02-21-1514 | Toner (OEM# C7115A) (3,000 Yield) | 10224 | CTG | \$59.00 |
| 02-21-1516 | High Yield Toner (OEM# C7115X) (3,500 Yield) | 10225 | CTG | \$77.00 |
| 02-21-15162 | Extended Yield Toner (OEM# C7115X) (7,000 Yield) | 10227 | CTG | \$109.00 |
| MSE - HP LJ 1010/1012/1015/1018/1020/1022/3015/3020/3030/3050/3052/3055/M1319 Mono Laser Supplies | | | | |
| 02-21-1214 | Toner (OEM# Q2612A) (2,000 Yield) | 10221 | CTG | \$59.00 |
| 02-21-1216 | Extended Yield Toner (OEM# Q2612A) (4,000 Yield) | 17425 | CTG | \$99.00 |
| MSE - HP LJ 1100/3200 Mono Laser Supplies | | | | |
| 02-21-9214 | Toner (OEM# C4092A) (2,500 Yield) | 10266 | CTG | \$50.00 |
| MSE - HP LJ 1150 Mono Laser Supplies | | | | |
| 02-21-2416 | Toner (OEM# Q2624X) (4,000 Yield) | 10235 | CTG | \$61.50 |
| MSE - HP LJ 1160/1320/3390 Mono Laser Supplies | | | | |
| 02-21-1114 | Toner (OEM# Q5949A) (2,500 Yield) | 12814 | CTG | \$62.00 |
| 02-21-1116 | High Yield Toner (OEM# Q5949X) (6,000 Yield) (For Use in 1320/3390 Models Only) | 12394 | CTG | \$92.00 |
| 02-21-11162 | Extended Yield Toner (OEM# Q5949X) (9,000 Yield) (For Use in 1320/3390 Models Only) | 108388 | CTG | \$137.00 |
| MSE - HP LJ 1300 Mono Laser Supplies | | | | |
| 02-21-1316 | High Yield Toner (OEM# Q2613X) (4,000 Yield) | 10223 | CTG | \$79.00 |
| 02-21-13162 | Extended Yield Toner (OEM# Q2613X) (8,000 Yield) | 800638 | CTG | \$89.00 |
| MSE - HP LJ 2100/2200 Mono Laser Supplies | | | | |
| 02-21-9614 | Toner (OEM# C4096A) (5,000 Yield) | 10268 | CTG | \$79.00 |
| 02-21-9616 | Extended Yield Toner (OEM# C4096A) (7,000 Yield) | 10269 | CTG | \$105.00 |
| MSE - HP LJ 2300 Mono Laser Supplies | | | | |
| 02-21-1014 | Toner (OEM# Q2610A) (6,000 Yield) | 10219 | CTG | \$99.00 |
| 02-21-1016 | Extended Yield Toner (OEM# Q2610A) (10,000 Yield) | 10220 | CTG | \$149.00 |
| MSE - HP LJ 2420/2430 Mono Laser Supplies | | | | |
| 02-21-2614 | Toner (OEM# Q6511A) (6,000 Yield) | 96132 | CTG | \$98.00 |
| 02-21-2616 | High Yield Toner (OEM# Q6511X) (12,000 Yield) | 12816 | CTG | \$155.00 |

All catalog content is subject to change.

| MFG# | Product Description | Part# | UOM | Retail |
|---|---|--------|-----|----------|
| MSE COMPATIBLES | | | | |
| MSE - HP LJ 4000/4050 Mono Laser Supplies | | | | |
| 02-21-2716 | Toner (OEM# C4127X) (10,000 Yield) | 10238 | CTG | \$125.00 |
| 02-21-27162 | Extended Yield Toner (OEM# C4127X) (15,000 Yield) | 10239 | CTG | \$170.00 |
| 02-21-2717 | MICR Toner (OEM# C4127X) (10,000 Yield) | 10367 | CTG | \$149.00 |
| MSE - HP LJ 4100 Mono Laser Supplies | | | | |
| 02-21-61163 | Toner (OEM# C8061X) (10,000 Yield) | 10258 | CTG | \$109.00 |
| 02-21-61162 | Extended Yield Toner (OEM# C8061X) (15,000 Yield) | 800640 | CTG | \$125.00 |
| MSE - HP LJ 4200 Mono Laser Supplies | | | | |
| 02-21-3814 | Toner (OEM# Q1338A) (12,000 Yield) | 10245 | CTG | \$129.00 |
| 02-21-3816 | High Yield Toner (OEM# Q1338A) (18,000 Yield) | 10246 | CTG | \$179.00 |
| 02-21-38162 | Extended Yield Toner (OEM# Q1338A, Q1339A, Q5942X, Q5945A) (22-28,000 Yield) (Yield Varies By Device) | 14636 | CTG | \$229.00 |
| 02-21-3815 | MICR Toner (OEM# Q1338A) (13,500 Yield) | 10369 | CTG | \$279.00 |
| MSE - HP LJ 4240/4250/4350 Mono Laser Supplies | | | | |
| 02-21-4214 | Toner (OEM# Q5942A) (10,000 Yield) | 23160 | CTG | \$110.00 |
| 02-21-42160 | Universal Toner (OEM# Q1338A, Q1339A, Q5942X, Q5945A) (18-20,000 Yield) (Yield Varies By Device) (For Use in 4250/4350 Models Only) | 17426 | CTG | \$179.00 |
| 02-21-4216 | High Yield Toner (OEM# Q5942X) (20,000 Yield) (For Use in 4250/4350 Models Only) | 10248 | CTG | \$189.00 |
| 02-21-38162 | Extended Yield Toner (OEM# Q1338A, Q1339A, Q5942X, Q5945A) (22-28,000 Yield) (Yield Varies By Device) (For Use in 4250/4350 Models Only) | 14636 | CTG | \$229.00 |
| 02-21-39162 | Extended Yield Universal Toner (OEM# Q1339A, Q5942X, Q5945A) (24-28,000 Yield) (Yield Varies By Device) (Contains Chip) (For Use in 4250/4350 Models Only) | 919472 | CTG | \$229.00 |
| 02-21-4217 | MICR Toner (OEM# Q5942X) (20,000 Yield) (For Use in 4250/4350 Models Only) | 12544 | CTG | \$295.00 |
| MSE - HP LJ 4300 Mono Laser Supplies | | | | |
| 02-21-3914 | Toner (OEM# Q1339A) (18,000 Yield) | 10247 | CTG | \$175.00 |
| 02-21-42160 | Universal Toner (OEM# Q1338A, Q1339A, Q5942X, Q5945A) (18-20,000 Yield) (Yield Varies By Device) | 17426 | CTG | \$179.00 |
| 02-21-38162 | Extended Yield Toner (OEM# Q1338A, Q1339A, Q5942X, Q5945A) (22-28,000 Yield) (Yield Varies By Device) | 14636 | CTG | \$229.00 |
| 02-21-39162 | Extended Yield Universal Toner (OEM# Q1339A, Q5942X, Q5945A) (24-28,000 Yield) (Yield Varies By Device) (Contains Chip) | 919472 | CTG | \$229.00 |
| 02-21-3915 | MICR Toner (OEM# Q1339A) (18,000 Yield) | 10370 | CTG | \$299.00 |
| MSE - HP LJ 4345/M4345 Mono Laser Supplies | | | | |
| 02-21-34514 | Toner (OEM# Q5945A) (18,000 Yield) | 10371 | CTG | \$159.00 |
| 02-21-42160 | Universal Toner (OEM# Q1338A, Q1339A, Q5942X, Q5945A) (18-20,000 Yield) (Yield Varies By Device) | 17426 | CTG | \$179.00 |
| 02-21-38162 | Extended Yield Toner (OEM# Q1338A, Q1339A, Q5942X, Q5945A) (22-28,000 Yield) (Yield Varies By Device) | 14636 | CTG | \$229.00 |
| 02-21-39162 | Extended Yield Universal Toner (OEM# Q1339A, Q5942X, Q5945A) (24-28,000 Yield) (Yield Varies By Device) (Contains Chip) | 919472 | CTG | \$229.00 |
| MSE - HP LJ 5000/5100 Mono Laser Supplies | | | | |
| 02-21-2914 | Toner (OEM# C4129X) (10,000 Yield) | 10240 | CTG | \$119.00 |
| MSE - HP LJ 5200/M5025/M5035 Mono Laser Supplies | | | | |
| 02-21-1614 | Toner (OEM# Q7516A, Q7570A) (15,000 Yield) | 906316 | CTG | \$139.00 |
| MSE - HP LJ 8100/8150/Mopier 320 Mono Laser Supplies | | | | |
| 02-21-8214 | Toner (OEM# C4182X) (20,000 Yield) | 10264 | CTG | \$149.00 |
| MSE - HP LJ 9000/9040/9050/M9040/M9050 Mono Laser Supplies | | | | |
| 02-21-4314 | Toner (OEM# C8543X) (30,000 Yield) | 10249 | CTG | \$239.00 |
| 02-21-43162 | Extended Yield Toner (OEM# C8543X) (40,000 Yield) | 108389 | CTG | \$289.00 |
| 02-21-4315 | MICR Toner (OEM# C8543X) (30,000 Yield) | 10374 | CTG | \$450.00 |
| MSE - HP LJ M125/M127/M201/M225 Mono Laser Supplies | | | | |
| 02-21-8314 | Toner (OEM# CF283A) (1,500 Yield) (Contains Chip) | 926631 | CTG | \$109.00 |
| MSE - HP LJ M401/M425 Mono Laser Supplies | | | | |
| 02-21-8014 | Toner (OEM# CF280A) (2,700 Yield) (Contains Chip) | 910695 | CTG | \$77.25 |
| 02-21-8016 | High Yield Toner (OEM# CF280X) (6,900 Yield) (Contains Chip) | 910696 | CTG | \$131.25 |
| 02-21-80162 | Extended Yield Toner (OEM# CF280X) (10,000 Yield) (Contains Chip) | 914941 | CTG | \$150.00 |
| 02-21-8017 | High Yield MICR Toner (OEM# CF280X) (6,800 Yield) | 915889 | CTG | \$206.25 |

| MFG# | Product Description | Part# | UOM | Retail |
|--|---|--------|-----|----------|
| MSE COMPATIBLES | | | | |
| MSE - HP LJ M521/M525/P3010/P3015 Mono Laser Supplies | | | | |
| 02-21-5514 | Toner (OEM# CE255A) (6,000 Yield) | 91483 | CTG | \$109.00 |
| 02-21-5516 | High Yield Toner (OEM# CE255X) (12,500 Yield) | 91484 | CTG | \$169.00 |
| MSE - HP LJ M601/M602/M603/M4555 Mono Laser Supplies | | | | |
| 02-21-9014 | Toner (OEM# CE390A) (10,000 Yield) | 906350 | CTG | \$131.25 |
| 02-21-90142 | Extended Yield Toner (OEM# CE390A) (18,000 Yield) | 906351 | CTG | \$212.40 |
| 02-21-4516 | High Yield Toner (OEM# CE390X) (24,000 Yield) (For Use in M602/M603/M4555 Models Only) | 505436 | CTG | \$189.00 |
| 02-21-45162 | Extended Yield Toner (OEM# CE390X) (40,000 Yield) (For Use in M602/M603/M4555 Models Only) | 901096 | CTG | \$249.00 |
| 02-21-9015 | MICR Toner (OEM# CE390A) (10,000 Yield) (Contains Chip) | 925996 | CTG | \$239.00 |
| 02-21-4517 | High Yield MICR Toner (OEM# CE390X) (24,000 Yield) (Contains Chip) (For Use in M602/M603/M4555 Models Only) | 925997 | CTG | \$345.00 |
| MSE - HP LJ M712/M725 Mono Laser Supplies | | | | |
| 02-21-1414 | Toner (OEM# CF214A) (10,000 Yield) (Contains Chip) | 926618 | CTG | \$215.00 |
| 02-21-1416 | High Yield Toner (OEM# CF214X) (17,500 Yield) (Contains Chip) | 926619 | CTG | \$299.00 |
| MSE - HP LJ M806/M830 Mono Laser Supplies | | | | |
| 02-21-2516 | High Yield Toner (OEM# CF325X) (34,500 Yield) (Contains Chip) | 930655 | CTG | \$258.00 |
| MSE - HP LJ M1120/M1522/P1505 Mono Laser Supplies | | | | |
| 02-21-43614 | Toner (OEM# CB436A) (2,000 Yield) | 11065 | CTG | \$59.00 |
| 02-21-436142 | Extended Yield Toner (OEM# CB436A) (3,000 Yield) | 101342 | CTG | \$79.00 |
| MSE - HP LJ M1130/M1132/M1134/M1136/M1137/M1138/M1139/M1212/M1213/M1214/M1216/M1217/M1219/P1102 Mono Laser Supplies | | | | |
| 02-21-2814 | Toner (OEM# CE285A) (1,600 Yield) | 105692 | CTG | \$49.00 |
| MSE - HP LJ M1536/P1566/P1606 Mono Laser Supplies | | | | |
| 02-21-7814 | Toner (OEM# CE278A) (2,100 Yield) | 105693 | CTG | \$59.00 |
| MSE - HP LJ M2727/P2014/P2015 Mono Laser Supplies | | | | |
| 02-21-5314 | Toner (OEM# Q7553A) (3,000 Yield) | 101821 | CTG | \$65.00 |
| 02-21-5316 | High Yield Toner (OEM# Q7553X) (7,000 Yield) | 101822 | CTG | \$119.00 |
| 02-21-53162 | Extended Yield Toner (OEM# Q7553X) (10,000 Yield) | 500018 | CTG | \$150.00 |
| MSE - HP LJ M3027/M3035/P3005 Mono Laser Supplies | | | | |
| 02-21-3514 | Toner (OEM# Q7551A) (6,500 Yield) | 903828 | CTG | \$109.00 |
| 02-21-3516 | High Yield Toner (OEM# Q7551X) (13,000 Yield) | 903838 | CTG | \$180.00 |
| 02-21-35162 | Extended Yield Toner (OEM# Q7551X) (18,000 Yield) | 800639 | CTG | \$220.00 |
| MSE - HP LJ P1005/P1006 Mono Laser Supplies | | | | |
| 02-21-43514 | Toner (OEM# CB435A) (1,500 Yield) | 11064 | CTG | \$55.00 |
| MSE - HP LJ P2035/P2055 Mono Laser Supplies | | | | |
| 02-21-0514 | Toner (OEM# CE505A) (2,300 Yield) | 19801 | CTG | \$69.00 |
| 02-21-05142 | Extended Yield Toner (OEM# CE505A) (4,000 Yield) | 101759 | CTG | \$99.00 |
| 02-21-0516 | High Yield Toner (OEM# CE505X) (6,500 Yield) (For Use in P2055 Only) | 19802 | CTG | \$119.00 |
| 02-21-05162 | Extended Yield Toner (OEM# CE505X) (9,750 Yield) (For Use in P2055 Only) | 101777 | CTG | \$136.50 |
| MSE - HP LJ P4014/P4015/P4515 Mono Laser Supplies | | | | |
| 02-21-6414 | Toner (OEM# CC364A) (10,000 Yield) | 3872 | CTG | \$129.00 |
| 02-21-64142 | Extended Yield Toner (OEM# CC364A) (18,000 Yield) | 101664 | CTG | \$209.00 |
| 02-21-6416 | High Yield Toner (OEM# CC364X) (24,000 Yield) (For Use in P4015/P4515 Models Only) | 3873 | CTG | \$219.00 |
| 02-21-64162 | Extended Yield Toner (OEM# CC364X) (40,000 Yield) (For Use in P4015/P4515 Models Only) | 105712 | CTG | \$345.00 |
| 02-21-6415 | MICR Toner (OEM# CC364A) (10,000 Yield) | 21402 | CTG | \$299.00 |
| MSE - HP Color LJ 1500/2500/2550/2800/2820/2830/2840 Laser Supplies | | | | |
| 02-21-25014 | Black Toner (OEM# C9700A, Q3960A) (5,000 Yield) | 12776 | CTG | \$69.00 |
| 02-21-25114 | Cyan Toner (OEM# C9701A, Q3961A) (4,000 Yield) | 12777 | CTG | \$84.75 |
| 02-21-25314 | Magenta Toner (OEM# C9703A, Q3963A) (4,000 Yield) | 12779 | CTG | \$84.75 |
| 02-21-25214 | Yellow Toner (OEM# C9702A, Q3962A) (4,000 Yield) | 12778 | CTG | \$84.75 |
| MSE - HP Color LJ 1600/2600n/2605/CM1015/CM1017 MFP Laser Supplies | | | | |
| <i>(Continued on next page)</i> | | | | |
| 02-21-26014 | Black Toner (OEM# Q6000A) (2,500 Yield) | 99766 | CTG | \$64.00 |

| MFG# | Product Description | Part# | UOM | Retail |
|--|---|--------|-----|----------|
| MSE COMPATIBLES | | | | |
| MSE - HP Color LJ 1600/2600n/2605/CM1015/CM1017 MFP Laser Supplies <i>(Continued)</i> | | | | |
| 02-21-26114 | Cyan Toner (OEM# Q6001A) (2,000 Yield) | 99767 | CTG | \$69.00 |
| 02-21-26314 | Magenta Toner (OEM# Q6003A) (2,000 Yield) | 99769 | CTG | \$69.00 |
| 02-21-26214 | Yellow Toner (OEM# Q6002A) (2,000 Yield) | 99768 | CTG | \$69.00 |
| MSE - HP Color LJ 3500/3550 Laser Supplies | | | | |
| 02-21-7014 | Black Toner (OEM# Q2670A) (6,000 Yield) | 12513 | CTG | \$111.00 |
| 02-21-7114 | Cyan Toner (OEM# Q2671A) (4,000 Yield) | 12514 | CTG | \$111.00 |
| 02-21-7314 | Magenta Toner (OEM# Q2673A) (4,000 Yield) | 12524 | CTG | \$111.00 |
| 02-21-7214 | Yellow Toner (OEM# Q2672A) (4,000 Yield) | 12523 | CTG | \$111.00 |
| MSE - HP Color LJ 3600 Laser Supplies | | | | |
| 02-21-70014 | Black (OEM# Q6470A) (6,000 Yield) | 92565 | CTG | \$110.00 |
| 02-21-70114 | Cyan (OEM# Q6471A) (4,000 Yield) | 92566 | CTG | \$109.00 |
| 02-21-70314 | Magenta (OEM# Q6473A) (4,000 Yield) | 92568 | CTG | \$109.00 |
| 02-21-70214 | Yellow (OEM# Q6472A) (4,000 Yield) | 92567 | CTG | \$109.00 |
| MSE - HP Color LJ 3700 Laser Supplies | | | | |
| 02-21-7014 | Black Toner (OEM# Q2670A) (6,000 Yield) | 12513 | CTG | \$111.00 |
| 02-21-37114 | Cyan Toner (OEM# Q2681A) (6,000 Yield) | 12552 | CTG | \$135.00 |
| 02-21-37314 | Magenta Toner (OEM# Q2683A) (6,000 Yield) | 12555 | CTG | \$135.00 |
| 02-21-37214 | Yellow Toner (OEM# Q2682A) (6,000 Yield) | 12554 | CTG | \$135.00 |
| MSE - HP Color LJ 3800 Laser Supplies | | | | |
| 02-21-70014 | Black (OEM# Q6470A) (6,000 Yield) | 92565 | CTG | \$110.00 |
| 02-21-80114 | Cyan (OEM# Q7581A) (6,000 Yield) | 92569 | CTG | \$160.00 |
| 02-21-80314 | Magenta (OEM# Q7583A) (6,000 Yield) | 92572 | CTG | \$160.00 |
| 02-21-80214 | Yellow (OEM# Q7582A) (6,000 Yield) | 92570 | CTG | \$160.00 |
| MSE - HP Color LJ 4600/4650 Laser Supplies | | | | |
| 02-21-2014 | Black Toner (OEM# C9720A) (9,000 Yield) (Contains SCS) | 10231 | CTG | \$129.00 |
| 02-21-2114 | Cyan Toner (OEM# C9721A) (8,000 Yield) (Contains SCS) | 10232 | CTG | \$169.00 |
| 02-21-2314 | Magenta Toner (OEM# C9723A) (8,000 Yield) (Contains SCS) | 10233 | CTG | \$169.00 |
| 02-21-2214 | Yellow Toner (OEM# C9722A) (8,000 Yield) (Contains SCS) | 10234 | CTG | \$169.00 |
| MSE - HP Color LJ 4700 Laser Supplies | | | | |
| 02-21-50014 | Black Toner (OEM# Q5950A) (11,000 Yield) (Contains SCS) | 95942 | CTG | \$139.00 |
| 02-21-50114 | Cyan Toner (OEM# Q5951A) (10,000 Yield) (Contains SCS) | 95943 | CTG | \$175.00 |
| 02-21-50314 | Magenta Toner (OEM# Q5953A) (10,000 Yield) (Contains SCS) | 95945 | CTG | \$175.00 |
| 02-21-50214 | Yellow Toner (OEM# Q5952A) (10,000 Yield) (Contains SCS) | 95944 | CTG | \$175.00 |
| MSE - HP Color LJ 4730 Laser Supplies | | | | |
| 02-21-47014 | Black Toner (OEM# Q6460A) (12,000 Yield) (Contains SCS) | 98392 | CTG | \$125.00 |
| 02-21-47114 | Cyan Toner (OEM# Q6461A) (12,000 Yield) (Contains SCS) | 98393 | CTG | \$195.00 |
| 02-21-47314 | Magenta Toner (OEM# Q6463A) (12,000 Yield) (Contains SCS) | 98395 | CTG | \$195.00 |
| 02-21-47214 | Yellow Toner (OEM# Q6462A) (12,000 Yield) (Contains SCS) | 98394 | CTG | \$195.00 |
| MSE - HP Color LJ 5500/5550 Laser Supplies | | | | |
| 02-21-3014 | Black Toner (OEM# C9730A) (13,000 Yield) (Contains SCS) | 12526 | CTG | \$175.00 |
| 02-21-3114 | Cyan Toner (OEM# C9731A) (12,000 Yield) (Contains SCS) | 12527 | CTG | \$250.00 |
| 02-21-3314 | Magenta Toner (OEM# C9733A) (12,000 Yield) (Contains SCS) | 12530 | CTG | \$250.00 |
| 02-21-3214 | Yellow Toner (OEM# C9732A) (12,000 Yield) (Contains SCS) | 12528 | CTG | \$250.00 |
| MSE - HP Color LJ CM1312/CP1215/CP1515/CP1518 Laser Supplies | | | | |
| 02-21-54014 | Black Toner (OEM# CB540A) (2,200 Yield) (Contains SCS) | 19518 | CTG | \$59.00 |
| 02-21-54114 | Cyan Toner (OEM# CB541A) (1,400 Yield) (Contains SCS) | 30835 | CTG | \$55.00 |
| 02-21-54314 | Magenta Toner (OEM# CB543A) (1,400 Yield) (Contains SCS) | 30837 | CTG | \$55.00 |
| 02-21-54214 | Yellow Toner (OEM# CB542A) (1,400 Yield) (Contains SCS) | 30836 | CTG | \$55.00 |
| MSE - HP Color LJ CM1415/CP1525 Laser Supplies | | | | |
| 02-21-20014 | Black Toner (OEM# CE320A) (2,000 Yield) (Contains SCS) | 106772 | CTG | \$59.00 |
| 02-21-20114 | Cyan Toner (OEM# CE321A) (1,300 Yield) (Contains SCS) | 106777 | CTG | \$59.00 |
| 02-21-20314 | Magenta Toner (OEM# CE323A) (1,300 Yield) (Contains SCS) | 106784 | CTG | \$59.00 |
| 02-21-20214 | Yellow Toner (OEM# CE322A) (1,300 Yield) (Contains SCS) | 106778 | CTG | \$59.00 |
| MSE - HP Color LJ CM2320/CP2025 Laser Supplies | | | | |
| 02-21-53014 | Black Toner (OEM# CC530A) (3,500 Yield) (Contains SCS) | 21398 | CTG | \$89.00 |
| 02-21-53114 | Cyan Toner (OEM# CC531A) (2,800 Yield) (Contains SCS) | 21399 | CTG | \$89.00 |
| 02-21-53314 | Magenta Toner (OEM# CC533A) (2,800 Yield) (Contains SCS) | 21401 | CTG | \$89.00 |
| 02-21-53214 | Yellow Toner (OEM# CC532A) (2,800 Yield) (Contains SCS) | 21400 | CTG | \$89.00 |

| MFG# | Product Description | Part# | UOM | Retail |
|--|---|--------|-----|----------|
| MSE COMPATIBLES | | | | |
| MSE - HP Color LJ CM3530/CP3525 Laser Supplies | | | | |
| 02-21-35014 | Black Toner (OEM# CE250A) (5,000 Yield) (Contains SCS) | 101262 | CTG | \$105.00 |
| 02-21-35114 | Cyan Toner (OEM# CE251A) (7,000 Yield) (Contains SCS) | 101269 | CTG | \$199.00 |
| 02-21-35314 | Magenta Toner (OEM# CE253A) (7,000 Yield) (Contains SCS) | 101271 | CTG | \$199.00 |
| 02-21-35214 | Yellow Toner (OEM# CE252A) (7,000 Yield) (Contains SCS) | 101275 | CTG | \$199.00 |
| 02-21-35016 | High Yield Black Toner (OEM# CE250X) (10,500 Yield) (Contains SCS) | 101267 | CTG | \$149.00 |
| 02-21-350162 | Extended Yield Black Toner (OEM# CE250X) (16,000 Yield) (Contains Chip) | 923152 | CTG | \$195.00 |
| 02-21-351142 | Extended Yield Cyan Toner (OEM# CE251A) (11,000 Yield) (Contains Chip) | 923153 | CTG | \$299.00 |
| 02-21-353142 | Extended Yield Magenta Toner (OEM# CE253A) (11,000 Yield) (Contains Chip) | 923155 | CTG | \$299.00 |
| 02-21-352142 | Extended Yield Yellow Toner (OEM# CE252A) (11,000 Yield) (Contains Chip) | 923154 | CTG | \$299.00 |
| MSE - HP Color LJ CM4540/CP4025/CP4525 Laser Supplies | | | | |
| 02-21-450014 | Black Toner (OEM# CE260A) (8,500 Yield) (Contains SCS) | 108324 | CTG | \$112.50 |
| 02-21-450016 | High Yield Black Toner (OEM# CE260X) (17,000 Yield) (Contains SCS) (For CP4525 Model Only) | 108325 | CTG | \$179.00 |
| 02-21-450114 | Cyan Toner (OEM# CE261A, CF031A) (11,000 Yield) (Contains SCS) | 108326 | CTG | \$209.00 |
| 02-21-450314 | Magenta Toner (OEM# CE263A, CF033A) (11,000 Yield) (Contains SCS) | 108328 | CTG | \$209.00 |
| 02-21-450214 | Yellow Toner (OEM# CE262A, CF032A) (11,000 Yield) (Contains SCS) | 108327 | CTG | \$209.00 |
| MSE - HP Color LJ CM4540 Laser Supplies | | | | |
| 02-21-540016 | High Yield Black Toner (OEM# CE264X) (17,000 Yield) (Contains Chip, SCS) | 911004 | CTG | \$149.00 |
| 02-21-540114 | Cyan Toner (OEM# CF031A) (12,500 Yield) (Contains Chip, SCS) | 911005 | CTG | \$189.00 |
| 02-21-540314 | Magenta Toner (OEM# CF033A) (12,500 Yield) (Contains Chip, SCS) | 911007 | CTG | \$189.00 |
| 02-21-540214 | Yellow Toner (OEM# CF032A) (12,500 Yield) (Contains Chip, SCS) | 911006 | CTG | \$189.00 |
| MSE - HP Color LJ CP1025/M175 Laser Supplies | | | | |
| 02-21-31014 | Black Toner (OEM# CE310A) (1,200 Yield) | 800020 | CTG | \$42.50 |
| 02-21-31114 | Cyan Toner (OEM# CE311A) (1,000 Yield) | 800145 | CTG | \$44.20 |
| 02-21-31314 | Magenta Toner (OEM# CE313A) (1,000 Yield) | 800232 | CTG | \$44.20 |
| 02-21-31214 | Yellow Toner (OEM# CE312A) (1,000 Yield) | 800148 | CTG | \$44.20 |
| MSE - HP Color LJ CP4005 Laser Supplies | | | | |
| 02-21-40014 | Black Toner (OEM# CB400A) (7,500 Yield) (Contains SCS) | 101875 | CTG | \$139.00 |
| 02-21-40114 | Cyan Toner (OEM# CB401A) (7,500 Yield) (Contains SCS) | 101876 | CTG | \$189.00 |
| 02-21-40314 | Magenta Toner (OEM# CB403A) (7,500 Yield) (Contains SCS) | 101878 | CTG | \$189.00 |
| 02-21-40214 | Yellow Toner (OEM# CB402A) (7,500 Yield) (Contains SCS) | 101877 | CTG | \$189.00 |
| MSE - HP Color LJ CP5225 Laser Supplies | | | | |
| 02-21-52014 | Black Toner (OEM# CE740A) (7,000 Yield) (Contains SCS) | 908433 | CTG | \$114.75 |
| 02-21-52114 | Cyan Toner (OEM# CE741A) (7,300 Yield) (Contains SCS) | 908432 | CTG | \$202.50 |
| 02-21-52314 | Magenta Toner (OEM# CE743A) (7,300 Yield) (Contains SCS) | 908430 | CTG | \$202.50 |
| 02-21-52214 | Yellow Toner (OEM# CE742A) (7,300 Yield) (Contains SCS) | 908431 | CTG | \$202.50 |
| MSE - HP Color LJ CP5525/Enterprise M750 Laser Supplies | | | | |
| 02-21-55014 | Black Toner (OEM# CE270A) (13,500 Yield) (Contains SCS) | 908429 | CTG | \$208.50 |
| 02-21-55114 | Cyan Toner (OEM# CE271A) (15,000 Yield) (Contains SCS) | 908446 | CTG | \$339.75 |
| 02-21-55314 | Magenta Toner (OEM# CE273A) (15,000 Yield) (Contains SCS) | 908444 | CTG | \$339.75 |
| 02-21-55214 | Yellow Toner (OEM# CE272A) (15,000 Yield) (Contains SCS) | 908445 | CTG | \$339.75 |
| MSE - HP Color LJ CP6015 Laser Supplies | | | | |
| 02-21-81014 | Black Toner (OEM# CB380A) (16,500 Yield) | 101514 | CTG | \$159.00 |
| 02-21-81114 | Cyan Toner (OEM# CB381A) (21,000 Yield) | 101513 | CTG | \$245.00 |
| 02-21-81314 | Magenta Toner (OEM# CB383A) (21,000 Yield) | 101511 | CTG | \$245.00 |
| 02-21-81214 | Yellow Toner (OEM# CB382A) (21,000 Yield) | 101512 | CTG | \$245.00 |
| MSE - HP LJ Pro Color M176/M177 Laser Supplies | | | | |
| 02-21-17014 | Black Toner (OEM# CF350A) (1,300 Yield) (Contains Chip) | 925992 | CTG | \$49.00 |
| 02-21-17114 | Cyan Toner (OEM# CF351A) (1,000 Yield) (Contains Chip) | 925993 | CTG | \$49.00 |
| 02-21-17314 | Magenta Toner (OEM# CF353A) (1,000 Yield) (Contains Chip) | 925995 | CTG | \$49.00 |
| 02-21-17214 | Yellow Toner (OEM# CF352A) (1,000 Yield) (Contains Chip) | 925994 | CTG | \$49.00 |
| MSE - HP LJ Pro 200 Color M251/MFP M276 Laser Supplies | | | | |
| 02-21-21014 | Black Toner (OEM# CF210A) (1,600 Yield) | 915884 | CTG | \$50.25 |
| 02-21-21016 | High Yield Black Toner (OEM# CF210X) (2,400 Yield) | 915885 | CTG | \$65.75 |
| 02-21-21114 | Cyan Toner (OEM# CF211A) (1,800 Yield) | 915886 | CTG | \$63.75 |
| 02-21-21314 | Magenta Toner (OEM# CF213A) (1,800 Yield) | 915888 | CTG | \$63.75 |
| 02-21-21214 | Yellow Toner (OEM# CF212A) (1,800 Yield) | 915887 | CTG | \$63.75 |

| MFG# | Product Description | Part# | UOM | Retail |
|--|--|--------|-----|----------|
| MSE COMPATIBLES | | | | |
| MSE - HP LJ Pro 300 Color M351/M451/MFP M375/M475 Laser Supplies | | | | |
| 02-21-41014 | Black Toner (OEM# CE410A) (2,200 Yield) (Contains SCS) | 908438 | CTG | \$61.50 |
| 02-21-41016 | High Yield Black Toner (OEM# CE410X) (4,000 Yield) (Contains SCS) | 908437 | CTG | \$77.25 |
| 02-21-41114 | Cyan Toner (OEM# CE411A) (2,600 Yield) (Contains SCS) | 908436 | CTG | \$87.75 |
| 02-21-41314 | Magenta Toner (OEM# CE413A) (2,600 Yield) (Contains SCS) | 908434 | CTG | \$87.75 |
| 02-21-41214 | Yellow Toner (OEM# CE412A) (2,600 Yield) (Contains SCS) | 908435 | CTG | \$87.75 |
| MSE - HP LJ M551/M570/M575 Color Laser Supplies | | | | |
| 02-21-51014 | Black Toner (OEM# CE400A) (5,500 Yield) (Contains SCS) | 908443 | CTG | \$112.50 |
| 02-21-51114 | Cyan Toner (OEM# CE401A) (6,000 Yield) (Contains SCS) | 908441 | CTG | \$168.00 |
| 02-21-51314 | Magenta Toner (OEM# CE403A) (6,000 Yield) (Contains SCS) | 908439 | CTG | \$168.00 |
| 02-21-51214 | Yellow Toner (OEM# CE402A) (6,000 Yield) (Contains SCS) | 908440 | CTG | \$168.00 |
| 02-21-51016 | High Yield Black Toner (OEM# CE400X) (11,000 Yield) (Contains SCS) | 908442 | CTG | \$150.00 |
| 02-21-510162 | Extended Yield Black Toner (OEM# CE400X) (16,000 Yield) (Contains Chip) | 926123 | CTG | \$168.00 |
| 02-21-511142 | Extended Yield Cyan Toner (OEM# CE401A) (11,000 Yield) (Contains Chip) | 926124 | CTG | \$175.00 |
| 02-21-513142 | Extended Yield Magenta Toner (OEM# CE403A) (11,000 Yield) (Contains Chip) | 926126 | CTG | \$175.00 |
| 02-21-512142 | Extended Yield Yellow Toner (OEM# CE402A) (11,000 Yield) (Contains Chip) | 926125 | CTG | \$175.00 |
| MSE - IBM Monochrome Laser Supplies | | | | |
| 02-24-3016 | 1130/1140 Toner (OEM# 28P2008) (30,000 Yield) | 10285 | CTG | \$249.00 |
| 02-24-1316 | 1332/1352/1372 High Yield Toner (OEM# 75P4302) (21,000 Yield) | 10276 | CTG | \$279.00 |
| 02-24-13162 | 1332/1352/1372 Extra High Yield Toner (OEM# 75P4304) (32,000 Yield) | 10277 | CTG | \$289.00 |
| 02-25-3316 | 1412 Toner (OEM# 75P5710) (6,000 Yield) (Contains Chip) | 908729 | CTG | \$75.00 |
| 02-24-1516 | 1532/1552/1570/1572/1614/1650 High Yield Toner (OEM# 75P6960, 75P6961) (21,000 Yield) | 19676 | CTG | \$199.00 |
| 02-24-3514 | 1612/1622 Toner (OEM# 39V1642) (6,000 Yield) | 105876 | CTG | \$99.00 |
| 02-24-3516 | 1612/1622 High Yield Toner (OEM# 39V1641, 39V1642) (9,000 Yield) (Contains Chip) | 911438 | CTG | \$139.00 |
| 02-24-35162 | 1622 Extended Yield Toner (OEM# 39V1641) (11,000 Yield) (Contains Chip) | 908903 | CTG | \$169.00 |
| 02-25-1816 | 1832/1852/1872/1892 Toner (OEM# 39V2513, 39V2514) (25,000 Yield) (Contains Chip) | 919285 | CTG | \$360.00 |
| MSE - Xerox Phaser 3600 Laser Supplies | | | | |
| 02-57-3616 | High Yield Toner (OEM# 106R01371) (14,000 Yield) (Contains Chip) | 922842 | CTG | \$189.00 |
| NUPOST COMPATIBLES | | | | |
| NuPost Postage Supplies | | | | |
| NPT1000 | Francotyp-Postalia T1000 Postage Meter Red Ribbon (3/Box) (OEM# 510019530100) (1,600 Yield) | 24140 | BOX | \$64.99 |
| NPT500 | Pitney Bowes DM500/550 Postage Meter Red Ink Cartridge (OEM# 621-1) (11,000 Yield) | 24144 | CTG | \$79.99 |
| NPTE700 | Pitney Bowes Personal Postage Meter E700/E707 Red Ink Cartridge (OEM# 769-0) (400 Yield) | 24147 | CTG | \$34.99 |
| NPTP700 | Pitney Bowes Postage Meter DM100i/DM200L/P700 Red Ink Cartridge (OEM# 793-5) (3,000 Yield) | 24150 | CTG | \$54.99 |
| NPTK700 | Pitney Bowes Postage Meter Mailstation/Mailstation2/K700/K7MO Red Ink Cartridge (OEM# 797-0, 797-M, 797-Q) (800 Yield) | 24149 | CTG | \$39.99 |
| NPT300C | Pitney Bowes DM300c/DM400c/DM450c Red Ink Cartridge (OEM# 765-9) (8,000 Yield) | 24142 | CTG | \$59.99 |
| WEST POINT PRODUCTS COMPATIBLES | | | | |
| West Point Products - Brother DCP-7020; Fax 2820/2920; HL-2040/2070N; MFC-7220/7225N/7420/7820N Mono Laser Supplies | | | | |
| 200089P | Toner (OEM# TN350) (2,500 Yield) | 913766 | CTG | \$62.00 |
| 200090P | Drum Unit (OEM# DR350) (12,000 Yield) | 913767 | EA | \$118.95 |
| West Point Products - Brother DCP-7030/7040; HL-2140/2170W; MFC-7340/7345N/7440N/7840W Mono Laser Supplies | | | | |
| 200114P | High Yield Toner (OEM# TN360) (2,600 Yield) | 913772 | CTG | \$61.15 |
| 200216P | Drum Unit (OEM# DR360) (12,000 Yield) | 913821 | EA | \$93.90 |
| West Point Products - Brother DCP-8060/8065DN; HL-5240/5250/5280DW; MFC-8460N/8660/8670DN/8860DN/8870DW Mono Laser Supplies | | | | |
| 200091P | High Yield Toner (OEM# TN580) (7,000 Yield) | 913768 | CTG | \$102.80 |
| 115988P | Drum Unit (OEM# DR520) (25,000 Yield) | 913715 | EA | \$194.20 |
| West Point Products - Brother DCP-8080DN/8085DN; HL-5340D/5350DN/5370DW/5370DWT/5380DN; MFC-8480DN/8680DN/8880DN/8890DW Mono Laser Supplies | | | | |
| 200027P | Toner (OEM# TN620) (3,000 Yield) | 913746 | CTG | \$63.70 |
| 200028P | High Yield Toner (OEM# TN650) (8,000 Yield) | 913747 | CTG | \$101.95 |
| 116413P | Drum Unit (OEM# DR620) (20,000 Yield) | 913719 | EA | \$127.45 |

All catalog content is subject to change.

| MFG# | Product Description | Part# | UOM | Retail |
|---|--|--------|-----|----------|
| WEST POINT PRODUCTS COMPATIBLES | | | | |
| West Point Products - Brother DCP-8110DN/8150DN/8155DN; HL-5440D/5450/5470/6180; MFC-8510DN/8710/8910DW/8950 Mono Laser Supplies | | | | |
| 200606P | Toner (OEM# TN720) (3,000 Yield) | 916614 | CTG | \$65.40 |
| 200607P | High Yield Toner (OEM# TN750) (8,000 Yield) | 916615 | CTG | \$106.20 |
| 200608P | Extra High Yield Toner (OEM# TN780) (12,000 Yield) (For HL-6180 and MFC-8950 Models Only) | 923305 | CTG | \$127.45 |
| 200614P | Drum Unit (OEM# DR720) (30,000 Yield) | 916618 | CTG | \$135.95 |
| West Point Products - Brother DCP-9040CN/9045CD; HL-4040CN/4040CDN/4070CDW; MFC-9440CN/9450CDN/9840CDW Color Laser Supplies | | | | |
| 200465P | High Yield Black Toner (OEM# TN115BK) (5,000 Yield) | 913839 | CTG | \$87.10 |
| 200466P | High Yield Cyan Toner (OEM# TN115C) (4,000 Yield) | 913840 | CTG | \$121.95 |
| 200467P | High Yield Magenta Toner (OEM# TN115M) (4,000 Yield) | 913841 | CTG | \$121.95 |
| 200468P | High Yield Yellow Toner (OEM# TN115Y) (4,000 Yield) | 913842 | CTG | \$121.95 |
| West Point Products - Brother Monochrome Laser Supplies | | | | |
| 200023P | DCP-1200/1400; HL-1030/1230/1240/1250/1270/1435/1440/1450/1470; IntelliFax 4100/4750/5750; MFC-8300/8500/8600/8700/9600/9700/9800/P2500 High Yield Toner (OEM# TN460) (6,000 Yield) | 913653 | CTG | \$85.40 |
| 102709P | DCP-1200/1400; HL-1030/1230/1240/1250/1270/1435/1440/1450/1470/ IntelliFax 4100/4750/5750; MFC-8300/8500/8600/8700/9600/9700/9800/P2500 Drum Unit (OEM# DR400) (20,000 Yield) | 913641 | EA | \$177.20 |
| 200206P | DCP-7060/7065; Fax 2840/2940; HL-2230/2240D/2270DW; MFC-7240/7360N/7460/7860 High Yield Toner (OEM# TN450) (2,300 Yield) | 913820 | CTG | \$58.20 |
| West Point Products - Canon Monochrome Laser Supplies | | | | |
| 200019P | CFX-LC2050/2060/L3500IF/L4500IF/L3500/L4000/L4500/L6000/L6000L/Fax L120/L200/L220/L240/L250/L260/ L260I/L280/L290/L295/L300/L350/L360/ FAXPHONE L75/L80/ imageCLASS 1100/ LaserClass 1060P/2050/2060/L300/L4000/ MultiPass L60-MFP/L90/L6000/ LBP-320/460/465/660/LBP-AX (FX3) Toner (OEM# 1557A002BA) (2,700 Yield) | 913740 | CTG | \$86.00 |
| 200039P | Fax L400/L170/ imageCLASS D320/D340/ LaserClass 310/510 (FX8/S35) Toner (OEM# 8955A001AA) (3,500 Yield) | 913751 | CTG | \$146.20 |
| 200024P | FC 200/204/220/310/330/336/ PC 100/140/150/160/170/300/310/320/325/330/400/420/425/428/430/500/530/550/700/710/720/730/735/740/745/750/760/770/775/785/780/790/795/860/880/890/900/920/921/940/941/950/980/981 (E40) High Yield Toner (OEM# 1491A002AC) (4,000 Yield) | 913743 | CTG | \$159.80 |
| 200099P | LaserClass 810/830i/ ImageClass 6530/6531/6540/6550/6560/6580/6590/6595/6595cx/ MF6500 Series (FX11/106) Toner (OEM# 1153B001AA) (5,000 Yield) | 913770 | CTG | \$186.15 |
| 200034P | imageCLASS 710/720i/730i/ L2000 (FX7) Toner (OEM# 7621A001AA) (4,500 Yield) | 913749 | CTG | \$100.00 |
| 200178P | imageCLASS D1120/D1150/D1170/D1180 (CRG-120) Toner (OEM# 2617B001AA) (5,000 Yield) | 913807 | CTG | \$177.65 |
| 200029P | imageCLASS D420/D480/MF4150/4270/4350/4370/4690/ Fax L100/Faxphone L20/L90/L120/I-Sensys 4120/4140/4150/ Satera MF4120/4130/4150/6570 (FX9/FX10/104) Toner (OEM# 0263B001BA) (2,000 Yield) | 913748 | CTG | \$88.40 |
| 200583P | imageCLASS D530/D550/MF4412/MF4420/MF4450/MF4550/MF4570DN/MF4570DW/ MF4580/MF4770N/MF4880DW /MF4890DW/ Faxphone L100/L190 (CRG-128) Toner (OEM# 3500B001AA) (2,100 Yield) | 913880 | CTG | \$96.90 |
| West Point Products - Dell Monochrome Laser Supplies | | | | |
| 200104P | 1100/1110 Toner (OEM# 310-6640, 310-7660, J9833) (2,000 Yield) | 913771 | CTG | \$74.55 |
| 200522P | 1130/1130n/1133/1135n High Yield Toner (OEM# 330-9523, 2MMJJP) (2,500 Yield) | 913854 | CTG | \$89.75 |
| 200194P | 1720 High Yield Toner (OEM# 310-8700, 310-8707, MW558) (6,000 Yield) | 913816 | CTG | \$122.35 |
| 200086P | 2330/2350 Series High Yield Toner (OEM# 330-2650, 330-2667, PK941) (6,000 Yield) | 913764 | CTG | \$129.15 |
| 200085P | 2335dn High Yield Toner (OEM# 330-2209, HX756) (6,000 Yield) | 913763 | CTG | \$112.15 |
| 200101P | 5210/5310 High Yield Toner (OEM# 341-2918, 341-2918, 310-7236, 310-7237, GD531, HD767) (21,000 Yield) | 913668 | CTG | \$253.55 |
| 200497P | 5530dn/5535dn High Yield Toner (OEM# 330-9787, 330-9788, 9GPVM) (25,000 Yield) | 913848 | CTG | \$377.35 |
| West Point Products - Dell 1250c/1350cnw/1355cn/1355cnw/C1760nw/C1765nf/C1765nfw Color Laser Supplies | | | | |
| 200652 | High Yield Black Toner (OEM# 810WH, 331-0778) (2,000 Yield) | 929991 | CTG | \$59.45 |
| 200653 | High Yield Cyan Toner (OEM# C5GC3, 331-0777) (1,400 Yield) | 929992 | CTG | \$59.45 |
| 200654 | High Yield Magenta Toner (OEM# XMX5D, 331-0780) (1,400 Yield) | 929993 | CTG | \$59.45 |
| 200655 | High Yield Yellow Toner (OEM# WM2JC, 331-0779) (1,400 Yield) | 929994 | CTG | \$59.45 |
| West Point Products - HP LJ 4/4M/4+/4M+/5/5M/5N/5Se Mono Laser Supplies | | | | |
| 200146P | Extended Yield Toner (OEM# 92298A) (10,000 Yield) | 913790 | CTG | \$242.75 |

| MFG# | Product Description | Part# | UOM | Retail |
|---|--|--------|-----|----------|
| WEST POINT PRODUCTS COMPATIBLES | | | | |
| West Point Products - HP LJ 1000/1200/1220/3300/3310/3320/3330/3380 Mono Laser Supplies | | | | |
| 200020P | Toner (OEM# C7115A) (2,500 Yield) | 913741 | CTG | \$91.90 |
| 200009P | High Yield Toner (OEM# C7115X) (3,500 Yield) | 913733 | CTG | \$100.25 |
| West Point Products - HP LJ 1012/1015/1018/1020/1022/3015/3020/3030/3050/3052/3055/M1319 Mono Laser Supplies | | | | |
| 200003P | Toner (OEM# Q2612A) (2,000 Yield) | 913731 | CTG | \$91.75 |
| West Point Products - HP LJ 1160/1320/3390 Mono Laser Supplies | | | | |
| 200008P | Toner (OEM# Q5949A) (2,500 Yield) | 913732 | CTG | \$107.80 |
| 200050P | High Yield Toner (OEM# Q5949X) (6,000 Yield) (For Use in 1320/3390 Models Only) | 913655 | CTG | \$197.30 |
| West Point Products - HP LJ 1300 Mono Laser Supplies | | | | |
| 200036P | Toner (OEM# Q2613A) (2,500 Yield) | 913750 | CTG | \$107.80 |
| West Point Products - HP LJ 2100/2200 Mono Laser Supplies | | | | |
| 200017P | Toner (OEM# C4096A) (5,000 Yield) | 913739 | CTG | \$151.15 |
| West Point Products - HP LJ 2300 Mono Laser Supplies | | | | |
| 200012P | Toner (OEM# Q2610A) (6,000 Yield) | 913736 | CTG | \$181.65 |
| 200157P | Extended Yield Toner (OEM# Q2610A) (10,000 Yield) | 913798 | CTG | \$302.75 |
| West Point Products - HP LJ 2410/2420/2430 Mono Laser Supplies | | | | |
| 200042P | Toner (OEM# Q6511A) (6,000 Yield) | 913752 | CTG | \$162.35 |
| 200051P | High Yield Toner (OEM# Q6511X) (12,000 Yield) | 913753 | CTG | \$272.65 |
| West Point Products - HP LJ 4000/4050 Mono Laser Supplies | | | | |
| 200007P | High Yield Toner (OEM# C4127X) (10,000 Yield) | 913649 | CTG | \$192.20 |
| West Point Products - HP LJ 4100 Mono Laser Supplies | | | | |
| 200004P | High Yield Toner (OEM# C8061X) (10,000 Yield) | 913646 | CTG | \$192.20 |
| West Point Products - HP LJ 4200 Mono Laser Supplies | | | | |
| 200002P | Toner (OEM# Q1338A) (12,000 Yield) | 913730 | CTG | \$201.35 |
| 200176P | Universal Extended Yield Toner (OEM# Q1338A,Q1339A, Q5942X, Q5945A) (25,000 Yield) | 913683 | CTG | \$488.25 |
| West Point Products - HP LJ 4300/4345/M4345 Mono Laser Supplies | | | | |
| 200006P | Universal Toner (OEM# Q1339A, Q5945A) (18,000 Yield) | 913648 | CTG | \$266.65 |
| 200176P | Universal Extended Yield Toner (OEM# Q1338A,Q1339A, Q5942X, Q5945A) (25,000 Yield) | 913683 | CTG | \$488.25 |
| West Point Products - HP LJ 4240/4250/4350 Mono Laser Supplies | | | | |
| 200041P | Toner (OEM# Q5942A) (10,000 Yield) | 913654 | CTG | \$195.30 |
| 200001P | High Yield Toner (OEM# Q5942X) (20,000 Yield) (For Use in 4250/4350 Models Only) | 913729 | CTG | \$295.50 |
| 200176P | Universal Extended Yield Toner (OEM# Q1338A, Q1339A, Q5942X, Q5945A) (25,000 Yield) (For Use in 4250/4350 Models Only) | 913683 | CTG | \$488.25 |
| West Point Products - HP LJ 5000/5100 Mono Laser Supplies | | | | |
| 200018P | Toner (OEM# C4129X) (10,000 Yield) | 913652 | CTG | \$207.55 |
| West Point Products - HP LJ 5200 Mono Laser Supplies | | | | |
| 114849P | Toner (OEM# Q7516A) (12,000 Yield) | 913713 | CTG | \$238.45 |
| West Point Products - HP LJ 8100/8150/Mopier 320 Mono Laser Supplies | | | | |
| 200010P | Toner (OEM# C4182X) (20,000 Yield) | 913734 | CTG | \$284.25 |
| West Point Products - HP LJ 9000/9040/9050/M9040/M9050 Mono Laser Supplies | | | | |
| 200175 | Toner (OEM# C8543X) (30,000 Yield) | 913682 | CTG | \$361.05 |
| 200162 | Extended Yield Toner (OEM# C8543X) (40,000 Yield) | 913803 | CTG | \$481.40 |
| West Point Products - HP LJ M521/M525/P3010/P3015 Mono Laser Supplies | | | | |
| 200179P | Toner (OEM# CE255A) (6,000 Yield) | 913808 | CTG | \$172.05 |
| 200180P | High Yield Toner (OEM# CE255X) (12,500 Yield) | 913809 | CTG | \$267.55 |
| 200490P | Extended Yield Toner (OEM# CE255X) (20,000 Yield) | 913847 | CTG | \$428.15 |

| MFG# | Product Description | Part# | UOM | Retail |
|--|--|--------|-----|----------|
| WEST POINT PRODUCTS COMPATIBLES | | | | |
| West Point Products - HP LJ M601/M602/M603/M4555 Mono Laser Supplies | | | | |
| 200553P | Toner (OEM# CE390A) (10,000 Yield) | 913864 | CTG | \$202.70 |
| 200554P | High Yield Toner (OEM# CE390X) (24,000 Yield) (For Use in M602/M603/M4555 Models Only) | 913693 | CTG | \$338.75 |
| 200557P | Extended Yield Toner (OEM# CE390X) (35,000 Yield) (For Use in M602/M603/M4555 Models Only) | 913865 | CTG | \$465.80 |
| West Point Products - HP LJ M712/M725 Mono Laser Supplies | | | | |
| 200610P | Toner (OEM# CF214A) (10,000 Yield) | 916616 | CTG | \$224.40 |
| 200611P | High Yield Toner (OEM# CF214X) (17,500 Yield) | 916617 | CTG | \$247.35 |
| West Point Products - HP LJ M1120/M1522/P1505 Mono Laser Supplies | | | | |
| 200121P | Toner (OEM# CB436A) (2,000 Yield) | 913778 | CTG | \$91.75 |
| 200154P | Extended Yield Toner (OEM# CB436A) (3,000 Yield) | 913795 | CTG | \$137.60 |
| West Point Products - HP LJ M1130/M1132/M1134/M1136/M1137/M1138/M1139/M1210/M1212/M1213/M1214/M1216/M1217/M1219/P1100/P1102 Mono Laser Supplies | | | | |
| 200182P | Toner (OEM# CE285A) (1,600 Yield) | 913811 | CTG | \$80.60 |
| 200250P | Extended Yield Toner (OEM# CE285A) (2,300 Yield) | 913828 | CTG | \$115.90 |
| West Point Products - HP LJ M1536/P1606/P1566 Mono Laser Supplies | | | | |
| 200181P | Toner (OEM# CE278A) (2,100 Yield) | 913810 | CTG | \$92.35 |
| 200249P | Extended Yield Toner (OEM# CE278A) (3,000 Yield) | 913827 | CTG | \$131.90 |
| West Point Products - HP LJ M2727/P2010/P2014/P2015 Mono Laser Supplies | | | | |
| 200094P | Toner (OEM# Q7553A) (3,000 Yield) | 913769 | CTG | \$105.40 |
| West Point Products - HP LJ M3027/M3035/P3005 Mono Laser Supplies | | | | |
| 200093P | Toner (OEM# Q7551A) (6,500 Yield) | 913667 | CTG | \$169.85 |
| West Point Products - HP LJ P1002/P1003/P1004/P1005/P1006/P1009 Mono Laser Supplies | | | | |
| 200120P | Toner (OEM# CB435A) (2,000 Yield) | 913777 | CTG | \$79.80 |
| 200153P | Extended Yield Toner (OEM# CB435A) (2,200 Yield) | 913794 | CTG | \$117.05 |
| West Point Products - HP LJ P2030/P2035/P2055 Mono Laser Supplies | | | | |
| 200173P | Toner (OEM# CE505A) (2,300 Yield) | 913804 | CTG | \$104.30 |
| 200174P | High Yield Toner (OEM# CE505X) (6,500 Yield) (For Use in P2055 Only) | 913805 | CTG | \$191.35 |
| 200221P | Extended Yield Toner (OEM# CE505X) (8,000 Yield) (For Use in P2055 Only) | 913822 | CTG | \$235.50 |
| West Point Products - HP LJ P4014/P4015/P4515 Mono Laser Supplies | | | | |
| 200126P | Toner (OEM# CC364A) (10,000 Yield) | 913669 | CTG | \$202.80 |
| 200014P | High Yield Toner (OEM# CC364X) (24,000 Yield) (For Use in P4015/P4515 Models Only) | 913651 | CTG | \$360.80 |
| 200202P | Extended Yield Toner (OEM# CC364X) (33,000 Yield) (For Use in P4015/P4515 Models Only) | 913817 | CTG | \$495.85 |
| West Point Products - HP LJ Pro 400 M401/M425 Mono Laser Supplies | | | | |
| 200551P | Toner (OEM# CF280A) (2,700 Yield) | 913862 | CTG | \$120.75 |
| 200552P | High Yield Toner (OEM# CF280X) (6,900 Yield) | 913863 | CTG | \$207.90 |
| 200577P | Extended Yield Toner (OEM# CF280X) (8,000 Yield) | 913879 | CTG | \$241.05 |
| West Point Products - HP Color LJ 1600/2600/2605/CM1015 MFP/CM1017 MFP Laser Supplies | | | | |
| 200073P | Black Toner (OEM# Q6000A) (2,500 Yield) | 913660 | CTG | \$99.05 |
| 200074P | Cyan Toner (OEM# Q6001A) (2,000 Yield) | 913661 | CTG | \$108.10 |
| 200075P | Magenta Toner (OEM# Q6003A) (2,000 Yield) | 913662 | CTG | \$108.10 |
| 200076P | Yellow Toner (OEM# Q6002A) (2,000 Yield) | 913762 | CTG | \$108.10 |
| West Point Products - HP Color LJ 3600 Laser Supplies | | | | |
| 200081P | Black Toner (OEM# Q6470A) (6,000 Yield) | 913663 | CTG | \$173.30 |
| 200082P | Cyan Toner (OEM# Q6471A) (4,000 Yield) | 913664 | CTG | \$172.70 |
| 200083P | Magenta Toner (OEM# Q6473A) (4,000 Yield) | 913665 | CTG | \$172.70 |
| 200084P | Yellow Toner (OEM# Q6472A) (4,000 Yield) | 913666 | CTG | \$172.70 |
| West Point Products - HP Color LJ 3800/CP3505 Laser Supplies | | | | |
| 200081P | Black Toner (OEM# Q6470A) (6,000 Yield) | 913663 | CTG | \$173.30 |
| 200132P | Cyan Toner (OEM# Q7581A) (6,000 Yield) | 913783 | CTG | \$222.90 |
| 200134P | Magenta Toner (OEM# Q7583A) (6,000 Yield) | 913785 | CTG | \$222.90 |
| 200133P | Yellow Toner (OEM# Q7582A) (6,000 Yield) | 913784 | CTG | \$222.90 |

| MFG# | Product Description | Part# | UOM | Retail |
|---|---|--------|-----|----------|
| WEST POINT PRODUCTS COMPATIBLES | | | | |
| West Point Products - HP Color LJ 4600/4610/4650 Laser Supplies | | | | |
| 200165P | Black Toner (OEM# C9720A) (9,000 Yield) | 913674 | CTG | \$233.25 |
| 200166P | Cyan Toner (OEM# C9721A) (8,000 Yield) | 913675 | CTG | \$316.05 |
| 200167P | Magenta Toner (OEM# C9723A) (8,000 Yield) | 913676 | CTG | \$316.05 |
| 200168P | Yellow Toner (OEM# C9722A) (8,000 Yield) | 913677 | CTG | \$316.05 |
| West Point Products - HP Color LJ 4700 Laser Supplies | | | | |
| 200169P | Black Toner (OEM# Q5950A) (11,000 Yield) | 913678 | CTG | \$232.80 |
| 200170P | Cyan Toner (OEM# Q5951A) (10,000 Yield) | 913679 | CTG | \$331.05 |
| 200171P | Magenta Toner (OEM# Q5953A) (10,000 Yield) | 913680 | CTG | \$331.05 |
| 200172P | Yellow Toner (OEM# Q5952A) (10,000 Yield) | 913681 | CTG | \$331.05 |
| West Point Products - HP Color LJ 4730/CM4730 MFP Laser Supplies | | | | |
| 200310P | Black Toner (OEM# Q6460A) (12,000 Yield) | 913830 | CTG | \$183.75 |
| 200311P | Cyan Toner (OEM# Q6461A) (12,000 Yield) | 913831 | CTG | \$396.00 |
| 200313P | Magenta Toner (OEM# Q6463A) (12,000 Yield) | 913833 | CTG | \$396.00 |
| 200312P | Yellow Toner (OEM# Q6462A) (12,000 Yield) | 913832 | CTG | \$396.00 |
| West Point Products - HP Color LJ 5500/5550 Laser Supplies | | | | |
| 200059P | Black Toner (OEM# C9730A) (13,000 Yield) | 913656 | CTG | \$323.45 |
| 200060P | Cyan Toner (OEM# C9731A) (12,000 Yield) | 913657 | CTG | \$453.60 |
| 200062P | Magenta Toner (OEM# C9733A) (12,000 Yield) | 913659 | CTG | \$453.60 |
| 200061P | Yellow Toner (OEM# C9732A) (12,000 Yield) | 913658 | CTG | \$453.60 |
| West Point Products - HP Color LJ CM1312/CP1210/CP1215/CP1510/CP1515/CP1518/P1200/P1215/P1217/P1500/P1515 Laser Supplies | | | | |
| 200122P | Black Toner (OEM# CB540A) (2,200 Yield) | 913779 | CTG | \$88.40 |
| 200123P | Cyan Toner (OEM# CB541A) (1,400 Yield) | 913780 | CTG | \$83.30 |
| 200125P | Magenta Toner (OEM# CB543A) (1,400 Yield) | 913782 | CTG | \$83.30 |
| 200124P | Yellow Toner (OEM# CB542A) (1,400 Yield) | 913781 | CTG | \$83.30 |
| West Point Products - HP Color LJ CM2320/CP2020/CP2025 Laser Supplies | | | | |
| 200127P | Black Toner (OEM# CC530A) (3,500 Yield) | 913670 | CTG | \$145.15 |
| 200128P | Cyan Toner (OEM# CC531A) (2,800 Yield) | 913671 | CTG | \$143.05 |
| 200130P | Magenta Toner (OEM# CC533A) (2,800 Yield) | 913673 | CTG | \$143.05 |
| 200129P | Yellow Toner (OEM# CC532A) (2,800 Yield) | 913672 | CTG | \$143.05 |
| West Point Products - HP Color LJ CM3530/CP3525 Laser Supplies | | | | |
| 200198P | Black Toner (OEM# CE250A) (5,000 Yield) | 913685 | CTG | \$158.95 |
| 200197P | High Yield Black Toner (OEM# CE250X) (10,500 Yield) | 913684 | CTG | \$230.65 |
| 200199P | Cyan Toner (OEM# CE251A) (7,000 Yield) | 913686 | CTG | \$312.15 |
| 200201P | Magenta Toner (OEM# CE253A) (7,000 Yield) | 913688 | CTG | \$312.15 |
| 200200P | Yellow Toner (OEM# CE252A) (7,000 Yield) | 913687 | CTG | \$312.15 |
| West Point Products - HP Color LJ CM4540 Laser Supplies | | | | |
| 200489P | Black Toner (OEM# CE260A) (8,500 Yield) | 913692 | CTG | \$187.40 |
| 200528P | High Yield Black Toner (OEM# CE264X) (17,000 Yield) | 913856 | CTG | \$238.75 |
| 200529P | Cyan Toner (OEM# CF031A) (12,500 Yield) | 913857 | CTG | \$298.20 |
| 200530P | Magenta Toner (OEM# CF033A) (12,500 Yield) | 913858 | CTG | \$298.20 |
| 200531P | Yellow Toner (OEM# CF032A) (12,500 Yield) | 913859 | CTG | \$298.20 |
| West Point Products - HP Color LJ CP1020/CP1025nw; Pro 100 MFP M175nw; Pro 200 MFP M275nw Laser Supplies | | | | |
| 200578P | Black Toner (OEM# CE310A) (1,200 Yield) | 916611 | CTG | \$60.35 |
| 200579P | Cyan Toner (OEM# CE311A) (1,000 Yield) | 916612 | CTG | \$67.10 |
| 200580P | Magenta Toner (OEM# CE313A) (1,000 Yield) | 916613 | CTG | \$67.10 |
| 200581P | Yellow Toner (OEM# CE312A) (1,000 Yield) | 916619 | CTG | \$67.10 |
| West Point Products - HP Color LJ CP4005 Laser Supplies | | | | |
| 115527P | Black Toner (OEM# CB400A) (7,500 Yield) | 913642 | CTG | \$211.80 |
| 115528P | Cyan Toner (OEM# CB401A) (7,500 Yield) | 913643 | CTG | \$315.15 |
| 115530P | Magenta Toner (OEM# CB403A) (7,500 Yield) | 913645 | CTG | \$315.15 |
| 115529P | Yellow Toner (OEM# CB402A) (7,500 Yield) | 913644 | CTG | \$315.15 |
| West Point Products - HP Color LJ CP4025/CP4520/CP4525 Laser Supplies | | | | |
| 200489P | Black Toner (OEM# CE264X, CE260A) (8,500 Yield) | 913692 | CTG | \$187.40 |
| 200508P | High Yield Black Toner (OEM# CE260X) (17,000 Yield) (For CP4525 Model Only) | 913851 | CTG | \$296.40 |
| 200241P | Cyan Toner (OEM# CE261A) (11,000 Yield) | 913689 | CTG | \$339.65 |
| 200243P | Magenta Toner (OEM# CE263A) (11,000 Yield) | 913691 | CTG | \$339.65 |
| 200242P | Yellow Toner (OEM# CE262A) (11,000 Yield) | 913690 | CTG | \$339.65 |

All catalog content is subject to change.

| MFG# | Product Description | Part# | UOM | Retail |
|--|--|--------|-----|----------|
| WEST POINT PRODUCTS COMPATIBLES | | | | |
| West Point Products - HP Color LJ CP6015 Laser Supplies | | | | |
| 200319 | Black Toner (OEM# CB380A) (16,500 Yield) | 923300 | CTG | \$266.75 |
| 200320 | Cyan Toner (OEM# CB381A) (21,000 Yield) | 923301 | CTG | \$417.60 |
| 200321 | Magenta Toner (OEM# CB383A) (21,000 Yield) | 923302 | CTG | \$417.60 |
| 200322 | Yellow Toner (OEM# CB382A) (21,000 Yield) | 923303 | CTG | \$417.60 |
| West Point Products - HP Color LJ CP5525/Enterprise M750 Laser Supplies | | | | |
| 200573P | Black Toner (OEM# CE270A) (13,500 Yield) | 913875 | CTG | \$290.10 |
| 200574P | Cyan Toner (OEM# CE271A) (15,000 Yield) | 913876 | CTG | \$472.10 |
| 200575P | Magenta Toner (OEM# CE273A) (15,000 Yield) | 913877 | CTG | \$472.10 |
| 200576P | Yellow Toner (OEM# CE272A) (15,000 Yield) | 913878 | CTG | \$472.10 |
| West Point Products - HP Color LJ Enterprise Pro 300 M351/MFP M375nw/Pro 400 M451/MFP M475 Laser Supplies | | | | |
| 200558P | Black Toner (OEM# CE410A) (2,200 Yield) | 913866 | CTG | \$98.65 |
| 200559P | High Yield Black Toner (OEM# CE410X) (4,000 Yield) | 913867 | CTG | \$121.15 |
| 200560P | Cyan Toner (OEM# CE411A) (2,600 Yield) | 913868 | CTG | \$140.55 |
| 200561P | Magenta Toner (OEM# CE413A) (2,600 Yield) | 913869 | CTG | \$140.55 |
| 200562P | Yellow Toner (OEM# CE412A) (2,600 Yield) | 913870 | CTG | \$140.55 |
| West Point Products - HP Color LJ M551/Enterprise 500 MFP M575 Laser Supplies | | | | |
| 200563P | Black Toner (OEM# CE400A) (5,500 Yield) | 913694 | CTG | \$174.75 |
| 200564P | High Yield Black Toner (OEM# CE400X) (11,000 Yield) | 913695 | CTG | \$235.15 |
| 200565P | Cyan Toner (OEM# CE401A) (6,000 Yield) | 913696 | CTG | \$235.15 |
| 200566P | Magenta Toner (OEM# CE403A) (6,000 Yield) | 913697 | CTG | \$260.35 |
| 200567P | Yellow Toner (OEM# CE402A) (6,000 Yield) | 913698 | CTG | \$260.35 |
| West Point Products - HP LJ Pro 200 Color M251/M276 Laser Supplies | | | | |
| 200616P | Black Toner (OEM# CF210A) (1,600 Yield) | 923307 | CTG | \$80.15 |
| 200617P | High Yield Black Toner (OEM# CF210X) (2,400 Yield) | 923308 | CTG | \$101.80 |
| 200618P | Cyan Toner (OEM# CF211A) (1,800 Yield) | 923309 | CTG | \$100.45 |
| 200619P | Magenta Toner (OEM# CF213A) (1,800 Yield) | 923310 | CTG | \$100.45 |
| 200620P | Yellow Toner (OEM# CF212A) (1,800 Yield) | 923311 | CTG | \$100.45 |
| West Point Products - HP Color LJ Pro CM1415/CP1525 Laser Supplies | | | | |
| 200187P | Black Toner (OEM# CE320A) (2,000 Yield) | 913812 | CTG | \$83.30 |
| 200188P | Cyan Toner (OEM# CE321A) (1,300 Yield) | 913813 | CTG | \$79.25 |
| 200189P | Magenta Toner (OEM# CE323A) (1,300 Yield) | 913814 | CTG | \$79.25 |
| 200190P | Yellow Toner (OEM# CE322A) (1,300 Yield) | 913815 | CTG | \$79.25 |
| West Point Products - HP Color LJ Pro CP5220/CP5225 Laser Supplies | | | | |
| 200569P | Black Toner (OEM# CE740A) (7,000 Yield) | 913871 | CTG | \$177.45 |
| 200570P | Cyan Toner (OEM# CE741A) (7,300 Yield) | 913872 | CTG | \$312.60 |
| 200571P | Magenta Toner (OEM# CE743A) (7,300 Yield) | 913873 | CTG | \$312.60 |
| 200572P | Yellow Toner (OEM# CE742A) (7,300 Yield) | 913874 | CTG | \$312.60 |
| West Point Products - Lexmark Monochrome Laser Supplies (Continued on next page) | | | | |
| 200368P | E250D/E250DN/E350D/E352DN Toner (OEM# E250A11A, E250A21A) (3,500 Yield) (Compliant) | 922339 | CTG | \$147.10 |
| 200369P | E260D/E260DN/E360D/E360DN/E460DN/E460DW/E462DTN Toner (OEM# E260A11A, E260A21A) (3,500 Yield) (Compliant) | 922340 | CTG | \$149.45 |
| 200671P | E260D/E260DN/E360D/E360DN/E460DN/E460DW/E462DTN High Yield Toner (OEM# E260A11A, E260A21A) (9,000 Yield) (Compliant) | 922351 | CTG | \$258.10 |
| 200664P | E320/E322/E322N High Yield Toner (OEM# 08A0477, 08A0478) (6,000 Yield) (Compliant) | 922348 | CTG | \$191.80 |
| 200660P | E321/E323/E323N High Yield Toner (OEM# 12A7305, 12A7405) (6,000 Yield) (Compliant) | 922345 | CTG | \$192.85 |
| 200662P | E330/E332N/E332TN/E340/E342N High Yield Toner (OEM# 34015HA, 34035HA) (6,000 Yield) (Compliant) | 922346 | CTG | \$176.20 |
| 115203P | E350D/E352DN High Yield Toner (OEM# E352H11A, E352H21A) (11,000 Yield) (Compliant) | 922333 | CTG | \$265.95 |
| 117103P | E360D/E360DN/E460DN/E460DW/E462DTN/X463DE/X464DE/X466DE/X466DTE/X466DWE High Yield Toner (OEM# E360H11A, E360H21A) (9,000 Yield) (Compliant) | 922334 | CTG | \$258.10 |
| 115193P | E450 High Yield Toner (OEM# E450H11A, E450H21A) (11,000 Yield) (Compliant) | 922332 | CTG | \$132.00 |
| 200543P | E460DN/E460DW/E462DTN/X463DE/X464DE/X466DE/X466DTE/X466DWE/XS463DE Extra High Yield Toner (OEM# E460X11A, E460X21A) (15,000 Yield) (Compliant) | 922344 | CTG | \$253.30 |
| 100801P | Optra S 1250/1255/1620/1625/1650/1855/2420/2450/2455 High Yield Toner (OEM# 1382625, 1382925) (17,600 Yield) (Special Label Applications Compatible) (Compliant) | 922328 | CTG | \$322.70 |

| MFG# | Product Description | Part# | UOM | Retail |
|---|---|--------|-----|----------|
| WEST POINT PRODUCTS COMPATIBLES | | | | |
| West Point Products - Lexmark Monochrome Laser Supplies (Continued) | | | | |
| 110914P | Optra T610/T610N/T612/T614/T614N/T614NL/T616/T616N High Yield Toner (OEM# 12A5745, 12A5845, 12A5849) (25,000 Yield) (Special Label Applications Compatible) (Compliant) | 922329 | CTG | \$450.65 |
| 200665P | T420D/T420DN High Yield Toner (OEM# 12A7315, 12A7415) (10,000 Yield) (Compliant) | 922349 | CTG | \$274.55 |
| 200666P | T430/T430D/T430DN High Yield Toner (OEM# 12A8325, 12A8425) (12,000 Yield) (Compliant) | 922350 | CTG | \$299.20 |
| 111950P | T520/T520D/T520DN/T520N/T520N SBE/T522/T522DN/T522N/X520/X522/X522S High Yield Toner (OEM# 12A6735, 12A6835, 12A6839) (20,000 Yield) (Special Label Applications Compatible) (Compliant) | 922330 | CTG | \$461.00 |
| 200399P | T620/T620DN/T622IN/T620N/T622/T622DN/T622IN/T622N/X620E High Yield Toner (OEM# 12A6765, 12A6865, 12A6869) (30,000 Yield) (Special Label Applications Compatible) (Compliant) | 922341 | CTG | \$537.85 |
| 200240P | T630/T630DN/T630N/T630N VE/T630VE/T632/T632DTN/T632DTNF/T632N/T632TN/T634/T634DTN/T634DTNF/T634N/T634TN/X630/X632/X632E/X632S/X634DTE/X634E High Yield Toner (OEM# 12A7362, 12A7462, 12A7468) (21,000 Yield) (Special Label Applications Compatible) (Compliant) | 922338 | CTG | \$484.15 |
| 114639P | T632/T632DTN/T632DTNF/T632N/T632TN/T634/T634DTN/T634DTNF/T634N/T634TN/X632/X632E/X632S/X634DTE/X634E Extra High Yield Toner (OEM# 12A7365, 12A7465, 12A7469) (32,000 Yield) (Special Label Applications Compatible) (Compliant) | 922331 | CTG | \$518.55 |
| 200222P | T640/T640DN/T640DTN/T640N/T640TN/T642/T642DTN/T642N/T642TN/T644/T644DTN/T644N/T644TN/X642E/X644E/X646E/X646DTE/X646EF High Yield Toner (OEM# 64004HA, 64015HA, 64035HA) (21,000 Yield) (Special Label Applications Compatible) (Compliant) | 922336 | CTG | \$482.25 |
| 200223P | T644/T644DTN/T644N/T644TN/X644E/X646E/X646DTE/X646EF Extra High Yield Toner (OEM# 64404XA, 64415XA, 64435XA, X644X11A) (32,000 Yield) (Special Label Applications Compatible) (Compliant) | 922337 | CTG | \$516.85 |
| 200408P | T650DN/T650DTN/T650N/T652DN/T652DTN/T652N/T654DN/T654DTN/T654N/T656DNE/X651DE/X652DE/X654DE/X656DE/X656DTE/X658DE/X658DFE/X658DME/X658DTE/X658DTFE/X658DTME High Yield Toner (OEM# T650H04A, T650H11A, T650H21A, X651H04A, X651H11A, X651H21A) (25,000 Yield) (Special Label Applications Compatible) (Compliant) | 922342 | CTG | \$535.90 |
| 200491P | T654DN/T654DTN/T654N/T656DNE/X654DE/X656DE/X656DTE/X658DE/X658DFE/X658DME/X658DTE/X658DTFE/X658DTME Extra High Yield Toner (OEM# T654X04A, T654X11A, X654X04A, X654X11A, X654X21A) (36,000 Yield) (Special Label Applications Compatible) (Compliant) | 922343 | CTG | \$567.70 |
| 117472P | X264DN/X363DN/X364DN/X364DW High Yield Toner (OEM# X264H11G, X264H21G) (9,000 Yield) (Compliant) | 922335 | CTG | \$259.30 |
| 200663P | X340/X342 High Yield Toner (OEM# X340H11G) (6,000 Yield) (Compliant) | 922347 | CTG | \$194.05 |
| West Point Products - Samsung Monochrome Laser Supplies | | | | |
| 200605P | ML-1640/2240 Toner (OEM# MLT-D108S) (1,500 Yield) | 923304 | CTG | \$75.60 |
| 200523P | ML-1910/1915/2525/2525W/2580N; SCX-4600/4623F/4623FN/4623FW; SF-650/650P High Yield Toner (OEM# MLT-D105L) (2,500 Yield) | 913855 | CTG | \$87.50 |
| 200513P | ML-2855ND; SCX-4826FN/4828FN High Yield Toner (OEM# MLT-D209L) (5,000 Yield) | 913853 | CTG | \$113.00 |
| 200609P | ML-3310ND/3312ND/3710ND/3712DW/3712ND; SCX-4833FD/4835FR/4835FD/5637FR/5639FR/5737FR/5739FW/5739FW High Yield Toner (OEM# MLT-D205L) (5,000 Yield) | 923306 | CTG | \$138.50 |
| 200636P | ML-3310ND/3312ND/3710ND/3712DW/3712ND; SCX-4833FD/4835FR/4835FD/5637FR/5639FR/5737FR/5739FW/5739FW Extra High Yield Toner (OEM# MLT-D205L) (10,000 Yield) | 923312 | CTG | \$212.45 |
| 116996P | SCX-5635FN/5835FN High Yield Toner (OEM# MLT-D208L) (10,000 Yield) | 913720 | CTG | \$186.95 |
| West Point Products - Xerox WorkCentre 3210/3220 Laser Supplies | | | | |
| 117122P | High Yield Toner (OEM# 106R01486) (4,100 Yield) | 913725 | CTG | \$119.00 |
| XEROX COMPATIBLES | | | | |
| Xerox Replacement Cartridges - Brother DCP-1200/1400; HL-1230/1250/1270N/1435/1440/1450/1470N; IntelliFax 4100/4750/5750; MFC-8300/8500/8600/8700/9600/9700/9800 Mono Laser Supplies | | | | |
| 6R1420 | Toner (OEM# TN430) (3,100 Yield) | 904881 | CTG | \$53.99 |
| 6R1421 | High Yield Toner (OEM# TN460) (7,100 Yield) | 904882 | CTG | \$77.49 |
| 6R1422 | Drum (OEM# DR400) (20,000 Yield) | 904883 | EA | \$150.99 |
| Xerox Replacement Cartridges - Brother DCP-7020; IntelliFax 2820/2910/2920; HL-2040/2070N; MFC-7220/7225N/7420/7820N Mono Laser Supplies | | | | |
| 6R1415 | Toner (OEM# TN350) (2,600 Yield) | 904876 | CTG | \$59.99 |
| 6R1416 | Drum (OEM# DR350) (12,000 Yield) | 904877 | EA | \$109.99 |

| MFG# | Product Description | Part# | UOM | Retail |
|---|--|--------|-----|----------|
| XEROX COMPATIBLES | | | | |
| Xerox Replacement Cartridges - Brother DCP-7030/7040; HL-2140/2170W; MFC-7340/7345N/7440N/7840W Mono Laser Supplies | | | | |
| 106R2323 | Toner (OEM# TN360) (2,600 Yield) | 930281 | CTG | \$57.59 |
| 6R3205 | Drum Kit (OEM# DR360) (12,000 Yield) | 930297 | EA | \$88.39 |
| Xerox Replacement Cartridges - Brother DCP-7060/7065; IntelliFax-2840;2940; HL-2220/2230/2240/2270/2275/2280; MFC-7240/7360/7365/7460/7860 Mono Laser Supplies | | | | |
| 106R2634 | Toner (OEM# TN450) (2,600 Yield) | 930282 | CTG | \$61.64 |
| Xerox Replacement Cartridges - Brother DCP-8040/8045D; HL-5140/5150/5170DN; MFC-8120/8220/8440/8640D/8840 Mono Laser Supplies | | | | |
| 6R1423 | Toner (OEM# TN540) (3,700 Yield) | 904884 | CTG | \$68.99 |
| 6R1424 | High Yield Toner (OEM# TN570) (6,700 Yield) | 904885 | CTG | \$82.99 |
| 6R1425 | Drum (OEM# DR510) (20,000 Yield) | 904886 | EA | \$157.99 |
| Xerox Replacement Cartridges - Brother DCP-8060/8065DN; HL-5240/5250DN/5250DNT/5280DW; MFC-8460N/8660DN/8860DN/8870DW Mono Laser Supplies | | | | |
| 6R1417 | Toner (OEM# TN550) (3,800 Yield) | 904878 | CTG | \$69.99 |
| 6R1418 | High Yield Toner (OEM# TN580) (8,000 Yield) | 904879 | CTG | \$94.99 |
| 6R1419 | Drum (OEM# DR520) (25,000 Yield) | 904880 | EA | \$160.99 |
| Xerox Replacement Cartridges - Brother DCP-9040CN/9045CDN/HL-4040CDN/4040CN/4070CDW/MFC-9440CN/9450CDN/9840CDW Color Laser Supplies | | | | |
| 6R3028 | Black Toner (OEM# TN115BK) (5,300 Yield) | 913560 | CTG | \$102.49 |
| 6R3029 | Cyan Toner (OEM# TN115C) (4,800 Yield) | 913561 | CTG | \$143.49 |
| 6R3030 | Magenta Toner (OEM# TN115M) (4,800 Yield) | 913562 | CTG | \$143.49 |
| 6R3031 | Yellow Toner (OEM# TN115Y) (4,800 Yield) | 913563 | CTG | \$143.49 |
| Xerox Replacement Cartridges - HP LJ 4/4M/4+/4M+/5/5N/5M/5se Mono Laser Supplies | | | | |
| 6R903 | Toner (OEM# 92298A) (7,100 Yield) | 99871 | CTG | \$87.99 |
| 6R904 | High Yield Toner (OEM# 92298X) (9,300 Yield) | 103057 | CTG | \$107.00 |
| Xerox Replacement Cartridges - HP LJ 5si/8000/Mopier 240 Mono Laser Supplies | | | | |
| 6R906 | Toner (OEM# C3909A) (15,600 Yield) | 101389 | CTG | \$163.50 |
| 106R2142 | High Yield Toner (OEM# C3909A) (25,800 Yield) | 930268 | CTG | \$270.40 |
| Xerox Replacement Cartridges - HP LJ 1010/1012/1015/1018/1020/1022/3015/3030/3050/3052/3055/M1319 Mono Laser Supplies | | | | |
| 6R1414 | Toner (OEM# Q2612A) (3,000 Yield) | 903493 | CTG | \$81.99 |
| 106R2274 | High Yield Toner (OEM# Q2612A) (4,100 Yield) | 930277 | CTG | \$112.05 |
| Xerox Replacement Cartridges - HP LJ 1100/3200 Mono Laser Supplies | | | | |
| 6R927 | Toner (OEM# C4092A) (3,200 Yield) | 4994 | CTG | \$72.99 |
| Xerox Replacement Cartridges - HP LJ 1150 Mono Laser Supplies | | | | |
| 6R956 | Toner (OEM# Q2624X) (4,000 Yield) | 5502 | CTG | \$103.20 |
| Xerox Replacement Cartridges - HP LJ 1160/1320/3390 Mono Laser Supplies | | | | |
| 6R960 | Toner (OEM# Q5949A) (3,100 Yield) | 90237 | CTG | \$99.50 |
| Xerox Replacement Cartridges - HP LJ 1200/1220/3300/3310/3320/3330/3380 Mono Laser Supplies | | | | |
| 6R932 | Toner (OEM# C7115X) (4,200 Yield) | 2082 | CTG | \$88.99 |
| 106R2146 | Extended Yield Toner (OEM# C7115X) (7,700 Yield) | 930269 | CTG | \$163.15 |
| Xerox Replacement Cartridges - HP LJ 1300 Mono Laser Supplies | | | | |
| 6R957 | Toner (OEM# Q2613X) (6,900 Yield) | 5499 | CTG | \$103.20 |
| 6R3200 | Extended Yield Toner (OEM# Q2613X) (8,000 Yield) | 930293 | CTG | \$119.65 |
| Xerox Replacement Cartridges - HP LJ 1320/3390 Mono Laser Supplies | | | | |
| 6R1320 | Toner (OEM# Q5949X) (7,200 Yield) | 105207 | CTG | \$136.99 |
| 106R2284 | Extended Yield Toner (OEM# Q5949X) (9,000 Yield) | 930279 | CTG | \$171.24 |
| Xerox Replacement Cartridges - HP LJ 2100/2200 Mono Laser Supplies | | | | |
| 6R928 | Toner (OEM# C4096A) (6,400 Yield) | 4819 | CTG | \$123.45 |

| MFG# | Product Description | Part# | UOM | Retail |
|--|--|--------|-----|----------|
| XEROX COMPATIBLES | | | | |
| Xerox Replacement Cartridges - HP LJ 2300 Mono Laser Supplies | | | | |
| 6R936 | Toner (OEM# Q2610A) (7,100 Yield) | 5949 | CTG | \$138.99 |
| 6R3199 | Extended Yield Toner (OEM# Q2610A) (10,000 Yield) | 930292 | CTG | \$195.76 |
| Xerox Replacement Cartridges - HP LJ 2420/2430 Mono Laser Supplies | | | | |
| 6R961 | Toner (OEM# Q6511X) (13,700 Yield) | 18649 | CTG | \$232.35 |
| Xerox Replacement Cartridges - HP LJ 4000/4050 Mono Laser Supplies | | | | |
| 6R926 | Toner (OEM# C4127X) (11,900 Yield) | 103667 | CTG | \$137.75 |
| Xerox Replacement Cartridges - HP LJ 4100 Mono Laser Supplies | | | | |
| 6R933 | Toner (OEM# C8061X) (10,800 Yield) | 2081 | CTG | \$137.80 |
| 106R2147 | Extended Yield Toner (OEM# C8061X) (15,000 Yield) | 930270 | CTG | \$191.39 |
| Xerox Replacement Cartridges - HP LJ 4200 Mono Laser Supplies | | | | |
| 6R934 | Toner (OEM# Q1338A) (14,600 Yield) | 5944 | CTG | \$176.99 |
| 106R2273 | Universal Toner (OEM# Q1338A, Q1339A, Q5942X, Q5945A) (Yield is 23,000 in 4200; 24,000 in 4300/4345/M4345; 28,000 in 4250/4350) | 930276 | CTG | \$254.04 |
| Xerox Replacement Cartridges - HP LJ 4240/4250/4350 Mono Laser Supplies | | | | |
| 106R2338 | Toner (OEM# Q5942A) (11,700 Yield) | 905437 | CTG | \$151.73 |
| 6R959 | High Yield Toner (OEM# Q5942X) (22,200 Yield) (For Use in 4250/4350 Models Only) | 12335 | CTG | \$239.99 |
| 106R2273 | Universal Toner (OEM# Q1338A, Q1339A, Q5942X, Q5945A) (Yield is 23,000 in 4200; 24,000 in 4300/4345/M4345; 28,000 in 4250/4350) (For Use in 4250/4350 Models Only) | 930276 | CTG | \$254.04 |
| Xerox Replacement Cartridges - HP LJ 4300/4345/M4345 Mono Laser Supplies | | | | |
| 6R935 | Toner (OEM# Q1339A, Q5945A) (22,200 Yield) | 103670 | CTG | \$234.99 |
| 106R2273 | Universal Toner (OEM# Q1338A, Q1339A, Q5942X, Q5945A) (Yield is 23,000 in 4200; 24,000 in 4300/4345/M4345; 28,000 in 4250/4350) | 930276 | CTG | \$254.04 |
| Xerox Replacement Cartridges - HP LJ 5000/5100 Mono Laser Supplies | | | | |
| 6R925 | Toner (OEM# C4129X) (10,500 Yield) | 108152 | CTG | \$152.40 |
| Xerox Replacement Cartridges - HP LJ 5200 Mono Laser Supplies | | | | |
| 6R1389 | Toner (OEM# Q7516A) (16,100 Yield) | 903130 | CTG | \$190.99 |
| Xerox Replacement Cartridges - HP LJ 8100/8150/Mopier 320 Mono Laser Supplies | | | | |
| 6R929 | Toner (OEM# C4182X) (21,800 Yield) | 107931 | CTG | \$192.55 |
| Xerox Replacement Cartridges - HP LJ 9000/9040/9050/M9040/M9050 Mono Laser Supplies | | | | |
| 6R958 | Toner (OEM# C8543X) (33,500 Yield) | 10396 | CTG | \$261.85 |
| Xerox Replacement Cartridges - HP LJ M401/M425 Mono Laser Supplies | | | | |
| 6R3026 | Toner (OEM# CF280A) (2,900 Yield) | 913558 | CTG | \$134.03 |
| 6R3027 | High Yield Toner (OEM# CF280X) (7,000 Yield) | 913559 | CTG | \$230.75 |
| 6R3206 | Extended Yield Toner (OEM# CF280X) (10,000 Yield) | 930298 | CTG | \$329.64 |
| Xerox Replacement Cartridges - HP LJ M521/M525/P3010/P3015 Mono Laser Supplies | | | | |
| 106R01621 | Toner (OEM# CE255A) (8,200 Yield) | 100911 | CTG | \$143.25 |
| 106R01622 | High Yield Toner (OEM# CE255X) (13,500 Yield) | 100912 | CTG | \$222.75 |
| Xerox Replacement Cartridges - HP LJ M601/M602/M603/M4555 Mono Laser Supplies | | | | |
| 106R2631 | Toner (OEM# CE390A) (10,000 Yield) | 908569 | CTG | \$157.50 |
| 6R3202 | Extended Yield Toner (OEM# CE390A) (18,000 Yield) | 930294 | CTG | \$283.50 |
| 106R2632 | High Yield Toner (OEM# CE390X) (25,400 Yield) (For Use in M602/M603/M4555 Models Only) | 908571 | CTG | \$263.20 |
| 6R3203 | Extended Yield Toner (OEM# CE390X) (40,000 Yield) (For Use in M602/M603/M4555 Models Only) | 930295 | CTG | \$414.49 |
| Xerox Replacement Cartridges - HP LJ M1120/M1522/P1505 Mono Laser Supplies | | | | |
| 6R1430 | Toner (OEM# CB436A) (2,200 Yield) | 10101 | CTG | \$82.49 |
| 6R3197 | Extended Yield Toner (OEM# CB436A) (3,000 Yield) | 930290 | CTG | \$112.49 |

| MFG# | Product Description | Part# | UOM | Retail |
|---|---|--------|-----|----------|
| XEROX COMPATIBLES | | | | |
| Xerox Replacement Cartridges - HP LJ M1130/M1132/M1134/M1136/M1137/M1138/M1139/M1212/M1213/M1214/M1216/M1217/M1219/P1102 Mono Laser Supplies | | | | |
| 106R02156 | Toner (OEM# CE285A) (1,700 Yield) | 106883 | CTG | \$67.13 |
| Xerox Replacement Cartridges - HP LJ M1536/P1566/P1606 Mono Laser Supplies | | | | |
| 106R02157 | Toner (OEM# CE278A) (2,100 Yield) | 106882 | CTG | \$76.88 |
| Xerox Replacement Cartridges - HP LJ M2727/P2014/P2015 Mono Laser Supplies | | | | |
| 106R2339 | Toner (OEM# Q7553A) (3,700 Yield) | 905438 | CTG | \$81.90 |
| 6R1387 | Extended Yield Toner (OEM# Q7553X) (8,400 Yield) | 903128 | CTG | \$153.99 |
| 106R2293 | High Yield Toner (OEM# Q7553X) (10,000 Yield) | 930280 | CTG | \$183.32 |
| Xerox Replacement Cartridges - HP LJ M3027/M3035/P3005 Mono Laser Supplies | | | | |
| 6R1388 | Toner (OEM# Q7551X) (14,700 Yield) | 903129 | CTG | \$223.99 |
| 106R2154 | Extended Yield Toner (OEM# Q7551X) (18,300 Yield) | 930271 | CTG | \$278.84 |
| Xerox Replacement Cartridges - HP LJ P1005/P1006 Mono Laser Supplies | | | | |
| 6R1429 | Toner (OEM# CB435A) (1,500 Yield) | 10099 | CTG | \$74.99 |
| 6R3198 | Extended Yield Toner (OEM# CB435A) (2,300 Yield) | 930291 | CTG | \$114.98 |
| Xerox Replacement Cartridges - HP LJ P2035/P2055 Mono Laser Supplies | | | | |
| 6R1489 | Toner (OEM# CE505A) (3,000 Yield) | 25516 | CTG | \$87.99 |
| 6R3195 | Extended Yield Toner (OEM# CE505A) (4,000 Yield) | 930288 | CTG | \$117.32 |
| 6R1490 | High Yield Toner (OEM# CE505X) (7,400 Yield) (For Use in P2055 Only) | 25520 | CTG | \$159.99 |
| 6R3196 | Extended Yield Toner (OEM# CE505X) (9,750 Yield) (For Use in P2055 Only) | 930289 | CTG | \$210.80 |
| Xerox Replacement Cartridges - HP LJ P4014/P4015/P4515 Mono Laser Supplies | | | | |
| 6R1443 | Toner (OEM# CC364A) (11,700 Yield) | 19315 | CTG | \$172.49 |
| 106R2275 | Extended Yield Toner (OEM# CC364A) (18,000 Yield) | 930278 | CTG | \$265.37 |
| 6R1444 | High Yield Toner (OEM# CC364X) (26,100 Yield) (For Use in P4015/P4515 Only) | 100910 | CTG | \$300.36 |
| 6R3204 | Extended Yield Toner (OEM# CC364X) (40,000 Yield) (For Use in P4015/P4515 Only) | 930296 | CTG | \$460.32 |
| Xerox Replacement Cartridges - HP Color LJ 1500/2500/2550/2800 Laser Supplies | | | | |
| 6R1285 | Black Toner (OEM# C9700A, Q3960A) (5,000 Yield) | 18650 | CTG | \$101.10 |
| 6R1286 | Cyan Toner (OEM# C9701A, Q3961A) (4,200 Yield) | 18651 | CTG | \$118.30 |
| 6R1288 | Magenta Toner (OEM# C9703A, Q3963A) (4,200 Yield) | 18652 | CTG | \$118.30 |
| 6R1287 | Yellow Toner (OEM# C9702A, Q3962A) (4,200 Yield) | 18653 | CTG | \$118.30 |
| Xerox Replacement Cartridges - HP Color LJ 1600/2600/CM1015 MFP/CM1017 MFP Laser Supplies | | | | |
| 6R1410 | Black Toner (OEM# Q6000A) (3,200 Yield) | 903124 | CTG | \$90.00 |
| 6R1411 | Cyan Toner (OEM# Q6001A) (2,400 Yield) | 903125 | CTG | \$98.45 |
| 6R1412 | Magenta Toner (OEM# Q6003A) (2,400 Yield) | 903126 | CTG | \$98.45 |
| 6R1413 | Yellow Toner (OEM# Q6002A) (2,400 Yield) | 903127 | CTG | \$98.45 |
| Xerox Replacement Cartridges - HP Color LJ 3500/3550 Laser Supplies | | | | |
| 6R1289 | Black Toner (OEM# Q2670A) (6,500 Yield) | 90238 | CTG | \$160.70 |
| 6R1290 | Cyan Toner (OEM# Q2671A) (5,100 Yield) | 90239 | CTG | \$163.80 |
| 6R1292 | Magenta Toner (OEM# Q2673A) (5,100 Yield) | 90241 | CTG | \$163.80 |
| 6R1291 | Yellow Toner (OEM# Q2672A) (5,100 Yield) | 90240 | CTG | \$163.80 |
| Xerox Replacement Cartridges - HP Color LJ 3600 Laser Supplies | | | | |
| 6R1338 | Black Toner (OEM# Q6470A) (6,700 Yield) | 105236 | CTG | \$151.40 |
| 6R1339 | Cyan Toner (OEM# Q6471A) (4,900 Yield) | 105237 | CTG | \$143.90 |
| 6R1341 | Magenta Toner (OEM# Q6473A) (4,900 Yield) | 105239 | CTG | \$143.90 |
| 6R1340 | Yellow Toner (OEM# Q6472A) (4,900 Yield) | 105238 | CTG | \$143.90 |
| Xerox Replacement Cartridges - HP Color LJ 3800/CP3505 Laser Supplies | | | | |
| 6R1338 | Black Toner (OEM# Q6470A) (6,700 Yield) | 105236 | CTG | \$151.40 |
| 6R1343 | Cyan Toner (OEM# Q7581A) (6,800 Yield) | 105242 | CTG | \$186.90 |
| 6R1345 | Magenta Toner (OEM# Q7583A) (6,800 Yield) | 105250 | CTG | \$186.90 |
| 6R1344 | Yellow Toner (OEM# Q7582A) (6,800 Yield) | 105243 | CTG | \$186.90 |
| Xerox Replacement Cartridges - HP Color LJ 4600 Laser Supplies | | | | |
| 6R941 | Black Toner (OEM# C9720A) (10,800 Yield) | 10431 | CTG | \$177.00 |
| 6R942 | Cyan Toner (OEM# C9721A) (10,000 Yield) | 10432 | CTG | \$220.80 |
| 6R944 | Magenta Toner (OEM# C9723A) (10,000 Yield) | 10434 | CTG | \$220.80 |
| 6R943 | Yellow Toner (OEM# C9722A) (10,000 Yield) | 10433 | CTG | \$220.80 |

| MFG# | Product Description | Part# | UOM | Retail |
|--|---|--------|-----|----------|
| XEROX COMPATIBLES | | | | |
| Xerox Replacement Cartridges - HP Color LJ 4700 Laser Supplies | | | | |
| 6R1330 | Black Toner (OEM# Q5950A) (13,900 Yield) | 105227 | CTG | \$206.00 |
| 6R1331 | Cyan Toner (OEM# Q5951A) (13,100 Yield) | 105228 | CTG | \$278.30 |
| 6R1333 | Magenta Toner (OEM# Q5953A) (13,100 Yield) | 105230 | CTG | \$278.30 |
| 6R1332 | Yellow Toner (OEM# Q5952A) (13,100 Yield) | 105229 | CTG | \$278.30 |
| Xerox Replacement Cartridges - HP Color LJ 4730/CM4730 Laser Supplies | | | | |
| 6R3022 | Black Toner (OEM# Q6460A) (12,000 Yield) | 913554 | CTG | \$203.95 |
| 6R3023 | Cyan Toner (OEM# Q6461A) (12,000 Yield) | 913555 | CTG | \$439.53 |
| 6R3024 | Magenta Toner (OEM# Q6463A) (12,000 Yield) | 913556 | CTG | \$439.53 |
| 6R3025 | Yellow Toner (OEM# Q6462A) (12,000 Yield) | 913557 | CTG | \$439.53 |
| Xerox Replacement Cartridges - HP Color LJ 5500/5550 Laser Supplies | | | | |
| 6R1313 | Black Toner (OEM# C9730A) (14,900 Yield) | 94992 | CTG | \$242.00 |
| 6R1314 | Cyan Toner (OEM# C9731A) (12,800 Yield) | 94993 | CTG | \$346.50 |
| 6R1316 | Magenta Toner (OEM# C9733A) (12,800 Yield) | 94995 | CTG | \$346.50 |
| 6R1315 | Yellow Toner (OEM# C9732A) (12,800 Yield) | 94994 | CTG | \$346.50 |
| Xerox Replacement Cartridges - HP Color LJ CM4540 Laser Supplies | | | | |
| 6R3004 | Black Toner (OEM# CE264X) (17,000 Yield) | 913540 | CTG | \$265.00 |
| 6R3005 | Cyan Toner (OEM# CF031A) (12,500 Yield) | 913541 | CTG | \$331.00 |
| 6R3006 | Magenta Toner (OEM# CF033A) (12,500 Yield) | 913542 | CTG | \$331.00 |
| 6R3007 | Yellow Toner (OEM# CF032A) (12,500 Yield) | 913543 | CTG | \$331.00 |
| Xerox Replacement Cartridges - HP Color LJ CP1025/M175/M275 Laser Supplies | | | | |
| 106R2257 | Black Toner (OEM# CE310A) (1,200 Yield) | 930272 | CTG | \$53.60 |
| 106R2258 | Cyan Toner (OEM# CE311A) (1,000 Yield) | 930273 | CTG | \$59.60 |
| 106R2260 | Magenta Toner (OEM# CE313A) (1,000 Yield) | 930275 | CTG | \$59.60 |
| 106R2259 | Yellow Toner (OEM# CE312A) (1,000 Yield) | 930274 | CTG | \$59.60 |
| Xerox Replacement Cartridges - HP Color LJ CP1201/P1215/CP1510/CP1515n/CM1312MFP Laser Supplies | | | | |
| 6R1439 | Black Toner (OEM# CB540A) (2,500 Yield) | 16524 | CTG | \$76.99 |
| 6R1440 | Cyan Toner (OEM# CB541A) (1,400 Yield) | 16560 | CTG | \$70.99 |
| 6R1442 | Magenta Toner (OEM# CB543A) (1,400 Yield) | 16562 | CTG | \$70.99 |
| 6R1441 | Yellow Toner (OEM# CB542A) (1,400 Yield) | 16561 | CTG | \$70.99 |
| Xerox Replacement Cartridges - HP Color LJ CP1525 Laser Supplies | | | | |
| 106R02221 | Black Toner (OEM# CE320A) (2,100 Yield) | 106857 | CTG | \$64.75 |
| 106R02223 | Cyan Toner (OEM# CE321A) (1,300 Yield) | 106870 | CTG | \$66.00 |
| 106R02222 | Magenta Toner (OEM# CE323A) (1,300 Yield) | 106863 | CTG | \$66.00 |
| 106R02224 | Yellow Toner (OEM# CE322A) (1,300 Yield) | 106872 | CTG | \$66.00 |
| Xerox Replacement Cartridges - HP Color LJ CP2025/CM2320 Laser Supplies | | | | |
| 6R1485 | Black Toner (OEM# CC530A) (4,600 Yield) | 25510 | CTG | \$121.95 |
| 6R1486 | Cyan Toner (OEM# CC531A) (3,100 Yield) | 25511 | CTG | \$118.95 |
| 6R1487 | Magenta Toner (OEM# CC533A) (3,100 Yield) | 25513 | CTG | \$118.95 |
| 6R1488 | Yellow Toner (OEM# CC532A) (3,100 Yield) | 25512 | CTG | \$118.95 |
| Xerox Replacement Cartridges - HP Color LJ CP3525/CM3530 MFP Laser Supplies | | | | |
| 106R01583 | Black Toner (OEM# CE250A) (6,900 Yield) | 100123 | CTG | \$131.90 |
| 106R02137 | High Yield Black Toner (OEM# CE250X) (12,600 Yield) | 100135 | CTG | \$192.04 |
| 106R01584 | Cyan Toner (OEM# CE251A) (8,400 Yield) | 100141 | CTG | \$259.87 |
| 106R01586 | Magenta Toner (OEM# CE253A) (8,400 Yield) | 100153 | CTG | \$259.87 |
| 106R01585 | Yellow Toner (OEM# CE252A) (8,400 Yield) | 100151 | CTG | \$259.87 |
| Xerox Replacement Cartridges - HP Color LJ CP4005 Laser Supplies | | | | |
| 6R1326 | Black Toner (OEM# CB400A) (11,300 Yield) | 105212 | CTG | \$184.40 |
| 6R1327 | Cyan Toner (OEM# CB401A) (11,800 Yield) | 105213 | CTG | \$264.60 |
| 6R1329 | Magenta Toner (OEM# CB403A) (11,800 Yield) | 105225 | CTG | \$264.60 |
| 6R1328 | Yellow Toner (OEM# CB402A) (11,800 Yield) | 105224 | CTG | \$264.60 |
| Xerox Replacement Cartridges - HP Color LJ CP4525 Laser Supplies | | | | |
| 106R02185 | Black Toner (OEM# CE260A) (8,500 Yield) | 106841 | CTG | \$155.48 |
| 106R02220 | High Yield Black Toner (OEM# CE260X) (17,000 Yield) | 106842 | CTG | \$230.30 |
| 106R02217 | Cyan Toner (OEM# CE261A) (12,700 Yield) | 106847 | CTG | \$263.90 |
| 106R02218 | Magenta Toner (OEM# CE263A) (12,700 Yield) | 106853 | CTG | \$263.90 |
| 106R02219 | Yellow Toner (OEM# CE262A) (12,700 Yield) | 106856 | CTG | \$263.90 |

| MFG# | Product Description | Part# | UOM | Retail |
|--|---|--------|-----|----------|
| XEROX COMPATIBLES | | | | |
| Xerox Replacement Cartridges - HP Color LJ CP5225 Laser Supplies | | | | |
| 106R2261 | Black Toner (OEM# CE740A) (7,700 Yield) | 913568 | CTG | \$197.00 |
| 106R2262 | Cyan Toner (OEM# CE741A) (8,300 Yield) | 913569 | CTG | \$347.00 |
| 106R2264 | Magenta Toner (OEM# CE743A) (8,300 Yield) | 913571 | CTG | \$347.00 |
| 106R2263 | Yellow Toner (OEM# CE742A) (8,300 Yield) | 913570 | CTG | \$347.00 |
| Xerox Replacement Cartridges - HP Color LJ CP5525/Enterprise M750 Laser Supplies | | | | |
| 106R2265 | Black Toner (OEM# CE270A) (14,200 Yield) | 913572 | CTG | \$322.00 |
| 106R2266 | Cyan Toner (OEM# CE271A) (16,300 Yield) | 913573 | CTG | \$524.00 |
| 106R2268 | Magenta Toner (OEM# CE273A) (16,300 Yield) | 913575 | CTG | \$524.00 |
| 106R2267 | Yellow Toner (OEM# CE272A) (16,300 Yield) | 913574 | CTG | \$524.00 |
| Xerox Replacement Cartridges - HP Color LJ M251/M276 Laser Supplies | | | | |
| 6R3180 | Black Toner (OEM# CF210A) (1,600 Yield) | 930283 | CTG | \$71.20 |
| 6R3181 | High Yield Black Toner (OEM# CF210X) (2,400 Yield) | 930284 | CTG | \$90.40 |
| 6R3182 | Cyan Toner (OEM# CF211A) (1,800 Yield) | 930285 | CTG | \$89.20 |
| 6R3183 | Magenta Toner (OEM# CF213A) (1,800 Yield) | 930286 | CTG | \$89.20 |
| 6R3184 | Yellow Toner (OEM# CF212A) (1,800 Yield) | 930287 | CTG | \$89.20 |
| Xerox Replacement Cartridges - HP Color LJ M351/Pro 300 MFP M375nw/Pro 400 M451/Pro 400 MFP M475 Series Laser Supplies | | | | |
| 6R3013 | Black Toner (OEM# CE410A) (2,200 Yield) | 913549 | CTG | \$109.50 |
| 6R3014 | High Yield Black Toner (OEM# CE410X) (4,000 Yield) | 913550 | CTG | \$134.50 |
| 6R3015 | Cyan Toner (OEM# CE411A) (2,600 Yield) | 913551 | CTG | \$156.00 |
| 6R3016 | Magenta Toner (OEM# CE413A) (2,600 Yield) | 913552 | CTG | \$156.00 |
| 6R3017 | Yellow Toner (OEM# CE412A) (2,600 Yield) | 913553 | CTG | \$156.00 |
| Xerox Replacement Cartridges - HP Color LJ M551/Enterprise 500 MFP M570/M575 Series Laser Supplies | | | | |
| 6R3012 | Black Toner (OEM# CE400A) (5,500 Yield) | 913548 | CTG | \$194.00 |
| 6R3008 | High Yield Black Toner (OEM# CE400X) (11,000 Yield) | 913544 | CTG | \$261.00 |
| 6R3009 | Cyan Toner (OEM# CE401A) (6,000 Yield) | 913545 | CTG | \$289.00 |
| 6R3010 | Magenta Toner (OEM# CE403A) (6,000 Yield) | 913546 | CTG | \$289.00 |
| 6R3011 | Yellow Toner (OEM# CE402A) (6,000 Yield) | 913547 | CTG | \$289.00 |
| 500 SERIES COMPATIBLES | | | | |
| 500 Series - Brother DCP-1200/1400; HL-1030/1230/1240/1250/1270N/1435/1440/1450/1470N; MFC-8300/8500/8600/8700/9600/9700/9800/P2500; PPF-4100/4750/5750 Mono Laser Supplies | | | | |
| 500-TN460 | Toner (OEM# TN430, TN460) (6,000 Yield) | 6085 | CTG | \$69.00 |
| 500-DR400 | Drum (OEM# DR400) (20,000 Yield) | 502767 | EA | \$175.00 |
| 500 Series - Brother DCP-7020; FAX 2820/2920; HL-2040/2070N; MFC-7220/7225N/7420/7820N Mono Laser Supplies | | | | |
| 500-TN350 | Toner (OEM# TN350) (2,500 Yield) | 901399 | CTG | \$55.00 |
| 500-DR350 | Drum Unit (OEM# DR350) (12,000 Yield) | 502870 | EA | \$95.00 |
| 500 Series - Brother DCP-7030/7040; HL-2140/2170W; MFC-7340/7345N/7440N/7840W Mono Laser Supplies | | | | |
| 500-TN360 | High Yield Toner (OEM# TN360) (2,600 Yield) | 31430 | CTG | \$51.00 |
| 500-DR360 | Drum Unit (12,000 Yield) | 99779 | EA | \$75.00 |
| 500 Series - Brother DCP-7060/7065; HL-2230/2240D/2270DW/2280; IntelliFax 2840/2940; MFC-7240/7360/7460/7860 Mono Laser Supplies | | | | |
| 500-TN450 | High Yield Toner (OEM# TN450) (2,600 Yield) | 501914 | CTG | \$49.00 |
| 500 Series - Brother DCP-8040/8045D; HL-5140/5150/5170; MFC-8220/8440/8840 Mono Laser Supplies | | | | |
| 500-TN540 | Toner (OEM# TN540) (3,500 Yield) | 502726 | CTG | \$59.00 |
| 500-TN570 | High Yield Toner (OEM# TN570) (6,700 Yield) | 10200 | CTG | \$79.00 |
| 500-DR510 | Drum Unit (OEM# DR510) (20,000 Yield) | 502751 | EA | \$109.00 |
| 500 Series - Brother DCP-8060/8065DN; HL-5240/5250/5280DW; MFC-8460N/8860DN/8870DW Mono Laser Supplies | | | | |
| 500-TN550 | Toner (OEM# TN550) (3,500 Yield) | 16271 | CTG | \$59.00 |
| 500-TN580 | High Yield Toner (OEM# TN580) (7,000 Yield) | 502739 | CTG | \$65.00 |
| 500-DR520 | Drum Unit (OEM# DR520) (25,000 Yield) | 106234 | EA | \$119.00 |

| MFG# | Product Description | Part# | UOM | Retail |
|---|--|--------|-----|----------|
| 500 SERIES COMPATIBLES | | | | |
| 500 Series - Brother DCP-8080DN/8085DN/HL-5340D/5350DN/5370/5380DN; MFC-8480DN/8680DN/8690DW/8880DN/8890DW Mono Laser Supplies | | | | |
| 500-TN620 | Toner (OEM# TN620) (3,000 Yield) | 502936 | CTG | \$59.00 |
| 500-TN650 | High Yield Toner (OEM# TN650) (8,000 Yield) | 99778 | CTG | \$85.00 |
| 500-DR620 | Drum Unit (OEM# DR620) (25,000 Yield) | 103035 | EA | \$89.00 |
| 500 Series - Brother DCP-8110/8150/8155; HL-5440/5450/5470/6180; MFC-8510/8710/8910/8950 Mono Laser Supplies | | | | |
| 500-TN750 | High Yield Toner (OEM# TN750) (8,000 Yield) | 926082 | CTG | \$77.25 |
| 500 Series - Brother DCP-9040CN/9045CDN/HL-4040CDN/4040CN/4070CDW/ MFC-9440CN/9450CDN/9840CDW Color Laser Supplies | | | | |
| 500-TN115B | High Yield Black Toner (OEM# TN115BK) (5,000 Yield) | 508090 | EA | \$70.00 |
| 500-TN115C | High Yield Cyan Toner (OEM# TN115C) (4,000 Yield) | 508091 | EA | \$99.75 |
| 500-TN115M | High Yield Magenta Toner (OEM# TN115M) (4,000 Yield) | 508134 | EA | \$99.75 |
| 500-TN115Y | High Yield Yellow Toner (OEM# TN115Y) (4,000 Yield) | 508133 | EA | \$99.75 |
| 500 Series - Canon Monochrome Laser Supplies | | | | |
| 500-CRG128 | imageCLASS D530/D550/MF4412/MF4420/MF4450/MF4550/MF4570/MF4580/MF4770/ MF4880/MF4890; Faxphone L100/L190 (CRG-128) Toner (OEM# 3500B001AA) (2,100 Yield) (Contains Chip) | 926764 | CTG | \$109.00 |
| 500-FX3 | (FX3) LC4000/4500/L6000/75 Toner (OEM# 1557A002BA) (2,700 Yield) | 3430 | CTG | \$59.00 |
| 500-FX4 | (FX4) LC8500/9000/9500 Toner (OEM# 1558A002AA) (4,000 Yield) | 3429 | CTG | \$75.00 |
| 500-FX6 | (FX6) LC3170/3175 Toner (OEM# 1559A002AA) (5,000 Yield) | 3428 | CTG | \$101.00 |
| 500-FX7 | (FX7) LC710/720i/730i Toner (OEM# 7621A001AA) (4,500 Yield) | 5613 | CTG | \$82.00 |
| 500-FX8 | (FX8) LC510 Toner (OEM# 8955A001AA) (3,500 Yield) | 10196 | CTG | \$79.00 |
| 500-FX10 | (FX10) Faxphone L120/imageCLASS MF4150 Toner (104) (OEM# 0263B001BA) (2,000 Yield) | 105013 | CTG | \$63.00 |
| 500 Series - Canon Copier Supplies | | | | |
| 500-1491A002AA | (E31) (E40) PC 300/310/320/325/330/330L/400/420/425/430/530/550/710/720/735/ 740/745/770/775/790/795/920/921/940/941/950/980 Toner (OEM# 1491A002AA) (4,000 Yield) | 6083 | CTG | \$95.00 |
| 500-6812A001AA | (L50) PC 1060/1061/1080F Toner (OEM# 6812A001AA) (5,500 Yield) | 6084 | CTG | \$109.00 |
| 500-8489A001AA | (X25) imageCLASS MF3110/3240/5530/5550/5730/5750/5770 Toner (OEM# 8489A001AA) (2,500 Yield) | 901400 | CTG | \$65.00 |
| 500-0264B001AA | (106) (FX11) imageCLASS MF6530/6531/6540/6550/6560/6560cx/6580/6580cx Toner (OEM# 0264B001AA) (5,000 Yield) | 910667 | CTG | \$122.00 |
| 500 Series - Dell Monochrome Laser Supplies | | | | |
| 500-D1100 | 1100/1110 Toner (OEM# 310-6640) (2,000 Yield) | 16266 | CTG | \$55.00 |
| 500-D1720 | 1720/1720dn Toner (OEM# 310-8700, 310-8707) (6,000 Yield) | 16269 | CTG | \$99.00 |
| 500-D1720J | 1720/1720dn High Yield Toner (OEM# 310-8700, 310-8707) (11,000 Yield) | 16270 | CTG | \$169.00 |
| 500-D1815 | 1815dn High Yield Toner (OEM# 310-7945) (5,000 Yield) | 31429 | CTG | \$73.00 |
| 500-D2330 | 2330d/2330dn/2350d/2350dn Toner (OEM# 330-2650, 330-2666, 330-2667, PK941) (6,000 Yield) | 906397 | CTG | \$98.00 |
| 500-D2335 | 2335dn High Yield Toner (OEM# HX756, 330-2209) (6,000 Yield) (Contains Chip) | 926084 | CTG | \$131.25 |
| 500-D2355 | 2355dn High Yield Toner (OEM# YTVTC, 331-0611) (10,000 Yield) (Contains Chip) | 926083 | CTG | \$159.00 |
| 500-D3330HY | 3330dn High Yield Toner (OEM# 330-5206, 330-5207, C233R) (14,000 Yield) | 906403 | CTG | \$214.99 |
| 500-75P6961 | 5210n/5310n High Yield Toner (OEM# 341-2938) (21,000 Yield) | 91207 | CTG | \$199.00 |
| 500-D5330 | 5330dn High Yield Toner (OEM# 330-2045, NY313) (20,000 Yield) (Contains Chip) | 926763 | CTG | \$150.00 |
| 500-75P4303 | M5200n High Yield Toner (OEM# 310-4133) (21,000 Yield) | 13092 | CTG | \$279.00 |
| 500-D1500U | P1500 Toner (OEM# 310-3543, 310-3545) (6,000 Yield) | 107190 | CTG | \$125.00 |
| 500-D1700U | P1700/1700n/1710/1710n High Yield Toner (OEM# 310-5402, Y5009) (6,000 Yield) | 107195 | CTG | \$75.00 |
| 500-D2500U | S2500/2500 High Yield Toner (OEM# 310-3674) (10,000 Yield) | 107150 | CTG | \$149.00 |
| 500-75P4305 | W5300n Jumbo Toner (OEM# 310-4587) (32,000 Yield) | 17770 | CTG | \$289.00 |
| 500 Series - HP LJ 4/4M/4+/4M+/5/5N/5M/5Se Mono Laser Supplies | | | | |
| 500-92298A | Toner (EX) (OEM# 92298A) (6,800 Yield) | 3451 | CTG | \$85.00 |
| 500-92298X | Extended Yield Toner (EX) (OEM# 92298X) (11,000 Yield) | 5210 | CTG | \$105.00 |
| 500-92298M | MICR Toner (OEM# 92298A) (6,800 Yield) | 93848 | CTG | \$125.00 |
| 500 Series - HP LJ 5P/5MP/6P/6MP/6PXi/6PSE/6RE Mono Laser Supplies | | | | |
| 500-C3903A | Toner (VX) (OEM# C3903A) (4,000 Yield) | 3448 | CTG | \$59.00 |
| 500 Series - HP LJ 5L/6Lxi/6Lsf/3100 Mono Laser Supplies | | | | |
| 500-C3906A | Toner (AX) (OEM# C3906A) (2,500 Yield) | 3447 | CTG | \$50.00 |
| 500 Series - HP LJ 5Si/8000 Mono Laser Supplies | | | | |
| 500-C3909A | Toner (WX) (OEM# C3909A) (15,000 Yield) | 3444 | CTG | \$175.00 |
| 500-C3909X | Extended Yield Toner (WX) (OEM# C3909X) (25,000 Yield) | 900611 | CTG | \$250.00 |

| MFG# | Product Description | Part# | UOM | Retail |
|---|--|--------|-----|----------|
| 500 SERIES COMPATIBLES | | | | |
| 500 Series - HP LJ 1010/1012/1015/1018/1020/1022/3015/3020/3030/3050/3052/3055/M1319 Mono Laser Supplies | | | | |
| 500-Q2612A | Toner (OEM# Q2612A) (2,000 Yield) | 12915 | CTG | \$59.00 |
| 500-Q2612J | Extended Yield Toner (OEM# Q2612A) (4,000 Yield) | 900613 | CTG | \$99.00 |
| 500 Series - HP LJ 1100/3200 Mono Laser Supplies | | | | |
| 500-C4092A | Toner (OEM# C4092A) (2,500 Yield) | 3437 | CTG | \$50.00 |
| 500 Series - HP LJ 1150 Mono Laser Supplies | | | | |
| 500-Q2624X | Toner (OEM# Q2624X) (4,000 Yield) | 12916 | CTG | \$61.50 |
| 500-Q2624J | Extended Yield Toner (OEM# Q2624X) (7,000 Yield) | 35725 | CTG | \$129.00 |
| 500 Series - HP LJ 1160/1320/3390 Mono Laser Supplies | | | | |
| 500-Q5949A | Toner (OEM# Q5949A) (2,500 Yield) | 13219 | CTG | \$62.00 |
| 500-Q5949X | High Yield Toner (OEM# Q5949X) (6,000 Yield) (For Use in 1320/3390 Models Only) | 12918 | CTG | \$92.00 |
| 500-Q5949J | Extended Yield Toner (OEM# Q5949X) (9,000 Yield) (For Use in 1320/3390 Models Only) | 105704 | CTG | \$137.00 |
| 500-Q5949M | MICR Toner (OEM# Q5949A) (2,500 Yield) | 93864 | CTG | \$110.00 |
| 500 Series - HP LJ 1200/1220/3300/3310/3320/3330/3380 Mono Laser Supplies | | | | |
| 500-C7115X | Toner (OEM# C7115X) (3,500 Yield) | 2569 | CTG | \$77.00 |
| 500-C7115J | Extended Yield Toner (OEM# C7115X) (7,000 Yield) | 904807 | CTG | \$109.00 |
| 500-C7115M | MICR Toner (OEM# C7115A) (2,500 Yield) | 93862 | CTG | \$119.00 |
| 500 Series - HP LJ 1300 Mono Laser Supplies | | | | |
| 500-Q2613A | Toner (OEM# Q2613A) (2,500 Yield) | 17771 | CTG | \$69.00 |
| 500-Q2613X | High Yield Toner (OEM# Q2613X) (4,000 Yield) | 6433 | CTG | \$79.00 |
| 500-Q2613J | Extended Yield Toner (OEM# Q2613X) (8,000 Yield) | 35724 | CTG | \$89.00 |
| 500 Series - HP LJ 2100/2200 Mono Laser Supplies | | | | |
| 500-C4096A | Toner (OEM# C4096A) (5,000 Yield) | 3436 | CTG | \$79.00 |
| 500-C4096J | Extended Yield Toner (OEM# C4096A) (7,000 Yield) | 904806 | CTG | \$105.00 |
| 500 Series - HP LJ 2300 Mono Laser Supplies | | | | |
| 500-Q2610A | Toner (OEM# Q2610A) (6,000 Yield) | 6082 | CTG | \$99.00 |
| 500-Q2610J | Extended Yield Toner (OEM# Q2610A) (10,000 Yield) | 904808 | CTG | \$149.00 |
| 500-Q2610M | MICR Toner (OEM# Q2610A) (6,000 Yield) | 93865 | CTG | \$199.00 |
| 500 Series - HP LJ 2420/2430 Mono Laser Supplies | | | | |
| 500-Q6511X | Toner (OEM# Q6511X) (12,000 Yield) | 12919 | CTG | \$155.00 |
| 500 Series - HP LJ 4000/4050 Mono Laser Supplies | | | | |
| 500-C4127X | Toner (OEM# C4127X) (10,000 Yield) | 3435 | CTG | \$125.00 |
| 500-C4127J | Extended Yield Toner (OEM# C4127X) (15,000 Yield) | 17767 | CTG | \$170.00 |
| 500-C4127M | MICR Toner (OEM# C4127A) (6,000 Yield) | 93867 | CTG | \$159.00 |
| 500 Series - HP LJ 4100 Mono Laser Supplies | | | | |
| 500-C8061X | Toner (OEM# C8061X) (10,000 Yield) | 2942 | CTG | \$109.00 |
| 500-C8061XX | Extended Yield Toner (OEM# C8061X) (15,000 Yield) | 508135 | EA | \$125.00 |
| 500-C8061M | MICR Toner (OEM# C8061X) (10,000 Yield) | 93871 | CTG | \$199.00 |
| 500 Series - HP LJ 4200 Mono Laser Supplies | | | | |
| 500-Q1338A | Toner (OEM# Q1338A) (12,000 Yield) | 12545 | CTG | \$129.00 |
| 500-Q5942XUJ | Universal Extended Yield Toner (OEM# Q1338A, Q1339A, Q5942X, Q5945A) (22,000-28,000 Yield) | 105016 | CTG | \$229.00 |
| 500-Q1338M | MICR Toner (OEM# Q1338A) (13,500 Yield) | 93875 | CTG | \$279.00 |
| 500 Series - HP LJ 4240/4250/4350 Mono Laser Supplies | | | | |
| 500-Q5942A | Toner (OEM# Q5942A) (10,000 Yield) | 23165 | CTG | \$110.00 |
| 500-Q5942X | High Yield Toner (OEM# Q5942X) (20,000 Yield) (For Use in 4250/4350 Models Only) | 10394 | CTG | \$189.00 |
| 500-Q5942XUJ | Universal Extended Yield Toner (OEM# Q1338A, Q1339A, Q5942X, Q5945A) (22,000-28,000 Yield) (Yield Varies By Device) (For Use in 4250/4350 Models Only) | 105016 | CTG | \$229.00 |
| 500-Q5942M | High Yield MICR Toner (OEM# Q5942X) (20,000 Yield) (For Use in 4250/4350 Models Only) | 93879 | CTG | \$295.00 |
| 500 Series - HP LJ 4300 Mono Laser Supplies | | | | |
| 500-Q1339A | Toner (OEM# Q1339A) (18,000 Yield) | 12549 | CTG | \$175.00 |
| 500-Q5942XUJ | Universal Extended Yield Toner (OEM# Q1338A, Q1339A, Q5942X, Q5945A) (22,000-28,000 Yield) | 105016 | CTG | \$229.00 |

All catalog content is subject to change.

| MFG# | Product Description | Part# | UOM | Retail |
|---|---|--------|-----|----------|
| 500 SERIES COMPATIBLES | | | | |
| 500 Series - HP LJ 4345/M4345 Mono Laser Supplies | | | | |
| 500-Q5945A | Toner (OEM# Q5945A) (18,000 Yield) | 12917 | CTG | \$159.00 |
| 500-Q5942XUJ | Universal Extended Yield Toner (OEM# Q1338A, Q1339A, Q5942X, Q5945A) (22,000-28,000 Yield) | 105016 | CTG | \$229.00 |
| 500 Series - HP LJ 5000/5100 Mono Laser Supplies | | | | |
| 500-C4129X | Toner (OEM# C4129X) (10,000 Yield) | 3434 | CTG | \$119.00 |
| 500 Series - HP LJ 5200/M5025/M5035 Mono Laser Supplies | | | | |
| 500-Q7516AU | Toner (OEM# Q7516A, Q7570A) (15,000 Yield) | 901403 | CTG | \$139.00 |
| 500 Series - HP LJ 8100/8150/Mopier 320 Mono Laser Supplies | | | | |
| 500-C4182X | Toner (OEM# C4182X) (20,000 Yield) | 3433 | CTG | \$149.00 |
| 500-C4182M | MICR Toner (OEM# C4182X) (20,000 Yield) | 93873 | CTG | \$249.00 |
| 500 Series - HP LJ 9000/9040/9050/M9040/M9050 Mono Laser Supplies | | | | |
| 500-C8543X | Toner (OEM# C8543X) (30,000 Yield) | 1129 | CTG | \$239.00 |
| 500-C8543J | Extended Yield Toner (OEM# C8543X) (40,000 Yield) | 29180 | CTG | \$289.00 |
| 500-C8543M | MICR Toner (OEM# C8543X) (30,000 Yield) | 93880 | CTG | \$450.00 |
| 500 Series - HP LJ M125/M127/M201/M225 Mono Laser Supplies | | | | |
| 500-CF283A | Toner (OEM# CF283A) (1,500 Yield) (Contains Chip) | 926762 | CTG | \$109.00 |
| 500 Series - HP LJ M401/M425 Mono Laser Supplies | | | | |
| 500-CF280A | Toner (OEM# CF280A) (2,700 Yield) (Contains Chip) | 910645 | CTG | \$77.25 |
| 500-CF280X | High Yield Toner (OEM# CF280X) (6,900 Yield) (Contains Chip) | 910646 | CTG | \$131.25 |
| 500-CF280XX | Extended Yield Toner (OEM# CF280X) (10,000 Yield) (Contains Chip) | 914966 | CTG | \$150.00 |
| 500-81551-001 | High Yield MICR Toner (OEM# CF280X) (6,800 Yield) | 915890 | CTG | \$206.25 |
| 500 Series - HP LJ M521/M525/P3010/P3015 Mono Laser Supplies | | | | |
| 500-CE255A | Toner (OEM# CE255A) (6,000 Yield) | 91476 | CTG | \$109.00 |
| 500-CE255X | High Yield Toner (OEM# CE255X) (12,500 Yield) | 91477 | CTG | \$169.00 |
| 500-CE255XM | High Yield MICR Toner (OEM# CE255X) (12,500 Yield) | 99910 | CTG | \$299.00 |
| 500 Series - HP LJ M601/M602/M603/M4555 Mono Laser Supplies | | | | |
| 500-CE390A | Toner (OEM# CE390A) (10,000 Yield) | 906348 | CTG | \$131.25 |
| 500-CE390AJ | Extended Yield Toner (OEM# CE390A) (18,000 Yield) | 906349 | CTG | \$212.40 |
| 500-CE390X | High Yield Toner (OEM# CE390X) (24,000 Yield) (For Use in M602/M603/M4555 Models Only) | 502594 | CTG | \$189.00 |
| 500-CE390XJ | Extended Yield Toner (OEM# CE390X) (40,000 Yield) (For Use in M602/M603/M4555 Models Only) | 505522 | CTG | \$249.00 |
| 500-CE390AM | MICR Toner (OEM# CE390A) (10,000 Yield) (Contains Chip) | 926100 | CTG | \$229.00 |
| 500-CE390XM | High Yield MICR Toner (OEM# CE390X) (24,000 Yield) (Contains Chip) (For Use in M602/M603/M4555 Models Only) | 926101 | CTG | \$389.00 |
| 500 Series - HP LJ M712/M725 Mono Laser Supplies | | | | |
| 500-CF214A | Toner (OEM# CF214A) (10,000 Yield) (Contains Chip) | 926760 | CTG | \$199.00 |
| 500-CF214X | High Yield Toner (OEM# CF214X) (17,500 Yield) (Contains Chip) | 926761 | CTG | \$249.00 |
| 500 Series - HP LJ M806/M830 Mono Laser Supplies | | | | |
| 500-CF325X | High Yield Toner (OEM# CF325X) (34,500 Yield) (Contains Chip) | 930654 | CTG | \$258.00 |
| 500 Series - HP LJ M1130/M1132/M1134/M1136/M1137/M1138/M1139/M1212/M1213/M1214/M1216/M1217/M1219/P1102 Mono Laser Supplies | | | | |
| 500-CE285A | Toner (OEM#CE285A) (1,600 Yield) | 96154 | CTG | \$49.00 |
| 500 Series - HP LJ M1522/P1505 Mono Laser Supplies | | | | |
| 500-CB436A | Toner (OEM# CB436A) (2,000 Yield) | 904515 | CTG | \$59.00 |
| 500-CB436J | Extended Yield Toner (OEM# CB436A) (3,000 Yield) | 101694 | CTG | \$79.00 |
| 500 Series - HP LJ M1536/P1566/P1606 Mono Laser Supplies | | | | |
| 500-CE278A | Toner (OEM# CE278A) (2,100 Yield) | 96153 | CTG | \$59.00 |
| 500 Series - HP LJ M2727/P2014/P2015 Mono Laser Supplies | | | | |
| 500-Q7553A | Toner (OEM# Q7553A) (3,000 Yield) | 96807 | CTG | \$65.00 |
| 500-Q7553X | High Yield Toner (OEM# Q7553X) (7,000 Yield) | 96809 | CTG | \$119.00 |
| 500-Q7553J | Extended Yield Toner (OEM# Q7553X) (10,000 Yield) | 105711 | CTG | \$150.00 |
| 500-Q7553M | MICR Toner (OEM# Q7553A) (3,000 Yield) | 901402 | CTG | \$149.00 |

| MFG# | Product Description | Part# | UOM | Retail |
|---|---|--------|-----|----------|
| 500 SERIES COMPATIBLES | | | | |
| 500 Series - HP LJ M3027/M3035/P3005 Mono Laser Supplies | | | | |
| 500-Q7551A | Toner (OEM# Q7551A) (6,500 Yield) | 96805 | CTG | \$109.00 |
| 500-Q7551X | High Yield Toner (OEM# Q7551X) (13,000 Yield) | 96806 | CTG | \$180.00 |
| 500-Q7551XX | Extended Yield Toner (OEM# Q7551X) (18,000 Yield) | 701627 | CTG | \$220.00 |
| 500-Q7551M | MICR Toner (OEM# Q7551X) (13,000 Yield) | 901401 | CTG | \$299.00 |
| 500 Series - HP LJ P1005/P1006 Mono Laser Supplies | | | | |
| 500-CB435A | Toner (OEM# CB435A) (1,500 Yield) | 904514 | CTG | \$55.00 |
| 500-CB435J | Extended Yield Toner (OEM# CB435A) (2,300 Yield) | 101693 | CTG | \$69.00 |
| 500 Series - HP LJ P2035/P2055 Mono Laser Supplies | | | | |
| 500-CE505A | Toner (OEM# CE505A) (2,300 Yield) | 17610 | CTG | \$69.00 |
| 500-CE505AJ | Extended Yield Toner (OEM# CE505A) (4,000 Yield) | 101696 | CTG | \$99.00 |
| 500-CE505X | High Yield Toner (OEM# CE505X) (6,500 Yield) (For Use in P2055 Only) | 17611 | CTG | \$119.00 |
| 500-CE505XJ | Extended Yield Toner (OEM# CE505X) (9,750 Yield) (For Use in P2055 Only) | 101697 | CTG | \$136.50 |
| 500-CE505AM | MICR Toner (OEM# CE505A) (2,300 Yield) | 31427 | CTG | \$129.00 |
| 500-CE505XM | High Yield MICR Toner (OEM# CE505X) (6,500 Yield) (For Use in P2055 Only) | 31428 | CTG | \$189.00 |
| 500 Series - HP LJ P4014/P4015/P4515 Mono Laser Supplies | | | | |
| 500-CC364A | Toner (OEM# CC364A) (10,000 Yield) | 3510 | CTG | \$129.00 |
| 500-CC364AJ | Extended Yield Toner (OEM# CC364A) (18,000 Yield) | 19279 | CTG | \$209.00 |
| 500-CC364X | High Yield Toner (OEM# CC364X) (24,000 Yield) (For Use in P4015/P4515 Models Only) | 3514 | CTG | \$219.00 |
| 500-CC364XJ | Extended Yield Toner (OEM# CC364X) (40,000 Yield) (For Use in P4015/P4515 Models Only) | 105702 | CTG | \$345.00 |
| 500-CC364M | MICR Toner (OEM# CC364A) (10,000 Yield) | 21397 | CTG | \$229.00 |
| 500-CC364XM | High Yield MICR Toner (OEM# CC364X) (24,000 Yield) (For Use in P4015/P4515 Models Only) | 502865 | CTG | \$389.00 |
| 500 Series - HP Color LJ 1500/2500/2550/2800/2820/2830/2840 Laser Supplies | | | | |
| 500-C9700A | Black Toner (OEM# C9700A, Q3960A) (5,000 Yield) | 19017 | CTG | \$69.00 |
| 500-C9701A | Cyan Toner (OEM# C9701A, Q3961A) (4,000 Yield) | 19018 | CTG | \$84.75 |
| 500-C9703A | Magenta Toner (OEM# C9703A, Q3963A) (4,000 Yield) | 19020 | CTG | \$84.75 |
| 500-C9702A | Yellow Toner (OEM# C9702A, Q3962A) (4,000 Yield) | 19019 | CTG | \$84.75 |
| 500 Series - HP Color LJ 1600/2600n/2605/CM1015/CM1017 MFP Laser Supplies | | | | |
| 500-Q6000A | Black Toner (OEM# Q6000A) (2,500 Yield) | 98361 | CTG | \$64.00 |
| 500-Q6001A | Cyan Toner (OEM# Q6001A) (2,000 Yield) | 98362 | CTG | \$69.00 |
| 500-Q6003A | Magenta Toner (OEM# Q6003A) (2,000 Yield) | 98371 | CTG | \$69.00 |
| 500-Q6002A | Yellow Toner (OEM# Q6002A) (2,000 Yield) | 98367 | CTG | \$69.00 |
| 500 Series - HP Color LJ 3500/3550 Laser Supplies | | | | |
| 500-Q2670A | Black Toner (OEM# Q2670A) (6,000 Yield) | 18674 | CTG | \$111.00 |
| 500-Q2671A | Cyan Toner (OEM# Q2671A) (4,000 Yield) | 18675 | CTG | \$111.00 |
| 500-Q2673A | Magenta Toner (OEM# Q2673A) (4,000 Yield) | 18677 | CTG | \$111.00 |
| 500-Q2672A | Yellow Toner (OEM# Q2672A) (4,000 Yield) | 18676 | CTG | \$111.00 |
| 500 Series - HP Color LJ 3600 Laser Supplies | | | | |
| 500-Q6470A | Black Toner (OEM# Q6470A) (6,000 Yield) | 92074 | CTG | \$110.00 |
| 500-Q6471A | Cyan Toner (OEM# Q6471A) (4,000 Yield) | 92075 | CTG | \$109.00 |
| 500-Q6473A | Magenta Toner (OEM# Q6473A) (4,000 Yield) | 92077 | CTG | \$109.00 |
| 500-Q6472A | Yellow Toner (OEM# Q6472A) (4,000 Yield) | 92076 | CTG | \$109.00 |
| 500 Series - HP Color LJ 3700 Laser Supplies | | | | |
| 500-Q2670A | Black Toner (OEM# Q2670A) (6,000 Yield) | 18674 | CTG | \$111.00 |
| 500-Q2681A | Cyan Toner (OEM# Q2681A) (6,000 Yield) | 102170 | CTG | \$135.00 |
| 500-Q2683A | Magenta Toner (OEM# Q2683A) (6,000 Yield) | 102177 | CTG | \$135.00 |
| 500-Q2682A | Yellow Toner (OEM# Q2682A) (6,000 Yield) | 102176 | CTG | \$135.00 |
| 500 Series - HP Color LJ 3800/CP3505 Laser Supplies | | | | |
| 500-Q6470A | Black Toner (OEM# Q6470A) (6,000 Yield) | 92074 | CTG | \$110.00 |
| 500-Q7581A | Cyan Toner (OEM# Q7581A) (6,000 Yield) | 92078 | CTG | \$160.00 |
| 500-Q7583A | Magenta Toner (OEM# Q7583A) (6,000 Yield) | 92080 | CTG | \$160.00 |
| 500-Q7582A | Yellow Toner (OEM# Q7582A) (6,000 Yield) | 92079 | CTG | \$160.00 |
| 500 Series - HP Color LJ 4600/4650 Laser Supplies | | | | |
| 500-C9720A | Black Toner (OEM# C9720A) (9,000 Yield) | 12188 | CTG | \$129.00 |
| 500-C9721A | Cyan Toner (OEM# C9721A) (8,000 Yield) | 12189 | CTG | \$169.00 |
| 500-C9723A | Magenta Toner (OEM# C9723A) (8,000 Yield) | 12191 | CTG | \$169.00 |
| 500-C9722A | Yellow Toner (OEM# C9722A) (8,000 Yield) | 12190 | CTG | \$169.00 |

| MFG# | Product Description | Part# | UOM | Retail |
|--|---|--------|-----|----------|
| 500 SERIES COMPATIBLES | | | | |
| 500 Series - HP Color LJ 4700 Laser Supplies | | | | |
| 500-Q5950A | Black Toner (OEM# Q5950A) (11,000 Yield) | 101840 | CTG | \$139.00 |
| 500-Q5951A | Cyan Toner (OEM# Q5951A) (10,000 Yield) | 101841 | CTG | \$175.00 |
| 500-Q5953A | Magenta Toner (OEM# Q5953A) (10,000 Yield) | 101843 | CTG | \$175.00 |
| 500-Q5952A | Yellow Toner (OEM# Q5952A) (10,000 Yield) | 101842 | CTG | \$175.00 |
| 500 Series - HP Color LJ 4730 Laser Supplies | | | | |
| 500-Q6460A | Black Toner (OEM# Q6460A) (12,000 Yield) | 31432 | CTG | \$125.00 |
| 500-Q6461A | Cyan Toner (OEM# Q6461A) (12,000 Yield) | 31433 | CTG | \$195.00 |
| 500-Q6463A | Magenta Toner (OEM# Q6463A) (12,000 Yield) | 31435 | CTG | \$195.00 |
| 500-Q6462A | Yellow Toner (OEM# Q6462A) (12,000 Yield) | 31434 | CTG | \$195.00 |
| 500 Series - HP Color LJ 5500/5550 Laser Supplies | | | | |
| 500-C9730A | Black Toner (OEM# C9730A) (13,000 Yield) (Contains Chip) | 18678 | CTG | \$175.00 |
| 500-C9731A | Cyan Toner (OEM# C9731A) (12,000 Yield) (Contains Chip) | 18679 | CTG | \$250.00 |
| 500-C9733A | Magenta Toner (OEM# C9733A) (12,000 Yield) (Contains Chip) | 18681 | CTG | \$250.00 |
| 500-C9732A | Yellow Toner (OEM# C9732A) (12,000 Yield) (Contains Chip) | 18680 | CTG | \$250.00 |
| 500 Series - HP Color LJ CM1312 MFP/CP1215/CP1515/CP1518 Laser Supplies | | | | |
| 500-CB540A | Black Toner (OEM# CB540A) (2,200 Yield) | 17612 | CTG | \$59.00 |
| 500-CB541A | Cyan Toner (OEM# CB541A) (1,400 Yield) | 17613 | CTG | \$55.00 |
| 500-CB543A | Magenta Toner (OEM# CB543A) (1,400 Yield) | 17615 | CTG | \$55.00 |
| 500-CB542A | Yellow Toner (OEM# CB542A) (1,400 Yield) | 17614 | CTG | \$55.00 |
| 500 Series - HP Color LJ CM1415/CP1525 Laser Supplies | | | | |
| 500-CE320A | Black Toner (OEM# CE320A) (2,000 Yield) | 96157 | CTG | \$59.00 |
| 500-CE321A | Cyan Toner (OEM# CE321A) (1,300 Yield) | 96158 | CTG | \$59.00 |
| 500-CE323A | Magenta Toner (OEM# CE323A) (1,300 Yield) | 96160 | CTG | \$59.00 |
| 500-CE322A | Yellow Toner (OEM# CE322A) (1,300 Yield) | 96159 | CTG | \$59.00 |
| 500 Series - HP Color LJ CM2320/CP2025 Laser Supplies | | | | |
| 500-CC530A | Black Toner (OEM# CC530A) (3,500 Yield) | 21393 | CTG | \$89.00 |
| 500-CC531A | Cyan Toner (OEM# CC531A) (2,800 Yield) | 21394 | CTG | \$89.00 |
| 500-CC533A | Magenta Toner (OEM# CC533A) (2,800 Yield) | 21396 | CTG | \$89.00 |
| 500-CC532A | Yellow Toner (OEM# CC532A) (2,800 Yield) | 21395 | CTG | \$89.00 |
| 500 Series - HP Color LJ CM3530 MFP/CP3525 Laser Supplies | | | | |
| 500-CE250A | Black Toner (OEM# CE250A) (5,000 Yield) | 94137 | CTG | \$105.00 |
| 500-CE250X | High Yield Black Toner (OEM# CE250X) (10,500 Yield) | 94138 | CTG | \$149.00 |
| 500-CE251A | Cyan Toner (OEM# CE251A) (7,000 Yield) | 94140 | CTG | \$199.00 |
| 500-CE253A | Magenta Toner (OEM# CE253A) (7,000 Yield) | 94148 | CTG | \$199.00 |
| 500-CE252A | Yellow Toner (OEM# CE252A) (7,000 Yield) | 94149 | CTG | \$199.00 |
| 500 Series - HP Color LJ CM4540/CP4025/CP4525 Laser Supplies | | | | |
| 500-CE260A | Black Toner (OEM# CE260A) (8,500 Yield) | 96650 | CTG | \$112.50 |
| 500-CE260X | High Yield Black Toner (OEM# CE260X) (17,000 Yield) (For Use in CP4525 Models Only) | 105314 | CTG | \$179.00 |
| 500-CE261A | Cyan Toner (OEM# CE261A, CF031A) (11,000 Yield) | 96651 | CTG | \$209.00 |
| 500-CE263A | Magenta Toner (OEM# CE263A, CF033A) (11,000 Yield) | 96653 | CTG | \$209.00 |
| 500-CE262A | Yellow Toner (OEM# CE262A, CF032A) (11,000 Yield) | 96652 | CTG | \$209.00 |
| 500 Series - HP Color LJ CP1025nw/M175nw Laser Supplies | | | | |
| 500-CE310A | Black Toner (OEM# CE310A) (1,200 Yield) | 701765 | CTG | \$42.50 |
| 500-CE311A | Cyan Toner (OEM# CE311A) (1,000 Yield) | 701766 | CTG | \$44.20 |
| 500-CE313A | Magenta Toner (OEM# CE313A) (1,000 Yield) | 800004 | CTG | \$44.20 |
| 500-CE312A | Yellow Toner (OEM# CE312A) (1,000 Yield) | 800003 | CTG | \$44.20 |
| 500 Series - HP Color LJ CP4005 Laser Supplies | | | | |
| 500-CB400A | Black Toner (OEM# CB400A) (7,500 Yield) | 101853 | CTG | \$139.00 |
| 500-CB401A | Cyan Toner (OEM# CB401A) (7,500 Yield) | 101854 | CTG | \$189.00 |
| 500-CB403A | Magenta Toner (OEM# CB403A) (7,500 Yield) | 101856 | CTG | \$189.00 |
| 500-CB402A | Yellow Toner (OEM# CB402A) (7,500 Yield) | 101855 | CTG | \$189.00 |
| 500 Series - HP Color LJ CP5225 Laser Supplies | | | | |
| 500-CE740A | Black Toner (OEM# CE740A) (7,000 Yield) | 908306 | CTG | \$114.75 |
| 500-CE741A | Cyan Toner (OEM# CE741A) (7,300 Yield) | 908307 | CTG | \$202.50 |
| 500-CE743A | Magenta Toner (OEM# CE743A) (7,300 Yield) | 908309 | CTG | \$202.50 |
| 500-CE742A | Yellow Toner (OEM# CE742A) (7,300 Yield) | 908308 | CTG | \$202.50 |

| MFG# | Product Description | Part# | UOM | Retail |
|--|--|--------|-----|----------|
| 500 SERIES COMPATIBLES | | | | |
| 500 Series - HP Color LJ CP5525/Enterprise M750 Laser Supplies | | | | |
| 500-CE270A | Black Toner (OEM# CE270A) (13,500 Yield) | 908292 | CTG | \$208.50 |
| 500-CE271A | Cyan Toner (OEM# CE271A) (15,000 Yield) | 908293 | CTG | \$339.75 |
| 500-CE273A | Magenta Toner (OEM# CE273A) (15,000 Yield) | 908295 | CTG | \$339.75 |
| 500-CE272A | Yellow Toner (OEM# CE272A) (15,000 Yield) | 908294 | CTG | \$339.75 |
| 500 Series - HP LJ Enterprise 500 Color M551/MFP M575/Pro 500 Color MFP M570 Laser Supplies | | | | |
| 500-CE400A | Black Toner (OEM# CE400A) (5,500 Yield) | 908296 | CTG | \$112.50 |
| 500-CE400X | High Yield Black Toner (OEM# CE400X) (11,000 Yield) | 908297 | CTG | \$150.00 |
| 500-CE401A | Cyan Toner (OEM# CE401A) (6,000 Yield) | 908298 | CTG | \$168.00 |
| 500-CE403A | Magenta Toner (OEM# CE403A) (6,000 Yield) | 908300 | CTG | \$168.00 |
| 500-CE402A | Yellow Toner (OEM# CE402A) (6,000 Yield) | 908299 | CTG | \$168.00 |
| 500 Series - HP LJ Pro Color M176/M177 Laser Supplies | | | | |
| 500-CF350A | Black Toner (OEM# CF350A) (1,300 Yield) (Contains Chip) | 926102 | CTG | \$50.00 |
| 500-CF351A | Cyan Toner (OEM# CF351A) (1,000 Yield) (Contains Chip) | 926103 | CTG | \$50.00 |
| 500-CF353A | Magenta Toner (OEM# CF353A) (1,000 Yield) (Contains Chip) | 926105 | CTG | \$50.00 |
| 500-CF352A | Yellow Toner (OEM# CF352A) (1,000 Yield) (Contains Chip) | 926104 | CTG | \$50.00 |
| 500 Series - HP LJ Pro 200 Color M251/MFP M276 Laser Supplies | | | | |
| 500-CF210A | Black Toner (OEM# CF210A) (1,600 Yield) | 915891 | CTG | \$50.25 |
| 500-CF210X | High Yield Black Toner (OEM# CF210X) (2,400 Yield) | 915892 | CTG | \$65.75 |
| 500-CF211A | Cyan Toner (OEM# CF211A) (1,800 Yield) | 915893 | CTG | \$63.75 |
| 500-CF213A | Magenta Toner (OEM# CF213A) (1,800 Yield) | 915895 | CTG | \$63.75 |
| 500-CF212A | Yellow Toner (OEM# CF212A) (1,800 Yield) | 915894 | CTG | \$63.75 |
| 500 Series - HP LJ Pro 300 MFP M375nw/Pro 400 M451/Pro 400 MFP M475 Laser Supplies | | | | |
| 500-CE410A | Black Toner (OEM# CE410A) (2,200 Yield) | 908301 | CTG | \$61.50 |
| 500-CE410X | High Yield Black Toner (OEM# CE410X) (4,000 Yield) | 908302 | CTG | \$77.25 |
| 500-CE411A | Cyan Toner (OEM# CE411A) (2,600 Yield) | 908303 | CTG | \$87.75 |
| 500-CE413A | Magenta Toner (OEM# CE413A) (2,600 Yield) | 908305 | CTG | \$87.75 |
| 500-CE412A | Yellow Toner (OEM# CE412A) (2,600 Yield) | 908304 | CTG | \$87.75 |
| 500 Series - IBM Monochrome Laser Supplies | | | | |
| 500-28P2494 | InfoPrint 1120/1125 High Yield Toner (OEM# 28P2494) (20,000 Yield) | 91206 | CTG | \$199.00 |
| 500-28P2010 | InfoPrint 1130/1140 High Yield Toner (OEM# 28P2010) (30,000 Yield) | 6086 | CTG | \$249.00 |
| 500-75P4303 | InfoPrint 1332/1352/1372 High Yield Toner (OEM# 75P4303) (21,000 Yield) | 13092 | CTG | \$279.00 |
| 500-75P4305 | InfoPrint 1352/1372 Jumbo Toner (OEM# 75P4305) (32,000 Yield) | 17770 | CTG | \$289.00 |
| 500-75P6961 | InfoPrint 1532/1552/1572 High Yield Toner (OEM# 75P6961) (21,000 Yield) | 91207 | CTG | \$199.00 |
| 500-75P6963 | InfoPrint 1532/1552/1570/1572 Extra High Yield Toner (OEM# 74P6963) (32,000 Yield) | 19432 | CTG | \$299.00 |
| 500 Series - Samsung Monochrome Laser Supplies | | | | |
| 500-ML1710D3 | ML-1710/1740/1750; SCX-4016/4116/4216F; SF-560/565P Toner (OEM# ML-1710D3, SCX-4216D3) (3,000 Yield) | 13216 | CTG | \$65.00 |
| 500-D105L | ML-1910/1915/2525/2525W/2545/2580N; SCX-4600/4623F/4623FW; SF-650/650P High Yield Toner (OEM# MLT-D105L) (2,500 Yield) (Contains Chip) | 915054 | CTG | \$60.00 |
| 500 Series - Source Technologies ST9530/ST9550 MICR Supplies | | | | |
| 500-ST9530 | ST9530/9550 High Yield MICR Toner (OEM# STI-204063H) (15,000 Yield) | 91417 | CTG | \$299.00 |
| 500 Series - Xerox Phaser 3600 Mono Laser Supplies | | | | |
| 500-106R01371 | High Yield Toner (OEM# 106R01371) (14,000 Yield) (Contains Chip) | 922843 | CTG | \$189.00 |
| 500 Series - Xerox Phaser 4500 Mono Laser Supplies | | | | |
| 500-113R00657 | High Yield Toner (OEM# 113R00657) (18,000 Yield) | 98237 | CTG | \$239.00 |

The smart choice to keep your printers in working condition.

- Refurbished HP and Lexmark parts offer up to **50% in savings**
- 1-year warranty, same as OEM parts

We are your source for refurbished printer parts.

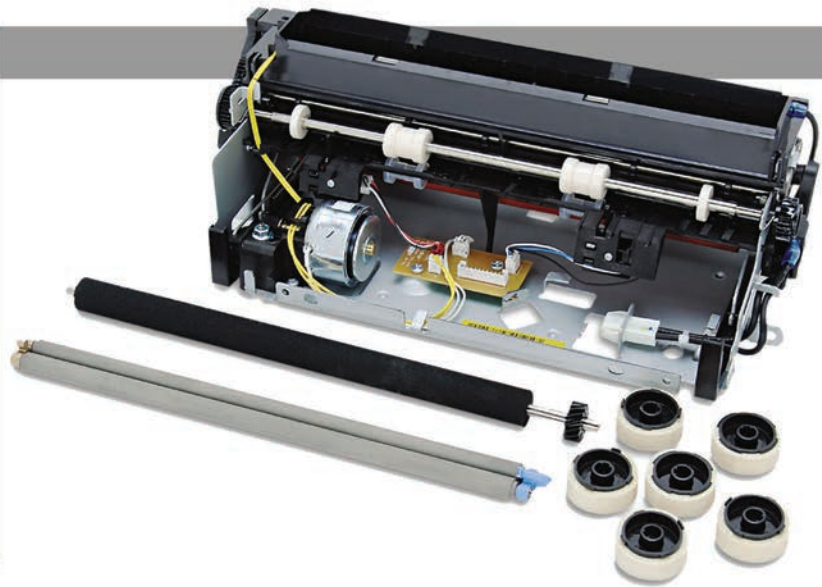

HP COMPATIBLE PARTS

HP LJ 4+/4M+ Refurbished & Aftermarket Parts

| | | | | |
|--------------|--|--------|----|---------|
| RG5-0879-REF | Refurbished Fuser Assembly (OEM# RG5-0879) (200,000 Yield) | 99310 | EA | \$57.77 |
| RF5-0349-AFT | Aftermarket Transfer Roller (OEM# RF5-0349) | 929911 | EA | \$6.49 |

HP LJ 5/5M/5N/5SE Refurbished & Aftermarket Parts

| | | | | |
|------------------|---|--------|----|---------|
| C3916-69001-REF | Refurbished Maintenance Kit (Includes Fuser Assembly, Separation Pad, Transfer Roller, Tray 1, 2 and 3 Pickup Rollers, Instructions) (OEM# C3916) (200,000 Yield) | 99313 | EA | \$72.98 |
| RG5-0879-REF | Refurbished Fuser Assembly (OEM# RG5-0879) (200,000 Yield) | 99310 | EA | \$57.77 |
| RF5-0349-AFT | Aftermarket Transfer Roller (OEM# RF5-0349) | 929911 | EA | \$6.49 |
| RB1-6730-000-AFT | Aftermarket Multipurpose Tray 1 Feed Roller (OEM# RB1-6730-000) | 929909 | EA | \$1.47 |
| RB1-7911-AFT | Aftermarket Tray 2 Pickup Roller (OEM# RB1-7911) | 923973 | EA | \$1.52 |

HP LJ 6 Refurbished & Aftermarket Parts

| | | | | |
|--------------|--|-------|----|---------|
| RG5-0879-REF | Refurbished Fuser Assembly (OEM# RG5-0879) (200,000 Yield) | 99310 | EA | \$57.77 |
|--------------|--|-------|----|---------|

HP LJ 5si/8000/Mopier 240 Refurbished & Aftermarket Parts

| | | | | |
|------------------|--|--------|----|----------|
| C3971-67902-REF | Refurbished Maintenance Kit (Includes Fuser Assembly, 8 Feed/Separation Rollers, Transfer Roller) (OEM# C3971) (350,000 Yield) | 99382 | EA | \$118.60 |
| RG5-4447-REF | Refurbished Fuser Assembly (OEM# RG5-4447-000) (350,000 Yield) | 99283 | EA | \$103.39 |
| RF5-1835-AFT | Aftermarket Pickup Roller (OEM# RF5-1835-000) | 923995 | EA | \$0.66 |
| RF5-2708-000-AFT | Aftermarket Pickup Roller for Optional 2 x 500-Sheet Drawer (OEM# RF5-2708) | 924000 | EA | \$0.38 |
| RF5-1834-AFT | Aftermarket Feed Roller (OEM# RF5-1834-000) | 923994 | EA | \$0.33 |
| RB1-6730-000-AFT | Aftermarket Multipurpose Tray 1 Feed Roller (OEM# RB1-6730-000) | 929909 | EA | \$1.47 |
| RF5-1455-000-AFT | Aftermarket Multipurpose Tray 1 Assembly Separation Pad (OEM# RF5-1455-000) | 929912 | EA | \$2.31 |

HP LJ 1000/1200/1220/3300 MFP/3310/3320 MFP/3330 MFP Refurbished & Aftermarket Parts

| | | | | |
|----------------|--|--------|----|---------|
| RG9-1493-REF | Refurbished Fuser Assembly (OEM# RG9-1493-000) (100,000 Yield) | 99442 | EA | \$64.62 |
| SLEEVE1300-AFT | Aftermarket Fuser Film Sleeve (OEM# LJ1200-FILM) | 924066 | EA | \$4.77 |
| RG9-1483-AFT | Aftermarket Transfer Roller (OEM# RG9-1483) | 924018 | EA | \$0.47 |
| RF0-1008-AFT | Aftermarket Pickup Roller (OEM# RF0-1008) | 923992 | EA | \$1.11 |
| RF0-1014-AFT | Aftermarket Separation Pad (OEM# RF0-1014) | 923993 | EA | \$1.74 |

| MFG# | Product Description | Part# | UOM | Retail |
|---|---|--------|-----|----------|
| HP COMPATIBLE PARTS | | | | |
| HP LJ 1010/1012/1015/1020/1022/3015/3020/3030/3050/M1005/M1319 | | | | |
| Refurbished & Aftermarket Parts | | | | |
| SLEEVE1300-AFT | Aftermarket Fuser Film Sleeve (OEM# LJ1200-FILM) | 924066 | EA | \$4.77 |
| RL1-0266-000CN-AFT | Aftermarket D-Shaped Pickup Roller (OEM# RL1-0266) | 924021 | EA | \$2.30 |
| HP LJ 1150/1300 Refurbished & Aftermarket Parts | | | | |
| RM1-0715-REF | Refurbished Fuser Assembly (100-127V) (OEM# RM1-0715) (100,000 Yield) | 924038 | EA | \$73.75 |
| SLEEVE3300-AFT | Aftermarket Fuser Film Sleeve (OEM# RG9-1493-FM3) | 924067 | EA | \$5.45 |
| RM1-0550-AFT | Aftermarket Transfer Roller (OEM# RM1-0545) | 924036 | EA | \$8.22 |
| RF0-1008-AFT | Aftermarket Pickup Roller (OEM# RF0-1008) | 923992 | EA | \$1.11 |
| RF0-1014-AFT | Aftermarket Separation Pad (OEM# RF0-1014) | 923993 | EA | \$1.74 |
| HP LJ 1160/1320 Refurbished & Aftermarket Parts | | | | |
| RM1-1289-080-REF | Refurbished Fuser Assembly (OEM# RM1-1289-080) (100,000 Yield) | 924042 | EA | \$71.46 |
| RL1-0540-AFT | Aftermarket Pickup Roller Assembly (OEM# RL1-0540) | 924022 | EA | \$0.81 |
| RM1-1298-AFT | Aftermarket Tray 2 Separation Pad Assembly (OEM# RM1-1298) | 924043 | EA | \$7.85 |
| HP LJ 2100 Refurbished & Aftermarket Parts | | | | |
| RG5-4132-REF | Refurbished Fuser Assembly (OEM# RG5-4132-170CN) (150,000 Yield) | 924012 | EA | \$77.55 |
| RG5-4164-AFT | Aftermarket Transfer Roller (OEM# RG5-4164) | 927414 | EA | \$10.04 |
| RB2-2891-AFT | Aftermarket D-Shaped Pickup Roller (OEM# RB2-2891) | 923981 | EA | \$0.60 |
| RB2-2835-AFT | Aftermarket Tray 1/Multipurpose Tray Separation Pad (OEM# RB2-2835) | 923980 | EA | \$1.52 |
| RB2-3008-AFT | Aftermarket Separation Pad for Optional 250-Sheet Tray (OEM# RB2-3008) | 923982 | EA | \$4.46 |
| HP LJ 2200 Refurbished & Aftermarket Parts | | | | |
| RG5-5559-REF | Refurbished Fuser Assembly (OEM# RG5-5559-000) (100,000 Yield) | 99282 | EA | \$91.23 |
| SLEEVEP3005-AFT | Aftermarket Fuser Film Sleeve (OEM# FILM3005) | 924071 | EA | \$10.04 |
| RB2-6304-AFT | Aftermarket Pickup Roller (OEM# RB2-6304-000CN) | 923985 | EA | \$0.81 |
| RB2-2891-AFT | Aftermarket D-Shaped Pickup Roller (OEM# RB2-2891) | 923981 | EA | \$0.60 |
| RB2-6349-AFT | Aftermarket Separation Pad (OEM# RB2-6349) | 923986 | EA | \$1.52 |
| RB2-3008-AFT | Aftermarket Separation Pad for Optional 250-Sheet Tray (OEM# RB2-3008) | 923982 | EA | \$4.46 |
| HP LJ 2300 Refurbished & Aftermarket Parts | | | | |
| U6180-60001-REF | Refurbished Maintenance Kit With Aftermarket Parts (Includes Fuser Assembly, Transfer Roller, Tray Pickup Rollers) (OEM# U6180-60001) (150,000 Yield) | 920232 | KIT | \$113.85 |
| RM1-0354-REF | Refurbished Fuser Assembly (OEM# RM1-0354-000) (100,000 Yield) | 99443 | EA | \$94.26 |
| SLEEVEP3005-AFT | Aftermarket Fuser Film Sleeve (OEM# FILM3005) | 924071 | EA | \$10.04 |
| RB2-6304-AFT | Aftermarket Pickup Roller (OEM# RB2-6304-000CN) | 923985 | EA | \$0.81 |
| RG5-5575-REF | Refurbished Tray 1 Assembly (OEM# RG5-5575) | 933836 | EA | \$59.97 |
| RC1-0939-AFT | Aftermarket Tray 1 Separation Pad (OEM# RC1-0939-000) | 923988 | EA | \$2.74 |
| RM1-0350-REF | Refurbished 250-Sheet Paper Tray (OEM# RM1-0350) | 933833 | EA | \$48.09 |
| RC1-0954-AFT | Aftermarket Tray 2 Separation Pad (OEM# RC1-0954) | 923989 | EA | \$2.35 |
| HP LJ 2410/2420/2430 Refurbished & Aftermarket Parts | | | | |
| H3980-60001-REO | Refurbished Maintenance Kit with OEM Rollers (Includes Fuser Assembly, Transfer Roller, Tray 1 Pickup Roller, Tray 2 Separation Pad and Pickup Roller, Gloves, Instructions) (OEM# H3980) (100,000 Yield) | 923917 | EA | \$148.25 |
| H3980-60001-REF | Refurbished Maintenance Kit (Includes Fuser Assembly, Transfer Roller, Tray 1 Pickup Roller, Tray 2 Separation Pad and Pickup Roller, Gloves, Instructions) (OEM# H3980) (100,000 Yield) | 99354 | EA | \$124.68 |
| RM1-1535-REF | Refurbished Fuser Assembly (OEM# RM1-1535-000) (100,000 Yield) | 99293 | EA | \$101.11 |
| SLEEVEP3005-AFT | Aftermarket Fuser Film Sleeve (OEM# FILM3005) | 924071 | EA | \$10.04 |
| RM1-1508-AFT | Aftermarket Transfer Roller Assembly (OEM# RM1-1508-000) | 924044 | EA | \$3.26 |
| RL1-0568-AFT | Aftermarket Tray 1/Multipurpose Tray D-Shaped Pickup Roller (OEM# RL1-0568) | 924024 | EA | \$0.91 |
| RL1-0542-AFT | Aftermarket Tray 2 Pickup Roller (OEM# RL1-0542) | 924023 | EA | \$0.81 |
| RC1-0939-AFT | Aftermarket Tray 1 Separation Pad (OEM# RC1-0939-000) | 923988 | EA | \$2.74 |
| RM1-1298-AFT | Aftermarket Tray 2 Separation Pad Assembly (OEM# RM1-1298) | 924043 | EA | \$7.85 |
| RU5-0377-AFT | Aftermarket 21 Tooth Gear (OEM# RU5-0377-000) | 924061 | EA | \$1.56 |
| RU5-0378-AFT | Aftermarket 20 Tooth Gear (OEM# RU5-0378-000) | 924074 | EA | \$1.56 |
| RU5-0379-AFT | Aftermarket 19 Tooth Gear (OEM# RU5-0379-000) | 924062 | EA | \$2.03 |
| Q6507-61006-REF | Refurbished Formatter Board-Network (OEM# Q6507-61006) | 930227 | EA | \$95.55 |
| Q2625-67951-AFT | Aftermarket 64MB 100-Pin DDR DIMM (OEM# Q2625-67951, Q7715-67951) | 929908 | EA | \$30.41 |
| HP LJ 3052/3055 Refurbished & Aftermarket Parts | | | | |
| RL1-0266-000CN-AFT | Aftermarket D-Shaped Pickup Roller (OEM# RL1-0266) | 924021 | EA | \$2.30 |
| 5851-3580-REF | Refurbished ADF Pickup Roller Assembly (OEM# 5851-3580) | 926572 | EA | \$29.56 |
| HP LJ 3330 Refurbished & Aftermarket Parts | | | | |
| SLEEVE3300-AFT | Aftermarket Fuser Film Sleeve (OEM# RG9-1493-FM3) | 924067 | EA | \$5.45 |
| RG9-1483-AFT | Aftermarket Transfer Roller (OEM# RG9-1483) | 924018 | EA | \$0.47 |
| RF0-1008-AFT | Aftermarket Pickup Roller (OEM# RF0-1008) | 923992 | EA | \$1.11 |

| MFG# | Product Description | Part# | UOM | Retail |
|---|--|--------|-----|----------|
| HP COMPATIBLE PARTS | | | | |
| HP LJ 3380 Refurbished & Aftermarket Parts | | | | |
| RG9-1483-AFT | Aftermarket Transfer Roller (OEM# RG9-1483) | 924018 | EA | \$0.47 |
| RF0-1008-AFT | Aftermarket Pickup Roller (OEM# RF0-1008) | 923992 | EA | \$1.11 |
| HP LJ 3390 Refurbished & Aftermarket Parts | | | | |
| RM1-1289-080-REF | Refurbished Fuser Assembly (OEM# RM1-1289-080) (100,000 Yield) | 924042 | EA | \$71.46 |
| RL1-0540-AFT | Aftermarket Pickup Roller Assembly (OEM# RL1-0540) | 924022 | EA | \$0.81 |
| 5851-3580-REF | Refurbished ADF Pickup Roller Assembly (OEM# 5851-3580) | 926572 | EA | \$29.56 |
| RM1-1298-AFT | Aftermarket Tray 2 Separation Pad Assembly (OEM# RM1-1298) | 924043 | EA | \$7.85 |
| HP LJ 4000/4050 Refurbished & Aftermarket Parts | | | | |
| C4118-67902-REO | Refurbished Maintenance Kit with OEM Rollers (Includes Fuser Assembly, Transfer Roller, 6 Pickup/Separation Rollers, Multipurpose Tray/Tray 1 Pickup Roller, Gloves, Instructions) (OEM# C4118) (200,000 Yield) | 923914 | EA | \$133.04 |
| C4118-67902-REF | Refurbished Maintenance Kit (Includes Fuser Assembly, Transfer Roller, 6 Pickup/Separation Rollers, Multipurpose Tray/Tray 1 Pickup Roller, Gloves, Instructions) (OEM# C4118) (200,000 Yield) | 99390 | EA | \$83.63 |
| RG5-2661-REF | Refurbished Fuser Assembly (OEM# RG5-2661-000) (200,000 Yield) | 99281 | EA | \$69.94 |
| SLEEVE4000-AFT | Aftermarket Fuser Film Sleeve (OEM# LJ4000-FILM, RG5-4290) | 924068 | EA | \$10.30 |
| RG5-4283-AFT | Aftermarket Transfer Roller Assembly (OEM# RG5-4283) | 924013 | EA | \$5.06 |
| C8056A-REF | Refurbished 500-Sheet Universal Paper Tray (OEM# C4125-67901) | 923947 | EA | \$73.75 |
| C8055-67901-REF | Refurbished 500-Sheet Paper Feeder and Tray/Cassette (OEM# C4124A, C8055-67901) | 929879 | EA | \$152.05 |
| RG5-2685-REF | Refurbished Feeder Control Board (OEM# RG5-2685) | 930665 | EA | \$75.67 |
| RF5-2484-AFT | Aftermarket Pickup Roller Assembly (OEM# RF5-2484) | 923997 | EA | \$5.40 |
| RG5-3718-AFT | Aftermarket Tray 1 Pickup Roller (OEM# RG5-3718) | 924011 | EA | \$1.01 |
| RB1-8865-AFT | Aftermarket Half-Moon-Shaped Pickup Roller (OEM# RB1-8865) | 923975 | EA | \$0.72 |
| RG5-2672-REF | Refurbished Pickup Drive Assembly (OEM# RG5-2672) | 924009 | EA | \$76.02 |
| RF5-1885-AFT | Aftermarket Tray 2/3/4 Feed Roller (OEM# RF5-1885) | 923996 | EA | \$0.60 |
| HP4000-SCNR-REF | Refurbished Scanner Assembly (OEM# C4118-69005) | 929890 | EA | \$55.52 |
| RG5-2673-REF | Refurbished Feeder Controller Board (OEM# RG5-2673) | 924010 | EA | \$34.41 |
| RG5-5281-AFT | Aftermarket Separation Pad Assembly (OEM# RG5-5281) | 924015 | EA | \$1.52 |
| RB1-8974-AFT | Aftermarket Separation Roller Clutch (OEM# RB1-8974-000CN) | 923977 | EA | \$10.04 |
| RS5-0922-AFT | Aftermarket 34 Tooth Gear (OEM# RS5-0922) | 924058 | EA | \$0.51 |
| HP LJ 4100/4100 MFP Refurbished & Aftermarket Parts | | | | |
| C8057-67901-REO | Refurbished Maintenance Kit with OEM Rollers (Includes Fuser Assembly, 3 Separation Rollers, Transfer Roller, 3 Feed Rollers, Pickup Roller, Instructions) (OEM# C8057) (200,000 Yield) | 923915 | EA | \$165.74 |
| C8057-67901-REF | Refurbished Maintenance Kit (Includes Fuser Assembly, 3 Separation Rollers, Transfer Roller, 3 Feed Rollers, Pickup Roller, Instructions) (OEM# C8057) (200,000 Yield) | 99314 | EA | \$120.12 |
| RG5-5063-REF | Refurbished Fuser Assembly (OEM# RG5-5063-000) (200,000 Yield) | 99284 | EA | \$98.83 |
| SLEEVE4100-AFT | Aftermarket Fuser Film Sleeve (OEM# LJ4100-FILM, RG5-5068) | 924069 | EA | \$9.13 |
| RG5-5295-AFT | Aftermarket Transfer Roller (OEM# RG5-5295) | 924016 | EA | \$5.34 |
| C8055-67901-REF | Refurbished 500-Sheet Paper Feeder and Tray/Cassette (OEM# C4124A, C8055-67901) | 929879 | EA | \$152.05 |
| RG5-3718-AFT | Aftermarket Tray 1 Pickup Roller (OEM# RG5-3718) | 924011 | EA | \$1.01 |
| RB1-8957-AFT | Aftermarket D-Shaped Pickup Roller (OEM# RB1-8957) | 923976 | EA | \$1.01 |
| RG5-5277-REF | Refurbished Tray 2 Pickup Assembly (OEM# RG5-5277) | 924014 | EA | \$70.17 |
| RF5-3114-AFT | Aftermarket Feed Roller (OEM# RF5-3114) | 924002 | EA | \$0.72 |
| RG5-2673-REF | Refurbished Feeder Controller Board (OEM# RG5-2673) | 924010 | EA | \$34.41 |
| RF5-3086-AFT | Aftermarket Separation Pad For Tray 1 Pickup Assembly (OEM# RF5-3086) | 924001 | EA | \$1.16 |
| RB1-8974-AFT | Aftermarket Separation Roller Clutch (OEM# RB1-8974-000CN) | 923977 | EA | \$10.04 |
| HP4100-POA-REF | Refurbished Paper Output Assembly (OEM# RG5-5094) | 933834 | EA | \$34.50 |
| HP4100-SCNR-REF | Refurbished Scanner Assembly (OEM# C8049-69005) | 929892 | EA | \$54.88 |
| RB1-8841-REF | Refurbished Toner Cartridge Access Panel (OEM# RB1-8841) | 923974 | EA | \$36.72 |
| HP LJ 4200 Refurbished & Aftermarket Parts <i>(Continued on next page)</i> | | | | |
| Q2429-67902-REO | Refurbished Maintenance Kit with OEM Rollers (Includes Fuser Assembly, Separation Roller, Transfer Roller, Feed Roller for Tray 1, 2 Feed Rollers for 500-Sheet Tray, 1 Feed Roller for 1,500-Sheet Tray) (OEM# Q2429) (200,000 Yield) | 923918 | EA | \$171.05 |
| Q2429-67902-REF | Refurbished Maintenance Kit (Includes Fuser Assembly, Separation Roller, Transfer Roller, Feed Roller for Tray 1, 2 Feed Rollers for 500-Sheet Tray, 1 Feed Roller for 1,500-Sheet Tray) (OEM# Q2429) (200,000 Yield) | 99403 | EA | \$139.88 |
| RM1-0013-REF | Refurbished Fuser Assembly (OEM# RM1-0013-000) (200,000 Yield) | 99294 | EA | \$120.12 |
| RM1-0699-AFT | Aftermarket Transfer Roller Assembly (OEM# LPR-1160-PN) | 924037 | EA | \$3.76 |
| Q2440B-REF | Refurbished 500-Sheet Paper Feeder and Tray (OEM# Q2440B) | 923965 | EA | \$226.55 |
| Q2444-67902-REF | Refurbished 1,500-Sheet High Capacity Feeder (OEM# Q2444B, Q2444-67902) | 933346 | EA | \$315.95 |
| RL1-0019-AFT | Aftermarket Tray 1 Pickup Roller (OEM# RL1-0019) | 924020 | EA | \$1.38 |
| RM1-0034-REF | Refurbished Pickup Assembly (OEM# RM1-0034) | 924031 | EA | \$46.77 |
| RM1-0036-AFT | Aftermarket Tray 2/500-Sheet Tray Pickup Roller (OEM# RM1-0036) | 924032 | EA | \$0.73 |
| RM1-0012-REF | Refurbished Feed Roller Assembly (OEM# RM1-0012) | 924030 | EA | \$32.22 |

| MFG# | Product Description | Part# | UOM | Retail |
|---|--|--------|-----|----------|
| HP COMPATIBLE PARTS | | | | |
| HP LJ 4200 Refurbished & Aftermarket Parts <i>(Continued)</i> | | | | |
| RM1-0037-AFT | Aftermarket Tray 2/500-Sheet Tray Feed Roller (OEM# RM1-0037-020) | 924033 | EA | \$0.66 |
| RL1-0007-AFT | Aftermarket Tray 1 Separation Pad (OEM# RL1-0007) | 924019 | EA | \$0.56 |
| RM1-1088KIT-AFT | Aftermarket Tray Repair Kit (Includes Rear Tray Assembly, Feed Roller Cover and Spring) (OEM# RM1-1088KIT) | 924039 | EA | \$36.26 |
| RM1-0033-REF | Refurbished Tray 2 Lifter Drive Assembly (OEM# RM1-0033) | 929915 | EA | \$16.53 |
| RM1-1088-SPR-AFT | Aftermarket 500-Sheet Tray Spring (OEM# RM1-1088SPR) | 924040 | EA | \$1.56 |
| RM1-0026-REF | Refurbished Paper Delivery/Output Roller Assembly (OEM# RM1-0026) | 933669 | EA | \$34.05 |
| RM1-0043-AFT | Aftermarket Swing Plate Assembly (OEM# RM1-0043) | 924034 | EA | \$5.77 |
| RM1-0043-GRB-AFT | Aftermarket Swing Plate Gear with Spacer (OEM# RM1-0043-GRB) | 924035 | EA | \$2.25 |
| RU5-0044-AFT | Aftermarket 51 Tooth White Swing Plate Assembly Gear (OEM# RU5-0044) | 924060 | EA | \$4.12 |
| HP4200-IBRD-REF | Refurbished Formatter Board (OEM# C9652-67902) | 933327 | EA | \$109.75 |
| RG1-4276-REF | Refurbished Control Panel Assembly (OEM# RG1-4276) | 917886 | EA | \$149.00 |
| Q2625-67951-AFT | Aftermarket 64MB 100-Pin DDR DIMM (OEM# Q2625-67951, Q7715-67951) | 929908 | EA | \$30.41 |
| HP LJ 4240/4250/4350 Refurbished & Aftermarket Parts | | | | |
| Q5421-67903-PREO | Refurbished Maintenance Kit with OEM Parts and OEM Sleeve (Includes Fuser Assembly, Separation Roller, Transfer Roller, Feed Roller for Tray 1, 2 Feed Rollers for 500-Sheet Tray, Instructions) (OEM# Q5421-67903) (225,000 Yield) | 923920 | EA | \$335.87 |
| Q5421-67903-REO | Refurbished Maintenance Kit with OEM Rollers (Includes Fuser Assembly, Separation Roller, Transfer Roller, Feed Roller for Tray 1, 2 Feed Rollers for 500-Sheet Tray, Instructions) (OEM# Q5421-67903) (225,000 Yield) | 923968 | EA | \$224.26 |
| Q5421-67903-REF | Refurbished Maintenance Kit (Includes Fuser Assembly, Separation Roller, Transfer Roller, Feed Roller for Tray 1, 2 Feed Rollers for 500-Sheet Tray, Instructions) (OEM# Q5421-67903) (225,000 Yield) | 99422 | EA | \$180.18 |
| RM1-1082-090-PREF | Refurbished Fuser Assembly with OEM Sleeve (OEM# RM1-1082-000) (225,000 Yield) | 923921 | EA | \$176.37 |
| RM1-1082-REF | Refurbished Fuser Assembly (OEM# RM1-1082-000) (225,000 Yield) | 99298 | EA | \$163.45 |
| SLEEVE4250-AFT | Aftermarket Fuser Film Sleeve (OEM# LJ4240-FILM) | 924070 | EA | \$33.45 |
| RC1-3324-ASM-AFT | Aftermarket Upper Fuser Roller Drive Gear (OEM# RC1-3324-000) (For Use in 4250/4350 Models) | 923990 | EA | \$1.94 |
| RM1-1110-AFT | Aftermarket Transfer Roller Assembly (OEM# RM1-1110) (225,000 Yield) | 924041 | EA | \$5.47 |
| Q2440B-REF | Refurbished 500-Sheet Paper Feeder and Tray (OEM# Q2440B) | 923965 | EA | \$226.55 |
| Q2444-67902-REF | Refurbished 1,500-Sheet High Capacity Feeder (OEM# Q2444B, Q2444-67902) | 933346 | EA | \$315.95 |
| RL1-0019-AFT | Aftermarket Tray 1 Pickup Roller (OEM# RL1-0019) | 924020 | EA | \$1.38 |
| RM1-0037-AFT | Aftermarket Tray 2/500-Sheet Tray Feed Roller (OEM# RM1-0037-020) | 924033 | EA | \$0.66 |
| RM1-0026-REF | Refurbished Paper Delivery/Output Roller Assembly (OEM# RM1-0026) | 933669 | EA | \$34.05 |
| RM1-0043-AFT | Aftermarket Swing Plate Assembly (OEM# RM1-0043) | 924034 | EA | \$5.77 |
| RM1-0043-GRB-AFT | Aftermarket Swing Plate Gear with Spacer (OEM# RM1-0043-GRB) | 924035 | EA | \$2.25 |
| HP4250-FBRD-REF | Refurbished Formatter Board (Network) (OEM# Q6505-69010) | 923955 | EA | \$121.37 |
| HP4250-CBRD-REF | Refurbished DC Controller Board (OEM# RM1-1108) | 933672 | EA | \$66.25 |
| Q2625-67951-AFT | Aftermarket 64MB 100-Pin DDR DIMM (OEM# Q2625-67951, Q7715-67951) | 929908 | EA | \$30.41 |
| HP LJ 4300 Refurbished & Aftermarket Parts | | | | |
| Q2436-67901-REO | Refurbished Maintenance Kit with OEM Rollers (Includes Fuser Assembly, Separation Roller, Transfer Roller, Feed Roller for Tray 1, 2 Feed Rollers for 500-Sheet Tray, 1 Feed Roller for 1,500-Sheet Tray, Instructions) (OEM# Q2436) (200,000 Yield) | 923919 | EA | \$187.02 |
| Q2436-67901-REF | Refurbished Maintenance Kit (Includes Fuser Assembly, Separation Roller, Transfer Roller, Feed Roller for Tray 1, 2 Feed Rollers for 500-Sheet Tray, 1 Feed Roller for 1,500-Sheet Tray, Instructions) (OEM# Q2436) (200,000 Yield) | 99408 | EA | \$158.13 |
| RM1-0101-REF | Refurbished Fuser Assembly (OEM# RM1-0101-000) (200,000 Yield) | 99296 | EA | \$142.17 |
| RM1-0699-AFT | Aftermarket Transfer Roller Assembly (OEM# LPR-1160-PN) | 924037 | EA | \$3.76 |
| Q2440B-REF | Refurbished 500-Sheet Paper Feeder and Tray (OEM# Q2440B) | 923965 | EA | \$226.55 |
| Q2444-67902-REF | Refurbished 1,500-Sheet High Capacity Feeder (OEM# Q2444B, Q2444-67902) | 933346 | EA | \$315.95 |
| RL1-0019-AFT | Aftermarket Tray 1 Pickup Roller (OEM# RL1-0019) | 924020 | EA | \$1.38 |
| RM1-0036-AFT | Aftermarket Tray 2/500-Sheet Tray Pickup Roller (OEM# RM1-0036) | 924032 | EA | \$0.73 |
| RM1-1088KIT-AFT | Aftermarket Tray Repair Kit (Includes Rear Tray Assembly, Feed Roller Cover and Spring) (OEM# RM1-1088KIT) | 924039 | EA | \$36.26 |
| RM1-0033-REF | Refurbished Tray 2 Lifter Drive Assembly (OEM# RM1-0033) | 929915 | EA | \$16.53 |
| RC1-0165-AFT | Aftermarket 500-Sheet Tray Stop (OEM# RC1-0165) | 923987 | EA | \$2.93 |
| RM1-1088-SPR-AFT | Aftermarket 500-Sheet Tray Spring (OEM# RM1-1088SPR) | 924040 | EA | \$1.56 |
| RM1-0012-REF | Refurbished Feed Roller Assembly (OEM# RM1-0012) | 924030 | EA | \$32.22 |
| RM1-0026-REF | Refurbished Paper Delivery/Output Roller Assembly (OEM# RM1-0026) | 933669 | EA | \$34.05 |
| RM1-0043-GRB-AFT | Aftermarket Swing Plate Gear with Spacer (OEM# RM1-0043-GRB) | 924035 | EA | \$2.25 |
| RG1-4276-REF | Refurbished Control Panel Assembly | 917886 | EA | \$149.00 |
| HP LJ 4345 MFP/M4345 MFP Refurbished & Aftermarket Parts <i>(Continued on next page)</i> | | | | |
| Q5998-67903-REO | Refurbished Maintenance Kit with OEM Rollers (Includes Fuser Assembly, Separation Rollers, Transfer Roller, Feed Rollers, Pickup Roller, Gloves, Instructions) (OEM# Q5998-67904) (200,000 Yield) | 923971 | EA | \$193.86 |

| MFG# | Product Description | Part# | UOM | Retail |
|--|--|--------|-----|----------|
| HP COMPATIBLE PARTS | | | | |
| HP LJ 4345 MFP/M4345 MFP Refurbished & Aftermarket Parts <i>(Continued)</i> | | | | |
| Q5998-67903-REF | Refurbished Maintenance Kit with Aftermarket Parts (Includes Fuser Assembly, Separation Rollers, Transfer Roller, Feed Rollers, Pickup Roller, Gloves, Instructions) (OEM# Q5998-67904) (200,000 Yield) | 923970 | EA | \$151.67 |
| RM1-1043-REF | Refurbished Fuser Assembly (OEM# RM1-1043-000) (200,000 Yield) | 99297 | EA | \$135.32 |
| RM1-1110-AFT | Aftermarket Transfer Roller Assembly (OEM# RM1-1110) (225,000 Yield) | 924041 | EA | \$5.47 |
| Q3701-60012-REF | Refurbished PCA-MFP Analog 300 ROHS Fax Modem (OEM# Q3701-60012) | 933297 | EA | \$264.76 |
| RL1-0019-AFT | Aftermarket Tray 1 Pickup Roller (OEM# RL1-0019) | 924020 | EA | \$1.38 |
| RM1-0036-AFT | Aftermarket Tray 2/500-Sheet Tray Pickup Roller (OEM# RM1-0036) | 924032 | EA | \$0.73 |
| RM1-0037-AFT | Aftermarket Tray 2/500-Sheet Tray Feed Roller (OEM# RM1-0037-020) | 924033 | EA | \$0.66 |
| Q5691-60501-REF | Refurbished 500-Sheet Stapler/Stacker Assembly with Aftermarket Kit Parts (OEM# Q5691-60501, Q5691-67901) | 933488 | EA | \$310.31 |
| HP4345-PSBRD-REF | Refurbished Engine Power Supply (OEM# RM1-1041) | 933837 | EA | \$310.00 |
| RM1-0043-AFT | Aftermarket Swing Plate Assembly (OEM# RM1-0043) | 924034 | EA | \$5.77 |
| RM1-0043-GRB-AFT | Aftermarket Swing Plate Gear with Spacer (OEM# RM1-0043-GRB) | 924035 | EA | \$2.25 |
| HP LJ 5000 Refurbished & Aftermarket Parts | | | | |
| C4110-67901-REF | Refurbished Maintenance Kit (Includes Fuser Assembly, Separation Rollers, Transfer Roller, Feed Rollers, Pickup Roller, Instruction Guide) (OEM# C4110) (150,000 Yield) | 99369 | EA | \$204.50 |
| RG5-3579-AFT | Aftermarket Transfer Roller (OEM# RG5-3579) | 927413 | EA | \$8.49 |
| RB2-1820-AFT | Aftermarket Tray 1 Pickup Roller (OEM# RB2-1795) | 923978 | EA | \$1.42 |
| RB1-8865-AFT | Aftermarket Half-Moon-Shaped Pickup Roller (OEM# RB1-8865) | 923975 | EA | \$0.72 |
| RB2-1821-AFT | Aftermarket D-Shaped Tray 2 Pickup Roller (OEM# RB2-1821) | 923979 | EA | \$1.42 |
| RF5-2634-AFT | Aftermarket Separation Feed Roller (OEM# RF5-2634) | 923998 | EA | \$0.38 |
| HP LJ 5100 Refurbished & Aftermarket Parts | | | | |
| RG5-7060-REF | Refurbished Fuser Assembly (OEM# RG5-7060) (150,000 Yield) | 99445 | EA | \$190.06 |
| RB1-8865-AFT | Aftermarket Half-Moon-Shaped Pickup Roller (OEM# RB1-8865) | 923975 | EA | \$0.72 |
| RB2-1821-AFT | Aftermarket D-Shaped Tray 2 Pickup Roller (OEM# RB2-1821) | 923979 | EA | \$1.42 |
| RF5-2634-AFT | Aftermarket Separation Feed Roller (OEM# RF5-2634) | 923998 | EA | \$0.38 |
| HP LJ 5200 Refurbished & Aftermarket Parts | | | | |
| Q7543-67909-REF | Refurbished Maintenance Kit (Includes Fuser Assembly, Tray 1 Pickup Roller, Separation Pad and Pickup Roller, Gloves, Instructions) (OEM# Q7543-67909) (200,000 Yield) | 923972 | EA | \$256.96 |
| RM1-2522-070-REF | Refurbished Fuser Assembly (OEM# RM1-2522-070) (100,000 Yield) | 924046 | EA | \$171.05 |
| RM1-0036-AFT | Aftermarket Tray 2/500-Sheet Tray Pickup Roller (OEM# RM1-0036) | 924032 | EA | \$0.73 |
| RM1-0037-AFT | Aftermarket Tray 2/500-Sheet Tray Feed Roller (OEM# RM1-0037-020) | 924033 | EA | \$0.66 |
| Q2625-67951-AFT | Aftermarket 64MB 100-Pin DDR DIMM (OEM# Q2625-67951, Q7715-67951) | 929908 | EA | \$30.41 |
| HP LJ 8100 Refurbished & Aftermarket Parts | | | | |
| C3914-69001-REO | Refurbished Maintenance Kit with OEM Rollers (Includes Fuser Assembly, 8 Feed/Separation Rollers, Transfer Roller) (OEM# C3914-67902) (350,000 Yield) | 923945 | EA | \$200.71 |
| C3914-69001-REF | Refurbished Maintenance Kit (Includes Fuser Assembly, 8 Feed/Separation Rollers, Transfer Roller) (OEM# C3914) (350,000 Yield) | 99377 | EA | \$142.17 |
| C4265-69008-REF | Refurbished Fuser Assembly (Same as RG5-6532-REF) (OEM# C4256-69008, RG5-6532-000) (350,000 Yield) | 923946 | EA | \$129.25 |
| RB2-3521-AFT | Aftermarket Upper Fuser Roller (OEM# RB2-3521CLN) | 923983 | EA | \$16.52 |
| RB2-3522-AFT | Aftermarket Lower Pressure Roller (OEM# RB2-3522CLN) | 923984 | EA | \$17.75 |
| RF5-2675-AFT | Aftermarket Transfer Roller (OEM# RF5-2675) | 923999 | EA | \$6.99 |
| RF5-1835-AFT | Aftermarket Pickup Roller (OEM# RF5-1835-000) | 923995 | EA | \$0.66 |
| HP8100-PFMECH-REF | Refurbished Paper Pickup Assembly (OEM# C4214-69004, C4214-69017) | 929897 | EA | \$117.99 |
| RF5-1834-AFT | Aftermarket Feed Roller (OEM# RF5-1834-000) | 923994 | EA | \$0.33 |
| RF5-2708-000-AFT | Aftermarket Pickup Roller for Optional 2 x 500-Sheet Drawer (OEM# RF5-2708) | 924000 | EA | \$0.38 |
| HP05SI-POA-REF | Refurbished Paper Output Assembly (OEM# RG5-1874) | 923953 | EA | \$127.73 |
| HP8100-PSBRD-REF | Refurbished Power Supply (OEM# C4214-69020) | 923958 | EA | \$83.63 |
| RG5-4021-REF | Refurbished Universal Power Supply (OEM# RG5-4021) | 927388 | EA | \$107.25 |
| RG5-2168-REF | Refurbished Sensor PCA (OEM# RG5-2168) | 929914 | EA | \$50.67 |
| HP LJ 8150/Mopier 320 Refurbished & Aftermarket Parts <i>(Continued on next page)</i> | | | | |
| C3914-69001-REO | Refurbished Maintenance Kit with OEM Rollers (Includes Fuser Assembly, 8 Feed/Separation Rollers, Transfer Roller) (OEM# C3914-67902) (350,000 Yield) | 923945 | EA | \$200.71 |
| C3914-69001-REF | Refurbished Maintenance Kit (Includes Fuser Assembly, 8 Feed/Separation Rollers, Transfer Roller) (OEM# C3914) (350,000 Yield) | 99377 | EA | \$142.17 |
| C4265-69008-REF | Refurbished Fuser Assembly (Same as RG5-6532-REF) (OEM# C4256-69008, RG5-6532-000) (350,000 Yield) | 923946 | EA | \$129.25 |
| RB2-3522-AFT | Aftermarket Lower Pressure Roller (OEM# RB2-3522CLN) | 923984 | EA | \$17.75 |
| RF5-2675-AFT | Aftermarket Transfer Roller (OEM# RF5-2675) | 923999 | EA | \$6.99 |
| RF5-1835-AFT | Aftermarket Pickup Roller (OEM# RF5-1835-000) | 923995 | EA | \$0.66 |
| HP8100-PFMECH-REF | Refurbished Paper Pickup Assembly (OEM# C4214-69004, C4214-69017) | 929897 | EA | \$117.99 |

| MFG# | Product Description | Part# | UOM | Retail |
|---|---|--------|-----|----------|
| HP COMPATIBLE PARTS | | | | |
| HP LJ 8150/Mopier 320 Refurbished & Aftermarket Parts (Continued) | | | | |
| RF5-1834-AFT | Aftermarket Feed Roller (OEM# RF5-1834-000) | 923994 | EA | \$0.33 |
| RF5-2708-000-AFT | Aftermarket Pickup Roller for Optional 2 x 500-Sheet Drawer (OEM# RF5-2708) | 924000 | EA | \$0.38 |
| HP8150-IBRD-REF | Refurbished Klondike Formatter Board (OEM# C4165-60002) (For 8150 Model Only) | 929899 | EA | \$89.09 |
| HP8100-PSBRD-REF | Refurbished Power Supply (OEM# C4214-69020) (For 8150 Model Only) | 923958 | EA | \$83.63 |
| RG5-4021-REF | Refurbished Universal Power Supply (OEM# RG5-4021) | 927388 | EA | \$107.25 |
| RG5-2168-REF | Refurbished Sensor PCA (OEM# RG5-2168) | 929914 | EA | \$50.67 |
| HP LJ 9000 Refurbished & Aftermarket Parts | | | | |
| C9152-69004-REO | Refurbished Maintenance Kit with OEM Rollers (Includes Fuser, 2 Pickup Rollers, 7 Feed Rollers, 1 Transfer Roller) (OEM# C9152) (350,000 Yield) | 923916 | EA | \$348.19 |
| C9152-69004-REF | Refurbished Maintenance Kit (Includes Fuser, 2 Pickup Rollers, 7 Feed Rollers, 1 Transfer Roller) (OEM# C9152) (350,000 Yield) | 99400 | EA | \$285.09 |
| C9153-69006-REO | Refurbished Maintenance Kit with OEM Parts (220V) (Includes Fuser Assembly, 7 Feed/ Separation Rollers, 2 Pickup Rollers, Transfer Roller) (OEM# C9153-69006) (350,000 Yield) | 923949 | EA | \$315.50 |
| C9152-67907-PREO | Refurbished Maintenance Kit with OEM Upper Roller (Includes Fuser Assembly, 7 Feed/ Separation Rollers, 2 Pickup Rollers, Transfer Roller) (OEM# C9152-67907) (350,000 Yield) | 923948 | EA | \$378.60 |
| RG5-5750-REF | Refurbished Fuser Assembly (OEM# C8519-69035, RG5-5750) (350,000 Yield) | 99309 | EA | \$550.00 |
| RF5-3319-AFT | Aftermarket Transfer Roller (OEM# RF5-3319) (350,000 Yield) | 924003 | EA | \$4.00 |
| RF5-3403-AFT | Aftermarket Tray 1 Pickup Roller (OEM# RF5-3403) | 924006 | EA | \$2.74 |
| RF5-3340-AFT | Aftermarket Tray 2/3 Pickup Roller (OEM# RF5-3340) | 924005 | EA | \$0.48 |
| RF5-3404-AFT | Aftermarket Tray 1 Feed Roller (OEM# RF5-3404) | 924007 | EA | \$2.48 |
| RF5-3338-AFT | Aftermarket Tray 2/3 Feed Roller (OEM# RF5-3338-000) | 924004 | EA | \$0.66 |
| C8532-69003-REF | Refurbished Duplexer Assembly (OEM# C8532-69003) | 17394 | EA | \$199.95 |
| RS6-0841-AFT | Aftermarket 49 Tooth Gear (OEM# RS6-0841) | 924059 | EA | \$2.08 |
| HP9050-PSBRD-REF | Refurbished Power Supply (OEM# RG5-7778) | 929903 | EA | \$211.42 |
| C8530A-REF | Refurbished 8MB Flash Firmware (OEM# C8530A) (For 9000hnf Model) | 929880 | EA | \$55.08 |
| HP LJ 9040/9050 Refurbished & Aftermarket Parts | | | | |
| C9152-67907-PREO | Refurbished Maintenance Kit with OEM Upper Roller (Includes Fuser Assembly, 7 Feed/ Separation Rollers, 2 Pickup Rollers, Transfer Roller) (OEM# C9152-67907) (350,000 Yield) | 923948 | EA | \$378.60 |
| C9152-69004-REO | Refurbished Maintenance Kit with OEM Rollers (Includes Fuser, 2 Pickup Rollers, 7 Feed Rollers, 1 Transfer Roller) (OEM# C9152) (350,000 Yield) | 923916 | EA | \$348.19 |
| C9152-69004-REF | Refurbished Maintenance Kit (Includes Fuser, 2 Pickup Rollers, 7 Feed Rollers, 1 Transfer Roller) (OEM# C9152) (350,000 Yield) | 99400 | EA | \$285.09 |
| RG5-5750-REF | Refurbished Fuser Assembly (OEM# C8519-69035, RG5-5750) (350,000 Yield) | 99309 | EA | \$550.00 |
| RF5-3319-AFT | Aftermarket Transfer Roller (OEM# RF5-3319) (350,000 Yield) | 924003 | EA | \$4.00 |
| RF5-3403-AFT | Aftermarket Tray 1 Pickup Roller (OEM# RF5-3403) | 924006 | EA | \$2.74 |
| RF5-3340-AFT | Aftermarket Tray 2/3 Pickup Roller (OEM# RF5-3340) | 924005 | EA | \$0.48 |
| RF5-3404-AFT | Aftermarket Tray 1 Feed Roller (OEM# RF5-3404) | 924007 | EA | \$2.48 |
| RF5-3338-AFT | Aftermarket Tray 2/3 Feed Roller (OEM# RF5-3338-000) | 924004 | EA | \$0.66 |
| C8532-69003-REF | Refurbished Duplexer Assembly (OEM# C8532-69003) | 17394 | EA | \$199.95 |
| HP9050-IBRDN-REF | Refurbished Formatter Board-Network for N/DN Models Only (OEM# Q3722-67902) | 929901 | EA | \$353.48 |
| HP9050-PSBRD-REF | Refurbished Power Supply (OEM# RG5-7778) | 929903 | EA | \$211.42 |
| Q3701-60012-REF | Refurbished PCA-MFP Analog 300 ROHS Fax Modem (OEM# Q3701-60012) | 933297 | EA | \$264.76 |
| Q2625-67951-AFT | Aftermarket 64MB 100-Pin DDR DIMM (OEM# Q2625-67951, Q7715-67951) | 929908 | EA | \$30.41 |
| HP LJ Enterprise 600 M601/M602/M603 Refurbished & Aftermarket Parts | | | | |
| CE988-67901-REF | Refurbished Fusing Assembly (110V) (225,000 Yield) (OEM# RM1-8395) | 930483 | EA | \$315.45 |
| RL1-1641-AFT | Aftermarket Tray 1/Multipurpose Tray Pickup Roller (OEM# RL1-1641) | 924026 | EA | \$2.90 |
| RM1-0036-AFT | Aftermarket Tray 2/500-Sheet Tray Pickup Roller (OEM# RM1-0036) | 924032 | EA | \$0.73 |
| RL1-1663-AFT | Aftermarket Tray 1/Multipurpose Tray Feed Roller (OEM# RL1-1663) | 924028 | EA | \$0.58 |
| RM1-8406-REF | Refurbished Laser/Scanner Assembly (OEM# RM1-8406) | 923227 | EA | \$292.32 |
| HP LJ M1522 MFP Refurbished & Aftermarket Parts | | | | |
| 5851-3580-REF | Refurbished ADF Pickup Roller Assembly (OEM# 5851-3580) | 926572 | EA | \$29.56 |
| HP LJ M2727nf MFP Refurbished & Aftermarket Parts | | | | |
| RM1-4247-020-REF | Refurbished Fuser Assembly (OEM# RM1-4247-020) (150,000 Yield) | 924051 | EA | \$68.45 |
| RL1-0540-AFT | Aftermarket Pickup Roller Assembly (OEM# RL1-0540) | 924022 | EA | \$0.81 |
| 5851-3580-REF | Refurbished ADF Pickup Roller Assembly (OEM# 5851-3580) | 926572 | EA | \$29.56 |
| RM1-1298-AFT | Aftermarket Tray 2 Separation Pad Assembly (OEM# RM1-1298) | 924043 | EA | \$7.85 |
| HPM2727-FBRD-REF | Refurbished Formatter Board (OEM# CC370-60001) | 923959 | EA | \$250.50 |
| HP LJ M3027/M3035 MFP Refurbished & Aftermarket Parts (Continued on next page) | | | | |
| HP3005-KIT-REO | Refurbished Maintenance Kit with OEM Parts (Includes Fuser Assembly, Rollers, Separation Pad, Transfer Roller) (OEM# 5851-3996) (100,000 Yield) | 923913 | EA | \$180.93 |
| HP3005-KIT-REF | Refurbished Maintenance Kit (Includes Fuser Assembly, Rollers, Separation Pad, Transfer Roller) (OEM# 5851-3996) (100,000 Yield) | 906364 | EA | \$150.53 |
| RM1-3717-REF | Refurbished Fuser Assembly (110-127V) (OEM# RM1-3717) (100,000 Yield) | 906363 | EA | \$120.12 |

| MFG# | Product Description | Part# | UOM | Retail |
|--|--|--------|-----|----------|
| HP COMPATIBLE PARTS | | | | |
| HP LJ M3027/M3035 MFP Refurbished & Aftermarket Parts <i>(Continued)</i> | | | | |
| RM1-1508-AFT | Aftermarket Transfer Roller Assembly (OEM# RM1-1508-000) | 924044 | EA | \$3.26 |
| RL1-0568-AFT | Aftermarket Tray 1/Multipurpose Tray D-Shaped Pickup Roller (OEM# RL1-0568) | 924024 | EA | \$0.91 |
| RL1-1370-AFT | Aftermarket Tray 2 Pickup Roller (OEM# RL1-1370-000CN) | 924025 | EA | \$2.72 |
| RM1-3738-AFT | Aftermarket 500-Sheet Tray Separation Pad and Holder (OEM# RM1-3738-000CN) | 924050 | EA | \$5.78 |
| CB414-67923-AFT | Aftermarket Replacement Gear Kit (Includes 17, 17, 19 and 20 Tooth Gears) (OEM# CB414-67923) | 923950 | EA | \$4.14 |
| RU5-0956-AFT | Aftermarket 20/20 Tooth Fuser Drive Assembly Gear (OEM# RU5-0956-000) | 924075 | EA | \$1.53 |
| RU5-0957-AFT | Aftermarket 20 Tooth Fuser Drive Assembly Gear (OEM# RU5-0957-000) | 924063 | EA | \$1.38 |
| RU5-0958-AFT | Aftermarket 17/17 Tooth Fuser Drive Assembly Gear (OEM# RU5-0958-000) | 924064 | EA | \$2.18 |
| RU5-0959-AFT | Aftermarket 19 Tooth Fuser Drive Assembly Gear (OEM# RU5-0959-000) | 924065 | EA | \$2.93 |
| Q3701-60012-REF | Refurbished PCA-MFP Analog 300 ROHS Fax Modem (OEM# Q3701-60012) | 933297 | EA | \$264.76 |
| Q2625-67951-AFT | Aftermarket 64MB 100-Pin DDR DIMM (OEM# Q2625-67951, Q7715-67951) | 929908 | EA | \$30.41 |
| HP LJ M4555 Refurbished & Aftermarket Parts | | | | |
| RM1-5462-AFT | Aftermarket Transfer Roller Assembly (OEM# RM1-5462-000CN) | 924053 | EA | \$8.14 |
| RL1-1641-AFT | Aftermarket Tray 1/Multipurpose Tray Pickup Roller (OEM# RL1-1641) | 924026 | EA | \$2.90 |
| RL1-1663-AFT | Aftermarket Tray 1/Multipurpose Tray Feed Roller (OEM# RL1-1663) | 924028 | EA | \$0.58 |
| RM1-0037-AFT | Aftermarket Tray 2/500-Sheet Tray Feed Roller (OEM# RM1-0037-020) | 924033 | EA | \$0.66 |
| RM1-7102-REF | Refurbished Engine DC Controller PC Board Assembly (OEM# RM1-7102) | 933513 | EA | \$78.29 |
| HP LJ M5025 MFP/M5035 MFP Refurbished & Aftermarket Parts | | | | |
| RM1-0037-AFT | Aftermarket Tray 2/500-Sheet Tray Feed Roller (OEM# RM1-0037-020) | 924033 | EA | \$0.66 |
| Q3701-60012-REF | Refurbished PCA-MFP Analog 300 ROHS Fax Modem (OEM# Q3701-60012) | 933297 | EA | \$264.76 |
| Q2625-67951-AFT | Aftermarket 64MB 100-Pin DDR DIMM (OEM# Q2625-67951, Q7715-67951) | 929908 | EA | \$30.41 |
| HP LJ M9040/M9050 Refurbished & Aftermarket Parts | | | | |
| C9152-67907-PREO | Refurbished Maintenance Kit with OEM Upper Roller (Includes Fuser Assembly, 7 Feed/Separation Rollers, 2 Pickup Rollers, Transfer Roller) (OEM# C9152-67907) (350,000 Yield) | 923948 | EA | \$378.60 |
| C9152-69004-REO | Refurbished Maintenance Kit with OEM Rollers (Includes Fuser, 2 Pickup Rollers, 7 Feed Rollers, 1 Transfer Roller) (OEM# C9152) (350,000 Yield) | 923916 | EA | \$348.19 |
| C9152-69004-REF | Refurbished Maintenance Kit (Includes Fuser, 2 Pickup Rollers, 7 Feed Rollers, 1 Transfer Roller) (OEM# C9152) (350,000 Yield) | 99400 | EA | \$285.09 |
| RG5-5750-REF | Refurbished Fuser Assembly (OEM# C8519-69035, RG5-5750) (350,000 Yield) | 99309 | EA | \$550.00 |
| RF5-3338-AFT | Aftermarket Tray 2/3 Feed Roller (OEM# RF5-3338-000) | 924004 | EA | \$0.66 |
| HP9050-PSBRD-REF | Refurbished Power Supply (OEM# RG5-7778) | 929903 | EA | \$211.42 |
| Q3701-60012-REF | Refurbished PCA-MFP Analog 300 ROHS Fax Modem (OEM# Q3701-60012) | 933297 | EA | \$264.76 |
| HP LJ P2014 Refurbished & Aftermarket Parts | | | | |
| RM1-4247-020-REF | Refurbished Fuser Assembly (OEM# RM1-4247-020) (150,000 Yield) | 924051 | EA | \$68.45 |
| RL1-0540-AFT | Aftermarket Pickup Roller Assembly (OEM# RL1-0540) | 924022 | EA | \$0.81 |
| RM1-1298-AFT | Aftermarket Tray 2 Separation Pad Assembly (OEM# RM1-1298) | 924043 | EA | \$7.85 |
| HP LJ P2015 Refurbished & Aftermarket Parts | | | | |
| RM1-4247-020-REF | Refurbished Fuser Assembly (OEM# RM1-4247-020) (150,000 Yield) | 924051 | EA | \$68.45 |
| RL1-0540-AFT | Aftermarket Pickup Roller Assembly (OEM# RL1-0540) | 924022 | EA | \$0.81 |
| RM1-1298-AFT | Aftermarket Tray 2 Separation Pad Assembly (OEM# RM1-1298) | 924043 | EA | \$7.85 |
| HPP2015-FBRD-REF | Refurbished Formatter Base (OEM# Q7804-60001) | 923960 | EA | \$82.13 |
| HPP2015-FBRDN-REF | Refurbished Formatter Board-Network/Duplex (OEM# Q7805-60002, Q7805-69003) | 929907 | EA | \$109.05 |
| HP LJ P2035/P2055 Refurbished & Aftermarket Parts | | | | |
| RM1-6405-000-REF | Refurbished Fuser Assembly (OEM# RM1-6405-000) (100,000 Yield) | 924056 | EA | \$123.77 |
| RM1-6414-AFT | Aftermarket Pickup Roller Assembly (OEM# RM1-6414-000CN) | 924057 | EA | \$3.58 |
| RL1-2120-AFT | Aftermarket Tray 1 Pickup Roller (OEM# RL1-2120) | 924029 | EA | \$2.93 |
| HP LJ P3005 Refurbished & Aftermarket Parts <i>(Continued on next page)</i> | | | | |
| HP3005-KIT-REO | Refurbished Maintenance Kit with OEM Parts (Includes Fuser Assembly, Rollers, Separation Pad, Transfer Roller) (OEM# 5851-3996) (100,000 Yield) | 923913 | EA | \$180.93 |
| HP3005-KIT-REF | Refurbished Maintenance Kit (Includes Fuser Assembly, Rollers, Separation Pad, Transfer Roller) (OEM# 5851-3996) (100,000 Yield) | 906364 | EA | \$150.53 |
| RM1-3717-REF | Refurbished Fuser Assembly (110-127V) (OEM# RM1-3717) (100,000 Yield) | 906363 | EA | \$120.12 |
| SLEEVEP3005-AFT | Aftermarket Fuser Film Sleeve (OEM# FILM3005) | 924071 | EA | \$10.04 |
| RM1-1508-AFT | Aftermarket Transfer Roller Assembly (OEM# RM1-1508-000) | 924044 | EA | \$3.26 |
| RL1-0568-AFT | Aftermarket Tray 1/Multipurpose Tray D-Shaped Pickup Roller (OEM# RL1-0568) | 924024 | EA | \$0.91 |
| RC1-0939-AFT | Aftermarket Tray 1 Separation Pad (OEM# RC1-0939-000) | 923988 | EA | \$2.74 |
| RL1-1370-AFT | Aftermarket Tray 2 Pickup Roller (OEM# RL1-1370-000CN) | 924025 | EA | \$2.72 |
| RM1-3732-REF | Refurbished 500-Sheet/Tray 2 Paper Cassette (OEM# RM1-3732-000) | 924049 | EA | \$88.28 |
| RM1-3738-AFT | Aftermarket 500-Sheet Tray Separation Pad and Holder (OEM# RM1-3738-000CN) | 924050 | EA | \$5.78 |

| MFG# | Product Description | Part# | UOM | Retail |
|---|---|--------|-----|----------|
| HP COMPATIBLE PARTS | | | | |
| HP LJ P3005 Refurbished & Aftermarket Parts <i>(Continued)</i> | | | | |
| CB414-67923-AFT | Aftermarket Replacement Gear Kit (Includes 17, 17, 19 and 20 Tooth Gears) (OEM# CB414-67923) | 923950 | EA | \$4.14 |
| RU5-0956-AFT | Aftermarket 20/20 Tooth Fuser Drive Assembly Gear (OEM# RU5-0956-000) | 924075 | EA | \$1.53 |
| RU5-0957-AFT | Aftermarket 20 Tooth Fuser Drive Assembly Gear (OEM# RU5-0957-000) | 924063 | EA | \$1.38 |
| HP3005-FBRDN-REF | Refurbished Formatter Board (Network) (OEM# Q7848-60002) | 924073 | EA | \$205.30 |
| HP3005-FBRD-REF | Refurbished Formatter Board (Non-Network) (OEM# Q7847-60001) | 923954 | EA | \$140.10 |
| HP LJ P3015 Refurbished & Aftermarket Parts | | | | |
| CE525-67901-REF | Refurbished Maintenance Kit with Aftermarket Parts (Includes Separation Pad for 500-Sheet Cassette, Tray 1 Pickup Roller, Tray 1 Separation Pad, Pickup and Feed Rollers for 500-Sheet Cassette, Transfer Roller, Fuser) (OEM# CE525-67901) (100,000 Yield) | 923951 | EA | \$232.79 |
| RM1-6274-000-REF | Refurbished Fuser Assembly (OEM# RM1-6274) (100,000 Yield) | 924054 | EA | \$175.35 |
| HP LJ P4014 Refurbished & Aftermarket Parts | | | | |
| CB388-67901-REO | Refurbished Maintenance Kit with OEM Rollers (110V) (Includes Fuser Assembly, Transfer Roller, Transfer Roller Tool, 8 Feed Rollers, Gloves) (OEM# CB388-67901) (100,000 Yield) | 906177 | KIT | \$346.67 |
| CB388A-REF | Refurbished Maintenance Kit (110V) (Includes Fuser Assembly, Transfer Roller, Transfer Roller Tool, Tray Pickup Rollers, 8 Feed Rollers, Gloves) (OEM# CB388A) (225,000 Yield) | 906366 | EA | \$302.58 |
| RM1-4554-REF | Refurbished Fuser Assembly (110V) (OEM# CB506-67901) (100,000 Yield) | 906365 | EA | \$287.37 |
| RM1-5462-AFT | Aftermarket Transfer Roller Assembly (OEM# RM1-5462-000CN) | 924053 | EA | \$8.14 |
| CB518-67901-REF | Refurbished Optional 500-Sheet Input Tray and Feeder (OEM# CB518-67901) | 929881 | EA | \$286.07 |
| RL1-1641-AFT | Aftermarket Tray 1/Multipurpose Tray Pickup Roller (OEM# RL1-1641) | 924026 | EA | \$2.90 |
| RL1-1663-AFT | Aftermarket Tray 1/Multipurpose Tray Feed Roller (OEM# RL1-1663) | 924028 | EA | \$0.58 |
| RM1-0037-AFT | Aftermarket Tray 2/500-Sheet Tray Feed Roller (OEM# RM1-0037-020) | 924033 | EA | \$0.66 |
| RL1-1654-AFT | Aftermarket Tray 1/Multipurpose Tray Separation Roller (OEM# RL1-1654) | 924027 | EA | \$0.51 |
| RC2-2484-REF | Refurbished Drum Drive Assembly (OEM# RC2-2484, RM1-8493) | 929910 | EA | \$126.69 |
| HP LJ P4015/P4515 Refurbished & Aftermarket Parts | | | | |
| CB388-67901-REO | Refurbished Maintenance Kit with OEM Rollers (110V) (Includes Fuser Assembly, Transfer Roller, Transfer Roller Tool, 8 Feed Rollers, Gloves) (OEM# CB388-67901) (100,000 Yield) | 906177 | KIT | \$346.67 |
| CB388A-REF | Refurbished Maintenance Kit (110V) (Includes Fuser Assembly, Transfer Roller, Transfer Roller Tool, Tray Pickup Rollers, 8 Feed Rollers, Gloves) (OEM# CB388A) (225,000 Yield) | 906366 | EA | \$302.58 |
| RM1-4554-REF | Refurbished Fuser Assembly (110V) (OEM# CB506-67901) (100,000 Yield) | 906365 | EA | \$287.37 |
| RC2-2432-AFT | Aftermarket Side Plate Fuser Drive (OEM# RC2-2432) (For Use in P4015 Model Only) | 923991 | EA | \$17.33 |
| RM1-5462-AFT | Aftermarket Transfer Roller Assembly (OEM# RM1-5462-000CN) | 924053 | EA | \$8.14 |
| CB518-67901-REF | Refurbished Optional 500-Sheet Input Tray and Feeder (OEM# CB518-67901) | 929881 | EA | \$286.07 |
| RL1-1641-AFT | Aftermarket Tray 1/Multipurpose Tray Pickup Roller (OEM# RL1-1641) | 924026 | EA | \$2.90 |
| RL1-1663-AFT | Aftermarket Tray 1/Multipurpose Tray Feed Roller (OEM# RL1-1663) | 924028 | EA | \$0.58 |
| RL1-1654-AFT | Aftermarket Tray 1/Multipurpose Tray Separation Roller (OEM# RL1-1654) | 924027 | EA | \$0.51 |
| RM1-0037-AFT | Aftermarket Tray 2/500-Sheet Tray Feed Roller (OEM# RM1-0037-020) | 924033 | EA | \$0.66 |
| HPP4015-FBRDN-REF | Refurbished Formatter Board (Network) (OEM# CB438-69001) | 923961 | EA | \$176.90 |
| RC2-2484-REF | Refurbished Drum Drive Assembly (OEM# RC2-2484, RM1-8493) | 929910 | EA | \$126.69 |
| HP LJ Pro MFP M521 Refurbished & Aftermarket Parts | | | | |
| CF116-67903-REO | Refurbished Maintenance Kit with OEM Rollers (OEM# CF116-67903) (100,000 Yield) | 933503 | EA | \$226.98 |
| CF116-67903-REF | Refurbished Maintenance Kit with Aftermarket Parts (OEM# CF116-67903) (100,000 Yield) | 933502 | EA | \$143.84 |
| RM1-6313-AFT | Aftermarket Pickup Roller Assembly (OEM# RM1-6313-000CN, RM1-6323) | 924055 | EA | \$3.42 |
| HP LJ Enterprise Flow/500 MFP M525 Refurbished & Aftermarket Parts | | | | |
| CF116-67903-REO | Refurbished Maintenance Kit with OEM Rollers (OEM# CF116-67903) (100,000 Yield) | 933503 | EA | \$226.98 |
| CF116-67903-REF | Refurbished Maintenance Kit with Aftermarket Parts (OEM# CF116-67903) (100,000 Yield) | 933502 | EA | \$143.84 |
| HP LJ Pro 200 Color M251/MFP M276 | | | | |
| RM1-8777-REF | Refurbished Intermediate Transfer Belt Assembly (OEM# RM1-8777) | 930232 | EA | \$60.65 |
| HP Color LJ 1600/2600 Refurbished & Aftermarket Parts | | | | |
| RM1-1820-080-REF | Refurbished Fuser Assembly (OEM# RM1-1820-080) (100,000 Yield) | 924045 | EA | \$98.45 |
| HP Color LJ 3000 Refurbished & Aftermarket Parts | | | | |
| RM1-2763-020-REF | Refurbished Fuser Assembly (OEM# RM1-2763-020) (100,000 Yield) | 924048 | EA | \$173.33 |
| RM1-2702-AFT | Aftermarket Tray 2 Pickup Roller (OEM# RM1-2702) | 924047 | EA | \$1.38 |
| HP Color LJ 3500/3550/3700 Refurbished & Aftermarket Parts | | | | |
| Q3655A-REF | Refurbished Fuser Kit (OEM# Q3655A) (60,000 Yield) | 19815 | EA | \$128.38 |
| RC1-0954-AFT | Aftermarket Tray 2 Separation Pad (OEM# RC1-0954) | 923989 | EA | \$2.35 |

| MFG# | Product Description | Part# | UOM | Retail |
|---|---|--------|-----|----------|
| HP COMPATIBLE PARTS | | | | |
| HP Color LJ 3600/3800/CP3505 Refurbished & Aftermarket Parts | | | | |
| RM1-2763-020-REF | Refurbished Fuser Assembly (OEM# RM1-2763-020) (100,000 Yield) | 924048 | EA | \$173.33 |
| RM1-2702-AFT | Aftermarket Tray 2 Pickup Roller (OEM# RM1-2702) | 924047 | EA | \$1.38 |
| HP3600-CBRD-REF | Refurbished DC Controller (OEM# RM1-2580) | 929887 | EA | \$98.83 |
| HP3600-HVPBRD-REF | Refurbished High Voltage Power Supply (OEM# RM1-2578) | 929889 | EA | \$196.14 |
| HP Color LJ 4500/4550 Refurbished & Aftermarket Parts | | | | |
| RB1-8865-AFT | Aftermarket Half-Moon-Shaped Pickup Roller (OEM# RB1-8865) | 923975 | EA | \$0.72 |
| RF5-1885-AFT | Aftermarket Tray 2/3/4 Feed Roller (OEM# RF5-1885) | 923996 | EA | \$0.60 |
| RB1-8974-AFT | Aftermarket Separation Roller Clutch (OEM# RB1-8974-000CN) | 923977 | EA | \$10.04 |
| HP Color LJ 4600 Refurbished & Aftermarket Parts | | | | |
| C9725A-REF | Refurbished Fuser Assembly (OEM# RG5-6493-000) (120,000 Yield) | 99307 | EA | \$141.40 |
| HP4650-ITB-REF | Refurbished Image Transfer Belt Kit (Includes Electrostatic Transfer Belt Assembly, Cleaning Cloth) (OEM# RG5-7455-000CN) (120,000 Yield) | 923956 | EA | \$179.41 |
| Q3673-69001-REF | Refurbished 500-Sheet Feeder (OEM# Q3673-69001) | 930140 | EA | \$266.24 |
| RF5-3739-AFT | Aftermarket Tray 2 Pickup Roller (OEM# RF5-3739) | 924008 | EA | \$1.96 |
| HP4600-SCNR-REF | Refurbished Scanner Assembly (OEM# RG5-6380, RG5-6390) | 929895 | EA | \$92.97 |
| HP4600-HVPBRD-REF | Refurbished High Voltage Power Supply PC Board (OEM# C9660-69022) | 929893 | EA | \$89.71 |
| HP Color LJ 4610/4650 Refurbished & Aftermarket Parts | | | | |
| RG5-7450-REF | Refurbished Fuser Assembly (OEM# RG5-7450) (100,000 Yield) | 99308 | EA | \$145.96 |
| HP4650-ITB-REF | Refurbished Image Transfer Belt Kit (Includes Electrostatic Transfer Belt Assembly, Cleaning Cloth) (OEM# RG5-7455-000CN) (120,000 Yield) | 923956 | EA | \$179.41 |
| Q3673-69001-REF | Refurbished 500-Sheet Feeder (OEM# Q3673-69001) | 930140 | EA | \$266.24 |
| RF5-3739-AFT | Aftermarket Tray 2 Pickup Roller (OEM# RF5-3739) | 924008 | EA | \$1.96 |
| HP4600-HVPBRD-REF | Refurbished High Voltage Power Supply PC Board (OEM# C9660-69022) | 929893 | EA | \$89.71 |
| HP Color LJ 4700/4730 MFP/CM4730 MFP Refurbished & Aftermarket Parts | | | | |
| RM1-3131-REF | Refurbished Maintenance Kit (Includes Fuser Assembly, Tray 1 Pickup Roller, Separation Pad and Pickup Roller, Gloves, Instructions) (OEM# RM1-3131-000) (150,000 Yield) | 906367 | EA | \$194.62 |
| Q7502A-REF | Refurbished Fuser Assembly (OEM# Q7502A, RM1-3131-000) (100,000 Yield) | 99311 | EA | \$179.41 |
| RM1-3161-130-REF | Refurbished Transfer Kit (Includes Electrostatic Transfer Belt (ETB) Assembly, Cleaning Cloth) (OEM# Q7504A, RM1-3161) (100,000 Yield) | 909977 | EA | \$196.14 |
| RL1-0019-AFT | Aftermarket Tray 1 Pickup Roller (OEM# RL1-0019) | 924020 | EA | \$1.38 |
| RM1-0036-AFT | Aftermarket Tray 2/500-Sheet Tray Pickup Roller (OEM# RM1-0036) | 924032 | EA | \$0.73 |
| RM1-0037-AFT | Aftermarket Tray 2/500-Sheet Tray Feed Roller (OEM# RM1-0037-020) | 924033 | EA | \$0.66 |
| HP Color LJ 5500 Refurbished & Aftermarket Parts | | | | |
| C9656-69001-REF | Refurbished Fuser Assembly (OEM# RG5-6848-300) (120,000 Yield) | 924072 | EA | \$196.14 |
| HP5550-ITB-REF | Refurbished Image Transfer Kit (OEM# C9656-69010) (120,000 Yield) | 923957 | EA | \$273.69 |
| HP5550-PFMECH-REF | Refurbished Tray 2 Paper Pickup Assembly (OEM# RG5-6670) | 930484 | EA | \$259.95 |
| RF5-3340-AFT | Aftermarket Tray 2/3 Pickup Roller (OEM# RF5-3340) | 924005 | EA | \$0.48 |
| RF5-3338-AFT | Aftermarket Tray 2/3 Feed Roller (OEM# RF5-3338-000) | 924004 | EA | \$0.66 |
| RG5-6647-REF | Refurbished Tray 2/500-Sheet Paper Cassette (OEM# RG5-6647) | 927389 | EA | \$407.46 |
| RG5-6780-REF | Refurbished Multipurpose Tray Assembly (OEM# RG5-6780) | 927430 | EA | \$45.90 |
| HP Color LJ 5550 Refurbished & Aftermarket Parts | | | | |
| Q3984A-REF | Refurbished Fuser Assembly (OEM# Q3984A) (120,000 Yield) | 923967 | EA | \$218.95 |
| HP5550-ITB-REF | Refurbished Image Transfer Kit (OEM# C9656-69010) (120,000 Yield) | 923957 | EA | \$273.69 |
| HP5550-PFMECH-REF | Refurbished Tray 2 Paper Pickup Assembly (OEM# RG5-6670) | 930484 | EA | \$259.95 |
| RF5-3340-AFT | Aftermarket Tray 2/3 Pickup Roller (OEM# RF5-3340) | 924005 | EA | \$0.48 |
| RF5-3338-AFT | Aftermarket Tray 2/3 Feed Roller (OEM# RF5-3338-000) | 924004 | EA | \$0.66 |
| HP5550-IBRD-REF | Refurbished Formatter Board (OEM# Q3713-69002) | 932809 | EA | \$484.79 |
| HP Color LJ 8500/8550 Refurbished & Aftermarket Parts | | | | |
| RF5-1834-AFT | Aftermarket Feed Roller (OEM# RF5-1834-000) | 923994 | EA | \$0.33 |
| RF5-1835-AFT | Aftermarket Pickup Roller (OEM# RF5-1835-000) | 923995 | EA | \$0.66 |
| RG5-4021-REF | Refurbished Universal Power Supply (OEM# RG5-4021) | 927388 | EA | \$107.25 |
| RG5-2168-REF | Refurbished Sensor PCA (OEM# RG5-2168) | 929914 | EA | \$50.67 |
| HP Color LJ 9500/9500 MFP Refurbished & Aftermarket Parts | | | | |
| RB2-1820-AFT | Aftermarket Tray 1 Pickup Roller (OEM# RB2-1795) | 923978 | EA | \$1.42 |
| RF5-3340-AFT | Aftermarket Tray 2/3 Pickup Roller (OEM# RF5-3340) | 924005 | EA | \$0.48 |
| RF5-3338-AFT | Aftermarket Tray 2/3 Feed Roller (OEM# RF5-3338-000) | 924004 | EA | \$0.66 |
| Q3701-60012-REF | Refurbished PCA-MFP Analog 300 ROHS Fax Modem (OEM# Q3701-60012) | 933297 | EA | \$264.76 |
| HP Color LJ CM1312nfi MFP Refurbished & Aftermarket Parts | | | | |
| 5851-3580-REF | Refurbished ADF Pickup Roller Assembly (OEM# 5851-3580) | 926572 | EA | \$29.56 |
| RM1-4426-REF | Refurbished D-Shaped Pickup Roller (OEM# RM1-4426) | 926578 | EA | \$23.87 |
| RM1-4426-AFT | Aftermarket D-Shaped Pickup Roller (OEM# RM1-4426) | 924052 | EA | \$3.73 |

| MFG# | Product Description | Part# | UOM | Retail |
|--|---|--------|-----|----------|
| HP COMPATIBLE PARTS | | | | |
| HP Color LJ CM1415/CP1215/CP1515/CP1518/CP1525/CP2025 Refurbished & Aftermarket Parts | | | | |
| RM1-4426-REF | Refurbished D-Shaped Pickup Roller (OEM# RM1-4426) | 926578 | EA | \$23.87 |
| RM1-4426-AFT | Aftermarket D-Shaped Pickup Roller (OEM# RM1-4426) | 924052 | EA | \$3.73 |
| HP Color LJ CM2320 Refurbished & Aftermarket Parts | | | | |
| RM1-4426-REF | Refurbished D-Shaped Pickup Roller (OEM# RM1-4426) | 926578 | EA | \$23.87 |
| RM1-4426-AFT | Aftermarket D-Shaped Pickup Roller (OEM# RM1-4426) | 924052 | EA | \$3.73 |
| 5851-3580-REF | Refurbished ADF Pickup Roller Assembly (OEM# 5851-3580) | 926572 | EA | \$29.56 |
| HP Color LJ CM3530 MFP/CP3525 Refurbished & Aftermarket Parts | | | | |
| CC468-67907-REF | Refurbished Electrostatic Transfer Belt (ETB) Assembly (OEM# CC468-67907, CC468-67927, CF081-67904) | 926574 | EA | \$532.01 |
| HP Color LJ CM6030/CP3525/CP6015 Refurbished & Aftermarket Parts | | | | |
| RM1-0037-AFT | Aftermarket Tray 2/500-Sheet Tray Feed Roller (OEM# RM1-0037-020) | 924033 | EA | \$0.66 |
| HP Color LJ CM6040 Refurbished & Aftermarket Parts | | | | |
| RM1-0036-AFT | Aftermarket Tray 2/500-Sheet Tray Pickup Roller (OEM# RM1-0036) | 924032 | EA | \$0.73 |
| HP Color LJ CP2025 Refurbished & Aftermarket Parts | | | | |
| HPCP2025-FBRD-REF | Refurbished Formatter Board (OEM# CB492-60002) | 929905 | EA | \$96.84 |
| HP Color LJ CP4005 Refurbished & Aftermarket Parts | | | | |
| RM1-3131-REF | Refurbished Maintenance Kit (Includes Fuser Assembly, Tray 1 Pickup Roller, Separation Pad and Pickup Roller, Gloves, Instructions) (OEM# RM1-3131-000) (150,000 Yield) | 906367 | EA | \$194.62 |
| Q7502A-REF | Refurbished Fuser Assembly (OEM# Q7502A, RM1-3131-000) (100,000 Yield) | 99311 | EA | \$179.41 |
| RM1-3161-130-REF | Refurbished Transfer Kit (Includes Electrostatic Transfer Belt (ETB) Assembly, Cleaning Cloth) (OEM# Q7504A, RM1-3161) (100,000 Yield) | 909977 | EA | \$196.14 |
| RL1-0019-AFT | Aftermarket Tray 1 Pickup Roller (OEM# RL1-0019) | 924020 | EA | \$1.38 |
| RM1-0036-AFT | Aftermarket Tray 2/500-Sheet Tray Pickup Roller (OEM# RM1-0036) | 924032 | EA | \$0.73 |
| RM1-0037-AFT | Aftermarket Tray 2/500-Sheet Tray Feed Roller (OEM# RM1-0037-020) | 924033 | EA | \$0.66 |
| HP Color LJ CP4025/CP4525 Refurbished & Aftermarket Parts | | | | |
| HPCP4025-FBRDN-REF | Refurbished Formatter Board (OEM# CC493-69001) | 928704 | EA | \$657.86 |
| HP Color LJ CP5225/M750/M775 Refurbished & Aftermarket Parts | | | | |
| CE516A-REF | Refurbished Image Transfer Belt (OEM# CE516A) (200,000 Yield) | 933499 | EA | \$353.26 |
| HP Color LJ CP5525 Refurbished & Aftermarket Parts | | | | |
| HPCP5525-KIT-REO | Refurbished Maintenance Kit with OEM Rollers (150,000 Yield) | 933507 | EA | \$543.08 |
| HPCP5525-KIT-REF | Refurbished Maintenance Kit with Aftermarket Parts (150,000 Yield) | 933506 | EA | \$340.85 |
| CE516A-REF | Refurbished Image Transfer Belt (OEM# CE516A) (200,000 Yield) | 933499 | EA | \$353.26 |
| HP LJ Pro 300 Color MFP M375/400 Color MFP M475 Refurbished & Aftermarket Parts | | | | |
| 5851-3580-REF | Refurbished ADF Pickup Roller Assembly (OEM# 5851-3580) | 926572 | EA | \$29.56 |
| HP LJ Enterprise 500 Color Printer M551n Refurbished & Aftermarket Parts | | | | |
| HPM551-KIT-REO | Refurbished Maintenance Kit with OEM Rollers (100,000 Yield) | 933511 | EA | \$451.10 |
| HPM551-KIT-REF | Refurbished Maintenance Kit with Aftermarket Parts (100,000 Yield) | 933510 | EA | \$256.04 |
| CC468-67907-REF | Refurbished Electrostatic Transfer Belt (ETB) Assembly (OEM# CC468-67907, CC468-67927, CF081-67904) | 926574 | EA | \$532.01 |
| RM1-8087-REF | Refurbished Lower High Voltage Power Supply Assembly (OEM# RM1-8087) | 933515 | EA | \$245.27 |
| HP LJ Pro Flow/500 Color MFP M570 Refurbished & Aftermarket Parts | | | | |
| RM1-8087-REF | Refurbished Lower High Voltage Power Supply Assembly (OEM# RM1-8087) | 933515 | EA | \$245.27 |
| Refurbished HP JetDirect Cards | | | | |
| J4169A-REF | Refurbished 610N JetDirect Card (OEM# J4169A) | 923962 | EA | \$80.37 |
| J6057A-JDBRD-REF | Refurbished 615N JetDirect Card (Replaces 610 card) (OEM# J4169-6100) | 923963 | EA | \$86.44 |
| J7934A-JDBRD-REF | Refurbished 620N JetDirect Card (OEM# J7934A) | 923964 | EA | \$153.95 |

LEXMARK COMPATIBLE PARTS**Lexmark C750/C752/C760/C762/C770/C772/C780/C782 Refurbished & Aftermarket Parts**

| | | | | |
|-------------|---|--------|----|--------|
| 99A0070-AFT | Aftermarket Pickup Rollers (2 Pack) (OEM# 40X0070, 99A0070) (150,000 Yield) | 923939 | EA | \$1.60 |
|-------------|---|--------|----|--------|

| MFG# | Product Description | Part# | UOM | Retail |
|--|--|--------|-----|----------|
| LEXMARK COMPATIBLE PARTS | | | | |
| Lexmark E220/E320/E321/E322/E323 Refurbished & Aftermarket Parts | | | | |
| 99A1017-AFT | Aftermarket Charge Roll (OEM# 99A1017) | 923944 | EA | \$6.58 |
| Lexmark E240/E250/E330/E350/E450/X203/X204 Refurbished & Aftermarket Parts | | | | |
| 56P1820-AFT | Aftermarket Pickup Rollers (2 Pack) (OEM# 40X1319, 56P1820) | 923937 | EA | \$2.44 |
| Lexmark E260/E360/E460/E462/X463/X464/X466 Refurbished & Aftermarket Parts | | | | |
| 40X5400-REF | Refurbished Maintenance Kit (110-127V) (Includes Fuser, Tray 1 ACM Feed Tires, Transfer Roller) (OEM# 40X5400) (120,000 Yield) | 927117 | EA | \$127.06 |
| Lexmark Optra S 1250/1255 Refurbished & Aftermarket Parts | | | | |
| 99A0179-AFT | Aftermarket Transfer Roller (OEM# 56P1357, 99A0179) | 923941 | EA | \$8.23 |
| 99A0076-AFT | Aftermarket Multipurpose Tray Pickup Roller (OEM# 99A0076) | 923940 | EA | \$1.76 |
| 99A0070-AFT | Aftermarket Pickup Rollers (2 Pack) (OEM# 40X0070, 99A0070) (150,000 Yield) | 923939 | EA | \$1.60 |
| 99A1017-AFT | Aftermarket Charge Roll (OEM# 99A1017) | 923944 | EA | \$6.58 |
| 99A0725-AFT | Aftermarket Fuser Wiper Assembly (OEM# 99A0725) | 923942 | EA | \$2.24 |
| 99A0128-REF | Refurbished Board Input Tray (OEM# 99A0128) | 929878 | EA | \$15.21 |
| Lexmark Optra S 1620/1625/1650/1855 Refurbished & Aftermarket Parts | | | | |
| 99A0967-REF | Refurbished Maintenance Kit (Includes Fuser, Transfer Roller, Charge Roller, Pick Rollers) (OEM# 99A0967) (100,000 Yield) | 99436 | EA | \$228.12 |
| 99A0179-AFT | Aftermarket Transfer Roller (OEM# 56P1357, 99A0179) | 923941 | EA | \$8.23 |
| 99A1017-AFT | Aftermarket Charge Roll (OEM# 99A1017) | 923944 | EA | \$6.58 |
| 99A0076-AFT | Aftermarket Multipurpose Tray Pickup Roller (OEM# 99A0076) | 923940 | EA | \$1.76 |
| 99A0070-AFT | Aftermarket Pickup Rollers (2 Pack) (OEM# 40X0070, 99A0070) (150,000 Yield) | 923939 | EA | \$1.60 |
| 99A0725-AFT | Aftermarket Fuser Wiper Assembly (OEM# 99A0725) | 923942 | EA | \$2.24 |
| 99A0128-REF | Refurbished Board Input Tray (OEM# 99A0128) | 929878 | EA | \$15.21 |
| Lexmark Optra S 2420/2450/2455 Refurbished & Aftermarket Parts | | | | |
| 99A1195-REF | Refurbished Maintenance Kit (Includes Fuser, Transfer Roller, Charge Roller, Pick Rollers) (OEM# 99A1195) (250,000 Yield) | 99437 | EA | \$228.12 |
| 99A0179-AFT | Aftermarket Transfer Roller (OEM# 56P1357, 99A0179) | 923941 | EA | \$8.23 |
| 99A1017-AFT | Aftermarket Charge Roll (OEM# 99A1017) | 923944 | EA | \$6.58 |
| DEP43H0711-AFT | Aftermarket Lower Roller (OEM# 43H0711, 99A0158, 010354) | 923952 | EA | \$12.71 |
| 99A0076-AFT | Aftermarket Multipurpose Tray Pickup Roller (OEM# 99A0076) | 923940 | EA | \$1.76 |
| 99A0070-AFT | Aftermarket Pickup Rollers (2 Pack) (OEM# 40X0070, 99A0070) (150,000 Yield) | 923939 | EA | \$1.60 |
| 99A0725-AFT | Aftermarket Fuser Wiper Assembly (OEM# 99A0725) | 923942 | EA | \$2.24 |
| 99A0128-REF | Refurbished Board Input Tray (OEM# 99A0128) | 929878 | EA | \$15.21 |
| Lexmark Optra Se 3455 Refurbished & Aftermarket Parts | | | | |
| 99A0179-AFT | Aftermarket Transfer Roller (OEM# 56P1357, 99A0179) | 923941 | EA | \$8.23 |
| 99A1017-AFT | Aftermarket Charge Roll (OEM# 99A1017) | 923944 | EA | \$6.58 |
| DEP43H0711-AFT | Aftermarket Lower Roller (OEM# 43H0711, 99A0158, 010354) | 923952 | EA | \$12.71 |
| 99A0070-AFT | Aftermarket Pickup Rollers (2 Pack) (OEM# 40X0070, 99A0070) (150,000 Yield) | 923939 | EA | \$1.60 |
| 99A0725-AFT | Aftermarket Fuser Wiper Assembly (OEM# 99A0725) | 923942 | EA | \$2.24 |
| 99A0128-REF | Refurbished Board Input Tray (OEM# 99A0128) | 929878 | EA | \$15.21 |
| Lexmark T520/T522/X520/X522 Refurbished & Aftermarket Parts | | | | |
| 99A2420-REF | Refurbished Maintenance Kit (Includes Fuser, Transfer Roller, Charge Roller, Pick Rollers) (OEM# 99A2420) (300,000 Yield) | 99355 | EA | \$281.00 |
| 99A1017-AFT | Aftermarket Charge Roll (OEM# 99A1017) | 923944 | EA | \$6.58 |
| 99A0076-AFT | Aftermarket Multipurpose Tray Pickup Roller (OEM# 99A0076) | 923940 | EA | \$1.76 |
| 99A0070-AFT | Aftermarket Pickup Rollers (2 Pack) (OEM# 40X0070, 99A0070) (150,000 Yield) | 923939 | EA | \$1.60 |
| 99A0725-AFT | Aftermarket Fuser Wiper Assembly (OEM# 99A0725) | 923942 | EA | \$2.24 |
| Lexmark T610/T612 Refurbished & Aftermarket Parts | | | | |
| 99A1970-REF | Refurbished Maintenance Kit (Includes Fuser, Transfer Roller, Charge Roller, Pick Rollers) (OEM# 99A1970) (300,000 Yield) | 99440 | EA | \$239.76 |
| 99A1015-AFT | Aftermarket Transfer Roller (OEM# 99A1015) | 923943 | EA | \$6.20 |
| 99A1017-AFT | Aftermarket Charge Roll (OEM# 99A1017) | 923944 | EA | \$6.58 |
| 99A0128-REF | Refurbished Board Input Tray (OEM# 99A0128) | 929878 | EA | \$15.21 |
| Lexmark T614/T616 Refurbished & Aftermarket Parts <i>(Continued on next page)</i> | | | | |
| 99A1978-REF | Refurbished Maintenance Kit (Includes Fuser, Transfer Roller, Charge Roller, Pick Rollers) (OEM# 99A1978A) (100,000 Yield) | 99434 | EA | \$206.40 |
| 99A1015-AFT | Aftermarket Transfer Roller (OEM# 99A1015) | 923943 | EA | \$6.20 |
| 99A1017-AFT | Aftermarket Charge Roll (OEM# 99A1017) | 923944 | EA | \$6.58 |
| DEP43H0711-AFT | Aftermarket Lower Roller (OEM# 43H0711, 99A0158, 010354) | 923952 | EA | \$12.71 |
| 99A0076-AFT | Aftermarket Multipurpose Tray Pickup Roller (OEM# 99A0076) | 923940 | EA | \$1.76 |
| 99A0070-AFT | Aftermarket Pickup Rollers (2 Pack) (OEM# 40X0070, 99A0070) (150,000 Yield) | 923939 | EA | \$1.60 |

| MFG# | Product Description | Part# | UOM | Retail |
|---|---|--------|-----|----------|
| LEXMARK COMPATIBLE PARTS | | | | |
| Lexmark T614/T616 Refurbished & Aftermarket Parts (Continued) | | | | |
| 99A0725-AFT | Aftermarket Fuser Wiper Assembly (OEM# 99A0725) | 923942 | EA | \$2.24 |
| 99A0128-REF | Refurbished Board Input Tray (OEM# 99A0128) | 929878 | EA | \$15.21 |
| Lexmark T620 Refurbished & Aftermarket Parts | | | | |
| 99A0076-AFT | Aftermarket Multipurpose Tray Pickup Roller (OEM# 99A0076) | 923940 | EA | \$1.76 |
| 99A0070-AFT | Aftermarket Pickup Rollers (2 Pack) (OEM# 40X0070, 99A0070) (150,000 Yield) | 923939 | EA | \$1.60 |
| 99A0725-AFT | Aftermarket Fuser Wiper Assembly (OEM# 99A0725) | 923942 | EA | \$2.24 |
| Lexmark T620/X620 Refurbished & Aftermarket Parts | | | | |
| 99A2408-REF | Refurbished Maintenance Kit (Includes Fuser, Transfer Roller, Charge Roller, Pick Rollers) (OEM# 99A2408) (300,000 Yield) | 99435 | EA | \$154.00 |
| 99A2402-REF | Refurbished Fuser Assembly (110-127V) (OEM# 99A2402) (300,000 Yield) | 927118 | EA | \$88.32 |
| 99A1015-AFT | Aftermarket Transfer Roller (OEM# 99A1015) | 923943 | EA | \$6.20 |
| 99A1017-AFT | Aftermarket Charge Roll (OEM# 99A1017) | 923944 | EA | \$6.58 |
| 99A0076-AFT | Aftermarket Multipurpose Tray Pickup Roller (OEM# 99A0076) | 923940 | EA | \$1.76 |
| 99A0070-AFT | Aftermarket Pickup Rollers (2 Pack) (OEM# 40X0070, 99A0070) (150,000 Yield) | 923939 | EA | \$1.60 |
| 99A0725-AFT | Aftermarket Fuser Wiper Assembly (OEM# 99A0725) | 923942 | EA | \$2.24 |
| 99A0128-REF | Refurbished Board Input Tray (OEM# 99A0128) | 929878 | EA | \$15.21 |
| Lexmark T622 Refurbished & Aftermarket Parts | | | | |
| 99A2411-REF | Refurbished Maintenance Kit (Includes Fuser, Transfer Roller, Charge Roller, Pick Rollers) (OEM# 99A2411) (300,000 Yield) | 99338 | EA | \$247.98 |
| 99A1017-AFT | Aftermarket Charge Roll (OEM# 99A1017) | 923944 | EA | \$6.58 |
| DEP43H0711-AFT | Aftermarket Lower Roller (OEM# 43H0711, 99A0158, 010354) | 923952 | EA | \$12.71 |
| 99A0076-AFT | Aftermarket Multipurpose Tray Pickup Roller (OEM# 99A0076) | 923940 | EA | \$1.76 |
| 99A0070-AFT | Aftermarket Pickup Rollers (2 Pack) (OEM# 40X0070, 99A0070) (150,000 Yield) | 923939 | EA | \$1.60 |
| 99A0725-AFT | Aftermarket Fuser Wiper Assembly (OEM# 99A0725) | 923942 | EA | \$2.24 |
| 99A0128-REF | Refurbished Board Input Tray (OEM# 99A0128) | 929878 | EA | \$15.21 |
| Lexmark T630/T632/X630/X632 Refurbished & Aftermarket Parts | | | | |
| 56P1409-REO | Refurbished Maintenance Kit with OEM Parts (OEM# 56P1409) (300,000 Yield) | 933352 | EA | \$158.13 |
| 56P2542-REF | Refurbished Fuser Assembly (OEM# 56P2542) (300,000 Yield) | 99449 | EA | \$127.73 |
| 99A0179-AFT | Aftermarket Transfer Roller (OEM# 56P1357, 99A0179) | 923941 | EA | \$8.23 |
| 99A1017-AFT | Aftermarket Charge Roll (OEM# 99A1017) | 923944 | EA | \$6.58 |
| 99A0076-AFT | Aftermarket Multipurpose Tray Pickup Roller (OEM# 99A0076) | 923940 | EA | \$1.76 |
| 99A0070-AFT | Aftermarket Pickup Rollers (2 Pack) (OEM# 40X0070, 99A0070) (150,000 Yield) | 923939 | EA | \$1.60 |
| 56P1309-REF | Refurbished Lower Front Cover Assembly (OEM# 56P1309, 99A1511) | 929877 | EA | \$46.77 |
| Lexmark T634/X634 Refurbished & Aftermarket Parts | | | | |
| 56P1855-REF | Refurbished Maintenance Kit (Includes Aftermarket Feed, Separation, Transfer Rollers) (OEM# 56P1855) (300,000 Yield) | 99454 | EA | \$244.59 |
| 99A0179-AFT | Aftermarket Transfer Roller (OEM# 56P1357, 99A0179) | 923941 | EA | \$8.23 |
| 99A1017-AFT | Aftermarket Charge Roll (OEM# 99A1017) | 923944 | EA | \$6.58 |
| 99A0076-AFT | Aftermarket Multipurpose Tray Pickup Roller (OEM# 99A0076) | 923940 | EA | \$1.76 |
| 99A0070-AFT | Aftermarket Pickup Rollers (2 Pack) (OEM# 40X0070, 99A0070) (150,000 Yield) | 923939 | EA | \$1.60 |
| 56P1309-REF | Refurbished Lower Front Cover Assembly (OEM# 56P1309, 99A1511) | 929877 | EA | \$46.77 |
| Lexmark T640/T642/T644/X642/X644/X646 Refurbished & Aftermarket Parts | | | | |
| 40X0100-REO | Refurbished Maintenance Kit with OEM Parts (Includes Fuser, Transfer Roller, Charge Roller, Pick Tires) (OEM# 40X0100) (300,000 Yield) | 933885 | EA | \$180.93 |
| 40X2592-REF | Refurbished Fuser Assembly (OEM# 40X2592) | 99306 | EA | \$144.44 |
| 40X2665-AFT | Aftermarket Fuser Cleaning Wand Wiper (OEM# 40X2665) | 923933 | EA | \$4.85 |
| 40X0130-AFT | Aftermarket Transfer Roll (OEM# 40X0130) | 923931 | EA | \$8.03 |
| 40X0127-AFT | Aftermarket Charge Roller Assembly (OEM# 40X0127) | 923930 | EA | \$11.19 |
| 20G0890-REF | Refurbished 500-Sheet Drawer Assembly (OEM# 20G0890) | 929876 | EA | \$233.91 |
| 40X4308-AFT | Aftermarket Pickup Roller (2 Pack) (OEM# 40X4308) | 923934 | EA | \$1.82 |
| Lexmark T650/T652/T654/T656/X651/X652/X654/X656/X658 Refurbished & Aftermarket Parts | | | | |
| 40X4724-REO | Refurbished Maintenance Kit with OEM Rollers (110-120V) (Type 1) (Includes Fuser Assembly, Transfer Roller, Charge Roll, Pick Tires) (OEM# 40X4724) (300,000 Yield) | 930305 | EA | \$259.00 |
| 40X4418-REF | Refurbished Fuser Assembly (OEM# 40X4418) (300,000 Yield) | 923935 | EA | \$212.19 |
| 40X1886-AFT | Aftermarket Transfer Roller Assembly (OEM# 40X1886) | 923932 | EA | \$16.43 |
| 40X4308-AFT | Aftermarket Pickup Roller (2 Pack) (OEM# 40X4308) | 923934 | EA | \$1.82 |
| 40X2665-AFT | Aftermarket Fuser Cleaning Wand Wiper (OEM# 40X2665) | 923933 | EA | \$4.85 |
| XEROX COMPATIBLE PARTS | | | | |
| Xerox Phaser 6200 Refurbished & Aftermarket Parts | | | | |
| 671-5290-81-REF | Refurbished Image Processor Board (OEM# 671-5290-81) | 930141 | EA | \$347.63 |



..... PRINT MEDIA

Print Media is a necessity in any office environment. Be sure to include labels, P-touch tapes and printer paper in your next order.

QUALITY AND RELIABILITY.

| MFG# | Product Description | Part# | UOM | Retail |
|---|--|--------|-----|----------|
| EVERY MEDIA | | | | |
| Avery Easy Peel Address Labels - White Labels For Laser Printers | | | | |
| 5167 | 1/2" x 1 3/4", 80 Labels/Sheet (100 Sheets/Box) | 10793 | BOX | \$45.91 |
| 5260 | 1" x 2 5/8", 30 Labels/Sheet (25 Sheets/Pkg) | 10555 | PK | \$13.37 |
| 5160 | 1" x 2 5/8", 30 Labels/Sheet (100 Sheets/Box) | 10536 | BOX | \$44.56 |
| 5960 | 1" x 2 5/8", 30 Labels/Sheet (250 Sheets/Box) | 1611 | BOX | \$100.16 |
| 5161 | 1" x 4", 20 Labels/Sheet (100 Sheets/Box) | 10541 | BOX | \$44.56 |
| 5162 | 1 1/3" x 4", 14 Labels/Sheet (100 Sheets/Box) | 10543 | BOX | \$44.56 |
| Avery Easy Peel Address Labels - Clear Labels For Laser Printers | | | | |
| 5660 | 1" x 2 5/8", 30 Labels/Sheet (50 Sheets/Box) | 10518 | BOX | \$56.26 |
| 18660 | 1" x 2 5/8", 10 Labels/Sheet (30 Sheets/Pkg) | 10753 | PK | \$12.66 |
| Avery Easy Peel Address Labels - White Labels For InkJet Printers | | | | |
| 8460 | 1" x 2 5/8", 30 Labels/Sheet (100 Sheets/Box) | 902488 | BOX | \$45.91 |
| Avery Shipping Labels With TrueBlock Technology - White Labels For Laser Printers | | | | |
| 5163 | 2" x 4", 10 Labels/Sheet (100 Sheets/Box) | 10544 | BOX | \$45.91 |
| 5963 | 2" x 4", 10 Labels/Sheet (250 Sheets /Box) | 5610 | BOX | \$100.16 |
| 5164 | 3 1/3" x 4", 6 Labels/Sheet (100 Sheets/Box) | 10545 | BOX | \$45.91 |
| 5168 | 3 1/2" x 5", 4 Labels/Sheet (100 Sheets/Box) | 10798 | BOX | \$45.91 |
| 5165 | 8 1/2" x 11", 1 Label/Sheet (100 Sheets/Box) | 10546 | BOX | \$45.91 |
| Avery Shipping Labels With TrueBlock Technology - White Labels For InkJet Printers | | | | |
| 8163 | 2" x 4", 10 Labels/Sheet (25 Sheets/Pkg) | 10759 | PK | \$13.39 |
| Avery Shipping Labels With Receipts - White Labels For Laser Printers | | | | |
| 5327 | 5 1/16" x 7 5/8", 1 Label and 1 Receipt/Sheet (25 Sheets/Pkg) | 101133 | PK | \$13.39 |
| Avery Shipping Labels With Receipts - White Labels For InkJet Printers | | | | |
| 8127 | 5 1/16" x 7 5/8", 1 Label and 1 Receipt/Sheet (25 Sheets/Pkg) | 101132 | PK | \$13.39 |
| Avery White Pin-Fed/Dot Matrix Printer Labels | | | | |
| 4013 | 3 1/2" x 15/16", 1 Label/Across (5,000/Box) | 10579 | BOX | \$34.54 |
| Avery File Folder Labels With TrueBlock Technology | | | | |
| 5366 | 2/3" x 3 7/16", Laser, 30 Labels/Sheet (50 Sheets/Box) | 10586 | BOX | \$45.00 |
| Avery Flexible White Name Badge Labels | | | | |
| 5395 | 2 1/3" x 3 3/8", 8 Labels/Sheet (50 Sheets/Box) | 10637 | BOX | \$61.44 |
| Avery CD/DVD Labels For Laser Printers | | | | |
| 5692 | CD Labels, 40 Disc Labels and 80 Jewel Case Spine Inserts | 2811 | PK | \$17.47 |
| Avery CD/DVD Labels For InkJet Printers | | | | |
| 8692 | CD Labels, 40 Disc Labels and 80 Jewel Case Spine Inserts | 10817 | PK | \$17.47 |
| Avery White Business Cards For Laser Printers | | | | |
| 5371 | 2" x 3 1/2", Perforated, 10 Cards/Sheet (25 Sheets/Pkg) | 10627 | PK | \$15.34 |
| 5871 | 2" x 3 1/2", Clean Edge, Matte, 10 Cards/Sheet (20 Sheets/Pkg) | 5804 | PK | \$17.91 |
| Avery White Business Cards For InkJet Printers | | | | |
| 8871 | 2" x 3 1/2", Clean Edge, Matte, 10 Cards/Sheet (20 Sheets/Pkg) | 10387 | PK | \$17.91 |
| 8873 | 2" x 3 1/2", Clean Edge, Linen, 10 Cards/Sheet (20 Sheets/Pkg) | 1650 | PK | \$20.31 |

BROTHER MEDIA

BROTHER P-TOUCH CROSS REFERENCE GUIDE CAN BE FOUND ON PAGES 190, 191.

Brother DK Tape: For Use With QL-500/550/570/570VM/580N/650TD/700/1050/1060N *(Continued on next page)*

| | | | | |
|--------|---|-------|----|---------|
| DK1201 | Standard Address Die-Cut Paper Label (400 Labels) (1/Pkg) | 5739 | PK | \$15.49 |
| DK1202 | Shipping Die-Cut Paper Label (300 Labels) (1/Pkg) | 5740 | PK | \$27.99 |
| DK1203 | File Folder Die-Cut Paper Label (300 Labels) (1/Pkg) | 5741 | PK | \$13.49 |
| DK1204 | Multipurpose Die-Cut Paper Label (400 Labels) (1/Pkg) | 5742 | PK | \$15.99 |
| DK1208 | Large Address Die-Cut Paper Label (400 Labels) (1/Pkg) | 5744 | PK | \$20.99 |
| DK1209 | Small Address Die-Cut Paper Label (800 Labels) (1/Pkg) | 5745 | PK | \$27.99 |
| DK1218 | 24mm (1") Diameter Round White Die-Cut Paper Labels (1,000 Labels) | 10424 | PK | \$20.99 |
| DK1219 | 12mm (1/2") Round Die-Cut Paper Label (1,200 Labels) | 10425 | PK | \$20.99 |
| DK1221 | Square White Paper Labels (10/11" x 10/11") (1,000/Pkg) | 30121 | PK | \$20.99 |
| DK2113 | 62mm (2 3/7") Black on Clear Continuous Length Film Label Tape (15m/50 Ft.) (1/Pkg) | 5746 | PK | \$99.99 |
| DK2205 | 62mm (2 3/7") Black on White Continuous Length Paper Label Tape (30m/100 Ft.) (1/Pkg) | 5747 | PK | \$28.99 |
| DK2210 | 29mm (1 1/7") Continuous Length Paper Label (30m/100 Ft.) (1/Pkg) | 5748 | PK | \$18.99 |

| MFG# | Product Description | Part# | UOM | Retail |
|---|---|--------|-----|---------|
| BROTHER MEDIA | | | | |
| <small>BROTHER P-TOUCH CROSS REFERENCE GUIDE CAN BE FOUND ON PAGES 190, 191.</small> | | | | |
| Brother DK Tape: For Use With QL-500/550/570/570VM/580N/650TD/700/1050/1060N (Continued) | | | | |
| DK2211 | 29mm (1 1/7") Continuous Length Film Label (15m/50 Ft.) (1/Pkg) | 5749 | PK | \$32.49 |
| DK2212 | 62mm (2 3/7") Black on White Continuous Length Film Label Tape (15m/50 Ft.) (1/Pkg) | 5750 | PK | \$64.99 |
| DK2214 | 12mm (1/2") Continuous Length White Paper Label (30m/100 Ft.) (1/Pkg) | 5751 | PK | \$14.99 |
| DK2606 | 62mm (2 3/7") Black on Yellow Continuous Length Film Label Tape (15m/50 Ft.) (1/Pkg) | 5752 | PK | \$99.99 |
| DK4205 | 62mm (2 3/7") Black on White Removable Continuous Length Paper Label Tape (30m/100 Ft.) (1/Pkg) | 10426 | PK | \$38.99 |
| DKN5224 | 54mm (2") Black on White Non-Adhesive Continuous Length Paper Label Tape (30m/100 Ft.) (1/Pkg) | 500039 | PK | \$19.99 |
| Brother M Tape: For Use With PT-65/70/80/85/90/100/110 | | | | |
| M131 | 12mm (1/2") Black on Clear Non-Laminated Tape (8m/26.2 Ft.) (1/Pkg) | 21527 | PK | \$10.49 |
| M231 | 12mm (1/2") Black on White Non-Laminated Tape (8m/26.2 Ft.) (1/Pkg) | 98717 | PK | \$10.49 |
| M2312PK | 12mm (1/2") Black on White Non-Laminated Tape (2 Pack of M231) (8m/26.2 Ft.) | 94733 | PK | \$19.49 |
| M531 | 12mm (1/2") Black on Blue Non-Laminated Tape (8m/26.2 Ft.) (1/Pkg) | 102396 | PK | \$10.49 |
| M721 | 9mm (3/8") Black on Metallic Green Non-Laminated Tape (8m/26.2 Ft.) (1/Pkg) | 105596 | PK | \$9.49 |
| (For use in M P-Touch: 65/85/100/110) | | | | |
| M831 | 12mm (1/2") Black on Gold Non-Laminated Tape (8m/26.2 Ft.) (1/Pkg) | 105598 | PK | \$10.49 |
| M921 | 9mm (3/8") Black on Silver Non-Laminated Tape (8m/26.2 Ft.) (1/Pkg) | 5170 | PK | \$9.49 |
| M931 | 12mm (1/2") Black on Silver Non-Laminated Tape (8m/26.2 Ft.) (1/Pkg) | 105452 | PK | \$10.49 |
| MK233 | 12mm (1/2") Blue on White Non-Laminated Tape (8m/26.2 Ft.) (1/Pkg) | 5771 | PK | \$10.49 |
| MK232 | 12mm (1/2") Red on White Non-Laminated Tape (8m/26.2 Ft.) (1/Pkg) | 4083 | PK | \$10.49 |
| MK631 | 12mm (1/2") Black on Yellow Non-Laminated Tape (8m/26.2 Ft.) (1/Pkg) | 5772 | PK | \$10.49 |
| Brother TC Tape: For Use With PT-6/8/10/12/12N/15/20/25/150/170 | | | | |
| TC10 | 12mm (1/2") Black on Clear Laminated Tape (7.7m/25 Ft.) (2/Pkg) | 91700 | PK | \$39.99 |
| TC20 | 12mm (1/2") Black on White Laminated Tape (7.7m/25 Ft.) (2/Pkg) | 91724 | PK | \$39.99 |
| TC20Z1 | 9mm (3/8") Black on White Laminated Tape (7.7m/25 Ft.) (1/Pkg) | 93425 | PK | \$21.99 |
| TC22 | 12mm (1/2") Blue on White Laminated Tape (7.7m/25 Ft.) (2/Pkg) | 90062 | PK | \$39.99 |
| TC7001 | 12mm (1/2") Black on Yellow Laminated Tape (7.7m/25 Ft.) (1/Pkg) | 93479 | PK | \$21.99 |
| Brother TX Tape: For Use With PT-30/35/8000, P-touch PC | | | | |
| TX1311 | 12mm (1/2") Black on Clear Laminated Tape (15m/50 Ft.) (1/Pkg) | 92664 | PK | \$39.99 |
| TX1511 | 24mm (1") Black on Clear Laminated Tape (15m/50 Ft.) (1/Pkg) | 92672 | PK | \$44.99 |
| TX2111 | 6mm (1/4") Black on White Laminated Tape (15m/50 Ft.) (1/Pkg) | 97283 | PK | \$34.49 |
| TX2311 | 12mm (1/2") Black on White Laminated Tape (15m/50 Ft.) (1/Pkg) | 94702 | PK | \$39.99 |
| TX2411 | 18mm (3/4") Black on White Laminated Tape (15m/50 Ft.) (1/Pkg) | 94340 | PK | \$44.99 |
| TX2511 | 24mm (1") Black on White Laminated Tape (15m/50 Ft.) (1/Pkg) | 94692 | PK | \$44.99 |
| TX6511 | 24mm (1") Black on Yellow Laminated Tape (15m/50 Ft.) (1/Pkg) | 94698 | PK | \$44.99 |
| TX7311 | 12mm (1/2") Black on Green Laminated Tape (15m/50 Ft.) (1/Pkg) | 106948 | PK | \$39.99 |
| Brother TZ Tape: For Use With All TZ Machines (Continued on next page) | | | | |
| TZEF231 | 12mm (1/2") Acid-Free Black on White Tape (8m/26.2 Ft.) (1/Pkg) | 21519 | PK | \$19.99 |
| TZE111 | 6mm (1/4") Black on Clear Laminated Tape (8m/26.2 Ft.) (1/Pkg) | 95346 | PK | \$13.99 |
| TZE121 | 9mm (3/8") Black on Clear Laminated Tape (8m/26.2 Ft.) (1/Pkg) | 96458 | PK | \$15.99 |
| TZE131 | 12mm (1/2") Black on Clear Laminated Tape (8m/26.2 Ft.) (1/Pkg) | 95345 | PK | \$17.99 |
| TZE1312PK | 12mm (1/2") Black on Clear Laminated Tape (2 Pack of TZ131) (8m/26.2 Ft.) | 94730 | PK | \$33.49 |
| TZE135 | 12mm (1/2") White on Clear Tape (8m/26.2 Ft.) (1/Pkg) | 5338 | PK | \$18.99 |
| TZE211 | 6mm (1/4") Black on White Laminated Tape (8m/26.2 Ft.) (1/Pkg) | 95349 | PK | \$15.99 |
| TZE221 | 9mm (3/8") Black on White Laminated Tape (8m/26.2 Ft.) (1/Pkg) | 96460 | PK | \$17.99 |
| TZE231 | 12mm (1/2") Black on White Laminated Tape (8m/26.2 Ft.) (1/Pkg) | 95348 | PK | \$18.99 |
| TZE2312PK | 12mm (1/2") Black on White Laminated Tape (2 Pack of TZ231) (8m/26.2 Ft.) | 94731 | PK | \$34.99 |
| TZE232 | 12mm (1/2") Red on White Laminated Tape (8m/26.2 Ft.) (1/Pkg) | 96462 | PK | \$18.99 |
| TZE315 | 6mm (1/4") White on Black Laminated Tape (8m/26.2 Ft.) (1/Pkg) | 96466 | PK | \$18.99 |
| TZE325 | 9mm (3/8") White on Black Laminated Tape (8m/26.2 Ft.) (1/Pkg) | 96467 | PK | \$19.99 |
| TZE334 | 12mm (1/2") Gold on Black Laminated Tape (8m/26.2 Ft.) (1/Pkg) | 2761 | PK | \$21.99 |
| TZE335 | 12mm (1/2") White on Black Laminated Tape (8m/26.2 Ft.) (1/Pkg) | 95351 | PK | \$21.99 |
| TZE354 | 24mm (1") Gold on Black Laminated Tape (8m/26.2 Ft.) (1/Pkg) | 96314 | PK | \$28.49 |
| TZE421 | 9mm (3/8") Black on Red Laminated Tape (8m/26.2 Ft.) (1/Pkg) | 102332 | PK | \$17.99 |
| TZE631 | 12mm (1/2") Black on Yellow Laminated Tape (8m/26.2 Ft.) (1/Pkg) | 107608 | PK | \$18.99 |
| TZEFA3 | 12mm (1/2") Navy Blue on White Fabric Iron-on Non-Laminated Tape (8m/26.2 Ft.) (1/Pkg) | 4269 | PK | \$26.49 |
| TZEFX231 | 12mm (1/2") Flexible ID Super Adhesive Black on White Industrial Tape (8m/26.2 Ft.) (1/Pkg) | 1045 | PK | \$19.99 |
| TZEFX631 | 12mm (1/2") Flexible ID Super Adhesive Black on Yellow Industrial Tape (8m/26.2 Ft.) (1/Pkg) | 94728 | PK | \$19.99 |
| TZEMQ835 | 12mm (1/2") Simply Stylish Tapes White on Satin Gold Tape (5m/16.4 Ft.) (1/Pkg) | 19770 | PK | \$14.99 |
| TZEMQ934 | 12mm (1/2") Simply Stylish Tapes White on Satin Silver Tape (5m/16.4 Ft.) (1/Pkg) | 19771 | PK | \$14.99 |
| TZEMQG35 | 12mm (1/2") Simply Stylish Tapes White on Lime Green Tape (5m/16.4 Ft.) (1/Pkg) | 19768 | PK | \$14.99 |
| TZEMQP35 | 12mm (1/2") Simply Stylish Tapes White on Berry Pink Tape (5m/16.4 Ft.) (1/Pkg) | 19769 | PK | \$14.99 |
| TZES121 | 9mm (3/8") Black on Clear Extra Strength Super Adhesive Industrial Tape (8m/26.2 Ft.) (1/Pkg) | 99886 | PK | \$18.99 |

brother TZe Tape Size Guide[†]

Find your *P-touch* model in the list below to see all the tape sizes it can use!

| MODELS | 9/64" (3.5mm) | 1/4" (6mm) | 3/8" (9mm) | 1/2" (12mm) | 3/4" (18mm) | 1" (24mm) | 1 1/2" (36mm) |
|---|---------------|------------|------------|-------------|-------------|-----------|---------------|
| PT-1010, 1090, 1230PC, 1280, 1290, D200, H100 | √ | √ | √ | √ | | | |
| PT-1830, 1880, 2100, 2110, 2030AD, 2030VP | √ | √ | √ | √ | √ | | |
| PT-2430PC, 2700, 2710, 2730, 2730VP | √ | √ | √ | √ | √ | √ | |
| GL-100, PT-200, 1000, 1100, 1100SB, 1120, 1130, 1160, 1170S, 1180, 1190, 1200, ST-1150, 1150DX | | √ | √ | √ | | | |
| PT-18R, 300, 310, 320, 1300, 1700, 1750, 1800, 1810, 1900, 1910, 1950, 1960, ST-5 | | √ | √ | √ | √ | | |
| PT-330, 350, 520, 540, 580C, 1400, 1500PC, 1600, 1650, 2200, 2210, 2300, 2310, 2400, 2410, 2500PC, 2600, 2610 | | √ | √ | √ | √ | √ | |
| PT-530, 550, 3600, 9200DX, 9200PC, 9400, 9500PC, 9600 | | √ | √ | √ | √ | √ | √ |

[†]Tape widths are approximate

| TZe TAPE | TZe Standard Laminated Tapes – 8m long | | | | | |
|----------------------|--|--------|--------|---------|---------|--------|
| | 6mm | 9mm | 12mm | 18mm | 24mm | 36mm |
| BLACK ON WHITE | TZe211 | TZe221 | TZe231 | TZe241 | TZe251 | TZe261 |
| BLACK ON CLEAR | TZe111 | TZe121 | TZe131 | TZe141 | TZe151 | TZe161 |
| BLACK ON RED | | TZe421 | | TZe441 | TZe451 | |
| BLACK ON YELLOW | | | TZe631 | TZe641 | TZe651 | TZe661 |
| BLACK ON GREEN | | | | TZe741 | | |
| BLACK ON BLUE | | | | TZe541 | | |
| BLACK ON FL. ORANGE* | | | | TZeB41* | TZeB51* | |
| WHITE ON BLACK | TZe315 | TZe325 | TZe335 | TZe345 | TZe355 | |
| WHITE ON CLEAR | | | TZe135 | TZe145 | | |
| WHITE ON BLUE | | | | TZe545 | | |
| RED ON WHITE | | | TZe232 | TZe242 | TZe252 | |
| BLUE ON WHITE | | | | TZe243 | | |
| GOLD ON BLACK | | | TZe334 | TZe344 | TZe354 | |

*5m long

| Simply Stylish Laminated Tapes – 5m long | | | | | | |
|--|-----|-----|-----------|------|------|------|
| | 6mm | 9mm | 12mm | 18mm | 24mm | 36mm |
| WHITE ON LIME GREEN | | | TZe-MQG35 | | | |
| WHITE ON BERRY PINK | | | TZe-MQP35 | | | |
| WHITE ON SATIN GOLD | | | TZe-MQ835 | | | |
| GOLD ON SATIN SILVER | | | TZe-MQ934 | | | |

| TZe TAPE | TZe Extra Strength Adhesive Laminated Tapes – 8m long | | | | | |
|-----------------------|---|---------|---------|---------|---------|---------|
| | 6mm | 9mm | 12mm | 18mm | 24mm | 36mm |
| BLACK ON WHITE | TZeS211 | TZeS221 | TZeS231 | TZeS241 | TZeS251 | TZeS261 |
| BLACK ON CLEAR | | TZeS121 | TZeS131 | TZeS141 | TZeS151 | |
| BLACK ON YELLOW | | TZeS621 | TZeS631 | TZeS641 | TZeS651 | TZeS661 |
| WHITE ON CLEAR | | | TZeS135 | | | |
| BLACK ON MATTE SILVER | | | | TZeS941 | TZeS951 | TZeS961 |

P-touch[®] Extra Strength Adhesive Laminated Tapes are a remarkable breakthrough in labeling your most challenging surfaces. Their extraordinary adhesive properties make them ideal for the toughest labeling tasks you face:

- Uneven and rough-textured surfaces
- Surfaces exposed to harsh environments
- Slippery painted metal and plastic surfaces
- And many more!

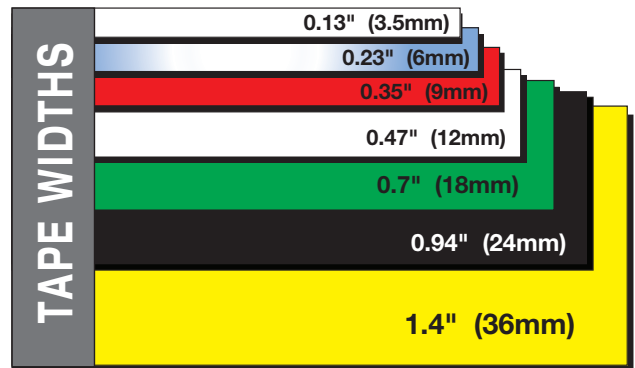

| TZe TAPE | TZe Specialty Tapes – 8m long | | | | | | |
|---|-------------------------------|-----|-----|----------|----------|----------|----------|
| | 3.5mm | 6mm | 9mm | 12mm | 18mm | 24mm | 36mm |
| Scrapbook / Photo Safe Laminated Acid-Free Adhesive[™] TZe Tapes Acid-free adhesive laminated tapes, safe for photo-labeling, scrapbooking and other photo-sensitive materials | | | | | | | |
| BLACK ON CLEAR | | | | TZeAF131 | | | |
| BLACK ON WHITE | | | | TZeAF231 | | | |
| Flexible ID Tape Flexible tape offers labeling solutions for textured surfaces, rounded edges, electrical wiring and audio/visual cables | | | | | | | |
| BLACK ON WHITE | | | | TZeFX231 | TZeFX241 | TZeFX251 | TZeFX261 |
| BLACK ON YELLOW | | | | TZeFX631 | | TZeFX651 | |



Tamper Evident Tape
Leaves evidence of tampering when removed

BLACK ON WHITE

TZeSE4



Fabric Iron-on Non-Laminated Tape*
Letters printed on cloth tape can be adhered, by ironing onto other cloth

NAVY BLUE ON WHITE

TZeFA3



Super-Narrow Non-Laminated Tape
Non-laminated, perfect for labeling CD case spines and other narrow spaces

BLACK ON WHITE

TZeN201

TC TAPE

TC Laminated Tapes^o – 7.7m long

| | 9mm | 12mm |
|----------------------|--------------|-------------|
| BLACK ON WHITE | TC20Z1 | TC20 (2 PC) |
| BLACK ON CLEAR | | TC10 (2 PC) |
| BLACK ON CLEAR MATTE | TCM0Z (2 PC) | |
| BLACK ON GOLD | TC90Z1 | |
| BLACK ON RED | | TC5001 |
| BLACK ON YELLOW | | TC7001 |
| BLACK ON GREEN | | TC8001 |
| BLACK ON BLUE | | TC6001 |
| BLACK ON FL. ORANGE | | TCB001 |
| WHITE ON BLACK | TC34Z (2 PC) | |
| WHITE ON CLEAR | TC14Z1 | |
| WHITE ON BLUE | TC64Z1 | |
| WHITE ON RED | TC54Z1 | |
| WHITE ON ORANGE | TC74Z1 | |
| RED ON WHITE | | TC21 (2 PC) |
| RED ON CLEAR | | TC11 (2 PC) |
| BLUE ON WHITE | | TC22 (2 PC) |
| BLUE ON CLEAR | | TC12 (2 PC) |
| GOLD ON BLACK | | TC33 (2 PC) |

^oFor use with PT-6, 8, 10, 12, 12N, 15, 20, 25, 150, 170K, PT-GOLD

Print Head Cleaning Tapes

Cleans print head for optimum performance.
Good for approximately 100 cleanings

DRY TAPE

TZeCL4

TZeCL6

*Claims that adhesive is "acid-free" and/or "photo-safe" are based upon: 1. Satisfactory test results obtained from Photographic Activity Tests per ISO14523 and non-acidic pH tests per TAPPI 509; 2. Certifications from material manufacturers; and 3. Atomic scans of adhesive following removal of backing paper.

**3m long



AD-24 Power Adapter

Can be used by the PT-1000, 1010, 1090, 1230PC, 1280, 1290, 1400, 1500PC, 1600, 1650, 1750, 1830, 1880, 1900, 1910, 1950, 1960, 2030, 2030AD, 2030VP, 2100, 2110, 2430PC, 2700, 2710, 2730, 2730VP, D200 and the GL-100.

TX TAPE

TX Laminated Tapes^y – 15m long

| | 6mm | 9mm | 12mm | 18mm | 24mm |
|---------------------|--------|--------|--------|--------|--------|
| BLACK ON WHITE | TX2111 | TX2211 | TX2311 | TX2411 | TX2511 |
| BLACK ON CLEAR | | | TX1311 | TX1411 | TX1511 |
| BLACK ON GRAY | | | TXA311 | | |
| BLACK ON RED | | | TX4311 | | TX4511 |
| BLACK ON YELLOW | | | TX6311 | | TX6511 |
| BLACK ON GREEN | | | TX7311 | | TX7511 |
| BLACK ON BLUE | | | TX5311 | | TX5511 |
| BLACK ON FL. ORANGE | | | | | TXB511 |
| WHITE ON BLACK | TX3151 | | TX3351 | | TX3551 |
| WHITE ON CLEAR | | | TX1351 | | TX1551 |
| RED ON WHITE | | | TX2321 | | TX2521 |
| BLUE ON WHITE | | | TX2331 | | TX2531 |

^yFor use with PT-30, 35, 8000, P-touch PC

M TAPE

M Non-Laminated Tapes[□] – 8m long

| | 9mm | 12mm |
|-----------------|------|-------|
| BLACK ON CLEAR | | M131 |
| BLACK ON WHITE | | M231 |
| BLACK ON GOLD | M821 | M831 |
| BLACK ON SILVER | M921 | M931 |
| BLACK ON GREEN | M721 | M731 |
| BLACK ON BLUE | M521 | M531 |
| BLACK ON PINK | ME21 | ME31 |
| RED ON WHITE | | MK232 |
| BLUE ON WHITE | | MK233 |
| BLACK ON YELLOW | | MK631 |

M TAPE

M Tape Assortment Packs – 8m long

| | 9mm | 12mm |
|---|-------|------|
| BLACK ON PINK/GREEN/SILVER [‡] | ME793 | |

[‡]For use with PT-65, 70, 80, 85, 90, 100, 110

[‡]1 tape of each color

Come and Explore
BROTHER CREATIVECENTER™

Free Greeting Cards, Brochures & More!
www.brother.com/creativecenter

brother
at your side

© 2011 Brother International Corporation, Bridgewater, NJ
Brother Industries, Ltd. Nagoya, Japan
All images are for illustrative purposes only.
Visit our website at www.brother.com

| MFG# | Product Description | Part# | UOM | Retail |
|------|---------------------|-------|-----|--------|
|------|---------------------|-------|-----|--------|

BROTHER MEDIA

BROTHER P-TOUCH CROSS REFERENCE GUIDE CAN BE FOUND ON PAGES 190, 191.

Brother TZ Tape: For Use With All TZ Machines (Continued)

| | | | | |
|---------|---|------|----|---------|
| TZES131 | 12mm (1/2") Extra Strength Super Adhesive Black on Clear Industrial Tape (8m/26.2 Ft.) (1/Pkg) | 1036 | PK | \$19.99 |
| TZES135 | 12mm (1/2") Extra Strength Super Adhesive White on Clear Industrial Tape (8m/26.2 Ft.) (1/Pkg) | 5350 | PK | \$19.99 |
| TZES211 | 6mm (1/4") Extra Strength Super Adhesive Black on White Industrial Tape (8m/26.2 Ft.) (1/Pkg) | 1037 | PK | \$16.99 |
| TZES221 | 9mm (3/8") Black on White Extra Strength Super Adhesive Industrial Tape (8m/26.2 Ft.) (1/Pkg) | 1038 | PK | \$18.99 |
| TZES231 | 12mm (1/2") Extra Strength Super Adhesive Black on White Industrial Tape (8m/26.2 Ft.) (1/Pkg) | 1039 | PK | \$19.99 |
| TZES621 | 9mm (3/8") Black on Yellow Extra Strength Super Adhesive Industrial Tape (8m/26.2 Ft.) (1/Pkg) | 5356 | PK | \$18.99 |
| TZES631 | 12mm (1/2") Extra Strength Super Adhesive Black on Yellow Industrial Tape (8m/26.2 Ft.) (1/Pkg) | 1040 | PK | \$19.99 |

Brother TZ Tape: For Use With All TZ Machines Except PT-200/1000/1100/1130/1160/1170S/1180/1200/1280/1300 and ST-1150/1150DX

| | | | | |
|----------|---|--------|----|---------|
| TZE141 | 18mm (3/4") Black on Clear Laminated Tape (8m/26.2 Ft.) (1/Pkg) | 96459 | PK | \$19.99 |
| TZE145 | 18mm (3/4") White on Clear Laminated Tape (8m/26.2 Ft.) (1/Pkg) | 107423 | PK | \$21.99 |
| TZE241 | 18mm (3/4") Black on White Laminated Tape (8m/26.2 Ft.) (1/Pkg) | 96463 | PK | \$21.99 |
| TZE242 | 18mm (3/4") Red on White Laminated Tape (8m/26.2 Ft.) (1/Pkg) | 102333 | PK | \$21.99 |
| TZE243 | 18mm (3/4") Blue on White Laminated Tape (8m/26.2 Ft.) (1/Pkg) | 96464 | PK | \$21.99 |
| TZE344 | 18mm (3/4") Gold on Black Laminated Tape (8m/26.2 Ft.) (1/Pkg) | 96468 | PK | \$25.49 |
| TZE345 | 18mm (3/4") White on Black Laminated Tape (8m/26.2 Ft.) (1/Pkg) | 96469 | PK | \$25.49 |
| TZE441 | 18mm (3/4") Black on Red Laminated Tape (8m/26.2 Ft.) (1/Pkg) | 96471 | PK | \$21.99 |
| TZE541 | 18mm (3/4") Black on Blue Laminated Tape (8m/26.2 Ft.) (1/Pkg) | 100460 | PK | \$21.99 |
| TZE545 | 18mm (3/4") White on Blue Laminated Tape (8m/26.2 Ft.) (1/Pkg) | 96473 | PK | \$25.99 |
| TZE641 | 18mm (3/4") Black on Yellow Laminated Tape (8m/26.2 Ft.) (1/Pkg) | 95352 | PK | \$21.99 |
| TZE741 | 18mm (3/4") Black on Green Laminated Tape (8m/26.2 Ft.) (1/Pkg) | 96475 | PK | \$21.99 |
| TZEB41 | 18mm (3/4") Black on Fluorescent Orange Laminated Tape (5m/16.4 Ft.) (1/Pkg) | 95353 | PK | \$26.49 |
| TZEFX241 | 18mm (3/4") Black on White Flexible ID Super Adhesive Industrial Tape (8m/26.2 Ft.) (1/Pkg) | 1046 | PK | \$23.49 |
| TZESE4 | 18mm (3/4") Black on White Laminated Security Tape (8m/26.2 Ft.) (1/Pkg) | 103512 | PK | \$31.49 |
| TZES141 | 18mm (3/4") Black on Clear Extra Strength Super Adhesive Industrial Tape (8m/26.2 Ft.) (1/Pkg) | 1041 | PK | \$23.49 |
| TZES241 | 18mm (3/4") Black on White Extra Strength Super Adhesive Industrial Tape (8m/26.2 Ft.) (1/Pkg) | 1042 | PK | \$23.49 |
| TZES641 | 18mm (3/4") Black on Yellow Extra Strength Super Adhesive Industrial Tape (8m/26.2 Ft.) (1/Pkg) | 1043 | PK | \$23.49 |
| TZES941 | 18mm (3/4") Black on Matte Silver Extra Strength Super Adhesive Industrial Tape (8m/26.2 Ft.) (1/Pkg) | 5359 | PK | \$27.49 |
| TZECL4 | 18mm (3/4") P-touch Cleaning Tape (8m/26.2 Ft.) (1/Pkg) | 5937 | PK | \$21.99 |

Brother TZ Tape: For Use With PT-330/350/520/530/540/550/580C/1400/1500PC/1600/1650/2200/2210/2300/2310/2400/2410/2500PC/2600/2610/2700/2710/3600/9200DX/9200PC/9400/9500PC/9600 Only

| | | | | |
|----------|---|--------|----|---------|
| TZE151 | 24mm (1") Black on Clear Laminated Tape (8m/26.2 Ft.) (1/Pkg) | 95344 | PK | \$24.49 |
| TZE251 | 24mm (1") Black on White Laminated Tape (8m/26.2 Ft.) (1/Pkg) | 95347 | PK | \$25.49 |
| TZE252 | 24mm (1") Red on White Laminated Tape (8m/26.2 Ft.) (1/Pkg) | 96465 | PK | \$25.49 |
| TZE261 | 36mm (1 1/2") Black on White Laminated Tape (8m/26.2 Ft.) (1/Pkg) | 105491 | PK | \$29.49 |
| TZE355 | 24mm (1") White on Black Laminated Tape (8m/26.2 Ft.) (1/Pkg) | 95350 | PK | \$28.49 |
| TZE451 | 24mm (1") Black on Red Laminated Tape (8m/26.2 Ft.) (1/Pkg) | 96472 | PK | \$25.49 |
| TZE651 | 24mm (1") Black on Yellow Laminated Tape (8m/26.2 Ft.) (1/Pkg) | 96474 | PK | \$25.49 |
| TZEB51 | 24mm (1") Black on Fluorescent Orange Laminated Tape (5m/16.4 Ft.) | 4273 | PK | \$31.49 |
| TZEFX251 | 24mm (1") Flexible ID Super Adhesive Black on White Industrial Tape (8m/26.2 Ft.) (1/Pkg) | 1047 | PK | \$27.99 |
| TZEFX651 | 24mm (1") Flexible ID Super Adhesive Black on Yellow Industrial Tape (8m/26.2 Ft.) (1/Pkg) | 94729 | PK | \$27.99 |
| TZES151 | 24mm (1") Extra Strength Super Adhesive Black on Clear Industrial Tape (8m/26.2 Ft.) (1/Pkg) | 1044 | PK | \$27.49 |
| TZES251 | 24mm (1") Extra Strength Super Adhesive Black on White Industrial Tape (8m/26.2 Ft.) (1/Pkg) | 4433 | PK | \$27.49 |
| TZES651 | 24mm (1") Extra Strength Super Adhesive Black on Yellow Industrial Tape (8m/26.2 Ft.) (1/Pkg) | 5357 | PK | \$27.49 |
| TZES951 | 24mm (1") Extra Strength Super Adhesive Black on Matte Silver Industrial Tape (8m/26.2 Ft.) (1/Pkg) | 5360 | PK | \$29.99 |

| MFG# | Product Description | Part# | UOM | Retail |
|---|--|--------|-----|---------|
| BROTHER MEDIA | | | | |
| <i>BROTHER P-TOUCH CROSS REFERENCE GUIDE CAN BE FOUND ON PAGES 190, 191.</i> | | | | |
| Brother TZ Tape: For Use With PT-530/550/3600/9200DX/9200PC/9400/9500PC/9600/9700PC/9800PCN Only | | | | |
| TZE161 | 36mm (1 1/2") Black on Clear Laminated Tape (8m/26.2 Ft.) (1/Pkg) | 104277 | PK | \$29.49 |
| TZE661 | 36mm (1 1/2") Black on Yellow Laminated Tape (8m/26.2 Ft.) (1/Pkg) | 1564 | PK | \$29.49 |
| TZES261 | 36mm (1 1/2") Extra Strength Super Adhesive Black on White Industrial Tape (8m/26.2 Ft.) (1/Pkg) | 5354 | PK | \$34.99 |
| TZES661 | 36mm (1 1/2") Extra Strength Super Adhesive Black on Yellow Industrial Tape (8m/26.2 Ft.) (1/Pkg) | 5358 | PK | \$34.99 |
| TZES961 | 36mm (1 1/2") Extra Strength Super Adhesive Black on Matte Silver Industrial Tape (8m/26.2 Ft.) (1/Pkg) | 5361 | PK | \$37.99 |
| Brother TZ Tape: For Use With PT-1010/1090/1230PC/1280/1290/1830/1880/2100/2110/2030AD/2030VP/2430PC/2700/2710/2730/2730VP | | | | |
| TZEN201 | 3.5mm (9/64") Black on White Non-Laminated Tape, Ideal for Labeling CD/DVD Cases (8m/26.2 Ft.) (1/Pkg) | 10423 | PK | \$16.99 |
| EPSON MEDIA | | | | |
| Epson Photo Paper Glossy | | | | |
| S041649 | Letter Size Glossy Photo Paper 60# (8 1/2" x 11") (50 Sheets/Pkg) | 3678 | PK | \$22.99 |
| Epson Premium Photo Paper Glossy | | | | |
| S041727 | Borderless Premium Glossy Photo Paper 68# (4" x 6") (100 Sheets/Pkg) | 1703 | PK | \$17.99 |
| S042183 | Letter Size Premium Glossy Photo Paper 68# (8 1/2" x 11") (25 Sheets/Pkg) | 106577 | PK | \$18.99 |
| S041667 | Letter Size Premium Glossy Photo Paper 68# (8 1/2" x 11") (50 Sheets/Pkg) | 2604 | PK | \$34.99 |
| Epson Ultra Premium Photo Paper Luster | | | | |
| S041405 | Letter Size Ultra Premium Luster Photo Paper 64# (8 1/2" x 11") (50 Sheets/Pkg) | 4931 | PK | \$38.99 |
| Epson Presentation Paper Matte | | | | |
| S041062 | Letter Size 27# (8 1/2" x 11") (100 Sheets/Pkg) | 95411 | PK | \$14.99 |
| S041070 | B Size 27# (11" x 17") (100 Sheets/Pkg) | 98605 | PK | \$34.99 |
| Epson Premium Presentation Paper Matte | | | | |
| S041257 | Letter Size 44# (8 1/2" x 11") (50 Sheets/Pkg) | 105214 | PK | \$12.99 |
| HP MEDIA | | | | |
| <i>HP CROSS REFERENCE GUIDE CAN BE FOUND ON PAGES 257-282.</i> | | | | |
| HP Small Format Media - Paper | | | | |
| C6817A | HP Inkjet Brochure Paper 180g, 48#, Glossy, 98 Bright (8.5" x 11") (Two Sided) (50 Sheets/Pkg) | 20973 | PK | \$15.99 |
| CG932A | HP Inkjet Brochure Paper 180g, 48#, Glossy, 98 Bright (11" x 17") (Two Sided) (150 Sheets/Pkg) | 24011 | PK | \$79.99 |
| Q1987A | HP Inkjet Brochure Paper 180g, 48#, Glossy, 98 Bright (8.5" x 11") (Two Sided) (150 Sheets/Pkg) | 1110 | PK | \$37.99 |
| CH016A | HP Inkjet Brochure Paper 180g, 48#, Matte, 103 Bright (8.5" x 11") (Two Sided) (150 Sheets/Pkg) | 24016 | PK | \$37.99 |
| C7020A | HP Inkjet Tri-fold Brochure Paper 180g, 48#, Glossy, 98 Bright (8.5" x 11") (Two Sided) (100 Sheets/Pkg) | 108201 | PK | \$33.99 |
| Q6612A | HP Laser Tri-Fold Brochure Paper 150g, 40#, Glossy, 97 Bright (8.5" x 11") (Two Sided) (150 Sheets/Pkg) | 30269 | PK | \$27.99 |
| Q8824A | HP Laser Brochure Paper 200g, 52#, Matte, 112 Bright (8.5" x 11") (Two Sided) (100 Sheets/Pkg) | 906260 | PK | \$20.99 |
| D0Z55A | HP Premium Inkjet Presentation Paper 120g, 32#, Matte, 98 Bright (8.5" x 11") (100 Sheets/Pkg) | 913586 | PK | \$14.99 |
| HP Small Format Media - Photo Paper (Continued on next page) | | | | |
| CR758A | HP Everyday Photo Paper 53#, Glossy (4" x 6") (50 Sheets/Pkg) | 908792 | PK | \$5.99 |
| CR759A | HP Everyday Photo Paper 53#, Glossy (4" x 6") (100 Sheets/Pkg) | 910076 | PK | \$10.99 |
| Q6638A | HP Advanced Photo Paper 66#, Glossy, 91 Bright, Borderless (4" x 6") (100 Sheets/Pkg) | 10889 | PK | \$14.99 |
| Q8690A | HP Advanced Photo Paper 66#, Glossy (5" x 7") (60 Sheets/Pkg) | 15158 | PK | \$17.99 |
| Q7852A | HP Advanced Photo Paper 66#, Glossy, 91 Bright (8.5" x 11") (25 Sheets/Pkg) | 10886 | PK | \$12.99 |
| Q7853A | HP Advanced Photo Paper 66#, Glossy, 91 Bright (8.5" x 11") (50 Sheets/Pkg) | 10887 | PK | \$22.99 |
| Q7854A | HP Advanced Photo Paper 66#, Glossy, 91 Bright (8.5" x 11") (100 Sheets/Pkg) | 10888 | PK | \$34.99 |
| CR696A | HP Advanced Photo Paper 66#, Glossy, 91 Bright (13" x 19") (20 Sheets/Pkg) | 100009 | PK | \$33.99 |
| CR665A | HP Premium Plus Photo Paper 80#, Glossy (4" x 6") (60 Sheets/Pkg) | 99983 | PK | \$14.99 |
| CR668A | HP Premium Plus Photo Paper 80#, Glossy (4" x 6") (100 Sheets/Pkg) | 99980 | PK | \$22.99 |
| CR669A | HP Premium Plus Photo Paper 80#, Glossy (5" x 7") (60 Sheets/Pkg) | 99978 | PK | \$22.99 |
| CR670A | HP Premium Plus Photo Paper 80#, Glossy (8.5" x 11") (25 Sheets/Pkg) | 99973 | PK | \$19.99 |
| CR664A | HP Premium Plus Photo Paper 80#, Glossy (8.5" x 11") (50 Sheets/Pkg) | 99984 | PK | \$27.99 |

| MFG# | Product Description | Part# | UOM | Retail |
|--|---|--------|-----|----------|
| HP MEDIA | | | | |
| <i>HP CROSS REFERENCE GUIDE CAN BE FOUND ON PAGES 257-282.</i> | | | | |
| HP Small Format Media - Photo Paper (Continued) | | | | |
| CV065A | HP Premium Plus Photo Paper 80#, Glossy (11" x 17") (25 Sheets/Pkg) | 910077 | PK | \$42.99 |
| CR667A | HP Premium Plus Photo Paper 80#, Soft Gloss (8.5" x 11") (50 Sheets/Pkg) | 99981 | PK | \$27.99 |
| HP Large Format Media - Paper & Film (Continued on next page) | | | | |
| C1860A | HP Bright White Inkjet Paper 24#, 113 Bright (24" x 150' Roll) | 20842 | EA | \$17.85 |
| C1861A | HP Bright White Inkjet Paper 24#, 113 Bright (36" x 150' Roll) | 20843 | EA | \$27.30 |
| C6810A | HP Bright White Inkjet Paper 24#, 113 Bright (36" x 300' Roll) | 20963 | EA | \$47.25 |
| 51631D | HP Special Inkjet Paper 24#, 96 Bright (24" x 150' Roll) | 20573 | EA | \$58.00 |
| 51631E | HP Special Inkjet Paper 24#, 96 Bright (36" x 150' Roll) | 20563 | EA | \$79.00 |
| C6019B | HP Coated Paper 24#, 89 Bright (24" x 150' Roll) | 20947 | EA | \$36.75 |
| C6020B | HP Coated Paper 24#, 89 Bright (36" x 150' Roll) | 20946 | EA | \$51.45 |
| C6980A | HP Coated Paper 24#, 89 Bright (36" x 300' Roll) | 106219 | EA | \$91.35 |
| C6029C | HP Heavyweight Coated Paper 35#, 89 Bright (24" x 100' Roll) | 107082 | EA | \$47.25 |
| C6030C | HP Heavyweight Coated Paper 35#, 89 Bright (36" x 100' Roll) | 107083 | EA | \$65.10 |
| C6569C | HP Heavyweight Coated Paper 35#, 89 Bright (42" x 100' Roll) | 107084 | EA | \$80.85 |
| Q1957A | HP Heavyweight Coated Paper 35#, 89 Bright (60" x 225' Roll) | 3247 | EA | \$260.40 |
| Q1396A | HP Universal Bond Paper 21#, 110 Bright (24" x 150' Roll) | 5282 | EA | \$13.65 |
| Q1397A | HP Universal Bond Paper 21#, 110 Bright (36" x 150' Roll) | 5283 | EA | \$19.95 |
| Q1398A | HP Universal Bond Paper 21#, 110 Bright (42" x 150' Roll) | 5284 | EA | \$23.10 |
| Q1404A | HP Universal Coated Paper 24#, 89 Bright (24" x 150' Roll) | 5285 | EA | \$23.10 |
| Q1405A | HP Universal Coated Paper 24#, 89 Bright (36" x 150' Roll) | 5286 | EA | \$34.65 |
| Q1406A | HP Universal Coated Paper 24#, 89 Bright (42" x 150' Roll) | 5287 | EA | \$40.95 |
| Q1413A | HP Universal Heavyweight Coated Paper 33#, 95 Bright (36" x 100' Roll) | 5292 | EA | \$42.00 |
| Q1414A | HP Universal Heavyweight Coated Paper 33#, 95 Bright (42" x 100' Roll) | 5293 | EA | \$48.30 |
| C3875A | HP Clear Film 5.2 ml (36" x 75' Roll) | 20708 | EA | \$176.30 |
| E4J54B | HP Artist Canvas 15.6 ml, Matte, 97 Bright (24" x 50' Roll) | 933854 | EA | \$124.00 |
| E4J55B | HP Artist Canvas 15.6 ml, Matte, 97 Bright (36" x 50' Roll) | 933855 | EA | \$186.00 |
| E4J56B | HP Artist Canvas 15.6 ml, Matte, 97 Bright (42" x 50' Roll) | 933856 | EA | \$217.00 |
| E4J57A | HP Artist Canvas 15.6 ml, Matte, 97 Bright (44" x 50' Roll) | 933857 | EA | \$227.33 |
| E4J58B | HP Artist Canvas 15.6 ml, Matte, 97 Bright (60" x 50' Roll) | 933858 | EA | \$310.00 |
| Q8708B | HP Collector Canvas 22 ml, Satin, 95 Bright (24" x 50' Roll) | 17547 | EA | \$225.75 |
| Q8709A | HP Collector Canvas 22 ml, Satin, 95 Bright (36" x 50' Roll) | 23296 | EA | \$338.10 |
| Q8710A | HP Collector Canvas 22 ml, Satin, 95 Bright (42" x 50' Roll) | 23298 | EA | \$394.80 |
| Q8711A | HP Collector Canvas 22 ml, Satin, 95 Bright (60" x 50' Roll) | 23300 | EA | \$563.85 |
| E4J59C | HP Professional Canvas 18.1ml, Matte, 101 Bright (24" x 50' Roll) | 933859 | EA | \$124.00 |
| E4J60B | HP Professional Canvas 18.1ml, Matte, 101 Bright (36" x 50' Roll) | 933860 | EA | \$186.00 |
| E4J61B | HP Professional Canvas 18.1ml, Matte, 101 Bright (42" x 50' Roll) | 933861 | EA | \$217.00 |
| J3E86A | HP Professional Canvas 18.1ml, Matte, 101 Bright (44" x 50' Roll) | 933862 | EA | \$227.33 |
| J3E87B | HP Professional Canvas 18.1ml, Matte, 101 Bright (60" x 50' Roll) | 933863 | EA | \$310.00 |
| Q8675A | HP Opaque Scrim 13.4 ml, 92 Bright (24" x 50' Roll) | 90886 | EA | \$174.30 |
| Q1898B | HP Opaque Scrim 13.4 ml, 92 Bright (36" x 50' Roll) | 5691 | EA | \$292.95 |
| Q1899B | HP Opaque Scrim 13.4 ml, 92 Bright (42" x 50' Roll) | 1229 | EA | \$341.25 |
| Q1901B | HP Opaque Scrim 13.4 ml, 92 Bright (54" x 50' Roll) | 15164 | EA | \$438.90 |
| Q1902B | HP Opaque Scrim 13.4 ml, 92 Bright (60" x 50' Roll) | 23272 | EA | \$488.25 |
| Q7973A | HP Litho-Realistic Paper 13 ml, Matte, 87 Bright (36" x 100' Roll) | 13203 | EA | \$135.50 |
| C0F12A | HP Durable Banner with DuPont Tyvek, 2-Pack, 11.8 ml, 99 Bright (36" x 75' Roll) (2 Rolls/Pkg) | 912428 | PK | \$513.00 |
| C0F13A | HP Durable Banner with DuPont Tyvek, 2-Pack, 11.8 ml, 99 Bright (42" x 75' Roll) (2 Rolls/Pkg) | 912340 | PK | \$598.00 |
| C0F14A | HP Durable Banner with DuPont Tyvek, 2-Pack, 11.8 ml, 99 Bright (60" x 75' Roll) (2 Rolls/Pkg) | 912429 | PK | \$855.00 |
| C0F08A | HP Colorfast Adhesive Vinyl, 2-Pack, 6.3 ml, 92 Bright (36" x 40' Roll) (2 Rolls/Pkg) | 912426 | PK | \$288.00 |
| C0F09A | HP Colorfast Adhesive Vinyl, 2-Pack, 6.3 ml, 92 Bright (54" x 40' Roll) (2 Rolls/Pkg) | 912427 | PK | \$432.00 |
| C2T51A | HP Universal Adhesive Vinyl, 2-Pack, 5.5 ml, 96 Bright (36" x 66' Roll) (2 Rolls/Pkg) | 912437 | PK | \$244.00 |
| C2T52A | HP Universal Adhesive Vinyl, 2-Pack, 5.5 ml, 96 Bright (42" x 66' Roll) (2 Rolls/Pkg) | 912438 | PK | \$285.00 |
| C0F18A | HP Everyday Adhesive Matte Polypropylene, 2-Pack, 7.1 ml, 101 Bright (24" x 75' Roll) (2 Rolls/Pkg) | 912430 | PK | \$128.00 |
| C0F19A | HP Everyday Adhesive Matte Polypropylene, 2-Pack, 7.1 ml, 101 Bright (36" x 75' Roll) (2 Rolls/Pkg) | 912431 | PK | \$192.00 |
| C0F20A | HP Everyday Adhesive Matte Polypropylene, 2-Pack, 7.1 ml, 101 Bright (42" x 75' Roll) (2 Rolls/Pkg) | 912432 | PK | \$224.00 |
| C0F22A | HP Everyday Adhesive Matte Polypropylene, 2-Pack, 7.1 ml, 101 Bright (60" x 75' Roll) (2 Rolls/Pkg) | 912433 | PK | \$320.00 |
| C0F28A | HP Everyday Adhesive Gloss Polypropylene, 2-Pack, 7.1 ml, 87.5 Bright (36" x 75' Roll) (2 Rolls/Pkg) | 912434 | PK | \$162.00 |
| C0F29A | HP Everyday Adhesive Gloss Polypropylene, 2-Pack, 7.1 ml, 87.5 Bright (42" x 75' Roll) (2 Rolls/Pkg) | 912435 | PK | \$189.00 |
| C2T53A | HP Premium Matte Polypropylene, 2-Pack, 9.1 ml, 99 Bright (36" x 75' Roll) (2 Rolls/Pkg) | 912439 | PK | \$188.00 |

| MFG# | Product Description | Part# | UOM | Retail |
|---|---|--------|-----|----------|
| HP MEDIA | | | | |
| <i>HP CROSS REFERENCE GUIDE CAN BE FOUND ON PAGES 257-282.</i> | | | | |
| HP Large Format Media - Paper & Film (Continued) | | | | |
| C2T54A | HP Premium Matte Polypropylene, 2-Pack, 9.1 ml, 99 Bright (42" x 75' Roll) (2 Rolls/Pkg) | 912440 | PK | \$219.00 |
| C5G02A | HP Premium Matte Polypropylene, 2-Pack, 9.1 ml, 99 Bright (60" x 75' Roll) (2 Rolls/Pkg) | 912441 | PK | \$313.00 |
| HP Large Format Media - Photo Paper | | | | |
| Q8916A | HP Everyday Instant-Dry Photo Paper, 9.1 ml, Gloss, 90 Bright (24" x 100' Roll) | 104415 | EA | \$57.75 |
| Q8917A | HP Everyday Instant-Dry Photo Paper, 9.1 ml, Gloss, 90 Bright (36" x 100' Roll) | 104417 | EA | \$86.63 |
| Q8918A | HP Everyday Instant-Dry Photo Paper, 9.1 ml, Gloss, 90 Bright (42" x 100' Roll) | 104419 | EA | \$101.20 |
| Q8919A | HP Everyday Instant-Dry Photo Paper, 9.1 ml, Gloss, 90 Bright (60" x 100' Roll) | 104422 | EA | \$144.38 |
| Q8920A | HP Everyday Instant-Dry Photo Paper, 9.1 ml, Satin, 90 Bright (24" x 100' Roll) | 104423 | EA | \$57.75 |
| Q8921A | HP Everyday Instant-Dry Photo Paper, 9.1 ml, Satin, 90 Bright (36" x 100' Roll) | 104428 | EA | \$86.63 |
| Q8922A | HP Everyday Instant-Dry Photo Paper, 9.1 ml, Satin, 90 Bright (42" x 100' Roll) | 104430 | EA | \$101.20 |
| Q8923A | HP Everyday Instant-Dry Photo Paper, 9.1 ml, Satin, 90 Bright (60" x 100' Roll) | 104431 | EA | \$144.38 |
| Q1426B | HP Universal Photo Paper, 7.4 ml, Gloss, 95 Bright (24" x 100' Roll) | 922647 | EA | \$70.35 |
| Q1427B | HP Universal Photo Paper, 7.4 ml, High-Gloss, 95 Bright (36" x 100' Roll) | 922757 | EA | \$105.00 |
| Q1428B | HP Universal Photo Paper, 7.4 ml, Gloss, 95 Bright (42" x 100' Roll) | 922974 | EA | \$122.85 |
| Q1420B | HP Universal Photo Paper, 7.4 ml, Semi-Gloss, 95 Bright (24" x 100' Roll) | 922975 | EA | \$70.35 |
| Q1421B | HP Universal Photo Paper, 7.4 ml, Semi-Gloss, 95 Bright (36" x 100' Roll) | 922976 | EA | \$105.00 |
| Q1422B | HP Universal Photo Paper, 7.4 ml, Semi-Gloss, 95 Bright (42" x 100' Roll) | 922977 | EA | \$122.85 |
| CG459B | HP Premium Photo Paper, 55#, 91 Bright, Matte (24" x 100' Roll) | 912871 | EA | \$69.30 |
| CZ984A | HP Premium Photo Paper, 76.1#, Gloss, 87 Bright (24" x 50' Roll) | 916690 | EA | \$85.00 |
| Q8806A | HP Premium Photo Paper, 76.1#, Gloss, 87 Bright (36" x 75' Roll) | 916691 | EA | \$189.00 |
| Q8807A | HP Premium Photo Paper, 76.1#, Gloss, 87 Bright (42" x 100' Roll) | 916692 | EA | \$292.00 |
| CZ987A | HP Premium Photo Paper, 76.1#, Satin, 87 Bright (24" x 50' Roll) | 916693 | EA | \$85.00 |
| Q8808A | HP Premium Photo Paper, 76.1#, Satin, 87 Bright (36" x 75' Roll) | 916694 | EA | \$189.00 |
| Q8809A | HP Premium Photo Paper, 76.1#, Satin, 87 Bright (42" x 100' Roll) | 916695 | EA | \$292.00 |
| Q7991A | HP Premium Instant-Dry Photo Paper, 10.3 ml, Gloss, 92 Bright (24" x 75' Roll) | 25526 | EA | \$113.40 |
| Q7993A | HP Premium Instant-Dry Photo Paper, 10.3 ml, Gloss, 92 Bright (36" x 100' Roll) | 12435 | EA | \$166.95 |
| Q7995A | HP Premium Instant-Dry Photo Paper, 10.3 ml, Gloss, 92 Bright (42" x 100' Roll) | 12437 | EA | \$198.45 |
| Q7999A | HP Premium Instant-Dry Photo Paper, 10.3 ml, Gloss, 92 Bright (60" x 100' Roll) | 12441 | EA | \$282.45 |
| Q7992A | HP Premium Instant-Dry Photo Paper, 10.3 ml, Satin, 92 Bright (24" x 75' Roll) | 25529 | EA | \$113.40 |
| Q7994A | HP Premium Instant-Dry Photo Paper, 10.3 ml, Satin, 92 Bright (36" x 100' Roll) | 12436 | EA | \$166.95 |
| Q7996A | HP Premium Instant-Dry Photo Paper, 10.3 ml, Satin, 92 Bright (42" x 100' Roll) | 12438 | EA | \$198.45 |
| Q8000A | HP Premium Instant-Dry Photo Paper, 10.3 ml, Satin, 92 Bright (60" x 100' Roll) | 12442 | EA | \$282.45 |
| Q6574A | HP Universal Instant-Dry Photo Paper, 53.3#, Gloss, 92 Bright (24" x 100' Roll) | 18637 | EA | \$73.50 |
| Q6575A | HP Universal Instant-Dry Photo Paper, 53.3#, Gloss, 92 Bright (36" x 100' Roll) | 6149 | EA | \$110.25 |
| Q6576A | HP Universal Instant-Dry Photo Paper, 53.3#, Gloss, 92 Bright (42" x 100' Roll) | 4560 | EA | \$129.15 |
| Q6579A | HP Universal Instant-Dry Photo Paper, 53.3#, Satin, 92 Bright (24" x 100' Roll) | 6152 | EA | \$73.50 |
| Q6580A | HP Universal Instant-Dry Photo Paper, 53.3#, Satin, 92 Bright (36" x 100' Roll) | 12999 | EA | \$110.25 |
| Q6581A | HP Universal Instant-Dry Photo Paper, 53.3#, Satin, 92 Bright (42" x 100' Roll) | 12828 | EA | \$129.15 |
| Q6582A | HP Universal Instant-Dry Photo Paper, 53.3#, Satin, 92 Bright (50" x 100' Roll) | 908279 | EA | \$153.30 |
| Q8759A | HP Professional Instant-Dry Photo Paper, 11.3 ml, Satin, 91 Bright (24" x 50' Roll) | 30020 | EA | \$115.50 |
| HP LaserJet Paper | | | | |
| Q6608A | HP Laser Brochure Paper 200g, 52#, Glossy, 97 Bright (8.5" x 11") (100 Sheets/Pkg) | 10401 | PK | \$20.99 |
| Q6611A | HP Laser Brochure Paper 150g, 40#, Glossy, 97 Bright (8.5" x 11") (150 Sheets/Pkg) | 10800 | PK | \$24.99 |
| Q6612A | HP Laser Tri-Fold Brochure Paper 150g, 40#, Glossy, 97 Bright (8.5" x 11") (Two Sided) (150 Sheets/Pkg) | 30269 | PK | \$27.99 |
| CG988A | HP Premium Presentation Paper 120g, 32#, Glossy, 95 Bright (8.5" x 11") (250 Sheets/Pkg) | 23468 | PK | \$16.99 |
| Q2547A | HP Premium Presentation Paper 120g, 32#, Glossy, 95 Bright (11" x 17") (250 Sheets/Pkg) | 21935 | PK | \$36.99 |
| Q8824A | HP Laser Brochure Paper 200g, 52#, Matte, 112 Bright (8.5" x 11") (Two Sided) (100 Sheets/Pkg) | 906260 | PK | \$20.99 |
| MACO MEDIA | | | | |
| Maco Thermal Roll Labels (Work in DYMO LabelWriter & Seiko Smart Label Printers) | | | | |
| M86205 | 9/16" x 3 7/16" White File Folder Labels (130 Labels/Roll) (2 Rolls/Box) (Interchangeable with Dymo# 30327, Seiko# SLP-FLW) | 909332 | BOX | \$7.99 |
| M86203 | 1 1/8" x 2" White Multipurpose Labels (220 Labels/Roll) (2 Rolls/Box) (Interchangeable with Seiko# SLP-MRL) | 909333 | BOX | \$9.99 |
| M86202 | 2 1/8" x 4" White Shipping Labels (220 Labels/Roll) (1 Roll/Box) (Interchangeable with Dymo# 30323, Seiko# SLP-SRL) | 909334 | BOX | \$15.79 |
| M86200 | 1 1/8" x 3 1/2" White Address Labels (130 Labels/Roll) (2 Rolls/Box) (Interchangeable with Dymo# 30251, Seiko# SLP-2RL) | 909335 | BOX | \$9.99 |
| M86201 | 1 1/8" x 3 1/2" White Address Labels (260 Labels/Roll) (2 Rolls/Box) (Interchangeable with Dymo# 30320, Seiko# SLP-2RLH) | 909336 | BOX | \$15.79 |
| M86204 | 7/16" x 1 1/2" Return Address/Pricing Labels (300 Labels/Roll) (1 Roll/Box) (Interchangeable with Seiko# SLP-35L) | 909337 | BOX | \$10.49 |

| MFG# | Product Description | Part# | UOM | Retail |
|------|---------------------|-------|-----|--------|
|------|---------------------|-------|-----|--------|

MACO MEDIA

Maco White Laser/Inkjet Mailing Labels

| | | | | |
|----------|--|-------|-----|---------|
| MML-8025 | 1/2" x 1 3/4", 80 Labels/Sheet (25 Sheets/Box) (Interchangeable with Avery# 5267) | 96065 | BOX | \$12.23 |
| MML-3025 | 1" x 2 5/8", 30 Labels/Sheet (25 Sheets/Box) (Interchangeable with Avery# 5260) | 96055 | BOX | \$12.23 |
| MML-3000 | 1" x 2 5/8", 30 Labels/Sheet (100 Sheets/Box) (Interchangeable with Avery# 5160) | 96056 | BOX | \$40.76 |
| MML-2000 | 1" x 4", 20 Labels/Sheet (100 Sheets/Box) (Interchangeable with Avery# 5161) | 96059 | BOX | \$40.76 |
| MML-1400 | 1 1/3" x 4", 14 Labels/Sheet (100 Sheets/Box) (Interchangeable with Avery# 5162) | 96061 | BOX | \$40.76 |
| MML-1000 | 2" x 4", 10 Labels/Sheet (100 Sheets/Box) (Interchangeable with Avery# 5163) | 96062 | BOX | \$40.76 |
| MML-0600 | 3 1/3" x 4", 6 Labels/Sheet (100 Sheets/Box) (Interchangeable with Avery# 5164) | 96063 | BOX | \$41.98 |
| MML-0400 | 5 1/2" x 4 1/4", Inkjet, 4 Labels/Sheet (100 Sheets/Box) (Not interchangeable with Avery) | 97997 | BOX | \$44.97 |
| MML-0200 | 5 1/2" x 8 1/2", Laser Internet Postal Label, 2 Labels/Sheet (100 Sheets/Pkg) (Interchangeable with Avery# 5126) | 97155 | PK | \$44.97 |
| MML-0100 | 8 1/2" x 11", 1 Label/Sheet (100 Sheets/Box) (Interchangeable with Avery# 5165) | 96064 | BOX | \$41.98 |

Maco White Laser/Inkjet Mailing Labels Bulk Value Packs

| | | | | |
|-----------|--|--------|-----|---------|
| MML-3000B | 1" x 2 5/8", 30 Labels/Sheet (250 Sheets/Box) (Interchangeable with Avery# 5960) | 96057 | BOX | \$87.36 |
| MML-2000B | 1" x 4", 20 Labels/Sheet (250 Sheets/Box) (Interchangeable with Avery# 5961) | 96060 | BOX | \$87.36 |
| MML-1000B | 2" x 4", 10 Labels/Sheet (250 Sheets/Box) (Interchangeable with Avery# 5963) | 106584 | BOX | \$87.36 |
| MML-0600B | 3 1/3" x 4", 6 Labels/Sheet (250 Sheets/Box) (Interchangeable with Avery# 5164) | 906288 | BOX | \$87.36 |
| MML-0200B | 5 1/2" x 8 1/2", Internet Postal Label, 2 Labels/Sheet (250 Sheets/Box) (Interchangeable with Avery# 5126) | 909314 | BOX | \$87.36 |

Maco Weather-Resistant White Laser/Inkjet Labels

| | | | | |
|----------|--|--------|-----|---------|
| ML-0250W | 5 1/2" x 8 1/2", Half-Sheet, 2 Labels/Sheet (50 Sheets/Box) (Interchangeable with Avery# 5526) | 100529 | BOX | \$53.16 |
| ML-0650W | 3 1/3" x 4", 6 Labels/Sheet (50 Sheets/Box) (Interchangeable with Avery# 5524) | 100530 | BOX | \$53.16 |
| ML-1050W | 2" x 4", 10 Labels/Sheet (50 Sheets/Box) (Interchangeable with Avery# 5523) | 100531 | BOX | \$53.16 |
| ML-1450W | 1 1/3" x 4", 14 Labels/Sheet (50 Sheets/Box) (Interchangeable with Avery# 5522) | 100535 | BOX | \$53.16 |
| ML-3050W | 1" x 2 5/8", 30 Labels/Sheet (50 Sheets/Box) (Interchangeable with Avery# 5520) | 100536 | BOX | \$53.16 |

Maco White Recycled Laser/Inkjet Labels (100% recycled post-consumer fiber; FSC-certified) (Continued on next page)

| | | | | |
|----------|--|------|-----|---------|
| MRL-8025 | 1/2" x 1 3/4", Return Address, 80 Labels/Sheet (25 Sheets/Pkg) (Interchangeable with Avery# 5267) | 6807 | PK | \$14.07 |
| MRL-8100 | 1/2" x 1 3/4", Return Address, 80 Labels/Sheet (100 Sheets/Box) (Interchangeable with Avery# 5167) | 6806 | BOX | \$48.28 |
| MRL-3025 | 1" x 2 5/8", 30 Labels/Sheet (25 Sheets/Pkg) (Interchangeable with Avery# 5260) | 6805 | PK | \$14.07 |
| MRL-3000 | 1" x 2 5/8", 30 Labels/Sheet (100 Sheets/Box) (Interchangeable with Avery# 5160) | 6804 | BOX | \$48.28 |



100% tree free 



SUGARCANE

Laser/Ink Jet/Copier Labels





- ✔ Made with 100% sugarcane bagasse and other renewable agricultural waste
- ✔ Even more environmentally-friendly than recycled wood paper pulp!
- ✔ Bright white label stock
- ✔ Guaranteed not to jam
- ✔ Machinable labels work in all desktop printers and dry toner copiers

By combining high quality materials with economical prices, MACO provides great solutions for you!



| MFG# | Product Description | Part# | UOM | Retail |
|---|---|--------|-----|---------|
| MACO MEDIA | | | | |
| Maco White Recycled Laser/Inkjet Labels (100% recycled post-consumer fiber; FSC-certified) (Continued) | | | | |
| MRL-2000 | 1" x 4", 20 Labels/Sheet (100 Sheets/Box) (Interchangeable with Avery# 5161) | 6803 | BOX | \$48.28 |
| MRL-1400 | 1 1/3" x 4", 14 Labels/Sheet (100 Sheets/Box) (Interchangeable with Avery# 5162) | 6802 | BOX | \$48.28 |
| MRL-1025 | 2" x 4" White Shipping Labels, 10 Labels/Sheet (25 Sheets/Pkg) (Interchangeable with Avery# 5263) | 6801 | PK | \$14.07 |
| MRL-1000 | 2" x 4", 10 Labels/Sheet (100 Sheets/Box) (Interchangeable with Avery# 5163) | 6800 | BOX | \$48.28 |
| MRL-0625 | 3 1/3" x 4", White Shipping Labels, 6 Labels/Sheet (25 Sheets/Pkg) (Interchangeable with Avery# 5264) | 6799 | PK | \$14.07 |
| MRL-0600 | 3 1/3" x 4", 6 Labels/Sheet (100 Sheets/Box) (Interchangeable with Avery# 5164) | 6798 | BOX | \$48.28 |
| MRL-0100 | 8 1/2" x 11", 1 Label/Sheet (100 Sheets/Box) (Interchangeable with Avery# 5165) | 6797 | BOX | \$48.28 |
| Maco Recycled Laser/Inkjet File Folder Labels (100% recycled post-consumer fiber; FSC-certified) | | | | |
| RL-FF30R | 2/3" x 3 7/16", Assorted Repositionable File Folder Labels, 30 Labels/Sheet (25 Sheets/Pkg) (Includes 5 sheets each color: Red, Blue, Green, White, Yellow) | 100552 | PK | \$16.75 |
| MRL-FF30 | 2/3" x 3 7/16", Assorted File Folder Labels, 30 Labels/Sheet (25 Sheets/Pkg) (Includes 5 sheets each color: Red, Blue, Green, White, Yellow) (Interchangeable with Avery# 5266) | 6808 | PK | \$26.85 |
| MRL-FF31 | 2/3" x 3 7/16", White File Folder Labels, 30 Labels/Sheet (50 Sheets/Pkg) (Interchangeable with Avery# 5366) | 6809 | PK | \$49.73 |
| Maco 100% Sugarcane Laser/Inkjet/Copier Labels *USDA Certified Biobased Product | | | | |
| MSL-0100 | 8 1/2" x 11", 1 Label/Sheet (100 Sheets/Box) (Interchangeable with Avery# 5165) | 916530 | BOX | \$43.61 |
| MSL-0200 | 5 1/2" x 8 1/2", Internet Postal Label, 2 Labels/Sheet (100 Sheets/Pkg) (Interchangeable with Avery# 5126) | 916531 | BOX | \$43.61 |
| MSL-0600 | 3 1/3" x 4", 6 Labels/Sheet (100 Sheets/Box) (Interchangeable with Avery# 5164) | 916532 | BOX | \$43.61 |
| MSL-1000 | 2" x 4", 10 Labels/Sheet (100 Sheets/Box) (Interchangeable with Avery# 5163) | 916533 | BOX | \$43.61 |
| MSL-1400 | 1 1/3" x 4", 14 Labels/Sheet (100 Sheets/Box) (Interchangeable with Avery# 5162) | 916534 | BOX | \$42.33 |
| MSL-2000 | 1" x 4", 20 Labels/Sheet (100 Sheets/Box) (Interchangeable with Avery# 5161) | 916535 | BOX | \$42.33 |
| MSL-3000 | 1" x 2 5/8", 30 Labels/Sheet (100 Sheets/Box) (Interchangeable with Avery# 5160) | 916536 | BOX | \$42.33 |
| MSL-3000B | 1" x 2 5/8", 30 Labels/Sheet (250 Sheets/Box) (Interchangeable with Avery# 5960) | 916537 | BOX | \$95.15 |
| MSL-3025 | 1" x 2 5/8", 30 Labels/Sheet (25 Sheets/Box) (Interchangeable with Avery# 5260) | 916538 | BOX | \$12.70 |
| MSL-7000 | 2 1/3" x 3 3/8", White Name Badges, 8 Labels/Sheet (50 Sheets/Box) (Interchangeable with Avery#5395) | 916539 | BOX | \$58.37 |
| MSL-8100 | 1/2" x 1 3/4", Return Address, 80 Labels/Sheet (100 Sheets/Box) (Interchangeable with Avery# 5167) | 916540 | BOX | \$43.61 |
| Maco 100% Sugarcane Laser/Inkjet/Copier File Folder Labels *USDA Certified Biobased Product | | | | |
| MSL-FF29 | 2/3" x 3 7/16", White File Folder Labels, 30 Labels/Sheet (25 Sheets/Pkg) (Interchangeable with Avery# 8366) | 916541 | BOX | \$23.51 |
| MSL-FF30 | 2/3" x 3 7/16", Assorted File Folder Labels, 30 Labels/Sheet (25 Sheets/Pkg) (Includes 5 sheets each color: Red, Blue, Green, White, Yellow) (Interchangeable with Avery# 5266) | 916542 | BOX | \$23.51 |
| MSL-FF31 | 2/3" x 3 7/16", White File Folder Labels, 30 Labels/Sheet (50 Sheets/Pkg) (Interchangeable with Avery# 5366) | 916543 | BOX | \$42.75 |
| Maco White Copier Labels | | | | |
| MM-5351 | 1" x 2 3/4", 33 Labels/Sheet (100 Sheets/Box) (Interchangeable with Avery# 5351) | 96107 | BOX | \$34.49 |
| Maco White Pin-Fed/Dot Matrix Printer Labels | | | | |
| M42-451 | 3 1/2" x 15/16", 1 Label/Sheet (5,000/Box) (Interchangeable with Avery# 4013) | 96119 | BOX | \$35.12 |
| Maco White Laser/Inkjet Name Badge Labels | | | | |
| MML-7000 | 2 1/3" x 3 3/8", 8 Labels/Sheet (50 Sheets/Box) (Interchangeable with Avery# 5395) | 96094 | BOX | \$62.68 |
| Maco White Laser Business Cards | | | | |
| MML-8550 | 2" x 3 1/2", 10 Cards/Sheet (25 Sheets/Box) (Interchangeable with Avery# 5371) | 96102 | BOX | \$15.62 |

Avery and Avery item numbers are registered trademarks of Avery Dennison Corporation

PRES-A-PLY MEDIA

PRES-a-ply White Copier Labels

| | | | | |
|-------|---|--------|-----|---------|
| 30403 | 8 1/2" x 11", 1 Label/Sheet (100 Sheets/Box) (Interchangeable with Avery# 5165) | 502450 | BOX | \$45.45 |
|-------|---|--------|-----|---------|

| MFG# | Product Description | Part# | UOM | Retail |
|---|--|--------|-----|---------|
| PRES-A-PLY MEDIA | | | | |
| PRES-a-ply White InkJet Labels | | | | |
| 30583 | 2" x 4", 10 Labels/Sheet (25 Sheets/Pkg) (Interchangeable with Avery# 8163, Maco# IJ-1025) | 502474 | PK | \$12.54 |
| PRES-a-ply White Laser Labels | | | | |
| 30600 | 1" x 2-5/8", 30 Labels/Sheet (100 Sheets/Box) (Interchangeable with Avery# 5160, Maco# ML-3000) | 501924 | BOX | \$42.78 |
| 30601 | 1" x 4", 20 Labels/Sheet (100 Sheets/Box) (Interchangeable with Avery# 5161, Maco# ML-2000) | 502048 | BOX | \$42.78 |
| 30602 | 1 1/3" x 4", 14 Labels/Sheet (100 Sheets/Box) (Interchangeable with Avery# 5162) | 502091 | BOX | \$42.78 |
| 30603 | 2" x 4", White Shipping Labels, 10 Labels/Sheet (100 Sheets/Box) (Interchangeable with Avery# 5163, Maco# ML-1000) | 501974 | BOX | \$42.78 |
| 30604 | 3-1/3" x 4", Mailing Labels, 6 Labels/Sheet (100 Sheets/Box) (Interchangeable with Avery# 5164, Maco# ML-0600) | 501983 | BOX | \$42.78 |
| 30605 | 8 1/2" x 11", 1 Label/Sheet (100 Sheets/Box) (Interchangeable with Avery# 5165, Maco# ML-0100) | 501993 | BOX | \$42.78 |
| 30606 | 1" x 2 5/8", 30 Labels/Sheet (250 Sheets/Box) (Interchangeable with Avery# 5960, Maco# ML-3000B) | 501973 | BOX | \$96.28 |
| 30607 | 1" x 4", 20 Labels/Sheet (250 Sheets/Box) (Interchangeable with Avery# 5961, Maco# ML-2000B) | 502473 | BOX | \$96.28 |
| 30608 | 1 1/3" x 4", 14 Labels/Sheet (250 Sheets/Box) (Interchangeable with Avery# 5962, Maco# ML-1400B) | 502440 | BOX | \$96.28 |
| 30609 | 2" x 4", 10 Labels/Sheet (250 Sheets/Box) (Interchangeable with Avery# 5963, Maco# ML-1000B) | 502105 | BOX | \$96.28 |
| 30610 | 1" x 2 5/8", 30 Labels/Sheet (25 Sheets/Pkg) (Interchangeable with Avery# 5260, Maco# ML-3025) | 502104 | PK | \$12.91 |
| PRES-a-ply White Laser/Inkjet Labels | | | | |
| 30640 | 1/2" x 1 3/4", Address Labels, 80 Labels/Sheet (100 Sheets/Box) (Interchangeable with Avery# 5167) | 930200 | BOX | \$42.78 |
| 30641 | 3 1/2" x 5", Shipping Labels, 4 Labels/Sheet (100 Sheets/Box) (Interchangeable with Avery# 5168) | 930201 | BOX | \$42.78 |
| 30642 | 8 1/2" x 11", Shipping Labels, 1 Label/Sheet (25 Sheets/Pkg) (Interchangeable with Avery# 5365) | 930202 | PK | \$12.91 |
| 30643 | 5 1/2" x 8 1/2", Internet Shipping Labels, 2 Labels/Sheet (100 Sheets/Pkg) (Interchangeable with Avery# 5126) | 930203 | PK | \$42.78 |
| PRES-a-ply Clear Laser Labels | | | | |
| 30620 | 1" x 2 5/8", 30 Labels/Sheet (50 Sheets/Box) (Interchangeable with Avery# 5660, Maco# ML-4000) | 502107 | BOX | \$56.58 |
| 30622 | 1 1/3" x 4 1/4", 14 Labels/Sheet (50 Sheets/Box) (Interchangeable with Avery# 5662) | 502456 | BOX | \$56.58 |
| 30623 | 2" x 4 1/4", 10 Labels/Sheet (50 Sheets/Box) (Interchangeable with Avery# 5663, Maco# ML-4003) | 502458 | BOX | \$56.58 |
| 30645 | 1/2" x 1 3/4", Address Labels, 80 Labels/Sheet (25 Sheets/Pkg) (Interchangeable with Avery# 5667) | 930205 | PK | \$28.27 |
| 30646 | 1" x 2 5/8", Address Labels, 30 Labels/Sheet (25 Sheets/Pkg) (Interchangeable with Avery# 5630) | 930206 | PK | \$28.27 |
| 30647 | 1" x 4", Address Labels, 20 Labels/Sheet (50 Sheets/Box) (Interchangeable with Avery# 5661) | 930207 | BOX | \$56.58 |
| PRES-a-ply File Folder Labels | | | | |
| 30632 | 2/3" x 3 7/16", 30 Labels/Sheet (50 Sheets/Box) (Interchangeable with Avery# 5366, Maco# ML-FF31) | 502101 | BOX | \$44.06 |
| 30644 | 2/3" x 3 7/16", Assorted Laser/Inkjet File Folder Labels (Blue, Green, Red, White, Yellow), 30 Labels/Sheet (25 Sheets/Pkg) (Interchangeable with Avery# 5266) | 930204 | PK | \$24.23 |
| PRES-a-ply White Pin-Fed Labels | | | | |
| 30720 | 3 1/2" x 15/16", 1 Label/Sheet (5,000 Sheets/Box) (Interchangeable with Avery# 4013, Maco# 42-451) | 502034 | BOX | \$34.59 |
| 30721 | 4" x 1 7/16", 1 Label/Sheet (5,000 Sheets/Box) (Interchangeable with Avery# 4014, Maco# 42-461) | 502102 | BOX | \$61.80 |



..... DATA STORAGE

Backing up electronic data is vital in today's business. Let us help you determine which storage media options fit your needs.

QUALITY AND RELIABILITY.

| MFG# | Product Description | Part# | UOM | Retail |
|---|---|--------|-----|-------------|
| HP MEDIA | | | | |
| HP Digital Linear Tape Cartridges | | | | |
| C7980AL | HP Super DLT I (110/220 GB) (160/320 GB) Custom Labeled Data Cartridge (20/Pkg) | 15115 | PK | \$1,556.20 |
| Q2020AL | HP Super DLT II (300/600 GB) Custom Labeled Data Cartridge (20/Pkg) | 100132 | PK | \$3,029.24 |
| HP LTO Ultrium Data Cartridges <i>(Continued on next page)</i> | | | | |
| C7971A | HP LTO 1 Ultrium (100/200 GB) Data Cartridge | 107504 | CTG | \$52.15 |
| C7971AL | HP LTO 1 Ultrium (100 /200 GB) Custom Labeled Data Cartridge (20/Ctn) (Includes 5 Cleaning Cartridge Labels) | 15705 | CTN | \$1,042.98 |
| C7972A | HP LTO 2 Ultrium (200/400 GB) Data Cartridge | 2592 | CTG | \$48.18 |
| C7972AL | HP LTO 2 Ultrium (200/400 GB) Custom Labeled Data Cartridge (20/Pkg) (Includes 5 Cleaning Cartridge Labels) | 5886 | PK | \$963.62 |
| C7972AN | HP LTO 2 Ultrium (200/400 GB) Non-Custom Labeled Data Cartridge (20/Pkg) (Includes 5 Cleaning Cartridge Labels) | 13566 | PK | \$963.62 |
| C7973A | HP LTO 3 Ultrium (400/800 GB) RW Data Cartridge | 6174 | CTG | \$50.14 |
| C7973AF | HP LTO 3 Ultrium (400/800 GB) RFID RW Custom Labeled Data Cartridge (20/Pkg) (Includes 5 Cleaning Cartridge Labels) | 910078 | PK | \$1,043.40 |
| C7973AJ | HP LTO 3 Ultrium (400/800 GB) RFID RW Non Custom Labeled Data Cartridge (20/Pkg) (Includes 5 Cleaning Cartridge Labels) | 916723 | PK | \$1,043.40 |
| C7973AL | HP LTO 3 Ultrium (400/800 GB) RW Custom Labeled Data Cartridge (20/Pkg) (Includes 5 Cleaning Cartridge Labels) | 13041 | PK | \$1,002.84 |
| C7973AN | HP LTO 3 Ultrium (400/800 GB) RW Non-Custom Labeled Data Cartridge (20/Pkg) (Includes 5 Cleaning Cartridge Labels) | 13567 | PK | \$1,002.84 |
| C7973W | HP LTO 3 Ultrium (400/800 GB) WORM Data Cartridge | 6175 | CTG | \$55.16 |
| C7973WL | HP LTO 3 Ultrium (400/800 GB) WORM Custom Labeled Data Cartridge (20/Pkg) (Includes 5 Cleaning Cartridge Labels) | 15116 | PK | \$1,103.23 |
| C7974A | HP LTO 4 Ultrium (800 GB/1.6 TB) RW Data Cartridge | 93595 | CTG | \$57.89 |
| C7974AB | HP LTO 4 Ultrium (800 GB/1.6 TB) RW Data Cartridge, No Case (960/Pallet) | 19737 | PLT | \$55,011.57 |
| C7974AC | HP LTO 4 Ultrium (800 GB/1.6 TB) RW Custom Labeled No Case Data Cartridge (20/Pkg) (Includes 5 Cleaning Cartridge Labels) | 916724 | PK | \$1,157.85 |
| C7974AF | HP LTO 4 Ultrium (800 GB/1.6 TB) RFID RW Custom Labeled Data Cartridge (20/Pkg) (Includes 5 Cleaning Cartridge Labels) | 910079 | PK | \$1,192.33 |
| C7974AJ | HP LTO 4 Ultrium (800 GB/1.6 TB) RFID RW Non Custom Labeled Data Cartridge (20/Pkg) (Includes 5 Cleaning Cartridge Labels) | 916725 | PK | \$1,192.33 |
| C7974AL | HP LTO 4 Ultrium (800 GB/1.6 TB) RW Custom Labeled Data Cartridge (20/Pkg) (Includes 5 Cleaning Cartridge Labels) | 902504 | PK | \$1,157.85 |
| C7974AN | HP LTO 4 Ultrium (800 GB/1.6 TB) RW Non-Custom Labeled Data Cartridge (20/Pkg) (Includes 5 Cleaning Cartridge Labels) | 30811 | PK | \$1,157.85 |
| C7974W | HP LTO 4 Ultrium (800 GB/1.6 TB) WORM Data Cartridge | 93590 | CTG | \$63.68 |
| C7974WL | HP LTO 4 Ultrium (800 GB/1.6 TB) WORM Custom Labeled Data Cartridge (20/Pkg) (Includes 5 Cleaning Cartridge Labels) | 910080 | PK | \$1,273.70 |
| C7975A | HP LTO 5 Ultrium (1.5/3.0 TB) RW Data Cartridge | 29047 | CTG | \$41.48 |
| C7975AC | HP LTO 5 Ultrium (1.5/3.0 TB) RW Custom Labeled No Case Data Cartridge (20/Pkg) (Includes 5 Cleaning Cartridge Labels) | 107678 | PK | \$829.49 |
| C7975AD | HP LTO 5 Ultrium (1.5 /3.0 TB) RW Data Cartridge (960/Pallet) | 27136 | PLT | \$39,417.67 |
| C7975AF | HP LTO 5 Ultrium (1.5/3.0 TB) RFID RW Custom Labeled Data Cartridge (20/Pkg) (Includes 5 Cleaning Cartridge Labels) | 906563 | PK | \$846.92 |
| C7975AJ | HP LTO 5 Ultrium (1.5/3.0 TB) RFID RW Non Custom Labeled Data Cartridge (20/Pkg) (Includes 5 Cleaning Cartridge Labels) | 916727 | PK | \$846.92 |
| C7975AL | HP LTO 5 Ultrium (1.5/3.0 TB) RW Custom Labeled Data Cartridge (20/Pkg) (Includes 5 Cleaning Cartridge Labels) | 30921 | PK | \$829.49 |
| C7975AN | HP LTO 5 Ultrium (1.5/3.0 TB) RW Non-Custom Labeled Data Cartridge (20/Pkg) (Includes 5 Cleaning Cartridge Labels) | 31072 | PK | \$829.49 |
| C7975W | HP LTO 5 Ultrium (1.5/3.0 TB) WORM Data Cartridge | 910081 | CTG | \$45.62 |
| C7975WL | HP LTO 5 Ultrium (1.5/3.0 TB) WORM Custom Labeled Data Cartridge (20/Pkg) (Includes 5 Cleaning Cartridge Labels) | 910082 | PK | \$912.42 |
| C7976A | HP LTO 6 Ultrium (2.5/6.25 TB) MP RW Data Cartridge | 910650 | CTG | \$68.35 |
| C7976AB | HP LTO 6 Ultrium (2.5/6.25 TB) MP RW Data Cartridge Without Case (960/Pallet) | 911729 | PLT | \$64,946.08 |
| C7976AC | HP LTO 6 Ultrium (2.5/6.25 TB) MP RW Custom Labeled No Case Data Cartridge (20/Pkg) (Includes 5 Cleaning Cartridge Labels) | 916728 | PK | \$1,365.65 |
| C7976AD | HP LTO 6 Ultrium (2.5/6.25 TB) MP RW Data Cartridge (960/Pallet) | 910655 | PLT | \$64,946.08 |
| C7976AF | HP LTO 6 Ultrium (2.5/6.25 TB) MP RFID RW Custom Labeled Data Cartridge (20/Pkg) (Includes 5 Cleaning Cartridge Labels) | 916729 | PK | \$1,447.02 |
| C7976AL | HP LTO 6 Ultrium (2.5/6.25 TB) MP RW Custom Labeled Data Cartridge (20/Pkg) (Includes 5 Cleaning Cartridge Labels) | 910651 | PK | \$1,365.65 |
| C7976AN | HP LTO 6 Ultrium (2.5/6.25 TB) MP RW Non-Custom Labeled Data Cartridge (20/Pkg) (Includes 5 Cleaning Cartridge Labels) | 910652 | PK | \$1,365.65 |
| C7976B | HP LTO 6 Ultrium (2.5/6.25 TB) BaFe RW Data Cartridge | 910653 | CTG | \$82.94 |
| C7976BB | HP LTO 6 Ultrium (2.5/6.25 TB) BaFe RW Data Cartridge Without Case (960/Pallet) | 911731 | PLT | \$78,832.65 |
| C7976BD | HP LTO 6 Ultrium (2.5/6.25 TB) BaFe RW Data Cartridge (960/Pallet) | 911730 | PLT | \$78,832.65 |

HP CROSS REFERENCE GUIDE CAN BE FOUND ON PAGES 257-282.



Welcome the similarity. Enjoy the difference.

The tapes are the same size but there's a world of difference between the first HP LTO-1 data cartridges and their new HP LTO-6 descendants. Capacities have soared to a massive 6.25 TB. Transfer rates are up by 1900%. Add WORM, encryption and LTF5 and today's LTO-6 cartridges are nothing short of revolutionary compared to their predecessors. But whilst these features are impressive, what matters most is the safety of your data. In that regard, HP LTO-6 cartridges share the same heritage of outstanding reliability that makes HP the most popular brand of storage media in the world. Like every generation before it, we test HP LTO-6 media to extremes to make sure you have the ultra reliable data protection your business demands. So if you're ready to evolve to LTO-6, become part of the HP family. For more information, visit hp.com/go/storagemedia.



New HP LTO-6

6.25 TB capacity - 400MB/sec transfer rate.

©2012 Hewlett-Packard Development Company, L.P.

Make it matter.



| MFG# | Product Description | Part# | UOM | Retail |
|------|---------------------|-------|-----|--------|
|------|---------------------|-------|-----|--------|

HP MEDIA

HP CROSS REFERENCE GUIDE CAN BE FOUND ON PAGES 257-282.

HP LTO Ultrium Data Cartridges *(Continued)*

| | | | | |
|---------|--|--------|-----|------------|
| C7976BN | HP LTO 6 Ultrium (2.5/6.25 TB) BaFe RW Non-Custom Labeled Data Cartridge (20/Pkg) (Includes 5 Cleaning Cartridge Labels) | 910654 | PK | \$1,658.88 |
| C7976BW | HP LTO 6 Ultrium (2.5/6.25 TB) BaFe WORM Data Cartridge | 916730 | CTG | \$91.24 |
| C7976W | HP LTO 6 Ultrium (2.5/6.25 TB) MP WORM Data Cartridge | 916731 | CTG | \$75.18 |
| C7976WL | HP LTO 6 Ultrium (2.5/6.25 TB) MP WORM Custom Labeled Data Cartridge (20/Pkg) (Includes 5 Cleaning Cartridge Labels) | 916735 | PK | \$1,503.37 |
| C7978A | HP LTO Ultrium Universal Cleaning Cartridge (15-50 Cleanings) | 3463 | CTG | \$96.36 |

HP RDX Removable Disk Cartridges & Docking Stations

| | | | | |
|--------|---|--------|-----|----------|
| Q2042A | HP RDX (500 GB) Removable Disk Cartridge | 904246 | CTG | \$167.96 |
| Q2044A | HP RDX (1 TB) Removable Disk Cartridge | 94896 | CTG | \$267.71 |
| Q2046A | HP RDX (2 TB) Removable Disk Cartridge | 922919 | CTG | \$421.99 |
| C8S06A | HP RDX USB 3.0 Internal Docking Station | 911732 | EA | \$180.23 |
| C8S07A | HP RDX USB 3.0 External Docking Station | 911733 | EA | \$192.46 |
| C8S08A | HP RDX USB 3.0 Gen8 DL Server Module Docking Station | 911734 | EA | \$225.00 |
| B7B62A | HP RDX (320 GB) Removable Disk Cartridge Backup System (Includes Internal USB 3.0 Dock, 1 Cartridge) | 910916 | EA | \$572.00 |
| B7B64A | HP RDX (500 GB) Removable Disk Cartridge Backup System (Includes Internal USB 3.0 Dock, 1 Cartridge) | 910918 | EA | \$758.16 |
| B7B67A | HP RDX (1 TB) Removable Disk Cartridge Backup System (Includes Internal USB 3.0 Dock, 1 Cartridge) | 910921 | EA | \$866.51 |
| E7X52A | HP RDX (2 TB) Removable Disk Cartridge Backup System (Includes Internal USB 3.0 Dock, 1 Cartridge) | 922920 | EA | \$643.50 |
| B7B63A | HP RDX (320 GB) Removable Disk Cartridge Backup System (Includes External USB 3.0 Dock, 1 Cartridge) | 910917 | EA | \$537.60 |
| B7B66A | HP RDX (500 GB) Removable Disk Cartridge Backup System (Includes External USB 3.0 Dock, 1 Cartridge) | 910920 | EA | \$744.00 |
| B7B69A | HP RDX (1 TB) Removable Disk Cartridge Backup System (Includes External USB 3.0 Dock, 1 Cartridge) | 910923 | EA | \$836.40 |
| E7X53A | HP RDX (2 TB) Removable Disk Cartridge Backup System (Includes External USB 3.0 Dock, 1 Cartridge) | 922921 | EA | \$650.10 |
| B7B65A | HP RDX (500 GB) Removable Disk Cartridge DL Server Backup Module (Includes Internal USB 3.0 Server Module, 1 Cartridge) | 910919 | EA | \$791.70 |
| B7B68A | HP RDX (1 TB) Removable Disk Cartridge DL Server Backup Module (Includes Internal USB 3.0 Server Module, 1 Cartridge) | 910922 | EA | \$897.90 |
| B7B70A | HP RDX (1 TB) Removable Disk Cartridge Backup System Gen8 DL Server Module (Includes Internal USB 3.0 Server Module, 1 Cartridge) | 910924 | EA | \$897.90 |

HP 4 mm Data Cartridges

| | | | | |
|--------|--|--------|-----|---------|
| C5708A | HP DDS-3 4 mm, 125 Meter (12/24 GB) Data Cartridge | 20940 | CTG | \$9.72 |
| C5718A | HP DDS-4 4 mm, 150 Meter (20/40 GB) Data Cartridge | 104672 | CTG | \$12.45 |
| C8010A | HP DAT 72, 170 Meter (36/72 GB) DDS-5 Data Cartridge | 1788 | CTG | \$24.68 |
| C8011A | HP DAT 160, 160 Meter (80/160 GB) Data Cartridge | 93593 | CTG | \$48.67 |
| C5709A | HP DDS/DAT 4 mm Cleaning Cartridge (50 Cleanings) | 20941 | CTG | \$9.69 |

IMATION MEDIA

Imation LTO Ultrium Data Cartridges

| | | | | |
|-------|---|--------|-----|----------|
| 17532 | LTO 3 Ultrium (400/800 GB) Data Cartridge | 6096 | CTG | \$54.61 |
| 26592 | LTO 4 Ultrium (800 GB/1.6 TB) Data Cartridge | 93627 | CTG | \$58.02 |
| 27672 | LTO 5 Ultrium (1.5/3.0 TB) Data Cartridge | 27094 | CTG | \$57.56 |
| 29080 | LTO 6 Ultrium (2.5/6.25 TB) Data Cartridge | 910761 | EA | \$112.33 |
| 15931 | LTO Ultrium Universal Cleaning Cartridge (Up to 20 Cleanings) | 3283 | CTG | \$89.78 |

Imation Standard Data Cartridges

| | | | | |
|-------|---|-------|-----|----------|
| 46168 | Magnus™ (2.5 GB) Data Cartridge (SLR 4, 5 GB) | 21682 | CTG | \$119.38 |
|-------|---|-------|-----|----------|

Imation RDX Removable Hard Disk Drive & Cartridges

| | | | | |
|-------|---|--------|-----|----------|
| 28109 | RDX External USB 3.0 Docking Station (Does not include cartridge) | 501431 | EA | \$199.99 |
| 27428 | RDX (320 GB) Removable Disk Cartridge | 906083 | CTG | \$150.99 |
| 27127 | RDX (500 GB) Removable Disk Cartridge | 20391 | CTG | \$166.99 |
| 27957 | RDX (1 TB) Removable Disk Cartridge | 94256 | CTG | \$259.99 |
| 28941 | RDX Media Secure (1 TB) Removable Disk Cartridge | 907001 | CTG | \$277.99 |
| 29104 | RDX (1.5 TB) Removable Disk Cartridge | 916589 | EA | \$377.99 |
| 29110 | RDX Media Secure (1.5 TB) Removable Disk Cartridge | 916590 | EA | \$394.99 |

Imation 4 mm Data Cartridges

| | | | | |
|-------|---|--------|-----|---------|
| 40963 | 4 mm, 150 Meter (20/40 GB) DDS-4 Data Cartridge | 21872 | CTG | \$13.76 |
| 17204 | DAT 72, 170 Meter (36/72 GB) DDS-5 Data Cartridge | 5802 | CTG | \$25.98 |
| 26837 | DAT 160, 150 Meter (80/160 GB) Data Cartridge | 902313 | CTG | \$58.47 |

| MFG# | Product Description | Part# | UOM | Retail |
|---|--|--------|-----|---------|
| IMATION MEDIA | | | | |
| Imation Classic Flash Drives | | | | |
| 28943 | USB Classic Flash Drive 8 GB | 908724 | EA | \$11.99 |
| 28944 | USB Classic Flash Drive 16 GB | 908725 | EA | \$17.19 |
| 28945 | USB Classic Flash Drive 32 GB | 908726 | EA | \$30.39 |
| 28946 | USB Classic Flash Drive 64 GB | 908727 | EA | \$55.39 |
| Imation Swivel Flash Drives | | | | |
| 26654 | USB 2.0 Flash Drive 8 GB | 91280 | EA | \$12.19 |
| 27125 | USB 2.0 Flash Drive 16 GB | 901825 | EA | \$17.59 |
| 27605 | USB 2.0 Flash Drive 32 GB | 15344 | EA | \$30.59 |
| 27794 | USB 2.0 Flash Drive 64 GB | 32030 | EA | \$55.99 |
| Imation DVD Write Once & Rewritable Media | | | | |
| 18060 | DVD+R (4.7 GB) (16x) Branded (100 Ea/Pkg) | 20432 | PK | \$59.79 |
| 17353 | DVD+R (4.7 GB) (16x) Inkjet and Hub Printable, White (50 Ea/Pkg) | 12857 | PK | \$24.59 |
| 27134 | DVD+RW (4.7 GB) (8x) Branded (25 Ea/Pkg) | 17890 | PK | \$35.39 |
| 17341 | DVD-R (4.7 GB) (16x) Branded (50 Ea/Pkg) | 12590 | PK | \$31.19 |
| 18059 | DVD-R (4.7 GB) (16x) Branded (100 Ea/Pkg) | 20431 | PK | \$59.79 |
| 17350 | DVD-R (4.7 GB) (16x) Inkjet and Hub Printable, White (Pkg=50/Spindle) | 12858 | PK | \$24.59 |
| 17346 | DVD-RW (4.7 GB) (4x) Branded (25 Ea/Pkg) | 11950 | PK | \$35.39 |
| Imation CD-R Write Once & Rewritable Media | | | | |
| 17332 | CD-R 80 Minute (700 MB) (52x) Branded With Slim Jewel Case (10 Ea/Pkg) | 11923 | PK | \$11.79 |
| 17301 | CD-R 80 Minute (700 MB) (52x) Branded (50 Ea/Pkg) | 5994 | PK | \$22.59 |
| 17262 | CD-R 80 Minute (700 MB) (52x) Branded (100 Ea/Pkg) | 6074 | PK | \$40.99 |
| 17274 | CD-R 80 Minute (700 MB) (52x) Thermal & Hub Printable, White (Pkg=100/Spindle) | 5885 | PK | \$34.39 |
| 17304 | CD-R 80 Minute (700 MB) (52x) Inkjet and Hub Printable, White (Pkg=50/Spindle) | 5917 | PK | \$18.79 |
| 17334 | CD-R 80 Minute (700 MB) (52x) Inkjet and Hub Printable, White (Pkg=100/Spindle) | 5914 | PK | \$39.39 |
| 41149 | CD-RW 80 Minute Rewritable (700 MB) (4x) Branded (25 Ea/Pkg) | 21889 | PK | \$23.99 |
| Imation CD/DVD Jewel Cases | | | | |
| 41017 | Slim Design Black Jewel Case (25 Ea/Pkg) | 10845 | PK | \$12.39 |
| MAXELL MEDIA | | | | |
| Maxell LTO Ultrium Data Cartridges | | | | |
| 183850 | LTO 2 Ultrium (200/400 GB) Data Cartridge | 2541 | CTG | \$54.44 |
| 183900 | LTO 3 Ultrium (400/800 GB) Data Cartridge | 6105 | CTG | \$45.31 |
| 183906 | LTO 4 Ultrium (800 GB/1.6 TB) Data Cartridge | 93598 | CTG | \$45.78 |
| 229323 | LTO 5 Ultrium (1.5/3.0 TB) Data Cartridge | 26692 | CTG | \$46.22 |
| 229558 | LTO 6 Ultrium (2.5/6.25 TB) Data Cartridge | 911000 | CTG | \$86.11 |
| 183804 | LTO Ultrium Universal Cleaning Cartridge (Works with all Ultrium Drives) (15-20 Cleanings) | 3590 | CTG | \$83.44 |
| Maxell 4 mm Data Cartridges | | | | |
| 200028 | 4 mm, 150 Meter (20 GB) DDS-4 Data Cartridge | 106459 | CTG | \$20.04 |
| 200200 | DAT 72, 170 Meter (36 GB) DDS-5 Data Cartridge | 1512 | CTG | \$34.42 |
| 186990 | 4 mm Cleaning Cartridge (40 Cleanings) | 92411 | CTG | \$13.58 |
| Maxell DVD Write Once Media | | | | |
| 638022 | DVD-R (4.7 GB) (16x) Inkjet Printable, White Matte (50 Ea/Pkg) | 34502 | PK | \$51.96 |
| 638000 | DVD-R (4.7 GB) (16x) Branded With Standard Jewel Case | 12884 | EA | \$1.91 |
| 638011 | DVD-R (4.7 GB) (16x) Branded (Pkg=50/Spindle) | 13551 | PK | \$23.29 |
| 638014 | DVD-R (4.7 GB) (16x) Branded (Pkg=100/Spindle) | 933353 | PK | \$45.47 |
| Maxell CD-R Write Once Media | | | | |
| 648201 | CD-R 80 Minute (700 MB) (48x) Branded With Slim Jewel Case | 1657 | EA | \$1.44 |
| 648250 | CD-R 80 Minute (700 MB) (48x) Branded (50 Ea/Pkg) | 1522 | PK | \$22.93 |
| 648200 | CD-R 80 Minute (700 MB) (48x) Branded (100 Ea/Pkg) | 1415 | PK | \$38.91 |
| 648720 | CD-R 80 Minute (700 MB) (48x) Inkjet Printable White, Matte (Pkg=100/Spindle) | 1713 | PK | \$50.38 |
| Maxell CD/DVD Sleeves | | | | |
| 190133 | CD/DVD White Paper Sleeves, Clear Front (100 Ea/Box) | 900619 | BOX | \$8.99 |
| MEMOREX MEDIA | | | | |
| Memorex TravelDrive Flash Drives | | | | |
| 98179 | Mini TravelDrive 8 GB | 17624 | EA | \$6.78 |
| 98180 | Mini TravelDrive 16 GB | 17623 | EA | \$17.19 |
| 98188 | Mini TravelDrive 32 GB | 94241 | EA | \$17.58 |
| 98515 | Mini TravelDrive 64 GB | 501432 | EA | \$26.00 |
| 98860 | Micro TravelDrive 8 GB | 916594 | EA | \$12.59 |
| 99043 | Micro TravelDrive 16 GB | 916596 | EA | \$18.79 |
| 99042 | Micro TravelDrive 32 GB | 916595 | EA | \$35.59 |

| MFG# | Product Description | Part# | UOM | Retail |
|--|---|--------|-----|----------|
| MEMOREX MEDIA | | | | |
| Memorex DVD Write Once & Rewritable Media | | | | |
| 05732 | DVD+R Double Layer (8.5 GB) (8x) Branded (50 Ea/Pkg) | 905112 | PK | \$85.79 |
| 05621 | DVD+R (4.7 GB) (16x) Branded (100 Ea/Pkg) | 21593 | PK | \$58.19 |
| 05541 | DVD+RW (4.7 GB) (4x) Branded (25 Ea/Pkg) | 21542 | PK | \$29.19 |
| 05669 | DVD-R (4.7 GB) (16x) Branded with Slim Jewel Case (10 Ea/Pkg) | 21628 | PK | \$11.19 |
| 05639 | DVD-R (4.7 GB) (16x) Branded (50 Ea/Pkg) | 21635 | PK | \$29.79 |
| 05641 | DVD-R (4.7 GB) (16x) Branded (100 Ea/Pkg) | 21637 | PK | \$58.19 |
| 05562 | DVD-RW (4.7 GB) (4x) Branded (25 Ea/Pkg) | 17882 | PK | \$32.39 |
| Memorex Blu-Ray Write Once Media | | | | |
| 98683 | Blu-Ray (BD-R) Write-Once (25 GB) (6x) Branded (15 Ea/Pkg) | 900094 | EA | \$41.79 |
| Memorex CD-R Write Once & Rewritable Media | | | | |
| 04514 | CD-R 80 Minute (700 MB) (52x) Branded with Slim Jewel Cases (10 Ea/Pkg) | 21666 | PK | \$10.59 |
| 04563 | CD-R 80 Minute (700 MB) (52x) Branded (50 Ea/Pkg) | 903855 | PK | \$23.19 |
| 04581 | CD-R 80 Minute (700 MB) (52x) Branded (100 Ea/Pkg) | 21692 | PK | \$44.99 |
| TDK MEDIA | | | | |
| TDK LTO Ultrium Data Cartridges | | | | |
| 27791 | LTO 3 Ultrium (400/800 GB) Data Cartridge | 100957 | CTG | \$52.89 |
| 48989 | LTO 4 Ultrium (800 GB/1.6 TB) Data Cartridge | 100958 | CTG | \$56.22 |
| 61857 | LTO 5 Ultrium (1.5/3.0 TB) Data Cartridge | 29986 | CTG | \$55.78 |
| TDK DVD Write Once Media | | | | |
| 48520 | DVD-R (4.7GB) (16x) Branded (100 Ea/Pkg) | 20660 | PK | \$56.99 |
| VERBATIM MEDIA | | | | |
| Verbatim Store'n'Go® Flash Drives | | | | |
| 95236 | 4GB Store'n'Go® USB Flash Drive - Red | 100163 | EA | \$8.50 |
| 95507 | 8GB Store'n'Go® USB Flash Drive - Red | 17897 | EA | \$9.00 |
| 96317 | 16GB Store'n'Go® USB Flash Drive - Red | 900698 | EA | \$14.00 |
| 96806 | 32GB Store'n'Go® USB Flash Drive - Red | 903587 | EA | \$27.00 |
| 97005 | 64GB Store'n'Go® USB Flash Drive - Red | 101908 | EA | \$44.00 |
| 97002 | 4GB Store'n'Go® USB Flash Drive - 3-Pack of Assorted Colors | 914940 | PK | \$25.00 |
| 49061 | 4GB Pinstripe USB Flash Drive - Black | 909982 | EA | \$8.50 |
| 49062 | 8GB Pinstripe USB Flash Drive - Black | 909983 | EA | \$9.00 |
| 49063 | 16GB Pinstripe USB Flash Drive - Black | 909984 | EA | \$14.00 |
| 49064 | 32GB Pinstripe USB Flash Drive - Black | 909985 | EA | \$27.00 |
| 49065 | 64GB Pinstripe USB Flash Drive - Black | 909986 | EA | \$44.00 |
| 97086 | 2GB Retractable USB Flash Drive - Blue | 90356 | EA | \$7.50 |
| 97087 | 4GB USB Flash Drive - Blue | 927424 | EA | \$7.90 |
| 97088 | 8GB USB Flash Drive - Blue | 913539 | EA | \$8.00 |
| Verbatim Store'n'Go® Portable Hard Drives | | | | |
| 97397 | USB 3.0 Store 'n' Go Portable Hard Drive 500 GB | 900321 | EA | \$124.00 |
| 97395 | USB 3.0 Store 'n' Go Portable Hard Drive 1 TB | 906931 | EA | \$164.00 |
| Verbatim SD Cards | | | | |
| 95407 | Secure Digital Flash Memory Card (2 GB) | 20374 | EA | \$9.50 |
| 96171 | Secure Digital High Capacity Flash Memory Card (Class 10) (4 MB) | 94673 | EA | \$9.50 |
| 96318 | Secure Digital High Capacity Memory Card (Class 10) (8 GB) | 909989 | EA | \$11.00 |
| 96808 | Secure Digital High Capacity Memory Card (Class 10) (16 GB) | 909992 | EA | \$20.00 |
| Verbatim DVD-R DataLifePlus Write Once Media | | | | |
| 94854 | DVD-R (4.7GB) (8X) Datalife Plus, Inkjet Printable White (Pk=50/Spindle) | 30423 | PK | \$30.00 |
| 94971 | DVD-R (4.7 GB) (8x) Inkjet Printable, White, No Stack Ring (Pk=50/Spindle) | 6425 | PK | \$24.00 |
| 94853 | DVD-R (4.7 GB) (8X) White, Thermal Printable, Hub Printable (Pk=50/Spindle) | 12285 | PK | \$32.00 |
| 95101 | DVD-R (4.7 GB) (16x) Branded (Pk=50/Spindle) | 909988 | PK | \$21.00 |
| 95102 | DVD-R (4.7 GB) (16x) Branded (Pk=100/Spindle) | 900324 | PK | \$42.00 |
| Verbatim CD-R Write Once & Rewritable Media | | | | |
| 94904 | CD-R 80 Minute (700 MB) (52x) DataLifePlus, Inkjet Printable, White (Pk=50/Spindle) | 5682 | PK | \$28.00 |
| 94691 | CD-R 80 Minute (700 MB) (52x) Branded Surface (Pk=50/Spindle) | 908813 | PK | \$16.00 |
| 94554 | CD-R 80 Minute (700 MB) (52x) DataLifePlus (Pk=100/Spindle) | 5965 | PK | \$32.00 |
| 95159 | CD-RW 80 Minute (700 MB) (2x-4x) DataLifePlus, Inkjet Printable, Silver (Pk=50/Spindle) | 12017 | PK | \$55.00 |
| 95251 | CD-R 80 Minute (700 MB) (52x) Inkjet Printable, White (Pk=100/Spindle) | 900737 | PK | \$52.00 |
| 95252 | CD-R 80 Minute (700 MB) (52x) Inkjet Printable, White, Hub Printable (Pk=100/Spindle) | 900850 | PK | \$52.00 |
| Verbatim CD/DVD Cases | | | | |
| 93975 | CD/DVD TRIMpak Clear Storage Cases Bulk Pack (200/Ctn) | 12764 | CTN | \$80.00 |



..... IMAGING EQUIPMENT

Not only do we have the **top printers and MFPs**, we also carry parts, maintenance kits and other essential office equipment.

QUALITY AND RELIABILITY.

| MFG# | Product Description | Part# | UOM | Retail |
|---|--|--------|-----|------------|
| HSM SHREDDERS | | | | |
| HSM 80.2 COMPACT Document Shredders | | | | |
| 1081 | HSM 80.2 COMPACT Strip Cut Personal Shredder (Level 2) (Sheet Capacity: 10-12) (Shred Size: 1/4") (Throat: 9") (16 FPM) (Waste Capacity: 4.5 Gal) (Motor: 120W) (Power: 115V/60Hz) (Stand By) (Auto Start/Stop) (Accepts Staples/Paper Clips) | 103182 | EA | \$368.84 |
| 1082 | HSM 80.2cc COMPACT Cross Cut Personal Shredder: Base Model + Level 3, Sheet Capacity: 5, Shred Size: 1/8" x 3/8" | 103183 | EA | \$488.05 |
| HSM 90.2 COMPACT Document Shredders | | | | |
| 1376 | HSM 90.2 COMPACT Strip Cut Personal Shredder (Level 2) (Sheet Capacity: 15) (Shred Size: 1/4") (Throat: 9") (12 FPM) (Waste Capacity: 6.6 Gal) (Motor: 150W)(Power: 115V/60Hz) (Stand By) (Auto Start/Stop) (Accepts Staples/Paper Clips/Credit Cards) | 103185 | EA | \$503.47 |
| 1188 | HSM 90.2cc COMPACT Cross Cut Personal Shredder: Base Model + Level 3, Sheet Capacity: 6, Shred Size: 1/4" x 25", Motor: 120W, Accepts Staples/Paper Clips | 103186 | EA | \$517.50 |
| HSM 102.2 COMPACT Document Shredders | | | | |
| 1104 | HSM 102.2 COMPACT Strip Cut Shredder (Level 2) (Sheet Capacity: 16-18) (Shred Size: 1/4") (Throat: 9") (12 FPM) (Waste Capacity: 5.7 Gal) (Motor: 150W) (Power: 115V/60Hz) (Stand By) (Auto Start/Stop) (Accepts Staples/Paper Clips/Credit Cards) | 103195 | EA | \$547.56 |
| 1105 | HSM 102.2cc COMPACT Cross Cut Shredder: Base Model + Level 3, Sheet Capacity: 6-7, Shred Size: 5/32" x 1" | 103197 | EA | \$571.32 |
| HSM 104.3 OFFICE Document Shredders | | | | |
| 1286 | HSM 104.3 OFFICE Strip Cut Shredder (Level 2) (Sheet Capacity: 22-24) (Shred Size: 1/4") (Throat: 9.5") (16 FPM) (Waste Capacity: 8.7 Gal) (Motor: 440W) (Power: 115V/60Hz) (Stand By) (Auto Start/Stop) (Accepts Staples/Paper Clips/Credit Cards/CD/DVD) | 103198 | EA | \$826.49 |
| 1288 | HSM 104.3cc OFFICE Cross Cut Shredder: Base Model + Level 3, Sheet Capacity: 12-14, Shred Size: 1/8" x 1 1/4", Accepts Staples/Paper Clips/Credit Cards | 103201 | EA | \$1,089.62 |
| 1310 | Waste Collection Bags (100 Bags/Roll) | 901998 | RL | \$64.42 |
| HSM 105.3 OFFICE Document Shredders | | | | |
| 1291 | HSM 105.3 OFFICE Strip Cut Shredder (Level 2) (Sheet Capacity: 22-24) (Shred Size: 1/4") (Throat: 9.5") (16 FPM) (Waste Capacity: 8.7 Gal) (Motor: 440W) (Power: 115V/60Hz) (Stand By) (Auto Start/Stop) (Reverse) (Accepts Staples/Paper Clips/Credit Cards/CD/DVD) | 103202 | EA | \$1,017.84 |
| 1293 | HSM 105.3cc OFFICE Cross Cut Shredder: Base Model + Level 3, Sheet Capacity: 12-14, Shred Size: 1/8" x 1 1/8", Accepts Staples/Paper Clips/Credit Cards | 103203 | EA | \$1,336.16 |
| 1310 | Waste Collection Bags (100 Bags/Roll) | 901998 | RL | \$64.42 |
| HSM 108.2 OFFICE Document Shredders | | | | |
| 1663 | HSM 108.2 OFFICE Strip Cut Shredder (Level 2) (Sheet Capacity: 22-24) (Shred Size: 1/4") (Throat: 9.5") (16 FPM) (Waste Capacity: 13 Gal) (Motor: 270W) (Power: 115V/60Hz) (Stand By) (Auto Start/Stop) (Reverse) (Accepts Staples/Paper Clips/Credit Cards/CD/DVD) | 103204 | EA | \$1,016.06 |
| 1665 | HSM 108.2cc OFFICE Cross Cut Shredder: Base Model + Level 3, Sheet Capacity: 12-14, Shred Size: 1/8" x 1 1/8", 18 FPM, Accepts Staples/Paper Clips/Credit Cards | 103225 | EA | \$1,270.83 |
| 1408 | HSM Waste Collection Bags (100 Bags/Roll) | 902012 | RL | \$58.46 |
| NB210R02830 | HSM Reusable Nylon Waste Collection Bag | 919888 | EA | \$36.14 |
| HSM 125.2 OFFICE Document Shredders | | | | |
| 1272 | HSM 125.2 OFFICE Strip Cut Shredder (Level 2) (Sheet Capacity: 28-30) (Shred Size: 1/4") (Throat: 10") (24 FPM) (Waste Capacity: 20 Gal) (Motor: 670W) (Power: 115V/60Hz) (Stand By) (Auto Start/Stop) (Reverse) (Accepts Staples/Paper Clips/Credit Cards/CD/DVD) | 103226 | EA | \$2,196.72 |
| 1274 | HSM 125.2cc OFFICE Cross Cut Shredder: Base Model + Level 3, Sheet Capacity: 16-18, Shred Size: 1/8" x 1 1/8", 26 FPM, Power: 115V/60Hz, Accepts Staples/Paper Clips | 103227 | EA | \$2,565.04 |
| 1275 | HSM 125.2 OFFICE High Security Cross Cut Shredder: Base Model + Level 5, Sheet Capacity: 6-7, Shred Size: 1/16" x 5/8", 26 FPM, Accepts Staples/Paper Clips, Auto Oiler Recommended | 103703 | EA | \$3,499.61 |
| 12754 | HSM 125.2 OFFICE High Security Cross Cut Shredder and Auto Oiler Bundle (Level 5) (Oil Included) | 904654 | EA | \$4,151.61 |
| 1687 | HSM 125.2 OFFICE High Security Field-Deployable Cross Cut Shredder: Base Model + Level 6, NSA/CSS 02-01 Approved, Sheet Capacity: 5-7, Shred Size: 1/32" x 7/16", 26 FPM, Accepts Paper Only | 24790 | EA | \$7,663.26 |
| 15624 | HSM 125.2 OFFICE High Security Field-Deployable Cross Cut Shredder and Auto Oiler Bundle (Level 6) (Oil Included) | 904658 | EA | \$6,204.60 |
| 1815 | HSM Waste Collection Bags (100 Bags/Roll) | 105503 | RL | \$79.08 |
| NB210R02830 | HSM Reusable Nylon Waste Collection Bag | 919888 | EA | \$36.14 |
| HSM 225.2 OFFICE Document Shredders (Continued on next page) | | | | |
| 1341 | HSM 225.2 OFFICE Strip Cut Shredder (Level 2) (Sheet Capacity: 40-42) (Shred Size: 1/4") (Throat: 12") (25 FPM) (Waste Capacity: 31.7 Gal) (Motor: 1400W) (Power: 115V/60Hz) (Stand By) (Auto Start/Stop) (Auto-Reverse) (Accepts Staples/Paper Clips/Credit Cards/CD/DVD) (Casters) | 103228 | EA | \$2,989.44 |

| MFG# | Product Description | Part# | UOM | Retail |
|--|--|--------|-----|-------------|
| HSM SHREDDERS | | | | |
| HSM 225.2 OFFICE Document Shredders (Continued) | | | | |
| 1343 | HSM 225.2cc OFFICE Cross Cut Shredder: Base Model + Level 3, Sheet Capacity: 25-27, Shred Size: 1/8" x 1 1/2", 27 FPM | 103229 | EA | \$3,370.68 |
| 1344 | HSM 225.2 OFFICE High Security Cross Cut Shredder: Base Model + Level 5, Sheet Capacity: 10-11, Shred Size: 1/32" x 7/16", 27 FPM, Accepts Staples/Paper Clips, Auto Oiler Recommended | 103707 | EA | \$5,257.45 |
| 14584 | HSM 225.2 OFFICE High Security Cross Cut Shredder and Auto Oiler Bundle: Base Model + Level 6, NSA/CSS 02-01 Approved, Sheet Capacity: 10-12, Shred Size: 1/32" x 3/16", 27 FPM, Oil Included | 904659 | EA | \$7,846.20 |
| 2117 | HSM Waste Collection Bags (100 Bags/Roll) | 106866 | RL | \$182.00 |
| NB210R03330 | HSM Reusable Nylon Waste Collection Bag | 919889 | EA | \$41.00 |
| HSM 386.2 PROFESSIONAL Document Shredders | | | | |
| 1276 | HSM 386.2 PROFESSIONAL Strip Cut Shredder (Level 2) (Sheet Capacity: 22-23) (Shred Size: 1/8") (Throat: 15") (24 FPM) (Waste Capacity: 31 Gal) (Motor: 670W) (Power: 115V/60Hz) (Stand By) (Auto Start/Stop) (Accepts Staples/Paper Clips/Credit Cards/CD/DVD) (Casters) | 103248 | EA | \$2,286.63 |
| 1278 | HSM 386.2cc PROFESSIONAL Cross Cut Shredder: Base Model + Level 3, Sheet Capacity: 14-16, Shred Size: 1/8" x 1 1/8", 26 FPM, Accepts Staples/Paper Clips/Credit Cards | 103249 | EA | \$2,746.38 |
| 2117 | HSM Waste Collection Bags (100 Bags/Roll) | 106866 | RL | \$182.00 |
| NB210NA3930 | HSM Reusable Nylon Waste Collection Bag | 919890 | EA | \$46.56 |
| HSM 390.3cc PROFESSIONAL Document Shredders | | | | |
| 1366 | HSM 390.3 PROFESSIONAL Strip Cut Shredder (Level 2) (Sheet Capacity: 40-42) (Shred Size: 1/4") (Throat: 16") (25 FPM) (Waste Capacity: 39 Gal) (Motor: 1400W) (Power: 115V/60Hz) (Stand By) (Auto Start/Stop) (Auto Reverse) (Accepts Staples/Paper Clips/Credit Cards/CD/DVD) (Casters) | 103250 | EA | \$3,852.36 |
| 1368 | HSM 390.3cc PROFESSIONAL Cross Cut Shredder: Base Model + Level 3, Sheet Capacity: 25-27, Shred Size: 1/8" x 1 1/2", 27 FPM | 103254 | EA | \$4,494.96 |
| 1369 | HSM 390.3 PROFESSIONAL High Security Cross Cut Shredder: Base Model + Level 5, Sheet Capacity: 10-11, Shred Size: 1/32" x 7/16", 27 FPM, Accepts Staples/Paper Clips, Auto Oiler Recommended | 103730 | EA | \$7,879.48 |
| 13694 | HSM 390.3 PROFESSIONAL High Security Cross Cut Shredder and Auto Oiler Bundle (Level 5) (Oil Included) | 904656 | EA | \$8,531.48 |
| 16604 | HSM 390.3 PROFESSIONAL High Security Cross Cut Shredder and Auto Oiler Bundle: Base Model + Level 6, NSA/CSS 02-01 Approved, Sheet Capacity: 10-12, Shred Size: 1/32" x 3/16", 27 FPM, Only Accepts Paper, Oil Included | 904660 | EA | \$9,833.40 |
| 2117 | HSM Waste Collection Bags (100 Bags/Roll) | 106866 | RL | \$182.00 |
| NB210NA3930 | HSM Reusable Nylon Waste Collection Bag | 919890 | EA | \$46.56 |
| HSM 411.2cc PROFESSIONAL Document & Optical Media Shredders | | | | |
| 1566 | HSM 411.2 PROFESSIONAL Strip Cut Shredder (Level 2) (Sheet Capacity: 65-67) (Shred Size: 1/4") (Throat: 16") (24 FPM) (Waste Capacity: 38.5 Gal) (Motor: 2100W) (Power: 115V/60Hz) (Stand By) (Auto Start/Stop) (Reverse) (Accepts Staples/Paper Clips/Credit Cards/CD/DVD/USB) | 103256 | EA | \$7,143.12 |
| 1568 | HSM 411.2cc PROFESSIONAL Cross Cut Shredder: Base Model + Level 3, Sheet Capacity: 38-40, Shred Size: 1/8" x 2" | 103257 | EA | \$8,693.65 |
| 1569 | HSM 411.2 PROFESSIONAL High Security Cross Cut Shredder: Base Model + Level 5, Sheet Capacity: 17-19, Shred Size: 1/32" x 7/16", Accepts Staples/Paper Clips, Auto Oiler Recommended | 103739 | EA | \$13,989.06 |
| 15694 | HSM 411.2 PROFESSIONAL High Security Cross Cut Shredder and Auto Oiler Bundle (Level 5) (Oil Included) | 904657 | EA | \$14,641.06 |
| 15644 | HSM 411.2 PROFESSIONAL High Security Cross Cut Shredder and Auto Oiler Bundle: Base Model + Level 6, NSA/CSS 02-01 Approved, Sheet Capacity: 14-16, Shred Size: 1/32" x 3/16", Accepts Paper Only, Oil Included | 904661 | EA | \$14,724.72 |
| 1570 | HSM 411.2 PROFESSIONAL High Security Cross Cut Optical Media Device Shredder: Base Model + Level 6, Shred Size: 0.86" x 0.157", 2,500 Pieces/Hr, Accepts Credit Cards/CD/DVD | 106845 | EA | \$17,253.55 |
| 2117 | HSM Waste Collection Bags (100 Bags/Roll) | 106866 | RL | \$182.00 |
| NB210NA3930 | HSM Reusable Nylon Waste Collection Bag | 919890 | EA | \$46.56 |
| HSM Securio B22 Document Shredders | | | | |
| 1831 | HSM Securio B22 Strip Cut Shredder (Level 2) (Sheet Capacity: 22-24) (Shred Size: 1/4") (Throat: 9.4") (16 FPM) (Waste Capacity: 8.7 Gal) (Motor: 440W) (Power: 115V/60Hz) (Stand By) (Auto Start/Stop) (Accepts Staples/Paper Clips/Credit Cards/CD/DVD) (Energy Management and Control System) | 915833 | EA | \$847.00 |
| 1833 | HSM Securio B22c Cross Cut Shredder: Base Model + Level 3, Sheet Capacity: 12-14, Shred Size: 1/8 x 1 1/8" | 12712 | EA | \$999.00 |

| MFG# | Product Description | Part# | UOM | Retail |
|---|---|--------|-----|------------|
| HSM SHREDDERS | | | | |
| HSM Securio B24 Document Shredders | | | | |
| 1780 | HSM Securio B24s Strip Cut Shredder (Level 2) (Sheet Capacity: 22-24) (Shred Size: 1/8") (Throat: 9.5") (13 FPM) (Waste Capacity: 9 Gal) (Motor: 500W) (Power:115V/60Hz) (Auto Start/Stop) (Accepts: Staples/Paper Clips/Credit Cards/CD/DVD) | 905218 | EA | \$879.00 |
| 1781 | HSM Securio B24s Strip Cut Shredder: Base Model + Level 2, Sheet Capacity: 28-30, Shred Size: 1/4" | 913448 | EA | \$879.00 |
| 1783 | HSM Securio B24c Cross Cut Shredder: Base Model + Level 3, Sheet Capacity: 17-19, Shred Size: 3/16" x 1 1/8" | 905219 | EA | \$1,039.00 |
| 17844 | HSM Securio B24 High Security Cross Cut Shredder: Base Model + Level 6, NSA/CSS 02-01 Approved, Sheet Capacity: 7-8, Shred Size: 1/32" x 3/16", Accepts Paper Only | 94320 | EA | \$3,036.01 |
| 1408 | HSM Waste Collection Bags (100 Bags/Roll) | 902012 | RL | \$58.46 |
| HSM Securio B26 Document Shredders | | | | |
| 1800 | HSM Securio B26s Strip Cut Shredder (Level 2) (Sheet Capacity: 22-24) (Shred Size: 1/8") (Throat: 11") (13 FPM) (Waste Capacity: 14.5 Gal) (Motor: 500W) (Power:115V/60Hz) (Auto Start/Stop) (Accepts: Staples/Paper Clips/Credit Cards/CD/DVD) | 919478 | EA | \$1,195.00 |
| 1801 | HSM Securio B26s Strip Cut Shredder: Base Model + Level 2, Sheet Capacity: 28-30, Shred Size: 1/4" | 919479 | EA | \$1,195.00 |
| 1803 | HSM Securio B26c Cross Cut Shredder: Base Model + Level 3, Sheet Capacity: 17-19, Shred Size: 3/16" x 1 1/8", Motor: 580W | 919480 | EA | \$1,395.00 |
| 1815 | HSM Waste Collection Bags (100 Bags/Roll) | 105503 | RL | \$79.08 |
| HSM Securio B32 Document Shredders | | | | |
| 1820 | HSM Securio B32s Strip Cut Shredder (Level 2) (Sheet Capacity: 22-24) (Shred Size: 1/8") (Throat: 12.2") (13 FPM) (Waste Capacity: 21.7 Gal) (Motor: 500W) (Power:115V/60Hz) (Auto Start/Stop) (Accepts: Staples/Paper Clips/Credit Cards/CD/DVD) | 919477 | EA | \$1,521.84 |
| 1821 | HSM Securio B32s Strip Cut Shredder: Base Model + Level 2, Sheet Capacity: 28-30, Shred Size: 1/4" | 905220 | EA | \$1,521.84 |
| 1822 | HSM Securio B32c Cross Cut Shredder: Base Model + Level 4, Sheet Capacity: 11-13, Shred Size: 1/16" x 9/16", Accepts: Staples/Paper Clips/Credit Cards | 96146 | EA | \$1,936.98 |
| 1823 | HSM Securio B32c Cross Cut Shredder: Base Model + Level 3, Sheet Capacity: 17-19, Shred Size: 3/16" x 1 1/8", Accepts: Staples/Paper Clips/Credit Cards/CD/DVD | 905221 | EA | \$1,668.62 |
| 1815 | HSM Waste Collection Bags (100 Bags/Roll) | 105503 | RL | \$79.08 |
| NB210R03330 | HSM Reusable Nylon Waste Collection Bag | 919889 | EA | \$41.00 |
| HSM Securio B34 Document Shredders | | | | |
| 1840 | HSM Securio B34s Strip Cut Shredder (Level 2) (Sheet Capacity: 28-30) (Shred Size: 1/8") (Throat: 12.2") (17 FPM) (Waste Capacity: 26.4 Gal) (Motor: 650W) (Power: 115V/60Hz) (Continuous) (Auto Start/Stop) (Accepts Staples/Paper Clips/Credit Cards/CD/DVD) | 12691 | EA | \$2,370.37 |
| 1841 | HSM Securio B34s Strip Cut Shredder: Base Model + Level 2, Sheet Capacity: 35-37, Shred Size: 1/4" | 913449 | EA | \$2,370.37 |
| 1843 | HSM Securio B34c Cross Cut Shredder: Base Model + Level 3, Sheet Capacity: 22-24, Shred Size: 3/16 x 1 1/8" | 12698 | EA | \$2,835.52 |
| 18444 | HSM Securio B34 High Security Cross Cut Shredder: Base Model + Level 6, NSA/CSS 02-01 Approved, Sheet Capacity: 10-12, Shred Size: 1/32" x 3/16", Accepts Paper Only | 94321 | EA | \$5,137.86 |
| 1815 | HSM Waste Collection Bags (100 Bags/Roll) | 105503 | RL | \$79.08 |
| NB210R03330 | HSM Reusable Nylon Waste Collection Bag | 919889 | EA | \$41.00 |
| HSM Securio B35 Document Shredders | | | | |
| 1920 | HSM Securio B35s Strip Cut Shredder (Level 2) (Sheet Capacity: 30-32) (Shred Size: 1/8") (Throat: 15.75") (18 FPM) (Waste Capacity: 34.3 Gal) (Motor: 590W) (Power: 115V/60Hz) (Accepts Staples/Paper Clips/Credit Cards/CD/DVD) | 919474 | EA | \$2,788.67 |
| 1921 | HSM Securio B35s Strip Cut Shredder: Base Model + Level 2, Sheet Capacity: 40-42, Shred Size: 1/4" | 919475 | EA | \$2,788.67 |
| 1923 | HSM Securio B35c Cross Cut Shredder: Base Model + Level 3, Sheet Capacity: 24-26, Shred Size: 3/16" x 1 1/8" | 919476 | EA | \$3,335.90 |
| 2117 | HSM Waste Collection Bags (100 Bags/Roll) | 106866 | RL | \$182.00 |
| HSM Securio C16 Document Shredders | | | | |
| 1901 | HSM Securio C16s Strip Cut Shredder (Level 2) (Sheet Capacity: 16-18) (Shred Size: 1/4") (Throat: 8.8") (8.67 FPM) (Waste Capacity: 6.6 Gal) (Motor: 300W) (Power: 115V/60Hz) (Standby) (Auto Start/Stop) (Auto Reverse) (Accepts Staples/Paper Clips/Credit Cards) | 919483 | EA | \$712.98 |
| 1902 | HSM Securio C16c Cross Cut Shredder: Base Model + Level 3, Sheet Capacity: 5-7, Shred Size: 5/32" x 1" | 916435 | EA | \$770.10 |
| HSM Securio C18 Document Shredders <i>(Continued on next page)</i> | | | | |
| 1911 | HSM Securio C18s Strip Cut Shredder (Level 2) (Sheet Capacity: 19-20) (Shred Size: 1/4") (Throat: 9.4") (8.66 FPM) (Waste Capacity: 6.6 Gal) (Accepts: Staples/Paper Clips/Credit Cards) | 913450 | EA | \$814.98 |

| MFG# | Product Description | Part# | UOM | Retail |
|---|--|--------|-----|-------------|
| HSM SHREDDERS | | | | |
| HSM Securio C18 Document Shredders (Continued) | | | | |
| 1913 | HSM Securio C18c Cross Cut Shredder: Base Model + Level 3 Security, Sheet Capacity: 10-11, Shred Size: 1/8" x 1 1/8" | 913451 | EA | \$899.00 |
| HSM Securio P36 Document Shredders | | | | |
| 1850 | HSM Securio P36s Strip Cut Shredder (Level 2) (Sheet Capacity: 35-39) (Shred Size: 1/8") (Throat: 13") (18 FPM) (Waste Capacity: 38.3 Gal) (Motor: 1800W) (Power: 115V/60Hz) (Stand By) (Auto Start/Stop) (Accepts Staples/Paper Clips/Credit Cards/CD/DVD) | 919469 | EA | \$4,541.00 |
| 1851 | HSM Securio P36s Strip Cut Shredder: Base Model + Level 2, Sheet Capacity: 45-49, Shred Size: 1/4", Accepts Credit Cards | 94296 | EA | \$4,541.00 |
| 1852 | HSM Securio P36c Cross Cut Shredder: Base Model + Level 4, Sheet Capacity: 15-20, Shred Size: 1/16" x 9/16", Accepts Staples/Paper Clips/Credit Cards | 96151 | EA | \$5,681.00 |
| 1853 | HSM Securio P36c Cross Cut Shredder: Base Model + Level 3, Sheet Capacity: 29-31, Shred Size: 3/16 x 1 1/8", Accepts Staples/Paper Clips/Credit Cards/CD/DVD | 94299 | EA | \$5,659.00 |
| 1854 | HSM Securio P36 High Security Cross Cut Shredder: Base Model + Level 6, Sheet Capacity: 10-14, Shred Size: 1/32" x 3/16" | 96152 | EA | \$9,020.45 |
| 1854M | HSM P36 High Security Cross Cut Optical Media Shredder: Base Model + Level 6, Sheet Capacity: 12-14, Shred Size: 1/32" x 3/16", Separate Optical Media Device Cutting Unit, Auto Oiler | 91459 | EA | \$10,914.00 |
| 2117 | HSM Waste Collection Bags (100 Bags/Roll) | 106866 | RL | \$182.00 |
| NB210NA3930 | HSM Reusable Nylon Waste Collection Bag | 919890 | EA | \$46.56 |
| HSM Securio P40 Document Shredders | | | | |
| 1881 | HSM Securio P40s Strip Cut Shredder (Level 2) (Sheet Capacity: 58-60) (Shred Size: 1/4") (Throat: 13") (18 FPM) (Waste Capacity: 40 Gal) (Motor: 2100W) (Power: 115V/60Hz) (Stand By) (Auto Start/Stop) (Accepts Staples/Paper Clips/Credit Cards) | 94297 | EA | \$6,486.22 |
| 1883 | HSM Securio P40c Cross Cut Shredder: Base Model + Level 3, Sheet Capacity: 35-37, Shred Size: 3/16 x 1 1/8", Accepts Staples/Paper Clips/Credit Cards/CD/DVD | 94300 | EA | \$8,040.58 |
| 1884 | HSM Securio P40 Cross Cut Shredder: Base Model + Level 6, Sheet Capacity: 14-16, Shred Size: 1/32 x 3/16", Accepts Paper Only | 99668 | EA | \$13,246.74 |
| 2117 | HSM Waste Collection Bags (100 Bags/Roll) | 106866 | RL | \$182.00 |
| HSM Securio P44 Document Shredders | | | | |
| 1870 | HSM Securio P44s Strip Cut Shredder (Level 2) (Sheet Capacity: 61-63) (Shred Size: 1/8") (Throat: 16") (18 FPM) (Waste Capacity: 55 Gal) (Motor: 2100W) (Power: 115V/60Hz) (Stand By) (Auto Start/Stop) (Accepts Staples/Paper Clips/Credit Cards/CD/DVD/USB) | 94298 | EA | \$8,172.70 |
| 1873 | HSM Securio P44c Cross Cut Shredder: Base Model + Level 3, Sheet Capacity: 43-46, Shred Size: 3/16 x 2" | 94301 | EA | \$10,042.00 |
| 2523-1 | HSM Waste Collection Bags (50/Ctn) | 902243 | CTN | \$186.11 |
| HSM Shredstar BS6M Document Shredder | | | | |
| 1054 | HSM Shredstar BS6Ms Micro Cut Shredder (Level 4) (Sheet Capacity: 6) (Shred Size: 5/32" x 1 3/8") (Throat: 8.9") (Waste Capacity: 5 Gal) (Motor: 250W) (Power: 115V/60Hz) (Side Profile) (Auto Start/Stop/Reverse) (Accepts Staples/Paper Clips) (Continuous Operation) | 910256 | EA | \$355.00 |
| HSM Shredstar BS10C Document Shredder | | | | |
| 1053 | HSM Shredstar BS10Cs Cross Cut Shredder (Level 3) (Sheet Capacity: 10) (Shred Size: 5/32" x 1 3/8") (Throat: 8.9") (Waste Capacity: 5 Gal) (Motor: 250W) (Power: 115V/60Hz) (Side Profile) (Auto Start/Stop/Reverse) (Continuous Operation) (Accepts Staples/Paper Clips) | 910255 | EA | \$335.00 |
| HSM Shredstar BS12C Document Shredder | | | | |
| 1056 | HSM Shredstar BS12C Cross Cut Shredder (Level 3) (Sheet Capacity: 12) (Shred Size: 5/32" x 1 3/8") (Throat: 8.74") (Waste Capacity: 5.8 Gal) (Motor: 230W) (Power: 115V/60Hz) (Auto Start/Stop/Reverse) (Continuous Operation) (Accepts Staples/Paper Clips/Credit Cards/CD/DVD) | 910258 | EA | \$405.00 |
| HSM Shredstar BS14C Document Shredder | | | | |
| 1057 | HSM Shredstar BS14C Cross Cut Shredder (Level 3) (Sheet Capacity: 14) (Shred Size: 5/32" x 1 3/8") (Throat: 8.74") (Waste Capacity: 5.8 Gal) (Motor: 300W) (Power: 115V/60Hz) (Auto Start/Stop/Reverse) (Accepts Staples/Paper Clips/Credit Cards/CD/DVD) (Continuous Operation) | 910259 | EA | \$477.63 |
| HSM Shredstar MS12C Document Shredder | | | | |
| 1055 | HSM Shredstar MS12C Cross Cut Shredder (Level 3) (Sheet Capacity: 12) (Shred Size: 1/8" x 3/8") (Throat: 8.6") (Waste Capacity: 2.1 Gal) (Motor: 230W) (Power: 115V/60Hz) (Auto Start/Stop/Reverse) (Accepts Staples/Paper Clips/Credit Cards/CD/DVD) | 910257 | EA | \$316.15 |

| MFG# | Product Description | Part# | UOM | Retail |
|---|---|--------|-----|-------------|
| HSM SHREDDERS | | | | |
| HSM Shredstar PS817C Document Shredder | | | | |
| SS-1030 | HSM Shredstar PS817C Cross Cut Shredder (Level 3) (Sheet Capacity: 17) (Shred Size: 5/32" x 1 3/8") (Throat: 9") (Waste Capacity: 7.1 Gal) (Motor: 380W) (Accepts Staples/Paper Clips/DVD/CD/Credit Cards) | 95979 | EA | \$588.00 |
| HSM Shredstar PS820C Document Shredder | | | | |
| 1051 | HSM Shredstar PS820C Cross Cut Shredder (Level 3) (Sheet Capacity: 20) (Shred Size: 1/8" x 3/8") (Throat: 9") (Waste Capacity: 7.1 Gal) (Motor: 380W) (Power: 115V/60Hz) (Accepts Staples/Paper Clips/DVD/CD/Credit Cards) (Continuous Operation) (Auto Start/Stop/Reverse) | 910253 | EA | \$617.60 |
| HSM Shredstar PS825S Document Shredder | | | | |
| 1052 | HSM Shredstar PS825S Strip Cut Shredder (Level 2) (Sheet Capacity: 25) (Shred Size: 1/4") (Throat: 9") (Waste Capacity: 7.1 Gal) (Motor: 200W) (Power: 115V/60Hz) (Auto Start/Stop/Reverse) (Accepts Staples/Paper Clips/Credit Cards/CD/DVD) | 910254 | EA | \$509.46 |
| HSM Shredstar S10 Document Shredder | | | | |
| SS-1013 | HSM Shredstar S10 Strip Cut Shredder (Level 2) (Sheet Capacity: 10-13) (Shred Size: 1/4") (Throat: 8.6") (Waste Capacity: 4.2 Gal) (Motor: 130W) (Power: 120V/60 Hz) (Accepts Staples/Paper Clips) (Auto Start/Stop) | 96145 | EA | \$153.47 |
| HSM Shredstar X5 Document Shredder | | | | |
| 1014 | HSM Shredstar X5 Cross Cut Shredder (Level 3) (Sheet Capacity: 7) (Shred Size: 5/32" x 1 1/2") (Throat: 8.5") (11.81 FPM) (Waste Capacity: 3 Gal.) (Accepts: Paper) (Auto Start/Stop) (LED Standby) | 912197 | EA | \$133.95 |
| HSM Shredstar X6Pro Document Shredder | | | | |
| 1058 | HSM Shredstar X6Pro Micro Cut Shredder (Level 4) (Sheet Capacity: 6) (Shred Size: 5/32" x 1 3/8") (Throat: 8.8") (Waste Capacity: 5.5 Gal) (Motor: 250W) (Power: 115V/60Hz) (Auto Start/Stop/Reverse) (Accepts Staples/Paper Clips/Credit Cards/CD/DVD) | 910260 | EA | \$232.34 |
| HSM Shredstar X10 Document Shredder | | | | |
| 1015 | HSM Shredstar X10 Cross Cut Shredder (Level 3) (Sheet Capacity: 10) (Shred Size: 5/32" x 1 3/8") (Throat: 8.8") (Waste Capacity: 5.5 Gal) (Motor: 250W) (Power: 115V/60Hz) (Auto Start/Stop/Reverse) (Accepts Staples/Paper Clips/Credit Cards/CD/DVD) | 910252 | EA | \$238.55 |
| HSM Shredstar X18 Document Shredder | | | | |
| SS-1017 | HSM Shredstar X18 Cross Cut Shredder (Level 3) (Sheet Capacity: 18) (Shred Size: 5/32" x 1 1/8") (Throat: 9") (Waste Capacity: 7 Gal) (Motor: 550W) (Power: 115V/60Hz) (Stand By) (Auto Start/Stop) (Reverse) (Accepts Staples/Paper Clips/Credit Cards/CD/DVD) | 20445 | EA | \$516.24 |
| HSM Powerline 450.2 Continuous-Duty Document Shredders | | | | |
| 1503 | HSM Powerline 450.2 Cross Cut Conveyor Belt Shredder (Level 3) (Sheet Capacity: 80-85) (Shred Size: 1/8" x 2") (Throat: 17.4") (43 FPM) (Waste Capacity: 76.6 Gal) (Motor: 4000W) (Power: 3x208V/60Hz) (Stand By) (Auto Start/Stop) (Accepts Staples/Paper Clips/Credit Cards/CD/DVD/Floppy Disks/USB Sticks) | 103265 | EA | \$16,913.29 |
| 15034 | HSM 450.2cc PROFESSIONAL Cross Cut Shredder Bundle: Includes Auto Oiler | 904653 | EA | \$17,565.29 |
| HSM Powerline FA400.2 Continuous-Duty Shredders | | | | |
| 1513 | HSM Powerline FA400.2 Strip Cut Conveyor Belt Shredder (Level 2) (Sheet Capacity: 130) (Shred Size: 1/4") (Throat: 17") (41 FPM) (Waste Capacity: 104 Gal) (Motor: 4,000W) (Power: 3x208V/60Hz) (Stand By) (Auto Start/Stop) (Accepts Staples/Paper Clips/Credit Cards/CD/DVD/Floppy Disks/USB) | 103276 | EA | \$18,358.92 |
| 1514 | HSM Powerline FA400.2cc Cross Cut Conveyor Belt Shredder: Base Model + Level 3, Sheet Capacity: 120, Shred Size: 1/4" x 2", 49 FPM | 103277 | EA | \$18,921.60 |
| HSM Powerline FA500.3 Continuous-Duty Shredder | | | | |
| 1991 | HSM Powerline FA500.3cc Cross Cut Conveyor Belt Shredder (Level 3) (Sheet Capacity: 450) (Shred Size: 9/32" x 1 1/2" - 3 5/32") (Throat: 20") (42 FPM) (Waste Capacity: 140 Gal) (Motor: 7500W) (Power: 3x208V/60Hz) (Accepts Staples/Paper Clips/Credit Cards/CD/DVD/USB) | 910263 | EA | \$51,029.73 |
| HSM Powerline HDS 230 Media Shredders | | | | |
| 1778 | HSM Powerline HDS 230-1 Cross Cut Hard Drive and Media Backup Shredder - Single Stage (Shred Size: 0.78" x 1.18" - 2") (Throat: 5" x 1.5" x 8.25") (2,000 Items/Hr) (Power: 3x208V/60Hz) (Continuous Duty) (Auto Stop) (Accepts Hard Drives/Credit Cards/CD/DVD/USB/Magnetic Tapes up to 3.5") | 910262 | EA | \$30,094.00 |
| 1777 | HSM Powerline HDS 230-2 Cross Cut Hard Drive and Media Backup Shredder - Dual Stage: Base Model + Shred Size: 0.39" x 1" - 1.18", 2,500 Items/Hr | 910261 | EA | \$44,461.00 |

| MFG# | Product Description | Part# | UOM | Retail |
|---|--|--------|-----|------------|
| HSM SHREDDERS | | | | |
| HSM ProfiPack Cardboard Converters | | | | |
| 1528 | HSM ProfiPack 400 Tabletop Single-Layer Cardboard Converter (Shred Capacity: 1 Layer of Cardboard) (Throat: 16.3") (Motor: 1400W) (Power: 120V/60Hz) | 7934 | EA | \$3,967.21 |
| 1531 | HSM ProfiPack 425 Multi-Layer Cardboard Converter (Shred Capacity: 2-3 Layers of Cardboard) (Throat: 16.7") (Motor: 2200W) (Power: 208V/60Hz) | 7910 | EA | \$9,212.60 |
| HSM Classic Nanoshred 726 Code Tape Shredder | | | | |
| 1674 | HSM Classic Nanoshred 726 Cross Cut Code Tape Destroyer (Level 5) (Sheet Capacity: 1) (Shred Size: 1/32" x 7/64") (Throat: 1.5") (DOD Approved) (Waste Capacity: 1.3 Gal) (Power: 120V/60Hz) (Auto Start/Stop) | 12716 | EA | \$3,071.22 |
| HSM Auto Oiler & Oil | | | | |
| 36159 | HSM Shredder Auto Oiler (For Use With Levels 1-6) (Factory Installed) | 103760 | EA | \$1,238.06 |
| 316 | HSM Oil Bottle (12 oz) | 103758 | EA | \$31.68 |
| 314 | HSM Pint Oil Bottle (16 oz) | 103752 | EA | \$38.19 |
| 315 | HSM Gallon Oil Bottle | 103757 | EA | \$47.19 |
| 316P | HSM Oil Bottles Case (12 oz) (6/Case) | 919887 | EA | \$190.08 |
| 314P | HSM Pint Oil Bottles Case (16 oz) (12/Case) | 91782 | EA | \$458.28 |
| 315P | HSM Gallon Oil Bottles Case (4/Case) (Includes Funnel) | 92293 | EA | \$188.77 |

BROTHER EQUIPMENT

BROTHER P-TOUCH CROSS REFERENCE GUIDE CAN BE FOUND ON PAGES 190, 191.

| | | | | |
|---|--|--------|----|----------|
| Brother P-touch Handheld Labeling Systems | | | | |
| PT-90 | Brother PT-90 Handheld Labeler (Tape Family: M) (Tape Sizes: 9mm, 12mm) (7.5mm/sec) (230 dpi) (QWERTY Keyboard) (12 Char x 1 Line LCD Display) (1 Font, 2 Sizes, 9 Styles, 173 Symbols) | 19362 | EA | \$49.95 |
| PT-D200 | Brother PT-D200 Handheld Labeler (Tape Family: TZe) (Tape Sizes: 3.5mm, 6mm, 9mm, 12mm) (20mm/sec) (180 dpi) (QWERTY Keyboard) (15 Char x 1 Line LCD Display) (8 Fonts, 3 Sizes, 10 Styles, 617 Symbols) | 906004 | EA | \$59.95 |
| PT-H100 | Brother PT-H100 Handheld Labeler (Tape Family: TZe) (Tape Sizes: 3.5mm, 6mm, 9mm, 12mm) (20mm/sec) (180 dpi) (ABCD Keyboard) (12 Char x 1 Line LCD Display) (1 Font, 3 Sizes, 9 Styles, 178 Symbols) | 908488 | EA | \$59.95 |
| PT-H300 | Brother PT-H300 Handheld Labeler (Tape Family: TZe) (Tape Sizes: 3.5mm, 6mm, 9mm, 12mm, 18mm) (20mm/sec) (180 dpi) (QWERTY Keyboard) (15 Char x 3 Line LCD Display) (14 Fonts, 8 Sizes, 10 Styles, 617 Symbols) (Barcode Printing) | 913196 | EA | \$109.95 |
| PT-H300LI | Brother PT-H300LI Rechargeable Handheld Labeler (Tape Family: TZe) (Tape Sizes: 3.5mm, 6mm, 9mm, 12mm, 18mm) (20mm/sec) (180 dpi) (QWERTY Keyboard) (15 Char x 3 Line LCD Display) (14 Fonts, 8 Sizes, 10 Styles, 617 Symbols) (Barcode Printing) (Li-ion Battery Included) | 913197 | EA | \$179.95 |
| PT-H500LI | Brother PT-H500LI Rechargeable Handheld Labeler (Tape Family: TZe) (Tape Sizes: 3.5mm, 6mm, 9mm, 12mm, 18mm, 24mm) (30mm/sec) (180 dpi) (QWERTY Keyboard) (16 Char x 3 Line LCD Display) (PC-Connectable/USB) (14 Fonts, 9 Sizes, 10 Styles, 617 Symbols) (Auto Cutter) (Barcode Printing) (Li-ion Battery Included) | 915035 | EA | \$229.95 |
| Brother P-touch Desktop Labeling Systems | | | | |
| PT-9600 | Brother PT-9600 Desktop Labeler (Tape Family: TZ/TZe/TZS/AV) (Tape Sizes: 6mm, 9mm, 12mm, 18mm, 24mm, 36mm) (20mm/sec) (360 dpi) (QWERTY Keyboard) (20 Char x 3 Line LCD Display) (PC-Connectable/USB + Serial) (10 Fonts, 24 Sizes, 12 Styles, 448 Symbols) (Auto Cutter) (Barcode Printing) | 1303 | EA | \$799.99 |
| PT-D400AD | Brother PT-D400AD Desktop Labeler (Tape Family: TZe) (Tape Sizes: 3.5mm, 6mm, 9mm, 12mm, 18mm) (20mm/sec) (180 dpi) (QWERTY Keyboard) (15 Char x 3 Line LCD Display) (14 Fonts, 7 Sizes, 10 Styles, 617 Symbols) (Barcode Printing) (AC Adapter Included) | 933330 | EA | \$89.99 |
| PT-D400VP | PT-D400AD with Carry Case and AC Adapter Included | 933331 | EA | \$129.99 |
| Brother P-touch PC-Connectable & Wireless Labeling Systems | | | | |
| PT-P700 | Brother PT-P700 PC-Connectable Label Printer (Tape Family: TZe) (Tape Sizes: 3.5mm, 6mm, 9mm, 12mm, 18mm, 24mm) (30mm/sec) (180 dpi) (USB) (TrueType Fonts/Symbols) (Auto Cutter) (Barcode Printing) | 915036 | EA | \$129.95 |
| PT-P750W | Brother PT-P750W Wireless/NFC Capable Label Printer for PC/Mac (Tape Family: TZe) (Tape Sizes: 3.5mm, 6mm, 9mm, 12mm, 18mm, 24mm) (30mm/sec) (180 dpi) (USB) (Wireless/NFC) (TrueType Fonts/Symbols) (Auto Cutter) (Barcode Printing) (Energy Star) | 923147 | EA | \$199.95 |
| PT-D450 | Brother PT-D450 PC-Connectable Desktop Labeler (Tape Family: TZe) (Tape Sizes: 3.5mm, 6mm, 9mm, 12mm, 18mm) (20mm/sec) (180 dpi) (USB) (QWERTY Keyboard) (20 Char x 3 Line LCD Display) (14 Fonts, 7 Sizes, 10 Styles, 617 Symbols) (Barcode Printing) (Energy Star) (AC Adapter Included) | 933333 | EA | \$129.99 |
| PT-D600 | Brother PT-D600 PC-Connectable Desktop Labeler (Tape Family: TZe) (Tape Sizes: 3.5mm, 6mm, 9mm, 12mm, 18mm, 24mm) (30mm/sec) (180 dpi) (USB) (QWERTY Keyboard) (20 Char x 3 Line LCD Display) (14 Fonts, 8 Sizes, 11 Styles, 617 Symbols) (Auto Cutter) (Barcode Printing) (Energy Star) (AC Adapter Included) | 933334 | EA | \$159.99 |
| PT-D600VP | PT-D600 with Carry Case and AC Adapter Included | 933335 | EA | \$179.99 |

NEW



PT-P750w NEW Compact Label Maker with Wireless Printing

Built-in wireless interface makes it easy to print customized labels from your PC or Mac. High print resolution supports crisp graphics and logos. **HIGHLIGHTS:** Brother iPrint&Label app for Apple® and Android™ mobile devices, easy to integrate using SDKs for Windows®, iOS and Android™ systems. Auto-cutter enables easy, multi-label printing. Powered by AC adapter (included), Li-Ion battery available.

Carton contents: PT-P750w, AC adapter, 24mm TZe starter tape, USB cable. Two-year limited warranty.



PT-D600VP PC-Connectable Labeling System with Carry Case

This labeler prints up to 7 lines of text on each label using 14 fonts, 11 type styles and 99 frames. Built-in Label Collection feature offers pre-designed labels for files, office signage, shipping labels and more! **HIGHLIGHTS:** Large, 20-character x 3-line graphical display with vivid backlit design for easy viewing, built-in automatic cutter, uses TZe laminated tapes up to 24mm wide. Powered by AC adapter (included) or 6 AA batteries (not included).

Carton contents: PT-D600, carry/storage case, AC adapter, USB cable, 24mm starter TZ laminated tape, user's manual. Two-year limited warranty.



PT-D450 PC-Connectable Desktop Office Labeler

Easily print professional labels with up to 5 lines of text using 14 fonts, 99 framing options, 10 type styles and 7 type sizes. **HIGHLIGHTS:** Large 20-character x 3-line graphical display, built-in manual tape cutter, uses laminated TZ tape up to 18mm wide, powered by AC adapter (included) or 6 AA batteries (not included).

Carton contents: PT-D450, AC adapter, USB cable, 18mm starter TZ laminated tape, user's manual. Two-year limited warranty.



PT-H300 Take-it-Anywhere Labeler

Easily print professional labels with up to 5 lines of text using 4 fonts, 16 framing options, 10 type styles, 7 type sizes and over 50 pre-designed labels for files, office signage and more! **HIGHLIGHTS:** 15 characters by 3 lines graphical display, built-in manual tape cutter, uses laminated TZ tape up to 18mm wide. Powered by AC adapter (not included) or 6 AA batteries (included).

Carton contents: PTH300, 18mm starter tape, 6 x "AA" batteries and wrist strap, user's manual. Two-year limited warranty.



PT-D200 Easy-to-use Handheld/Desktop Labeler

Features convenient one-touch keys and an easy-to-read graphical display for creating labels using 8 professional fonts, 600 symbols, 95 frames and 12 deco mode patterns. **HIGHLIGHTS:** Graphical display shows you how your label will look, easy-access memory, store up to 30 favorite labels, uses TZe laminated tapes up to 12mm wide – great for indoor or outdoor use. Powered by AC adapter* or 6 AAA batteries (neither included).

Carton contents: PT-D200, B/W standard laminated TZe starter tape 12mm x 4m, user's manual. One-year limited warranty.

*AC adapter available to order, OEM # AD24.



| MFG# | Product Description | Part# | UOM | Retail |
|--|--|--------|-----|----------|
| BROTHER EQUIPMENT | | | | |
| <i>BROTHER P-TOUCH CROSS REFERENCE GUIDE CAN BE FOUND ON PAGES 190, 191.</i> | | | | |
| Brother QL Label Printers | | | | |
| QL-500 | Brother QL-500 Label Printer (Tape Sizes: Die Cut and Continuous up to 2.4" Wide) (50 Labels/Min) (300 x 300 dpi) (PC-Connected Only/USB) (TrueType Fonts, 1,379 Symbols) (Barcode Printing) | 18511 | EA | \$119.95 |
| QL-700 | Brother QL-700 Label Printer (Tape Sizes: Die Cut and Continuous up to 2.4" Wide) (93 Labels/Min) (300 x 600 dpi) (PC-Connected Only/USB) (TrueType Fonts, 1,379 Symbols) (Auto Cutter) (Barcode Printing) | 506665 | EA | \$169.99 |
| QL-710W | Brother QL-710W Label Printer (Tape Sizes: Die Cut and Continuous up to 2.4" Wide) (93 Labels/Min) (300 x 600 dpi) (PC-Connected Only/USB/Wireless) (TrueType Fonts, 1,379 Symbols) (Auto Cutter) (Barcode Printing) | 907070 | EA | \$199.99 |
| QL-720NW | Brother QL-720NW Label Printer (Tape Sizes: Die Cut and Continuous up to 2.4" Wide) (93 Labels/Min) (300 x 600 dpi) (PC-Connected or Stand-alone/USB/Serial/Ethernet/Wireless) (TrueType Fonts, 1,379 Symbols) (Auto Cutter) (Barcode Printing) | 907071 | EA | \$229.99 |
| QL-1060N | Brother QL-1060N Wide Format Label Printer (Tape Sizes: Die Cut and Continuous up to 4" Wide) (69 Labels/Min) (300 x 300 dpi) (PC-Connected or Standalone/USB/Ethernet) (TrueType Fonts, 1,379 Symbols) (Auto Cutter) (Barcode Printing) | 701203 | EA | \$499.99 |
| Brother P-touch Parts and Accessories | | | | |
| AD24 | PT-1000/1010/1090/1230PC/1280/1290/1400/1500PC/1600/1650/1750/1830/1880/1900/1910/1950/1960/2030/2030VP/2100/2110/2430PC/2700/2710/2730/2730VP/D200/GL100 AC Adapter | 18780 | EA | \$27.99 |
| DKBU99 | QL-500/QL-550/QL-650TD Cutter Blade (2/Pk) | 906105 | PK | \$13.49 |
| ADE001 | PT-H300/H300LI/H500LI/P700/P750W Power Adapter | 915033 | EA | \$29.99 |
| BAE001 | PT-H300/H300LI/H500LI/P750W Rechargeable Li-ion Battery Pack | 915034 | EA | \$37.99 |
| Brother HL-5450DN Mono Laser Printer | | | | |
| HL-5450DN | Brother HL-5450DN Mono Laser Printer (40 ppm) (400 MHz) (64 MB) (8.5" x 14") (1200 x 1200 dpi) (Max Duty Cycle 50,000 Pages) (Duplex) (USB) (Ethernet) (Energy Star) (250 Sheet Input Tray) (50 Sheet Multipurpose Tray) | 908478 | EA | \$299.99 |
| LT5400 | 500-Sheet Optional Lower Paper Tray | 906796 | EA | \$209.99 |
| Brother HL-5470DW/5470DWT Mono Laser Printers | | | | |
| HL-5470DW | Brother HL-5470DW Mono Laser Printer (40 ppm) (400 MHz) (128 MB) (8.5" x 14") (1200 x 1200 dpi) (Max Duty Cycle 50,000 Pages) (Duplex) (USB) (Ethernet) (Wireless) (Energy Star) (250 Sheet Input Tray) (50 Sheet Multipurpose Tray) | 908479 | EA | \$399.99 |
| HL-5470DWT | Brother HL-5470DWT: Base Model + 500-Sheet Input Tray | 908480 | EA | \$549.99 |
| LT5400 | 500-Sheet Optional Lower Paper Tray | 906796 | EA | \$209.99 |
| Brother HL-6180DW/6180DWT Mono Laser Printers | | | | |
| HL-6180DW | Brother HL-6180DW Mono Laser Printer (42 ppm) (400 MHz) (128 MB) (8.5" x 14") (1200 x 1200 dpi) (Max Duty Cycle 100,000 Pages) (Duplex) (USB) (Ethernet) (Wireless) (Energy Star) (500 Sheet Input Tray) (50 Sheet Multipurpose Tray) | 908481 | EA | \$449.99 |
| HL-6180DWT | Brother HL-6180DWT: Base Model + 500-Sheet Input Tray | 908482 | EA | \$649.99 |
| LT5400 | 500-Sheet Optional Lower Paper Tray | 906796 | EA | \$209.99 |
| Brother HL-L2300D/L2340DW Mono Laser Printers | | | | |
| HL-L2300D | Brother HL-L2300D Mono Laser Printer (27 ppm) (266 MHz) (8 MB) (8.5" x 14") (2400 x 600 dpi) (Max Duty Cycle 10,000 Pages) (Duplex) (USB) (Energy Star) (250 Sheet Input Capacity) (1 Sheet Bypass Feed) | 932810 | EA | \$199.99 |
| HL-L2340DW | Brother HL-L2340DW: Base Model + Wireless Connectivity, 32 MB Memory | 932811 | EA | \$229.99 |
| Brother HL-L2380DW Mono Laser MFP | | | | |
| HL-L2380DW | Brother HL-L2380DW Mono Laser MFP (32 ppm) (266 MHz) (64 MB) (8.5" x 14") (2400 x 600 dpi) (Max Duty Cycle 10,000 Pages) (p/s/c) (Duplex) (USB) (Ethernet) (Wireless) (Touchscreen) (Energy Star) (250 Sheet Input Capacity) (1 Sheet Bypass Feed) | 932812 | EA | \$299.99 |
| Brother DCP-8110DN Mono Laser MFP | | | | |
| DCP-8110DN | Brother DCP-8110DN Mono Laser MFP (38 ppm) (400 MHz) (64 MB) (8.5" x 14") (1200 x 1200 dpi) (Max Duty Cycle 50,000 Pages) (p/s/c) (Duplex) (USB) (Ethernet) (Energy Star) (250 Sheet Input Capacity) (50 Sheet Multipurpose Tray) (35 Sheet ADF) | 908475 | EA | \$499.99 |
| Brother DCP-8150DN Mono Laser MFP | | | | |
| DCP-8150DN | Brother DCP-8150DN Mono Laser MFP (40 ppm) (400 MHz) (64 MB) (8.5" x 14") (1200 x 1200 dpi) (Max Duty Cycle 50,000 Pages) (p/s/c) (Duplex) (USB) (Ethernet) (Energy Star) (250 Sheet Input Capacity) (50 Sheet Multipurpose Tray) (50 Sheet ADF) | 908476 | EA | \$599.99 |
| LT5400 | 500-Sheet Optional Lower Paper Tray | 906796 | EA | \$209.99 |

| MFG# | Product Description | Part# | UOM | Retail |
|--|--|--------|-----|------------|
| BROTHER EQUIPMENT | | | | |
| Brother DCP-8155DN Mono Laser MFP | | | | |
| DCP-8155DN | Brother DCP-8155DN Mono Laser MFP (40 ppm) (400 MHz) (128 MB) (8.5" x 14") (1200 x 1200 dpi) (Max Duty Cycle 50,000 Pages) (p/s/c) (Duplex) (USB) (Ethernet) (Energy Star) (250 Sheet Input Capacity) (50 Sheet Multipurpose Tray) (50 Sheet ADF) | 908477 | EA | \$649.99 |
| LT5400 | 500-Sheet Optional Lower Paper Tray | 906796 | EA | \$209.99 |
| Brother DCP-L2520DW Mono Laser MFP | | | | |
| DCP-L2520DW | Brother DCP-L2520DW Mono Laser MFP (27 ppm) (266 MHz) (32 MB) (8.5" x 14") (2400 x 600 dpi) (Max Duty Cycle 10,000 Pages) (p/s/c) (Duplex) (USB) (Ethernet) (Wireless) (Energy Star) (250 Sheet Input Capacity) (1 Sheet Bypass Feed) | 932808 | EA | \$299.99 |
| Brother DCP-L2540DW Mono Laser MFP | | | | |
| DCP-L2540DW | Brother DCP-L2540DW Mono Laser MFP (30 ppm) (266 MHz) (32 MB) (8.5" x 14") (2400 x 600 dpi) (Max Duty Cycle 10,000 Pages) (p/s/c) (Duplex) (USB) (Ethernet) (Wireless) (Energy Star) (250 Sheet Input Capacity) (35 Sheet ADF) | 932712 | EA | \$329.99 |
| Brother MFC-7240 Mono Laser MFP | | | | |
| MFC-7240 | Brother MFC-7240 Mono Laser All-in-One (21 ppm) (16 MB) (8.5" x 14") (2400 x 600 dpi) (Max Duty Cycle 10,000 Pages) (p/s/c/f) (USB) (Energy Star) (250 Sheet Input Capacity) (20 Sheet ADF) | 908483 | EA | \$349.99 |
| Brother MFC-7860DW Mono Laser MFP | | | | |
| MFC-7860DW | Brother MFC-7860DW Mono Laser MFP (27 ppm) (32 MB) (8.5" x 14") (2400 x 600 dpi) (Max Duty Cycle 10,000 Pages) (p/s/c/f) (Duplex) (USB) (Ethernet) (Wireless) (Energy Star) (250 Sheet Input Capacity) | 505683 | EA | \$499.99 |
| Brother MFC-8220 Mono Laser MFP | | | | |
| MFC-8220 | Brother MFC-8220 Mono Laser MFP (21 ppm) (32 MB) (33.6 Kbps) (8.5" x 14") (2400 x 600 dpi) (Max Duty Cycle 20,000 Pages) (p/s/c/f) (USB) (Parallel) (250 Sheet Input Tray) (30 Sheet ADF) | 5267 | EA | \$499.99 |
| LT5000 | 250-Sheet Optional Lower Paper Tray | 11858 | EA | \$209.99 |
| Brother MFC-8510DN Mono Laser Printer | | | | |
| MFC-8510DN | Brother MFC-8510DN Mono Laser Printer (38 ppm) (64 MB) (8.5" x 14") (1200 x 1200 dpi) (Max Duty Cycle 50,000 Pages) (p/s/c/f) (Duplex) (USB) (Ethernet) (Energy Star) (250 Sheet Input Tray) (50 Sheet Multipurpose Tray) (35 Sheet ADF) | 908761 | EA | \$549.99 |
| Brother MFC-8710DW Mono Laser MFP | | | | |
| MFC-8710DW | Brother MFC-8710DW Mono Laser MFP (40 ppm) (64 MB) (8.5" x 14") (1200 x 1200 dpi) (Max Duty Cycle 50,000 Pages) (p/s/c/f) (Duplex) (USB) (Ethernet) (Wireless) (Energy Star) (250 Sheet Input Capacity) (50 Sheet Multipurpose Tray) (50 Sheet ADF) | 908484 | EA | \$649.99 |
| LT5400 | 500-Sheet Optional Lower Paper Tray | 906796 | EA | \$209.99 |
| Brother MFC-8910DW Mono Laser MFP | | | | |
| MFC-8910DW | Brother MFC-8910DW Mono Laser MFP (42 ppm) (128 MB) (8.5" x 14") (1200 x 1200 dpi) (Max Duty Cycle 50,000 Pages) (p/s/c/f) (Duplex) (Ethernet) (USB) (Wireless) (Energy Star) (250 Sheet Input Tray) (50 Sheet Multipurpose Tray) (50 Sheet ADF) | 908485 | EA | \$799.99 |
| LT5400 | 500-Sheet Optional Lower Paper Tray | 906796 | EA | \$209.99 |
| Brother MFC-8950DW/8950DWT Mono Laser MFPs | | | | |
| MFC-8950DW | Brother MFC-8950DW Mono Laser All-in-One (42 ppm) (128 MB) (8.5" x 14") (1200 x 1200 dpi) (Max Duty Cycle 100,000 Pages) (p/s/c/f) (Duplex) (Ethernet) (USB) (Wireless) (Energy Star) (Touchscreen) (500 Sheet Input Capacity) (50 Sheet Multipurpose Tray) (50 Sheet ADF) | 908486 | EA | \$949.99 |
| MFC-8950DWT | Brother MFC-8950DWT: Base Model + 500-Sheet Input Tray | 908487 | EA | \$1,099.99 |
| LT5400 | 500-Sheet Optional Lower Paper Tray | 906796 | EA | \$209.99 |
| Brother MFC-L2700DW/L2720DW/L2740DW Mono Laser MFPs | | | | |
| MFC-L2700DW | Brother MFC-L2700DW Mono Laser MFP (27 ppm) (266 MHz) (32 MB) (8.5" x 14") (2400 x 600 dpi) (Max Duty Cycle 10,000 Pages) (p/s/c/f) (Duplex) (USB) (Ethernet) (Wireless) (Energy Star) (250 Sheet Input Capacity) (35 Sheet ADF) | 932813 | EA | \$349.99 |
| MFC-L2720DW | Brother MFC-L2720DW: Base Model + 30 ppm, 64 MB Memory, Touchscreen | 932814 | EA | \$399.99 |
| MFC-L2740DW | Brother MFC-L2740DW: Base Model + 32 ppm, 64 MB Memory, Touchscreen | 932815 | EA | \$499.99 |
| Brother HL-3140CW Color Laser Printer | | | | |
| HL-3140CW | Brother HL-3140CW Color Laser Printer (19 ppm) (333 MHz) (64 MB) (8.5" x 14") (600 x 2400 dpi) (Max Duty Cycle 30,000 Pages) (USB) (Ethernet) (Wireless) (Energy Star) (250 Sheet Input Capacity) | 912988 | EA | \$379.99 |

DON'T SUPERSIZE.



OPTIMIZE.

Together we can work with your customer using a balanced deployment approach to put the right amount of printing technology right where their business needs it, to help save time and money.



HL-6180DWT



MFC-8950DWT



MFC-L9550CDWT



HL-L9200CDWT



brother
at your side

| MFG# | Product Description | Part# | UOM | Retail |
|---|--|--------|-----|----------|
| BROTHER EQUIPMENT | | | | |
| Brother HL-3170CDW Color Laser Printer | | | | |
| HL-3170CDW | Brother HL-3170CDW Color Laser Printer (23 ppm) (333 MHz) (128 MB) (8.5" x 14") (600 x 2400 dpi) (Max Duty Cycle 30,000 Pages) (Duplex) (USB) (Ethernet) (Wireless) (Energy Star) (250 Sheet Input Capacity) | 912989 | EA | \$429.99 |
| Brother HL-L8250CDN Color Laser Printer | | | | |
| HL-L8250CDN | Brother HL-L8250CDN Color Laser Printer (30 ppm) (400 MHz) (128 MB) (8.5" x 14") (2400 x 600 dpi) (Max Duty Cycle 40,000 Pages) (Duplex) (USB) (Ethernet) (Energy Star) (250 Sheet Input Tray) (50 Sheet Multipurpose Tray) | 922870 | EA | \$549.99 |
| LT320CL | Optional 500-Sheet Lower Paper Tray | 923216 | EA | \$249.99 |
| Brother HL-L8350CDW/L8350CDWT Color Laser Printers | | | | |
| HL-L8350CDW | Brother HL-L8350CDW Color Laser Printer (32 ppm) (400 MHz) (128 MB) (8.5" x 14") (2400 x 600 dpi) (Max Duty Cycle 40,000 Pages) (Duplex) (USB) (Ethernet) (Wireless) (Energy Star) (250 Sheet Input Capacity) (50 Sheet Multipurpose Tray) | 922871 | EA | \$649.99 |
| HL-L8350CDWT | Brother HL-L8350CDWT: Base Model + Extra 500-Sheet Input Tray | 922872 | EA | \$799.99 |
| LT320CL | Optional 500-Sheet Lower Paper Tray (For HL-L8350CDW Model Only) | 923216 | EA | \$249.99 |
| Brother MFC-9130CW Color Laser MFP | | | | |
| MFC-9130CW | Brother MFC-9130CW Color Laser MFP (19 ppm) (192 MB) (8.5" x 14") (600 x 2400 dpi) (Max Duty Cycle 30,000 Pages) (p/s/c/f) (USB) (Ethernet) (Wireless) (Touchscreen) (Energy Star) (250 Sheet Input Capacity) (35 Sheet ADF) | 912986 | EA | \$649.99 |
| Brother MFC-9330CDW Color Laser MFP | | | | |
| MFC-9330CDW | Brother MFC-9330CDW Color Laser MFP (23 ppm) (192 MB) (8.5" x 14") (600 x 2400 dpi) (Max Duty Cycle 30,000 Pages) (p/s/c/f) (Duplex) (USB) (Ethernet) (Wireless) (Touchscreen) (Energy Star) (250 Sheet Input Capacity) (35 Sheet ADF) | 912987 | EA | \$699.00 |
| Brother MFC-L8600CDW/L8850CDW Color Laser MFPs | | | | |
| MFC-L8600CDW | Brother MFC-L8600CDW Color Laser MFP (30 ppm) (256 MB) (8.5" x 14") (2400 x 600 dpi) (Max Duty Cycle 40,000 Pages) (p/s/c/f) (Duplex) (USB) (Ethernet) (Wireless) (Touchscreen) (Energy Star) (250 Sheet Input Tray) (50 Sheet Multipurpose Tray) (35 Sheet ADF) | 926161 | EA | \$849.99 |
| MFC-L8850CDW | Brother MFC-L8850CDW: Same as MFC-L8600CDW + 32 ppm, Max Duty Cycle 60,000 Pages, 50 Sheet ADF | 926163 | EA | \$949.99 |
| LT320CL | Optional 500-Sheet Lower Paper Tray | 923216 | EA | \$249.99 |
| Brother Inkjet MFPs (Continued on next page) | | | | |
| MFC-J245 | Brother MFC-J245 Color Inkjet MFP (27 ppm Mono/10 ppm Color) (32 MB) (8.5" x 14") (6000 x 1200 dpi) (Max Duty Cycle 2,500 Pages) (p/s/c/f) (USB) (Energy Star) (100 Sheet Input Capacity) (20 Sheet ADF) | 922686 | EA | \$129.99 |
| MFC-J650DW | Brother MFC-J650DW Color Inkjet MFP (33 ppm Mono/27 ppm Color) (8.5" x 14") (6000 x 12000 dpi) (Max Duty Cycle 2,500 Pages) (p/s/c/f) (Duplex) (USB) (Wireless) (PictBridge) (Touchscreen) (Energy Star) (100 Sheet Input Capacity) (20 Sheet Photo Tray) | 914746 | EA | \$229.99 |
| MFC-J870DW | Brother MFC-J870DW Color Inkjet All-In-One (33 ppm Mono/27 ppm Color) (8.5" x 14") (6000 x 1200 dpi) (Max Duty Cycle 2,500 Pages) (p/s/c/f) (Duplex) (USB) (Ethernet) (Wireless) (Touchscreen) (Energy Star) (100 Sheet Input Capacity) (20 Sheet ADF/Photo Tray) | 914639 | EA | \$249.99 |
| MFC-J4320DW | Brother MFC-J4320DW Color Inkjet MFP (20 ppm Black/18 ppm Color) (128 MB) (11" x 17") (6000 x 1200 dpi) (Max Duty Cycle 13,000 Pages) (p/s/c/f) (Duplex) (USB) (Wireless) (Touchscreen) (Energy Star) (150 Sheet Input Tray) (1 Sheet Bypass) | 933336 | EA | \$249.99 |
| MFC-J4410DW | Brother MFC-J4410DW Color Inkjet MFP (33 ppm Black/25 ppm Color Print) (12 cpm Black/9 cpm Color Copy) (11" x 17") (6000 x 1200 dpi) (Max Duty Cycle 130,000 Pages) (p/s/c/f) (Duplex) (Ethernet) (USB) (Wireless) (150 Sheet Input Capacity) (20 Page ADF) (Touchscreen) | 908839 | EA | \$299.99 |
| MFC-J4420DW | Brother MFC-J4420DW Color Inkjet MFP (35 ppm Black/27 ppm Color Print) (12 cpm Black/9 cpm Color Copy) (128 MB) (11" x 17") (6000 x 1200 dpi) (Max Duty Cycle 13,000 Pages) (p/s/c/f) (Duplex) (USB) (Wireless) (Touchscreen) (Energy Star) (150 Sheet Input Tray) (1 Sheet Bypass Tray) (20 Page ADF) | 930529 | EA | \$279.99 |
| MFC-J4620DW | Brother MFC-J4620DW Color Inkjet MFP (22 ppm Black/20 ppm Color) (128 MB) (11" x 17") (6000 x 1200 dpi) (Max Duty Cycle 13,000 Pages) (p/s/c/f) (Duplex) (USB) (Ethernet) (Wireless) (Touchscreen) (Energy Star) (150 Sheet Input Tray) (1 Sheet Bypass) (20 Sheet ADF) | 933337 | EA | \$299.99 |
| MFC-J4710DW | Brother MFC-J4710DW Color Inkjet MFP (35 ppm Black/27 ppm Color) (11" x 17") (6000 x 1200 dpi) (Max Duty Cycle 13,000 Pages) (p/s/c/f) (Duplex) (Ethernet) (USB) (Wireless) (Touchscreen) (Energy Star) (400 Sheet Input Capacity) (20 Sheet ADF) | 913029 | EA | \$429.99 |
| MFC-J5520DW | Brother MFC-J5520DW Color Inkjet MFP (22 ppm Black/20 ppm Color) (128 MB) (11" x 17") (6000 x 1200 dpi) (Max Duty Cycle 30,000 Pages) (p/s/c/f) (Duplex) (USB) (Ethernet) (Wireless) (Touchscreen) (Energy Star) (250 Sheet Input Tray) (80 Sheet Multipurpose Tray) (35 Sheet ADF) | 933343 | EA | \$349.99 |

| MFG# | Product Description | Part# | UOM | Retail |
|--|---|--------|-----|------------|
| BROTHER EQUIPMENT | | | | |
| Brother Inkjet MFPs (Continued) | | | | |
| MFC-J5720DW | Brother MFC-J5720DW Color Inkjet MFP (22 ppm Black/20 ppm Color) (256 MB) (11" x 17") (6000 x 1200 dpi) (Max Duty Cycle 30,000 Pages) (p/s/c/f) (Duplex) (USB) (Ethernet) (Wireless) (Touchscreen) (Energy Star) (500 Sheet Input Tray) (80 Sheet Multipurpose Tray) (50 Sheet ADF) | 933344 | EA | \$429.99 |
| MFC-J5910DW | Brother MFC-J5910DW Color Inkjet MFP (35 ppm Mono/27 ppm Color) (11" x 17") (6000 x 1200 dpi) (Max Duty Cycle 7,000 Pages) (p/s/c/f) (Duplex) (USB) (Ethernet) (Wireless) (Touchscreen) (Energy Star) (250 Sheet Input Tray) (35 Sheet ADF) | 505638 | EA | \$349.99 |
| MFC-J6520DW | Brother MFC-J6520DW Color Inkjet MFP (35 ppm Mono/27 ppm Color) (128 MB) (11" x 17") (6000 x 1200 dpi) (Max Duty Cycle 26,000 Pages) (p/s/c/f) (Duplex) (USB) (Ethernet) (Wireless) (Touchscreen) (250 Sheet Input Capacity) (35 Sheet ADF) | 915429 | EA | \$349.99 |
| MFC-J6720DW | Brother MFC-J6720DW Color Inkjet MFP (35 ppm Mono/27 ppm Color) (11" x 17") (p/s/c/f) (Duplex) (Wireless) (Touchscreen) (500 Sheet Input Capacity) | 914793 | EA | \$429.99 |
| MFC-J6920DW | Brother MFC-J6920DW Color Inkjet MFP (35 ppm Mono/27 ppm Color) (128 MB) (11" x 17") (6000 x 1200 dpi) (Max Duty Cycle 26,000 Pages) (p/s/c/f) (Duplex) (USB) (Ethernet) (Wireless) (Touchscreen) (500 Sheet Input Capacity) (35 Sheet ADF) | 915430 | EA | \$499.99 |
| Brother Scanners | | | | |
| DS-620 | Brother DS-620 Mobile Color Scanner (8 ppm) (256 MB) (8.5" x 14") (600 x 600 dpi) (USB) (Energy Star) | 914794 | EA | \$169.99 |
| DS-720D | Brother DS-720D Mobile Color Scanner (8 ppm) (256 MB) (8.5" x 14") (600 x 600 dpi) (Duplex) (USB) (Energy Star) | 914795 | EA | \$199.99 |
| DS-820W | Brother DS-820W Mobile Color Scanner (8 ppm) (256 MB) (8.5" x 14") (600 x 600 dpi) (USB) (Wireless) (Energy Star) | 914796 | EA | \$229.99 |
| DS-920DW | Brother DS-920DW Mobile Color Scanner (8 ppm) (256 MB) (8.5" x 14") (600 x 600 dpi) (Duplex) (USB) (Wireless) (Energy Star) | 914797 | EA | \$249.99 |
| ADS-1000W | Brother ADS-1000W Compact Color Scanner (16 ppm) (8.5" x 34") (600 x 600 dpi) (Duplex) (USB) (Wireless) (20 Sheet DADF) | 914798 | EA | \$349.99 |
| ADS-1500W | Brother ADS-1500W Compact Color Scanner (18 ppm) (8.5" x 34") (600 x 600 dpi) (Duplex) (USB) (Wireless) (Touchscreen) (20 Sheet DADF) | 914799 | EA | \$399.99 |
| ADS2000 | Brother ImageCenter ADS2000 Color Desktop Scanner (24 ppm) (8.5" x 34") (1200 x 1200 dpi) (50 Sheet ADF) (Duplex) (USB) | 906319 | EA | \$499.99 |
| ADS2500W | Brother ADS2500W Color Desktop Scanner (24 ppm) (600 x 600 dpi) (Duplex) (Ethernet) (Wireless) (Touchscreen) (50 Sheet ADF) | 910003 | EA | \$999.99 |
| Brother Fax Machines | | | | |
| FAX-575 | Brother IntelliFax 575 Thermal Transfer Fax (512 KB) (9.6 Kbps) (400 x 400 dpi) (Fax/Copy) (Energy Star) (50 Sheet Input Tray) (10 Sheet ADF) | 92148 | EA | \$99.99 |
| FAX-2840 | Brother IntelliFax 2840 Mono Laser MFP (21 ppm) (16 MB) (8.5" x 14") (2400 x 600 dpi) (USB) (Energy Star) (250 Sheet Input Capacity) (20 Sheet ADF) | 910109 | EA | \$329.99 |
| FAX-2940 | Brother IntelliFax 2940 Mono Laser Facsimile/Copier (21 ppm) (16 MB) (8.5" x 14") (300 x 600 dpi) (USB) (Energy Star) (250 Sheet Input Capacity) (20 Sheet ADF) | 909329 | EA | \$499.99 |
| FAX-4100E | Brother IntelliFax 4100E Mono Laser MFP (15 ppm) (8 MB) (33.6 Kbps) (8.5" x 14") (600 dpi) (Max Duty Cycle 15,000 Pages) (p/c/f) (USB) (Parallel) (250 Sheet Input Tray) (30 Sheet ADF) | 27036 | EA | \$499.99 |
| PPF-4750E | Brother IntelliFax 4750E Mono Laser MFP (15 ppm) (8 MB) (33.6 Kbps) (8.5" x 14") (600 x 600 dpi) (Max Duty Cycle 15,000 Pages) (p/c/f) (USB) (Parallel) (250 Sheet Input Tray) (50 Sheet ADF) | 903026 | EA | \$799.99 |
| PPF-5750e | Brother IntelliFax 5750E Mono Laser MFP (15 ppm) (8 MB) (33.6 Kbps) (8.5" x 14") (600 x 600 dpi) (Max Duty Cycle 15,000 Pages) (p/s/c/f) (USB) (Parallel) (Network Ready) (500 Sheet Input Tray) (50 Sheet ADF) | 1251 | EA | \$1,299.99 |
| LT400 | 250-Sheet Optional Lower Paper Tray (For Use With IntelliFax 4100E, 4750E and 5750E) | 97848 | EA | \$209.99 |

CANON EQUIPMENT**Canon imageCLASS D530 Mono Laser MFP**

| | | | | |
|----------|---|--------|----|----------|
| 6371B049 | Canon imageCLASS D530 Mono Laser MFP (26 ppm Print) (26 cpm Copy) (64 MB) (8.5" x 14") (1200 x 600 dpi) (Max Duty Cycle 10,000 Pages) (p/s/c) (Duplex) (USB) (Energy Star) (251 Sheet Input Capacity) | 911274 | EA | \$395.00 |
| 5707B039 | Extended Service Plan (Exchange/Carry-In) (2 Year) | 914652 | EA | \$25.00 |
| 5707B040 | Extended Service Plan (Exchange/Carry-In) (3 Year) | 914653 | EA | \$35.00 |

Canon imageCLASS D550 Mono Laser MFP

| | | | | |
|----------|--|--------|----|----------|
| 4509B061 | Canon imageCLASS D550 Mono Laser MFP (26 ppm Print) (26 cpm Copy) (64 MB) (8.5" x 14") (1200 x 600 dpi) (Max Duty Cycle 10,000 Pages) (p/s/c) (Duplex) (USB) (Energy Star) (251 Sheet Input Capacity) (50 Sheet ADF) | 911260 | EA | \$595.00 |
| 5707B043 | Extended Service Plan (Exchange/Carry-In) (2 Year) | 914656 | EA | \$40.00 |
| 5707B044 | Extended Service Plan (Exchange/Carry-In) (3 Year) | 914657 | EA | \$60.00 |

| MFG# | Product Description | Part# | UOM | Retail |
|--|---|--------|-----|------------|
| CANON EQUIPMENT | | | | |
| Canon imageCLASS D1320 Mono Laser MFP | | | | |
| 4839B002 | Canon imageCLASS D1320 Mono Laser MFP (35 ppm Print) (35 ppm Copy) (128 MB) (8.5" x 14") (1200 x 600 dpi) (Max Duty Cycle 20,000 Pages) (p/s/c) (Duplex) (USB) (Ethernet) (Energy Star) (500 Sheet Input Capacity) (50 Sheet Multipurpose Tray) (50 Sheet ADF) | 911263 | EA | \$995.00 |
| 0732A023 | 500-Sheet Feeder | 911278 | EA | \$299.00 |
| 5707B047 | Extended Service Plan (Exchange/Carry-In) (2 Year) | 914660 | EA | \$60.00 |
| 5707B048 | Extended Service Plan (Exchange/Carry-In) (3 Year) | 914661 | EA | \$85.00 |
| Canon imageCLASS D1350 Mono Laser MFP | | | | |
| 4839B003 | Canon imageCLASS D1350 Mono Laser MFP (35 ppm Print) (35 ppm Copy) (128 MB) (8.5" x 14") (1200 x 600 dpi) (Max Duty Cycle 20,000 Pages) (p/s/c/f) (Duplex) (USB) (Ethernet) (Energy Star) (500 Sheet Input Capacity) (50 Sheet Multipurpose Tray) (50 Sheet ADF) | 911264 | EA | \$1,195.00 |
| 0732A023 | 500-Sheet Feeder | 911278 | EA | \$299.00 |
| 5707B051 | Extended Service Plan (Exchange/Carry-In) (2 Year) | 914664 | EA | \$90.00 |
| 5707B052 | Extended Service Plan (Exchange/Carry-In) (3 Year) | 914665 | EA | \$130.00 |
| Canon imageCLASS D1370 Mono Laser MFP | | | | |
| 4839B006 | Canon imageCLASS D1370 Mono Laser MFP (35 ppm Print) (35 ppm Copy) (256 MB) (8.5" x 14") (1200 x 600 dpi) (Max Duty Cycle 20,000 Pages) (p/s/c/f) (Duplex) (USB) (Ethernet) (Energy Star) (500 Sheet Input Capacity) (50 Sheet Multipurpose Tray) (50 Sheet DADF) | 911265 | EA | \$1,595.00 |
| 0732A023 | 500-Sheet Feeder | 911278 | EA | \$299.00 |
| 5707B051 | Extended Service Plan (Exchange/Carry-In) (2 Year) | 914664 | EA | \$90.00 |
| 5707B052 | Extended Service Plan (Exchange/Carry-In) (3 Year) | 914665 | EA | \$130.00 |
| Canon imageCLASS LBP6200d Mono Laser Printer | | | | |
| 4514B002 | Canon imageCLASS LBP6200d Mono Laser Printer (26 ppm) (8 MB) (2400 x 600 dpi) (8.5" x 14") (Max Duty Cycle 8,000 Pages) (Duplex) (USB) (Energy Star) (250 Sheet Input Tray) | 926563 | EA | \$325.00 |
| 5707B039 | Extended Service Plan (Exchange/Carry-In) (2 Year) | 914652 | EA | \$25.00 |
| 5707B040 | Extended Service Plan (Exchange/Carry-In) (3 Year) | 914653 | EA | \$35.00 |
| Canon imageCLASS LBP6670dn Mono Laser Printer | | | | |
| 5152B009 | Canon imageCLASS LBP6670dn Mono Laser Printer (35 ppm) (528 MHz) (512 MB) (8.5" x 14") (2400 x 600 dpi) (Max Duty Cycle 50,000 Pages) (Duplex) (USB) (Ethernet) (Energy Star) (300 Sheet Input Capacity) | 912733 | EA | \$599.00 |
| 3439B001 | 500-Sheet Feeder | 911281 | EA | \$299.00 |
| 5707B043 | Extended Service Plan (Exchange/Carry-In) (2 Year) | 914656 | EA | \$40.00 |
| 5707B044 | Extended Service Plan (Exchange/Carry-In) (3 Year) | 914657 | EA | \$60.00 |
| Canon imageCLASS LBP6780dn Mono Laser Printer | | | | |
| 6469B006 | Canon imageCLASS LBP6780dn Mono Laser Printer (42 ppm) (768 MB) (8.5" x 14") (1200 x 1200 dpi) (Max Duty Cycle 100,000 Pages) (Duplex) (USB) (Ethernet) (Energy Star) (500 Sheet Input Capacity) (100 Sheet Multipurpose Tray) | 911727 | EA | \$1,395.00 |
| 4098B001 | 500-Sheet Feeder (PF-45) | 914534 | EA | \$349.00 |
| 5707B051 | Extended Service Plan (Exchange/Carry-In) (2 Year) | 914664 | EA | \$90.00 |
| 5707B052 | Extended Service Plan (Exchange/Carry-In) (3 Year) | 914665 | EA | \$130.00 |
| Canon imageCLASS MF212w Mono Laser MFP | | | | |
| 9540B056 | Canon imageCLASS MF212w Mono Laser MFP (24 ppm) (256 MB) (8.5" x 14") (1200 x 1200 dpi) (Max Duty Cycle 8,000 Pages) (p/s/c) (USB) (Ethernet) (Wireless) (Energy Star) (250 Sheet Tray) (1 Sheet Multipurpose Tray) | 930367 | EA | \$375.00 |
| 5707B039 | Extended Service Plan (Exchange/Carry-In) (2 Year) | 914652 | EA | \$25.00 |
| 5707B040 | Extended Service Plan (Exchange/Carry-In) (3 Year) | 914653 | EA | \$35.00 |
| Canon imageCLASS MF216n Mono Laser MFP | | | | |
| 9540B043 | Canon imageCLASS MF216n Mono Laser MFP (24 ppm) (256 MB) (8.5" x 14") (1200 x 1200 dpi) (Max Duty Cycle 8,000 Pages) (p/s/c/f) (USB) (Ethernet) (Touchscreen) (Energy Star) (250 Sheet Tray) (1 Sheet Multipurpose Tray) (35 Sheet ADF) | 930366 | EA | \$395.00 |
| 5707B039 | Extended Service Plan (Exchange/Carry-In) (2 Year) | 914652 | EA | \$25.00 |
| 5707B040 | Extended Service Plan (Exchange/Carry-In) (3 Year) | 914653 | EA | \$35.00 |
| Canon imageCLASS MF227dw/MF229dw Mono Laser MFPs (Continued on next page) | | | | |
| 9540B013 | Canon imageCLASS MF227dw Mono Laser MFP (28 ppm) (256 MB) (8.5" x 14") (1200 x 1200 dpi) (Max Duty Cycle 10,000 Pages) (p/s/c/f) (Duplex) (USB) (Ethernet) (Wireless) (Touchscreen) (Energy Star) (250 Sheet Tray) (1 Sheet Multipurpose Tray) (35 Sheet ADF) | 930365 | EA | \$495.00 |

| MFG# | Product Description | Part# | UOM | Retail |
|---|--|--------|-----|------------|
| CANON EQUIPMENT | | | | |
| Canon imageCLASS MF227dw/MF229dw Mono Laser MFPs (Continued) | | | | |
| 9540B009 | Canon imageCLASS MF229dw: Same as MF227 + 50-Sheet DADF | 930344 | EA | \$595.00 |
| 5707B043 | Extended Service Plan (Exchange/Carry-In) (2 Year) | 914656 | EA | \$40.00 |
| 5707B044 | Extended Service Plan (Exchange/Carry-In) (3 Year) | 914657 | EA | \$60.00 |
| Canon imageCLASS MF3010 Mono Laser MFP | | | | |
| 5252B001 | Canon imageCLASS MF3010 Mono Laser MFP (19 ppm Print) (19 cpm Copy) (64 MB) (8.5" x 14") (1200 x 600 dpi) (Max Duty Cycle 8,000 Pages) (p/s/c) (USB) (Energy Star) (150 Sheet Input Capacity) | 911268 | EA | \$295.00 |
| 5707B039 | Extended Service Plan (Exchange/Carry-In) (2 Year) | 914652 | EA | \$25.00 |
| 5707B040 | Extended Service Plan (Exchange/Carry-In) (3 Year) | 914653 | EA | \$35.00 |
| Canon imageCLASS MF6160dw Mono Laser MFP | | | | |
| 8482B004 | Canon imageCLASS MF6160dw Mono Laser MFP (35 ppm) (256 MB) (8.5" x 14") (1200 x 600 dpi) (Max Duty Cycle 50,000 Pages) (p/s/c/f) (Duplex) (USB) (Ethernet) (Wireless) (Energy Star) (250 Sheet Input Capacity) (50 Sheet Multipurpose Tray) (50 Sheet ADF) | 916547 | EA | \$795.00 |
| 3439B001 | 500-Sheet Feeder | 911281 | EA | \$299.00 |
| 5707B043 | Extended Service Plan (Exchange/Carry-In) (2 Year) | 914656 | EA | \$40.00 |
| 5707B044 | Extended Service Plan (Exchange/Carry-In) (3 Year) | 914657 | EA | \$60.00 |
| Canon imageCLASS MF6180dw Mono Laser MFP | | | | |
| 8482B008 | Canon imageCLASS MF6180dw Mono Laser MFP (35 ppm) (256 MB) (8.5" x 14") (1200 x 600 dpi) (Max Duty Cycle 50,000 Pages) (p/s/c/f) (Duplex) (USB) (Ethernet) (Wireless) (Energy Star) (250 Sheet Input Capacity) (50 Sheet Multipurpose Tray) (50 Sheet ADF) | 916548 | EA | \$995.00 |
| 3439B001 | 500-Sheet Feeder | 911281 | EA | \$299.00 |
| 5707B047 | Extended Service Plan (Exchange/Carry-In) (2 Year) | 914660 | EA | \$60.00 |
| 5707B048 | Extended Service Plan (Exchange/Carry-In) (3 Year) | 914661 | EA | \$85.00 |
| Canon imageCLASS MF7460 Mono Laser MFP | | | | |
| 2237B001 | Canon imageCLASS MF7460 Mono Laser MFP (25 ppm) (256 MB) (11" x 17") (1200 x 1200 dpi) (Max Duty Cycle 50,000 Pages) (p/c/f) (Duplex) (USB) (Energy Star) (500 Sheet Input Capacity) (80 Sheet Multipurpose Tray) (50 Sheet ADF) | 911255 | EA | \$2,995.00 |
| 5707B063 | Extended Service Plan (Onsite Service) (2 Year) | 914676 | EA | \$380.00 |
| 5707B064 | Extended Service Plan (Onsite Service) (3 Year) | 914677 | EA | \$550.00 |
| Canon imageCLASS MF7470 Mono Laser MFP | | | | |
| 2237B007 | Canon imageCLASS MF7470 Mono Laser MFP (25 ppm) (256 MB) (11" x 17") (1200 x 1200 dpi) (Max Duty Cycle 50,000 Pages) (p/s/c/f) (Duplex) (USB) (Ethernet) (Energy Star) (500 Sheet Input Capacity) (80 Sheet Multipurpose Tray) (50 Sheet ADF) | 911256 | EA | \$3,995.00 |
| 5707B063 | Extended Service Plan (Onsite Service) (2 Year) | 914676 | EA | \$380.00 |
| 5707B064 | Extended Service Plan (Onsite Service) (3 Year) | 914677 | EA | \$550.00 |
| Canon imageCLASS MF7480 Mono Laser MFP | | | | |
| 2237B008 | Canon imageCLASS MF7480 Mono Laser MFP (25 ppm) (256 MB) (11" x 17") (1200 x 1200 dpi) (Max Duty Cycle 50,000 Pages) (p/s/c/f) (Duplex) (USB) (Ethernet) (Energy Star) (500 Sheet Input Capacity) (80 Sheet Multipurpose Tray) (50 Sheet ADF) | 911257 | EA | \$4,995.00 |
| 5707B067 | Extended Service Plan (Onsite Service) (2 Year) | 914680 | EA | \$705.00 |
| 5707B068 | Extended Service Plan (Onsite Service) (3 Year) | 914681 | EA | \$1,025.00 |
| Canon imageCLASS LBP7110Cw Color Laser Printer | | | | |
| 6293B023 | Canon imageCLASS LBP7110Cw Color Laser Printer (14 ppm) (64 MB) (8.5" x 14") (1200 x 1200 dpi) (Max Duty Cycle 30,000 Pages) (USB) (Ethernet) (Wireless) (Energy Star) (150 Sheet Input Tray) | 926566 | EA | \$565.00 |
| 5707B043 | Extended Service Plan (Exchange/Carry-In) (2 Year) | 914656 | EA | \$40.00 |
| 5707B044 | Extended Service Plan (Exchange/Carry-In) (3 Year) | 914657 | EA | \$60.00 |
| Canon imageCLASS LBP7660Cdn Color Laser Printer | | | | |
| 5089B010 | Canon imageCLASS LBP7660Cdn Color Laser Printer (21 ppm) (768 MB) (8.5" x 11") (2400 x 600 dpi) (Duplex) (USB) (Ethernet) (Energy Star) (300 Sheet Input Capacity) | 912734 | EA | \$995.00 |
| 3330B003 | 250-Sheet Feeder (PF-701) | 914533 | EA | \$299.00 |
| 5707B055 | Extended Service Plan (Onsite Service) (2 Year) | 914668 | EA | \$100.00 |
| 5707B056 | Extended Service Plan (Onsite Service) (3 Year) | 914669 | EA | \$135.00 |
| Canon imageCLASS LBP7780Cdn Color Laser Printer (Continued on next page) | | | | |
| 6140B006 | Canon imageCLASS LBP7780Cdn Color Laser Printer (33 ppm) (768 MB) (8.5" x 14") (9600 x 600 dpi) (Max Duty Cycle 75,000 Pages) (Duplex) (USB) (Ethernet) (Energy Star) (500 Sheet Input Capacity) (100 Sheet Multipurpose Tray) | 911728 | EA | \$1,795.00 |
| 3338B008 | 500-Sheet Feeder (PF-723A) | 914535 | EA | \$325.00 |

| MFG# | Product Description | Part# | UOM | Retail |
|--|--|--------|-----|------------|
| CANON EQUIPMENT | | | | |
| Canon imageCLASS LBP7780Cdn Color Laser Printer (Continued) | | | | |
| 5707B059 | Extended Service Plan (Onsite Service) (2 Year) | 914672 | EA | \$215.00 |
| 5707B060 | Extended Service Plan (Onsite Service) (3 Year) | 914673 | EA | \$315.00 |
| Canon imageCLASS MF8280Cw Color Laser MFP | | | | |
| 6848B001 | Canon imageCLASS MF8280Cw Color Laser MFP (14 ppm) (256 MB) (8.5" x 14") (2400 x 600 dpi) (Max Duty Cycle 30,000 Pages) (p/s/c/f) (USB) (Ethernet) (Wireless) (Energy Star) (150 Sheet Input Capacity) (50 Sheet ADF) | 912408 | EA | \$895.00 |
| 5707B047 | Extended Service Plan (Exchange/Carry-In) (2 Year) | 914660 | EA | \$60.00 |
| 5707B048 | Extended Service Plan (Exchange/Carry-In) (3 Year) | 914661 | EA | \$85.00 |
| Canon imageCLASS MF8580Cdw Color Laser MFP | | | | |
| 6849B001 | Canon imageCLASS MF8580Cdw Color Laser MFP (21 ppm) (512 MB) (8.5" x 14") (2400 x 600 dpi) (Max Duty Cycle 40,000 Pages) (p/s/c/f) (Duplex) (USB) (Ethernet) (Wireless) (Energy Star) (250 Sheet Input Capacity) (50 Sheet DADF) | 912409 | EA | \$1,195.00 |
| 0732A024 | 250-Sheet Feeder | 911279 | EA | \$299.00 |
| 5707B051 | Extended Service Plan (Exchange/Carry-In) (2 Year) | 914664 | EA | \$90.00 |
| 5707B052 | Extended Service Plan (Exchange/Carry-In) (3 Year) | 914665 | EA | \$130.00 |
| Canon imageCLASS MF9220Cdn Color Laser MFP | | | | |
| 4495B001 | Canon imageCLASS MF9220Cdn Color Laser MFP (22 ppm) (384 MB) (8.5" x 14") (2400 x 600 dpi) (Max Duty Cycle 65,000 Pages) (p/s/c/f) (Duplex) (USB) (Ethernet) (Energy Star) (250 Sheet Input Capacity) (100 Sheet Multipurpose Tray) (50 Sheet ADF) | 911258 | EA | \$1,495.00 |
| 2339B002 | 500-Sheet Feeder Cassette Pedestal | 911280 | EA | \$349.00 |
| 5707B059 | Extended Service Plan (Onsite Service) (2 Year) | 914672 | EA | \$215.00 |
| 5707B060 | Extended Service Plan (Onsite Service) (3 Year) | 914673 | EA | \$315.00 |
| Canon imageCLASS MF9280Cdn Color Laser MFP | | | | |
| 4497B001 | Canon imageCLASS MF9280Cdn Color Laser MFP (22 ppm) (768 MB) (8.5" x 14") (2400 x 600 dpi) (Max Duty Cycle 65,000 Pages) (p/s/c/f) (Duplex) (USB) (Ethernet) (Energy Star) (250 Sheet Input Capacity) (100 Sheet Multipurpose Tray) (50 Sheet ADF) | 911259 | EA | \$2,295.00 |
| 2339B002 | 500-Sheet Feeder Cassette Pedestal | 911280 | EA | \$349.00 |
| 5707B059 | Extended Service Plan (Onsite Service) (2 Year) | 914672 | EA | \$215.00 |
| 5707B060 | Extended Service Plan (Onsite Service) (3 Year) | 914673 | EA | \$315.00 |
| Canon Monochrome Laser Portable Copiers | | | | |
| 8461A062 | Canon PC170 Mono Laser Personal Copier (4 cpm Copy) (8.5" x 11") (600 x 600 dpi) (Energy Star) (50 Sheet Input Capacity) | 911275 | EA | \$345.00 |
| 0000A011 | Canon PC430 Mono Laser Personal Copier (4 cpm Copy) (8.5" x 14") (600 x 600 dpi) (Energy Star) (50 Sheet Input Capacity) | 903606 | EA | \$595.00 |
| Canon Fax Machines | | | | |
| 5258B001 | Canon Faxphone L100 Mono Laser MFP (19 ppm Print) (12 cpm Copy) (64 MB) (8.5" x 14") (1200 x 600 dpi) (Max Duty Cycle 8,000 Pages) (p/c/f) (USB) (Energy Star) (150 Sheet Input Capacity) (30 Sheet ADF) | 911269 | EA | \$395.00 |
| 6356B002 | Canon Faxphone L190 Mono Laser MFP (26 ppm Print) (26 cpm Copy) (128 MB) (8.5" x 14") (1200 x 600 dpi) (Max Duty Cycle 10,000 Pages) (p/c/f) (Duplex) (USB) (Energy Star) (250 Sheet Input Capacity) (50 Sheet ADF) | 911270 | EA | \$545.00 |
| Canon Compact Inkjet Photo Printers | | | | |
| 6219B002 | Canon PIXMA iP7220 Inkjet Photo Printer (Prints 4" x 6" Photo in 21 sec) (15 ipm Black/10 ipm Color Print) (8.5" x 14") (9600 x 2400 dpi) (Duplex) (USB) (Wireless) (Energy Star) (CD/DVD Printing) | 923081 | EA | \$99.99 |
| 6221B030 | Canon PIXMA MG2220 Color Inkjet Photo All-in-One (8.4 ipm Mono/4.8 ipm Color) (8.5" x 14") (4800 x 1200 dpi) (p/s/c) (USB) (Energy Star) (100 Sheet Input Capacity) (Includes 5 Sheets of Paper OEM# PP-201) | 914650 | EA | \$69.99 |
| 8331B002 | Canon PIXMA MG3520 Color Inkjet Photo All-in-One (9.9 ipm Mono/5.7 ipm Color) (8.5" x 14") (4800 x 1200 dpi) (p/s/c) (Duplex) (USB) (Wireless) (Energy Star) (100 Sheet Input Capacity) | 925742 | EA | \$79.99 |
| 8750B002 | Canon PIXMA MX532 Inkjet MFP (9.7 ppm Black/5.5 ppm Color) (Prints 4" x 6" Photo in 46 sec) (8.5" x 14") (4800 x 1200 dpi) (p/s/c/f) (Duplex) (USB) (Wireless) (Energy Star) (100 Sheet Input Capacity) (30 Sheet ADF) | 930235 | EA | \$149.99 |
| 5960B001 | Canon SELPHY CP900 Color Dye-Sublimation Inkjet Compact Photo Printer (Prints 4" x 6" Photo in 47 sec) (300 x 300 dpi) (USB) (Memory Card) (Wireless) (PictBridge) (Energy Star) (Product Color: White) | 914683 | EA | \$99.99 |
| 8426B001 | Canon SELPHY CP910 Color Dye-Sublimation Inkjet Compact Photo Printer (Prints 4" x 6" Photo in 47 sec) (300 x 300 dpi) (USB) (Memory Card) (Wireless) (PictBridge) (Energy Star) (Optional Battery) (Product Color: Black) | 929110 | EA | \$99.99 |

| MFG# | Product Description | Part# | UOM | Retail |
|---|---|--------|-----|------------|
| HP EQUIPMENT | | | | |
| HP LaserJet P2035 Mono Laser Printer | | | | |
| CE461A#ABA | HP LaserJet P2035 Mono Laser Printer (30 ppm) (266 MHz) (16 MB) (8.5" x 14") (1200 dpi) (Max Duty Cycle 25,000) (USB) (Parallel) (250 Sheet Input Capacity) (50 Sheet Multipurpose Tray) | 903588 | EA | \$317.50 |
| UK930E | HP Electronic Care Pack (Next Business Day) (Hardware Support) (1 Year) | 903979 | EA | \$59.00 |
| UK932E | HP Electronic Care Pack (Next Business Day) (Hardware Support) (3 Year) | 7440 | EA | \$99.00 |
| HP LaserJet P3015n Mono Laser Printer | | | | |
| CE527A#ABA | HP LaserJet P3015n Mono Laser Printer (42 ppm) (540 MHz) (128 MB) (8.5" x 14") (1200 dpi) (Max Duty Cycle 100,000 Pages) (USB) (Ethernet) (Energy Star) (500 Sheet Input Capacity) | 91780 | EA | \$765.00 |
| CE528A#ABA | HP LaserJet P3015dn: Base Model + Duplex Printing | 16262 | EA | \$957.00 |
| CE528A#201 | Government HP LaserJet P3015dn: TAA-Compliant Version | 16263 | EA | \$957.00 |
| CE529A#ABA | HP LaserJet P3015x: Base Model + Duplex Printing, Total 1,100-Sheet Input Capacity | 16264 | EA | \$1,084.00 |
| CE529A#201 | Government HP LaserJet P3015x: TAA-Compliant Version | 16265 | EA | \$1,084.00 |
| CE530A | HP 500-Sheet Input Tray | 21298 | EA | \$227.19 |
| UP872E | HP Electronic Care Pack (Next Business Day) (Hardware Support) (3 Year) | 15884 | EA | \$229.00 |
| UP874E | HP Electronic Care Pack (Next Business Day) (Hardware Support) (4 Year) | 15885 | EA | \$329.00 |
| HP LaserJet Enterprise 500 Series Mono Laser MFPs | | | | |
| CF116A#BGJ | HP LaserJet Enterprise 500 MFP M525dn Mono Laser MFP (42 ppm) (800 MHz) (1 GB) (8.5" x 14") (1200 x 1200 dpi) (Max Duty Cycle 75,000 Pages) (p/s/c) (Duplex) (USB) (Ethernet) (Energy Star) (Touchscreen) (600 Sheet Input Tray) (50 Sheet ADF) | 907589 | EA | \$2,113.83 |
| CF117A#BGJ | HP LaserJet Enterprise 500 MFP M525f: Base Model + Fax Capabilities | 906980 | EA | \$2,466.33 |
| CF117A#201 | Government HP LaserJet Enterprise 500 MFP M525f: TAA-Compliant Version | 919945 | EA | \$2,466.33 |
| CF118A#BGJ | HP LaserJet Enterprise Flow MFP M525c: Same as M525f + 1.5GB Total Memory, 100-Sheet ADF | 910142 | EA | \$3,054.00 |
| CE530A | HP 500-Sheet Input Tray | 21298 | EA | \$227.19 |
| CF338A | HP Printer Cabinet | 912235 | EA | \$320.00 |
| U5X53E | HP Electronic Care Pack (Next Business Day) (Hardware Support) (3 Year) | 913598 | EA | \$599.00 |
| U5X57E | HP Electronic Care Pack (Next Business Day) (Hardware Support) (5 Year) | 919900 | EA | \$1,119.00 |
| HP LaserJet Enterprise 600 Series Mono Laser Printers | | | | |
| CE989A#BGJ | HP LaserJet Enterprise 600 Series M601n Mono Laser Printer (45 ppm) (800 MHz) (512 MB) (8.5" x 14") (1200 x 1200 dpi) (Max Duty Cycle 175,000 Pages) (USB) (Ethernet) (500 Sheet Input Tray) (100 Sheet Multipurpose Tray) | 503539 | EA | \$893.17 |
| CE990A#BGJ | HP LaserJet Enterprise M601dn: Base Model + Duplex Printing, Energy Star Certified | 503549 | EA | \$1,148.72 |
| CE991A#BGJ | HP LaserJet Enterprise M602n: Base Model + 52 ppm, Duty Cycle 225,000 Pages | 503551 | EA | \$1,276.50 |
| CE992A#BGJ | HP LaserJet Enterprise M602dn: Same as M602n + Duplex Printing, Energy Star | 503555 | EA | \$1,532.06 |
| CE992A#201 | Government HP LaserJet Enterprise M602dn: TAA-Compliant Version | 919938 | EA | \$1,532.06 |
| CE993A#BGJ | HP LaserJet Enterprise M602x: Same as M602n + 1,100-Sheet Total Input Capacity, Energy Star Certified | 503560 | EA | \$1,851.50 |
| CE993A#201 | Government HP LaserJet Enterprise M602x: TAA-Compliant Version | 907703 | EA | \$1,851.50 |
| CE994A#BGJ | HP LaserJet Enterprise M603n: Base Model + 62 ppm, Duty Cycle 275,000 Pages, Wireless Connectivity, Energy Star Certified | 503562 | EA | \$1,915.39 |
| CE995A#BGJ | HP LaserJet Enterprise M603dn: Same as M603n + Duplex Printing | 503563 | EA | \$2,234.84 |
| CE995A#201 | Government HP LaserJet Enterprise M603dn: TAA-Compliant Version | 919940 | EA | \$2,234.84 |
| CE996A#BGJ | HP LaserJet Enterprise M603xh: Same as M603n + Duplex Printing, Total 1,100-Sheet Input Capacity, Encrypted Hard Drive | 503581 | EA | \$3,065.39 |
| CE996A#201 | Government HP LaserJet Enterprise M603xh: TAA-Compliant Version | 919942 | EA | \$3,065.39 |
| CE998A | 500-Sheet Paper Tray Feeder | 700031 | EA | \$318.17 |
| CE398A | 1,500-Sheet Paper Tray | 507871 | EA | \$637.61 |
| HZ466E | HP LaserJet Enterprise M601 Series Electronic Care Pack (Next Business Day) (Hardware Support + DMR) (3 Year) | 912737 | EA | \$199.00 |
| HZ478E | HP LaserJet Enterprise M602 Series Electronic Care Pack (Next Business Day) (Hardware Support) (3 Years) | 908673 | EA | \$329.00 |
| HZ503E | HP LaserJet Enterprise M603 Series Electronic Care Pack (Next Business Day) (Hardware Support) (3 Years) | 909418 | EA | \$469.00 |
| HP LaserJet Enterprise 700 Series Mono Laser Printers & MFPs <i>(Continued on next page)</i> | | | | |
| CF235A#BGJ | HP LaserJet Enterprise 700 M712n Mono Laser Printer (40 ppm) (800 MHz) (512 MB) (11" x 17") (1200 x 1200 dpi) (Max Duty Cycle 100,000 Pages) (USB) (Ethernet) (600 Sheet Input Capacity) | 910267 | EA | \$2,426.50 |
| CF236A#BGJ | HP LaserJet Enterprise 700 M712dn: Base Model + Duplex Printing, Energy Star Certified | 910268 | EA | \$2,809.83 |
| CF238A#BGJ | HP LaserJet Enterprise 700 M712xh: Same as M712dn + Extra 500-sheet Input Tray, Hard Disk | 910269 | EA | \$3,640.39 |
| CF066A#BGJ | HP LaserJet Enterprise 700 M725dn: Same as M712dn + 1GB Total Memory, Duty Cycle 200,000 Pages, Scan and Copy Functions, Touchscreen, 100-Sheet ADF | 913005 | EA | \$4,228.83 |
| CF067A#BGJ | HP LaserJet Enterprise 700 M725f: Same as M725dn + Fax Function, Total 1,700-Sheet Input Capacity | 913009 | EA | \$5,521.33 |

| MFG# | Product Description | Part# | UOM | Retail |
|---|--|--------|-----|------------|
| HP EQUIPMENT | | | | |
| HP LaserJet Enterprise 700 Series Mono Laser Printers & MFPs (Continued) | | | | |
| CF068A#BGJ | HP LaserJet Enterprise 700 M725z: Same as M725f + Total 2,200-Sheet Input Capacity | 913010 | EA | \$6,578.83 |
| CF069A#BGJ | HP LaserJet Enterprise 700 M725z+: Same as M725f + Total 4,100-Sheet Input Capacity | 913012 | EA | \$6,931.33 |
| CF239A | HP 500-Sheet Feeder and Tray | 913007 | EA | \$431.40 |
| CF243A | HP 500-Sheet Feeder with Cabinet and Stand | 913008 | EA | \$740.43 |
| U6Z05E | HP LaserJet Enterprise 700 M712 Series Electronic Care Pack (Next Business Day) (Hardware Support + DMR) (3 Year) | 919915 | EA | \$499.00 |
| U6Z06E | HP LaserJet Enterprise 700 M712 Series Electronic Care Pack (Next Business Day) (Hardware Support + DMR) (4 Year) | 919916 | EA | \$729.00 |
| U7A14E | HP LaserJet Enterprise 700 M725 Series Electronic Care Pack (Next Business Day) (Hardware Support + DMR) (3 Year) | 919917 | EA | \$1,099.00 |
| U7A16E | HP LaserJet Enterprise 700 M725 Series Electronic Care Pack (Next Business Day) (Hardware Support + DMR) (5 Year) | 919918 | EA | \$2,059.00 |
| HP LaserJet Enterprise Flow M830z Mono Laser MFP | | | | |
| D7P68A#BGJ | HP LaserJet Enterprise Flow M830z Mono Laser MFP (55 ppm) (800 MHz) (1.5 GB) (11" x 17") (1200 x 1200 dpi) (Max Duty Cycle 300,000 Pages) (p/s/c/f) (Duplex) (USB) (Ethernet) (Wireless) (Energy Star) (4,600 Sheet Input Capacity) (200 Sheet ADF) | 916371 | EA | \$9,986.33 |
| D7P68A#201 | Government HP LaserJet Enterprise Flow M830z: TAA-Compliant Base Model | 916372 | EA | \$9,986.33 |
| CZ285A | HP LaserJet Booklet Maker/MFP Finisher (3,500 Sheet) | 919307 | EA | \$4,325.15 |
| CZ995A | HP LaserJet 3,500-Sheet Stapler/Stacker with 2-3 Hole Punch | 919308 | EA | \$3,954.32 |
| U8C89E | HP Electronic Care Pack (Next Business Day) (Hardware Support + DMR) (3 Year) | 919920 | EA | \$2,599.00 |
| U8C91E | HP Electronic Care Pack (Next Business Day) (Hardware Support + DMR) (5 Year) | 919921 | EA | \$4,879.00 |
| HP LaserJet Enterprise M806 Mono Laser Printers | | | | |
| CZ244A#BGJ | HP LaserJet Enterprise M806dn Mono Laser Printer (55 ppm) (800 MHz) (1 GB) (12" x 18") (1200 x 1200 dpi) (Max Duty Cycle 300,000 Pages) (Duplex) (USB) (Ethernet) (Touchscreen) (Energy Star) (1,100 Sheet Input Capacity) | 916374 | EA | \$4,343.17 |
| D7P69A#BGJ | HP LaserJet Enterprise M806x+: Base Model + NFC/Wireless Direct Connectivity, Total 4,600-Sheet Input Capacity | 916376 | EA | \$6,898.72 |
| CZ245A#201 | Government HP LaserJet Enterprise M806x+: TAA-Compliant Version | 919279 | EA | \$6,898.72 |
| CZ994A | HP 3,500-Sheet Stapler/Stacker | 916722 | EA | \$3,089.04 |
| U8C59E | HP Electronic Care Pack (Next Business Day) (Hardware Support + DMR) (3 Year) | 919922 | EA | \$1,099.00 |
| U8C61E | HP Electronic Care Pack (Next Business Day) (Hardware Support + DMR) (5 Year) | 919923 | EA | \$2,059.00 |
| HP LaserJet M4555 Mono Laser MFPs | | | | |
| CE738A#BGJ | HP LaserJet M4555h Mono Laser MFP (55 ppm) (800 MHz) (1.25 GB) (8.5" x 14") (1200 x 1200 dpi) (Max Duty Cycle 250,000 Pages) (p/s/c) (Duplex) (USB) (Ethernet) (Touchscreen) (Energy Star) (500 Sheet Input Tray) (100 Sheet Multipurpose Tray) (50 Sheet ADF) | 106446 | EA | \$3,265.50 |
| CE504A#BGJ | HP LaserJet M4555fskm: Base Model + Fax Capability, 3 Extra 500-Sheet Input Trays, Stapler/Stacker | 106444 | EA | \$5,248.83 |
| CE734A | HP 500-Sheet Feeder with Cabinet | 917877 | EA | \$715.20 |
| CE735A | HP 3 x 500-Sheet Stand | 906610 | EA | \$1,431.00 |
| HN909E | HP Electronic Care Pack (Next Business Day) (Hardware Support) (3 Year) | 507408 | EA | \$999.00 |
| HP562E | HP Electronic Care Pack (Next Business Day) (Hardware Support) (4 Year) | 919924 | EA | \$1,469.00 |
| HP LaserJet Pro 400 Series Mono Laser Printers & MFPs | | | | |
| CZ195A#BGJ | HP LaserJet Pro 400 M401n Mono Laser Printer (35 ppm) (800 MHz) (128 MB) (8.5" x 14") (1200 x 1200 dpi) (Max Duty Cycle 50,000 Pages) (USB) (Ethernet) (300 Sheet Input Capacity) | 906853 | EA | \$343.72 |
| CF399A#BGJ | HP LaserJet Pro 400 M401dne: Base Model + Duplex Printing, 256MB Total Memory, Energy Star Certified | 911083 | EA | \$382.06 |
| CF399A#201 | Government HP LaserJet Pro 400 M401dne: TAA-Compliant Version | 911920 | EA | \$382.06 |
| CF285A#BGJ | HP LaserJet Pro 400 M401dw: Base Model + Duplex Printing, 256MB Total Memory, Wireless Connectivity, Touchscreen | 906982 | EA | \$509.83 |
| CF286A#BGJ | HP LaserJet Pro 400 MFP M425dn: M401n + 33 ppm, Duplex Printing, 256MB Total Memory, Scan/Copy/Fax Functions, Touchscreen, Energy Star Certified | 906887 | EA | \$637.00 |
| CF284A | HP LaserJet Pro 400 M401 Series 500-Sheet Feeder/Tray | 908809 | EA | \$155.00 |
| U5Z49E | HP LaserJet Pro 400 M401 Series Electronic Care Pack (Next Business Day) (Hardware Support) (3 Year) | 911250 | EA | \$99.00 |
| CF406A | HP LaserJet Pro 400 M425 MFP 500-Sheet Feeder | 909327 | EA | \$155.00 |
| U5X82E | HP LaserJet Pro 400 M425 MFP Electronic Care Pack (Next Business Day) (Hardware Support) (3 Year) | 912191 | EA | \$179.00 |
| HP LaserJet Pro M127 Mono Laser MFPs (Continued on next page) | | | | |
| CZ181A#BGJ | HP LaserJet Pro M127fn Mono Laser MFP (21 ppm) (600 MHz) (128 MB) (8.5" x 14") (1200 x 1200 dpi) (Max Duty Cycle 8,000 Pages) (p/s/c/f) (USB) (Ethernet) (Energy Star) (150 Sheet Input Tray) (35 Sheet ADF) | 916741 | EA | \$266.77 |

Meet the HP Officejet Pro printers that save on every page.

Get printing as sharp as laser for up to 50% less per page.¹

We've engineered the inkjet for business. HP Officejet Pro printers give you professional color that won't smudge—at speeds that can rival laser² for up to half the cost per page. Innovation to meet every challenge, it matters.



Make it matter.



HP Officejet Pro 8620 e-All-in-One



HP Officejet Pro X576dw MFP with PageWide Technology
The world's fastest desktop printer³



HP Officejet Pro 276 MFP

¹ Compared with the following: Officejet Pro X series: Majority of color laser MFPs <\$1000 USD and color laser printers <\$800 USD as of August 2013; Officejet Pro 200 series: Majority of color laser AiO's <\$500 USD and color laser printers <\$300 USD as of September 2012; Officejet Pro 8610/20/30: Majority of color laser AiO's <\$500 USD as of October 2013. Speed comparison based on ISO 24734 standard and manufacturers' published specifications of fastest available print mode based on market share as on ISO 24734 standard and manufacturers' published specifications of fastest available print mode.

² Compared with the following: Officejet Pro X series: Majority of color laser MFPs <\$1000 USD and color laser printers <\$800 USD as of August 2013; Officejet Pro 200 series: Majority of color laser AiO's <\$500 USD and color laser printers <\$300 USD as of September 2012; Officejet Pro 8610/20/30: Majority of color laser AiO's <\$500 USD as of October 2013. Speed comparison based on ISO 24734 standard and manufacturers' published specifications of fastest available print mode based on market share as on ISO 24734 standard and manufacturers' published specifications of fastest available print mode.

³ Guinness World Record for fastest time to print 500 sheets by an office color desktop printer, April 2012. Record set on HP X576dw model. Details at guinness-worldrecords.com. Record supervised and verified by WirthConsulting.org. Test documents ISO 24734 from sample 4-page category test file printed in fastest available color mode for all products. Competitive set includes laser and inkjet color desktop MFPs <\$1000 USD and printers <\$800 USD available March 2012.

| MFG# | Product Description | Part# | UOM | Retail |
|---|--|--------|-----|-------------|
| HP EQUIPMENT | | | | |
| HP LaserJet Pro M127 Mono Laser MFPs (Continued) | | | | |
| CZ183A#BGJ | HP LaserJet Pro M127fw: Base Model + Wireless Connectivity, Touchscreen | 916742 | EA | \$328.79 |
| U6M41E | HP Electronic Care Pack (Business Priority Support) (Onsite Exchange) (2 Year) | 919925 | EA | \$55.00 |
| U6M42E | HP Electronic Care Pack (Business Priority Support) (Onsite Exchange) (3 Year) | 919926 | EA | \$80.00 |
| HP LaserJet Pro M201dw Mono Laser Printer | | | | |
| CF456A#BGJ | HP LaserJet Pro M201dw Mono Laser Printer (26 ppm) (750 MHz) (128 MB) (8.5" x 14") (600 x 600 dpi) (Max Duty Cycle 8,000 Pages) (Duplex) (USB) (Ethernet) (Wireless) (Energy Star) (250 Sheet Input Tray) | 930493 | EA | \$254.00 |
| U6M41E | HP Electronic Care Pack (Business Priority Support) (Onsite Exchange) (2 Year) | 919925 | EA | \$55.00 |
| U6M42E | HP Electronic Care Pack (Business Priority Support) (Onsite Exchange) (3 Year) | 919926 | EA | \$80.00 |
| HP LaserJet Pro M225 Mono Laser MFPs | | | | |
| CF484A#BGJ | HP LaserJet Pro M225dn Mono Laser MFP (26 ppm) (600 MHz) (256 MB) (8.5" x 14") (600 x 600 dpi) (Max Duty Cycle 8,000 Pages) (p/s/c/f) (Duplex) (USB) (Ethernet) (Energy Star) (250 Sheet Input Tray) (35 Sheet ADF) | 930494 | EA | \$356.00 |
| CF485A#BGJ | HP LaserJet Pro M225dw: Base Model + Wireless Connectivity, Touchscreen | 930495 | EA | \$420.00 |
| U6M44E | HP Electronic Care Pack (Business Priority Support) (Onsite Exchange) (2 Year) | 915000 | EA | \$80.00 |
| U6M45E | HP Electronic Care Pack (Business Priority Support) (Onsite Exchange) (3 Year) | 915001 | EA | \$115.00 |
| HP LaserJet Pro M521dn Mono Laser MFP | | | | |
| A8P79A#BGJ | HP LaserJet Pro M521dn Mono Laser MFP (42 ppm) (800 MHz) (256 MB) (8.5" x 14") (1200 x 1200 dpi) (Max Duty Cycle 75,000 Pages) (p/s/c/f) (Duplex) (USB) (Ethernet) (Touchscreen) (Energy Star) (600 Sheet Input Capacity) (50 Sheet ADF) | 912331 | EA | \$1,148.72 |
| CE530A | HP 500-Sheet Input Tray | 21298 | EA | \$227.19 |
| CF338A | HP Printer Cabinet | 912235 | EA | \$320.00 |
| U6Z65E | HP Electronic Care Pack (Next Business Day) (Hardware Support + DMR) (3 Year) | 919927 | EA | \$249.00 |
| HP LaserJet Pro P1102w Mono Laser Printer | | | | |
| CE658A#BGJ | HP LaserJet Pro P1102w Mono Laser Printer (19 ppm) (266 MHz) (8 MB) (8.5" x 14") (600 x 600 dpi) (Max Duty Cycle 5,000 Pages) (USB) (Wireless) (Energy Star) (160 Sheet Input Capacity) | 909030 | EA | \$203.80 |
| U6M38E | HP Electronic Care Pack (Business Priority Support) (Onsite Exchange) (2 Year) | 919493 | EA | \$50.00 |
| U6M39E | HP Electronic Care Pack (Business Priority Support) (Onsite Exchange) (3 Year) | 919494 | EA | \$70.00 |
| HP LaserJet CM4540 Color Laser MFPs | | | | |
| CC419A#BGJ | HP LaserJet CM4540 Color Laser MFP (42 ppm) (800 MHz) (1.25 GB) (8.5" x 14") (600 x 600 dpi) (Max Duty Cycle 175,000 Pages) (p/s/c) (Duplex) (USB) (Ethernet) (Touchscreen) (Energy Star) (600 Sheet Input Tray) (50 Sheet ADF) | 96112 | EA | \$4,408.00 |
| CC419A#201 | Government HP LaserJet CM4540: TAA-Compliant Version | 914532 | EA | \$4,408.00 |
| CC420A#BGJ | HP LaserJet CM4540f: Base Model + Fax Capabilities, Total 1,100-Sheet Input Capacity | 506778 | EA | \$5,220.00 |
| CC421A#BGJ | HP LaserJet CM4540f: Base Model + Fax Capabilities, Total 2,100-Sheet Input Capacity, Stapler/Stacker | 105919 | EA | \$6,438.00 |
| CC421A#201 | Government HP LaserJet CM4540f: TAA-Compliant Version | 914537 | EA | \$6,438.00 |
| CC425A | HP 500-Sheet Feeder | 90842 | EA | \$392.00 |
| CC423A | HP Paper Feeder + Stand (3 x 500-Sheet Paper Trays) | 90915 | EA | \$1,575.00 |
| UV259E | HP Electronic Care Pack (Next Business Day) (Hardware Support) (3 Year) | 102630 | EA | \$1,599.00 |
| UV265E | HP Electronic Care Pack (Next Business Day) (Hardware Support) (5 Year) | 102649 | EA | \$3,009.00 |
| HP LaserJet CM6040f Color Laser MFP | | | | |
| Q3939A#BCC | HP LaserJet CM6040f Color Laser MFP (40 ppm) (835 MHz) (512 MB) (11" x 17") (1200 x 600 dpi) (Max Duty Cycle 200,000 Pages) (p/s/c/f) (Duplex) (USB) (Ethernet) (Energy Star) (Touchscreen) (2,100 Sheet Input Capacity) (50 Sheet ADF) | 904067 | EA | \$10,498.00 |
| CC517A | HP Stapler/Stacker (2,000 Sheet) | 901435 | EA | \$2,404.00 |
| UJ165E | HP Electronic Care Pack (Next Business Day) (Hardware Support) (3 Year) | 904709 | EA | \$3,479.00 |
| UJ166E | HP Electronic Care Pack (Next Business Day) (Hardware Support) (4 Year) | 7357 | EA | \$5,109.00 |
| HP LaserJet CP5225 Color Laser Printers | | | | |
| CE711A#BGJ | HP LaserJet CP5225n Color Laser Printer (20 ppm) (540 MHz) (192 MB) (11" x 17") (600 x 600 dpi) (Max Duty Cycle 75,000 Pages) (USB) (Ethernet) (350 Sheet Input Capacity) | 95828 | EA | \$1,895.00 |
| CE712A#BGJ | HP LaserJet CP5225dn: Base Model + Duplex Printing, Energy Star Certified | 500747 | EA | \$2,125.00 |
| CE860A | HP 500-Sheet Paper Tray | 105343 | EA | \$523.20 |
| UT431E | HP Electronic Care Pack (Next Business Day) (Hardware Support) (3 Year) | 102320 | EA | \$499.00 |
| UT430E | HP Electronic Care Pack (Next Business Day) (Hardware Support) (4 Year) | 102319 | EA | \$729.00 |
| HP LaserJet Enterprise 500 Series Color Laser Printers & MFPs (Continued on next page) | | | | |
| CF081A#BGJ | HP LaserJet Enterprise 500 Series M551n Color Laser Printer (33 ppm) (800 MHz) (1 GB) (8.5" x 14") (1200 x 1200 dpi) (Max Duty Cycle 75,000 Pages) (USB) (Ethernet) (Energy Star) (600 Sheet Input Capacity) (100 Sheet Multipurpose Tray) | 503529 | EA | \$721.52 |
| CF082A#BGJ | HP LaserJet Enterprise 500 M551dn: Base Model + Duplex Printing | 503530 | EA | \$949.77 |

| MFG# | Product Description | Part# | UOM | Retail |
|--|---|--------|-----|-------------|
| HP EQUIPMENT | | | | |
| HP LaserJet Enterprise 500 Series Color Laser Printers & MFPs (Continued) | | | | |
| CF082A#201 | Government HP LaserJet Enterprise 500 Series M551dn: TAA-Compliant Version | 919369 | EA | \$949.77 |
| CF083A#BGJ | HP LaserJet Enterprise 500 M551xh: Base Model + Duplex Printing, Total 1,200-Sheet Input Capacity, Hard Drive | 503531 | EA | \$1,647.20 |
| CF083A#201 | Government HP LaserJet Enterprise 500 M551xh: TAA-Compliant Version | 919944 | EA | \$1,647.20 |
| CD644A#BGJ | HP LaserJet Enterprise 500 MFP M575dn: M551 + 31 ppm, Duplex Printing, Scan/Copy Functions, Touchscreen, Total 350-Sheet Input Capacity | 907007 | EA | \$2,667.00 |
| CD645A#BGJ | HP LaserJet Enterprise 500 MFP M575f: M575dn + Fax Capabilities | 907591 | EA | \$3,131.00 |
| CD646A#BGJ | HP LaserJet Enterprise flow MFP M575c: Same as M575f + 1.5GB Total Memory, 100-Sheet ADF | 910141 | EA | \$3,710.00 |
| CF084A | HP 500-Sheet Paper and Heavy Media Tray | 906753 | EA | \$433.95 |
| HZ626E | HP LaserJet Enterprise 500 M551 Series Electronic Care Pack (Next Business Day) (Hardware Support + DMR) (3 Year) | 919967 | EA | \$229.00 |
| HZ629E | HP LaserJet Enterprise 500 M551 Series Electronic Care Pack (Next Business Day) (Hardware Support + DMR) (4 Year) | 919968 | EA | \$329.00 |
| U1Q32E | HP LJ Enterprise 500 Color MFP M575dn/M575f/flow M575c Electronic Care Pack (Next Business Day) (Hardware Support) (3 Year) | 912325 | EA | \$899.00 |
| U1Q42E | HP LJ Enterprise 500 Color MFP M575dn/M575f/flow M575c Electronic Care Pack (Next Business Day) (Hardware Support) (4 Year) | 912328 | EA | \$1,319.00 |
| HP LaserJet Enterprise 700 Series Color Laser MFPs | | | | |
| CC522A#BGJ | HP LaserJet Enterprise 700 Color MFP M775dn (30 ppm Print) (30 cpm Copy) (800 MHz) (1536 MB) (12" x 18") (600 x 600 dpi) (Max Duty Cycle 120,000 Pages) (p/s/c) (Duplex) (USB) (Ethernet) (Energy Star) (Touchscreen) (250 Sheet Input Capacity) (100 Sheet Multipurpose Tray) (100 Sheet ADF) | 910168 | EA | \$4,985.00 |
| CC523A#BGJ | HP LaserJet Enterprise 700 MFP M775f: Base Model + Fax Capabilities, Total 1,250-Sheet Input Capacity | 910169 | EA | \$6,319.00 |
| CC524A#BGJ | HP LaserJet Enterprise 700 MFP M775z: Base Model + Fax Capabilities, Total 1,750-Sheet Input Capacity, Stapler/Stacker | 910170 | EA | \$7,363.00 |
| CC524A#201 | Government HP LaserJet Enterprise 700 Color MFP M775z: TAA-Compliant Version | 919934 | EA | \$7,363.00 |
| CF304A#BGJ | HP LaserJet Enterprise 700 Color MFP M775z+: Base Model + Fax Capabilities, Total 3,750-Sheet Input Capacity, Stapler/Stacker | 910171 | EA | \$7,710.00 |
| CE792A | HP 500-Sheet Feeder and Stand | 916555 | EA | \$740.00 |
| U6W62E | HP Electronic Care Pack (Next Business Day) (Hardware Support + DMR) (3 Year) | 916640 | EA | \$1,699.00 |
| U6W63E | HP Electronic Care Pack (Next Business Day) (Hardware Support + DMR) (4 Year) | 919981 | EA | \$2,489.00 |
| HP LaserJet Enterprise CP4025 Color Laser Printers | | | | |
| CC489A#BGJ | HP LaserJet Enterprise CP4025n Color Laser Printer (35 ppm) (800 MHz) (512 MB) (8.5" x 14") (1200 x 1200 dpi) (Max Duty Cycle 100,000 Pages) (USB) (Ethernet) (600 Sheet Input Capacity) | 24159 | EA | \$1,300.00 |
| CC490A#BGJ | HP LaserJet Enterprise CP4025dn: Base Model + Duplex Printing, Energy Star Certified | 99535 | EA | \$1,690.00 |
| CC425A | HP 500-Sheet Feeder | 90842 | EA | \$392.00 |
| CC422A | HP 500-Sheet Feeder and Cabinet | 20769 | EA | \$786.00 |
| UG825E | HP Electronic Care Pack (Next Business Day) (Hardware Support) (3 Year) | 7317 | EA | \$399.00 |
| UG826E | HP Electronic Care Pack (Next Business Day) (Hardware Support) (4 Year) | 7318 | EA | \$579.00 |
| HP LaserJet Enterprise flow M880z Color Laser MFPs | | | | |
| A2W75A#BGJ | HP Color LaserJet Enterprise flow M880z Color Laser MFP (45 ppm) (800 MHz) (1.5 GB) (12" x 18") (1200 x 1200 dpi) (Max Duty Cycle 200,000 Pages) (p/s/c/f) (Duplex) (USB) (Ethernet) (Touchscreen) (Energy Star) (2,100 Sheet Input Capacity) (200 Sheet ADF) | 916379 | EA | \$10,436.34 |
| D7P71A#BGJ | HP Color LaserJet Enterprise flow M880z+: Base Model + Wireless Connectivity | 916373 | EA | \$10,784.26 |
| A2W84A | HP Booklet Maker Finisher with 2-3 Hole Punch | 919306 | EA | \$5,375.85 |
| U8D23E | HP Electronic Care Pack (Next Business Day) (Hardware Support + DMR) (3 Year) | 919982 | EA | \$2,799.00 |
| U8D25E | HP Electronic Care Pack (Next Business Day) (Hardware Support + DMR) (5 Year) | 922324 | EA | \$5,259.00 |
| HP LaserJet Enterprise M630/Flow M630 Mono Laser MFPs | | | | |
| J7X28A#BGJ | HP LaserJet Enterprise MFP M630h Mono Laser MFP (60 ppm) (800 MHz) (1.5 GB) (8.5" x 14") (1200 x 1200 dpi) (Max Duty Cycle 250,000 Pages) (p/s/c) (Duplex) (USB) (Ethernet) (Touchscreen) (Energy Star) (500 Sheet Input Tray) (100 Sheet Multipurpose Tray) (100 Sheet ADF) (320 GB Hard Disk) | 930488 | EA | \$3,288.83 |
| B3G85A#BGJ | HP LaserJet Enterprise MFP M630f: Base Model + Fax Function, Extra 500-Sheet Input Tray | 930489 | EA | \$4,111.33 |
| B3G86A#BGJ | HP LaserJet Enterprise Flow MFP M630z: Base Model + Fax, Function, Total 3,100-Sheet Input Capacity | 930490 | EA | \$5,873.83 |
| B3G86A#201 | Government HP LaserJet Enterprise Flow MFP M630z: TAA-Compliant Version | 930491 | EA | \$5,873.83 |
| U1ZU5E | HP Electronic Care Pack (Next Business Day) (Onsite Service + DMR) (3 Year) | 933392 | EA | \$849.00 |
| U1ZU6E | HP Electronic Care Pack (Next Business Day) (Onsite Service + DMR) (4 Year) | 933393 | EA | \$1,239.00 |

| MFG# | Product Description | Part# | UOM | Retail |
|---|---|--------|-----|------------|
| HP EQUIPMENT | | | | |
| HP LaserJet Enterprise M651 Color Laser Printers | | | | |
| CZ255A#BGJ | HP Color LaserJet Enterprise M651n Color Laser Printer (45 ppm) (800 MHz) (1.5 GB) (8.5" x 14") (1200 x 1200 dpi) (Max Duty Cycle 120,000 Pages) (USB) (Ethernet) (Touchscreen) (Energy Star) (500 Sheet Input Tray) (100 Sheet Multipurpose Tray) | 922319 | EA | \$1,708.73 |
| CZ256A#BGJ | HP LaserJet Enterprise M651dn: Base Model + Duplex Printing | 922320 | EA | \$2,025.40 |
| CZ257A#BGJ | HP LaserJet Enterprise M651xh: Base Model + Duplex Printing, 3,000-Sheet Input Capacity | 922321 | EA | \$3,798.73 |
| CZ257A#201 | Government HP LaserJet Enterprise M651xh: TAA-Compliant Version | 922322 | EA | \$3,798.73 |
| CZ261A | HP 500-Sheet Paper Tray | 923140 | EA | \$392.00 |
| CZ263A | HP 2 x 500-Sheet Paper Feeder, 1,500-Sheet High Capacity Paper Feeder and Stand | 926204 | EA | \$1,729.32 |
| U1UJ8E | HP Electronic Care Pack (Next Business Day) (Onsite Service + DMR) (3 Year) | 923212 | EA | \$449.00 |
| HP LaserJet Enterprise M680 Color Laser MFPs | | | | |
| CZ248A#BGJ | HP Color LaserJet Enterprise M680dn Color Laser MFP (45 ppm) (800 MHz) (2 GB) (8.5" x 14") (1200 x 1200 dpi) (Max Duty Cycle 120,000 Pages) (p/s/c) (Duplex) (USB) (Ethernet) (Touchscreen) (Energy Star) (500 Sheet Input Tray) (100 Sheet Multipurpose Tray) (100 Sheet DADF) | 922313 | EA | \$4,231.83 |
| CZ249A#BGJ | HP LaserJet Enterprise M680f: Base Model + Fax Function, 1,000-Sheet Input Capacity | 922314 | EA | \$5,043.63 |
| CZ250A#BGJ | HP LaserJet Enterprise Flow M680z: Base Model + Fax Function, 3,000-Sheet Input Capacity | 922315 | EA | \$6,841.20 |
| CZ250A#201 | Government HP LaserJet Enterprise Flow M680z: TAA-Compliant Version | 922316 | EA | \$6,841.20 |
| CZ261A | HP 500-Sheet Paper Tray | 923140 | EA | \$392.00 |
| CZ263A | HP 2 x 500-Sheet Paper Feeder, 1,500-Sheet High Capacity Paper Feeder and Stand | 926204 | EA | \$1,729.32 |
| U1PF8E | HP Electronic Care Pack (Next Business Day) (Hardware Support + DMR) (3 Year) | 925916 | EA | \$1,299.00 |
| U1PF9E | HP Electronic Care Pack (Next Business Day) (Hardware Support + DMR) (4 Year) | 926205 | EA | \$1,899.00 |
| HP LaserJet Enterprise M750 Color Laser Printers | | | | |
| D3L08A#BGJ | HP LaserJet Enterprise M750n Color Laser Printer (30 ppm) (800 MHz) (1 GB) (11" x 17") (600 x 600 dpi) (Max Duty Cycle 120,000 Pages) (USB) (Ethernet) (750 Sheet Input Trays) (100 Sheet Multipurpose Tray) | 917894 | EA | \$3,165.40 |
| D3L09A#BGJ | HP LaserJet Enterprise M750dn: Base Model + Duplex Printing, Energy Star Certification | 917895 | EA | \$3,418.73 |
| D3L10A#BGJ | HP LaserJet Enterprise M750xh: Base Model + Duplex Printing, Total 2,250-Sheet Input Capacity, Encrypted Hard Drive, Energy Star Certification | 917896 | EA | \$5,572.07 |
| D3L10A#201 | Government HP LaserJet Enterprise M750xh: TAA-Compliant Version | 919373 | EA | \$5,572.07 |
| CE860A | HP 500-Sheet Paper Tray | 105343 | EA | \$523.20 |
| CE792A | HP 500-Sheet Feeder and Stand | 916555 | EA | \$740.00 |
| CE725A | HP 3 x 500-Sheet Paper Feeder and Stand | 800261 | EA | \$1,548.00 |
| UX964E | HP Electronic Care Pack (Next Business Day) (Hardware Support) (3 Year) | 102971 | EA | \$899.00 |
| UV280E | HP Electronic Care Pack (Next Business Day) (Hardware Support) (4 Year) | 102673 | EA | \$1,319.00 |
| HP LaserJet Enterprise M855 Color Laser Printers | | | | |
| A2W77A#BGJ | HP LaserJet Enterprise M855dn Color Laser Printer (45 ppm) (800 MHz) (1 GB) (11" x 17") (1200 x 1200 dpi) (Max Duty Cycle 175,000 Pages) (Duplex) (USB) (Ethernet) (Touchscreen) (Energy Star) (500 Sheet Input Tray) (100 Sheet Multipurpose Tray) | 917892 | EA | \$4,685.40 |
| A2W78A#BGJ | HP LaserJet Enterprise M855xh: Base Model + Total 2,000-Sheet Input Capacity, Encrypted Hard Drive | 917893 | EA | \$6,838.73 |
| A2W78A#201 | Government HP LaserJet Enterprise M855xh: TAA-Compliant Version | 921408 | EA | \$6,838.73 |
| D7P73A#BGJ | HP LaserJet Enterprise M855x+: Base Model + Total 4,000-Sheet Input Capacity | 917897 | EA | \$7,218.73 |
| A2W84A | HP Booklet Maker Finisher with 2-3 Hole Punch | 919306 | EA | \$5,375.85 |
| U0LX2E | HP Electronic Care Pack (Next Business Day) (Hardware Support + DMR) (3 Year) | 919986 | EA | \$1,099.00 |
| HP LaserJet Pro M177fw Color Laser MFP | | | | |
| CZ165A#BGJ | HP Color LaserJet Pro M177fw Color Laser MFP (17 ppm Mono/4 ppm Color) (600 MHz) (128 MB) (8.5" x 14") (2400 x 1200 dpi) (Max Duty Cycle 20,000 Pages) (p/s/c/f) (USB) (Ethernet) (Wireless) (Touchscreen) (Energy Star) (150 Sheet Input Tray) (35 Sheet ADF) | 916743 | EA | \$455.64 |
| U6M45E | HP Electronic Care Pack (Business Priority Support) (Onsite Exchange) (3 Year) | 915001 | EA | \$115.00 |
| U6M46E | HP Electronic Care Pack (Business Priority Support) (Onsite Exchange) (4 Year) | 915002 | EA | \$150.00 |
| HP LaserJet Pro 200 Series Color Laser Printers & MFPs | | | | |
| CF147A#BGJ | HP LaserJet Pro 200 M251nw Color Laser Printer (14 ppm) (750 MHz) (128 MB) (8.5" x 14") (600 x 600 dpi) (Max Duty Cycle 30,000 Pages) (USB) (Ethernet) (Wireless) (Touchscreen) (Energy Star) (150 Sheet Input Capacity) | 909032 | EA | \$382.06 |
| CF145A#BGJ | HP LaserJet Pro 200 M276nw MFP: M251 + Scan/Copy/Fax Functions, 256MB Total Memory, 35-Sheet ADF | 909031 | EA | \$548.17 |
| U6M45E | HP Electronic Care Pack (Business Priority Support) (Onsite Exchange) (3 Year) | 915001 | EA | \$115.00 |
| U6M46E | HP Electronic Care Pack (Business Priority Support) (Onsite Exchange) (4 Year) | 915002 | EA | \$150.00 |

| MFG# | Product Description | Part# | UOM | Retail |
|---|---|--------|-----|------------|
| HP EQUIPMENT | | | | |
| HP LaserJet Pro 400 Series Color Laser Printers & MFPs | | | | |
| CE956A#BGJ | HP LaserJet Pro 400 M451nw Color Laser Printer (21 ppm) (128MB) (60 MHz) (600 x 600 dpi) (Max Duty Cycle 40,000 Pages) (USB) (Ethernet) (Wireless) (250 Sheet Input Capacity) (50 Sheet Multipurpose Tray) | 906018 | EA | \$509.83 |
| CE957A#BGJ | HP LaserJet Pro 400 M451dn: Base Model + Duplex Printing (Wireless Connectivity Not Standard) | 905520 | EA | \$573.72 |
| CE957A#201 | Government HP LaserJet Pro 400 M451dn: TAA-Compliant Version | 919953 | EA | \$573.72 |
| CE958A#BGJ | HP LaserJet Pro 400 M451dw: Base Model + Duplex Printing, Wireless Connectivity | 906197 | EA | \$637.61 |
| CF385A#BGJ | HP LaserJet Pro MFP M476nw: Same as M451nw + 900 MHz, 256 MB, Scan/Copy/Fax Functions, Touchscreen, Energy Star Certified, 50-Sheet DADF | 922325 | EA | \$675.94 |
| CF386A#BGJ | HP LaserJet Pro MFP M476dn: Base Model + Duplex Printing (Wireless Connectivity Not Standard) | 922326 | EA | \$803.72 |
| CF387A#BGJ | HP LaserJet Pro MFP M476dw: Base Model + Duplex Printing, Wireless Connectivity | 922327 | EA | \$867.61 |
| CF106A | HP 250-Sheet Paper Tray | 906341 | EA | \$142.15 |
| U1H88E | HP LaserJet Pro 400 Color M451 Series Electronic Care Pack (Next Business Day) (Exchange) (3 Year) | 909521 | EA | \$89.00 |
| HP LaserJet Pro 500 Series Color Laser MFP | | | | |
| CZ271A#BGJ | HP LaserJet Pro 500 M570dn Color Laser MFP (31 ppm) (256 MB) (8.5" x 14") (600 x 600 dpi) (Max Duty Cycle 75,000 Pages) (p/s/c/f) (Duplex) (USB) (Ethernet) (Energy Star) (Touchscreen) (350 Sheet Input Capacity) (50 Sheet ADF) | 910496 | EA | \$1,276.50 |
| CF084A | HP 500-Sheet Paper and Heavy Media Tray | 906753 | EA | \$433.95 |
| CF085A | HP Printer Cabinet | 913080 | EA | \$457.97 |
| U6Y78E | HP Electronic Care Pack (Next Business Day) (Hardware Support) (3 Year) | 914529 | EA | \$349.00 |
| HP Designjet T120 Wide Format Inkjet Printer | | | | |
| CQ891A#B1K | HP Designjet T120 24-in ePrinter Wide Format Color Inkjet Printer (241 sq ft/hr) (256 MB) (1200 x 1200 dpi) (USB) (Ethernet) (Wireless) (Touchscreen) (Energy Star) (Dye and Pigment) | 911718 | EA | \$1,201.00 |
| B3Q35A | HP 24-in Printer Stand | 919987 | EA | \$286.00 |
| U1V95E | HP Electronic Care Pack (Next Business Day) (Hardware Support) (3 Year) | 919988 | EA | \$309.00 |
| HP Designjet T520 Wide Format Inkjet Printers | | | | |
| CQ890A#B1K | HP Designjet T520 24-in ePrinter Wide Format Color Inkjet Printer (241 sq ft/hr) (1 GB) (2400 x 1200 dpi) (USB) (Ethernet) (Wireless) (Touchscreen) (Energy Star) (Dye and Pigment) (Floor Standing) | 911717 | EA | \$2,105.00 |
| CQ890A#BCB | Government HP Designjet T520 24-in: TAA-Compliant Version | 919454 | EA | \$2,105.00 |
| CQ893A#B1K | HP Designjet T520 36-in: Accepts Media up to 36-in Wide, Prints up to 275 sq ft/hr | 911719 | EA | \$3,427.00 |
| CQ893A#BCB | Government HP Designjet T520 36-in: TAA-Compliant Version | 915089 | EA | \$3,427.00 |
| U1W23E | HP Designjet T520 24-in ePrinter Electronic Care Pack (Next Business Day) (Hardware Support) (3 Year) | 913214 | EA | \$179.00 |
| U1W24E | HP Designjet T520 24-in ePrinter Electronic Care Pack (Next Business Day) (Hardware Support) (4 Year) | 927150 | EA | \$669.00 |
| U6T82E | HP Designjet T520 36-in ePrinter Electronic Care Pack (Next Business Day) (Hardware Support) (2 Year) | 927152 | EA | \$109.00 |
| U6T83E | HP Designjet T520 36-in ePrinter Electronic Care Pack (Next Business Day) (Hardware Support) (3 Year) | 927153 | EA | \$209.00 |
| HP Designjet T790 Wide Format Inkjet Printer | | | | |
| CR648A#B1K | HP Designjet T790PS 24-in ePrinter Wide Format Color Inkjet Printer (445 sq ft/hr Color) (8 GB) (2400 x 1200 dpi) (USB) (Ethernet) (Touchscreen) (Energy Star) (Floor Standing) (Dye and Pigment) | 906766 | EA | \$3,600.00 |
| CR648B#BCB | Government HP Designjet T790PS 24-in: TAA-Compliant Version, Encrypted Hard Disk | 915090 | EA | \$3,900.00 |
| HP601E | HP Electronic Care Pack (Next Business Day) (Hardware Support) (4 Year) | 920070 | EA | \$949.00 |
| HP Designjet T795 Wide Format Inkjet Printer | | | | |
| CR649C#B1K | HP Designjet T795 44-in ePrinter Wide Format Color Inkjet Printer (445 sq ft/hr) (16 GB) (2400 x 1200 dpi) (USB) (Ethernet) (Touchscreen) (Energy Star) (Floor Standing) (Dye and Pigment) | 926264 | EA | \$5,190.00 |
| HQ007E | HP Electronic Care Pack (Next Business Day) (Hardware Support) (2 Year) | 926265 | EA | \$449.00 |
| HP Designjet T920 Wide Format Inkjet Printers | | | | |
| CR354A#B1K | HP Designjet T920 36-in ePrinter Wide Format Color Inkjet Printer (120 D prints/hr) (32 GB) (2400 x 1200 dpi) (USB) (Ethernet) (Touchscreen) (Energy Star) | 913613 | EA | \$5,395.00 |
| CR355A#B1K | HP Designjet T920PS 36-in: Includes PostScript Emulation | 913614 | EA | \$6,145.00 |
| CR355B#BCB | Government HP Designjet T920PS 36-in: TAA-Compliant Version, Encrypted Hard Disk | 914476 | EA | \$6,695.00 |
| U7Y85E | HP Electronic Care Pack (Next Business Day) (Onsite Service + DMR) (3 Year) | 919370 | EA | \$949.00 |
| U7Y87E | HP Electronic Care Pack (Next Business Day) (Onsite Service + DMR) (5 Year) | 919371 | EA | \$1,799.00 |

| MFG# | Product Description | Part# | UOM | Retail |
|---|---|--------|-----|-------------|
| HP EQUIPMENT | | | | |
| HP Designjet T1200 Wide Format Inkjet MFP | | | | |
| CQ653C#B1K | HP Designjet T1200 HD 44-in Wide Format Color Inkjet MFP (445 sq ft/hr) (32 GB) (2400 x 1200 dpi) (p/s/c) (USB) (Ethernet) (Touchscreen) (Windows 7 Panel PC) (Dye and Pigment) | 914531 | EA | \$22,675.00 |
| UX956E | HP Electronic Care Pack (Next Business Day) (Hardware Support) (2 Year) | 920071 | EA | \$2,298.00 |
| UT911E | HP Electronic Care Pack (Next Business Day) (Hardware Support) (3 Year) | 102361 | EA | \$4,399.00 |
| HP Designjet T1300 Wide Format Inkjet Printer | | | | |
| CR652A#B1K | HP Designjet T1300PS 44-in ePrinter Wide Format Color Inkjet Printer (445 sq ft/hr) (32 GB) (2400 x 1200 dpi) (USB) (Ethernet) (Energy Star) (Touchscreen) (Dye and Pigment) (Floor Standing) | 911722 | EA | \$8,690.00 |
| CR652B#BCB | Government HP Designjet T1300PS 44-in: TAA-Compliant Version, Encrypted Hard Disk | 915092 | EA | \$9,250.00 |
| HP586E | HP Electronic Care Pack (Next Business Day) (Hardware Support) (2 Year) | 920072 | EA | \$679.00 |
| HP587E | HP Electronic Care Pack (Next Business Day) (Hardware Support + DMR) (3 Year) | 927498 | EA | \$1,299.00 |
| HP Designjet T1500 Wide Format Inkjet Printers | | | | |
| CR356A#B1K | HP Designjet T1500 36-in ePrinter Large Format Color Inkjet Printer (64 GB) (36" x 48") (2400 x 1200 dpi) (USB) (Ethernet) (Touchscreen) (Energy Star) | 913626 | EA | \$7,495.00 |
| CR357A#B1K | HP Designjet T1500PS 36-in: Includes PostScript Emulation | 914474 | EA | \$8,395.00 |
| U7Z11E | HP Electronic Care Pack (Next Business Day) (Hardware Support + DMR) (3 Year) | 920081 | EA | \$1,179.00 |
| U7Z13E | HP Electronic Care Pack (Next Business Day) (Hardware Support + DMR) (5 Year) | 920082 | EA | \$2,209.00 |
| HP Designjet T2500 Wide Format Inkjet MFPs | | | | |
| CR358A#B1K | HP Designjet T2500 36-in Wide Format Color Inkjet MFP (120 D prints/hr) (128 GB) (2400 x 1200 dpi) (p/s/c) (Ethernet) (Touchscreen) (Energy Star) (Dye and Pigment) | 916377 | EA | \$9,895.00 |
| CR359A#B1K | HP Designjet T2500PS 36-in: Includes PostScript Emulation | 916378 | EA | \$10,995.00 |
| CR359B#BCB | Government HP Designjet T2500PS 36-in: TAA-Compliant Version, Encrypted Hard Disk | 916744 | EA | \$11,995.00 |
| U0ME7E | HP Electronic Care Pack (Next Business Day) (Hardware Support + DMR) (3 Year) | 920083 | EA | \$2,199.00 |
| UX913E | HP Electronic Care Pack (Next Business Day) (Hardware Support + DMR) (5 Year) | 102890 | EA | \$4,249.00 |
| HP Designjet T3500 Wide Format Inkjet MFPs | | | | |
| B9E24A#B1K | HP Designjet T3500 36-in Production Wide Format Color Inkjet eMFP (21 sec/page) (120 D prints/hr) (128 GB) (2400 x 1200 dpi) (p/s/c) (USB) (Ethernet) (Touchscreen) (Energy Star) (2 Auto-Front-Loading Roll Feeds) | 927416 | EA | \$14,750.00 |
| B9E24B#B1K | HP Designjet T3500 36-in: Base Model + 3 Year Warranty | 927417 | EA | \$19,190.00 |
| B9E24B#BCB | Government HP Designjet T3500 36-in: TAA Compliant Version | 930077 | EA | \$19,190.00 |
| U1ZY0E | HP Electronic Care Pack (Next Business Day) (Hardware Support + DMR) (5 Year) | 927418 | EA | \$1,939.00 |
| U1ZY1PE | HP Electronic Care Pack Post Warranty Service (Next Business Day) (Hardware Support + DMR) (1 Year) | 927419 | EA | \$1,119.00 |
| HP Designjet T7200 Wide Format Inkjet Printer | | | | |
| F2L46A#B1K | HP Designjet T7200 42-in Wide Format Color Inkjet Printer (1265 sq ft/hr) (64 GB) (2400 x 1200 dpi) (USB) (Ethernet) (Energy Star) | 927420 | EA | \$12,644.00 |
| F2L46B#BCB | Government HP Designjet T7200 42-in: TAA Compliant Version, Encrypted Hard Disk | 930078 | EA | \$13,175.00 |
| U1ZY3E | HP Electronic Care Pack (Next Business Day) (Hardware Support + DMR) (3 Year) | 927421 | EA | \$2,649.00 |
| HP Designjet Z2100 Wide Format Inkjet Printer | | | | |
| Q6675D#B1K | HP Designjet Z2100 24-in Wide Format Color Inkjet Printer (150 sq ft/hr) (128 MB) (2400 x 1200 dpi) (USB) (Ethernet) (Energy Star) (Pigment) (Floor Standing) | 911723 | EA | \$3,575.00 |
| UF017E | HP Electronic Care Pack (Next Business Day) (Hardware Support) (3 Year) | 105654 | EA | \$1,099.00 |
| HP Designjet Z3200 Wide Format Inkjet Printers | | | | |
| Q6721B#B1K | HP Designjet Z3200PS 44-in Wide Format Color Inkjet Printer (182.93 sq ft/hr) (256 MB) (2400 x 1200 dpi) (USB) (Ethernet) (Energy Star) (Floor Standing) | 911725 | EA | \$5,789.00 |
| Q6721B#BCB | Government HP Designjet Z3200PS 44-in: TAA-Compliant Version | 915094 | EA | \$5,789.00 |
| UK890E | HP Electronic Care Pack (Next Business Day) (Hardware Support) (2 Year) | 920084 | EA | \$699.00 |
| UF035E | HP Electronic Care Pack (Next Business Day) (Hardware Support) (3 Year) | 7297 | EA | \$1,399.00 |
| HP Designjet Z5200 Wide Format Inkjet Printer | | | | |
| CQ113A#B1K | HP Designjet Z5200PS 44-in Wide Format Color Inkjet Printer (445 sq ft/hr) (32 GB) (2400 x 1200 dpi) (USB) (Ethernet) (Energy Star) (Pigment) (Floor Standing) | 911714 | EA | \$5,950.00 |
| CQ113A#BCB | Government HP Designjet Z5200PS 44-in: TAA-Compliant Version | 90383 | EA | \$5,950.00 |
| UX958E | HP Electronic Care Pack (Next Business Day) (Hardware Support) (2 Year) | 920086 | EA | \$739.00 |
| UV213E | HP Electronic Care Pack (Next Business Day) (Hardware Support + DMR) (3 Year) | 102531 | EA | \$1,399.00 |
| HP Designjet Z5400 Wide Format Inkjet Printer | | | | |
| E1L21A#B1K | HP Designjet Z5400PS 44-in Wide Format Color Inkjet Printer (570 sq ft/hr) (64 GB) (2400 x 1200 dpi) (USB) (Ethernet) (Energy Star) | 915495 | EA | \$7,095.00 |
| E1L21B#BCB | Government HP Designjet Z5400PS 44-in: TAA-Compliant Version, Encrypted Hard Disk | 915093 | EA | \$7,945.00 |
| U0LZ6E | HP Electronic Care Pack (Next Business Day) (Hardware Support + DMR) (3 Year) | 919379 | EA | \$1,189.00 |
| U0LZ7E | HP Electronic Care Pack (Next Business Day) (Hardware Support + DMR) (5 Year) | 920087 | EA | \$2,259.00 |

| MFG# | Product Description | Part# | UOM | Retail |
|--|--|--------|-----|-------------|
| HP EQUIPMENT | | | | |
| HP Designjet Z6200 Wide Format Inkjet Printer | | | | |
| CQ109A#B1K | HP Designjet Z6200 42-in Vivid Photo Inkjet Printer (1162 sq ft/hr Color) (32 GB) (2400 x 1200 dpi) (USB) (Ethernet) (Energy Star) (Floor Standing) | 908473 | EA | \$10,619.00 |
| CQ109B#BCB | Government HP Designjet Z6200 42-in: TAA-Compliant Version, SED Drive | 915087 | EA | \$11,150.00 |
| HP Designjet Z6600 Wide Format Inkjet Printer | | | | |
| F2S71A#B1K | HP Designjet Z6600 60" Wide Format Color Inkjet Printer (1,500 sq ft/hr) (64 GB) (2400 x 1200 dpi) (Ethernet) (Energy Star) (Pigment) (6 Printheads) (Floor Standing) | 925939 | EA | \$10,995.00 |
| U1ZM8E | HP Electronic Care Pack (Next Business Day) (Hardware Support + DMR) (3 Years) | 933664 | EA | \$2,399.00 |
| U1ZM9E | HP Electronic Care Pack (Next Business Day) (Hardware Support + DMR) (5 Years) | 933667 | EA | \$3,999.00 |
| HP Designjet Z6800 Wide Format Inkjet Printer | | | | |
| F2S72A#B1K | HP Designjet Z6800 60" Wide Format Color Inkjet Photo Production Printer (1,500 sq ft/hr) (64 GB) (2400 x 1200 dpi) (Ethernet) (Energy Star) (Pigment) (8 Printheads) (Floor Standing) | 925940 | EA | \$16,495.00 |
| U1ZS8E | HP Electronic Care Pack (Next Business Day) (Hardware Support + DMR) (2 Years) | 933666 | EA | \$1,519.00 |
| U1ZS9E | HP Electronic Care Pack (Next Business Day) (Hardware Support + DMR) (3 Years) | 933665 | EA | \$2,899.00 |
| HP Designjet HD Wide Format Scanner | | | | |
| CQ654C#B1K | HP Designjet HD 42-in Wide Format Scanner (10 in/sec Mono/3in/sec Color) (2.8 GHz) (1 GB) (600 x 600 dpi) (USB) (Ethernet) (Touchscreen Windows 7 Panel PC) (Floor Standing) | 916015 | EA | \$20,425.00 |
| G6H51A#B1K | HP Designjet HD Pro 42-in Wide Format Sheetfed Scanner | 929594 | EA | \$19,495.00 |
| UT932E | HP Electronic Care Pack (Next Business Day) (Hardware Support) (3 Year) | 102395 | EA | \$2,999.00 |
| UT934E | HP Electronic Care Pack (Next Business Day) (Hardware Support) (5 Year) | 102398 | EA | \$5,639.00 |
| HP Officejet Enterprise X555/X585 Series Inkjet Printers & MFPs | | | | |
| C2S11A#BGJ | HP Officejet Enterprise Color X555dn Inkjet Printer (72 ppm) (796 MHz) (1.3 GB) (8.5" x 14") (2400 x 1200 dpi) (Max Duty Cycle 75,000 Pages) (Duplex) (USB) (Ethernet) (Touchscreen) (Energy Star) (500 Sheet Input Tray) (50 Sheet Multipurpose Tray) | 922431 | EA | \$948.73 |
| C2S12A#BGJ | HP Officejet Enterprise Color X555xh: Base Model + Extra 500-Sheet Input Tray | 922432 | EA | \$1,518.73 |
| B5L04A#BGJ | HP Officejet Enterprise Color X585dn MFP: Base Model + Scan/Copy Functions, 1.8 GB Total Memory, 50 Sheet ADF | 922428 | EA | \$2,318.28 |
| B5L05A#BGJ | HP Officejet Enterprise Color X585f: Same as X585dn + Fax Function | 922429 | EA | \$2,666.20 |
| B5L06A#BGJ | HP Officejet Enterprise Color X585z: Same as X585dn + Fax Function, 100-Sheet ADF | 922430 | EA | \$3,246.06 |
| B5L07A | HP 500-Sheet Paper Tray | 923072 | EA | \$369.60 |
| B5L08A | HP Printer Cabinet and Stand | 923073 | EA | \$369.60 |
| U1UM8E | HP Officejet Enterprise Color X555 Series Electronic Care Pack (Next Business Day) (Hardware Support + DMR) (3 Year) | 925929 | EA | \$199.00 |
| U1UM9E | HP Officejet Enterprise Color X555 Series Electronic Care Pack (Next Business Day) (Hardware Support + DMR) (4 Year) | 925930 | EA | \$289.00 |
| U1PC8E | HP Officejet Enterprise Color X585 Series Electronic Care Pack (Next Business Day) (Hardware Support + DMR) (3 Year) | 925917 | EA | \$629.00 |
| U1PC9E | HP Officejet Enterprise Color X585 Series Electronic Care Pack (Next Business Day) (Hardware Support + DMR) (4 Year) | 925918 | EA | \$919.00 |
| HP Officejet Pro X451/X476 Series Inkjet Printers & MFPs | | | | |
| CN459A#B1H | HP Officejet Pro X451dn Color Inkjet Printer (55 ppm) (792 MHz) (512 MB) (8.5" x 14") (2400 x 1200 dpi) (Max Duty Cycle 50,000 Pages) (Duplex) (USB) (Ethernet) (Energy Star) (550 Sheet Input Capacity) | 911282 | EA | \$574.99 |
| CN463A#B1H | HP Officejet Pro X451dw: Base Model + Wireless Connectivity | 914206 | EA | \$638.88 |
| CN460A#B1H | HP Officejet Pro X476dn MFP: Same as X451dn + Scan/Copy/Fax Functions, 768MB Total Memory, Touchscreen, 50-Sheet ADF | 911283 | EA | \$830.54 |
| CN461A#B1H | HP Officejet Pro X476dw MFP: Same as X451dw + Scan/Copy/Fax Functions, 768MB Total Memory, Touchscreen, 50-Sheet ADF | 912451 | EA | \$894.43 |
| CN595A | HP 500-Sheet Paper Tray | 912452 | EA | \$305.00 |
| U6Z51E | HP Officejet Pro X451 Electronic Care Pack (Next Business Day Exchange) (3 Year) | 912193 | EA | \$119.00 |
| U6Z43E | HP Officejet Pro X476 Electronic Care Pack (Next Business Day Exchange) (3 Year) | 911696 | EA | \$169.00 |
| HP Officejet Pro X551/X576 Series Inkjet Printers & MFPs | | | | |
| CV037A#B1H | HP Officejet Pro X551dw Color Inkjet Printer (70 ppm) (792 MHz) (512 MB) (8.5" x 14") (2400 x 1200 dpi) (Max Duty Cycle 75,000 Pages) (Duplex) (USB) (Ethernet) (Wireless) (Touchscreen) (Energy Star) (550 Sheet Input Capacity) | 911285 | EA | \$766.65 |
| CN598A#B1H | HP Officejet Pro X576dw MFP: Same as X551 + Scan/Copy/Fax Functions, 768MB Total Memory, 50-Sheet ADF | 911284 | EA | \$1,022.21 |
| CN595A | HP 500-Sheet Paper Tray | 912452 | EA | \$305.00 |
| U6Z51E | HP Officejet Pro X551dw Electronic Care Pack (Next Business Day Exchange) (3 Year) | 912193 | EA | \$119.00 |
| U6Z43E | HP Officejet Pro X576dw Electronic Care Pack (Next Business Day Exchange) (3 Year) | 911696 | EA | \$169.00 |

| MFG# | Product Description | Part# | UOM | Retail |
|---|--|--------|-----|----------|
| HP EQUIPMENT | | | | |
| HP Inkjet Printers & MFPs (Continued on next page) | | | | |
| CZ022A#B1H | HP ENVY 120 e-All-in-One Color Inkjet Printer (28 ppm Print) (28 cpm Black/23 cpm Color Copy) (512 MB) (8.5" x 11") (4800 x 1200 dpi) (p/s/c) (Duplex) (USB) (Wireless) (Energy Star) (Touchscreen) (80 Sheet Input Capacity) | 910270 | EA | \$307.00 |
| A9T80A#B1H | HP ENVY 4500 e-All-in-One Color Inkjet MFP (21 ppm Mono/17 ppm Color) (360 MHz) (32 MB) (8.5" x 14") (4800 x 120 dpi) (Max Duty Cycle 1,000 Pages) (p/s/c) (Duplex) (USB) (Ethernet) (Wireless) (Energy Star) (100 Sheet Input Capacity) | 913599 | EA | \$123.00 |
| A9J40A#B1H | HP ENVY 5530 e-All-in-One Color Inkjet MFP (21 ppm Mono/17 ppm Color) (500 MHz) (128 MB) (8.5" x 14") (4800 x 1200 dpi) (Max Duty Cycle 1,000 Pages) (p/s/c) (Duplex) (USB) (Wireless) (Touchscreen) (Energy Star) (100 Sheet Input Capacity) | 914640 | EA | \$160.00 |
| F8B04A#B1H | HP ENVY 5560 e-All-in-One Color Inkjet MFP (22 ppm Black/21 ppm Color) (525 MHz) (128 MB) (8.5" x 14") (4800 x 1200 dpi) (Max Duty Cycle 1,000 Pages) (p/s/c) (Duplex) (USB) (Wireless) (Touchscreen) (Energy Star) (125 Sheet Input Capacity) (15 Sheet Photo Tray) | 930306 | EA | \$185.00 |
| E4W43A#B1H | HP ENVY 7640 e-All-in-One Color Inkjet MFP (22 ppm Black/21 ppm Color) (525 MHz) (128 MB) (8.5" x 14") (1200 x 1200 dpi) (Max Duty Cycle 1,000 Pages) (p/s/c/f) (Duplex) (USB) (Ethernet) (Wireless) (Touchscreen) (Energy Star) (125 Sheet Input Tray) (25 Sheet ADF) | 933391 | EA | \$246.00 |
| CN550A#B1H | HP Officejet 150 Mobile All-in-One L511a Color Inkjet MFP (22 ppm Mono/18 ppm Color) (220 MHz) (8.5" x 14") (600 x 600 dpi) (Max Duty Cycle 500 Pages) (p/s/c) (USB) (Bluetooth) (PictBridge) (Touchscreen) (Energy Star) (50 Sheet Input Capacity) | 913057 | EA | \$488.00 |
| B4L03A#B1H | HP Officejet 4630 e-All-in-One Color Inkjet MFP (21 ppm Mono/17 ppm Color) (360 MHz) (64 MB) (8.5" x 14") (1200 x 600 dpi) (Max Duty Cycle 1,000 Pages) (p/s/c/f) (Duplex) (USB) (Ethernet) (Wireless) (Energy Star) (100 Sheet Input Capacity) (35 Sheet ADF) | 915500 | EA | \$123.00 |
| B9S76A#B1H | HP Officejet 5740 Inkjet MFP (22 ppm Black/21 ppm Color) (525 MHz) (128 MB) (8.5" x 14") (4800 x 1200 dpi) (Max Duty Cycle 1,000 Pages) (p/s/c/f) (Duplex) (USB) (Ethernet) (Wireless) (Touchscreen) (Energy Star) (125 Sheet Input Capacity) (15 Sheet Photo Tray) (25 Sheet ADF) | 930308 | EA | \$185.00 |
| CN583A#B1H | HP Officejet 6700 Premium e-All-in-One H711n Color Inkjet Printer (34 ppm Black/31 ppm Color) (128 MB) (8.5" x 14") (4800 x 1200 dpi) (Max Duty Cycle 12,000 Pages) (p/s/c/f) (USB) (Ethernet) (Wireless) (Energy Star) (250 Sheet Input Capacity) (35 Sheet ADF) | 909033 | EA | \$209.00 |
| CR768A#B1H | HP Officejet 7110 H812a Wide Format Color Inkjet Printer (33 ppm Black/29 ppm Color) (128 MB) (13" x 44") (4800 x 1200 dpi) (Max Duty Cycle 12,000 Pages) (USB) (Ethernet) (Wireless) (Energy Star) (250 Sheet Input Capacity) | 911238 | EA | \$242.00 |
| CR769A#B1H | HP Officejet 7610 H912a Wide Format Color Inkjet MFP (33 ppm Mono/29 ppm Color) (500 MHz) (256 MB) (13" x 19") (4800 x 1200 dpi) (Max Duty Cycle 12,000 Pages) (p/s/c/f) (Duplex) (USB) (Ethernet) (Wireless) (Energy Star) (250 Sheet Input Capacity) | 914211 | EA | \$307.00 |
| G1X85A#B1H | HP Officejet 7612 Wide Format Color Inkjet MFP (15 ppm Mono/8 ppm Color) (256 MB) (500 MHz) (13" x 19") (4800 x 1200 dpi) (Max Duty Cycle 12,000 Pages) (p/s/c/f) (Duplex) (USB) (Ethernet) (Wireless) (Touchscreen) (Energy Star) (250 Sheet Input Tray) (35 Sheet ADF) | 926841 | EA | \$307.00 |
| F5A16A#ABA | HP Officejet 8040 Color Inkjet MFP (22 ppm Black/21 ppm Color) (128 MB) (525 MHz) (8.5" x 14") (4800 x 1200 dpi) (Max Duty Cycle 1,000 Pages) (p/s/c/f) (Duplex) (USB) (Ethernet) (Wireless) (Touchscreen) (Energy Star) (125 Sheet Input Tray) (15 Sheet Photo Tray) (25 Sheet ADF) | 932818 | EA | \$488.00 |
| CV136A#B1H | HP Officejet Pro 251dw Color Inkjet Printer (25 ppm) (480 MHz) (256 MB) (8.5" x 14") (1200 x 1200 dpi) (Max Duty Cycle 30,000 Pages) (Duplex) (USB) (Ethernet) (Wireless) (Touchscreen) (Energy Star) (250 Sheet Input Capacity) | 912445 | EA | \$283.00 |
| CR770A#B1H | HP Officejet Pro 276dw Color Inkjet MFP (25 ppm) (480 MHz) (512 MB) (8.5" x 14") (1200 x 1200 dpi) (Max Duty Cycle 30,000 Pages) (p/s/c/f) (Duplex) (USB) (Ethernet) (Wireless) (Touchscreen) (Energy Star) (250 Sheet Input Capacity) (50 Sheet ADF) | 912450 | EA | \$488.00 |
| E3E03A#B1H | HP Officejet Pro 6230 Color Inkjet ePrinter (29 ppm Black/24 ppm Color) (500 MHz) (256 MB) (8.5" x 14") (600 x 1200 dpi) (Max Duty Cycle 15,000 Pages) (Duplex) (USB) (Ethernet) (Wireless) (Energy Star) (225 Sheet Input Tray) | 932817 | EA | \$123.00 |
| E3E02A#B1H | HP Officejet Pro 6830 Inkjet MFP (29 ppm Black/24 ppm Color) (500 MHz) (1 GB) (8.5" x 14") (4800 x 1200 dpi) (Max Duty Cycle 15,000 Pages) (p/s/c/f) (Duplex) (USB) (Ethernet) (Wireless) (Touchscreen) (Energy Star) (225 Sheet Input Tray) (35 Sheet ADF) | 930307 | EA | \$222.00 |
| CM752A#B1H | HP Officejet Pro 8100 N811A ePrinter Color Inkjet Printer (20 ppm Black/16 ppm Color) (128 MB) (8.5" x 14") (1200 x 600 dpi) (25,000 Max Duty Cycle) (250 Sheet Input Capacity) (USB) (Ethernet) (Wireless) (Network Ready) (Energy Star) | 906116 | EA | \$183.00 |
| A7F64A#B1H | HP Officejet Pro 8610 Color Inkjet MFP (31 ppm) (600 MHz) (128 MB) (8.5" x 14") (4800 x 1200 dpi) (Max Duty Cycle 30,000 Pages) (p/s/c/f) (Duplex) (USB) (Ethernet) (Wireless) (Touchscreen) (Energy Star) (250 Sheet Input Tray) (35 Sheet ADF) | 922873 | EA | \$246.00 |
| A7F65A#B1H | HP Officejet Pro 8620 Color Inkjet MFP (34 ppm) (600 MHz) (128 MB) (8.5" x 14") (4800 x 1200 dpi) (Max Duty Cycle 30,000 Pages) (p/s/c/f) (Duplex) (USB) (Ethernet) (Wireless) (Touchscreen) (Energy Star) (250 Sheet Input Tray) (50 Sheet ADF) | 922874 | EA | \$367.00 |
| A7F66A#B1H | HP Officejet Pro 8630 Color Inkjet MFP (34 ppm) (600 MHz) (128 MB) (8.5" x 14") (4800 x 1200 dpi) (Max Duty Cycle 30,000 Pages) (p/s/c/f) (Duplex) (USB) (Ethernet) (Wireless) (Touchscreen) (Energy Star) (2 x 250 Sheet Input Trays) (50 Sheet ADF) | 922875 | EA | \$488.00 |

| MFG# | Product Description | Part# | UOM | Retail |
|--|---|--------|-----|------------|
| HP EQUIPMENT | | | | |
| HP Inkjet Printers & MFPs (Continued) | | | | |
| CX017A#B1H | HP Photosmart 6520 e-All-in-One Color Inkjet Printer (22 ppm) (128 MB) (8.5" x 14") (4800 x 1200 dpi) (Max Duty Cycle 500 Pages) (p/s/c) (Duplex) (USB) (Wireless) (Energy Star) (80 Sheet Input Capacity) (Touchscreen) | 909036 | EA | \$185.00 |
| CZ045A#B1H | HP Photosmart 7520 e-All-in-One Color Inkjet Printer (34 ppm Black/33 ppm Color) (128 MB) (8.5" x 14") (9600 x 2400 dpi) (Max Duty Cycle 1,250 Pages) (p/s/c/f/e) (Duplex) (USB) (Wireless) (Energy Star) (125 Sheet Input Capacity) (25 Sheet ADF) (Touchscreen) | 909038 | EA | \$246.00 |
| HP Scanners | | | | |
| L2722A#BGJ | HP Scanjet 1000 Mobile Sheetfed Scanner (8.5" x 14") (600 x 600 dpi) (USB) | 913034 | EA | \$292.85 |
| L2698A#B1H | HP Scanjet G3110 Flatbed Photo Scanner (21 sec) (48 bit Color/8 bit Grayscale) (8.5" x 11") (4800 x 9600 dpi) (USB) (Energy Star) | 919949 | EA | \$133.00 |
| L2703A#BGJ | HP Scanjet N6350 Sheetfed Scanner (48 bit Color/8 bit Grayscale) (8.5" x 11") (2400 x 2400 dpi) (Duplex) (USB) (Ethernet) (Energy Star) (50 Sheet ADF) | 34560 | EA | \$1,003.00 |
| L2738A#BGJ | HP Scanjet Enterprise Flow 5000 s2 Sheetfed Scanner (25 ppm) (50 ipm) (8.5" x 122") (600 x 600 dpi) (USB) (Energy Star) (50 Sheet ADF) | 914993 | EA | \$899.00 |
| L2730B#BGJ | HP Scanjet Enterprise Flow 7000 s2 Sheetfed Color Scanner (45 ppm/90 ipm) (8.5" x 122") (600 x 600 dpi) (Up to 3,000 Pages Per Day) (48 Bit Depth) (Duplex) (USB) (Energy Star) (50 Sheet ADF) | 919303 | EA | \$1,320.00 |
| L2725B#BGJ | HP Scanjet Enterprise flow 7500 Sheetfed/Flatbed Scanner (50 ppm/100 ipm) (8.5" x 34") (600 x 600 dpi) (24-bit) (Duplex) (USB) (Energy Star) (100 Sheet ADF) | 916745 | EA | \$1,670.31 |
| L2683B#BGJ | HP Scanjet Enterprise Flow N9120 Flatbed Scanner (50 ppm/100 ipm) (11" x 34") (600 x 600 dpi) (48 bit) (5,000 Page Daily Duty Cycle) (Duplex) (USB) (Energy Star) (200 Sheet ADF) | 919350 | EA | \$4,457.00 |
| L2737A#BGJ | HP Scanjet Pro 3000 s2 Sheetfed Scanner (20 ppm) (40 ipm) (48-bit) (8.5" x 34") (600 x 600 dpi) (Duplex) (USB) (Energy Star) (50 Sheet ADF) | 913088 | EA | \$520.00 |
| L2737A#201 | Government HP Scanjet Pro 3000 s2 Sheet-Fed Scanner (20 ppm) (40 ipm) (48-bit) (8.5" x 34") (600 x 600 dpi) (Duplex) (USB) (Energy Star) (50 Sheet ADF) | 913089 | EA | \$520.00 |
| L2719A#BGJ | HP Digital Sender flow 8500 Sheetfed/Flatbed Document Capture Workstation (60 ppm/120 ipm) (8.5" x 11") (600 x 600 dpi) (24-bit) (Duplex) (USB) (Ethernet) (Touchscreen) (Energy Star) (100 Sheet ADF) | 916746 | EA | \$3,695.00 |
| LEXMARK EQUIPMENT | | | | |
| Lexmark W850 Mono Laser Printers | | | | |
| 19Z0300 | Lexmark W850n Mono Laser Printer (50 ppm) (800 MHz) (256 MB) (11" x 17") (1200 x 1200 dpi) (Max Duty Cycle 300,000 Pages) (USB) (Ethernet) (2 x 500-Sheet Input Trays) (100 Sheet Multipurpose Tray) | 105991 | EA | \$3,727.14 |
| 19Z0004 | Government Lexmark W850n: TAA-Compliant Version | 921299 | EA | \$3,727.14 |
| 19Z0301 | Lexmark W850dn: Base Model + Duplex Printing | 105992 | EA | \$4,194.29 |
| 19Z0127 | Government Lexmark W850dn: TAA-Compliant Version | 26660 | EA | \$4,194.29 |
| 15r0146 | 2 x 500-Sheet Drawer | 900380 | EA | \$1,027.14 |
| 15r0145 | 2,000-Sheet High Capacity Feeder | 900379 | EA | \$1,427.14 |
| 2351517 | Onsite Repair Extended Warranty (2 Year) | 26451 | EA | \$1,299.00 |
| 2351518 | Onsite Repair Extended Warranty (3 Year) | 26452 | EA | \$1,909.00 |
| Lexmark MS312dn/MS315dn Mono Laser Printers | | | | |
| 35S0060 | Lexmark MS312dn Mono Laser Printer (35 ppm) (800 MHz) (128 MB) (8.5" x 14") (1200 x 1200 dpi) (Max Duty Cycle 50,000 Pages) (Duplex) (USB) (Ethernet) (Energy Star) (250 Sheet Input Tray) (50 Sheet Multipurpose Tray) | 923021 | EA | \$255.71 |
| 35S0160 | Lexmark MS315dn: Same as MS312dn + 37 ppm, 256 MB Memory, Max Duty Cycle 60,000 Pages | 923022 | EA | \$384.29 |
| 35ST160 | Government Lexmark MS315dn: TAA-Compliant Version | 927121 | EA | \$384.29 |
| 35S0267 | 250-Sheet Tray | 909002 | EA | \$165.71 |
| 35S0567 | 550-Sheet Tray | 909003 | EA | \$255.71 |
| 3073173 | Swivel Cabinet | 909058 | EA | \$284.29 |
| 35S8502 | Adjustable Printer Stand | 909071 | EA | \$384.29 |
| 2356648 | Lexmark MS312 Extended Warranty (Next Business Day) (Onsite Repair) (2 Year) | 923036 | EA | \$90.00 |
| 2356649 | Lexmark MS312 Extended Warranty (Next Business Day) (Onsite Repair) (3 Year) | 923037 | EA | \$140.00 |
| 2356701 | Lexmark MS315 Extended Warranty (Next Business Day) (Onsite Repair) (2 Year) | 923049 | EA | \$99.00 |
| 2356702 | Lexmark MS315 Extended Warranty (Next Business Day) (Onsite Repair) (3 Year) | 923050 | EA | \$159.00 |
| Lexmark MS510dn Mono Laser Printer | | | | |
| 35S0300 | Lexmark MS510dn Mono Laser Printer (45 ppm) (800 MHz) (256 MB) (8.5" x 14") (1200 x 1200 dpi) (Max Duty Cycle 80,000 Pages) (Duplex) (USB) (Ethernet) (250 Sheet Input Capacity) (100 Sheet Multipurpose Tray) | 909163 | EA | \$770.00 |
| 35ST300 | Government Lexmark MS510dn: TAA-Compliant Version | 921372 | EA | \$770.00 |
| 35S0267 | 250-Sheet Tray | 909002 | EA | \$165.71 |
| 35S0567 | 550-Sheet Tray | 909003 | EA | \$255.71 |
| 2355741 | Onsite Repair Extended Warranty (2 Year) | 909239 | EA | \$229.00 |
| 2355742 | Onsite Repair Extended Warranty (3 Year) | 909240 | EA | \$329.00 |

| MFG# | Product Description | Part# | UOM | Retail |
|--|---|--------|-----|------------|
| LEXMARK EQUIPMENT | | | | |
| Lexmark MS610 Mono Laser Printers | | | | |
| 35S0400 | Lexmark MS610dn Mono Laser Printer (50 ppm) (800 MHz) (256 MB) (8.5" x 14") (1200 x 1200 dpi) (Max Duty Cycle 100,000 Pages) (Duplex) (USB) (Ethernet) (550 Sheet Input Capacity) (100 Sheet Multipurpose Tray) | 909164 | EA | \$898.57 |
| 35ST400 | Government Lexmark MS610dn: TAA-Compliant Version | 921373 | EA | \$898.57 |
| 35S0450 | Lexmark MS610dtn: Base Model + Extra 550-Sheet Input Tray | 909165 | EA | \$1,155.71 |
| 35ST450 | Government Lexmark MS610dtn: TAA-Compliant Version | 921374 | EA | \$1,155.71 |
| 35S0500 | Lexmark MS610de: Base Model + 512MB Total Memory, Duty Cycle 150,000 Pages, Touchscreen | 909166 | EA | \$1,155.71 |
| 35ST500 | Government Lexmark MS610de: TAA-Compliant Version | 921375 | EA | \$1,155.71 |
| 35S0550 | Lexmark MS610dte: Base Model + 512MB Total Memory, Duty Cycle 150,000 Pages, Touchscreen, Extra 550-Sheet Input Tray | 909167 | EA | \$1,412.86 |
| 35ST550 | Government Lexmark MS610dte: TAA-Compliant Version | 921376 | EA | \$1,412.86 |
| 35S0267 | 250-Sheet Tray | 909002 | EA | \$165.71 |
| 35S0567 | 550-Sheet Tray | 909003 | EA | \$255.71 |
| 2355787 | Onsite Repair Extended Warranty (2 Year) | 909248 | EA | \$229.00 |
| 2355788 | Onsite Repair Extended Warranty (3 Year) | 909249 | EA | \$329.00 |
| Lexmark MS810 Mono Laser Printers | | | | |
| 40G0100 | Lexmark MS810n Mono Laser Printer (55 ppm) (800 MHz) (512 MB) (8.5" x 14") (1200 x 1200 dpi) (Max Duty Cycle 250,000 Pages) (USB) (Ethernet) (550 Sheet Input Capacity) (100 Sheet Multipurpose Tray) | 909178 | EA | \$908.57 |
| 40G0110 | Lexmark MS810dn: Base Model + Duplex Printing | 909179 | EA | \$1,168.57 |
| 40GT110 | Government Lexmark MS810dn: TAA-Compliant Version | 921382 | EA | \$1,168.57 |
| 40G0150 | Lexmark MS810de: Base Model + Duplex Printing, Touchscreen | 909180 | EA | \$1,428.57 |
| 40GT150 | Government Lexmark MS810de: TAA-Compliant Version | 921383 | EA | \$1,428.57 |
| 40G0410 | Lexmark MS810dtn: Base Model + Duplex Printing, Extra 550-Sheet Input Tray | 909185 | EA | \$1,494.29 |
| 40GT410 | Government Lexmark MS810dtn: TAA-Compliant Version | 921387 | EA | \$1,494.29 |
| 16J0300 | MX6500e Multifunction Option | 913086 | EA | \$3,392.86 |
| 40G0800 | 250-Sheet Tray | 909007 | EA | \$227.14 |
| 40G0855 | Caster Base | 909092 | EA | \$398.57 |
| 2355833 | Onsite Repair Extended Warranty (2 Year) | 909256 | EA | \$199.00 |
| 2355834 | Onsite Repair Extended Warranty (3 Year) | 909257 | EA | \$289.00 |
| Lexmark MS811 Mono Laser Printers | | | | |
| 40G0200 | Lexmark MS811n Mono Laser Printer (63 ppm) (800 MHz) (512 MB) (8.5" x 14") (1200 x 1200 dpi) (Max Duty Cycle 275,000 Pages) (USB) (Ethernet) (550 Sheet Input Capacity) (100 Sheet Multipurpose Tray) | 909181 | EA | \$1,298.57 |
| 40G0210 | Lexmark MS811dn: Base Model + Duplex Printing | 909182 | EA | \$1,558.57 |
| 40GT210 | Government Lexmark MS811dn: TAA-Compliant Version | 921384 | EA | \$1,558.57 |
| 40G0440 | Lexmark MS811dtn: Base Model + Duplex Printing, Extra 550-Sheet Input Tray | 909186 | EA | \$1,884.29 |
| 40GT440 | Government Lexmark MS811dtn: TAA-Compliant Version | 921388 | EA | \$1,884.29 |
| 16J0300 | MX6500e Multifunction Option | 913086 | EA | \$3,392.86 |
| 40G0800 | 250-Sheet Tray | 909007 | EA | \$227.14 |
| 40G0855 | Caster Base | 909092 | EA | \$398.57 |
| 2355879 | Onsite Repair Extended Warranty (2 Year) | 909265 | EA | \$329.00 |
| 2355880 | Onsite Repair Extended Warranty (3 Year) | 909266 | EA | \$479.00 |
| Lexmark MS812 Mono Laser Printers | | | | |
| 40G0310 | Lexmark MS812dn Mono Laser Printer (70 ppm) (800 MHz) (512 MB) (8.5" x 14") (1200 x 1200 dpi) (Max Duty Cycle 300,000 Pages) (Duplex) (USB) (Ethernet) (550 Sheet Input Capacity) (100 Sheet Multipurpose Tray) | 909183 | EA | \$2,274.29 |
| 40GT310 | Government Lexmark MS812dn: TAA-Compliant Version | 921385 | EA | \$2,274.29 |
| 40G0350 | Lexmark MS812de: Base Model + Touchscreen | 909184 | EA | \$2,534.29 |
| 40GT350 | Government Lexmark MS812de: TAA-Compliant Version | 921386 | EA | \$2,534.29 |
| 40G0470 | Lexmark MS812dtn: Base Model + Extra 550-Sheet Input Tray | 909187 | EA | \$2,598.57 |
| 40GT470 | Government Lexmark MS812dtn: TAA-Compliant Version | 921389 | EA | \$2,598.57 |
| 16J0300 | MX6500e Multifunction Option | 913086 | EA | \$3,392.86 |
| 40G0800 | 250-Sheet Tray | 909007 | EA | \$227.14 |
| 40G0855 | Caster Base | 909092 | EA | \$398.57 |
| 2355925 | Onsite Repair Extended Warranty (2 Year) | 909274 | EA | \$469.00 |
| 2355926 | Onsite Repair Extended Warranty (3 Year) | 909275 | EA | \$679.00 |
| Lexmark MS911de Mono Laser Printer (Continued on next page) | | | | |
| 26Z0000 | Lexmark MS911de Mono Laser Printer (55 ppm) (800 MHz) (512 MB) (12" x 18") (1200 x 1200 dpi) (Max Duty Cycle 300,000 Pages) (Duplex) (USB) (Ethernet) (Touchscreen) (Energy Star) (1,150 Sheet Input Capacity) | 926480 | EA | \$4,321.43 |
| 26Z0085 | 2 x 500-Sheet Tray | 926530 | EA | \$1,484.29 |
| 26Z0086 | 2,500-Sheet Tandem Tray | 926531 | EA | \$1,827.14 |
| 26Z0088 | 3,000-Sheet Tray | 926532 | EA | \$1,827.14 |

| MFG# | Product Description | Part# | UOM | Retail |
|---|--|--------|-----|------------|
| LEXMARK EQUIPMENT | | | | |
| Lexmark MS911de Mono Laser Printer (Continued) | | | | |
| 2356941 | Extended Warranty (Next Business Day) (Onsite Repair) (2 Year) | 926511 | EA | \$1,099.00 |
| 2356942 | Extended Warranty (Next Business Day) (Onsite Repair) (3 Year) | 926512 | EA | \$1,609.00 |
| Lexmark MX310dn Mono Laser MFP | | | | |
| 35S5700 | Lexmark MX310dn Mono Laser MFP (35 ppm) (800 MHz) (256 MB) (8.5" x 14") (1200 x 1200 dpi) (Max Duty Cycle 50,000 Pages) (p/s/c/f) (Duplex) (USB) (Ethernet) (250 Sheet Input Capacity) (50 Sheet Multipurpose Tray) (50 Sheet ADF) | 909168 | EA | \$501.43 |
| 35S0267 | 250-Sheet Tray | 909002 | EA | \$165.71 |
| 35S0567 | 550-Sheet Tray | 909003 | EA | \$255.71 |
| 2355489 | Onsite Repair Extended Warranty (2 Year) | 909209 | EA | \$215.00 |
| 2355490 | Onsite Repair Extended Warranty (3 Year) | 910191 | EA | \$349.00 |
| Lexmark MX410de Mono Laser MFP | | | | |
| 35S5701 | Lexmark MX410de Mono Laser MFP (40 ppm) (800 MHz) (512 MB) (8.5" x 14") (1200 x 1200 dpi) (Max Duty Cycle 80,000 Pages) (p/s/c/f) (Duplex) (USB) (Ethernet) (Touchscreen) (250 Sheet Input Capacity) (50 Sheet Multipurpose Tray) (50 Sheet ADF) | 909169 | EA | \$752.86 |
| 35ST871 | Government Lexmark MX410de: TAA-Compliant Version | 921377 | EA | \$752.86 |
| 35S0267 | 250-Sheet Tray | 909002 | EA | \$165.71 |
| 35S0567 | 550-Sheet Tray | 909003 | EA | \$255.71 |
| 2355527 | Onsite Repair Extended Warranty (2 Year) | 910203 | EA | \$259.00 |
| 2355528 | Onsite Repair Extended Warranty (3 Year) | 910200 | EA | \$429.00 |
| Lexmark MS415dn Mono Laser Printer | | | | |
| 35S0260 | Lexmark MS415dn Mono Laser Printer (40 ppm) (800 MHz) (256 MB) (8.5" x 14") (1200 x 1200 dpi) (Max Duty Cycle 80,000 Pages) (Duplex) (USB) (Ethernet) (Energy Star) (250 Sheet Input Tray) (50 Sheet Multipurpose Tray) | 923023 | EA | \$512.86 |
| 35S0267 | 250-Sheet Tray | 909002 | EA | \$165.71 |
| 35S0567 | 550-Sheet Tray | 909003 | EA | \$255.71 |
| 3073173 | Swivel Cabinet | 909058 | EA | \$284.29 |
| 35S8502 | Adjustable Printer Stand | 909071 | EA | \$384.29 |
| 2356754 | Extended Warranty (Next Business Day) (Onsite Repair) (2 Year) | 923062 | EA | \$99.00 |
| 2356755 | Extended Warranty (Next Business Day) (Onsite Repair) (3 Year) | 923063 | EA | \$159.00 |
| Lexmark MX510de Mono Laser MFP | | | | |
| 35S5702 | Lexmark MX510de Mono Laser MFP (45 ppm) (800 MHz) (512 MB) (8.5" x 14") (1200 x 1200 dpi) (Max Duty Cycle 100,000 Pages) (p/s/c) (Duplex) (USB) (Ethernet) (Touchscreen) (250 Sheet Input Capacity) (100 Sheet Multipurpose Tray) (50 Sheet ADF) | 909170 | EA | \$1,130.00 |
| 35ST872 | Government Lexmark MX510de: TAA-Compliant Version | 921378 | EA | \$1,130.00 |
| 35S0267 | 250-Sheet Tray | 909002 | EA | \$165.71 |
| 35S0567 | 550-Sheet Tray | 909003 | EA | \$255.71 |
| 2355565 | Onsite Repair Extended Warranty (2 Year) | 909213 | EA | \$599.00 |
| 2355566 | Onsite Repair Extended Warranty (3 Year) | 909214 | EA | \$879.00 |
| Lexmark MX511 Mono Laser MFPs | | | | |
| 35S5703 | Lexmark MX511de Mono Laser MFP (45 ppm) (800 MHz) (512 MB) (8.5" x 14") (1200 x 1200 dpi) (Max Duty Cycle 100,000 Pages) (p/s/c/f) (Duplex) (USB) (Ethernet) (Touchscreen) (250 Sheet Input Capacity) (100 Sheet Multipurpose Tray) (50 Sheet ADF) | 909171 | EA | \$1,255.71 |
| 35ST873 | Government Lexmark MX511de: TAA-Compliant Version | 921379 | EA | \$1,255.71 |
| 35S5704 | Lexmark MX511dhe: Base Model + Hard Drive | 909172 | EA | \$1,632.86 |
| 35ST874 | Government Lexmark MX511dhe: TAA-Compliant Version | 921380 | EA | \$1,632.86 |
| 35S5941 | Lexmark MX511dte: Base Model + Extra 550-Sheet Input Tray | 909173 | EA | \$1,507.14 |
| 35ST969 | Government Lexmark MX511dte: TAA-Compliant Version | 921381 | EA | \$1,507.14 |
| 35S0267 | 250-Sheet Tray | 909002 | EA | \$165.71 |
| 35S0567 | 550-Sheet Tray | 909003 | EA | \$255.71 |
| 2355565 | Onsite Repair Extended Warranty (2 Year) | 909213 | EA | \$599.00 |
| 2355566 | Onsite Repair Extended Warranty (3 Year) | 909214 | EA | \$879.00 |
| Lexmark MX610de Mono Laser MFP | | | | |
| 35S6700 | Lexmark MX610de Mono Laser MFP (50 ppm) (800 MHz) (1024 MB) (8.5" x 14") (1200 x 1200 dpi) (Max Duty Cycle 150,000 Pages) (p/s/c) (Duplex) (USB) (Ethernet) (Touchscreen) (550 Sheet Input Capacity) (100 Sheet Multipurpose Tray) (50 Sheet ADF) | 909174 | EA | \$1,758.57 |
| 35ST000 | Government Lexmark MX610de: TAA-Compliant Version | 921364 | EA | \$1,758.57 |
| 35S0267 | 250-Sheet Tray | 909002 | EA | \$165.71 |
| 35S0567 | 550-Sheet Tray | 909003 | EA | \$255.71 |
| 2355603 | Onsite Repair Extended Warranty (2 Year) | 909217 | EA | \$599.00 |
| 2355604 | Onsite Repair Extended Warranty (3 Year) | 909218 | EA | \$879.00 |

| MFG# | Product Description | Part# | UOM | Retail |
|---|---|--------|-----|------------|
| LEXMARK EQUIPMENT | | | | |
| Lexmark MX611 Mono Laser MFPs | | | | |
| 35S6701 | Lexmark MX611de Mono Laser MFP (50 ppm) (800 MHz) (1024 MB) (8.5" x 14") (1200 x 1200 dpi) (Max Duty Cycle 150,000 Pages) (p/s/c/f) (Duplex) (USB) (Ethernet) (Touchscreen) (550 Sheet Input Capacity) (100 Sheet Multipurpose Tray) (50 Sheet ADF) | 909175 | EA | \$1,884.29 |
| 35ST001 | Government Lexmark MX611de: TAA-Compliant Version | 921365 | EA | \$1,884.29 |
| 35S6702 | Lexmark MX611dhe: Base Model + Hard Drive | 909176 | EA | \$2,261.43 |
| 35ST003 | Government Lexmark MX611dhe: TAA-Compliant Version | 921367 | EA | \$2,261.43 |
| 35S6800 | Lexmark MX611dte: Base Model + Extra 550-Sheet Input Tray | 909177 | EA | \$2,135.71 |
| 35ST002 | Government Lexmark MX611dte: TAA-Compliant Version | 921366 | EA | \$2,135.71 |
| 35S6744 | Lexmark MX611dfe: Base Model + Staple Finisher | 925724 | EA | \$2,261.43 |
| 35S0267 | 250-Sheet Tray | 909002 | EA | \$165.71 |
| 35S0567 | 550-Sheet Tray | 909003 | EA | \$255.71 |
| 2355603 | Onsite Repair Extended Warranty (2 Year) | 909217 | EA | \$599.00 |
| 2355604 | Onsite Repair Extended Warranty (3 Year) | 909218 | EA | \$879.00 |
| Lexmark MX710 Mono Laser MFPs | | | | |
| 24T7401 | Lexmark MX710de Mono Laser MFP (63 ppm) (800 MHz) (512 MB) (8.5" x 14") (1200 x 1200 dpi) (Max Duty Cycle 275,000 Pages) (p/s/c/f) (Duplex) (USB) (Ethernet) (Touchscreen) (550 Sheet Input Tray) (100 Sheet Multipurpose Tray) (150 Sheet DADF) | 909114 | EA | \$2,890.00 |
| 24TT101 | Government Lexmark MX710de: TAA-Compliant Version | 921304 | EA | \$2,890.00 |
| 24T7310 | Lexmark MX710dhe: Base Model + Hard Drive | 909112 | EA | \$3,267.14 |
| 24TT102 | Government Lexmark MX710dhe: TAA-Compliant Version | 921305 | EA | \$3,267.14 |
| 40G0800 | 250-Sheet Tray | 909007 | EA | \$227.14 |
| 40G0855 | Caster Base | 909092 | EA | \$398.57 |
| 2355109 | Onsite Repair Extended Warranty (2 Year) | 909191 | EA | \$999.00 |
| 2355110 | Onsite Repair Extended Warranty (3 Year) | 909192 | EA | \$1,469.00 |
| Lexmark MX711 Mono Laser MFPs | | | | |
| 24T7404 | Lexmark MX711de Mono Laser MFP (70 ppm) (800 MHz) (1024 MB) (8.5" x 14") (1200 x 1200 dpi) (Max Duty Cycle 300,000 Pages) (p/s/c/f) (Duplex) (USB) (Ethernet) (Touchscreen) (550 Sheet Input Tray) (100 Sheet Multipurpose Tray) (150 Sheet DADF) | 909115 | EA | \$4,021.43 |
| 24TT104 | Government Lexmark MX711de: TAA-Compliant Version | 921306 | EA | \$4,021.43 |
| 24T7320 | Lexmark MX711dhe: Base Model + Hard Drive | 909113 | EA | \$4,398.57 |
| 24TT105 | Government Lexmark MX711dhe: TAA-Compliant Version | 921307 | EA | \$4,398.57 |
| 24T7406 | Lexmark MX711dthe: Base Model + Extra 550-Sheet Input Tray, Hard Drive | 909116 | EA | \$4,712.86 |
| 24TT106 | Government Lexmark MX711dthe: TAA-Compliant Version | 921308 | EA | \$4,712.86 |
| 40G0800 | 250-Sheet Tray | 909007 | EA | \$227.14 |
| 40G0855 | Caster Base | 909092 | EA | \$398.57 |
| 2355137 | Onsite Repair Extended Warranty (2 Year) | 909195 | EA | \$999.00 |
| 2355138 | Onsite Repair Extended Warranty (3 Year) | 909196 | EA | \$1,469.00 |
| Lexmark MX810 Mono Laser MFPs (Continued on next page) | | | | |
| 24T7407 | Lexmark MX810de Mono Laser MFP (55 ppm) (800 MHz) (1 GB) (8.5" x 14") (1200 x 1200 dpi) (Max Duty Cycle 300,000 Pages) (p/s/c/f) (Duplex) (USB) (Ethernet) (Touchscreen) (Energy Star) (1,100 Sheet Input Capacity) (100 Sheet Multipurpose tray) (150 Sheet ADF) | 909117 | EA | \$4,398.57 |
| 24TT107 | Government Lexmark MX810de: TAA-Compliant Version | 921309 | EA | \$4,398.57 |
| 24T7408 | Lexmark MX810dfe: Base Model + Stapler | 909118 | EA | \$4,775.71 |
| 24TT108 | Government Lexmark MX810dfe: TAA-Compliant Version | 921310 | EA | \$4,775.71 |
| 24T7410 | Lexmark MX810dme: Base Model + 4-Bin Mailbox | 909119 | EA | \$4,775.71 |
| 24TT110 | Government Lexmark MX810dme: TAA-Compliant Version | 921312 | EA | \$4,775.71 |
| 24T7409 | Lexmark MX810dpe: Base Model + Stapler/Hole Punch Finisher | 915861 | EA | \$5,152.86 |
| 24TT109 | Government Lexmark MX810dpe: TAA-Compliant Version | 921311 | EA | \$5,152.86 |
| 24T7411 | Lexmark MX810dte: Base Model + Stacker, Extra 550-Sheet Input Tray | 909120 | EA | \$4,712.86 |
| 24TT111 | Government Lexmark MX810dte: TAA-Compliant Version | 921313 | EA | \$4,712.86 |
| 24T7412 | Lexmark MX810dtfe: Base Model + Stapler, Extra 550-Sheet Input Tray | 909121 | EA | \$5,090.00 |
| 24TT112 | Government Lexmark MX810dtfe: TAA-Compliant Version | 921314 | EA | \$5,090.00 |
| 24T7414 | Lexmark MX810dtme: Base Model + 4-Bin Mailbox, Extra 550-Sheet Input Tray | 909122 | EA | \$5,090.00 |
| 24TT114 | Government Lexmark MX810dtme: TAA-Compliant Version | 921316 | EA | \$5,090.00 |
| 24T7413 | Lexmark MX810dtpe: Base Model + Stapler/Hole Punch Finisher, Extra 550-Sheet Input Tray | 915862 | EA | \$5,467.14 |
| 24TT113 | Government Lexmark MX810dtpe: TAA-Compliant Version | 921315 | EA | \$5,467.14 |
| 24T7415 | Lexmark MX810dxe: Base Model + Stapler/Stacker, Total 2,650-Sheet Input Tray Capacity | 909123 | EA | \$5,027.14 |
| 24TT115 | Government Lexmark MX810dxe: TAA-Compliant Version | 921317 | EA | \$5,027.14 |
| 24T7416 | Lexmark MX810dxfe: Base Model + Stapler, Total 2,650-Sheet Input Tray Capacity | 909124 | EA | \$5,404.29 |
| 24TT116 | Government Lexmark MX810dxfe: TAA-Compliant Version | 921318 | EA | \$5,404.29 |
| 24T7418 | Lexmark MX810dxme: Base Model + 4-Bin Mailbox/Stapler, Total 2,650-Sheet Input Tray Capacity | 909125 | EA | \$5,404.29 |

| MFG# | Product Description | Part# | UOM | Retail |
|---|--|--------|-----|------------|
| LEXMARK EQUIPMENT | | | | |
| Lexmark MX810 Mono Laser MFPs (Continued) | | | | |
| 24TT118 | Government Lexmark MX810dxme: TAA-Compliant Version | 921320 | EA | \$5,404.29 |
| 24T7417 | Lexmark MX810dxpe: Base Model + Stapler/Hole Punch Finisher, Total 2,650-Sheet Input Tray Capacity | 915863 | EA | \$5,781.43 |
| 24TT117 | Government Lexmark MX810dxpe: TAA-Compliant Version | 921319 | EA | \$5,781.43 |
| 24T7300 | 550-Sheet Tray | 909000 | EA | \$312.86 |
| 24T7350 | 2,100-Sheet Tray | 909001 | EA | \$627.14 |
| 2355165 | Onsite Repair Extended Warranty (2 Year) | 909199 | EA | \$999.00 |
| 1355166 | Onsite Repair Extended Warranty (3 Year) | 909188 | EA | \$1,469.00 |
| Lexmark MX811 Mono Laser MFPs | | | | |
| 24T7419 | Lexmark MX811de Mono Laser MFP (63 ppm) (800 MHz) (1 GB) (8.5" x 14") (1200 x 1200 dpi) (Max Duty Cycle 300,000 Pages) (p/s/c/f) (Duplex) (USB) (Ethernet) (Touchscreen) (Energy Star) (Stacker) (1,200 Sheet Input Capacity) (150 Sheet DADF) | 909126 | EA | \$5,152.86 |
| 24TT119 | Government Lexmark MX811de: TAA-Compliant Version | 921321 | EA | \$5,152.86 |
| 24T7420 | Lexmark MX811dfe: Base Model + Stapler | 909127 | EA | \$5,530.00 |
| 24TT120 | Government Lexmark MX811dfe: TAA-Compliant Version | 921322 | EA | \$5,530.00 |
| 24T7422 | Lexmark MX811dme: Base Model + 4-Bin Mailbox | 909128 | EA | \$5,530.00 |
| 24TT122 | Government Lexmark MX811dme: TAA-Compliant Version | 921324 | EA | \$5,530.00 |
| 24T7421 | Lexmark MX811dpe: Base Model + Stapler/Hole Punch Finisher | 915864 | EA | \$5,907.14 |
| 24TT121 | Government Lexmark MX811dpe: TAA-Compliant Version | 921323 | EA | \$5,907.14 |
| 24T7423 | Lexmark MX811dte: Base Model + Extra 550-Sheet Input Tray | 909129 | EA | \$5,467.14 |
| 24TT123 | Government Lexmark MX811dte: TAA-Compliant Version | 921325 | EA | \$5,467.14 |
| 24T7424 | Lexmark MX811dtfe: Base Model + Stapler, Extra 550-Sheet Input Tray | 909130 | EA | \$5,844.29 |
| 24TT124 | Government Lexmark MX811dtfe: TAA-Compliant Version | 921326 | EA | \$5,844.29 |
| 24T7426 | Lexmark MX811dtme: Base Model + 4-Bin Mailbox, Extra 550-Sheet Input Tray | 909131 | EA | \$5,844.29 |
| 24TT126 | Government Lexmark MX811dtme: TAA-Compliant Version | 921328 | EA | \$5,844.29 |
| 24T7425 | Lexmark MX811dtpe: Base Model + Stapler/Hole Punch Finisher, Extra 550-Sheet Input Tray | 915865 | EA | \$6,221.43 |
| 24TT125 | Government Lexmark MX811dtpe: TAA-Compliant Version | 921327 | EA | \$6,221.43 |
| 24T7427 | Lexmark MX811dxe: Base Model + Total 2,750-Sheet Input Capacity | 909132 | EA | \$5,781.43 |
| 24TT127 | Government Lexmark MX811dxe: TAA-Compliant Version | 921329 | EA | \$5,781.43 |
| 24T7428 | Lexmark MX811dxfe: Base Model + Stapler, Total 2,750-Sheet Input Capacity | 909133 | EA | \$6,158.57 |
| 24TT128 | Government Lexmark MX811dxfe: TAA-Compliant Version | 921330 | EA | \$6,158.57 |
| 24T7430 | Lexmark MX811dxme: Base Model + 4-Bin Mailbox, Total 2,750-Sheet Input Capacity | 909134 | EA | \$6,158.57 |
| 24TT130 | Government Lexmark MX811dxme: TAA-Compliant Version | 921332 | EA | \$6,158.57 |
| 24T7429 | Lexmark MX811dxpe: Base Model + Stapler/Hole Punch Finisher, Total 2,750-Sheet Input Capacity | 915866 | EA | \$6,535.71 |
| 24TT129 | Government Lexmark MX811dxpe: TAA-Compliant Version | 921331 | EA | \$6,535.71 |
| 24T7300 | 550-Sheet Tray | 909000 | EA | \$312.86 |
| 24T7350 | 2,100-Sheet Tray | 909001 | EA | \$627.14 |
| 2355193 | Onsite Repair Extended Warranty (2 Year) | 909201 | EA | \$999.00 |
| 2355194 | Onsite Repair Extended Warranty (3 Year) | 909202 | EA | \$1,469.00 |
| Lexmark MX812 Mono Laser MFPs (Continued on next page) | | | | |
| 24T7431 | Lexmark MX812de Mono Laser MFP (70 ppm) (800 MHz) (1 GB) (8.5" x 14") (1200 x 1200 dpi) (Max Duty Cycle 300,000 Pages) (p/s/c/f) (Duplex) (USB) (Ethernet) (Touchscreen) (Energy Star) (Stacker) (1,200 Sheet Input Capacity) (150 Sheet DADF) | 909135 | EA | \$5,907.14 |
| 24TT131 | Government Lexmark MX812de: TAA-Compliant Version | 921333 | EA | \$5,907.14 |
| 24T7432 | Lexmark MX812dfe: Base Model + Stapler | 909136 | EA | \$6,284.29 |
| 24TT132 | Government Lexmark MX812dfe: TAA-Compliant Version | 921334 | EA | \$6,284.29 |
| 24T7434 | Lexmark MX812dme: Base Model + 4-Bin Mailbox | 909137 | EA | \$6,284.29 |
| 24TT134 | Government Lexmark MX812dme: TAA-Compliant Version | 921336 | EA | \$6,284.29 |
| 24T7433 | Lexmark MX812dpe: Base Model + Stapler/Hole Punch Finisher | 915867 | EA | \$6,661.43 |
| 24TT133 | Government Lexmark MX812dpe: TAA-Compliant Version | 921335 | EA | \$6,661.43 |
| 24T7435 | Lexmark MX812dte: Base Model + Extra 550-Sheet Input Tray | 909138 | EA | \$6,221.43 |
| 24TT135 | Government Lexmark MX812dte: TAA-Compliant Version | 921337 | EA | \$6,221.43 |
| 24T7436 | Lexmark MX812dtfe: Base Model + Stapler, Extra 550-Sheet Input Tray | 909139 | EA | \$6,598.57 |
| 24TT136 | Government Lexmark MX812dtfe: TAA-Compliant Version | 921338 | EA | \$6,598.57 |
| 24T7438 | Lexmark MX812dtme: Base Model + 4-Bin Mailbox, Extra 550-Sheet Input Tray | 909140 | EA | \$6,598.57 |
| 24TT138 | Government Lexmark MX812dtme: TAA-Compliant Version | 921340 | EA | \$6,598.57 |
| 24T7437 | Lexmark MX812dtpe: Base Model + Stapler/Hole Punch Finisher, Extra 550-Sheet Input Tray | 915868 | EA | \$6,975.71 |
| 24TT137 | Government Lexmark MX812dtpe: TAA-Compliant Version | 921339 | EA | \$6,975.71 |
| 24T7439 | Lexmark MX812dxe: Base Model + Total 2,750-Sheet Input Capacity | 909141 | EA | \$6,535.71 |
| 24TT139 | Government Lexmark MX812dxe: TAA-Compliant Version | 921341 | EA | \$6,535.71 |
| 24T7440 | Lexmark MX812dxfe: Base Model + Stapler, Total 2,750-Sheet Input Capacity | 909142 | EA | \$6,912.86 |
| 24TT140 | Government Lexmark MX812dxfe: TAA-Compliant Version | 921342 | EA | \$6,912.86 |
| 24T7442 | Lexmark MX812dxme: Base Model + 4-Bin Mailbox, Total 2,750-Sheet Input Capacity | 909143 | EA | \$6,912.86 |
| 24TT142 | Government Lexmark MX812dxme: TAA-Compliant Version | 921344 | EA | \$6,912.86 |

| MFG# | Product Description | Part# | UOM | Retail |
|---|--|--------|-----|-------------|
| LEXMARK EQUIPMENT | | | | |
| Lexmark MX812 Mono Laser MFPs (Continued) | | | | |
| 24T7441 | Lexmark MX812dxe: Base Model + Stapler/Hole Punch Finisher, Total 2,750-Sheet Input Capacity | 915869 | EA | \$7,290.00 |
| 24TT141 | Government Lexmark MX812dxe: TAA-Compliant Version | 921343 | EA | \$7,290.00 |
| 24T7300 | 550-Sheet Tray | 909000 | EA | \$312.86 |
| 24T7350 | 2,100-Sheet Tray | 909001 | EA | \$627.14 |
| 2355221 | Onsite Repair Extended Warranty (2 Year) | 909205 | EA | \$999.00 |
| 2355222 | Onsite Repair Extended Warranty (3 Year) | 909206 | EA | \$1,469.00 |
| Lexmark MX910de Mono Laser MFP | | | | |
| 26Z0100 | Lexmark MX910de Mono Laser MFP (45 ppm) (800 MHz) (1 GB) (12" x 18") (1200 x 1200 dpi) (Max Duty Cycle 200,000 Pages) (p/s/c/f) (Duplex) (USB) (Ethernet) (Touchscreen) (Energy Star) (1,150 Sheet Input Capacity) (100 Sheet DADF) | 926482 | EA | \$9,598.57 |
| 26Z0085 | 2 x 500-Sheet Tray | 926530 | EA | \$1,484.29 |
| 26Z0086 | 2,500-Sheet Tandem Tray | 926531 | EA | \$1,827.14 |
| 26Z0088 | 3,000-Sheet Tray | 926532 | EA | \$1,827.14 |
| 2356830 | Extended Warranty (Next Business Day) (Onsite Repair) (2 Year) | 926490 | EA | \$2,699.00 |
| 2356831 | Extended Warranty (Next Business Day) (Onsite Repair) (3 Year) | 926491 | EA | \$3,959.00 |
| Lexmark MX911dte Mono Laser MFP | | | | |
| 26Z0101 | Lexmark MX911dte Mono Laser MFP (55 ppm) (800 MHz) (1 GB) (12" x 18") (1200 x 1200 dpi) (Max Duty Cycle 300,000 Pages) (p/s/c/f) (Duplex) (USB) (Ethernet) (Touchscreen) (Energy Star) (2,150 Sheet Input Capacity) (100 Sheet DADF) | 926483 | EA | \$13,699.00 |
| 26Z0088 | 3,000-Sheet Tray | 926532 | EA | \$1,827.14 |
| 2356867 | Extended Warranty (Next Business Day) (Onsite Repair) (2 Year) | 926497 | EA | \$3,399.00 |
| 2356868 | Extended Warranty (Next Business Day) (Onsite Repair) (3 Year) | 926498 | EA | \$5,399.00 |
| Lexmark MX912dxe Mono Laser MFP | | | | |
| 26Z0102 | Lexmark MX912dxe Mono Laser MFP (65 ppm) (800 MHz) (1 GB) (12" x 18") (1200 x 1200 dpi) (Max Duty Cycle 300,000 Pages) (p/s/c/f) (Duplex) (USB) (Ethernet) (Touchscreen) (Energy Star) (3,650 Sheet Input Capacity) (100 Sheet DADF) | 926484 | EA | \$19,199.00 |
| 26Z0088 | 3,000-Sheet Tray | 926532 | EA | \$1,827.14 |
| 2356904 | Extended Warranty (Next Business Day) (Onsite Repair) (2 Year) | 926504 | EA | \$4,800.00 |
| 2356905 | Extended Warranty (Next Business Day) (Onsite Repair) (3 Year) | 926505 | EA | \$7,680.00 |
| Lexmark X860/X862/X864 Series Mono Laser MFPs | | | | |
| 19Z0100 | Lexmark X860de 3 Mono Laser MFP (35 ppm) (800 MHz) (256 MB) (11" x 17") (1200 x 1200 dpi) (Max Duty Cycle 150,000 Pages) (p/s/c) (Duplex) (USB) (Ethernet) (Touchscreen) (Energy Star) (1,000 Sheet Input Capacity) (100 Sheet Multipurpose Tray) (75 Sheet ADF) | 19356 | EA | \$7,440.00 |
| 19Z0129 | Government Lexmark X860de 3: TAA-Compliant Version | 921301 | EA | \$7,440.00 |
| 19Z0200 | Lexmark X860de 4: Base Model + Fax Function | 106059 | EA | \$7,797.14 |
| 19Z0121 | Government Lexmark X860de 4: TAA-Compliant Version | 90684 | EA | \$7,797.14 |
| 19Z0201 | Lexmark X862dte 4: Same as X860de 4 + 45 ppm, Duty Cycle 200,000 Pages, 2,000-Sheet Input Capacity | 106060 | EA | \$10,625.71 |
| 19Z0122 | Government Lexmark X862dte 4: TAA-Compliant Version | 26658 | EA | \$10,625.71 |
| 19Z0102 | Lexmark X864dhe 3: Base Model + 55 ppm, Duty Cycle 300,000 Pages, 3,000-Sheet Input Capacity | 106058 | EA | \$13,884.29 |
| 19Z0131 | Government Lexmark X864dhe 3: TAA-Compliant Version | 26662 | EA | \$13,884.29 |
| 19Z0202 | Lexmark X864dhe 4: Same as X864dhe 3 + Fax Function | 106065 | EA | \$14,255.71 |
| 19Z0123 | Government Lexmark X864dhe 4: TAA-Compliant Version | 921300 | EA | \$14,255.71 |
| 15r0146 | Lexmark X860 2 x 500-Sheet Drawer | 900380 | EA | \$1,027.14 |
| 15r0145 | Lexmark X860 2,000-Sheet High Capacity Feeder | 900379 | EA | \$1,427.14 |
| 2351545 | Lexmark X860 Onsite Repair Extended Warranty (2 Year) | 26456 | EA | \$2,699.00 |
| 2351546 | Lexmark X860 Onsite Repair Extended Warranty (3 Year) | 26457 | EA | \$3,959.00 |
| 15r0145 | Lexmark X862/X864 2,000-Sheet High Capacity Feeder | 900379 | EA | \$1,427.14 |
| 2351573 | Lexmark X862 Onsite Repair Extended Warranty (2 Year) | 26461 | EA | \$2,699.00 |
| 2351574 | Lexmark X862 Onsite Repair Extended Warranty (3 Year) | 26462 | EA | \$3,959.00 |
| 2351601 | Lexmark X864 Onsite Repair Extended Warranty (2 Year) | 26466 | EA | \$2,699.00 |
| 2351602 | Lexmark X864 Onsite Repair Extended Warranty (3 Year) | 26467 | EA | \$3,959.00 |
| Lexmark C746 Color Laser Printers (Continued on next page) | | | | |
| 41G0000 | Lexmark C746n Color Laser Printer (35 ppm) (800 MHz) (512 MB) (8.5" x 14") (2400 x 600 dpi) (Max Duty Cycle 85,000 Pages) (USB) (Ethernet) (550 Sheet Input Tray) (100 Sheet Multipurpose Tray) | 906524 | EA | \$715.71 |
| 41GT000 | Government Lexmark C746n: TAA-Compliant Version | 921390 | EA | \$878.57 |
| 41G0050 | Lexmark C746dn: Base Model + Duplex Printing, Energy Star Certified | 906523 | EA | \$941.43 |
| 41GT001 | Government Lexmark C746dn: TAA-Compliant Version | 921391 | EA | \$1,130.00 |
| 41G0100 | Lexmark C746dtn: Base Model + Duplex Printing, Extra 550-Sheet Input Drawer, Energy Star Certified | 906522 | EA | \$1,318.57 |

| MFG# | Product Description | Part# | UOM | Retail |
|--|---|--------|-----|------------|
| LEXMARK EQUIPMENT | | | | |
| Lexmark C746 Color Laser Printers (Continued) | | | | |
| 27S2100 | 550-Sheet Drawer | 93617 | EA | \$341.43 |
| 27S2400 | 2,000-Sheet High Capacity Feeder | 93616 | EA | \$684.29 |
| 34T5114 | Caster Base | 919485 | EA | \$398.57 |
| 3052765 | Swivel Cabinet | 26484 | EA | \$284.29 |
| 2354997 | Onsite Repair Extended Warranty (2 Year) | 906577 | EA | \$249.00 |
| 2354998 | Onsite Repair Extended Warranty (3 Year) | 906578 | EA | \$359.00 |
| Lexmark C748 Color Laser Printers | | | | |
| 41H0000 | Lexmark C748e Color Laser Printer (35 ppm) (800 MHz) (512 MB) (8.5" x 14") (2400 x 600 dpi) (Max Duty Cycle 100,000 Pages) (Ethernet) (USB) (Touchscreen) (550 Sheet Input Tray) (100 Sheet Multipurpose Tray) | 906521 | EA | \$1,255.71 |
| 41HT000 | Government Lexmark C748e: TAA-Compliant Version | 921392 | EA | \$1,255.71 |
| 41H0050 | Lexmark C748de: Base Model + Duplex Printing, Energy Star Certified | 906520 | EA | \$1,507.14 |
| 41HT001 | Government Lexmark C748de: TAA-Compliant Version | 921393 | EA | \$1,507.14 |
| 41H0100 | Lexmark C748dte: Base Model + Duplex Printing, Extra 550-Sheet Input Drawer, Energy Star Certified | 906528 | EA | \$1,884.29 |
| 41HT002 | Government Lexmark C748dte: TAA-Compliant Version | 921394 | EA | \$1,884.29 |
| 27S2100 | 550-Sheet Drawer | 93617 | EA | \$341.43 |
| 27S2400 | 2,000-Sheet High Capacity Feeder | 93616 | EA | \$684.29 |
| 34T5114 | Caster Base | 919485 | EA | \$398.57 |
| 3052765 | Swivel Cabinet | 26484 | EA | \$284.29 |
| 2355025 | Onsite Repair Extended Warranty (2 Year) | 906584 | EA | \$399.00 |
| 2355026 | Onsite Repair Extended Warranty (3 Year) | 906585 | EA | \$559.00 |
| Lexmark C792 Color Laser Printers | | | | |
| 47B0000 | Lexmark C792e Color Laser Printer (50 ppm) (512 MB) (8.5" x 14") (1200 x 1200 dpi) (Max Duty Cycle 150,000 Pages) (USB) (Ethernet) (Touchscreen) (550 Sheet Input Tray) (100 Sheet Multipurpose Tray) | 106009 | EA | \$1,695.71 |
| 47BT000 | Government Lexmark C792e: TAA-Compliant Version | 921395 | EA | \$1,695.71 |
| 47B0001 | Lexmark C792de: Base Model + Duplex Printing, Energy Star Certified | 95988 | EA | \$2,010.00 |
| 47BT001 | Government Lexmark C792de: TAA-Compliant Version | 921396 | EA | \$2,010.00 |
| 47B0002 | Lexmark C792dte: Base Model + Duplex Printing, Extra 550-Sheet Input Drawer, Energy Star Certified | 106015 | EA | \$2,387.14 |
| 47BT002 | Government Lexmark C792dte: TAA-Compliant Version | 921397 | EA | \$2,387.14 |
| 47B0003 | Lexmark C792dhe: Base Model + Duplex Printing, 2,200-Sheet Input Capacity, Hard Disk, Energy Star Certified | 106019 | EA | \$3,770.00 |
| 47BT003 | Government Lexmark C792dhe: TAA-Compliant Version | 921398 | EA | \$3,770.00 |
| 47B0110 | 550-Sheet Drawer | 905288 | EA | \$398.57 |
| 47B0111 | 2,000-Sheet High Capacity Feeder | 905289 | EA | \$1,027.14 |
| 47B0114 | Caster Base | 905292 | EA | \$398.57 |
| 2353755 | Onsite Repair Extended Warranty (2 Year) | 102025 | EA | \$599.00 |
| 2353756 | Onsite Repair Extended Warranty (3 Year) | 102026 | EA | \$879.00 |
| Lexmark C925 Color Laser Printers | | | | |
| 24Z0000 | Lexmark C925de Color Laser Printer (30 ppm) (800 MHz) (256 MB) (11" x 17") (600 x 600 dpi) (Max Duty Cycle 200,000 Pages) (Duplex) (USB) (Ethernet) (Touchscreen) (Energy Star) (400 Sheet Input Capacity) (50 Sheet Multipurpose Tray) | 106021 | EA | \$2,324.29 |
| 24Z0056 | Lexmark C925dte: Base Model + 950-Sheet Input Capacity | 106023 | EA | \$2,890.00 |
| 24Z0609 | Government Lexmark C925dte: TAA-Compliant Version | 921345 | EA | \$2,890.00 |
| 24Z0030 | 550-Sheet Drawer | 904307 | EA | \$438.57 |
| 24Z0031 | Printer Stand (Cabinet and Caster Base) | 904308 | EA | \$564.29 |
| 2353799 | Onsite Repair Extended Warranty (2 Year) | 102031 | EA | \$949.00 |
| 2353800 | Onsite Repair Extended Warranty (3 Year) | 102033 | EA | \$1,399.00 |
| Lexmark C950de Color Laser Printer | | | | |
| 22Z0000 | Lexmark C950de Color Laser Printer (50 ppm Mono/45 ppm Color) (1024 MB) (1200 x 1200 dpi) (Max Duty Cycle 225,000 Pages) (Duplex) (USB) (520 Sheet Input Tray) (100 Sheet Multipurpose Tray) | 101904 | EA | \$4,021.43 |
| 22ZT171 | Government Lexmark C950de: TAA-Compliant Version | 921302 | EA | \$4,021.43 |
| 22Z0012 | 520-Sheet Drawer Stand (Up to 12" x 18") | 903581 | EA | \$730.00 |
| 22Z0013 | 3 x 520-Sheet Drawer Stand (Up to 12" x 18") | 903582 | EA | \$1,541.43 |
| 22Z0015 | 2,000-Sheet High Capacity Feeder (Up to 8.5" x 14") | 903584 | EA | \$1,370.00 |
| 2354208 | Onsite Repair Extended Warranty (2 Year) | 701566 | EA | \$1,399.00 |
| 2354209 | Onsite Repair Extended Warranty (3 Year) | 701567 | EA | \$2,049.00 |
| Lexmark CS310 Color Laser Printers (Continued on next page) | | | | |
| 28C0000 | Lexmark CS310n Color Laser Printer (25 ppm) (800 MHz) (256 MB) (8.5" x 14") (1200 x 1200 dpi) (Max Duty Cycle 60,000 Pages) (USB) (Ethernet) (250 Sheet Input Capacity) | 909144 | EA | \$384.29 |

| MFG# | Product Description | Part# | UOM | Retail |
|---|--|--------|-----|------------|
| LEXMARK EQUIPMENT | | | | |
| Lexmark CS310 Color Laser Printers (Continued) | | | | |
| 28CT000 | Government Lexmark CS310n: TAA-Compliant Version | 921346 | EA | \$384.29 |
| 28C0050 | Lexmark CS310dn: Base Model + Duplex Printing | 909145 | EA | \$512.86 |
| 28CT001 | Government Lexmark CS310dn: TAA-Compliant Version | 921347 | EA | \$512.86 |
| 38C0626 | 550-Sheet Duo Tray with 100-Sheet Feeder | 909005 | EA | \$227.14 |
| 35S8502 | Adjustable Printer Stand | 909071 | EA | \$384.29 |
| 3073173 | Swivel Cabinet | 909058 | EA | \$284.29 |
| 2356081 | Onsite Repair Extended Warranty (2 Year) | 909284 | EA | \$119.00 |
| 2356082 | Onsite Repair Extended Warranty (3 Year) | 909285 | EA | \$189.00 |
| Lexmark CS410 Color Laser Printers | | | | |
| 28D0000 | Lexmark CS410n Color Laser Printer (32 ppm) (800 MHz) (256 MB) (8.5" x 14") (1200 x 1200 dpi) (Max Duty Cycle 75,000 Pages) (USB) (Ethernet) (250 Sheet Input Capacity) | 909148 | EA | \$512.86 |
| 28DT010 | Government Lexmark CS410n: TAA-Compliant Version | 921350 | EA | \$577.14 |
| 28D0050 | Lexmark CS410dn: Base Model + Duplex Printing | 909149 | EA | \$577.14 |
| 28DT011 | Government Lexmark CS410dn: TAA-Compliant Version | 921351 | EA | \$641.43 |
| 28D0100 | Lexmark CS410dtn: Base Model + Duplex Printing, 900-Sheet Input Capacity | 909150 | EA | \$834.29 |
| 28DT012 | Government Lexmark CS410dtn: TAA-Compliant Version | 921352 | EA | \$898.57 |
| 38C0636 | 550-Sheet Tray | 909006 | EA | \$227.14 |
| 38C0626 | 550-Sheet Duo Tray with 100-Sheet Feeder | 909005 | EA | \$227.14 |
| 35S8502 | Adjustable Printer Stand | 909071 | EA | \$384.29 |
| 3073173 | Swivel Cabinet | 909058 | EA | \$284.29 |
| 2356127 | Onsite Repair Extended Warranty (2 Year) | 909291 | EA | \$149.00 |
| 2356128 | Onsite Repair Extended Warranty (3 Year) | 909292 | EA | \$249.00 |
| Lexmark CS510 Color Laser Printers | | | | |
| 28E0050 | Lexmark CS510de Color Laser Printer (32 ppm) (800 MHz) (512 MB) (8.5" x 14") (1200 x 1200 dpi) (Max Duty Cycle 85,000 Pages) (Duplex) (USB) (Ethernet) (Touchscreen) (250 Sheet Input Capacity) | 909154 | EA | \$962.86 |
| 28ET021 | Government Lexmark CS510de: TAA-Compliant Version | 921357 | EA | \$962.86 |
| 28E0100 | Lexmark CS510dte: Base Model + 900-Sheet Input Capacity | 909155 | EA | \$1,220.00 |
| 28ET022 | Government Lexmark CS510dte: TAA-Compliant Version | 921358 | EA | \$1,220.00 |
| 38C0636 | 550-Sheet Tray | 909006 | EA | \$227.14 |
| 38C0626 | 550-Sheet Duo Tray with 100-Sheet Feeder | 909005 | EA | \$227.14 |
| 35S8502 | Adjustable Printer Stand | 909071 | EA | \$384.29 |
| 2356173 | Onsite Repair Extended Warranty (2 Year) | 909299 | EA | \$229.00 |
| 2356174 | Onsite Repair Extended Warranty (3 Year) | 909300 | EA | \$329.00 |
| Lexmark CX310 Color Laser MFPs | | | | |
| 28C0500 | Lexmark CX310n Color Laser MFP (25 ppm) (800 MHz) (512 MB) (8.5" x 14") (1200 x 1200 dpi) (Max Duty Cycle 60,000 Pages) (p/s/c) (USB) (Ethernet) (250 Sheet Input Capacity) (50 Sheet ADF) | 909146 | EA | \$641.43 |
| 28CT500 | Government Lexmark CX310n: TAA-Compliant Version | 921348 | EA | \$641.43 |
| 28C0550 | Lexmark CX310dn: Base Model + Duplex Printing | 909147 | EA | \$770.00 |
| 28CT550 | Government Lexmark CX310dn: TAA-Compliant Version | 921349 | EA | \$770.00 |
| 38C0626 | 550-Sheet Duo Tray with 100-Sheet Feeder | 909005 | EA | \$227.14 |
| 35S8502 | Adjustable Printer Stand | 909071 | EA | \$384.29 |
| 3073173 | Swivel Cabinet | 909058 | EA | \$284.29 |
| 2356211 | Onsite Repair Extended Warranty (2 Year) | 909303 | EA | \$300.00 |
| 2356212 | Onsite Repair Extended Warranty (3 Year) | 910196 | EA | \$495.00 |
| Lexmark CX410 Color Laser MFPs | | | | |
| 28D0500 | Lexmark CX410e Color Laser MFP (32 ppm) (800 MHz) (512 MB) (8.5" x 14") (1200 x 1200 dpi) (Max Duty Cycle 75,000 Pages) (p/s/c/f) (USB) (Ethernet) (Touchscreen) (250 Sheet Input Capacity) (50 Sheet ADF) | 909151 | EA | \$898.57 |
| 28DT500 | Government Lexmark CX410e: TAA-Compliant Version | 921353 | EA | \$898.57 |
| 28D0550 | Lexmark CX410de: Base Model + Duplex Printing | 909152 | EA | \$1,027.14 |
| 28DT550 | Government Lexmark CX410de: TAA-Compliant Version | 921354 | EA | \$1,027.14 |
| 28D0600 | Lexmark CX410dte: Base Model + Duplex Printing, 900-Sheet Input Capacity | 909153 | EA | \$1,284.29 |
| 28DT600 | Government Lexmark CX410dte: TAA-Compliant Version | 921355 | EA | \$1,284.29 |
| 38C0636 | 550-Sheet Tray | 909006 | EA | \$227.14 |
| 38C0626 | 550-Sheet Duo Tray with 100-Sheet Feeder | 909005 | EA | \$227.14 |
| 35S8502 | Adjustable Printer Stand | 909071 | EA | \$384.29 |
| 3073173 | Swivel Cabinet | 909058 | EA | \$284.29 |
| 2356249 | Onsite Repair Extended Warranty (2 Year) | 909305 | EA | \$380.00 |
| 2356250 | Onsite Repair Extended Warranty (3 Year) | 910198 | EA | \$595.00 |

| MFG# | Product Description | Part# | UOM | Retail |
|---|---|--------|-----|-------------|
| LEXMARK EQUIPMENT | | | | |
| Lexmark CX510 Color Laser MFPs | | | | |
| 28E0500 | Lexmark CX510de Color Laser MFP (32 ppm) (800 MHz) (1024 MB) (8.5" x 14") (1200 x 1200 dpi) (Max Duty Cycle 85,000 Pages) (p/s/c/f) (Duplex) (USB) (Ethernet) (Touchscreen) (250 Sheet Input Capacity) (50 Sheet ADF) | 909156 | EA | \$1,798.57 |
| 28ET500 | Government Lexmark CX510de: TAA-Compliant Version | 921359 | EA | \$1,798.57 |
| 28E0615 | Lexmark CX510dhe: Base Model + Hard Disk | 909158 | EA | \$1,991.43 |
| 28ET550 | Government Lexmark CX510dhe: TAA-Compliant Version | 921360 | EA | \$1,991.43 |
| 28E0550 | Lexmark CX510dthe: Base Model + Hard Disk, 900-Sheet Input Capacity | 909157 | EA | \$2,248.57 |
| 38C0636 | 550-Sheet Tray | 909006 | EA | \$227.14 |
| 38C0626 | 550-Sheet Duo Tray with 100-Sheet Feeder | 909005 | EA | \$227.14 |
| 35S8502 | Adjustable Printer Stand | 909071 | EA | \$384.29 |
| 3073173 | Swivel Cabinet | 909058 | EA | \$284.29 |
| 2356287 | Onsite Repair Extended Warranty (2 Year) | 909307 | EA | \$899.00 |
| 2356288 | Onsite Repair Extended Warranty (3 Year) | 909308 | EA | \$1,319.00 |
| Lexmark X746de Color Laser MFP | | | | |
| 34T5011 | Lexmark X746de Color Laser MFP (35 ppm) (1.2 GHz) (512 MB) (8.5" x 14") (2400 x 600 dpi) (Max Duty Cycle 100,000 Pages) (p/s/c/f) (Duplex) (Ethernet) (USB) (Energy Star) (550 Sheet Input Tray) (100 Sheet Multipurpose Tray) | 906527 | EA | \$2,764.29 |
| 34TT000 | Government Lexmark X746de: TAA-Compliant Version | 921361 | EA | \$2,764.29 |
| 27S2100 | 550-Sheet Drawer | 93617 | EA | \$341.43 |
| 27S2400 | 2,000-Sheet High Capacity Feeder | 93616 | EA | \$684.29 |
| 34T5114 | Caster Base | 919485 | EA | \$398.57 |
| 3052765 | Swivel Cabinet | 26484 | EA | \$284.29 |
| 2355053 | Onsite Repair Extended Warranty (2 Year) | 906598 | EA | \$999.00 |
| 2355054 | Onsite Repair Extended Warranty (3 Year) | 906599 | EA | \$1,459.00 |
| Lexmark X748 Color Laser MFPs | | | | |
| 34T5012 | Lexmark X748de Color Laser MFP (35 ppm) (1.2 GHz) (512 MB) (8.5" x 14") (2400 x 600 dpi) (Max Duty Cycle 100,000 Pages) (p/s/c/f) (Duplex) (Ethernet) (USB) (Energy Star) (Touchscreen) (550 Sheet Input Tray) (100 Sheet Multipurpose Tray) (50 Sheet ADF) | 906526 | EA | \$3,141.43 |
| 34TT001 | Government Lexmark X748de: TAA-Compliant Version | 921362 | EA | \$3,141.43 |
| 34T5013 | Lexmark X748dte: Base Model + Extra 550-Sheet Input Drawer | 906525 | EA | \$3,518.57 |
| 34TT002 | Government Lexmark X748dte: TAA-Compliant Version | 921363 | EA | \$3,518.57 |
| 27S2100 | 550-Sheet Drawer | 93617 | EA | \$341.43 |
| 27S2400 | 2,000-Sheet High Capacity Feeder | 93616 | EA | \$684.29 |
| 34T5114 | Caster Base | 919485 | EA | \$398.57 |
| 3052765 | Swivel Cabinet | 26484 | EA | \$284.29 |
| 2355081 | Onsite Repair Extended Warranty (2 Year) | 906605 | EA | \$999.00 |
| 2355082 | Onsite Repair Extended Warranty (3 Year) | 906606 | EA | \$1,459.00 |
| Lexmark X792 Color Laser MFPs | | | | |
| 47B1000 | Lexmark X792de Color Laser MFP (50 ppm) (1.2 GHz) (1 GB) (8.5" x 14") (1200 x 1200 dpi) (Max Duty Cycle 150,000 Pages) (p/s/c/f) (Duplex) (USB) (Ethernet) (Touchscreen) (Energy Star) (550 Sheet Input Tray) (100 Sheet Multipurpose Tray) (75 Sheet ADF) | 106052 | EA | \$5,404.29 |
| 47BT020 | Government Lexmark X792de: TAA-Compliant Version | 505368 | EA | \$5,404.29 |
| 47B1001 | Lexmark X792dte: Base Model + 1,650-Sheet Input Capacity | 106053 | EA | \$6,158.57 |
| 47BT021 | Government Lexmark X792dte: TAA-Compliant Version | 102051 | EA | \$6,158.57 |
| 47B1002 | Lexmark X792dtfe: Base Model + 1,650-Sheet Input Capacity, Stapler Finisher | 106054 | EA | \$6,975.71 |
| 47BT022 | Government Lexmark X792dtfe: TAA-Compliant Version | 921399 | EA | \$6,975.71 |
| 47B1120 | Lexmark X792dtp: Base Model + 1,650-Sheet Input Capacity, Stapler/Hole Punch Finisher | 106055 | EA | \$7,415.71 |
| 47BT023 | Government Lexmark X792dtp: TAA-Compliant Version | 921400 | EA | \$7,415.71 |
| 47B1121 | Lexmark X792dtme: Base Model + 1,650-Sheet Input Capacity, 5-Bin Mailbox | 106056 | EA | \$6,975.71 |
| 47BT024 | Government Lexmark X792dtme: TAA-Compliant Version | 921401 | EA | \$6,975.71 |
| 47B0110 | 550-Sheet Drawer | 905288 | EA | \$398.57 |
| 47B0111 | 2,000-Sheet High Capacity Feeder | 905289 | EA | \$1,027.14 |
| 47B0114 | Caster Base | 905292 | EA | \$398.57 |
| 2353777 | Onsite Repair Extended Warranty (2 Year) | 102028 | EA | \$1,599.00 |
| 2353778 | Onsite Repair Extended Warranty (3 Year) | 102029 | EA | \$2,349.00 |
| Lexmark X950de Color Laser Printer <i>(Continued on next page)</i> | | | | |
| 22Z0019 | Lexmark X950de Color Laser Printer (45 ppm Mono/40 ppm Color) (1 GB) (1200 x 1200 dpi) (Max Duty Cycle 200,000 Pages) (p/s/c/f) (Duplex) (Ethernet) (USB) (520 Sheet Input Tray) (100 Sheet Multipurpose Feeder) | 101905 | EA | \$12,855.71 |
| 22ZT173 | Government Lexmark X950de: TAA-Compliant Version | 921303 | EA | \$12,855.71 |
| 22Z0012 | 520-Sheet Drawer Stand (Up to 12" x 18") | 903581 | EA | \$730.00 |
| 22Z0013 | 3 x 520-Sheet Drawer Stand (Up to 12" x 18") | 903582 | EA | \$1,541.43 |
| 22Z0015 | 2,000-Sheet High Capacity Feeder (Up to 8.5" x 14") | 903584 | EA | \$1,370.00 |

| MFG# | Product Description | Part# | UOM | Retail |
|---|---|--------|-----|------------|
| LEXMARK EQUIPMENT | | | | |
| Lexmark X950de Color Laser Printer (Continued) | | | | |
| 2354236 | Onsite Repair Extended Warranty (2 Year) | 701572 | EA | \$3,499.00 |
| 2354237 | Onsite Repair Extended Warranty (3 Year) | 701573 | EA | \$5,819.00 |
| OKI EQUIPMENT | | | | |
| OKI B411 Mono Laser Printers | | | | |
| 91659801 | OKI B411d LED Mono Laser Printer (35 ppm) (330 MHz) (64 MB) (8.5" x 14") (2400 x 600 dpi) (Max Duty Cycle 80,000 Pages) (Duplex) (Parallel) (USB) (Energy Star) (251 Sheet Input Capacity) (Product Color: Black) | 913187 | EA | \$199.00 |
| 91659803 | OKI B411dn: Base Model + Ethernet | 913067 | EA | \$249.00 |
| OKI B420dn Mono Laser Printer | | | | |
| 91642903 | OKI B420dn LED Mono Laser Printer (30 ppm) (32 MB) (8.5" x 11") (2400 x 600 dpi) (Max Duty Cycle 70,000 Pages) (Duplex) (Parallel) (USB) (Ethernet) (Energy Star) (580 Sheet Input Capacity) | 92717 | EA | \$536.00 |
| 43990706 | 530-Sheet Paper Tray | 95175 | EA | \$229.00 |
| 38005002 | Warranty Extension Program (Exchange) (2 Year) | 916237 | EA | \$49.00 |
| 38005003 | Warranty Extension Program (Exchange) (3 Year) | 916238 | EA | \$89.00 |
| OKI B431 Mono Laser Printers | | | | |
| 91659901 | OKI B431d LED Mono Laser Printer (40 ppm) (330 MHz) (64 MB) (8.5" x 14") (1200 x 1200 dpi) (Max Duty Cycle 80,000 Pages) (Duplex) (Parallel) (USB) (Energy Star) (350 Sheet Input Capacity) | 913188 | EA | \$299.00 |
| 91659903 | OKI B431dn: Base Model + Ethernet | 913069 | EA | \$349.00 |
| OKI B710 Mono Laser Printers | | | | |
| 62435504 | OKI B710n LED Mono Laser Printer (42 ppm) (600 MHz) (128 MB) (8.5" x 14") (1200 x 1200 dpi) (Max Duty Cycle 250,000 Pages) (Parallel) (Serial) (USB) (Ethernet) (Energy Star) (700 Sheet Input Capacity) | 913071 | EA | \$625.00 |
| 62435506 | OKI B710dn: Base Model + Duplex Printing | 913171 | EA | \$775.00 |
| 70062701 | 550-Sheet Paper Tray | 95198 | EA | \$389.00 |
| OKI B721dn Mono Laser Printer | | | | |
| 62442001 | OKI B721dn LED Mono Printer (49 ppm) (800 MHz) (256 MB) (8.5" x 14") (1200 x 1200 dpi) (Max Duty Cycle 250,000 Pages) (Duplex) (USB) (Ethernet) (Energy Star) (630 Sheet Input Capacity) | 916411 | EA | \$899.00 |
| 45478901 | 530-Sheet Paper Tray | 919377 | EA | \$279.00 |
| 45530101 | 2,000-Sheet Large Capacity Feeder with Casters | 919376 | EA | \$875.00 |
| 38034603 | Warranty Extension Program (Onsite Service) (3 Year) | 919378 | EA | \$240.00 |
| OKI B731dn Mono Laser Printer | | | | |
| 62442101 | OKI B731dn LED Mono Laser Printer (55 ppm) (800 MHz) (256 MB) (8.5" x 14") (1200 x 1200 dpi) (Max Duty Cycle 280,000 Pages) (Duplex) (USB) (Ethernet) (Energy Star) (630 Sheet Input Capacity) | 916019 | EA | \$1,199.00 |
| 45478901 | 530-Sheet Paper Tray | 919377 | EA | \$279.00 |
| 45530101 | 2,000-Sheet Large Capacity Feeder with Casters | 919376 | EA | \$875.00 |
| 38034603 | Warranty Extension Program (Onsite Service) (3 Year) | 919378 | EA | \$240.00 |
| OKI B930 Mono Laser Printers | | | | |
| 62429901 | OKI B930n Mono Laser Printer (50 ppm) (600 MHz) (256 MB) (11" x 17") (1200 x 1200 dpi) (Max Duty Cycle 300,000 Pages) (Parallel) (USB) (Ethernet) (Energy Star) (1,100 Sheet Input Capacity) | 913152 | EA | \$3,490.00 |
| 62429904 | OKI B930dn: Base Model + Duplex Printing | 913153 | EA | \$3,997.00 |
| 70053801 | 2,000-Sheet High Capacity Feeder | 95216 | EA | \$1,129.00 |
| 70054001 | 2,000-Sheet Letter Tandem Tray | 95332 | EA | \$1,129.00 |
| OKI B4600 Mono Laser Printers | | | | |
| 62427201 | OKI B4600 LED Mono Laser Printer (27 ppm) (32 MB) (8.5" x 14") (1200 x 600 dpi) (Max Duty Cycle 40,000 Pages) (Parallel) (USB) (250 Sheet Input Capacity) | 92730 | EA | \$299.00 |
| 62427204 | OKI B4600n: Base Model + Ethernet | 913147 | EA | \$499.00 |
| 62427206 | OKI B4600n PS: Base Model + Ethernet, PostScript Emulation | 913148 | EA | \$549.00 |
| 40834411 | 500-Sheet Tray | 922132 | EA | \$229.00 |
| 58263102 | Warranty Extension Program (Exchange) (3 Year) | 916351 | EA | \$89.00 |
| OKI MB280 Mono Laser MFP | | | | |
| 62431801 | OKI MB280 Mono Laser MFP (22 ppm) (100 MHz) (32 MB) (8.5" x 14") (600 x 600 dpi) (Max Duty Cycle 10,000 Pages) (p/s/c/f) (USB) (250 Sheet Input Capacity) | 913161 | EA | \$374.00 |

| MFG# | Product Description | Part# | UOM | Retail |
|---|---|--------|-----|------------|
| OKI EQUIPMENT | | | | |
| OKI MB451w LED Mono Laser MFP | | | | |
| 62439001 | OKI MB451w LED Mono Laser MFP (30 ppm) (330 MHz) (256 MB) (8.5" x 14") (2400 x 600 dpi) (Max Duty Cycle 50,000 Pages) (p/s/c/f) (Duplex) (USB) (Ethernet) (Wireless) (Energy Star) (350 Sheet Input Capacity) (50 Sheet RADF) | 913183 | EA | \$299.00 |
| 38030102 | Warranty Extension Program (Onsite Service) (2 Year) | 916311 | EA | \$141.00 |
| 38030103 | Warranty Extension Program (Onsite Service) (3 Year) | 916312 | EA | \$268.00 |
| OKI MB461 Mono Laser MFP | | | | |
| 62438601 | OKI MB461 LED Mono Laser MFP (35 ppm) (330 MHz) (256 MB) (8.5" x 11") (2400 x 600 dpi) (Max Duty Cycle 60,000 Pages) (p/s/c) (Duplex) (USB) (Ethernet) (251 Sheet Input Capacity) (50 Sheet RADF) | 913179 | EA | \$349.00 |
| 44575708 | 530-Sheet Paper Tray | 920261 | EA | \$229.00 |
| 38030102 | Warranty Extension Program (Onsite Service) (2 Year) | 916311 | EA | \$141.00 |
| 38030103 | Warranty Extension Program (Onsite Service) (3 Year) | 916312 | EA | \$268.00 |
| OKI MB471 Mono Laser MFPs | | | | |
| 62438701 | OKI MB471 LED Mono Laser MFP (35 ppm) (330 MHz) (256 MB) (8.5" x 11") (1200 x 1200 dpi) (Max Duty Cycle 60,000 Pages) (p/s/c/f) (Duplex) (USB) (Ethernet) (351 Sheet Input Capacity) (50 Sheet RADF) | 913180 | EA | \$399.00 |
| 62438703 | OKI MB471w: Base Model + Wireless Connectivity | 913181 | EA | \$475.00 |
| 44575708 | 530-Sheet Paper Tray | 920261 | EA | \$229.00 |
| 38030102 | Warranty Extension Program (Onsite Service) (2 Year) | 916311 | EA | \$141.00 |
| 38030103 | Warranty Extension Program (Onsite Service) (3 Year) | 916312 | EA | \$268.00 |
| OKI MB480 LED Mono Laser MFP | | | | |
| 62433301 | OKI MB480 LED Mono Laser MFP (30 ppm) (297 MHz) (64 MB) (8.5" x 14") (1200 x 1200 dpi) (Max Duty Cycle 70,000 Pages) (p/s/c/f) (Duplex) (Parallel) (USB) (Ethernet) (Energy Star) (580 Sheet Input Capacity) (50 Sheet ADF) | 913162 | EA | \$626.00 |
| 43990706 | 530-Sheet Paper Tray | 95175 | EA | \$229.00 |
| OKI MB491 Mono Laser MFPs | | | | |
| 62438801 | OKI MB491 LED Mono Laser MFP (42 ppm) (40 cpm) (330 MHz) (256 MB) (8.5" x 11") (1200 x 1200 dpi) (Max Duty Cycle 80,000 Pages) (p/s/c/f) (Duplex) (USB) (Ethernet) (351 Sheet Input Capacity) (50 Sheet RADF) | 913182 | EA | \$499.00 |
| 62439201 | OKI MB491+LP: Base Model + 47 ppm | 913184 | EA | \$549.00 |
| 44575708 | 530-Sheet Paper Tray | 920261 | EA | \$229.00 |
| 38030102 | Warranty Extension Program (Onsite Service) (2 Year) | 916311 | EA | \$141.00 |
| 38030103 | Warranty Extension Program (Onsite Service) (3 Year) | 916312 | EA | \$268.00 |
| OKI MB760 Mono Laser MFP | | | | |
| 62441604 | OKI MB760 Mono Laser MFP (49 ppm) (1.3 GHz) (2 GB) (8.5" x 14") (1200 x 1200 dpi) (Max Duty Cycle 250,000 Pages) (p/s/c/f) (Duplex) (USB) (Ethernet) (Touchscreen) (Energy Star) (630 Sheet Input Capacity) (100 Sheet RADF) | 914835 | EA | \$1,399.00 |
| 45479001 | 530-Sheet Paper Tray | 922160 | EA | \$279.00 |
| 45681801 | Printer Cabinet with Casters | 922161 | EA | \$239.00 |
| 38034702 | Warranty Extension Program (Onsite Service) (2 Year) | 922148 | EA | \$186.00 |
| 38034703 | Warranty Extension Program (Onsite Service) (3 Year) | 922149 | EA | \$352.00 |
| OKI MB770 Mono Laser MFP | | | | |
| 62441704 | OKI MB770 Mono Laser MFP (55 ppm) (1.3 GHz) (2 GB) (8.5" x 14") (1200 x 1200 dpi) (Max Duty Cycle 280,000 Pages) (p/s/c/f) (Duplex) (USB) (Ethernet) (Touchscreen) (Energy Star) (630 Sheet Input Capacity) (100 Sheet RADF) | 916817 | EA | \$1,899.00 |
| 62441707 | OKI MB770f: Base Model + 2 x 530-Sheet Input Trays, Stacker/Stapler | 933349 | EA | \$3,199.00 |
| 62441710 | OKI MB770fx: Base Model + 2,000-Sheet Feeder, Stacker/Stapler | 933348 | EA | \$3,499.00 |
| 45479001 | 530-Sheet Paper Tray | 922160 | EA | \$279.00 |
| 45681801 | Printer Cabinet with Casters | 922161 | EA | \$239.00 |
| 38034802 | Warranty Extension Program (Onsite Service) (2 Year) | 922150 | EA | \$200.00 |
| 38034803 | Warranty Extension Program (Onsite Service) (3 Year) | 922151 | EA | \$394.00 |
| OKI C331dn Color Laser Printer | | | | |
| 62443601 | OKI C331dn LED Color Laser Printer (25 ppm Mono/23 ppm Color) (533 MHz) (128 MB) (8.5" x 14") (1200 x 600 dpi) (Max Duty Cycle 45,000 Pages) (Duplex) (USB) (Ethernet) (Energy Star) (350 Sheet Input Capacity) | 913704 | EA | \$349.00 |
| 38035303 | Warranty Extension Program (Onsite Service) (3 Year) | 916333 | EA | \$232.00 |
| 38035304 | Warranty Extension Program (Onsite Service) (4 Year) | 916334 | EA | \$400.00 |
| OKI C531dn Color Laser Printer <i>(Continued on next page)</i> | | | | |
| 62443701 | OKI C531dn LED Color Laser Printer (31 ppm Mono/27 ppm Color) (533 MHz) (256 MB) (8.5" x 14") (1200 x 600 dpi) (Max Duty Cycle 60,000 Pages) (Duplex) (USB) (Ethernet) (Energy Star) (350 Sheet Input Capacity) | 913705 | EA | \$449.00 |

| MFG# | Product Description | Part# | UOM | Retail |
|---|--|--------|-----|------------|
| OKI EQUIPMENT | | | | |
| OKI C531dn Color Laser Printer (Continued) | | | | |
| 38035503 | Warranty Extension Program (Onsite Service) (3 Year) | 916342 | EA | \$244.00 |
| 38035504 | Warranty Extension Program (Onsite Service) (4 Year) | 916343 | EA | \$412.00 |
| OKI C610 Color Laser Printers | | | | |
| 62433401 | OKI C610n LED Color Laser Printer (34 ppm Mono/32 ppm Color) (533 MHz) (256 MB) (8.5" x 14") (1200 x 600 dpi) (Max Duty Cycle 75,000 Pages) (USB) (Ethernet) (Energy Star) (400 Sheet Input Capacity) | 92307 | EA | \$699.00 |
| 62433407 | OKI C610cdn: Base Model + Duplex Printing | 913164 | EA | \$889.00 |
| 62433405 | OKI C610dtn: Base Model + Duplex Printing, 930-Sheet Input Capacity | 913163 | EA | \$979.00 |
| 44274501 | 530-Sheet Paper Tray | 95224 | EA | \$229.00 |
| OKI C711 Color Laser Printers | | | | |
| 62433501 | OKI C711n LED Color Printer (36 ppm Black/34 ppm Color) (533 MHz) (256 MB) (8.5" x 14") (1200 x 600 dpi) (Max Duty Cycle 100,000 Pages) (USB) (Ethernet) (Energy Star) (530 Sheet Input Tray) (100 Sheet Multipurpose Tray) | 92349 | EA | \$1,219.00 |
| 62433503 | OKI C711dn: Base Model + Duplex Printing | 913165 | EA | \$1,139.00 |
| 62433505 | OKI C711dtn: Base Model + 1,160-Sheet Input Capacity | 913166 | EA | \$1,349.00 |
| 44274501 | 530-Sheet Paper Tray | 95224 | EA | \$229.00 |
| OKI C831 LED Color Laser Printers | | | | |
| 62441001 | OKI C831n LED Color Laser Printer (35 ppm) (800 MHz) (256 MB) (11" x 17") (1200 x 600 dpi) (Max Duty Cycle 75,000 Pages) (USB) (Ethernet) (Energy Star) (400 Sheet Input Capacity) | 916424 | EA | \$1,699.00 |
| 62441004 | OKI C831dn: Base Model + Duplex Printing | 925991 | EA | \$1,929.00 |
| 44713902 | 530-Sheet Paper Tray | 922154 | EA | \$379.00 |
| 38036302 | Warranty Extension Program (Onsite Service) (2 Year) | 922152 | EA | \$195.00 |
| 38036303 | Warranty Extension Program (Onsite Service) (3 Year) | 922153 | EA | \$369.00 |
| OKI C911dn Series LED Color Laser Printer | | | | |
| 62439901 | OKI C911dn Digital LED Color Printer (50 ppm) (1 GHz) (2 GB) (13" x 52") (1200 x 1200 dpi) (Max Duty Cycle 300,000 Pages) (Duplex) (USB) (Ethernet) (Energy Star) (530 Sheet Input Tray) (300 Sheet Multipurpose Tray) | 919437 | EA | \$3,699.00 |
| 45530702 | 530-Sheet Paper Tray | 919421 | EA | \$529.00 |
| 45530902 | 530-Sheet Paper Tray with Caster Base | 919423 | EA | \$590.00 |
| 45530802 | High Capacity Feeder with Caster Base | 919422 | EA | \$1,379.00 |
| 38036602 | Warranty Extension Program (Onsite Service) (2 Year) | 919412 | EA | \$412.00 |
| 38036603 | Warranty Extension Program (Onsite Service) (3 Year) | 919413 | EA | \$780.00 |
| OKI C931dn LED Color Laser Printer | | | | |
| 62440001 | OKI C931dn Digital LED Color Printer (50 ppm) (1.2 GHz) (2 GB) (13" x 52") (1200 x 1200 dpi) (Max Duty Cycle 300,000 Pages) (Duplex) (USB) (Ethernet) (Energy Star) (530 Sheet Input Tray) (300 Sheet Multipurpose Tray) | 919438 | EA | \$5,199.00 |
| 45530702 | 530-Sheet Paper Tray | 919421 | EA | \$529.00 |
| 45530902 | 530-Sheet Paper Tray with Caster Base | 919423 | EA | \$590.00 |
| 45530802 | High Capacity Feeder with Caster Base | 919422 | EA | \$1,379.00 |
| 38036702 | Warranty Extension Program (Onsite Service) (2 Year) | 919414 | EA | \$532.00 |
| 38036703 | Warranty Extension Program (Onsite Service) (3 Year) | 919415 | EA | \$1,012.00 |
| OKI C9650 Color Laser Printers | | | | |
| 62430604 | OKI C9650n LED Color Laser Printer (40 ppm Mono/36 ppm Color) (512 MB) (11" x 17") (1200 x 600 dpi) (Max Duty Cycle 150,000 Pages) (Parallel) (USB) (Ethernet) (760 Sheet Input Capacity) | 913154 | EA | \$4,199.00 |
| 62430606 | OKI C9650dn: Base Model + Duplex Printing | 913155 | EA | \$4,599.00 |
| 62430608 | OKI C9650hdn: Base Model + Duplex Printing, 2,350-Sheet Input Capacity | 913156 | EA | \$5,199.00 |
| 42831301 | 530-Sheet Paper Tray | 95254 | EA | \$529.00 |
| 42831501 | 1,590-Sheet High Capacity Paper Feeder | 95257 | EA | \$1,379.00 |
| 70050901 | Printer Cabinet | 922133 | EA | \$449.00 |
| 58272501 | Warranty Extension Program (Onsite Service) (2 Year) | 916368 | EA | \$795.00 |
| OKI MC362w LED Color Laser MFP | | | | |
| 62441804 | OKI MC362w LED Color Laser MFP (25 ppm Mono/23 ppm Color) (533 MHz) (256 MB) (8.5" x 14") (1200 x 600 dpi) (Max Duty Cycle 45,000 Pages) (p/s/c/f) (Duplex) (USB) (Ethernet) (Wireless) (Energy Star) (350 Sheet Input Capacity) (50 Sheet RADF) | 913700 | EA | \$549.00 |
| 38035603 | Warranty Extension Program (Onsite Service) (3 Year) | 916345 | EA | \$302.00 |
| 38035604 | Warranty Extension Program (Onsite Service) (4 Year) | 916346 | EA | \$516.00 |

| MFG# | Product Description | Part# | UOM | Retail |
|--|--|--------|-----|------------|
| OKI EQUIPMENT | | | | |
| OKI MC562w LED Color Laser MFP | | | | |
| 62441904 | OKI MC562w LED Color Laser MFP (31 ppm Mono/27 ppm Color) (533 MHz) (256 MB) (8.5" x 14") (1200 x 600 dpi) (Max Duty Cycle 60,000 Pages) (p/s/c/f) (Duplex) (USB) (Ethernet) (Wireless) (Energy Star) (350 Sheet Input Capacity) (50 Sheet RADF) | 913703 | EA | \$749.00 |
| 38035703 | Warranty Extension Program (Onsite Service) (3 Year) | 915920 | EA | \$352.00 |
| 38035704 | Warranty Extension Program (Onsite Service) (4 Year) | 916348 | EA | \$600.00 |
| OKI MC770 Color Laser MFP | | | | |
| 62439401 | OKI MC770 LED Color Laser MFP (37 ppm Mono/35 ppm Color) (1.3 GHz) (2 GB) (8.5" x 14") (1200 x 600 dpi) (Max Duty Cycle 120,000 Pages) (p/s/c/f) (Duplex) (USB) (Ethernet) (Touchscreen) (Energy Star) (630 Sheet Input Capacity) (100 Sheet RADF) | 914834 | EA | \$2,499.00 |
| 45466501 | 530-Sheet Paper Tray | 922158 | EA | \$279.00 |
| 45393301 | 2,000-Sheet Large Capacity Feeder | 922157 | EA | \$875.00 |
| 45466601 | Printer Stand with Casters | 922159 | EA | \$216.00 |
| 45681801 | Printer Cabinet with Casters | 922161 | EA | \$239.00 |
| 38034902 | Warranty Extension Program (Onsite Service) (2 Year) | 916319 | EA | \$203.00 |
| 38034903 | Warranty Extension Program (Onsite Service) (3 Year) | 916320 | EA | \$386.00 |
| OKI MC780 Color Laser MFPs | | | | |
| 62439701 | OKI MC780 LED Color Laser MFP (42 ppm) (1.3 GHz) (2 GB) (8.5" x 14") (1200 x 600 dpi) (Max Duty Cycle 150,000 Pages) (p/s/c/f) (Duplex) (USB) (Ethernet) (Touchscreen) (Energy Star) (530 Sheet Input Tray) (100 Sheet Multipurpose Tray) (100 Sheet RADF) | 916818 | EA | \$3,499.00 |
| 62439504 | OKI MC780f: Base Model + Extra 530-Sheet Tray, Stacker/Stapler Finisher | 933555 | EA | \$4,199.00 |
| 62439507 | OKI MC780fx: Base Model + 2,000-Sheet Feeder, Stacker/Stapler Finisher | 933556 | EA | \$4,499.00 |
| 45466501 | 530-Sheet Paper Tray | 922158 | EA | \$279.00 |
| 45393301 | 2,000-Sheet Large Capacity Feeder | 922157 | EA | \$875.00 |
| 45466601 | Printer Stand with Casters | 922159 | EA | \$216.00 |
| 45681801 | Printer Cabinet with Casters | 922161 | EA | \$239.00 |
| 38035002 | Warranty Extension Program (Onsite Service) (2 Year) | 916323 | EA | \$219.00 |
| 38035003 | Warranty Extension Program (Onsite Service) (3 Year) | 916324 | EA | \$415.00 |
| RICOH EQUIPMENT | | | | |
| Ricoh SP 201Nw/SP 204SN Mono Laser Printer & MFP | | | | |
| 407203 | Ricoh SP 201NW Mono Laser Printer (23 ppm) (66 MHz) (32 MB) (8.5" x 14") (1200 x 600 dpi) (USB) (Ethernet) (Wireless) (150 Sheet Input Tray) (1 Sheet Bypass) | 933792 | EA | \$175.00 |
| 407205 | Ricoh SP 204SN Mono Laser MFP: Same as 201 + Scan/Copy Functions, 15-Sheet ADF (Wireless Not Standard) | 914987 | EA | \$185.00 |
| Ricoh Aficio SP 311 Mono Laser Printer & MFP | | | | |
| 407234 | Ricoh SP 311DNw Mono Laser Printer (30 ppm) (360 MHz) (128 MB) (8.5" x 14") (1200 x 600 dpi) (Duplex) (USB) (Ethernet) (Wireless) (Energy Star) (250 Sheet Input Capacity) (50 Sheet Multipurpose Tray) | 915057 | EA | \$200.00 |
| 407240 | Ricoh SP 311SFNw MFP: Base Model + Scan/Copy/Fax Functions, 35-Sheet ADF | 915061 | EA | \$378.00 |
| Ricoh Aficio SP 3500N/3510DN/3500SF/3510SF Mono Laser Printers & MFPs | | | | |
| 406957 | Ricoh Aficio SP 3500N Mono Laser Printer (30 ppm) (295 MHz) (64 MB) (8.5" x 14") (1200 x 1200 dpi) (USB) (Ethernet) (Energy Star) (250 Sheet Input Tray) (50 Sheet Multipurpose Tray) | 908701 | EA | \$239.00 |
| 406962 | Ricoh Aficio SP 3510DN: Base Model + Duplex Printing | 908689 | EA | \$299.00 |
| 406967 | Ricoh Aficio SP 3500SF MFP: Base Model + 350 MHz, 128 Total Memory, Scan/Copy/Fax Functions, 35-Sheet ADF | 908692 | EA | \$419.00 |
| 406971 | Ricoh Aficio SP 3510SF: Same as 3500SF + Duplex Printing, 50-Sheet DADF | 908693 | EA | \$479.00 |
| 406496 | 250-Sheet Paper Tray (Type TK1080) | 909398 | EA | \$149.00 |
| 007067MIU | Ricoh Aficio SP 3500N Advanced Exchange Limited Warranty (2 Year) | 909391 | EA | \$121.00 |
| 007069MIU | Ricoh Aficio SP 3500SF Advanced Exchange Limited Warranty (2 Year) | 909839 | EA | \$320.00 |
| Ricoh Aficio SP 4100NL Mono Laser Printer | | | | |
| 406636 | Ricoh Aficio SP 4100NL Mono Laser Printer (31 ppm) (400 MHz) (192 MB) (1200 x 600 dpi) (Ethernet) (USB) (Parallel) (Energy Star) (600 Sheet Input Tray) | 908698 | EA | \$549.00 |
| 402807 | 500-Sheet Feeder (Type TK1030) | 901691 | EA | \$275.00 |
| 001686MIU | Extended Warranty (Onsite Service) (2 Year) | 14399 | EA | \$249.00 |
| 001561MIU | Extended Warranty (Advanced Exchange) (2 Year) | 14377 | EA | \$159.00 |
| Ricoh Aficio SP 4310N Mono Laser Printer | | | | |
| 406799 | Ricoh Aficio SP 4310N Mono Laser Printer (37 ppm) (466 MHz) (256 MB) (8.5" x 14") (1200 x 600 dpi) (Max Duty Cycle 150,000 Pages) (USB) (Ethernet) (Energy Star) (600 Sheet Input Capacity) | 908676 | EA | \$799.00 |
| 402807 | 500-Sheet Feeder (Type TK1030) | 901691 | EA | \$275.00 |
| 006882MIU | Extended Warranty (Advanced Exchange) (2 Year) | 909380 | EA | \$165.00 |
| 006885MIU | Extended Warranty (Onsite Service) (2 Year) | 909383 | EA | \$257.00 |

| MFG# | Product Description | Part# | UOM | Retail |
|---|--|--------|-----|------------|
| RICOH EQUIPMENT | | | | |
| Ricoh Aficio SP 5200DN/5210DN Mono Laser Printers | | | | |
| 406722 | Ricoh Aficio SP 5200DN Mono Laser Printer (47 ppm) (533 MHz) (256 MB) (8.5" x 11") (1200 x 600 dpi) (Max Duty Cycle 200,000 Pages) (Duplex) (USB) (Ethernet) (Energy Star) (650 Sheet Input Capacity) | 908691 | EA | \$1,599.00 |
| 406726 | Ricoh Aficio SP 5210DN: Base Model + 52 ppm, 768 MB Total Memory | 909402 | EA | \$1,999.00 |
| 406730 | 550-Sheet Feeder (Type TK1120) | 908694 | EA | \$300.00 |
| 406732 | 550-Sheet Feeder with Casters (Type TK1120) | 909403 | EA | \$325.00 |
| 006905MIU | Extended Warranty (Onsite Service) (2 Year) | 909388 | EA | \$625.00 |
| 006906MIU | Extended Warranty (Onsite Service) (3 Year) | 909389 | EA | \$855.00 |
| Ricoh Aficio SP 5200S/5210SR/5210SF Mono Laser MFPs | | | | |
| 406851 | Ricoh Aficio SP 5200S Mono Laser MFP (47 ppm) (1 GB) (8.5" x 14") (1200 x 600 dpi) (Max Duty Cycle 200,000 Pages) (p/s/c) (Duplex) (USB) (Ethernet) (Energy Star) (650 Sheet Input Capacity) (50 Sheet ADF) | 909850 | EA | \$3,299.00 |
| 406853 | Ricoh Aficio SP 5210SR: Base Model + 52 ppm, Touchscreen | 909852 | EA | \$4,449.00 |
| 406852 | Ricoh Aficio SP 5210SF: Base Model + 52 ppm, Fax Function, Touchscreen | 909851 | EA | \$4,319.00 |
| 406599 | 550-Sheet Paper Feeder (Type TK1090) | 909847 | EA | \$310.00 |
| 406600 | 550-Sheet Paper Feeder with Casters (Type TK1100) | 909848 | EA | \$335.00 |
| 006909MIU | Extended Warranty (Onsite Service) (2 Year) | 909832 | EA | \$785.00 |
| 006910MIU | Extended Warranty (Onsite Service) (3 Year) | 909833 | EA | \$1,065.00 |
| Ricoh Aficio SP 6330N Mono Laser Printer | | | | |
| 406716 | Ricoh Aficio SP 6330N Mono Laser Printer (35 ppm) (466 MHz) (256 MB) (11" x 17") (1200 x 1200 dpi) (Max Duty Cycle 200,000 Pages) (Duplex) (USB) (Ethernet) (Energy Star) (600 Sheet Input Capacity) | 908697 | EA | \$1,244.00 |
| 406617 | 500-Sheet Feeder (Type PB3090) | 909399 | EA | \$373.00 |
| 001686MIU | Extended Warranty (Onsite Service) (2 Year) | 14399 | EA | \$249.00 |
| 001561MIU | Extended Warranty (Advanced Exchange) (2 Year) | 14377 | EA | \$159.00 |
| Ricoh Aficio SP 8300DN Mono Laser Printer | | | | |
| 407285 | Ricoh Aficio SP 8300DN Mono Laser Printer (50 ppm) (533 MHz) (512 MB) (11" x 17") (600 x 600 dpi) (Duplex) (USB) (Ethernet) (Touchscreen) (Energy Star) (1,100 Sheet Input Capacity) (100 Sheet Multipurpose Tray) | 911048 | EA | \$3,060.00 |
| 415984 | 1,200-Sheet Large Capacity Input Tray (8.5" x 11") (Type RT3020) (Installed On Right Side) | 911052 | EA | \$1,910.00 |
| 415795 | 2,000-Sheet Large Capacity Paper Tray (Type PB3140) | 911076 | EA | \$1,960.00 |
| 416407 | FAC56 Cabinet Stand | 911059 | EA | \$290.00 |
| 007143MIU | Extended Warranty (Onsite Service) (2 Year) | 911072 | EA | \$1,019.00 |
| Ricoh SP C250DN/C250SF Color Laser Printer & MFP | | | | |
| 407519 | Ricoh SP C250DN Color Laser Printer (21 ppm) (350 MHz) (128 MB) (8.5" x 14") (2400 x 600 dpi) (Duplex) (USB) (Ethernet) (Wireless) (Energy Star) (250 Sheet Input Tray) (1 Sheet Bypass Tray) | 927122 | EA | \$360.00 |
| 407523 | Ricoh SP C250SF Color Laser MFP: Base Model + Scan/Copy/Fax Functions, 400 MHz, 256 MB | 927123 | EA | \$499.99 |
| 406019 | 500-Sheet Feeder (Type TK1010) | 106605 | EA | \$179.00 |
| Ricoh SP C252DN/C252SF Color Laser Printer & MFP | | | | |
| 407521 | Ricoh SP C252DN Color Laser Printer (21 ppm) (350 MHz) (128 MB) (8.5" x 14") (2400 x 600 dpi) (Duplex) (USB) (Ethernet) (Wireless) (Energy Star) (250 Sheet Input Tray) (1 Sheet Bypass Tray) | 927130 | EA | \$550.00 |
| 407525 | Ricoh SP C252SF: Base Model + Scan/Copy/Fax Functions, 400 MHz Processor, 256 MB Memory, 35-Sheet ADF | 927127 | EA | \$899.00 |
| 406019 | 500-Sheet Feeder (Type TK1010) | 106605 | EA | \$179.00 |
| Ricoh Aficio SP C320DN Color Laser Printer | | | | |
| 406790 | Ricoh Aficio SP C320DN Color Laser Printer (26 ppm) (533 MHz) (384 MB) (8" x 13") (1200 x 1200 dpi) (Duplex) (Ethernet) (USB) (Energy Star) (600 Sheet Input Capacity) | 908680 | EA | \$799.00 |
| 406019 | 500-Sheet Feeder (Type TK1010) | 106605 | EA | \$179.00 |
| 003341MIU | Extended Warranty (Onsite Service) (2 Year) | 14419 | EA | \$215.00 |
| 003342MIU | Extended Warranty (Onsite Service) (3 Year) | 14427 | EA | \$315.00 |
| Ricoh Aficio SP C430DN/C431DN Color Laser Printers | | | | |
| 406654 | Ricoh Aficio SP C430DN Color Laser Printer (37 ppm) (600 MHz) (384 MB) (8.5" x 13") (1200 x 1200 dpi) (Duplex) (USB) (Ethernet) (Energy Star) (650 Sheet Input Capacity) | 908678 | EA | \$1,499.00 |
| 406658 | Ricoh Aficio SP C431DN: Base Model + 42 ppm, 768 MB Total Memory | 909592 | EA | \$1,999.00 |
| 406681 | 550-Sheet Feeder (Type PB1020) | 908696 | EA | \$390.00 |
| 406755 | Caster Table (Type C) | 909595 | EA | \$199.00 |
| 005798MIU | Extended Warranty (Onsite Service) (2 Year) | 909574 | EA | \$452.00 |
| 005799MIU | Extended Warranty (Onsite Service) (3 Year) | 909575 | EA | \$665.00 |

| MFG# | Product Description | Part# | UOM | Retail |
|---|--|--------|-----|------------|
| RICOH EQUIPMENT | | | | |
| Ricoh Aficio SP C830DN/C831DN Color Laser Printers | | | | |
| 430709 | Ricoh Aficio SP C830DN Color Laser Printer (45 ppm) (600 MHz) (512 MB) (11" x 17") (1200 x 1200 dpi) (Duplex) (USB) (Ethernet) (Touchscreen) (Energy Star) (1,200 Sheet Input Capacity) | 910747 | EA | \$3,884.00 |
| 430713 | Ricoh Aficio SP C831DN: Base Model + 55 ppm, 1 GHz | 910748 | EA | \$4,934.00 |
| 415794 | 550-Sheet Paper Feed Unit (Type PB3120) | 910758 | EA | \$760.00 |
| 415793 | 1,100-Sheet Paper Feed Unit (2 x 550 Sheets) (Type PB3130) | 910759 | EA | \$1,650.00 |
| 415795 | 2,000-Sheet Large Capacity Paper Tray (Type PB3140) | 911076 | EA | \$1,960.00 |
| 416337 | FAC52 Cabinet | 911058 | EA | \$250.00 |
| 415811 | Caster Table (Type D) | 911050 | EA | \$270.00 |
| 007146MIU | Extended Warranty (Onsite Service) (2 Year) | 911075 | EA | \$1,180.00 |
| Ricoh Inkjet Printers | | | | |
| 405777 | Ricoh Aficio SG 3100SNw GelSprinter Color Inkjet MFP (29 ppm Print) (29 cpm Copy) (192 MB) (8.5" x 11") (3600 x 1200 dpi) (p/s/c) (Duplex) (USB) (Ethernet) (Wireless) (250 Sheet Input Capacity) | 911024 | EA | \$249.00 |
| 405750 | Ricoh Aficio SG 3110DN GelSprinter Color Inkjet Printer (29 ppm) (128 MB) (8.5"x 14") (3600 x 1200 dpi) (Max Duty Cycle 10,000 Pages) (Duplex) (Ethernet) (USB) (Energy Star) (250 Sheet Input) | 908677 | EA | \$225.00 |
| 405753 | Ricoh Aficio SG 3110DNw GelSprinter Color Inkjet Printer (29 ppm) (128 MB) (8.5"x 14") (3600 x 1200 dpi) (Max Duty Cycle 10,000 Pages) (Duplex) (USB) (Ethernet) (Wireless) (Energy Star) (250 Sheet Input) | 909792 | EA | \$225.00 |
| 405780 | Ricoh Aficio SG 3110SFNw GelSprinter Color Inkjet MFP (29 ppm Print) (29 cpm Copy) (800 MHz) (256 MB) (8.5" x 14") (3600 x 1200 dpi) (p/s/c/f) (Duplex) (USB) (Ethernet) (Wireless) (Energy Star) (250 Sheet Input Capacity) | 911025 | EA | \$271.00 |
| 405809 | Ricoh SG 7100DN GeJet Color Inkjet Printer (29 ppm) (32 MB) (11" x 17") (3600 x 1200 dpi) (Duplex) (USB) (Ethernet) (250 Sheet Input Capacity) | 915056 | EA | \$1,299.00 |

ST9700 SERIES SECURE MICR CHECK PRINTERS



Our secure MICR printers virtually eliminate the risk of check fraud and offer companies significant cost savings by eliminating the need for expensive pre-printed checks. Our MICR printers feature the most extensive check printing security features available and are used in retail banks, credit unions and accounts payables departments in hundreds of industries.

| MFG# | Product Description | Part# | UOM | Retail |
|--|---|--------|-----|------------|
| SOURCE TECHNOLOGIES EQUIPMENT | | | | |
| Source Technologies ST9700 Series Standard MICR Printers & MFPs | | | | |
| T201-0000000 | Source Technologies Standard MICR ST9720 Printer Base Model (50 ppm) (800 MHz) (256 MB) (1200 x 1200 dpi) (Max Duty Cycle 150,000 Pages) (Duplex) (USB) (Ethernet) (Energy Star) (650 Sheet Input Capacity) (For Use With MICR Toner Only) | 913058 | EA | \$1,387.00 |
| X201-0000000 | Source Technologies Standard MICR ST9722 MFP Base Model (50 ppm) (800 MHz) (1 GB) (1200 x 1200 dpi) (Max Duty Cycle 150,000 Pages) (p/s/c/f) (Duplex) (USB) (Ethernet) (Touchscreen) (Energy Star) (650 Sheet Input Capacity) (For Use With MICR Toner Only) | 913063 | EA | \$2,494.00 |
| Y201-0000000 | Source Technologies Standard MICR ST9730 Printer Base Model (55 ppm) (800 MHz) (512 MB) (1200 x 1200 dpi) (Max Duty Cycle 250,000 Pages) (USB) (Ethernet) (650 Sheet Input Capacity) (For Use With MICR Toner Only) | 913059 | EA | \$1,895.00 |
| YH01-0000000 | Source Technologies ST9730: Base Model + Duplex Printing | 913061 | EA | \$2,052.00 |
| Source Technologies ST9700 Series Secure MICR Printers & MFPs | | | | |
| B101-0000000 | Source Technologies Secure MICR ST9715 Printer Base Model (35 ppm) (800 MHz) (128 MB) (1200 x 1200 dpi) (Max Duty Cycle 50,000 Pages) (Duplex) (USB) (Ethernet) (Parallel) (Energy Star) (300 Sheet Input Capacity) | 927439 | EA | \$649.00 |
| A101-0000000 | Source Technologies Secure MICR ST9717 Printer Base Model (37 ppm) (800 MHz) (256 MB) (1200 x 1200 dpi) (Max Duty Cycle 60,000 Pages) (Duplex) (USB) (Ethernet) (Parallel) (Energy Star) (300 Sheet Input Capacity) | 927443 | EA | \$1,099.00 |
| T101-0000000 | Source Technologies Secure MICR ST9720 Printer Base Model (50 ppm) (800 MHz) (256 MB) (1200 x 1200 dpi) (Max Duty Cycle 100,000 Pages) (Duplex) (USB) (Ethernet) (Energy Star) (650 Sheet Input Capacity) | 913035 | EA | \$1,529.00 |
| X101-0000000 | Source Technologies Secure MICR ST9722 MFP Base Model (50 ppm) (800 MHz) (1 GB) (1200 x 1200 dpi) (Max Duty Cycle 150,000 Pages) (p/s/c/f) (Duplex) (USB) (Ethernet) (Touchscreen) (Energy Star) (650 Sheet Input Capacity) | 913064 | EA | \$2,637.00 |
| Y101-0000000 | Source Technologies Secure MICR ST9730 Printer Base Model (55 ppm) (800 MHz) (512 MB) (1200 x 1200 dpi) (Max Duty Cycle 250,000 Pages) (USB) (Ethernet) (650 Sheet Input Capacity) | 913060 | EA | \$2,045.00 |
| YG01-0000000 | Source Technologies ST9730: Base Model + Duplex Printing | 913062 | EA | \$2,205.00 |
| TROY EQUIPMENT | | | | |
| TROY MICR 401 Mono Laser Printers | | | | |
| 01-04010-101 | TROY MICR 401n Mono Laser Printer (35 ppm) (256 MB) (8.5" x 14") (1200 x 1200 dpi) (Max Duty Cycle 50,000 Pages) (USB) (Ethernet) (Energy Star) (250 Sheet Input Tray) (50 Sheet Multipurpose Tray) | 908590 | EA | \$745.00 |
| 01-04010-111 | TROY MICR 401n + Locking Input Tray | 908591 | EA | \$815.00 |
| 01-04010-201 | TROY MICR 401n + Extra 500-Sheet Input Tray | 908592 | EA | \$947.00 |
| 01-04010-211 | TROY MICR 401n + Locking 250-Sheet Input Tray, Extra 500-Sheet Input Tray | 908593 | EA | \$975.00 |
| 01-04010-221 | TROY MICR 401n + Locking 250- and 500-Sheet Input Trays | 908594 | EA | \$1,026.00 |
| 01-07020-101 | TROY MICR 401dn: Base Model + Duplex Printing | 908424 | EA | \$895.00 |
| 01-07020-201 | TROY MICR 401dn + Extra 500-Sheet Input Tray | 908426 | EA | \$1,097.00 |
| 01-07020-211 | TROY MICR 401dn + Locking 250-Sheet Input Tray, Extra 500-Sheet Input Tray | 908427 | EA | \$1,125.00 |
| 01-07020-221 | TROY MICR 401dn + Locking 250- and 500-Sheet Input Trays | 908428 | EA | \$1,176.00 |
| 05-00201-001 | 500-Sheet Input Tray | 919445 | EA | \$135.00 |
| 02-20629-001 | 500-Sheet Input Tray with Lock | 910661 | EA | \$257.00 |
| 77-00031-401 | Next Day Service Warranty (3 Year) | 910644 | EA | \$565.00 |
| 77-00051-401 | Next Day Service Warranty (5 Year) | 922301 | EA | \$998.00 |
| TROY MICR 601 Mono Laser Printers | | | | |
| 01-03010-101 | TROY MICR 601n Mono Laser Printer (45 ppm) (800 MHz) (512 MB) (8.5" x 14") (1200 x 1200 dpi) (Max Duty Cycle 175,000 Pages) (USB) (Ethernet) (500 Sheet Input Tray) | 910480 | EA | \$1,845.00 |
| 01-03010-111 | TROY MICR 601n + Locking Input Tray | 910481 | EA | \$1,965.00 |
| 01-03010-201 | TROY MICR 601tn: Base Model + Extra 500-Sheet Input Tray | 908404 | EA | \$2,150.00 |
| 01-03010-221 | TROY MICR 601tn: Base Model + 2 Locking Input Trays | 908405 | EA | \$2,375.00 |
| 05-00194-001 | 500-Sheet Input Tray | 911726 | EA | \$289.00 |
| 02-03011-001 | 500-Sheet Input Tray with Lock | 908695 | EA | \$475.00 |
| 02-03012-001 | 500-Sheet Input Tray with Combination Lock | 922290 | EA | \$490.00 |
| 05-00195-001 | 1,500-Sheet Input Tray | 911470 | EA | \$529.00 |
| 02-03016-001 | 1,500-Sheet Input Tray with Lock | 913370 | EA | \$750.00 |
| 02-03150-001 | 1,500-Sheet Input Tray with Combination Lock | 919447 | EA | \$765.00 |
| 77-00031-601 | Next Day Service Warranty (3 Year) | 912464 | EA | \$642.00 |
| 77-00051-601 | Next Day Service Warranty (5 Year) | 912468 | EA | \$1,010.00 |
| TROY MICR 602 Secure Mono Laser Printers (Continued on next page) | | | | |
| 01-03020-101 | TROY MICR 602n Secure Mono Laser Printer (52 ppm) (800 MHz) (512 MB) (8.5" x 14") (1200 x 1200 dpi) (Max Duty Cycle 225,000 Pages) (USB) (Ethernet) (500 Sheet Input Tray) (100 Sheet Multipurpose Tray) | 910482 | EA | \$2,550.00 |
| 01-03020-111 | TROY MICR 602n + Locking Input Tray | 910486 | EA | \$2,645.00 |
| 01-03020-201 | TROY MICR 602tn: Base Model + Extra 500-Sheet Input Tray | 908406 | EA | \$2,910.00 |

| MFG# | Product Description | Part# | UOM | Retail |
|--|---|--------|-----|------------|
| TROY EQUIPMENT | | | | |
| TROY MICR 602 Secure Mono Laser Printers (Continued) | | | | |
| 01-03020-221 | TROY MICR 602tn: Base Model + 2 Locking Input Trays | 908407 | EA | \$3,115.00 |
| 01-03030-111 | TROY MICR 602n SecureEx: Base Model + Enhanced Security Features, Locking Input Tray | 910283 | EA | \$3,060.00 |
| 01-03030-221 | TROY MICR 602tn SecureEx: Base Model + Enhanced Security Features, 2 Locking Input Trays | 910284 | EA | \$3,365.00 |
| 05-00194-001 | 500-Sheet Input Tray | 911726 | EA | \$289.00 |
| 02-03011-001 | 500-Sheet Input Tray with Lock | 908695 | EA | \$475.00 |
| 02-03012-001 | 500-Sheet Input Tray with Combination Lock | 922290 | EA | \$490.00 |
| 05-00195-001 | 1,500-Sheet Input Tray | 911470 | EA | \$529.00 |
| 02-03016-001 | 1,500-Sheet Input Tray with Lock | 913370 | EA | \$750.00 |
| 02-03150-001 | 1,500-Sheet Input Tray with Combination Lock | 919447 | EA | \$765.00 |
| 77-00031-602 | Next Day Service Warranty (3 Year) | 922297 | EA | \$751.20 |
| 77-00051-602 | Next Day Service Warranty (5 Year) | 922302 | EA | \$1,183.00 |
| TROY MICR 603 Secure Mono Laser Printers | | | | |
| 01-03024-101 | TROY MICR 603n Secure Mono Laser Printer (62 ppm) (800 MHz) (512 MB) (8.5" x 14") (1200 x 1200 dpi) (Max Duty Cycle 275,000 Pages) (USB) (Ethernet) (500 Sheet Input Tray) | 910483 | EA | \$3,675.00 |
| 01-03024-111 | TROY MICR 603n + Locking Input Tray | 910484 | EA | \$3,770.00 |
| 01-03024-201 | TROY MICR 603tn: Base Model + Extra 500-Sheet Input Tray | 908408 | EA | \$4,010.00 |
| 01-03024-221 | TROY MICR 603tn: Base Model + 2 Locking Input Trays | 908409 | EA | \$4,490.00 |
| 01-03034-111 | TROY MICR 603n SecureEx: Base Model + Enhanced Security Features, Locking Input Tray | 910285 | EA | \$4,170.00 |
| 01-03034-221 | TROY MICR 603tn SecureEx: Base Model + Enhanced Security Features, 2 Locking Input Trays | 910286 | EA | \$5,250.00 |
| 05-00194-001 | 500-Sheet Input Tray | 911726 | EA | \$289.00 |
| 02-03011-001 | 500-Sheet Input Tray with Lock | 908695 | EA | \$475.00 |
| 02-03012-001 | 500-Sheet Input Tray with Combination Lock | 922290 | EA | \$490.00 |
| 05-00195-001 | 1,500-Sheet Input Tray | 911470 | EA | \$529.00 |
| 02-03016-001 | 1,500-Sheet Input Tray with Lock | 913370 | EA | \$750.00 |
| 02-03150-001 | 1,500-Sheet Input Tray with Combination Lock | 919447 | EA | \$765.00 |
| 77-00031-603 | Next Day Service Warranty (3 Year) | 922300 | EA | \$1,047.00 |
| 77-00051-603 | Next Day Service Warranty (5 Year) | 922303 | EA | \$1,682.00 |
| TROY MICR 806dn Mono Laser & Secure Mono Laser Printers | | | | |
| 01-04910-201 | TROY MICR 806dn Mono Laser Printer (55 ppm) (800 MHz) (1 GB) (11" x 17") (1200 x 1200 dpi) (Max Duty Cycle 300,000 Pages) (Duplex) (USB) (Ethernet) (Touchscreen) (Energy Star) (2 x 500-Sheet Input Trays) (100 Sheet Multipurpose Tray) | 917977 | EA | \$6,099.00 |
| 01-04910-221 | TROY MICR 806dn + Locking Input Trays | 917978 | EA | \$6,299.00 |
| 01-04920-201 | TROY MICR 806dn Secure Mono Laser Printer | 917979 | EA | \$6,449.00 |
| 01-04920-221 | TROY MICR 806dn Secure + Locking Input Trays | 917980 | EA | \$6,649.00 |
| 01-04930-221 | TROY MICR 806dn SecureEx Mono Laser Printer | 917981 | EA | \$6,999.00 |
| TROY MICR 1606dn Mono Laser Printer | | | | |
| 01-00975-101 | TROY MICR 1606dn Mono Laser Printer (26 ppm) (400 MHz) (32 MB) (8.5" x 14") (1200 dpi) (Max Duty Cycle 8,000 Pages) (Duplex) (USB) (Ethernet) (Energy Star) (250 Sheet Input Tray) | 908388 | EA | \$399.00 |
| TROY MICR 3015 Mono Laser Printers | | | | |
| 01-02010-101 | TROY MICR 3015dn Mono Laser Printer (42 ppm) (128 MB) (8.5" x 14") (1200 x 1200dpi) (Max Duty Cycle 100,000 Pages) (Duplex) (USB) (Ethernet) (500 Sheet Input Tray) | 908389 | EA | \$1,697.00 |
| 01-02010-111 | TROY MICR 3015dn + Locking Input Tray | 908390 | EA | \$1,847.00 |
| 01-02010-201 | TROY MICR 3015dt: Base Model + Extra 500-Sheet Input Tray | 908391 | EA | \$2,047.00 |
| 01-02010-211 | TROY MICR 3015dt: Base Model With 1 Regular Input Tray, 1 Locking Input Tray | 908392 | EA | \$2,197.00 |
| 01-02010-221 | TROY MICR 3015dt: Base Model + 2 Locking Input Trays | 908393 | EA | \$2,322.00 |
| 01-02020-101 | TROY MICR 3015dn Secure: Base Model + Enhanced Security Features | 908394 | EA | \$1,997.00 |
| 01-02020-111 | TROY MICR 3015dn Secure: Base Model + Enhanced Security Features, Locking Input Tray | 908395 | EA | \$2,147.00 |
| 01-02020-201 | TROY MICR 3015dt Secure: Base Model + Enhanced Security Features, Extra 500-Sheet Input Tray | 908396 | EA | \$2,347.00 |
| 01-02020-211 | TROY MICR 3015dt Secure: Base Model + Enhanced Security Features, 1 Regular Input Tray, 1 Locking Input Tray | 908397 | EA | \$2,497.00 |
| 01-02020-221 | TROY MICR 3015dt Secure: Base Model + Enhanced Security Features, 2 Locking Input Trays | 908398 | EA | \$2,622.00 |
| 01-02030-111 | TROY MICR 3015d Secure Ex: Base Model + Highest Security Level, Locking Input Tray | 913044 | EA | \$2,397.00 |
| 01-02030-211 | TROY MICR 3015dt Secure Ex: Base Model + Highest Security Level, 1 Regular Input Tray, 1 Locking Input Tray | 922832 | EA | \$2,292.00 |
| 01-02030-221 | TROY MICR 3015dt Secure Ex: Base Model + Highest Security Level, 2 Locking Input Trays | 94661 | EA | \$2,872.00 |
| 05-00192-001 | 500-Sheet Feeder | 922299 | EA | \$165.00 |
| 02-20627-001 | 500-Sheet Input Tray with Lock | 913579 | EA | \$343.00 |
| 77-00031-3015 | Next Day Service Warranty (3 Year) | 912463 | EA | \$1,030.00 |
| 77-00051-3015 | Next Day Service Warranty (5 Year) | 912467 | EA | \$1,812.00 |

| MFG# | Product Description | Part# | UOM | Retail |
|--|---|--------|-----|------------|
| TROY EQUIPMENT | | | | |
| TROY 401 Security Mono Laser Printers | | | | |
| 01-04040-111 | TROY 401n Security Mono Laser Printer (35 ppm) (800 MHz) (128 MB) (8.5" x 14") (1200 x 1200 dpi) (Max Duty Cycle 50,000 Pages) (USB) (Ethernet) (250 Sheet Locking Input Tray) | 910668 | EA | \$625.00 |
| 01-04040-211 | TROY 401n Security + Extra 500-Sheet Input Tray | 910662 | EA | \$763.00 |
| 01-04040-221 | TROY 401n Security + Extra Locking 500-Sheet Input Tray | 910658 | EA | \$885.00 |
| 02-20629-001 | 500-Sheet Input Tray with Lock | 910661 | EA | \$257.00 |
| 05-00201-001 | 500-Sheet Input Tray | 919445 | EA | \$135.00 |
| TROY 601 Security Mono Laser Printers | | | | |
| 01-03040-111 | TROY 601n Security Mono Laser Printer (45 ppm) (800 MHz) (512 MB) (8.5" x 14") (1200 x 1200 dpi) (Max Duty Cycle 175,000 Pages) (USB) (Ethernet) (500 Sheet Locking Input Tray) | 908410 | EA | \$1,250.00 |
| 01-03040-211 | TROY 601tn Security: Base Model + Extra 500-Sheet Input Tray | 908411 | EA | \$1,550.00 |
| 01-03040-221 | TROY 601tn Security: Base Model + 2 Locking Input Trays | 908412 | EA | \$1,675.00 |
| 01-03041-111 | TROY 601n Security: Base Model + Combination Lock on Tray | 908413 | EA | \$1,265.00 |
| 01-03041-211 | TROY 601n Security: Base Model + Combination Lock on Input Tray, Extra 500-Sheet Input Tray | 908414 | EA | \$1,565.00 |
| 01-03041-221 | TROY 601tn Security: Base Model + Combination Lock on Both Input Trays | 908415 | EA | \$1,705.00 |
| 05-00194-001 | 500-Sheet Input Tray | 911726 | EA | \$289.00 |
| 02-03011-001 | 500-Sheet Input Tray with Lock | 908695 | EA | \$475.00 |
| 02-03012-001 | 500-Sheet Input Tray with Combination Lock | 922290 | EA | \$490.00 |
| 05-00195-001 | 1,500-Sheet Input Tray | 911470 | EA | \$529.00 |
| 02-03016-001 | 1,500-Sheet Input Tray with Lock | 913370 | EA | \$750.00 |
| 02-03150-001 | 1,500-Sheet Input Tray with Combination Lock | 919447 | EA | \$765.00 |
| 77-00031-601 | Next Day Service Warranty (3 Year) | 912464 | EA | \$642.00 |
| 77-00051-601 | Next Day Service Warranty (5 Year) | 912468 | EA | \$1,010.00 |
| TROY 602 Security Mono Laser Printers | | | | |
| 01-03044-111 | TROY 602n Security Mono Laser Printer (52 ppm) (800 MHz) (512 MB) (8.5" x 14") (1200 x 1200 dpi) (Max Duty Cycle 225,000 Pages) (USB) (Ethernet) (500 Sheet Locking Input Tray) | 910485 | EA | \$1,310.00 |
| 01-03044-211 | TROY 602tn Security: Base Model + 1 Regular Input Tray, 1 Locking Input Tray | 908416 | EA | \$1,630.00 |
| 01-03044-221 | TROY 602tn Security: Base Model + 2 Locking Input Trays | 910487 | EA | \$1,755.00 |
| 01-03045-111 | TROY 602n Security: Base Model + 1 Input Tray with Combination Lock | 908417 | EA | \$1,325.00 |
| 01-03045-221 | TROY 602tn Security: Base Model + 2 Input Trays with Combination Locks | 908418 | EA | \$1,785.00 |
| 05-00194-001 | 500-Sheet Input Tray | 911726 | EA | \$289.00 |
| 02-03012-001 | 500-Sheet Input Tray with Combination Lock | 922290 | EA | \$490.00 |
| 05-00195-001 | 1,500-Sheet Input Tray | 911470 | EA | \$529.00 |
| 02-03150-001 | 1,500-Sheet Input Tray with Combination Lock | 919447 | EA | \$765.00 |
| 77-00031-602 | Next Day Service Warranty (3 Year) | 922297 | EA | \$751.20 |
| 77-00051-602 | Next Day Service Warranty (5 Year) | 922302 | EA | \$1,183.00 |
| TROY 603 Security Mono Laser Printers | | | | |
| 01-03046-111 | TROY 603 Security Mono Laser Printer (62 ppm) (800 MHz) (512 MB) (8.5" x 14") (1200 x 1200 dpi) (Max Duty Cycle 275,000 Pages) (USB) (Ethernet) (500 Sheet Locking Input Tray) | 908419 | EA | \$1,995.00 |
| 01-03046-221 | TROY 603tn Security: Base Model + 2 Locking Input Trays | 908420 | EA | \$2,395.00 |
| 01-03047-111 | TROY 603n Security: Base Model + 1 Input Tray with Combination Lock | 908421 | EA | \$2,015.00 |
| 01-03047-221 | TROY 603tn Security: Base Model + 2 Input Trays with Combination Locks | 908422 | EA | \$2,430.00 |
| 05-00194-001 | 500-Sheet Input Tray | 911726 | EA | \$289.00 |
| 02-03012-001 | 500-Sheet Input Tray with Combination Lock | 922290 | EA | \$490.00 |
| 05-00195-001 | 1,500-Sheet Input Tray | 911470 | EA | \$529.00 |
| 02-03150-001 | 1,500-Sheet Input Tray with Combination Lock | 919447 | EA | \$765.00 |
| 77-00031-603 | Next Day Service Warranty (3 Year) | 922300 | EA | \$1,047.00 |
| 77-00051-603 | Next Day Service Warranty (5 Year) | 922303 | EA | \$1,682.00 |
| TROY 806dn Security Mono Laser Printer | | | | |
| 01-04938-221 | TROY 806dn Security Mono Laser Printer (55 ppm) (800 MHz) (1 GB) (11" x 17") (1200 x 1200 dpi) (Max Duty Cycle 300,000 Pages) (Duplex) (USB) (Ethernet) (Touchscreen) (Energy Star) (2 x 500-Sheet Locking Input Trays) (100 Sheet Multipurpose Tray) | 917982 | EA | \$4,975.00 |
| TROY 3015 Security Mono Laser Printers (Continued on next page) | | | | |
| 01-02040-111 | TROY 3015sd Security Mono Laser Printer (42 ppm) (128 MB) (8.5" x 14") (1200 x 1200 dpi) (Max Duty Cycle 100,000 Pages) (Duplex) (USB) (Ethernet) (500 Sheet Locking Input Tray) | 908399 | EA | \$1,531.00 |
| 01-02040-211 | TROY 3015sdt Security: Base Model + Extra 500-Sheet Input Tray | 908400 | EA | \$1,660.00 |
| 01-02040-221 | TROY 3015sd Security: Base Model + 2 Locking Input Trays | 908401 | EA | \$1,760.00 |
| 01-02050-111 | TROY 3015dn SecureDXI: Base Model + Input Tray with Key Lock and 3-Position Key Control | 908402 | EA | \$1,850.00 |

| MFG# | Product Description | Part# | UOM | Retail |
|---|--|--------|-----|------------|
| TROY EQUIPMENT | | | | |
| TROY 3015 Security Mono Laser Printers (Continued) | | | | |
| 01-02050-221 | TROY 3015x SecureDXI: Base Model + 2 Input Trays with Key Locks and 3-Position Key Control | 908403 | EA | \$2,100.00 |
| 05-00192-001 | 500-Sheet Feeder | 922299 | EA | \$165.00 |
| 02-20627-001 | 500-Sheet Input Tray with Lock | 913579 | EA | \$343.00 |
| TROY 8100 Officejet SecureUV Security Printer | | | | |
| 01-06810-001 | TROY 8100 Officejet SecureUV Color Inkjet Printer (20 ppm Mono/16 ppm UV) (8.5" x 14") (Max Duty Cycle 25,000 Pages) (USB) (Ethernet) (Wireless) (250 Sheet Input Tray) | 927437 | EA | \$274.99 |
| CQ696A | 250-Sheet Paper Tray | 912446 | EA | \$80.00 |
| TROY SecureUV Security Printer | | | | |
| 01-00980-001 | TROY SecureUV Desktop UV Security Printer (20 ppm Mono/10 ppm Color) (8.5" x 14") (High Resolution LED) (Max Duty Cycle 25,000 Pages) (USB) (Ethernet) (150 Sheet Input Capacity) | 917983 | EA | \$1,599.00 |
| 02-00236-001 | UV Verification Flashlight | 923086 | EA | \$47.52 |
| TROY 100 Portable MICR/Color Inkjet Printer | | | | |
| 01-06100-001 | TROY 100 Portable MICR/Color Inkjet Printer (5 ppm MICR/18 ppm Color) (8.5" x 14") (Max Duty Cycle 500 Pages) (USB) (Bluetooth) (50 Sheet Input Capacity) (Battery-Powered) | 927436 | EA | \$379.99 |
| TROY SecurePro JetX451 Security Inkjet Printers | | | | |
| 01-04510-111 | TROY SecurePro JetX451 Security Color Inkjet Printer (55 ppm) (512 MB) (8.5" x 14") (1200 x 1200 dpi Black) (2400 x 1200 dpi Color) (Max Duty Cycle 50,000 Pages) (Duplex) (USB) (Ethernet) (Energy Star) (500 Sheet Locking Input Tray) | 917984 | EA | \$630.00 |
| 01-04511-111 | TROY SecurePro JetX451 + Downloadable Print Security Features | 917985 | EA | \$999.00 |
| 05-00204-001 | 500-Sheet Input Tray | 919449 | EA | \$215.00 |
| 02-20632-001 | 500-Sheet Input Tray with Lock | 919448 | EA | \$349.00 |
| 77-00035-451 | Next Business Day Exchange Warranty (3 Year) | 922425 | EA | \$339.00 |
| TROY SecurePro JetX476 Security Inkjet MFPs | | | | |
| 01-04760-111 | TROY SecurePro JetX476 Security Color Inkjet MFP (55 ppm) (512 MB) (8.5" x 14") (1200 x 1200 dpi Black) (2400 x 1200 dpi Color) (Max Duty Cycle 50,000 Pages) (p/s/c/f) (Duplex) (USB) (Ethernet) (Touchscreen) (Energy Star) (500 Sheet Locking Input Tray) | 917986 | EA | \$870.00 |
| 01-04761-111 | TROY SecurePro JetX476 + Downloadable Print Security Features | 917987 | EA | \$1,199.00 |
| 05-00204-001 | 500-Sheet Input Tray | 919449 | EA | \$215.00 |
| 02-20632-001 | 500-Sheet Input Tray with Lock | 919448 | EA | \$349.00 |
| 77-00035-476 | Next Business Day Exchange Warranty (3 Year) | 922427 | EA | \$433.00 |
| XEROX EQUIPMENT | | | | |
| Xerox Phaser 3260 Mono Laser Printers | | | | |
| 3260/DI | Xerox Phaser 3260DI Mono Laser Printer (29 ppm) (600 MHz) (256 MB) (8.5" x 14") (4800 x 600 dpi) (Max Duty Cycle 30,000 Pages) (Duplex) (USB) (Wireless) (Energy Star) (250 Sheet Input Tray) | 930632 | EA | \$224.00 |
| 3260/DNI | Xerox Phaser 3260DNI: Base Model + Network Ready | 930633 | EA | \$247.00 |
| E3260Q3 | Extended Quick Exchange Service (2 Years) | 930640 | EA | \$89.00 |
| E3260Q4 | Extended Quick Exchange Service (3 Years) | 930641 | EA | \$129.00 |
| Xerox Phaser 3320DNI Mono Laser Printer | | | | |
| 3320/DNI | Xerox Phaser 3320DNI Mono Laser Printer (37 ppm) (600 MHz) (128 MB) (8.5" x 14") (1200 x 1200 dpi) (Max Duty Cycle 80,000 Pages) (Duplex) (USB) (Ethernet) (Wireless) (Energy Star) (250 Sheet Input Tray) (50 Sheet Multipurpose Tray) | 906653 | EA | \$466.00 |
| 497N01412 | 520-Sheet Tray | 911863 | EA | \$297.42 |
| E3320S3 | Extended Onsite Service (2 Year) | 911534 | EA | \$99.00 |
| E3320S4 | Extended Onsite Service (3 Year) | 911535 | EA | \$149.00 |
| Xerox Phaser 3610 Mono Laser Printers | | | | |
| 3610/N | Xerox Phaser 3610N Mono Laser Printer (47 ppm) (400 MHz) (512 MB) (8.5" x 14") (1200 x 1200 dpi) (Max Duty Cycle 110,000 Pages) (USB) (Ethernet) (Energy Star) (550 Sheet Input Tray) (150 Sheet Multipurpose Tray) | 915877 | EA | \$700.00 |
| 3610/DN | Xerox Phaser 3610DN: Base Model + Duplex Printing | 915878 | EA | \$758.00 |
| 3610/YDN | Government Xerox Phaser 3610DN: TAA-Compliant Version | 915880 | EA | \$758.00 |
| 497K13620 | 550-Sheet Tray | 917880 | EA | \$231.00 |
| 497K13660 | Printer Stand | 917878 | EA | \$343.00 |
| E3610S3 | Extended Onsite Service (3 Year) | 915027 | EA | \$199.00 |
| E3610S4 | Extended Onsite Service (4 Year) | 915028 | EA | \$269.00 |

| MFG# | Product Description | Part# | UOM | Retail |
|---|---|--------|-----|------------|
| XEROX EQUIPMENT | | | | |
| Xerox Phaser 4622 Mono Laser Printers | | | | |
| 4622/DN | Xerox Phaser 4622DN Mono Laser Printer (65 ppm) (600 MHz) (256 MB) (8.5" x 14") (1200 x 1200 dpi) (Max Duty Cycle 275,000 Pages) (Duplex) (USB) (Ethernet) (Energy Star) (550 Sheet Input Tray) (100 Sheet Multipurpose Tray) | 923084 | EA | \$1,408.00 |
| 4622/DT | Xerox Phaser 4622DT: Base Model + Extra 550-Sheet Input Tray | 923085 | EA | \$1,642.00 |
| 097N01874 | 550-Sheet Paper Tray | 910798 | EA | \$297.00 |
| 097N01875 | 2,000-Sheet High Capacity Feeder with Printer Stand | 911757 | EA | \$890.00 |
| 097N01916 | Printer Stand | 911762 | EA | \$236.00 |
| E4622S3 | Extended Onsite Service (2 Year) | 923143 | EA | \$349.00 |
| E4622S4 | Extended Onsite Service (3 Year) | 923144 | EA | \$499.00 |
| Xerox Phaser 5550 Mono Laser Printers | | | | |
| 5550/N | Xerox Phaser 5550N Mono Laser Printer (50 ppm) (500 MHz) (256 MB) (11" x 17") (1200 x 1200 dpi) (Max Duty Cycle 300,000 Pages) (USB) (Ethernet) (Parallel) (Energy Star) (1,000 Sheet Input Capacity) (100 Sheet Multipurpose Tray) | 6606 | EA | \$2,863.00 |
| 5550/YN | Government Xerox Phaser 5550N: TAA-Compliant Version | 914961 | EA | \$2,863.00 |
| 5550/DN | Xerox Phaser 5550DN: Base Model + Duplex Printing | 6604 | EA | \$3,361.00 |
| 5550/YDN | Government Xerox Phaser 5550DN: TAA-Compliant Version | 914959 | EA | \$3,361.00 |
| 5550/DT | Xerox Phaser 5550DT: Base Model + Duplex Printing, Total 2,100-Sheet Input Capacity | 6605 | EA | \$4,357.00 |
| 5550/YDT | Government Xerox Phaser 5550DT: TAA-Compliant Version | 914960 | EA | \$4,357.00 |
| 097S03716 | 1,000-Sheet Feeder, 2 Trays (Adjustable Up To 11" x 17") | 911790 | EA | \$939.00 |
| 097S03717 | 2,000-Sheet High Capacity Feeder, 1 Tray (8.5" x 11") | 911791 | EA | \$1,059.00 |
| E5550S3 | Extended Onsite Service (2 Year) | 911588 | EA | \$799.00 |
| E5550S4 | Extended Onsite Service (3 Year) | 911589 | EA | \$1,199.00 |
| Xerox WorkCentre 3215/3225 Mono Laser MFPs | | | | |
| 3215/NI | Xerox WorkCentre 3215NI Mono Laser MFP (27 ppm) (600 MHz) (256 MB) (8.5" x 14") (4800 x 600 dpi) (Max Duty Cycle 30,000 Pages) (p/s/c/f) (USB) (Ethernet) (Wireless) (Energy Star) (250 Sheet Input Tray) (40 Sheet ADF) | 930630 | EA | \$303.00 |
| 3225/DNI | Xerox WorkCentre 3225DNI: Same as 3215NI + 29 ppm, Duplex Printing | 930631 | EA | \$373.00 |
| E32X5S3 | Conversion Warranty (Converts 1-Year Depot Warranty Plus 2 Additional Years of Onsite Service for a Total of 3 Years Onsite Service) | 930645 | EA | \$289.00 |
| E32X5S4 | Conversion Warranty (Converts 1-Year Depot Warranty Plus 3 Additional Years of Onsite Service for a Total of 4 Years Onsite Service) | 930646 | EA | \$399.00 |
| Xerox WorkCentre 3315DN Mono Laser MFP | | | | |
| 3315/DN | Xerox WorkCentre 3315DN Mono Laser MFP (33 ppm) (360 MHz) (128 MB) (8.5" x 14") (600 x 600 dpi) (Max Duty Cycle 50,000 Pages) (p/s/c/f) (Duplex) (USB) (Ethernet) (Energy Star) (250 Sheet Input Tray) (50 Sheet Multipurpose Tray) (50 Sheet ADF) | 906654 | EA | \$515.00 |
| 497N01412 | 520-Sheet Tray | 911863 | EA | \$297.42 |
| E3315S3 | Extended Onsite Service (2 Year) | 911529 | EA | \$159.99 |
| E3315S4 | Extended Onsite Service (3 Year) | 911530 | EA | \$229.99 |
| Xerox WorkCentre 3325DNI Mono Laser MFP | | | | |
| 3325/DNI | Xerox WorkCentre 3325DNI Mono Laser MFP (37 ppm) (600 MHz) (256 MB) (8.5" x 14") (600 x 600 dpi) (Max Duty Cycle 80,000 Pages) (Duplex) (p/s/c/f) (USB) (Ethernet) (Wireless) (Energy Star) (250 Sheet Input Tray) (50 Sheet Multipurpose Tray) (50 Sheet ADF) | 906655 | EA | \$687.00 |
| 497N01412 | 520-Sheet Tray | 911863 | EA | \$297.42 |
| E3325S3 | Extended Onsite Service (2 Year) | 911539 | EA | \$219.99 |
| E3325S4 | Extended Onsite Service (3 Year) | 911540 | EA | \$299.99 |
| Xerox WorkCentre 3615DN Mono Laser MFP | | | | |
| 3615/DN | Xerox WorkCentre 3615DN Mono Laser MFP (47 ppm) (525 MHz) (1 GB) (8.5" x 14") (1200 x 1200 dpi) (Max Duty Cycle 110,000 Pages) (p/s/c/f) (Duplex) (USB) (Ethernet) (Touchscreen) (Energy Star) (550 Sheet Input Tray) (150 Sheet Multipurpose Tray) (60 Sheet DADF) | 915834 | EA | \$1,090.00 |
| 497K13630 | 550-Sheet Tray | 917882 | EA | \$231.00 |
| 497K13660 | Printer Stand | 917878 | EA | \$343.00 |
| E3615M3 | Extended Onsite Service (3 Year) | 915030 | EA | \$399.00 |
| E3615M4 | Extended Onsite Service (4 Year) | 915031 | EA | \$599.00 |
| Xerox WorkCentre 3655 Mono Laser MFPs | | | | |
| 3655/S | Xerox WorkCentre 3655S Mono Laser MFP (47 ppm) (1 GHz) (2 GB) (8.5" x 14") (1200 x 1200 dpi) (Max Duty Cycle 150,000 Pages) (p/s/c) (Duplex) (USB) (Ethernet) (Energy Star) (550 Sheet Input Tray) (150 Sheet Multipurpose Tray) (60 Sheet DADF) | 930248 | EA | \$2,354.00 |
| 3655/X | Xerox WorkCentre 3655X: Base Model + Fax Function | 930250 | EA | \$2,616.00 |
| 097S04625 | 550-Sheet Tray | 930238 | EA | \$274.00 |
| 497K14670 | Printer Stand | 930253 | EA | \$412.00 |
| E3655S3 | Extended Onsite Service (2 Years) | 930256 | EA | \$599.00 |
| E3655S4 | Extended Onsite Service (3 Years) | 930257 | EA | \$899.00 |

| MFG# | Product Description | Part# | UOM | Retail |
|---|---|--------|-----|------------|
| XEROX EQUIPMENT | | | | |
| Xerox WorkCentre 4265 Mono Laser MFPs | | | | |
| 4265/S | Xerox WorkCentre 4265S Mono Laser MFP (55 ppm) (1 GHz) (2 GB) (8.5" x 14") (1200 x 1200 dpi) (Max Duty Cycle 250,000 Pages) (p/s/c) (Duplex) (USB) (Ethernet) (Touchscreen) (Energy Star) (620 Sheet Input Capacity) (100 Sheet DADF) | 930634 | EA | \$3,532.00 |
| 4265/X | Xerox WorkCentre 4265X: Base Model + Fax Function | 930636 | EA | \$4,317.00 |
| 4265/XF | Xerox WorkCentre 4265XF: Base Model + Fax Function, Staple Finisher, High Capacity Feeder | 930637 | EA | \$6,541.00 |
| 097N01524 | 500-Sheet Paper Tray | 35692 | EA | \$399.00 |
| 097N01684 | 2,000-Sheet High Capacity Paper Tray | 35013 | EA | \$1,066.00 |
| 097S03677 | Printer Stand | 906848 | EA | \$267.00 |
| 097S03678 | 4-Tray Printer Stand (Holds up to 3 x 500-Sheet Trays, Trays Not Included, (OEM# 097N01524 Required)) | 911788 | EA | \$248.00 |
| E4265S3 | Extended Onsite Service (2 Years) | 930648 | EA | \$999.00 |
| E4265S4 | Extended Onsite Service (3 Years) | 930649 | EA | \$1,469.00 |
| Xerox Phaser 6010N Color Laser Printer | | | | |
| 6010/N | Xerox Phaser 6010N Color Laser Printer (15 ppm Mono/12 ppm Color) (384 MHz) (128 MB) (8.5" x 14") (600 x 600 dpi) (Max Duty Cycle 30,000 Pages) (USB) (Ethernet) (Energy Star) (160 Sheet Input Tray) | 906279 | EA | \$357.00 |
| E6010Q3 | Extended Quick Exchange Service (2 Year) | 911592 | EA | \$64.99 |
| E6010Q4 | Extended Quick Exchange Service (3 Year) | 911593 | EA | \$74.99 |
| Xerox Phaser 6500 Color Laser Printers | | | | |
| 6500/N | Xerox Phaser 6500N Color Laser Printer (24 ppm) (400 MHz) (256 MB) (8.5" x 14") (600 x 600 dpi) (Max Duty Cycle 40,000 Pages) (USB) (Ethernet) (Energy Star) (250 Sheet Input Tray) | 906281 | EA | \$477.00 |
| 6500/DN | Xerox Phaser 6500DN: Base Model + Duplex Printing | 906280 | EA | \$597.00 |
| 097S04070 | 250-Sheet Feeder | 911826 | EA | \$235.00 |
| E6500S3 | Extended Onsite Service (2 Year) | 911631 | EA | \$149.00 |
| E6500S4 | Extended Onsite Service (3 Year) | 911632 | EA | \$229.00 |
| Xerox Phaser 6600 Color Laser Printers | | | | |
| 6600/N | Xerox Phaser 6600N Color Laser Printer (36 ppm) (533 MHz) (256 MB) (8.5" x 14") (1200 x 1200 dpi) (Max Duty Cycle 80,000 Pages) (USB) (Ethernet) (Energy Star) (550 Sheet Input Tray) (150 Sheet Multipurpose Tray) | 908909 | EA | \$659.56 |
| 6600/DN | Xerox Phaser 6600DN: Base Model + Duplex Printing | 908910 | EA | \$779.70 |
| 6600/YDN | Government Xerox Phaser 6600DN: TAA-Compliant Version | 914964 | EA | \$779.70 |
| 097S04400 | 550-Sheet Feeder | 911286 | EA | \$344.68 |
| 497K13660 | Printer Stand | 917878 | EA | \$343.00 |
| E6600S3 | Extended Onsite Service (2 Year) | 911638 | EA | \$229.00 |
| E6600S4 | Extended Onsite Service (3 Year) | 911639 | EA | \$349.00 |
| Xerox Phaser 6700 Color Laser Printers | | | | |
| 6700/N | Xerox Phaser 6700N Color Laser Printer (47 ppm) (1.25 GHz) (1 GB) (8.5" x 14") (2400 x 1200 dpi) (Max Duty Cycle 120,000 Pages) (USB) (Ethernet) (Energy Star) (700 Sheet Input Tray) | 906286 | EA | \$1,611.28 |
| 6700/YN | Government Xerox Phaser 6700N: TAA-Compliant Version | 914226 | EA | \$1,611.28 |
| 6700/DN | Xerox Phaser 6700DN: Base Model + Duplex Printing | 906282 | EA | \$1,850.28 |
| 6700/YDN | Government Xerox Phaser 6700DN: TAA-Compliant Version | 914223 | EA | \$1,850.28 |
| 6700/DT | Xerox Phaser 6700DT: Base Model + Duplex Printing, Total 1,250-Sheet Input Capacity | 906287 | EA | \$2,268.45 |
| 6700/YDT | Government Xerox Phaser 6700DT: TAA-Compliant Version | 914224 | EA | \$2,268.45 |
| 6700/DX | Xerox Phaser 6700DX: Base Model + Duplex Printing, Total 1,800-Sheet Input Capacity | 906289 | EA | \$3,463.28 |
| 6700/YDX | Government Xerox Phaser 6700DX: TAA-Compliant Version | 914225 | EA | \$3,463.28 |
| 097S04150 | 550-Sheet Feeder | 911830 | EA | \$476.58 |
| 097S04151 | 1,100-Sheet High Capacity Feeder | 911831 | EA | \$954.36 |
| 097S04552 | Storage Cart | 911848 | EA | \$349.00 |
| E6700S3 | Extended Onsite Service (2 Year) | 911646 | EA | \$599.00 |
| E6700S4 | Extended Onsite Service (3 Year) | 911647 | EA | \$879.00 |
| Xerox Phaser 7100 Color Laser Printers | | | | |
| 7100/N | Xerox Phaser 7100N Color Laser Printer (30 ppm) (667 MHz) (1 GB) (11" x 17") (1200 x 1200 dpi) (Max Duty Cycle 52,000 Pages) (USB) (Ethernet) (Energy Star) (250 Sheet Input Tray) (150 Sheet Multipurpose Tray) | 908901 | EA | \$1,909.92 |
| 7100/DN | Xerox Phaser 7100DN: Base Model + Duplex Printing | 908902 | EA | \$2,148.81 |
| 097S04485 | 550-Sheet Feeder | 911207 | EA | \$476.58 |
| 097S04552 | Storage Cart | 911848 | EA | \$349.00 |
| E7100S3 | Extended Onsite Service (2 Year) | 911650 | EA | \$559.00 |
| E7100S4 | Extended Onsite Service (3 Year) | 911651 | EA | \$809.00 |

| MFG# | Product Description | Part# | UOM | Retail |
|--|---|--------|-----|------------|
| XEROX EQUIPMENT | | | | |
| Xerox Phaser 7500 Color Laser Printers | | | | |
| 7500/N | Xerox Phaser 7500N Color Laser Printer (35 ppm) (1 GHz) (512 MB) (13" x 18") (1200 x 1200 dpi) (Max Duty Cycle 150,000 Pages) (USB) (Ethernet) (Energy Star) (600 Sheet Input Capacity) | 906290 | EA | \$3,583.00 |
| 7500/DN | Xerox Phaser 7500DN: Base Model + Duplex Printing | 20750 | EA | \$3,942.00 |
| 7500/YDN | Government Xerox Phaser 7500DN: TAA-Compliant Version | 96627 | EA | \$3,942.00 |
| 7500/DT | Xerox Phaser 7500DT: Base Model + Duplex Printing, Total 1,100-Sheet Input Capacity | 906285 | EA | \$4,532.00 |
| 7500/YDT | Government Xerox Phaser 7500DT: TAA-Compliant Version | 914227 | EA | \$4,532.00 |
| 7500/DX | Xerox Phaser 7500DX: Base Model + Duplex Printing, Total 2,100-Sheet Input Capacity | 906291 | EA | \$5,963.00 |
| 7500/YDX | Government Xerox Phaser 7500DX: TAA-Compliant Version | 914228 | EA | \$5,963.00 |
| 097S04023 | 500-Sheet Feeder | 911820 | EA | \$596.00 |
| 097S04024 | 1,500-Sheet High Capacity Feeder | 911821 | EA | \$1,432.00 |
| 097S04552 | Storage Cart | 911848 | EA | \$349.00 |
| E7500S3 | Extended Onsite Service (2 Year) | 911657 | EA | \$1,499.00 |
| E7500S4 | Extended Onsite Service (3 Year) | 911658 | EA | \$2,099.00 |
| Xerox Phaser 7800 Color Laser Printers | | | | |
| 7800/DN | Xerox Phaser 7800DN Color Laser Printer (45 ppm) (1.33 GHz) (2 GB) (12" x 18") (1200 x 2400 dpi) (Max Duty Cycle 225,000 Pages) (Duplex) (USB) (Ethernet) (Energy Star) (Touchscreen) (620 Sheet Input Tray) | 906283 | EA | \$5,471.00 |
| 7800/YDN | Government Xerox Phaser 7800DN: TAA-Compliant Versions | 914231 | EA | \$5,471.00 |
| 7800/GX | Xerox Phaser 7800GX: Base Model + Total 2,180-Sheet Input Capacity | 906293 | EA | \$6,977.78 |
| 7800/YGX | Government Xerox Phaser 7800GX: TAA-Compliant Versions | 914237 | EA | \$6,977.78 |
| 7800/DX | Xerox Phaser 7800DX: Base Model + Total 3,140-Sheet Input Capacity | 906292 | EA | \$6,909.72 |
| 7800/YDX | Government Xerox Phaser 7800DX: TAA-Compliant Versions | 914234 | EA | \$6,909.72 |
| 097S04159 | 1,560-Sheet Feeder (3 x 520-Sheet Trays) | 911833 | EA | \$1,599.00 |
| 097S04160 | 2,500-Sheet High Capacity Tandem Tray | 911834 | EA | \$1,999.00 |
| 097S04552 | Storage Cart | 911848 | EA | \$349.00 |
| E7800S3 | Extended Onsite Service (2 Year) | 906758 | EA | \$1,399.00 |
| E7800S4 | Extended Onsite Service (3 Year) | 906759 | EA | \$1,999.00 |
| Xerox WorkCentre 6015NI Color Laser MFP | | | | |
| 6015/NI | Xerox WorkCentre 6015NI Color Laser MFP (15 ppm Mono/12 ppm Color) (295 MHz) (128 MB) (8.5" x 14") (1200 x 2400 dpi) (Max Duty Cycle 30,000 Pages) (p/s/c/f) (USB) (Ethernet) (Wireless) (Energy Star) (150 Sheet Input Tray) (15 Sheet ADF) | 906294 | EA | \$551.87 |
| E6015Q3 | Extended Quick Exchange Service (2 Year) | 911595 | EA | \$89.00 |
| E6015Q4 | Extended Quick Exchange Service (3 Year) | 911596 | EA | \$99.00 |
| Xerox WorkCentre 6400 Color Laser MFPs | | | | |
| 6400/S | Xerox WorkCentre 6400S Color Laser MFP (37 ppm Mono/32 ppm Color) (800 MHz) (1 GB) (80 GB HDD) (8.5" x 14") (2400 x 600 dpi) (Max Duty Cycle 120,000 Pages) (p/s/c) (Duplex) (USB) (Ethernet) (Energy Star) (500 Sheet Input Tray) (100 Sheet Multipurpose Tray) (50 Sheet ADF) | 7904 | EA | \$3,938.00 |
| 6400/X | Xerox WorkCentre 6400X: Base Model + Fax Function | 15742 | EA | \$4,255.00 |
| 6400/XF | Xerox WorkCentre 6400XF: Base Model + Fax Function, Total 1,500-Sheet Input Capacity | 15743 | EA | \$6,048.00 |
| 097S03874 | 500-Sheet Paper Tray | 15745 | EA | \$349.00 |
| 097S04552 | Storage Cart | 911848 | EA | \$349.00 |
| E6400S3 | Extended Onsite Service (2 Year) | 911627 | EA | \$1,199.00 |
| E6400S4 | Extended Onsite Service (3 Year) | 911628 | EA | \$1,649.00 |
| Xerox WorkCentre 6505 Color Laser MFPs | | | | |
| 6505/N | Xerox WorkCentre 6505N Color Laser MFP (24 ppm) (533 MHz) (256 MB) (8.5" x 14") (600 x 600 dpi) (Max Duty Cycle 40,000 Pages) (p/s/c/f) (USB) (Ethernet) (Energy Star) (250 Sheet Input Tray) (35 Sheet ADF) | 106771 | EA | \$812.06 |
| 6505/DN | Xerox WorkCentre 6505DN: Base Model + Duplex Printing | 906284 | EA | \$945.71 |
| 097S04264 | 250-Sheet Paper Tray | 911467 | EA | \$246.78 |
| E6505S3 | Extended Onsite Service (2 Year) | 911635 | EA | \$199.00 |
| E6505S4 | Extended Onsite Service (3 Year) (Parts & Labor) | 909860 | EA | \$229.00 |
| Xerox WorkCentre 6605 Color Laser MFPs | | | | |
| 6605/N | Xerox WorkCentre 6605N Color Laser MFP (36 ppm) (533 MHz) (512 MB) (8.5" x 14") (1200 x 1200 dpi) (Max Duty Cycle 80,000 Pages) (p/s/c/f) (USB) (Ethernet) (Touchscreen) (Energy Star) (550 Sheet Input Tray) (150 Sheet Multipurpose Tray) (50 Sheet DADF) | 908900 | EA | \$1,207.13 |
| 6605/DN | Xerox WorkCentre 6605DN: Base Model + Duplex Printing | 908891 | EA | \$1,297.43 |
| 097S04400 | 550-Sheet Feeder | 911286 | EA | \$344.68 |
| 497K13660 | Printer Stand | 917878 | EA | \$343.00 |
| E6605M3 | Extended Onsite Service (2 Year) | 911642 | EA | \$339.99 |
| E6605M4 | Extended Onsite Service (3 Year) | 911643 | EA | \$509.99 |

| MFG# | Product Description | Part# | UOM | Retail |
|---|--|--------|-----|------------|
| XEROX EQUIPMENT | | | | |
| Xerox WorkCentre 6655 Color Laser MFP | | | | |
| 6655/X | Xerox WorkCentre 6655X Color Laser MFP (36 ppm) (1 GHz) (4 GB) (8.5" x 14") (2400 x 600 dpi) (Max Duty Cycle 100,000 Pages) (p/s/c/f) (Duplex) (USB) (Ethernet) (Energy Star) (550 Sheet Input Tray) (150 Sheet Multipurpose Tray) (60 Sheet DADF) (Convenience Stapler) | 930254 | EA | \$3,270.00 |
| 097S04664 | 550-Sheet Tray | 930239 | EA | \$412.00 |
| E6655S3 | Extended Onsite Service (2 Years) | 930260 | EA | \$899.00 |
| E6655S4 | Extended Onsite Service (3 Years) | 930261 | EA | \$1,319.00 |
| Xerox ColorQube 8570 Solid Ink Printers | | | | |
| 8570/N | Xerox ColorQube 8570N Color Solid Ink Printer (40 ppm) (1 GHz) (512 MB) (8.5" x 14") (2400 dpi) (Max Duty Cycle 85,000 Pages) (USB) (Ethernet) (Energy Star) (625 Sheet Input Tray) | 105988 | EA | \$855.00 |
| 8570/YN | Government Xerox ColorQube 8570N: TAA-Compliant Version | 914245 | EA | \$855.00 |
| 8570/DN | Xerox ColorQube 8570DN: Base Model + Duplex Printing | 906302 | EA | \$979.00 |
| 8570/YDN | Government Xerox ColorQube 8570DN: TAA-Compliant Version | 914243 | EA | \$979.00 |
| 8570/DT | Xerox ColorQube 8570DT: Base Model + Duplex Printing, Total 1,150-Sheet Input Capacity | 906303 | EA | \$1,325.00 |
| 8570/YDT | Government Xerox ColorQube 8570DT: TAA-Compliant Version | 914244 | EA | \$1,325.00 |
| 097S04142 | 525-Sheet Feeder | 911827 | EA | \$346.00 |
| 097S03636 | Printer Cart with Storage Capacity | 911784 | EA | \$332.00 |
| E8570S3 | Extended Onsite Service (2 Year) | 911664 | EA | \$229.00 |
| E8570S4 | Extended Onsite Service (3 Year) | 911665 | EA | \$349.00 |
| Xerox ColorQube 8700 Solid Ink MFPs | | | | |
| 8700/S | Xerox ColorQube 8700S Color Solid Ink MFP (44 ppm) (1.33 GHz) (1 GB) (8.5" x 14") (2400 dpi) (Max Duty Cycle 120,000 Pages) (Duplex) (p/s/c) (USB) (Ethernet) (Energy Star) (625 Sheet Input Tray) | 906304 | EA | \$2,915.00 |
| 8700/X | Xerox ColorQube 8700X: Base Model + Fax Function | 906305 | EA | \$3,109.71 |
| 8700/XF | Xerox ColorQube 8700XF: Base Model + Fax Function, Total 3,475-Sheet Input Capacity | 906306 | EA | \$5,555.00 |
| 097S04383 | 525-Sheet Feeder | 908669 | EA | \$342.60 |
| 097S04382 | 1,800-Sheet High Capacity Feeder | 911841 | EA | \$1,431.15 |
| 097S04388 | Printer Cart with Storage Drawer | 908668 | EA | \$457.19 |
| E8700S3 | Extended Onsite Service (2 Year) | 911672 | EA | \$999.00 |
| E8700S4 | Extended Onsite Service (3 Year) | 911673 | EA | \$1,459.00 |
| Xerox ColorQube 8870DN Solid Ink Printer | | | | |
| 8870/DN | Xerox ColorQube 8870DN Color Solid Ink Printer (40 ppm) (1 GHz) (512 MB) (8.5" x 14") (2400 dpi) (Max Duty Cycle 120,000 Pages) (Duplex) (USB) (Ethernet) (Energy Star) (625 Sheet Input Tray) | 906308 | EA | \$2,708.00 |
| 097S04142 | 525-Sheet Feeder | 911827 | EA | \$346.00 |
| 097S03636 | Printer Cart with Storage Capacity | 911784 | EA | \$332.00 |
| E8870S3 | Extended Onsite Service (2 Year) | 911682 | EA | \$359.00 |
| E8870S4 | Extended Onsite Service (3 Year) | 911683 | EA | \$509.00 |
| Xerox ColorQube 8900X Solid Ink MFP | | | | |
| 8900/X | Xerox ColorQube 8900X Color Solid Ink MFP (44 ppm) (1.33 GHz) (1 GB) (8.5" x 14") (2400 dpi) (Max Duty Cycle 120,000 Pages) (p/s/c/f) (Duplex) (USB) (Ethernet) (Energy Star) (625 Sheet Input Tray) | 906307 | EA | \$5,416.00 |
| 097S04383 | 525-Sheet Feeder | 908669 | EA | \$342.60 |
| 097S04382 | 1,800-Sheet High Capacity Feeder | 911841 | EA | \$1,431.15 |
| 097S04388 | Printer Cart with Storage Drawer | 908668 | EA | \$457.19 |
| E8900S3 | Extended Onsite Service (2 Year) | 911686 | EA | \$1,599.00 |
| E8900S4 | Extended Onsite Service (3 Year) | 911687 | EA | \$2,349.00 |
| PRINTERS DIRECT REFURBISHED EQUIPMENT | | | | |
| Printers Direct Refurbished HP LaserJet 4100n Mono Laser Printer | | | | |
| C8050A-MPS | Refurbished HP LaserJet 4100n Mono Printer (MPS Ready) (25 ppm) (250 MHz) (32 MB) (8.5" x 14") (1200 dpi) (Max Duty Cycle 150,000 Pages) (Ethernet) (600 Sheet Input Capacity) (12 Month Warranty) | 906113 | EA | \$515.00 |
| C8055A-MPS | Refurbished 500-Sheet Feeder | 922423 | EA | \$135.00 |
| Printers Direct Refurbished HP LaserJet 4200n Mono Laser Printer | | | | |
| Q2426A-MPS | Refurbished HP LaserJet 4200n Mono Printer (MPS Ready) (35 ppm) (300 MHz) (64 MB) (8.5" x 14") (1200 dpi) (Max Duty Cycle 150,000 Pages) (Parallel) (Ethernet) (600 Sheet Input Capacity) (12 Month Warranty) | 906114 | EA | \$725.00 |
| Q2440A-MPS | Refurbished 500-Sheet Tray | 907655 | EA | \$112.00 |

| MFG# | Product Description | Part# | UOM | Retail |
|--|---|--------|-----|------------|
| PRINTERS DIRECT REFURBISHED EQUIPMENT | | | | |
| Printers Direct Refurbished HP LaserJet 4250n Mono Laser Printer | | | | |
| Q5401A-MPS | Refurbished HP LaserJet 4250n Mono Printer (MPS Ready) (45 ppm) (460 MHz) (64 MB) (8.5" x 14") (1200 dpi) (Max Duty Cycle 200,000 Pages) (Parallel) (USB) (Ethernet) (Energy Star) (600 Sheet Input Capacity) (12 Month Warranty) | 906038 | EA | \$900.00 |
| Q2440B-MPS | Refurbished 500-Sheet Tray | 906752 | EA | \$250.00 |
| Printers Direct Refurbished HP LaserJet 4300 Mono Laser Printers | | | | |
| Q2431A-MPS | Refurbished HP LaserJet 4300 Mono Printer (MPS Ready) (45 ppm) (350 MHz) (64 MB) (8.5" x 14") (1200 dpi) (Max Duty Cycle 200,000 Pages) (600 Sheet Input Capacity) (No NIC Card Included) (12 Month Warranty) | 908550 | EA | \$725.00 |
| Q2432A-MPS | Refurbished 4300n: Base Model + Ethernet Connectivity | 906115 | EA | \$800.00 |
| Q2440A-MPS | Refurbished 500-Sheet Tray | 907655 | EA | \$112.00 |
| Printers Direct Refurbished HP LaserJet 4350n Mono Laser Printer | | | | |
| Q5407A-MPS | Refurbished HP LaserJet 4350n Mono Printer (MPS Ready) (55 ppm) (460 MHz) (96 MB) (8.5" x 14") (1200 dpi) (Max Duty Cycle 250,000 Pages) (Parallel) (Ethernet) (Energy Star) (600 Sheet Input Capacity) (12 Month Warranty) | 906236 | EA | \$1,050.00 |
| Q2440B-MPS | Refurbished 500-Sheet Tray | 906752 | EA | \$250.00 |
| Printers Direct Refurbished HP LaserJet 5100 Mono Laser Printer | | | | |
| Q1860A-MPS | Refurbished HP LaserJet 5100 Mono Laser Printer (MPS Ready) (21 ppm) (300 MHz) (16 MB) (11" x 17") (1200 x 1200 dpi) (Max Duty Cycle 65,000 Pages) (Parallel) (350 Sheet Input Capacity) (12 Month Warranty) | 910059 | EA | \$699.00 |
| Printers Direct Refurbished HP LaserJet 5200n Mono Laser Printer | | | | |
| Q7544A-MPS | Refurbished HP LaserJet 5200n Mono Printer (MPS Ready) (35 ppm) (460 MHz) (64 MB) (8.5" x 14") (1200 x 1200 dpi) (Max Duty Cycle 20,000 Pages) (Parallel) (USB) (Ethernet) (500 Sheet Input Capacity) (12 Month Warranty) | 909316 | EA | \$929.00 |
| Q7548A-MPS | Refurbished 500-Sheet Feeder | 909320 | EA | \$295.00 |
| Printers Direct Refurbished HP LaserJet 9050 Mono Laser Printer & MFP | | | | |
| Q3722A-MPS | Refurbished HP LaserJet 9050n Mono Printer (MPS Ready) (50 ppm) (533 MHz) (128 MB) (11" x 17") (600 x 600 dpi) (Max Duty Cycle 40,000 Pages) (Parallel) (Ethernet) (1,100 Sheet Input Capacity) (12 Month Warranty) | 906238 | EA | \$2,200.00 |
| Q3728A-MPS | Refurbished HP LaserJet 9050 MFP: Base Model + Scan/Copy/Fax Functions, 256 MB Total Memory, Duplex Printing, Energy Star Certified, 3,100-Sheet Input Capacity | 906338 | EA | \$6,000.00 |
| C8531A-MPS | Refurbished 2,000-Sheet Feeder | 906818 | EA | \$400.00 |
| Printers Direct Refurbished HP LaserJet Enterprise 600 Series Mono Laser Printers | | | | |
| CE994A-MPS | Refurbished HP LaserJet Enterprise 600 Series M603n Mono Laser Printer (MPS Ready) (62 ppm) (800 MHz) (512 MB) (8.5" x 14") (1200 x 1200 dpi) (Max Duty Cycle 275,000 Pages) (USB) (Ethernet) (Wireless) (Energy Star) (600 Sheet Input Capacity) (12 Month Warranty) | 914538 | EA | \$1,348.50 |
| CE995A-MPS | Refurbished M603dn: Base Model + Duplex Printing | 914539 | EA | \$1,498.50 |
| Printers Direct Refurbished HP LaserJet P2015dn Mono Laser Printer | | | | |
| CB368A-MPS | Refurbished HP LaserJet P2015dn Mono Laser Printer (MPS Ready) (26 ppm) (400 MHz) (32 MB) (8.5" x 14") (1200 x 1200 dpi) (Max Duty Cycle 15,000 Pages) (Duplex) (USB) (Ethernet) (Energy Star) (250 Sheet Input Capacity) (50 Sheet Multipurpose Tray) | 926780 | EA | \$380.00 |
| Q5931A-MPS | Refurbished 250-Sheet Paper Tray | 906767 | EA | \$110.00 |
| Printers Direct Refurbished HP LaserJet P2055dn Mono Laser Printer | | | | |
| CE459A-MPS | Refurbished HP LaserJet P2055dn Mono Printer (MPS Ready) (35 ppm) (600 MHz) (128 MB) (8.5" x 14") (1200 x 1200 dpi) (Max Duty Cycle 3,000 Pages) (Duplex) (USB) (Ethernet) (Energy Star) (300 Sheet Input Capacity) (12 Month Warranty) | 906108 | EA | \$500.00 |
| CE464A-MPS | Refurbished 250-Sheet Tray | 906915 | EA | \$186.00 |
| Printers Direct Refurbished HP LaserJet P3005 Mono Laser Printers | | | | |
| Q7814A-MPS | Refurbished HP LaserJet P3005n Mono Printer (MPS Ready) (35 ppm) (400 MHz) (80 MB) (8.5" x 14") (1200 x 1200 dpi) (Max Duty Cycle 100,000 Pages) (USB) (Ethernet) (600 Sheet Input Capacity) (12 Month Warranty) | 906109 | EA | \$560.00 |
| Q7815A-MPS | HP LaserJet P3005dn: Base Model + Duplex Printing, Energy Star Certified | 920067 | EA | \$665.00 |
| CE530A-MPS | Refurbished 500-Sheet Feeder | 910794 | EA | \$186.00 |
| Printers Direct Refurbished HP LaserJet P3015 Mono Laser Printers | | | | |
| CE527A-MPS | Refurbished HP LaserJet P3015n Mono Laser Printer (MPS Ready) (42 ppm) (540 MHz) (128 MB) (8.5" x 14") (1200 x 1200 dpi) (Max Duty Cycle 100,000 Pages) (USB) (Ethernet) (600 Sheet Input Capacity) (12 Month Warranty) | 910792 | EA | \$486.00 |
| CE528A-MPS | Refurbished P3015dn: Base Model + Duplex Printing | 910793 | EA | \$569.00 |
| CE530A-MPS | Refurbished 500-Sheet Feeder | 910794 | EA | \$186.00 |

| MFG# | Product Description | Part# | UOM | Retail |
|--|--|--------|-----|------------|
| PRINTERS DIRECT REFURBISHED EQUIPMENT | | | | |
| Printers Direct Refurbished HP LaserJet P4015n Mono Laser Printer | | | | |
| CB509A-MPS | Refurbished HP LaserJet P4015n Mono Printer (MPS Ready) (52 ppm) (540 MHz) (128 MB) (8.5" x 14") (1200 dpi) (Max Duty Cycle 225,000 Pages) (USB) (Ethernet) (Energy Star) (600 Sheet Input Capacity) (12 Month Warranty) | 906039 | EA | \$1,298.00 |
| Printers Direct Refurbished HP LaserJet P4515n Mono Laser Printer | | | | |
| CB514A-MPS | Refurbished HP LaserJet P4515n Mono Printer (MPS Ready) (62 ppm) (540 MHz) (128 MB) (8.5" x 14") (1200 dpi) (Max Duty Cycle 20,000 Pages) (USB) (Ethernet) (Energy Star) (600 Sheet Input Capacity) (12 Month Warranty) | 906237 | EA | \$1,500.00 |
| Printers Direct Refurbished HP LaserJet 4345 Mono Laser MFPs | | | | |
| Q3942A-MPS | Refurbished HP LaserJet 4345 MFP Mono Printer (MPS Ready) (45 ppm) (256 MB) (8.5" x 14") (1200 x 1200 dpi) (Max Duty Cycle 200,000 Pages) (p/s/c) (Ethernet) (600 Sheet Input Capacity) (50 Sheet ADF) (12 Month Warranty) | 906324 | EA | \$2,000.00 |
| Q3943A-MPS | Refurbished 4345x: Base Model + Duplex Printing, Fax Function, Total 1,100-Sheet Input Capacity | 906336 | EA | \$2,800.00 |
| Q3944A-MPS | Refurbished 4345xs: Base Model + Duplex Printing, Fax Function, Total 1,100-Sheet Input Capacity, Stapler/Stacker | 906333 | EA | \$3,400.00 |
| Q5968A-MPS | Refurbished 500-Sheet Tray | 909322 | EA | \$225.00 |
| Printers Direct Refurbished HP LaserJet M3035 Mono Laser MFPs | | | | |
| CB414A-MPS | Refurbished HP LaserJet M3035 Mono MFP (MPS Ready) (35 ppm) (256 MB) (8.5" x 14") (1200 x 1200 dpi) (Max Duty Cycle 75,000 Pages) (p/s/c) (Duplex) (USB) (Ethernet) (Energy Star) (600 Sheet Input Capacity) (50 Sheet ADF) (Touchscreen) (12 Month Warranty) | 909317 | EA | \$1,300.00 |
| CC477A-MPS | Refurbished M3035xs: Base Model + Fax Function, Total 1,100-Sheet Input Capacity | 906044 | EA | \$2,600.00 |
| Q7817A-MPS | Refurbished 500-Sheet Feeder | 908369 | EA | \$107.00 |
| Printers Direct Refurbished HP LaserJet M4345 Mono Laser MFPs | | | | |
| CB425A-MPS | Refurbished HP LaserJet M4345 Mono Laser MFP (MPS Ready) (45 ppm) (256 MB) (8.5" x 14") (1200 x 1200 dpi) (p/s/c) (USB) (Ethernet) (600 Sheet Input Tray) (50 Sheet ADF) (12 Month Warranty) | 919364 | EA | \$1,758.40 |
| CB426A-MPS | Refurbished HP LaserJet M4345x: Base Model + Duplex Printing, 1,100-Sheet Input Capacity | 906043 | EA | \$3,700.00 |
| CB427A-MPS | Refurbished M4345xs: Same as M4345x + Stacker/Stapler | 906337 | EA | \$5,100.00 |
| Printers Direct Refurbished HP LaserJet M4555f Mono Laser MFP | | | | |
| CE503A-MPS | Refurbished HP LaserJet M4555f Mono Laser MFP (MPS Ready) (55 ppm) (800 MHz) (1.25 GB) (8.5" x 14") (1200 x 1200 dpi) (Max Duty Cycle 250,000 Pages) (p/s/c/f) (Duplex) (USB) (Ethernet) (Touchscreen) (Energy Star) (1,100 Sheet Input Capacity) (50 Sheet ADF) | 930653 | EA | \$3,400.00 |
| Printers Direct Refurbished HP LaserJet M5035x Mono Laser MFP | | | | |
| Q7830A-MPS | Refurbished HP LaserJet M5035x Mono Laser MFP (MPS Ready) (35 ppm) (460 MHz) (256 MB) (11" x 17") (1200 x 1200 dpi) (Max Duty Cycle 200,000 Pages) (p/s/c/f) (Duplex) (USB) (Ethernet) (Energy Star) (Touchscreen) (2,000 Sheet Input Capacity) (50 Sheet ADF) (12 Month Warranty) | 919363 | EA | \$2,718.40 |
| Printers Direct Refurbished HP LaserJet M9050 Mono Laser MFP | | | | |
| CC395A-MPS | Refurbished HP LaserJet M9050 MFP Mono Printer (MPS Ready) (50 ppm) (384 MB) (11" x 17") (600 x 600 dpi) (Max Duty Cycle 40,000 Pages) (p/s/c/f) (Duplex) (USB) (Ethernet) (3,100 Sheet Input Capacity) (100 Sheet ADF) (Touchscreen) (12 Month Warranty) | 906339 | EA | \$7,000.00 |
| Printers Direct Refurbished HP LaserJet 3600 Color Laser Printers | | | | |
| Q5987A-MPS | Refurbished HP Color LaserJet 3600n Printer (MPS Ready) (360 MHz) (17 ppm) (64 MB) (8.5" x 14") (Max Duty Cycle 4,000 Pages) (USB) (Ethernet) (250 Sheet Input Capacity) (12 Month Warranty) | 906340 | EA | \$800.00 |
| Q5988A-MPS | Refurbished 3600dn: Base Model + Duplex Printing | 908381 | EA | \$549.00 |
| Q5985A-MPS | Refurbished 500-Sheet Tray | 909324 | EA | \$159.00 |
| Printers Direct Refurbished HP LaserJet 3800 Color Laser Printers | | | | |
| Q5982A-MPS | Refurbished HP Color LaserJet 3800n Printer (MPS Ready) (22 ppm) (533 MHz) (160 MB) (8.5" x 14") (Max Duty Cycle 65,000 Pages) (USB) (Ethernet) (350 Sheet Input Capacity) (12 Month Warranty) | 906041 | EA | \$890.00 |
| Q5983A-MPS | Refurbished 3800dn: Base Model + Duplex Printing | 914642 | EA | \$525.00 |
| Q5985A-MPS | Refurbished 500-Sheet Tray | 909324 | EA | \$159.00 |

| MFG# | Product Description | Part# | UOM | Retail |
|--|---|--------|-----|------------|
| PRINTERS DIRECT REFURBISHED EQUIPMENT | | | | |
| Printers Direct Refurbished HP LaserJet 4650 Color Laser Printers | | | | |
| Q3669A-MPS | Refurbished HP Color LaserJet 4650n Printer (MPS Ready) (22 ppm) (533 MHz) (160 MB) (8.5" x 14") (Max Duty Cycle 15,000 Pages) (Parallel) (USB) (Ethernet) (600 Sheet Input Capacity) (12 Month Warranty) | 906353 | EA | \$900.00 |
| Q3670A-MPS | Refurbished 4650dn: Base Model + Duplex Printing | 908549 | EA | \$900.00 |
| Q3676A-MPS | Refurbished 500-Sheet Feeder | 906849 | EA | \$135.00 |
| Printers Direct Refurbished HP LaserJet 4700 Color Laser Printers | | | | |
| Q7492A-MPS | Refurbished HP LaserJet 4700n Color Printer (MPS Ready) (31 ppm) (533 MHz) (8.5" x 14") (USB) (Parallel) (Ethernet) (600 Sheet Input Capacity) (12 Month Warranty) | 906042 | EA | \$1,400.00 |
| Q7493A-MPS | Refurbished 4700dn: Base Model + Duplex Printing | 908763 | EA | \$619.00 |
| Q7499A-MPS | Refurbished 500-Sheet Feeder | 908766 | EA | \$275.00 |
| Printers Direct Refurbished HP LaserJet 5550n Color Laser Printer | | | | |
| Q3714A-MPS | Refurbished HP Color LaserJet 5550n Printer (MPS Ready) (27 ppm) (533 MHz) (160 MB) (11" x 17") (Max Duty Cycle 15,000 Pages) (Parallel) (USB) (Ethernet) (600 Sheet Input Capacity) (12 Month Warranty) | 906354 | EA | \$2,000.00 |
| Printers Direct Refurbished HP LaserJet CM4730 Color Laser MFP | | | | |
| CB480A-MPS | Refurbished HP Color LaserJet CM4730 MFP Printer (MPS Ready) (31 ppm) (448 MB) (600 x 600 dpi) (Max Duty Cycle 15,000 Pages) (p/s/c/f) (Duplex) (Parallel) (USB) (Energy Star) (1,600 Sheet Input Capacity) (50 Sheet ADF) (Floor Standing) (12 Month Warranty) | 906356 | EA | \$6,000.00 |
| Printers Direct Refurbished HP LaserJet CM6040f Color Laser MFP | | | | |
| Q3939A-MPS | Refurbished HP LaserJet CM6040f Color Laser MFP (MPS Ready) (40 ppm) (835 MHz) (512 MB) (11" x 17") (1200 x 600 dpi) (Max Duty Cycle 200,000 Pages) (p/s/c) (Duplex) (USB) (Ethernet) (Energy Star) (Touchscreen) (2,100 Sheet Input Capacity) (50 Sheet ADF) (12 Month Warranty) | 919366 | EA | \$6,760.00 |
| Printers Direct Refurbished HP LaserJet CP3505 Color Laser Printers | | | | |
| CB442A-MPS | Refurbished HP Color LaserJet CP3505n Printer (MPS Ready) (22 ppm) (450 MHz) (256 MB) (8.5" x 14") (1200 x 600 dpi) (Max Duty Cycle 65,000 Pages) (USB) (Ethernet) (Energy Star) (350 Sheet Input Capacity) (12 Month Warranty) | 909978 | EA | \$480.00 |
| CB443A-MPS | Refurbished CP3505dn: Base Model + 384MB Total Memory, Duplex Printing | 909979 | EA | \$540.00 |
| CB444A-MPS | Refurbished CP3505x: Base Model + Duplex Printing, 384MB Total Memory, Total 850-Sheet Input Capacity | 909980 | EA | \$695.00 |
| Printers Direct Refurbished HP LaserJet CP3525 Color Laser Printers | | | | |
| CC469A-MPS | Refurbished HP Color LaserJet CP3525n Printer (MPS Ready) (30 ppm) (515 MHz) (256 MB) (8.5" x 14") (1200 x 600 dpi) (Max Duty Cycle 75,000 Pages) (USB) (Ethernet) (250 Sheet Input Tray) (100 Sheet Multipurpose Tray) (12 Month Warranty) | 910789 | EA | \$676.00 |
| CC470A-MPS | Refurbished CP3525dn: Base Model + Duplex Printing, 384MB Total Memory | 910790 | EA | \$774.00 |
| CE522A-MPS | Refurbished 500-Sheet Feeder | 910791 | EA | \$210.00 |
| Printers Direct Refurbished HP LaserJet CP6015x Color Laser Printer | | | | |
| Q3933A-MPS | Refurbished HP LaserJet CP6015x Color Laser Printer (MPS Ready) (40 ppm) (835 MHz) (512 MB) (11" x 17") (1200 x 600 dpi) (Max Duty Cycle 175,000 Pages) (Duplex) (USB) (Ethernet) (1,100 Sheet Input Tray) (100 Sheet Multipurpose Tray) (12 Month Warranty) | 919365 | EA | \$4,639.40 |
| Printers Direct Refurbished Lexmark Optra T642/T644 Mono Laser Printers | | | | |
| 20G0250-MPS | Refurbished Lexmark Optra T642n Mono Laser Printer (MPS Ready) (45 ppm) (457 MHz) (128 MB) (8.5" x 14") (1200 x 1200 dpi) (Max Duty Cycle 20,000 Pages) (USB) (Parallel) (Ethernet) (600 Sheet Input Capacity) | 909315 | EA | \$469.00 |
| 20G0350-MPS | Refurbished Lexmark Optra T644n: Same as T642 + 50 ppm, 514 MHz | 908538 | EA | \$499.00 |
| Printers Direct Refurbished Lexmark T652dn Mono Laser Printer | | | | |
| 30G0200-MPS | Refurbished Lexmark T652dn Mono Laser Printer (MPS Ready) (50 ppm) (500 MHz) (128 MB) (8.5" x 14") (1200 x 1200 dpi) (Max Duty Cycle 225,000 Pages) (Duplex) (USB) (Ethernet) (Energy Star) (550 Sheet Input Tray) (100 Sheet Multipurpose Tray) | 919361 | EA | \$900.00 |
| 30G0802-MPS | Refurbished 550-Sheet Paper Tray | 919362 | EA | \$250.00 |

HP Supplies Compatibility Matrix

U.S. and Canada Version
December 2014



- 258 HP LaserJet Supplies
- 262 HP Inkjet Supplies
- 267 HP Small-format Paper
- 269 HP Designjet Ink Supplies
- 274 HP Designjet Printing Material
- 280 HP Information Storage Supplies



HP Small-format Paper

1 of 2

| Product • Size | Product no. | | | |
|--|------------------|--------------------|---|---|
| HP Professional Papers - InkJet Printers | | | | |
| | | Sheets/ream | Compatibility | |
| HP Premium Presentation Paper, Matte • 8.5 x 11 in, 120 g/m ² , 32 lb | DOZ55A | 100 | Optimized for HP InkJet printers. Compatible with all InkJet printers | |
| HP Brochure Paper, Matte • 8.5 x 11 in, 180 g/m ² , 48 lb | CH016A | 150 | Optimized for HP InkJet printers. Compatible with all InkJet printers | |
| HP Brochure Paper, Glossy • 8.5 x 11 in, 180 g/m ² , 48 lb | C6817A | 50 | Optimized for HP InkJet printers. Compatible with all InkJet printers | |
| HP Brochure Paper, Glossy • 8.5 x 11 in, 180 g/m ² , 48 lb | Q1987A | 150 | Optimized for HP InkJet printers. Compatible with all InkJet printers | |
| HP Brochure Paper, Glossy • 11 x 17 in, 180 g/m ² , 48 lb | CG932A | 150 | Optimized for HP InkJet printers. Compatible with all InkJet printers | |
| HP Tri-fold Brochure Paper, Glossy • 8.5 x 11 in, 180 g/m ² , 48 lb | C7020A | 100 | Optimized for HP InkJet printers. Compatible with all InkJet printers | |
| HP Tri-fold Brochure Paper, Matte • 8.5 x 11 in, 180 g/m ² , 48 lb | Q5443A | 100 | Optimized for HP InkJet printers. Compatible with all InkJet printers | |
| HP Professional Papers - Laser Printers | | | | |
| | | Sheets/ream | Compatibility | |
| HP Premium Presentation Paper, Glossy 8.5 x 11 in, 120 g/m ² , 32 lb | CG988A | 250 | Guaranteed for optimal performance with HP Color LaserJet printers. Compatible with most laser printers and copiers. Not recommended for: HP Color LaserJet CP6015/CM6030/CM6040 printers | |
| HP Premium Presentation Paper, Glossy 11 x 17 in, 120 g/m ² , 32 lb | Q2547A | 250 | Guaranteed for optimal performance with HP Color LaserJet printers. Compatible with most laser printers and copiers. Not recommended for: HP Color LaserJet CP6015/CM6030/CM6040 printers | |
| HP Tri-fold Brochure Paper, Glossy 8.5 x 11 in, 150 g/m ² , 40 lb | Q6612A | 150 | Guaranteed for optimal performance with HP Color LaserJet printers. Compatible with most laser printers and copiers | |
| HP Brochure Paper, Glossy 8.5 x 11 in, 150 g/m ² , 40 lb | Q6611A | 150 | Guaranteed for optimal performance with HP Color LaserJet printers. Compatible with most laser printers and copiers. | |
| HP Brochure Paper, Matte 8.5 x 11 in, 150 g/m ² , 40 lb | Q6543A | 150 | Guaranteed for optimal performance with HP Color LaserJet printers. Compatible with most laser printers and copiers. Check supported paper weights in printer manual | |
| HP Brochure Paper, Matte 8.5 x 11 in, 200 g/m ² , 52 lb | Q8824A | 100 | Guaranteed for optimal performance with HP Color LaserJet printers. Compatible with most laser printers and copiers. Check supported paper weights in printer manual | |
| HP Brochure Paper, Glossy 8.5 x 11 in, 200 g/m ² , 52 lb | Q6608A | 100 | Guaranteed for optimal performance with HP Color LaserJet printers. Compatible with most laser printers and copiers | |
| HP Everyday Papers - Laser Printers | | | | |
| | | Sheets/ream | Brightness | Compatibility |
| HP LaserJet Paper • 8.5 x 11 in, 24 lb | HPJ115RC | 500 | 98 | Optimized for HP LaserJet printers. Compatible with all LaserJet printers. |
| HP LaserJet Paper • 8.5 x 11 in, 24 lb | HPJ1124 | 500 | 98 | Optimized for HP LaserJet printers. Compatible with all LaserJet printers. |
| HP Color LaserJet • 8.5 x 11 in, 28 lb | INP205050 | 500 | 98 | Optimized for all HP Color LaserJet printers. Compatible with all LaserJet printers. |
| HP Premium Choice LaserJet Paper • 8.5 x 11 in, 32 lb | HPU1132 | 500 | 98 | Optimized for all HP Color LaserJet printers. Compatible with all LaserJet printers . |
| HP Everyday Papers - Multi-machine | | | | |
| | | Sheets/ream | Brightness | Compatibility |
| HP EcoFICIENT™ Paper* • 8.5 x 11 in, 16 lb | INP216000 | 625 | 92 | Optimized for HP InkJet and LaserJet printers. Compatible with all printers. |
| HP Business Copy Ultra White Paper • 8.5 x 11 in, 20 lb | HPBC11 | 500 | 92 | Optimized for HP InkJet and LaserJet printers. Compatible with all printers. |
| HP Everyday Copy & Print Paper • 8.5 x 11 in, 20 lb | INP200350 | 500 | 92 | Optimized for HP InkJet and LaserJet printers. Compatible with all printers. |
| HP Everyday Copy & Print Paper • 8.5 x 11 in, 20 lb | HPA510 | 500 | 92 | Optimized for HP InkJet and LaserJet printers. Compatible with all printers. |
| HP Everyday Copy & Print Paper • 8.5 x 11 in, 20 lb | INP200010 | 400 | 92 | Optimized for HP InkJet and LaserJet printers. Compatible with all printers. |
| HP Everyday Copy & Print Paper • 8.5 x 11 in, 20 lb | INP200030 | 750 | 92 | Optimized for HP InkJet and LaserJet printers. Compatible with all printers. |
| HP Office Ultra White Paper • 8.5 x 11 in, 20 lb | HPC115RC | 500 | 92 | Optimized for HP InkJet and LaserJet printers. Compatible with all printers. |
| HP Office Ultra White Paper • 8.5 x 11 in, 20 lb | HPC8511R | 500 | 92 | Optimized for HP InkJet and LaserJet printers. Compatible with all printers. |
| HP Office Ultra White Paper • 8.5 x 11 in, 20 lb | HPC8511C | 500 | 92 | Optimized for HP InkJet and LaserJet printers. Compatible with all printers. |
| HP Office Ultra White Paper (3-hole) • 8.5 x 11 in, 20 lb | HPC3HP | 500 | 92 | Optimized for HP InkJet and LaserJet printers. Compatible with all printers. |
| HP Office Ultra White Paper • 8.5 x 14 in, 20 lb | HPC8514 | 500 | 92 | Optimized for HP InkJet and LaserJet printers. Compatible with all printers. |
| HP Office Ultra White Paper • 11 x 17 in, 20 lb | HPC1117 | 500 | 92 | Optimized for HP InkJet and LaserJet printers. Compatible with all printers. |
| HP Office Ultra White Paper Quickpack • 8.5 x 11 in, 20 lb | HPZ500S | 2,500 | 92 | Optimized for HP InkJet and LaserJet printers. Compatible with all printers. |
| HP Recycled Paper • 8.5 x 11 in, 20 lb | HPPE1120R | 500 | 92 | Optimized for HP InkJet and LaserJet printers. Compatible with all printers. |
| HP Recycled Paper • 8.5 x 11 in, 20 lb | HPPE1120C | 500 | 92 | Optimized for HP InkJet and LaserJet printers. Compatible with all printers. |
| HP Multipurpose Ultra White Paper • 8.5 x 11 in, 20 lb | HPM1120R | 500 | 96 | Optimized for HP InkJet and LaserJet printers. Compatible with all printers. |
| HP Multipurpose Ultra White Paper • 8.5 x 11 in, 20 lb | HPM1120C | 500 | 96 | Optimized for HP InkJet and LaserJet printers. Compatible with all printers. |
| HP Multipurpose Ultra White Paper • 8.5 x 11 in, 20 lb | HPM115RC | 500 | 96 | Optimized for HP InkJet and LaserJet printers. Compatible with all printers. |
| HP Multipurpose Ultra White Paper (3-hole) • 8.5 x 11 in, 20 lb | HPM113H | 500 | 96 | Optimized for HP InkJet and LaserJet printers. Compatible with all printers. |
| HP Multipurpose Ultra White Paper • 8.5 x 14 in, 20 lb | HPM1420 | 500 | 96 | Optimized for HP InkJet and LaserJet printers. Compatible with all printers. |
| HP Multipurpose Ultra White Paper • 11 x 17 in, 20 lb | HPM1720 | 500 | 96 | Optimized for HP InkJet and LaserJet printers. Compatible with all printers. |
| HP All-in-One Printing Paper • 8.5 x 11 in, 22 lb • 5-ream carton | HPT115 | 500 | 96 | Optimized for HP InkJet and LaserJet printers. Compatible with all printers. |
| HP All-in-One Printing Paper • 8.5 x 11 in, 22 lb • 10-ream carton | HPT1122 | 500 | 96 | Optimized for HP InkJet and LaserJet printers. Compatible with all printers. |
| HP Color InkJet & Laser Paper • 8.5 x 11 in, 24 lb | HPK115 | 500 | 97 | Optimized for HP InkJet and LaserJet printers. Compatible with all printers. |
| HP Color InkJet & Laser Paper • 8.5 x 11 in, 24 lb | HPK400 | 400 | 97 | Optimized for HP InkJet and LaserJet printers. Compatible with all printers. |
| HP Everyday Papers - InkJet Printers | | | | |
| | | Sheets/ream | Brightness | Compatibility |
| HP Bright White InkJet Paper • 8.5 x 11 in, 24 lb | HPB1124 | 500 | 97 | Optimized for HP InkJet printers. Compatible with all InkJet printers. |

HP Small-format Paper

2 of 2

| Product • Size | Product no. | Sheets/ pack | Thickness | Compatibility |
|--|----------------|-----------------|-----------|--|
| HP Photo Papers - InkJet Printers | | | | |
| HP Everyday Photo Paper, Glossy • 4 x 6 in, 200 g/m ² , 53 lb | CR759A | 100 | 8 mil | Compatible with all inkJet printers |
| HP Everyday Photo Paper, Glossy • 8.5 x 11 in, 200 g/m ² , 53 lb | Q5498A | 25 | 8 mil | Compatible with all inkJet printers |
| HP Everyday Photo Paper, Glossy • 8.5 x 11 in, 200 g/m ² , 53 lb | Q8723A | 50 | 8 mil | Compatible with all inkJet printers |
| HP Everyday Photo Paper, Glossy • 5 x 7 in, 200 g/m ² , 53 lb | CH097A | 60 | 8 mil | Compatible with all inkJet printers |
| HP Advanced Photo Paper, Glossy • 4 x 6 in, 250 g/m ² , 66 lb | Q6638A | 100 | 10.5 mil | Compatible with all inkJet printers |
| HP Advanced Photo Paper, Glossy • 5 x 7 in, 250 g/m ² , 66 lb | Q8690A | 60 | 10.5 mil | Compatible with all inkJet printers |
| HP Advanced Photo Paper, Glossy • 8.5 x 11 in, 250 g/m ² , 66 lb | Q7853A | 50 | 10.5 mil | Compatible with all inkJet printers |
| HP Advanced Photo Paper, Glossy • 13 x 19 in, 250 g/m ² , 66 lb | CR696A | 20 | 10.5 mil | Compatible with all inkJet printers |
| HP Photo Card Pack • 5 x 7 in | SF791A | - | - | Compatible with all inkJet printers |
| HP Premium Plus Photo, Glossy • 8.5 x 11 in, 300 g/m ² , 80 lb | CR664A | 50 | 11.5 mil | Compatible with all inkJet printers |
| HP Premium Plus Photo, Glossy • 4 x 6 in, 300 g/m ² , 80 lb | CR668A | 100 | 11.5 mil | Compatible with all inkJet printers |
| HP Premium Plus Photo, Glossy • 5 x 7 in, 300 g/m ² , 80 lb | CR669A | 60 | 11.5 mil | Compatible with all inkJet printers |
| HP Premium Plus Photo, Glossy • 8.5 x 11 in, 300 g/m ² , 80 lb | CR670A | 25 | 11.5 mil | Compatible with all inkJet printers |
| HP Premium Plus Photo, Glossy • 11 x 17 in, 300 g/m ² , 80 lb | CV065A | 25 | 11.5 mil | Compatible with all inkJet printers |
| HP Premium Plus Photo, Soft Gloss • 4 x 6 in, 300 g/m ² , 80 lb | CR666A | 100 | 11.5 mil | Compatible with all inkJet printers |
| HP Premium Plus Photo, Soft Gloss • 8.5 x 11 in, 300 g/m ² , 80 lb | CR667A | 50 | 11.5 mil | Compatible with all inkJet printers |
| HP Premium Plus Photo, Soft Gloss • 8.5 x 11 in, 300 g/m ² , 80 lb | CR671A | 25 | 11.5 mil | Compatible with all inkJet printers |
| HP Premium Photo, Satin • 13 x 19 in, 240 g/m ² , 64 lb | CZ988A | 25 | 11.5 mil | Compatible with HP DesignJet 130/30 Printer Series, HP DeskJet 9600 and 9300 Printer Series |
| HP Premium Photo, Glossy • 13 x 19 in, 240 g/m ² , 64 lb | CZ985A | 25 | 11.5 mil | Compatible with HP DesignJet 130/30 Printer Series, HP DeskJet 9600 and 9300 Printer Series |
| HP Photo Value Pack | | | | |
| HP 564 Photo & Card Value Pack, Glossy • 4 x 6 in and 5 x 7 in, 250 g/m ² , 66 lb | J2X80AN | 70 | 10.5 mil | Compatible with HP DeskJet 3520, 3521, 3522, 3525, 3526; HP OfficeJet 4620, 4622; HP Photosmart B8550, C6340, C6350, C6380, D5445, D5460, D7560, 5510, 5511, 5512, 5514, 5515, 5520, 5522, 5525, 6510, 6512, 6515, 6520, 6525, 7510, 7515, 7520, 7525, Photosmart Plus, Premium, eStation |
| HP 60 Series Photo Value Pack, Glossy • 4 x 6 in, 250 g/m ² , 66 lb | CG845AN | 50 | 10.5 mil | Compatible with HP DeskJet D1660, F2440, D2545, D2560, D2530, D2660, D2680, F4240, F4280, F4480, F4440, F4435, F4580, D5560; HP ENVY 110, 114; HP Photosmart C4640, C4650, C4680, C4635, C4780, C4795, C4750, C4740 |
| HP 62 Photo and Card Value Pack, Glossy • 4 x 6 in and 5 x 7 in, 250 g/m ² , 66 lb | K3W67AN | 45 | 10.5 mil | Compatible with HP OfficeJet 5740, 5742, 5745, 8040, 8045; HP ENVY 5660, 5665, 7640, 7645 |
| HP Custom 57/58 Series Photo Value Pack, Glossy • 4 x 6 in, 240 g/m ² , 64 lb | CR685AN | 100 | 10 mil | Compatible with HP DeskJet 450ci, 450cbi, 450wbt, F4135, F4140, F4180, 5150, 5150w, 5550, 5650, 5650w, 5850, 5850w, 9650, 9670, 9680; HP Photosmart 1311, 1315, 1315v, 1315xi, 1350, 1350v, 1350xi, 2110, 2110v, 2110xi, 2175, 2175v, 2175xi, 2210, 2210v, 2210xi, 2410, 2410v, 2410xi, 2510, 2510xi, 7150, 7260, 7260v, 7260w, 7350, 7450, 7450v, 7450xi, 7550, 7660, 7660v, 7660w, 7755, 7760, 7760v, 7760w, 7960, 7960w; HP OfficeJet 4215, 4215v, 4215xi, 6110, 6110xi; Digital Copier 410 |
| HP Custom O2 Series Photo Value Pack, Glossy • 4 x 6 in, 250 g/m ² , 66 lb | Q7964AN | 150 | 10.5 mil | Compatible with HP Photosmart 3110, 3210, 3310, 3310xi, C5140, C5150, C5180, C6150, C6180, D6160, C6240, C6250, C6280, C6283, C6288, C7150, C7180, D7145, D7155, D7160, C7250, C7280, D7260, D7345, D7355, D7360, D7460, C8150, C8180, C8183, 8250 |
| HP Custom 110 Series Photo Value Pack, Glossy • 4 x 6 in, 250 g/m ² , 66 lb | Q8700BN | 140 | 10.5 mil | Compatible with HP Photosmart A434, A440, A445, A516, A526, A536, A616, A626, A636, A646, A716, A826 |

N/A¹ = Not applicable¹EcoFFICIENT is a trademark of International Paper Company.

HP DesignJet Ink Supplies 2 of 5

| Product | Cartridge no. | Product no. |
|--|---------------|-------------|
| HP DesignJet Z2100/Z3100/Z3200 series Original HP Photo Ink Supplies | | |
| HP Ink Cartridges | | |
| HP 70 130-ml Blue Ink Cartridge (130 ml) | 70 | C9458A |
| HP 70 130-ml Gloss Enhancer Ink Cartridge (130 ml) | 70 | C9459A |
| HP 70 130-ml Gray Ink Cartridge (130 ml) | 70 | C9450A |
| HP 70 130-ml Green Ink Cartridge (130 ml) | 70 | C9457A |
| HP 70 130-ml Light Cyan Ink Cartridge (130 ml) | 70 | C9390A |
| HP 70 130-ml Light Gray Ink Cartridge (130 ml) | 70 | C9451A |
| HP 70 130-ml Light Magenta Ink Cartridge (130 ml) | 70 | C9455A |
| HP 70 130-ml Magenta Ink Cartridge (130 ml) | 70 | C9453A |
| HP 70 130-ml Matte Black Ink Cartridge (130 ml) | 70 | C9448A |
| HP 70 130-ml Photo Black Ink Cartridge (130 ml) | 70 | C9449A |
| HP 70 130-ml Red Ink Cartridge (130 ml) | 70 | C9456A |
| HP 70 130-ml Yellow Ink Cartridge (130 ml) | 70 | C9454A |
| HP 70 130-ml Cyan Ink Cartridge (130 ml) | 70 | C9452A |
| HP 73 130-ml Chromatic Red Ink Cartridge (130 ml) | 70 | CD951A |
| HP Printheads | | |
| HP 70 Blue and Green Printhead | 70 | C9408A |
| HP 70 Gloss Enhancer and Gray Printhead | 70 | C9410A |
| HP 70 Light Magenta and Light Cyan Printhead | 70 | C9405A |
| HP 70 Magenta and Yellow Printhead | 70 | C9406A |
| HP 70 Matte Black and Red Printhead | 70 | C9409A |
| HP 70 Photo Black and Light Gray Printhead | 70 | C9407A |
| HP 70 Matte Black and Cyan Printhead | 70 | C9404A |
| HP 73 Matte Black and Chromatic Red Printhead | 73 | CD949A |
| HP DesignJet T7200/T7100 and HP DesignJet T7100 Monochrome Original HP Ink Supplies | | |
| HP Ink Cartridges | | |
| HP 761 400-ml Matte Black DesignJet Ink Cartridge | 761 | CM991A |
| HP 761 400-ml Yellow DesignJet Ink Cartridge | 761 | CM992A |
| HP 761 400-ml Magenta DesignJet Ink Cartridge | 761 | CM993A |
| HP 761 400-ml Cyan DesignJet Ink Cartridge | 761 | CM994A |
| HP 761 400-ml Gray DesignJet Ink Cartridge | 761 | CM995A |
| HP 761 400-ml Dark Gray DesignJet Ink Cartridge | 761 | CM996A |
| HP 761 775-ml Matte Black DesignJet Ink Cartridge | 761 | CM997A |
| HP Printheads and Maintenance Cartridges | | |
| HP 761 Yellow DesignJet Printhead | 761 | CH645A |
| HP 761 Magenta and Cyan DesignJet Printhead | 761 | CH646A |
| HP 761 Gray and Dark Gray DesignJet Printhead | 761 | CH647A |
| HP 761 Matte Black and Matte Black DesignJet Printhead | 761 | CH648A |
| HP 761 DesignJet Maintenance Cartridge | 761 | CH649A |
| HP 762 Dark Gray DesignJet Printhead | 762 | CH074A |
| HP 762 DesignJet Maintenance Cartridge | 762 | CM998A |
| HP DesignJet T7200 Original HP Ink Supplies | | |
| HP 765 400-ml Yellow DesignJet Ink Cartridge* | 765 | F9J50A |
| HP 765 400-ml Magenta DesignJet Ink Cartridge* | 765 | F9J51A |
| HP 765 400-ml Cyan DesignJet Ink Cartridge* | 765 | F9J52A |
| HP 765 400-ml Gray DesignJet Ink Cartridge* | 765 | F9J53A |
| HP 765 775-ml Dark Gray DesignJet Ink Cartridge* | 765 | F9J54A |
| HP 765 775-ml Matte Black DesignJet Ink Cartridge* | 765 | F9J55A |
| HP DesignJet 5000/5500 series Original HP Ink Supplies | | |
| HP Ink Cartridges | | |
| HP 81 680-ml Black Dye Ink Cartridge (680 ml) | 81 | C4930A |
| HP 81 680-ml Cyan Dye Ink Cartridge (680 ml) | 81 | C4931A |
| HP 81 680-ml Magenta Dye Ink Cartridge (680 ml) | 81 | C4932A |
| HP 81 680-ml Yellow Dye Ink Cartridge (680 ml) | 81 | C4933A |
| HP 81 680-ml Light Cyan Dye Ink Cartridge (680 ml) | 81 | C4934A |
| HP 81 680-ml Light Magenta Dye Ink Cartridge (680 ml) | 81 | C4935A |
| HP 83 680-ml Black UV Ink Cartridge (680 ml) | 83 | C4940A |
| HP 83 680-ml Cyan UV Ink Cartridge (680 ml) | 83 | C4941A |
| HP 83 680-ml Magenta UV Ink Cartridge (680 ml) | 83 | C4942A |
| HP 83 680-ml Yellow UV Ink Cartridge (680 ml) | 83 | C4943A |
| HP 83 680-ml Light Cyan UV Ink Cartridge (680 ml) | 83 | C4944A |
| HP 83 680-ml Light Magenta UV Ink Cartridge (680 ml) | 83 | C4945A |
| HP 3-ink Multipacks (includes 3 Ink Cartridges) | | |
| HP 81 3-pack 680-ml Black Dye Cartridges (680 ml x 3) | 81 | C5066A |
| HP 81 3-pack 680-ml Cyan Dye Cartridges (680 ml x 3) | 81 | C5067A |
| HP 81 3-pack 680-ml Magenta Dye Cartridges (680 ml x 3) | 81 | C5068A |
| HP 81 3-pack 680-ml Yellow Dye Cartridges (680 ml x 3) | 81 | C5069A |
| HP 81 3-pack 680-ml Light Cyan Dye Cartridges (680 ml x 3) | 81 | C5070A |
| HP 81 3-pack 680-ml Light Magenta Dye Cartridges (680 ml x 3) | 81 | C5071A |
| HP 83 3-pack 680-ml Black UV Cartridges (680 ml x 3) | 83 | C5072A |
| HP 83 3-pack 680-ml Cyan UV Cartridges (680 ml x 3) | 83 | C5073A |
| HP 83 3-pack 680-ml Magenta UV Cartridges (680 ml x 3) | 83 | C5074A |
| HP 83 3-pack 680-ml Yellow UV Cartridges (680 ml x 3) | 83 | C5075A |
| HP 83 3-pack 680-ml Light Cyan UV Cartridges (680 ml x 3) | 83 | C5076A |
| HP 83 3-pack 680-ml Light Magenta UV Cartridges (680 ml x 3) | 83 | C5077A |

| Product | Cartridge no. | Product no. |
|--|---------------|-------------|
| HP DesignJet 100ps/200ps/500ps (13" x 19") | | |
| HP DesignJet 30 Series | | |
| HP DesignJet 70 | | |
| HP DesignJet 90 Series | | |
| HP DesignJet 100/100 Plus | | |
| HP DesignJet 200/220/230 | | |
| HP DesignJet 110 | | |
| HP DesignJet 120 | | |
| HP DesignJet 130/6/Mini-Format | | |
| HP DesignJet 130/430 Series | | |
| HP DesignJet 350/450C/455C/455CN/480CA | | |
| HP DesignJet 500/500ps/580/600ps/615MP/620MP | | |
| HP DesignJet 510 Series | | |
| HP DesignJet 600 Series | | |
| HP DesignJet 700 Series | | |
| HP DesignJet 750C/750C Plus/755CM Series | | |
| HP DesignJet 1050C/1050C Plus/1055CM/1055CM Plus | | |
| HP DesignJet 402/400/400Dps/4500/4500ps/4500MP | | |
| HP DesignJet 5000/5000ps/5200/5500/5500ps Dye (indoor) | | |
| HP DesignJet 5000/5000ps/5200/5500/5500ps UV (indoor) | | |
| HP DesignJet T120 ePrinter | | |
| HP DesignJet T220 ePrinter Series | | |
| HP DesignJet T610 Series | | |
| HP DesignJet T620 | | |
| HP DesignJet T770 Hard Disk | | |
| HP DesignJet T795/T790 Series | | |
| HP DesignJet T920/T1500 ePrinter Series | | |
| HP DesignJet T1100/T1100ps/T1120/T1120ps/T1120 3D-MFP | | |
| HP DesignJet T200/T200ps Series | | |
| HP DesignJet T300/T300ps ePrinter Series | | |
| HP DesignJet T300/T300ps Series | | |
| HP DesignJet T7100 and T7100 Monochrome Series | | |
| HP DesignJet T7200 | | |
| HP DesignJet Z2100 Photo Printer Series | | |
| HP DesignJet Z2500 eMultifunction Printer Series | | |
| HP DesignJet Z3100 Photo Printer Series | | |
| HP DesignJet Z3200/Z3200ps 6P Photo Series | | |
| HP DesignJet Z3500 Series | | |
| HP DesignJet Z520 Series | | |
| HP DesignJet Z5400 PostScript® ePrinter | | |
| HP DesignJet Z610/Z6100ps Series | | |
| HP DesignJet Z6200 Photo Printer Series | | |
| HP DesignJet Z6600 Printer Series | | |
| HP DesignJet Z6800 Printer Series | | |

* Only available through select channels in US & Canada.

HP DesignJet Ink Supplies 5 of 5

| Product | Cartridge no. | Product no. |
|--|---------------|-------------|
| HP DesignJet 70 and 100/110/111 series Original HP Ink Supplies | | |
| HP Ink Cartridges | | |
| HP 10 Black Ink Cartridge (69 ml) | 10 | C4844A |
| HP 11 Cyan Ink Cartridge (28 ml) | 11 | C4836A |
| HP 11 Magenta Ink Cartridge (28 ml) | 11 | C4837A |
| HP 11 Yellow Ink Cartridge (28 ml) | 11 | C4838A |
| HP Printheads | | |
| HP 11 Black Printhead | 11 | C4810A |
| HP 11 Cyan Printhead | 11 | C4811A |
| HP 11 Magenta Printhead | 11 | C4812A |
| HP 11 Yellow Printhead | 11 | C4813A |
| HP DesignJet 30/30/130 series Original HP Ink Supplies | | |
| HP Ink Cartridges | | |
| HP 84 69-ml Black Ink Cartridge (69 ml) | 84 | C5016A |
| HP 85 28-ml Cyan Ink Cartridge (28 ml) | 85 | C9425A |
| HP 85 28-ml Magenta Ink Cartridge (28 ml) | 85 | C9426A |
| HP 85 69-ml Yellow Ink Cartridge (69 ml) | 85 | C9427A |
| HP 85 69-ml Light Cyan Ink Cartridge (69 ml) | 85 | C9428A |
| HP 85 69-ml Light Magenta Ink Cartridge (69 ml) | 85 | C9429A |
| HP Printheads | | |
| HP 84 Black Printhead | 84 | C5019A |
| HP 85 Cyan Printhead | 85 | C9420A |
| HP 85 Magenta Printhead | 85 | C9421A |
| HP 85 Yellow Printhead | 85 | C9422A |
| HP 85 Light Cyan Printhead | 85 | C9423A |
| HP 85 Light Magenta Printhead | 85 | C9424A |
| HP DesignJet 10PS/20PS/50PS (13" x 19") and 120 series Original HP Ink Supplies | | |
| HP Ink Cartridges | | |
| HP 84 69-ml Black Ink Cartridge (69 ml) | 84 | C5016A |
| HP 84 69-ml Light Cyan Ink Cartridge (69 ml) | 84 | C5017A |
| HP 84 69-ml Light Magenta Ink Cartridge (69 ml) | 84 | C5018A |
| HP 11 Cyan Ink Cartridge (28 ml) | 11 | C4836A |
| HP 11 Magenta Ink Cartridge (28 ml) | 11 | C4837A |
| HP 82 69-ml Yellow Ink Cartridge (69 ml) | 82 | C4913A |
| HP Printheads | | |
| HP 84 Black Printhead | 84 | C5019A |
| HP 84 Light Cyan Printhead | 84 | C5020A |
| HP 84 Light Magenta Printhead | 84 | C5021A |
| HP 11 Cyan Printhead | 11 | C4811A |
| HP 11 Magenta Printhead | 11 | C4812A |
| HP 11 Yellow Printhead | 11 | C4813A |

| Product | Cartridge no. | Product no. |
|---|---------------|-------------|
| HP DesignJet 10PS/20PS/50PS (13" x 19") | | |
| HP DesignJet 30 Series | | |
| HP DesignJet 70 | | |
| HP DesignJet 90 Series | | |
| HP DesignJet 100/100 Plus | | |
| HP DesignJet 200/220/230 | | |
| HP DesignJet 110 | | |
| HP DesignJet 111 | | |
| HP DesignJet 120 | | |
| HP DesignJet 130/130 Multi-Format | | |
| HP DesignJet 350/430 Series | | |
| HP DesignJet 350/450C/455CA/488CA | | |
| HP DesignJet 500/500ps/800/800ps/C800ps/815MFP/820MFP | | |
| HP DesignJet 510 Series | | |
| HP DesignJet 600 Series | | |
| HP DesignJet 700 Series | | |
| HP DesignJet 750C/750C Plus/755CM Series | | |
| HP DesignJet 1050C/1050C Plus/1055CM/1055CM Plus | | |
| HP DesignJet 4020/4020/4020ps/4500/4500ps/4500MFP | | |
| HP DesignJet 5000/5000ps/5200/5500/5500ps DyeT (London) | | |
| HP DesignJet 5000/5000ps/5200/5500/5500ps UV1 (London) | | |
| HP DesignJet 1120 ePrinter | | |
| HP DesignJet T120 ePrinter Series | | |
| HP DesignJet T620 | | |
| HP DesignJet T770 Hard Disk | | |
| HP DesignJet T795/T790 Series | | |
| HP DesignJet T920/T1500 ePrinter Series | | |
| HP DesignJet T1000/T1100ps/T1120/T1120ps/T1120 5D-MFP | | |
| HP DesignJet T1200/T2000ps Series | | |
| HP DesignJet T3000/T3000ps ePrinter Series | | |
| HP DesignJet T2300/T2300ps Series | | |
| HP DesignJet T7100 and T7100 Monochrome Series | | |
| HP DesignJet Z2100 Photo Printer Series | | |
| HP DesignJet Z2500 eMultifunction Printer Series | | |
| HP DesignJet Z2100 Photo Printer Series | | |
| HP DesignJet Z200/Z200ps ePrinter Series | | |
| HP DesignJet Z500 Series | | |
| HP DesignJet Z520 Series | | |
| HP DesignJet Z540 PostScript® ePrinter | | |
| HP DesignJet Z6100/Z6100ps Series | | |
| HP DesignJet Z6200 Photo Printer Series | | |
| HP DesignJet Z6600 Printer Series | | |
| HP DesignJet Z6800 Printer Series | | |

HP Large Format Printing Material

HP Sign and Display Printing Materials

1 of 6

| Part number | Metric size (mm x m) | Imperial size (in x ft) | HP Latex, DesignJet, and Scitex Printer and Press Compatibility and Ink Technology | | | | | | | | | | | | | | | | | | | | | | | | | |
|---|----------------------|-------------------------|--|---|------------------------------|------------------------------|-----------|---------------|---------------------------------|--------------|---------------------------|--------------------------|------------|-----------------|-----------------|------------------|------------------|------------------|------------------|------------------|---------------------------|---------------------------|---------------------------|---------------------------|--------------|--------------|--------------|---------------|
| | | | Latex | | | | | | | | | Low-solvent | | | UV-curable | | | | Solvent | | | | | | | | | |
| | | | DesignJet L25500 | Latex 210 (DesignJet L26100) | Latex 260 (DesignJet L26500) | Latex 280 (DesignJet L28500) | Latex 310 | Latex 330/360 | Scitex LX800 (DesignJet L65500) | Scitex LX800 | Latex 850 (Scitex LX8500) | Latex 820 (Scitex LX820) | Latex 3000 | DesignJet 8000s | DesignJet 9000s | DesignJet 10000s | DesignJet H35100 | DesignJet H35500 | DesignJet H45100 | DesignJet H45500 | Scitex FB900 ¹ | Scitex FB700 ¹ | Scitex FB910 ¹ | Scitex FB950 ¹ | Scitex 15000 | Scitex T8300 | Scitex T8350 | Scitex XL1200 |
| HP Banners | | | | | | | | | | | | | | | | | | | | | | | | | | | | |
| HP HDPE Reinforced Banner ¹ | E4J12A | 965 x 45,7 | 38 x 150 | ● | ● | ● | ● | ● | ● | ● | ● | ● | ● | ● | ● | ● | ● | ● | ● | ● | ● | ● | ● | ● | ● | ● | ● | ● |
| | E4J13A | 1372 x 45,7 | 54 x 150 | ● | ● | ● | ● | ● | ● | ● | ● | ● | ● | ● | ● | ● | ● | ● | ● | ● | ● | ● | ● | ● | ● | ● | ● | ● |
| | E4J14A | 1524 x 45,7 | 60 x 150 | ● | ● | ● | ● | ● | ● | ● | ● | ● | ● | ● | ● | ● | ● | ● | ● | ● | ● | ● | ● | ● | ● | ● | ● | ● |
| HP Double-sided HPDE Reinforced Banner ¹ | CR691A | 914 x 45,7 | 36 x 150 | ● | ● | ● | ● | ● | ● | ● | ● | ● | ● | ● | ● | ● | ● | ● | ● | ● | ● | ● | ● | ● | ● | ● | ● | ● |
| | CR692A | 1067 x 45,7 | 42 x 150 | ● | ● | ● | ● | ● | ● | ● | ● | ● | ● | ● | ● | ● | ● | ● | ● | ● | ● | ● | ● | ● | ● | ● | ● | ● |
| | CR693A | 1524 x 45,7 | 60 x 150 | ● | ● | ● | ● | ● | ● | ● | ● | ● | ● | ● | ● | ● | ● | ● | ● | ● | ● | ● | ● | ● | ● | ● | ● | ● |
| HP Durable Frontlit Scrim Banner | CG439A | 1067 x 35 | 42 x 115 | ● | ● | ● | ● | ● | ● | ● | ● | ● | ● | ● | ● | ● | ● | ● | ● | ● | ● | ● | ● | ● | ● | ● | ● | ● |
| | CG440A | 1372 x 35 | 54 x 115 | ● | ● | ● | ● | ● | ● | ● | ● | ● | ● | ● | ● | ● | ● | ● | ● | ● | ● | ● | ● | ● | ● | ● | ● | ● |
| HP Everyday Matte Polypropylene, 3-in Core ¹ | D9R28A | 914 x 61 | 36 x 200 | ● | ● | ● | ● | ● | ● | ● | ● | ● | ● | ● | ● | ● | ● | ● | ● | ● | ● | ● | ● | ● | ● | ● | ● | ● |
| | D9R29A | 1067 x 61 | 42 x 200 | ● | ● | ● | ● | ● | ● | ● | ● | ● | ● | ● | ● | ● | ● | ● | ● | ● | ● | ● | ● | ● | ● | ● | ● | ● |
| | D9R30A | 1270 x 61 | 50 x 200 | ● | ● | ● | ● | ● | ● | ● | ● | ● | ● | ● | ● | ● | ● | ● | ● | ● | ● | ● | ● | ● | ● | ● | ● | ● |
| | D9R31A | 1524 x 61 | 60 x 200 | ● | ● | ● | ● | ● | ● | ● | ● | ● | ● | ● | ● | ● | ● | ● | ● | ● | ● | ● | ● | ● | ● | ● | ● | ● |
| HP Self-adhesive Materials | | | | | | | | | | | | | | | | | | | | | | | | | | | | |
| HP Air Release Adhesive Gloss Cast Vinyl | CG935A | 1372 x 45,7 | 54 x 150 | ● | ● | ● | ● | ● | ● | ● | ● | ● | ● | ● | ● | ● | ● | ● | ● | ● | ● | ● | ● | ● | ● | ● | ● | ● |
| HP Clear Gloss Cast Overlaminate | CH037A | 1372 x 45,7 | 54 x 150 | For use with HP Air Release Adhesive Gloss Cast Vinyl. For more lamination compatibility see global.BMG.com/hp/laminationcomp | | | | | | | | | | | | | | | | | | | | | | | | |
| HP One-view Perforated Adhesive Window Vinyl | CH004A | 1067 x 50 | 42 x 164 | ● | ● | ● | ● | ● | ● | ● | ● | ● | ● | ● | ● | ● | ● | ● | ● | ● | ● | ● | ● | ● | ● | ● | ● | ● |
| | CH005A | 1372 x 50 | 54 x 164 | ● | ● | ● | ● | ● | ● | ● | ● | ● | ● | ● | ● | ● | ● | ● | ● | ● | ● | ● | ● | ● | ● | ● | ● | ● |
| HP Permanent Gloss Adhesive Vinyl | CG423A | 1067 x 45,7 | 42 x 150 | ● | ● | ● | ● | ● | ● | ● | ● | ● | ● | ● | ● | ● | ● | ● | ● | ● | ● | ● | ● | ● | ● | ● | ● | ● |
| | CG424A | 1372 x 45,7 | 54 x 150 | ● | ● | ● | ● | ● | ● | ● | ● | ● | ● | ● | ● | ● | ● | ● | ● | ● | ● | ● | ● | ● | ● | ● | ● | ● |
| | CG425A | 1524 x 45,7 | 60 x 150 | ● | ● | ● | ● | ● | ● | ● | ● | ● | ● | ● | ● | ● | ● | ● | ● | ● | ● | ● | ● | ● | ● | ● | ● | ● |
| | CG426A | 1524 x 91,4 | 60 x 300 | ● | ● | ● | ● | ● | ● | ● | ● | ● | ● | ● | ● | ● | ● | ● | ● | ● | ● | ● | ● | ● | ● | ● | ● | ● |
| HP Permanent Matte Adhesive Vinyl | CG453A | 1067 x 45,7 | 42 x 150 | ● | ● | ● | ● | ● | ● | ● | ● | ● | ● | ● | ● | ● | ● | ● | ● | ● | ● | ● | ● | ● | ● | ● | ● | ● |
| | CG454A | 1372 x 45,7 | 54 x 150 | ● | ● | ● | ● | ● | ● | ● | ● | ● | ● | ● | ● | ● | ● | ● | ● | ● | ● | ● | ● | ● | ● | ● | ● | ● |
| | CG455A | 1524 x 45,7 | 60 x 150 | ● | ● | ● | ● | ● | ● | ● | ● | ● | ● | ● | ● | ● | ● | ● | ● | ● | ● | ● | ● | ● | ● | ● | ● | ● |
| | CG456A | 1524 x 91,4 | 60 x 300 | ● | ● | ● | ● | ● | ● | ● | ● | ● | ● | ● | ● | ● | ● | ● | ● | ● | ● | ● | ● | ● | ● | ● | ● | ● |
| HP Everyday Adhesive Matte Polypropylene, 3-in Core | D9R24A | 914 x 30,5 | 36 x 100 | ● | ● | ● | ● | ● | ● | ● | ● | ● | ● | ● | ● | ● | ● | ● | ● | ● | ● | ● | ● | ● | ● | ● | ● | ● |
| | D9R25A | 1067 x 30,5 | 42 x 100 | ● | ● | ● | ● | ● | ● | ● | ● | ● | ● | ● | ● | ● | ● | ● | ● | ● | ● | ● | ● | ● | ● | ● | ● | ● |
| | D9R26A | 1270 x 30,5 | 50 x 100 | ● | ● | ● | ● | ● | ● | ● | ● | ● | ● | ● | ● | ● | ● | ● | ● | ● | ● | ● | ● | ● | ● | ● | ● | ● |
| | D9R27A | 1524 x 30,5 | 60 x 100 | ● | ● | ● | ● | ● | ● | ● | ● | ● | ● | ● | ● | ● | ● | ● | ● | ● | ● | ● | ● | ● | ● | ● | ● | ● |
| HP Films | | | | | | | | | | | | | | | | | | | | | | | | | | | | |
| HP Backlit Polyester Film ¹ | CR660B | 914 x 30,5 | 36 x 100 | ● | ● | ● | ● | ● | ● | ● | ● | ● | ● | ● | ● | ● | ● | ● | ● | ● | ● | ● | ● | ● | ● | ● | ● | ● |
| | CR661B | 1067 x 30,5 | 42 x 100 | ● | ● | ● | ● | ● | ● | ● | ● | ● | ● | ● | ● | ● | ● | ● | ● | ● | ● | ● | ● | ● | ● | ● | ● | ● |
| | CR662B | 1372 x 30,5 | 54 x 100 | ● | ● | ● | ● | ● | ● | ● | ● | ● | ● | ● | ● | ● | ● | ● | ● | ● | ● | ● | ● | ● | ● | ● | ● | ● |
| | CR663B | 1524 x 30,5 | 60 x 100 | ● | ● | ● | ● | ● | ● | ● | ● | ● | ● | ● | ● | ● | ● | ● | ● | ● | ● | ● | ● | ● | ● | ● | ● | ● |
| HP Fabrics | | | | | | | | | | | | | | | | | | | | | | | | | | | | |
| HP Heavy Textile Banner (Oeko-Tex® certified) ^{1,1} | CG436B | 1524 x 40 | 60 x 130 | ● | ● | ● | ● | ● | ● | ● | ● | ● | ● | ● | ● | ● | ● | ● | ● | ● | ● | ● | ● | ● | ● | ● | ● | ● |
| HP Light Textile Display Banner (Oeko-Tex® certified) ^{1,1} | CH006A | 1067 x 50 | 42 x 164 | ● | ● | ● | ● | ● | ● | ● | ● | ● | ● | ● | ● | ● | ● | ● | ● | ● | ● | ● | ● | ● | ● | ● | ● | ● |
| | CH007A | 1524 x 50 | 60 x 164 | ● | ● | ● | ● | ● | ● | ● | ● | ● | ● | ● | ● | ● | ● | ● | ● | ● | ● | ● | ● | ● | ● | ● | ● | ● |
| HP Papers/Photographic Papers | | | | | | | | | | | | | | | | | | | | | | | | | | | | |
| HP PVC-free Wall Paper (FSC® and GREENGUARD GOLD certified) ^{7,8} | CH098B | 1067 x 30,5 | 42 x 100 | ● | ● | ● | ● | ● | ● | ● | ● | ● | ● | ● | ● | ● | ● | ● | ● | ● | ● | ● | ● | ● | ● | ● | ● | ● |
| | CH003B | 1372 x 30,5 | 54 x 100 | ● | ● | ● | ● | ● | ● | ● | ● | ● | ● | ● | ● | ● | ● | ● | ● | ● | ● | ● | ● | ● | ● | ● | ● | ● |
| | CH103A | 1372 x 91,4 | 54 x 300 | ● | ● | ● | ● | ● | ● | ● | ● | ● | ● | ● | ● | ● | ● | ● | ● | ● | ● | ● | ● | ● | ● | ● | ● | ● |
| HP White Satin Poster Paper ³ | CH010A | 1067 x 61 | 42 x 200 | ● | ● | ● | ● | ● | ● | ● | ● | ● | ● | ● | ● | ● | ● | ● | ● | ● | ● | ● | ● | ● | ● | ● | ● | ● |
| | CH001A | 1372 x 61 | 54 x 200 | ● | ● | ● | ● | ● | ● | ● | ● | ● | ● | ● | ● | ● | ● | ● | ● | ● | ● | ● | ● | ● | ● | ● | ● | ● |
| | CH002A | 1524 x 61 | 60 x 200 | ● | ● | ● | ● | ● | ● | ● | ● | ● | ● | ● | ● | ● | ● | ● | ● | ● | ● | ● | ● | ● | ● | ● | ● | ● |
| HP Photo-realistic Poster Paper ³ | CG419A | 914 x 61 | 36 x 200 | ● | ● | ● | ● | ● | ● | ● | ● | ● | ● | ● | ● | ● | ● | ● | ● | ● | ● | ● | ● | ● | ● | ● | ● | ● |
| | CG420A | 1372 x 61 | 54 x 200 | ● | ● | ● | ● | ● | ● | ● | ● | ● | ● | ● | ● | ● | ● | ● | ● | ● | ● | ● | ● | ● | ● | ● | ● | ● |
| | CG421A | 1524 x 61 | 60 x 200 | ● | ● | ● | ● | ● | ● | ● | ● | ● | ● | ● | ● | ● | ● | ● | ● | ● | ● | ● | ● | ● | ● | ● | ● | ● |
| HP Blue Back Billboard Paper | CG502A | 1372 x 80 | 54 x 262 | ● | ● | ● | ● | ● | ● | ● | ● | ● | ● | ● | ● | ● | ● | ● | ● | ● | ● | ● | ● | ● | ● | ● | ● | ● |
| | CG503A | 1603 x 80 | 63 x 262 | ● | ● | ● | ● | ● | ● | ● | ● | ● | ● | ● | ● | ● | ● | ● | ● | ● | ● | ● | ● | ● | ● | ● | ● | ● |
| HP Coated Paper, 3-in Core ³ (FSC® certified) ⁷ | D9R21A | 914 x 61 | 36 x 200 | ● | ● | ● | ● | ● | ● | ● | ● | ● | ● | ● | ● | ● | ● | ● | ● | ● | ● | ● | ● | ● | ● | ● | ● | ● |
| | D9R22A | 1067 x 61 | 42 x 200 | ● | ● | ● | ● | ● | ● | ● | ● | ● | ● | ● | ● | ● | ● | ● | ● | ● | ● | ● | ● | ● | ● | ● | ● | ● |
| | D9R23A | 1372 x 61 | 54 x 200 | ● | ● | ● | ● | ● | ● | ● | ● | ● | ● | ● | ● | ● | ● | ● | ● | ● | ● | ● | ● | ● | ● | ● | ● | ● |
| HP Universal Coated Paper, 3-in Core ³ (FSC® certified) ⁷ | D9R40A | 914 x 61 | 36 x 200 | ● | ● | ● | ● | ● | ● | ● | ● | ● | ● | ● | ● | ● | ● | ● | ● | ● | ● | ● | ● | ● | ● | ● | ● | ● |
| | D9R41A | 1067 x 61 | 42 x 200 | ● | ● | ● | ● | ● | ● | ● | ● | ● | ● | ● | ● | ● | ● | ● | ● | ● | ● | ● | ● | ● | ● | ● | ● | ● |
| | D9R42A | 1372 x 61 | 54 x 200 | ● | ● | ● | ● | ● | ● | ● | ● | ● | ● | ● | ● | ● | ● | ● | ● | ● | ● | ● | ● | ● | ● | ● | ● | ● |
| | D9R43A | 1524 x 61 | 60 x 200 | ● | ● | ● | ● | ● | ● | ● | ● | ● | ● | ● | ● | ● | ● | ● | ● | ● | ● | ● | ● | ● | ● | ● | ● | ● |

HP Large Format Printing Material

HP Technical Printing Materials

5 of 6

HP CROSS REFERENCE

| Part number | Metric size (mm x m) | Imperial size (in x ft) | HP DesignJet Printer/ePrinter/eMultifunction Printer Compatibility and Ink Technology | | | | | | | | | | | | | | | | | | | | | | | | | | | | | | | | | | | | | |
|---|----------------------|-------------------------|---|---------------------------|-------------------------|--------------------|-------------------|---------|--------------------------------|------------------------------|----------------|----------------|----------------|---------------------|-----------------|-----------------|-----------------|-----------------|----------------------|----------------|-----------------|----------------------|----------------------|----------------|-----------------|-----------------|----------------|----------------|----------------|----------------|---------------|---------------|---------------|----------------|---|---|---|---|---|---|
| | | | T series application categories | | | | | | HP dye color inks | | | | | | | | | | | | | | | | | | | | | | | | | | | | | | | |
| | | | Trade show and event displays | Posters and presentations | POP and retail displays | Photo enlargements | Art reproductions | Banners | Geographic Information Systems | Architecture and engineering | DesignJet T120 | DesignJet T610 | DesignJet T770 | DesignJet T790/T795 | DesignJet T1100 | DesignJet T1120 | DesignJet T1200 | DesignJet T1300 | DesignJet T2300 eMFP | DesignJet T920 | DesignJet T1500 | DesignJet T2500 eMFP | DesignJet T3500 eMFP | DesignJet T620 | DesignJet T7100 | DesignJet T7200 | DesignJet 4000 | DesignJet 4020 | DesignJet 4500 | DesignJet 4520 | DesignJet 500 | DesignJet 510 | DesignJet 111 | DesignJet 1303 | | | | | | |
| HP Bond and Coated Papers | | | | | | | | | | | | | | | | | | | | | | | | | | | | | | | | | | | | | | | | |
| HP Universal Bond Paper (FSC® certified) ^{4,5} | | | | | | | | | | | | | | | | | | | | | | | | | | | | | | | | | | | | | | | | |
| SA025A | 610 x 45,7 | | | • | • | | | | • | • | • | • | • | • | • | • | • | • | • | • | • | • | • | • | • | • | • | • | • | • | • | • | • | • | | | | | | |
| Q1396A | 610 x 45,7 | 24 x 150 | • | • | | | | | • | • | • | • | • | • | • | • | • | • | • | • | • | • | • | • | • | • | • | • | • | • | • | • | • | • | | | | | | |
| Q1397A | 914 x 45,7 | 36 x 150 | • | • | | | | | • | • | • | • | • | • | • | • | • | • | • | • | • | • | • | • | • | • | • | • | • | • | • | • | • | • | • | | | | | |
| Q1398A | 1067 x 45,7 | 42 x 150 | • | • | | | | | • | • | • | • | • | • | • | • | • | • | • | • | • | • | • | • | • | • | • | • | • | • | • | • | • | • | • | | | | | |
| Q8751A | 914 x 175 | 36 x 57,4 | • | • | | | | | • | • | • | • | • | • | • | • | • | • | • | • | • | • | • | • | • | • | • | • | • | • | • | • | • | • | • | • | | | | |
| SA089A | (A1) 594 x 45,7 | | • | • | | | | | • | • | • | • | • | • | • | • | • | • | • | • | • | • | • | • | • | • | • | • | • | • | • | • | • | • | • | • | | | | |
| Q8003A | (A1) 594 x 45,7 | | • | • | | | | | • | • | • | • | • | • | • | • | • | • | • | • | • | • | • | • | • | • | • | • | • | • | • | • | • | • | • | • | • | | | |
| Q8004A | (A1) 594 x 91,4 | | • | • | | | | | • | • | • | • | • | • | • | • | • | • | • | • | • | • | • | • | • | • | • | • | • | • | • | • | • | • | • | • | • | | | |
| Q8005A | (A0) 841 x 91,4 | | • | • | | | | | • | • | • | • | • | • | • | • | • | • | • | • | • | • | • | • | • | • | • | • | • | • | • | • | • | • | • | • | • | • | | |
| HP Bright White Inkjet Paper (FSC® certified) ^{4,5} | | | | | | | | | | | | | | | | | | | | | | | | | | | | | | | | | | | | | | | | |
| C1860A | 610 x 45,7 | 24 x 150 | • | • | | | | | • | • | • | • | • | • | • | • | • | • | • | • | • | • | • | • | • | • | • | • | • | • | • | • | • | • | • | • | • | | | |
| C1861A | 914 x 45,7 | 36 x 150 | • | • | | | | | • | • | • | • | • | • | • | • | • | • | • | • | • | • | • | • | • | • | • | • | • | • | • | • | • | • | • | • | • | • | | |
| C6035A | 610 x 45,7 | | • | • | | | | | • | • | • | • | • | • | • | • | • | • | • | • | • | • | • | • | • | • | • | • | • | • | • | • | • | • | • | • | • | • | | |
| C6036A | 914 x 45,7 | | • | • | | | | | • | • | • | • | • | • | • | • | • | • | • | • | • | • | • | • | • | • | • | • | • | • | • | • | • | • | • | • | • | • | | |
| C6810A | 914 x 91,4 | 36 x 300 | • | • | | | | | • | • | • | • | • | • | • | • | • | • | • | • | • | • | • | • | • | • | • | • | • | • | • | • | • | • | • | • | • | • | | |
| Q1446A | (A2) 420 x 45,7 | | • | • | | | | | • | • | • | • | • | • | • | • | • | • | • | • | • | • | • | • | • | • | • | • | • | • | • | • | • | • | • | • | • | • | | |
| Q1445A | (A1) 594 x 45,7 | | • | • | | | | | • | • | • | • | • | • | • | • | • | • | • | • | • | • | • | • | • | • | • | • | • | • | • | • | • | • | • | • | • | • | • | |
| Q1444A | (A0) 841 x 45,7 | | • | • | | | | | • | • | • | • | • | • | • | • | • | • | • | • | • | • | • | • | • | • | • | • | • | • | • | • | • | • | • | • | • | • | • | |
| HP Universal Coated Paper (FSC® certified) ^{4,5} | | | | | | | | | | | | | | | | | | | | | | | | | | | | | | | | | | | | | | | | |
| SA027A | 610 x 45,7 | | • | • | | | | | • | • | • | • | • | • | • | • | • | • | • | • | • | • | • | • | • | • | • | • | • | • | • | • | • | • | • | • | • | • | | |
| Q1404A | 610 x 45,7 | 24 x 150 | • | • | | | | | • | • | • | • | • | • | • | • | • | • | • | • | • | • | • | • | • | • | • | • | • | • | • | • | • | • | • | • | • | • | • | |
| Q1405A | 914 x 45,7 | 36 x 150 | • | • | | | | | • | • | • | • | • | • | • | • | • | • | • | • | • | • | • | • | • | • | • | • | • | • | • | • | • | • | • | • | • | • | • | |
| Q1406A | 1067 x 45,7 | 42 x 150 | • | • | | | | | • | • | • | • | • | • | • | • | • | • | • | • | • | • | • | • | • | • | • | • | • | • | • | • | • | • | • | • | • | • | • | |
| C6019B | 610 x 45,7 | 24 x 150 | • | • | | | | | • | • | • | • | • | • | • | • | • | • | • | • | • | • | • | • | • | • | • | • | • | • | • | • | • | • | • | • | • | • | • | |
| C6020B | 914 x 45,7 | 36 x 150 | • | • | | | | | • | • | • | • | • | • | • | • | • | • | • | • | • | • | • | • | • | • | • | • | • | • | • | • | • | • | • | • | • | • | • | |
| C6567B | 1067 x 45,7 | 42 x 150 | • | • | | | | | • | • | • | • | • | • | • | • | • | • | • | • | • | • | • | • | • | • | • | • | • | • | • | • | • | • | • | • | • | • | • | |
| C6980A | 914 x 91,4 | 36 x 300 | • | • | | | | | • | • | • | • | • | • | • | • | • | • | • | • | • | • | • | • | • | • | • | • | • | • | • | • | • | • | • | • | • | • | • | |
| Q1443A | (A2) 420 x 45,7 | | • | • | | | | | • | • | • | • | • | • | • | • | • | • | • | • | • | • | • | • | • | • | • | • | • | • | • | • | • | • | • | • | • | • | • | |
| Q1442A | (A1) 594 x 45,7 | | • | • | | | | | • | • | • | • | • | • | • | • | • | • | • | • | • | • | • | • | • | • | • | • | • | • | • | • | • | • | • | • | • | • | • | |
| Q1441A | (A0) 841 x 45,7 | | • | • | | | | | • | • | • | • | • | • | • | • | • | • | • | • | • | • | • | • | • | • | • | • | • | • | • | • | • | • | • | • | • | • | • | • |
| HP Universal Heavyweight Coated Paper (FSC® certified) ^{4,5} | | | | | | | | | | | | | | | | | | | | | | | | | | | | | | | | | | | | | | | | |
| SA029A | 610 x 30,5 | | • | • | | | | | • | • | • | • | • | • | • | • | • | • | • | • | • | • | • | • | • | • | • | • | • | • | • | • | • | • | • | • | • | • | • | |
| Q1412A | 610 x 30,5 | 24 x 100 | • | • | | | | | • | • | • | • | • | • | • | • | • | • | • | • | • | • | • | • | • | • | • | • | • | • | • | • | • | • | • | • | • | • | • | |
| Q1413A | 914 x 30,5 | 36 x 100 | • | • | | | | | • | • | • | • | • | • | • | • | • | • | • | • | • | • | • | • | • | • | • | • | • | • | • | • | • | • | • | • | • | • | • | • |
| Q1414A | 1067 x 30,5 | 42 x 100 | • | • | | | | | • | • | • | • | • | • | • | • | • | • | • | • | • | • | • | • | • | • | • | • | • | • | • | • | • | • | • | • | • | • | • | • |
| HP Heavyweight Coated Paper (PEFC™ certified) ^{4,5} | | | | | | | | | | | | | | | | | | | | | | | | | | | | | | | | | | | | | | | | |
| C6029C | 610 x 30,5 | 24 x 100 | • | • | | | | | • | • | • | • | • | • | • | • | • | • | • | • | • | • | • | • | • | • | • | • | • | • | • | • | • | • | • | • | • | • | • | |
| C6030C | 914 x 30,5 | 36 x 100 | • | • | | | | | • | • | • | • | • | • | • | • | • | • | • | • | • | • | • | • | • | • | • | • | • | • | • | • | • | • | • | • | • | • | • | • |
| C6569C | 1067 x 30,5 | 42 x 100 | • | • | | | | | • | • | • | • | • | • | • | • | • | • | • | • | • | • | • | • | • | • | • | • | • | • | • | • | • | • | • | • | • | • | • | • |
| Q1956A | 1067 x 68,5 | 42 x 225 | • | • | | | | | • | • | • | • | • | • | • | • | • | • | • | • | • | • | • | • | • | • | • | • | • | • | • | • | • | • | • | • | • | • | • | |
| HP Super Heavyweight Plus Matte Paper ³ | | | | | | | | | | | | | | | | | | | | | | | | | | | | | | | | | | | | | | | | |
| Q6626B | 610 x 30,5 | 24 x 100 | • | • | • | | | | • | • | • | • | • | • | • | • | • | • | • | • | • | • | • | • | • | • | • | • | • | • | • | • | • | • | • | • | • | • | • | |
| Q6627B | 914 x 30,5 | 36 x 100 | • | • | • | | | | • | • | • | • | • | • | • | • | • | • | • | • | • | • | • | • | • | • | • | • | • | • | • | • | • | • | • | • | • | • | • | |
| Q6628B | 1067 x 30,5 | 42 x 100 | • | • | • | | | | • | • | • | • | • | • | • | • | • | • | • | • | • | • | • | • | • | • | • | • | • | • | • | • | • | • | • | • | • | • | • | |
| HP Technical Papers | | | | | | | | | | | | | | | | | | | | | | | | | | | | | | | | | | | | | | | | |
| HP Natural Tracing Paper ³ | | | | | | | | | | | | | | | | | | | | | | | | | | | | | | | | | | | | | | | | |
| C3869A | 610 x 45,7 | 24 x 150 | | | | | | | • | | | | | | | | | | | | | | | | | | | | | | | | | | | | | | | |

| | | | | | | | | | | | |
|------------|----------|------------|-----|------------|-----|------------|-----|------------|-----|---------------------|-----|
| CTG4025M | 136 | CTG6125B | 140 | CTGB4300 | 139 | CTGD3130M | 127 | CTGLC75C | 123 | CTGTN115C | 124 |
| CTG4025Y | 136 | CTG6125C | 140 | CTGB4600 | 139 | CTGD3130Y | 127 | CTGLC75M | 123 | CTGTN115M | 124 |
| CTG4025Y | 136 | CTG6125M | 140 | CTGB6300 | 139 | CTGD3330 | 126 | CTGLC75Y | 123 | CTGTN115Y | 124 |
| CTG402RF | 123 | CTG6125Y | 140 | CTGBC20 | 124 | CTGD3333 | 126 | CTGLC79B | 123 | CTGTN330 | 123 |
| CTG41A | 129 | CTG6180B | 140 | CTGBX3 | 124 | CTGD3335 | 126 | CTGLC79C | 123 | CTGTN350 | 123 |
| CTG42AM | 133 | CTG6180C | 140 | CTGC0032 | 138 | CTGD333LB | 126 | CTGLC79M | 123 | CTGTN360 | 123 |
| CTG42AP | 133 | CTG6180M | 140 | CTGC6100B | 139 | CTGD33XLC | 126 | CTGLC79Y | 123 | CTGTN430 | 123 |
| CTG42JUP | 133 | CTG6180Y | 140 | CTGC6100C | 139 | CTGD33XLM | 126 | CTGLX3402 | 139 | CTGTN450 | 124 |
| CTG42JUP | 133 | CTG61AP | 132 | CTGC6100M | 139 | CTGD33XLY | 126 | CTGM251B | 137 | CTGTN460 | 123 |
| CTG42JUP | 133 | CTG61JP | 132 | CTGC6100Y | 139 | CTGD3460 | 126 | CTGM251BX | 137 | CTGTN540 | 123 |
| CTG42JUP | 133 | CTG61TM | 132 | CTGC635A | 131 | CTGD3460X | 126 | CTGM251C | 137 | CTGTN550 | 124 |
| CTG42XM | 133 | CTG61WN | 129 | CTGC653AN | 130 | CTGD451 | 126 | CTGM251AM | 137 | CTGTN570 | 123 |
| CTG42XP | 133 | CTG61XP | 132 | CTGC654AN | 130 | CTGD453 | 126 | CTGM251Y | 137 | CTGTN580 | 124 |
| CTG430222C | 139 | CTG62WN | 129 | CTGC656AN | 130 | CTGD4587 | 126 | CTGM410 | 138 | CTGTN620 | 124 |
| CTG43JP | 133 | CTG6360B | 140 | CTGCL211 | 124 | CTGD5007 | 126 | CTGM451B | 137 | CTGTN650 | 124 |
| CTG43P | 133 | CTG6360C | 140 | CTGCL211XL | 124 | CTGD5100B | 127 | CTGM451BX | 137 | CTGTN670 | 124 |
| CTG43TM | 133 | CTG6360M | 140 | CTGCL241XL | 124 | CTGD5100C | 127 | CTGM451C | 137 | CTGTN720 | 124 |
| CTG4525BX | 136 | CTG6360Y | 140 | CTGCL31 | 124 | CTGD5100M | 127 | CTGM451M | 137 | CTGTN750 | 124 |
| CTG4540BX | 136 | CTG63WN | 129 | CTGCL41 | 124 | CTGD5100Y | 127 | CTGM451Y | 137 | CTGTN780 | 124 |
| CTG4540C | 136 | CTG640WN | 129 | CTGCL51 | 125 | CTGD5110B | 127 | CTGM4640 | 126 | CTGW820 | 139 |
| CTG4540M | 136 | CTG641WN | 129 | CTGCL1221B | 124 | CTGD5110C | 127 | CTGM4646 | 126 | CTGWC564XLB | 131 |
| CTG4540Y | 136 | CTG643WN | 129 | CTGCL1221C | 124 | CTGD5110M | 127 | CTGM551B | 137 | CTGWC564XLC | 131 |
| CTG45A | 129 | CTG644WN | 129 | CTGCL1221M | 125 | CTGD5110Y | 127 | CTGM551BX | 137 | CTGWC564XLM | 131 |
| CTG45AP | 133 | CTG64AJP | 134 | CTGCL1221Y | 125 | CTGD5210 | 126 | CTGM551C | 137 | CTGWC564XLPB | 131 |
| CTG4600B | 135 | CTG64AM | 134 | CTGCL1226B | 125 | CTGD5230 | 126 | CTGM551M | 137 | CTGWC564XLY | 131 |
| CTG4600C | 135 | CTG64AP | 134 | CTGCL1226C | 125 | CTGD5310 | 126 | CTGM551Y | 137 | CTGWC920B | 130 |
| CTG4600M | 135 | CTG64JP | 134 | CTGCL1226M | 125 | CTGD5330 | 126 | CTGMK990 | 126 | CTGWC920XLB | 130 |
| CTG4600Y | 135 | CTG64WN | 129 | CTGCL1226Y | 125 | CTGD5417 | 126 | CTGMK991 | 126 | CTGWC920XLC | 130 |
| CTG4700B | 135 | CTG64XM | 134 | CTGLI36 | 124 | CTGD5460 | 126 | CTGML1210 | 139 | CTGWC920XLM | 130 |
| CTG4700C | 135 | CTG64XP | 134 | CTGLI8BK | 124 | CTGD5460X | 126 | CTGML1610 | 139 | CTGWC920XLY | 130 |
| CTG4700M | 135 | CTG65WN | 129 | CTGLI8C | 124 | CTGD5535 | 126 | CTGML1710 | 139 | CTGWC940XLB | 130 |
| CTG4700Y | 135 | CTG66WN | 129 | CTGLI8M | 124 | CTGD5878B | 126 | CTGML2010 | 139 | CTGWC940XLC | 130 |
| CTG4730B | 135 | CTG67WN | 129 | CTGLI8PC | 124 | CTGD5882C | 126 | CTGML2150 | 139 | CTGWC940XLM | 130 |
| CTG4730C | 135 | CTG69P | 138 | CTGLI8PM | 124 | CTGD6640 | 126 | CTGML2250 | 139 | CTGWC940XLY | 130 |
| CTG4730M | 135 | CTG69WN | 129 | CTGLI8Y | 124 | CTGD7Y745C | 126 | CTGML2850 | 139 | CTGX203 | 139 |
| CTG4730Y | 135 | CTG6R914 | 140 | CTGCLP315B | 140 | CTGDH828 | 126 | CTGML6060 | 139 | CTGX204 | 139 |
| CTG49A | 128 | CTG70AP | 134 | CTGCLP315C | 140 | CTGDH829 | 126 | CTGMLT105 | 139 | CTGX215 | 139 |
| CTG49AM | 132 | CTG71WN | 131 | CTGCLP315M | 140 | CTGDR350 | 123 | CTGMLT108 | 139 | CTGX25 | 125 |
| CTG49AP | 132 | CTG727A | 129 | CTGCLP315Y | 140 | CTGDR360 | 123 | CTGMLT205 | 140 | CTGX264 | 139 |
| CTG49JP | 132 | CTG728A | 129 | CTGCLP320B | 140 | CTGDR400 | 123 | CTGMLT205X | 140 | CTGX364 | 139 |
| CTG49XP | 132 | CTG72WN | 131 | CTGCLP320C | 140 | CTGDR510 | 123 | CTGMLT206 | 140 | CTGX657 | 140 |
| CTG5100B | 139 | CTG73WN | 131 | CTGCLP320M | 140 | CTGDR520 | 124 | CTGMLT208 | 140 | EPC24120 | 128 |
| CTG5100C | 139 | CTG74BK | 130 | CTGCLP320Y | 140 | CTGDR620 | 124 | CTGMLT209 | 139 | EPC24220 | 128 |
| CTG5100M | 139 | CTG74P | 131 | CTGD0887 | 126 | CTGDR720 | 124 | CTGP10 | 139 | EPC24320 | 128 |
| CTG5100Y | 139 | CTG74WN | 131 | CTGD0893 | 126 | CTGE120 | 138 | CTGP13P | 139 | EPC24420 | 128 |
| CTG51AN | 129 | CTG74XL | 130 | CTGD1125 | 126 | CTGE20 | 125 | CTGP20 | 139 | EPC26120 | 128 |
| CTG51AP | 134 | CTG75CLR | 130 | CTGD1130 | 126 | CTGE210 | 138 | CTGP30/40 | 139 | EPC26220 | 128 |
| CTG51JP | 134 | CTG75WN | 131 | CTGD1230B | 126 | CTGE240 | 138 | CTGP50P | 139 | EPC26320 | 128 |
| CTG51TM | 134 | CTG75XL | 129 | CTGD1230C | 126 | CTGE250 | 138 | CTGPB21C | 137 | EPC26420 | 128 |
| CTG51XP | 134 | CTG78AM | 134 | CTGD1230M | 126 | CTGE260 | 138 | CTGPB21DC | 137 | EPC27120 | 128 |
| CTG5208 | 128, 137 | CTG78AP | 134 | CTGD1230Y | 126 | CTGE260M | 139 | CTGPB99 | 137 | EPC27220 | 128 |
| CTG5208 | 128, 137 | CTG78DN | 129 | CTGD1250B | 126 | CTGE260X | 138 | CTGPC201 | 123 | EPC27320 | 128 |
| CTG5220B | 136 | CTG78JP | 134 | CTGD1250C | 126 | CTGE310 | 138 | CTGPC301 | 123 | EPC27420 | 128 |
| CTG5220C | 136 | CTG80AM | 134 | CTGD1250M | 126 | CTGE320 | 138 | CTGPC401 | 123 | EPC48120 | 127 |
| CTG5220M | 136 | CTG80AP | 134 | CTGD1250Y | 126 | CTGE321 | 138 | CTGPC501 | 123 | EPC48220 | 127 |
| CTG5220Y | 136 | CTG80JP | 134 | CTGD1260 | 126 | CTGE330 | 138 | CTGPG210 | 125 | EPC48320 | 127 |
| CTG5288 | 128 | CTG80XM | 134 | CTGD1320B | 127 | CTGE330DR | 138 | CTGPG210XL | 125 | EPC48420 | 127 |
| CTG52AN | 129 | CTG80XP | 134 | CTGD1320C | 127 | CTGE350 | 138 | CTGPG240XL | 125 | EPC48520 | 127 |
| CTG53AP | 134 | CTG82P | 133 | CTGD1320M | 127 | CTGE360 | 138 | CTGPG40 | 125 | EPC48620 | 128 |
| CTG53JP | 134 | CTG82TM | 133 | CTGD1320Y | 127 | CTGE40 | 125 | CTGPG50 | 125 | EPC60120 | 128 |
| CTG53TM | 134 | CTG836A | 128 | CTGD1720 | 126 | CTGE450 | 138 | CTGPGI220B | 125 | EPC60220 | 128 |
| CTG53XP | 134 | CTG837A | 128 | CTGD1815 | 126 | CTGE450DR | 126 | CTGPGI225B | 125 | EPC60320 | 128 |
| CTG5400 | 128 | CTG838A | 128 | CTGD2046 | 126 | CTGE450X | 138 | CTGPGI35 | 125 | EPC60420 | 128 |
| CTG5500B | 135 | CTG83AM | 134 | CTGD2130B | 127 | CTGE460 | 138 | CTGPGI5BK | 125 | | |
| CTG5500C | 135 | CTG83AP | 134 | CTGD2130C | 127 | CTGFO47ND | 140 | CTGR311 | 140 | DATAPRODUCTS | |
| CTG5500M | 135 | CTG844A | 128 | CTGD2130M | 127 | CTGFO50ND | 140 | CTGR371 | 140 | COMPATIBLES | |
| CTG5500Y | 135 | CTG85AM | 133 | CTGD2130Y | 127 | CTGFX11P | 126 | CTGR374 | 140 | E2110 | 141 |
| CTG5525B | 136 | CTG85AP | 133 | CTGD2145B | 127 | CTGFX2P | 125 | CTGR402 | 140 | E2117 | 141 |
| CTG5525C | 136 | CTG85JP | 133 | CTGD2145C | 127 | CTGFX3P | 125 | CTGR404 | 140 | E3027 | 141 |
| CTG5525M | 136 | CTG88B | 130 | CTGD2145M | 127 | CTGFX4P | 125 | CTGR412 | 140 | P1334 | 141 |
| CTG5525Y | 136 | CTG88BXL | 130 | CTGD2145Y | 127 | CTGFX6P | 125 | CTGR486 | 140 | P1412 | 141 |
| CTG55AM | 133 | CTG88CXL | 130 | CTGD2150B | 127 | CTGFX7P | 125 | CTGR530 | 140 | P1634 | 141 |
| CTG55AP | 133 | CTG88MXL | 130 | CTGD2150C | 127 | CTGFX8P | 125 | CTGR712 | 140 | P1877 | 141 |
| CTG55JP | 133 | CTG88YXL | 130 | CTGD2150M | 127 | CTGH1882 | 137 | CTGR795 | 140 | P34126 | 141 |
| CTG55XM | 133 | CTG90AJP | 133 | CTGD2150Y | 127 | CTGI2514 | 137 | CTGS35 | 125 | P3460 | 141 |
| CTG55XP | 133 | CTG90AM | 133 | CTGD2230 | 126 | CTGI4303 | 137 | CTGT430 | 138 | P5020 | 141 |
| CTG561WN | 128 | CTG90AP | 133 | CTGD22BXL | 126 | CTGI6960 | 137 | CTGT520NS | 138 | P5030 | 141 |
| CTG562WN | 128 | CTG90JP | 133 | CTGD22CXLS | 126 | CTGK30BXL | 137 | CTGT620NS | 138 | P5040 | 141 |
| CTG563WN | 128 | CTG90XM | 133 | CTGD2330 | 126 | CTGK30CXL | 137 | CTGT630 | 138 | P5190 | 141 |
| CTG564WN | 128 | CTG90XP | 133 | CTGD2335 | 126 | CTGKX136 | 139 | CTGT632 | 138 | P6010 | 141 |
| CTG56A | 128 | CTG92P | 132 | CTGD2355 | 126 | CTGKX83 | 139 | CTGT640 | 138 | P6070 | 141 |
| CTG5766 | 137 | CTG96P | 132 | CTGD2360 | 126 | CTGL50P | 125 | CTGT640M | 139 | P6600 | 141 |
| CTG57A | 128 | CTG96TM | 132 | CTGD3100B | 127 | CTGLC51B | 123 | CTGT644 | 138 | R1420 | 141 |
| CTG58A | 129 | CTG96X | 132 | CTGD3100C | 127 | CTGLC51C | 123 | CTGT650 | 138 | R1420 | 141 |
| CTG59P | 138 | CTG98P | 131 | CTGD3100M | 127 | CTGLC51M | 123 | CTGT654 | 139 | R1427 | 141 |
| CTG6015B | 136 | CTG98TM | 131 | CTGD3100Y | 127 | CTGLC51Y | 123 | CTGTK312 | 137 | R3027 | 141 |
| CTG6015C | 136 | CTG98X | 131 | CTGD3115B | 127 | CTGLC61B | 123 | CTGTK322 | 137 | R4000 | 141 |
| CTG6015C | 136 | CTGAL100DR | 140 | CTGD3115C | 127 | CTGLC65B | 123 | CTGTK332 | 137 | R4640 | 141 |
| CTG6015M | 136 | CTGAL100TD | 140 | CTGD3115M | 127 | CTGLC65C | 123 | CTGTK352 | 137 | R5020 | 141 |
| CTG6015M | 136 | CTGAL110TD | 140 | CTGD3115Y | 127 | CTGLC65M | 123 | CTGTK352 | 137 | R5110 | 141 |
| CTG6015Y | 136 | CTGB410 | 139 | CTGD3130B | 127 | CTGLC65Y | 123 | CTGTK362 | 137 | R5190 | 141 |
| CTG6015Y | 136 | CTGB411 | 139 | CTGD3130C | 127 | CTGLC75B | 123 | CTGTN115B | 124 | R5470 | 141 |

| | | | | | | | | | | | | | |
|----------------------|--------|-------|--------|--------------------------------|--------|------------|----|-------------------------|----|----------------------------|-------------------------|-----------------|-----|
| R6010 | 141 | HX756 | 25 | PY408 | 24 | ERC-09B | 32 | T087820 | 29 | 44A507014-G08B | 32, 107 | | |
| R6041 | 141 | HY723 | 26 | R272N | 26 | ERC-23B | 32 | T087920 | 29 | 44A509160-G03 | 32, 107 | | |
| R6070 | 141 | J3815 | 24 | R273N | 26 | ERC-23BR | 32 | T088120 | 29 | 4A0040B02 | 32, 107 | | |
| R6405 | 141 | J5566 | 23 | R9PYX | 28 | ERC-27B | 32 | T088220 | 29 | 4A0040B05 | 32, 107 | | |
| R8210 | 141 | J5567 | 23 | RF012 | 25 | ERC-38B | 32 | T088320 | 29 | 4A0040B13 | 32, 107 | | |
| DELL SUPPLIES | | | | | | | | | | | | | |
| 03YNJ | 27 | J6343 | 26 | RF013 | 26 | ERC-38BR | 32 | T088420 | 29 | GESTETNER SUPPLIES | | | |
| 05C8C | 27 | J95NM | 24, 28 | RF223 | 24 | S015086 | 32 | T088520 | 29 | 89839 | 33 | | |
| 1HK6 | 27 | J95NM | 24, 28 | RPFY9 | 27 | S015091 | 32 | T09120 | 30 | 89846 | 33 | | |
| 1M4KP | 28 | J9833 | 24 | T222N | 26 | S015329 | 32 | T096220 | 30 | 89875 | 33 | | |
| 2FV35 | 25 | JD746 | 26 | T229N | 26 | S015335 | 32 | T096320 | 30 | 411844 | 33 | | |
| 2K1VC | 28 | JD750 | 26 | T272J | 25 | S015337 | 32 | T096420 | 30 | 413460 | 33 | | |
| 2MMJP | 24 | JH565 | 25 | T6412 | 25 | S015384 | 32 | T096420 | 30 | 841333 | 33 | | |
| 3070F | 28 | K247F | 26 | T6412 | 25 | S020118 | 31 | T096520 | 30 | 841334 | 33 | | |
| 3DRPP | 27 | K2885 | 28 | T6J1J | 27 | S020122 | 32 | T096620 | 30 | 841335 | 33 | | |
| 3GDT0 | 27 | K3756 | 24 | T6J1J | 27 | S020126 | 31 | T096720 | 30 | 841336 | 33 | | |
| 4G9HP | 27 | K4971 | 25 | T9FKK | 23 | S020130 | 31 | T096820 | 30 | 841337 | 33 | | |
| 67H2T | 28 | K4971 | 25 | TH204 | 25 | S187093 | 31 | T096920 | 30 | 841338 | 33 | | |
| 6M6FG | 23 | K4972 | 25 | TJ987 | 24 | S189108 | 31 | T097120 | 30 | 841339 | 33 | | |
| 769T5 | 25 | K4973 | 25 | TW3NN | 28 | S191089 | 31 | T099220 | 30 | 841342 | 33 | | |
| 7Y743 | 23 | K4974 | 25 | U157N | 26 | T007201 | 32 | T099320 | 30 | 841343 | 33 | | |
| 7Y745 | 23 | K756K | 25 | U162N | 26 | T008201 | 32 | T099420 | 30 | 841344 | 33 | | |
| 810WH | 24, 28 | KD557 | 26 | U163N | 26 | T009201 | 32 | T099520 | 30 | 841345 | 33 | | |
| 810WH | 24, 28 | KD566 | 26 | U313R | 23 | T019201 | 31 | T099620 | 30 | 841718 | 33 | | |
| 8DNKH | 23 | KGR81 | 25 | UD314 | 26 | T020201 | 31 | T099920 | 30 | 888308 | 33 | | |
| 8WNV5 | 25 | KU051 | 24 | UF100 | 26 | T026201 | 32 | T124120 | 30 | 888309 | 33 | | |
| 9GG2G | 27 | KVK63 | 27 | UF100 | 26 | T027201 | 32 | T124220 | 30 | 888310 | 33 | | |
| 9GPVM | 27 | KVK63 | 27 | UG190 | 26 | T034120 | 32 | T124320 | 30 | 888311 | 33 | | |
| 9M2WC | 25 | KX494 | 26 | UK852 | 23 | T034220 | 32 | T124420 | 30 | 888340 | 33 | | |
| 9PN5P | 27 | KX701 | 23 | UU255 | 23 | T034320 | 32 | T125120 | 30 | 888341 | 33 | | |
| 9PN5P | 27 | KX703 | 23 | V1620 | 28 | T034420 | 32 | T125220 | 30 | 888342 | 33 | | |
| C233R | 26 | M11XH | 27 | V3W4C | 27 | T034520 | 32 | T125320 | 30 | 888343 | 33 | | |
| C5GC3 | 24, 28 | M11XH | 27 | V4TG6 | 28 | T034620 | 32 | T125420 | 30 | 888442 | 33 | | |
| C5GC3 | 24, 28 | M2925 | 28 | V53F6 | 27 | T034720 | 32 | T125520 | 30 | 888443 | 33 | | |
| C7D6F | 27 | M4640 | 23 | W8D60 | 28 | T034820 | 32 | T126120 | 30 | 888444 | 33 | | |
| C815K | 24 | M4646 | 23 | WH006 | 25 | T043120 | 31 | T126220 | 30 | 888445 | 33 | | |
| C920K | 24 | M6935 | 25 | WHPFG | 25 | T044120 | 28 | T126320 | 30 | HP COMPATIBLE PARTS | | | |
| CR963 | 25 | M6935 | 25 | WM138 | 24 | T044220 | 28 | T126420 | 30 | 5851-3580-REF | 176, 177, 180, 183, 184 | | |
| CR963 | 25 | M795K | 25 | WM2JC | 24, 28 | T044320 | 28 | T126520 | 30 | 5851-3580-REF | 176, 177, 180, 183, 184 | | |
| D4283 | 24 | M797K | 25 | WM2JC | 24, 28 | T044420 | 28 | T127120 | 30 | 5851-3580-REF | 176, 177, 180, 183, 184 | | |
| D524T | 27 | M802K | 25 | WP322 | 23 | T048120 | 28 | T127120-D2 | 30 | 5851-3580-REF | 176, 177, 180, 183, 184 | | |
| D593K | 24 | MD8G4 | 28 | X5GDJ | 27 | T048220 | 28 | T127220 | 30 | 5851-3580-REF | 176, 177, 180, 183, 184 | | |
| D625J | 27 | MF790 | 25 | X5GDJ | 27 | T048320 | 28 | T127320 | 30 | 5851-3580-REF | 176, 177, 180, 183, 184 | | |
| DH828 | 23 | MHT79 | 24, 28 | X730H | 27 | T048420 | 28 | T127420 | 30 | 5851-3580-REF | 176, 177, 180, 183, 184 | | |
| DH829 | 23 | MHT79 | 24, 28 | X942N | 26 | T048520 | 28 | T127520 | 30 | 5851-3580-REF | 176, 177, 180, 183, 184 | | |
| DJMKY | 27 | MJ264 | 23 | X951N | 26 | T048620 | 28 | T157120 | 30 | 5851-3580-REF | 176, 177, 180, 183, 184 | | |
| DM254 | 25 | MK992 | 23 | XG8R3 | 23 | T054020 | 32 | T157220 | 30 | 5851-3580-REF | 176, 177, 180, 183, 184 | | |
| DRYXV | 27 | MK992 | 23 | XH005 | 25 | T054120 | 32 | T157320 | 30 | 5851-3580-REF | 176, 177, 180, 183, 184 | | |
| DT615 | 24 | MPXDF | 27 | XKGF | 28 | T054220 | 32 | T157420 | 30 | 5851-3580-REF | 176, 177, 180, 183, 184 | | |
| DW905 | 23 | MW558 | 24 | XKP2P | 24, 27 | T054320 | 32 | T157520 | 30 | 5851-3580-REF | 176, 177, 180, 183, 184 | | |
| DW906 | 23 | MY323 | 24 | XKP2P | 24, 27 | T054420 | 32 | T157620 | 31 | C3914-69001-REF | 179 | | |
| DWGCP | 27 | N3769 | 24 | XM5D | 24, 28 | T054720 | 32 | T157720 | 31 | C3914-69001-REF | 179 | | |
| DX506 | 23 | N51XP | 25 | XM5D | 24, 28 | T054820 | 32 | T157820 | 31 | C3914-69001-REO | 179 | | |
| DX516 | 23 | N848N | 26 | XP092 | 24 | T054920 | 32 | T157920 | 31 | C3914-69001-REO | 179 | | |
| F361T | 27 | N856N | 26 | XP407 | 24 | T059120 | 32 | T159020 | 31 | C3916-69001-REF | 175 | | |
| F362T | 27 | NF485 | 24 | Y7NPH | 27 | T059220 | 32 | T159120 | 31 | C3971-67902-REF | 175 | | |
| F479K | 24 | NF555 | 25 | Y924J | 24 | T059320 | 32 | T159220 | 31 | C4110-67901-REF | 179 | | |
| F562K | 24 | NF556 | 26 | YK1PM | 27 | T059420 | 32 | T159320 | 31 | C4118-67902-REF | 177 | | |
| FM064 | 24 | NPDYG | 25 | YTVTC | 25 | T059520 | 32 | T159420 | 31 | C4118-67902-REF | 177 | | |
| FM065 | 24 | NT6X2 | 25 | YX24V | 24, 28 | T059620 | 32 | T159720 | 31 | C4265-69008-REF | 179 | | |
| FM066 | 25 | NY312 | 27 | YX24V | 24, 28 | T059720 | 32 | T159820 | 31 | C4265-69008-REF | 179 | | |
| FM067 | 25 | NY313 | 27 | DIGITAL IMPACT SUPPLIES | | | | | | | | | |
| FN172 | 23 | P237C | 24 | 44A507014-G08B | 28, 32 | T060120 | 28 | T200120 | 31 | C8055-67901-REF | 177 | | |
| FN178 | 23 | P237C | 24 | LA30R-KA | 28 | T060220 | 28 | T200220 | 31 | C8056A-REF | 177 | | |
| G447J | 27 | P237C | 24 | LA40R-KA | 28 | T060320 | 28 | T200320 | 31 | C8057-67901-REF | 177 | | |
| G7D0Y | 26 | P238C | 24 | ECOPOST COMPATIBLES | | | | | | | | C8057-67901-REO | 177 |
| G907C | 26 | P238C | 24 | ECO20 | 142 | T060420 | 28 | T200420 | 31 | C8530A-REF | 180 | | |
| G908C | 26 | P239C | 24 | ECO25RED | 141 | T060520 | 28 | T200520 | 31 | C8532-69003-REF | 180 | | |
| G909C | 26 | P239C | 24 | ECO280 | 142 | T068120-D2 | 29 | T252120 | 31 | C8532-69003-REF | 180 | | |
| G910C | 26 | P240C | 24 | ECO34 | 142 | T068520 | 29 | T252220 | 31 | C9152-67907-REF | 181 | | |
| GD531 | 26 | P240C | 24 | ECO4560 | 141 | T069120 | 29 | T252320 | 31 | C9152-67907-REF | 181 | | |
| GD898 | 26 | P4210 | 24 | ECO4HC | 142 | T069220 | 29 | T252420 | 31 | C9152-67907-REF | 181 | | |
| GD900 | 26 | P4866 | 25 | ECO85185 | 142 | T069320 | 29 | T252520 | 31 | C9152-67907-REF | 181 | | |
| GD907 | 26 | P4866 | 25 | EPSON MEDIA | | | | | | | | T273020 | 31 |
| GD908 | 26 | P4866 | 25 | S041062 | 193 | T069420 | 29 | T273120 | 31 | T273020 | 31 | | |
| GG577 | 26 | P586K | 25 | S041070 | 193 | T069520 | 29 | T273220 | 31 | T273120 | 31 | | |
| GG578 | 26 | P614N | 26 | S041257 | 193 | T078120 | 29 | T273320 | 31 | T273220 | 31 | | |
| GG579 | 26 | P615N | 26 | S041405 | 193 | T078220 | 29 | T273420 | 31 | T273320 | 31 | | |
| GP3M4 | 28 | P623N | 26 | S041469 | 193 | T078320 | 29 | T5570 | 31 | T5570 | 31 | | |
| GR274 | 23 | P6731 | 25 | S041667 | 193 | T078420 | 29 | T5846 | 31 | T5846 | 31 | | |
| GR277 | 23 | P6731 | 25 | S041727 | 193 | T078520 | 29 | T676XL120 | 31 | T676XL120 | 31 | | |
| GRW63 | 24 | P976R | 26 | S042183 | 193 | T078620 | 29 | T676XL220 | 31 | T676XL220 | 31 | | |
| H3730 | 24 | PF028 | 25 | EPSON SUPPLIES | | | | | | | | T786120 | 31 |
| H513C | 26 | PF029 | 26 | 7753 | 32 | T079320 | 29 | T786220 | 31 | T786120 | 31 | | |
| H514C | 26 | PF030 | 26 | 8750 | 32 | T079420 | 29 | T786320 | 31 | T786220 | 31 | | |
| H515C | 26 | PK492 | 25 | 8766 | 32 | T079520 | 29 | T786420 | 31 | T786320 | 31 | | |
| H516C | 26 | PK496 | 25, 26 | 7762L | 32 | T079620 | 29 | T786520 | 31 | T786420 | 31 | | |
| HD47M | 28 | PK496 | 25, 26 | ERC-03B | 32 | T087020 | 29 | GENICOM SUPPLIES | | | | | |
| HD767 | 26 | PK937 | 25 | 3A0100B02 | | | | | | | | 32 | |
| HG308 | 26 | PK941 | 25 | 3A1600B21 | | | | | | | | 32 | |
| HW679 | 27 | PN124 | 24 | 3A1600B22 | | | | | | | | 32 | |

| | | | | | | | | | | | |
|-------------|------------|-------------|--------|-------------|------------|-------------|--------|---------|--------|--------------|--------|
| C6195A | 40 | C9413A | 34 | CB435D | 45 | CE260AG | 49, 50 | CF032A | 49 | CN053AN | 39 |
| C6578AN | 35 | C9414A | 35 | CB436A | 44 | CE260AG | 49, 50 | CF033A | 49 | CN054AN | 39 |
| C6578DN | 35 | C9415A | 34 | CB436D | 44 | CE260X | 50 | CF064A | 44 | CN055AN | 39 |
| C6602A | 34 | C9416A | 34 | CB457A | 49 | CE261A | 50 | CF210A | 52 | CN056AN | 39 |
| C6602B | 40 | C9417A | 34 | CB459A | 49 | CE261AG | 50 | CF210X | 52 | CN057AN | 39 |
| C6602G | 40 | C9418A | 35 | CB463A | 49 | CE262A | 50 | CF211A | 52 | CN058AN | 39 |
| C6602R | 34 | C9419A | 35 | CB506-67901 | 45 | CE262AG | 50 | CF212A | 52 | CN059AN | 39 |
| C6614D | 34 | C9420A | 37 | CB506-67903 | 45 | CE263A | 50 | CF213A | 52 | CN060AN | 39 |
| C6615DN | 34 | C9421A | 37 | CB540A | 48 | CE263AG | 50 | CF214A | 44 | CN065FN | 34 |
| C6625A | 34 | C9422A | 37 | CB540AD | 48 | CE264X | 49 | CF214X | 44 | CN069FN | 34 |
| C6656AN | 35 | C9423A | 37 | CB541A | 48 | CE265A | 49, 50 | CF249A | 44 | CN621AM | 39 |
| C6657AN | 35 | C9424A | 37 | CB542A | 48 | CE265A | 49, 50 | CF280A | 42 | CN622AM | 39 |
| C6658AN | 35 | C9425A | 37 | CB543A | 48 | CE265A | 49, 50 | CF280X | 42 | CN623AM | 39 |
| C7115A | 40 | C9426A | 37 | CC364A | 45 | CE265A | 49, 50 | CF280XD | 42 | CN624AM | 39 |
| C7115AG | 40 | C9427A | 37 | CC364AG | 45 | CE270A | 50 | CF281A | 44 | CN625AM | 39 |
| C7115X | 40 | C9428A | 37 | CC364X | 45 | CE271A | 50 | CF281X | 44 | CN625AM#201 | 39 |
| C8057A | 41 | C9429A | 37 | CC364XD | 45 | CE272A | 50 | CF283A | 46 | CN626AM | 39 |
| C8061X | 41 | C9448A | 35 | CC468-67927 | 49 | CE273A | 50 | CF283A | 46 | CN626AM#201 | 39 |
| C8091A | 48, 49 | C9449A | 35 | CC468-67927 | 49 | CE278A | 46 | CF283X | 46 | CN627AM | 39, 40 |
| C8091A | 48, 49 | C9450A | 35 | CC530A | 48, 49 | CE278D | 46 | CF300A | 51 | CN627AM#201 | 40 |
| C8543X | 42 | C9451A | 35 | CC530AD | 49 | CE285A | 46 | CF301A | 51 | CN628AM | 39, 40 |
| C8550A | 48 | C9452A | 35 | CC530AG | 48 | CE285D | 46 | CF302A | 51 | CN628AM#201 | 40 |
| C8551A | 48 | C9453A | 35 | CC531A | 48 | CE310A | 52 | CF303A | 51 | CN629A | 39 |
| C8552A | 48 | C9454A | 35 | CC531AG | 48 | CE310AD | 52 | CF310A | 50 | CN630A | 39 |
| C8553A | 48 | C9455A | 35 | CC532A | 48 | CE311A | 52 | CF311A | 50 | CN631A | 39 |
| C8554A | 48 | C9456A | 35 | CC532AG | 48 | CE312A | 52 | CF312A | 50 | CN632A | 39 |
| C8555A | 48 | C9457A | 35 | CC533A | 48 | CE313A | 52 | CF313A | 50 | CN633A | 39 |
| C8556A | 48 | C9458A | 35 | CC533AG | 48 | CE314A | 52 | CF320A | 50 | CN634A | 39 |
| C8560A | 48 | C9459A | 35 | CC604FN | 33 | CE320A | 53 | CF320A | 50 | CN635A | 39 |
| C8561A | 48 | C9460A | 38 | CC635A | 38 | CE320AD | 53 | CF320X | 50 | CN636A | 39 |
| C8562A | 48 | C9461A | 38 | CC640WN | 35 | CE321A | 53 | CF321A | 50 | CN684WN | 38 |
| C8563A | 48 | C9462A | 38 | CC641WN | 35 | CE322A | 53 | CF322A | 50 | CQ849A | 40 |
| C8721WN | 33, 34 | C9463A | 38 | CC643WN | 35 | CE323A | 53 | CF323A | 50 | CR259FN | 33 |
| C8727AN | 34 | C9464A | 38 | CC644WN | 35 | CE340A | 52 | CF325X | 44 | CR314FN | 34 |
| C8728AN | 34 | C9465A | 38 | CC653AN | 34, 39 | CE341A | 52 | CF330X | 50 | CZ075FN | 34 |
| C8730WN | 34 | C9466A | 38 | CC654AN | 39 | CE342A | 52 | CF331A | 50 | CZ129A | 38 |
| C8731WN | 34 | C9467A | 38 | CC656AN | 34, 39 | CE343A | 52 | CF332A | 50 | CZ130A | 34, 38 |
| C8732WN | 34 | C9468A | 38 | CC659FN | 33 | CE390A | 44 | CF333A | 50 | CZ131A | 34, 38 |
| C8765WN | 38 | C9469A | 38 | CD644-67908 | 52 | CE390A | 44 | CF340A | 48 | CZ132A | 34, 38 |
| C8766WN | 33, 38 | C9470A | 38 | CD971AN | 39 | CE390X | 44 | CF341A | 52 | CZ133A | 38 |
| C8767WN | 34, 38 | C9471A | 38 | CD972AN | 39 | CE390X | 44 | CF350A | 51 | CZ134A | 34 |
| C8771WN | 34 | C9500FN | 33 | CD973AN | 39 | CE390XD | 44 | CF351A | 51 | CZ135A | 34 |
| C8772WN | 34 | C9508FN | 33 | CD974AN | 39 | CE390XD | 44 | CF352A | 51 | CZ136A | 34 |
| C8773WN | 34 | C9509FN | 33 | CD975AN | 39 | CE390XG | 44 | CF353A | 51 | D7H14A | 51 |
| C8774WN | 34 | C9513FN | 33 | CE017A | 38 | CE400A | 52, 53 | CF358A | 50, 51 | D7H14A | 51 |
| C8775WN | 33, 34 | C9514FN | 34 | CE018A | 38 | CE400A | 52, 53 | CF358A | 50, 51 | D8J07A | 40 |
| C8842A | 40 | C9518A | 38 | CE019A | 38 | CE400AG | 52, 53 | CF359A | 50, 51 | D8J07AG | 40 |
| C9148-67909 | 41 | C9720A | 47 | CE020A | 38 | CE400AG | 52, 53 | CF359A | 50, 51 | D8J08A | 40 |
| C9152A | 42 | C9721A | 47 | CE246A | 50 | CE400X | 52, 53 | CF364A | 51 | D8J08AG | 40 |
| C9348FN | 34 | C9722A | 47 | CE246A | 50 | CE400X | 52, 53 | CF364A | 51 | D8J09A | 40 |
| C9351AN | 33, 34 | C9723A | 47 | CE248A | 44, 49 | CE401A | 52, 53 | CF365A | 50, 51 | D8J09AG | 40 |
| C9352AN | 33, 34 | C9725A | 47 | CE248A | 44, 49 | CE401A | 52, 53 | CF365A | 50, 51 | D8J10A | 40 |
| C9353FN | 34 | C9730A | 48 | CE249A | 50 | CE401AG | 52, 53 | CF370AM | 52 | D8J10AG | 40 |
| C9354FN | 33 | C9731A | 48 | CE249A | 50 | CE401AG | 52, 53 | CF371AM | 53 | D8J23FN | 33 |
| C9361WN | 33, 38 | C9732A | 48 | CE250A | 49 | CE402A | 52, 53 | CF380A | 52 | F6U00FN | 33 |
| C9362WN | 33, 38 | C9733A | 48 | CE250A | 49 | CE402A | 52, 53 | CF380X | 52 | F6U03FN | 34 |
| C9363WN | 34, 38 | C9734-67901 | 48 | CE250AG | 49 | CE402AG | 52, 53 | CF381A | 52 | H3980 | 41 |
| C9364WN | 33, 34, 38 | C9735A | 48 | CE250AG | 49 | CE402AG | 52, 53 | CF382A | 52 | PF2288K050NI | 42 |
| C9369WN | 38 | CB304AN | 38 | CE250X | 49 | CE403A | 52, 53 | CF383A | 52 | Q1338A | 41 |
| C9370A | 35 | CB316WN | 34, 38 | CE250X | 49 | CE403A | 52, 53 | CH561WN | 33, 35 | Q1338AG | 41 |
| C9371A | 35 | CB317WN | 38 | CE251A | 49 | CE403AG | 52, 53 | CH562WN | 33, 35 | Q1338D | 41 |
| C9372A | 35 | CB318WN | 38 | CE251A | 49 | CE403AG | 52, 53 | CH563WN | 35 | Q1339A | 42 |
| C9373A | 35 | CB319WN | 38 | CE251AG | 49 | CE410A | 52 | CH564WN | 35 | Q1339AG | 42 |
| C9374A | 35 | CB320WN | 38 | CE251AG | 49 | CE410AG | 52 | CH565A | 37 | Q1860 | 42 |
| C9380A | 35 | CB322WN | 38 | CE252A | 49 | CE410X | 52 | CH566A | 37 | Q2321A | 40 |
| C9381A | 37 | CB323WN | 38 | CE252A | 49 | CE410XD | 52 | CH567A | 37 | Q2344A | 40 |
| C9382A | 37 | CB324WN | 38 | CE252AG | 49 | CE411A | 52 | CH568A | 37 | Q2392A | 40 |
| C9383A | 35 | CB325WN | 38 | CE252AG | 49 | CE411AG | 52 | CH575A | 38 | Q2429 | 41 |
| C9384A | 35 | CB327FN | 33 | CE253A | 49 | CE412A | 52, 53 | CH634AN | 39 | Q2436A | 42 |
| C9385AN | 37 | CB335WN | 35 | CE253A | 49 | CE412AG | 53 | CH635AN | 39 | Q2610A | 41 |
| C9386AN | 37 | CB336WN | 35 | CE253AG | 49 | CE413A | 52 | CH636AN | 39 | Q2610D | 41 |
| C9387AN | 37 | CB337WN | 33, 35 | CE253AG | 49 | CE413AG | 52 | CH644A | 39 | Q2612A | 40 |
| C9388AN | 37 | CB338WN | 35 | CE254A | 49, 52, 53 | CE484A | 49 | CH645A | 38 | Q2612AG | 40 |
| C9390A | 35 | CB380A | 49 | CE254A | 49, 52, 53 | CE484A | 49 | CH646A | 38 | Q2612D | 40 |
| C9391AN | 37 | CB381A | 49 | CE254A | 49, 52, 53 | CE505A | 45 | CH647A | 38 | Q2613A | 41 |
| C9392AN | 37 | CB382A | 49 | CE254A | 49, 52, 53 | CE505D | 45 | CH648A | 38 | Q2613X | 41 |
| C9393AN | 37 | CB383A | 49 | CE255A | 44-46 | CE505X | 45 | CH649A | 38 | Q2613XG | 41 |
| C9396AN | 37 | CB384A | 49 | CE255A | 44-46 | CE505XD | 45 | CM991A | 38 | Q2624A | 40 |
| C9397A | 35 | CB385A | 49 | CE255A | 44-46 | CE514A | 52 | CM992A | 38 | Q2670A | 46, 47 |
| C9398A | 35 | CB386A | 49 | CE255AG | 44-46 | CE516A | 50, 52 | CM993A | 38 | Q2670A | 46, 47 |
| C9399A | 35 | CB387A | 49 | CE255AG | 44-46 | CE516A | 50, 52 | CM994A | 38 | Q2671A | 46 |
| C9400A | 35 | CB388A | 45 | CE255AG | 44-46 | CE525-67901 | 44, 45 | CM995A | 38 | Q2672A | 46 |
| C9401A | 35 | CB390A | 49 | CE255X | 44-46 | CE525-67901 | 44, 45 | CM996A | 38 | Q2673A | 46 |
| C9403A | 35 | CB400A | 50 | CE255X | 44-46 | CE731A | 44 | CM997A | 38 | Q2681A | 47 |
| C9404A | 35 | CB400AG | 50 | CE255X | 44-46 | CE740A | 51 | CN045AN | 39 | Q2682A | 47 |
| C9405A | 35 | CB401A | 50 | CE255XD | 44-46 | CE741A | 51 | CN046AN | 39 | Q2683A | 47 |
| C9406A | 35 | CB401AG | 50 | CE255XD | 44-46 | CE742A | 51 | CN047AN | 39 | Q3216A | 41, 42 |
| C9407A | 35 | CB402A | 50 | CE255XD | 44-46 | CE743A | 51 | CN048AN | 39 | Q3216A | 41, 42 |
| C9408A | 35 | CB402AG | 50 | CE257A | 46 | CE977A | 50 | CN049AN | 39 | Q3655A | 46, 47 |
| C9409A | 35 | CB403A | 50 | CE259A | 48 | CE980A | 50, 52 | CN050AN | 39 | Q3655A | 46, 47 |
| C9410A | 35 | CB403AG | 50 | CE260A | 49, 50 | CE980A | 50, 52 | CN051AN | 39 | Q3658A | 46, 47 |
| C9412A | 34 | CB435A | 45 | CE260A | 49, 50 | CF031A | 49 | CN052AN | 34, 39 | Q3658A | 46, 47 |

| | | | | | | | | | | | |
|----------------|--------|----------------|------------|-------------|---------------|-------|----|---------|--------|---------|-----|
| Q3676A | 47 | RM1-0550 | 40, 41 | 1408 | 206, 208 | 473-7 | 53 | 39V2441 | 55 | KP32177 | 143 |
| Q3938-67969 | 49 | RM1-0865 | 40 | 1503 | 210 | 473-8 | 53 | 39V2446 | 56 | KP32213 | 143 |
| Q3960A | 46 | RM1-1043 | 42 | 1513 | 210 | 484-5 | 53 | 39V2447 | 56 | KP32214 | 143 |
| Q3961A | 46 | RM1-1082 | 42 | 1514 | 210 | 485-3 | 53 | 39V2448 | 56 | KP32215 | 143 |
| Q3962A | 46 | RM1-1110 | 42 | 1528 | 211 | 485-5 | 53 | 39V2449 | 56 | KP32233 | 142 |
| Q3963A | 46 | RM1-1110 | 42 | 1531 | 211 | 485-7 | 53 | 39V2511 | 54 | KP32235 | 142 |
| Q3964A | 46 | RM1-1289 | 41 | 1566 | 207 | 666-5 | 53 | 39V2515 | 54 | KP32239 | 142 |
| Q3984A | 48 | RM1-1471 | 41 | 1568 | 12-14, 207 | 794-3 | 53 | 39V2598 | 54 | KP32259 | 142 |
| Q5421 | 42 | RM1-1508 | 41, 44, 45 | 1569 | 207 | 816-8 | 53 | 39V2598 | 54 | KP32261 | 142 |
| Q5942A | 41 | RM1-1508 | 41, 44, 45 | 1570 | 207 | 817-5 | 53 | 39V2600 | 54 | KP32265 | 143 |
| Q5942X | 41, 42 | RM1-1508 | 41, 44, 45 | 1663 | 206 | | | 39V2603 | 54 | KP32266 | 143 |
| Q5942XD | 42 | RM1-1535 | 41 | 1665 | 206 | | | 39V2617 | 55 | KP32267 | 143 |
| Q5945A | 42 | RM1-1820 | 46 | 1674 | 117, 118, 120 | | | 39V2634 | 54 | KP32268 | 143 |
| Q5945AG | 42 | RM1-1828 | 46 | 1687 | 206 | | | 39V2640 | 54 | KP32269 | 143 |
| Q5949A | 41 | RM1-1885 | 46 | 1777 | 210 | | | 39V2695 | 55, 56 | KP32270 | 143 |
| Q5949AG | 41 | RM1-1891 | 46 | 1778 | 210 | | | 39V2695 | 55, 56 | KP32271 | 143 |
| Q5949X | 41 | RM1-1892 | 46 | 1780 | 22, 208 | | | 39V2699 | 55, 56 | KP32271 | 143 |
| Q5949XD | 41 | RM1-2049 | 40 | 1781 | 208 | | | 39V2699 | 55, 56 | KP32296 | 143 |
| Q5949XG | 41 | RM1-2522 | 42 | 1783 | 208 | | | 39V2773 | 55 | KP33207 | 142 |
| Q5950A | 47 | RM1-2752 | 47 | 1800 | 208 | | | 39V2969 | 55 | KP33957 | 143 |
| Q5951A | 47 | RM1-2752 | 47 | 1801 | 208 | | | 39V2971 | 55 | KP33957 | 143 |
| Q5952A | 47 | RM1-2759 | 47 | 1803 | 106, 208 | | | 39V3204 | 54 | KP33958 | 143 |
| Q5953A | 47 | RM1-2759 | 47 | 1815 | 206, 208 | | | 39V3207 | 54, 55 | KP33959 | 143 |
| Q5997-67901 | 42, 48 | RM1-2763 | 47 | 1815 | 206, 208 | | | 39V3207 | 54, 55 | KP33960 | 143 |
| Q5997-67901 | 42, 48 | RM1-2763 | 47 | 1815 | 206, 208 | | | 39V3352 | 55 | KP33961 | 143 |
| Q5998 | 42 | RM1-3007 | 45 | 1815 | 206, 208 | | | 39V3354 | 55 | KP33962 | 143 |
| Q6000A | 46 | RM1-3044 | 40 | 1820 | 208 | | | 39V3394 | 54 | KP33963 | 143 |
| Q6000AD | 46 | RM1-3131 | 47, 48, 50 | 1821 | 208 | | | 39V3412 | 55, 56 | KP33964 | 144 |
| Q6001A | 46 | RM1-3131 | 47, 48, 50 | 1822 | 208 | | | 39V3412 | 55, 56 | KP33965 | 144 |
| Q6002A | 46 | RM1-3131 | 47, 48, 50 | 1823 | 208 | | | 39V3525 | 54, 55 | KP33966 | 144 |
| Q6003A | 46 | RM1-3161 | 47, 48, 50 | 1831 | 207 | | | 39V3525 | 54, 55 | KP33967 | 144 |
| Q6460A | 47, 48 | RM1-3161 | 47, 48, 50 | 1833 | 207 | | | 39V3590 | 54, 55 | KP34169 | 145 |
| Q6460AG | 48 | RM1-3161 | 47, 48, 50 | 1840 | 68, 69, 208 | | | 39V3590 | 54, 55 | KP34170 | 145 |
| Q6461A | 47, 48 | RM1-3717 | 44, 45 | 1841 | 69, 208 | | | 39V3600 | 55 | KP34171 | 145 |
| Q6461AG | 48 | RM1-3717 | 44, 45 | 1843 | 68, 69, 208 | | | 39V3628 | 55 | KP34172 | 145 |
| Q6462A | 48 | RM1-4023 | 45 | 1850 | 209 | | | 39V3629 | 55 | KP35838 | 145 |
| Q6462AG | 48 | RM1-4247 | 44 | 1851 | 209 | | | 39V3717 | 55 | KP35839 | 145 |
| Q6463A | 48 | RM1-4279 | 44 | 1852 | 209 | | | 39V4052 | 56 | KP35840 | 145 |
| Q6463AG | 48 | RM1-4310 | 46 | 1853 | 209 | | | 39V4053 | 56 | KP35841 | 145 |
| Q6470A | 47 | RM1-4430 | 48, 53 | 1854 | 209 | | | 39V4054 | 56 | KP35842 | 143 |
| Q6470A | 47 | RM1-4430 | 48, 53 | 1870 | 209 | | | 39V4055 | 56 | KP35843 | 143 |
| Q6470AG | 47 | RM1-4436 | 48, 53 | 1873 | 209 | | | 41U1680 | 53 | KP35844 | 143 |
| Q6470AG | 47 | RM1-4436 | 48, 53 | 1881 | 209 | | | 41U2235 | 53 | KP35845 | 143 |
| Q6471A | 47 | RM1-4852 | 49, 53 | 1883 | 209 | | | 44D7762 | 53 | KP36680 | 144 |
| Q6471AG | 47 | RM1-4852 | 49, 53 | 1884 | 209 | | | 45U3891 | 53 | KP36681 | 144 |
| Q6472A | 47 | RM1-6405 | 45 | 1901 | 208 | | | 45U3895 | 53 | KP36682 | 144 |
| Q6472AG | 47 | RM1-6450 | 45 | 1902 | 208 | | | 53P9372 | 55 | KP36683 | 144 |
| Q6473A | 47 | RM1-6740 | 49 | 1911 | 208 | | | 56Y2500 | 55 | KP36704 | 145 |
| Q6473AG | 47 | RM1-8061-000CN | 53 | 1913 | 17, 209 | | | 56Y2501 | 55 | KP36706 | 145 |
| Q6511A | 41 | RM1-8072 | 44 | 1920 | 208 | | | 57P1743 | 53 | KP36922 | 145 |
| Q6511X | 41 | RM1-8808 | 42 | 1921 | 208 | | | 57P1888 | 55 | KP36973 | 145 |
| Q7432-67001 | 45 | RM1-9175 | 42 | 1923 | 208 | | | 57P2308 | 53 | KP37020 | 145 |
| Q7457A | 40 | RM2-5177 | 53 | 1991 | 210 | | | 69G7370 | 55 | KP37085 | 143 |
| Q7516A | 42 | | | 2117 | 207-209 | | | 69G7377 | 55 | KP37086 | 142 |
| Q7516AG | 42 | | | 2117 | 207-209 | | | 75P4301 | 54 | KP37309 | 143 |
| Q7551A | 44, 45 | | | 2117 | 207-209 | | | 75P4303 | 54 | KP37310 | 143 |
| Q7551A | 44, 45 | | | 2117 | 207-209 | | | 75P5709 | 54 | KP37311 | 143 |
| Q7551X | 44, 45 | | | 2117 | 207-209 | | | 75P5711 | 54 | KP37312 | 143 |
| Q7551X | 44, 45 | | | 2117 | 207-209 | | | 75P5712 | 54 | KP37316 | 142 |
| Q7551XD | 44, 45 | | | 2117 | 207-209 | | | 75P6877 | 54 | KP37318 | 143 |
| Q7551XD | 44, 45 | | | 12754 | 206 | | | 75P6878 | 54 | KP37409 | 144 |
| Q7553A | 44 | | | 13694 | 207 | | | 75P6959 | 54 | KP37410 | 144 |
| Q7553X | 44 | | | 14584 | 207 | | | 75P6961 | 54 | KP37411 | 144 |
| Q7553XD | 44 | | | 15034 | 210 | | | 75P6963 | 54 | KP37412 | 144 |
| Q7570A | 45 | | | 15624 | 206 | | | | | KP37480 | 143 |
| Q7581A | 47 | | | 15644 | 207 | | | | | KP37481 | 143 |
| Q7581AG | 47 | | | 15694 | 207 | | | | | KP37482 | 143 |
| Q7582A | 47 | | | 16604 | 207 | | | | | KP37483 | 143 |
| Q7582AG | 47 | | | 17844 | 208 | | | | | KP37489 | 143 |
| Q7583A | 47 | | | 18444 | 208 | | | | | KP37767 | 145 |
| Q7583AG | 47 | | | 36159 | 211 | | | | | KP37768 | 145 |
| Q7829-67928 | 45 | | | 1854M | 209 | | | | | KP37769 | 145 |
| Q7832-67901 | 45 | | | 2523-1 | 209 | | | | | KP37770 | 145 |
| Q7964AN | 33 | | | 314P | 211 | | | | | KP37826 | 143 |
| RF5-3319 | 42 | | | 315P | 211 | | | | | KP37983 | 145 |
| RF5-4067 | 46 | | | 316P | 211 | | | | | KP37984 | 145 |
| RG5-4283 | 41 | | | | 211 | | | | | KP37985 | 145 |
| RG5-4589 | 40 | | | NB210NA3930 | 207, 209 | | | | | KP37986 | 145 |
| RG5-5063 | 41 | | | NB210NA3930 | 207, 209 | | | | | KP37991 | 146 |
| RG5-5068 | 41 | | | NB210NA3930 | 207, 209 | | | | | KP37992 | 146 |
| RG5-5295 | 41 | | | NB210RO2830 | 206 | | | | | KP37993 | 146 |
| RG5-5581 | 41 | | | NB210RO2830 | 206 | | | | | KP37994 | 145 |
| RG5-6532 | 42 | | | NB210RO3330 | 207, 208 | | | | | KP38880 | 145 |
| RG5-7162 | 46 | | | NB210RO3330 | 207, 208 | | | | | KP39013 | 142 |
| RG5-7455 | 47 | | | NB210RO3330 | 207, 208 | | | | | KP39083 | 145 |
| RG5-7572 | 46 | | | SS-1013 | 210 | | | | | KP39104 | 142 |
| RG5-7602 | 46 | | | SS-1017 | 210 | | | | | KP39107 | 142 |
| RG9-1361 | 42 | | | SS-1030 | 210 | | | | | KP39111 | 143 |
| RM1-0013 | 41 | | | | | | | | | KP39272 | 144 |
| RM1-0101-300CN | 42 | | | | | | | | | KP39275 | 144 |
| RM1-0354 | 41 | | | | | | | | | KP39276 | 144 |
| RM1-0550 | 40, 41 | | | | | | | | | | |
| RM1-0550 | 40, 41 | | | | | | | | | | |

IMATION MEDIA

| | |
|-------|-----|
| 15931 | 202 |
| 17204 | 202 |
| 17262 | 203 |
| 17274 | 203 |
| 17301 | 203 |
| 17304 | 203 |
| 17332 | 203 |
| 17334 | 203 |
| 17341 | 203 |
| 17346 | 203 |
| 17350 | 203 |
| 17353 | 203 |
| 17532 | 202 |
| 18059 | 203 |
| 18060 | 203 |
| 26592 | 202 |
| 26654 | 203 |
| 26837 | 202 |
| 27125 | 203 |
| 27127 | 202 |
| 27134 | 203 |
| 27428 | 202 |
| 27605 | 203 |
| 27672 | 202 |
| 27794 | 203 |
| 27957 | 202 |
| 28109 | 202 |
| 28941 | 202 |
| 28943 | 203 |
| 28944 | 203 |
| 28945 | 203 |
| 28946 | 203 |
| 29080 | 202 |
| 29104 | 202 |
| 29110 | 202 |
| 40963 | 202 |
| 41017 | 203 |
| 41149 | 203 |
| 46168 | 202 |

INFOPRINT SUPPLIES

| | |
|---------|----|
| 719110 | 55 |
| 719111 | 55 |
| 1053685 | 53 |
| 1402822 | 55 |
| 1402823 | 55 |
| 28P1882 | 54 |
| 28P1883 | 54 |
| 28P2010 | 54 |
| 28p2012 | 54 |
| 28P2625 | 54 |
| 39V0311 | 55 |
| 39V0312 | 55 |
| 39V0313 | 55 |
| 39V0314 | 55 |
| 39V0384 | 55 |
| 39V0529 | 54 |
| 39V0530 | 54 |
| 39V0542 | 54 |
| 39V1063 | 54 |
| 39V1635 | 55 |
| 39V1638 | 54 |
| 39V1642 | 54 |
| 39V1644 | 54 |
| 39V1645 | 54 |
| 39V1645 | 54 |
| 39V1919 | 55 |
| 39V1920 | 55 |
| 39V1921 | 55 |
| 39V1922 | 55 |
| 39V1923 | 55 |
| 39V2313 | 55 |
| 39V2318 | 55 |

| | | | | | | | | | | | |
|----------|-----------|---------|----------|---------|-----------------------|---------|--------|---------------|---------|---------------|----------------|
| 28C0500 | 238 | 35ST160 | 231 | 1382625 | 66, 67 | 12A7462 | 68, 69 | 15G041C | 79, 80 | 25A0013 | 64, 65, |
| 28C0550 | 238 | 35ST300 | 231 | 1382925 | 66, 67 | 12A7462 | 68, 69 | 15G041C | 79, 80 | 70-73, 84, 87 | |
| 28CT000 | 238 | 35ST400 | 232 | 1382925 | 66, 67 | 12A7462 | 68, 69 | 15G041C | 79, 80 | 25A0013 | 64, 65, |
| 28CT001 | 238 | 35ST450 | 232 | 1382925 | 66, 67 | 12A7465 | 69 | 15G041K | 79, 80 | 70-73, 84, 87 | |
| 28CT500 | 238 | 35ST500 | 232 | 1382929 | 66, 67 | 12A7465 | 69 | 15G041K | 79, 80 | 25A0013 | 64, 65, |
| 28CT550 | 238 | 35ST550 | 232 | 1382929 | 66, 67 | 12A7468 | 68, 69 | 15G041K | 79, 80 | 70-73, 84, 87 | |
| 28D0000 | 238 | 35ST871 | 233 | 1382929 | 66, 67 | 12A7468 | 68, 69 | 15G041M | 79, 80 | 25A0013 | 64, 65, |
| 28D0050 | 238 | 35ST872 | 233 | 3070166 | 60 | 12A7468 | 68, 69 | 15G041M | 79, 80 | 70-73, 84, 87 | |
| 28D0100 | 238 | 35ST873 | 233 | 3070169 | 60 | 12A7469 | 69 | 15G041M | 79, 80 | 25A0013 | 64, 65, |
| 28D0500 | 238 | 35ST874 | 233 | 08A0477 | 62 | 12A7469 | 69 | 15G041Y | 79, 80 | 70-73, 84, 87 | |
| 28D0550 | 238 | 35ST969 | 233 | 08A0478 | 62 | 12A7775 | 67 | 15G041Y | 79, 80 | 25A0013 | 64, 65, |
| 28D0600 | 238 | 38C0626 | 238, 239 | 10B3100 | 80-83 | 12A8302 | 61, 62 | 15G042C | 79, 80 | 70-73, 84, 87 | |
| 28D7010 | 238 | 38C0626 | 238, 239 | 10B3100 | 80-83 | 12A8302 | 61, 62 | 15G042C | 79, 80 | 34015HA | 62 |
| 28DT011 | 238 | 38C0626 | 238, 239 | 10B3100 | 80-83 | 12A8302 | 61, 62 | 15G042C | 79, 80 | 34035HA | 62 |
| 28DT012 | 238 | 38C0626 | 238, 239 | 10B3100 | 80-83 | 12A8325 | 67 | 15G042K | 79, 80 | 34060HW | 62 |
| 28DT500 | 238 | 38C0626 | 238, 239 | 10B3100 | 80-83 | 12A8420 | 67 | 15G042K | 79, 80 | 3558500 | 66 |
| 28DT550 | 238 | 38C0626 | 238, 239 | 10B3100 | 80-83 | 12A8425 | 67 | 15G042M | 79, 80 | 40X0076 | 69, 70, 72 |
| 28DT600 | 238 | 38C0636 | 238, 239 | 10B3100 | 80-83 | 12A9684 | 68 | 15G042M | 79, 80 | 40X0076 | 69, 70, 72 |
| 28E0500 | 239 | 38C0636 | 238, 239 | 10N0016 | 60 | 12A9684 | 68 | 15G042Y | 79, 80 | 40X0076 | 69, 70, 72 |
| 28E0550 | 239 | 38C0636 | 238, 239 | 10N0026 | 60 | 12A9685 | 68, 69 | 15G042Y | 79, 80 | 40X0076 | 69, 70, 72 |
| 28E0615 | 239 | 38C0636 | 238, 239 | 10N0202 | 60 | 12A9685 | 68, 69 | 15G642C | 79, 80 | 40X0076 | 69, 70, 72 |
| 28ET021 | 238 | 40G0100 | 232 | 11K3188 | 67-70, 80, 81, 83, 84 | 12A9685 | 68, 69 | 15G642C | 79, 80 | 40X0100 | 69, 70, 72 |
| 28ET022 | 238 | 40G0110 | 232 | 11K3188 | 67-70, 80, 81, 83, 84 | 12A9686 | 69 | 15G642K | 79, 80 | 40X0100 | 69, 70, 72 |
| 28ET500 | 239 | 40G0150 | 232 | 11K3188 | 67-70, 80, 81, 83, 84 | 12A9686 | 69 | 15G642K | 79, 80 | 40X0100 | 69, 70, 72 |
| 28ET550 | 239 | 40G0200 | 232 | 11K3188 | 67-70, 80, 81, 83, 84 | 12G6301 | 80 | 15G642M | 80 | 40X0100 | 69, 70, 72 |
| 34T5011 | 239 | 40G0210 | 232 | 11K3188 | 67-70, 80, 81, 83, 84 | 12G6303 | 80 | 15G642M | 80 | 40X0100 | 69, 70, 72 |
| 34T5012 | 239 | 40G0310 | 232 | 11K3188 | 67-70, 80, 81, 83, 84 | 12G6303 | 80 | 15G642Y | 80 | 40X0100 | 69, 70, 72 |
| 34T5013 | 239 | 40G0350 | 232 | 11K3188 | 67-70, 80, 81, 83, 84 | 12G6303 | 80 | 15G642Y | 80 | 40X0127 | 69, 70, 72 |
| 34T5114 | 237, 239 | 40G0410 | 232 | 11K3188 | 67-70, 80, 81, 83, 84 | 12G6496 | 80 | 18C0034 | 61 | 40X0127 | 69, 70, 72 |
| 34T5114 | 237, 239 | 40G0440 | 232 | 11K3188 | 67-70, 80, 81, 83, 84 | 12N0768 | 83 | 18C0533 | 60 | 40X0127 | 69, 70, 72 |
| 34T5114 | 237, 239 | 40G0470 | 232 | 11K3188 | 67-70, 80, 81, 83, 84 | 12N0769 | 83 | 18C1428 | 60 | 40X0127 | 69, 70, 72 |
| 34T5114 | 237, 239 | 40G0800 | 232, 234 | 11K3188 | 67-70, 80, 81, 83, 84 | 12N0770 | 83 | 18C1429 | 60 | 40X0127 | 69, 70, 72 |
| 34TT000 | 239 | 40G0800 | 232, 234 | 11K3188 | 67-70, 80, 81, 83, 84 | 12N0771 | 83 | 18C1523 | 60 | 40X0130 | 69, 70, 72 |
| 34TT001 | 239 | 40G0800 | 232, 234 | 11K3188 | 67-70, 80, 81, 83, 84 | 12N0772 | 84 | 18C1524 | 60 | 40X0130 | 69, 70, 72 |
| 34TT002 | 239 | 40G0800 | 232, 234 | 11K3188 | 67-70, 80, 81, 83, 84 | 12N0772 | 84 | 18C1528 | 60 | 40X0130 | 69, 70, 72 |
| 35S0060 | 231 | 40G0800 | 232, 234 | 11K3188 | 67-70, 80, 81, 83, 84 | 12N0773 | 83, 84 | 18C1529 | 61 | 40X0130 | 69, 70, 72 |
| 35S0160 | 231 | 40G0855 | 232, 234 | 11K3188 | 67-70, 80, 81, 83, 84 | 12N0773 | 83, 84 | 18C1571 | 60 | 40X0342 | 81 |
| 35S0260 | 233 | 40G0855 | 232, 234 | 11K3188 | 67-70, 80, 81, 83, 84 | 13L0034 | 60 | 18C2080 | 60 | 40X0342 | 81 |
| 35S0267 | 231-234 | 40G0855 | 232, 234 | 11K3188 | 67-70, 80, 81, 83, 84 | 14L0086 | 61 | 18C2090 | 60 | 40X0343 | 82, 83 |
| 35S0267 | 231-234 | 40G0855 | 232, 234 | 11K3188 | 67-70, 80, 81, 83, 84 | 14L0087 | 61 | 18C2100 | 60 | 40X0343 | 82, 83 |
| 35S0267 | 231-234 | 40G0855 | 232, 234 | 11K3188 | 67-70, 80, 81, 83, 84 | 14L0088 | 60, 61 | 18C2110 | 60 | 40X0394 | 73 |
| 35S0267 | 231-234 | 40GT110 | 232 | 11K3188 | 67-70, 80, 81, 83, 84 | 14L0173 | 61 | 18C2130 | 61 | 40X0394 | 73 |
| 35S0267 | 231-234 | 40GT150 | 232 | 11K3188 | 67-70, 80, 81, 83, 84 | 14L0174 | 61 | 18C2140 | 60, 61 | 40X0450 | 72 |
| 35S0267 | 231-234 | 40GT210 | 232 | 11K3188 | 67-70, 80, 81, 83, 84 | 14L0175 | 61 | 18C2150 | 61 | 40X0450 | 72 |
| 35S0267 | 231-234 | 40GT310 | 232 | 11K3188 | 67-70, 80, 81, 83, 84 | 14L0176 | 61 | 18C2160 | 61 | 40X0450 | 72 |
| 35S0267 | 231-234 | 40GT350 | 232 | 11K3188 | 67-70, 80, 81, 83, 84 | 14L0177 | 60, 61 | 18C2170 | 61 | 40X0616 | 71, 73 |
| 35S0267 | 231-234 | 40GT410 | 232 | 11K3188 | 67-70, 80, 81, 83, 84 | 14L0268 | 60 | 18C2180 | 60, 61 | 40X0616 | 71, 73 |
| 35S0267 | 231-234 | 40GT440 | 232 | 11K3188 | 67-70, 80, 81, 83, 84 | 14L0269 | 60 | 18C2190 | 61 | 40X0616 | 71, 73 |
| 35S0300 | 231 | 40GT470 | 232 | 120155A | 61, 138 | 14N0683 | 60 | 18C2200 | 61 | 40X0616 | 71, 73 |
| 35S0400 | 232 | 41G0000 | 236 | 12026XW | 61 | 14N0684 | 60 | 18C2229 | 60 | 40X0647 | 71 |
| 35S0450 | 232 | 41G0050 | 236 | 12A4715 | 71 | 14N0685 | 60 | 18C2239 | 60 | 40X0647 | 71 |
| 35S0500 | 232 | 41G0100 | 236 | 12A5361 | 67 | 14N0820 | 60, 61 | 18C2249 | 60 | 40X0956 | 71 |
| 35S0550 | 232 | 41GT000 | 236 | 12A5745 | 67, 68 | 14N0822 | 60, 61 | 18Y0144 | 61 | 40X0956 | 71 |
| 35S0567 | 231-234 | 41H0000 | 237 | 12A5745 | 67, 68 | 14N0843 | 60 | 20K0500 | 73 | 40X1056 | 84 |
| 35S0567 | 231-234 | 41H0050 | 237 | 12A5840 | 67, 68 | 14N0900 | 61 | 20K0501 | 73 | 40X1249 | 84 |
| 35S0567 | 231-234 | 41H0100 | 237 | 12A5840 | 67, 68 | 14N0901 | 61 | 20K0502 | 73 | 40X1276 | 61 |
| 35S0567 | 231-234 | 41HT000 | 237 | 12A5840 | 67, 68 | 14N0902 | 60, 61 | 20K0503 | 73 | 40X1287 | 61 |
| 35S0567 | 231-234 | 41HT001 | 237 | 12A5845 | 67, 68 | 14N1068 | 60, 61 | 20K0504 | 73 | 40X1322 | 61, 62 |
| 35S0567 | 231-234 | 41HT002 | 237 | 12A5845 | 67, 68 | 14N1069 | 61 | 20K0505 | 73 | 40X1322 | 61, 62 |
| 35S0567 | 231-234 | 47B0000 | 237 | 12A5849 | 67, 68 | 14N1070 | 61 | 20K1400 | 73 | 40X1322 | 61, 62 |
| 35S0567 | 231-234 | 47B0001 | 237 | 12A5849 | 67, 68 | 14N1071 | 60, 61 | 20K1401 | 73 | 40X1401 | 74 |
| 35S0567 | 231-234 | 47B0002 | 237 | 12A5849 | 67, 68 | 14N1607 | 61 | 20K1402 | 73 | 40X1401 | 74 |
| 35S0567 | 231-234 | 47B0003 | 237 | 12A6591 | 66, 67 | 14N1608 | 61 | 20K1403 | 73 | 40X1401 | 74 |
| 35S5700 | 233 | 47B0110 | 237, 239 | 12A6591 | 66, 67 | 14N1609 | 61 | 20K1440 | 73 | 40X1831 | 81-83 |
| 35S5701 | 233 | 47B0110 | 237, 239 | 12A6592 | 67, 68 | 14N1610 | 60, 61 | 20K1441 | 73 | 40X1831 | 81-83 |
| 35S5702 | 233 | 47B0110 | 237, 239 | 12A6592 | 67, 68 | 14N1614 | 61 | 20K1442 | 73 | 40X1831 | 81-83 |
| 35S5703 | 233 | 47B0111 | 237, 239 | 12A6592 | 67, 68 | 14N1615 | 61 | 20K1443 | 73 | 40X1886 | 70, 72, 73 |
| 35S5704 | 233 | 47B0111 | 237, 239 | 12A6735 | 67 | 14N1616 | 61 | 20K1452 | 73 | 40X1886 | 70, 72, 73 |
| 35S5941 | 233 | 47B0114 | 237, 239 | 12A6765 | 68 | 14N1618 | 61 | 23800SW | 62 | 40X1886 | 70, 72, 73 |
| 35S6700 | 233 | 47B0114 | 237, 239 | 12A6765 | 68 | 14N1619 | 60, 61 | 24015SA | 61, 62 | 40X1886 | 70, 72, 73 |
| 35S6701 | 234 | 47B1000 | 239 | 12A6835 | 67 | 14N1835 | 60 | 24015SA | 61, 62 | 40X1958 | 81-83 |
| 35S6702 | 234 | 47B1001 | 239 | 12A6839 | 67 | 14N1837 | 60 | 24035SA | 61, 62 | 40X1958 | 81-83 |
| 35S6744 | 234 | 47B1002 | 239 | 12A6860 | 68 | 15G031C | 79, 80 | 24035SA | 61, 62 | 40X1958 | 81-83 |
| 35S6800 | 234 | 47B1120 | 239 | 12A6860 | 68 | 15G031C | 79, 80 | 24060SW | 61, 62 | 40X1958 | 81-83 |
| 35S8502 | 231, 233, | 47B1121 | 239 | 12A6865 | 68 | 15G031C | 79, 80 | 24060SW | 61, 62 | 40X2254 | 76-78 |
| 238, 239 | | 47BT000 | 237 | 12A6865 | 68 | 15G031K | 79, 80 | 24B1429 | 67, 68 | 40X2254 | 76-78 |
| 35S8502 | 231, 233, | 47BT001 | 237 | 12A6869 | 68 | 15G031K | 79, 80 | 24B1429 | 67, 68 | 40X2254 | 76-78 |
| 238, 239 | | 47BT002 | 237 | 12A7305 | 62 | 15G031K | 79, 80 | 24B1434 | 68 | 40X2503 | 73 |
| 35S8502 | 231, 233, | 47BT003 | 237 | 12A7315 | 67 | 15G031M | 79, 80 | 24B1434 | 68 | 40X2503 | 73 |
| 238, 239 | | 47BT020 | 239 | 12A7362 | 68 | 15G031M | 79, 80 | 24B1439 | 68, 69 | 40X2540 | 69, 70, 81, 83 |
| 35S8502 | 231, 233, | 47BT021 | 239 | 12A7362 | 68 | 15G031Y | 79, 80 | 24B1439 | 68, 69 | 40X2540 | 69, 70, 81, 83 |
| 238, 239 | | 47BT022 | 239 | 12A7362 | 68 | 15G031Y | 79, 80 | 25A0013 | 64, 65, | 40X2540 | 69, 70, 81, 83 |
| 35S8502 | 231, 233, | 47BT023 | 239 | 12A7365 | 69 | 15G031Y | 79, 80 | 70-73, 84, 87 | | 40X2540 | 69, 70, 81, 83 |
| 238, 239 | | 47BT024 | 239 | 12A7365 | 69 | 15G032C | 79, 80 | 25A0013 | 64, 65, | 40X2592 | 69, 70, 72 |
| 35S8502 | 231, 233, | | | 12A7400 | 62 | 15G032C | 79, 80 | 70-73, 84, 87 | | 40X2592 | 69, 70, 72 |
| 238, 239 | | | | 12A7405 | 62 | 15G032K | 79, 80 | 25A0013 | 64, 65, | 40X2592 | 69, 70, 72 |
| 35S8502 | 231, 233, | | | 12A7410 | 67 | 15G032K | 79, 80 | 70-73, 84, 87 | | 40X2592 | 69, 70, 72 |
| 238, 239 | | | | 12A7415 | 67 | 15G032M | 79, 80 | 25A0013 | 64, 65, | 40X2592 | 69, 70, 72 |
| 35S8502 | 231, 233, | | | 12A7460 | 68, 69 | 15G032M | 79, 80 | 70-73, 84, 8 | | | |

| | | | | | | | | | | | |
|-----------|------------|-----------|------------|-----------|--------|----------|------------|-----------|--------|-----------|-----|
| C540H2CG | 76, 77 | C734X77G | 78, 79, 86 | C780H1KG | 82 | C950X71G | 84, 87 | X340A11G | 71 | ML-0650W | 196 |
| C540H2KG | 76, 77 | C734X77G | 78, 79, 86 | C780H1KG | 82 | C950X73G | 84, 87 | X340A21G | 71 | ML-1050W | 196 |
| C540H2KG | 76, 77 | C734X77G | 78, 79, 86 | C780H1MG | 82 | C950X76G | 85, 87 | X340A21G | 71 | ML-1450W | 196 |
| C540H2MG | 76, 77 | C736H1CG | 78, 79 | C780H1MG | 82 | C950X76G | 85, 87 | X340H11G | 71 | ML-3050W | 196 |
| C540H2MG | 76, 77 | C736H1CG | 78, 79 | C780H1YG | 82 | C950X76G | 85, 87 | X340H22G | 71 | MM-5351 | 197 |
| C540H2MG | 76, 77 | C736H1MG | 79 | C780H1YG | 82 | E250A11A | 62, 138 | X340H22G | 71 | MML-0100 | 196 |
| C540H2YG | 76, 77 | C736H1MG | 79 | C780H2CG | 82 | E250A11A | 62, 138 | X340H41G | 71 | MML-0200 | 196 |
| C540H2YG | 76, 77 | C736H2CG | 78 | C780H2CG | 82 | E250A21A | 62, 162 | X463A11G | 71 | MML-0200B | 196 |
| C540H4CG | 76, 77 | C736H2CG | 78 | C780H2KG | 81, 82 | E250A21A | 62, 162 | X463A41G | 71 | MML-0400 | 196 |
| C540H4CG | 76, 77 | C736H2KG | 78 | C780H2KG | 81, 82 | E250A41G | 62 | X463H11G | 71 | MML-0600 | 196 |
| C540H4CG | 76, 77 | C736H2MG | 78 | C780H2MG | 82 | E250A41G | 62 | X463H41G | 71 | MML-0600B | 196 |
| C540H4CG | 76, 77 | C736H2YMG | 78 | C780H2MG | 82 | E250X22G | 62, 63 | X463X11G | 71 | MML-1000 | 196 |
| C540H4KG | 76, 77 | C736H4CG | 79 | C780H2YMG | 82 | E250X22G | 62, 63 | X463X41G | 71 | MML-1000B | 196 |
| C540H4KG | 76, 77 | C736H4KG | 79 | C780H2YMG | 82 | E250X22G | 62, 63 | X560H2CG | 86 | MML-1400 | 196 |
| C540H4MG | 76, 77 | C736H4MG | 79 | C780H4CG | 82 | E250X42G | 62, 63 | X560H2KG | 86 | MML-2000 | 196 |
| C540H4MG | 76, 77 | C736H4YMG | 79 | C780H4CG | 82 | E250X42G | 62, 63 | X560H2MG | 86 | MML-2000B | 196 |
| C540H4YG | 76, 77 | C746A1CG | 79 | C780H4KG | 82 | E250X42G | 62, 63 | X560H2YMG | 86 | MML-3000 | 196 |
| C540X31G | 76-78 | C746A1MG | 79 | C780H4KG | 82 | E260A11A | 62, 63 | X644A11A | 72 | MML-3000B | 196 |
| C540X31G | 76-78 | C746A1YG | 79 | C780H4MG | 82 | E260A11A | 62, 63 | X644A11A | 72 | MML-3025 | 196 |
| C540X31G | 76-78 | C746A4CG | 79 | C780H4MG | 82 | E260A11A | 62, 63 | X644A21A | 72 | MML-7000 | 197 |
| C540X32G | 76-78 | C746A4MG | 79 | C780H4YMG | 82 | E260A11A | 62, 63 | X644A21A | 72 | MML-8025 | 196 |
| C540X32G | 76-78 | C746A4YMG | 79 | C780H4YMG | 82 | E260A21A | 62, 63 | X644H01A | 72 | MML-8550 | 197 |
| C540X32G | 76-78 | C746H1KG | 79 | C782U1CG | 82, 83 | E260A21A | 62, 63 | X644H01A | 72 | MRL-0100 | 197 |
| C540X32G | 76-78 | C746H4KG | 79 | C782U1KG | 82 | E260A21A | 62, 63 | X644H11A | 72 | MRL-0600 | 197 |
| C540X33G | 76-78 | C748H1CG | 79 | C782U1MG | 82, 83 | E260A21A | 62, 63 | X644H11A | 72 | MRL-0625 | 197 |
| C540X33G | 76-78 | C748H1MG | 79 | C782U1YMG | 82, 83 | E260A41G | 62, 63 | X644H41G | 72 | MRL-1000 | 197 |
| C540X33G | 76-78 | C748H1YMG | 79 | C782U4CG | 83 | E260A41G | 62, 63 | X644H41G | 72 | MRL-1025 | 197 |
| C540X34G | 76-78 | C748H4CG | 79 | C782U4KG | 82 | E260A41G | 62, 63 | X644X11A | 72 | MRL-1400 | 197 |
| C540X34G | 76-78 | C748H4MG | 79 | C782U4MG | 83 | E260A41G | 62, 63 | X644X41G | 72 | MRL-2000 | 197 |
| C540X34G | 76-78 | C748H4YMG | 79 | C782U4YMG | 83 | E260X22G | 62, 63, 71 | X651A11A | 72 | MRL-3000 | 196 |
| C540X35G | 76-78 | C7700CH | 81 | C782X1CG | 82 | E260X22G | 62, 63, 71 | X651A11A | 72 | MRL-3025 | 196 |
| C540X35G | 76-78 | C7700CH | 81 | C782X1KG | 82 | E260X22G | 62, 63, 71 | X651A21A | 72 | MRL-8025 | 196 |
| C540X35G | 76-78 | C7700CS | 80, 81 | C782X1MG | 82 | E260X22G | 62, 63, 71 | X651A21A | 72 | MRL-8100 | 196 |
| C540X71G | 76-78 | C7700CS | 80, 81 | C782X1YMG | 82 | E260X22G | 62, 63, 71 | X651A41G | 72 | MRL-FF30 | 197 |
| C540X71G | 76-78 | C7700KH | 81 | C782X4CG | 82 | E260X22G | 62, 63, 71 | X651A41G | 72 | MRL-FF31 | 197 |
| C540X71G | 76-78 | C7700KH | 81 | C782X4KG | 82 | E260X42G | 62, 63 | X651H04A | 72 | MSL-0100 | 197 |
| C540X74G | 76-78 | C7700KS | 80, 81 | C782X4MG | 82 | E260X42G | 62, 63 | X651H04A | 72 | MSL-0200 | 197 |
| C540X74G | 76-78 | C7700KS | 80, 81 | C782X4YMG | 82 | E260X42G | 62, 63 | X651H11A | 72 | MSL-0600 | 197 |
| C540X74G | 76-78 | C7700MH | 81 | C792A1CG | 83 | E260X42G | 62, 63 | X651H11A | 72 | MSL-1000 | 197 |
| C540X75G | 76-78 | C7700MH | 81 | C792A1KG | 83 | E352H11A | 62 | X651H21A | 72 | MSL-1400 | 197 |
| C540X75G | 76-78 | C7700MS | 80, 81 | C792A1MG | 83 | E352H21A | 62 | X651H21A | 72 | MSL-2000 | 197 |
| C540X75G | 76-78 | C7700MS | 80, 81 | C792A1YMG | 83 | E352H41G | 62 | X651H41G | 72 | MSL-3000 | 197 |
| C544X1CG | 77, 78 | C7700YH | 81 | C792A4CG | 83 | E360H11A | 63 | X651H41G | 72 | MSL-3000B | 197 |
| C544X1CG | 77, 78 | C7700YH | 81 | C792A4KG | 83 | E360H11A | 63 | X654X04A | 73 | MSL-3025 | 197 |
| C544X1MG | 77, 78 | C7700YH | 80, 81 | C792A4MG | 83 | E360H11A | 63 | X654X11A | 72, 73 | MSL-7000 | 197 |
| C544X1MG | 77, 78 | C7700YH | 80, 81 | C792A4YMG | 83 | E360H21A | 63 | X654X21A | 72 | MSL-8100 | 197 |
| C544X1MG | 77, 78 | C7702CH | 81 | C792X1CG | 83 | E360H21A | 63 | X654X41G | 73 | MSL-FF29 | 197 |
| C544X1YMG | 77, 78 | C7702CH | 81 | C792X1KG | 83 | E360H21A | 63 | X746A1CG | 86 | MSL-FF30 | 197 |
| C544X1YMG | 77, 78 | C7702CS | 80, 81 | C792X1MG | 83 | E360H41G | 63 | X746A1MG | 86 | MSL-FF31 | 197 |
| C544X2CG | 77, 78 | C7702CS | 80, 81 | C792X1YMG | 83 | E360H41G | 63 | X746A1YMG | 86 | RL-FF30R | 197 |
| C544X2CG | 77, 78 | C7702KH | 80, 81 | C792X4CG | 83 | E360H41G | 63 | X746A4CG | 86 | | |
| C544X2KG | 77 | C7702KH | 80, 81 | C792X4KG | 83 | E450A11A | 63 | X746A4MG | 86 | | |
| C544X2MG | 77, 78 | C7702KS | 80, 81 | C792X4MG | 83 | E450H11A | 63 | X746A4YMG | 86 | | |
| C544X2MG | 77, 78 | C7702KS | 80, 81 | C792X4YMG | 83 | E450H21A | 63 | X746H1KG | 86 | | |
| C544X2YMG | 77, 78 | C7702MH | 81 | C792X77G | 83 | E450H41G | 63 | X746H4KG | 86 | | |
| C544X4YMG | 77, 78 | C7702MH | 81 | C9202CH | 84 | E460X11A | 63 | X748H1CG | 86 | | |
| C544X4YMG | 77, 78 | C7702MS | 80, 81 | C9202KH | 84 | E460X11A | 63 | X748H1MG | 86 | | |
| C544X4YMG | 77, 78 | C7702MS | 80, 81 | C9202MH | 84 | E460X41G | 63 | X748H1YMG | 86 | | |
| C544X4YMG | 77, 78 | C7702YH | 81 | C9202YH | 84 | E462U11A | 63 | X792X1CG | 83 | | |
| C544X4YMG | 77, 78 | C7702YH | 81 | C92035X | 84 | E462U41G | 63 | X792X1KG | 83 | | |
| C546U1KG | 78 | C7702YS | 80, 81 | C9206CH | 84 | GSA7405 | 62 | X792X1MG | 83 | | |
| C546U2KG | 78 | C7702YS | 80, 81 | C9206KH | 84 | GSA8302 | 61, 62 | X792X1YMG | 83 | | |
| C546U4KG | 78 | C7706CH | 81 | C9206MH | 84 | GSA8302 | 61, 62 | X792X4CG | 83 | | |
| C734A1CG | 78 | C7706CH | 81 | C9206YH | 84 | GSA8302 | 61, 62 | X792X4KG | 83 | | |
| C734A1CG | 78 | C7706KH | 81 | C925H2CG | 84 | T650A11A | 70 | X792X4MG | 83 | | |
| C734A1CG | 78 | C7706KH | 81 | C925H2KG | 84 | T650A11A | 70 | X792X4YMG | 83 | | |
| C734A1KG | 78 | C7706MH | 81 | C925H2MG | 84 | T650A21A | 70 | X850H21G | 73 | | |
| C734A1KG | 78 | C7706MH | 81 | C925H2YMG | 84 | T650A21A | 70 | X850H22G | 73 | | |
| C734A1KG | 78 | C7706YH | 81 | C925X72G | 84 | T650A21A | 70 | X860H21G | 73 | | |
| C734A1KG | 78 | C7706YH | 81 | C925X73G | 84 | T650A41G | 70 | X860H22G | 73 | | |
| C734A1MG | 78 | C7720CX | 81 | C925X74G | 84 | T650A41G | 70 | X925H2CG | 84 | | |
| C734A1MG | 78 | C7720KX | 81 | C925X75G | 84 | T650H04A | 70 | X925H2KG | 84 | | |
| C734A1YMG | 78 | C7720MX | 81 | C925X76G | 84 | T650H11A | 70 | X925H2MG | 84 | | |
| C734A1YMG | 78 | C7720YX | 81 | C930H2CG | 84 | T650H11A | 70 | X925H2YMG | 84 | | |
| C734A4CG | 78 | C780A1CG | 81, 82 | C930H2KG | 84 | T650H21A | 70 | X945X2CG | 87 | | |
| C734A4CG | 78 | C780A1CG | 81, 82 | C930H2MG | 84 | T650H21A | 70 | X945X2KG | 86 | | |
| C734A4KG | 78 | C780A1KG | 81, 82 | C930H2YMG | 84 | T650H41G | 70 | X945X2MG | 87 | | |
| C734A4KG | 78 | C780A1KG | 81, 82 | C930X72G | 84, 87 | T650H41G | 70 | X945X2YMG | 87 | | |
| C734A4MG | 78 | C780A1MG | 81, 82 | C930X72G | 84, 87 | T654X04A | 70 | X950X2CG | 87 | | |
| C734A4MG | 78 | C780A1MG | 81, 82 | C930X73G | 84, 87 | T654X11A | 70 | X950X2KG | 87 | | |
| C734A4YMG | 78 | C780A1YMG | 81, 82 | C930X73G | 84, 87 | T654X41G | 70 | X950X2MG | 87 | | |
| C734A4YMG | 78 | C780A1YMG | 81, 82 | C930X76G | 84, 87 | W84020H | 70 | X950X2YMG | 87 | | |
| C734X20G | 78, 79, 86 | C780A2CG | 81, 82 | C930X76G | 84, 87 | W84030H | 70 | | | | |
| C734X20G | 78, 79, 86 | C780A2CG | 81, 82 | C930X82G | 84, 87 | W850H21G | 71 | | | | |
| C734X20G | 78, 79, 86 | C780A2KG | 81, 82 | C930X82G | 84, 87 | W850H22G | 71 | | | | |
| C734X20G | 78, 79, 86 | C780A2MG | 81, 82 | C930X83G | 84, 87 | X203A11G | 71 | | | | |
| C734X24G | 78, 79, 86 | C780A2MG | 81, 82 | C930X83G | 84, 87 | X203A21G | 71 | | | | |
| C734X24G | 78, 79, 86 | C780A2YMG | 81, 82 | C950X2CG | 84 | X203H22G | 71 | | | | |
| C734X24G | 78, 79, 86 | C780A2YMG | 81, 82 | C950X2KG | 84 | X264A11G | 71 | | | | |
| C734X24G | 78, 79, 86 | C780A2YMG | 81, 82 | C950X2MG | 84 | X264A41G | 71 | | | | |
| C734X44G | 78, 79 | C780H1CG | 82 | C950X2YMG | 84 | X264H11G | 71 | | | | |
| C734X44G | 78, 79 | C780H1CG | 82 | C950X71G | 84, 87 | X340A11G | 71 | | | | |
| C734X44G | 78, 79 | C780H1YMG | 82 | | | | | | | | |
| C734X44G | 78, 79 | C780H1YMG | 82 | | | | | | | | |
| C734X44G | 78, 79 | C780H1YMG | 82 | | | | | | | | |

MAXELL MEDIA

| | |
|--------|-----|
| 183804 | 203 |
| 183850 | 203 |
| 183900 | 203 |
| 183906 | 203 |
| 186990 | 203 |
| 190133 | 203 |
| 200028 | 203 |
| 200200 | 203 |
| 229323 | 203 |
| 229558 | 203 |
| 638000 | 203 |
| 638011 | 203 |
| 638014 | 203 |
| 638022 | 203 |
| 648200 | 203 |
| 648201 | 203 |
| 648250 | 203 |
| 648720 | 203 |

MEDIA SCIENCES COMPATIBLES

| | |
|-------|-----|
| 40000 | 147 |
| 40001 | 147 |
| 40002 | 147 |
| 40003 | 147 |
| 40004 | 150 |
| 40035 | 150 |
| 40036 | 150 |
| 40037 | 150 |
| 40066 | 146 |
| 40067 | 146 |
| 40068 | 146 |
| 40069 | 146 |
| 40074 | 150 |
| 40075 | 150 |
| 40076 | 150 |
| 40077 | 150 |
| 40082 | 150 |
| 40083 | 150 |
| 40084 | 150 |

MACO MEDIA

| | |
|---------|-----|
| M42-451 | 197 |
| M86200 | 195 |
| M86201 | 195 |
| M86202 | 195 |

| | | | | | | | | | | | |
|------------|-----|-----------------|-----|--------------|-----|--------------|-----|-------------|----------|----------|----------|
| 40085 | 150 | MS5000M | 150 | 02-21-4516 | 154 | 02-21-352142 | 156 | 02-24-13162 | 157 | 45466501 | 243 |
| 40090 | 146 | MS5000Y | 150 | 02-21-4517 | 154 | 02-21-35314 | 156 | 02-24-1516 | 157 | 45466501 | 243 |
| 40091 | 146 | MS510C | 146 | 02-03-4616 | 151 | 02-21-353142 | 156 | 02-24-15162 | 152 | 45466601 | 243 |
| 40092 | 146 | MS510K | 146 | 02-21-5314 | 154 | 02-21-37114 | 155 | 02-24-35162 | 152, 157 | 45466601 | 243 |
| 40093 | 146 | MS510M | 146 | 02-21-5316 | 154 | 02-21-37214 | 155 | 02-24-35162 | 152, 157 | 45478901 | 240 |
| 40126 | 150 | MS510Y | 146 | 02-21-5514 | 154 | 02-21-37314 | 155 | 02-25-1816 | 157 | 45478901 | 240 |
| 40127 | 150 | MS511C-HC | 146 | 02-21-5516 | 154 | 02-21-38162 | 153 | 02-57-3616 | 157 | 45479001 | 241 |
| 40128 | 150 | MS511K-HC | 146 | 02-03-5716 | 151 | 02-21-38162 | 153 | 02-70-0616 | 152 | 45479001 | 241 |
| 40129 | 150 | MS511M-HC | 146 | 02-03-5816 | 151 | 02-21-38162 | 153 | 02-70-0916 | 152 | 45530101 | 240 |
| 40176 | 150 | MS511Y-HC | 146 | 02-21-6414 | 154 | 02-21-38162 | 153 | 02-70-2016 | 152 | 45530101 | 240 |
| 40177 | 150 | MS630C | 150 | 02-21-6415 | 154 | 02-21-39162 | 153 | 02-70-2214 | 152 | 45530702 | 242 |
| 40178 | 150 | MS630K | 150 | 02-21-6416 | 154 | 02-21-39162 | 153 | 02-70-2316 | 152 | 45530702 | 242 |
| 40179 | 150 | MS630M | 150 | 02-03-6516 | 151 | 02-21-39162 | 153 | 02-70-5316 | 152 | 45530802 | 242 |
| 41077 | 146 | MS630Y | 150 | 02-21-7014 | 155 | 02-21-40014 | 156 | 04-06-0714 | 151 | 45530802 | 242 |
| 41078 | 146 | MS636C-HC | 150 | 02-21-7014 | 155 | 02-21-40114 | 156 | 04-06-0814 | 151 | 45530902 | 242 |
| 41079 | 146 | MS636K-HC | 150 | 02-21-7114 | 155 | 02-21-40214 | 156 | 06-06-1014 | 152 | 45530902 | 242 |
| 41080 | 146 | MS636M-HC | 151 | 02-21-7214 | 155 | 02-21-40314 | 156 | 58-03-3514 | 151 | 45681801 | 241, 243 |
| 41081 | 151 | MS636Y-HC | 151 | 02-21-7314 | 155 | 02-21-41014 | 157 | 58-03-3614 | 151 | 45681801 | 241, 243 |
| 41082 | 151 | MSOK5855C-HC-NA | 150 | 02-03-7516 | 151 | 02-21-41016 | 157 | 58-03-4014 | 151 | 45681801 | 241, 243 |
| 41083 | 151 | MSOK5855K-HC-NA | 150 | 02-21-7814 | 154 | 02-21-41114 | 157 | 58-03-6216 | 151 | 45681801 | 241, 243 |
| 41084 | 151 | MSOK5855M-HC-NA | 150 | 02-21-8014 | 153 | 02-21-41214 | 157 | | | 58263102 | 240 |
| 41085 | 146 | MSOK5855Y-HC-NA | 150 | 02-21-8016 | 153 | 02-21-41314 | 157 | | | 58272501 | 242 |
| 41086 | 146 | MSOK96C-HCNA | 150 | 02-21-8017 | 153 | 02-21-42160 | 153 | | | 62427201 | 240 |
| 41087 | 146 | MSOK96K-HCNA | 150 | 02-21-8214 | 153 | 02-21-42160 | 153 | DK2550 | 87 | 62427204 | 240 |
| 41088 | 146 | MSOK96M-HCNA | 150 | 02-21-8314 | 153 | 02-21-42160 | 153 | DK40360 | 87 | 62427206 | 240 |
| 41093 | 151 | MSOK96Y-HCNA | 150 | 02-21-9014 | 154 | 02-21-43162 | 153 | PF155 | 87 | 62429901 | 240 |
| 41094 | 151 | MSX74C-HC | 151 | 02-21-9015 | 154 | 02-21-43514 | 154 | TS120 | 87 | 62429904 | 240 |
| 41095 | 151 | MSX74K-HC | 151 | 02-21-9214 | 152 | 02-21-43614 | 154 | TS2030 | 87 | 62430604 | 242 |
| 41096 | 151 | MSX74M-HC | 151 | 02-21-9614 | 152 | 02-21-436142 | 154 | TS40360 | 87 | 62430606 | 242 |
| 41116 | 147 | MSX74Y-HC | 151 | 02-21-9616 | 152 | 02-21-450014 | 156 | TS560 | 87 | 62430608 | 242 |
| 41117 | 147 | | | 02-21-9814 | 152 | 02-21-450016 | 156 | TS565 | 87 | 62431801 | 240 |
| 41118 | 147 | | | 02-21-9816 | 152 | 02-21-450114 | 156 | | | 62433301 | 241 |
| 41119 | 147 | | | 02-03-40016 | 151 | 02-21-450214 | 156 | | | 62433401 | 242 |
| 43744 | 147 | | | 02-03-40116 | 151 | 02-21-450314 | 156 | S2518 | 87 | 62433405 | 242 |
| 43749 | 147 | | | 02-03-40216 | 151 | 02-21-45162 | 154 | S3518 | 87 | 62433407 | 242 |
| MS3031C-HC | 146 | 04563 | 204 | 02-03-40316 | 151 | 02-21-47014 | 155 | | | 62433501 | 242 |
| MS3031K-HC | 146 | 04581 | 204 | 02-21-0314 | 152 | 02-21-47114 | 155 | | | 62433503 | 242 |
| MS3031M-HC | 146 | 05541 | 204 | 02-21-0514 | 154 | 02-21-47214 | 155 | | | 62433505 | 242 |
| MS3031Y-HC | 146 | 05562 | 204 | 02-21-05142 | 154 | 02-21-47314 | 155 | | | 62435504 | 240 |
| MS39825 | 147 | 05621 | 204 | 02-21-0516 | 154 | 02-21-50014 | 155 | | | 62435506 | 240 |
| MS39826 | 147 | 05639 | 204 | 02-21-05162 | 154 | 02-21-50114 | 155 | | | 62438601 | 241 |
| MS39827 | 147 | 05669 | 204 | 02-21-0914 | 152 | 02-21-50214 | 155 | | | 62438701 | 241 |
| MS39828 | 147 | 05732 | 204 | 02-21-0916 | 152 | 02-21-50314 | 155 | | | 62438703 | 241 |
| MS40912 | 147 | 98179 | 203 | 02-21-1014 | 152 | 02-21-51014 | 157 | | | 62438801 | 241 |
| MS40913 | 147 | 98180 | 203 | 02-21-1016 | 152 | 02-21-51016 | 157 | | | 62439001 | 241 |
| MS40914 | 147 | 98188 | 203 | 02-21-1114 | 152 | 02-21-510162 | 157 | | | 62439201 | 241 |
| MS40915 | 147 | 98515 | 203 | 02-21-1116 | 152 | 02-21-51114 | 157 | | | 62439401 | 243 |
| MS40920 | 147 | 98683 | 204 | 02-21-1162 | 152 | 02-21-51142 | 157 | | | 62439504 | 243 |
| MS40921 | 147 | 98860 | 203 | 02-21-1214 | 152 | 02-21-51214 | 157 | | | 62439507 | 243 |
| MS40922 | 147 | 99042 | 203 | 02-21-1216 | 152 | 02-21-512142 | 157 | | | 62439701 | 243 |
| MS40923 | 147 | 99043 | 203 | 02-21-1316 | 152 | 02-21-51314 | 157 | | | 62439901 | 242 |
| MS40928 | 147 | | | 02-21-13162 | 152 | 02-21-513142 | 157 | | | 62440001 | 242 |
| MS40929 | 147 | | | 02-21-1414 | 154 | 02-21-52014 | 156 | | | 62441001 | 242 |
| MS40930 | 147 | | | 02-21-1416 | 154 | 02-21-52114 | 156 | | | 62441004 | 242 |
| MS40931 | 147 | | | 02-21-1514 | 152 | 02-21-52214 | 156 | | | 62441604 | 241 |
| MS40966 | 147 | | | 02-21-1516 | 152 | 02-21-52314 | 156 | | | 62441704 | 241 |
| MS40966 | 147 | | | 02-21-15162 | 152 | 02-21-53014 | 155 | | | 62441707 | 241 |
| MS40967 | 147 | | | 02-21-1614 | 153 | 02-21-53114 | 155 | | | 62441710 | 241 |
| MS40968 | 147 | | | 02-21-17014 | 156 | 02-21-53162 | 154 | | | 62441804 | 242 |
| MS40969 | 147 | | | 02-21-17114 | 156 | 02-21-53214 | 155 | | | 62441904 | 243 |
| MS40970 | 147 | | | 02-21-17214 | 156 | 02-21-53314 | 155 | | | 62442001 | 240 |
| MS40971 | 147 | | | 02-21-17314 | 156 | 02-21-540016 | 156 | | | 62442101 | 240 |
| MS40972 | 147 | | | 02-21-20014 | 155 | 02-21-540114 | 156 | | | 62443601 | 241 |
| MS43709 | 147 | | | 02-21-20114 | 155 | 02-21-54014 | 155 | | | 62443701 | 241 |
| MS43710 | 147 | | | 02-21-20214 | 155 | 02-21-540214 | 156 | | | 70050901 | 242 |
| MS43711 | 147 | | | 02-21-20314 | 155 | 02-21-540314 | 156 | | | 70053801 | 240 |
| MS43712 | 147 | | | 02-21-21014 | 156 | 02-21-54114 | 155 | | | 70054001 | 240 |
| MS43713 | 147 | | | 02-21-21016 | 156 | 02-21-54214 | 155 | | | 70062701 | 240 |
| MS43714 | 147 | | | 02-21-21114 | 156 | 02-21-54314 | 155 | | | 91642903 | 240 |
| MS43715 | 147 | | | 02-21-21214 | 156 | 02-21-55014 | 156 | | | 91659801 | 240 |
| MS43716 | 147 | | | 02-21-21314 | 156 | 02-21-55114 | 156 | | | 91659803 | 240 |
| MS43736 | 147 | | | 02-21-25014 | 154 | 02-21-55214 | 156 | | | 91659901 | 240 |
| MS43747 | 147 | | | 02-21-25114 | 154 | 02-21-55314 | 156 | | | 91659903 | 240 |
| MS43752 | 147 | | | 02-21-25214 | 154 | 02-21-61162 | 153 | | | | |
| MS44641 | 146 | | | 02-21-25314 | 154 | 02-21-61163 | 153 | | | | |
| MS44642 | 146 | | | 02-21-26014 | 154 | 02-21-64142 | 154 | | | | |
| MS44643 | 146 | | | 02-21-26114 | 155 | 02-21-64162 | 154 | | | | |
| MS44644 | 146 | | | 02-21-26214 | 155 | 02-21-70014 | 155 | | | | |
| MS44645 | 146 | | | 02-21-26314 | 155 | 02-21-70014 | 155 | | | | |
| MS44646 | 146 | | | 02-21-27162 | 153 | 02-21-70114 | 155 | | | | |
| MS44647 | 146 | | | 02-21-31014 | 156 | 02-21-70214 | 155 | | | | |
| MS44648 | 146 | | | 02-21-31114 | 156 | 02-21-70314 | 155 | | | | |
| MS44649 | 150 | | | 02-21-31214 | 156 | 02-21-80114 | 155 | | | | |
| MS44650 | 150 | | | 02-21-31314 | 156 | 02-21-80162 | 153 | | | | |
| MS44651 | 150 | | | 02-21-34514 | 153 | 02-21-80214 | 155 | | | | |
| MS44652 | 150 | | | 02-21-35014 | 156 | 02-21-80314 | 155 | | | | |
| MS44653 | 150 | | | 02-21-35016 | 156 | 02-21-81014 | 156 | | | | |
| MS44654 | 150 | | | 02-21-350162 | 156 | 02-21-81114 | 156 | | | | |
| MS44655 | 150 | | | 02-21-35114 | 156 | 02-21-81214 | 156 | | | | |
| MS44656 | 150 | | | 02-21-351142 | 156 | 02-21-81314 | 156 | | | | |
| MS5000C | 150 | | | 02-21-35162 | 154 | 02-21-90142 | 154 | | | | |
| MS5000K | 150 | | | 02-21-35214 | 156 | 02-24-1316 | 157 | | | | |

| | | | | | | | | | | | |
|-----------|----------|-----------|----------|-----------|---------------|----------------|----------|--------------|----------|--------------|----------|
| 106R01436 | 115 | 108R00579 | 115, 116 | 109R00746 | 111 | 500-75P6961 | 169, 174 | 500-CE390AM | 171 | 500-Q5942XUJ | 170, 171 |
| 106R01437 | 115 | 108R00580 | 115, 116 | 109R00747 | 111 | 500-75P6963 | 174 | 500-CE390X | 171 | 500-Q5942XUJ | 170, 171 |
| 106R01438 | 115 | 108R00581 | 115 | 109R00783 | 116, 117 | 500-81551-001 | 171 | 500-CE390XJ | 171 | 500-Q5942XUJ | 170, 171 |
| 106R01439 | 115 | 108R00582 | 115 | 109R00783 | 116, 117 | 500-8489A001AA | 169 | 500-CE390XM | 171 | 500-Q5945A | 171 |
| 106R01452 | 113 | 108R00591 | 113 | 109R00783 | 116, 117 | 500-92298A | 169 | 500-CE400A | 174 | 500-Q5949A | 170 |
| 106R01453 | 113 | 108R00592 | 113 | 109R00783 | 116, 117 | 500-92298M | 169 | 500-CE400X | 174 | 500-Q5949J | 170 |
| 106R01454 | 113 | 108R00600 | 112 | 109R00784 | 116, 117 | 500-92298X | 169 | 500-CE401A | 174 | 500-Q5949M | 170 |
| 106R01455 | 113 | 108R00603 | 116 | 109R00784 | 116, 117 | 500-C3903A | 169 | 500-CE402A | 174 | 500-Q5949X | 170 |
| 106R01477 | 113 | 108R00604 | 116 | 109R00784 | 116, 117 | 500-C3906A | 169 | 500-CE403A | 174 | 500-Q5950A | 173 |
| 106R01478 | 113 | 108R00605 | 116 | 109R00784 | 116, 117 | 500-C3909A | 169 | 500-CE410A | 174 | 500-Q5951A | 173 |
| 106R01479 | 113 | 108R00606 | 116 | 113R00195 | 118 | 500-C3909X | 169 | 500-CE410X | 174 | 500-Q5952A | 173 |
| 106R01480 | 113 | 108R00607 | 116 | 113R00457 | 121 | 500-C4092A | 170 | 500-CE411A | 174 | 500-Q5953A | 173 |
| 106R01485 | 118 | 108R00608 | 116 | 113R00459 | 118 | 500-C4096A | 170 | 500-CE412A | 174 | 500-Q6000A | 172 |
| 106R01486 | 118 | 108R00645 | 114 | 113R00628 | 112 | 500-C4096J | 170 | 500-CE413A | 174 | 500-Q6001A | 172 |
| 106R01503 | 114 | 108R00645 | 114 | 113R00634 | 121 | 500-C4127J | 170 | 500-CE505A | 172 | 500-Q6002A | 172 |
| 106R01504 | 114 | 108R00645 | 114 | 113R00655 | 118 | 500-C4127M | 170 | 500-CE505AJ | 172 | 500-Q6003A | 172 |
| 106R01505 | 114 | 108R00646 | 114 | 113R00656 | 112 | 500-C4127X | 170 | 500-CE505AM | 172 | 500-Q6460A | 173 |
| 106R01506 | 114 | 108R00646 | 114 | 113R00657 | 112 | 500-C4129X | 171 | 500-CE505X | 172 | 500-Q6461A | 173 |
| 106R01507 | 114 | 108R00646 | 114 | 113R00663 | 118, 120, 121 | 500-C4182M | 171 | 500-CE505XJ | 172 | 500-Q6462A | 173 |
| 106R01508 | 114 | 108R00647 | 115 | 113R00663 | 118, 120, 121 | 500-C4182X | 171 | 500-CE505XM | 172 | 500-Q6463A | 173 |
| 106R01509 | 114 | 108R00648 | 115 | 113R00663 | 118, 120, 121 | 500-C7115J | 170 | 500-CE740A | 173 | 500-Q6470A | 172 |
| 106R01510 | 114 | 108R00649 | 115 | 113R00667 | 121 | 500-C7115M | 170 | 500-CE741A | 173 | 500-Q6470A | 172 |
| 106R01528 | 118 | 108R00650 | 115 | 113R00668 | 112 | 500-C7115X | 170 | 500-CE742A | 173 | 500-Q6471A | 172 |
| 106R01530 | 118 | 108R00660 | 120 | 113R00670 | 112 | 500-C8061M | 170 | 500-CE743A | 173 | 500-Q6472A | 172 |
| 106R01533 | 112 | 108R00661 | 120 | 113R00670 | 112 | 500-C8061X | 170 | 500-CF210A | 174 | 500-Q6473A | 172 |
| 106R01535 | 112 | 108R00662 | 120 | 113R00671 | 117, 119, 120 | 500-C8061XX | 170 | 500-CF210X | 174 | 500-Q6511X | 170 |
| 106R01563 | 116 | 108R00663 | 120 | 113R00671 | 117, 119, 120 | 500-C8543J | 171 | 500-CF211A | 174 | 500-Q7516AU | 171 |
| 106R01564 | 116 | 108R00664 | 120 | 113R00671 | 117, 119, 120 | 500-C8543M | 171 | 500-CF212A | 174 | 500-Q7551A | 172 |
| 106R01565 | 116 | 108R00668 | 116 | 113R00692 | 112 | 500-C8543X | 171 | 500-CF213A | 174 | 500-Q7551M | 172 |
| 106R01566 | 116 | 108R00669 | 116 | 113R00693 | 112 | 500-C9700A | 172 | 500-CF214A | 171 | 500-Q7551X | 172 |
| 106R01567 | 116 | 108R00670 | 116 | 113R00694 | 113 | 500-C9701A | 172 | 500-CF214X | 171 | 500-Q7551XX | 172 |
| 106R01568 | 116 | 108R00671 | 116 | 113R00695 | 112 | 500-C9702A | 172 | 500-CF280A | 171 | 500-Q7553A | 171 |
| 106R01569 | 116 | 108R00672 | 116 | 113R00711 | 112 | 500-C9703A | 172 | 500-CF280X | 171 | 500-Q7553J | 171 |
| 106R01582 | 116 | 108R00675 | 116 | 113R00712 | 112 | 500-C9720A | 172 | 500-CF280XX | 171 | 500-Q7553M | 171 |
| 106R01591 | 114 | 108R00675 | 116 | 113R00719 | 113 | 500-C9721A | 172 | 500-CF283A | 171 | 500-Q7553X | 171 |
| 106R01592 | 114 | 108R00676 | 116 | 113R00720 | 113 | 500-C9722A | 172 | 500-CF325X | 171 | 500-Q7581A | 172 |
| 106R01593 | 114 | 108R00676 | 116 | 113R00721 | 113 | 500-C9723A | 172 | 500-CF350A | 174 | 500-Q7582A | 172 |
| 106R01594 | 114 | 108R00691 | 113 | 113R00722 | 113 | 500-C9730A | 173 | 500-CF351A | 174 | 500-Q7583A | 172 |
| 106R01595 | 114 | 108R00697 | 115 | 113R00723 | 113 | 500-C9731A | 173 | 500-CF352A | 174 | 500-ST9530 | 174 |
| 106R01596 | 114 | 108R00713 | 116 | 113R00724 | 113 | 500-C9732A | 173 | 500-CF353A | 174 | 500-TN115B | 169 |
| 106R01597 | 114 | 108R00717 | 112 | 113R00725 | 113 | 500-C9733A | 173 | 500-CRG128 | 169 | 500-TN115C | 169 |
| 106R01627 | 112 | 108R00723 | 116 | 113R00726 | 113 | 500-CB400A | 173 | 500-D105L | 174 | 500-TN115M | 169 |
| 106R01628 | 112 | 108R00724 | 116 | 113R00730 | 111 | 500-CB401A | 173 | 500-D1100 | 169 | 500-TN115Y | 169 |
| 106R01629 | 112 | 108R00725 | 116 | 113R00736 | 116 | 500-CB402A | 173 | 500-D1500U | 169 | 500-TN350 | 168 |
| 106R01630 | 112 | 108R00726 | 116 | 113R00755 | 119 | 500-CB403A | 173 | 500-D1700U | 169 | 500-TN360 | 168 |
| 106R02180 | 111 | 108R00727 | 116 | 113R00762 | 112 | 500-CB435A | 172 | 500-D1720 | 169 | 500-TN450 | 168 |
| 106R02225 | 114 | 108R00746 | 116 | 113R00769 | 112 | 500-CB435J | 172 | 500-D1720J | 169 | 500-TN460 | 168 |
| 106R02226 | 114 | 108R00747 | 116 | 113R00770 | 119 | 500-CB436A | 171 | 500-D1815 | 169 | 500-TN540 | 168 |
| 106R02227 | 114 | 108R00748 | 116 | 113R00773 | 112 | 500-CB436J | 171 | 500-D2330 | 169 | 500-TN550 | 168 |
| 106R02228 | 114 | 108R00749 | 116 | 113R00776 | 119 | 500-CB540A | 173 | 500-D2335 | 169 | 500-TN570 | 168 |
| 106R02241 | 114 | 108R00774 | 119 | 115R00025 | 115 | 500-CB541A | 173 | 500-D2355 | 169 | 500-TN580 | 168 |
| 106R02242 | 114 | 108R00775 | 119 | 115R00029 | 113 | 500-CB542A | 173 | 500-D2500U | 169 | 500-TN620 | 169 |
| 106R02243 | 114 | 108R00776 | 119 | 115R00035 | 114 | 500-CB543A | 173 | 500-D3330HY | 169 | 500-TN650 | 169 |
| 106R02244 | 114 | 108R00777 | 119 | 115R00035 | 114 | 500-CC364A | 172 | 500-D5330 | 169 | 500-TN750 | 169 |
| 106R02305 | 111 | 108R00793 | 112 | 115R00037 | 115 | 500-CC364AJ | 172 | 500-DR350 | 168 | | |
| 106R02307 | 111 | 108R00795 | 112 | 115R00049 | 116 | 500-CC364M | 172 | 500-DR360 | 168 | | |
| 106R02309 | 118 | 108R00861 | 115 | 115R00055 | 114 | 500-CC364X | 172 | 500-DR400 | 168 | | |
| 106R02311 | 118 | 108R00865 | 115 | 115R00059 | 119 | 500-CC364XJ | 172 | 500-DR510 | 168 | | |
| 106R02313 | 118 | 108R00926 | 116 | 115R00061 | 115 | 500-CC364XM | 172 | 500-DR520 | 168 | | |
| 106R02599 | 115 | 108R00927 | 116 | 115R00063 | 119 | 500-CC530A | 173 | 500-DR620 | 169 | | |
| 106R02600 | 115 | 108R00928 | 116 | 115R00069 | 112 | 500-CC531A | 173 | 500-FX10 | 169 | | |
| 106R02601 | 115 | 108R00929 | 116 | 115R00073 | 116 | 500-CC532A | 173 | 500-FX3 | 169 | | |
| 106R02602 | 115 | 108R00930 | 116 | 115R00084 | 112 | 500-CC533A | 173 | 500-FX4 | 169 | | |
| 106R02603 | 115 | 108R00950 | 117 | 115R00086 | 119 | 500-CE250A | 173 | 500-FX6 | 169 | | |
| 106R02604 | 115 | 108R00951 | 117 | 115R00088 | 119 | 500-CE250X | 173 | 500-FX7 | 169 | | |
| 106R02605 | 115 | 108R00952 | 117 | 126K32220 | 115 | 500-CE251A | 173 | 500-FX8 | 169 | | |
| 106R02624 | 115 | 108R00953 | 117 | 604K64582 | 114 | 500-CE252A | 173 | 500-ML1710D3 | 174 | | |
| 106R02638 | 112 | 108R00971 | 114 | 604K73140 | 115 | 500-CE253A | 173 | 500-Q1338A | 170 | | |
| 106R02639 | 112 | 108R00972 | 114 | 675K47089 | 113 | 500-CE255A | 171 | 500-Q1338M | 170 | | |
| 106R02650 | 119 | 108R00973 | 114 | 675K65655 | 113 | 500-CE255X | 171 | 500-Q1339A | 170 | | |
| 106R02720 | 112 | 108R00974 | 114 | 675K65655 | 113 | 500-CE255XM | 171 | 500-Q2610A | 170 | | |
| 106R02722 | 112 | 108R00975 | 115 | 675K70596 | 113 | 500-CE260A | 173 | 500-Q2610J | 170 | | |
| 106R02731 | 112 | 108R00982 | 116 | 675K92002 | 113 | 500-CE260X | 173 | 500-Q2610M | 170 | | |
| 106R02734 | 119 | 108R00990 | 117 | 676K05360 | 113, 114 | 500-CE261A | 173 | 500-Q2612A | 170 | | |
| 106R02736 | 118 | 108R00991 | 117 | 676K05360 | 113, 114 | 500-CE262A | 173 | 500-Q2612J | 170 | | |
| 106R02738 | 118 | 108R00992 | 117 | 676K05360 | 113, 114 | 500-CE263A | 173 | 500-Q2613A | 170 | | |
| 106R02740 | 118 | 108R00993 | 117 | 676K05360 | 113, 114 | 500-CE270A | 174 | 500-Q2613J | 170 | | |
| 106R02744 | 119 | 108R00994 | 117 | 676K05360 | 113, 114 | 500-CE271A | 174 | 500-Q2613X | 170 | | |
| 106R02745 | 119 | 108R01014 | 117 | | | 500-CE272A | 174 | 500-Q2624J | 170 | | |
| 106R02746 | 119 | 108R01015 | 117 | | | 500-CE273A | 174 | 500-Q2624X | 170 | | |
| 106R02747 | 119 | 108R01016 | 117 | | | 500-CE278A | 171 | 500-Q2670A | 172 | | |
| 106R02775 | 111 | 108R01017 | 117 | | | 500-CE285A | 171 | 500-Q2670A | 172 | | |
| 106R02777 | 111 | 108R01036 | 116 | | | 500-CE310A | 173 | 500-Q2671A | 172 | | |
| 106R03102 | 119 | 108R01053 | 116 | | | 500-CE311A | 173 | 500-Q2672A | 172 | | |
| 106R03104 | 119 | 108R01121 | 114 | | | 500-CE312A | 173 | 500-Q2673A | 172 | | |
| 108R00493 | 117 | 108R01124 | 114 | | | 500-CE313A | 173 | 500-Q2681A | 172 | | |
| 108R00497 | 112 | 108R01148 | 115 | | | 500-CE320A | 173 | 500-Q2682A | 172 | | |
| 108R00535 | 119, 121 | 108R01266 | 119 | | | 500-CE321A | 173 | 500-Q2683A | 172 | | |
| 108R00535 | 119, 121 | 108R01267 | 119 | | | 500-CE322A | 173 | 500-Q5942A | 170 | | |
| 108R00575 | 115, 116 | 109R00048 | 118 | | | 500-CE323A | 173 | 500-Q5942M | 170 | | |
| 108R00575 | 115, 116 | 109R00731 | 112 | | | 500-CE390A | 171 | 500-Q5942X | 170 | | |
| 108R00579 | 115, 116 | 109R00731 | 112 | | | 500-CE390AJ | 171 | 500-Q5942XUJ | 170, 171 | | |
| | | | | | | 500-75P6961 | 169, 174 | | | | |

500 SERIES COMPATIBLES

| | |
|----------------|-----|
| 500-0264B001AA | 169 |
| 500-106R01371 | 174 |
| 500 | |