

Installation Manual

(UK)

ISDN Telephone Systems

tiptel.com 410 **tiptel.com 810**

tiptel.com 411 **tiptel.com 811**

tiptel.comPact 42 IP 8

tiptel.comPact 82 IP 8



tiptel

Table of contents

Table of contents	3
Introduction	9
Safety notes	10
Notes	11
Product package	11
Environmental compatibility	12
Functioning in the event of power failure	12
Setting of country	12
Interfaces	13
ISDN-ports (S ₀)	14
Analogue ports (a/b)	14
Analogue FXO ports	14
Network connection	14
Terminals	15
Analogue telephones	15
ISDN- and TIPTTEL-system telephones	15
First start-up	16
Connecting the telephone system	17
Removing the cabinet cover	17
Connecting the telephone system to an analogue exchange office	18
Connecting the telephone system to an ISDN (NTBA) connection	19
Connection of ISDN or system telephones.....	19
Connecting several ISDN telephones by using an ISDN switch.....	21
Connecting several ISDN telephones by using an S ₀ bus	22
Connection of ISDN telephones by using network cable	23
Changing S ₀ port settings	24
Connecting analogue terminal devices	25
Connection via TAE or western jacks directly at the telephone system	25
Connection by using installation cable	26
Connection by using network installation cable	27
Connection of IP telephones.....	28
Connecting the telephone system to the network.....	28
Connection your telephone system to mains	29
Testing the connection.....	29
Configuration access	31
Identification of the IP address.....	31

Changing the IP address at a telephone	32
Direct connection to a computer.....	33
Web configuration access.....	33
Trouble shooting	34
Necessary settings in your web browser (all operating systems)	34
Network settings in Windows 7	35
Network settings in Windows XP	37
The configuration wizard.....	39
Country setting	40
Configure the external connection	41
Fax switch at an analogue exchange office line	42
External telephone numbers an call distribution for the S ₀ ports	43
External telephone numbers an call distribution for the analogue exchange office ports	44
Assigning the telephone number for outgoing calls.....	45
End.....	45
Main Configuration Interface	46
General	46
Menu Settings	48
Settings.....	48
Speed dialling.....	51
Service.....	51
Phonebook	52
Service.....	52
Call filter	53
Applications.....	55
Dialling control.....	56
Emergency numbers.....	57
Call data.....	57
Call analysis software	58
Day/night switching	58
Settings	59
Timecontrol	60
Public holidays.....	60
LCR	60
Settings	60
Provider	61
Zone	61
Timecontrol	61
Public holidays.....	61
Configuration examples.....	62

Expert mode	63
Date / time	63
Service.....	63
Voicemail	65
SIP	65
Menu: Ports.....	67
ISDN.....	67
Settings	67
Entry of MSN/DDI.....	68
Call forwarding external	69
Analogue (FXOs)	69
Settings	70
Entry of Phone Number	70
Analogue (FXS)	70
Settings	70
VoIP (SIP)	71
Subscriber list	71
Set-up SIP Account.....	72
Entry of phone number	74
Set-up SIP Provider.....	74
Settings	75
Menu: Subscriber	76
General	76
Groups	76
Day/night Switching	77
Group	77
Select group member	78
Allocation for incoming external calls.....	78
Call distribution.....	79
Subscriber – Sub-menu: Administrator.....	79
Copying a subscriber.....	79
Modifying a subscriber	80
Subscriber	80
Authorisations	80
Extensions allocated to subscriber.....	81
Allocation for incoming external calls.....	82
Allocation for outgoing external calls	82
External PABX dial in (call through / call back)	82
Subscriber	83
Settings	83
Call forwarding.....	85

Charge account	85
System telephone.....	85
Assignment of the functional keys.....	87
Remote dial-in.....	92
Voice box	92
Activate voice box for an user.....	92
Settings voice box.....	93
Uploading OGMs	93
Settings Remote control	94
Message transfer.....	96
Set-up service.....	97
Remote configuration.....	97
External dial-in.....	98
SMS.....	98
Call Manager	99
Automatic switchboard	99
Greeting and transfer	101
Information system.....	102
Menu: Network.....	105
Status.....	105
Settings.....	105
LAN.....	105
IP-settings.....	106
Name server addresses (DNS)	106
DHCP.....	106
STUN-server, WAN	107
Setting the type of WAN interface.....	107
General settings	108
Reset the telephone system.....	108
Troubleshooting	109
Status-LEDs	109
Description of possible malfunctions.....	110
An analogue terminal cannot be called.....	110
Analogue terminal with no dial tone	110
An ISDN terminal cannot be called.....	110
ISDN terminal cannot conduct external calls	110
No incoming external calls possible.....	110
Tips and tricks	112
Function call-through / call-back.....	112
Groups.....	113

Different companies - one telephone system	114
Greeting and answering machine	114
Technical notes for analogue FXO lines	116
Function call-back/call-through	116
AS and IS	116
Three party conference	116
Forwarding	117
Busy internal target	117
Single person operation	117
ACD via an FXO	117
ACD group + call management	117
Answering machine	117
Busy signal detection with AS, GT, and IS	117
Function "reject waiting party"	118
Sending one's own number (CLIP)	118
Pick-up of an external line	118
Assignment for outgoing external calls	118
Technical notes when using a VoIP module	119
Acknowledge signal	119
Outgoing telephone number	119
Music on Hold rehearsal	119
Special functions using * and #	119
Three party conference	119
Switching	120
Display of IP address and subnet mask	120
Call-through and call-back	120
Telephone system with internet access	120
Technical Specifications	121
Appendix	122
General command summary	122
Function codes for analogue terminals	125
During the call	125
Flow chart outgoing calls	126
Flow chart outgoing number transfer	126
Flow diagrams for call manager	129
Automatic switchboard	129
Greeting and transfer	130
Information system	131
Explanation of terms	132
Service	136

Table of contents

Guarantee	136
CE sign	137
Ecological information.....	137
Notes on care	138
Index.....	139

Introduction

Congratulations on your purchase of this ISDN telephone system - a future-proof solution,

- Already prepared for Voice-over-IP (VoIP), (*)
- Permits modern telephone calls to be made with the high performance telephone system,
- An optional (*) Voicemail- and Callmanagement-Module not only provides you with an individual answering machine for each subscriber. It also serves as a professional call management system,
- Can be upgraded by two additional FXO-ports with an optional FXO-Module (*)
- Can be integrated in existing network environments which allows you
- Configuration on end user level. Each subscriber is able to access and configure basic features via his/her PC, e.g. call forwarding, or playback of recorded messages.
- Computer Telephony Integration (CTI) via TSPI(TAPI)-driver provided with your telephone system (for Windows operating systems)

(*) Note: Included in tiptel.comPact 42/82 IP 8

Safety notes

The device may not be installed or operated in the following environments:

- in the open
 - in damp or wet rooms (bathroom, shower, swimming pool ...)
 - at locations with direct sunlight
 - in explosive areas
 - with ambient temperatures below 0 °C or above 40 °C
 - with strong concussions or vibrations
 - in dusty environment
- The device has been designed for wall mounting, the device must not be covered and must have a distance of at least 10 cm to any other objects (this of course does not apply to the module)
 - During a thunderstorm you should neither use the phone nor connect or disconnect any cables (Danger of an electric shock when a lightning hits the telephone network).
 - Unauthorized removal of the telephone system's cover or inappropriate repairs may result in hazard for the user.
 - When disposing of the device all applicable national laws and regulations must be obeyed.
 - In case of a power outage emergency calls cannot be made without a UPS. For exceptions to this rule please see the User's Manual of your device. Dial locks may block emergency calls.
 - Install all connection cables with care so that no tripping hazards result from the installation. Connection cables may not be bent excessively, pulled, or stressed mechanically. Connection cables may only be installed inside of buildings.
 - ISDN connections, data and audio ports are SELV circuits and may only be connected to circuits which are also SELV themselves.
 - With any malfunction the power cord must be removed from the wall outlet and all telecommunication cables must be disconnected.
 - FXO lines (external analogue lines) may not be connected to the public telephone network in the following countries: Finland, Norway, and Sweden.
 - External analogue lines may only be connected to TNV circuits with a maximum source voltage of 60 V.
 - Installations must be carried out by persons having the appropriate technical training and experience necessary to be aware of the hazards to which they are exposed in performing a task and of measures to minimise the danger to themselves or other persons.
 - Applicable regulations in accordance with IEC60950 and IEC60364 have to be observed.
 - Equipment with connection to AC supply circuits may lead to an accumulation of contact currents at the telephone system. The service personnel must make sure that the touch current (leakage current) at no time will exceed 3.5 mA.
 - Devices with protective earth plugs (safety plugs) may only be connected to wall outlets with protective earth contact.
 - Before opening the cabinet the system must be disconnected from mains (remove power cord) and from any telecommunication cables
 - Power supplies may only be used if approved by the manufacturer

Notes

We reserve the right to make changes to this User's Manual or the hardware described at any time and without prior notice. The current version of the User's Manual is also available as a pdf file on the Internet at www.tiptel.com. The texts and illustrations of this user's manual have been compiled with the utmost care. However, errors cannot be ruled out completely. The publisher cannot be held liable for any incorrect information or consequences arising as a result.

Important: This manual reflects the telephone system, release 7.xx. If necessary, perform an update.

© 2010 Tiptel.com GmbH Ratingen. All rights reserved

Product package

Please check that you have received everything before starting installation. The delivery includes:

- 1 tiptel.com 410, 810, 411, 811, tiptel.comPact 42/82 IP 8, tiptel 41/42 Home telephone system + AC adapter
- 1 ISDN connector cable
- 1 LAN connector cable for connection to a computer
- 1 Quick start guide
- 1 accessories kit with mounting material (2 wood screws, 2 raw plugs)
- 1 User's Manual
- 1 CD with manuals, Call Charges Analysis Software MicroBX, CTI-Software „Estos ProCall“, TAPI-drivers

For CTI-enabled applications you can download the current TSPI drivers for the relevant telephone system from the download area at www.tiptel.com. These drivers enable you to implement all TAPI-enabled CTI applications via the network for computer-supported telephone calls (3rd party CTI).

Tiptel.com GmbH and ESTOS GmbH have certified their telephone systems and the „Estos ProCall“ CTI application (www.estos.de). You may continue using the time-limited full version on the attached CD if you buy a licence key. A new installation is not necessary.

A full version of the „tiptel MicroBX“ charge analysis software can be downloaded for the relevant telephone system from the download area at www.tiptel.com. Same as the version on the attached CD it is fully functional for a period of 6 weeks. When the trial-period has expired graphic charts are no longer available. After purchasing a licence key you can continue using the unlimited full version „MicroBX“ (graphic charts inclusive) or upgrade to a hotel version (with check-in, check-out, unlocking guest room phones and - if applicable - a hotel booking software). A new installation is not necessary. For details please refer to the User's Manual contained in the download for further information.

Environmental compatibility

No contact with substances harmful to human health can occur if the system is used properly. The synthetic materials used in this device consist of partially recycled granulate. Our packaging does not contain any synthetic materials. Only cardboard and paper from partially recycled material is used.

Functioning in the event of power failure

If you want to guarantee that your telephone system is also available in the event of a power failure, an uninterruptible power supply (UPS) is available as an optional accessory. This ensures that the system will continue to function for several hours in the event of a power failure.

Setting of country

This telephone system can be used in most European countries. To use all the features the system must be set to the country in which you want to use it. This is done either through the Configuration Wizard or in the main configuration at the point Administrator -> Settings -> Settings -> Setting of country.

Interfaces

The system provides interfaces as follows:

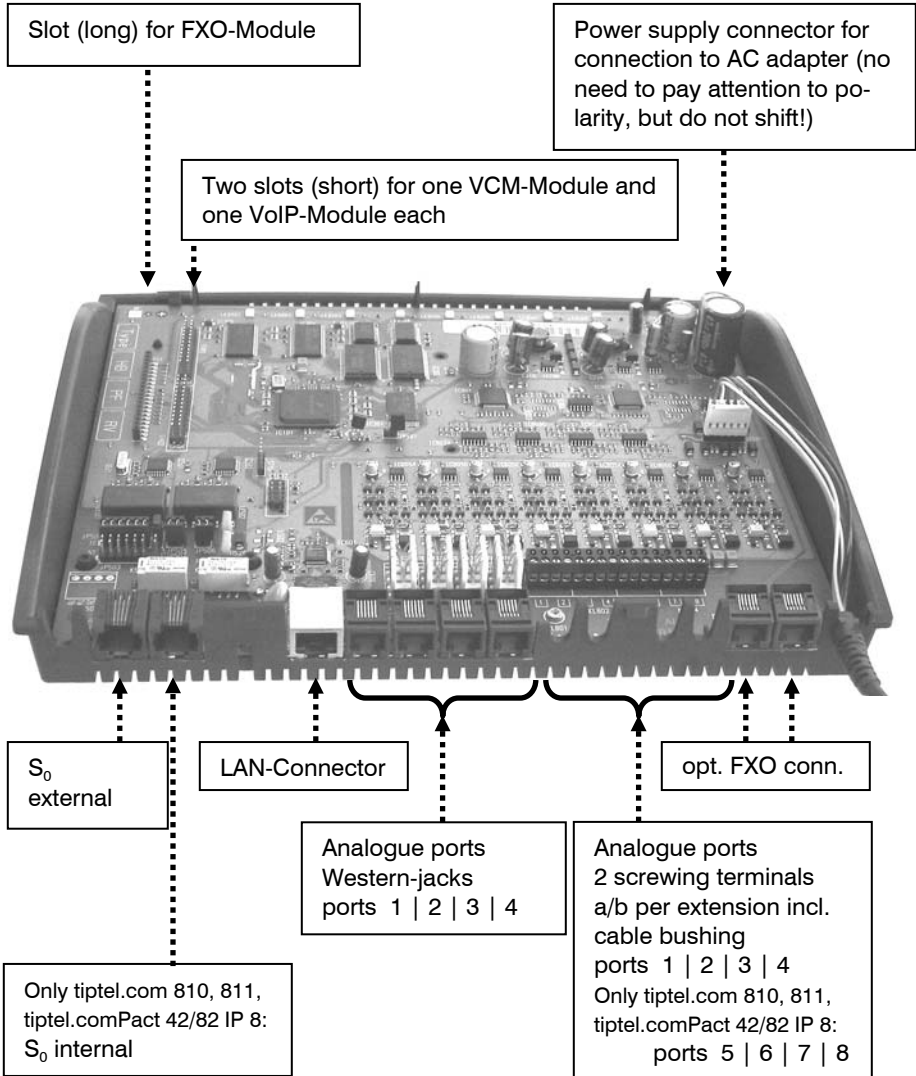

ISDN-ports (S₀)

- **S₀ external:**
Connection to a point-to-point or multipoint interface according to Euro ISDN (DSS1)
- **S₀ internal (not included in tiptel.com 410, tiptel.com 810 and tiptel 41 Home):**
Connection to multipoint interface for ISDN devices according to Euro ISDN (DSS1)

Analogue ports (a/b)

The system provides Western-jacks for the first 4 analogue extension ports. In order to be able to use the screwing terminals the cover has to be removed. For details please see chapter „Installation“. Ports 5 through 8 are only available as screwing terminals.

You can connect analogue telephones, cordless telephones, answering machines, and fax machines with the first 4 ports via western jacks or screwing terminals. TIPTEL strongly recommends not to use more than one terminal at the same port. Those terminals would comprise a parallel circuit which makes it impossible to call them individually. Also malfunctions might occur (terminals do not ring anymore, caller's numbers are not displayed, low volume). Please use a separate port for each terminal.

Analogue FXO ports

This telephone system is ready for installation of an optional FXO-Module. Close to the cable bushing for the power cord there are two extra western jacks. With no FXO-Module installed, these jacks are not operable.

Network connection

The telephone system comprises one 10/100 Ethernet connector. Connection is established via a standard Ethernet cable (CAT 5). Cross-over will be detected automatically and switched accordingly.

Terminals

It is possible to connect analogue telephones, answering machines, fax machines and PCs to the tiptel.com telephone system family. tiptel.com 411, 811, tiptel.comPact 42/82 IP 8 and tiptel 42 Home also support ISDN telephones and TIPTEL system telephones. The range of operation and use of features depend on the terminal used. Please also observe the User's Manuals for the terminals.

Only CE-approved terminal units complying with standards ETSI TS 103 021 (analogue terminals) or CTR 3 (ISDN terminals) should be connected to the telephone system.

Analogue telephones

Analogue telephones must comply with the following specifications:

- **DTMF telephones (dual tone multiple frequency):**
The dialling information is transmitted via a tone sequence. In addition to the **1-9** and **0** keys, the „*****“ and „**#**“ keys are also available.

Additionally, the following feature should be supported by the analogue telephones in order to ensure full functionality of the telephone system:

- **CLIP and/or CNIP function:**
Telephones that can display the caller's number and/or name.
- **MWI-function (with VCM-Module installed)**
Telephones that can indicate when new messages have arrived (Message Waiting Indication). In most cases this will be indicated by an LED or  on the display, e.g. with tiptel 140, tiptel 160, and tiptel easyDECT 6600.

Note: Pulse dialling telephones are NOT supported.

ISDN- and TIPTEL-system telephones

Telephones that can be operated on S₀-ports according to Euro ISDN standard DSS1. Only tiptel.com 411, 811, tiptel.comPact 42/82 IP 8 and tiptel 42 Home.

For this function, ISDN telephones require the associated internal subscriber number (MSN). You need to enter the desired extension number (also to be configured in your telephone system) as MSN at the telephone. The input procedure is described in the User's Manual for the ISDN telephone.

First start-up

This telephone system has been designed as a Plug & Play device, i.e. after connecting the terminals, connecting the telephone system to the mains supply and switching on the power supply, the system is ready to use. In case you wish to operate the system at a point-to-point connection please dial ***912*0000#** from any phone.

There is a difference between configuring the telephone system, e.g. by an administrator, and configuring by individual subscribers. The administrator defines subscribers by assigning call numbers. Using this call number or the user's name and a password, the subscriber can edit personal settings (e.g. set call forwarding) via a browser. But only the administrator also defines the extensions for signalling and which external MSNs are available.

Your telephone system has the following factory default settings (the following list is not complete and only gives the settings necessary for configuration).

- External S_0 configured for Euro-ISDN point-multipoint and PP connection (DSS1).
- All calls will be signalled at all subscribers.
- Only tiptel.com 411, 811, tiptel.comPact 42/82 IP 8 and tiptel 42 Home: The internal S_0 is configured for the Euro ISDN multipoint interface. Subscribers (MSNs) 20 – 21 are preset.
- The analogue extensions 1 – 8 are assigned to subscribers 50 – 57.
- All subscribers have international exchange authorisation.
- Standard exchange connection with the digit **0**.
- Charges are only displayed on ISDN terminals, not at analogue terminals.
- The PIN (needed for important programming codes) is preset to 0000.
- The Ethernet address is preset to 192.168.34.100.
- The subnet mask is preset to 255.255.255.0.
- The basic DHCP address is 192.168.34.100.
- The username/password for the web-based configuration is admin/admin.

Note: To enable full functionality of your ISDN terminal units you will have to assign MSNs to them. The desired (and configured in the telephone system) subscriber's telephone number is to be used as MSN for the individual subscriber. For details on assigning those MSNs please consult the User's Manual for your ISDN terminal units.

Connecting the telephone system

Removing the cabinet cover

In case you wish to use port 5 through 8 with telephone systems comprising 8 analogue ports or you wish to jumper ISDN ports from internal to external or vice versa, or you wish to install or remove terminations resistors of the S_0 ports, or you wish to install modules you will have to remove the cabinet cover.



Please pay attention to applicable safety regulations, in particular EN 60950 und VDE 0100!

Removing the cover is done as follows:

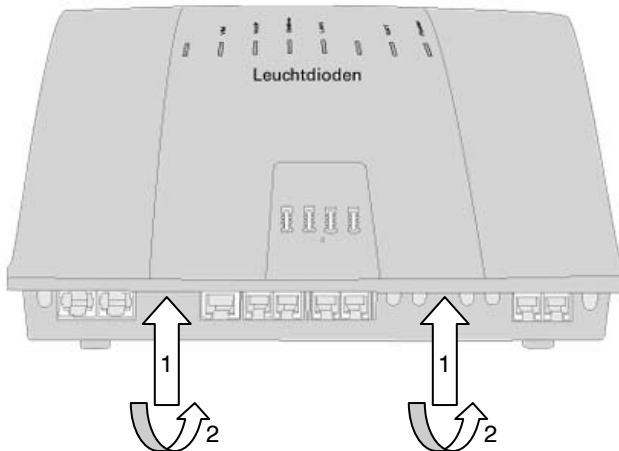

At the indicated areas (1) insert a slot screwdriver (4 mm) or a similar tool as far as it goes from bottom of the housing in the direction towards the top. Pull the screwdriver towards you (2) which will slacken the snap mechanism and lift the cover towards the back of the unit.

When refitting the cover please make sure that the rear fittings of the cover are matching the rear slots of the housing bottom. Now push the cover down at the terminal area until it snaps in.

Connecting the telephone system to an analogue exchange office

In order to operate tiptel.com 410-811 at an analogue exchange office you need the optional 2FXO Module. With tiptel.comPact 42/82 IP 4 this module has already been integrated.

The telephone system can be operated at up to two analogue exchange office lines.



Take both connection cables and make a loop through the ferrite clamp beads which came along with your telephone system.

Connect the RJ-11 western plugs to the two ports on the lower right hand side of the telephone system. In case you wish to operate the telephone system only at a single analogue office exchange line, please use only one cable.

Connect the other end of the cables to the all outlet of your analogue exchange office line.

Note: Analogue exchange office lines can only be connected by using the western ports of the telephone system, there are no screwing terminals.

Connecting the telephone system to an ISDN (NTBA) connection

Take the ISDN cable which has 8 pin western plugs at both ends. Connect one end to the port at the very left of your telephone system. Connect the other end to the connector of your ISDN NTBA.

The second S_0 of your telephone system next to the left hand port is set to internal as factory default. If you have jumpered this port to external you can connect the NTBA of a second ISDN connection to this port.

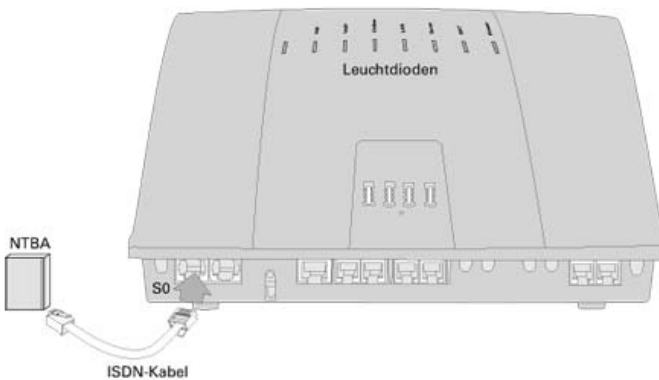

Connection of ISDN or system telephones

For system or ISDN terminal devices telephone systems tiptel.com 411, tiptel.com 811, tiptel.comPact 42 IP 8, and 82 IP 8 provide you with one internal ISDN port in factory default settings.

Take the ISDN cable which has 8 pin western plugs at both ends. Connect one end to the second S_0 port from the left at your telephone system. Connect the other end of the cable to your ISDN or system terminal device.



In case the ISDN cable to your terminal device is longer than 10 m you need to install a termination resistor at the telephone. Your specialist dealer will provide you with termination resistors which can be connected to the network outlet to have a jack for connecting the telephone cable.

Connecting the telephone system

In case you do not want to use the first S_0 port of your telephone system for an external ISDN connection you can jumper this port to internal and then connect another ISDN or system telephone.

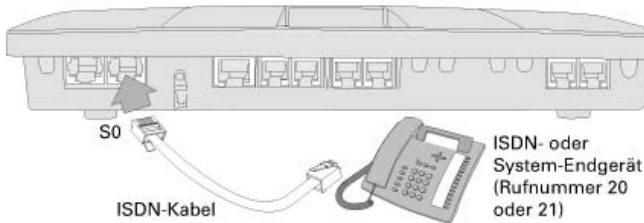

Notes: ISDN terminal devices in order to operate a corresponding internal telephone number. For this the desired (and in the telephone system configured) extension number has to be programmed as MSN in your telephone; as factory default for the internal S_0 port extensions 20 and 21 have been pre-configured. For programming MSNs to the telephone please read the telephone's User's Manual.

At one S_0 you can operate up to eight ISDN telephones, up to two ISDN phones without external power supply may be used. It is recommended to use only two telephones since at each S_0 bus there are only two channels (lines) available at any one time. This means that only two devices are able to telephone at the same time. If you wish to connect more than one ISDN telephone you can use an ISDN switch or install an S_0 bus with corresponding cable.

Note: At each S_0 port you can only operate one single system telephone.

Connecting several ISDN telephones by using an ISDN switch

ISDN S_0 buses of the telephone systems are installed as jacks for a RJ-45 western connector. At the internal S_0 buses of the telephone systems you can directly connect an ISDN or system telephone. If you wish to connect more than one telephone you may use an ISDN switch.

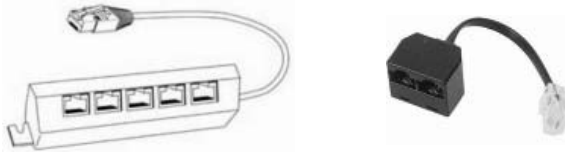

This switch is connected to the telephone system's connector and provides you with the option to connect a number of ISDN telephones. Such ISDN switches are available from two up to eight connectors. ISDN switches with two ports are available with and without integrated termination resistors. ISDN switches with more than two ports usually have integrated termination resistors.

When using an ISDN switch with integrated termination resistors the cable length of the connected ISDN telephones may not exceed 10 m.

When using a two port ISDN switch without termination resistors the cable length of both telephones together - depending on the cable quality - may not exceed 100 m together. In this case at both telephones termination resistors will have to be installed and the termination resistor at the telephone's system's S_0 port has to be removed.



Your specialist dealer can provide you with termination resistors which can be plugged into the network jack and which have a jack for connecting the telephone cable.

Note: At each S_0 port you can only operate one single Tiptel system telephone.

Connecting several ISDN telephones by using an S₀ bus

As an alternative to directly connecting the telephones you can also install an S₀ bus from the telephone system. In order to do so below the telephone system you must install an ISDN wall socket or a universal wall socket. With ISDN wall socket outlets both jacks are in parallel, with universal wall socket outlets the two jacks can be connected to separate cables. In case you installed a universal wall socket outlet below the telephone system you can install two S₀ buses at this outlet.

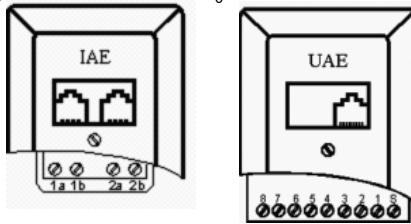

At pins 1a, 1b, 2a, and 2b (with a universal wall socket at pins 3, 4, 5, and 6) a telephone or network cable has to be connected. At the other end of the cable another ISDN- or universal wall socket and starting from this where applicable further ISDN- or universal wall sockets can be connected. Wiring has to be made 1:1 (no crossover).

The last ISDN wall socket will have to carry a (100 Ohms) termination resistor between 1a and 1b and between 2a and 2b each. With a universal wall socket termination are between pins 4 and 5 and between Pins 3 and 6.

Termination resistors are also available for plugging them into the jack of the last outlet, and also ISDN wall sockets with integrated (switched) termination resistors are available.

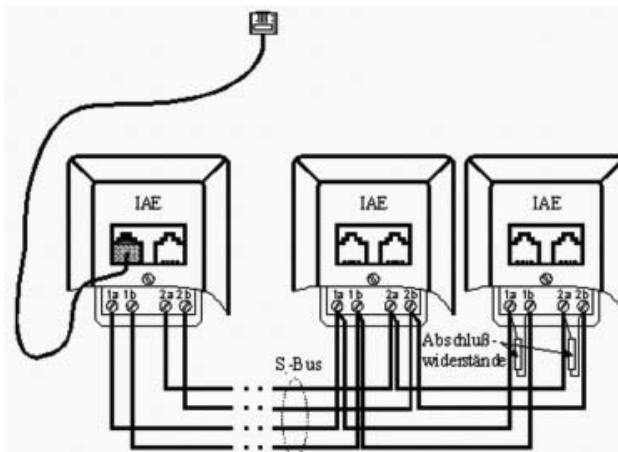

The first wall socket has to be connected to the internal S_0 port of the telephone system by using an ISDN or network patch cable. Further wall sockets are used for plugging in ISDN or system telephones.

With this type of bus outlets are in series. The last outlet gets termination resistors installed. The other side of the bus is terminated within the telephone system (termination resistors are installed). The telephone system in this case is the start of the bus.

As an alternative the telephone system may also be located in the centre of the bus. For this at the wall socket at the telephone system two telephone or network cables have to be connected. At the other end of both cables again there are one or more wall sockets.

In this case the last outlets at both cables will have to carry termination resistors each and the termination resistor of the S_0 port in the telephone system has to be removed.

Note: At each S_0 port you can only operate one single Tiptel system telephone.

Connection of ISDN telephones by using network cable

In case there is a network infrastructure with patch panel and network outlets close to the telephone system you can also use this wiring for connecting ISDN or system telephones.

Connect the S_0 port of your telephone system to the patch panel and connect the ISDN or system telephone to the network outlet in the corresponding room. At the telephone you will have to install a termination resistor.

In case you wish to connect two ISDN telephones to one S_0 port please use a two port ISDN switch without termination resistors and connect this switch to you telephone system. Connect both jacks of the switch with the two jacks of the patch panel and the connect the telephones to the corresponding network outlets. At both telephones you will have to install a termination resistor and the termination resistor at the telephone system's S_0 port has to be removed.



Your specialist dealer can provide you with termination resistors which can be plugged into the network jack and which have a jack for connecting the telephone cable.

Changing S₀ port settings

As factory default setting the first (left hand side) S₀ port of the telephone system is set to external for operating at the NTBA of an ISDN connection, the second S₀ port (second jack from the left) is set to internal intern for operating ISDN or system telephones.

If you wish to operate the telephone system at two ISDN connections you can also set the second S₀ port to external.

In case the telephone system shall not be operated at an ISDN connection you can also set the first S₀ port to internal for connecting additional ISDN or system telephones.

In order to do so please remove the cabinet cover as shown above.

To set the first (standard: external) S₀ bus to internal move the jumper from JP504 and 502 (designation TE) to JP503 and JP501 in front of them (designation NT) (2).

To set the second (standard: internal) S₀ bus to external move the jumper from JP509 and 507 (designation NT) to JP510 and JP508 right behind them (designation TE) (3).

As an alternative to connecting NTBA or ISDN and system telephones to the S₀ ports of the telephone system you can also use installation cable at the screwing terminals KL501 and 502 (4). The pinning is printed on the printed circuit board.

If you wish to go into two directions with your wiring from an S₀ port which is set to internal you will have to remove the internal termination resistors. In order to do so please remove the two jumpers of JP505 (1) for the first S₀ port (left hand side) and the two jumpers of JP506 (1) for the second S₀ port (second port from the left).

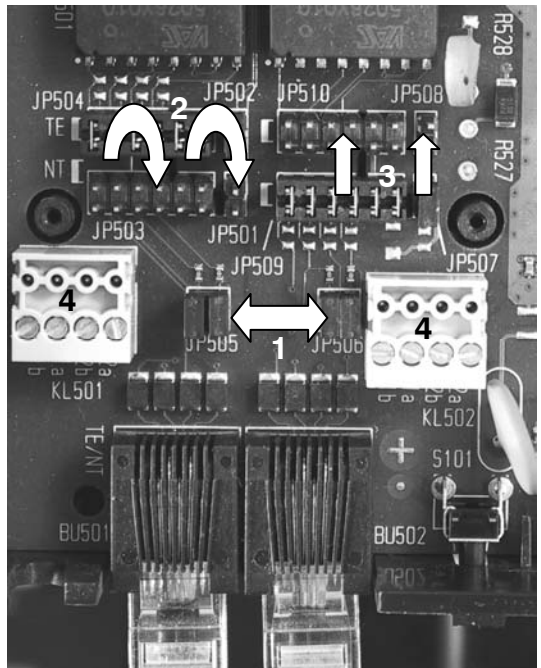



In case both S_0 ports are jumpered to internal the total power consumption must not exceed 2 W. Please pay attention to the power requirements of terminal devices fed via S_0 .

Connecting analogue terminal devices

Connection of the first four analogue terminal devices can be done by directly using the TAE or western connectors of those telephones by plugging them into the corresponding jacks of the telephone system or by connecting installation cable at the screwing terminals of the telephone system. Further analogue terminal devices can only be connected by using screwing terminals.

Note: All three connection types of the first four extensions are in parallel. Only use one single type at any one time.

Connection via TAE or western jacks directly at the telephone system

For terminal devices with TAE connector please use one TAE jack for each device on the top of the cabinet. In case the TAE cover has been closed you can remove it by lifting it at the front edge.

For terminal devices with western connector please use one western jack for each device in the centre of the connector array. Pinning is in compliance with the international standard using both centre wires as a/b. If need you can consult the supplier of your telephone about cables that will fit.

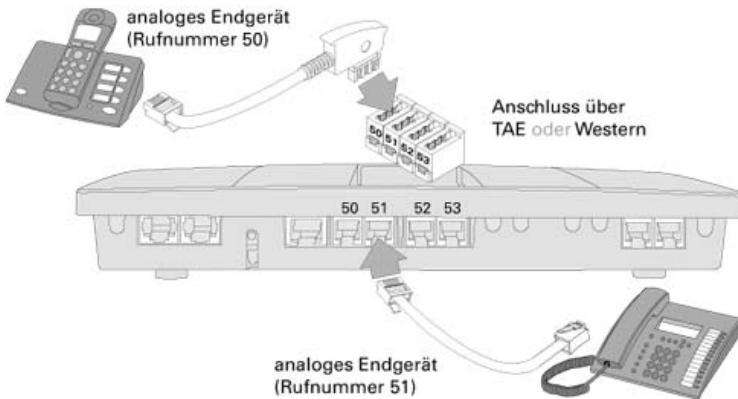

Connection by using installation cable

In order to do so you will have to remove the cabinet cover (as shown above).

Connect one pair of wires each to the corresponding screwing terminal pairs 1 through 8. Only used twisted pair cable, type J-Y/ST/Y.

Here you can connect telephone cable with the other end connected to a telephone wall outlet.

In Germany for this purpose telephone wall outlets type TAE are being used.

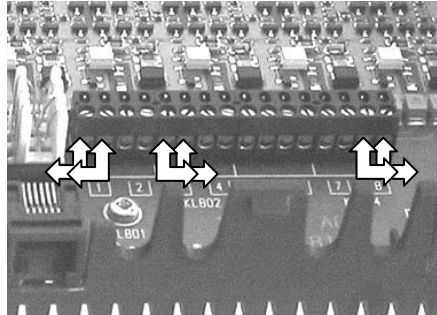

As TAE outlets usually outlets with three jacks using NFN or NFF coding are available. N jacks are used for answering machines, fax, or modems, F jacks are used for telephones.

With an NFN outlet the connectors are in a series circuit. This type of outlet is being used in case there are two terminal units (answering machine, fax, or modem) and a telephone are being used.

With an NFF outlet the left hand jack is N and the centre jack is F coded for a secondary device and a telephone at one extension and the right hand side F coded jack is meant for a second telephone of another extension.

For each analogue extension there are two connectors on the screwing terminal bar of your telephone system, So, for each extension you will need two wires of the cable. Since there are telephone or network installation cables available with 4, 8, 12, and 20 wired, you can also use one cable for a number of extensions.

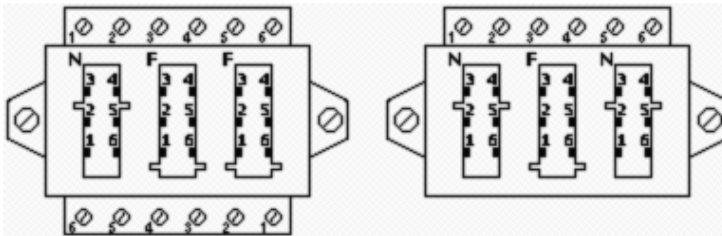

At the TAE outlet both wires will be connected to pins 1 and 2 of a screwing terminal bar at the top of an NFN outlet.

With an NFF outlet the first extension will be connected to pins 1 and 2 at the top screwing terminal bar (using the left hand side N coded and the centre F coded jack) and the second extension will be connected to pins 1 and 2 of the lower screwing terminal bar (using the right hand F coded jack).

Note: In other countries instead of TAE type outlets other standards are being used for wall outlets.

Connection by using network installation cable

In case there is a network infrastructure with patch panel and network outlets close to the telephone system you can also use this wiring for connecting analogue telephones.

Connect the RJ-11 jack of your telephone system to the patch panel and connect the analogue telephone to the network outlet in the corresponding room. For both installations you need a cable with a 4 pin RJ-11 plug at one end and an 8 pin RJ-45 plug at the other end. Your specialist dealer will provide you with such cables.

To integrate extension 5 - 8 in you patch panel wiring below the telephone system you should install a UAE (Universal Anschluss Einheit-) wall outlet. Connect the two wires of an analogue extension at the screwing terminal bar at your telephone system by using an installation cable with terminals 4 and 5 of the UAE outlet. Now you can connect the jack of the UAE outlet with the jack on the patch panel.

Note: By using the circuit as explained above the two centre wires of the patch cable and thus, also at the telephone are being used. This is correct with most telephones. A few telephones, however, do not use the centre wires but instead are using the wires right next to those wires to the left and the right. If this is the case with your analogue telephone you must use terminals 3 and 6 of your UAE outlet instead of 4 and 5.

Connection of IP telephones

In telephone system's configuration you must first set up a subscriber, in whose settings und "Designation of extensions" the item "SIP Proxy Port" must be activated. In order to be able to use an IP telephone at the subscriber's end a password must be set.

In the configuration of the IP telephone as registrar the IP address of the telephone system, and as port the SIP proxy port (factory default is 5062) set in the telephone system must be used. As SIP ID or user name the internal telephone number of the subscriber and as password the password of the subscriber has to be set.

After saving those settings the IP telephone will register with your telephone system as telephone.

Connecting the telephone system to the network

Take the attached network cable. Connect one end to a free LAN connector (next to the cable of your PC) of your router/switch/hub. Connect the other end to the shielded LAN connector of your telephone system. In case you should not use any internet connection or router, you should connect the network cable directly to the LAN connector of your PC.

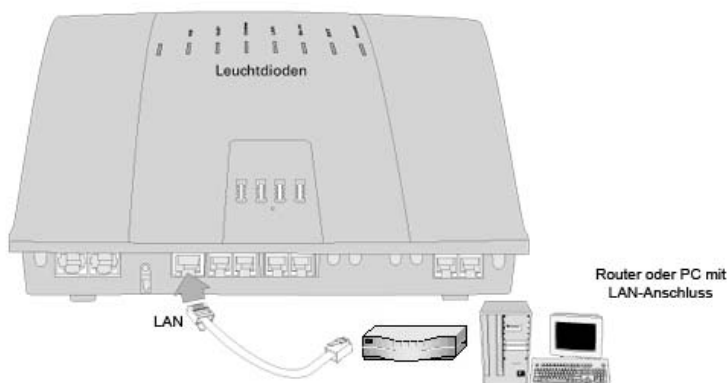

Connection your telephone system to mains

Connect your telephone system to mains by using the AC adaptor.

The "power" LED at your telephone system will start flashing. Different LEDs will come on and off. The "power" LED will flash for some 90 seconds. After that it should be lit permanently.

By all means wait that long. Only after that the telephone system will be in operation.

Testing the connection

Programme your connected ISDN or system telephones where applicable with the corresponding telephone numbers (MSNs). Default setting in the telephone system is 20 and 21 at S₀2.

Now, pick up the handset at all telephones one after the other. You will hear a dial tone. When there is no dial tone please check the connection of the telephone with no tone.

Now, dial at one of the telephones all internal telephone numbers of the other telephones connected to the telephone system. Each telephone should ring.

Note: With the analogue extensions telephone numbers 50 - 58 are factory programmed. At the second S₀ port for ISDN or system telephones this is 20 and 21. In case you have set the first S₀ port to internal, before using any telephones at this port a configuration in the telephone system is needed.

If an ISDN or system telephone does not ring but you get a dial tone when picking up the handset you have not programmed the internal telephone number to the telephone which is valid for the corresponding S₀ port of the telephone system.

When this test was successful at the connected telephones please dial a 0 (zero) followed by an external telephone number. A connection will be set up to the dialled subscriber. If external connections do work from analogue terminal devices but do not work from ISDN or system telephones and after dialling the first digit of the external telephone number a busy signal, you have not programmed the internal telephone number to the telephone which is valid for the corresponding S₀ port of the telephone system.

Note: The first S₀ port of the telephone system is factory default set to ISDN point-to-multipoint connection. If you have an ISDN point-to-point connection, at a connected telephone you must dial the digits ***912*0000#** to set the port to point-to-point connection. Only after doing so external calls are possible.

In case you do neither have an analogue nor an ISDN connection and you wish to telephone exclusively over the internet (VoIP) a certain configuration of your telephones system is necessary.

With factory default settings of the telephone system all telephones will ring with all telephone numbers and for external calls a 0 (zero) must be dialled before the external telephone number. This can be changed in the telephone system's configuration.

Configuration access

Configuration of the telephone system is done via a web browser. There is no need for any other software.

Most users have an internet access via a router with computers connected to that router to which also the telephone system was connected.

A router usually has a DHCP server integrated, which assigns correct IP addresses to all connected devices. The telephone system acts as a DHCP client and obtains at the start from the DHCP server of the telephone system automatically a correct IP address. So, there is access to the telephone system's configuration without the need of any modification of the computer's or the telephone system's configuration.

In case there is no DHCP server within your network, the IP address of the telephone system must be set matching the IP address range of the network. This can be done via a connected telephone.

If there is no network the telephone system can also be connected directly to the LAN port of your computer. The telephone system has an integrated DHCP server which assigns the computer automatically with correct IP settings.

If there is no network and the computer does not have any network adapter, as alternative configuration is also possible by using an ISDN connection (in order to be able to do so the computer must comprise an ISDN adapter card) or via a serial interface (in order to be able to do so the computer must comprise a serial port). Due to the low speed network configuration should be preferred.

To access the configuration via network (LAN) you must know the telephone system's IP address.

Identification of the IP address

This chapter only applies if the telephone system is connected to the network via a router or a switch and the network comprises a DHCP server (usually in the router). With all internet routers this is the factory default setting.

When starting up the telephone system it has been assigned with an IP address from the network's DHCP server.

Enter at one or the telephones connected to the telephone system the digits ***941#** and pick up the handset. As an acknowledge signal of a valid string the telephone system will answer with a positive prompt ("TaTaa"). Hang up the handset after that prompt.

Some 10 seconds later the telephone system will call the telephone and show you the IP address on the telephone's display. It should be an IP address from the address range of your network. Write down this IP address.

Note: You can either use an analogue, an ISDN, or an system telephone to query the IP address. However, the telephone must be equipped with a display. IP telephones cannot be used for this purpose.

In case the telephone shows as an answer to your query the IP address 192.168.34.100, the telephone system has not received any valid IP address from your network's DHCP server. In this case please check whether the LAN port of the telephone system has been connected correctly to a LAN port of your router (or to a switch connected to your router). Disconnect the telephone system's power supply and then reconnect it. Wait for three minutes and then again query the IP address.

Changing the IP address at a telephone

This chapter only applies when your telephone system has been connected to a router or a switch of an existing network, but there is no active DHCP server.

When there is no active DHCP server the telephone system could not obtain an IP address at start up. In this case its IP address is 192.168.34.100 and its internal DHCP server with the start IP 192.168.34.10 has been activated.

When you are experienced enough in network technology and you which IP address you want to assign to your telephone system, you can do so by dialling *941*0000*xxx* xxx* xxx* xxx# at any connected telephone. Instead of "xxx" you will have to enter the four IP address segments. For example: Setting the IP address 192.168.1.100 would be done by entering the string *941*0000*192*168*001*100#.

After dialling that string and picking up the handset the telephone system would send a positive prompt ("TaTaa"). Then hang up the handset. For verifying the IP address please dial *941# at any telephone with a display.

Factory default settings is a class C network with the subnet mask 255.255.255.0. If needed you can change this by dialling *942*0000*xxx* xxx* xxx* xxx#. With *942# you can query the subnet mask.

Configuration access then can be achieved via the IP address set this way.

Note: After changing the IP address the telephone system's DHCP server still is active. If needed you can deactivate it via the web configuration.

Direct connection to a computer

If you do not have a network you can also connect the telephone system directly to a computer which has a network adapter integrated. In this case connect the LAN port of the telephone system with the LAN port of your computer by using the attached network cable. After that power up the telephone system her, wait for three minutes and then start up your computer.

The telephone system's IP address now is 192.168.34.100. Your computer has automatically been assigned with an IP address in this network range by your telephone system.

Web configuration access

Now start your web browser and enter the IP address of your telephone system in the address bar. So not use "www".

In the picture below the telephone system's IP address set via a telephone was 192.168.1.35. Instead of this address you must enter the IP address set by you, or - in case the computer has been directly connected to your telephone system - you must enter the factory default address 192.168.34.100.

A window for entering username and password will pop up. As factory default setting both is **admin**. After entering username and password the web configuration can be accessed.

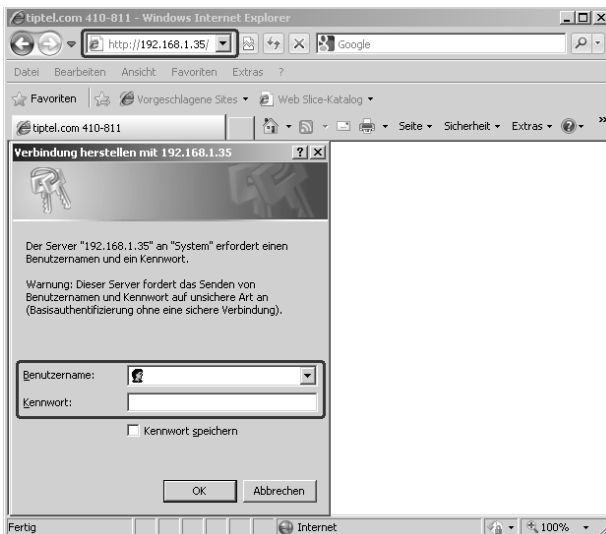

Trouble shooting

If you do not see the window asking you for username and password after entering the IP address, the telephone system has not been connected properly via LAN to your network or computer of your computer's network settings are not correct.

In this case please connect your telephone system's LAN port directly to the computer's LAN port by using the attached network cable. The power up the telephone system her, wait for three minutes and the start up your computer.

The IP address of the telephone system now is 192.168.34.100. Your computer has automatically been assigned with an IP address by your telephone system in this address range. Now try again to access the telephone system's web configuration by entering 192.168.34.100 in the web browser's address bar.

If you still do not see the window asking you for username and password, please check your computer's network settings. Follow the instructions below depending on your operating system used.

Note: Here you will find instructions for the operating systems Windows 7 and Windows XP. With other operating systems settings may slightly different.

Necessary settings in your web browser (all operating systems)

In case on your PC internet access has already been configured, first one setting in your web browser will have to be reset.

In Internet Explorer please click on "Tools" then on "Internet Options" ... and finally on "Connections".

Then check the box "Never dial connection".

With any other browsers please use the equivalent settings - if available - same as the procedure described above. It is important that the browser is configured in such a way that it does not automatically dial a (standard) connecting by itself when starting.

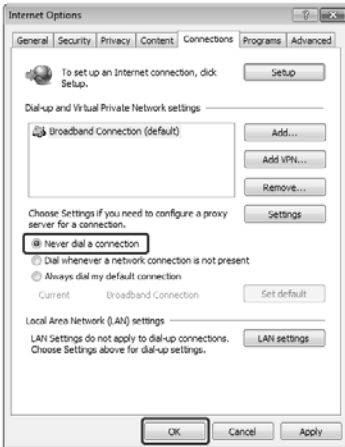

Windows 7



Windows XP

Network settings in Windows 7

Click on "Start", then on "Control Panel" -> Network and Internet -> View network status and tasks" and the select on the left hand side "Change adapter settings". Then you can see the LAN connection.



Double-click on LAN connection and the "Local Area Connection Status" will open. There you will have to select "Properties".

Select "Internet Protocol Version 4 (TCP/IPv4)" and then "Properties".

In the configuration which will then open up select "Obtain IP address automatically" and "Obtain DNS server address automatically". Confirm these settings with "OK".

Configuration access

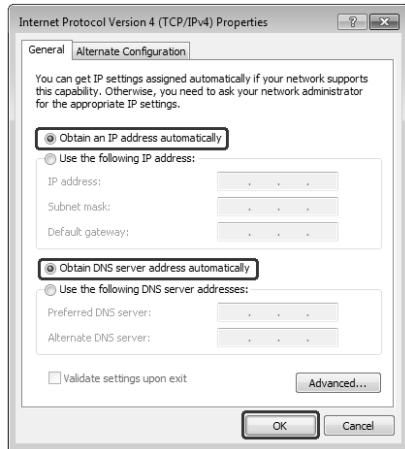
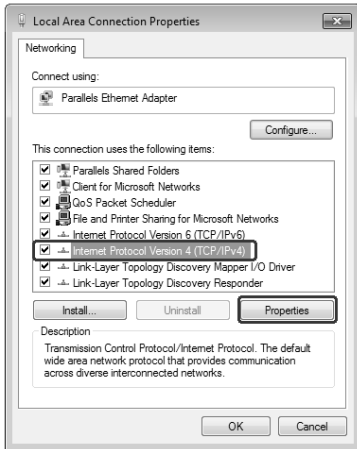

Now you are again in the dialogue " Local Area Connection Status ".

Now select "Details".

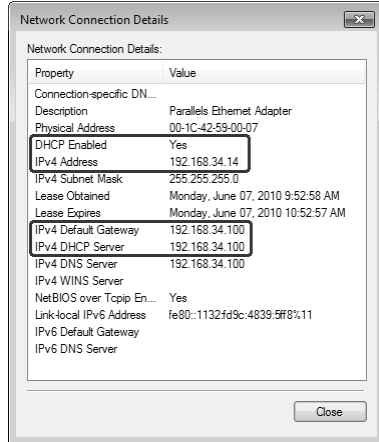
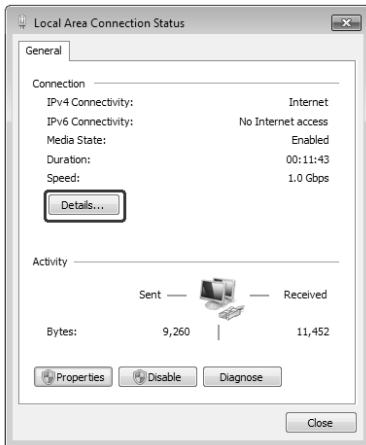

In the example shown above the computer was set to obtain IP addresses automatically (DHCP activated "yes"), and it has obtained the IP address 192.168.34.14. The "IPv4 Default Gateway" has the IP address 192.168.34.100 and at the same time was DHCP server. The settings must look the same as shown above, then you have access to the configuration under the IP address 192.168.34.100.

Note: The IP address of the Computers will be different regarding the last segment. The first computer connected will be assigned by the telephone system's DHCP server with 10, the second with 11 and so on.

Network settings in Windows XP

Click on "Start", then on "Control Panel", then on "Network and Internet Connections". Now click on "Network Connections". In the window which pops up now you will see the LAN connection.

LAN or High-Speed Internet

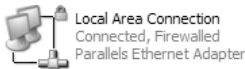

Double-click on the LAN connection and the "Local Area Connection Status" will open. There you will have to select "Properties".

Select "Internet Protocol TCP/IP" and then "Properties".

In the configuration which will then open up select "Obtain IP address automatically" and "Obtain DNS server address automatically". Confirm these settings with "OK".

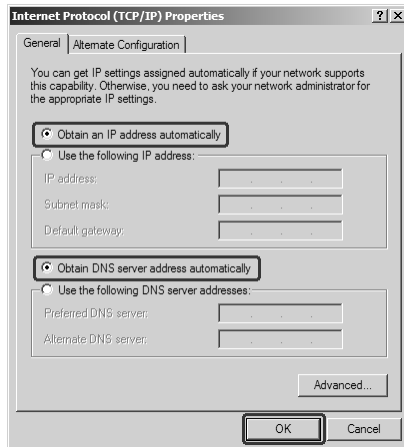
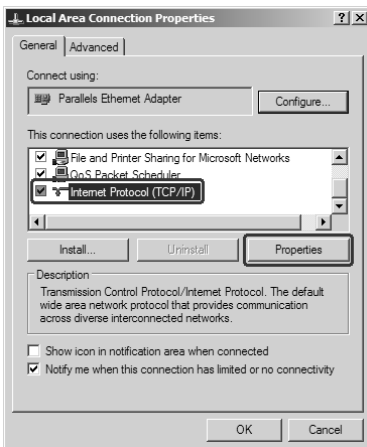

Now you are again in the dialogue " Local Area Connection Status ". Now select the tab "Support".

Configuration access

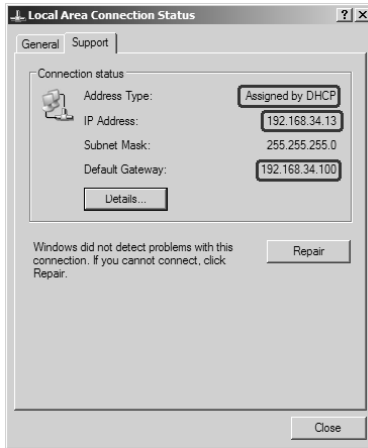

In the example shown above the computer was set to obtain IP addresses automatically (assigned by DHCP), and it has obtained the IP address 192.168.34.13. The "Default Gateway" has the IP address 192.168.34.100. The settings must look the same as shown above, then you have access to the configuration under the IP address 192.168.34.100.

Note: The IP address of the Computers will be different regarding the last segment. The first computer connected will be assigned by the telephone system's DHCP server with 10, the second with 11 and so on.

The configuration wizard

Start the web configuration by entering the identified IP address of the telephone system in the address bar of your web browser followed by /wizard/ e.g. 192.168.34.100/wizard/. As username and password enter **admin** each.

The configuration wizard allows you making the basic settings of the most important data, i.e. distribution of external calls to the extensions as well as the assignment of the extension's telephone numbers to the numbers sent with outgoing calls (important with e.g. charging). In order to do so it uses fixed extension numbers being fixed assigned to the corresponding ports.

The telephone numbers 50 - 53 are fixed for the analogue extensions 1 - 4.

With telephone systems with 8 analogue extensions additionally the telephone numbers 54 - 57 are assigned also fixed to the analogue extensions 5 - 8.

With tiptel.com 411 and 811 additionally the telephone numbers 20 and 21 are assigned to the internal S₀ bus 2. By all means programme your ISDN or system telephone with these numbers.

The configuration wizard can also be used after changing these fixed telephone numbers (of course this is possible in the normal configuration. It will then also show you the modified telephone numbers. But please observe warning messages in this context.

Country setting

In order to comply with country specific settings you must select the required country.

Country Phone type Entry of phone numbers Assignment of telephone numbers End ?

tiptel

Help

Setting of country

To come up to country-specific requirements, it is necessary to select the requested country here. If the required country is not included in the list, please choose "INT"

INT ▾

Use wizard as cover page

Continue

If you do not find your country in the list please select "INT".

Note: The language in the configuration will not be selected by the country setting. This setting is made by the configuration (language setting) of your browser.

Deactivate the box behind "Use wizard as cover page" in case you wish to access the configuration of the telephone system directly from now on. As long as this box is activated when accessing the configuration every time the wizard will be started.

Configure the external connection

This configuration item is only available when at least one of the two S₀ ports is set to external, i.e. for connection to the NTBA of an ISDN connection.

Country	Phone type	Entry of phone numbers	Assignment of telephone numbers	End	?
---------	------------	------------------------	---------------------------------	-----	---



Help

Configure external port

Type of external S0 (T0)

A public ISDN access may be either Point-to-Point or Point-to-Multipoint. For further info have a look into the order confirmation of your ISDN access.

Please, select type

S0 port 1 (main board)	<div style="border: 1px solid gray; padding: 2px;"> Point-to-multipoint access </div> <div style="border: 1px solid gray; padding: 2px;"> Point-to-point access </div>
------------------------	--

Here you configure whether you have an ISDN point-to-multipoint or a point-to-point connection. With an ISDN point-to-multipoint connection with one connection you have more than one (usually three, ten at most) different telephone numbers. These can also be consecutive. The point-to-multipoint connection is the connection usually used at home or in small companies. If you have more than one point-to-multipoint connection these will have different telephone numbers. With an ISDN point-to-point connection you will get a trunk number with an extension range. As extension numbers with one ISDN connection you will get one digit extensions (0 - 9), with more than one connection you will get two digit connections (e.g. 0 and 10 - 29). All ISDN connections have the same telephone numbers.

In case of doubt consult the documents of your ISDN connection or your telephony service provider.

Note: The wizard can only configure your telephone system with the connection type point-to-multipoint connection. If you select point-to-point connection the wizard will be closed. In this case you will have to perform the configuration manually.

Fax switch at an analogue exchange office line

This menu is only available with an installed foreign exchange office module for accessing analogue external lines. If you wish to divert incoming fax messages automatically to a certain extension the you will have to activate the fax switch.

Fax switch at analogue exchange

In case you wish to forward incoming fax messages to a specific extension with an analogue exchange, please activate the fax switch by selecting one subscriber from the list as fax machine. In case you don't have a fax machine please select option "OFF".

Please select fax switch

analogue FXO port 5 (Analogamt 1)	54 - Analog54
analogue FXO port 6 (Analogamt 2)	Off

If you have activated the fax switch as shown above the telephone system will automatically take incoming calls and verifies whether this call is a fax message or a voice call. With a voice call the telephone system will let the telephones ring which where configured by you in the additional settings for an analogue exchange office. If the call is a fax message the telephone system will not let the telephones ring configured by you but instead it will let the fax machine ring connected to the extension configured here.

External telephone numbers and call distribution for the S₀ ports

This dialogue is only available when at least one of the two S₀ ports has been set to external, i.e. for connection to the NTBA of an ISDN connection.

External tel. numbers for S0 port 1 (main board)

Enter the phone numbers of your exchange access here. Usually the phone number will have to be entered without area code. Then, by selecting among preset subscribers, you may define which subscriber may be reached under which external phone number. You have entered e.g. phone number 4280 and selected subscribers 50 and 51. On a call for this number internal analogue port 1 (assigned to subscriber 50) as well as the internal analogue port 2 (assigned to subscriber 51) will ring. The internal phone numbers, however, are 50 for subscriber 50 respectively 51 for subscriber 51.

Select

Own MSN S0 port 1 (main board)	Internal ports
<input type="text" value="428322"/> Label (facultative) : <input type="text" value="Fax"/>	<input type="checkbox"/> 10 - 1234567890123456789a <input type="checkbox"/> 57 - Analog57 <input type="checkbox"/> 50 - Analog50 <input type="checkbox"/> 9311 - AZ1 <input type="checkbox"/> 51 - Analog51 <input type="checkbox"/> 9321 - BV1 <input type="checkbox"/> 52 - Analog52 <input type="checkbox"/> 9331 - IS1 <input type="checkbox"/> 53 - Analog53 <input type="checkbox"/> 20 - ISDN20 <input checked="" type="checkbox"/> 54 - Analog54 <input type="checkbox"/> 21 - ISDN21 <input type="checkbox"/> 55 - Analog55 <input type="checkbox"/> 88 - Zentrale-Callmanager <input type="checkbox"/> 56 - Analog56
<input type="text" value="428888"/> Label (facultative) : <input type="text" value="Zentrale"/>	<input type="checkbox"/> 10 - 1234567890123456789a <input type="checkbox"/> 57 - Analog57 <input checked="" type="checkbox"/> 50 - Analog50 <input type="checkbox"/> 9311 - AZ1 <input checked="" type="checkbox"/> 51 - Analog51 <input type="checkbox"/> 9321 - BV1 <input type="checkbox"/> 52 - Analog52 <input type="checkbox"/> 9331 - IS1 <input type="checkbox"/> 53 - Analog53 <input checked="" type="checkbox"/> 20 - ISDN20 <input type="checkbox"/> 54 - Analog54 <input type="checkbox"/> 21 - ISDN21 <input type="checkbox"/> 55 - Analog55 <input type="checkbox"/> 88 - Zentrale-Callmanager <input type="checkbox"/> 56 - Analog56

Here you enter the number of the first ISDN connection. You can enter up to telephone numbers. The number(s) have to be entered without area code.

To each telephone number you can optionally also assign a designation. This is only for your orientation.

On the right hand side you select the extension(s) which should ring when the individual telephone number(s) are being called.

To each programmed telephone number you must at least enter one internal extensions as target an. Each telephone number may only be entered once.

In case you also set the second S₀ port to external, in the next step you will be asked for the telephone numbers and the call distribution for the second ISDN access.

External telephone numbers an call distribution for the analogue exchange office ports

This menu is only available when the analogue exchange office module has been installed.

External tel. numbers for analogue FXO port 5 (Analogamt 1)

Enter the phone numbers of your exchange access here. Usually the phone number will have to be entered without area code. Then, by selecting among preset subscribers, you may define which subscriber may be reached under which external phone number. You have entered e.g. phone number 4280 and selected subscribers 50 and 51. On a call for this number internal analogue port 1 (assigned to subscriber 50) as well as the internal analogue port 2 (assigned to subscriber 51) will ring. The internal phone numbers, however, are 50 for subscriber 50 respectively 51 for subscriber 51.

Select

Own Phone number analogue FXO port 5 (Analogamt 1)	Internal ports
<input type="text" value="42855667"/>	<input type="checkbox"/> 10 - 1234567890123456789a <input type="checkbox"/> 57 - Analog57 <input checked="" type="checkbox"/> 50 - Analog50 <input type="checkbox"/> 9311 - AZ1 <input checked="" type="checkbox"/> 51 - Analog51 <input type="checkbox"/> 9321 - BV1 <input type="checkbox"/> 52 - Analog52 <input type="checkbox"/> 9331 - IS1 <input type="checkbox"/> 53 - Analog53 <input checked="" type="checkbox"/> 20 - ISDN20 <input type="checkbox"/> 54 - Analog54 <input type="checkbox"/> 21 - ISDN21 <input type="checkbox"/> 55 - Analog55 <input type="checkbox"/> 88 - Zentrale-Callmanager <input type="checkbox"/> 56 - Analog56
Label (facultative) :	
<input type="text" value="Analogamt 1"/>	

Here you enter the telephone number for the first analogue port (port 5, second connector from the left) and optionally a designation. The number has to be entered without area code.

On the right hand side you select the extension(s) which should ring when the individual telephone number(s) are being called.

To each programmed telephone number you must at least enter one internal extensions as target an.

Note: If you have activated the integrated fax switch, the internal connection for the fax machine must not be selected here.

In the following step you will be asked for the settings regarding the second analogue exchange office port (Port 6 at the very right hand side).

Assigning the telephone number for outgoing calls

Here you enter for each subscriber the telephone number being used with outgoing external calls.

Allocation of tel. numbers for outgoing calls

With an outgoing call the public exchange will be advised on the phone number of the access via the call shall be placed. Any charges will be assigned to that phone number. With CLIP being activated the called party will see this number on the telephone's display. Please, note: Allocation will be stored for the first position of the sequence only. Other entries are deleted.

Select

Internal ports	Outgoing MSN
10 - 1234567890123456789a	428322 - Fax
50 - Analog50	428888 - Zentrale
51 - Analog51	428888 - Zentrale
52 - Analog52	428888 - Zentrale
53 - Analog53	428888 - Zentrale
54 - Analog54	428322 - Fax
55 - Analog55	42855667 - Analogamt 1
56 - Analog56	4289894 - Analogamt 2
57 - Analog57	428888 - Zentrale
20 - ISDN20	428888 - Zentrale
21 - ISDN21	428888 - Zentrale

Here you configure which telephone number will be signalled to the called party with outgoing calls. At the same time you set which external exchange office line will be used by the telephone connected to the extension when placing outgoing external calls.

End

Once you have finished the setup by using the configuration wizard you can already use your telephone system for placing and receiving calls.

Note: The configuration wizard will now guide you to the main configuration of the telephone system (see next chapter). If the basic configuration is sufficient for you for the time being you may now close the browser window.

Main Configuration Interface

General

The configuration is divided into subscriber configuration and administrator configuration.

In the following we use the administrator configuration as an example for describing the configuration procedures. The subscriber settings can be taken from the User's Manual of your telephone system.

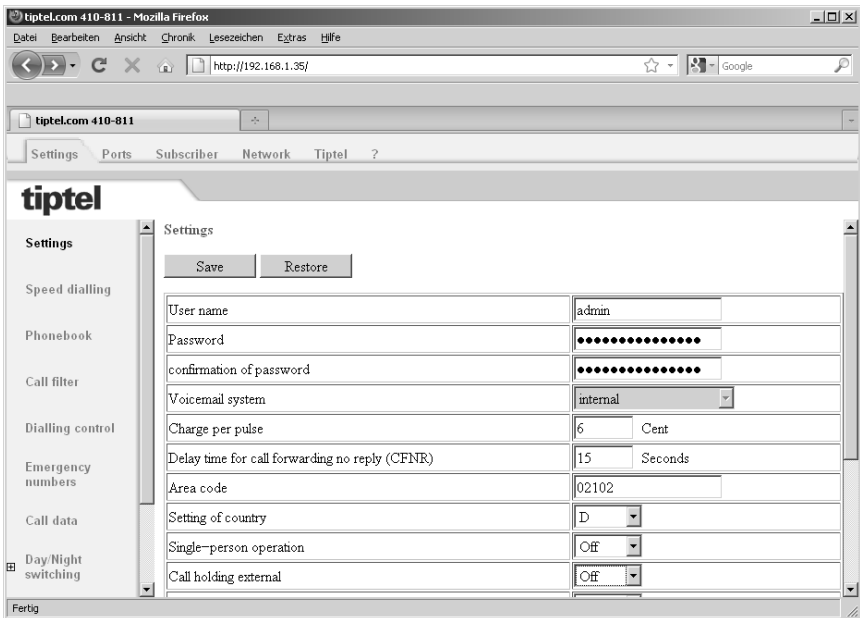

Use the „administrator” link in order to get to the administrator settings.

The above screenshot displays the start window after logging in to the telephone system and clicking the „administrator tab”.

Note: The configuration includes comprehensive online help. After clicking a coloured heading, a pop-up window appears displaying the help text for this topic.

The configuration pages are marked by headlines shown as tabs in the horizontal menu selection (top of the screen) and by web-links in the vertical menu selection at the left edge of the screen.

For each tab you will see a number of different sub-items at the left edge of the screen. It is recommended after selecting the first menu item „Settings“ to go through the menu items displayed on the left edge of the screen from top to bottom. You should then proceed with the second tab, the third tab, and so on.

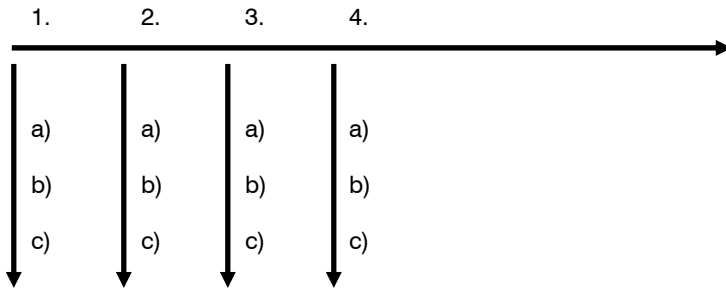

By doing so, you will scroll through all necessary settings and steps in the intended order. And there is need to jump back and forth from one menu to the other. The following chapters also follow the rule given above.

Menu Settings

This defines the main settings for the telephone system.

Settings

This menu plays a global role as you can enable or disable the basic functions of the telephone system. Please use the online-help as it might be more up-to-date as this User's Manual - in particular when the firmware of the telephone system had been updated.

User name

Here you can enter a new user name for the administrator. The factory pre-set user name is „admin“.

Password

Here you can enter a new password for the administrator. Please re-enter the new password in the second entry field as confirmation. The factory pre-set password is „admin“.

Voicemail system

Your telephone system supports the optional internal tiptel VCM-Module (included in tiptel.comPact-models).

The individual voicemail boxes (personal answering machines) are assigned in the subscriber menu.

Charges per pulse

The transmission of charge information at the analogue ports is realised via charge pulses. Each pulse corresponds to a certain amount which has to be defined here. If the rates are obtained from the exchange in the form of units, the base unit value has to be entered here. This means that the value of one charge unit from the exchange is identical to the value of one charge pulse.

Note: Charge pulses will only be transmitted if AOCD has been enabled.

Time for delayed call forwarding

Each subscriber may programme a delayed call forwarding for his/her internal telephone number. The delay time may be globally set for every subscriber between 5 and 40 seconds.

Area Code

Please enter the area code of your city here. This information is needed for cross-checking existing phone book entries with received CLIP information (caller's phone number)

Setting of country

To satisfy country-specific requirements, it is necessary to select the desired country here. If the required country is not included in the list, choose „INT”.

Note: The language is not set when selecting the country code. The corresponding setting is applied based on the configuration (setting of language) of your browser!

Single-person operation (busy-on-busy)

This menu is used to enable the single-person operation mode. This is useful if you are alone and unable to answer several calls at the same time. If single-person operation mode is enabled, each external caller hears the busy tone as soon as one extension is busy.

Note: This is a global setting valid for the telephone system as a whole! But you may set this function also for call groups only (please see menu item“ Groups“ for details.

Call holding external

This menu is used to set whether calls are to be placed on hold externally within the public exchange (call holding external enabled) or internally within your telephone system (for each call placed on hold internally, one free B-channel must be available). If a call is placed on hold within your telephone system, the caller hears music while on hold. Otherwise, the caller hears the announcement of your network provider.

Note: To transfer an external call to another external subscriber the „call holding external - off” setting is required.
A three party conference cannot be set up with the „call holding external - on”.
„Call holding external“ is only available with a „point-to-multipoint“ connection.

Music on Hold (MOH)

It is possible to place external or internal calls on hold within your telephone system. In this case, the caller on hold hears the internal music-on-hold. The following settings are available for this function:

Off = no music played while call is on hold

Int = internal MOH is played back when a call is placed on hold

wav = the melody uploaded via the web interface is played when call is on hold (see Uploading).

To listen to the recorded music, press the key code ***922*** for any desired extension.

Note: In order to allow problem-free functionality, it is recommended to use the following data format: PCM, 8 kHz, 16 bit, mono. If the existing file is available in a different format, it is possible to convert the file, e.g. by using the „sound recorder“ in Microsoft Windows. To do this, start the „sound recorder“ via „Start“, „Programmes“, „Accessories“, „Entertainment“, „Sound recorder“ (depending on the version of the Microsoft operating system). Then, select the requested file and choose the „Save as“ option. Using the „modify“ button, you can select the following format: „PCM, 8,000 kHz, 16 bit, mono“. This new file can now be transferred to the tiptel.com telephone system.

Use the „Upload“ menu item in „Expert mode service“ to upload the file.

Call filter

You can switch the call filter function on or off here.

Day/Night switching

You can switch the day/night switching function for the complete device on or off here. On delivery this function is deactivated. On activation you will see the applicable configuration menus.

LCR

Here you can activate or deactivate LCR for the telephone system as a. This function is deactivated as factory default setting. On activation you will see the applicable configuration menus.

Use wizard as cover page

You can define whether the configuration wizard shall start automatically at access to the web-configuration or not.

Speed dialling

Your telephone system provides a speed-dialling list with a maximum of 100 phone numbers, each consisting of 24 digits. The speed dialling numbers can only be used to call external destinations. Consequently, you do not have to enter the prefix for the exchange connection. For each speed dialling number a name consisting of a maximum of 20 digits can be entered.

Speed dialling numbers can be dialled at the extensions with the key sequence ***7** (**00-99**).

Note: The speed-dialling list can be exported or imported as a table in CSV format. Each entry starts in a new line and is formatted as follows: „name”, „phone number”

When entering data, observe the maximum text length for the name (20 characters) and the phone number (24 characters).

Service

In the upper right corner on your screen you will find the tab „Service“. By clicking this tab you will see a sub-menu which provides you with administration settings for the speed dial directory.

Save speed dial list

The speed dial list may be saved here in CSV-format You may import these data to Outlook Express by using the import option of that programme.

Upload (speed dial list)

The speed dial directory may be transferred from your PC to the telephone system. You may also transfer a telephone book which has been exported from Outlook Express to your telephone system. In order to be able to do this you have to choose the text file format. You may only export the items name and phone number.

Transfer all entries to phonebook

By clicking the button „Transfer“ the speed dial directory will be transferred to the telephone book.

Delete speed dial directory

By clicking the button „Delete“ the speed dial directory will be deleted.

Back

Back to the speed dialling menu.

Phonebook

You can save around 5000 entries with name and call number in the phonebook. You can conveniently make and modify entries via the web interface. Functions „Modify“ or „Add“ enable you to change existing records or create a new entry. You search for a name in the telephone book by clicking the „Search“ button. If you enter only the phone number the record for that phone number will be searched. By clicking the „Delete“ button selected entries will be deleted. Clicking the button „Transfer“ will have selected entries transferred to the speed dial directory.

Phonebook control

The telephone book may be controlled via an ISDN- or TIPTEL-system telephone. In order to be able to display it your telephone must support „Display info“ while in the dial state. In that dial state selection is carried out via the number keys of the telephone.

The buttons have the following functions:

- Open telephone book Dial **#7**
- Search for entry Enter letters via the number buttons
- Delete letters ***** button
- Insert letters **#** button
- Switch between searching and scrolling Press **1** button
- Scrolling ***** or **#** button
- Start dialling Press **0** button

Note: With tiptel 82/83 system telephone it is also possible to use the cursor keys to control the telephone book. System telephone tiptel 85 system support menu guided control of the telephone book.

Service

In the upper right corner on your screen you will find the tab „Service“. By clicking this tab you will see a sub-menu which provides you with administration settings for the telephone book.

Save phonebook

The phonebook may be saved here in CSV-format You may import these data to Outlook Express by using the import option of that programme.

Upload (phonebook)

The phonebook may be transferred from your PC to the telephone system. You may also transfer a phonebook which has been exported from Outlook Express to your telephone system. In order to be able to do this you have to choose the text file format. You may only export the items name and phone number. Special characters are not allowed in the telephone book and will be deleted or replaced during the import session.

Delete phonebook

By clicking the button „Delete“ the phonebook will be deleted.

Back

Back to the phonebook menu.

Call filter

This chapter is a brief instruction how to use your call filter.

Create Call filter

Your telephone system can manage up to 100 call filters Each call filter may be assigned to a phone number / MSN / DDI or to all calls. A call filter will be created by clicking „Create“.

Select call filter

The call filter you wish to configure has to be selected here. In case you wish to create a new call filter you may select subscriber „New“.

Delete call filter

Click „Delete“ next to the selection in case you wish to delete a call filter.

Name

The name for the call filter has to be entered here.

Filtering of incoming calls via following phone number / MSN / DDI of the telephone system

Select „All“ in case you want the filter to verify all incoming calls. Select a phone number / MSN / DDI of the telephone system in case you want the call filter only to verify callers who are calling this particular phone number / MSN / DDI of your telephone system.

Exception phone numbers / MSNs / DDIs of the telephone system

Only enabled in case you selected „All“ first. You may define up to 3 phone numbers / MSNs / DDIs of your telephone system as exception, not to be verified by the call filter.

Filter criteria

- Caller without number = Call is being received without a phone number transferred
- Caller without number, except 3.1 kHz audio = Call is being received without a phone number transferred. Caller with identification 3.1 kHz (e.g. origin from the analogue telephone network) will not be filtered.
- Number suppressed = Call with identification „Restricted“
- Caller's number = Here you may enter up to 10 phone numbers the filter function shall apply to.
- Area code of caller = Here you may enter up to 10 area codes the filter function shall apply to.

Remark: The filter can only work orderly if your telecom provider supports the needed features.

Caller's number

Enabled only in case you selected „Caller's phone number“ first. Here you may enter up to 10 caller's phone numbers the filter function shall apply to.

Area code of caller

Enabled only in case you selected „Caller's area code“ first. Here you may enter up to 10 area codes the filter function shall apply to.

Priority

Call filters with priority „1“ have the highest, those with priority „5“ have the lowest priority. Selecting a priority is absolutely necessary when criteria of different call filters you set are overlapping with respect to the same phone number / MSM / DDI of your telephone system (or for all calls).

If filter criteria matches caller, then

Your telephone system will not accept that call. In case of an ISDN multipoint access terminal units in parallel may accept that call.

Forward call to drop target = The call is being signalled only to one specific subscriber.

Use standard call distribution = The filter function will be exit and the call will be signalled according to the call distribution set.

Applications

Unsolicited promotional calls

Most unsolicited calls have no caller id. Proceed as follows:

- Select „Filtering of incoming calls via following phone number / MSN / DDI of telephone system“ = „All“
- Select filter criteria“ = „Caller without phone number“
- Select „If criteria matches caller, then“ = „Ignore call“

Caller from abroad

In case you wish to forward calls, e.g. from the Netherlands to a caller speaking the language, then proceed as follows:

- Select „Filtering of incoming calls via following phone number / MSN / DDI of telephone system“ = „All“
- „Select filter criteria“ = „Caller's area code“
- Enter „Caller's area code“ = „0031“
- Select „If criteria matches caller, then“ = „Forward call to drop target“
- Under „drop target“ select that subscriber who should pick up those callers - e.g. a group

Callers from abroad with VIP customers from that country

In case you wish to forward calls, e.g. from the Netherlands to a caller speaking the language. At the same time you want a particular Dutch VIP customer to be signalled without that a.m. filter being applied.

Set up two filters:

- Select „Filtering of incoming calls via following phone number / MSN / DDI of telephone system“ = „All“
- „Select filter criteria“ = „Caller's phone number“
- Enter phone number of your VIP customer as „Caller's phone number“
- Set „priority“ to = „1“
- Select „If criteria matches caller, then“ = „Use standard call distribution“

This filter makes sure that your Dutch VIP customer can reach you as usual. I.e. all calls from that customer will be distributed according to the call distribution set.

- Select „Filtering of incoming calls via following phone number / MSN / DDI of telephone system“ = „All“
- „Select filter criteria“ = „Caller's area code“
- Enter „Caller's area code“ = „0031“
- Set „priority“ to = = „2“
- Select „If criteria matches caller, then“ = „Forward call to drop target“
- Under „drop target“ select that subscriber who should pick up those callers - e.g. a group

All other callers from the Netherlands will be signalled at the selected drop target.

Dialling control

The telephone system performs a dialling check for internal subscribers who have enabled this feature. The dialled phone number will be compared with the blocked numbers list. If there is a match, the number is then checked against the exception phone numbers list. If the dialled phone number is contained in the blocked numbers list and not in the exception numbers list, the connection attempt is stopped automatically. There is no dialling control for emergency numbers.

This feature can be individually enabled for each subscriber. The blocked numbers list and the exception list contain 10 entries, each with name and maximum 24 digits. You can switch between the two lists in the drop-down menu.

Example:

The phone number 01901234 can be dialled. All other 0190-numbers are blocked:

Enter the number 0190 in the blocked phone numbers list.

Enter the phone number 01901234 in the exception phone numbers list.

Requirement: This feature must be individually enabled for each subscriber.

List of blocked phone numbers

Your telephone system provides a list for a maximum of 10 blocked phone numbers, each consisting of 24 digits.

List of exception phone numbers

Your telephone system provides a list for a maximum of 10 exception phone numbers consisting of 24 digits each.

Emergency numbers

Your telephone system provides a list for phone numbers that can also be dialled if authorisation for external calls has not been enabled. Up to 10 numbers of external subscribers (with 24 digits each) can be entered. This ensures that police, fire brigade, or other emergency numbers can be called from every extension.

Call data

Your telephone system has convenient features for logging call data. The telephone system stores up to 1000 data records. This is a first in / first out system. Attempted outgoing calls are not listed. Attempted incoming calls are listed. When signalling several subscribers only the first subscriber on the list is displayed.

- The following call data of external calls is logged:
- date and time of the call
- call duration in hours, minutes, and seconds
- call direction (coming / going)
- phone numbers of the telephone system
- phone number of the external subscriber
- subscriber, who placed or received the call
- charges (if transmitted by the exchange office)
- cost centre

Note: The call data can be exported in the form of a table in CSV format and can be edited with a suitable programme.

The cost centre must be stated before dialling or during the call using the digit sequence *93 (digit number 00-12) (cost centre) - followed by the actual phone number and the outgoing call prefix (when stating the cost centre before dialling).

With tiptel.com 411 and tiptel.com 811 you may enter the cost centre during the call on an ISDN telephone via keypad. With tiptel 83 system you will only have to press the left cursor key and select the option „keypad“, enter the code, and confirm the

entry. tiptel 85 system support a menu guided operation and also supports a list with project codes / cost centres.

Example for a three digit cost centre with the target phone number **021024280**:
***93031230021024280**

Note: This function can be used very comfortably with computer-integrated telephony. Use of project codes / cost centres is supported by a huge number of CTI applications.

Call analysis software

Remote access to call data

The telephone system provides a special file to enable you to regularly query the call data. This file is protected by its own password that you can configure here. The query is usually made at „[hostname]/charges/charges.txt“. Hostname is e.g. „192.168.34.100“ (factory default). The call analysis software MicroBX supports this format and can read these data automatically.

Charge printer / server

Your telephone system also has the option of sending charge data directly. You can send these data to the network (charge server).

Charge server

This setting supports the TeKoWIN charge analysis software. Enter the IP address for the PC that runs the TeKoWIN software. The TeKoWIN application on the PC is addressed via the stated port.

Day/night switching

Note: This menu is only available when it has been enabled in the „Settings“ menu.

Your telephone system has a convenient day/night switching function. After activation you can open the configuration from the configuration icon. You can change the following settings using the day/night switching:

- Call distribution
- Call forwarding external
- Authorisation to access an outside line

- Call deflection subscriber
- Answering machine ready (only with tiptel VCM-Module installed)
- Announcement of answering machine (only with tiptel VCM-Module installed)
-

With day/night switching enabled you can define up to 6 different profiles. This is done via the corresponding configuration page with the above-mentioned settings (e.g. subscriber settings).

On each of these configuration pages you will then find a new bar „day/night switching“ at the top. By clicking the corresponding profile the display of the current configuration page with the corresponding settings will change accordingly. All settings of this page marked in yellow are dependent from the chose profile. Change of these settings will only apply to the currently chose profile.

Note: You may want to check the yellow marked settings in all profiles in case switching between the profiles unwanted changes in subscriber configuration appears.

Settings

Profile name

There are 6 profiles available in the configuration. You can enter a different name for each profile (e.g. day, night, break etc.).

Activating individual profiles (on/off)

Here you can switch individual profiles on or off. The activated profiles are available for selection on the corresponding configuration pages. Switching between profiles either takes place using the system buttons on the system telephone, through the web interface or the time control.

Activated profile

Here you can activate the desired profile.

Timecontrol

Here you can activate the time-controlled switching of profiles.

Day/Night switching (web configuration)

Here you can set the authorisation to select a profile over the web. For this select the desired subscriber. After dialling using the subscriber access data, the subscriber is available on the relevant menu.

Timecontrol

Using the time control you can switch between the various profiles for day/night switching. Manual switching is retained until the next time for switching.

You can enter up to six switching times for each day of the week. At the switching time the selected profile is activated for day/night switching.

Public holidays

You can enter up to 30 holidays here. These days are treated in the time control as Sundays.

Note: The sub-menu „Public holidays“ is identical between „day/night“ and „LCR“. Data will have to be entered only once.

LCR

Note: This menu is only available when it has been enabled in the „Settings“ menu.

LCR (least cost routing) means that the telephone system selects the cheapest provider depending on the time and call destination (prefix) and dials the relevant prefix automatically.

Settings

LCR mode

Set the mode of the LCR module here. Normal or economical.

- Normal
The router tries to dial via the provider set. If the connection is not possible the connection is made automatically via the subscriber's standard settings.
- Economical
A connection is made only via the set provider.

Store LCR table

You can save the current LCR table on your PC.

Upload (LCR table)

Select the file with the LCR table using the BROWSE button. To transfer click the TRANSFER button.

In Germany up-to-date lists for your TIPTEL telephone system you may find on www.telefonsparbuch.de for the time being. Pay attention to the download section of your telephone system on www.tiptel.com.

Delete LCR table

You can delete the current LCR table here.

Provider

The connection set up via another telephone company (provider) takes place via a special provider prefix. Enter the desired provider with the provider prefix here. By selecting the ISDN port you can also determine which connection is used to make the call. If you simply want to specify the connection, just leave the provider prefix field empty.

Zone

You specify a range of call numbers for assigning providers with the tariff zones input. To do this the dialled call number is compared with the tariff zone. The best fitting tariff is determined for the assignment.

Example:

Tariff zone A 02102

Tariff zone B 021024280

For call number **021024280** tariff zone B is specified.

Timecontrol

The time control permits the provider assignment to be switched in a time-controlled manner. First select the desired tariff zone. Subsequently you can assign a provider for the individual days and times. If you do not want to preset a provider for the selected tariff zone you simply select the „default” provider.

Public holidays

You can enter up to 30 holidays here. These days are handled in the time control as Sundays. Enter the days in the format „dd.mm” (e.g. 31.12.).

Note: The sub-menu „Public holidays“ is identical between „day/night“ and „LCR“. Data will have to be entered only once.

Configuration examples

Example 1:

You want to call in Germany with Arcor, but when calling Munich you want to use your standard provider.

Under „Provider“ define: „Arcor“ provider name – provider prefix 01070.

Define two zones:

- „Germany“ with the call number 0
- „Munich“ with the call number 089

Select „Germany“ as the tariff zone under „Timer control“.

Enter „Arcor“ as the provider under time control for weekdays, Saturdays and Sundays/holidays.

Select „Munich“ as the tariff zone under „Timer control“. Enter the value „default“ everywhere.

Example 2:

You have already programmed your LCR with your preferred providers, but you also want to have the option of manually selecting another provider using call-by-call prefixes.

Under „Zone“ define: Tariff tone, e.g. call-by-call – code 010

Under time control define the „call-by-call“ tariff zone and enter the „default“ value everywhere.

Example 3:

You want all calls to the special number 0900 to be forwarded to your mobile phone.

Under „Provider“ define an entry, e.g. „My mobile“. Enter your mobile call number as the provider prefix. End the call number with the „#“ character.

Under „Zone“ define a tariff zone e.g. „0900“ and enter the special call number 0900 for codes.

Under „Time control” define the „0900” tariff zone and enter the „My mobile” value everywhere.

Note: The final „#” character means that after replacing the code with the provider prefix all numbers in the dialled call number will be ignored.

Expert mode

The expert mode is mainly intended to provide you with service functions.

Date / time

Your telephone system comprises a buffered clock module. The system time can be set either via the web configuration or via the ISDN network (if available). The date/time information is used for creating call information data records.

Requirement: Transfer of date and time via the ISDN telephone network depends on whether or not that feature has been unlocked by your telephone network provider.

Service

Protocol trace

Tracing of the system protocol can be enabled or disabled here. With protocol trace enabled internal processes will be save to a file. The protocol trace is meant for service purposes and should only be enabled if requested by our technical support.

Protocol file

You can save the protocol file to your PC. Eventually this file will be requested by our technical support.

Configuration file

You can save the current configuration file to your PC.

Note: This configuration file can also be used to transfer the configuration to other tiptel.com telephone systems of the same type. This includes all passwords. Out of security considerations you should handle this file with care.

Printable version of configuration

In this menu, all settings are saved in an HTML file. This file can be opened and printed out from your web browser. Eventually this file will be requested by our technical support.

Software version

The software version of your telephone system is displayed here.

Upload (update/configuration)

Loading new operating software:

Here you have the option to import the current software version. To do this, select the current software or file extension in .fls on your PC. You will find this file on our homepage www.tiptel.com.

Note: After a firmware update, the telephone system will automatically be restarted. The current settings remain unchanged. During the download and the initialization phase of the telephone system, the power supply **MUST NOT** be interrupted. Should the update fail, please contact the support team of Tiptel.com GmbH.

Loading configuration data:

This menu is used to transfer the current configuration data to your telephone system. After a data backup, select the configuration file extension in .cfg on your PC.

Note: After loading new configuration data, the telephone system will automatically be restarted. When transferring the data to your telephone system, all call data records will automatically be deleted.

Loading WAV-file for music-on-hold

It is possible to record an audio file in WAV format and to save it in the telephone system. For recording or converting you can use the „Sound Recorder“ of your Windows PC to be found under „Start“, „Programmes“, „Accessories“, „Entertainment“, „Sound recorder“ (depending on the version of the Microsoft operating system). Set the volume under „Modify/Audio Properties“. In case you would like to change the volume later you can use the corresponding function in the „Effects Menu“. After completion of your recording, it is recommended to convert it to the following data format: PCM, 8 kHz, 16 bit, mono. Then you can save the recording and transfer it via the web interface to the telephone system. The length of the recording must not exceed 90 seconds.

Note: The volume will be determined by the generated wave file. You may want to adjust the volume by using the „Sound Recorder“. Note for recording studios: The factory default music in the telephone system has a sound level of -12 dBm.

Telephone system restart

Use this function to restart your telephone system manually.

Voicemail

Note: This menu is only available with a tiptel VCM-Module installed

Unassigned folder on the MMC

ICM and OGM from deleted subscribers or cancelled voice boxes are retained until they are deleted manually. At this point you can assign the complete directory with all of a subscriber's or services' ICM and OGM whose voice box is not yet switched on. Please note that under some circumstances there is no access to ICM or certain OGM if the subscriber or service does not use ICM or certain OGM.

Memory assignment

The memory occupancy lists all the voice boxes that are switched on and the memory space reserved for them. Please note that for technical reasons it is not possible to reserve the whole space on the MMC for voice boxes. Unassigned directories from former voice boxes also reduce the available memory space.

SIP

Note: This menu is only available with a tiptel VoIP-Module installed

RTP Settings

This setting allows you to determine how long the device collects all speech data packets that are to be sent before actually sending them. The shorter this time frame is, the greater the necessary bandwidth. Reason: The speech data is sent in smaller packets. For each packet, however, what is known as a header has to be calculated. This header is sent less frequently in the case of larger speech data packets. If, however, a larger speech data packet does not reach the recipient, this is noticeable due to an acoustic interruption.

Dejitter buffer size: Jitter describes the time fluctuation between the receiving of two data packets. To compensate for time fluctuations, a buffer (dejitter buffer) is employed. When setting the size of the dejitter buffer, please keep the following effects

in mind:

Too small of a dejitter buffer can result in speech interruptions if data packages with a longer runtime are rejected.

If the buffer is too large, there may possibly be a perceptible echo.

Special Settings

QoS for SIP (TOS/DiffServ), QoS for RTP (TOS/DiffServ): These settings allow you to influence the prioritization of speech data in the network/Internet.

Pause between 2 dialled figures: Using this setting you influence the maximum amount of time that may pass between the last input of a dialled number and the placing of the call.

Note: You can accelerate the placing of the call by pressing the # button after entering the last digit.

Menu: Ports

ISDN

At this menu external and internal S₀-ports are configured

Settings

Your telephone system has up to two S₀-ports which can be switched to external or internal. For the external S₀, you can choose between a point-to-point and multipoint interface. If you choose the multipoint interface, you can additionally select „layer 2 always active“. This setting is required by some public exchanges. For a point-to-point connection, it is additionally necessary to enter the basic number of the telephone system. Enter the extension numbers for the point-to-point connection in the „Entry MSN/DDI“ menu.

Type/Status

For the external S₀ you can choose between point-to-point and multipoint interface.

Layer 2 always active (only with multipoint access)

If you have chosen a multipoint interface, you can additionally define whether the connection to the switchboard shall always remain active (layer 2 always active). Thus, the connection can be monitored via the switchboard. With a point-to-point access, layer 2 is automatically always active.

CD external

If a subscriber activates call forwarding to an external destination, an external caller is normally diverted via a second voice channel (B-channel). This has the following disadvantages, however:

- The external destination receives CLIP information containing the call number of the telephone system and not that of the caller. However, you can correct this by having the service „CLIP – no screening“ unlocked by your telephone network provider. Please note that this service is liable to pay costs. The telephone system supports this service by the option to programme any outgoing telephone number!
- Two voice channels are occupied and therefore are no longer available for other calls.
- If no further voice channel is available for call forwarding, forwarding cannot take place.

If the CD external function is activated, the call forwarding is carried out directly by the external line. The disadvantages described above no longer occur. However this service must be enabled.

Note: This service is not supported by every telephony network provider. When more than one subscriber is being addressed external CD will not be carried out. In this case call deflection is being carried out via the second voice channel (B channel). This makes sure that - despite a call deflection is carried out - all other extensions will continue ringing.

Basic number (only point-to-point connection)

For a point-to-point connection, it is additionally necessary to enter the basic number of the telephone system. Enter the extension numbers for the point-to-point connection in the „enter MSN/DDI“ menu.

With this telephone system DDIs must not be identical with the internal phone numbers (extension numbers). You can, however, programme it this way.

Operator

In this menu you can select one subscriber for the switchboard function. The following calls will be routed to this subscriber:

- calls for a DDI / MSN which has been assigned to no internal subscriber
- calls for an unknown DDI
- calls for this subscriber

Entry of MSN/DDI

In this menu you enter the corresponding MSNs for each external S_0 connection. In case of a multipoint interface, you are provided with up to 10 phone numbers (MSNs) for each S_0 connection. For a point-to-point connection, you have a basic number to which extension numbers (DDIs) are added. Enter the requested DDI. One MSN/DDI must not be assigned to several external ports. Furthermore you can assign a name to each number. This name will be displayed in the „From/For Display“, which is available with system phones and internal voicemail systems.

Example:

Caller John (name taken from phone book) calls subscriber 50 via external MSN 4280. The telephone displays the name „John“ in the first line while in the second line „Call for MSN 1“ (MSN 1 = 50) is being displayed. If you e.g. assigned the name „Private“ to MSN 4280, the telephone will display the name „Private“ instead of „Call for MSN 1“.

Note: External and internal numbers may be identical. With this telephone system DDIs must not be identical with internal extension numbers. You can, however programme them this way. In case you also received the DDI „0“ from your provider, you must assign this DDI to an extension by all means. This can of course also be the extension which has been defined as operator.

Call forwarding external

Call forwarding can be set up for each MSN at a multipoint interface. The „number for call forwarding“ item informs you how many MSNs have call forwarding enabled. In order to modify the call forwarding, select the desired MSN and enter the desired data in the lower entry fields. Should several external S₀-ports be used, individual settings are possible for each S₀. If the call forwarding is reprogrammed via a parallel-connected terminal unit, the settings of the telephone system will also be changed accordingly, provided that the CFI ISDN feature is available. If the CFI feature is not available, the reprogrammed parameters will automatically be reset within the telephone system after a short delay (depending on the exchange office).

You can choose among the following settings:

- Call Forwarding Unconditional (CFU)
- Call Forwarding On Busy (CFB)
- Call Forwarding No Reply (CFNR)

Requirements: Connection to a multipoint interface. This feature has been enabled. Entry of the external MSNs.

Call forwarding external (CFI)

Here you can set whether or not a query of the current call forwarding external should be carried out. For public switches that do not support the call forwarding function via the CF ISDN service, it is recommended to set the inquiry option to „OFF“.

Analogue (FXOs)

Note: This menu is only available with a tiptel 2FXO-Module installed

Settings

Operator

Here you can define the subscriber to be used as operator. With a not existing call distribution the call will be signalled at the operator defined. This function will only be needed with DDI-capable analogue exchanges.

Fax switch

With an enabled fax switch all calls will be accepted without exceptions. Upon accepting the telephone system will check whether or not the caller is a fax machine. If yes, the call will be forwarded to the extension defined as fax. If no, standard call distribution will be carried out.

Note: Please make sure that for the defined fax extension neither „Call waiting“ nor „Pick Up“ has been enabled.

Entry of Phone Number

Here please assign to every external port the corresponding phone number. In addition you may also want to assign a name to each phone number. This name will appear in the „From/For-Display“ applicable when using system telephones and/or the internal VCM-Module option.

Analogue (FXS)

Here you define the analogue extensions per port.

Settings

Rhythm of ringing signal for internal call

Here you program whether or not call signalling with internal calls shall have another signal sequence as with external calls.

Please note that the correct playback of the call rhythm depends on the settings for the ringing signal with your analogue telephone. You should select a ringing signal which can follow the call rhythm set.

Advice of charges

This menu is used to set whether charges shall be signalled at your analogue port“. If a fax machine or a modem is connected, the charging signal should be disabled in order to avoid the interruption of connections.

Call waiting signal allowed

This menu is used to allow or block the call waiting signal. The setting can also be made directly via a telephone on an analogue extension by dialling *43# = on and #43# = off.

If a fax machine or a modem is connected, the call waiting signal should be disabled in order to avoid the interruption of connections.

Phone number transmission

This menu is used to allow or block the transmission of phone numbers. The setting can also be made directly on the telephone at an analogue extension by dialling *30# = on and #30# = off.

Outgoing MSN

Here you can select the desired outgoing internal phone number (for example subscriber 41). For external calls the subscriber will be transferred accordingly to the external MSN.

Kind of CLIP signalling

This menu is used to define whether the phone number shall be signalled at the analogue extensions via DTMF or FSK. In German-speaking countries, FSK is generally used. The relevant information can be taken from the User's Manual of your analogue telephones.

VoIP (SIP)

Note: This menu is only available with a tiptel VoIP-Module installed

Subscriber list

The overview page shows you a window displaying the status of all SIP accounts that have been set up.

Choose a name from the **SIP Account** column. A window with all of the SIP account settings is displayed.

The **Phone number** column always lists the first telephone number of a SIP account.

The **Status** column indicates if a SIP account is registered or if an error has occurred.

Under **Selectable SIP account** a dialling code is listed that enables manual selection of a SIP account. This is an alternative to the choices of the SIP accounts through the outgoing phonenumber.

By selecting the ▶ symbol you can register the corresponding account with the SIP provider again. If an error has occurred then you will be provided with additional help after clicking on the ⓘ symbol.

Note: Please note that when checking for errors, the Network status as well as the Network settings are checked.

Set-up SIP Account

Before you can use the device to place calls it is necessary to set up a SIP account. Using the information contained in the SIP account the device is then able to log in to the SIP provider.

Now check in „SIP settings“ under „Provider“ to see whether your SIP provider is listed in the factory defaults. Click on the field „List of Providers“. A list of available providers is shown.

- Choose your SIP provider from the list. The provider that is selected is displayed in the right column.
The list displays all providers that you have created followed by those created ex factory. The providers created ex factory are also designated with a country symbol. If you also want to list all foreign providers that were specified ex factory, you need to check „Foreign provider“.
- If your SIP provider is not listed, you will next have to set up a new provider. To do this, go to the menu „Internet telephony/SIP provider“.
If you would like to save changes for a SIP account, press the „Apply“ button. „Reset“ will restore the last settings that were changed as long as these have not yet been transmitted to the device.

Note: Depending on the changes that have been made, the device will automatically log off from the provider and re-registers itself with the new settings. Any existing speech connections are terminated.

Account

Here you choose whether you would like to change an existing account or create a new account.

Go to **Account name** and enter a name of your choice to designate the data record. You can choose any name for the account as it is irrelevant to communications with your SIP provider.

Note: Changing the name of the account later will only change the existing data record. No additional copy of the data record is created.

Using **Account active** (on/off) you can switch off the SIP account as necessary. The SIP account is then temporarily logged off from the SIP provider. Then you will be unable to make calls using this account.

SIP Settings

Provider: Choose your SIP provider from the list. The provider that is selected is displayed in the right column.

The list displays all providers that you have created followed by those created ex factory. The providers created ex factory are also designated with a country symbol. If you also want to list all foreign providers that were specified ex factory, you need to check „Foreign provider“.

You can also create additional providers. To do this, go to the menu „Set up SIP provider“.

Name: In the case of some providers/devices the name of the person you are calling is shown instead of the telephone number.

Username/SIP-ID, Password, Authentication: Please refer to the user registration information provided by your SIP provider.

Note 1: The input fields for **Name**, **User name/SIP-ID** and **Authentication** in our experience are called something different depending on the provider. Often the **authentication** input is dropped altogether.

Note 2: After choosing an ex factory-defined provider, the input fields for **Name**, **User name/SIP-ID** and **Authentication** are labelled in the same way they are found in the registration documentation of the provider. This should simplify the input of settings.

Operator: Here you can define the subscriber to be used as operator. Following calls will be forwarded to that subscriber:

- Calls being placed to a phone number which has not been assigned to any subscriber.
- Calls being place to an unknown phone number.

Use optimized parameter for fax: Here you can select a subscriber for fax connections. With this selection data transfer will automatically be optimized for a fax connection. A successful transmission depends on the quality of the connection and therefore cannot be guaranteed.

Voice compression: Adjust the desired compression of speech data with this setting. Please note that the speech quality can deteriorate. In addition, the compression you have selected has to be supported by the Internet telephony provider and by the device. Choose the „off“ option if you would like to send or receive faxes.

Overview of settings for the selected provider

The settings for user-defined SIP providers can be changed under „Set-up SIP Provider“. The parameters for an SIP provider defined ex factory cannot be changed. In this case, create a new SIP provider and make the desired changes.

Entry of phone number

Here please enter the phone number of your SIP account. The entered phone number will be treated the same way as a phone number at an external ISDN access.

Set-up SIP Provider

On this page you can create SIP providers yourself. If you would like to communicate via a SIP server in your local network, you also create a SIP provider. The number of providers is unlimited.

If you would like to save changes for a provider, press the „Apply“ button. „Reset“ will restore the last settings that were changed as long as these have not yet been transmitted to the device.

Note: Changing provider data is applied immediately to the SIP accounts that use this provider. Depending on the change that has been made, the device will automatically log off from the providers and will re-register itself with the new settings. Speech connections in progress are terminated.

SIP Provider

Here you choose whether you would like to create a new provider data record or change an existing user-created data record.

Enter the provider name to give the data record a designation. You can choose any provider name as this is unimportant for communicating with your SIP provider.

Note: Changing the name of the provider later will only change the existing data record. No additional copy of the data record is created.

Provider settings

Your provider provides the addresses for realm, registrar, proxy server, STUN server. Enter this data without spaces.

If you are running a SIP server in your local network, as an alternative you can also enter the IP addresses. Example: 192.168.20.180

Note: If your provider specifies a port for the STUN server that is not 3478, enter the port as follows: Provider:Port. Example: stun.Provider.net:10000

Settings

SIP client ports

Here you can change the port for the SIP control protocol. If you need to set up port forwarding in your DSL router, do this for UDP ports.

Speech data is exchanged via RTP ports. In our experience you must define an individual RTP port range for each VoIP device. Specify the beginning of the range with an even port number. Set up port forwarding for UDP ports in the DSL router for the ports shown in green boxes.

Proxy settings

Please enter the port for service proxy server here. In case you wish to use that service from another network you will have to set up port forwarding for UDP for this ports within your gateway.

Menu: Subscriber

General

The subscriber list shows all subscribers at a glance. Busy extensions / busy subscribers are marked red and those called are marked in yellow.

Subscribers who are notified at several extensions or who have the call-waiting signal enabled can be called even if they are busy. If several subscribers have been assigned to one extension, this may result in congestion. In this case, a free subscriber is not able to place a call. In order to access the configuration for one subscriber, simply click on the name. Upon entering the password, the available settings are shown. Additional settings can only be made by the administrator.

For better clarity, the subscriber list can be sorted as follows:

- alphabetically: check „name/configuration”
- according to phone numbers: check „phone number”
- according to status: check „subscriber status”.

Note: If you have enabled the „auto update” option, you can also use the subscriber list in order to see currently busy extensions. However, please note that an update interval of less than 5 seconds can severely strain the network and your PC.

Same applies to the status display of the voice boxes (subscriber answering machines) with installed tiptel VCM-Module. By clicking the status display you can also switch directly to the recordings for having them played back.

Groups

It is possible to assign several subscribers to one extension (also to analogue extensions). Vice versa, a call for one subscriber can also be signalled at several extensions. Thus, group or team signalling is possible.

Day/night Switching

Day/night profile

Here you can select the day/night profile for which your settings should apply.

Group

Group selection

Select the group that you want to configure here. Create a new group using the „New” setting or select an existing group. After the configuration you can create the group with the button „Create“. If you wish to configure a group after the configuration click on the button „Save“.

Name

Enter a meaningful name for the group here.

Phone number

Assign a call number for the group here.

Group type

Select the group type here.

- Open: The group can be reached internally and externally
- Closed: The group can only be reached externally.

Group mode

Your telephone system distinguishes between dynamic and static groups. In the static setting all group subscribers and call numbers are available. In the dynamic setting the individual group subscribers have the opportunity to log in via

*23*GroupsMSN# or to log out via #23#Group-MSN#. After logging off the relevant subscriber receives no call signals.

Call distribution (ACD)

Here you can set the various functions for automatic call distribution (Automatic Call Distribution). The following functions are available:

- Simultaneous
This option means that all group subscribers receive a call signal. If a rejection location has been defined for this group, the call is transferred to the rejection location.
- Busy on busy
This option means a call is only signalled if no group subscriber is on the

phone. The caller hears the „subscriber busy” signal as a rejection or is transferred to the entered rejection location.

- **Linear (chain call without time out)**
this option means that only the first subscriber (Index 01) from the subscriber list receives the signal for a call. If this subscriber is busy, the next subscriber on the list is called. If no other subscribers are available in the list, the caller receives the „subscriber busy” signal or is transferred to the rejection location.
- **Linear (chain call) with time out**
This option means that only the first subscriber (Index 01) from the subscriber list receives the signal for a call. If this subscriber is busy or he does not accept the call within 10s, the next subscriber on the list is called. If no other subscribers are available in the list, the caller receives the „subscriber busy” signal or is transferred to the rejection location.
- **Depends on breaks**
This option means the subscriber who has not made a call for the longest period of time receives the signal. If this subscriber is busy, the next subscriber on the list is called. The function is reset when a group subscriber logs in. If no other subscribers are available in the list, the caller receives the „subscriber busy” signal or is transferred to the rejection location.
- **Load dependent**
This option means the subscriber who has the lowest total call time receives the call. If this subscriber is busy, the next subscriber on the list is called. The function is reset when a group subscriber logs in. If no other subscribers are available in the list, the caller receives the „subscriber busy” signal or is transferred to the rejection location.

Central phone

Assign the rejection location for the group here. In case you want to reject to an installed tiptel VCM-Module, just install a pseudo subscriber and enable his answering machine with a very short delay. Of course you can also reject to an existing subscriber with activated answering machine.

Select group member

Select the individual group subscribers here. For dynamic groups you can also specify the current status of the group subscribers. But please beware of the fact that this is subject to change as group members are allowed to log on/off themselves.

Allocation for incoming external calls

Here you can set via which external MSNs or DDIs the group can be called.

Call distribution

You specify the call distribution when creating a subscriber under „incoming external call assignment”. This indicates which subscriber is assigned to a particular external call number (MSN/DDI). All subscribers are listed for each call number. The assigned subscribers are marked accordingly. Here you can also change the call distribution. You must activate or deactivate the desired subscribers with the mouse while holding down the „Ctrl” button.

Note: This menu not only gives you a quick overview, it also allows you to change the call distribution for several subscribers in a comfortable way. Settings performed here can also be found in the subscriber settings in the following menu item. Under that menu item performed settings can again be found under this menu. Those settings are redundant.

Subscriber – Sub-menu: Administrator

Here you can configure the individual subscribers. The administrator settings listed as follows, however, cannot be changed by the individual subscriber.

Your telephone system can manage up to 48 subscribers. Each subscriber can be assigned to one or several extensions. If you wish to save changes to a subscriber's settings, click on „OK, Save”. If you wish to save modified settings under a new subscriber's name, click „Create”. When clicking „Reset”, the last modifications are not stored.

Here you can choose a subscriber in order to change the settings. The selection is always a combination of the internal number and name. If you want to create a new subscriber, you have to select „New” subscriber.

Copying a subscriber

Existing subscribers can easily be copied.

To do this, select the corresponding subscriber you want to copy. Modify the name of the subscriber, the internal phone number and other parameters / settings.

Using the „Create” button, the subscriber is now copied and created.

Note: Name as well as the internal phone number may only be assigned once.

Modifying a subscriber

From the subscriber selection options determine the subscriber you want to modify.

Modify the desired settings.

The modified parameters are stored by pressing the „Save” button.

Subscriber

Name

Enter the subscriber’s name here.

Phone number

The telephone system manages internal phone numbers consisting of 1 to 20 digits each. It is recommended to standardise the number of digits for internal phone numbers. For a point-to-point interface, the DDI should be the same as the internal phone number (subscriber).

Example: Main number 428 / internal number 12 => Number for subscriber 12 = 42812

Brief description

For documentation purposes you can enter a brief description here, e.g. the room number.

Password

After accessing one subscriber’s configuration menu, you have to enter a user name (subscriber name) and a password. Enter the desired password here. You may want to inform the individual subscribers on their passwords, in order to grant them access to their individual settings.

Authorisations

Exchange authorisation

Individual exchange authorisation can be assigned to each subscriber for outgoing calls. The following authorisation levels are available:

- No exchange authorisation
- National exchange authorisation
- International exchange authorisation

Special numbers (where available and released) and emergency numbers can override the exchange authorisation set.

Requirement: An MSN/DDI for outgoing calls must be selected for the subscriber.

Call forwarding targets

This menu is used to programme the authorisation for call forwarding. In case of external call forwarding destinations, the restrictions via dialling control will be taken into account. Exchange authorisation restrictions will not. The following authorisation levels are available:

- No call forwarding permitted
- Call forwarding permitted only to internal destinations
- Call forwarding permitted to internal and external destinations

Outgoing number (CID) in case of forwarded calls

Here you select whether the caller's number or the system's call number is to be transmitted.

Dialling control

This menu is used to activate the global setting for the subscriber.

LCR

This menu is used to activate the global LCR functions for the subscriber.

Charge account, limit

It is possible to activate a charge account for each subscriber. As soon as the subscriber exceeds his / her charge limit, no further external calls (except emergency calls) can be made. Active calls will not be interrupted after exceeding the charge limit. A negative credit is indicated instead.

Day/night switching (web configuration)

This menu is used to activate the day/night switching for the subscriber.

Extensions allocated to subscriber

Here you can define at which extensions the selected subscriber is to be signalled. Simply select the desired extensions in the table that is displayed.

Allocation for incoming external calls

Here you can set which external MSNs or DDIs are used to call the subscriber. Simply select the desired MSNs in the table that is displayed. Requirement: entry of external MSNs in menu „ISDN-access“ (see above).

Allocation for outgoing external calls

Here you have the option to choose between „random“ and „according to allocation table“. If you select „random“, an outgoing call will be routed through any random S_0 port. If you select „according to allocation table“, an outgoing call will be routed via the defined S_0 port with the selected MSN.

It is also possible to select several S_0 ports. In this case, the selection is made according to the order that was specified. First, the dialling procedure is initiated via the S_0 marked „1“. If this S_0 is in use, the dialling procedure is initiated via the S_0 marked „2“. The possible settings depend on the number of external ports and will be of concern with optional modules such as a 2 a/b FXO-Module or a VoIP-Module.

External PABX dial in (call through / call back)

It is possible to realise remote access to your telephone system. After dialling-in, a standard internal dialling tone can be heard. A certain extension or an external subscriber can be called via DTMF.

All authorisations correspond to your subscriber configuration. Even keypad functions, such as call forwarding via the key sequence *21*destination# are possible. If you are using a tiptel VCM-Module, you may also directly reach and query your personal voicemail box.

Note: This service has to be configured in advance under „Set-up service“.

Call-back number

If you already know which external connection should be used to dial into the telephone system (e. g. calling the telephone system with a mobile phone), it is recommended to enter the appropriate call number in this menu. If this phone number is transmitted as CLIP data, access to the telephone system will be available after the dialling-in process. In this case, it is not necessary to enter the PIN code.

PIN

A four-digit PIN code has to be entered here. You will hear a request tone after dialling up the telephone system. Now enter the four digit PIN plus # (e.g. 1234#). The

correct entry is confirmed by a confirmation tone. You will then hear the internal or external dialling tone. When the dialling tone can be heard DTMF detection is activated. Via DTMF you can now dial another extension or an external subscriber. With activated callback the connection will be cut automatically after the confirmation tone and you will receive a call back to the entered number (see below).

Call back

In order to register the charges incurred when dialling-in (e. g. for employees with remote access), a callback can be activated. This callback is then made to the telephone number entered above. When the transferred CLIP information matches the phone number, the call is not accepted. The callback is initiated within 15 sec.

Note: The exchange authorisation for the corresponding subscriber must be activated for a callback.

Subscriber

Note: As an administrator simply select the desired subscriber in the administrator menus (see previous chapter). Then you will see additional menu items on the left edge of your screen, inter alia also sub-menu „Subscriber“.

Each subscriber can change his/her settings with his/her user name and password. The subscriber settings can be accessed provided that the subscriber logs on the telephone system with his/her user name.

Settings

Automatic CO line access

After picking up the handset, the telephone system will automatically initiate a standard exchange connection, i.e. the telephone system dials „0“ for you. If a free CO line is available, you will immediately hear the external dialling tone. If all external lines assigned to the subscriber are busy, you hear an internal busy tone. An automatic exchange connection is only executed for the first connection attempt. For further connection attempts – for example for an inquiry call – the internal dialling tone is heard first. If a further external connection is to be made, the exchange must be dialled.

In case of an activated automatic exchange connection, it is possible to activate the internal dialling process using the key combination „#*#“. In addition, ten seconds after the handset has been lifted, the telephone system is automatically switched to the internal dialling tone. Afterwards, internal calls can immediately be held. Automat-

ic exchange connection is also executed if no exchange authorisation is available. This is necessary in order to ensure that emergency phone numbers can be dialled. As soon as additional digits that do not belong to an emergency number are dialled, the connection is terminated.

Note: The „automatic exchange connection” feature must be enabled. The required exchange authorisation must also be available.

Call pickup (Pick-Up)

Use this menu to define whether an incoming call may be picked up by another subscriber. Select the „answering machine” setting if you wish to operate an answering machine at this extension. You are now able to pick up the call even after it has already been answered by the answering machine.

Follow me

This function allows you to transfer the call forwarding of your internal number to the phone number of your current location.

Press the following buttons to apply call forwarding to the other extension: *22* (individual phone number) #

Password

After calling up the configuration menu for a subscriber, you have to enter a user name (subscriber name) and a password. Enter the desired password here. Every subscriber is able to replace the password assigned to him by the administrator with his/her own password. In this case the password in the sub-menu „Administrator“ assigned by the administrator no longer identical with the one entered here. As administrator you cannot see the password entered by the subscriber but you can overwrite it any time.

Outgoing number

When placing a call to an external subscriber the telephone system will advise the exchange via which MSN the call shall be established. The exchange will assign the charges to this MSN. In case CLIP is activated that MSN can also be displayed on the called party's telephone. Is that number, however, not known to the exchange, usually the base number will be used. Some exchanges - if ordered - will also transfer unknown numbers transparently through to the called party. In order to be able to use this service „CLIP – no screening“, you will have to order this service from your provider which is usually with costs. This service might be of interest for outgoing transfer e.g. of service numbers (e.g.0180) or numbers of another subsidiary. But please make sure not to violate the contract of with your provider concerning this service.

You now have the option to enter that number. If you do not wish to change the pre-settings carried out by the administrator, just leave that field empty - which should be the normal case.

Call forwarding

Call forwarding is executed within the telephone system and can be configured individually for every subscriber. It is possible to forward calls to internal and external calling destinations. A maximum of two calls can be programmed for forwarding in succession within the telephone system. An external phone number must always contain the **0** for exchange connection.

Call Forwarding Unconditional (CFU)

Incoming calls are immediately routed to the call-forwarding destination. Your own terminal does not display a notification for the call. This setting is recommended for business trips, holidays, etc.

Call Forwarding on Busy (CFB)

Incoming calls are forwarded to another extension when your terminal is busy.

Note: In order for the CFB feature to operate properly, the call waiting signal must be disabled at the relevant telephones.

Call Forwarding No Reply (CFNR)

In this case, the incoming call is indicated on your terminal for a specific period of time. If the call is not taken during this time, it is diverted to the rejection destination.

It is also possible to enable call forwarding at individual terminals (refer to the User's Manual for your telephone system).

Charge account

You can see the current credit on your charge account here. Without any credit with an activated charge account it is not possible to place a call with costs.

System telephone

Note: Disregard this chapter in case you are using tiptel.com 410 or tiptel.com 810.

Your telephone system supports the „tiptel 82/83 and 85 system” system telephones. An individual MSN has to be entered in each system telephone for identification purposes. If several MSNs are entered, only the first MSN will be used for identification. The system functions are configured using the web configuration interface of your telephone system. First, determine the desired system telephone using the MSN/subscriber option. Afterwards, system functions can be assigned to the function keys. The allocation of the functional keys cannot be modified by the user of the telephone. Exception: select the „free macro key” option.

Selection of subscriber

Select the subscriber for whom you want to configure the system telephone. Your telephone system will already show all system telephones detected with their designations.

Select system phone

Select the model of the system telephone.

Copy Functional keys

Here you can copy current settings of one subscriber to other subscribers. In order to be able to do this select the desired subscriber in the selection filed (with more than one subscriber just hold down the CTRL key) and then click the „Copy” button.

Labelling field

 You can print out the telephone labels fields for your system telephones with the print function.

Remote control of system telephones

With your system telephone functions like room monitoring, hands-free, or announcement can be activated remotely. The functions hands-free and room monitoring are protected by PIN. Control is activated by the following key sequences:

Room monitoring (with p = PIN, n = MSN of the system telephone):

*25*pppp*nn#

Hands-free (with p = PIN, n = MSN of the system telephone)

*26*pppp*nn#

Announcement (with n = MSN of the system telephone)

*27*nn#

Here you can enter the necessary PINs. If you wish that function to be disabled just leave the field empty.

PIN for hands-free mode

You can define a 4-digit PIN for hands-free operation here. The default value is „0000”.

PIN for room monitoring

You can define a 4-digit PIN for room monitoring here. The default value is „0000”.

Assignment of the functional keys**Status CO-line access**

For this function, the LED indicates whether a CO-line is available for an external call. Those external S₀ connections that have been assigned to the subscriber will be taken into account. It is therefore possible that no external line is available even though not all external S₀ connections are busy.

- LED on => no CO line available
Action: none
- LED off => an external line is available
Action: pressing the key activates the hands-free mode and provides a CO line (external dialling tone after standard exchange connection). The hands-free mode is not automatically activated when the handset is lifted.
- LED flashing => outside line authorisation is withdrawn
Action: none

Note: Do not assign this function to any key if the CO-line access for this subscriber has been blocked (menu item „exchange authorisation for outgoing calls”: none). Otherwise, this key will be flashing permanently. For example, the exchange authorisation can be withdrawn because the subscriber concerned has exceeded the limit of his charge account.

CO-line access with specific MSN/DDI (line key)

Here you specify which MSN/DDI of your telephone system should be used for an outgoing external call. As the MSNs/DDIs are assigned to certain external S₀ connections, you determine at the same time which port should be used for the telephone call. The status is indicated by the LED as follows:

- LED on => this MSN/DDI is being used for the telephone call
Action: none
- LED off => Standby mode
Action: Pressing this key activates the hands-free mode and provides an external line (dialling tone after destination exchange connection). The hands-free mode is not automatically activated when the handset is lifted.
Note: This setting permits access for this subscriber to an otherwise blocked

outside line (menu option „outside line permission for outgoing calls”: None) to an outside line via a special MSN/DDI!

- LED flashing => an incoming call for this MSN/DDI
- Action: Pressing the key activates the hands-free mode, and the incoming call is picked up. The hands-free mode is not automatically activated when the handset is lifted.

Internal destination

The subscriber's phone number (internal destination number) has to be entered here. The status is indicated by the LED as follows:

- LED on => the subscriber is holding a telephone call
Action: Pressing the key activates the hands-free mode and the other subscriber's call is picked up (condition: a call pick-up is allowed according to the other subscriber's settings, pick-up parameter: answering machine). The hands-free mode is not automatically activated when the handset is lifted.
- LED off => idle state
Action: Pressing the key activates the hands-free mode and the other subscriber is called. The hands-free mode is not automatically activated when the handset is lifted.
- LED flashing => an incoming call for this subscriber
Action: Pressing the key activates the hands-free mode and the incoming call is picked up (pick-up parameter: on). The hands-free mode is not automatically activated when the handset is lifted.

Note: If the same subscriber receives a second call during an active conversation (LED on), this status is indicated by a flashing LED. This means that the second incoming call (waiting call) can be picked up.

Speed dialling key

It is possible to enter any destination number here. This destination number will be dialled when the function key is pressed.

Call forwarding: unconditional

Enter the call number of the forwarding destination (internal or external) here. By pressing the function key, direct call forwarding to the indicated subscriber is activated for your system telephone. Incoming calls are no longer signalled on your telephone. The status is indicated by the LED as follows:

- LED on => call forwarding is active
- LED off => call forwarding is not active

Call forwarding no response

Enter the call number of the forwarding destination (internal or external) here. When the function key is pressed, your system telephone will engage a delayed forwarding for the specified subscriber. The telephone rings for 15 seconds (pre-set parameter, time can be set according to individual requirements) before the incoming call is forwarded to the programmed destination number. The status is indicated by the LED as follows:

- LED on => call forwarding is active
- LED off => call forwarding is not active

Call forwarding: busy

Enter the call number of the forwarding destination (internal or external) here. When the function key is pressed, your system telephone engages forwarding if the specified subscriber is busy. The status is indicated by the LED as follows:

- LED on => call forwarding is active
- LED off => call forwarding is not active

Call forwarding delayed & busy

This is a combination of the two functions mentioned above. Both call forwarding options have the same destination. If two different destination numbers should be entered, one key has to be assigned to each type of call forwarding.

Note: When using multiple call forwarding keys, you have to take into account that their functions might conflict with each other.

B-channel display

In this function the LED indicates the busy status of the individual voice channels (B-channels) for the external S_0 accesses. All available B-channels are shown in the selection list.

- LED on => a call is taking place via the corresponding B-channel.
- Action: none
- LED off => idle
- Action: none
- LED flashing => a call is taking place via the corresponding B-channel.
- Action: Pressing the key activates the hands-free mode, and the incoming call is picked up. The hands-free mode is not automatically activated when the handset is lifted.

Day/night switching

Here you can stipulate the individual profiles for day/night switching on the buttons of your system telephone. When making the selection, please note that the selected profile and day/night switching must be activated in advance for the function.

- LED on => the corresponding profile is activated
- Action: none
- LED off => the corresponding profile is not activated
- Action: Pressing the button activates the profile.

Voicemail box status on / off

The LED displays the relevant status of your voicemail box.

- LED on => your voicemail box is active.
If the subscriber is busy or does not accept the call within 15 seconds, your voicemail box answers the call.
- Action: Pressing the key switches the voicemail box off. All incoming calls are exclusively signalled on the subscriber's phone.
- LED off => your voicemail box is not active.
All incoming calls are exclusively signalled on the subscriber's phone.
- Action: Pressing the key activates the voicemail box. If the subscriber then is busy or does not accept the call within 15 seconds, the call is accepted by the voicemail box.
- LED flashing => new incoming messages available in the voicemail box
Action: Pressing the key activates the hands-free mode and your voicemail box is called. Refer to the „Remote query” chapter in the appropriate User's Manual for information on the functions of your voicemail system that are available now. The hands-free mode is not automatically activated when the handset is lifted. Note: If there are new incoming messages in the voicemail box it cannot be switched off. This ensures that messages are always heard. In addition the voicemail box may receive other calls during the query (subscriber is finally busy).

Voicemail box pick-up

The pick-up option for the subscriber's voicemail box is activated here. The status is indicated by the LED as follows:

- LED on => the voicemail box has accepted an incoming call
Action: Pressing the key activates the hands-free mode and the call is picked up from the voicemail box. The hands-free mode is not automatically activated when the handset is lifted.
- LED off => idle state
Action: Pressing the key activates the hands-free mode and the voicemail

box is called. The hands-free mode is not automatically activated when the handset is lifted.

- LED flashing=> an incoming call for the voicemail box
Action: Pressing the key activates the hands-free mode, and the incoming call is picked up. The hands-free mode is not automatically activated when the handset is lifted.

Voicemail box status warning

You can set a display to notify you when your voicemail box is full.

- LED off => All incoming messages in the voicemail box are deleted (voicemail box empty).
Action: Pressing the key activates the hands-free mode and your voicemail box is called. The hands-free mode is not automatically activated when the handset is lifted. Now, parameters in your voicemail box can be programmed. For information on the functions available in your voicemail system, please refer to the „Remote query” chapter in the corresponding User's Manual.
- LED on => messages already played back are available in the voicemail box
Action: Pressing the key activates the hands-free mode and your voicemail box is called. The hands-free mode is not automatically activated when the handset is lifted. It is now possible, for example, to playback or to delete existing messages. For information on the functions available in your voicemail system, please refer to the „Remote query” chapter in the corresponding User's Manual.
- LED flashing=> The voicemail box is full and the voicemail box has been deactivated or set to the „announcement-only mode” (if outgoing message 1 has been programmed as ‘announcement-only’).
Action: Pressing the key activates the hands-free mode and your voicemail box is called. The hands-free mode is not automatically activated when the handset is lifted. It is necessary to delete incoming messages. For information on the functions available in your voicemail system, please refer to the „Remote query” chapter in the corresponding User's Manual.

Free macro key

This setting allows the user to free up the corresponding function key for individual assignment. In contrast to the abovementioned system functions, the assignment determined by the user is only saved in the telephone and has to be re-entered if the device is exchanged.

Recording

You can record the current call by pressing this function button.

Remote dial-in

The dialling-in process of your telephone system enables you to log on to your telephone system externally via ISDN and to access the configuration user interface.

Note: Please make sure that your ISDN adapter and CAPI driver have been configured correctly.

Install the PPP data service for an external MSN and use a dial-in connection with the settings indicated in the „PPP data service” menu.

After connection setup you can configure the telephone system as usual via the web browser.

The subscriber authorisation for dialling-in by remote data transmission is set here. The dialling-in process is then realised via the MSN which has been assigned in the ‘set up service’ menu. To prevent unauthorised access, the dialling-in process is secured by the user name and the password of the individual subscribers. Additional limitations can also be activated here.

Dialling in control

To increase the system security even more, it is possible to activate the dialling-in control in this menu. The telephone system now additionally verifies whether the CLIP information transferred corresponds to the data entered under phone number 1 – 5

Note: Please consider the lower speed (64 kbps) of an ISDN connection. Transferring large data volumes can take quite some time.

Voice box

With the optional voicemail system, you have the facility for setting up a voice box for each subscriber.

Note: A tiptel VCM modul must be installed to see this menu.

Activate voice box for an user

Subscriber

You can set up a voice box for each subscriber in your telephone system. Select the subscriber you wish to set up a voice box for here.

Voice box (function)

Activate the voice box for the selected subscriber here.

Maximum memory

Your voicemail system has a recording capacity of 3 up to 15 hours. Assign the desired recording capacity to the subscriber here.

Settings voice box

Stand-by mode

This switch toggles the telephone's stand-by mode on and off.

Language

Select the language for the voice box's voice announcement here. The voice announcement is required for the following functions:

- For defined default OGMs
- For voice OGMs via remote control
- For voice OGMs via message transfer
-
- Memory assignment
- The free recording capacity is shown here.

Select OGM

Select the OGM that is to be played to the caller here. The default OGM is available when the voice box is activated. Customized OGMs can be recorded on this configuration page (see below).

Time until call pick-up

Enter the time until the calls are answered.

Maximum recording capacity

Enter the maximum recording capacity here. At the end of the recording, the voice box will play the end message and then switch off.

Uploading OGMs

OGMs can be created on a PC and uploaded to the telephone system. To record the OGM, use your PC's audio recorder (Programs/Accessories/Entertainment/Audio Recorder). You can set the volume before making the recording in the audio recorder

with "Edit/Audio Properties". If you wish to change the volume later, use the corresponding function in the "Effects" menu. After recording or opening an existing OGM, set the format conversion to "PCM (8kHz; 16Bit; mono)" under "Properties". You can then save the file (OGM) and upload it to the telephone system via the web interface. In this format, OGMs with a maximum length of 15 minutes can be uploaded.

Note: If you wish to speak the OGM via a telephone, use the relevant function in the remote control.

File selection

Select the desired audio file here. Then start the transfer via the web interface. You will then find the OGM with the same name in the OGM selection menu.

Changing the name

Here, you have the option of changing the file name. First select the OGM you wish to rename. Then enter the new name. After confirming the change, the OGM will be stored with the new name.

Playback / delete

Here you have the option of having the OGM played back to you. To do this, the OGM is transferred from your telephone system to your PC. Since this is a WAV file, the audio player program will generally launch automatically.

"Memory full" OGM

Here you have the option of selecting a special OGM to be used in the event of the voice box memory being full. The OGM will be activated automatically by your system.

End message

You can restrict the recording time allowed for each caller. Select the OGM here that the caller is to hear after the allocated recording time has elapsed.

Settings Remote control

You can also configure or listen to your voice box via telephone. It is controlled via an MFV (DTMF)-enabled telephone. You can access remote control mode under the following conditions:

- You call from an external location and the outgoing MSN of your telephone is identical to the QRC number on your answering machine.
- You have activated the "remote access via 930" function. An internal call on 930 goes directly to the remote access. The answering machine is selected by the

caller's outgoing MSN (subscriber 50 calls the 930 => subscriber 50's answering machine moves to remote access).

- In configuration you have activated the remote access and entered a remote access code. After a call you can now enter the remote access code during the OGM to enter remote access mode.

QRC-(Quick Remote Control)

The QRC (quick remote access) number allows you to carry out remote access externally without entering the remote access code. For example, if you have entered your mobile phone number and call the answering machine from your mobile you are recognized as being authorized for remote access and can start up remote access without entering the remote access code. It is not possible to enter an internal subscriber call number. You can use the "remote access via 930" function to remotely control your answering machine internally.

Remote control using 930

You can activate a simple remote access to your answering machine here. After activation and calling 930 you can directly enter remote access for your answering machine. Authentication occurs via the outgoing MSN of your telephone.

Remote access code

The remote access code is a 1 to 4 digit number between 0 and 9999.

Remote control

You can switch remote access on and off here. This switch does not apply to remote access via 930 or QRC.

Remote activation of VB

You stipulate here whether remote activation of telephone answering should be possible here. For the "Yes" setting the answering machine answers a call after 50 seconds even if telephone answering is switched off and waits for a remote access code to be entered. This is how to switch on telephone answering remotely.

Note: The answering machine now rings in parallel to the subscriber. A call then receives a dial tone although the subscriber is busy and call waiting has been deactivated. The "call deviation on busy" setting is therefore not carried out.

Remote deletion

You can set here whether the "Delete ICMs remotely" option is activated or not.

Message transfer

Message forwarding gives you the opportunity to be informed of received messages automatically.

Activate message forwarding

You can switch message forwarding on here. The following services are available:

1. SMS

After receiving a voice recording an SMS is sent automatically The following settings are relevant for this function:

- Target call number
- SMS settings under "Set up service"

2. Call

After receiving a voice recording a stipulated destination is dialled automatically. As soon as "other terminal ringing" is recognized the answering machine hangs up after a 3s delay. If the target call number is busy the dialling is repeated three times at 3 minute intervals. The other terminal now detects that there is a voice message via the Clip information in the call list.

Note: In some cases the provider (e.g. a GSM or LCR provider) sends "other terminal ringing" although the other terminal has not received a signal. In these cases the "call" message forwarding does not work The dialling of an LCR provider can be prevented by selectively dialling an external line (dial #51# instead of 0).

3. Call with voice message

After receiving a voice recording a stipulated destination is dialled automatically. When the target call number answers the OGM for message forwarding starts: "Automatic call, x incoming message(s), please collect remotely, I repeat ..." or if you have entered your own call number as identification "automatic call from subscriber (own call number), x incoming message(s), please collect remotely, I repeat " The OGM is fixed and in addition to the callers' OGM It is possible to start remote access for the recorded message(s) during the message. If the target call number is busy the dialling is repeated three times at 3 minute intervals. If within the settable reminder period (5 – 60 min) no remote access is carried out the answering machine calls the target call number again as a reminder. Without remote access depending on the setting your answering machine makes one, two or no reminders. After ending all unsuccessful messaging attempts the answering machine stops forwarding temporarily until a new message is recorded. The following settings are relevant for this function:

- Target call number

- Repeating the OGMs
- Message collection
- Number of reminders
- Reminder time

Target call number

You enter the number of the messaging here. The target call number can be up to 40 digits in length and must contain the outside line and area code for external destinations.

Repeating the OGMs

The frequency for stipulating the message forwarding OGM is stipulated here. You can enter a number between 1 and 8.

Number of recordings (message collection).

You stipulate here whether the answering machine should forward the messages after 1, 2, 3, 4 or 5 messages.

Number of reminders

Enter the number of reminders here. Entries 0, 1 or 2 are possible.

Reminder time

You enter the necessary parameters here. An entry between 5 and 60 minutes is possible.

Set-up service

Your telephone system provides the following services:

Remote configuration

- Dial in (configuring the telephone system via ISDN (internal or external)).

These services are accessed via virtual extensions.

Please note: The phone number 99 is pre-set and cannot be modified.

Configuration

Similar to LAN, the configuration is performed via a web browser. To do this, it is necessary to set up a remote data transmission network on your PC. Select your ISDN. Enter the following data for access to the system:

- Call number: 99
- User name: admin
- Password: admin

The user names and passwords of individual subscribers are also permitted here: If access to your telephone system from an external location is desired, it is necessary to assign to the ISDN data service an MSN from one of your external S_0 ports (allocation table: incoming external connections). External access to the telephone system is then realised via this phone number.

In addition, it is possible to set the relevant rights for remote access individually for each subscriber. After selecting the subscriber, you perform the configuration through the 'Dial-up remote access' menu. The administrator generally does not have authorisation rights for remote access. In this case, a subscriber's password must be used.

External dial-in

First, you will have to unlock your telephone system for external dial-in (Call-Through/Call-Back). For this purpose, enter the external MSNs that are to be used for this dialling-in process. Subscribers who want to use Call-Through and/or Callback must use these particular MSNs when dialling in.

SMS

Set up SMS

The SMS service allows you to send or receive SMS messages to/from other terminals. The messages are not transferred directly to the other terminal but instead are sent to your telephone system's message centre. The SMS function in your telephone system with an integrated voicemail system (answering machine) is used for SMS message forwarding. The message is comprised of the date, time and caller's call number. You configure access to the message centre here.

External message centre

You have to register your telephone system for your network operator's SMS service to receive fixed network SMS. You enter the necessary parameters here.

Provider Name

To provide a better overview enter the name of your provider here.

Call number provider

Enter the call number of your provider here. In Germany, for example, you can reach the Deutsche Telekom message centre nationally by calling "0193010".

Log in call number

To log in and out you have to send an SMS to an address stated by the provider. The target address for Deutsche Telekom is 8888 and is set as the default. The content of the SMS is stipulated under log in and log out message. For Germany the default text is set to ANMELD and ABMELD.

Carry out log in

Here you can send the SMS for logging in.

Carry out log out

Here you can send the SMS for logging out.

External SMS call number

Here you state the outgoing MSN to be used for logging in to the provider.

Call Manager

Note: This menu is only available with a tiptel VCM-Module installed.

Automatic switchboard

The call uses the automatic switchboard function to decide the target with which he wants to be connected by pressing a number on his tone dialling (MFV) telephone. This makes your system into a direct dial system. In addition calls are removed from any available switchboard as the caller himself can connect to the desired contact. A total of 9 target connections are possible, each with an alternative target. A connection target may occur several times here. A classification can be made via the transferred names on the system telephone (e.g. target 1 with number 50 and the name service, target 2 with the number 50 and the name sales)

Remark: To avoid pending calls the pabx disconnects incoming external calls via analogue ports automatically after one minute in some cases, e.g. in idle state or if the called target does not pick up the phone.

Settings

The automatic switchboard can be entered in various ways. This gives you the option of entering an automatic switchboard for several external MSNs. In the same way you can activate various automatic switchboards depending on the time of day via the day/night switching.

Automatic switchboard (function)

The selected automatic switchboard is activated via this switch.

Select Language

The position is announced in the holding loop depending on the position. You stipulate the language for the position here.

Maximum memory for OGM

Your voicemail system has a recording capacity between 3 and up to 15 hours for announcements and messages. The desired capacity for announcements should be assigned to the function „automatic switchboard“ here.

Memory assignment

The free recording capacity is shown here.

Name

You can change the name of the information system here to provide better clarity.

Phone number

Your automatic switchboard is also available internally for test purposes using the call number stated here.

Brief description

For documentation purposes you can enter a brief description here, e.g. the room number.

Default target

Here you should select a transfer target which will automatically be called in case the caller does not make a choice.

Maximum number of simultaneous calls

Enter here how many callers should be accepted at the same time. In case you wish to unlock external voice channels for other phone calls you will have to select a smaller value here

Outgoing messages

Welcome message

A call is answered with the welcome message. During the message the caller can select a connection target using the 1 - 9 (MFV dialling) buttons on the telephone. The message can be restarted by pressing 0. If no key is pressed after the message the forwarding target of key 1 will be dialed.

Position message

After the welcome message the caller is transferred to the holding loop. This collects all calls and if possible transfers them to the desired target. During this time the caller is informed of the automatically generated position number. Press the 0 button to go back to the welcome message.

Note: The announcement of the queue position can be deactivated.

Enter targets

You state here the target that is to be connected for each number button.

Allocation for incoming external calls

Here you can set via which external MSNs or DDIs the subscriber can be called. Simply select the desired MSNs in the displayed table.

Greeting and transfer

The greeting and transfer function transfers the caller directly to the connection target. During the signal the caller hears the welcome message. If the target is engaged the caller is played the position message until they are connected.

Remark: To avoid pending calls the pabx disconnects incoming external calls via analogue ports automatically after one minute in some cases, e.g. in idle state or if the called target does not pick up the phone.

Settings

WT selection

The greeting and transfer can be entered in several ways. This gives you the option of entering a greeting and transfer for several external MSNs.

Greeting and transfer (function)

The selected greeting and transfer is activated via this button

Select language

The position is announced in the holding loop depending on the position. You stipulate the language for the position here.

Maximum memory for OGM

Your voicemail system has a recording capacity between 3 and up to 15 hours for announcements and messages. The desired capacity for announcements should be assigned to the function „greeting and transfer“ here.

Memory assignment

The free recording capacity is shown here.

Name

You can change the name of the greeting and transfer here to provide better clarity.

Phone number

Your greeting and transfer is also available internally for test purposes using the call number stated here.

Brief description

For documentation purposes you can enter a brief description here, e.g. the room number.

Target number for CF

Enter the subscriber here that is to be connected after the welcome message.

Maximum number of simultaneous calls

Enter here how many callers should be accepted at the same time. In case you wish to unlock external voice channels for other phone calls you will have to select a smaller value here.

Outgoing messages

Welcome message

A call is answered with the welcome message.

Position message

After the welcome message the caller is transferred to the holding loop. This collects all calls and if possible transfers them to the desired target. During this time the caller is informed of the automatically generated position number.

Note: The announcement of the queue position can be deactivated.

Allocation for incoming external calls

Here you can set via which external MSNs or DDIs the subscriber can be called. Simply select the desired MSNs in the displayed table.

Information system

Using the information system with 10 separate numbers of any length, the caller himself decides which information he wishes to hear by pressing a number on his tone-enabled (MFV) telephone. Each company that wishes to give its customers various,

longer items of information over the phone (travel agent, weekly discounts, manufacturer's product information line) can use the „information system“ function so that its staff do not have to constantly give the same standard information.

Remark: To avoid pending calls the pabx disconnects incoming external calls via analogue ports automatically after ten minutes in some cases, e.g. in idle state or if the called target does not pick up the phone. A longer information message will be played one time anyway.

IS selection

There are multiple instances of the information system. Here you can select the information system you wish to configure. This gives you the option of entering an information system for several external MSNs. In the same way you can change the call distribution via the day/night switch in order to receive different information systems at a particular external MSN depending on the time of day.

Maximum memory for OGM

Your voicemail system has a recording capacity between 3 and up to 15 hours for announcements and messages. The desired capacity for announcements should be assigned to the function „information system“ here.

Memory assignment

The free recording capacity is shown here.

Name

You can change the name of the information system here to provide better clarity.

Phone number

The information system is also available internally for test purposes using the call number stated here.

Brief description

For documentation purposes you can enter a brief description here, e.g. the room number.

Maximum number of simultaneous calls

Enter here how many callers should be accepted at the same time. In case you wish to unlock external voice channels for other phone calls you will have to select a smaller value here.

Outgoing messages

You can record the welcome message and the 9 information messages here. The caller can use the 1-9 buttons to select an OGM during the welcome message. You

can switch to another information message from inside any message by pressing the relevant button. The welcome message can be played again by pressing the 0 digit button.

Allocation for incoming external calls

Here you can set via which external MSNs or DDIs the subscriber can be called. Simply select the desired MSNs from the table shown.

Menu: Network

Your telephone system has one Ethernet jack and provides the following network functions:

- A web server to configure the telephone system via a web browser
- A DHCP server to automatically assign IP addresses

Status

Here you can see the current status of your telephone system. You can see whether or not a static IP address is being used and which gateways or servers have been set or enabled. You can edit those settings in the following menu.

With activated DHCP server you will find a list of network devices under „DHCP clients“ which have already an IP address been assigned to. Furthermore you can see the network name and the MAC address.

Settings

Here you can configure the network settings of your telephone system.

LAN

MAC-Address

Here you can see the Ethernet address of your telephone system.

Network name

For easier location of your telephone system in a LAN you can assign a name to your telephone system here.

IP-configuration mode

In case your LAN is equipped with a DHCP-server for assigning IP addresses to the network clients you may use that server. In IP-configuration mode please select „Obtain IP-address automatically“

IP-settings

IP-Address, subnet mask

In order for the network to communicate with the telephone system, the system must be assigned an IP address and a network via the subnet mask. By default the IP address is set to 192.168.34.100 and the subnet mask to 255.255.255.0. In this menu you can change the IP address and subnet mask as required.

If you want to set up a new network, you do not need to make the necessary changes here. If you want to integrate the telephone system into an existing network, you have to change the IP address and subnet mask of your network. The DHCP server should be deactivated for integration in an existing network. In case of any questions please contact your local network administrator.

Note: The telephone system will automatically restart after a change.

Use of the standard gateway

This function is only to be used if you want to reach the telephone system via another network (e.g. the internet) or when the telephone system should transfer information to another network (e.g. a server application on telephone charges).

In this case the IP address of the external router must be entered in this field.

Note: For these applications you should only use fixed IP addresses. And you should disable the DHCP server integrated with you telephone system.

Name server addresses (DNS)

DNS-server

Under „Preferred DNS-server“ please enter the IP-address of the DNS-server to be used. In most cases this is the address of the router/gateway used. But you can also enter up to two different DNS-servers, which may be contacted by the device.

DHCP

You can also use your telephone system as your network's DHCP-server. This means that computers in your network no longer require a fixed IP-Address. Instead they will be assigned with an IP-address during the start-up of your telephone system. You telephone system is capable of assigning IP-addresses to the number of clients you enter in the corresponding field.

In order to be able to use the DHCP please tick the box „Enable DHCP-server“.

Enable DHCP

Under „DHCP – IP-Base address“ please enter the first IP-address to be assigned. Click „Save“ when you finished all settings.

Note: In case there are clients in your network having fixed IP-addresses these addresses must not be part of the address range of the DHCP-server.

Logged on DHCP-Clients

Here you can see which computers already have been assigned with an IP-address. You can also see the network name and the MAC-address of those computers.

STUN-server, WAN

Setting the type of WAN interface

Here you set whether your DSL router works with a dynamic or static external WAN IP address. You will find the correct setting in the settings or status page of your DSL router.

If you do not find any clues here, perform this simple test: If the WAN IP address of your DSL router changes each time you switch it on, the device works with dynamically assigned WAN IP addresses.

The factory default of the device is configured to use dynamic WAN IP addresses.

STUN server / operation with dynamic WAN IP address

A STUN server is used to determine the external WAN IP address of the DSL router while accounting for an existing firewall. The WAN IP address is required for the communication with the SIP providers. The WAN IP address is displayed in the status window on the network page.

Choose the preferred and alternative STUN server. The STUN servers in the listing come from the ex factory default providers and user-defined SIP providers.

STUN server / operation with static WAN IP address

Enter the static WAN-IP address of the standard gateway here. To find these, please consult the documentation from your Internet provider or the status page of your DSL router.

General settings

Reset the telephone system

The factory default settings of the telephone system can be restored using the following key combination:

***98* PIN #**

Please wait until the telephone system is again ready to be operated (Power LED permanently ON).

If you cannot find the telephone system any longer in your network because e.g. the network setting were changed you can reset these to factory default separately. All settings of the „Network“ configuration menu will be reset to factory default. All other settings remain as they are.

The factory default network settings of the telephone system can be restored using the following key combination:

***96#**

You do not need any PIN for this. Just wait until the telephone system is again ready to be operated (Power LED permanently ON).

The default personal identification number (PIN) is **0000**. The identification number can be altered as follows:

***99* PIN old * PIN new * PIN new #**

Factory default settings can also be restored with no telephone available. Remove the housing cover, set jumper (1), push the reset-button (2) left hand next to the LAN connector, wait until all LEDs are OFF, remove the jumper again and push the reset-button once again. The telephone system will be reset to factory default settings at the next start-up.

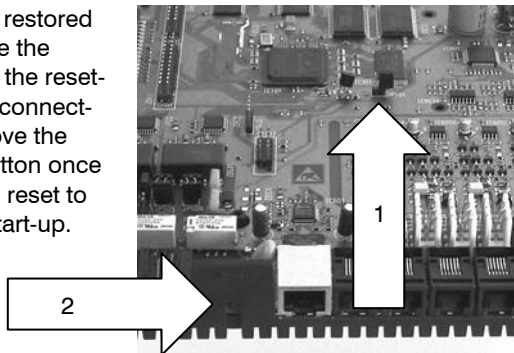

Troubleshooting

Status-LEDs

If you suspect that a malfunction or fault has occurred, the status LEDs of the telephone system can provide first indications of a possible cause.

Status-LEDs

Subject to change without notice!

- Power:
FLASHING during the boot process.
ON, when system is ready.
- EXT:
FLASHING if at least on analogue CO line is busy
(only with analogue CO-Module installed).
ON, if at least one ext. B channel is busy.
- So int (only tiptel.com 411/811):
ON, if at least one B channel is busy.
- LAN:
ON, if there is an active LAN connection.
- Online (only with VoIP-Module):
FLASHING, when all SIP-Providers active, but at least one subscription not successful.
ON, when all SIP-Providers active, and all subscriptions successful.
- VoIP (only with VoIP-Module):
ON, with at least one active VoIP call
- VM (only with installed tiptel VCM-Module):
FLASHING, when there are new messages in at least one mailbox
ON, when VCM-Module ready.

Note: When starting the telephone system, a rotating light over all LEDs is seen during the initialisation phase.
After the tiptel VCM-Module has been installed for the first time, it has to be initialised. LED „VM“ does not light for some 5 minutes. When it comes on, it indicates that the tiptel VCM-Module is now ready.

Description of possible malfunctions

A number of possible errors and suggestions how to resolve them are listed below.

An analogue terminal cannot be called

Pick up the receiver of the terminal. If you hear a special dialling tone, the „call forwarding” feature is enabled. Deactivate this feature and check it again.

Analogue terminal with no dial tone

The terminal is probably faulty. Pull out the plug of the terminal and plug it into a functioning extension. If the terminal does not work for this extension either, contact your local dealer to replace the device.

If the terminal functions at the new extension, either the analogue connection is faulty or there is a problem with the wiring. Please contact the company that installed your telephone system.

An ISDN terminal cannot be called

Pick up the receiver of the terminal. If you hear a special dialling tone, the „call forwarding” feature is enabled. Deactivate this feature and check it again.

Check whether you have programmed an MSN in the terminal. Consult the User's Manual of your ISDN terminal for information on querying and programming an MSN.

ISDN terminal cannot conduct external calls

If no external calls are possible (although the relevant authorisations have been assigned and the exchange dialling tone can be heard after dialling „0” and the call is aborted after dialling the next digit), this normally indicates that MSN is incorrectly programmed in the terminal. Check whether the correct extension number is programmed for the first MSN. Consult the User's Manual for your ISDN terminal.

No incoming external calls possible

- If you hear a message that the subscriber's line is temporarily unavailable, check the connecting cable between telephone system and NTBA and replace it if necessary. If this does not solve the problem, check if your multipoint connection is functioning properly by doing the following.

- If the telephone system is connected to a multipoint interface, remove the system plug from the NTBA and plug the NTBA mains plug into a functioning mains wall outlet. Take an ISDN terminal and plug it into the NTBA. If you hear a dialling tone in the receiver of your ISDN terminal, the multipoint interface is functioning properly and the fault can only be within the telephone system or the wiring between NTBA and telephone system.

Check the S₀ ports of your telephone system. If the S₀ interfaces are functioning properly, it is highly likely that there is a problem with the wiring. Please contact the company that installed your telephone system.

Note: For further questions please contact your specialist dealer who may also provide remote servicing. The Tiptel Service Centre offers comprehensive support.

Tips and tricks

This telephone system provides you with a large number of functions. It is not always easy to realise how a particular job can be done. Sometimes it is a number of functions that is needed to achieve the goal. Following please find some ideas on more comprehensive solutions.

Function call-through / call-back

...and what else you can use it for.

When you are using the telephone number set by your administrator you will either be identified by a PIN or by the telephone number sent by you (CLIP-information) by the telephone system as an authorized person. This identification procedure uses data that can be set for each particular user individually. The telephone system is always aware which subscriber the call-in belongs to. So, it is possible to use all original subscriber settings for that phone call.

In case you dialled in from the outside the telephone system behaves exactly the same as if you picked up the receiver of your local phone (your own extension that is). E.g., if you have automatic exchange access activated at you extension the telephone system will provide you with an exchange connection automatically as well. It will obey all rules set up for your exchange access and it will also use the outgoing number assigned to your extension. Of course you will also get in internal dial tone by pressing „**#**“ same as if you had not activated your automatic exchange access.

Substitute for a dedicated line and charging via your company's account

Set up call forwarding for your extension e.g. from your office phone to your private phone or your mobile phone. Enter the phone number of your private phone or your mobile phone for call-through/call-back. All calls for your extension will be forwarded without the caller becoming aware of this. Any calls you will place this way will send your company extension as outgoing phone number vice versa.

Pretend being in the office

For service-oriented companies nowadays it is very important to be available to the customer all the time. When calling back the customer cannot tell where you actually are. In fact to the customer it looks as if you were at your desk in your company.

Remote log-on/off with groups (home office)

When your extension is routed to your home your colleagues as well as external callers will reach you via you normal office number. In case your extension is part of a group in „dynamic“ mode you may log on or off to that group from your home. In case of callback just call the dial-in number. The telephone system will call you back

after some 10 seconds and you will hear the internal dialling tone of your company's extension. Then dial the code for logging on or off, *23*nn# or #23*nn# that is, with „nn“ being the internal group phone number of your telephone system. You may also log on or off to more than only one group.

Saving telephone costs while staying at a hotel

Ask for your hotel room telephone number before leaving the office or programme that number later in your telephone system e.g. via remote configuration. Calling your company's telephone system is usually not with costs as it will not be answered by the system. However, pay attention to the telephone rates of your hotel! With some hotels even unanswered calls are liable to costs! In case your company has a flat rate contract with the telephone network provider even callback is not liable to costs. So, even when staying abroad it could make sense to place calls via your company's telephone system. And the called party will only see your office phone number and not the phone number of your hotel room while you are on vacation.

Saving telephone costs using your mobile

In case you have a special rate when calling particular phone numbers or local numbers, it might be cheaper to use dial into your telephone system via call-through and call other phone numbers with costs of the cheaper fixed network rate. Again the called party will only see your office phone number and not the phone number of your mobile phone.

Remote configuration via telephone

Once you are connected with your telephone system and you hear the internal dial tone there are of course all programming options available to you (see annex)! You can e.g. configure call forwarding in case you forgot to do this before leaving.

Groups

Time control for group members

The telephone system provides you with time-controlled assignment of groups to external phone numbers: Signalling callers at different times of the day with different groups. That's why it is also possible to switch between „logged on“ and logged off“, to change group type or mode, and to change subscribers.

Just set up a number of groups with different individually desired configurations. Then assign the incoming number in different day/night profiles to the matching group.

Integration of external subscribers in groups

If e.g. a service technician is often only available on his/her mobile, his/her extension can be forwarded to that mobile, even when he/she is member of a group. This will

not have any influence on other local subscribers. Forwarded calls will be treated like internal calls, i.e. in case the mobile is busy it will jump on to the next extension. Logging on or off is possible as well (see above).

If you want to integrate someone into a group who has no local extension just set up a new subscriber. This subscriber will not have to be assigned to a real existing phone. Just set up call forwarding.

Voicebox as drop extension (with tiptel VCM-Module)

In case all subscribers are busy the last option is to forward the caller to a voicebox. Just set up one more subscriber who does not have to be assigned to a real existing phone. Just enable his/her personal answering machine. If possible use a very short answering delay.

Different companies - one telephone system

With tiptel.com 411 or tiptel.com 811 the operator can see at a system telephone which external phone number has been called and answer accordingly. A very comfortable solution is using the tiptel VCM-Module when e.g. you are only using one phone number: The „Automatic switchboard“ option says hello to the caller and asks him/her to dial a certain number to reach e.g. XYZ company or ABC company, technical support, hotline, etc. The target phone, however, is always the same as you e.g. are alone in your office in the evening. It would help you just to see the dialled number as this will be always the same. The „Automatic switchboard“ option, however, will replace the calling party's number with information on the number dialled to reach the desired company or department. So, you can see on your phone whether the called wants to talk to XYZ or ABC company, technical support, or hotline, whatsoever.

So-called „From - For“-display on TIPTEL system-phones also supports CNIP (name display) - i.e. in the display you see something like „call from Miller LTD for technical support of ABC LTD“.

Greeting and answering machine

The optional tiptel VCM-Module e.g. allows you to use an option called „Greeting and transfer“. First thing the caller hears is a friendly message while the assigned phones are already ringing. This way you can avoid repeating the same text again and again and the called person will only have to say his or her name. In case the called person has his/her answering machine running, it can happen that the machine will pick up the call immediately after the greeting - depending on how long that address is. It is advisable to programme the answering delay accordingly.

As an example for a complex configuration let's assume following customer requirement will have to be met:

During office hours automatic greeting and signalling the call to a three person group. In case of subscriber busy or absent (not at the desk for a short period of time) the call shall be forwarded to the company's voice mailbox.

Solution:

Two profiles are needed, time control and one group.

In „day“ profile „Greeting and transfer“ will have to be set up as well as group 20 with subscribers 21,22, and 23. That group will have to operate in „Linear mode with timeout“, drop subscriber will have to be subscriber 30 with activated personal answering machine (in this case: company's voice mailbox). All calls (MSNs) will have to be assigned to „Greeting and transfer“.

In „night“ profile all calls (MSNs) will have to be assigned to subscriber 30. This makes sure that outside the office hours only the company's voice mailbox will be addressed.

Switching between the profiles can be either carried out automatically via time control, or manual via web interface, or with system telephones (tiptel.com 411 and 811).

Technical notes for analogue FXO lines

An FXO connection offered by a network provider does not comprise the same scope of features as an ISDN connection. When using an analogue FXO line of the 2FXO module following special cases have to be taken into account.

An analogue FXO connection is mainly limited to detecting a number of audio signals (ringing signal, busy signal, DTMF) or messages. It is in the nature of these signals that they cannot be that well-defined as protocol messages of the ISDN network. That's why within the telephone system some safety measures have been taken to ensure distinct functions.

Function call-back/call-through

If you try to call a busy extension after successful set-up of an external connection you will not hear the internal dialling signal of the telephone system (fall-back). The connection will be terminated.

With the function with call-back the caller has to terminate the initial call immediately. The telephone system cannot disconnect the caller automatically such as with ISDN.

When dialling in with call-through by using an FXO line you will not hear any dialling signal.

AS and IS

With AS and IS FTMF detection is limited to the options of an analogue FXO line. For better detection we recommend not too loud announcements or intentional pauses at times where pressing of a key is expected.

Three party conference

When a conference is in progress a busy signal detection is not possible. This detection only works with outgoing calls. A three party conference cannot be terminated by the telephone system automatically, all subscribers have to hang up themselves.

Forwarding

If a caller was forwarded to an external target and he/she hangs up after a while the second call (placed by the telephone system) cannot be terminated automatically. The called subscriber will have to disconnect the call manually after e.g. hearing the busy signal.

Busy internal target

The caller will not hear a busy signal. This service is only available with an ISDN connection.

Single person operation

The caller will not hear a busy signal. This service is only available with an ISDN connection.

ACD via an FXO

The caller will not hear a busy signal after having run through a group without drop target. This service is only available with an ISDN connection.

ACD group + call management

With an activated fax switch there will be no recall since the call was already taken (by the fax switch). Using the fax switch together with ACD groups and call management functions with an identical telephone number is therefore not recommended.

Answering machine

The answering machine is also being turned off after a silence period of 10 seconds. This recorded silence period will be cut off.

Busy signal detection with AS, GT, and IS

Busy signal detection is limited to the options of an analogue FXO line. The following safety measure therefore have been taken:

AS and GT

The forwarding target will receive the ring for max. 90 seconds. After time-out there will be two more attempts. If an analogue extension is permanently busy the time-out will be reduced from 90 seconds to some 2 seconds.

IS

The basic announcement will be played back 10 times at most. A selected announcement will be played back 7 times at most.

Function "reject waiting party"

A rejected waiting party will not receive any busy signal. This service is only being supported in ISDN networks.

Sending one's own number (CLIP)

The setting "CLIP" in the extension menu is ineffective for outgoing analogue calls.

Even though it is possible to pre-dial *31# (before every outgoing call (case by case suppression of sending the caller ID - e.g. by using a corresponding dialling rule with LCR), but this code is not necessarily being accepted by the public switchboard.

Pick-up of an external line

With an activated fax switch this function is not available with incoming calls via an analogue external line. Extensions ringing after the detection, however, can still be picked.

Assignment for outgoing external calls

The telephone system cannot detect whether FXO lines are being connected to both analogue ports. In case only one external line has been connected, setting "in any order" in the "assignment for outgoing external calls" may result in not getting an FXO line. When using analogue FXO lines in "assignment for outgoing external calls" the assignment should be set to "according to assignment table".

Technical notes when using a VoIP module

With an installed VoIP module regarding dialling an external number via VoIP and regarding the connection of VoIP terminals there are some technical deviations in operation compared to an external ISDN line or an ISDN or analogue terminal device.

Acknowledge signal

When activating system functions such as with activation/deactivation of a call forwarding or logging in/out to/from a caller group with an IP telephone there is no positive or negative acknowledge signal. The user will only hear the busy signal.

Outgoing telephone number

In the field "display name" in the SIP client configuration your own name or the "outgoing number" can be entered. If the transfer shall be made same as with ISDN connections "***" will have to be entered. Then the number defined as outgoing number in the subscriber configuration will be sent. Allowed characters in the field "display name" are being defined by the provider.

Music on Hold rehearsal

A rehearsal of "music on hold" (MOH) activated within the telephone system by using the code *922* is not possible with IP telephones.

Special functions using * and

A number of special functions (e.g. selective FXO line) are being activated by special codes containing the keys * and #. Some IP telephones are not able to send these digits or they will have to be reprogrammed before a connection is being set up..

Three party conference

A three party conference with IP telephones can only be initiated from an IP telephone. Engaging a three party conference with virtual channels (Voice mail system) is not possible.

Switching

Due to technical reasons the function "Switching to an external line" is limited. Switching without query does not work. In case both connections were set up via VoIP, in order to be able to switch both need to use the same codec.

Display of IP address and subnet mask

Display of IP address and subnet mask of the telephone system is not being supported by IP telephones.

Call-through and call-back

These functions cannot be used via external VoIP accounts.

Telephone system with internet access

In case the network settings of the telephone system have not been carried out correctly, so that the telephone system does not find a valid gateway to the internet, the IP telephones cannot be registered correctly.

When there is no internet access the configuration "network" may only use static IP addresses and the STUN query must be turned off (WAN IP address set to off).

Appendix

General command summary

Select outgoing internal number	*0internal number#
Completion of Call on No Reply on (CCNR)	R*10#
Completion of Call on No Reply off (CCNR)	#10#
Call forwarding always off	#21#
Call forwarding always on	*21* Ziel #
Team log on (only with team mode „dynamic“)	*23*nnn# (nnn=Team number)
Team log off (only with team mode „dynamic“)	*23*nnn# (nnn=Team number)
Call forwarding always on (follow me)	*22* own phone number#
Forward external connection off (only Austria)	#24# S ₀ Port #
Forward external connection on (only Austria)	*24* S ₀ Port * Ziel #
Room monitoring	*25*PIN*nnn# (PINuser room mon., n=extension)
Hands-free	*26*PIN*nnn# (PINuser hands-free n=extension)
Announcement	*27*nnn# (n=Extension)
Phone number transmission off	#30#
Phone number transmission on	*30#
Call number transfer for a call	*31#
Completion of call to busy subscriber on	R*37#

(CCBS)

Completion of call to busy subscriber off (CCBS)	#37#
Call waiting off	#43#
Call waiting on	*43#
Pick-up	*5
Targeted exchange connection via external S ₀ (important with FXO- and/or VoIP-Module)	#51#
Call forwarding on no reply off	#61#
Call forwarding on no reply on	*61* destination #
Call forwarding when busy off	#67#
Call forwarding when busy on	*67* destination #
Speed dial (from central speed dial register of telephone system), 100 entries	*7 00 - *7 99
Telephone book (only with System / ISDN telephones)	#7
Pick-up answering machine	*83*
Reset ISDN	*90*PIN#
Reset HDLC	*91*PIN#
Remote maintenance on	*911*PIN#
Remote maintenance on, after switching to point-to-point access	*912*PIN#
Play music on hold	*922*
Assigning the cost centre	*93 (cost centre digit number) (cost centre) (destination call number)
Display IP address	*941#

(display via Displayinfo and call-back)

Programme IP address	*941*PIN*xxx*xxx*xxx*xxx#
Display subnet mask (display via Displayinfo and call-back)	*942#
Programme subnet mask	*942*PIN*xxx*xxx*xxx*xxx#
Display subscriber: Incoming routing (display the first assigned incoming MSN)	*953*
Display subscriber: Outgoing routing (display the first assigned outgoing MSN)	*952*
Subscriber configuration: Set routing (outgoing and incoming MSN)	*951 x *PIN*ext. MSN# (x=ext. So Port)
Subscriber configuration: Delete routing (All MSN assignments are deleted)	*951* PIN #
Reset (telephone system restart)	*96*PIN#
Reset network settings (restore factory default network settings only)	*97*PIN#
Reset factory settings (restore factory default settings of all settings, all data will be lost!)	*98*PIN#
Change PIN (factory default: 0000)	*99*PIN old*PIN new#

Function codes for analogue terminals

During the call

Hold / inquiry	R
Reject waiting call	R0
End active call and switch to call waiting	R1
Hold active call, accept call waiting or switch to held call	R2
Start conference between held and active call	R3
Forward call waiting (without accepting it)	R4
Trace subscriber (MCID)	R#0R
Parking a call	R*80* nn # nn = 2 digit park number
Reconnecting a parked call	R*81* nn # nn = 2 digit park number

Flow chart outgoing calls

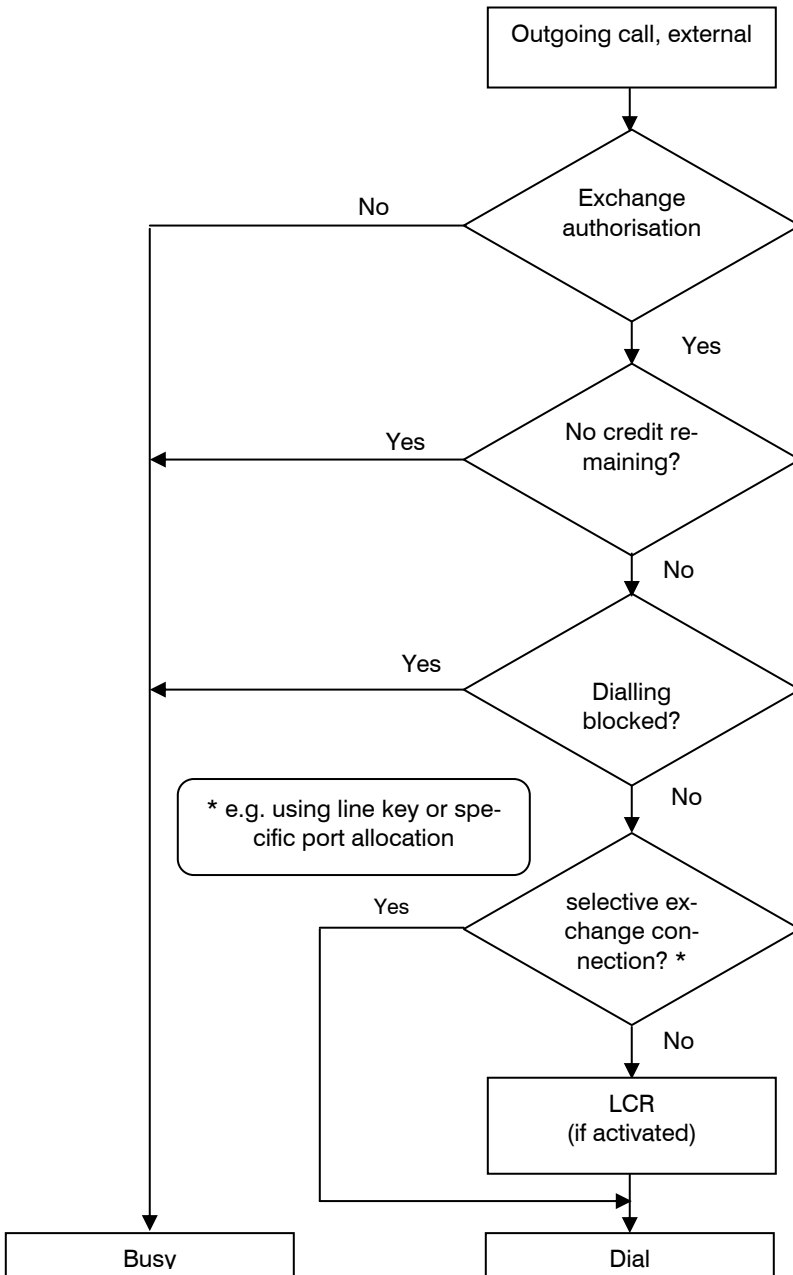

Flow chart outgoing number transfer

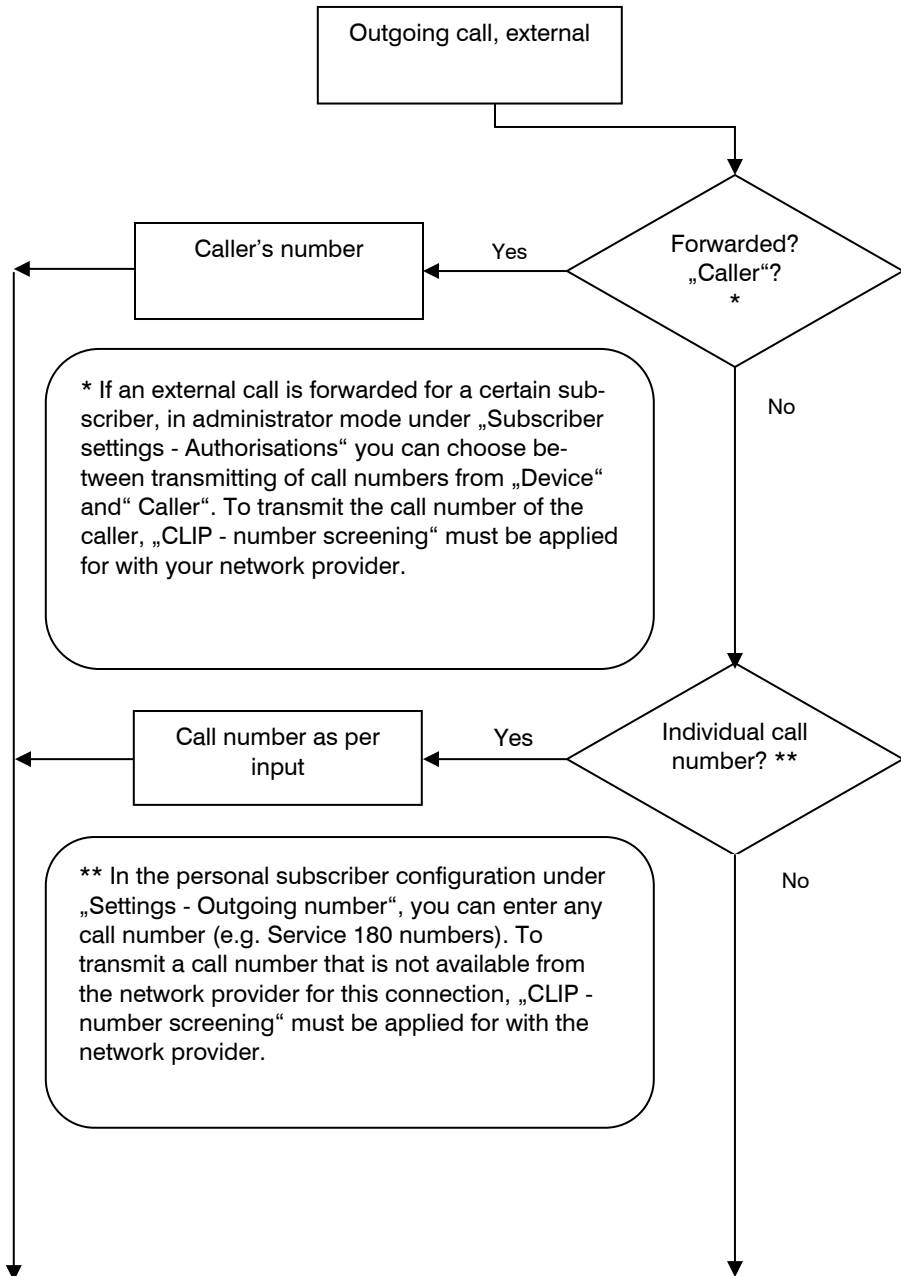

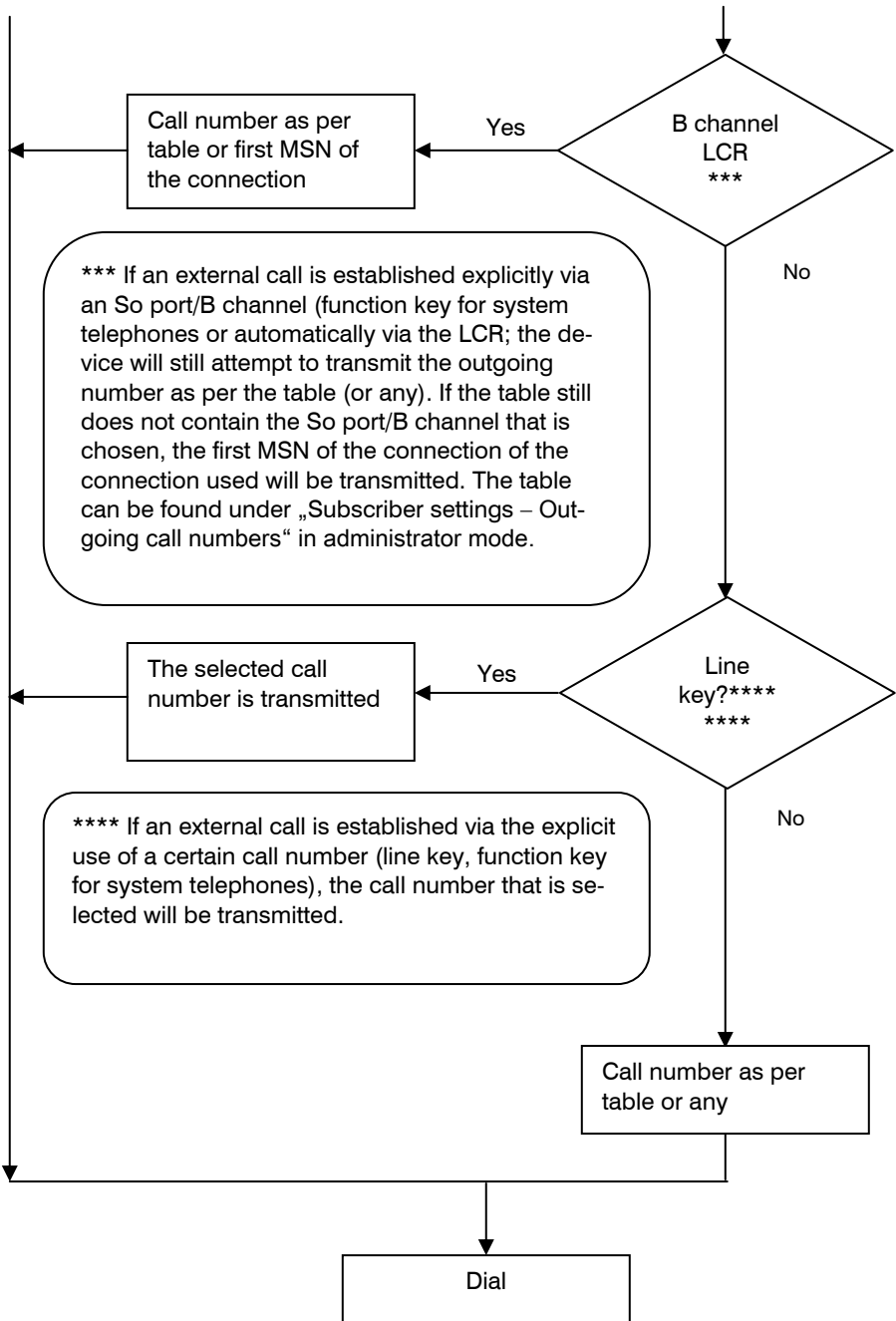

Flow diagrams for call manager

Automatic switchboard

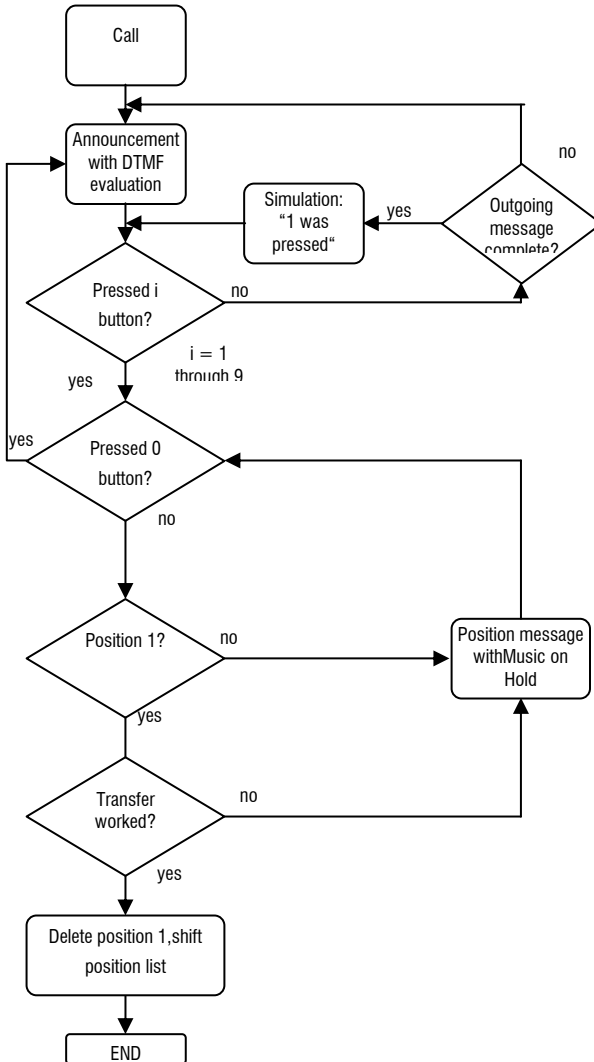

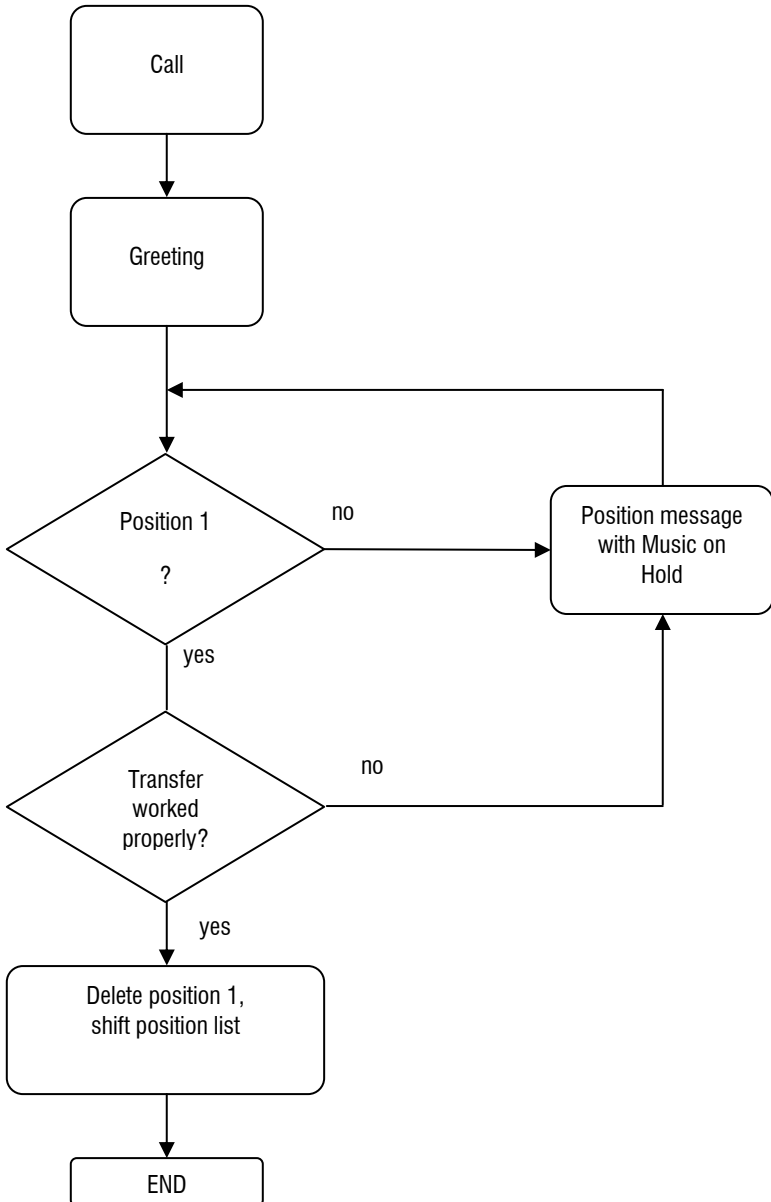
Greeting and transfer

Information system

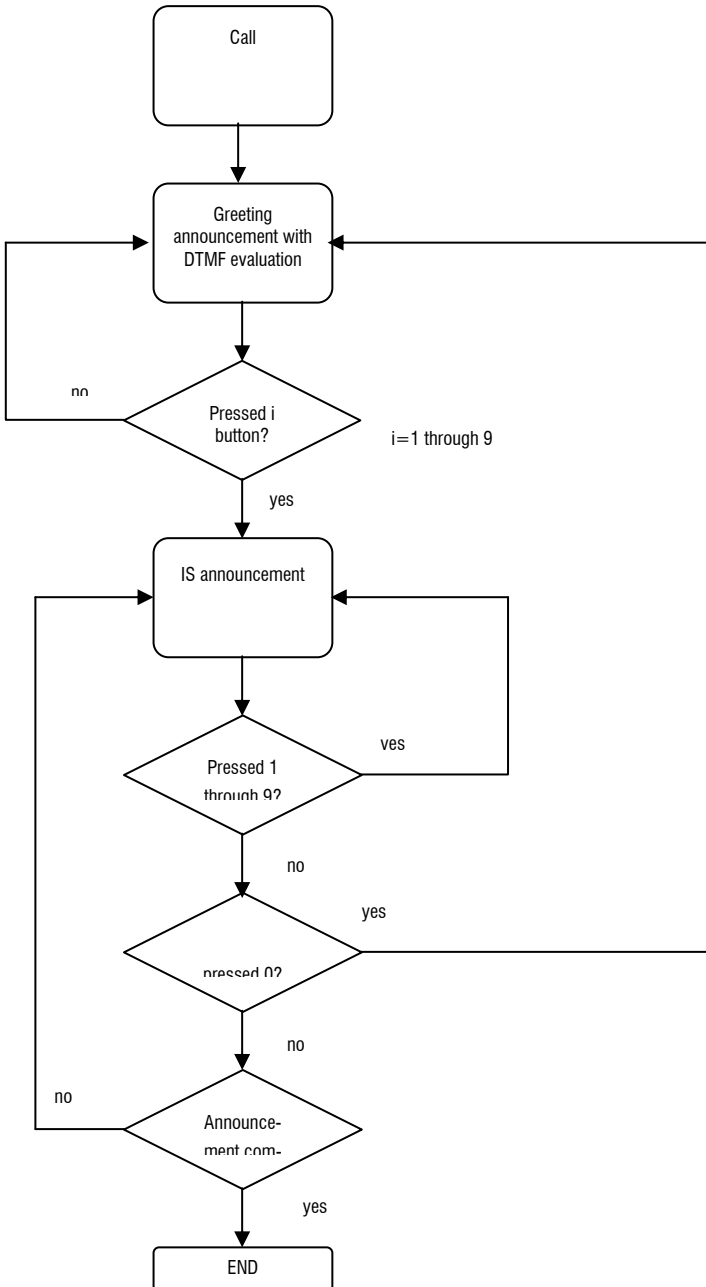

Explanation of terms

Exchange connection	Method of setting up an external call. A distinction is made between manual, automatic, destination and VIP exchange connection.
Exchange tone	Network operator's dialling tone. Possibility to dial an external subscriber number.
Call-waiting tone	Different signals are used for internal and external waiting calls.
Point-to-point connection	This type of connection is also referred to as point-to-point operation (PP). Point-to-point connection also allows you to connect a telephone system to the S ₀ basic connection. It is possible to directly dial the destination subscriber on this connection (refer also to DDI).
AOCD	Transferring charge information during the call.
AOCE	Transferring charge information at the end of the call.
Busy tone	This tone indicates that the line of the destination subscriber called is busy or that there is no free line to establish the connection (lane occupied).
B channel	Refer to S ₀ interface
Clients	Computers or users who are connected.
DDI	„Direct Dialling-In“: This is a call number that is added to the system's call number in order to reach the person required (also referred to as „direct-dial number“). The DDI does not have to (but can) be the same as the subscriber' internal number.
DHCP	Dynamic Host Configuration Protocol. DHCP servers assign a free IP address to connected computers on start-up.
Service identification	With ISDN, incoming calls are subdivided according to different services. Service identification ensures that terminals only signal calls for which they support service identification.
D channel	Refer to S ₀ interface
DNS	Domain Name Server. IP addresses are translated into names using a DNS.
Dynamic IP address	IP address that is assigned by an Internet provider that is only valid for the dial-in period. When dialling in again a new/altered IP address is usually assigned.

Single person operation Busy-on-busy	Mode for operating the telephone system in which incoming external calls receive a busy tone as soon as an extension is occupied.
Terminal	General term for a device connected to the telephone system. This can be a telephone, fax machine, modem, PC card, etc.
Hold	Connection state whereby there is no voice connection. Required for features such as Inquiry call.
http	Hypertext Mark-up Transport Protocol. Describes the method by which WWW pages are transmitted over the network.
Internal traffic	Communication connection between two telephone system subscribers. Internal connections are toll-free.
IP	Internet Protocol (TCP/IP = Transmission on Control Protocol/Internet Protocol) for Internet data communication.
IP address	IP stands for „Internet Protocol“. An IP address contains four numbers separated by dots and is used to identify an individual, distinct host computer in the Internet. Example: 192.34.45.8.
ISDN	ISDN stands for „Integrated Services Digital Network“.
Keypad	Dialling process using special features in the network operator’s exchange.
Conference	Interconnection of a maximum of three subscribers to conduct a conference.
LAN	Local Area Network. Local network between computers for exchanging data or joint use of drives or printers.
LCR	Least Cost Routing. Automatic selection of the network operator offering the cheapest rate.
LED	Light-emitting diodes or indicator lights making it possible to monitor the status of the system or individual terminals.
MAC address	Is saved firmly on the card and is distinct across the world. It is a unique serial number for a network card.
Switching between lines	Changing between two calls using the \square key. The subscriber on hold hears a hold tone or music.
Mbps	Megabits per second. Measuring unit for data transfer rate (bandwidth) e.g. in networks.

multipoint interface	This type of connection is known as multipoint interface. It enables the parallel connection of up to eight terminals to one S_0 bus.
DTMF	Dialling process where the dialling information is transmitted via a tone sequence.
MSN	Message switching network. Also called multiple subscriber number. On a multipoint interface, up to 10 random subscriber numbers can be allocated for a basic line. The assignment of these MSNs to the terminals must be programmed in the terminals by the user.
Extension	The extension is the physical connection to which the analogue or ISDN terminals are connected. An extension can be assigned to several subscribers.
Network	Connection of several computers and other communication devices with the aim of allowing several users to access such common resources as files, printers etc.
NT	Network termination: Network connection at which the network operator's connecting cable ends and the building's installation begins (also referred to as NTBA).
PIN	Short for Personal Identification Number. Certain sensitive features can be protected by a PIN.
Ping	Command for transmitting small data packets to check whether or not a target IP address exists and/or is in operation
Port	Input/output channel on a network computer on which TCP/IP is executed. Various Internet applications require certain ports for communication.
Programming tone	Special tone indicating to the user that he/she is in the programming mode.
Protocol	Rules for transmitting and receiving data.
S_0 -Bus	An S_0 bus (also known as ISDN bus) is the series switching of up to 12 wiring boxes for ISDN terminals via a 4-core cable connected to the telephone system. The connected terminal can be configured in any manner and a maximum of 8 terminals can be connected to one bus.
S_0 interface	Term for an ISDN connection. The S_0 interface comprises two B(asic) channels and one D(ata) channel. A connection can be set up on each of the S_0 interface's B channels. The S_0 interface is controlled via the D channel.
Server	A computer that is connected with the network and shares resources with other network users.

Stimulus	Key sequence entered via a telephone keypad to start or activate certain features.
Subnet mask	A subnet mask is a string of 4 dot separated figures having the same structure as an IP address. You may receive it from your internet service provider together with TCP/IP-information. A subnet mask enables you to define IP addresses limited to a certain network (in contrast to valid IP addresses being recognized all over the internet).
Switch	Device to connect a number of computers to a network. Today switches have replaced so called hubs.
TCP/IP	Transmission Control Protocol / Internet Protocol. Standard protocol for transferring data on the internet.
UPS	Uninterruptible power supply. A device that enables operation of your telephone system even in case of power failure for a limited time.
Dial tone	There is an internal and an external (exchange) dial tone.
WAN	Wide-Area-Network. Combinations of different LANs via fast long distance lines are called WAN. The best-known example is the internet.
Access control	Protective measure to keep unauthorised persons from accessing your own network.

Service

You have purchased a modern product by Tiptel which was designed and manufactured in Ratingen near Düsseldorf. The high-tech manufacturing facilities „Made in Germany” grant a continuous level of the highest quality. This is even underlined by the certification according to DIN EN ISO 9001.

If, however, problems occur or you have questions on operating the device, please contact your local dealer.

Guarantee

Please contact your local dealer or importer for details of guarantee for non EC countries.

Within the European Community the following guarantee regulation applies:

Your contact for services arising from guarantee obligations is the authorised dealer where you bought the device.

Tiptel.com GmbH will grant a guarantee of 2 years from the date of handover for the material and for the manufacturing of the telecommunications terminal unit.

Initially, the purchaser shall have only the right of subsequent performance. Subsequent performance entails either repair or the supply of an alternative product. Exchanged devices or parts shall become the property of the authorised dealer.

If the subsequent performance fails, the purchaser can either demand a reduction in the purchase price or withdraw from the contract.

The purchaser shall notify the dealer immediately of any defects found. Proof of the guarantee entitlement shall be furnished by standard proof of purchase (receipt or invoice).

The guarantee entitlement shall expire if the purchaser or an unauthorised third party interferes with the device. Damage caused by inappropriate handling, operation, storage or by force majeure or other external influences shall not be covered by the guarantee.

The guarantee shall not cover any consumable material (e.g. batteries) or defects that only slightly impair the value or the usability of the device.

Claims for damage caused by transport shall be asserted to the delivery company.

Notes on settlement:

Repairs can only be conducted by the Tiptel Service. A warranty repair does not prolong the warranty period – neither for the replaced parts nor for the device. This guarantee is not transferable and shall expire if the device is sold on to another party. It shall also expire if the device is interfered with by third parties or if the serial number on the device has been removed or made illegible. There is a guarantee seal on the device. Please do not damage or remove this seal because otherwise, your guarantee will expire.

The General Terms and Conditions of Tiptel.com GmbH, which are part of the contract for a dealer, shall also apply. In the event of a complaint, the defective product shall be sent to the relevant Tiptel subsidiary, the importer or dealer along with a description of the defect and the proof of purchase.

CE sign

This device is approved for the connection and use within the public telephone networks in all EC countries – according to the European Requirements. Due to technical deviations in individual countries, we cannot grant an unlimited guarantee for the successful operation at all types of telephone accesses.

Tiptel.com GmbH hereby declares that the device complies with all fundamental requirements of the European directive 1999/5/EC. This conformity is confirmed by the CE sign on the device.

Further details on the declaration of conformity can be found under the following internet address:

<http://www.tiptel.com>

Ecological information

During the normal use of the device you will not have any contact to substances damaging to your health. The device is not battery-operated. The plastics used for manufacturing this device exclusively consist of partially recycled granules. The packaging materials do not consist of plastics but of partially recycled cardboard and paper.

If you do not have further use of your device, Tiptel.com GmbH will take back the device without any charge. The device will be properly taken to pieces for recycling.

Notes on care

Your telephone system does not require maintenance. Clean the housing surface only with a soft, slightly damp cloth or an antistatic cloth. Never use a dry cloth (electrostatic charges may result in malfunctions in the electronics). Please do not use chemicals or abrasive cleaners.

Index

A

ACD	77
Activate charge account	81
Allocation for incoming external calls	78
Analogue exchange office	18
Analogue FXO lines, notes	116
Analogue telephones	25
Appendix	122
Assignment table	
extensions	81
incoming external calls	82
Authorisations	80

B

Basic number	68
Blocked phone numbers	56
Busy on Busy	49

C

Call analysis software	58
Call back	83
Call data	57
Call distribution	43, 77, 79
Call forwarding	81, 85
unconditional	85
Call forwarding external	69
Call holding external	49
Call Manager	99
Call number	77, 80, 82
Call-Back	98
Call-Through	98
call-through / call-back	82
CD external	67
CE sign	137
CFB	85
CFNR	85
CFU	85
Changing the IP address	32
Charge account	85
charge unit	48
Command summary	
analogue terminals	125
Command summary	

general	122
Configuration	
Settings	46
Configuration	
ISDN access	67
Configuration	
subscriber	76
Configuration	
Network	105
Configuration file	63
Configure network settings	105
Copying a subscriber	79
country code	49
Country setting	40

D

Data Services	97
Date/time	63
Day/Night profile	77
Day/night switching	58
DHCP	106
Dial-in control	92
Dialling control via blocked numbers	56
DTMF telephone	15

E

Ecological information	137
Emergency numbers	57
Environmental compatibility	12
Exchange authorisation	80
Expert mode	63
Expert Mode	63
Explanation of terms	132
External dial-in	98
external dialling-in the telephone	
system	82

F

Factory default settings	108
Fault	109
Fax switch	42
Follow me	84
Funktionstasten	87

G

General settings.....	108
Group mode.....	77
Group selection.....	77
Group signalling.....	76
Group type.....	77
Groups.....	76
Guarantee.....	136

H

hands-free operation.....	87
Holidays.....	60

I

Interfaces.....	13
Introduction.....	8
IP address.....	31
ISDN access.....	67
ISDN connection.....	19
ISDN switch.....	21
ISDN telephones.....	19

L

LCR.....	50, 60
Loading configuration data.....	64
Loading operating software.....	64

M

Malfunctions.....	110
Modifying a subscriber.....	80
MOH.....	49
MSN/DDI.....	68
Music on Hold.....	49

N

Name.....	77
Network.....	105
network settings.....	105
Notes.....	9
Notes on care.....	138

O

Operating the telephone system.....	11
Operator.....	68
Outgoing MSN.....	127
Outgoing telephone number.....	84
Outside line.....	126

P

Packaging materials.....	137
Password.....	48, 80, 84
Pick-Up.....	84
PIN.....	82, 87
Power failure.....	12
PPP-data service.....	97
printout of configuration data.....	64
Product package.....	10
Protocol file.....	63
Protocol trace.....	63

R

record MOH.....	64
Recording.....	91
Rejection location.....	78
Remote dial-in.....	92
Remote service.....	111
Removing the cabinet cover.....	17
Reset the telephone system.....	108
Restart.....	65
Room monitoring.....	87

S

S ₀ bus.....	22
S ₀ ports.....	24
Select group subscribers.....	78
Service.....	136
Settings.....	46
single-person operation.....	49
SMS.....	98
Software version.....	64
Special numbers.....	57
Speed dial.....	51
Start-up.....	16
status inquiry (CFI).....	69
Status Network settings.....	105
Status-LEDs.....	109
Subscriber.....	76, 83
Create.....	79
Subscriber name.....	80
Subscriber selection.....	79
Subscriber selection.....	86
System telephone.....	85

T

TAE wall outlets.....	26
-----------------------	----

Team signalling..... 76
Technical specifications 121
telephone book.....52
Terminals 15
Time control 60, 61
Tips And tricks 112
Troubleshooting 109

U

Update 64
UPS..... 12

User name48

V

Voicemail65
voicemail system48

W

web configuration33
Wizard.....39

Tiptel.com GmbH Business Solutions

Halskestraße 1
40880 Ratingen
Deutschland

Tel.: 0900 100 – 84 78 35*

Vanity Tel.: 0900 100 – TIPTEL*

Internet: www.tiptel.de **International:** www.tiptel.com

* (1,49 EURO/Min. aus dem Festnetz der Deutschen

Telekom, abweichende Mobilfunkpreise möglich)

Tiptel GmbH

Ricoweg 30/B1
2351 Wiener Neudorf
Österreich

Tel.: 02236/677 464-0

E-Mail: office@tiptel.at

Internet: www.tiptel.at

Tiptel AG

Bahnstrasse 46
8105 Regensdorf
Schweiz / Suisse / Svizzera

Tel.: 044 - 843 13 13

E-Mail: tiptel@tiptel-online.ch

Internet: www.tiptel-online.ch

Tiptel B.V.

Camerastraat 2
1322 BC Almere
Nederland

Telefoon: 036 – 53 666 50

E-Mail: info@tiptel.nl

Internet: www.tiptel.nl

Tiptel NV

Leuvensesteenweg 510 bus 4
1930 Zaventem
Belgique/België

Telefoon: 0903 99 333 (1,12 Euro / min.)

Fax: 02 714 93 34

E-Mail: tech@tiptel.be

Internet: www.tiptel.be

Tiptel sarl

23, avenue René Duguay-Trouin
78960 Voisins-Le-Bretonneux
France

Tél. : 01 / 39 44 63 30

E-Mail : support@tiptel.fr

Internet : www.tiptel.fr



(UK) 02/2012