

TMEiC

We drive industry



TMACS[®]

TM Advanced Control Solutions

metals

cranes

mining

testing

oil & gas

renewable
energy

power
generation

cement

TM Advanced Control Solutions - TMACS®

Providing Control Solutions to a Wide Variety of Industries



Hot Mills

TMACS' high-speed communication and signal resolution brings tight control and highly integrated level 1 and 2 control to hot mills, coordinating all the sections:

- Caster
- Sizing press and roughing mill
- Finishing mill
- Controlled strip cooling
- Coilers, conveyors, and finished product transport

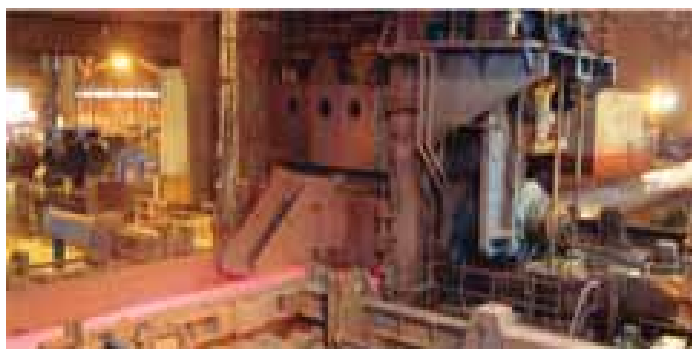

Plate Mills

TMACS' high-speed communication and excellent signal resolution with highly integrated level 1 and 2 control allows multi-plate temperature controlled rolling and accurate plate quenching control for:

- Plate mills
- Steckel mills



Cold Mills

TMACS' advanced control features including integrated level 2 models are applied to cold mills of all types:

- Tandem cold mills
- Single and multistand reversing mills
- Temper mills
- Sendzimir mills

Providing Control Solutions to a Wide Variety of Industries



Long Product Mills

TMACS provides tight and fully coordinated control with product tracking and machine monitoring for long product mills:

- Rod and bar mills
- Beam mills
- Tube mills



Process Lines

TMACS fully coordinates the drives for speed, tension, and strip transport control, and provides product tracking for all types of high speed process lines:

- Continuous galvanizing and tinning lines
- Pickle lines
- Continuous annealing lines
- Painting and coating lines



Paper Mills

TMACS' superior control allows close speed and torque coordination of large numbers of drives for the effective high speed control of:

- Paper machines and winders
- Off-machine coaters
- Super calendars

System Overview

System Features and Functions

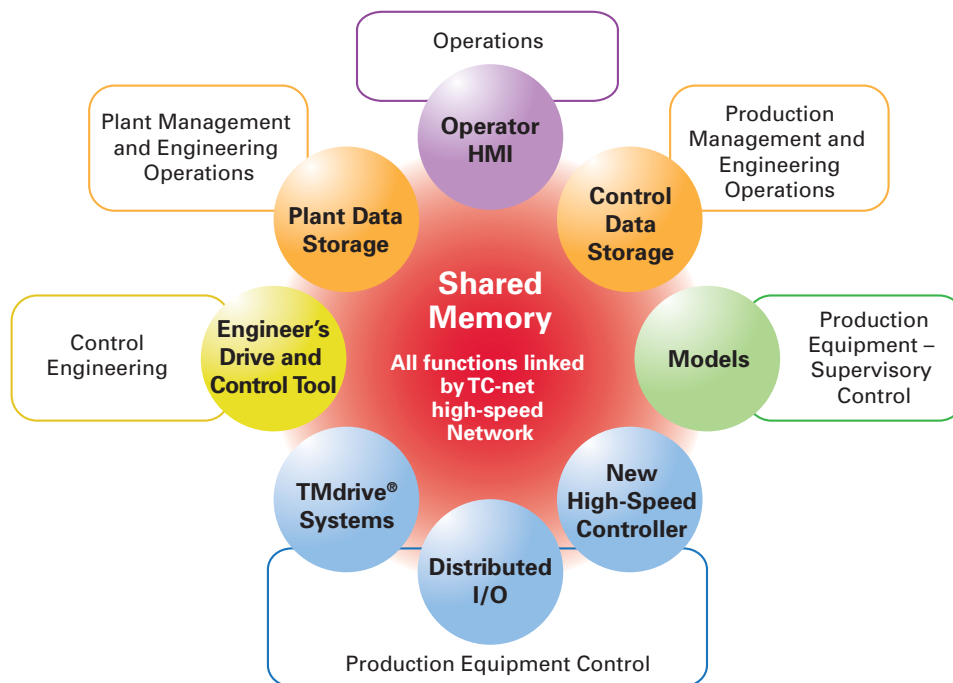

| System Features | Benefits |
|---|---|
| Shared Memory links all functions using fast control network and fast I/O network; 100 Mbps | 0.1 millisecond update; real-time data available to all system functions |
| Advanced control diagnostics for the operator | Quicker resolution of problems |
| Control Data Store and Plant Data Storage | Comprehensive real time and historic data for control and analysis |
| Four programming languages and graphics editor | Powerful programming capability and ability to mix languages increases productivity |
| Common graphical interface for programming tools | Easier to learn and use the configuration and programming tools |
| Fast controller - 20 nsec per basic instruction word | Better control through faster program execution |
| Field distributed I/O with high-speed serial link | Two-thirds reduction in I/O wiring; faster I/O scanning |
| Serial I/O board hot swap capability | Improved on-line maintainability |
| I/O point name is universally used | No name translation or mapping required; savings in programming |
| Process models for supervisory control | Improved product quality and yield |
| Compatible with legacy systems and tools | Easily connects to existing systems |

TMACS – The Solution for Complex Machinery Control

All levels of the TMACS system are shown in the illustration below:

- Supervisory computers (Level 2) provide set points to the Level 1 controllers
- Realtime controllers (Level 1) provide control outputs to the I/O and drives
- I/O monitors and actuates the equipment functions
- Drives (Level 0) control the speed and torque of the motors

Plant equipment locations:

- HMIs are in the operator control rooms
- Controllers and drives are in the electrical equipment room
- I/O cabinets can be adjacent to the mechanical equipment
- Sensors and actuators are on the mechanical equipment

Typical Large System

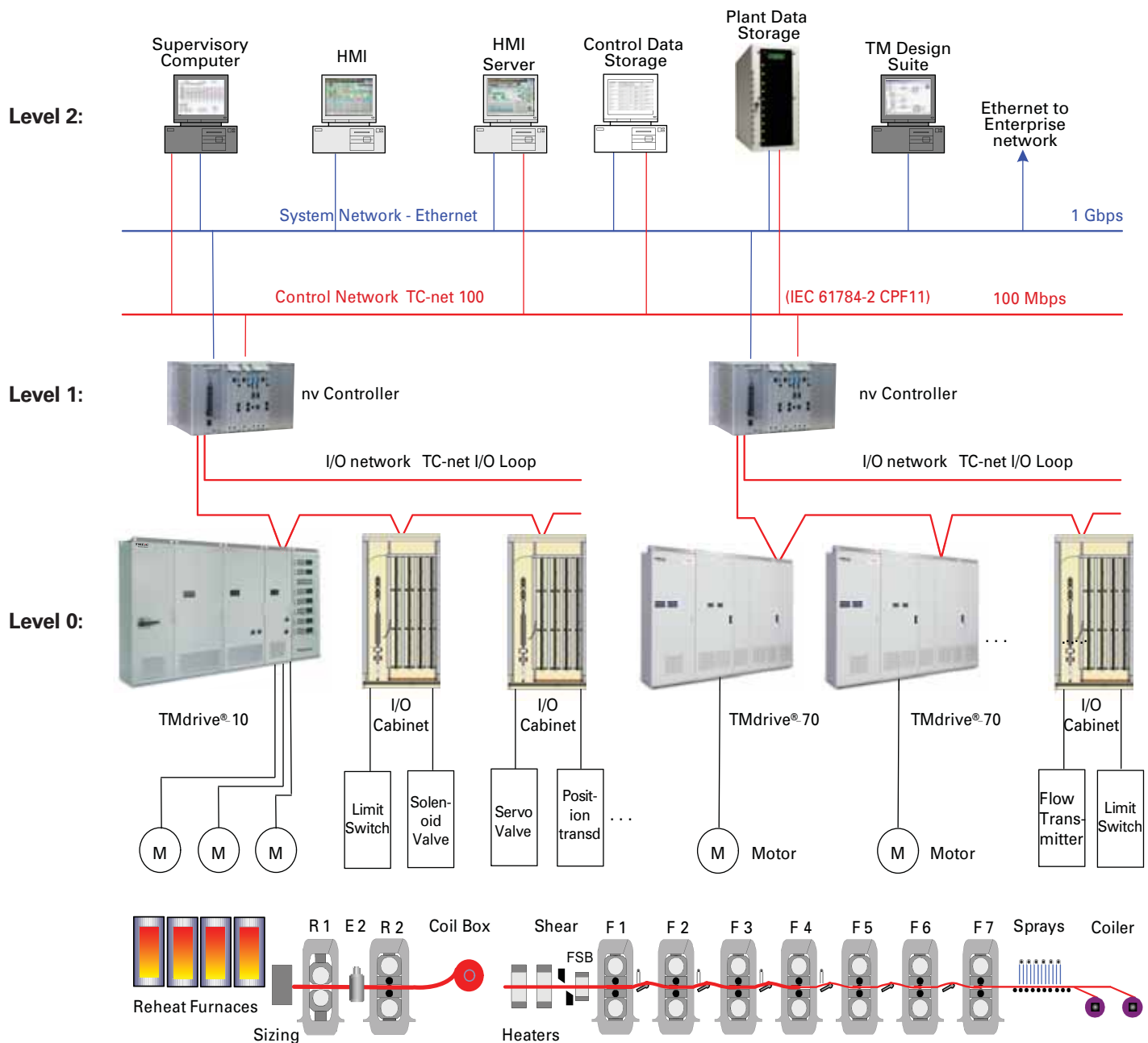

Controller Features

The nv Controller

Toshiba's latest industrial controller, the Unified nv Series Controller, is a big step beyond the existing V series used in industry around the world. The capabilities include high-speed logic, sequencing, motor speed control, and continuous control. High-speed I/O communication uses the industry's first 100 Mbps fault tolerant ring network "TC-net I/O," linking remote and field mounted I/O.

- The main features of this powerful controller are:
- Fault tolerant ring 100 Mbps I/O communication
 - Enhanced speed by direct execution of IEC standard control languages in ASIC hardware
 - Higher reliability using redundant modules, and error checking and correcting ECC memory
 - Gigabit supervisory control network

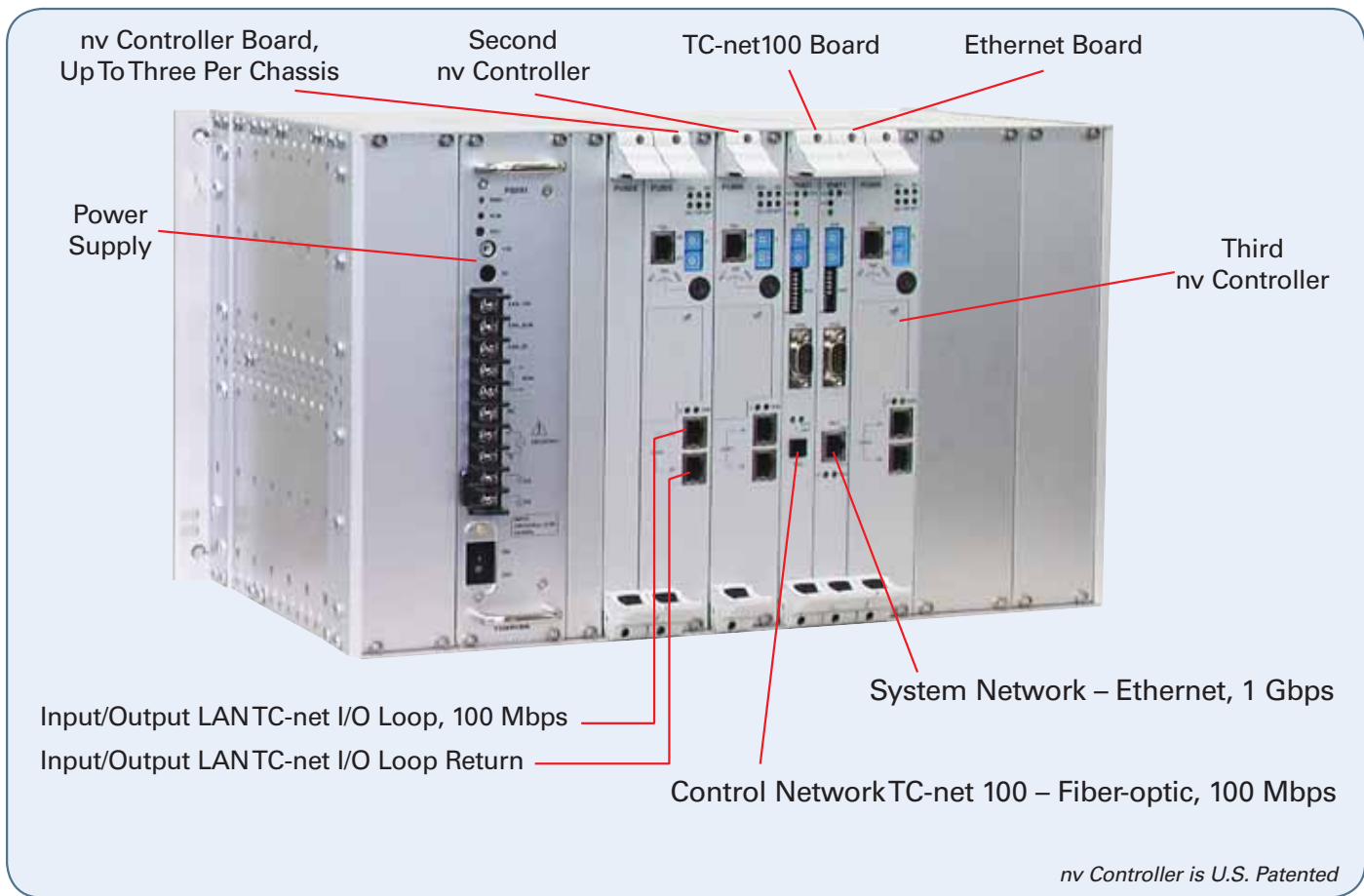

nv Controller is U.S. Patented

| Feature | Details |
|-------------------------|---|
| High-speed Processing | Bit and integer processing: 20 ns ; Floating point add/multiply: 120 ns |
| Short Control Cycle | Three separately scheduled periodic tasks: 0.5 ms to 1,000 ms |
| Large Program Capacity | Programs up to 256 kilo steps (instructions), up to 385 periodic programs |
| High Data Capacity | Local/global variables 256 K words; I/O variables 16,384 16-bit words |
| Interrupts | Total of 16 interrupt tasks |
| Multiple Controllers | Up to three controllers per chassis; Up to four communication modules; Redundant controller and network configurations possible |
| Programming Flexibility | Four IEC 61131-3 standard languages: LD, FBD, SFC, and ST |
| Memory Reliability | An error correcting ECC circuit in the internal memory of each module |

Controller Programming

TMdrive-Navigator – Simple Drive Configuration and Maintenance

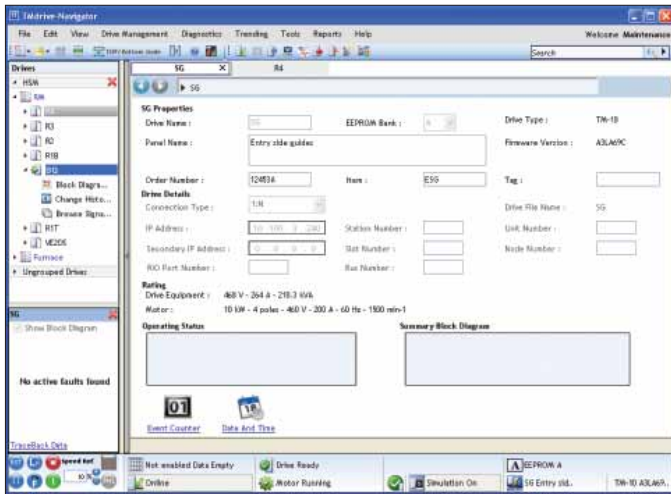

The TMdrive-Navigator tool helps users maintain TMEIC drives themselves. Engineers and technicians are empowered to understand how the drive works and what the drive is doing. Any user can easily access current drive performance data and a variety of drive expertise and know-how.

Drive tuning functions are supported by Wizards, and live block diagrams provide a real-time graphical view of drive functions.

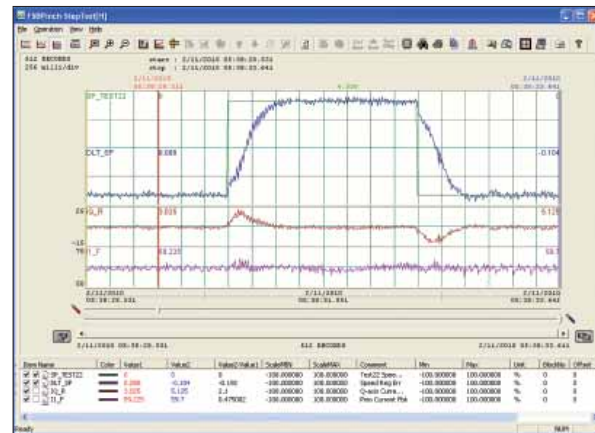

High speed data is automatically captured and saved in the event of a drive fault. Users can also capture and trend high speed data based on their own trigger conditions.

Desktop-like search technology links topical signal lists, block diagrams, help files, product documentation, change history, and user notes.

TMEIC's Library of Control Modules

Engineering Tool contains the standard IEC control functions for discrete and continuous control.

Project-specific control modules developed over 50 years of mill experience are included in TMEIC's library of function blocks. Use of these function blocks speeds up sophisticated control system programming and simplifies simulation, test, and commissioning. A few of the blocks are listed here.

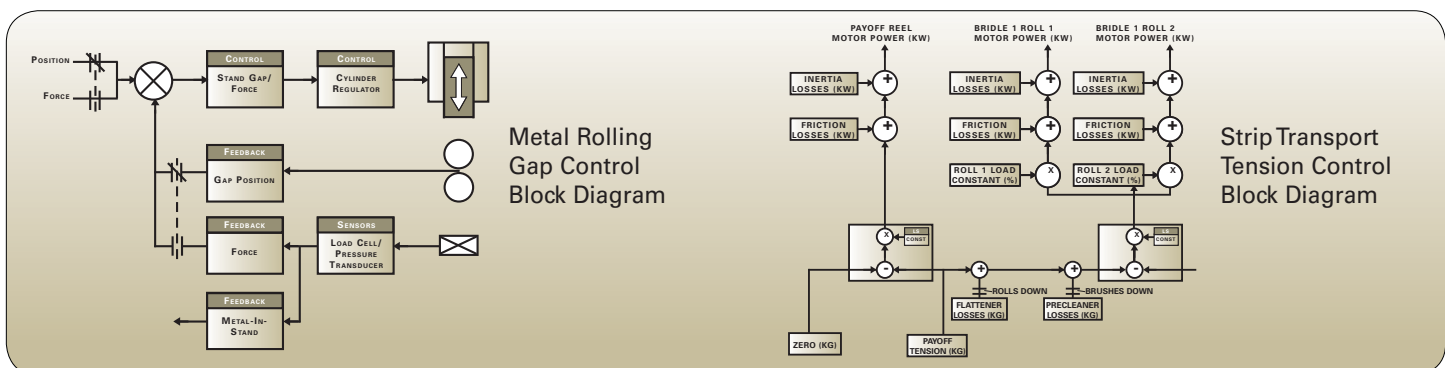

Hot Mills and Cold Mills Function Blocks

- Hydraulic Gap Control
- Gauge Control
- Coiler Automatic Jump Control
- Hydraulic/Electric Interstand Looper Control
- Cold Mill Interstand Tension Control

Process Lines Function Blocks

- Zone Tension Control
- Loop Car/Tower Control
- Coil Sequencing Control

All-Purpose Function Blocks

- Position Regulator
- Special PID
- Drive Control Standard

Controller Programming

Engineering Tool 4 – Choose from Four International Standard Programming Languages

The Engineering Tool 4 software for the nv Series controller provides four IEC-61131-3 standard programming languages: Ladder Diagrams (LD), Function Block Diagrams (FBD), Sequential Functions Charts (SFC), and StructuredText (ST). The first three can be mixed in the same program and displayed on the same screen.

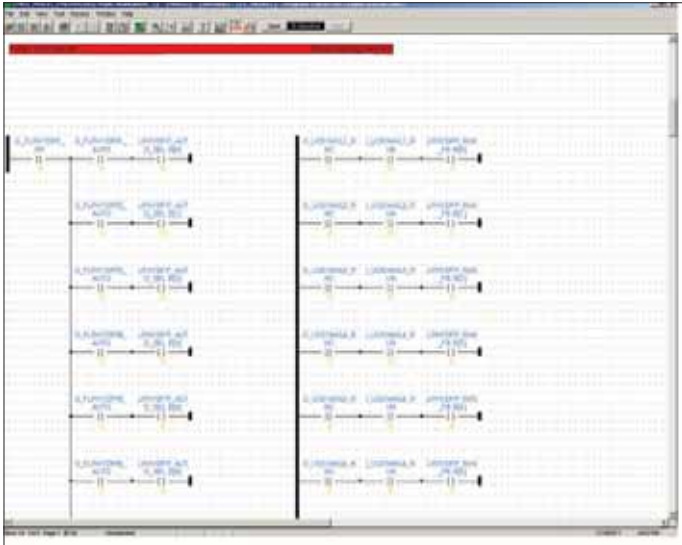

Function Block Diagrams

FBDs are a familiar graphical control representation using function blocs containing sections of logic or analog control for easy manipulation and connection. Custom control blocks can be kept for re-use. Features include high density notation, line crossing and skip, and return lines.

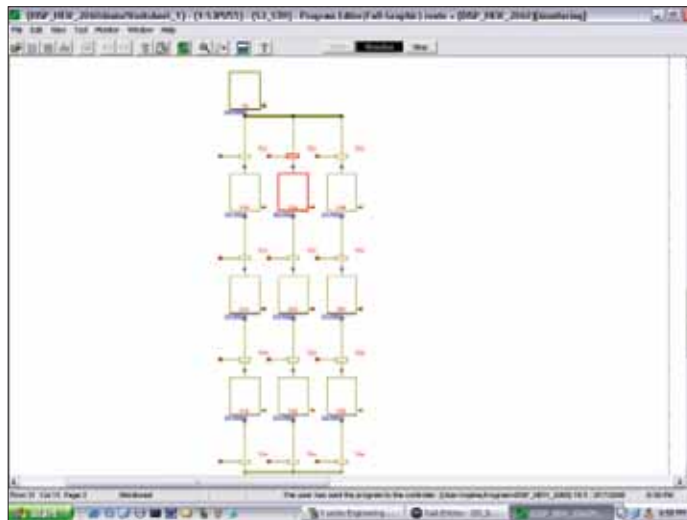

Sequential Function Charts

SFC charts show the control flow and the action unit, which shows the action performed at each step, and the transition conduction unit, which shows the conditions for advancing to the next step.

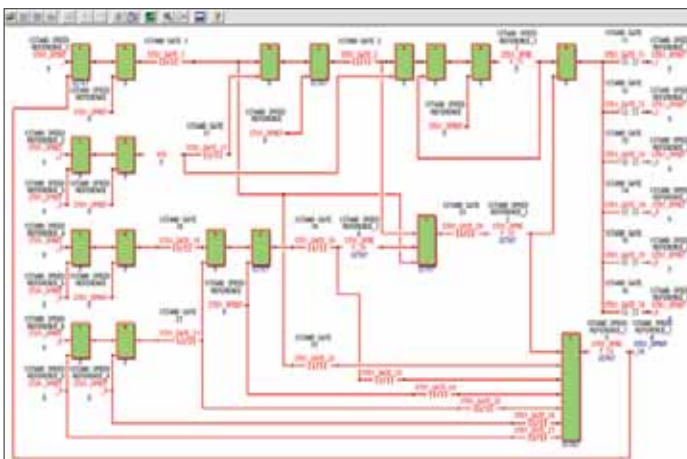

Ladder Diagrams

LD is the preferred programming language for logic control and sequencing. It shows relay circuit contacts and coils, and indicates power flow using color to allow easy test and debug of logic circuits before actual use.

Engineering Tool 4 – Choose from Four International Standard Programming Languages

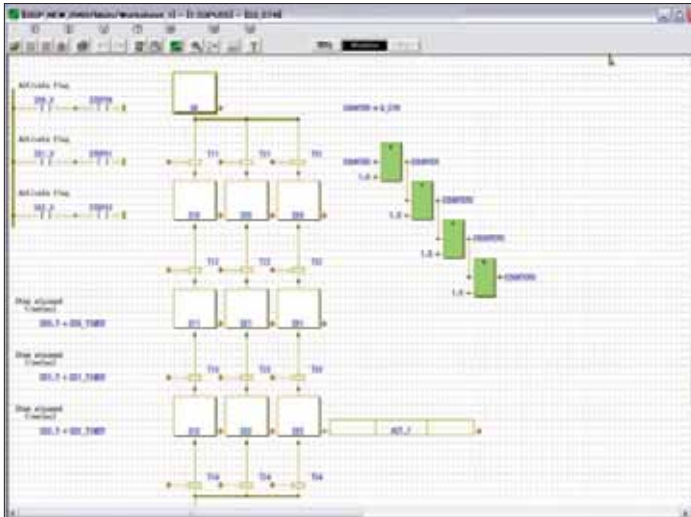

Mix all three programs on one screen.
Using all the graphical programs offers the best programming convenience

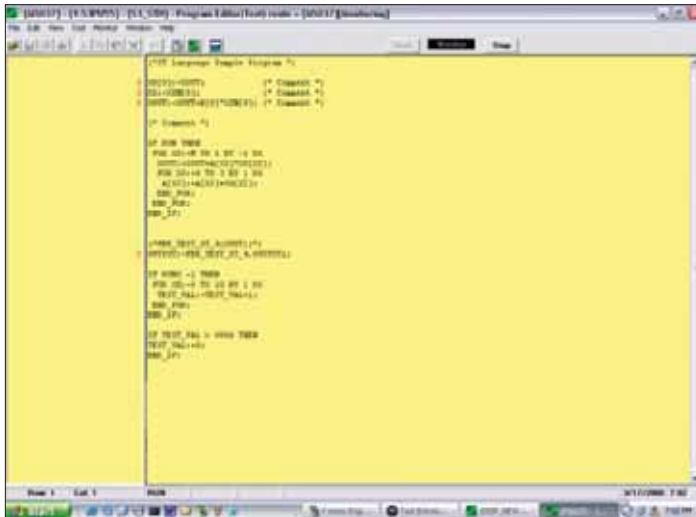
A screenshot of a software interface showing a Structured Text (ST) program. The code is displayed in a yellow background with black text. The code includes comments and function calls, such as `IF (M101) THEN` and `IF (M102) THEN`. The code is organized into sections, with comments indicating the purpose of each section. The interface includes a menu bar at the top and a toolbar with various icons for editing and execution.

Structured Text Language
ST allows difficult applications not easily programmed with LDs, SFCs, or FDBs to be handled with languages such as Visual Basic or C. Note that StructuredText cannot be mixed with the other three languages.

Control System Functions

HMI – Human Machine Interface Monitoring and Rapid Operator Control

Common operator interface to all control levels.



Operator's HMI Screen

Customers can choose their HMI, for example: Intouch or iFIX. The HMI provides a hierarchy of process monitoring and operator displays with:

- Connectivity to shared memory to obtain real time process data.
- Rapid access to the controllers to issue commands like Start/Stop
- Animated color graphic objects
- Immediate alarm annunciation

Supervisory Control Functions – Analysis and Reporting

- **Clear Design**
Object Oriented Design
Using Definition Forms
Unified Data Management
Auto Generated Programming
- **Scalable System**
Distributed processing
Easy Maintenance
- **Common Data Handling by Shared Memory**
- **Multi Operating System**

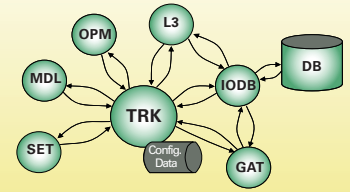

OPM–Operations Management
L3–Interface to Business System
IODB–Data Handling (PDI,PDO)
GAT–Data Gathering
TRK–Material Tracking
SET–Setup Distribution
MDL–Models

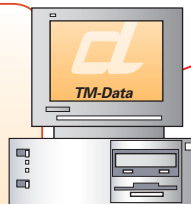
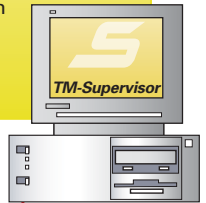

Shared Memory

- All users are linked by TC-net 100 interface board to the High-Speed Network, which accesses field distributed memory
- TC-net IO scan time as fast as 0.1 msec brings real-time data to all users
- Shared memory is open to all levels

Data Collection and Archiving

Collecting Plant Real-Time data and Managing Historical Data

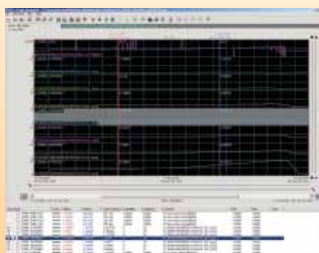

- **Real-Time Control Data.** Any data on TC-net can be gathered with a sampling time as fast as 1 ms, and then stored for two weeks. Real-time trending is available, and special data collection can be triggered by a select event.
- **System Parameters.** Current parameters of the drives, level 1 control, and level 2 are stored, and also maintenance data such as programs and trace back data.
- **Historical Data.** Data to be kept long term is stored off-line.

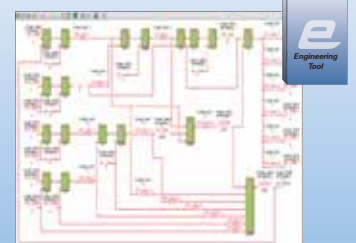

Models – Process Supervision for Increased Performance and High Product Quality

TMEIC process models use analysis of the physical process, research results, and plant experience. The models provide inputs to the control system to achieve the best quality product and yield.

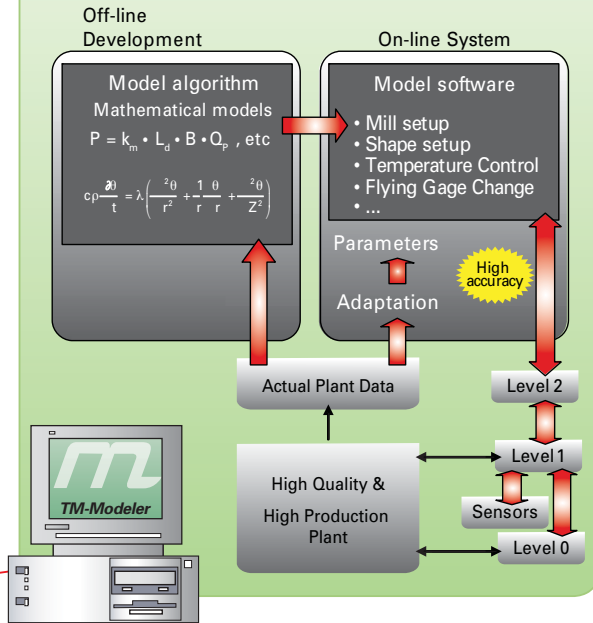

Field IO cabinet

Controllers Provide Process, Speed and Sequence Control

Control capabilities include logic, sequencing, coordinated drive control, and continuous control. Data from the drives, and field-mounted analog and digital I/O is acquired over the high-speed LAN TC-net I/O Loop. Data is updated at the very high-speed of 0.1 millisecond, and made available to the system shared memory through the controller TC-net 100 interface card.

The TM-Design Suite: World Class User-Friendly Software Products

The *TM-Design Suite* offers the user unified programming utilities for configuring all equipment in the system. From one station, the engineer can prepare and edit programs for the controller, drives, operator stations, and supervisory functions, off-line and on-line.



Engineering Tool: Controller Programming and Real-time Monitoring Software

The nv Controller is programmed with the Engineering Tool, which provides all four IEC standard control languages and allows program mixing.



TMdrive-Navigator: Drive Configuration and Real-time Monitoring Software

All the TMdrive family of drives are configured with the Navigator. Wizards intelligently guide the user through the required configuring steps, and high-performance trending simplifies drive maintenance.



TM-Supervisor: Supervisory Functions Configuration Software

The supervisor software configures the level 2 functions such as the variables, references, tracking, trending, statistics, and reporting.



TM-Modeler: Model Configuration Software

TM-Modeler software configures the process model parameters based on operation requirements. TM-Modeler provides user-friendly parameter setting without modifying software programs or performing unnecessary work.



TM-Editor: HMI Graphic Display Editor

TM-Editor supports building of the HMI color graphic displays, creation of objects, object animation, insertion of real-time process data, and creation of active points to provide operator control.



TM-Data: Data Collection and Archiving Software

TM-Data allows real-time and historic collection of variables to be selected, plus other long term data including control system parameters, maintenance data, and traceback data. Historical data can be analyzed and displayed.

High Speed Distributed I/O

Conventional I/O Handling

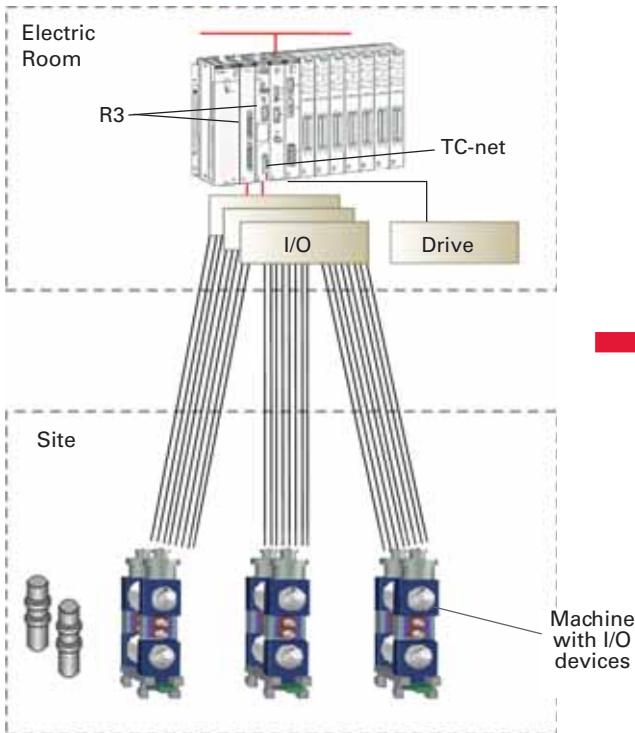

New Field Distributed I/O Subsystem

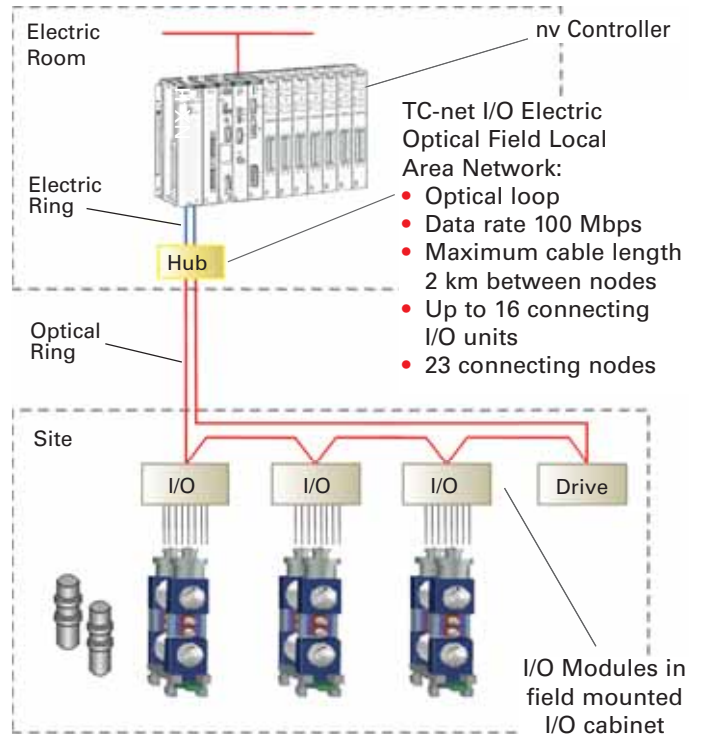

Field Mounted I/O Cabinet and I/O Modules

I/O modules for devices such as proximity switches, limit switches, solenoid valves, and servo valve sensors can be installed in I/O panels adjacent to the machines, instead of installed in the electrical equipment room. These I/O modules, which perform conversions such as A/D, linearization, and counting, are connected by the field LAN to the controller in the electric equipment room.

Output commands from the controller arriving on the LAN are processed in the modules, for example D/A conversion, voltage and current conversions.

I/O modules can be swapped with the power on, which permits the control to continue running while a module failure is repaired.

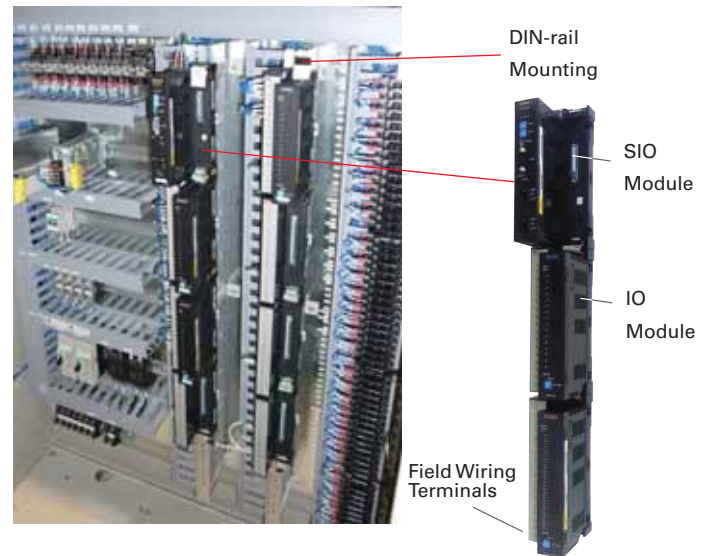

I/O System Features

- High-speed field LAN
- Serial communication to I/O
- Fiber optic transmission
- Industrial duty modules and cabinet
- DIN-rail mounted modules
- Easier to design and test the system

Benefits

- Faster I/O communication and update time
- Reduction in copper wiring cost
- Noise-free communication
- Reliable operation in remote location
- Improved maintainability and cable routing flexibility

I/O Communications over TC-net I/O

The nv series I/O modules can be mounted in the electrical room or remotely, adjacent to the machinery or process. TC-net I/O communication with the local I/O is over an electrical Cat 5e fault tolerant ring (shown in blue), which connects to the electrical serial I/O modules (SIO). Field mounted I/O is connected using fault tolerant optical rings (shown in red), which connect to optical SIOs while the drives typically use an optical converter or hub (shown in yellow).

Large cabinet mounted drives such as the TMdrive-30, 50, and 70 are connected in star configuration to a hub device. The smaller draw-out TMdrive-10e2 drives are mounted in multistage panels and share an electrical multidrop cable using an optical-electrical converter mounted in the drive panel.

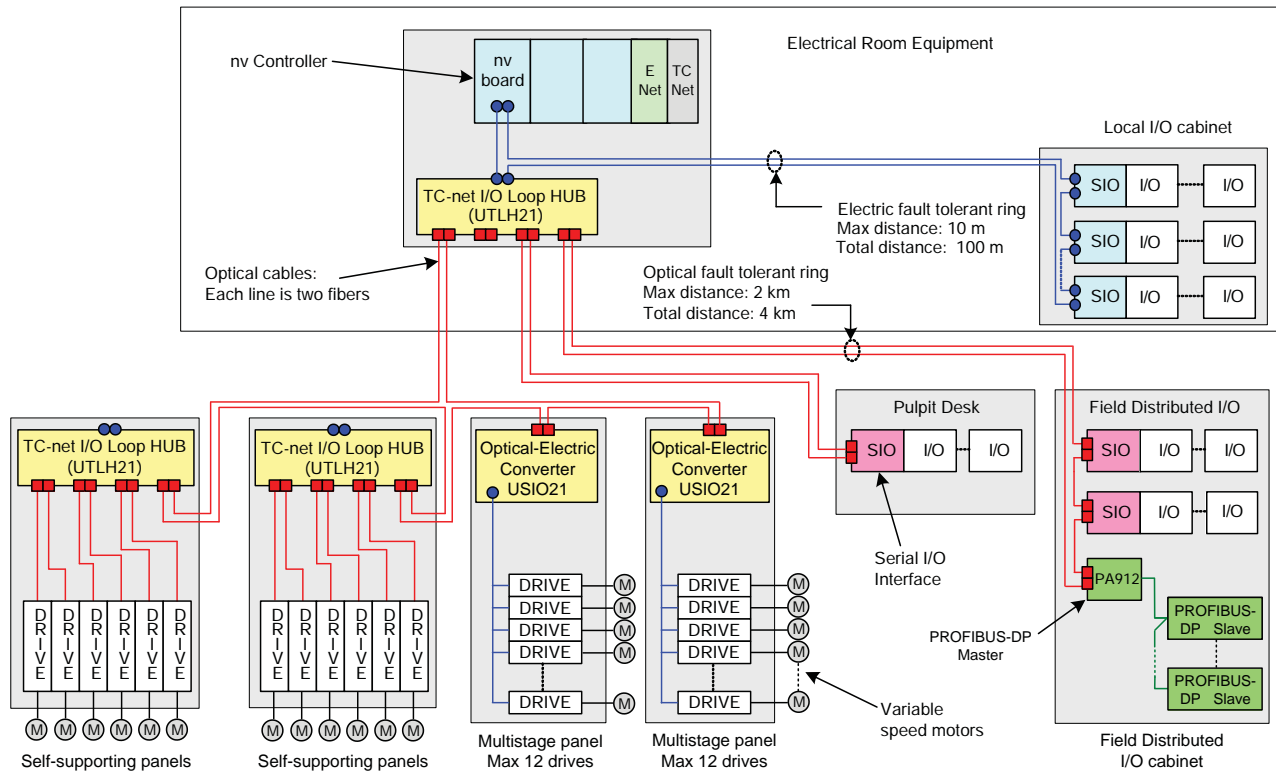

TC-net I/O Feature

Details

| | |
|-------------------------|--|
| Topology | Fault tolerant rings, each cable has a transmit and receive wire or fiber. Any loop connection can be severed without loss of communication. |
| Data Rate | Transmission and reception at 100 Mbps. |
| Number of Interfaces | 32 SIO interfaces per loop plus up to 200 drives per controller. |
| Serial Interfaces – SIO | Electrical SA911; Optical SA912; Profibus DP Master PA912 (optical); Modbus RTU MD911-M |
| Number of Modules | 16 I/O modules per SIO interface. |
| Scan Cycle | High-speed scan: 100µ sec. or more; Medium speed scan: 1 ms or more |
| Cable Length | Electrical distance between nodes 10 m (32 ft.); optical distance 2 km (6,550) ft. |
| Cable Type | Electrical cable is category 5 shielded twisted pair; optical cable is GI 50x125 |

Powerful Diagnostics

Operator Accessible Machine Diagnostic Displays

The HMI, programmed in conjunction with the Tool software, brings the operator instant feedback on the cause of machinery problems, and presents the information in an easily understood way to reduce the time spent diagnosing the problem. During initial programming, permissive logic blocks, DIAG_D, are used in the ladder logic program. The illustration below shows the sequence of events when a problem occurs with the machine.

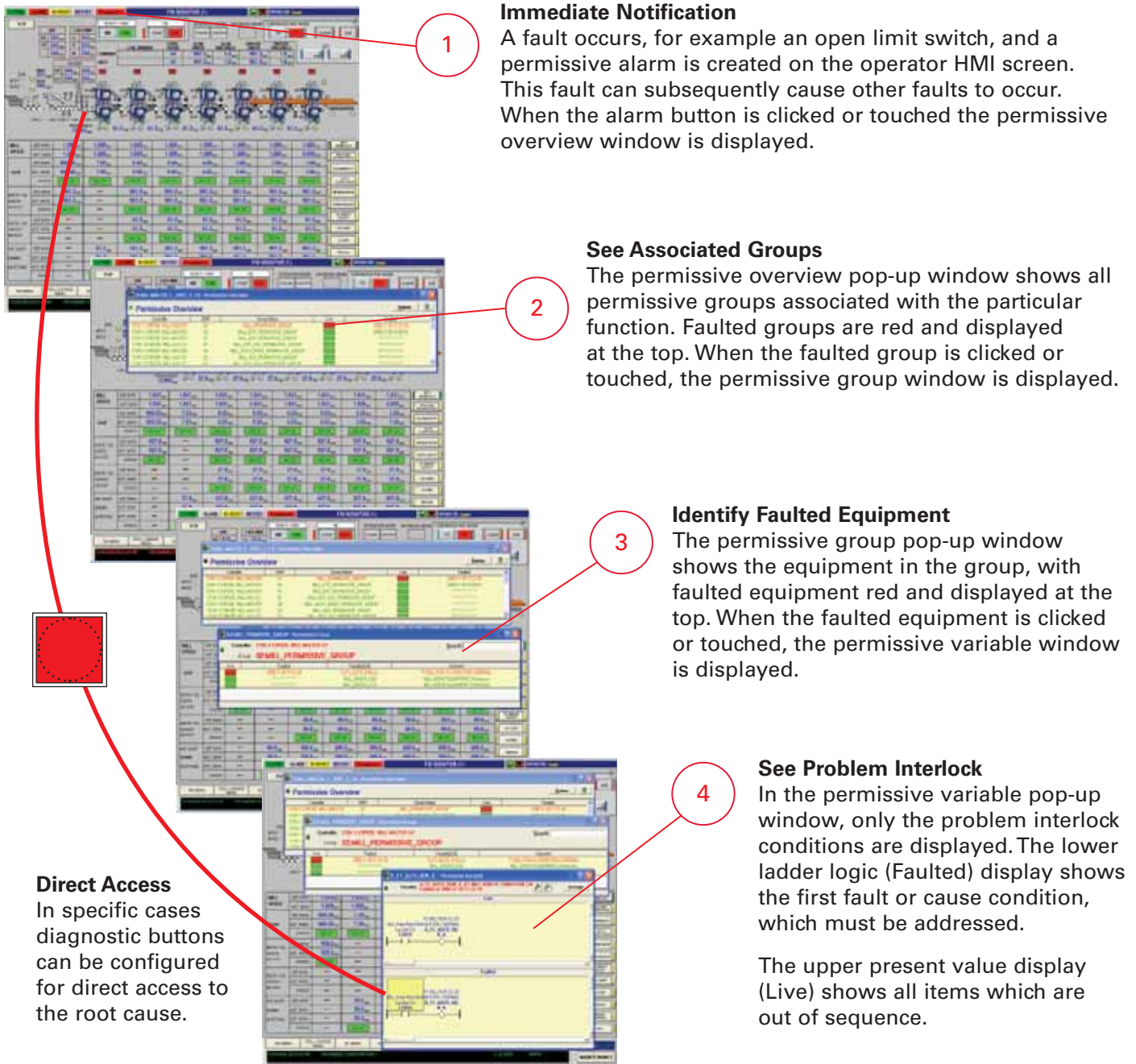

Advanced Features

The Integrated Tool Set Increases Productivity

Customers need to configure their control system quickly to get up and running on schedule. To minimize downtime, they need to be able to solve operation problems quickly. Finally, they need to study and improve their control system for optimum performance.

The integrated tool software provides this capability, for all users:

- Commissioning engineers
- Maintenance engineers
- Operations personnel
- Management

With the same look and feel on the screens, the integrated tool offers the customer ease of use. Immediate benefits include:

- Higher productivity
- System wide problem solving
- Simplified equipment diagnostics
- Easy system configuration
- Simplified system enhancement



Models for Optimum Product Quality

TMACS uses process models based on physical phenomena and material behavior to set up the level 1 controls for the optimum reference values. The heat transfer model illustrated here is used

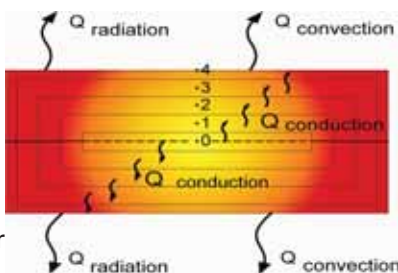

for all phases of rolling and coiling control.

In a finishing mill for example, models calculate references:

- Stand roll gap position, speed, pair cross angle, roll shifting position, and roll bending references
- Looper tension and position references
- Position references for the finishing stand side guides
- X-Ray gauge thickness and width gauge setpoints
- Reference for the bar's exit width, gauge, and temperature
- Finish mill speed-up rate and limit
- A set of automatic gauge control predicted forces and transfer functions
- Inter-stand cooling spray patterns and flow references from the outputs of the temperature model

The Unified Tool Set Increases Productivity

Level 2 provides analysis and reporting, from a fully configurable and structured software.

Level 2 distributes references to the level 1 controllers in a timely manner, and receives process feedbacks for model updates and data collection.

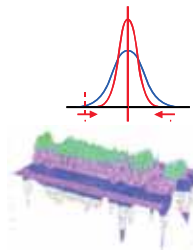

Typical level 2 functions include:

- Material tracking through process zones
- Distribution of process references
- Acquisition of process feedback data
- Production data logging
- Engineering data logging
- Performance classification and reports

Customer benefits include high product quality, low cost of system ownership, and simple maintenance and troubleshooting.

Global Support

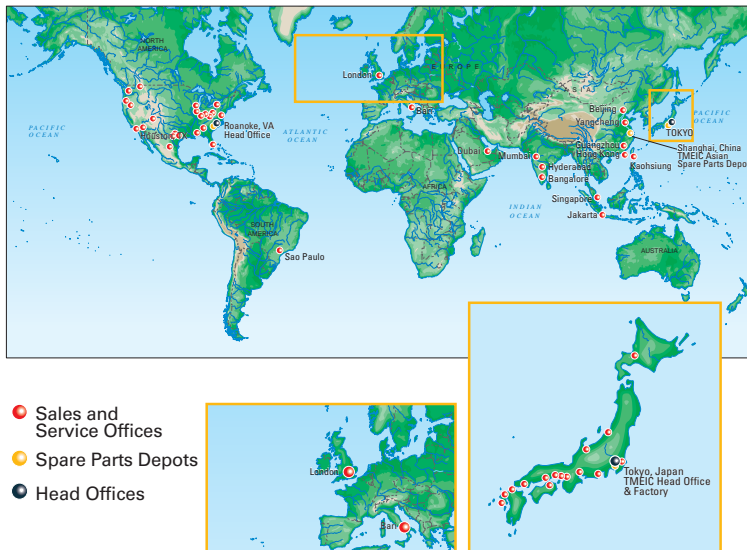

Wherever You Are, We Are Right Next Door

TMEIC has the capability to provide world-wide service support with trained field service engineers. Spare parts depots are strategically located close to main industrial centers.

In Asia & Pacific: Customers are supported by TMEIC service personnel and the TMEIC factory in Japan.

In North America: Customers are supported by TMEIC factory service personnel from Roanoke, Virginia.

In Europe: Customers are supported by TMEIC European service personnel.



Customer Training

Customer personnel are trained on the control system at the TMEIC training facility in Tokyo or the TMEIC training center in Virginia, USA. This center is a world-class facility with large classrooms and fully equipped training labs, offering a range of product courses to customers. As an alternative to standard factory training, TMEIC can offer a course tailored to the customer's needs and held on site.

TMEiC

Global Office Locations:

TMEIC Corporation

Office: 1325 Electric Road, Roanoke, VA, 24018, USA
Mailing: 2060 Cook Drive, Salem, VA, 24153, USA
Tel.: +1-540-283-2000; Fax: +1-540-283-2001
Email: info@tmeic.com; Web: www.tmeic.com

TMEIC Corporation - Houston Branch

2901 Wilcrest Dr., Houston, TX 77042, USA
Tel.: +1-713-784-2163; Fax.: +1-713-784-2842
Email: OilGas@tmeic.com; Web: www.tmeic.com

TMEIC Power Electronic Products Corporation

13131 W. Little York Road, Houston, Texas 77041, USA

Toshiba Mitsubishi-Electric Industrial Systems Corporation

Tokyo Square Garden
3-1-1 Kyobashi, Chuo-kyo, Tokyo, 104-0031, Japan
Tel.: +81-0-3327-5511
Web: www.tmeic.co.jp

TMEIC Europe Limited

6-9 The Square, Stockley Park, Uxbridge, Middlesex,
United Kingdom, UB7 7LT
Tel.: +44 870 950 7220; Fax: +44 870 950 7221
Email: info@tmeic.eu; Web: www.tmeic.com/Europe

TMEIC Industrial Systems India Private Limited

Unit # 03-04, Third Floor,
Block 2, Cyber Pearl, HITEC City, Madhapur,
Hyderabad, 500081, Andhra Pradesh, India
Tel.: +91-40-44434-0000; Fax: +91-40-4434-0034
Email: inquiry_india@tmeic.com; Web: www.tmeic.in

Toshiba Mitsubishi-Electric Industrial Systems Corp (Beijing)

21/F, Building B, In.do Mansion, 48 Zhichunlu A, Haidian District, Beijing 100098, PRC
Tel.: +86 10 5873-2277; Fax: +86 10 5873-2208
Email: sales@tmeic-cn.com

TMEIC – Sistemas Industriais da América do Sul Ltda.

Av. Paulista, 1439 cj72
Bela Vista, CEP:01311-200
São Paulo/SP, Brasil
Tel: +55-11-3266-6161; Fax: +55-11-3253-0697

TMACS is a registered trademark of TOSHIBA MITSUBISHI-ELECTRIC INDUSTRIAL SYSTEMS CORPORATION.

Tmdrive is a trademark of TOSHIBA MITSUBISHI-ELECTRIC INDUSTRIAL SYSTEMS CORPORATION.

All other products mentioned are registered trademarks and/or trademarks of their respective companies.

All specifications in this document are subject to change without notice. This brochure is provided free of charge and without obligation to the reader or to TMEIC, and is for informational purposes only. TMEIC does not accept, nor imply, the acceptance of any liability with regard to the use of the information provided. TMEIC provides the information included herein as is and without warranty of any kind, express or implied, including but not limited to any implied statutory warranty of merchantability or fitness for particular purposes. The brochure is not an implied or express contract.