

TOSHIBA

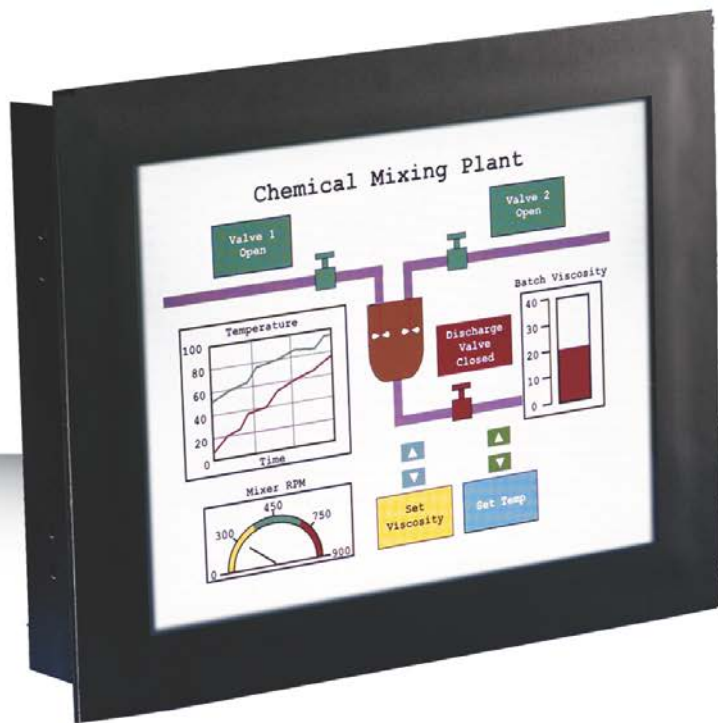

OIS PLUS SERIES 
OPERATOR INTERFACE STATIONS

OIS PLUS

OIS PLUS = PLC + OIS + Clip-on I/O

The OIS PLUS Series touchscreens are updated versions of the operator interface stations OIS55 and OIS60. The PLUS versions contain PLC functionality and accommodate optional clip-on I/O modules (digital, analog & c

OIS60 PLUS

6" Color Touchscreen

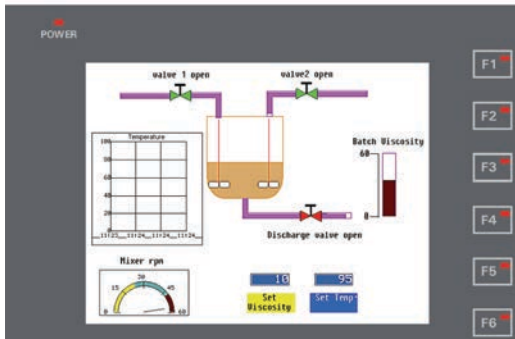

OIS55 PLUS

3 1/2" Color Touchscreen

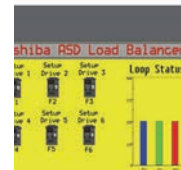

3 Clip-on I/O Modules

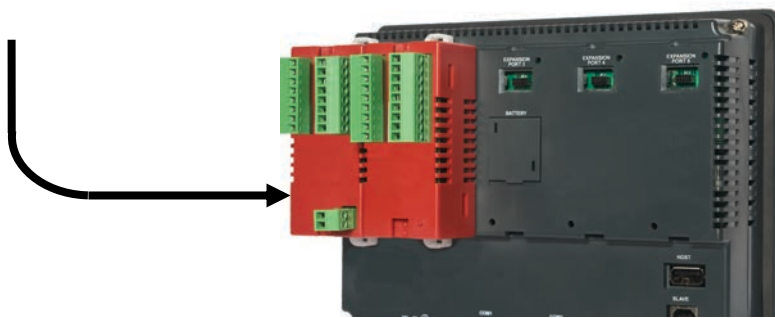

on I/O Module

Multi-Language with True Type Fonts

◆ Connection to Modbus Field Networks

Wide Variety of I/O & Com Modules

◆ USB port; Programming & Data Collection

Touchscreen--OIS PLUS



OIS45E PLUS
Color Touchscreen w/Ethernet



2 USB Po



OIS70E PLUS
Color Touchscreen w/Ethernet



- ◆ OIS60 PLUS & OIS70 PLUS have same dimensional cutouts.
- ◆ Only OIS55 PLUS and OIS60 PLUS have function keys with indicator LEDs.
- ◆ I/O Modules are common to all OIS PLUS touchscreens. For a list of I/O modules see page 17.

Large Touchscreen—OIS120A

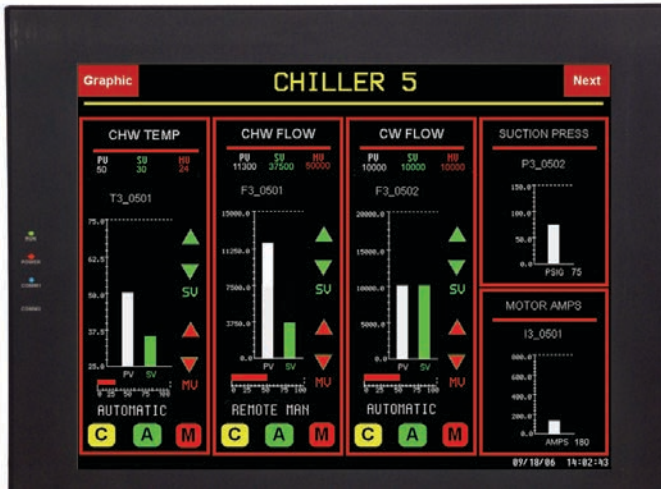

Large Display for Monitoring & Logging Data in Toshiba Control Devices

Alarms & Trending

Large Number of Special Objects

Unlimited Screens (based on memory)

3 Communications Ports (1 Ethernet).

Multiple Language (Unicode) Support

Compact Flash Memory

LCD Touchscreens

OIS40/42 PLUS

Multicolor backlit Touchscreen. Screens can be Red, Green, Blue or combination of the 2 or 3 colors

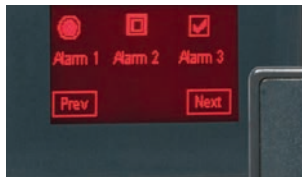

Screen color can be determined by the status of the connected devices

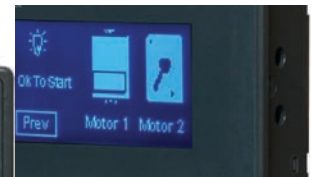

Full PLC Ladder Logic Functionally



- 0-24 Vdc Inputs, 4 I/O inputs, 20 kHz.
- 6 Relay Outputs
- 2 Transistor Outputs/2 HS Outputs, 25Khz
- 2 Analog Inputs
mA, Vdc, TC, and RTD.
- 1 Analog Output

KeyPad OIS



OIS12 is same as OIS10 PLUS but no built-in I/O. For connection to Toshiba PLCs, Integrated Controllers, ASDs, or any device with Modbus serial protocol.



All the best features of past Toshiba PLCs are built into the OIS20 PLUS. Remember the EX20 (80s), M20 (90s) & T1-28 (00s), now there is the OIS20 PLUS (10s)



In addition, the OIS20 PLUS has:

- 3.1" Graphical, Multicolor, Backlit LCD Display
- 18 Function/Numerical Entry Keys
- 1 Serial Communications Port
Modbus, Toshiba ASD, or Serial Printer

OIS PLUS I/O Modules

These modules clip onto the back of the OIS PLUS. All terminal strips are removable.

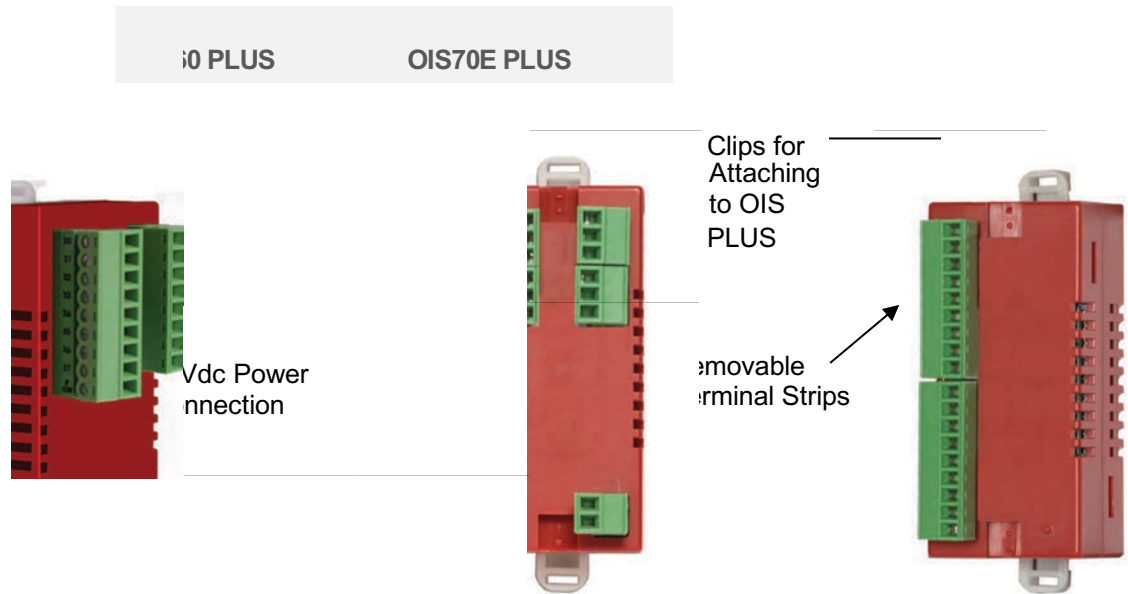

The following modules are available.

TRPDOX0016P Outputs 24, Vdc, transistor PNP.

TRPHIO0808N Outputs (4 HSC), 24 Vdc (sink/source), 8 Outputs (2 HS/1 PWM),
transistor, 24 Vdc, NPN.

Analog I/O

KEY FEATURES

Connection to ASDs:

The OIS PLUS can receive multiple types of inputs (digital, analog, thermocouple, RTD, etc) and use these to control ASDs (adjustable speed drives). The OIS PLUS has the ASD parameters immediately available in the software, **no special programming is necessary.**

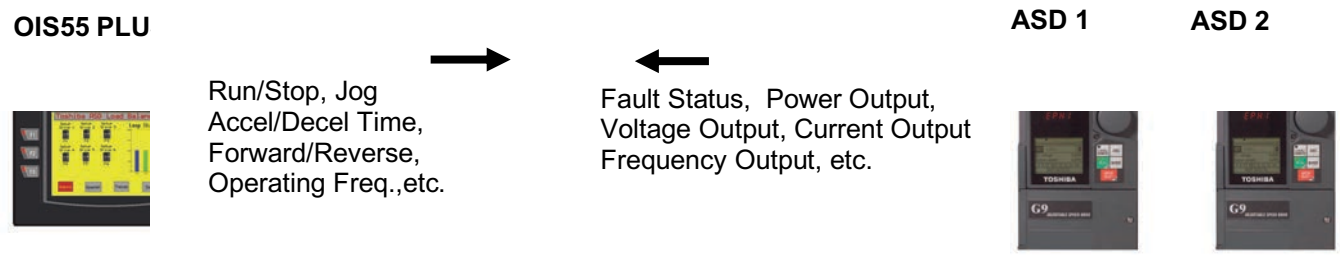

Ethernet connection is also available (requires Ethernet switch for more than 1 ASD)

Setup ASDs:

Simple setup software allows each type of equipment to be defined, mapped, and tagged.

Navigate with Project Navigator

Project Navigator: All Files > Project List > Demolnverter.pzm > Com1 > Toshiba Inverter > nC1

Tag List: Toshiba T Series, Toshiba Inverter, S9, G7, S9, G7, S7, S11, A7, G3, nC1

Assign Tags to each Device

Accel/Decel Time Parameters: Basic Parameters, Code Parameters, Command Parameters, Communication Parameters, Data registers, Drive Mode Parameters, Frequency Monitoring, Frequency Parameters, Fwd/Rev bit, I/O Parameters, Jog bit, Monitoring FC, Operating Freq, Panel Parameters, Protection Parameters, Reset Trip bit, Ret. Basic Parameters, Ret.Accel/Decel Time Parameters, Ret.Communication Parameters, Ret.Drive Mode Parameters, Ret.Frequency Parameters, Ret.I/O Parameters, Ret.Panel Parameters, Ret.Protection Parameters, Ret.Torque Performance, Run/Stop bit

Graphic Symbols:

The OIS PLUS (operator display) has a large selection of graphics for almost any industrial or process application. For the really special applications, user created bit maps can be imported into the OIS PLUS.

Multi-State Indicators



Normal Warning Alarm

Colors and text can change based on the ON/OFF bit status or the value in a register.

Switch Pairs

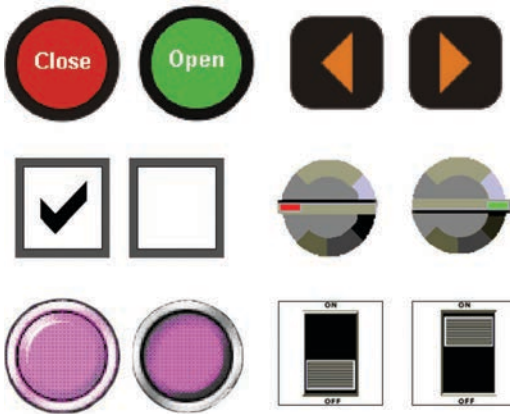

One or the other of the pair will be displayed depending on bit status (Inputs, Outputs, etc..)

Trending

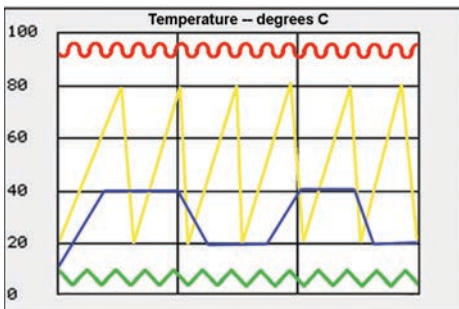

Displaying trends graphically provides easier interpretation of process/system change. Both simple trending and historical trending are available.

Tanks, Pipes, & Valves

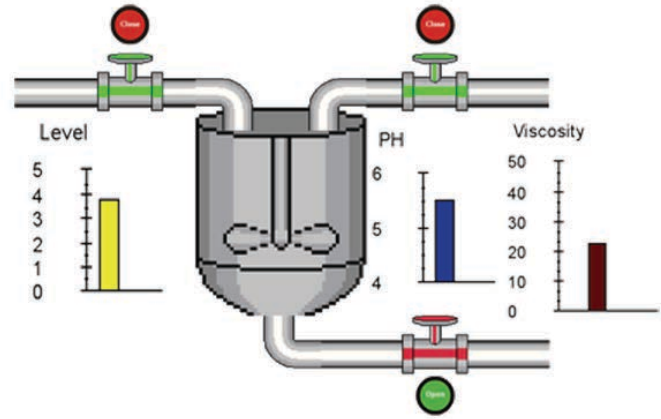

Create a graphical representation for a designated process. Add process indicators as desired.

Multiple Languages



温度警報3

温度警報3

Alarma 3 de la temperatura

Temperature Alarm 3

Сигнал тревоги 3 температуры

Tags can be created in any language supported by Microsoft. Selecting the language button will cause all tags to be displayed in the selected language.

Data Logging:

In many testing procedures, production runs, or process steps, it is as important to log system parameters as it is to control the sequences. The larger OIS PLUS have the capability to log user defined data. This data can be exported to a *.csv file and saved on a USB memory drive. From the memory drive, the data can be imported into MS Excel, MS Access, Lotus 1-2-3, etc. for further analysis. Logging can be specified by group and by when to start: Logging can start and stop on command at:

Power-up	Time/Date	Key Task	Event Occurrence	File	
	10/08/1	13:30	5	100	0
	10/08/2	15:00	3	100	0

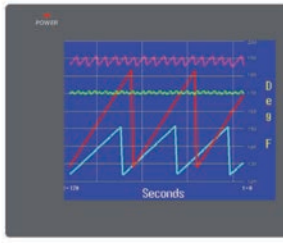

ladder program. File transfer to the USB memory drive can be done without stopping the OIS Plus. Data transfer from the OIS PLUS can either overwrite an existing file on the USB memory drive or create a new file.

Logged data can be very useful for many different purposes:

- ◆ QC verification that all parameters are within acceptable range.
- ◆ Confirmation that critical parameters meet regulatory agency compliance specifications.
- ◆ Substantiation of system status for use in incident analysis.

PROGRAMMING SOFTWARE

The OIL-DS (Operator Interface & Logic Development Software) runs on any Toshiba notebook computer or PC compatible computer running MS Windows 2000/XP/Win7 (32/64 bit). It is used for developing both the display screens and the control program (using ladder logic and function blocks).

Programming Environment:

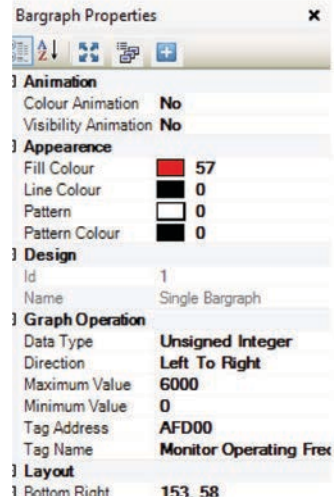
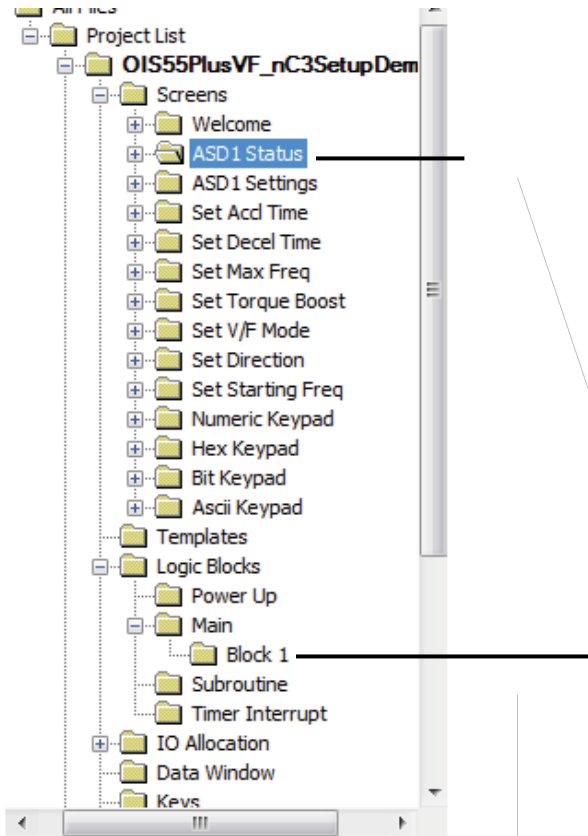

Display Screen Work Area

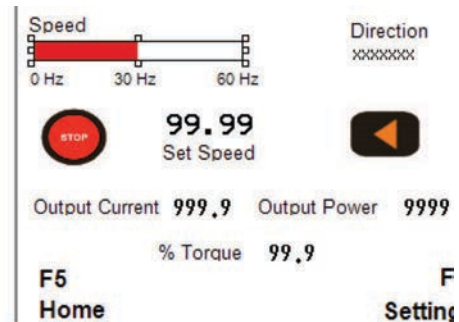

Ladder Logic Development Area

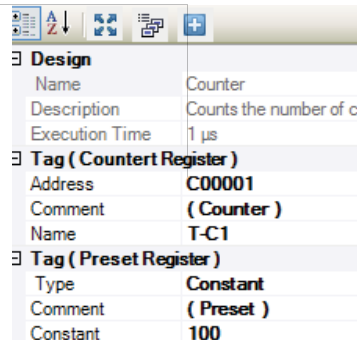
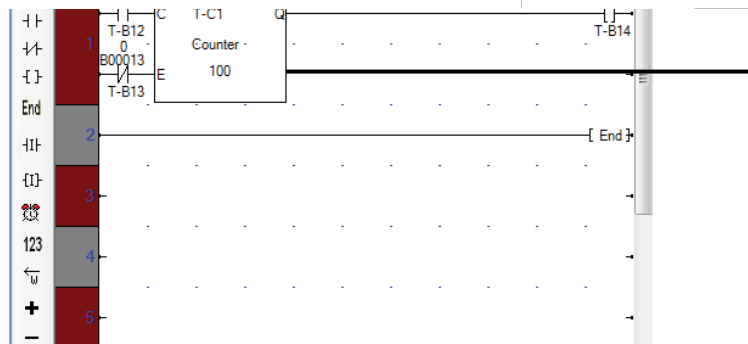

Programming Ladder Logic Blocks:

Several different types of programming blocks are available for organizing the ladder program and for making it efficient.

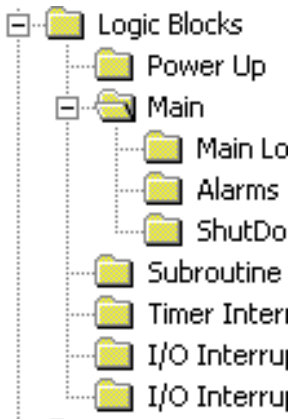

Power Up block runs one time at startup. block is used for variable initialization.

Interrupt blocks are available for immediate updates.

Common Tag Database:

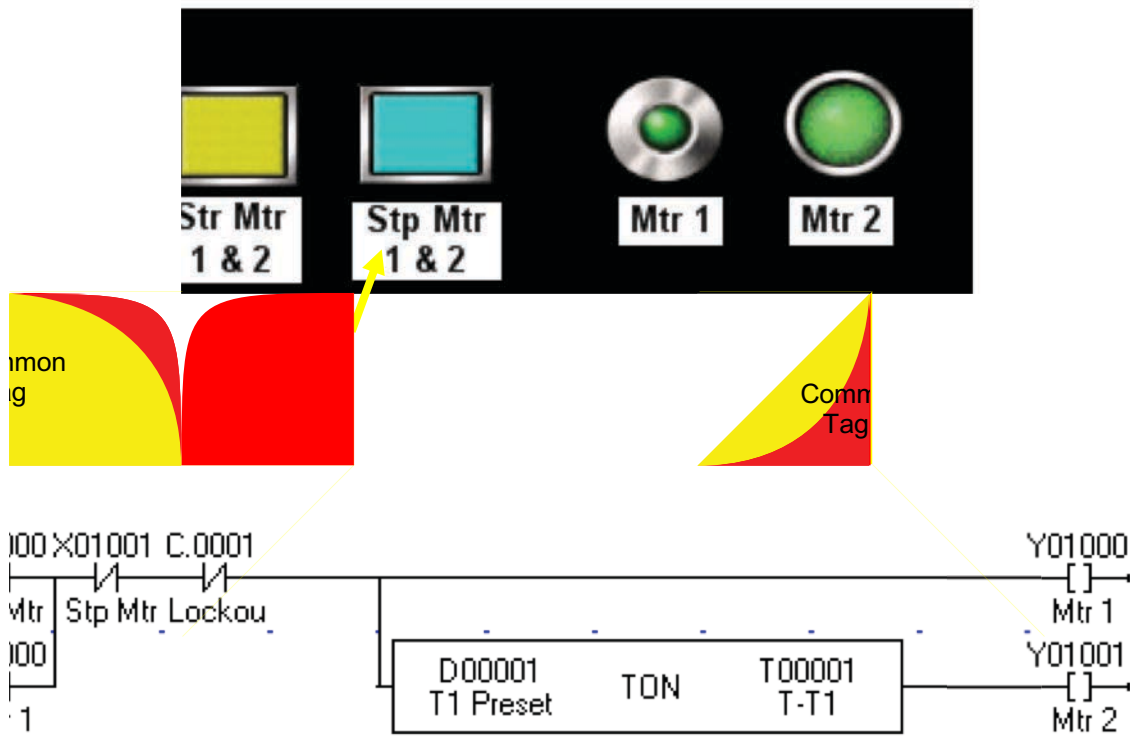

A

PLUS display uses the same tag data base as the OIS PLUS PLC.

Webpage Server:

These OIS PLUS displays have sufficient memory and an Ethernet port to support webpage servers:

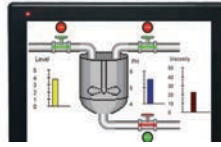

The OIS PLUS displays are pre-installed with the OIL-DS software, then downloaded into the OIS PLUS along with a static IP address. After this is done, connect the OIS PLUS to an internet access point thru its Ethernet port. A remote user will then be able to see the OIS PLUS's webserver page.

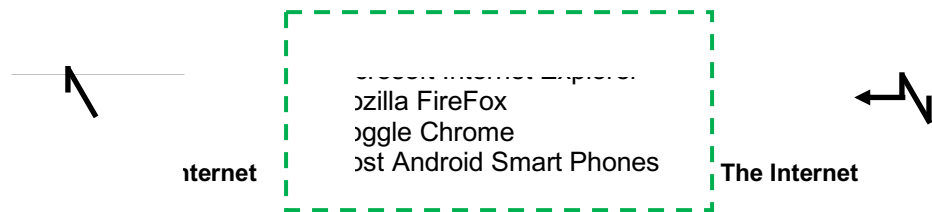

◆ Data Display

▶ Bit Map Objects

Navigation Buttons

Requires OIL-DS Ver. 2.2 or Higher

The OIS PLUS are small, general purpose controllers. The Operator Display, PLC & I/O are all in one compact block. This makes these ideally suited for a wide variety of control applications. Applications include:

Automation Machines

Water Management

Power Generation

Process Control

Other typical applications are:

- ◆ Packing Machinery
- ◆ Wash & Dry Control
- ◆ Compliance Monitoring
- ◆ Punch Press
- ◆ Pneumatic Control
- ◆ Alarm Systems
- ◆ Material Handling
- ◆ Conveyor Control
- ◆ Robotics

Call Toshiba to discuss Special Applications

SPECIFICATIONS

General Specifications:

Item	Specification
Power	24 Vdc, $\pm 10\%$
Bezel	IP65
Operating Temperature:	0° to 50° C
Storage Temperature:	-20° to 80° C
LCD Life	50,000 hrs at 25° C
Humidity:	10% to 90% (Non-Condensing)
Atmosphere	No corrosive gas, No flammable gas
Cooling	Natural air cooling
Immunity to ESD:	IEC61000-4-2
Immunity to Transients:	IEC61000-4-4
Radiated Susceptibility:	IEC61000-4-3
Surge Withstand	IEC61000-4-5
Conducted Disturbances	IEC61000-4-6
Emissions:	EN55011
Grounding	100 Ω or less (type D grounding)
Safety Certifications	CE, UL, cUL (Class 1 Div2), RoHS

Internal PLC Specifications

Item	Specification	Item	Specification
Control Method	Stored program, cyclic scan	User Data -/O Reg	X/XW, Y/YW 6400 pts/400 regs
Scan System	Floating scan	-Auxiliary Reg	B/BW 4096 pts/256 regs
I/O Update	Batch I/O refresh (direct I/O possible)	-Special Reg	S/SW 4096 pts/256 regs
Program memory	Program stored in flash memory	-Data Reg	D 4096 regs
Program capacity	8 K steps	-Counters	C./C 256 regs
Program Language	Ladder diagram	-Timers	T./T 61 @0.01 sec, 130 @ 0.1 sec
Instructions	Basic: 20 Function: 96		64 @ 1 sec.
Program Types	1 Main program	-Index Reg	I/J/K 3 regs total
	1 Initialize program	Execution Time	1.03 μ s/contact, 2 μ s/coil
	1 Timer interrupt program		2.32 μ s/16 bit transfer,
	2 I/O Interrupt programs		3 μ s/16 bit addition
	256 Subroutine programs		

OIS10 PLUS/OIS12

Item	Specification	Item	Specification
Display:	3.1" Multicolor Backlit LCD, 16 x 2 Display	I/O	OIS10 PLUS: 8in & 8out OIS12: None
Keys	Six User-Defined Function Keys	Memory-Total	512 Kb
LEDs	1 Pwr, 6 User Defined, 12 Data Entry	-Screen	84 Kb
Com Ports-Serial:	1 RS232/RS485	-Data Log	None
-Ethernet	None	PLC Steps	10 K (OIS10 Plus only)
-USB	1 Device	Back-up Battery	3 Yrs at 25° C
Clock-Calendar	Yr/Mo/Day/Hr/Min/Sec	Power Consumption	85 mA OIS10+, 72 mA OIS12
Weight:	220 g OIS10+, 172 OIS12		

OIS20 PLUS

Item	Specification	Item	Specification
Display:	3.1" Multicolor Backlit LCD, 16 x4 Display	I/O	12 in & 8 out
Keys	Six User-Defined Function Keys	Memory-Total	512 Kb
LEDs	1 Pwr, 6 User Defined, 12 Data Entry	-Screen	84 Kb
Com Ports-Serial:	1 RS232/RS485	-Data Log	None
-Ethernet	None	PLC Steps	10 K
-USB	1 Device	Back-up Battery	3 Yrs at 25° C
Clock-Calendar	Yr/Mo/Day/Hr/Min/Sec	Power Consumption	125 mA
Weight:	320 g		

OIS40 PLUS

Item	Specification	Item	Specification
Display:	3" Graphical Monochrome Touchscreen w/Tri Color-Backlight	I/O	None
Keys	None	Memory-Total	1.5 Mb
LEDs	1 Power	-Screen	1 Mb
Com Ports-Serial:	1 RS232/RS485	-Data Log	None
-Ethernet	None	PLC Steps	10 K
-USB	1 Device	Back-up Battery	3 Yrs at 25° C
Clock-Calendar	Yr/Mo/Day/Hr/Min/Sec	Power Consumption	110 mA
Weight:	156 g		

OIS42 PLUS

Item	Specification	Item	Specification
Display:	3" Graphical Monochrome Touchscreen w/Tri Color-Backlight	I/O Digital Inputs	8 24 Vdc, bidirectional
Keys	None	Digital Outputs	6 Relay, 2 amp each
LEDs	1 Power	Analog Inputs	2 24 Vdc Trans., 300 mA each
Com Ports-Serial:	1 RS232/RS485		2, 16 bit, 0-5 Vdc, 0-10 Vdc,
-Ethernet	None		0/4-20 mA, Thermocouple, J/K
-USB	1 Device	Analog Outputs	RTD PT100 α1 & α2
Clock-Calendar	Yr/Mo/Day/Hr/Min/Sec	Memory-Total	1, 12 bit, 0-10 Vdc, 4 -20 mA
Back-up Battery	3 Yrs at 25° C		1.5 Mb
Power Consumption	420 mA	-Screen	1 Mb
Weight:	300 g	-Data Log	None
		PLC Steps	10 K

OIS55 PLUS

Item	Specification	Item	Specification
Display:	3.5" TFT 320 x 240 Graphical Color Touchscreen	I/O	3 Clip-on Modules
Keys	Six User-Defined Function Keys	Memory-PLC	512 Kb
LEDs	1 Power, 6 User Defined	-Screen	6 Mb
Com Ports-Serial:	1 RS232/RS485	-Data Log	Yes
-Ethernet	None	PLC Steps	160 K
-USB	1 Device, 1 Host	Back-up Battery	3 Yrs at 25° C
Clock-Calendar	Yr/Mo/Day/Hr/Min/Sec	Power Consumption	210 mA
Weight:	285 g		

OIS60 PLUS

Item	Specification	Item	Specification
Display:	5.7" TFT 320 x 240 Graphical Color Touchscreen	I/O	5 Clip-on Modules
Keys	Six User-Defined Function Keys	Memory-	10 Mb
LEDs	1 Power, 6 User Defined	-Screen	6 Mb
Com Ports-Serial:	1 RS232/RS485	-Data Log	Yes
-Ethernet	None	PLC Steps	160 K
-USB	1 Device, 1 Host	Back-up Battery	3 Yrs at 25° C
Clock-Calendar	Yr/Mo/Day/Hr/Min/Sec	Power Consumption	420 mA
Weight:	710 g		

OIS45E PLUS

Item	Specification	Item	Specification
Display:	4.3" TFT 480 x 272 Graphical Color Touchscreen	I/O	3 Clip-on Modules
Keys	None	Memory-	128 Mb
LEDs	1 Power	-Screen	10
Com Ports-Serial:	1 RS232/RS485	-Data Log	Yes
-Ethernet	1 10/100 Mbps, Modbus TCP/IP	PLC Steps	160 K
-USB	1 Device, 1 Host	Back-up Battery	3 Yrs at 25° C
Clock-Calendar	Yr/Mo/Day/Hr/Min/Sec	Power Consumption	250 mA
Weight:	330 g		

OIS70E PLUS

Item	Specification	Item	Specification
Display:	7" TFT 800 x 480 Graphical Color Touchscreen	I/O	5 Clip-on Modules
Keys	None	Memory-PLC	128 Mb
LEDs	1 Power	-Screen	10 Mb
Com Ports-Serial:	2 RS232/RS485	-Data Log	Yes
-Ethernet	1 10/100 Mbps, Modbus TCP/IP	PLC Steps	160 K
-USB	1 Device, 1 Host	Back-up Battery	3 Yrs at 25° C
Clock-Calendar	Yr/Mo/Day/Hr/Min/Sec	Power Consumption	420mA
Weight:	690 g		

OIS120A

Item	Specification	Item	Specification
Display:	12.1" TFT 800 x 600 Graphical Color Touchscreen	I/O	None
Keys	None	Memory-PLC	512 Kb
LEDs	1 Power	-Screen	10 Mb
Com Ports-Serial:	2 RS232/RS485	-Data Log	Yes
-Ethernet	1 10/100 Mbps, Modbus TCP/IP	PLC Steps	160 K
-USB	1 Device, 1 Host	Back-up Battery	3 Yrs at 25° C
Clock-Calendar	Yr/Mo/Day/Hr/Min/Sec	Power Consumption	500 mA
Weight:	1680 g		

Discrete I/O Modules

Specification		TRPDIX1600	TRPDOX0016N	TRPDOX0016P	TRPRO0012R
Inputs	Input Type	DC input,			
	Input Points	16 points (8p/com)			
	Rated Input Voltage	24Vdc, ±10%			
	Rated Input Current	5mA			
	Min. ON Voltage	15.0 Vdc			
	Max. OFF Voltage	5.0 Vdc			
	ON/OFF Delay Time	10ms or less			
	Isolation	Optical			
Outputs	Output Type		DC Output	DC Output	Relay Output
	Output Points		16points (8p/com)	16 points (8p/com)	12 points (3p/com)
	Outputs Type		NPN Transistor	PNP Transistor	Relay
	Rated Load Voltage		5-24Vdc, ±10%	5-24Vdc, ±10%	24 Vdc – 240 Vac
	Max. Load Current		0.5A/point	0.5A/point	2A/point
	Leak Current at OFF		0.1mA or less	0.1mA or less	None
	ON/OFF Delay Time		1ms/2ms or less	1ms/2ms or less	10ms/5ms or less
	Isolation		Optical	Optical	Optical
External Connection	Removable Term. Block	Removable Term. Block	Removable TB	Removable TB	
Max Current @ 24 Vdc	80 mA	80 mA	80 mA	80 mA	
Weight	65 g	65 g	75 g	90 g	

Specification		TRPDIO0808N	TRPDIO0808P	TRPHIO0808N	TRPHIO0808P
Inputs	Input Type	DC input,	DC input,	DC input	DC input
	Input Points	8 points (8p/com)	8 points (8p/com)	8 pts. (4 HSCs)	8 pts. (4 HSCs)
	Rated Input Voltage	24Vdc, ±10%	24Vdc, ±10%	24Vdc, ±10%	24Vdc, ±10%
	Rated Input Current	5mA	5mA	5mA	5mA
	Min. ON Voltage	15.0 Vdc	15.0 Vdc	15.0 Vdc	15.0 Vdc
	Max. OFF Voltage	5.0 Vdc	5.0 Vdc	5.0 Vdc	5.0 Vdc
	ON/OFF Delay Time	10ms or less	10ms or less	10ms or less	10ms or less
	Isolation	Optical	Optical	Optical	Optical
Outputs	Output Type	DC Output	DC Output	DC Output	DC Output
	Output Points	8 points (8p/com)	8 points (8p/com)	8 pts (2 HS/1PWM)	8 pts (2 HS/1PWM)
	Outputs Type	NPN Transistor	PNP Transistor	NPN Transistor	PNP Transistor
	Rated Load Voltage	5-24Vdc , ±10%	5-24Vdc , ±10%	5-24Vdc , ±10%	5-24Vdc , ±10%
	Max. Load Current	0.5A/point	0.5A/point	0.5A/point	0.5A/point
	Leak Current at OFF	0.1mA or less	0.1mA or less	0.1mA or less	0.1mA or less
	ON/OFF Delay Time	1ms/2ms or less	1ms/2ms or less	1ms/2ms or less	1ms/2ms or less
	Isolation	Optical	Optical	Optical	Optical
	External Connection	Removable Term. Block	Removable Term. Block	Removable Term.	Removable Term.
	Max Current @ 24 Vdc	80 mA	80 mA	80 mA	80 mA
Weight	70 g	70 g	70 g	70 g	

Analog I/O Modules

Specification		TRPAIO0400L	TRPAIO0202L	TRPRTX0402		
Inputs	Input Type	Analog	Analog	Analog		
	Input Points	4 Channels	2 Channels	4 Channels		
	Input Signal	0-20 mA/±10 Vdc	0-20 mA/±10 Vdc	mA, Vdc, TC, RTD		
	Resolution	12 bit (1-4000)	12 bit (1-4000)	16 bit (1-65,000)		
	Accuracy	± 1% at 25° C	± 1% at 25° C	± 1% at 25° C		
	Conversion Cycle	0.6 s	0.75 s	≈ 1 s var by type		
Outputs	Output		Analog Output	Analog Output		
	Output Points		2 Channels	2 Channels		
	Output Signal		2-20 mA/0-10 Vdc	2-20 mA/0-10 Vdc		
	Resolution		12 bit (1-4000)	16 bit (1-65,000)		
	Accuracy		± 5% at 25° C	± 5% at 25° C		
	Conversion Cycle		0.7 s	≈ 1 s var by type		
External Connection	Removable TB	Removable TB	Removable TB			
Max Current @ 5 Vdc	80 mA	80 mA	80 mA			
Weight	80 g	85 g	90 g			

More modules in development.

DIMENSIONS

Dimensions:

OIS10 PLUS/OIS12

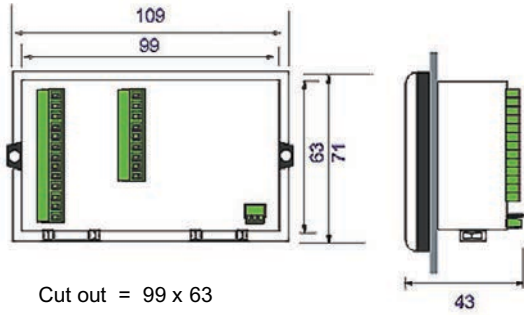

Cut out = 99 x 63

OIS20 PLUS

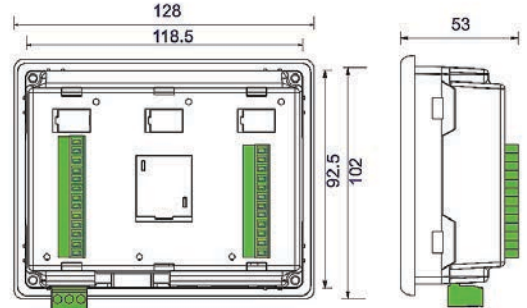

Cut out = 118.5 x 92.5

OIS40/42 PLUS

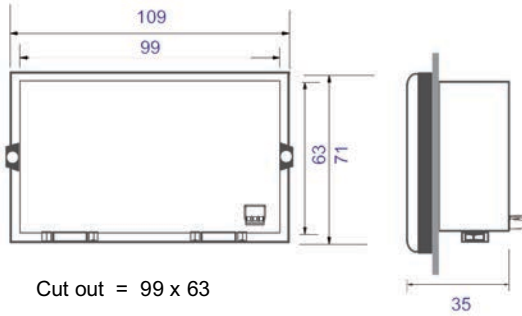

Cut out = 99 x 63

OIS55/OIS45E PLUS

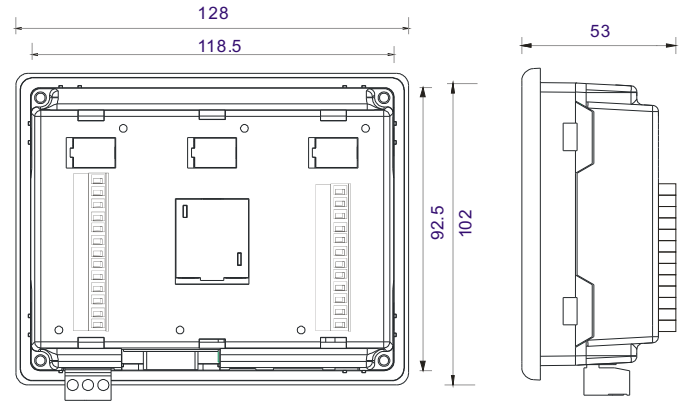

Cut out = 119 x 93

OIS PLUS I/O Modules

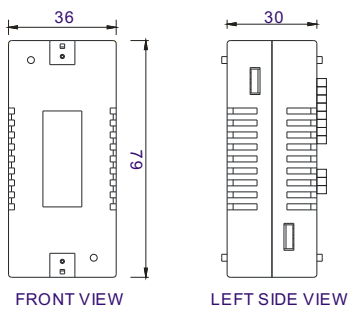

FRONT VIEW

LEFT SIDE VIEW

All Dimensions in mm

OIS60/OIS70E PLUS

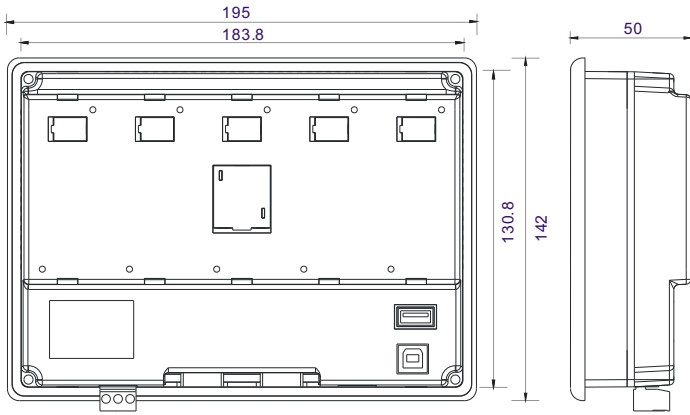

Cut out = 184 x 131

OIS120A

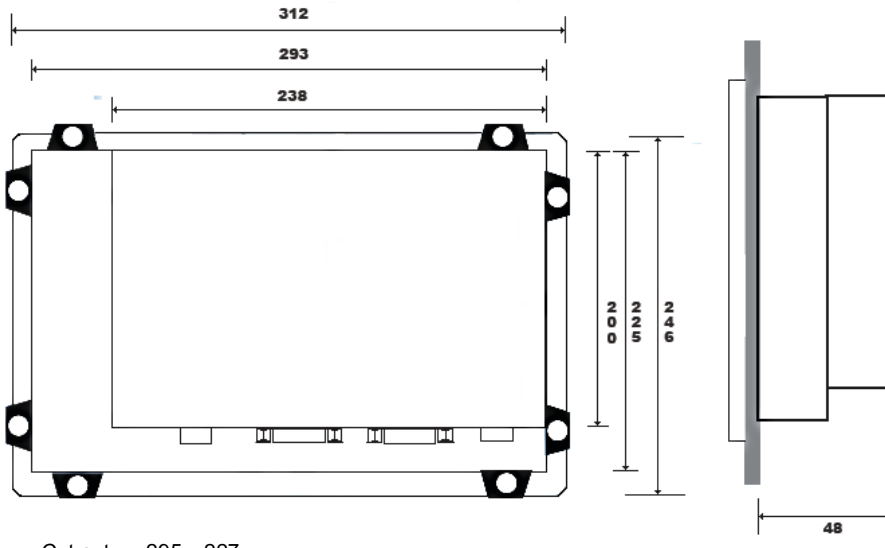

Cut out = 295 x 227

All Dimensions in mm.

Part Number Description

Displays

OIS10 PLUS	16 x 2 Text with Multicolor Backlit LCD, numeric Keypad, 6 Function Keys w/built-in LEDs, Has built-in 8 -24 Vdc inputs, 6 Relay outputs, 2 - 24 Vdc NPN transistor outputs, requires OIL-DS setup software.
OIS12	16 x 2 Text with Multicolor Backlit LCD, Same as OIS10 Plus but no I/O, used for T/C access, message display, data value change for all Toshiba PLCs, Integrated Controllers and ASDs, requires OIL-DS setup software.
OIS20 PLUS	3.1" Multicolor Backlit LCD, Numeric Keypad, 6 Function Keys, Has built-in 12 -24 Vdc inputs, 6 Relay outputs, 2 - 24 Vdc NPN transistor outputs, requires OIL-DS setup software.
OIS40 PLUS	3" Multicolor Touchscreen, 24 Vdc PS, Requires OIL-DS setup software.
OIS42N PLUS	3" Multicolor Touchscreen, 8 DI, 6 RO, 2 TRO NPN , 2 AI, 1 AO, 24 Vdc PS, Requires OIL-DS setup software.
OIS42P PLUS	3" Multicolor Touchscreen, 8 DI, 6 RO, 2 TRO PNP , 2 AI, 1 AO, 24 Vdc PS, Requires OIL-DS setup software.
OIS55 PLUS	3.5" TFT Color Touch Panel, 6 Function Keys 24 Vdc PS. requires OIL-DS setup software.
OIS45 PLUS	4.3" TFT 480 x 272 Color Touchscreen, Ethernet Port, Accepts 3 clip-on I/O modules, 24 Vdc PS, Requires OIL-DS setup software.
OIS60 PLUS	6" TFT Color Touch Panel, 24 Vdc PS, 6 Function Keys requires OIL-DS setup software.
OIS70 PLUS	7" TFT 800 x 480 Color Touchscreen, Ethernet Port, Accepts 5 clip-on I/O modules, Ethernet Port, 24 Vdc PS, Requires OIL-DS setup software.
OIS120A	12" TFT 800 x 600 Color Touchscreen, Ethernet Port, 24 Vdc PS, Requires OIL-DS setup software.

Digital I/O

TRPDIX1600	16 Inputs, 24 Vdc (sink/source).
TRPDOX0016N	16 Outputs 24, Vdc, transistor NPN.
TRPDOX0016P	16 Outputs 24, Vdc, transistor PNP.
TRPROX0012	12 Outputs, Relay, 240/120 Vac, 2a per common.
TRPDIO0808N	8 Inputs, 24 Vdc (sink/source), 8 Outputs, Transistor, 24 Vdc, NPN .
TRPDIR0808P	8 Inputs, 24 Vdc (sink/source), 8 Outputs, Transistor, 24 Vdc, PNP .
TRPHIO0808N	8 Inputs (4 HSC), 24 Vdc (sink/source), 8 Outputs (2 HS/1 PWM), Transistor, 24 Vdc, NPN .
TRPHIO0808P	8 Inputs (4 HSC), 24 Vdc (sink/source), 8 Outputs (2 HS/1 PWM), Transistor, 24 Vdc, PNP .

Analog I/O

TRPADT0400	4 Inputs, 4-20 mA/0-10 Vdc, 12 bit.
TRPAIO0202L	2 Inputs, 0-20 mA/0-10 Vdc, & 2 Outputs, 0-20 mA/0-10 Vdc, 12 bits each.
TRPRTX0402	4 - Inputs, 0-10 V, 4-20 mA, RTD, TC, 2-Outputs, 0-10 V, 4-20 mA, 16 bits each.

Cables

EC-P-108-00	Connects OIS PLUS to S9/S11//VF-nC1/VF-nC3 TTL Port, smart cable, 2 m.
EC-P-108A-00	Connects OIS PLUS to Toshiba G9/AS1 ASDs RS485 port, 4 wire, 2m.
EC-P-019A-00	Connects OIS40R/OISPLUS/OIS120A/GWY to T1 Programming Port, 2 m.
EC-P-019B-00	Connects OIS40R/OISPLUS/OIS120A/GWY to T2/T3/S2E/S2T Programming Port, 2 m.
EC-P-108C-00	Connects OIS PLUS to Toshiba FS1/nC3 ASDs RS485 port, 2 wire, 2m.
EC-P-046A-00	Connects OIS40R/OIS PLUS/OIS120A/GWY to T1/T2E/T3/S2E/S2T RS485 Port, Pigtail on PLC end, 2 m.
EC-P-045B-00	Connects OIS PLUS/OIS120A to T2/T3/S2E/S2T Programming Port, 2 m.
RC-P-009H-00	Connects OIS PLUS/GWY to V200 Series PLC, RS232, 2 m.
RC-P-009I-00	Connects OIS PLUS/GWY to V200 Series PLC, RS485, 2 m.
IBM-0909-1-00 ²	Programming Cable, For Download from Computer to all OIS/OIS PLUS. Use with OISeup32 & OIL-DS setup software.

- Notes:
1. Analog Inputs are Non Isolated (unless noted)
 2. Standard USB printer cable can be used for programming/monitoring OIS PLUS Displays.

TOSHIBA INDUSTRIAL PRODUCTS:

- Adjustable Speed Drives
- Motors
- Motor Controls
- Instrumentation & PLCs
- Uninterruptible Power Systems

T
Le
w
plc