

# **TOSHIBA**

TOSHIBA Barcode Printer

## **B-SA4TP SERIES**

**Owner's Manual**  
**Mode d'emploi**  
**Bedienungsanleitung**  
**Manual de instrucciones**  
**Gebruikershandleiding**  
**Manuale Utente**  
**Manual do Utilizador**



## CE Compliance (for EU only)

This product complies with the requirements of EMC and Low Voltage Directives including their amendments.

### **VORSICHT:**

- *Schallemission: unter 70dB (A) nach DIN 45635 (oder ISO 7779)*
- *Die für das Gerät Vorgesehene Steckdose muß in der Nähe des Gerätes und leicht zugänglich sein.*

Centronics is a registered trademark of Centronics Data Computer Corp.  
Microsoft is a registered trademark of Microsoft Corporation.  
Windows is a trademark of Microsoft Corporation.

This equipment has been tested and found to comply with the limits for a Class A digital device, pursuant to Part 15 of the FCC Rules. These limits are designed to provide reasonable protection against harmful interference when the equipment is operated in a commercial environment. This equipment generates, uses, and can radiate radio frequency energy and, if not installed and used in accordance with the instruction manual, may cause harmful interference to radio communications. Operations of this equipment in a residential area is likely to cause harmful interference in which case the user will be required to correct the interference at his own expense.

(for USA only)

Changes or modifications not expressly approved by manufacturer for compliance could void the user's authority to operate the equipment.

"This Class A digital apparatus meets all requirements of the Canadian Interference-Causing Equipment Regulations."

"Cet appareil numérique de la classe A respecte toutes les exigences du Règlement sur le matériel brouilleur du Canada."

(for CANADA only)



**N258**

**IP20**

# **TOSHIBA**

TOSHIBA Barcode Printer

## **B-SA4TP SERIES**

### **Owner's Manual**

**Waste Recycling information for users:**

Following information is only for EU-member states:

The use of the crossed-out wheeled bin symbol indicates that this product may not be treated as general household waste.

By ensuring this product is disposed of correctly you will help prevent potential negative consequences for the environment and human health, which could otherwise be caused by inappropriate waste handling of this product. For more detailed information about the take-back and recycling of this product, please contact your supplier where you purchased the product.



The following wireless communication device can be installed in this printer.

**B-SA704-RFID-U2-EU-R**

Please be sure to read the following precaution for handling of wireless communication devices before using this product.

**Precautions for Handling of Wireless Communication Device**

TRW-EUM-01 (B-SA704-RFID-U2-EU-R)

**For Safety**

Do not use the product in locations where the use is forbidden, for example in a hospital.

When you do not know the forbidden areas, please refer to and follow the medical institution.

Otherwise medical equipment may be affected, causing a serious accident.

This product may affect the operation of some implanted cardiac pacemakers and other medically implanted equipment. Pace maker patients should be aware that the use of this product very close to a pacemaker might cause the device to malfunction.

If you have any reason to suspect that interference is taking place, immediately turn off the product and contact your TOSHIBA TEC sales agent.

Do not disassemble, modify, or repair the product.

Doing so may cause injury. Also, modification is against the Laws and Regulations for Radio Equipment. Please ask your TOSHIBA TEC sales agent for repair.

**For Europe**

This product is a wireless communication device, and the use of this product is restricted to the following countries or areas. If the product is used in the countries or areas other than the following, you may be punished according to the laws of those countries or areas.



Hereby, Toshiba TEC Corporation, declares that this TRW-EUM-01 (B-SA704-RFID-U2-EU-R) is in compliance with the essential requirements and other relevant provisions of Directive 1999/5/EC.

This equipment uses the radio frequency band which has not been harmonized throughout all EU and EFTA countries, and can be used in the following countries.

Austria, Belgium, Cyprus, Czech Republic, Denmark, Estonia, Finland, France, Hungary, Germany, Greece, Ireland, Italy, Latvia, Lithuania, Luxembourg, Malta, Netherlands, Poland, Portugal, Slovakia, Slovenia, Spain, Sweden, United Kingdom, Norway, Liechtenstein, Iceland, Switzerland

### Safety Summary

Personal safety in handling or maintaining the equipment is extremely important. Warnings and Cautions necessary for safe handling are included in this manual. All warnings and cautions contained in this manual should be read and understood before handling or maintaining the equipment.

Do not attempt to effect repairs or modifications to this equipment. If a fault occurs that cannot be rectified using the procedures described in this manual, turn off the power, unplug the machine, then contact your authorised TOSHIBA TEC representative for assistance.

### Meanings of Each Symbol



This symbol indicates warning items (including cautions). Specific warning contents are drawn inside the  $\Delta$  symbol. (The symbol on the left indicates a general caution.)



This symbol indicates prohibited actions (prohibited items). Specific prohibited contents are drawn inside or near the  $\odot$  symbol. (The symbol on the left indicates “no disassembling”.)



This symbol indicates actions which must be performed. Specific instructions are drawn inside or near the  $\bullet$  symbol. (The symbol on the left indicates “disconnect the power cord plug from the outlet”.)



### WARNING

This indicates that there is the risk of **death** or **serious injury** if the machines are improperly handled contrary to this indication.



Any other than the specified AC voltage is prohibited.

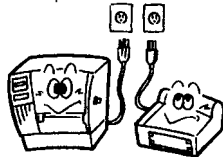

Do not use voltages other than the voltage (AC) specified on the rating plate, as this may cause **fire** or **electric shock**.



Prohibited



Do not plug in or unplug the power cord plug with wet hands as this may cause **electric shock**.



Prohibited



If the machines share the same outlet with any other electrical appliances that consume large amounts of power, the voltage will fluctuate widely each time these appliances operate. Be sure to provide an exclusive outlet for the machine as this may cause **fire** or **electric shock**.



Prohibited



Do not place metal objects or water-filled containers such as flower vases, flower pots or mugs, etc. on top of the machines. If metal objects or spilled liquid enter the machines, this may cause **fire** or **electric shock**.



Prohibited



Do not insert or drop metal, flammable or other foreign objects into the machines through the ventilation slits, as this may cause **fire** or **electric shock**.



Prohibited



Do not scratch, damage or modify the power cords. Also, do not place heavy objects on, pull on, or excessively bend the cords, as this may cause **fire** or **electrical shock**.



Disconnect the plug.











If the machines are dropped or their cabinets damaged, first turn off the power switches and disconnect the power cord plugs from the outlet, and then contact your authorised TOSHIBA TEC representative for assistance. Continued use of the machine in that condition may cause **fire** or **electric shock**.



Disconnect the plug.



Continued use of the machines in an abnormal condition such as when the machines are producing smoke or strange smells may cause **fire** or **electric shock**. In these cases, immediately turn off the power switches and disconnect the power cord plugs from the outlet. Then, contact your authorised TOSHIBA TEC representative for assistance.

 <p>Disconnect the plug.</p> 	<p>If foreign objects (metal fragments, water, liquids) enter the machines, first turn off the power switches and disconnect the power cord plugs from the outlet, and then contact your authorised TOSHIBA TEC representative for assistance. Continued use of the machine in that condition may cause <b>fire</b> or <b>electric shock</b>.</p>	 <p>Disconnect the plug.</p> 	<p>When unplugging the power cords, be sure to hold and pull on the plug portion. Pulling on the cord portion may cut or expose the internal wires and cause <b>fire</b> or <b>electric shock</b>.</p>
 <p>Connect a grounding wire.</p> 	<p>Ensure that the equipment is properly grounded. Extension cables should also be grounded. <b>Fire</b> or <b>electric shock</b> could occur on improperly grounded equipment.</p>	 <p>No disassembling.</p> 	<p>Do not remove covers, repair or modify the machine by yourself. You may be <b>injured</b> by high voltage, very hot parts or sharp edges inside the machine.</p>



**CAUTION**

This indicates that there is the risk of personal **Injury** or **damage** to objects if the machines are improperly handled contrary to this indication.

**Precautions**

The following precautions will help to ensure that this machine will continue to function correctly.

- Try to avoid locations that have the following adverse conditions:
  - \* Temperatures out of the specification
  - \* Shared power source
- \* Direct sunlight
- \* Excessive vibration
- \* High humidity
- \* Dust/Gas
- The cover should be cleaned by wiping with a dry cloth or a cloth slightly dampened with a mild detergent solution. NEVER USE THINNER OR ANY OTHER VOLATILE SOLVENT on the plastic covers.
- USE ONLY TOSHIBA TEC SPECIFIED paper and ribbons.
- DO NOT STORE the paper or ribbons where they might be exposed to direct sunlight, high temperatures, high humidity, dust, or gas.
- Ensure the printer is operated on a level surface.
- Any data stored in the memory of the printer could be lost during a printer fault.
- Try to avoid using this equipment on the same power supply as high voltage equipment or equipment likely to cause mains interference.
- Unplug the machine whenever you are working inside it or cleaning it.
- Keep your work environment static free.
- Do not place heavy objects on top of the machines, as these items may become unbalanced and fall causing **injury**.
- Do not block the ventilation slits of the machines, as this will cause heat to build up inside the machines and may cause **fire**.
- Do not lean against the machine. It may fall on you and could cause **injury**.
- Care must be taken not to injure yourself with the printer paper cutter.
- Unplug the machine when it is not used for a long period of time.
- Place the machine on a stable and level surface.

**Request Regarding Maintenance**

- Utilize our maintenance services.  
After purchasing the machine, contact your authorised TOSHIBA TEC representative for assistance once a year to have the inside of the machine cleaned. Otherwise, dust will build up inside the machines and may cause a **fire** or a **malfunction**. Cleaning is particularly effective before humid rainy seasons.
- Our preventive maintenance service performs the periodic checks and other work required to maintain the quality and performance of the machines, preventing accidents beforehand.  
For details, please consult your authorised TOSHIBA TEC representative for assistance.
- Using insecticides and other chemicals  
Do not expose the machines to insecticides or other volatile solvents. This will cause the cabinet or other parts to deteriorate or cause the paint to peel.

## TABLE OF CONTENTS

	Page
<b>1. PRODUCT OVERVIEW.....</b>	<b>E1- 1</b>
1.1 Introduction.....	E1- 1
1.2 Features .....	E1- 1
1.3 Accessories .....	E1- 2
1.4 Appearance .....	E1- 3
1.4.1 Dimensions.....	E1- 3
1.4.2 Front View .....	E1- 3
1.4.3 Rear View.....	E1- 3
1.4.4 Operation Panel.....	E1- 4
1.4.5 Interior .....	E1- 4
1.5 Options .....	E1- 5
<b>2. PRINTER SETUP .....</b>	<b>E2- 1</b>
2.1 Installation .....	E2- 2
2.2 Connecting the Power Cord .....	E2- 2
2.3 Loading the Media .....	E2- 3
2.4 Loading the Ribbon .....	E2-11
2.5 Connecting the Printer to Your Host Computer .....	E2-14
2.6 Turning the Printer ON .....	E2-15
2.7 Setting an Operating Environment .....	E2-16
2.7.1 Parameter Setting.....	E2-17
2.7.2 Dump Mode Setting.....	E2-32
2.7.3 BASIC Expansion Mode .....	E2-34
2.7.4 Automatic Calibration .....	E2-35
2.7.5 LAN Setting .....	E2-36
2.7.6 Real Time Clock Setting .....	E2-37
2.7.7 IP Address Setting (TCP/IP).....	E2-39
2.8 Installing the Printer Drivers .....	E2-45
2.8.1 Introduction.....	E2-45
2.8.2 General Description.....	E2-45
2.8.3 Installing the Printer Driver .....	E2-45
2.8.4 Uninstalling the Printer Driver .....	E2-58
2.8.5 Adding/Deleting a LAN Port.....	E2-59
2.8.6 Cautions .....	E2-61
2.8.7 Using the Printer Driver .....	E2-62
2.9 Print Test .....	E2-63
2.10 Position and Print Tone Fine Adjustment .....	E2-65
2.11 Threshold Setting .....	E2-73
<b>3. ON LINE OPERATION .....</b>	<b>E3- 1</b>
3.1 Operation Panel.....	E3- 1
3.2 Operation.....	E3- 2
3.3 Reset .....	E3- 2



<b>4. MAINTENANCE .....</b>	<b>E4- 1</b>
4.1 Cleaning .....	E4- 1
4.1.1 Print Head/Platen/Sensors .....	E4- 1
4.1.2 Covers and Panels .....	E4- 2
4.1.3 Optional Cutter Module.....	E4- 3
4.1.4 Optional Strip Module .....	E4- 4
<b>5. TROUBLESHOOTING .....</b>	<b>E5- 1</b>
5.1 Error Messages .....	E5- 1
5.2 Possible Problems .....	E5- 3
5.3 Removing Jammed Media .....	E5- 4
<b>6. PRINTER SPECIFICATIONS .....</b>	<b>E6- 1</b>
<b>7. SUPPLY SPECIFICATIONS .....</b>	<b>E7- 1</b>
7.1 Media.....	E7- 1
7.1.1 Media Type .....	E7- 1
7.1.2 Detection Area of the Transmissive Sensor .....	E7- 2
7.1.3 Detection Area of the Reflective Sensor.....	E7- 3
7.1.4 Effective Print Area.....	E7- 3
7.1.5 RFID Tag .....	E7- 4
7.2 Ribbon .....	E7- 8
7.3 Recommended Media and Ribbon Types .....	E7- 9
7.4 Care/Handling of Media and Ribbon .....	E7-10
<b>APPENDIX 1 MESSAGES AND LEDS.....</b>	<b>EA1-1</b>
<b>APPENDIX 2 INTERFACE.....</b>	<b>EA2-1</b>
<b>APPENDIX 3 POWER CORD .....</b>	<b>EA3-1</b>
<b>APPENDIX 4 PRINT SAMPLES .....</b>	<b>EA4-1</b>
<b>APPENDIX 5 GLOSSARIES .....</b>	<b>EA5-1</b>
<b>INDEX</b>	

**WARNING!**

*This is a Class A product. In a domestic environment this product may cause radio interference in which case the user may be required to take adequate measures.*

**CAUTION!**

- 1. This manual may not be copied in whole or in part without prior written permission of TOSHIBA TEC.*
- 2. The contents of this manual may be changed without notification.*
- 3. Please refer to your local Authorised Service representative with regard to any queries you may have in this manual.*

# 1. PRODUCT OVERVIEW

## 1.1 Introduction

Thank you for choosing the TOSHIBA B-SA4TP series thermal printer. This Owner's Manual contains from general set-up through how to confirm the printer operation using an online test print, and should be read carefully to help gain maximum performance and life from your printer. For most queries please refer to this manual and keep it safe for future reference. Please contact your TOSHIBA TEC representative for further information concerning this manual.

## 1.2 Features

This printer has the following features:

### • Space-saving design

An area required to place a printer is about A4 size, in spite of both media and ribbon being loaded inside it. Also, the Top Cover is opened upward, which saves the installation space.

The optional cutter module and strip module are as slim and small as the Front Cover.

### • Various kinds of interface

Various kinds of interface are provided:

- | <Standard>     | <Option>        |
|----------------|-----------------|
| • Parallel     | • Serial        |
| • USB          | • Wireless LAN  |
| • Built-in LAN | • Expansion I/O |

### • Superior hardware

Clear print is realized by an 8 dots/mm (203 dpi) (B-SA4TP-GS12) or 11.8 dots/mm (300 dpi) (B-SA4TP-TS12) print head, at a printing speed of 50.8 mm/sec. (2 inches/sec.), 101.6 mm/sec. (4 inches/sec.), or 152.4 mm/sec. (6 inches/sec.)

### • Easy maintenance

Design of the printer is simple. Especially, attachment and removal of the print head and platen are very simple, which makes maintenance easy.

### • A variety of options

The following optional devices are available:

- Cutter module
- Strip module
- Serial interface board
- Wireless LAN board
- RFID module
- 300-dpi print head
- Expansion I/O
- Real Time Clock

### 1.3 Accessories

When unpacking the printer, please make sure all the following accessories are supplied with the printer.

**NOTE:**  
 As a power cord is not supplied with this printer, please purchase one that meets each country's safety standard. For details, refer to **APPENDIX 3**.

- Start-up CD-ROM (1 pc.)

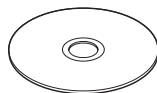

<Contents>

- Bar code print application (Bartender ultra lite)
- Windows Driver
- Owner's Manual
- Specifications (Programming, Key operation, etc.)
- Product information (Catalogue)

- Supply Loading Instructions (Doc. No.: EO2-33017)

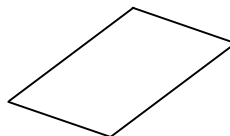

- Safety Precautions (Doc. No.: EO2-33016)

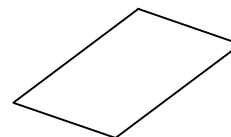

- Quality Control Report (1 sheet)

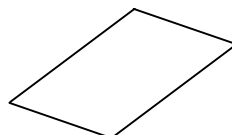

- Warranty Disclaimer Sheet (1 sheet)

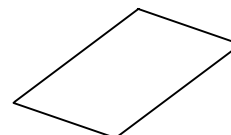

- Cable Clamp (1 pc.)
- SMW-3x8 Screw (1 pc.)



## 1.4 Appearance

The names of the parts or units introduced in this section are used in the following chapters.

### 1.4.1 Dimensions

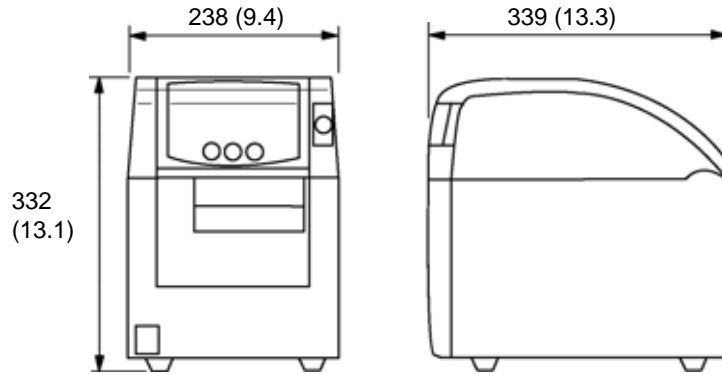

Dimensions in mm (inches)

### 1.4.2 Front View



### 1.4.3 Rear View

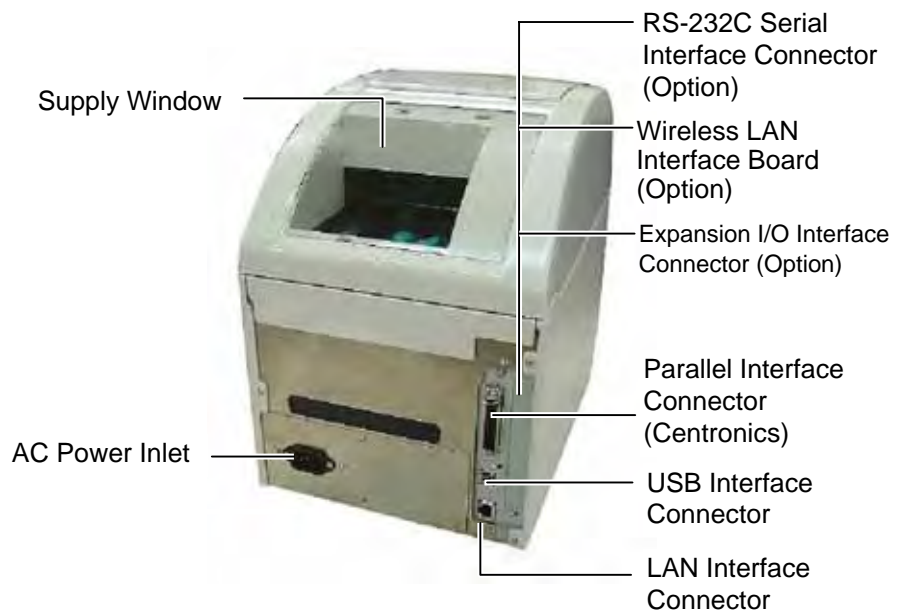

1.4.4 Operation Panel

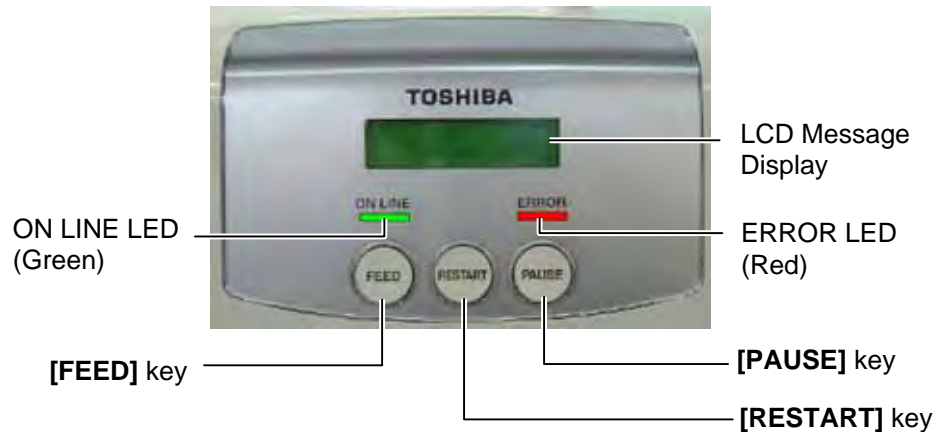

Please see **Section 3.1** for further information about the Operation Panel.

1.4.5 Interior

<b>WARNING!</b>
1. Do not touch the Print Head or around it just after printing. You may get burned as the Print Head becomes very hot during printing.
2. Do not touch any moving parts. To reduce the risk of fingers, jewellery, clothing, etc., being drawn into the moving parts, be sure to load the media once the printer has stopped moving completely.
3. To avoid injury, be careful not to trap your fingers while opening or closing the cover.
4. The stepping motor will become very hot after media is issued continuously for about 1 hour. Care must be taken not to touch it when the front cover is opened, or you may get burned.

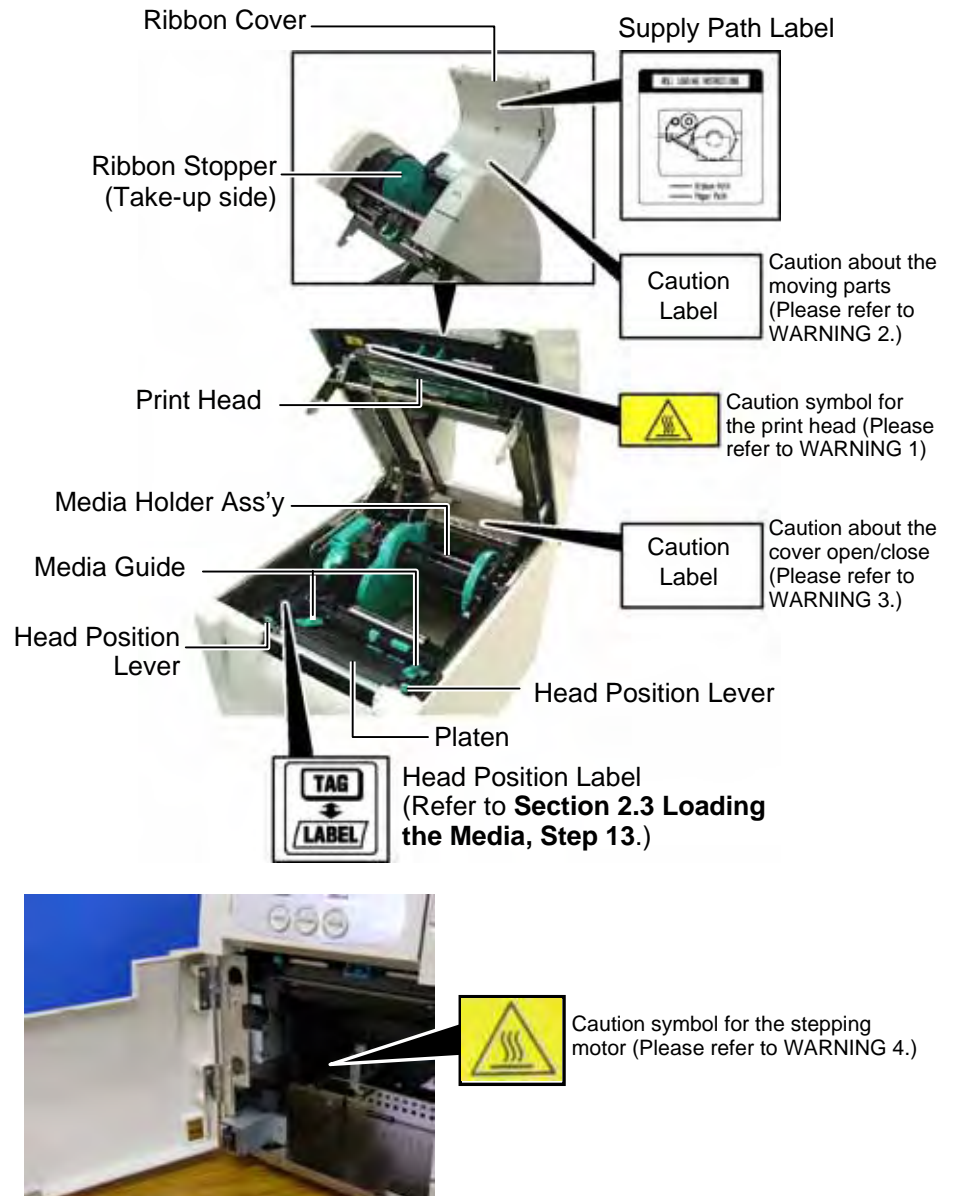

## 1.5 Options

Option Name	Type	Usage
300-dpi Print Head	B-SA704-TPH3-QM-R	This print head enables a conversion of a 203-dpi print head of the B-SA4TM-GS12/B-SA4TP-GS12 model into a 300-dpi print head. This option is intended for use when you desire to print Kanji (Chinese characters) or to obtain clearer print.
Cutter module	B-SA204P-QM-R	A cutter which cuts the media one by one. This module is slim and compact enough to be fitted in the Front Cover.
Strip module	B-SA904P-H-QM-R	This module peels off a printed label from the backing paper at the media outlet. It is slim and compact enough to be fitted in the Front Cover.
Serial Interface Board	B-SA704-RS-QM-R	Installing this PC board provides an RS232C interface port.
Wireless LAN Board	B-SA704-WLAN-QM-R	Installing this PC board allows a communication by wireless LAN.
RFID module	B-SA704-RFID-U2-EU-R	Installing this module enables read and write of RFID tags. This optional kit is for use in Europe only.
Expansion I/O Board	B-SA704-IO-QM-R	Installing this board in the printer allows a connection with an external device with the exclusive interface.
Real Time Clock	B-SA704-RTC-QM-R	This module holds the current time: year, month, day, hour, minute, second.

## 2. PRINTER SETUP

This section outlines the procedures to setup your printer prior to its operation. The section includes precautions, loading media and ribbon, connecting cables, setting the operating environment of the printer, and performing an online print test.

Setup Flow	Procedure	Reference
Installation	After referring to the Safety Precautions in this manual, install the printer on a safe and stable location.	2.1 Installation
Connecting the power cord	Connect a power cord to the power inlet of the printer, then, to an AC outlet.	2.2 Connecting the Power Cord
Loading the media	Load a label stock or tag stock.	2.3 Loading the Media
Media sensor position alignment	Adjust the position of feed gap sensor or black mark sensor according to the media to be used.	2.3 Loading the Media
Loading the ribbon	In case of thermal transfer printing, load the ribbon.	2.4 Loading the Ribbon
Connecting to a host computer	Connect the printer to a host computer or a network.	2.5 Connecting the Printer to Your Host Computer
Turning the power ON	Turn on the printer power.	2.6 Turning the Power ON
Setting the operating environment	Set the printer parameters in the system mode.	2.7 Setting an Operating Environment
Installing the printer driver	If necessary, install the printer driver in your host computer.	2.8 Installing the Printer Drivers
Print test	Make a print test in your operating environment and check the print result.	2.9 Print Test
Position and Print Tone Fine adjustment	If necessary, fine adjust the print start position, cut/strip position, print tone, etc.	2.10 Position and Print Tone Fine Adjustment
Automatic threshold setting	If the print start position cannot be detected properly when pre-printed label is used, set the threshold automatically.	2.11 Threshold Setting
Manual threshold setting	If the print start position cannot be detected properly even an automatic threshold setting is performing, manually set the threshold.	2.11 Threshold Setting

## 2.1 Installation

### **CAUTION!**

*As the enclosure of this product is made from plastic, do not install the printer where it might be exposed to oil or solvent.*

To insure the best operating environment, and to assure the safety of the operator and the equipment, please observe the following precautions.

- Operate the printer on a stable, level, operating surface in a location free from excessive humidity, high temperature, dust, vibration or direct sunlight.
- Keep your work environment static free. Static discharge can cause damage to delicate internal components.
- Make sure that the printer is connected to a clean source of AC Power and that no other high voltage devices that may cause line noise interference are connected to the same mains.
- Assure that the printer is connected to the AC mains with a three-prong power cable that has the proper ground (earth) connection.

## 2.2 Connecting the Power Cord

### **CAUTION!**

*As a Power Cord is not supplied with the printer, please purchase an approved one that meets the safety standard of each country. (Refer to **APPENDIX 3.**)*

1. Make sure that the printer Power Switch is in the OFF (O) position. Connect the Power Cord to the printer as shown in the figure below



Power Switch



Power Cord

2. Plug the other end of the Power Cord into a grounded outlet as shown in the figure below.

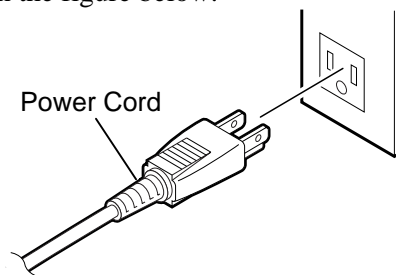

[Example of US Type]

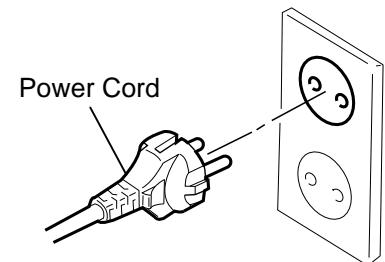

[Example of EU Type]



### 2.3 Loading the Media

**WARNING!**

1. Do not touch any moving parts. To reduce the risk of fingers, jewellery, clothing, etc., being drawn into the moving parts, be sure to load the media once the printer has stopped moving completely.
2. The Print Head becomes hot immediately after printing. Allow it to cool before loading the media.
3. To avoid injury, be careful not to trap your fingers while opening or closing the cover.

**CAUTION!**

1. Make sure that the Upper Sensor Ass'y is closed when taking out the Media Holder Ass'y. If the Upper Sensor Ass'y is opened, it may be damaged.
2. Be careful not to touch the Print Head Element when opening the Top Cover. Failure to do this may cause missing dots by static electricity or other print quality problems.

**NOTE:**

1. As the Top Cover is heavy, be sure to support it with your hand when opening it. Failure to do this may cause the printer to fall over backward.
2. For the specification of available media, refer to **Section 7.1 Media**.
3. When the inner core diameter of the media roll is 40 mm, remove the Spacers from the Media Holders.

The following procedure shows the steps to properly load the media into the printer so that it feeds straight and true through the printer. Use the same procedure when replacing the media, also. The printer prints both labels and tags.

1. Press the Top Cover Release Button and gently open the Top Cover to its fully open position supporting it with your hand.

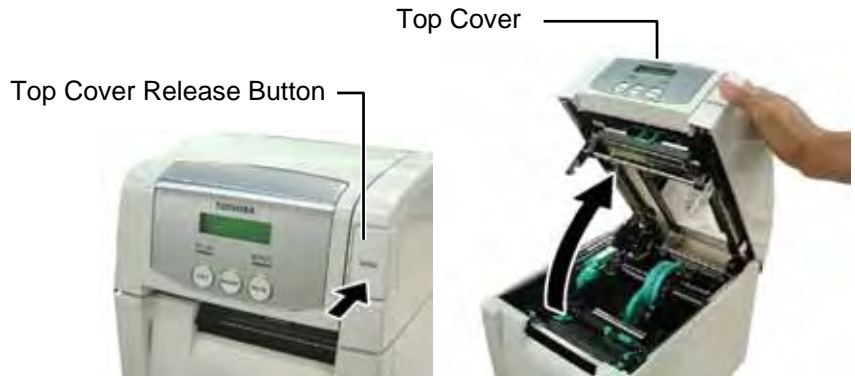

2. Take out the Media Holder Ass'y from the printer.

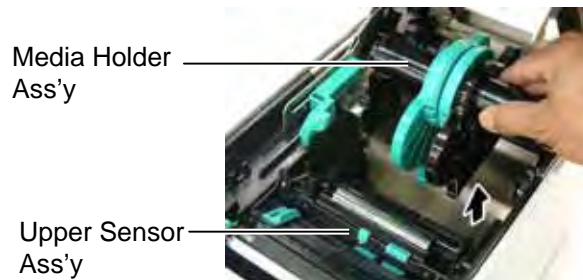

3. Raise the Release Lever and remove the Media Holder (Left).



4. Insert the Media Shaft into the core of a media roll.



### 2.3 Loading the Media (Cont.)

- 5. Put the Media Holder (Left) onto the Media Shaft. Push the Media Holder (Left) and the Media Holder (Right) against the media until the media is held firmly in place. This will automatically centre the media.

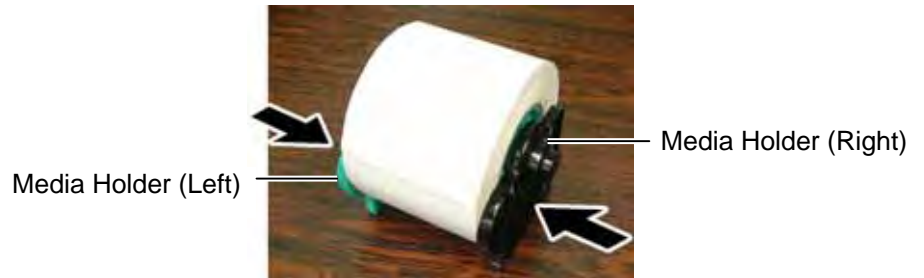

- 6. Fold the Release Lever to lock the Media Holder (Left).



- 7. Place the Media Holder Ass'y into the printer.

**CAUTION!**  
Make sure that the Upper Sensor Ass'y is closed when placing the Media Holder Ass'y into the printer. If the Upper Sensor Ass'y is opened, it may be damaged.

**NOTE:**  
Be careful of the orientation of the Media Holder Ass'y and the media.



- 8. Slightly push the Upper Sensor Lever inside (①), and open the Upper Sensor Ass'y (②).

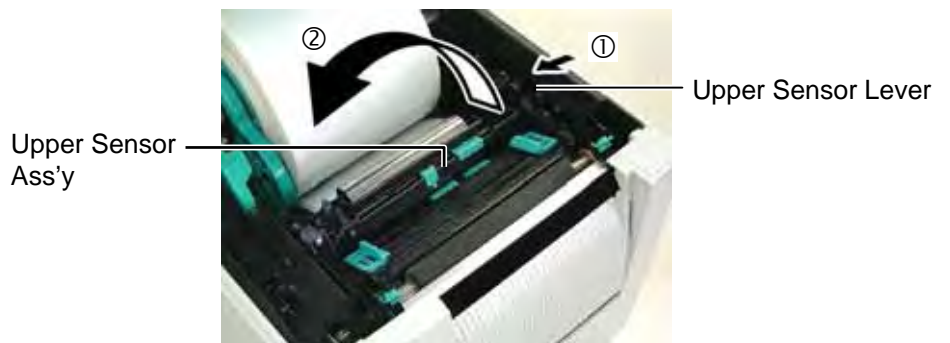

### 2.3 Loading the Media (Cont.)

9. Pull the media out of the front of the printer, and adjust the Media Guides to the media width. This will automatically centre the media.



10. Lower the Upper Sensor Ass'y until the Upper Sensor Lever clicks into position.

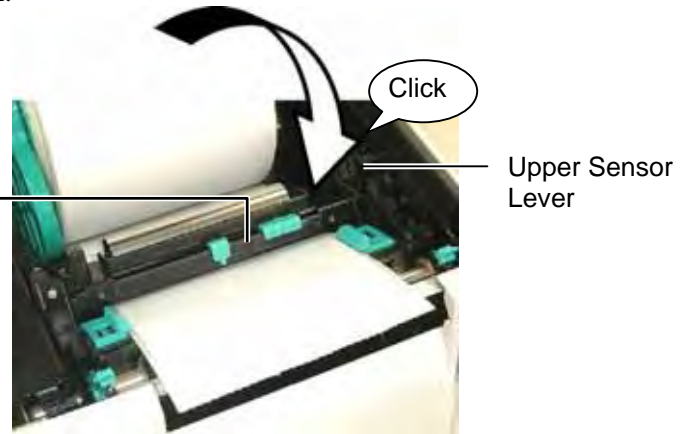

**CAUTION!**

1. Be sure to close the Upper Sensor Ass'y before closing the Top Cover. If the Upper Sensor Ass'y is opened, it may be damaged.
2. When a media with large outer roll diameter is loaded, fold the Damper Roller first (①), then close the Upper Sensor Ass'y (②). The media may interfere with the Upper Sensor Ass'y. Be sure to completely close the Upper Sensor Ass'y to keep the good print quality.

Damper Roller



Upper Sensor Ass'y

**NOTE:**

Make sure that the Upper Sensor Ass'y is locked. If it is unlocked, a paper jam or print failure may occur.

## 2.3 Loading the Media (Cont.)

11. After loading the media, it may be necessary to set the position of the Media Sensor used to detect the print start position for label or tag printing.

### Setting the Feed Gap Sensor position

When using a label stock without black marks, the Feed Gap Sensor is used to detect a print start position.

- (1) Push the Upper Sensor Lever inside and open the Upper Sensor Ass'y.
- (2) Slide the Lower Sensor Tab with your finger to move the Feed Gap Sensor so that the Feed Gap Sensor is positioned at the centre of the labels. ( O indicates the position of the Feed Gap Sensor).

It may be easier to move the Lower Sensor Tab if you use a pen inserting its tip into the pinhole of the tab.

It may be easier to move the Lower Sensor Tab if you use a pen inserting its tip into the pinhole of the tab.

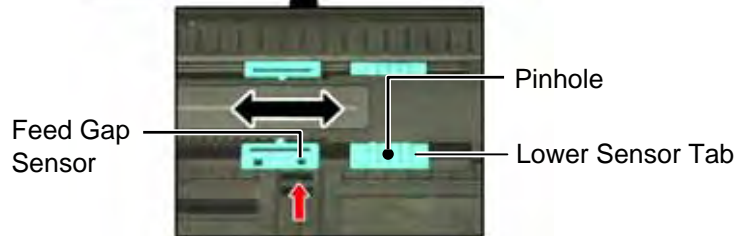
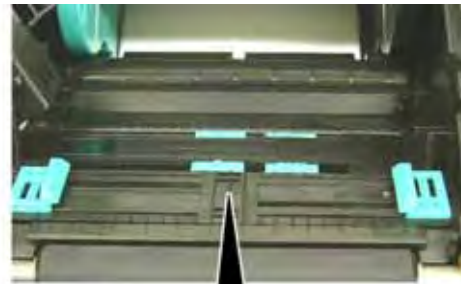

**NOTE:**  
 Be sure to align the Upper Feed Gap Sensor with the Lower Feed Gap Sensor. Failure to do this cause a paper jam error.

- (3) Lower the Upper Sensor Ass'y until the Upper Sensor Lever clicks into position.
- (4) Slide the Upper Sensor Tab to move the Feed Gap Sensor so that it aligns with the lower Feed Gap Sensor.

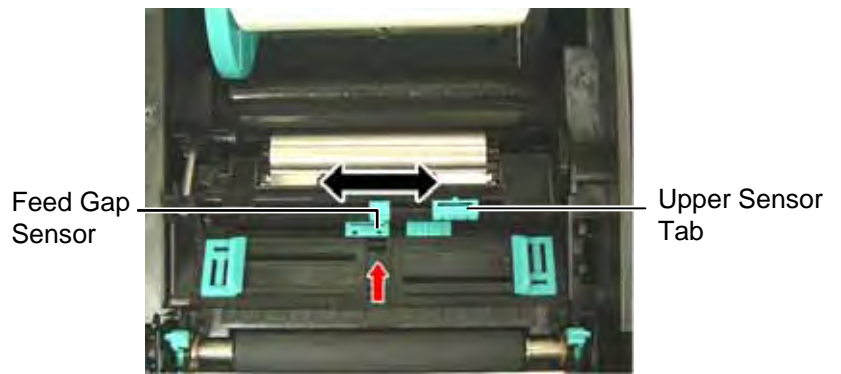

## 2.3 Loading the Media (Cont.)

### NOTES:

1. Be sure to set the Black Mark Sensor to detect the centre of the black mark, otherwise a paper jam or no paper error may occur.
2. After adjusting the Black Mark Sensor position, align the Upper Feed Gap Sensor with the Lower Feed Gap Sensor. This is because a paper end is detected by the Feed Gap Sensor.

### Setting the Black Mark Sensor position

When using media with black marks, the Black Mark Sensor is used to detect a print start position.

- (1) Push the Upper Sensor Lever inside and open the Upper Sensor Ass'y.
- (2) Check the reverse side of the media for the black mark position.
- (3) Slide the Lower Sensor Tab to move the Black Mark Sensor so that it is in line with the centre of the black mark on the media.  
(  indicates the position of the Black Mark Sensor).

It may be easier to move the Lower Sensor Tab if you use a pen inserting its tip into the pinhole of the tab.

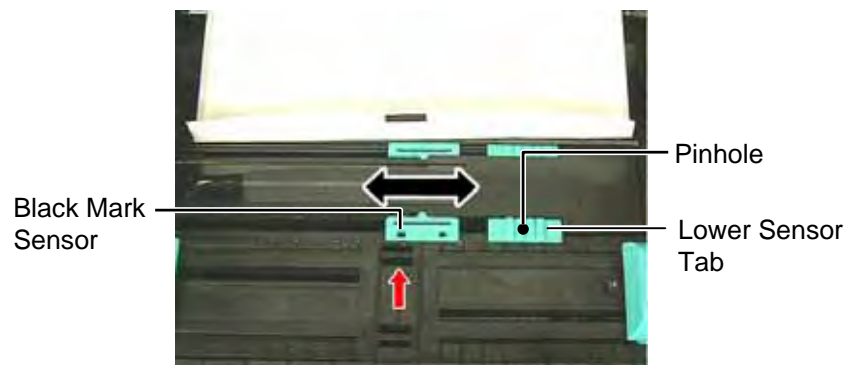

- (4) Lower the Upper Sensor Ass'y until the Upper Sensor Lever clicks in position.

## 2.3 Loading the Media (Cont.)

12. There are three issue modes available on this printer. How to set the media for each mode is provided below.

### Batch mode

In the batch mode, the media is continuously printed and fed until the number of labels/tags specified in the issue command have been printed.

(1) Pull the top edge of the media past the Platen.



(2) Close the Top Cover until it clicks.



### Strip mode (Option)

When the optional Strip Module is fitted, a label is automatically removed from the backing paper at the Strip Plate as each label is printed.

(1) Open the Front Cover holding its right side.

**WARNING!**  
 Be careful that your fingers, jewellery, clothing, etc., are not draw into the rollers of the Strip Unit.



### 2.3 Loading the Media (Cont.)

- (2) Press down the Release Bar to open the Strip Unit.

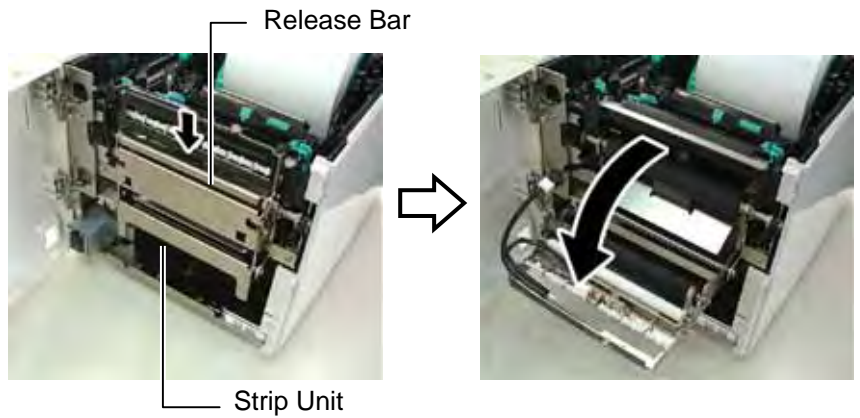

- (3) Remove enough labels from the leading edge of the media to leave 300mm of backing paper free.
- (4) Pass the backing paper through the opening under the Backing Paper Feed Roller. Then, close the Strip Unit until it clicks.

**NOTE:**  
*Be sure to close the Strip Unit completely. Failure to do this may cause a paper jam.*

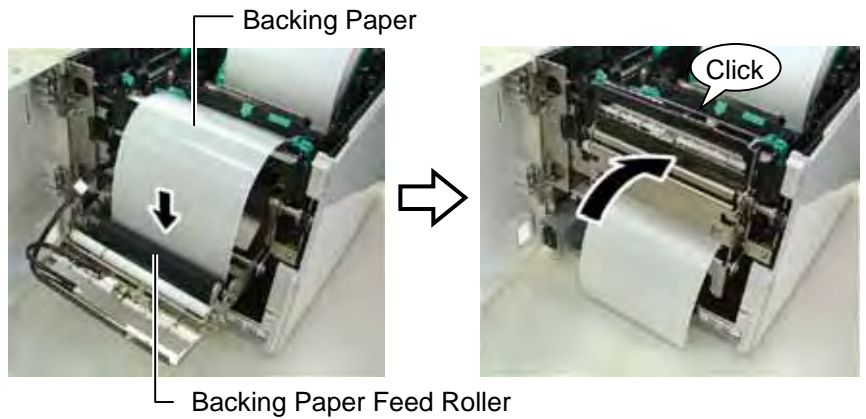

- (5) Insert the leading edge of the backing paper into the slot of the Front Cover.
- (6) Close the Front Cover and the Top Cover.

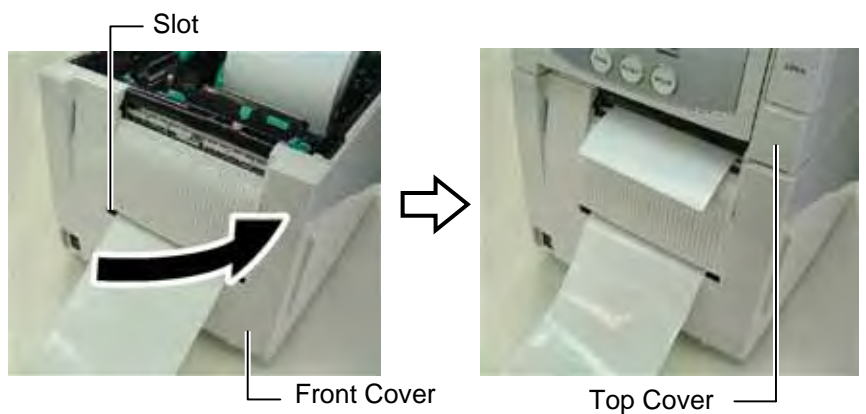

### 2.3 Loading the Media (Cont.)

**WARNING!**  
The cutter is sharp, so care must be taken not to injure your fingers when handling the cutter.

**CAUTION!**

1. When using a label stock, be sure to cut the gaps. Cutting labels will cause the glue to stick to the cutter, which may affect the cutter quality and shorten the cutter life.
2. Use of tag paper which thickness exceeds specified value may affect the cutter life. For the specification of the media, refer to **Section 7.1 Media**.

**NOTES:**

1. Be sure to set both Head Position Levers in the same direction. Failure to do this may cause blurred printing.
2. Do not leave the Head Position Levers positioned at the middle. When closing the Top Cover, they block the Print Head Positioning Shaft, and the Top Cover cannot be closed.

Print Head Positioning Shaft



Head Position Lever

#### Cut mode (Option)

When the optional Cutter Module is fitted, the media is automatically cut.

Insert the leading edge of the media into the Media Outlet of the Cutter Module.

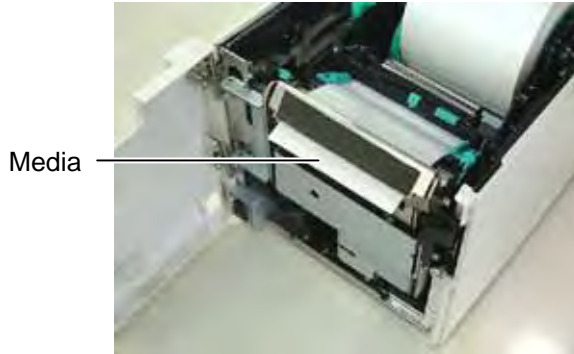

13. Change the print head pressure according to the thickness of the media to be used, by using the Head Position Lever.

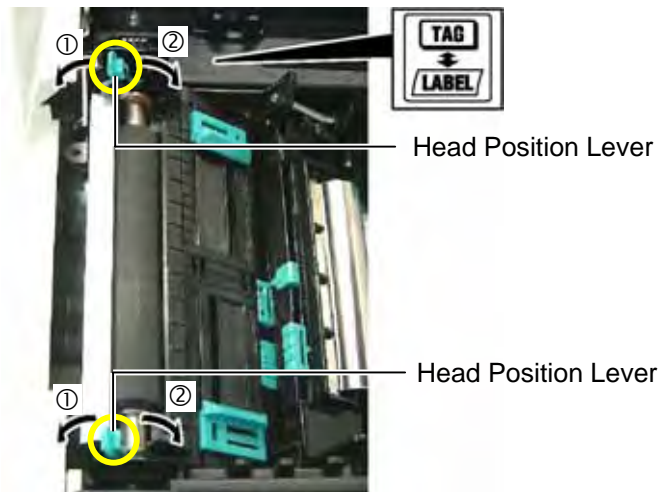

	Media type or thickness	Head Position Lever
① <b>LABEL</b>	<b>Label or Thin media</b> If a clear print cannot be obtained, change the position to ②.	Move the levers toward the front of the printer.
② <b>TAG</b>	<b>Tag paper or Thick paper</b> If a clear print cannot be obtained, change the position to ①.	Move the levers toward the back of the printer.

14. If the loaded media is direct thermal media (with a chemically treated surface), the media loading procedure is now completed. Close the Top Cover.

If the media is normal media, it is also necessary to load a ribbon. Refer to **Section 2.4 Loading the Ribbon**.



## 2.4 Loading the Ribbon

**WARNING!**

1. Do not touch any moving parts. To reduce the risk of fingers, jewellery, clothing, etc., being drawn into the moving parts, be sure to load the ribbon once the printer has stopped moving completely.
2. The print head becomes hot immediately after printing. Allow it to cool before loading the ribbon.
3. To avoid injury, be careful not to trap your fingers while opening or closing the cover.

**CAUTION!**

Be careful not touch the Print Head Element when opening the Top Cover. Failure to do this may cause missing dots by static electricity or other print quality problems.

**NOTE:**

When replacing the ribbon, leave the printer power on. Then, press the **[RESTART]** key to restart an operation.

There are two types of media available for printing on: these are thermal transfer media (normal media) and direct thermal media (with a chemically treated surface). **DO NOT LOAD** a ribbon when using a direct thermal media.

1. Press the Top Cover Release Button and gently open the Top Cover to its fully open position supporting it with your hand.

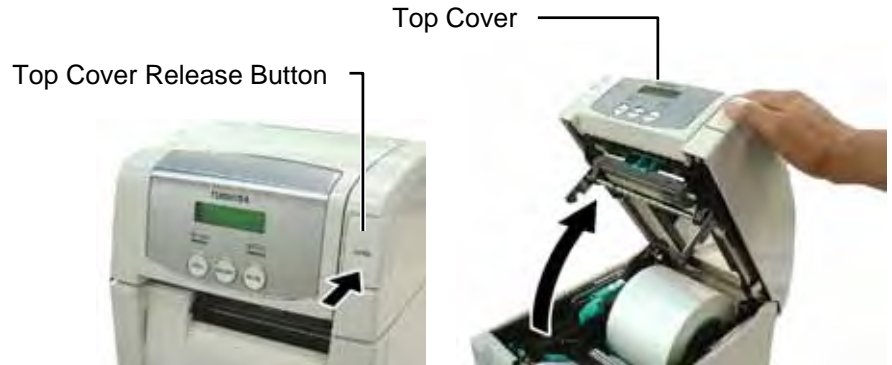

2. Fit the core of the ribbon supply roll into the Ribbon Holders (Supply side), aligning the notch of the ribbon core with the protrusion of the Ribbon Stopper.

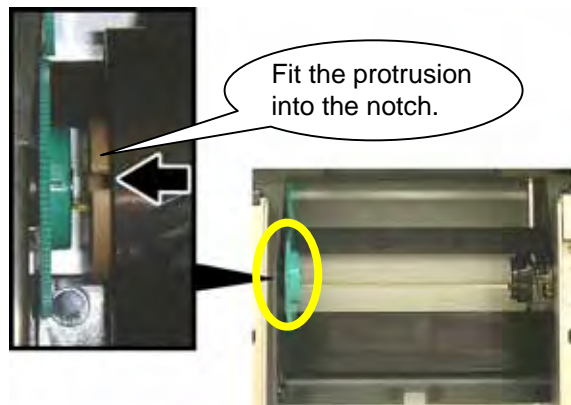
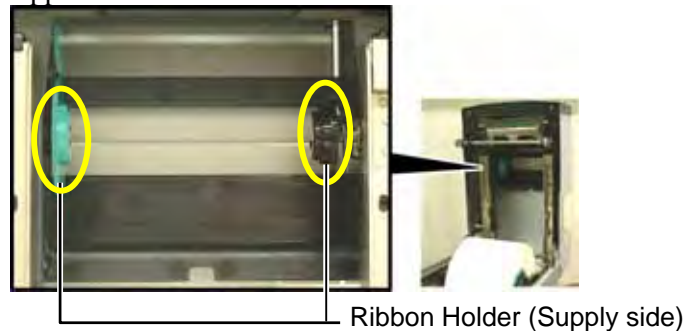

## 2.4 Loading the Ribbon (Cont.)

3. Lower the Top Cover to its 45° angle open position. While pushing the Top Cover Stopper, raise the Top Cover again. This will fix the Top Cover.

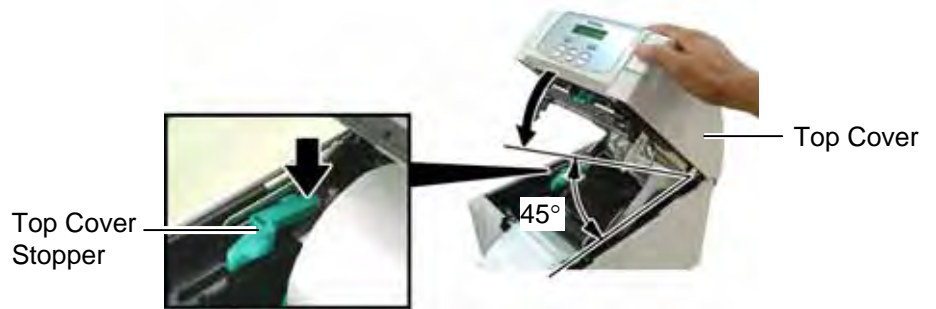

4. Open the Ribbon Cover.

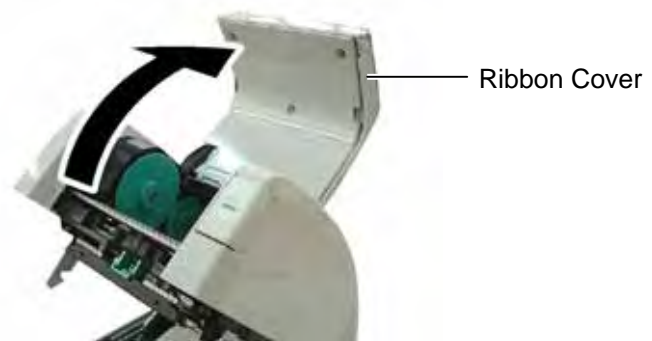

5. Fit the ribbon take-up core into the Ribbon Holder (Take-up side), aligning the notch of the ribbon core with the protrusion of the Ribbon Stopper.

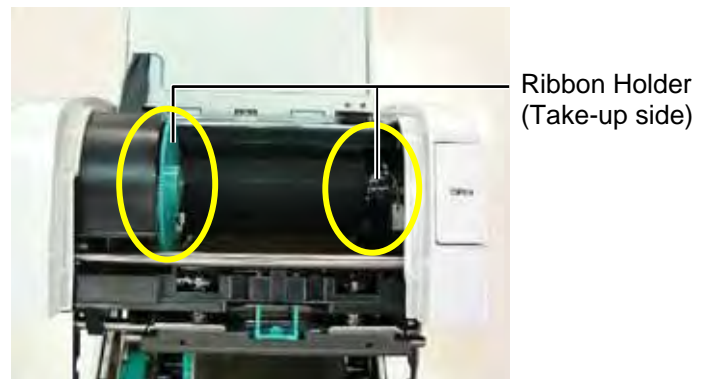

### NOTES:

1. Be sure to remove any slack in the ribbon when printing. Printing with a wrinkled ribbon will lower the print quality.
2. When a ribbon end is detected, "RIBBON ERROR" message will appear on the display and the ERROR LED will illuminate.
3. When disposing of the ribbons, please follow the local rules.
4. For the specification of available ribbon, refer to **Section 7.2 Ribbon**.

6. Turn the ribbon take-up core in the direction indicated by the arrow to remove any slack.



## 2.4 Loading the Ribbon (Cont.)

7. Close the Ribbon Cover until it clicks.

<b>WARNING!</b>
<i>Be sure to close the Ribbon Cover before closing the Top Cover. It is dangerous to close the Top Cover with the Ribbon Cover opened, as the Ribbon Cover slams shut.</i>

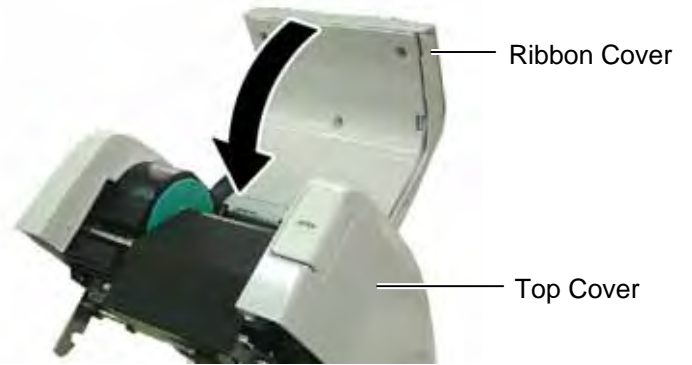

8. Gently close the Top Cover until it clicks.

## 2.5 Connecting the Printer to Your Host Computer

**NOTE:**

When using the USB interface, fix the USB Interface Cable to the printer back with the supplied Cable Clamp and the SMW-3x8 screw.



SMW-3x8 Cable Clamp

The following paragraphs outline how to connect your host computer to the printer, and will also show how to make cable connections to other devices. Depending on the system configuration you use to print labels, there are 5 possibilities for connecting the printer to your host computer. These are:

- A parallel cable connection between the printer’s standard parallel connector and your host computer’s parallel port (LPT).
- An Ethernet connection using the standard LAN board.
- A USB cable connection between the printer’s standard USB connector and your host computer’s USB port. (Conforming to USB 2.0 Full Speed)
- A serial cable connection between the printer’s optional RS-232C serial connector and one of your host computer’s COM ports. <Option>
- Wireless LAN using an optional Wireless LAN board. <Option>

For details of each interface, refer to **APPENDIX 2**.

After connecting the necessary interface cables, set an operating environment of the printer. Refer to **Section 2.7.1 Parameter Setting**.

The diagram below shows all the possible cable connections to the current version of the printer.

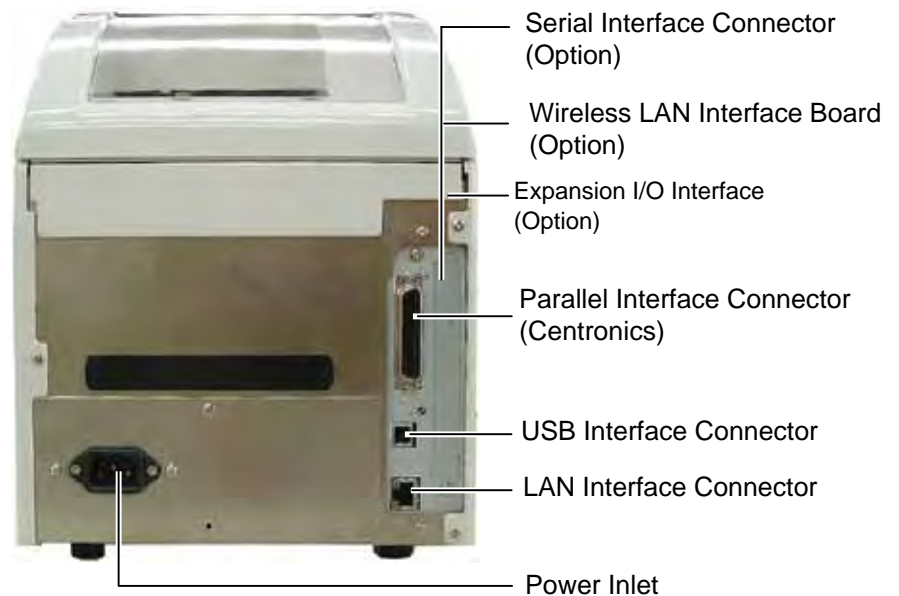

## 2.6 Turning the Printer ON

When the printer is connected to your host computer it is good practice to turn the printer ON before turning on your host computer and turn OFF your host computer before turning off the printer.

### **CAUTION!**

Use the power switch to turn the printer On/Off. Plugging or unplugging the Power Cord to turn the printer On/Off may cause fire, an electric shock, or damage to the printer.

### **NOTES:**

1. If a message other than ON LINE appears on the display or the ERROR LED (Red) is illuminated, go to Section 5.1, **Error Messages**.
2. To turn OFF the printer power turn the Power Switch to the "O" side position.

1. To turn ON the printer power, press the Power Switch as shown in the diagram below. Note that ( | ) is the power ON side of the switch.

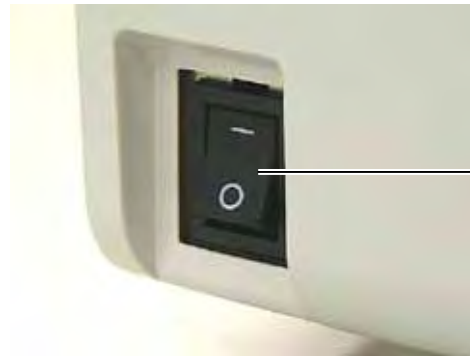

Power Switch

2. Check that the ON LINE message appears in the LCD Message Display and that the ON LINE LED (Green) is illuminated.

## 2.7 Setting an Operating Environment

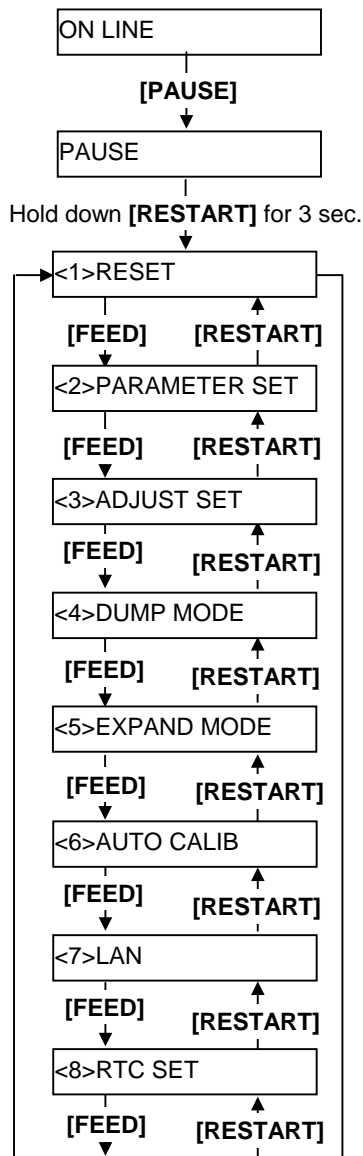

Depending on the settings of your host computer or an interface to be used, it may be necessary to change the printer parameter settings.

Follow the procedures described below to change the printer parameter settings in the System Mode to correspond to your environment.

**NOTE:**  
*Incorrect settings can cause the printer to function erroneously. If you have any problems with the parameter settings, please contact your nearest TOSHIBA TEC service representative.*  
*For the settings this manual does not cover, please contact your nearest TOSHIBA TEC service representative, or refer to the **B-SA4T Series Key Operation Specification** stored in the CD-ROM.*

### How to enter the System Mode

1. Turn on the printer and confirm that “ONLINE” appears on the LCD Message Display.
2. Press the [PAUSE] key to pause the printer.
3. Hold down the [RESTART] key for three seconds until “<1>RESET” is displayed.

The System Mode consists of the following menus.

- |   |   |
|---|---|
| <p>&lt;1&gt;RESET</p> <p>&lt;2&gt;PARAMETER SET</p> <p>&lt;3&gt;ADJUST SET</p> <p>&lt;4&gt;DUMP MODE</p> <p>&lt;5&gt;EXPAND MODE</p> <p>&lt;6&gt;AUTO CALIB</p> <p>&lt;7&gt;LAN</p> <p>&lt;8&gt;RTC SET</p> | <p>This menu is used to clear print data sent from a PC and return the printer to an idle state. Refer to <b>Section 3.3 Reset</b>.</p> <p>This menu is used to set the printer parameters. Refer to <b>Section 2.7.1 Parameter Setting</b>.</p> <p>This menu is used to make a fine adjustment of a print start position, cut position, etc. Refer to <b>Section 2.10 Position and Print Tone Fine Adjustment</b>.</p> <p>This menu is used to print the data in the receive buffer for debug. Refer to <b>Section 2.7.2 Dump Mode Setting</b>.</p> <p>This menu is used to start the program for BASIC mode. Refer to <b>Section 2.7.3 BASIC Expansion Mode</b>.</p> <p>This menu is used to enable or disable the automatic calibration function. Refer to <b>Section 2.7.4 Automatic Calibration</b>.</p> <p>This menu is used to enable or disable the LAN communication and SNMP. Refer to <b>Section 2.7.5 LAN Setting</b>.</p> <p>This menu is used to set the date and time of the real time clock, enable or disable the low battery check, and choose a real time renewal timing. Refer to <b>Section 2.7.6 Real Time Clock Setting</b>.</p> |
|---|---|

**NOTES:**

1. System Mode menus can be selected with the [RESTART] or [FEED] key.
2. To enter each of the above System Mode menus, press the [PAUSE] key when the menu is displayed.
3. If the [PAUSE] key is pressed with “<1>RESET” being displayed, the printer will turn to an idle state and the message will change to “ONLINE”

### 2.7.1 Parameter Setting

While “<2>PARAMETER SET” is displayed on the LCD Message Display, press the **[PAUSE]** key to enter the Parameter Setting Mode.

The Parameter Setting Mode contains the following sub menus. Each time the **[PAUSE]** key is pressed, the sub menus are displayed sequentially.

- (1) Character code selection
- (2) Character zero selection
- (3) Baud rate selection
- (4) Data length selection
- (5) Stop bit length selection
- (6) Parity selection
- (7) Flow control code selection
- (8) LCD language selection
- (9) Auto forward wait selection
- (10) Control code selection
- (11) Strip wait status selection
- (12) FEED key function selection
- (13) KANJI code selection
- (14) EURO code selection
- (15) Auto print head check selection
- (16) Centronics ACK/BUSY timing selection
- (17) Web printer function selection
- (18) Input prime selection
- (19) Ribbon near end selection
- (20) Expansion I/O interface selection
- (21) Plug & Play selection
- (22) Label end/ribbon error selection
- (23) Pre-strip selection
- (24) Reverse feed speed selection
- (25) Maxi code specification selection
- (26) Keyboard interface selection
- (27) Strip motor torque selection
- (28) Print head applied current table selection

**2.7.1 Parameter Setting (Cont.)**

**NOTE:**  
 Be careful if the printer is turned off without pressing the **[PAUSE]** key, the selected value does not become effective.

**(1) Character Code Selection**

This parameter is to choose a character code used for printing. Printed characters differ depending on a chosen character code and font. For details of characters, refer to the **B-SA4T Series External Equipment Interface Specification** (Printer Command Manual).

When “<2>PARAMETER SET” appears, press the **[PAUSE]** key.

<2>PARAMETER SET  
 FONT CODE PC-850

Use the **[FEED]** or **[RESTART]** key to select a desired option.

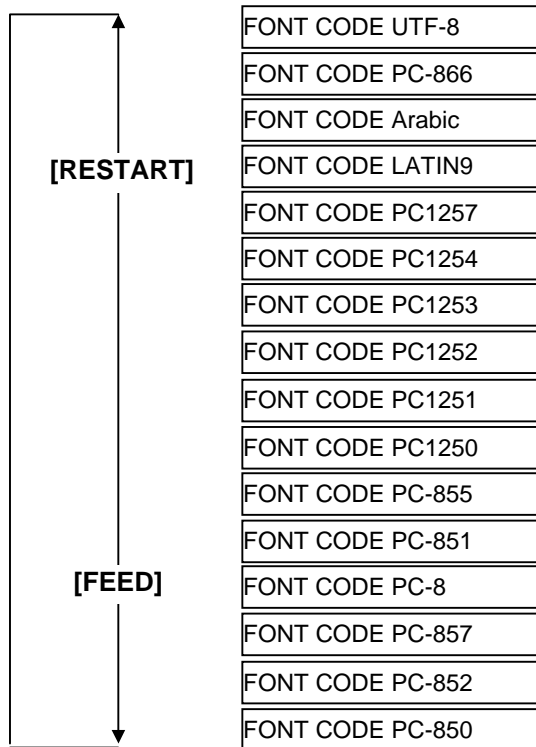

After selecting a character code, press the **[PAUSE]** key.

**(2) Character Zero Selection**

This parameter is to choose the way to indicate zero between “0” and “Ø”. When “<2>PARAMETER SET” appears, press the **[PAUSE]** key twice.

<2>PARAMETER SET  
 ZERO FONT 0

Use the **[FEED]** or **[RESTART]** key to select a desired option.

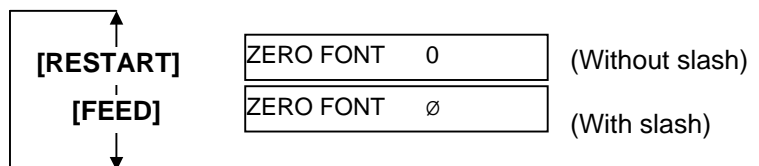

After selecting a character zero, press the **[PAUSE]** key.

**NOTE:**  
 The following fonts do not support a zero with slash.  
Bit Map Font:  
 OCR-A, OCR-B, GOTHIC 725 Black, Kanji, Chinese  
Outline Font:  
 Price Font 1, Price Font 2, Price Font 3, DUTCH 801 Bold, BRUSH 738 Regular, GOTHIC 725 Black, True Type Font



### 2.7.1 Parameter Setting (Cont.)



<Reference>  
Properties screen of Serial (COM) port under Windows98

#### (3) Baud Rate Selection

This parameter is to choose a baud rate of the RS-232C interface. When the printer communicates with a host computer by serial interface, be sure to match the setting with the host.

When “<2>PARAMETER SET” appears, press the **[PAUSE]** key until the following display appears.

```
<2>PARAMETER SET
SPEED 9600bps
```

Use the **[FEED]** or **[RESTART]** key to select a desired option.

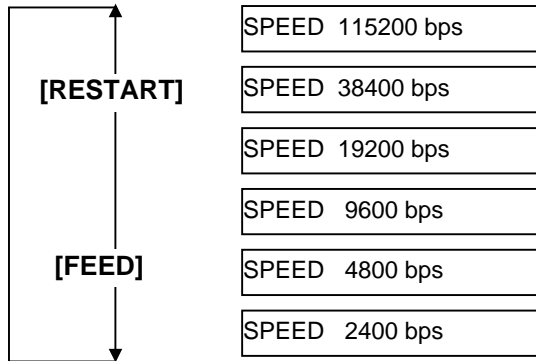

After selecting a baud rate, press the **[PAUSE]** key.

#### (4) Data Length Selection

This parameter is to choose a communication data length of the RS-232C interface.

7 bits is used when transmitting alphanumeric data only. 8 bits is used to when transmitting special characters. Be sure to match a setting with a host computer.

When “<2>PARAMETER SET” appears, press the **[PAUSE]** key until the following display appears.

```
<2>PARAMETER SET
DATA LENG. 8bits
```

Use the **[FEED]** or **[RESTART]** key to select a desired option.



After selecting a data length, press the **[PAUSE]** key.

### 2.7.1 Parameter Setting (Cont.)

**NOTES:**

- When using the hardware flow control, the control signals and data must be in pairs between the printer and the PC.  

Printer		Host
TD	→	RD
RD	←	TD
RTS	→	CTS
CTS	←	RTS
DSR	→	DTR
DTR	←	DSR

Refer to the RS-232C connector's pin layout in **APPENDIX 2**.  
Check if the printer and the PC is properly connectable with your cable.
- Be careful that there are two types of RS-232C cable; straight cable and cross cable.  
Use a straight cable for this printer.

**NOTE:**

- The following is the detailed descriptions for each transmission control code.
- XON/XOFF AUTO**  
At the power on time, the printer outputs XON. At the power off time, the printer outputs XOFF.
  - XON+READY AUTO**  
At the power on time, the printer outputs XON. At the power off time, the printer outputs XOFF.
  - READY/BUSY**  
At the power on time, the DTR signal output from the printer turns to High level (READY). At the power off time, the printer does not output XOFF.
  - ON/XOFF**  
At the power on time, the printer outputs XON. At the power off time, the printer does not output XOFF.
  - READY/BUSY RTS**  
At the power on time, the RTS signal output from the printer turns to High level (READY). At the power off time, the printer does not output XOFF.

#### (5) Stop Bit Length Selection

This parameter is to choose a stop bit length of the RS-232C interface. Be sure to match a setting with a host computer. When “<2>PARAMETER SET” appears, press the **[PAUSE]** key until the following display appears.

```
<2>PARAMETER SET
STOP BIT 1bit
```

Use the **[FEED]** or **[RESTART]** key to select a desired option.



After selecting a stop bit length, press the **[PAUSE]** key.

#### (6) Parity Selection

This parameter is to choose the parity of the RS-232C interface. When “<2>PARAMETER SET” appears, press the **[PAUSE]** key until the following display appears.

```
<2>PARAMETER SET
PARITY NONE
```

Use the **[FEED]** or **[RESTART]** key to select a desired option.

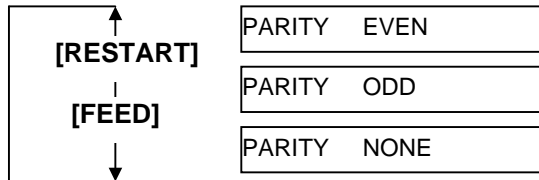

After selecting the parity, press the **[PAUSE]** key.

#### (7) Flow Control Code Selection

This parameter is to choose a flow control code of the RS-232C interface. When “<2>PARAMETER SET” appears, press the **[PAUSE]** key until the following display appears.

```
<2>PARAMETER SET
XON+READY AUTO
```

Use the **[FEED]** or **[RESTART]** key to select a desired option.

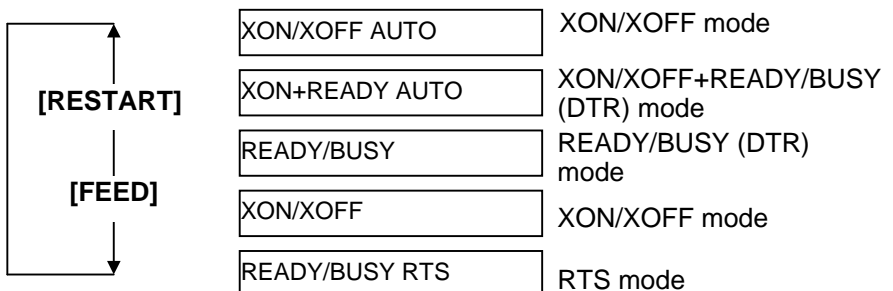

After selecting a flow control code, press the **[PAUSE]** key.

**2.7.1 Parameter Setting (Cont.)**

**(8) LCD Language Selection**

This parameter is to choose a language in which the LCD message is displayed.

When “<2>PARAMETER SET” appears, press the **[PAUSE]** key until the following display appears.

<2>PARAMETER SET LCD ENGLISH
---------------------------------

Use the **[FEED]** or **[RESTART]** key to select a desired option.

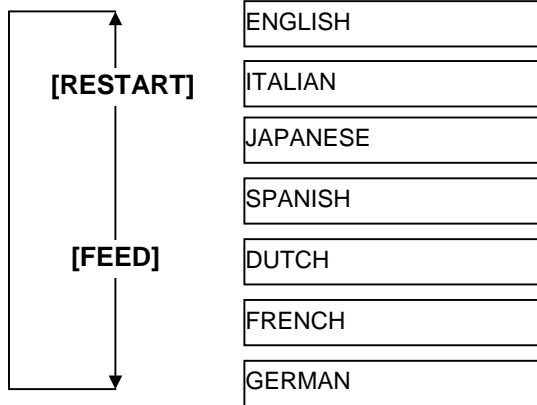

After selecting a language, press the **[PAUSE]** key.

**(9) Auto Forward Wait Selection**

This parameter is to choose whether to activate the Auto Forward Wait function or not.

This function, used in the cut mode, automatically feeds the media forward for about 17 mm if there is more than 1-second idle time after printing, to prevent the top edge of the media from curling.

When “<2>PARAMETER SET” appears, press the **[PAUSE]** key until the following display appears.

<2>PARAMETER SET FORWARD WAIT OFF
--------------------------------------

Use the **[FEED]** or **[RESTART]** key to select a desired option.

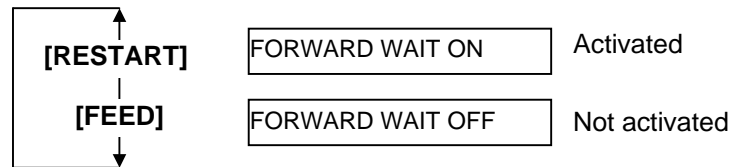

After selecting an auto forward wait, press the **[PAUSE]** key.

**NOTES:**

1. If the printer is not used for a few days, the top edge of the media may become curly, which may cause a paper jam. The Auto Forward Wait Function prevents this problem since the media feed amount is increased so that the media stops past the platen.
2. When the Stop Position Fine Adjustment Value is set in + direction, the media will stop past the media outlet.  
When the value is set in - direction, the media will stop inside the media outlet.
3. This setting will be useful to fine adjust the cut position of labels.

**2.7.1 Parameter Setting (Cont.)**

When ON is selected, pressing the **[PAUSE]** key will result that the LCD Message Display shows the stop position fine adjustment value setting screen.

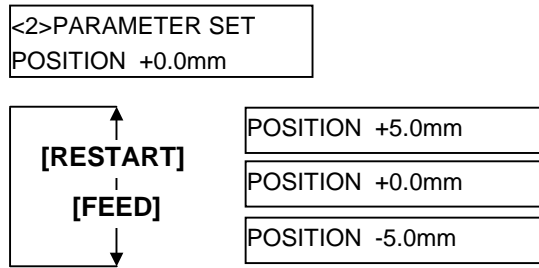

**[FEED]** key: Pressing the **[FEED]** key one time causes a -0.1mm change, up to -5.0 mm.

**[RESTART]** key: Pressing the **[RESTART]** key one time causes a +0.1mm change, up to +5.0 mm.

After selecting an auto forward wait, press the **[PAUSE]** key.

**(10) Control Code Selection**

This parameter is to choose a Control Code.

When “<2>PARAMETER SET” appears, press the **[PAUSE]** key until the following display appears.

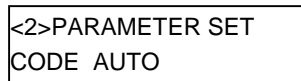

Use the **[FEED]** or **[RESTART]** key to select a desired option.

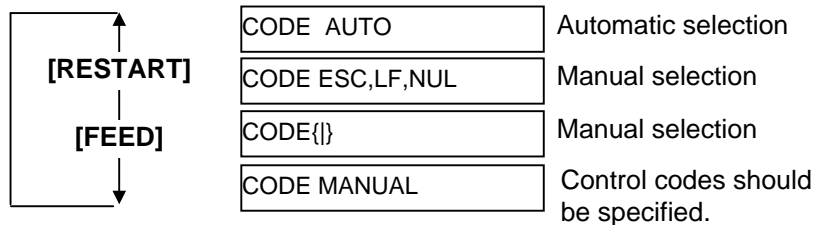

When “CODE MANUAL” is selected and the **[PAUSE]** key is pressed, the LCD display will show the setting screen of CONTROL CODE1 to CONTROL CODE3 as follows.

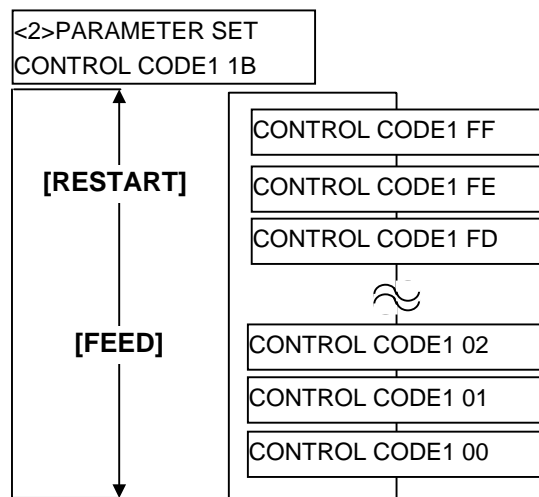

### 2.7.1 Parameter Setting (Cont.)

After setting the control code for Control Code 1, press the **[PAUSE]** key to show the CONTROL CODE2 screen. In a same manner, press the **[PAUSE]** key after setting the control code for Control Code 2 to display the CONTROL CODE3 screen.

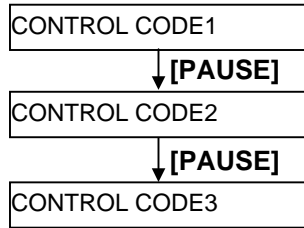

Press the **[PAUSE]** key after setting the control code for Control Code 3.

#### (11) Strip Wait Status Selection

This parameter is to choose when the printer sends a strip wait status (05H) to a host in response to a status request command.

When “<2>PARAMETER SET” appears, press the **[PAUSE]** key until the following display appears.

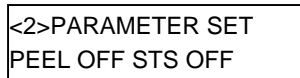

Use the **[FEED]** or **[RESTART]** key to select a desired option.

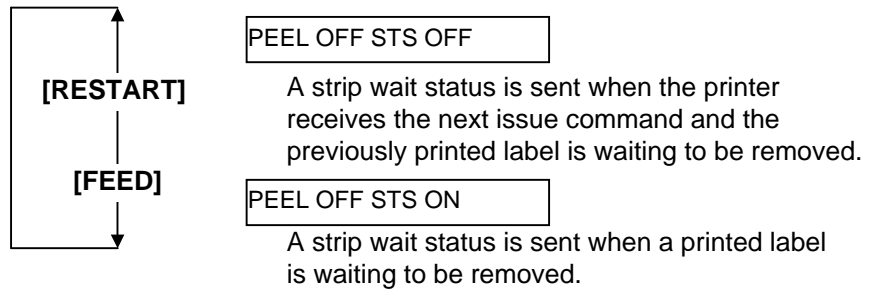

After selecting the Strip Wait Status, press the **[PAUSE]** key.

#### (12) FEED Key Function Selection

This parameter is to choose the function of the **[FEED]** key.

When “<2>PARAMETER SET” appears, press the **[PAUSE]** key until the following display appears.

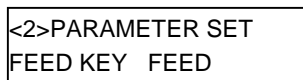

Use the **[FEED]** or **[RESTART]** key to select a desired option.

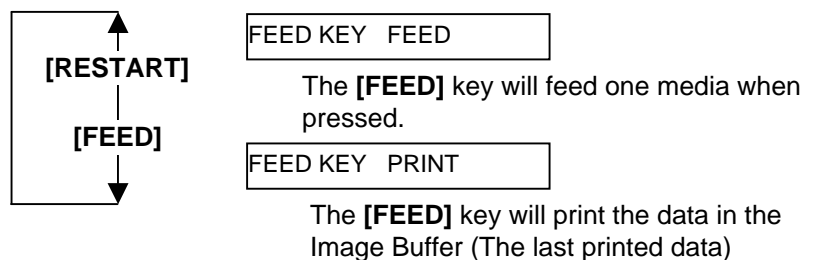

After selecting the FEED key function, press the **[PAUSE]** key.

**2.7.1 Parameter Setting (Cont.)**

**NOTE:**  
*Kanji code selection is not supported by the QM model as the Kanji ROMs are not installed.*

**(13) KANJI Code Selection**

This parameter is to choose a KANJI code.  
 When “<2>PARAMETER SET” appears, press the **[PAUSE]** key until the following display appears.

```
<2>PARAMETER SET
KANJI CODE TYPE1
```

Use the **[FEED]** or **[RESTART]** key to select a desired option.

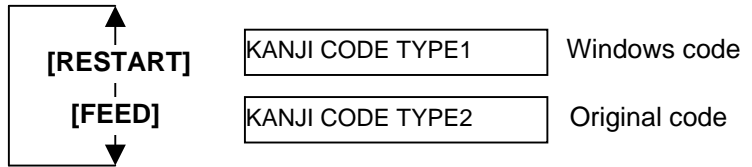

After selecting a Kanji code, press the **[PAUSE]** key.

**NOTE:**  
*Pressing the **[FEED]** or **[RESTART]** key causes 1 byte change in the Euro Code value.*

**(14) EURO Code Selection**

This parameter is to choose a Euro code (€).  
 When “<2>PARAMETER SET” appears, press the **[PAUSE]** key until the following display appears.

```
<2>PARAMETER SET
EURO CODE B0
```

Use the **[FEED]** or **[RESTART]** key to select a desired option.

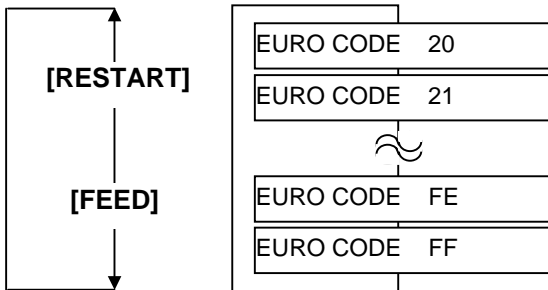

After selecting a Euro code, press the **[PAUSE]** key.

**2.7.1 Parameter Setting (Cont.)**

**NOTES:**

1. It is recommended that this function should be activated when high quality printing such as bar codes printing is required. Otherwise, choose OFF.
2. When a broken element is found, the printer stops, displaying "HEAD ERROR". The error state can be cleared by pressing the [RESTART] key, but if the broken element affects bar code readability or actual operations, please replace the print head with a proper one.

**(15) Auto Print Head Check Selection**

This parameter is to choose whether to perform the Auto Print Head Check function at the power on time. When "<2>PARAMETER SET" appears, press the [PAUSE] key until the following display appears.

<2>PARAMETER SET  
 AUTO HD CHK OFF

Use the [FEED] or [RESTART] key to select a desired option.

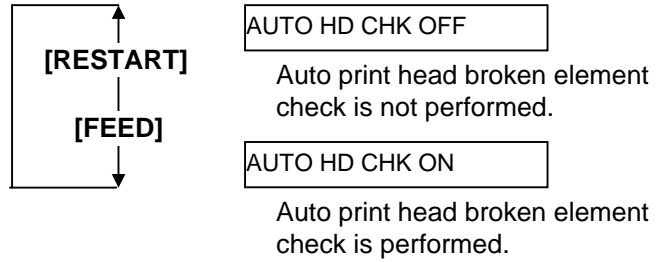

After selecting auto print head check, press the [PAUSE] key.

**(16) Centronics Interface ACK/BUSY Timing Selection**

This parameter is to choose an ACK/BUSY timing of the Centronics interface.

"TYPE1" has been chosen as default, but if a communication error occurs or a communication is not properly made, change to "TYPE2".

When "<2>PARAMETER SET" appears, press the [PAUSE] key until the following display appears".

<2>PARAMETER SET  
 ACK/BUSY TYPE1

Use the [FEED] or [RESTART] key to select a desired option.

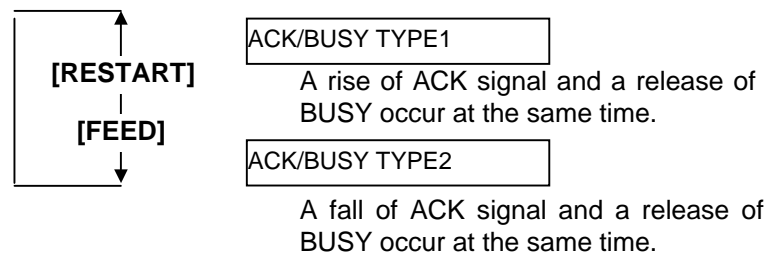

After selecting an ACK/BUSY timing, press the [PAUSE] key.

### 2.7.1 Parameter Setting (Cont.)

**NOTE:**

When "WEB PRINTER ON" is selected, the status of the printer connected in a network can be checked through the Web browser.

#### (17) Web Printer Function Selection

This parameter is to choose whether to use the printer as a web printer. When "<2>PARAMETER SET" appears, press the [PAUSE] key until the following display appears.

```
<2>PARAMETER SET
WEB PRINTER OFF
```

Use the [FEED] or [RESTART] key to select a desired option.

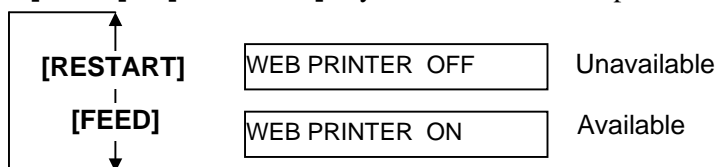

After selecting the Web printer function, press the [PAUSE] key.

#### (18) Input Prime Selection

This parameter is to choose whether to enable a reset operation when  $\overline{\text{INIT}}$  signal is ON.

Normally, when the printer receives a reset request signal (nInit signal) from the host via Centronics interface, the printer will be reset and turn to the idle state.

When the INPUT PRIME parameter is set to OFF, the printer is reset but does not turn to idle.

When this parameter is set to ON, the host sends an  $\overline{\text{INIT}}$  signal and the printer turns to idle each time the printer is turned on. If you would like to avoid this processing, set this parameter to OFF.

When "<2>PARAMETER SET" appears, press the [PAUSE] key until the following display appears.

```
<2>PARAMETER SET
INPUT PRIME ON
```

Use the [FEED] or [RESTART] key to select a desired option.

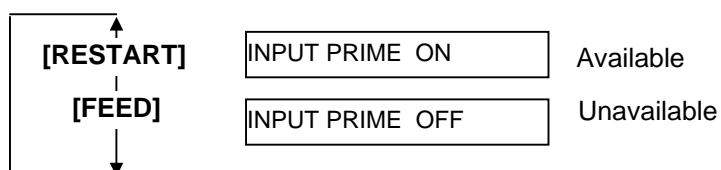

After selecting the Input Prime, press the [PAUSE] key.



### 2.7.1 Parameter Setting (Cont.)

#### (19) Ribbon Near End Selection

This parameter is to choose the remaining ribbon length where the ribbon near end is detected.

When “<2>PARAMETER SET” appears, press the **[PAUSE]** key until the following display appears.

```

<2>PARAMETER SET
RBN NEAR END 70m
```

Use the **[FEED]** or **[RESTART]** key to select a desired option.

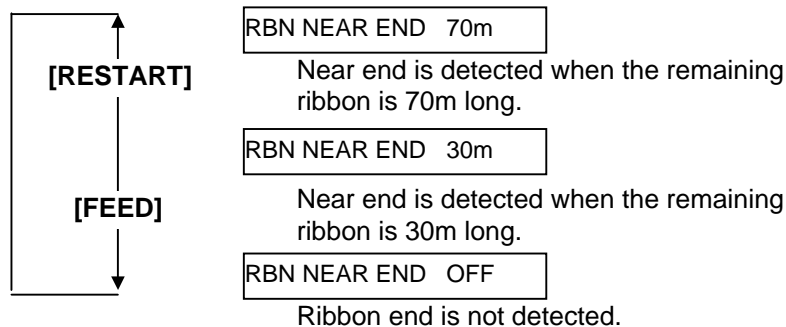

After selecting the ribbon near end function, press the **[PAUSE]** key.

#### (20) Expansion I/O Interface Type Selection

This parameter is to choose a type of the Expansion I/O interface operating mode.

This parameter should be set depending on the expansion I/O control specification of the device to be connected via the expansion I/O interface. For details, refer to the **External Equipment Interface Specification**.

When “<2>PARAMETER SET” appears, press the **[PAUSE]** key until the following display appears.

```

<2>PARAMETER SET
EX.I/O TYPE1
```

Use the **[FEED]** or **[RESTART]** key to select a desired option.

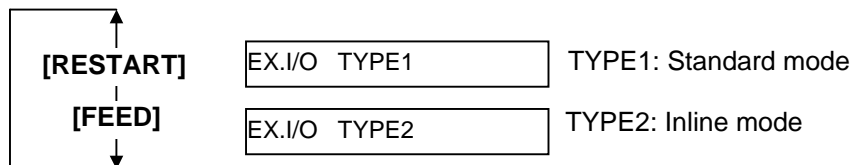

After selecting an Expansion I/O Interface type, press the **[PAUSE]** key.

**2.7.1 Parameter Setting (Cont.)**

**NOTE:**  
 If the printer and the PC are connected by USB, plug & play will be automatically enabled, regardless of the setting of this parameter.

**(21) Plug & Play Selection**

This parameter is to choose whether to enable a Plug & Play function. When “<2>PARAMETER SET” appears, press the **[PAUSE]** key until the following display appears.

<2>PARAMETER SET  
 PLUG & PLAY OFF

Use the **[FEED]** or **[RESTART]** key to select a desired option.

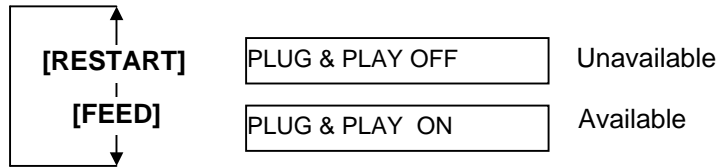

After selecting a Plug & Play, press the **[PAUSE]** key.

**(22) Label End/Ribbon Error Selection**

This parameter is to choose a printing process when a label end or ribbon error is detected.

When “<2>PARAMETER SET” appears, press the **[PAUSE]** key until the following display appears.

<2>PARAMETER SET  
 LBL/RBN END TYP1

Use the **[FEED]** or **[RESTART]** key to select a desired option.

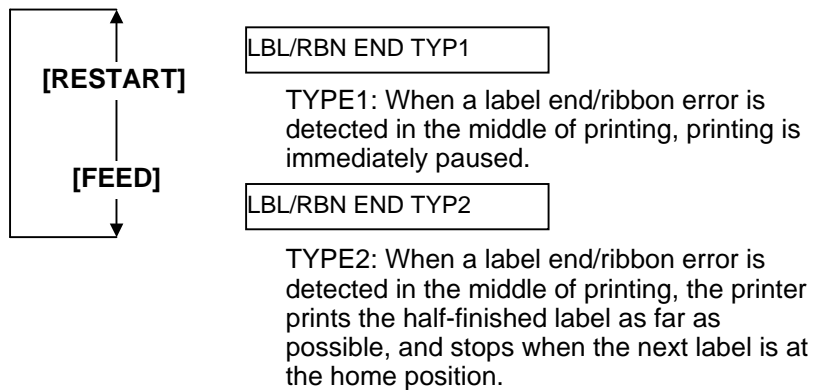

After selecting a Label End/Ribbon Error type, press the **[PAUSE]** key.

**2.7.1 Parameter Setting (Cont.)**

**(23) Pre-Strip Selection**

This parameter is to choose whether to activate the Pre Strip function. When this parameter is set to ON (Available), the top edge of a label is separated (pre-stripped) from the backing paper before the label is printed. This function is intended to make the strip issue easier in case the labels are hard to strip due to the label intensity, adhesive power, or the printing speed.

When “<2>PARAMETER SET” appears, press the **[PAUSE]** key until the following display appears.

```

<2>PARAMETER SET
PRE PEEL OFF OFF
    
```

Use the **[FEED]** or **[RESTART]** key to select a desired option.

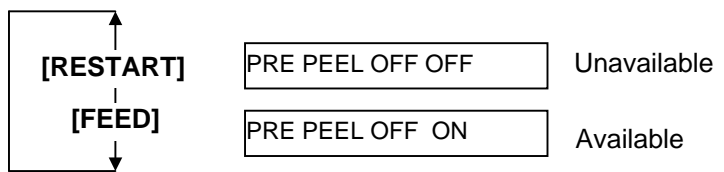

When ON is selected, pressing the **[PAUSE]** key enables the adjustment value setting.

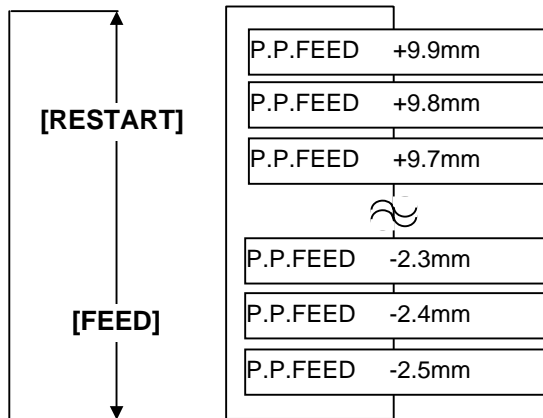

After setting an adjustment value, press the **[PAUSE]** key to make a pre-strip function test.

When the **[FEED]** key is pressed, the printer feeds a label.

If the label stops with its top edge aligning with the strip shaft edge, the adjustment value has been properly set. Press the **[PAUSE]** key to go to the next parameter setting.

If further adjustment is required, press the **[RESTART]** key to return to the adjustment value setting.

**2.7.1 Parameter Setting  
(Cont.)**

**(24) Reverse Feed Speed Selection**

This parameter is to choose a reverse feed speed.  
 In the strip issue, the back feed speed of 3"/sec. may cause a shortage of feed amount due to a lack of torque, slippery media surface, etc. In such case, reduce the back feed speed to 2"/sec. to secure the feed amount.  
 When "<2>PARAMETER SET" appears, press the **[PAUSE]** key until the following display appears.

```

    <2>PARAMETER SET
    BACK SPEED  STD
```

Use the **[FEED]** or **[RESTART]** key to select a desired option.

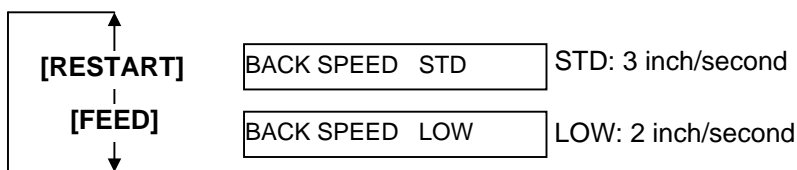

After selecting the Back Feed Speed, press the **[PAUSE]** key.

**(25) Maxi Code Specification Selection**

This parameter is to choose a Maxi code specification.  
 When "<2>PARAMETER SET" appears, press the **[PAUSE]** key until the following display appears.

```

    <2>PARAMETER SET
    MAXI CODE  TYPE1
```

Use the **[FEED]** or **[RESTART]** key to select a desired option.

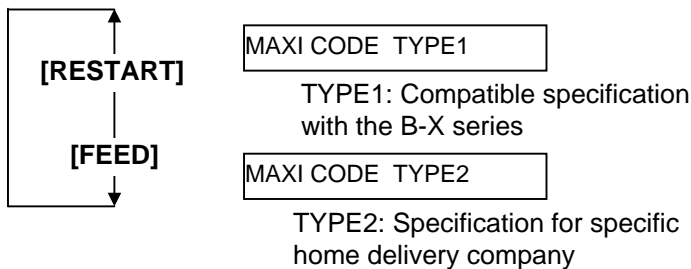

After selecting a Maxi code specification, press the **[PAUSE]** key.

**2.7.1 Parameter Setting (Cont.)**

**(26) Keyboard Interface Selection**

This parameter is to choose a keyboard interface. When “<2>PARAMETER SET” appears, press the [PAUSE] key until the following display appears.

<2>PARAMETER SET	
KB I/F	OFF

Use the [FEED] or [RESTART] key to select a desired option.

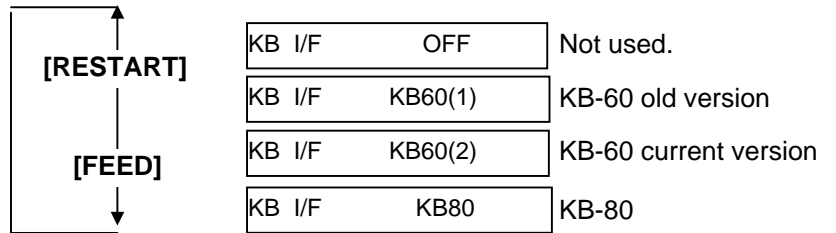

After selecting a keyboard interface, press the [PAUSE] key.

**(27) Strip Motor Torque Selection**

This parameter is to choose a strip motor torque. When “<2>PARAMETER SET” appears, press the [PAUSE] key until the following display appears.

<2>PARAMETER SET	
PEEL OFF TRQ R0	

Use the [FEED] or [RESTART] key to select a desired option.

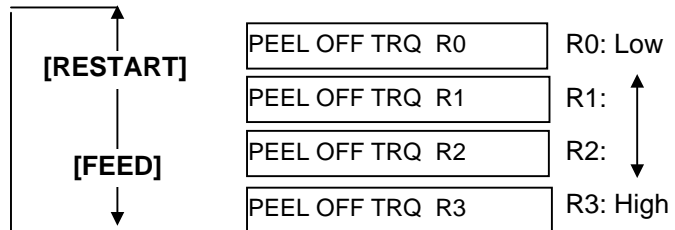

After selecting a strip motor torque, press the [PAUSE] key.

**(28) Print Head Applied Current Table Selection**

This parameter is to choose the applied current level to the print head. When “<2>PARAMETER SET” appears, press the [PAUSE] key until the following display appears.

<2>PARAMETER SET	
TONE TABLE TYPE1	

Use the [FEED] or [RESTART] key to select a desired option.

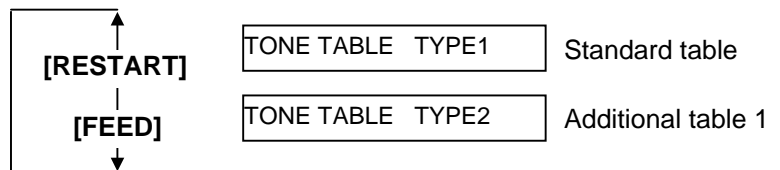

After selecting the print head applied current table, press the [PAUSE] key.

**NOTE:**  
When the print tone is too light, turn up the print tone in the positive (+) direction first. If the print tone does not improve by the print tone fine adjustment, choose TONE TABLE TYPE 2. Please do not turn up the print tone excessively, as doing this may cause ribbon wrinkles.

### 2.7.2 Dump Mode Setting

While “<4>DUMP MODE” is displayed on the LCD Message Display, press the **[PAUSE]** key to enter the Dump Mode.

In the Dump Mode, data in the receive buffer are printed. Data are expressed in hexadecimal values. This operation allows the user to verify programming commands or debug the program.

When “<4>DUMP MODE” appears, press the **[PAUSE]** key.

```

<4>DUMP MODE
BUFFER RS-232C
    
```

Use the **[FEED]** or **[RESTART]** key to choose a receive buffer to be dumped.

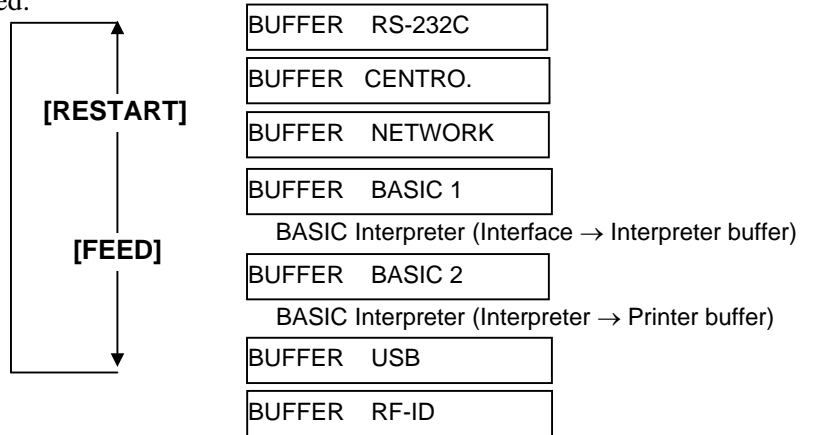

After selecting the receive buffer, press the **[PAUSE]** key.

```

<4>DUMP MODE
PRINT ON DEMAND
    
```

Use the **[FEED]** or **[RESTART]** key to select a printing method.

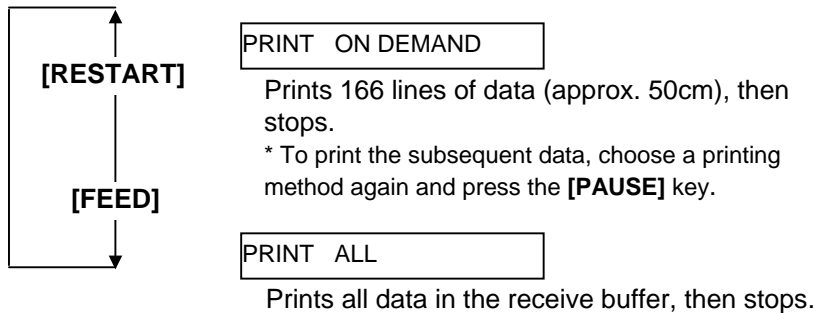

After selecting a printing method, press the **[PAUSE]** key.

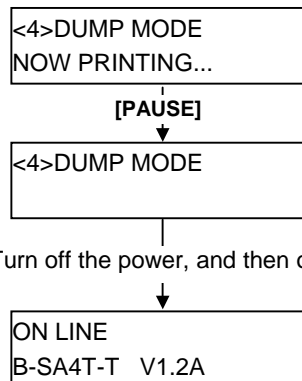

**NOTES:**

1. When “ON DEMAND” is selected, it is required to choose a printing method again and press the **[PAUSE]** key to print the subsequent data until the all data has been printed.
2. If an error occurs during dumping, the printer will display an error message and stop printing. The error can be cleared by pressing the **[PAUSE]** key, and then the display will show “<4>DUMP MODE” again. After a recovery from the error the printer will not start printing automatically.

### 2.7.2 Dump Mode Setting (Cont.)

**Print Conditions**

- Printing width: 3.9 inches (100 mm)
- Sensor selection: None
- Print speed: 4"/sec.
- Printing mode: Depends on the selection in use.
- 16 bytes/line
- Data is printed in the order from the new one to the old one.
- Data specified by the receive buffer write pointer will be printed in boldface.

The data in the receive buffer is printed as follows:

```

00 00 00 00 00 00 00 00 00 00 00 00 00 00 00 00
00 00 00 00 00 00 00 00 00 00 00 00 00 00 00 00
00 00 00 00 00 00 00 00 00 00 00 00 00 00 00 00
7B 41 58 3B 2B 30 30 30 2C 2B 30 30 30 2C 2B 30      {AX;+000,+000,+0
30 7C 7D 7B 44 30 37 37 30 2C 31 31 30 30 2C 30      0}}{D0760,1100,0
37 34 30 7C 7D 7B 43 7C 7D 7B 4C 43 3B 30 30 33      740}}{C}}{LC;003
30 2C 30 30 32 30 2C 30 30 33 30 2C 30 36 36 30      0,0020,0030,0660
2C 30 2C 32 7C 7D 7B 4C 43 3B 30 30 37 30 2C 30      ,0,2}}{LC;0070,0
30 32 30 2C 30 30 37 30 2C 30 36 36 30 2C 30 2C      020,0070,0660,0,
39 7C 7D 7B 4C 43 3B 30 30 35 30 2C 30 30 32 30      9}}{LC;0050,0020
:
:
:
44 45 46 47 48 49 4A 7C 7D 7B 50 43 31 30 3B 30      DEFGHIJ}}{PC10;0
33 35 30 2C 30 34 30 30 2C 31 2C 31 2C 4B 2C 30      350,0400,1,1,K,0
30 2C 42 3D 41 42 43 44 65 66 67 68 69 6A 6B 6C      0,B=ABCDefghijkl

6D 6E 6F 70 7C 7D 7B 50 56 30 32 3B 30 33 33 30      mnop}}{PV02;0330
2C 30 36 36 30 2C 30 32 37 30 2C 30 32 35 30 2C      ,0660,0270,0250,
41 2C 30 30 2C 42 3D 42 7C 7D 7B 50 56 30 33 3B      A,00,B=B}}{PV03;
:
:
:
3B 30 39 30 30 2C 30 31 38 30 2C 54 2C 48 2C 30      :0900,0180,T,H,0
35 2C 41 2C 30 3D 31 32 33 34 35 36 37 38 39 30      5,A,0=1234567890
41 42 43 44 45 7C 7D 00 00 00 00 00 00 00 00 00      ABCDE}}
:
:
:
    
```

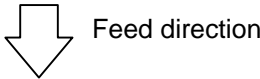

**Receive Buffer Size**

Interface	Buffer size
RS-232C	1MB (65536 lines)
Centronics	1MB (65536 lines)
Network Interface	1MB (65536 lines)
BASIC 1	8KB (512 lines)
BASIC 2	8KB (512 lines)
USB	1MB (65536 lines)
RFID	8KB (512 lines)

**Required Label Length**

Interface	Media length*
RS-232C	198.2m
Centronics	198.2m
Network Interface	198.2m
BASIC 1	2m
BASIC 2	2m
USB	198.2m
RFID	2m

\*: Media length required for printing all data in the receive buffer.

### 2.7.3 BASIC Expansion Mode

While “<5>EXPAND MDOE” is displayed on the LCD Message Display, press the **[PAUSE]** key to enter the BASIC Expansion Mode.

**NOTE:**  
*For the BASIC enable setting mode, refer to the **B-SA4T Series Key Operation Specification** stored in the CD-ROM.*

In the BASIC Expansion Mode, it is possible to execute the BASIC expansion mode program under the following conditions.

- The BASIC expansion mode program has already been loaded.
- The BASIC enable setting mode is selected.

The basic expansion mode ends when the basic expansion program is exited.

When “<5>EXPAND MODE” appears, press the **[PAUSE]** key.

<5>EXPAND MODE

When the **[PAUSE]** key is pressed, BASIC program is executed.



### 2.7.4 Automatic Calibration

While “<6>AUTO CALIB” is displayed on the LCD Message Display, press the **[PAUSE]** key to enter the Automatic Calibration Mode.

In the Automatic Calibration Mode, whether to activate the automatic calibration at a power on time or not is selectable. When the automatic calibration is activated, the printer feeds the media for about 160 mm each time the power is turned on or the Top Cover is opened, to detect a print start position.

When “<6>AUTO CALIB” appears, press the **[PAUSE]** key.

<6>AUTO CALIB OFF
----------------------

Use the **[FEED]** or **[RESTART]** key to select a desired option.

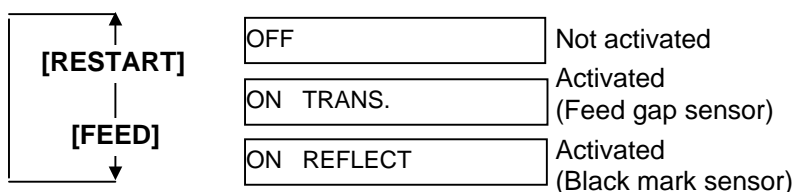

After selecting the automatic calibration, press the **[PAUSE]** key.

**NOTES:**

1. This function is available only when the media pitch is 10.0 mm to 150.0 mm.
2. When this function is activated, the media length, effective print length, and sensor type specified in the command are ignored.
3. When the printer cannot find a print start position properly, it will continue to feed the media for up to 500.0 mm. If that does not work, the printer will stop, resulting in a paper jam.
4. During an automatic calibration, the printer also feeds the ribbon.
5. An automatic forward feed is not performed immediately after an automatic calibration, even if the auto forward wait parameter is set to ON.

### 2.7.5 LAN Setting

While “<7>LAN” is displayed on the LCD Message Display, press the **[PAUSE]** key to enter the LAN Setting Mode.

In the LAN Setting Mode, whether to enable the LAN communication and SNMP or not is selectable.

When “<7>LAN” appears, press the **[PAUSE]** key.

<7>LAN
ON SNMP ON

Use the **[FEED]** or **[RESTART]** key to select a desired option.

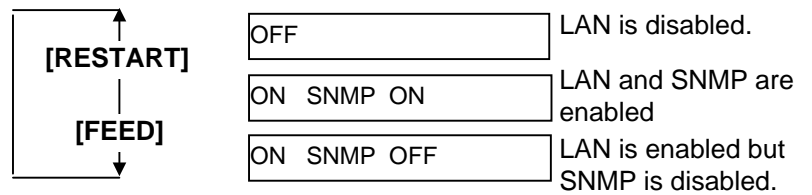

After selecting the LAN setting, press the **[PAUSE]** key.

### 2.7.6 Real Time Clock Setting

While “<8>RTC SET” is displayed on the LCD Message Display, press the **[PAUSE]** key to enter the Real Time Clock Setting Mode.

**NOTE:**  
The Real Time Clock Setting is effective only when an optional Real Time Clock, B-SA704-RTC-QM-R, is installed.

The Real Time Clock Setting Mode contains the following sub menus. Each time the **[PAUSE]** key is pressed, the sub menus are displayed sequentially.

- (1) Date setting (Year, Month, Day)
- (2) Time setting (Hour, Minute, Second)
- (3) Low battery check setting
- (4) RTC data renewal timing setting

#### (1) Date Setting

This parameter is to set the Year, Month, and Day, in order. When “<8>RTC SET” appears, press the **[PAUSE]** key.

<8>RTC SET  
DATE 05/01/01

Press the **[PAUSE]** key to set the date.

**NOTE:**  
Use the **[FEED]** or **[RESTART]** key to set the value.

<8>RTC SET  
DATE Y 06/01/01

↓  
**[PAUSE]**

Year

<8>RTC SET  
DATE M 06/03/01

↓  
**[PAUSE]**

Month

<8>RTC SET  
DATE D 06/03/01

Day

After selecting the date, press the **[PAUSE]** key.

#### (2) Time Setting

This parameter is to set the Hour, Minute, and Second, in order.

<8>RTC SET  
TIME 00/00/00

Press the **[PAUSE]** key to set the time.

<8>RTC SET  
TIME H 10/01/01

↓  
**[PAUSE]**

Hour

<8>RTC SET  
TIME M 10/30/01

↓  
**[PAUSE]**

Minute

<8>RTC SET  
TIME S 10/30/00

Second

After selecting the time, press the **[PAUSE]** key.

**2.7.6 Real Time Clock Setting (3) Low Battery Check Setting (Cont.)**

This parameter is to choose whether to activate the low battery check function or not.

**NOTE:**

1. Be sure to load the battery and set the low battery check function to ON whenever the real time clock is used. If the battery is not loaded or the battery voltage is low, the real time clock data is erased at the power off time.
2. When the low battery check function is set to ON and if the battery voltage is 1.9V or less, the printer will result in a "LOW BATTERY" error and stop at the power on time. As a restart is invalidated in this case, hold down the [RESTART] key to cause the printer to enter <1>RESET mode, access the Real Time Clock setting mode, and set the low battery function to OFF.

<8>RTC SET  
LOW BATT. CHECK

Press the [PAUSE] key to set.

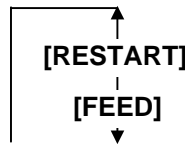

LOW BATT. ON

Low battery check is activated.

LOW BATT. OFF

Low battery check is not activated.

After selecting the low battery check, press the [PAUSE] key.

**(4) RTC Data Renewal Timing Setting**

This parameter is to choose the RTC data renewal timing.

<8>RTC SET  
RENEWAL

Press the [PAUSE] key to set.

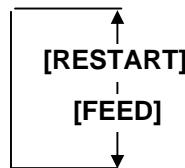

RENEWAL BATCH

Batch print is possible. However, the same time is printed on the all media issued in a batch because the real time clock data is read only for the first media.

RENEWAL PAGE

A real time can be printed on each media. However, the printer needs to stop the motion before printing each media to read the real time clock data.

After selecting the RTC data renewal timing, press the [PAUSE] key. The current date is displayed.

<8>RTC SET  
DATE 06/03/01

Press the [FEED] and [RESTART] keys at the same time to return to the <8>RTC SET display.

<8>RTC SET

### 2.7.7 IP Address Setting (TCP/IP)

When the printer is connected to a PC through TCP/IP by using a LAN cable, it is necessary to set an IP address in the System Mode for system administrators.

The System Mode for system administrators consists of the following menus.

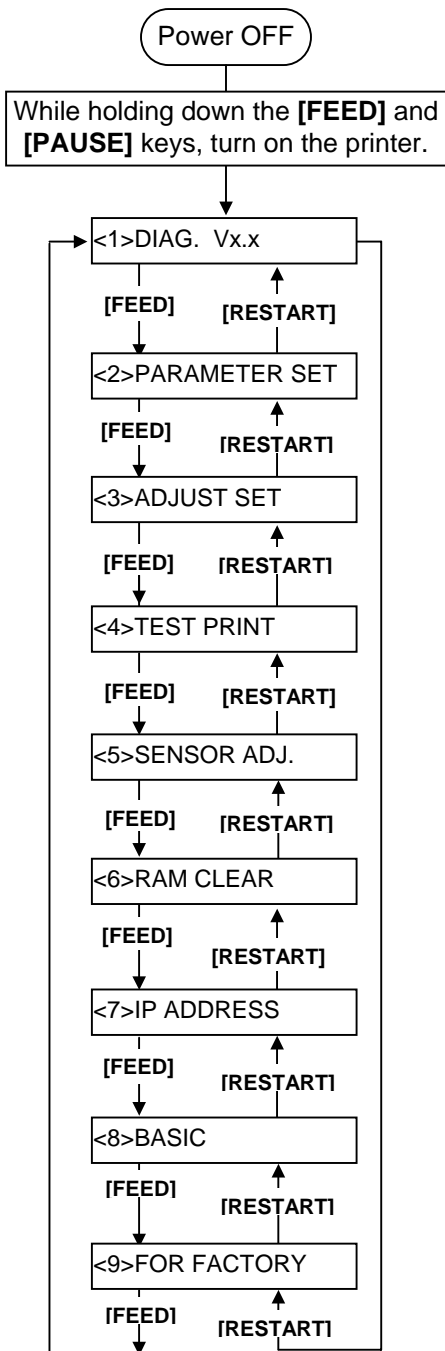

- <1>DIAG. Vx.x
This menu is used to check and print the printer system information and maintenance counter status.
- <2>PARAMETER SET
This menu is used to set the printer parameters.
- <3>ADJUST SET
This menu is used to make a fine adjustment of a print start position, cut position, etc.
- <4>TEST PRINT
This menu is used to perform print tests.
- <5>SENSOR ADJ.
This menu is used to check the sensor statuses and adjust each sensor.
- <6>RAM CLEAR
This menu is used to perform a RAM clear. DO NOT USE this menu.
- <7>IP ADDRESS
This menu is used to set an IP address.
- <8>BASIC
This menu is used to enable the printer to use Basic program.
- <9>FOR FACTORY
This menu is intended for an in-process inspection. Do not use this menu.

**2.7.7 IP Address Setting (TCP/IP) (Cont.)**

In this section, how to set the IP address is described. First, you need to access the System Mode for system administrators.

1. While holding down the **[FEED]** and **[PAUSE]** keys, turn on the printer.
2. When “<1>DIAG” appears on the LCD Message Display, release the **[FEED]** and **[PAUSE]** keys.

Now, the printer is in the System Mode for system administrators.

3. Press the **[FEED]** or **[RESTART]** key until “<7>IP ADDRESS” appears on the LCD Message Display.
4. Press the **[PAUSE]** key to enter the IP Address Setting Mode.

The IP Address Setting Mode contains the following sub menus. To enter each sub menu, press the **[PAUSE]** key.

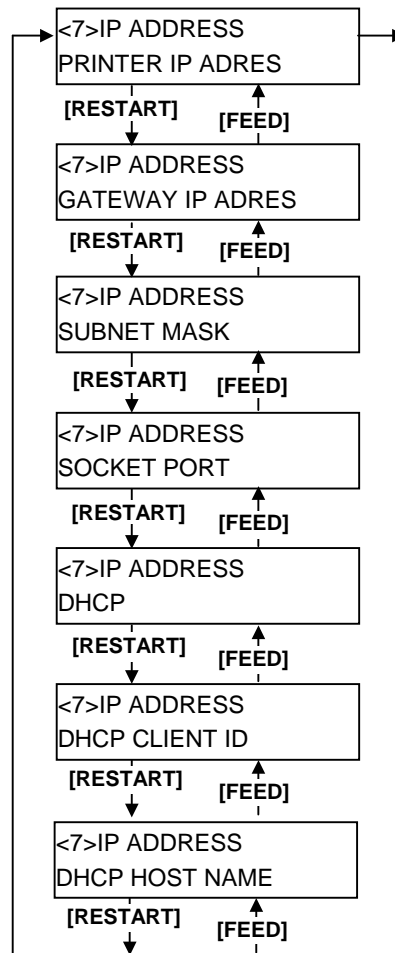

**2.7.7 IP Address Setting (TCP/IP) (Cont.)**

- NOTES:**
1. Set each 3-digit value by using the **[RESTART]** or **[FEED]** key.  
**[RESTART]** key: Increment  
**[FEED]** key: Decrement  
 Range: 0 to 255
  2. Press the **[PAUSE]** key to move the cursor to the next 3-digit value.
  3. After the last 3-digit value is set, press the **[PAUSE]** key to go to Gateway IP Address Setting.

**(1) Printer IP Address**

This parameter is to set an IP address.

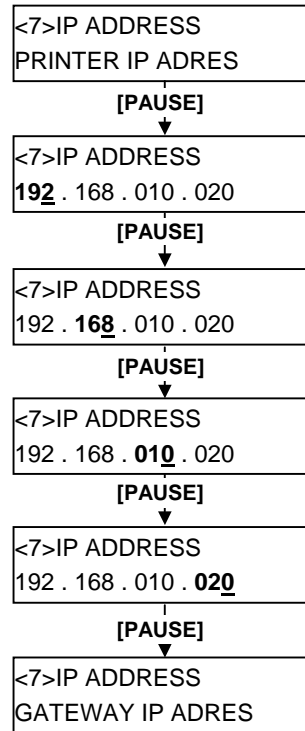

**(2) Gateway IP Address**

This parameter is to set a Gateway IP address.

**NOTE:**  
 After the last 3-digit value is set, press the **[PAUSE]** key to go to Subnet Mask Setting.

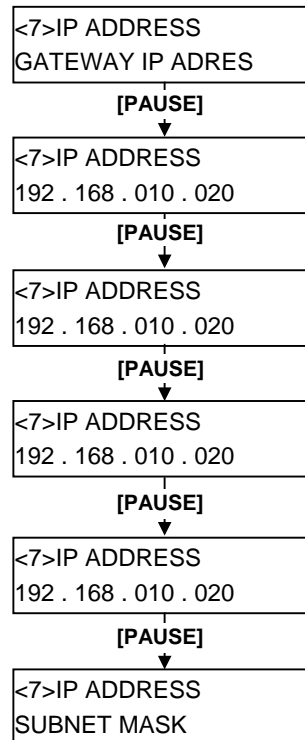

**2.7.7 IP Address Setting (TCP/IP) (Cont.)**

**NOTE:**  
After the last 3-digit value is set, press the **[PAUSE]** key to go to Socket Port Setting.

**(3) Subnet Mask**

This parameter is to set a Subnet Mask.

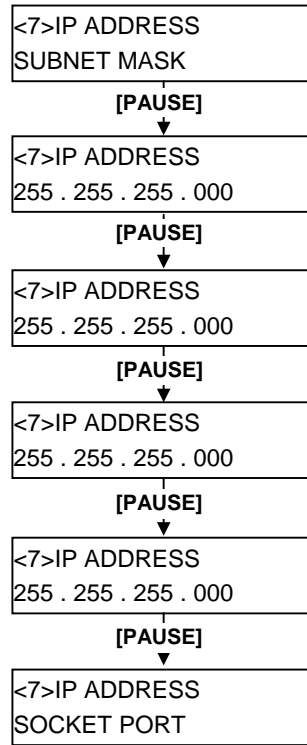

**(4) Socket Port**

This parameter is to enable a socket port and set a socket number.

**NOTES:**

1. Pressing the **[PAUSE]** key while "PORT ON 08000" is displayed allows you to set the port number.
2. Set a number for each digit by using the **[RESTART]** or **[FEED]** key.  
**[RESTART]** key: Increment  
**[FEED]** key: Decrement  
Range: 00000 to 65535  
A number exceeding 65535 will be automatically corrected to 65535.
3. Be careful not to set the same port number that other applications are using.
4. Press the **[PAUSE]** key to move the cursor to the next digit.
5. After the last digit is set, press the **[PAUSE]** key to go to DHCP Setting.

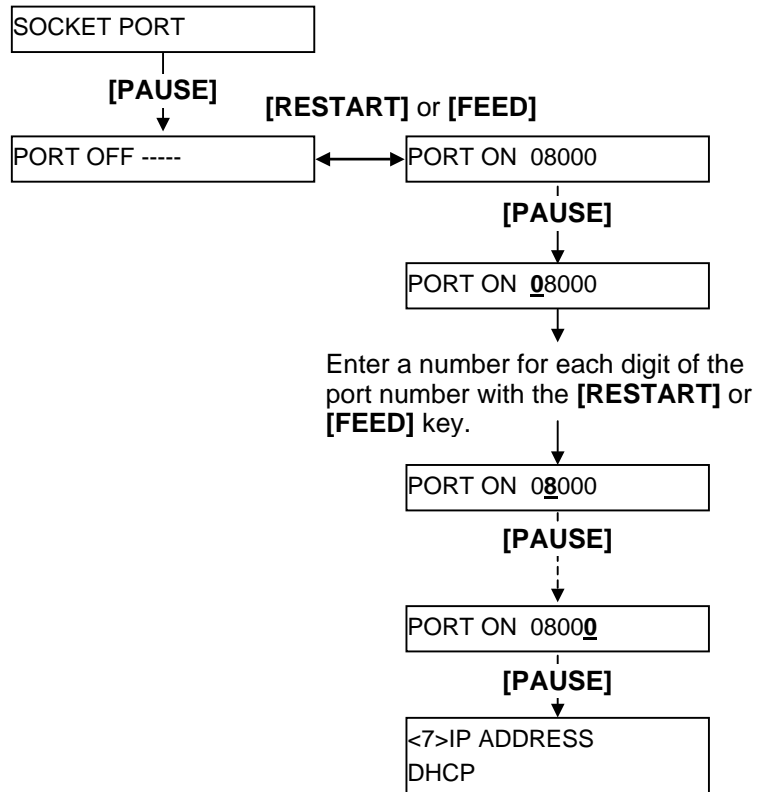



**2.7.7 IP Address Setting (TCP/IP) (Cont.)**

**NOTE:**  
Pressing the **[PAUSE]** key while "DHCP ON" is displayed allows you to set a DHCP client ID.

**(5) DHCP**

This parameter is to enable DHCP.

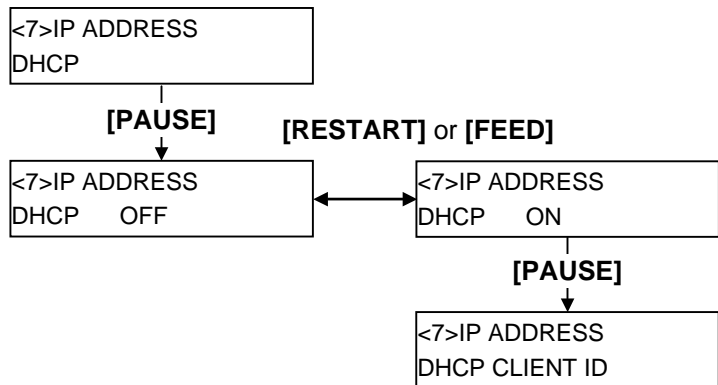

**(6) DHCP Client ID**

This parameter is to set a DHCP client ID.

**NOTES:**

- Code used to enter a DHCP client ID is selectable between ASCII code (alphanumeric) and Hex code.
- Set a character or value for each byte by using the **[RESTART]** or **[FEED]** key. **[RESTART]** key: Increment **[FEED]** key: Decrement
- Press the **[PAUSE]** key to enter the next byte. Repeat this until 16th byte is entered.
- A DHCP ID can be used to check what IP address is assigned to which client on a DHCP server. If a DHCP ID is not assigned, MAC address of a network device (LAN card or LAN interface board) will be notified to the server as a DHCP ID instead. A DHCP ID is a 16-byte character string. As "FFH" (hex. code) is recognized as a terminator, if the top byte of DHCP ID is "FFH", it is considered that a DHCP ID is not assigned.

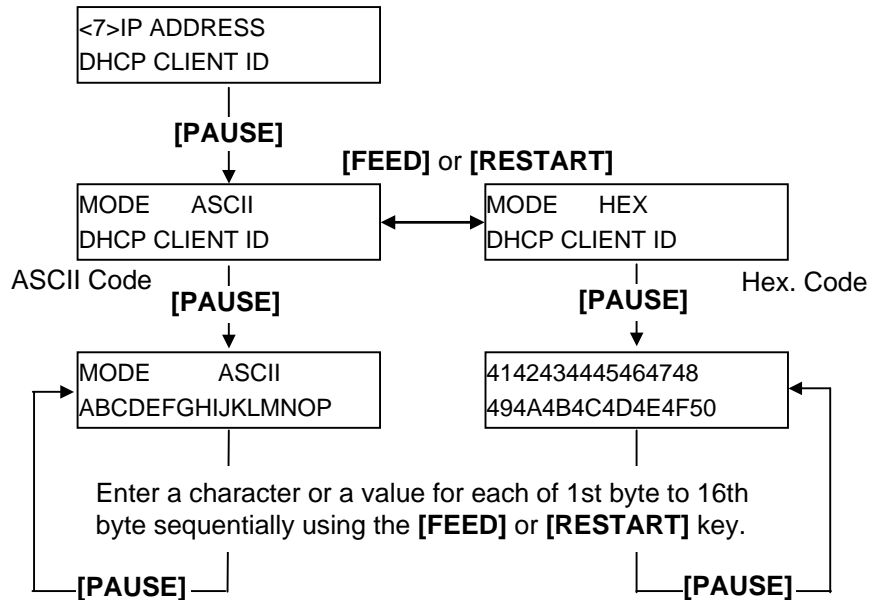

**2.7.7 IP Address Setting (TCP/IP) (Cont.)**

**(7) DHCP Host Name**

This parameter is to set a DHCP host name.

**NOTE:**  
After the 16th byte of the DHCP host name is set, press the [PAUSE] key. At this time, the display will turn to "<7>IP ADDRESS".

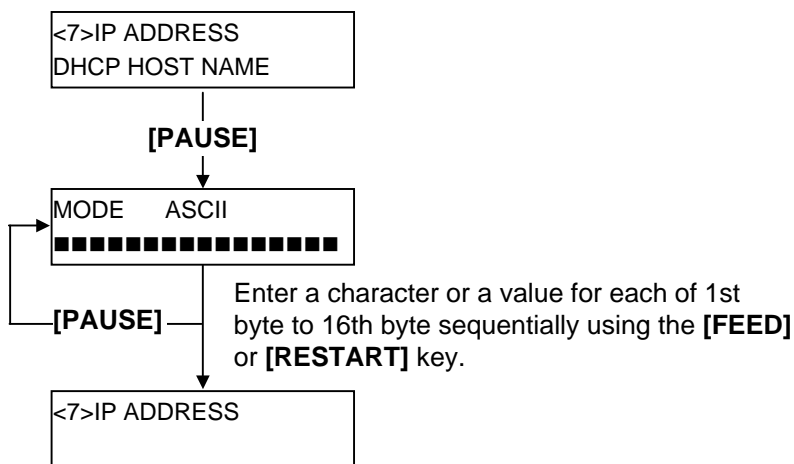

**ASCII code and Hex. code correspondence table**

Upper 4 bits \ Lower 4 bits	2	3	4	5	6	7
0	SP	0	@	P	`	p
1	!	1	A	Q	a	q
2	“	2	B	R	b	r
3	#	3	C	S	c	s
4	\$	4	D	T	d	t
5	%	5	E	U	e	u
6	&	6	F	V	f	v
7	‘	7	G	W	g	w
8	(	8	H	X	h	x
9	)	9	I	Y	i	y
A	*	:	J	Z	j	z
B	+	;	K	[	k	{
C	,	<	L	\	l	
D	-	=	M	]	m	}
E	.	>	N	^	n	/
F	/	?	O	_	o	/

SP = Space

**(Example)** To enter “TOSHIBA” in Hex. code:

54 4F 53 48 49 42 41

When the system mode settings have been completed, turn off the printer.

## 2.8 Installing the Printer Drivers

### 2.8.1 Introduction

This manual describes how to install the TOSHIBA printer driver for the TOSHIBA bar code printer on your Windows host computer; install and delete the printer driver, the procedure for adding the LAN port, cautions and limitations.

The examples provided here illustrate the procedure for installing the printer driver version V7.0 for the B-SA4T series.

### 2.8.2 General Description

#### (1) Features

Once you install the TOSHIBA printer driver on your Windows host computer, you can use the TOSHIBA bar code printer, as well as the easy-to-use general printers.

You can use this printer by connecting a parallel interface cable (printer cable), a USB cable, or a LAN cable to your host computer.

#### (2) System Requirements

To install the TOSHIBA printer driver on your host computer, the following system and environment are required:

- Operating system: Windows 98, Windows Me, Windows 2000, Windows XP
- Hardware: A DOS-/V (IBM PC/AT compatible) machine running an above operating system.
- Interface:
  - Parallel interface conforming to the IEEE1284 standard
  - USB interface
  - LAN interface

### 2.8.3 Installing the Printer Driver

The installation procedure differs depending on the interface connected to the printer and the operation system you are using. Please install the printer driver by performing the appropriate procedure.

If the previous version of the printer driver has been installed on your host computer, be sure to uninstall it before you install this printer driver. (Refer to **Section 2.8.4 Uninstalling the Printer Driver**.)

To print via your network, please install the printer driver by performing the installation procedure for the parallel interface, and also perform the following:

1. In the procedure, select "LPT1" for the port.
2. After installation of the printer driver is completed, add the LAN port by referring to **Section 2.8.5 Adding/Deleting a LAN Port**, and specify the LAN port.

#### (1) Parallel Interface

To use the parallel interface, the following settings are required, after installing the printer driver:

For Windows 98/Me: Open the printer properties. Select the "Details" tab and click on the **[Spool Settings...]** button. The "Spool Settings" dialog box is displayed. Select "Disable bi-directional support for this printer".

For Windows 2000/XP: Open the printer properties and select the "Ports" tab. Mark off the "Enable bidirectional support" checkbox.

**NOTE:**

*In case of the B-SX4T or B-SX5T series, make sure that the Centronics interface type is set to SPP (default).*

<b>Windows 98/Me</b>
----------------------

- (1) Select “Settings” – “Printers” from the “Start” menu to open the printer folder.
- (2) Double-click on the “Add Printer” icon. The Add Printer Wizard runs. Click on the **[Next]** button.
- (3) Select “Local printer”, then click on the **[Next]** button. The screen listing “Manufacturers and Printers” is displayed.
- (4) Click on the **[Have Disk...]** button. The “Install From Disk” dialog box is displayed. Specify the “\driver” folder in the CD-ROM drive, then click on the **[OK]** button.

**NOTE:**

The latest printer driver is available from the web site.

(<http://www.toshibatec-ris.com/products/barcode/download/index.html>)

- (5) Select the printer to be installed from “Printers” list, then click on the **[Next]** button.

Driver name	Model	Driver name	Model	Driver name	Model
TEC B-372	B-372-QP	TEC B-415	B-415-GH24-QM B-415-GH25-QM	TEC B-419	B-419-GS10-QQ B-419-GS12-QP B-419-GS12-CN
TEC B-431	B-431-GS10-QP B-431-GS10-CN	TEC B-452	B-452-TS10-QQ B-452-TS10-QQ-US B-452-TS11-QQ-PAC B-452-TS12-QP B-452-TS12-QP-PAC B-452-TS12-CN	TEC B-452H	B-452-HS12-QQ B-452-HS12-QQ-US B-452-HS12-QP B-452-HS12-CN
TEC B-472	B-472-QQ B-472-QQ-US B-472-GH12-QQ B-472-QP	TEC B-472-CN	B-472-GH12-CN B-472-GH14-CN	TEC B-482	B-482-TS10-QQ B-482-TS10-QQ-US B-482-TS10-QP
TEC B-492	B-492L-TH10-QQ B-492R-TH10-QQ B-492L-TH10-QP B-492R-TH10-QP	TEC B-572	B-572-QQ B-572-QQ-US B-572-QP	TEC B-672	B-672-QQ B-672-QQ-US B-672-QP
TEC B-682	B-682-TS10-QQ B-682-TS10-QQ-US B-682-TS10-QP	TEC B-852	B-852-TS12-QQ B-852-TS12-QQ-US B-852-TS12-QP	TEC B-852-R	B-852-TS22-QQ-R B-852-TS22-QP-R
TEC B-872	B-872-QQ B-872-QQ-US B-872-QP	TEC B-882	B-882-TS10-QQ B-882-TS10-QQ-US B-882-TS10-QP	TEC B-SA4G	B-SA4TM-GS12-QM-R B-SA4TP-GS12-QM-R
TEC B-SA4T	B-SA4TM-TS12-QM-R B-SA4TP-TS12-QM-R	TEC B-SA4T-CN	B-SA4TM-TS12-CN B-SA4TP-TS12-CN	TEC B-SP2D	B-SP2D-GH20-QM B-SP2D-GH30-QM B-SP2D-GH30-QM B-SP2D-GH20-QM-R B-SP2D-GH30-QM-R B-SP2D-GH30-QM-R
TEC B-SV4	B-SV4D-GS10-QM B-SV4D-GH10-QM B-SV4D-GS10-QM-R B-SV4D-GH10-QM-R	TEC B-SX4	B-SX4T-GS10-QQ B-SX4T-GS10-QQ-US B-SX4T-GS10-QP B-SX4T-GS20-QQ B-SX4T-GS20-QQ-US B-SX4T-GS20-QP B-SX4T-GS20-QM-R	TEC B-SX4-CN	B-SX4T-GS10-CN B-SX4T-GS20-CN
TEC B-SX5	B-SX5T-TS12-QQ B-SX5T-TS12-QQ-US B-SX5T-TS12-QP B-SX5T-TS22-QQ B-SX5T-TS22-QQ-US B-SX5T-TS22-QP B-SX5T-TS22-QM-R	TEC B-SX5-CN	B-SX5T-TS12-CN B-SX5T-TS22-CN	TEC B-SX6T-R	B-SX6T-TS12-QM-R
TEC B-SX8T-R	B-SX8T-TS12-QM-R	TEC CB-416-T3	CB-416-T3-QQ CB-416-T3-QQ-US CB-416-T3-QP	TEC CB-426-T3	CB-426-T3-QQ CB-426-T3-QQ-US CB-426-T3-QP

- (6) The screen to select the existing installed printer driver or use the new one, is displayed. Select “Replace existing driver”, then click on the **[Next]** button. If you install the printer driver for the first time, this screen is not displayed.
- (7) Select the port to be used for printing from the “Available ports” list, then click on the **[Next]** button.
- (8) Change the printer name if necessary, and select whether or not you use the printer as the default printer (“Yes” or “No”). Click on the **[Finish]** button.
- (9) The printer driver is installed. When installation is completed, the new printer icon is added in the “Printers” folder.

**Windows 2000/XP**

- (1) Log on to your host computer as a member who has full control access privilege concerning the printer settings.
- (2) Select “Settings” – “Printers” from the “Start” menu to open the printer folder.
- (3) Double-click on the “Add Printer” icon. The Add Printer Wizard runs. Click on the **[Next]** button.
- (4) Select “Local printer”. Mark off the “Automatically detect and install my Plug and Play printer” checkbox, then click on the **[Next]** button.
- (5) Select the port to be used for printing from the “Available ports” list, then click on the **[Next]** button.
- (6) On the screen listing “Manufacturers and Printers”, click on the **[Have Disk...]** button. The “Install From Disk” dialog box is displayed.
- (7) Specify the “\driver” folder in the CD-ROM drive, then click on the **[OK]** button.

**NOTE:**

The latest printer driver is available from the web site.

(<http://www.toshibatec-ris.com/products/barcode/download/index.html>)

- (8) Select the printer to be installed from “Printers” list, then click on the **[Next]** button.

Driver name	Model	Driver name	Model	Driver name	Model
TEC B-372	B-372-QP	TEC B-415	B-415-GH24-QM B-415-GH25-QM	TEC B-419	B-419-GS10-QQ B-419-GS12-QP B-419-GS12-CN
TEC B-431	B-431-GS10-QP B-431-GS10-CN	TEC B-452	B-452-TS10-QQ B-452-TS10-QQ-US B-452-TS11-QQ-PAC B-452-TS12-QP B-452-TS12-QP-PAC B-452-TS12-CN	TEC B-452H	B-452-HS12-QQ B-452-HS12-QQ-US B-452-HS12-QP B-452-HS12-CN
TEC B-472	B-472-QQ B-472-QQ-US B-472-GH12-QQ B-472-QP	TEC B-472-CN	B-472-GH12-CN B-472-GH14-CN	TEC B-482	B-482-TS10-QQ B-482-TS10-QQ-US B-482-TS10-QP
TEC B-492	B-492L-TH10-QQ B-492R-TH10-QQ B-492L-TH10-QP B-492R-TH10-QP	TEC B-572	B-572-QQ B-572-QQ-US B-572-QP	TEC B-672	B-672-QQ B-672-QQ-US B-672-QP
TEC B-682	B-682-TS10-QQ B-682-TS10-QQ-US B-682-TS10-QP	TEC B-852	B-852-TS12-QQ B-852-TS12-QQ-US B-852-TS12-QP	TEC B-852-R	B-852-TS22-QQ-R B-852-TS22-QP-R
TEC B-872	B-872-QQ B-872-QQ-US B-872-QP	TEC B-882	B-882-TS10-QQ B-882-TS10-QQ-US B-882-TS10-QP	TEC B-SA4G	B-SA4TM-GS12-QM-R B-SA4TP-GS12-QM-R
TEC B-SA4T	B-SA4TM-TS12-QM-R B-SA4TP-TS12-QM-R	TEC B-SA4T-CN	B-SA4TM-TS12-CN B-SA4TP-TS12-CN	TEC B-SP2D	B-SP2D-GH20-QM B-SP2D-GH30-QM B-SP2D-GH30-QM B-SP2D-GH20-QM-R B-SP2D-GH30-QM-R B-SP2D-GH30-QM-R
TEC B-SV4	B-SV4D-GS10-QM B-SV4D-GH10-QM B-SV4D-GS10-QM-R B-SV4D-GH10-QM-R	TEC B-SX4	B-SX4T-GS10-QQ B-SX4T-GS10-QQ-US B-SX4T-GS10-QP B-SX4T-GS20-QQ B-SX4T-GS20-QQ-US B-SX4T-GS20-QP B-SX4T-GS20-QM-R	TEC B-SX4-CN	B-SX4T-GS10-CN B-SX4T-GS20-CN
TEC B-SX5	B-SX5T-TS12-QQ B-SX5T-TS12-QQ-US B-SX5T-TS12-QP B-SX5T-TS22-QQ B-SX5T-TS22-QQ-US B-SX5T-TS22-QP B-SX5T-TS22-QM-R	TEC B-SX5-CN	B-SX5T-TS12-CN B-SX5T-TS22-CN	TEC B-SX6T-R	B-SX6T-TS12-QM-R
TEC B-SX8T-R	B-SX8T-TS12-QM-R	TEC CB-416-T3	CB-416-T3-QQ CB-416-T3-QQ-US CB-416-T3-QP	TEC CB-426-T3	CB-426-T3-QQ CB-426-T3-QQ-US CB-426-T3-QP

- (9) The “Use Existing Driver” screen is displayed. Select “Replace existing driver”, then click on the **[Next]** button. If you install the printer driver for the first time, this screen is not displayed.
- (10) Change the printer name if necessary, and select whether or not you use the printer as the default printer (“Yes” or “No”). Click on the **[Next]** button.
- (11) Select whether or not the printer will be shared with other network users (“Shared” or “Not shared”). Click on the **[Next]** button.
- (12) Select whether or not the test page will be printed (“Yes” or “No”), then click on the **[Finish]** button.
- (13) If the “Digital Signature Not Found” screen is displayed, click on the **[Yes]** button.
- (14) When the “Completing the Add Printer Wizard” screen is displayed, click on the **[Finish]** button.
- (15) When installation is completed, the new printer icon is added in the “Printers” folder.

## (2) USB INTERFACE

Installation starts by the operating system's plug-and-play function.

### Windows 98/Me

- (1) Turn the printer ON, then connect it to your host computer with the USB cable.  
The "New Hardware Found" dialog box is displayed, and "USB Device" is detected.

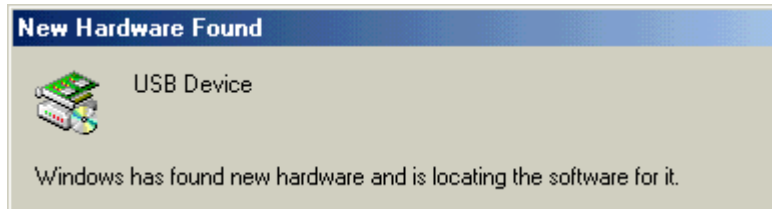

- (2) After a while, the "Add New Hardware Wizard" dialog box is displayed. Select "Specify the location of the driver (Advanced)", then click on the **[Next]** button.





- (3) Select “Search for the best driver for your device. (Recommended)”  
Mark the “Specify a location” checkbox, then click on the **[Browse]** button.  
Specify “\driver” folder, then click on the **[Next]** button.

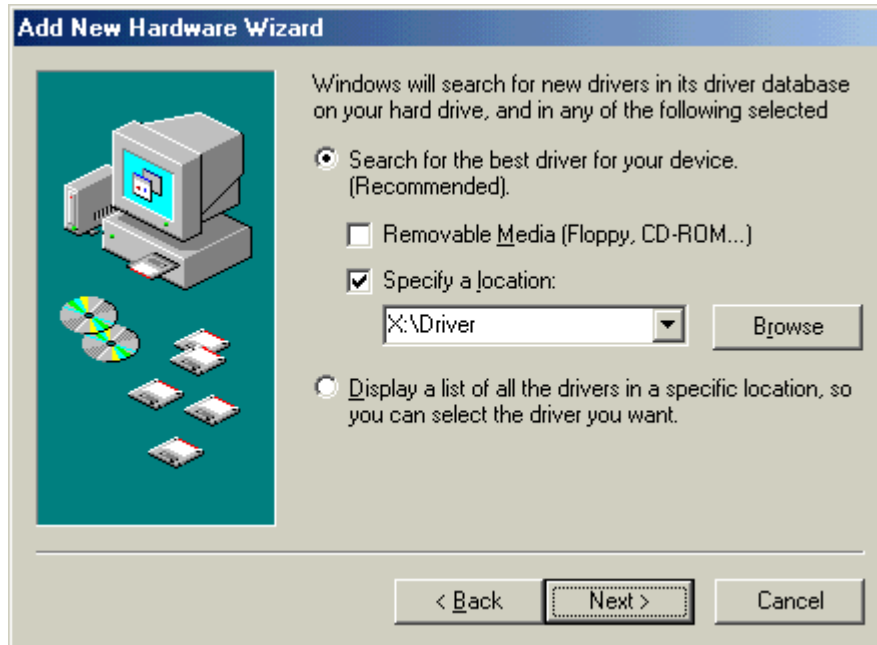

- (5) When the screen which indicates the USB Printing Support driver has been installed, is displayed, click on the **[Finish]** button.



- (6) After a while, “TEC B-SA4T” is detected as a new hardware.

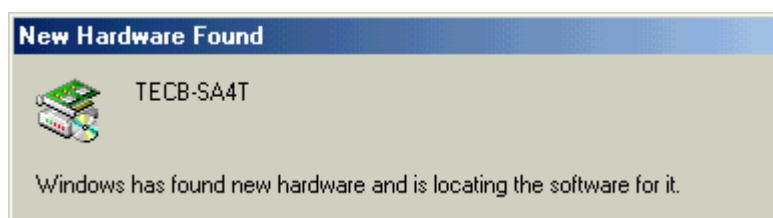

- (7) The “Add New Hardware Wizard” dialog box is displayed. Select “Specify the location of the driver (Advanced)”, then click on the **[Next]** button.



- (8) Select “Search for the best driver for your device. (Recommended)”  
Mark the “Specify a location” checkbox, then click on the **[Browse]** button.  
Specify “\driver” folder, then click on the **[Next]** button.



- (9) Check to see that the “TEC B-SA4T” driver is detected, then click on the **[Next]** button.

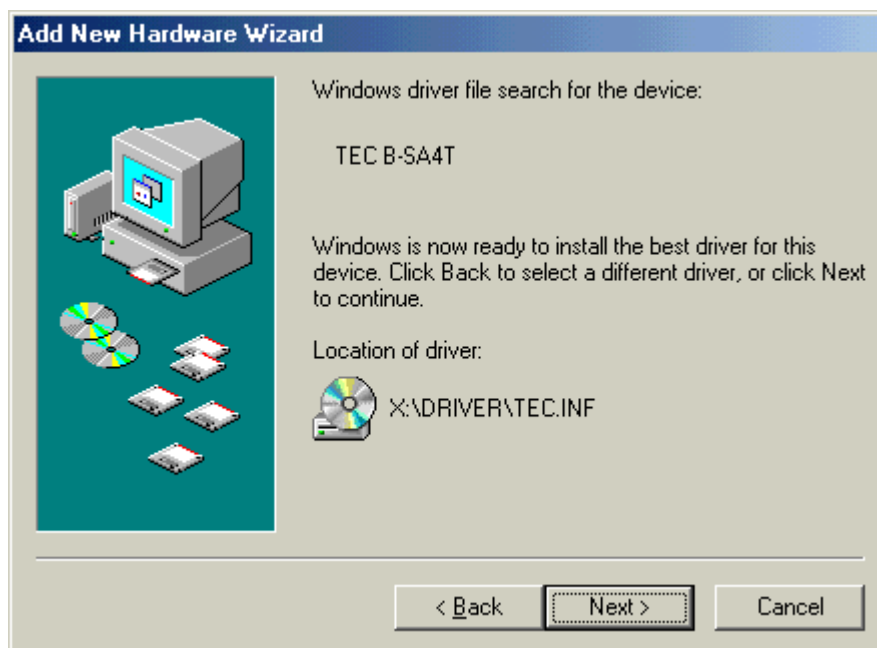

- (10) Change the printer name if necessary, and select whether or not you use the printer as the default printer (“Yes” or “No”). Click on the **[Finish]** button.

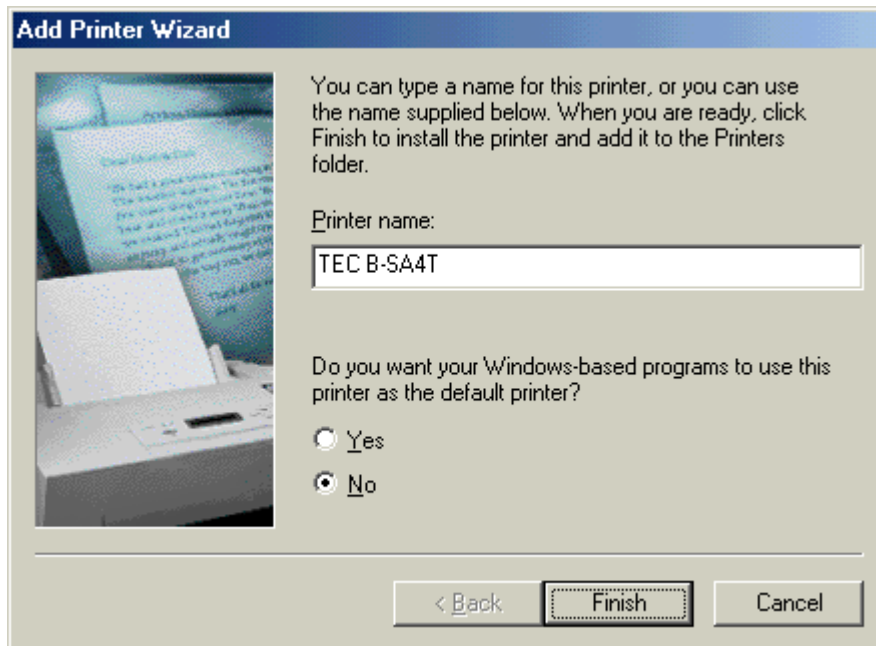

- (11) When the screen, which indicates TEC B-SA4T has been installed, is displayed, click on the **[Finish]** button.



- (12) When installation is completed, the new printer icon is added in the “Printers” folder.

**Windows 2000/XP****NOTE:**

*When plug-and-play printer installation in progress is stopped, be sure to delete the printer detected and displayed on the “Device Manager” tab of the “System Properties” dialog box.*

- (1) Log on to your host computer as a member who has full control access privilege concerning the printer settings.
- (2) Turn the printer ON, then connect it to your host computer with the USB cable.
- (3) “USB Device” is automatically detected, and “USB Printing Support” is automatically installed.
- (4) After a while, for Windows XP, “TEC B-SA4T” is detected as a new device.  
For Windows 2000, “Unknown” device is detected as a new device. In both cases, perform the following steps, though dialog boxes for Windows XP are used.
- (5) The “Found New Hardware Wizard” dialog box is displayed.  
Select “No, not this time”, then click on the **[Next]** button.



- (6) Select “Install from a list or specific location (Advanced)”, then click on the **[Next]** button.

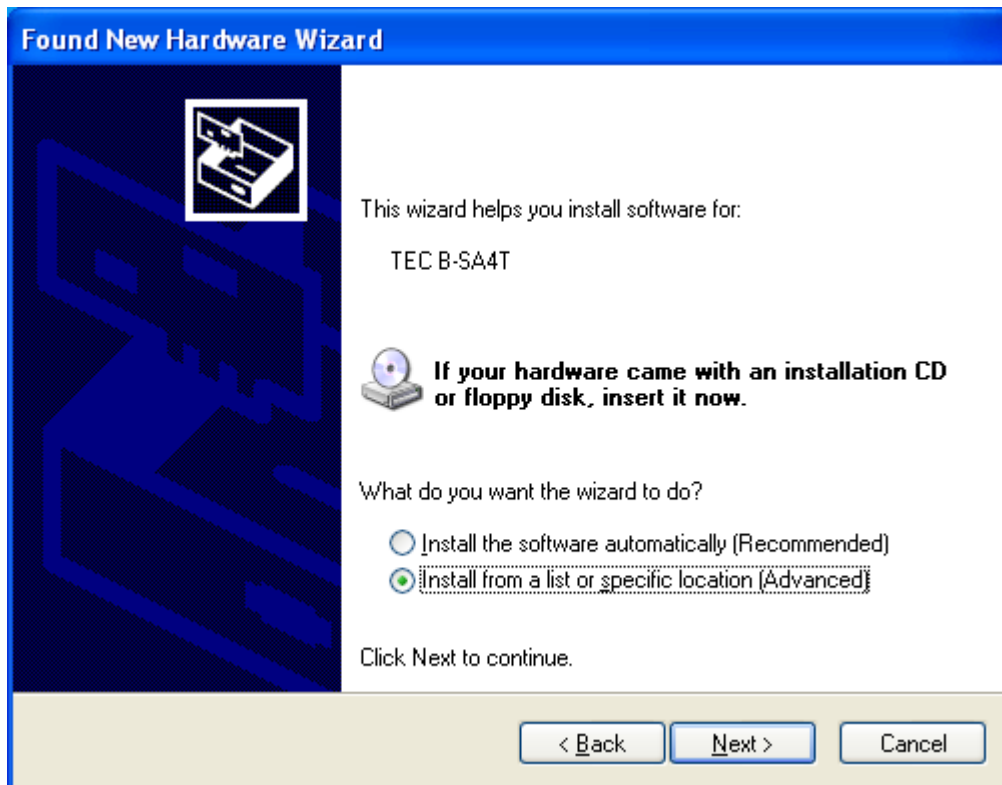

- (7) Select “Search for the best driver in these locations”. Mark the “Include this location in the search” checkbox, then click on the **[Browse]** button. Specify the “\driver” folder in the CD-ROM, then click on the **[Next]** button.

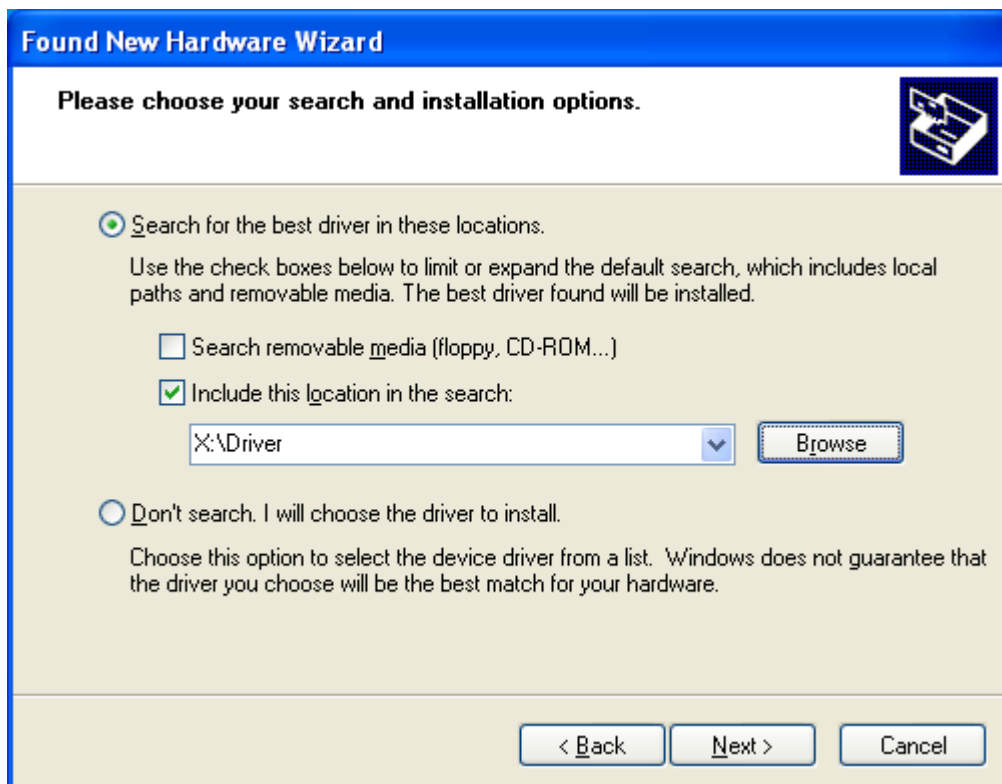

- (8) When the dialog box below is displayed, click on the **[Continue Anyway]** button.



- (9) When the "Completing the Found New Hardware Wizard" screen is displayed, click on the **[Finish]** button.

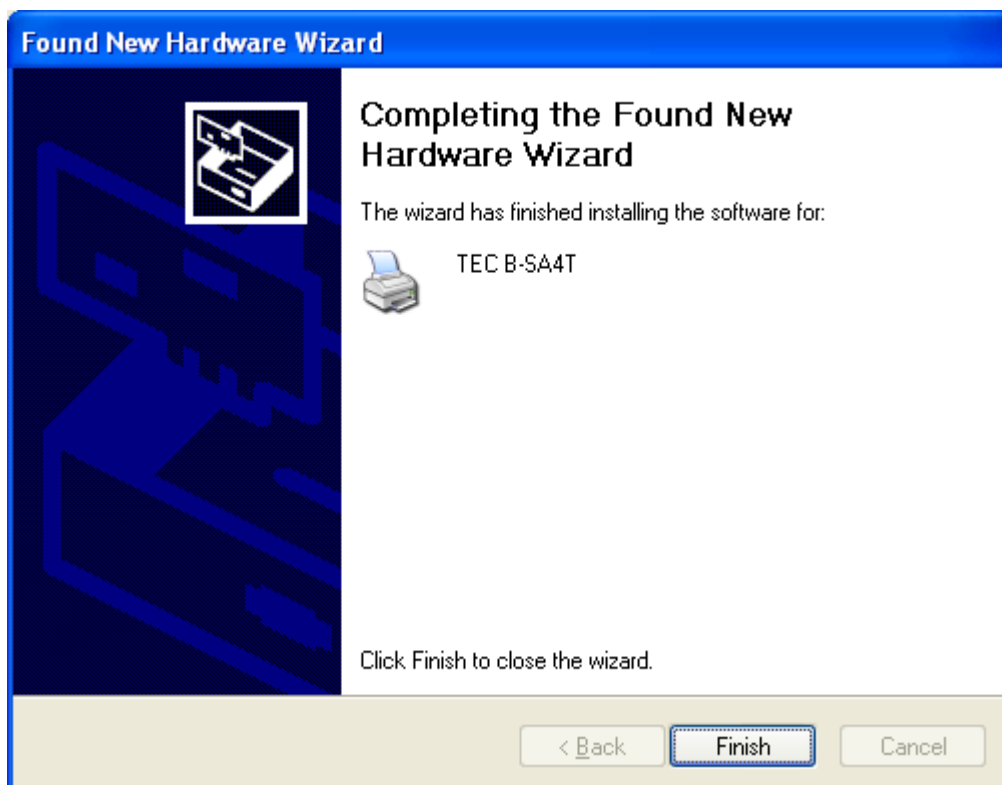

- (10) When installation is completed, the new printer icon is added in the "Printers" folder.

### 2.8.4 Uninstalling the Printer Driver

**NOTE:**

*Before uninstalling the printer driver, be sure to complete all of printing, the status monitor, and properties settings.*

**Windows 98/ME**

- (1) Select “Settings” – “Printers” from the “Start” menu to open the printer folder.
- (2) Right-click on the printer driver icon to be deleted, then select “Delete”. The confirmation message is displayed.
- (3) Click on the **[Yes]** button to delete.
- (4) After the printer driver icon is deleted, restart your host computer.

**Windows 2000/XP**

- (1) Log on to your host computer as a member who has full control access privilege concerning the printer settings.
- (2) Select “Settings” – “Printers” from the “Start” menu to open the printer folder.
- (3) Right-click on the printer driver icon to be deleted, then select “Delete”. The confirmation message is displayed.
- (4) Click on the **[Yes]** button to delete.
- (5) After the printer icon is deleted, select “Server Properties” from “File” menu of the “Printers” folder.
- (6) Select the printer driver to be deleted, then click on the **[Remove]** button. After the printer driver is deleted, restart your host computer.



### 2.8.5 Adding/Deleting a LAN Port

To use the LAN interface, first, you have to make the following settings in “<7> IP ADDRESS” in the system mode of the printer. (Refer to TOSHIBA TEC support representative.)

- Set the printer IP address (“**PRINTER IP ADRES**”), the gateway IP address (“**GATEWAY IP ADRES**”), and subnet mask (“**SUBNET MASK**”).
- Set the port number (“**SOCKET PORT**”).

Among these settings, the printer IP address and the port number are also required for adding a LAN port.

#### (1) Adding a LAN Port

##### Windows 98/ME

- (1) Right-click on the printer icon. Select “Properties” to open the printer “Properties” dialog box.
- (2) Select the “Details” tab, and click on the **[Add Port...]** button. The “Add Port” dialog box is displayed.
- (3) Select “Other”.  
Select “Seagull Scientific TCP/IP Port” from the list, then click on the **[OK]** button.
- (4) On the “Add Seagull TCP/IP Port” dialog box, enter the name or IP address, the port number, and the port name. For the IP address and the port number, enter the same ones as you have set in “<7> IP ADDRESS” in the system mode of the printer. After entering these, click on the **[OK]** button.

**Add Seagull TCP/IP Port**

TCP/IP Settings

You may specify the printer's location by name or IP address.

A name may be either a name on the local network, such as 'PRINTER6', or a fully-qualified internet name, such as 'printer6.seagullscientific.com'.

IP addresses are specified as four numbers separated by periods, for example, 10.1.2.3.

Name or IP Address:

The port number determines which TCP port is used to communicate with the printer. Most printers use port 9100.

Port Number:

Port Settings

The port name is displayed in the Ports dialog. For example, 'LPT1' is the name of the parallel port. The name generated by default is acceptable.

Port Name:

OK Cancel

- (5) When addition of the port is completed, the port is added to the drop down list for “Print to the following port”.

**Windows 2000/XP**

- (1) Right-click on the printer icon. Select “Properties” to open the printer “Properties” dialog box.
- (2) Select the “Ports” tab, and click on the **[Add Port...]** button. The “Printer Ports” dialog box is displayed.
- (3) Select “Seagull Scientific TCP/IP Port” from the “Available Printer Ports” list, then click on the **[OK]** button.
- (4) On the “Add Seagull TCP/IP Port” dialog box, enter the name or IP address, the port number, and the port name. For the IP address and the port number, enter the same ones as you have set in “<7> **IP ADDRESS**” in the system mode of the printer. After entering these, click on the **[OK]** button.
- (5) When addition of the port is completed, the port is added to the “Print to the following port(s)” list.

**(2) Deleting a LAN Port****NOTE:**

*Before deleting a port, be sure to check if other printers also use it. If there are printers which use the port to be deleted, change their port to another, before deleting the port.*

**Windows 98/ME**

- (1) Right-click on the printer icon. Select “Properties” to open the printer “Properties” dialog box.
- (2) Select the “Details” tab, and click on the **[Delete Port...]** button.
- (3) Select the port to be deleted, then click on the **[OK]** button.
- (4) When deletion of the port is completed, the port is also deleted from the “Print to the following port” list.

**Windows 2000/XP**

- (1) Right-click on the printer icon. Select “Properties” to open the printer “Properties” dialog box.
- (2) On the “Ports” tab, select the port to be deleted, then click on the **[Delete Port]** button.
- (3) When deletion of the port is completed, the port is also deleted from the “Print to the following port(s)” list.

## 2.8.6 Cautions

### (1) Printer Driver Upgrades

- To upgrade the printer driver to this version, uninstall the previous version of the printer driver, before installing this printer driver.
- Be sure to restart your host computer, after you upgrade the printer driver.
- When your operating system is Windows 98, or Windows Me, be sure to restart your host computer, after you uninstall the previous version of the printer driver. Or, the printer driver is not upgraded properly.

### (2) Others

- If your operating system is Windows 2000 or Windows XP, when plug-and-play printer installation in progress is stopped, be sure to delete the printer detected and displayed on the “Device Manager” tab of the “System Properties” dialog box.
- Before uninstalling the printer driver, be sure to complete all of printing, the status monitor, and properties settings.
- Before deleting a port, be sure to check if other printers also use it. If there are printers which use the port to be deleted, change their port to another, before deleting the port.

### 2.8.7 Using the Printer Driver

For how to use the Printer Driver, please refer to the Help for Windows Printer Drivers screen.

- 1) Open the Properties screen of the Printer Driver.
- 2) Clicking on the **About** tab causes the following screen to appear.  
Click on the **[Help]** button.

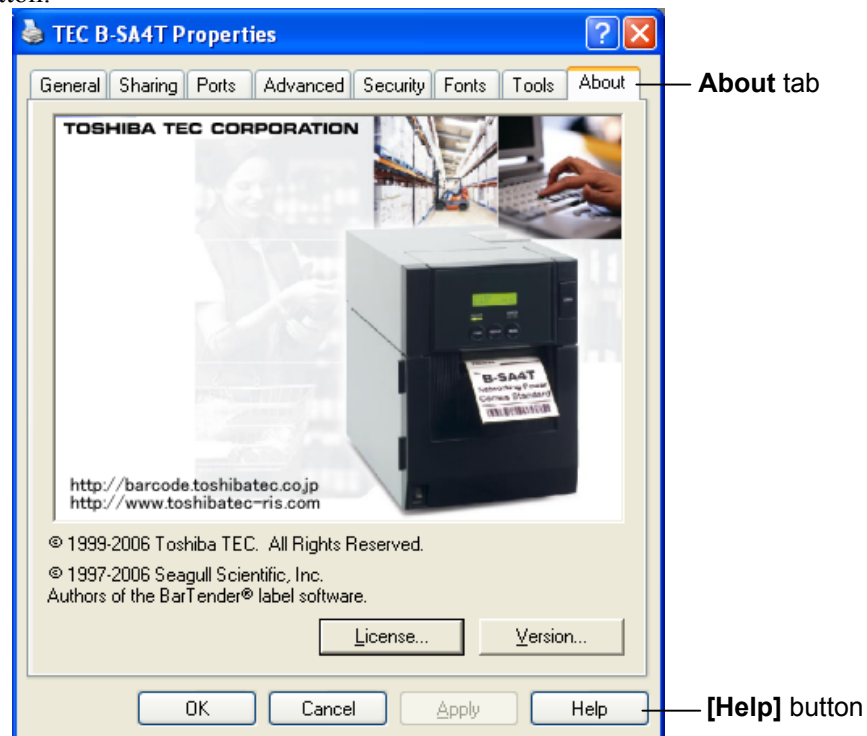

- 3) The Help for Windows Printer Drivers screen appears. This screen will provide how to use the printer driver.

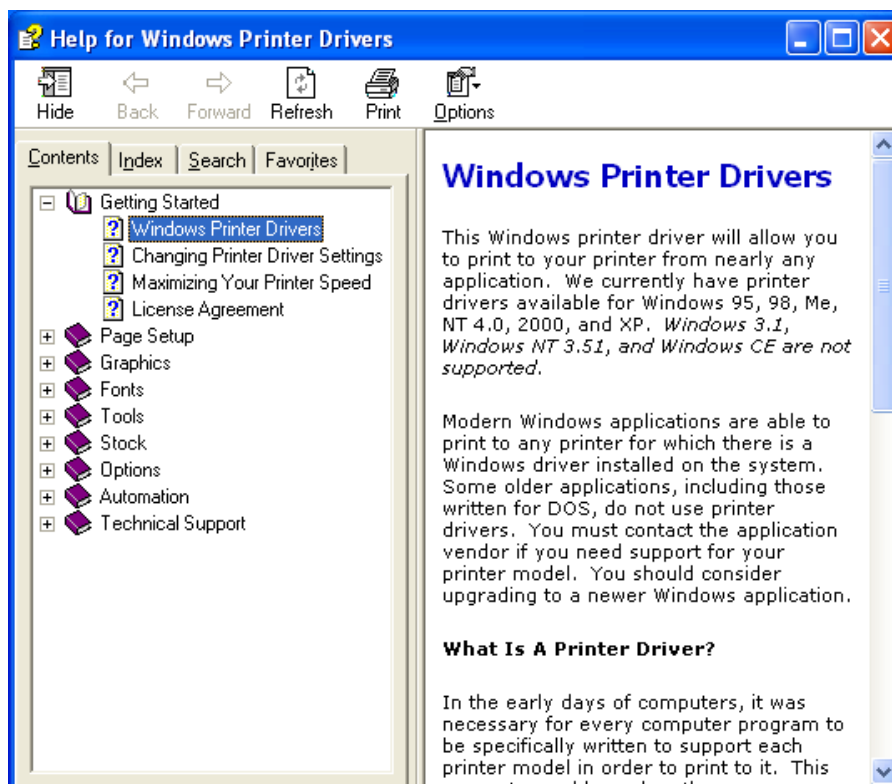

## 2.9 Print Test

After your operating environment has been set, perform a print test.

### 1. Perform a print test by using the Printer Driver or an Issue Command.

The printer driver's Properties screen allows you to set the communication conditions, media size, and other printing conditions in accordance with your operating environment. For details, refer to the **Help for the Windows Printer Drivers** screen.

Example: Stock tab display of the Printer Driver's Properties Screen

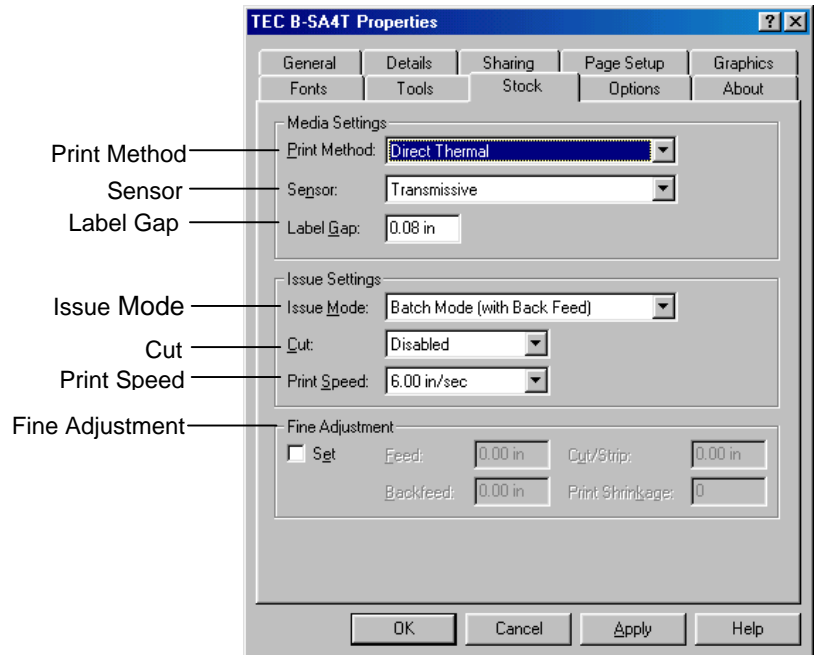

- |                  |   |
|------------------|---|
| Print Method:    | Direct thermal or thermal transfer is selectable.                           |
| Sensor:          | Media sensor type is selectable.  |
| Issue Mode:      | Batch or strip is selectable.   |
| Cut:             | Whether to use the cutter or not is selectable.                             |
| Fine Adjustment: | Adjustment values for the feed amount, cut/strip position, etc. can be set. |

### 2. Confirm the print test result.

- When a print start position, cut/strip position, or print tone needs to be adjusted: ⇒ **Section 2.10 Position and Print Tone Fine Adjustment**
- When pre-printed media is used, and if a print start position is not properly detected: ⇒ **Section 2.11 Threshold Setting**

## 2.9 Print Test (Cont.)

### When using an optional Cutter Module or Strip Module

It is necessary to set the issue mode, cut/strip position, etc. for the Printer Driver or TPCL (TEC Printer Command Language) in accordance with your printing condition.

For details of the TPCL, refer to the **B-SA4T Series External Equipment Interface Specification** stored in the CD-ROM.

Regarding how to use the Printer Driver, refer to the **Help for the Windows Printer Drivers** screen.

To gain maximum performance and life from the Cutter Module or Strip Module, periodic cleaning is required.

Before starting a cleaning, be sure to TURN OFF the printer to avoid risk of injury.

For details of cleaning, refer to **Section 4.1.3 Optional Cutter Module** or **Section 4.1.4 Optional Strip Module**.

## 2.10 Position and Print Tone Fine Adjustment

This section describes how to fine adjust a print start position, cut/strip position, reverse feed amount, print tone, and ribbon motor torque. When a fine adjustment is required, such as print start position, print tone, etc, follow the procedure below.

1. Turn on the printer and confirm that “ONLINE” appears on the LCD Message Display.
2. Press the **[PAUSE]** key to pause the printer.
3. Hold down the **[RESTART]** key for three seconds until “<1>RESET” is displayed.
4. Press the **[FEED]** or **[RESTART]** key until “<3>ADJUST SET” appears on the LCD Message Display.
5. When “<3>ADJUST SET.” appears, press the **[PAUSE]** key to enter the Parameter Fine Adjustment Mode.

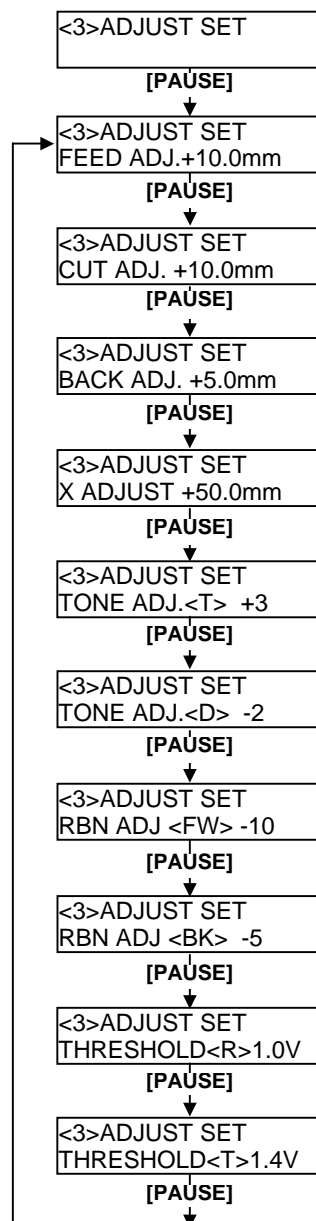

The Parameter Fine Adjustment Mode contains the following sub menus. Each time the **[PAUSE]** key is pressed, the sub menus are displayed sequentially.

### Feed Amount Fine Adjustment:

Feed amount to the print start position is fine adjusted.

### Cut/Strip Position Fine Adjustment:

Cut position or strip position is fine adjusted.

### Reverse Feed Amount Fine Adjustment:

Reverse feed amount is fine adjusted.

### X-coordinate Fine Adjustment:

X-coordinate of a print position is fine adjusted.

### Print Tone Fine Adjustment (Thermal transfer):

Print tone is fine adjusted for thermal transfer mode.

### Print Tone Fine Adjustment (Thermal direct):

Print tone is fine adjusted for thermal direct mode.

### Ribbon Motor Drive Voltage Fine Adjustment (Take-up motor):

Drive voltage of the ribbon take-up motor is fine adjusted.

### Ribbon Motor Drive Voltage Fine Adjustment (Feed motor)

Drive voltage of the ribbon feed motor is fine adjusted.

### Threshold Fine Adjustment (Black mark sensor):

Threshold for the black mark sensor is fine adjusted. See **Section 2.11**.

### Threshold Fine Adjustment (Feed gap sensor):

Threshold for the feed gap sensor is fine adjusted. See **Section 2.11**.

#### NOTE:

The printer driver's properties screen also has Parameter Fine Adjustment menu.

## 2.10 Position and Print Tone Fine Adjustment (Cont.)

### Print Start Position Fine Adjustment

**NOTES:**  
 Choose a desired value by using the **[RESTART]** or **[FEED]** key.  
 Pressing the **[FEED]** key one time causes a  $-0.1\text{mm}$  change, up to  $-50.0\text{mm}$ .  
 Pressing the **[RESTART]** key one time causes a  $+0.1\text{mm}$  change, up to  $+50.0\text{mm}$ .

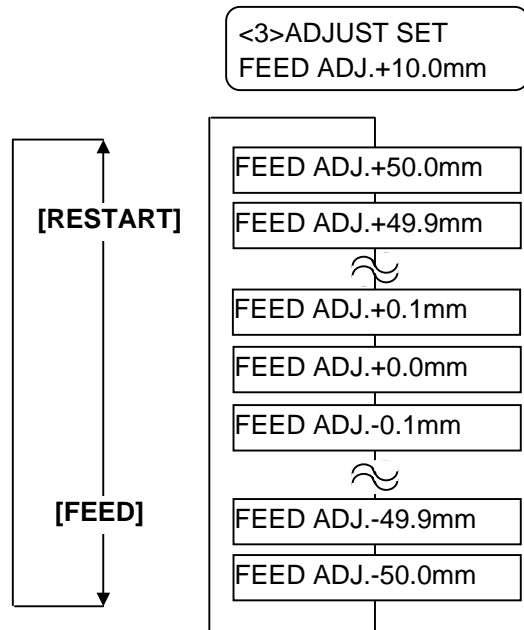

After selecting a fine adjustment value, press the **[PAUSE]** key.

#### • Example of Print Start Position Fine Adjustment

When setting  $+3.0\text{mm}$

Compared with “ $+0.0\text{mm}$ ” position, the print start position is shifted forward.

When setting  $+0.0\text{mm}$

When setting  $-3.0\text{mm}$

Compared with “ $+0.0\text{mm}$ ” position, the print start position is shifted backward.

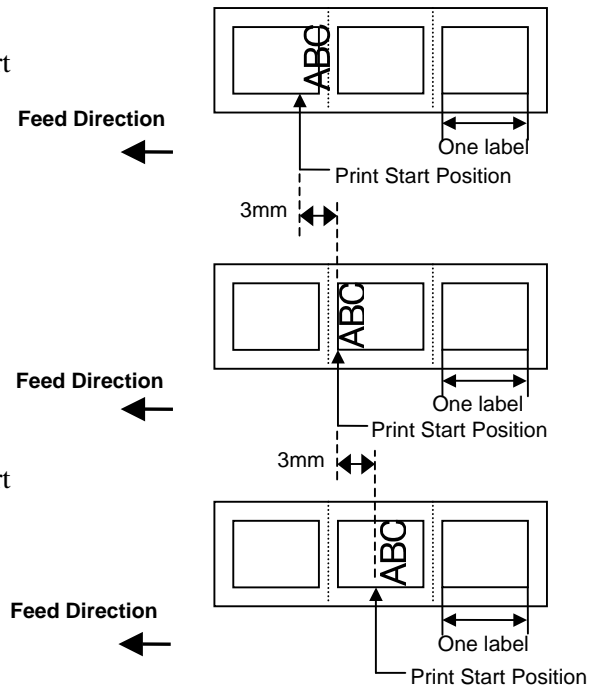



## 2.10 Position and Print Tone Fine Adjustment (Cont.)

### Cut/Strip Position Fine Adjustment

**NOTES:**  
 Choose a desired value by using the **[RESTART]** or **[FEED]** key.  
 Pressing the **[FEED]** key one time causes a  $-0.1\text{mm}$  change, up to  $-50.0\text{mm}$ .  
 Pressing the **[RESTART]** key one time causes a  $+0.1\text{mm}$  change, up to  $+50.0\text{mm}$ .

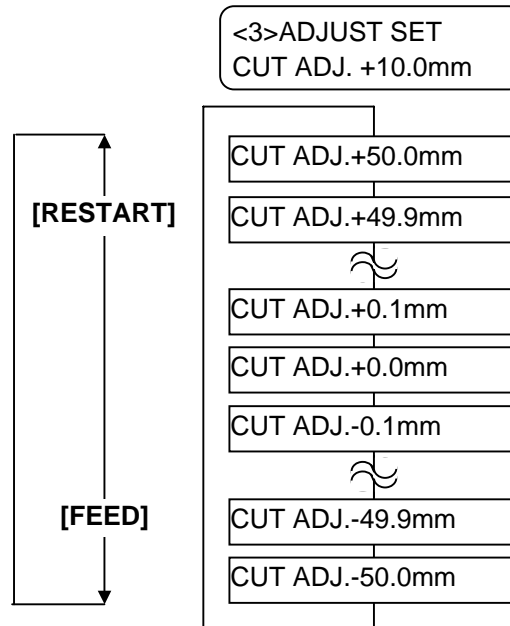

After selecting a fine adjustment value, press the **[PAUSE]** key.

#### • Example of Cut Position Fine Adjustment

When setting +3.0 mm

Compared with “+0.0mm” position, the cut position is shifted forward.

When setting +0.0 mm

When setting -3.0 mm

Compared with “+0.0mm” position, the cut position is shifted backward.

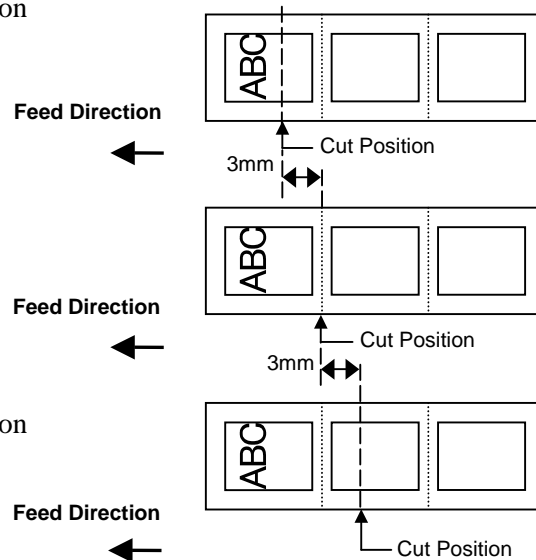

**• Example of Strip Position Fine Adjustment**When setting +3.0 mm

Compared with “+0.0mm” position, the stop position after printing is shifted forward.

When setting +0.0 mmWhen setting -3.0 mm

Compared with “+0.0mm” position, the stop position after printing is shifted backward.

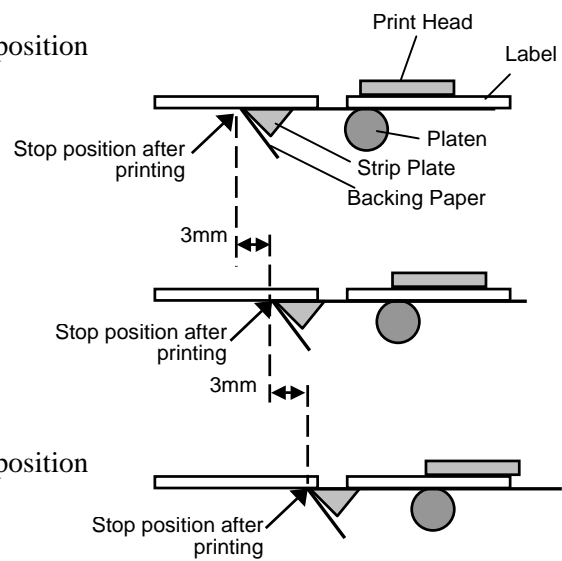

## 2.10 Position and Print Tone Fine Adjustment (Cont.)

### Reverse Feed Amount Fine Adjustment

**NOTES:**  
 Choose a desired value by using the **[RESTART]** or **[FEED]** key.  
 Pressing the **[FEED]** key one time causes a  $-0.1\text{mm}$  change, up to  $-9.9\text{mm}$ .  
 Pressing the **[RESTART]** key one time causes a  $+0.5\text{mm}$  change, up to  $+9.9\text{mm}$ .

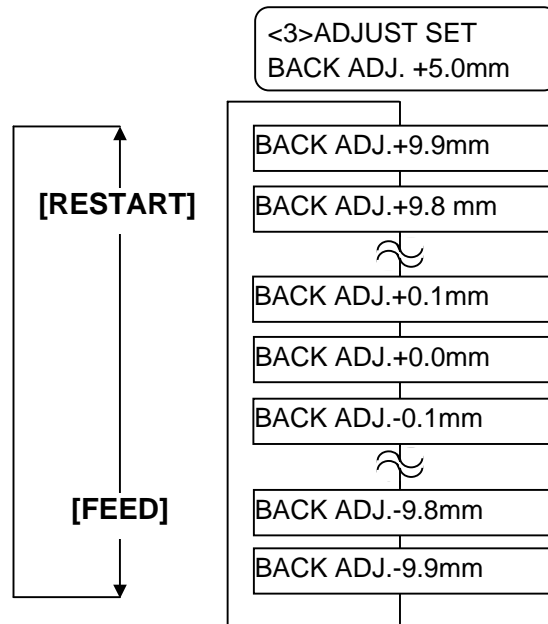

After selecting a fine adjustment value, press the **[PAUSE]** key.

#### • Example of Reverse Feed Amount Fine Adjustment

##### When setting +3.0 mm

Compared with “+0.0mm” position, the print start position after a reverse feed is shifted forward.

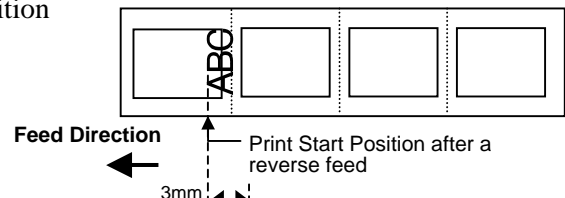

##### When setting +0.0 mm

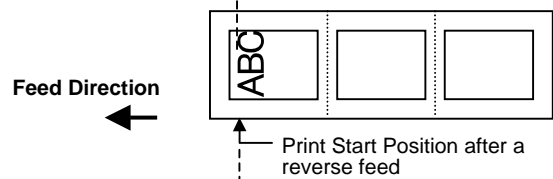

##### When setting -3.0 mm

Compared with “+0.0mm” position, the print start position after a reverse feed is shifted backward.

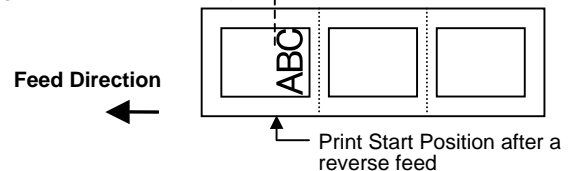

## 2.10 Position and Print Tone Fine Adjustment (Cont.)

### X Coordinate Fine Adjustment

**NOTES:**  
 Choose a desired value by using the **[RESTART]** or **[FEED]** key.  
 Pressing the **[FEED]** key one time causes a  $-0.1\text{mm}$  change, up to  $-99.9\text{mm}$ .  
 Pressing the **[RESTART]** key one time causes a  $+0.1\text{mm}$  change, up to  $+99.9\text{mm}$ .

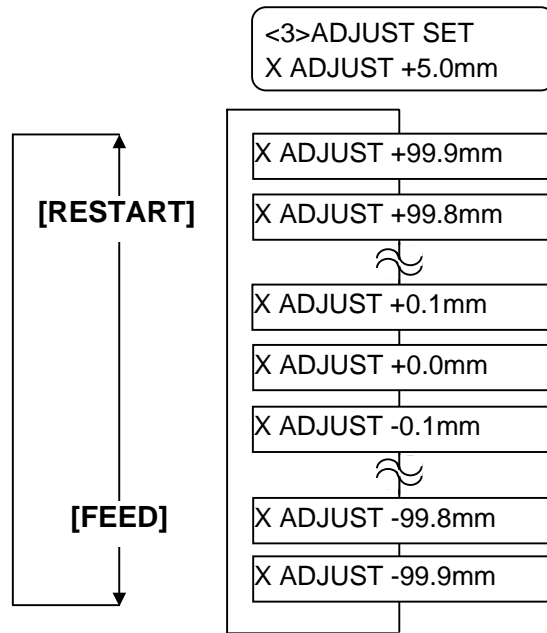

After selecting a fine adjustment value, press the **[PAUSE]** key.

#### • Example of X Coordinate Fine Adjustment

When setting  $-50.0\text{mm}$   
 Compared with “ $+0.0\text{mm}$ ” position, the print position is shifted to the left.

When setting  $+0.0\text{mm}$

When setting  $+50.0\text{mm}$   
 Compared with “ $+0.0\text{mm}$ ” position, the print position is shifted to the right.

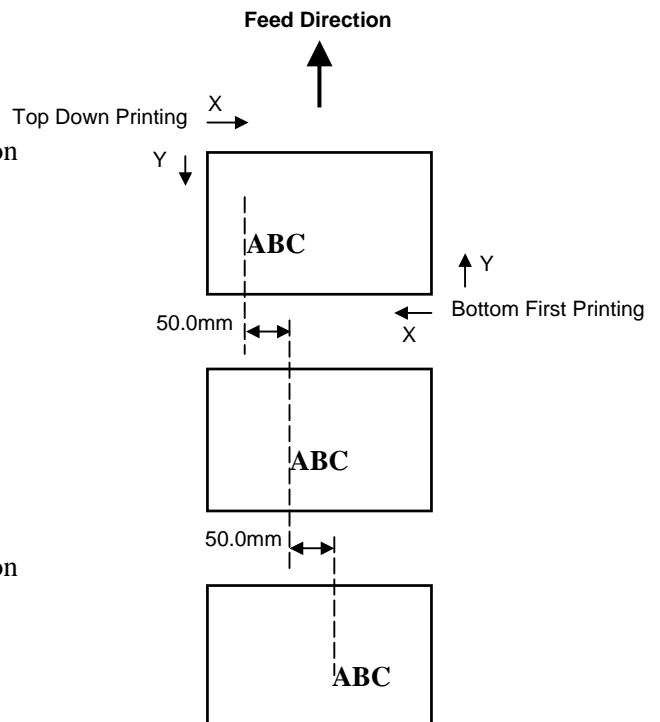

## 2.10 Position and Print Tone Fine Adjustment (Cont.)

### Print Tone Fine Adjustment

#### Thermal Transfer Print

**NOTES:**  
 Choose a desired value by using the **[RESTART]** or **[FEED]** key.  
 Pressing the **[FEED]** key one time causes a -1 tone change, up to -10 tones.  
 Pressing the **[RESTART]** key one time causes a +1 tone change, up to +10 tones.

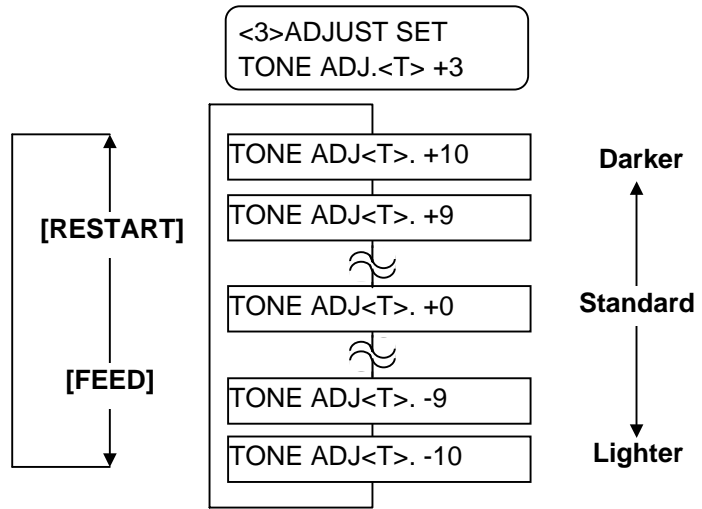

After selecting a fine adjustment value or to skip this menu, press the **[PAUSE]** key.

#### Thermal Direct Print

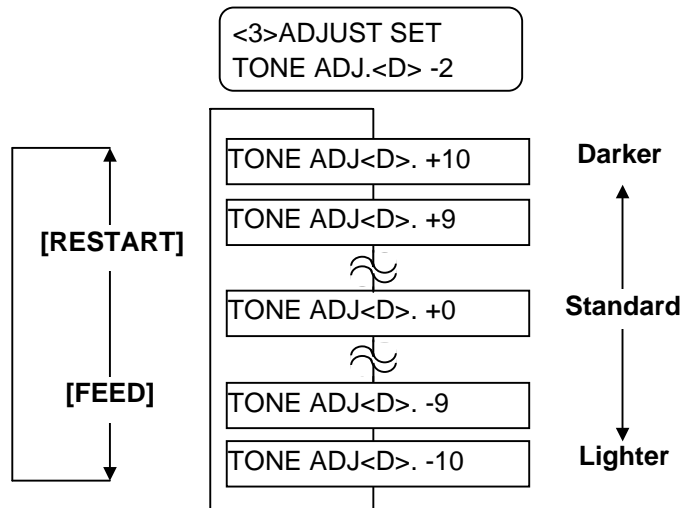

After selecting a fine adjustment value or to skip this menu, press the **[PAUSE]** key.

## 2.10 Position and Print Tone Fine Adjustment (Cont.)

### Ribbon Motor Voltage Fine Adjustment

When the ribbon is slack or wrinkled and printing is affected, fine adjust the ribbon motor torque by using the following procedure.

#### Take-up Motor (RBN ADJ <FW>)

**NOTES:**  
 Choose a desired value by using the **[RESTART]** or **[FEED]** key.  
 Pressing the **[FEED]** key one time causes a -1 step change, up to -15 steps.  
 Pressing the **[RESTART]** key one time causes a +1 step change, up to +2 steps.

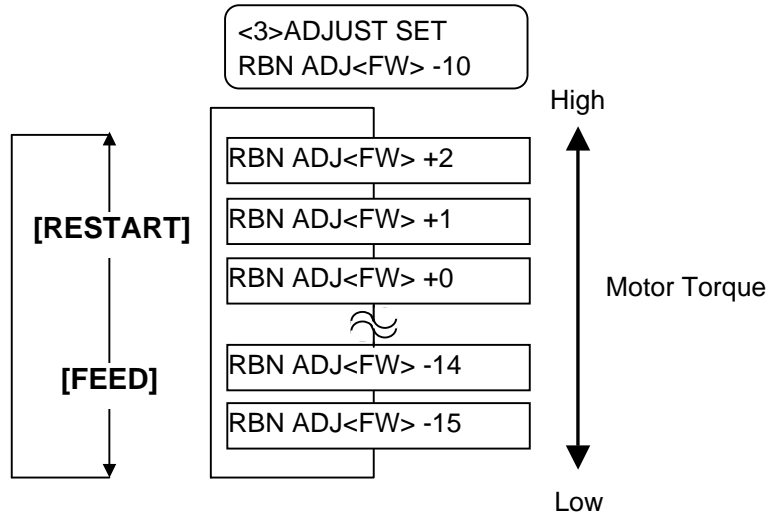

After selecting a fine adjustment value or to skip this menu, press the **[PAUSE]** key.

#### Feed Motor (RBN ADJ <BK>)

**NOTES:**  
 Choose a desired value by using the **[RESTART]** or **[FEED]** key.  
 Pressing the **[FEED]** key one time causes a -1 step change, up to -15 steps.  
 Pressing the **[RESTART]** key one time causes a +1 step change, up to +10 steps.

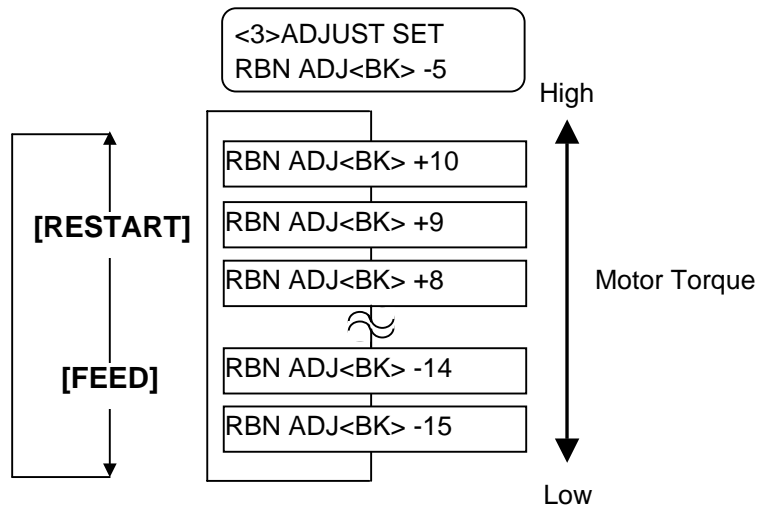

After selecting a fine adjustment value or to skip this menu, press the **[PAUSE]** key.

## 2.11 Threshold Setting

To maintain a constant print position the printer uses the media sensor to detect a print start position according to the difference of voltage between a print area and a gap or black mark. When the media is pre-printed, the darker (or more dense) inks can interfere with this process causing paper jam errors.

To get around this problem, first, try an automatic threshold setting. If the problem still occurs, then, the threshold voltage needs to be manually set.

### Automatic threshold setting procedure

1. Turn the power ON. The printer is in online mode.
2. Load a pre-printed media roll.  
When using a label stock, move the Feed Gap Sensor so that it is in line with the centre of the label.  
When using a tag stock, move the Black Mark Sensor so that it is in line with the centre of a black mark.
3. Press the **[PAUSE]** key.
4. The printer enters the pause mode.
5. Press and hold the **[PAUSE]** key in the pause state until the following screen appears.
6. The sensor type is displayed.
7. Select the sensor to be adjusted by using the **[FEED]** key.

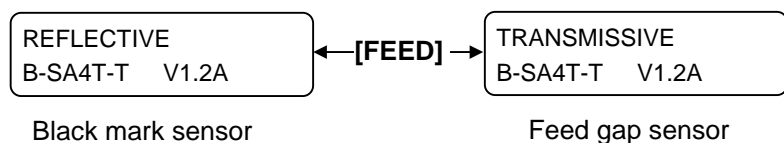

**NOTES:**

1. Failure to feed more than 1.5 labels may result in an incorrect threshold setting.
2. While the Top Cover is raised, the **[PAUSE]** key does not work.
3. A paper end error cannot be detected during paper feed.

8. Press and hold the **[PAUSE]** key until more than 1.5 labels (tags) have been issued.  
The media will continue to be fed until the **[PAUSE]** key is released. (An automatic threshold setting for the selected sensor is completed by this operation.)

PAUSE  
B-SA4T-T V1.2A

9. Press the **[RESTART]** key.

ON LINE  
B-SA4T-T V1.2A

10. The printer returns to online mode.  
Send an issue command from the host computer to the printer.

## 2.11 Threshold Setting (Cont.)

### Manual threshold setting procedure

If a paper jam error still occurs even after an automatic threshold setting has been performed, manually set the threshold voltage.

To make a threshold value manually set in this section effective, select the Transmissive Sensor (when using manual threshold value) or Reflective Sensor (when using manual threshold value) within software commands or the printer driver.

1. While holding down the **[FEED]** and **[PAUSE]** keys, turn on the printer.
2. When “<1>DIAG.” appears on the LCD Message Display, release the **[FEED]** and **[PAUSE]** keys.

<1>DIAG.

Now, the printer is in the System Mode for system administrators.

3. Press the **[FEED]** or **[RESTART]** key until “<5>SENSOR ADJ.” appears on the LCD Message Display.

<5>SENSOR ADJ.

4. Press the **[PAUSE]** key to enter the Sensor Adjustment Mode.

<5>SENSOR ADJ.  
[H]28°C [A]28°C

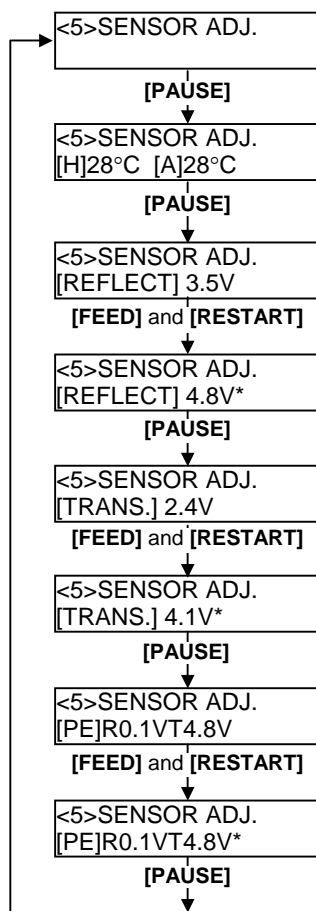

The Sensor Adjustment Mode contains sub menus for displaying the current status of each sensor and for storing “media level” voltage and “no media level” voltage. Each time the **[PAUSE]** key is pressed, the sub menus are displayed sequentially.

#### Sensor Status Display:

Temperatures being detected by the Print Head Thermistor and the Ambient Thermistor are displayed.

#### Black Mark Sensor Status Display:

Voltage being detected by the Black Mark Sensor is displayed.

#### Black Mark Sensor Adjustment:

Using the media actually used, a “media level” voltage is stored.

#### Feed Gap Sensor Status Display:

Voltage being detected by the Feed Gap Sensor is displayed.

#### Feed Gap Sensor Adjustment:

Using the media actually used, a “media level” voltage is stored.

#### Black Mark Sensor/Feed Gap Sensor Status Display (No media):

“No media level” voltage detected by the Black Mark Sensor/Feed Gap Sensor is displayed.

#### Black Mark Sensor/Feed Gap Sensor Adjustment (No media):

“No media level” voltage is stored.



### 2.11 Threshold Setting (Cont.)

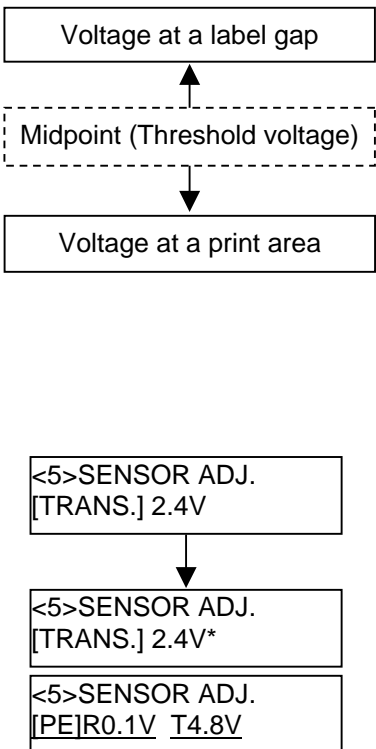
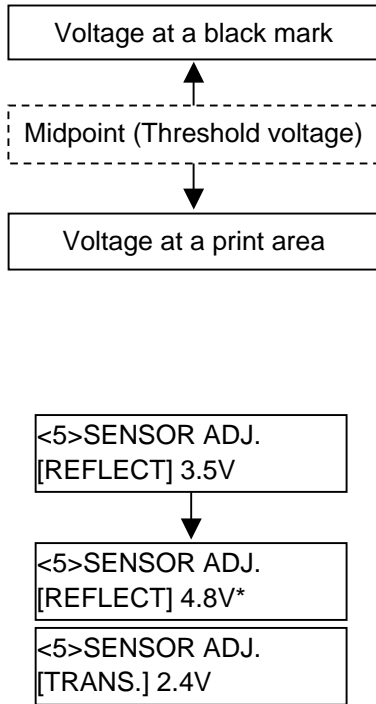

#### ■ When using the Black Mark Sensor

- (1) While “<5>SENSOR ADJ.” is displayed, press the **[PAUSE]** key until the message appears.  
The displayed value is a real-time voltage being detected by the Black Mark Sensor.

<5>SENSOR ADJ.  
[REFLECT] 3.5V

- (2) Measure a voltage at a blank part of media and a black mark, respectively. At this time, write down the midpoint between both voltages. (This value is used later for a threshold setting.)

(Example)

Print area = 4.8V, Black mark = 2.4V → Midpoint = 3.6V

**NOTES:**

1. When measuring a voltage of a blank area, be careful not to align a pre-print with the sensor by mistake.
2. Confirm that there is at least 0.7V difference between the two values. If the difference in voltage is less than 0.7V, a print start position cannot be detected. In that case, please consider changing the media type.
3. Make sure that the Top Cover is closed when measuring the voltages.

- (3) Press and hold the **[RESTART]** or **[FEED]** key for about 3 seconds aligning a blank part of print area with the Black Mark Sensor.
- (4) When storing a “media level” voltage is completed, an asterisk “\*” is displayed on the right side of a voltage. Press the **[PAUSE]** key.
- (5) A real-time voltage being detected by the Feed Gap Sensor is displayed.

#### ■ When using the Feed Gap Sensor

- (1) Measure a voltage at a blank part of label and a label gap, respectively. At this time, write down the midpoint of both voltages. (This value is used later for a threshold setting.)

(Example)

Print area = 2.4V, Gap = 4.0V → Midpoint = 3.2V

**NOTES:**

1. When measuring a voltage at a blank area, be careful not to align a pre-print with the sensor by mistake.
2. Confirm that there is at least 0.7V difference between the two values. If the difference in voltage is less than 0.7V, a print start position cannot be detected. In that case, please consider changing the media type.
3. Make sure that the Top Cover is closed when measuring the voltages.

- (2) Press and hold the **[RESTART]** or **[FEED]** key for about 3 seconds aligning a blank part of print area with the Feed Gap Sensor.
- (3) When storing a “media level” voltage is completed, an asterisk “\*” is displayed on the right side of a voltage. Press the **[PAUSE]** key.
- (4) The display changes as shown on the left.

## 2.11 Threshold Setting (Cont.)

### ■ Storing a “No Media Level” Voltage

The following is how to set a “No media level” voltage that is used to detect a paper end.

If a “NO PAPER” is displayed even if the media has not run out yet, this voltage needs to be set again.

(1) Remove any media from the Black Mark Sensor/Feed Gap Sensor.

(2) A real-time voltages being detected by the Black Mark Sensor and Feed Gap Sensor are displayed.

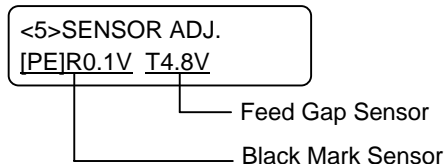

(3) Press and hold the **[RESTART]** or **[FEED]** key for about 3 seconds.



(4) When storing a “no media level” voltage is completed, an asterisk “\*” is displayed on the right side of a voltage. Press the **[PAUSE]** key.

(5) The message returns to “<5>SENSOR ADJ.”.



### ■ Manual Threshold Setting

Then, set the calculated threshold voltage in the Parameter Fine Adjustment mode.

(1) While “<5>SENSOR ADJ.” is displayed, press the **[FEED]** or **[RESTART]** key until “<3>ADJUST SET” is displayed.

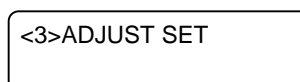

(2) Press the **[PAUSE]** key to enter the Parameter Fine Adjustment Mode.

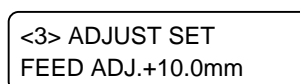

(3) While “<3>ADJUST SET.” is displayed, press the **[PAUSE]** key until the target sensor type is displayed.

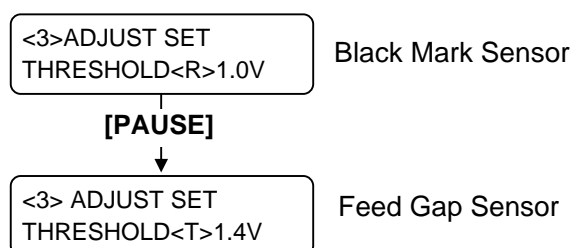

## 2.11 Threshold Setting (Cont.)

- (4) Set a threshold voltage (calculated in Sensor Adjustment Menu) by using the **[FEED]** or **[RESTART]** key, as shown below.

**Threshold voltage = Midpoint between voltage at a print area and voltage at a gap/black mark**

**NOTE:**  
 Pressing the **[FEED]** key one time causes a  $-0.1V$  change, up to  $0.0V$ .  
 Pressing the **[RESTART]** key one time causes a  $+0.1V$  change, up to  $+4.0V$ .

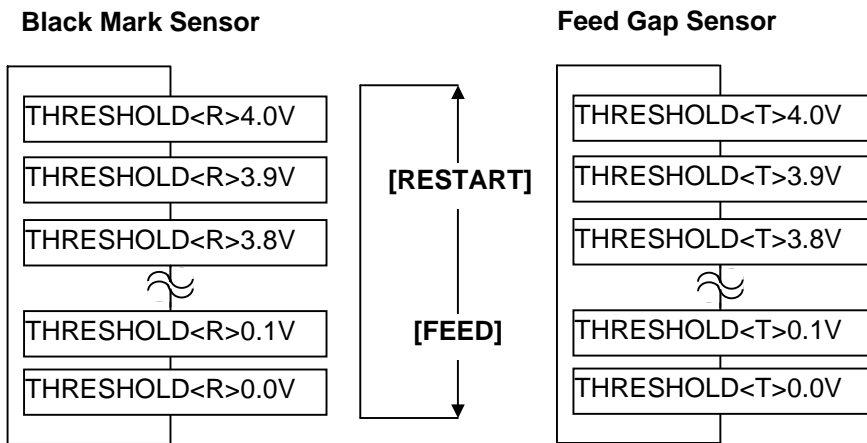

- (5) After choosing a threshold voltage, press the **[PAUSE]** key.
- (6) To check for a proper operation, issue the pre-printed media in online.  
 If an error still occurs even after a manual threshold setting, change the threshold voltage a little, and retry.

### 3. ON LINE OPERATION

This chapter describes usage of the keys on the Operation Panel in On Line mode.

When the printer is in On Line mode and connected to a host computer, the normal operation of printing images on labels or tags can be accomplished.

#### 3.1 Operation Panel

The figure below illustrates the Operation Panel and key functions.

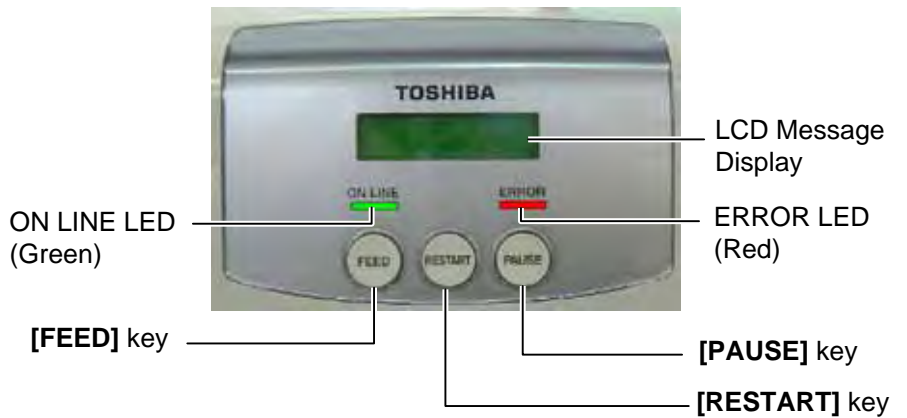

The LCD Message Display shows messages in alphanumeric characters and symbols to indicate the printer's current status. Up to 32 characters can be displayed on two lines.

There are two LEDs on the Operation Panel.

LED	Illuminates when...	Flashes when...
<b>ON LINE</b>	The printer is ready to print.	The printer is communicating with your computer.
<b>ERROR</b>	Any error occurs with the printer.	The ribbon is nearly over. (See NOTE 1.)

**NOTES:**

1. *Flashes only when the Ribbon Near End Detection function is selected.*
2. *Use the [RESTART] key to resume printing after a pause, or after clearing an error.*

There are three keys on the operation panel.

<b>PAUSE</b>	Used to stop printing temporarily.
<b>RESTART</b>	Used to restart printing.
<b>FEED</b>	Used to feed media.

## 3.2 Operation

### NOTES:

- Description of model name on the 2nd line of the LCD.  
B-SA4T-T  
    └T: 300 dpi print head  
    G: 203 dpi print head
- For the meaning of error messages and actions to be taken, refer to **Section 5 TROUBLESHOOTING** and **APPENDIX 1**.

When the printer is turned on, the "ON LINE" message appears on the LCD Message Display. It is shown during standby or normal printing.

- The printer is turned on, standing by, or printing.

```
ON LINE
B-SA4T-T V1.2A
```

- If any error occurs during printing, an error message appears. The printer stops printing automatically. (The number on the right side shows the remaining number of media to be printed.)

```
NO PAPER 125
B-SA4T-T V1.2A
```

- To clear an error, press the **[RESTART]** key. The printer resumes printing.

```
ON LINE
B-SA4T-T V1.2A
```

- If the **[PAUSE]** key is pressed during printing, the printer stops printing temporarily. (The number on the right side shows the remaining number of media to be printed.)

```
PAUSE 52
B-SA4T-T V1.2A
```

- When the **[RESTART]** key is pressed, the printer resumes printing.

```
ON LINE
B-SA4T-T V1.2A
```

## 3.3 Reset

A reset operation clears the print data sent from the computer to the printer, and returns the printer to an idle condition.

- The printer is turned on, standing by, or printing.

```
ON LINE
B-SA4T-T V1.2A
```

- To stop printing, or clear the data sent from the computer, press the **[PAUSE]** key. The printer stops printing.

```
PAUSE 52
B-SA4T-T V1.2A
```

- Press and hold the **[RESTART]** key for 3 seconds or longer.

```
<1>RESET
```

- Press the **[PAUSE]** key. The data sent from the computer will be cleared, and the printer returns to an idle condition.

```
ON LINE
B-SA4T-T V1.2A
```

### NOTE:

If the **[RESTART]** key is held for less than 3 seconds when the printer is in an error or pause state, the printer restarts printing. However, when a communication error or command error occurs, the printer returns to an idle condition.

## 4. MAINTENANCE

**WARNING!**

1. *Be sure to disconnect the power cord before performing maintenance. Failure to do this may cause an electric shock.*
2. *To avoid injury, be careful not to pinch your fingers while opening or closing the cover and print head block.*
3. *The print head becomes hot immediately after printing. Allow it to cool before performing any maintenance.*
4. *Do not pour water directly onto the printer.*

This chapter describes how to perform routine maintenance. To ensure the continuous high quality operation of the printer, refer to the following table and perform a regular maintenance routine.

Cleaning cycle	Frequency
High throughput	Every day
Every ribbon roll or media roll	Once

### 4.1 Cleaning

To maintain the printer performance and print quality, please clean the printer regularly, or whenever the media or ribbon is replaced.

#### 4.1.1 Print Head/Platen/Sensors

**CAUTION!**

1. *Do not use any volatile solvent including thinner and benzene, as this may cause discoloration to the cover, print failure, or breakdown of the printer.*
2. *Do not touch the Print Head Element with bare hands, as static may damage the Print Head.*
3. *Be sure to use a Print Head Cleaner. Failure to do this may shorten the Print Head life.*

**NOTE:**

*A Print Head Cleaner (P/No. 24089500013) is available from your authorised TOSHIBA TEC service representative.*

1. Turn off the power and unplug the printer.
2. Press the Top Cover Release Button and gently open the Top Cover to its full open position.
3. Remove the ribbon and media from the printer.
4. Clean the Print Head Element with a Print Head Cleaner, or a cotton swab or soft cloth slightly moistened with absolute ethyl alcohol.



### 4.1.1 Print Head/Platen/Sensors (Cont.)

5. Wipe the Platen and Dumper Roller with a soft cloth slightly moistened with absolute ethyl alcohol. Remove dust or foreign substances from the internal part of the printer.
6. Wipe the Feed Gap Sensor and Black Mark Sensor with a dry soft cloth.
7. Wipe the media path.

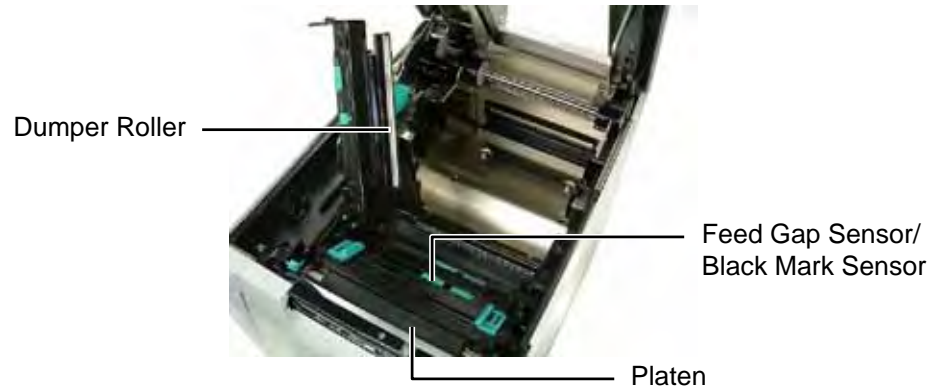

### 4.1.2 Covers and Panels

**CAUTION!**

1. *DO NOT POUR WATER directly onto the printer.*
2. *DO NOT APPLY cleaner or detergent directly onto any cover or panel.*
3. *NEVER USE THINNER OR OTHER VOLATILE SOLVENT on the plastic covers.*
4. *DO NOT clean the panel, covers, or the supply window with alcohol as it may cause them to discolour, loose their shape or develop structural weakness.*

Wipe the covers and panels with a dry soft cloth or a cloth slightly moistened with mild detergent solution.



**4.1.3 Optional Cutter Module**

1. Open the Front Cover.
2. Loosen the Set Screw of the Cutter Unit to open it.
3. Remove jammed media, if any.

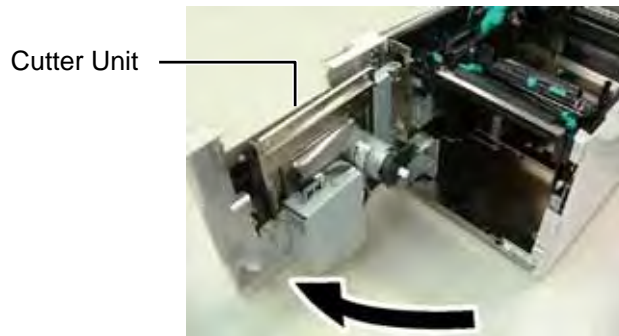
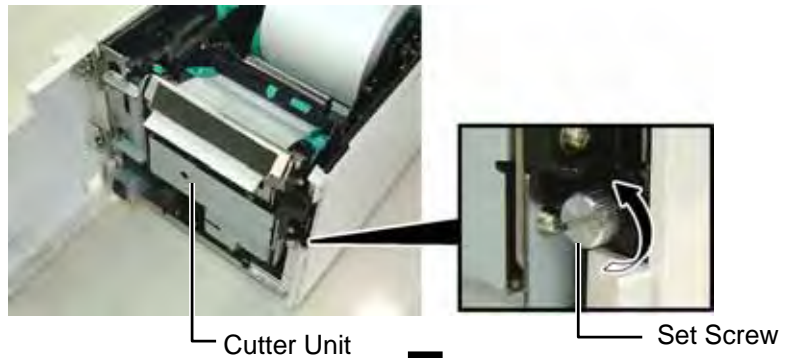

**WARNING!**  
*As the cutter blade is sharp, care should be taken not to injure yourself when cleaning.*

4. Clean the inside of the Cutter Blade with a cotton swab moistened with absolute ethyl alcohol. The cutter blade moves up and down when the Cutter Motor Shaft is rotated manually.

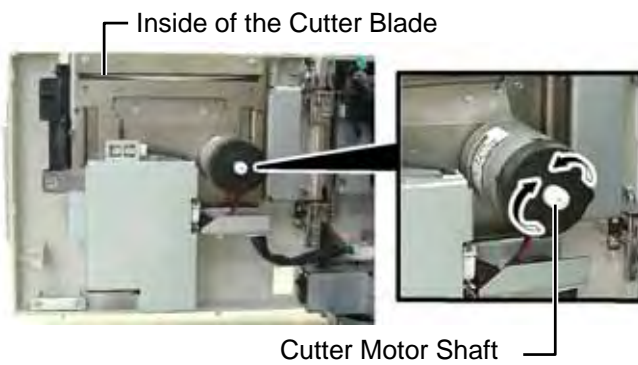

5. In the same way, clean the outside of the Cutter Blade.





### 4.1.4 Optional Strip Module

1. Open the Front Cover holding its right side.

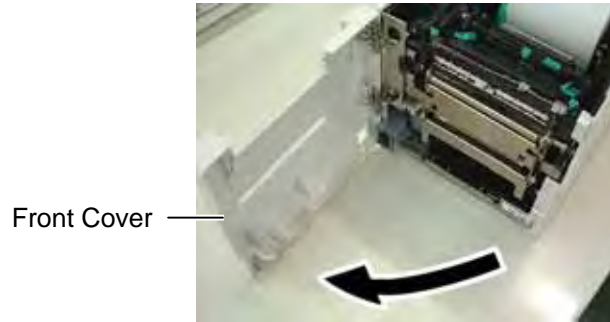

2. Press down the Release Bar to open the Strip Unit.

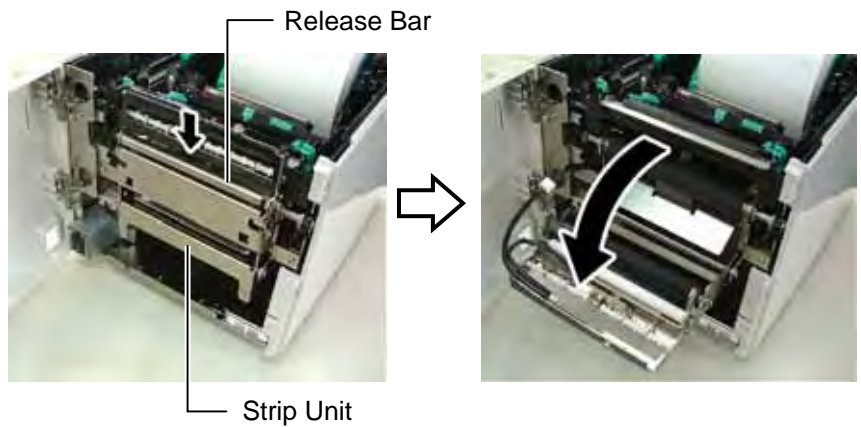

3. Remove jammed media or backing paper, if any
4. Wipe the Backing Paper Feed Rollers, Guide Roller, and Strip Roller with a soft cloth slightly moistened with absolute ethyl alcohol.

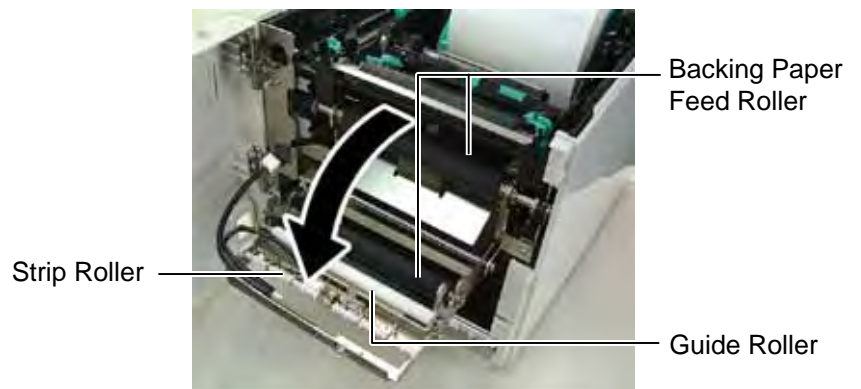

## 5. TROUBLESHOOTING

This chapter lists the error messages, possible problems, and their solutions.

### WARNING!

*If a problem cannot be solved by taking the actions described in this chapter, do not attempt to repair the printer. Turn off and unplug the printer, then contact an authorised TOSHIBA TEC service representative for assistance.*

### 5.1 Error Messages

#### NOTES:

1. If an error is not cleared by pressing the **[RESTART]** key, turn the printer off and then on.
2. After the printer is turned off, all print data in the printer is cleared.
3. "\*\*\*\*\*" indicates the number of unprinted media. Up to 9999 (in pieces).

Error Messages	Problems/Causes	Solutions
<b>HEAD OPEN</b>	The Top Cover is opened in Online mode.	Close the Top Cover.
<b>HEAD OPEN *****</b>	A feed or an issue was attempted with the Top Cover opened.	Close the Top Cover. Then press the <b>[RESTART]</b> key.
<b>COVER OPEN *****</b>	A feed or an issue was attempted with the Front Cover opened.	Close the Front Cover, then press the <b>[RESTART]</b> key.
<b>COMMS ERROR</b>	A communication error has occurred.	Make sure the interface cable is correctly connected to the printer and the host, and the host is turned on.
<b>PAPER JAM *****</b>	1. The media is jammed in the media path. The media is not fed smoothly.	1. Remove the jammed media, and clean the Platen. Then reload the media correctly. Finally press the <b>[RESTART]</b> key. ⇒ <b>Section 5.3.</b>
	2. A wrong Media Sensor is selected for the media being used.	2. Turn the printer off and then on. Then select the Media Sensor for the media being used. Finally resend a print job.
	3. The Black Mark Sensor is not correctly aligned with the Black Mark on the media.	3. Adjust the sensor position. Then press the <b>[RESTART]</b> key. ⇒ <b>Section 2.3.</b>
	4. Size of the loaded media is different from the programmed size.	4. Replace the loaded media with one that matches the programmed size then press the <b>[RESTART]</b> key, or turn the printer off and then on, select a programmed size that matches the loaded media. Finally resend the print job.
	5. The Upper Sensor and the Lower Sensor misalign with each other.	5. Align the Upper Sensor with the Lower Sensor. ⇒ <b>Section 2.3.</b>
	6. The Feed Gap Sensor cannot distinguish a print area from a label gap.	6. Refer to <b>Section 2.11</b> to set the threshold. If this does not solve the problem, turn off the printer, and call a TOSHIBA TEC authorised service representative.

## 5.1 Error Messages (Cont.)

Error Messages	Problems/Cause	Solutions
<b>CUTTER ERROR ****</b> (When an optional cutter module is installed.)	The media is jammed in the cutter.	Remove the jammed media. Then press the <b>[RESTART]</b> key. If this does not solve the problem, turn off the printer, and call a TOSHIBA TEC authorised service representative. ⇒ <b>Section 4.1.3.</b>
<b>NO PAPER ****</b>	1. The media has run out.	1. Load new media. Then press the <b>[RESTART]</b> key. ⇒ <b>Section 2.3.</b>
	2. The media is not loaded properly.	2. Reload the media correctly. Then press the <b>[RESTART]</b> key. ⇒ <b>Section 2.3.</b>
	3. The media is slack.	3. Take up any slack in the media.
<b>RIBBON ERROR ****</b>	1. The ribbon is not fed properly.	1. Remove the ribbon, and check the status of the ribbon. Replace the ribbon, if necessary. If the problem is not solved, turn off the printer, and call a TOSHIBA TEC authorised service representative.
	2. The ribbon has run out.	2. Load a new ribbon. Then press the <b>[RESTART]</b> key. ⇒ <b>Section 2.4.</b>
<b>EXCESS HEAD TEMP</b>	The Print Head has overheated.	Turn off the printer, and allow it to cool down (about 3 minutes). If this does not solve the problem, call a TOSHIBA TEC authorised service representative.
<b>HEAD ERROR</b>	There is a problem with the Print Head.	The Print Head is required to be replaced. Call a TOSHIBA TEC authorized service representative.
<b>SYSTEM ERROR</b>	1. The printer is used in a location where it is subject to noise. Or, there are power cords of other electrical appliances near the printer or interface cable.	1. Keep the printer and the interface cables away from the source of noise.
	2. The Power Cord of the printer is not grounded.	2. Ground the Power Cord.
	3. The printer shares the same power source with any other electrical appliances.	3. Provide an exclusive power source for the printer.
	4. An application software used on your host computer has an error or malfunction.	4. Confirm the host computer operates properly.
<b>FLASH WRITE ERR.</b>	An error has occurred in writing to the flash ROM.	Turn the printer off, and then on again.
<b>FORMAT ERROR</b>	An error has occurred in formatting the flash ROM.	Turn the printer off, and then on again.
<b>FLASH CARD FULL</b>	Saving failed because of an insufficient capacity of the flash ROM.	Turn the printer off, and then on again.
<b>EEPROM ERROR</b>	Data cannot be read from/written to a backup EEPROM properly.	Turn the printer off, and then on again.
<b>RFID WRITE ERROR</b>	The printer did not succeed in writing data onto an RFID tag after having retried for a specified times.	Press the <b>[RESTART]</b> key.

## 5.1 Error Messages (Cont.)

Error Messages	Problems/Cause	Solutions
<b>RFID ERROR</b>	The printer cannot communicate with the RFID module.	Turn the printer off, and then on again.
<b>SYNTAX ERROR</b>	While the printer is in the Download mode for upgrading the firmware, it receives an improper command, for example, an Issue Command.	Turn the printer off, and then on again.
<b>POWER FAILURE</b>	A momentary power failure has occurred.	Check the power source which supplies power to the printer. If the rating is not correct, or if the printer shares the same power outlet with other electrical appliances that consume large amounts of power, change the outlet.
<b>LOW BATTERY</b>	The voltage of the Real Time Clock Battery is 1.9V or less.	Hold down the <b>[RESTART]</b> key until “<1>RESET” is displayed. If you would like to keep using the same battery even after “LOW BATTERY” error occurs, set the Low battery check function to OFF, and set the date and time to the real time. As long as the power is on, the Real Time Clock will function. However, once the power is turned off, the date and time will be reset. Call a TOSHIBA TEC authorised service representative for replacement of the battery.
Other error messages	A hardware or software problem may have occurred.	Turn the printer off and then on. If this does not solve the problem, turn off the printer again, and call a TOSHIBA TEC authorised service representative.

## 5.2 Possible Problems

This section describes problems that may occur when using the printer, and their causes and solutions.

Possible Problems	Causes	Solutions
The printer will not turn on.	1. The Power Cord is disconnected.	1. Plug in the Power Cord.
	2. The AC outlet is not functioning correctly.	2. Test with a power cord from another electric appliance.
	3. The fuse has blown, or the circuit breaker has tripped.	3. Check the fuse or breaker.
The media is not fed.	1. The media is not loaded properly.	1. Load the media properly. ⇒ <b>Section 2.3.</b>
	2. The printer is in an error condition.	2. Solve the error in the message display. (See <b>Section 5.1</b> for more detail.)
Pressing the <b>[FEED]</b> key in the initial state results in an error.	A feed or an issue was attempted not on the following default conditions. Sensor type: Feed gap sensor Printing method: Thermal transfer Media pitch: 76.2 mm	Change the print condition by using the printer driver or a print command so that it corresponds to your printing conditions. Then, clear the error state by pressing the <b>[RESTART]</b> key.

### 5.2 Possible Problems (Cont.)

Possible Problems	Causes	Solutions
Nothing is printed on the media.	1. The media is not loaded properly.	1. Load the media properly. ⇒ <b>Section 2.3.</b>
	2. The ribbon is not loaded properly.	2. Load the ribbon properly. ⇒ <b>Section 2.4.</b>
	3. The ribbon and media are not matched.	3. Select an appropriate ribbon for the media type being used.
The printed image is blurred.	1. The ribbon and media are not matched.	1. Select an appropriate ribbon for the media type being used.
	2. The Print Head is not clean.	2. Clean the print head using a Print Head Cleaner or a cotton swab slightly moistened with ethyl alcohol.
The optional cutter module does not cut.	1. The Cutter Unit is not closed properly.	1. Close the Cutter Unit properly.
	2. The media is jammed in the Cutter.	2. Remove the jammed paper. ⇒ <b>Section 4.1.3.</b>
	3. The cutter blade is dirty.	3. Clean the cutter blade. ⇒ <b>Section 4.1.3.</b>
The optional Strip Module does not remove labels from the backing paper.	Label stock is too thin or the glue is too sticky.	Refer to <b>Section 7.1 Media</b> and change the label.

### 5.3 Removing Jammed Media

This section describes in detail how to remove jammed media from the printer.

**CAUTION!**  
Do not use any tool that may damage the Print Head.

**NOTE:**  
If you get frequent jams in the cutter, contact a TOSHIBA TEC authorised service representative.

1. Turn off and unplug the printer.
2. Press the Top Cover Release Button and gently open the Top Cover to its fully open position supporting it with your hand.
3. Press the Upper Sensor Lever inside, and open the Upper Sensor Ass'y.
4. Remove the ribbon and media from the printer.



5. Remove the jammed media from the printer. DO NOT USE any sharp implements or tools as these could damage the printer.
6. Clean the Print Head and Platen, then remove any further dust or foreign substances.
7. Paper jams in the Cutter Unit can be caused by wear or residual glue from label stock on the cutter. Do not use non-specified media in the cutter.

## 6. PRINTER SPECIFICATIONS

This section describes the printer specifications.

<b>Model</b>		<b>B-SA4TP-GS12-QM</b>	<b>B-SA4TP-TS12-QM</b>
<b>Item</b>			
Dimension (W × D × H)		238 mm × 339 mm × 332 mm (9.4" × 13.3" × 13.1")	
Weight		26.5 lb (12 kg) (Media and ribbon are not included.)	
Operating temperature range	Thermal direct	0°C to 40°C (32°F to 104°F)	
	Thermal transfer	5°C to 40°C (41°F to 104°F)	
Relative humidity		25% to 85% RH (no condensation)	
Power supply		Universal power source AC100V to 240V, 50/60Hz±10%	
Input voltage		AC100 to 240V, 50/60Hz ±10%	
Power consumption	During a print job	2.1A (100V) to 1.1A (240V), 155W rating	
	During standby	0.19A (100V) to 0.15A (240V), 13W (100V) to 22W (240V)	
Resolution		8 dots/mm (203 dpi)	11.8 dots/mm (300 dpi)
Printing method		Thermal transfer or Thermal direct	
Printing speed		50.8 mm/sec. (2 inches/sec.) 101.6 mm/sec (4 inches/sec.) 152.4 mm/sec (6 inches/sec.)	
Available media width (including backing paper)	Thermal direct	25.0 mm to 118.0 mm (1 inch to 4.6 inches)	
	Thermal transfer	25.0 mm to 114.0 mm (1 inch to 4.5 inches)	
Maximum effective print width		104.0 mm (4.1 inches)	105.7 mm (4.2 inches)
Issue mode		Batch, Strip (option), and Cut (option)	
LCD Message display		16 characters × 2 lines	

Item \ Model	B-SA4TP-GS12-QM	B-SA4TP-TS12-QM
Available bar code types	JAN8, JAN13, EAN8, EAN8+2 digits, EAN8+5 digits, EAN13, EAN13+2 digits, EAN13+5 digits, UPC-E, UPC-E+2 digits, UPC-E+5 digits, UPC-A, UPC-A+2 digits, UPC-A+5 digits, MSI, ITF, NW-7, CODE39, CODE93, CODE128, EAN128, Industrial 2 to 5, Customer Bar Code, POSTNET, KIX CODE, RM4SCC (ROYAL MAIL 4STATE CUSTOMER CODE), RSS14	
Available two-dimensional code	Data Matrix, PDF417, QR code, Maxi Code, Micro PDF417, CP Code	
Available font	Times Roman (6 sizes), Helvetica (6 sizes), Presentation (1 size), Letter Gothic (1 size), Prestige Elite (2 sizes), Courier (2 sizes), OCR (2 types), Gothic (1 size), Outline font (4 types), Price font (3 types)	
Rotations	0°, 90°, 180°, 270°	
Standard interface	Parallel interface (Centronics, Bidirectional 1284 Nibble mode) USB interface (V2.0 Full speed) LAN interface (10/100BASE)	
Optional equipment	Serial interface board (RS-232C) (B-SA704-RS-QM-R) Wireless LAN interface board (B-SA704-WLAN-QM-R) RFID module (B-SA704-RFID-U2-EU-R) Cutter module (B-SA204P-QM-R) Strip module (B-SA904P-H-QM-R) 300-dpi Print Head (B-SA704-TPH3-QM-R) Expansion I/O Board (B-SA704-IO-QM-R) Real Time Clock (B-SA704-RTC-QM-R)	

**NOTES:**

- *Data Matrix™* is a trademark of International Data Matrix Inc., U.S.
- *PDF417™* is a trademark of Symbol Technologies Inc., US.
- *QR Code* is a trademark of DENSO CORPORATION.
- *Maxi Code* is a trademark of United Parcel Service of America, Inc., U.S.

## 7. SUPPLY SPECIFICATIONS

### 7.1 Media

Please make sure that the media being used is approved by TOSHIBA TEC. The warranty does not apply when a problem is caused by using media that is not approved by TOSHIBA TEC.

For information regarding TOSHIBA TEC approved media, please contact a TOSHIBA TEC authorised service representative.

#### 7.1.1 Media Type

Two types of media can be loaded for this thermal transfer and direct thermal printer: label or tag. The table below shows size and shape of the media available for this printer.

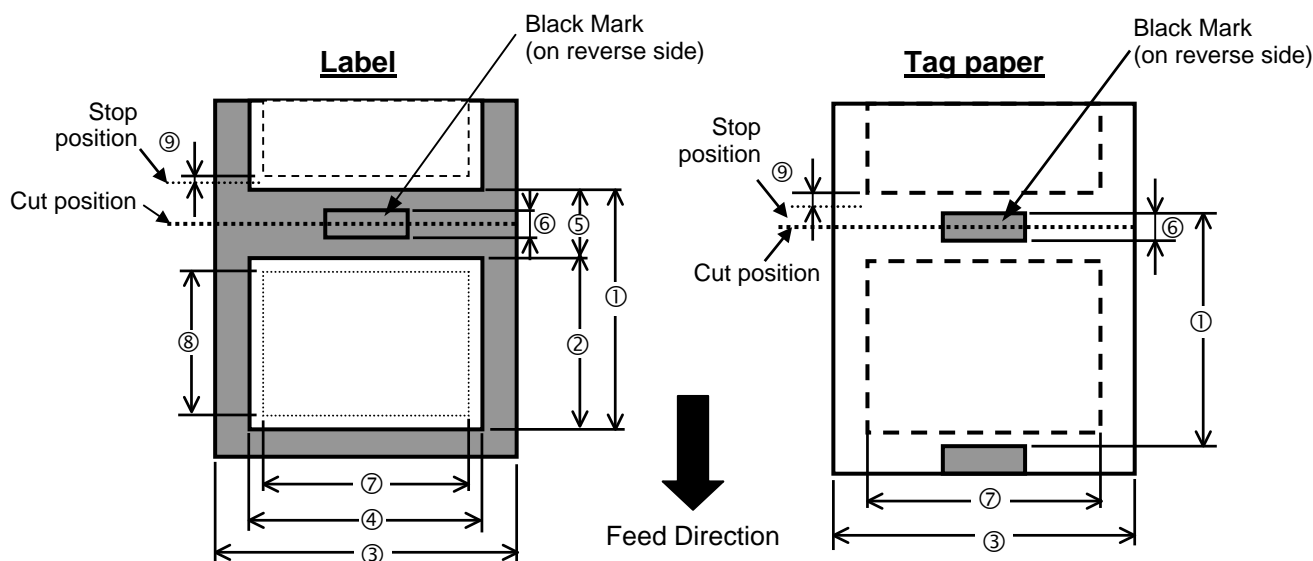

[Unit: mm]

Item		Label dispensing mode		
		Batch mode	Strip mode	Cut mode
① Media pitch	Thermal direct	10.0 – 999.0	19.0 – 999.0	19.0 – 999.0
	Thermal transfer	15.0 – 999.0		
② Label length	Thermal direct	8.0 – 997.0	17.0 – 997.0	16.0 – 997.0
	Thermal transfer	13.0 – 997.0		
③ Media width/backing paper width	Thermal direct	25.0 – 118.0		
	Thermal transfer	25.0 – 114.0		
④ Label width	Thermal direct	22.0 – 115.0		
	Thermal transfer	22.0 – 111.0		
⑤ Gap length		2.0 – 20.0	2.0 – 5.0	3.0 – 20.0
⑥ Black mark length (Tag paper)		2.0 – 10.0		
⑦ Maximum effective print width		104.0 (200-dpi type), 105.7 (300-dpi type)		
⑧ Effective print length	Label	Thermal direct	15.0 – 995.0	14.0 – 995.0
		Thermal transfer		
	Tag paper	Thermal direct	-----	17.0 – 997.0
		Thermal transfer		
⑨ Print speed up/slow down area		1.0		
Thickness	Thermal direct	0.08 – 0.17 (Note 4)	0.13 – 0.17	0.08 – 0.17 (Note 4)
	Thermal transfer	0.1 – 0.17 (Note 4)	0.13 – 0.17	0.1 – 0.17 (Note 4)
Maximum outer roll diameter		Ø152.4		
Roll direction		Inside/Outside		
Inner core diameter		Ø38, 40, 42, 76.2±0.3		



**NOTES:**

1. To ensure print quality and print head life use only TOSHIBA TEC specified media.
2. The ratio of a label length to a gap length must be a minimum of 3 to 1 (3:1).
3. Backing paper must be wider than a label; the distance between the edge of the backing paper and that of a label should be at least 1.5 mm.
4. Use of the tag paper of 25 mm to 50 mm in width, and 171  $\mu\text{m}$  to 263  $\mu\text{m}$  in thickness may shorten the platen life.
5. When using a label stock in cut mode, be sure to cut the gaps. Cutting labels will cause the glue to stick to the cutter, which may affect the cutter performance and shorten the cutter life.
6. To tear off printed media in batch issue easier, set the Auto Forward Wait function (FORWARD WAIT parameter) to ON in the system mode. When this function is effective, the printer stops feeding the printed media past the strip shaft. In case of a label stock, however, if a next label is issued without tearing off the printed label, the label may peel while it is fed backward, causing a printer failure.

**7.1.2 Detection Area of the Transmissive Sensor**

The Transmissive Sensor is movable from the centre to the left edge of media.  
The Transmissive Sensor detects a gap between labels, as illustrated below.

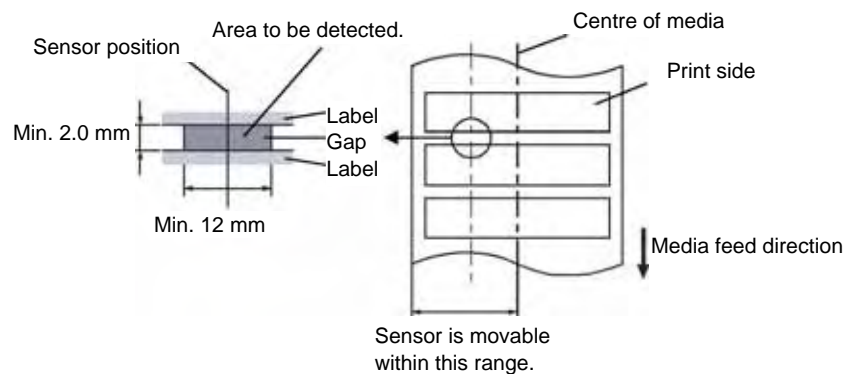
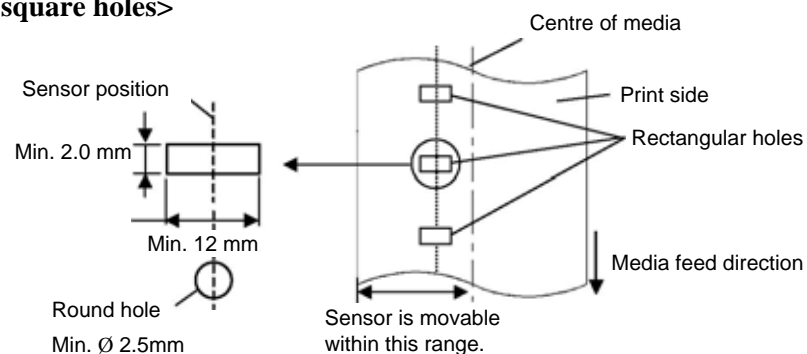
**<Label>****<Tag paper with square holes>**

### 7.1.3 Detection Area of the Reflective Sensor

The Reflective Sensor is movable from the centre to the left edge of media.  
 The reflection factor of the Black Mark must be 10% or lower with a waveform length of 950 nm.  
 The Reflective Sensor should be aligned with the centre of the Black Mark.

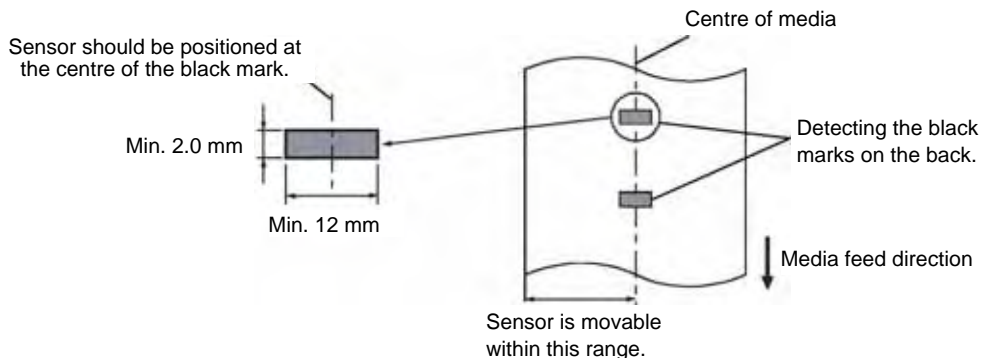

### 7.1.4 Effective Print Area

The figure below illustrates the relation between the head effective print width and media width.

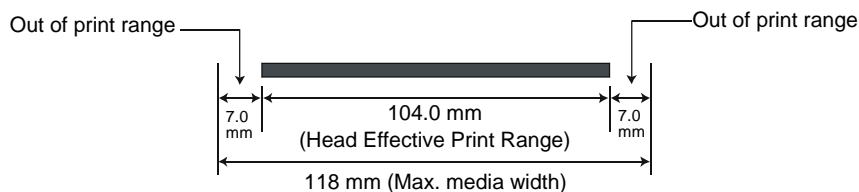

The figure below shows the effective print area on the media.

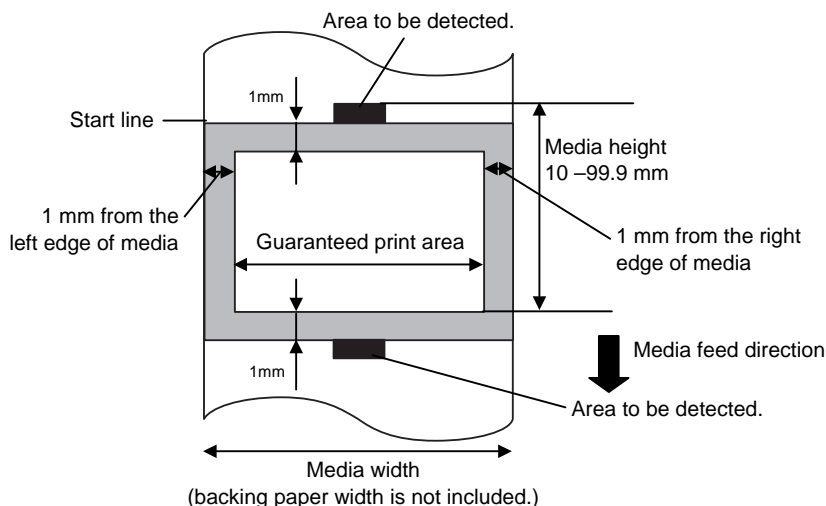

**NOTES:**

1. Be sure not to print on the 1-mm wide area from the media edges (shaded area in the above figure). Printing this area may cause ribbon wrinkles, resulting in a poor print quality of the guaranteed print area.
2. The centre of media is positioned at the centre of the Print Head.
3. Print quality in the 3-mm area from the print head stop position (including 1-mm non-printable area for print speed slow down) is not guaranteed.

### 7.1.5 RFID Tag

The B-SA704-RFID-U2-EU-R supports EPC C1 Gen2 tags.

#### Cautions for using RFID Tags

##### (1) Location of RFID Tag

The location of an RFID tag in a label influences on the accuracy of writing data on the RFID tag. It is impossible to define the one best location for every RFID tag in labels because the best location depends on the type of RFID tag and RFID tag antenna.

The RFID Analyze Tool can evaluate the accuracy of writing data on the RFID tag.

For the RFID Analyze Tool, please contact the dealer or your nearest TOSHIBA TEC representative.

As a guideline, the best location for some common RFID tags is given below.

It is recommended to use the RFID Analyze Tool to evaluate the accuracy of writing data on an RFID tag to be used, then determine a specific location of the RFID tag.

If the RFID tag cannot be placed on the best location specified, contact the dealer or nearest TOSHIBA TEC representative.

Note that the best location described in this specification may not be applicable depending on the type or paper or glue even if the same RFID tags are used. This guideline applies to RFID labels for thermal transfer issue. When using the media made of PET or thermal paper, the best location needs to be found again.

#### Example 1) UPM Raflatac's Rafsec Short Dipole 2 Tag

It is recommended to locate the vertical center of an RFID tag at 27 mm  $\pm$  3 mm from a leading edge of a label and align the horizontal center with the horizontal center of the label.

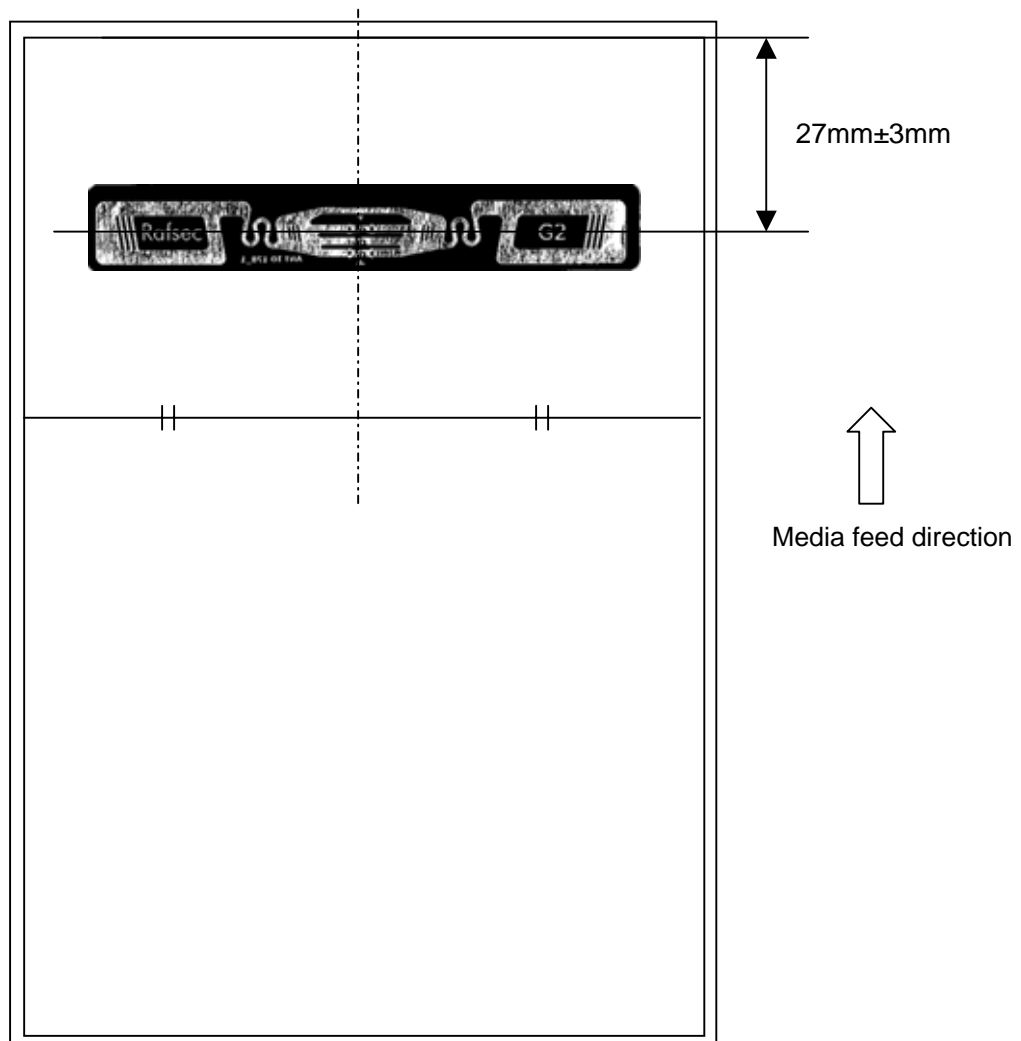

**Example 2) UPM Raflatac's Rafsec WEB Tag**

It is recommended to locate the vertical center of an RFID tag at  $58\text{ mm} \pm 6\text{ mm}$  from a leading edge of a label and align the horizontal center with the horizontal center of the label.

When the operating temperature is low ( $5^{\circ}\text{C}$  to  $10^{\circ}\text{C}$ ), the sensitivity tends to become low. Variation of the sensitivity of tags may also lower the read rate. Operation at normal temperature ( $15^{\circ}\text{C}$  to  $30^{\circ}\text{C}$ ) is desired.

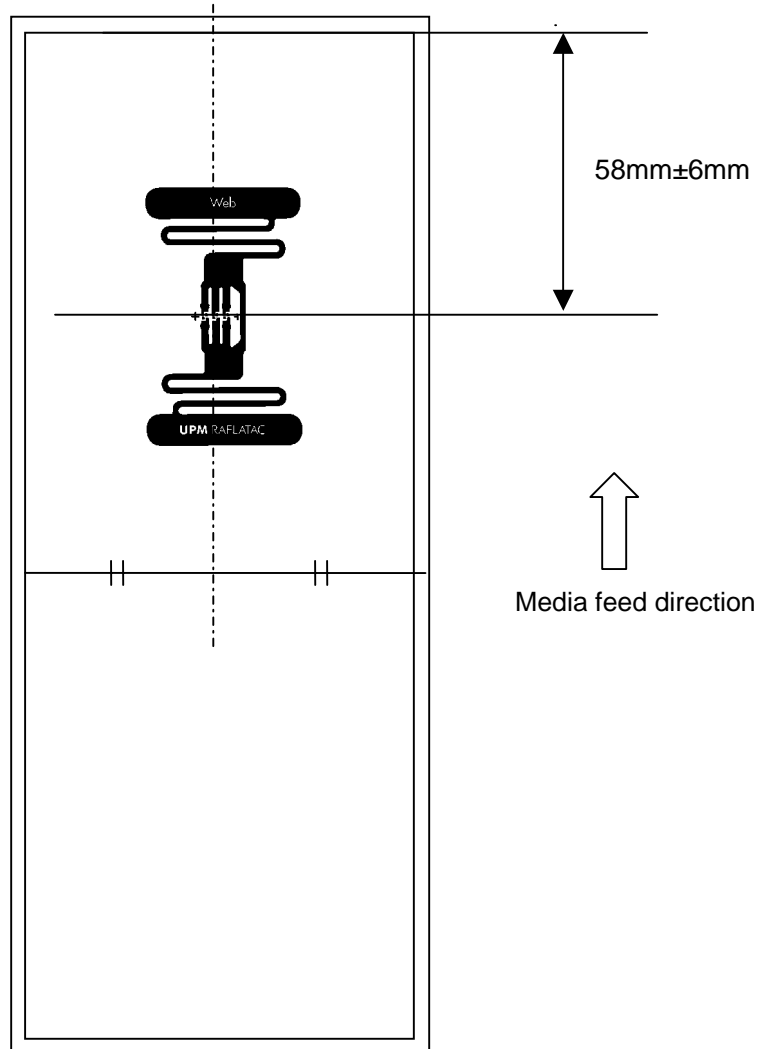

**Example 3) Rafsec Short Dipole 2 (short-pitch tag)**

A Shield Sheet is supplied with the B-SA704-RFID-U2-EU-R to enable the RFID kit to encode short-pitch tags properly. When the Shield Sheet is attached to the printer, the write field will be narrower. The RFID kit is designed so that the second label is positioned just above the antenna while the first label is at the print start position, when using the following short-pitch label.

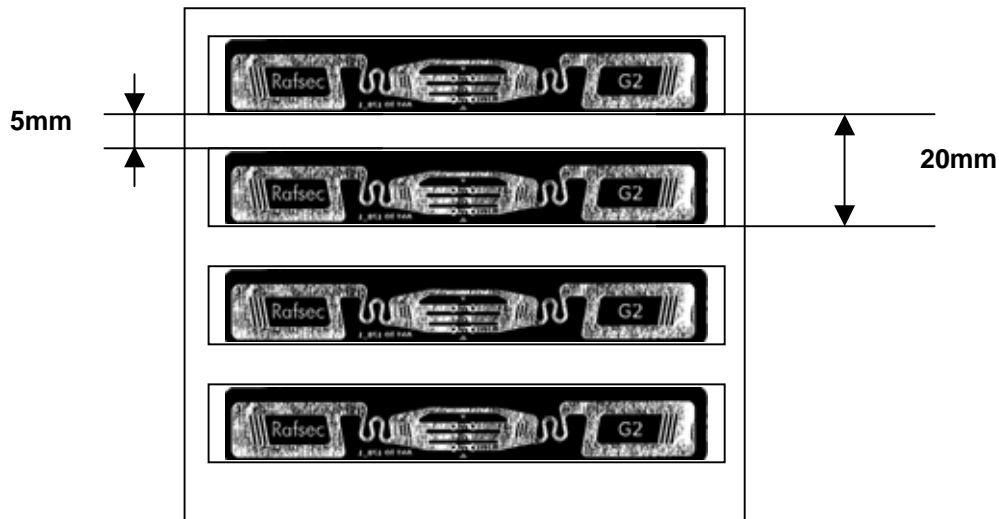
**(2) Storage of RFID Supplies**

Do not store RFID tags close to printers, or their communication performance may not be as specified when they are used.

**(3) Roll-type RFID Supplies**

When RFID supplies are to be rolled, roll hardness must be concerned.

Although it depends on the type of glue, tag, and backing paper, RFID-tag embedded labels tend to stay rolled. Especially, when they are wound outside, a paper jam error may occur. Unless otherwise specified, it is recommended that the RFID-tag embedded labels be wound inside.

**(4) Sensor**

When the transmissive sensor or reflective sensor is enabled, transmissivity or reflectivity of a label or tag may vary at an RFID-tag embedded area depending on the pattern of an antenna or other factors. In such cases, a manual threshold setting is required. For details, refer to **Section 2.11 Threshold Setting**.

**(5) Cutter**

When an RFID label or tag is used in cut issue mode, care must be taken not to cut an antenna of the RFID tag or an IC chip in order not to damage the cutter.

**(6) Static Electricity**

When printing is performed in a place where humidity is low or under some specific conditions, writing data on an RFID tag may fail due to static electricity generated by a label or a ribbon.

## (7) Printing on Bump (Chip/Antenna) Area

Embedding an RFID tag in labels creates bumps on the label surface, causing incomplete printing. Uneven printing or incomplete printing can occur easily, especially within 5 mm back and forth and right and left sides of the RFID-tag embedded area, as shown in the figure below.

**NOTE:** The degree of poor printing quality differs depending on height of a chip/antenna used.

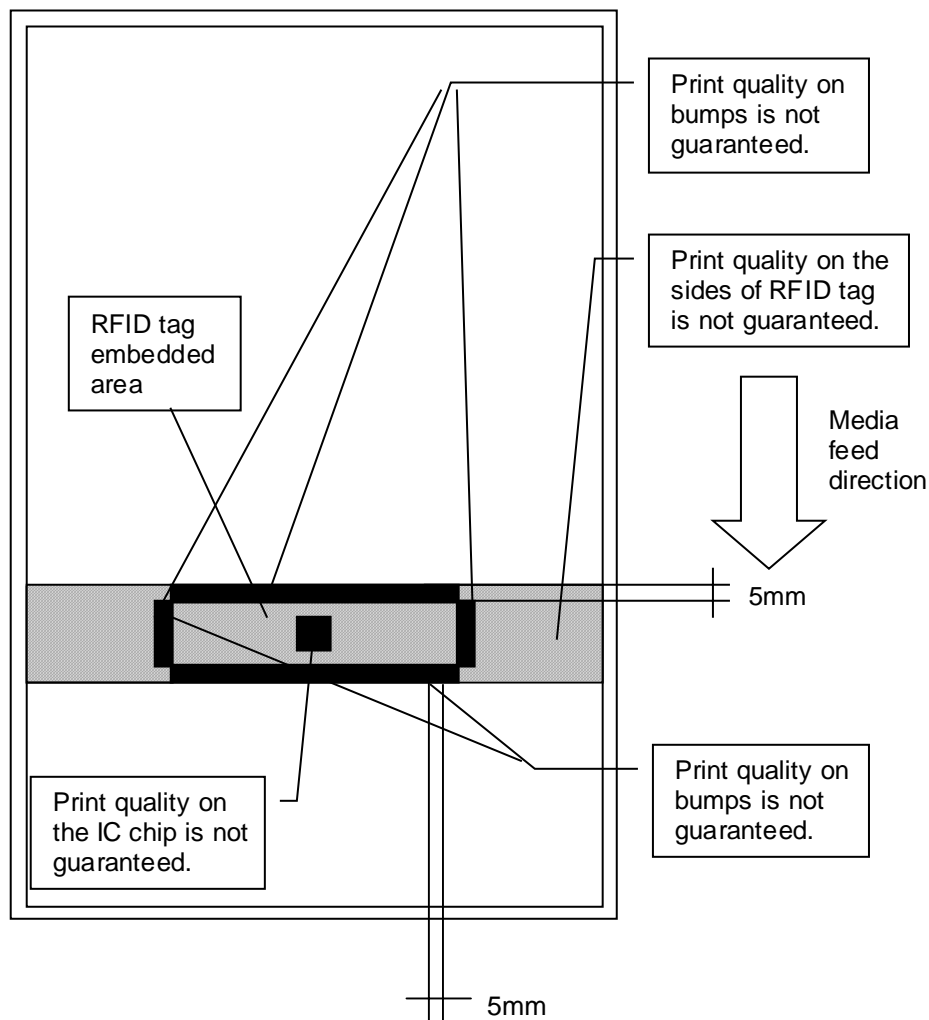

## (8) Ambient Temperature

As low temperature deteriorates wireless performance, writing data on an RFID tag may fail under such conditions.

## (9) Strip Issue

Stripping performance in strip issue mode depends on the type of glue, tag, and backing paper. For some RFID supplies used, a strip issue may not be performed properly.

## (10) Caution for Minimum Label Pitch Length

When media, of which label pitch length is short, is used, data may be written on an RFID tag next to the target RFID tag.

As the location, where data is to be written, differs among RFID tag types, a check must be performed to make sure that the data is written on the target RFID tags. The B-SX RFID Analyze Tool can be used for this purpose. For details, please contact the nearest TOSHIBA TEC service representative.

**(11) Print Position Accuracy**

When using RFID tag embedded media, the print position accuracy may exceed the guaranteed tolerance of  $\pm 1$  mm in all issue modes.

It is required to check the print position accuracy for each media type.

**(12) Paper Jam Error**

Depending on the type of glue or the flexibility of labels, a label may come unstuck in front of the sensor unit, which cause a paper jam. Particularly, the frequency of paper jam could become higher on the condition of low operating temperature or use of short-pitch labels.

It is required to check the media feed using the media to be used under the actual operating environment.

## 7.2 Ribbon

Please make sure that the ribbon being used is approved by TOSHIBA TEC. The warranty does not apply to any problem caused by using non-approved ribbons.

For information regarding TOSHIBA TEC approved ribbon, please contact a TOSHIBA TEC service representative.

Type	Spool type
Width	60 – 110 mm Recommended width is 60, 90, and 110 mm.
Length	450 m (within $\varnothing 75$ mm)
Outside Diameter	$\varnothing 75$ mm (max.)

The table below shows the correlation between ribbon width and media width (backing paper is not included.)

Ribbon width	Media width
60 mm	25 – 55 mm
90 mm	55 – 85 mm
110 mm	85 – 105 mm

**NOTES:**

1. To ensure print quality and print head life use only TOSHIBA TEC specified ribbons.
2. Too much difference in width between media and ribbon may cause ribbon wrinkles. To avoid ribbon wrinkles use a ribbon for proper media width shown in the above table. Do not use a ribbon that is narrower than media.
3. When discarding ribbons, please follow the local rule.

### 7.3 Recommended Media and Ribbon Types

Media type	Description
Vellum paper and labels	General use for low cost applications.
Coated paper	Matt coated paper General use including applications that require small letters and/or symbols. Glossy coated paper Used where a high-grade finish is required
Plastic films	Synthetic film (Polypropylene, etc.) This water-proof and solvent-resistant material has high physical strength and low-temperature resistance, but poor heat resistance (dependant upon material). This material can be used for labels stuck to recyclable containers, so it can be recycled in the same process. PET film This water-proof and solvent-resistant material has high physical strength, and low-temperature resistance as well as heat resistance. This material is used for many applications, especially where high durability is required. Mode/serial plate labels, caution labels, etc. Polyimide This material gives the best performance on heat resistance (greater than PET film). It is often used for PCB labels as it can withstand passage through a solder bath.

Ribbon type	Description
Vellum wax ribbon	This ribbon is mainly used for vellum paper and labels. It has a very high ink density to cope with uneven printing surface
Standard wax ribbon	Good match for coated paper (Matt coat and glossy coat).
Smear-less ribbon (Wax resin ribbon)	Good match for coated paper. The printed image will resist water and light rubbing.
Scratch and solvent resistance ribbon	Very good match for plastic films (synthetic paper, PET, polyimide, etc.) Scratch and solvent resistance Heat resistance with PET and polyimide.

#### Combination of Media and Ribbon

Media type \ Ribbon type	Vellum paper and label	Coated paper	Plastic films
Vellum wax ribbon	○		
Standard wax ribbon		○	
Smear-less ribbon (wax-resin ribbon)		○	
Scratch/solvent resistance ribbon			○

○: Good match



## 7.4 Care/Handling of Media and Ribbon

**CAUTION!**

*Be sure to carefully review and understand the Supply Manual. Use only media and ribbons that meet specified requirements. Use of non-specified media and ribbons may shorten the head life and result in problems with bar code readability or print quality. All media and ribbons should be handled with care to avoid any damage to the media, ribbons or printer. Read the guidelines in this section carefully.*

- Do not store the media or ribbon for longer than the manufacturer's recommended shelf life.
- Store media rolls on the flat end. Do not store them on the curved sides as this might flatten that side causing erratic media advance and poor print quality.
- Store the media in plastic bags and always reseal after opening. Unprotected media can get dirty and the extra abrasion from the dust and dirt particles will shorten the print head life.
- Store the media and ribbon in a cool, dry place. Avoid areas where they would be exposed to direct sunlight, high temperature, high humidity, dust or gas.
- The thermal paper used for direct thermal printing must not have specifications which exceed  $\text{Na}^+$  800 ppm,  $\text{K}^+$  250 ppm and  $\text{Cl}^-$  500 ppm.
- Some ink used on pre-printed media may contain ingredients which shorten the print head's product life. Do not use labels pre-printed with ink which contain hard substances such as carbonic calcium ( $\text{CaCO}_3$ ) and kaolin ( $\text{Al}_2\text{O}_3, 2\text{SiO}_2, 2\text{H}_2\text{O}$ ).

For further information, please contact your local distributor or your media and ribbon manufacturers.

## APPENDIX 1 MESSAGES AND LEDS

Appendix 1 describes the LCD messages displayed on the operation panel.

### Symbols in the message

- 1: ○: The LED is illuminated. ◎: The LED is flashing. ●: The LED is unlit.  
 2: \*\*\*\*: the number of unprinted media. Up to 9999 (in pieces)  
 3: ###: Flash memory card remaining memory for PC save area: 0 to 895 (in K bytes)  
 4: &&&&: Remaining flash memory capacity for storing writable characters 0 to 3147 (in K bytes)

No.	LCD Message	LED Indication		Printer Status	Restoration by RESTART key Yes/No	Acceptance of Status Request Reset Command Yes/No
		ONLINE	ERROR			
1	ON LINE	○	●	Online mode	----	Yes
	ON LINE	◎	●	Online mode (communicating)	----	Yes
2	HEAD OPEN	●	●	The Top Cover is opened in online mode.	----	Yes
3	PAUSE ****	●	●	Pause state	Yes	Yes
4	COMMS ERROR	●	○	A parity, overrun, or framing error has occurred during a communication by RS-232C.	Yes	Yes
5	PAPER JAM ****	●	○	A paper jam has occurred during paper feed.	Yes	Yes
6	CUTTER ERROR****	●	○	A problem has occurred at the cutter module.	Yes	Yes
7	NO PAPER ****	●	○	The media has run out, or the media is not loaded properly.	Yes	Yes
8	HEAD OPEN ****	●	○	A feed or an issue was attempted with the Top Cover opened. (Except when the [FEED] key is pressed.)	Yes	Yes
9	HEAD ERROR	●	○	The print head has a problem.	Yes	Yes
10	EXCESS HEAD TEMP	●	○	The print head is overheated.	No	Yes
11	RIBBON ERROR****	●	○	<ul style="list-style-type: none"> <li>The ribbon has run out.</li> <li>The ribbon has been torn. A problem has occurred with the sensor that determines the torque for the ribbon motor.</li> </ul>	Yes	Yes
12	COVER OPEN ****	●	○	A feed or printing was attempted with the Front Cover opened.	Yes	Yes
13	SAVING #####&&&&	○	●	In writable character or PC command save mode	----	Yes
14	FLASH WRITE ERR.	●	○	An error has occurred in writing to the flash ROM.	No	Yes
15	FORMAT ERROR	●	○	An error has occurred in formatting the flash ROM.	No	Yes
16	FLASH CARD FULL	●	○	Saving failed because of an insufficient capacity of the flash ROM.	No	Yes
17	Display of error message (See Note.)	●	○	A command error has occurred in analyzing the command.	Yes	Yes
18	POWER FAILURE	●	○	A momentary power failure has occurred.	No	No
19	INITIALIZING...	●	●	The flash ROM is being initialised.	----	----
20	EEPROM ERROR	●	○	Data cannot be read from/written to a backup EEPROM properly.	----	----

No.	LCD Message	LED Indication		Printer Status	Restoration by RESTART key (Yes/No)	Acceptance of Status Request Reset Command (Yes/No)
		ONLINE	ERROR			
21	SYSTEM ERROR	●	○	When the following abnormal operations are performed, a system error occurs: (a) Command fetch from an odd address (b) Access to word data at an odd address (c) Access to long-word data at an odd address (d) Access to the area of 80000000H to FFFFFFFFH in the logic space in user mode. (e) An undefined instruction in an area other than a delay slot was decoded. (f) An undefined instruction in a delay slot was decoded. (g) An instruction to rewrite a delay slot was decoded.	No	No
22	100BASE LAN INITIALIZING...	●	●	100 Base LAN Board is being initialised.	----	----
23	DHCP CLIENT INITIALIZING...	●	●	The DHCP client is being initialized. *When the DHCP function is enabled.	----	----
24	RFID WRITE ERROR	●	○	The printer did not succeed in writing data onto an RFID tag after having retried for a specified times.	Yes	Yes
25	RFID ERROR	●	○	The printer cannot communicate with the RFID module.	No	Yes
26	LOW BATTERY	●	○	The voltage of the Real Time Clock Battery is 1.9V or less.	No	Yes

**NOTE:** When an error message listed above appears on the LCD message display, please refer to **Section 5 TROUBLESHOOTING** for solution.

**NOTE: Description of Command Error**

- If a command error is found in a command received, 16 bytes of the command error, starting from the command code, will be displayed. (However, [LF] and [NUL] will not be displayed.)

**Example 1**

[ESC] T20 G30 [LF] [NUL]  
                   └─── Command error

The following message appears.

```
T20G30
B-SA4T-T V1.2A
```

**Example 2**

[ESC] XR; 0200, 0300, 0450, 1200, 1, [LF] [NUL]  
   └─── Command error

The following message appears.

```
XR;0200,0300,045
B-SA4T-T V1.2A
```

**Example 3**

[ESC] PC001; 0A00, 0300, 2, 2, A, 00, B [LF] [NUL]  
   └─── Command error

The following message appears.

```
PC001;0A00,0300,
B-SA4T-T V1.2A
```

- When the error command is shown, "? (3FH)" appears for codes other than codes 20H to 7FH and A0H to DFH.
- For details, please refer to the **B-SA4T Series External Equipment Interface Specification** stored in the CD-ROM.

## APPENDIX 2 INTERFACE

**NOTE:**

To prevent radiation and reception of electrical noise, the interface cables must meet the following requirements:

- In case of a parallel interface cable or serial interface cable, fully shielded and fitted with metal or metallised connector housings.
- Keep as short as possible.
- Should not be bundled tightly with power cords.
- Should not be tied to power line conduits.
- A parallel interface cable to be used should conform to IEEE1284.

### ■ Parallel interface (Centronics)

Mode: Conforming to IEEE1284  
Compatible mode (SPP mode), Nibble mode

Data input method: 8 bit parallel

Control signal:

SPP Mode	Nibble Mode
nStrobe	HostClk
nAck	PtrClk
Busy	PtrBusy
Perror	AckDataReq
Select	Xflag
nAutoFd	HostBusy
nInIt	nInIt
nFault	nDataAvail
nSelectIn	IEEE1284Active

Data input code: ASCII code  
European 8 bit code  
Graphic 8 bit code  
JIS8 code  
Shift JIS Kanji code  
JIS Kanji code

Receive buffer: 1M byte

Connector:

PIN No.	Signal	
	SPP Mode	Nibble Mode
1	nStrobe	HostClk
2	Data 1	Data 1
3	Data 2	Data 2
4	Data 3	Data 3
5	Data 4	Data 4
6	Data 5	Data 5
7	Data 6	Data 6
8	Data 7	Data 7
9	Data 8	Data 8
10	nAck	PtrClk
11	Busy	PtrBusy
12	PError	AckDataReq
13	Select	Xflag
14	nAutoFd	HostBusy
15	NC	NC
16	0V	0V
17	CHASSIS GND	CHASSIS GND
18	+5V (For detection)	+5V (For detection)
19	TWISTED PAIR GND(PIN1)	TWISTED PAIR GND(PIN1)
20	TWISTED PAIR GND(PIN2)	TWISTED PAIR GND(PIN2)
21	TWISTED PAIR GND(PIN3)	TWISTED PAIR GND(PIN3)
22	TWISTED PAIR GND(PIN4)	TWISTED PAIR GND(PIN4)
23	TWISTED PAIR GND(PIN5)	TWISTED PAIR GND(PIN5)
24	TWISTED PAIR GND(PIN6)	TWISTED PAIR GND(PIN6)
25	TWISTED PAIR GND(PIN7)	TWISTED PAIR GND(PIN7)
26	TWISTED PAIR GND(PIN8)	TWISTED PAIR GND(PIN8)
27	TWISTED PAIR GND(PIN9)	TWISTED PAIR GND(PIN9)
28	TWISTED PAIR GND(PIN10)	TWISTED PAIR GND(PIN10)
29	TWISTED PAIR GND(PIN11)	TWISTED PAIR GND(PIN11)
30	TWISTED PAIR GND(PIN31)	TWISTED PAIR GND(PIN31)
31	nInIt	nInIt
32	nFault	NDataAvail
33	0V	0V
34	NC	NC
35	NC	NC
36	nSelectIn	IEEE1284Active

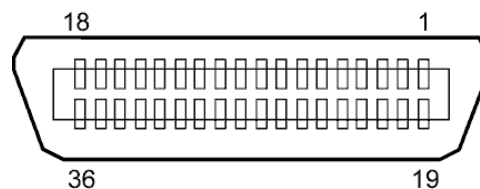

IEEE1284-B Connector

■ **USB interface**

Standard: Conforming to V2.0 Full speed  
 Transfer type: Control transfer, Bulk transfer  
 Transfer rate: Full speed (12M bps)  
 Class: Printer class  
 Control mode: Status with the receive buffer free space information  
 Number of ports: 1  
 Power source: Self power  
 Connector: Type B

Pin No.	Signal
1	VCC
2	D-
3	D+
4	GND



Series B Plug

■ **LAN**

Standard: IEEE802.3 10BASE-T/100BASE-TX  
 Number of ports: 1  
 Connector: RJ-45  
 LED status: Link LED  
 Activity LED

LED	LED Status	LAN status
Link	ON	10Mbps link or 100Mbps link is detected.
	OFF	No link is detected. * Communication cannot be made while the Link LED is off.
Activity	ON	Communicating
	OFF	Idle

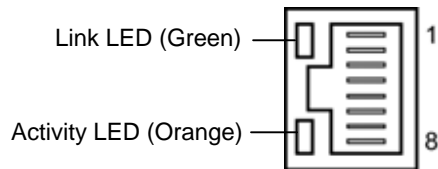

LAN cable: 10BASE-T: UTP category 3 or category 5  
 100BASE-TX: UTP category 5  
 Cable length: Segment length Max. 100 m

**NOTES:**

1. For IP address setting, refer to **Section 2.7.3 IP Address Setting (TCP/IP)**.
2. When a generally-used twisted pair Ethernet (TPE) or UTP cable is used, a communication error may occur depending on your operating environment. In such case, you may be requested to use a shielded twisted pair cable.

■ **Serial interface (Option)**

Type: RS-232C  
 Communication mode: Full duplex  
 Transmission speed: 2400 bps, 4800 bps, 9600 bps, 19200 bps, 38400 bps, 115200 bps  
 Synchronization: Start-stop synchronization  
 Start bit: 1 bit  
 Stop bit: 1 bit, 2 bit  
 Data length: 7 bit, 8 bit  
 Parity: None, EVEN, ODD  
 Error detection: Parity error, Framing error, Overrun error  
 Protocol: Unprocedure communication  
 Data input code: ASCII code, European character 8 bit code, graphic 8 bit code, JIS8 code, Shift JIS Kanji code, JIS Kanji code  
 Receive buffer: 1M byte  
 Connector:

Pin No.	Signal
1	N.C
2	TD (Transmit Data)
3	RD (Received Data)
4	DSR (Data Set Ready)
5	SG (Signal Ground)
6	DTR (Data Terminal Ready)
7	CTS (Clear to Send)
8	RTS (Request to Send)
9	N.C

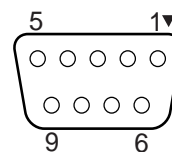

■ **RFID (Option: B-SA704-RFID-U2-EU-R)**

Module: TOSHIBA TEC TRW-EUM-01 for Europe  
 Applicable standard: ETSI EN 300 220  
 Frequency range: 869.7-870.0MHz  
 Center frequency: 869.85MHz  
 Output power (ERP): Max. 5mW (Power class 7a)  
 Output power (Conducted): 100mW  
 Modulation method (RW → Tag): DSB-ASK  
 Modulation method (Tag → RW): Back scatter ASK  
 Transmission speed (RW → Tag): 40kbps  
 Transmission speed (Tag → RW): 40kbps  
 Encoding (RW → Tag): PIE  
 Encoding (Tag → RW): FM0  
 Number of channels: 1  
 Duty Cycle: Max. 100% (Class 4)  
 Carrier sensor feature: None  
 Environmental standard: RoHS directive  
 Available RFID tag types: EPC C1 Gen2



**■ Wireless LAN (Option)**

Standard:	Conforming to IEEE802.11a, IEEE802.11b, and IEEE802.11g
Protocol:	IP (RFC791), ICMP (RFC792), UDP (RFC768), TCP (RFC793,896), ARP (RFC826), HTTPD (RFC1866), TELNET, FTPD (RFC959), DHCP (RFC2131), SNMP
Security protocol:	WEP (64 bits/128 bits/152 bits) or AES, AES-OCB (128 bits) TKIP (only when using WPA, WPA-PSK) TWSL (unique encryption)
Antenna:	Chip type, diversity antenna
Parameter setting:	via HTTP
Default IP address:	192.168.10.21
Default subnet mask:	255.255.255.0

**NOTE:**

*MAC address of the Wireless LAN module will be necessary when setting the MAC address filtering function of an access point. Please ask a service person of your nearest TOSHIBA TEC service representative.*

■ Expansion I/O Interface (Option: B-SA704-IO-QM-R)

Input Signal IN0 to IN5  
 Output Signal OUT0 to OUT6  
 Connector (External Device Side) FCN-781P024-G/P or equivalent  
 Connector (Printer Side) FCN-685J0024 or equivalent

Pin	Signal	I/O	Function	Pin	Signal	I/O	Function
1	IN0	Input	FEED	13	OUT6	Output	
2	IN1	Input	PRINT	14	N.C.	----	
3	IN2	Input	PAUSE	15	COM1	Common (Power)	
4	IN3	Input		16	N.C.	----	
5	IN4	Input		17	N.C.	----	
6	IN5	Input		18	N.C.	----	
7	OUT0	Output	FEED	19	N.C.	----	
8	OUT1	Output	PRINT	20	N.C.	----	
9	OUT2	Output	PAUSE	21	COM2	Common (Ground)	
10	OUT3	Output	ERROR	22	N.C.	----	
11	OUT4	Output		23	N.C.	----	
12	OUT5	Output	POWER ON	24	N.C.	----	

N.C.: No Connection

Input Circuit

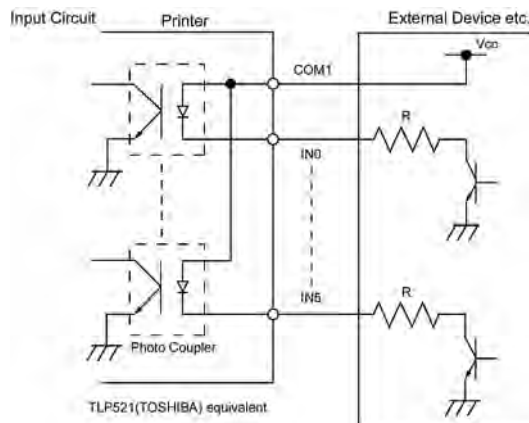

Output Circuit

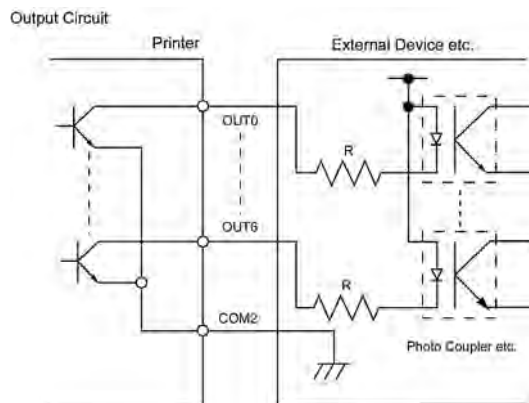

Operating environment Temperature: 0 to 40 °C  
 Humidity: 20 to 90% (No Condensation)

# APPENDIX 3 POWER CORD

## When purchasing the power cord:

Since the power cord set is not enclosed in this unit, please purchase an approved one that meets the following standard from your authorized TOSHIBA TEC representative.

(As of September 2004)

Country	Agency	Certification mark	Country	Agency	Certification mark	Country	Agency	Certification mark
Australia	SAA		Germany	VDE		Sweden	SEMKKO	
Austria	OVE		Ireland	NSAI		Switzerland	SEV	
Belgium	CEBEC		Italy	IMQ		UK	ASTA	
Canada	CSA		Japan	METI		UK	BSI	
Denmark	DEMKO		Netherlands	KEMA		U.S.A.	UL	
Finland	FEI		Norway	NEMKO		Europe	HAR	
France	UTE		Spain	AEE				

### Power Cord Instruction

1. For use with 100 – 125 Vac mains power supply, please select a power cord rated Min. 125V, 10A.
2. For use with 200 – 240 Vac mains power supply, please select a power cord rated Min. 250V.
3. Please select a power cord with the length of 4.5m or less.

Country/Region	North America	Europe	United Kingdom	Australia
Power Cord Rated (Min.) Type	125V, 10A SVT	250V H05VV-F	250V H05VV-F	250V AS3191 approved, Light or Ordinary Duty type
Conductor size (Min.)	No. 3/18AWG	3 x 0.75 mm <sup>2</sup>	3 x 0.75 mm <sup>2</sup>	3 x 0.75 mm <sup>2</sup>
Plug Configuration (locally approved type)				
Rated (Min.)	125V, 10A	250V, 10A	250V, *1	250V, *1

\*1: At least, 125% of the rated current of the product.

---

## APPENDIX 4 PRINT SAMPLES

The following are the image samples of the fonts, bar codes, and two-dimensional codes provided for the B-SA4T series as standard. The size of each font may be different from the actual one. Font type and size can be specified by a command. For details, please refer to the **B-SA4T Series External Equipment Interface Specification** stored in the CD-ROM.

### ■ Font

<A>Times Roman medium

<B>Times Roman medium

<C>Times Roman bold

<D>Times Roman bold

<E>Times Roman bold

<F>*Times Roman italic*

<G>Helvetica medium

<H>Helvetica medium

<I>Helvetica medium

<J>Helvetica bold

<K>Helvetica bold

<L>*Helvetica italic*

<M>**PRESENTATION BOLD**

<N>Letter Gothic medium

<O>Prestige Elite medium

<P>Prestige Elite bold

<Q>Courier medium

<R>Courier bold

<S>OCR-A

<T>OCR-B

<q>Gothic 725 Black

**APPENDIX 4 PRINT SAMPLES (Cont.)**

<Outline Font:A> **H e l v e t i c a   b o l d**

<Outline Font:B> **Helvetica bold(P)**

<Outline Font:E> *0 1 2 3 4 5 6 7 8 9, ¥ \$*

<Outline Font:F> **0 1 2 3 4 5 6 7 8 9, ¥ \$**

<Outline Font:G> **0 1 2 3 4 5 6 7 8 9, ¥ \$**

<Outline Font:H> **Dutch 801 bold**

<Outline Font:I> *Brush 738 regular*

<Outline Font:J> **Gothic 725 Black**

# APPENDIX 4 PRINT SAMPLES (Cont.)

■ Bar codes

JAN8, EAN8



MSI



Interleaved 2 of 5



CODE39 (Standard)



NW7



JAN13, EAN13



UPC-E



EAN13+2 digits



EAN13+5 digits



CODE128



CODE39 (Full ASCII)



CODE93



UPC-E+2 digits



UPC-E+5 digits



EAN8+2 digits



EAN8+5 digits



UPC-A



UPC-A+2 digits



# APPENDIX 4 PRINT SAMPLES (Cont.)

UPC-A+5 digits



UCC/EAN128



Industrial 2 of 5



POSTNET



Customer bar code



Customer bar code of high priority



KIX Code



RM4SCC



RSS-14



RSS-14 Stacked



RSS-14 Stacked Omnidirectional



RSS Limited



RSS Expanded



Data Matrix



PDF417



QR code



Micro PDF417



MaxiCode



CP Code



## APPENDIX 5 GLOSSARIES

### **Bar code**

A code which represents alphanumeric characters by using a series of black and white stripes in different widths. Bar codes are used in various industrial fields: Manufacturing, Hospitals, Libraries, Retail, Transportation, Warehousing, etc. Reading bar codes is a fast and accurate means of capturing data while keyboard entry tends to be slow and inaccurate.

### **Batch mode**

Issue mode that continuously prints media until the specified number of media has been printed.

### **Black mark**

A mark printed on the media so that the printer can maintain a constant print position by detecting this mark.

### **Black mark sensor**

A reflective sensor which detects the difference of potential between a black mark and print area to find the print start position.

### **Cut mode**

One of the printer modes of operation where an optional cutter module is installed to automatically cut media from the media roll after they are printed. The print command can specify to cut every media or to cut after a set number of media have been printed.

### **Cutter module**

A device used to cut the media.

### **DHCP**

Dynamic Host Configuration Protocol

A communications protocol which lets a network administrator temporarily assign an IP address to a computer plugged into a different place in the network.

### **DPI**

Dot Per Inch

The unit used to express print density.

### **Feed gap sensor**

A transmissive sensor which detects the difference of potential between the label gaps and the label to find the print position of the label.

### **Font**

A complete set of alphanumeric characters in one style of type. E.g. Helvetica, Courier, Times

### **Gap**

Clearance between labels

### **IPS**

Inch per second

The unit used to express print speed.

### **Label**

A type of media with adhesive backing.

### **LCD**

Liquid Crystal Display

Installed on the operation panel and displays operation modes, error message and so on.

### **Media**

Material on which data is printed by the printer. Label, tag paper, fanfold paper, perforated paper, etc.

### **Plug and Play**

When Plug and Play is enabled, the PC will automatically identify the printer (if the PC supports Plug & Play), optimize the system resource (IRQ and DMA), and display a message prompting a printer driver installation.

### **Pre-printed media**

A type of media on which characters, logos, and other designs have been already printed.



**Printer IP address**

A 32-bit address of a printer connected to TCP/IP network, which identifies the network printer. An IP address is written as 4 sets of numbers, separated by periods.

**Print head element**

The thermal print head consists of a single line of tiny resistive elements and when current is allowed to flow through each element it heats up causing a small dot to be burned onto thermal paper or a small dot of ink to be transferred from a thermal ribbon to ordinary paper.

**Print speed**

The speed at which printing occurs. This speed is expressed in units of ips (inches per second).

**Resolution**

The degree of detail to which an image can be duplicated. The minimum unit of divided image is called a pixel. As the resolution becomes higher, the number of pixels increased, resulting in more detailed image

**RFID (Radio Frequency Identification)**

A method of automatically identifying people or objects using radio waves. In case of the B-SX series, the RFID module writes digital information to an RFID tag mounted inside labels or tag paper while the printer is printing data on them. The RFID tag is a microchip attached to an antenna. The microchip holds data and the antenna enables the tag to send and receive data.

**Ribbon**

An inked film used to transfer an image onto the media. In the thermal transfer printing, it is heated by the thermal print head, causing an image to be transferred onto the media.

**Strip mode**

One of the printer modes of operation where an optional strip module is installed to separate printed labels from the backing paper one by one.

**Strip module**

A device used to remove labels from the backing paper.

**Supply**

Media and ribbon

**Tag**

A type of media with no adhesive. Usually tags are made of cardboard or other durable material.

**Thermal direct printing**

A printing method using no ribbon, but thermal media which reacts to heat. The thermal print head heats the thermal media directly, causing print image to be printed on the media.

**Thermal print head**

A print head using thermal transfer or thermal direct printing method.

**Thermal transfer printing**

A printing method that the thermal print head heats an ink or resin coating on the ribbon against the media, causing the ink/resin to transfer onto the media.

**Threshold setting**

A sensor setting operation to have the printer maintain a constant print position of pre-printed media.

**USB (Universal Serial Bus)**

An interface that is used to connect peripherals, such as a printer, keyboard, mouse. The USB allows disconnection of a USB device without turning off the power.

**Web printer**

The web printer function allows you to browse the printer status on the PC, issue media, check or change the settings, or download the firmware to the printer. For details, refer to the **Network Specification**.

# INDEX

## A

Auto print head check 2-25  
Automatic threshold setting 2-1, 2-73

## B

Backing paper 2-9, 2-68, 7-1  
Bar code 6-2, A4-3, A5-1  
Batch mode 2-8, 7-1, A5-1  
Black mark 2-7, 7-1, 7-3, A5-1  
Black mark length 7-1  
Black mark sensor 2-7, 2-65, 2-73, 2-74, 2-75, 4-2, A5-1

## C

Centronics 1-3, 2-14, 2-25, 6-2, A2-1  
Cut mode 2-10, 7-1, A5-1  
Cut position 2-67, 7-1  
Cutter module 1-1, 1-5, 2-10, 2-64, 4-3, 6-2, A5-1

## D

DHCP 2-43  
DHCP client ID 2-43  
DHCP host name 2-44  
Dimensions 1-3, 6-1

## E

Effective Print length 7-1  
Effective print width 6-1, 7-1  
Error message 5-1  
Expansion I/O 1-1, 1-3, 1-5, 2-14, 2-27, 6-2, A2-6

## F

Feed gap sensor 2-6, 2-65, 2-73, 2-74, 2-75, 4-2, A5-1  
Front cover 2-8, 2-9, 4-3, 5-1, A1-1

## G

Gap 2-75, 2-77, 7-2, A5-1  
Gap length 7-1  
Gateway IP address 2-41  
Guaranteed print area 7-3

## H

Head position lever 1-4, 2-10

## I

Interface 1-1, 1-3, 2-14, 6-2, A2-1  
IP address 2-39, 2-59  
Issue mode 2-8, 2-63, 6-1

## J

Jammed media 4-3, 4-4, 5-4

## L

Label 2-3, 2-10, 7-1, 7-2, 7-9  
LCD message display 1-3, 1-4, 3-1, 6-1  
LCD language 2-21

## M

Manual threshold setting 2-74, 2-76  
Media 2-3, 7-1, 7-9, 7-10

## O

Operation panel 1-3, 1-4, 3-1  
Options 1-1, 1-5

## P

Parallel interface 1-3, 2-14, 2-45, 6-2, A2-1  
Parameter setting 2-16, 2-17  
Platen 1-4, 4-2  
Plug & play 2-28, A5-1  
Power consumption 6-1  
Power cord 2-2, A3-1  
Power switch 1-3, 2-2, 2-15  
Pre-printed media 4-3, 5-4  
Print head 1-4, 4-1, 4-2  
Print head cleaner 4-1  
Print start position 2-6, 2-66, 2-73  
Print test 2-1, 2-48  
Print tone 2-65, 2-71  
Printer driver 2-1, 2-45  
Printing method 6-1  
Printing speed 1-1, 6-1

**R**

Real time clock 1-1, 1-5, 2-16, 2-37, 5-3, 6-2, A1-2  
Resolution 6-1, A5-2  
Reverse feed amount 2-69  
RFID module 1-1, 1-5, 6-2, A1-2  
Ribbon 2-11, 7-8, 7-9, 7-10  
Ribbon cover 1-3, 1-4, 2-12  
Ribbon motor voltage 2-72  
Ribbon stopper 1-4, 2-11, 2-12  
RS-232C 1-3, 2-14, 6-2, A2-4

**S**

Serial interface 1-1, 1-3, 2-14, 6-2, A2-4  
Socket port 2-42  
Strip mode 2-8, 7-1, A5-2  
Strip module 1-1, 1-5, 2-8, 2-64, 4-4, 5-3, 6-2  
Strip position 2-67, 2-68  
Subnet mask 2-27  
System mode 2-16, 2-39

**T**

Tag 2-10, 7-1, A5-2  
Thermal direct 2-65, 6-1, 7-1, A5-2  
Thermal transfer 2-65, 6-1, 7-1, A5-2  
Threshold setting 2-73, A5-2  
Top cover 1-3, 2-3, 2-11, 5-1, A1-1  
Top cover stopper 2-12

**U**

Upper sensor ass'y 2-3, 2-5, 5-4  
Upper sensor lever 2-4, 2-5  
USB interface 1-1, 1-3, 2-14, 2-50, 6-2, A2-3

**W**

Web printer 2-26, A5-2  
Wireless LAN 1-1, 1-3, 1-5, 2-14, 6-2, A2-5

**X**

X coordinate 2-70

