

TOSHIBA

TOSHIBA Barcode Printer

B-450-R SERIES

Owner's Manual



TOSHIBA TEC CORPORATION

CE Compliance (for EU only)

This product complies with the requirements of EMC and Low Voltage Directives including their amendments.

CE marking is the responsibility of TOSHIBA TEC GERMANY IMAGING SYSTEMS GmbH, Carl-Schurz-Str. 7, 41460 Neuss, Germany.

For a copy of the related CE Declaration of Conformity, please contact your dealer or TOSHIBA TEC.

VORSICHT:

*Maschinenlärminformations-Verordnung 3. GPSGV,
der höchste Schalldruckpegel beträgt 70 dB(A) oder weniger gemäss EN ISO 7779*

Centronics is a registered trademark of Centronics Data Computer Corp.

Microsoft is a registered trademark of Microsoft Corporation.

Windows is a trademark of Microsoft Corporation.

This equipment has been tested and found to comply with the limits for a Class A digital device, pursuant to Part 15 of the FCC Rules. These limits are designed to provide reasonable protection against harmful interference when the equipment is operated in a commercial environment. This equipment generates, uses, and can radiate radio frequency energy and, if not installed and used in accordance with the instruction manual, may cause harmful interference to radio communications. Operations of this equipment in a residential area is likely to cause harmful interference in which case the user will be required to correct the interference at his own expense.

(for USA only)

Changes or modifications not expressly approved by manufacturer for compliance could void the user's authority to operate the equipment.

This Class A digital apparatus complies with Canadian ICES-003.

Cet appareil numérique de la classe A est conforme à la norme NMB-003 du Canada.

(for CANADA only)



IP20

WARNING!

This is a Class A product. In a domestic environment this product may cause radio interference in which case the user may be required to take adequate measures.

AVERTISSEMENT!

Ceci est un produit de Classe A. Dans un environnement domestique, ce produit peut causer des interférences radio, et dans ce cas l'utilisateur pourrait être amené à prendre les mesures nécessaires.

WARNUNG!

Dies ist ein Klasse A Produkt. In der direkten Umgebung des Gerätes kann es zu Funkstörungen kommen.

¡AVISO!

Este es un producto Clase A. En un entorno doméstico este producto puede provocar interferencias de radio, en cuyo caso puede ser necesario que el usuario tome las medidas oportunas.

VERWITTINGING!

Dit is een product van de categorie A. Het gebruik van dit product in een huishoudelijke omgeving kan aanleiding geven tot radio interferenties die de gebruiker kunnen dwingen tot het nemen van de nodige maatregelen.

ATTENZIONE!

Questo è un prodotto di Classe A. Negli ambienti domestici potrebbe causare interferenze radio, in tale caso dovrete prendere adeguate contromisure.

ATENÇÃO!

É uma produto Classe A. Num ambiente doméstico este produto pode causar interferência de radio nesse caso o utilizador deverá tomar as medidas e cuidados adequados.

This product is designed for commercial usage and is not consumer product.

California Proposition 65 Warning: USA-California only

This Product contains chemicals known to the State of California to cause cancer, birth defects, or other reproductive harm.

Safety Summary

Personal safety in handling or maintaining the equipment is extremely important. Warnings and Cautions necessary for safe handling are included in this manual. All warnings and cautions contained in this manual should be read and understood before handling or maintaining the equipment.

Do not attempt to effect repairs or modifications to this equipment. If a fault occurs that cannot be rectified using the procedures described in this manual, turn off the power, unplug the machine, and then contact your authorised TOSHIBA TEC representative for assistance.

Meanings of Each Symbol



This symbol indicates warning items (including cautions). Specific warning contents are drawn inside the Δ symbol. (The symbol on the left indicates a general caution.)



This symbol indicates prohibited actions (prohibited items). Specific prohibited contents are drawn inside or near the \odot symbol. (The symbol on the left indicates “no disassembling”.)



This symbol indicates actions which must be performed. Specific instructions are drawn inside or near the \bullet symbol. (The symbol on the left indicates “disconnect the power cord plug from the outlet”.)



WARNING

This indicates that there is the risk of **death** or **serious injury** if the machine is improperly handled contrary to this indication.



Use only specified AC voltage.

Do not use voltages other than the AC voltage specified on the rating plate, as this may cause **fire** or **electric shock**.

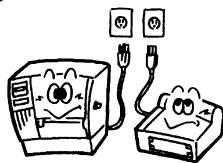

Prohibited

Do not plug in or unplug the power cord with wet hands as this may cause **electric shock**.

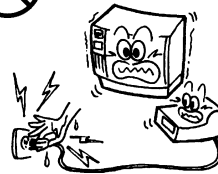

Prohibited

If the machine shares the same electrical outlet, with any other appliance that consumes a large amount of power, the voltage will fluctuate widely each time these appliances operate. Be sure to provide an exclusive outlet for the machine as this may cause **fire** or **electric shock**.



Prohibited

Do not place metal objects or water-filled containers (flower vases, flower pots or mugs etc) on top of the machine. If metal objects or spilled liquids enter the machine, this may cause **fire** or **electric shock**.

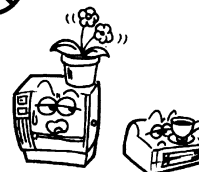

Prohibited

Do not insert or drop metal, flammable or other foreign objects into the machine through ventilation slits, as this may cause **fire** or **electric shock**.

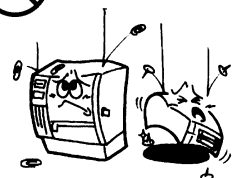

Prohibited

Do not scratch, damage or modify the power cords. Do not place heavy objects on, pull on, or excessively bend the power cords, as this may cause **fire** or **electrical shock**.



Disconnect the plug.



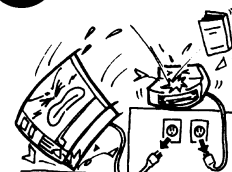





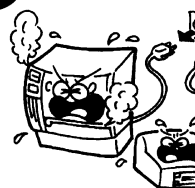

If the machine is dropped or the cabinet is damaged, turn off the power switch and disconnect the power cord plug from the outlet, and then contact your authorised TOSHIBA TEC representative for assistance. Continued use of a damaged machine may cause **fire** or **electric shock**.

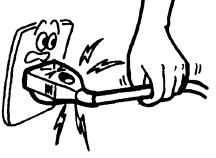

Disconnect the plug.

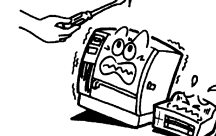
Continued use of the machine in an abnormal condition (the machine is producing smoke or a strange smell) may cause **fire** or **electric shock**. In these cases, immediately turn off the power switch and disconnect the power cord plug from the outlet. Then, contact your authorised TOSHIBA TEC representative for assistance.



 <p>Disconnect the plug.</p> 	<p>If foreign objects (metal fragments, water, liquids) enter the machine, turn off the power switch and disconnect the power cord plug from the outlet, and then contact your authorised TOSHIBA TEC representative for assistance. Continued use of the machine in that condition may cause fire or electric shock.</p>	 <p>Disconnect the plug.</p> 	<p>When unplugging the power cords, be sure to hold and pull on the plug. Pulling on the cord may cut or expose the internal wires and cause fire or electric shock.</p>
 <p>Connect a grounding wire.</p> 	<p>Ensure that the equipment is properly grounded. Extension cables should also be grounded. Fire or electric shock could occur on improperly grounded equipment.</p>	 <p>No disassembling.</p> 	<p>Do not remove covers, repair or modify the machine yourself. Contact your TOSHIBA TEC representative for assistance. You may be injured by high voltage, very hot parts or sharp edges inside the machine.</p>
 <p>Prohibited</p> 	<p>Do not use a spray cleaner containing flammable gas for cleaning this product, as this may cause a fire.</p>	 <p>Prohibited</p> 	<p>Care must be taken not to injure yourself with the printer paper cutter.</p>



CAUTION

This indicates that there is the risk of personal **injury** or **damage** to objects if the machine is improperly handled contrary to this indication.

Precautions

The following precautions will help to ensure that this machine will continue to function correctly.

- Try to avoid locations that have the following adverse conditions:
 - * Temperatures out of the specification
 - * Shared power source
 - * Direct sunlight
 - * Excessive vibration
 - * High humidity
 - * Dust/Gas
- The cover should be cleaned by wiping with a dry cloth or a cloth slightly dampened with a mild detergent solution. **NEVER USE THINNER OR ANY OTHER VOLATILE SOLVENT** on the plastic covers.
- **USE ONLY TOSHIBA TEC SPECIFIED** paper and ribbons.
- **DO NOT STORE** the paper or ribbons where they might be exposed to direct sunlight, high temperatures, high humidity, dust, or gas.
- Ensure the printer is operated on a level surface.
- Any data stored in the memory of the printer could be lost during a printer fault.
- Try to avoid using this equipment on the same power supply as high voltage equipment or equipment likely to cause mains interference.
- Unplug the machine whenever you are working inside it or cleaning it.
- Keep your work environment static free.
- Do not place heavy objects on top of the machine, as these items may become unbalanced and fall causing **injury**.
- Do not block the ventilation slits of the machine, as this will cause heat to build up inside the machine and may cause **fire**.
- Do not lean against the machine. It may fall on you and could cause **injury**.
- Unplug the machine when it is not used for a long period of time.
- Place the machine on a stable and level surface.
- **RISK OF EXPLOSION IF BATTERY IS REPLACED BY AN INCORRECT TYPE. DISPOSE OF USED BATTERIES ACCORDING TO THE INSTRUCTIONS.**

Request Regarding Maintenance

- Utilise our maintenance services.
After purchasing the machine, contact your authorised TOSHIBA TEC representative for assistance once a year to have the inside of the machine cleaned. Dust will build up inside the machines and may cause a **fire** or a **malfunction**. Cleaning is particularly effective before humid rainy seasons.
- Our preventive maintenance service performs periodic checks and other work required to maintain the quality and performance of the machine.
For details, please consult your authorised TOSHIBA TEC representative.
- Do not expose the machine to insecticides or other volatile solvents. This may cause the cabinet, or other parts, to deteriorate and may cause the paint to peel.

Notification (for Turkey)

EEE Yönetmeliğine Uygundur

Résumé des précautions

La sécurité personnelle lors de la manipulation ou de l'entretien du matériel est extrêmement importante. Les avertissements et précautions nécessaires à la manipulation en toute sécurité du matériel sont inclus dans ce manuel. Les avertissements et précautions contenus dans ce manuel doivent être lus et assimilés avant toute manipulation ou entretien.

Ne tentez pas d'effectuer des réparations ou des modifications sur ce matériel. Si une erreur se produit qui ne peut être résolue en suivant les instructions de ce manuel, coupez le courant, déconnectez le câble secteur et contactez votre revendeur agréé TOSHIBA TEC pour une assistance technique.

Explication des symboles



Ce symbole signale une mise en garde (ou des précautions).
Le dessin à l'intérieur du Δ symbole précise quelle est l'action à exécuter. (Le symbole ci-contre indique une précaution d'ordre général.)



Ce symbole signale une action interdite (interdictions).
Le dessin à l'intérieur ou près du O symbole précise quelle est l'action interdite. (Le symbole ci-contre indique "Ne pas démonter".)



Ce symbole indique une action à effectuer.
Le dessin à l'intérieur du Z symbole précise quelle est l'action à exécuter. (Le symbole ci-contre indique "Retirer la fiche secteur de la prise".)



ATTENTION

Indique un danger de **mort** ou de **blessures graves** si l'équipement est utilisé en négligeant ces instructions.



Interdiction d'utiliser une tension autre que celle spécifiée

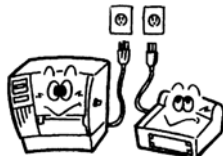

Ne faites pas fonctionner la machine avec une tension électrique différente de celle indiquée sur la plaquette des caractéristiques. Ceci pourrait provoquer un **incendie** ou une **électrocution**.



Interdit



Ne branchez pas et ne débranchez pas la fiche secteur avec les mains mouillées. Vous risqueriez une **électrocution**.



Interdit



Si la machine partage une même prise avec d'autres appareils consommant beaucoup d'électricité, il y aura des fluctuations de tension importantes lorsque ces appareils fonctionnent. Pour éviter tout risque d'**incendie** ou de **choc électrique**, ne branchez pas d'autres appareils à la même prise que la machine.



Interdit



Ne placez pas d'objets métalliques ou de récipients contenant un liquide (vases, pots de fleurs, tasses, etc.) sur la machine. Un objet métallique ou un liquide peut provoquer un **incendie** ou une **électrocution** s'il pénètre accidentellement dans la machine.



Interdit



N'introduisez pas et ne faites pas tomber de pièces métalliques, de matières inflammables ou d'autres objets dans les ouvertures d'aération de la machine. Ils pourraient provoquer un **incendie** ou une **électrocution**.



Interdit



N'essayez pas de réparer ou de modifier vous-même la machine. Ceci pourrait provoquer un **incendie** ou une **électrocution**. Pour toute question sur les réparations, adressez-vous à votre revendeur (ou au service après-vente).



Débranchez la fiche.













Si les machines tombent, ou que leur capot est endommagé, commencez fi par positionner le bouton marche/arrêt sur arrêt et par déconnecter le câble secteur de la prise murale. Ensuite, contactez votre revendeur agréé TOSHIBA TEC pour une assistance technique. Une utilisation prolongée de l'imprimante dans ces conditions peut être source d'**incendie** ou de **choc électrique**.



Débranchez la fiche.

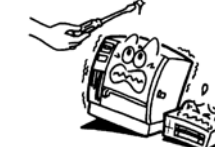

Une utilisation prolongée de l'imprimante dans une condition anormale, comme par exemple lorsque l'imprimante produit de la fumée ou des odeurs étranges peut être source d'**incendie** ou de **choc électrique**. Dans ce cas, éteignez immédiatement l'interrupteur marche/arrêt et déconnectez le câble secteur de la prise murale. Ensuite, contactez votre revendeur agréé TOSHIBA TEC pour une assistance technique.

 <p>Débranchez la fiche.</p> 	<p>Si des corps étrangers (fragments de métal, eau, liquides) pénètrent commencez par positionner le bouton marche/arrêt sur arrêt et par déconnecter le câble secteur de la prise murale. Ensuite, contactez votre revendeur agréé TOSHIBA TEC pour une assistance technique. Une utilisation prolongée de l'imprimante dans ces conditions peut être source d'incendie ou de choc électrique</p>	 <p>Débranchez la fiche.</p> 	<p>Pour débrancher le câble d'alimentation, tirez-le par la prise. Ne tirez pas directement sur le câble. Ceci pourrait sectionner et exposer les fils internes du câble et causer un incendie ou une électrocution.</p>
 <p>Connectez un fil de terre.</p> 	<p>Assurez-vous que votre installation est correctement reliée à la terre. Une mauvaise installation peut provoquer un début d'incendie ou un choc électrique.</p>	 <p>Démontage interdit</p> 	<p>Ne pas retirer les capots, réparer ou modifier l'imprimante par vous-même. Vous pouvez recevoir un choc électrique ou vous blessés par des bords tranchants dans l'imprimante.</p>
 <p>Interdit</p> 	<p>Ne pas utiliser de spray nettoyant contenant du gaz inflammable pour nettoyer ce produit, ceci pourrait provoquer un feu.</p>	 <p>Interdit</p> 	<p>Faire attention au couteau de l'imprimante.</p>



PRECAUTION

Indique un risque de **blessures** ou de **dommages** si l'équipement est utilisé en négligeant ces instructions.

Précautions

Les précautions suivantes vous permettront d'avoir un fonctionnement correct de l'imprimante.

- Evitez les endroits qui présentent les conditions défavorables suivantes:
 - * Température hors des spécifications
 - * Exposition directe au soleil
 - * Humidité élevée
 - * Alimentation secteur partagée avec d'autres dispositifs.
 - * Vibrations excessives
 - * Poussière/Gaz
- Nettoyez le couvercle en l'essuyant au moyen d'un chiffon sec ou d'un chiffon imbibé de détergent. **NE JAMAIS UTILISER DE DILUANT NI D'AUTRES SOLVANTS VOLATILES** sur les capots en plastique.
- Utilisez des étiquettes et des rubans recommandés par TOSHIBA TEC.
- N'entrez pas les films et media à un endroit où ils seraient exposés à la lumière directe du soleil, à des températures élevées, à une humidité importante, à de la poussière ou à des gaz.
- Assurez-vous d'utiliser l'imprimante sur une surface plane.
- Toute information mémorisée dans la mémoire de l'imprimante peut être perdue lors d'une erreur d'impression.
- Evitez d'utiliser cet équipement sur la même ligne secteur que des appareils de forte puissance ou susceptibles d'émettre des interférences.
- Eteindre l'imprimante lors des interventions à l'intérieur ou lors des nettoyages.
- s'assurer de garder l'environnement de travail à l'abri de l'électricité statique.
- Ne placez pas d'objets lourds sur la machine. Ils pourraient tomber et blesser quelqu'un.
- Ne bouchez pas les ouvertures d'aération de la machine. La chaleur s'accumulerait à l'intérieur et pourrait provoquer un **incendie**.
- Ne pas s'appuyer contre l'imprimante Celle-ci peut tomber et vous pouvez être blessé.
- Débranchez l'imprimante lorsqu'elle n'est pas utilisée pendant une longue période.
- Placer la machine sur une surface stable.
- **RISQUE D'EXPLOSION SI LA BATTERIE EST REMPLACÉE PAR UN TYPE INCORRECT.** Mettez au rebut les batteries usagées conformément aux instructions du fabricant.

Au sujet de la maintenance

- Faites appel à nos services de maintenance. Après avoir reçu le matériel, prenez contact avec votre revendeur agréé TOSHIBA TEC pour une visite de maintenance annuelle, de manière à effectuer un nettoyage complet de l'intérieur de la machine. Autrement, la poussière qui s'accumule à l'intérieur de la machine peut être source d'incendie ou de mauvais fonctionnement. Le nettoyage est particulièrement nécessaire avant les saisons humides ou pluvieuses.
- Nos services de maintenance effectuent les vérifications périodiques et les autres opérations nécessaires à maintenir la qualité et la performance des imprimantes. Prévenant de ce fait les problèmes. Pour tous détails, consultez votre revendeur agréé TOSHIBA TEC.
- Utilisations d'insecticides et d'autres produits. N'exposez pas les machines aux insecticides ou à d'autres solvants volatiles, dans la mesure où cela peut endommager les capots ou entraîner un écaillage de la peinture.

TABLE OF CONTENTS

	Page
1. INTRODUCTION	1- 1
1.1 APPLICABLE MODEL	1- 1
1.2 ACCESSORIES	1- 1
2. SPECIFICATIONS	2- 1
2.1 GENERAL SPECIFICATIONS	2- 1
2.2 PRINTING SPECIFICATIONS	2- 1
2.3 PAPER (LABEL/TAG) SPECIFICATIONS	2- 2
2.4 RIBBON SPECIFICATIONS	2- 2
2.5 OPTION	2- 2
3. APPEARANCE	3- 1
3.1 FRONT/REAR VIEW	3- 1
3.2 OPERATION PANEL	3- 1
4. INSTALLATION PROCEDURE	4- 1
4.1 INSTALLING THE SUPPLY HOLDER UNIT	4- 1
4.2 CONNECTING THE POWER CORD AND CABLES	4- 1
5. LOADING THE RIBBON	5- 1
6. LOADING THE PAPER	6- 1
7. CARE/HANDLING OF THE PAPER AND RIBBON	7- 1
8. CONNECTING THE PRINTER TO YOUR COMPUTER	8- 1
9. TURNING THE POWER ON	9- 1
10. INSTALLING THE PRINTER DRIVERS	10- 1
10.1 INTRODUCTION	10- 1
10.2 GENERAL DESCRIPTION	10- 1
10.3 INSTALLING THE PRINTER DRIVER	10- 1
10.4 UNINSTALLING THE PRINTER DRIVER	10-14
10.5 ADDING/DELETING A LAN PORT	10-15
10.6 CAUTIONS	10-17
10.7 USING THE PRINTER DRIVER	10-18
11. ON LINE MODE	11- 1
11.1 ON LINE OPERATION	11- 1
11.2 DIAGNOSTIC TEST OPERATION AND TEST PRINT	11- 3
11.3 LAN AND BASIC SETTING	11- 5

	Page
12. GENERAL MAINTENANCE	12- 1
12.1 CLEANING	12- 1
12.2 COVERS	12- 2
12.3 REMOVING JAMMED PAPER	12- 3
13. TROUBLESHOOTING	13- 1
APPENDIX 1 LED INDICATION	A1- 1
APPENDIX 2 INTERFACE	A2- 1
APPENDIX 3 ASCII CODE/FONT/BARCODE SAMPLES	A3- 1
INDEX	

CAUTION:

1. *This manual may not be copied in whole or in part without prior written permission of TOSHIBA TEC.*
2. *The contents of this manual may be changed without notification.*
3. *Please refer to your local Authorized Service representative with regard to any queries you may have in this manual.*

ATTENTION!

1. *Ce manuel ne peut être copié entièrement ou en partie, sans l'autorisation écrite de TOSHIBA TEC.*
2. *Le contenu de ce manuel pourra être changé sans notification préalable.*
3. *Prière de vous référer à votre représentant de service autorisé concernant n'importe quelles questions que vous pouvez avoir de ce manuel.*

This product is designed for commercial usage and is not consumer product.

1. INTRODUCTION

Thank you for choosing the TOSHIBA B-450-R Series thermal direct/thermal transfer printer. This new generation high performance high quality printer is equipped with the latest hardware including the newly developed high density (11.8 dot/mm, 300 dot/inch) print head. This allows very clear print at a maximum speed of 101.6 mm/sec. (4 inch/sec.). Other standard features include an external paper supply. Optional features include a strip mechanism and cutter mechanism.

This manual contains general set-up and maintenance information and should be read carefully to help gain maximum performance and life from your printer. For most queries please refer to this manual and keep it safe for future reference.

1.1 APPLICABLE MODEL

- B-452-TS22-QQ-R
- B-452-TS22-QP-R

Model name description

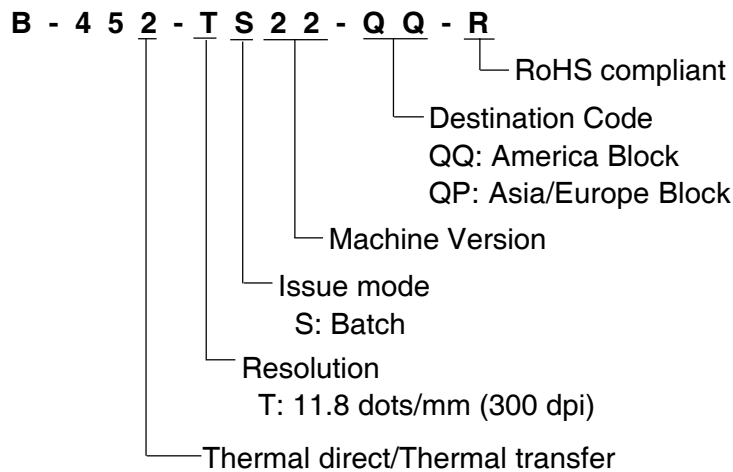

1.2 ACCESSORIES

Power Cord (for QQ model)

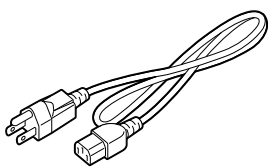

Supply Holder Unit

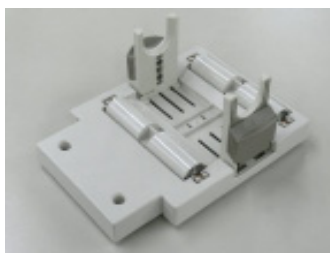

Power Cord (for QP model)

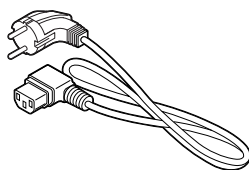

CD-ROM



Supply Holder



Spacer



2. SPECIFICATIONS

2.1 GENERAL SPECIFICATIONS

Item	Model	B-452-TS22-QQ/QP-R
Supply voltage		QQ: 100 ~ 120V, 60Hz QP: 220 - 240V, 50Hz
Power consumption		QQ: 0.94 A, 47 W maximum (standby: 0.3 A, 18 W maximum) QP: 0.41 A, 74 W maximum (standby: 0.15 A, 23.5 W maximum)
Operating temperature		5°C ~ 40°C
Relative humidity		25% ~ 85%RH (no condensation)
Dimensions		270 mm (width) x 245 mm (height) x 200 mm (depth), with Supply holder unit 410 mm (depth)
Weight		5.2 kg (without paper and ribbon)

2.2 PRINTING SPECIFICATIONS

Item	Model	B-452-TS22-QQ/QP-R
Print head		Thermal print head 11.8 dots per mm (300 dots per inch)
Printing methods		Direct thermal or Thermal transfer
Print speeds		50.8 mm/sec. (2 inch/sec.) for serial barcodes and two-dimensional codes, 101.6 mm/sec. (4 inch/sec.)
Maximum print width		105.7 mm (4.16 inches)
Dispensing modes		Batch (Continuous), Strip (Option) and Cut modes (Option) (Both cut and strip modes are available only when their respective modules are fitted.)
Available bar-code types		JAN8, JAN13, EAN8, EAN8 + 2 digits, EAN8 + 5 digits, EAN13, EAN13 + 2digits, EAN13 + 5 digits, UPC-E, UPC-E + 2 digits, UPC-E + 5 digits, UPC-A, UPC-A + 2 digits, UPC-A + 5 digits, MSI, ITF, NW-7, CODE39 (Standard), CODE39 (Full ASCII), CODE93, CODE128, High priority customer bar code, Industrial 2 to 5, UCC/EAN128, Customer bar code, POSTNET, RM4SCC, KIX code, Matrix 2 of 5 for NEC, GS1 DataBar, GS1 DataBar stacked, GS1 DataBar stacked omnidirectional, GS1 DataBar limited, GS1 DataBar expanded, GS1 DataBar expanded stacked
Two-dimensional code		Data Matrix, PDF417, Micro PDF417, QR code, Maxi code, CP code
Graphics		All types of graphic files are available when using the windows driver. However, only BMP and PCX files are available when using the programming commands.
Fonts		Times Roman (6 sizes), Helvetica (6 sizes), Presentation (1 size), Letter Gothic (1 size), Prestige Elite (2 sizes), Courier (2 sizes), OCR (2 types), Writable characters, Outline font (8 type) Optional True Type Fonts (21 type), Gothic725 Black (1 type)
Rotations		0°, 90°, 180°, 270°
Standard interfaces		USB interface LAN interface Parallel interface (Centronics)
Option interfaces		Serial interface (RS-232C) (B-7704-RS-QM-R) Expansion I/O interface (B-SA704-IO-QM-R) Wireless LAN interface (B-SA704-WLAN-QM-R)

* Data Matrix™ is a trademark of International Data Matrix, Inc.
PDF417 is a trademark of Symbol Technologies, Inc.
Micro PDF417 is a trademark of Symbol Technologies, Inc.
QR code is a trademark of DENSO CORPORATION.
Maxi code is a trademark of United Parcel Service of America, Inc.

2.3 PAPER (LABEL/TAG) SPECIFICATIONS

[Unit: mm]

Item	Label dispensing mode		
	Batch mode	Strip mode	Cut mode
Span of one label/tag	15.0 ~ 999.0	25.4 ~ 999.0	Label: 37.0 ~ 999.0 Tag: 25.4 ~ 999.0
Label length	13.0 ~ 997.0	23.4 ~ 997.0	31.0 ~ 993.0
Width including backing paper	25.4 ~ 114.0		
Label width	22.4 ~ 111.0		
Gap length	2.0 ~ 20.0	2.0 ~ 20.0	6.0 ~ 20.0
Black mark length (Tag paper)	2.0 ~ 20.0		
Effective print width	10.0 ~ 105.7		
Effective print length	Label	15.0 ~ 500.0	
	Tag	15.0 ~ 500.0	
Print speed up/slow down area	1.0		
Black mark length (Label)	MIN. 2.0		
Outer roll diameter	MAX. ϕ 152.4 (Paper Core ϕ 38, 40, 42 or 76.2)		
Thickness	0.1 ~ 0.17	0.13 ~ 0.17	0.1 ~ 0.17

2.4 RIBBON SPECIFICATIONS

Type	Spool type
Width	60 mm ~ 110 mm
Length	(300 m)
Outer diameter	ϕ 65 mm (max.)

- NOTES:**
1. To ensure good print quality and maximum print head life use only TOSHIBA TEC specified paper and ribbons.
 2. For further information about paper and ribbon, refer to Section 7. CARE/HANDLING OF THE PAPER AND RIBBON.

2.5 OPTION

Option Name	Type	Use
Cutter module	B-7204-QM-R	This cutter module uses a rotary cutter. It cuts backing paper of labels and tag paper automatically in "stop and cut" mode.
Strip module	B-7904-H-QM-R	This strip module strips the label from the backing paper with the take-up block and strip block. When the rewinder guide plate is attached, the tag paper and label with backing paper are wound.
Expansion I/O interface board	B-SA704-IO-QM-R	Installing this board in the printer allows a connection with an external device with the exclusive interface.
Serial Interface	B-7704-RS-QM-R	Installing this PC board provides an RS232C interface port.
Wireless LAN Interface	B-SA704-WLAN-QM-R	Installing this PC board allows a communication by wireless LAN.

NOTE: To purchase the OPTIONAL KIT, please contact your authorized TOSHIBA TEC representative or TOSHIBA TEC Head Quarter.

3. APPEARANCE

3.1 FRONT/REAR VIEW

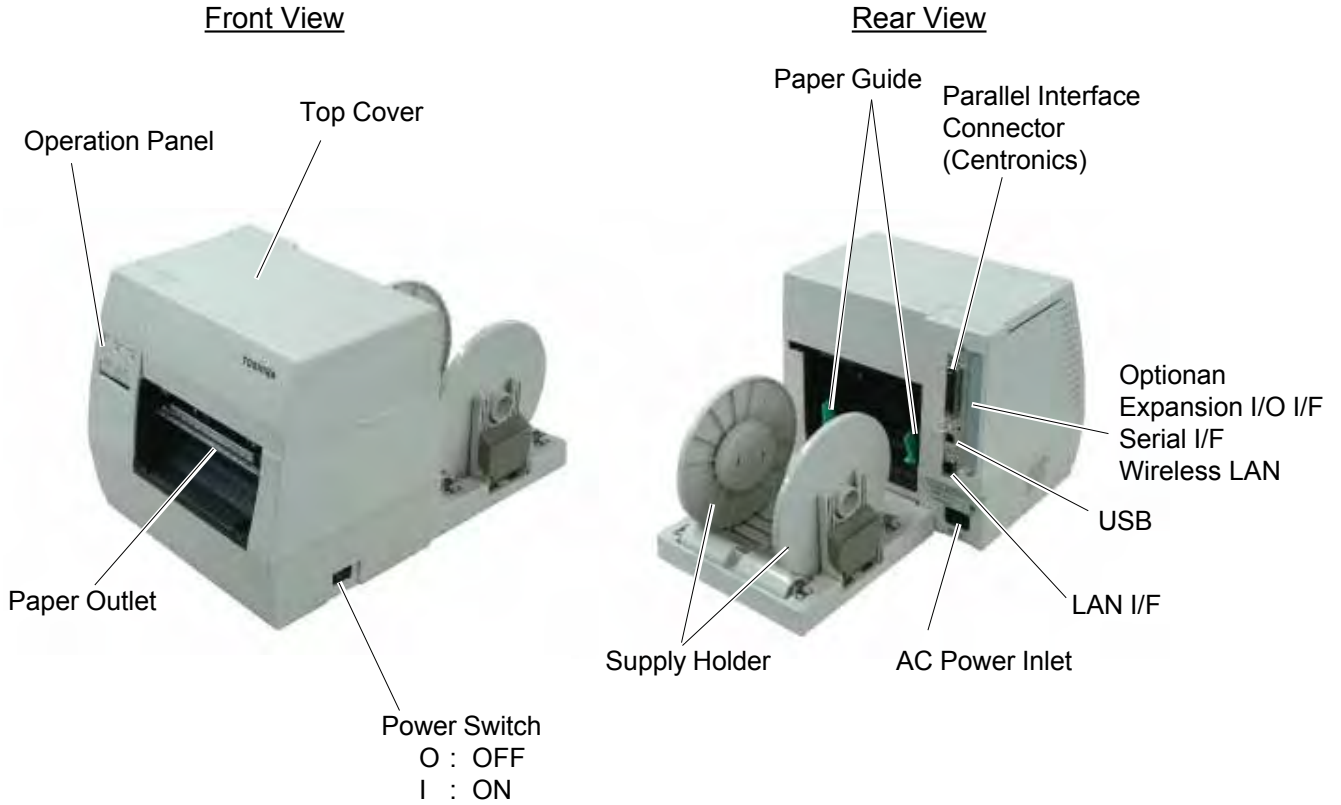

Fig. 3-1

3.2 OPERATION PANEL

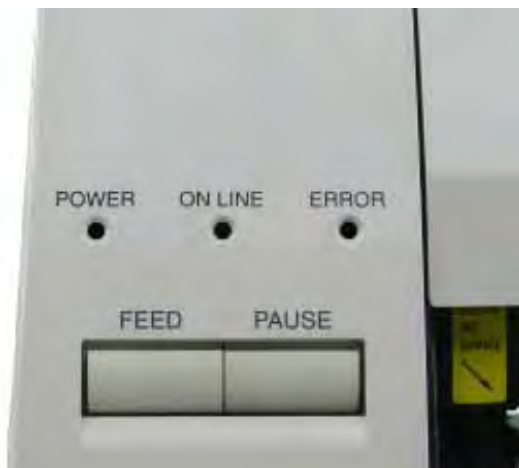

Fig. 3-2

POWER LED (Green)

Lights when the power is turned on.

ON-LINE LED (Green)

- 1) Flashes when communicating with a host computer.
- 2) On while printing.

ERROR LED (Red)

Lights when a communication error occurs, when the paper/ribbon ends or the printer is not operating correctly.

FEED Key

Feeds paper.

PAUSE Key

Pauses printing.
Resets the printer when paused or when an error occurs.

4. INSTALLATION PROCEDURE

4.1 INSTALLING THE SUPPLY HOLDER UNIT

WARNING!

Turn the power OFF before installing the supply holder unit.

AVERTISSEMENT!

Éteignez avant d'installer l'unité de support d'approvisionnement.

Fit the two studs on the bottom of the printer into the holes in the supply holder unit.

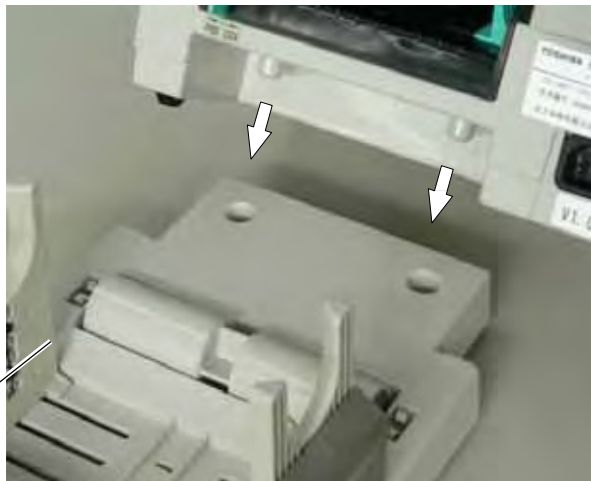

Supply Holder Unit

Fig. 4-1

4.2 CONNECTING THE POWER CORD AND CABLES

WARNING!

*Turn the **POWER SWITCH to OFF** before connecting the power cord or cables.*

AVERTISSEMENT!

Mettez l'interrupteur sur la position éteinte avant de brancher le cordon d'alimentation ou les câbles

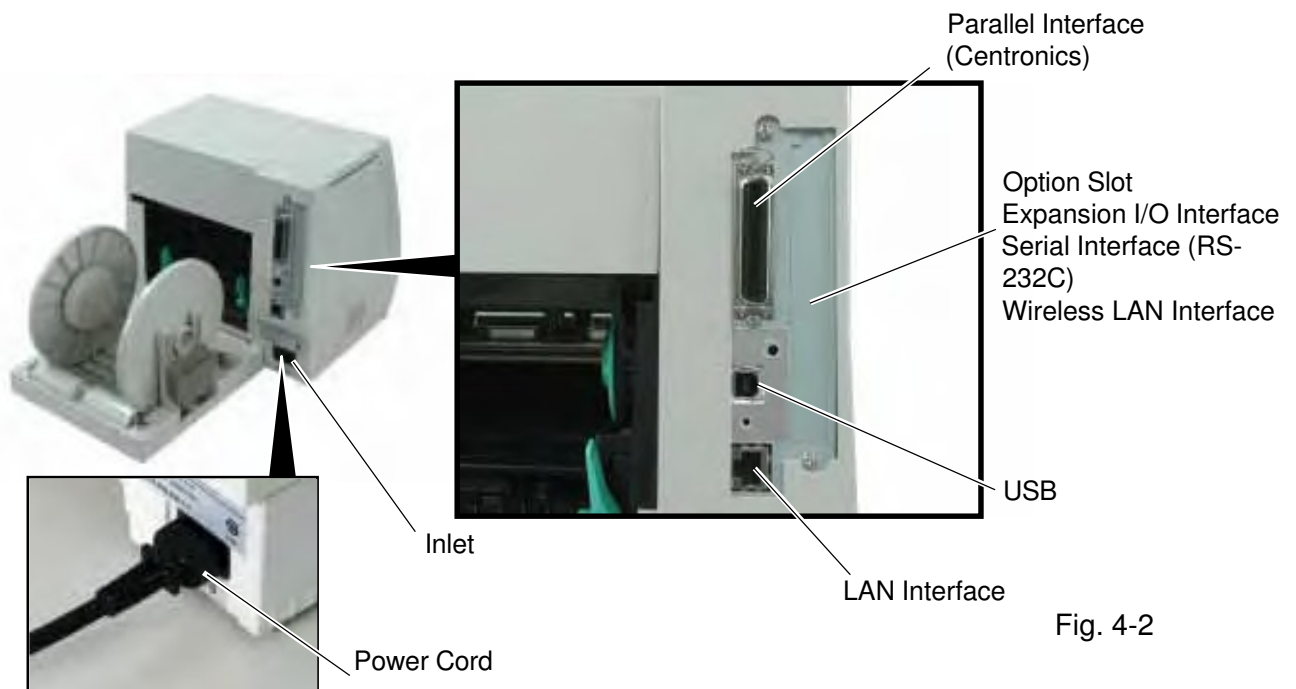

Fig. 4-2

5. LOADING THE RIBBON

The printer is capable of printing in both direct thermal and thermal transfer modes.

DO NOT LOAD a ribbon when using a direct thermal paper.

1. Turn the power off and open the top cover.
2. Move the head release lever toward the front of the printer and raise the print head block.



Fig. 5-1

3. Fit the protrusion of the guide wheel into the notch of the ribbon core (take-up side).
4. Pull the knob and set the ribbon core to the spring guide wheel.

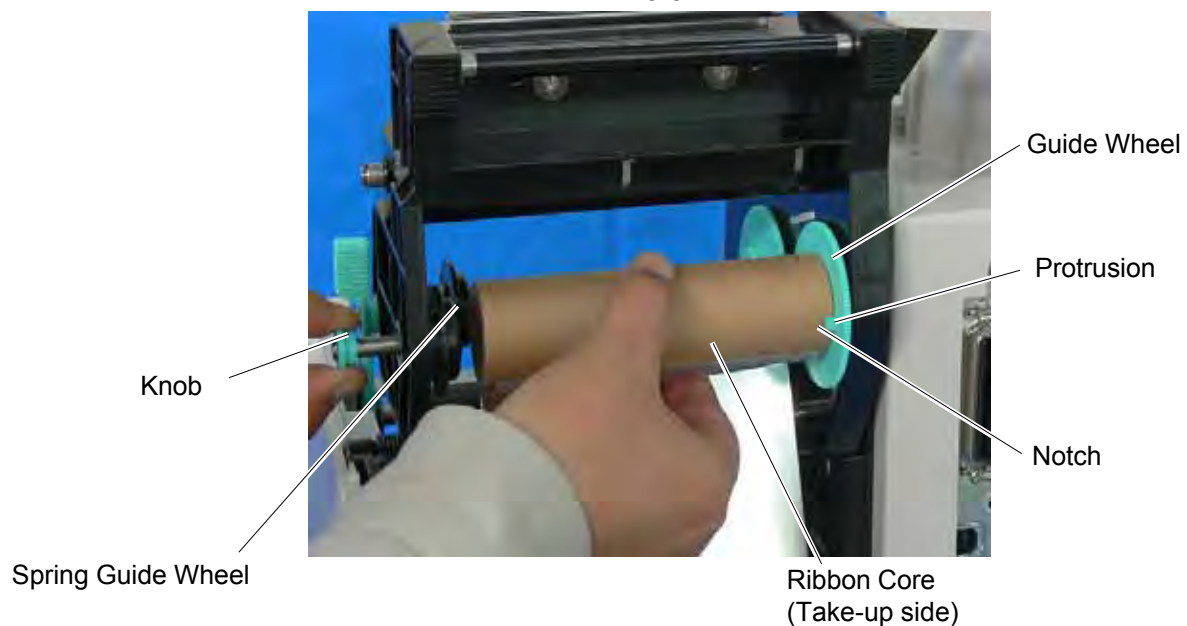

Fig. 5-2

5. Set the ribbon core (supply side) by fitting the protrusion into the notch.



Fig. 5-3

6. Turn the guide wheel in the arrow-indicating direction to remove any slack of the ribbon.

NOTE: Make sure that the ribbon has no wrinkles and the protrusions are fitted into the notches of the ribbon cores.

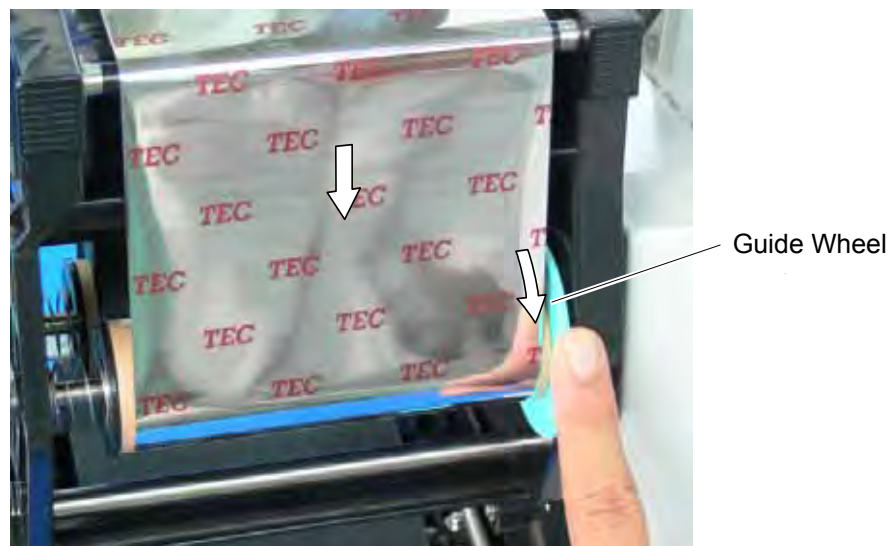

Fig. 5-4

6. LOADING THE PAPER

This supply holder accepts four sizes of label core: 38 mm, 40 mm, 42 mm and 76.2 mm. When using a paper roll of 38 mm, 40 mm or 42 mm, remove the spacers from the supply holders using the following procedure.

1. Push both hooks of the spacer to remove it from the supply holder. Keep the removed spacers safe.

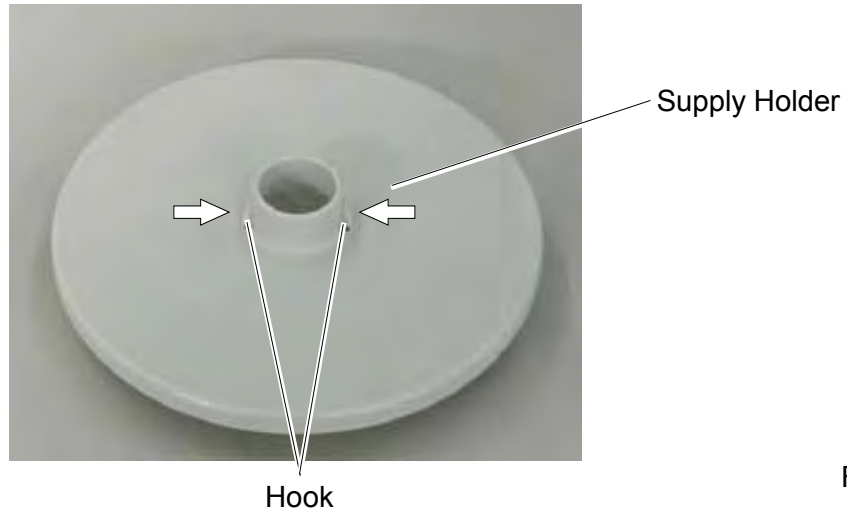

Fig. 6-1



Spacer

Fig. 6-2

2. Set the supply holders to both sides of the paper roll.



Fig. 6-3

3. Put the paper roll and supply holders on the supply holder unit.

NOTE: Paper may be wound outside or inside. Regardless of the paper roll, the paper must be loaded so that the print side faces upward.

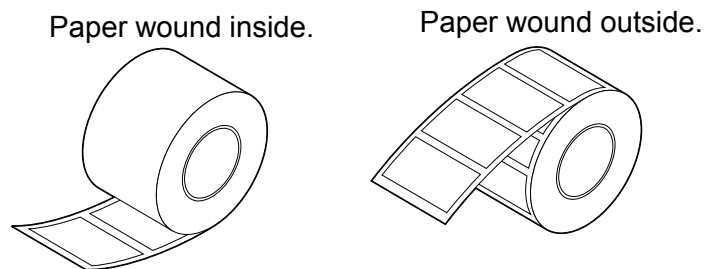

Fig. 6-4

4. Push both sides of the supply holder guides against the paper roll, then lock them with the lock lever.

NOTE: Make sure that the supply holders rotate slightly.

5. Pass the paper through the printer until it is past the paper outlet.

6. Adjust the position of the paper guides to the paper width, then lock them with the lock lever.

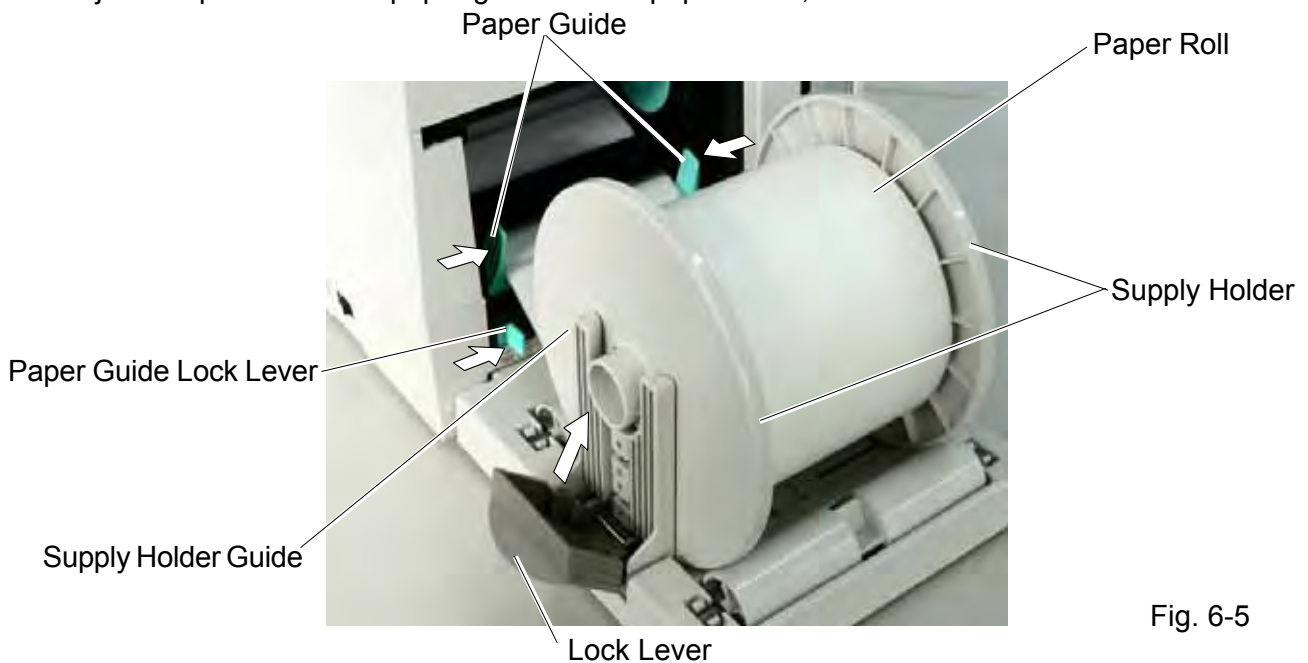

Fig. 6-5

7. Close the print head block by pressing both sides of the print head block's top until it clicks.



Fig. 6-6

NOTE: Pass the paper straight from the supply holder to paper outlet. Failure to do this may cause skew feeding or paper jam.

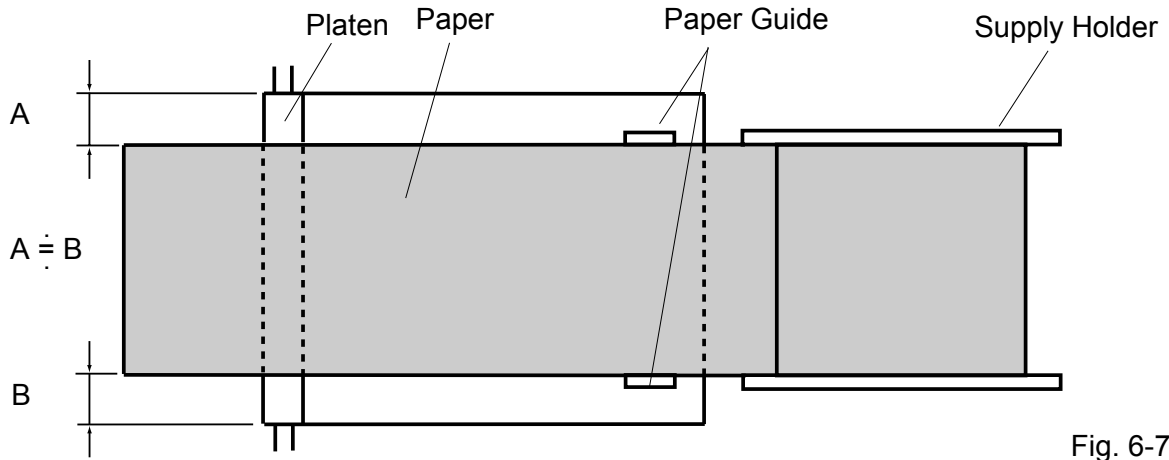

Fig. 6-7

8. Close the top cover. Paper loading is now completed.

Batch type:

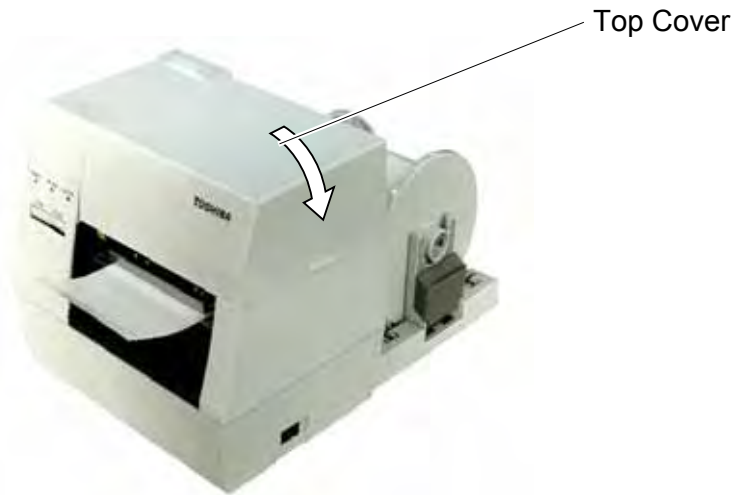

Fig. 6-8

Cutter type: Where a cutter is fitted load the paper as standard and feed it through the cutter module.

NOTES: 1. When using the cutter, be sure to cut the backing paper between the labels. Cutting on the label will cause the glue to stick to the cutter, which may affect the cutter quality and shorten its life.

2. Use of tag paper that exceeds the specified thickness may affect the cutter life.

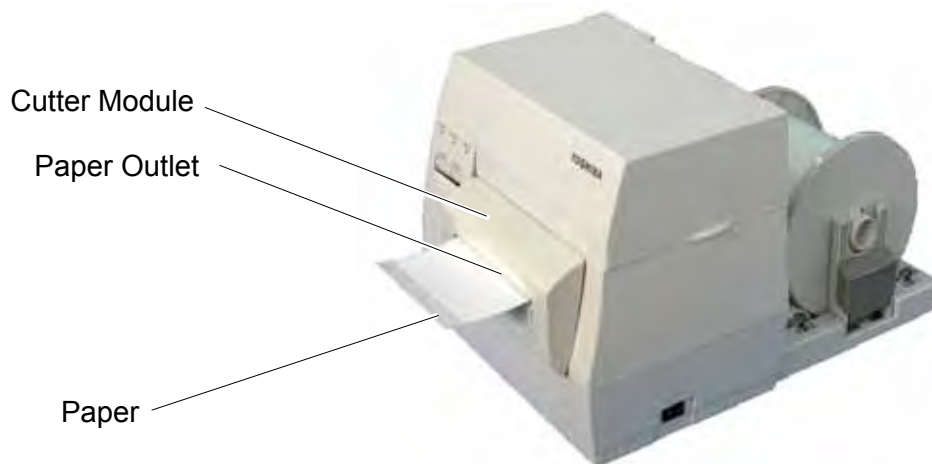

Fig. 6-9

Strip type:

1. Strip the labels from the backing paper for about 200-mm long from the top edge of the label roll.
2. First push the strip lever toward the printer to release the hook, and then pull the strip lever.
3. Pass the backing paper between the strip roller and the strip guide roller. After taking up any slack of the paper, set the strip lever in position.



Fig. 6-10

7. CARE/HANDLING OF THE PAPER AND RIBBON

CAUTION:

Be sure to read carefully and understand the Supply Manual. Ask your nearest authorized TOSHIBA TEC representative for the Supply Manual. Use only paper and ribbon which meet specified requirements. Use of non-specified paper and ribbon may shorten the head life and result in problems with bar code readability or print quality. All paper and ribbon should be handled with care to avoid any damage to the paper, ribbon or printer. Read the following guideline carefully.

ATTENTION :

Rassurez-vous d'avoir lu attentivement et compris le manuel d'approvisionnement. Demandez le manuel à votre représentant autorisé le plus proche de TOSHIBA TEC. Utilisez uniquement le papier et le ruban qui remplit les critères spécifiés. L'utilisation du papier et du ruban non spécifiés pourrait raccourcir la vie de la tête et les problèmes de lecture des codes à barres ou la qualité d'impression en résulteront. Tout papier et ruban doivent être manipulés avec soin pour éviter tout dommage quelconque au papier, au ruban ou à l'imprimante. Lisez attentivement cette directive.

1. Do not store the paper and ribbon for longer than the manufactures recommended shelf life.
2. Store paper rolls on the flat end, do not store them on the curved sides as this might flatten that side causing erratic media advance and poor print quality.
3. Store the paper in plastic bags and always reseal after opening. Unprotected paper can get dirty and the extra abrasion from the dust and dirt particles will shorten the print head life.
4. Store the paper and ribbon in a cool, dry place. Avoid areas where they would be exposed to direct sunlight, high temperature, high humidity, dust or gas.
5. The thermal paper used for direct thermal printing must not have the specifications which exceed Na⁺ 800 ppm, K⁺ 250 ppm and CL⁻ 500 ppm.
6. Some ink used on pre-printed labels may contain ingredients which shorten the print head's product life. Do not use labels pre-printed with ink which contain hard substances such as carbonic calcium (CaCO₃) and kaolin (Al₂O₃, 2SiO₂, 2H₂O).

For further information please contact your local distributor or your paper and ribbon manufacturer.

8. CONNECTING THE PRINTER TO YOUR COMPUTER

The following paragraphs outline how to connect your host computer to the printer, and will also show how to make cable connections to other devices. Depending on the system configuration you use to print labels, there are 5 possibilities for connecting the printer to your host computer.

These are:

1. A parallel cable connection between the printer's standard parallel connector and your host computer's parallel port (LPT).
2. An Ethernet connection using the standard LAN board.
3. A USB cable connection between the printer's standard USB connector and your host computer's USB port. (Conforming to USB 2.0 Full Speed)
4. A serial cable connection between the printer's optional RS-232C serial connector and one of your host computer's COM ports. <Option>
5. Wireless LAN using an optional Wireless LAN board. <Option>

For details of each interface, refer to APPENDIX 2.

The diagram below shows all the possible cable connections to the current version of the printer.

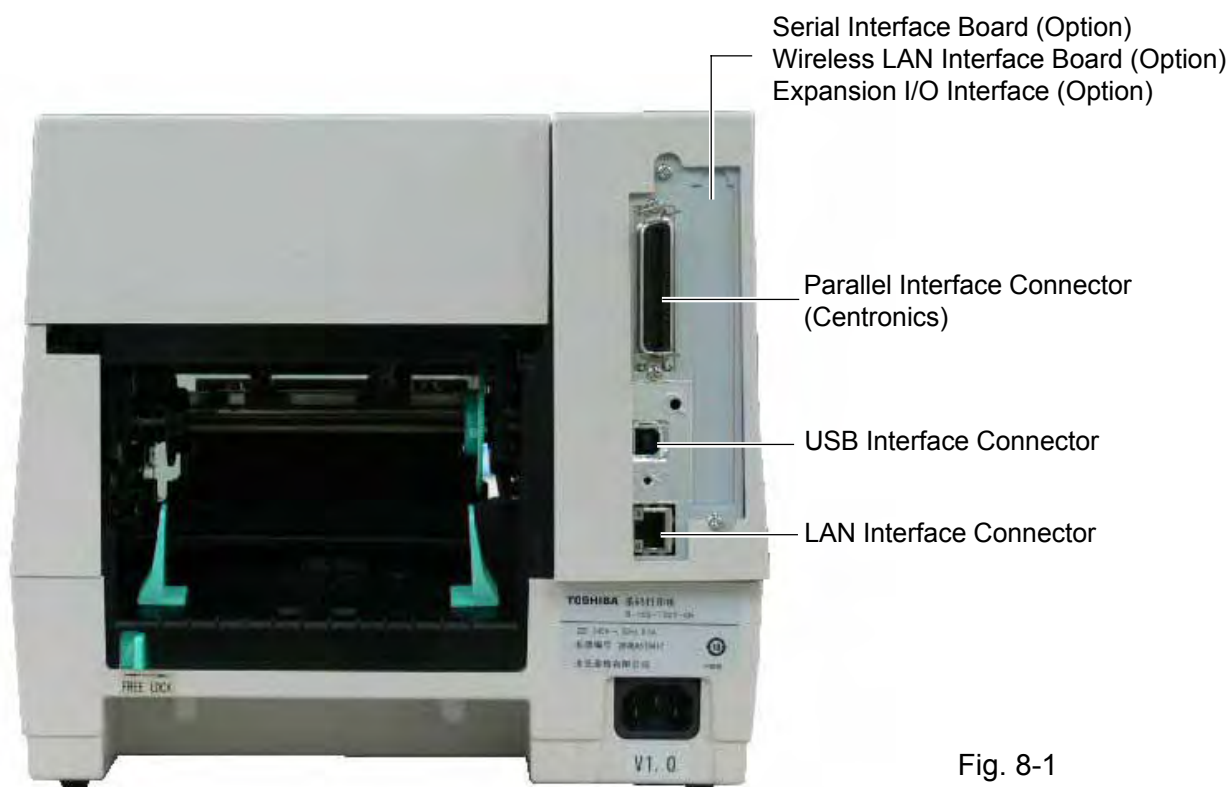

9. TURNING THE POWER ON

CAUTION!

Use the power switch to turn the printer On/Off. Plugging or unplugging the Power Cord to turn the printer On/Off may cause fire, an electric shock, or damage to the printer.

ATTENTION!

Utilisez l'interrupteur pour allumer /éteindre

l'imprimante. Branchez ou débranchez le cordon d'alimentation pour allumer ou éteindre l'imprimante pourra entraîner un incendie, un choc électrique ou un dommage à l'imprimante.

When the printer is connected to your host computer it is good practice to turn the printer ON before turning on your host computer and turn OFF your host computer before turning off the printer.

1. To turn ON the printer power, press the Power Switch as shown in the diagram below. Note that (|) is the power ON side of the switch.
2. Check that the ON LINE message appears in the LCD Message Display and that the ON LINE LED (Green) is illuminated.

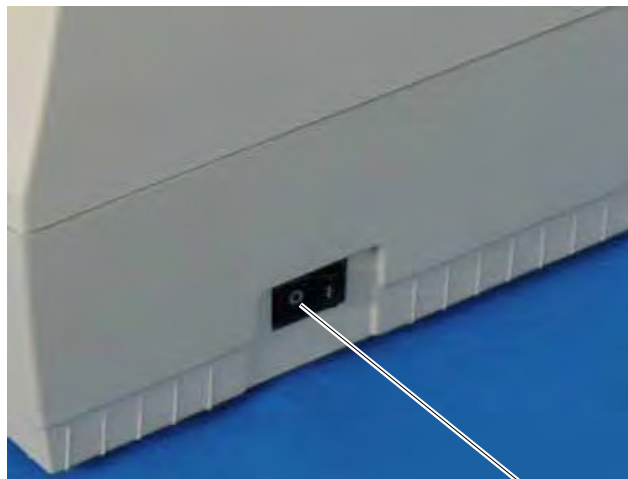

Fig. 9-1

Power Switch

10 INSTALLING THE PRINTER DRIVERS

10.1 INTRODUCTIONS

This manual describes how to install the TOSHIBA printer driver for the TOSHIBA bar code printer on your Windows host computer; install and delete the printer driver, the procedure for adding the LAN port, cautions and limitations.

The examples provided here illustrate the procedure for installing the printer driver version V7.0 for the B-SA4T series.

10.2 GENERAL DESCRIPTION

1. Features

Once you install the TOSHIBA printer driver on your Windows host computer, you can use the TOSHIBA bar code printer, as well as the easy-to-use general printers.

You can use this printer by connecting a parallel interface cable (printer cable), a USB cable, or a LAN cable to your host computer.

2. System Requirements

To install the TOSHIBA printer driver on your host computer, the following system and environment are required:

- Operating system: Windows 98, Windows Me, Windows 2000, Windows XP
- Hardware: A DOS-IV (IBM PC/AT compatible) machine running an above operating system.
- Interface:
 - Parallel interface conforming to the IEEE1284 standard
 - USB interface
 - LAN interface

10.3 INSTALLING THE PRINTER DRIVER

The installation procedure differs depending on the interface connected to the printer and the operation system you are using. Please install the printer driver by performing the appropriate procedure.

If the previous version of the printer driver has been installed on your host computer, be sure to uninstall it before you install this printer driver. (Refer to **Section 10.4 Uninstalling the Printer Driver.**)

To print via your network, please install the printer driver by performing the installation procedure for the parallel interface, and also perform the following:

1. In the procedure, select "LPT1" for the port.
2. After installation of the printer driver is completed, add the LAN port by referring to **Section 10.5 Adding/Deleting a LAN Port**, and specify the LAN port.

1. Parallel Interface

To use the parallel interface, the following settings are required, after installing the printer driver:

For Windows 98/Me: Open the printer properties. Select the "Details" tab and click on the **[Spool Settings...]** button. The "Spool Settings" dialog box is displayed. Select "Disable bi-directional support for this printer".

For Windows 2000/XP: Open the printer properties and select the "Ports" tab. Mark off the "Enable bidirectional support" checkbox.

Windows 98/Me

1. Select "Settings" – "Printers" from the "Start" menu to open the printer folder.
2. Double-click on the "Add Printer" icon. The Add Printer Wizard runs. Click on the **[Next]** button.
3. Select "Local printer", then click on the **[Next]** button. The screen listing "Manufacturers and Printers" is displayed.
4. Click on the **[Have Disk...]** button. The "Install From Disk" dialog box is displayed. Specify the "**driver**" folder in the CD-ROM drive, then click on the **[OK]** button.

NOTE:

The latest printer driver is available from the web site.

(<http://www.toshibatec-ris.com/products/barcode/index.html>)

5. Select the printer to be installed from "Printers" list, then click on the **[Next]** button.

Driver name	Model	Driver name	Model	Driver name	Model
TEC B-372	B-372-QP	TEC B-415	B-415-GH24-QM B-415-GH25-QM	TEC B-419	B-419-GS10-QQ B-419-GS12-QP B-419-GS12-CN
TEC B-431	B-431-GS10-QP B-431-GS10-CN	TEC B-452	B-452-TS10-QQ B-452-TS10-QQ-US B-452-TS11-QQ-PAC B-452-TS12-QP B-452-TS12-QP-PAC B-452-TS12-CN B-452-TS22-QQ-R B-452-TS22-QP-R B-452-TS22-CN	TEC B-452H	B-452-HS12-QQ B-452-HS12-QQ-US B-452-HS12-QP B-452-HS12-CN
TEC B-472	B-472-QQ B-472-QQ-US B-472-GH12-QQ B-472-QP	TEC B-472-CN	B-472-GH12-CN B-472-GH14-CN	TEC B-482	B-482-TS10-QQ B-482-TS10-QQ-US B-482-TS10-QP
TEC B-492	B-492L-TH10-QQ B-492R-TH10-QQ B-492L-TH10-QP B-492R-TH10-QP	TEC B-572	B-572-QQ B-572-QQ-US B-572-QP	TEC B-672	B-672-QQ B-672-QQ-US B-672-QP
TEC B-682	B-682-TS10-QQ B-682-TS10-QQ-US B-682-TS10-QP	TEC B-852	B-852-TS12-QQ B-852-TS12-QQ-US B-852-TS12-QP	TEC B-852-R	B-852-TS22-QQ-R B-852-TS22-QP-R
TEC B-872	B-872-QQ B-872-QQ-US B-872-QP	TEC B-882	B-882-TS10-QQ B-882-TS10-QQ-US B-882-TS10-QP	TEC B-SA4G	B-SA4TM-GS12-QM-R B-SA4TP-GS12-QM-R
TEC B-SA4T	B-SA4TM-TS12-QM-R B-SA4TP-TS12-QM-R	TEC B-SA4T-CN	B-SA4TM-TS12-CN B-SA4TP-TS12-CN	TEC B-SP2D	B-SP2D-GH20-QM B-SP2D-GH30-QM B-SP2D-GH30-QM-R B-SP2D-GH20-QM-R B-SP2D-GH30-QM-R B-SP2D-GH30-QM-R
TEC B-SV4	B-SV4D-GS10-QM B-SV4D-GH10-QM B-SV4D-GS10-QM-R B-SV4D-GH10-QM-R	TEC B-SX4	B-SX4T-GS10-QQ B-SX4T-GS10-QQ-US B-SX4T-GS10-QP B-SX4T-GS20-QQ B-SX4T-GS20-QQ-US B-SX4T-GS20-QP B-SX4T-GS20-QM-R	TEC B-SX4-CN	B-SX4T-GS10-CN B-SX4T-GS20-CN
TEC B-SX5	B-SX5T-TS12-QQ B-SX5T-TS12-QQ-US B-SX5T-TS12-QP B-SX5T-TS22-QQ B-SX5T-TS22-QQ-US B-SX5T-TS22-QP B-SX5T-TS22-QM-R	TEC B-SX5-CN	B-SX5T-TS12-CN B-SX5T-TS22-CN	TEC B-SX6T-R	B-SX6T-TS12-QM-R
TEC B-SX8T-R	B-SX8T-TS12-QM-R	TEC CB-416-T3	CB-416-T3-QQ CB-416-T3-QQ-US CB-416-T3-QP	TEC CB-426-T3	CB-426-T3-QQ CB-426-T3-QQ-US CB-426-T3-QP

6. The screen to select the existing installed printer driver or use the new one, is displayed. Select “Replace existing driver”, then click on the **[Next]** button. If you install the printer driver for the first time, this screen is not displayed.
7. Select the port to be used for printing from the “Available ports” list, then click on the **[Next]** button.
8. Change the printer name if necessary, and select whether or not you use the printer as the default printer (“Yes” or “No”). Click on the **[Finish]** button.
9. The printer driver is installed. When installation is completed, the new printer icon is added in the “Printers” folder.

Windows 2000/XP

1. Log on to your host computer as a member who has full control access privilege concerning the printer settings.
2. Select "Settings" – "Printers" from the "Start" menu to open the printer folder.
3. Double-click on the "Add Printer" icon. The Add Printer Wizard runs. Click on the **[Next]** button.
4. Select "Local printer". Mark off the "Automatically detect and install my Plug and Play printer" checkbox, then click on the **[Next]** button.
5. Select the port to be used for printing from the "Available ports" list, then click on the **[Next]** button.
6. On the screen listing "Manufacturers and Printers", click on the **[Have Disk...]** button. The "Install From Disk" dialog box is displayed.
7. Specify the "**driver**" folder in the CD-ROM drive, then click on the **[OK]** button.

NOTE:

The latest printer driver is available from the web site.
(<http://www.toshibatec-ris.com/products/barcode/index.html>)

8. Select the printer to be installed from "Printers" list, then click on the **[Next]** button.

Driver name	Model	Driver name	Model	Driver name	Model
TEC B-372	B-372-QP	TEC B-415	B-415-GH24-QM B-415-GH25-QM	TEC B-419	B-419-GS10-QQ B-419-GS12-QP B-419-GS12-CN
TEC B-431	B-431-GS10-QP B-431-GS10-CN	TEC B-452	B-452-TS10-QQ B-452-TS10-QQ-US B-452-TS11-QQ-PAC B-452-TS12-QP B-452-TS12-QP-PAC B-452-TS12-CN B-452-TS22-QQ-R B-452-TS22-QP-R B-452-TS22-CN	TEC B-452H	B-452-HS12-QQ B-452-HS12-QQ-US B-452-HS12-QP B-452-HS12-CN
TEC B-472	B-472-QQ B-472-QQ-US B-472-GH12-QQ B-472-QP	TEC B-472-CN	B-472-GH12-CN B-472-GH14-CN	TEC B-482	B-482-TS10-QQ B-482-TS10-QQ-US B-482-TS10-QP
TEC B-492	B-492L-TH10-QQ B-492R-TH10-QQ B-492L-TH10-QP B-492R-TH10-QP	TEC B-572	B-572-QQ B-572-QQ-US B-572-QP	TEC B-672	B-672-QQ B-672-QQ-US B-672-QP
TEC B-682	B-682-TS10-QQ B-682-TS10-QQ-US B-682-TS10-QP	TEC B-852	B-852-TS12-QQ B-852-TS12-QQ-US B-852-TS12-QP	TEC B-852-R	B-852-TS22-QQ-R B-852-TS22-QP-R
TEC B-872	B-872-QQ B-872-QQ-US B-872-QP	TEC B-882	B-882-TS10-QQ B-882-TS10-QQ-US B-882-TS10-QP	TEC B-SA4G	B-SA4TM-GS12-QM-R B-SA4TP-GS12-QM-R
TEC B-SA4T	B-SA4TM-TS12-QM-R B-SA4TP-TS12-QM-R	TEC B-SA4T-CN	B-SA4TM-TS12-CN B-SA4TP-TS12-CN	TEC B-SP2D	B-SP2D-GH20-QM B-SP2D-GH30-QM B-SP2D-GH30-QM B-SP2D-GH20-QM-R B-SP2D-GH30-QM-R B-SP2D-GH30-QM-R
TEC B-SV4	B-SV4D-GS10-QM B-SV4D-GH10-QM B-SV4D-GS10-QM-R B-SV4D-GH10-QM-R	TEC B-SX4	B-SX4T-GS10-QQ B-SX4T-GS10-QQ-US B-SX4T-GS10-QP B-SX4T-GS20-QQ B-SX4T-GS20-QQ-US B-SX4T-GS20-QP B-SX4T-GS20-QM-R	TEC B-SX4-CN	B-SX4T-GS10-CN B-SX4T-GS20-CN
TEC B-SX5	B-SX5T-TS12-QQ B-SX5T-TS12-QQ-US B-SX5T-TS12-QP B-SX5T-TS22-QQ B-SX5T-TS22-QQ-US B-SX5T-TS22-QP B-SX5T-TS22-QM-R	TEC B-SX5-CN	B-SX5T-TS12-CN B-SX5T-TS22-CN	TEC B-SX6T-R	B-SX6T-TS12-QM-R
TEC B-SX8T-R	B-SX8T-TS12-QM-R	TEC CB-416-T3	CB-416-T3-QQ CB-416-T3-QQ-US CB-416-T3-QP	TEC CB-426-T3	CB-426-T3-QQ CB-426-T3-QQ-US CB-426-T3-QP

9. The “Use Existing Driver” screen is displayed. Select “Replace existing driver”, then click on the **[Next]** button. If you install the printer driver for the first time, this screen is not displayed.
10. Change the printer name if necessary, and select whether or not you use the printer as the default printer (“Yes” or “No”). Click on the **[Next]** button.
11. Select whether or not the printer will be shared with other network users (“Shared” or “Not shared”). Click on the **[Next]** button.
12. Select whether or not the test page will be printed (“Yes” or “No”), then click on the **[Finish]** button.
13. If the “Digital Signature Not Found” screen is displayed, click on the **[Yes]** button.
14. When the “Completing the Add Printer Wizard” screen is displayed, click on the **[Finish]** button.
15. When installation is completed, the new printer icon is added in the “Printers” folder.

2. USB INTERFACE

Installation starts by the operating system's plug-and-play function.

Windows 98/Me

1. Turn the printer ON, then connect it to your host computer with the USB cable. The "New Hardware Found" dialog box is displayed, and "USB Device" is detected.

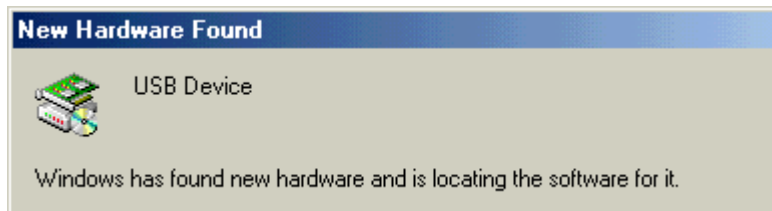

2. After a while, the "Add New Hardware Wizard" dialog box is displayed. Select "Specify the location of the driver (Advanced)", then click on the **[Next]** button.



3. Select "Search for the best driver for your device. (Recommended)". Mark the "Specify a location" checkbox, then click on the **[Browse]** button. Specify "**\driver**" folder, then click on the **[Next]** button.

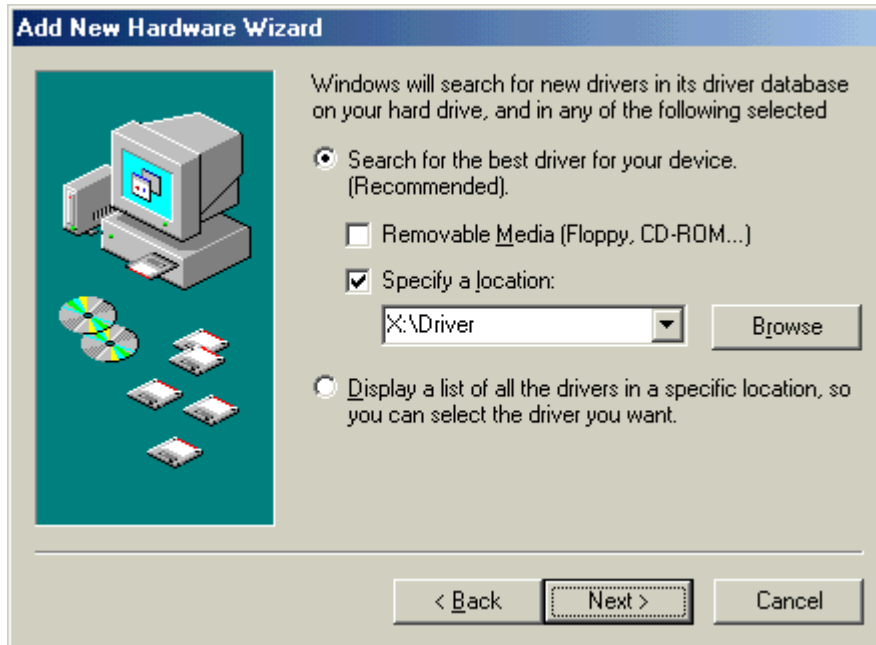

4. Check to see that the "USB Printing Support" driver is detected, then click on the **[Next]** button.



5. When the screen which indicates the USB Printing Support driver has been installed, is displayed, click on the **[Finish]** button.



6. After a while, “TEC B-SA4T” is detected as a new hardware.

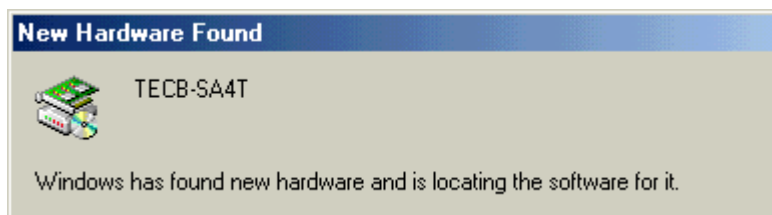

7. The “Add New Hardware Wizard” dialog box is displayed. Select “Specify the location of the driver (Advanced)”, then click on the **[Next]** button.



8. Select "Search for the best driver for your device. (Recommended)". Mark the "Specify a location" checkbox, then click on the **[Browse]** button. Specify "**driver**" folder, then click on the **[Next]** button.

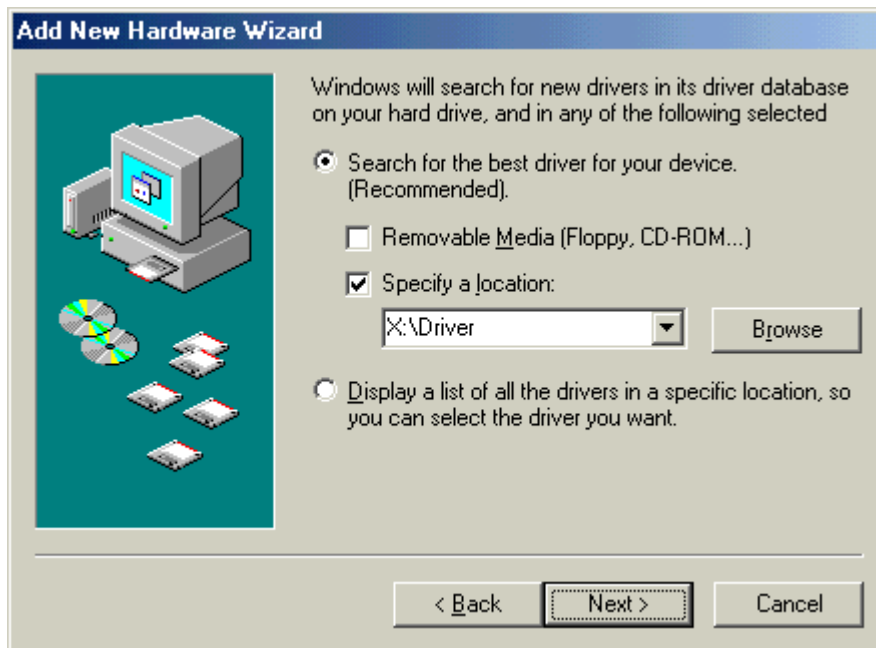

9. Check to see that the "**TEC B-SA4T**" driver is detected, then click on the **[Next]** button.



10. Change the printer name if necessary, and select whether or not you use the printer as the default printer (“Yes” or “No”). Click on the **[Finish]** button.

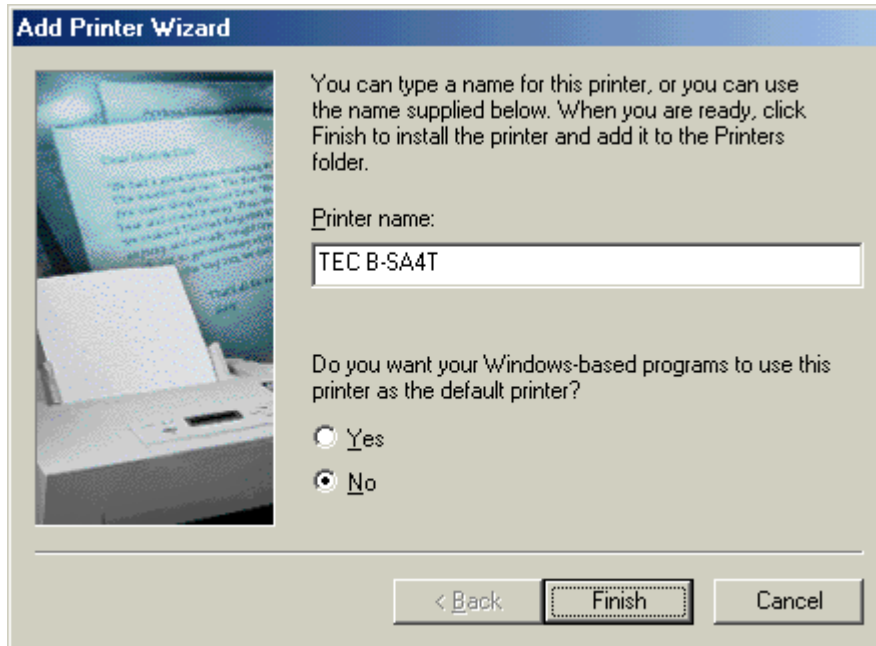

11. When the screen, which indicates TEC B-SA4T has been installed, is displayed, click on the **[Finish]** button.



12. When installation is completed, the new printer icon is added in the “Printers” folder.

Windows 2000/XP**NOTE:**

When plug-and-play printer installation in progress is stopped, be sure to delete the printer detected and displayed on the "Device Manager" tab of the "System Properties" dialog box.

1. Log on to your host computer as a member who has full control access privilege concerning the printer settings.
2. Turn the printer ON, then connect it to your host computer with the USB cable.
3. "USB Device" is automatically detected, and "USB Printing Support" is automatically installed.
4. After a while, for Windows XP, "TEC B-SA4T" is detected as a new device. For Windows 2000, "Unknown" device is detected as a new device. In both cases, perform the following steps, though dialog boxes for Windows XP are used.
5. The "Found New Hardware Wizard" dialog box is displayed. Select "No, not this time", then click on the **[Next]** button.



6. Select “Install from a list or specific location (Advanced)”, then click on the **[Next]** button.

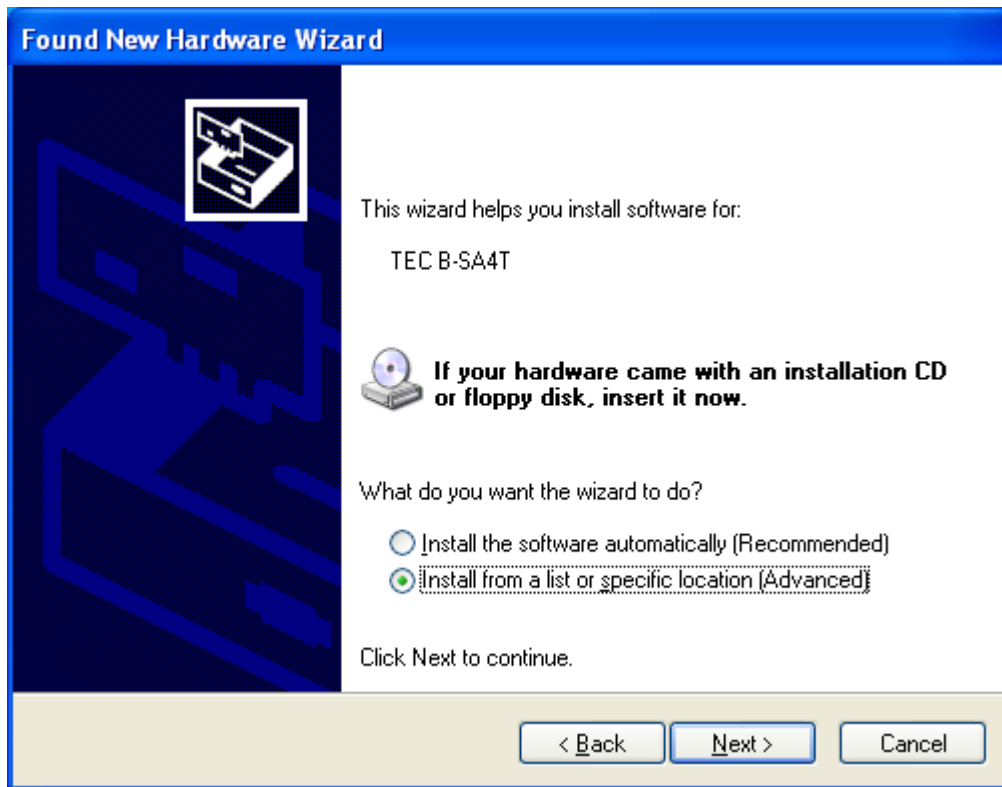

7. Select “Search for the best driver in these locations”. Mark the “Include this location in the search” checkbox, then click on the **[Browse]** button. Specify the “\driver” folder in the CD-ROM, then click on the **[Next]** button.

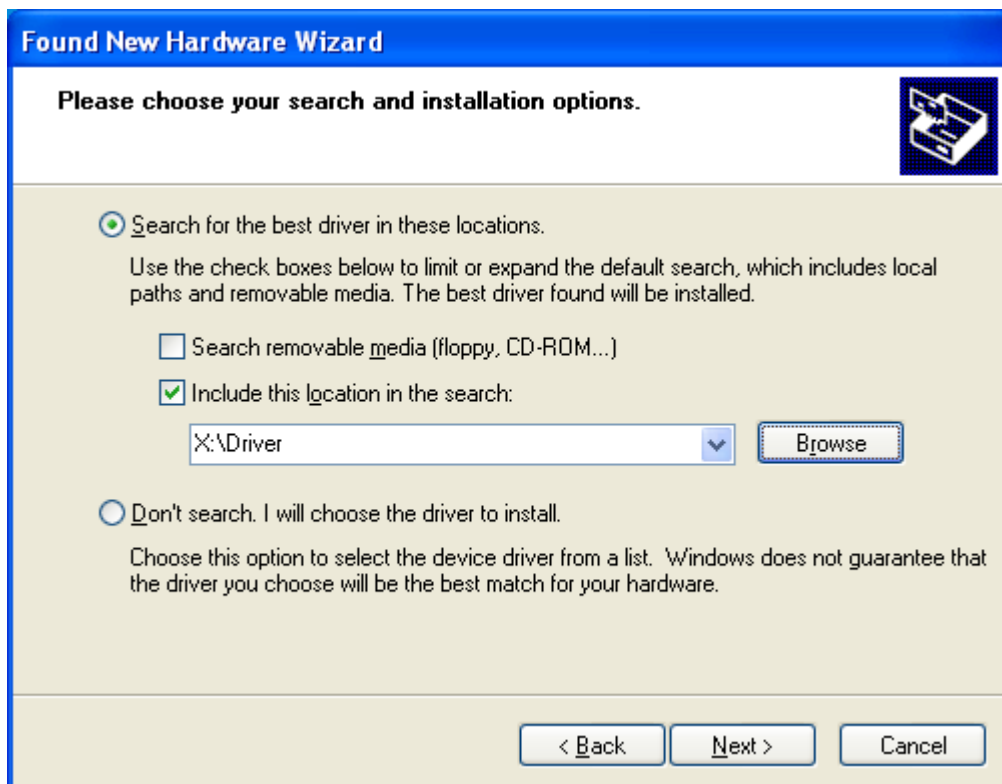

8. When the dialog box below is displayed, click on the **[Continue Anyway]** button.



9. When the "Completing the Found New Hardware Wizard" screen is displayed, click on the **[Finish]** button.

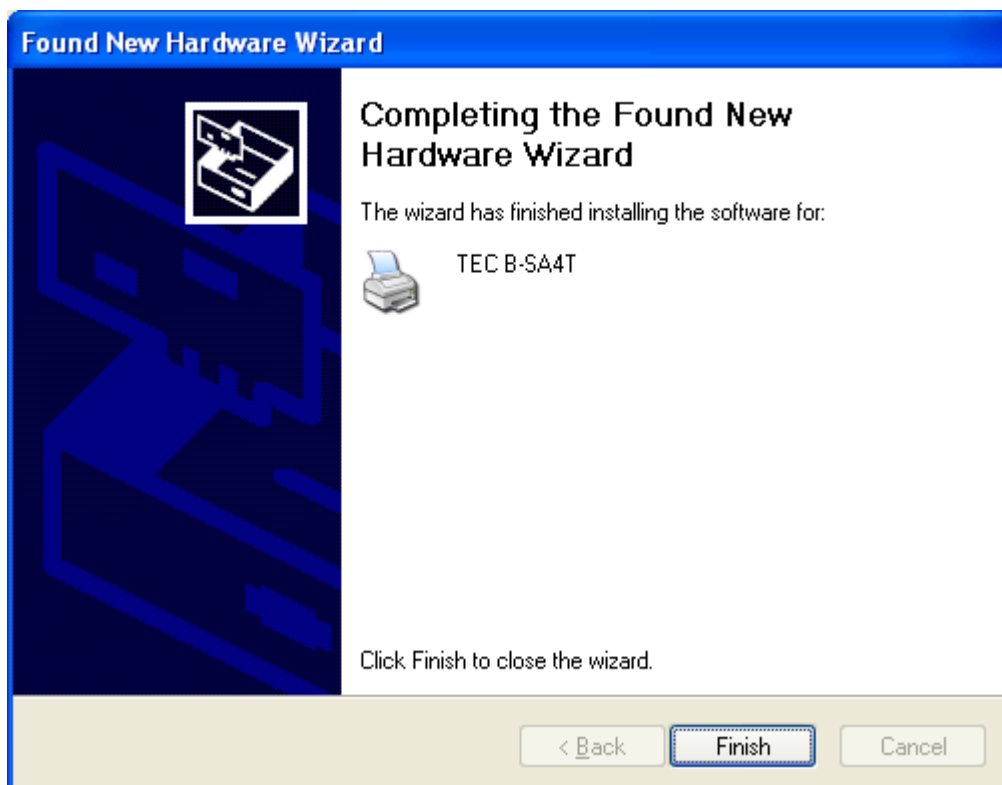

10. When installation is completed, the new printer icon is added in the "Printers" folder.

10.4 UNINSTALLING THE PRINTER DRIVER

NOTE:

Before uninstalling the printer driver, be sure to complete all of printing, the status monitor, and properties settings.

Windows 98/ME

1. Select “Settings” – “Printers” from the “Start” menu to open the printer folder.
2. Right-click on the printer driver icon to be deleted, then select “Delete”. The confirmation message is displayed.
3. Click on the **[Yes]** button to delete.
4. After the printer driver icon is deleted, restart your host computer.

Windows 2000/XP

1. Log on to your host computer as a member who has full control access privilege concerning the printer settings.
2. Select “Settings” – “Printers” from the “Start” menu to open the printer folder.
3. Right-click on the printer driver icon to be deleted, then select “Delete”. The confirmation message is displayed.
4. Click on the **[Yes]** button to delete.
5. After the printer icon is deleted, select “Server Properties” from “File” menu of the “Printers” folder.
6. Select the printer driver to be deleted, then click on the **[Remove]** button. After the printer driver is deleted, restart your host computer.

10.5 ADDING/DELETING A LAN PORT

To use the LAN interface, first, you have to make the following settings (Refer to TOSHIBA TEC support representative.)

- Set the printer IP address (“**PRINTER IP ADRES**”), the gateway IP address (“**GATEWAY IP ADRES**”), and subnet mask (“**SUBNET MASK**”).
- Set the port number (“**SOCKET PORT**”).

Among these settings, the printer IP address and the port number are also required for adding a LAN port.

1. Adding a LAN Port

Windows 98/ME

1. Right-click on the printer icon. Select “Properties” to open the printer “Properties” dialog box.
2. Select the “Details” tab, and click on the **[Add Port...]** button. The “Add Port” dialog box is displayed.
3. Select “Other”.
Select “Seagull Scientific TCP/IP Port” from the list, then click on the **[OK]** button.
4. On the “Add Seagull TCP/IP Port” dialog box, enter the name or IP address, the port number, and the port name. For the IP address and the port number, enter the same ones as you have set. After entering these, click on the **[OK]** button.

Add Seagull TCP/IP Port

TCP/IP Settings
You may specify the printer's location by name or IP address.
A name may be either a name on the local network, such as 'PRINTERS6', or a fully-qualified internet name, such as 'printer6.seagullscientific.com'.
IP addresses are specified as four numbers separated by periods, for example, 10.1.2.3.

Name or IP Address:

The port number determines which TCP port is used to communicate with the printer. Most printers use port 9100.

Port Number:

Port Settings
The port name is displayed in the Ports dialog. For example, 'LPT1' is the name of the parallel port. The name generated by default is acceptable.

Port Name:

OK Cancel

5. When addition of the port is completed, the port is added to the drop down list for “Print to the following port”.

Windows 2000/XP

1. Right-click on the printer icon. Select “Properties” to open the printer “Properties” dialog box.
2. Select the “Ports” tab, and click on the **[Add Port...]** button. The “Printer Ports” dialog box is displayed.
3. Select “Seagull Scientific TCP/IP Port” from the “Available Printer Ports” list, then click on the **[OK]** button.
4. On the “Add Seagull TCP/IP Port” dialog box, enter the name or IP address, the port number, and the port name. For the IP address and the port number, enter the same ones as you have set. After entering these, click on the **[OK]** button.
5. When addition of the port is completed, the port is added to the “Print to the following port(s)” list.

2. Deleting a LAN Port**NOTE:**

Before deleting a port, be sure to check if other printers also use it. If there are printers which use the port to be deleted, change their port to another, before deleting the port.

Windows 98/ME

1. Right-click on the printer icon. Select “Properties” to open the printer “Properties” dialog box.
2. Select the “Details” tab, and click on the **[Delete Port...]** button.
3. Select the port to be deleted, then click on the **[OK]** button.
4. When deletion of the port is completed, the port is also deleted from the “Print to the following port” list.

Windows 2000/XP

1. Right-click on the printer icon. Select “Properties” to open the printer “Properties” dialog box.
2. On the “Ports” tab, select the port to be deleted, then click on the **[Delete Port]** button.
3. When deletion of the port is completed, the port is also deleted from the “Print to the following port(s)” list.

10.6 CAUTIONS

1. Printer Driver Upgrades

- To upgrade the printer driver to this version, uninstall the previous version of the printer driver, before installing this printer driver.
- Be sure to restart your host computer, after you upgrade the printer driver.
- When your operating system is Windows 98, or Windows Me, be sure to restart your host computer, after you uninstall the previous version of the printer driver. Or, the printer driver is not upgraded properly.

2. Others

- If your operating system is Windows 2000 or Windows XP, when plug-and-play printer installation in progress is stopped, be sure to delete the printer detected and displayed on the “Device Manager” tab of the “System Properties” dialog box.
- Before uninstalling the printer driver, be sure to complete all of printing, the status monitor, and properties settings.
- Before deleting a port, be sure to check if other printers also use it. If there are printers which use the port to be deleted, change their port to another, before deleting the port.

10.7 USING THE PRINTER DRIVER

For how to use the Printer Driver, please refer to the Help for Windows Printer Drivers screen.

1. Open the Properties screen of the Printer Driver.
2. Clicking on the **About** tab causes the following screen to appear.
Click on the **[Help]** button.

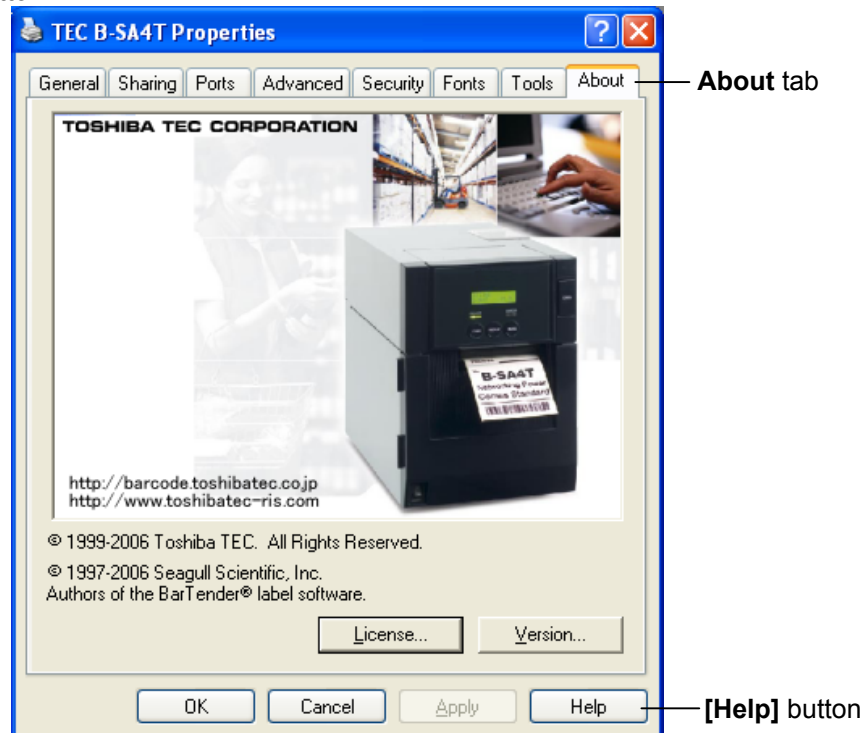

3. The Help for Windows Printer Drivers screen appears. This screen will provide how to use the printer driver.

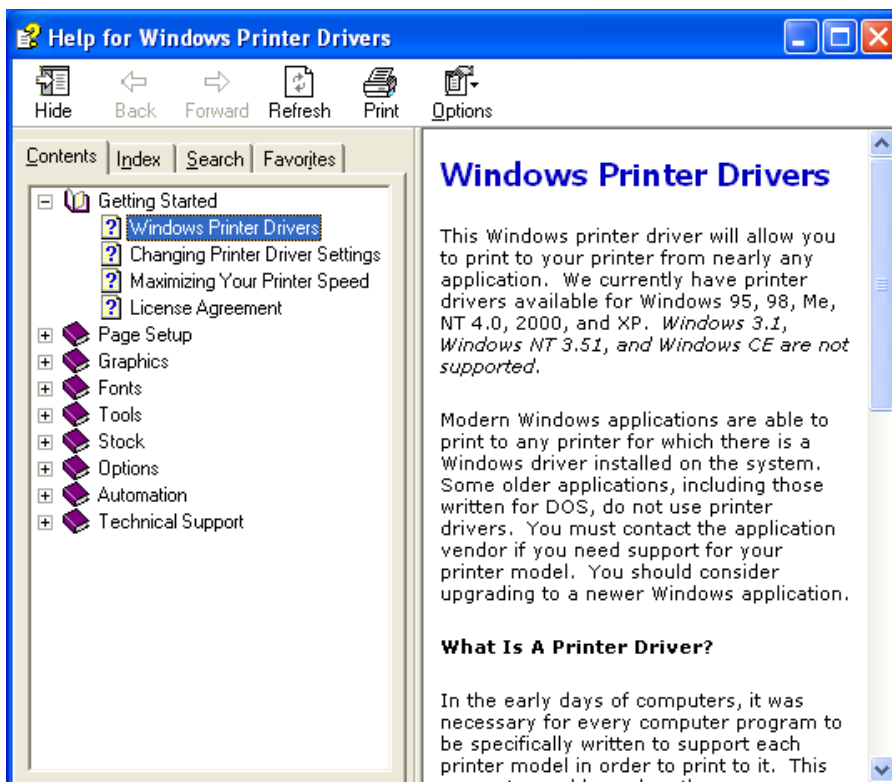

11. ON LINE MODE

In the ON LINE mode, the following settings can be performed.

- Diagnostic Test Operation
- LAN and BASIC Setting Mode (Enabling/disabling the LAN and BASIC)

This section describes the Diagnostic Test Operation and Enabling/disabling the LAN and BASIC.

11.1 ON LINE OPERATION

■ Operation Panel

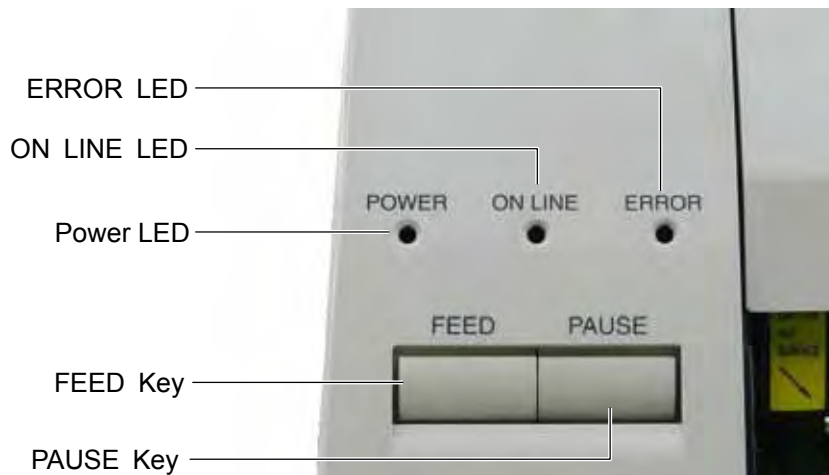

■ Key Function Table

Key Name	Function
[FEED] Key	Feeds a piece of paper. Feeds the paper to the print start position. When printing is performed with the print position misaligned, the printer cannot print data on a proper position, therefore, feed one or two pieces of paper to set the paper to the proper position before printing. Also sets the feed speed adjustment value.
[PAUSE] Key	Pauses the label issue. Restarts printing after a pause or an error.

■ LED Function Table

LED Name	Function
POWER LED	Indicates that the printer is ON.
ON LINE LED	Indicates that the printer is communicable.
ERROR LED	Indicates that the printer is in an error status.

■ Example of ON LINE Mode Operation

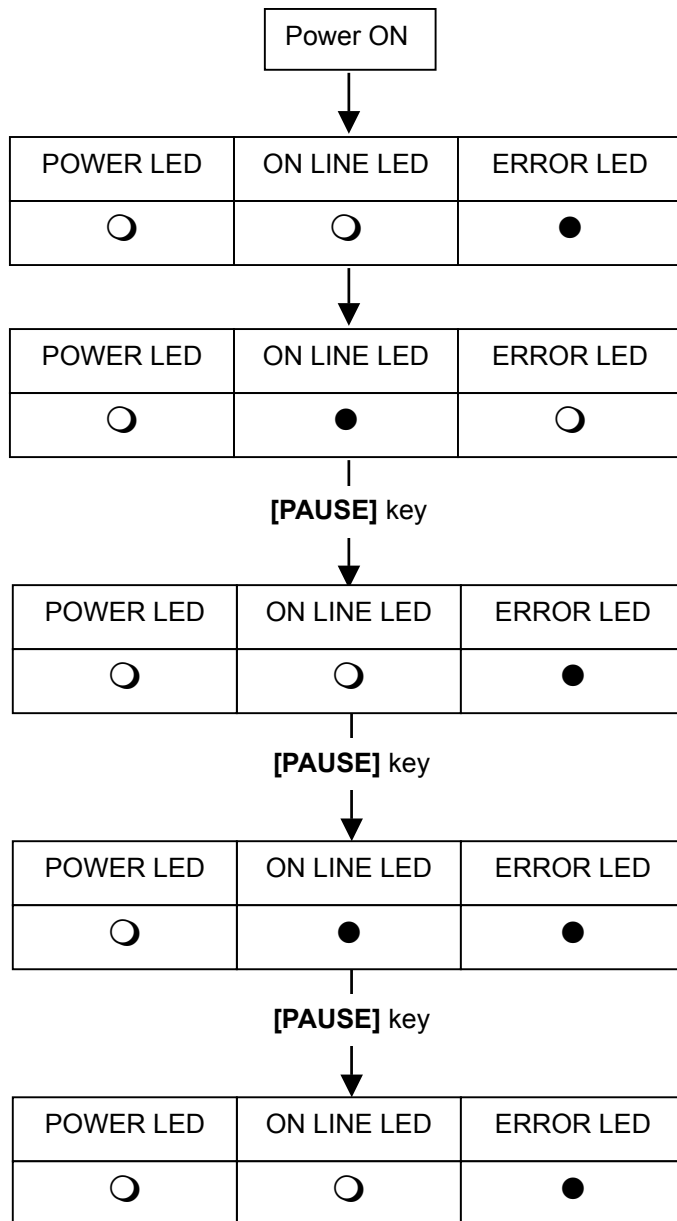

Turn the power on.

The printer is in idle state or printing.

Error occurs

Press the **[PAUSE]** key.

Restart

Press the **[PAUSE]** key.

Press the **[PAUSE]** key.
The printer enters the pause mode.

Press the **[PAUSE]** key.

Restart

○: The LED is illuminated.

⊙: The LED is flashing.

●: The LED is unlit.

11.2 DIAGNOSTIC TEST OPERATION AND TEST PRINT

In self test mode the printer status is printed in two types of sample print.

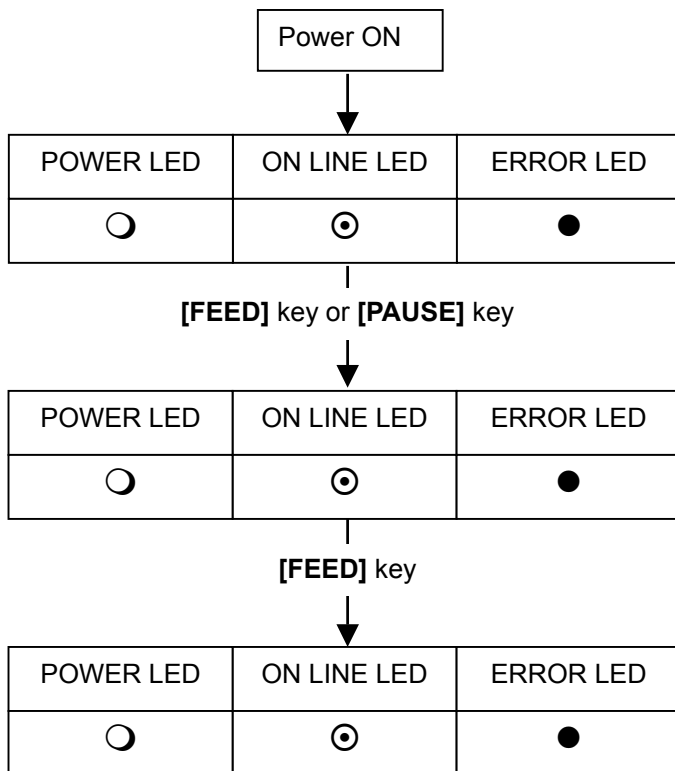

Turn on the power while holding down the **[PAUSE]** key.
Diagnostic test is started.

Diagnostic test is finished.

Select the print method
[FEED] key: Thermal transfer print
[PAUSE] key: Thermal direct print

The result of the Diagnostic test is printed.

Press the **[FEED]** key.
Test print is started.

■ Sample Print of Maintenance Counter and Parameter Setting

TOTAL FEED	1.1km	[QQ]
FEED	1.1km	
PRINT	0.5km	
CUT	96	
RIBBON	3h	
232C ERR	255	
SYSTEM ERR	0	
POWER FAIL	0	
[PC]		[KEY]
FEED	+2.0mm	FEED +0.0mm
CUT	+0.0mm	CUT +1.0mm
BACK	+0.0mm	BACK +0.0mm
TONE(T)	+0 step	TONE(T) +0 step
TONE(D)	+0 step	TONE(D) +0 step
RBN(FW)	-10	RBN (FW) -8
RBN (BK)	+0	RBN (BK) +0
X ADJ.	+0.0mm	
THRESHOLD (R)	1.0V	
THRESHOLD (T)	1.4V	
FONT	[PC-850]	[0]
SPEED	[9600]	
DATA LENG.	[8]	
STOP BIT	[1]	
PARITY	[EVEN]	
CONTROL	[XON+READY AUTO]	
FORWARD WAIT	[ON]+0.0mm	
CODE	[AUTO]	
PEEL OFF STATUS	[ON]	
FEED KEY	[FEED]	
KANJI	[TYPE1]	
EURO CODE	[B0]	
AUTO HD CHK	[OFF]	
ACK/BUSY	[TYPE1]	
WEB PRINTER	[OFF]	
INPUT PRIME	[ON]	
RIBBON NEAR END	[OFF]	
EX. I/O MODE	[TYPE1]	
PLUG & PLAY	[OFF]	
LBL/RBN END	[TYPE1]	
PRE PEEL OFF	[OFF] +0.0mm	
BACK SPEED	[STD]	
MAXI CODE SPEC.	[TYPE1]	
KB I/F	[OFF]	
LAN	[ON]	
PRTR IP ADDRESS	[192.168.010.020]	
GATE IP ADDRESS	[000.000.000.000]	
SUBNET MASK	[255.255.255.000]	
MAC ADDRESS	[00-80-91-34-00-CC]	
TTF AREA	[1280KB]	
EXT CHR AREA	[256KB]	
BASIC AREA	[128KB]	
PC SAVE AREA	[128KB]	
SOCKET PORT	[OFF][08000]	
BASIC	[OFF]	
DHCP	[OFF]	
DHCP ID	[FFFFFFFFFFFFFFFFFFFFF]	
	[FFFFFFFFFFFFFFF]	
DHCP HOST NAME	[ABCDEFGHIJKLMNQP]	
PEEL OFF TRQ	[R0]	

■ Sample Print of Diagnostic Test

PROGRAM	B-450-R
	MAIN 15OCT2005 V1.0A: 1A00
	BOOT 20SEP2005 V1.0: 8500
	HTML 20SEP2005 V1.0: 8500
FONT	AE00
KANJI	GOTHIC: 9900
	MINCHO: 1E00
EEPROM	OK
SDRAM	16MB
SENSOR1	00000000, 00000111
SENSOR2	[H]23°C [A]22°C
	[R]4.2V [T]2.5V
PE LV.	[R]1.2V [T]4.3V
M THRE.	[R]5.0V [T]5.0V
	[RANK]1 300DPI
EXP.I/O	NG
EX.232C	NG
SIO	NG NG
STRIP	NG

■ Print Sample of Slant Line (3 dots)

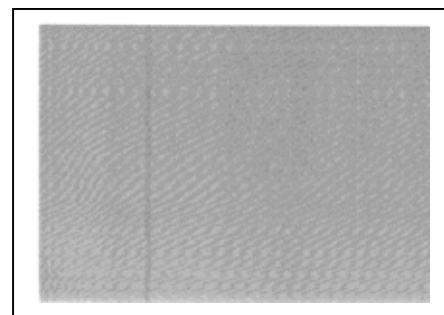

11.3 LAN AND BASIC SETTING

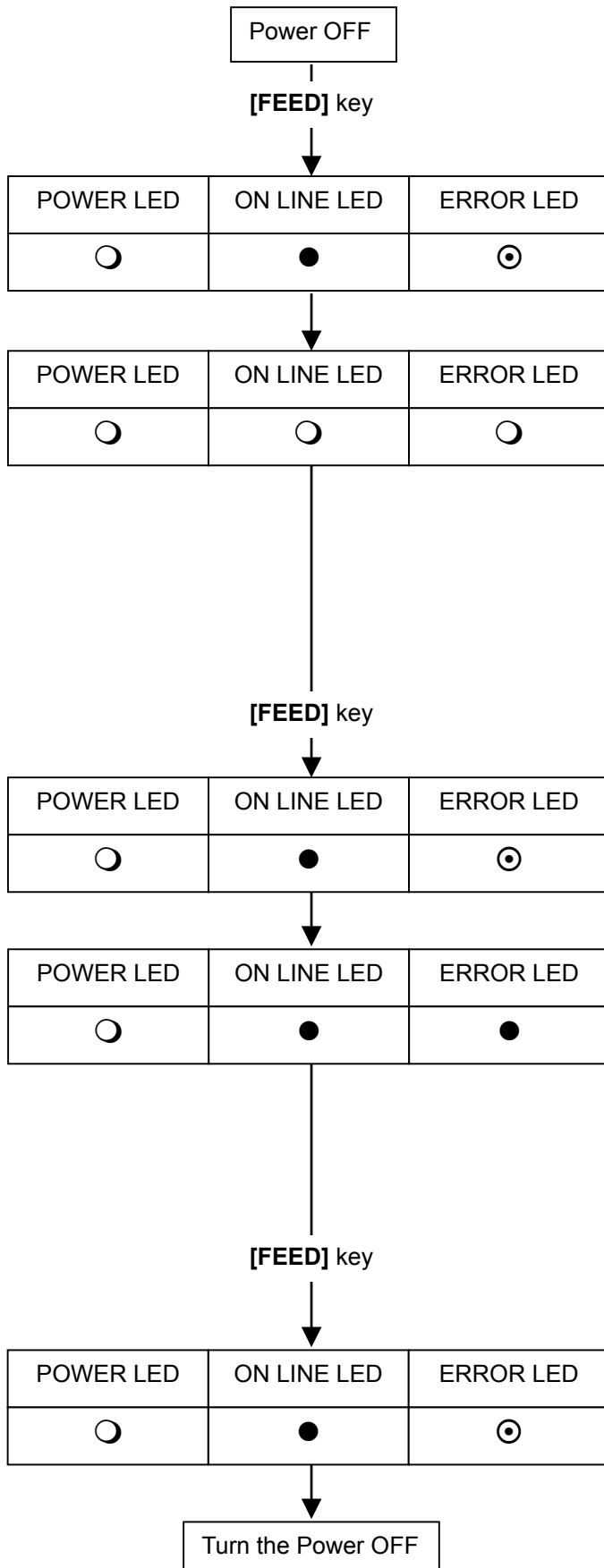

Turn the power ON while pressing and holding the **[FEED]** key for 3 seconds or more in the Expansion Operation Setting mode.

The printer enters the expansion operation setting mode.

When the **[FEED]** key is released, the current LAN interface setting status is indicated by the LEDs.

Use the **[PAUSE]** key to select a LAN setting.

	ON LINE LED	ERROR LED
LAN OFF	●	●
LAN ON SNMP ON	○	○
LAN ON SNMP OFF	●	○

Hold down the **[FEED]** key for more than 3 seconds to save the setting.

Save of the setting is completed.

When the **[FEED]** key is released, the current BASIC setting status is indicated by the LEDs. Use the **[PAUSE]** key to select a BASIC setting.

	ON LINE LED	ERROR LED
BASIC ON	●	●
BASIC OFF	●	○

Hold down the **[FEED]** key for more than 3 seconds to save the setting.

Save of the setting is completed.

12. GENERAL MAINTENANCE

WARNING! / AVERTISSEMENT!

Be careful when handling the print head as it becomes very hot.

Soyez prudent lorsque vous manipulez la tête d'impression puisqu'elle devient chaude

12.1 CLEANING

WARNING! / AVERTISSEMENT!

1. Be sure to disconnect the power cord prior to performing any maintenance.

2. DO NOT POUR WATER directly onto the printer.

1. Rassurez-vous de débrancher le câble d'alimentation avant d'effectuer tout entretien.

2. NE VERSEZ PAS DE L'EAU directement sur l'imprimante.

CAUTION / ATTENTION :

1. Do not use any sharp objects to clean the print head and platen. Doing so may damage them, causing poor print quality or missing dots.

2. Never use a organic solvents like thinners or venzene for cleaning. Using such solvents may discolor the covers, cause poor print quality, or printer failure.

3. Do not touch the print head element as static build-up may damage the print head.

1. N'utilisez aucun objet pointu pour nettoyer la tête d'impression et le plateau. Le faire pourrait les endommager, entraînant une mauvaise qualité d'impression ou des points manquants.

2. N'utilisez jamais un solvant organique comme les diluants ou le benzène pour nettoyer. L'utilisation de pareils solvants pourrait entraîner la décoloration des boîtiers, une mauvaise qualité d'impression, ou la panne de l'imprimante.

3. Ne touchez pas le composant de la tête d'impression, l'électricité statique accumulée pourra endommager la tête d'impression.

To help retain the high quality and performance of your printer it should be regularly cleaned. The greater the usage of the printer, the more frequent the cleaning. (i.e. low usage=weekly : high usage=daily).

1. Turn the power off.
2. Open the top cover.
3. Turn the head lever to raise the print head.
4. Remove the ribbon and paper.
5. Clean the print head element with print head cleaner

NOTE: Please purchase the print head cleaner from the authorized TOSHIBA TEC service representative.



Fig. 12-1

6. Clean the platen with a cloth moistened with alcohol.
7. Remove any dust or glue from the detection area of the sensors and paper path with a soft cloth.

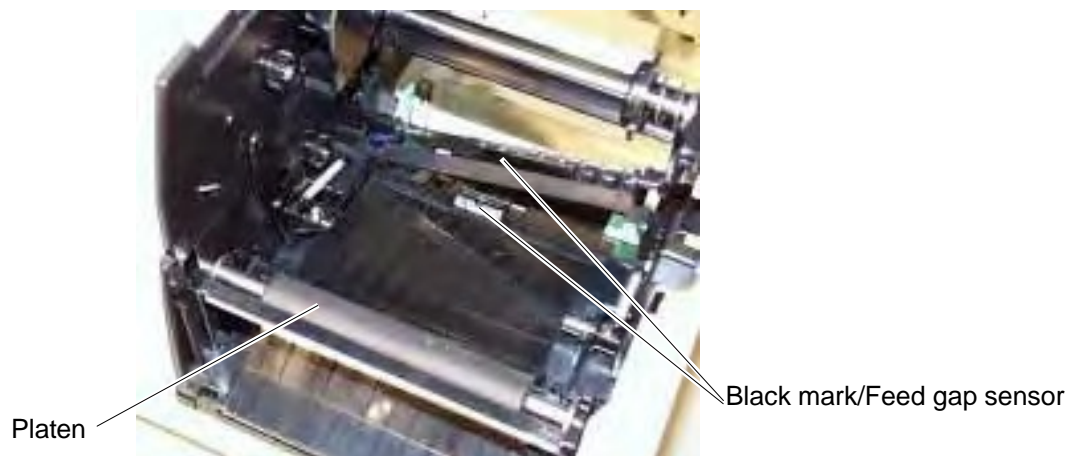

Fig. 12-2

8. Remove the supply holder rollers from the supply holder unit. Remove any dust from the recessed portions of the base and wipe glues from the rollers with a slightly moistened soft cloth.



Fig. 12-3

12.2 COVERS

The covers should be cleaned by wiping with a dry cloth or a cloth slightly dampened with a mild detergent solution.

NOTE: Clean printer cover with an electrostatic free cleaner for automated office equipment.

WARNING!

1. *DO NOT POUR WATER directly onto the printer.*
2. *DO NOT APPLY cleaner or detergent directly onto any cover.*
3. *NEVER USE THINNER OR OTHER VOLATILE SOLVENT on the plastic covers.*
4. *DO NOT clean the covers with alcohol as it may cause them to discolor, loose their shape or develop structural weakness.*

AVERTISSEMENT :

1. *NE VERSEZ PAS DE L'EAU directement sur l'imprimante.*
2. *N'APPLIQUEZ PAS de nettoyant ou détergent directement sur un boîtier ou le panneau.*
3. *N'UTILISEZ JAMAIS LE DILUANT OU AUCUN AUTRE SOLVANT sur les boîtiers.*
4. *NE nettoyez pas les boîtiers ou la fenêtre d'approvisionnement avec de l'alcool, ceci pourrait entraîner leur décoloration, la perte de leur forme ou présenter des faiblesses structurelles.*

12.3 REMOVING JAMMED PAPER

1. Turn the power off.
2. Open the top cover.
3. Move the head release lever toward the front of the printer to raise the print head block.
4. Remove the ribbon and paper.
5. Remove the jammed paper. **DO NOT USE** any sharp implement or tool as these could damage the printer.
6. Clean the print head and platen, then remove any further dust or foreign substances.

Top Cover

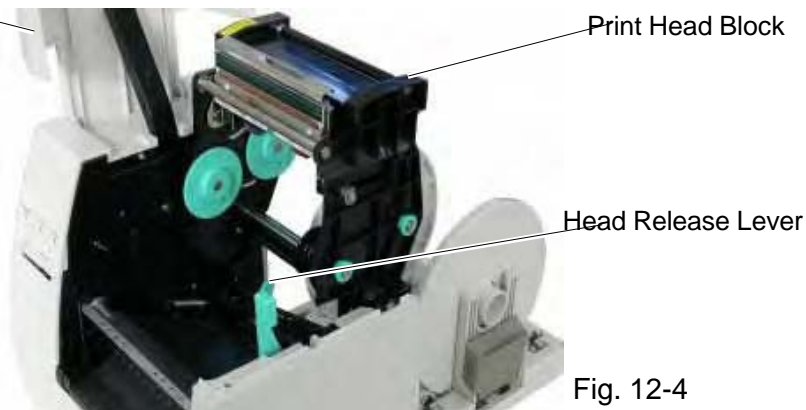

Fig. 12-4

7. Paper jams in the cutter unit can be caused by wear or residual glue from label stock on the cutter. Do not use unspecified paper in the cutter. If frequent jams occur in the cutter contact your Authorized Service representative.

Cleaning the Cutter Unit

WARNING!

1. Be sure to disconnect the power cord before cleaning the cutter unit.
2. The cutters are sharp and care should be taken not to injure yourself when cleaning.

AVERTISSEMENT!

1. Rassurez-vous de débrancher le cordon d'alimentation avant de nettoyer le coupeur.
2. Les coupeurs sont tranchants et il convient de faire attention à ne pas se couper lors du nettoyage.

1. Press the cutter cover release lever to detach the cutter cover.

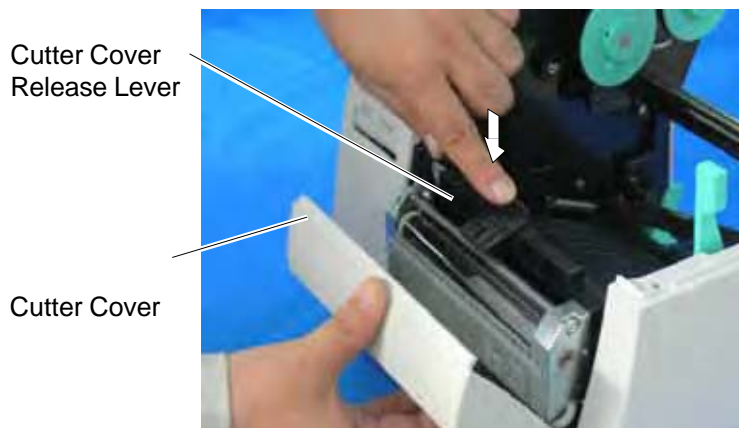

Fig. 12-5

2. Fit the enclosed Allen Key into the right side of the cutter unit to rotate the cutter manually. Remove the jammed paper and any paper particles from the cutter.
3. Clean the cutter with dry cloth.



Fig. 12-6

4. Assembling is reverse order of removal.

Cleaning the Strip Unit

WARNING!

1. Be sure to disconnect the power cord before cleaning the strip unit.
2. Do not touch the moving parts. To reduce the risk that fingers, jewelry, clothing, etc., be drawn into the moving parts, push the switch in the "OFF" position to stop movement.

AVERTISSEMENT!

1. Rassurez-vous de débrancher le cordon d'alimentation avant le nettoyage de la bande.
2. Ne touchez pas aux éléments en mouvement. Pour éviter les risques que les doigts, les bijoux, les habits, etc. soient tirés vers les éléments en mouvement, mettez l'interrupteur sur la position « ÉTEINTE » pour arrêter le mouvement.

1. First push the strip lever toward the printer to release the hook, and then pull the strip lever.
2. Remove the jammed paper, if any.
3. Clean the strip guide rollers A and B with a cloth moistened with alcohol.

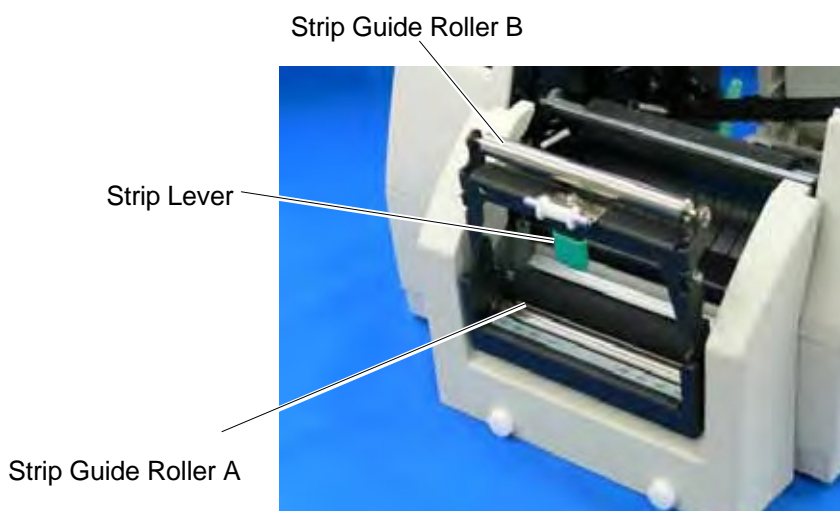

Fig. 12-7

13. TROUBLESHOOTING

WARNING!

If you cannot solve a problem with the following solutions, do not attempt to repair it yourself. Turn the power off, unplug the printer, then contact your TOSHIBA TEC representative for assistance.

AVERTISSEMENT!

Si vous ne pouvez pas résoudre un problème avec les solutions suivantes, n'essayez pas de le réparer vous-même. Éteignez, débranchez l'imprimante, puis contactez le représentant de TOSHIBA TEC pour assistance.

If the error lamp lights during printing, refer to the following troubleshooting to solve the problem.

Error type	Problem	Solution
PAPER JAM	<ol style="list-style-type: none"> The paper is not fitted correctly. The paper path is jammed and does not feed smoothly. The installed paper type does not match the selected sensor. The installed paper size is different from the programmed size. The feed gap sensor cannot see the difference between the print area and the gap. 	<ol style="list-style-type: none"> Reload the paper correctly. -> Press the [PAUSE] key. Remove the cause of the jam and replace the paper correctly. -> Press the [PAUSE] key. Turn the power off then on again. Select the correct sensor. -> Feed the paper. Turn the power off then on again. Set the correct paper size. -> Feed the paper. Set the threshold. Else Turn the power off and call your Authorized Service representative.
HEAD OPEN	Feeding or printing has been attempted while the print head is raised.	Lower the print head block. -> Press the [PAUSE] key.
NO PAPER	The paper has run out.	Load new paper. -> Press the [PAUSE] key.
EXCESS HEAD TEMP.	The print head is too hot.	Turn the power off and decrease the print head temperature.
RIBBON ERROR	<ol style="list-style-type: none"> The ribbon has run out. There is a fault with the ribbon sensor. 	<ol style="list-style-type: none"> Load a new ribbon. -> Press the [PAUSE] key. Turn the power off and contact your Authorized Service representative.

Error type	Problem	Solution
CUTTER ERROR	Paper is jammed in the cutter.	Remove the jammed paper and feed the undamaged media through the cutter. -> Press the [PAUSE] key. Else Turn the power off and contact your Authorized Service representative.
Other Error	Hardware or software trouble.	Turn the power off then on again. If the problem still exists turn the power off and contact your Authorized Service representative.
<p>NOTE: <i>If an error cannot be cleared by pressing the [PAUSE] key, the power must be switched off then on again. Once the power has been switched off and on, all the print data in the printer is cleared.</i></p>		

Problem	Solution
No print.	<ol style="list-style-type: none"> 1. Check that the paper and ribbon are loaded correctly. 2. Check that print head is set correctly. 3. Check the cabling between the printer and the host.
Dots missing in the print.	Dirty print head. -> Clean the print head. Call your Authorized Service representative if necessary.
Unclear (or blurred) printing.	<ol style="list-style-type: none"> 1. Dirty print head. -> Clean the print head. 2. Bad or faulty ribbon. -> Replace ribbon. 3. Poor paper quality. -> Change paper type.
Power does not come on.	<ol style="list-style-type: none"> 1. Plug power cord into an AC socket. 2. Check the circuit breakers or fuses. 3. Plug another appliance into the AC socket to check if there is power supplied. Call your Authorized Service representative if necessary.
Printer does not cut.	Check for a paper jam in the cutter. Call your Authorized Service representative if necessary.
You see a raised nap where the paper has been cut.	<ol style="list-style-type: none"> 1. Clean the cutter blades. 2. The blades are worn. -> Call your Authorized Service representative.

APPENDIX 1 LED INDICATION

Symbols in the message

○: The LED is illuminated. ⊙: The LED is flashing. ●: The LED is unlit.

No.	LED Indication			Printer Status	Restoration by PAUSE key Yes/No	Acceptance of Status Request Reset Command Yes/No
	POWER	ONLINE	ERROR			
1	○	○	●	Online mode	----	Yes
	○	⊙	●	Online mode (communicating)	----	Yes
2	○	●	●	The print head block is opened in online mode.	----	Yes
3	○	●	●	Pause state	Yes	Yes
4	○	●	○	A parity, overrun, or framing error has occurred during a communication by RS-232C.	Yes	Yes
5	○	●	○	A paper jam has occurred during paper feed.	Yes	Yes
6	○	●	○	A problem has occurred at the cutter module.	Yes	Yes
7	○	●	○	The media has run out, or the media is not loaded properly.	Yes	Yes
8	○	●	○	A feed or an issue was attempted with the print head block opened. (Except when the [FEED] key is pressed.)	Yes	Yes
9	○	●	○	The print head has a problem.	Yes	Yes
10	○	●	○	The print head is overheated.	No	Yes
11	○	●	○	<ul style="list-style-type: none"> • The ribbon has run out. • The ribbon has been torn. A problem has occurred with the sensor that determines the torque for the ribbon motor. 	Yes	Yes
12	○	●	○	A feed or printing was attempted with the Front Cover opened.	Yes	Yes
13	○	○	●	In writable character or PC command save mode	----	Yes
14	○	●	○	An error has occurred in writing to the flash ROM.	No	Yes
15	○	●	○	An error has occurred in formatting the flash ROM.	No	Yes
16	○	●	○	Saving failed because of an insufficient capacity of the flash ROM.	No	Yes
17	○	●	○	A command error has occurred in analyzing the command.	Yes	Yes
18	○	●	○	A momentary power failure has occurred.	No	No
19	○	●	●	The flash ROM is being initialized.	----	----
20	○	●	○	Data cannot be read from/written to a backup EEPROM properly.	----	----

No.	LED Indication			Printer Status	Restoration by PAUSE key Yes/No	Acceptance of Status Request Reset Command Yes/No
	POWER	ONLINE	ERROR			
21	○	●	○	When the following abnormal operations are performed, a system error occurs: (a) Command fetch from an odd address (b) Access to word data at an odd address (c) Access to long-word data at an odd address (d) Access to the area of 80000000H to FFFFFFFFH in the logic space in user mode. (e) An undefined instruction in an area other than a delay slot was decoded. (f) An undefined instruction in a delay slot was decoded. (g) An instruction to rewrite a delay slot was decoded.	No	No

APPENDIX 2 INTERFACE

NOTE:

To prevent radiation and reception of electrical noise, the interface cables must meet the following requirements:

- In case of a parallel interface cable or serial interface cable, fully shielded and fitted with metal or metallised connector housings.
- Keep as short as possible.
- Should not be bundled tightly with power cords.
- Should not be tied to power line conduits.
- A parallel interface cable to be used should conform to IEEE1284.

■ Parallel interface (Centronics)

Mode: Conforming to IEEE1284
Compatible mode (SPP mode), Nibble mode

Data input method: 8 bit parallel

Control signal:

SPP Mode	Nibble Mode
nStrobe	HostClk
nAck	PtrClk
Busy	PtrBusy
Perror	AckDataReq
Select	Xflag
nAutoFd	HostBusy
nInIt	nInIt
nFault	nDataAvail
nSelectIn	IEEE1284Active

Data input code: ASCII code
European 8 bit code
Graphic 8 bit code
JIS8 code
Shift JIS Kanji code
JIS Kanji code

Receive buffer: 1M byte

Connector:

PIN No.	Signal	
	SPP Mode	Nibble Mode
1	nStrobe	HostClk
2	Data 1	Data 1
3	Data 2	Data 2
4	Data 3	Data 3
5	Data 4	Data 4
6	Data 5	Data 5
7	Data 6	Data 6
8	Data 7	Data 7
9	Data 8	Data 8
10	nAck	PtrClk
11	Busy	PtrBusy
12	PError	AckDataReq
13	Select	Xflag
14	nAutoFd	HostBusy
15	NC	NC
16	0V	0V
17	CHASSIS GND	CHASSIS GND
18	+5V (For detection)	+5V (For detection)
19	TWISTED PAIR GND(PIN1)	TWISTED PAIR GND(PIN1)
20	TWISTED PAIR GND(PIN2)	TWISTED PAIR GND(PIN2)
21	TWISTED PAIR GND(PIN3)	TWISTED PAIR GND(PIN3)
22	TWISTED PAIR GND(PIN4)	TWISTED PAIR GND(PIN4)
23	TWISTED PAIR GND(PIN5)	TWISTED PAIR GND(PIN5)
24	TWISTED PAIR GND(PIN6)	TWISTED PAIR GND(PIN6)
25	TWISTED PAIR GND(PIN7)	TWISTED PAIR GND(PIN7)
26	TWISTED PAIR GND(PIN8)	TWISTED PAIR GND(PIN8)
27	TWISTED PAIR GND(PIN9)	TWISTED PAIR GND(PIN9)
28	TWISTED PAIR GND(PIN10)	TWISTED PAIR GND(PIN10)
29	TWISTED PAIR GND(PIN11)	TWISTED PAIR GND(PIN11)
30	TWISTED PAIR GND(PIN31)	TWISTED PAIR GND(PIN31)
31	nInit	nInit
32	nFault	NDataAvail
33	0V	0V
34	NC	NC
35	NC	NC
36	nSelectIn	IEEE1284Active

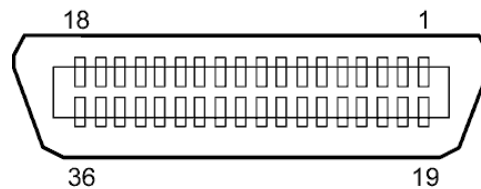

IEEE1284-B Connector

■ **USB interface**

Standard: Conforming to V2.0 Full speed
 Transfer type: Control transfer, Bulk transfer
 Transfer rate: Full speed (12M bps)
 Class: Printer class
 Control mode: Status with the receive buffer free space information
 Number of ports: 1
 Power source: Self power
 Connector: Type B

Pin No.	Signal
1	VCC
2	D-
3	D+
4	GND

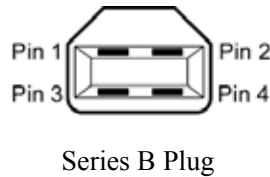

■ **LAN**

Standard: IEEE802.3 10BASE-T/100BASE-TX
 Number of ports: 1
 Connector: RJ-45
 LED status: Link LED
 Activity LED

LED	LED Status	LAN status
Link	ON	10Mbps link or 100Mbps link is detected.
	OFF	No link is detected. * Communication cannot be made while the Link LED is off.
Activity	ON	Communicating
	OFF	Idle

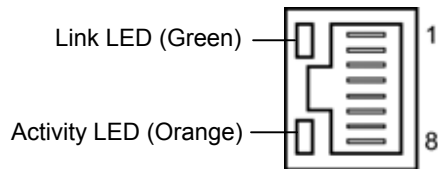

LAN cable: 10BASE-T: UTP category 3 or category 5
 100BASE-TX: UTP category 5
 Cable length: Segment length Max. 100 m

NOTE: When a generally-used twisted pair Ethernet (TPE) or UTP cable is used, a communication error may occur depending on your operating environment. In such case, you may be requested to use a shielded twisted pair cable.

■ Serial interface (Option: B-7704-RS-QM-R)

Type: RS-232C
 Communication mode: Full duplex
 Transmission speed: 2400 bps, 4800 bps, 9600 bps, 19200 bps, 38400 bps, 115200 bps
 Synchronization: Start-stop synchronization
 Start bit: 1 bit
 Stop bit: 1 bit, 2 bit
 Parity: None, EVEN, ODD
 Connector:

Pin No.	Signal	I/O
1	CD (N.C)	-
2	TXD (Transmit Data)	Output
3	RXD (Received Data)	Input
4	DSR (Data Set Ready)	Input
5	SG (Signal Ground)	-
6	DTR (Data Terminal Ready)	Output
7	CTS (Clear to Send)	Input
8	RTS (Request to Send)	Output
9	CI (N.C)	-

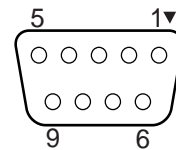

■ Wireless LAN (Option: B-SA704-WLAN-QM-R)

Standard: Conforming to IEEE802.11a, IEEE802.11b, and IEEE802.11g
 Protocol: IP (RFC791), ICMP (RFC792), UDP (RFC768), TCP (RFC793,896), ARP (RFC826), HTTPD (RFC1866), TELNET, FTPD (RFC959), DHCP (RFC2131), SNMP
 Security protocol: WEP (64 bits/128 bits/152 bits) or AES, AES-OCB (128 bits)
 TKIP (only when using WPA, WPA-PSK)
 TWSL (unique encryption)
 Antenna: Chip type, diversity antenna
 Parameter setting: via HTTP
 Default IP address: 192.168.10.21
 Default subnet mask: 255.255.255.0

NOTE:

MAC address of the Wireless LAN module will be necessary when setting the MAC address filtering function of an access point. Please ask a service person of your nearest TOSHIBA TEC service representative.

■ Expansion I/O Interface (Option: B-SA704-IO-QM-R)

Input Signal IN0 to IN5
 Output Signal OUT0 to OUT6
 Connector FCN-781P024-G/P or equivalent
 (External Device Side)
 Connector FCN-685J0024 or equivalent
 (Printer Side)

Pin	Signal	I/O	Function	Pin	Signal	I/O	Function
1	IN0	Input	FEED	13	OUT6	Output	
2	IN1	Input	PRINT	14	N.C.	-----	
3	IN2	Input	PAUSE	15	COM1	Common (Power)	
4	IN3	Input		16	N.C.	-----	
5	IN4	Input		17	N.C.	-----	
6	IN5	Input		18	N.C.	-----	
7	OUT0	Output	FEED	19	N.C.	-----	
8	OUT1	Output	PRINT	20	N.C.	-----	
9	OUT2	Output	PAUSE	21	COM2	Common (Ground)	
10	OUT3	Output	ERROR	22	N.C.	-----	
11	OUT4	Output		23	N.C.	-----	
12	OUT5	Output	POWER ON	24	N.C.	-----	

N.C.: No Connection

Input Circuit

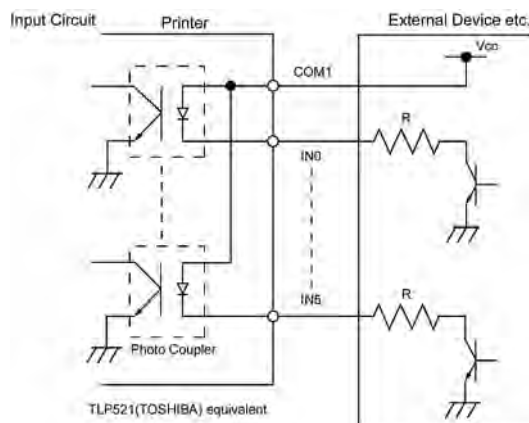

Output Circuit

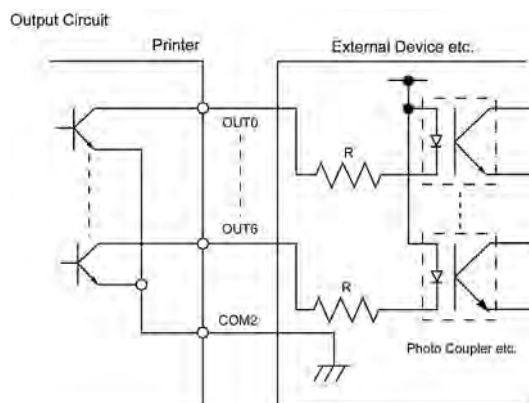

Operating environment Temperature: 0 to 40 °C
 Humidity: 20 to 90% (No Condensation)

APPENDIX 3 ASCII CODE/FONT/BARCODE SAMPLES

■ ASCII Code Chart

	0	1	2	3	4	5	6	7	8	9	A	B	C	D	E	F
0			0	@	P	`	p	Ç	É	á	€		ò	Ó	-	
1		!	1	A	Q	a	q	ü	æ	í	€		Ð	ß	±	
2		"	2	B	R	b	r	é	Æ	ó			Ê	Ô	=	
3		#	3	C	S	c	s	â	ô	ú			Ë	Õ	¼	
4		\$	4	D	T	d	t	ä	ö	ñ			È	õ	¶	
5		%	5	E	U	e	u	à	ò	Ñ	Á		×	Ö	§	
6		&	6	F	V	f	v	â	û	+	Â	ã	Í	µ	÷	
7		'	7	G	W	g	w	ç	ù	⊙	À	Ã	Î	þ	,	
8		(8	H	X	h	x	ê	ÿ	¿	©		Ï	ð	°	
9)	9	I	Y	i	y	ë	ÿ	®			Ú	·		
A		*	:	J	Z	j	z	è	Û	¬			Û	.		
B		+	;	K	[k	í	ï	ø	½			Ü	¹		
C		,	<	L	\	l	î	£	¼				Ý	³		
D		-	=	M]	m	ï	Ø	í	¢			ÿ	²		
E		.	>	N	^	n	~	Å	×	«	¥		ÿ	¹		■
F		/	?	O	_	o		Ä	f	»		□		·		

■ Font Sample

A/0123456789@ABCDEFGHIJKL G/0123456789@ABCDEFGHIJKLMNQRST
 B/0123456789@ABCDEF H/0123456789@ABCDEFGHIJ
 C/0123456789@ABCDEF I /0123456789@ABCDEF
 D/0123456789@ABCDEF J /0123456789@ABCDEF
 E/0123456789@ABCD K/0123456789@ABC
 F/0123456789@ABCDEF L/0123456789@ABCDEF
M/0123456789@ABCDEFGHIJKLM
 N/0123456789@ABCDEFGHIJKLMNO
 O/0123456789@ABCDEFGHIJKLMNO
 P/0123456789@ABCDEFGHI
 Q/0123456789@ABCDEFGHI
 R/0123456789@ABCDEF
 S/0123456789@ABCDEF
 T/0123456789@ABCDEF

ABC

■ Barcode Sample

	0: JAN8, EAN8 49400458	4: NW7 a1234567890a
	2: ITF 012345678905	5: JAN13, EAN13 4 901480079516
	3: CODE39 (Standard) *ABC123*	9, A: CODE128 ABCDEFGHI

INDEX

- A**
AC Power inlet 3-1
- B**
Bar code types 2-1
- C**
Cleaning 12-1
- F**
Fonts 2-1
- I**
Interface 2-1
Centronics cable 3-1, 4-1, 8-1
Parallel interface 3-1, 4-1, 8-1
Serial interface 4-1, 8-1
Issue mode 1-1
- J**
Jammed paper 12-3
- L**
Label length 2-2
Label width 2-2
- O**
Operation panel 11-1
ERROR LED 11-1
FEED key 11-1
ON-LINE LED 11-1
PAUSE key 11-1
POWER LED 11-1
Option 2-2
Cutter 12-3
Cutter module 2-2
Expansion I/O interface board 2-2
Strip mechanism 1-1
Strip module 2-2
- P**
Paper 2-2, 10-1
Paper jam 12-3
Power cord 1-1, 4-1
Power switch 4-1
Print head 1-1, 2-1, 12-1
Print head cleaner 12-1
Print length 2-2
Print speed 2-1
Print width 2-1
Printing method 2-1
- R**
Relative humidity 2-1
Resolution 1-1
Ribbon 2-2, 5-1, 10-1
- S**
Sensor
Feed gap sensor 12-2
Specifications 2-1
Supply holder 1-1, 3-1, 4-1, 6-1
Supply holder unit 1-1, 4-1
Supply voltage 2-1
- T**
Thermal print head 2-1
Thermal transfer 1-1, 2-1
Troubleshooting 13-1
Two-dimensional code 2-1
- W**
Weight 2-1

English

Waste Recycling information for users:

Following information is only for EU-member states:

The crossed out wheeled bin symbol is used to indicate that the product must not be treated as general household waste. By ensuring that this product is disposed of correctly you will be helping to prevent potentially negative consequences for the environment and human health, which could otherwise be caused by incorrect waste handling of this product. For more detailed information about the take-back and recycling of this equipment, please contact the supplier that provided you with the product in question.



French

Information aux utilisateurs concernant le recyclage des déchets:

Les informations suivantes sont uniquement destinées aux pays membres de l'Union Européenne:

L'utilisation du symbole de "poubelle à roulettes barrée" indique que ce produit ne doit pas être traité comme un déchet ménager classique.

En vous assurant que ce produit est correctement mis au rebut, vous participerez à la prévention de l'environnement et de la santé publique, contre des conséquences négatives potentielles qui pourraient résulter d'un traitement inapproprié des déchets de ce produit. Pour obtenir des informations complémentaires concernant la récupération et le recyclage de ce produit, veuillez contacter le fournisseur auprès duquel vous avez acheté le produit.



German

Wiederverwertungsinformationen für Verbraucher:

Die folgenden Informationen gelten nur für EU-Mitgliedsstaaten:

Das durchgestrichene Mülltonnensymbol weist darauf hin, dass dieses Produkt nicht wie allgemeiner Haushaltsmüll behandelt werden darf.

Indem Sie aktiv mitwirken, dieses Produkt ordnungsgemäß zu entsorgen, helfen Sie mit, mögliche negative Auswirkungen auf die Umwelt sowie die menschliche Gesundheit zu vermeiden, die sonst durch die unsachgemäße Entsorgung dieses Produktes beeinträchtigt werden könnten. Für nähere Informationen zur Rücknahme und Wiederverwertung dieses Produktes wenden sie sich bitte an den Lieferanten, von dem Sie dieses Produkt erworben haben.



Spanish

Información para usuarios sobre el reciclaje de residuos:

La siguiente información sólo concierne a los Estados Miembros de la UE:

El uso del símbolo de un contenedor con ruedas tachado indica que este producto no puede ser tratado como si fuera un residuo doméstico.

Asegurando que nos deshacemos de este producto de forma correcta, ayudaremos a evitar potenciales consecuencias negativas tanto para el medio ambiente como para la salud pública, que podrían producirse debido a un tratamiento inapropiado de este producto. Para obtener una información más detallada sobre la recogida y reciclaje de su producto, por favor, póngase en contacto con el proveedor donde lo compró.



Dutch

Gebruikersinformatie over het recycleren van afval:

De volgende informatie geldt enkel in EU-lidstaten:

Het symbool met de doorkruiste afvalbak geeft aan dat dit product niet mag worden behandeld als algemeen huishoudelijk afval.

Door dit product op de juiste manier van de hand te doen beschermt u het milieu en de volksgezondheid tegen mogelijke negatieve gevolgen, die anders zouden kunnen voortvloeien uit het onjuist verwerken van de resten van dit product. Voor gedetailleerde informatie over het terugnemen en recycleren van dit product, gelieve contact op te nemen met de leverancier van dit product.



Italian

Informazioni sul riciclo del prodotto:

Le seguenti informazioni riguardano gli stati membri EU:

Il simbolo con il bidone sbarrato indica il non poter smaltire questo prodotto come rifiuto domestico.

L'accertamento che questo prodotto sia smaltito correttamente contribuirà ad impedire le potenziali conseguenze negative per l'ambiente e la salute umana che potrebbero essere causati, al contrario, dall'errato smaltimento dello stesso. Per informazioni più dettagliate sulle modalità di resa e riciclaggio di questo prodotto mettetevi in contatto con il fornitore da cui l'avete acquistato.



Portuguese

Informação sobre reciclagem:

A informação que se segue é apenas dirigida a países membros da CEE:

A utilização deste símbolo indica que este produto não pode ser tratado como lixo comum.

Ao assegurar-se que este produto é tratado correctamente está a ajudar a prevenir potenciais consequências negativas para o ambiente e para a saúde humana, que poderiam ser causadas pelo inapropriado tratamento deste produto. Para mais informação sobre a reciclagem e tratamento deste produto, contacte o seu fornecedor.





TOSHIBA TEC CORPORATION

© 2008-2015 TOSHIBA TEC CORPORATION All Rights Reserved
1-11-1, Osaki, Shinagawa-ku, Tokyo 141-8562, JAPAN

E EO1-33076H