

TOSHIBA

TOSHIBA Barcode Printer

B-FV4D SERIES

Owner's Manual

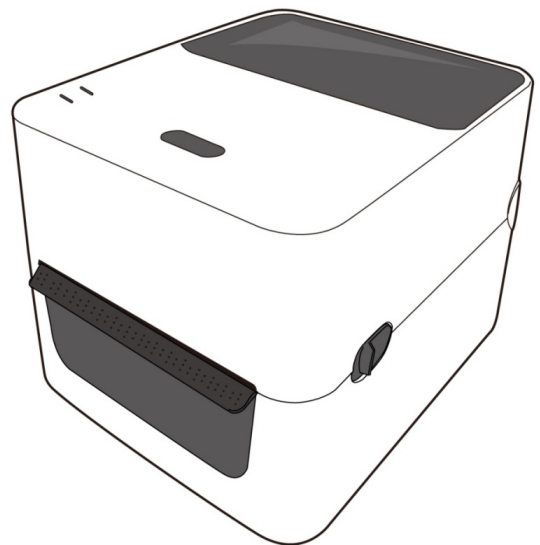

CE Compliance (for EU only)

This product complies with the requirements of EMC and Low Voltage Directives including their amendments. CE marking is the responsibility of TOSHIBA TEC GERMANY IMAGING SYSTEMS GmbH, Carl-Schurz-Str. 7, 41460 Neuss, Germany.
For a copy of the related CE Declaration of Conformity, please contact your dealer or TOSHIBA TEC.

This is a Class A product. In a domestic environment this product may cause radio interference in which case the user may be required to take adequate measures.

FCC Notice

This equipment has been tested and found to comply with the limits for a Class A digital device, pursuant to Part 15 of the FCC Rules. These limits are designed to provide reasonable protection against harmful interference when the equipment is operated in a commercial environment. This equipment generates, uses, and can radiate radio frequency energy and, if not installed and used in accordance with the instruction manual, may cause harmful interference to radio communications. Operations of this equipment in a residential area is likely to cause harmful interference in which case the user will be required to correct the interference at his own expense.

WARNING

Changes or modifications not expressly approved by the party responsible for compliance could void the user's authority to operate the equipment.

(for USA only)

CAN ICES-3 (A) / NMB-3 (A)

This Class A digital apparatus complies with Canadian ICES-003.

(for CANADA only)



The EA1050B-240 AC adapter should be exclusively used for the B-FV4D-xxxx-QM-R Series printer.
The B-FV4D-xxxx-QM-R Series printer must be powered by the EA1050B-240 AC adapter.
The EA10681P-240 AC adapter should be exclusively used for the B-FV4D-xxxx-QQ-R Series printer.
The B-FV4D-xxxx-QQ-R Series printer must be powered by the EA10681P-240 AC adapter.

California Proposition 65 Warning: USA-California only

This Product contains chemicals known to the State of California to cause cancer, birth defects, or other reproductive harm.

The following information is for EU-member states only:

Disposal of products

(based on EU-Directive 2002/96/EC,
Directive on Waste electrical and electronic equipment – WEEE)



The use of the symbol indicates that this product may not be disposed as unsorted municipal waste and has to be collected separately. Integrated batteries and accumulators can be disposed of with the product. They will be separated at the recycling centers.

The black bar indicates that the product was placed on the market after August 13, 2005.

By ensuring this product is disposed of correctly, you will help prevent potential negative consequences for the environmental and human health, which could otherwise be caused by inappropriate waste handling of this product.

For more detailed information about the take-back and recycling of this product, please contact your supplier where you purchased this product.

Notification (for Turkey)

AEEE Yönetmeliğine Uygundur

Following information is only for India:



The use of the symbol indicates that this product may not be treated as household waste. By ensuring this product is disposed of correctly, you will help prevent potential negative consequences for the environment and human health, which could otherwise be caused by inappropriate waste handling of this product.

For more detailed information about the take-back and recycling of this product, please contact your supplier where you purchased the product.

This product including components, consumables, parts and spares complies with the "India E-Waste Rules" and prohibits use of lead, mercury, hexavalent chromium, polybrominated biphenyls or polybrominated diphenyl ethers in concentrations exceeding 0.1% by weight and 0.01% by weight for cadmium, except for the exemption set in the Rule.

This product is designed for commercial usage and is not consumer product.

Precautions for the handling of Wireless Communication Devices

This product is classified as “wireless equipment for stations of low-power data transmissions systems” under the Wireless Telegraphy Act, and does not require a radio transmission license. The law prohibits modification of the interior of this product.

■ Regulatory Information

This product must be installed and used in strict accordance with the manufacturer’s instructions as described in the user documentation that comes with the product. This device complies with the following radio frequency and safety standards.

Standards below are certified under the operation with the provided antenna. Do not use this product with other antennas.

□ Europe - EU Declaration of Conformity

Hereby, TOSHIBA TEC, declares that B-FV4D / B-FV4T series are in compliance with the essential requirements and other relevant provisions of Directive 2014/53/EU.

□ USA-Federal Communications Commission (FCC)

NOTE: This equipment has been tested and found to comply with the limits for a Class A digital device, pursuant to part 15 of the FCC Rules. These limits are designed to provide reasonable protection against harmful interference when the equipment is operated in a commercial environment. This equipment generates, uses, and can radiate radio frequency energy and, if not installed and used in accordance with the instruction manual, may cause harmful interference to radio communications. Operation of this equipment in a residential area is likely to cause harmful interference in which case the user will be required to correct the interference at his own expense.

CAUTION:

This device complies with Part 15 of the FCC Rules.

Operation is subject to the following two conditions:

- (1) this device may not cause harmful interference, and
 - (2) this device must accept any interference received, including interference that may cause undesired operation.
- Any changes or modifications not expressly approved by the grantee of this device could void the user's authority to operate the equipment.

RF EXPOSURE WARNING:

This equipment must be installed and operated in accordance with provided instructions and the antenna(s) used for this transmitter must be installed to provide a separation distance of at least 20 cm from all persons and must not be co-located or operating in conjunction with any other antenna or transmitter. End-users and installers must be provide with antenna installation instructions and transmitter operating conditions for satisfying RF exposure compliance.

□ Canada - Industry Canada (IC)

This device complies with Canada licence-exempt RSS standard(s).

Operation is subject to the following two conditions:

- (1) this device may not cause interference, and
- (2) this device must accept any interference, including interference that may cause undesired operation of the device.

Cet appareil est conforme avec Industrie Canada exemptes de licence RSS standard(s).

Son fonctionnement est soumis aux deux conditions suivantes:

- (1) cet appareil ne doit pas causer d'interférence et
- (2) cet appareil doit accepter toute interférence, notamment les interférences qui peuvent affecter son fonctionnement.

Radio Frequency (RF) Exposure Information

The radiated output power of the Wireless Device is below the Industry Canada (IC) radio frequency exposure limits. The Wireless Device should be used in such a manner such that the potential for human contact during normal operation is minimized.

This device has also been evaluated and shown compliant with the IC RF Exposure limits under mobile exposure conditions. (antennas are greater than 20cm from a person's body).

Informations concernant l'exposition aux fréquences radio (RF)

La puissance de sortie émise par l'appareil de sans fil est inférieure à la limite d'exposition aux fréquences radio d'Industry Canada (IC). Utilisez l'appareil de sans fil de façon à minimiser les contacts humains lors du fonctionnement normal.

Ce périphérique a également été évalué et démontré conforme aux limites d'exposition aux RF d'IC dans des conditions d'exposition à des appareils mobiles (antennes sont supérieures à 20 cm à partir du corps d'une personne).

■ Approved Countries/Regions for use for the devices

This equipment is approved to the radio standard by the specific countries/regions. Please ask TOSHIBA TEC authorized dealer or service engineer.

■ Precaution for Use

This product communicates with other devices by radio. Depending on the installation location, orientation, environment, etc., its communication performance may deteriorate or devices installed near by may be affected. Bluetooth® and Wireless LAN devices operate within the same radio frequency range and may interfere with one another. If you use Bluetooth® and Wireless LAN devices simultaneously, you may occasionally experience a less than optimal network performance or even lose your network connection.

If you should experience any such problem, immediately turn off your Bluetooth® or Wireless LAN device.

Keep away from a microwave.

Communication performance may deteriorate or a communication error may occur due to the radio emitted from a microwave.

Do not use the product on a metal table or near a metal object. Communication performance may be deteriorated.

* Bluetooth® is a registered trademark owned by Bluetooth SIG, Inc.

Safety Summary

Personal safety in handling or maintaining the equipment is extremely important. Warnings and Cautions necessary for safe handling are included in this manual. All warnings and cautions contained in this manual should be read and understood before handling or maintaining the equipment.

Do not attempt to effect repairs or modifications to this equipment. If a fault occurs that cannot be rectified using the procedures described in this manual, turn off the power, unplug the machine, and then contact your authorised TOSHIBA TEC CORPORATION representative for assistance.

Meanings of Each Symbol



WARNING

This symbol indicates a potentially hazardous situation which, if not avoided, could result in death, serious injury, or serious damage, or fire in the equipment or surrounding objects.



CAUTION

This symbol indicates a potentially hazardous situation which, if not avoided, may result in minor or moderate injury, partial damage to the equipment or surrounding objects, or loss of data.



PROHIBITED

This symbol indicates prohibited actions (prohibited items). Specific prohibited contents are drawn inside or near the  symbol. (The symbol on the left indicates “no disassembling”.)



MUST be Performed

This symbol indicates actions which must be performed. Specific instructions are drawn inside or near the  symbol. (The symbol on the left indicates “disconnect the power cord plug from the outlet”.)

NOTE: Indicates information to which you should pay attention when operating the manual.



WARNING

This indicates that there is the risk of **death** or **serious injury** if the machine is improperly handled contrary to this indication.



Any other than the specified AC voltage is prohibited.

Do not use voltages other than the AC voltage specified on the rating plate, as this may cause **fire** or **electric shock**.

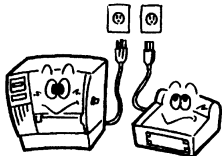

Prohibited

Do not plug in or unplug the power cord with wet hands as this may cause **electric shock**.

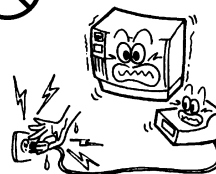

Prohibited

If the machine share the same electrical outlet with any other appliance that consumes a large amount of power, the voltage will fluctuate widely each time these appliances operate. Be sure to provide an exclusive outlet for the machine as this may cause **fire** or **electric shock**.



Prohibited

Do not place metal objects or water-filled containers such as flower vases, flower pots or mugs, etc. on top of the machine. If metal objects or spilled liquid enter the machine, this may cause **fire** or **electric shock**.

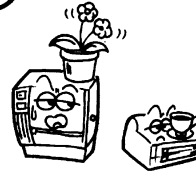

Prohibited

Do not insert or drop metal, flammable or other foreign objects into the machine through the ventilation slits, as this may cause **fire** or **electric shock**.

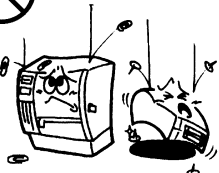

Prohibited

Do not scratch, damage or modify the power cords. Also, do not place heavy objects on, pull on, or excessively bend the power cords, as this may cause **fire** or **electrical shock**.



Disconnect the plug.











If the machine is dropped or their cabinet damaged, first turn off the power switch and disconnect the power cord plug from the outlet, and then contact your authorised TOSHIBA TEC CORPORATION representative for assistance. Continued use of the machine in that condition may cause **fire** or **electric shock**.

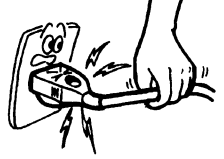

Disconnect the plug.

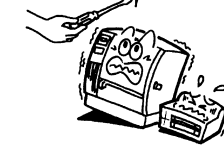
Continued use of the machine in an abnormal condition such as when the machine is producing smoke or strange smells may cause **fire** or **electric shock**. In these cases, immediately turn off the power switches and disconnect the power cord plug from the outlet. Then, contact your authorised TOSHIBA TEC CORPORATION representative for assistance.

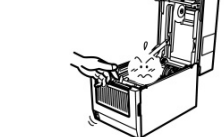

 <p>Disconnect the plug.</p> 	<p>If foreign objects (metal fragments, water, liquids) enter the machine, turn off the power switch and disconnect the power cord plug from the outlet, and then contact your authorised TOSHIBA TEC CORPORATION representative for assistance. Continued use of the machine in that condition may cause fire or electric shock.</p>	 <p>Disconnect the plug.</p> 	<p>When unplugging the power cords, be sure to hold and pull on the plug. Pulling on the cord may cut or expose the internal wires and cause fire or electric shock.</p>
 <p>Connect a grounding wire.</p> 	<p>Ensure that the equipment is properly grounded. Extension cables should also be grounded. Fire or electric shock could occur on improperly grounded equipment.</p>	 <p>No disassembling.</p> 	<p>Do not remove covers, repair or modify the machine by yourself. Contact your authorised TOSHIBA TEC CORPORATION representative for assistance. You may be injured by high voltage, very hot parts or sharp edges inside the machine.</p>
 <p>Prohibited</p> 	<p>Do not use a spray cleaner containing flammable gas for cleaning this product, as this may cause a fire.</p>	 <p>Prohibited</p> 	<p>Care must be taken not to injure yourself with the printer paper cutter.</p>

CAUTION

This indicates that there is the risk of personal **Injury** or **damage** to objects if the machine is improperly handled contrary to this indication.

Precautions

The following precautions will help to ensure that this machine will continue to function correctly.

- Try to avoid locations that have the following adverse conditions:
 - * Temperatures out of the specification
 - * Shared power source
- * Direct sunlight
- * Excessive vibration
- * High humidity
- * Dust/Gas
- The cover should be cleaned by wiping with a dry cloth or a cloth slightly dampened with a mild detergent solution. NEVER USE THINNER OR ANY OTHER VOLATILE SOLVENT on the plastic covers.
- USE ONLY TOSHIBA TEC CORPORATION SPECIFIED paper and ribbons.
- DO NOT STORE the paper or ribbons where they might be exposed to direct sunlight, high temperatures, high humidity, dust, or gas.
- Ensure the printer is operated on a level surface.
- Any data stored in the memory of the printer could be lost during a printer fault.
- Try to avoid using this equipment on the same power supply as high voltage equipment or equipment likely to cause mains interference.
- Unplug the machine whenever you are working inside it or cleaning it.
- Keep your work environment static free.
- Do not place heavy objects on top of the machine, as these items may become unbalanced and fall causing **injury**.
- Do not block the ventilation slits of the machine, as this will cause heat to build up inside the machine and may cause **fire**.
- Do not lean against the machine. It may fall on you and could cause **injury**.
- Unplug the machine when it is not used for a long period of time.
- Place the machine on a stable and level surface.
- RISK OF EXPLOSION IF BATTERY IS REPLACED BY AN INCORRECT TYPE. DISPOSE OF USED BATTERIES ACCORDING TO THE INSTRUCTIONS.

Request Regarding Maintenance

- Utilize our maintenance services.
After purchasing the machine, contact your authorised TOSHIBA TEC CORPORATION representative for assistance once a year to have the inside of the machine cleaned. Dust will build up inside the machine and may cause a **fire** or a **malfunction**. Cleaning is particularly effective before humid rainy seasons.
- Our preventive maintenance service performs periodic checks and other work required to maintain the quality and performance of the machine, preventing accidents beforehand.
For details, please consult your authorised TOSHIBA TEC CORPORATION representative.
- Using insecticides and other chemicals
Do not expose the machine to insecticides or other volatile solvents. This will cause the cabinet or other parts to deteriorate and may cause the paint to peel.

TABLE OF CONTENTS

	Page
1. PRODUCT OVERVIEW	E1-1
1.1 Introduction.....	E1-1
1.2 Features.....	E1-1
1.3 Unpacking.....	E1-1
1.4 Accessories.....	E1-1
1.5 Appearance.....	E1-3
1.5.1 Dimensions.....	E1-3
1.5.2 Front View.....	E1-3
1.5.3 Rear View.....	E1-4
1.5.4 Interior.....	E1-4
1.5.5 Button and Indicator Lamp.....	E1-5
2. PRINTER SETUP	E2-1
2.1 Precautions.....	E2-1
2.2 Procedure before Operation.....	E2-2
2.3 Turning the Printer ON/OFF.....	E2-2
2.3.1 Turning ON the Printer.....	E2-2
2.3.2 Turning OFF the Printer.....	E2-3
2.4 Connecting Cables to the Printer.....	E2-4
2.5 Connecting the Power Adapter and the Power Cord.....	E2-5
2.6 Opening/Closing the Top Cover.....	E2-6
2.7 Loading the Media.....	E2-7
2.8 Media Sensor Calibration, Self Print Test, and Dump Mode Utilities.....	E2-15
2.8.1 Media Sensor Calibration.....	E2-15
2.8.2 Self Print Test and Dump Mode.....	E2-16
3. MAINTENANCE	E3-1
3.1 Cleaning.....	E3-1
3.1.1 Print Head.....	E3-1
3.1.2 Sensors.....	E3-2
3.1.3 Platen Roller.....	E3-2
3.1.4 Media Housing.....	E3-3
3.2 Care/Handling of the Media.....	E3-4
4. TROUBLESHOOTING	E4-1
4.1 Troubleshooting Guide.....	E4-1
4.2 Status Lamp.....	E4-2
4.3 Removing Jammed Media.....	E4-3
APPENDIX 1 SPECIFICATIONS	EA1-1
A1.1 Printer.....	EA1-1
A1.2 Options.....	EA1-3
A1.3 Media.....	EA1-3
A1.3.1 Media Type.....	EA1-3
A1.3.2 Detection Area of the Feed Gap (Transmissive) Sensor.....	EA1-5
A1.3.3 Detection Area of the Black Mark (Reflective) Sensor.....	EA1-5
A1.3.4 Effective Print Area.....	EA1-5
APPENDIX 2 INTERFACE	EA2-1
GLOSSARIES	

NOTES:

- *This manual may not be copied in whole or in part without prior written permission of TOSHIBA TEC CORPORATION.*
- *The contents of this manual may be changed without notification.*
- *Please refer to your local Authorized Service representative with regard to any queries you may have in this manual.*
- *Centronics is a registered trademark of Centronics Data Computer Corp.*
- *Windows is a registered trademark of Microsoft Corporation.*

1. PRODUCT OVERVIEW

1.1 Introduction

Thank you for choosing the TOSHIBA B-FV4D series barcode printer. This Owner's Manual contains valuable information from general set-up to confirming the printer's operation using test prints. You should read it carefully to help you gain maximum performance and life from your printer. This manual should be kept close at hand for everyday reference. Please contact your TOSHIBA TEC CORPORATION representative for further information concerning this manual.

1.2 Features

This printer has the following features:

Interfaces

The printer comes fitted with a USB port and Ethernet port interfaces as standard. Moreover, it contains either a Serial (RS-232C) or a Centronics interface*¹ depending on the model, and thus either Wireless LAN or Bluetooth can be installed.

*¹The Centronics interface provided for this printer does not support bi-directional communications.

Easy to use

The printer mechanism is designed to allow very easy operation and easy access for maintenance.

Flexible hardware

Sharp clear print can be produced by an 8 dots/mm (203 dpi) (in the B-FV4D-GS) print head at speeds up to 152.4 mm/sec. (6 inches/sec.) or an 11.8 dots/mm (300 dpi) (in the B-FV4D-TS) print head at speeds up to 101.6 mm/sec. (4 inches/sec.)

Full range of options

The printer can also be fitted with the following optional devices:

- Cutter Module
- External Media Stand
- Peel-off Module
- Wireless LAN Interface
- Bluetooth Interface

1.3 Unpacking

1. Unpack the printer.
2. Check for damage or scratches on the printer. However, please note that TOSHIBA TEC CORPORATION shall have no liability for any damage of any kind sustained during transportation of the product.
3. Keep the carton and internal packaging for future transportation of the printer.

1.4 Accessories











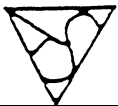







When unpacking the printer, please check that the following accessories are supplied with the printer.

- CD-ROM (1 copy)
- Power Adapter (1 pc.)
- Quick Installation Manual (1 copy)
- Safety Precautions (1 copy)
- USB Cable (1 pc.)

■ When you need to purchase a power cord

In some countries the power cord is not provided with this unit, if this is the case then please purchase an approved one that meets the following standards or contact your authorised TOSHIBA TEC CORPORATION representative.

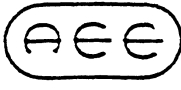

(As of Oct. 2014)

Country/Region	Agency	Certification mark	Country/Region	Agency	Certification mark	Country/Region	Agency	Certification mark
Australia	SAA		Germany	VDE		Sweden	SEMKKO	
Austria	OVE		Ireland	NSAI		Switzerland	SEV	
Belgium	CEBEC		Italy	IMQ		UK	ASTA	
Canada	CSA		Japan	METI		UK	BSI	
Denmark	DEMKO		Netherlands	KEMA		U.S.A.	UL	
Finland	FEI		Norway	NEMKO		Europe	HAR	
France	UTE		Spain	AEE		China	CCC	

Power Cord Instruction

1. For use with 100 – 125 Vac mains power supply, please select a power cord rated Min. 125V, 10A.
2. For use with 200 – 240 Vac mains power supply, please select a power cord rated Min. 250V.
3. Please select a power cord with the length of 2m or less.
4. The power cord plug connected to the AC adapter must be able to be inserted into an ICE-320-C14 inlet. Refer to the following figure for the shape.

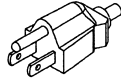
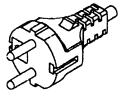
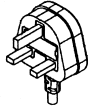

Country/Region	North America	Europe	United Kingdom	Australia	China
Power Cord Rated (Min.) Type	125V, 10A SVT	250V H05VV-F	250V H05VV-F	250V AS3191 approved, Light or Ordinary Duty type	250V GB5023
Conductor size (Min.)	No. 3/18AWG	3 x 0.75 mm ²	3 x 0.75 mm ²	3 x 0.75 mm ²	3 x 0.75 mm ²
Plug Configuration (locally approved type)					
Rated (Min.)	125V, 10A	250V, 10A	250V, *1	250V, *1	250V, *1

*1: At least, 125% of the rated current of the product.

1.5 Appearance

The parts and units shown and named in this section are used for descriptions in the following chapters.

1.5.1 Dimensions

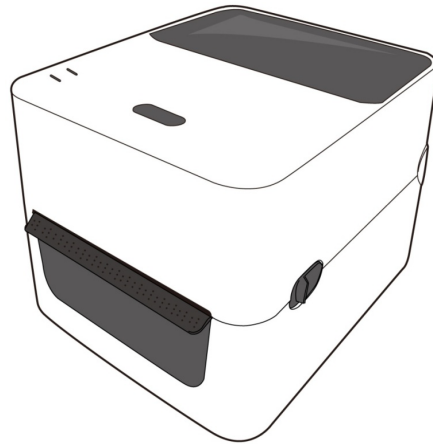

W: 183.8 (7.2") x D: 226.2 (8.9") x H: 166.0 (6.5")

Dimensions in mm (inches)

1.5.2 Front View

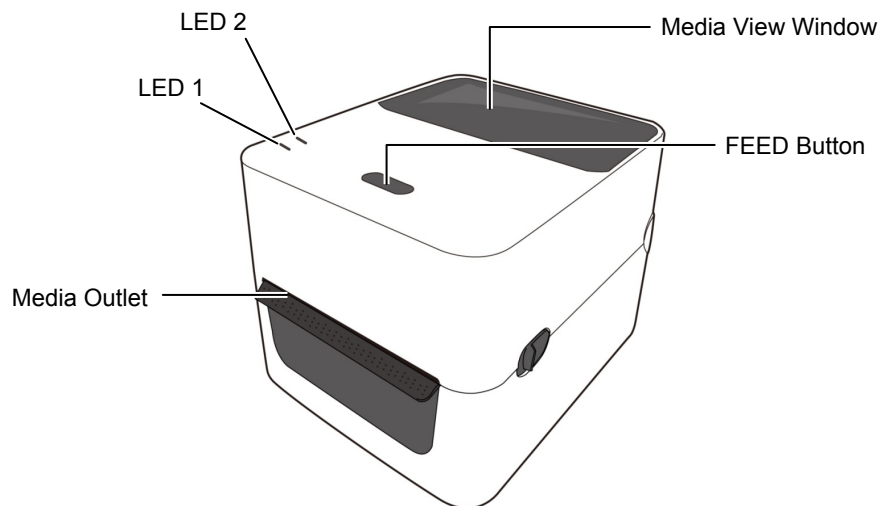

1.5.3 Rear View

⚠ CAUTION!
To avoid injury, be careful not to trap your fingers in the Paper Slot while opening or closing the Top Cover.

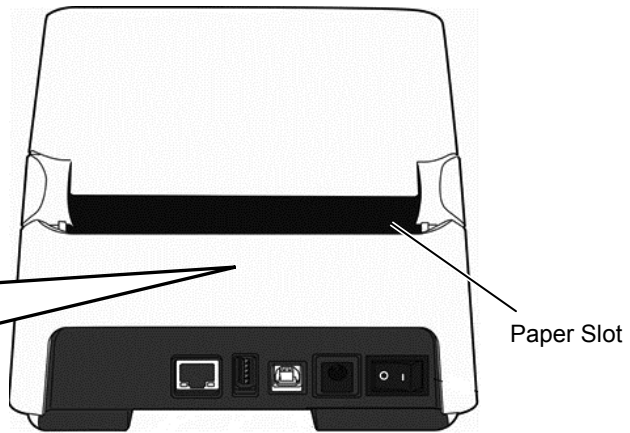

For details of the rear view, refer to *Section 2.4 Connecting the Cables to the Printer.*

1.5.4 Interior

⚠ WARNING!
The print head becomes very hot during printing. Do not touch the print head or touch around it directly after printing. By doing so you may get burnt.

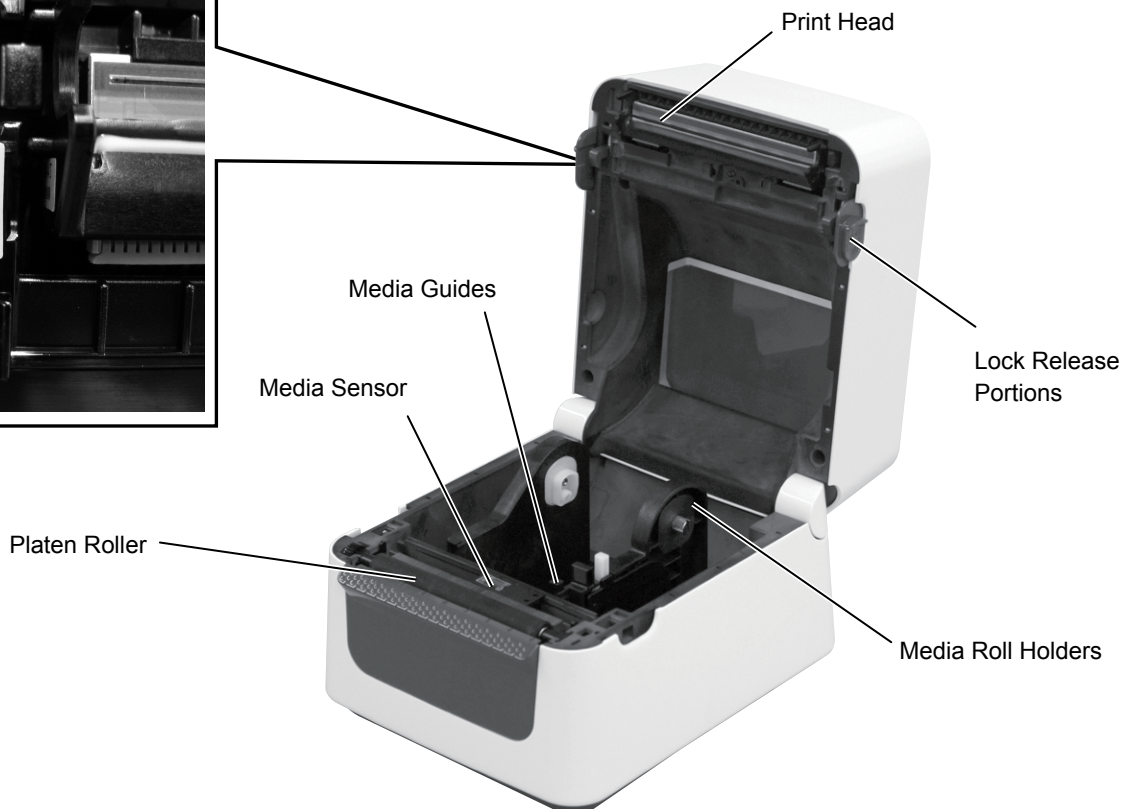
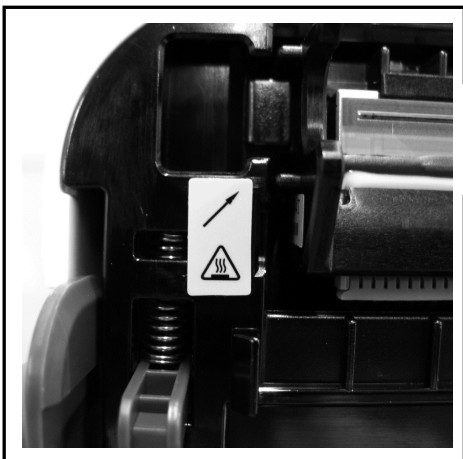

1.5.5 Button and Indicator Lamp

The [FEED] button has three functions. It can operate as a FEED, RESTART or PAUSE button depending on current the printer state.

As a FEED button	<ul style="list-style-type: none"> Pressing this button when the printer is online will cause the media to feed forwards.
As a RESTART button	<ul style="list-style-type: none"> Pressing this button after removing the cause of an error returns the printer to an online state. Pressing this button with the printer is paused will resume printing.
As a PAUSE button	<ul style="list-style-type: none"> Pressing this button while the printer is printing will stop the printing after completing the current label. The printer is then paused.

The indicator lamps (LED1 and LED 2) light up or flash in different colors and sequences depending on the printer status. A quick guide to lamp statuses and their meaning is shown inside the top cover.

LED 1	LED 2	Printer Status
Unlit	Unlit	The power is off. The print head block is open if the printer power is on.
Green	Unlit	Stand-by
Green ^S	Unlit	Printing is temporarily stopped (paused).
Green ^F	Unlit	Communicating with a host
Green	Green	Writing data to the flash or USB memory
Green	Green ^M	The Flash ROM on the CPU board or USB memory is being initialized.
Orange	Green	A paper jam occurred.
Orange	Red	The media has ended.
Orange	Red ^F	The media has ended while the print data is being sent to the printer.
Red	Red ^M	Thermal Head open error. The thermal head has been opened during an operation.
Red	Orange ^F	The print head temperature exceeded the upper limit.
Red	Green	A communication error occurred. (Only when the RS-232C is used.)
Red	Green ^S	Command error
Red	Green ^M	<ul style="list-style-type: none"> Flash ROM on the CPU board error, or USB memory error An erase error while formatting the Flash ROM on the CPU board or USB memory Unable to save files due to insufficient storage space on the Flash ROM on the CPU board or USB memory.
Red	Green ^F	A paper jam occurred in the cutter unit. (Only when the cutter unit is fitted.)
Red	Orange ^M	The print head is broken.

F: Flashes fast (0.5 sec)

M: Flashes at medium speed (1.0 sec)

S: Flashes slowly (2.0 sec)

2. PRINTER SETUP

This section outlines the steps necessary to setup your printer prior to its operation. The section includes precautions, connecting cables, assembling accessories, loading media, and performing a test print.

2.1 Precautions

 **CAUTION!**

Avoid using the printer in the locations where it is subjected to intense light (e.g. direct sunlight, desk light). Such light may affect the sensors of the printer, causing malfunctions.

To insure the best operating environment, and to assure the safety of the operator and the equipment, please observe the following precautions.

- Operate the printer on a stable, level, operating surface in a location free from excessive humidity, high temperature, dust, vibration or direct sunlight.
- Keep your work environment static free. Static discharges can cause damage to delicate internal components.
- Make sure that the printer is connected to a clean source of AC Power and that no other high voltage devices that may cause line noise interference are connected to the same mains.
- Ensure that the printer is connected only to AC mains that has a proper ground (earth) connection.
- Do not operate the printer with the cover open. Be careful not to allow fingers or articles of clothing to get caught into any of the moving parts of the printer.
- Make sure to turn off the printer power and to remove the power adapter connector from the printer whenever working on the inside of the printer or when cleaning the printer.
- For best results, and longer printer life, use only TOSHIBA TEC CORPORATION recommended media. (Refer to the Supply Manual.)
- Store the media in accordance with the specifications.
- This printer mechanism contains high voltage components; therefore you should never remove any of the covers of the machine as you may receive an electrical shock. Additionally, the printer contains many delicate components that may be damaged if accessed by unauthorised personnel.
- Clean the outside of the printer with a clean dry cloth or a clean cloth slightly dampened with a mild detergent solution.
- Use caution when cleaning the thermal print head as it may become very hot while printing. Wait until it has had time to cool before cleaning.
Use only the TOSHIBA TEC CORPORATION recommended print head cleaner to clean the print head.
- Do not turn off the printer power or remove the power plug while the printer is printing or while the Indicator Lamp is flashing.
- The socket-outlet needs to be installed near the equipment and must be easily accessible.
- Pull out the plug from the outlet more than once a year to clean around the prongs. Accumulating dust and dirt could cause a fire due to the heat released by electric leakage.

2.2 Procedure before Operation

NOTES:

1. To be able to communicate with a host computer, an RS-232C, Centronics, Ethernet, or USB cable connection is required.
 - (1) RS-232C cable: 9 pins
(do not use a null modem cable)
 - (2) Centronics cable: 36 pins
 - (3) Ethernet cable: 10/100 Base
 - (4) USB cable: V2.0 (Full Speed)
2. Use of the Windows Driver will enable printing from Windows applications.
The printer can also be controlled with its own programming commands. For details, please contact your TOSHIBA TEC CORPORATION representative.

This section describes the steps needed to setup the printer correctly.

1. Unpack the printer and its accessories from the box.
2. Place the printer where it is to be used referring to Safety Precautions supplied with the printer for tips on the correct use and placement.
3. Make sure that the Power Switch is off. (Refer to **Section 2.3.**)
4. Connect the printer to a host computer or network using an RS-232C, Centronics, Ethernet or USB cable. (Refer to Section 2.4.)
5. Connect the Power Adapter to the printer, and then plug the Power Cord into a properly grounded power outlet. (Refer to **Section 2.5**)
6. Load the media. (Refer to **Section 2.7.**)
7. Adjust the position of the Feed Gap Sensor or Black Mark Sensor to match the media being used. (Refer to **Section 2.7.**)
8. Install the Printer Driver on the host computer. (Refer to the Printer Driver on the CD-ROM.)
9. Turn the Power ON. (Refer to **Section 2.3.**)

2.3 Turning the Printer ON/OFF

2.3.1 Turning ON the Printer

⚠ CAUTION!

Use the power switch to turn the printer on/off. Plugging or unplugging the power cord to turn the printer on/off may cause fire, an electric shock, or damage to the printer.

NOTE:

If the LED 1 or 2 is illuminated in red, go to **Section 4.1, Troubleshooting Guide.**

When the printer is connected to a host computer it is good practice to turn the printer ON before turning on the host computer and to turn OFF the host computer before turning off the printer.

1. To turn ON the printer power, press the power switch as shown in the diagram below. Note that (|) is the power ON side of the switch.

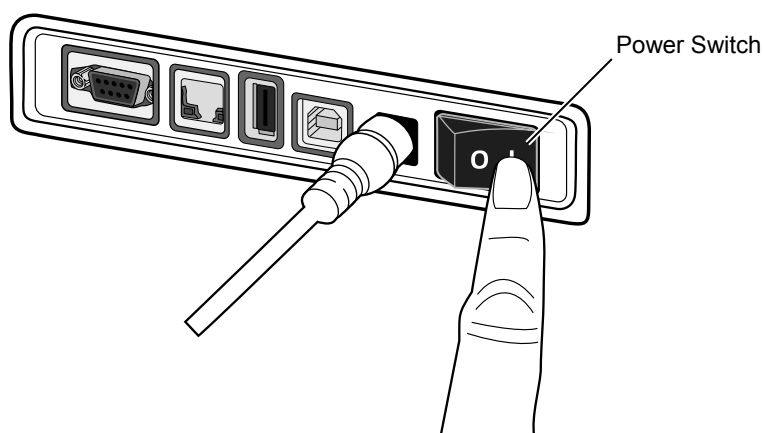

2. As the printer powers on LED 1 and 2 will lite first in orange then off and finally LED 1 should stay illuminated in green.

2.3.2 Turning OFF the Printer

⚠ CAUTION!

1. Do not turn off the printer power while the printer is printing as this may cause a paper jam or damage to the printer.
2. Do not turn off the printer power while LED 1 is flashing as this may lead to loss or corruption of the data being downloaded.

1. Before turning off the printer power switch, verify that: LED 1 is illuminated in green (not flashing) and LED 2 is extinguished.
2. To turn OFF the printer power, press the power switch as shown in the diagram below. Note that (O) is the power OFF side of the switch.

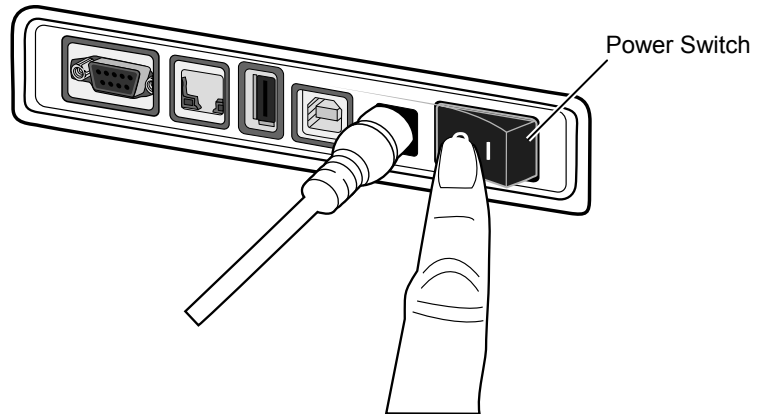

2.4 Connecting Cables to the Printer

⚠ CAUTION!
 Be sure to connect the serial or parallel cable while the printer and the host computer are in a powered-off state. Failure to do this may cause electric shocks, short-circuits, or damage to the printer or Host computer.

NOTE:
 For the specifications of the serial interface cable, refer to **APPENDIX 2, INTERFACE.**

This section details how to connect communication cables to the printer from your host computer or other devices. There are four different means of connection that can be used on the printer. These are:

- An Ethernet cable connection can be used to connect to a network or directly to your host computer’s Ethernet port.

NOTE:

- Use an Ethernet cable conforming to the standard.

10BASE-T: Category 3 or greater

100BASE-TX: Category 5 or greater

Cable length: Up to 100 m segment length

- In some environments communication errors may be caused by electromagnetic interference on the cable. If this occurs you may need to use a shielded cable (STP).

- A USB cable connection between the printer’s USB interface port and one of your host computer’s USB ports.

NOTE:

- When disconnecting the USB cable from the host computer, follow the “Safely remove hardware” procedure on the host computer.

- Use a USB cable conforming to V2.0 or greater and with a Type B plug on one end.

- A serial cable connection between the printer’s RS-232C serial port and one of your host computer’s COM ports.

- A parallel cable connection between the printer’s standard parallel port and your host computer’s parallel port (LPT).

The diagrams below show all the possible cable connections to the current versions of the printer.

Printer having the USB and Ethernet Interfaces

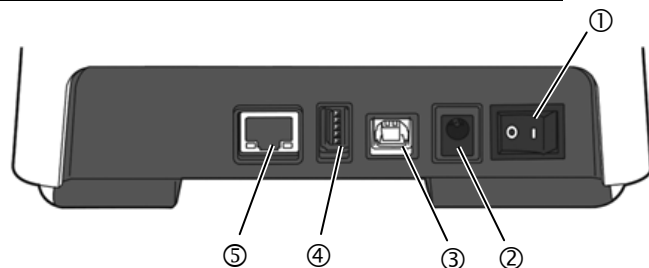

Printer having the Serial Interface (RS-232C)

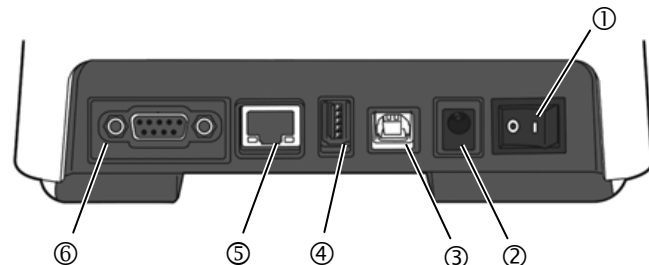

Printer having the Parallel Interface (Centronics)

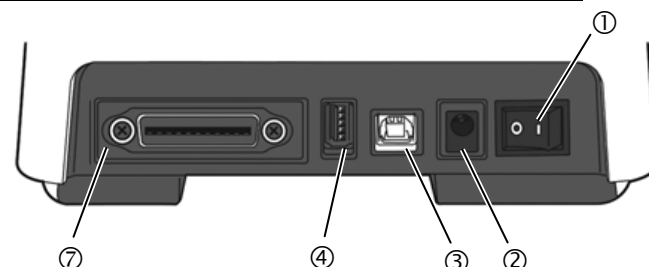

- ① Power Switch
- ② Power Jack
- ③ USB Interface for connecting a host computer
- ④ USB Interface for connecting a USB memory
- ⑤ Ethernet Interface
- ⑥ Serial Interface (RS-232C)*
- * Some models have no serial interface (RS-232C).
- ⑦ Parallel Interface (Centronics)

2.5 Connecting the Power Adapter and the Power Cord

NOTES:

1. If a power cord is not provided with this printer, please purchase the correct one referring to page 1-2.
2. The EA1050B-240 AC adapter should be exclusively used for the B-FV4D-xxxx-QM-R Series printer. The B-FV4D-xxxx-QM-R Series printer must be powered by the EA1050B-240 AC adapter.
3. The EA10681P-240 AC adapter should be exclusively used for the B-FV4D-xxxx-QQ-R Series printer. The B-FV4D-xxxx-QQ-R Series printer must be powered by the EA10681P-240 AC adapter.

1. Make sure that the printer power switch is in the OFF (O) position.
2. Insert the Power Cord into the inlet of the Power Adapter.



3. Insert the Power Adapter connector into the Power Jack on the rear of the printer.

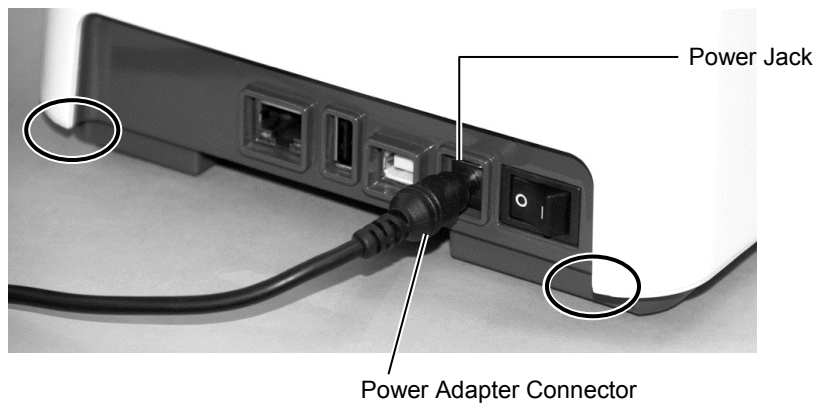

! WARNING!

The areas indicated by the ellipse have sharp edges. To avoid injury, be careful not to touch them when handling the printer.

2.6 Opening/Closing the Top Cover

When opening or closing the Top Cover, please be sure to follow the instructions below.

⚠ WARNING!

To avoid injury, be careful not to trap your fingers while opening or closing the cover.

⚠ CAUTION!

1. Be careful not to touch the Print Head Element when opening the Top Cover. Failure to do this may cause missing dots by static electricity or other print quality problems.
2. Do not cover the Cover Open Sensor with your finger, hand, etc. Doing so may cause the sensor to wrongly detect a cover close state.

NOTE:

Be sure to close the Top Cover completely. Failure to do this may affect the print quality.

To open the Top Cover:

1. Open the Top Cover while pulling the Lock Release Portions as indicated by the arrows.



To close the Top Cover:

1. Close the Top Cover.



2.7 Loading the Media

⚠ WARNING!

1. Do not touch any moving parts. To reduce the risk of fingers, jewellery, clothing, etc. being drawn into the mechanism, be sure to load the media **only** once the printer has completely stopped moving.
2. To avoid injury, be careful not to trap your fingers while opening or closing the Top Cover.

⚠ CAUTION!

Be careful not to touch the Print Head Elements when opening the Top Cover. Doing this may cause damage to some of the dots through static discharge or other print quality problems.

This section describes how to load the media in the printer. This printer accepts label rolls, tag rolls, and fanfold paper stocks. Please use TOSHIBA TEC CORPORATION approved media.

NOTES:

1. Please perform a media sensor calibration whenever you change the media type.
2. The size of the media which can be loaded inside the printer is as follows:
 - Outer roll diameter: Max. 127mm (5")
 - Inner core diameter: 25.4 (1") mm or 38.1 mm (1.5")
 When the outer roll diameter exceeds 127 mm or the inner core diameter exceeds 38.1 mm, an optional External Media Stand is required. For details, refer to the *Installation Manual for the B-FV904-PH-QM-R External Media Stand*.

At factory shipment, the core holder size is set for 1.5" on the Media Roll Holders. If you want to use 1" core media, detach the core holders by loosening the thumb screws, reverse the core holders then re-attach them with the thumb screws to the Media Roll Holders as shown below.

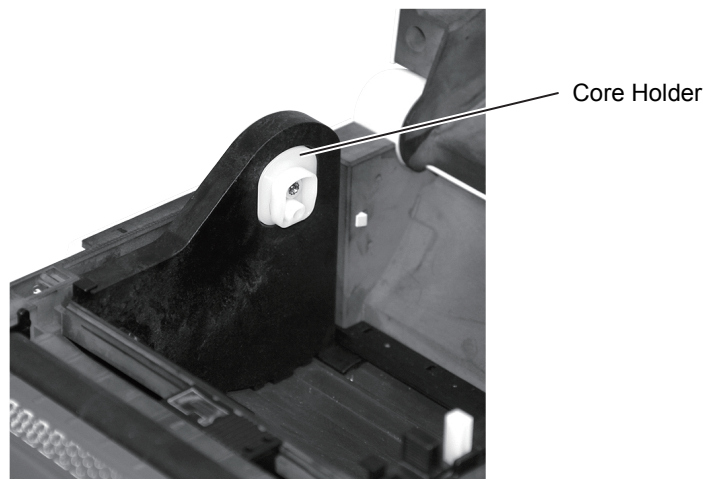

3. Media rolls can be wound inside or wound outside. (See the diagram below.) Both types of media roll should be loaded so that the print side faces up.

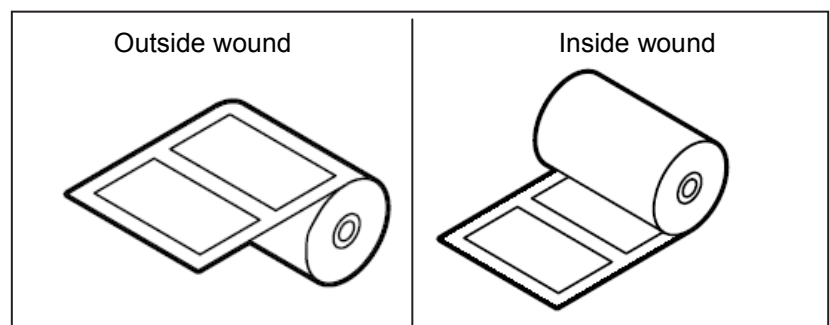

2.7 Loading the Media (Cont.)

1. Open the Top Cover while pulling the Lock Release Portions as indicated by the arrows.



NOTE: Media path

For the outside- wound media

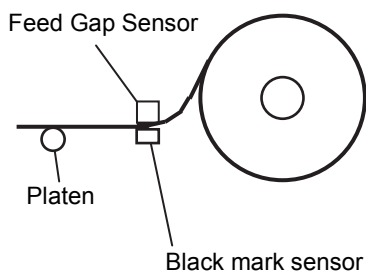

For the inside- wound media

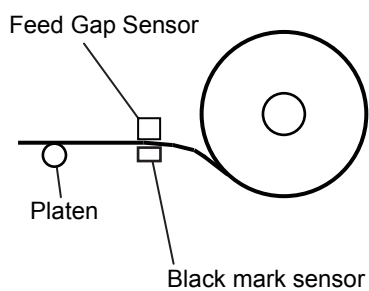

2. Open the Media Roll Holders by pressing the Holder Lock Lever and slide them outward. Place the media roll between the holders ensuring that print side is facing up, then using Holder Lock Lever slide the Media Roll Holders to clamp the media roll tightly.



NOTES:

1. Make sure that the print side faces up.
2. Cut the leading edge of the media straight with scissors.

2.7 Loading the Media (Cont.)

3. Pass the media through the Media Guides. Pull the media until it reaches the front of the printer.

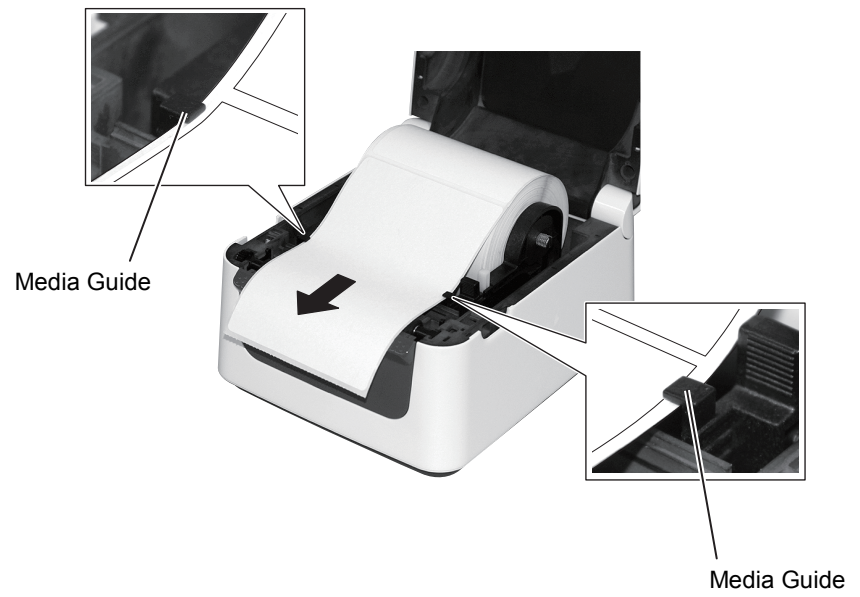

2.7 Loading the Media (Cont.)

NOTES:

1. The sensor type used in the last print job is selected by default. To change the sensor type, refer to **Section 2.8.1 Media Sensor Calibration**.
2. The Feed Gap Sensor is positioned 6.35 mm right from the media centre.

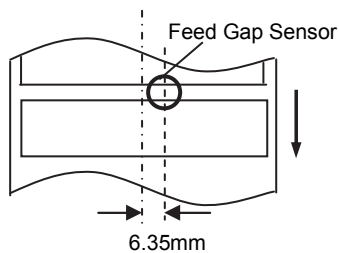

3. The Black Mark Sensor is movable over the range of the media width.

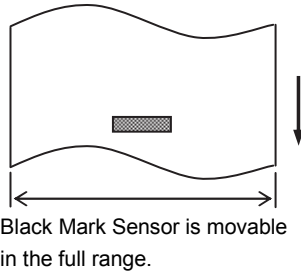

NOTE:

Be careful not to squeeze the media with the Media Guides. Doing so bends the media, which can cause a paper jam or feed failure.

4. Check and adjust the media sensor position and select the sensor type to be used. (Refer to **Section 2.8.1**.)

This printer has a Black Mark Sensor which can detect black marks printed on the reverse side of the media, and a Feed Gap Sensor which detects inter-label gaps. As the Feed Gap Sensor position is fixed, it is not necessary to adjust it. When using the Black Mark Sensor, align it with the centre of the black mark on the media. Failure to do this will disable the detection of printed black marks, resulting in an error.

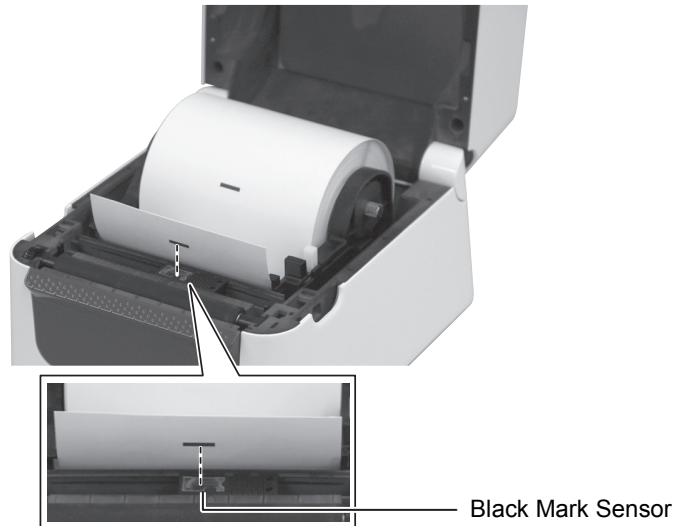

2.7 Loading the Media (Cont.)

5. Close the Top Cover, then press the [FEED] button to check the media feeds correctly.

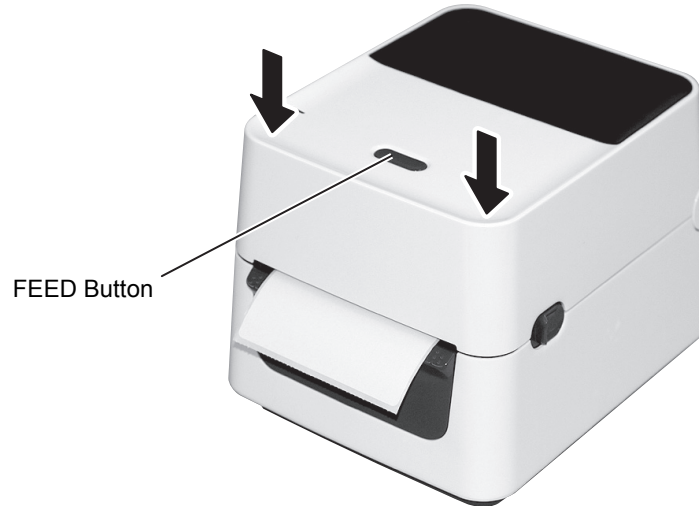

There are three issue modes available for this printer.

⚠ CAUTION!

To separate the printed media from the printer in batch mode, be sure to tear the media off at the Media Outlet or cut the media past the Strip Plate. If you tear the media off at the Print Head by mistake, be sure to feed one label (10 mm or more) with the FEED Button prior to the next issue. Failure to do this may cause a paper jam.

Batch mode:

In the batch mode, the media is continuously printed and fed until the number of prints specified in the issue command has been printed.



2.7 Loading the Media (Cont.)

NOTES:

1. When printing labels without removing them from the backing paper, it is not necessary to pass the media through the Strip Block.
2. When the media is correctly set, the backing paper should be pinched between the Platen and the Strip Feed Roller as shown below.

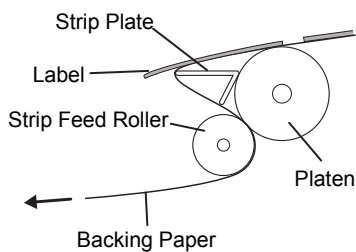

⚠ CAUTION!

When opening the Peel-off Unit for loading the media, be careful not to drop metal or other foreign objects, such as a paper clip into the module, as this may cause a malfunction of the printer.

Strip mode (Option):

When printing in strip mode, labels are automatically removed from the backing paper as each label is printed.

• How to set the media

When issuing labels in the strip mode, set the label in the following procedure:

1. Load the media as described on the previous pages.
2. Open the Peel-off Unit by pulling it out.

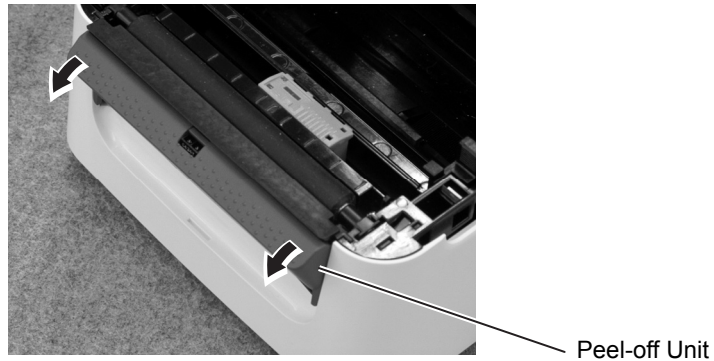

3. Remove enough labels from the leading edge of the media to leave 20 cm of backing paper free, and insert the top edge of the backing paper into the media slot in the Peel-off Unit as shown below.



4. Close the Peel-off Unit and Top Cover.

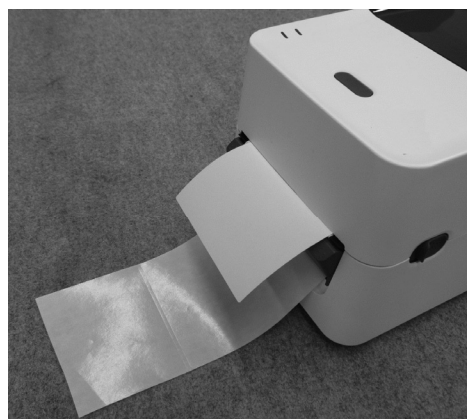

2.7 Loading the Media (Cont.)

⚠ WARNING!

**HAZARDOUS MOVING PARTS
KEEP FINGERS AND OTHER
BODY PARTS AWAY**

The cutter is sharp, so care must be taken not to injure yourself when handling the cutter.

⚠ CAUTION!

1. Be sure to cut only the backing paper of the label. Cutting labels will cause glue to stick to the cutter blades which may affect the cutter quality and shorten the cutter life.
2. Use of tag paper which thickness exceeds the maximum specified value may affect the cutter life.

NOTE:

When placing fanfold paper stock at the rear of the printer, care should be taken of the following points.

1. Face the print surface up.
2. The fanfold paper stock is parallel to the fanfold paper slot.
3. The interface and power cables do not interfere with the feeding of the fanfold paper.

Cut mode (Option):

When a Cutter is fitted, the media can be automatically cut. When loading the media as described on the previous pages, insert the leading edge of the media through the Media Outlet of the Cutter Cover while pulling the media through the printer.

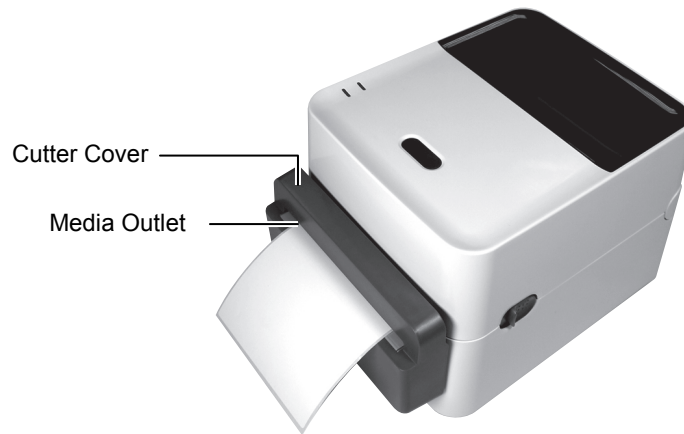

How to Load Fanfold Paper Stock

1. Place the fanfold paper stock at the rear of the printer, insert the leading edge of the paper into the Fanfold Paper Slot.

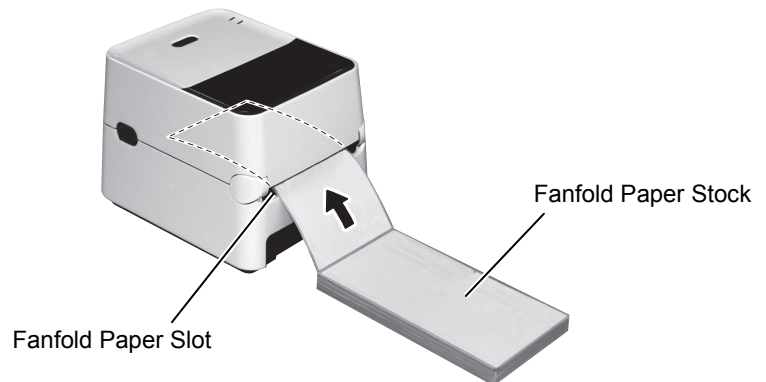

2. Refer to the previous pages to feed the fanfold paper through the printer until it extends past the media outlet.

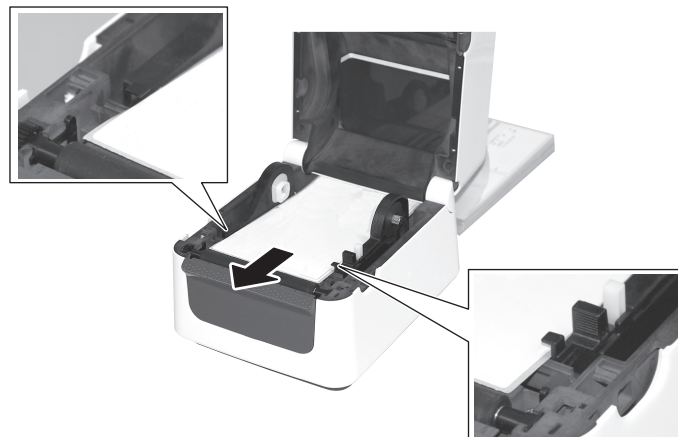

2.7 Loading the Media (Cont.)

When the media roll has an outside diameter exceeding 127 mm (5") or the inner core diameter is 76.2 mm (3"), the optional External Media Stand is needed.

Remark:

Pictures below is the thermal transfer printing model of the B-FV4 series.

1. Fit the feet on the bottom of the printer as shown below.

External Media Stand (Option)

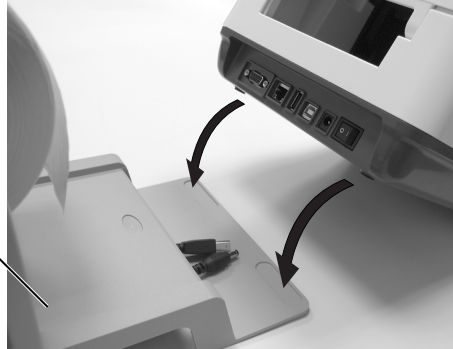

2. Insert the Media Shaft into the core of the media roll.

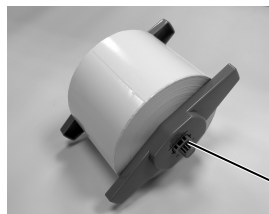

Media Shaft (Option)

3. Place it into the slots on the External Media Stand.
4. Pull the media forward and insert the leading edge into the Fanfold Paper Slot.

Fanfold Paper Slot

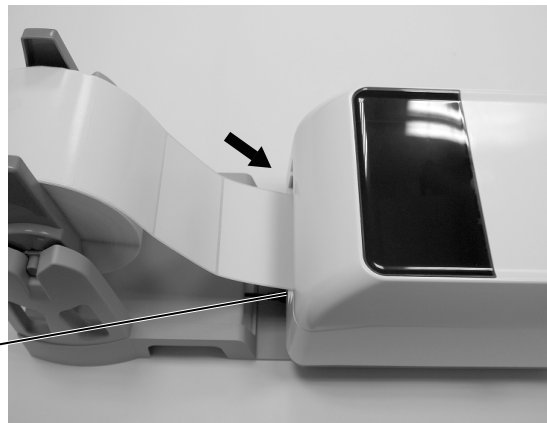

5. Refer to the previous pages to complete the media loading.

2.8 Media Sensor Calibration, Self Print Test, and Dump Mode Utilities

These utilities are used to calibrate the sensitivity of the Feed Gap/Black Mark Sensor, Print out a test with details of the printer settings and set the printer into Dump mode.

When changing from one type of media to another, it is necessary to calibrate the media sensors.

2.8.1 Media Sensor Calibration

NOTE:

The selected sensor used in the last print job is remembered and always used. The factory default sensor is the Feed Gap Sensor.

1. Turn off the printer, make sure the media is correctly loaded, and close the Top Cover.
Note: Do not place a pre-printed area above the media sensor, as doing so disables correct sensor calibration.
2. Press and hold the [FEED] Button while turning on the printer.
3. Both status lights (LED 1 and LED 2) will light up in the following order:
Orange → Green → Other colour sequences
4. Release the [FEED] button when LED 1 and LED 2 light to match the sensor you want to calibrate.
Feed Gap (Transmissive) Sensor: LED 1 green, LED 2 in red.
Black Mark (Reflective) Sensor: LED 1 green, LED 2 orange.
5. Press the [FEED] button.
The printer will feed the media and perform the sensor calibration.
6. To return to Online operation, turn the printer off, then on again.

2.8.2 Self Print Test and Dump Mode

1. Turn off the printer power and install a full width media roll (104mm/4inch) in the printer.
2. Press and hold the [FEED] Button while turning on the printer. The status lamps (LED 1 and LED 2) will light up in the following order:
Orange → Green → Other colour sequences
3. Release the [FEED] Button when LED 1 lights in orange and LED 2 lights in green.
4. Press the [FEED] button.
5. The printer prints the self print test, and then enters Dump Mode.
6. To return to Online operation, turn the printer off, then on again.

Print test label sample

NOTE:

The following commands will have no effect the test print. D, AX, XS, Z2;1, Z2;2 (only the AY command will)

```

B-FV4D-G PRINTER INFO.

PROGRAM VERSION          05MAY2014B-FV4  V1.1J
TPCL VERSION             28APR2014 V1.0K
CG VERSION               27FEB2014 V1.0
CHINESE VERSION         27FEB2014 V1.0
CODEPAGE VERSION        27FEB2014 V1.0
BOOT VERSION             V1.1C
KERNEL FONT VERSION     1.0.03
WLAN MODULE              [Installed]
BLUETOOTH MODULE        [Installed]
[PARAMETERS]
HW DETECT                [0000000000000000]
TONE ADJUST(T)          [---]
TONE ADJUST(D)          [+00]
FEED ADJUST              [+0.0mm]
CUT ADJUST               [+0.0mm]
BACKFEED ADJUST         [+0.0mm]
X-COORD. ADJUST         [+0.0mm]
CODEPAGE                [PC-850]
ZERO SLASH               [0]
FEED KEY                 [FEED]
EURO CODE                [B0]
CONTROL CODE             [AUTO]
MAXI CODE SPEC.         [TYPE 1]
SENSOR SELECT            [Transmissive]
PRINT SPEED              [5ips]
FORWARD WAIT             [ON]
AUTO CALIB.              [OFF]
MULTI LABEL              [OFF]
AUTO THP CHK             [OFF]
BASIC                    [OFF]
Reserved item1
Reserved item2
FLASH ROM                [16MB]
SDRAM                    [32MB]
USB SERIAL NUM.         [000000000001]
[INFORMATION]
INFORMATION              [B-FV4D-GS12-QM-R]
                        [2303A000006]
TOTAL FEED1              [0.00km]
TOTAL FEED2              [00000cm]
                        [0000.0inch]
TOTAL PRINT              [0.00km]
TOTAL CUT                [0]
[RS-232C]
BAUD RATE                [9600]
BIT                      [8]
STOP BIT                 [1]
PARITY                   [None]
FLOW                     [XON/XOFF]

```

2.8.2 Self Print Test and Dump Mode (Cont.)

Printed when the Wireless LAN interface option is installed.

Printed when the Bluetooth interface option is installed.

```

[LAN]
IP ADDRESS           [192.168.010.020]
SUBNET MASK          [255.255.255.000]
GATEWAY              [000.000.000.000]
MAC ADDRESS          [ab-cd-ef-01-23-45]
DHCP                 [OFF]
DHCP CLIENT ID       [FFFFFFFFFFFFFFF]
                    [FFFFFFFFFFFFFFF]
DHCP HOST NAME       [          ]
                    [          ]
SOCKET COMM.         [ON]
SOCKET PORT          [8000]

[WLAN]
WLAN IP ADDRESS      [192.168.10.200]
WLAN SUBNET MASK     [255.255.255.000]
WLAN GATEWAY         [0.0.0.0]
WLAN MAC ADDRESS     [00-80-92-4F-44-B]
WLAN DHCP            [OFF]
WLAN DHCP HOSTNAME   [00-80-92-4F-44-B]
                    [ E          ]
WLAN SOKET PORT      [9100]
ESS ID               [TOSHIBA_B-FV4]
                    [          ]
WLAN MODE            [Infrastructure]
NETWORK AUTH.        [OPEN]
WEP                  [OFF]
WEP DEFAULT KEY      [1]
WPA ENCRYPTION        [DISABLE]
EAP METHOD            [DISABLE]
REGION CODE          [USA]
CHANNEL              [AUTO]

[BLUETOOTH]
DEVICE NICKNAME      [B-FV4]
INQUIRY              [EVERY]
ADDRESS



Barcode



* The barcode printed here displays a Bluetooth address.

```

The test print content are different based on the emulation mode. The list below is for TPCL mode.

- PROGRAM VERSION -----
 - TPCL VERSION -----
 - CG VERSION -----
 - CHINESE VERSION-----
 - CODEPAGE VERSION -----
 - BOOT VERSION -----
 - KERNEL FONT VERSION-----
- } Firmware version
- WLAN MODULE ----- WLAN module installation flag
 - BLUETOOTH MODULE ----- Bluetooth module installation flag
 - HW DETECT----- Hardware detection flag
 - TONE ADJUST(T) ----- Reserved parameter
 - TONE ADJUST(D)----- Print tone fine adjustment value
 - FEED ADJUST----- Print position fine adjustment value
 - CUT ADJUST ----- Cut position fine adjustment value

BACKFEED ADJUST -----	Back feed amount fine adjustment value
X-COORD. ADJUST-----	X-coordinate fine adjustment value
CODEPAGE -----	Character code selection
ZERO SLASH-----	Font "0" selection
FEED KEY-----	[FEED] key function setting
EURO CODE-----	Euro code setting
CONTROL CODE-----	Control code type
MAXI CODE SPEC. -----	Maxicode specification setting
SENSOR SELECT-----	Sensor type
PRINT SPEED -----	Print Speed
FORWARD WAIT -----	Forward feed standby after issue
AUTO CALIB. -----	Automatic calibration setting
MULTI LABEL -----	Multi label setting
AUTO TPH CHECK -----	Automatic print head check for broken dots setting
BASIC -----	Basic interpreter setting
Reserved item1 -----	} Reserved parameter
Reserved item2 -----	
FLASH ROM-----	Flash ROM Capacity
SDRAM -----	SDRAM Capacity
USB SERIAL NUM. -----	USB serial number
INFORMATION -----	Printer model name and serial number.
TOTAL FEED1 -----	Total feed distance (condition1)
TOTAL FEED2 -----	Total feed distance (condition2)
TOTAL PRINT-----	Total Print distance
TOTAL CUT -----	Total Cut Count
[RS-232C]-----	RS-232C setting value (BAUD RATE, BIT, STOP BIT, PARITY, FLOW)
[LAN]-----	Network setting values (IP ADDRESS, SUBNET MASK, GATEWAY, MAC ADDRESS, DHCP, DHCP CLIENT ID, SOCKET COMM., SOCKET PORT)
[WLAN]-----	Network setting values (WLAN IP ADDRESS, WLAN SUBNET MASK, WLAN GATEWAY, WLAN MAC ADDRESS, WLAN DHCP, WLAN DHCP HOSTNAME, WLAN SOKET PORT, ESS ID, WLAN MODE, NETWORK AUTH., WEP, WEP DEFAULT KEY, WPA ENCRYPTION, EAP METHOD, REGION CODE, CHANNEL)
[BLUETOOTH]-----	Network setting values (DEVICE NICKNAME, INQUIRY, ADDRESS*)

*ADDRESS (Bluetooth address) is displayed with a barcode.

3. MAINTENANCE

⚠ WARNING!

1. *Be sure to turn OFF the power before performing any maintenance. Failure to do this may cause an electric shock.*
2. *To avoid injury, be careful not to trap your fingers while opening or closing the cover.*
3. *Be careful when handling the print head as it becomes very hot during printing. Allow it to cool before performing any maintenance.*
4. *Do not pour water directly onto the printer.*

This chapter details the routine maintenance procedures.

To ensure the continuous high quality operation of your printer, you should regularly perform these maintenance routines. Where the printer is intensively used (high throughput) it should be done on a daily basis. Where the printer is not intensively used (low throughput) it should be done on a weekly basis.

3.1 Cleaning

To maintain the printer performance and print quality, please clean the printer regularly, or whenever the media is replaced.

3.1.1 Print Head

⚠ CAUTION!

1. *Do not allow any hard objects to touch the print head or platen, as this may cause damage to them.*
2. *Do not use any volatile solvents including thinner and benzene, as this may cause discoloration of the cover, print failure, or breakdown of the printer.*
3. *Do not touch the print head element with bare hands, as static may damage the print head.*

NOTE:

Print Head Cleaners can be purchased from your authorised TOSHIBA TEC CORPORATION service representative.

1. Turn the power off.
2. Open the Top Cover.
3. Clean the Print Head Element with a Print Head Cleaner, cotton swab or soft cloth slightly moistened with ethyl alcohol.

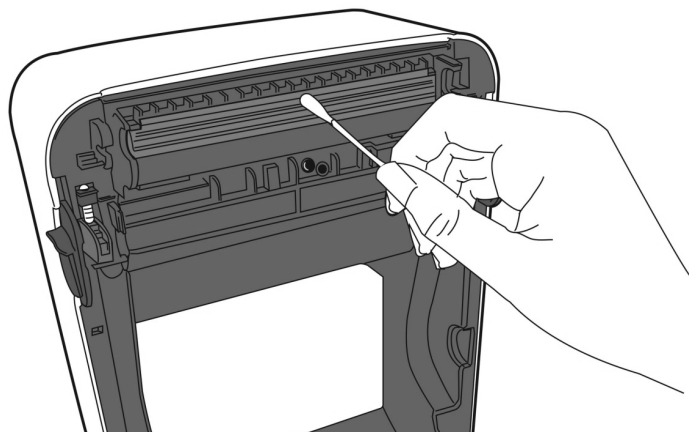

3.1.2 Sensors

1. Wipe the media sensors with a soft cloth or a cotton swab lightly moistened with absolute (pure) ethyl alcohol.
2. To remove dust or paper particles wipe the media sensors with a dry soft cloth.

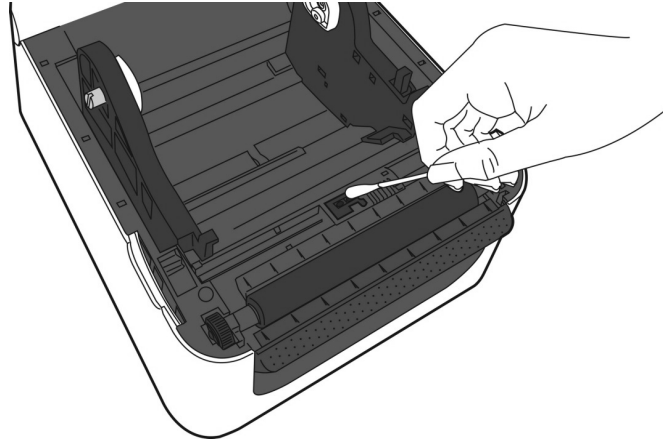

3.1.3 Platen Roller

Wipe the platen roller with a soft cloth moistened with absolute (pure) ethyl alcohol.

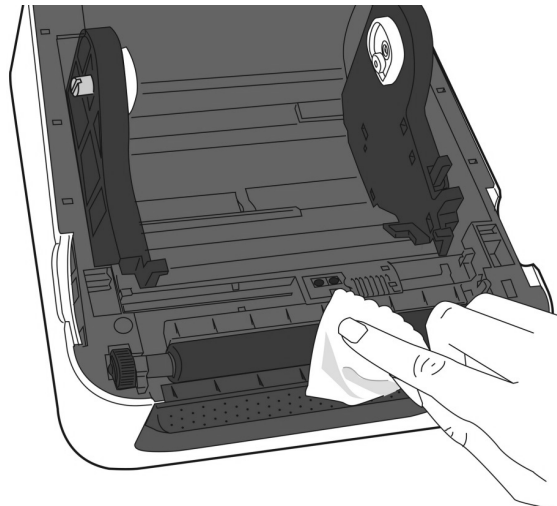

3.1.4 Media Housing

Wipe the media housing with a dry soft cloth. Wipe off dirt with a soft cloth slightly moistened with mild detergent solution.

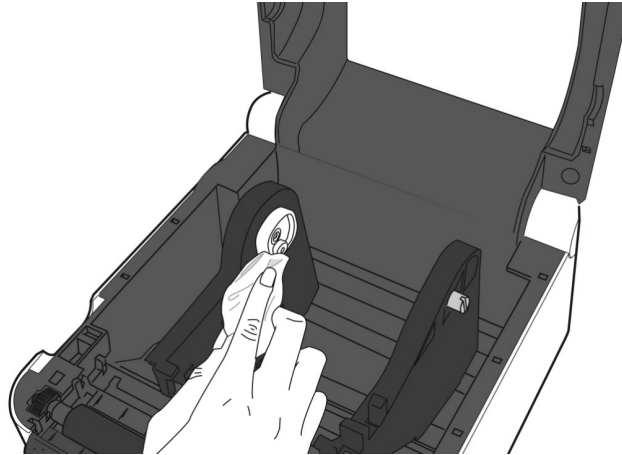

3.2 Care/Handling of the Media

 **CAUTION!**

Be sure to carefully review and understand the Supply Manual. Use only media which meet specified requirements. Use of non-specified media may shorten the head life and result in problems with barcode readability or print quality. All media should be handled with care to avoid any damage to the media, or printer. Read the guideline in this section carefully.

- Do not store media for longer than the manufacturer's recommended shelf life
- Store media rolls on the flat end. Do not store them on the curved sides as this might flatten that side causing erratic media advance and poor print quality.
- Store the media in plastic bags and always reseal after opening. Unprotected media can get dirty and the extra abrasion from the dust and dirt particles will shorten the print head life.
- Store the media in a cool, dry place. Avoid areas where they would be exposed to direct sunlight, high temperature, high humidity, dust or gas.
- The thermal paper used for direct thermal printing must not have specifications which exceed Na^+ 800 ppm, K^+ 250 ppm and Cl^- 500 ppm.
- Some ink used on pre-printed media may contain ingredients which shorten the print head's product life. Do not use labels pre-printed with ink which contain hard substances such as carbonic calcium (CaCO_3) and kaolin ($\text{Al}_2\text{O}_3, 2\text{SiO}_2, 2\text{H}_2\text{O}$).

For further information, please contact your local distributor or your media manufacturer.

4. TROUBLESHOOTING

WARNING!

If a problem cannot be solved by taking actions described in this chapter, do not attempt to repair the printer. Turn off and unplug the printer. Then contact an authorised TOSHIBA TEC CORPORATION service representative for assistance.

4.1 Troubleshooting Guide

Symptom	Cause	Solutions
The power lamp of the Power Adapter does not light up though the power cord is plugged in an AC outlet.	The power cord is not connected to the Power Adapter.	Disconnect the power cord from the AC outlet, connect the power cord to the Power Adapter, then connect it to the AC outlet. (⇒ Section 2.5)
	There is a power failure or the power is not being supplied to the AC outlet.	Test the AC outlet with a power cord from another electric appliance. If power is not being supplied, consult an electrician or your Electricity supplier.
	The fuse of the building has blown or the circuit breaker has tripped.	Check the fuse or circuit breaker.
LED 1 does not light up in green when the power switch is turned on though the power lamp of the Power Adapter is lit.	The Power Adapter Connector is disconnected from the Power Jack.	Disconnect the power cord from the AC outlet, insert the Power Adapter Connector into the Power Jack, then connect the power cord to the AC outlet. (⇒ Section 2.5)
Media is not issued.	The media is not loaded correctly.	Reload the media correctly. (⇒ Section 2.7)
	The interface cable is not connected correctly.	Connect the interface cable again. (⇒ Section 2.4)
	The media sensor is dirty.	Clean the media sensor. (⇒ Section 3.1.2)
Nothing is printed.	The media loaded is not direct thermal media though direct thermal mode is selected.	Load a thermal paper roll. (⇒ Section 2.7)
	The media is not correctly loaded.	Reload the media correctly. (⇒ Section 2.7)
	Print data is not sent from the host computer.	Send the print data.
Poor print	TOSHIBA TEC CORPORATION approved media is not used.	Replace the media with an approved one.
	The print head is dirty.	Clean the print head. (⇒ Section 3.1.1)
Missing dots	The print head is dirty.	Clean the print head. (⇒ Section 3.1.1)
	Some of the print head elements are broken.	When missing dots affect the printout, turn off the printer and contact the nearest TOSHIBA TEC CORPORATION representative to ask for the replacement of the print head.

Symptom	Cause	Solutions
Labels are not correctly separated from the backing paper. (When the optional Peel-off unit is fitted.)	TOSHIBA TEC CORPORATION approved media is not used.	Replace the media with an approved one.
	The labels have been loaded incorrectly.	Load the label correctly. (⇒ Section 2.7)
The media is not cut cleanly. (When the optional cutter unit is fitted.)	The cutter blade has reached the end of its useful life.	Turn off the printer and contact the nearest TOSHIBA TEC CORPORATION representative to ask for the replacement of the cutter unit.
The Wireless LAN communication error occurs immediately after turning on the printer.	It takes approx. 10 seconds to enable the Wireless LAN communication after the Status Lamp shows a stand-by state.	Turn on the printer, and wait more than 10 seconds after the Status Lamp shows a stand-by state, then start the communication.

4.2 Status Lamp

LED 1	LED 2	Cause	Solutions
Green	Unlit	Stand-by	Normal
Green ^F	Unlit	Communicating with a host	Normal
Green ^S	Unlit	Printing is temporarily stopped (paused.)	Press the [FEED] Button. Printing is resumed.
Red	Orange ^F	The print head temperature exceeded the upper limit.	Stop printing and allow the print head to cool until LED 1 lights in green. If LED 1 does not light in green or this problem occurs frequently, contact the nearest TOSHIBA TEC CORPORATION representative.
Red	Green	A communication error occurred. (Only when the RS-232C is used.)	Press the [FEED] Button to restart the printer or Turn off the power and then back on. If this problem frequently occurs, turn off the printer and contact the nearest TOSHIBA TEC CORPORATION representative.
Orange	Red	The media has ended.	Load a new media roll, then press the [FEED] Button. (⇒ Section 2.7)
Orange	Green	A paper jam occurred.	Remove the jammed media, then reload the media correctly and press the [FEED] Button. (⇒ Section 4.3)
Red	Red ^M	An issue or feed was attempted with the print block opened.	Close the print block correctly, then press the [FEED] button. Printing will resume.
Red	Green ^F	A paper jam occurred in the cutter unit. (Only when the cutter unit is fitted.)	Remove the jammed media, then reload the media correctly and press the [FEED] Button. (⇒ Section 4.3)
Red	Orange ^M	The print head is broken.	Turn off the power switch and contact the nearest TOSHIBA TEC CORPORATION representative.
Unlit	Unlit	The power is off. The print head block is open if the printer power is on.	Turn the power on. Close the print block correctly.

Flashing speed of the LED

Symbol	Status	Flashing interval
S	Flashing slowly	2.0 sec.
M	Flashing at medium speed	1.0 sec.
F	Flashing fast	0.5 sec.

4.3 Removing Jammed Media

This section describes in detail how to remove jammed media from the printer.

⚠ CAUTION!

Do not use any tool that may damage the print head.

1. Turn the power off.
2. Open the Top Cover and open the print head block.
3. Remove the media roll.
4. Remove the jammed media from the printer. **DO NOT USE** any sharp implements or tools as these could damage the printer.

If a paper jam has occurred inside the Cutter Unit, follow the steps below to remove the paper.

- 1) Turn the power off.
- 2) Tilt the printer to the left.
- 3) Remove the jammed paper by forcibly rotating the cutter motor using a cross/philips screwdriver.



Remark:

The picture above is the thermal transfer printing model of the B-FV4 series.

5. Clean the Print Head and Platen, then remove any further dust or foreign substances.
6. Load the media again, and close the Top Cover.

APPENDIX 1 SPECIFICATIONS

Appendix 1 describes the printer specifications and supplies for use on the B-FV4D printer.

A1.1 Printer

The following are the printer specifications.

Item	B-FV4D-GS Series
Supply voltage	AC100 to 240V, 50/60 Hz (External Power Adapter)
Power consumption	
During a print job	100 to 120V: 1.0 A, 60 W maximum, 200 to 240V: 0.6 A, 59 W maximum
During standby	100 to 120V: 0.12A, 3.7 W maximum, 200 to 240V: 0.07 A, 3.8 W maximum
Operating temperature range	5°C to 40°C (41°F to 104°F)
Storage temperature range	-20°C to 60°C(-4°F to 140°F)
Relative humidity	25% to 85% RH (no condensation)
Humidity for storage	10% to 90% RH (no condensation)
Resolution	203 dpi (8 dots/mm)
Printing method	Direct thermal
Issue mode	Batch, Strip (option), Cut (option)
Printing speed	
In the batch/cut mode	50.8 mm/sec. (2"/sec.), 76.2 mm/sec. (3"/sec.), 101.6 mm/sec. (4"/sec.), 127 mm/sec. (5"/sec.), 152.4 mm/sec. (6"/sec.)
In the strip mode	50.8 mm/sec. (2"/sec.), 76.2 mm/sec. (3"/sec.)
Available media width (including backing paper)	25.4 mm (1.0") to 118 mm (4.6")
Effective print width (max.)	108.0 mm (4.25")
Max. print ratio	Average 15%
Dimension (W × D × H)	183.8 mm x 226.2 mm x 166.0 mm (7.2" x 8.9" x 6.5")
Weight	1.76 kg (3.8 lb) (Excluding media)
Available barcode types	EAN8/13, EAN8/13 add on 2&5, UPC-A, UPC-E, UPC-A add on 2&5, UPC-E add on 2&5, CODE39, CODE93, CODE128, GS1-128 (UCC/EAN128), NW7, MSI, Industrial 2 of 5, ITF, RM4SCC, KIX-Code, POSTNET, USPS Intelligent mail barcode, GS1 DataBar
Available two-dimensional code	Data matrix, PDF417, QR Code, Maxi Code, Micro PDF417
Available composite symbol	GS1-128 Composite (CC-A/CC-B/CC-C)
Available font	Times Roman (6 sizes), Helvetica (6 sizes), Presentation (1 size), Letter Gothic (1 size), Courier (2 sizes), Prestige Elite (2 sizes), OCR-A (1 type), OCR-B (1 type), Simplified Chinese (1 size)
Rotations	0°, 90°, 180°, 270°
Standard interface	USB 2.0 full speed Ethernet interface (10/100 Base) Serial interface (RS-232C) (factory option) Parallel interface (Centronics) (factory option)
Option interface	Wireless LAN interface (IEEE802.11b/g/n) Bluetooth interface (Ver.2.1)

NOTES:

- Data Matrix™ is a trademark of International Data Matrix Inc., U.S.
- PDF417™ is a trademark of Symbol Technologies Inc., US.
- QR Code is a trademark of DENSO CORPORATION.
- Maxi Code is a trademark of United Parcel Service of America, Inc., U.S.
- Bluetooth® is a registered trademark owned by Bluetooth SIG, Inc.

Item	B-FV4D-TS Series
Supply voltage	AC100 to 240V, 50/60 Hz (External Power Adapter)
Power consumption	
During a print job	100 to 120V: 1.0 A, 60 W maximum, 200 to 240V: 0.6 A, 59 W maximum
During standby	100 to 120V: 0.12A, 3.7 W maximum, 200 to 240V: 0.07 A, 3.8 W maximum
Operating temperature range	5°C to 40°C (41°F to 104°F)
Storage temperature range	-20°C to 60°C(-4°F to 140°F)
Relative humidity	25% to 85% RH (no condensation)
Humidity for storage	10% to 90% RH (no condensation)
Resolution	300 dpi (11.8 dots/mm)
Printing method	Direct thermal
Issue mode	Batch, Strip (option), Cut (option)
Printing speed	
In the batch/cut mode	50.8 mm/sec. (2"/sec.), 76.2 mm/sec. (3"/sec.), 101.6 mm/sec. (4"/sec.),
In the strip mode	50.8 mm/sec. (2"/sec.), 76.2 mm/sec. (3"/sec.)
Available media width	25.4 mm (1.0") to 118 mm (4.6")
(including backing paper)	
Effective print width (max.)	105.7 mm (4.16")
Max. print ratio	Average 15%
Dimension (W × D × H)	183.8 mm x 226.2 mm x 166.0 mm (7.2" x 8.9" x 6.5")
Weight	1.76 kg (3.8 lb) (Excluding media)
Available barcode types	EAN8/13, EAN8/13 add on 2&5, UPC-A, UPC-E, UPC-A add on 2&5, UPC-E add on 2&5, CODE39, CODE93, CODE128, GS1-128 (UCC/EAN128), NW7, MSI, Industrial 2 of 5, ITF, RM4SCC, KIX-Code, POSTNET, USPS Intelligent mail barcode, GS1 DataBar
Available composite symbol	GS1-128 Composite (CC-A/CC-B/CC-C)
Available two-dimensional code	Data matrix, PDF417, QR Code, Maxi Code, Micro PDF417
Available font	Times Roman (6 sizes), Helvetica (6 sizes), Presentation (1 size), Letter Gothic (1 size), Courier (2 sizes), Prestige Elite (2 sizes), OCR-A (1 type), OCR-B (1 type), Simplified Chinese (1 size)
Rotations	0°, 90°, 180°, 270°
Standard interface	USB 2.0 full speed
	Ethernet interface (10/100 Base)
	Serial interface (RS-232C) (factory option)
	Parallel interface (Centronics) (factory option)
Option interface	Wireless LAN interface (IEEE802.11b/g/n)
	Bluetooth interface (Ver.2.1)

NOTES:

- *Data Matrix™* is a trademark of International Data Matrix Inc., U.S.
- *PDF417™* is a trademark of Symbol Technologies Inc., US.
- *QR Code* is a trademark of DENSO CORPORATION.
- *Maxi Code* is a trademark of United Parcel Service of America, Inc., U.S.
- *Bluetooth®* is a registered trademark owned by Bluetooth SIG, Inc.

A1.2 Options

Option Name	Type	Description
Cutter module	B-FV204D-F-QM-R	A cutter unit that fully cuts (separates) the printed media.
	B-FV204D-P-QM-R	A cutter unit that partial cuts (does not fully separate) the printed media.
Peel-off module	B-FV904D-H-QM-R	This module enables the printer to strip the backing paper from the print labels and present the striped labels on-demand (one by one) by detecting the presence or removal of a label from the peel bar.
External media stand	B-FV904-PH-QM-R	When this option is attached to the printer, a media roll with an outer roll diameter up to 203mm (8") and inner core diameter of 76.2mm (3") can be used.
Wireless LAN kit	B-FV700-WLAN-QM-R	This interface kit enables wireless LAN (WLAN) communication.
Bluetooth interface kit	B-FV704D-BLTH-QM-R	This interface kit enables Bluetooth communication.

NOTE:

The above options are available from your nearest TOSHIBA TEC CORPORATION representative or TOSHIBA TEC CORPORATION Head Quarters.

A1.3 Media

Please make sure that the media to be used is approved by TOSHIBA TEC CORPORATION. The warranties do not apply to problems caused by using media that is not approved by TOSHIBA TEC CORPORATION. For information regarding TOSHIBA TEC CORPORATION-approved media, please contact a TOSHIBA TEC CORPORATION authorised representative.

A1.3.1 Media Type

The table below shows the size and shape of the media that can be used on this printer.

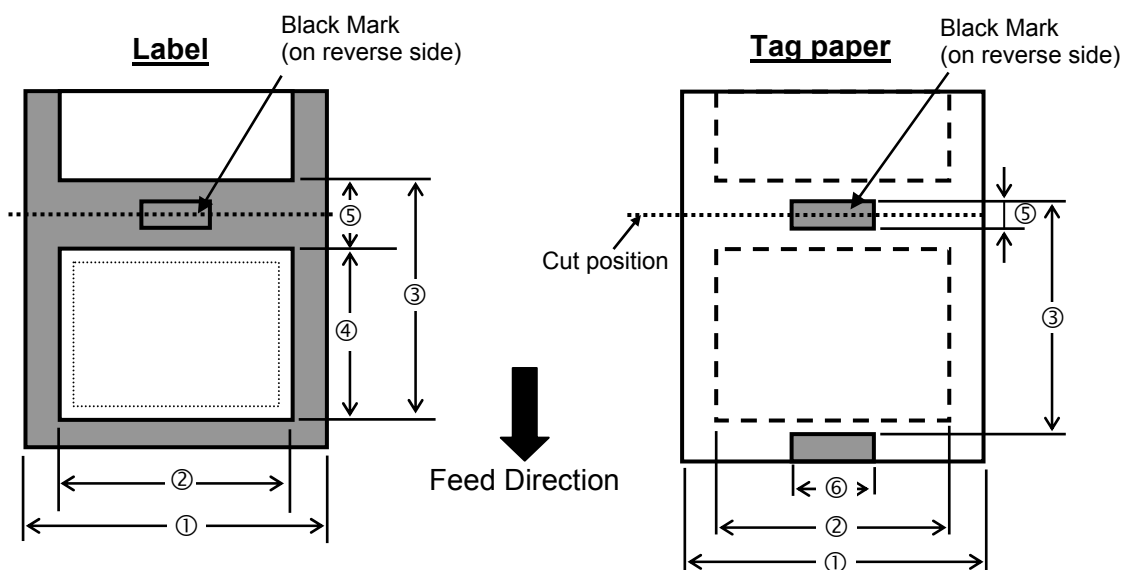

A1.3.1 Media Type (Cont.)

Unit: mm (inch)

Item	Issue mode	Batch mode	Batch mode (Tear-off)	Strip mode	Cut mode
① Media width (Including backing paper)		25.4 to 118.0 (1.00 to 4.65)			
② Label width		22.4 to 115.0 (0.88 to 4.53)			
③ Media pitch	Label	10 to 999 (0.39 to 39.3) <i>See NOTE 3.</i>	25.4 to 152.4 (1.0 to 6.0) <i>See NOTE 3.</i>	25.4 to 999 (1.0 to 39.3) <i>See NOTE 3.</i>	
	Tag	10 to 999 (0.39 to 39.3) <i>See NOTE 3.</i>	—	25.4 to 999 (1.0 to 39.3) <i>See NOTE 3.</i>	
④ Label length		8 to 997 (0.31 to 39.2) <i>See NOTE 3.</i>	23.4 to 150.4 (0.92 to 5.92) <i>See NOTE 3.</i>	19.4 to 993 (0.76 to 39.1) <i>See NOTE 3.</i>	
⑤ Gap/black mark length		2.0 to 10.0 (0.08 to 0.39)			6.0 to 10.0 (0.24 to 0.39)
⑥ Black mark width		Min. 8.0 (0.31)			
Thickness		0.06 to 0.19 (0.0024 to 0.0075)			
Max. outer roll diameter		Ø127 (5.0) Ø203.2 (8.0): When the optional External Media Stand is used.			
Roll direction		Outside (standard), Inside <i>(See NOTE 3)</i>			
Inner core diameter		25.4, 38.1, or 76.2 (1.0, 1.5, or 3.0) <i>(See NOTE 2, 3.)</i>			

NOTES:

- To ensure print quality and print head life use only TOSHIBA TEC CORPORATION approved media.
- When using a media roll of 76.2-mm (3") inner core diameter, the 3"-Diameter Media Shaft included in the optional External Media Stand is required.
- When you use inside wound media, the specifications are restricted as follows:

Unit: mm (inch)

Issue mode	Batch mode / Batch mode (Tear-off)	Strip mode	Cut mode
③ Media pitch	10 to 999 (0.39 to 39.3)	25.4 to 86.2 (1.0 to 3.39)	25.4 to 82.2 (1.0 to 3.24)
④ Label length	8 to 997 (0.31 to 39.2)	23.4 to 76.2 (0.92 to 3.0)	19.4 to 76.2 (0.76 to 3.0)
Inner core diameter	38.1 or 76.2 (1.5 or 3.0)	38.1 or 76.2 (1.5 or 3.0)	76.2 (3.0)

A1.3.2 Detection Area of the Feed Gap (Transmissive) Sensor

The Transmissive Sensor is fixed and positioned at 6.35 mm right of the centre of the media path. The Transmissive Sensor detects a gap between labels, as illustrated below.

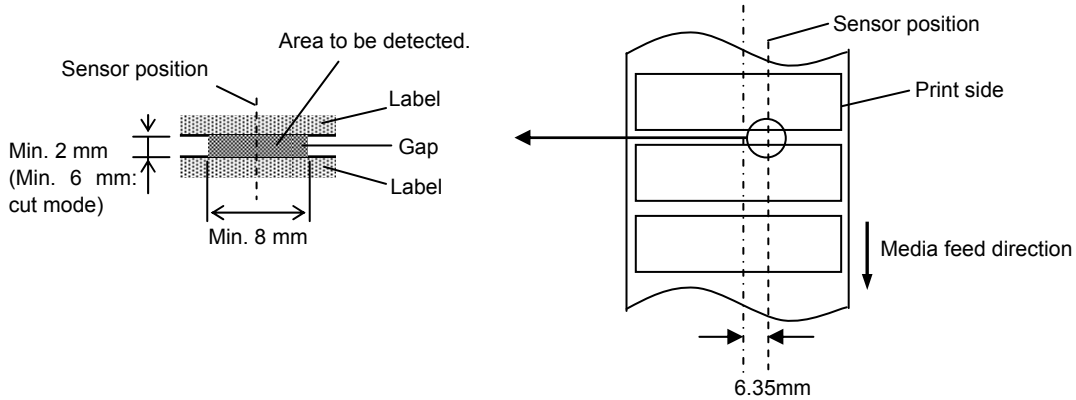

A1.3.3 Detection Area of the Black Mark (Reflective) Sensor

The Reflective Sensor is movable within the full range of the media width. The reflection factor of the Black Mark must be 10% or lower with a waveform length of 950 nm. The Reflective Sensor should be aligned with the centre of the Black Mark.

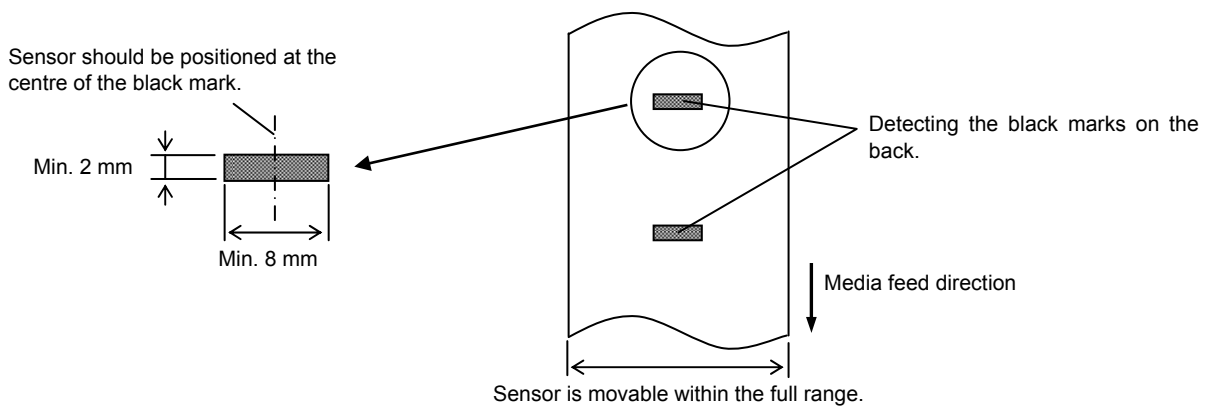

A1.3.4 Effective Print Area

The figure below illustrates the relation between the head effective print width and media width. (for GS Type)

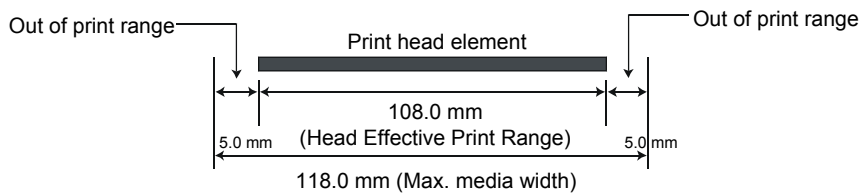

(for TS Type)

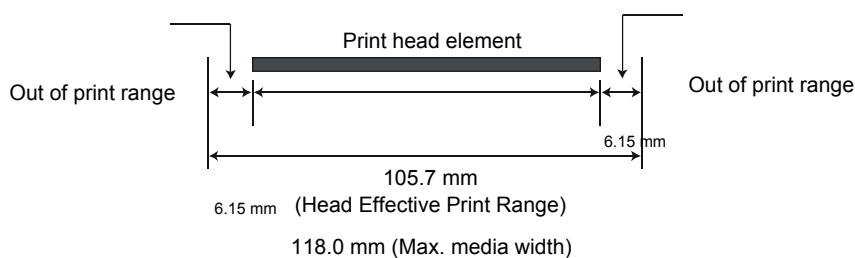

The figure below shows the effective print area on the media.

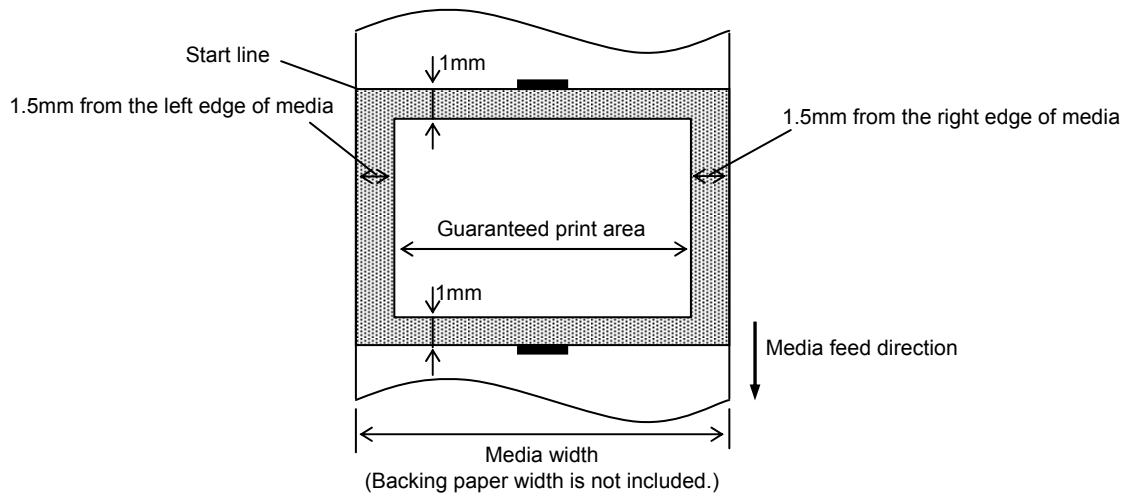

NOTES:

1. Be sure not to print on the 1.5-mm wide area from the media edges (shaded area in the above figure).
2. The centre of media should be positioned at the centre of the print head.
3. Print quality is not guaranteed within 3 mm from the print head stop position (including 1-mm slow-up.)
4. Average print (black) rate should be 15% or less. For barcode print area, the print rate should be 30% or less.
5. Line weight should be 3 to 12 dots.

APPENDIX 2 INTERFACE

■ Interface Cables

To prevent radiation and reception of electrical noise, the interface cables must meet the following requirements:

- Fully shielded and fitted with metal or metallized connector housings.
- Keep as short as possible.
- Should not be bundled tightly with power cords.
- Should not be tied to power line conduits.

■ RS-232C Cable description (only for printers having a serial interface)

The serial data cable used to connect the printer to a host computer should be one of the following two types (9-pin or 25-pin connector):

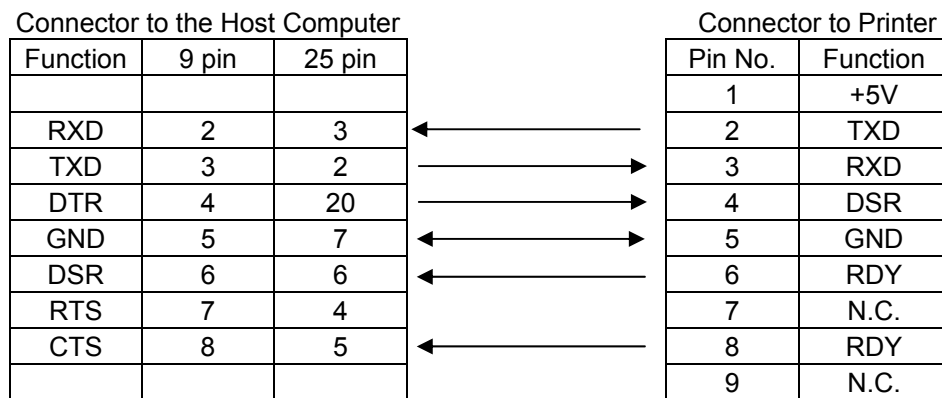

NOTE:

Use an RS-232C cable with a connector with inch type securing screws.

GLOSSARIES

Barcode

A code which represents alphanumeric characters by using a series of black and white stripes in different widths. Barcodes are used in various industrial fields: Manufacturing, Hospitals, Libraries, Retail, Transportation, Warehousing, etc. Reading barcodes is a fast and accurate means of capturing data while keyboard entry tends to be slow and inaccurate.

Batch mode

Issue mode that continuously prints media until the required number has been printed.

Black mark

A mark printed on the media enabling the printer to detect the correct start position of the media, helping to maintain constant print position.

Black mark sensor

A reflective sensor that detects the difference between a black mark and the print area to find the print start position.

Cut mode

Printer mode of operation where an (optional) cutter module is installed to automatically cut media from the supply roll after they are printed. The print command can specify to cut every media or to cut after a set number of media have been printed.

Direct thermal printing

A printing method using no ribbon, but thermal media which reacts to heat. The thermal print head heats the thermal media directly, causing print image to be printed on the media.

DPI

Dots Per Inch

A unit used to express print density or resolution.

Feed gap sensor

A transmissive sensor that detects the difference between the gap between labels and the label itself, to find the print start position of the label.

Font

A complete set of alphanumeric characters in one style of type. E.g. Helvetica, Courier, Times

Gap

Distance from the bottom of one label to the top of the next label.

IPS

Inch per second

A unit used to express print speed.

Label

A type of media with adhesive backing supplied on a backing paper.

Media

Material on which images are printed by the printer. Label, tag paper, fanfold paper, perforated paper, etc.

Printer driver

A software program that will convert the application program's printing request into the language that the printer understands.

Print head element

The thermal print head consists of a single line of tiny resistive elements which when current is allowed to flow through them it heats up causing a small dot to be burned onto thermal paper or a small dot of ink to be transferred from a thermal ribbon to ordinary paper.

Printing speed

The speed at which printing occurs. This speed is expressed in units of IPS (inches per second).

Resolution

The degree of detail to which an image can be duplicated. The minimum unit of divided image is called a pixel. As the resolution becomes higher, the number of pixels increases, resulting in a more detailed image.

Ribbon

An inked film used to transfer an image onto the media. In the thermal transfer printing, it is heated by the thermal print head, causing an image to be transferred onto the media.

Strip mode

One of the printer modes of operation where an optional Peel-off unit is installed to separate printed labels from the backing paper one by one.

Supply

Media and ribbon

Tag

A type of media having no adhesive backing but black marks to indicate the print area. Usually tags are made of cardboard or other durable material.

Thermal print head

A print head using thermal transfer or thermal direct printing method.

Thermal transfer printing

A printing method that the thermal print head heats an ink or resin coating on the ribbon against the media, causing the ink/resin to transfer onto the media.



TOSHIBA TEC CORPORATION

© 2015, 2016 TOSHIBA TEC CORPORATION All Rights Reserved
1-11-1, Osaki, Shinagawa-ku, Tokyo 141-8562, JAPAN

E EO1-33097E
R141020P4805-TTEC
Ver05 F 2016-08