

# TOSHIBA

TOSHIBA Thermal Printer

## B-EX4 SERIES

### Maintenance Manual

Document No. **EO18-33027**

Original    Mar, 2011  
(Revised            )

**(PRELIMINARY VERSION)**

PRINTED IN JAPAN

**TOSHIBA TEC CORPORATION**

## TABLE OF CONTENTS

	Page
<b>1. UNPACKING-----</b>	<b>1- 1</b>
1.1 PROCEDURES -----	1- 1
1.2 CHECKS -----	1- 3
<b>2. PRINTER INSTALLATION-----</b>	<b>1- 3</b>
<b>3. NOTE FOR OPTIONAL EQUIPMENT INSTALLATION</b>	
<b>/MAJOR UNIT REPLACEMENT/MAINTENANCE-----</b>	<b>3- 1</b>
3.1 OPENING/CLOSING THE TOP COVER -----	3- 3
3.2 REMOVING THE SIDE PANEL (L) -----	3- 3
3.3 OPENING/CLOSING THE PRINTER BLOCK -----	3- 3
3.4 REMOVING THE OPERATION PANEL -----	3- 5
<b>4. INSTALLATION PROCEDURE FOR OPTIONAL EQUIPMENT -----</b>	<b>4- 1</b>
4.1 DISK CUTTER (B-EX204-QM-R)-----	4- 2
4.2 ROTARY CUTTER (B-EX204-R-QM-R)-----	4- 4
4.3 PEEL OFF MODULE (B-EX904-H-QM-R) -----	4-12
4.4 RIBBON SAVING MODULE (B-EX904-R-QM-R) -----	4-20
4.5 RTC/USB INTERFACE BOARD (B-EX700-RTC-QM-R)-----	4-23
4.6 EXPANSION I/O INTERFACE BOARD (B-EX700-IO-QM-R) -----	4-25
4.7 WIRELESS LAN BOARD (B-EX700-WLAN-QM-R) -----	4-28
4.8 PARALLEL INTERFACE BOARD (B-EX700-CEN-QM-R) -----	4-31

**TBD:**

- B-EX700-RS-QM-R Serial I/F card
- B-EX700-RFID-QM-R HF RFID module mount kit
- B-EX700-RFID-EU-QM-R UHF RFID kit for EU
- B-EX700-RFID-U2-QM-R UHF RFID kit for US
- B-EX700-RFID-U2-CN-R UHF RFID kit for CN

<b>5. SYSTEM MODE</b>	<b>5- 1</b>
5.1 OPERATION PANEL	5- 1
5.2 OVERVIEW	5- 2
5.3 SELF-DIAGNOSTIC TEST	5- 3
5.3.1 Counter, Parameter / MAINTENACE COUNT	5- 3
5.3.2 Auto Diagnostic / AUTO DIAGNOTICS	5-16
5.3.3 Print Head Element Check	5-23
5.4 PARAMETER SETTING	5-24
5.4.1 Printer setting / PRINTER SET	5-24
5.4.1.1 Media loading / MEDIA LOAD	5-24
5.4.1.2 Setting for forward feed standby / FORWARD WAIT	5-25
5.4.1.3 Forward feed standby position / FORWARD WAIT POS.	5-25
5.4.1.4 Standby action / FW/BK ACT.	5-25
5.4.1.5 HU CUT/RWD	5-25
5.4.1.6 Ribbon save / RBN SAVE	5-25
5.4.1.7 Pre peel-off / PRE PEEL OFF	5-26
5.4.1.8 Back feed / BACK SPEED	5-26
5.4.2 Soft control setting / SOFTWARE SET	5-27
5.4.2.1 Character code / FONT CODE	5-28
5.4.2.2 Font "0" type / ZERO FONT	5-28
5.4.2.3 Control code / CODE	5-28
5.4.2.4 Manual selection / MANUAL	5-29
5.4.2.5 Peel-off wait status / PEEL OFF STATUS	5-29
5.4.2.6 USB STATUS / USB I/F STATUS	5-29
5.4.2.7 FEED Key Function	5-29
5.4.2.8 Kanji special code / KANJI CODE	5-30
5.4.2.9 Euro code / EURO CODE	5-30
5.4.2.10 Auto head broken check / AUTO HD CHK	5-30
5.4.2.11 WEB Printer / WEB PRINTER	5-30
5.4.2.12 Ribbon near end / RBN NEAR END	5-31
5.4.2.13 External I/O mode / EX.I/O	5-31
5.4.2.14 Paper / ribbon end / LBL/RBN END	5-31
5.4.2.15 MaxiCode specification / MAXI CODE	5-32
5.4.2.16 XML	5-32
5.4.2.17 Threshold selection / THRESHOLD SELECT	5-33
5.4.2.18 Print method / ENERGY TYPE	5-33
5.4.2.19 Power save time / PW SAVE TIME	5-33
5.4.3 LCD DISPLAY SETTING / PANEL	5-34
5.4.3.1 Language of LCD display / LCD LANGUAGE	5-34
5.4.3.2 Machine name / MACHINE NAME	5-34
5.4.3.3 Print page / PRINT PAGE	5-34
5.4.3.4 IP address / IP ADDRESS	5-34
5.4.3.5 Contrast adjustment / CONTRAST	5-35
5.4.4 Password setting / PASSWORD	5-35
5.4.4.1 Boot display of system mode and user mode when password is enabled	5-36

5.5	Fine adjustment value setting/ ADJUST SET -----	5-37
5.5.1	Feed / FEED ADJ.-----	5-38
5.5.2	Cut position / CUT ADJ -----	5-38
5.5.3	Back feed / BACK ADJ-----	5-43
5.5.4	X direction position / X ADJUST -----	5-44
5.5.5	Density fine tune (Thermal transfer) / TONE ADJ.(TRANS.) -----	5-44
5.5.6	Density fine tune (Direct thermal transfer) / TONE ADJ.(DIRECT) -----	5-44
5.5.7	Ribbon (Rewinder) / RBN ADJ.<FW> -----	5-45
5.5.8	Ribbon (Feeder) / RBN ADJ.<BK>-----	5-45
5.5.9	Refractive sensor fine tune / THRESHOLD <REFL.> -----	5-46
5.5.10	Transmissive sensor fine tune / THRESHOLD <TRANS.> -----	5-46
5.6	TEST PRINT -----	5-48
5.6.1	Print condition setting / PRINT CONDITION-----	5-48
5.6.2	1-dot slant line print / SLANT LINE(1DOT) -----	5-51
5.6.3	3-dot slant line print / SLANT LINE(3DOT) -----	5-51
5.6.4	Character print / CHARACTERS -----	5-52
5.6.5	Barcode print / BARCODE -----	5-52
5.6.6	White line print / NON-PRINTING -----	5-53
5.6.7	Factory test / FACTORY TEST -----	5-53
5.6.8	Auto print (Transmissive) / AUTO PRINT (TRANS.) -----	5-53
5.6.9	Auto print (Reflective) / AUTO PRINT (REFL.) -----	5-54
5.7	SENSOR ADJUSTMENT -----	5-55
5.7.1	Temperature sensor/ TEMPERATURE -----	5-55
5.7.2	Reflective sensor / REFLECT -----	5-55
5.7.3	Transmissive / TRANS. -----	5-56
5.7.4	Paper empty level / PE REFL./TRANS. -----	5-56
5.7.5	Ribbon end / RIBBON-----	5-56
5.8	RAM CLEAR -----	5-57
5.8.1	No RAM clear / NO RAM CLEAR -----	5-57
5.8.2	Counter clear / MAINTC.CNT CLEAR -----	5-57
5.8.3	Parameter clear / PARAMETER CLEAR -----	5-58
5.9	IP ADDRESS SETTING -----	5-64
5.9.1	Network / NETWORK -----	5-64
5.9.2	USB-----	5-69
5.9.3	RS-232C-----	5-70
5.9.4	Centronics / CENTRO. -----	5-71
5.10	BASIC SETTING-----	5-72
5.10.1	Basic function / BASIC -----	5-72
5.10.2	File display / FILE MAINTENANCE -----	5-72
5.10.3	Trace function / TRACE-----	5-72
5.10.4	Extended mode / EXPAND MODE-----	5-72
5.11	RFID Module Setting-----	5-73
5.11.1	Test / TEST -----	5-74
5.11.2	Module / MODULE -----	5-75
5.11.3	Retry / RETRY -----	5-77
5.11.4	UHF setting / UHF SETTING -----	5-79
5.11.5	Other / OTHER-----	5-83

<b>6.</b>	<b>ON LINE MODE</b>	<b>6-1</b>
6.1	THRESHOLD SETTING	6-8
6.2	ONLINE MODE LCD DISPLAY	6-11
6.3	HELP DISPLAY	6-14
<b>7.</b>	<b>PERIODIC MAINTENANCE PROCEDURE</b>	<b>7- 1</b>
<b>8</b>	<b>TROUBLESHOOTING</b>	<b>8 1</b>
<b>9.</b>	<b>(TBD)</b>	
<b>10.</b>	<b>MAJOR UNIT REPLACEMENT (T.B.D)</b>	<b>10-</b>
10.1	POWER SUPPLY UNIT	10-
10.2	MAIN PC BOARD	10-
10.3	PANEL PC BOARD AND LCD UNIT	10-
10.3.1	LCD	10-
10.3.2	Panel PC Board	10-
10.4	STEPPING MOTOR	10-
10.5	RIBBON MOTORS (TAKE-UP, FEED)	10-
10.5.1	Ribbon Motor (Take-up)	10-
10.5.2	Ribbon Motor (Feed)	10-
10.6	RIBBON MOTOR SENSORS (TAKE-UP, FEED)	10-
10.6.1	Ribbon Motor Sensor (Take-up)	10-
10.6.2	Ribbon Motor Sensor (Feed)	10-
10.7	PRINT HEAD	10-
10.8	PLATEN	10-
10.9	FEED ROLLER	10-
10.10	PINCH ROLLER ASS'Y	10-
10.11	MEDIA SENSORS (UPPER, LOWER)	10-
10.11.1	Removing the Media Sensor Ass'y	10-
10.11.2	Replacing the Media Sensor (Upper)	10-
10.11.3	Replacing the Media Sensor (Lower)	10-
10.11.4	Reassembling the Media Sensor Ass'y	10-
10.12	HEAD UP SENSOR	10-
10.13	PRINTER OPEN SENSOR	10-
10.14	RIBBON END SENSOR	10-
10.15	FAN MOTOR	10-

<b>11. RFID ANALYZE TOOL</b>	<b>11-</b>
11.1 System Requirement	11-
11.2 Set up	11-
11.3 Application Functions	11-
11.4 Operating Procedure	11-

**CAUTION!**

- 1. This manual may not be copied in whole or in part without prior written permission of TOSHIBA TEC.*
- 2. The contents of this manual may be changed without notification.*

# 1. UNPACKING

## 1.1 PROCEDURE

- 1) Open the carton.
- 2) Unpack the accessories and the front pad from the carton.



- 3) Unpack the pads and the printer from the carton.
- 4) Remove the four pieces of tape and the rear pad from the printer.



- 5) Open the top cover and remove the five pieces of tape. And then, open the ribbon shaft holder plate to remove the ribbon shaft pad from the printer.

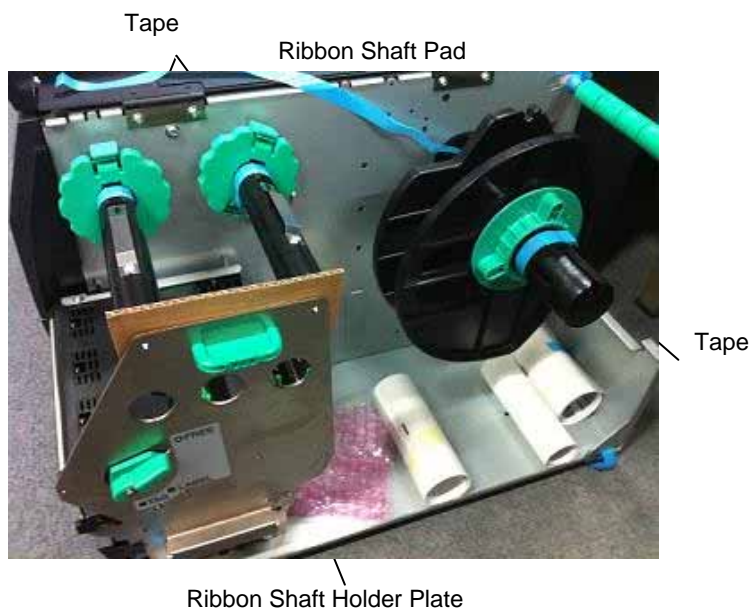
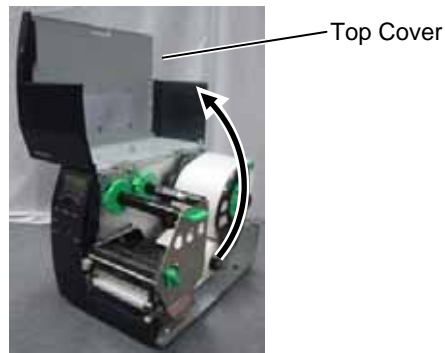



### 1.2 CHECKS

- 1) Check for damage or scratches on the printer.
- 2) Confirm that none of the accessories are missing. The parts below are provided as accessories.

CD-ROM (1 pc.)



<Contents>

- Bar code printer application (BarTender Ultra Lite)
- Windows Driver
- Owner's Manual
- Specifications (Programming, Key operation, etc.)
- Product information (Catalogue)

Carton

Safety precautions

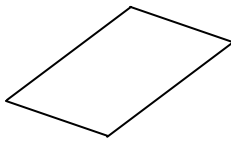

Quick installation manual

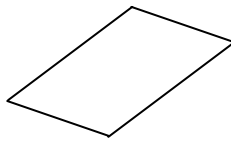

**NOTES:**     *Keep the carton and pads for later transport.*

## 2. PRINTER INSTALLATION

- 1) Place the printer on the level surface.
- 2) Keep the slit free or the printer will be overheated. Also keep enough space for replacing and maintenance works while the top cover is opened.

Side panel



Top Cover

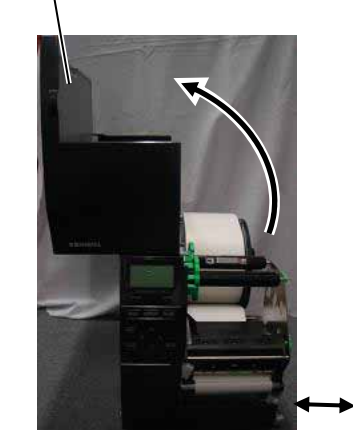

### 3. NOTE FOR OPTIONAL EQUIPMENT INSTALLATION /MAJOR UNIT REPLACEMENT/MAINTENANCE

**WARNING!**

1. Turn the power off and disconnect the power cord before replacing the main parts.

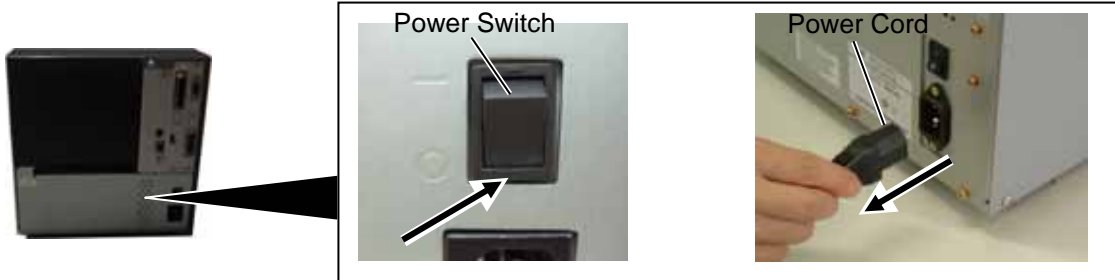

2. Never perform disassembling, assembling, and cleaning just after printing. Doing so may cause you to be injured by the print head and the inner parts of the printer being hot.
3. When cleaning the cutter, be careful not to be injured by the cutter blade.
4. Be careful not to pinch your fingers or hands with the covers.

**CAUTION!**

1. Fix the harnesses and the cord bushes with the cable clamp. Failure to do this may cause the covers to catch them.

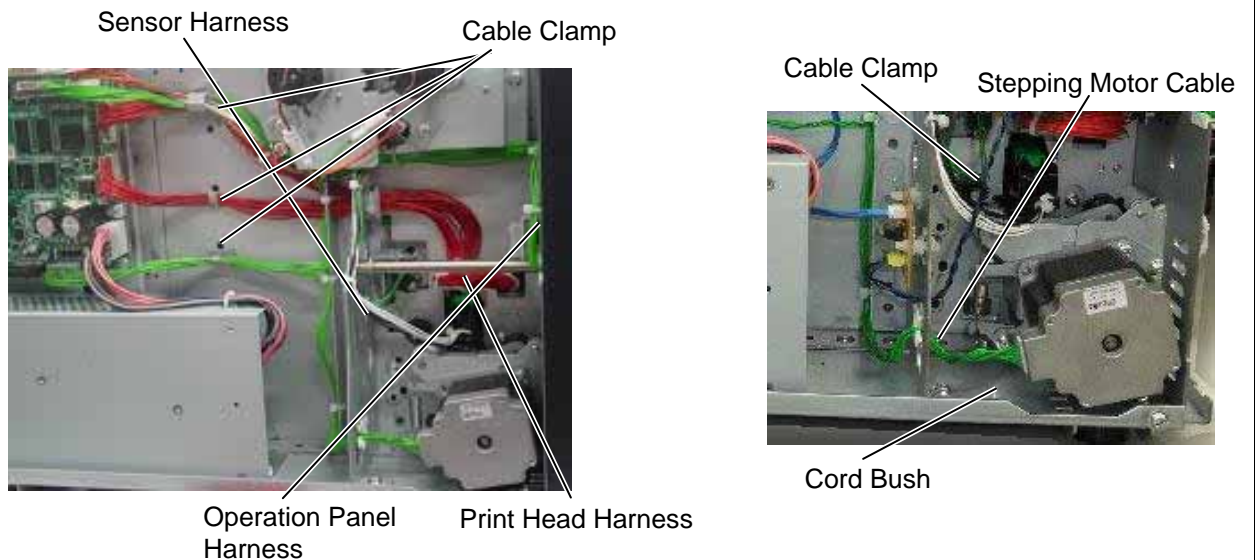

continued

2. Do not remove the screws below. Doing so will require the printer block position adjustment with the jig.

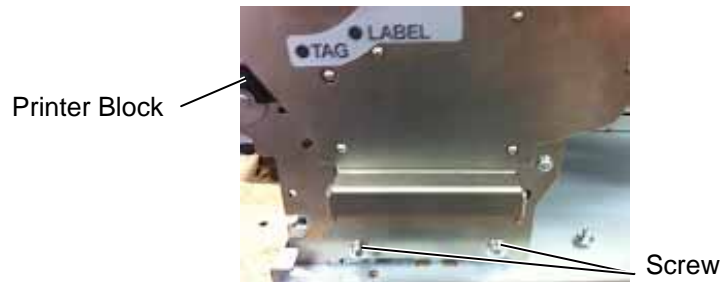

3. Be careful not to damage the sensor window. If so, the sensor cannot detect the feed gap or the black mark correctly, causing improper printing.



4. When replacing parts or performing maintenance on the printer, be careful not to damage the print head with a hard object like a watch or a ring.



Since the print head element can be easily damaged by shock, please treat it carefully by not hitting a hard object against it.

### 3.1 OPENING/CLOSING THE TOP COVER

When opening the top cover, fully open the top cover to the open position.  
When closing, softly close it to the close position.

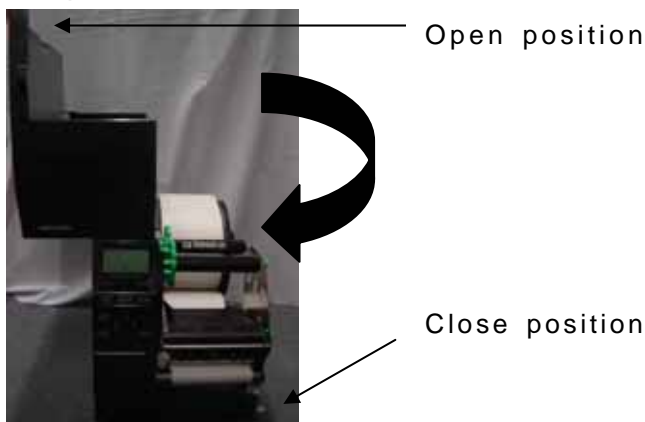

### 3.2 REMOVING THE SIDE PANEL (L)

Remove the three M3x6 screws from the side panel (L). Move the side panel (L) to the back and push up it to remove.

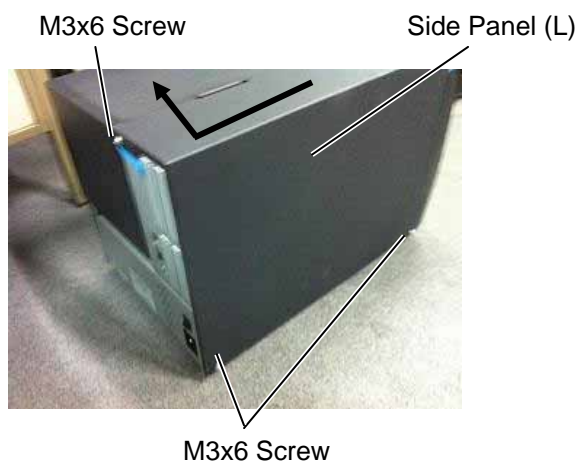

### 3.3 OPENING/CLOSING THE PRINTER BLOCK

- 1) Open the top cover.
- 2) Turn the head lever counterclockwise to **Free** position.
- 3) Open the ribbon shaft holder plate.

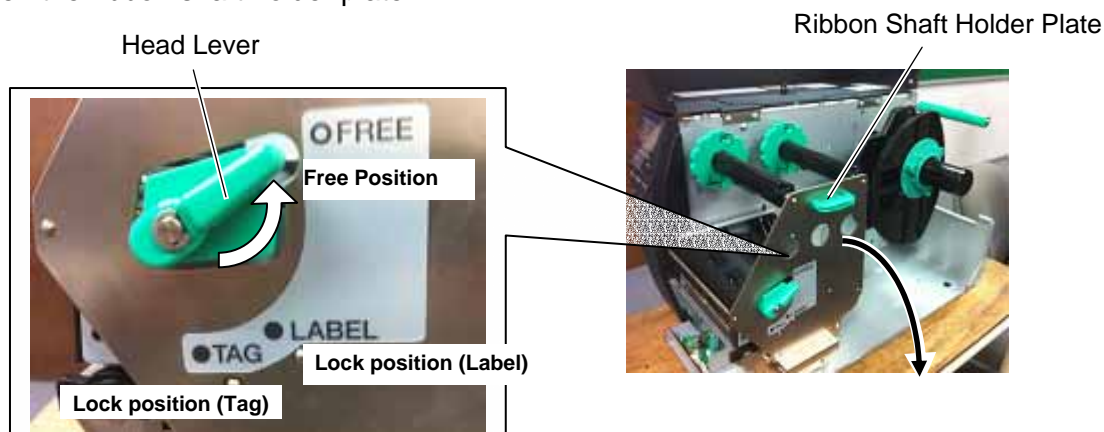

- 4) Raise the print head block until it stops.

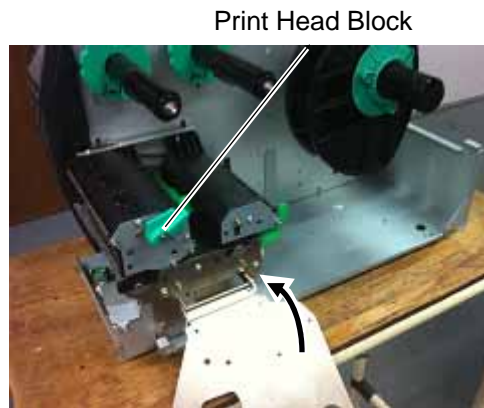

**NOTE:** *DO NOT excessively push down the print head block to close it. Dosing so may cause a failure of the print head block or damage to the print head.*

### 3.4 REMOVING THE OPERATION PANEL

- 1) Open the top cover. (Refer to section 3.1.)
- 2) Remove the side panel (L) from the printer. (Refer to section 3.2.)
- 3) Fully open the top cover, otherwise the operation panel ass'y is stuck on the tab and cannot be removed from the printer.

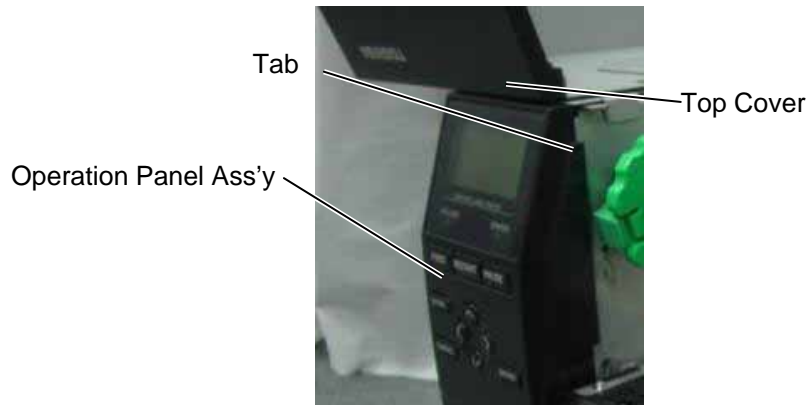

- 4) Push the operation panel ass'y out through the top hooks direction.



- 5) Lift the operation panel ass'y to release the bottom hook, and then remove the operation panel ass'y by moving it forward.





- 6) Disconnect the operation panel harness from the operation panel ass'y.

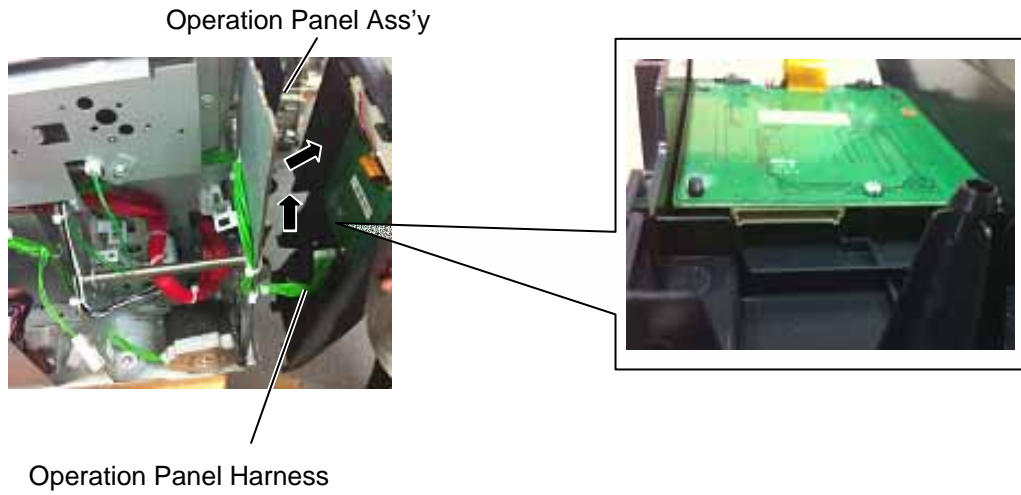

## 4. INSTALLATION PROCEDURE FOR OPTIONAL EQUIPMENT

### WARNING!

1. Make sure to unplug the power cord before installing the optional equipment.
2. Be careful not to pinch your fingers or hands with the covers.

### CAUTION!

When replacing parts or performing maintenance on the printer, be careful not to damage the print head with a hard object like a watch or a ring.



Care must be taken not to allow the metal or glass part of a watch to touch the print head edge.



Care must be taken not to allow a metal object like a ring to touch the print head edge.

Since the print head element can be easily damaged by shock, please treat it carefully by not hitting a hard object against it.

The following optional equipments are provided for this printer.

- |                       |                          |                    |                         |
|-----------------------|--------------------------|--------------------|-------------------------|
| B-EX204-QM-R:         | Disc cutter              | B-EX904-PK-QM-R:   | Narrow width platen kit |
| B-EX204-R-QM-R:       | Rotary cutter            | B-EX700-WLAN-QM-R: | Wireless LAN I/F card   |
| B-EX904-H-QM-R:       | Peel off module          | B-EX700-RTC-QM-R:  | RTC/USB host I/F card   |
| B-EX904-R-QM-R:       | Ribbon Saving Module     | B-EX700-IO-QM-R:   | Expansion I/O card      |
| B-EX700-CEN-QM-R:     | Parallel I/F card        | B-EX700-RS-QM-R:   | Serial I/F card         |
| B-EX700-RFID-H1-QM-R: | HF RFID module mount kit |                    |                         |
| B-EX700-RFID-U2-EU-R: | UHF RFID kit for EU      |                    |                         |
| B-EX700-RFID-U2-US-R: | UHF RFID kit for US      |                    |                         |
| B-EX700-RFID-U2-CN-R: | UHF RFID kit for CN      |                    |                         |

In this section, installation procedures for these optional equipments are described.



### 4.1 DISC CUTTER (B-EX204-QM-R)

**WARNING!**

*Be careful not to injure your fingers when installing the cutter unit.*

All the following parts are supplied with the kit. Make sure you have all items shown below.

Description	Q'ty/Unit	Description	Q'ty/Unit
Cutter Unit	1	Installation manual	1
Cutter Cover	1	Screw (M3x6)	2
Cutter Harness	1	Bush	1
Print Head Cleaner	1		

- 1) Turn the power off and disconnect the power cord.
- 2) Open the top cover, and push up the hooker and take out the front cover bottom.

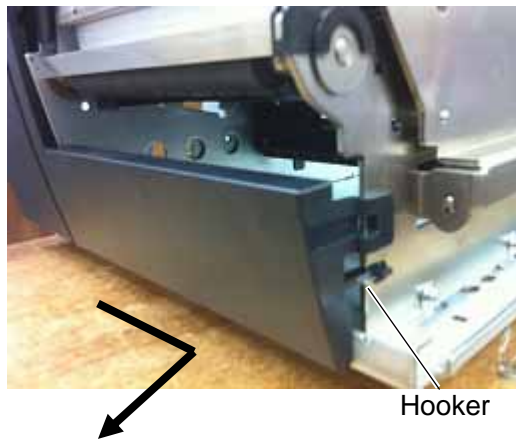

- 3) Remove the three M3x6 screws from the side panel (L). Move the side panel (L) to the back and push up it to remove.

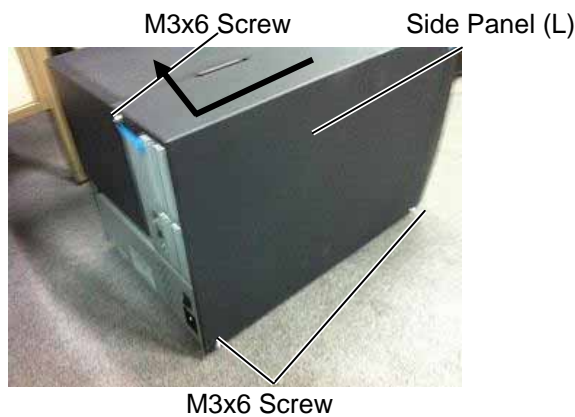

4) Put the cutter in front of the printer. Connect one side of the cutter harness to CN15 on the Main PC Board. And connect another side to the disc cutter PC Board.

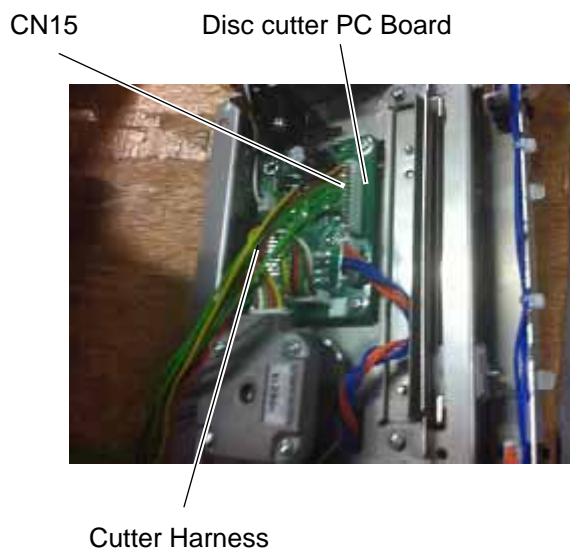
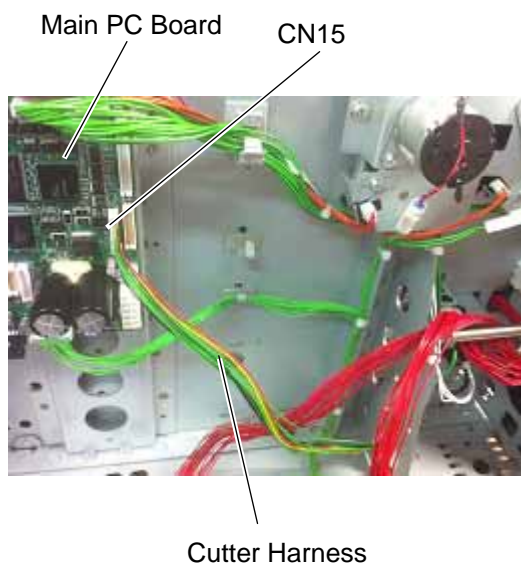

5) Put the cutter on the printer through fit the hooks. And fix it to the printer with the two M4x6 screws.

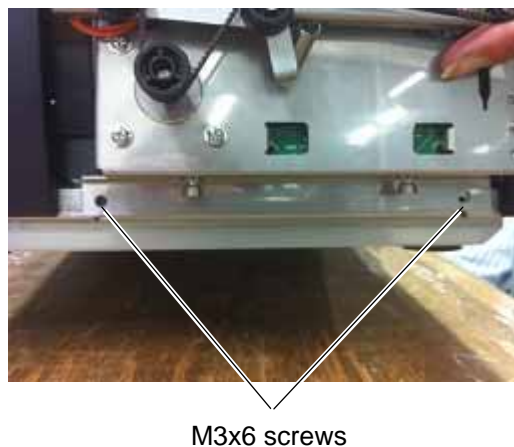
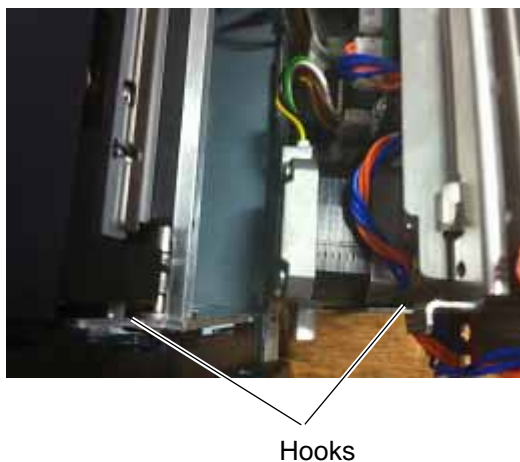

6) Fit the cutter cover on the cutter attachment screws, and fix it to the cutter unit with the two cutter screws.



Screw



7) Reassemble the side panel (L) and close the top cover. Finally check the cutter operation.

## 4.2 ROTARY CUTTER (B-EX204-R-QM-R)

**WARNING!**

*Be careful not to injure your fingers when installing the cutter unit.*

All the following parts are supplied with the kit. Make sure you have all items shown below.

Description	Q'ty/Unit	Description	Q'ty/Unit
Cutter Unit	1	Cord Bush	1
Cutter Cover	1	Print Head Cleaner	1
Cutter Drive Unit	1	B-SX Cutter Paper Guide	1
Harness Ass'y (2-pin & 9-pin)	1	SM-4x8 Screw	5
Installation Manual	1		

**NOTES:**

- When using the rotary cutter on the B-E4T series, the print speed of 10"/sec. is not supported. Also, when using the rotary cutter, be sure to install the ribbon saving module (B-EX904-R-QM-R). Failure to do this may cause a paper jam or ribbon error. (For the installation procedure, please refer to Section 4.9.)
- The B B-EX204-R-QM-R with the serial number of 2805Dxxxxxx or earlier cannot be installed on an RFID-ready printer (2804Sxxxxxx or later) without changing some parts of the cutter drive unit. For the parts change procedure, refer to the following:
  - Release the four Locking Supports to remove the Rotary Cutter PC Board from the frame.
 

**NOTE:** Locking supports are not used. Please discard them.

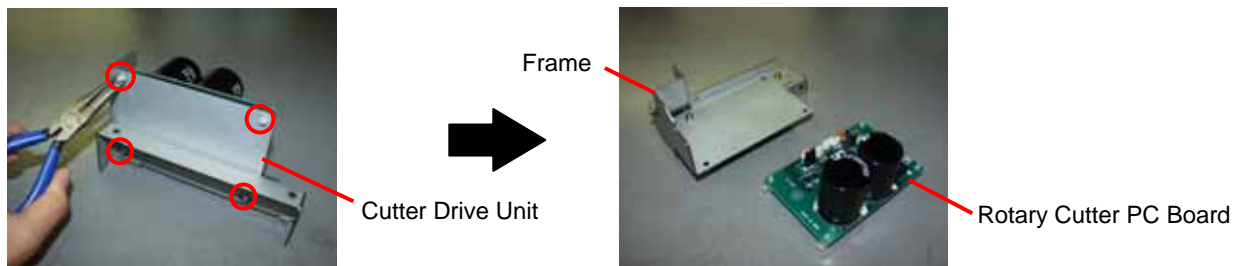

2) Disassemble the frame into 3 parts.

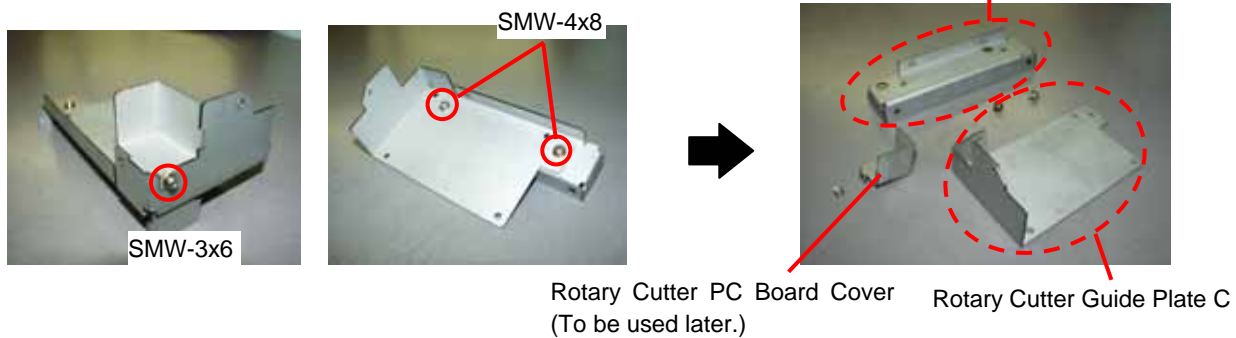

3) Replace the Rotary Cutter Guide Plate B and the Rotary Cutter Guide Plate C with the Rotary Cutter Frame A and Rotary Cutter Frame B, respectively.

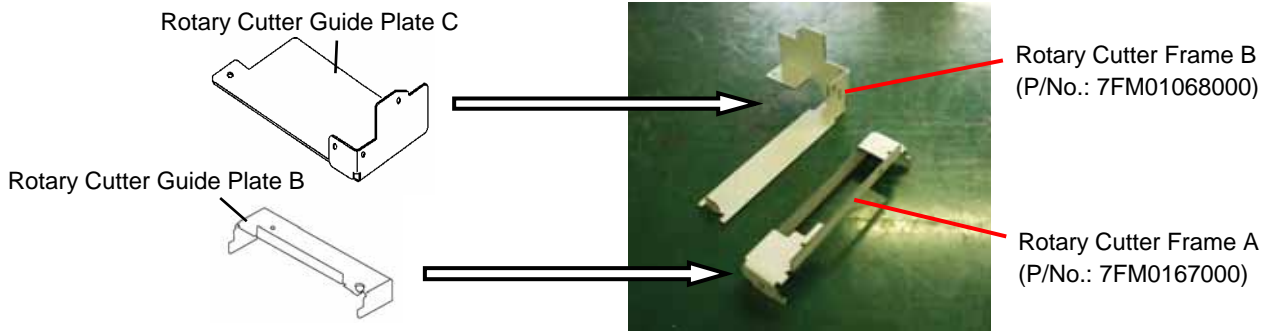

4) Assemble the Rotary Cutter Frame A and Rotary Cutter Frame B with an SMW-4x8 screw removed in step 2).

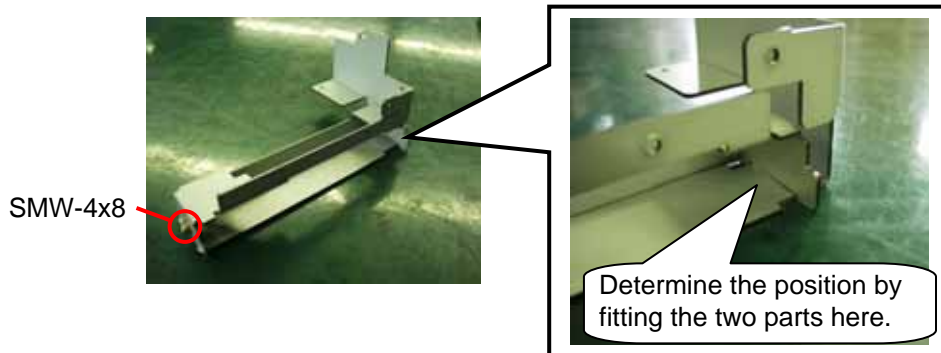

5) Confirming the orientation of the Rotary Cutter PC Board, fix it to the Rotary Cutter Frames A and B with three SMW-3x6 screws. Then, attach the Rotary Cutter PC Board Cover with an SMW-3x6 screw.

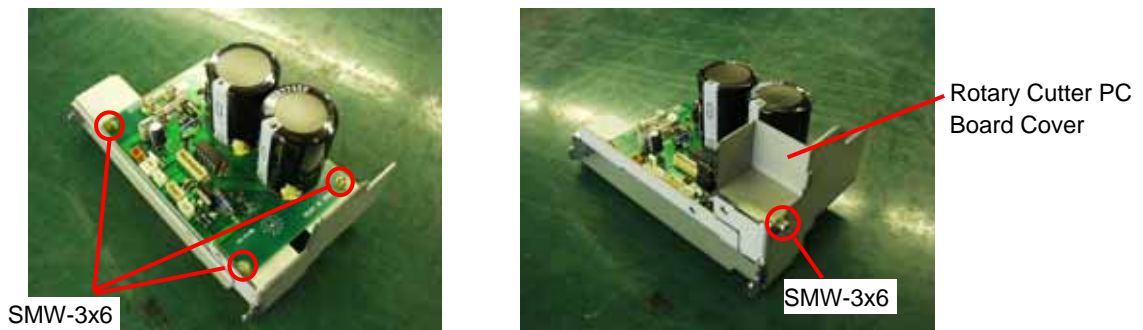



**NOTE:** When attaching the B-8204-QM cutter module, replace the original cutter paper guide C with the enclosed B-SX cutter paper guide C using the following procedure.

**CAUTION!**

Do not hold the cutter paper guides when attaching the Cutter Unit to the printer. Doing so may deform the cutter paper guides, causing a paper jam.

**DO NOT!**

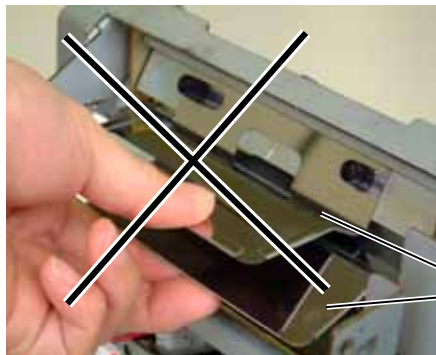

Cutter Paper Guide

- (1) Remove the two M-4x6 Set Screws from the cutter unit to detach the cutter paper guide C.

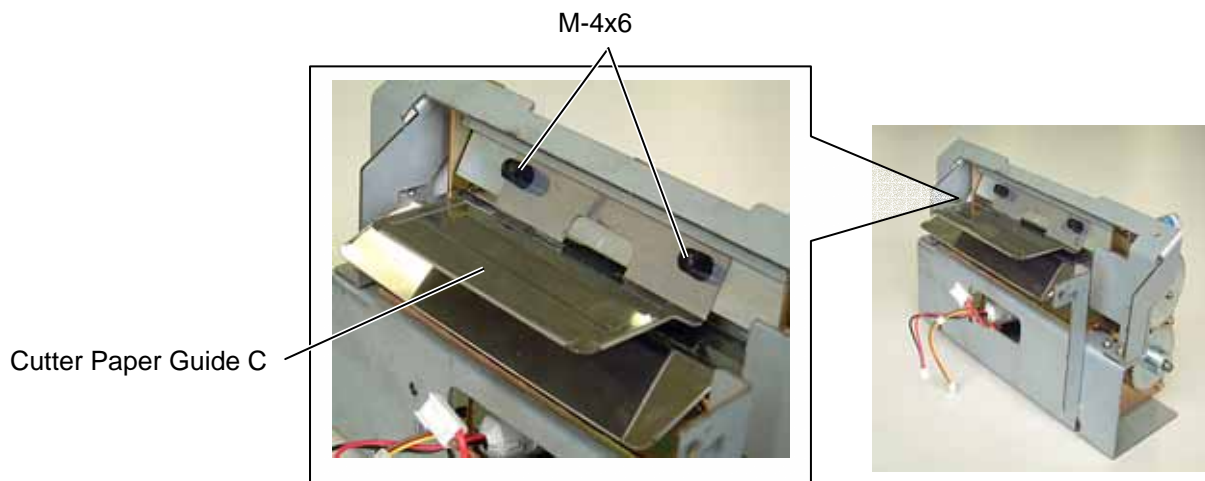

- (2) Secure the B-SX cutter paper guide C with the M-4x6 set screws while pushing it upward.

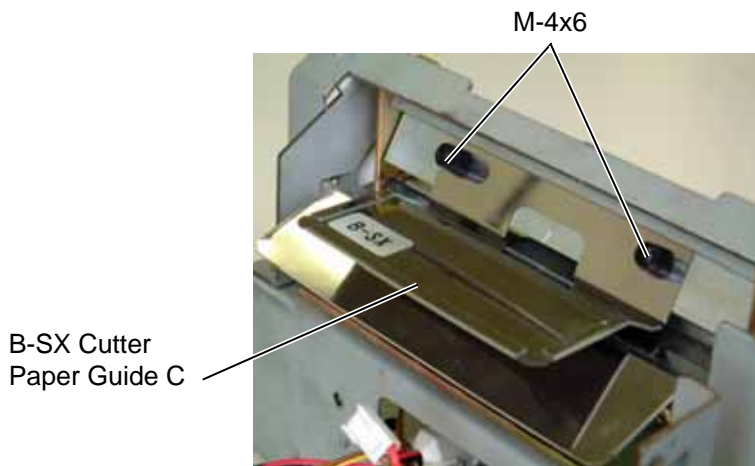

- 1) Turn the power off and disconnect the power cord.
- 2) Open the top cover, and push up the hooker and take out the front cover bottom.



- 3) Remove the three M3x6 screws from the side panel (L). Move the side panel (L) to the back and push up it to remove.

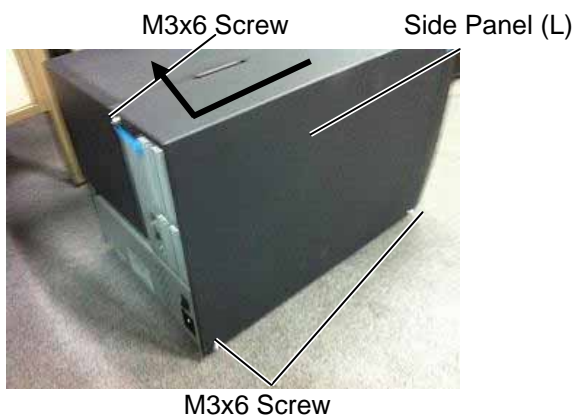

- 4) Fix the cutter drive unit to the printer with the three M-4x8 screws.

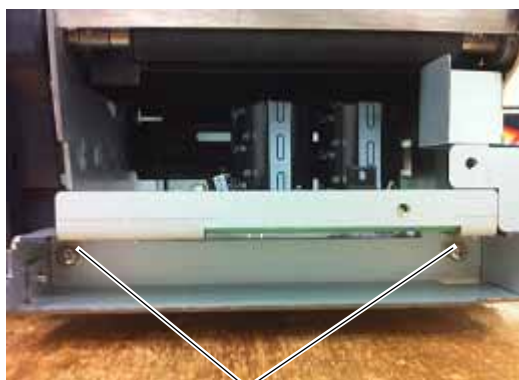

5) Connect the 9-pin connector of the harness ass'y to CN7 on the cutter driver unit, respectively.



6) Fit the bush to the harness ass'y in the orientation as shown below.

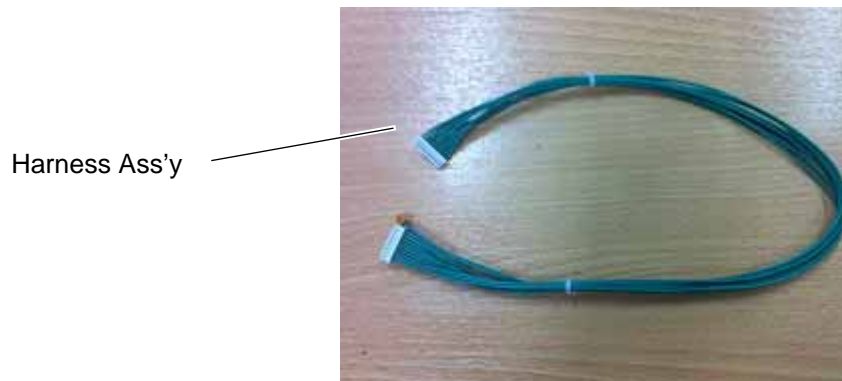

7) Insert the harness ass'y into the hole in the main frame. Fit the bush into the hole.

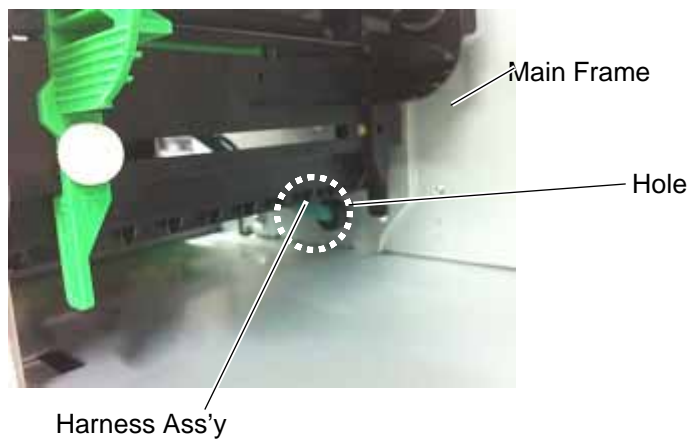

- 8) Fix the harness ass'y with the clamp.
- 9) Connect the 9-pin connector of the harness ass'y to CN15, and 2-pin connector to CN18 on the Main PC board, respectively.

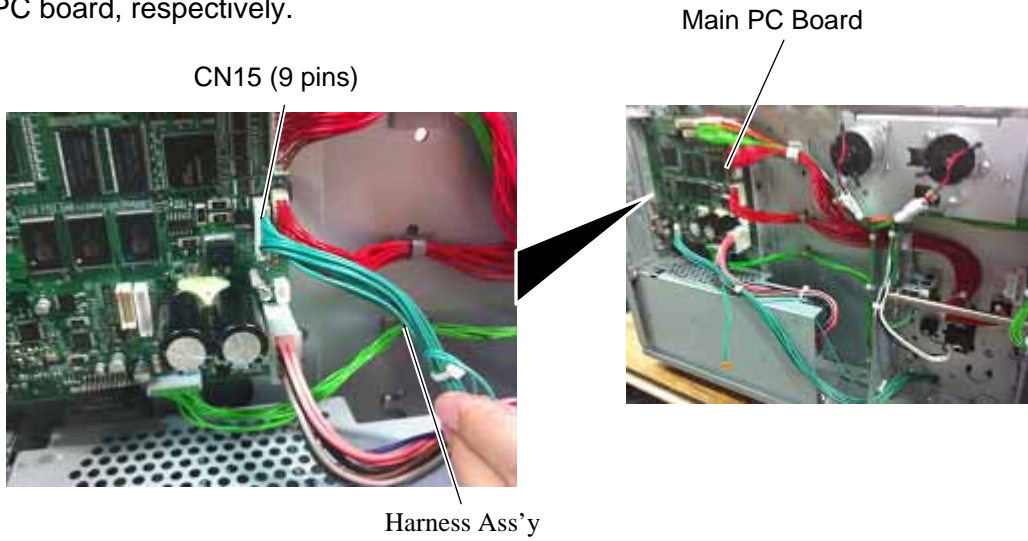

- 10) Turn the head lever counterclockwise to **Free** position.
- 11) Open the ribbon shaft holder plate.

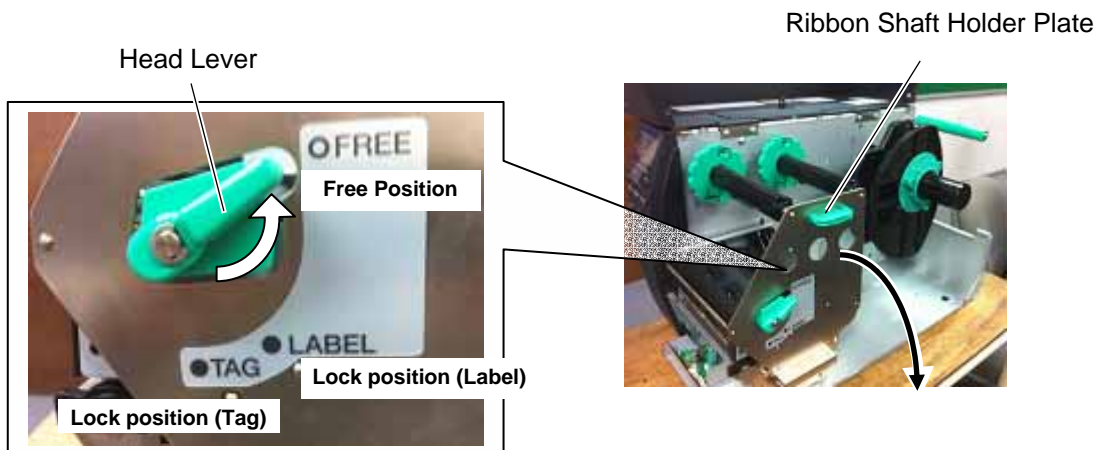

- 12) Raise the print head block until it stops.

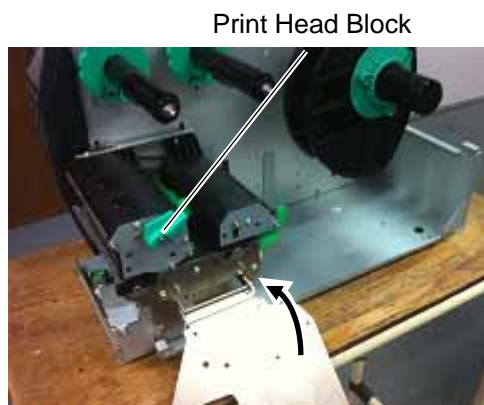



- 13) Connect the four harnesses of the cutter unit to CN8, CN10, CN11 and CN12 on the cutter drive unit.

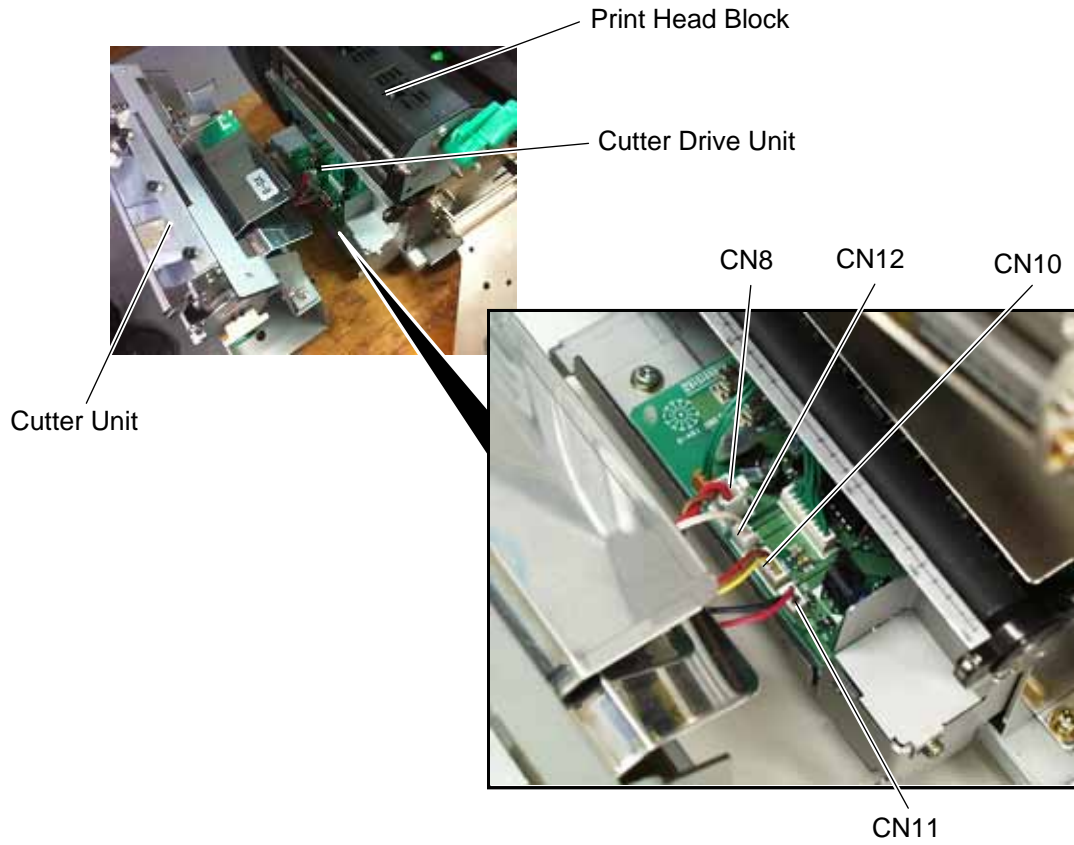

- 14) Fit the two tabs of the cutter drive unit into the notches, and then fix the cutter unit with the three SM-4x8 screws.



- 15) Attach the cutter cover to the cutter unit with the two screws so that the tab of the cutter cover turns on the cutter cover open switch.

**NOTES:** 1. Be careful not to pinch the cutter harness by the cutter cover.  
2. Make sure that the anti-static brush is protruding from the media outlet.

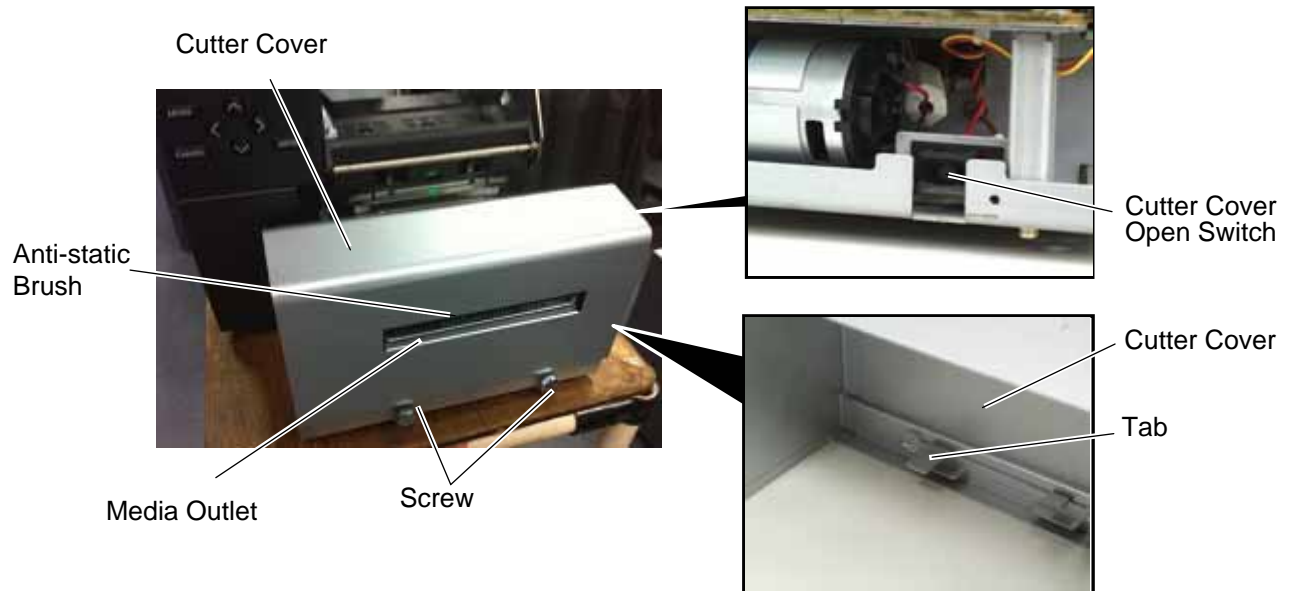

- 16) Close the print head block and ribbon shaft holder plate.

**NOTE:** DO NOT excessively push down the print head block to close it. Doing so may cause a failure of the print head block or damage to the print head.







- 17) Reassemble the side panel (L) and close the top cover. Finally check the cutter operation.

### 4.3 PEEL OFF MODULE (B-EX904-H-QM-R)

This optional device is used for strip print, which cannot be used together with either B-EX204-QM-R or B-EX204-R-QM-R.

When using a strip module together with an RFID module, be sure to install the RFID module prior to the strip module.

All the following parts are supplied with the kit. Make sure you have all items shown below.

<p>Rewinder Ass'y (1 pc.)</p> 	<p>Rewinder Guide Plate (1 pc.)</p> 	<p>Bush (1 pc.)</p> 
<p>Strip Sensor (TR) (1 pc.)</p> 	<p>Strip Sensor (LED) (1 pc.)</p> 	<p>Rewind Paper Guide (1 pc.)</p> 

- Installation Manual (1 copy)
- SM-4x8B Screw (10 pcs.)
- SM-3x6B Screw (1 pc.)
- SM-4x8C Screw (1 pc.)

- 1) Turn the power off and disconnect the power cord.
- 2) Open the top cover, and push up the hooker and take out the front cover bottom.

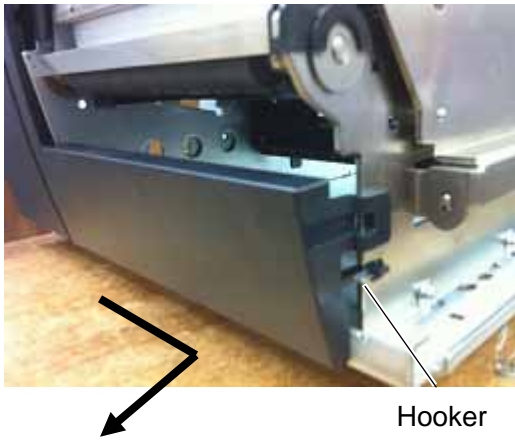

- 3) Remove the three M3x6 screws from the side panel (L). Move the side panel (L) to the back and push up it to remove.



- 4) Lock off the hook and remove the iron sheet.

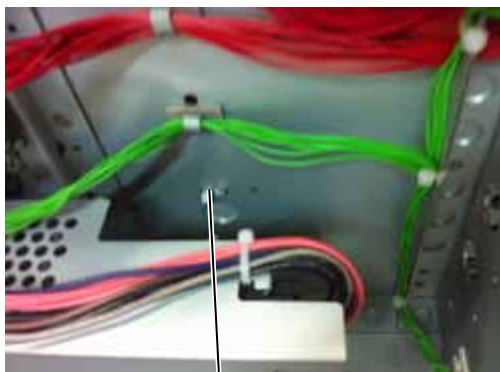

- 5) Align the notch of the take-up holder with the screw hole of the rewinder ass'y, and attach them to the printer with the four M-3x6 screws and the M-3x6 screw.
- 6) Attach the rewind full sensor (LED) to the base with the SM-3x6 screw.
- 7) Fit the bush to the longer harness of the rewind full sensor (Tr) and the rewinder harness in the orientation shown below.

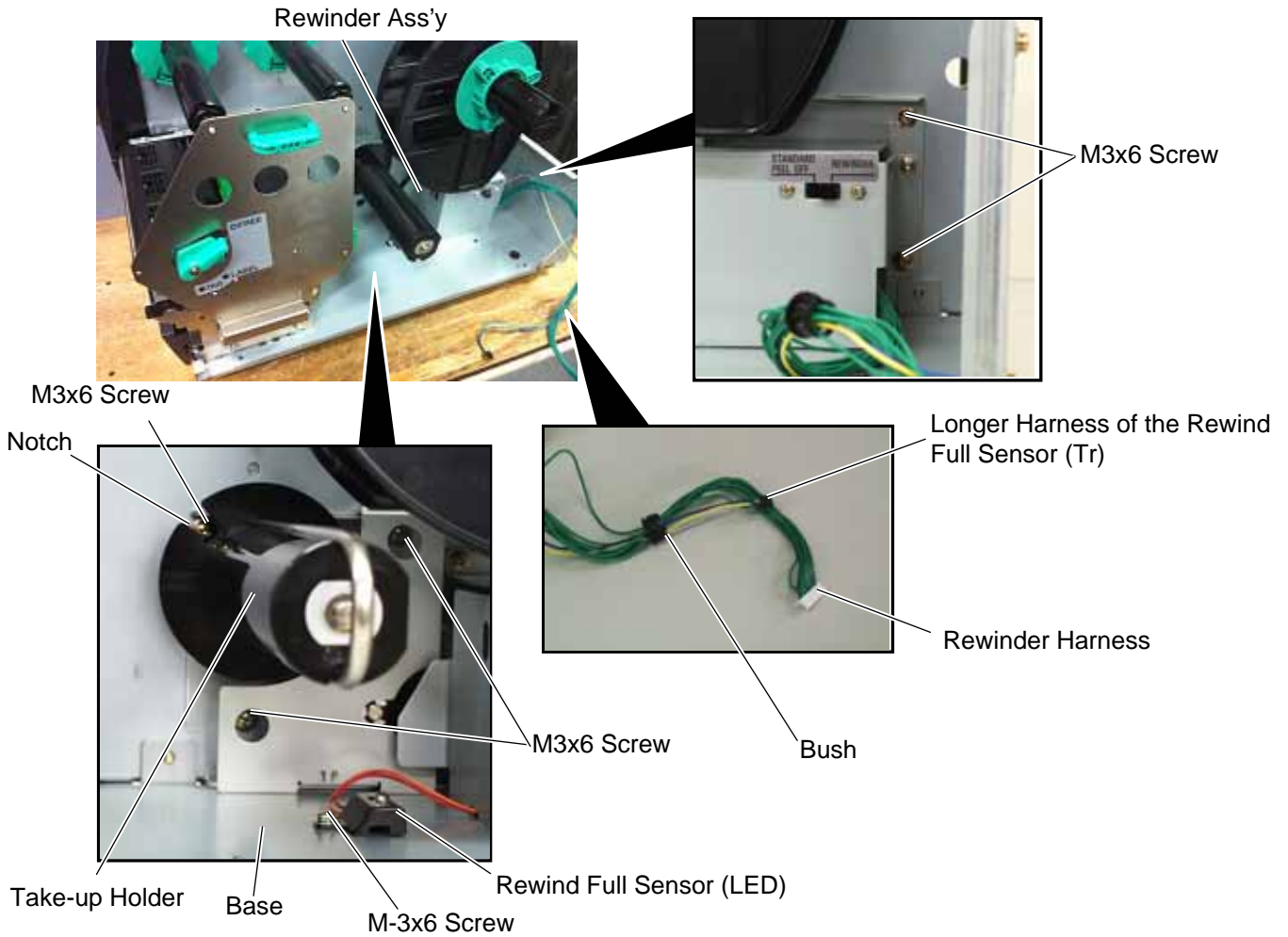



- 8) Insert the longer harness of the rewind full sensor (Tr) into the hole in the printer frame. Fit the bush into the hole.

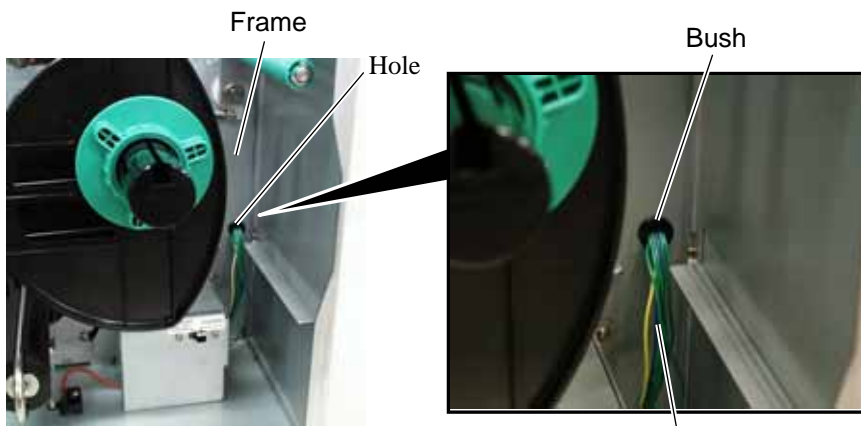

Longer Harness of the Rewind Full Sensor (Tr)

- 9) Connect the longer harness of the rewind full sensor (Tr) and the rewinder harness to CN4 and CN15 on the Main PC board.

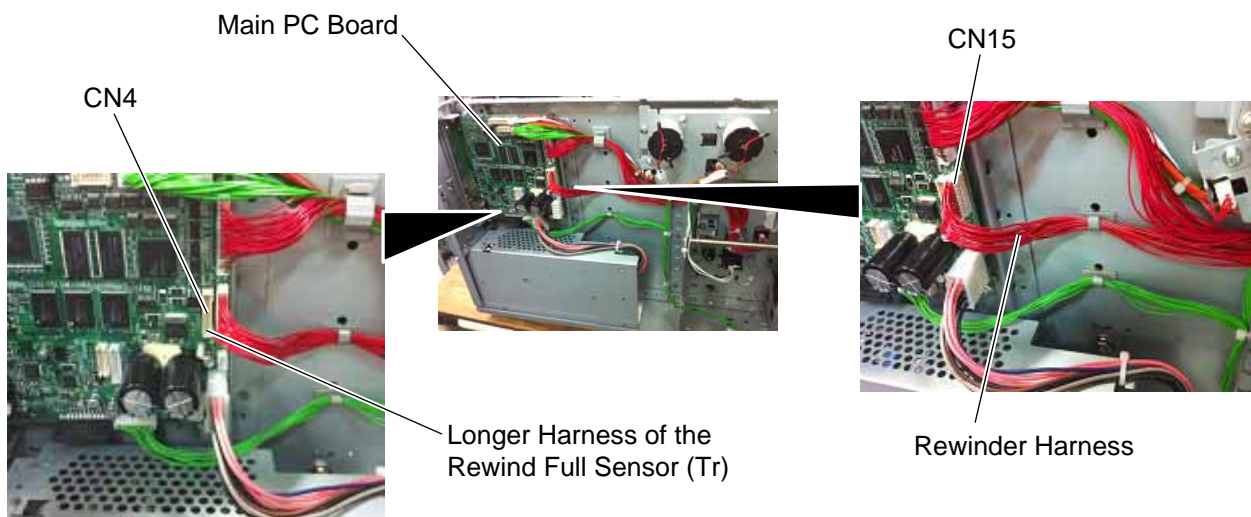

**NOTES:** 1. You should change the selection switch setting depending on the issue mode. Improper setting may affect the print quality.

STANDARD/PEEL OFF (STRIP): Batch or strip mode  
 REWINDER: Built-in rewinder mode  
 For the cut mode, the selection switch can be set to either position.

Selection Switch



2. The backing paper can be wound directly onto the Take-up Spool or a paper core. When using the Take-up Spool, detach the holder stopper by removing the B-3x4 screw. Otherwise, it may be difficult to pull out the wound backing paper roll. When using a paper core, put the core on the Take-up Spool with the Holder Stopper on it, and attach the top edge of the backing paper to the core with adhesive tape. The Take-up clip is not necessary. This winding method is applicable to the Built-in Rewinder mode.

Holder Stopper

B-3x4 Screw

Take-up Spool

Take-up Clip

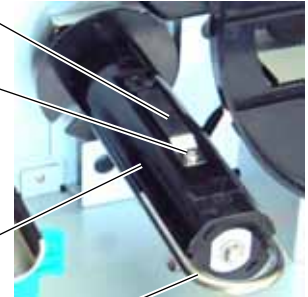

- 10) Turn the head lever counterclockwise to **Free** position.
- 11) Open the ribbon shaft holder plate.

Head Lever

Ribbon Shaft Holder Plate

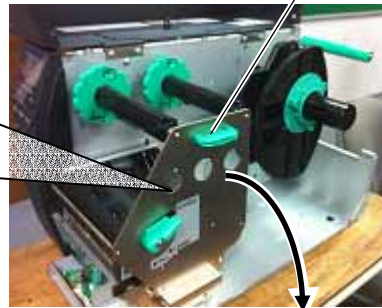
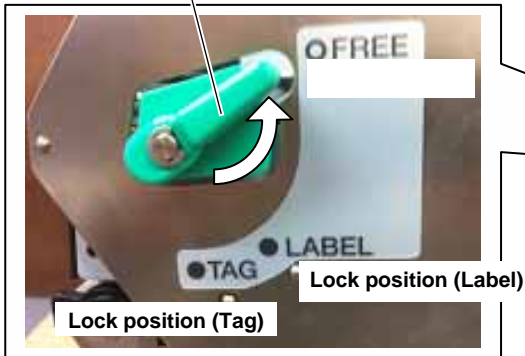

- 12) Raise the print head block until it stops.

Print Head Block

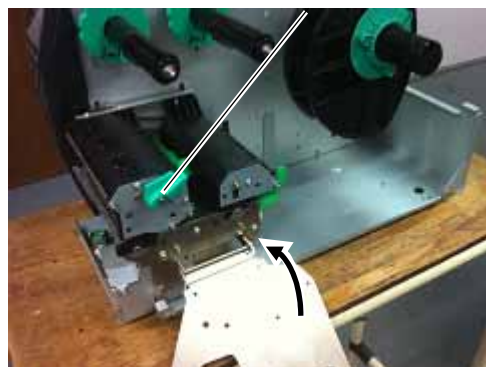

13) Raise the print head block until it stops.

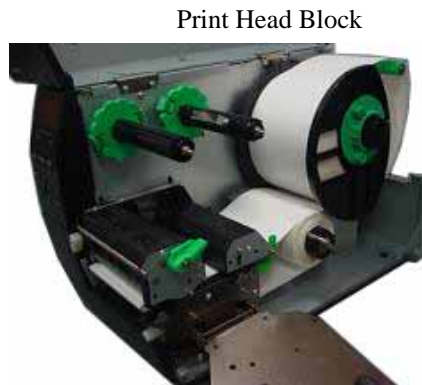

14) Secure the strip sensor (LED) and strip sensor (Tr) to the printer with the M4x6 screws.

15) Connect the shorter harness of the strip sensor (Tr) to the strip sensor harness (for LED).

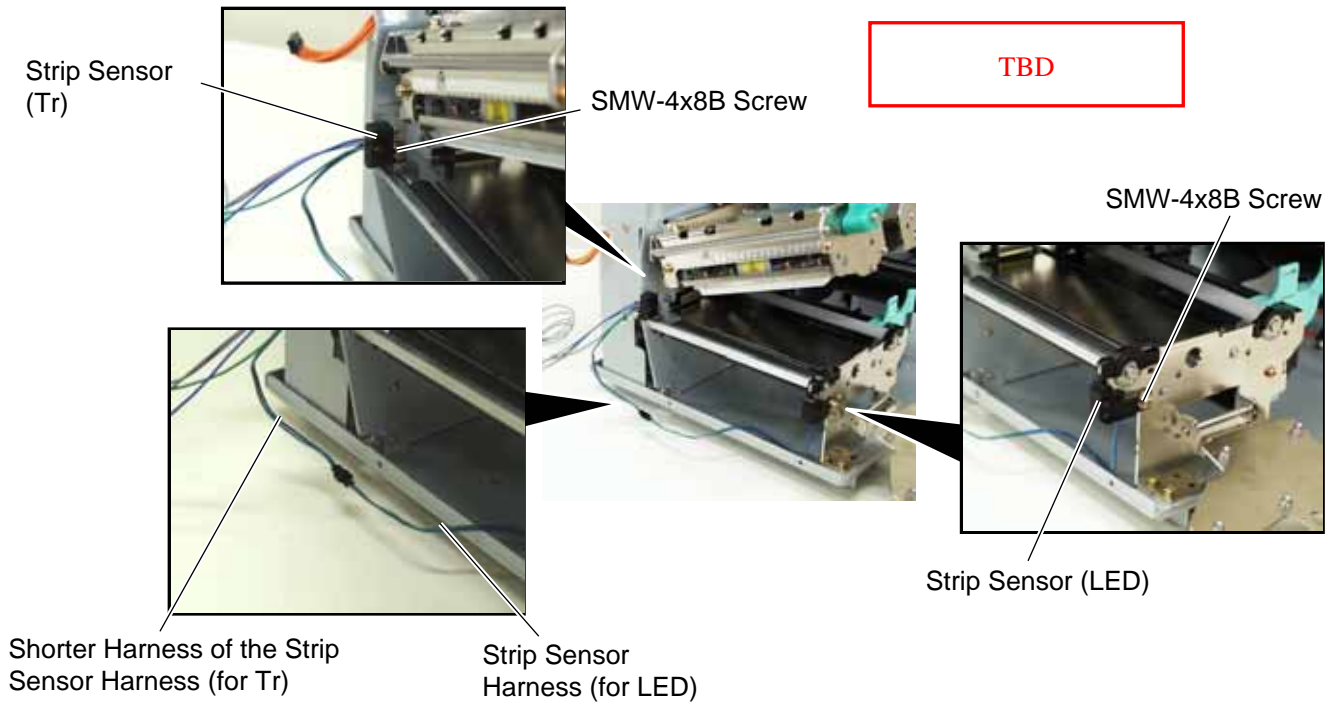



- 16) Fix the connected strip sensor harness (for LED) to the base with the cable clamp. While passing the other strip sensor harness through the cut and the bush, reassemble the operation panel ass'y to the printer. Then pass the strip sensor harness over the tab on the back of the operation panel ass'y.

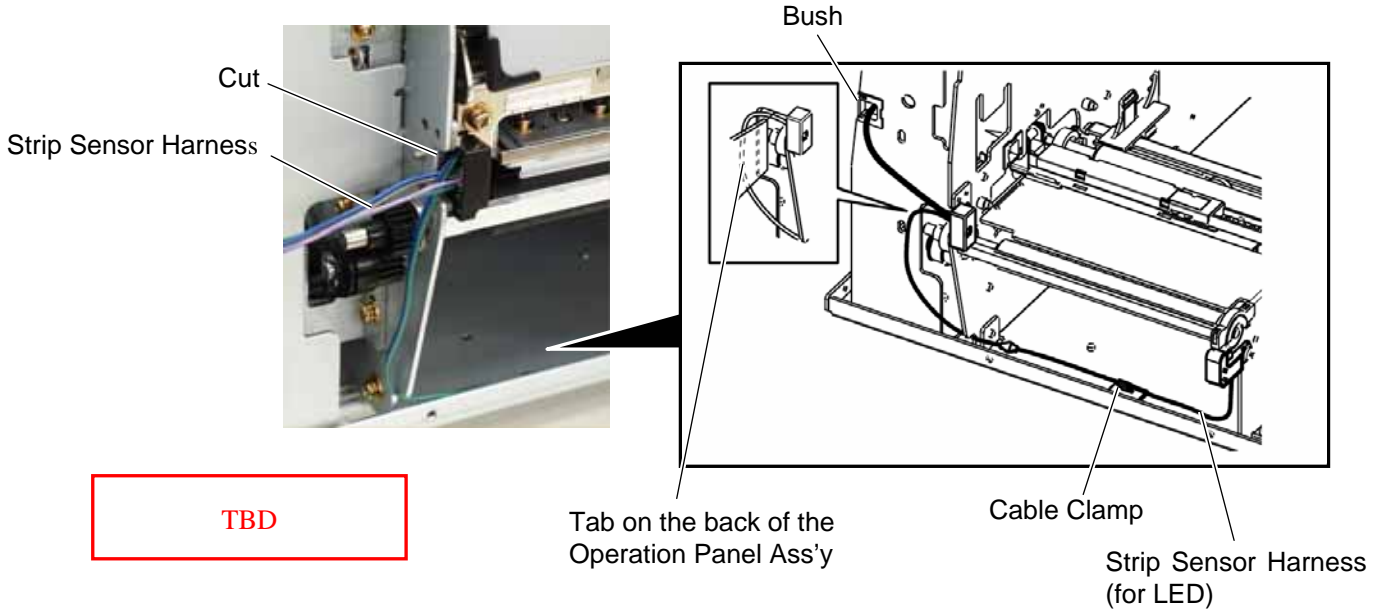

- 17) Fix the strip sensor harness with the three cable clamps and connect it to CN20 on the Main PC board.

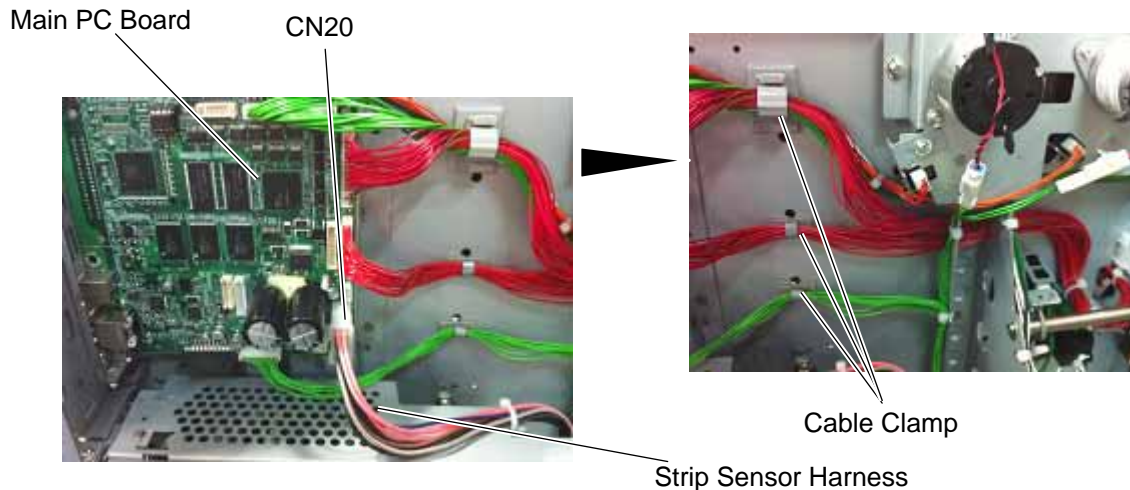

- 18) Reassemble the side panel (L) in the reverse order of removal.  
 19) Close the print head block and ribbon shaft holder plate.

**NOTE:** DO NOT excessively push down the print head block to close it. Doing so may cause a failure of the print head block or damage to the print head.

- 20) When using the printer in batch mode or strip mode, attach the front plate removed in step 2).
- 21) When using the printer in built-in rewinder mode, attach the rewinder guide plate to the front of the printer with the two SMW-4x8B screws.

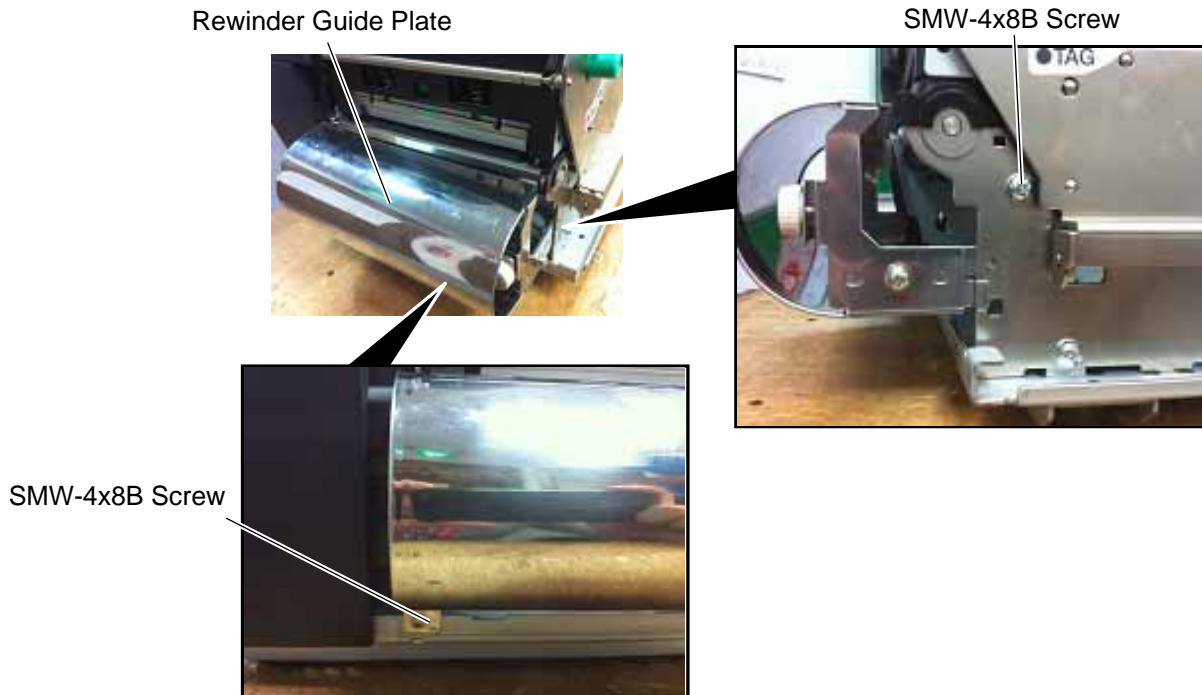

## 22) Adjustment

If the label skews when using the built-in rewinder unit, turn the adjustment knob of the rewinder guide plate to correct the media feed. Clockwise turn moves the rewinder guide plate forward and counterclockwise turn moves it backward.



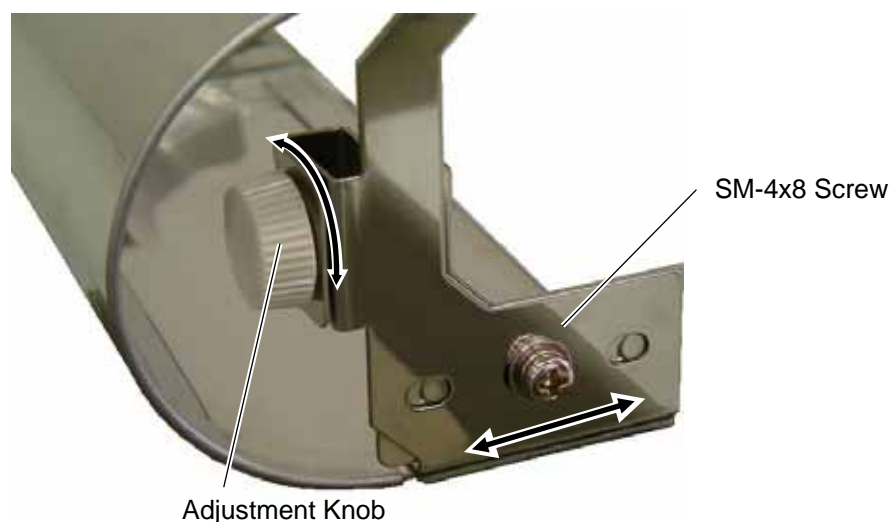

- When labels skew to the right:  
Loosen the SM-4x8 screws, turn the adjustment knob clockwise, and tighten the SM-4x8 screw when the rewinder guide plate is positioned correctly.
- When labels skew to the left:  
Loosen the SM-4x8 screw, turn the adjustment knob counterclockwise, and tighten the SM-4x8 screw when the rewinder guide plate is positioned correctly.



### 4.4 RIBBON SAVING MODULE (B-EX904-R-QM-R)

All the following parts are supplied with the kit. Make sure you have all items shown below.

**NOTE:** The ribbon saving module is standard on the B-EX4T series.

<p>Solenoid (1 pc.)</p> 	<p>RSV PC Board (1 pc.)</p> 	<p>Solenoid Harness (1 pc.)</p> 
<p>Cable Clamp (1 pc.)</p> 	<p>Locking Support (3 pcs.)</p> 	<ul style="list-style-type: none"> <li>• Installation Manual (1 copy)</li> <li>• SM-4x8 Screw (2 pcs.)</li> </ul>



- 1) Remove the side panel (L) from the printer. (Refer to section 3.2.)
- 2) Remove the operation panel ass'y from the printer. (Refer to section 3.4.)
- 3) Fit the three locking supports into the RSV PC board.

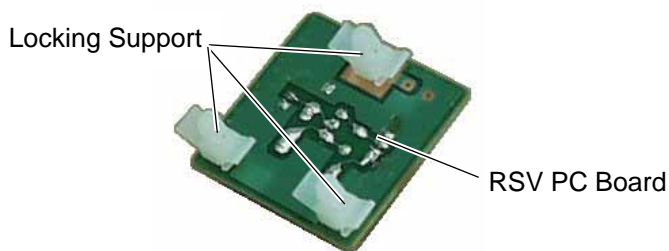

- 4) Secure the RSV PC board to the printer with the locking supports.

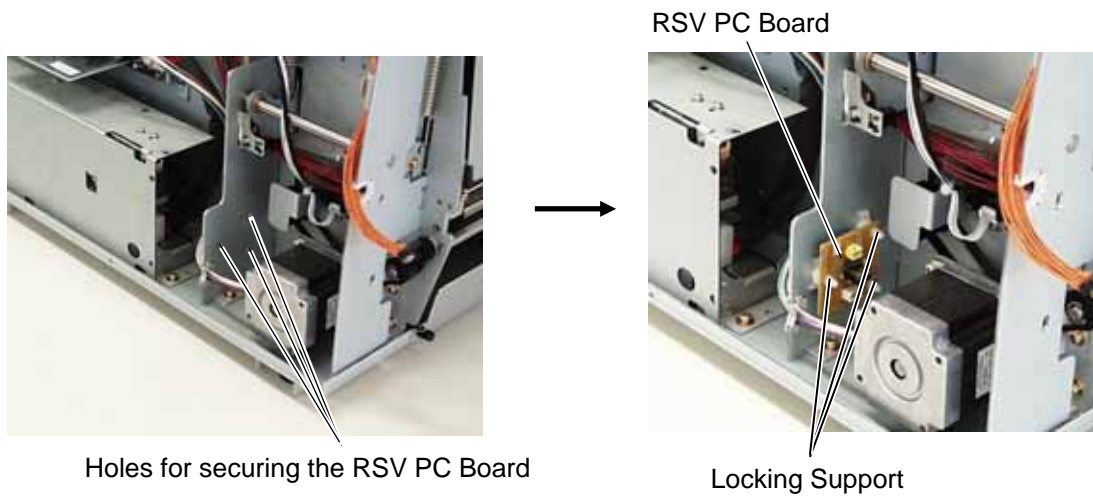

**NOTE:** Do not push the center of the RSV PC board when attaching it to the printer. Doing so may break the PC board. Hold the locking supports and push them into the holes for securing the RSV PC board.

- 5) Insert folded tag paper (1.5-mm thick) between the print head and the platen, and then turn the head lever to **Lock** position. Insert the head up arm into the plunger of the solenoid. While holding down the head up arm slightly, lift the solenoid. Secure the solenoid to the frame with the two SM-4x8 screws keeping the solenoid in contact with the spacer.

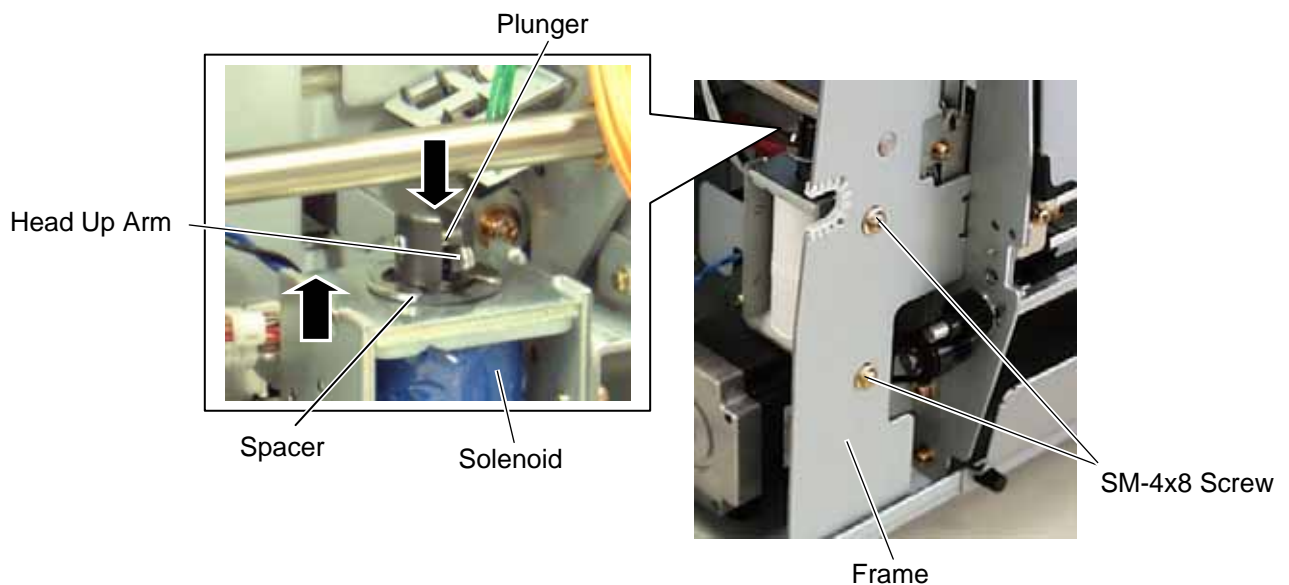



- 6) Attach the cable clamp to the frame of the printer. Fix the solenoid cable with this cable clamp.

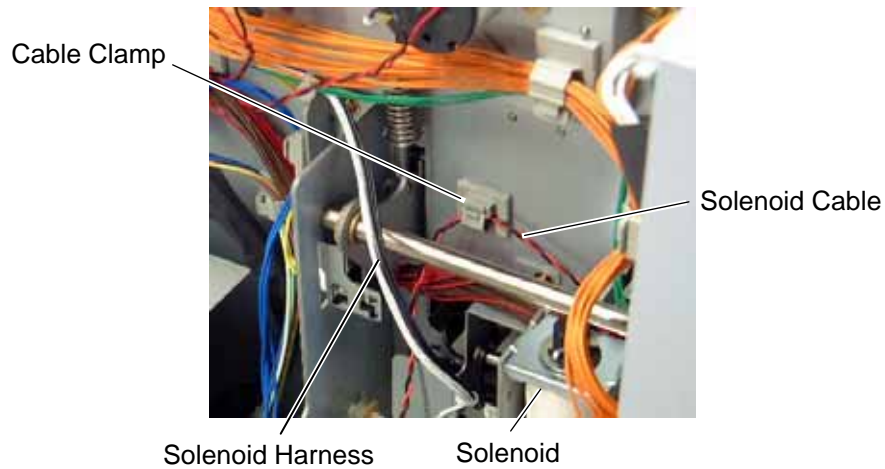

**NOTE:** Be careful not to snag the solenoid harness when running it.

- 7) Connect the solenoid harness to CN1 on the RSV PC board and CN11 on the Main PC board. Pass the solenoid harness through the cut.
- 8) Connect the solenoid cable to CN2 on the RSV PC board.

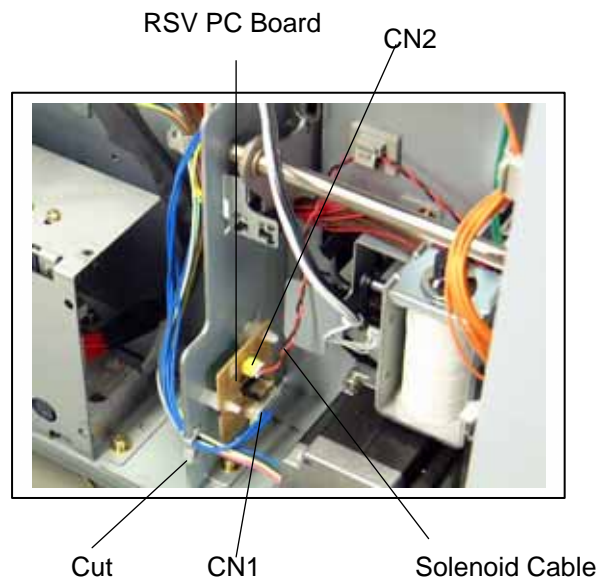
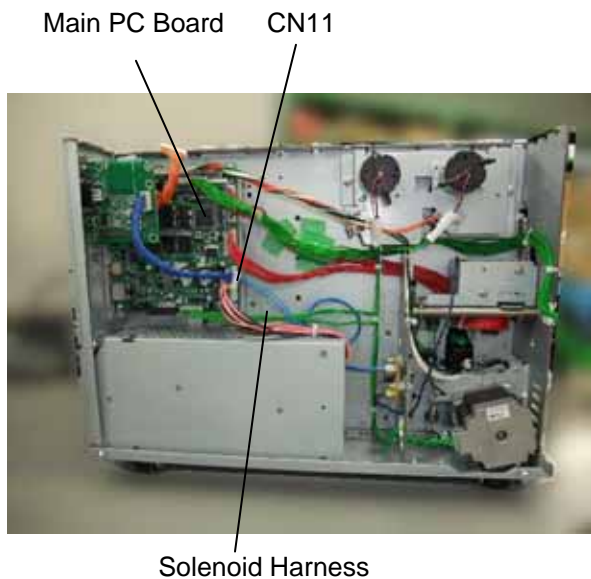

- 9) After attaching the solenoid, reassemble the operation panel ass'y and the side panel (L) in the reverse order of removal.

### 4.5 RTC/USB Host I/F Card (B-EX700-RTC-QM-R)



This optional interface board is provided with the interface port, which allows for the installation of USB devices.

**WARNING!**

1. *Follow all manual instructions. Failure to do so could create safety hazards such as fire or electrocution.*
  - *Manual instructions must be followed when installing option kits or adding cables to avoid system failures and to insure proper performance and operation.*
  - *Failure to follow manual instructions or any unauthorized modifications, substitution or change to this product will void the limited product warranty.*
2. *Turn the power off and disconnect the power cord before installing the RTC/USB host I/F card.*
3. *Be careful not to pinch your fingers or hands with the covers.*

### Packing List

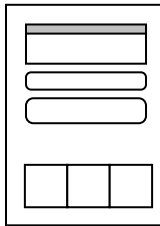
The following parts are supplied with the kit. Make sure you have all items shown below.

RTC/USB host I/F card (1 pc.) 	Installation Manual (1 copy) 	SMW-3x6 Screw (6 pcs.) 
---	--	--

### Installation Procedure

Step 1. Remove the three M3x6 screws from the side panel (L). Move the side panel (L) to the back and push up it to remove.



Step 2. Remove the Blind Plate C from the back.

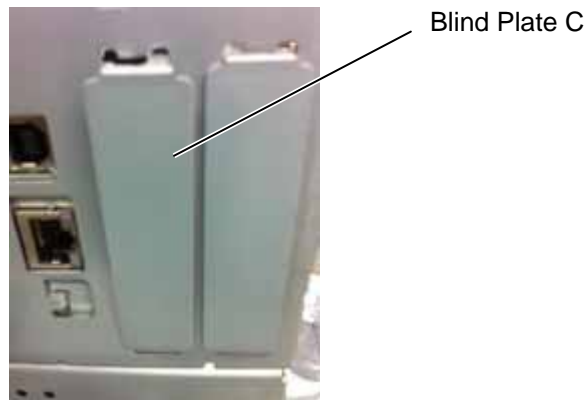

Step 3. Install the B-EX700-RTC-QM-R RTC/USB host I/F card in the printer. And fix the 2 M-3x6 screws from the back.

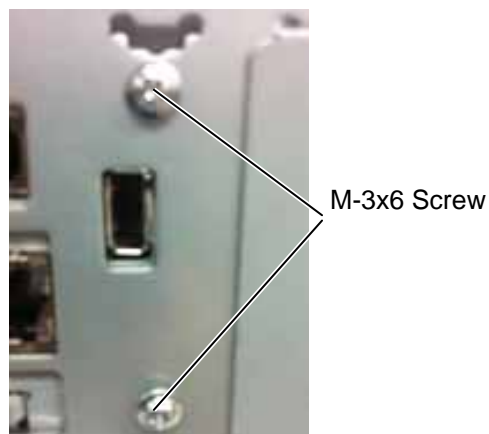

Step 4. Connect the RTC/USB host I/F card harness to J21 on the Main PC Board.

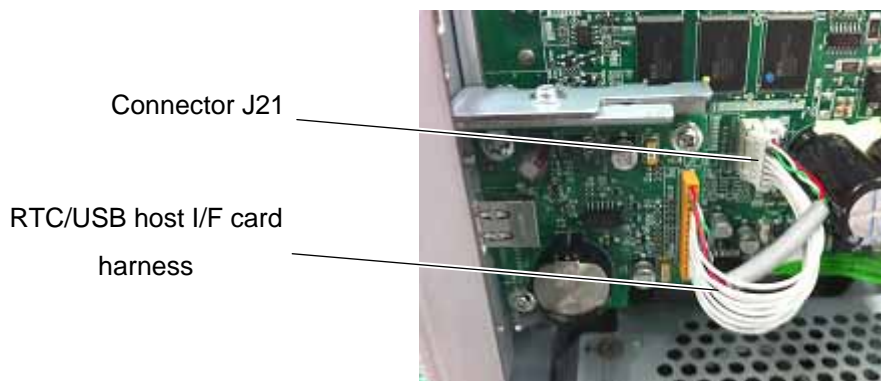

Step 5. Re-attach the Side Panel (L) to the printer.



### 4.6 EXPANSION I/O INTERFACE BOARD (B-EX700-IO-QM-R)

This optional interface board is provided with an expansion I/O interface.

<b>WARNING!</b>
<ol style="list-style-type: none"> <li>1. <i>Follow all manual instructions. Failure to do so could create safety hazards such as fire or electrocution.</i> <ul style="list-style-type: none"> <li>• <i>Manual instructions must be followed when installing option kits or adding cables to avoid system failures and to insure proper performance and operation.</i></li> <li>• <i>Failure to follow manual instructions or any unauthorized modifications, substitution or change to this product will void the limited product warranty.</i></li> </ul> </li> <li>2. <i>Turn the power off and disconnect the power cord before installing the Expansion I/O Board.</i></li> <li>3. <i>Be careful not to pinch your fingers or hands with the covers.</i></li> </ol>

### Packing List

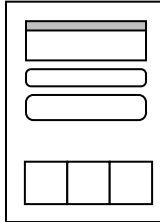
The following parts are supplied with the kit. Make sure you have all items shown below.

<p>Expansion I/O Board (1 pc.)</p> 	<p>Installation Manual (1 copy)</p> 	<p>SMW-3x6 Screw (3 pcs.)</p> 
---	--	--



## Installation Procedure

- Step 1. Remove the three M3x6 screws from the side panel (L). Move the side panel (L) to the back and push up it to remove.

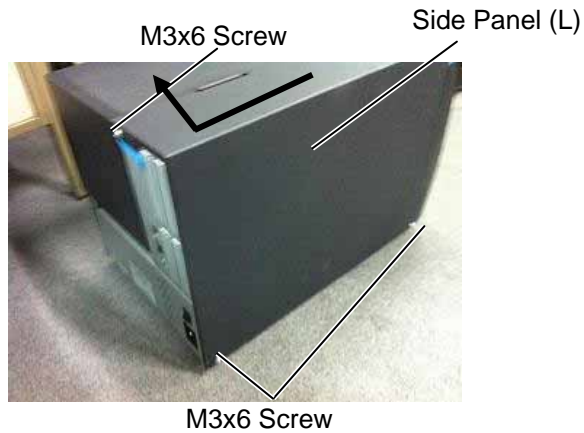

- Step 2. Remove the Blind Plate D from the back.



- Step 3. Install the B-EX700-IO-QM-R Expansion I/O Board in the printer. And fix the 2 M-3x6 screws from the back.

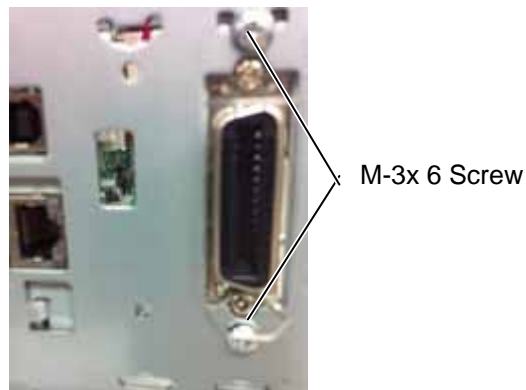

Step 4. Connect the Expansion I/O Board harness to J3 on the Main PC Board.

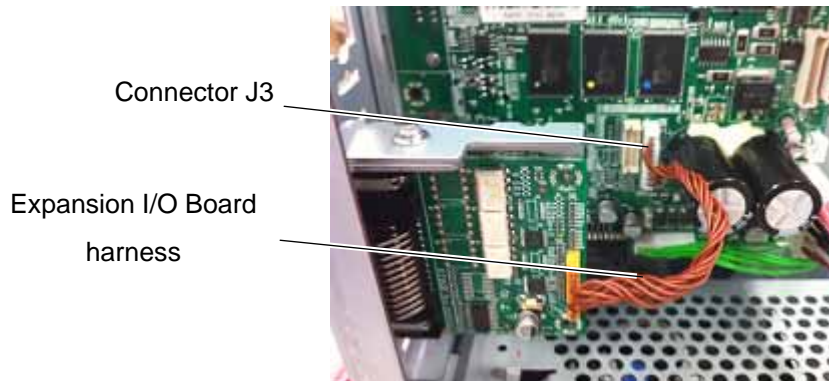

Step 5. Reassemble the side panel (L) in the reverse order of removal.

Step 6. Perform a loop back check to confirm that the expansion I/O board functions properly.

### 4. 7 WIRELESS LAN BOARD (B-EX700-WLAN-QM-R)



This optional interface board is provided with an expansion I/O interface.

**WARNING!**

1. *Follow all manual instructions. Failure to do so could create safety hazards such as fire or electrocution.*
  - *Manual instructions must be followed when installing option kits or adding cables to avoid system failures and to insure proper performance and operation.*
  - *Failure to follow manual instructions or any unauthorized modifications, substitution or change to this product will void the limited product warranty.*
2. *Turn the power off and disconnect the power cord before installing the Expansion I/O Board.*
3. *Be careful not to pinch your fingers or hands with the covers.*

### Packing List

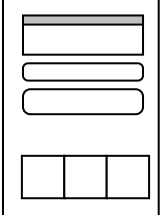
The following parts are supplied with the kit. Make sure you have all items shown below.

<p>WLAN Board (1 pc.)</p> 	<p>Installation Manual (1 copy)</p> 	<p>SMW-3x6 Screw (6 pcs.)</p> 
--	--	--

## Installation Procedure

- Step 1. Remove the three M3x6 screws from the side panel (L). Move the side panel (L) to the back and push up it to remove.

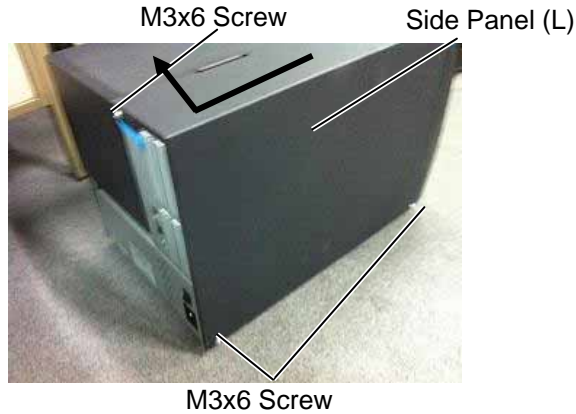

- Step 2. Remove the Blind Plate D from the back.



- Step 3. Install the B-EX700-IO-QM-R Expansion I/O Board in the printer. And fix the 2 M-3x6 screws from the back.

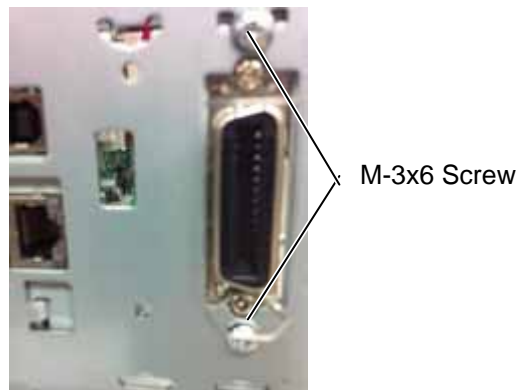

Step 4. Connect the Expansion I/O Board harness to J3 on the Main PC Board.

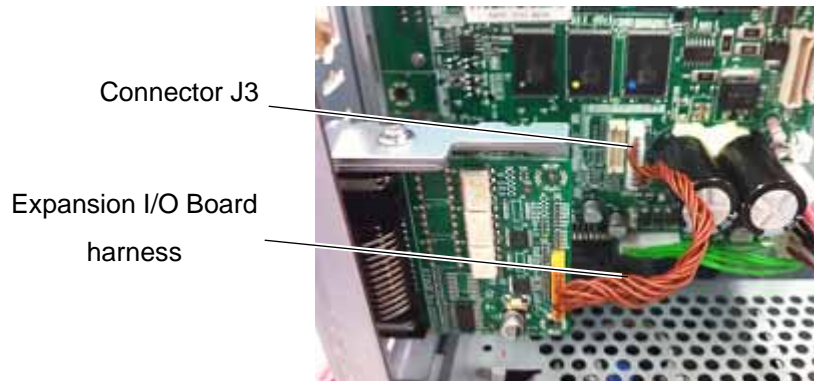

Step 5. Reassemble the side panel (L) in the reverse order of removal.

Step 6. Perform a loop back check to confirm that the expansion I/O board functions properly.



### 4.8 PARALLEL INTERFACE card (B-EX700-CEN-QM-R)

B-EX700-CEN-QM-R is an optional parallel interface card for the B-EX4T/EX6T-QM-R Series.

<b>WARNING!</b>
<ol style="list-style-type: none"> <li>1. <i>Follow all manual instructions. Failure to do so could create safety hazards such as fire or electrocution.</i> <ul style="list-style-type: none"> <li>• <i>Manual instructions must be followed when installing option kits or adding cables to avoid system failures and to insure proper performance and operation.</i></li> <li>• <i>Failure to follow manual instructions or any unauthorized modifications, substitution or change to this product will void the limited product warranty.</i></li> </ul> </li> <li>2. <i>Turn the power off and disconnect the power cord before installing the parallel interface card.</i></li> <li>3. <i>Be careful not to pinch your fingers or hands with the covers.</i></li> </ol>

### Packing List

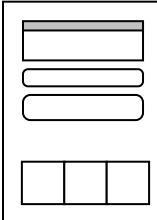
The following parts are supplied with the kit. Make sure you have all items shown below.

<p>Parallel I/F Card (1 pc.)</p> 	<p>Installation Manual (1 copy)</p> 	<p>-3x6 Screw (3 pcs.)</p> 
---	--	---



### Installation Procedure

Step 1. Remove the three M3x6 screws from the side panel (L). Move the side panel (L) to the back and push up it to remove.

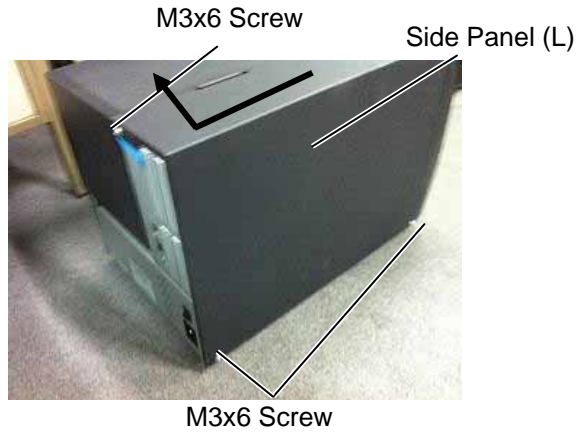

Step 2. Remove the Blind Plate A from the back.



Step 3. Install the B-EX700-CEN-QM-R Parallel I/F card in the printer. And fix the 2 M-3x6 screws from the back.

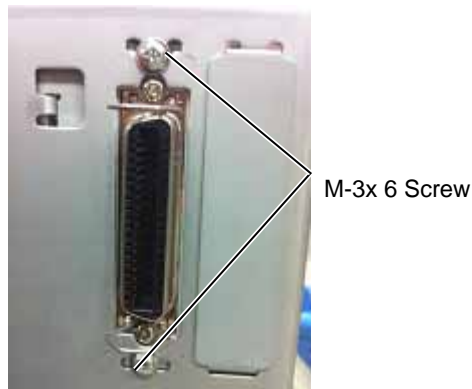

Step 4. Connect the parallel interface harness to J2 on the Main PC Board.

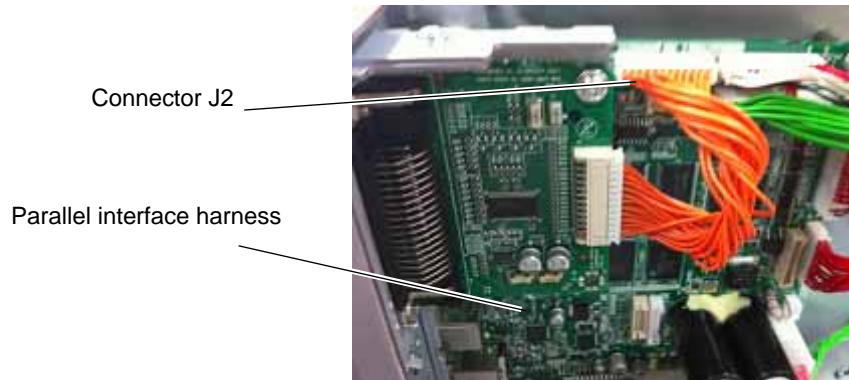

Step 5. Re-attach the Side Panel (L) to the printer.

## 5. SYSTEM MODE

The system mode can be entered by the following procedure from printer power off condition.

- Press [FEED] key and [PAUSE] key at the same time
- Press [MODE] Key

In this mode, the printer self-test operation and parameter setting operation are performed.

When displaying top menu, main firmware version is shown at right side of title.

The language displayed on the panel is Japanese if Japanese is selected by language setting and English if English, German, French, Dutch, Spanish, Italian or Portuguese is selected.

### 5.1 OPERATION PANEL

The figure below illustrates the Operation Panel and key functions.

The figure below illustrates the Operation Panel and key functions.

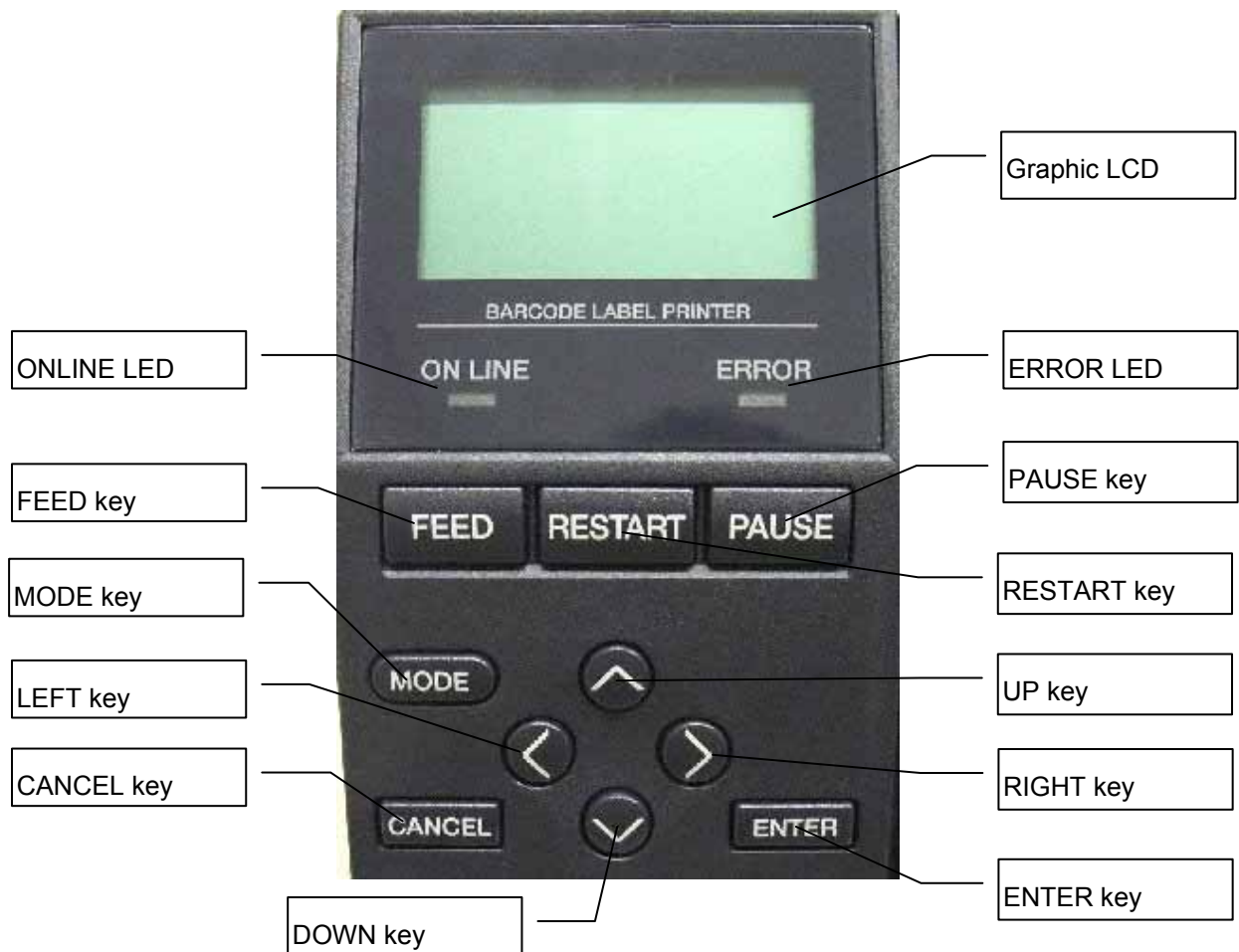

The LCD Message Display shows messages in alphanumeric characters and symbols to indicate the printer's status. Up to 16 characters in 2 lines can be displayed.

There are three LEDs on the Operation Panel.

LED	Illuminates when...
POWER	The printer is turned on.
ON LINE	The printer is ready to print.
ERROR	Any error occurs with the printer.

In System Mode, the keys function as described below.

Key	Compatible Key	Function
[MODE]	Non	Display top menu without saving setting.
[CANCEL]	[FEED] + [RESTART]	Display upper menu without saving setting.
[ENTER]	[PAUSE]	Display next menu.
[UP]	[FEED]	Move cursor up. Not move when cursor in the upset position.
[DOWN]	[RESTART]	Move cursor down. Not move when cursor is in the lowest position.
[LEFT]	Non	No function.
[RIGHT]	Non	No function

## 5.2 OVERVIEW

System Mode consists of nine main menus:

DIAG.	Perform self diagnostics test and print result, print head failure test.
PARAMETER SET	Set the parameter for each function of printer.
ADJUST SET	Adjust printer mechanism position and sensor.
TEST PRINT	Perform slant line printing, character printing and barcode printing.
SENSOR ADJUST	Display outer temperature and head temperature and adjust each paper sensor.
RAM CLEAR	Clear maintenance counter and parameter.
INTERFACE	Set interface setting like network, USB, RS232C and parallel.
BASIC	Set the function of basic program when it is loaded printer.
FOR FACTORY	Set factory default.
RFID	Set RFID parameter.
RTC	Set date&time and time which is reflected for printing.
Z-MODE	Same as BASIC. It is not displayed if the model is JA.
USB MEMORY	Load the firmware which is stored in USB memory and save information to USB memory.
RESET	Restart the printer.

## 5.3 SELF-DIAGNOSTIC TEST

### ■ Outline of Self-Diagnostic Test

In the Self-Diagnostic Test mode, the printer checks and prints out the printer system information such as the sensor or interface, and the Maintenance Counter. Also it makes the print head broken element check.

The **Self-Diagnostic Test** contains the following sub menus:

DIAG. menu item list

MENU ITEM	
System Mode / SYSTEM MODE	
<1>	Diagnostics / <1>DIAG.
	Counter, Parameter / MAINTENANCE CONT
	Auto Diagnostics / AUTO DIAGNOSTIC
	Head broken dot check / HEAD CHECK

### 5.3.1 Counter, Parameter/ MAINTENANCE COUNT

The MAINTENANCE COUNT print procedure of DIAG. is described.

The menu layer from DIAG. to MAINTENANCE COUNT is below.

MENU ITEM	
System Mode / SYSTEM MODE	
<1>	Diagnostics / <1>DIAG.
	Counter, Parameter / MAINTENANCE CONT
	Print method / PRINT TYPE
	Thermal transfer / TRANSFR
	Direct thermal / DIRECT
	Cut type / CUT TYPE
	Disable / OFF
	Enable / ON
	Print/ CHECKING & PRINT

If error occur during printing, the error message is displayed, the error LED turns on and the onlineLED turns off. The error can be canceled by [ENTER], [CANCEL] or [MODE] key, but printer did not perform re^printing.

• **Menu operation procedure example**

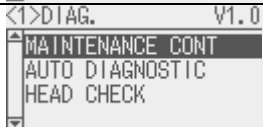
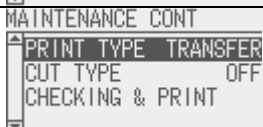
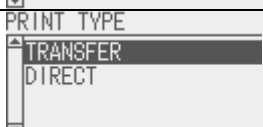
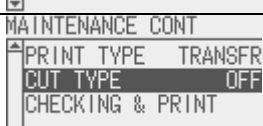
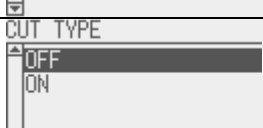
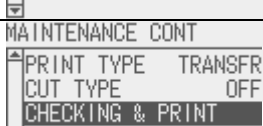
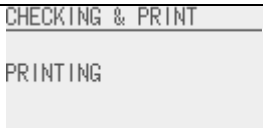
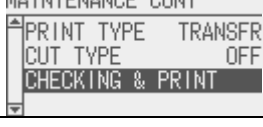
English	Procedure
	Press [FEED] key and [RESTART] key when turning on the printer. Display 「System Mode / SYSTEM MODE」.
	Select <1>Diagnostics/<1>DIAG.」 and press [ENTER] Key. Display 「<1>Diagnostics/<1>DIAG.」 menu.
	Select 「Counter, Parameter/MAINTENANCE CONT」 and press [ENTER] Key. Display 「Counter, Parameter/MAINTENANCE CONT」 menu.
	Select 「Print method / PRINT TYPE」 and press [ENTER] Key. Display 「Print method / PRINT TYPE」 menu.
	Setting printing method. Display 「Counter, Parameter/MAINTENANCE CONT」 menu by pressing [ENTER].
	Press [DOWN] Key, select 「Cut type/ CUT TYPE」 and press [ENTER] Key. Display 「Cut type / CUT TYPE」 menu.
	Setting 「Cut type / CUT TYPE」. Display 「Counter, Parameter/MAINTENANCE CONT」 menu by pressing [ENTER].
	Press [DOWN] Key, select 「Print / CHECKING & PRINT」 and press [ENTER] Key. Print 「Counter, Parameter/MAINTENANCE CONT」.
Printing	
	Display "PRINTING".
Normal printing	
	Display 「Counter, Parameter/MAINTENANCE CONT」 menu.
Print error occur	
	Display the error message and stop issuing. The error LED turns on and the online LED turns off. Display 「Counter, Parameter/MAINTENANCE CONT」 menu by pressing [ENTER] Key or [CANCEL] Key. The error LED turns off and the online LED turns on. After recovery from error, printer does not start printing automatically.



## • COUNTER PARAMETE PRINT CONTENTS

```

<< COUNTER >>
TOTAL FEED 0.0km [QM]
FEED 0.0km
FEED1 0.0km
FEED2 0.0km
FEED3 0.0km
FEED4 0.0km
PRINT 0.0km
PRINT1 0.0km
PRINT2 0.0km
PRINT3 0.0km
PRINT4 0.0km
CUT 0
HEAD U/D 0
RIBBON 0h
SOLENOID 0h
232C ERR 0
SYSTEM ERR 0
POWER FAIL 0
<< ADJUST >>
[PC] [KEY]
FEED +0.0mm FEED +0.0mm
CUT +0.0mm CUT +0.0mm
BACK +0.0mm BACK +0.0mm
TONE(T) +0step TONE(T) +0step
TONE(D) +0step TONE(D) +0step
RBN(FW) +0 RBN(FW) +0
RBN(BK) +0 RBN(BK) +0
X ADJ. +0.0mm
THRESHOLD(R) 0.0V
THRESHOLD(T) 0.0V
<< PARAMETER SETTINGS >>
MEDIA LOAD [STD]
FORWARD WAIT [ON] +0.0mm [MODE1]
HU CUT/RWD. [OFF]
RIBBON SAVE [ON:TAG]
PRE PEEL OFF [OFF]
BACK SPEED [STD]
AUTO CALIB [OFF]
FONT [PC-850] [0]
CODE [AUTO]
PEEL OFF STATUS [ON]
USB I/F STATUS [OFF]
FEED KEY [FEED]
KANJI [TYPE1]
EURO CODE [B0]
AUTO HD CHK [OFF]
WEB PRINTER [OFF]
RIBBON NEAR END [OFF]
EX.I/O MODE [TYPE1]
LBL/RBN END [TYPE1]
MAXI CODE SPEC. [TYPE1]
XML [STD]
THRESHOLD SEL(R) [MANUAL SET]
THRESHOLD SEL(T) [MANUAL SET]
ENERGY TYPE(T) [Semi regin1]
ENERGY TYPE(D) [Standard]
POWER SAVE TIME [15min]
BASIC [OFF]
BASIC TRACE [OFF]
<< PANEL >>
MESSAGE [ENGLISH]
MACHINE NAME [ON]
PRINT PAGE [ON]
IP ADDRESS [ON]
CONTRAST [40]
SYSTEM PASSWORD [OFF]
<< STORAGE AREA >>
TTF AREA [ OKB]
EXT CHR AREA [ OKB]
BASIC AREA [ OKB]
PC SAVE AREA [ OKB]

```

```

<< USB >>
SERIAL NUMBER [DISABLE]
[XXXXXXXXXXXX]
<< RS-232C >>
SPEED [9600]
DATA LENGTH [8]
STOP BIT [1]
PARITY [EVEN]
CONTROL [XON+READY AUTO]
<< CENTRO >>
ACK/BUSY [TYPE1]
INPUT PRIME [ON]
PLUG & PLAY [OFF]
<< LAN/WLAN >>
LAN/WLAN [OFF]
SNMP [OFF]
PRTR IP ADDRESS [192.168.010.020]
GATE IP ADDRESS [000.000.000.000]
SUBNET MASK [255.255.255.000]
SOCKET PORT [OFF] [08000]
DHCP [OFF]
DHCP CLIENT ID [FFFFFFFFFFFFFFFF]
[FFFFFFFFFFFFFFFF]
[FFFFFFFFFFFFFFFF]
[FFFFFFFFFFFFFFFF]
[FFFFFFFFFFFFFFFF]
[FFFFFFFF]
DHCP HOST NAME [ABCDEFGHJKLMNQRST]
[UVWXYZ123456]
WLAN STANDARD [11b/g]
WLAN MODE [INFRASTRUCTURE]
ESS ID [ ]
ENCRYPT [OFF]
WPA MODE [OFF]
AUTH [OPEN SYSTEM]
DEFAULT KEY [1]
802.1X SUPPLICANT [OFF]
802.11b CHANNEL [01]
802.11b BAUD RATE [11M]
802.11g CHANNEL [01]
802.11g BAUD RATE [54M]
POWER SAVE [ON]
WINS [OFF]
WINS IP ADDRESS [000.000.000.000]
LPR [OFF]
<< RFID >>
MODULE [NONE]
TAG TYPE [NONE]
RF CHANNEL [AUTO]
ADJUST RETRY [+00mm]
ISSUE RETRY [ 3labels]
READ RETRY [ 5times] [4.0sec]
WRITE RETRY [ 5times] [4.0sec]
POWER LEVEL [ 0]
Q VALUE [ 0]
AGC THRESHOLD [ 0]
WRITE AGC [ 0]
RETRY MIN AGC [ 0]
TAG CHECK [PASSWORD] [ON] [ON]
MULTI WRITE [OFF]
WRITE OK TAGS 9999999
VOID PRINT TAGS 9999999
<< RTC >>
BATTERY CHECK [ON]
RENEWAL [BATCH]

```

**Print condition:**

Label length	490mm	
Print method	Setting by user	
Sensor type	Non	
Speed	203dpi	6ips
	305dpi	5ips
Issuing number	1 piece	
Issuing mode	Setting by user	
Other	No mount winding motor	

**<< COUNTER >>**

Item	Content	Range
Count condition		
TOTAL FEED	Total label distance covered (cannot be cleared)	0.0 ~ 3200.0 km
Counts when the paper feed motor are driven to feed a paper or print. (Counts also during a reverse feed operation.) When the power is off, the label distance of 50.0 cm or less may be rounded down and backed up.		
FEED	Label distance covered	0.0 ~ 3200.0 km
Counts when the paper feed motor are driven to feed a paper or print. (Counts also during a reverse feed operation.) When the power is off, the label distance of 50.0 cm or less may be rounded down and backed up.		
FEED1 ~ FEED4	Label distance covered historical	0.0 ~ 3200.0 km
The label historical distance.		
PRINT	Print distance	0.0 ~ 200.0 km
Counts while printing. (Counting is not performed during reverse feed operation.) B-EX4T1-G: When the power is off, the print distance of 8.2 m or less is rounded down and backed up. B-EX4T1-T: When the power is off, the print distance of 5.5 m or less is rounded down and backed up.		
PRINT1 ~ PRINT4	Print distance historical	0.0 ~ 3200.0 km
The historical print distance.		
CUT	Cut count	0 ~ 1000000
Every cut operation is counted. When the power is off, a cut count of 31 or less is rounded down and backed up.		
HEAD U/D	Head up/down count	0 ~ 2000000
Counts head up/down operations using the ribbon saving solenoid. (Combination of up and down operations is counted as one.) When the power is off, an up/down count of 31 or less is rounded down and backed up.		
RIBBON	Ribbon motor drive time	0 ~ 2000 Hour
Counts when the ribbon motor is driven to feed a paper or print. (Counts also during a reverse feed operation.) For B-EX4T1-G: When the power is off, a drive time of 32 seconds or less is rounded down and backed up. For B-EX4T1-T: When the power is off, a drive time of 27 seconds or less is rounded down and backed up.		
SOLENOID	Head-up solenoid drive time	0 ~ 1000 Hour
Counts when the ribbon saving operation is performed. For B-EX4T1-G: When the power is off, a drive time of 32 seconds or less is rounded down and backed up. For B-EX4T1-T:		

When the power is off, a drive time of 27 seconds or less is rounded down and backed up.		
232C ERR	RS-232C hardware error count	0 ~ 255
Counts when a parity error or a framing error occurs. * When data of several bytes is transmitted continuously, counting is performed per byte.		
SYSTEM ERR	System error count	0 ~ 15
Counts when a system error occurs.		
POWER FAIL	Momentary power interruption count	0 ~ 15
Counts when a momentary power interruption occurs.		

## &lt;&lt; ADJUST &gt;&gt;

Item	Content	Remark
[PC]FEED	Feed fine adjustment	-50.0mm ~ +50.0mm (*1)
CUT	Cut position (or strip position) fine adjustment	-50.0mm ~ +50.0mm (*1)
BACK	Back feed fine adjustment	-9.9mm ~ +9.9mm (*1)
TONE(T)	Print density fine adjustment (Thermal transfer print mode)	-10 ~ +10step
TONE(D)	Print density fine adjustment (Direct thermal print mode)	-10 ~ +10step
RBN(FW)	Ribbon motor drive voltage fine adjustment (Rewind)	-15 ~ +10step
RBN(BK)	Ribbon motor drive voltage fine adjustment (Back tension)	-15 ~ +10step
[KEY]FEED	Feed fine adjustment	-50.0mm ~ +50.0mm
CUT	Cut position (or strip position) fine adjustment	-50.0mm ~ +50.0mm
BACK	Back feed fine adjustment	-9.5mm ~ +9.5mm
TONE(T)	Print density fine adjustment (Thermal transfer print mode)	-20 ~ +10step
TONE(D)	Print density fine adjustment (Direct thermal print mode)	-20 ~ +10step
RBN(FW)	Ribbon motor drive voltage fine adjustment (Rewind)	-15 ~ +10step
RBN(BK)	Ribbon motor drive voltage fine adjustment (Back tension)	-15 ~ +10step
X ADJ.	X-coordinate fine adjustment	-99.5mm ~ +99.5mm
THRESHOLD<R>	Reflective sensor manual threshold fine adjustment	0.0V ~ 4.0V
THRESHOLD<T>	Transmissive sensor manual threshold fine adjustment	0.0V ~ 4.0V

NOTES: For B-EX4T1-G, "x.3mm" is printed as maintenance counter regardless the selection "x.2 mm" or "x.3mm" since head resolution is 8 dots/mm. The selection of "x.7mm" and "x.8mm" is same manner.

## &lt;&lt; PARAMETER SETTINGS &gt;&gt;

Item	Content	Print value	
MEDIA LOAD	Media loading	OFF	Disable
		STD	Feed detected gap/mark to stop position.
		ECO	Feed gap/mark between head and sensor to stop position.
		ECO+BFeed	Perform back feed after completion of ECO.
FORWARD WAIT	Forward feed standby after an issue	ON	Performed (A fine adjustment value for the stop position is also printed.)
		OFF	Not performed
FW/BK ACT.	Forward feed standby action	MODE1	Stops after 13.7-mm forward feed.
		MODE2	Stops after 6-mm back feed and 3-mm forward feed. (Only when the cut mode, thermal transfer, and feed gap sensor are selected.) In other cases, the printer stops after 13.7-mm forward feed.
HU CUT/RWD.	Head-up operation in cut issue mode, or use of the rewinder	ON	Head-up operation is performed, or the rewinder is used.
		OFF	Head-up operation is not performed, or the rewinder is not used.
RBN SAVE	Ribbon saving system setting	ON(TAG)	Used when the head lever position is "TAG"
		ON(LBL)	Used when the head lever position is "LABEL".
		OFF	Not used
PRE PEEL OFF	Pre-peel-off process setting	ON	Pre-peel-off operation is performed.
		OFF	Pre-peel-off operation is not performed.
BACK SPEED	Back feed speed setting	STD	3ips
		LOW	2ips
AUTO CALIB	Auto calibration setting	OFF	Auto calibration is not preformed.
		ON TRANS.	Auto calibrating is performed by transmissive sensor.
		ON REFLECT	Auto calibrating is performed by reflective sensor.
		ON ALL	Auto calibrating is performed by both sensor.
		ON TRANS.+Bfeed	Perform back feed after movement of ON TRANS.

		ON REFLECT+Bfeed	Perform back feed after movement of ON REFLECT.
		ON ALL+Bfeed	Perform back feed after movement of ON ALL.
FONT	Character code selection	PC-850	PC-850
		PC-852	PC-852
		PC-857	PC-857
		PC-8	PC-8
		PC-851	PC-851
		PC-855	PC-855
		PC-1250	PC-1250
		PC-1251	PC-1251
		PC-1252	PC-1252
		PC-1253	PC-1253
		PC-1254	PC-1254
		PC-1257	PC-1257
		LATIN9	LATIN9
		PC-866	PC-866
		Arabic	Arabic
UTF-8	UTF-8		
	Font "0" selection	0	No slash used
		∅	Slash used
CODE	Control code type	AUTO	Automatic selection
		ESC LF NUL	ESC LF NUL method
		{ }	{ } method
		xx oo □□	Any set code (Described in hex. code)
PEEL OFF STATUS	Peel-off wait status selection	ON	Selected
		OFF	Not selected
USB I/F STATUS	USB interface status	ON	Send
		OFF	Not send
FEED KEY	[FEED] key function setting	FEED	One label is fed.
		PRINT	Data in the image buffer is printed on one label.
KANJI	Kanji code type	TYPE1	For WINDOWS codes
		TYPE2	For original codes
EURO CODE	Euro code setting		
AUTO HD CHK	Automatic broken dots check setting	ON	Automatic broken dots check is performed.
		OFF	Automatic broken dots check is not performed.
WEB PRINTER	Web printer function setting	ON	Enabled.
		OFF	Disabled.
RIBBON NEAR END	Ribbon near end detection setting	30m	Ribbon near end state is detected when the remaining ribbon length is approximately 30 m.
		70m	Ribbon near end state is detected when the remaining ribbon length is approximately 70 m.
		OFF	Ribbon near end state is not detected.
EX.I/O MODE	Expansion I/O operation mode	TYPE1	Standard mode.
		TYPE2	In-line mode.

LBL/RBN END	Label end/ribbon end process setting	TYPE1	When a label end or ribbon end state is detected, the printer stops even if it is printing.
		TYPE2	When a label end or ribbon end state is detected, the printer prints the current label as far as possible, then stops.
MAXI CODE SPEC.	MaxiCode specification setting	TYPE1	Compatible with the current version
		TYPE2	Special specification
XML	XML function setting	OFF	Disabled.
		STD	Standard specification.
		ORACLE	Specification for Oracle
		SAP	Specification for SAP
		STD EXTERNAL	Standard specification (use external memory)
		ORACLE EXTERNAL	Specification for Oracle (use external memory)
		SAP EXTERNAL	Specification for SAP (use external memory)
THRESHOLD SEL(R)	Threshold selection for reflective sensor	MANUAL SET	Manual setting takes priority.
		COMMAND SET	Command specified.
THRESHOLD SEL(T)	Threshold selection for transmissive sensor	MANUAL SET	Manual setting takes priority.
		COMMAND SET	Command specified.
ENERGY TYPE(T)	Energy control for thermal transfer print	Semi regin1	Semi regin 1.
		Semi regin2	Semi regin 2.
		Regin1	Regin 1.
		Regin2	Regin 2.
		Reserve1	Reserved.
		Reserve2	Reserved.
		Reserve3	Reserved.
		Reserve4	Reserved.
ENERGY TYPE(D)	Energy control for direct thermal print	Standard	Standard.
		Reserve1	Reserved.
		Reserve2	Reserved.
		Reserve3	Reserved.
		Reserve4	Reserved.
		Reserve5	Reserved.
		Reserve6	Reserved.
		Reserve7	Reserved.
		Reserve8	Reserved.
Reserve9	Reserved.		
POWER SAVE TIME	Time to switch to power saving mode		
BASIC	Basic interpreter setting	ON	Basic interpreter is enabled.
		OFF	Basic interpreter is disabled.



BASIC TRACE	Basic interpreter trace setting	ON	Trace is enabled.
		OFF	Trace is disabled.

## &lt;&lt; PANEL &gt;&gt;

Item	Content	Print value	
MESSAGE	Language selection for LCD messages	ENGLISH	English
		GERMAN	German
		FRENCH	French
		DUTCH	Dutch
		SPANISH	Spanish
		JAPANESE	Japanese
		ITALIAN	Italian
		PORTUGUESE	Portuguese
MACHINE NAME	LCD detail setting, machine name on/off selection	ON	Display.
		OFF	Not display.
PRINT PAGE	LCD detail setting, print number on/off	ON	Display.
		OFF	Not display.
IP ADDRESS	LCD detail setting IP address on/off	ON	Display.
		OFF	Not display.
CONTRAST	LCD contrast		
SYSTEM PASSWORD	Password for system mode	ON	Password is enabled.
		OFF	Password is disabled.

## &lt;&lt; STORAGE AREA &gt;&gt;

Item	Content	Print value	
TTF AREA	TrueType Font saving area size	0KB ~ 3072KB	(128KB units)
EXT CHR AREA	Download character saving area size	0KB ~ 3072KB	(128KB units)
BASIC AREA	Basic file saving area size	0KB ~ 3072KB	(128KB units)
PC SAVE AREA	PC save area size	0KB ~ 3072KB	(128KB units)

## &lt;&lt; USB &gt;&gt;

Item	Content	Print value	
SERIAL NUMBER	USB serial number enable/disable	ENABLE	Enabled.
		DISABLE	Disabled.
	USB serial number		

## &lt;&lt; RS-232C &gt;&gt;

Item	Content	Print value	
SPEED	Communication speed selection	2400	2400bps
		4800	4800bps
		9600	9600bps
		19200	19200bps
		38400	38400bps
		115200	115200bps
DATA LENG.	Data length selection	7	7bit
		8	8bit
STOP BIT	Stop bit length selection	1	1bit

		2	2bit
PARITY	Parity selection	NONE	Non parity.
		ODD	Odd parity.
		EVEN	Even parity.
CONTROL	Transmission control method selection	XON/XOFF	XON/XOFF protocol (No XON output when the power is on, no XOFF output when the power is off)
		READY/BUSY	READY/BUSY (DTR) protocol (No XON output when the power is on, no XOFF output when the power is off)
		XON+READY AUTO	XON/XOFF + READY/BUSY (DTR) protocol (XON output when the power is on, XOFF output when the power is off)
		XON/XOFF AUTO	XON/XOFF protocol (XON output when the power is on, XOFF output when the power is off)
		READY/BUSY RTS	RTS protocol (No XON output when the power is on, no XOFF output when the power is off )

## &lt;&lt; CENTRO &gt;&gt;

Item	Content	Print value	
ACK/BUSY	Centronics ACK/BUSY timing setting	TYPE1	The ACK signal is sent to match the rising edge of ACK signal and the falling edge of the BUSY signal.
		TYPE2	The ACK signal is sent to match the falling edge of ACK signal and the falling edge of the BUSY signal.
INPUT PRIME	Reset process when the nInit signal is ON	ON	Reset is performed.
		OFF	Reset is not performed.
PLUG & PLAY	Plug-and-play operation setting	ON	Plug-and-play operation is enabled.
		OFF	Plug-and-play operation is disabled.

## &lt;&lt; LAN/WLAN &gt;&gt;

Item	Content	Print value	
LAN/WLAN	LAN selection	OFF	Disabled
		AUTO	Auto
		LAN	Wired LAN
		WLAN	Wireless LAN
SNMP	SNMP enabled/disable	ON	Enable
		OFF	Disable
PRTR IP ADDRESS	Printer IP address	***.***.***.***	
GATE IP ADDRESS	Gateway IP address	***.***.***.***	
SUBNET MASK	Subnet mask	***.***.***.***	

SOCKET PORT	Socket communication enable/disable	ON	Enable
		OFF	Disable
	Socket communication port number	0 ~ 65535	
DHCP	DHCP setting	ON	DHCP function is enabled.
		OFF	DHCP function is disabled.
DHCP CLIENT ID	DHCP client ID setting (hex decimal display)	Max. 64 characters	
DHCP HOST NAME	DHCP host name (ASCII display)	Max. 32 characters	
WLAN STANDARD	Wireless LAN: Standard	11b/g	11b/g
		11b	11b
		11g	11g
WLAN MODE	Wireless LAN: Connection setting	INFRASTRUCTURE	Infrastructure mode
		ADHOC	Adhoc mode
ESS ID	Wireless LAN: ESS ID	Max. 32 characters	
ENCRYPT	Wireless LAN: Encryption key setting	OFF	OFF
		WEP40	WEP40
		WEP104	WEP104
		AES	AES
		TKIP	TKIP
WPA MODE	Wireless LAN: WPA setting	OFF	OFF
		WPA	WPA
		WPA-PSK	WPA-PSK
		WPA2	WPA2
		WPA2-PSK	WPA2-PSK
AUTH	Wireless LAN: Authentication method	OPEN	Open system method
		SHARED	Shared key method
DEFAULT KEY	Wireless LAN: Encryption key for sending	1 ~ 4	
802.1X SUPPLICANT	Wireless LAN: Authentication method	OFF	OFF
		EAP-TLS	EAP-TLS
		PEAP	PEAP
		EAP-TTLS	EAP-TTLS
		EAP-FAST	EAP-FAST
		EAP-MD5	EAP-MD5
		LEAP	LEAP
802.11b CHANNEL	Wireless LAN: 11b connection channel setting	00 ~ 14	
802.11b BAUD RATE	Wireless LAN: 11b speed setting	11M	11M
		5.5M	5.5M
		2M	2M
		1M	1M
802.11g CHANNEL	Wireless LAN: 11g connection channel setting	00 ~ 14	
802.11g BAUD RATE	Wireless LAN: 11g speed setting	54M	54M
		48M	48M
		36M	36M
		24M	24M
		18M	18M

		12M	12M
		9M	9M
		6M	6M
		11M	11M
		5.5M	5.5M
		2M	2M
		1M	1M
POWER SAVE	Wireless LAN: Power save	ON	Enable
		OFF	Disable
WINS	WINS enable/disable	ON	Enable
		OFF	Disable
WINS IP ADDRESS	WINS IP address	***.***.***.***	
LPR	LPR enable/disable	ON	Enable
		OFF	Disable

## &lt;&lt; RFID &gt;&gt;

Item	Content	Print value	
MODULE	RFID module type selection	NONE	No RFID kit is installed.
		H1	B-9704-RFID-U1-US/EU(-R)
		H2	B-SX704-RFID-H2
		U2	B-SX704-RFID-U2(-EU/US/CN/AU-R)
TAG TYPE	RFID tag type selection	NONE	
		I-Code	11
		Tag-it	12
		C220	13
		ISO15693	14
		C210	15
		C240	16
		C320	17
RF CHANNEL	RFID channel setting	2CH ~ 8CH	
		AUTO	
ADJUST RETRY	RFID adjustment for retry	-99mm ~ +99mm	
ISSUE RETRY	Max. number of RFID issue retries	0 ~ 255	
READ RETRY	Max. number of RFID read retries	0 ~ 255	
	RFID read retry time-out	0 ~ 9.9 sec	
WRITE RETRY	Max. number of RFID write retries	0 ~ 255	
	RFID write retry time-out	0 ~ 9.9 sec	
POWER LEVEL	RFID wireless power level setting	B-SX704-RFID-U2-R: 18 ~ 26 B-SX704-RFID-U2-EU/US/CN/AU-R: 9 ~ 18	
Q VALUE	RFID module Q value	0 ~ 5	

AGC THRESHOLD	RFID AGC threshold setting	0 ~ 15	
WRITE AGC	AGC threshold for data write	0 ~ 15	
RETRY MIN AGC	AGC threshold lower limit for retry	0 ~ 15	
TAG CHECK	RFID error tag detection	OFF	Detection is disabled.
		ON(ID)	RFID error tag detection for ID area data
		ON ( ACCESS PASSWORD)	When PASS is selected, the following settings are subsequently displayed: Password setting to protect error tag detection ON: Enabled OFF: Disabled Automatic unlock function setting ON: Enabled OFF: Disabled
MULTI WRITE	Hibiki tag multi-word write	ON	Enable
		OFF	Disable
WRITE OK TAGS	Count of RFID success label write issue	0 ~ 9999999	
VOID PRINT TAGS	Count of RFID failure label write issue	0 ~ 9999999	

## &lt;&lt; RTC &gt;&gt;

Item	Content	Print value	
BATTERY CHECK	Battery check	ON	Enable
		OFF	Disable
RENEWAL	Time update timing	BATCH	Each batch
		PAGE	Each page

### 5.3.2 Auto Diagnostics/AUTO DIAGNOSTICS

The printing procedure of "AUTO DIAGNOSTIC" of "DIAG." is same as '5.3.1 Counter, Parameter/ MAINTENANCE COUNT'.

The manu layer from top menu of system mode to AUTO DIAGNOSTICS is below.

MENU ITEM	
System Mode / SYSTEM MODE	
<1>	Diagnostics / <1>DIAG.
<2>	Auto Diagnostics / AUTO DIAGNOSTIC
<3>	Print method / PRINT TYPE
<4>	Thermal transfer / TRANSFR
<5>	Direct thermal / DIRECT
<6>	Cut setting / CUT TYPE
<7>	Disable / OFF
<8>	Enable / ON
<9>	Print / CHECKING & PRINT

If error occur during printing, the error message is displayed, the error LED turns on and the onlineLED turns off. The erro can be canceled by [ENTER], [CANCEL] or [MODE] key, but printer did not perform re^printing.

- AUTO SELF DIAG. PRINT CONTENTS

PROGRAM	B-EX4T1-T
MAIN	XXXXXXXX V1.0A:1A00
BOOT	XXXXXXXX V1.0 :8500
HTML	XXXXXXXX V1.0 :6100
FONT	5600
KANJI	NONE :0000
	NONE :0000
EEPROM	256B
SDRAM	32MB
SENSOR1	00000000,00000111
SENSOR2	[H]23 ° C [A]22 ° C
	[R]4.2V [T]2.5V [E]0.6V
HEAD	[RANK]7 305DPI
EXP. I/O	NG
EX.232C	NG
RFID	OK #00RV972 (EU0) R01
WLAN	OK Ver1.1.3
MAC	00-11-22-33-44-55
RTC	NG
USB MEMORY	NG
BASIC M	Z-SX4-MV10F. V1.0F:7479
BASIC S	Z-SX4-SV10E. V1.0E:AD36

**Print condition:**

Label length		100mm
Print method		Setting by user
Sensor type		Non
Speed	203dpi	Speed
	305dpi	
Issuing number		1 piece
Issuing mode		Setting by user
Other		No mount winding motor

**NOTES:**

“ ” (degree) of “xx□” may not be printed correctly depend on code page selection.

Main program file name of basic and system mode program file name is printed.

The version and check sum is printed if the first 4 characters of Main program file name of basic and system mode program file name is “Z-EX”.

PROGRAM B-EX4T1-G

Model name B-EX

MAIN 15OCT2002 V1.0A:1A00

Checksum  
Version  
Creation date (Day-Month-Year)  
PROGRAM: Program area

BOOT 20SEP2002 V1.0:8500

Checksum  
Version  
Creation date (Day-Month-Year)  
BOOT: Boot area

HTML 25OCT2010 V1.0:6100

Checksum  
Version  
Creation date (Day-Month-Year)  
Name HTML: (WLAN) HTML area

FONT 5600

Checksum of font area

KANJI NONE : 0000

Checksum of bit map Kanji ROM for Gothic font  
NONE: No Kanji ROM installed  
GOTHIC: Bit map Kanji ROM for Gothic font installed

NONE : 0000

Checksum of bit map Kanji ROM for Mincho font  
(or Chinese Kanji)  
NONE: No Kanji ROM installed  
MINCHO: Bit map Kanji ROM for Mincho font installed  
CHINESE: Bit map Kanji ROM for Chinese Kanji installed



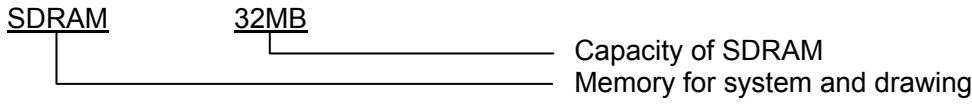
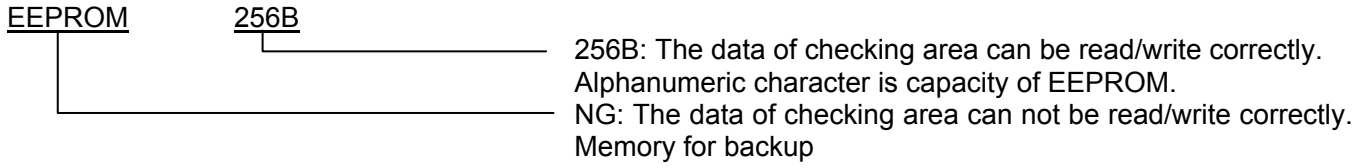

Sensor check contents

The sensor value which is not mounted is unsettled.

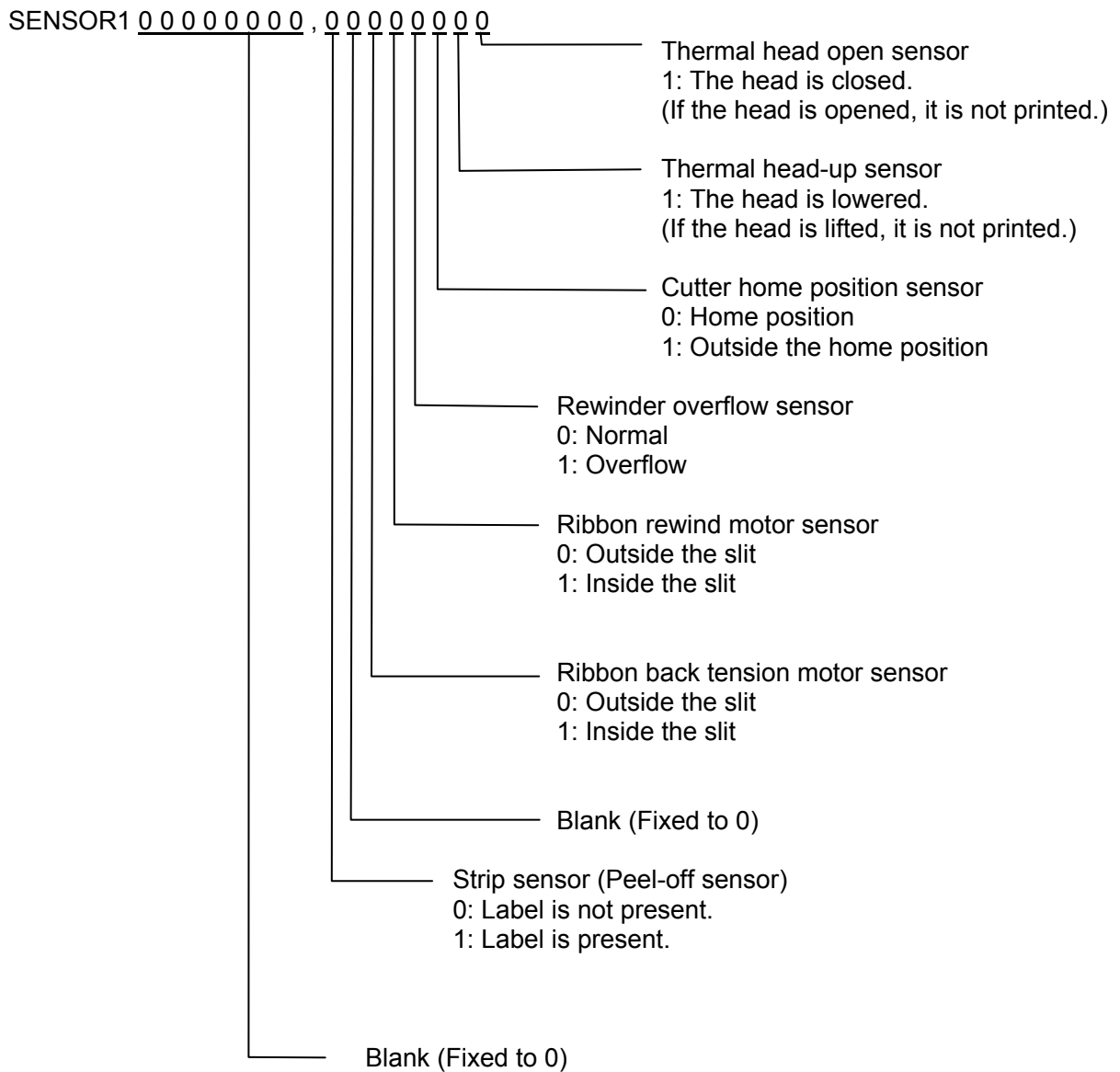

SENSOR2

[H]20 ° C [A]22 ° C

Open-air temperature sensor status  
0 to 86 °C, --°C if it cannot be detected)  
Thermal head temperature sensor status (0 to 86 °C)

[R]4.2V [T]2.5V [E]2.7V

Reflective sensor status for detecting  
the ribbon end state (0.0 to 5.0 V)  
Transmissive sensor status (0.0 to 5.0 V)  
Reflective sensor status (0.0 to 5.0 V)

HEAD

[RANK] 7

305DPI

Mounted head resolution (203DPI / 305DPI)  
Thermal head resistance rank

Resistance rank	203dpi	305dpi
	Average resistance (ohm)	
0	704 ~ 728	880 ~ 910
1	729 ~ 752	911 ~ 940
2	753 ~ 776	941 ~ 970
3	777 ~ 800	971 ~ 1000
4	801 ~ 824	1001 ~ 1030
5	825 ~ 848	1031 ~ 1060
6	849 ~ 872	1061 ~ 1090
7	873 ~ 896	1091 ~ 1120

Expansion I/O check contents

EXP.I/O NG

OK: Normal data  
 NG: Abnormal data or the loop-back jig is not connected.  
 Expansion I/O

Connect the cable as illustrated below, then check the high output/high input, low output/low input.

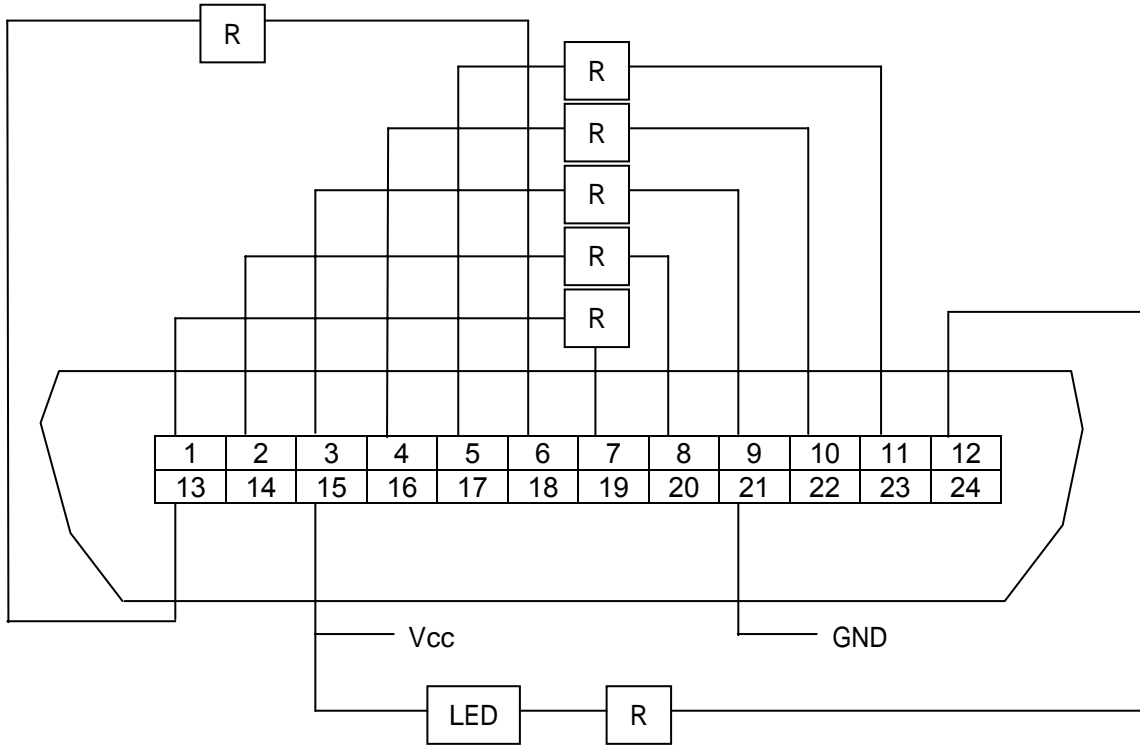

R = 300 Ohms  
 Connector: FCN-781P024-G/P

Internal serial I/F check contents

EX.232C NG

OK: Normal data  
 NG: Abnormal data or the loop-back jig is not connected.  
 Internal serial I/F

RFID module check contents

( RFID module  
U2 series only )

RFID OK #00RV972 (EU0) R01

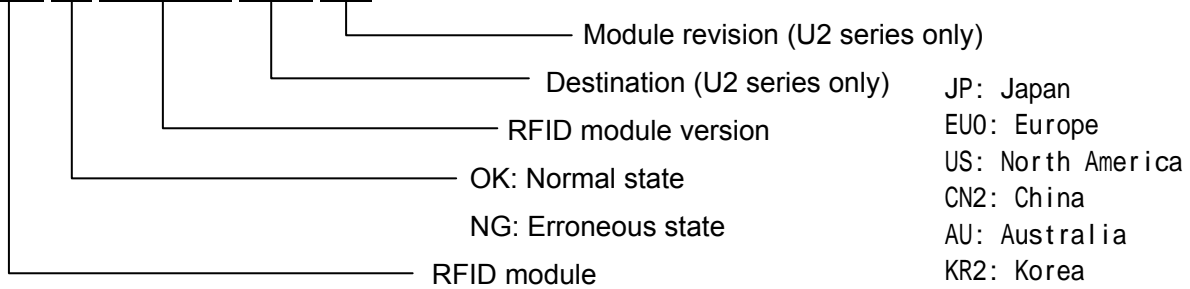

Module revisions and corresponding countries

B-SX704-RFID-U2-US-R

Revision	Country
R00	US
R01	US, AU, TW
R02	US, AU, KR2, TW

B-SX704-RFID-U2-EU-R

Revision	Country
R00	EU
R11	EU, IN

B-SX704-RFID-U2-R

Revision	Country
R00	JP

Wireless LAN mount check contents

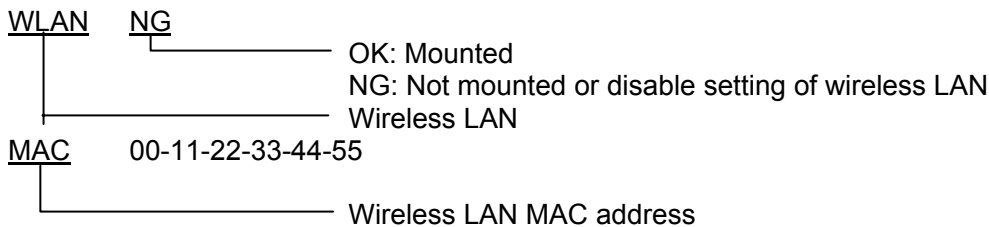

RTC mount check contents

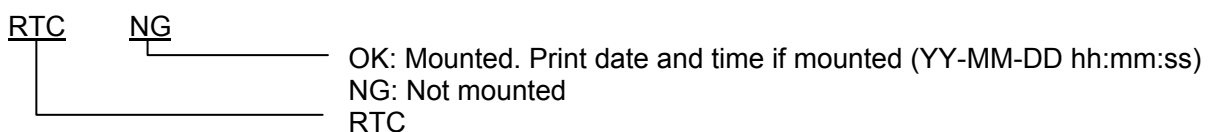

USB memory mounts check contents

USB MEMORY NG

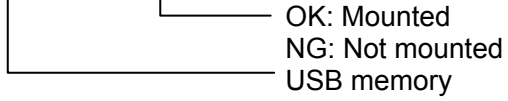

BASIC program check contents

BASIC M NONE

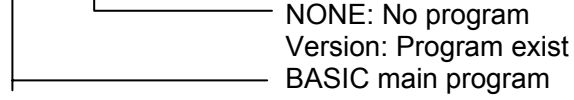

BASIC S NONE

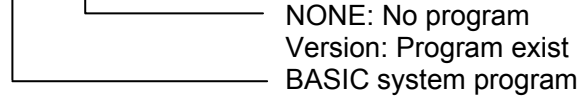

### 5.3.3 Head broken dot check/HEAD CHECK

The printing procedure of “Head check” of “DIAG.” is same as 「5.3.1 Counter, Parameter/ MAINTENANCE COUNT」.

The menu layer from top menu of system mode to HEAD CHECK is below.

MENU ITEM	
System Mode / SYSTEM MODE	
<1>	Diagnostics / <1>DIAG.
<1>	Head broken dot check / HEAD CHECK

Checking		
ヘッド断線チェック チェック中	HEAD CHECK CHECKING	Display “CHECKING”.
Normal		
ヘッド断線チェック 正常終了	HEAD CHECK NORMAL END	Display “NORMAL END”
Broken dots		
ヘッド断線チェック 断線エラー発生 2/1824 dots	HEAD CHECK HEAD ERROR 2/1824 dots	Turn off online LED and turn on error LED. Display broken dots number. The format is “Broken dot/total dot” and total dot is right aligned.
ヘッド断線チェック 断線エラー発生 2/ 832 dots	HEAD CHECK HEAD ERROR 2/ 832 dots	

## 5.4 PARAMETER SETTING

### ■ Outline of Parameter Setting

In the Parameter Setting mode, various kinds of parameters, such as communication, key, LCD, etc. can be set. This will allow the use of the printer to comply with your operating conditions.

The **Parameter Setting** menu contains the following:

MENU ITEM	
System Mode / SYSTEM MODE	
<2>	Parameter setting / <2>PARAMETER SET
	Printer setting / PRINTER SET
	Soft control setting / SOFTWARE SET
	LCD DISPLAY SETTING / PANEL
	Password setting / PASSWORD

#### 5.4.1 Printer setting / PRINTER SET

Menu list of "Printer setting / PRINTER SET"

MENU ITEM	
System Mode / SYSTEM MODE	
<2>	Parameter setting / <2>PARAMETER SET
	Printer setting / PRINTER SET
	Media loading / MEDIA LOAD
	Setting for forward feed standby / FORWARD WAIT
	Forward feed standby position / FORWARD WAIT POS.
	Standby action / FW/BK ACT.
	HU CUT/RWD.
	Ribbon save / RBN SAVE
	Pre peel-off / PRE PEEL OFF
	Back feed / BACK SPEED



**5.4.1.1 Media loading / MEDIA LOAD**

- Disable / OFF      Media loading function is disabled (Same as feed by machine's key)
- Standard / STD      When printer is tuned on, printer is resettled batch, or head is closed, printer detects gap/mark and feed the paper from sensor to thermal head which is home position.
- Economy / ECO      When power of batch process, head close, label is loaded. In this mode, printer calculate the position based on previous saved label pitch then feed the label to head position.
- Economy / ECO+Bfeed

**5.4.1.2 Setting for forward feed standby / FORWARD WAIT**

- Disable / OFF      Disable forward feed standby
- Enable / ON      Enable forward feed standby

**5.4.1.3 Forward feed standby position / FORWARD WAIT POS.**

Max.	Min.	Step	Display	Sign	Integer digit	Decimal point digit	0 fullfil	Unit
5.0	-5.0	0.1	Decimal	Exist	2	1	Non	mm

- + (Plus)      Rotate forward more then stop.
- - (Minus)      Rotate forward less then stop.

**5.4.1.4 Standby action / FW/BK ACT.**

- MODE1      Wait at 13.7 mm forward rotation point.
- MODE2      Wait at the position 6 mm reverse rotate and 3 mm forward rotate in case of copy, transmissive sensor and cut issue.

**5.4.1.5 HU CUT/RWD.**

Selection of head up cut and rewinder usage for cut issue.

Head up cut is selected when cut issue is selected and internal rewinder usage is selected when continuous issue is performed.

\* Head up may not be performed due to solenoid temperature rise when head up issue is performed.

- Disable / OFF      Disable Head up and no rewinder usage.
- Enable / ON      Enable Head up and rewinder usage.

#### 5.4.1.6 Ribbon save / RBN SAVE

- Tag / TAG Enable ribbon save function (Head open/close lever: Tag position)
- Label / LABEL Enable ribbon save function (Head open/close lever: Label position))
- Disable / OFF Disable ribbon save function

(\*1) If this setting is enabled when ribbon module is not mounted, ribbon may be slack and printer may not print correctly. So, be careful for this setting.

Ribbon save function may not work correctly if lock position of actual head open/close lever is different from this setting.

#### 5.4.1.7 Pre peel-off / PRE PEEL OFF

- Disable / OFF Disable pre peel off
- Enable / ON Enable pre peel off

(\*) Pre peel off is enabled regardless this setting if 10 ips is selected.

#### 5.4.1.8 Back feed / BACK SPEED

- Standard speed/ STD 3ips
- Low speed / LOW 2ips

## 5.4.2 Soft control setting / SOFTWARE SET

Menu list Soft control setting / SOFTWARE SET

MENU ITEM
System Mode / SYSTEM MODE
<2>Parameter setting / <2>PARAMETER SET
Soft control setting / SOFTWARE SET
Character code / FONT CODE
Font "0" type / ZERO FONT
Control code / CODE
ESC LF NUL / MANUAL
Peel-off wait status / PEEL OFF STATUS
USB status / USB I/F STATUS
FEED Key / FEED KEY
Kanji special code / KANJI CODE
Euro code / EURO CODE
Auto head broken dot check
/ AUTO HD CHK
WEB Printer / WEB PRINTER
Ribbon near end / RBN NEAR END
External I/I mode / EX.I/O
Paper/Ribbon end / LBL/RBN END
MaxiCode specification / MAXI CODE
XML
Threshold selection / THRESHOLD SELECT
Reflective sensor / REFLECT
Transmissive sensor / TRANS.
Print method / ENERGY TYPE
Thermal transfer / TRANSFER
Direct thermal / DIRECT
Power save time / PW SAVE TIME

#### 5.4.2.1 Character code / FONT CODE

- PC-850
- PC-852
- PC-857
- PC-8
- PC-851
- PC-855
- PC-1250
- PC-1251
- PC-1252
- PC-1253
- PC-1254
- PC-1257
- LATIN9
- Arabic
- PC-866
- UTF-8

#### 5.4.2.2 Font “0” type / ZERO FONT

- 0            Non slash used
- Ø            Slash used

(\*) The following fonts do not support a zero with a slash. Therefore, even if a zero with a slash is specified, a zero without a slash is used.

[Bit map fonts]

OCR-A, OCR-B, GOTHIC725 Black, Kanji, Chinese Kanji

[Outline fonts]

Price fonts 1, 2, and 3, DUTCH801 Bold, BRUSH738 Regular, GOTHIC725 Black,

True type font

#### 5.4.2.3 Control code / CODE

- Automatic selection / AUTO
- {} method / {,|,}
- ESC, LF, NUL / ESC,LF,NUL
- Manual selection / MANUAL

**5.4.2.4 Manual selection / MANUAL**

Max.	Min.	Step	Display	Sign	Integer digit	Decimal point digit	0 fullfil	Unit
0xFF	0x00	1	Hex decimal	Non	2	0	Non	h

- CODE1
- CODE2
- CODE3

**5.4.2.5 Peel-off wait status / PEEL OFF STATUS**

- Disable / OFF      Disable change
- Enable / ON        Enable change

**5.4.2.6 USB STATUS / USB I/F STATUS**

- Disable / OFF      Disable response
- Enable / ON        Enable response

**5.4.2.7 FEED Key Function**

- Feed / FEED        Feed paper one piece
- Re-print / PRINT    Print image buffer one piece

### 5.4.2.8 Kanji special code / KANJI CODE

- TYPE1            Windows code
- TYPE2            Original code

Printing character list for each type

PRINT CHARACTER	TYPE 1	TYPE 2
□	2 D 2 1	2 C 4 4
□	2 D 2 2	2 C 4 5
□	2 D 2 3	2 C 4 6
□	2 D 2 4	2 C 4 7
□	2 D 2 5	2 C 4 8
□	2 D 2 6	2 C 4 9
□	2 D 2 7	2 C 4 A
□	2 D 2 8	2 C 4 B
□	2 D 2 9	2 C 4 C
□	2 D 2 A	2 C 4 D
□	2 D 3 5	2 2 3 1
□	2 D 3 6	2 2 3 2
□	2 D 3 7	2 2 3 3
□	2 D 3 8	2 2 3 4
□	2 D 3 9	2 2 3 5
□	2 D 3 A	2 2 3 6
□	2 D 3 B	2 2 3 7
□	2 D 3 C	2 2 3 8
□	2 D 3 D	2 2 3 9
□	2 D 3 E	2 C 3 4

PRINT CHARACTER	TYPE 1	TYPE 2
mm	2 D 5 0	2 C 6 6
cm	2 D 5 1	2 C 6 7
km	2 D 5 2	2 C 6 9
mg	2 D 5 3	2 2 4 3
kg	2 D 5 4	2 2 4 4
cc	2 D 5 5	2 C 7 0
m <sup>2</sup>	2 D 5 6	2 C 6 B
"	2 D 6 0	2 A 2 2
№	2 D 6 2	2 2 4 9
□	2 D 6 4	2 2 4 8
(株)	2 D 6 A	2 2 2 F
(代)	2 D 6 C	2 2 4 6
∫	2 D 7 2	2 8 4 1

### 5.4.2.9 Euro code / EURO CODE

Max.	Min.	Step	Display	Sign	Integer digit	Decimal point digit	0 fullfil	Unit
0xFF	0x20	1	Hex decimal	Non	2	0	Non	h

### 5.4.2.10 Auto head broken check / AUTO HD CHK

- Disable / OFF    Disable auto broken dots check
- Enable / ON     Enable auto broken dots check

### 5.4.2.11 WEB Printer / WEB PRINTER

- Disable / OFF    Disable WEB printer function
- Enable / ON     Enable WEB printer function

#### 5.4.2.12 Ribbon near end / RBN NEAR END

- Disable / OFF      Disable ribbon near end detection
- 30m                Enable ribbon near end: Remaining 30 m (Ribbon diameter is 38 mm)
- 70m                Enable ribbon near end: Remaining 70 m (Ribbon diameter is 43 mm)

(\*) There is a margin of error for this ribbon near end detection. Use this ribbon near end detection as reference.

#### 5.4.2.13 External I/O mode / EX.I/O

- TYPE1              Standard specification
- TYPE2              In-line specification

#### 5.4.2.14 Paper / ribbon end / LBL/RBN END

- TYPE1              Stop issue when label end/ ribbon end is detected.
- TYPE2              Print as long as possible when label end/ribbon end is detected.

##### TYPE1:

When label end or ribbon end is detected, the issuing is stopped immediately as error.  
When printer is restarted, printer starter-issuing of error label after initial feeding.

##### TYPE2

TYPE 2 is available only when the ribbon saving function is set to OFF. If the ON (LBL) or ON (TAG) is selected, TYPE 1 will be automatically performed regardless of the selection.

##### [Label end]

When a label end is detected in the middle of printing, the printer completes the half-finished label and stops when the next label is at the home position, displaying the error message "NO PAPER X". ("X" indicates the remaining number of labels.) The remaining number of labels = [Specified number of labels] – [The number of finished labels including half-finished one]

If a label end is detected while the specified last label is printed, the position of "X" will be blank. When the printing is restarted, first the initial feed is performed, and then the printer starts printing from the next label. In case of the label end while the specified last label is printed, only the initial feed is performed, and if the status response is set to ON, an issue end status is sent following a feed end status.

##### [Ribbon end]

When a ribbon end is detected when the unfinished label length is 30 mm or more, printer prints for 20 mm and stops printing, displaying an error message "NO RIBBON X". ("X" indicates the remaining number of labels.)

The remaining number labels = [Specified number of labels] – [The number of finished labels] – 1  
If a ribbon end is detected while the specified last label is printed, the position of "X" will be blank. When the printing is restarted, first the initial feed is performed, and then the printer starts printing from the next label. In case of the ribbon end while the specified last label is printed, only the initial feed is performed.



## Example of TYPE2

## 「Case 1」

Issuing number = 5, When label end is detected at 3<sup>rd</sup> label issuing.

(1) (2) (3)

↑

Stop by error after (3), LCD: "NO PAPER 2"

When printer is restarted, issue (4) (5) after initial feed.

The complete issued label is (1) (2) (3) (4) (5).

## 「Case 2」

Issuing number = 5, When label end is detected at 3<sup>rd</sup> label issuing. The remaining label length is longer than 30 mm.

(1) (2) (3)

↑

Stop printing after 20mm printing as error, LCD: "NO RIBBON 2"

When printer is restarted, issue (4) (5) after initial feed.

The complete issued label is (1) (2) (4) (5).

## 「Case 3」

Issuing number = 5, When label end is detected at 3<sup>rd</sup> label issuing. The remaining label length is shorter than 30 mm.

(1) (2) (3)

↑

Stop printing after issuing (3) as error, LCD: "NO RIBBON 2"

When printer is restarted, issue (4) (5) after initial feed.

The complete issued label is (1) (2) (3) (4) (5).

**5.4.2.15 MaxiCode specification / MAXI CODE**

- TYPE1                      Compatible with the current version
- TYPE2                      Special specification

The mode specified by the command may be different from the actual mode, depending on the status of this parameter. Also, the data transmission method differs partly. For details, refer to the External Equipment Interface Specification (EAA-03466).

**5.4.2.16 XML**

- Disable / OFF                      Disable XML function
- Standard / STD                      Standard specification
- Oracle / ORACLE                      Specification for Oracle
- SAP                                      Specification for SAP
- Standard external / STD EXT                      Standard specification (Use external memory)
- Oracle external / ORACLE EXT                      Specification for Oracle (Use external memory)
- SAP external / SAP EXT                      Specification for SAP (Use external memory)

**5.4.2.17 Threshold selection / THRESHOLD SELECT**

- Refractive sensor / REFLECT      Set threshold mode of refractive sensor
- Transmissive sensor / TRANS.      Set threshold mode of transmissive sensor

## Refractive sensor / REFLECT

- Manual setting / MANUAL SET      Use setting value by threshold mode
- Command setting / COMMAND SET      Use setting value by command

## Transmissive sensor / TRANS.

- Manual setting / MANUAL SET      Use setting value by threshold mode
- Command setting / COMMAND SET      Use setting value by command

**5.4.2.18 Print method / ENERGY TYPE**

- Thermal transfer / TRANSFER
- Direct thermal / DIRECT

## Thermal transfer / TRANSFER

- Semi regin1                      Semi-regin 1
- Semi regin2                      Semi-regin 2
- Regin1                              Regin 1
- Regin2                              Regin 2
- Reserve1 ~ Reserve6          Reserved

## Direct thermal / DIRECT

- Standard                              Standard
- Reserve1 ~ Reserve9          Reserved

**5.4.2.19 Power save time / PW SAVE TIME**

Max.	Min.	Step	Display	Sign	Integer digit	Decimal point digit	0 fullfil	Unit
240	1	1	Decimal	Non	3	0	Non	Min

### 5.4.3 LCD DISPLAY SETTING / PANEL

Menu item list LCD DISPLAY SETTING / PANEL

MENU ITEM			
System Mode / SYSTEM MODE			
<2>Parameter setting / <2>PARAMETER SET			
LCD DISPLAY SETTING / PANEL			
		Language of LCD display / LCD LANGUAGE	
		LCD detail setting / DISPLAY	
		Machine name / MACHINE NAME	
		Print page / PRINT PAGE	
		IP address / IP ADDRESS	
Contrast adjustment / CONTRAST			

#### 5.4.3.1 Language of LCD display / LCD LANGUAGE

- English / ENGLISH
- Germany / GERMAN
- French / FRANCH
- Dutch / DUTCH
- Spanish / SPANISH
- Japanese / JAPANESE
- Italian / ITALIAN
- Portuguese / PORTUGUESE

The language displayed font panel is Japanese when Japanese is selected as language setting and English when English, German, French, Dutch, Spanish, Italian; Portuguese is selected as language setting.

#### 5.4.3.2 Machine name / MACHINE NAME

- No Display / OFF
- Display / ON

#### 5.4.3.3 Print page / PRINT PAGE

- No Display / OFF
- Display / ON

#### 5.4.3.4 IP address / IP ADDRESS

- No Display / OFF
- Display / ON

**5.4.3.5 Contrast adjustment / CONTRAST**

Max.	Min.	Step	Display	Sign	Integer digit	Decimal point digit	0 fullfil	Unit
50	24	2	Decimal	Non	2	0	Exist	Non

- + (Plus) Strong contrast
- - (Minus) Weak contrast

**5.4.4 Password setting / PASSWORD**

Menu list of Password setting / PASSWORD

MENU ITEM			
System Mode / SYSTEM MODE			
	<2>Parameter setting / <2>PARAMETER SET		
		Password setting / PASSWORD	
			Password setting / PASSWORD

Password setting / PASSWORD

- Disable / OFF
- Enable / ON

Password setting / PASSWORD



Each input value for password input display

Max.	Min.	Step	Display	Sign	Integer digit	Decimal point digit	0 fullfil	Unit
F	0	1	Hex decimal	Non	1	0	Non	Non



#### 5.4.4.1 Boot display of system mode and user mode when password is enabled

Password input display is displayed when booting system mode and user mode if password is enabled.

##### Password input for system mode

English	Procedure
	Press [FEED] key and [RESTART] key at the same time when printer turns on. Display password input display.
	Input password.
	Open system mode.
When wrong password is inputted or pressing [CANCEL] key or [MODE] key	
	Display wrong password message.
Wrong password 3 times	
	Boot online mode.

##### Password input for user mode

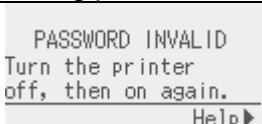
English	Procedure
	Hold down [RESTART] key or [MODE] key for 3 seconds when printer is pausing after power on. Display password input display.
	Input password.
	Open user mode.
When wrong password is inputted or pressing [CANCEL] key or [MODE] key	
	Display wrong password message.
Wrong password 3 times	
	Printer is locked. Turn on printer again.

password by @010 commands if user forgets password.

## 5.5 Fine adjustment value setting/ ADJUST SET

### ■ Outline of Printer Parameter Fine Adjustment

In the Printer Parameter Fine Adjustment mode, you can fine adjust each parameter, such as Print tone, Print start position, Threshold, etc. which are set by the PC command. This is useful when using several types of media by turns or when the print start position or cut/strip position is required to be fine adjusted.

The **Printer Parameter Fine Adjustment** menu contains the following.

MENU ITEM	
System Mode / SYSTEM MODE	
<3>Fine adjustment value setting / <3>ADJUST SET	
	Feed / FEED ADJ.
	Cut position / CUT ADJ.
	Back feed / BACK ADJ.
	X direction position / X ADJUST
	Density adjustment (Thermal transfer) / TONE ADJ.(TRANS.)
	Density adjustment (Direct thermal) / TONE ADJ.(DIRECT)
	Ribbon (Rewinder) / RBN ADJ.<FW>
	Ribbon (Feeder) / RBN ADJ.<BK>
	Reflective sensor fine tune / THRESHOLD <REFL.>
	Transmissive sensor fine tune / THRESHOLD <TRANS.>

5.5.1 Feed / FEED ADJ.

Max.	Min.	Step	Display	Sign	Integer digit	Decimal point digit	0 fullfil	単位
50.0	-50.0	0.1	Decimal	Exist	2	1	Non	mm

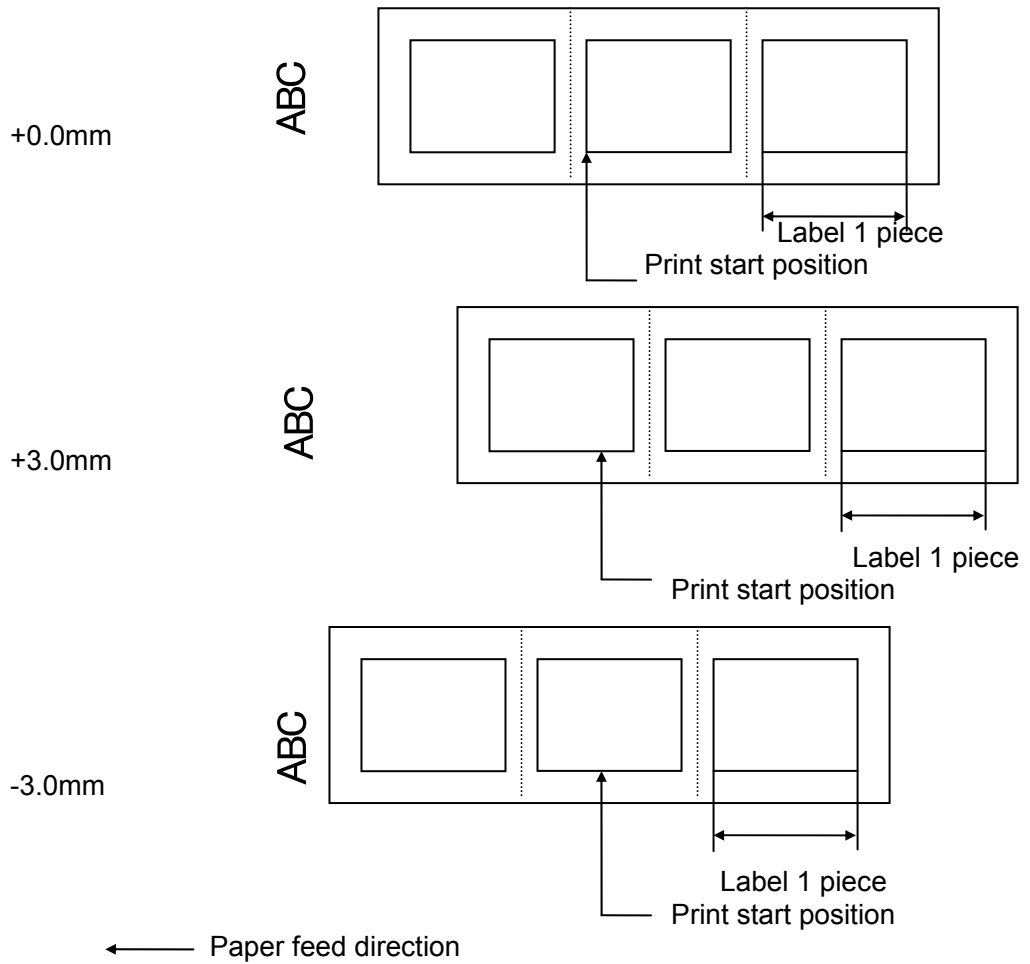

5.5.2 Cut position / CUT ADJ

Max.	Min.	Step	Display	Sign	Integer digit	Decimal point digit	0 fullfil	Unit
50.0	-50.0	0.1	10進	Exist	2	1	Non	mm

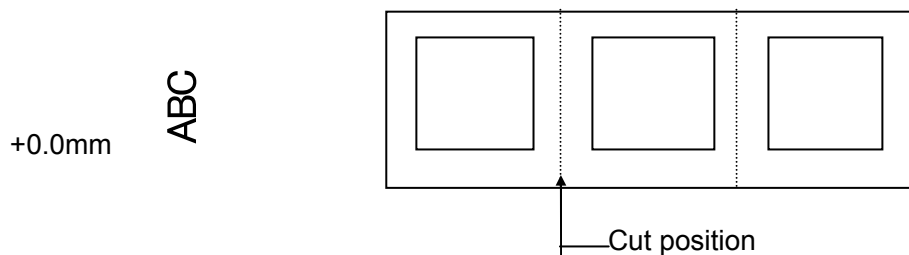



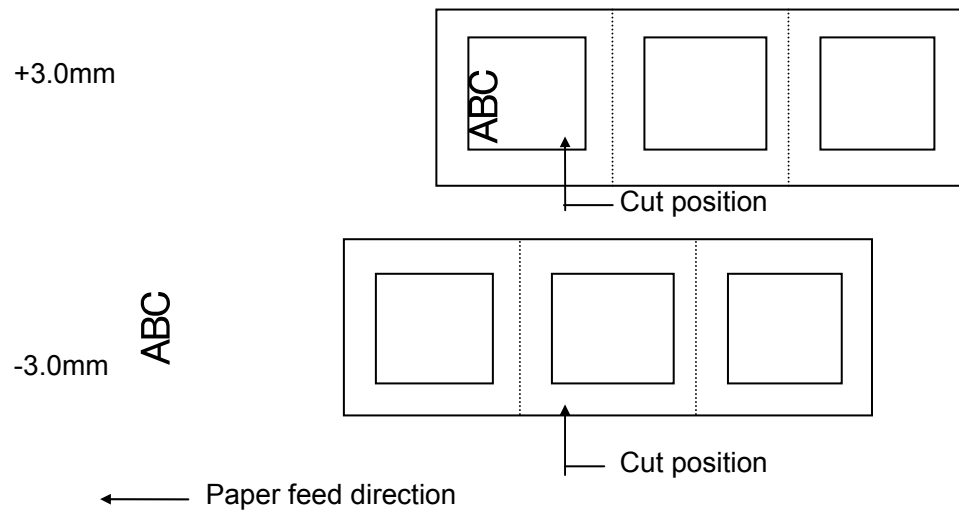

[Procedure for label having label pitch of less than 38 mm when the swing cutter is used]

The minimum label pitch of the label which can be cut in normal use is 38.0 mm. When a label having a label pitch of less than 38.0 mm is used (although it is out of specifications), the edge of the label is caught by the edge of the thermal head during a back feed to the home position after cutting the gap area between labels. Therefore, the label may not be fed back to the proper home position. By performing either method below, the problem will be solved.

[Method 1] Lift the head.

When the following conditions are all met, the cut operation is as follows.

Head lifted → Forward feed to the cut position → Head lowered → Cut →  
Head lifted → Reverse feed to the home position → Head lowered

Conditions: Issue Command, Feed Command, and Eject Command received.  
Label pitch of 38.0 mm or less, cut performed, transmissive sensor designated, cut position fine adjustment of  $\pm 10.0$  mm or less, and issue mode "C"

\* The head is lifted/lowered only when the optional ribbon save module is attached and the ribbon saving system is set to ON in the parameter setting. When the ribbon save module is not installed, use Method 2 since the head is not lifted/lowered.

**NOTES:**

1. If the head is lifted up when the edge of the label being ejected passes the paper feed roller, the sensor may not be able to detect an error even if it occurs (a feed cannot be performed).
2. If the head-up solenoid temperature is high when a cut issue is about to be performed with the head lifted, the head may not be lifted.

[Method 2] Adjust the cut position fine adjustment value.

When this procedure is used, one or more printed labels are left between the head and the cutter. Therefore, these labels should be removed by an issue or a label feed.

(a) Cut position fine adjustment value calculation

The cut position fine adjustment value can be calculated using the following method. If a back feed to the proper home position cannot be performed using this value, the cut position should be adjusted with any value.

$$\begin{aligned} \text{Cut position fine adjustment value} &= (\text{Number of labels left between head and cutter}) \times (\text{Label pitch}) \\ &= \left( \frac{32.8 \text{ mm}}{\text{Label pitch}} \right) \times (\text{Label pitch}) \end{aligned}$$

\* Any decimal remainders are dropped.

Ex) Label pitch: 30.0 mm

$$\begin{aligned} \text{Cut position fine Adjustment value} &= \left( \frac{32.8 \text{ mm}}{30.0 \text{ mm}} \right) \times (30.0 \text{ mm}) \\ &= 1 \times 30.0 \text{ mm} \\ &= +30.0 \text{ mm} \end{aligned}$$

(b) Operation example

Issue count: 2, Cut interval = 1

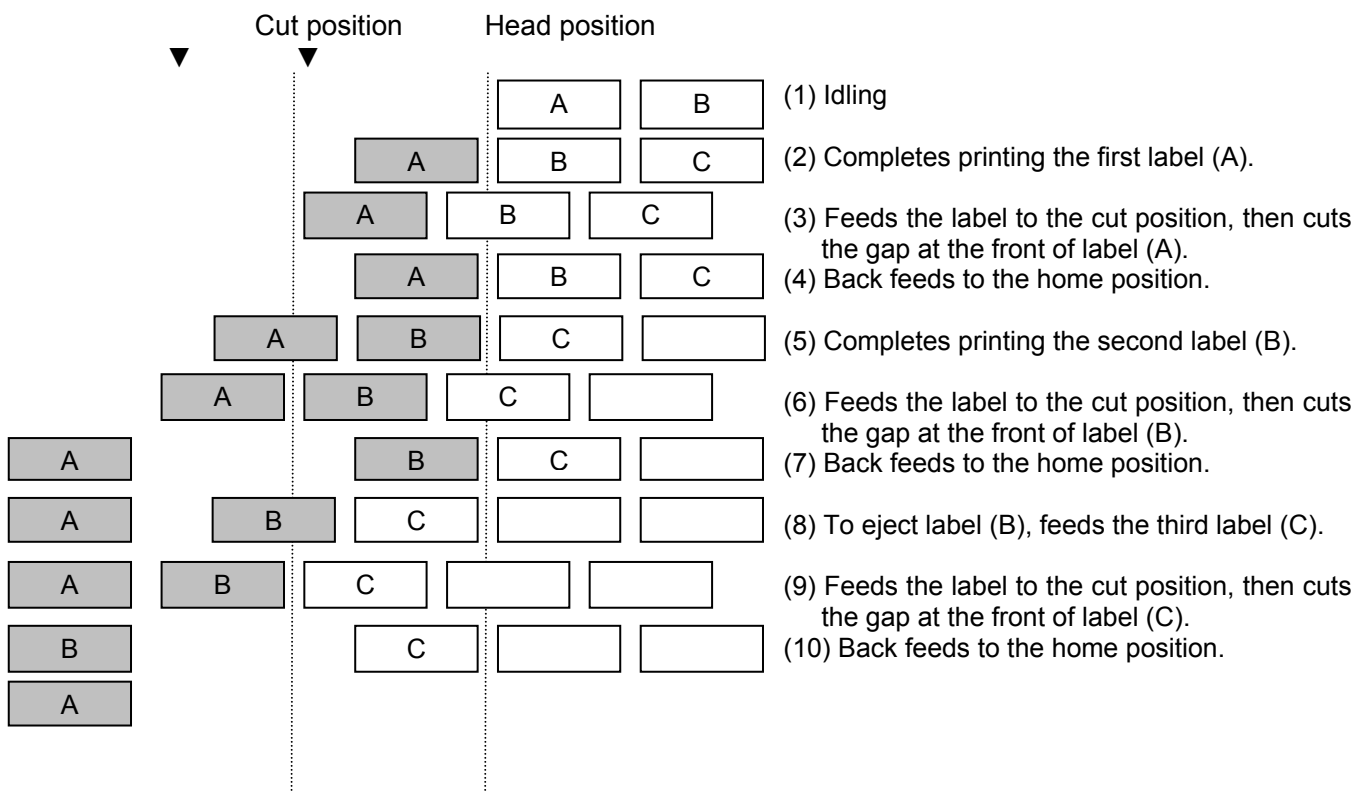

[Procedure for label having less than the min. label pitch for each issue speed when the rotary cutter is used]

When the following conditions are all met, the cut operation for the last label to be cut is as follows.

Forward feed to the cut position → Cut with feeding → Feed stops →  
Head lifted → Reverse feed to the home position → Head lowered

Conditions: Issue Command, Feed Command, and Eject Command received.

Label pitch: Less than the min. label pitch for each issue speed,  
cut performed, transmissive sensor designated, cut position fine adjustment  
of  $\pm 10.0$  mm or less, and issue mode "C"

- \* For the Issue Command, this procedure is effective only for the last label to be cut when the next Issue Command is not received.
- \* The head is lifted/lowered only when the optional ribbon save module is attached and the ribbon saving system is set to ON in the parameter setting. When the ribbon save module is not installed, the head-up/down operations are not performed. See "NOTES" below.

- NOTES:**
1. *If the head is being lifted up when the edge of the label which is being ejected passes the paper feed roller, the sensor may not be able to detect an error even if it occurs (a feed cannot be performed more).*
  2. *If the head-up solenoid temperature is high when a cut issue is about to be performed with the head lifted, the head may not be lifted.*

[Strip position fine adjustment]

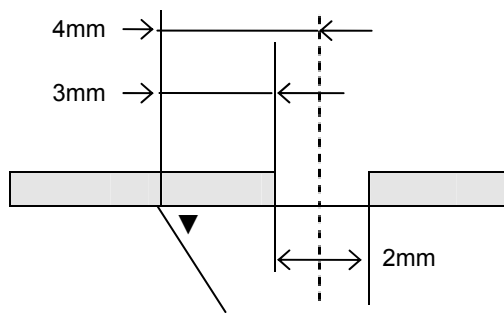
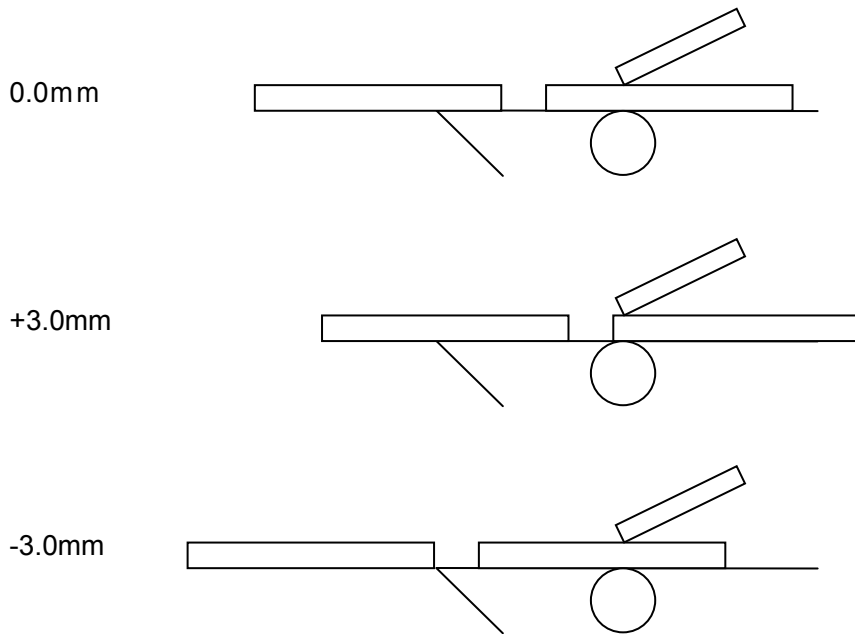

Printing in strip issue mode is stopped at the position where the distance from the middle point of the gap between labels to the end of the strip shaft is 4 mm, since the gap between labels is assumed to be 2 mm.

When the print stop position is not proper due to a greater gap, the print stop position should be adjusted using the strip position fine adjust function.

## 5.5.3 Back feed / BACK ADJ

Max.	Min.	Step	Display	Sign	Integer digit	Decimal point digit	0 fullfil	Unit
9.9	-9.9	0.1	Decimal	Exist	1	1	Non	mm

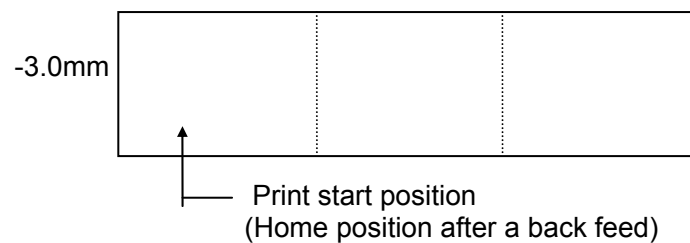
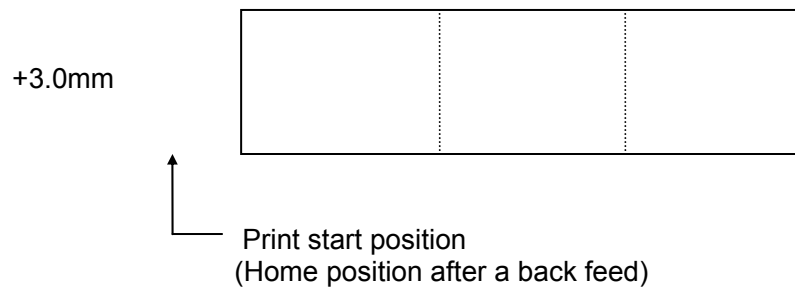
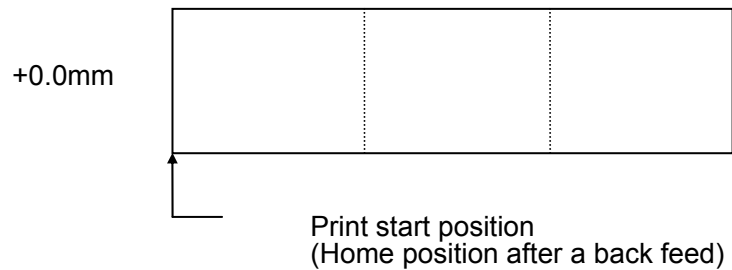

(\*) There may be cases where a label is not returned to the home position depending on the print conditions, even if a back feed, of which the length is the same as the forward feed, is performed. In issues where any paper sensor is used, if the label pitch length is almost the same as the distance between the thermal print head and the paper sensors (75.5 mm), a label/tag may not be returned to the home position when operations with a back feed (such as cut issues, strip issues, automatic forward feed standby) are performed. It may result in an error. In such cases, to prevent an error from occurring, the back feed length should be increased by performing the back feed fine adjustment in the + direction.

**5.5.4 X direction position / X ADJUST**

Max.	Min.	Step	Display	Sign	Integer digit	Decimal point digit	0 fullfil	Unit
99.5	-99.5	0.1	Decimal	Exist	2	1	Non	mm

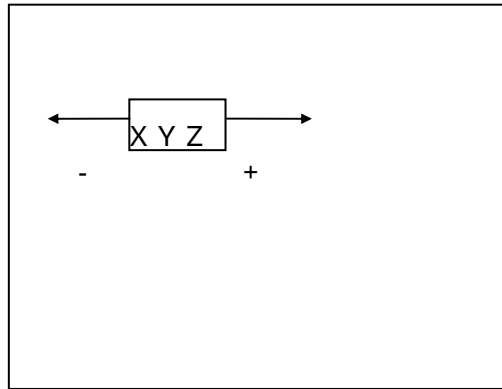

**5.5.5 Density fine tune (Thermal transfer) / TONE ADJ.(TRANS.)**

Max.	Min.	Step	Display	Sign	Integer digit	Decimal point digit	0 fullfil	Unit
10	-20	1	Decimal	Exist	2	0	Non	step

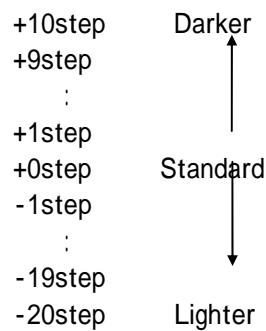

**5.5.6 Density fine tune (Direct thermal transfer) / TONE ADJ.(DIRECT)**

Max.	Min.	Step	Display	Sign	Integer digit	Decimal point digit	0 fullfil	Unit
10	-20	1	Decimal	Exist	2	0	Non	step

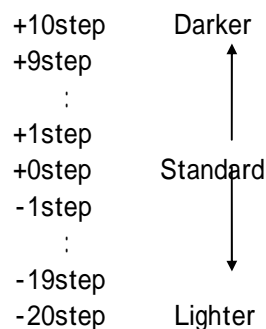

**5.5.7 Ribbon (Rewinder) / RBN ADJ.<FW>**

Max.	Min.	Step	Display	Sign	Integer digit	Decimal point digit	0 fullfil	Unit
10	-15	1	Decimal	Exist	2	0	Non	step

+10step

+0step (Standard)

-1step ( $-5\% \times 5 = -5\%$ )-14step ( $-5\% \times 14 = -70\%$ )-15step ( $-5\% \times 15 = -75\%$ )

1step = 5%

**5.5.8 Ribbon (Feeder) / RBN ADJ.<BK>**

Max.	Min.	Step	Display	Sign	Integer digit	Decimal point digit	0 fullfil	Unit
10	-15	1	10進	Exist	2	0	Non	step

+10step

+0step (Standard)

-1step ( $-5\% \times 5 = -5\%$ )-14step ( $-5\% \times 14 = -70\%$ )-15step ( $-5\% \times 15 = -75\%$ )

1step = 5%

**5.5.9 Reflective sensor fine tune / THRESHOLD <REFL.>**

Max.	Min.	Step	Display	Sign	Integer digit	Decimal point digit	0 fullfil	Unit
4.0	0.0	0.1	Decimal	Non	1	1	Non	V

(\*) If "0.0 V" is set, when the power is turned OFF then ON, the value "0.0 V" is returned to the initial value (1.0 V).

**5.5.10 Transmissive sensor fine tune / THRESHOLD <TRANS.>**

Max.	Min.	Step	Display	Sign	Integer digit	Decimal point digit	0 fullfil	Unit
4.0	0.0	0.1	Decimal	Non	1	1	Non	V

(\*) If "0.0 V" is set, when the power is turned OFF then ON, the value "0.0 V" is returned to the initial value (1.4 V).

## Supplementary explanation

- When the [RESTART] and [FEED] keys are pressed at the same time, the display shows the system mode menu.
- If the [RESTART] or [FEED] key is held down for 0.5 seconds or more when a fine adjustment value is being set, the printer enters the repeat mode, in which the key is entered repeatedly.
- A changed fine adjustment value is stored in memory by pressing the [PAUSE] key.
- The printer is controlled by the sum of the fine adjustment parameter programmed on the printer and the fine adjustment command from the PC. However, the maximum values for each fine adjustment are as follows:
  - Feed fine adjustment ..... ±50.0 mm
  - Strip position fine adjustment..... ±50.0 mm
  - Back feed fine adjustment ..... ±9.9 mm
  - Print density fine adjustment..... ±10 step
  - X-coordinate fine adjustment..... ±99.5 mm
  - Ribbon motor drive voltage fine adjustment (Rewind)..... -15 to +0 step
  - Ribbon motor drive voltage fine adjustment (Back tension)..... -15 to +0 step
- The X-coordinate fine adjustment is performed to finely adjust the X-coordinate of the drawing in the left or right direction. Adjust the X-coordinate in the effective print range. (After the value reaches the coordinate "0", the value remains unchanged even if a subsequent fine adjustment is performed in the negative direction.)
- The X-coordinate fine adjustment is not effective for the self-test results printout (maintenance counter, various parameters, and automatic self-test) and the test print.
- The print density fine adjustment value is +0 step at the time of shipment from the factory.
- The ribbon rewind/back tension motors drive voltage fine adjustment values are the sum of the fine adjustment by the command (from the PC) and the fine adjustment in the system mode (by key operation). The maximum fine adjustment values are -15 for both the ribbon rewind motor and the ribbon back tension motor.
- The print density fine adjustment value is the sum of the fine adjustment by command (from the PC) and the fine adjustment in the system mode (by key operation). The respective max.



fine adjustment values are  $\pm 10$ . The max. value for each print speed is as below. When the value exceeds the maximum, it is automatically corrected to the max. value.

Speed	B-EX4T1-G		B-EX4T1-T	
	Direct thermal	Thermal transfer	Direct thermal	Thermal transfer
3ips	+10step	+10step	+10step	+10step
5ips	+10step	+10step	+10step	+10step
6ips	+10step	+10step	+10step	+10step
8ips	+10step	+10step	+10step	+10step
10ips	+10step	+10step	+10step	+10step
12ips	+10step	+10step	+10step	+10step
14ips	+10step	+10step	+10step	+10step

## 5.6 TEST PRINT

### ■ Outline of Test Print

In the Test Print mode, you can print the test pattern and set its conditions. This is useful to check the print quality of new media or ribbon.

The **Test Print** menu contains the following:

MENU ITEM
System Mode / SYSTEM MODE
<4>Test print / <4>TEST PRINT
Print condition setting / PRINT CONDITION
Issue count / ISSUE COUNT
Print speed / PRINT SPEED
Sensor / SENSOR
Print method / PRINT TYPE
Issue type / ISSUE TYPE
Label pitch / LABEL PITCH
Paper feed / PAPER FEED
1-dot slant line print / SLANT LINE(1DOT)
3-dot slant line print / SLANT LINE(3DOT)
Character print / CHAACTERS
Barcode print / BARCODE
White paper print / NON-PRINTING
Factory test / FACTORY TEST
Auto print (Transmissive) / AUTO PRINT (TRANS.)
Auto print (Reflective) / AUTO PRINT (REFL.)

#### 5.6.1 Print condition setting / PRINT CONDITION

It sets printing condition of printer for test print.

##### 5.6.1.1 Issue count / ISSUE COUNT

- 1 page / 1
- 3 page / 3
- 5 page / 5
- 10 page / 10
- 50 page / 50
- 100 page / 100
- 500 page / 500
- 1000 page / 1000
- 5000 page / 5000

### 5.6.1.2 Print speed / PRINT SPEED

The selection of printer speed has variation depend on resolution of printer.

203dpi	305dpi
· 3ips	· 3ips
· 6ips	· 5ips
· 8ips	· 8ips
· 10ips	· 10ips
· 12ips	· 12ips
· 14ips	· 14ips

When the peel-off is selected as the issue type, the maximum speed becomes 10 ips if over 10 ips print speed is selected.

### 5.6.1.3 Sensor / SENSOR

- None / NONE
- Transmissive / TRANS.
- Reflective / REFLECT
- Transmissive (Manual) / MANUAL TRANS.
- Reflective (Manual) / MANUAL REFL.

### 5.6.1.4 Print method / PRINT TYPE

- Thermal transfer / TRANSFR
- Direct thermal / DIRECT

### 5.6.1.5 Issue type / ISSUE TYPE

- Batch issue / NO CUT
- Issue with cut / WITH CUT
- Issue with peel-off / PEEL OFF

### 5.6.1.6 Label pitch / LABEL PITCH

Max.	Min.	Step	Display	Sign	Integer digit	Decimal point digit	0 fullfil	Unit
999	0	1	Decimal	Non	3	0	Non	mm

### 5.6.1.7 Paper feed / PAPER FEED

- Disable / NO FEED
- Enable / FEED

Initial parameter values when turning the power on

ISSUE COUNT	1 piece
PRINT SPEED	203dpi: 6"/sec
	305dpi: 5"/sec
SENSOR	Transmittive sensor
PRT TYPE	Thermal transfer
TYPE	Batch issue
LABEL LEN.	76mm
PAPER	Enable paper feeding

Supplementary explanation:

- Each fine adjustment parameter is effective for test print. However, the X-coordinate fine adjustment is excluded.
- When an error occurs during a test print, the error message is displayed and printing is stopped. The error LED turns on and the online LED turns off.
- The error is cleared by pressing the [CANCEL] key/[ENTER] key and the display shows the test print menu. The error LED turns off and the online LED turns on. Printing is not automatically resumed after the error is cleared.
- The label size greater than the image buffer length cannot be designated. If it is designated, the printer prints in the image buffer length then stops, or the printer stops because of an error.
- When the transmissive sensor is selected, the gap between labels should be 3 mm.

For B-EX4, the print speed "10 ips" is not supported for printing with the rotary cutter. If "10 ips" is specified when the rotary cutter has been installed, the print speed is corrected from 10 ips to 8 ips, regardless of the cut designation.

For B-EX4T1-G, if less than 15.0 mm and 30.0 mm of the label pitch is specified for printing at 3 ips and 6 ips, respectively, an issue without a cut is performed.

For B-EX4T1-T, if less than 15.0 mm, 25.0 mm, 38.0 mm of the label pitch is specified for printing at 3 ips, 5 ips, and 8 ips, respectively, an issue without a cut is performed.

5.6.2 1-dot slant line print / SLANT LINE(1DOT)

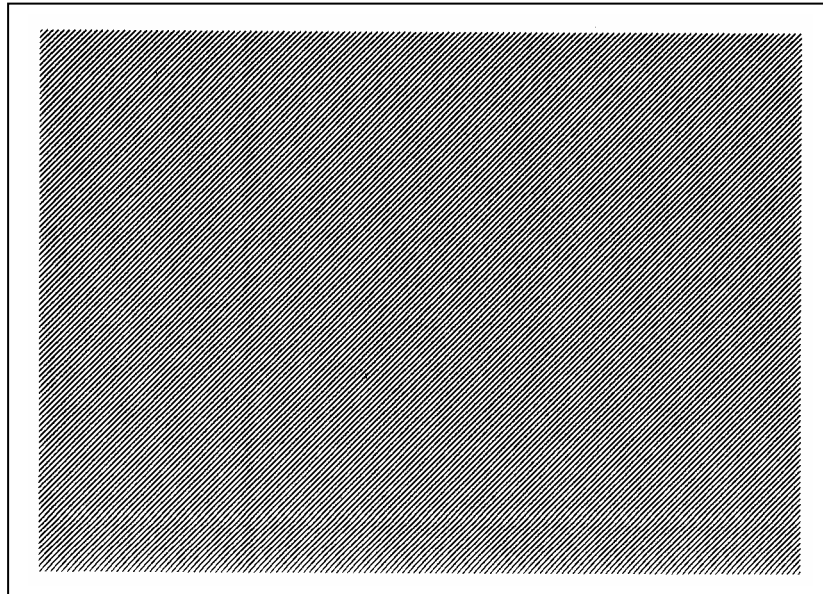

1-dot slant line

Magnification of slant line

1-dot slant line (Black area ratio: 16.7%)

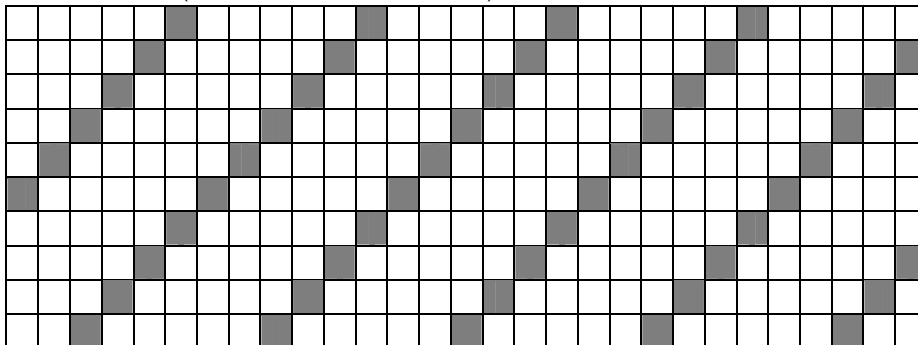

5.6.3 3-dot slant line print / SLANT LINE(3DOT)

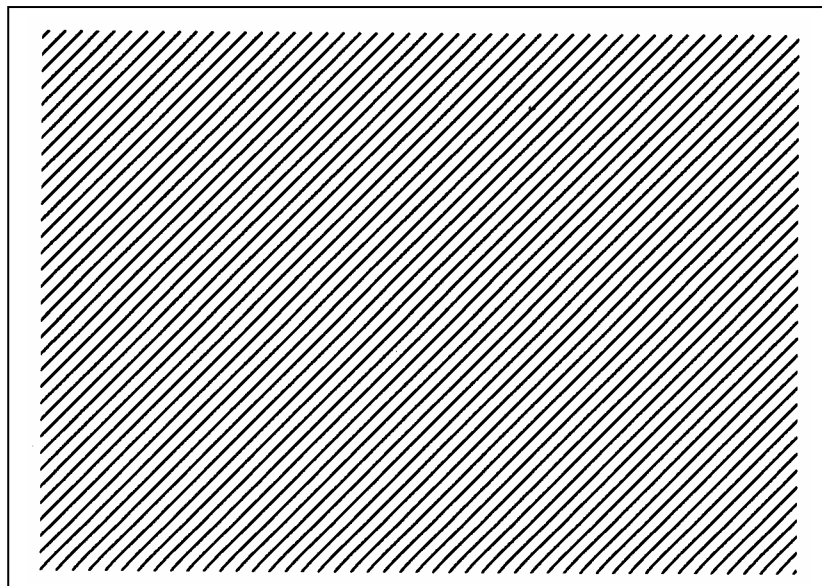

3-dot slant line

Magnification of slant line

3-dot slant line (Black area ratio: 16.7%)

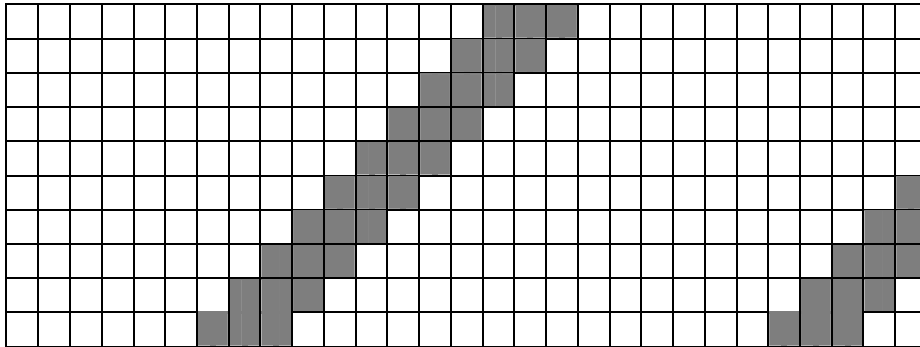

5.6.4 Character print / CHARACTERS

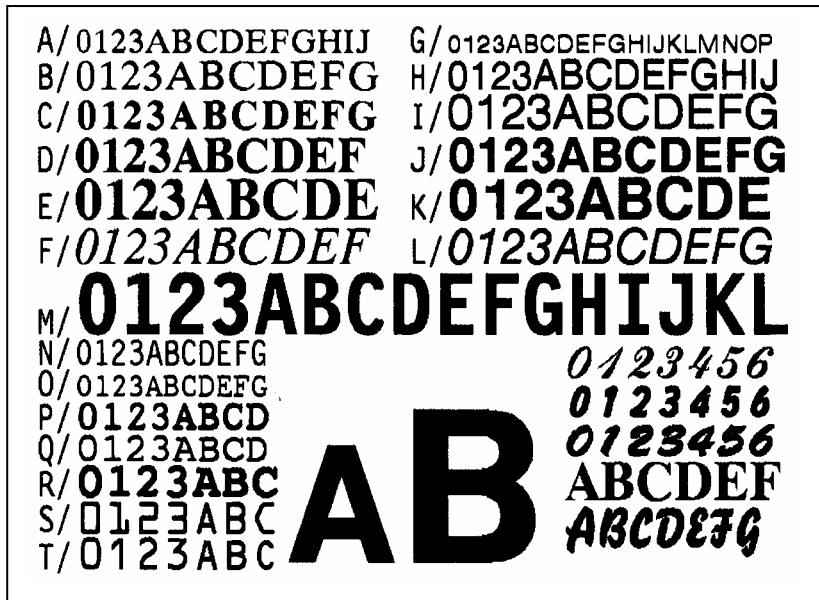

5.6.5 Barcode print / BARCODE

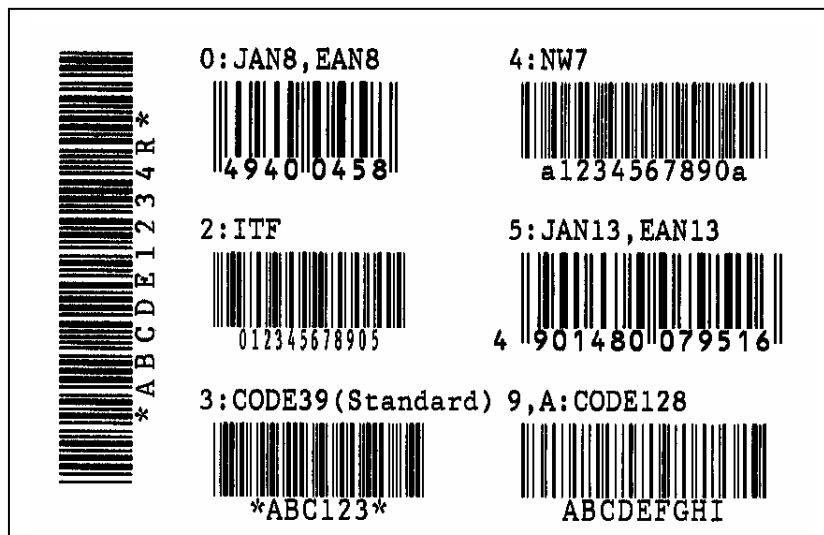

**5.6.6 White line print / NON-PRINTING**

The printer feed white paper.

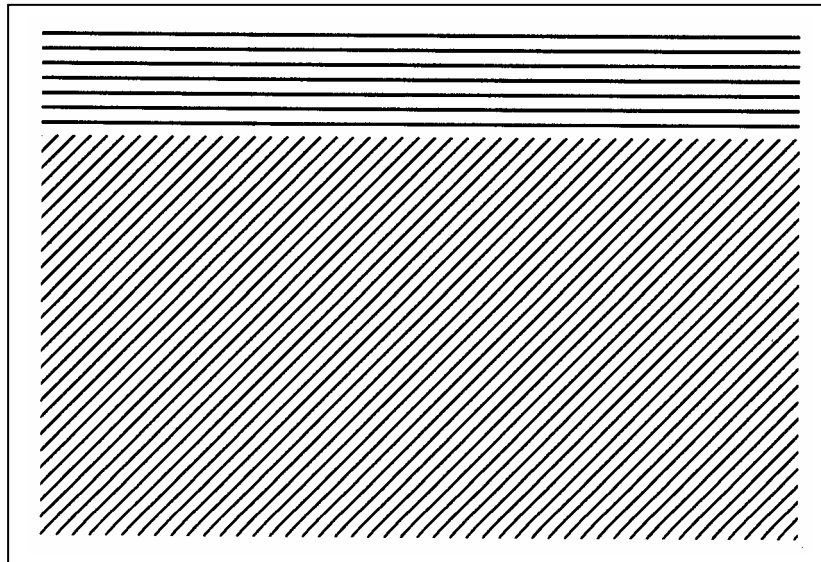
**5.6.7 Factory test / FACTORY TEST****5.6.8 Auto print (Transmissive) / AUTO PRINT (TRANS.)**

The test print for manufacturing is started by the following conditions. The parameter setting content and print density fine adjustment value are ignored.

- ✧ The following test print is started by press any key except [CANCEL] key after each printing.
- ✧ When [CANCEL] key is pressed, return to menu.

Movement contents	1 piece paper feed
	3-dot slan line print
	Barcode print
	Character print
Issue piece5 pieces each	5 pieces each
Print speed	203dpi: 6"/sec
	305dpi: 5"/sec
Sensor type	Transmissive sensor
Print method	Thermal transfer
Issue type	Continuous issue
Label pitch	76mm
Print density fine adjustment value	±0

**5.6.9 Auto print (Reflective) / AUTO PRINT (REFL.)**

The test print for manufacturing is started by the following conditions. The parameter setting content and print density fine adjustment value are ignored.

- ◇ The following test print is started by press any key except [CANCEL] key after each printing.
- ◇ When [CANCEL] key is pressed, return to menu.

Movement contents	1 piece paper feed
	3-dot slant line print
	Barcode print
	Character print
Issue piece5 pieces each	5 pieces each
Print speed	203dpi: 6"/sec
	305dpi: 5"/sec
Sensor type	Reflective sensor
Print method	Thermal transfer
Issue type	Continuous issue
Label pitch	76mm
Print density fine adjustment value	±0



## 5.7 SENSOR ADJUSTMENT

### ■ Outline of the Sensor Adjustment

In the Sensor Adjustment mode, the status of the sensors and thermistors is displayed. Also you can make a Threshold Setting for the Black Mark, Feed Gap, and Ribbon End Sensors.

The **Sensor Adjustment** menu contains the following:

MENU ITEM	
System Mode / SYSTEM MODE	
<5>	Sensor adjustment / <5>SENSOR ADJUST
	Temperature sensor / TEMPERATURE
	Reflective sensor/ REFLECT
	Transmissive sensor / TRANS.
	Paper end level / PE REFL./TRANS.
	Ribbon end / RIBBON

### 5.7.1 Temperature sensor/ TEMPERATURE

It display outer temperature and head temperature.

The sign of temperature is displayed only when temperature is minus (-).

The display content is updated each 200 msec.

The range of each temperature is below.

Outer temperature	-20 ~ 100
Head temperature	-20 ~ 100

### 5.7.2 Reflective sensor / REFLECT

It adjusts the sensor level of reflective sensor.

Set tag paper on reflective sensor and the black mark should not be located on the sensor.

The display content of sensor level is updated each 200 msec.

The sensor level is adjusted by holding down [ENTER] key for 3 seconds.

When the adjustment is finished, "Adjustment complete" is displayed and asterisk (\*) is marked at the right side or voltage.

The range is below.

Reflective sensor	0.0V ~ 5.0 V
-------------------	--------------

**5.7.3 Transmissive / TRANS.**

It adjusts the sensor level of transmissive sensor.

Remove the label from the label paper and load the backing paper on the transmissive sensor and the label should not be located on the sensor.

The display content of sensor level is updated each 200 msec.

The sensor level is adjusted by holding down [ENTER] key for 3 seconds.

When the adjustment is finished, "Adjustment complete" is displayed and asterisk (\*) is marked at the right side or voltage.

The range is below.

Transmissive sensor	0.0V ~ 5.0 V
---------------------	--------------

**5.7.4 Paper empty level / PE REFL./TRANS.**

It adjusts the paper empty level of reflective sensor and transmissive sensor.

Remove the paper located on the sensor.

The display content of sensor level is updated each 200 msec.

The sensor level is adjusted by holding down [ENTER] key for 3 seconds.

When the adjustment is finished, "Adjustment complete" is displayed and asterisk (\*) is marked at the right side or voltage.

The range is below.

Reflective sensor	0.0V ~ 5.0 V
Transmissive sensor	0.0V ~ 5.0 V

**5.7.5 Ribbon end / RIBBON**

It adjusts the ribbon end level.

Set the ribbon on the sensor.

The display content of sensor level is updated each 200 msec.

The sensor level is adjusted by holding down [ENTER] key for 3 seconds.

When the adjustment is finished, "Adjustment complete" is displayed and asterisk (\*) is marked at the right side or voltage.

The range is below.

Ribbon end sensor	0.0V ~ 5.0 V
-------------------	--------------

## 5.8 RAM CLEAR

### ■ Outline of RAM Clear

In the RAM Clear mode, clearing the Maintenance Counter and initializing the Parameters are possible. After replacing the print head, ribbon motor, or platen, perform maintenance clear.

The **RAM Clear** menu contains the following:

MENU ITEM	
System Mode / SYSTEM MODE	
	<6>RAM クリア / <6>RAM CLEAR
	Clear Disable / NO RAM CLEAR
	Counter clear / MAINTE.CNT CLEAR
	All counter / ALL COUNTER
	Label distance covered / FEED
	Print distance / PRINT
	Cut count / CUT
	Others / OTHER
	Parameter clear / PARAMETER CLEAR
	QM type / QM TYPE
	JA type / JA TYPE
	CN type / CN TYPE

#### 5.8.1 No RAM clear / NO RAM CLEAR

This is a selection to prevent wrong user operation.

#### 5.8.2 Counter clear / MAINTE.CNT CLEAR

It clears maintenance counter, like label distance covered etc.

Initial value after maintenance counter clear

Item	Initial value
Label distance covered	0 km
Print distance	0 km
Cut count	0
Head up/down count	0
Ribbon motor drive time	0 hours
Head-up solenoid driver time	0 Hours
RS-232C hardware error count	0
System error count	0
Momentary power interruption count	0

English	
ALL COUNTER CLEAR...	Clearing
ALL COUNTER COMPLETED Turn off the printer	After clear

「COMPLETED Turn off the printer」 is displayed after finishing Ram clear. Turn off printer

### 5.8.3 Parameter clear / PARAMETER CLEAR

It clears each parameters of printer setting.

The destination for which RAM clear has been performed is printed on the top right corner of the maintenance counter printout.

English	
QM TYPE CLEAR...	Clearing
QM TYPE COMPLETED Turn off the printer	After clear

The setting value for each destination is below.

System mode

Parameter setting/printer movement setting

Function	QM	CN	JA
Media Load	OFF	←	←
Forward wait	OFF	←	←
Auto forward/reverse wait fine adjustment value	0.0mm	←	←
Wait movement	MODE1	←	←
HU CUT/RWD.	OFF	←	←
Ribbon save	TAG	←	←
Pre peel-off process	OFF	←	←
Back feed	STD	←	←

## Parameter setting/Soft control setting

Function	QM	CN	JA
Character code	PC-850	←	←
0 character type	Non slash	←	←
Control code	AUTO	←	←
Control code (CODE1)	0x1b	←	←
Control code (CODE2)	0x0a	←	←
Control code (CODE3)	0x00	←	←
Peel-off wait status	OFF	←	←
USB STATUS	OFF	←	←
FEED Key	FEED	←	←
Kanji special code	TYPE1	←	←
Euro code	0xb0	←	←
Auto broken dot check	OFF	←	←
WEB printer	OFF	←	←
Ribbon near end	OFF	←	←
Expansion I/O mode	TYPE1	←	←
Paper/ribbon end	TYPE1	←	←
MaxiCode specification	TYPE1	←	←
XML	STD	←	←
Threshold selection (Reflective sensor)	Priority for Manual setting	←	←
Threshold selection (Transmissive sensor)	Priority for Manual setting	←	←
Print control (Thermal transfer)	Semi regin1	←	←
Print control (Direct Thermal)	Standard	←	←
Power save mode time	15 minute	←	←

## Parameter setting/LCD display

Function	QM	CN	JA
LCD display language	English	←	Japanese
LCD detail display: model name	ON	←	←
LCD detail display: print number	ON	←	←
LCD detail display: IP address	OFF	←	←
Contrast adjustment	40	←	←

## Parameter setting/Password setting

Function	QM	CN	JA
Password enable/disable	No initialization	←	←
Password value	No initialization	←	←

## Fine adjustment value setting

Function	QM	CN	JA
Feed	0.0mm	←	←
Cut position	0.0mm	←	←
Back feed	0.0mm	←	←
X-coordinate	0.0mm	←	←
Print density (Thermal transfer)	0step	←	←
Print density (Direct Thermal)	0step	←	←
Ribbon (Rewind)	0step	←	←
Ribbon (Back tension)	0step	←	←
Reflective sensor	1.0V	←	←
Transmissive sensor	1.4V	←	←

## Interface setting/Network

Function	QM	CN	JA
Wire/Wireless LAN selection	AUTO	←	←
SNMP	ON	←	←
IP address	No initialization	←	←
Gateway	No initialization	←	←
Subnet mask	No initialization	←	←
Socket port	No initialization	←	ON
Port number	No initialization	←	←
DHCP	OFF	←	←
DHCP client ID	No initialization	←	←
DHCP host name	No initialization	←	←
Wireless LAN standard	802.11b/g	←	←
Wireless LAN connection mode	INFRA/OPEN/ WEP:OFF	←	←
WEP default Key	1	←	←
802.11b channel	1	←	←
802.11b send rate	11M	←	←
802.11g channel	1	←	←
802.11g send rate	54M	←	←
WLAN power save	ON	←	←
WINS	OFF	←	←
WINS address	0,0,0,0	←	←
LPR	OFF	←	←

## INTERFACE setting/USB

Function	QM	CN	JA
USB serial ID	OFF	←	←

## INTERFACE setting/RS-232C

Function	QM	CN	JA
Communication speed	9600bps	←	←
Data length	8bit	←	←
Stop bit	1bit	←	←
Parity	NONE	←	EVEN
Flow control	XON+READY AUTO	←	←

## INTERFACE setting/Centro

Function	QM	CN	JA
ACK/BYSY	TYPE1	←	←
Input prime	ON	←	←
Plug and play	OFF	←	←

## BASIC setting

Function	QM	CN	JA
Basic function	OFF	←	←
Trace function	OFF	←	←

## RFID setting

Function	QM	CN	JA
Module setting	NONE	←	←
Tag type setting	NONE	←	←
Tag detection setting	OFF	←	←
Error tag	No initialization	←	←
Access password	No initialization	←	←
Password protection enable/disable	No initialization	←	←
Password protection	No initialization	←	←
Auto un-lock	No initialization	←	←
Issue retry number	3	←	←
Read retry count	5	←	←
Read retry time	4.0 second	←	←
Write retry count	5	←	←
Write retry time	2.0 second	←	←
Write retry position	0mm	←	←
Wireless output level	251	←	←
AGC threshold	0	←	←
Channel	AUTO	←	←
Q value	0	←	←
AGC threshold	0	←	←
AGC threshold Min.	0	←	←
Multi word write	OFF	←	←
RFID write success label issue number	No initialization	←	←
RFID write failure label issue number	No initialization	←	←



## RTC setting

Function	QM	CN	JA
Parity check	No initialization	←	←
Overwrite for printing	No initialization	←	←

## Compatible (Z-MODE)

Function	QM	CN	JA
Enable/Disable	OFF	←	←

## User mode

## Auto paper measurement

Function	QM	CN	JA
Enable/Disable	OFF	←	←

## [Attention of reprint]

The limit value of label setting command is different between Japan mode (JA) and others.

## 5.9 IP ADDRESS SETTING

### ■ Outline of the IP Address Setting

In the IP Address Setting mode, you can set the IP Address, Gateway Address, Subnet Mask, DHCP, and DHCP ID which are necessary for a network communication. Since each setting value is different depending on your operating environment.

The **IP Address Setting** menu contains the following:

MENU ITEM	
System Mode / SYSTEM MODE	
<7>INTERFACE setting / <7>INTERFACE	
Network / NETWORK	
Wire/Wireless LAN selection / LAN/WLAN	
SNMP	
Network setting / SETTING	
USB	
RS-232C	
Centronics / CENTRO.	

### 5.9.1 Network / NETWORK

Menu list of Network / NETWORK

MENU ITEM	Display pattern and key operation
System Mode / SYSTEM MODE	Scroll display
<7>INTERFACE setting / <7>INTERFACE	
Network/ NETWORK	
Wire/Wireless LAN selection / LAN/WLAN	
SNMP	
Network setting / SETTING	

The general network setting is selected.

#### 5.9.1.1 Wire/Wireless LAN selection / LAN/WLAN

- Disable / OFF
- Enable(Auto) / ON(AUTO)
- Enable(Wire LAN) / ON(LAN)
- Enable(Wireless LAN) / ON(WLAN)

#### 5.9.1.2 SNMP

- Disable / OFF
- Enable / ON

## 5.9.1.3 Network setting / SETTING

MENU ITEM	Display pattern and key operation
System Mode / SYSTEM MODE	Scroll display
<7>INTERFACE setting / <7>INTERFACE	
Network / NETWORK	
Network setting / SETTING	
Basic information / BASIC INFORMATION	INFORMATION DISPLAY
IP Address / IP ADDRESS	Setting value display
Gateway / GATEWAY ADDRESS	
Subnet mask / SUBNET MASK	
Socket port / SOCKET PORT	Scroll display
Port number / PORT NUMBER	Setting value display
DHCP	Scroll display
DHCP Client ID / DHCP CLIENT ID	
ASCII input / ASCII	Scroll display
HEX input / HEX	
DHCP HOST name / DHCP HOST NAME	
Wireless LAN standard / WLAN STANDARD	Setting value display
Wireless LAN connection mode / WLAN MODE	
WEP default Key / DEFAULT KEY	Setting value display
802.11b channel / 802.11b CHANNEL	
802.11b transfer rate / 802.11b BAUD	Scroll display
802.11g channel / 802.11g CHANNEL	Setting value display
802.11g transfer rate / 802.11g BAUD	Scroll display
WLAN power save / WLAN POWER SAVE	
WINS	
WINS Address / WINS ADDRESS	Setting value display
LPR	Scroll display

**5.9.1.3.1 Basic information / BASIC INFORMATION**

The following information related network setting is displayed.

- IP address
- Gateway
- Subnet mask
- Socket port enable/disable
- Socket port number

**5.9.1.3.2 IP Address / IP ADDRESS**

IP address is display and set.

**5.9.1.3.3 Gateway / GATEWAY ADDRESS**

Gateway address is display and set.

**5.9.1.3.4 Subnet mask / SUBNET MASK**

Subnet mask is display and set.

**5.9.1.3.5 Socket port / SOCKET PORT**

- OFF
- ON

**5.9.1.3.6 Port number / PORT NUMBER**

Socket port number is display and set.

**5.9.1.3.7 DHCP**

- OFF
- ON

**5.9.1.3.8 DHCP Client ID / DHCP CLIENT ID**

- ASCII input / ASCII
- HEX input / HEX
- ASCII input / ASCII
- Input DHCP client ID by ASCII (64 Characters (00 - 63))
- HEX input / HEX
- Input DHCP client ID by hex decimal (64 Characters (00 - 63))

**5.9.1.3.9 DHCP HOST name / DHCP HOST NAME**

Input DHCP host name by ASCII (32 Characters (00 - 31))

**5.9.1.3.10 Wireless LAN standard / WLAN STANDARD**

- 11b/g
- 11b
- 11g

**5.9.1.3.11 Wireless LAN connection mode / WLAN MODE**

The combination list of wireless LAN connection mode and certification

ADHOC	OPEN		OFF		
			WEP40		
			WEP104		
	SHARED	No use	WEP40		
			WEP104		
INFRA	OPEN		OFF		
			WEP40		
			WEP104		
	SHARED		WEP40		
			WEP104		
	802.1x	OPEN	TLS	WEP40	
				WEP104	
			TTLS	WEP40	
				WEP104	
			LEAP	WEP40	
				WEP104	
			PEAP	WEP40	
				WEP104	
			MD5	WEP40	
				WEP104	
			EAP-FAST	WEP40	
				WEP104	
			SHARED KEY	EAP-MD5	WEP40
					WEP104
			NETWORK EAP		WEP40
	WEP104				
	WPA	OPEN	TLS		
			TTLS		
			LEAP		
			PEAP		
			EAP-FAST		
			NETWORK EAP		
WPA-SK					
WPA2	OPEN	TLS			
		TTLS			
		LEAP			
		PEAP			
		EAP-FAST			
		NETWORK EAP			
WPA2PSK					

**5.9.1.3.12 WEP default Key / DEFAULT KEY**

Max.	Min.	Step	Display	Sign	Integer digit	Decimal point digit	0 fullfil	Unit
4	1	1	Decimal	Non	1	0	Non	Non

**5.9.1.3.13 802.11b channel / 802.11b CHANNEL**

Max.	Min.	Step	Display	Sign	Integer digit	Decimal point digit	0 fullfil	Unit
14	1	1	Decimal	Non	2	0	Non	Non

**5.9.1.3.14 802.11b transfer rate / 802.11b BAUD**

- 11M
- 5.5M
- 2M
- 1M

**5.9.1.3.15 802.11g channel / 802.11g CHANNEL**

Max.	Min.	Step	Display	Sign	Integer digit	Decimal point digit	0 fullfil	Unit
14	1	1	Decimal	Non	1	0	Non	Non

**5.9.1.3.16 802.11g transfer rate / 802.11g BAUD**

- 54M
- 48M
- 36M
- 24M
- 18M
- 12M
- 9M
- 6M
- 11M
- 5.5M
- 2M
- 1M

**5.9.1.3.17 WLAN power save / WLAN POWER SAVE**

- Disable / OFF
- Enable / ON

**5.9.1.3.18 WINS**

- Disable / OFF
- Enable(Manual) / ON(MANUAL)
- Enable(DHCP) / ON(DHCP)

**5.9.1.3.19 WINS Address / WINS ADDRESS**

Display and set WINS Address.

**5.9.1.3.20 LPR**

- Disable / OFF
- Enable / ON

**5.9.2 USB**

Menu list of USB

MENU ITEM	Display pattern and key operation
System Mode / SYSTEM MODE	Scroll display
<7>INTERFACE setting / <7>INTERFACE	
USB	

**5.9.2.1 USB serial ID / USB SERIAL ID**

- Disable / OFF
- Enable / ON

**5.9.3 RS-232C**

Menu list of RS-232C

MENU ITEM	Display pattern and key operation
System Mode / SYSTEM MODE	Scroll display
<7>INTERFACE SETTING / <7>INTERFACE	
RS-232C	
Baud rate / SPEED	
Data length / DATA LENGTH	
Stop bit / STOP BIT	
Parity / PARITY	
Flow control / CONTROL	

**5.9.3.1 Baud rate / SPEED**

- 2400bps
- 4800bps
- 9600bps
- 19200bps
- 38400bps
- 115200bps

**5.9.3.2 Data length / DATA LENGTH**

- 8bits
- 7bits

**5.9.3.3 Stop bit / STOP BIT**

- 1bit
- 2bits

**5.9.3.4 Parity / PARITY**

- Non / NONE
- Even / EVEN
- Odd / ODD

**5.9.3.5 Flow control / CONTROL**

- XON+READY AUTO (Output XON at power on, XOFF at power off)
- XON+XOFF AUTO (Output XON at power on, XOFF at power off)
- READY/BUSY RTS (Output no XON/OFF at power on/off)
- XON+XOFF (Output no XON/OFF at power on/off)
- READY/BUSY (Output no XON/OFF at power on/off)



**5.9.4 Centronics / CENTRO.**

Menu list of Centronics / CENTRO.

MENU ITEM	Display pattern and key operation
System Mode / SYSTEM MODE	Scroll display
<7>INTERFACE SETTING / <7>INTERFACE	
Centronics / CENTRO.	
ACK/BUSY	
Input prime / INPUT PRIME	
Plug and play / PLUG & PLAY	

**5.9.4.1 ACK/BUSY**

- TYPE1
- TYPE2

**5.9.4.2 Input prime / INPUT PRIME**

- Disable / OFF
- Enable / ON

**5.9.4.3 Plug and play / PLUG & PLAY**

- Disable / OFF
- Enable / ON

(\*) Plug & play function of USB is always enabled regardless of this setting.

## 5.10 BASIC SETTING

### ■ Outline of Basic Setting

The Basic function enables the B-SX4T/SX5T printer to operate with the program created for other printers, by converting it to Basic program and downloading this Basic program to the B-SX4T/SX5T printer. Setting the downloaded Basic program to be enabled/disabled, browsing the program file, data file, and area file, etc. are available in this mode.

The Basic Setting menu contains the following.

MENU ITEM		
System Mode / SYSTEM MODE		
	<8>BASIC SETTING / <8>BASIC	
		Basic function / BASIC
		File display / FILE MAINTENANCE
		Trace function / TRACE
		Extended mode / EXPAND MODE

#### 5.10.1 Basic function / BASIC

- Disable / OFF
- Enable / ON

#### 5.10.2 File display / FILE MAINTENANCE

The block number and file name (12 characters) of BASIC stored block are displayed. If file name exceed 12 characters, the 13<sup>th</sup> character on ward is not displayed.

When file is not stored, hyphen ("-") is displayed as file name.

#### 5.10.3 Trace function / TRACE

- Disable / OFF
- Enable / ON

#### 5.10.4 Extended mode / EXPAND MODE

It performs BASIC program.

## 5.11 RFID Module Setting

### ■ Outline of the RFID Module Setting

In the RFID Module Setting mode, you can set various parameters related to the RFID module. It is necessary to set these parameters before operating the RFID module.

If a read or write error occurs frequently, adjust the values for the parameters.

The **RFID Module Setting** menu contains the following:

MENU ITEM	Display pattern and key operation
System Mode / SYSTEM MODE	Scroll display
<10>RFID SETTING / <10>RFID	
Test / TEST	
ID read / ID READ	Information display
Module / MODULE	Scroll display
Module type / MODULE TYPE	
Country / COUNTRY	
Tag type setting / TAG	
RF channel / RF CHANNEL	
Retry / RETRY	
Position adjust for re-issue / ADJ RETRY POSITION	Setting value display
Retry issue label / ISSUE RETRY LABELS	
Read retry / READ RETRY	
Write retry / WRITE RETRY	
UHF setting / UHF SETTING	Scroll display
Output level / POWER LEVEL	Setting value display
Q value / Q VALUE	
Tag performance measurement / AGC THRESHOLD	
Write threshold value / WRITE AGC THRESHOLD	
Write retry min AGC / WRITE RETRY MIN AGC	
Other	Scroll display
Tag test setting / TAG CHECK	
Multi word write / MULTI WRITE	
Carrier sense / CARRIER SENSE	

### 5.11.1 Test / TEST

The following item related test is displayed.

- ID Read / ID READ

#### 5.11.1.1 ID Read / ID READ

It changes to reading test mode and the printer read RFID tag. The printer perform reading test by pressing [ENTER] key. The reading data is displayed on LCD once RFID tag is read.

The error message is displayed on LCD if tag is not read.

Error content	English
No module or not available for communication / NO RFID MODULE	MODULE TYPE ERROR
No country setting / RFID CONFIG ERR	COUNTRY CONFIG ERROR
Read tag is different from setting tag / RFID READ ERROR	READ ERROR Confirm Setting or set other Tag.
Not available / NOT AVAILABLE	NOT AVAILABLE
No response / NO RESPONSE	NO REPOSE
Time out / TIME OUT	READ TIMEOUT set a RF-Tag on Ant.
Other error / UNKNOWN ERROR	UNKNOWN ERROR

The only tag which is selected by RFID tag type setting can be read. If tag type is different from RFID tag type setting, RDID tag reading error is detected. Therefore select RFID tag type before this reading test.

- The display is 16 columns and 2 lines.
- Display example

English	
ID READ	
TAG	1/1
AGC	0
00010203	04050607
08090A0B	0C0D0E0F

- 1st line data X/Y, X: Tag number for result, Y: Total tag number  
(Most of the case, only 1 tag is read.)
- If UHF module is used, "Performance/AGC" id displayed on the 2<sup>nd</sup> line by decimal.

- The data of the 3<sup>rd</sup> and 4<sup>th</sup> line is displayed by hex decimal.  
The displayed data is below.  
B-9704-RFID-H1-QM: Tag ID  
B-SX704-RFID-U2: TAG ID  
B-SX704-RFID-U2-R/EU-R/US-R/CN-R: EPC code of EPC area
- If the reading data exceed 16 digits, only first 16 digits is displayed, If the reading data is less than 16 digits, space is displayed.
- When multiple tags are read at the one time like short pitch tag reading, reading data of tag can be changed by pressing [UP]/[DOWN] key.

### 5.11.2 Module / MODULE

The following information related module setting is displayed.

- Module type / MODULE TYPE
- Country / COUNTRY
- Tag type / TAG
- RF channel / RF CHANNEL

#### 5.11.2.1 Module type / MODULE TYPE

- NONE No RFID module
- H1 HF RFID kit B - 9704 - RFID - H1 - QM
- H2 HF RFID kit B - SX704 - RFID - H2
- U2 UHF RFID kit B-SX704-RFID-U2-R Japan  
B-SX704-RFID-U2-EU-R Europe, India  
B-SX704-RFID-U2-US-R North America, Australia,  
Taiwan, Korea  
B-SX704-RFID-U2-CN-R China

This module setting can be applicable after power off/on.

### 5.11.2.2 Country / COUNTRY

When module setting is “U2”, country which mounted module support is displayed.

When module setting is “U2”, “INVALID” message is displayed.

The country can be changed when module setting is “U2” and mounted module is EU/US.

This setting is protected by password to prevent setting by user since RFID radio frequency is changed once this country setting is changed.

The following message is displayed depends on module setting and mounted module type and module mount condition.

	English
No module	(No message)
H1/H2	(No message)
U2(No module)	No RFID Module
U2(After country setting)	[ENTER] for Setting
U2(No country setting)	Need Setting for use [ENTER] for Setting
U2(Japan/China)	Cannot change COUNTRY Setting.

### 5.11.2.3 Tag type / TAG

The display content of tag type varies based on module setting.

The following number of table is the display order of scroll line.

	NONE	H1	H2	U2
NONE	1	1	1	1
I-Code	2	2		
Tag-It	3	3		
C220	4	4		
ISO15693	5	5	2	
C210	6	6		
C240	7	7		
C320	8	8		
EPC C1 Gen2	9			2

#### 5.11.2.4 RF channel / RF CHANNEL

It sets channel value of RFID write.

When the channel is set from 2CH to 8CH, the selected channel is used as fix.

When "AUTO" is selected, printer search available channel and set radio frequency to searched channel. The order of searched channel is below.

(2 -> 8 -> 6 -> 4 -> 3 -> 7 -> 5 -> 2)

This setting is applicable for all models. But this setting is most effective to B-SX704-RFID-U2-R (UHF for Japan) only.

- AUTO
- 2CH
- 3CH
- 4CH
- 5CH
- 6CH
- 7CH
- 8CH

#### 5.11.3 Retry / RETRY

The following information related retry setting is displayed.

- Position adjustment for re-issue / ADJ RETRY POSITION
- Retry number for re-issue / ISSUE RETRY LABELS
- Read retry / READ RETRY
- Write retry / WRITE RETRY

##### 5.11.3.1 Position adjustment for re-issue / ADJ RETRY POSITION

When RFID write error occur, printer feed and reverse tag by this setting distance and retry then retry EFID write. When "0 is set, retry is not performed.

The setting between -3mm and +3mm is ignored.

Max.	Min.	Step	Display	Sign	Integer digit	Decimal point digit	0 fullfil	Unit
99	-99	1	Decimal	Non	2	0	Non	mm

**5.11.3.2 Issue retry label / ISSUE RETRY LABELS**

This is a issue retry number after printing error pattern (void pattern) automatically when RFID write error occur. Printer stop as RFID write error if RFID write does not success after retrying this number.

Max.	Min.	Step	Display	Sign	Integer digit	Decimal point digit	0 fullfil	Unit
255	0	1	Decimal	Non	3	0	Non	Labels

**5.11.3.3 Read retry / READ RETRY**

It sets reading retry count and reading retry time.

The printer retries to read the data in the RFID tag for up to specified number of times. If the time-out has come before the maximum number retries have been done, the printer stops the retries at the time.

Whenever the printer writes data onto the RFID tag, the tag is read first. The maximum number of retries set by this parameter becomes also effective in this pre-read.

Max.	Min.	Step	Display	Sign	Integer digit	Decimal point digit	0 fullfil	Unit
255	0	1	Decimal	Non	3	0	Non	times

Set the time-out for retry to read the RFID tag.

If the printer has retried for the maxim number of times within the RFID read retry time-out, the printer stops the retries at the time.

Whenever the printer writes data onto the RFID tag, the tag is read first. The read retry time-out set by this parameter becomes also effective in this pre-read.

Max.	Min.	Step	Display	Sign	Integer digit	Decimal point digit	0 fullfil	Unit
9.9	0.0	0.1	Decimal	Non	1	1	Non	second



**5.11.3.4 Write retry / WRITE RETRY**

Set the maximum number of retries to write data onto the RFID tag.

The printer retries to write data onto the RFID tag for up to specified number of times. If the time-out has come before the maximum number of retries have been done, the printer stops the retries at the time.

Max.	Min.	Step	Display	Sign	Integer digit	Decimal point digit	0 fullfil	Unit
255	0	1	Decimal	Non	3	0	Non	times

Set the time-out for retry to write data onto the RFID tag.

If the printer has retried for the maximum number of times within the RFID write retry time-out, the printer stops the retries at the time.

Max.	Min.	Step	Display	Sign	Integer digit	Decimal point digit	0 fullfil	Unit
9.9	0.0	0.1	Decimal	Non	1	1	Non	second

**5.11.4 UHF setting / UHF SETTING**

The formation related UHF setting is displayed.

- Output level / POWER LEVEL
- Q value / Q VALUE
- AGC threshold / AGC THRESHOLD
- Write AGC threshold / WRITE AGC THRESHOLD
- Write minimum AGC / WRITE RETRY MIN AGC

**5.11.4.1 Output level / POWER LEVEL**

Max.	Min.	Step	Display	Sign	Integer digit	Decimal point digit	0 fullfil	Unit
*1	*1	1	Decimal	Non	3	0	Non	Non

It sets wireless output level of UHF.

The range of output level is 26 (approximately 500mW) to 9 (approximately 10mW).

\*1: The maximum and minimum value vary depend on module setting and the value is below.

	Initial value	Max. value	Min. value
B-SX704-RFID-U2-R	18	26	18
B-SX704-RFID-U2-EU-R/US-R /CN-R	18	18	9

#### 5.11.4.2Q value / Q VALUE

It is applicable for only B-SX704-RFID-U2-R/EU-R/US-R/CN-R.

In the case multiple RFID tags are read at the same time, this menu is useful to pinpoint a target tag. Set the Q value to "1" or greater (2 is recommended.). Q value "0" caused the tags to interfere with each other and disables proper data write. When a Q value is set, set an AGC threshold for data write and an AGC threshold lower limit for retry, also. Setting all these values enable writing data to a tag placed just above the antenna.

However, the problem that multiple tags are read the same time does not occur on the B-EX series with most RFID tag types. It is not necessary to change the default setting.

Max.	Min.	Step	Display	Sign	Integer digit	Decimal point digit	0 fullfil	Unit
15	0	1	Decimal	Non	2	0	Non	Non

#### 5.11.4.3AGC threshold / AGC THRESHOLD

It is applicable for only B-SX704-RFID-U2-R/EU-R/US-R/US-R.

Obtain the gain of the RFID tag, and when that gain is lower than the AGC threshold, tags are considered as error tags even if a data write succeeds.

When the AGC threshold is set to "0", all tags are writable. When set to 8, for example, only tags with the AGC threshold level set to 9 or greater are writable.

The optimal value is different depending on the tags.

Max.	Min.	Step	Display	Sign	Integer digit	Decimal point digit	0 fullfil	Unit
15	0	1	Decimal	Non	2	0	Non	Non

#### 5.11.4.4 Write AGC threshold / WRITE AGC THRESHOLD

It is applicable for only B-SX704-RFID-U2-R/EU-R/US-R/CN-R.

When the Q value is set to 1 or greater, the AGC threshold for data write becomes effective.

When the obtained gain of an RFID tag is lower than the AGC threshold for data write, a data write operation is not performed. In other words, setting an AGC threshold for data write enables writing data only to a tag placed just above the antenna.

Supposing that the gain of a tag just above the antenna is 14 and that of a tag off the antenna is 7, setting the threshold to 11 (a value between 8 and 14) enables the printer to write data only to the tag just above the antenna.

When the threshold is set to 0, a data write operation is performed regardless of the gain of a tag.

Both of the AGC threshold and the AGC threshold for data write are used to determine whether a tag is defective or not, but the timing of a gain measurement is different. In the case of the AGC threshold, this is performed after data is written to a tag.

On the contrary, when the AGC threshold for data write is effective a measurement is performed before data is written. And if a gain value is lower than the threshold, a data write operation is not performed.

The optimum value differs depending on the tag type.

However, the problem that multiple tags are read at the same time does not occur on the B-EX series with most RFID tag types. It is not necessary to change the default setting.

Max.	Min.	Step	Display	Sign	Integer digit	Decimal point digit	0 fullfil	Unit
15	0	1	Decimal	Non	2	0	Non	Non

#### 5.11.4.5 Write retry minimum AGC / WRITE RETRY MIN AGC

It is applicable for only B-SX704-RFID-U2-R/EU-R/US-R/US-R.

When the Q value is set to 1 or greater, the AGC threshold lower limit for retry becomes effective.

Even if a tag's gain is lower than the AGC threshold for data write, a data write to the tag may be successful in a retry if the gain is greater than the lower limit. For a retry, the printer lowers the threshold to the highest gain of the tag if it is greater than the lower limit or to the lower limit if it is greater than the highest gain of the tag.

##### Example 1

AGC threshold for data write: 11

Lower limit for retry: 9

Detected tag's gain: 10

As the gain of the tag is lower than the threshold, a data write operation is not performed for this tag at the first try. However, the gain is greater than the lower limit. Then the printer retries to write data to this tag according to a new AGC threshold of 10. In this case, a retry of a data write will mostly succeed because the detected tag's gain is greater than the new threshold. (However, the success rate is not 100% because a gain of a tag is not always the same.)

##### Example 2

AGC threshold for data write: 11

Lower limit for retry: 9

Detected tag's gain: 8

As the gain of the tag is lower than the threshold, a data write operation is not performed for this tag at the first try. Also, the gain is lower than the lower limit. Then the printer retries to write data to this tag according to a new AGC threshold of 9. In this case, a retry of data write will mostly fail because the detected tag's gain is lower than the new threshold. (However, the error rate is not 100% because a gain of a tag is not always the same.)

When the same value is set to the AGC threshold for data write and the AGC threshold lower limit for retry, respectively, the threshold will not be changed for a retry.

The optimum value differs depending on the tag type.

However, the problem that multiple tags are read at the same time does not occur on the B-EX series with most RFID tag types. It is not necessary to change the default setting.

Max.	Min.	Step	Display	Sign	Integer digit	Decimal point digit	0 fullfil	Unit
15	0	1	Decimal	Non	2	0	Non	Non

### 5.11.5 Other / OTHER





The following information related RFID is displayed.

- Tag test setting / TAG CHECK
- Multi word write / MULTI WRITE
- Carrier sense / CARRIER SENSE

#### 5.11.5.1 Tag test setting / TAG CHECK

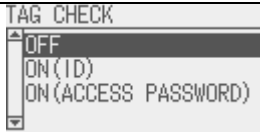
Disable / OFF	Disable error tag detection: Printer read tag before writing data to tag, but printer write data regardless the first data.
Enable(ID) / ON(ID)	Enable error tag detection: Printer reads tag before writing data (EPC area for Gen2 tag) to tag, and writing data if the first data is "A5A".
Enable(Password) / ON(Access Password)	Enable error tag detection: This is enabled for only GEN2 tag. Printer reads access password area before writing data to tag and write data if access password matches to password setting.

To prevent unauthorized changes of the setting, a password to protect the error tag detection setting can be registered.

English	Operation
The password input display is shown when protected password is enabled. The following explanation is for when protected password is enabled.	
	Input 4 digit protected password. It is displayed when password setting is ON.
The setting display of error tag is shown when protected password is correct.	
The error message is displayed and change upper display is shown when protected password is not correct.	
	Select tag test setting <ul style="list-style-type: none"> <li>· Disable</li> <li>· Enable (ID)</li> <li>· Enable (Password)</li> </ul>
When "Disable" or "Enable (ID)" is selected, protected password is disabled and upper display is shown.	
When "Enable (Password)" is enabled, access password input display is shown.	
	Input 8 digit accessible passwords
	Set auto unlock password <ul style="list-style-type: none"> <li>· Disable / OFF</li> <li>· Enable / ON</li> </ul>
	Set protected password. <ul style="list-style-type: none"> <li>· Disable / OFF</li> <li>· Enable / ON</li> </ul>
When "OFF" is selected, this menu is ended and the upper display is shown.	
When "ON" is selected, protected password input display is shown.	
	Input 4 digit protected password.

### 5.11.5.2 Multi word write / MULT WRITE

Gen2-compatible Hibiki tag (HITACHI) has a function which reduces the time to write data on the RFID chips. This is called “Multi-word writes”. Use of this function enables a speed-up of the data write operation. However, this function is unique to the Hibiki tag, and not usable with the other Gen2-compatible chips.

- Disable / OFF
- Enable / ON

### 5.11.5.3 Carrier sense / CARRIER SENSE

The printer enters the carrier sense mode, and performs a carrier sense. In 5 seconds, environmental radio wave of each channel is picked up for about 30 times (Enabled only when the B-SX704-RFID-U2 is used.)

LCD Display example

English		
CARRIER SENSE		
CH	Available	MAX
1	0%	0000
2	0%	0000
3	0%	0000

- The left-most number indicates a channel number, and a percentage means the availability of the channel which is determined by performing approx. 30 carrier senses. Thus, “100%” means that this channel is not used by any other devices.
- Strength (MAX): Method to detect other carrier. There is strong radio origin if value is larger.
- “MAX 0011” means the value of the maximum radio wave picked up.
- The display can be scrolled up or down, from Channel 1 (1CH) to channel 9 (9CH)
- Pressing the [ENTER] key causes the printer to perform a carrier sense again. To quit a carrier sense, press the [CANCEL] key.
- When the RFID module type is set to “NONE” or a communication cannot be established, a message, “NON RFID MODULE”, is displayed.
- When the RFID module type is set to other than U2, a message, “NOT AVAILABLE” is displayed.
- When the RFID module type is set to U2 but effective data cannot be obtained, a message, “NO RESPONSE” is displayed.
- When the B-SX704-RFID-U2-US-R is used and if a RFID module’s destination code is not specified (user-inaccessible setting), an “RFID CONFIG ERR” error message is displayed.

## 6. ON LINE MODE

In the ON LINE mode, the following settings can be performed.

Threshold Setting for the Feed Gap Sensor  
 Threshold Setting for the Black Mark Sensor  
 Reset  
 Parameter Settings  
 Printer Parameter Fine Adjustment  
 Dump Mode

### ■ LED function

[ON LINE] LED	Indicates that the printer is in online condition. Blinks that the printer is communicating with host.
[ERROR] LED	Indicates that the printer is in error condition. Blinks when ribbon is in near end condition. Blinks when the system error occurs.

### ■ Key function

Key	Function
[FEED]	<p>(1) Feeds one sheet of paper. This key can be used to eject one sheet of paper. This key can also be used to adjust the paper to the proper position when the paper is not properly positioned. If printing is attempted when the paper is not properly positioned, printing is not performed at the proper position. One or two sheets of paper should be fed to adjust the paper position before printing.</p> <p>(2) Prints the data in the image buffer on one label according to the system mode setting.</p> <p><b>NOTE:</b> A clear command or a command for drawing should not be sent during printing by the [FEED] key. If it is sent, the correct layout will be lost, and the label will not be printed properly. If an issue is performed by the [FEED] key while the data is being drawn in the image buffer, the correct layout may be lost.</p> <p>* For the following, refer to the parameter setting section.</p> <ul style="list-style-type: none"> <li>• The procedure for using the label having a label pitches of less than 38 mm in the cut issue mode when the disk cutter is used.</li> <li>• The procedure for using the label having less than the min. label pitch for each issue speed in the cut issue mode when the rotary cutter is used.</li> </ul> <p>* Feeds label even though there is label at peel off sensor in peel-off mode.</p>

- [RESTART] (1) Resumes printing after a temporary stop of label printing or after an error.  
 (2) Places the printer in the usual initial state which is obtained when the power is turned on.  
 (3) Switches to user mode.
- [PAUSE] (1) Stops label printing temporarily.  
 (2) Programs the threshold values.
- [MODE] (1) Switches to user mode.
- [CANCEL] (1) Clears the job.
- [ENTER] (1) Displays help messages.
- [UP] (1) No function.
- [DOWN] (1) No function.
- [LEFT] (1) No function.
- [RIGHT] (1) Displays help messages.

#### ■ Error messages

- NOTES:** 1. If an error is not cleared by pressing the **[RESTART]** key, turn the printer off and then on.  
 2. After the printer is turned off, all print data in the printer is cleared.  
 3. "\*\*\*\*" indicates the number of unprinted media. Up to 9999 (in pieces).

Error Messages	Problems/Causes	Solutions
<b>HEAD OPEN</b>	The Print Head Block is opened in Online mode.	Close the Print Head Block.
<b>HEAD OPEN ****</b>	Feeding or printing has been attempted with the Print Head Block open.	Close the Print Head Block. Then press the <b>[RESTART]</b> key.
<b>COMMS ERROR</b>	A communication error has occurred.	Make sure the interface cable is correctly connected to the printer and the host, and the host is turned on.
<b>CUTTER ERROR ****</b> (Only when the cutter module is installed on the printer.)	The media is jammed in the cutter.	Remove the jammed media. Then press the <b>[RESTART]</b> key. If this does not solve the problem, turn off the printer, and call a TOSHIBA TEC authorised service representative.



### ■ Error messages (continued)

Error Messages	Problems/Cause	Solutions
<b>PAPER JAM ****</b>	<ol style="list-style-type: none"> <li>1. The media is jammed in the media path. The media is not fed smoothly.</li> <li>2. A wrong Media Sensor is selected for the media being used.</li> <li>3. The Black Mark Sensor is not correctly aligned with the Black Mark on the media.</li> <li>4. Size of the loaded media is different from the programmed size.</li> <li>5. The Feed Gap Sensor cannot distinguish the print area from a label gap.</li> </ol>	<ol style="list-style-type: none"> <li>1. Remove the jammed media, and clean the Platen. Then reload the media correctly. Finally press the <b>[RESTART]</b> key.</li> <li>2. Turn the printer off and then on. Then select the Media Sensor for the media being used. Finally resend the print job.</li> <li>3. Adjust the sensor position. Then press the <b>[RESTART]</b> key.</li> <li>4. Replace the loaded media with one which matches the programmed size then press the <b>[RESTART]</b> key, or turn the printer off and then on, select a programmed size that matches the loaded media. Finally resend the print job.</li> <li>5. Refer to Section 5.4 to set the threshold. If this does not solve the problem, turn off the printer, and call a TOSHIBA TEC authorised service representative.</li> </ol>
<b>NO PAPER ****</b>	<ol style="list-style-type: none"> <li>1. The media has run out.</li> <li>2. The media is not loaded properly.</li> <li>3. The media is slack.</li> </ol>	<ol style="list-style-type: none"> <li>1. Load new media. Then press the <b>[RESTART]</b> key.</li> <li>2. Reload the media correctly. Then press the <b>[RESTART]</b> key.</li> <li>3. Take up any slack in the media.</li> </ol>
<b>RIBBON ERROR ****</b>	The ribbon is not fed properly.	Remove the ribbon, and check the status of the ribbon. Replace the ribbon, if necessary. If the problem is not solved, turn off the printer, and call a TOSHIBA TEC authorised service representative.
<b>NO RIBBON ****</b>	The ribbon has run out.	Load a new ribbon. Then press the <b>[RESTART]</b> key.
<b>REWIND FULL ****</b>	The Built-In Rewinder Unit is full.	Remove the backing paper from the Built-In Rewinder Unit. Then press the <b>[RESTART]</b> key.
<b>EXCESS HEAD TEMP</b>	The Print Head has overheated.	Turn off the printer, and allow it to cool down (about 3 minutes). If this does not solve the problem, call a TOSHIBA TEC authorised service representative.
<b>HEAD ERROR</b>	There is a problem with the Print Head.	Replace the Print Head.
<b>PASSWORD INVALID Please Power OFF</b>	The password entered was not correct consecutively for three times.	Turn off the printer and back to on, then enter a password again. If the correct password is unknown, disable the password setting by sending a @010 command. (For details, please refer to External Equipment Interface Specification.)
Other error messages	A hardware or software problem may have occurred.	Turn the printer off and then on. If this does not solve the problem, turn off the printer again, and call a TOSHIBA TEC authorised service representative.

## ■ LCD message and LED indication

### Symbols in the message

Mark	Explanation	Range
○:	ON	-
□:	OFF	-
●:	BLINKING	-
%%,%%%,%%%:	Remaining memory size of external USB storage	0 ~ 09,999,999 (1Kbyte unit)
####:	Remaining memory size of internal PC storage	0 ~ 3072 (1Kbyte unit)
&&&&:	Remaining memory size of character storage	0 ~ 3147 (1Kbyteunit)

No	LCD Message 2 <sup>nd</sup> line (English)	LED indications		Printer status	Restoration by the [RESTART] key Yes/No	Acceptance of Status Request and Reset Command Yes/No
		ON LINE	ERR OR			
1	ONLINE	○	●	In the online mode	-	Yes
	ONLINE	□	●	In the online mode (Communicating)	-	Yes
2	HEAD OPEN	●	●	Paper fed or issue when head open	-	Yes
3	PAUSE	●	●	In a pause state	Yes	Yes
4	COMMS ERROR	●	○	A parity error or framing error has occurred during communication by RS-232C.	Yes	Yes
5	PAPER JAM	●	○	A paper jam occurred during paper feed. A paper was not set properly. An actual label did not match to the selected paper sensor type. The paper sensor position did not match to black mark position of paper. The actual paper size did not match to selected label length. The level of paper sensor did not match to paper. The gap of label was not detected due to pre-printing.	Yes	Yes
6	CUTTER ERROR	●	○	A paper jam occurred at cutter. A cutter did not move from home position. A cutter cover was open.	Yes	Yes
7	NO PAPER	●	○	A paper has run out. A paper was not set. A level of paper sensor did not match to paper.	Yes	Yes
8	NO RIBBON	●	○	The ribbon has run out.	Yes	Yes
9	HEAD OPEN	●	○	A feed or an issue was attempted with the head opened.	Yes	Yes

				(except [FEED] key, Extended I/O)		
10	HEAD ERROR	●	○	A broken dot error has occurred in the thermal head. The error has occurred in the head driver.	Yes	Yes
11	EXCESS HEAD TEMP	●	○	The thermal head temperature has become excessively high.	Yes	Yes
12	RIBBON ERROR	●	○	An abnormal condition occurred in the sensor for determining the torque for the ribbon motor. The ribbon jam occurred. The ribbon empty occurred. The ribbon was not set.	Yes	Yes
13	REWIND FULL	●	○	An overflow error has occurred in the rewinder.	Yes	Yes
14	SAVING ####KB/####KB or SAVING %,%%%. %%%KB	○	●	In writable character of PC command save mode.	-	Yes
15	FORMAT ####KB/####KB or FORMAT %,%%%. %%%KB	○	●	Initializing storage area.	-	Yes
16	NOW LOADING...	○	●	Downloading mode for TrueTypeFont, BASIC	-	Yes
17	MEMORY WRITE ERR.	●	○	An error has occurred in writing data into memory for storage. (USB memory, flash ROM on the CPU board)	No	Yes
18	FORMAT ERROR	●	○	An erase error has occurred in formatting memory for storage (USB memory, flash Rom on the CPU board)	No	Yes
19	MEMORY FULL	●	○	Saving failed because of the insufficient capacity of memory for storage (USB memory, flash ROM on the CPU board)	No	Yes
20	SYNTAX ERROR Command error (Refer *1, *2)	●	○	A command error has occurred in analyzing the command.	Yes	Yes
21	POWER FAILURE	●	○	A momentary power interruption has occurred.	No	No
22	EEPROM ERROR	●	○	An EEPROM for back-up cannot be read/write properly.	No	No
23	SYSTEM ERROR	●	○	When any abnormal operations as below are performed, a system error occurs. (a) Command fetch from an odd address (b) Access to the word data from a place other than the boundary of the word data (c) Access to the long	No	No

				word data from a place other than the boundary of the long word data (d) Access to the area of 80000000H to FFFFFFFFH in the logic space in the user mode. (e) Undefined command placed in other than the delay slot has been decoded. (f) Undefined command in the delay slot has been decoded. (g) Command to rewrite the delay slot has been decoded.		
24	DHCP CLIENT INITIALIZING...	•	•	Initializing DHCP CLIENT. * In case of enabling DHCP	-	-
25	RFID WRITE ERROR	•	○	The printer does not succeed in writing data onto the RFID tag after having retried for the specified times.	Yes	Yes
26	RFID ERROR	•	○	The printer can not communicate with the RFID module.	No	Yes
27	INPUT PASSWORD	•	•	The printer is waiting for a password to be entered.	No	No
28	PASSWORD INVALID	•	•	Password entered was not correct consecutively for three times.	No	No
29	RFID CONFIG ERR	•	○	B-SX704-RFID-U2-US-R only RFID module's destination code is not specified.	No	No
30	LOW BATTERY (Refer *4,5)	•	○	RTC battery is low.	No	No
31	INTERNAL COM ERR	•	•	The hardware error has occurred in internal serial interface.	No	No

**NOTES:**

(\*1) When there is command error in received command, maximum 48 bytes of error command are shown on 3<sup>rd</sup> and 4<sup>th</sup> line of LCD.

(But [LF] and [Nu] are not shown on LCD. The error command exceed 42 bytes are not shown.)

Display example (English)

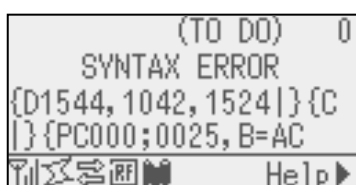

(Ex. 1)

`[ESC]PC001;0A00,0300,2,2,A,00,B[LF][NUL]`

Command error

LCD Display

Command error PC001;0A00,0300,2,2,A ,00,B
---

(Ex. 2)

`[ESC]T20G30[LF][NUL]`

Command error

LCD Display

Command Error T20G30
-------------------------

(Ex. 3)

`[ESC] PC002;0100,0300,15,15,A,00,00,J0101,+000000000A,Z10,P1[LF][NUL]`

Command error

LCD display

Command error PC002;0100,0300,15,15 ,A,00,00,J0101,+00000
---

(\*2) When command error is displayed, the code except 20H-7FH, A0H-DFH are displayed as "?" (3FH).

(\*3) When the ribbon near end detection is enabled, the error LED blinks 1Hz (50msec ON, 500msec OFF) during ribbon near end and condition is from No.1 to No.3.

(\*4) The battery check is not work when resetting and RTC is not mounted.

(\*5) It is necessary to set any following item to use RTC function at low battery condition.

1. Turn off printer power from error condition, turn of printer by system mode, set date and time of RTC, reset printer, and change to online condition.
2. Move to user mode by holding down [RESTART] key for 3 seconds, reset printer, set to online condition, and set date and time by command.

\* It is possible to printer by setting date and time till turning off printer.

## 6.1 THRESHOLD SETTING

When a label is printed, the printer detects the gap between the labels using the transmissive sensor, and corrects the print position automatically to obtain a constant print position. However, when a preprinted label is used, some inks may prevent proper positioning correction. In this case, determine the transmissive sensor threshold manually by key operation and store the value in the non-volatile memory (EEPROM).

A constant print position can also be obtained when printing on a preprinted label since the print position is always corrected using the threshold stored in the non-volatile memory (EEPROM) by selecting “3: Transmissive Sensor (when using the preprinted label)” for the sensor type of the Issue Command.

When a label is printed by detecting the black mark on the back of the label, the reflective rate variation of a place other than the black mark may prevent the proper positioning correction. In this case, determine the reflective sensor threshold manually by key operation and store the value in the non-volatile memory (EEPROM).

A constant print position can also be obtained when printing on a tag since the print position is always corrected using the threshold stored in the non-volatile memory (EEPROM) by selecting “4: Reflective Sensor (when using a manual threshold value)” for the sensor type of the Issue Command.

### Threshold Setting Operation Example ( English )

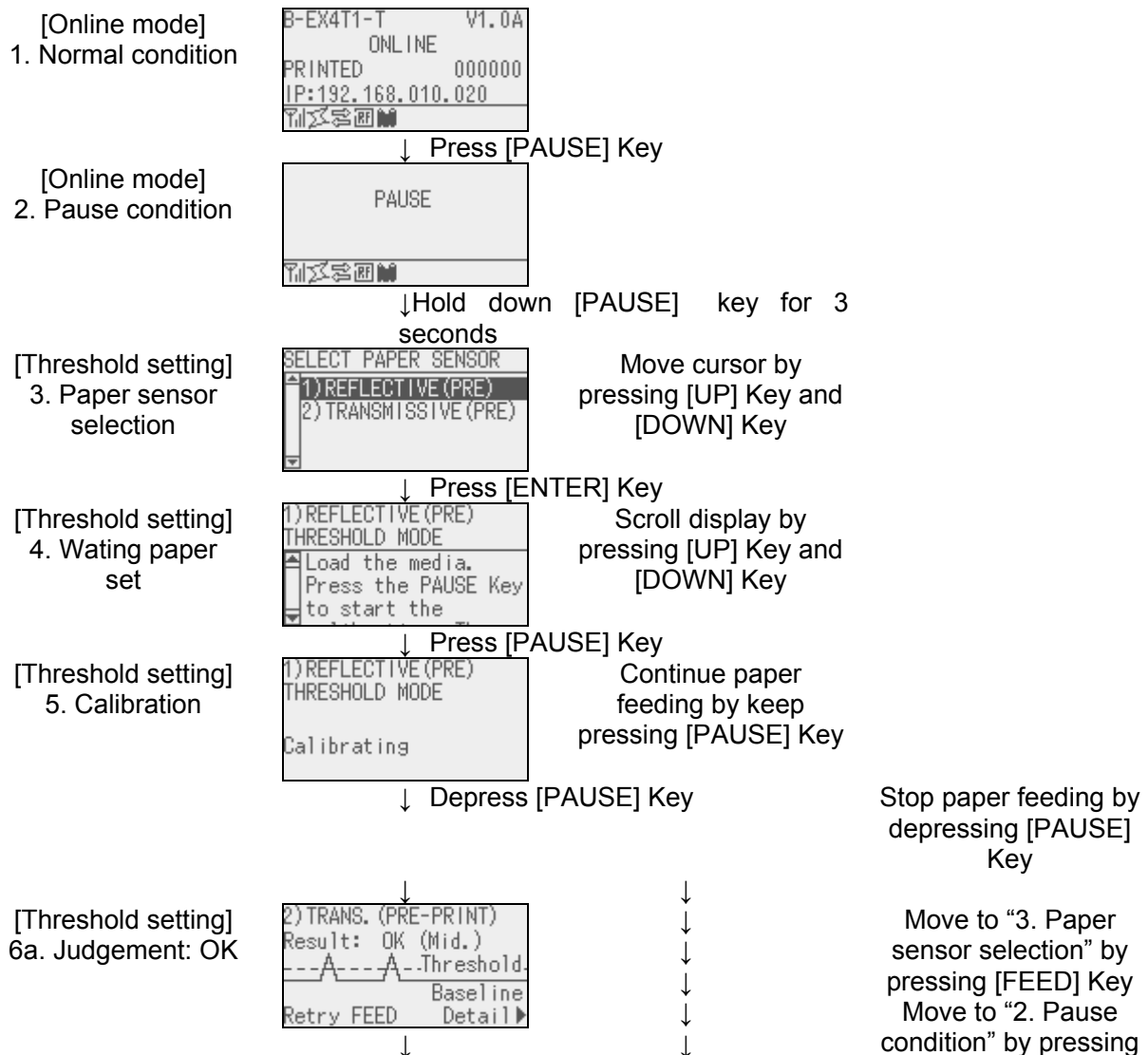

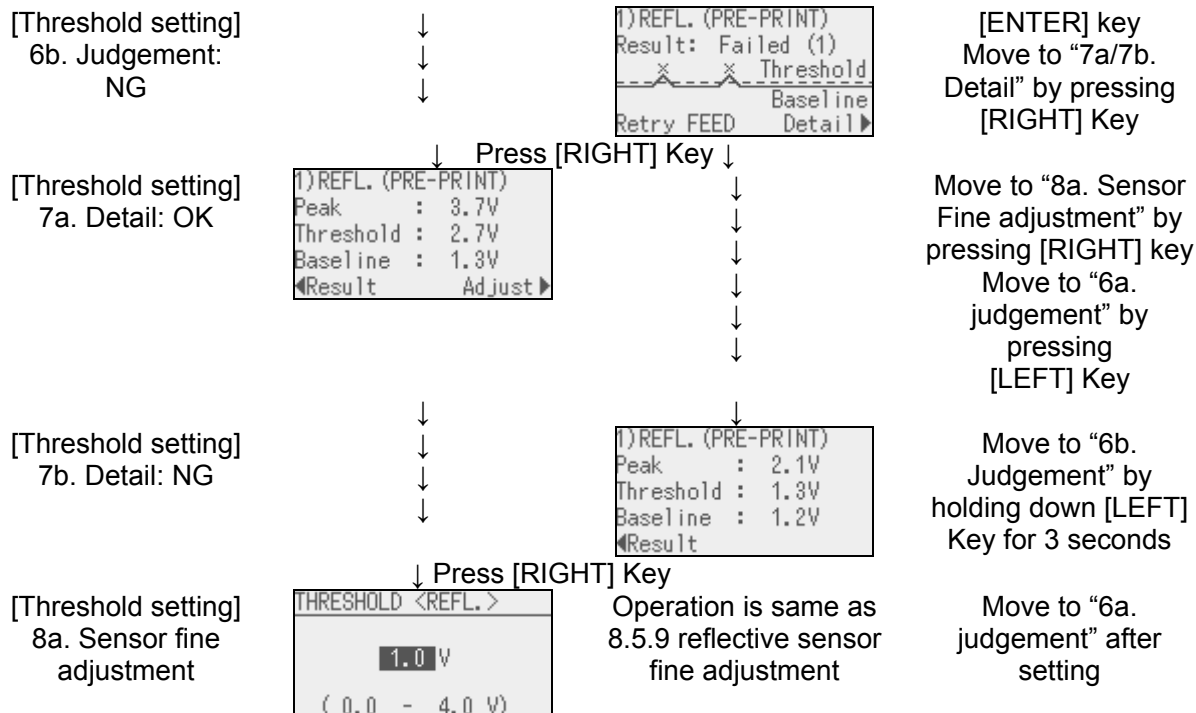



**Judgment display**

Display example	Display content	Explanation
	<ul style="list-style-type: none"> <li>- Sensor type</li> <li>- Judgement result (Text)</li> <li>- Judgement result (Graph)</li> <li>- Key operation guide</li> </ul>	<p>The setting result is displayed after threshold setting. Threshold can be set by returning to sensor selection by pressing [FEED] key from whit display. Sensor detection result and threshold can be displayed by pressing [RIGHT] key and threshold setting can be displayed by pressing [ENTER] key.</p>
	<ul style="list-style-type: none"> <li>- Sensor type</li> <li>- Judgement result (Text)</li> <li>- Judgement result (Graph)</li> <li>- Key operation guide</li> </ul>	<p>Judgement result is displayed after fine adjustment setting and reflects it. Manual threshold fine adjustment setting can be performed by pressing [LEFT] key from this display. The [RIGHT] and [ENTER] key function are same as above.</p>

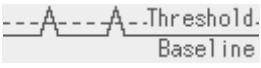
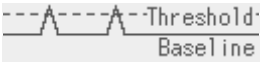

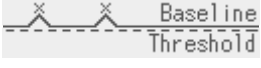
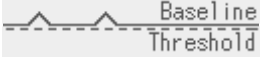
The icon types to indicate judgement in judgement result display of threshold setting are below.

No.	Display example (English)	Icon name	Explanation
1		OK(Mid.)	· Available to detect by paper sensor. Threshold value is middle.
2		OK (High)	· Available to detect by paper sensor. Threshold value is around peak. (The threshold should be adjusted around middle to detect paper correctly in reflective sensor/transmitive sensor fine adjust setting.)
3		OK (Low)	· Available to detect by paper sensor. Threshold value is around base. (The threshold should be adjusted around middle to detect paper correctly in reflective sensor/transmitive sensor fine adjust setting.)
4		NG (1)	· Not available to detect paper gap by paper sensor. Sensor adjustment is necessary.
5		NG (1)	· Not available to detect paper gap by paper sensor. Sensor adjustment is necessary. (Threshold <= Base)
6		NG (2)	· Not available to detect by paper sensor. (The paper gap can be detected by calibration but is very difficult level.)



## 6.2 ONLINE MODE LCD DISPLAY

### 1. ONLINE MODE LCD DISPLAY EXAMPLE ( English )

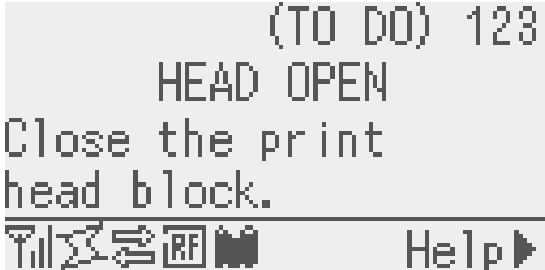
Printer condition	LCD Display	Display contents
Online		← Model name, Version No. (*5) ← Message ← Printing page number (*1) ← IP address etc. (*4)
Pause		← Remaining page number (*2) ← Message ← Error message 1 <sup>st</sup> line ← Error message 2 <sup>nd</sup> line (*6)
Head open		← Remaining page number (*2) ← Message ← Error message 1 <sup>st</sup> line ← Error message 2 <sup>nd</sup> line ← Icon, Help guide (*3)

\* The 1<sup>st</sup>, 3<sup>rd</sup> and 4<sup>th</sup> line of online mode display can be selected to display by the stting of system mode.

\* Refer "Icon display" for Icon in detail.

(\*1) The printing page number is reset to zero when the printer is turned on and is cumulated by each printing. If the cut interval issuing mode is selected, the page number is updated when paper is cut normally.

(\*2) [Remaining number] = [Reserved number] – [Normal printed number when error occurs or pause]  
 When remaining number is zero, it is not displayed. If the cut interval issuing mode is selected, the remaining page number is updated when paper is cut normally.

(\*3) In help guide, only key is displayed if there is help message.

(\*4) The message displayed in this area is an additional information like IP address, ribbon near end etc.

- The IP address is not displayed when LAN/WLAN setting is disabled even though display setting is system mode is enabled.
- The ribbon near end message is displayed when ribbon near end is detected regardless the setting in system mode.  
 The ribbon near end detection is to check the remaining size of ribbon. The diameter is 38mm for 3

0 meter ribbon and the diameter is 43 mm for 70 meter ribbon.

(\*5) The configuration of model name is below.

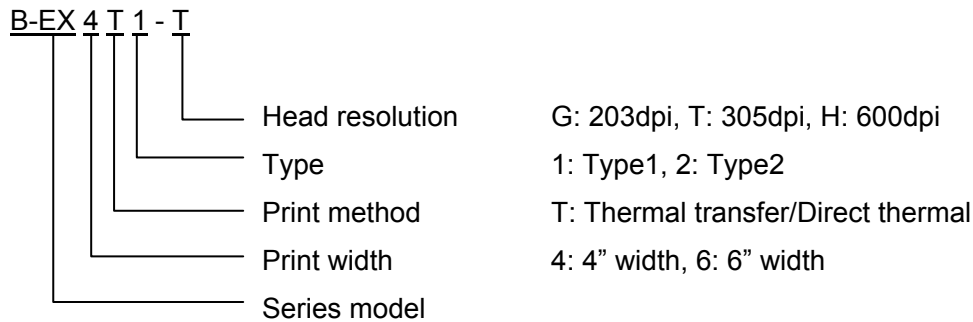









(\*6)) The ribbon near end message may be displayed in this line. The condition of display is same as \*4.

## 2. ICON

Five kinds of icon are displayed in the lowest line of online mode display.

These icons are displayed in only online mode display.

Icon	Explanation
Wireless LAN icon	<ul style="list-style-type: none"> <li>It is used when wireless LAN module is mounted. It is not displayed when wireless LAN module is not mounted.</li> <li>Graph shows the strength of radio wave.</li> </ul>
	 Graph 0: Out of range
	 Graph 1: Strength of radio wave is weak.
	 Graph 2: Strength of radio wave is middle
	 Graph 3: Strength of radio wave is strong
Link icon	<ul style="list-style-type: none"> <li>It is used when wireless LAN module is mounted. It is not displayed when wireless LAN module is not mounted.</li> <li>Is displayed during wireless LAN communication.</li> <li>It blinks during communication.</li> </ul>
	 OFF: No link
	 ON: Link connection
	 Blink: Roaming (*4)
Data receive icon	<ul style="list-style-type: none"> <li>It is displayed when printer has received data. It is turned on from the timing that printer receives the data from PC till printer completes to process received data.</li> </ul>
	 ON: Receiving data or Processing received data

RFID icon

- It is used when RFID module is mounted. It is not displayed when RFID module is not mounted.
  - It is ON when module is enabled and ready to communicate.
  - It blinks when module is communicating and processing.
- The communication includes the one not related radio wave output.  
 - It blinks even though radio wave is not out after instructing radio wave output to module.
- (It blinks during pausing radio wave output or changing channel by the influence of other carrier.)



ON: Module is enabled and ready to communicate



Blinking: Communicating

Ribbon near end icon

- The ribbon near end is detected.
- It blinks when the ribbon is close to the end.
- The ribbon near end is detected by diameter of remaining ribbon. The diameter is 38 mm for 30 meter ribbon and 43 mm for 70 meter ribbon.



Blinking: Ribbon near end condition (\*4)

3. ONLINE MODE DISPLAY TRANSITION, Operation example ( English )

```

B-EX4T1-T      V1.0A
  ONLINE
PRINTED      000000
IP:192.168.010.020
  
```

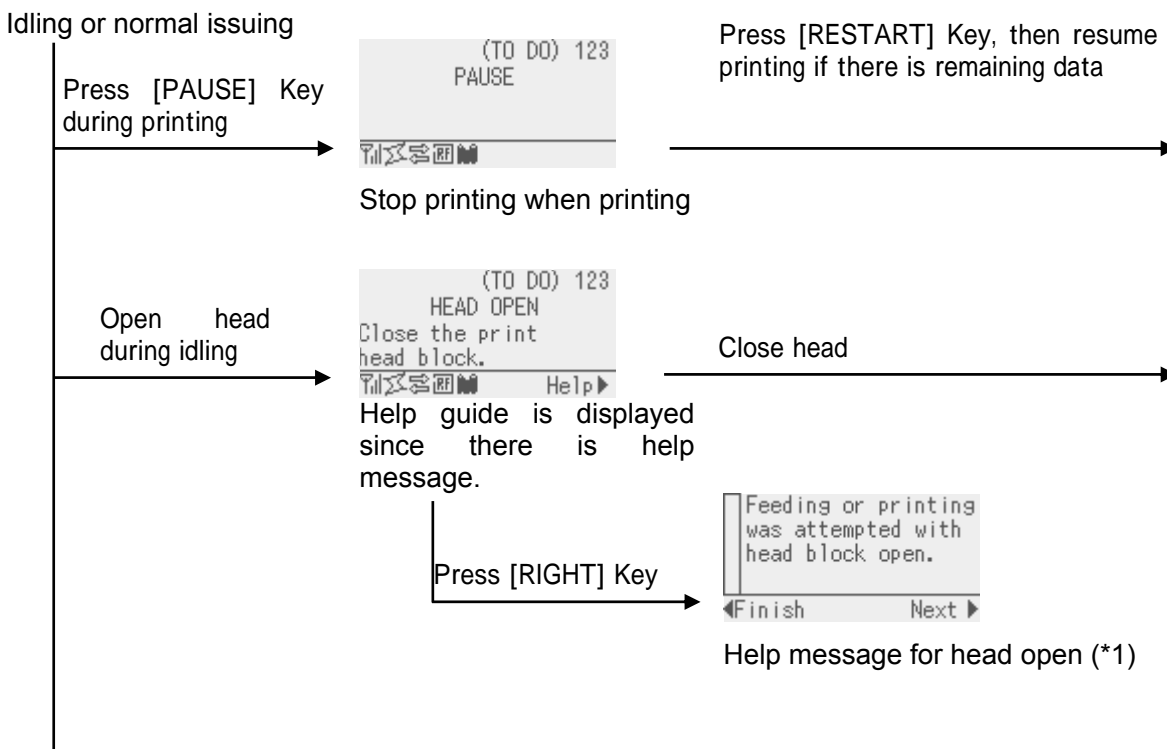

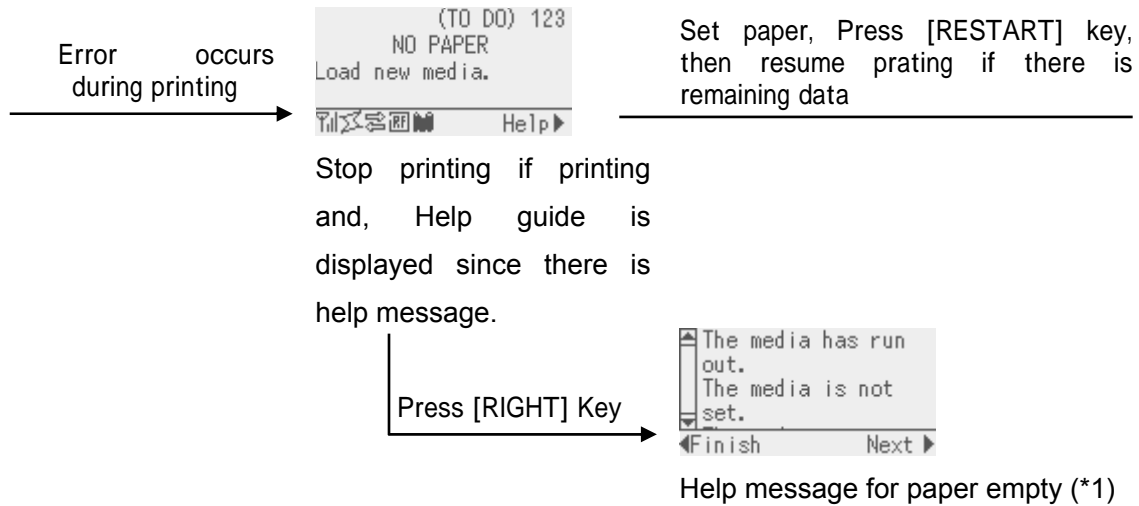

### 6.3 HELP DISPLAY

#### EXPLANATION OF HELP DISPLAY

The help display can be shown by pressing [RIGHT] key or [ENTER] key in case help guide is displayed at the lower right of online mode display.

The help message is shown at the upper four lines of help display. When help message exceed four lines, message is shown by scrolling. The up-down arrow is displayed of the left side scroll bar if there is long message exceed four lines.

Display example: (English)

```

      Feeding or printing
      was attempted with
      head block open.
      ◀Finish      Next▶
    
```

- ← Help display 1<sup>st</sup> line
- ← Help display 2<sup>nd</sup> line
- ← Help display 3<sup>rd</sup> line
- ← Help display 4<sup>th</sup> line
- ← Help display guide

The help message is three lines, so up-down arrow is not shown on scroll bar.

```

      ▲
      The media has run
      out.
      The media is not
      set.
      ▼
      ◀Finish      Next▶
    
```

- ← Help display 1<sup>st</sup> line
- ← Help display 2<sup>nd</sup> line
- ← Help display 3<sup>rd</sup> line
- ← Help display 4<sup>th</sup> line
- ← Help display guide

The help message exceed four lines, so up-down arrow is shown on scroll bar.

HELP DISPLAY TRANSITION, OPERATION EXAMPLE (English)

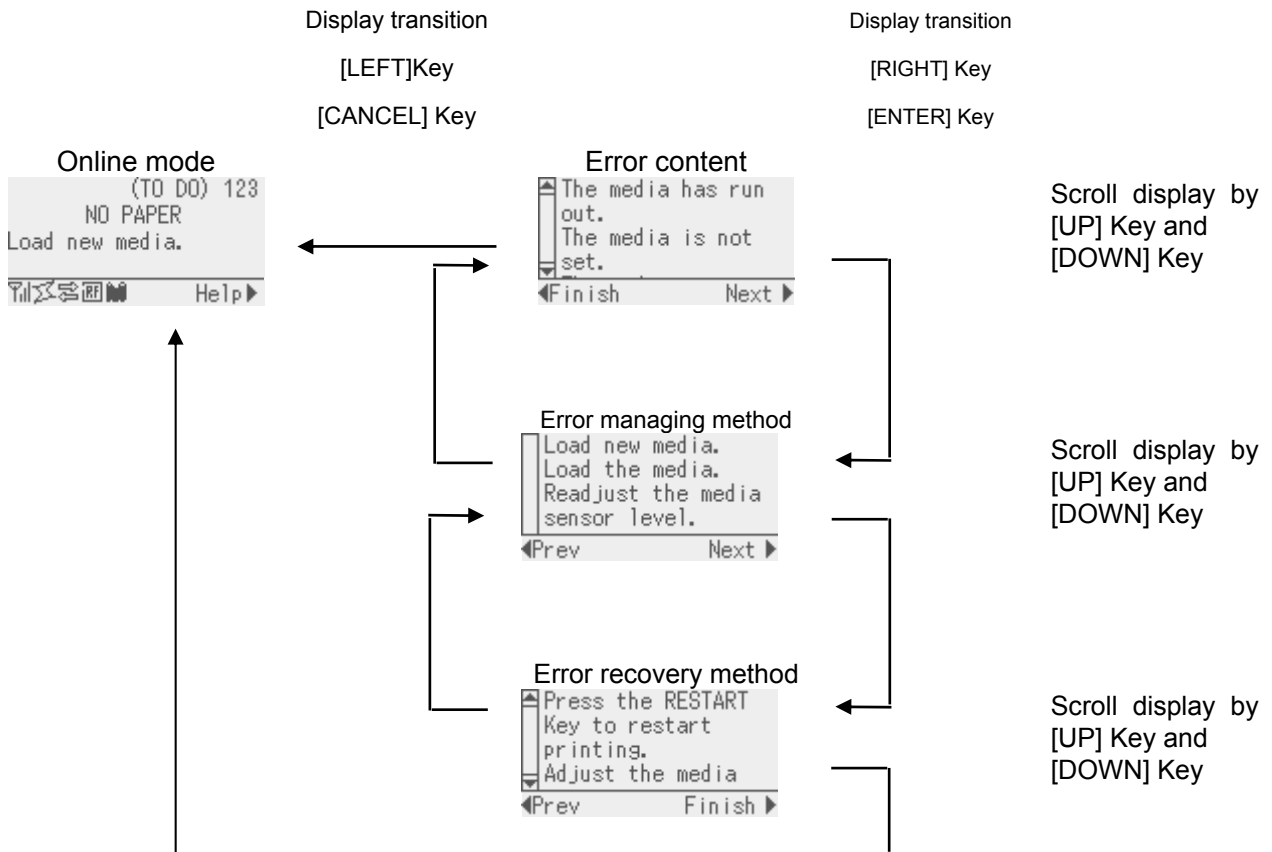

## 7. PERIODIC MAINTENANCE PROCEDURE

All machines are generally delivered in their best condition. To maintain optimal operating condition and help gain maximum performance and life of machines, we would recommend you to conduct periodic maintenance. Doing this is also effective in preventing unexpected troubles and avoiding wasteful system down time, by which more benefit is produced to your customers and greater reliance is placed on the product quality.

Please refer to the following general maintenance procedure and perform periodic servicing.

### CAUTION!

*When replacing parts or performing maintenance on the printer, be careful not to damage the print head with a hard object like a watch or a ring.*



Care must be taken not to allow the metal or glass part of a watch to touch the print head edge.



Care must be taken not to allow a metal object like a ring to touch the print head edge.

*Since the print head element can be easily damaged by shock, please treat it carefully by not hitting a hard object against it.*

**NOTE:** Before starting the periodic maintenance, be sure to read carefully and understand the Service Manuals, especially warnings, cautions and adjustment.

1. Ask an operator or a manager about any machine trouble.
2. Check the run distance on the maintenance counter.
3. Turn the power off and disconnect the power cord.
4. Open the top cover.
5. Clean the inside of the printer.
  - (1) The entire inside of the printer should be cleaned.
  - (2) Wipe the platen, capstan roller, and pinch roller with a cloth moistened with alcohol.
  - (3) Clean the print head elements with the TOSHIBA TEC-approved print head cleaner.

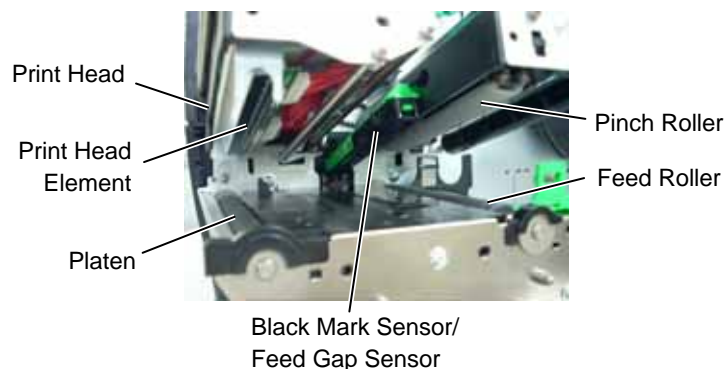

- (4) Remove paper debris or label glue from the media path.

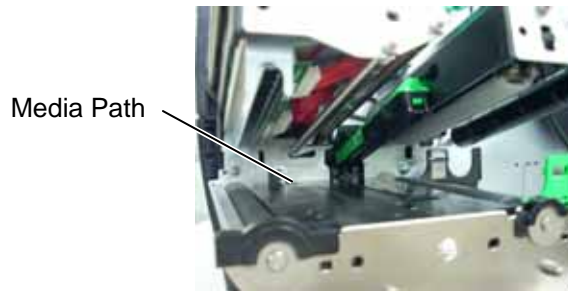

- (5) When using the cutter unit, clean the cutter blade and the media path.

**WARNING!**

*When cleaning the cutter, be careful not to be injured by the cutter blade.*

1. Loosen the two Plastic Head Screws to remove the Cutter Cover.
2. Remove the jammed paper.
3. Clean the Cutter with a soft cloth slightly moistened with alcohol.
4. Attach the Cutter Cover.

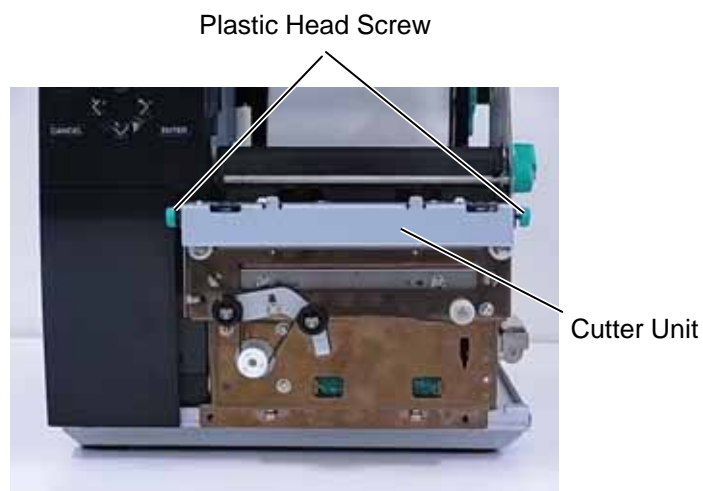

6. Apply FLOIL G-488 to the cutter unit using a soft cloth.

**CAUTION!**

1. *Lubrication: During parts replacement*
2. *Kinds of oil: FLOIL G-488: 1 Kg can. (Parts No. 19454906001)*
3. *Do not spray the inside of the printer with lubricants. Unsuitable oil can damage the mechanism.*

All machines are generally delivered in their best condition. Efforts should be made to keep them that way. Lack of oil, or the presence of debris or dust, may cause an unexpected failure. To maintain in optional operating condition, periodically clean the machine and apply the proper kind of oil to each part in which lubrication is needed.

Although the frequency of lubrication varies according to how often the machine is used, as a minimum it is necessary to lubricate before any part becomes dry. It is also necessary to wipe off excessive oil or it will collect dirt.

7. Confirm that the problem occurs as reported, and then take corrective action.
8. Replace the following parts periodically, if necessary. The following table shows approximate product life for each part.

No.	Part Name	Standard interval of replacement
1	Cutter unit (Option: B-EX204-QM-R)	300,000 cuts
2	Cutter unit (Option: B-EX204-R-QM-R)	300,000 cuts
3	Platen	50 km
4	Feed Roller	50 km
5	Pinch Roller	50 km

- NOTES:**
1. *The above values of the cutter life are obtained on condition that the periodically maintained cutter is used with TOSHIBA TEC-approved supplies by the proper method described in the manuals.*
  2. *The above values differ depending on the thickness and substances of the media to be used. When using the cutter to cut the labels, be sure to cut the backing paper. Failure to do this may cause the glue to stick to the cutter and shorten the cutter life.*

9. Confirm each part adjustment. Make any necessary adjustments.



10. Conduct the following tests and make sure that there is no problem.

- (1) Print test with TOSHIBA TEC-approved media and ribbon. (Print tone, print head position, etc.)
- (2) Paper skew

**When the Strip Module is used;**

If the label skews when using the built-in Rewinder unit, turn the adjustment knob of the rewinder guide plate to correct the label feed. Clockwise turn moves the rewinder guide plate forward and counterclockwise turn moves it backward.

- When labels skew to the right:  
Loosen the SM-4x8 screw with a phillips-head screwdriver. Turn the adjustment knob clockwise, and tighten the SM-4x8 screw when the rewinder guide plate is positioned correctly.
- When labels skew to the left:  
Loosen the SM-4x8 screw with a phillips-head screwdriver. Turn the adjustment knob counterclockwise, and tighten the SM-4x8 screw when the rewinder guide plate is positioned correctly.

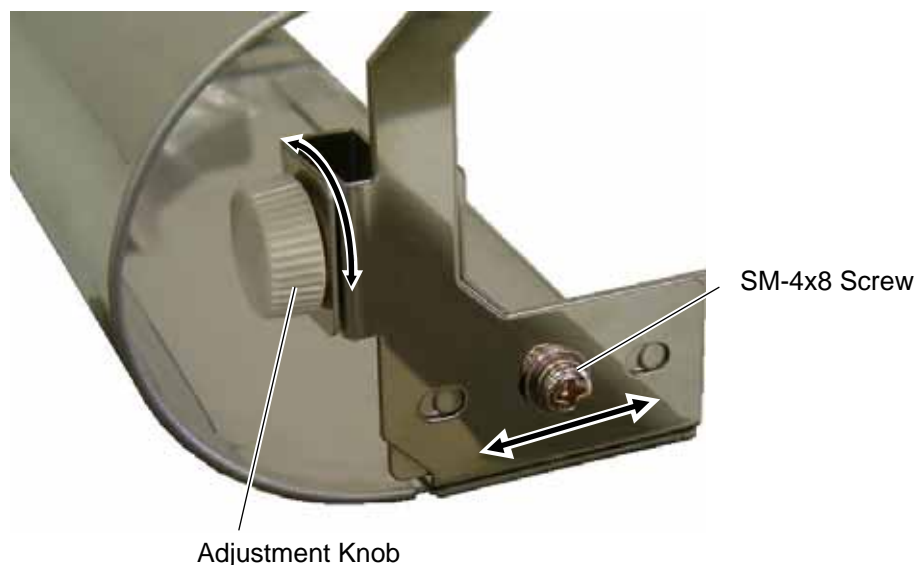

- (3) Print start position adjustment (Horizontal: media position, vertical: sensor adjustment/adjustment by issuing commands.)
  - (4) Communication test
  - (5) Abnormal noise
  - (6) Confirm that there are not any other errors.
11. Close the top cover.
12. Clean the outside of the printer.
13. Fill out a report form. Hand it to the manager and obtain a signature.

## 8. TROUBLESHOOTING

Problems	Cause	Solution
Power does not turn ON.	<ol style="list-style-type: none"> <li>1. Input voltage to the printer is not within the rated voltage. (Check by connector on the PS unit.)</li> <li>2. Output voltage from the printer is not within the rated voltage. [Check that the voltage between +24V pins and PG pins of connector on the PS unit is 24V. And check that the voltage between +5V and SG is 5V.]</li> <li>3. No voltage to the MAIN PC board. [Check that the voltage between +27V and PG pins of connector on the MAIN PC board is 24V. And check that the voltage between +5V and LG is 5V.]</li> <li>4. Failure of MAIN PC board.</li> </ol>	<p>Replace the power cable or power inlet.</p> <p>Replace the PS unit.</p> <p>Replace the power harness.</p> <p>Replace the MAIN PC board.</p>
LED or LCD does not light.	<ol style="list-style-type: none"> <li>1. Failure of the panel PC board or operation panel</li> <li>2. Failure of the operation panel harness</li> <li>3. Failure of the MAIN PC board</li> </ol>	<p>Replace the panel PC board or operation panel.</p> <p>Replace the operation panel harness.</p> <p>Replace the MAIN PC board.</p>
Poor printing	<ol style="list-style-type: none"> <li>1. Poor media quality.</li> <li>2. Dirty print head</li> <li>3. The print head block is not set completely.</li> </ol>	<p>Use the media approved by TOSHIBA TEC.</p> <p>Clean the print head.</p> <p>Close the print head block completely.</p>
Printer does not print.	<ol style="list-style-type: none"> <li>1. Print head failure</li> <li>2. Connection of the print head connector is incomplete, a bad contact, or broken elements.</li> <li>3. Failure in rewinding/feeding of the ribbon.</li> <li>4. Failure of the MAIN PC board.</li> <li>5. Failure of the software</li> <li>6. Failure of the printer cable.</li> </ol>	<p>Replace the print head.</p> <p>Connect the harness completely, or replace the harness.</p> <p>Replace the ribbon take-up motor, ribbon feed motor or MAIN PC board.</p> <p>Replace the MAIN PC board.</p> <p>Check the program.</p> <p>Replace the printer cable.</p>
Dot missing	<ol style="list-style-type: none"> <li>1. Broken print head element</li> <li>2. Broken print head cable wires</li> <li>3. Failure of the MAIN PC board</li> </ol>	<p>Replace the print head.</p> <p>Replace the print head harness.</p> <p>Replace the MAIN PC board.</p>
Blurred print	<ol style="list-style-type: none"> <li>1. Poor media quality.</li> <li>2. Dust is on the media.</li> </ol>	<p>Use only TOSHIBA TEC-approved media.</p> <p>Clean the print head and remove any dust from the media.</p>

Problems	Cause	Solution
Ribbon wrinkle	<ol style="list-style-type: none"> <li>1. Poor ribbon quality.</li> <li>2. Ribbon is not rewound or fed smoothly.</li> </ol>	<p>Use only TOSHIBA TEC-approved ribbon.</p> <p>Replace the ribbon rewind motor or ribbon feed motor.</p>
Media feed failure	<ol style="list-style-type: none"> <li>1. Media is not set properly.</li> <li>2. Poor media quality</li> <li>3. Improper adjustment of the feed gap sensor or black mark sensor.</li> <li>4. Threshold is improper.</li> <li>5. Failure of the feed gap sensor or black mark sensor</li> <li>6. The cutter mechanism is not installed properly.</li> <li>7. Failure of the stepping motor.</li> </ol>	<p>Set the media properly.</p> <p>Use the media approved by TOSHIBA TEC.</p> <p>Re-adjust the sensor.</p> <p>Set the threshold correctly.</p> <p>Replace the feed gap sensor or black mark sensor.</p> <p>Install the cutter module properly.</p> <p>Replace the stepping motor or MAIN PC board.</p>
Communication error	<ol style="list-style-type: none"> <li>1. Failure of the communication cable</li> <li>2. Failure of the RS-232C connector</li> <li>3. Failure of the communication connector</li> <li>4. Failure of the PC or application software</li> <li>5. Failure of the MAIN PC board</li> </ol>	<p>Replace the cable.</p> <p>Replace the connector</p> <p>Replace the connector.</p> <p>Modify the program.</p> <p>Replace the MAIN PC board.</p>

## 9. TROUBLESHOOTING

Problems	Cause	Solution
Power does not turn ON.	<ol style="list-style-type: none"> <li>1. Input voltage to the printer is not within the rated voltage. (Check by CN1 on the PS unit.)</li> <li>2. Output voltage from the printer is not within the rated voltage. [Check that the voltage between +24V pins (1, 2 and 6) and PG pins (3, 7 and 8) of CN4 on the PS unit is 24V. And check that the voltage between +5V pin (5) and SG pin (4) is 5V.]</li> <li>3. No voltage to the MAIN PC board. [Check that the voltage between +27V pins (1, 2 and 6) and PG pins (3, 7 and 8) of CN501 on the MAIN PC board is 24V. And check that the voltage between +5V pin (5) and LG pin (4) is 5V.]</li> <li>4. Failure of MAIN PC board.</li> </ol>	<p>Replace the power cable or power inlet.</p> <p>Replace the PS unit.</p> <p>Replace the power harness.</p> <p>Replace the MAIN PC board.</p>
LED or LCD does not light.	<ol style="list-style-type: none"> <li>1. Failure of the panel PC board or operation panel</li> <li>2. Failure of the operation panel harness</li> <li>3. Failure of the MAIN PC board</li> </ol>	<p>Replace the panel PC board or operation panel.</p> <p>Replace the operation panel harness.</p> <p>Replace the MAIN PC board.</p>
Poor printing	<ol style="list-style-type: none"> <li>1. Poor media quality.</li> <li>2. Dirty print head</li> <li>3. The print head block is not set completely.</li> </ol>	<p>Use the media approved by TOSHIBA TEC.</p> <p>Clean the print head.</p> <p>Close the print head block completely.</p>
Printer does not print.	<ol style="list-style-type: none"> <li>1. Print head failure</li> <li>2. Connection of the print head connector is incomplete, a bad contact, or broken elements.</li> <li>3. Failure in rewinding/feeding of the ribbon.</li> <li>4. Failure of the MAIN PC board.</li> <li>5. Failure of the software</li> <li>6. Failure of the printer cable.</li> </ol>	<p>Replace the print head.</p> <p>Connect the harness completely, or replace the harness.</p> <p>Replace the ribbon take-up motor, ribbon feed motor or MAIN PC board.</p> <p>Replace the MAIN PC board.</p> <p>Check the program.</p> <p>Replace the printer cable.</p>
Dot missing	<ol style="list-style-type: none"> <li>1. Broken print head element</li> <li>2. Broken print head cable wires</li> <li>3. Failure of the MAIN PC board</li> </ol>	<p>Replace the print head.</p> <p>Replace the print head harness.</p> <p>Replace the MAIN PC board.</p>
Blurred print	<ol style="list-style-type: none"> <li>1. Poor media quality.</li> <li>2. Dust is on the media.</li> </ol>	<p>Use only TOSHIBA TEC-approved media.</p> <p>Clean the print head and remove any dust from the media.</p>

Problems	Cause	Solution
Ribbon wrinkle	<ol style="list-style-type: none"> <li>1. Poor ribbon quality.</li> <li>2. Ribbon is not rewound or fed smoothly.</li> </ol>	<p>Use only TOSHIBA TEC-approved ribbon.</p> <p>Replace the ribbon rewind motor or ribbon feed motor.</p>
Media feed failure	<ol style="list-style-type: none"> <li>1. Media is not set properly.</li> <li>2. Poor media quality</li> <li>3. Improper adjustment of the feed gap sensor or black mark sensor.</li> <li>4. Threshold is improper.</li> <li>5. Failure of the feed gap sensor or black mark sensor</li> <li>6. The cutter mechanism is not installed properly.</li> <li>7. Failure of the stepping motor.</li> </ol>	<p>Set the media properly.</p> <p>Use the media approved by TOSHIBA TEC.</p> <p>Re-adjust the sensor.</p> <p>Set the threshold correctly.</p> <p>Replace the feed gap sensor or black mark sensor.</p> <p>Install the cutter module properly.</p> <p>Replace the stepping motor or MAIN PC board.</p>
Communication error	<ol style="list-style-type: none"> <li>1. Failure of the communication cable</li> <li>2. Failure of the RS-232C connector</li> <li>3. Failure of the communication connector</li> <li>4. Failure of the PC or application software</li> <li>5. Failure of the MAIN PC board</li> </ol>	<p>Replace the cable.</p> <p>Replace the connector</p> <p>Replace the connector.</p> <p>Modify the program.</p> <p>Replace the MAIN PC board.</p>