

TOSHIBA

TOSHIBA Thermal Printer

B-SX4T SERIES

Owner's Manual
Mode d'emploi
Bedienungsanleitung
Manual de instrucciones
Gebruikershandleiding
Manuale Utente
Manual do Utilizador



CE Compliance (for EU only)

This product complies with the requirements of EMC and Low Voltage Directives including their amendments.

VORSICHT:

- *Schallemission: unter 70dB (A) nach DIN 45635 (oder ISO 7779)*
- *Die für das Gerät Vorgesehene Steckdose muß in der Nähe des Gerätes und leicht zugänglich sein.*

Centronics is a registered trademark of Centronics Data Computer Corp.
Microsoft is a registered trademark of Microsoft Corporation.
Windows is a trademark of Microsoft Corporation.

As an ENERGY STAR® Partner, TOSHIBA TEC has determined that this product meets the ENERGY STAR® guidelines for energy efficiency.



-- Outline of the International ENERGY STAR® Office Equipment Program --

The International ENERGY STAR® Office Equipment Program is an international program that promotes energy saving through the penetration of energy efficient computers and other office equipment. The program backs the development and dissemination of products with functions that effectively reduce energy consumption. It is an open system in which business proprietors can participate voluntarily. The targeted products are office equipment such as computers, monitors, printers, facsimiles, copiers, scanners, and multifunction devices. Their standards and logos are uniform among participating nations.

ENERGY STAR is a U.S. registered mark.

This equipment has been tested and found to comply with the limits for a Class A digital device, pursuant to Part 15 of the FCC Rules. These limits are designed to provide reasonable protection against harmful interference when the equipment is operated in a commercial environment. This equipment generates, uses, and can radiate radio frequency energy and, if not installed and used in accordance with the instruction manual, may cause harmful interference to radio communications. Operations of this equipment in a residential area is likely to cause harmful interference in which case the user will be required to correct the interference at his own expense.

(for USA only)

Changes or modifications not expressly approved by manufacturer for compliance could void the user's authority to operate the equipment.

"This Class A digital apparatus meets all requirements of the Canadian Interference-Causing Equipment Regulations."

"Cet appareil numérique de la classe A respecte toutes les exigences du Règlement sur le matériel brouilleur du Canada."

(for CANADA only)



N258

IP20

TOSHIBA

TOSHIBA Thermal Printer

B-SX4T SERIES

Owner's Manual

Waste Recycling information for users:

Following information is only for EU-member states:

The use of the crossed-out wheeled bin symbol indicates that this product may not be treated as general household waste.

By ensuring this product is disposed of correctly you will help prevent potential negative consequences for the environment and human health, which could otherwise be caused by inappropriate waste handling of this product. For more detailed information about the take-back and recycling of this product, please contact your supplier where you purchased the product.



This product is equipped with a wireless communication device,
TEC-RFID-US1 (B-9704-RFID-U1-US-R)
TEC-RFID-EU1 (B-9704-RFID-U1-EU-R)

Please be sure to read the enclosed precaution for handling of wireless communication devices before using this product.

Precautions for Handling of Wireless Communication Devices

RFID kit: TEC-RFID-US1 (B-9704-RFID-U1-US-R)
TEC-RFID-EU1 (B-9704-RFID-U1-EU-R)

For all countries and areas

This product is a wireless communication device, and the use of this product is restricted to the following countries or areas. If the product is used in the countries or areas other than the following, you may be punished according to the laws of those countries or areas.

TEC-RFID-US1 (B-9704-RFID-U1-US-R): USA, Canada

TEC-RFID-EU1 (B-9704-RFID-U1-EU-R): Austria, Belgium, Cyprus, Czech Republic, Denmark, Estonia, Finland, France, Hungary, Germany, Greece, Ireland, Italy, Latvia, Lithuania, Luxembourg, Malta, Netherlands, Poland, Portugal, Slovakia, Slovenia, Spain, Sweden, United Kingdom, Norway, Liechtenstein, Iceland, Switzerland

For safety

Do not use the product in locations where the use is forbidden, for example in a hospital.

When you do not know the forbidden areas, please refer to and follow the medical institution.

Otherwise medical equipment may be affected, causing a serious accident.

This product may affect the operation of some implanted cardiac pacemakers and other medically implanted equipment. Pace maker patients should be aware that the use of this product very close to a pacemaker might cause the device to malfunction.

If you have any reason to suspect that interference is taking place, immediately turn off the product and contact your TOSHIBA TEC sales agent.

Do not disassemble, modify, or repair the product.

Doing so may cause injury. Also, modification is against the Laws and Regulations for Radio Equipment. Please ask your TOSHIBA TEC sales agent for repair.

For USA

This device complies with Part 15 of the FCC Rules.

Operation is subject to the following two conditions:

- (1) this device may not cause harmful interference, and
- (2) this device must accept any interference received, including interference that may cause undesired operation.

Changes or modification not expressly approved by manufacturer for compliance could void the user's authority to operate the equipment.

For Canada

Operation is subject to the following two conditions:

- (1) this device may not cause interference, and
- (2) this device must accept any interference, including interference that may cause undesired operation of the device.

For Europe

CE 0682 

Hereby, Toshiba TEC Corporation, declares that this TEC-RFID-EU1 (B-9704-RFID-U1-EU-R) is in compliance with the essential requirements and other relevant provisions of Directive 1999/5/EC.

This equipment uses the radio frequency band which has not been harmonized throughout all EU and EFTA countries, and can be used in the following countries.

Austria, Belgium, Cyprus, Czech Republic, Denmark, Estonia, Finland, France, Hungary, Germany, Greece, Ireland, Italy, Latvia, Lithuania, Luxembourg, Malta, Netherlands, Poland, Portugal, Slovakia, Slovenia, Spain, Sweden, United Kingdom, Norway, Liechtenstein, Iceland, Switzerland

Safety Summary

Personal safety in handling or maintaining the equipment is extremely important. Warnings and Cautions necessary for safe handling are included in this manual. All warnings and cautions contained in this manual should be read and understood before handling or maintaining the equipment.

Do not attempt to effect repairs or modifications to this equipment. If a fault occurs that cannot be rectified using the procedures described in this manual, turn off the power, unplug the machine, then contact your authorised TOSHIBA TEC representative for assistance.

Meanings of Each Symbol



This symbol indicates warning items (including cautions). Specific warning contents are drawn inside the Δ symbol. (The symbol on the left indicates a general caution.)



This symbol indicates prohibited actions (prohibited items). Specific prohibited contents are drawn inside or near the \odot symbol. (The symbol on the left indicates “no disassembling”.)



This symbol indicates actions which must be performed. Specific instructions are drawn inside or near the \bullet symbol. (The symbol on the left indicates “disconnect the power cord plug from the outlet”.)



WARNING

This indicates that there is the risk of **death** or **serious injury** if the machines are improperly handled contrary to this indication.



Any other than the specified AC voltage is prohibited.

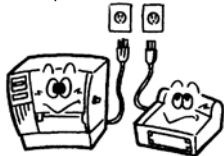

Do not use voltages other than the voltage (AC) specified on the rating plate, as this may cause **fire** or **electric shock**.



Prohibited

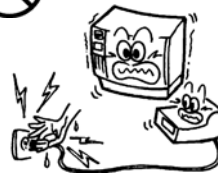

Do not plug in or unplug the power cord plug with wet hands as this may cause **electric shock**.



Prohibited



If the machines share the same outlet with any other electrical appliances that consume large amounts of power, the voltage will fluctuate widely each time these appliances operate. Be sure to provide an exclusive outlet for the machine as this may cause **fire** or **electric shock**.



Prohibited



Do not place metal objects or water-filled containers such as flower vases, flower pots or mugs, etc. on top of the machines. If metal objects or spilled liquid enter the machines, this may cause **fire** or **electric shock**.



Prohibited



Do not insert or drop metal, flammable or other foreign objects into the machines through the ventilation slits, as this may cause **fire** or **electric shock**.



Prohibited



Do not scratch, damage or modify the power cords. Also, do not place heavy objects on, pull on, or excessively bend the cords, as this may cause **fire** or **electrical shock**.



Disconnect the plug.











If the machines are dropped or their cabinets damaged, first turn off the power switches and disconnect the power cord plugs from the outlet, and then contact your authorised TOSHIBA TEC representative for assistance. Continued use of the machine in that condition may cause **fire** or **electric shock**.



Disconnect the plug.



Continued use of the machines in an abnormal condition such as when the machines are producing smoke or strange smells may cause **fire** or **electric shock**. In these cases, immediately turn off the power switches and disconnect the power cord plugs from the outlet. Then, contact your authorised TOSHIBA TEC representative for assistance.

 <p>Disconnect the plug.</p> 	<p>If foreign objects (metal fragments, water, liquids) enter the machines, first turn off the power switches and disconnect the power cord plugs from the outlet, and then contact your authorised TOSHIBA TEC representative for assistance. Continued use of the machine in that condition may cause fire or electric shock.</p>	 <p>Disconnect the plug.</p> 	<p>When unplugging the power cords, be sure to hold and pull on the plug portion. Pulling on the cord portion may cut or expose the internal wires and cause fire or electric shock.</p>
 <p>Connect a grounding wire.</p> 	<p>Ensure that the equipment is properly grounded. Extension cables should also be grounded. Fire or electric shock could occur on improperly grounded equipment.</p>	 <p>No disassembling.</p> 	<p>Do not remove covers, repair or modify the machine by yourself. You may be injured by high voltage, very hot parts or sharp edges inside the machine.</p>



CAUTION

This indicates that there is the risk of personal **Injury** or **damage** to objects if the machines are improperly handled contrary to this indication.

Precautions

The following precautions will help to ensure that this machine will continue to function correctly.

- Try to avoid locations that have the following adverse conditions:
 - * Temperatures out of the specification
 - * Shared power source
- The cover should be cleaned by wiping with a dry cloth or a cloth slightly dampened with a mild detergent solution. NEVER USE THINNER OR ANY OTHER VOLATILE SOLVENT on the plastic covers.
- USE ONLY TOSHIBA TEC SPECIFIED paper and ribbons.
- DO NOT STORE the paper or ribbons where they might be exposed to direct sunlight, high temperatures, high humidity, dust, or gas.
- Ensure the printer is operated on a level surface.
- Any data stored in the memory of the printer could be lost during a printer fault.
- Try to avoid using this equipment on the same power supply as high voltage equipment or equipment likely to cause mains interference.
- Unplug the machine whenever you are working inside it or cleaning it.
- Keep your work environment static free.
- Do not place heavy objects on top of the machines, as these items may become unbalanced and fall causing **injury**.
- Do not block the ventilation slits of the machines, as this will cause heat to build up inside the machines and may cause **fire**.
- Do not lean against the machine. It may fall on you and could cause **injury**.
- Care must be taken not to injure yourself with the printer paper cutter.
- Unplug the machine when it is not used for a long period of time.
- Place the machine on a stable and level surface.

Request Regarding Maintenance

- Utilize our maintenance services.
After purchasing the machine, contact your authorised TOSHIBA TEC representative for assistance once a year to have the inside of the machine cleaned. Otherwise, dust will build up inside the machines and may cause a **fire** or a **malfunction**. Cleaning is particularly effective before humid rainy seasons.
- Our preventive maintenance service performs the periodic checks and other work required to maintain the quality and performance of the machines, preventing accidents beforehand.
For details, please consult your authorised TOSHIBA TEC representative for assistance.
- Using insecticides and other chemicals
Do not expose the machines to insecticides or other volatile solvents. This will cause the cabinet or other parts to deteriorate or cause the paint to peel.

TABLE OF CONTENTS

	Page
1. PRODUCT OVERVIEW.....	E1- 1
1.1 Introduction.....	E1- 1
1.2 Features	E1- 1
1.3 Unpacking.....	E1- 1
1.4 Accessories	E1- 2
1.5 Appearance	E1- 3
1.5.1 Dimensions.....	E1- 3
1.5.2 Front View	E1- 3
1.5.3 Rear View	E1- 3
1.5.4 Operation Panel.....	E1- 4
1.5.5 Interior	E1- 4
1.6 Options	E1- 5
2. PRINTER SETUP	E2- 1
2.1 Installation	E2- 2
2.2 Fitting the Fan Filter.....	E2- 3
2.3 Connecting the Power Cord	E2- 3
2.4 Loading the Media	E2- 4
2.5 Loading the Ribbon	E2- 9
2.6 Connecting the Cables to Your Printer	E2-11
2.7 Turning the Printer ON/OFF	E2-12
2.7.1 Turning ON the Printer	E2-12
2.7.2 Turning OFF the Printer.....	E2-12
2.8 Inserting the Optional PCMCIA Cards.....	E2-13
2.9 Setting an Operating Environment	E2-14
2.9.1 Parameter Setting.....	E2-15
2.9.2 Dump Mode Setting.....	E2-32
2.9.3 BASIC Expansion Mode	E2-34
2.10 Installing the Printer Drivers	E2-35
2.10.1 Introduction.....	E2-35
2.10.2 General Description.....	E2-35
2.10.3 Installing the Printer Driver	E2-36
2.10.4 Uninstalling the Printer Driver	E2-49
2.10.5 Adding/Deleting a LAN Port.....	E2-50
2.10.6 Cautions	E2-52
2.10.7 Using the Printer Driver	E2-53
2.11 Print Test	E2-54
2.12 Position and Print Tone Fine Adjustment	E2-56
2.13 Threshold Setting	E2-64
3. ON LINE MODE.....	E3- 1
3.1 Operation Panel.....	E3- 1
3.2 Operation.....	E3- 2
3.3 Reset	E3- 2

	Page
4. MAINTENANCE	E4- 1
4.1 Cleaning	E4- 1
4.1.1 Print Head/Platen/Sensors	E4- 1
4.1.2 Covers and Panels	E4- 2
4.1.3 Optional Cutter Module.....	E4- 3
5. TROUBLESHOOTING	E5- 1
5.1 Error Messages	E5- 1
5.2 Possible Problems.....	E5- 3
5.3 Removing Jammed Media.....	E5- 5
6. PRINTER SPECIFICATIONS.....	E6- 1
7. SUPPLY SPECIFICATIONS	E7- 1
7.1 Media.....	E7- 1
7.1.1 Media Type.....	E7- 1
7.1.2 Detection Area of the Transmissive Sensor	E7- 2
7.1.3 Detection Area of the Reflective Sensor.....	E7- 3
7.1.4 Effective Print Area.....	E7- 3
7.1.5 RFID Tags	E7- 4
7.2 Ribbon	E7- 6
7.3 Recommended Media and Ribbon Types	E7- 6
7.4 Care/Handling of Media and Ribbon	E7- 7
APPENDIX 1 MESSAGES AND LEDS.....	EA1-1
APPENDIX 2 INTERFACE.....	EA2-1
APPENDIX 3 POWER CORD	EA3-1
APPENDIX 4 PRINT SAMPLES	EA4-1
APPENDIX 5 GLOSSARIES.....	EA5-1
INDEX	

WARNING!

This is a Class A product. In a domestic environment this product may cause radio interference in which case the user may be required to take adequate measures.

CAUTION!

1. *This manual may not be copied in whole or in part without prior written permission of TOSHIBA TEC.*
2. *The contents of this manual may be changed without notification.*
3. *Please refer to your local Authorised Service representative with regard to any queries you may have in this manual.*

1. PRODUCT OVERVIEW

1.1 Introduction

Thank you for choosing the TEC B-SX4T series thermal printer. This Owner's Manual contains from general set-up through how to confirm the printer operation using a test print, and should be read carefully to help gain maximum performance and life from your printer. For most queries please refer to this manual and keep it safe for future reference. Please contact your TOSHIBA TEC representative for further information concerning this manual.

1.2 Features

This printer has the following features:

- The print head block can be opened providing smooth loading of media and ribbon.
- Various kinds of media can be used as the media sensors can be moved from the centre to the left edge of the media.
- When the optional interface board is installed, Web functions such as remote maintenance and other advanced network features are available.
- Superior hardware, including the specially developed 8 dots/mm (203 dots/inch) thermal print head which will allow very clear print at a printing speed of 76.2 mm/sec. (3 inches/sec.), 152.4 mm/sec. (6 inches/sec.), or 254.0 mm/sec. (10 inches/sec.).
- Besides the optional Cutter Module, there is also an optional Strip Module, Ribbon Saving Module, PCMCIA Interface Board, Expansion I/O Interface Board, LAN Interface Board, Wireless LAN Board, the USB Interface Board, RFID module, and Fanfold Paper Guide Module.

1.3 Unpacking

NOTES:

1. Check for damage or scratches on the printer. However, please note that TOSHIBA TEC shall have no liability for any damage of any kind sustained during transportation of the product.
2. Keep the cartons and pads for future transportation of the printer.

Unpack the printer as per the Unpacking Instructions supplied with the printer.

1.4 Accessories

When unpacking the printer, please make sure all the following accessories are supplied with the printer.

NOTE:
As a power cord is not supplied with this printer, please purchase one that meets each country's safety standard. For details, refer to APPENDIX 3.

- CD-ROM (1 pc.)
(P/No.: 7FM1647000)



<Contents>

- Bar code print application (Bartender ultra lite)
- Windows Driver
- Owner's Manual
- Specifications (Programming, Key operation, etc.)
- Product information (Catalogue)

- Warranty Disclaimer Sheet (1 sheet)
- Fan Filter (1 pc.)
(P/No. FMBB0036801)

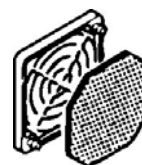
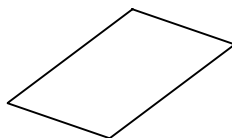

- Supply Loading Instructions
(Doc. No.: EO2-33021)

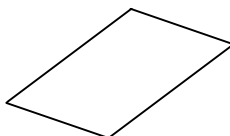

- Safety Precautions
(Doc. No.: EO2-33020)

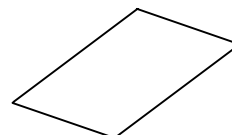

- Quality Control Report
(1 sheet)

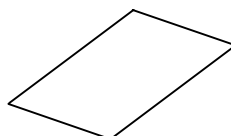

1.5 Appearance

The names of the parts or units introduced in this section are used in the following chapters.

1.5.1 Dimensions

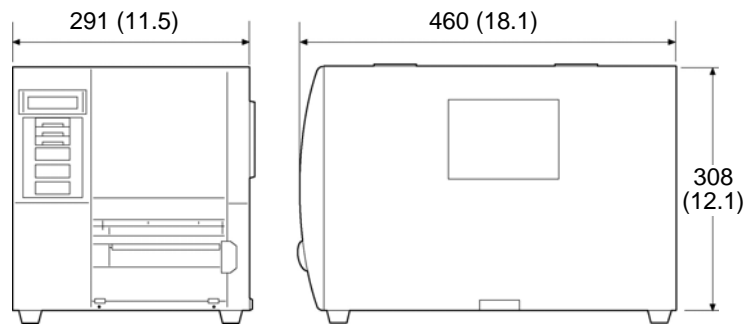

Dimensions in mm (inches)

1.5.2 Front View



1.5.3 Rear View

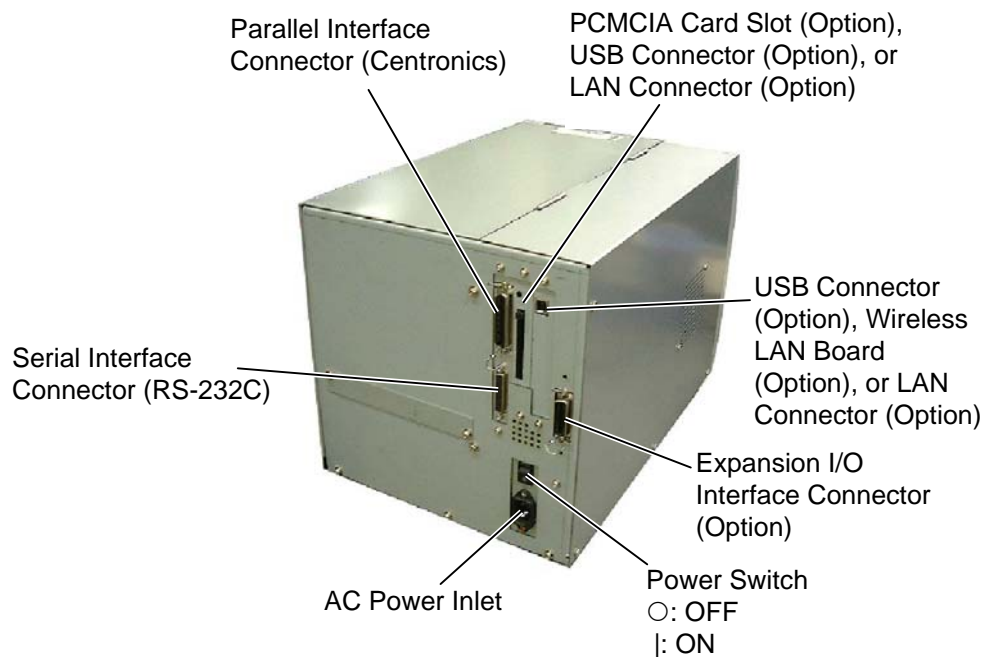

1.5.4 Operation Panel

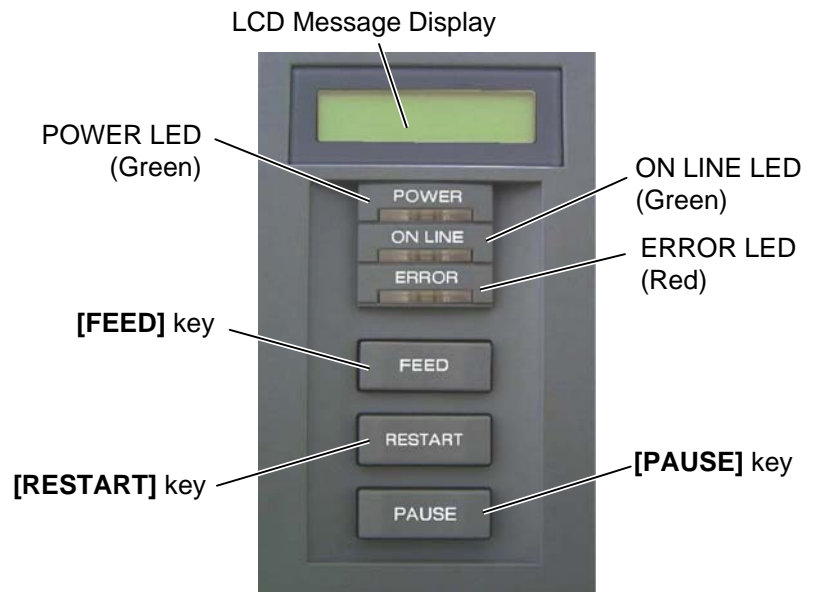

Please see **Section 3.1** for further information about the Operation Panel.

1.5.5 Interior

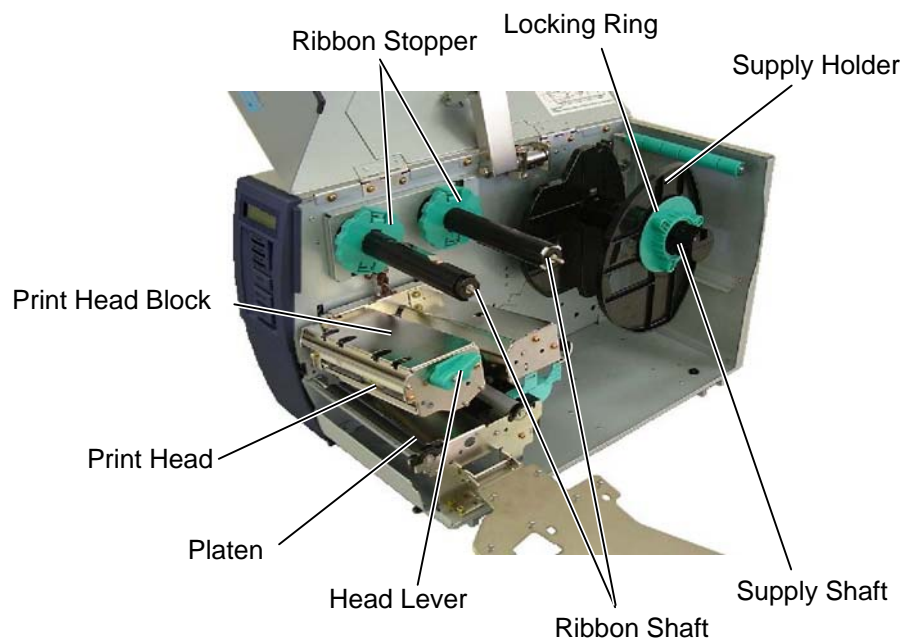

1.6 Options

Option Name	Type	Description
Swing cutter module	B-4205-QM-R	A stop and cut swing cutter.
Rotary cutter module	B-8204-QM-R	Rotary cutter
Strip module	B-9904-H-QM-R	This allows use of on-demand (peel-off) operation or to take-up labels and backing paper together when using the rewind guide plate. To purchase the strip module, please inquire at your local distributor.
Ribbon saving module	B-9904-R2-QM-R	This module moves the print head up and down by using a solenoid to minimise ribbon usage as far as possible.
Expansion I/O interface board	B-7704-IO-QM-R	Installing this board in the printer allows connection to an external device with the exclusive interface.
PCMCIA interface board	B-9700-PCM-QM-R	This board enables the use of the following PCMCIA cards. ATA card: Conforming to PC card ATA standard Flash memory card: 1MB and 4MB cards (See Section 2.8.)
Built-in LAN interface board	B-9700-LAN-QM-R	This board enables the printer to be used in a LAN network.
USB interface board	B-9700-USB-QM-R	Installing this board enables a connection to a PC which has a USB interface.
RFID module	B-9704-RFID-U1-US-R B-9704-RFID-U1-EU-R B-9704-RFID-H1-QM-R	Installing this module enables read and write of RFID tags. Applicable frequency range differs depending on the module types: U1-US: UHF, 902MHz to 928MHz U1-EU: UHF, 869.5MHz H1-QM: HF, 13.56MHz
Fanfold paper guide module	B-4905-FF-QM-R	This is a paper guide exclusively used for fanfold paper.
Wireless LAN board	B-9700-WLAN-QM-R	Installing this PC board allows a communication by wireless LAN.

NOTE:

To purchase the optional kits, please contact the nearest authorised TOSHIBA TEC representative or TOSHIBA TEC Head Quarters.

2. PRINTER SETUP

This section outlines the procedures to setup your printer prior to its operation. The section includes precautions, loading media and ribbon, connecting cables, setting the operating environment of the printer, and performing an online print test.

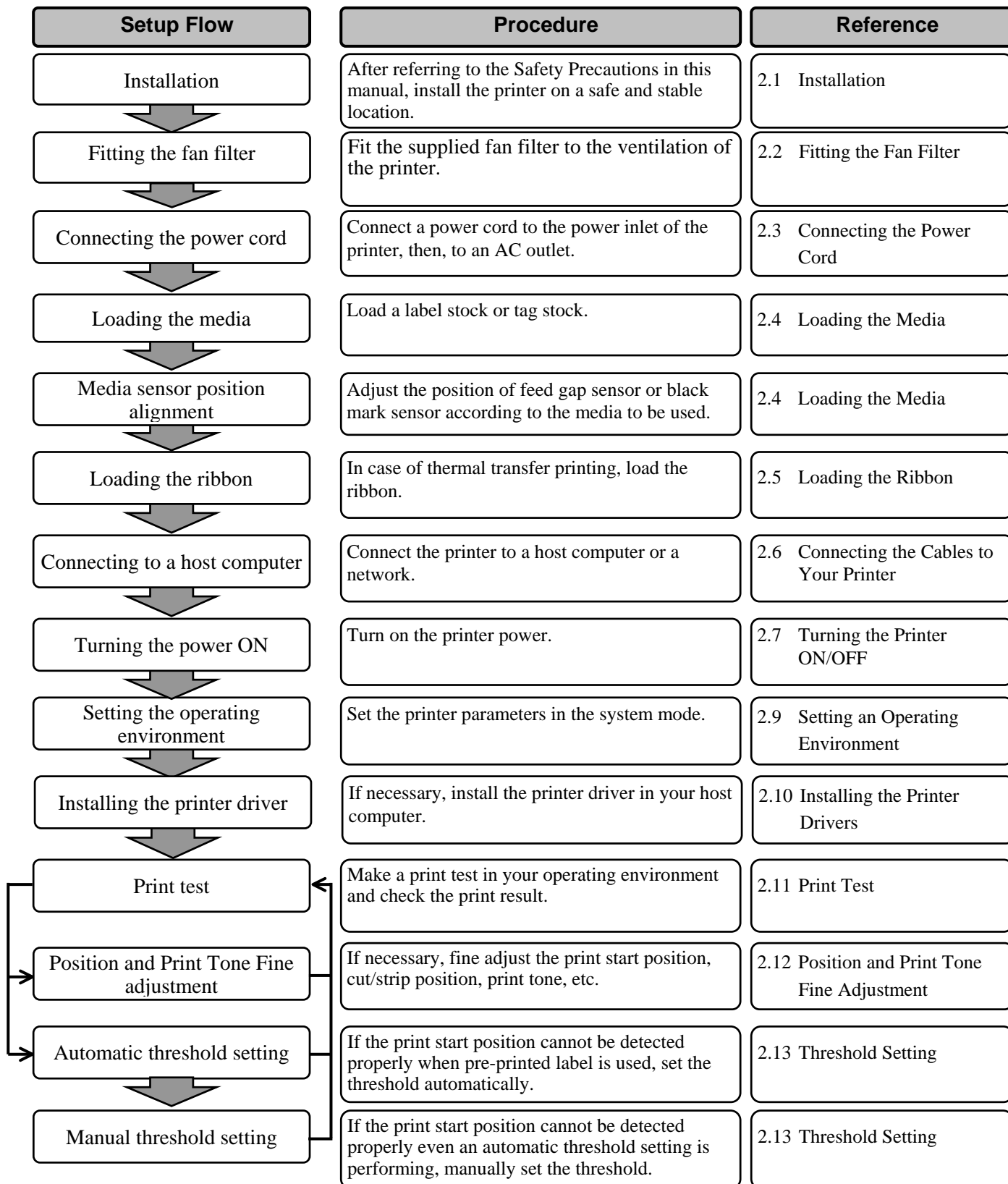

2.1 Installation

To insure the best operating environment, and to assure the safety of the operator and the equipment, please observe the following precautions.

- Operate the printer on a stable, level, operating surface in a location free from excessive humidity, high temperature, dust, vibration or direct sunlight.
- Keep your work environment static free. Static discharge can cause damage to delicate internal components.
- Make sure that the printer is connected to a clean source of AC Power and that no other high voltage devices that may cause line noise interference are connected to the same mains.
- Assure that the printer is connected to the AC mains with a three-prong power cable that has the proper ground (earth) connection.
- Do not operate the printer with the cover open. Be careful not to allow fingers or articles of clothing to get caught into any of the moving parts of the printer especially the optional cutter mechanism.
- Make sure to turn off the printer power and to remove the power cord from the printer whenever working on the inside of the printer such as changing the ribbon or loading the media, or when cleaning the printer.
- For best results, and longer printer life, use only TOSHIBA TEC recommended media and ribbons.
- Store the media and ribbons in accordance with their specifications.
- This printer mechanism contains high voltage components; therefore you should never remove any of the covers of the machine as you may receive an electrical shock. Additionally, the printer contains many delicate components that may be damaged if accessed by unauthorised personnel.
- Clean the outside of the printer with a clean dry cloth or a clean cloth slightly dampened with a mild detergent solution.
- Use caution when cleaning the thermal print head as it may become very hot while printing. Wait until it has had time to cool before cleaning. Use only the TOSHIBA TEC recommended print head cleaner to clean the print head.
- Do not turn off the printer power or remove the power plug while the printer is printing or while the ON LINE lamp is blinking.

2.2 Fitting the Fan Filter

When installing the printer, it is important to ensure that the Fan Filter is attached before using the printer. The Fan Filter consists of 2 parts:

- (1) Filter Pad
- (2) Filter Retainer

To fit the Fan Filter, put the Filter Pad inside the Filter Retainer and simply press into place as shown in the diagram below, ensuring connecting pins are aligned with the connecting holes.

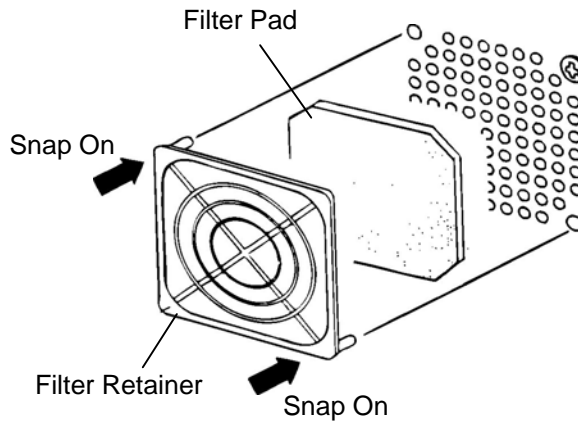

2.3 Connecting the Power Cord

1. Make sure that the printer Power Switch is in the OFF (O) position. Connect the Power Cord to the printer as shown in the figure below



Power Switch



Power Cord

2. Plug the other end of the Power Cord into a grounded outlet as shown in the figure below.

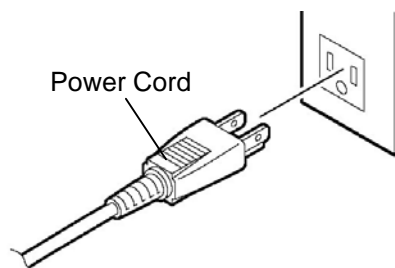

[Example of US Type]

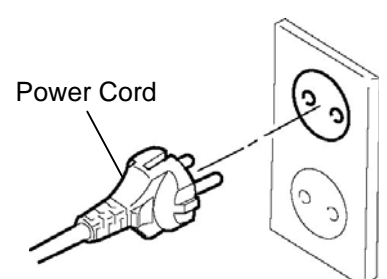

[Example of EU Type]

CAUTION!

1. As a Power Cord is not supplied with the printer, please purchase an approved one that meets the safety standard of each country. (Refer to **APPENDIX 3.**)
2. Make sure that the printer Power Switch is turned to the OFF position (O) before connecting the Power Cord to prevent possible electric shock or damage to the printer.
3. Connect the Power Cord to a supply outlet with a properly grounded (earthed) connection.

2.4 Loading the Media

WARNING!

1. Do not touch any moving parts. To reduce the risk of fingers, jewellery, clothing, etc., being drawn into the moving parts, be sure to load the media once the printer has stopped moving completely.
2. The Print Head becomes hot immediately after printing. Allow it to cool before loading the media.
3. To avoid injury, be careful not to trap your fingers while opening or closing the cover.

CAUTION!

Be careful not to touch the Print Head Element when raising the Print Head Block. Failure to do this may cause missing dots by static electricity or other print quality problems.

NOTES:

1. When the Head Lever is turned to **Free** position, the Print Head is raised.
2. To allow printing the Head Lever must be set to **Lock** position. (This ensures that the Print Head is closed.) There are two head pressure levels in the **Lock** position. Set the Head Lever depending on the media type:
 Position ①: Labels
 Position ②: Tags
 However, proper position may differ depending on media. For details, refer to TOSHIBA TEC authorised service representative.
3. Do not turn the Locking Ring counterclockwise too far or it may come off the Supply Holder.

The following procedure shows the steps to properly load the media into the printer so that it feeds straight and true through the printer.

The printer prints both labels and tags.

1. Turn off the power and open the Top Cover.
2. Turn the Head Lever to **Free** position, then release the Ribbon Shaft Holder Plate.
3. Open the Print Head Block.

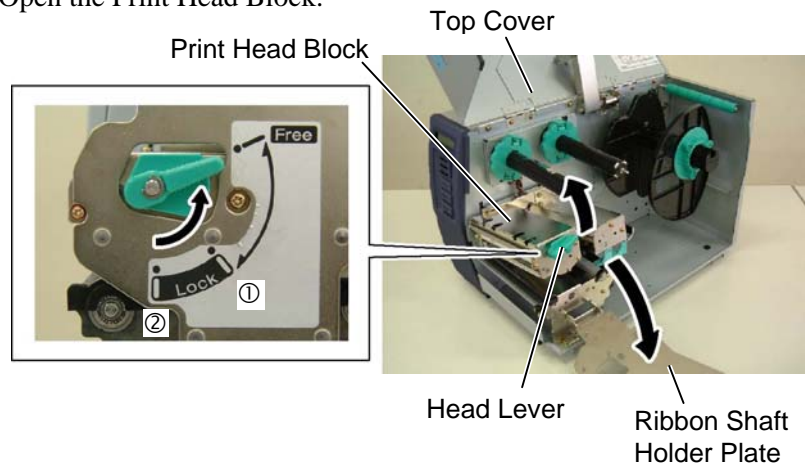

CAUTION!

When loading or replacing the media or a ribbon, be careful not to damage the print head with a hard object like a watch or a ring.

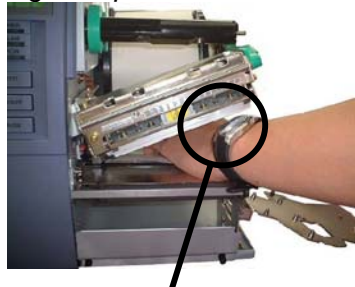

Care must be taken not to allow the metal or glass part of a watch to touch the print head edge.



Care must be taken not to allow a metal object like a ring to touch the print head edge.

Since the print head element can be easily damaged by shock, please treat it carefully by not hitting a hard object against it.

4. Turn the Locking Ring counterclockwise and remove the Supply Holder from the Supply Shaft.

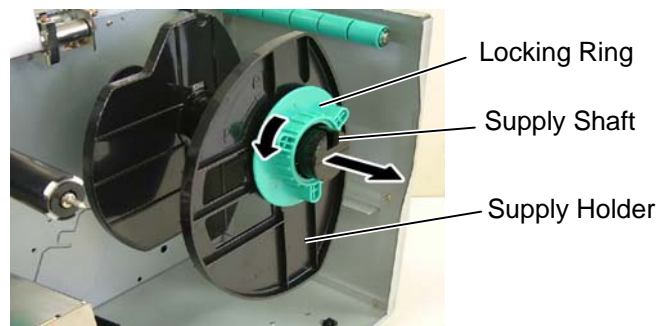

2.4 Loading the Media (Cont.)

NOTE:
Do not over-tighten the Locking Ring of the Supply Holder.

5. Put the media on the Supply Shaft.
6. Pass the media around the Damper, then pull the media towards the front of the printer.
7. Align the projection of the Supply Holder with the groove of the Supply Shaft, and push the Supply Holder against the media until the media is held firmly in place. This will centre the media automatically.
Then turn the Locking Ring clockwise to secure the Supply Holder.

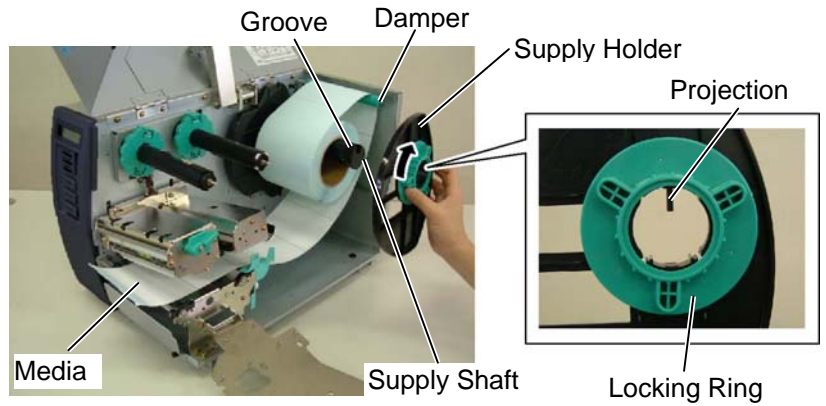

In case of a label rolled with the print side facing inside.

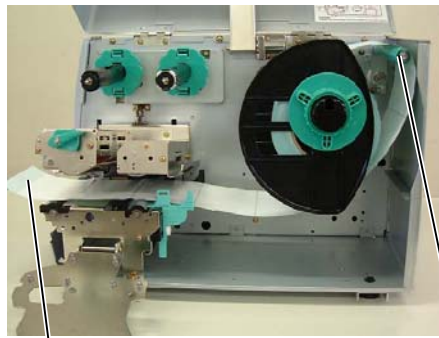

Media

In case of a label rolled with the print side facing outside.

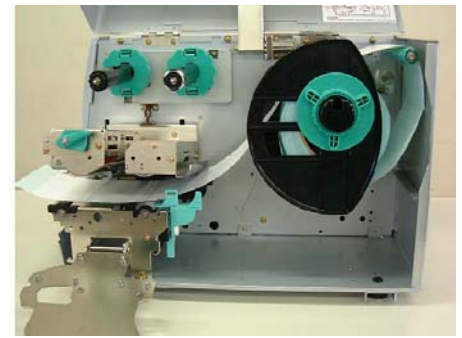

Damper

8. Place the media between the Media Guides, adjust the Media Guides to the media width, and tighten the Locking Screw.
9. Check that the media path through the printer is straight. The media should be centred under the Print Head.

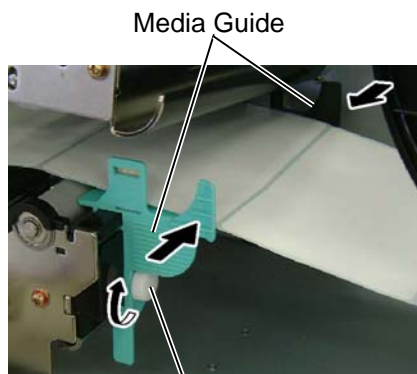

Locking Screw

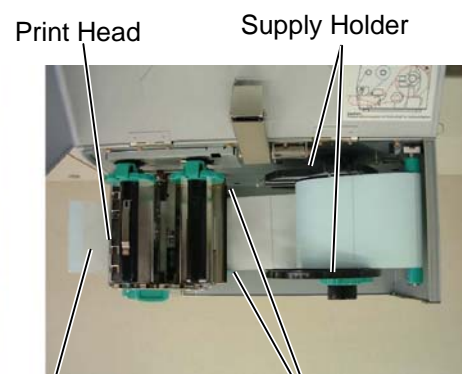

Media

Media Guide

2.4 Loading the Media (Cont.)

10. Lower the Print Head Block until it stops.
11. After loading the media, it may be necessary to set the Media Sensors used to detect the print start position for label or tag printing.

Setting the Feed Gap Sensor position

- (1) Remove the Locking Screw that secures the Media Sensor.
- (2) Manually move the Media Sensor so that the Feed Gap Sensor is positioned at the centre of the labels. (➔ indicates the position of the Feed Gap Sensor).
- (3) Tighten the Locking Screw.

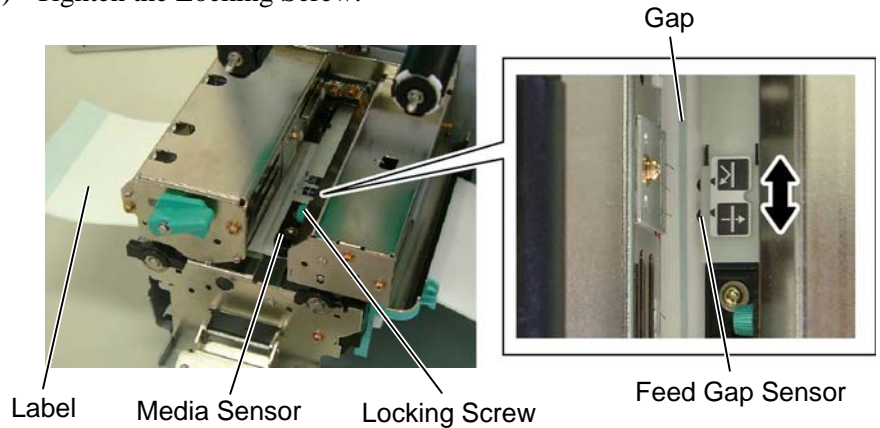

Setting the Black Mark Sensor position

NOTE:
 Be sure to set the black mark sensor to detect the centre of the black mark, otherwise a paper jam or no paper error may occur.

- (1) Remove the Locking Screw that secures the Media Sensor.
- (2) Pull about 500 mm of media out of the front of the printer, turn the media back on itself and feed it under the Print Head past the sensor so that the black mark can be seen from above.
- (3) Manually move the Media Sensor so that the Black Mark Sensor is in line with the centre of the black mark on the media. (⤴ indicates the position of the Black Mark Sensor).
- (4) Tighten the Locking Screw.

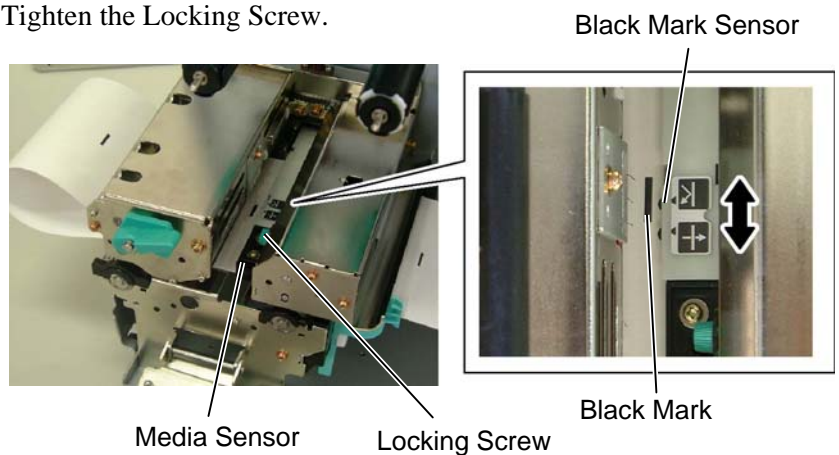

2.4 Loading the Media (Cont.)

12. There are four issue modes available on this printer. How to set the media for each mode is provided below.

Batch mode

In the batch mode, the media is continuously printed and fed until the number of labels/tags specified in the issue command have been printed.

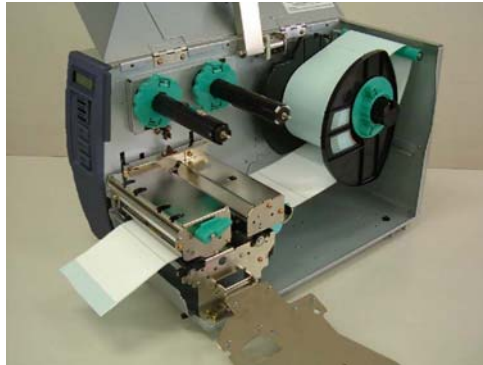

NOTES:

1. Be sure to set the Selection Switch to **STANDARD/PEEL OFF** position.
2. The backing paper is easier to feed back to the Take-Up Spool if the Front Plate is removed.
3. Fit the Take-Up Clip so that the longer side of the clip is fitted into the shallow groove in the Take-Up Spool.
4. The backing paper can be wound directly onto the Take-up Spool or a paper core. When using the Take-up Spool, detach the Holder Stopper by removing the B-3x4 screw. Otherwise, it may be difficult to pull out the wound backing paper roll.

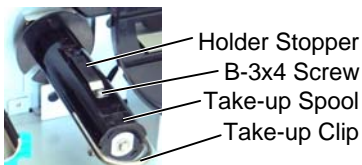

When using a paper core, put the core on the Take-up Spool with the Holder Stopper on it, and attach the top edge of the backing paper to the core with adhesive tape. The Take-up Clip is not necessary. This winding method is applicable to the Built-in Rewinder mode.

Strip mode (Option)

When the optional Strip Module is fitted, the backing paper is automatically removed from the label at the Strip Plate as each label is printed.

- (1) Remove enough labels from the leading edge of the media to leave 500mm of backing paper free.
- (2) Insert the backing paper under the Strip Plate.
- (3) Wind the backing paper onto the Take-up Spool and fix it in position with the Take-up Clip. (Wind the paper counterclockwise around the spool as this is the direction it rotates.)
- (4) Rotate the Take-up Spool anti-clockwise a few times to remove any slack in the backing paper.
- (5) Set the Selection Switch mounted on the Rewinder Assembly to **STANDARD/PEEL OFF** position.

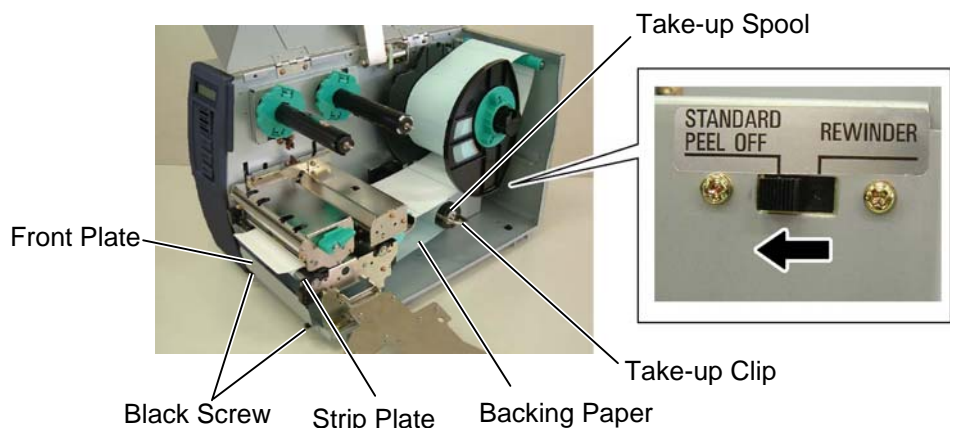

2.4 Loading the Media (Cont.)

NOTE:

Be sure to set the Selection Switch to **REWINDER** position.

ADJUSTMENT:

If the media skews when using the Built-in Rewinder, turn the Adjustment Knob of the Rewinder Guide Plate to correct the media feed. Clockwise turn moves the Rewinder Guide Plate forward and counter-clockwise moves it backward.

When the media skews to the right:
Loosen the SM-4x8 screw, turn the Adjustment Knob clockwise, and then tighten the SM-4x8 screw when the Rewinder Guide Plate is positioned correctly.

When the media skews to the left:
Loosen the SM-4x8 screw, turn the Adjustment Knob counter-clockwise, and tighten the SM-4x8 screw when the Rewinder Guide Plate is positioned correctly.

Built-in rewinder mode (Option)

The Rewinder Assembly of the Strip Module can be used in batch mode to take up the printed media as a Built-in Rewinder.

- (1) Remove the two Black Screws to detach the Front Plate.
- (2) Attach the Rewinder Guide Plate enclosed with the optional Strip Module to the Strip Plate with the SMW-4x8 sems screws.
- (3) Insert the media under the Rewinder Guide Plate.
- (4) Wind the media onto the Take-up Spool and fix it in position with the Take-up Clip.
- (5) Rotate the Take-up Spool counterclockwise a few times to remove any slack in the media.
- (6) Set the Selection Switch mounted on the Rewinder Assembly to **REWINDER** position.

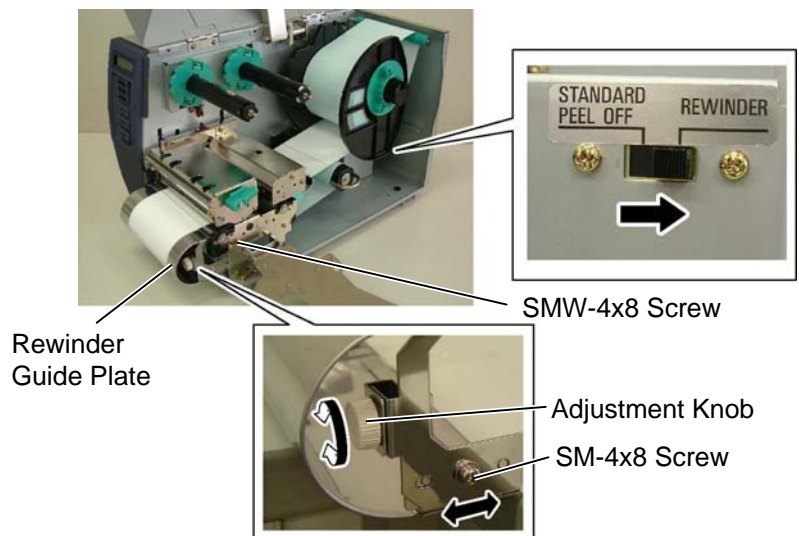

Cut mode (Option)

When the optional Cutter Module is fitted, the media is automatically cut. A swing cutter and a rotary cutter are available as an option, but they are used in the same way. Insert the leading edge of the media into the Media Outlet of the Cutter Module.

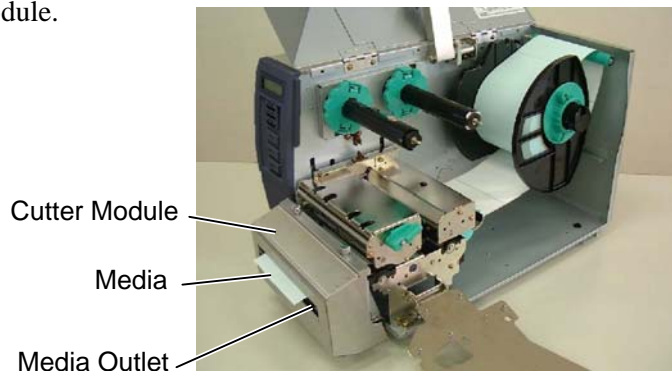

WARNING!

The cutter is sharp, so care must be taken not to injure yourself when handling the cutter.

CAUTION!

1. Be sure to cut the backing paper of the label. Cutting labels will cause the glue to stick to the cutter which may affect the cutter quality and shorten the cutter life.
2. Use of tag paper when the thickness exceeds the specified value may affect the cutter life.

NOTE:

When using the Rotary Cutter, be sure to install the Ribbon Saving Module (B-9904-R2-QM-R). Failure to do this may cause a paper jam or ribbon error.

13. If the loaded media is direct thermal media (a chemically treated surface), the media loading procedure is now completed. Close the Ribbon Shaft Holder Plate, and turn the Head Lever to **Lock** position to close. Then, close the Top Cover. If the media is thermal transfer media, it is also necessary to load a ribbon. Refer to **Section 2.5 Loading the Ribbon**.

2.5 Loading the Ribbon

WARNING!

1. Do not touch any moving parts. To reduce the risk of fingers, jewellery, clothing, etc., being drawn into the moving parts, be sure to load the ribbon once the printer has stopped moving completely.
2. The print head becomes hot immediately after printing. Allow it to cool before loading the ribbon.
3. To avoid injury, be careful not to trap your fingers while opening or closing the cover.

CAUTION!

Be careful not to touch the Print Head Element when raising the Print Head Block. Failure to do this may cause missing dots by static electricity or other print quality problems.

NOTES:

1. When attaching the ribbon stoppers, make sure that the pinchers face into the printer.
2. Be sure to remove any slack in the ribbon when printing. Printing with a wrinkled ribbon will lower the print quality.
3. The Ribbon Sensor is mounted on the rear of the Print Head Block to detect a ribbon end. When a ribbon end is detected, "NO RIBBON" message will appear on the display and the ERROR LED will illuminate.

There are two types of media available for printing on: these are thermal transfer media and direct thermal media (a chemically treated surface). DO NOT LOAD a ribbon when using a direct thermal media.

1. Grasp the tabs on the top and bottom of the Ribbon Stoppers and move the Ribbon Stoppers back to the end of the Ribbon Shaft.

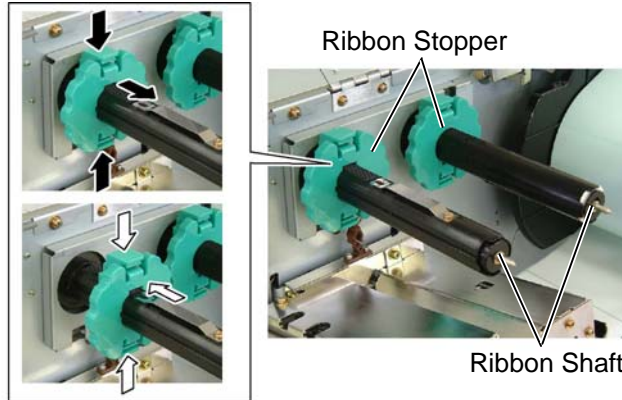

2. Leaving plenty of slack between the ribbon spools, place the ribbon onto the Ribbon Shafts as shown below.

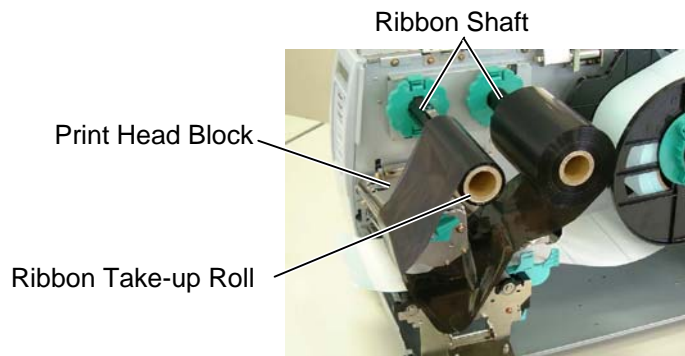

CAUTION!

When loading or replacing the media or a ribbon, be careful not to damage the print head with a hard object like a watch or a ring.

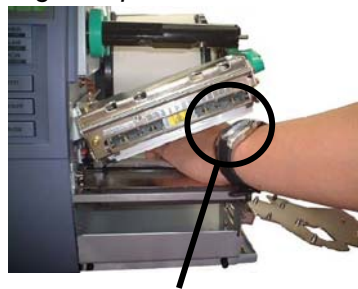

Care must be taken not to allow the metal or glass part of a watch to touch the print head edge.



Care must be taken not to allow a metal object like a ring to touch the print head edge.

Since the print head element can be easily damaged by shock, please treat it carefully by not hitting a hard object against it.

2.5 Loading the Ribbon (Cont.)

3. Slide the Ribbon Stoppers along the Ribbon Shafts to a position where the ribbon is centred when fitted.
4. Lower the Print Head Block and set the Ribbon Shaft Holder Plate aligning its holes with the Ribbon Shafts.
5. Take up any slack in the ribbon. Wind the leading tape onto the ribbon take-up roll until the ink ribbon can be seen from the front of the printer.

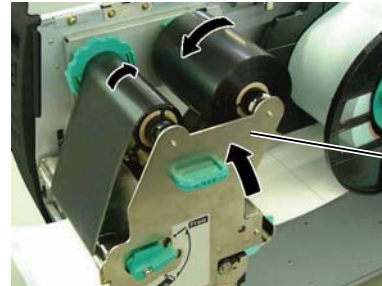

Ribbon Shaft
Holder Plate

6. Turn the Head Lever to **Lock** position to close the Print Head.
7. Close the Top Cover.

NOTE:

Ribbon loss per ribbon saving varies according to the relation between the outer roll diameter of the used ribbon and the print speed.

Print speed	Ribbon loss/Ribbon saving
3"/sec.	Approx. 6 mm
6"/sec.	Approx. 10 mm
10"/sec.	Approx. 20 mm

■ Auto Ribbon Saving Mode

When the auto ribbon saving function is selected, it will be activated to reduce ribbon loss when a no print area extends more than 20 mm (3 or 6 ips) or 30 mm (10 ips). For further information on this function, please ask a TOSHIBA TEC authorised service representative.

2.6 Connecting the Cables to Your Printer

The following paragraphs outline how to connect the cables from the printer to your host computer, and will also show how to make cable connections to other devices. Depending on the application software you use to print labels, there are 4 possibilities for connecting the printer to your host computer. These are:

- A serial cable connection between the printer's RS-232 serial connector and one of your host computer's COM ports. (Refer to **APPENDIX 2**.)
- A parallel cable connection between the printer's standard parallel connector and your host computer's parallel port (LPT).
- An Ethernet connection using the optional LAN board.
- A USB cable connection between the printer's optional USB connector and your host computer's USB port. (Conforming to USB 1.1)

The diagram below shows all the possible cable connections to the current version of the printer.

NOTES:

1. The picture on the right shows the layout of the interface connectors when the options are fully installed. It may be different depending on your system configuration.
2. The USB interface and LAN interface cannot be used at the same time.

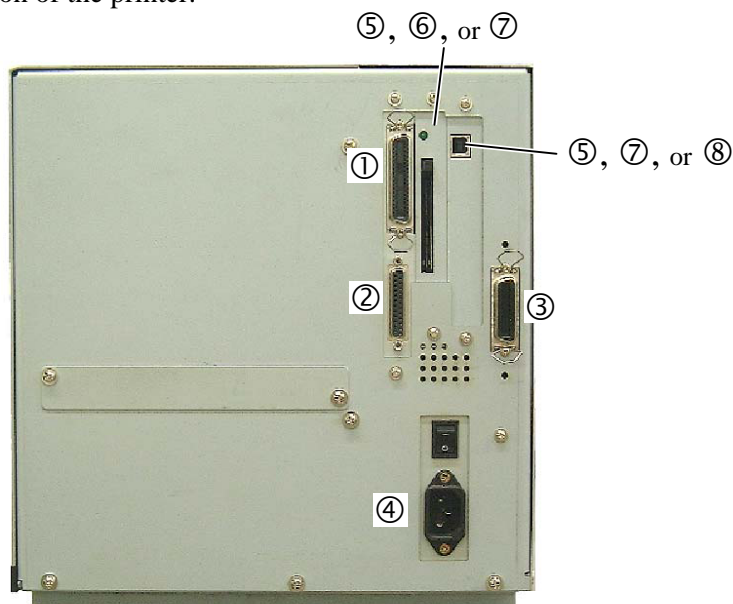

- ① Parallel Interface Connector (Centronics)
- ② Serial Interface Connector (RS-232C)
- ③ Expansion I/O Interface Connector (Option)
- ④ Power Inlet
- ⑤ USB Interface Connector (Option)
- ⑥ PCMCIA Card Slot (Option)
- ⑦ LAN Interface Connector (Option)
- ⑧ Wireless LAN Board (Option)

2.7 Turning the Printer ON/OFF

When the printer is connected to your host computer it is good practice to turn the printer ON before turning on your host computer and turn OFF your host computer before turning off the printer.

2.7.1 Turning ON the Printer

CAUTION!

Use the power switch to turn the printer On/Off. Plugging or unplugging the Power Cord to turn the printer On/Off may cause fire, an electric shock, or damage to the printer.

NOTE:

If a message other than ON LINE appears on the display or the ERROR LED lamp is illuminated, go to **Section 5.1, Error Messages**.

1. To turn ON the printer power, press the Power Switch as shown in the diagram below. Note that (|) is the power ON side of the switch.



Power Switch

2. Check that the ON LINE message appears in the LCD Message Display and that the ON LINE and POWER LED lights are illuminated.

2.7.2 Turning OFF the Printer

1. Before turning off the printer Power Switch verify that the ON LINE message appears in the LCD Message Display and that the ON LINE LED light is on and is not flashing.
2. To turn OFF the printer power press the Power Switch as shown in the diagram below. Note that (O) is the power OFF side of the switch.

CAUTION!

1. Do not turn off the printer power while the media is being printed as this may cause a paper jam or damage to the printer.
2. Do not turn off the printer power while the ON LINE lamp is blinking as this may cause damage to your computer.



Power Switch

2.8 Inserting the Optional PCMCIA Cards

When the optional PCMCIA Interface Board is installed into the printer, there will be a PCMCIA slot available as shown in the figure below. This allows the use of a Flash Memory type card. The following paragraphs outline how to insert PCMCIA cards.

1. Make sure that the printer's Power Switch is in the OFF position.
2. Hold the PCMCIA Card so that the side with the model name faces right.

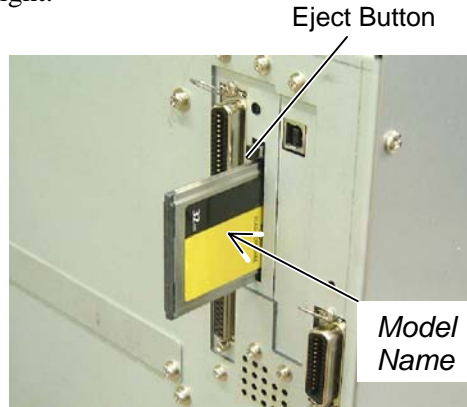

CAUTION!

1. To protect PC cards, discharge static electricity from your body by touching the metal cabinet of the printer before touching the card.
2. Before inserting or removing a PCMCIA card make sure that the printer's power is turned off.
3. Be sure to protect PCMCIA Cards when not in use by putting them into their protective covers.
4. Do not subject the card to any shocks or excessive force nor expose the card to extremes in temperature or humidity.
5. The card may be inserted into the slot halfway even in the wrong orientation. However, the slot is safety designed so that the card will not seat against the connector pins.

NOTE:

Reading a read-only-type flash memory is possible if it has been used on the TOSHIBA printer, such as B-472 and B-572.

3. The following PCMCIA cards or equivalent can be used.

Type	Maker	Description	Remarks
ATA Card	San Disk, Hitachi	A card conforming to the PC card ATA standard	-----
Flash Memory Card (4 MB)	Maxell	EF-4M-TB CC	Read/Write
	Maxell	EF-4M-TB DC	
	Centennial Technologies INC.	FL04M-15-11119-03	Read (See NOTE.)
	INTEL	IMC004FLSA	
	Simple TECHNOLOGY	STI-FL/4A	
	Mitsubishi	MF84M1-G7DAT01	
	PC Card KING MAX	FJN-004M6C	
	Centennial Technologies Inc.	FL04M-20-11138-67	
	PC Card	FJP-004M6R	
	Mitsubishi	MF84M1-GMCAV01	
Flash Memory Card (1 MB)	Maxell	EF-1M-TB AA	
	Mitsubishi	MF81M1-GBDAT01	

2.9 Setting an Operating Environment

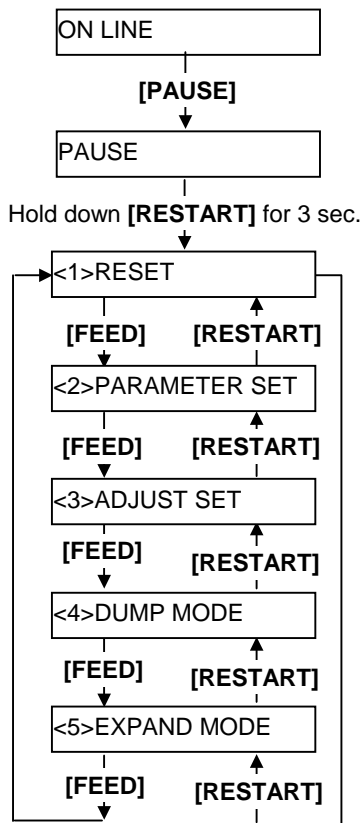
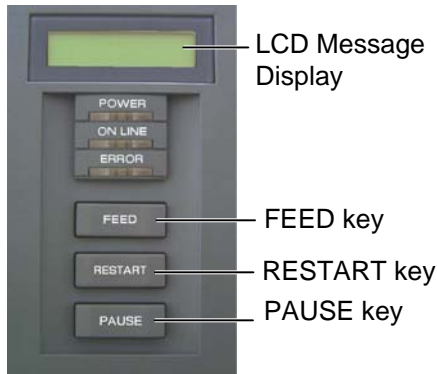

Depending on the settings of your host computer or an interface to be used, it may be necessary to change the printer parameter settings.

Follow the procedures described below to change the printer parameter settings in the System Mode to correspond to your environment.

NOTE:

Incorrect settings can cause the printer to function erroneously. If you have any problems with the parameter settings, please contact your nearest TOSHIBA TEC service representative.

*For the settings this manual does not cover, please contact your nearest TOSHIBA TEC service representative, or refer to the **B-SX4T/SX5T Series Key Operation Specification** stored in the CD-ROM.*

How to enter the System Mode

1. Turn on the printer and confirm that "ONLINE" appears on the LCD Message Display.
2. Press the [PAUSE] key to pause the printer.
3. Hold down the [RESTART] key for three seconds until "<1>RESET" is displayed.

The System Mode consists of the following menus.

- | | |
|--|--|
| <p><1>RESET</p> <p><2>PARAMETER SET</p> <p><3>ADJUST SET</p> <p><4>DUMP MODE</p> <p><5>EXPAND MODE</p> | <p>This menu is used to clear print data sent from a PC and return the printer to an idle state. Refer to Section 3.3 Reset.</p> <p>This menu is used to set the printer parameters. Refer to Section 2.9.1 Parameter Setting.</p> <p>This menu is used to make a fine adjustment of a print start position, cut position, etc. Refer to Section 2.12 Position and Print Tone Fine Adjustment.</p> <p>This menu is used to print the data in the receive buffer for debug. Refer to Section 2.9.2 Dump Mode Setting.</p> <p>This menu is used to start the program for BASIC mode. Refer to Section 2.9.3 BASIC Expansion Mode.</p> |
|--|--|

NOTES:

1. System Mode menus can be selected with the [RESTART] or [FEED] key.
2. To enter each of the above System Mode menus, press the [PAUSE] key when the menu is displayed.
3. If the [PAUSE] key is pressed with "<1>RESET" being displayed, the printer will turn to an idle state and the message will change to "ONLINE".

2.9.1 Parameter Setting

While “<2>PARAMETER SET” is displayed on the LCD Message Display, press the **[PAUSE]** key to enter the Parameter Setting Mode.

The Parameter Setting Mode contains the following sub menus. Each time the **[PAUSE]** key is pressed, the sub menus are displayed sequentially.

- (1) Character code selection
- (2) Character zero selection
- (3) Baud rate selection
- (4) Data length selection
- (5) Stop bit selection
- (6) Parity selection
- (7) Flow control code selection
- (8) LCD language selection
- (9) Auto forward wait selection
- (10) Head up cut/Rewinder selection
- (11) Solenoid type selection
- (12) Ribbon saving function selection
- (13) Control code selection
- (14) Strip wait status selection
- (15) FEED key function selection
- (16) KANJI code selection
- (17) EURO code selection
- (18) Auto print head check selection
- (19) Centronics ACK/BUSY timing selection
- (20) Web printer function selection
- (21) Input prime selection
- (22) Ribbon near end selection
- (23) Expansion I/O interface selection
- (24) Centronics interface selection
- (25) Plug & Play selection
- (26) Label end/ribbon end selection
- (27) Pre-strip selection
- (28) Reverse feed speed selection
- (29) Maxi code specification selection
- (30) Print head type selection

2.9.1 Parameter Setting (Cont.)

NOTE:
 Be careful if the printer is turned off without pressing the **[PAUSE]** key, the selected value does not become effective.

(1) Character Code Selection

This parameter is to choose a character code used for printing. Printed characters differ depending on a chosen character code and font. For details of characters, refer to the **B-SX4T/SX5T Series External Equipment Interface Specification** (Printer Command Manual).
 When “<2>PARAMETER SET” appears, press the **[PAUSE]** key.

<2>PARAMETER SET
 FONT CODE PC-850

Use the **[FEED]** or **[RESTART]** key to select a desired option.

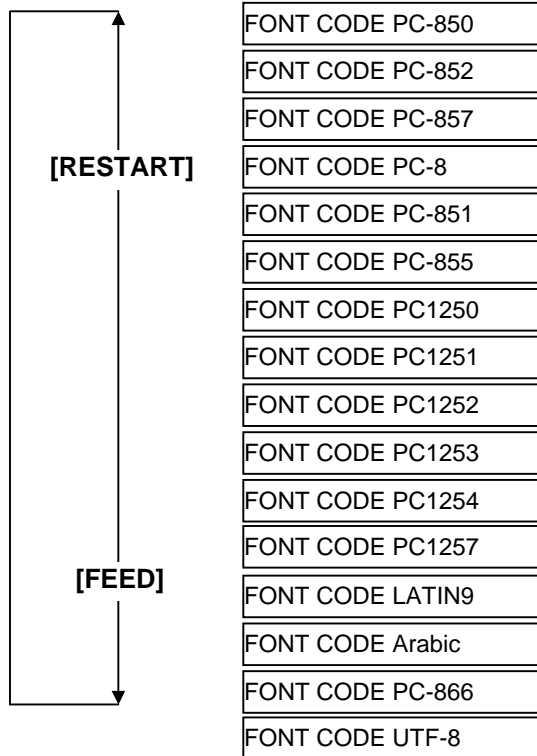

After selecting a character code, press the **[PAUSE]** key.

(2) Character Zero Selection

This parameter is to choose the way to indicate zero between “0” and “Ø”.
 When “<2>PARAMETER SET” appears, press the **[PAUSE]** key twice.

<2>PARAMETER SET
 ZERO FONT 0

Use the **[FEED]** or **[RESTART]** key to select a desired option.

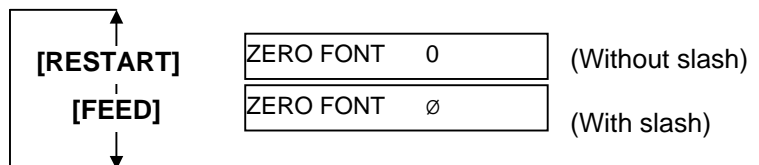

After selecting a character zero, press the **[PAUSE]** key.

NOTE:
 The following fonts do not support a zero with slash.
Bit Map Font:
 OCR-A, OCR-B, GOTHIC 725 Black, Kanji, Chinese
Outline Font:
 Price Font 1, Price Font 2, Price Font 3, DUTCH 801 Bold, BRUSH 738 Regular, GOTHIC 725 Black, True Type Font

2.9.1 Parameter Setting (Cont.)

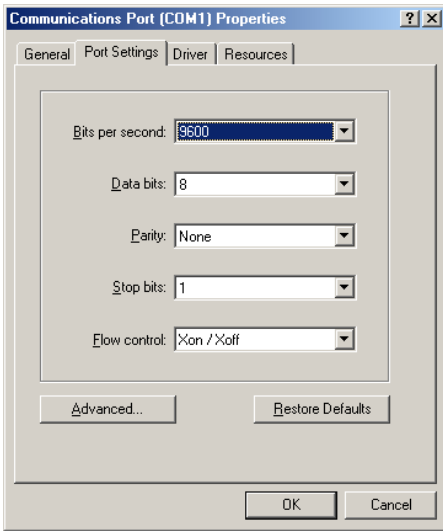

<Reference>
Properties screen of Serial (COM) port under Windows98

(3) Baud Rate Selection

This parameter is to choose a baud rate of the RS-232C interface. When the printer communicates with a host computer by serial interface, be sure to match the setting with the host.

When “<2>PARAMETER SET” appears, press the **[PAUSE]** key until the following display appears.

```
<2>PARAMETER SET
SPEED 9600bps
```

Use the **[FEED]** or **[RESTART]** key to select a desired option.

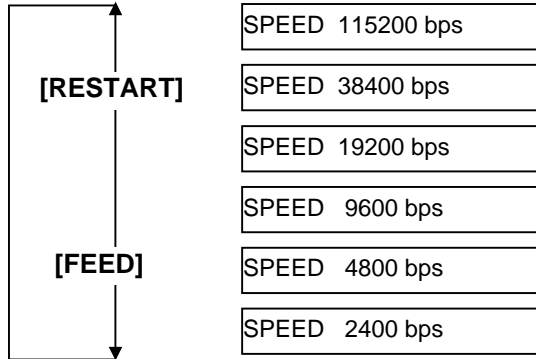

After selecting a baud rate, press the **[PAUSE]** key.

(4) Data Length Selection

This parameter is to choose a communication data length of the RS-232C interface.

7 bits is used when transmitting alphanumeric data only. 8 bits is used to when transmitting special characters. Be sure to match a setting with a host computer.

When “<2>PARAMETER SET” appears, press the **[PAUSE]** key until the following display appears.

```
<2>PARAMETER SET
DATA LENG. 8bits
```

Use the **[FEED]** or **[RESTART]** key to select a desired option.



After selecting a data length, press the **[PAUSE]** key.

2.9.1 Parameter Setting (Cont.)

NOTES:

- When using the hardware flow control, the control signals and data must be in pairs between the printer and the PC.

Printer		Host
TD	→	RD
RD	←	TD
RTS	→	CTS
CTS	←	RTS
DSR	→	DTR
DTR	←	DSR

Refer to the RS-232C connector's pin layout in **APPENDIX 2**.
Check if the printer and the PC is properly connectable with your cable.
- Be careful that there are two types of RS-232C cable; straight cable and cross cable. Use a straight cable for this printer.

NOTE:

- The following is the detailed descriptions for each transmission control code.
- XON/XOFF AUTO**
At the power on time, the printer outputs XON. At the power off time, the printer outputs XOFF.
 - XON+READY AUTO**
At the power on time, the printer outputs XON. At the power off time, the printer outputs XOFF.
 - READY/BUSY**
At the power on time, the DTR signal output from the printer turns to High level (READY). At the power off time, the printer does not output XOFF.
 - ON/XOFF**
At the power on time, the printer outputs XON. At the power off time, the printer does not output XOFF.
 - READY/BUSY RTS**
At the power on time, the RTS signal output from the printer turns to High level (READY). At the power off time, the printer does not output XOFF.

(5) Stop Bit Selection

This parameter is to choose a stop bit of the RS-232C interface. Be sure to match a setting with a host computer. When "<2>PARAMETER SET" appears, press the **[PAUSE]** key until the following display appears.

```
<2>PARAMETER SET
STOP BIT 1bit
```

Use the **[FEED]** or **[RESTART]** key to select a desired option.



After selecting a stop bit, press the **[PAUSE]** key.

(6) Parity Selection

This parameter is to choose the parity of the RS-232C interface. When "<2>PARAMETER SET" appears, press the **[PAUSE]** key until the following display appears.

```
<2>PARAMETER SET
PARITY NONE
```

Use the **[FEED]** or **[RESTART]** key to select a desired option.

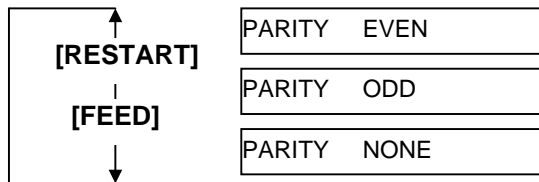

After selecting the parity, press the **[PAUSE]** key.

(7) Flow Control Code Selection

This parameter is to choose a flow control code of the RS-232C interface. When "<2>PARAMETER SET" appears, press the **[PAUSE]** key until the following display appears.

```
<2>PARAMETER SET
XON+READY AUTO
```

Use the **[FEED]** or **[RESTART]** key to select a desired option.

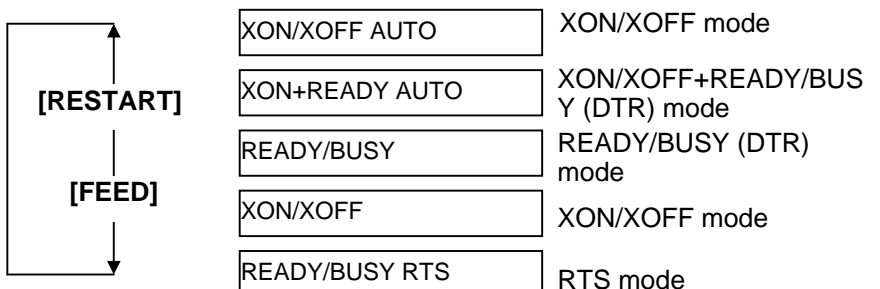

After selecting a flow control code, press the **[PAUSE]** key.

2.9.1 Parameter Setting (Cont.)

(8) LCD Language Selection

This parameter is to choose a language in which the LCD message is displayed.

When “<2>PARAMETER SET” appears, press the **[PAUSE]** key until the following display appears.

```

<2>PARAMETER SET
LCD ENGLISH
    
```

Use the **[FEED]** or **[RESTART]** key to select a desired option.

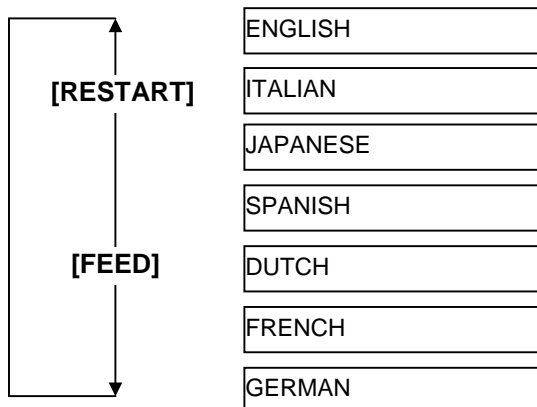

After selecting a language, press the **[PAUSE]** key.

(9) Auto Forward Wait Selection

This parameter is to choose whether to activate the Auto Forward Wait function or not.

This function, used in the cut mode, automatically feeds the media forward for about 18 mm if there is more than 1-second idle time after printing, to prevent the top edge of the media from curling.

When “<2>PARAMETER SET” appears, press the **[PAUSE]** key until the following display appears.

```

<2>PARAMETER SET
FORWARD WAIT OFF
    
```

Use the **[FEED]** or **[RESTART]** key to select a desired option.

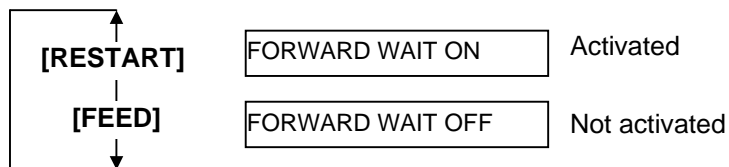

After selecting an auto forward wait, press the **[PAUSE]** key.

NOTES:

1. If the printer is not used for a few days, the top edge of the media may become curly, which may cause a paper jam. The Auto Forward Wait Function prevents this problem since the media feed amount is increased so that the media stops past the platen.
2. When the Stop Position Fine Adjustment Value is set in + direction, the media will stop past the media outlet.
When the value is set in – direction, the media will stop inside the media outlet.
3. This setting will be useful to fine adjust the cut position of labels.

2.9.1 Parameter Setting (Cont.)

When ON is selected, pressing the **[PAUSE]** key will result that the LCD Message Display shows the stop position fine adjustment value setting screen.

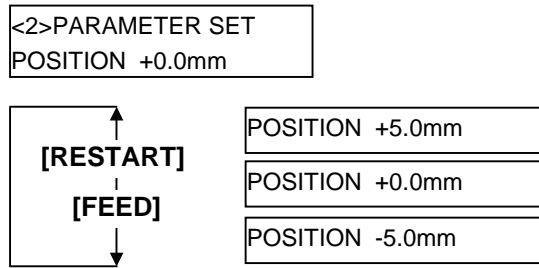

[FEED] key: Pressing the **[FEED]** key one time causes a -0.5mm change, up to -5.0 mm.

[RESTART] key: Pressing the **[RESTART]** key one time causes a +0.5mm change, up to +5.0 mm.

After selecting an auto forward wait, press the **[PAUSE]** key.

(10) Head Up Cut/Rewinder Selection

This parameter is to choose whether to activate the head up action in the cut issue or to use the Rewinder in the batch or strip issue.

This function prevents ribbon smudges by raising the print head during a reverse feed to the print start position.

When “<2>PARAMETER SET” appears, press the **[PAUSE]** key until the following display appears.

NOTE:
The print head may not be raised depending on the rise of the solenoid's temperature.

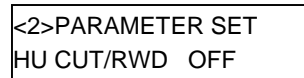

Use the **[FEED]** or **[RESTART]** key to select a desired option.

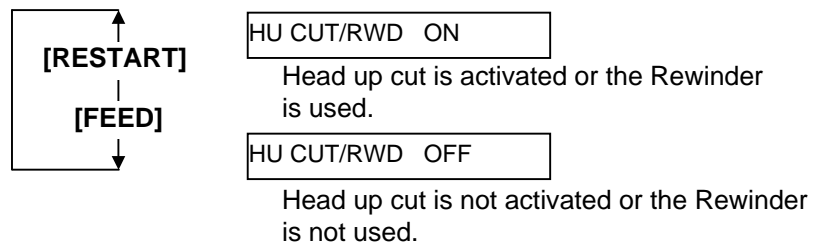

After selecting the head up action in cut issue or use of the Rewinder, press the **[PAUSE]** key.

2.9.1 Parameter Setting (Cont.)

NOTE:
 Improper setting of the solenoid type may disable the ribbon saving function.

(11) Solenoid Type Selection

This parameter is to choose the solenoid type that is actually installed. When “<2>PARAMETER SET” appears, press the **[PAUSE]** key until the following display appears.

<2>PARAMETER SET
 SOLENOID TYPE1

Use the **[FEED]** or **[RESTART]** key to select a desired option.

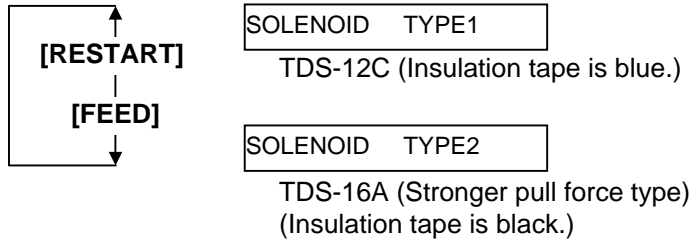

After selecting the solenoid type, press the **[PAUSE]** key.

(12) Ribbon Saving Function Selection

This parameter is to choose whether to activate the Ribbon saving function or not.

This function enables reducing the ribbon loss caused by taking up unused ribbon during non-print areas.

When “<2>PARAMETER SET” appears, press the **[PAUSE]** key until the following display appears.

<2>PARAMETER SET
 RBN SAVE ON (TAG)

Use the **[FEED]** or **[RESTART]** key to select a desired option.

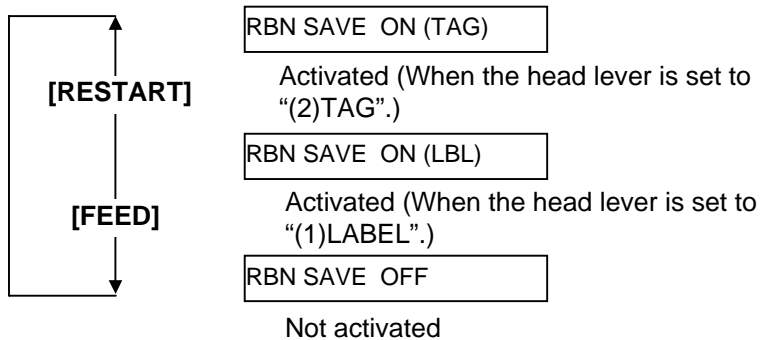

After selecting the ribbon saving function, press the **[PAUSE]** key.

NOTES:

1. The ribbon saving function is available only when an optional ribbon saving module (B-9904-R2-QM-R) is installed.
2. Ribbon saving option should be selected according to the head lever position. Incorrect setting may disable the proper ribbon saving function.
3. The ribbon saving function is activated when there is a 20-mm or more non-print area in the media feed direction.
4. Ribbon saving is enabled up to 4 areas per media.

2.9.1 Parameter Setting
(Cont.)

(13) Control Code Selection

This parameter is to choose a Control Code.

When “<2>PARAMETER SET” appears, press the **[PAUSE]** key until the following display appears.

```

<2>PARAMETER SET
CODE AUTO
    
```

Use the **[FEED]** or **[RESTART]** key to select a desired option.

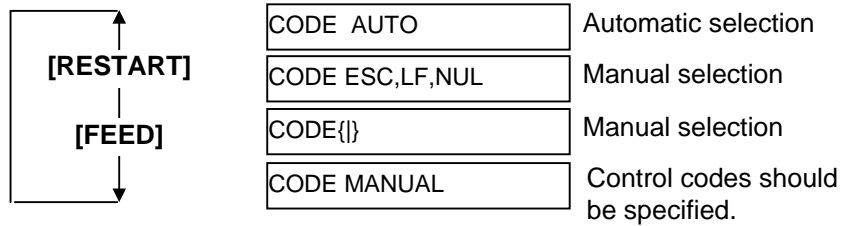

When “CODE MANUAL” is selected and the **[PAUSE]** key is pressed, the LCD display will show the setting screen of CONTROL CODE1 to CONTROL CODE3 as follows.

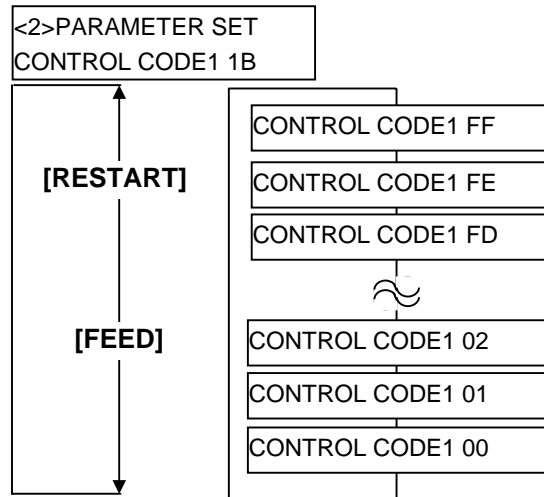

After setting the control code for Control Code 1, press the **[PAUSE]** key to show the CONTROL CODE2 screen. In a same manner, press the **[PAUSE]** key after setting the control code for Control Code 2 to display the CONTROL CODE3 screen.

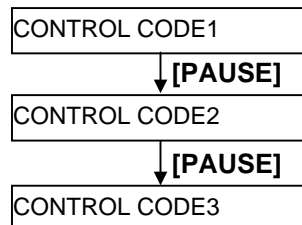

Press the **[PAUSE]** key after setting the control code for Control Code 3, and the Strip Wait Status Selection screen will appear.

2.9.1 Parameter Setting (Cont.)

(14) Strip Wait Status Selection

This parameter is to choose when the printer sends a strip wait status (05H) to a host in response to a status request command.

When “<2>PARAMETER SET” appears, press the **[PAUSE]** key until the following display appears.

```
<2>PARAMETER SET
PEEL OFF STS OFF
```

Use the **[FEED]** or **[RESTART]** key to select a desired option.

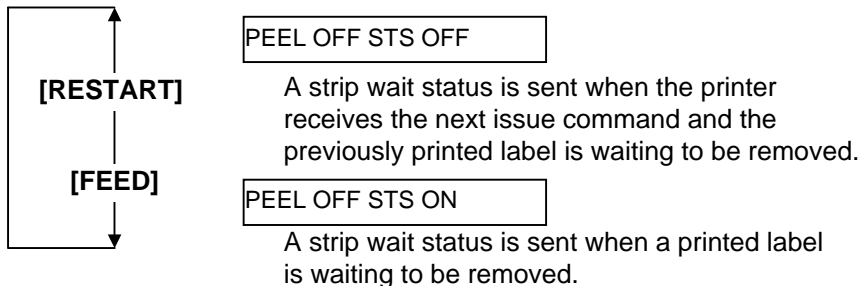

After selecting the Strip Wait Status, press the **[PAUSE]** key.

(15) FEED Key Function Selection

This parameter is to choose the function of the **[FEED]** key.

When “<2>PARAMETER SET” appears, press the **[PAUSE]** key until the following display appears.

```
<2>PARAMETER SET
FEED KEY FEED
```

Use the **[FEED]** or **[RESTART]** key to select a desired option.

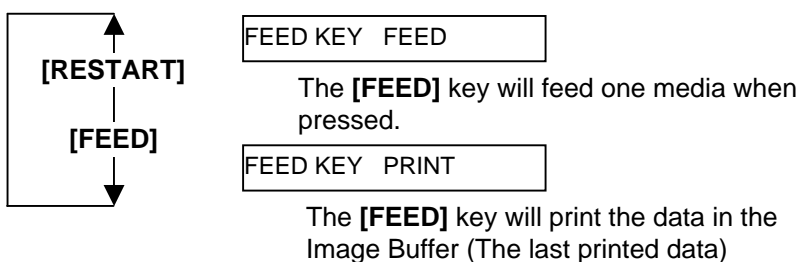

After selecting the FEED key function, press the **[PAUSE]** key.

2.9.1 Parameter Setting (Cont.)

NOTE:
Kanji code selection is not supported by the QM model as the Kanji ROMs are not installed.

(16) KANJI Code Selection

This parameter is to choose a KANJI code.
 When “<2>PARAMETER SET” appears, press the **[PAUSE]** key until the following display appears.

<2>PARAMETER SET
 KANJI CODE TYPE1

Use the **[FEED]** or **[RESTART]** key to select a desired option.

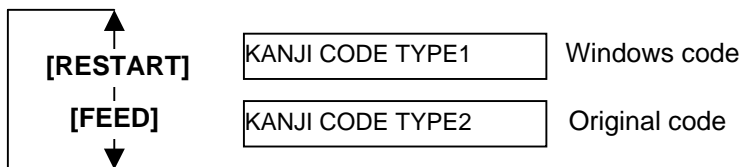

After selecting a Kanji code, press the **[PAUSE]** key.

(17) EURO Code Selection

This parameter is to choose a Euro code (€).
 When “<2>PARAMETER SET” appears, press the **[PAUSE]** key until the following display appears.

<2>PARAMETER SET
 EURO CODE B0

Use the **[FEED]** or **[RESTART]** key to select a desired option.

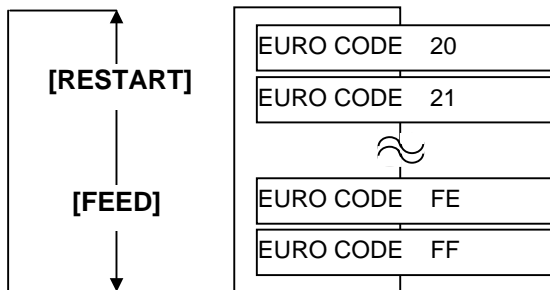

After selecting a Euro code, press the **[PAUSE]** key.

NOTE:
*Pressing the **[FEED]** or **[RESTART]** key causes 1 byte change in the Euro Code value.*

2.9.1 Parameter Setting (Cont.)

- NOTES:**
1. It takes about 2 seconds to perform an Auto Print Head check.
 2. It is recommended that this function should be activated when high quality printing such as bar codes printing is required. Otherwise, choose OFF.
 3. When a broken element is found, the printer stops, displaying "HEAD ERROR". The error state can be cleared by pressing the [RESTART] key, but if the broken element affects bar code readability or actual operations, please replace the print head with a proper one.

(18) Auto Print Head Check Selection

This parameter is to choose whether to perform the Auto Print Head Check function at the power on time. When "<2>PARAMETER SET" appears, press the [PAUSE] key until the following display appears.

<2>PARAMETER SET
AUTO HD CHK OFF

Use the [FEED] or [RESTART] key to select a desired option.

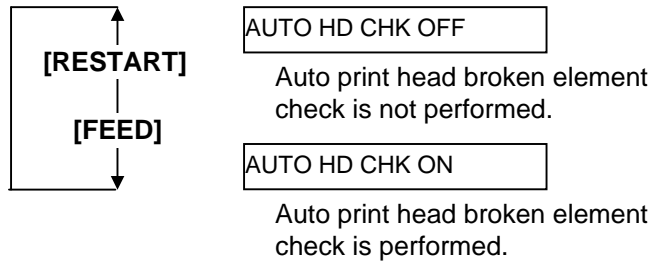

After selecting auto print head check, press the [PAUSE] key.

(19) Centronics Interface ACK/BUSY Timing Selection

This parameter is to choose an ACK/BUSY timing of the Centronics interface.

"TYPE1" has been chosen as default, but if a communication error occurs or a communication is not properly made, change to "TYPE2".

When "<2>PARAMETER SET" appears, press the [PAUSE] key until the following display appears".

<2>PARAMETER SET
ACK/BUSY TYPE1

Use the [FEED] or [RESTART] key to select a desired option.

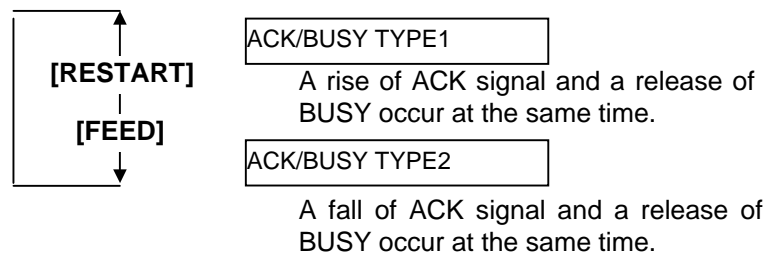

After selecting an ACK/BUSY timing, press the [PAUSE] key.

2.9.1 Parameter Setting (Cont.)

NOTE:
When "WEB PRINTER ON" is selected, the status of the printer connected in a network can be checked through the Web browser.

(20) Web Printer Function Selection

This parameter is to choose whether to use the printer as a web printer. When "<2>PARAMETER SET" appears, press the [PAUSE] key until the following display appears.

<2>PARAMETER SET
WEB PRINTER OFF

Use the [FEED] or [RESTART] key to select a desired option.

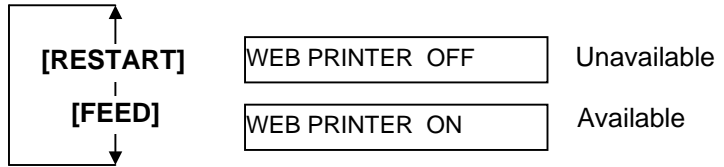

After selecting the Web printer function, press the [PAUSE] key.

(21) Input Prime Selection

This parameter is to choose whether to enable a reset operation when $\overline{\text{INIT}}$ signal is ON.

Normally, when the printer receives a reset request signal (nInit signal) from the host via Centronics interface, the printer will be reset and turn to the idle state.

When the INPUT PRIME parameter is set to OFF, the printer is reset but does not turn to idle.

When this parameter is set to ON, the host sends an $\overline{\text{INIT}}$ signal and the printer turns to idle each time the printer is turned on. If you would like to avoid this processing, set this parameter to OFF.

When "<2>PARAMETER SET" appears, press the [PAUSE] key until the following display appears.

<2>PARAMETER SET
INPUT PRIME ON

Use the [FEED] or [RESTART] key to select a desired option.

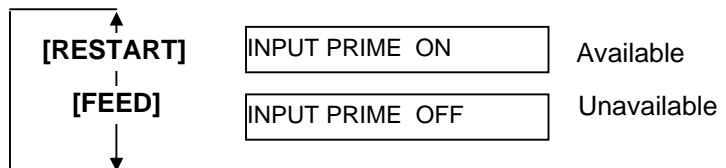

After selecting the Input Prime, press the [PAUSE] key.

2.9.1 Parameter Setting (Cont.)

(22) Ribbon Near End Selection

This parameter is to choose the remaining ribbon length where the ribbon near end is detected.

When “<2>PARAMETER SET” appears, press the **[PAUSE]** key until the following display appears”.

```

<2>PARAMETER SET
RBN NEAR END 70m
```

Use the **[FEED]** or **[RESTART]** key to select a desired option.

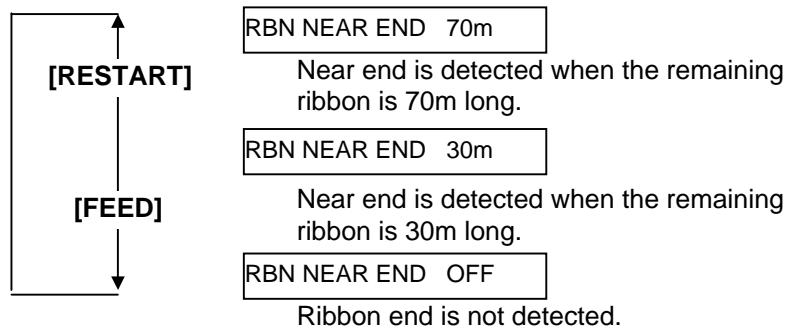

After selecting the ribbon near end function, press the **[PAUSE]** key.

(23) Expansion I/O Interface Type Selection

This parameter is to choose a type of the Expansion I/O interface operating mode.

This parameter should be set depending on the expansion I/O control specification of the device to be connected via the expansion I/O interface. For details, refer to the **External Equipment Interface Specification**.

When “<2>PARAMETER SET” appears, press the **[PAUSE]** key until the following display appears.

```

<2>PARAMETER SET
EX.I/O TYPE1
```

Use the **[FEED]** or **[RESTART]** key to select a desired option.

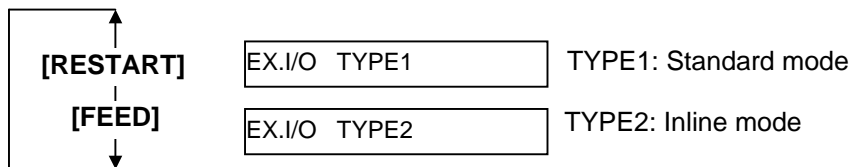

After selecting an Expansion I/O Interface type, press the **[PAUSE]** key.

2.9.1 Parameter Setting (Cont.)

(24) Centronics Interface Selection

This parameter is to choose the type of the Centronics interface operating mode.

When “<2>PARAMETER SET” appears, press the **[PAUSE]** key until the following display appears.

```

<2>PARAMETER SET
CENTRO MODE  SPP
```

Use the **[FEED]** or **[RESTART]** key to select a desired option.

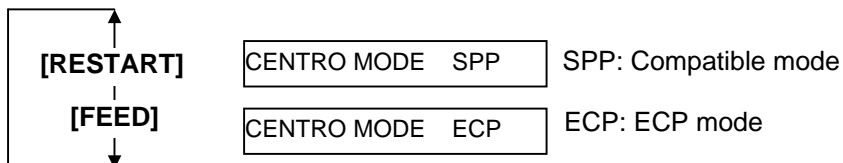

After selecting the Centronics interface operating mode, press the **[PAUSE]** key.

(25) Plug & Play Selection

This parameter is to choose whether to enable a Plug & Play function.

When “<2>PARAMETER SET” appears, press the **[PAUSE]** key until the following display appears.

NOTE:
If the printer and the PC are connected by USB, plug & play will be automatically enabled, regardless of the setting of this parameter.

```

<2>PARAMETER SET
PLUG & PLAY OFF
```

Use the **[FEED]** or **[RESTART]** key to select a desired option.

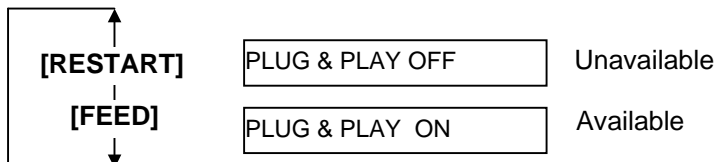

After selecting a Plug & Play, press the **[PAUSE]** key.

2.9.1 Parameter Setting (Cont.)

(26) Label End/Ribbon End Selection

This parameter is to choose a printing process when a label end or ribbon end is detected.

When “<2>PARAMETER SET” appears, press the **[PAUSE]** key until the following display appears.

<2>PARAMETER SET
LBL/RBN END TYP1

Use the **[FEED]** or **[RESTART]** key to select a desired option.

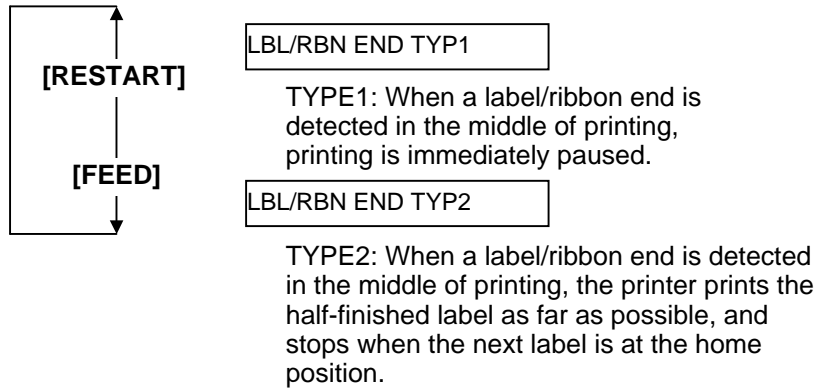

After selecting a Label End/Ribbon End type, press the **[PAUSE]** key.

(27) Pre-Strip Selection

This parameter is to choose whether to activate the Pre-strip function. When this parameter is set to ON (Available), the top edge of a label is separated (pre-stripped) from the backing paper before the label is printed. This function is intended to make the strip issue easier in case the labels are hard to strip due to the label intensity, adhesive power, or the printing speed.

When “<2>PARAMETER SET” appears, press the **[PAUSE]** key until the following display appears.

<2>PARAMETER SET
PRE PEEL OFF OFF

Use the **[FEED]** or **[RESTART]** key to select a desired option.

NOTE:
When the print speed is set to 10"/sec., the pre-strip function will be activated regardless of this parameter setting.

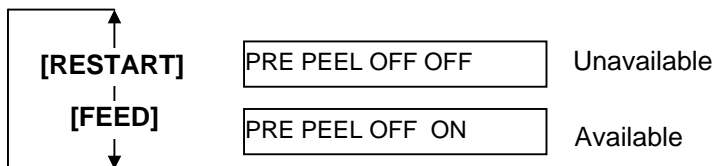

After selecting the Pre-strip function, press the **[PAUSE]** key.

2.9.1 Parameter Setting (Cont.)

(28) Reverse Feed Speed Selection

This parameter is to choose a reverse feed speed.

In the strip issue, the back feed speed of 3"/sec. may cause a shortage of feed amount due to a lack of torque, slippery media surface, etc. In such case, reduce the back feed speed to 2"/sec. to secure the feed amount.

When "<2>PARAMETER SET" appears, press the **[PAUSE]** key until the following display appears.

```
<2>PARAMETER SET
BACK SPEED  STD
```

Use the **[FEED]** or **[RESTART]** key to select a desired option.

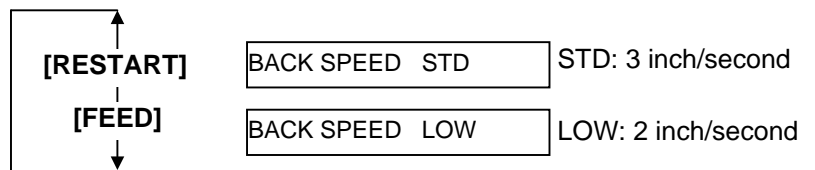

After selecting the Back Feed Speed, press the **[PAUSE]** key.

(29) Maxi Code Specification Selection

This parameter is to choose a Maxi code specification.

When "<2>PARAMETER SET" appears, press the **[PAUSE]** key until the following display appears.

```
<2>PARAMETER SET
MAXI CODE  TYPE1
```

Use the **[FEED]** or **[RESTART]** key to select a desired option.

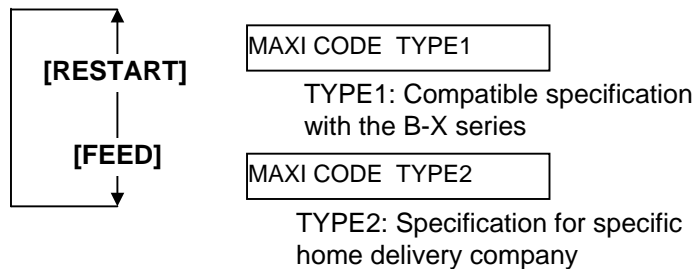

After selecting a Maxi code specification, press the **[PAUSE]** key.

2.9.1 Parameter Setting (Cont.)

NOTE:

When the installed print head type is changed, this parameter should be also changed accordingly. Failure to do this may affect the print quality or print head life.

(30) Print Head Type Selection

This parameter is to choose the print head type that is actually installed. When “<2>PARAMETER SET” appears, press the **[PAUSE]** key until the following display appears.

```
<2>PARAMETER SET
THERMAL HEAD  V2
```

Use the **[FEED]** or **[RESTART]** key to select a desired option.

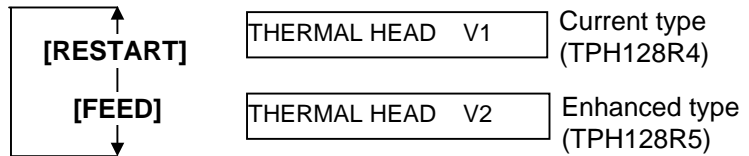

After selecting a print head type, press the **[PAUSE]** key.

2.9.2 Dump Mode Setting

While “<4>DUMP MODE” is displayed on the LCD Message Display, press the **[PAUSE]** key to enter the Dump Mode.

In the Dump Mode, data in the receive buffer are printed. Data are expressed in hexadecimal values. This operation allows the user to verify programming commands or debug the program.

When “<4>DUMP MODE” appears, press the **[PAUSE]** key.

```
<4>DUMP MODE
BUFFER RS-232C
```

Use the **[FEED]** or **[RESTART]** key to choose a receive buffer to be dumped.

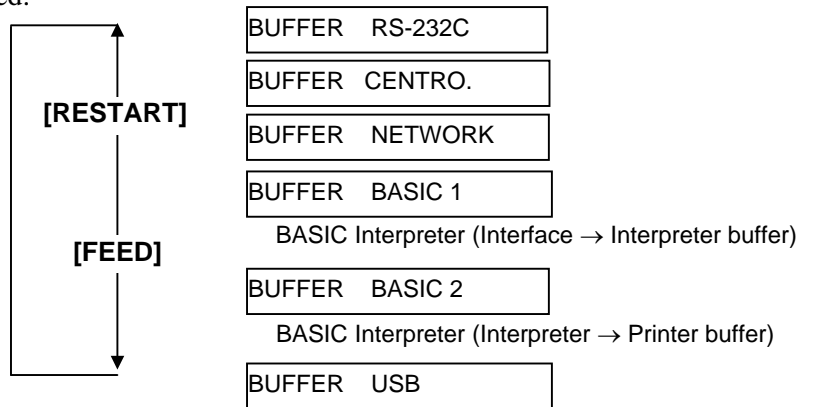

After selecting the receive buffer, press the **[PAUSE]** key.

```
<4>DUMP MODE
PRINT ON DEMAND
```

Use the **[FEED]** or **[RESTART]** key to select a printing method.

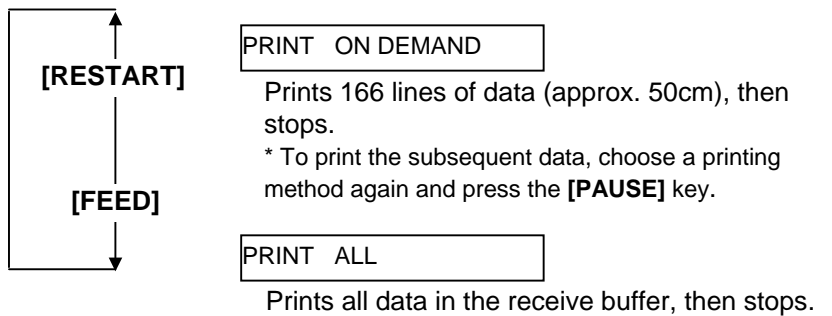

After selecting a printing method, press the **[PAUSE]** key.

```
<4>DUMP MODE
NOW PRINTING...
```

[PAUSE]

```
<4>DUMP MODE
```

Turn off the power, and then on.

```
ON LINE
B-SX4T Vx.x
```

NOTES:

1. When “ON DEMAND” is selected, it is required to choose a printing method again and press the **[PAUSE]** key to print the subsequent data until the all data has been printed.
2. If an error occurs during dumping, the printer will display an error message and stop printing. The error can be cleared by pressing the **[PAUSE]** key, and then the display will show “<4>DUMP MODE” again.
After a recovery from the error the printer will not start printing automatically.

2.9.2 Dump Mode Setting (Cont.)

Print Conditions

- Printing width: 3.9 inches (100 mm)
- Sensor selection: None
- Print speed: 4"/sec.
- Printing mode: Depends on the selection in use.
- 16 bytes/line
- Data is printed in the order from the new one to the old one.
- Data specified by the receive buffer write pointer will be printed in boldface.

The data in the receive buffer is printed as follows:

```

00 00 00 00 00 00 00 00 00 00 00 00 00 00 00 00
00 00 00 00 00 00 00 00 00 00 00 00 00 00 00 00
00 00 00 00 00 00 00 00 00 00 00 00 00 00 00 00
7B 41 58 3B 2B 30 30 30 2C 2B 30 30 30 2C 2B 30 {AX; +000, +000, +0
30 7C 7D 7B 44 30 37 37 30 2C 31 31 30 30 2C 30 0|}{D0760, 1100, 0
37 34 30 7C 7D 7B 43 7C 7D 7B 4C 43 3B 30 30 33 740|}{C|}{LC; 003
30 2C 30 30 32 30 2C 30 30 33 30 2C 30 36 36 30 0, 0020, 0030, 0660
2C 30 2C 32 7C 7D 7B 4C 43 3B 30 30 37 30 2C 30 , 0, 2|}{LC; 0070, 0
30 32 30 2C 30 30 37 30 2C 30 36 36 30 2C 30 2C 020, 0070, 0660, 0,
39 7C 7D 7B 4C 43 3B 30 30 35 30 2C 30 30 32 30 9|}{LC; 0050, 0020
:
:
44 45 46 47 48 49 4A 7C 7D 7B 50 43 31 30 3B 30 DEFGHI J|}{PC10; 0
33 35 30 2C 30 34 30 30 2C 31 2C 31 2C 4B 2C 30 350, 0400, 1, 1, K, 0
30 2C 42 3D 41 42 43 44 65 66 67 68 69 6A 6B 6C 0, B=ABCDefghi j kI
:
6D 6E 6F 70 7C 7D 7B 50 56 30 32 3B 30 33 33 30 mnop|}{PV02; 0330
2C 30 36 36 30 2C 30 32 37 30 2C 30 32 35 30 2C , 0660, 0270, 0250,
41 2C 30 30 2C 42 3D 42 7C 7D 7B 50 56 30 33 3B A, 00, B=B|}{PV03;
:
:
3B 30 39 30 30 2C 30 31 38 30 2C 54 2C 48 2C 30 ; 0900, 0180, T, H, 0
35 2C 41 2C 30 3D 31 32 33 34 35 36 37 38 39 30 5, A, 0=1234567890
41 42 43 44 45 7C 7D 00 00 00 00 00 00 00 00 00 ABCDE|}
:
:

```

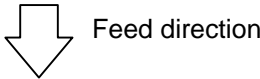

Receive Buffer Size

Interface	Buffer size
RS-232C	1MB (65536 lines)
Centronics	1MB (65536 lines)
Network Interface	1MB (65536 lines)
BASIC 1	8KB (512 lines)
BASIC 2	8KB (512 lines)
USB	1MB (65536 lines)

Required Label Length

Interface	Media length*
RS-232C	198.2m
Centronics	198.2m
Network Interface	198.2m
BASIC 1	2m
BASIC 2	2m
USB	198.2m

*: Media length required for printing all data in the receive buffer.

2.9.3 BASIC Expansion Mode

While “<5>EXPAND MDOE” is displayed on the LCD Message Display, press the **[PAUSE]** key to enter the BASIC Expansion Mode.

NOTE:
*For the BASIC enable setting mode, refer to the **B-SX4T/SX5T Series Key Operation Specification** stored in the CD-ROM.*

In the BASIC Expansion Mode, it is possible to execute the BASIC expansion mode program under the following conditions.

- The BASIC expansion mode program has already been loaded.
- The BASIC enable setting mode is selected.

The basic expansion mode ends when the basic expansion program is exited.

When “<5>EXPAND MODE” appears, press the **[PAUSE]** key.

<5>EXPAND MODE

When the **[PAUSE]** key is pressed, BASIC program is executed.

2.10 Installing the Printer Drivers

2.10.1 Introduction

This manual describes how to install the TOSHIBA printer driver for the TOSHIBA bar code printer on your Windows host computer; install and delete the printer driver, the procedure for adding the LAN port, cautions and limitations.

The examples provided here illustrate the procedure for installing the printer driver version V7.0 for the B-SA4T series.

2.10.2 General Description

(1) Features

Once you install the TOSHIBA printer driver on your Windows host computer, you can use the TOSHIBA bar code printer, as well as the easy-to-use general printers.

You can use this printer by connecting a parallel interface cable (printer cable), a USB cable, or a LAN cable to your host computer.

(2) System Requirements

To install the TOSHIBA printer driver on your host computer, the following system and environment are required:

- Operating system: Windows 98, Windows Me, Windows 2000, Windows XP
- Hardware: A DOS-/V (IBM PC/AT compatible) machine running an above operating system.
- Interface:
 - Parallel interface conforming to the IEEE1284 standard
 - USB interface
 - LAN interface

2.10.3 Installing the Printer Driver

The installation procedure differs depending on the interface connected to the printer and the operation system you are using. Please install the printer driver by performing the appropriate procedure.

If the previous version of the printer driver has been installed on your host computer, be sure to uninstall it before you install this printer driver. (Refer to **Section 2.10.4 Uninstalling the Printer Driver.**)

To print via your network, please install the printer driver by performing the installation procedure for the parallel interface, and also perform the following:

1. In the procedure, select “LPT1” for the port.
2. After installation of the printer driver is completed, add the LAN port by referring to **Section 2.10.5 Adding/Deleting a LAN Port**, and specify the LAN port.

(1) Parallel Interface

To use the parallel interface, the following settings are required, after installing the printer driver:

For Windows 98/Me: Open the printer properties. Select the “Details” tab and click on the **[Spool Settings...]** button. The “Spool Settings” dialog box is displayed. Select “Disable bi-directional support for this printer”.

For Windows 2000/XP: Open the printer properties and select the “Ports” tab. Mark off the “Enable bidirectional support” checkbox.

NOTE:

In case of the B-SX4T or B-SX5T series, make sure that the Centronics interface type is set to SPP (default).

Windows 98/Me

- (1) Select “Settings” – “Printers” from the “Start” menu to open the printer folder.
- (2) Double-click on the “Add Printer” icon. The Add Printer Wizard runs. Click on the **[Next]** button.
- (3) Select “Local printer”, then click on the **[Next]** button. The screen listing “Manufacturers and Printers” is displayed.
- (4) Click on the **[Have Disk...]** button. The “Install From Disk” dialog box is displayed. Specify the “\driver” folder in the CD-ROM drive, then click on the **[OK]** button.

NOTE:

The latest printer driver is available from the web site, “**the Barcode Master**”.

(<http://www.toshibatec-ris.com/products/barcode/download/index.html>)

- (5) Select the printer to be installed from “Printers” list, then click on the **[Next]** button.

Driver name	Model	Driver name	Model	Driver name	Model
TEC B-372	B-372-QP	TEC B-415	B-415-GH24-QM B-415-GH25-QM	TEC B-419	B-419-GS10-QQ B-419-GS12-QP B-419-GS12-CN
TEC B-431	B-431-GS10-QP B-431-GS10-CN	TEC B-452	B-452-TS10-QQ B-452-TS10-QQ-US B-452-TS11-QQ-PAC B-452-TS12-QP B-452-TS12-QP-PAC B-452-TS12-CN	TEC B-452H	B-452-HS12-QQ B-452-HS12-QQ-US B-452-HS12-QP B-452-HS12-CN
TEC B-472	B-472-QQ B-472-QQ-US B-472-GH12-QQ B-472-QP	TEC B-472-CN	B-472-GH12-CN B-472-GH14-CN	TEC B-482	B-482-TS10-QQ B-482-TS10-QQ-US B-482-TS10-QP
TEC B-492	B-492L-TH10-QQ B-492R-TH10-QQ B-492L-TH10-QP B-492R-TH10-QP	TEC B-572	B-572-QQ B-572-QQ-US B-572-QP	TEC B-672	B-672-QQ B-672-QQ-US B-672-QP
TEC B-682	B-682-TS10-QQ B-682-TS10-QQ-US B-682-TS10-QP	TEC B-852	B-852-TS12-QQ B-852-TS12-QQ-US B-852-TS12-QP	TEC B-852-R	B-852-TS22-QQ-R B-852-TS22-QP-R
TEC B-872	B-872-QQ B-872-QQ-US B-872-QP	TEC B-882	B-882-TS10-QQ B-882-TS10-QQ-US B-882-TS10-QP	TEC B-SA4G	B-SA4TM-GS12-QM-R B-SA4TP-GS12-QM-R
TEC B-SA4T	B-SA4TM-TS12-QM-R B-SA4TP-TS12-QM-R	TEC B-SA4T-CN	B-SA4TM-TS12-CN B-SA4TP-TS12-CN	TEC B-SP2D	B-SP2D-GH20-QM B-SP2D-GH30-QM B-SP2D-GH30-QM B-SP2D-GH20-QM-R B-SP2D-GH30-QM-R B-SP2D-GH30-QM-R
TEC B-SV4	B-SV4D-GS10-QM B-SV4D-GH10-QM B-SV4D-GS10-QM-R B-SV4D-GH10-QM-R	TEC B-SX4	B-SX4T-GS10-QQ B-SX4T-GS10-QQ-US B-SX4T-GS10-QP B-SX4T-GS20-QQ B-SX4T-GS20-QQ-US B-SX4T-GS20-QP B-SX4T-GS20-QM-R	TEC B-SX4-CN	B-SX4T-GS10-CN B-SX4T-GS20-CN
TEC B-SX5	B-SX5T-TS12-QQ B-SX5T-TS12-QQ-US B-SX5T-TS12-QP B-SX5T-TS22-QQ B-SX5T-TS22-QQ-US B-SX5T-TS22-QP B-SX5T-TS22-QM-R	TEC B-SX5-CN	B-SX5T-TS12-CN B-SX5T-TS22-CN	TEC B-SX6T-R	B-SX6T-TS12-QM-R
TEC B-SX8T-R	B-SX8T-TS12-QM-R	TEC CB-416-T3	CB-416-T3-QQ CB-416-T3-QQ-US CB-416-T3-QP	TEC CB-426-T3	CB-426-T3-QQ CB-426-T3-QQ-US CB-426-T3-QP

- (6) The screen to select the existing installed printer driver or use the new one, is displayed. Select “Replace existing driver”, then click on the **[Next]** button. If you install the printer driver for the first time, this screen is not displayed.
- (7) Select the port to be used for printing from the “Available ports” list, then click on the **[Next]** button.
- (8) Change the printer name if necessary, and select whether or not you use the printer as the default printer (“Yes” or “No”). Click on the **[Finish]** button.
- (9) The printer driver is installed. When installation is completed, the new printer icon is added in the “Printers” folder.

Windows 2000/XP

- (1) Log on to your host computer as a member who has full control access privilege concerning the printer settings.
- (2) Select “Settings” – “Printers” from the “Start” menu to open the printer folder.
- (3) Double-click on the “Add Printer” icon. The Add Printer Wizard runs. Click on the **[Next]** button.
- (4) Select “Local printer”. Mark off the “Automatically detect and install my Plug and Play printer” checkbox, then click on the **[Next]** button.
- (5) Select the port to be used for printing from the “Available ports” list, then click on the **[Next]** button.
- (6) On the screen listing “Manufacturers and Printers”, click on the **[Have Disk...]** button. The “Install From Disk” dialog box is displayed.
- (7) Specify the “\driver” folder in the CD-ROM drive, then click on the **[OK]** button.

NOTE:

The latest printer driver is available from the web site, “**the Barcode Master**”.
(<http://www.toshibatec-ris.com/products/barcode/download/index.html>)

- (8) Select the printer to be installed from “Printers” list, then click on the **[Next]** button.

Driver name	Model	Driver name	Model	Driver name	Model
TEC B-372	B-372-QP	TEC B-415	B-415-GH24-QM B-415-GH25-QM	TEC B-419	B-419-GS10-QQ B-419-GS12-QP B-419-GS12-CN
TEC B-431	B-431-GS10-QP B-431-GS10-CN	TEC B-452	B-452-TS10-QQ B-452-TS10-QQ-US B-452-TS11-QQ-PAC B-452-TS12-QP B-452-TS12-QP-PAC B-452-TS12-CN	TEC B-452H	B-452-HS12-QQ B-452-HS12-QQ-US B-452-HS12-QP B-452-HS12-CN
TEC B-472	B-472-QQ B-472-QQ-US B-472-GH12-QQ B-472-QP	TEC B-472-CN	B-472-GH12-CN B-472-GH14-CN	TEC B-482	B-482-TS10-QQ B-482-TS10-QQ-US B-482-TS10-QP
TEC B-492	B-492L-TH10-QQ B-492R-TH10-QQ B-492L-TH10-QP B-492R-TH10-QP	TEC B-572	B-572-QQ B-572-QQ-US B-572-QP	TEC B-672	B-672-QQ B-672-QQ-US B-672-QP
TEC B-682	B-682-TS10-QQ B-682-TS10-QQ-US B-682-TS10-QP	TEC B-852	B-852-TS12-QQ B-852-TS12-QQ-US B-852-TS12-QP	TEC B-852-R	B-852-TS22-QQ-R B-852-TS22-QP-R
TEC B-872	B-872-QQ B-872-QQ-US B-872-QP	TEC B-882	B-882-TS10-QQ B-882-TS10-QQ-US B-882-TS10-QP	TEC B-SA4G	B-SA4TM-GS12-QM-R B-SA4TP-GS12-QM-R
TEC B-SA4T	B-SA4TM-TS12-QM-R B-SA4TP-TS12-QM-R	TEC B-SA4T-CN	B-SA4TM-TS12-CN B-SA4TP-TS12-CN	TEC B-SP2D	B-SP2D-GH20-QM B-SP2D-GH30-QM B-SP2D-GH30-QM B-SP2D-GH20-QM-R B-SP2D-GH30-QM-R B-SP2D-GH30-QM-R
TEC B-SV4	B-SV4D-GS10-QM B-SV4D-GH10-QM B-SV4D-GS10-QM-R B-SV4D-GH10-QM-R	TEC B-SX4	B-SX4T-GS10-QQ B-SX4T-GS10-QQ-US B-SX4T-GS10-QP B-SX4T-GS20-QQ B-SX4T-GS20-QQ-US B-SX4T-GS20-QP B-SX4T-GS20-QM-R	TEC B-SX4-CN	B-SX4T-GS10-CN B-SX4T-GS20-CN
TEC B-SX5	B-SX5T-TS12-QQ B-SX5T-TS12-QQ-US B-SX5T-TS12-QP B-SX5T-TS22-QQ B-SX5T-TS22-QQ-US B-SX5T-TS22-QP B-SX5T-TS22-QM-R	TEC B-SX5-CN	B-SX5T-TS12-CN B-SX5T-TS22-CN	TEC B-SX6T-R	B-SX6T-TS12-QM-R
TEC B-SX8T-R	B-SX8T-TS12-QM-R	TEC CB-416-T3	CB-416-T3-QQ CB-416-T3-QQ-US CB-416-T3-QP	TEC CB-426-T3	CB-426-T3-QQ CB-426-T3-QQ-US CB-426-T3-QP

- (9) The “Use Existing Driver” screen is displayed. Select “Replace existing driver”, then click on the **[Next]** button. If you install the printer driver for the first time, this screen is not displayed.
- (10) Change the printer name if necessary, and select whether or not you use the printer as the default printer (“Yes” or “No”). Click on the **[Next]** button.
- (11) Select whether or not the printer will be shared with other network users (“Shared” or “Not shared”). Click on the **[Next]** button.
- (12) Select whether or not the test page will be printed (“Yes” or “No”), then click on the **[Finish]** button.
- (13) If the “Digital Signature Not Found” screen is displayed, click on the **[Yes]** button.
- (14) When the “Completing the Add Printer Wizard” screen is displayed, click on the **[Finish]** button.
- (15) When installation is completed, the new printer icon is added in the “Printers” folder.

(2) USB Interface

Installation starts by the operating system's plug-and-play function.

Windows 98/Me

- (1) Turn the printer ON, then connect it to your host computer with the USB cable.
The "New Hardware Found" dialog box is displayed, and "USB Device" is detected.

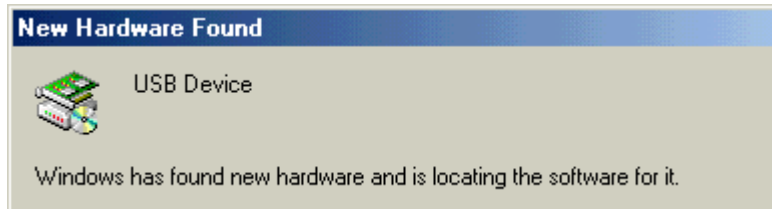

- (2) After a while, the "Add New Hardware Wizard" dialog box is displayed. Select "Specify the location of the driver (Advanced)", then click on the **[Next]** button.



- (3) Select “Search for the best driver for your device. (Recommended)”
Mark the “Specify a location” checkbox, then click on the **[Browse]** button.
Specify “\driver” folder, then click on the **[Next]** button.

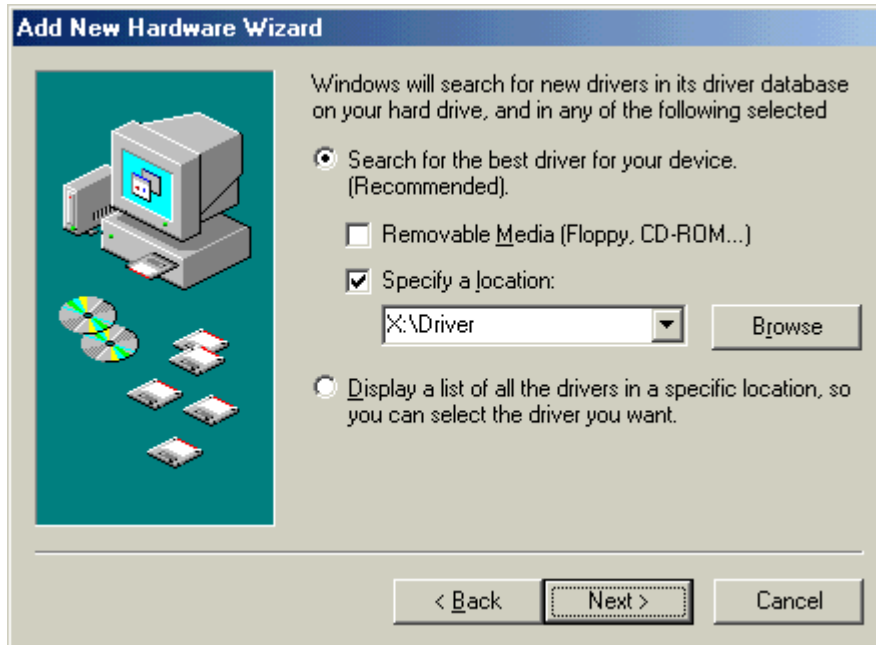

- (5) When the screen which indicates the USB Printing Support driver has been installed, is displayed, click on the **[Finish]** button.



- (6) After a while, “TEC B-SA4T” is detected as a new hardware.

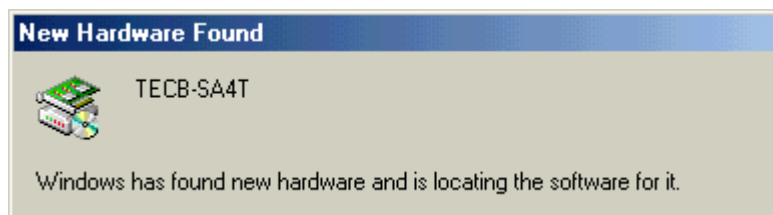

- (7) The “Add New Hardware Wizard” dialog box is displayed. Select “Specify the location of the driver (Advanced)”, then click on the **[Next]** button.



- (8) Select “Search for the best driver for your device. (Recommended)”
Mark the “Specify a location” checkbox, then click on the **[Browse]** button.
Specify “\driver” folder, then click on the **[Next]** button.

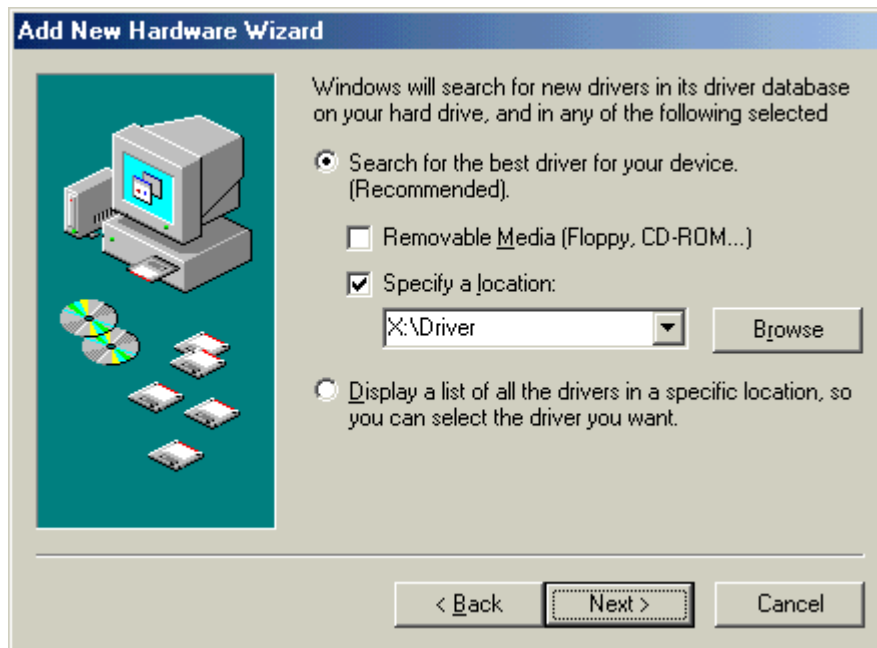

- (9) Check to see that the “TEC B-SA4T” driver is detected, then click on the **[Next]** button.

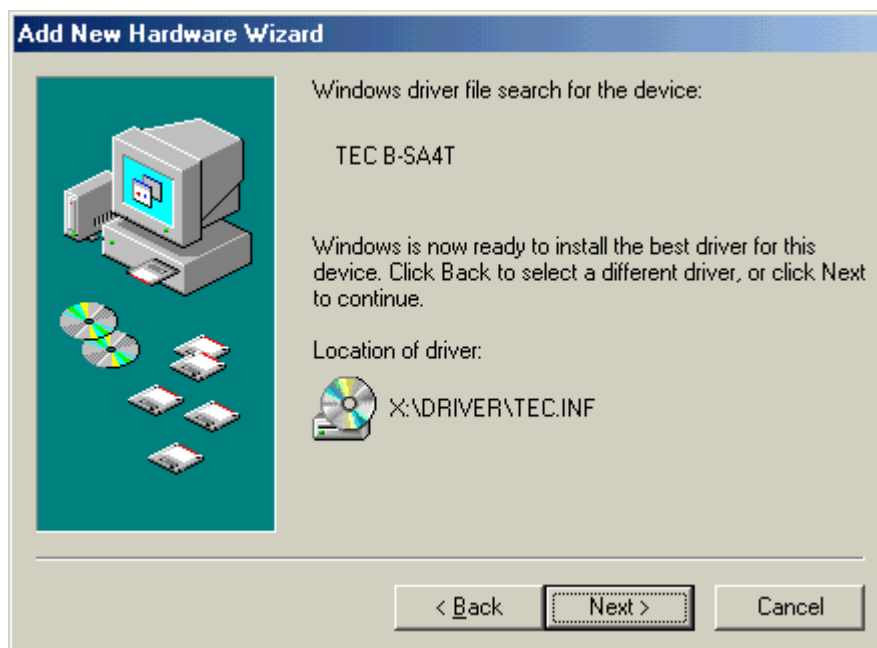

- (10) Change the printer name if necessary, and select whether or not you use the printer as the default printer (“Yes” or “No”). Click on the **[Finish]** button.

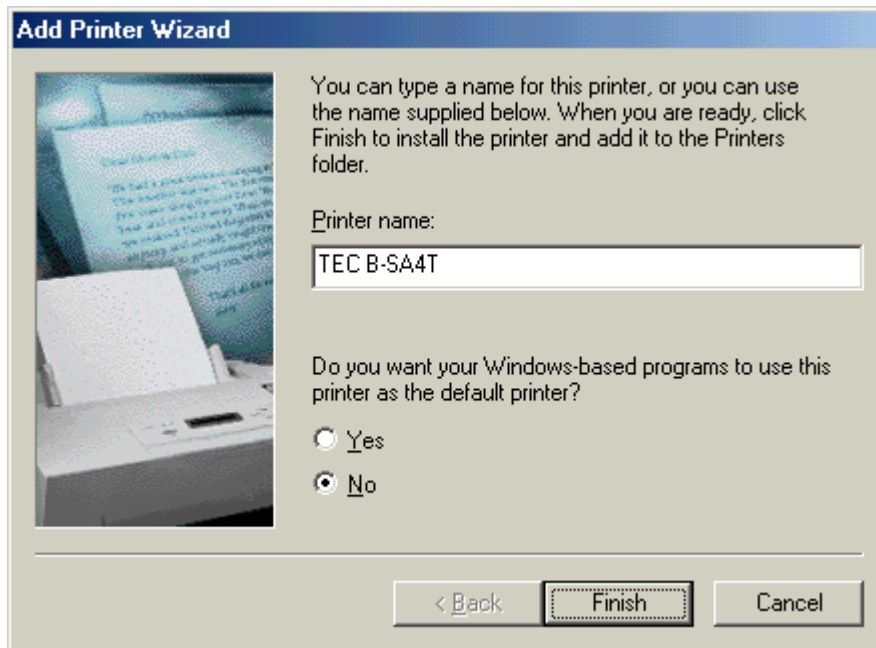

- (11) When the screen, which indicates TEC B-SA4T has been installed, is displayed, click on the **[Finish]** button.



- (12) When installation is completed, the new printer icon is added in the “Printers” folder.

Windows 2000/XP**NOTE:**

When plug-and-play printer installation in progress is stopped, be sure to delete the printer detected and displayed on the “Device Manager” tab of the “System Properties” dialog box.

- (1) Log on to your host computer as a member who has full control access privilege concerning the printer settings.
- (2) Turn the printer ON, then connect it to your host computer with the USB cable.
- (3) “USB Device” is automatically detected, and “USB Printing Support” is automatically installed.
- (4) After a while, for Windows XP, “TEC B-SA4T” is detected as a new device.
For Windows 2000, “Unknown” device is detected as a new device. In both cases, perform the following steps, though dialog boxes for Windows XP are used.
- (5) The “Found New Hardware Wizard” dialog box is displayed.
Select “No, not this time”, then click on the **[Next]** button.



- (6) Select “Install from a list or specific location (Advanced)”, then click on the **[Next]** button.

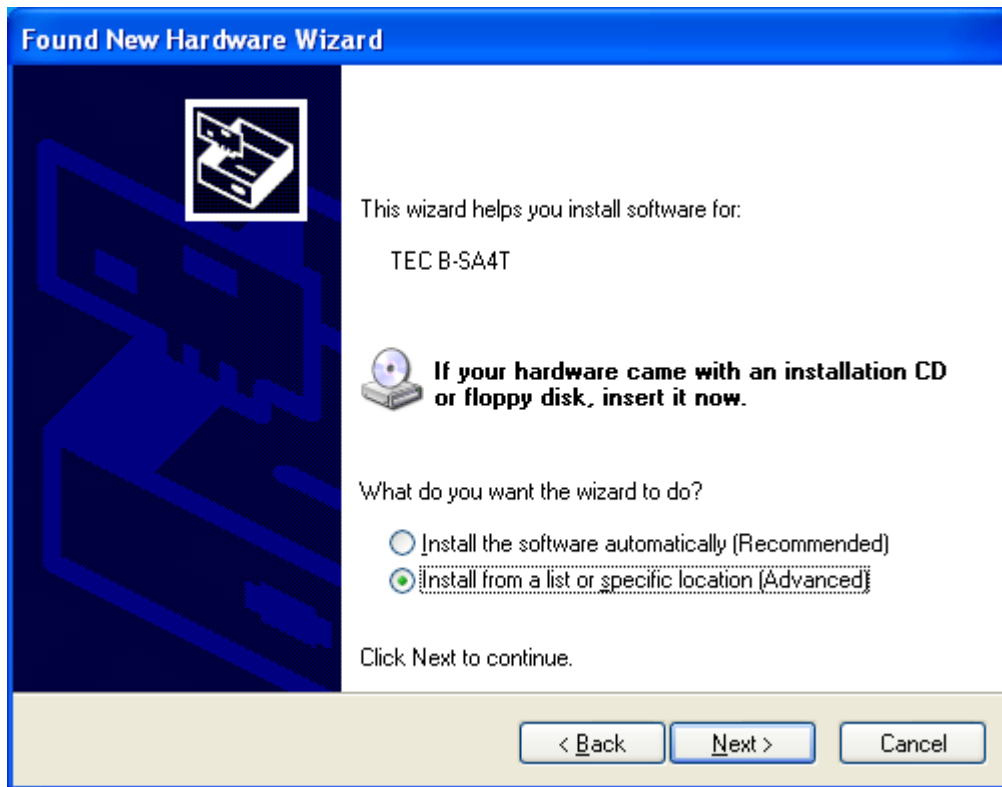

- (7) Select “Search for the best driver in these locations”. Mark the “Include this location in the search” checkbox, then click on the **[Browse]** button. Specify the “\driver” folder in the CD-ROM, then click on the **[Next]** button.

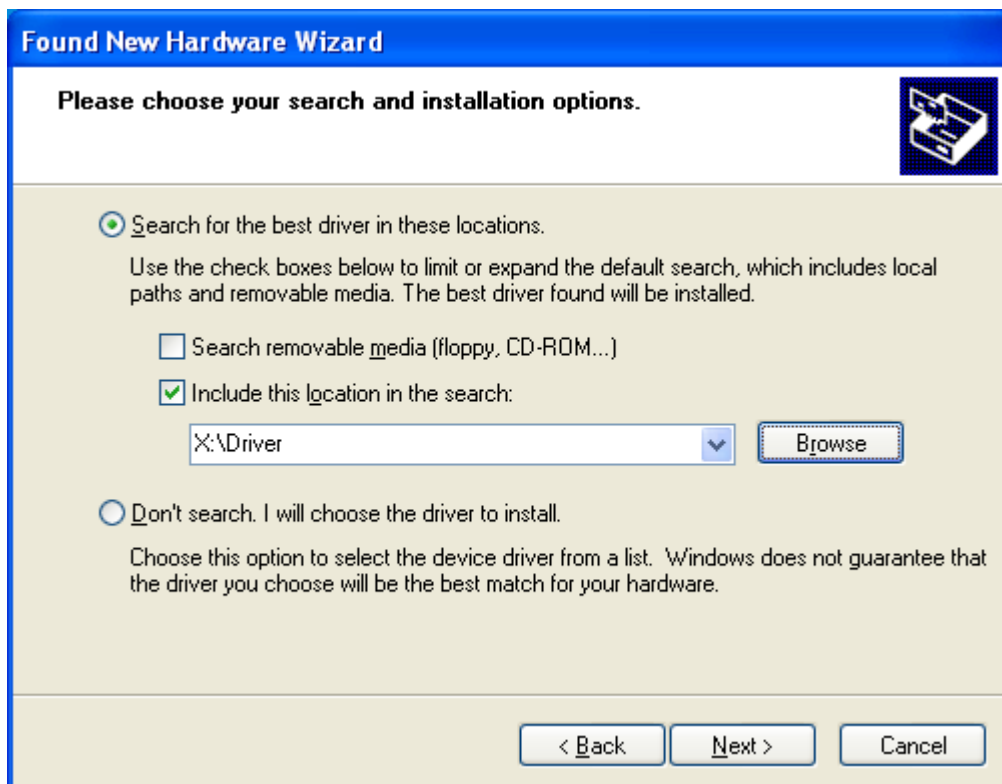

- (8) When the dialog box below is displayed, click on the **[Continue Anyway]** button.



- (9) When the "Completing the Found New Hardware Wizard" screen is displayed, click on the **[Finish]** button.

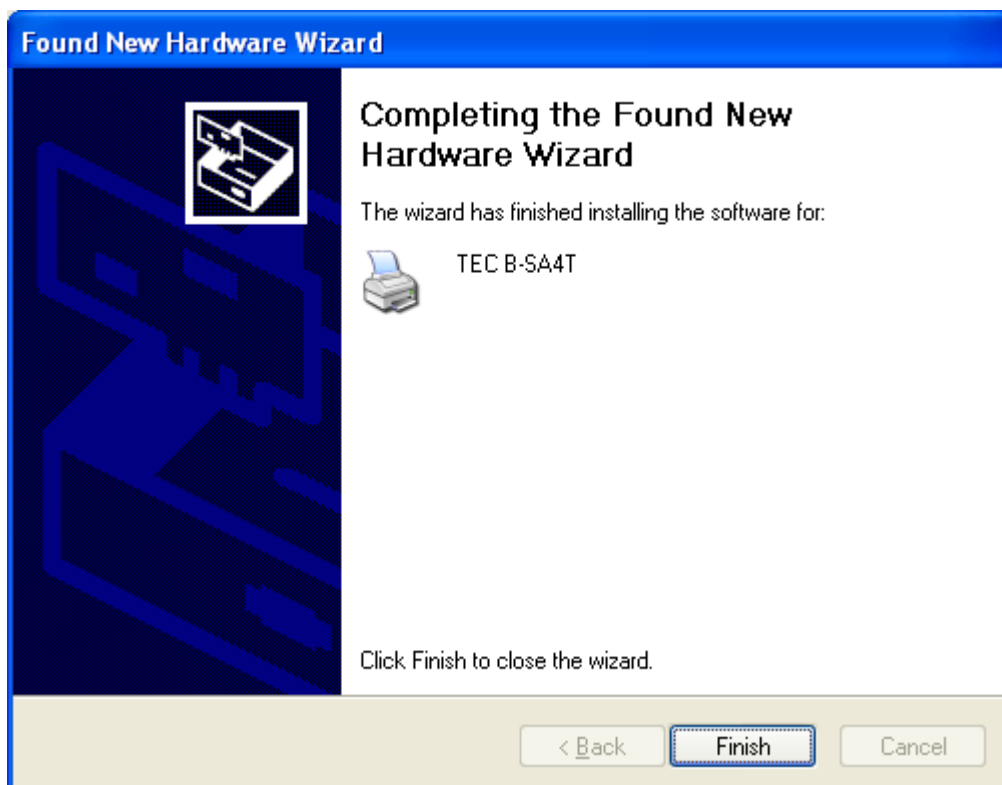

- (10) When installation is completed, the new printer icon is added in the "Printers" folder.

2.10.4 Uninstalling the Printer Driver

NOTE:

Before uninstalling the printer driver, be sure to complete all of printing, the status monitor, and properties settings.

Windows 98/ME

- (1) Select “Settings” – “Printers” from the “Start” menu to open the printer folder.
- (2) Right-click on the printer driver icon to be deleted, then select “Delete”. The confirmation message is displayed.
- (3) Click on the **[Yes]** button to delete.
- (4) After the printer driver icon is deleted, restart your host computer.

Windows 2000/XP

- (1) Log on to your host computer as a member who has full control access privilege concerning the printer settings.
- (2) Select “Settings” – “Printers” from the “Start” menu to open the printer folder.
- (3) Right-click on the printer driver icon to be deleted, then select “Delete”. The confirmation message is displayed.
- (4) Click on the **[Yes]** button to delete.
- (5) After the printer icon is deleted, select “Server Properties” from “File” menu of the “Printers” folder.
- (6) Select the printer driver to be deleted, then click on the **[Remove]** button. After the printer driver is deleted, restart your host computer.

2.10.5 Adding/Deleting a LAN Port

To use the LAN interface, first, you have to make the following settings in “<7> IP ADDRESS” in the system mode of the printer. (Refer to TOSHIBA TEC support representative.)

- Set the printer IP address (“**PRINTER IP ADRES**”), the gateway IP address (“**GATEWAY IP ADRES**”), and subnet mask (“**SUBNET MASK**”).
- Set the port number (“**SOCKET PORT**”).

Among these settings, the printer IP address and the port number are also required for adding a LAN port.

(1) Adding a LAN Port

Windows 98/ME

- (1) Right-click on the printer icon. Select “Properties” to open the printer “Properties” dialog box.
- (2) Select the “Details” tab, and click on the **[Add Port...]** button. The “Add Port” dialog box is displayed.
- (3) Select “Other”.
Select “Seagull Scientific TCP/IP Port” from the list, then click on the **[OK]** button.
- (4) On the “Add Seagull TCP/IP Port” dialog box, enter the name or IP address, the port number, and the port name. For the IP address and the port number, enter the same ones as you have set in “<7> IP ADDRESS” in the system mode of the printer. After entering these, click on the **[OK]** button.

Add Seagull TCP/IP Port

TCP/IP Settings
 You may specify the printer's location by name or IP address.
 A name may be either a name on the local network, such as 'PRINTER6', or a fully-qualified internet name, such as 'printer6.seagullscientific.com'.
 IP addresses are specified as four numbers separated by periods, for example, 10.1.2.3.

Name or IP Address:

The port number determines which TCP port is used to communicate with the printer. Most printers use port 9100.

Port Number:

Port Settings
 The port name is displayed in the Ports dialog. For example, 'LPT1' is the name of the parallel port. The name generated by default is acceptable.

Port Name:

OK Cancel

- (5) When addition of the port is completed, the port is added to the drop down list for “Print to the following port”.

Windows 2000/XP

- (1) Right-click on the printer icon. Select “Properties” to open the printer “Properties” dialog box.
- (2) Select the “Ports” tab, and click on the **[Add Port...]** button. The “Printer Ports” dialog box is displayed.
- (3) Select “Seagull Scientific TCP/IP Port” from the “Available Printer Ports” list, then click on the **[OK]** button.
- (4) On the “Add Seagull TCP/IP Port” dialog box, enter the name or IP address, the port number, and the port name. For the IP address and the port number, enter the same ones as you have set in “<7> **IP ADDRESS**” in the system mode of the printer. After entering these, click on the **[OK]** button.
- (5) When addition of the port is completed, the port is added to the “Print to the following port(s)” list.

(2) Deleting a LAN Port**NOTE:**

Before deleting a port, be sure to check if other printers also use it. If there are printers which use the port to be deleted, change their port to another, before deleting the port.

Windows 98/ME

- (1) Right-click on the printer icon. Select “Properties” to open the printer “Properties” dialog box.
- (2) Select the “Details” tab, and click on the **[Delete Port...]** button.
- (3) Select the port to be deleted, then click on the **[OK]** button.
- (4) When deletion of the port is completed, the port is also deleted from the “Print to the following port” list.

Windows 2000/XP

- (1) Right-click on the printer icon. Select “Properties” to open the printer “Properties” dialog box.
- (2) On the “Ports” tab, select the port to be deleted, then click on the **[Delete Port]** button.
- (3) When deletion of the port is completed, the port is also deleted from the “Print to the following port(s)” list.

2.10.6 Cautions

(1) Printer Driver Upgrades

- To upgrade the printer driver to this version, uninstall the previous version of the printer driver, before installing this printer driver.
- Be sure to restart your host computer, after you upgrade the printer driver.
- When your operating system is Windows 98, or Windows Me, be sure to restart your host computer, after you uninstall the previous version of the printer driver. Or, the printer driver is not upgraded properly.

(2) Others

- If your operating system is Windows 2000 or Windows XP, when plug-and-play printer installation in progress is stopped, be sure to delete the printer detected and displayed on the “Device Manager” tab of the “System Properties” dialog box.
- Before uninstalling the printer driver, be sure to complete all of printing, the status monitor, and properties settings.
- Before deleting a port, be sure to check if other printers also use it. If there are printers which use the port to be deleted, change their port to another, before deleting the port.

2.10.7 Using the Printer Driver

For how to use the Printer Driver, please refer to the Help for Windows Printer Drivers screen.

- 1) Open the Properties screen of the Printer Driver.
- 2) Clicking on the **About** tab causes the following screen to appear.
Click on the **[Help]** button.

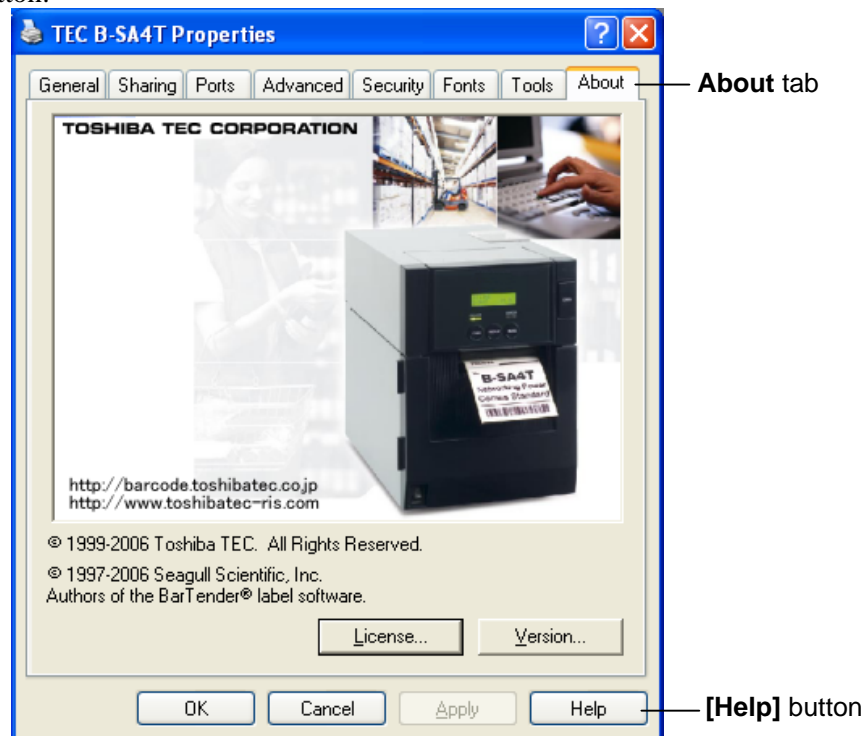

- 3) The Help for Windows Printer Drivers screen appears. This screen will provide how to use the printer driver.

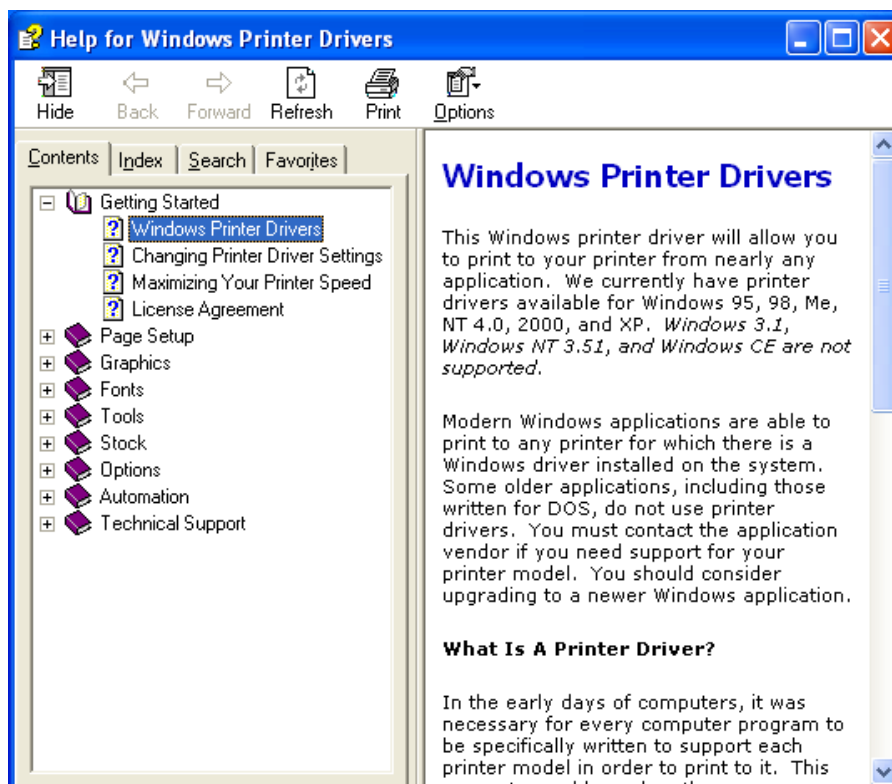

2.11 Print Test

After your operating environment has been set, perform a print test.

1. Perform a print test by using the Printer Driver or an Issue Command.

The printer driver's Properties screen allows you to set the communication conditions, media size, and other printing conditions in accordance with your operating environment. For details, refer to the **Help for the Windows Printer Drivers** screen.

Example: Stock tab display of the Printer Driver's Properties Screen

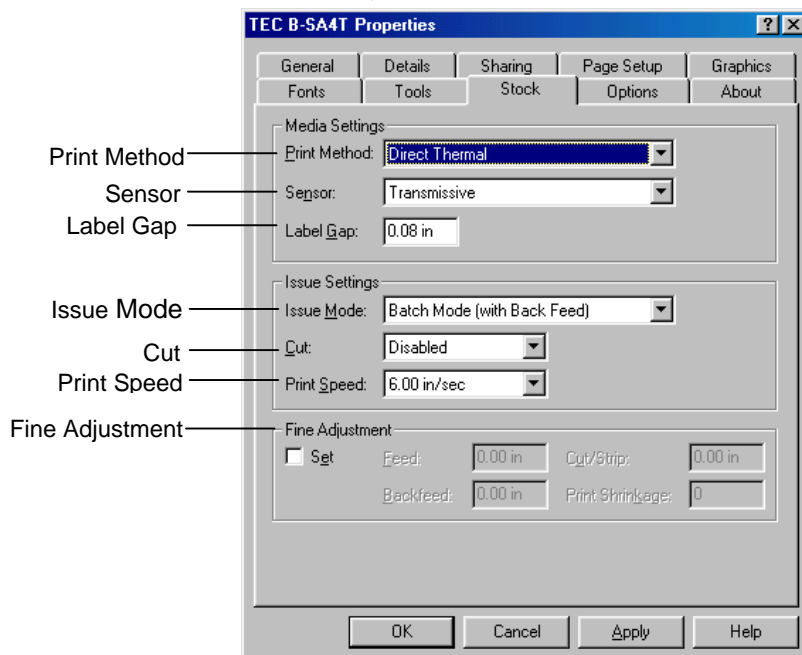

- | | |
|------------------|---|
| Print Method: | Direct thermal or thermal transfer is selectable. |
| Sensor: | Media sensor type is selectable. |
| Issue Mode: | Batch or strip is selectable. |
| Cut: | Whether to use the cutter or not is selectable. |
| Fine Adjustment: | Adjustment values for the feed amount, cut/strip position, etc. can be set. |

2. Confirm the print test result.

- When a print start position, cut/strip position, or print tone needs to be adjusted: ⇒ **Section 2.12 Position and Print Tone Fine Adjustment**
- When pre-printed media is used, and if a print start position is not properly detected: ⇒ **Section 2.13 Threshold Setting**

2.11 Print Test (Cont.)

When using a Strip Module or an optional Cutter Module

It is necessary to set the issue mode, cut/strip position, etc. for the Printer Driver or TPCL (TEC Printer Command Language) in accordance with your printing condition.

For details of the TPCL, refer to the **B-SX4T/SX5T Series External Equipment Interface Specification** stored in the CD-ROM.

Regarding how to use the Printer Driver, refer to the **Help for the Windows Printer Drivers** screen.

To gain maximum performance and life from the Cutter Module or Strip Module, periodic cleaning is required.

Before starting a cleaning, be sure to TURN OFF the printer to avoid risk of injury.

For details of cleaning, refer to **Section 4.1.3 Optional Cutter Module**.

2.12 Position and Print Tone Fine Adjustment

This section describes how to fine adjust a print start position, cut/strip position, reverse feed amount, print tone, and ribbon motor torque. When a fine adjustment is required, such as print start position, print tone, etc, follow the procedure below.

1. Turn on the printer and confirm that “ONLINE” appears on the LCD Message Display.
2. Press the **[PAUSE]** key to pause the printer.
3. Hold down the **[RESTART]** key for three seconds until “<1>RESET” is displayed.
4. Press the **[FEED]** or **[RESTART]** key until “<3>ADJUST SET” appears on the LCD Message Display.
5. When “<3>ADJUST SET” appears, press the **[PAUSE]** key to enter the Parameter Fine Adjustment Mode.

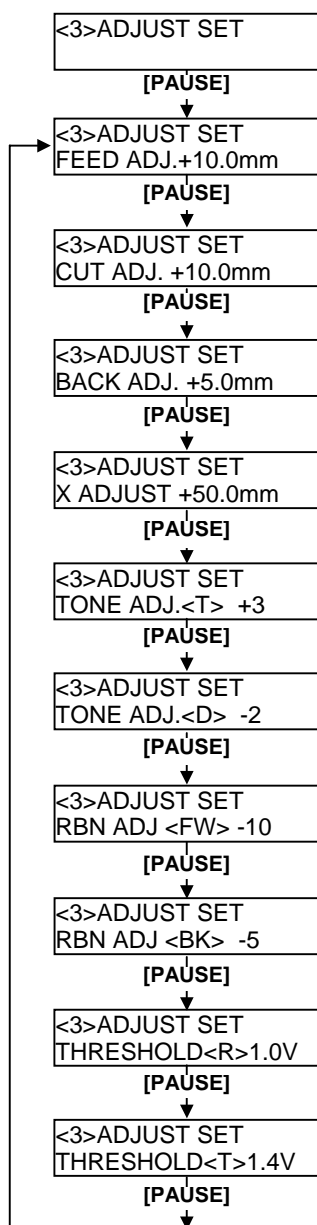

The Parameter Fine Adjustment Mode contains the following sub menus. Each time the **[PAUSE]** key is pressed, the sub menus are displayed sequentially.

- (1) **Feed Amount Fine Adjustment:**
Feed amount to the print start position is fine adjusted.
- (2) **Cut/Strip Position Fine Adjustment:**
Cut position or strip position is fine adjusted.
- (3) **Reverse Feed Amount Fine Adjustment:**
Reverse feed amount is fine adjusted.
- (4) **X-coordinate Fine Adjustment:**
X-coordinate of a print position is fine adjusted.
- (5) **Print Tone Fine Adjustment (Thermal transfer):**
Print tone is fine adjusted for thermal transfer mode.
- (6) **Print Tone Fine Adjustment (Thermal direct):**
Print tone is fine adjusted for thermal direct mode.
- (7) **Ribbon Motor Drive Voltage Fine Adjustment (Take-up motor):**
Drive voltage of the ribbon take-up motor is fine adjusted.
- (8) **Ribbon Motor Drive Voltage Fine Adjustment (Feed motor)**
Drive voltage of the ribbon feed motor is fine adjusted.
- (9) **Threshold Fine Adjustment (Black mark sensor):**
Threshold for the black mark sensor is fine adjusted. See **Section 2.13**.
- (10) **Threshold Fine Adjustment (Feed gap sensor):**
Threshold for the feed gap sensor is fine adjusted. See **Section 2.13**.

NOTE:

The printer driver's properties screen also has Parameter Fine Adjustment menu.

2.12 Position and Print Tone Fine Adjustment (Cont.)

Print Start Position Fine Adjustment

NOTES:
 Choose a desired value by using the **[RESTART]** or **[FEED]** key.
 Pressing the **[FEED]** key one time causes a -0.5mm change, up to -50.0mm .
 Pressing the **[RESTART]** key one time causes a $+0.5\text{mm}$ change, up to $+50.0\text{mm}$.

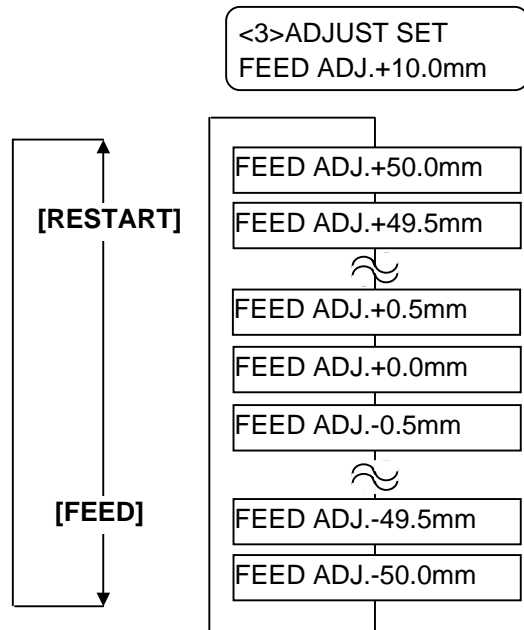

After selecting a fine adjustment value, press the **[PAUSE]** key.

• Example of Print Start Position Fine Adjustment

When setting +3.0 mm

Compared with “+0.0mm” position, the print start position is shifted forward.

When setting +0.0 mm

When setting -3.0 mm

Compared with “+0.0mm” position, the print start position is shifted backward.

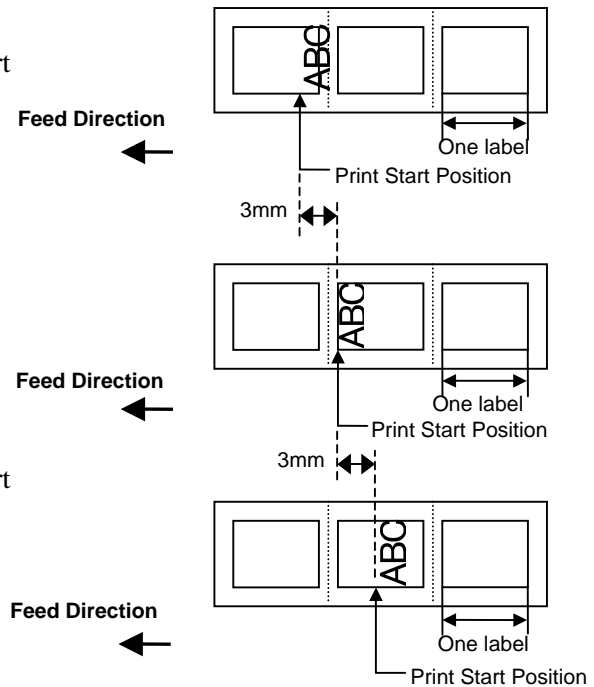

2.12 Position and Print Tone Fine Adjustment (Cont.)

Cut/Strip Position Fine Adjustment

NOTES:
 Choose a desired value by using the **[RESTART]** or **[FEED]** key.
 Pressing the **[FEED]** key one time causes a -0.5mm change, up to -50.0 mm .
 Pressing the **[RESTART]** key one time causes a $+0.5\text{mm}$ change, up to $+50.0\text{ mm}$.

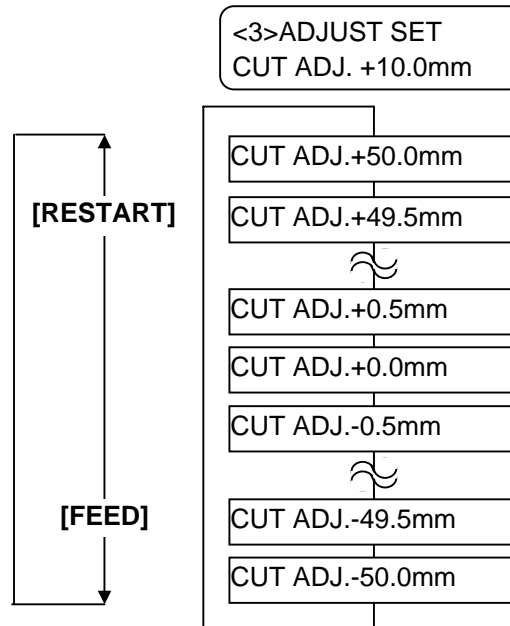

After selecting a fine adjustment value, press the **[PAUSE]** key.

• Example of Cut Position Fine Adjustment

When setting $+3.0\text{ mm}$

Compared with “ $+0.0\text{mm}$ ” position, the cut position is shifted forward.

When setting $+0.0\text{ mm}$

When setting -3.0 mm

Compared with “ $+0.0\text{mm}$ ” position, the cut position is shifted backward.

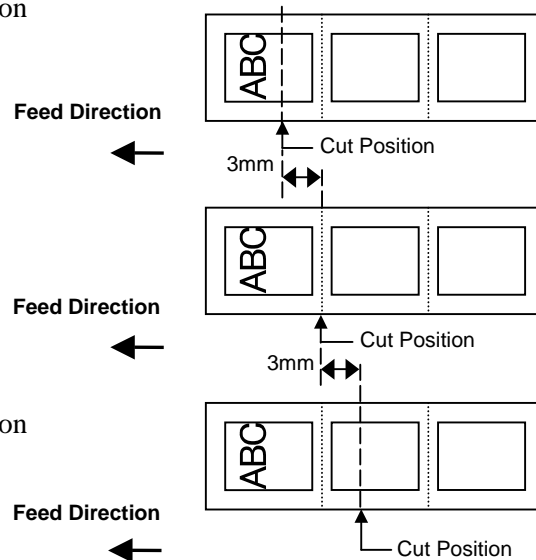

• Example of Strip Position Fine AdjustmentWhen setting +3.0 mm

Compared with “+0.0mm” position, the stop position after printing is shifted forward.

When setting +0.0 mmWhen setting -3.0 mm

Compared with “+0.0mm” position, the stop position after printing is shifted backward.

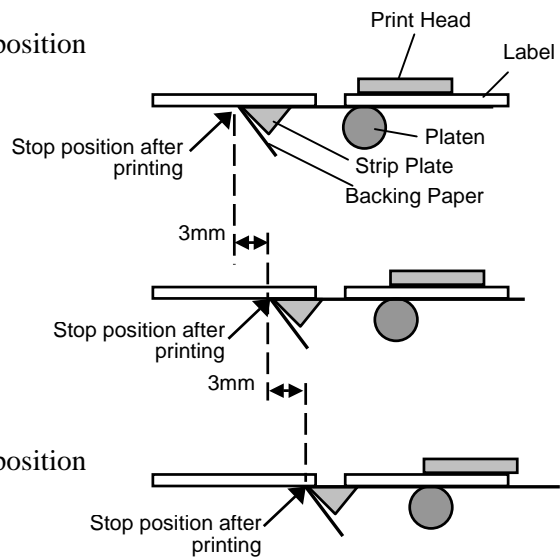

2.12 Position and Print Tone Fine Adjustment (Cont.)

Reverse Feed Amount Fine Adjustment

NOTES:
 Choose a desired value by using the **[RESTART]** or **[FEED]** key.
 Pressing the **[FEED]** key one time causes a -0.5mm change, up to -9.5 mm .
 Pressing the **[RESTART]** key one time causes a $+0.5\text{mm}$ change, up to $+9.5\text{ mm}$.

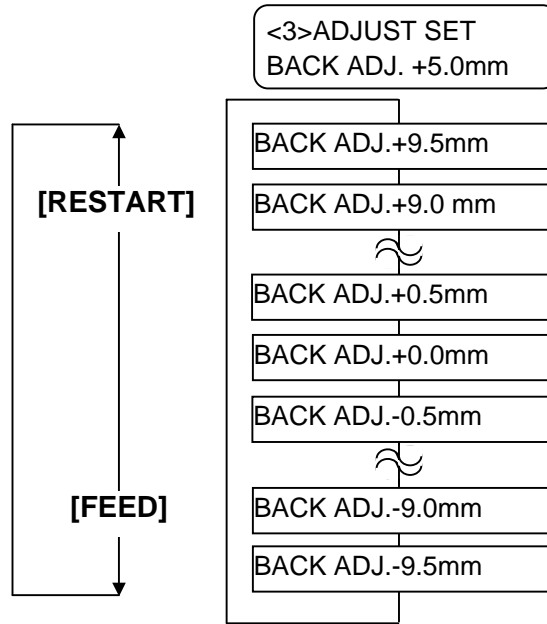

After selecting a fine adjustment value, press the **[PAUSE]** key.

• Example of Reverse Feed Amount Fine Adjustment

When setting +3.0 mm

Compared with “+0.0mm” position, the print start position after a reverse feed is shifted forward.

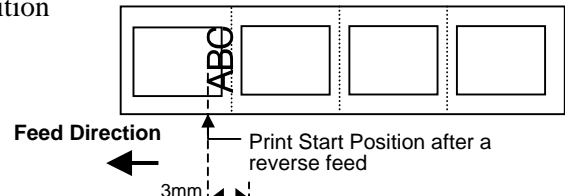

When setting +0.0 mm

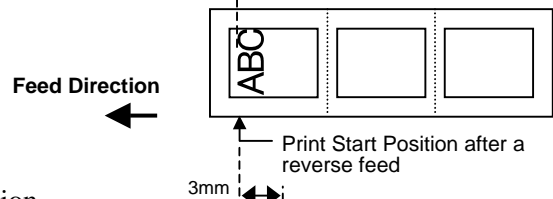

When setting -3.0 mm

Compared with “+0.0mm” position, the print start position after a reverse feed is shifted backward.

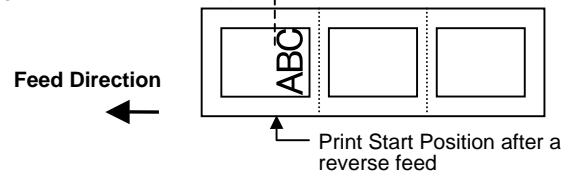

2.12 Position and Print Tone Fine Adjustment (Cont.)

X Coordinate Fine Adjustment

NOTES:
 Choose a desired value by using the **[RESTART]** or **[FEED]** key.
 Pressing the **[FEED]** key one time causes a -0.5mm change, up to -99.5mm .
 Pressing the **[RESTART]** key one time causes a $+0.5\text{mm}$ change, up to $+99.5\text{mm}$.

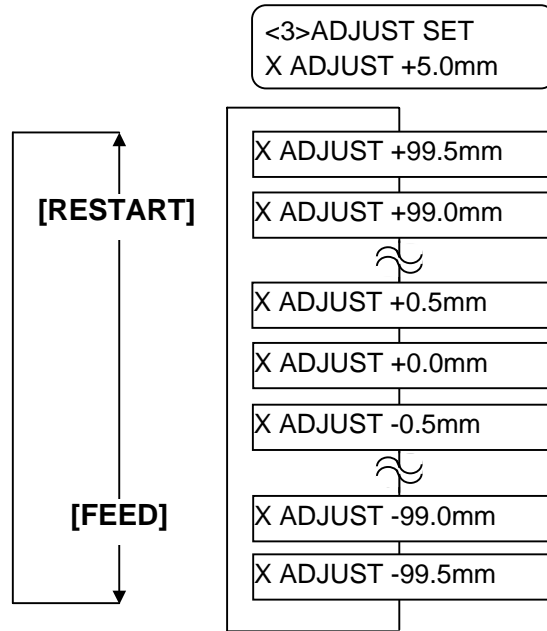

After selecting a fine adjustment value, press the **[PAUSE]** key.

• Example of X Coordinate Fine Adjustment

When setting -50.0mm
 Compared with “ $+0.0\text{mm}$ ” position, the print position is shifted to the left.

When setting $+0.0\text{mm}$

When setting $+50.0\text{mm}$
 Compared with “ $+0.0\text{mm}$ ” position, the print position is shifted to the right.

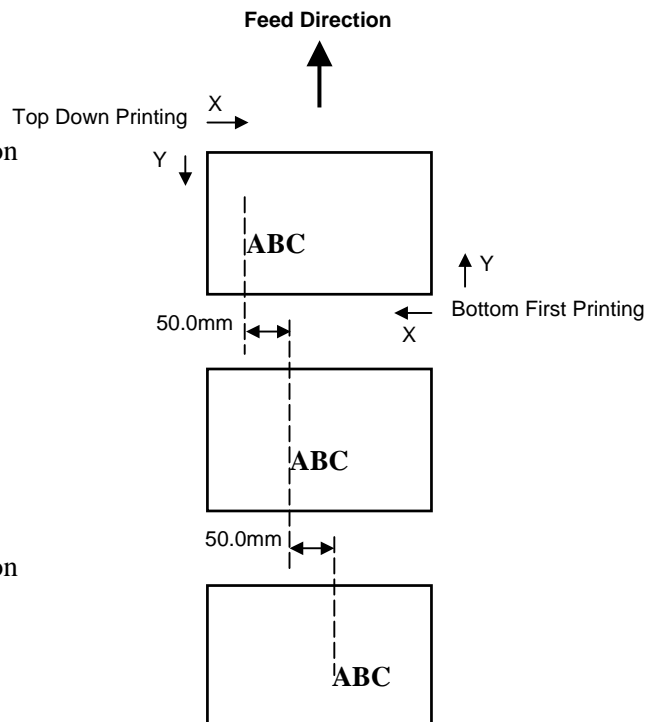

2.12 Position and Print Tone Fine Adjustment (Cont.)

Print Tone Fine Adjustment

Thermal Transfer Print

NOTES:
 Choose a desired value by using the **[RESTART]** or **[FEED]** key.
 Pressing the **[FEED]** key one time causes a -1 tone change, up to -10 tones.
 Pressing the **[RESTART]** key one time causes a +1 tone change, up to +10 tones.

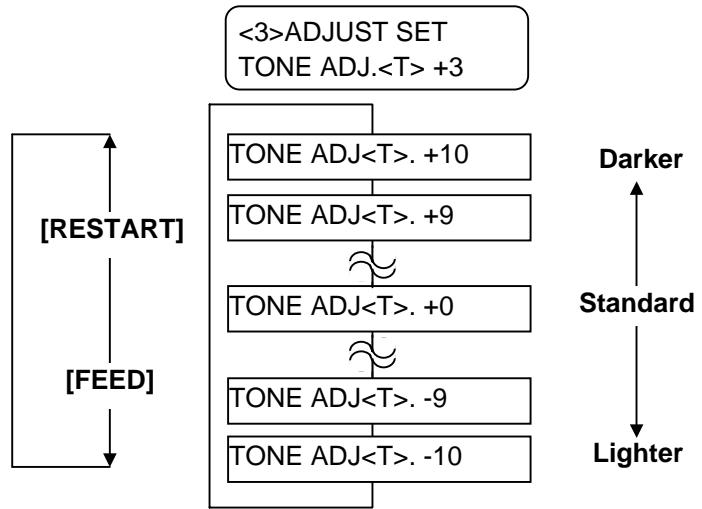

After selecting a fine adjustment value or to skip this menu, press the **[PAUSE]** key.

Thermal Direct Print

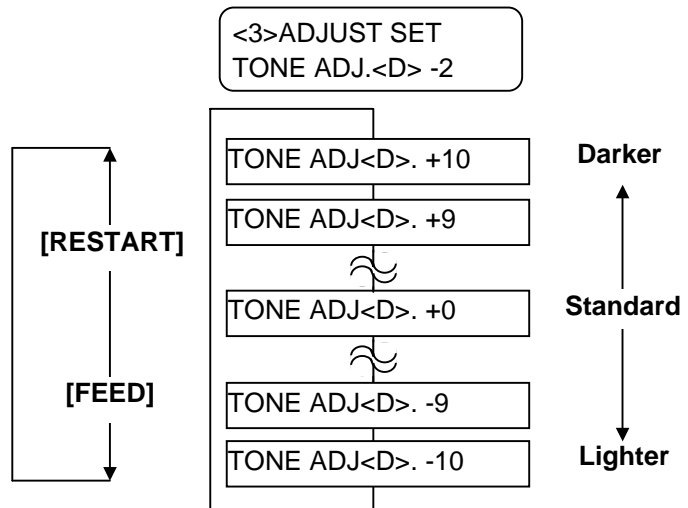

After selecting a fine adjustment value or to skip this menu, press the **[PAUSE]** key.

2.12 Position and Print Tone Fine Adjustment (Cont.)

Ribbon Motor Voltage Fine Adjustment

When the ribbon is slack or wrinkled and printing is affected, fine adjust the ribbon motor torque by using the following procedure.

Take-up Motor (RBN ADJ <FW>)

NOTES:
 Choose a desired value by using the **[RESTART]** or **[FEED]** key.
 Pressing the **[FEED]** key one time causes a -1 step change, up to -15 steps.
 Pressing the **[RESTART]** key one time causes a +1 step change, up to +0 steps.

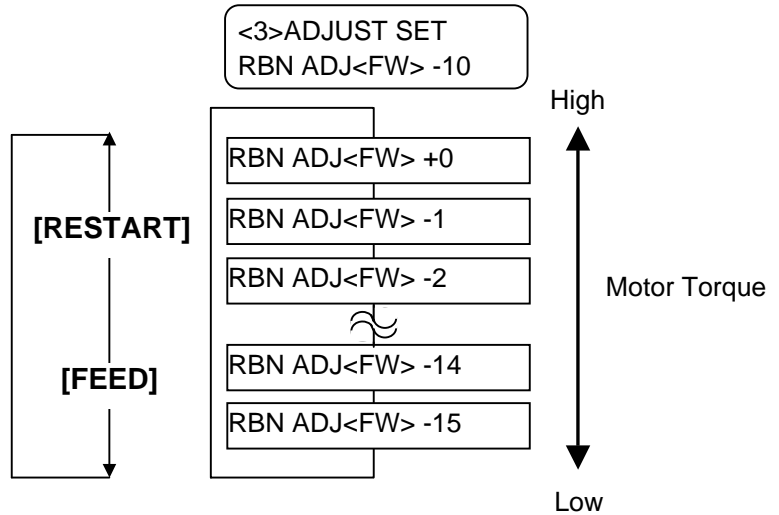

After selecting a fine adjustment value or to skip this menu, press the **[PAUSE]** key.

Feed Motor (RBN ADJ <BK>)

NOTES:
 Choose a desired value by using the **[RESTART]** or **[FEED]** key.
 Pressing the **[FEED]** key one time causes a -1 step change, up to -15 steps.
 Pressing the **[RESTART]** key one time causes a +1 step change, up to +0 steps.

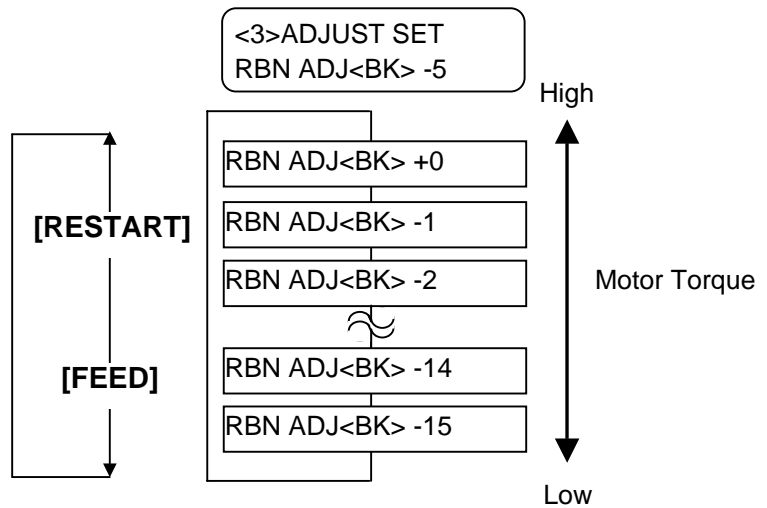

After selecting a fine adjustment value or to skip this menu, press the **[PAUSE]** key.

2.13 Threshold Setting

To maintain a constant print position the printer uses the media sensor to detect a print start position according to the difference of voltage between a print area and a gap or black mark. When the media is pre-printed, the darker (or more dense) inks can interfere with this process causing paper jam errors.

To get around this problem, first, try an automatic threshold setting. If the problem still occurs, then, the threshold voltage needs to be manually set.

Automatic threshold setting procedure

1. Turn the power ON. The printer is in online mode.
2. Load a pre-printed media roll.
When using a label stock, move the Feed Gap Sensor so that it is in line with the centre of the label.
When using a tag stock, move the Black Mark Sensor so that it is in line with the centre of a black mark.
3. Press the **[PAUSE]** key.
4. The printer enters the pause mode.
5. Press and hold the **[PAUSE]** key in the pause state until the following screen appears.
6. The sensor type is displayed.

TRANSMISSIVE
B-SX4T V1.0A

7. Select the sensor to be adjusted by using the **[FEED]** key.

REFLECTIVE
B-SX4T V1.0A

Black mark sensor

TRANSMISSIVE
B-SX4T V1.0A

Feed gap sensor

8. Press and hold the **[PAUSE]** key until more than 1.5 labels (tags) have been issued.
The media will continue to be fed until the **[PAUSE]** key is released. (An automatic threshold setting for the selected sensor is completed by this operation.)

PAUSE
B-SX4T V1.0A

9. Press the **[RESTART]** key.

ON LINE
B-SX4T V1.0A

10. The printer returns to online mode.
Send an issue command from the host computer to the printer.

NOTES:

1. Failure to feed more than 1.5 labels may result in an incorrect threshold setting.
2. While the Top Cover is raised, the **[PAUSE]** key does not work
3. A paper end error cannot be detected during paper feed.

2.13 Threshold Setting (Cont.)

Manual threshold setting procedure

If a paper jam error still occurs even after an automatic threshold setting has been performed, manually set the threshold voltage.

To make a threshold value manually set in this section effective, select the Transmissive Sensor (when using manual threshold value) or Reflective Sensor (when using manual threshold value) within software commands or the printer driver.

1. While holding down the **[FEED]** and **[PAUSE]** keys, turn on the printer.
2. When “<1>DIAG.” appears on the LCD Message Display, release the **[FEED]** and **[PAUSE]** keys.

<1>DIAG.

Now, the printer is in the System Mode for system administrators.

3. Press the **[FEED]** or **[RESTART]** key until “<5>SENSOR ADJ.” appears on the LCD Message Display.

<5>SENSOR ADJ.

4. Press the **[PAUSE]** key to enter the Sensor Adjustment Mode.

<5>SENSOR ADJ.
[H]28°C [A]28°C

The Sensor Adjustment Mode contains sub menus for displaying the current status of each sensor and for storing “media level” voltage and “no media level” voltage. Each time the **[PAUSE]** key is pressed, the sub menus are displayed sequentially.

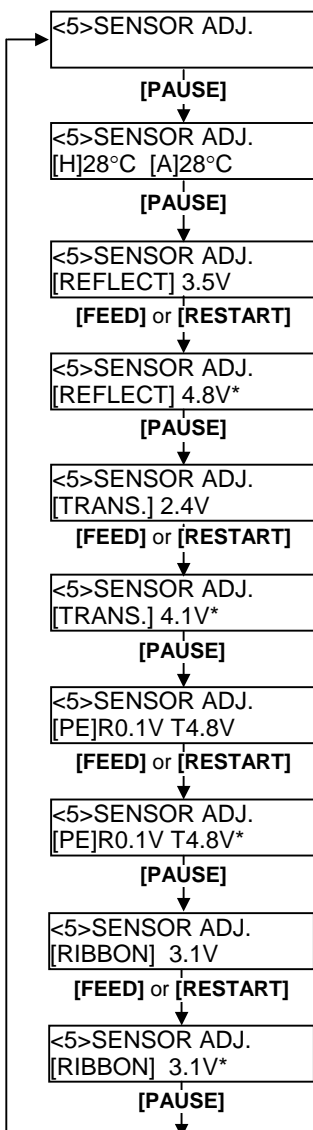

- (1) **Sensor Status Display:**
Temperatures being detected by the Print Head Thermistor and the Ambient Thermistor are displayed.
- (2) **Black Mark Sensor Status Display:**
Voltage being detected by the Black Mark Sensor is displayed.
- (3) **Black Mark Sensor Adjustment:**
Using the media actually used, a “media level” voltage is stored.
- (4) **Feed Gap Sensor Status Display:**
Voltage being detected by the Feed Gap Sensor is displayed.
- (5) **Feed Gap Sensor Adjustment:**
Using the media actually used, a “media level” voltage is stored.
- (6) **Black Mark Sensor/Feed Gap Sensor Status Display (No media):**
“No media level” voltage detected by the Black Mark Sensor/Feed Gap Sensor is displayed.
- (7) **Black Mark Sensor/Feed Gap Sensor Adjustment (No media):**
“No media level” voltage is stored.
- (8) **Ribbon End Sensor Status Display:**
Voltage being detected by the Ribbon End Sensor is displayed.
- (9) **Ribbon End Sensor Adjustment:**
Using the ribbon actually used, a “ribbon level” voltage is stored.

2.13 Threshold Setting (Cont.)

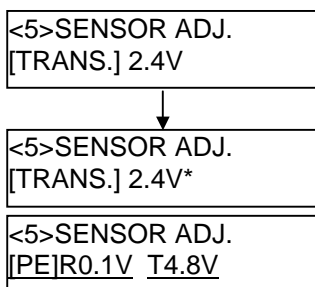
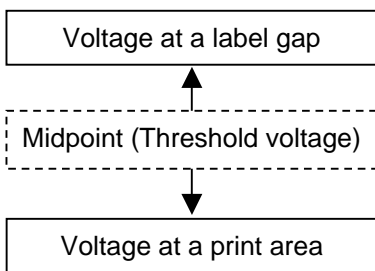
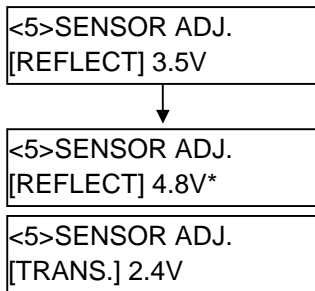
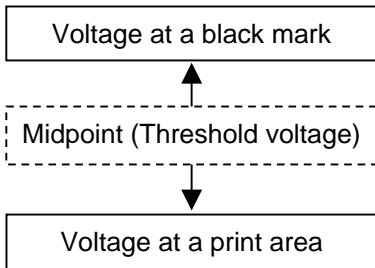

■ When using the Black Mark Sensor

- (1) While “<5>SENSOR ADJ.” is displayed, press the **[PAUSE]** key until the message appears.
The displayed value is a real-time voltage being detected by the Black Mark Sensor.

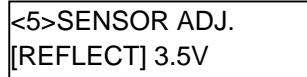

- (2) Measure a voltage at a blank part of media and a black mark, respectively. At this time, write down the midpoint between both voltages. (This value is used later for a threshold setting.)

(Example)

Print area = 4.8V, Black mark = 2.4V → Midpoint = 3.6V

NOTES:

1. When measuring a voltage of a blank area, be careful not to align a pre-print with the sensor by mistake.
2. Confirm that there is at least 0.7V difference between the two values. If the difference in voltage is less than 0.7V, a print start position cannot be detected. In that case, please consider changing the media type.
3. Make sure that the Top Cover is closed when measuring the voltages.

- (3) Press and hold the **[RESTART]** or **[FEED]** key for about 3 seconds aligning a blank part of print area with the Black Mark Sensor.

- (4) When storing a “media level” voltage is completed, an asterisk “*” is displayed on the right side of a voltage. Press the **[PAUSE]** key.

- (5) A real-time voltage being detected by the Feed Gap Sensor is displayed.

■ When using the Feed Gap Sensor

- (1) Measure a voltage at a blank part of label and a label gap, respectively. At this time, write down the midpoint of both voltages. (This value is used later for a threshold setting.)

(Example)

Print area = 2.4V, Gap = 4.0V → Midpoint = 3.2V

NOTES:

1. When measuring a voltage at a blank area, be careful not to align a pre-print with the sensor by mistake.
2. Confirm that there is at least 0.7V difference between the two values. If the difference in voltage is less than 0.7V, a print start position cannot be detected. In that case, please consider changing the media type.
3. Make sure that the Top Cover is closed when measuring the voltages.

- (2) Press and hold the **[RESTART]** or **[FEED]** key for about 3 seconds aligning a blank part of print area with the Feed Gap Sensor.

- (3) When storing a “media level” voltage is completed, an asterisk “*” is displayed on the right side of a voltage. Press the **[PAUSE]** key.

- (4) The display changes as shown on the left.

2.13 Threshold Setting (Cont.)

■ Storing a “No Media Level” Voltage

The following is how to set a “No media level” voltage that is used to detect a paper end.

If a “NO PAPER” is displayed even if the media has not run out yet, this voltage needs to be set again.

- (1) Remove any media from the Black Mark Sensor/Feed Gap Sensor.
- (2) A real-time voltages being detected by the Black Mark Sensor and Feed Gap Sensor are displayed.

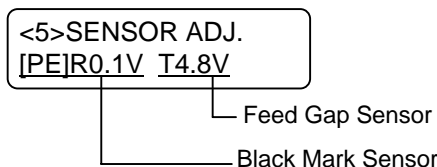

- (3) Press and hold the **[RESTART]** or **[FEED]** key for about 3 seconds.

<5>SENSOR ADJ.
 [PE]R0.1VT4.8V*

- (4) When storing a “no media level” voltage is completed, an asterisk “*” is displayed on the right side of a voltage. Press the **[PAUSE]** key.

- (5) The message returns to “<5>SENSOR ADJ.”.

<5>SENSOR ADJ.

■ Manual Threshold Setting

Then, set the calculated threshold voltage in the Parameter Fine Adjustment mode.

- (1) While “<5>SENSOR ADJ.” is displayed, press the **[FEED]** or **[RESTART]** key until “<3>ADJUST SET” is displayed.

<3>ADJUST SET

- (2) Press the **[PAUSE]** key to enter the Parameter Fine Adjustment Mode.

<3> ADJUST SET
 FEED ADJ.+10.0mm

2.13 Threshold Setting (Cont.)

(3) Press the **[PAUSE]** key until the target sensor type is displayed.

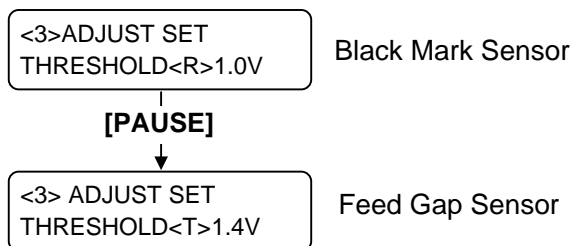

(4) Set a threshold voltage (calculated in Sensor Adjustment Menu) by using the **[FEED]** or **[RESTART]** key, as shown below.

Threshold voltage = Midpoint between voltage at a print area and voltage at a gap/black mark

Black Mark Sensor

Feed Gap Sensor

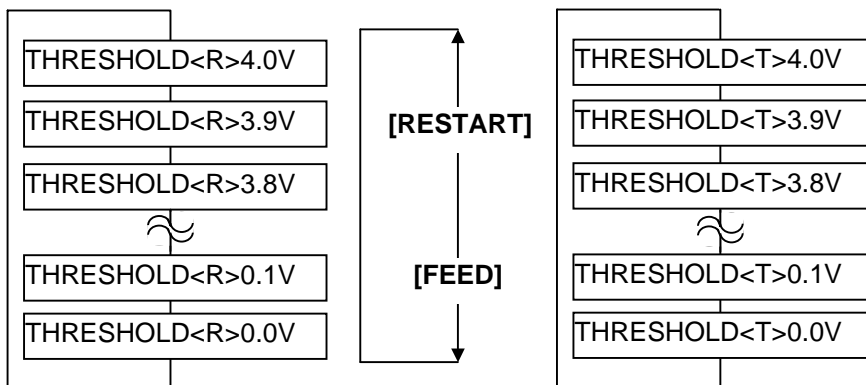

NOTE:
 Pressing the **[FEED]** key one time causes a $-0.1V$ change, up to $0.0V$.
 Pressing the **[RESTART]** key one time causes a $+0.1V$ change, up to $+4.0V$.

(5) After choosing a threshold voltage, press the **[PAUSE]** key.

(6) To check for a proper operation, issue the pre-printed media in online. If an error still occurs even after a manual threshold setting, change the threshold voltage a little, and retry.

3. ON LINE MODE

This chapter describes usage of the keys on the Operation Panel in On Line mode.

When the printer is in On Line mode and connected to a host computer, the normal operation of printing images on labels or tags can be accomplished.

3.1 Operation Panel

- The figure below illustrates the operation panel and key functions.

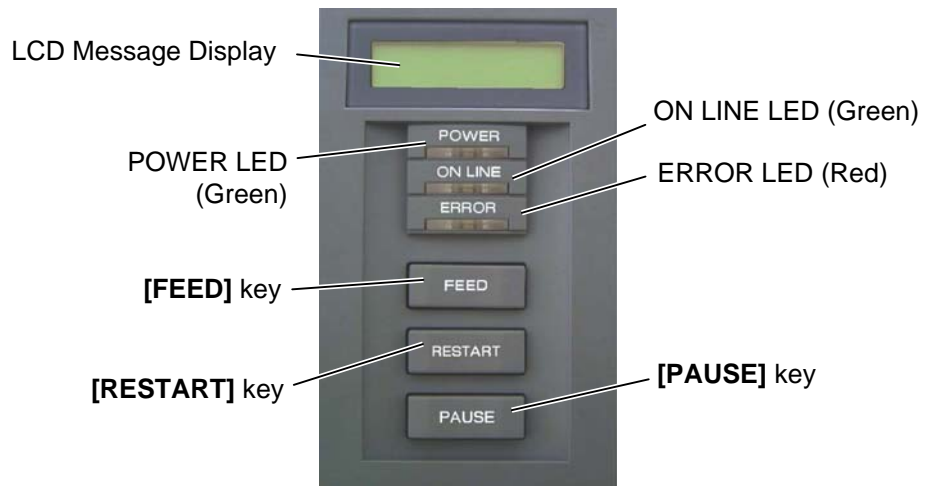

The LCD Message Display shows messages in alphanumeric characters and symbols to indicate the printer's current status. Up to 32 characters can be displayed on two lines.

There are three LED lights on the operation panel.

LED	Illuminates when...	Flashes when...
POWER	The printer is turned on.	-----
ON LINE	The printer is ready to print.	The printer is communicating with your computer.
ERROR	Any error occurs with the printer.	The ribbon is nearly over. (See NOTE.)

NOTE:
Flashes only when the Ribbon Near End Detection function is selected.

NOTE:
Use the **[RESTART]** key to resume printing after a pause, or after clearing an error.

There are three keys on the operation panel.

PAUSE	Used to stop printing temporarily.
RESTART	Used to restart printing.
FEED	Used to feed the media.

3.2 Operation

When the printer is turned on, the "ON LINE" message appears on the LCD Message Display. It is shown during standby or normal printing.

1. The printer is turned on, standing by, or printing.

```
ON LINE
B-SX4T V1.0A
```

2. If any error occurs during printing, an error message appears. The printer stops printing automatically. (The number on the right side shows the remaining number of media to be printed.)

```
NO PAPER 125
B-SX4T V1.0A
```

3. To clear the error, press the **[RESTART]** key. The printer resumes printing.

```
ON LINE
B-SX4T V1.0A
```

4. If the **[PAUSE]** key is pressed during printing, the printer stops printing temporarily. (The number on the right side shows the remaining number of media to be printed.)

```
PAUSE 52
B-SX4T V1.0A
```

5. When the **[RESTART]** key is pressed, the printer resumes printing.

```
ON LINE
B-SX4T V1.0A
```

NOTE:
For the meaning of error messages and actions to be taken, refer to **Section 5 TROUBLESHOOTING** and **APPENDIX 1**.

3.3 Reset

A reset operation clears the print data sent from the computer to the printer, and returns the printer to an idle condition.

1. The printer is turned on, standing by, or printing.

```
ON LINE
B-SX4T V1.0A
```

2. To stop printing, or clear the data sent from the computer, press the **[PAUSE]** key. The printer stops printing.

```
PAUSE 52
B-SX4T V1.0A
```

3. Press and hold the **[RESTART]** key for 3 seconds or longer.

```
<1>RESET
```

4. Press the **[PAUSE]** key. The data sent from the computer will be cleared, and the printer returns to an idle condition.

```
ON LINE
B-SX4T V1.0A
```

NOTE:
If the **[RESTART]** key is held for less than 3 seconds when the printer is in an error or pause state, the printer restarts printing. However, when a communication error or command error occurs, the printer returns to an idle condition.

4. MAINTENANCE

WARNING!

1. Be sure to disconnect the power cord before performing maintenance. Failure to do this may cause an electric shock.
2. To avoid injury, be careful not to pinch your fingers while opening or closing the cover and print head block.
3. The print head becomes hot immediately after printing. Allow it to cool before performing any maintenance.
4. Do not pour water directly onto the printer.

This chapter describes how to perform routine maintenance.

To ensure the continuous high quality operation of the printer, you should perform a regular maintenance routine. For high throughput it should be done on a daily basis. For low throughput it should be done on a weekly basis.

4.1 Cleaning

To maintain the printer performance and print quality, please clean the printer regularly, or whenever the media or ribbon is replaced.

4.1.1 Print Head/Platen/Sensors

CAUTION!

1. Do not use any volatile solvent including thinner and benzene, as this may cause discoloration to the cover, print failure, or breakdown of the printer.
2. Do not touch the Print Head Element with bare hands, as static may damage the Print Head.

1. Turn off the power and unplug the printer.
2. Open the Top Cover.
3. Turn the Head Lever to **Free** position, then release the Ribbon Shaft Holder Plate.
4. Open the Print Head Block.
5. Remove the ribbon and media.

CAUTION!

When cleaning the print head, be careful not to damage the print head with a hard object like a watch or a ring.

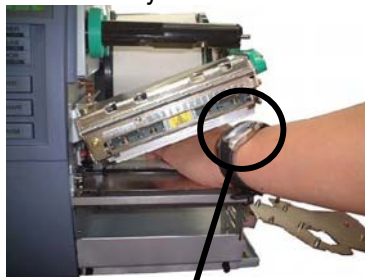

Care must be taken not to allow the metal or glass part of a watch to touch the print head edge.

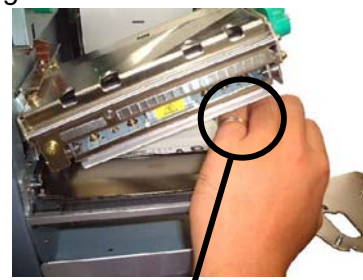

Care must be taken not to allow a metal object like a ring to touch the print head edge.

Since the print head element can be easily damaged by shock, please treat it carefully by not hitting a hard object against it.

4.1.1 Print Head/Platen/Sensors (Cont.)

NOTE:

Please purchase the Print Head Cleaner (P/No. 24089500013) from your authorised TOSHIBA TEC service representative.

6. Clean the Print Head Element with a Print Head Cleaner or a cotton swab or soft cloth slightly moistened with alcohol.

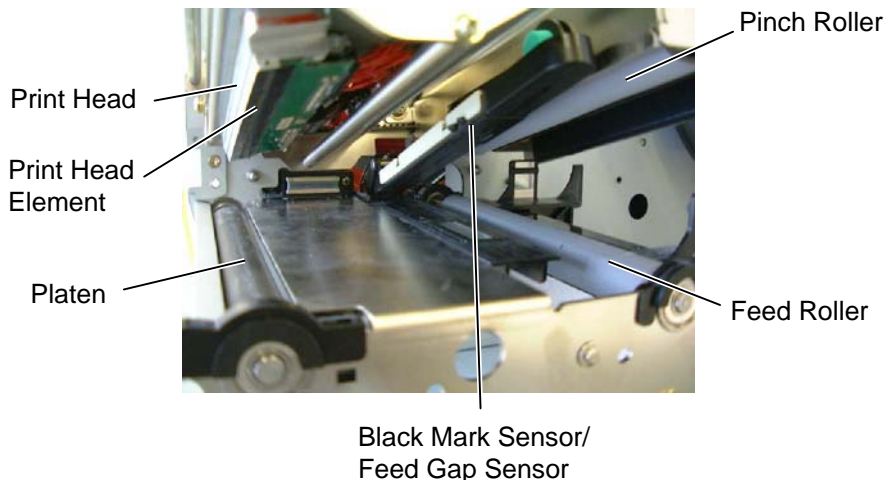

7. Wipe the Platen, Feed Roller, and Pinch Roller with a soft cloth slightly moistened with alcohol. Remove dust or foreign substances from the internal part of the printer.
8. Wipe the Feed Gap Sensor and Black Mark Sensor with a dry soft cloth.

4.1.2 Covers and Panels

CAUTION!

1. DO NOT POUR WATER directly onto the printer.
2. DO NOT APPLY cleaner or detergent directly onto any cover or panel.
3. NEVER USE THINNER OR OTHER VOLATILE SOLVENT on the plastic covers.
4. DO NOT clean the panel, covers, or the supply window with alcohol as it may cause them to discolour, loose their shape or develop structural weakness.

Wipe the covers and panels with a dry soft cloth or a cloth slightly moistened with mild detergent solution.



4.1.3 Optional Cutter Module

The swing cutter and rotary cutter are available as an option. They are both cleaned in the same way. When removing the Cutter Cover of the rotary cutter unit, remove the screws from the bottom of the cover.

WARNING!

1. Be sure to turn the power off before cleaning the Cutter Module.
2. As the cutter blade is sharp, care should be taken not to injure yourself when cleaning.

1. Loosen the two screws to remove the Cutter Cover.
2. Remove the Plastic Head Screw to detach the Media Guide.
3. Remove the jammed paper.
4. Clean the Cutter with a soft cloth slightly moistened with alcohol.
5. Reassemble the Cutter Module in the reverse order of removal.

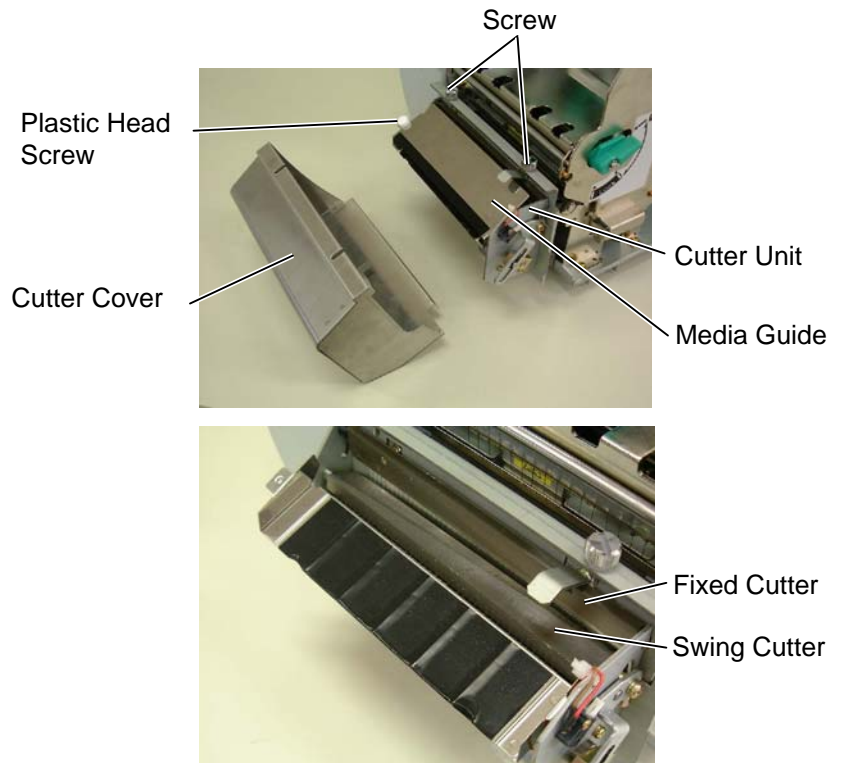

5. TROUBLESHOOTING

This chapter lists the error messages, possible problems, and their solutions.

WARNING!

If a problem cannot be solved by taking the actions described in this chapter, do not attempt to repair the printer. Turn off and unplug the printer, then contact an authorised TOSHIBA TEC service representative for assistance.

5.1 Error Messages

NOTES:

- *If an error is not cleared by pressing the **[RESTART]** key, turn the printer off and then on.*
- *After the printer is turned off, all print data in the printer is cleared.*
- *“****” indicates the number of unprinted media. Up to 9999 (in pieces).*

Error Messages	Problems/Causes	Solutions
HEAD OPEN	The Print Head Block is opened in Online mode.	Close the Print Head Block.
HEAD OPEN ****	Feeding or printing has been attempted with the Print Head Block open.	Close the Print Head Block. Then press the [RESTART] key.
COMMS ERROR	A communication error has occurred.	Make sure the interface cable is correctly connected to the printer and the host, and the host is turned on.
PAPER JAM ****	1. The media is jammed in the media path. The media is not fed smoothly.	1. Remove the jammed media, and clean the Platen. Then reload the media correctly. Finally press the [RESTART] key. ⇒ Section 5.3.
	2. A wrong Media Sensor is selected for the media being used.	2. Turn the printer off and then on. Then select the Media Sensor for the media being used. Finally resend the print job.
	3. The Black Mark Sensor is not correctly aligned with the Black Mark on the media.	3. Adjust the sensor position. Then press the [RESTART] key. ⇒ Section 2.4.
	4. Size of the loaded media is different from the programmed size.	4. Replace the loaded media with one that matches the programmed size then press the [RESTART] key, or turn the printer off and then on, select a programmed size that matches the loaded media. Finally resend the print job.
	5. The Feed Gap Sensor cannot distinguish the print area from a label gap.	5. Refer to Section 2.13 to set the threshold. If this does not solve the problem, turn off the printer, and call a TOSHIBA TEC authorised service representative.

5.1 Error Messages (Cont.)

Error Messages	Problems/Cause	Solutions
CUTTER ERROR **** (Only when the cutter module is installed on the printer.)	The media is jammed in the cutter.	Remove the jammed media. Then press the [RESTART] key. If this does not solve the problem, turn off the printer, and call a TOSHIBA TEC authorised service representative. ⇒ Section 4.1.3.
NO PAPER ****	1. The media has run out.	1. Load new media. Then press the [RESTART] key. ⇒ Section 2.4.
	2. The media is not loaded properly.	2. Reload the media correctly. Then press the [RESTART] key. ⇒ Section 2.4.
	3. The media is slack.	3. Take up any slack in the media.
RIBBON ERROR ****	The ribbon is not fed properly.	Remove the ribbon, and check the status of the ribbon. Replace the ribbon, if necessary. If the problem is not solved, turn off the printer, and call a TOSHIBA TEC authorised service representative.
NO RIBBON ***	The ribbon has run out.	Load a new ribbon. Then press the [RESTART] key. ⇒ Section 2.5.
REWIND FULL ****	The Built-In Rewinder Unit is full.	Remove the backing paper from the Built-In Rewinder Unit. Then press the [RESTART] key.
EXCESS HEAD TEMP	The Print Head has overheated.	Turn off the printer, and allow it to cool down (about 3 minutes). If this does not solve the problem, call a TOSHIBA TEC authorised service representative.
HEAD ERROR	There is a problem with the Print Head.	Replace the Print Head.
POWER FAILURE	A momentary power failure has occurred.	Check the power source which supplies power to the printer. If the rating is not correct, or if the printer shares the same power outlet with other electrical appliances that consume large amounts of power, change the outlet.
SYSTEM ERROR	1. The printer is used in a location where it is subject to noise. Or, there are power cords of other electrical appliances near the printer or interface cable.	1. Keep the printer and the interface cables away from the source of noise
	2. The Power Cord of the printer is not grounded.	2. Ground the Power Cord.
	3. The printer shares the same power source with any other electrical appliances.	3. Provide an exclusive power source for the printer.
	4. An application software used on your host computer has an error or malfunction.	4. Confirm the host computer operates properly.
FLASH WRITE ERR.	An error has occurred in writing to the flash ROM.	Turn the printer off, and then on again.

5.1 Error Messages (Cont.)

Error Messages	Problems/Cause	Solutions
FORMAT ERROR	An error has occurred in formatting the flash ROM.	Turn the printer off, and then on again.
FLASH CARD FULL	Saving failed because of an insufficient capacity of the flash ROM.	Turn the printer off, and then on again.
EEPROM ERROR	Data cannot be read from/written to a backup EEPROM properly.	Turn the printer off, and then on again.
RFID WRITE ERROR	The printer did not succeed in writing data onto an RFID tag after having retried for a specified times.	Press the [RESTART] key.
RFID ERROR	The printer cannot communicate with the RFID module.	Turn the printer off, and then on again.
SYNTAX ERROR	While the printer is in the Download mode for upgrading the firmware, it receives an improper command, for example, a Issue Command.	Turn the printer off, and then on again.
Other error messages	A hardware or software problem may have occurred.	Turn the printer off and then on. If this does not solve the problem, turn off the printer again, and call a TOSHIBA TEC authorised service representative.

5.2 Possible Problems

This section describes problems that may occur when using the printer, and their causes and solutions.

Possible Problems	Causes	Solutions
The printer will not turn on.	1. The Power Cord is disconnected.	1. Plug in the Power Cord.
	2. The AC outlet is not functioning correctly.	2. Test with a power cord from another electric appliance.
	3. The fuse has blown, or the circuit breaker has tripped.	3. Check the fuse or breaker.
The media is not fed.	1. The media is not loaded properly.	1. Load the media properly. ⇒ Section 2.4.
	2. The printer is in an error condition.	2. Solve the error in the message display. (See Section 5.1 for more detail.)
Pressing the [FEED] key in the initial state results in an error.	A feed or an issue was attempted not on the following default conditions. Sensor type: Feed gap sensor Printing method: Thermal transfer Media pitch: 76.2 mm	Change the print condition by using the printer driver or a print command so that it corresponds to your printing conditions. Then, clear the error state by pressing the [RESTART] key.
Nothing is printed on the media.	1. The media is not loaded properly.	1. Load the media properly. ⇒ Section 2.4.
	2. The ribbon is not loaded properly.	2. Load the ribbon properly. ⇒ Section 2.5.
	3. The print head is not installed properly.	3. Install the print head properly. Close the Print Head Block.
	4. The ribbon and media are not matched.	4. Select an appropriate ribbon for the media type being used.

5.2 Possible Problems (Cont.)

Possible Problems	Causes	Solutions
The printed image is blurred.	1. The ribbon and media are not matched.	1. Select an appropriate ribbon for the media type being used.
	2. The Print Head is not clean.	2. Clean the print head using the Print Head Cleaner or a cotton swab slightly moistened with ethyl alcohol.
The cutter does not cut.	1. The Cutter Cover is not attached properly.	1. Attach the Cutter Cover properly.
	2. The media is jammed in the Cutter.	2. Remove the jammed paper. ⇒ Section 4.1.3.
	3. The cutter blade is dirty.	3. Clean the cutter blade. ⇒ Section 4.1.3.
The Strip Module does not remove labels from the backing paper.	Label stock is too thin or the glue is too sticky.	1. Refer to Section 7.1 Media and change the label.
		2. Set the Pre-strip function to ON. ⇒ Section 2.9.1.

5.3 Removing Jammed Media

This section describes in detail how to remove jammed media from the printer.

CAUTION!
Do not use any tool that may damage the Print Head.

1. Turn off and unplug the printer.
2. Open the Top Cover.
3. Turn the Head Lever to **Free** position, then open the Ribbon Shaft Holder Plate.
4. Open the Print Head Block.
5. Remove the ribbon and media.

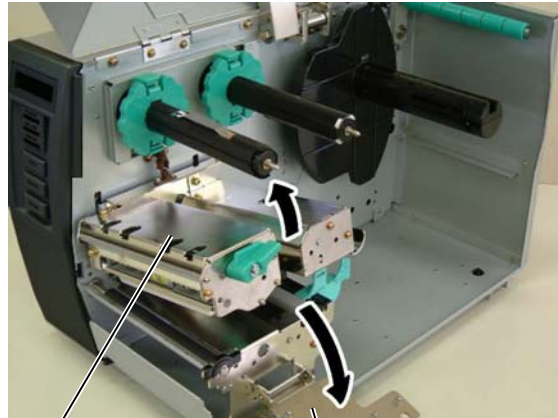

Print Head Block

Ribbon Shaft Holder Plate

6. Remove the jammed media from the printer. **DO NOT USE** any sharp implements or tools as these could damage the printer.
7. Clean the Print Head and Platen, then remove any further dust or foreign substances.
8. Paper jams in the Cutter Unit can be caused by wear or residual glue from label stock on the cutter. Do not use non-specified media in the cutter.

NOTE:
If you get frequent jams in the cutter, contact a TOSHIBA TEC authorised service representative.

CAUTION!

When removing the jammed media, be careful not to damage the print head with a hard object like a watch or a ring.

Care must be taken not to allow the metal or glass part of a watch to touch the print head edge.

Care must be taken not to allow a metal object like a ring to touch the print head edge.

Since the print head element can be easily damaged by shock, please treat it carefully by not hitting a hard object against it.

6. PRINTER SPECIFICATIONS

This section describes the printer specifications.

Item		Model	B-SX4T-GS20-QM-R
Dimension (W × D × H)			291 mm × 460 mm × 308 mm (11.5" × 18.1" × 12.1")
Weight			39.7 lb (18 kg) (Media and ribbon are not included.)
Operating temperature range			5°C to 40°C (40°F to 104°F)
Relative humidity			25% to 85% RH (no condensation)
Power supply			Universal switching power source AC100V to 240V, 50/60Hz±10%
Input voltage			AC100 – 240V, 50/60 Hz ±10%
Power consumption	During a print job		100V: 2.5 A, 130 W maximum 240V: 1.1 A, 138 W maximum
	During standby		100V: 0.18 A, 11 W maximum 240V: 0.17 A, 20 W maximum
Resolution			8 dots/mm (203 dpi)
Printing method			Thermal transfer or Thermal direct
Printing speed			76.2 mm/sec. (3 inches/sec.) 152.4 mm/sec (6 inches/sec.) 254.0 mm/sec (10 inches/sec.) } For details, refer to Section 7.1.1.
Available media width (including backing paper)			30.0 mm to 112.0 mm (1.2 inches to 4.4 inches)
Effective print width (max.)			104.0 mm (4.1 inches)
Issue mode			Batch Strip (Strip mode is enabled only when the optional Strip Module is installed.) Cut (Cut mode is enabled only when the optional Cutter Module is installed.)
LCD Message display			16 characters × 2 lines

Item \ Model	B-SX4T-GS20-QM-R
Available bar code types	JAN8, JAN13, EAN8, EAN8+2 digits, EAN8+5 digits, EAN13, EAN13+2 digits, EAN13+5 digits, UPC-E, UPC-E+2 digits, UPC-E+5 digits, UPC-A, UPC-A+2 digits, UPC-A+5 digits, MSI, ITF, NW-7, CODE39, CODE93, CODE128, EAN128, Industrial 2 to 5, Customer Bar Code, POSTNET, KIX CODE, RM4SCC (ROYAL MAIL 4STATE CUSTOMER CODE), RSS14
Available two-dimensional code	Data Matrix, PDF417, QR code, Maxi Code, Micro PDF417, CP Code
Available font	Times Roman (6 sizes), Helvetica (6 sizes), Presentation (1 size), Letter Gothic (1 size), Prestige Elite (2 sizes), Courier (2 sizes), OCR (2 types), Gothic (1 size), Outline font (4 types), Price font (3 types)
Rotations	0°, 90°, 180°, 270°
Standard interface	Serial interface (RS-232C) Parallel interface (Centronics)
Optional interface	PCMCIA interface (B-9700-PCM-QM-R) USB interface (B-9700-USB-QM-R) LAN interface (B-9700-LAN-QM-R) Expansion I/O interface (B-7704-IO-QM-R) Wireless LAN board (B-9700-WLAN-QM-R)

NOTES:

- *Data Matrix™* is a trademark of International Data Matrix Inc., U.S.
- *PDF417™* is a trademark of Symbol Technologies Inc., US.
- *QR Code* is a trademark of DENSO CORPORATION.
- *Maxi Code* is a trademark of United Parcel Service of America, Inc., U.S.

7. SUPPLY SPECIFICATIONS

7.1 Media

Please make sure that the media being used is approved by TOSHIBA TEC. The warranty does not apply when a problem is caused by using media that is not approved by TOSHIBA TEC.

For information regarding TOSHIBA TEC approved media, please contact a TOSHIBA TEC authorised service representative.

7.1.1 Media Type

Two types of media can be loaded for this thermal transfer and direct thermal printer: label or tag. The table below shows size and shape of the media available for this printer.

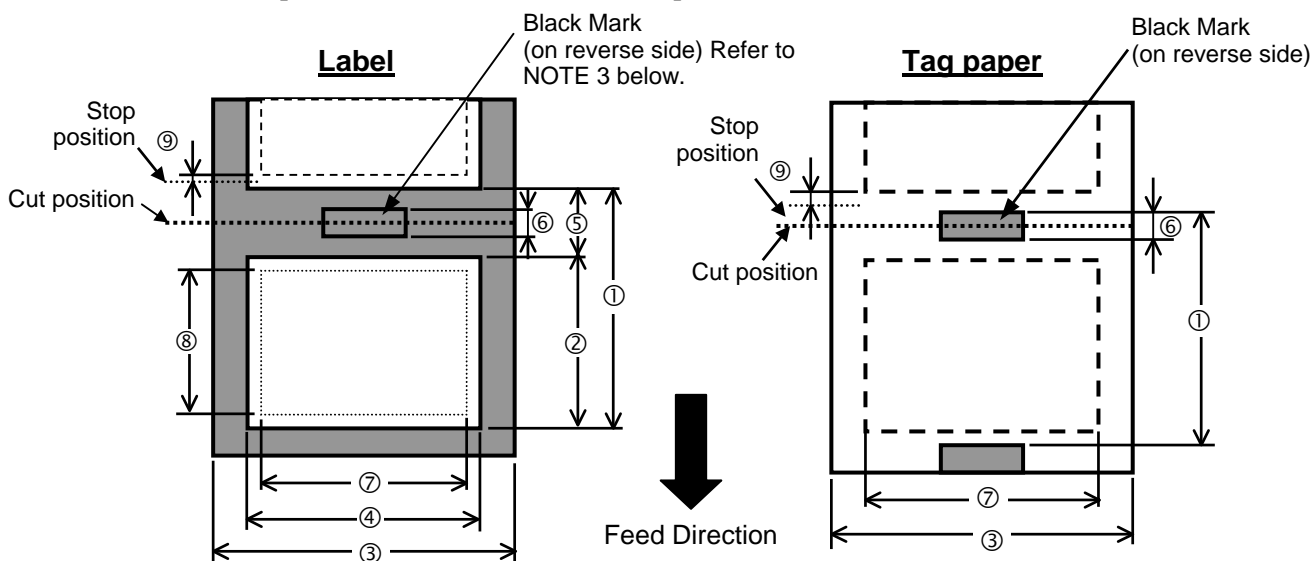

[Unit: mm]

Item	Label dispensing mode	Batch mode	Strip mode	Cut mode	
				Rotary cutter (*2)	Swing cutter
① Media pitch	Label	10.0 – 1500.0	25.4 – 1500.0	3"/sec., 6"/sec.: 38.0 - 1500.0	38.0 – 1500.0
	Tag	10.0 – 1500.0	---	3"/sec., 6"/sec.: 30.0 – 1500.0	25.4 – 1500.0
② Label length		8.0 – 1498.0	23.4 – 1498.0	3"/sec., 6"/sec.: 32.0 – 1494.0	25.0 – 1494.0(*1)
③ Width including backing paper (See NOTE 5.)		30.0 – 112.0	50.0 – 112.0	30.0 – 112.0	
④ Label width (See NOTE 5.)		27.0 – 109.0	47.0 – 109.0	27.0 – 109.0	
⑤ Gap length		2.0 – 20.0		6.0 – 20.0	
⑥ Black mark length (Tag paper)		2.0 – 10.0			
⑦ Effective print width		10.0 – 104.0			
⑧ Effective print length	Label	6.0 – 1496.0	21.4 – 1496.0	3"/sec., 6"/sec.: 30.0 – 1492.0	23.0 – 1492.0
	Tag	8.0 – 1498.0	---	3"/sec., 6"/sec.: 28.0 – 1496.0	23.0 – 1496.0
⑨ Print speed up/slow down area		1.0			
Thickness	Label	0.13 – 0.17			
	Tag	0.15 – 0.29			
Maximum effective length for on the fly issue		1361.0			
Maximum outer roll diameter		Ø200			
Roll direction		Inside			
Inner core diameter		Ø76.2±0.3			

NOTES:

1. To ensure print quality and print head life use only TOSHIBA TEC specified media.
2. The media length specifications for use of the cutter are:
 - *1: When issuing a label using the swing cutter, label length should be $35.0 \text{ mm} - (\text{Gap length}/2)$.
 - *2: The rotary cutter does not support the print speed of $10''/\text{sec}$.
When using the Rotary Cutter, be sure to install the Ribbon Saving Module (B-9904-R/R2 series). Failure to do this may cause a paper jam or ribbon error.
3. When marking black marks on the label rolls, they should be marked at the gaps.
4. "On the fly issue" means that the printer can feed and print without stopping between labels.
5. There are restrictions in use of the media which is narrower than 50 mm. For details, refer to TOSHIBA TEC service representative.
6. The ratio of a label length to a gap length must be a minimum of 3 to 1 (3:1).
7. When using a label stock in cut mode, be sure to cut the gaps. Cutting labels will cause the glue to stick to the cutter, which may affect the cutter performance and shorten the cutter life.

7.1.2 Detection Area of the Transmissive Sensor

The Transmissive Sensor is movable from the centre to the left edge of media.
The Transmissive Sensor detects a gap between labels, as illustrated below.

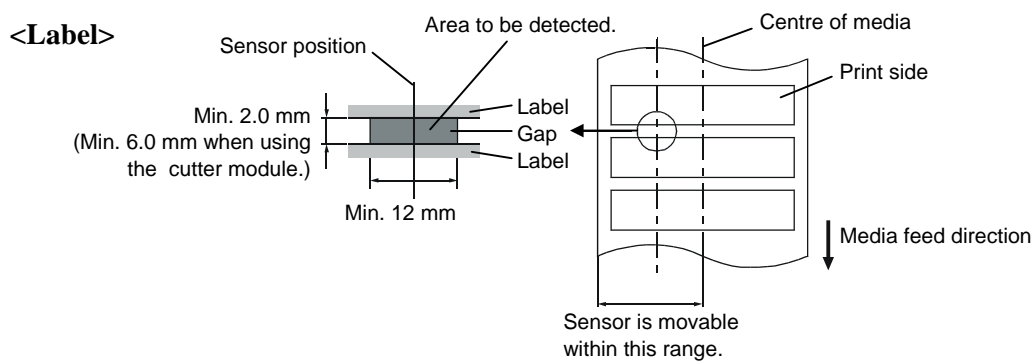
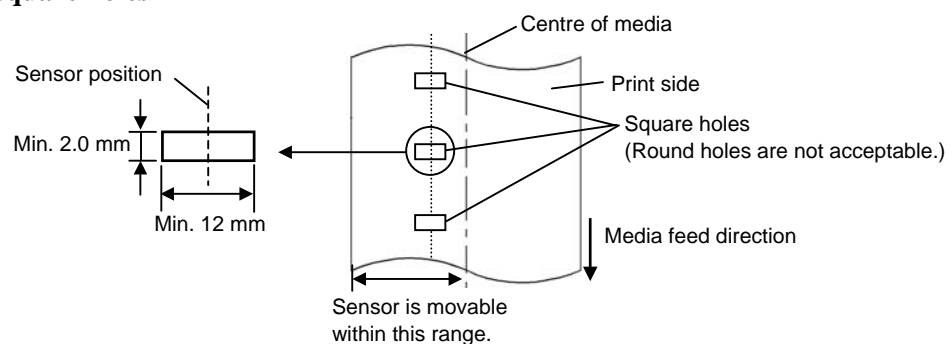
**<Tag paper with square holes>****NOTE:**

Round holes are not acceptable.

7.1.3 Detection Area of the Reflective Sensor

The Reflective Sensor is movable from the centre to the left edge of media.

The reflection factor of the Black Mark must be 10% or lower with a waveform length of 950 nm.

The Reflective Sensor should be aligned with the centre of the Black Mark.

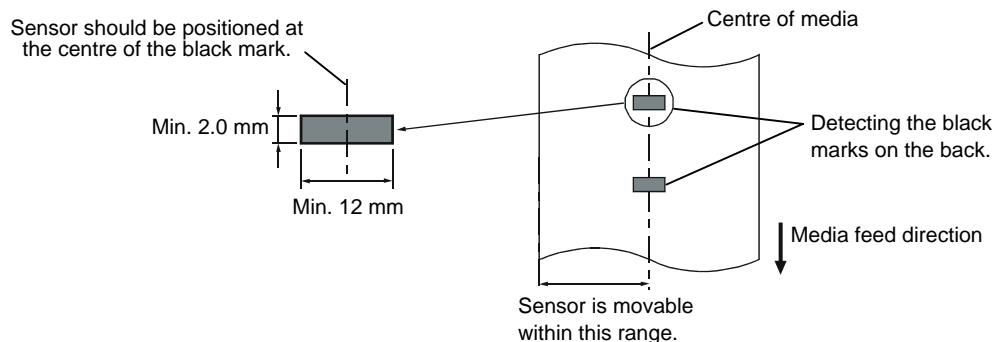

7.1.4 Effective Print Area

The figure below illustrates the relation between the head effective print width and media width.

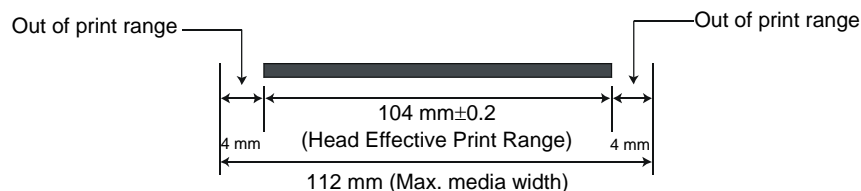

The figure below shows the effective print area on the media.

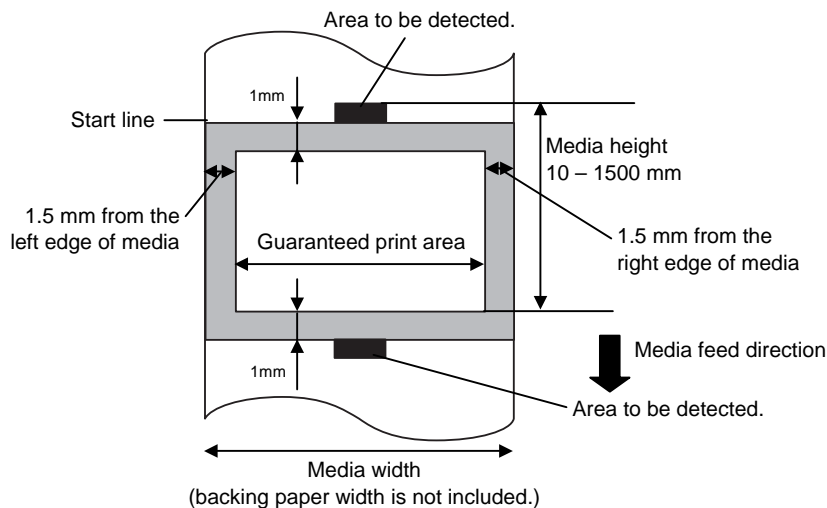

NOTES:

1. Be sure not to print on the 1.5-mm wide area from the media edges (shaded area in the above figure). Printing this area may cause ribbon wrinkles, resulting in a poor print quality of the guaranteed print area.
2. The centre of media is positioned at the centre of the Print Head.
3. Print quality in the 3-mm area from the print head stop position (including 1-mm non-printable area for print speed slow down) is not guaranteed.

7.1.5 RFID Tags

Available RFID tag types are different depending on the RFID modules, as follows:

■ **B-9704-RFID-U1-US-R and B-9704-RFID-U1-EU-R**

- EPC Class 1
- ISO18000-6B

■ **B-9704-RFID-H1-QM-R**

- TAGSYS C210
- TAGSYS C220
- TAGSYS C240
- I-Code
- Tag-it
- ISO15693

Cautions for using RFID Tags

(1) Lift-up of Print Head

An RFID tag chip or the print head may be damaged when the print head passes over the chip.

This can be prevented by using the ribbon saving module (standard feature for the B-SX5T and optional for the B-SX4T). The print head is lifted by the ribbon saving module when it passes over the chip to prevent it from touching the chip.

The print head is lifted by approximately 1 mm from the platen.

(2) Storage of RFID Supplies

Do not store RFID tags close to printers, or their communication performance may not be as specified when they are used.

(3) Roll-type RFID Supplies

When RFID supplies are to be rolled, roll hardness must be concerned.

Although it depends on the type of glue, tag, and backing paper, RFID-tag embedded labels tend to stay rolled. Especially, when they are wound outside, a paper jam error may occur. Unless otherwise specified, it is recommended that the RFID-tag embedded labels be wound inside.

(4) Sensor

When the transmissive sensor or reflective sensor is enabled, transmissivity or reflectivity of a label or tag may vary at an RFID-tag embedded area depending on the pattern of an antenna or other factors. In such cases, a manual threshold setting is required. For details, refer to **Section 2.13 Threshold Setting**.

(5) Cutter

When an RFID label or tag is used in cut issue mode, care must be taken not to cut an antenna of the RFID tag or an IC chip in order not to damage the cutter.

(6) Static Electricity

When printing is performed in a place where humidity is low or under some specific conditions, writing data on an RFID tag may fail due to static electricity generated by a label or a ribbon.

(7) Printing on Bump (Chip/Antenna) Area

Embedding an RFID tag in labels creates bumps on the label surface, causing incomplete printing. Uneven printing or incomplete printing can occur easily, especially within 5 mm back and forth, and right and left sides of the RFID-tag embedded area, as shown in the figure below.

NOTE: The degree of poor printing quality differs depending on height of a chip/antenna used.

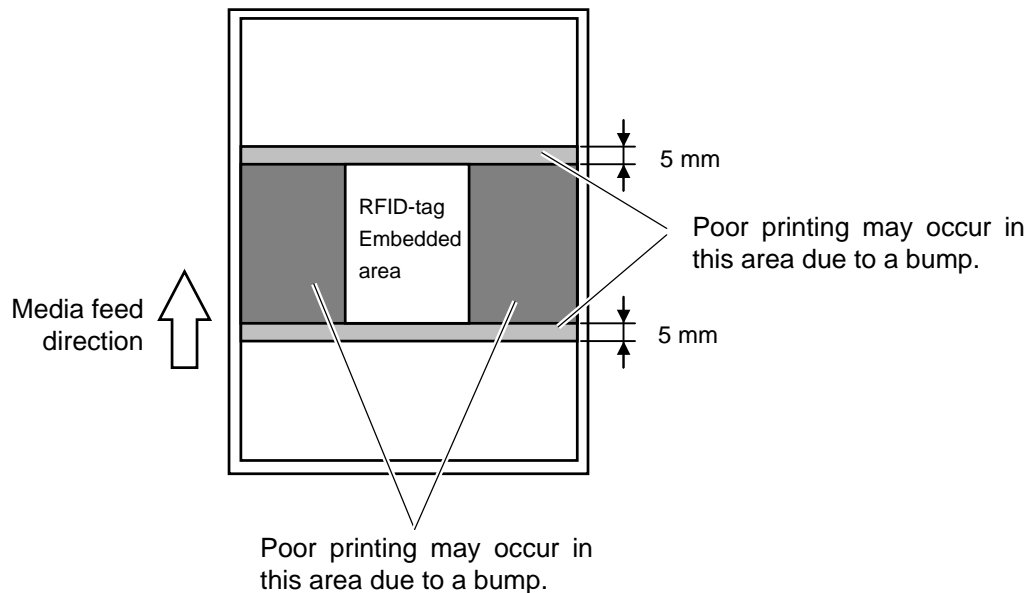

(8) Ambient Temperature

As low temperature deteriorates wireless performance, writing data on an RFID tag may fail under such conditions.

(9) Head-up Reverse Feed

When an RFID label is used, a reverse feed may be required before an issue depending on the location of an RFID tag in the label.

A printer without the ribbon saving module may not be able to perform a reverse feed properly because the print head may be caught by an edge of the label. For this reason, the ribbon saving module must be installed in the printer when media, which requires a reverse feed before an issue, is used.

(10) Strip Issue

Stripping performance in strip issue mode depends on the type of glue, tag, and backing paper. For some RFID supplies used, a strip issue may not be performed properly.

(11) Caution for Minimum Label Pitch Length

When media, of which label pitch length is short, is used, data may be written on an RFID tag next to the target RFID tag.

As the location, where data is to be written, differs among RFID tag types, a check must be performed to make sure that the data is written on the target RFID tags. The B-SX RFID Analyze Tool can be used for this purpose. For details, please contact the nearest TOSHIBA TEC support representative.

(12) Defective RFID Supply

RFID supplies may include defective RFID tags at the time of shipment from the maker. The defect rate differs depending on tag types, method of converting to supplies, etc.

The RFID supply manufacturer should provide a way to identify defective tags by printing a mark on them or any other methods.

Or, defective tags should be rejected in the production process.

The end users must be notified on how to identify a defective tag from a good one.

7.2 Ribbon

Please make sure that the ribbon being used is approved by TOSHIBA TEC. The warranty does not apply to any problem caused by using non-approved ribbons.

For information regarding TOSHIBA TEC approved ribbon, please contact a TOSHIBA TEC service representative.

Type	Spool type
Width	41 – 112 mm Recommended width is 41, 50, 68, 84, and 112 mm.
Length	600 m
Outside Diameter	φ90 mm (max.)

The table below shows the correlation between ribbon width and media width (backing paper is not included.)

Ribbon width	Media width	Ribbon width	Media width
41 mm	30 – 36 mm	84 mm	63 – 79 mm
50 mm	36 – 45 mm	112 mm	71 – 112 mm
68 mm	45 – 63 mm		

NOTES:

1. To ensure print quality and print head life use only TOSHIBA TEC specified ribbons.
2. To avoid ribbon wrinkles use a ribbon that is wider than the media by 5 mm or more. However, too much difference in width between the two may cause wrinkles.
3. When using a 112 mm wide media, be sure to use a 108 mm wide ribbon. Use of other ribbons may cause ribbon wrinkles.

7.3 Recommended Media and Ribbon Types

Media type	Description
Vellum paper and labels	General use for low cost applications.
Coated paper	Matt coated paper General use including applications that require small letters and/or symbols. Glossy coated paper Used where a high-grade finish is required
Plastic films	Synthetic film (Polypropylene, etc.) This water-proof and solvent-resistant material has high physical strength and low-temperature resistance, but poor heat resistance (dependant upon material). This material can be used for labels stuck to recyclable containers, so it can be recycled in the same process. PET film This water-proof and solvent-resistant material has high physical strength, and low-temperature resistance as well as heat resistance. This material is used for many applications, especially where high durability is required. Mode/serial plate labels, caution labels, etc. Polyimide This material gives the best performance on heat resistance (greater than PET film). It is often used for PCB labels as it can withstand passage through a solder bath.

7.3 Recommended Media and Ribbon Types (Cont.)

Ribbon type	Description
Vellum wax ribbon	This ribbon is mainly used for vellum paper and labels. It has a very high ink density to cope with uneven printing surface
Standard wax ribbon	Good match for coated paper (Matt coat and glossy coat).
Smear-less ribbon (Wax resin ribbon)	Good match for coated paper. The printed image will resist water and light rubbing.
Scratch and solvent resistance ribbon	Very good match for plastic films (synthetic paper, PET, polyimide, etc.) Scratch and solvent resistance Heat resistance with PET and polyimide.

Combination of Media and Ribbon

Media type Ribbon type	Vellum paper and label	Coated paper	Plastic films
Vellum wax ribbon	○		
Standard wax ribbon		○	
Smear-less ribbon (wax-resin ribbon)		○	
Scratch/solvent resistance ribbon			○

○: Good match

7.4 Care/Handling of Media and Ribbon

CAUTION!

Be sure to carefully review and understand the Supply Manual. Use only media and ribbons that meet specified requirements. Use of non-specified media and ribbons may shorten the head life and result in problems with bar code readability or print quality. All media and ribbons should be handled with care to avoid any damage to the media, ribbons or printer. Read the guidelines in this section carefully.

- Do not store the media or ribbon for longer than the manufacturer's recommended shelf life.
- Store media rolls on the flat end. Do not store them on the curved sides as this might flatten that side causing erratic media advance and poor print quality.
- Store the media in plastic bags and always reseal after opening. Unprotected media can get dirty and the extra abrasion from the dust and dirt particles will shorten the print head life.
- Store the media and ribbon in a cool, dry place. Avoid areas where they would be exposed to direct sunlight, high temperature, high humidity, dust or gas.
- The thermal paper used for direct thermal printing must not have specifications which exceed Na⁺ 800 ppm, K⁺ 250 ppm and Cl⁻ 500 ppm.
- Some ink used on pre-printed media may contain ingredients which shorten the print head's product life. Do not use labels pre-printed with ink which contain hard substances such as carbonic calcium (CaCO₃) and kaolin (Al₂O₃, 2SiO₂, 2H₂O).

For further information, please contact your local distributor or your media and ribbon manufacturers.

APPENDIX 1 MESSAGES AND LEDS

Appendix 1 describes the LCD messages displayed on the operation panel.

Symbols in the message

- 1: ○: The LED is illuminated. ⊙: The LED is flashing. ●: The LED is unlit.
- 2: ****: the number of unprinted media. Up to 9999 (in pieces)
- 3: %%%: ATA Card's remaining memory 0 to 9999999 (in K bytes)
- 4: ###: Flash memory card remaining memory for PC save area: 0 to 895 (in K bytes)
- 5: &&&: Remaining flash memory capacity for storing writable characters 0 to 3147 (in K bytes)

No.	LCD Message	LED Indication			Printer Status	Restoration by RESTART key Yes/No	Acceptance of Status Request Reset Command Yes/No
		POWER	ONLINE	ERROR			
1	ON LINE	○	○	●	In online mode	-----	Yes
	ON LINE	○	⊙	●	In online mode (The printer in communication)	-----	Yes
2	HEAD OPEN	○	●	●	The print head block is opened in online mode.	-----	Yes
3	PAUSE ****	○	●	●	The printer is paused.	Yes	Yes
4	COMMS ERROR	○	●	○	A parity, overrun, or framing error has occurred during communication through the RS-232C.	Yes	Yes
5	PAPER JAM ****	○	●	○	The media is jammed during paper feed.	Yes	Yes
6	CUTTER ERROR****	○	●	○	A problem has occurred with the cutter module.	Yes	Yes
7	NO PAPER ****	○	●	○	The media has run out, or the media is not loaded properly.	Yes	Yes
8	NO RIBBON ****	○	●	○	The ribbon has run out.	Yes	Yes
9	HEAD OPEN ****	○	●	○	Feed or printing was attempted with the print head block open.	Yes	Yes
10	HEAD ERROR	○	●	○	There is a problem with the print head.	Yes	Yes
11	EXCESS HEAD TEMP	○	●	○	The print head is overheated.	No	Yes
12	RIBBON ERROR****	○	●	○	The ribbon has been torn. A problem has occurred with the sensor that determines the torque for the ribbon motor.	Yes	Yes
13	REWIND FULL ****	○	●	○	An overflow error has occurred in the rewinder unit.	Yes	Yes
14	SAVING%%%%%%%% or SAVING ###&&&	○	○	●	In writable character or PC command save mode	-----	Yes
15	FLASH WRITE ERR.	○	●	○	An error has occurred while writing to flash memory or ATA card.	No	Yes
16	FORMAT ERROR	○	●	○	An erase error has occurred in formatting the flash memory or ATA card.	No	Yes
17	FLASH CARD FULL	○	●	○	Data cannot be stored because the flash memory or ATA card is full.	No	Yes
18	Display of error message (See Notes.)	○	●	○	A command error has occurred in analyzing the command.	Yes	Yes
19	POWER FAILURE	○	●	○	A power failure has occurred.	No	No
20	INITIALIZING...	○	●	●	A flash memory card is being initialised.	-----	-----
21	EEPROM ERROR	○	●	○	Data cannot be read from/written to a backup EEPROM properly.	-----	-----

No.	LCD Message	LED Indication			Printer Status	Restoration by RESTART key Yes/No	Acceptance of Status Request Reset Command Yes/No
		POWER	ONLINE	ERROR			
22	SYSTEM ERROR	○	●	○	When the following abnormal operations are performed, a system error occurs: (a) Command fetch from an odd address (b) Access to word data at an odd address (c) Access to long-word data at an odd address (d) Access to the area of 80000000H to FFFFFFFFH in the logic space in user mode. (e) An undefined instruction in an area other than a delay slot was decoded. (f) An undefined instruction in a delay slot was decoded. (g) An instruction to rewrite a delay slot was decoded.	No	No
23	100BASE LAN INITIALIZING...	○	●	●	100 Base LAN Board is being initialized.	----	----
24	RFID WRITE ERROR	○	●	○	The printer did not succeed in writing data onto an RFID tag after having retried for a specified times.	Yes	Yes
25	RFID ERROR	○	●	○	The printer cannot communicate with the RFID module.	Yes	Yes

NOTE: When an error message listed above appears on the LCD message display, please refer to **Section 5 TROUBLESHOOTING** for solution.

APPENDIX 2 INTERFACE

NOTE:

To prevent radiation and reception of electrical noise, the interface cables must meet the following requirements:

- In case of a parallel interface cable or serial interface cable, fully shielded and fitted with metal or metallised connector housings.
- Keep as short as possible.
- Should not be bundled tightly with power cords.
- Should not be tied to power line conduits.
- A parallel interface cable to be used should conform to IEEE1284.

■ Parallel interface (Centronics) (Standard)

Mode: Conforming to IEEE1284
Compatible mode (SPP mode), Nibble mode, ECP mode

Data input method: 8 bit parallel

Control signal:

SPP Mode	Nibble Mode	ECP Mode
nStrobe	HostClk	HostClk
nAck	PtrClk	PeriphClk
Busy	PtrBusy	PeriphAck
Perror	AckDataReq	NAckReverse
Select	Xflag	Xflag
nAutoFd	HostBusy	HostAck
nInit	nInit	nReverseRequest
nFault	nDataAvail	nPeriphRequest
nSelectIn	IEEE1284Active	IEEE1284Active

Data input code: ASCII code
European 8 bit code
Graphic 8 bit code
JIS8 code
Shift JIS Kanji code
JIS Kanji code

Receive buffer: 1M byte

Connector:

PIN No.	Signal		
	SPP Mode	Nibble Mode	ECP Mode
1	nStrobe	HostClk	HostClk
2	Data 1	Data 1	Data 1
3	Data 2	Data 2	Data 2
4	Data 3	Data 3	Data 3
5	Data 4	Data 4	Data 4
6	Data 5	Data 5	Data 5
7	Data 6	Data 6	Data 6
8	Data 7	Data 7	Data 7
9	Data 8	Data 8	Data 8
10	nAck	PtrClk	PeriphClk
11	Busy	PtrBusy	PeriphAck
12	PError	AckDataReq	nAckReverse
13	Select	Xflag	XFlag
14	nAutoFd	HostBusy	HstAck
15	NC	NC	NC
16	0V	0V	0V
17	CHASSIS GND	CHASSIS GND	CHASSIS GND
18	+5V (For detection)	+5V (For detection)	+5V (For detection)
19	TWISTED PAIR GND(PIN1)	TWISTED PAIR GND(PIN1)	TWISTED PAIR GND(PIN1)
20	TWISTED PAIR GND(PIN2)	TWISTED PAIR GND(PIN2)	TWISTED PAIR GND(PIN2)
21	TWISTED PAIR GND(PIN3)	TWISTED PAIR GND(PIN3)	TWISTED PAIR GND(PIN3)
22	TWISTED PAIR GND(PIN4)	TWISTED PAIR GND(PIN4)	TWISTED PAIR GND(PIN4)
23	TWISTED PAIR GND(PIN5)	TWISTED PAIR GND(PIN5)	TWISTED PAIR GND(PIN5)
24	TWISTED PAIR GND(PIN6)	TWISTED PAIR GND(PIN6)	TWISTED PAIR GND(PIN6)
25	TWISTED PAIR GND(PIN7)	TWISTED PAIR GND(PIN7)	TWISTED PAIR GND(PIN7)
26	TWISTED PAIR GND(PIN8)	TWISTED PAIR GND(PIN8)	TWISTED PAIR GND(PIN8)
27	TWISTED PAIR GND(PIN9)	TWISTED PAIR GND(PIN9)	TWISTED PAIR GND(PIN9)
28	TWISTED PAIR GND(PIN10)	TWISTED PAIR GND(PIN10)	TWISTED PAIR GND(PIN10)
29	TWISTED PAIR GND(PIN11)	TWISTED PAIR GND(PIN11)	TWISTED PAIR GND(PIN11)
30	TWISTED PAIR GND(PIN31)	TWISTED PAIR GND(PIN31)	TWISTED PAIR GND(PIN31)
31	nInit	nInit	nReverseRequest
32	nFault	NDataAvail	nPeriphRequest
33	0V	0V	0V
34	NC	NC	NC
35	NC	NC	NC
36	nSelectIn	IEEE1284Active	IEEE1284Active

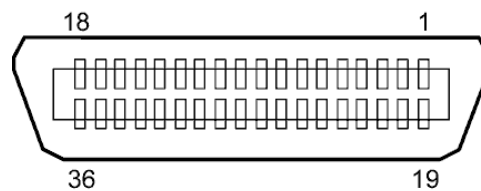

IEEE1284-B Connector

■ **Serial interface (Standard)**

Type: RS-232C
 Communication mode: Full duplex
 Transmission speed: 2400 bps, 4800 bps, 9600 bps, 19200 bps, 38400 bps, 115200 bps
 Synchronization: Start-stop synchronization
 Start bit: 1 bit
 Stop bit: 1 bit, 2 bit
 Data length: 7 bit, 8 bit
 Parity: None, EVEN, ODD
 Error detection: Parity error, Framing error
 Protocol: Unprocedure communication
 Data input code: ASCII code, European character 8 bit code, graphic 8 bit code, JIS8 code, Shift JIS Kanji code, JIS Kanji code
 Receive buffer: 1M byte
 Connector:

Pin No.	Signal
1	FG
2	RD (Received Data)
3	TD (Transmit Data)
4	CTS (Clear to Send)
5	RTS (Request to Send)
6	DTR (Data Terminal Ready)
7	SG (Signal Ground)
20	DSR (Data Set Ready)

■ **USB interface (Option: B-9700-USB-QM-R)**

Physical Layer: Conforming to V1.1 Full speed
 Transfer type: Control transfer, Bulk transfer
 Transfer rate: Full speed (12M bps)
 Class: Printer class
 Number of ports: 1
 Power source: Self power
 Connector: Type B

Pin No.	Signal
1	VCC
2	D-
3	D+
4	GND

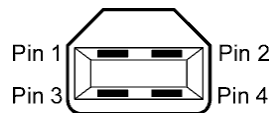

Series B Plug

■ LAN (Option: B-9700-LAN-QM-R)

Physical Layer: IEEE802.3 10BASE-T/100BASE-TX
 Number of ports: 1
 Connector: RJ-45
 LED status: Link LED, Activity LED

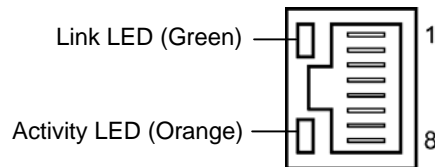

LED	LED Status	LAN status
Link	ON	10Mbps link or 100Mbps link is detected.
	OFF	No link is detected. * Communication cannot be made while the Link LED is off.
Activity	ON	Communicating
	OFF	Idle

LAN cable: 10BASE-T: UTP category 3 or category 5
 100BASE-TX: UTP category 5
 Cable length: Segment length Max. 100 m

NOTES:

1. For IP address setting, refer to the **B-SX4T/SX5T Series Key Operation Specification** stored in the CD-ROM.
2. When a generally-used twisted pair Ethernet (TPE) or UTP cable is used, a communication error may occur depending on your operating environment. In such case, you may be requested to use a shielded twisted pair cable.

■ Wireless LAN (Option: B-9700-WLAN-QM-R)

Standard: Conforming to IEEE802.11a, IEEE802.11b, and IEEE802.11g
 Protocol: IP (RFC791), ICMP (RFC792), UDP (RFC768), TCP (RFC793,896), ARP (RFC826), HTTPD (RFC1866), TELNET, FTPD (RFC959), DHCP (RFC2131), SNMP
 Security protocol: WEP (64 bits/128 bits/152 bits) or AES, AES-OCB (128 bits)
 TKIP (only when using WPA, WPA-PSK)
 TWSL (unique encryption)
 Antenna: Chip type, diversity antenna
 Parameter setting: via HTTP
 Default IP address: 192.168.10.21
 Default subnet mask: 255.255.255.0

NOTE:

MAC address of the Wireless LAN module will be necessary when setting the MAC address filtering function of an access point. Please ask a service person of your nearest TOSHIBA TEC service representative.

■ Expansion I/O Interface (Option: B-7704-IO- QM-R)

Input Signal IN0 to IN5
 Output Signal OUT0 to OUT6
 Connector (External Device Side) FCN-781P024-G/P or equivalent
 Connector (Printer Side) FCN-685J0024 or equivalent

Pin	Signal	I/O	Function	Pin	Signal	I/O	Function
1	IN0	Input	FEED	13	OUT6	Output	
2	IN1	Input	PRINT	14	N.C.	----	
3	IN2	Input	PAUSE	15	COM1	Common (Power)	
4	IN3	Input		16	N.C.	----	
5	IN4	Input		17	N.C.	----	
6	IN5	Input		18	N.C.	----	
7	OUT0	Output	FEED	19	N.C.	----	
8	OUT1	Output	PRINT	20	N.C.	----	
9	OUT2	Output	PAUSE	21	COM2	Common (Ground)	
10	OUT3	Output	ERROR	22	N.C.	----	
11	OUT4	Output		23	N.C.	----	
12	OUT5	Output	POWER ON	24	N.C.	----	

N.C.: No Connection

Input Circuit

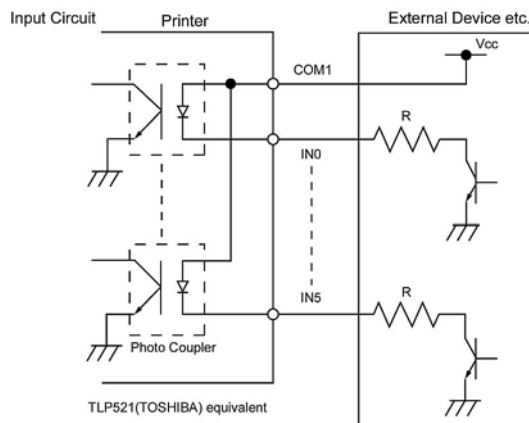

Output Circuit

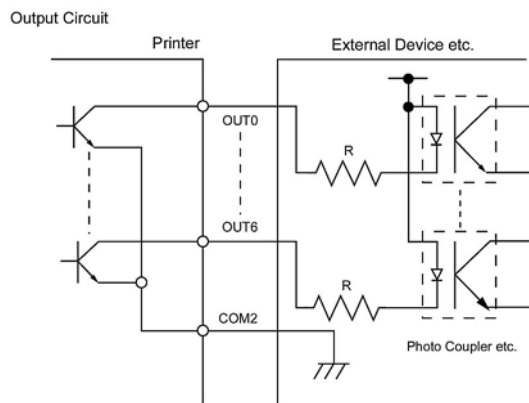

Operating environment Temperature: 0 to 40 °C
 Humidity: 20 to 90% (No Condensation)

■ RFID (Option)**• B-9704-RFID-U1-US**

Module: AWID MPR-1510A-RM
Frequency: 902 MHz to 928 MHz (FH-SS (Frequency Hopping Spectrum Spread))
Output: 500 mW
Available RFID tag: EPC Class 0, 1, ISO018000-6B

• B-9704-RFID-U1-EU

Module: AWID MPR-1580A-RM
Frequency: 869.5 MHz
Output: 500 mW
Available RFID tag: EPC Class 0, 1, ISO018000-6B

• B-9704-RFID-H1-QM

Module: TagSys MEDIOS002 (Not included in an optional kit.)
Frequency: 13.56 MHz
Output: 200 mW
Available RFID tag: TagSys C210, C220, C240, I-Code, Tag-it, ISO15693

PCMCIA Interface (Option: B-9700-PCM-QM-R)

The PCMCIA Interface board allows use of the ATA card or flash memory card when connected to the CPU PC board.

- Conforming to PCMCIA V2.1/JEIDA V4.2
- Number of slots: 1 Type II slot
- Available cards: Refer to **Section 2.8 Inserting the Optional PCMCIA Cards**

APPENDIX 3 POWER CORD

When purchasing the power cord:

Since the power cord set is not enclosed in this unit, please purchase an approved one that meets the following standard from your authorized TOSHIBA TEC representative.

(As of September 2004)

Country	Agency	Certification mark	Country	Agency	Certification mark	Country	Agency	Certification mark
Australia	SAA		Germany	VDE		Sweden	SEMKKO	
Austria	OVE		Ireland	NSAI		Switzerland	SEV	
Belgium	CEBEC		Italy	IMQ		UK	ASTA	
Canada	CSA		Japan	METI		UK	BSI	
Denmark	DEMKO		Netherlands	KEMA		U.S.A.	UL	
Finland	FEI		Norway	NEMKO		Europe	HAR	
France	UTE		Spain	AEE				

Power Cord Instruction

1. For use with 100 – 125 Vac mains power supply, please select a power cord rated Min. 125V, 10A.
2. For use with 200 – 240 Vac mains power supply, please select a power cord rated Min. 250V.
3. Please select a power cord with the length of 4.5m or less.

Country/Region	North America	Europe	United Kingdom	Australia
Power Cord Rated (Min.) Type	125V, 10A SVT	250V H05VV-F	250V H05VV-F	250V AS3191 approved, Light or Ordinary Duty type
Conductor size (Min.)	No. 3/18AWG	3 x 0.75 mm ²	3 x 0.75 mm ²	3 x 0.75 mm ²
Plug Configuration (locally approved type)				
Rated (Min.)	125V, 10A	250V, 10A	250V, *1	250V, *1

*1: At least, 125% of the rated current of the product.

APPENDIX 4 PRINT SAMPLES

■ Font

<A>Times Roman medium:12point

Times Roman medium:15point

<C>Times Roman bold:15point

<D>Times Roman bold:18point

<E>Times Roman bold:21point

<F>Times Roman italic:18point

<G>Helvetica medium:9point

<H>Helvetica medium:15point

<I>Helvetica medium:18point

<J>Helvetica bold:18point

<K>Helvetica bold:21point

<L>Helvetica italic:18point

<M>PRESENTATION BOLD:27POINT

<N>Letter Gothic medium:14.3point

<O>Prestige Elite medium:10.5point

<P>Prestige Elite bold:15point

<Q>Courier medium:15point

<R>Courier bold:18point

<S>OCR-A 12POINT

<T>OCR-B 12POINT

<q>Gothic 725 Black:6point

<Outline Font:A> **H e l v e t i c a b o l d**

<Outline Font:B> **Helvetica bold(P)**

<Outline Font:E> *0 1 2 3 4 5 6 7 8 9, y \$*

<Outline Font:F> **0 1 2 3 4 5 6 7 8 9, ¥ \$**

<Outline Font:G> **0 1 2 3 4 5 6 7 8 9, ¥ \$**

<Outline Font:H> **Dutch 801 bold**

<Outline Font:I> *Brush 738 regular*

<Outline Font:J> **Gothic 725 Black**

APPENDIX 4 PRINT SAMPLES (Cont.)

■ Bar codes

JAN8, EAN8



MSI



Interleaved 2 of 5



CODE39 (Standard)



NW7



JAN13, EAN13



UPC-E



EAN13+2 digits



EAN13+5 digits



CODE128



CODE39 (Full ASCII)



CODE93



UPC-E+2 digits



UPC-E+5 digits



EAN8+2 digits



EAN8+5 digits



UPC-A



UPC-A+2 digits



APPENDIX 4 PRINT SAMPLES (Cont.)

UPC-A+5 digits



UCC/EAN128



Industrial 2 of 5



POSTNET



Customer bar code



Customer bar code of high priority



KIX Code



RM4SCC



RSS-14



RSS-14 Stacked



RSS-14 Stacked Omnidirectional



RSS Limited



RSS Expanded



Data Matrix



PDF417



QR code



Micro PDF417



MaxiCode



CP Code



APPENDIX 5 GLOSSARIES

Bar code

A code which represents alphanumeric characters by using a series of black and white stripes in different widths. Bar codes are used in various industrial fields: Manufacturing, Hospitals, Libraries, Retail, Transportation, Warehousing, etc. Reading bar codes is a fast and accurate means of capturing data while keyboard entry tends to be slow and inaccurate.

Batch mode

Issue mode that continuously prints media until the specified number of media has been printed.

Black mark

A mark printed on the media so that the printer can maintain a constant print position by detecting this mark.

Black mark sensor

A reflective sensor which detects the difference of potential between the black mark and print area to find the print start position.

Built-in rewinder mode

Printer mode of operation where an optional strip module is installed to take up printed media onto the build-in rewinder.

Cut mode

Printer mode of operation where an optional cutter module is installed to automatically cut media from the supply roll after they are printed. The print command can specify to cut every media or to cut after a set number of media have been printed.

Cutter module

A device used to cut the media.

DPI

Dot Per Inch

The unit used to express print density.

Expansion I/O interface

An optional interface circuit that may be installed into printer to allow the printer to be connected to an external device such as a wrapping machine and to receive feed, print start, and pause signals from the external device and to send back print, pause, and error status signals to the external device.

Feed gap sensor

A transmissive sensor which detects the difference of potential between the gap between labels and the label to find the print position of the label.

Font

A complete set of alphanumeric characters in one style of type. E.g. Helvetica, Courier, Times

Gap

Clearance between labels

IPS

Inch per second

The unit used to express print speed.

Label

A type of media with adhesive backing.

LCD

Liquid Crystal Display

Installed on the operation panel and displays operation modes, error message and so on.

Media

Material on which data is printed by the printer. Label, tag paper, fanfold paper, perforated paper, etc.

PCMCIA interface

An optional interface circuit that may be installed into the printer to allow the use of the small credit card sized PC cards such as flash memory cards and LAN cards. PCMCIA is the acronym for Personal Computer Memory Card International Association.

Pre-printed media

A type of media on which characters, logos, and other designs have been already printed.

Print head element

The thermal print head consists of a single line of tiny resistive elements and when current is allowed to flow through each element it heats up causing a small dot to be burned onto thermal paper or a small dot of ink to be transferred from a thermal ribbon to ordinary paper.

Print speed

The speed at which printing occurs. This speed is expressed in units of ips (inches per second).

Reflective sensor

See Black mark sensor.

Resolution

The degree of detail to which an image can be duplicated. The minimum unit of divided image is called a pixel. As the resolution becomes higher, the number of pixels increased, resulting in more detailed image

RFID (Radio Frequency Identification)

A method of automatically identifying people or objects using radio waves. In case of the B-SX series, the RFID module writes digital information to an RFID tag mounted inside labels or tag paper while the printer is printing data on them. The RFID tag is a microchip attached to an antenna. The microchip holds data and the antenna enables the tag to send and receive data.

Ribbon

An inked film used to transfer an image onto the media. In the thermal transfer printing, it is heated by the thermal print head, causing an image to be transferred onto the media

Strip mode

A device used to remove labels from the backing paper.

Supply

Media and ribbon

Tag

A type of media with no adhesive. Usually tags are made of cardboard or other durable material.

Thermal direct printing

A printing method using no ribbon, but thermal media which reacts to heat. The thermal print head heats the thermal media directly, causing print image to be printed on the media.

Thermal print head

A print head using thermal transfer or thermal direct printing method.

Thermal transfer printing

A printing method that the thermal print head heats an ink or resin coating on the ribbon against the media, causing the ink/resin to transfer onto the media.

Threshold setting

A sensor setting operation to have the printer maintain a constant print position of pre-printed media.

Transmissive sensor

See Feed gap sensor.

USB (Universal Serial Bus)

An interface that is used to connect peripherals, such as a printer, keyboard, mouse. The USB allows disconnection of a USB device without turning off the power.

INDEX

A

Auto ribbon saving 2-10

B

Backing paper 2-7, 7-1

Bar code 6-2, A5-1

Batch mode 2-7, 7-1, A5-1

Black mark 2-6, 7-1, 7-3, A5-1

Black mark length 7-1

Black mark sensor 2-6, 2-66, 4-2, A5-1

Built-in rewinder 2-8, A5-1

C

Centronics 1-3, 2-11, 2-25, 2-28, 6-2, A2-2

Cut mode 2-8, 7-1, A5-1

Cut/strip position fine adjustment 2-58

Cutter module 1-1, 1-5, 2-8, 2-55, 4-3, A5-1

E

Effective Print length 7-1

Effective print width 7-1

ERROR LED 1-4, 3-1, A1-1

Error message 5-1

Expansion I/O interface 1-3, 2-11, 2-27, 6-2, A2-6,
A5-1

Expansion I/O interface board 1-1, 1-5

F

Fan filter 1-2, 2-3

Fanfold paper guide module 1-5

Feed gap sensor 2-6, 2-66, 4-2, A5-1

Flash memory card 1-5, 2-13

G

Gap 2-6, 7-2, A5-1

Gap length 7-1

Guaranteed print area 7-3

H

Head lever 1-4, 2-4

I

Input voltage 6-1

Interface 2-11, 6-2, A2-1

Issue mode 2-7, 2-54, 6-1

J

Jammed media 5-5

L

Label 2-4, 7-1, 7-2, A5-1

LAN interface 1-1, 1-5, 2-11, 6-2

LCD language 2-19

LCD message display 1-3, 1-4, 2-14, 3-1, 6-1

M

Media 7-1, 7-7, A5-1

Media pitch 7-1

Media sensor 2-6

O

ON LINE LED 1-4, 3-1, A1-1

Operation Panel 1-3, 1-4, 3-1

P

Parallel interface 1-3, 2-11, 6-2, A2-2

PCMCIA card 1-5, 2-13

PCMCIA interface 1-1, 1-5, 2-13, 6-2, A2-7

Platen 1-4, 4-2

Power consumption 6-1

Power cord 2-3, A3-1

POWER LED 1-4, 3-1, A1-1

Power switch 1-3, 2-3, 2-12

Pre-printed media 2-54, 2-64, 7-7, A5-2

Print head 1-4, 2-4, 2-31, 4-2

Print head block 1-4, 2-4, 2-9, 5-5

Printing method 6-1

Printing speed 1-1, 6-1, A5-2

Print start position fine adjustment 2-58

Print tone fine adjustment 2-62

R

Reflective sensor 2-65, 7-3

Resolution 6-1, A5-2

RFID A2-7, A5-2

RFID module 1-5

Ribbon 2-9, 7-6, 7-7, A5-2

Ribbon saving module 1-1, 1-5, 2-8, 2-21, 7-4

Ribbon shaft 1-4, 2-9

Ribbon stopper 1-4, 2-9

Ribbon width 7-6

RS-232C 1-3, 2-11, 2-17, 2-18, 6-2, A2-1

S

Serial interface 1-3, 2-11, 6-2, A2-4

Strip mode 2-7, 7-1, A5-2

Strip module 1-1, 1-5, 2-7, 2-8, 2-55

T

Tag 2-4, 7-1, A5-2

Thermal direct 2-62, 6-1, A5-2

Thermal transfer 2-62, 6-1, A5-2

Transmissive sensor 2-65, 7-2

U

USB interface 1-3, 1-5, 2-11, 6-2, A2-3, A5-2

W

Web printer 2-26

Wireless LAN 1-1, 1-3, 1-5, 2-11, 6-2, A2-5

