

# Professional Monitor Family 2013

PVM OLED / PVM 4K LCD / LMD Series LCD Monitor

**SONY**  
make.believe



TRIMASTER **EL** TRIMASTER **4K**



# Comprehensive, Innovative, Reliable Line of Picture Monitors

Building on a long history as a leading supplier of high-definition technology products, Sony continues to offer professional monitors in a variety of types and sizes, suitable for a wide range of applications in the studio and in the field.

Now, incorporating innovative wider viewing angles\*<sup>1</sup>, the TRIMASTER EL™ OLED (organic light-emitting diode) picture monitors include the new A Series: the PVM-2541A (25-inch\*<sup>2</sup>) and PVM-1741A (17-inch\*<sup>3</sup>).

These two new monitors enable group monitoring – for example, video engineers or colourists can view the display properly from many different angles. This allows greater efficiency and improves quality during content creation.

There is more good news for the PVM-2541A and PVM-1741A. These PVM-41 Series monitors, along with LMD-41 Series monitors (the LMD-2341W, LMD-2041W, and LMD-1541W), are equipped with a variety of convenient professional features including new waveform capabilities, vector scope, closed caption display, and camera focus in colour.

Two small monitors in the PVM / LMD-41 Series – the PVM-741 7-inch\*<sup>4</sup> OLED monitor and LMD-941W 9-inch\*<sup>5</sup> LCD monitor – also offer these new professional features in their compact bodies. And these small-size monitors are further upgraded with the addition of two 3G/HD-SDI interfaces. Moreover, the LMD-941W incorporates a full-HD resolution LCD panel, delivering superb crisp picture quality.

The PVM-X300 30-inch\*<sup>6</sup> true-4K (4096 x 2160 pixels) resolution LCD monitor also joins Sony's picture monitor line-up. This monitor is ideal for 4K previewing in onset and editing applications.

Designed for every professional need, it's time you experienced the immense value of Sony's new picture monitors.

\*1 This improves colour shift by half when compared with predecessor models. Sony's measurement. Results may differ between monitors.

\*2 623.4 mm viewable area, measured diagonally.

\*3 419.7 mm viewable area, measured diagonally.

\*4 188 mm viewable area, measured diagonally.

\*5 227 mm viewable area, measured diagonally.

\*6 767.5 mm viewable area, measured diagonally.

## Viewing angle innovation

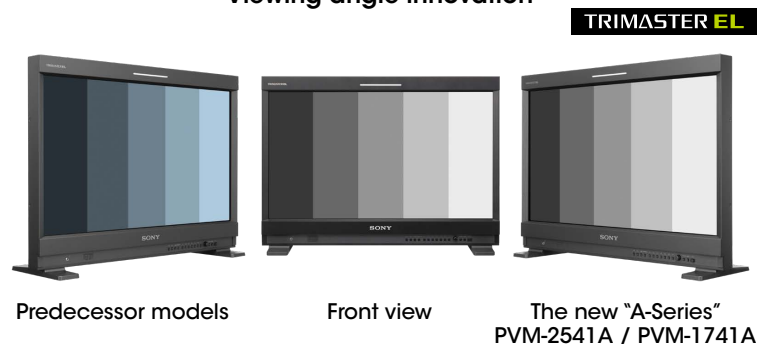

\* Simulated images

# Sony's Professional Monitor Line-up

## PVM Series – TRIMASTER EL Picture Monitors



TRIMASTER **EL**

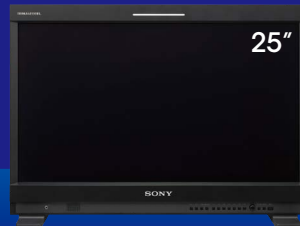

PVM-2541A



PVM-1741A



PVM-741

## LMD-41 Series – LCD Picture Monitors



LMD-2341W



LMD-2041W



LMD-1541W



LMD-941W

## LMD-30/10 Series – Entry LCD Monitors



LMD-1530W



LMD-2110W



LMD-1510W

## PVM-X Series

– 4K Professional Video Monitor

TRIMASTER **4K**



PVM-X300

## LMD-51 Series

– Versatile 3D/2D LCD Monitors

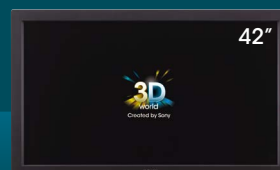

LMD-4251TD



LMD-2451TD

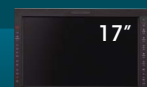

LMD-1751W

# Sony Picture Monitor Technology and Features



## Wide Viewing Angles

PVM-41 LMD-41 LMD-51 LMD-30/10

PVM-2541A and PVM-1741A monitors feature significantly improved viewing angles, reducing the colour shift by half\* when compared with their predecessor models, offering the industry-leading wide viewing angles in the professional flat panel market.

LMD monitors incorporating IPS LCD panels offer stable images when viewed from various angles: both horizontally and vertically. This allows precise images to be clearly viewed from various positions and angles – a critical requirement in professional video monitoring – and makes these monitors suitable for group viewing.

\* Sony measured. Results may differ between monitors.



PVM-2541A with an OLED panel



LMD-2341W with an IPS LCD  
\* Simulated images

## 10-bit Signal Processing

PVM-41 LMD-41 LMD-51 LMD-30/10

All PVM-41 Series and LMD Series monitors incorporate a 10-bit signal processing system to offer a smooth grey scale along CRT-like gamma.



8-bit (256-levels) image\*



10-bit (1024-levels) image\*

\* Simulated images

## ChromaTRU Colour Processing

ChromaTRU  
LMD-41 LMD-51

For an extra level of colour-reproduction accuracy, every LCD panel used in LMD-41 and LMD-51 Series monitors is precisely colour calibrated at the factory, providing characteristics consistent with those of broadcast standards. Also white balance is maintained at a consistent colour temperature throughout all grey scale levels. The ChromaTRU™ process reproduces consistent light output extremely close to that of a CRT.

## Wide Colour Gamut and High-purity Deep Colour Reproduction

PVM-41

TRIMASTER EL technology shows the largest colour range of any Sony monitor ever offered. Colour standards such as ITU-R BT.709, EBU, and SMPTE-C are displayed more accurately and, if desired, the OLED panel's native colour gamut can be displayed. Sony's micro-cavity structure uses an optical resonance effect in combination with accurate colour filters to calibrate and stabilize RGB colour accuracy. This combination is also effective in reducing ambient light reflection, and consequently deep colour reproduction can be achieved without degradation, particularly in bright environments.

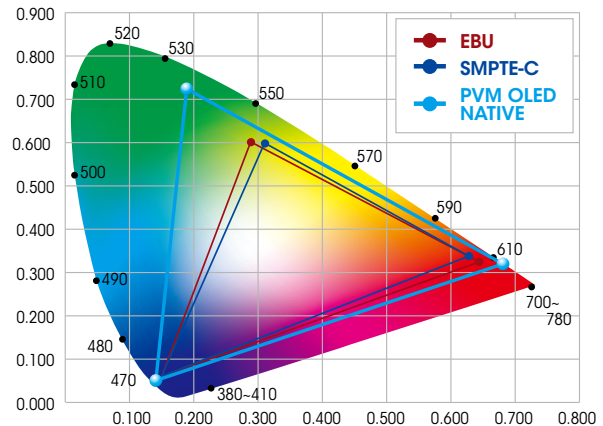

PVM Series OLED monitors colour gamut

## 3G-SDI Input

PVM-41 LMD-41 LMD-51

PVM-41, LMD-41 and LMD-51 Series monitors can accept 3G-SDI input. \* Sony's 3G-SDI interface is compliant with the SMPTE 425 standard, transmitting up to 4:2:2/10-bit 1080/50p and 1080/60p video data using one SDI cable.

\* The LMD-51 Series monitors require an optional BKM-250TG 3G-SDI input adaptor. No models support a dual-link HD-SDI interface.



LMD-2451TD with the BKM-250TG 3G-SDI board

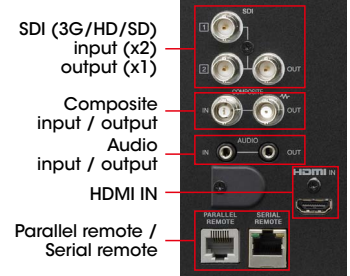

PVM-41, LMD-41 Series interfaces



## I/P Mode Selection

PVM-41 LMD-41 LMD-51 LMD-30/10

The PVM and LMD Series monitors provide a variety of I/P modes so that users can select the most suitable mode for each purpose:

### INTRA-FIELD:\*1

This mode interpolates images within the field, and delivers naturally reproduced images and quick picture processing. This mode is available for 1920 x 1080 SDI signal input.

### INTER-FIELD:

This mode interpolates images between fields. This is used for picture quality precedence (e.g., to reduce the jagged effect on moving pictures).

### FIELD MERGE:\*2

This mode combines lines alternately in odd and even fields, regardless of picture movements. This is used for PsF (Progressive Segmented Frame) processing and still image monitoring.

### LINE DOUBLER:

This mode interpolates by repeating each line. This is used for editing and monitoring fast-moving images, and checking line flicker. The minimum processing time is less than one field (0.5 frames).

\*1 PVM-41 and LMD-41 Series only.

\*2 PVM-41, LMD-41, and LMD-51 Series only.

## Auto White Balance

PVM-41 LMD-41 LMD-51

The PVM-41, LMD-41, and LMD-51 Series monitors employ a software-based white balance calibration function, which is called "Monitor\_AutoWhiteAdjustment". Combined with a PC and commercially available calibration tools\*, this function enables simple adjustment of the monitor's white balance.

\* Konica Minolta CA-210, CA-310, CS-200, DK-Technologies PM5639/06, X-Rite i1 Pro/i1 Pro2, Photo Research PR-655/670, Klein K-10, and JETI specbos 1211.

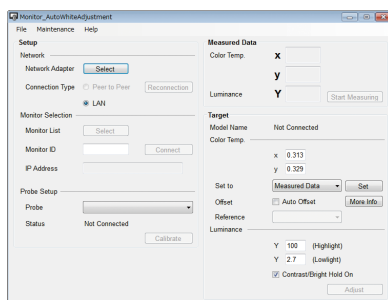

"Monitor\_AutoWhiteAdjustment" GUI image

## External Remote Control Function

### Serial Remote

PVM-41 LMD-41 LMD-51

The PVM-41, LMD-41, and LMD-51 Series have an external remote control capability for input/output signal selection and adjustment of various items via an Ethernet (10BASE-T/100BASE-TX) connection. Up to 32 monitors and up to four control units can be connected via Ethernet connection and controlled remotely on the network. Also these monitors support some functions of the BKM-16R – an optional remote control unit for BVM-E/BVM-L/PVM-L Series monitors – such as the power on/off switch and the Input Select function.\*

\* PVM-41, LMD-41, and LMD-51 Series do not support all BKM-16R functions.

### Parallel Remote

LMD-41 LMD-51 LMD-30/10

All LMD monitors can be remotely controlled via their parallel remote 8-pin modular connector. Seven of each monitor's available functions can be assigned to the available connector pins, such as tally switching, marker switching, and input switching.

## A variety of marker settings

PVM-41 LMD-41 LMD-51 LMD-30/10

All PVM and LMD Series monitors can display a center marker, aspect markers, and safety area markers.

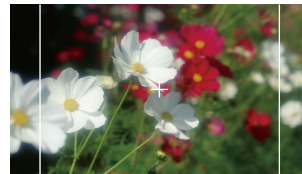

4:3 aspect marker image



16:9 aspect marker image



Safety area marker image

## Power-saving Mode

LMD-41 LMD-51

When no input signal is received for over a minute, the monitor goes into power-saving mode and consumes minimal power. This function prevents unnecessary electrical consumption.

## TRIMASTER EL – RGB 10-bit, Full HD

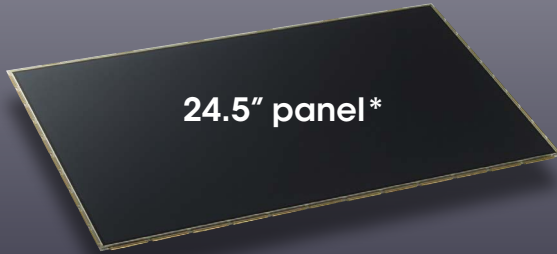

- Sony’s unique Super Top Emission technology
- Deep black with wide dynamic range
- Quick response with virtually no motion blur
- Wide colour gamut and accurate colour reproduction

\* 623.4 mm, and 419.7 mm (respectively), measured diagonally.

### ▲ TRIMASTER EL – Self-emitting Display Device

TRIMASTER EL creates light by recombining an electron and a hole within certain organic materials. The process of emitting light is extremely efficient when compared to other technologies currently used for display. Its organic materials react to the control of the electrical current immediately, and do not emit light in the absence of an electrical current. In this way, the OLED display panel features superb black performance and quick response to fast-motion pictures. In addition, Sony’s OLED display panel delivers a wider colour gamut.

### ▲ Super Top Emission Technology

Sony’s Super Top Emission OLED panel is designed to deliver light emission with the TFT layer on the rear side of the panel. Therefore, the top emission structure offers more efficient light emission than is typical with bottom emission structures where TFT layers are placed on the front side of the panel, limiting the light-emission aperture.

This Super Top Emission technology has a micro-cavity structure which incorporates colour filters. This cavity structure uses an optical resonance effect to enhance colour purity and improve light-emission efficiency. In addition, the colour filter of each RGB also enhances the colour purity of emitted light, and reduces ambient light reflection.

Sony’s Super Top Emission OLED panel is completely sealed by a glass substrate, and the electroluminescent layer is fully isolated from outside air and moisture. This contributes to stability and reliability.

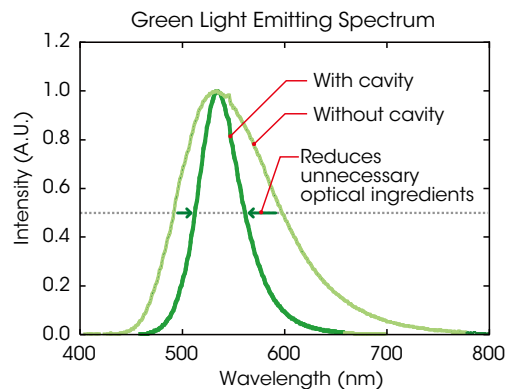
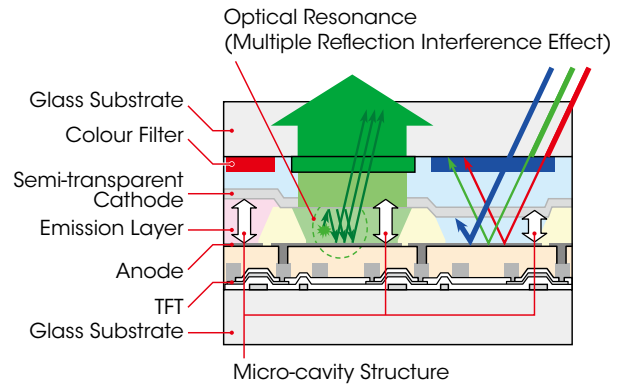



## The TRIMASTER EL processor - Dedicated to eliciting full performance.

- Accurate signal processing across all signal levels
- Accurate gamma control
- Superb uniformity control

### ▲ Dedicated TRIMASTER EL Processor\*

The PVM Series of OLED monitors incorporate newly developed OLED-dedicated signal processors to elicit and maximize OLED panel performance. This technology allows these TRIMASTER EL monitors to provide the level of performance required for critical imaging. These processors accurately control gamma and uniformity, and deliver precision stability control.

\* The PVM-741 is equipped with a different processing technology (ChromaTRU).

#### Accurate gamma control

Since TRIMASTER EL panel can display a deeper black than any other display device, the TRIMASTER EL processor controls gamma accuracy (black reproduction) by increased signal processing bit depth.

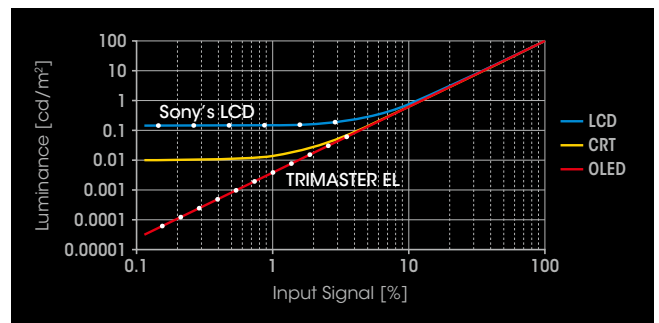

#### Superb uniformity control

TRIMASTER EL processor offers superb uniformity across all signal levels at every point of the screen. At the factory, OLED-panel uniformity is precisely measured and corrected using a proprietary RGB LUT (look-up table) adjustment system.

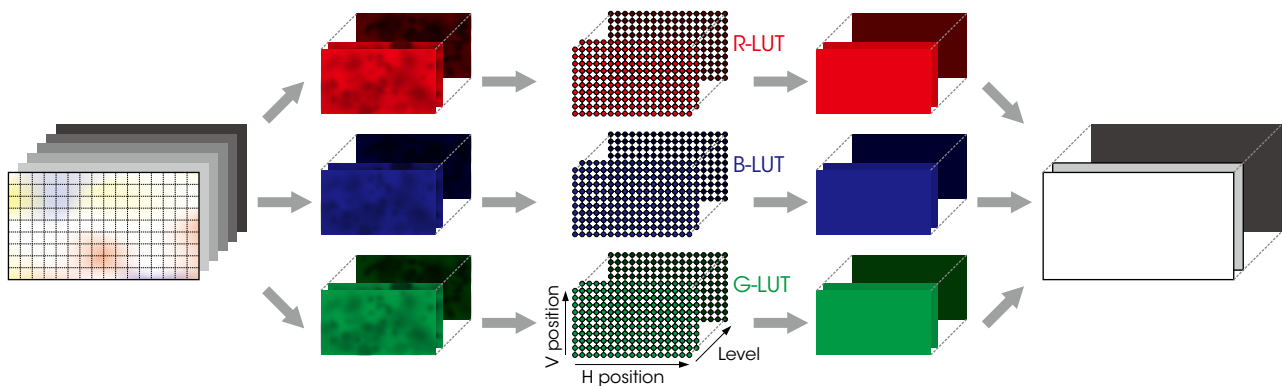

### ▲ Accurate Black Reproduction

A key advantage of TRIMASTER EL is the fact that each pixel can be turned completely off. No other display technology is able to offer this. LCD either raises black luminance due to intrinsic light leakage, or reduces black luminance with artificial local dimming technologies. CRT always applies a bias voltage to place the gun at the proper operating level. All of these display devices have some limitation in accuracy of black reproduction. In comparison, TRIMASTER EL is capable of reproducing accurate black with each individual pixel, enabling users to evaluate each picture image faithfully to the signal.

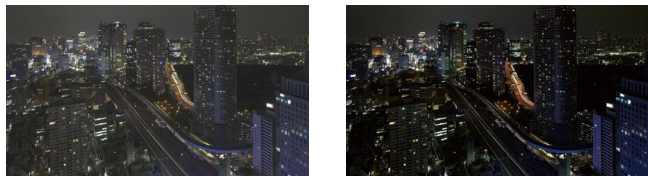
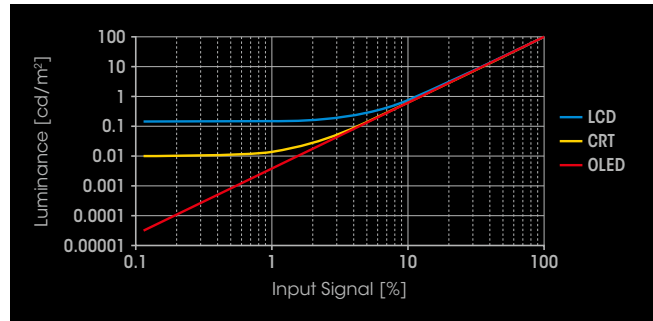

LCD\*

TRIMASTER EL\*

\* Simulated images



Grey scale images corresponding to the input signal

\* Grey scales are simulated images.

### ▲ Accurate Colour Reproduction

Sony's Super Top Emission technology not only offers a wide colour gamut with its purity of the three primary colours, but also maintains this wide colour gamut throughout the entire luminance range. While all other display devices have limitations in reproducing accurate colours, especially in the low signal levels, TRIMASTER EL system is truly an ideal display device for picture evaluation. With OLED, users see the details in the blacks, and see the colours as well.

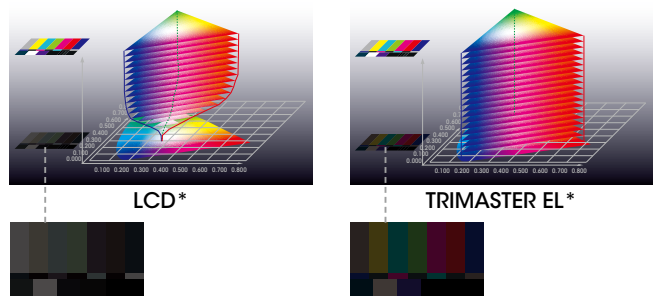

LCD\*

TRIMASTER EL\*

\* Colour gamut images based on Sony's test results

### ▲ Quick Response with Virtually No Motion Blur

The TRIMASTER EL grey-to-grey switching speed (measured in microseconds,  $\mu$ s) is much faster than that of the LCD (measured in milliseconds, ms). \* This fast response benefits a variety of applications and uses. For example, in sports broadcasting, when camera pans would become blurred with an LCD, they remain sharp and clear with OLED. And with moving titles or graphics, when text can be difficult to read on an LCD, OLED displays clear text, regardless of speed or direction.

\* Sony's test results.

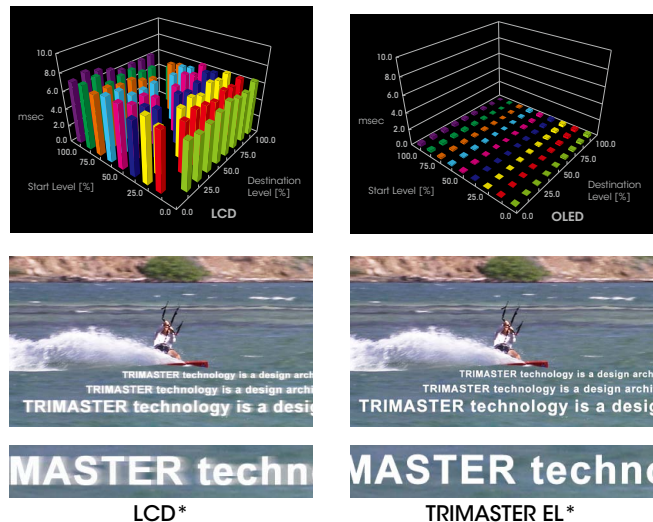

LCD\*

TRIMASTER EL\*

\* Simulated images



## 41 Series - All-in-one Features

### PVM-41 OLED Picture monitor

**TRIMASTER EL**

**PVM-2541A**

**PVM-1741A**

**PVM-741**

### LMD-41 LCD Picture monitor

**LMD-2341W**

**LMD-2041W**

**LMD-1541W**

**LMD-941W**

- Compact metal chassis and lightweight, robust metal body
- 3G/HD/SD-SDI input (x2), HDMI (HDCP) (x1), and Composite (x1)
- Built-in analyzers
  - Waveform monitor, vector scope, audio level meter, time code, camera focus in colour
- Closed caption display
- Easy-to-use control panel
  - Rotary-type switch for quick menu access
  - Seven function-assignable buttons for direct and quick access
- DC 12V operations (PVM-1741A, PVM-741, LMD-2041W, LMD-1541W, LMD-941W)
- Auto white Adjustment with PC application software
- Fast I/P conversion with the INTRA-FIELD process mode

**PVM-41:**

Sony's Super Top Emission OLED display panel with 10-bit RGB:

**LMD-41:**

Slim-bezel suitable for monitor wall installations

IMD (in-monitor display)

Wide viewing angle with an IPS panel

9" Full HD (1920 x 1080 pixels) resolution LCD panel (LMD-941W)

## Lightweight Compact Design – Flexible Mounting For Picture Monitoring

The PVM-2541A and PVM-1741A incorporate a lightweight, compact metal body. Their design offers flexibility, and can be adapted according to the application: a desktop unit with standard table feet, or used with an optional SU-561 stand, or without the stand for wall applications.

These monitors support VESA™ mounting with a 100 mm pitch, and EIA 19-inch standard racks. \* This allows the monitors to be used for all types of application – desktop editing, office viewing, on a studio monitor wall, or installed in OB vans.

\* The PVM-1741A only is available with standard rack-mount brackets.



LMD-41 only

### Slim bezel, compact design for monitor-wall Installation

Incorporating a lightweight and robust aluminium slim bezel and compact body, the LMD-2341W, LMD-2041W, and LMD-1541W are a highly appropriate solution for monitor-wall installation, both in studio sub-control rooms and OB vans.



## Easy-to-use Control Panel

A rotary-type switch and seven function-assignable buttons allow users quick and intuitive operation. Operation buttons with LED indicators enable error-free operation, even in dark environments.\*

\* LED lights can be switched on/off.



Control panel with LED lights-on

## Input Versatility

The PVM-41 and LMD-41 Series monitors are equipped with built-in standard input interfaces: 3G/HD/SD-SDI (x2), HDMI (HDCP) input (x1) and composite (x1).

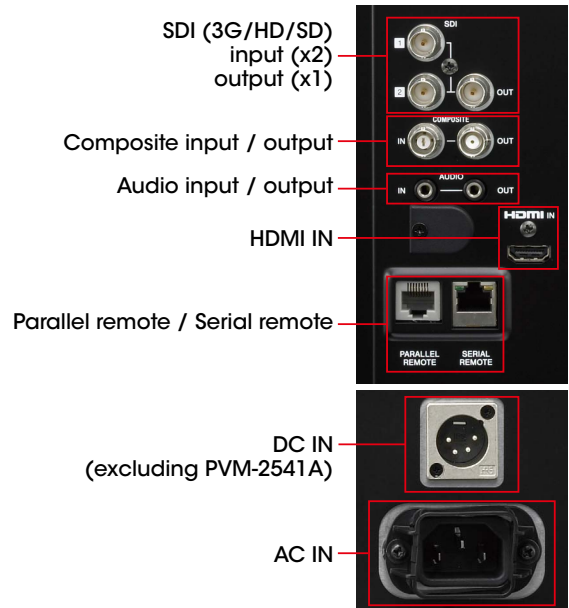

## Desk-top editing and office viewing

With a standard-supplied monitor feet or by installing an optional monitor stand\*, the LMD-2341W, LMD-2041W, and LMD-1541W can be used as desk-top monitors both for editing and office viewing.

\* The optional SU-561 stand can be used for any 41 Series monitors, and the optional SU-562 stand is for the LMD-1541W only.



\* Simulated images  
\* The SU-561 and SU-562 monitor stands are optional

## ▲ Waveform Monitor and Vector Scope Display

An input signal's waveform and vector scope with an SDI-embedded 2-channel audio level meter can be displayed on screen. Both the waveform monitor and vector scope have various modes, including a zoom function (in an area of 0 to 20 IRE) with the waveform monitor, and a zoom function (in the central black area) with the vector scope, for adjusting white balance. The waveform of a specified line can also be displayed.



Waveform monitor

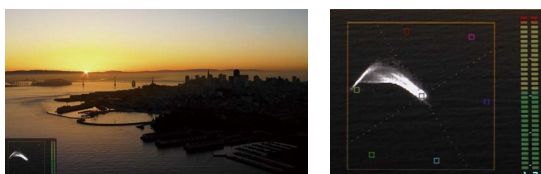

Vector scope

## ▲ Time Code Display

Time code embedded on SDI signals can be displayed on screen. Users can select either LTC or VITC.

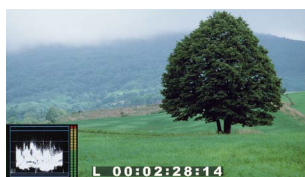

\* Simulated image

## ▲ Camera Focus Function

The PVM-41 and LMD-41 Series monitors can control the aperture level of a video signal, and display images on the screen with sharpened edges to help camera focus operation. Further to this, the sharpened edges can be displayed in user-selectable colours (white, red, green, blue, and yellow) for more precise focusing. This camera focus function can even be enhanced when combined with native scan mode.

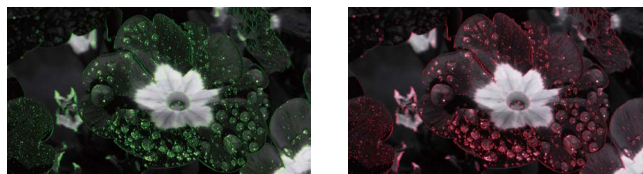

## ▲ Closed-caption Display

When inputting SD-SDI or HD-SDI signals, closed-caption signals of EIA/CEA-608 and EIA/CEA-708 are decoded and displayed on screen.

**In-monitor display (IMD) function**

The LMD-2341W, LMD-2041W, LMD-1541W, and LMD-941W support the TSL UMD protocol and can display on screen two tally lamps and dynamic text information received via Ethernet. Up to 16 unicode characters\*<sup>1</sup> can be displayed. IMD text can be positioned at the top or bottom of the screen. Both the text colour and the tally lamp colour are separately selectable either in a commanded colour or in one of eight preinstalled colours.\*<sup>2</sup>

\*<sup>1</sup> English alphabets, numbers, symbolic codes, and Japanese letters.  
 \*<sup>2</sup> White, red, green, blue, yellow, cyan, magenta, and amber.



The IMD, waveform monitor, 2-channel audio level meter, and time code display\*



The IMD, 8-channel audio level meter, and time code display.\*

\* Simulated images

**Scan mode selection**

Scan size can be selected from normal scan (0%), over scan (5%), full scan, and native scan modes.\*

- The aspect ratio can be switched between 16:9 and 4:3 according to the input signal.

As a new function of the LMD-2041W and LMD-1541W, when a 1920 x 1080i or 1080p signal is input, the image frame of native scan can be shifted in five patterns: center, top-left, top-right, bottom-right, and bottom-left.

\* Full Scan and Native Scan modes work on specific signal formats.



1920 x 1080 signal

→ Display in NATIVE scan mode



1600 x 900 (LMD-2041W)  
1280 x 768 (LMD-1541W)  
resolution

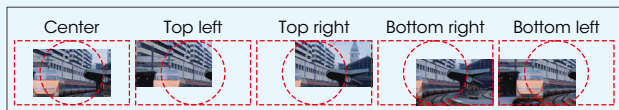

Native scan framing image (LMD-2041W and LMD-1541W)

**Ideal for CRT monitor replacement**

The LMD-1541W and the PVM-14L2, Sony's most popular 14-inch 4:3 aspect CRT monitor, share almost the same viewable area height. The body of the LMD-1541W - which houses a 15.3-inch diagonal, 15:9 aspect screen - is 74.5 mm shorter in height and only 27.2 mm wider than the PVM-14L2 body. And with its space-saving design, the LMD-1541W can be installed effectively in small spaces.

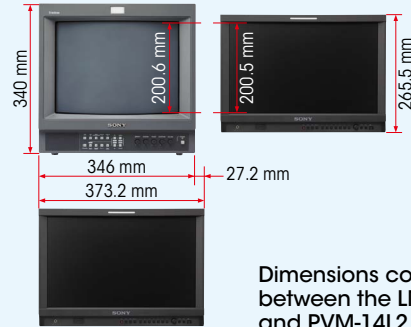

Dimensions comparison between the LMD-1541W and PVM-14L2





PVM-741

- Sony's Super-Top-Emission OLED panel with a 10-bit driver
- 960 x 540 pixels resolution



LMD-941W

- Full HD (1920 x 1080 pixels) resolution IPS LCD panel

\* Simulated images

## ▲ PVM / LMD-41 Series features

- Two 3G/HD/SD-SDI and an HDMI input interfaces
- Waveform monitor, Vector scope, Audio level meter, Time code, Closed caption display, Camera focus function
- Easy-to-use control panel

### ■ Robust, light-weight, and compact body

Incorporating a light-weight and compact aluminium-diecast body with a detachable AR-coated protection panel, this model is flexible enough to change style according to user requirements.



AR-coated protection panel



PVM-741 installed in the optional MB-531 19" mounting bracket with MB-532 mounting panel

### ■ Retractable Carrying Handle

A retractable carrying handle is provided as a supplied accessory, allowing users to carry these monitors anytime, anywhere.



PVM-741 with carrying handle

### ■ Easy Mounting into A Camera System

With 3/8-inch and 1/4-inch screw holes on its base, the PVM-741 and LMD-941W can be installed in a camera system. Also with the supplied arm-mount bracket fixed on the top, these monitors can be installed in a camera arm.



Rear and bottom



Arm-mount bracket is attached on the top

### ■ ENG Kit VF-510

For use in ENG and EFP field, the optional VF-510 ENG Kit provides a viewing hood, carrying handle, and connector protector.



VF-510 ENG Kit

### ■ Input versatility

The PVM-741 and LMD-941W are equipped with built-in standard input interfaces: 3G/HD/SD-SDI (x2), composite (x1), and HDMI input (x1).



### ■ Flip function (PVM-741 only)

The PVM-741 monitor has a feature to flip a picture without frame delay, horizontally, vertically, or horizontally and vertically.

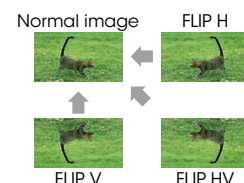

### ■ Easy-to-use control panel design

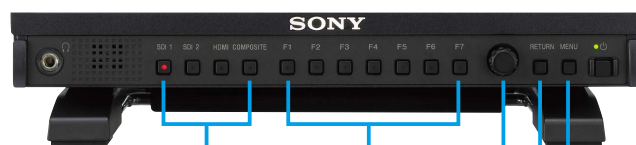

Input selection buttons

Assignable function buttons Default setting:  
 F1 (BRIGHTNESS) F2 (CONTRAST)  
 F3 (CHROMA) F4 (SCAN)  
 F5 (H/V DELAY) F6 (VOLUME)  
 F7 (I/P MODE\*)  
 \*Picture Delay Minimum Mode

Up/down Volume & Enter/set button

Return button

Menu on/off button



## It's Time for 4K Don't Miss the Wave; Catch the PVM-X300 4K Monitor

Full-HD production has widely impacted the broadcast and video production industry, yet now another wave is forming – the 4K content creation wave. Its rise is rapid, and it looks set to dramatically change the content creation industry, especially digital cinema.

Seeing this wave develop, you may be looking around for a versatile, dependable 4K video monitor. You can catch one right now – a right-size, easy-to-use monitor for every element of the production workflow including 4K cinema production (onset monitoring, dailies, and editing), 4K live production (camera control and program preview) and real-time 4K presentation.

Sony is proud to introduce the PVM-X300, 30-inch\*1 true 4K (4096 x 2160 pixels) resolution LCD video monitor, ideal for 4K previewing in onset and editing applications.

The PVM-X300 monitor realizes true 4K resolution in a portable 30-inch size. It's packed with features such as a wide-viewing-angle IPS LCD panel, and versatile input interfaces including 3G/HD-SDI x 4, HDMI x 4 and DisplayPort\*2 x 2 inputs. In addition, it delivers a user-application-oriented monitor control system, and supports an optional 4K SxS player.\*2

Want to review immediately the 4K images from your camera without an external box, and would you like to free yourself from complicated wired connections? It's easy with an optional 4K SxS player. Combine the PVM-X300 4K video monitor with this player to achieve an integrated total workflow with Sony's PMW-F55 4K cameras.

Catch every advantage of the 4K wave not just in film and TV production, but also in a wide range of other applications. The PVM-X300 is also ideal in industrial design and visualization systems, computer graphics systems, and in museum and laboratory environments. Catch it now!

\*1 767.5 mm viewing area, measured diagonally.

\*2 Supported by V1.1 or later.

The graphic consists of three overlapping circles. The left circle is green and titled '4K Cinema Production', showing a car on a desert road and a camera on a tripod. The middle circle is light green and titled '4K Live Production', showing a bullfight and a control room. The right circle is teal and titled '4K Business and Industry Production', showing a museum gallery and a 3D car model on a monitor.

\* Produced by TV Globo with the F65

### True 4K (4096 x 2160) Resolution Panel

The PVM-X300 incorporates a 30-inch wide-viewing-angle IPS LCD panel delivering true 4K (4096 x 2160) resolution. This new professional video monitor also incorporates a RGB 10-bit panel with uniformity control, and can accurately display the industry-standard ITU-R BT.709 colour space.

With its convenient size, you can easily carry the PVM-X300 to an onset site to monitor 4K resolution motion pictures. You can also achieve 4K monitoring in postproduction by putting the PVM-X300 monitor on a desk in the edit suite. From acquisition to editing, you'll have a true 4K workflow all the way. Soon you'll be wondering how you ever managed without the PVM-X300 in your production and postproduction environments!

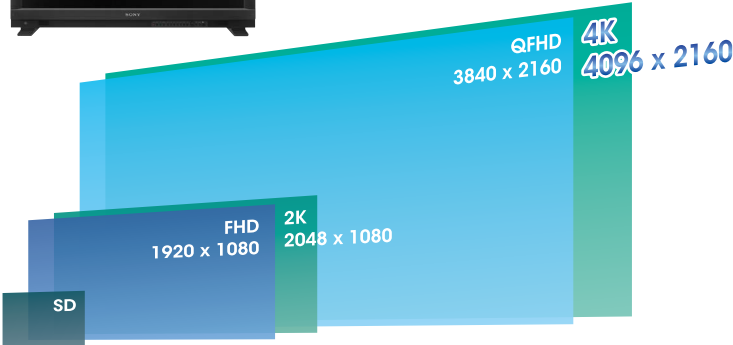

4K Resolution image

### Application images



Onset monitoring



OBVAN, Program/Preview



Edit suite

### Versatile Input Interfaces

The PVM-X300 4K monitor is equipped with variable interfaces including 3G/HD-SDI x 4 and HDMI x 4, allowing a direct connection with any type of 4K cinema camera and live product.

#### 3G/HD-SDI x 4 inputs

This monitor supports 3G-SDI receiving a wide range of 3G-SDI signals up to 4096 x 2160, 50p/60p, 10-bit Y/Cb/Cr 4:2:2.

#### HDMI x 4 inputs

This monitor supports 4096 x 2160/24p and 3840 x 2160/24p, 25p, 30p\* with one single HDMI cable. The PVM-X300 is also equipped with a unique capability - it can display 4096 x 2160/60p video signals with one single HDMI cable when connected to Sony's new PMW-F55 4K camera system.

#### DisplayPort\* x 2 inputs

\* Supported by V1.1 or later.

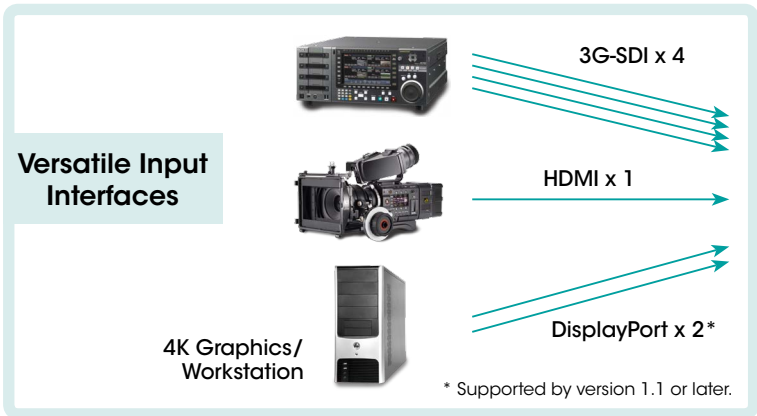

\* Supported by version 1.1 or later.

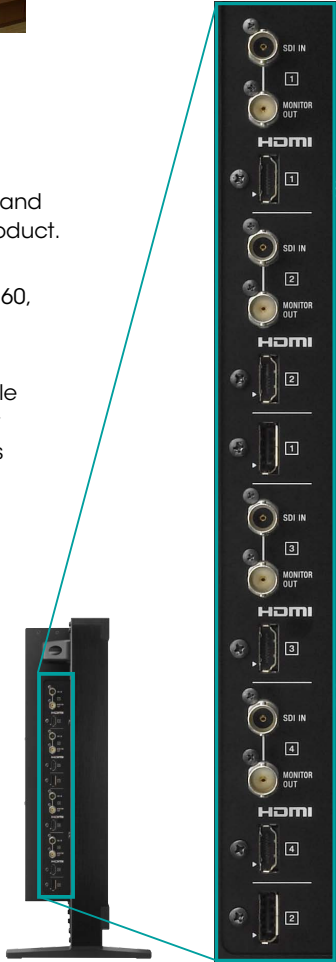

PVM-X300 connector panel

### ▲ 4K SxS Player\* (option)

You can combine the PVM-X300 with an optional 4K SxS player for easy playback of 4K content. Simply insert the newly developed SxS PRO+ high-speed memory media, which supports XAVC™ 4K and XAVC HD high-frame-rate recording, into the player to achieve immediate viewing of 4K camera images and 4K programs from a nonlinear editing system. This frees you from using an expensive, fragile HDD external player and complicated wired connections.

Thumbnails of each clip recorded on SxS PRO+ media are displayed on the monitor and can be controlled by the monitor's control panel.

\* Supported by V1.1 or later.



Thumbnail clip operation\*\*

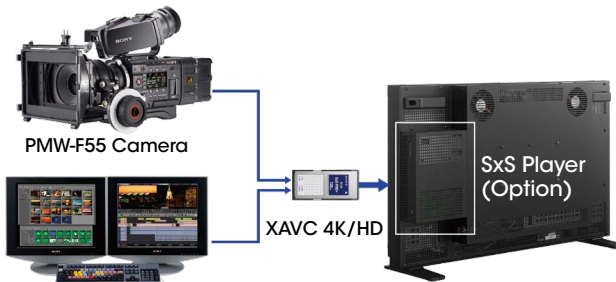

Nonlinear Editing System\*\*

#### 4K SxS player (option)

\*\* Future support. Images are simulated.



#### SxS PRO+ Media

This is newly developed memory card for XAVC recording. XAVC is a scalable video format that supports HD, 2K, QFHD, and up to true 4K resolution. The XAVC 4K format provides exquisite 4K image quality in storage-efficient file sizes.

### ▲ User-application-oriented Monitor Control

The PVM-X300 4K monitor provides a diverse range of monitor control, allowing you to choose from a wide selection of control systems:

- Direct control with the monitor's control panel
- Indirect control via a BKM-16R optional monitor control unit in OB vans and studio-sub systems\*
- PC operation\* for general business and industry applications

\* Supported by V1.1 or later.



Onset acquisition / Camera control



Monitor's Control Panel

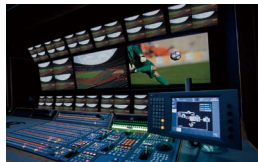

OBVAN/Studio



BKM-16R



General applications



PC

### ▲ Control Panel Design

With its user-friendly control panel design, the PVM-X300 allows seven functions to be allocated to assignable buttons. Button lights are dimmable and indicator lights are on/off switchable - this means you can operate the monitor easily in a dark environment.



Input select buttons

Function buttons

- (default setting)
- F1 (BRIGHTNESS)
- F2 (CONTRAST)
- F3 (CHROMA)
- F4 (BACKLIGHT)
- F5 (FOCUS ASSIST)
- F6 (VOLUME)
- F7 (VIEW MODE)

Switch and indicator

Menu operation buttons and knob



### ▲ Display Mode

The PVM-X300 provides different display modes: 4K/QFHD and 2K/HD Zoom. You can use 4K/QFHD mode when you want to display 4096 x 2160 or 3840 x 2160 signal inputs. And you can use 2K/HD Zoom mode to zoom and display 2048 x 1080\* or 1920 x 1080 signal inputs scaled to the 4K screen.

\* Supported by V1.1 or later.



4K/QFHD Mode

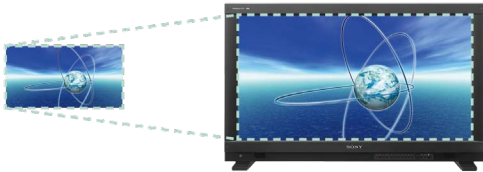

2K/HD Zoom Mode

### ▲ Zoom Function\*

Each of the five divided areas of the screen can be magnified by scaling to full-screen size.

\* Supported by V1.1 or later.



### ▲ Camera Focus Function

The PVM-X300 can control the aperture level of a video signal, and display images on screen with sharpened edges to help camera focus operation. Further to this, the sharpened edges can be displayed in user-selectable colours (white, red, green, blue, and yellow) for more precise focusing.

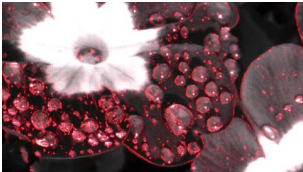

Focus in red

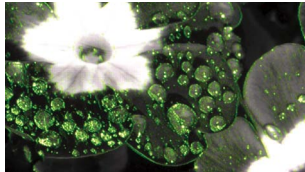

Focus in green

### ▲ Marker Settings\*

This useful feature enables the PVM-X300 to display various markers including an aspect marker, safe area marker, and center marker.

\* Supported by V1.1 or later.



\* Simulated image

### ▲ Gamma Selection

The PVM-X300 supports Gamma 2.4 as specified by the ITU-R BT.1886. In addition, Gamma 2.2, 2.6, and S-Log2 can be selected.

### ▲ Robust and Lightweight Aluminium Body

A solid aluminium housing ensures durability, especially for outdoor usage.

### ▲ Auto White Adjustment\*1

The PVM-X300 4K monitor employs a software-based colour temperature (white balance) calibration function, which is called "Monitor\_AutoWhiteAdjustment". Combined with a PC and commercially available colour analyzers\*2, this function enables simple adjustment of the monitor's white balance.

\*1 Supported with version 1.1 or later.

\*2 Konica Minolta CA-210, CA-310, CS-200, DK-Technologies PM5639/06, X-Rite i1 Pro/i1 Pro2, Photo Research PR-655/670, Klein K-10, and JETI specbos 1211. A connector is required for each colour analyzer.

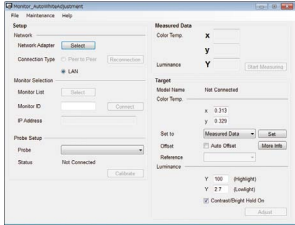

### ▲ Other Convenient Features

- Audio: Stereo speakers, line out, and stereo headphone jack
- VESA mounting (200 x 100 mm pitch)
- Timecode display\*
- SDI-embedded 8-ch audio level meter display\*
- Chroma Up

\* Supported by V1.1 or later.

# LMD-51 Series – Versatile 3D/2D LCD Monitors



LMD-4251TD





LMD-2451TD



LMD-1751W

## Model Types

	LMD-4251TD 	LMD-2451TD 	LMD-1751W
Panel size (diagonal)	42-inch	24-inch	17-inch
Resolution (pixels)	1920 x 1080 (Full HD)	1920 x 1200 (WUXGA)	1280 x 768 (WXGA)
Aspect ratio	16:9	16:10	15:9
Desktop stand	N/A	Standard	Optional SU-561
EIA 19-inch rack-mount	N/A	N/A	Optional MB-530
VESA mounting (mm)	400 x 400	100 x 100	100 x 100, 75 x 75

- Stylish control panel design – sheet-type switches with on/off switchable LED lights
- Option slots for flexibility and expandability
- Multi-format inputs including 3G-SDI input\*1
- 3D display (LMD-4251TD and LMD-2451TD)
- 10-bit signal processing and ChromaTRU colour processing technology
- Auto white balance calibration function for colour consistency\*2
- Wide viewing angle with an IPS panel
- Sophisticated I/P conversion and I/P mode selection
- Waveform monitor, audio level meter, and time code display\*3
- External remote control function (serial remote and parallel remote)
- Power-saving mode

\*1 The optional BKM-250TG 3G-SDI input adaptor is required.

\*2 This function uses a PC and the commercially available calibration probes: Konica Minolta CA-210, CA-310, CS-200, DK-Technologies PM5639/06, X-Rite i1 Pro/i1 Pro2, Photo Research PR-655/670, Klein K-10, and JETI specbos 1211.

\*3 The LMD-4251TD does not support waveform monitor. Audio level meter and Time code can be displayed when the optional BKM-250TG input adaptor is installed and SDI signal is received.



## ▲ Superb Picture Performance and Convenient Features

### High-performance LCD panels

The LMD-51 Series monitors incorporate high-resolution professional LCD panels\* with an excellent wide viewing angle, and use precisely manufactured RGB colour filters, allowing the reproduction of colours with stunning depth and saturation to create highly natural images.

\* LMD-4251TD (42-inches, 1920 x 1080 pixels), LMD-2451TD (24-inches, 1920 x 1200 pixels), and LMD-1751W (17-inches, 1280 x 768 pixels).

### 10-bit signal processing and ChromaTRU colour matching technology



Added to the high-grade LCD panels, a 10-bit signal processing and ChromaTRU technology offer a smooth grey scale along CRT-like gamma and stable white balance.

### Waveform monitor, audio level meter, and time code display\*

The input signal's waveform can be displayed on screen. When an SDI interface is connected, the embedded audio level can be displayed on screen with a 2-channel audio level meter. Installing an optional BKM-250TG 3G-SDI input adaptor, the LMD-51 Series monitors can display on screen an 8-channel audio level meter and a time code – either LTC or VITC is selectable.

\* The LMD-4251TD does not support waveform monitor. Audio level meter and Time code can be displayed when the optional BKM-250TG input adaptor is installed and SDI signal is received.



\* Simulated images

### Stereo audio monitoring

LMD-51 Series monitors are equipped with stereo speakers (1.0 W + 1.0 W) and a stereo headphone jack, which enable users to monitor audio. The SDI-embedded audio can be monitored by the built-in speakers and the monitor output.

### Closed-caption decoder

The closed caption information embedded in EIA 608 and EIA 708\* can be decoded for display.

\* For EIA 708, the optional BKM-244CC Closed Caption Adaptor is required.

### Colour temperature

Colour temperatures of D93, D65, or a user preset value can be Selected.

### Selectable scan size for video input and aspect ratio

Scan size can be selected between Normal scan (0%), over Scan (5%), Full scan, and Native scan modes.\* The aspect ratio can be switched between 16:9 and 4:3 according to the input signal.

\* Full scan and native scan modes work on specific signal formats.

### Marker settings

LMD-51 Series monitors can display various area markers, including a center marker, aspect markers, and safety area marker. The brightness of these markers can be selected from three different levels: white, grey, and dark grey.

Users can also select either a black or grey mat to fill the outer area of the aspect markers. These flexible marker controls, together with the choice of many different aspect markers, make the LMD-51 Series monitors extremely convenient display devices for a variety of shooting scenarios, from standard video acquisition to digital cinematography.

### Marker settings

	16:9 Mode	4:3 Mode
Aspect Marker	4:3, 15:9, 14:9, 13:9, 1.85:1, 2.35:1, 1.85:1 & 4:3	16:9
Center Marker	Yes	
Safety Area	80%, 85%, 88%, 90%, 93%	

### Mounting flexibility

The LMD-1751W is rack-mountable in the EIA 19-inch standard rack, using an optional MB-530 mounting bracket.

### VESA mounting

LMD-51 Series monitors provide VESA standard mounting holes which support installation on a wall or ceiling:  
 LMD-4251TD – 400 x 400 mm pitch  
 LMD-2451TD – 100 x 100 mm pitch  
 LMD-1751W – 100 x 100 mm and 75 x 75 mm pitch

### Other features

- Multi-display mode
- H/V Delay Function
- ACC Off
- DC Operation
  - 24 V: LMD-2451TD, 12 V: LMD-1751W
- Setup Level for Analogue Component and NTSC signal
- Sub Control on Contrast, Chroma, Phase, and Brightness
- Blue-Only Mode
- Monochrome Mode
- Auto Chroma / Phase Setup
- Three-colour Tally (LMD-4251TD is not equipped with Tally)
- Key-inhibit function
- Smart APA (Auto Pixel Alignment) for Computer Input

## Input Versatility

### Standard and optional signal interfaces

In addition to the standard input interfaces of analogue composite, component and RGB, and Y/C (S-Video), LMD-51 Series monitors are equipped with two slots for optional input adaptors of any combination for SD or HD video inputs. Users can expand the input capability according to their budget and needs.

### Computer signal interfaces

LMD-51 Series monitors are equipped with standard interfaces for HD-15 and DVI-D\* interfaces, respectively.

\* 1920 x 1080 images are down-converted for display on the LMD-1751W.

### 3G-SDI interface\*

LMD-51 Series monitors can accept 3G-SDI input by installing on an optional BKM-250TG 3G-SDI input adaptor. Sony's 3G-SDI interface is compliant with the SMPTE 425 standard, transmitting up to 4:2:2/10-bit 1080/50p and 1080/60p video data using one SDI cable. When an upgrade to these 1080/p systems is required, this single-link 3G-SDI system is an ideal, future-proof solution.

\* No models support a dual-link HD-SDI interface.

## Signal-interface Options

### BKM-250TG, 3G/HD/SD-SDI Input Adaptor\*

- 3G/HD/SD-SDI signal input (x2)
- 3G/HD/SD-SDI monitor output (x2)

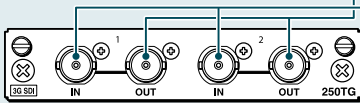

\* 3G-SDI, HD-SDI and SD-SDI signals are detected automatically

### BKM-244CC, HD/SD-SDI Closed Caption Adaptor\*

- HD-SDI/SD-SDI signal input (x2)
- HD-SDI/SD-SDI monitor output (x1)

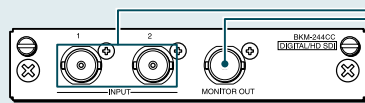

\* HD-SDI and SD-SDI signals are detected automatically  
\* Closed-caption decoders (EIA 608 and EIA 708) are equipped

### BKM-243HS, HD-SDI/SD-SDI Input Adaptor\*

- HD-SDI/SD-SDI signal input (x2)
- HD-SDI/SD-SDI monitor output (x1)

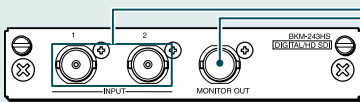

\* HD-SDI and SD-SDI signals are detected automatically

### BKM-229X, Analogue Component Adaptor

- RGB, Y/Pb/Pr input (x1)
- EXT SYNC (x1)

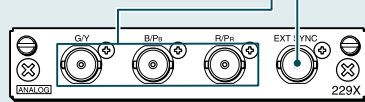

### BKM-227W, NTSC/PAL Input Adaptor

- Composite input/output (x1)
- Y/C input/output (x1)

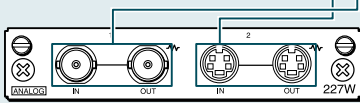

### BKM-220D, SD-SDI 4:2:2 Input Adaptor

- SD-SDI signal input (x2)
- SD-SDI monitor output (x1)

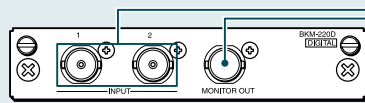

LMD-2451TD connector panel and option slots



LMD-2451TD connector panel



With the BKM-250TG 3G-SDI board



LMD-2451TD option slots



LMD-1751W connector panel and option slots



## 3D Features



Sony offers two models of high-performance professional 3D LCD monitor: the LMD-4251TD (42-inch\*1) and the LMD-2451TD (24-inch\*2). These monitors are supplied with the BKM-30G circular-polarizer 3D glasses as a supplied accessory.\*3

- \*1 1067-mm viewing area, measured diagonally.
- \*2 613-mm viewing area, measured diagonally.
- \*3 Also available BKM-31G clip-on type 3D glasses as an option.

### Circular-polarizer 3D system

The LMD-4251TD and LMD-2451TD incorporate a micropolarizer filter attached to the LCD panel. Wearing Sony's BKM-30G or BKM-31G 3D glasses, users experience smooth, uninterrupted viewing of multiple monitors and flicker-free 3D images. This image quality helps users to engage in 3D production operations with minimal stress.

### Unique lightweight circular-polarizer 3D glasses

Sony provides two types of 3D glasses: the standard BKM-30G, and the clip-on BKM-31G.

BKM-30G and BKM-31G circular-polarizer 3D glasses are optimized for LMD-4251TD and LMD-2451TD 3D monitors. These 3D glasses are extremely lightweight\*1 and comfortable to wear. Designed with a soft frame and center-support structure, BKM-30G glasses fit any size and shape of head and face, so the wearer experiences minimal stress even during continuous production tasks. The center-support structure of the BKM-30G does not put the lenses under stress, and so there is no lens distortion. With clip-on BKM-31G 3D glasses, the wearer can simply flip up the lenses when not required.

Both the BKM-30G and BKM-31G block approximately 99% of the sun's ultraviolet rays.\*2

- \*1 BKM-30G glasses weigh approx. 18 g; BKM-31G glasses weigh approx. 16 g.
- \*2 These circular-polarizer glasses cannot be used as sunglasses. The blocked spectral range is 280 nm to 380 nm.

### Fully compatible with 2D monitors

The LMD-4151TD and LMD-2451TD monitors are equipped with consistent quality, functionality, and operability – essential for professional monitors. Both 3D monitors can be used as 2D monitors, and their features are fully compatible with those of current LMD-51W Series monitors.\*

- \* The LMD-4251TD does not support 2-channel audio level meter and waveform monitor display.

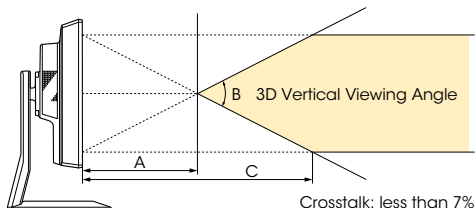

	A (typical)	B (typical)	C (typical)
LMD-2451TD	320 mm	54°	640 mm
LMD-4251TD	620 mm	46°	1240 mm

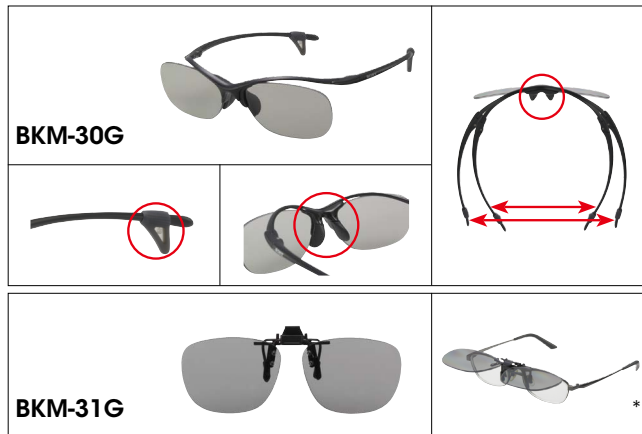

\* Clip-on BKM-31G glasses are worn with the user's own corrective glasses

### Multiple 3D input signal formats and interfaces

The LMD-4251TD and LMD-2451TD accept a variety of 3D signal formats including 3G-SDI, Dual-stream HD-SDI, HD-SDI side-by-side, HD-SDI Line interleave (line-by-line), HD-SDI Field sequential using an optional BKM-250TG 3G-SDI input adaptor, and DVI Line interleave (line-by-line). This input flexibility enables versatile 3D production both in the studio and the field.

### Various 3D signals and video formats support

Type of 3D signals	3G (level-B) Dual-stream 3G*1/HD-SDI x 2*1	Side-by-side*3		Line-by-line		Sequential
		HD-SDI*1	HD-SDI*1	DVI	HD-SDI*1	
1080/50i	○	○	-	-	-	-
1080/60i*2	○	○	-	-	-	-
1080/24P	○	○	○	-	-	-
1080/25P	○	○	○	-	-	-
1080/30P*2	○	○	○	-	-	-
1080/50P	-	-	○	-	-	-
1080/60P	-	-	○	-	-	-
1080/24PsF*2	○	○	-	-	-	○
1080/25PsF	○	○	-	-	-	○
720/50P	○	○	○	-	-	-
720/60P*2	○	○	○	-	-	-
1920 x 1080/50Hz	-	-	-	○	-	-
1920 x 1080/60Hz	-	-	-	○	-	-

- \*1 BKM-250TG (Ser.7100001 or later) is required for the 3D 3G/HD-SDI signals.
- \*2 The frame rates are also compatible with 1/1.001.
- \*3 L/R pictures are displayed as "side-by-side" in 2D display mode, and are displayed as "line-by-line" in 3D display mode. The pictures is aligned as side by side in 2D display mode are not compressed vertically.

**Variety of 3D/2D display functions**

There is a variety of convenient 3D production features\*1\*2 – ideal for high-quality creative 3D production. These capabilities are assignable to function keys on the front panel of the LMD-4251TD and LMD-2451TD, and can also be assigned to an external remote control unit. Plus and minus menu switches (“+” and “-”) are also assignable to the parallel remote.\*3 The 2D/3D select function is assigned to the front panel buttons or parallel remote, locations that are very convenient for users who frequently switch between 2D and 3D mode during 3D production work.

\*1 These functions work when the optional BKM-250TG 3G-SDI input adaptor is installed. Some features are unavailable depending on input signals or display modes. Multiple functions may not be used simultaneously.

\*2 The 1920 x 1080 image displays with black bands at the top and bottom of the LMD-2451TD WUXGA screen.

\*3 This function will be available from V1.10, and requires a BKM-250TG serial number of 740001 or higher.

**Disparity simulation [3D mode]**

Either the left or right signal phase (or both phases) of a 3D image can be shifted horizontally.

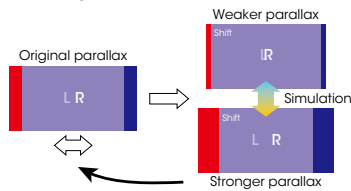

**Difference display\***

This function displays the difference between the luminance signal of the left (L) and right (R) images of the 3D signal. This function is useful for checking the amount of parallax.

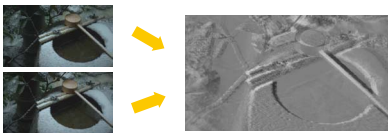

**Grid display\***

The primary function is to display arbitrary multiple numbers of vertical lines for users to review the overall parallax of captured images.

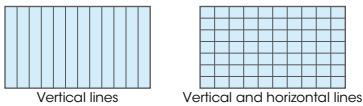

Examples of grid display

\* Number of vertical lines can be set variable with 0.1% (2-pixel) pitch.

**Disparity ruler\***

This function works to precisely measure disparity by setting L-line and R-line to L/R objects respectively on the screen.

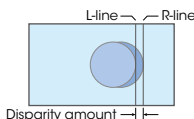

**Virtual Subject Marker\***

This function simulates disparity in a subject on any part of the screen, before the shot is taken.



**Checker board [2D mode]**

Left and right input signals are displayed in a grid pattern on screen. By comparing adjacent images, users can recognize a difference in brightness and colour setting of the left and right images.

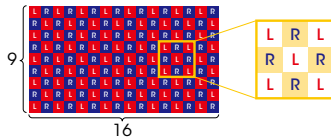

**L/R switch [2D mode]**

Left and right signals can be swapped in a moment without inserting black frames, simply by manually pushing a function key. Automatic sequential mode is also available.\*

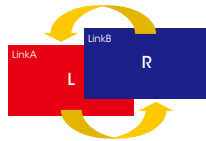

**3D/2D colour matching function (3D offset adjustment)\***

In 3D mode, this function offsets the white balance of a 3D image. This enables closer image colour matching between a 3D image viewed through 3D glasses and a 2D image when the viewer takes off their 3D glasses.

**720p Scan Mode Selection\***

With this resolution scan size (1280 x 720 pixels), users can choose either Normal or Native display mode. Normal mode enlarges the 720p image size to 1920 x 1080 pixel resolution.



\* Screen images are simulated.

**Side-by-side signals display**

In addition to the popular squeezed side-by-side display (SBS1) mode, non-squeezed side-by-side display (SBS2) mode is also provided.\*

\* The SBS2 mode is available from V1.10.

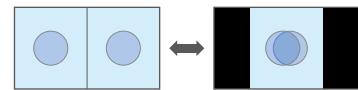

**Dual time code display [3D modes]\***

Left and right channels' individual time codes can be displayed on the screen.



\* Time code displays and images are simulated.

**Flip H [3D mode]**

The Flip H function turns the reversed image to the normal view. This is helpful because the user can refer directly to the rig camera, achieving a simple and cost-saving system.

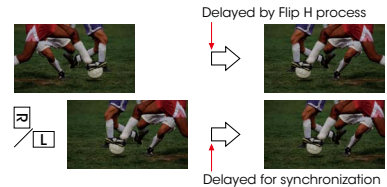

**Horopter check [3D mode]**

This function helps users to perceive the subtle difference of depth between different objects placed on the 3D screen surface.

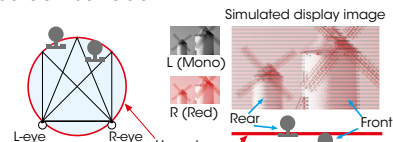

Image overview when viewed from above

**Payload ID display**

This function allows users simply to check whether the left and right channels of 3D signals are connected correctly in the menu.

\* This function will be available from V1.10, and requires a BKM-250TG serial number of 740001 or higher.

## LMD-30/10 Series – Entry-level LCD Monitor



LMD-1530W



LMD-2110W



LMD-1510W

### Model Types

	LMD-1530W	LMD-2110W	LMD-1510W
Panel size (diagonal)	15.3-inch	21.5-inch	15.6-inch
Resolution (pixels)	1280 x 768 (WXGA)	1920 x 1080 (Full HD)	1366 x 768 (WXGA)
Aspect ratio	15:9	16:9	16:9
Desktop stand	Standard	Standard	Standard
EIA 19-inch rack-mount	Optional MB-533	Optional MB-529	Optional MB-535
VESA mounting (mm)	100 x 100	100 x 100	100 x 100

- High-purity colour filters, and excellent brightness and contrast
- 109% peak white and 10-bit signal processing
- Colour temperature and gamma selection
- Picture delay minimum mode (LINE DOUBLER)
- Versatile signal inputs including SDI\* and HDMI
- Marker setting including aspect markers, a center marker, and safety area markers

\* HD/SD-SDI input with the optional BKM-341HS HD/SD-SDI input adaptor.

Full compatibility  
with professional HD equipment



Easy connection  
with consumer products



## ▲ High Picture Performance

### High purity colour filters

Equipped with high-purity RGB colour filters, LMD-30/10 Series monitors achieve colour reproduction with stunning depth and saturation.

### Excellent brightness and contrast

LMD-30/10 Series monitors provide high-brightness, high contrast images thanks to their wide aperture LCD panels. In addition, the use of precisely manufactured RGB colour filters allows these monitors to reproduce colours with stunning depth and saturation – creating highly natural images.

### 109% peak white and 10-bit signal processing

Incorporating high-purity RGB colour filters and 10-bit signal processing engine, LMD-30/10 Series monitors offer stunning 109% peak white reproduction without clipping and a smooth grey scale along CRT-like gamma.

### Colour temperature/gamma selection

With the LMD-30/10 Series monitors, users can select from high, low, or preset colour temperatures. A variety of gamma modes can also be selected.

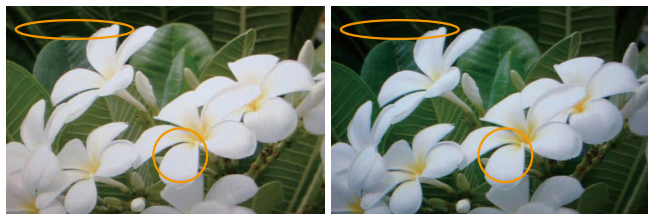

Incorrect gamma image\*

Correct gamma image\*

\* Simulated images

### I/P mode selection

LMD-30/10 Series monitors provide two I/P modes so that users can select the most suitable mode for each purpose:

#### ■ INTER-FIELD:

This mode interpolates images between fields. This is used for picture quality precedence (e.g., to reduce the jagged effect on moving pictures).

#### ■ LINE DOUBLER:

This mode interpolates by repeating each line. This is used for editing and monitoring fast-moving images, and checking line flicker. The minimum processing time is less than one field (0.5 frames).

### Picture Delay Minimum

Audio is just as much a part of the show as video, and timing is always an issue. Picture Delay Minimum mode is selectable to minimize I/P conversion times for audio synchronization during editing. By selecting "LINE DOUBLER" in IP mode, the signal processing (I/P conversion) period is less than one field (0.5 frames).

## ▲ Operational Convenience

### Marker settings

LMD-30/10 Series monitors can display a center marker, aspect markers, and safety area markers in different sizes.\* The brightness of these markers can be set at different levels. These flexible marker settings make these monitors extremely convenient display devices for a variety of shooting scenarios.

\* 80%, 85%, 88%, 90%, or 93% can be selected.

### Selectable scan size for video input and aspect ratio

With LMD-30/10 Series monitors, the scan size can be selected: Normal (0%), Over (5%), and Full scan.

The aspect ratio can be switched between 16:9 and 4:3 according to the input signal.

### Three-colour tally

LMD-30/10 Series monitors are equipped with a tally lamp that can be lit via a parallel remote connector. The status of the signal displayed on the monitor can be identified by the tally colour: red, green, or amber.

### Monaural audio monitoring

LMD-30/10 Series monitors are equipped with a speaker (0.5 W), which enables the user to monitor audio.

### Protected controls

With LMD-30/10 Series monitors, the key-inhibit function helps prevent inadvertent operation from the control panel.



## ▲ Mounting Flexibility and Remote Access

### Mountable in an EIA 19-inch Standard Rack

LMD-30/10 Series monitors can be mounted in a EIA 19-inch standard rack using optional mounting brackets. The 7U-high LMD-1530W uses the MB-533 and LMD-1510W uses MB-535 respectively. The 9U-high LMD-2110W uses MB-529 Mounting Bracket.

### VESA mounting

VESA standard mounting holes (100 x 100 mm pitch) are provided on LMD-30/10 Series monitors to enable wall or ceiling installation.

### Parallel remote control

These entry-level type LMD-30/10 Series monitors can be controlled remotely via their parallel remote connectors. In the remote menu, there are 16 functions for the LMD-1530W and LMD-2110W, and 21 functions for the LMD-1510W, of which seven can be allocated to the remote connector.

## ▲ Input Versatility

### Standard inputs and expandability

LMD-30/10 Series monitors are equipped with a full range of analogue SD inputs including analogue composite NTSC and PAL, Y/C (S-Video), and 525i/625i component and RGB. These monitors can also handle HD/SD-SDI input with an optional BKM-341HS HD/SD-SDI input adaptor. This optional feature allows this monitor to connect to HD/SD-SDI equipment for wide range of broadcast and post-production applications. Furthermore, these monitors offer an HD signal input capability via their HDMI and analogue component interface, and also can accept DVI signals via the HDMI interface.\*

\* Requires a DVI conversion cable.



LMD-30/10 Series with the optional BKM-341HS HD/SD-SDI adaptor

## Control panel

### LMD-1530W / LMD-2110W / LMD-1510W

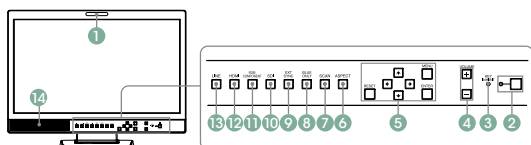

- 1 Tally lamp
- 2 standby switch and indicator
- 3 KEY INHIBIT indicator
- 4 VOLUME buttons
- 5 Menu operation buttons
- 6 ASPECT select button
- 7 SCAN select button
- 8 BLUE ONLY button
- 9 EXT SYNC (external sync) button
- 10 SDI button
- 11 RGB/COMPONENT button
- 12 HDMI button
- 13 LINE
- 14 Speaker



LMD-1510W

## Connector panel

### LMD-1530W / LMD-2110W / LMD-1510W

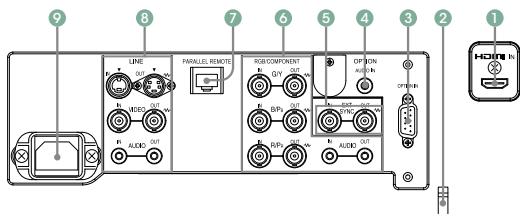

- 1 HDMI IN connector
- 2 HDMI cable holder
- 3 OPTION In connector
- 4 OPTION AUDIO In (Phono jack)
- 5 EXT SYNC In/Out (external sync) (BNC)
- 6 RGB/COMPONENT (BNC), Audio (Phono jack)
- 7 PARALLEL REMOTE (modular connector)
- 8 LINE [composite (BNC), Y/C (Mini DIN 4-pin), Audio (Phono jack)]
- 9 AC In



LMD-1510W

**PVM-2541A / PVM-1741A / PVM-741  
LMD-2341W / LMD-2041W / LMD-1541W / LMD-941W Signal Formats**

System	Signal standard			
	Analogue composite	HD/SD-SDI	3G-SDI	HDMI
575/50i (PAL)	○	○	–	○
480/60i (NTSC)*1	○	○	–	○
576/50p	–	–	–	○
480/60p*1	–	–	–	○
640 x 480/60p*1	–	–	–	○
1080/24PsF*1*2	–	○	○*3	–
1080/25PsF*2	–	○	○*3	–
1080/30PsF*1*2	–	–	○*3	–
1080/24p*1	–	○	○*3	○
1080/25p	–	○	○*3	○
1080/30p*1	–	○	○*3	○
1080/50i	–	○	○*3	○
1080/60i*1	–	○	○*3	○
1080/50p	–	–	○*4	○*6
1080/60p*1	–	–	○*4	○*6
720/24p*1	–	–	○*5	–
720/25p	–	–	○*5	–
720/30p*1	–	–	○*5	–
720/50p	–	○	○*3	○*6
720/60p*1	–	○	○*3	○*6

\*1 Compatible with 1/1.001 frame rates.

\*2 1080/24PsF, 25PsF, and 30PsF are displayed as 1080/48i, 50i, and 60i on the screen, respectively.

\*3 10-bit 4:4:4 Y/Cb/Cr and 4:4:4 RGB of 3G-SDI signals are supported.

\*4 10-bit 4:2:2 Y/Cb/Cr of 3G-SDI signal is supported.

\*5 10-bit 4:4:4 Y/Cb/Cr of 3G-SDI signal is supported.

\*6 PVM-2541A, PVM-1741A, LMD-2341W, LMD-2041W, and LMD-1541W can accept DVI signals via the HDMI interface using a conversion cable.

**PVM-2541A / PVM-1741A  
LMD-2341W / LMD-2041W / LMD-1541W DVI Input Signals**

Resolution	Dot clock (MHz)	fH (kHz)	fV (Hz)
640 x 480	25.175	31.5	60
1280 x 768	68.250	47.4	
1280 x 1024	108.000	64.0	
1360 x 768	85.500	47.7	
1440 x 900	88.750	55.5	
1680 x 1050	119.000	64.7	

• When a DVI signal is input to the HDMI IN connector using a DVI conversion cable.

• Sides of the displayed picture may be hidden depending on the input signal.

## PVM-X300 Signal Formats HD-SDI / 3G-SDI

Signal System	Signal Format	
HD-SDI Single-link	1920 x 1080/24PsF*	10 bit YCbCr 4:2:2
	1920 x 1080/24P*	
	1920 x 1080/25PsF	
	1920 x 1080/30PsF*	
HD-SDI Quad-link	3840 x 2160/24PsF*	10 bit YCbCr 4:2:2
	3840 x 2160/25PsF	
	3840 x 2160/30PsF*	
	3840 x 2160/24p*	
	3840 x 2160/25p	
	3840 x 2160/30p*	
	4096 x 2160/24PsF*	
	4096 x 2160/25PsF	
	4096 x 2160/30PsF*	
	4096 x 2160/24p*	
	4096 x 2160/25p	
	4096 x 2160/30p*	
3G-SDI Single-link	1920 x 1080/24PsF*	12/10 bit YCbCr 4:4:4 12/10 bit RGB 4:4:4
	1920 x 1080/24P*	
	1920 x 1080/25PsF	
	1920 x 1080/30PsF*	
3G-SDI Quad-link	3840 x 2160/50p	10 bit YCbCr 4:2:2
	3840 x 2160/60p*	
	3840 x 2160/24PsF*	12/10 bit RGB 4:4:4 12/10 bit YCbCr 4:4:4
	3840 x 2160/25PsF	
	3840 x 2160/30PsF*	
	3840 x 2160/24p*	
	3840 x 2160/25p	
	3840 x 2160/30p*	
	4096 x 2160/50p	10 bit YCbCr 4:2:2
	4096 x 2160/60p*	
	4096 x 2160/24PsF*	12/10 bit RGB 4:4:4 12/10 bit YCbCr 4:4:4
	4096 x 2160/25PsF	
	4096 x 2160/30PsF*	
	4096 x 2160/24p*	
	4096 x 2160/25p	
	4096 x 2160/30p*	

\* Compatible with 1/1.001 frame rates.

## HDMI

Signal System	Signal Format
640 x 480p@60* <sup>1</sup>	12/10/8 bit RGB 4:4:4* <sup>2</sup> 12/10/8 bit YCbCr 4:4:4* <sup>2</sup> 12 bit YCbCr 4:2:2* <sup>2</sup>
720 x 480p@60* <sup>1</sup>	12/10/8 bit RGB 4:4:4* <sup>2</sup>
720 x 576p@50	12/10/8 bit YCbCr 4:4:4* <sup>2</sup>
1920 x 1080p@24* <sup>1</sup>	12 bit YCbCr 4:2:2* <sup>2</sup>
4096 x 2160p@24* <sup>1</sup>	8 bit RGB 4:4:4 8 bit YCbCr 4:4:4 12 bit YCbCr 4:2:2

\*<sup>1</sup> Compatible with 1/1.001 frame rates.

\*<sup>2</sup> RGB/YCbCr formats and 12/10/8 bit are detected and switched automatically.

## LMD-51 Series Input Signals / Input Adaptors (As for the 3D signals, refer to the page 21.)

Video Signal Formats	Input signals				LMD-4251TD / LMD-2451TD / LMD-1751W								
	Total Line	Active Line	Aspect Ratio	Frame Rate*1	Composite Y/C	RGB Component	SDI 4:2:2	HD-SDI SD-SDI	3G/HD/SD-SDI				
					Standard					Options			
					BKM-227W	BKM-229X	BKM-220D	BKM-243HS BKM-244CC	BKM-250TG				
575/50i (PAL)	625	575	16:9 & 4:3	25	○	○	○	○	○				
480/60i (NTSC)*1	525	483	16:9 & 4:3	30	○	○	○	○	○				
576/50p	625	576	16:9 & 4:3	50	N.A.	○	N.A.	N.A.	N.A.				
480/60p	525	483	16:9 & 4:3	60	N.A.	○	N.A.	N.A.	N.A.				
1080/24PsF*1*3	1125	1080	16:9	24	N.A.	○*2	N.A.	○	○				
1080/25PsF*3	1125	1080	16:9	25	N.A.	○*2	N.A.	○	○				
1080/24p*1	1125	1080	16:9	24	N.A.	○*2	N.A.	○	○				
1080/25p	1125	1080	16:9	25	N.A.	○*2	N.A.	○	○				
1080/30p*1	1125	1080	16:9	30	N.A.	○*2	N.A.	○	○				
1080/50i	1125	1080	16:9	25	N.A.	○	N.A.	○	○				
1080/60i*1	1125	1080	16:9	30	N.A.	○	N.A.	○	○				
720/50p	750	720	16:9	50	N.A.	○*2	N.A.	○	○				
720/60p*1	750	720	16:9	60	N.A.	○	N.A.	○	○				
1080/50p	1125	1080	16:9	50	N.A.	N.A.	N.A.	N.A.	○*4				
1080/60p*1	1125	1080	16:9	60	N.A.	N.A.	N.A.	N.A.	○*4				

\*1 Compatible with 1/1.001.

\*2 For component input only.

\*3 Displayed as 1080/48i and 1080/50i on the screen, respectively.

\*4 10-bit 4:2:2 Y/Cb/Cr is supported.

## LMD-30/10 Series Video Input Signals / Input Adaptors

Input Signal				Interface					
System	Total Line	Active Line	Aspect Ratio	Composite Y/C	RGB Component	HD-SDI SD-SDI	HDMI		
				Standard					Standard
				Option					
				BKM-341HS					
575/50i (PAL)	625	575	16:9/4:3	○	○	○	○		
480/60i (NTSC)*1	525	483	16:9/4:3	○	○	○	○		
576/50p	625	576	16:9/4:3	N.A.	○	N.A.	○		
480/60p	525	483	16:9/4:3	N.A.	○	N.A.	○		
1080/24PsF	1125	1080	16:9	N.A.	N.A.	○	N.A.		
1080/25PsF	1125	1080	16:9	N.A.	N.A.	○	N.A.		
1080/24p*1	1125	1080	16:9	N.A.	○*2	○	○		
1080/25p	1125	1080	16:9	N.A.	○*2	○	○		
1080/30p*1	1125	1080	16:9	N.A.	○*2	○	○		
1080/50i	1125	1080	16:9	N.A.	○	○	○		
1080/60i*1	1125	1080	16:9	N.A.	○	○	○		
720/50p	750	720	16:9	N.A.	○*2	○	○		
720/60p*1	750	720	16:9	N.A.	○	○	○		

\*1 Compatible with 1/1.001.

\*2 For component input only.



## LMD-51 Series HD-15 Input Signal Formats

Resolution	H Total	H addr.	V Total	V Addr.	Dot Clock	fH	fV	Sync Polarity		LMD-4251TD	LMD-2451TD	LMD-1751W
					[MHz]	[kHz]	[Hz]	Horizontal	Vertical			
640 x 480@60Hz*	800	640	525	480	25.175	31.469	59.940	N	N	○	○	○
640 x 480@60Hz	800	640	494	480	23.625	29.531	59.780	P	N	○	○	○
720 x 400@70Hz*2	900	720	449	400	28.322	31.469	70.087	N	P	○	○	○
800 x 600@56Hz*	1024	800	625	600	36.000	35.156	56.250	P	P	○	○	○
800 x 600@60Hz*	1056	800	628	600	40.000	37.879	60.317	P	P	○	○	○
800 x 600@60Hz	960	800	618	600	35.500	36.979	59.837	P	N	○	○	○
800 x 600@72Hz*	1040	800	666	600	50.000	48.077	72.188	P	P	○	○	○
800 x 600@75Hz*	1056	800	625	600	49.500	46.875	75.000	P	P	○	○	○
800 x 600@85Hz*	1048	800	631	600	56.250	53.674	85.061	P	P	○	○	○
1024 x 768@60Hz*	1344	1024	806	768	65.000	48.363	60.004	N	N	○	○	○
1024 x 768@60Hz	1184	1024	790	768	56.000	47.297	59.870	P	N	○	○	○
1024 x 768@70Hz*	1328	1024	806	768	75.000	56.476	70.069	N	N	○	○	○
1024 x 768@75Hz*	1312	1024	800	768	78.750	60.023	75.029	P	P	○	○	○
1024 x 768@85Hz*	1376	1024	808	768	94.500	68.677	84.997	P	P	○	○	○
1152 x 864@75Hz*	1600	1152	900	864	108.000	67.500	75.000	P	P	○	○	○
1280 x 768@50Hz	1648	1280	791	768	65.125	39.518	49.959	N	P	○	○	○
1280 x 768@60Hz	1680	1280	795	768	80.125	47.693	59.992	N	P	○	○	○
1280 x 768@60Hz	1440	1280	790	768	68.250	47.396	59.995	P	N	○	○	○
1280 x 768@75Hz	1712	1280	802	768	102.875	60.091	74.926	N	P	○	○	○
1280 x 800@60Hz*1					68.900	48.935	59.969	N	N	○	○	○
1280 x 960@60Hz*	1800	1280	1000	960	108.000	60.000	60.000	P	P	○	○	○
1280 x 960@60Hz	1440	1280	988	960	85.250	59.201	59.920	P	N	○	○	○
1280 x 1024@60Hz*	1688	1280	1066	1024	108.000	63.981	60.020	P	P	○	○	○
1280 x 1024@60Hz	1440	1280	1054	1024	91.000	63.194	59.957	P	N	○	○	○
1360 x 768@50Hz	1760	1360	791	768	69.500	39.489	49.922	N	P	○	○	○
1360 x 768@60Hz	1776	1360	768	768	84.625	47.649	59.936	N	P	○	○	○
1360 x 768@60Hz	1520	1360	790	768	72.000	47.368	59.960	P	N	○	○	○
1600 x 1200@50Hz	2144	1600	1235	1200	132.375	61.742	49.994	N	P	○	○	○
1600 x 1200@60Hz	1760	1600	1235	1200	130.375	74.077	59.981	P	N	○	○	○
1920 x 1080@50Hz	2544	1920	1112	1080	141.375	55.572	49.975	N	P	○	○	○
1920 x 1080@60Hz	2080	1920	1111	1080	138.625	66.647	59.988	P	N	○	○	○

○ =VESA-DMT    ○ =VESA-CVT VCRT    N = Negative P = Positive \* SOG \*1 Anycast Station \*2 Matrix

## LMD-51 Series DVI-D Input Signal Formats

	LMD-4251TD / LMD-2451TD	LMD-1751W
Vertical frequency	50.0 Hz to 85.1 Hz	
Horizontal frequency	31.5 kHz to 77.0 kHz	
Dot clock	25.175 MHz to 148.500 MHz	25.175 MHz to 141.000 MHz
Picture size, phase	Automatically detected by the DE (Data Enable) signal	

## LMD-30/10 Series DVI Input Signals

Resolution	Dot clock (MHz)	fH (kHz)	fV (Hz)	LMD-1530W	LMD-2110W / LMD-1510W
720 x 400 70Hz	28.322	31.469	70.087	○	○
800 x 600 56Hz	36.000	35.156	56.250	○	○
800 x 600 60Hz	40.000	37.879	60.317	○	○
1024 x 768 60Hz	65.000	48.363	60.004	○	○
1280 x 768 60Hz	79.500	47.776	59.870	○	-
1280 x 1024 60Hz	108.000	63.981	60.020	-	○

\* A DVI conversion cable is required.

# Feature Comparison

	PVM-2541A	PVM-1741A	PVM-741
Panel type	OLED		
Picture size (viewable area, measured diagonally)	24.5-inch	16.5-inch	7.4-inch
Resolution (pixels)	1920 x 1080 (Full HD)		960 x 540 (QHD)
Aspect ratio	16:9		
Panel drive / Colours	10-bit		
<b>Input interface</b>			
Composite	BNC (x1)		
3G/HD/SD-SDI	BNC (x2)		
HDMI	HDMI (x1)*1		HDMI (x1)
Audio	Stereo mini jack (x1)		
<b>Output interface</b>			
Composite	BNC (x1)*2		
3G/HD/SD-SDI	BNC (x1)*2		
Audio monitor out	Stereo mini jack (x1)		
Speaker (built-in)	1.0 W (mono)		0.5 W (mono)
Headphone output	Stereo mini jack (x1)		
<b>Remote control</b>			
Parallel remote	Modular connector 8-pin (x1)		
Serial remote (LAN)	RJ-45 modular connector (Ethernet) (x1)		
<b>Features</b>			
Signal processing	10-bit		
Auto white balance calibration*3	○		
I/P mode selection	4 modes		
Screen saver	○		
Markers	Aspect, Center, Safety		
Waveform monitor	○		
Vector scope	○		
Camera focus in colour	○		
Audio level meter (SDI-embedded audio)	○		
Time code display (SDI-embedded time code)	○		
Colour temperature (D65, D93, and user)	○		
Closed caption	○		
Aspect switch (16:9, 4:3)	○		
Scan mode (Normal (0%), Over (5%), Native)	○		
Blue only	○		
H/V delay	○		
Tally	3 colours		
EIA 19-inch rack-mounting	-	Supplied brackets	Optional MB-531
VESA mounting	100 x 100 mm		-
Desktop stand	Standard monitor feet, Optional SU-561		Standard
DC operation	-		12 V

\*1 DVI signals can be input via the HDMI interface using a conversion cable.

\*2 Loop-through, automatic termination.

\*3 This works with the combination of a PC and a commercially available calibration tools (Konica Minolta CA-210, CA-310, CS-200, DK-Technologies PM5639/06, X-Rite i1 Pro/i1 Pro2, Photo Research PR-655/670, Klein K-10, and JETI specbos 1211).

	LMD-2341W	LMD-2041W	LMD-1541W	LMD-941W
Panel type	a-Si TFT Active Matrix LCD			
Picture size (viewable area, measured diagonally)	23-inch	20-inch	15.3-inch	9-inch
Resolution (pixels)	1920 x 1080 (Full HD)	1600 x 900	1280 x 768 (WXGA)	1920 x 1080 (Full HD)
Aspect ratio	16:9		15:9	16:9
Panel drive / Colours	Approx. 16.7 million colours			
<b>Input interface</b>				
Composite	BNC (x1)			
3G/HD/SD-SDI	BNC (x2)			
HDMI	HDMI (x1)*1			HDMI (x1)
Audio	Stereo mini jack (x1)			
<b>Output interface</b>				
Composite	BNC (x1)*2			
3G/HD/SD-SDI	BNC (x1)*2			
Audio monitor out	Stereo mini jack (x1)			
Speaker (built-in)	1.0 W (mono)			0.5 W (mono)
Headphone output	Stereo mini jack (x1)			
<b>Remote control</b>				
Parallel remote	Modular connector 8-pin (x1)			
Serial remote (LAN)	RJ-45 modular connector (Ethernet) (x1)			
<b>Features</b>				
Signal processing	10-bit			
Auto white balance calibration*3	○			
I/P mode selection	4 modes			
Power saving mode	○			
Markers	Aspect, Center, Safety			
Waveform monitor	○			
Vector scope	○			
Camera focus in colour	○			
Audio level meter (SDI-embedded audio)	○			
Time code display (SDI-embedded time code)	○			
Colour temperature (D65, D93, and user)	○			
Closed caption	○			
Aspect switch (16:9, 4:3)	○			
Scan mode (Normal (0%), Over (5%), Native)	○			
Blue only	○			
H/V delay	○			
Tally	3 colours			
EIA 19-inch rack-mounting	–	Supplied brackets	Optional MB-534	Optional MB-531
VESA mounting	100 x 100 mm			–
Desktop stand	Supplied monitor feet			Standard
	Optional SU-561		Optional SU-561, SU-562	
DC operation	24 V	12 V		

\*1 DVI signals can be input via the HDMI interface using a conversion cable.

\*2 Loop-through, automatic termination.

\*3 This works with the combination of a PC and a commercially available calibration tools (Konica Minolta CA-210, CA-310, CS-200, DK-Technologies PM5639/06, X-Rite i1 Pro/i1 Pro2, Photo Research PR-655/670, Klein K-10, and JETI specbos 1211).

	PVM-X300	LMD-4251TD	LMD-2451TD	LMD-1751W
Panel type	a-Si TFT Active Matrix LCD	a-Si TFT Active Matrix LCD		
Picture size (viewable area, measured diagonally)	30.2-inch	42-inch	24-inch	17-inch
Resolution (pixels)	4096 x 2160 (True 4K)	1920 x 1080 (Full HD)	1920 x 1200 (WUXGA)	1280 x 768 (WXGA)
Aspect ratio	17:9	16:9	16:10	15:9
Panel drive / Colours	RGB 10-bit	Approx. 16.7 million colours		
<b>Input interface</b>				
Composite	-	BNC (x1), Optional BKM-227W BNC (x1)		
Y/C	-	Mini-DIN 4-pin (x1), Optional BKM-227W Mini-DIN 4-pin (x1)		
RGB / Component	-	BNC (x3), Optional BKM-229X BNC (x3)		
SD-SDI	-	Optional BKM-220D BNC (x2)		
HD/SD-SDI	-	Optional BKM-243HS, BKM-244CC BNC (x2)		
3G/HD/SD-SDI	BNC (x4) (3G/HD-SDI)	Optional BKM-250TG BNC (x2)		
HDMI	HDMI (x4)*1	-		
DVI-D	-	DVI-D (x1)		
HD15	-	D-sub 15-pin (x1)		
Audio	-	Phono jack (x2) (L/R)		
External sync	-	BNC (x1), Optional BKM-229X BNC (x1)		
Option slot	-	2 slots		
<b>Output interface</b>				
Composite	-	BNC (x1)*2, Optional BKM-227W BNC (x1)*2		
Y/C	-	Mini-DIN 4-pin (x1)*2, Optional BKM-227W Mini-DIN 4-pin (x1)*2		
RGB / Component	-	BNC (x3)*2		
SD-SDI	-	Optional BKM-220D BNC (x1)*2		
HD/SD-SDI	-	Optional BKM-243HS, BKM-244CC BNC (x1)*2		
3G/HD/SD-SDI	BNC (x4) (3G/HD-SDI)*2	Optional BKM-250TG BNC (x2)*2		
External sync	-	BNC (x1)*2		
Audio monitor out	Stereo mini jack (x1)	Phono jack (x2) (L/R)		
Speaker (built-in)	1.0 W (stereo)	1.0 W + 1.0 W (stereo)		
Headphone output	Stereo mini jack (x1)	-		
<b>Remote control</b>				
Parallel remote	-	Modular connector 8-pin (x1)		
Serial remote (LAN)	-	RJ-45 modular connector (Ethernet) (x1) D-sub 9-pin (RS-232C) (x1)		
<b>Features</b>				
Signal processing	10-bit	10-bit		
Auto white balance calibration*3	○*3	○		
I/P mode selection	-	3 modes*4		
Power saving mode	-	○		
Screen saver	-	-		
Markers	Aspect, Center, Safety*8	Aspect, Center, Safety		
Waveform monitor	-	-	-	○
Audio level meter (SDI-embedded audio)	○*8	○*5		
Time code display (SDI-embedded time code)	○*8	○*6		
Colour temperature (D65, D93, and user)	○	○		
Closed caption	-	EIA 608 (standard), EIA 708 (optional BKM-244CC)		
Aspect switch (16:9, 4:3)	-	○		
Scan mode (Normal (0%), Over (5%), Native)	-	○	-	○*7
Blue only	-	○		
H/V delay	-	○		
Tally	-	3 colours		
EIA 19-inch rack-mounting	-	-		Optional MB-530
VESA mounting	200 x 100 mm	400 x 400 mm	100 x 100 mm	100 x 100 mm 75 x 75 mm
Desktop stand	Monitor feet	-	Standard	Optional SU-561
DC operation	-	-	24 V	12 V
<b>3D Features</b>		<b>LMD-4251TD</b>	<b>LMD-2451TD</b>	
Micro-polarizer 3D filter		○		
Light-weight circular polarizer 3D glasses		Supplied BKM-30G (2 sets)		
3G-SDI level-B input*6		○		
Dual-stream HD-SDI input*6		○		
HD-SDI input*6		○		
DVI-D line-by-line input		○		
3D display functions*6		○		
2D/3D select		○		

\*1 DVI signals can be input via the HDMI interface using a conversion cable. \*2 Loop-through, automatic termination. \*3 This works with the combination of a PC and a commercially available calibration tools (Konica Minolta CA-210, CA-310, CS-200, DK-Technologies PM5639/06, X-Rite i1 Pro/i1 Pro2, Photo Research PR-670, Klein K-10, and JETI specbos 1211). \*4 With the LMD-4251TD and LMD-2451TD 3D monitors, the I/P mode is fixed to Field Merge mode on 3D mode. \*5 The 8-ch audio level meter can be displayed when the optional BKM-250TG input adaptor is installed. \*6 An optional BKM-250TG 3G-SDI input adaptor is required. \*7 LMD-1751W further support a full scan mode. The full scan and native scan modes work on specific signal formats. \*8 Supported by V1.1 or later.



	LMD-1530W	LMD-2110W	LMD-1510W
Panel type	a-Si TFT Active Matrix LCD		
Picture size (viewable area, measured diagonally)	15.3-inch	21.5-inch	15.6-inch
Resolution (pixels)	1280 x 768 (WXGA)	1920 x 1080 (Full HD)	1366 x 768 (WXGA)
Aspect ratio	15:9	16:9	
Panel drive / Colours	Approx. 16.7 million colours		
<b>Input interface</b>			
Composite	BNC (x1)		
Y/C	Mini-DIN 4-pin (x1)		
RGB / Component	BNC (x3)		
HD/SD-SDI	Optional BKM-341HS BNC (x1)		
HDMI	HDMI (x1)*1		
Audio	Phono jack (x3)		
External sync	BNC (x1)		
<b>Output interface</b>			
Composite	BNC (x1)*2		
Y/C	Mini-DIN 4-pin (x1)*2		
RGB / Component	BNC (x3)*2		
External sync	BNC (x1)*2		
Audio monitor out	Phono jack (x2)		
Speaker (built-in)	0.5 W (mono)		
<b>Remote control</b>			
Parallel remote	Modular connector 8-pin (x1)		
<b>Features</b>			
Signal processing	10-bit		
I/P mode selection	2 modes		
Markers	Aspect, Center, Safety		
Colour temperature	High, Low, User		
Aspect switch (16:9, 4:3)	○		
Scan mode	0%, 5%, Full		
Blue only	○		
Tally	3 colours		
EIA 19-inch rack-mounting	Optional MB-533	Optional MB-529	Optional MB-535
VESA mounting	100 x 100 mm		
Desktop stand	Standard		

\*1 DVI signals can be input via the HDMI interface using a conversion cable.

\*2 Loop-through, automatic termination.

# Specifications

## PVM Series



**PVM-2541A**



**PVM-1741A**



**PVM-741**

Picture Performance			
Panel	OLED panel		
Picture size (diagonal)	623.4 mm 24 5/8 inches	419.7 mm 16 1/2 inches	188.0 mm 7 1/2 inches
Effective picture size (H x V)	543.4 x 305.6 mm 21 1/2 x 12 1/8 inches	365.8 x 205.7 mm 14 1/2 x 8 1/8 inches	163.9 x 92.2 mm 6 1/2 x 3 5/8 inches
Resolution (H x V)	1920 x 1080 pixels (Full HD)		960 x 540 pixels (QHD)
Aspect	16:9		
Panel drive	RGB 10-bit		
Viewing angle (panel specification)	89°/89°/89°/89° (typical) (up/down/left/right contrast > 10:1)		
Input			
Composite	BNC (x1), 1.0 Vp-p ±3 dB sync negative		
SDI	BNC (x2)		
HDMI	HDMI (x1) (HDCP correspondence)		
Audio	Stereo mini jack (x1), -5 dBu 47 kilohms or higher		
Parallel remote	Modular connector 8-pin (x1) (pin-assignable)		
Serial remote (LAN)	RJ-45 modular connector (Ethernet) (x1) (10BASE-T/100BASE-TX)		
DC IN connector	-	XLR-type 4-pin (male) (x1), 12 V DC (output impedance 0.05 ohms or less)	
Output			
Composite	BNC (x1), loop-through, with 75 ohms automatic termination		
SDI	BNC (x1), output signal amplitude: 800 mVp-p ±10%, output impedance: 75 ohms unbalanced		
Audio monitor out	Stereo mini jack (x1)		
Speaker (Built-in)	1.0 W (mono)	0.5 W (mono)	
Headphones output	Stereo mini jack (x1)		
General			
Power requirement	AC 100 V to 240 V, 50/60 Hz, 1.4 A to 0.6 A	AC 100 V to 240 V, 50/60 Hz, 1.0 A to 0.5 A, DC 12 V, 7.0 A	AC 100 V to 240 V, 50/60 Hz, 0.5 A to 0.3 A, DC 12 V, 1.9 A
Power consumption	Approx. 130 W (max.) Approx. 88 W (average power consumption in the default status)	Approx. 90 W (AC power supply) (max.) Approx. 70 W (AC power supply) (average power consumption in the default status)	Approx. 30 W (max.)
Operating temperature	0°C to 35°C (32°F to 95°F) Recommended: 20°C to 30°C (68°F to 86°F)		0°C to 40°C (32°F to 104°F) Recommended: 20°C to 30°C (68°F to 86°F)
Operating humidity	30% to 85% (no condensation)		
Storage and transport temperature	-20°C to +60°C (-4°F to +140°F)		
Storage and transport humidity	0% to 90%		
Operating, storage, and transport pressure	700 hPa to 1060 hPa		
Dimensions (W x H x D) (with stand)	576.0 x 424.8 x 171.4 mm 22 3/4 x 16 3/4 x 6 3/4 inches	436.0 x 305.6 x 161.0 mm 17 1/4 x 12 1/8 x 6 3/8 inches	222.4 x 183.5 x 161.8 mm 8 7/8 x 7 1/4 x 6 3/8 inches (when AC adaptor is attached)
Dimensions (W x H x D) (without stand)	576.0 x 408.8 x 110.0 mm 22 3/4 x 16 1/8 x 4 3/8 inches	436.0 x 289.6 x 120.0 mm 17 1/4 x 11 1/2 x 4 3/4 inches	222.4 x 166 x 70 mm 8 7/8 x 6 5/8 x 2 7/8 inches (when AC adaptor is detached)
Mass	10.6 kg 23 lb 5.9 oz  12.7 kg 27 lb 16 oz (with an optional SU-561 monitor stand)	7.2 kg 15 lb 14 oz  9.3 kg 20 lb 8 oz (with an optional SU-561 monitor stand)	2.0 kg 4 lb 6 oz  2.6 kg 5 lb 12 oz (When AC adaptor is installed)
Supplied accessories	AC power cord (1), AC plug holder (1), Operating Instructions (1), CD-ROM (1), Using the CD-ROM manual (1)	AC power cord (1), AC plug holder (1), Mounting bracket (2) (including 4 screws), Operating Instructions (1), CD-ROM (1), Using the CD-ROM manual (1)	AC power cord (1), AC plug holder (1), AC adaptor (1), Handle (1), Arm mount bracket (1), Screws (4), Operating Instructions (1), CD-ROM (1), Using the CD-ROM manual (1)

# LMD-41 Series



**LMD-2341W**



**LMD-2041W**



**LMD-1541W**



**LMD-941W**

Picture Performance				
Panel	a-Si TFT Active Matrix LCD			
Picture size (diagonal)	584.2 mm 23 inches	508.0 mm 20 inches	388.6 mm 15 3/8 inches	228.0 mm 9 inches
Effective picture size (H x V)	509.1 x 286.4 mm 20 1/8 x 11 3/8 inches	442.8 x 249.1 mm 17 1/2 x 9 7/8 inches	334.1 x 200.5 mm 13 1/4 x 8 inches	198.7 x 111.8 mm 7 7/8 x 4 1/2 inches
Resolution (H x V)	1920 x 1080 pixels (Full HD)	1600 x 900 pixels	1280 x 768 pixels (WXGA)	1920 x 1080 pixels (Full HD)
Aspect	16:9		15:9	16:9
Colours	Approx. 16.7 million colours			
Viewing angle	89°/89°/89°/89° (typical) (up/down/left/right contrast > 10:1)			
Input				
Composite	BNC (x1), 1.0 Vp-p ±3 dB sync negative			
SDI	BNC (x2)			
HDMI	HDMI (x1) (HDCP correspondence)			
Audio	Stereo mini jack (x1), -5 dBu 47 kilohms or higher			
Parallel remote	Modular connector 8-pin (x1) (pin-assignable)			
Serial remote	RJ-45 modular connector (Ethernet) (x1) (10BASE-T/100BASE-TX)			
DC in	XLR-type 4-pin (male) (x1), DC 24 V (output impedance 0.05 ohms or less)	XLR-type 4-pin (male) (x1), DC 12 V (output impedance 0.05 ohms or less)		
Output				
Composite	BNC (x1), loop-through, with 75 ohms automatic termination			
SDI	BNC (x1), Output signal amplitude: 800 mVp-p ±10%, Output impedance: 75 ohms unbalanced			
Audio monitor out	Stereo mini jack (x1)			
Speaker (built-in)	1.0 W (mono)		0.5 W (mono)	
Headphones output	Stereo mini jack (x1)			
General				
Power requirements	AC 100 V to 240 V, 50/60 Hz, 0.8 A to 0.4 A DC 24 V, 2.4 A	AC 100 V to 240 V, 50/60 Hz, 0.8 A to 0.4 A, DC 12 V, 4.4 A	AC 100 V to 240 V, 50/60 Hz, 0.8 A to 0.4 A DC 12 V, 3.4 A	AC 100 V to 240 V, 50/60 Hz, 0.7 A to 0.4 A DC 12 V, 2.5 A
Power consumption	Approx. 70 W (max.)	Approx. 66 W (max.)	Approx. 50 W (max.)	Approx. 36 W (max.)
Operating temperature	0°C to 35°C (32°F to 95°F) Recommended: 20°C to 30°C (68°F to 86°F)			0°C to 40°C (32°F to 104°F) Rec.: 20°C to 30°C (68°F to 86°F)
Operating humidity	30% to 85% (no condensation)			
Storage and transport temperature	-20°C to +60°C (-4°F to +140°F)			
Storage and transport humidity	0% to 90%			
Operating, storage and transport pressure	700 hPa to 1060 hPa			
Dimensions (W x H x D) (with stand)	549.5 x 370.5 x 171.4 mm 21 3/4 x 14 5/8 x 6 3/4 inches (with supplied monitor feet) 549.5 x 467.4 x 269.9 mm 21 3/4 x 18 1/2 x 10 3/4 inches (with optional stand SU-561)	482.6 x 332.8 x 171.4 mm 19 x 13 1/8 x 6 3/4 inches (with supplied monitor feet) 482.6 x 452.0 x 269.9 mm 19 x 17 7/8 x 10 3/4 inches (with SU-561 optional stand)	373.2 x 283.5 x 171.4 mm 14 3/4 x 11 1/4 x 6 3/4 inches (with supplied monitor feet) 373.2 x 423.9 x 269.9 mm 14 3/4 x 16 3/4 x 10 3/4 inches (with optional stand SU-561) 373.2 x 319.0 x 264.5 mm 14 3/4 x 12 5/8 x 10 1/2 inches (with optional stand SU-562)	222.4 x 183.5 x 161.8 mm 8 7/8 x 7 1/4 x 6 3/8 inches (when AC adaptor is attached)
Dimensions (W x H x D) (without stand)	549.5 x 352.5 x 100.3 mm 21 3/4 x 14 x 4 inches	482.6 x 314.8 x 100.2 mm 19 x 12 1/2 x 4 inches	373.2 x 265.5 x 70.4 mm 14 3/4 x 10 1/2 x 2 7/8 inches	222.4 x 166.0 x 70.0 mm 8 7/8 x 6 5/8 x 2 7/8 inches (when AC adaptor is detached)
Mass (with stand)	9.4 kg (20 lb 12 oz) (with supplied monitor feet) 11.3 kg (24 lb 15 oz) (with optional stand SU-561)	6.9 kg (15 lb 3 oz) (with supplied monitor feet) 8.8 kg (19 lb 6 oz) (with optional stand SU-561)	5.3 kg (11 lb 11 oz) (with supplied monitor feet) 7.2 kg (15 lb 14 oz) (with optional stand SU-561) 6.8 kg (14 lb 16 oz) (with optional stand SU-562)	2.6 kg (5 lb 12 oz) (when AC adaptor is installed)
Mass (without stand)	9.2 kg (20 lb 4.5 oz)	6.7 kg (14 lb 12 oz)	5.1 kg (11 lb 4.2 oz)	2.0 kg (4 lb 6 oz)
Supplied accessories	AC power cord (1), AC plug holder (1), Control panel cover (1) (including 3 screws), Monitor foot (2) (including 6 screws), Operating Instructions (1), CD-ROM (1), Using the CD-ROM Manual (1)	AC power cord (1), AC plug holder (1), Mounting bracket (2) (including 8 screws), Monitor foot (2) (including 6 screws), Operating Instructions (1), CD-ROM (1), Using the CD-ROM Manual (1)	AC power cord (1), AC plug holder (1), Monitor foot (2) (including 6 screws), Operating Instructions (1), CD-ROM (1), Using the CD-ROM Manual (1)	AC power cord (1), AC plug holder (1), AC adaptor (1), Handle (1), Arm mount bracket (1), Screws (4), Operating Instructions (1), CD-ROM (1), Using the CD-ROM manual (1)

# PVM-X300



**PVM-X300**

Picture Performance	
Panel	a-Si TFT Active Matrix LCD
Picture size (diagonal)	767.5 mm 30.2 inches
Effective picture size (H x V)	678.9 x 358.0 mm 26 3/4 x 14 1/8 inches
Resolution (H x V)	4096 x 2160 pixels
Aspect	17:9
Panel drive	RGB 10-bit
Viewing angle (panel specification)	89°/89°/89°/89° (typical) (up/down/left/right contrast > 10:1)
Input	
SDI	BNC (x4)
HDMI	HDMI (x4) (HDCP correspondence)
Output	
SDI	BNC (x4) Output signal amplitude: 800 mVp-p ±10% Output impedance: 75 Ω unbalanced
Audio monitor	Stereo mini jack (x1)
Speaker (built-in)	1.0 W (stereo)
Headphone	Stereo mini jack (x1)
General	
Power requirements	AC 100 V to 240 V, 2.4 A to 1.2 A, 50/60 Hz
Power consumption	Approx. 220 W (max.)
Operating temperature	0°C to 35°C (32°F to 95°F) Recommended: 20°C to 30°C (68°F to 86°F)
Operating humidity	30% to 85% (no condensation)
Storage and transport temperature	-20°C to +60°C -4°F to +140°F
Storage and transport humidity	0% to 90%
Operating, storage, and transport pressure	700 hPa to 1060 hPa
Dimensions (W x H x D)*	754 x 457 x 120 mm 29 3/4 x 18 x 4 3/4 inches 754 x 475 x 205 mm (with monitor feet) 29 3/4 x 18 3/4 x 8 1/8 inches (with monitor feet)
Mass	17 kg 37 lb 8 oz
Supplied accessories	AC power cord (1), AC plug holder (1), Operating instructions (1), CD-ROM (1)

\* The values for dimensions are approximate.

# LMD-51 Series



**LMD-4251TD**



**LMD-2451TD**



**LMD-1751W**

Picture Performance			
Panel	a-Si TFT Active Matrix LCD		
Picture size (diagonal)	1067.0 mm 42 1/8 inches	613.2 mm 24 1/4 inches	431.1 mm 17 inches
Effective picture size (H x V)	930.0 x 523.0 mm 36 3/4 x 20 3/4 inches	518.4 x 324.0 mm 20 1/2 x 12 7/8 inches	369.6 x 221.8 mm 14 5/8 x 8 3/4 inches
Resolution (H x V)	1920 x 1080 pixels (Full HD)	1920 x 1200 pixels (WUXGA)	1280 x 768 pixels (WXGA)
Aspect	16:9	16:10	15:9
Colours	Approx. 16.7 million colours		
Viewing angle (2D mode)	89°/89°/89°/89° (typical) (up/down/left/right contrast > 10:1)		
Vertical viewing angle (3D mode)	46° at a viewing distance more than 620 mm, crosstalk less than 7% (typical)	54° at a viewing distance more than 320 mm, crosstalk less than 7% (typical)	-
Input			
Composite	BNC (x1), 1.0 Vp-p ±3 dB sync negative		
Y/C	Mini DIN 4-pin (x1) Y: 1.0 Vp-p ±3 dB sync negative C: 0.286 Vp-p ±3 dB (NTSC burst signal level), 0.3 Vp-p ±3 dB (PAL burst signal level)		
RGB, Component	BNC (x3) RGB: 0.7 Vp-p ±3 dB (Sync On Green, 0.3 Vp-p sync negative) Component: 0.7 Vp-p ±3 dB (75% chrominance standard colour bar signal)		
DVI-D	DVI-D (x1), TMDS single link		
HD15	D-sub 15-pin (x1) R/G/B: 0.7 Vp-p sync positive (Sync On Green, 0.3 Vp-p sync negative) Sync: Total level (polarity free, H/V separate sync) Plug & Play function: corresponds to DDC2B		
Audio	Phono jack (x2) (L, R), -5 dBu 47 kilohms or higher		
External sync	BNC (x1) 0.3 Vp-p to 4.0 Vp-p ± bipolarity ternary or negative polarity binary		
Option slot	2 slots, Signal format: H: 15 kHz to 45 kHz, V: 48 Hz to 60 Hz		
Parallel remote	Modular connector 8-pin (x1) (Pin-assignable)		
Serial remote	D-sub 9-pin (RS-232C) (x1), RJ-45 modular connector (Ethernet) (x1) (10BASE-T/100BASE-TX)		
DC in	-	XLR-type 4-pin (male) (x1) DC 24 V (output impedance 0.05 ohms or less)	XLR-type 4-pin (male) (x1) DC 12 V (output impedance 0.05 ohms or less)
Output			
Composite	BNC (x1), loop-through, with 75 ohms automatic termination		
Y/C	Mini DIN 4-pin (x1), loop-through, with 75 ohms automatic termination		
RGB, Component	BNC (x3), loop-through, with 75 ohms automatic termination		
External sync	BNC (x1), loop-through, with 75 ohms automatic termination		
Audio monitor out	Phono jack (x2) (L, R)		
Speaker (built-in)	1.0 W + 1.0 W (stereo)		
General			
Power requirements	AC 100 V to 240 V, 50/60 Hz, 2.7 A to 1.1 A	AC 100 V to 240 V, 50/60 Hz, 1.5 A to 0.7 A DC 24 V, 5.7 A	AC 100 V to 240 V, 50/60 Hz, 0.8 A to 0.4 A DC 12 V, 5.7 A
Power consumption	Approx. 250 W (max.) (with 2 x BKM-229X)	Approx. 130 W (max.) (with 2 x BKM-229X)	Approx. 77 W (max.) (with 2 x BKM-229X)
Operating temperature	0°C to 35°C (32°F to 95°F) Recommended: 20°C to 30°C (68°F to 86°F)		
Operating humidity	30% to 85% (no condensation)		
Storage and transport temperature	-20°C to +60°C (-4°F to +140°F)		
Storage and transport humidity	0% to 90%		
Operating, storage, and transport pressure	700 hPa to 1060 hPa		
Dimensions (W x H x D) (with stand)	-	602.4 x 497.9 x 269.9 mm 23 3/4 x 19 5/8 x 10 3/4 inches	439.5 x 385.7 x 269.9 mm 17 3/8 x 15 1/4 x 10 3/4 inches (stand is optional)
Dimensions (W x H x D) (without stand)	1027.0 x 616.0 x 130.0 mm 40 1/2 x 24 3/8 x 5 1/8 inches	602.4 x 386.2 x 110.0 mm 23 3/4 x 15 1/4 x 4 3/8 inches	439.5 x 284.0 x 105.0 mm 17 3/8 x 11 1/4 x 4 1/4 inches
Mass (with options)	23.5 kg 51 lb 13 oz (with 2 x BKM-229X)	11.5 kg 25 lb 6 oz (with 2 x BKM-229X)	8.8 kg 19 lb 6 oz (with SU-561 and 2 x BKM-229X)
Mass	23.0 kg 50 lb 11 oz	11.0 kg 24 lb 4 oz	6.3 kg 13 lb 14 oz
Supplied accessories	AC power cord (1), AC plug holder (1), 3D glasses (including case) (2), L/R labels (1), Operating Instructions (1), CD-ROM (1), Using the CD-ROM Manual (1)		AC power cord (1), AC plug holder (1), Operating Instructions (1), CD-ROM (1), Using the CD-ROM Manual (1)



# LMD-30/10 Series



**LMD-1530W**

**LMD-2110W**

**LMD-1510W**

Picture Performance			
Panel	a-Si TFT Active Matrix LCD		
Picture size (diagonal)	390.0 mm 15 3/8 inches	547.0 mm 21 5/8 inches	395.0 mm 15 5/8 inches
Effective picture size (H x V)	334.0 x 200.0 mm 13 1/4 x 7 7/8 inches	477.0 x 268.0 mm 18 7/8 x 10 5/8 inches	344.0 x 194.0 mm 13 5/8 x 7 3/4 inches
Resolution (H x V)	1280 x 768 pixels (WXGA)	1920 x 1080 pixels (Full HD)	1366 x 768 pixels (WXGA)
Aspect	15:9	16:9	
Colours	Approx. 16.7 million colours		
Viewing angle	89°/89°/89°/89° (typical) (up/down/left/right contrast > 10:1)	170°/160° (typical) (horizontal/vertical contrast > 10:1)	
Input			
Composite	BNC (x1), 1.0 Vp-p ±3 dB sync negative		
Y/C	Mini DIN 4-pin (x1) Y: 1.0 Vp-p ±3 dB sync negative C: 0.286 Vp-p ±3 dB (NTSC burst signal level), 0.3 Vp-p ±3 dB (PAL burst signal level)		
RGB, Component	BNC (x3) RGB: 0.7 Vp-p ±3 dB (Sync On Green, 0.3 Vp-p sync negative) Component: 0.7 Vp-p ±3 dB (75% chrominance standard colour bar signal)		
HDMI	HDMI (x1) (HDCP correspondence)		
Audio	Phono jack (x2), -5 dBu 47 kilohms or higher OPTION AUDIO IN: Phono jack (x1), -5 dBu 47 kilohms or higher		
External sync	BNC (x1), 0.3 Vp-p to 4 Vp-p negative polarity binary		
Option in connector	D-sub 9-pin (x1), female		
Parallel remote	Modular connector 8-pin (x1) (pin-assignable)		
Output			
Composite	BNC (x1), loop-through, with 75 ohms automatic termination		
Y/C	Mini DIN 4-pin (x1), loop-through, with 75 ohms automatic termination		
RGB, Component	BNC (x3), loop-through, with 75 ohms automatic termination		
External sync	BNC (x1), loop-through, with 75 ohms automatic termination		
Audio monitor out	Phono jack (x2), loop-through		
Speaker (built-in)	0.5 W (mono)		
General			
Power requirements	AC 100 V to 240 V, 50/60 Hz, 1.0 A to 0.5 A	AC 100 V to 240 V, 50/60 Hz, 1.3 A to 0.6 A	AC 100 V to 240 V, 50/60 Hz, 0.7 A to 0.4 A
Power consumption	Approx. 50 W (max.)	Approx. 69 W (max.)	Approx. 40 W (max.)
Operating temperature	0°C to 35°C (32°F to 95°F) Recommended: 20°C to 30°C (68°F to 86°F)		
Operating humidity	30% to 85% (no condensation)		
Storage and transport temperature	-20°C to +60°C (-4°F to +140°F)		
Storage and transport humidity	0% to 90%		
Operating, storage, and transport pressure	700 hPa to 1060 hPa		
Dimensions (W x H x D) (with stand)	372.0 x 336.0 x 264.0 mm 14 3/4 x 13 1/4 x 10 1/2 inches	515.0 x 403.0 x 264.0 mm 20 3/8 x 15 7/8 x 10 1/2 inches	378.0 x 325.6 x 264.4 mm 15 x 12 7/8 x 10 1/2
Dimensions (W x H x D) (without stand)	372.0 x 288.0 x 100.0 mm 14 3/4 x 11 3/8 x 4 inches	515.0 x 355.0 x 86.0 mm 20 3/8 x 14 x 3 1/2 inches	378.0 x 280.6 x 90.0 mm 15 x 11 1/8 x 3 5/8
Mass	5.9 kg 13 lb	8.6 kg 18 lb 15 oz	5.8 kg 12 lb 13 oz
Mass (without stand)	4.2 kg 9 lb 4 oz	6.9 kg 14 lb 19 oz	4.1 kg 9 lb 6 oz
Supplied accessories	AC power cord (1), AC plug holder (1), Operating Instructions (1), CD-ROM (1), Using the CD-ROM Manual (1)		

# Optional Accessories



**BKM-250TG**  
3G/HD/SD-SDI Input Adaptor  
(for LMD-51 Series)



**BKM-244CC**  
HD/SD-SDI Closed Caption  
Adaptor  
(for LMD-51 Series)



**BKM-243HS**  
HD/SD-SDI Input Adaptor  
(for LMD-51 Series)



**BKM-220D**  
SD-SDI 4:2:2 Input Adaptor  
(for LMD-51 Series)



**BKM-229X**  
Analogue Component Adaptor  
(for LMD-51 Series)



**BKM-227W**  
NTSC/PAL Input Adaptor  
(for LMD-51 Series)



**SU-561**  
Monitor Stand  
(for PVM-2541A, PVM-1741A,  
LMD-1751W, LMD-2341W,  
LMD-2041W, and LMD-1541W)



**SU-562**  
Monitor Stand  
(for LMD-1541W)



**MB-529**  
Mounting Bracket  
(for LMD-2110W)



**MB-530**  
Mounting Bracket  
(for LMD-1751W)



**MB-531**  
Mounting Bracket  
(for PVM-741 and LMD-941W)



**MB-532**  
Mounting Panel  
(for PVM-741 and LMD-941W)

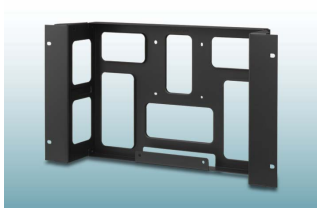

**MB-534**  
Mounting Bracket  
(for LMD-1541W)



**VF-510**  
ENG Kit (Viewing Hood, Carrying  
Handle and Connector Protector)  
(for PVM-741 and LMD-941W)



**BKM-30G**  
3D Glasses  
(for LMD-4251TD and LMD-2451TD)



**BKM-31G**  
3D Glasses  
(for LMD-4251TD and LMD-2451TD)



**BKM-341HS**  
HD/SD-SDI Input Adaptor  
(for LMD-30/10 Series)



**MB-533**  
Mounting Bracket  
(for LMD-1530W)



**MB-535**  
Mounting Bracket  
(for LMD-1510W)



**BKM-XP1**  
4K SxS Player  
(for PVM-X300\*)  
\* Supported by V1.1 or later.

# Dimensions

## PVM Series

Unit: mm (inches)

### PVM-2541A

Front

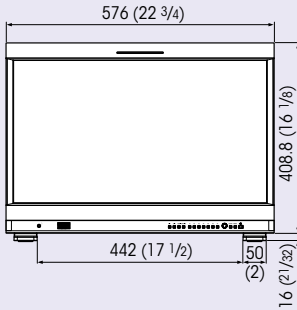

Rear

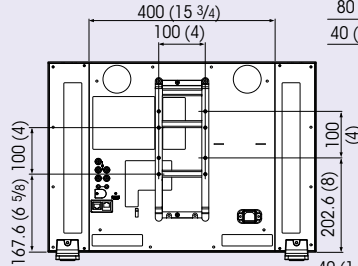

Side

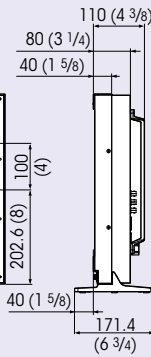

### PVM-2541A with the optional SU-561 stand

Front

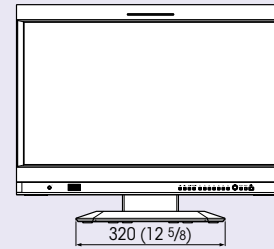

Side

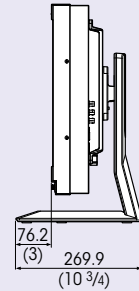

### PVM-1741A

Front

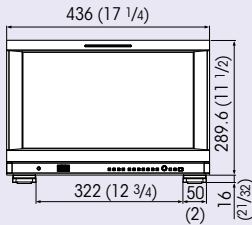

Rear

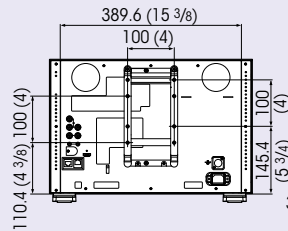

Side

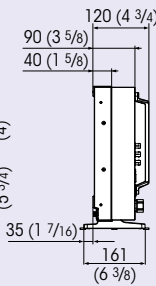

### PVM-1741A with the optional SU-561 stand

Front

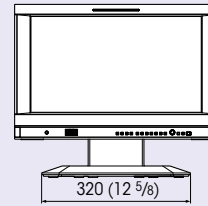

Side

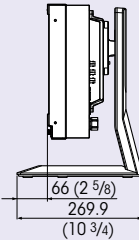

### PVM-741

Front

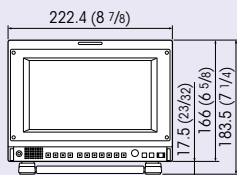

Side

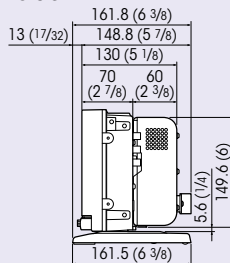

Bottom (Without the stand)

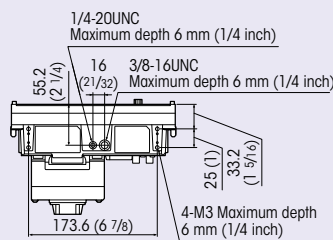

Top (With the arm mount bracket)

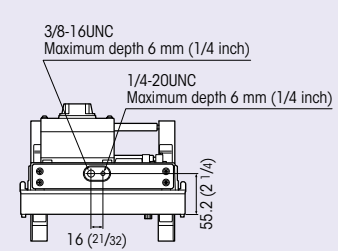

# LMD-41 Series

Unit: mm (inches)

## LMD-2341W

Front with monitor feet

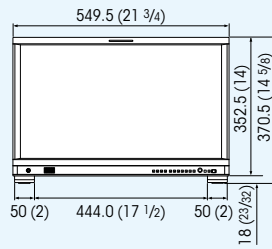

Side with monitor feet

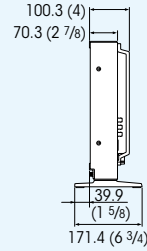

Front with optional SU-561

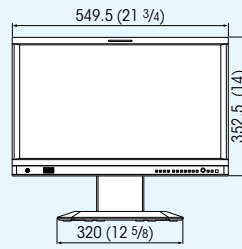

Side with optional SU-561

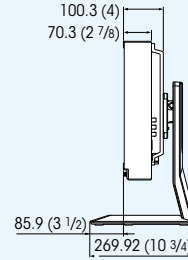

Rear

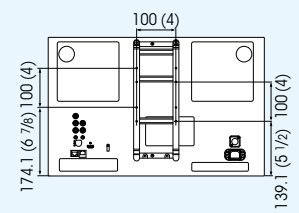

## LMD-2041W

Front with monitor feet

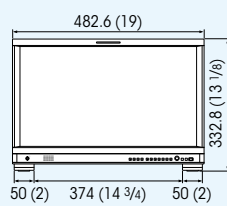

Side with monitor feet

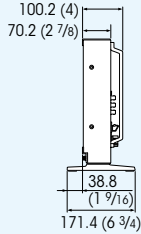

Front with optional SU-561

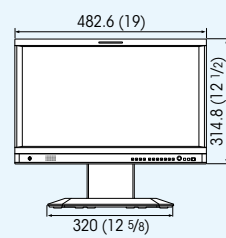

Side with optional SU-561

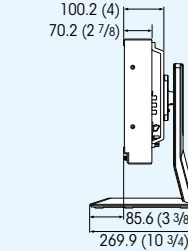

Rear

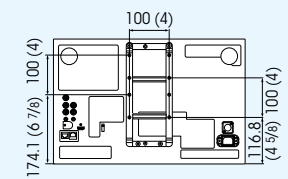

## LMD-1541W

Front with monitor feet

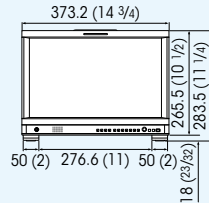

Side with monitor feet

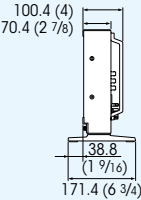

Front with optional SU-561

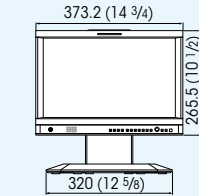

Side with optional SU-561

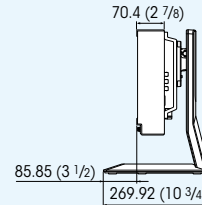

Front with optional SU-562

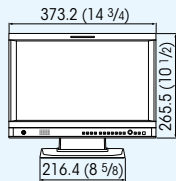

Side with optional SU-562

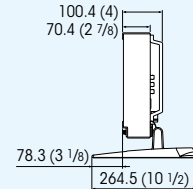

Rear with optional SU-562

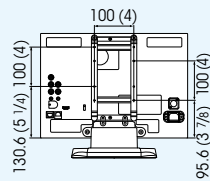

## LMD-941W

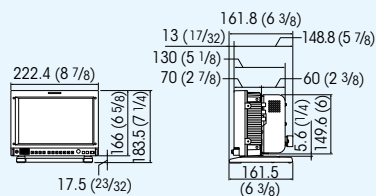

## PVM-X300

Unit: mm (inches)

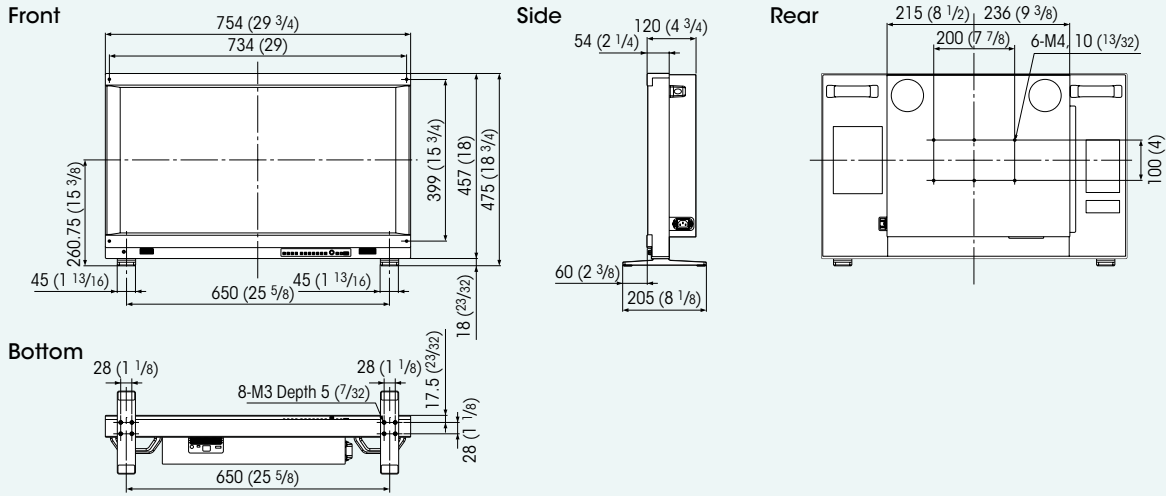

## LMD-51 Series

Unit: mm (inches)

### LMD-4251TD

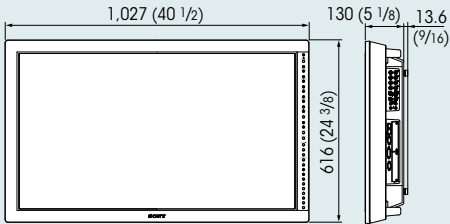

### LMD-2451TD

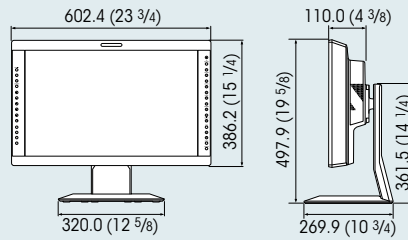

### LMD-1751W

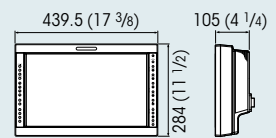

## LMD-30/10 Series

Unit: mm (inches)

### LMD-1530W

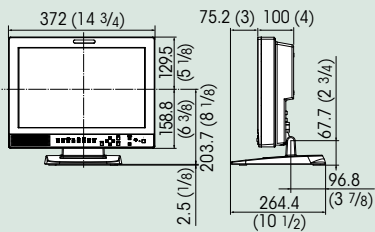

### LMD-2110W

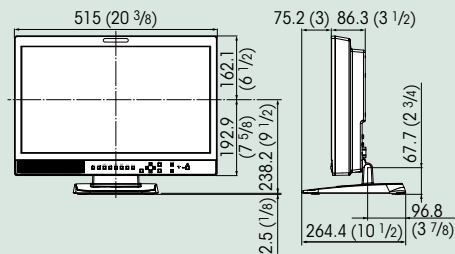

### LMD-1510W

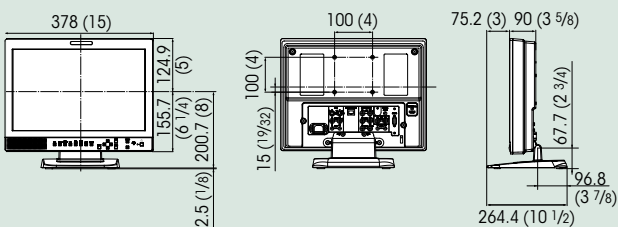



OLED Master Monitor

**BVM-E / BVM-F Series – Master Monitors for Critical picture evaluation**

**BVM-E Series for High-end Cinema / Broadcast Applications**



**BVM-E250A**



**BVM-E170A**

**BVM-F Series for Broadcast Applications**



**BVM-F250A**



**BVM-F170A**

# SONY

make.believe

Distributed by

©2013 Sony Corporation. All rights reserved.

Reproduction in whole or in part without written permission is prohibited.

Features and specifications are subject to change without notice.

Screen images are simulated.

The values for mass and dimension are approximate.

"SONY", "make.believe", "TRIMASTER EL", "ChromaTRU", "SxS", and "XAVC"

are trademarks of Sony Corporation.

HDMI is a trademark of HDMI Licensing, LLC.

All other trademarks are the properties of their respective owners.

The PVM-X300 is produced at Sony EMCS Corporation Kosai Site, which has received ISO14001 Environmental Management System certification. The PVM-2541A, PVM-1741A, and PVM-741 are produced under control of Sony EMCS Corporation Kosai Site.



MK10816V5EYIT13MAR