UNITED STATES MARINE CORPS
THE BASIC SCHOOL
MARINE CORPS TRAINING COMMAND
CAMP BARRETT, VIRGINIA 22134-5019

MILITARY TOPOGRAPHIC MAP I
B170229XQ
STUDENT HANDOUT

Military Topographic Map I

Introduction Cartography is the art and science of expressing the known physical features of the earth graphically by maps and charts. No one knows who drew, molded, laced together, or scratched the first map in the dirt, but a historical study reveals that the most pressing demands for mapping accuracy and detail are the result of military needs.

Importance Today, due to the complexities of tactical operations and deployment of troops, it is essential for all Marines to be able to read and interpret their maps in order to move quickly and effectively on the battlefield.

In This Lesson This lesson discusses how to evaluate and interpret map information, how to neatly and accurately plot grid coordinates on the map, and how to measure ground distance on a map.

This lesson covers the following topics:

Topic	Page
Part 1: Maps	4
Definition of Maps	4
Security	4
Categories and Types of Maps	4
Military Map Substitutes	5
Part 2: Marginal Information and Symbols	6
Marginal Information on a Map	8
Topographic Map Symbols	13
Part 3: Grids	14
Reference System	14
Geographic Coordinates	14
Military Grids	18
Locating a Point Using Grid Coordinates	19
Part 4: Scale and Distance	23
Representative Fraction	23
Graphic (Bar) Scales	24
Review Questions	26

Learning Objectives**Terminal Learning Objective**

TBS-PAT-1002 Given a military topographic map, protractor, lensatic compass, and objective, navigate with a map and compass to arrive within 100 meters of the objective.

**Learning Objectives
(Continued)****Enabling Learning Objectives**

TBS-PAT-1002a Given a military topographic map, identify marginal information without error.

TBS-PAT-1002b Given a military topographic map, identify contour lines without error.

TBS-PAT-1002d Given a military topographic map, identify colors on a map without error.

TBS-PAT-1002e Given a military topographic map, protractor, determine/plot grid coordinates to within 30 meters.

TBS-PAT-1002f Given a military topographic map, protractor, string, and paper, determine distance between two points using bar scale within tolerance of 30 meters.

Maps

Definition of Maps	<p>A map is a graphic representation of a portion of the earth's surface drawn to scale, as seen from above.</p> <p>To be understandable, features are represented by conventional signs and symbols. To be legible, many of these are exaggerated in size, often far beyond the actual ground limits of the feature represented.</p>		
Purpose	<p>A map provides information on the existence of the location and the distance between ground features, such as populated places and routes of travel, and communication. It also indicates variations in terrain, heights of natural features, and the extent of vegetation cover. With our military forces dispersed throughout the world, it is necessary to rely on maps that provide information to our combat elements and resolve logistical operations far from our shores.</p> <p>All operations require maps; however, the finest maps available are worthless unless the map user knows how to read them.</p>		
Security	<p>All maps are considered to be documents that require special handling. If a map falls into unauthorized hands, it could easily endanger military operations by providing information of friendly plans or areas of interest to the enemy.</p> <p>Maps are documents that must not fall into unauthorized hands.</p>		
Categories of Maps	<p>The National Geospatial-Intelligence Agency (NGA) mission is to provide mapping, charting, and all geodesy support to the armed forces, and all other national security operations. NGA produces four categories of products and services: hydrographic, topographic, aeronautical, and digital. Military maps are categorized by scale and type.</p> <table> <tr> <td data-bbox="581 1612 771 1688">Small Scale Maps</td> <td data-bbox="906 1612 1433 1837"> <ul style="list-style-type: none"> • Used for general planning and for strategic studies. • Covers a large area at the expense of detail. • Small-scale maps are 1:1,000,000 and smaller. </td> </tr> </table>	Small Scale Maps	<ul style="list-style-type: none"> • Used for general planning and for strategic studies. • Covers a large area at the expense of detail. • Small-scale maps are 1:1,000,000 and smaller.
Small Scale Maps	<ul style="list-style-type: none"> • Used for general planning and for strategic studies. • Covers a large area at the expense of detail. • Small-scale maps are 1:1,000,000 and smaller. 		

Categories of Maps (Cont)	Medium Scale Maps	<ul style="list-style-type: none"> • Used for operational planning. • Contain moderate amount of detail, but terrain analysis is best done with the large-scale maps. • Medium-scale maps are between 1:75,000 and 1:1,000,000.
<hr/>		
	Large Scale Maps	<ul style="list-style-type: none"> • Are used for tactical, administrative, and logistical planning. • These are the maps a Marine or junior leader are most likely to encounter. • Large-scale maps are 1:75,000 and larger.

Map Types. The map of choice for land navigators is the 1:50,000-scale military topographic map. When operating in foreign places, there may be other times units use obtained maps such as tourist maps or other commercially produced maps. (In Grenada, many of our troops used a British tourist map.) It is also important to know how to use the many other products available from the NGA: (List not all inclusive)

Topographic map: A topographic map portrays terrain features in a measurable way, as well as the horizontal positions of the features represented. The vertical positions, or relief, are normally represented by contour lines on military topographic maps. On maps showing relief, the elevations and contours are measured from a specific vertical datum plane, usually mean sea level.

Other Types of Maps:

- Planimetric maps
- Digital maps
- Photomap
- Terrain Model
- Military City Map

Military Map Substitutes: If military maps are not available, use substitute maps. These can range from foreign military or commercial maps, to field sketches. The NGA can provide black and white reproductions of many foreign maps, and produce its own maps based upon intelligence.

-
- Foreign Maps
 - Atlases
 - Geographic Maps
 - Tourist Road Maps
 - City/Utility Maps
 - Field Sketches

Standards of Accuracy: Accuracy is the degree of conformity that horizontal positions and vertical values are clearly represented on a map in relation to an established standard. The NGA determines the standard based upon user requirements. Unless otherwise specified in the marginal information, consider maps to meet accuracy requirements.

Marginal Information and Topographic Map Symbols

We use marginal information for:

- Identification – indicates which area coverage the map represents.
- Interpretation – provides correlation between actual terrain features and map topographic symbols.
- Evaluation – helps determine the validity of the information represented on the map.

Some key elements contained in marginal information are listed below with a brief description. Refer to Figure 1 to see where each element is located on the Quantico topographic map.

Sheet Name (1)	The sheet name is found in bold print at the center of the top and in the lower left area of the map margin. A map is generally named for the largest settlement contained within the area covered by the sheet, or for the largest natural feature located within the area at the time the map was drawn.
Sheet Number (2)	The sheet number is found in bold print in the upper right and lower left areas of the margin, and in the center box of the adjoining sheets diagram found in the lower right margin. To link specific maps to overlays, operations orders, and plans, use the sheet number as reference. For maps at 1:100,000-scale and larger, the sheet numbering system is arbitrary and makes possible the ready orientation of maps at scales of 1:100,000, 1:50,000, and 1:25,000.

Series Name (3)	<p>The map series name is found in bold print in the upper left corner of the margin. The name given to the series is generally that of a major political subdivision such as a state within the United States or a European nation. A map series usually includes a group of similar maps at the same scale and on the same sheet lines or format. They are designed to cover a particular geographic area and may be a group of maps that serve a common purpose, such as military city maps.</p>
Scale (4)	<p>The scale is found in the upper left margin after the series name and in the center of the lower margin. The scale note is a representative fraction that gives the ratio of a map distance to the corresponding distance on the earth's surface. For example, the scale note 1:50,000 indicates that one unit of measure on the map equals 50,000 units of the same measure on the ground.</p>
Series Number (5)	<p>The series number is found in the upper right margin and the lower left margin. It is a sequence reference expressed either as a four-digit numeral (1125) or as a letter followed by a three- or four-digit numeral (M661, T7110).</p>
Edition Number (6)	<p>The edition number is found in bold print in the upper right area of the top margin and the lower left area of the bottom margin. Editions are numbered consecutively; if there is more than one edition, the highest numbered sheet is the most recent. The map information date is found immediately below the word "LEGEND" in the lower left margin of the map. This date is important when determining how accurately the map data might be expected to match what is encountered on the ground</p>
Index to Boundaries (7)	<p>The index to boundaries diagram appears in the lower or right margin of all sheets. This diagram, which is a miniature of the map, shows the boundaries that occur within the map area such as county lines and state boundaries.</p>

Adjoining Sheets Diagram (8)	<p>Maps at all standard scales contain a diagram that illustrates the adjoining sheets. It consists of as many rectangles representing the adjoining sheets as are necessary to surround the rectangle that represents the sheet under consideration. The diagram usually contains nine rectangles, but the number may vary depending on the locations of the adjoining sheets. All represented sheets are identified by their sheet numbers. Sheets of an adjoining series, whether published or planned, that are at the same scale are represented by dashed lines. The series number of the adjoining series is indicated along the appropriate side of the division line between the series.</p>
Elevation Guide (9)	<p>The elevation guide is normally found in the lower right margin. It is a miniature characterization of the terrain shown. The terrain is represented by bands of elevation, spot elevations, and major drainage features. The elevation guide provides the map reader with a means of quick recognition of major landforms.</p>
Declination Diagram (10)	<p>The declination diagram is located in the lower margin of large-scale maps and indicates the angular relationships of true north, grid north, and magnetic north. In recent edition maps, there is a note indicating the conversion of azimuths from grid to magnetic and from magnetic to grid next to the declination diagram.</p>
Bar Scales (11)	<p>Bar scales are located in the center of the lower margin. They are rulers used to convert map distance to ground distance. Maps have three or more bar scales, each in a different unit of measure. Care should be exercised when using the scales, especially in the selection of the unit of measure that is needed.</p>
Contour Interval Note (12)	<p>The contour interval note is found in the center of the lower margin normally below the bar scales. It states the vertical distance between adjacent contour lines of the map. When supplementary contours are used, the interval is indicated. In recent edition maps, the contour interval is given in meters instead of feet.</p>
Spheroid (13)	<p>The spheroid note is located in the center of the lower margin. Spheroids (ellipsoids) have specific parameters that define the X Y Z axis of the earth. The spheroid is an integral part of the datum.</p>

Grid Note (14)	The grid note is located in the center of the lower margin. It gives information pertaining to the grid system used and the interval between grid lines, and it identifies the UTM grid zone number.
Projection Note (15)	<p>The projection system is the framework of the map. For military maps, this framework is of the conformal type; small areas of the surface of the earth retain their true shapes on the projection; measured angles closely approximate true values; and the scale factor is the same in all directions from a point. The projection note is located in the center of the lower margin. The three types of projection notes are:</p> <ul style="list-style-type: none">• Between 80 degrees south and 84 degrees north, maps at scales larger than 1:500,000 are based on the transverse Mercator projection. The note reads TRANSVERSE MERCATOR PROJECTION.• Between 80 degrees south and 84 degrees north, maps at 1:1,000,000 scale and smaller are based on standard parallels of the Lambert conformal conic projection. The note reads, for example, LAMBERT CONFORMAL CONIC PROJECTIONS 36 DEGREES 40 MINUTES NORTH AND 39 DEGREES 20 MINUTES NORTH.• Maps of the polar regions (south of 80 degrees south and north of 84 degrees north) at 1:1,000,000 and larger scales are based on the polar stereographic projection. The note reads POLAR STEREOGRAPHIC PROJECTION.
Vertical Datum Note (16)	The vertical datum note is located in the center of the lower margin. The vertical datum or vertical-control datum is defined as a level surface taken as a surface of reference from which to determine elevations. In the United States, Canada, and Europe, the vertical datum refers to the mean sea level surface. However, in parts of Asia and Africa, the vertical-control datum may vary locally and is based on an assumed elevation that has no connection to the sea level surface. Map readers should habitually check the vertical datum note on maps, particularly if the map is used for low-level aircraft navigation, naval gunfire support, or missile target acquisition.

Horizontal Datum Note (17) The horizontal datum note is located in the center of the lower margin. The horizontal datum or horizontal-control datum is defined as a geodetic reference point (of which five quantities are known: latitude, longitude, azimuth of a line from this point, and two constants, which are the parameters of reference ellipsoid). These are the basis for horizontal-control surveys. The horizontal-control datum may extend over a continent or be limited to a small local area. Maps and charts produced by NGA are produced on 32 different horizontal-control data. Map readers should habitually check the horizontal datum note on every map or chart, especially adjacent map sheets, to ensure the products are based on the same horizontal datum. If products are based on different horizontal-control data, coordinate transformations to a common datum is performed. UTM coordinates from the same point computed on different data may differ as much as 900 meters (m).

Control Note (18) The control note is located in the center of the lower margin. It indicates the special agencies involved in the control of the technical aspects of all the information that is disseminated on the map.

Preparation Note (19) The preparation note is located in the center of the lower margin. It indicates the agency responsible for preparing the map.

Printing Note (20) The printing note is also located in the center of the lower margin. It indicates the agency responsible for printing the map and the date the map was printed. The printing data should not be used to determine when the map information was obtained.

Marginal Information and Topographic Map Symbols (Continued)

Grid Reference Box (21) The grid reference box is normally located in the center of the lower margin. It contains instructions for composing a grid reference.

Unit Imprint and Symbol (22) The unit imprint and symbol is on the left side of the lower margin identifies the agency that prepared and printed the map and its respective symbol. This information is important to the map user in evaluating the reliability of the map.

Legend (23)	The legend is located in the lower left margin. It illustrates and identifies the topographic symbols used to depict some of the more prominent features on the map. The symbols are not always the same on every map. Always refer to the legend to avoid errors when reading a map.
Special Notes (24)	A special note is a statement of general information that relates to the mapped area. It is normally found in the lower right margin. For example, a particular note could be "this map is red-light readable."
User's Note (25)	The user's note is normally located in the lower right-hand margin. It requests cooperation in correcting errors or omissions on the map. Errors should be marked and the map forwarded to the agency identified in the note.
Stock Number (26) Identification	All maps published by the NGA that are in the Department of the Army map supply system contain stock number identifications that are used in requisitioning map supplies.

Marginal Information and Topographic Map Symbols (Continued)

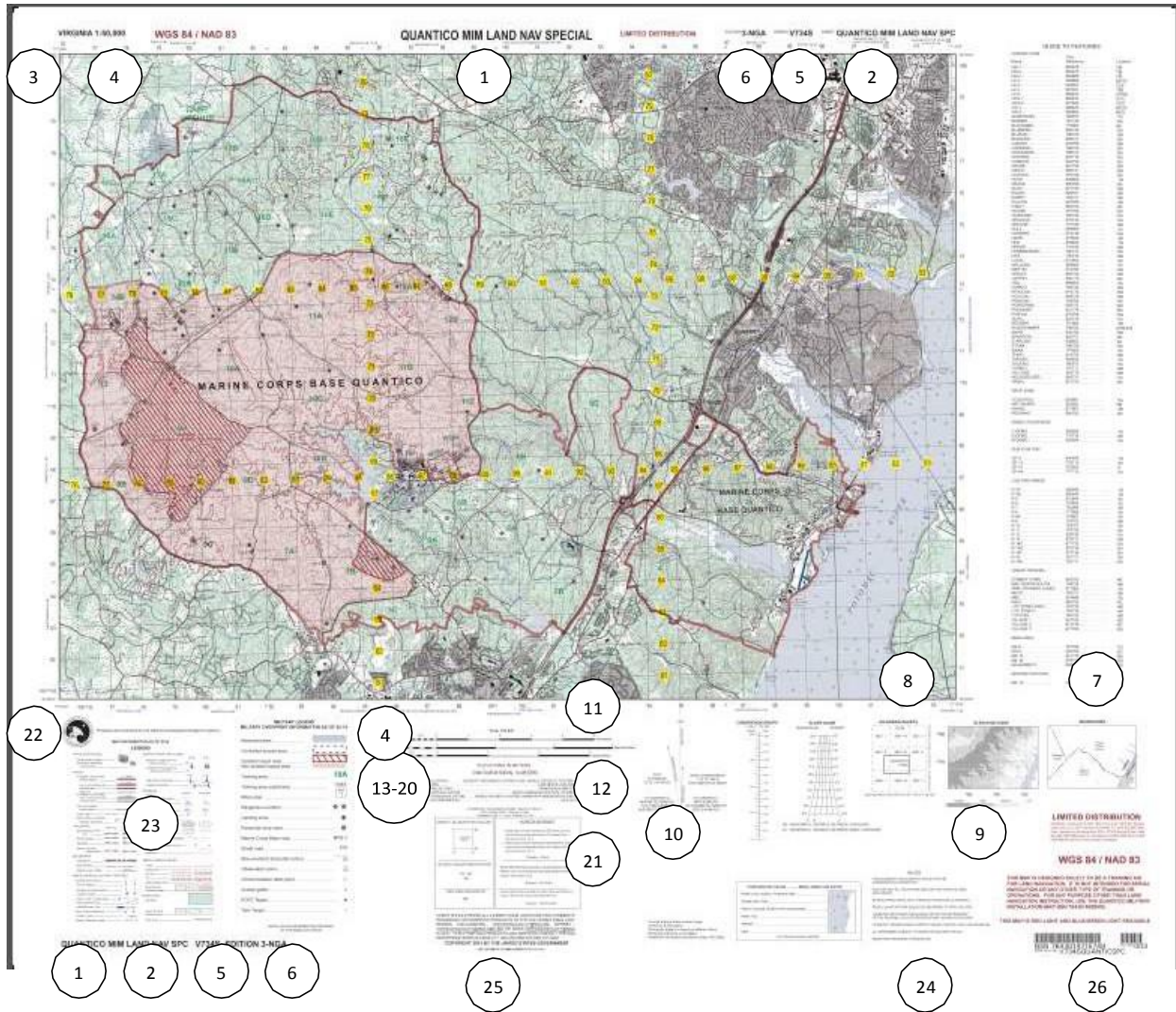

Figure 1: Reduced scale of a large-scale topographic map

Marginal Information and Topographic Map Symbols (Continued)

The purpose of a map is to visualize an area of the earth's surface with pertinent features properly positioned. The map's legend contains the symbols most commonly used in a particular series or on that specific topographic map sheet. The legend should be referred to each time a new map is used. Every effort is made to design standard symbols that resemble the features they represent. If this is not possible, symbols are selected that logically imply the features they portray. For example, an open-pit mining operation is represented by a small black drawing of a crossed hammer and pickax.

In addition to the topographic symbols used to represent the natural and man-made features of the earth, military personnel require some method for showing identity, size, location, or movement of Marines, military activities, and installations. These are known as military symbols and are not normally printed on maps because the features and units they represent are constantly moving or changing; military security is also a consideration. They do appear in special maps and overlays. The map user draws them in, according to proper security precautions.

To facilitate the identification of features on a map, the topographical and cultural information is usually printed in different colors. These colors may vary from map to map. On a standard large-scale topographic map, the colors used and the features they represent are:

Colors	Black	Indicates cultural (man-made) features such as buildings and roads, surveyed spot elevations, and all labels.
	Red-Brown / Gray	The colors red and brown are combined to identify cultural features, all relief features, non-surveyed spot elevations, and elevation such as contour lines on red-light readable maps. The color gray is also used to make maps readable under blue or green light.
	Blue	Identifies hydrography or water features such as lakes, swamps, rivers, and drainage.
	Green	Identifies vegetation with military significance such as woods, orchards, and vineyards.
	Brown	Identifies all relief features and elevation such as contours on older edition maps, and cultivated land on red-light readable maps.

Colors	Red	Classifies cultural features such as populated areas, main roads, and boundaries on older maps.
	Other	Occasionally, other colors may be used to show special information. As a rule, these are indicated in the marginal information.

Grids

This part covers how to determine and report positions on the ground in terms of locations on a map. Knowing where one is (position fixing) and being able to communicate that knowledge is crucial for successful land navigation, effective employment of direct and indirect fire, tactical air support, and medical evacuation. It is essential for valid target acquisition; accurate reporting of various danger areas, and nuclear, biological, and chemical contamination areas; and obtaining emergency resupply. Few factors contribute as much to the survivability of troops and equipment, and to the successful accomplishment of a mission, as always knowing one's location. This part includes explanations of geographical coordinates, Universal Transverse Mercator (UTM) grids, the military grid reference system, and the use of grid coordinates.

Reference System	In a city, it is quite simple to find a location; the streets are named and the buildings have numbers. The only thing needed is the address. However, finding locations in undeveloped areas or in unfamiliar parts of the world can be a problem. To cope with this difficulty, a uniform and precise system of referencing has been developed.
------------------	---------------------------------------------------------------------------------------------------------------------------------------------------------------------------------------------------------------------------------------------------------------------------------------------------------------------------------------------------

Geographic Coordinates	One of the oldest systematic methods of location is based upon the geographic coordinate system. By drawing a set of east-west rings around the globe (parallel to the equator), and a set of north-south rings crossing the equator at right angles and converging at the poles, a network of reference lines is formed from which a point on the earth's surface can be located.
------------------------	------------------------------------------------------------------------------------------------------------------------------------------------------------------------------------------------------------------------------------------------------------------------------------------------------------------------------------------------------------------------------------

Geographic Coordinates	Latitude	The distance of a point north or south of the equator is known as its latitude. The rings around the earth parallel to the equator are called parallels of latitude, or simply parallels. Lines of latitude run east-
------------------------	----------	-----------------------------------------------------------------------------------------------------------------------------------------------------------------------------------------------------------------------

Geographic Coordinates (Continued)	west but north-south distances are measured between them.
Longitude	<p>A second set of rings that run around the globe at right angles to the lines of latitude and passing through the poles are known as meridians of longitude, or simply meridians. One meridian is established as the prime meridian. The prime meridian of the system we use runs through Greenwich, England and is known as the Greenwich Meridian. The distance east or west of a prime meridian to a point is known as its longitude. Lines of longitude (meridians) run north-south but east-west distances are measured between them. (See Figures 4-1 and 4-2.)</p>
<p>Geographic coordinates are expressed in angular measurement. Each circle is divided into 360 degrees, each degree into 60 minutes, and each minute into 60 seconds. The degree is symbolized by °, the minute by ' and the second by ".</p>	
Latitude Angular Measurements	<p>Starting with 0° at the equator, the parallels of latitude are numbered to 90° both north and south. The extremities are the North Pole at 90° north latitude and the South Pole at 90° south latitude. Latitude can have the same numerical value north (N) or south (S) of the equator, so the direction N or S is always given.</p>
Longitude Angular Measurements	<p>Starting with 0° at the prime meridian, longitude is measured both east (E) and west (W) around the world. Lines east of the prime meridian are numbered to 180° and identified as east longitude; lines west of the prime meridian are numbered to 180° and identified as west longitude. The direction E or W is always given. The line directly opposite the prime meridian, 180°, may be referred to as either east or west longitude.</p>
Value of Coordinates	<p>The values of geographic coordinates, being in units of angular measure, mean more if they are compared with more familiar units of measure. At any point on the earth, the ground distance covered by one degree of latitude is about 111 kilometers (km) or 69 miles; one second is equal to about 30 m (or 100 feet). The ground distance covered by one degree of longitude at the equator is also about 111 km, but decreases as one moves north or south, until it</p>

becomes zero at the poles. For example, one second of longitude represents about 30 m at the equator; but at the latitude of Washington, D.C., one second of longitude is about 24 m (78 feet). Latitude and longitude are illustrated in Figure 4-3.

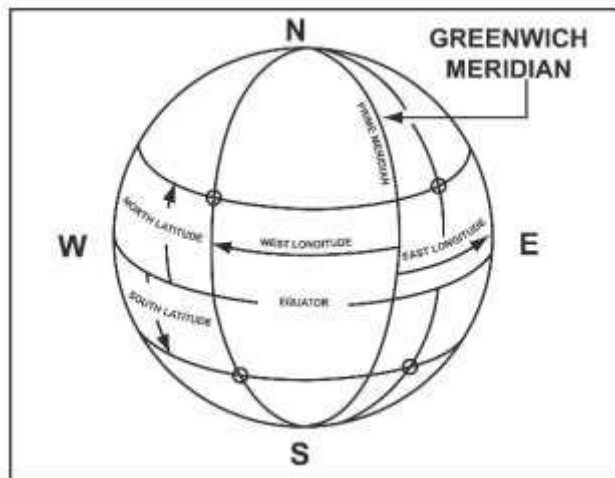

Figure 1-1. Prime meridian and equator

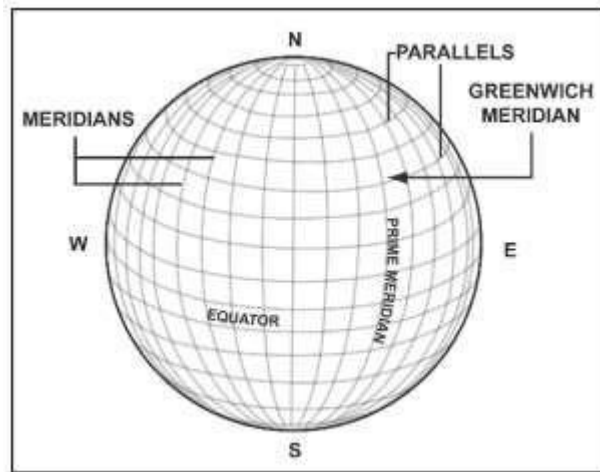

Figure 1-2. Reference lines

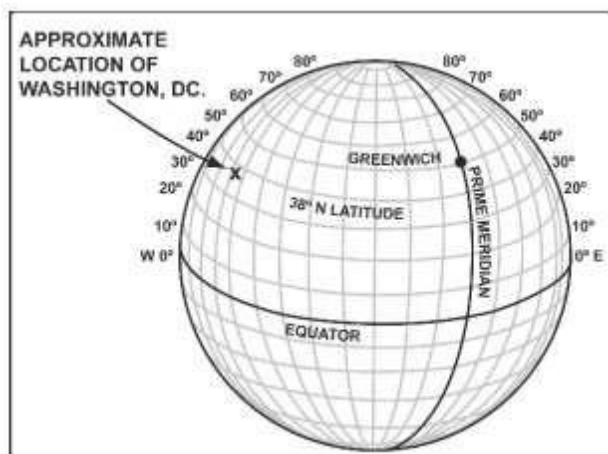

Figure 1-3. Latitude and longitude

Grids (Continued)

Universal Transverse Mercator (UTM) Grid

The UTM grid system was adopted by the U.S. Army in 1947 for designating rectangular coordinates on large-scale military maps. The UTM is currently used by the U.S. and North Atlantic Treaty Organization armed forces. With the advent of inexpensive GPS receivers, many other map users are adopting the UTM grid system for coordinates that are simpler to use than latitude and longitude.

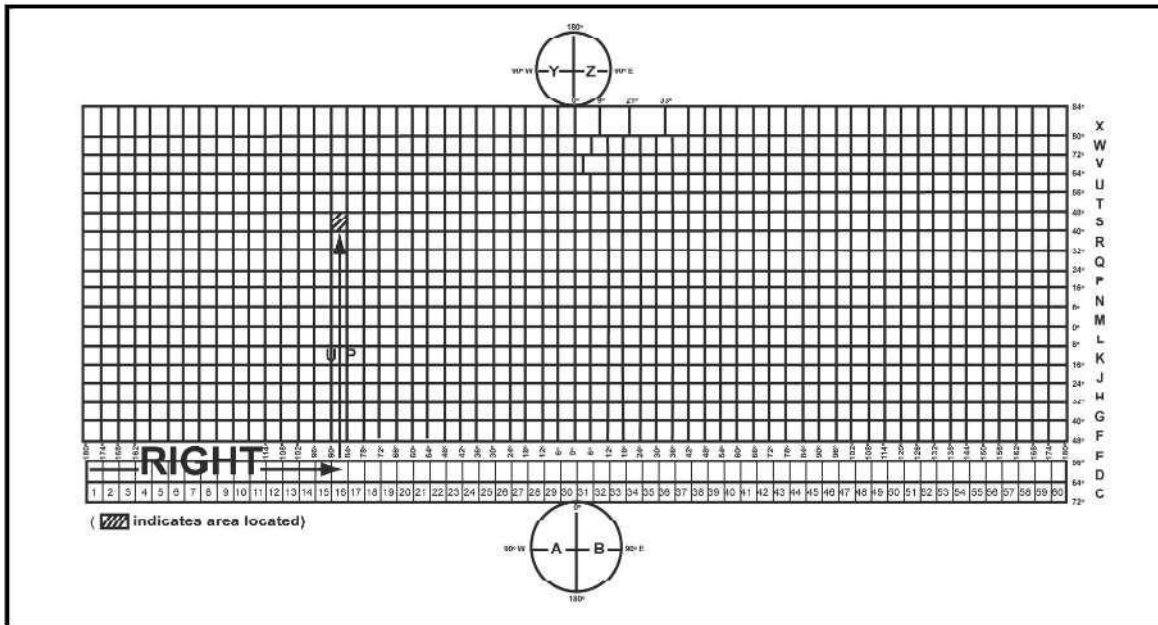

Figure 1-4. UTM grid zone location

Universal Polar
Stereographic (UPS)
Grid

North Polar
Area

The origin of the UPS grid applied to the north polar area is the North Pole. The "north-south" base line is the line formed by the 0 degree and 180-degree meridians; the "east-west" base line is formed by the two 90-degree meridians.

South Polar
Area

The origin of the UPS grid in the south polar area is the South Pole. The base lines are similar to those of the north polar area.

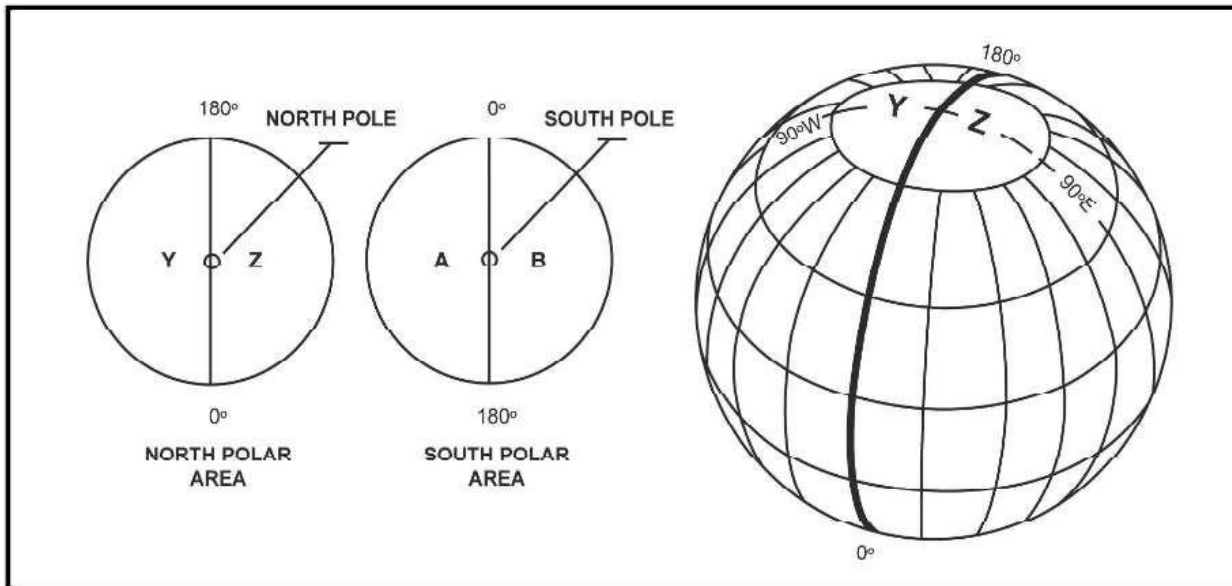

United States Military
Grid Reference
System (MGRS)

This grid reference system is used with the UTM and UPS grids. The coordinate value of points in these grids could contain as many as 15 digits if numerals alone were used. The U.S. military grid reference system reduces the length of written coordinates by substituting single letters for several numbers.

Using the UTM and the UPS grids, it is possible for the location of a point (identified by numbers alone) to be in many different places on the surface of the earth. With the use of the military grid reference system, there is no possibility of this happening.

Grid Squares	The north-south and east-west grid lines intersect at 90 degrees, forming grid squares. Normally, the size of one of these grid squares on large-scale maps is 1000 m (1 km).
--------------	-------------------------------------------------------------------------------------------------------------------------------------------------------------------------------

Grid Coordinate Scales	The primary tool for plotting grid coordinates is the grid coordinate scale. This scale divides the grid square more accurately than can be done by estimation and the results are more consistent. When used correctly, it presents less chance for making errors. (Also known as a protractor)
------------------------------	--------------------------------------------------------------------------------------------------------------------------------------------------------------------------------------------------------------------------------------------------------------------------------------------------

Determine Grids Without a Coordinate Scale

In order to determine grids without a coordinate scale, the reader refers to the north-south grid lines numbered at the bottom margin of a map. Then read RIGHT to the north-south grid line that precedes the desired point (this first set of two digits is the RIGHT reading).

Then, by referring to the east-west grid lines numbered at either side of the map, the map reader moves UP to the east-west grid line that precedes the desired point (these two digits are the UP reading). In Figure 4-17, coordinates 1484 locate the 1000-m grid square in which point X is located; the next square to the right would be 1584; the next square up would be 1485, and so forth.

To locate the point to the nearest 100 m, use estimation. By mentally dividing the grid square in tenths, estimate the distance from the grid line to the point in the same order (RIGHT and UP). Give complete coordinate RIGHT, then complete coordinate UP. Point X is about two-tenths or 200 m to the RIGHT into the grid square and about seven-tenths or 700 m UP. The coordinates to the nearest 100 m are 142847.

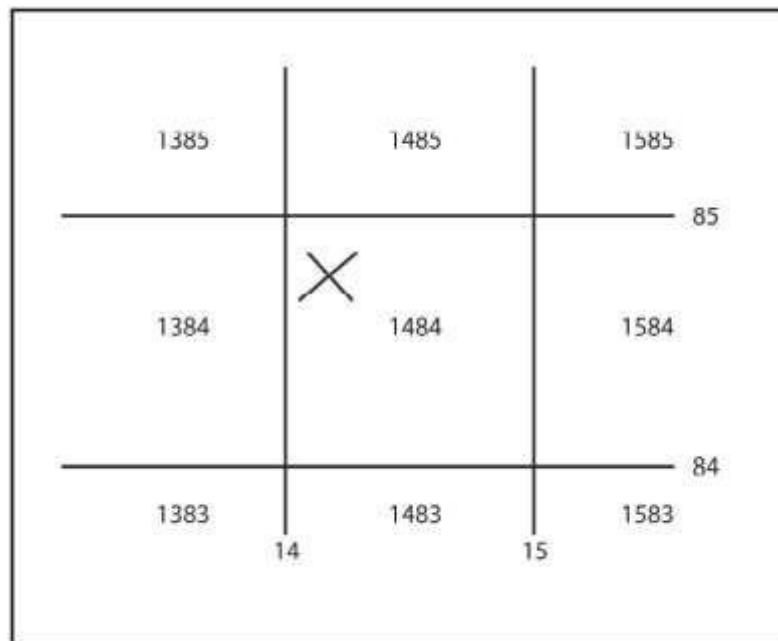

Figure 1-5. UTM grid zone location

Determine Grids With a Coordinate Scale

In order to use the coordinate scale for determining grid coordinates, the map user has to make sure that the appropriate scale is being used on the corresponding map, and that the scale is right side up. To ensure the scale is correctly aligned, place it with the zero-zero point at the lower left corner of the grid square. Keeping the horizontal line of the scale directly on top of the east-west grid line, slide it to the right until the vertical line of the scale touches the point for which the coordinates are desired.

When reading coordinates, examine the two sides of the coordinate scale to ensure that the horizontal line of the scale is aligned with the east-west grid line, and the vertical line of the scale is parallel with the north-south grid line. The scale is used when precision of more than 100 m is required. To locate the point to the nearest 10 m, measure the hundredths of a grid square RIGHT and UP from the grid lines to the point. Point X is about 21-hundredths or 210 m RIGHT and 73-hundredths or 730 m UP. The coordinates to the nearest 10 m are 14218473.

Recording and Reporting Grid Coordinates

Coordinates are written as one continuous number without spaces, parentheses, dashes, or decimal points; they always contain an even number of digits. Therefore, whoever is to use the written coordinates knows where to make the split between the RIGHT and UP readings. It is a military requirement that the 100,000-m square identification letters be included in a point designation. Normally, grid coordinates are determined to the nearest 100 m (six digits) for reporting locations. With practice, this can be done without using plotting scales. The location of targets and other point locations for fire support are determined to the nearest 10 m (eight digits).

Placing a coordinate scale on a grid

Care should be exercised by the map reader using the coordinate scale when the desired point is located within the zero-zero point and the number 1 on the scale. Always prefix a zero if the hundredths reading is less than 10. In Figure 1-6, the desired point should be reported as 14838425.

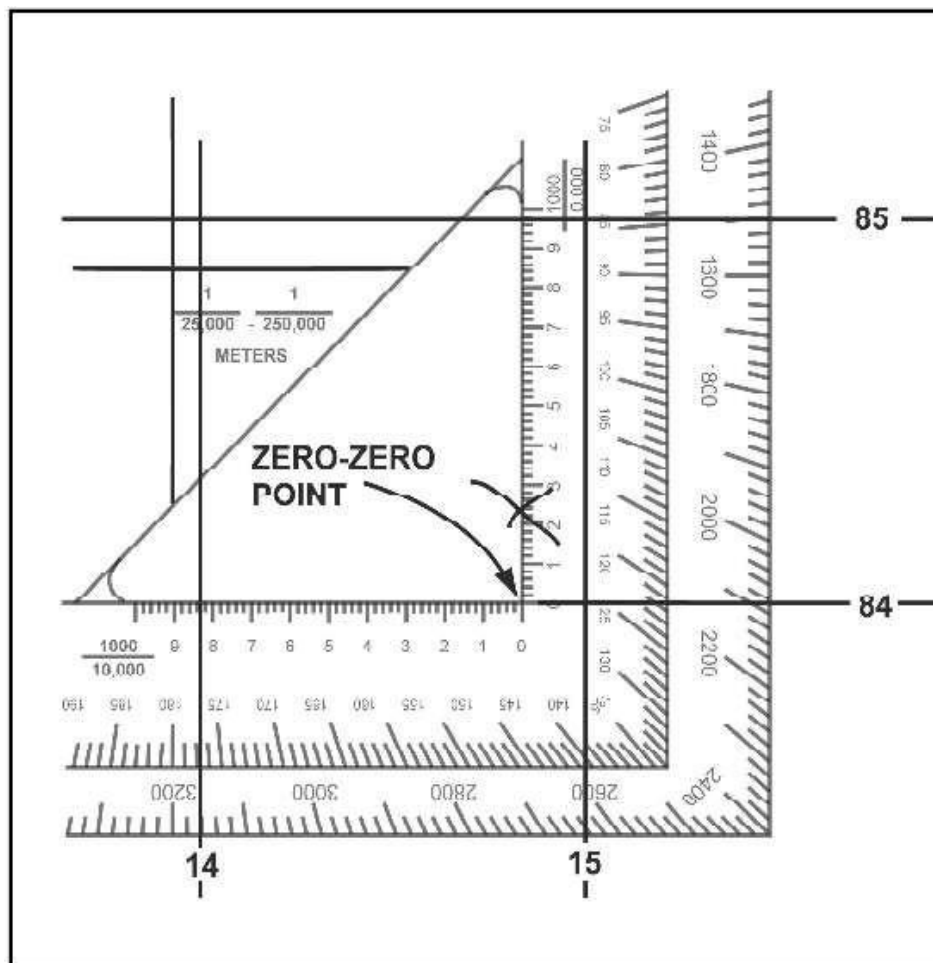

Figure 1-6. UTM grid zone location

Military Grid Reference System (Continued)

Locating A Point Using MGRS

There is only one rule to remember when reading or reporting grid coordinates----always read to the RIGHT and then UP. The first half of the reported set of coordinate digits represents the left-to-right (easting) grid label, and the second half represents the label as read from the bottom-to-top (northing). The grid coordinates may represent the location to the nearest 10-m, 100-m, or 1000-m increment. These coordinates are found by taking the following steps:

Grid Zone The number 16 locates a point within zone 16, which is an area 6-degrees wide and extends between 80°S latitude and 84°N latitude.

Grid Zone Designation The number and letter combination 16S, further locates a point within the grid zone designation 16S, which is a quadrangle 6-degrees wide by 8-degrees high. There are 19 of these quads in zone 16. Quad X, which is located between 72°N and 84°N latitude, is 12-degrees high.

100,000-M Square Identification The addition of two more letters locates a point within the 100,000-m grid square. The coordinates 16SGL locates the point within the 100,000-m square GL in the grid zone designation 16S. (Refer to the Defense Mapping Agency Technical Manual 8358.1 for more information.)

1000-meter grid square To obtain the 1000-m grid squares, each side of the 10000-m square is divided into 10 equal parts. This division appears on large-scale maps as the actual grid lines; they are 1000 meters apart (1 km).
Figure 1-8

PLATE 12																	
30°				500,000m				30°				500,000m				84°	
DV	TD	UC	VG	WQ	XQ	YQ	BV	DV	DV	EV	FV	GV	HQ				
QU	TP	UP	VP	WP	XP	YP	BU	CU	DU	EU	FU	GU	KP				
QT	TN	UN	VN	WN	XN	YN	BT	CT	DT	ET	FT	GT	KN				
QS	TM	UM	VM	WM	XM	YM	BS	CS	DS	ES	FS	GS	KM				
QR	TL	UL	VL	WL	XL	YL	BR	CR	DR	ER	FR	GR	KL				
QQ	TK	UK	VK	WK	XK	YK	BQ	CQ	DQ	EQ	FQ	GQ	KK				
QP	TJ	UJ	VJ	WJ	XJ	YJ	BP	CP	DP	EP	FP	GP	KJ				
QN	TI	UI	VI	WI	XI	YI	BN	CN	DN	EN	FN	GN	KN				
QM	TG	UG	VG	WG	XG	YG	BM	CM	DM	EM	FM	GM	KG				
QL	TF	UF	VF	WF	XF	YF	BL	CL	DL	EL	FL	GL	KF				

Figure 1-7. Grid zone designation and 100,000-m square identification.

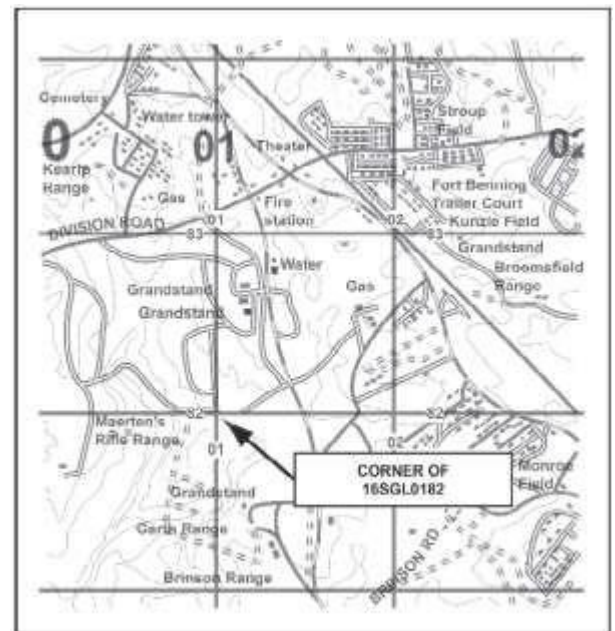

Figure 1-8. Grid 1,000-m square

Scale and Distance

A map is a scaled graphic representation of a portion of the earth's surface. The scale of the map permits the user to convert distance on the map to distance on the ground, or vice versa. The ability to determine distance on a map, as well as on the earth's surface, is an important factor in planning and executing military missions.

Representative Fraction

The numerical scale of a map indicates the relationship of distance measured on a map and the corresponding distance on the ground. This scale is usually written as a fraction and is called the representative fraction.

The RF is always written with the map distance as 1, and is independent of a unit of measure. (It could be yards, meters, inches, or something else.) An RF of 1/50,000 or 1:50,000 means that one unit of measure on the map is equal to 50,000 units of the same measure on the ground.

Graphic (Bar) Scales

A graphic scale is a ruler printed on the map that is used to convert distances on the map to actual ground distances. The graphic scale is divided into two parts:

1. To the right of the zero, the scale is marked in full units of measure and is called the primary scale.
2. To the left of the zero, the scale is divided into tenths and is called the extension scale. Most

maps have three or more graphic scales, each using a different unit of measure. When using the graphic scale, be sure to use the correct scale for the unit of measure desired. (See Figure 1-9)

Using Graphic Bar

To determine the straight-line distance between two points on a map, lay a straight-edged piece of paper on the map so that the edge of the paper touches both points and extends past them. Make a tick mark on the edge of the paper at each point. (Figure 1-10)

Measuring Straight Line Distance

To convert the map distance to a measured ground distance, move the paper down to the graphic bar scale, and align the right tick mark (b) with a printed number in the primary scale so that the left tick mark (a) is in the extension scale. (See Figure 1-11.) The primary scale provides the whole unit distance, while the extension scale provides the divided scale used to determine smaller increments of measure.

Graphic Scale and Distance on a Map (Continued)

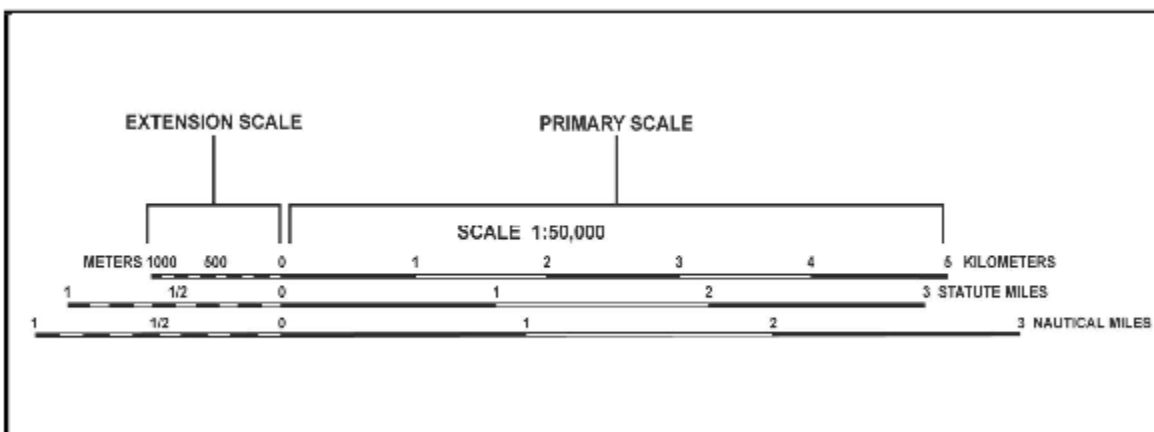

Figure 1-9

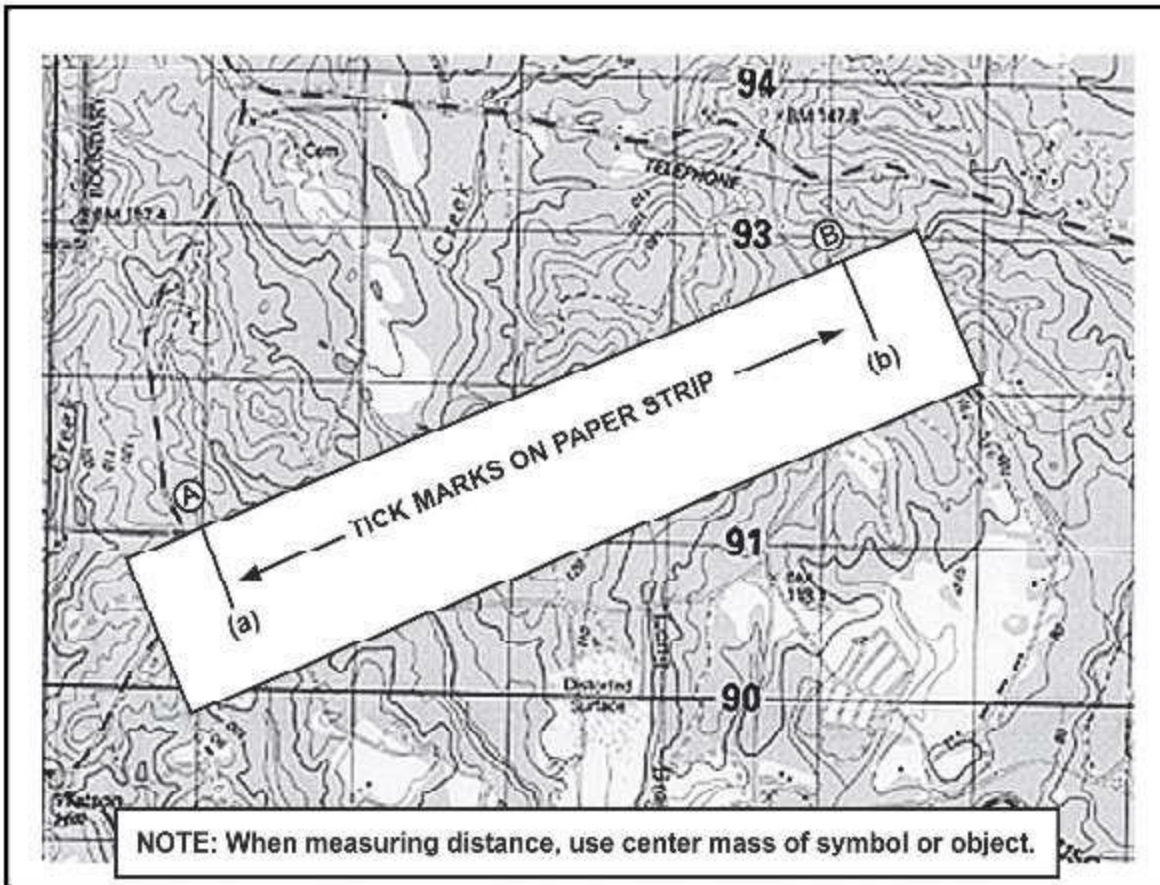

Figure 1-10

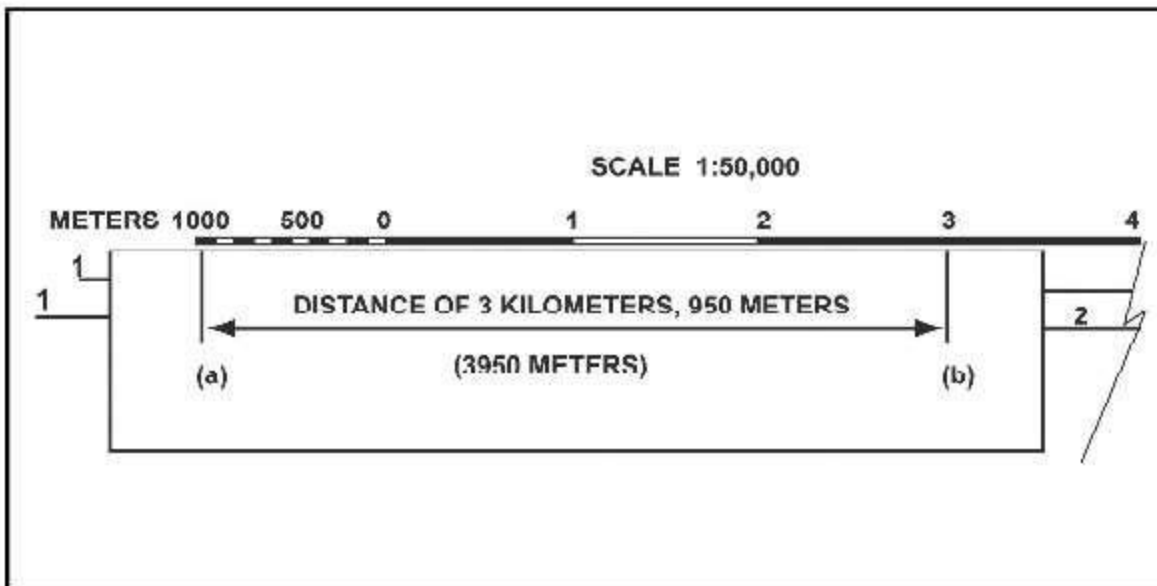

Figure 1-11

Requirement 1 Review Questions

Requirement 1 map: Virginia, 1:50,000, Quantico MIM LND NAV SPECIAL, Edition 4-NGA.

1. What are the map sheet number and series number on which you would find grid square (GS) 9572?

Answer: Map sheet number _____

Answer: Series number _____

2. What are the coordinates of the following objectives to the nearest 100 meters?

a. Bench Mark in GS 9177 Answer: _____

b. Tower in GS 8879 Answer: _____

c. 617 FARM GATE in GS 8371 Answer: _____

d. Major road intersection in GS 9378 Answer: _____

3. What are the map sheet number and series number on which you find grid square 8959?

Answer: Map sheet number _____

Answer: Series number _____

4. What is located at each of the following coordinates?

a. 03507480 Answer: _____

b. 99307380 Answer: _____

c. 86277683 Answer: _____

5. What are the coordinates of the following objectives to the nearest ten meters?

a. IOC Village Gate in GS 8375 Answer: _____

b. HQ Horizontal Control Station in GS 9570 Answer: _____

c. Intersection of stream and unimproved surface road in SE corner road of GS 9079 Answer: _____

d. Bridge in GS 9863 Answer: _____

e. School in GS 8164 Answer: _____

6. What are the map sheet number and series number on which you would find GS 7470?

Answer: Map sheet number _____

Answer: Series number _____

7. What is located at each of the following coordinates:

a. 92508055 Answer: _____

b. 89656670 Answer: _____

c. 00407965 Answer: _____

d. 88506945 Answer: _____

Requirement 1 Review Questions (Continued)

8. What are the 8-digit grid coordinates of the following objectives?
- a. Post chapel in GS 9865 Answer: _____
 - b. Community College in GS 0077 Answer: _____
 - c. DZ Raven Pit in GS 8766 Answer: _____
-

Requirement 1 Review Answers

1. Map sheet number 5561 III or Quantico MIM Land Nav SPC
Series number V734 or V734S
-
2. 6-digit grid coordinates; no tolerance.
- a. 910776
 - b. 881796
 - c. 839712
 - d. 933785
-
3. Map sheet number 5560 IV
Series number V734
-
4.
 - a. Railroad bridge
 - b. Road junction
 - c. Stream junction
-
5. Questions requiring accuracy to the nearest 10 meters require an 8-digit grid coordinate as an answer. Your 8-digit grid coordinate should be within 50 meters of the solution.
- a. 83157520
 - b. 95507045
 - c. 90807923
 - d. 98696365
 - e. 81296435
-
6. Map sheet number 5461 II
Series number V734
-
7.
 - a. High School
 - b. Fuel Farm
 - c. Potomac Mills
 - d. LZ Mallard
-
8. Answers should be within $\pm 50\text{m}$ of the solution.
- a. 98356520
 - b. 00587738
 - c. 87766615
-

Summary

This lesson has begun to set the foundation for the warfighter's ability (**YOU**) to demonstrate mastery in one of the many art and sciences of tactics. The science of Maps will be followed by the science of Direction. These combined will complete Map Reading which will be followed by Land Navigation. This lesson is applicable to all students regardless of MOS preference. The ability to read maps aids in accomplishing specific tasks within a tactical action.

Tactics includes "...those techniques and procedures for accomplishing specific tasks within a tactical action" p.3 MCDP 1-3

"Logistics, transport, roads, and **maps**...these essentially nonmilitary technologies probably did as much to shape warfare, as did any number of weapons and arms." p. 48 Technology and War

References

Reference Number or Author	Reference Title
TC 3-25.26	Map Reading and Land Navigation

Glossary of Terms and Acronyms

Term or Acronym	Definition or Identification
DMA	Defense Mapping Agency
GS	Grid square
M	Meter
MGRS	Military Grid Reference System
NGA	National Geospatial-Intelligence Agency
NIMA	National Imagery Mapping Agency

