

H61MHV2 Setup Manual

FCC Information and Copyright

This equipment has been tested and found to comply with the limits of a Class B digital device, pursuant to Part 15 of the FCC Rules. These limits are designed to provide reasonable protection against harmful interference in a residential installation. This equipment generates, uses, and can radiate radio frequency energy and, if not installed and used in accordance with the instructions, may cause harmful interference to radio communications. There is no guarantee that interference will not occur in a particular installation.

The vendor makes no representations or warranties with respect to the contents here and specially disclaims any implied warranties of merchantability or fitness for any purpose. Further the vendor reserves the right to revise this publication and to make changes to the contents here without obligation to notify any party beforehand.

Duplication of this publication, in part or in whole, is not allowed without first obtaining the vendor's approval in writing.

The content of this user's manual is subject to be changed without notice and we will not be responsible for any mistakes found in this user's manual. All the brand and product names are trademarks of their respective companies.



Dichiarazione di conformità sintetica

Ai sensi dell'art. 2 comma 3 del D.M. 275 del 30/10/2002

Si dichiara che questo prodotto è conforme alle normative vigenti e soddisfa i requisiti essenziali richiesti dalle direttive

2004/108/CE, 2006/95/CE e 1999/05/CE

quando ad esso applicabili

Short Declaration of conformity

We declare this product is complying with the laws in force and meeting all the essential requirements as specified by the directives

2004/108/CE, 2006/95/CE and 1999/05/CE

whenever these laws may be applied

Table of Contents

Chapter 1: Introduction	1
1.1 Before You Start	1
1.2 Package Checklist	1
1.3 Motherboard Features	2
1.4 Rear Panel Connectors	3
1.5 Motherboard Layout	3
Chapter 2: Hardware Installation	4
2.1 Installing Central Processing Unit (CPU)	4
2.2 Install a Heatsink	6
2.3 FAN Headers	7
2.4 Installing System Memory	8
2.5 Connectors and Slots	9
Chapter 3: Headers & Jumpers Setup	12
3.1 How to Setup Jumpers	12
3.2 Detail Settings	12
Chapter 4: Useful Help	15
4.1 Driver Installation Note	15
4.2 BIOS Update	16
4.3 AMI BIOS Beep Code	18
4.4 Troubleshooting	18
Appendix: SPEC in Other Languages	21
German	21
French	23
Italian	25
Spanish	27
Portuguese	29
Polish	31
Russian	33
Arabic	35
Japanese	37

CHAPTER 1: INTRODUCTION

1.1 BEFORE YOU START

Thank you for choosing our product. Before you start installing the motherboard, please make sure you follow the instructions below:

- Prepare a dry and stable working environment with sufficient lighting.
- Always disconnect the computer from power outlet before operation.
- Before you take the motherboard out from anti-static bag, ground yourself properly by touching any safely grounded appliance, or use grounded wrist strap to remove the static charge.
- Avoid touching the components on motherboard or the rear side of the board unless necessary. Hold the board on the edge, do not try to bend or flex the board.
- Do not leave any unfastened small parts inside the case after installation. Loose parts will cause short circuits which may damage the equipment.
- Keep the computer from dangerous area, such as heat source, humid air and water.
- The operating temperatures of the computer should be 0 to 45 degrees Celsius.
- To avoid injury, be careful of:
 - Sharp pins on headers and connectors
 - Rough edges and sharp corners on the chassis
 - Damage to wires that could cause a short circuit

1.2 PACKAGE CHECKLIST

- Serial ATA Cable x2
- Rear I/O Panel for ATX Case x1
- Quick Installation Guide x1
- Fully Setup Driver DVD x1

Note: The package contents may be different due to the sales region or models in which it was sold. For more information about the standard package in your region, please contact your dealer or sales representative.

1.3 MOTHERBOARD FEATURES

<i>SPEC</i>		
CPU	Socket 1155 Intel Core i7 / i5 / i3 / Pentium / Celeron processor	Supports Execute Disable Bit / Enhanced Intel SpeedStep® / Intel Architecture-64 / Extended Memory 64 Technology / Virtualization Technology / Hyper Threading
Chipset	Intel H61	
Super I/O	IT8772E Provides the most commonly used legacy Super I/O functionality Low Pin Count Interface	Environment Control initiatives Hardware Monitor Controller Fan Speed Controller ITE's "Smart Guardian" function
Main Memory	DDR3 DIMM Slots x 2 Max Memory Capacity 16GB Each DIMM supports 512MB/ 1GB/2GB/4GB/8GB DDR3	Dual Channel Mode DDR3 memory module Supports DDR3 1066 / 1333 Supports DDR3 1600 (depending on CPU) Registered DIMM and ECC DIMM is not supported
SATA 2	Integrated Serial ATA Controller	Data transfer rates up to 3.0 Gb/s SATA Version 2.0 specification compliant
LAN	RTL8111H	10 / 100 / 1000Mb/s auto negotiation
Sound Codec	ALC662	5.1 channels audio out , High Definition Audio
Slots	PCI-E Gen3x16 slot x1 (depending on CPU)	Supports PCI-E Gen2/3 x16 expansion card
	PCI-E Gen2 x1 slot x1	Supports PCI-E Gen2 x1 expansion card
On Board Connectors	SATA2 Connector x4	Each connector supports 1 SATA2 device
	Front Panel Connector x1	Supports front panel facilities
	Chassis Speaker Connector x1	Supports chassis speaker
	Front Audio Connector x1	Supports front panel audio function
	CPU Fan Header x1	CPU Fan power supply (with Smart Fan function)
	System Fan Header x1	System Fan Power supply
	Clear CMOS Header x1	Restore CMOS data to factory default
	USB2.0 Connector x2	Each connector supports 2 front panel USB2.0 ports
	Serial Port Connector x1	Connects to RS-232 Port
Rear Panel I/O	Power Connector (24pin) x1	Connects to Power supply
	Power Connector (4pin) x1	Connects to Power supply
	PS/2 Keyboard/ Mouse x1	Connects to PS/2 Keyboard & Mouse
	VGA Port x1	Connect to D-SUB monitor
	HDMI Port x1	Connect to HDMI monitor
	LAN port x1	Connect to RJ-45 Ethernet cable
Board Size	USB2.0 Port x4	Connect to USB2.0 devices
	Audio Jack x3	Provide Audio-In/Out and Mic. Connection
	170 (W) x 191 (L) mm	
OS Support	Windows XP / Vista / 7 / 8 / 8.1 / 10	Biostar reserves the right to add or remove support for any OS with or without notice

1.4 REAR PANEL CONNECTORS



Note1: VGA Output requires an Intel Core family processor with Intel Graphics Technology.
Note2: VGA Maximum resolution: 2048 x 1536 @75Hz

1.5 MOTHERBOARD LAYOUT

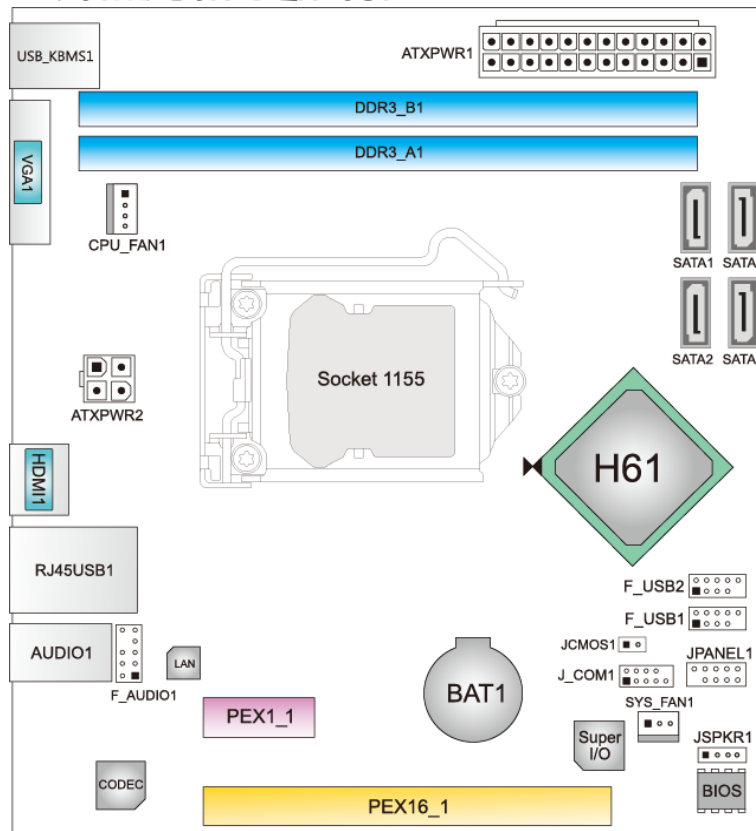

Note1: ■ represents the 1st pin.

CHAPTER 2: HARDWARE INSTALLATION

2.1 INSTALLING CENTRAL PROCESSING UNIT (CPU)

Step 1: Locate the CPU socket on the motherboard

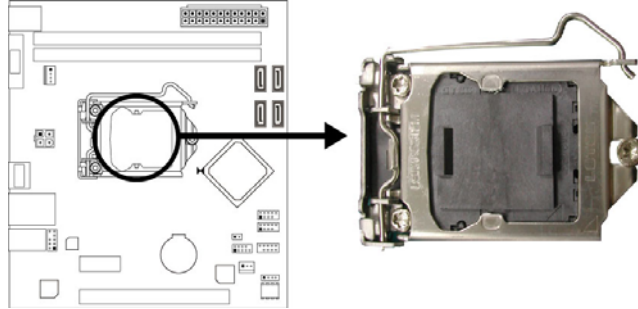

Note1: Remove Pin Cap before installation, and make good preservation for future use. When the CPU is removed, cover the Pin Cap on the empty socket to ensure pin legs won't be damaged.
Note2: The motherboard might equip with two different types of pin cap. Please refer below instruction to remove the pin cap.

Step 2: Pull the socket locking lever out from the socket and then raise the lever up.

Type A

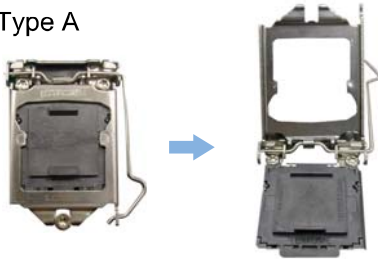

Type B

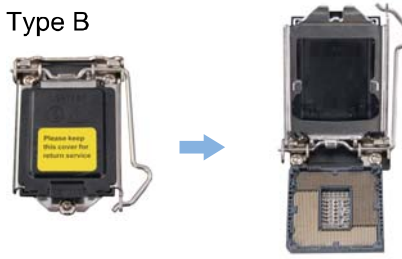

Step 3: Remove the Pin Cap.

Type A

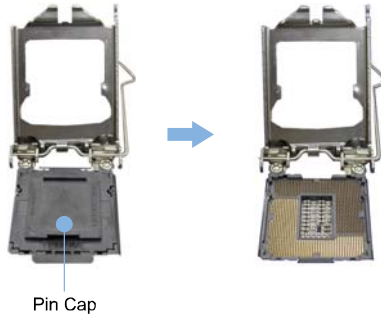

Type B

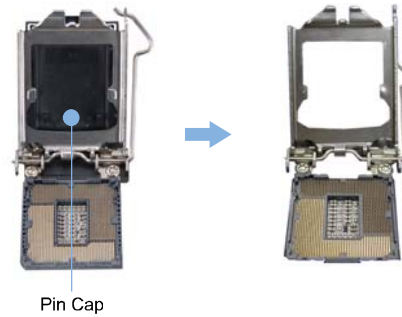

H61MHV2

Step 4: Hold processor with your thumb and index fingers, oriented as shown. Align the notches with the socket. Lower the processor straight down without tilting or sliding the processor in the socket.



Note: The CPU fits only in one correct orientation. Do not force the CPU into the socket to prevent damaging the CPU.

Step 5: Hold the CPU down firmly, and then lower the lever to locked position to complete the installation.



2.2 INSTALL A HEATSINK

Step 1: Place the CPU fan assembly on top of the installed CPU and make sure that the four fasteners match the motherboard holes. Orient the assembly and make the fan cable is closest to the CPU fan connector.



Step 2: Press down two fasteners at one time in a diagonal sequence to secure the CPU fan assembly in place. Ensure that all four fasteners are secured.

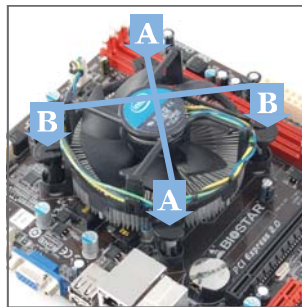

Note1: Do not forget to connect the CPU fan connector.

Note2: For proper installation, please kindly refer to the installation manual of your CPU heatsink.

2.3 FAN HEADERS

These fan headers support cooling-fans built in the computer. The fan cable and connector may be different according to the fan manufacturer. Connect the fan cable to the connector while matching the black wire to pin#1.

CPU_FAN1: CPU Fan Header

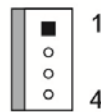
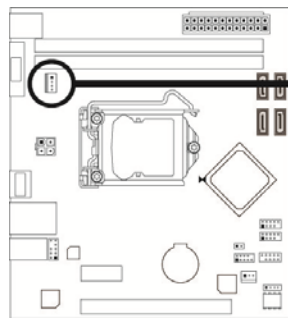

Pin	Assignment
1	Ground
2	+12V
3	FAN RPM rate sense
4	Smart Fan Control (By Fan)

SYS_FAN1: System Fan Header

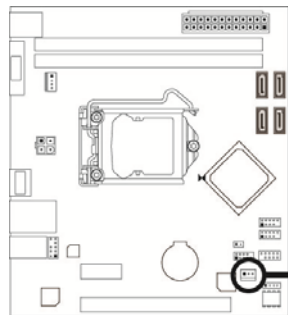

Pin	Assignment
1	Ground
2	+12V
3	FAN RPM rate sense

Note: CPU_FAN1 support 4-pin and 3-pin head connectors. When connecting with wires onto connectors, please note that the red wire is the positive and should be connected to pin#2, and the black wire is Ground and should be connected to GND.
SYS_FAN3 support 3-pin head connectors. When connecting with wires onto connectors, please note that the red wire is the positive and should be connected to pin#2, and the black wire is Ground and should be connected to GND.

2.4 INSTALLING SYSTEM MEMORY

A. Memory Modules

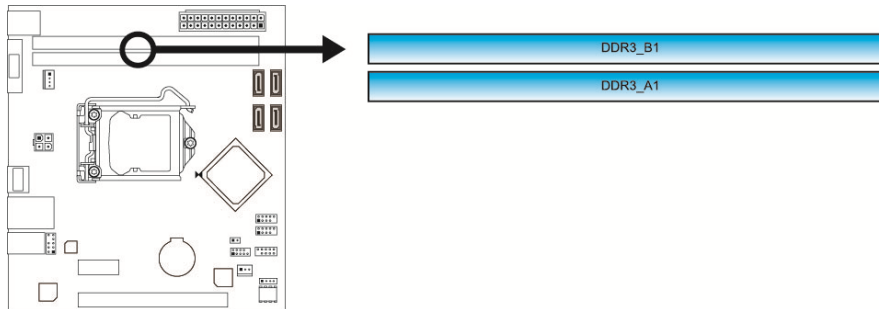

Step 1: Unlock a DIMM slot by pressing the retaining clips outward. Align a DIMM on the slot such that the notch on the DIMM matches the break on the slot.

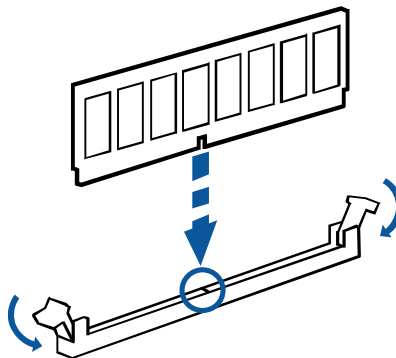

Step 2: Insert the DIMM vertically and firmly into the slot until the retaining chip snap back in place and the DIMM is properly seated.

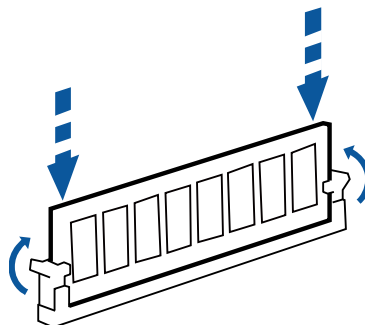

Note: If the DIMM does not go in smoothly, do not force it. Pull it all the way out and try again.

B. Memory Capacity

DIMM Socket Location	DDR3 Module	Total Memory Size
DDR3_A1	512MB/1GB/2GB/4GB/8GB	Max is 16GB.
DDR3_B1	512MB/1GB/2GB/4GB/8GB	

C. Dual Channel Memory Installation

Please refer to the following requirements to activate Dual Channel function:
Install memory module of the same density in pairs, shown in the table.

Dual Channel Status	DDR3_A1	DDR3_B1
Disabled	O	X
Disabled	X	O
Enabled	O	O

(O means memory installed; X, not installed.)

Note: The DRAM bus width of the memory module must be the same (x8 or x16)

2.5 CONNECTORS AND SLOTS

SATA1~SATA4: Serial ATA Connectors

These connectors connect to SATA hard disk drives via SATA cables.
Those satisfy the SATA 2.0 spec and with transfer rate of 3.0Gb/s.

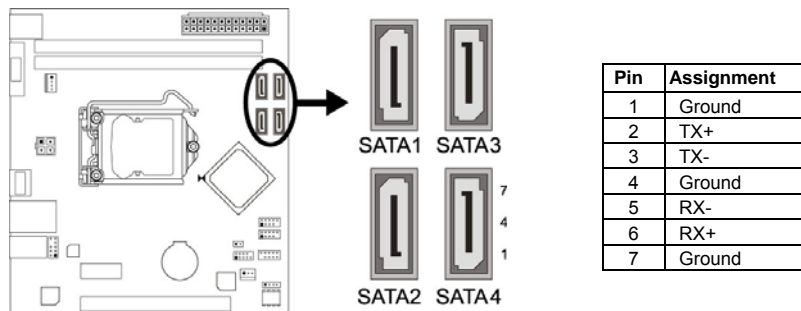

ATXPWR2: ATX Power Source Connector

This connector provides +12V to CPU power circuit.

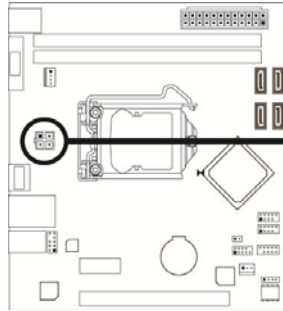

Pin	Assignment
1	+12V
2	+12V
3	Ground
4	Ground

ATXPWR1: ATX Power Source Connector

This connector allows user to connect 24-pin power connector on the ATX power supply.

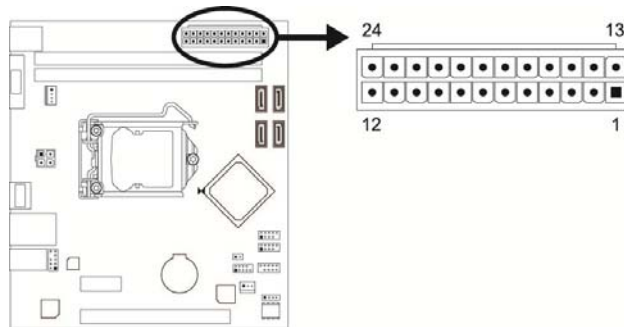

Pin	Assignment	Pin	Assignment
13	+3.3V	1	+3.3V
14	-12V	2	+3.3V
15	Ground	3	Ground
16	PS_ON	4	+5V
17	Ground	5	Ground
18	Ground	6	+5V
19	Ground	7	Ground
20	NC	8	PW_OK
21	+5V	9	Standby Voltage+5V
22	+5V	10	+12V
23	+5V	11	+12V
24	Ground	12	+3.3V

Note1: Before you power on the system, please make sure that both ATXPWR1 and ATXPWR2 connectors have been plugged-in.

Note2: Insufficient power supplied to the system may result in instability or the peripherals not functioning properly. Use of a PSU with a higher power output is recommended when configuring a system with more power-consuming devices.

PEX16_1: PCI-Express Gen3 x16 Slot

- PCI-Express 3.0 compliant.
- Maximum theoretical realized bandwidth of 16GB/s simultaneously per direction, for an aggregate of 32GB/s totally.
- PCI-E 3.0 is supported by Core i7-3xxx / i5-3xxx CPU.

PEX1_1: PCI-Express Gen2 x1 Slot

- PCI-Express 2.0 compliant.
- Data transfer bandwidth up to 500MB/s per direction; 1GB/s in total.

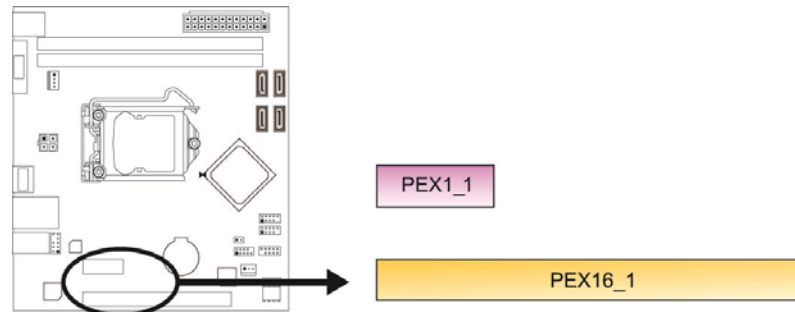
**Install an Expansion Card**

You can install your expansion card by following steps:

1. Read the related expansion card's instruction document before install the expansion card into the computer.
2. Remove your computer's chassis cover, screws and slot bracket from the computer.
3. Place a card in the expansion slot and press down on the card until it is completely seated in the slot.
4. Secure the card's metal bracket to the chassis back panel with a screw.
5. Replace your computer's chassis cover.
6. Power on the computer, if necessary, change BIOS settings for the expansion card.
7. Install related driver for the expansion card.

CHAPTER 3: HEADERS & JUMPERS SETUP

3.1 HOW TO SETUP JUMPERS

The illustration shows how to set up jumpers. When the jumper cap is placed on pins, the jumper is “close”, if not, that means the jumper is “open”.



3.2 DETAIL SETTINGS

JPANEL1: Front Panel Header

This connector includes Power-on, Reset, HDD LED and Power LED connections. It allows user to connect the PC case’s front panel switch functions.

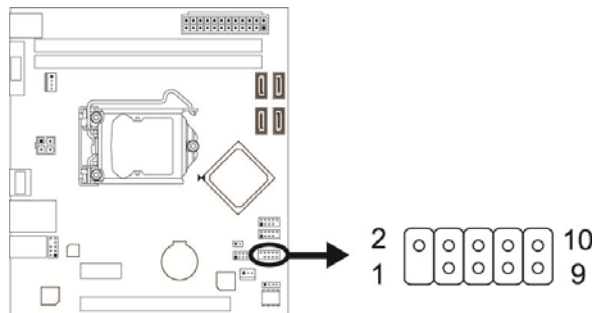

Pin	Assignment	Function	Pin	Assignment	Function
1	N/A	N/A	2	Power LED (+)	Power LED
3	HDD LED(+)	HDD LED	4	Power LED (+)	
5	HDD LED(-)		6	Power LED (-)	
7	Ground	Reset Button	8	Power Button	Power-On Button
9	Reset Control		10	Ground	

JSPKR1: Chassis Speaker Header

Please connect the chassis speaker to this header.

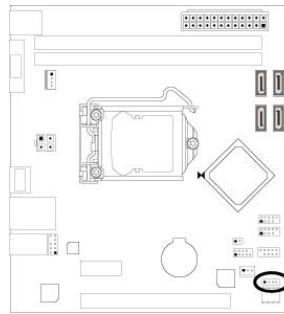

Pin	Assignment
1	+5V
2	N/A
3	N/A
4	Speaker

F_USB1/F_USB2: Headers for USB 2.0 Ports at Front Panel

These headers allow users to connect additional USB cable on the PC front panel, and also can be connected with internal USB devices, like USB card reader.

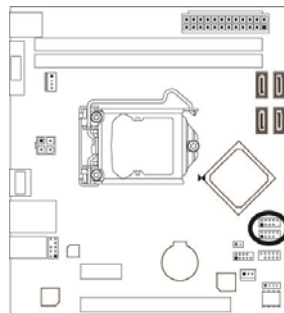

Pin	Assignment
1	+5V (fused)
2	+5V (fused)
3	USB-
4	USB-
5	USB+
6	USB+
7	Ground
8	Ground
9	Key
10	NC

J_COM1: Serial Port Connector

The motherboard has a Serial Port Connector for connecting RS-232 Port.

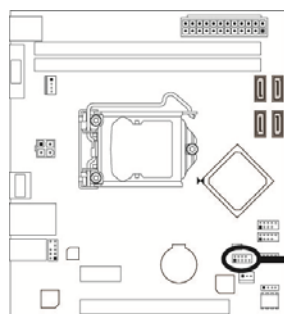

Pin	Assignment
1	Carrier detect
2	Received data
3	Transmitted data
4	Data terminal ready
5	Signal ground
6	Data set ready
7	Request to send
8	Clear to send
9	Ring indicator
10	Key

F_AUDIO1: Front Panel Audio Header

This header allows users to connect the front audio output cable with the PC front panel.

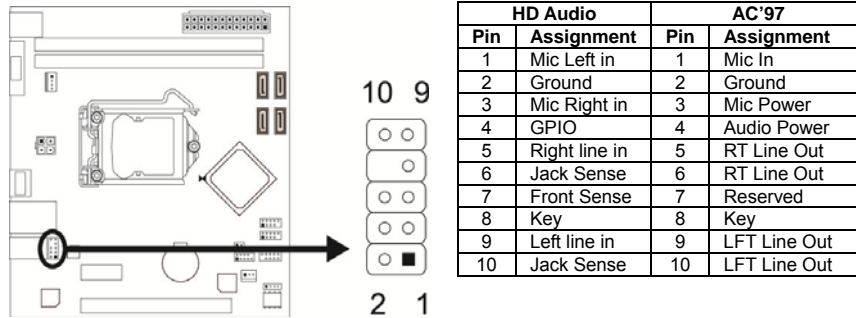

Note1: It is recommended that you connect a high-definition front panel audio module to this connector to avail of the motherboard's high definition audio capability.
Note2: Please try to disable the "Front Panel Jack Detection" if you want to use an AC'97 front audio output cable. The function can be found via O.S. Audio Utility.

JCMOS1: Clear CMOS Jumper

The jumper allows users to restore the BIOS safe setting and the CMOS data. Please carefully follow the procedures to avoid damaging the motherboard.

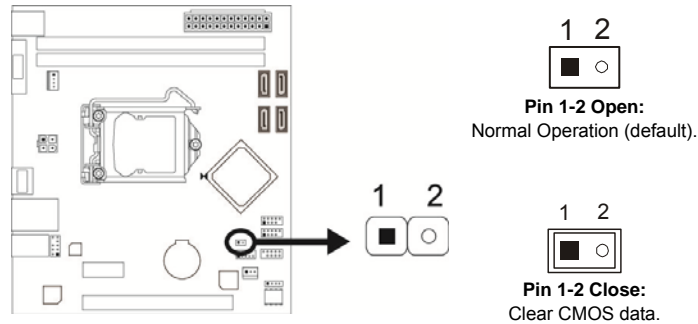

※ **Clear CMOS Procedures:**

1. Remove AC power line.
2. Set the jumper to "Pin 1-2 close", you can use a metal object like a screwdriver to touch the two pins.
3. Wait for five seconds.
4. After clearing the CMOS values, be sure the jumper is "Pin 1-2 open".
5. Power on the AC.
6. Load Optimal Defaults and save settings in CMOS.

CHAPTER 4: USEFUL HELP

4.1 DRIVER INSTALLATION NOTE

After you installed your operating system, please insert the Fully Setup Driver DVD into your optical drive and install the driver for better system performance. You will see the following window after you insert the DVD



The setup guide will auto detect your motherboard and operating system.

Note: If this window didn't show up after you insert the Driver DVD, please use file browser to locate and execute the file SETUP.EXE under your optical drive.

A. Driver Installation

To install the driver, please click on the Driver icon. The setup guide will list the compatible driver for your motherboard and operating system. Click on each device driver to launch the installation program.

B. Software Installation

To install the software, please click on the Software icon. The setup guide will list the software available for your system, click on each software title to launch the installation program.

C. Manual

Aside from the paperback manual, we also provide manual in the Driver DVD. Click on the Manual icon to browse for available manual.

Note: You will need Acrobat Reader to open the manual file. Please download the latest version of Acrobat Reader software from <http://get.adobe.com/reader/>

4.2 BIOS UPDATE

There are three ways to update the BIOS: BIOSTAR BIOS Flasher.

Note: The programming procedure may take minutes, please do not make any operation during the programming process.

BIOSTAR BIOS Flasher

BIOSTAR BIOS Flasher is a BIOS flashing utility providing you an easy and simple way to update your BIOS via USB pen drive.

The BIOSTAR BIOS Flasher is built in the BIOS ROM. To enter the utility, **press <F12> during the Power-On Self Tests (POST) procedure** while booting up.

Note1: This utility only allows storage device with FAT32/16 format and single partition.

Note2: Shutting down or resetting the system while updating the BIOS will lead to system boot failure.

Updating BIOS with BIOSTAR BIOS Flasher

1. Go to the website to download the latest BIOS file for the motherboard.
2. Then, copy and save the BIOS file into a USB flash (pen) drive.
3. Insert the USB pen drive that contains the BIOS file to the USB port.
4. Power on or reset the computer and then press <F12> during the **POST** process.

5. After entering the POST screen, the BIOS-FLASHER utility pops out. Choose [fs0] to search for the BIOS file.

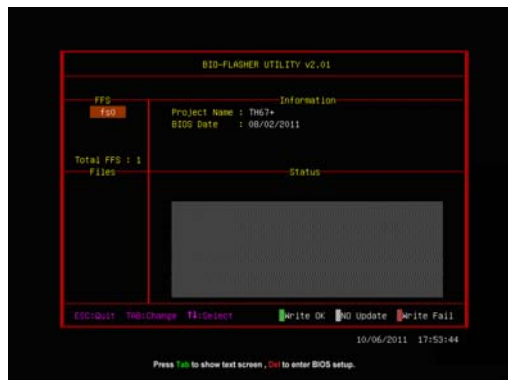

6. Select the proper BIOS file, and a message asking if you are sure to flash the BIOS file. Click Yes to start updating BIOS.

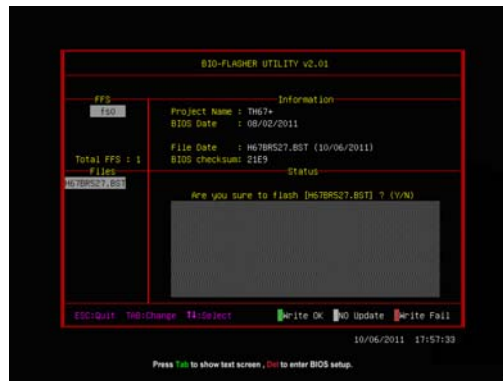

7. A dialog pops out after BIOS flash is completed, asking you to restart the system. Press the [Y] key to restart system.



8. While the system boots up and the full screen logo shows up, press  <Delete> key to enter BIOS setup.

After entering the BIOS setup, please go to the **Save & Exit**, using the **Restore Defaults** function to load Optimized Defaults, and select **Save Changes and Reset** to restart the computer. Then, the BIOS Update is completed.

4.3 AMI BIOS BEEP CODE

Boot Block Beep Codes

Number of Beeps	Description
Continuing	Memory sizing error or Memory module not found

POST BIOS Beep Codes

Number of Beeps	Description
1	Success booting.
8	Display memory error (system video adapter)

4.4 TROUBLESHOOTING

Probable	Solution
<ol style="list-style-type: none"> There is no power in the system. Power LED does not shine; the fan of the power supply does not work Indicator light on keyboard does not shine. 	<ol style="list-style-type: none"> Make sure power cable is securely plugged in. Replace cable. Contact technical support.
System is inoperative. Keyboard lights are on, power indicator lights are lit, and hard drives are running.	Using even pressure on both ends of the DIMM, press down firmly until the module snaps into place.
System does not boot from a hard disk drive, but can be booted from optical drive.	<ol style="list-style-type: none"> Check cable running from disk to disk controller board. Make sure both ends are securely plugged in; check the drive type in the standard CMOS setup. Backing up the hard drive is extremely important. All hard disks are capable of breaking down at any time.
System only boots from an optical drive. Hard disks can be read, applications can be used, but system fails to boot from a hard disk.	<ol style="list-style-type: none"> Back up data and applications files. Reformat the hard drive. Re-install applications and data using backup disks.
Screen message shows "Invalid Configuration" or "CMOS Failure."	Review system's equipment. Make sure correct information is in setup.
System cannot boot after the user installs a second hard drive.	<ol style="list-style-type: none"> Set master/slave jumpers correctly. Run SETUP program and select correct drive types. Call the drive manufacturers for compatibility with other drives.

CPU Overheated

If the system shutdown automatically after power on system for seconds, that means the CPU protection function has been activated.

When the CPU is over heated, the motherboard will shutdown automatically to avoid a damage of the CPU, and the system may not power on again.

In this case, please double check:

1. The CPU cooler surface is placed evenly with the CPU surface.
2. CPU fan is rotated normally.
3. CPU fan speed is fulfilling with the CPU speed.

After confirmed, please follow steps below to relief the CPU protection function.

1. Remove the power cord from power supply for seconds.
2. Wait for seconds.
3. Plug in the power cord and boot up the system.

Or you can:

1. Clear the CMOS data.
(See "Close CMOS Header: JCMOS1" section)
2. Wait for seconds.
3. Power on the system again.

This Page Intentionally Left Blank

APPENDIX: SPEC IN OTHER LANGUAGES

GERMAN

<i>Spezifikationen</i>		
CPU	Socket 1155 Intel Core i7 / i5 / i3 / Pentium / Celeron Prozessoren	Unterstützt Execute Disable Bit / Enhanced Intel SpeedStep® / Intel Architecture-64 / Extended Memory 64 Technology / Virtualization Technology / Hyper Threading
Chipsatz	Intel H61	
Super E/A	IT8772E Bietet die häufig verwendeten alten Super E/A-Funktionen. Low Pin Count-Schnittstelle	Umgebungskontrolle, Hardware-Überwachung Lüfterdrehzahl-Controller/-Überwachung "Smart Guardian"-Funktion von ITE
Arbeitsspeicher	DDR3 DIMM-Steckplätze x 2 Max. 16GB Arbeitsspeicher Jeder DIMM unterstützt 512MB/ 1GB/2GB/4GB/8GB DDR3.	Dual-Kanal DDR3 Speichermodul Unterstützt DDR3 1066 / 1333 / 1600 registrierte DIMMs. ECC DIMMs werden nicht unterstützt.
SATA 2	Integrierter Serial ATA-Controller	Datentransferrate bis zu 3.0Gb/s Konform mit der SATA-Spezifikation Version 2.0
LAN	RTL8111H	10 / 100 / 1000Mb/s Auto-Negotiation
HD Audio-Unterstützung	ALC662	Unterstützt High-Definition Audio 5.1-Kanal-Audioausgabe
Steckplätze	PCI-E Gen3 x 16 Steckplatz x1 PCI-E Gen2 x1-Steckplatz x1	(je nach CPU)
Onboard-Anschluss	SATA2-Anschluss x4 Fronttafelanschluss x1 Front-Audioanschluss x1 CPU-Lüfter-Sockel x1 System-Lüfter-Sockel x1	Jeder Anschluss unterstützt 1 SATA2-Laufwerk Unterstützt die Fronttafel-funktionen Unterstützt die Fronttafel-Audioanschlussfunktion CPU-Lüfterstromversorgungsanschluss (mit Smart Fan-Funktion) System-Lüfter-Stromversorgungsanschluss

Spezifikationen			
	Chassis Lautsprecher-Anschluss	x1	Jeder Anschluss unterstützt 2 Fronttafel-USB2.0-Anschlüsse
	"CMOS löschen"-Sockel	x1	
	USB2.0-Anschluss	x2	
	Serieller Anschluss	x1	
	Stromanschluss (24-polig)	x1	
	Stromanschluss (4-polig)	x1	
Rückseiten-E /A	PS/2-Tastatur/ Maus	x1	
	VGA-Anschluss	x1	
	HDMI-Anschluss	x1	
	LAN-Anschluss	x1	
	USB2.0-Anschluss	x4	
	Audioanschluss	x3	
Platinengröße	170 mm (B) X 191 mm (L)		
OS-Unterstützung	Windows XP / Vista / 7 / 8 / 8.1 / 10		Biostar behält sich das Recht vor, ohne Ankündigung die Unterstützung für ein Betriebssystem hinzuzufügen oder zu entfernen.

FRENCH

<i>SPEC</i>		
UC	Socket 1155 Processeurs Intel Core i7 / i5 / i3 / Pentium / Celeron	Prend en charge les technologies d'exécution de bit de désactivation / Intel SpeedStep® optimisée/ d'architecture Intel 64 / de mémoire étendue 64 / de virtualisation / Hyper Threading
Chipset	Intel H61	
Super E/S	IT8772E Fournit la fonctionnalité de Super E/S patrimoniales la plus utilisée. Interface à faible compte de broches	Initiatives de contrôle environnementales, Moniteur de matériel Contrôleur /moniteur de vitesse de ventilateur Fonction "Gardien intelligent" de l'ITE
Mémoire principale	Fentes DDR3 DIMM x 2 Capacité mémoire maximale de 16 Go Chaque DIMM prend en charge des DDR3 de 512Mo/1Go/2Go/4Go/8Go	Module de mémoire DDR3 à mode à double voie Prend en charge la DDR3 1066 / 1333 / 1600 Les DIMM à registres et DIMM avec code correcteurs d'erreurs ne sont pas prises en charge
SATA 2	Contrôleur Serial ATA intégré	Taux de transfert jusqu'à 3.0Go/s. Conforme à la spécification SATA Version 2.0
LAN	RTL8111H	10 / 100 / 1000 Mb/s négociation automatique
Prise en charge audio HD	ALC662	Prise en charge de l'audio haute définition Sortie audio à 5.1 voies
Fentes	Fente PCI-E Gen3 x 16 x1 Fente PCI-E Gen2 x1 x1	(en fonction du CPU)
Connecteur embarqué	Connecteur SATA2 x4	Chaque connecteur prend en charge 1 périphérique SATA2
	Connecteur du panneau avant x1	Prend en charge les équipements du panneau avant
	Connecteur Audio du panneau avant x1	Prend en charge la fonction audio du panneau avant
	Embase de ventilateur UC x1	Alimentation électrique du ventilateur UC (avec fonction de ventilateur intelligent)
	Embase de ventilateur système x1	Alimentation électrique du ventilateur système

SPEC			
	Châssis Connecteur Haut-parleur	x1	Chaque connecteur prend en charge 2 ports USB2.0 de panneau avant
	Embase d'effacement CMOS	x1	
	Connecteur USB2.0	x2	
	Port série	x1	
	Connecteur d'alimentation (24 broches)	x1	
	Connecteur d'alimentation (4 broches)	x1	
E/S du panneau arrière	Souris / Clavier PS/2	x1	
	Port VGA	x1	
	Port HDMI	x1	
	Port LAN	x1	
	Port USB2.0	x4	
	Fiche audio	x3	
Dimensions de la carte	170 mm (l) X 191 mm (H)		
Support SE	Windows XP / Vista / 7 / 8 / 8.1 / 10		Biostar se réserve le droit d'ajouter ou de supprimer le support de SE avec ou sans préavis

ITALIAN

SPECIFICA		
CPU	Socket 1155 Processore Intel Core i7 / i5 / i3 / Pentium / Celeron	Supporto di Execute Disable Bit / Enhanced Intel SpeedStep® / Architettura Intel 64 / Tecnologia Extended Memory 64 / Tecnologia Virtualization / Hyper Threading
Chipset	Intel H61	
Super I/O	IT8772E Fornisce le funzionalità legacy Super I/O usate più comunemente. Interfaccia LPC (Low Pin Count)	Funzioni di controllo dell'ambiente: Monitoraggio hardware Controller / Monitoraggio velocità ventolina Funzione "Smart Guardian" di ITE
Memoria principale	Alloggi DIMM DDR3 x 2 Capacità massima della memoria 16GB Ciascun DIMM supporta DDR3 512MB/1GB/2GB/4GB/8GB	Modulo di memoria DDR3 a canale doppio Supporto di DDR3 1066 / 1333 / 1600 DIMM registrati e DIMM ECC non sono supportati
SATA 2	Controller Serial ATA integrato	Velocità di trasferimento dei dati fino a 3.0Gb/s. Compatibile specifiche SATA Versione 2.0
LAN	RTL8111H	Negoziazione automatica 10 / 100 / 1000 Mb/s
Supporto audio HD	ALC662	Supporto audio High-Definition (HD) Uscita audio 5.1 canali
Alloggi	Alloggio PCI-E Gen3 x16 x1 Alloggio PCI Express Gen2 x1 x1	(a seconda del CPU)
Connettori su scheda	Connettore SATA2 x4	Ciascun connettore supporta 1 unità SATA2
	Connettore pannello frontale x1	Supporta i servizi del pannello frontale
	Connettore audio frontale x1	Supporta la funzione audio pannello frontale
	Collettore ventolina CPU x1	Alimentazione ventolina CPU (con funzione Smart Fan)
	Collettore ventolina sistema x1	Alimentazione ventolina di sistema
	Chassis Connettore altoparlante x1	

SPECIFICA		
	Collettore cancellazione CMOS x1	
	Connettore USB2.0 x2	Ciascun connettore supporta 2 porte USB2.0 pannello frontale
	Porta seriale x1	
	Connettore alimentazione (24 pin) x1	
	Connettore alimentazione (4 pin) x1	
I/O pannello posteriore	Mouse/ Tastiera PS/2 x1	
	Porta VGA x1	
	Porta HDMI x1	
	Porta LAN x1	
	Porta USB2.0 x4	
	Connettore audio x3	
Dimensioni scheda	170 mm (larghezza) x 191 mm (altezza)	
Sistemi operativi supportati	Windows XP / Vista / 7 / 8 / 8.1 / 10	Biostar si riserva il diritto di aggiungere o rimuovere il supporto di qualsiasi sistema operativo senza preavviso.

SPANISH

Especificación			
CPU	Socket 1155 Procesador Intel Core i7 / i5 / i3 / Pentium / Celeron		Admite Bit de deshabilitación de ejecución / Intel SpeedStep® Mejorado / Intel Architecture-64 / Tecnología Extended Memory 64 / Tecnología de virtualización / Hyper Threading
Conjunto de chips	Intel H61		
Súper E/S	IT8772E Le ofrece las funcionalidades heredadas de uso más común Súper E/S. Interfaz de cuenta Low Pin		Iniciativas de control de entorno, Monitor hardware Controlador/monitor de velocidad de ventilador Función "Guardia inteligente" de ITE
Memoria principal	Ranuras DIMM DDR3 x 2 Capacidad máxima de memoria de 16GB Cada DIMM admite DDR de 512MB/1GB/2GB/4GB/8GB		Módulo de memoria DDR3 de canal Doble Admite DDR3 de 1066 / 1333 / 1600 No admite DIMM registrados o DIMM compatibles con ECC
SATA 2	Controlador ATA Serie Integrado		Tasas de transferencia de hasta 3.0 Gb/s. Compatible con la versión SATA 2.0
Red Local	RTL8111H		Negociación de 10 / 100 / 1000 Mb/s
Soporte de sonido HD	ALC662		Soporte de sonido de Alta Definición Salida de sonido de 5.1 canales
Ranuras	Ranura PCI-E Gen3 x16 X1 Ranura PCI-E Gen2 x 1 X1		(dependiendo de la CPU)
Conectores en placa	Conector SATA2 X4		Cada conector soporta 1 dispositivos SATA2
	Conector de panel frontal X1		Soporta instalaciones en el panel frontal
	Conector de sonido frontal X1		Soporta funciones de sonido en el panel frontal
	Cabecera de ventilador de CPU X1		Fuente de alimentación de ventilador de CPU (con función Smart Fan)
	Cabecera de ventilador de sistema X1		Fuente de alimentación de ventilador de sistema
	Cabecera de borrado de CMOS X1		

Especificación			
	Chasis Conector de altavoz	X1	Cada conector soporta 2 puertos USB2.0 frontales
	Conector USB2.0	X2	
	Puerto serie	X1	
	Conector de alimentación (24 patillas)	X1	
	Conector de alimentación (4 patillas)	X1	
Panel trasero de E/S	Ratón / Teclado PS/2	X1	
	Puerto VGA	X1	
	Puerto HDMI	X1	
	Puerto de red local	X1	
	Puerto USB2.0	X4	
	Conector de sonido	X3	
Tamaño de la placa	170 mm. (A) X 191 Mm. (H)		
Soporte de sistema operativo	Windows XP / Vista / 7 / 8 / 8.1 / 10		Biostar se reserva el derecho de añadir o retirar el soporte de cualquier SO con o sin aviso previo.

PORTUGUESE

ESPECIFICAÇÕES		
CPU	Socket 1155 Processador Intel Core i7 / i5 / i3 / Pentium / Celeron	Suporta as tecnologias Execute Disable Bit / Enhanced Intel SpeedStep® / Intel Architecture -64 / Extended Memory 64 / Virtualization / Hyper Threading
Chipset	Intel H61	
Especificação do Super I/O	IT8772E Proporciona as funcionalidades mais utilizadas em termos da especificação Super I/O. Interface LPC (Low Pin Count).	Iniciativas para controlo do ambiente Monitorização do hardware Controlador/Monitor da velocidade da ventoinha Função "Smart Guardian" da ITE
Memória principal	Ranuras DIMM DDR3 x 2 Capacidade máxima de memória: 16 GB Cada módulo DIMM suporta uma memória DDR3 de 512MB/ 1GB/2GB/4GB/8GB	Módulo de memória DDR3 de canal duplo Suporta módulos DDR3 1066 / 1333 / 1600 Os módulos DIMM registados e os DIMM ECC não são suportados
SATA 2	Controlador Serial ATA integrado	Velocidades de transmissão de dados até 3.0 Gb/s. Compatibilidade com a especificação SATA versão 2.0
LAN	RTL8111H	Auto negociação de 10 / 100 / 1000 Mb/s
Suporte para áudio de alta definição	ALC662	Suporta a especificação High-Definition Audio Saída de áudio de 5.1 canais
Ranuras	Ranura PCI-E Gen3 x16 x1 Ranura PCI-E Gen2 x 1 x1	(dependendo da CPU)
Conectores na placa	Conector SATA2 x4	Cada conector suporta 1 dispositivo SATA2
	Conector do painel frontal x1	Para suporte de várias funções no painel frontal
	Conector de áudio frontal x1	Suporta a função de áudio no painel frontal
	Conector da ventoinha da CPU x1	Alimentação da ventoinha da CPU (com a função Smart Fan)
	Conector da ventoinha do sistema x1	Alimentação da ventoinha do sistema

ESPECIFICAÇÕES			
	Chassis Conector Speaker	x1	Cada conector suporta 2 portas USB2.0 no painel frontal
	Conector para limpeza do CMOS	x1	
	Conector USB2.0	x2	
	Porta série	x1	
	Conector de alimentação (24 pinos)	x1	
	Conector de alimentação (4 pinos)	x1	
Entradas/Saídas no painel traseiro	Rato / Teclado PS/2	x1	
	Porta VGA	x1	
	Porta HDMI	x1	
	Porta LAN	x1	
	Porta USB2.0	x4	
	Tomada de áudio	x3	
Tamanho da placa	170 mm (L) X 191 mm (A)		
Sistemas operativos suportados	Windows XP / Vista / 7 / 8 / 8.1 / 10		A Biostar reserva-se o direito de adicionar ou remover suporte para qualquer sistema operativo com ou sem aviso prévio.

POLISH

<i>SPEC</i>		
Procesor	Socket 1155 Procesor Intel Core i7 / i5 / i3 / Pentium / Celeron	Obsługa Execute Disable Bit / Enhanced Intel SpeedStep® / Intel Architecture-64 / Extended Memory 64 Technology / Virtualization Technology / Hyper Threading
Chipset	Intel H61	
Pamięć główna	Gniazda DDR3 DIMM x 2 Maks. wielkość pamięci 16GB Każde gniazdo DIMM obsługuje moduły 512MB/1GB/2GB/4GB/8GB DDR3	Moduł pamięci DDR3 z trybem podwójnego kanału Obsługa DDR3 1066 / 1333 / 1600 Brak obsługi Registered DIMM oraz ECC DIMM
Super I/O	IT8772E Zapewnia najbardziej powszechne funkcje Super I/O. Interfejs Low Pin Count	Funkcje kontroli warunków pracy, Monitor H/W Kontroler/Monitor prędkości wentylatora Funkcja ITE "Smart Guardian"
SATA 2	Zintegrowany kontroler Serial ATA	Transfer danych do 3.0 Gb/s. Zgodność ze specyfikacją SATA w wersji 2.0
LAN	RTL8111G	10 /100 /1000Mb/s z automatyczną negocjacją szybkości
Obsługa audio HD	ALC662	Obsługa High-Definition Audio 5.1 kanałowe wyjście audio
Gniazda	Gniazdo PCI-E Gen3 x16 x1 Gniazdo PCI-E Gen2 x 1 x1	(w zależności od procesora)
Złącza wbudowane	Złącze SATA2 x4	Każde złącze obsługuje 1 urządzenie SATA2
	Złącze panela przedniego x1 Przednie złącze audio x1 Złącze główkowe wentylatora procesora x1	Obsługa elementów panela przedniego Obsługa funkcji audio na panelu przednim Zasilanie wentylatora procesora (z funkcją Smart Fan)
	Złącze główkowe wentylatora systemowego x1	Zasilanie wentylatora systemowego

SPEC		
	Chassis Speaker Connector x1 Złącze główkowe kasowania CMOS x1 Złącze USB2.0 x2 Port szeregowy x1 Złącze zasilania (24 pinowe) x1 Złącze zasilania (4 pinowe) x1	Każde złącze obsługuje 2 porty USB2.0 na panelu przednim
Back Panel I/O	Mysz / Klawiatura PS/2 x1 Port VGA x1 Port HDMI x1 Port LAN x1 Port USB2.0 x4 Gniazdo audio x3	
Wymiary płyty	170 mm (S) X 191 mm (W)	
Obsługa systemu operacyjne go	Windows XP / Vista / 7 / 8 / 8.1 / 10	Biostar zastrzega sobie prawo dodawania lub odwoływania obsługi dowolnego systemu operacyjnego bez powiadomienia.

RUSSIAN

СПЕЦ		
CPU (центральный процессор)	Socket 1155 Процессор Intel Core i7 / i5 / i3 / Pentium / Celeron	Поддержка технологий Execute Disable Bit / Enhanced Intel SpeedStep® / Intel Architecture-64 / Extended Memory 64 Technology / технологии виртуализация / Hyper Threading
Набор микросхем	Intel H61	
Основная память	Слоты DDR3 DIMM x 2 Максимальная ёмкость памяти 16 ГБ Каждый модуль DIMM поддерживает 512МБ/1ГБ/2ГБ/4ГБ/8ГБ DDR3	Модуль памяти с двухканальным режимом DDR3 Поддержка DDR3 1066 / 1333 / 1600 Не поддерживает зарегистрированные модули DIMM and ECC DIMM
Super I/O	IT8772E Обеспечивает наиболее используемые действующие функциональные возможности Super I/O. Интерфейс с низким количеством выводов	Инициативы по охране окружающей среды, Аппаратный монитор Регулятор скорости вентилятора/ монитор Функция ITE "Smart Guardian" (Интеллектуальная защита)
SATA 2	Встроенное последовательное устройство управления ATA	скорость передачи данных до 3.0 гигабит/с. Соответствие спецификации SATA версия 2.0
Локальная сеть	RTL8111H	Автоматическое согласование 10/ 100 /1000 Мб/с
Звуковая поддержка жесткого диска	ALC662	Звуковая поддержка High-Definition 5.1канальный звуковой выход
Слоты	Слот PCI-E Gen3 x16 @ x16 x1 Слот PCI-E Gen2 x 1 x1	(в зависимости от процессора)
Встроенный разъём	Разъём SATA2 x4 Разъём на лицевой панели x1 Входной звуковой разъём x1 Контактирующее приспособление вентилятора центрального процессора x1	Каждый разъём поддерживает 1 устройство SATA2 Поддержка устройств на лицевой панели Поддержка звуковых функций на лицевой панели Источник питания для вентилятора центрального процессора (с функцией интеллектуального вентилятора)

СПЕЦ		
	Контактующее приспособление вентилятора системы x1 Шасси акустической системы x1 Открытое контактирующее приспособление CMOS x1 USB2.0-разъём x2 Последовательный порт x1 Разъём питания (24 вывод) x1 Разъём питания (4 вывод) x1	Источник питания для вентилятора системы Каждый разъём поддерживает 2 USB2.0-порта на лицевой панели
Задняя панель средств ввода-выв ода	Мышь/ Клавиатура PS/2 x1 Порт VGA x1 ПортHDMI x1 Порт LAN x1 USB2.0-порт x4 Гнездо для подключения наушников x3	
Размер панели	170 мм (Ш) X 191 мм (В)	
Поддержка OS	Windows XP / Vista / 7 / 8 / 8.1 / 10	Biostar сохраняет за собой право добавлять или удалять средства обеспечения для OS с или без предварительного уведомления.

ARABIC

المواصفات		
Execute Disable Bit / Enhanced Intel SpeedStep® / Intel Architecture-64 / Extended Memory 64 Technology / Virtualization Technology / Hyper Threading	Socket 1155 وحدة المعالجة المركزية يتردد يصل إلى Celeron	Intel Core i7 / i5 / i3 / Pentium / Celeron
	Intel H61	مجموعة الشرائح
عدد 2 قناة DDR3 DIMM سعة ذاكرة قصوى 16 جيجابايت ميجابايت و1/512/سعة DDR3 تدعم ذاكرة من نوع DIMM تدعم كل قناة و2/4/8 جيجابايت	مزودة القناة DDR3 وحدة ذاكرة 1066 / 1333 / 1600 سعات DDR3 تدعم الذاكرة من نوع ECC وتلك التي لا تتوافق مع DIMM لا تدعم نقل الذاكرة	الذاكرة الرئيسية بايت ميجا
وسائل التحكم في البيئة: مراقب لمعرفة حالة الأجهزة مراقب في سرعة المروحة ITE من "Smart Guardian" وظيفة	IT8772E الأكثر استخداماً، Super I/O توفر وظيفة Low Pin Count Interface تدعم تقنية	Super I/O
جيجابايت/ثانية 3.0 نقل البيانات بسرعات تصل إلى 2.0 الإصدار SATA مطابقة لمواصفات	SATA 2 متكامل Serial ATA متحكم	
تقويض تلقائي 1000/100/10 ميجابايت / ثانية	RTL8111H	شبكة داخلية
تدعم تقنية الصوت عالي التعريف من 5.1 قنوات لخرج الصوت	ALC662	دعم الصوت عالي التعريف
(اعتماداً على وحدة المعالجة المركزية)	قناة PCI-E Gen3 x16 عدد 1 قناة PCI-E Gen2 x 1 عدد 1	القنوات
يدعم كل منفذ واحد من أجهزة SATA2 يدعم تجهيزات اللوحة الأمامية يدعم وظيفة الصوت باللوحة الأمامية لتوصيل الطاقة لمروحة وحدة المعالجة مع وظيفة Smart Fan	منفذ SATA2 عدد 4 منفذ اللوحة الأمامية عدد 1 منفذ الصوت الأمامي عدد 1 وصلة مروحة وحدة المعالجة المركزية عدد 1	المنفذ على سطح اللوحة
لتوصيل الطاقة لمروحة النظام	وصلة مروحة النظام عدد 1	

المواصفات		
يدعم كل منفذ قحطي USB2.0 باللوحة الأمامية	عدد 1	قفل رئيس رابط
	عدد 1	وصلة مسح CMOS
	عدد 2	منفذ USB2.0
	عدد 1	منفذ تسلسلي
	عدد 1	منفذ توصيل الطاقة (24دبوس)
	عدد 1	منفذ توصيل الطاقة (4دبابيس)
	عدد 1	موس / لوحة مفاتيح PS/2
	عدد 1	منفذ VGA
	عدد 1	منفذ HDMI
	عدد 1	منفذ دخول/مخرج اللوحة الخلفية
	عدد 4	منفذ USB2.0
	عدد 3	مقيس صوت
		حجم اللوحة 170 مم (عرض) X 191 مم (ارتفاع)
بخطأ في إضائة أو إزالة الدعم لأي نظام تشغيل بإخطار أو بدون Biostar احتفظ بخطأ .	Windows XP / Vista / 7 / 8 / 8.1 / 10	دعم أنظمة التشغيل

JAPANESE

仕様		
CPU	Socket 1155 Intel Core i7 / i5 / i3 / Pentium / Celeron プロセッサ	Execute Disable Bit / Enhanced Intel SpeedStep® / Intel Architecture-64 / Extended Memory 64 Technology / Virtualization Technology / Hyper Threadingをサポートします
チップセット	Intel H61	
メインメモリ	DDR3 DIMMスロット x 2 最大メモリ容量16GB 各DIMMは 512MB/1GB/2GB/4GB/8GB DDR3をサポート	デュアル チャンネルモードDDR3メモリモジュール DDR3 1066 / 1333 / 1600をサポート 登録済みDIMMとECC DIMMはサポートされません
Super I/O	IT8772E もともと一般に使用されるレガシーSuper I/O機能を採用しています。 低ピンカウントインターフェイス	環境コントロールイニシアチブ、 H/Wモニター ファン速度コントローラ/ モニター ITEの「スマートガーディアン」機能
SATA 2	統合シリアルATAコントローラ	最高3.0 Gb/秒のデータ転送速度 SATAバージョン2.0仕様に準拠
LAN	RTL8111H	10 / 100 / 1000 Mb/秒のオートネゴシエーション
HDオーディオのサポート	ALC662	ハイデフィニションオーディオのサポート 5.1 チャンネルオーディオアウト
スロット	PCI-E Gen3 x16スロット x1 PCI Express Gen2 x 1スロット x1	(CPUに依存)
オンボードコネクタ	SATA2コネクタ x4 フロントパネルコネクタ x1 フロントオーディオコネクタ x1 CPUファンヘッダ x1 システムファンヘッダ x1 シャーシスピーカーコネクタ x1 CMOSクリアヘッダ x1	各コネクタは1つのSATA2デバイスをサポートします フロントパネル機能をサポートします フロントパネルオーディオ機能をサポートします CPUファン電源装置(スマートファン機能を搭載) システムファン電源装置

仕様			
	USB2.0コネクタ	x2	各コネクタは2つのフロントパネルUSB2.0ポートをサポートします
	シリアルポート	x1	
	電源コネクタ(24ピン)	x1	
	電源コネクタ(4ピン)	x1	
背面パネル I/O	PS/2キーボード/ マウス	x1	
	VGAポート	x1	
	HDMIポート	x1	
	LANポート	x1	
	USB2.0ポート	x4	
	オーディオジャック	x3	
ボードサイズ	170 mm (幅) X 191 mm (高さ)		
OSサポート	Windows XP / Vista / 7 / 8 / 8.1 / 10		Biostarは事前のサポートなしにOSサポートを追加または削除する権利を留保します。