

CITIZEN
Micro HumanTech

MOBILE THERMAL PRINTER

MODEL CMP-20 series

User's Manual



CITIZEN SYSTEMS JAPAN CO., LTD.

WEEE MARK

En

If you want to dispose of this product, do not mix it with general household waste. There is a separate collection systems for used electronics products in accordance with legislation under the WEEE Directive (Directive 2002/96/EC) and is effective only within European Union.

Ge

Wenn Sie dieses Produkt entsorgen wollen, dann tun Sie dies bitte nicht zusammen mit dem Haushaltsmüll. Es gibt im Rahmen der WEEE-Direktive innerhalb der Europäischen Union (Direktive 2002/96/EC) gesetzliche Bestimmungen für separate Sammelsysteme für gebrauchte elektronische Geräte und Produkte.

Fr

Si vous souhaitez vous débarrasser de cet appareil, ne le mettez pas à la poubelle avec vos ordures ménagères. Il existe un système de récupération distinct pour les vieux appareils électroniques conformément à la législation WEEE sur le recyclage des déchets des équipements électriques et électroniques (Directive 2002/96/EC) qui est uniquement valable dans les pays de l'Union européenne. Les appareils et les machines électriques et électroniques contiennent souvent des matières dangereuses pour l'homme et l'environnement si vous les utilisez et vous vous en débarrassez de façon inappropriée.

Sp

Si desea deshacerse de este producto, no lo mezcle con residuos domésticos de carácter general. Existe un sistema de recogida selectiva de aparatos electrónicos usados, según establece la legislación prevista por la Directiva 2002/96/CE sobre residuos de aparatos eléctricos y electrónicos (RAEE), vigente únicamente en la Unión Europea.

It

Se desiderate gettare via questo prodotto, non mescolatelo ai rifiuti generici di casa. Esiste un sistema di raccolta separato per i prodotti elettronici usati in conformità alla legislazione RAEE (Direttiva 2002/96/CE), valida solo all'interno dell'Unione Europea.

Du

Deponer dit product niet bij het gewone huishoudelijk afval wanneer u het wilt verwijderen. Er bestaat ingevolge de WEEE-richtlijn (Richtlijn 2002/96/EG) een speciaal wettelijk voorgeschreven verzamelstelsel voor gebruikte elektronische producten, welk alleen geldt binnen de Europese Unie.

Da

Hvis du vil skille dig af med dette produkt, må du ikke smide det ud sammen med dit almindelige husholdningsaffald. Der findes et separat indsamlingssystem for udtjente elektroniske produkter i overensstemmelse med lovgivningen under WEEE-direktivet (direktiv 2002/96/EC), som kun er gældende i den Europæiske Union.

Por

Se quiser deitar fora este produto, não o misture com o lixo comum. De acordo com a legislação que decorre da Directiva REEE – Resíduos de Equipamentos Eléctricos e Electrónicos (2002/96/CE), existe um sistema de recolha separado para os equipamentos electrónicos fora de uso, em vigor apenas na União Europeia.

Pol

Jeżeli zamierzasz pozbyć się tego produktu, nie wyrzucaj go razem ze zwykłymi domowymi odpadkami. Według dyrektywy WEEE (Dyrektywa 2002/96/EC) obowiązującej w Unii Europejskiej dla używanych produktów elektronicznych należy stosować oddzielne sposoby utylizacji.



Declaration of Conformity

This printer conforms to the following Standards:

The Low Voltage Directive 2006/95/EC, the EC/R&TTE Directive, the RoHS Directive 2002/95/EC, and the WEEE Directive 2002/96/EC.

LVD : EN60950-1
EC/R&TTE: EN55022 Class B
 EN301 489-1
 EN301 489-17
 EN300 328
 EN55024



FCC Compliance Statement for American Users

This equipment has been tested and found to comply with the limits for a Class B digital device, pursuant to Part 15 of the FCC Rules. These limits are designed to provide reasonable protection against harmful interference in a residential installation. This equipment generates, uses, and can radiate radio frequency energy and, if not installed and used in accordance with the instructions, may cause harmful interference to radio communications. However, there is no guarantee that interference will not occur in a particular installation. If this equipment does cause interference to radio or television reception, which can be determined by turning the equipment off and on, the user is encouraged to try to correct the interference by one or more of the following measures:

- Reorient or relocate the receiving antenna.
- Increase the separation between the equipment and receiver.
- Connect the equipment into an outlet on a circuit different from that to which receiver is connected.
- Consult the dealer or an experienced radio/TV technician for help.

CAUTION: Use shielded cables to connect this device to computers.

Any changes or modifications not expressly approved by the grantee of this device could void the user's authority to operate the equipment.

EMI Compliance Statement for Canadian Users

- This Class B digital apparatus complies with Canadian ICES-003.
- Cet appareil numérique de la classe B est conforme à la norme NMB-003 du Canada.

GENERAL PRECAUTIONS

- Before using this product, be sure to read through this manual. After having read this manual, keep it in a safe, readily accessible place for future reference.
- The information contained herein is subject to change without prior notice.
- Reproduction or transfer of part or all of this document in any means is prohibited without permission from CITIZEN SYSTEMS.
- Note that CITIZEN SYSTEMS is not responsible for any operation results regardless of missing, error, or misprinting in this manual.
- Note that CITIZEN SYSTEMS is not responsible for any trouble caused as a result of using options or consumables that are not specified in this manual.
- Except explained elsewhere in this manual, do not attempt to service, disassemble or repair this product.
- Note that CITIZEN SYSTEMS is not responsible for any damage attributable to incorrect operation/handling or improper operating environments which are not specified in this manual.
- Due to the nature of thermal paper, printed data should be considered for temporary use, not stored for a long period or permanently. Please note that CITIZEN SYSTEMS is not responsible for damage or lost profit resulting from the loss of data caused by accidents, repairs, tests or other occurrence.
- If you find loss of information, error, or uncertain matter, please contact your CITIZEN SYSTEMS dealer.
- If you find any disordered or missing page (s), contact you CITIZEN SYSTEMS dealer for replacement.



CITIZEN is a registered trade mark of Citizen Holdings Co., Japan
CITIZEN es una marca registrada de Citizen Holdings Co., Japón
Company names and product names in this manual are trademarks or
registered trademarks of relevant companies.

Copyright © 2010 by CITIZEN SYSTEMS JAPAN CO., LTD.

SAFETY PRECAUTIONS

What the Icons Mean

Precautions and notices necessary to follow for preventing hazards to the user or other person or their properties are defined as shown below. Hazards and degrees of damage that may be caused by ignoring the instructions are categorized as shown below. Please be familiar with the content of these definitions before reading this manual.

| | |
|--|--|
|  Danger | Indicates the case that may result in death or serious injury. |
|  Warning | This symbol indicates that using the product improperly in defiance of this symbol may result in death or serious injury. |
|  Caution | This symbol indicates that using the product improperly in defiance of this symbol may result in injury or damage to properties. |

Definition of the icons



This symbol indicates the hazard that needs precautions.



This symbol indicates prohibited actions.



This symbol indicates mandatory actions.

Precautions in Handling Printer



WARNING



- If the product continues to be used when heat or smoke is generated or an abnormal odor is produced, a fire may occur. Immediately turn the printer power off, and carefully but quickly remove the battery, then contact our service agent.
- If any foreign matter (metal tip, water, liquid) enters the product, immediately turn the printer power OFF, and carefully but quickly remove the battery, then contact our service agent. Ignoring this instruction may result in a fire.



CAUTION



- Do not place the printer on a shaky table or other unbalanced place. The printer may drop or fall resulting in injury.
- Avoid using or storing in the following place. Damage to printer may be caused.
 - In a car parked in a sunny place, a place exposed to direct sunlight, near heat generating equipment, or the like.
 - A place where temperature or humidity is excessively high or low, or its change is radical.
 - A dusty place.
 - A place likely to get a splash of water or liquid.
- Avoid dropping, impacting or vibrating the printer otherwise damage may be caused.
- Avoid entry of foreign material. Otherwise, fault may occur.
- Do not use volatile liquid (thinner, benzine, etc.) or wet cloth when cleaning the printer. Deterioration or discoloration may occur. Use a dry, soft cloth for cleaning.
- Do not move the printer or give any shock or vibration to it while the printer is in operation or in standby operation. The printer power may be disconnected and the print data may be lost.

Precautions on Using Printer



WARNING



- Do not touch the print head or paper cutter while replacing print paper. Heated print head may cause burn. The cutter may cause injury to the hand.



CAUTION



- Use of print paper other than specified may result in not only deteriorated print quality but shortened life of print head (printing portion).
- Do not tap or rub the print head with edged or hard material.
- When condensation is present on the print head, dry it completely before printing. Printing with condensation may damage the print head.



Precaution on Overheating



CAUTION



- To prevent the motor from overheating, continuous printing (or feeding) of the printer should be 1.5 m or less in print length. After printing for this distance we recommend a pause of at least 30 seconds for cooling.

Precautions on Using Battery



DANGER



- Leaked liquid from the battery may result in loss of eyesight if it enters the eye. Immediately wash eyes with fresh water and get medical care.
- If liquid from the battery is ingested, immediately seek medical attention.
- Keep the following in mind when handling battery. Otherwise, liquid leakage, heat generation, and explosion may result.
 - Do not throw battery into fire or do not apply heat.
 - Do not peel or scratch the external battery casing.
 - Soldering is prohibited.
 - Do not give strong shock to battery or throw it away.
 - Do not short-circuit the positive and negative terminals with a metal such as metal wire.
- Never disassemble or modify battery. Otherwise, liquid leakage, heat generation, or explosion may occur.



WARNING



- If battery liquid attaches to skin or cloth, immediately wash it out with fresh water. Otherwise, skin disorder may be caused.



CAUTION



- Risk of explosion if battery is replaced by an incorrect type.
- Dispose of used batteries according to the instructions.
- Use only the approved external charger or charge the battery within the printer.
- Never use another charger or one that looks to be similar.



CAUTION



- Do not dip battery in water or sea water. Wet battery may generate heat or may be subject to corrosion.
- Do not use or leave battery at high temperature. Using or leaving battery in a place of high temperature may result in liquid leakage, deteriorated performance, or shortened lifetime.



- Keep battery beyond the reach of a baby or child. Pay attention not to let a child take out the battery.
- If the battery is used for the first time, be sure to charge it completely before use.
- If any abnormality is found while the battery is in use, stop the operation and carry the battery in local sales agent.
- The battery in the printer is shipped partially charged. Please fully charge the battery prior to using the printer.

Precautions on Installing New Paper



CAUTION



- Before printing, confirm that print paper is set straight forward at the exit from the print (thermal) head. Skewed setting may result in paper jamming.
- To prevent skewed insertion of paper, use the following form for the end of paper.

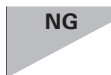
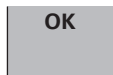

Precautions on Using Thermal Paper



CAUTION



- Print density may change with different kinds of paper.
- Observe the following when using thermal paper. Thermal paper is not resistant to discoloration, deterioration in quality, and thin printing.
 - Do not leave printed thermal paper exposed to light for a long time.
 - Avoid exposure to high temperature, humidity, liquid, or sunlight.
 - When keeping the printer thermal paper on a board, do not use paste, adhesive, or adhesive tape containing volatile organic solvent.
 - For long-time storage, use thermal paper of high storage type or copy it with plain paper copier.
 - Avoid contact with a film of vinyl chloride for a long time.
 - Avoid using ammonia. Do not put thermal paper near the paper copied by use of ammonia.
 - Avoid putting sweat or grease from your hands on the surface (printed or to be printed) of thermal paper.
 - Store thermal paper in a dark place with average temperature below 25°C and relative humidity below 65% .
- Using print paper with a thickness outside the recommended range may cause improper print quality.

Precautions on Using Special Serial Cable



WARNING



- With one side of the connector connected to this product, do not touch the metal part of the other connector.



CAUTION



- Static electricity may cause breakdown of internal circuit of this product.
- Do not leave this product with a cable wound around it for a long time. Disconnection or discoloration may result.
- Plugging and unplugging the contactor shall be done securely in the correct direction.

Precautions on Using Charger



CAUTION



- Do not use the product at a voltage and frequency other than specified.
- Do not use Charger other than specified.
- Before use, confirm that the power receptacle has sufficient capacity.
- Do not connect to the power receptacle where multiple connections are used.
- Do not step on, tap, or put any object, on the cable of the Charger.
- Before connecting or disconnecting Charger, turn the printer power OFF. Do the operation securely.

THE TABLE OF CONTENTS

| | |
|--|-----------|
| GENERAL PRECAUTIONS | 4 |
| SAFETY PRECAUTIONS | 5 |
| 1. GENERAL OUTLINE | 13 |
| 1.1 Features | 13 |
| 1.2 Unpacking | 14 |
| 1.3 Model Classifications | 16 |
| 1.4 Basic Specifications | 17 |
| 2. EXPLANATION OF PRINTER PARTS | 18 |
| 2.1 Printer Appearance | 18 |
| 2.2 Operation Panel | 20 |
| 3. OPERATION | 21 |
| 3.1 Setting/Replacing the paper roll | 21 |
| 3.2 Installing Belt Clip | 22 |
| 3.3 Installing Battery | 23 |
| 3.4 Charging the Battery | 24 |
| 3.5 Removing Battery (with Belt Clip) | 25 |
| 3.6 Wireless Communication | 26 |
| 3.7 Interface Cable Connection | 28 |
| 3.8 Self Test | 29 |
| 3.9 Reading Magnetic Stripe | 31 |
| 3.10 Reading IC Card | 32 |

1. GENERAL OUTLINE

CMP-20 is a compact, full featured portable line thermal printer, which can be used in a large variety of job environments.

Bluetooth/WiFi communication with a PDA or similar device is useful for business activities at the point of sale or service.

1.1 Features

- Compact and Robust
- High speed and low noise emission of the line thermal printing
- Long-life printing head with high reliability
- Easy paper-handling, owing to the paper-drop-in style
- Lithium-ion rechargeable battery
- 3 LED to indicate battery status
- Equipped with USB and serial port as standard
- Built-in Bluetooth function (CMP-20BT)
- Built-in Wi-Fi function (CMP-20WF)
- Built-in magnetic stripe reader (Option)
- Built-in IC card reader (Option)

1.2 Unpacking

Standard



Printer

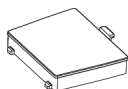

Battery
(CMP-BA20)

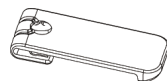

Belt Clip

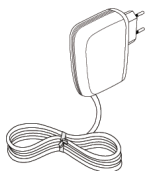

Charger
(CMP-AD20US)

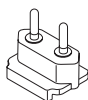

EU Plug

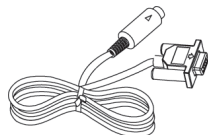

Serial Cable
(CA20-S01)

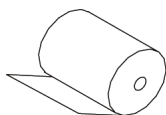

Paper Roll

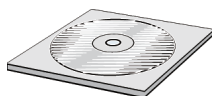

CD-ROM

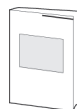

Quick Start Guide

Option

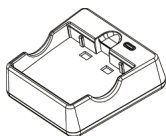

Battery Cradle
(CMP-BC20)



Car Charger
(CMP-CC20)

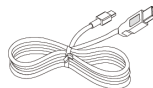

USB Cable
(CA20-U01)

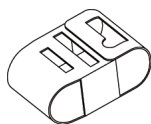

Leather Case
(SC20-01)



Strap
(STP20-01)

1.3 Model Classifications

Classified by the following designation.

CMP-20BT U MC

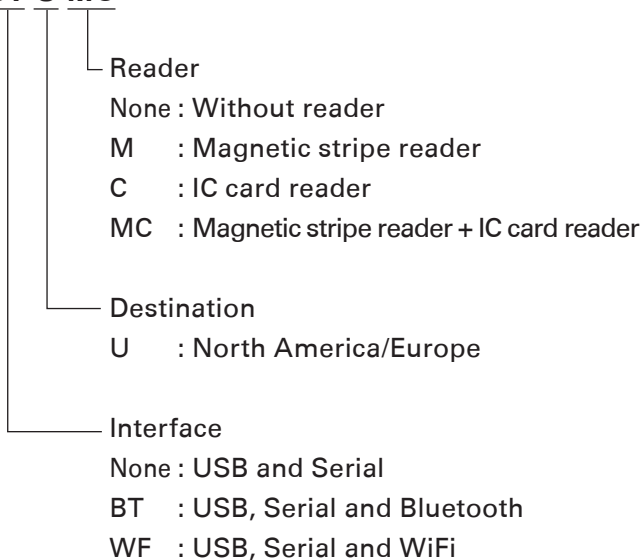

1.4 Basic Specifications

| | | |
|--------------------|-------------------|---|
| Printing Method | | Direct line thermal printing |
| Printing Speed | | Max. 80mm/sec |
| Resolution | | 203 DPI x 203 DPI |
| Print width | | 48mm, 384dot |
| Character | | ALPHA NUMERIC Character, Extension Character 18 codepages, 14 international characters |
| Font | | Font A (12 x 24 dot), Font B (9 x 17 dot) |
| Number of columns | | 32 (Font A), 42 (Font B) |
| Barcode | | EAN-8, EAN-13, Code39, ITF, UPC-A, Codabar, Code93, Code128, PDF417(2D) |
| Emulation | | ESC/POS |
| Driver | | Window CE 4.2&5.0, Window Mobile 5.0 |
| Sensor | | Paper End Sensor, Gap Sensor, Cover Open Sensor |
| Paper | Paper type | Thermal Paper |
| | Width | 58mm |
| | Thickness | 65 μ m |
| | External Diameter | Max. ϕ 48mm |
| | Internal Diameter | 12.5mm +/-0.5mm |
| Reliability | Thermal Head | 50km |
| | Battery | Continuous printing for 90min Standby for 24hours |
| Communications | Standard | Serial(RS-232C), USB, Bluetooth Class2 (CMP-20BT), Wireless Lan 802.11b/g (CMP-20WF) |
| MSR (Optional) | Card Standard | ISO7811/2 |
| | Track | Track1, Track2, Track3 |
| | Magnet Head Life | 300,000 Passes (minimum) |
| IC CARD (Optional) | | EMV level one certified smart card reader |
| Battery Charger | Input | AC100~240V, 50/60 Hz |
| | Output | 8.4V , 1200 mA |
| Battery | Battery type | Li-ion |
| | Output | 7.4V, 1800mAh |
| | Charging time | 2 hours |
| Size | | 96(W) x 136(D) x 58(H) mm |
| | | 3.7(W) x 5.3(D) x 2.2(H) inch |
| Temperature | Operation | 5~40 $^{\circ}$ C |
| | Storage | -10~50 $^{\circ}$ C |
| Humidity | Operation | 35 ~ 95% |
| | Storage | 10 ~ 95% |

2. EXPLANATION OF PRINTER PARTS

2.1 Printer Appearance

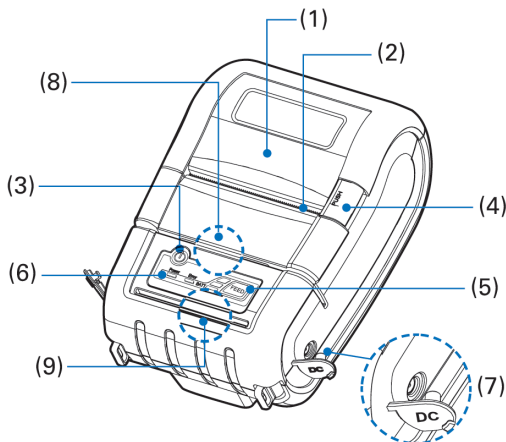

- (1) **Paper Cover**
Set paper roll inside this cover.
- (2) **Manual Cutter (Tear Bar)**
To cut the printed paper, gently pull the paper from the edge of the paper at the angle so that paper firmly contacts the serrated cutter.
- (3) **Power Button**
Press and hold the Power button for approximately 3 seconds to turn the printer power ON.
To turn OFF the printer, press and hold the Power button until the Power LED gets off.
- (4) **Paper Cover Open Button (blue colour)**
Press down to open the paper cover for replacing the paper roll.
- (5) **Paper Feed Button**
Press once for 1 line paper feed.
Press down and hold for continuous paper feed to any required length.



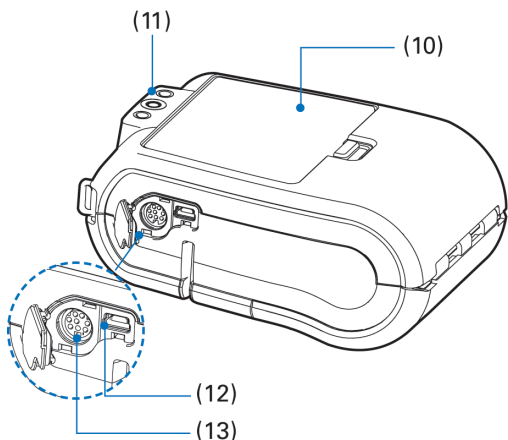

- (6) Control Panel
Refer to section 2.2 Operation Panel.
- (7) DC jack
Connect Charger for recharging battery.
- (8) MSR Slot (Optional)
Swipe magnetic stripe.
- (9) IC Card Slot (Optional)
Insert IC card.

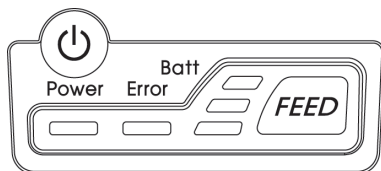

- (10) Battery
Refer to section 3.3 Installing Battery to 3.5 Removing Battery (with Belt Clip).
- (11) Belt Clip Hole
Refer to section 3.2 Installing Belt Clip.
- (12) USB Port (Mini B connector)
For USB cable connection to host.
- (13) Serial port
For serial cable connection to host.

2.2 Operation Panel



| Button/LED | Name | Function |
|---|--------------------|---|
|  | Power Button | This button is used to turn the printer on and off. When the printer is off, press this button for approximately 3 seconds and it will turn on the power. When on, pressing the button will switch off the printer. |
|  | Paper Feed Button | Paper can be fed manually by pressing this button. Additionally, a self-test can be produced - refer to "3.8" for self test information. |
|  | Battery Status LED | <ol style="list-style-type: none">1. If all three of the "Batt" LEDs are lit, the battery is fully charged.2. If you can hear beeping sound and all lights are turned off, it means that the battery is at the lowest level.3. If the battery is not charged at all, the printer turns off automatically. |
|  | Error LED | If the red light is turned on, it means there is no paper roll or the paper cover is open. |

NOTE

1. The battery status LEDs give an indication of power remaining. Actual run-time remaining will depend on many factors such as the contents of the output, distance to the computer, etc.
2. When the battery level is very low, high density printing can result in the printer switching off during printing resulting in possible loss of data.

3. OPERATION

3.1 Setting/Replacing the paper roll

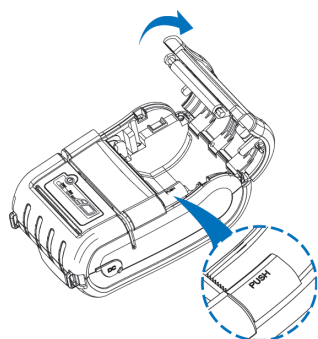

- (1) Press the Blue Paper Cover Open button and lift the paper cover.

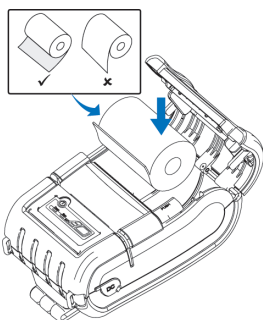

- (2) Place the paper roll as shown. Make sure the paper is placed in right direction.

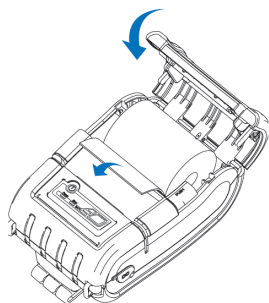

- (3) Pull a short length of paper out of the printer and then press center of the paper cover to close the cover.

3.2 Installing Belt Clip

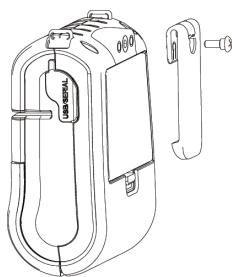

(1) Insert screw into belt clip.

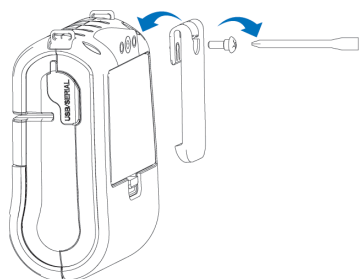

(2) Tighten the screw with driver as shown.

NOTE

The belt clip is included in the pack as a standard item but does not need to be used or installed!

3.3 Installing Battery

- (1) Align battery hook as shown in the picture.
- (2) Push the battery into the printer until it locks in place.
- (3) To release or remove the battery, gently pull the release catch towards the battery module and rotate the battery from the printer.

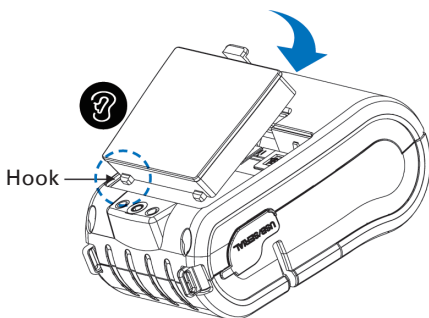

NOTE

As the battery is not charged at the time of your purchase, charge the battery fully prior to using the printer.
(Batteries can be charged in the printer or optional external cradle.)

3.4 Charging the Battery

- (1) Be sure that the printer is turned off and AC plug is correct one. If AC plug is wrong, change the plug to correct one.
- (2) Open the DC Jack cover by pulling on the rubber cover and insert DC JACK into the printer.
- (3) Plug the power code to electrical outlet.
- (4) The Charge Indicator LED is on the AC Charger itself (not the printer) and shows red or green according to the status.

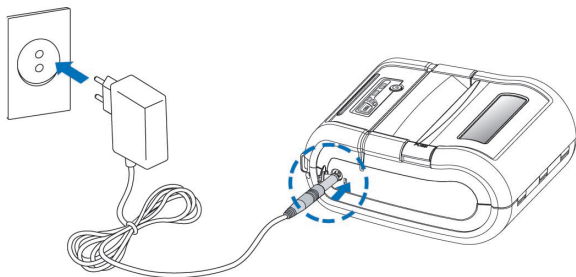

NOTE

In case of a trouble while charging the battery, the charge is suspended with charge LED blinking Green. Try unplugging and reconnecting charger, then charge should resume. The charging is completed when the LED changes to solid (continuous) green.

NOTE

1. Unless the exclusive charger is used provided by the manufacturer, the printer can be damaged, and the manufacturer is not liable for the consequential damage.
2. Before removing the battery, make sure that power is turned off.
3. A battery must be installed for printing. The printer will not operate from the charger alone.
4. It is not recommended to use or operate the printer whilst charging as it can reduce the battery's overall lifetime.

3.5 Removing Battery (with Belt Clip)

(1) Rotate the belt clip as shown.

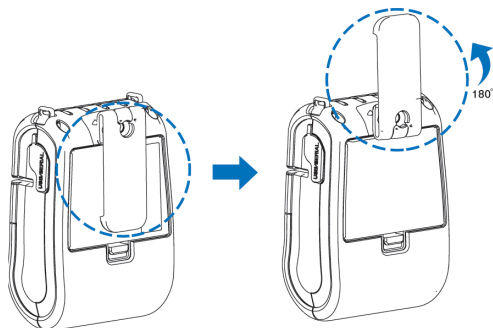

(2) Remove the battery as shown.



3.6 Wireless Communication

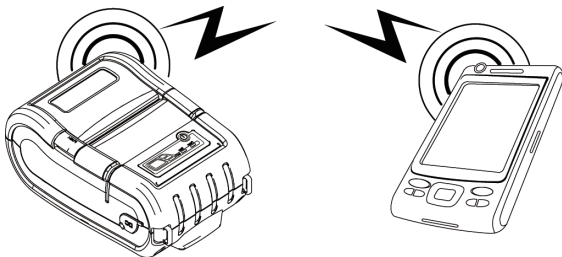

Bluetooth Connection

- (1) The Printer can be connected to devices equipped with a Bluetooth interface such as PDAs, PCs or mobile telephones and handheld scanners.
- (2) Use the Bluetooth connection function supported by the device to connect to the printer.
- (3) The default PIN code for pairing is "0000" but this can be changed with the Utilities supplied on the CD-ROM.

Wireless LAN Connection

- (1) The Printer can be connected to devices equipped with Wireless LAN connection according to the WiFi standards of 802.11b and .11g.
- (2) Use the WiFi(802.11b/g) connection function supported by the device to connect to the printer.

! NOTE

Refer to Configuration Tool in the CD-ROM for the WiFi setting.

| | |
|-----------------------------|--|
| Standard | 802.11b, 802.11g |
| Communication Speed (Max) | 54M bps |
| Transmission Distance (Max) | 100m (Indoors without obstructs) • The distance depends on the environment. |
| Channel | 1-14 |
| Security | 64/128 WEP, WPA |

3.7 Interface Cable Connection

- (1) Connect USB or Serial cable into the cable connector on the printer.

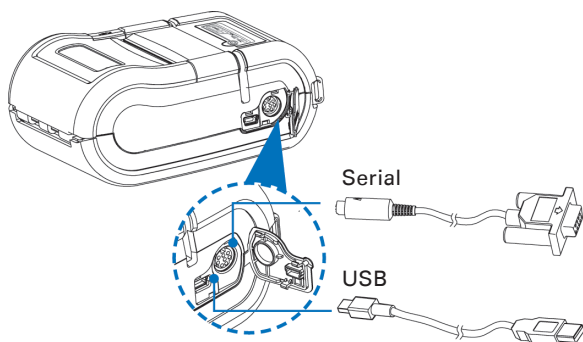

NOTE

Use the cable offered by the manufacturer (Serial).

- (2) Connect the interface cable into the USB or Serial port of the device (PDA, PC, etc.).

3.8 Self Test

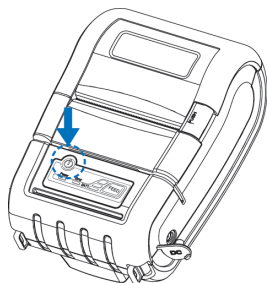

- (1) Turn off the power pressing the Power Button for approximately 3 seconds.

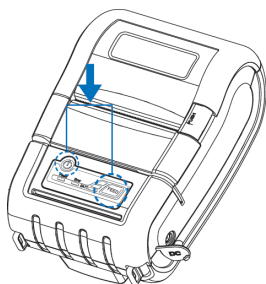

- (2) Whilst pressing and holding the Paper FEED button, press the Power Button.

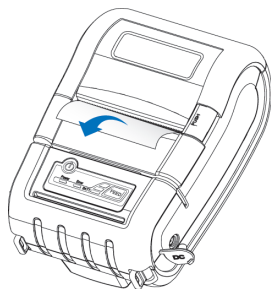

- (3) The printout is produced.



NOTE

1. To print ASCII pattern additionally, press the Paper Feed button once more.
2. After printing ASCII pattern, the self test will be finished automatically.
3. If the Paper Feed button is not pressed to print ASCII pattern, self test will be finished automatically after 30 seconds.

When the printer is installed initially or when you face a problem, you can run the self test and check the information about

- Firmware version, Codepage, Board version, serial interface setting, Bluetooth address and so on.

After checking with self-test and no issues are found, you can examine other devices and software. This function is working independent of devices and software.

● Motor protection from being overheated

To prevent the motor from overheating, the printer should be stopped for at least 30 seconds after continuously printing a 1.5 metre long receipt.

3.9 Reading Magnetic Stripe

Optional

Insert and swipe the card in the direction of the arrow as shown in the picture.

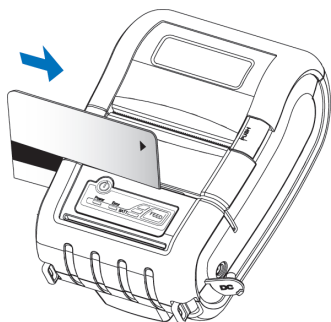

| | |
|--------------------|----------------------------------|
| Card Standard | ISO 7811/2 |
| DualTrack | 1, 2Track or 2, 3Track |
| Card Swipe Speed | 10cm ~ 15cm/sec (4 ~ 6 inch/sec) |
| Magnetic Head Life | 300,000 passes (minimum) |

3.10 Reading IC Card

Optional

Insert the card in the direction of the arrow as shown in the picture.

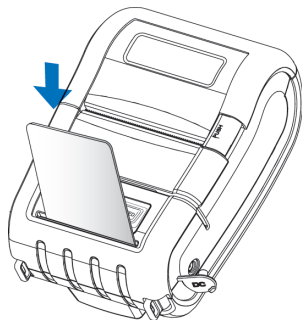

CITIZEN SYSTEMS JAPAN CO., LTD.

6-1-12, Tanashi-cho, Nishi-Tokyo-shi Tokyo, 188-8511, Japan

Tel: +81 (0) 42 468 4608 Fax: +81 (0) 42 468 4996

<http://www.citizen-systems.co.jp>

PM74901-00F

PMC-1007