

## Filters Used in Reference Design



Figure 1 shows a block diagram of the reference radio design. This radio has been designed to conform to the IEEE 802.11 specification for 2.4GHz ISM band Direct Sequence Wireless LAN.

Referring to the block diagram in Figure 1, there are eight RF and IF filters used in the reference radio.

From the antenna, the received input is applied to FL1 and FL2, a pair of Toko TDF2A-2450T-10 two pole dielectric bandpass filters, which are used to provide image rejection for the receiver.

The IF frequency is 280MHz, and low-side injection is used, thereby placing the received image frequency 560MHz below the tuned channel. FL1 and FL2 also provide protection for the RF front-end from out of band interfering signals.

In the transmit mode, following the T/R switch, FL1 and FL2 are reused to attenuate harmonics generated in the HFA3925 RFPA, as well as to provide additional suppression of the LO.

Filter FL3 is used to suppress image noise generated in both the HFA3424 LNA and the HFA3624 LNA, and is a Murata LFJ30-03B2442B084 two pole monolithic LC bandpass filter. At this point, a less expensive solution is used because of the fact that pin to pin isolation of the HFA3624 is 20dB and only modest attenuation at the image frequency is required. The insertion loss is not critical, since at this point in the receiver, component loss or noise figure (NF) is offset by the preceding gain stages.

The IF receive filter, FL4, is a Toyocom TQS-432-7R SAW bandpass filter. The center frequency is 280MHz, the 3dB bandwidth is 17MHz, and the differential group delay is less than 100ns. Insertion loss is typically 6dB when the filter is well matched, making it ideal for single-conversion systems. The impedance of the SAW filter is 270Ω in parallel with 5pF, and a series 33nH inductor is used to match the filter input to 50Ω. A direct impedance match of the mixer output to the IF filter, FL4, could be implemented if desired (refer to Application Note AN9618 "Using the HFA3624EVAL Board" and HFA3624 Data Sheet). The 50Ω environment is chosen to allow ease in measurement of portions of the radio with external test equipment. The SAW filter output is matched directly to the IF input of the HFA3724 Quadrature IF Modulator/Demodulator, using a shunt 33nH inductor and 261Ω resistor. This presents a source impedance to the limiter input, that optimizes the limiter's NF.

A discrete one pole LC differential filter, FL5, is placed between the two limiters to restrict the noise bandwidth of the first limiter. As both limiters exhibit a broadband response, with over 400MHz bandwidth, a noise bandwidth reduction filter is appropriate to ensure that the second limiter is fully limiting on the front-end noise within the signal bandwidth, as opposed to the broadband noise generated by the first limiter. This filter has a center frequency of 280MHz, and a 3dB bandwidth of 50MHz. It consists of a fixed 10nH inductor and a fixed 20pF capacitor, as described in the HFA3724 data sheet.

In the transmit path, the 5th order Butterworth low pass filter of the HFA3724 provides initial shaping of the PSK waveform. Final shaping is provided by a transmit IF filter, FL6, a Toyocom TQS-432-7R SAW bandpass filter. The IF output of the HFA3724 is reactively matched to FL6, with a 250Ω resistive load presented to the HFA3724. A shunt 33nH inductor, in parallel with a 316Ω resistor, is used to provide this match, negate the effects of board and component capacitance, and provide a DC return to  $V_{CC}$  to prevent saturation in the IF output stage of the HFA3724.

The output of FL6 is terminated in a 200Ω potentiometer that is used for transmit gain control. A shunt 27nH inductor is used to negate the effects of parasitic board and component shunt capacitance, as well as to match the SAW output to the potentiometer. This potentiometer has its center wiper connected to the HFA3624 RF/IF Converter transmit IF input, which has an input resistance of approximately 3kΩ. By varying the potentiometer, the gain of the transmit chain is controlled, allowing for precise control of the signal back-off at the HFA3925 RFPA. Therefore, this potentiometer is adjusted to achieve the desired compromise between transmit output power and the main-lobe to first side-lobe ratio of the output PSK waveform, typically -32dBc to -35dBc, at an output power of +17.5dBm.

Upconversion to the 2.4GHz - 2.5GHz band is performed in the HFA3624 RF/IF Converter transmit mixer. The mixer output is filtered with FL7, a Murata LFJ30-03B2442B084 two pole monolithic LC bandpass filter. This filter suppresses the LO feedthrough from the mixer, and selects the upper sideband.

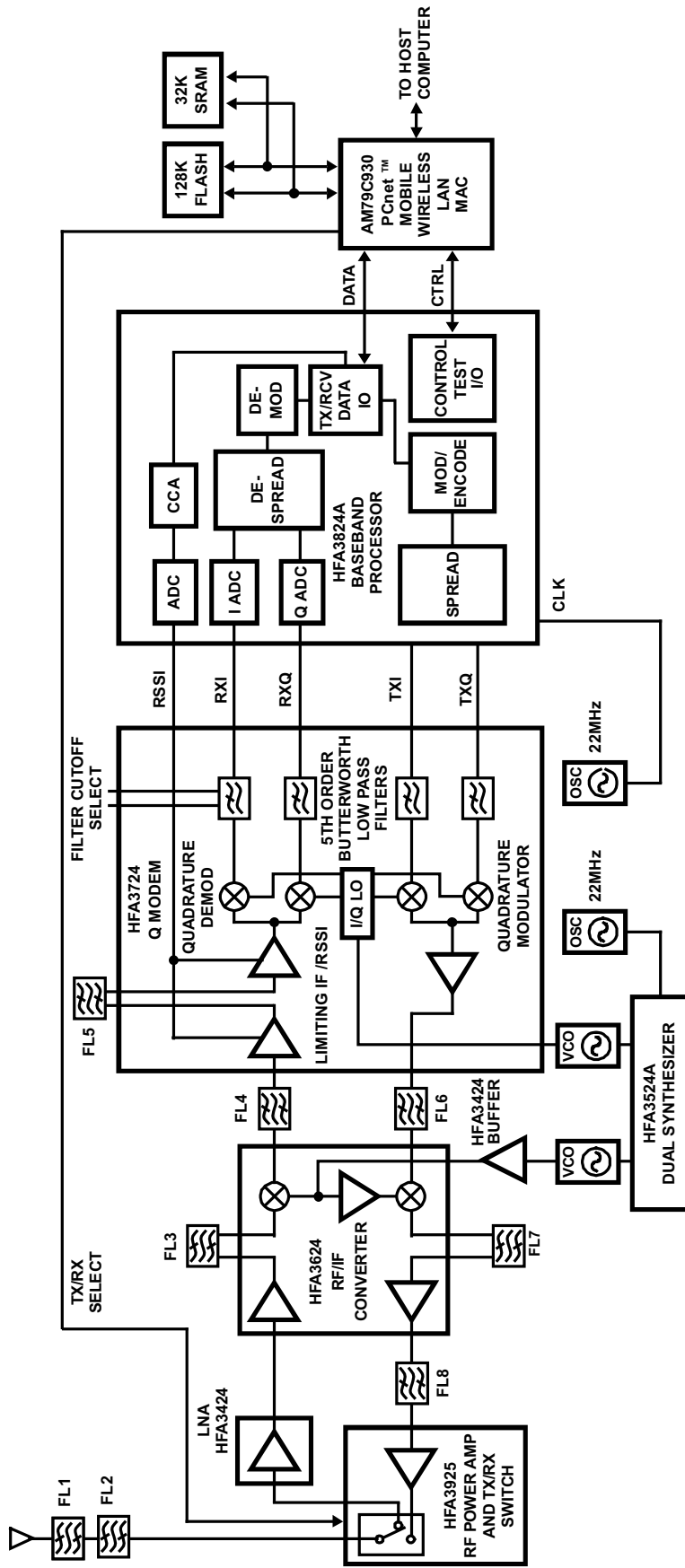

FIGURE 1. PRISM™ REFERENCE RADIO BLOCK DIAGRAM

PCnet™ is a trademark of AMD, Inc.

## Application Note 9817

Filter FL8, a Toko TDF2A-2450T-10 two pole dielectric bandpass filter, is used to further suppress both the transmit LO leakage and the undesired sideband.

As the transmit chain is operated linearly, any gain variation vs. frequency from the HFA3624 and HFA3925, as well as from FL6, FL7, FL8, FL2 and FL1 will result in the transmit output power varying across the operating channels. To reduce the amount of the variation, three 1pF capacitors are used as coupling elements to provide a form of simple equalization. Overall care must be exercised in the radio design to ensure that the filter rejection is still acceptable in meeting the transmitter requirements of FCC 15.247.

Some basic specification of all mentioned filters are given in following tables:

**TABLE 1.**

<b>TOKO TDF2A-2450T-10</b>	
Center Frequency	2450MHz
Bandwidth	100MHz
Insertion Loss (Max)	2dB
Attenuation (Min)	20dB, 16dB ( $f_0-280\text{MHz}$ , $f_0+280\text{MHz}$ )
Impedance	50Ω

**TABLE 2.**

<b>MURATA LFJ30-03B2442B084</b>	
Center Frequency	2442MHz
Bandwidth	84MHz
Insertion Loss (Max)	2.5dB
Attenuation (Min)	20dB ( $f_0-240\text{MHz}$ )
Impedance	50Ω

**TABLE 3.**

<b>TOYOCOM TQS-432E-7R, SAW FILTER</b>	
Center Frequency	280MHz
Bandwidth	17MHz
Insertion Loss (Max)	10dB
Attenuation (Min)	50dB ( $f_0-38.8\text{MHz}$ , $f_0+38.8\text{MHz}$ )
Terminating Impedance	270Ω    -5pF

### Possible Filter Changes

The reason for using two filters (FL1 and FL2) in series, is meeting FCC requirements. However, FCC requirements have been met with one filter here, but only a small spur margin remains and INTERSIL recommends the use of two filters in series.

The specification for the total thickness of the Type II PCMCIA card is 5mm. The PRISM reference radio use the coverset (0.216mm thickness) and the copper tape (0.035mm thickness, with backing included) on both sides of the PCB. The thickness of used PCB is 0.628mm. At one side of the PCB, the highest component under the copper tape is the VCO (1.8mm Max height). At the other side of the PCB, the filters are the highest

components. That leaves us with 2.07mm ( $5 - 0.628 - 2 \times 0.035 - 2 \times 0.216 - 1.8 = 2.07$ ) for the maximum height of the filters. A special PCB offset has been used in order to utilize TOKO filter TDF2A-2450T-10 in the Type II PCMCIA card.

Filters FL1, FL2 and FL8 can easily be replaced by TDFM1A-2450T-10, although the footprints are not the same. It has similar characteristics, maximal height of 2mm (which is enough for Type II PCMCIA card) and better price.

**TABLE 4.**

<b>TOKO TDFM1A-2450T-10</b>	
Center Frequency	2450MHz
Bandwidth	100MHz
Insertion Loss (Max)	2dB
Attenuation (Min)	20dB, 16dB ( $f_0-280\text{MHz}$ , $f_0+280\text{MHz}$ )
Impedance	50Ω

TOKO has a few other filters with better characteristics (TDFM1B-2450T-10,...), these are three- and four-pole filters which make them more expensive than the first two.

NTK recently designed filter (MFK2450CBF01) which also can be used as a replacement for TDF2A-2450T-10 with appropriate height, better price and similar characteristics (notice 3dB insertion loss).

**TABLE 5.**

<b>NTK MFK2450CBF01</b>	
Center Frequency	2450MHz
Bandwidth	100MHz
Insertion Loss (Max)	3dB
Attenuation (Min)	40dB (1840MHz and 1940MHz) 35dB (2000MHz to 2100MHz) 30dB (4800MHz to 5000MHz)
Impedance	50Ω

There are few manufacturers which should be considered for FL3 and FL7. All of them have filters with center frequencies of 2450MHz and bandwidth of 100MHz which are desired values. Filters that can be used are MDR624C, MDR641C, MDR642E (Soshin Electronics of America Inc.), B69812-N2457-A501 and B69813-N2457-A501 (Siemens Microelectronics Inc.), LFSN30N17C2450B and DFC22R45P100BHD (Murata).

**TABLE 6.**

<b>MURATA LFSN30N17C2450B</b>	
Center Frequency	2450MHz
Bandwidth	100MHz
Insertion Loss (Max)	2dB
Attenuation (Min)	40dB (1950MHz) 20dB (2200MHz)
Impedance	50Ω

## Application Note 9817

Soshin filter MDR641C is considered as an appropriate replacement for filters FL3 and FL7. It has correct center frequency and bandwidth, better attenuation at frequencies of interest and better price.

**TABLE 7.**

<b>SOSHIN MDR641C</b>	
Center Frequency	2450MHz
Bandwidth	100MHz
Insertion Loss (Max)	2dB
Attenuation (Min)	25dB (1750MHz and 2100MHz) 22dB (4800MHz and 5000MHz)
Impedance	50Ω

All of these filters have appropriate height, better price and similar characteristics compared to the TOKO filter TDF2A-2450T-10, but most of these filters have very poor attenuation at the second harmonic of the RF and LO frequencies. Measured attenuation for TDF2A-2450T-10 at 4900MHz is 33dB. That means, if a customer would like to use these filters as a solution for FL1, FL2 and FL8, it is necessary to use a low-pass filter in series. There are several solutions for the cheap low-pass filter on the market, like TOKO LTF series and Murata low-pass filter LFK30-05E2484L026. They have small footprints, insertion loss less than 1dB, appropriate height and 30dB Min attenuation at the second harmonic of the RF and LO frequencies. The cheapest possible solution for filters FL1, FL2 and FL8 is to design some simple discrete LC low-pass filter which should be used in series with one or all of the new bandpass filters. The number of the components in added low pass filter depends on the new bandpass filter's attenuation at the second harmonic of the RF and LO frequencies. Even with the addition of few passive components, this solution is less expensive, but it is time and space consuming. Designing the filter at 2.4GHz is very complex task. Special attention is needed for the PCB and Intersil does not recommend this solution to the customers without RF expertise. One example of the discrete low-pass filter is shown at Figure 2. A Butterworth low pass filter with 4 components is used. Component values for this filter are determined by APPCAD (HP freeware) simulation, and simulation has given the following results: insertion loss is 0.8dB, attenuation at 4900MHz is 17.7dB. However, verification with a real PCB should be done.

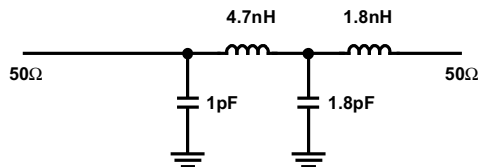

**FIGURE 2.**

Filters FL4 and FL6 can easily be replaced with Toyocom TQS-444F-7R (smaller footprints), which has similar characteristics and a better price. The same input and output matching networks can be used.

**TABLE 8.**

<b>TOYOCOM TQS-444F-7R, SAW FILTER</b>	
Center Frequency	280MHz
Bandwidth	17MHz
Insertion Loss (Max)	10dB
Attenuation (Min)	50dB (180-240MHz, 320-380MHz)
Terminating impedance	270Ω    -5pF

P/N 855392 SAWTEK SAW filter can also be used for FL4 and FL6. It has a low characteristic impedance compared to Toyocom SAW filters, but SAWTEK has provided a matching network for the PRISM reference radio which is shown in Figure 3.

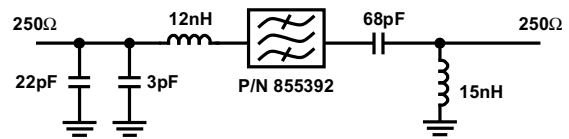

**FIGURE 3.**

**TABLE 9.**

<b>SAWTEK P/N 855392, SAW FILTER</b>	
Center Frequency	280MHz
Bandwidth	17MHz
Insertion Loss (Max)	10dB
40dB Bandwidth	60MHz (Max)

Siemens Matsushita Components also have a SAW filter which can be used for this application, part number L761B.

In choosing an IF SAW filter for this kind of application, special attention should be given to the values of passband insertion loss ripple, group delay variation and triple-transit point. Some measurements of these characteristics should be performed.

In choosing filters in the transmit path, special care should be taken that the filter attenuation at the second harmonic of the RF and LO ensure meeting the transmitter requirements of FCC 15.247. Most of the manufacturers do not include this data in Data Sheets and some measurements need to be taken. Some measurements should be done for filters which are used in the receive path, but this time the concern is the attenuation at the image frequency ( $f_{IMAGE} = f_{CHANNEL} - 560MHz$ ).

All of these issues should be resolved during the system design phase.

Characteristics of some of the filters are given in Figures 4-14. (Data from Data Sheets or measured in INTERSIL lab.)

**If a customer would like to use some other solution instead of the filters used in the reference design, Inter-**

# Application Note 9817

sil recommends that the characteristics of these filters

should be met.

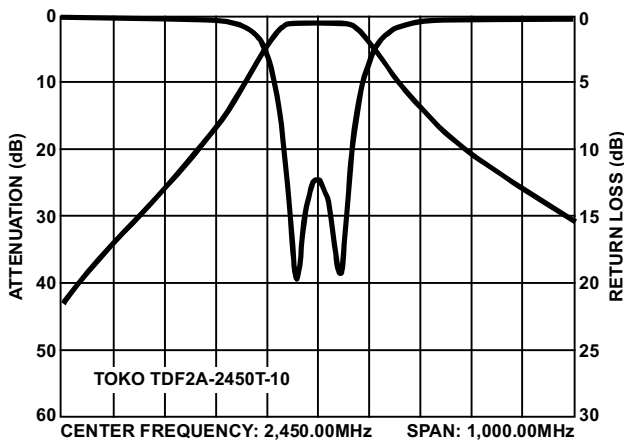

FIGURE 4.

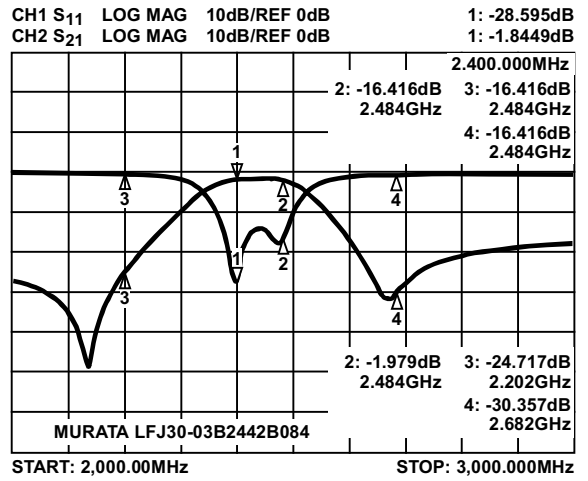

FIGURE 5.

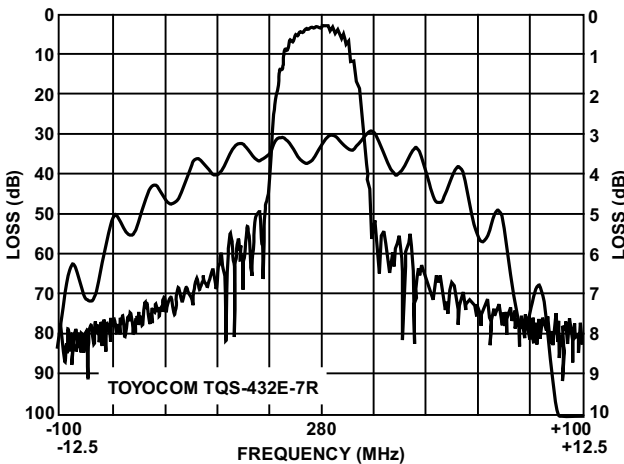

FIGURE 6.

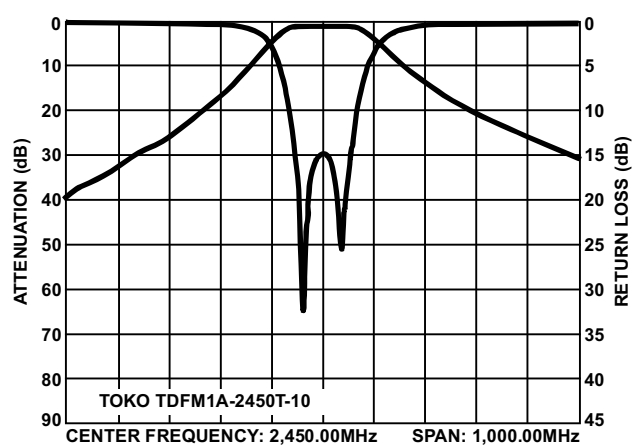

FIGURE 7.

All Intersil semiconductor products are manufactured, assembled and tested under ISO9000 quality systems certification.

Intersil semiconductor products are sold by description only. Intersil Corporation reserves the right to make changes in circuit design and/or specifications at any time without notice. Accordingly, the reader is cautioned to verify that data sheets are current before placing orders. Information furnished by Intersil is believed to be accurate and reliable. However, no responsibility is assumed by Intersil or its subsidiaries for its use; nor for any infringements of patents or other rights of third parties which may result from its use. No license is granted by implication or otherwise under any patent or patent rights of Intersil or its subsidiaries.

For information regarding Intersil Corporation and its products, see web site [www.intersil.com](http://www.intersil.com)

# Application Note 9817

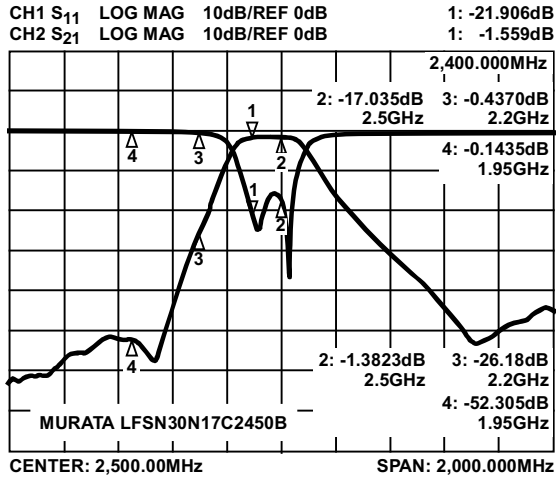

FIGURE 8.

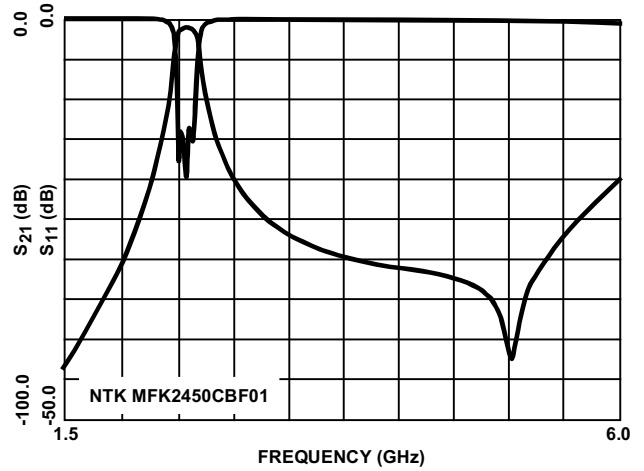

FIGURE 9.

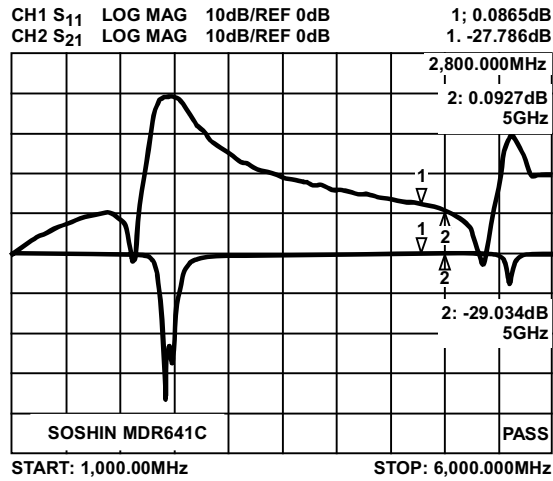

FIGURE 10.

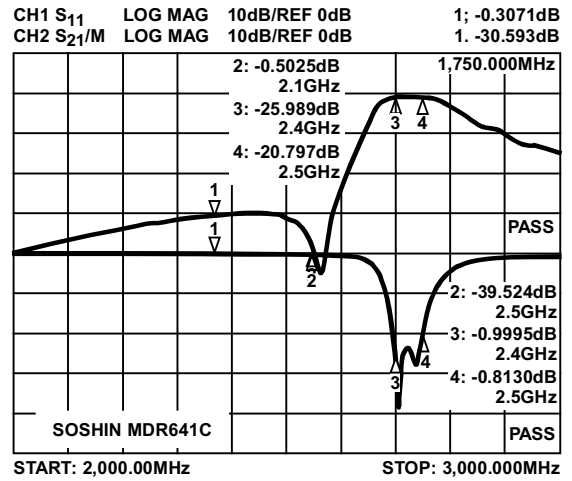

FIGURE 11.

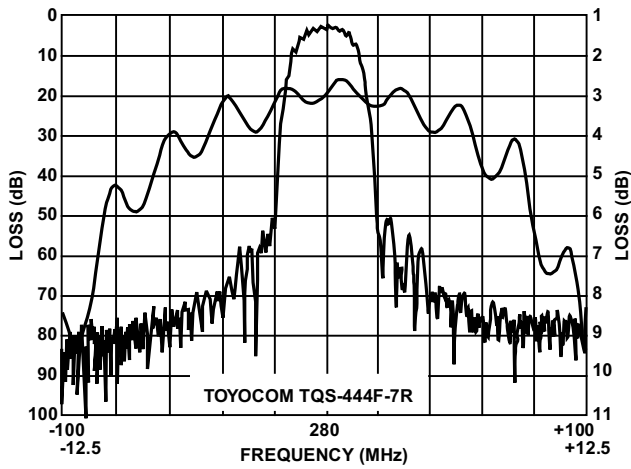

FIGURE 12.

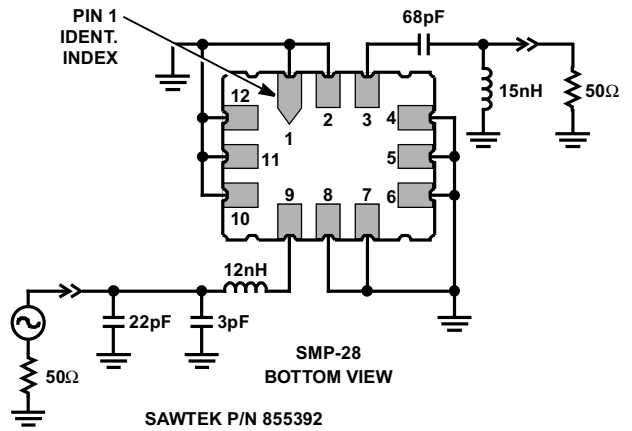

FIGURE 13. MATCHING SCHEMATIC FOR THE 17MHz WLAN FILTER

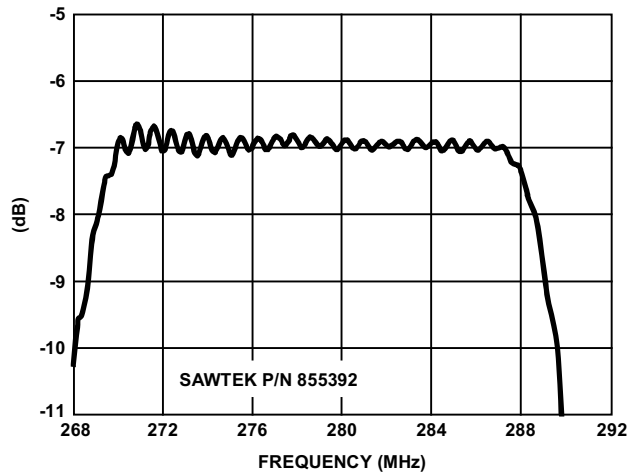

FIGURE 14. MATCHING PASSBAND FOR THE 17MHz WLAN FILTER

## Contacts

- 1. TOKO America**  
Danbury, CT  
Tom Mulloy (561) 7338926
- 2. Murata**  
Smyrna, GA  
Ray Drogos (770) 4361300
- 3. Toyocom U.S.A., Inc.**  
Arlington Heights, IL  
Robert Schragger (847) 5938780
- 4. Sawtek**  
Orlando, FL  
Clark Ragan (407) 8868860
- 5. Siemens Microelectronics Inc.**  
Iselin, NJ  
Cliff Zatz (732) 9064386
- 6. Soshin**  
Santa Clara, CA  
Takumi "Mick" Sakai (408) 5660325
- 7. D-Associates, Inc. (NTK representative)**  
Winter Park, FL  
Paul Nye (407) 6792633

## References

For Intersil documents available on the internet, see web site <http://www.intersil.com/>  
Intersil AnswerFAX (407) 724-7800.

- [1] *HFA3724 Data Sheet*, Intersil Corporation, "400MHz Quadrature IF Modulator/Demodulator." AnswerFAX Doc. No. 4067.
- [2] *HFA3624 Data Sheet*, Intersil Corporation, "2.4GHz Up/Down Converter". AnswerFAX Doc. No. 4066.
- [3] *AN9624 Application Note*, Intersil Corporation, "PRISM DSSS PC Card Wireless LAN Description", Carl Andren, Mike Paljug and Doug Schultz. AnswerFAX Doc. No. 99624.
- [4] TOKO, Chip Dielectric Filters, TDF and TDFM Series.
- [5] Murata, LC Filter Bandpass Chip Monolithic LFJ series, Bandpass Filter LFSN30 Series and Preliminary Specification Part Number DFC22R45P100BHD.
- [6] Toyocom, TQS-432E-7R and TQS-444F-7R VHF-range wideband low loss SAW filters.
- [7] Sawtek, P/N 855392 SAW Filter Specification, SAW Scene Winter 1998.
- [8] Soshin, Wireless LAN RF BPF Type No. MDR641C and MDR624C.
- [9] Siemens Microelectronics Inc., Microwave Ceramics RF filters for W-LAN Standard B69812-N2457-A501 and B68813-N2457-A501 and SAW Components Low-Loss Filter L761B.
- [10] NTK, 3-Pole Dielectric Filter MFK2450CBF01.