



**BSCBO- 203**

**B.Sc. II YEAR**  
**Plant Ecology and Biostatistics**



**DEPARTMENT OF BOTANY**  
**SCHOOL OF SCIENCES**  
**UTTARAKHAND OPEN UNIVERSITY**

# PLANT ECOLOGY AND BIOSTATISTICS



**SCHOOL OF SCIENCES  
DEPARTMENT OF BOTANY  
UTTARAKHAND OPEN UNIVERSITY**

**Phone No. 05946-261122, 261123**

**Toll free No. 18001804025**

**Fax No. 05946-264232, E. mail [info@uou.ac.in](mailto:info@uou.ac.in)**

**<http://uou.ac.in>**

---

**Expert Committee****Prof. J. C. Ghildiyal**

Retired Principal  
Government PG College  
Karnprayag

**Prof. G.S. Rajwar**

Principal  
Government PG College  
Augustmuni

**Prof. Lalit Tewari**

Department of Botany  
DSB Campus,  
Kumaun University, Nainital

**Dr. Hemant Kandpal**

School of Health Science  
Uttarakhand Open University  
Haldwani

**Dr. Pooja Juyal**

Department of Botany  
School of Sciences  
Uttarakhand Open University, Haldwani

---

**Board of Studies****Late Prof. S. C. Tewari**

Department of Botany  
HNB Garhwal University,  
Srinagar

**Prof. Uma Palni**

Department of Botany  
Retired, DSB Campus,  
Kumoun University, Nainital

**Dr. R.S. Rawal**

Scientist, GB Pant National Institute of  
Himalayan Environment & Sustainable  
Development, Almora

**Dr. H.C. Joshi**

Department of Environmental Science  
School of Sciences  
Uttarakhand Open University,  
Haldwani

**Dr. Pooja Juyal**

Department of Botany  
School of Sciences  
Uttarakhand Open University, Haldwani

---

**Programme Coordinator****Dr. Pooja Juyal**

Department of Botany  
School of Sciences  
Uttarakhand Open University, Haldwani

---

**Unit Written By:** **Unit No.**

---

1-Dr. Pooja Juyal Department of Botany School of Sciences Uttarakhand Open University Haldwani, Nainital	1, 4 & 5
2-Dr. Harsh Bodh Paliwal Asst Prof. (Senior Grade) School of Forestry & Environment SHIATS Deemed University, Naini, Allahabad	2 & 3
3-Dr. Seema Rawat Asst Prof, Department of Botany, H.N.B. Garhwal University, Srinagar Campus, Srinagar, Uttarakhand	6
4-Prof. A.B. Bhatt Department of Botany, H.N.B. Garhwal University, Srinagar Campus, Srinagar, Uttarakhand	7 & 8
5-Dr. Narendra Sijwali Asst Prof., Department of Maths Govt. PG College, Dwarahat	9, 10, 11 & 12

---

**Course Editor**

---

Dr. Pooja Juyal  
 Department of Botany, School of Sciences  
 Uttarakhand Open University, Haldwani

<b>Title</b>	: <b>Plant Ecology and Biostatistics</b>
<b>ISBN No.</b>	: <b>978-93-90845-36-1</b>
<b>Copyright</b>	: <b>Uttarakhand Open University</b>
<b>Edition</b>	: <b>2021</b>

**Published By: Uttarakhand Open University, Haldwani, Nainital-263139**

**CONTENTS**

---

<b>BLOCK-1 GENERAL ECOLOGY AND ECOSYSTEM</b>	<b>PAGE NO.</b>
Unit-1-Definition, Branches and Scope of Ecology	6-16
Unit-2- Ecosystem Ecology-I	17-47
Unit-3- Ecosystem Ecology-II	48-75
Unit-4- Ecological Factors	76-99
Unit-5- Pollution Ecology	100-115
Unit-6 -Biogeographical regions of India, Vegetation types of Uttarakhand	116-134

---

<b>BLOCK-2 APPLIED ECOLOGY AND REMOTE SENSING</b>	<b>PAGE NO.</b>
Unit-7- Remote sensing- Tools and Techniques	136-165
Unit-8 -Aerial and Space platforms, Aerial photography and Photo-interpretation	166-194

---

<b>BLOCK-3 BIOSTATISTICS</b>	<b>PAGE NO.</b>
Unit-9-Methods Graphic and Non-graphic presentation of data	196-218
Unit-10-Measurements of Central tendencies	219-240
Unit-11-Measures of Dispersions and Deviations	241-267
Unit-12-Correlation, Statutory test	268-291

---

**BLOCK-1      GENERAL      ECOLOGY      AND  
ECOSYSTEM**

---

# **UNIT-1 BRANCHES, APPLICATION AND SCOPE OF ECOLOGY**

---

- 1.1-Objectives
- 1.2-Introduction
- 1.3- History and Branches of Ecology
- 1.4- Application of ecology
- 1.5- Scope of ecology
- 1.6- Summary
- 1.7- Glossary
- 1.8-Self Assessment Question
- 1.9- References
- 1.10-Suggested Readings
- 1.11-Terminal Questions

---

## ***1.1 OBJECTIVES***

---

After going through this unit students will be able to know:

- What is ecology
- Discuss about the branches of ecology
- Discuss about the applications of ecology

---

## ***1.2 INTRODUCTION***

---

The term Ecology was introduced by H.Reiter in 1868, but it was properly defined by Ernst Haeckel, a German Biologist in 1869. The word ecology (old spelling-oekologie) is derived from Greek word, “oikos” meaning house and “logos” meaning the study. Thus, the word ecology literally means the study of living organism in their natural habitat or home. Ecology has been defined by different ecologists. To mention some of them are, by Eudgene Odum (1963) has defined ecology as the study of the structure and the function of nature. Allee et al (1949) considered ecology as ‘the science of inter – relation between living organisms and their environment, including both the physical and biotic environments, and emphasizing inter-species as well as intra species relations’. Taylor (1936) called ecology is the science of all the relations of all organisms to all their environment. According to Charles J. Krebs (1972), Ecology is the scientific study of interactions that determine the distribution and abundance of organisms. Clements Elton (1927) defined it as ‘the scientific natural history concerned with the sociology and economics of animals’. Pinaka (1974) defined ecology as ‘the study of relations between organisms and the totality of the biological and physical factors affecting them or influenced by them’. According to Southwick (1976), Ecology is the scientific study of the relationships of living organisms with each other and with their environment’.

Ecology includes the study of plant and animal populations, plant and animal communities and ecosystems. It was in 1935 that Arthur Tansley, the British ecologist, coined the term ecosystem. Ecosystem simply means ‘ecological systems’. Ecology is defined as the study of ecosystems. Ecologists study the interaction of all the organisms in an ecosystem. Ecosystems describe the web or network of relations among organisms at different scales of organization. Since ecology refers to any form of biodiversity, ecologists research everything from tiny bacteria's role in nutrient recycling to the effects of tropical rainforest on the Earth’s atmosphere.

Ecology deals with numerous and varied components of nature, which can be categorized variously as climate, plants, animals, soil, litter lying over soil, production, dominance, decomposition, diversity etc.

---

## ***1.3 HISTORY AND BRANCHES OF ECOLOGY***

---



## History of Ecology

Although modern ecology developed mainly since 1900, but the ecological ideas were deep rooted into human history. Pre historic man utilized environment information for food, shelter, medicines etc. One of the first ecologists was probably Theophrastus described vivid description of inter-relationships between animals and their environment as early as the 4<sup>th</sup> century BC (Ramalay, 1940). In the early eighteenth century two schools of thought dominated the growing scientific study of ecology. First, Gilbert White a “Parson-naturalist” is attributed with developing and endorsing the view of Arcadian ecology. Arcadian ecology advocates for a “simple, humble life for man” and a harmonious relationship with man and nature. On the other hand, opposing the Arcadian view is Francis Bacon’s ideology ‘imperial ecology’. Imperial Ecology believes in the establishment of man’s dominance over nature through the exercise of reason and by hard work. Both views continued their rivalry through the early 18<sup>th</sup> century until Carl Linnaeus’s support of imperialism and in short time due to Linnaeus’s popularity, imperial ecology became the dominant view within the discipline. Carl Linnaeus, a Swedish naturalist (1707-1778), is well known for his work with taxonomy, the science of naming and classifying organisms. Linnaeus discovered a vast number of plants and animals and recorded them in his book “Systema Naturae”. His ideas helped to lay the ground work for modern ecology. Charles Darwin (1859) proposed his theory of evolution and adaptation. According to this theory, organisms change over time because of their inherited traits and characters. Such evolutionary changes are what then allow them to adapt better to their environment. In 1869 Ernst Haeckel coined the term “ecology” since then; ecology became the study of the relationships of organisms with their environment. Eduard Seuss (1875) first defined the term biosphere as the system composed of living organisms and their environment. The plant community in ecology was introduced by Le cog Sendtner and kerner and the animal community introduced by Karl Mobius (1877), Warming (1909), Elements (1916), Cowles (1899), etc. Schroeter and Kirchner (1896) introduced the term Synecology in literature. In 1935 Arthur Tansley coined the term ecosystem as the biological community of interacting organisms and their physical environment. Because of this, ecology became the Science of ecosystems. Eugene Odum and Howard Odum (1953) wrote the first ecology text book and ecology became a University Course.

Andrewartha and Birch, 1954 emphasized the importance of climate and other factors on determining the size of populations. Margolef (1968) has drawn attention to the unifying principles in ecology and considers maturity of ecosystems as measured by diversity and in terms of energetic, 1970’s James Lovelock’s idea of Gaia, that the whole earth is one living entity and will ensure its own survival even if humans destroy themselves. 1978 conservation Biology established as a discipline focusing on environmental management.

Ecology emerged as a distinct discipline at the turn of the 20<sup>th</sup> century, and that it gained public prominence in the 1960s; due to wide spread concern for the state of the environment. From the conventional regional floristic and vegetation studies the switch over to ecosystem approach in the fifties and early sixties. The Science of ecology after undergoing a several

hundreds of years gestation period has emerged today as a matured, honoured and scholarly discipline in biological Science.

Prof. Ramdeo Mishra (1908-1998) is revered as father of Ecology in India. His researches laid the foundation for understanding of tropical communities and their succession, environmental responses of plant populations, and productivity and nutrient cycling in tropical forests and grassland ecosystems. Other early ecologists in India were F.R. Bharucha (Royal Institute of Science, Bombay) and G.S. Puri, whose focus was on forest ecology, and who together with Ramdeo Misra founded the International society for Tropical Ecology and the journal, Tropical ecology. F.R. Bharucha introduced the methodology of Zurich- Montpellier school of vegetation analysis in India. We find many references to ecological thought in Indian writings of Vedic, Epic and Pauranic etc. Chakra described the importance of vayu (air and gas), desha (topography), Jata (water), and time in regulation of life. In India, the earliest contributions to modern ecology were made by British ecologists to the forests and grasslands. Our early ecological studies have been influenced by European thought due to the fact that most of the workers were Europeans. The first comprehensive ecological contribution was made by Winfield Dudgeon (1921) who published an ecological account of the upper Gangetic plains employing the concept of seasonal succession therein. This was, elaborated later by Saxton (1922), Mishra (1946, 1958, 1959). Phytosociological analysis of plant communities was for the first time made by Agharkar (1924) mainly for the grasslands. Bharucha and Shankarnarayana (1958) contributed mainly to the Phytosociology of grassland vegetation of Western Ghats using Braun-Blanquet system. Autecological studies on a number of forest trees were made by Pant and Champion (1931), Champion and Griffith (1947), Jagat Singh (1925), and Phadnis (1925). The publication of a book entitled “Indian forest ecology” by G.S. Puri (1960), presents a comprehensive survey of the vegetation and its environment in this sub-continent. Champion and Seth (1965) proposed a detailed classification of Indian vegetation. Autecological and Synecological studies of forest communities have been made by Bhatia (1954, 1955, 1956), Sharma (1955), Puri (1949, 1950), Mohan and Puri (1955, 1956), Arora (1961-1964), Misra and Joshi (1952), Rao (1967). Productivity studies of forests have been made by Misra (1969), Singh (1971), Raman (1970), Sharma (1972), Bandhu (1971), Faruqui (1971) etc.

### **Branches of Ecology**

On the basis of study of organism individually or in group, ecology may be divided mainly in two branches, which are (i) autecology, and (ii) synecology.

In the words of C.F. Harried II (1977), “the two types of study, autecology and synecology are inter-related, the synecologist painting with a broad brush the outline of the picture and autecologist stroking in the finer details”.

**Autecology:** Autecology is the study of individual species or its population including the effect of other organisms and environmental conditions on every stage of life cycle. This is also called

as species ecology. Studies on individual species first started, when human adopted agricultural practices. Misra and Puri (1954) stated that agriculture and silviculture are extensions of autecology. Although, autecology work has been done extensively, still only a few species have been worked out in detail. The important aspects of autecological studies of an individual organism are- Physiology of the plant, Taxonomy and nomenclature of the species, environmental complex (germination, flowering, seed output reproduction capacity, morphology or the plant etc. Prof. R. Mishra and his associates at Banaras Hindu University, Varanasi, has been studied the autecology of several plants.

**Synecology:** The study of the relationships of plants and animals making up a natural community is known as community ecology or synecology. Synecology is further subdivided into aquatic and terrestrial ecology.

(a) The aquatic ecology includes marine ecology, water ecology, and estuarine ecology.

(b) Terrestrial ecology, subdivided further into areas such as grassland ecology, forest ecology, cropland ecology and desert ecology is concerned with terrestrial (land) ecosystems- their microclimate, soil chemistry, nutrient hydrological cycle and productivity.

Many ecologists have divided ecology into a number of divisions; some of them are as follows-

**(i) Paleocology (Fossil ecology):** It deals with the organisms and its relationship with geological environment of the past.

**(ii) Cytoecology:** It is concerned with the cytological details in a species in relation to populations in different environmental conditions.

**(iii) Conservation ecology:** It is concerned with the proper management of natural resources such as plant, soil, water, land, mineral resources etc for human welfare.

**(iv) Ecological energetics and Production ecology:** These modern branches of ecology are still in development stage. These deals with the mechanism and quantity of energy conversions and it flow through organisms, production processes, rate of increase in organic weight in relation to space and time both by green plants and animals.

**(v) Space ecology:** It deals with the development of partially or completely regenerating ecosystems for supporting life during long space flights.

**(vi) Microbial ecology:** It is the study of the ecology of microorganisms that live in all natural ecosystems.

**(vii) Habitat ecology:** It is dependent upon the nature of habitat. It includes grassland ecology, fresh water ecology, marine ecology, desert ecology etc.

**(viii) Ecosystem ecology:** Organisms obtain energy through photosynthesis or by consuming other organisms. These energy transformations are associated with the movements of materials within and between organisms and the physical environment.

Thus, the interaction between the biotic and abiotic components called an ecosystem is the sub-field of ecology called ecosystem ecology. Issues of interest at this level are how human activities affect food webs, energy flow and global cycling of nutrients.

**(ix) Taxonomic ecology:** It is the study of organisms belonging to different taxonomic categories and thus the study will be named as bacterial ecology, fungal ecology, algal ecology, insect ecology etc.

---

## ***1.4 APPLICATIONS OF ECOLOGY***

---

Ecological applications are concerned broadly with the applications of ecological science to environmental problems. Ecology is very important subject it has applications in major areas such as-

**(i) Wild Life Management:** Wild life ecology began as applied science discipline during the 1920 s and 1930 s. Wild life ecology is the science behind the practice of wildlife management that seeks to manage wildlife populations for the benefit of humans. Early emphasis was on managing populations and habitats to support recreational hunting. Modern views are well characterized in Sinclair et al.2006, still retaining the utilization values of wildlife but broadening to embrace the preservation of biodiversity, non consumption uses of wildlife, and ecosystem management.

**(ii) Soil Conservation:** Soil conservation is the preventing of soil loss from erosion or reduced fertility caused by over usage, acidification, salinization or other chemical soil contamination. Soil conservation is important because it provides food, filters air and water and helps to decompose biological waste into nutrients for new plant life. Certain human activities are disturbing the soil. Such as many cultivated lands are being disturbed by construction of buildings, farming or timber.

**(iii) Watershed Management:** Watershed is a term used to describe the process of implementing land use practices and water management practices to protect and improve the quality of the water and other natural resources within a watershed by managing the use of those land and water resources in a comprehensive manner. In recent decades, watershed management has seen a paradigm shift from predominantly supply based considerations of water quantity and quality to broader considerations of the ecological services provided by watersheds and a more holistic perspective interested in understanding and managing feed backs between hydrological and ecological processes.

**(iv) Agriculture:** Agriculture is an important global human enterprise that exerts a major influence on ecosystems. Looking to the future, there remains a strong role ecologists to continue contributing to the development of sustainable agricultural systems. The knowledge of ecological agriculture provides a holistic understanding of how agroecosystems work and the science of sustainable agriculture. Ecology emphasizes the interrelationships among soils, insects, plants, animals, humans and other components of agroecosystems including ecosystem dynamics,

agroecology of food crops, and the role of agriculture in rural and urban landscape. All these factors are studied by ecologists, so without information of all aspects it will be very difficult to grow a plants and it can result in economic loss. Agriculture ecology provides solutions to the challenge of sustainable food production.

**(v) Aquaculture:** Aquaculture is the farming of aquatic organisms such as fish, crustaceans, prawns, molluscs and aquatic plants related directly or indirectly to human consumption. Aqua culture involves cultivating fresh water and salt water populations under controlled conditions, and can be contrasted with commercial fishing, which is the harvesting of wild fish. The market for Sea food is huge, and growing fast, but stocks of fish are dropping due to over fishing, pollution and other human activities. On balance, global aquaculture production, the growing aquaculture industry is to sustain its contribution to world fish supplies and adopt more ecologically sound management practices. Other ecological studies such as temperature and soil conditions are important in fish culturing.

**(vi) Land Utilization:** Humans are the major force of change around the globe, transforming land to provide food, shelter, and products for use. Ecological principles for land use and management deal with time, species, place, disturbance and the landscape. The principles result in several guidelines that serve as practical rules of thumb for incorporating ecological principles into making decisions about the land. Specifying ecological principles and understanding their implications for land-use and land-management decisions are essential steps on the path toward ecologically based land use.

**(vii) Air Pollution:** Pollution is the introduction of contaminants into the natural environment that causes adverse change. Pollution can overwhelm the natural stability of an ecosystem and result in irreversible changes and losses for example air pollution and acid deposition results in decline of forests, loss of timber growth, due to nutrient losses caused by mercury poisoning of microbes and soil insects, loss of fish production, due to death of invertebrates from copper pollution etc. For the control of pollution, we have to studies causes of pollution. These causes can be controlled by ecological studies.

**(viii) Forestry:** The management of forests is known as forestry. Forest ecology is a highly diverse and important branch of ecological study. Forest ecology is the scientific study of the interrelated patterns, processes, flora, fauna and ecosystems in forests. Forests are home to many invaluable ecosystem goods and services as well as a source of wood products for economics around the world. Scientists and experts evaluate the effectiveness of forest management policies by accounting for the economics, social and environmental goals.

---

## ***1.5 SCOPE OF ECOLOGY***

---

The scope of ecology is huge, and it encompasses all organisms living on earth and their physical and chemical surroundings. For this reason, the field is usually divided into different levels of study including organismal ecology, population ecology, ecosystem ecology and community ecology. Organismal ecology looks at how individuals interact with their environment. Population ecology examines the factors affecting population density and distribution. Community ecology looks at the interactions between the populations. Ecosystem ecology is an extension of organismal, population and community ecology. The ecosystem is composed of all the biotic and abiotic components of that area. An ecosystem biologist examines how nutrients and energy are stored and how they move among organisms and the surrounding atmosphere, soil and water. The scope of ecological study includes:

- 1-It deals with the study of flow of energy and materials in the environment.
- 2- It deals with the study of nature and its function.

Taylor (1936), in an attempt to define ecology, has very rightly pointed out that scope of ecology by stating that ecology is the Science of all relations of ecosystem, all organisms to all their environment.

The scope of ecology has expanded considerably as man has become increasingly aware of the problems of the environment. Ecologists have been warn people, of the consequences of the gradual disappearance and destruction of natural resources by humans. With the proper and intelligent knowledge of ecological studies, man may establish a healthy and long lasting balance between the living beings and their environment through ecological studies and management which may solve the many big problems.

Prof. R. Misra (1976) in his address on ecology and development at the ‘All India Symposium on advancement of Ecology at Muzaffarnagar’ pointed out that potent advance in ecology will accure from the attempts to apply the knowledge to the economic development of India and development of ecological concepts in redressing or reversing the progress of degradation of the environment. The knowledge of ecology is of great help to tackle many of the problems resulting from over exploitation of the resources. There are many subcategories of Ecology. Plant ecology looks at the differences and similarities of various plants in differing climates and habitats. The study of plant in their environment has yielded a large body of knowledge which provides aids to the Science of conservation of natural resources. The knowledge of ecology is being applied in agriculture, food production and horticulture. The International Biological Programme (IBP) was launched since July 1, 1967 to study the biological basis of organic productivity and conservation of natural resources in relation to human welfare.

Bombay Natural History Society (Science-based NGO) has conducted commendable long term ecological studies in the wetlands of Bharatpur, Bhitarkanika, and point Calimer with particular reference to Birds.

The modern ecology revolves round the biological production processes and ecological energetic. Ecology provides scientific basis for resource management.

---

## ***1.6 SUMMARY***

---

The term Ecology was introduced by H.Reiter but it was properly defined by Ernst Haeckel. Ecology literally means the study of living organism in their natural habitat or home. Ecology deals with numerous and varied components of nature. On the basis of study of organism individually or in group, ecology may be divided in two branches, which are (i) autecology and (ii) Synecology. The term Autecology denotes ecological studies at the species level while the term synecology denotes ecological studies at the community level. Ecologists have divided ecology into a number of divisions such as- Cytoecology, Paleoecology, Conservation Ecology, Ecological Energetics and Production ecology, Space ecology, Microbial ecology, Habitat ecology, Ecosystem ecology, Taxonomic ecology. Ecological applications are concerned with the applications of ecological science to environmental problems. Ecology has applications in major areas such as- wildlife management, Soil conservation, Watershed management, Agriculture, Aquaculture, Land utilization, Air pollution, Forestry.

---

## ***1.7 GLOSSARY***

---

**Ecology:** Study of interaction between living things and their environment.

**Ecosystem:** An ecosystem includes all of the living things (plants, animals and organisms) in a given area, interacting with each other, and also with their non-living environments (weather, earth, sun, soil, climate, atmosphere).

**Biodiversity:** Biodiversity refers to the variety of life on Earth.

**Taxonomy:** The science of naming and classifying organisms.

**Succession:** Succession refers to a directional, predictable change in community structure over time (Grime 1979, Huston & Smith 1987).

**Autecology:** Study of individual organism or species in relation to its environment.

**Synecology:** study of relations between natural communities and their environments.

**Aquatic:** related to water

**Terrestrial:** related to land

**Microclimate:** A *microclimate* is a smaller area within a general climate zone that has its own unique climate.

**Habitat:** a specific place or natural conditions in which a plant or animals lives

**Paradigm shift:** an important change that happens when the usual way of thinking about or doing something is replaced by a new and different way

**Agroecosystem:** an ecosystem on agricultural land.

**Aquaculture:** is the farming of fish and other aquatic organisms.

**Biosphere:** layer of the planet Earth where life exists.

---

## ***1.8 SELF ASSESSMENT QUESTION***

---

### **1.8.1 Objective type Questions:**

1-Term ecology was proposed by-

- |             |            |
|-------------|------------|
| (a) Taylor  | (b) Odum   |
| (c) Haeckel | (d) Reiter |

2- The term ecosystem was coined by-

- |             |             |
|-------------|-------------|
| (a) Tansley | (b) Warming |
| (c) Reiter  | (d) Dorwin  |

3-Who reversed as father of ecology in-

- |                   |           |
|-------------------|-----------|
| (a) Ramdeo Mishra | (b) Pant  |
| (c) Bhatia        | (d) Mohan |

4-Two main branches of ecology-

- |                               |                               |
|-------------------------------|-------------------------------|
| (a) Autecology and Genecology | (b) Genecology and Synecology |
| (c) Autecology and Synecology | (d) None                      |

5-Synecology is the study of-

- |                          |                 |
|--------------------------|-----------------|
| (a) Individual           | (b) Communities |
| (c) Study of environment | (d) None        |

6-Theory of evolution and adaptation is proposed by-

- |                    |                 |
|--------------------|-----------------|
| (a) Charles Darwin | (b) Linnaeus    |
| (c) Theophrastus   | (d) Eugene Odum |

7-The book “Systema Nature” is written by-

- |                  |                   |
|------------------|-------------------|
| (a) Eduard Seuss | (b) Linnaeus      |
| (c) Shelford     | (d) Francis Bacon |

8-Autecology refers to-

- |                                 |                                |
|---------------------------------|--------------------------------|
| (a) Study of individual species | (b) Study of different species |
| (c) Study of environment        | (d) Both (a) and (b)           |

9-The term Ecology was properly defined by-



- (a) Linnaeus (b) Ernst Haeckel  
(c) Gilbert white (d) Howard Odum

10-The book “Indian Forest Ecology” is written by-

- (a) G.S.Puri (b) Champion  
(c) Bandhu (d) Faruqui

**1.8.1 Answer Key:** 1- (d), 2-(a), 3-(a), 4-(c), 5-(b), 6-(a), 7-(b), 8-(a), 9-(b), 10-(a)

---

## ***1.9 REFERENCES***

---

- S.K. Agarwal, Fundamentals of Ecology, APH Publishing Corporation, New Delhi
- Dr. R.S, Shukla and Dr. P.S.Chandel , A Textbook of Plant Ecology including Ethnobotany and Soil Science, S.Chand and company Pvt., LTD, Ramnagar, New Delhi
- Prof. P.R.Trivedi, Ecology and Environment, APH Publishing Corporation, New Delhi
- Sharma, P.D. 2005. Ecology and Environment. Rastogi Publication

---

## ***1.10 SUGGESTED READINGS***

---

- Fundamentals of Ecology by S.K. Agarwal,
- A Textbook of Plant Ecology including Ethnobotany and Soil Science by Dr. R.S, Shukla and Dr. P.S.Chandel,
- Ecology and Environment by Prof. P.R.Trivedi
- Ecology and Environment by P.D. Sharma

---

## ***1.11 TERMINAL QUESTIONS***

---

1- Define the term Ecology and discuss about the history of ecology?

2-Describe the applications of ecology.

3- Write the detail account on different branches of ecology?

4-Explain the following terms:

- (a) Synecology  
(b) Autecology

---

## UNIT-2 ECOSYSTEM ECOLOGY-I

---

- 2.1- Objectives
- 2.2- Introduction
- 2.3- Ecosystem
  - 2.3.1 Types of ecosystem
  - 2.3.2-Structure
- 2.4- Abiotic and Biotic components
- 2.5-Food Chain
- 2.6-Food Web
- 2.7-Ecological Pyramid
- 2.8-Energy flow
- 2.9-Productivity in an ecosystem
- 2.10-Biogeochemical Cycles (Material Cycles)
  - 2.10.1 Nitrogen Cycle
  - 2.10.2 Oxygen Cycle
  - 2.10.3 Carbon Cycle
  - 2.10.4 Sulfur Cycle
  - 2.10.5 Phosphorus Cycle
- 2.11- Summary
- 2.12- Glossary
- 2.13- References
- 2.14-Suggested Readings
- 2.15-Self Assessment Question
- 2.16-Terminal Questions

---

## ***2.1 OBJECTIVES***

---

After reading this unit students will be able to-

- Explain the importance of biodiversity to ecosystems.
- Understand the interaction of organisms and their interactions for population, community and ecosystem dynamics.
- Describe the applicability of thermodynamic laws in biological energy flow.

---

## ***2.2 INTRODUCTION***

---

An ecosystem is defined as natural functional ecological unit comprising of living organism and their non-living environment that interact to form a stable self supporting system. The term ecology was coined by Earnst Hackel in 1869 and derived from two Greek words “oikos” meaning house, habitation or place of living and “logos” meaning study.

Ecosystem is a collection of living and non-living entities, all biotic and abiotic organisms are inter dependent on each other for their survival i.e. living organisms cannot live isolated from their non-living environment because the later provides material and energy for the survival of the former. Natural ecosystem has evolved over millions of years manifesting a wide variety of life forms with complimentary interaction and dynamic equilibrium. Human being has manipulated the environment for his gain these manipulation has brought large changes in the ecosystem. It has deviated from natural trends and is losing the equilibrium through evolution and test of time. So, any interruption in the function of any of the factor may disbalance the ecosystem. So there must be a constant interaction between both of them to maintain the stability of ecosystem.

---

## ***2.3 ECOSYSTEM***

---

### **2.3.1 Types of Ecosystem**

The kind of organism which can live in a particular ecosystem depends upon their physical and metabolic adaptations to the environment of that place of ecosystem and on certain aspects of the history of our planet, which has determined what organisms have been able to travel where. On earth, there are sets of ecosystems within a geographical region which are exposed to same climatic conditions and having dominant species with a similar life cycle, climatic adaptations and physical structure. This set of ecosystem is called Biome. In the biosphere, there are natural and artificial biomes (ecosystem).

#### **1. Natural ecosystem (Biomes)**

Natural ecosystems operate by themselves under natural conditions without any interference by man. Natural ecosystems carry out many public service functions for us. Waste water from

houses and industries is often converted to drinkable water by filtration through natural ecosystems, such as soil. Air pollutants from industries and automobiles are often trap on leaves or converted to harmless compound by forests. On the basis of particular type of habitat, they are further sub-divided as

**a) Terrestrial Biomes:** They are often classified by the vegetation type that dominates the community. The types of vegetation affect the climate and soil structure and that characterize the particular biome. Terrestrial vegetation has a rapid exchange of oxygen, water and carbon dioxide. The carbon dioxide concentration is affected by terrestrial vegetation seasonally and annually. Terrestrial biomes include tropical rain forests, grassland, deserts, cultivated land, etc.

**b) Aquatic biomes:** They fall into two categories, Fresh water and Marine. Fresh water biomes may be lotic (running water) such as streams, rivers and springs, or lentic (standing water) such as lakes, ponds and swamps, whereas, marine biomes include deep Sea and Oceans.

## 2. Artificial Ecosystem

They are maintained artificially by man. A pond constructed as a part of a waste water treatment plant is an example of artificial ecosystem, the management can vary over a wide range of actions. Agriculture can be thought of as partial management of certain kind of ecosystem. Here, natural balance is distributed regularly by addition of energy and panned manipulation. For e.g. Wheat maize and rice- fields etc, where man tries to control the biotic community as well as the physiochemical environment. The smallest artificial ecosystem that has been non to sustain a life over long period of time is 'Folsom bottles'. These materially closed ecosystems were created by Professor Claire Folsom of university of Hawaii by placing water algae, bacteria and sediment from Honolulu bay in a liter flask and sealing the top. The sealed bottles were placed near the window so that some energy is utilized by the biotic components during day time. Some of these have sustained life for nearly twenty years.

## Types of ecosystem based on energy resources

Ecosystems are based on two major source of energy, the sun and chemical or nuclear fuels. So, on the basis of the major input, there can be solar powered and fuel powered ecosystems. On the basis of energy resources, the ecosystems are classified as:

**1. Unsubsidized natural solar powered ecosystem:** In these types of ecosystem, the only source of power/energy is solar energy. For e.g.: ocean, upland forest, grasslands etc.

These are unsubsidized in the sense that there is no auxiliary source of energy available to supplement solar radiation/energy.

**2. Naturally subsidized solar powered ecosystem:** In these types of ecosystems the main source of energy is sun, which is originated by natural non solar energy. As a result of which extra amount of energy is available to the system that can be used for the production of more organic

matter that may be exported to other systems or stored in themselves. The auxiliary natural source of energy may be tides, waves and currents, wind, torrential rains etc.

**3. Man subsidized solar powered ecosystem:** In these types of ecosystems auxiliary fuels or other energy, like man and machine labor, is supplied by man. Here again, the main source of energy is sun. Examples of these types of ecosystems are agriculture and aquaculture. The power/energy input by man may be in the form of fertilizers, animal power, machine power, sprays etc.

**4. Fuel powered ecosystems:** In these ecosystems, the sun energy is replaced by highly concentrated potential energy of fuel, chemical or nuclear fuel. Examples of these systems are cities, suburbs, industrial parks, etc. these systems are man's wealth generating and also pollution generating systems. In this system there is no limit of energy input.

### 2.3.2-Structure

The structure of an ecosystem is basically a description of the organisms and physical features of environment including the amount of description of nutrients in a particular habitat. It also provides information regarding the range of climatic conditions prevailing in the area.

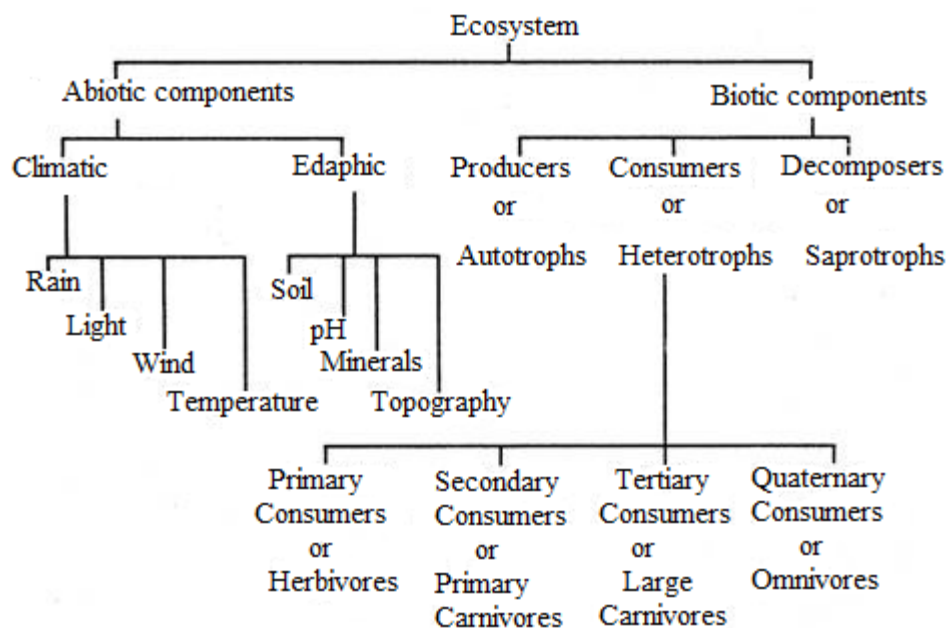

Fig.2.1 Schematic Representation of the Structure of an Ecosystem

---

## 2.4 ABIOTIC AND BIOTIC COMPONENTS

---

Each ecosystem has two main components:

**1. Abiotic components:** The non living factory or the physical environment prevailing in an ecosystem from the abiotic components. They have a strong influence on the structure,

distribution, behavior and inter-relationship of organisms. Abiotic components are mainly of two types:

- a. Climatic factors
- b. Edaphic factors

The functions of important factors in abiotic components are given below:

Soils are much more complex than simple sediments, they contain a mixture of weathered rock fragments, highly altered soil mineral particles, organic matter, and living organism, soils provide nutrition's, water, a none and a structural organism medium for fragments and organisms. The vegetation found growing on top of a soil is closely linked to this component of an ecosystem through nutrient cycling. The atmosphere provides organism found within ecosystem with carbon dioxide for photosynthesis and oxygen for respiration. The process of evaporation transpiration and precipitation cycle water b/w the atmosphere and the earth surface.

## 2- Biotic components:

The living organisms including plants animals and microorganisms (bacteria and fungi) that are present in an ecosystem from the biotic components. On the basis of their role in the ecosystem the biotic component can be classified into three main groups

**A. Producers:** The green plants have chlorophyll with the help of which they trap solar energy and change it into chemical energy of carbohydrate using simple inorganic compounds using namely water and carbon dioxide. This process is known as photosynthesis as the green plants manufactures their own food they are also known as autotrops. (i.e. auto= self, trophos= feeder). The chemical energy stored by the producer is utilized partially by the producer for their own growth and survival and the remaining is stored in the plants parts for their future use.

**B. Consumers:** The animal lack chlorophyll and are unable to synthesis their own food. Therefore, they depend on the producers for their food. They are known as hetrotrops. (i.e. htros= other, trophos= feeder). The consumers are of four types, namely

- i.** Primary consumers or first order consumer or herbivores: these are the animal which feed on plants are the producers, they are called herbivores. Examples are rabbit, deer, goat etc.
- ii.** Secondary consumer or second order consumer or primary carnivores: the animal which feed on the herbivores is called the primary carnivores. Examples are cats, foxes, snakes etc.
- iii.** Tertiary consumers or third order consumers: these are large carnivores which feed on secondary consumers. Examples are wolves etc.
- iv.** Quartinary consumer or forth order consumer or omnivores: these are the largest carnivores which feed on the tertiary consumers and are not eaten by the any other animals. Examples are lions, tigers, etc.

**C. Decomposers or reducers:** Bacteria and fungi belong to this group. They break down the dead organic materials of producers (plants) and consumer (animals). For there food and release

to the environment. The simple organic and inorganic substances produced as by products of their metabolisms. These simple substances are reused by the producers resulting in the cyclic exchange of materials b/w the biotic community and abiotic environment of ecosystem. The decomposers are known as saprotrophos (i.e. sparos= roftn, trophos= feeder).

---

## 2.5 FOOD CHAIN

---

**Definition:** - In an ecosystem the living organisms (biotic community) have a pattern of feeding. The producers are eaten by the herbivores. Herbivores in turn are eaten by carnivores. Carnivores may further be eaten by other larger carnivores. In this process the food energy is transferred from plants to herbivores to carnivores to larger carnivores who feed on them.

A food chain is a linear network of links in a food web starting from producer organics & ending at apex predator species, detritivores, or decomposer species.

<b>Tertiary consumer</b>	Fourth trophic level (Top Carnivores)	Man, lion
<b>Secondary consumer</b>	Third trophic level (Carnivore)	Birds, fishes wolf
<b>Primary consumer</b>	Second trophic level (Herbivores)	Zooplankton Grasshopper and cow
<b>Producer</b>	First trophic level	Phytoplankton grass, trees

### Characteristics of food chain:

1. In a food chain, there is a repeated eating in which each group eats the smaller one and is eaten by the larger are so a food chain involves a nutritive interaction between biotic components of an ecosystems.
2. The plants & animal which depend successively on one another from form the links of a food chain.
3. In a food chain there is a unidirectional flow of energy from sun to producers and then to a series of consumers of various types.
4. Usually there are 4 or 5 trophic level in the food chain shorter food chain will provide greater availability of energy and vice versa.
5. Omnivorous generally occupy more than are trophic level in the food chain.
6. Some organisms (e.g. man) occupy different trophic positions in different food chains.
7. The respiration cast increases along successive trophic levels of a food chain on an average, it is about 20% at producers level, about 30% at the level of herbivores, and as high as 60% at the level of carnivores. So the residual energy decreases at successive trophic levels.

8. A food chain consists of series of population which are related by eating & be eaten.
9. A food chain is generally straight.
10. The number of trophic levels is 3-6.
11. There is progressive reduction in available biomass energy & no. of individuals with the rise is trophic level.
12. In each trophic level a lot of biomass is consumed is liberating energy.
13. A major part of energy made available at each trophic level is lost as heat.
14. Some organisms like human operate at more than are trophic level.
15. Food chains are sustained by producers & decomposers.

### Types of food chain:

There are two basic types of food chain

**1- Grazing food chain (GFC):-** It is a simple food chain that extends from producers to herbivores to carnivores.

These types of food chains originate from plants & go to grazing animals and then on to animal eaters.

e.g.,- Phytoplanktons – Zooplanktons – fish

Grass – rabbit – fox – lion

Producers –	Herbivores –	Carnivores	Other Carnivores
(Primary consumer)	(Secondary consumer)	(Tertiary consumer)	

### Characteristics:

- (i) There are directly dependent on solar radiation as the primary source of energy.
- (ii) Green plants (or producers) form the first trophic level of the food chain. These synthesize their plant biomass by the process of photo synthesis in which kinetic energy of color radiations is trapped in the presence of  $Mg^{++}$  containing green pigment chlorophyll and is converted into potential energy of organic food (i.e glucose).
- (iii) Herbivores or primary consumers eat upon the producers and form the second trophic level.
- (iv) Herbivores are eaten up by carnivores which are of different categories.
- (v) These always end at decomposer level.

e.g.,- Phytoplanktons – zooplanktons – fish

grass – rabbit – fox – lion

### 2- Detritus food chain:

It begins with dead organisms or dead organic matter and passes through detritus feeding organisms in soil to organisms feeding on detritus feeders.

This type of food chain goes from dead organic matter into microorganisms to organisms feeding on detritivores & their predator. This system is thus less dependent on solar energy.

e.g.- Detritus – Earthworm – sparrow – Falcon



Frog --- Snake --- Peacock

**Characteristics:**

- (i) Primary energy source of detritus food chain is dead organic matter called detritus.
- (ii) Main source of dead organic matter are fallen leaves or dead animal bodies.
- (iii) Primary consumers are detritivores (detritus eating). These include protozoan's, bacteria, fungi etc. which feed upon the detritus saprophytically.
- (iv) The detritivores, in turn, are eaten by secondary consumers which include insect larvae, nematodes etc.
- (v) They are generally shorter than grazing food chain.
- (vi) In nature, detritus food chain is indispensable as the dead organic matter of grazing food chains is acted upon by the detritivores to recycle the inorganic elements into the ecosystem.

---

## ***2.6 FOOD WEB***

---

**Definition:** - A food web (or food cycle) is the natural interconnection of food chains and generally a graphical representation of what – eats – what in an ecological community. Another name for food web is a consumer resource system.

e.g.- grass or plants may be eaten by grass hoppers as well as rabbits, cattle and deer. Each of their herbivores may be eaten up by number of carnivores like frogs, birds, crickets and tiger depending on their food habits.

**Characteristics:**

- (i) In an ecosystem, no food chain is independent and the linear arrangement of food chains hardly occurs.
- (ii) It is formed by interlinking of 3 types of food chains. e.g., predatory chains (proceeds from smaller to larger organisms), parasitic chains (proceed from larger to smaller organisms) and saprophytic chains (starting from dead organic matter).
- (iii) Food web provides the alternative pathways of food availability. e.g., if a particular crop is destroyed due to some disease, the herbivores in that area do not perish as they can graze other type of crop or herbs. Similarly, Dogs (secondary consumers) may feed on rats and mice in the event of decrease in the number of rabbits on which they also feed. Greater number of these pathways, more stable is the ecosystem.
- (iv) These also help in checking the overpopulation of some species of plants and animals.
- (v) The age and size of the species and availability of food source are important factors in determining the position of an animal in a food web.
- (vi) Normally, a food web operates according to taste and food preferences of organisms at each trophic level for e.g. Tigers in Sunderbans eat fish and crab instead of their natural prey.
- (vii) Food web also helps in ecosystem developments time allows increasingly intimate associations and reciprocal adaptations between plants and animals.

- (viii) Food web is more real than food chain.
- (ix) It consists of a number of food chains interlinked at various trophic levels.
- (x) Food web is not straight. The component food chains do not run parallel.
- (xi) Food checks operate in food webs that keep the population of different species rarely constant.
- (xii) It is essential for satiability of ecosystem.

---

## ***2.7 ECOLOGICAL PYRAMID***

---

An Ecological Pyramid is graphical representation of the trophic structure and also trophic function. In ecological pyramid the first all producer level forms the base and successive level from the tier which make up apex.

The idea of ecological pyramid was developed by Charles Elton (1928). So the Ecological Pyramid are also called Eltonian Pyramid. An Ecological pyramid may be upright tapering towards the tip) or inverted (widen towards the tip) or spindle shaped (broader in the middle and narrow above and below an upright ecological pyramid indicated that the producers outnumber or outweigh the herbivores which in turn, Outweigh or outnumber the carnivores.

On basis of Ecological Parameters there are three types of ecological pyramid

1. The Pyramid of number
2. The pyramid of biomass
3. The pyramid of Energy

### **1. Pyramid of number**

It is graphic representation showing the arrangement of the number of individual organization at different level in an ecosystem is depicted.

There are three types of pyramid no.

- (a) Upright pyramid of Number.
- (b) Partially Upright pyramid of Number.
- (c) Inverted Pyramid of Number.

**(a) Upright Pyramid of Number-** This type of upright pyramid of number is found in grassland Ecosystem are band ecosystem the size of aquarium increase from the carnivore level while their no decrease in food chain.

**(b) Partially Upright pyramid of Number-** This type of pyramid is found in tree dominated Ecosystem single large size tree (T.) Is attacked by numerous minute plant eating and carnivorous insect (T3) which are further less by small sized (T4) and (T5).

**(c) Inverted Pyramid of Number-** In parasitic food chain e.g.:- an oak tree pyramid Number is an inverted pyramid in which single oak tree supports large no. of fruit eating birds and large no. of parasites. Hyper parasite like bacteria, fungi etc are the greatest in no. and occupy the top of inverted pyramid of number.

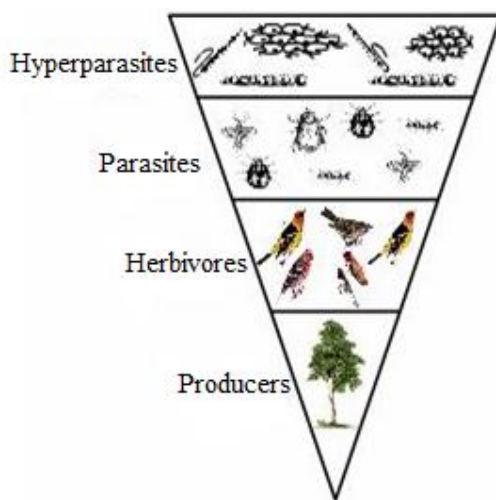

Fig.2.1 Inverted pyramid of number

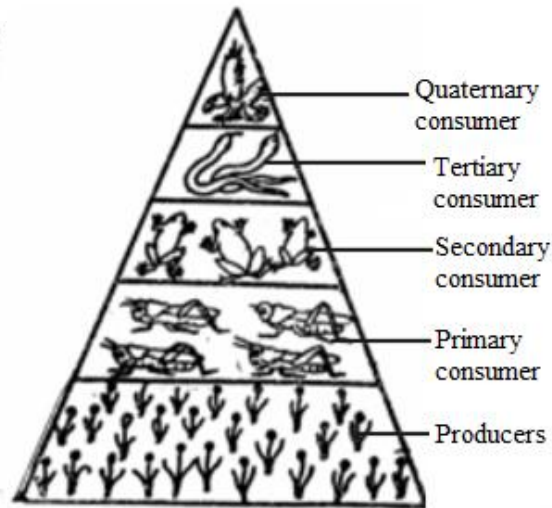

Fig.2.2 Pyramid of numbers in a grassland

## 2. Pyramid of Biomass

It is a graphic representation of biomass (total amount of living or organic matters in an ecosystem at any time) present per unit area in different tropic levels. A typical pyramid of biomass is more fundamental as it shows the quantitative relationships of the standing crop. Pyramid of biomass may also be straight or inverted. In grassland and forest ecosystems, there is a gradual decrease in biomass of organisms at successive tropic levels from producers onwards to top carnivores (uprights or straight pyramid). In pond ecosystem, on the other hand, produces are the smallest organisms while carnivores are large in size. Consequently, there is a gradual increase in biomass of Aryanisms at successive tropic levels from producers onwards to top carnivores resulting in inverted pyramid. There the biomass of phytoplanktons will be smaller than that of zooplanktons; the biomass of zooplanktons will be lesser than of primary carnivores (E.g. Small fishes). In such an inverted pyramid of biomass a small standing crop of phytoplankton supports a large standing crop of zooplanktons.

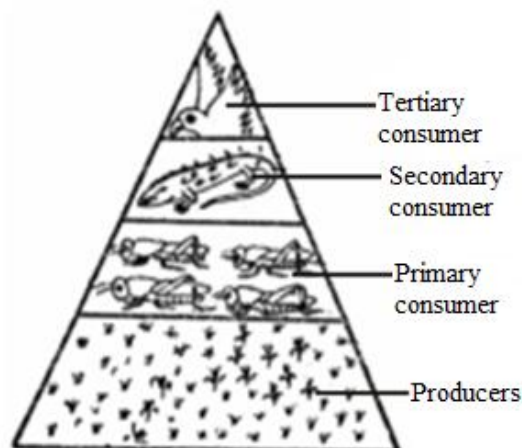

Fig.2.3 Pyramid of Biomass in a grassland

### 3. Pyramid of Energy

“An energy pyramid is a graphical model of energy flow in community. The different levels represent different groups of organisms that might compose a food chain. From the bottom-up, they are as follow: producers bring energy from nonliving sources into the community”. When the production of a community is measured in terms of energy. We find that a pyramid is formed starting from each trophic level. Than that was put into it. Energy pyramid gives the best information on the nature of the states of passage of food mass through the food chain.

There is always a gradual decreasing the energy content at successive levels from the producers to consumers.

The Source of energy for living being on earth is the sun. The energy that the sun emits at present is of  $1366.75\text{W}/\text{m}^2$ . When the studies of the capture of energy by the producer organisms (photosynthetic organisms) were made, the solar Irradiance (SI) was of  $1365.45\text{W}/\text{m}^2$ .

The energy usable by photosynthetic organisms is  $697.04\text{W}/\text{m}^2$ ; never the less, the photosynthetic organisms take only  $0.65\text{W}/\text{m}^2$  and the rest of the incident energy on the surface is transferred to the biotic surroundings (oceans, soil, atmosphere, etc) and from there, the energy is emitted to the outer space and to the gravity field. The atmosphere absorbs  $191.345\text{W}/\text{m}^2$ , maintaining the tropospheric temperature of earth in the hospitable  $35.40^\circ\text{C}$  ( $95.72^\circ\text{F}$ ).

Energy pyramid Example-

When Organisms eat other organism, energy is transferred.

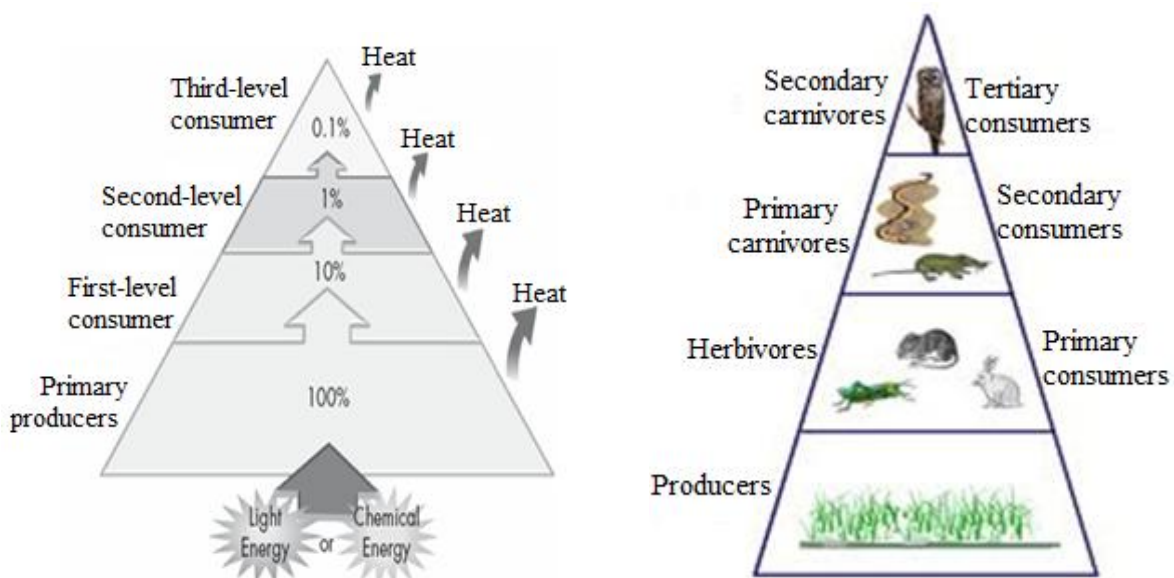

Fig.2.4 Pyramid of Energy

---

## ***2.8 ENERGY FLOW***

---

Energy flow is the movement of energy through an ecosystem from the external environment through a series of organisms and back to the external environment.

Every ecosystem resources energy for its survival. The supply of energy has to be continuous to maintain the biotic structures and their function. The energy flow refers to a cyclic movement of energy comes from the environment which is external to the ecosystem, passes through a series of organism, and then return to same external environment from where it has come. The flow of energy through an ecosystem is very essential requirement. The quality and quantity of energy flow helps to tell or decide the richness or poorness and shortness of life. The Biosphere, the sun is ultimate source of energy.

In every ecosystem the energy flow provides a foundation for life and thus impure a limit on shortness and richness of life. The behaviour of energy on ecosystem can be termed energy flow due to unidirectional flow of energy. From energetic point of view it is essential to understand for an ecosystem.

1. The efficiency of the producers in absorption and conversion of solar energy.
2. The use of this converted chemical form of energy by the consumers.
3. The total input of energy in form of food and its efficiency of assimilatory.
4. The loss through respiration, heat, excretion etc
5. The gross net production

Summarize in the flow of energy and inorganic nutrients through the ecosystem, a few generalizations can be made.

1. The ultimate source of energy (for most ecosystem is the scene)
2. The ultimate fate of energy in ecosystem is for it to be lost as heat.
3. Energy and nutrients are passed from organism to organism. Through the food chain as one organism eat another.
4. Decomposers remove the last energy from the remains of organism.
5. Inorganic nutrients are yield energy.

### **Continuous and One way flow of energy**

The nutrient low in a cyclic manner in different ecosystem. The non energy yielding components like C, N, H<sub>2</sub>O etc, also calculate from abiotic segment to biotic segments and vice versa. But the energy does not do so; it does not circulate rather flow unidirectionally.

The flow of energy is continuous and one way in every ecosystem. A Unidirectional flow of energy from “sun” to decomposer is shown in fig.2.5

The path of energy transverse through producers and main consumers before reaching decomposer. However it cannot flow in reverse direction. It is because of one way nature of energy flow.

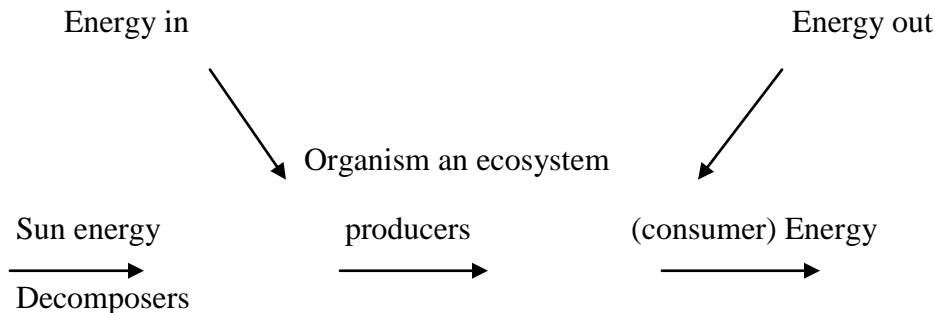

**Fig.2.5 Unidirectional flow of Energy**

## Ecosystem

Ecosystems maintain themselves by cycling energy and nutrients obtained from external sources. At the best trophic level, primary producers use solar energy to produce organic plant material through photosynthesis. Herbivore animals that feed solely on plant make up the second trophic level. Predators that eat herbivore comprise the third trophic level, if larger predators are present, they represent still higher trophic level and organisms that feed at survival trophic levels are classified as the highest on the trophic levels at which they feed. Decomposers which include Bacteria, fungi, worms and insects break down waste and dead organisms and return to the soil.

On average about 10 percent of energy production at one trophic level is passed on to the next level processes that reduce the energy transferred because consumers can conserve high quality food sources into new living tissue more efficiently than low quality food sources.

The low rate of energy transfers between trophic levels makes decomposers generally more important than producers in terms of energy flow. Decomposers process large amount of organic material and return.

How many trophic levels can an ecosystem support? The answer depends on served including the amount of energy entering the ecosystem, energy loss between trophic levels, and the formed structure and physiology of organism at each level. At higher trophic levels predators generally are physically layer and are able to utilize a fraction of the energy that was produced at level beneath them, so they have to over increasingly large area to meet their calorie needs.

Due to energy losses, most ecosystems have no more than five levels, and marine ecosystem is likely due to difference in the fundamental characteristics of land. Phytoplankton are small organisms with extremely simple structures so most of their primary production is consumed and used for energy by grazing organisms that feeds on them. In contrast, a large fraction of the bio mass that fund plant produce such as roots, trunks and branches cannot be used by herbivore for

food. So proportionally less of the energy fixed through primary production travels up the food chain.

The simplest way to describe the fluxes of energy through ecosystem is as a food chain in which energy passes from the one trophic level to the next, without factoring In more complex relationship between individuals species some very simple ecosystem may consist of food chain with only a few trophic levels for example the ecosystem of the remote wind spot Taylor valley in Antarctica consist mainly of bacteria and algae that are eaten by nematodes worms more commonly, however producers and consumers are connected in intricate food web with some consumers Breeding at several trophic levels.

Important consequences of the loss of energy between trophic levels that contaminants collect in an animal tissue a process called bioaccumulation

The insecticide DDT which was widely used in a USA from the 1940 s through the 1960s is a famous case of bioaccumulation. DDT build up in Eagle and other raptors to levels high enough to effect the reproduction, causing the birds to lay thin shelled Eggs that broke in their nests fortunately population have bound over nutrients to the ecosystem in a organic form which are then taken up again by primary producers. Energy is not recycled during decompositions but rather is released mostly as a heat.

An ecosystem is a gross primary productivity is the total amount of organic matter that is produces through photosynthesis net primary productivity describes the amount of energy that remains available for a plant to growth after subtracting the fraction that plant use for respiration productivity in land ecosystem generally rises with temperature upto 30`c after which is a declines and is positively corrected with moisture on land primary productivity thus is a highest in warm, wet zones in the tropics where tropical forest biomes are located in contrast desert have lowest productivity .

In the oceans light and nutrients are important controlling factors for productivity. Photosynthesis occurs in surface and near surface water.

Bioaccumulation can threaten humans as well as animal. For example in the USA many federal and state agencies currently warn consumer to avoid or limit their consumption of large predatory fish that contain high level of Mercury such as shark, swordfish. To avoid resting neurological damage and birth defects.

### **Energy flow in Ecosystem**

The behaviour of energy in ecosystem can be termed **energy flow** due to unidirectional flow of energy. From energetics point of view it is essential to understand for an ecosystem (i) the efficiency of the producers in absorption and conversion of solar energy, (ii) the use of this converted chemical form of energy by the consumers, (iii) the total input of energy in form of food and its efficiency of assimilation, (iv) the loss through respiration, heat, excretion etc, and (v) the gross net production.

**1-Single Channel Energy Flow Model:** The flow of energy takes place in an unidirectional manner through a single channel of green plants or producers to herbivores and carnivores. From the energy flow model shown in Fig.2.6, two things are clear:

- (i) There is unidirectional flow of energy. The energy captured by autotrophs does not revert back to solar input but passes to herbivores; and that which passes to herbivores does not go back to the autotrophs but passes to consumers. Due to one way flow of energy, the system would collapse if the primary sources of energy (i.e., sun) were cut off.
- (ii) At each trophic level, there occurs progressive decrease in energy. This is accounted largely by the energy lost as heat in metabolic reactions (respiration) coupled with unutilized energy.

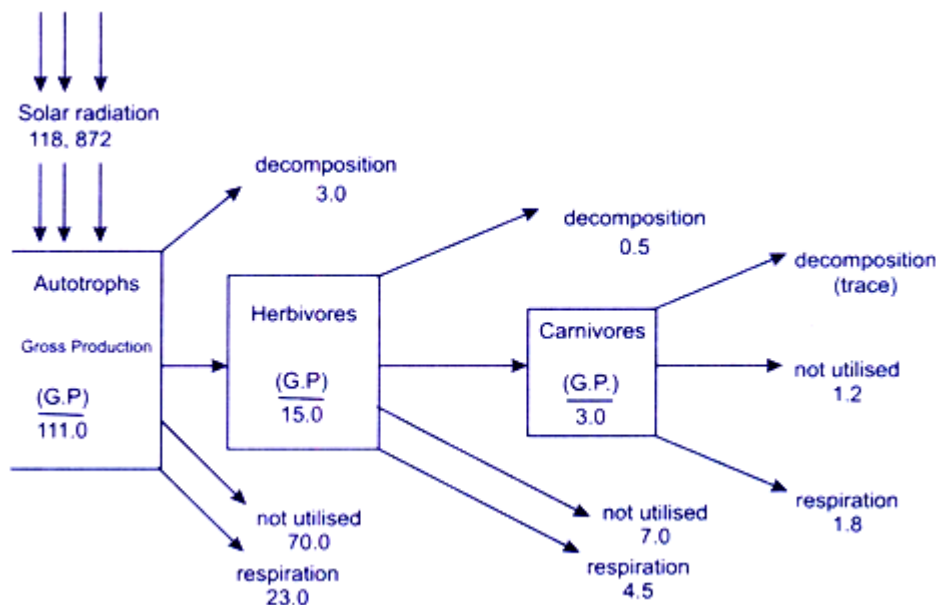

**Fig.2.6 Energy flow diagram for a lake (freshwater ecosystem) in g cal/cm<sup>2</sup>/yr**

Fig.2.7 depicts a simplified energy flow model of three trophic levels. One can clearly note that the energy flow is greatly decreased at each successive trophic level starting from producers (autotrophs) to herbivores and then to carnivores. In the Figure, boxes represent the trophic levels and pipes represent the energy flow in and out of each level. Working of both the laws of thermodynamics is clearly seen as energy inflows balance outflows at each trophic level (as per first law of thermodynamics) and energy transfer is accompanied by dissipation of energy into unavailable heat i.e., respiration as per the second law of thermodynamics. Thus, of the total 3,000 kcal of light falling upon green plants, 1,500 kcal (50%) is absorbed level (first trophic level). 1% (15 kcal) is converted at autotroph level (first trophic level). Thus, net production is nearly 15 kcal. Secondary productivity (shown as P<sub>2</sub> and P<sub>3</sub> in Fig.2.7) tends to be about 10% at successive consumer levels i.e., at herbivore level and carnivore level. As has earlier been mentioned, there is successive decrease in energy flow at successive trophic levels. Therefore, shorter the food chain, greater would be the available food energy.



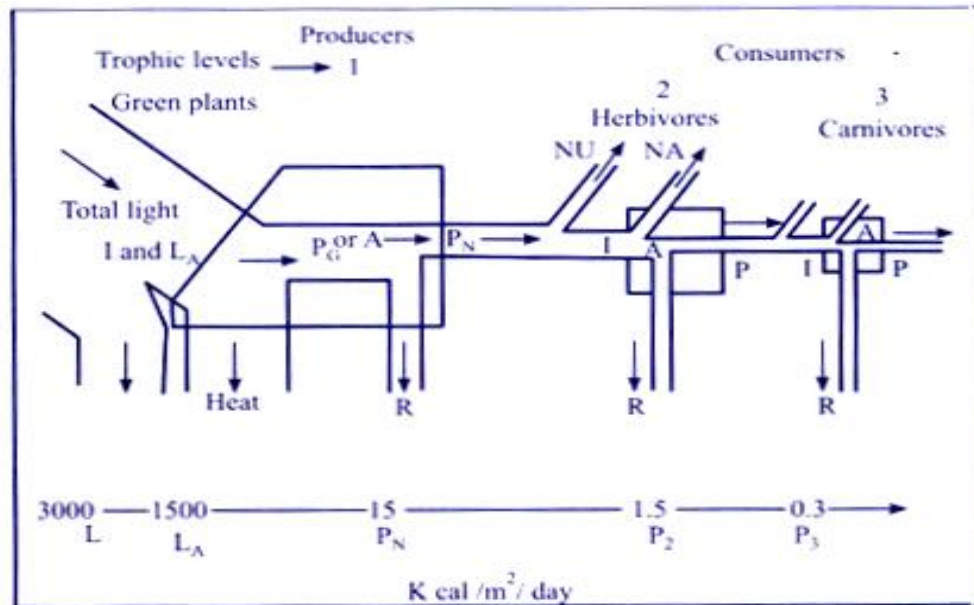

Fig.2.7 A simplified energy flow diagram showing three trophic levels

**2-Y-Shaped or Double Channel Energy Flow Model:** Fig.2.8 describes Y-shaped energy flow models as pioneered by H.T. Odum in 1956. This model shows a common boundary, light and heat flows as well as the import, export and storage of organic matter. Decomposers are placed in a separate box as a means of partially separating the grazing and detritus food chains. In terms of energy levels, decomposers are, in fact, a mixed group. The significant part in Y-shaped model is that the two food chains are not isolated from each other.

Y-shaped energy flow is more realistic and practical than the single-channel energy flow model because of following points:

- (i) It conforms to the basic stratified structure of ecosystems.
- (ii) It separates the two chains i.e., grazing food chain and detritus food chain in both time and space.
- (iii) Microconsumers (e.g., bacteria, fungi) and the macroconsumers (animals) differ greatly in size-metabolism relations in two models.

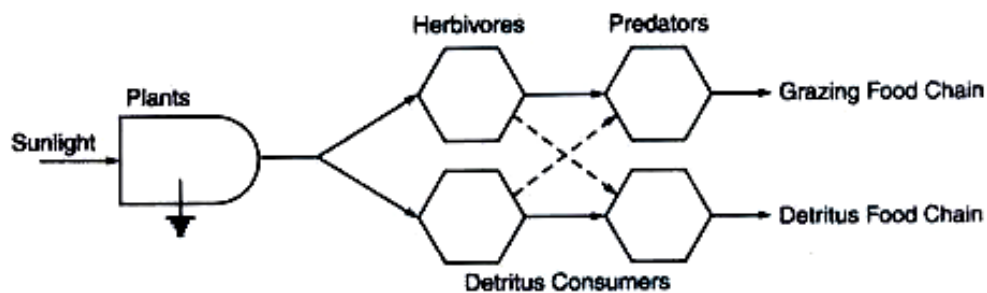
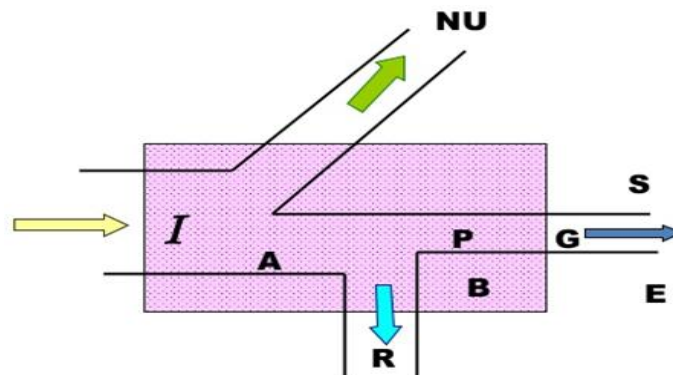

Fig.2.8 Y-shaped energy flow model showing linkage between the grazing and detritus food chains

**3- Universal Energy Flow Model:** E.P. Odum (1983) gave a generalized model by combining both single channel model and Y-shaped models which are both applicable to terrestrial and aquatic ecosystem and this combined model is known as Universal energy flow model. In this model I- Incident solar rays; A- Assimilated energy; P-net production; G-Growth; B-Biomass; R-Respiration; S-Stored energy; E-Excreted energy; NU-Unutilized energy.

This model can be used in two ways as:

- It can represent a species population in which case the appropriate energy inputs and links with other species would be shown as a conventional species oriented food levels and
- The model can represent a discrete energy level in which case the biomass and energy channels represent many populations supported by the same energy source.



I=input or ingested energy; NU= not used; A= assimilated energy; P = production; R= respiration; B= biomass; G = growth; S= stored energy; E= excreted energy

**Fig.2.9 Components for a Universal model of energy flow**

---

## ***2.9 PRODUCTIVITY IN AN ECOSYSTEM***

---

The amount of food energy produced or obtained or stored by a particular trophic level per unit area, in a unit time is referred to as productivity. It is a rate function and is expressed in terms of dry matter and energy captured per unit area of land per unit time. It is generally expressed in terms of gm<sup>-2</sup> year<sup>-1</sup> or kcal m<sup>-2</sup> year<sup>-1</sup>.

In ecology, productivity or production refers to the rate of generation of biomass in an ecosystem. It is usually expressed in units of mass per unit surface (or volume) per unit time, for instance grams per square metre per day (gm<sup>-2</sup>d<sup>-2</sup>). The mass unit may relate to dry matter or to the mass of carbon generated. Productivity of autotrophs such as plants is called primary productivity, while that of the heterotrophs such as animals is called secondary productivity.

**1. Primary productivity:** It refers to rate at which sunlight is captured by producers for the synthesis of energy-rich organic compounds.

Primary production is the synthesis of new organic material from inorganic molecules such as H<sub>2</sub>O and CO<sub>2</sub>. It is dominated by the process of photosynthesis which uses sunlight to

synthesize organic molecules such as sugar, although chemosynthesis represents a small fraction of primary production. Organisms responsible for primary production includes land, plants, marine algae and some bacteria (including cyanobacteria).

Primary production is the synthesis of organic compounds from atmospheric or aqueous carbon dioxide. It principal occurs through the process of photosynthesis, which uses light as it source of energy, but it also occurs through chemosynthesis, which uses the oxidation or reduction of inorganic chemical compounds as it source of energy. Almost all life on earth relies directly or indirectly on primary production. The organisms responsible for primary production are known as primary producers or autotrophs and forms the base of food chain. In terrestrial ecoregions, these are mainly plants, while in aquatic ecoregions algae predominates in this role. Ecologist distinguish primary production as either net or gross, the former accounting for losses to processes such as cellular respiration, the latter not.

Under primary productivity it is again classified in two types:

**(a) Gross primary productivity (G.P.P.) or Total photosynthesis:** During the measurement period, the total photosynthesis including the amount of organic matter used up in respiration is called as gross primary productivity.

It is defined as the total rate of photosynthesis during the measurement period. The rate of gross productivity is limited by the number and activity of producers and by the amount of solar energy available. It is associated with photosynthetic and chemosynthetic organisms. It includes green plants, photoplanktons and bacteria. The rate of primary productivity is estimated in terms of either chlorophyll contents as chl/g dry weight/unit area, or photosynthetic number i.e., amount of CO<sub>2</sub> fixed/g chl/hr.

**(b) Net primary productivity (N.P.P.):** It refers to gross production minus losses by way of respiration and decomposition ( $GPP - \text{losses} = NPP$ ). It is called as apparent photosynthesis.

It is defined as the rate of storage of organic matter in plants in excess of the organic matter used up in respiration during the period of measurement. Thus by definition it is the balance between total photosynthesis and respiration. It is also known as net assimilation. It is the energy which is potentially available to the next trophic level.

Net primary production is the rate at which all the plants in an ecosystem produce net useful chemical energy; it is equal to the difference between the rate at which the plants in an ecosystem produce useful chemical energy (GPP) and the rate at which they use some of that energy during respiration.

**2. Secondary Productivity:** The rate of energy storage at consumer's level is called secondary productivity. The total energy flow at heterotrophic levels, which is analogous to gross production of autotrophs should be distinguished as assimilation and not production. This productivity is not static.

The efficiency of any ecosystem greatly depends upon the production rates of its primary producers. Oceans form the largest ecosystem and their productivity varies in different regions. On the shores, the productivity may be 2 to 3.5 g/m<sup>2</sup>/day, and in deep seas only 0.5g. In highly productive lakes the productivity value may be 5 to 10 g/m<sup>2</sup>/day and reaches up to 50g in exceptionally favorable conditions. The net productivity of crop plants ranges from 0.25 to 1 kg or a little more for wheat and rice crops per m<sup>2</sup>/year. Sugarcane is one of the very efficient converters of solar energy and its NPP value ranges from 2 to 4 kg/m<sup>2</sup>/year or even more.

On the other hand, secondary productivity is associated with the heterotrophic and saprophytic types of nutrition and applies to all consumers and decomposers. The primary productivity remains largely in situ, while the secondary productivity remains mobile and potential for dispersion.

**3. Net Productivity:** The amount of the food energy not utilized by heterotrophs per unit area time is referred to as net productivity.

N.P.P.- Consumption of heterotrophs = N.P.

---

## ***2.10 BIOGEOCHEMICAL CYCLES (MATERIAL CYCLES)***

---

The major plant nutrients derived from soil are nitrogen, phosphorus, potassium, because these are biologically available to plants, out of these three nutrients .

**Nitrogen** stands out as the most significant to microbial transformations as it builds up protein and many components of micro organisms, plants and animal .

**Phosphorus** is the 2<sup>nd</sup> to nitrogen which is required by both plants and microorganisms. It plays an important role in release of energy during metabolism .

**Potassium** which is obtained from soil. In addition, there are many important chemicals present in plants, animals and micro organisms.

**Principle:** The nutrients flow from non living to living and they again return back to non living in the form of waste product or dead bodies' i.e., the nutrients are neither created nor destroyed.

### **Aspects of a Nutrient Cycle**

#### **Input of Nutrients**

In this, an ecosystem receives the nutrients from external sources and stores them for their reutilization in the biological processes for the growth and development of living organisms.

#### **Output of Nutrients**

In this type of nutrients are mixed out of an ecosystem e.g loss of nutrients like calcium, magnesium etc through runoff water and soil erosion.

**Internal cycling of nutrients**

1. Regeneration of nutrients during decomposition of detritus by bacteria and fungi.
2. Nutrients absorption involves uptake of nutrients from soil by the plants.

**2.10.1 Nitrogen Cycle****Importance of Nitrogen**

Nitrogen is found in the atmosphere in the concentration (78%)-gaseous state. It is an essential constituent of proteins and nucleic acid and chlorophyll found in organisms .Nitrogen is essential constituent of protoplasm.

Conc. Of Nitrogen In Soil Directly Proportional To Soil Fertility Is Directly Proportional To Microbial Activity

The nitrogen cycle can be further conveniently discussed under the following heads:

**Nitrogen fixation** :It is a process of conversion of gaseous form of nitrogen into combined forms i.e. ;ammonia or organic nitrogen by some bacteria and cyanobacteria .These are free living as well as symbiotic living organisms which fix N<sub>2</sub> into proteins . The nitrogen –fixing, micro-organisms are called diazotrophs and the phenomenon of this activity is known as daizotrophy .

The nitrogen fixation is done by;

Bacteria e.g.; Rhizobium.

Cyanobacteria e.g Aulosoria , nostoc .

**Industrial fixation:** nitrogen and hydrogen combines to form ammonia industrially under extremely high temp of 400 and a high pressure of about 200 atmospheres

**Ammonification:** It is the decomposition of proteins, urea, uric acid etc by micro organisms like ammonifying bacteria, actinomycetes and fungi .They convert nitrogen presenting wastes dead wastes and decaying bodies into ammonia compounds. The process of conversion of organic nitrogenous compounds into ammonia ammonification

Ammonifying bacteria =Bacillus remosur ,B vulgaris

In this process ,energy is also produced ,ao called as exothermic process

PROTIENS  $\implies$  AMINO ACIDS  $\implies$  AMMONIA

**Nitrification:** It involves the oxidation of ammonia or ammonium ions to nitrate ions in the presence of nitrifying bacteria is known as nitrification . The ammonium acts as the starting point for nitrification.

AMMONIA  $\implies$  nitrosomonas nitrates  $\implies$  nitrobacteria nitrates

These nitrates are absorbed by the plants from the soil

**Denitrification** ;It is a biological process by which ammonium compounds nitrates are reduced to molecular nitrogen .Nitrogen in the presence of de nitrifying bacteria like bacillus subtilis etc. It reduces the soil fertility

It involves the following steps

$\text{NO}_3$  ----- $\text{NO}_2$ (nitrate)

$\text{NO}_2$ -----  $\text{NO}$  (nitrous oxide )

$\text{NO}$ ----- $\text{N}_2\text{O}$ (NITRIC oxide

$\text{N}_2\text{O}$ ----- $\text{N}_2$ (nitrogen)

Free nitrogen refers to the atmospheric poor and nitrous and nitric oxides are taken up by the plants.

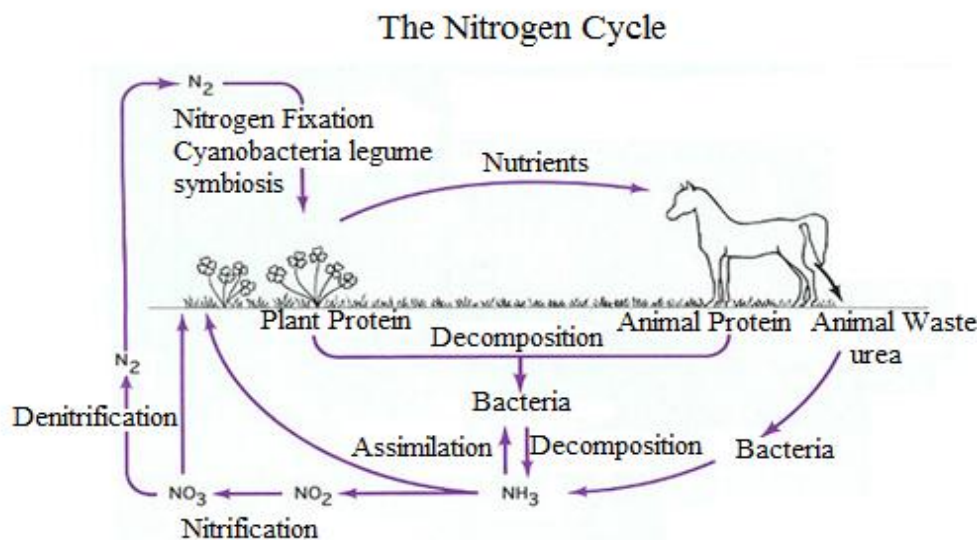

**Fig.2.10 Nitrogen Cycle**

## 2.10.2 Oxygen Cycle

### Sources of oxygen

Oxygen is the most abundant of all elements .It occurs in the free form as  $\text{O}_2$  and makes up to 21% by volume of the atmosphere. Oxygen makes up 46.6% by weight of the earth's crust. It combines 89% of weight of oceans .Oxygen occurs as ozone  $\text{O}_3$  in the upper atmosphere and is of great importance. Under normal conditions oxygen exists as gas organisms respire aerobically in the presence of oxygen .During respiration; it combines with hydrogen to form water.

**Oxygen Utilization:** It enters the plants and animals through respiration during which carbohydrate is oxidized to form  $\text{CO}_2$  and water .It is also used in combustion of wood, coal, petroleum, etc to yield  $\text{CO}_2$ ,  $\text{SO}_2$  water etc .The oxygen in the atmosphere is in a state of dynamic equilibrium. Organisms get it from air or water for respiration.

**Oxygen production:** Oxygen is mainly produced during the photolysis of water in the light phase of photosynthesis. Oxygen returns to the surroundings in the form of  $\text{CO}_2$  and  $\text{H}_2\text{O}$ . It also

enters the plant body as  $\text{CO}_2$  or  $\text{H}_2\text{O}$  during photosynthesis and is released in the form of molecular as a big product in the same process for use in respiration. Thus the cycle is completed

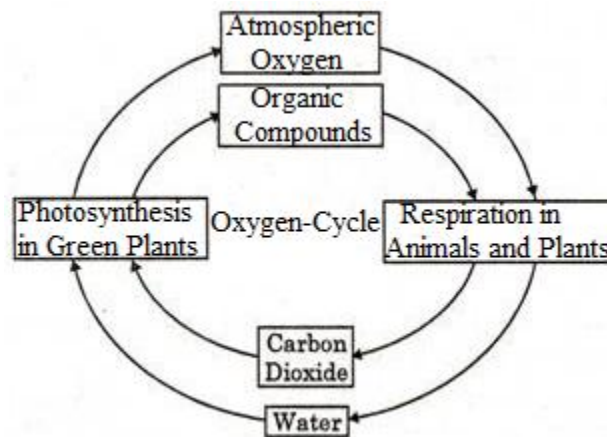

Fig.2.11 Oxygen cycle

### 2.10.3 Carbon Cycle

**Importance of carbon:** Carbon is the most important element of the protoplasm. It is the major constituent of carbohydrates, proteins, fats and nucleic acid of the cells of an organism. So, carbon is generally considered as the basis of life. Carbon constitutes 49% of the dry weight of organisms.

**Sources of carbon:** In the biosphere there are four sources of carbon

- 1- As carbon in atmosphere and in water (oceans). They act as reservoirs of carbon. In atmosphere 0.034% carbon is present. It constitutes about 1% of total global C.
- 2- As carbon molecule in fossil fuels like coal is petroleum.
- 3- As carbonates in the rocks of earth's crust.
- 4- Oceans where it remains stored as bio carbonates as limestone and marble rocks.

Thus the major reservoirs of carbon in the biosphere are atmosphere, oceans and fossil fuels.

**Carbon utilization:** carbon present in the atmosphere is the basic source that enters the organism through photosynthesis by plants or producers and then to herbivores to small and large carnivores and finally to decomposers. During photosynthesis  $\text{O}_2$  is released as a byproduct.

**Carbon production:**  $\text{CO}_2$  is returned back to atmosphere to various sources like.

- 1- During respiration plants and animals release carbon back to the surrounding medium as  $\text{CO}_2$ .
- 2- By decomposition of organic wastes and dead bodies by decomposers by the action of bacteria and fungi.
- 3- By burning or combustion of fossil fuels and wood.
- 4- Volcanic eruption and hot springs also release  $\text{CO}_2$  in the atmosphere.

5-Weathering of carbonate contains rocks also add to  $\text{CO}_2$  in atm.

Hence carbon cycling occurs through atmosphere occurs and living and dead organisms. The 'C' cycle is the perfect cycle in the sense that carbon is required to atm. as soon as it is required. The recycling of carbon is essentially a self regulating feedback system. However, human beings may upset the system by excessive use of fossil fuels and other activities like deforestation massive burning of fossil fuels etc.

Carbon cycle is an example of one way cycle.

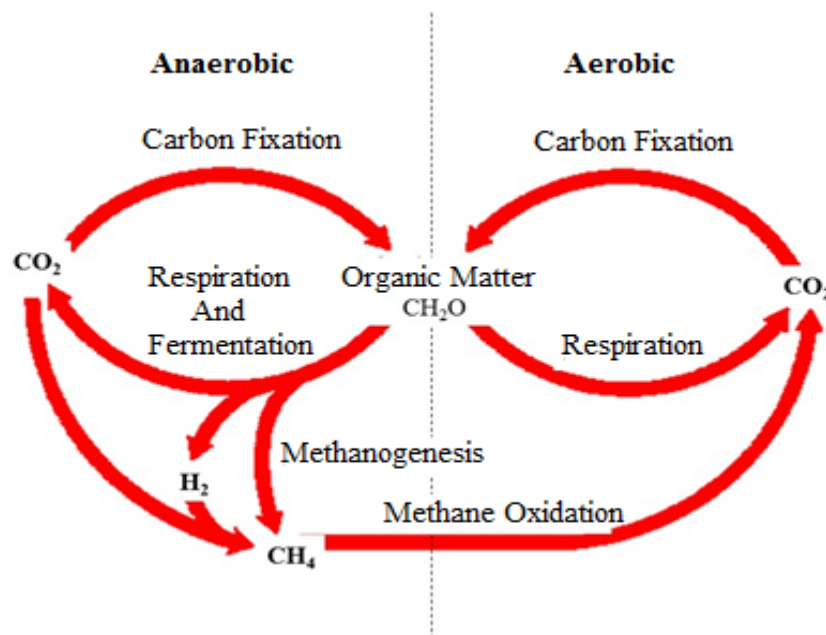

Fig.2.12 Carbon Cycle

## 2.10.4 Sulfur cycle

### Importance of Sulfur

It is an essential nutrient of plants and animals. Sulfur is a component of three amino acids (cystine, cysteine and methionine). So it is a component of most proteins some enzymes and vitamins.

### Sources

It is the most abundant in the earth's crust in low concentration and is unavailable to plants. Sulfur is a sedimentary cycle as it is found in nature as element and also as sulphates in soil, water and rocks. So the reservoir of elements in the soil.

Organic and inorganic forms of Sulfur compounds are micro biologically metabolized in soil through a different transformation process as given below .

1. Decomposition of organic Sulfur compounds by micro organisms into smaller units and finally into inorganic compounds .



2. Assimilation of simple Sulfur compounds and their incorporation into bacterial fungi and actino myctes cells
3. Inorganic ions or compounds such as sulfides thio sulfate and essential Sulfur.
4. Reaction of sulphate and other anions to sulfide.

### Sulfur Utilization

1. Producers (green plants need Sulfur in the form of sulphates ( $\text{SO}_4$ ) from soil or water (aquatic plants). some plants get their Sulfur in the form of amino acids.
2. Animals get Sulfur by feeding plants or animals
3. Animals get Sulfur through food chain.

### Sulfur Production

After the death of plants and animals they are decomposed by aerobic microbes like *Aspergillus neurospora* and anaerobic microbes releasing hydrogen sulphide ( $\text{H}_2\text{S}$ ).

1. A part of  $\text{H}_2\text{S}$  is obtained to soluble sulphates by Sulfur bacteria like thio bacillus while Beggiatoa (colorless, Sulfur, bacteria) oxidize a part of  $\text{H}_2\text{S}$  to essential Sulfur.
2. Many industries release  $\text{SO}_2$  in the atmosphere. As the lichens are very sensitive to  $\text{SO}_2$  they disappear in polluted air containing  $\text{SO}_2$ .
3. Fossil fuels in burning release  $\text{SO}_2$  into the air.
4. Volcanic emissions also add sulphates to soil and air.
5. The filamentous fungi(e.g., species of asper genus . penciliian , micro sperm) , produce Sulfur from organic substances such as methonine and cystine etc

Sulfur cycle is an perfect example as Sulfur has the potential for being bound under anaerobic conditions to cations like iron and calcium to form highly insoluble ferrous sulphide ( $\text{FeS}$ ) ferric sulphide (Ferric) sulphide ( $\text{Fe}_2\text{S}_3$ )or calcium sulphate ( $\text{CaSO}_4$ ).

$\text{SO}_2$  is a major source of air pollution atmospheric Sulfur in the form of elemental Sulfur or  $\text{H}_2\text{S}$  or  $\text{SO}_2$  is oxidized to  $\text{SO}_3$  which combines with water to form Sulfuric acid which comes from land acid rain.

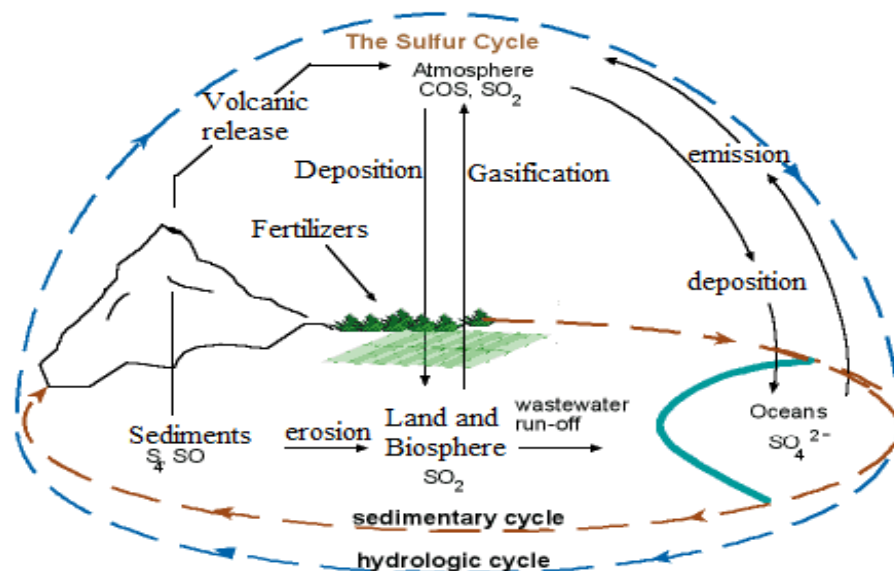

Fig.2.13 The Sulfur Cycle

## 2.10.5 Phosphorus Cycles

### Importance of phosphorus cycle:

It is an important constituent of protoplasm and for metabolism of all living organisms. It is the constituent of energy in rich compounds e.g. ADP, ATP, & GTP. It is also found in plasma membrane, bones and teeth. 'P' is also required for encoding of the information in genes as it is also the component of nucleotides of n.a.

### Sources of Phosphorus:

The major store house of the potassium is the rock deposits. Agriculture crops contain 0.05 to 0.5% of phosphorus in their tissue. In soil 15 to 85% of total 'P' is organic. Potassium cycle is an example of sedimentary cycle having its main reservoir in insoluble ferric and calcium phosphate as rocks. 'P' is usually used in phosphate form.

### Phosphorus cycle Pathway:

In the phosphorus cycle the main importance comes from the weathering. Weathering of phosphorus contain rocks and deposits. In soil potassium gets released from rocks and deposits from weathering. Some plants may be added to soil by man in the form of natural fertilizer. The plants get potassium from soil especially as ortho-phosphate  $\text{PO}_4$  ions and are then transferred to consumers and decomposers as organic phosphate through food chain.

Absorption of potassium by the higher plants is promoted by the presence of mycorrhizae.

**Decomposition:** Potassium goes back to soil by decomposition of dead and decay organisms especially by phosphate- solubilizing bacteria.

‘P’ cycle is imperfect cycle as the biological process like teeth and bone formation and excretion account for considerable losses of phosphorus from the cycle.

High concentration of phosphorus in natural water causes eutrophication and pollution.

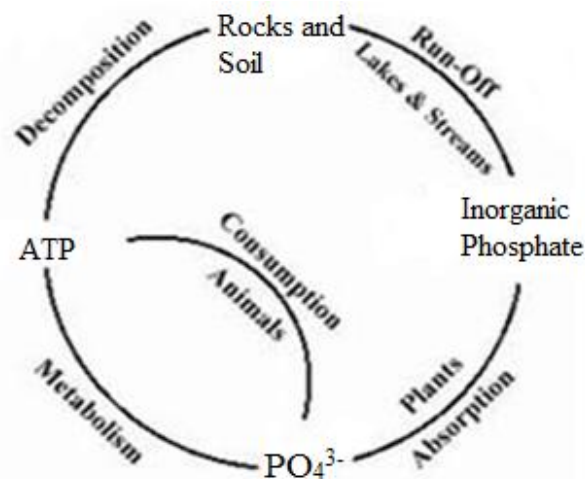

Fig.2.14 Phosphorus Cycle

---

## 2.11 SUMMARY

---

1. Ecosystem made of a biotic (non living environmental) and biotic & components and these basic components are important to nearly all types of ecosystem. Ecosystem ecology looks at energy transformation and biogeochemical cycling within ecosystem.
2. Energy is continually input into an ecosystem in the form of light energy and some energy is lost with each transfer to highest specification tropic level. Nutrients on the other hand are recycled within an ecosystem and their supply normally limits biological activity so “energy flows elements cycle”.
3. Energy is moved through an ecosystem via a food web which is a model up of interlocking food chains. Energy is first captured by photosynthesis (primary production) the amount of primary production determines the amount of energy available at higher tropic levels.
4. The study of how chemical elements cycle through an ecosystem is termed biogeochemistry. A biogeochemical cycle can be expressed as a set of stores and transfers can be studied using the concept of stoichiometry “mass balance” and “resident time”.
5. Ecosystem function is control mainly by two system “top down” and “bottom up” controls.
6. A biome is a major vegetation type extending over a large area. Biome distributions are determined largely by temperature and precipitation patterns on the earth surface.

Geographical Area, Mean Plant Biomass and Productivity In Major World System

Ecosystem	Area	Mean Plant Biomass	Mean net primary productivity
-----------	------	--------------------	-------------------------------

Tropical rain forest	17	440	20
Tropical deciduous forest	8	360	15
Temperate coniferous forest	12	200	8
Temperate deciduous forest	7	300	12
Savanna	15	40	9
Temperate grassland	9	20	5
Desert Shrub	18	10	0.7
T= ton= 1000kg			
Ha= 10,000 meter square			

---

## 2.12 GLOSSARY

---

**Abiotic components:** The non living factory or the physical environment prevailing in an ecosystem from the abiotic components.

**Biotic:** Living; usually applied to the biological aspects of an organism's environment, i.e. the influence of other organisms (opposite of abiotic).

**Biogeochemical Cycle:** The movement of chemical elements between organisms and non-living compartments of the atmosphere, lithosphere and hydrosphere.

**Biogeography:** The study of the geographical distribution of organisms.

**Biomagnification:** The increasing concentration of a compound in the tissues of organisms as the compound passes along a food chain

**Biomass** (organic matter): Total dry weight of all organisms in a particular population, sample or area; [J/m<sup>2</sup>];

**Community:** The species that occur together in space and time; (see diversity and isotherms).

**Cycle:** Biogeochemical cycles on a global and local scale.

**Decomposer:** Organisms (bacteria, fungi, heterotrophic protists) in ecosystems that break down complex organic material into smaller inorganic molecules that then are recirculated.

**Denitrification:** The conversion of nitrate to gaseous nitrogen; carried out by a few genera of free-living soil bacteria.

**Density:** In relation to population, the number of individuals in a certain amount of space.

**Disturbance:** In community ecology, an event that removes organisms and opens up space which can be colonized by individuals of the same or different species.

**Detritus:** Primary energy source of detritus food chain is dead organic matter called detritus.

**Ecosystem:** All of the organisms of a given area and the encompassing physical environment.

**Epidemic:** The outbreak of a disease which affects a large number and/or proportion of individuals in a population at the same time.

**Food chain:** A sequence of transfer of food energy from organism in one trophic level to those in other.

**Food Web:** A graphic depiction of the interrelationships by which organisms consume other organisms showing the complex and interlocking series of food chains.

**Productivity:** The rate at which biomass is produced per unit area by any class of organisms (see biomass).

**Population:** Any group of individuals, usually of a single species, occupying a given area at the same time; groups of organisms with homologous (same) alleles.

**Organic:** Pertaining to living organisms in general, to compounds formed by living organisms, and to the chemistry of compounds containing carbon.

**Organism (individual):** Any individual living creature, either unicellular or multicellular.

---

## 2.13 REFERENCES

---

- LINK=<http://www.yourarticlelibrary.com/environment/ecosystem/ecosystems-concept-structure-and-functions-of-ecosystem-with-diagram/28211/>
- <https://en.wikipedia.org/wiki/food-chain>
- [www.biocab.org/Energy.Pyramid.htm](http://www.biocab.org/Energy.Pyramid.htm).
- <https://en.m.wikipedia.org>.
- <http://www.google.com.in/search?energy+flow+of+ecosystem&aqs>
- <https://en.m.wikipedia.org/wiki/productivity>
- Dhameja S. K. ,Environmental studies , Page No. 131
- Deshwal S. and Deshwal A., page No. 3.19
- Kumar Satish and Deepshikha ,Environmental Studies
- Sharma Balwant ,Modern publisher
- Sharma P.D., Ecology and Environmental studies, Rastogi publication.
- 1990, Concise Science Dictionary, Oxford University Press.
- Annual reports of ministry of Environmental and Forests.
- 2002, Glossary of Useful terms in EIA, a Wildlife Institute of India Publication.

---

## 2.14 SUGGESTED READINGS

---

- Ecology in practice, Castri and Barker
- Environmental studies , S.C. Shantra
- Ecosystem Ecology, David G. Raffaelli
- Fundamental concepts in Environmental studies by Dr. D.D .Mishra
- Ecology and Environment Rastogi publication (PD Sharma)
- Environmental studies (Dr. Suresh K. Dhameja)

---

## 2.15 SELF ASSESSMENT QUESTION

---

**2.15.1 Objective type Questions:**

1- Natural ecosystem carries out many public service functions for us like –

- a) Air pollutants from automobiles.
- b) Wastewater from houses & industries is often converted to drinkable water through natural ecosystem, such as soil.
- c) Both of them.
- d) None of the above.

2- Which of the following statement are correct about ecosystem classification

On the basis of energy resources:

P: Naturally subsidized solar powered ecosystem.

Q: Fuel powered and radioactive ecosystem.

R: Unsubsidized natural and man subsidized solar powered ecosystem

S: Fuel powered and thermal powered ecosystem.

- a) P, and R
- b) Q and S
- c) P, Q and R
- d) P, R, and S

3- Chemosynthetic bacteria found around deep sea vents are example of

- a) producers
- b) consumer
- c) chemical cycling
- d) decompsers

4- Decomposers includes:

- a) Fungi and bacteriophage
- b) Bacteria and virus
- c) Fungi and algae
- d) Fungi and bacteria

5- Autotrophs are also known as –

- a) producers only
- b) lithotrophs
- c) lithotrophs and producers
- d) producers and osmotrophs

6-Which of the followings are correct for decomposers:

P: saprotrophs and osmotrophs .

Q: reducers and scavenger only.

R: saprotrophs and reducers.

S: scavengers and detritivores

- a) P and R
- b) Q and S
- c) R and Q
- d) P, Q, R, and S

7- Food web is a natural inter connection of food chains.....

- a) on ecosystems
- b) in ecosystems
- c) with in ecosystem
- d) at ecosystem

8- Which of the following trophic levels would have the largest number of individual

- a) primary producers                                        b) primary consumer  
c) opportunistic feeders                                      d) scavenger

9- Productivity is generally expressed in terms of:

- a) gm<sup>2</sup>year<sup>-1</sup> only    b) gm<sup>2</sup>year<sup>-1</sup> and tonnes per hectare  
c) K cal m<sup>-2</sup> year    d) both b and c

### **2.15.2 Fill in the blanks:**

- 1- Set of ecosystems within geographical regions which are exposed to .....
- 2- Aquatic biome falls into ..... categories.
- 3- Example of unsubsidized natural solar powered ecosystem are.....
- 4- Some organisms occupy ..... in different food chain.
- 5- There is.....reduction in available biomass, energy and no. of individual with the rise in trophic level.
- 6-.....food chain begins with dead organism or dead organic matter.
- 7- The idea of ecological pyramid was developed by.....in.....
- 8- Partially upright pyramid of number is found in.....
- 9- The quality and quantity of energy flow helps to tell the.....of life.
- 10- Process of nitrification involves the oxidation of .....into.....

### **Answer Keys:**

**2.15.1** - 1. c, 2. d, 3. a, 4. d, 5. c, 6. a, 7. c, 8. a, 9. d.

**2.15.2**- 1-Same Climatic Condition and Physical Structure, 2-Two, 3- Ocean, Upland forest, Grasslands, 4-Different trophic Position, 5-Progressive, 6- Detritus, 7-Charls Elton, 1928, 8-Tree dominated Ecosystem, 9- Richness or Poorness and Shortness, 10-Ammonium Ion, Nitrite

## ***2.16 TERMINAL QUESTIONS:***

### **2.16.1 Write short notes on --**

- 1-*Lithotrophs*
- 2- Pyramids of biomass
- 3- Scavenger and Decomposers
- 4- Predator
- 5- Ammonification
- 6- Net primary product
- 7- Edaphic factor

- 8- Importance of phosphorous cycle
- 9- Basis of energy flow
- 10- Man subsidized solar powered ecosystem

**2.16.2 Long answer type questions:**

- 1- Describe the categories of carnivores with suitable examples.
- 2- What is the applicability of laws in biological energy flow?
- 3- What is pyramid? Elaborate its different types.
- 4- Describe the nitrogen cycle and also draw the daigram of this.
- 5- Define food chain and also differentiate between its two types.



---

## **UNIT-3 ECOSYSTEM ECOLOGY-II**

---

- 3.1- Objectives
- 3.2- Introduction
- 3.3-Population ecology
- 3.4- Ecological Succession
- 3.5-Community ecology
- 3.6-Study of Plant Community Structure
- 3.7- Summary
- 3.8- Glossary
- 3.9-Self Assessment Question
- 3.10- References
- 3.11-Suggested Readings
- 3.12-Terminal Questions

---

### ***3.1 OBJECTIVES***

---

After reading this unit students will be able to understand-

- What factors have felt the stability of an ecosystem.
- Appreciate types of disturbances caused by humans
- How systems can shift from one stable to another.
- about the Population ecology
- Ecological Succession
- Community ecology

---

### ***3.2 INTRODUCTION***

---

“We all worry about the population explosion, but we don’t worry about it at the right time”

The rising population of India is one of the major problems of the country. It is causing a great problem not only to the India but also to all the development countries in the world. As population is increasing faster than agricultural and other production it thus needs food, shelter, and other basic amenities of life and education.

Ask anyone in such big cities as Mumbai, Delhi, and Bangalore to compare the present quality of life then and now. He will roll out the entire panorama of the paradise sort of which he lived half a century ago to the present era in which is living since the increase in population.

The population of India was around 361 million during the census of 1951. It reached over 1.21 billion during the census of 2011.

Thomas Malthus argued in the late 1700s “the power of population is indefinitely greater than the power of the earth to produce substance for men” this simple statement means that the human population will always exceed the limits of the earth to support it leading to famine, epidemics and human conflicts.

Life has become miserable with the crowding syndrome everywhere. There are queues everywhere. There is filth around you and growing pollution of the air and water. Alarming rise in population is causing downfall to us. Thus population bomb is ticking. We need to control this as any delay in defusing it on time could bring national disaster.

Population ecology or autecology is a sub-field of ecology that deals with the dynamics of species populations and how these populations interact with the environment.[1] It is the study of how the population sizes of species change over time and space. The term population ecology is often used interchangeably with population biology or population dynamics.

The development of population ecology owes much to demography and actuarial life tables. Population ecology is important in conservation biology, especially in the development of population viability analysis (PVA) which makes it possible to predict the long-term probability of a species persisting in a given habitat patch. Although population ecology is a subfield of biology, it provides interesting problems for mathematicians and statisticians who work in population dynamics.

### Fundamental Terms used to describe natural groups of individuals in ecological studies

<u>Term</u>	<u>Definition</u>
<b>Species population</b>	All individuals of a species.
<b>Meta-population</b>	A set of spatially disjunctive populations, among Which there is some immigration?
<b>Population</b>	A group of conspecific individuals that is Demographically, genetically, or spatially Disjunctive from other groups of individuals.
<b>Aggregation</b>	A spatially clustered group of individuals.

**Local population:**-A group of individuals within an investigator-delimited area smaller than the geographic range of the species and often within a population (as defined above). A local population could be a disjunct population as well.

**Subpopulation:**-An arbitrary spatially delimited subset of individuals from within a population (as defined above).

A population will grow (or decline) exponentially as long as the environment experienced by all individuals in the population remains constant.

This principle in population ecology provides the basis for formulating predictive theories and tests that follow:

Simplified population models usually start with four key variables (four demographic processes) including death, birth, immigration, and emigration. Mathematical models used to calculate changes in population demographics and evolution hold the assumption (or null hypothesis) of no external influence. Models can be more mathematically complex where "...several competing hypotheses are simultaneously confronted with the data."For example, in a closed system where immigration and emigration does not take place, the rate of change in the number of individuals in a population can be described as:

Population ecology is the branch of ecology that studies the structure and dynamics of populations.

Physiology studies individual characteristics and individual processes. These are use as a basis for prediction of processes at the population level.

Community ecology studies the structure and dynamics of animal and plant communities. Population ecology provides modeling tools that can be used for predicting community structure and dynamics.

Population genetics studies gene frequencies and microevolution in populations. Selective advantages depend on the success of organisms in their survival, reproduction and competition. And these processes are studied in population ecology. Population ecology and population genetics are often considered together and called "population biology". Evolutionary ecology is one of the major topics in population biology.

Systems ecology is a relatively new ecological discipline which studies interaction of human population with environment. One of the major concepts are optimization of ecosystem exploitation and sustainable ecosystem management.

Landscape ecology is also a relatively new area in ecology. It studies regional large-scale ecosystems with the aid of computer-based geographic information systems. Population dynamics can be studied at the landscape level, and this is the link between landscape- and population ecology.

---

### ***3.3 POPULATION ECOLOGY***

---

The term "population" is interpreted differently in various sciences:

- In human demography a population is a set of humans in a given area.
- In genetics a population is a group of interbreeding individuals of the same species, which is isolated from other groups.
- In population ecology a population is a group of individuals of the same species inhabiting the same area.

Interbreeding is seldom considered in ecological studies of populations. The exceptions are studies in population genetics and evolutionary ecology.

Populations can be defined at various spatial scales. Local populations can occupy very small habitat patches like a puddle. A set of local populations connected by dispersing individuals is called a metapopulation. Populations can be considered at a scale of regions, islands, continents or seas. Even the entire species can be viewed as a population.

Populations differ in their stability. Some of them are stable for thousands of years. Other populations persist only because of continuous immigration from other areas. On small islands, populations often get extinct, but then these islands can be re-colonized. Finally, there are temporary populations that consist of organisms at a particular stage in their life cycle. For example, larvae of dragonflies live in the water and form a hemipopulation.

### 3.3.1 Population Growth

Size of population for any particular species is not static, it keeps changing with time. Depending on various factors which includes food availability and reduce weather. These changes give us an idea whether population is inclining or declining.

Population changes due to four basic processes:

**1) Natality** - “number of birth during a given period in the population that are added to the initial density”.

**2) Mortality** - “number of death in the population during a given period”.

**3) Immigration** - “number of individual of the same species that have come into the habitat from elsewhere during the time period under consideration”.

**4) Emigration** - “number of individual of the population who left the habitat and gone the where during the time period under consideration”.

### 3.3.2 Growth Models

**Exponential Growth:** In case resources are unlimited in the habitat each species has innate potential to grow in number.

If in a population of size  $N$ , the birth rates (per capita birth) are represented as “ $b$ ” and death rates (per capita death) as “ $d$ ”, then the increase or decrease in  $N$  during a unit time period  $t$  ( $dN/dt$ ) will be

$$dN / dt = (b-d) \times N$$

$$\text{Let } (b-d) = r$$

then,

$$dN / dt = rN$$

The “ $r$ ” in the equation is called intrinsic rate of natural increase.

**Logistic Growth:** No species in the nature has unlimited access to resources, there is competition between individuals for limited resources. The fittest individual survives and reproduces.

In nature, there exists a carrying capacity ( $K$ ) for every species beyond which no further growth is possible.

A population growing with limited resources shows an initial log phase, followed by phases of acceleration and deceleration and finally an asymptote. When the population density reaches the carrying capacity, a plot of  $N$  in relation to time ( $t$ ) results in sigmoid curve. This type of population growth is called Verhulst Pearl Logistic Growth.

$$dN/dt = rN(K-N/k)$$

Where

$N$  = population density at time  $t$

$r$  = intrinsic rate of natural decrease

$K$  = carrying capacity.

Since resources are finite and becoming limiting. Logistic model is considered more realistic.

### 3.3.3. Causes of Population Growth

Decline in death rate for the balance in ecology death and birth rate should be in equal proportion. Hence decline in death rate leads to increase in birth rate and forward lead to population growth.

Better medical facilities-> Because of this, now a days pregnancies are far safer than earlier.

Technology advancement in fertility treatment-> IVF is a best example for population growth due to case of technology advancement.

Immigration-> Immigration of people from developing country to developed countries where best facilities are available in terms of medical, education, security, employment etc. In end result, the developed countries become overcrowded.

Lack of Family Planning-> Because of illiteracy, peoples has little knowledge about family planning. Getting their children married at early age that increase the chances of producing more kids.

### 3.3.4 Effect of Population Growth

Only because of the rapidly increase in population growth, our earth, our country, our nation have to suffer a lots of problems. Some are as follows ----

- (i) Depletion of Natural resources
- (ii) Increase in illiteracy
- (iii) Degradation of environment
- (iv) Increase in number of crime over year
- (v) Conflicts and wars
- (vi) Rise in Unemployment
- (vii) High cost of living
- (viii) Richer gets richer and poor gets poorer

### Modeling Strategy

- (i) Select optimal level of complexity.
- (ii) Never plan model development for more than 1 year.
- (iii) Follow specific objectives; don't try to make a universal model.
- (iv) Avoid temptation to incorporate all available information into the model.
- (v) If possible, incorporate already existing models.

## System Properties and Model Properties

(i) Many system properties are not respected in this model.

Example: age structure is not represented in both exponential and logistic models.

(ii) Some model properties in this model cannot be found in real system.

Example: solutions of differential equations are always smooth, while trajectories of real system are always noisy.

Example of a wrong question: Do the population have an equilibrium density?

(iii) The stable equilibrium is a state to which all the trajectories of the system coverage infinitely close with increasing time. The model (e.g. the differential equation) may have an equilibrium density but real problem don't have it because:

(iv) Population density cannot be measured with infinite accuracy.

(v) Weather fluctuations always add noise to system's dynamics.

(vi) Time series are never long enough to talk about limits and convergence.

---

## 3.4 ECOLOGICAL SUCCESSION

---

Ecological succession is the process of change in the species structure of an ecological community over time. The time scale can be decades or even millions of years after a mass extinction.

The community begins with relatively few pioneering plants and animals and develops through increasing complexity until it becomes stable or self-perpetuating as a climax community. The engine of succession the cause of ecosystem change is the impact of established species upon their own environment. A consequence of living is the sometimes alteration of one's own environment. It is a phenomenon or process by which an ecological community undergoes more or less orderly and predictable changes following a disturbance or the initial colonization of a new habitat. Succession may be initiated either by formation of new unoccupied habitat such as from lava flow or a severe landslide.

### Factors

The path of succession change can be governed by site conditions, by the character of the events initiating succession by the interactions of the species present, and by many more factors such as availability of colonists or seeds or weather conditions at the time of disturbance. Some of these factors contribute to predictability of succession dynamics; others add more probabilistic elements.

In general, communities in early succession will be dominated by fast-growing, well-dispersed species. As succession proceeds, these species will tend to be replaced by more competitive (k-selected) species.

Trends in ecosystem and community properties in succession have been suggested, but few appear to be general. For example, species diversity almost necessarily increases during early

succession as new species arrive, but may decline in later succession as competition eliminates opportunistic species and leads to dominance by locally superior competitors. Net Primary Productivity, biomass, and trophic properties all show variable patterns over succession.

### 3.4.1 Types of Ecological Succession

There are many kind of ecological succession. They are as follows:

**A) Primary Succession:** In any of the basic environment i.e., fresh water, marine or terrestrial, there is always a one type of succession known as primary succession that starts in a given area where life's conditions such are not favorable in the beginning. In the starting of primary succession, for example on exposed rock surface. Lichens and mosses are all first to appear and in return they change the physical environment such that the new species of autotrophs in that area can be established. Consequently, heterotrophs also arrive in the area. In this way succession continues leading to stable community.

**B) Secondary Succession:** It usually starts from previously build-up substrata with already existing living matters. In this type of succession, life's conditions are favorable due to the fact that these areas were earlier occupied by a well settled community. These types of succession are comparatively more rapid.

**C) Autotrophic Succession:** These types of succession are characterized by early and continued dominance to autotrophic organisms like green plants. These types of succession take place in predominant inorganic environment and their energy flow is maintained indefinitely.

**D) Allogenic Succession:** Sometimes existing community is taken over for work by any other external conditions than by an existing organism. Such type of succession is referred to as allogenic succession.

**E) Autogenic Succession:** In some cases, after a succession has begun, these are many community itself which as a result of its reactions with surroundings, they modifies their own environment leading its own replacement by new community.

### 3.4.2 Forest succession

The forests, being an ecological system, are subject to the species succession process. There are "opportunistic" or "pioneer" species that produce great quantities of seed that are disseminated by the wind, and therefore can colonize big empty extensions. They are capable of germinating and growing in direct sunlight. Once they have produced a closed canopy, the lack of direct sun radiation at soil makes it difficult for their own seedlings to develop. It is then the opportunity for shade-tolerant species to become established under the protection of the pioneers. When the pioneers die, the shade-tolerant species replace them. These species are capable of growing beneath the canopy, and therefore, in the absence of catastrophes, will stay. For this reason it is



then said the stand has reached its climax. When a catastrophe occurs, the opportunity for the pioneers opens up again.

Succession is the natural replacement of plant or animal species, or species association, in an area over time. When we discuss forest succession, we are usually talking about replacement of three species or tree associations.

Each stage of succession creates the condition for the next stage.

Temporary plant communities are replaced by more stable communities until a sort of equilibrium is reached between the plant and the environment.

Foresters and ecologists have long known that the growth of forests decreases as they age; however the cause for the age-related decline has remained a mystery until recently.

During the early stages of succession a high proportion of the litter is comprised of leaf tissue which, compared to branches and stems, is more easily decomposed by decomposers because of its greater nutrient concentration, Woody tissue decomposes slower than foliage.

### 3.4.3 Ecological Stability

Ecological stability can be defined as the ability of an ecosystem to resist changes in the presence of perturbations which leads to consideration of the effective choice of the pathways for energy flow.

In another definition ecological stability can refer to types of stability can refer to types of stability in a continuum ranging from regeneration or we can say resilience. The role of diversity and interdependence in determining stability has arisen naturally in the development of an index from the qualitative concepts of information theory.

Today we all have an important partial application of ecological stability.

- (i) There is a concern about human damage to ecosystems.
- (ii) Understanding the natural degree of stability help us to understand how much damage they can withstand.

### Types of Ecological stability

Stability actually refers two concepts and these are useful when we go on to look at the things which challenge natural stability. Now we can define Resistance and Resilience.

**1- Resistance** measures how much a system resist change. A system which remains the same in spite of disturbance or changes in, for example, nutrient input, as a high resistance.

**2- Resilience** measure how quickly a system recovers from disturbance and returns to a steady state. Human activities that adversely affect ecosystem resilience such as reduction of biodiversity, exploitation of natural resources, pollution land use and anthropogenic climate change are inverlingly causing regime shifts in ecosystems.

**(a) Constancy:** observational studies of ecosystems use constancy to describe living system that can remain unchanged.

**(b) Amplitude:** It is a measure of how far a system can be moved from the previous state and still return. Ecology borrows the idea of neighbourhood stability and a domain of attraction from dynamical systems theory.

### **Intermediate Disturbance Hypothesis**

According to some scientists and ecologists the persistence of large distributed patches and rapid recovery of smaller ones are synthesized through the intermediate disturbance hypothesis.

IDH can be explained as increased in local species diversity as a result of not much rare ecological disturbance. When the scale of disturbance increases as a result of man caused forest fires or deforestation the habitat and the species come under the risk of getting extinct given below is a graphical representation of intermediate disturbance hypothesis.

Hence IDH can be concluded as follows in two conditions prime conditions the succession will not develop it will thus seize if the disturbance is frequent. The succession will seize above the pioneer phase (gap phase) whereas in the case when disturbance is rare the diversity will reduce or minimize as per the competitive exclusion principle.

### **Connell – Slatyer model of Ecological Succession**

Ecological Succession can be understood as a process of changing species composition. Within a community due to an ecological disturbance, and varies largely according to the initial disturbances prompting the succession.

In 1997 connell and slatyer chose to focus on autogenic succession, which occurs on newly exposed landforms is initiated by changes from within the community rather than a geophysical transformation.

The targeted plant immobile aquatic organisms that demand the greater surface area within an environment could modify the physical landscape. They defined community as “the set of organisms that occur together and that significantly affect each other's distribution abundance.

### **Model**

**Facilitation model:** Based on the assumption that only particular species with qualities ideal for “early succession” can colonize the newly exposed landforms after an ecological disturbance.

These “colonizing” qualities include: highly effective methods of dispersal, the ability to remain dormant for long periods of time, a rapid growth rate. However the pioneer species are often subsequently less successful once an area has been heavily populated by surroundings species due to increased shade, litter or concentrated roots in the soil etc .

Example:-Essentially, the facilitation model suggests that the presence of an initial species aids increase the probability of the growth of a second species. The increased availability of nitrogen aids the growth of both willow popular seedlings in areas without other competition.

### **Cyclic Succession**

Cyclic succession is a pattern of vegetation change in which in a small number of species tend to replace each other over time in the absence of large-scale disturbance. Observations of cyclic replacement have provided evidence against traditional

Clementsian views of an end-state climax community with stable species compositions. Cyclic succession is one of several kinds of ecological succession, a concept in community ecology.

When used narrowly, ‘cyclic succession’ refers to processes not initiated by wholesale exogenous disturbances or long-term physical changes in the environment. However, broader cyclic processes can also be observed in cases of secondary succession in which regular disturbances such as insect outbreaks can ‘reset’ an entire community to a previous stage.

The cyclic model of succession was proposed in 1947 by British ecologist

Alexander Watt. In a seminal paper on vegetation patterns in grass, heath, and bog communities, Watt describes the plant community is a regenerating entity consisting of a “space-time mosaic” of species, whose cyclic behaviour can be characterized by patch dynamics .

---

## ***3.5 COMMUNITY ECOLOGY***

---

All the organisms that live together in a place are called a community. Community ecology is the study of the interaction between species in communities on many spatial and temporal scales, including the distribution, structure and interaction between coexisting populations.

“Ecology” is the science of communities. A study of the relations of a single species to the environment. Community ecology has its origin in European plant sociology. Modern community ecology examines pattern such as variations in species richness equitability, productivity and food web structure it also examines process such as predator prey population dynamics, succession and community assembly.

“An Ecological community is a group of actually or potentially interacting species living in the same location”

Communities have traditionally been understood on a fine scale in terms of local processes constructing an assembly age of species such as the way climate change is likely to affect the makeup of grass communities.

### **3.5.1 Communities and Their Members**

Community ecologists recognize and classify communities in a variety of ways. Most of these have something to do with various no. of species found in community. Community ecologists use several different communities which are as follows:

1. Physically, by discrete habitat boundaries
2. Taxonomically by the identity of a dominant indicator species
3. Interactively by the existence of strong interactions among species on
4. Statistically, by patterns of associations among species

Physically defined communities include a group of species found at a particular place on a habitat. The boundaries of the habitat are easily known. These include lakes, ponds; contain equally distributed communities of organisms.

Biomes are basic categories of communities that differ in their physical environments and in the life style of their dominant organisms. A list of the major biomes of would recognized by Whittaker the point is that biomes are a useful short hand for describing certain kind of communities and as such help to facilitate communication among ecologists .

### 3.5.2 Community Properties

There are many ways to see about analyzing community properties. The subject can split into several broad themes, which can help us to determine the best approach for your situation and requirements.

**Species Richness:** Robert may(1975)observed that one single number that goes a long way towards characterizing a biological community is simply the total no. of species present, known as species richness, that is related to the basic notation of biodiversity. In we have the ability to identify all the species found in a particular place, there would have problems of deciding whether we have put one best effort in searching the species that are found there. Species richness is more than a convenient device. There is increasing evidence which is related to the important functions of communities. Recently through an experimental work it is proved that all the natural disturbance and resistance etc, are all increase as species richness increases.

**Diversity:** Although species richness provides an important role among the community, it says nothing about the species and the way that individuals are distributed among the species in community. One measure is the shannen weaves index of diversity.

There is the total number of species present in sample and is the fraction of the total no. of the individuals in the sample that belong to species.

The comparison of diversity becomes complicated when it is compared to the community that varies in both species richness and distribution of individual among the species. The amount of diversity found in single type of habitat, sometimes called alpha diversity. Within some years, the species among the different habitats will contribute it into a region. This inter habitat component of diversity is known as beta diversity.

## **Trophic pyramids and the flow of energy**

All biological communities have a basic structure of interaction that forms a trophic pyramid .the trophic pyramid is made up of trophic levels and food energy is passed from one level to the next along the food chain.

The base of pyramid is composed of species called autotrophs primary producer of the ecosystem.

All the other organisms are consumers called heterotrophs which either directly or indirectly depend on the producer for food energy.

## **Food Chain and Food Web**

Because all species are specialized in their diets each trophic pyramid is made up of a series of inter connected feeding relationships called food chains.

However eat more than one species and a large number of animal species eat different foods at different stages of their life histories. Food chains combine into highly complex food webs.

## **Mimicry**

In evolutionary biology we can say that mimicry is a similarity of one organism, usually an animal, to another that has evolved because if the resemblance is selectively can be favoured by the means of behavior of a shared signal and receiver that can respond to both.

In another words Mimicry may evolve between different species, or between the individuals of the same species. Often, mimicry evolves to protect a species from predators, making it an antipredator.

The resemblances that evolve in mimicry can be in appearance, behaviour, sound or scent. Mimicry may be to the advantage of both organisms that share a resemblance, in which case it is a mutualism, or mimicry can be to the detriment of one, making it parasitic or competitive.

We can say that Mimicry occurs when a group of organisms the mimics, evolve to share perceived characteristics with another group, the models.

The evolutionary convergence between groups is driven by the selective action of a signal-receiver or dupe.

For example use sight to identify palatable insects, whilst avoiding the noxious ones. Over time, palatable insects may evolve to resemble noxious ones, making them mimics and the noxious ones models. In the case of mutualism, sometimes both groups are referred to as "co-mimics".

In its broadest definition we can say the mimicry can include non-living models.

The specific terms masquerade and mimesis are sometimes used when the models are inanimate.

For example animals such as flower mantises, plant hoppers and geometer moth caterpillars that resemble twigs, bark, leaves or flowers practice masquerade. Some authors would consider this mimicry, others would not.

Many animals bear eyespots, which are hypothesized to resemble the eyes of larger animals.

They may not resemble any specific organism's eyes, and whether or not animals respond to them as eyes is also unclear. Nonetheless, eyespots are the subject of a rich contemporary literature.

## Parasitism

In biology/ecology we can define as parasitism is a non-mutual symbiotic relationship between species, where one species, the parasite, benefits at the expense of the other, the host.

Traditionally parasite (in biological usage) referred primarily to organisms visible to the naked eye, or macroparasites (such as helminthes).

Parasites show a high degree of specialization, and reproduce at a faster rate than their hosts. Classic examples of parasitism include interactions between vertebrate hosts and tapeworms, flukes, the Plasmodium species, and fleas. Parasitism differs from the parasitoid relationship in that parasitoids generally kill their hosts.

Parasites increase their own fitness by exploiting hosts for resources necessary for their survival, e.g. food, water, heat, habitat, and transmission.

## Types of Parasites

Parasites are classified based on their interactions with their hosts and on their life cycles. An obligate parasite is totally dependent on the host to complete its life cycle, while a facultative parasite is not. A direct parasite has only one host while an indirect parasite has multiple hosts. For indirect parasites, there will always be a definitive host and an intermediate host.

**1. Ectoparasites:** Parasites that live on the outside of the host, either on the skin or the outgrowths of the skin, are called ectoparasites (e.g. lice, fleas, and some mites).

**2. Endoparasites:** Those that live inside the host are called endoparasites (including all parasitic worms). Endoparasites can exist in one of two forms: intercellular parasites (inhabiting spaces in the host's body) or intracellular parasites (inhabiting cells in the host's body).

Intracellular parasites, such as protozoa, bacteria or viruses, tend to rely on a third organism, which is generally known as the carrier or vector.[17] The vector does the job of transmitting them to the host. An example of this interaction is the transmission of malaria, caused by a protozoan of the genus Plasmodium, to humans by the bite of an anopheline mosquito.

**3. Mesoparasites:** Those parasites living in an intermediate position, being half-ectoparasites and half-endoparasites, are called **mesoparasites**.

## **Predators and their prey coevolves**

**Predation:** It is the consuming of one organism by another. According to the predation includes everything from a leopard capturing and eating an antelope, too a deer grazing on spring grass. When experimental populations are setup of under simple laboratory conditions, the predators often ex: terminates its prey and then becomes extinct itself, having nothing left to eat. However, if refuges are provided for the prey. It's population will drop to low levels but not to extinction. Low prey population levels will provide inadequate food for the predators, causing the predators population to decrease. When this occurs, the prey population to decrease can be recovering.

## **Predation and prey populations**

In nature, predators can often have large effects on prey populations. Some of the most dramatic examples involve situations in which humans have either added or eliminated predators from an area. For example, the elimination of large carnivores from much of the eastern United States has led to population explosions of white tailed deer, which strip the habitat of all edible plant life. Similarly when sea otters were hunted to near extinction on the western coast of the United States, sea urchin populations exploded.

Conversely, the introduction of rats, dogs, and cats too many islands around the world has led to the decimation of native faunas. Populations of Galapagos tortoises on several islands are endangered, for example, by introduced rats, dogs, and cats, which eat eggs and young tortoises. Similarly, several species of birds and reptiles have been eradicated by rat predation from New Zealand and now only occur on a few offshore islands, near New Zealand, every individual of the now extinct Stephen Island wren was killed by a single lighthouse keeper's cat!

Predation can have substantial effects on prey populations. As a result prey species often evolve defensive adaptations.

## **Animal Defenses against Predators**

Throughout millions of years of evolution, animals have evolved numerous of defending themselves against predators.

Obviously, being able to flee a predator in the choice of many prey animals we can consider.

However, there are some often overlooked but interesting methods of defense which involve deception and chemistry. These include using toxic chemical, camouflage, and mimicry.

**(i)Chemical defense:-**There are two main ways; animal can use chemicals to defend themselves. Animals can synthesize toxin by using their own metabolic processes, or they can accumulate toxin from the food they eat.

Example: - The poison dart frog has poison glands scattered all over its body.

**(ii)Camouflage:-**Animals that camouflage themselves pretend to be something they are not.

Their collaboration, marking pattern, or entire body resembles something else in their environment.

Example:- The four eyed butterfly fish uses deceptive marking.

**(iii) Mimicry:-**In mimicry, an organism (the mimic) closely resembles another organism (the model) in order to deceive the third, (the operator). The model and the mimic are not always closely related, but both usually live in the same area. This is generally in same a camouflage, but in mimicry the model is generally a similar organism rather than a static part of the background environment.

**There are similar types of mimicry.**

**(i) Batesian mimicry:-**it occurs when a edible mimic resembles an unpalatable or poisonous model. In this type of mimicry, only the mimic benefits.

Example: The scarlet king snake, a non-poisonous mimic of the extremely venomous coral snake.

**(ii) Mullerian Mimicry:-**It occurs when two or more distasteful poisonous organism resembles each other. Both species benefit because a predator who learns too avoids one species will most likely avoid to the other, too.

Example: In the figure there are two invertebrate on the left are different species of sea slug, while the on of the right is a marine flatworm. All three secrete noxious substances and are unpalatable. (Notice their similar aposematic coloring.)

## Symbiosis

It is a kind of positive inter specific interaction in which members of two different species favour the growth and survival of each other and their association is obligatory.

Species A=(+)                      Species B=(+)

In this interaction the members have widely different requirements and so interdependent that they cannot survive separately. Example:-

a) Mutualism Between Animal And Animal Species- Presence of a multi flagellate protozoan- Trichonympha as a symbiont in the intestine of white ant Termite.

b) Mutualism Between Plant And Animal Species- Green alga, zoochlorella is found as symbiont in the parenchyma of flatworm convoluta and the gastrodermal cells of Hydra Viridissima.

c) Mutualism Between Animal and Bacteria- Symbiotic bacteria like Ruminococcus are found in the rumen part of compound stomach of cud- chewing mammals like cattle, goat, camel etc.

d) Mutualism Between Plants and Fungus- Lichens involve the symbiotic interspecific association of a green alga (phycobiont) and a fungus (mycobiont).

e) Mutualism Between Plants and Bacteria- Nitrogen fixing bacteria like Rhizobium leguminosarum are found in the nodules on the secondary roots of leguminous plants like pea, gram etc.



## Co-Evolution

Co-evolution means the evolution of two species are linked with one another. These are mostly seen in Mutualism between plants and animal species.

Pollination of flowers by insects is also a nice example of mutualism (e.g- pollination of yuccaplant by female yucca moth- *Pronubayuccasella*). The insect gets nectar and pollens as food while for plants the pollination is essential for seed formation and continuity of race.

The flowers of fig plant are pollinated by species- specific wasp. There is one-to-one relationship between the fig species and wasp species. Female wasp lays its eggs in the ovary of fig flower with its ovipositor. The larvae hatched out of eggs feed upon some of the developing seeds of the fig fruit. During the process of oviposition pollens are transferred by the female wasp. These examples confirm the co-evolution of the mutualistic partners i.e. their evolution is linked with one another.

## Predators

Ecological community can be envisioned as food web in which species are linked with each other in a network of interconnection carnivores are ubiquitous components of ecological communities and are instrumental in determining.

The kinds and abundance of species that coexist within communities as well as functioning of those system .Earth and fragment or convert their habitat to other purposes .because of food web connection, predators will also have repel effect on the resources of the prey because of changes in prey abundance and prey anti predator's behavior.

Predation is pervasive all organisms within ecological communities are effectively predators of recourses.

This is nevertheless focuses on 1 group of predators namely carnivores species occupying level or food web. Studying predators a deep appreciation for their cunning adaptively to thrive in their natural environments.

---

## ***3.6 STUDY OF PLANT COMMUNITY STRUCTURE***

---

The special field of synecology which is concerned with the structure and classification of plant community is known as phytosociology.

The study of structure and composition of plant communities led by J. Braun-Blanquet who has outlined several methods grouping them into phytosociology.

Two sets of characters, viz., analytical and synthetic are studied in a community at the same time.

**(I) Analytical Characters:** According to Hanson (1950) and Braun Blanquet (1932), analytical characteristics are those features of community which can be observed or measured directly in each stand. They include kinds and number of species, distribution of individuals, species vigour,

form, number of individuals height of plants, area volume, growth rate and periodicity, etc. There are two different aspects of vegetational analysis-namely quantitative characters which can be measured more readily than the others, and qualitative characters (which are described and not measured).

**(II) Synthetic Characters:** Those aspects of community which are based on analytical characteristics and utilize data obtained in the analysis of a number of stands.

**A. Qualitative Structures of Plant Community:** The qualitative structure and composition of plant community can be described on the basis of visual observations without any special sampling and measurement. In the qualitative Characteristics floristic enumeration (species content), stratification, aspection, sociability, interspecific associations, life-forms and biological spectrum, etc. are studied in the field.

**1. Floristic composition or species content of community:** The study of species content in a community is of paramount importance. The species content of a community can be studied by periodic collection and identification of plant species for the whole year. This will show the tolerance of each species for different environmental conditions (Hanson, 1950).

**2. Stratification and aspection:** The number of strata or layers in a community can be determined by general observation of the vegetation. If one periodically observes the flora for the whole year, changes in the appearance of vegetation may be apparent with the change in the season. This is known as aspection. For this phenology of species in relation to different seasons of the year is recorded. Phenology, thus forms a part of community periodism. It is applied to those ecosystems where seasonal changes are not well marked such as desert ecosystem.

**3. Life-forms:** On the basis of general appearance and growth, the species of community are grouped into different life-form classes. The chief criteria for recognizing life-form classes. On the basis of percentage values of different life-form classes, real nature of habitat and community can be understood.

**Raunkiaer plant life-form:** The **Raunkiaer system** is a system for categorizing plants using life-form categories, devised by Danish botanist Christen C. Raunkiaer and later extended by various authors. The subdivisions of the Raunkiaer system are based on the place of the plant's growth-point (bud) during seasons with adverse conditions (cold seasons and dry seasons):

**(a) Phanerophytes:** Projecting stems into the air – normally woody perennials - with resting buds more than 25 cm above soil level, e.g. trees and shrubs.

Raunkiaer further subdivided the phanerophytes according to height as *megaphanerophytes*, *mesophanerophytes*, *microphanerophytes*, and *nanophanerophytes*.

**(b) Chamaephytes:** Buds on persistent shoots near the ground – woody plants with perennating buds borne close to the ground, no more than 25 cm above the soil surface, (e.g., bilberry and periwinkle).

**(c) Hemicryptophytes:** Buds at or near the soil surface, e.g. daisy, dandelion.

**(d) Cryptophytes:** Below ground or under water - with resting buds lying either beneath the surface of the ground as a rhizome, bulb, corm, etc., or a resting bud submerged under water.

**(e) Therophytes:** Annual plants which complete their life-cycle rapidly under favorable conditions and survive the unfavorable cold or dry season in the form of seed. Many desert plants are by necessity therophytes.

**4. Sociability:** In a plant community, the individuals of species are not evenly distributed. Individuals of some species grow widely spaced while those of some other species are found in clumps or mats. The space relationship of plants is referred to as sociability.

**Braun-Blanquet (1951) has recognized five sociability classes which accommodate different types of species:**

Class 1. Shoots grow singly,

Class 2. Scattered groups or tufts of plants.

Class 3. Small scattered patches or cushions,

Class 4. Large patches or broken mats, and

Class 5. Very large mats of nearly pure population covering the entire area.

**5. Interspecific associations:** When the plants belonging to two or more different species grow near one another they form a community. This type of association is known as interspecific association.

**(B) Quantitative Structure of Plant Community:** Coexistence and competition both are affected directly by the number of individuals in the community. Therefore, it is essential to know the quantitative structure of community. To characterize the community as a whole certain numerical constants called parameters are used. The total counts of individuals of each species, mean value of individuals of a species per plot, for example, are parameters.

**1. Density:** The numerical strength of a species in relation to a definite unit space is called its density. The crude density refers to the number of individuals of a particular species per unit area. Each organism occupies only the area that can adequately meet its requirements. Thus the density of an organism refers to the area available as living space. This would be ecological density.

Density of a species per unit area = Total number of individuals of a species in all the sample plots/Total No. of sample plots studied

**2. Frequency:** In the community, the individuals of all the species are not evenly distributed. Individuals of some species are widely spaced while those of some other species are found in clumps or mats.

Frequency refers to the degree of dispersion in terms of percentage occurrence. In order to study the frequency of species in an area, the study area is sampled by any sampling method at several places in desired pattern or at random and only the names, not the numbers, of individual species encountered sample are listed.

**The frequency of a species is determined with the help of the following formula:**

Frequency = Total no. of quadrats in which the species occur/ Total no. of quadrats studied x 100

**3. Abundance:** The estimated number of individuals of a species per unit area is referred to as abundance. To determine abundance, the sampling is done by quadrat or other methods at random at many places and the number of individuals of a species is added for all the quadrats studied.

**The abundance is determined by the following formula:**

Abundance of a species = Total number of individuals of the species in all quadrats /Total number of quadrats in which the species occurred

Abundance refers actually to density of population in those quadrates in which a given species occurs. In low form of vegetation like grasslands abundance can be recorded by uprooting the plants.

**4. Cover:** The cover implies the area covered or occupied by the leaves, stems and flowers, as viewed from the top. The coverage is studied at the canopy level and the basal region. In forest, where several strata are well marked, each layer of vegetation is considered separately for measuring the coverage. Basal cover is best expressed as the basal area, the ground actually covered by the crowns or by stems penetrating the soil. In forest the basal area is the cross section area of a tree measured at 4.5 feet above the ground (cross section area of a tree at breast height). It is estimated by point method of sampling (quarter method).

**5. Total estimate:** Although abundance and coverage have their own importance in the community structure, yet they can be combined in a community description as total estimate. It is probably the best method for obtaining a complete general picture of a plant community.

**6. Association Index and Index of similarity:** The inter-specific association can be evaluated by association index and also by calculating the index of similarity. The index of similarity is utilized to compare two coexisting groups.

**7. Importance value:** The overall picture of ecological importance of a species in relation to the community structure can be obtained by adding the values of relative density, relative

dominance, and relative frequency. This total value out of 300 is called Importance Value Index (IVI) of the species.

---

### 3.7 SUMMARY

---

Ecologists study many different aspects of ecosystems. One aspect that is of particular importance is **population ecology**. This field of study is concerned with populations and how they interact with their environment.

1. Population density can also influence the health and thus the survival of organisms.
2. As crowding increases, the transmission rate of a disease may increase.
3. Tuberculosis, caused by bacteria that spread through the air when an infected person coughs or sneezes, affects a higher percentage of people living in high-density cities than in rural areas.
4. Predation may be an important cause of density-dependent mortality for a prey species if a predator encounters and captures more food as the population density of the prey increases.
5. As a prey population builds up, predators may feed preferentially on that species, consuming a higher percentage of individuals.
6. **Batesian mimicry**:-it occurs when an edible mimic resembles an unpalatable or poisonous.
7. **Mullerian Mimicry**:-It occurs when two or more distasteful poisonous organisms resemble each other. In this type of mimicry, only the mimic benefits.
8. Succession takes place because through the processes of living, growing and reproducing, organisms interact with and affect the environment within an area, gradually changing it.
9. The most often quoted examples of succession deal with plant succession. It is worth remembering that as plant communities change, so will the associated micro-organisms, fungus and animal species. Succession involves the **whole** community, not just the plants.
10. Change in the plant species present in an area is one of the driving forces behind changes in animal species. This is because each plant species will have associated animal species which feed on it. The presence of these herbivore species will then dictate which particular carnivores are present.

---

### 3.8 GLOSSARY

---

**Abiotic**: Non-living; usually applied to the physical and chemical aspects of an organism's environment; e.g. salinity, pH, humidity, light (is a biotic necessity in autotrophic organisms) etc. the environment can be considered a heteromosaic of abiotic conditions, changing with time and space.

**Abundance**: The number of organisms in a population, combining "intensity" (density within inhabited areas) and "prevalence" (number and size of inhabited areas).

**Adaptation:** 1) Characteristics of organisms evolved as a consequence of natural selection; 2) Changes in the form or behavior of an organism during life as a response to environmental stimuli; 3) Changes in the excitability of a sense organ as a result of continuous stimulation.

**Autochoton:** Organic matter produced within a community e.g., fresh-water plants within a river.

**Allogenic S.:** A temporal succession of species at a location that is driven by external influences which alter conditions (contrary to autogenic); e.g. silt deposits changes a marshland to woodland.

**Autogenic S.:** A temporal succession of species at a location that is driven by processes operating with the community (contrary to allogenic), e.g. primary and secondary succession, that occur on newly exposed land.

**Autotropic S.:** A temporal succession of species location principally involving plants.

**Biodiversity:** (Gk. bios, life) Refers to aspects of variety in the living world; used to describe the number of species, the amount of genetic variation or the number of community types present in the area.

**Biogeochemical Cycle:** The movement of chemical elements between organisms and non-living compartments of the atmosphere, lithosphere and hydrosphere.

**Biogeography:** The study of the geographical distribution of organisms.

**Biomagnification:** The increasing concentration of a compound in the tissues of organisms as the compound passes along a food chain.

**Biomass** (organic matter): Total dry weight of all organisms in a particular population, sample or area; [J/m<sup>2</sup>];

**Biome:** Large, ecological unit composed of similar types of climax communities on a global scale, arising as a result of complex interactions of climate, other physical factors, and biotic factors (e.g., rainforest, tundra, grassland....)

**Biosphere:** The zone of air, land and water at the surface of the earth that is occupied by organisms.

**Biotic:** Living; usually applied to the biological aspects of an organism's environment, i.e. the influence of other organisms (opposite of abiotic).

**Canopy:** (Gk. canopion, net) The dense roof-forming vegetation, typically represented by the crowns of the trees; kelps, brown algae, can also form dense forest-like canopies.

**Carrying Capacity (K):** The maximum population size that can be supported indefinitely by a given environment, at which intraspecific competition has reduced the per capita net rate of increase to zero.

**Climate:** The accumulation of seasonal weather patterns in an area over a long period of time.

**Climax:** The presumed endpoint of a successional sequence.

**Climax Community:** Is largely determined by the climate and soil of the region; such a community has reached a steady state in a successional series (see there).

**Climax Mosaic:** A once established climax community can't be considered stationary but rather follows a pattern of micro-successional events caused by death and birth cycles of every

organism living within. Succession occurs anywhere at any time and just depends upon the scale based on (climatic region, altitude, etc.).

**Coexistence:** The living together of two species (or organisms) in the same habitat, such as that neither tends to be eliminated by the other.

**Community:** The species that occur together in space and time; (see diversity and isotherms).

**Community Stability:** The tendency of a community to return to its original state after a disturbance (competition, temporarily changing environment, etc.)

**Competition:** Interaction between members of the same population or of two or more populations to obtain a resource that both require and which is available in limited supply, hence, limiting overall fitness (survival, growth, reproduction of an organism).

**Competitive Exclusion Principle:** Two species with similar environmental requirements cannot coexist indefinitely in the same habitat.

**Consumer:** An organism within an ecosystem, plant or animal that derives its food from another organism (see predator).

**Cycle:** Biogeochemical cycles on a global and local scale.

**Decomposer:** Organisms (bacteria, fungi, heterotrophic protists) in ecosystems that break down complex organic material into smaller inorganic molecules that then are recirculated.

**Denitrification:** The conversion of nitrate to gaseous nitrogen; carried out by a few genera of free-living soil bacteria.

**Density:** In relation to population, the number of individuals in a certain amount of space.

**Disturbance:** In community ecology, an event that removes organisms and opens up space which can be colonized by individuals of the same or different species.

**Diversity:** An index of community diversity that takes into account both species richness and the relative abundance of species.

**Ecosystem:** All of the organisms of a given area and the encompassing physical environment.

**Exclusion C.:** The elimination from an area or habitat of one species by another through interspecific competition.

**Exploitation C.:** Competition in which any adverse effects on an organism are brought about by reductions in resource levels caused by other competing organisms (on a first come first serve basis).

**Epidemic:** The outbreak of a disease which affects a large number and/or proportion of individuals in a population at the same time.

**Eutrophication :** Enrichment of a water body with plant nutrients (P and N), usually resulting in a community dominated by phytoplankton (see cycle - P,N).

**Eutrophic :** An aquatic environment with high nutrient levels, characterized by dense blooms of algae and other aquatic plants.

**Evolution:** (L. *evolvere*, to evolve) Changes in gene frequencies in a population over time.

**Gause Law:** The idea that if two competing species coexist in a stable environment, then they do so as a result of differentiation of their realized niches; but if there is no such differentiation,

or if it is precluded by the habitat, then one competing species will eliminate or exclude the other.

**Genet:** The organism developed from a zygote.

**Grazer:** A consumer which attacks large numbers of large prey during its lifetime, but removes only a part of each prey individual, so that the effect although often harmful, is rarely lethal in the short term, and never predictably lethal; e.g. cow, mosquito, etc.

**Greenhouse Effect:** Warming of the earth's atmosphere as a result of increases in CO<sub>2</sub> and other gases.

**Growth:** An increase in size (see population and carrying capacity). Intrinsic rate of growth:  $r = (\text{natality} + \text{immigration}) - (\text{mortality} + \text{emigration})$

**Heterothermic:** (Gk. heteros, other) Body temperature fluctuate between Homeo- and poikilothermic.

**Homeothermic:** (Gk. homos, same) Warm blooded; generate so much heat within itself that they can raise its body temperature significantly (such animals can maintain a constant internal body temperature, also named **endothermic**).

**Intrinsic Factors:** Factors acting from within, e.g. intraspecific competition, etc. (see density factors).

**Island Biogeography Theory:** Is in the application on nature conservation. This is because many conserved areas and nature reserves are surrounded by an 'ocean' of habitat made unsuitable, and therefore hostile, by humans

**Isotherms:** Virtual lines of identical temperature patterns across a given area in which similar species and communities can prosper - they are more numerous in the equatorial regions (more numerous predator prey communities, a larger primary production etc.) than near the poles.

**Keystone Species:** Top predator affecting the prosperity of organisms lower in trophic level (see predator).

**Mortality:** Death rate = Number of dead individuals over time (see carrying capacity). Natality and mortality graphs together form the life table (see there).

**Macroclimate:** Global climatic patterns.

**Microclimate:** The climate within a very small area or in a particular, often tightly defined habitat; e.g., temperature gradient a few mm above a leaf, or along a tree trunk, etc.).

**Natality:** Rate of birth

**Nitrification:** The oxidation of ammonium ions or ammonia to nitrate; a process carries out by a specific free living soil bacterium.

**Predator:** An organism that consumes other organisms, such as true predators, grazers, parasites, and parasitoids etc.

**Predator Prey Systems:** Prey community can flourish if more dominant than the

**Prey:** An individual liable to be, or actually, consumed (killed) by a predator.

**Productivity:** The rate at which biomass is produced per unit area by any class of organisms (see biomass).



**Population:** Any group of individuals, usually of a single species, occupying a given area at the same time; groups of organisms with homologue (same) alleles.

**Organic:** Pertaining to living organisms in general, to compounds formed by living organisms, and to the chemistry of compounds containing carbon.

**Organism (individual):** Any individual living creature, either unicellular or multicellular.

**Succession:** The orderly progression of changes in a community composition that occurs during development of vegetation in any area; from initial colonization to the attainment of the climax typical of a particular geographic area.

**Specialist:** Utilizes a certain spectrum of resources available, regardless whether in abundance or limited supply, e.g. koala-, panda bear etc.

**Selection:** Individuals best suited to an existing environment will survive and reproduce to a greater extent.

### ***3.9 SELF ASSESSMENT QUESTION***

#### **3.9.1 Multiple choice questions:**

1-Changing population is:

- |                          |                         |
|--------------------------|-------------------------|
| (a) population growth    | (b) population dynamics |
| (c) population explosion | (d) population ecology  |

2- Population dynamics is related to:

- |                            |                            |
|----------------------------|----------------------------|
| (a) increase in population | (b) decrease in population |
| (c) change in population   | (d) all of the above       |

3-Community is:

- (a) Group of independent ,intresting population of same species
- (b) Group of independent,and interacting population of same species in specific area .
- (c) Group of independent,and interacting population of different species in specific area .
- (d) Group of independent,and interacting population of different species .

4-Which of the following is true for exponential growth:

- |                              |                                 |
|------------------------------|---------------------------------|
| (a) Resources are unlimited. | (b) $dn / dt = ( b-d ) \cdot N$ |
| (c) $( b - d ) = r$          | (d) all of the above            |

5-Which of the following is not the effect of increase in population growth:

- |                                |                                   |
|--------------------------------|-----------------------------------|
| (a) Increase in illiteracy     | (b) increase in natural resources |
| (c) Degradation of environment | (d) rise in unemployment          |

6- Which is correct statement for ecological succession-

- (a) It is also called biotic succession.
- (b) it is universal and multidirectional change in vegetation during ecological time
- (c) Early succession will be dominated by fast growing.
- (d) a and c

7- IDH stands for:

- (a) International data harmonization
- (b) Intermediate disturbance hypothesis
- (c) Independent design hypothesis
- (d) None of the above

8- Cyclic succession is:

- (a) Pattern of vegetation change in small number of species.
- (b) Short term physical changes in environment.
- (c) Proposed in 1957 by British ecologist.
- (d) It cannot be observed in secondary succession.

9-The level of competition between species depends on:

- (a) Availability of resources
- (b) population of density
- (c) Group interaction of organism.
- (d) all of the above.

10- Pollination of yucca plant by female yucca moth is example of:

- (a) Mutualism
- (b) mimicry
- (c) Co-evolution
- (d) protocooperation

### 3.9.2 Fill in the blanks:

- 1-Transmission of malaria caused by protozoa is an example of .....
- 2- Poison dart frog has poison gland scattered all over its body is an example of.....
- 3-.....Mimicry, when an edible mimic resembles an unpalatable model.
- 4-Species richness first observed by.....
- 5- .....can be explained as increase in local species diversity as a result of not much rare ecological succession.
- 6- .....measures how quickly a system recovers from disturbance and returns to a steady state.
- 7- .....cannot be measured with infinite accuracy.
- 8-Population genetics studies.....and .....in population.
- 9- Animal life also exhibit changes with changing .....
- 10- Succession is the natural .....of plant or animal species

### Answer key:

**3.9.1:** 1-(b), 2-(d), 3-(c), 4-(d), 5-(b), 6-(d), 7-(b), 8-(a), 9-(d), 10-(c)

**3.9.2:** 1-Parasitism, 2-Chemical Defense, 3-Batesion, 4-Robert May, 5-I.D.H., 6-Resilience, 7-Population Density, 8-Frequency, Micro-evolution, 9-Communities, 10-Replacement

---

### ***3.10 REFERENCES***

---

- <http://www.thefreshquotes.com/population-quotes-and-slogans/>
- <http://www.importantindia.com/10606/population-explosion-in-india/>
- [https://en.m.wikipedia.org/wiki/Population\\_growth?\\_e\\_pi\\_=7%2CPAGE\\_ID10%2C3462862008](https://en.m.wikipedia.org/wiki/Population_growth?_e_pi_=7%2CPAGE_ID10%2C3462862008)
- [https://en.m.wikipedia.org/wiki/Ecological\\_succession](https://en.m.wikipedia.org/wiki/Ecological_succession)
- [www.preservearticles.com/what-are-the-different-types-of-ecological-succession](http://www.preservearticles.com/what-are-the-different-types-of-ecological-succession)
- [Url -https://en.m.wikipedia.org/wiki/Ecological\\_succession](https://en.m.wikipedia.org/wiki/Ecological_succession)
- [https://en.m.wikipedia.org/wiki/Ecological\\_stability](https://en.m.wikipedia.org/wiki/Ecological_stability)
- [url : https://en.m.wikipedia.org/wiki/Intermediate\\_Disturbances\\_hypothesis](https://en.m.wikipedia.org/wiki/Intermediate_Disturbances_hypothesis)
- [https://googleweblight.com/?lite\\_url=https://en.m.wikipedia.org/wiki/Connell%25E2%2580%2593Slatyer\\_model\\_of\\_ecological\\_succession](https://googleweblight.com/?lite_url=https://en.m.wikipedia.org/wiki/Connell%25E2%2580%2593Slatyer_model_of_ecological_succession)
- [https://en.m.wikipedia.org/wiki/Cyclic\\_succession](https://en.m.wikipedia.org/wiki/Cyclic_succession)
- <https://en.wikipedia.org/wiki/Parasitism#Types>
- <https://en.wikipedia.org/wiki/mimicry#Types>
- [www.nature.com/community\\_ecology](http://www.nature.com/community_ecology)
- Kumar Satish and Deepshikha ,Environmental Studies
- Morin J. Peter , Community ecology, [second edition], page no. 17and 20
- Sharma Balwant ,Modern publisher
- Sharma P.D., Ecology and Environmental studies, Rastogi publication
- Verhony, “community ecology”

---

### ***3.11 SUGGESTED READINGS***

---

- Ecology in practice, Castri and Barker
- Environmental studies , S.C. Shantra
- Ecosystem Ecology, David G. Raffaelli
- Fundamental concepts in Environmental studies by Dr. D.D .Mishra
- Ecology and Environment Rastogi publication (PD Sharma)
- Environmental studies (Dr. Suresh K. Dhameja)

---

### ***3.12 TERMINAL QUESTIONS***

---

**3.12.1 Short Answer Type Question:**

- 1- Define ecological stability.
- 2- Differentiate between primary and secondary succession.
- 3- Define population with suitable example.
- 4- Explain logistic growth model.
- 5- Define community and biome.
- 6- Explain Batesian mimicry with example.
- 7- Derive the equation of exponential growth curve with diagram.
- 8- Define co-evolution.
- 9- Write the example of mutualism.
- 10- Define forest succession.

**3.12.2 Long Answer Type Questions:**

- 1- Describe different types of ecological succession.
- 2- What are the causes and effects of population growth?
- 3- Discuss upon Autoecology and Synecology.
- 4- Describe Connell – Slatyer model of ecological succession.
- 5- Elaborate the symbiosis and parasitism with its type.

---

## **UNIT-4 ECOLOGICAL FACTORS**

---

- 4.1-Objectives
- 4.2-Introduction
- 4.3-Climatic factors
- 4.4-Edaphic factors
- 4.5-Physiographic factors
- 4.6-Biotic factors
- 4.7- Summary
- 4.8- Glossary
- 4.9-Self Assessment Question
- 4.10- References
- 4.11-Suggested Readings
- 4.12-Terminal Questions

---

## 4.1 OBJECTIVES

---

After reading this unit students will be able:

- What are the ecological factors
- Discuss about climatic factors
- Know about the Edaphic factors
- Able to explain Physiographic factors
- Which one comes under Biotic factors

---

## 4.2 INTRODUCTION

---

Ecology is the scientific analysis and study of interactions between organisms and its environment. The term environment literally means the surrounding. The life supporting environment of this planet is restricted to a very irregular layer (5 to 20 km thick) around the earth. This thin veil of living material on the earth is known as biosphere (from Greek bios-life, sphaira- sphere). According to Hutchinson, (1970), Biosphere is that part of Earth in which life exists. There are different sub-divisions of biosphere. These are known as-

- a) **Hydrosphere:** water on the earth surface, in the ground, in the air make up the hydrosphere.
- b) **Atmosphere:** Atmosphere is the layer of air that stretches above the Lithosphere.
- c) **Lithosphere:** A solid surface layer of the earth.

Scientists describe the earth in terms of spheres. Life exists on the ground, in the air, and in the water. The biosphere overlaps all these spheres. All that surrounds and affect an organism is its environment. In any ecosystem, a living organism is influenced by a number of extreme factors and forces and which affect the organisms in any way is referred as environmental factor. Environmental factor or ecological factor is any factor biotic (living) or abiotic (non-living) that influences living organisms and affect the growth of plants. The study of abiotic factors and substances has been described as environmental ecology by A.S. Boughey (1971). These environmental factors include light, temperature, soil, water, wind, moisture etc. The sum total of all these factors constitutes the environment of an organism. Every organism has an ecological minimum and maximum for every factor and the range between two limits is known as limit or zone of tolerance. To explain the effect of different limiting factors on living organisms, number of laws and principles has been proposed by different Scientists.

The law of tolerance, usually called Shelford's law of tolerance presented by American Zoologist Victor Ernest Shelford in 1911. The law states that, the abundance or distribution of an organism can be controlled by certain factors (e.g., the climatic, topographic and biological requirements of animals and plants) where levels of these exceed the maximum or minimum limits of tolerance of that organism. For example- For the proper development and growth of plants, all the soil nutrients are equally important, but anything in excess might limit the uptake of the other

nutrient, restricting the proper growth. German Biochemist, Justus Liebig in 1840, presented the Law of minimum, it states that the growth of an organism is dependent on the amount of food stuff which is presented to it in minimum quantity. For example- if the soil is deficient in any one nutrient, it will make the other nutrient metabolically inactive and the proper growth of the plants will get restricted. Liebig's Law of minimum is also incorporated with the Laws of limiting factors developed by British Physiologist F.F. Blackman (1905). This law of limiting factor states that a biological process is controlled by a number of factors and the deficiency of any of these factors will affect the process on the whole. For ex. - Photosynthesis by plants. Blackman listed five factors involved controlling the rate of photosynthesis are amount of water, carbondioxide, chlorophyll, intensity of Solar radiation and temperature of the chloroplast. The same principle of limiting factors applies to animal functions also.

All these ecological factors can be classified into the following divisions:

- 1) Climatic factors (related to aerial environment)
- 2) Physiographic (topographic) factors
- 3) Edaphic factors (related to soil conditions)
- 4) Biotic factors

---

### ***4.3 CLIMATIC FACTORS***

---

Climate is one of the important natural factors which affect the plant life. Its study is known as climatology. The climatic factors are grouped under four categories-

1. Light
2. Temperature
3. Atmospheric humidity and Precipitation
4. Wind

**1. LIGHT:** Light is one of the most influences abiotic factor without which life cannot exist. The chief natural sources of light are Sunlight, moonlight, starlight and the light producing or luminescent organisms. Sun is the chief source of light. Light is the visible portion of the solar radiation or electromagnetic spectrum. Electromagnetic spectrum is the term used by scientists to describe the entire range of light that exists. The seven types of electromagnetic waves are radio waves, micro-waves, infrared waves, visible light waves, ultraviolet waves, x-rays and gamma waves. Each particle of electromagnetic radiation, called a photon, has certain amount of energy. Types of radiation with short wave length have high energy photons, whereas types of radiation with long wave lengths have low energy photons. Scientists break it electromagnetic spectrum into three separate categories or division. The short wave include cosmic rays x-rays and ultra violet rays, which have wavelengths shorter than 0.4 to 0.7 mm. This is also known as photosynthetically active radiation (PAR). The medium sized waves are called infrared waves

(longer than 0.740 mm). Radiant energy reaching the surface of earth on a clear day is about 10% ultraviolet, 45 % visible and 45 % infrared.

It is a form of kinetic energy that comes from the Sun in tiny particles called quanta or Photons, travelling in waves. The collection of all possible wavelength of electromagnetic energy is called as electromagnetic spectrum that comprises gamma rays, x-rays, ultraviolet light (< 400 nm), visible light (400 nm to 700 nm), infrared radiations (> 740 nm); the microwaves (radar waves), and radio waves (greater than 100000nm). When the visible light, Sunlight is passed through a prism, we see these wavelengths exhibiting seven different colours- violet, indigo, blue, green, yellow, orange and red (VIBGYOR).

On the basis of wave length, there are three types of ultraviolet radiation. These are:

- (i) UV-A radiation (320 to 400 nm)
- (ii) UV-B radiation (280 to 320 nm)
- (iii) UV- C radiation (100 to 280 nm)

Out of these three radiation types, UV-C is lethal to organisms, and UV-B, is harmful to the organisms. The intensity of light reaching the earth's surface varies with the angle of incidence, degrees of latitude and altitude, season, time of the day, amount absorbed and dispersed by the atmosphere and a number of climatic and topographical features.

**Importance of light to plants:** Three properties of this climatic factor that affect plant growth and development are light intensity, light quality and day length or photoperiod. The intensity of light is measured in terms of foot candle is equal to 10.76 Lux. An increased light intensity leads to a high rate of photosynthesis and a low light intensity would mean low rate of photosynthesis. Light quality refers to the colour or wavelength reaching the plant surface. Day length or photoperiod refers to the amount of time that a plant is exposed to sunlight with respect to the night period.

Light affects many physiological activities of the plants. Light influences the plants in the following ways-

**i) Photosynthesis:** Photosynthesis is the process by which plant life converts light energy into chemical energy (in the presence of chlorophyll) which is subsequently used for the preparation of carbohydrate from carbondioxide and water. It has been estimated that light used in photosynthesis is less than 2% of the light energy incident on well illuminated leaves. The various wavelengths in Sunlight are not all used equally in photosynthesis. Instead, photosynthetic organisms contain light absorbing molecules called pigments that absorb only specific wavelengths of visible light, while reflecting others. The set of wavelengths absorbed by a pigment is its absorption spectrum. Red (610-700 nm) and blue (450-500 nm) wavelengths are most effective in promoting photosynthesis. Green (500-570 nm) light is least effective. When we look at a plant and see green, it is because the chlorophyll molecules in the plant absorb blue and red light and reflect other colours, resulting in the green colour we see. The rate of photosynthesis is greater in intermittent light than in the continuous light.



**ii) Respiration:** Plant respiration is a process of the oxidation of carbohydrate (produced in the photosynthesis) into carbondioxide and water. Plants respire all the time, whether it is dark or light. There is no direct effect of light on the respiration. Indirect effect is very important because in the presence of light the respiratory substrates are synthesized. Light at which both photosynthesis and respiration become equal is called as light compensation point. This means that the carbondioxide released from respiration is equivalent to that which is taken up during photosynthesis. The compensation point is reached as light intensity increases. If the light intensity is increased beyond the compensation point, the rate of photosynthesis increases proportionally until the point of light saturation is reached, beyond which the rate of photosynthesis is no longer affected by light intensity.

**Effect on transpiration and opening and closing of stomata:** Transpiration is the process of water movement through a plant and its evaporation from aerial parts, such as stems, flowers and leaves. The rises in atmospheric temperature which may be due to the conversion of solar radiation into heat increase the rate of transpiration and indirectly the rate of water absorption. Stomata are pores in the leaf that allow gas exchange when water vapor leaves the plant and carbondioxide enters. Special cells called guard cells control each pores opening or closing. When stomata are open, transpiration rates increase, when they are closed, transpiration rates decrease. The opening and closing of stomata is regulated by the presence or absence of light. Stomata are triggered to open in light so plants transpire more rapidly at higher temperatures because water evaporates more rapidly as the temperature rises.

**Growth and flowering of plants:** The day length, the quality and intensity of light are the most important factors which affect growth and flowering of plants. The duration of light (photoperiod) is of considerable importance of plants. According to the response of the plants to the length of the photo-period, the plants have been classified into three groups:

**(a) Short-day plants:** The short day plants in general develop flowers when the days are less than 12 hurs long. Example- *Saccharum officinarum* (Sugarcane), *Glycine max* (Soybean), *Xanthium strumarium* (Cocklebur). Day length is critical and varies from species to species.

**(b) Long-day plants:** The long day plants develop flower when the days are longer than 12 hours. Example - *Daucus carota* (Carrot), *Lactuca sativa* (lettuce), *Spinacea oleracea* (Spinach).

**(c) Day neutral plants:** Day neutral plants are those whose flowering are not affected by day length, but rather is controlled by age, number of nodes, previous cold treatment etc. e.g., *Helianthus annuus* (Sunflower), *Cucumis sativus* (Cucumber), *Gossypium hirsutum* (Cotton).

Plants which grow in bright Sunlight are called **heliophytes** and those growing in the shades are called **Sciophytes**. There are some heliophytes which can grow in shade are known as facultative sciophytes and those heliophytes which fail to grow in shade said to be obligate sciophytes. Similarly facultative heliophytes are those sciophytes which may grow in light and obligate

heliophytes are those sciophytes which fail to grow in bright Sunlight. The shade plants maintain a high rate of photosynthesis in low light intensities, while the heliophytes are adversely affected by shade.

**Movement:** Sunlight affects the movement of some plants which is called heliotropism or phototropism. Heliotropism is a plants turning response (mostly diurnal) to light intensity and direction. Plants can either face the light (positive response) or turn away from it (negative response). The leaves, roots and stems show different responses to light. The stem elongates towards light (positive phototropism) and the roots are negatively phototropic. Heliotropic plants are solar tracking plants. Heliotropism can be easily seen in sunflower, which slowly turns their large flower so that they continually face the sun.

**Effect of Seed Germination:** There are many seeds which respond to light for germination and these seeds are said to be photoblastic. e.g., *Astercantha longifolia*, *Ruellia tuberosa*, some seeds find light a hindrance and germinate in darkness e.g., *Cenchrus*, *Dectylo ctenium*. In most of the plants, the red light induces seed germination and in some plants blue light promotes the process. In some cases, far-red light is seen to inhibit seed germination. The quality of light also influences the rate of germination. The germination of lettuce seeds is stimulated by red light and inhibited by far-red sensitivity of seeds is due to the presence of a photo-receptive pigment called as phytochrome. Germination of Typha seeds is promoted in yellow light. Yellow light counters the inhibitory effect of blue light. Oxygen tension, osmotic stress, presence of growth promoters or inhibitors and several other factors influence the germination of seed.

The intensity of light varies with the angle of incidence, time of the day, degrees of latitude and altitude, season, amount absorbed and dispersed by the atmosphere. Smoke, dust particles etc dispersed in the air have great screening effect. In industrial areas, the smoke of factories may reduce 90 % of light.

**Effect of light on animals:** Light affects the various aspects of animal life such as growth, development, reproduction and diapause (resting phase), migration, locomotion, metabolism etc. Some major effects of light on animals are described below:

**(i) Effect on metabolism:** The metabolic rate of different animals is largely influenced by light intensity. The increased intensity of light results in an increase in enzyme activity, general metabolic rate and solubility of minerals and salts in the protoplasm. The cave-dwelling animals are not influenced much by light. Solubility of gases decreases at high light intensity.

**(ii) Effect on pigmentation:** Formation of pigments depends on light. It is found that higher the intensity of light, higher will be pigmentation. For example the darkly pigmented skins of

human inhabitants of the tropical region have higher concentration of melanin in their skin. Cave animals and many inhabitants of deep sea, where light has no ecological significance, have vestigial eyes or are blind.

**(iii) Effect on development:** Light in some cases accelerates the development, and in some other cases, it retards. For example, Salmon larvae undergo normal development in sufficient light whereas, Mytilus larvae grows larger in darkness.

**(iv) Effect on reproduction:** In many animals and birds, the breeding activities are induced by light through its inoculating action over the gonads. The gonads of birds are found to become active during summer (increased illumination) and to regress during winter (shorter periods of illumination).

**(v) Effect on animal movement:** In certain lower animals, the speed of locomotion is regulated by light. The phenomenon is known as photokinesis. They are of two types:

**(a) Phototaxis:** Oriented locomotory movements towards and away from a source of light is called as Phototaxis. When an animal moves towards the light source, it is called positively photoactic. Euglena, Ranatra are the examples of positively photoactic animals. When an animal moves away from the light source, it is known as negatively photoactic. Earthworms, planarians, cope-podes, slugs, siphonophores are negatively photoactic animals.

**(b) Phototropism:** Phototropism occurs when only a part of organism shows responsive movement to light stimulus. It is seen in sessile animals.

**2-Temperature:** Temperature is another influential climatic factor. The degree of hotness and coldness of a substance is called temperature. Absorption of radiant energy raises the temperature of the absorbing substance. Temperature is commonly expressed in degree Celsius or centigrade (c) and degree Fahrenheit (F). Every organism has a definite temperature range. The temperature at which physiological processes are at their maximum efficiency is called optimum temperature. Minimum temperature is that below which all metabolic processes necessary for life cannot initiate and proceed with lowest pace. Maximum temperature is that above which the living activities are not detectable. The minimum, optimum and maximum temperatures are called cardinal temperature varies from species to species, and in the same individual from part to part. Temperature affects almost all the physiological processes, growth and distribution of plants and animals.

**(a) Temperature and cell:** The minimum and maximum temperatures have lethal effects on the cells and their components. In the extremely low temperature, cell proteins may be frozen to ice. On the other hand; heat coagulates proteins.

Few organisms can survive temperatures  $> 45^{\circ}\text{C}$ , because of protein denaturation at high temperature. Certain organisms can exist at higher temperature due to heat stable proteins where as some organisms can exist at slightly lower temperatures using antifreezes such as glycerol, salts.

**(b) Temperature and metabolism:** Usually the various metabolic activities of plants, animals and microbes are regulated by different kinds of enzymes and enzymes in turn are influenced by temperature, consequently increase in temperature, upto a certain limit, brings about increased enzymatic activity, resulting in an increased rate of metabolism. However, the metabolic rate may decrease when there is higher increase in temperature.

**(c) Temperature and reproduction:** The maturation of gonads and gametogenesis need specific temperature which varies from species to species. Some species breed throughout the year, some only in winter or in summer. Temperature determines the breeding season of most organisms.

**(d) Temperature and sex ratio:** In some animals the environmental temperature determines the sex ratio. For example, the sex ratio in the copepod *maerocyclops albidu* is determined by temperature. As the temperature rises there is a significant increase in number of males. In *Daphnia*, under normal condition parthenogenetic eggs are produced, which develop into female. But when the temperature is raised, they give rise to sexual eggs, which after fertilization may develop either into females or males.

**(e) Temperature and growth:** The growth rate of plants and animals is also influenced by temperature. When the temperature is slightly increased, the poikilothermic invertebrates indicate an increase in temperature the seedlings of several plants exhibit the elongation of the hypocotyle.

**(f) Temperature and colouration:** In warm humid climates many animals like birds, insects and mammals bear darker pigmentation than the races of some species found in cool and dry climates. The phenomenon is known as Gieger rule.

**(g) Temperature and respiration:** Usually, the rate of respiration become doubles as per the Vant Hoff's law with increase in temperature by  $10^{\circ}\text{C}$  in case of Poikilothermic animals. According to Smith (1974), optimum temperature for photosynthesis is lower than that for respiration.

**(h) Temperature and transpiration in plants:** Transpiration is the process of loss of water from the aerial surface of plants. Higher temperature increases the capacity of air to hold more moisture in vapour form, which results in nigner difference between vapour pressure defects,

hence the rate of transpiration increases. Besides increasing the rate of transpiration if temperature rises above maximum limits, the plant becomes inactive, and may develop choruses.

On the basis of the response of plants to temperature of environment, the entire vegetation can be divided into four classes as:

**(i) Megatherms:** Plants which require more or less constant high temperature throughout the year for their optimal growth and development. They are found in areas with tropical climates. e.g., desert plants.

**(ii) Mesotherms:** Plants of habitat which is neither very cold nor very hot. These plants cannot endure extreme high or low temperature. These plants are found in tropical and sub tropical regions.

**(iii) Microtherms:** These plants require low temperature for their growth. These plants cannot endure high temperature. All high altitude plants of the tropical and subtropical regions included in this group.

**(iv) Hekistotherms:** These are the plants of cold and alpine regions. They endure long and extremely cold winter months.

**3. Atmospheric humidity and Precipitation:** Water is essential for the sustenance of human life and activities. Without water no vital activity is possible in the plants and animals. It is the essence of life on earth. Water affects the inner and outer morphology of plant organs that together determine the physiology of vegetation. Water occurs in the atmosphere in three physical states, solid (snow, sleet, hail and ice), liquid (rain, water droplets) and gas (water vapour). The cycle of water begins with rainfall and ends in condensation of water vapour in the form of clouds. The clouds on cooling and condensation produce rain or ice. This process is known as hydrologic cycle.

In the atmosphere, water is present in the form of water vapours. This is called atmospheric humidity. Humidity is greatly influenced by intensity of solar radiation, wind, water, status of soil, temperature, altitude etc. Evaporation of water from earth surface and transpiration from plants are the main cause of atmospheric humidity. Clouds and fog are the visible forms of humidity.

Humidity is described in three different terms:

**(i) Specific humidity:** It refers to the “amount of water vapours present per unit weight of air”.

**(ii) Absolute humidity:** It refers to the “amount of water vapours present per unit volume of air”.

**(iii) Relative humidity:** It is the amount of water vapours actually present in the air, and is expressed as percentage of the amount which the air can hold at saturation at the existing temperature.”

**Effects of humidity on organisms:** It influences the rate of transpiration in plants. Higher the humidity, lesser is the rate of transpiration. It also influences the rate of perspiration in humans. So, at high humidity sweating is less. It is an important source of water for epiphytes like lichens,

mosses. It plays an important role in the germination of spores of fungi. Higher humidity reduce the effectiveness of sweating in cooling the body by reducing the rate of evaporation of moisture from the skin.

Humidity is measured using a psychrometer and hygrometer and is measured as a percentage.

Precipitation generally means a process of separating some substance from its solution. This applies to weather, too, because water is separated from the air when precipitation occurs. Precipitation is caused when a mass of warm, moist air hits a mass of cold air. Condensation causes the moisture to form droplets that become rain or crystals that become snow or ice. When these droplets or crystals become too heavy to be suspended in the atmosphere, they fall to earth as precipitation.

**Forms of precipitation are-** rain, sleet, snow, hail and drizzle plus a few less common occurrences such as ice pellets, diamond dust and freezing rain. Rainfall is the predominant form of precipitation is used synonymously with rainfall. Rainfall is an important factor as in determines the vegetation of particular region, because of its significance for plants as a source of soil moisture. Moderate and continuous rains are beneficial instead of heavy rains because in the heavy rains a large amount of water is lost from the surface of soil as runoff and the soil is eroded. The distinction between equatorial forests zones, desert zones near the tropics and temperate forest zones is based upon rainfall. In India the tropical evergreen forest is found with 100 inch rainfall tropical moist deciduous forest are monsoon forest of Western Ghats, Chota Nagur correspond to a rainfall of 60 to 68 inches, the tropical dry deciduous forest of Saal and Teak occur in regions with only 40-50 inch rainfall. The regions of negligible rainfall consists of deserts.

In terrestrial habitats precipitation is the only source of water for growth of most plants.

**4. Wind:** Air is a mixture of gases present in the troposphere. Air in motion is called wind. Air currents or winds are a result of interaction between expansion of hot air and convection in the mid latitudes. The ecological influences of wind- energy facilities are complex, and can vary with spatial and temporal scale, season, weather, species, ecosystem type and other factors. Wind is both an ecological provider and disturbance facilitator influences trees and other organisms. Impacts of wind on trees and forests depend on the intensity of wind and the stability of the trees. When the wind is strong, it can carry sand and snow particles, and thus has a considerable abrasive effect on the ground as well as on plants. Desert are continuously being moved and reshaped by erosion and sand storms caused by wind displacing sand form one place to another. Wind erosion also leads to dispersal of top soil. Wind erosion also displaces soil for plant growth by removing the most fertile top layer of soil from the earth. The sand particles blown with the wind deposit on leaf surface and reduce photosynthesis, cause rise in temperature and lead to rapid desiccation. The wind accelerates transpiration. Plants are able to grow successfully only so long as they can balance their water income with water outgo. When transpiration rate

exceeds that of water absorption, partial or complete closure of the stomata may ensure which will restrict the diffusion of carbon dioxide into the leaves. As a result, there will be decrease in the rate of photosynthesis, growth and yield. Thus, the plants tend to become dwarf, profusely branched and usually have small leaves. The direct effect of strong winds is mechanical and it causes uprooting of trees and shrubs, breaking off branches and twigs. Winds help in dispersal of pollen grains of some plants and also in dispersal of insects. The most of gymnosperms are pollinated by the wind and this phenomenon is called as anemophily. Larger plants which are often exposed to violent winds and are adapted to such conditions for example high mountain tops and seashores, the trunk and branches of trees are twisted chiefly in the direction of prevailing wind. In such plants, usually, the growth of buds is checked on the windward side.

---

#### ***4.4 EDAPHIC FACTORS (SOIL FACTORS)***

---

Soil is one of the most important ecological factors called edaphic factors. Edaphic factors are those which act upon plants through soils: physical properties of soils, drainage, soil nutrient, soil temperature etc. Soil is the outermost layer of the surface of the earth in which roots grow and anchor the plants and from which plants derive water and nutrients.

Treshow (1970) defined Soil as a complex physical biological system providing support, water nutrient and oxygen for plants. The Study of Soil Science is known as Pedology.

**Soil formation:** Soil are complex mixture of minerals, water, air, organic matter and countless organisms that are the decaying remains of once-living things.

Soil is formed by disintegration and decomposition of rocks by fragmentation or break-down or weathering and the action of soil organisms such as Fungi, bacteria etc and through interactions of various chemical substances present in the soil.

**Soil Profile:** There are different types of Soil, each with its own set of characteristics. Dig down deep into any soil, and you will see that soil is made up of distinct layers which often differ in colour and which are known as "Soil horizons". The sequence of horizons from the surface down is known as "Soil Profile".

Edaphic factors deal with different aspects of soil, such as the structure and composition of soil, its physical and chemical properties. The physical properties include the soil texture, soil structure, and bulk density which affect the capacity of the soil to retain and supply water whereas the chemical properties consist of the soil pH and cation exchange capacity (CEC) which determine its capacity to supply nutrients. Chemical and physical properties of the soil affect its fertility.

**Horizons:** Soil Scientists, who are also called pedologists, use the capital letters O, A, B, C, and E to identify the master horizons, and lower case letters for distinctions of these horizons. Most soils have three major horizons- the surface horizon (A), the subsoil (B), and the substratum (C). Some soils have an organic horizon (O) on the surface, but this horizon can also be buried. The master horizon E, is used for surface horizons that have a significant loss of minerals (eluviation). Hard bed rock, which is not soil, uses the letter D.

From the surface down ward the following layers can be conveniently made out in this horizon:

**A-** Designates the top stratum. The A horizon is also described as the zone of maximum leaching of elements. It is divided into three subzones which are denoted by A<sub>1</sub>, A<sub>2</sub> and A<sub>3</sub>.

**A<sub>1</sub> Horizon-** It is dark coloured. It contains fungi and bacteria and in this rich humus is mixed with minerals.

**A<sub>2</sub> Horizon-** It is light coloured with less humus and maximum leaching of Silicates, oxides of iron and aluminium.

**A<sub>3</sub> Horizon-** It is transition zone between A and B horizons.

**B horizon-** This is known as subsoil lying under A horizon. Roots develop poorly in this zone. Rich in minerals that leached (moved down) from the A horizons and accumulated here. It is also divided into B<sub>1</sub>, B<sub>2</sub> and B<sub>3</sub> zones. A and B horizons collectively represent the true soil.

**C Horizon-** It is at the bottom of B horizon and represents the more or less unmodified parent material which is in the form of weathered rock.

**D Horizon-** It is located under the C horizon. A mass of rock such as granite, basalt, quartzite, limestone or sandstone that forms the parent material for some soils- if the bed rock is close enough to the surface to weather. This is not soil.



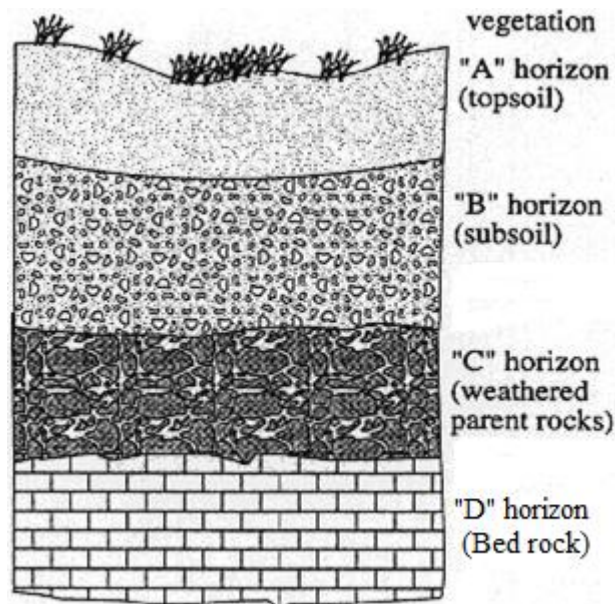

**Fig.4.1 Soil profile (Soil horizons)**

The important edaphic factors which affect the vegetation are as follows-

- (1) Soil moisture
- (2) Soil reactions
- (3) Soil nutrients
- (4) Soil atmosphere
- (5) Soil temperature
- (6) Soil Organism

**(1) Soil moisture:** Water contained in soil is called soil moisture. Plants absorb a small quantity of rain water the rest is lost in many ways like evaporation and run-off. The main source of soil water is precipitation. Types of water in the soil-

**(a) Gravitational water:** It is that surplus of water which, percolates downwardly through the pore spaces between soil particles and accumulates in the pore spaces in the form of ground water. This type of water not much use to plants.

**(b) Capillary water:** When the gravitational water descends it moisture the soil particles in the path, and large amount of water is retained between the soil particles due to the phenomenon of surface tension is called capillary water. It is the most common available form of water for absorption.

**(c) Hygroscopic water:** It refers to the water that is present as a thin film around the soil particles. The water is held so tightly by the soil that it cannot be taken up by roots.

**(d) Water vapour:** This is water vapour present in air, which can be absorbed by hanging roots of the epiphytes due to presence of spongy velamen tissue and hygroscopic hairs.

**(e) Combined water:** The amount of water present in the chemical compounds, which are present in the particles of soil. This type of water is not available to the plants.

Total amount of water present in the soil is called holard. Chresard or available water refers to the amount of water than can be used by plants. The amount of water that cannot be absorbed by plants is termed as echard or non-available water.

The availability of soil moisture is influenced by so many conditions, such as the sizes of soil particles, the quantity, duration and intensity of rainfall, the distribution of precipitation, throughout the year, the rate at which water percolates.

The quantity of soil water available to plants is a great determining factor of nature, composition and stature of vegetation at any place.

**(2) Soil reactions:** Soil pH or soil reaction is an indication of the acidity or alkalinity of soil and is measured in pH units. There are three types of soil reactions: i) Acidic, ii) Alkaline, iii) Neutral. The acidity or alkalinity (pH) of soil has profound effects upon plant communities. The plants habituated to grow on acidic soil would not grow on normal or alkaline soil. For example species of Rhododendron, Cranberris are acid loving. Most of the field crops, such as maize, soybeans, barley, rye, tomato, potato, flourish in slightly acidic soils where as many ferns and beech trees thrive best in slightly alkaline soils. When salts of strong base as sodium carbonate go into soil solution and hydrolyze, consequently they give rise to alkalinity.

Soil alkalinity is a condition that results from the accumulation of soluble salts such as sodium, calcium and magnesium in the soil. Because alkaline soil is less soluble than acidic or neutral soil, availability of nutrients is often limited. Because of this, stunted growth and nutrient deficiency are common. Most of the alkaline soils are found in the desert environments.

The acidity, alkalinity and neutrality of soils are described in terms of hydrogen ion concentration or pH values. The pH scale goes from 0 to 14. A pH value of 7.0 indicates neutrality, a pH value above this figure (7.1-14.0) indicates alkaline condition and pH value below (0.0-6.9) indicates acid conditions. Normally the pH value of soils lies between 2.2 and 9.6. PH plays important role in determining the type of vegetation. Soil acidity affects the availability of iron, manganese, phosphate and other ions. In the acid soils, iron and manganese are available in appreciable quantities, but in the neutral or alkaline soils they are available in major quantities to plants.

Neutral or slightly acidic soils are best for the growth of majority of plants.

In India, acidic soils (pH below 5.5 to 5.6) occur in the high rainfall areas of Western Ghats, Kerala, Eastern Orissa, Manipur, Assam and Tripura. The saline, alkali or basic soils of India

occur in Uttar Pradesh, Punjab, Bihar, Orissa, Maharashtra, Madras, Andhra Pradesh, Madhya Pradesh, Gujarat, Delhi and Rajasthan.

**3. Soil Nutrients:** Soil is a major source of nutrients needed by plants for growth. Nutrient absorption by roots is a process of ion exchange at the surface. Usually, inorganic solutes are absorbed by the plants in the ionic forms. The chief inorganic components of soil are the compounds of Aluminium, Silica, Magnesium, Calcium, Sodium, Potassium and Iron. Soil also contains trace elements like Manganese, copper, Boron, Zinc, Iodine, Cobalt, Molybdenum etc. The chief organic component of soil is humus (The inorganic portion of soil is made up of small rock fragments and minerals.) a dark coloured amorphous substance formed by partial degradation of dead organic remains. Humus chemically contains amino acids, purines, proteins, aromatic compounds, pyrimidines, hexose sugars, sugar alcohols, methyl sugars, oil, fat, waxes etc.

**4. Soil Atmosphere:** In the soil, the spaces between soil particles are called pore spaces. They are the portion of the soil occupied by air and water. The soil air present in the interspaces of soil particles is very important as it helps in normal respiration of soil organisms. The aeration of soil is essential for the absorption of water by roots. The water absorption by root is rapid in well aerated soil while very little where soils are deficient in oxygen supply usually, plenty of oxygen for the soil is necessary for the life of micro-organisms and other soil inhabitants. The network of pores within the soil aerates, or ventilates the soil. An increase in soil water content often causes a reduction in soil aeration. Reducing soil water content may mean an increase in soil aeration.

**5. Soil temperature:** Soil temperature is the measurement of the warmth in soil. It's the detection of the internal energy of the soil. Soil temperature may be determined with the help of soil thermometer. A thermometer with a long prong can be plunged into the ground to accurately assess the soil temperature. Ideal soil temperature for planting most plants are 65 to 75 F (18 to 24 C). Soil temperature affects the rate of water absorption, seed germination and rate of growth of roots and underground parts. The perfect temperature for planting varies dependent upon the variety of plants. Tender bulbs, such as caladiums, should be planted only when soil temperatures are warm enough to induce sprouting- cold spring soil can cause the bulbs to rot instead of sprout.

**6. Soil Organism:** Organisms present in the soil are called soil organisms. The soil organisms include bacteria, algae, fungi, protozoa, rotifers, Earthworms, nematodes, mollusks, arthropods, insects and mites. These soil organisms feed on the organic matter of the soil and indulge in various activities such as nitrogen fixation in the soil, mixing of soil, improvement in soil aeration, production of growth stimulating substances, decompose the dead organic matter and increase plant nutrients in available forms. They transfer the elements from the lower to the upper horizons. The animals of burrowing habit also play important role in the soil by turning

over the soil. Earthworms by the burrowing habit make the soil loose and fertile. Bacteria and blue green fix atmospheric nitrogen and improves soil fertility. In the absence of oxygen some soil microbes secrete chemicals, such as organic acid, aldehydes which may show toxic effects on many plants.

---

## ***4.5 PHYSIOGRAPHIC FACTORS (TOPOGRAPHIC FACTORS)***

---

Physiographic factors are those associated with the physical nature of the area. Such factors include topography of the area, slope of the land, land elevation from sea level, silting and blowing up of sand, degree of erosion etc. These factors influence vegetation which causes variation in climate of a geographic region, ultimately give rise to a characteristic microclimate. The microclimate represents the climatic conditions that prevail at local scale or in areas of limited size, e.g., the immediate surroundings of plants and animals. Some of the important physiographic factors are discussed below:

**1. Altitude of the place:** Altitude is the height of the land above Sea level. At high altitude, the velocity of wind is high, temperature and air pressure decrease, humidity and light intensity increases. All these factors together give a definite pattern of vegetational zone. With the increasing altitude, wind velocity also increases thus promoting the rate of transpiration. Plants growing at higher altitudes show stunted growth because of the effects of wind.

**2. Steepness and exposure of the slope:** Slope is the gradient or steepness of a particular surface of the Earth. It affects the amount of solar radiation received during the day. The steepness of the slope especially in comparatively high altitudes increases the exposure to the Sun. In northern hemisphere, South facing slopes receives more solar radiation than the north facing slope. This may be due to the fact that the steep Southern slope receives the solar radiation almost at right angles during the mid-day whereas the northern slopes receive only oblique rays during morning and evening hours. Slopes play a very important part in determining the character of the soil. The downward movement of rain water removes soil from a slope and carries it down and may deposit in the valley. The water moving over the slopes causes erosion of the top soil and as a result of this vegetation disappears from the areas.

**3. Direction of mountain chains:** The direction of mountain chains considerably influences the rainfall in an area. The mountain chains steer wind into definite directions, capture moisture from the wind on certain sides and condense aqueous vapours in the form of clouds and rains in higher region. This may be the reason that on certain sides of the high mountain, one can see rich vegetation, whereas on the other side, there occurs scanty vegetation.

---

## ***4.6 BIOTIC FACTORS***

---

Biotic means living, and biotic factors are the other, living things, such as plants, animals, microorganisms. Under natural situations, organisms live together with their interactions directly

and indirectly. Removal of even a single population from an ecosystem can upset the whole ecological balance. The population occurring together in an area interacts with each other in several ways. The relationship between organisms of the same species is called intraspecific relationship, while a relationship between two different species is known as interspecific relationship. Such relationships can be found in any community. It may be either beneficial to both partners or harmful to both, or beneficial to one and harmful to the other, or it may be neutral for the others.

Ecological interactions are classified as intraspecific or interspecific.

**Interspecific Relationship:** Interspecific relationships between two or more species can be found in any community and belong to two main categories- Symbiosis and antagonism.

**1. Symbiotic Relationships:** Symbiosis means 'living together' when the populations help one another and either one or both the species are benefited, the interactions are known as Positive interactions or symbiotic relationship. Symbiotic relationships include mutualism, commensalism, proto-co-operation.

**(a) Mutualism:** Mutualism is the beneficial inter-specific interactions in which both participants benefit and which is obligatory for their survival. The organisms involved in mutual relationship cover a wider range, namely (1) Plant-plant, (2) animal-animal, or (3) Plant-animal associations. Some examples of mutualism are as follows:

**(i) Pollination by animals:** Bright coloured flowers or highly scented or honey producing flowers attract insects for pollination. Butterflies, Bees, moths and other pollinators visit to the flowers in search of honey and edible pollens. Pollinators serve as vectors of pollination, the transfer of pollen from an anther to a stigma, which is a precondition for the development of fruits and seeds from flowers in the angiosperms. In turn, the pollinators feed on the nectar that the flower secretes or obtain some plants are specialized in their pollination by particular type of animals such as Rafflesia is pollinated by elephants and birds, bilipped flowers of Salvia are pollinated by bees.

**(ii) Role of animals in the dispersal of fruits and seeds:** Generally, the animals are helpful in the dispersal of fruits and seeds from one place to another. Some seeds are very hard and fail to germinate unless the same have passes through the gut of birds, F.E. Reus. Ants are good agents for transporting oily seeds and small grains of cereals.

**(iii) Symbiotic nitrogen fixation:** Symbiotic nitrogen occurs through associations of plant roots with nitrogen-fixing bacteria. The best studied example is the association between legumes and bacteria in the genus Rhizobium. The rhizobia enter the roots through the root hair and the infected root cells respond by developing root nodules. In these nodules, the host plant provides nutrients for the bacteria and the bacteria in return fix atmospheric nitrogen to the host plant in adsorbable form. Nitrogen is an essential macronutrients for plant growth and development.

**(b) Commensalism:** In this type of association, one species benefits while the other is neither benefit nor is harmed. A commensal as an organism requires food and shelter from the host,

without any harm to the host. For example hydroids like *Hydractinia* live as commensals on the gastropod shells occupied by crabs. Some plants grow on the surface of animals. For example *Basidiocladia* (cladophoraceae) grows on the backs of freshwater turtles as commensals.

(c) **Proto-cooperation:** It is a positive interaction in which both the species benefit but which is not obligatory for their survival. Example of proto-cooperation is the removal of ecto-parasites from the back of bovines by some birds that eat the parasites. In this interaction birds get food from the bovines they clean, and in turn the bovines get rid of parasites.

**2. Antagonism or Negative Interaction:** The relationship between members of different species in which one or both are harmed is termed as antagonism. The relationships of antagonism include:

- (a) Parasitism
- (b) Predation
- (c) Competition
- (d) Ammensalism

(a) **Parasitism:** It is a kind of harmful interaction in which one species (parasite) is benefited at the expense of the other species (host). A parasite derives its food, shelter and protection from the host. The parasite may live inside (endoparasite) or outside (ectoparasite) the host. Usually, the host is larger than the parasite. The parasite often does not cause the immediate death of the host since it needs the host alive to survive. For example, mosquito species serve as vectors for the protozoan malarial parasite, *Plasmodium*. Majority of the parasites are micro-organisms, of which fungi (*Albugo candida*, *Sclerospora*, *Puccinia*), bacteria (*Xanthomonas citri*, *Pseudomonas solanacearum*), and viruses (Potato virus I, Papaya Mosaic virus, Banana virus I). Trees (host) and Parasitic helminthes (parasite) dogs (host) and lice (parasite), cattle (host) and ticks (parasite).

(b) **Predation:** The term predation is generally used to describe the killing and eating of one species by another. An organism which feeds on another organism for their food is called predator while the organism that is fed upon is termed as the prey. Typical predation occurs when a carnivore kills a herbivore or another carnivore for food. Examples of predation are bats eating the insects, snakes eating mice etc. Majority of predatory organisms are animals, but there are some plants also, like nepenthes, *Darlingtonia*, *Dioneae*, *Sarracennia*, *Drosera* etc consume insects and other small species for their food. They are called as Carnivorous plants. Aquatic plants are eaten by animals like duck, fish etc.

(c) **Competition:** Competition is a relationship in which different organisms or populations in the ecosystem attempt to use the same limited resources at the same time. However, in nature competition may not be always apparent although it is occurring. Competition can occur both

within (intraspecific) and between (interspecific) species the limiting resource may be water, prey, light etc which is responsible for the growth and survival of organisms. Plants compete for light, nutrients in a forest and animals for food and shelter.

Schoener (1983) divided competition into six categories. These are consumptive competition (based on the utilization of some renewable resource), pre-emptive competition (based on the occupation of open space), over-growth competition (occurring when one organism grows over another thereby depriving it of light, water, or some other resource), chemical competition (by production of a toxin acting at a distance), territorial competition (defense of territory), and encounter competition (involving transient interactions over a resource resulting in loss of time or energy, physical harm, or theft of food).

**(d) Ammensalism:** Ammensalism is the ecological interaction in which one species harms another without obtaining benefit. For example- ammensalism is between humans and other species under threat of extinction due to human actions. Such as ecological accidents, habitat devastation by fires etc. In many cases the harmful effects are due to certain chemical substances secreted by one population as specific toxins into the environment. These chemicals are called allelochemicals. They are of three types: (i) allomones, (ii) depressants, (iii) Kairomones. Allomones are chemicals which give adaptive advantage to the organisms that produce the chemical. Production of allomones is a common form of defence, particularly by plant species against insect herbivores. Depressants released by certain organisms inhibit or poison the receiver without benefit to the releasing organisms. Example is the red tide, a proliferation of algae that can lead to death by intoxication of fish and other water animals. Kairomones are chemicals produced and released by a living organism that benefits the receiver but disadvantages the donor. For example, the chemicals released by nematodes stimulates certain fungi to develop traps for nematode worms are used to protect the nematodes from predators.

Inter-relationship among plants of a community affect the morphology, reproduction and other activities of other plants of the same community. Various plants in a community react with one another in several ways for light, water, food, essential minerals and organic compounds. Following are the instances of mutual relationship among plants growing in the same area:-

**(a) Lianas:** Lianas are woody vascular plants rooted in the soil at ground level and use trees, as well as other means of vertical support, to reach on the top of the plants canopy. They are autotrophs and commonly found in tropical or dense forests. Lianas grow at the top of the trees and form the top layer of the forest canopy. *Bauhinia vahlii*, *Tinospora*, *Entada gigas* etc are examples of Lianas.

**(b) Epiphytes:** The epiphytes (Epi= above, phyton= plant, i.e, plant growing upon plant) grow harmlessly on the leaves and stems of other plants. They are autotrophs and do not obtain food from the supporting plant. They absorb sufficient moisture from the atmosphere and mineral

nutrients through their absorbing roots from the soil present in the crevices and cracks on the surface of the supporting trees. The majority of epiphytic plants are angiosperms (flowering plants); they include many species of orchids, tillandsias, and other members of the pineapple family (Bromeliaceae). These plants develop two types of roots, namely the aerial and clinging roots. The aerial roots have a special, water absorbing tissue, called velamen, on their surface. The clinging roots fix the epiphytes on the surface of supporting plants.

**(c) Parasitic plants:** Plant that obtain all or part of its nutritional requirements from another living plant. They grow either on stem or root of the host plant. Parasitic plants have special sucking roots, called haustoria, which penetrate the host plant connecting them to the conductive system- either the phloem, the xylem or both. Examples of parasitic plants are *Cuscuta* (total stem parasites), *Balanophora*, *Rafflesia*, *Orobancha* (Total root parasites), *Cassytha*, *Viscum*, *Loranthus* (Partial stem parasites), *Striga*, *Santalum album* (Partial root parasites).

**3. Symbiotic Plants:** Symbiosis is an interaction in which both the participants mutually beneficial to each other without any harm to either of the partner. The perfect example of symbiotic relationship between two plants is Lichen. In lichens, the algae and fungi live together in an intimate symbiotic relationship. The alga synthesizes organic food which is utilized by both the algal and fungal components. In exchange, the fungal component provides moisture and mineral elements to alga.

**Interrelationship between plants and microorganisms:** There are several living organisms remain present in soil and as a result of their activities vegetation on the surface is greatly affected. The common soil organisms are bacteria, fungi, protozoa, mites, nematodes, earthworms, insects etc. Microorganisms in the soil are important for plant health. Both positive and negative health effects can result from microorganisms. Microorganisms that promote healthy plant growth called beneficial microbes. Microorganisms which injure crops by causing disease are called as pathogens. Soil microbes, such as bacteria, nematodes etc cause many diseases in the underground parts of plants. For example viruses cause several mosaic and other diseases in many plants as, the curling of tomato leaves, mosaic patterns in papaya and lady's finger, bean mosaic etc. Some microbes secrete certain mucilaginous substances in the soil. The mucilage converts soil micro-parasites into large aggregates which adversely affect the growth of plants growing on that soil. Beneficial microbes help plants by several different methods. One of the most important roles played by soil microorganisms is in the decomposition of dead organic matter present in the soil and its conversion into simple forms which can be used by higher plants as nutrients. Microorganisms may also have mutualistic relationships with plants. For example nitrogen fixing bacteria i.e. *Rhizobium* growing in the roots of legumes. In this *Rhizobium*-legume association, *Rhizobium* bacteria are benefited by protection from the environmental stress while in turn plant is beneficial by getting readily available nitrate nitrogen released by the bacterial partner. Another type of Symbiotic association which exists between the



roots of higher plants and fungus is Mycorrhiza. In this association Mycorrhizal fungi help plant roots absorb nutrients and fight off harmful, soil-dwelling predators. In exchange, the fungus receives sugar and nutrients from its host plant. Burrowing vertebrates, earthworms and decaying roots improve aeration and water holding capacity of the soil.

**Effects of human activities on vegetation:** Human activities have caused a number of changes in a variety of ecosystems through agriculture, forestry, urbanization and industry. The most obvious way that humans impact vegetation is by burning it, both intentionally and accidentally. Man has used fire for the clearance of forest cover, mainly for the use of land for cultivation or for habitation. This practice was common during the early stages of the development of civilization. But, it is still prevalent among many tribals. Although controlled burning is a part of forest management, uncontrolled and deliberate fire destructs not only vegetation but also animals and other forest creatures. Long term effects of fire are: clearance of vegetation, soil erosion, flooding and wind erosion. When the fire is extremely severe, the vegetation is almost destroyed and upper part of the humus is also burnt down. This reduces the fertility of the soil. Compounds of calcium, phosphorus and potassium are converted into soluble forms which easily leach away from the soil thus making it deficient in these minerals. Nitrogen compounds are converted into their gaseous forms and hence disappear. When the fire is over, such areas are invaded by low nitrogen requiring plants such as *Funaria* and *Marchantia*. The effects of fire are not always destructive on every plant. Some fungi like *Pyronema* confluents actively grow in recently burnt areas. Such fungi are known as Pyrophilous. Fire of low intensity may sometime result in increased soil fertility. Mineral salts of calcium, magnesium, potassium and phosphorus

Increase with burning. Several grasses like *Aristidastride*, *Gynodondactiylon* etc get stimulated by fire to produce large quantities of seeds. Fire is a good method of range management. In the rangelands are burnt at regular intervals of annual or longer cycles in order to destroy less palatable and hardy species which otherwise over take range lands on account of grazing in course of time. Uncontrolled and heavy grazing is a cause of the disappearance of vegetation cover.

---

## 4.7 SUMMARY

---

Ecology is the scientific study of interactions between organisms and its environment. Ecological factor is any factor biotic or abiotic that influences plants and organisms. Ecological factors can be classified into four divisions- climatic factors, physiographic factors, edaphic factors and biotic factors. The climatic factors are grouped under four categories: Light, temperature, precipitation and atmospheric humidity, wind. Edaphic factors are those which act upon plants through soils. Physiographic factors are those associated with the physical nature of the area. Such factors include topography of the area, slope of the land, land elevation from Sea level,

silting and blowing up of sand, degree of erosion etc. Biotic factors are the other, living things, such as plants, animals, microorganisms.

---

## 4.8 GLOSSARY

---

**Topography:** Topography is the land scale shape which is determined by the aspects of slopes and elevations.

**Ecology:** The study of interactions between organisms and their environment.

**Predation:** The preying of one animal on others.

**Phototropism:** Plants in response to light stimulus.

**Phototaxis:** An organisms movement in response to light.

**Soil Profile:** The vertical layered structure of soil.

**Precipitation:** A form of water, such as rain, snow, or sleet, that condenses from the atmosphere and falls to the earth's surface.

**Humidity:** It is defined as the amount of wetness or water vapour in the air.

**Transpiration:** The process of water movement through a plant and its evaporation from aerial parts, such as leaves, stems, and flowers.

**Heliophytes:** Plants which grow in bright Sunlight.

**Sciophytes:** Plants which grow in the shades.

**Edaphic factor:** The physical or chemical composition of the soil found in a particular area.

**Stratum:** A layer or a series of layers of rock in the ground.

**Humus:** The organic components of soil, formed by the decomposition of leaves and other plant material by soil microorganisms.

**Capillary water:** Water that remains in the soil after gravitational water is drained out.

**Gravitational water:** Free water that moves through the soil due to the force of gravity.

---

## 4.9 SELF ASSESSMENT QUESTION

---

### 4.9.1 Multiple Choice Questions:

1. Which of the following interaction is beneficial to both the parents?

- |                  |                |
|------------------|----------------|
| (a) Competition  | (b) Mutualism  |
| (c) Commensalism | (d) Parasitism |

2. Environmental factors which deal with the structure of soil are termed as-

- |                         |                      |
|-------------------------|----------------------|
| (a) Biotic factors      | (b) Edaphic factors  |
| (c) Topographic factors | (d) Climatic factors |

3. Ecosystem has two components:

- (a) Biotic and abiotic  
(c) Plants & animals
- (b) Frogs and lizards  
(d) Man and animals
4. Plant group growing in zones where high temperature alternates with low temperature are called:
- (a) Mesotherms  
(c) Hekistotherms
- (b) Microtherms  
(d) Megatherms
5. The branch of biology that deals with the study of interaction between organisms and environment is called-
- (a) Morphology  
(c) Ecology
- (b) Methology  
(d) Physiology
6. Plants which blooms when the light duration is more than 12 hours per day is known as:
- (a) Long day plants  
(c) Day neutral plants
- (b) Short day plants  
(d) Long day and short night plants
7. The plant of cold or temperate habitat require low temperature for their growth are called-
- (a) Megatherms  
(c) Microtherms
- (b) Mesotherms  
(d) Ekistotherms
8. Edaphic factors are included in:
- (a) Abiotic components  
(c) Producers
- (b) Biotic components  
(d) Consumers
9. Which of the following is an abiotic component-
- (a) Plants  
(c) Soil
- (b) animals  
(d) microorganisms
10. The Law of tolerance presented by which of the following Scientists:
- (a) Victor Ernest Shelford  
(c) F.F. Blackman
- (b) Justus Liebig  
(d) None

**4.9.1- Answer Key:** 1. (b), 2. (b), 3. (a), 4. (a), 5. (c), 6. (a), 7. (c), 8. (a), 9. (c), 10. (a)

---

## 4.10 REFERENCES

---

- Singh H.R. (2005), *Environmental Biology*, S. Chand & company.

- Sahoo A.K. (2001), *The Text book of forest ecology, biodiversity and conservation*, International Book Distributors.
- Shukla R.S. & Chandel P.S. (1972), *A Text book of Plant Ecology*, S. Chand & company.
- Agarwal S.K. (2008), *Fundamentals of Ecology*, APH Publishing Corporation.
- Singh. J.S, Singh S.P. & Gupta S.R. (2014), *Ecology, Environmental Science and Conservation*, S. Chand & company
- B.P. Pandey (2007), *Botany for Degree Students (B.Sc.III)*, S. Chand & company

---

#### ***4.11 SUGGESTED READINGS***

---

- *Environmental Biology*, 2005 by Dr. H.R Singh, S. Chand & company.
- *The Text book of forest ecology, biodiversity and conservation*, by Sahoo A.K. (2001), International Book Distributors.
- *A Text book of Plant Ecology* by R.S. Shukla & P.S. Chandel (1972), S. Chand & company.
- *Fundamentals of Ecology*, S.K. Agarwal (2008), APH Publishing Corporation.
- *Ecology, Environmental Science and Conservation*, J.S, Singh, S.P. Singh. & S.R. Gupta (2014), S. Chand & company
- *Botany for Degree Students (B.Sc.III)*, B.P. Pandey (2007), S. Chand & company

---

#### ***4.12 TERMINAL QUESTIONS***

---

1. Define Ecology. Discuss in detail about the climatic factor.
2. What is soil profile? Describe it in detail.
3. Differentiate between:
  - (a) Parasitism and Predation
  - (b) Competition and Ammensalism
  - (c) Gravitational water and Capillary water
4. Give a detailed note on importance of light factor.
5. Explain about the physiographic factor.

---

## **UNIT-5 POLLUTION ECOLOGY**

---

- 5.1-Objectives
- 5.2-Introduction
- 5.3-Air pollution
- 5.4-Noise pollution
- 5.5-Water pollution
- 5.6-Soil pollution
- 5.7- Summary
- 5.8- Glossary
- 5.9-Self Assessment Question
- 5.10- References
- 5.11-Suggested Readings
- 5.12-Terminal Questions

---

## ***5.1 OBJECTIVES***

---

After reading this unit, students will be able to:

- define the terms pollution and pollutants
- list various kinds of pollution
- describe types of pollution, sources, harmful effects on human health and control of air pollution
- describe water pollution, its causes and control
- describe soil pollution, its causes and control

---

## ***5.2 INTRODUCTION***

---

The term pollution is derived from the latin word “Polluere” which means to defile or contaminate any feature of the environment.

Pollution is an undesirable change in the physical, chemical or biological characteristics of our air, land (soil) and water that can harmfully affect human life or that of other species, our industrial processes, living condition and cultural assets. This definition is based on the report of committee on pollution, National Academy of Sciences, USA 1966.

In simple language, any addition to air, water, soil or food that threatens the health and survival capabilities of humans or other living beings is known as pollution.

According to Southwick (1976), Pollution is the unfavourable alteration of our environment as human activities.

The human population is increasing rapidly with the increase of population; necessities of man are also increasing. Man is exploiting the natural resources for its own interest. Man has disturbed the natural balance and changed the environment of many places to such an extent that they are not suitable for inhabitation by living beings.

According to smith (1927), every human society including rural, urban, industrial and technologically advanced dispose of certain kinds of byproducts and waste products which when injected into the biosphere they affect the normal functioning of ecosystem and have an adversw effect on plants, animals and man are collectively called Pollutants.

In simple language any substance which causes pollution is called Pollutant.

In Environmental Protection Act, 1986 of India, environmental Pollutant means “any solid, liquid, or gaseous substance present in such concentration as may be or tend to be injurious to environment; and the environmental pollution means the presence in the environment of any environmental pollutant”

According to Odum (1971), from the ecological view point, these pollutants can be bio-degradable and non-degradable pollutants.

**1-Non-degradable Pollutants:** The materials that do not degrade or degrade very slowly in the natural environmental conditions are called non-degradable pollutants. Such as- mercurial salts, aluminium cans, DDT and long chain Phenolic chemicals.

**2-Bio-degradable Pollutants:** These pollutants are natural organic compounds which are degraded by biological or microbial action. e.g., domestic sewage, cloth, paper, wood, etc.

*In this unit we will discuss about air, noise, water and soil (land) pollution.*

---

## 5.3 AIR POLLUTION

---

Air pollution is essential for the existence and survival of humans or other living organisms. No one can survive without air. With the advancement of time air is polluting day by day by human activities or naturally. Air pollution may be defined as the contamination of earth's atmosphere generally resulting from the human activities which adversely affects the living organisms, plants and causes damage to the property. According to the World Health Organization- Air pollution is the presence in the outer atmosphere of substances or contaminants put there by man, in quantities and concentrations and of a duration as to cause any, discomfort to a substantial number of inhabitants of a district of which are injurious to public health or to humans, plant or animal life or property or which interfere with the reasonable comfortable enjoyment of life and property throughout the territories or areas of State. According to Environment Perform Index 2014, India's air quality was among 5 worst nations, smoke, dust, fire, exhaust, gases from motor vehicles etc get mixed up in atmosphere and affects the quality of air.

Air pollution is one of the most dangerous and common kind of environmental problem. Air pollution is the accumulation in the atmosphere of substances that, in sufficient concentrations, endanger human health or produce other measured effects on living matter and other materials.

Air Pollution is the introduction of chemicals, particulate matter, or biological materials that cause harm or endanger to humans or other living organisms or cause damage to the natural environment.

There are two types of Pollutants-1) Primary Pollutant and 2) Secondary Pollutant.

**1-Primary Pollutant:** Primary pollutants are directly released into the atmosphere e.g., CO<sub>2</sub>, CO are directly emitted from burning of fossil fuel.

The six major types of primary pollutants are nitrogen oxides, hydrocarbons, carbon monoxide, particulates, photochemical oxidants, sulphur dioxide.

**a) Sulphur dioxide (SO<sub>2</sub>):** Sulphur dioxide is originated primarily from the combustion of coal and petroleum. Coal and Petroleum often contain sulphur compounds, and their combustion generates sulphur dioxide. Sulphur dioxide (SO<sub>2</sub>) is also released from smelters, oil refineries, fertilizer industries, sulphuric acid manufacturing industries, paper and pulp industries etc.

In the atmosphere, sulphur dioxide reacts with moisture to form sulphuric acid (H<sub>2</sub>SO<sub>4</sub>) which causes many respiratory diseases and produce acid rainfall over the Earth. Acid rainfall reduces forest growth.

**b) Nitrogen oxides (NO<sub>2</sub>):** Oxides of nitrogen are the second most abundant atmospheric pollutants. Nitrogen oxides are formed when fuel is burnt at very high temperature, such as transportation (automobiles), industrial plants (power). Coal and petroleum often contain sulphur compounds, and their combustion generates sulphur dioxide. Nitrogen oxides contribute to a number of problems as direct exposure to nitrogen oxides irritates the eyes and lungs, poisonous to plant.

**c) Carbon monoxide (CO):** Carbon monoxide is a colourless, odourless, toxic yet non-irritating gas. Carbon monoxide is an incomplete combustion of fuel such as natural gas, coal and wood and accounts for more than 50 percent of total weight of pollutants added to the atmosphere.

**d) Volatile organic compounds:** VOCs are organic chemicals, easily vaporize at room temperature, contain the element carbon in their molecular structures, have no colour, taste or smell. They are found in everyday household items such as, craft kits, paints, varnishes, fuels, dry cleaned clothes, pesticides, cigarette smoke, etc.

**e) Particulates:** Particulate air pollutants may be solid or liquid suspended in a gas, solid particulate air pollutants are heavy metals, pesticides, photochemical smog, smoke, radioactive elements etc. Particulates of liquid nature are liquid aerosols, sprays; some particulates occur naturally, as forest fires, volcanoes, dust storms. Burning of fossils fuels in vehicles, domestic hearths, factory chimneys also generate aerosols.

**f) Radioactive Pollutants:** A large number of radioactive elements are released in the atmosphere from cooled powder reactors, atomic explosions, testing of nuclear weapons.

**2-Secondary Pollutant:** Secondary Pollutant is formed in the atmosphere when primary pollutants react or interact. e.g., formation of Peroxy Acetyl Nitrate (PAN-Nitrogen oxides react with unsaturated hydrocarbons and produce Peroxy acetyl nitrate called PAN).

**5.3.1 Effects of Air Pollution:** Air pollution is harmful to humans, animals and plants.

**1) In Plants:** The effect of air pollution on plants develops over time chemicals such as fluorides, peroxyacyl nitrate, sulfur dioxide harms the leaves of plants, tissue collapse due to plasmolysis of cells of leaves by air pollution. High concentrations of SO<sub>2</sub> and carbon dioxide lead to chronic injury in plants. Due to air pollution dropping of leaves, small fruit formation, stunted growth takes place. NO<sub>x</sub> and Peroxy acetyl nitrate (PAN) reduces photosynthetic efficiency, damages chloroplast which affects the growth of plant, cause death of forest trees by blocking Hill reaction. Photochemical smog causes damage to plant foliage, severe smog damage to spinach leaf.

**2) Effects on humans:** Pollutants have a serious effect on human health. Inhaling carbon monoxide combines with the blood hemoglobin and reduces the oxygen carrying capacity of hemoglobin causes headaches, dizziness, hard breathing and irritation of mucous membranes. Lead can damage the brain of young children, Nitrogen dioxide (NO<sub>2</sub>). Inhalation causes eye irritation, bronchitis, pulmonary congestion and even causes death. Photochemical oxidant, e.g.,



ozone causes dryness of mucous membrane of mouth, coughing, irritation in eye, soreness and coughing in chest, pulmonary congestion and edema, cadmium is poison for respiratory system and causes oxygen deficiency. Particulate air pollution causes respiratory problems worldwide, people suffering from asthma, bronchitis.

**3) Effects on Building materials:** Air pollution damages building materials. Smoke, dust, fog, grit and oxides of sulphur cause erosion of building materials.  $\text{SO}_2$ , Nitrogen oxide ( $\text{NO}_x$ ), hydrocarbons formed during combustion of coal and petroleum. They produce acids in the rain water or may remain in the atmosphere. Acid rain corrodes monuments, buildings, furnishing Worldwide famous Taj Mahal is greatly affected by the acid deposition and facing corrosive problem from the  $\text{SO}_2$  fumes released from Mathura refinery.

**4) Change of climate:** Climate change refers to changes in the climate of the earth caused by human activities. Air pollution causes contamination of the upper atmosphere and the change of climate. Ayyar (1973) reported that air pollutant like dust, smoke,  $\text{CO}_2$ , oxides of  $\text{N}_2$  and  $\text{SO}_2$  when present in higher concentration causes scattering of light, bringing about climate changes.

Certain gaseous pollutants and aerosols such as ammonium sulphate mists and sulphuric acid mists reach the atmosphere where they have effects on the absorption and penetration of sunlight. The concentration of aerosols,  $\text{SO}_2$ , ammonium acid fumes affects the pH of rain water.

**5.3.2 Ozone layer depletion:** The ozone layer is the outer layer of the gas mixture present in the stratosphere, the second layer of the atmosphere. Ozone layer is found between 15 and 35 kms above the surface of the earth. Stratospheric ozone is a naturally occurring gas that filters the Sun's ultraviolet radiation and protects the surface of the earth from the harmful effects of radiation. Ozone absorbs most of the UV radiation of the Sun. The ozone layer is thinning out due to human activities. CFCs (Chloro fluoro carbons) are compounds that consist of chlorine, fluorine and carbon. These gases are used in air conditioners and refrigerators (as coolants), aerosol spray cans, cleaning solvents, fire extinguisher, polyurethane foams. On molecule of CFCs can damage 100,000 molecules of ozone. It was first observed in 1985 over Antarctica that thinning of ozone layer is maximum in spring season and is called ozone hole. Space rockets and planes, supersonic aircrafts also contribute to the destruction of the ozone layer. A diminished ozone layer allows more radiation to reach the Earth's surface. For humans over exposure to UV rays can lead to skin cancer particularly melanoma, cataracts, loss of immunity systems. In plants chlorophyll content is decreased, reduced crop yield interferes with oxygen cycle and affects weather patterns. It damage nucleic acids in living organisms (mutation).

**5.3.3 Green House Effect:** The green house effect is a natural process that warms the earth's surface. When the solar radiation reaches the earth's atmosphere, some of it is reflected back into space and the rest is absorbed and re-radiated by green house gases. This process keeps the earth warm enough to sustain life. Carbon dioxide, Methane, Nitrous oxide, ozone, CFCs, CO and  $\text{SO}_2$  are green house gases. Concentration of  $\text{CO}_2$  is increasing due to human activities

like burning of fossil fuels, deforestation, agriculture industrial process etc. An increased concentration of CO<sub>2</sub> forms a thick layer and prevents the heat from being reradiated out into space. This thick layer of CO<sub>2</sub> thus functions as a glass panel of green house. Green house is a house of glass used for growing plants that require high temperature for growth. A glass panel of green house allows the sunlight to filter through it but prevents the heat from getting reflected back into space. Similarly an increased concentration of Carbon dioxide and other gases allow the sunlight to filter through but prevent the heat from being re-radiated in outer space. Thus most heat is absorbed by CO<sub>2</sub> layer and water vapours in the atmosphere which is contributing to warming of the earth and causing the earth's temperature to rise. This is so-called Green House Effect. Nearly 100 years ago the atmospheric level of CO<sub>2</sub> was 275 ppm. Presently it is 350 ppm and by the year 2040 it is expected to reach 450 ppm. Enhancement of green house effect results in global warming. Global warming may cause change in weather and climate.

**5.3.4 Management control of Air Pollution:** Air pollution can be better controlled by Environment management aims at controlling pollution problems and improvement of the atmosphere. To control and reducing air pollution few steps are as follows-

- 1-Environmental education should be given to everyone.
- 2-Unleaded gasoline is supplied.
- 3- Change from high-sulphur coal to low-sulphur coal.
- 4-Regular pollution control checks on the vehicles.
- 5-Factories should be situated far from the city.
- 6-The chimneys of factories should be fitted with filters like cyclone, separators, scrubbers or electric precipitators.
- 7-Gobar gas for domestic use should be encouraged.
- 8-For purifying the environment encourage plantation.
- 9-Non-conventional energy such as solar energy, wind energy should be adopted.
- 10-Transport systems must have an antismog device.
- 11- Proper arrangements for recycling of wastes and sewage should be done.
- 12- Smoking should be banned. It is noticed that there is 50, 00,000 tones tobacco pollution per year.
- 13-Cyclone collectors and electrostatic precipitators can be used to remove particulate matters.

---

## **5.4 NOISE POLLUTION**

---

The word noise is derived from the latin term nausea. It has been defined as unwanted and unpleasant sound. A given sound is pleasant or as unpleasant as noise depends on its loudness and the mood of the person. At times, what is music for someone can be noise for others. But loudness is definitely the most significant criterion which converts sound into noise that causes irritation or annoyance.

Section 2 (a) of the Air (Prevention and control of pollution) Act, 1981 includes noise in definition of 'air pollutant'. Section 2 (a) air pollution means any solid, liquid or gaseous substance including noise present in the atmosphere such concentration as may be tent to injurious to human beings or other living creatures or plants or property or environment.

Noise is that form of sound energy which is unpleasant or undesirable for human ears. Noise pollution causes temporary disruption into the atmosphere. Noise pollution effects on the sense organs, nervous systems, glandular and cardiovascular systems.

**Measurement:** The frequency of sound is measured in Hertz and the loudness of noise is measured on a logarithmic scale called 'decibel'. Decibel is the basic unit of sound. Noise level above 80 db causes noise pollution. According to National Physical Laboratory, Report that the noise level in India is increasing at the rate of 1db per year. The standard for the measurement of noise is decibel. 60 db is normal conversation. Sounds beyond 80 db are responsible for noise pollution as they become physically painful.

#### **5.4.1 Sources of Noise Pollution:** The industrial revolution brought noise pollution.

- 1- **Industrialization:** Industries uses huge machines which produces a lot of noise during production work. Various industries and big machines working at a very high speed and high noise intensity.
- 2- **Construction activities:** Construction activities such as road construction and repair, building construction, street work, construction of bridges, dams, flyover, etc. These construction equipments produce a lot of noise. Bulldozers, dump trucks, loaders is a nuisance to the people. The automobile repair shops, blasting, bulldozing, stone crushing etc are other sources of noise pollution.
- 3- **Transportation:** Different types of road vehicles produce heavy noise. Traffic is the main source of noise pollution in cities. Two wheeler, four wheeler, Trains, Jet planes, horns of engines, pressure horns in automobiles are the major sources of noise. It is very annoying condition. People loose their temperament while driving a vehicle it may cause so many accidental cases.
- 4- **Household appliances:** Household appliances also make noise and contribute a minor amount of noise. Today's world is a world of gadgets. People use modern domestic gadgets in daily life. Kitchen gadgets such as mixer grinder exhaust fans, pressure cooker, etc. Cleaning gadgets such as vacuum cleaner, washing machine, dish washer etc. For amusement purposes Television, radio, tape recorder etc is used. Air conditioners, coolers, fans etc all these house hold items produce so much noise.
- 5- **Social events and festivals:** Social gathering or events where loudspeakers, amplifiers or other equipments are used which produce offending noise, fire crackers burst during Diwali, marriages and on other occasions for celebration creates a lot of noise pollution and create disturbances to the patients, students and others.
- 6- **Loudspeaker:** Loudspeaker is used on every occasion such as marriage, party, birthday, festivals, etc. People play songs on full volume till midnight which is torturous for people

living nearby. In religious places such as temples, mosque, gurudwaras, churches and other places loud speaker is frequently used. Hackers play loud noise to attract the attention of people which disturbs the people living nearby.

The various sources of Noise Pollution are industries, traffic noise, thunder storm, building construction, aeroplane, etc. House hold appliances also makes noise and contributes a minor amount of noise as washing machine, pressure cooker, mixer grinder, T.V., vacuum cleaners, cooler, social gathering and social events such as marriage, birthday party. Place of worship where people play the loud speakers on full volume which disturbs the people living nearby. Hackers play loud noise to attract the attention of people. Most of the industries and factories are capable of producing large amount of noise.

**5.4.2 Effects of Noise pollution:** We hear noise through our ears and continuous exposure to noise level of more than 90db result in the damage of ear drums and impaired hearing. It may be temporary or permanent. Excessive noise pollution can influence psychological health and may reduce the efficiency of work. Noise has a great impact on cardiovascular systems. It causes rise in blood pressure, levels and stress related heart problems. It increases heart beat rate. Constant loud and sharp noise can give severe headache, giddiness and disturb emotional balance. Other health related negative effects of sound pollution are sweating fatigue. Noise pollution affects on pattern. Noise pollution disturbs sleeping pattern and may led to irritation and annoyance and people lose their temper.

**5.4.3 Prevention and control of Noise pollution:** Noise pollution can be controlled by the following suggestions-

- 1- Industries or Noise producing factories should be situated far from the cities. Schools and Hospitals should be marked as silent zones.
- 2- The use of loudspeaker should be banned from 10 pm to 6 am. The banned should be strictly followed.
- 3- Use sound proofing system where it can be used.
- 4- Cultivation of thick vegetation may reduce noise pollution.
- 5- Laws should be implement strictly.
- 6- Factory workers and traffic controller should use ear muffs, to avoid ear related problems. Specially designed earmuffs can reduce the sound level reaching the ear drum by as much as 40dB.
- 7- Fire crackers burst during festival and use of loud speakers should be prohibited or at least regulated.
- 8- Industrial zones should be separated from the residential zones of the city.

---

## 5.5 WATER POLLUTION

---

Water is essential for life. No one can survive without water. Water is one of the greatest natural resources. Water is also facing threats of pollution. Water pollution has reached alarming proportions. Water pollution may be defined as “the adverse change in composition or condition of the water such that it degrades the quality of the water. Water pollution affects the biotic and abiotic factors and its ultimate effect on man remains quite drastic.

**5.5.1 Sources of water pollution:** Both inorganic or organic or biological substances are responsible for water pollution.

- 1- **Domestic sewage and domestic wastes:** Domestic sewage contains kitchen and bathroom, washing and human faecal matter. Discharge of untreated sewage into water bodies are degraded by oxygen requiring microorganisms. Untreated sewage into rivers causes depletion of O<sub>2</sub> content. Oxygen depletion causes decreases of algae and clean water fauna may cause floating scums, algal obnoxious blooms. Bacteria and viruses are present in certain sewage wastes which may responsible for water borne diseases such as typhoid, poliomyelitis, amoebic dysentery (loose motions).
- 2- **Industrial wastes:** Most of the industrial wastes are into water. Industrial wastes of these industries include mercury, copper, zinc, chlorine, arsenic, and many other toxicants. These industrial chemicals wastes are toxic to animals.
- 3- **Marine pollution:** Marine pollution is caused by discharge of sewage and rubbish from ships and tankers, oil and petroleum products, pollution of coastal water due to the dumping of domestic and industrial wastes, oil drilling in coastal waters. According to Hunt (1966), oil spills have killed mammals, water birds, vegetation and fish.
- 4- **Thermal pollution:** Thermal pollution is pollution due to release of excessive amounts of heated water. Thermal pollution may be defined as “the warming up of an aquatic ecosystem to the point where desirable organisms are adversely affected” (Owen, 1885). A large number of industrial plants like coal or oil fired generators thermal, nuclear, atomic etc use cold water for cooling purposes and resultant warmed water has often been discharged into ponds or rivers. Waste heat causes thermal pollution. Thermal pollution causes reduction in DO (dissolved oxygen) content of water which can kill fish and alter food chain composition. It changes the physical and chemical properties of water. With rising temperatures fresh water fauna populations decline and reduce species biodiversity.

### 5.5.2 Effects of water pollution on the process eutrophication:

**Eutrophication (Biological effects):** The word eutrophication literally means “well nourished or enriched”. According to Hutchinson (1970), Eutrophication is a natural state in ponds and lakes which have a rich supply of nutrients and also occurs as a part of the aging procession ponds and lakes, as nutrients accumulate through natural succession. The process of

eutrophication accelerate or speeded up by domestic wastes, industrial wastes, fertilizers, animal wastes, urban drainage, detergents, sediments etc. With the addition of nutrients the growth of micro-organisms and aquatic vegetation increase in large number. Excessive growth of algae occupy the entire area in water causes the phenomenon of water bloom, which produce certain toxins that are responsible for the death of fish, birds and other aquatic animals life. Decomposition of algal bloom leads to oxygen depletion in water due to oxygen depletion aquatic organisms begins to die. Bacterial decomposition of organic wastes too requires oxygen and they with heavy loads the oxygen depletion contents of water may reduce causes below the point where most fish cannot survive.

**Effects on humans:** Water pollution causes a number of water borne diseases such as jaundice, typhoid, cholera, diarrhea, amoebic dysentery. Arsenic poisoning through water can cause liver and nervous system damage, skin cancer and vascular diseases.

**Pesticides:** Pesticides in water can damage the nervous system due to the carbonates and organophosphate that they contain. Chlorides can be harmful for reproductive and endocrinal.

**Nitrates:** Nitrates are dangerous to babies 1) that drink formula milk as it restricts the amount of oxygen that reaches the brain. It causes the “blue baby” syndrome.

2) It causes algae to bloom resulting in eutrophication in surface water.

**Lead:** Accumulation of lead in the body can damage the central nervous system. Children and women are most at risk.

**Fluride:** Excess fluorides can cause yellowing of the teeth and damage to the spinal cord.

**Chlorinated solvents:** These are linked to reproduction disorder and skin cancer. Water pollution could even indirectly affect people through the food chain. Toxic substances that are deposited in water may be consumed by aquatic organisms, such as fish. When people consume contaminated fish some toxic effects are passed on to them.

**Arsenic:** Arsenic is absorbed through skin and lung. It causes cancer of skin and lung. Chronic exposure to arsenic causes “Black-foot” disease which is prevalent in the parts of West Bengal.

**5.5.3 Water pollution control:** Proper management of water resources has become the need of today’s world.

- 1- Don’t throw litter in the ocean
- 2- Don’t dispose of chemicals, point in water supplies.
- 3- Tree plantation is very effective to check excessive run off of polluted agricultural water.
- 4- Proper disposal of municipal sewage so as to avoid contamination of ground water reserves

There are several measures to control water pollution.

**A) Domestic sewage disposal:** Sewage should be properly treated. Proper disposal of domestic sewage is done by using septic tanks, so along pits ad municipal sewage plants. In soaking pits the sewage is discharged into a underground tank. Through the holes of tank sewage water comes out and percolate into the soil and the solid wastes are decomposed by microorganisms inside the tank. In septic tank method sewage is discharged into

underground septic tanks through pipes. The solid wastes of the sewage collected at the bottom of the septic tank and it is decomposed by microbes and remaining part of the sewage is drained into the field. In the municipal sewage treatment is done in three stages-primary, secondary and tertiary treatment (advanced). Primary treatment first removes large objects through screening, and then smaller objects such as stones and sand. Remaining suspended solids are settled out in a sedimentation tank. After that the waste water is collected into secondary settling tanks and air current under pressure is passed through the waste water to promote microbial decomposition. In tertiary treatment the water obtained after secondary treatment is subjected to chlorination and testing it is supplies for domestic use.

- B) Disposable of Industrial waste water:** Industrial waste are of two types- Non degradable pollutants such as mercurial salts, cans etc. Biodegradable pollutants- some photochemical substances are added to help in decomposition of these materials when dumped. The biodegradable wastes are disposed through primary, secondary and tertiary treatment.
- C) Effects on Aquatic ecosystem:** Thermal pollution causes reduction in dissolved oxygen, fasten the process of Eutrophication, increase in Biochemical oxygen demand (BOD) indicates intense level of microbial pollution. Thermal pollution causes change in the physical and chemical properties of water, increase in toxicity. The vapour pressure increases, and solubility of gases in water decreases. Aquatic food supply is affected due to rapid setting of sediment load in water.
- D) Physiochemical effects of Water Pollution:** The pollutants adversely affect the colour, taste and odour of water. Chemically, water contains one part oxygen and two parts hydrogen. The chemical pollution of water causes in alkalinity, acidity, dissolved oxygen in water.

---

## 5.6 SOIL POLLUTION

---

The word soil is derived from a Latin word ‘solum’ which means earthy material in which plants grow. Soil is the top layer of the earth crust. According to R.F. Daubenmire, “Soil is the upper part of earth crust in which plants are anchored”.

Soil may be defined as the upper layer of the unsaturated zone of earth. Soil pollution is defined as “contamination of soil by human activities or other alteration in the natural soil environment”.

The upper layer of the earth suitable for vegetation. Geological, climatological and biological factors are very important factors for the process of soil formation. When the physical, chemical and biological properties of soil adversely affected this condition may be known as soil pollution.

**5.6.1 Sources of Soil pollution:** Following are the sources of soil pollution-

**1-Discharge of Industrial waste into the soil:** Improper disposal of industrial waste contaminates the soil with harmful chemicals. Wastes from industries such as mercurial salts, cans, DDT, garbage, leather, rubber do not degrade or degrade very slowly. Most industries do

require large amount of raw materials to make them into finished products. This requires extraction of minerals from the earth. The extracted minerals can cause soil pollution when spilled on the earth. Whether it is iron ore or coal, the byproducts are contaminated and they are not properly disposed. As a result, the industrial waste lingers in the soil surface and contaminates the soil environment.

**2-Agricultural activities:** Farmers use an excessive amount of fertilizer on their land to increase crop yields. They use herbicides which kills herbs, insecticides to avoid the damage of crops by pests, fumigants to kill pests of stored products etc. They are synthetic chemicals. Excessive use of these synthetic chemicals has lead to soil pollution. Pesticides are used for pest control. Many of the chemicals are not decomposed and are deposited in soil. As a result, through spraying, run off, rain they mix with water and slowly reduce the fertility of soil.

Pesticides, herbicides are designed chemicals for the control of used pests and unwanted plant growth. Many of pesticides and herbicides have persisted and accumulated in the environment and defile plants and animals.

**3-Sewage and domestic waste:** Drainage of contaminated surface water into the soil. Sewage sludge contains heavy metals and, if applied in large amounts, the treated soil may accumulate heavy metals and become unable to even support plant life.

**4- Acid rain:** Air borne  $\text{SO}_2$  and  $\text{SO}_3$  react with water or water vapour to form  $\text{H}_2\text{SO}_4$ . Nitrogen oxides get dissolved into water vapour to form nitric acid. These acids are dissolved in water falling down on earth in the form of rain. This is known as acid rain. The acid rain water reaches on earth and pollutes the soil and adversely affects the productivity of crops.

**5- Nuclear explosions:** Nuclear explosions release radioactive substances which pollutes the natural quality of soil.

### 5.6.2 Effects of Soil pollution:

- 1- The effects of soil pollution on humans:** Soil pollution is dangerous for human's health. The presence of heavy metals in soil in toxic amounts can cause irreversible developmental damage in children. Excessive exposure to mercury in soil may cause kidney or liver damage. Regular exposures to benzene cause leukemia.
- 2- Soil pollution reduce soil fertility:** Excess use of fertilizers and application of toxic chemicals such as pesticides can decrease soil fertility. Thereby and decreasing the soil yield the contaminated soil may produce fruits and vegetables which lacks nutrients and may contain some poisonous substance to cause health problems in human. Crops grown on polluted soil cause health problems on consumption.
- 3- Toxic dust:** Emissions of toxic gases from landfills pollute the environment. The unpleasant smell of foul odor causes inconvenience to people.



- 4- Effect on plant growth:** Due to the contamination of the soil the balance of ecological system is affected. Mostly plants are unable to adapt to the change in the chemistry of the soil in a short period of time. Bacteria and Fungi found in the soil that bind it together begin to decline.

### 5.6.3 Steps to reduce Soil pollution:

- a) **Bioremediation:** Bioremediation is a technique where microorganisms are used to consume the pollution causing compounds and electromechanical systems for extracting chemicals by paving over the trainted area. Use and incite the growth of naturally occurring microorganisms to break down contaminants.
- b) **Reuse and Recycle:** The National Science Digital Library NSDL, Reports that reusing and recycling products will help conserve natural resources and save more land from contamination. So glass, khulhad, leaves made should be used. Solid wastes such as plastic, Scrap metal should be recycle and then reused.
- c) **Proper solid waste treatment:** To avoid soil pollution waste should be disposed of properly. Acidic and alkaline waste be neutralized before they are disposed of to avoid soil contamination.
- d) **Use soil additives:** To maintain soil PH to sustainable levels use soil additives, such as lime and organic matter from composting.
- e) **Crop rotation:** Crop rotation is a very effective system than recycling on chemicals. Crop rotation prevents the buildup of pests and diseases. It helps to maintain soil fertility and soil organic matter levels or structure. They ensure that enough nutrients are available to different crops each year.
- f) **Organic manure:** Organic fertilizers are derived from human excreta, animal matter, vegetable matter etc.
- g) **Public awareness:** Public awareness programs either formal or informal should be introduced.
- h) **Ban on Toxic chemicals:** Harmful chemicals and pesticides like DDT, BHC, etc should be banned.
- i) **Control acid rain:** To reduce acid rain the emission of chemicals such as nitrogen oxides and sulphur dioxide from industries that cause acid rain should be checked by pollution controlling devices.

---

## 5.7 SUMMARY

---

Pollution is a worldwide environmental problem. Pollution includes water, air, noise and soil which adversely effecting the whole environment. It is studied that pollution is increasing day by day due to human activities. Human population and the needs of modern man are increasing but the natural resources are limited. Exploitation of natural resources disturbs the natural balance lead to undesirable change in physical, chemical and biological characteristics of water, air and

soil. Any substance that causes pollution is called pollutant. Pollutants can be biodegradable and non-degradable. Air pollution is due to gaseous emissions from factories, automobiles etc which affects the natural quality of air, injurious to environment and living organisms. Noise is that form of sound energy which is undesirable for human ears. Industries, transportation, construction home appliances work etc are the sources of noise pollution which affects the human psychologically and physically. Water pollution may be defined as the adverse change in the composition or condition of water that it degrades the natural quality of the water. Domestic sewage and domestic waste, industrial waste etc are the sources of water pollution. Soil pollution may be defined as the contamination of soil by human activities such as farmers' excessive use of chemical fertilizers, improper disposal of industrial waste, acid rain, etc. Soil pollution reduces soil fertility which effects on plant growth, human health and whole environment. Pollution can be controlled by human awareness. Proper waste treatment, reuse and recycle. Ban on toxic chemicals, regular pollution control checks on vehicles, environmental education, plantation etc are some steps to control pollution.

---

## 5.8 GLOSSARY

---

**Pollutant:** Substance that causes pollution

**Sewage :** Wastes including solid or liquid from houses and industries

**Thermal pollution:** Pollution due to release of excessive amounts of heated water

**Eutrophication:** Lowering of dissolved oxygen concentration due to release of large amounts of phosphate, nitrate and organic matter into water.

**Chlorofluorocarbons:** Chemicals which are responsible for green house effect and ozone layer depletion.

**Green house effect:** increase in earth's temperature due to high concentration of CO<sub>2</sub> in the atmosphere results in trapping of heat within the earth's atmosphere.

**Acid Rain:** rain water with a pH of less than 4.5

**BOD Biological oxygen demand:** a chemical procedure for determining how fast biological organisms use up oxygen in a body of water.

**Bioremediation:** a process using organisms to remove or neutralise contaminants (e.g. petrol), mostly in soil or water.

---

## 5.9 SELF ASSESSMENT QUESTION

---

### 5.9.1 Choose the correct answer from the given below:

- (i) Which one of the following is Non-degradable pollutant:
- |                     |           |
|---------------------|-----------|
| (a) Domestic sewage | (b) Cloth |
| (c) Paper           | (d) DDT   |

(ii) Which one of the following is responsible for the depletion of ozone layer:

- (a) Methane (b) Carbon dioxide  
(c) Chlorofluorocarbon (d) Ethane

(iii) Indication of decreased BOD is:

- (a) High CO<sub>2</sub> contents (b) High O<sub>2</sub> contents  
(c) High microbial activity (d) Low microbial activity

(iv) Acid rain is caused by:

- (a) NO<sub>2</sub> and SO<sub>2</sub> (b) SO<sub>2</sub> and CO  
(c) Phosphates (d) All of these

(v) Which of the following is secondary air pollutant:

- (a) SO<sub>2</sub> (b) CO<sub>2</sub>  
(c) PAN (d) Aerosol

(vi) What is the intensity of sound in normal conversation:

- (a) 90 (b) 60  
(c) 150 (d) 20

### Answers Key:

**5.9.1-** (i) d, (ii) b, (iii) d, (iv) a, (v) b, (vi) b

---

## 5.10 REFERENCES

---

- Shukla R.S. and P.S. Chandel ( 2014 ), A Text Book of Plant Ecology, S. Chand and company Publication, New Delhi
- Sundara Rajan S. 2013, College Botany (Vol.-2), Himalaya Publishing House, Mumbai
- Singh H.R. (2014), Environmental Biology, S. Chand and company Publication, New Delhi
- Khitoliya R.K. (2014), Environmental Pollution, S. Chand and company Publication, New Delhi
- B.P. Pandey.( 2007), Botany for Degree students, S. Chand and company Publication
- [www.benefits-of-recycling.com/pollution ecology/](http://www.benefits-of-recycling.com/pollution_ecology/)
- [en.wikipedia.org/wiki/Pollution](http://en.wikipedia.org/wiki/Pollution)
- [en.wikipedia.org/wiki/Air pollution](http://en.wikipedia.org/wiki/Air_pollution)
- [en.wikipedia.org/wiki/Water pollution](http://en.wikipedia.org/wiki/Water_pollution)
- [en.wikipedia.org/wiki/Soil contamination](http://en.wikipedia.org/wiki/Soil_contamination)
- Ambasht. R.S. (1990) , A text book of Plant Ecology

---

### ***5.11 SUGGESTED READINGS***

---

- A text book of Plant Ecology by Dr. R.S.Shukla and Dr. P.S. Chandel (S. Chand and company Publication)
- Concepts of Modern Ecology by S.C.Tewari (Bishen Singh, Mahendra Pal Singh, Dehradun)
- Plant Ecology by P.D.Sharma

---

### ***5.12 TERMINAL QUESTIONS***

---

1. Define Pollution. Explain different types of Pollution.
2. Give a brief account of Water Pollution.
3. What is air pollution? Describe the causes and control of it.
4. Write short notes on the following:
  - (i) Pollutants of air
  - (ii) Soil pollution

---

## **UNIT-6 BIOGEOGRAPHICAL REGIONS OF INDIA, VEGETATION TYPES OF UTTARAKHAND**

---

- 6.1 Objectives
- 6.2 Introduction
- 6.3 Biogeographical regions of India
- 6.4 Vegetation types of Uttarakhand
  - 6.4.1 Forests
  - 6.4.2 Grasslands
- 6.5 Summary
- 6.6 Glossary
- 6.7 Self Assessment Questions
- 6.8 References
- 6.9 Suggested Readings
- 6.10 Terminal Questions

---

## 6.1 OBJECTIVES

---

After reading this unit students will be able-

- to know basic concepts and information about various biogeographical regions of India
- To familiarize with various vegetation types of Uttarakhand

---

## 6.2 INTRODUCTION

---

**Biogeography** is the study of the distribution of species and ecosystems in geographic space and through (geological) time. Organisms and biological communities often vary in a regular fashion along geographic gradients of latitude, elevation, isolation and habitat area. Knowledge of spatial variation in the numbers and types of organisms is as vital to us today as it was to our early human ancestors, as we adapt to heterogeneous but geographically predictable environments.

The patterns of species distribution across geographical areas can usually be explained through a combination of historical factors such as: speciation, extinction, continental drift, and glaciations. Through observing the geographic distribution of species, we can see associated variations in sea level, river routes, habitat, and river capture.

Over periods of ecological changes, biogeography includes the study of plant and animal species in: their past and/or present living *refugium* habitat; their interim living sites; and/or their survival locales. Biogeography is most keenly observed on the world's islands. The discoveries that contributed to the development of biogeography as a science began in the mid-18<sup>th</sup> century, as Europeans explored the world and discovered the biodiversity of life. During the 18<sup>th</sup> century most views on the world were shaped around religion and for many natural theologians, the bible. Carl Linnaeus, in the mid-18th century, initiated the ways to classify organisms through his exploration of undiscovered territories. Closely after Linnaeus, Georges-Louis Leclerc, Comte de Buffon observed shifts in climate and how species spread across the globe as a result. Buffon's Law eventually became a principle of biogeography by explaining how similar environments were habitats for comparable types of organisms. Augustin de Candolle contributed to the field of biogeography as he observed species competition and the several differences that influenced the discovery of the diversity of life. In the 19th century, several additional scientists contributed new theories to further develop the concept of biogeography. Charles Lyell, being one of the first contributors in the 19th century, developed the Theory of Uniformitarianism after studying fossils. This theory explained how the world was not created by one sole catastrophic event, but instead from numerous creation events and locations.

Biogeographic regions, identified originally by the English ornithologist Philip L. Sclater (1829-1913) and German botanist H.G. Adolf Engler (1844-1930), are large areas with particular flora and fauna, due to their isolation during continental drift. Originally, six regions were identified:

Palaearctic (Europe and Asia), Nearctic (North America), Neotropical (Mexico, Central and South America), Ethiopian (Africa), Indian (Southeast Asia, Indonesia) and Australian (Australia and New Guinea). Currently, eight are recognised since the addition of Oceania (Polynesia, Fiji and Micronesia) and Antarctica. Mexico is on the boundary between two biogeographic regions, the Nearctic and Neotropical, which contributes to its great natural richness.

---

### **6.3 BIOGEOGRAPHICAL REGIONS OF INDIA**

---

Biogeographic classification of India is the division of India according to biogeographic characteristics. Biogeography is the study of the distribution of species (biology), organisms, and ecosystems in geographic space and through geological time. There are ten biogeographic zones in India.

1. Trans Himalayan zone
2. Himalayan zone
3. Desert zone
4. Semiarid zone
5. Western ghat zone
6. Deccan plateau zone
7. Gangetic plain zone
8. North east zone
9. Coastal zone
10. Islands present near the shore line

#### **1- Trans-Himalayan Zone**

The Himalayan ranges immediately north of the Great Himalayan range are called the Trans-Himalayas. The Trans-Himalayan region with its sparse vegetation has the richest wild sheep and goat community in the world. The snow leopard is found here, as is the migratory black-necked crane.

#### **2- Himalayas**

The Himalayas consist of the youngest and loftiest mountain chains in the world. The Himalayas have attained a unique personality owing to their high altitude, steep gradient and rich temperate flora. The forests are very dense with extensive growth of grass and evergreen tall trees. Oak, chestnut, conifer, ash, pine, deodar are abundant in Himalayas. There is no vegetation above the snowline. Several interesting animals live in the Himalayan ranges. Chief species include wild sheep, mountain goats, ibex, shrew, and tapir. Panda and snow leopard are also found here.

#### **3- Semi-Arid Areas**

Adjoining the desert are the semi-arid areas, a transitional zone between the desert and the denser forests of the Western Ghats. The natural vegetation is thorn forest. This region is characterized

by discontinuous vegetation cover with open areas of bare soil and soil-water deficit throughout the year. Thorny scrubs, grasses and some bamboos are present in some regions. A few species of xerophytic herbs and some ephemeral herbs are found in this semi-arid tract. Birds, jackals, leopards, eagles, snakes, fox, buffaloes are found in this region.

#### **4- Western Ghats**

The mountains along the west coast of peninsular India are the Western Ghats, which constitute one of the unique biological regions of the world. The Western Ghats extend from the southern tip of the peninsula (8°N) northwards about 1600 km to the mouth of the river Tapti (21°N). The mountains rise to average altitudes between 900 and 1500 m above sea level, intercepting monsoon winds from the southwest and creating a rain shadow in the region to their East. The varied climate and diverse topography create a wide array of habitats that support unique sets of plant and animal species. Apart from biological diversity, the region boasts of high levels of cultural diversity, as many indigenous people inhabit its forests.

You should always remember that Western Ghats are amongst the 25 biodiversity hot-spots recognized globally. These hills are known for their high levels of endemism expressed at both higher and lower taxonomic levels. Most of the Western Ghat endemic plants are associated with evergreen forests. The region also shares several plant species with Sri Lanka. The higher altitude forests were, if at all, sparsely populated with tribal people. Rice cultivation in the fertile valley proceeded gardens of early commercial crops like areca nut and pepper. The original vegetation of the ill-drained valley bottoms with sluggish streams in elevations below 100m would be often a special formation, the *Myristica* swamp.

Expansion of traditional agriculture and the spread of particularly rubber, tea, coffee and forest tree plantations would have wiped out large pockets of primary forests in valleys. The Western Ghats are well known for harboring 14 endemic species of caecilians (i.e., legless amphibians) out of 15 recorded from the region so far.

#### **5- North-West Desert Regions**

This region consists of parts of Rajasthan, Kutch, Delhi and parts of Gujarat. The climate is characterised by very hot and dry summer and cold winter. Rainfall is less than 70 cm. The plants are mostly xerophytic. Babul, Kikar, wild palm grows in areas of moderate rainfall. Indian Bustard, a highly endangered bird is found here. Camels, wild asses, foxes, and snakes are found in hot and arid deserts.

#### **6- Deccan Plateau**

Beyond the Ghats is Deccan Plateau, a semi-arid region lying in the rain shadow of the Western Ghats. This is the largest unit of the Peninsular Plateau of India. The highlands of the plateau are covered with different types of forests, which provide a large variety of forest products. The Deccan plateau includes the region lying south of the Satpura range. It extends up to the southern



tip of peninsular India. Anai mudi is the highest peak of this region. The Deccan plateau is surrounded by the western and the eastern ghats. These ghats meet each other at the Nilgiri hills. The western ghats includes the Sahyadri, Nilgiris, Anamalai, and cardamom hills. Many rivers such as Mahanadi, Godavari, Krishna, and Kaveri originates from western ghats and flow toward the east. The eastern ghats are broken into small hill ranges by river coming from the western ghats. Most of these rivers fall into the bay of bengal. The Godavari is the longest river in the Deccan plateau, the Narmada and the Tapi flow westwards and fall into the Arabian sea.

## 7- Gangetic Plain

In the North is the Gangetic plain extending up to the Himalayan foothills. This is the largest unit of the Great Plain of India. Ganga is the main river after whose name this plain is named. The aggradational Great Plains cover about 72.4mha area with the Ganga and the Brahmaputra forming the main drainage axes in the major portion.

The thickness in the alluvial sediments varies considerably with its maximum in the Ganga plains. The physio-geographic scenery varies greatly from arid and semi-arid landscapes of the Rajasthan Plains to the humid and per-humid landscapes of the Delta and Assam valley in the east. Topographic uniformity, except in the arid Western Rajasthan is a common feature throughout these plains. The plain supports some of the highest population densities depending upon purely agro-based economy in some of these areas. The trees belonging to these forests are teak, sal, shisham, mahua, khair etc.

## 8- North-East India

North-east India is one of the richest flora regions in the country. It has several species of orchids, bamboos, ferns and other plants. Here the wild relatives of cultivated plants such as banana, mango, citrus and pepper can be grown.

## 9- Islands

The two groups of islands, i.e., the Arabian Sea islands and Bay Islands differ significantly in origin and physical characteristics. The Arabian Sea Islands (Laccadive, Minicoy, etc.) are the foundered remnants of the old land mass and subsequent coral formations. On the other hand, the Bay Islands lay only about 220 km. Away from the nearest point on the main land mass and extend about 590 km. With a maximum width of 58 km the island forests of Lakshadweep in the Arabian Sea have some of the best-preserved evergreen forests of India. Some of the islands are fringed with coral reefs. Many of them are covered with thick forests and some are highly dissected.

## 10- Coasts

India has a coastline extending over 5,500 km. The Indian coasts vary in their characteristics and structures. The west coast is narrow except around the Gulf of Cambay and the Gulf of Kutch. In

the extreme south, however, it is somewhat wider along the south Sahyadri. The backwaters are the characteristic features of this coast. The east coast plains, in contrast are broader due to depositional activities of the east-flowing rivers owing to the change in their base levels.

Extensive deltas of the rivers, Godavari, Krishna and Kaveri are the characteristic features of this coast. Mangrove vegetation is characteristic of estuarine tracts along the coast for instance, at Ratnagiri in Maharashtra. Larger parts of the coastal plains are covered by fertile soils on which different crops are grown. Rice is the main crop of these areas. Coconut trees grow all along the coast. Coconut and rubber are the main vegetation of coastal area. Main states of coastal areas are- Gujarat, Maharashtra, Goa, Karnataka, Kerala, West Bengal, Odisha, Andhra Pradesh, Tamil Nadu and Puducherry.

---

## 6.4 VEGETATION TYPES OF UTTARAKHAND

---

The state of Uttarakhand is bestowed with varied vegetation types ranging from tropical deciduous to alpine vegetation. In the lower altitude region up to 800 m, moist tropical and dry deciduous forest of Sal, teak or mixed/pure forest of *Acacia*, *Aegle*, *Haldina*, *Syzygium* and *Terminalia* are found. At places, scrub forests having evergreen species are also found.

The dominant trees in the region are *Acacia catechu* (Khair), *Aegle marmelos* (Bel), *Albizia lebbek* (Siris), *Anogeissus latifolia* (Bakli, Dhaura), *Buchanania lanzan* (Chironji), *Butea monosperma* (Dhak, Palas), *Cassia fistula* (Amaltas), *Dalbergia sissoo* (Sheesham), *Diospyros melanoxylon*, *Fauriculata* sp. (Timla), *F. semicordata* (Khainu), *F. virens* (Pakad), *F. benghalensis* (Bargad), *Ficus religiosa* (Peepal), *Haldina cordifolia* (Haldu), *Holoptelea integrifolia* (Dhamina), *Lannea coromandelica* (Jigma Jhingan), *Madhuca longifolis* var. *latifolia* (Mahua), *Mallotus philippensis* (Rohini), *Mitragyna parvifolia* (Kaim or Tekui), *Oroxylum indicum*, *Pongamia pinnata* (Karanj), *Shorea robusta* (Sal, Shaku), *Streblus asper* (Sehore), *Syzygium cumini* (Jamun), *Terminalia alata* (Asna, Asain), *T. bellirica* (Bahera), etc.

At places, successful plantation of *Tectona grandis* (Teak) has been done. Amongst the dominant shrubs found in the state, *Adhatoda vasica* (Bansa, Adusa), *Ardisia solonacea* (Jalkaima), *Berberis lycium* (Kinger), *Carissa opaca*, *Colebrookea oppositifolia* (Chavova, Binda), *Crotalaria juncea* (Bansai), *Glycosmis arborea* (Gutahru), *Grewia hirsuta* Seetachabeni), *G. subinaequalis* (Pharsa), *Holarrhena pubescens* (Kachri), *Jatropha gossypifolia* (Lal arand), *Lantana camara* (Kuri), *Murraya koenigi* (Gandela, Kathneem), *Rubus ellipticus* (Hisalu), *Zanthoxylum armatum* (Timur), *Ziziphus mauritiana* (Ber) and *Z. oenoplia* (Makoi) are important.

The major species that constitute climbers, twines and stragglers include *Abrus precatorius* (Ratti), *Ampelocissus latifolia* (Pata Bel), *Asparagus adscendens* (Satawar), *Aspidopterys wallichii*, *Bauhinia vahlii* (Maljhan), *Celastrus paniculata* (Malkangani), *Cryptolepis buchanani* (Lakhun), *Gloriosa superba* (Karihari), *Hiptage benghalensis* (Gulabbas, Madhavilata),

*Ichnocarpus frutescens* (Dudhibel), *Ipomoea* spp., *Mucuna* spp. (Konch), *Piper longum* (Peepar-mul), *Pueraria tuberosa*, (Gindaru), *Smilax* spp. (Ran datun), *Tiliacora acuminata* (Karot, Rangoya) and *Tinospora cordifolia* (Giloy, Guruch).

The most common herbs including grasses and sedges form the ground flora of the forest as well as the grassland amidst forest. Some of them are, *Argemone mexicana* (Bharbhanda), *Arundo donax* (Kiliknal), *Boerhavia diffusa* (Punarnava), *Bothriochloa intermedia* (Sindhur), *Cassia tora* (Chakwar), *Chlorophytum tuberosum* (Safed musli), *Chrysopogon fulvus* (Senra), *Clerodendrum viscosum* (Bhant), *Curculigo orchioides* (Kali musli), *Cymbopogon martinii* (Jarakush), *Dactyloctenium aegyptium* (Makra), *Desmostachya bipinnata* (Kush), *Eclipta alba* (Bhringraj), *Eulalipsis binata* (Bhabbar, Bankas), *Heteropogon contortus* (*Sura padura*), *Imperata cylindrica* (Bhalai or Charni), *Malvastrum coromandelianum* (Bariari), *Ocimum basilicum* (Bantulsi), *Phragmites karka* (Narkul), *Saccharum spontaneum* (Kans), *Solanum surattense* (Bhatkataiya), *Tribulus terrestris* (Gokhuru), *Vernonia cinerea* (Sahdevi) and *Vetiveria zizanioides* (Garra or Khuskhus).

Hydrophytic vegetation occupies considerable areas of Terai belt. Some of the common aquatic and semi-aquatic plants are, *Acorus calamus*, *Aeschynomene aspera*, *Ammannia bacifera*, *Bacopa monnieri*, *Centella asiatica* ("Brahmi"), *Ceratophyllum demersum*, *Coix aquatica*, *Cyperus platystylis*, *Eichhornia crassipes*, *Eleocharis* spp., *Fimbristylis bisumbellata*, *Hydrilla verticillata*, *Hygrophila auriculata*, *Ipomoea aquatica* (Kalmi sag), *Ludwigia octovalvis* (Laungra), *Marsilea minuta*, *Nelumbo nucifera* (Kamal), *Nymphaea pubescens*, *Pistia stratiotes*, *Polygonum barbatum*, *P. glabrum*, *Potamogeton nodosus*, *Sagittaria guayanensis*, *Scirpus articulatus*, *Trapa natans*, *Typha angustata*, *Utricularia aurea* and *Vallisneria spiralis*.

With an altitudinal increase a change in the vegetation is clearly visible. Higher up between 1000-3000 m mixed forest of *Lyonia ovalifolia* (Anyar), *Myrica esculenta* (Kaphal), *Quercus leucotrichopora* (Banj) and *Rhododendron arboreum* are first to appear. In between *Cornus macrophylla*, *Lonicera quinquelocularis*, *Neolitsea umbrosa*, *Symplocos paniculata*, *Viburnum cotinifolium*, etc. are also seen mixed up. The undergrowth constitutes *Coriaria nepalensis*, *Daphne cannabina*, *Deutzia staminea*, *Elaeagnus* sp., *Myrsine africana* and *Sarcococca saligna* together with herbaceous elements. *Pinus roxburghii* is the first to make appearance among the gymnosperms. These mixed forests are followed by *Acer* sp. (Thuner), *Aesculus indica* (Pangar), *Carpinus viminea*, *Prunus puddum*, *Quercus dilatata* (Tilonj), *Q. semecarpifolia* (Kharsu), forest with species of *Euonymus* and *Ilex excelsa*. Some trees like *Cotoneasters* spp. and *Juglans regia* (Akhrot) also make scattered appearance. At certain places pure strands of *Abies pindrow* (Ransula), *Cedrus deodara*, *Pinus roxburghii* or *Taxus wallichiana* make a sight to watch. On dry slopes *Berberis lycium*, *Prinsepia utilis*, *Pyrus pashia* etc. are dominant.

The herbaceous growth at this altitude mainly consists of *Anemone obtusiloba*, *A. vitifolia*, *Bergenia* sp., *Corydalis* spp., *Morina longifolia*, *Paeonia emodi*, *Paris polyphylla*, *Podophyllum*

*hexandrum* and species of *Geranium*, *Valeriana*, *Viola* etc. Species of *Calanthe*, *Cypripedium*, *Pleione* and *Cardiocrinum giganteum* are occasionally noticed. Another orchid *Gastrochilus distichus* makes frequent appearance on *Quercus* sp. *Kingidium taenialis* is also seen perching on *Albizia* sp. and *Lyonia ovalifolia* at some places. *Cayratia trifolia*, *Clematis* spp., *Dioscorea* sp., *Herdera nepalensis*, *Rubus paniculatus*, *Smilax glaucophylla*, etc. are the common climbers, while *Holboellia latifolia*, *Sabia campanulata* and *Schisandra grandiflora* are seen occasionally. *Aristolochia dilatata* and *Jasminum dispersum* are also seen hanging from rocks. Still higher up is *Betula utilis* (Bhojpatra) that forms the tree limit in this part of Himalaya. Above this altitude shrubby or herbaceous plants like species of *Corydalis*, *Hippophae*, *Juniperus*, *Pleurospermum*, *Primula*, *Rheum*, *Saussurea* and *Meconopsis aculeate*, *Rhododendron anthopogon*, etc. make the vegetational cover.

A number of species have been reported from Uttarakhand state as new additions to the country or the state following explorations and critical studies. Some of them are, *Achyranthes aquatica*, *Ageratum houstonianum*, *Ambrosia artemisifolia*, *Aristolochia indica*, *Argyreia sericea*, *Cleome monophylla*, *Crotalaria pusilla*, *Cyperus meeboldii*, *C. cyperoides*, *Diplomeris hirsuta*, *Eleocharis fistulosa*, *Eupatorium riparium*, *Fimbristylis aestivalis*, *Fimbristylis merguensis*, *Fimbristylis narayanii*, *Hydrobryum griffithii*, *Lalldhwojia cooperi*, *Mikania cordata*, *Modiola caroliniana*, *Myagrurn perfoliatum*, *Oberonia wightiana*, *Phippsia algida*, *Pseudelephantopus spicatus*, *Ranunculus* sp., *Rhododendron nivale*, *Rynchospora hookeri*, *Sebaea khasiana*, *Solanum rostratum*, *S. trilobatum*, *Soliva anthemifolia*, *Trisetum scitulum*, *Urtica urens*, *Vernonia albicans*.

The Dafia-Dhoora, Baram-shandev area in the Kumaun is rich in orchid wealth. Out of the 236 species of orchids reported from the Uttarakhand, about two third are found in this area. Many of the East Himalayan orchid species such as *Cirrhopetalum guttulatum*, *Cryptochilus lutea*, *Cymbidium eburneum*, *Diplomeris hirsuta*, etc. have been collected from this area. Pure strands of pine forest in Uttarkashi extend to miles together. This forest has the tallest pine tree of Asia measuring 60.65 m with a girth of 2.50 m (as measured in 1989). The other localities where pure strands of Pine forest can be seen are Diva Danda and Listiyakhet. The forests of Bhujgarh and Surraithata in Chamoli district are also worth mentioning for pure stands of *Betula utilis* and *Cupressus torulosa* respectively.

*Quercus* – *Rhododendron* – *Lyonia* association is the general feature of temperate region but in the “Govind Pashu Vihar” in Uttarkashi district, *Aesculus* – *Juglans* – *Carpinus* – *Corylus* association is dominant between Taluka and Osla and, is therefore, worth mentioning. Though cold arid regions of Western Himalaya are mostly confined to Jammu and Kashmir and Himachal Pradesh, yet some parts of Kumaun and Garhwal Himalaya like Niti, Malari and Milam fall under the same category. Like other cold deserts, here also *Astragalus* sp., *Cicer microphyllum*, *Corydalis flabellata*, *Dracocephalum heterophyllum*, *Hussopus officinalis*, *Hyoscyamus niger*, *Lagotis glauca*, *Lamium rhomboideum*, and *Thylacospermum caespitosum*

are common. *Oxytropis duthieana*, a rare species has also been described on the basis of collections from this area.

### 6.4.1 Forests

Uttarakhand is covered with rich forests across all 13 districts. The recorded forest area of the state is 3.47 m ha which constitutes 64.81% of the state's geographic area. Of these 68.74% constitutes the Reserved Forest, 0.36% is under protected forest and unclassed. Forests occupy 30.9% of the state's geographic area. As per 1996 satellite data assessment, the forest cover of the state is 23,260 km<sup>2</sup>, covering 43.5% of the total geographic area of the state (Table 1). About 76.7% (17,849 km<sup>2</sup>) of the total forest area falls under dense forest and 23.3% (5,411 km<sup>2</sup>) under open forest category.

Forest plays an important role in the economy of the state. Timber and fuel form the major produce group, while bamboo, drugs, grasses, gum and resins etc., the minor produce group. Forests are the major source of raw materials for industries, buildings, railways and other tertiary sectors. They are one of the most important natural resource of the state, as besides maintaining ecological health they also have economic value.

Though the contribution of forests to gross domestic product of the state is negligible as compared to agriculture yet forests have many indirect and invisible benefits that are difficult to calculate. Hence, conservation of forests is vital for health and economy of nations. The forests are home to millions of people, providing a diverse range of products such as timber, fuelwood, fibers, fruits, seeds, mushrooms, resins, ornamentals, rubber and animal proteins. Further, forests play a key role in regulation and conserving water, ameliorating local climate and preventing floods and soil erosion.

There is an increased pressure on forests for fuel, fodder and timber requirements that is having an effect on the desired level of forest density and productivity of forests. The destruction and degradation of forests are taking a heavy toll on soil and water resources, making the land less productive and leading to impoverishment of the rural population.

In the pre-British times there was no system of recorded ownership of land. People had customary hereditary ownership rights on land that was under their cultivation. The non-tilled land was treated as unregulated commons that was used for fodder, fuel wood and construction timber.

The British presence in the Kumaun division was felt for the first time during 1817-1823 when Trail made seven land settlements which demarcated the village boundaries for exercising the village rights of grazing, cutting trees and collecting firewood (Trail's Sal Assi Settlement).

However, the land and forest settlement procedures introduced by the colonial government catered to the vested interests of colonial rule. Whether it was the native King of Tehri state or the commissioner of Kumaun, both tried to gain control and domination over natural resources through administrative measures. The practical need to stabilize the tax system prompted the British at the outset of the colonial rule to introduce a concept of the modern form of private ownership of landed property in India. The private ownership rights over agricultural land tenure, which were traditionally owned by the native king, were granted to individuals. These two conflicting trends of ownership of prescriptive rights on forest resources and the granting of the proprietary tenure on agricultural land had far reaching consequences.

The government had not paid much attention to the forest wealth of this area till 1858 when forest reservation emerged and rules regarding this were made in Madras and Burma. In 1868, the first Forest Act was enacted. Certain forests of Ranikhet and Almora were demarcated and declared as "Reserves" in 1873 and 1875 respectively. Realising the commercial importance of the forests, the British, under the Forest Reservation Order 1877, formally demarcated and brought a total area of about 1700 km<sup>2</sup> in Almora and Naini Tal districts under the control of the Forest Department. A large part of this was in the terai region for the purpose of exploiting sal forests for meeting Government demand.

In 1893, by a proclamation dated 17th October, all non-agricultural land was declared as Protected Forest under the Indian Forest Act and placed under the control of the Deputy Commissioners. In 1894, rules for the management of these forests were made under the supervision of the Deputy Commissioner who was invested with the powers of Conservator of Forests. For the first time, people were prohibited from cutting trees within 100 feet on either side of a road and outside five miles of the boundaries of a village. Certain trees like Deodar, Cyprus, Chir and Sal were declared as protected trees. Permission for the felling of deodar trees was to be granted by the District Magistrate, and for other trees by the village Patwari. These lands excluding what had been transferred to the Forest Department and Van Panchayats are called civil lands in Kumaon and British Garhwal, whereas in Tehri Garhwal and Uttarkashi they are known as soyam (literal meaning, grade III) lands. Restrictions were also imposed on breaking up cultivable wasteland and hunting in forests by an order-dated 24th October 1894.

Indian Forest Policy was declared by government of India on October 19, 1895. Under this, revenue was placed as secondary to well-being of the population. The policy objectives thus laid down persisted over long time despite the fast changing ecological and socio-economic conditions, staggeredly increasing population and increasing pressure on forest and other natural resources, over the years.

Gradually, as the rights of local people to use the forest products were curbed by the states in favour of the government and private contractors, strong protests started coming-up. In Kumaun and Garhwal division, social protests were aimed directly at the colonial state itself, and the agitation reached its zenith in the summer of 1921, when wide range campaign to burn forest controlled by the Government virtually paralyzed the administration. This forced the Government to appoint the Kumaon Forest Grievance Committee (KFGC), in 1921 under the Chairmanship of Wyndham, Commissioner Kumaun with the Conservator of Forests, Western Circle and two members of the public as members, to enquire into the grievances of people regarding forests and suggest remedial action. The report of the committee appointed in 1921 was known as the 'Forest Grievances Committee Report'.

The grievances, which were brought to the notice of the committee were: Demarcation, owing to which forest boundary pillars often, came too close to cultivation or buildings; Lopping restrictions; Restrictions on grazing; Employment of forest guards to enforce numerous rules and regulations and their constant interference with women and children, who under the custom in the vogue in the hills are the chief people who on behalf of the villagers exercise such rights as of lopping, collection of minor produce, grazing, etc.; Large number of forest cases which were either to be compounded or fought out in a criminal court; Unsatisfactory methods of dealing with indents for timber; Rules regarding fire protection; Taking up of measured land within the reserves and in some cases inadequate or no compensation was given; Prohibition of all extension of cultivation within reserves.

Subsequently, the Kumaon Grievances committee reclassified the forests into two categories: Class I (oak etc., not commercial species) and Class II (chir, deodar – commercially exploitable species) forests, and handed over effective control of the former to the revenue department. Thus a substantial part (4,460 sq km) of land reclassified as Class II forest was handed back to the control of the District Magistrates with the restriction that protected trees could not be felled without the permission of the Patwari, and forest produce could be used only for bonafide domestic purpose and not for sale. Lopping and grazing restrictions were relaxed, except in regeneration areas. Sheep and goats, which were earlier prohibited from grazing in reserves, were again permitted.

The forest policy resolutions in 1894 and subsequently in 1952 laid considerable emphasis on the provision of basic needs of the villagers in terms of small timber, fuel wood and fodder. However, the movement towards the concept of sustainable development ushered not only in protecting natural resources but also conveyed dictum of conservation and protection culture. This fact led to the shift in forest policy, which is evident in 1988 National Forest Policy formulated by the Government of India. It stressed on people's involvement as one of the essential component for forest management and development. In 1990, Ministry of Environment

and Forests, Government of India issued guidelines to state forest departments for ensuring participation of communities and Non-Government Organisations in the management, regeneration and protection of degraded forest lands.

In 1993, the Government declared the hilltops outside the limits of the agricultural areas to be closed for regeneration. The protected forests of the hill tracts of Kumaun, generally known as civil forests were to be managed for the benefit of people. Under the new rules, these civil forests were classified as follows:

1. Closed civil forests, in which issues related to rights and concessions of the local populations were to be taken care of by the District Magistrate.
2. Open civil forests, in which village people could enjoy unhindered rights and concessions of cutting grass and ringal and quarrying of stones. Permission for felling of deodar trees was to be granted by the District Magistrate and for all other trees by the village Pradhan and Patwari.

From the viewpoint of people, the most important change was introduced by the new settlement of forests from 1911, which increased the area under reserved forests in the Kumaun-Garhwal circle by more than 7500 km<sup>2</sup>. Reserves created before 1911 are called old reserves while those created after 1911 are called new reserves. As a result of the Forest Settlements of 1911-1917, the new reserves were classified as A, B and C classes. A class forests were designated primarily for fulfillment of local needs and the sale of forest produce. B class forests were designated for meeting the needs of grass, fuel, timber and grazing etc. Forests of A and B class were placed under the control of the forest department but there was less severe control in the B class forests. The C class forests were outside the control of the forest department and were left to the uncontrolled use of the people.

### Forest Types

As the altitude of the state varies from 300m to 3,500m and above, 8 out of the 16 forest types existing in India can be found in Uttarakhand. These are:

- **Moist alpine scrub:** Occurs at tree line around an altitude of 3,500 m. The major species are *Betula utilis* and *Rhododendron campanulatum*.
- **Sub-alpine forest:** This type of forest exists at altitudes of 2,900 m to 3,500 m above sea level in the middle and upper Himalayas. The forests are characterised by patches of *Abeis-Betula* forest interspersed with shrubby growth and grassy patches or alpine grasslands called bugyals.
- **Himalayan dry temperate forest:** This type is found in the inner dry trans-Himalayan valleys of the state. Major species occurring here are *Cedrus deodara*, *Juniperus* spp. and *Pinus wallichiana*. It is found in Chakrata, Tons Valley, Uttarkashi and Joshimath areas.



- **Himalayan moist temperate forest:** This type occurs between 1600-2900 m altitudes in the Himalayas. This type is mainly characterized by coniferous species such as *Abies pindrow*, *Betula* spp., *Cedrus deodara*, *Picea smithiana* and *Quercus* spp.
- **Sub-tropical pine forest:** The type grows in lower regions of the Himalayas with Pines as the dominant species.
- **Tropical dry deciduous forest:** This type occurs in the dry southern face of Shiwaliks and adjoining plains. The forest is open and mixed with the major species as *Anogeissus latifolia*, *Shorea robusta*, *Terminalia tomentosa*, etc.
- **Littoral and swamp forest:** This type occurs at a few locations in the valleys in the foothills, characterized by the presence of moisture loving species such as *Diospyros embriopterys*, *Ficus glomerata*, *Pterospermum acerifolium* and *Syzigium cumini*. The undergrowth is characterized by the presence of cane, *Calamus tenuis*.
- **Tropical moist deciduous forest:** This multi-storey type forest is found in moist regions of the lower Himalayas and terai arc. This type of forest is characterised by a top storey of deciduous species such as *Adina cardifolia*, *Anogeissus latifolia*, *Shorea robusta*, *Terminalia tomentosa* and a second storey of many species with some evergreen shrubby undergrowth interspersed with patches of Bamboo, Climbers and Canes.

**Table 1: District-wise forest cover in Uttarakhand**

District	Geographical area (G.A.)	Very dense forest	Moderate dense forest	Open forest	Total	% of G.A.	Change	Scrub
Almora	3,139	168	969	440	1,577	50.24	0	10
Bageshwar	2,246	159	875	346	1,380	61.44	0	4
Chamoli	8,030	406	1,558	734	2,698	33.60	0	7
Champawat	1,766	327	605	230	1,162	65.80	0	9
Dehra Dun	3,088	487	664	442	1,593	51.59	0	27
Pauri Garhwal	5,329	450	2,065	756	3,271	61.38	0	64
Haridwar	2,360	29	327	274	630	26.69	-8	0
Nainital	4,251	548	1,936	604	3,088	72.64	-3	17

Pithoragarh	7,090	470	1,229	378	2,077	29.29	0	69
Rudraprayag	1,984	179	605	336	1,120	56.45	0	5
Tehri Garhwal	3,642	227	1,255	656	2,138	58.70	0	85
Udham Singh Nagar	2,542	144	246	174	564	22.19	-7	0
Uttarkashi	8,016	408	2,062	674	3,144	39.20	0	23
<b>Total</b>	<b>53,483</b>	<b>4,002</b>	<b>14,396</b>	<b>6,044</b>	<b>24,442</b>	<b>45.70</b>	<b>-18</b>	<b>320</b>

Source: FSI (2005).

### 6.4.2 Grasslands

The state of Uttarakhand is bestowed with two kinds of grasslands: the plains and the high altitude grasslands. The grasslands or the chauris of Corbett National Park can grow up to 2m, making it an ideal habitat as ambush cover for predators while providing forage and fawning cover for herbivores. The major species of grasses occurring in the area include *Apluda mutica* (Bassi), *Arundo donax*, *Bothriochloa bladhii* (Sindhur), *Cymbopogon* sp. (Jarakush), *Imperata cylindrica*, *Oryza rufipogon* (Tinna), *Phragmites karka*, *Sachharum narenga*, *Sclerostachya fusca* and *Themeda arundinacea* (Ulla).

The alpine grasslands locally called 'bugyals', occur at altitudes above 1000m and are primarily composed of such species as *Anemone*, *Arnunculus*, *Cyananthus*, *Gentiana*, *Pedicularis*, *Polygonum*, and many important medicinal plants like *Dactylorhiza hatagirea*, *Nardostachys grandiflora*, *Rheum moorcroftianum*. The alpine meadows of Martoli bugyal in Kumaun is home to insectivorous plant species such as *Pinguicula alpina*.

---

## 6.5 SUMMARY

---

Biogeography is the study of the distribution of species (biology), organisms, and ecosystems in geographic space and through geological time. Biogeographic classification of India is the division of India according to biogeographic characteristics. There are ten biogeographic zones in India: Trans Himalayan zone; Himalayan zone; Desert zone; Semiarid zone; Western ghat zone; Deccan plateau zone; Gangetic plain zone; North east zone; Coastal zone and Islands present near the shore line. The state of Uttarakhand is bestowed with varied vegetation types ranging from tropical deciduous to alpine vegetation. In the lower altitude region up to 800 m, moist tropical and dry deciduous forest of Sal, teak or mixed/pure forest of *Acacia*, *Aegle*, *Haldina*, *Syzygium* and *Terminalia* are found. At places, scrub forests having evergreen species are also found. The recorded forest area of the state is 3.47 m ha which constitutes 64.81% of the

state's geographic area. Of these 68.74% constitutes the Reserved Forest, 0.36% is under protected forest and unclassed. Forests occupy 30.9% of the state's geographic area. 8 out of the 16 forest types existing in India can be found in Uttarakhand. These are: Moist Alpine scrub, Sub-alpine forest, Himalayan dry temperate forest, Himalayan moist temperate forest, Sub-tropical pine forest, Tropical dry deciduous forest, Littoral and swamp forest and Tropical moist deciduous forest. The state of Uttarakhand is bestowed with two kinds of grasslands: the plains and the high altitude grasslands. The alpine grasslands locally called 'bugyals', occur at altitudes above 1000m.

---

## 6.6 GLOSSARY

---

**Biogeography:** It is the study of the distribution of species and ecosystems in geographic space and through (geological) time.

**Speciation:** It is the evolutionary process by which biological populations evolve to become distinct species.

**Extinction:** It is the end of an organism or a group of organism, usually a species.

**Continental drift:** It is the movement of the earth's continents relative to each other, thus appearing to drift across the ocean bed.

**Island:** It is any piece of sub-continental land that is surrounded by water.

**Species:** A group of organisms consisting of similar individuals capable of exchanging genes or interbreeding. It is the principal taxonomic unit ranking below genus.

**Ecosystem:** It is a community of living organism in conjunction with the non-living components of their environment like water, air, soil. The biotic and abiotic components are linked together through nutrient cycles and energy flows.

**Geographic space:** It is the area in which human groups coexist and interact with the environment.

**Geological time:** It is a system of chronological dating that relates geological strata to time.

**Xerophytes:** It is a species of plants that has adapted to survive in an environment with little water such as desert.

**Endangered species:** A species of animal or plant that is at the risk of extinction.

**Tropic-** It is the region of the earth surrounding equator.

**Deciduous:** It means falling off at maturity. It refers to trees or shrubs that lose their leaves seasonally.

**Alpine vegetation:** It refers to the zone of vegetation between the altitudinal limit of tree growth and nival zone.

**Reserved Forest:** It is a specific term used to designate forests or other natural areas which enjoy judicial and/ or constitutional protection under the legal systems of many countries.

**Unclassed Forest:** These are those forests which are neither reserved nor protected.

---

## 6.7 SELF ASSESSMENT QUESTIONS

---

### 6.7.1 Give brief answers to the following questions:

- (i) Name the scientists who originally identified biogeographic regions.
- (ii) What do you mean by biogeography?
- (iii) Who is known as father of biogeography?
- (iv) Name the different biogeographical regions of World.
- (v) Name the different biogeographical regions of India?
- (vi) Name the different rivers that originate from Western Ghats.
- (vii) Name the main crops of coastal regions.
- (viii) Name the different states of coastal areas.
- (ix) What is the percentage of reserve forests in Uttarakhand?
- (x) Name the various forest types of Uttarakhand.
- (xi) Name the various kinds of grasslands found in Uttarakhand.

### 6.7.2 True or False

- (i) Deccan unit is the smallest unit of Peninsular plateau of India.
- (ii) Oaks are found in Himalayan zone.
- (iii) Uttarakhand is a state of coastal area.
- (iv) Alpine vegetation is not found in Uttarakhand.
- (v) The Dafia-Dhoora area in Kumaun region is rich in pine.
- (vi) *Quercus* is the general feature of temperate region of the state.
- (vii) *Ficus glomerata* is the major species of moist alpine scrub forests.
- (viii) Bugyals are found in sub-alpine forest.
- (ix) *Shorea robusta* form the top storey of deciduous species in tropical moist deciduous forest.
- (x) Oak is the dominant species of sub-tropical pine forest.
- (xi) Bugyals occur at an altitude of 500m.

### 6.7.3 Fill in the blanks

- (i) Biogeography is most keenly observed on the world's .....
- (ii) Western ghats include ....., ....., .....and ..... hills.
- (iii) ....., ..... and ..... animals are found in trans-himalayan zone.
- (iv) The natural vegetation of semi-arid areas is ..... Forest.
- (v) ..... is the longest river of Deccan Plateau.
- (vi) ..... region is one of the most richest flora regions of India.
- (vii) ....., ..... and ..... are grown in North-East India.
- (viii) ....., ..... and ..... are the dominant trees in Uttarakhand.
- (ix) ..... vegetation occupies the terai belt of Uttarakhand.
- (x) The Baram-shandev area in Kumaun region is rich in .....

- (xi)..... and ..... are the major species of moist alpine scrub forests.  
 (xii) Sub-alpine forest are characterised by patches of ..... forest.  
 (xiii) Major species of tropical dry deciduous forest are ....., ..... and .....  
 (xiv) ....., ....., ..... and ..... form the top storey of deciduous species in Tropical moist deciduous forest.  
 (xv) ..... and ..... species are components of bugyals.

### 6.7.1 Answers Key:

- (i) Philip L. Sclater and H.G. Adolf Engler  
 (ii) It is the study of the distribution of species and ecosystems in geographic space and through (geological) time.  
 (iii) Carl Linnaeus  
 (iv) Palearctic (Europe and Asia), Nearctic (North America), Neotropical (Mexico, Central and South America), Ethiopian (Africa), Indian (Southeast Asia, Indonesia) and Australian (Australia and New Guinea). Currently, eight are recognised since the addition of Oceania (Polynesia, Fiji and Micronesia) and Antarctica.  
 (v) Trans Himalayan zone; Himalayan zone; Desert zone; Semiarid zone; Western ghat zone; Deccan plateau zone; Gangetic plain zone; North east zone; Coastal zone; Islands present near the shore line  
 (vi) Mahanadi, Godavari, Krishna, and Kaveri  
 (vii) Rice and Coconut  
 (viii) Gujarat, Maharashtra, Goa, Karnataka, Kerala, West Bengal, Odisha, Andhra Pradesh, Tamil Nadu and Puducherry  
 (ix) 68.74%  
 (x) Moist alpine scrub, Sub-alpine forest, Himalayan dry temperate forest, Himalayan moist temperate forest, Sub-tropical pine forest, Tropical dry deciduous forest, Littoral and swamp forest, Tropical moist deciduous forest.  
 (xi) Plains and High altitude grasslands

**6.7.2 Answers Key:** (i) False, (ii) True, (iii) False, (iv) False, (v) False, (vi) True, (vii) False, (viii) False, (ix) True, (x) False, (xi) False

**6.7.3 Answers Key:** (i) Islands, (ii) Sahyadri, Nilgiris, Anamalai, and cardamom hills, (iii) Wild sheep, Goat, Snow leopard, (iv) Thorn forest, (v) Godavari, (vi) North-east India, (vii) orchids, bamboos and ferns, (viii) *Acacia catechu* and *Aegle marmelos*, (ix) Hydrophytic, (x) Orchids, (xi) *Betula utilis* and *Rhododendron campanulatum*, (xii) *Abeis-Betula*, (xiii) *Anogeissus latifolia*, *Shorea robusta*, *Terminalia tomentosa*, (xiv) *Adina cardifolia*, *Anogeissus latifolia*, *Shorea robusta*, *Terminalia tomentosa*, (xv) *Anemone*, *Arnunculus*

---

## 6.8 REFERENCE

---

- Anon. (1922). *Report of the Forest Grievances Committee*. Government Printing Press, Allahabad. pp. 3-7.
- Barry, C.C. and Moore, P. 2005. *Biogeography: An ecological and evolutionary approach*. Malden, MA: Blackwell Publications.
- Bhat, J.L. (1995). Joint Forest Management. *Emp. News*, 20 (37): 1-2.
- Browne, J. 1983. *The secular ark: Studies in the history of biogeography*. New Haven: Yale University Press.
- Cavalcanti, M. (2009). *Biogeography and GIS*. <http://digitaltaxonomy.infobio.net>.
- Champion, H.G. and Seth, S.K. 1968. *A Revised Survey of the Forest types of India*. Manager of Publications, Delhi. 404p.
- Chauhan, B.S. 2008. *Environmental studies*. Firewall Media. pp. 107–111.
- Dansereau, P. 1957. *Biogeography: An ecological perspective*. New York: Ronald Press Co.
- FSI. 2000. *State of Forest Report 1999. Supplementary, Forest Survey of India*, Ministry of Environment and Forests, Dehradun.
- FSI. 2005. *State of Forest Report. Forest Survey of India*, Ministry of Environment and Forests, Dehra Dun.
- <https://en.wikipedia.org/wiki/Biogeography>.
- [https://en.wikipedia.org/wiki/Biogeographic\\_classification\\_of\\_India](https://en.wikipedia.org/wiki/Biogeographic_classification_of_India).
- Jønsson, K.A. and Fjeldså, J. 2006. Determining biogeographical patterns of dispersal and diversification in oscine passerine birds in Australia, Southeast Asia and Africa. *Journal of Biogeography*. 33(7): 1155–1165.
- Lyell, C. 1830. *Principles of geology, being an attempt to explain the former changes of the Earth's surface, by reference to causes now in operation*. London: John Murray. Volume 1.
- MacArthur R.H. and Wilson E.O. 1967. *The theory of island biogeography*.
- Martiny JBH et al. 2006. *Microbial biogeography: Putting microorganisms on the map* Nature, vol. 4.
- Negi, A.K., Bhatt, B.P., Todaria, N.P. and Saklani, A. (1997). The effect of colonialism on forests and the local people in Garhwal Himalaya, India. *Mount. Res. & Dev.*, 17(2): 159-168.
- Nicolson, D.H. 1991. A history of botanical nomenclature. *Annals of the Missouri Botanical Garden*. 78 (1): 33–56.
- Quammen, D. 1996. *Song of the Dodo: Island biogeography in an age of extinctions*. New York: Scribner. 17p.
- Rawat, A.S. (1991). History of forest management: conflicts and their impact in the Central Himalaya. *In: History of Forestry in India* (Ed. A.S. Rawat). pp. 280-325.

- Saklani, A. (1987). The History of a Himalayan Princely State: Change, Conflicts and Awakening. Durga Publishers, Delhi.
- Stephen D.P. and Goward, S.N. 1995. Global Primary Production: A Remote Sensing Approach. Journal of Biogeography, 22: No. 4/5, Terrestrial Ecosystem Interactions with Global Change, Volume 2 (Jul. - Sep., 1995), pp. 815-835
- Uniyal, B.P., Khanna K.K. and Balodi, B. 1999. Uttar Pradesh. *In*: Floristic diversity and conservation studies in India (Eds. V. Mudgal and P.K. Hazara). Botanical Survey of India, Calcutta. Vol III.
- [www.biodiversidad.gob.mx/v\\_ingles/region/biogeographicReg.html](http://www.biodiversidad.gob.mx/v_ingles/region/biogeographicReg.html).

---

## ***6.9 SUGGESTED READINGS***

---

- Kumar, A. and Rawat, S. 2011. Bioresources of Uttarakhand: Their conservation and management. Bishen Singh and Mahendra Pal Singh, Dehradun.

---

## ***6.10 TERMINAL QUESTIONS***

---

1. Describe the classical concept of biogeography.
2. What are the modern applications of biogeography?
3. Write a detailed note on different biogeographical regions of India.
4. Describe the different forest types found in Uttarakhand.
5. Write a short note on grasslands of Uttarakhand.

## **BLOCK-2 APPLIED ECOLOGY AND REMOTE SENSING**



---

# **UNIT-7      REMOTE      SENSING:      TOOLS      AND TECHNIQUES**

---

7.1 Objectives

7.2 Introduction

7.3 Remote Sensing

    7.3.1- Tools and Techniques

    7.3.2- Applications

7.4 Physical basis of Remote Sensing

7.5 Summary

7.6 Glossary

7.7 Self-assessment questions

7.8 References

7.9 Suggested Readings

7.10 Terminal Questions

---

## ***7.1 OBJECTIVES***

---

After reading this unit students will be able -

- to know basic concepts and information about remote sensing
- to make you familiar with new techniques of remote sensing.

---

## ***7.2 INTRODUCTION***

---

Sensing is defined as the collection of information about an object or a target. It is proximal sensing when you gather the information about an object from a near distance with a device such as contact, vision, etc. When we gather the information about a target from a distance without being in physical contact and interpret, it is referred as remote sensing. The term remote sensing was coined by Miss Evelyn Pruitt (1961) at the office of Naval Research, USA. Remote sensing is the art and science of recording, measuring and analysing information about a phenomenon from distance. Human with the aid of their eyes, noses, ears and brain are constantly seeing, smelling and hearing things from a distance as they move through an environment. Thus human beings are naturally designed to be a remote sensor.

Aerial photography is the original form of remote sensing and remains the most widely used conventional method. We know aerial photography analyses have played major roles in the study of forest types and discovery of many oil, mineral deposits and various other natural resources. Besides this conventional technique, the other forms of remote sensing include surveillance through radars and satellites.

---

## ***7.3 REMOTE SENSING***

---

Remote sensing is the acquisition of information about an object without making physical contact with it. In remote sensing three things are involved viz., an object (target), a sensor and an information carrier. The object may be any ground feature such as a building, railway line, trees, hill, ship or a terrain. Sensors are the devising instrument such as our eyes, a camera or a telescope, etc. We make use of electromagnetic radiations (EMR) as an information carrier. You know the sun is a source of regular supply of electromagnetic radiations, a part of which is received by our earth. A flashgun in your camera or mobile or a transmitter in Radar is artificial type of EMR (energy) sources. Therefore you can split the remote sensing into active remote sensing (when an energy signal is first produced and emitted from an aircraft or radar or flashgun of a camera ) or passive when the natural energy source (sunlight is used).

### 7.3.1 Tools and Techniques

The remote sensing as we now call it had begun with the initial attempts of aerial photography of an area using a balloon or from a hill top. With the invention of airplanes in the beginning of 20<sup>th</sup> century and during First World War there was a boom in the field of remote sensing. Several tools were developed along with new techniques to study the objects with greater accuracy. Today you see a number of devices and instruments for recording the information, analysis of data and its interpretation. In last few decades with the development of computers we have different type of software for visual as well as digital image processing.

Aerial photography comprised of camera systems. The design and function of modern adjustable cameras is conceptually identical to that of early simple lens camera with a film and filter combination. Different type of film and filters are used to obtain optimum information from aerial photographs. To study the aerial photographs a number of devices have been developed. These include both laboratory equipments and field instruments. The instruments comprised of magnifiers, pocket (lens) stereoscopes and mirror stereoscopes, zoom stereoscope, transparent dot grid, mechanical polar planimeter, parallax bars, additive colour viewer, precision coordinate digitizer, sketchmaster, stereo zoom transfer scope, reconnaissance camera (single lens frame camera), mapping camera, multi lens frame camera, strip camera, panoramic camera, photographic products viz., prints and transparencies, radiometers, etc.,

Today the remote sensing techniques include space technology and comprises of sophisticated devices some of which are Microwave radiometers, MW altimeter, Magnetic sensors, Spectrometers, Solid scanners, TV camera, Optical mechanical scanner, Thematic mappers, Laser distance meter and Laser water depth meter, Radars, real and synthetic aperture radars and, many more devices depending upon the requirements and information desired. To store and analyse the data there are super computers with number of software designed for the purpose. You will learn various applications of remote sensing in following paragraphs.

### 7.3.2 Applications

You know that the remote sensing is basically a tool for the study of earth resources, atmosphere and for space studies. Some of these applications are being listed here.

Aerial photography is conventional form of remote sensing where air borne platforms like an aircraft, drones, helicopter, balloon or even a kite is used with aerial cameras along with various lenses and film combinations to record and collect information in the form of photographic images. The aerial photography has application in various fields as a source of data which can be analysed quantitatively and qualitatively. It is used in all type of mapping jobs; stereographic pairs of aerial photograph are used to prepare topographic maps by terrain analysis; in interpretation of data and, as substitutes to maps and photomaps

The applications of conventional radar are mostly associated with aerial traffic control, early warning (in coastal areas) and meteorological information. Doppler radar is used in enhanced

meteorological knowledge viz., wind speed and direction, precipitation, location and intensity. Synthetic Aperture Radar is used to generate precise digital elevation model of terrains.

Laser and Radar altimeters on satellite help in measuring height (bulges) and wavelength of ocean waves. These also measure wind speed and direction as well as surface ocean currents and directions.

Light detection and ranging (LIDAR) are mostly used in weapon ranging and laser illuminated projectiles. Air borne LIDAR is used to measure height of objects and other ground features with more accuracy. It is also used to detect and measure the concentration of various chemicals in the atmosphere. These radars are also used in analysis and mapping of vegetation.

Radiometers and photometers are used to collect reflected/emitted EMR in a wide range of frequency. These include gamma rays, ultra violet, infra-red and microwave sensors. All these devices are used to detect emission spectra of various chemicals present in atmosphere.

The digital data obtained from various remote sensing satellites are used to generate thematic maps that can be used to prospect for minerals, land use pattern, invasive vegetation, forests and deforestation and, monitoring the health of forests, grazing lands, wetlands, etc. Hyper spectral imagers are very beneficial in mineralogy, biology, defence and environmental measurements.

Digital Image Processing accompanied with GIS has given new dimensions in the application field.

---

## ***7.4 PHYSICAL BASIS OF REMOTE SENSING (ACQUISITION OF REMOTE SENSING DATA)***

---

There are many steps in the acquisition of remote sensing data.

- (i) A source of electromagnetic energy (sun or self emission).
- (ii) Transmission of the energy from the source to the surface of the earth.
- (iii) Interaction of electromagnetic radiations with the earth surface. It may result in absorption, reflection or re-emission.
- (iv) Transmission of reflected energy from the surface or target to the remote sensor.
- (v) Standard data on computer compatible tapes for processing, analysis and interpretation (digital, graphic, hard copy).

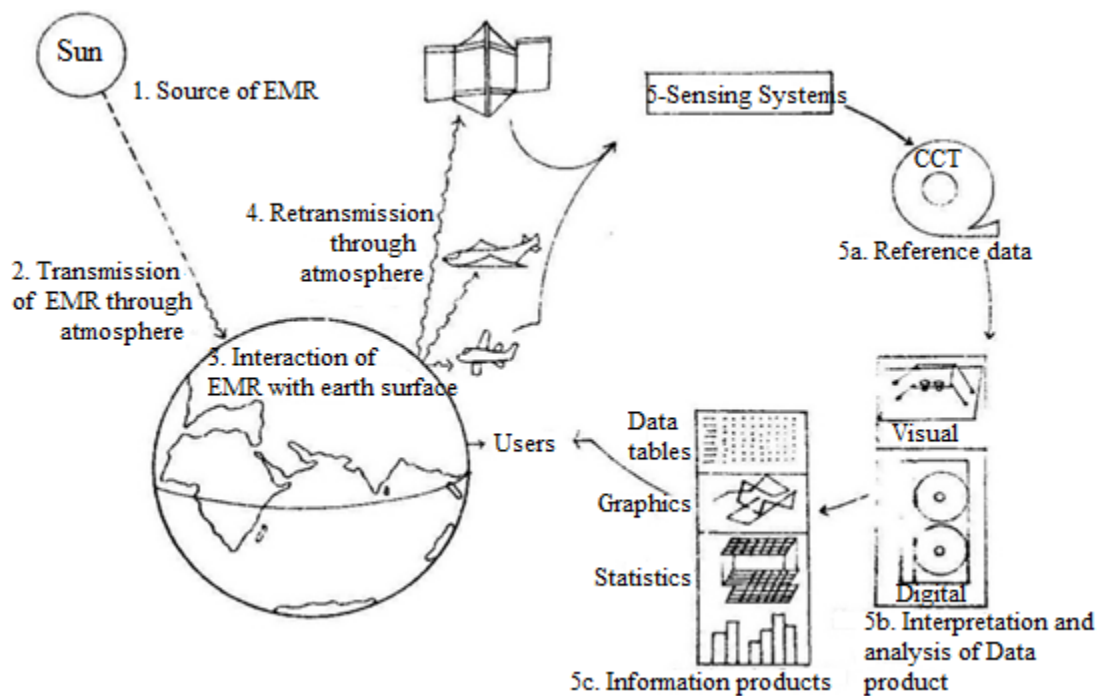

**Fig. 7.1: Stages in the acquisition of remote sensing data**

Aerial photography (conventional remote sensing) and modern remote sensing technique differs in following respect:

- i. In conventional aerial photography only few portions of EMR were used while in modern remote sensing extended portions of electromagnetic spectrum are used.
- ii. The sensor technology in remote sensing is of highly advanced type.
- iii. Aerial photography comprised of aerial platforms viz. balloons, helicopters and aircrafts. The remote sensing platforms include spacecrafts in addition to aircrafts.
- iv. In remote sensing there is more emphasis on the use of spectral information as compared to spatial information.
- v. Similarly in remote sensing there is advancement in image processing and enhancement techniques.
- vi. The image analysis is done with both automated and manual interpretations.

In order to have a clear knowledge of remote sensing techniques and stages we shall discuss the elementary physics involved and learn the technical terms.

### 7.4.1 Electromagnetic Radiations

You know that the energy travels in form of waves. The different waves differ in their wavelength and frequencies (cycles per second). The scale showing the wavelength and frequencies is called electromagnetic spectrum (Fig. 7.2). The electromagnetic spectrum is the

continuum of energy that ranges from nanometers to meters in wavelength, travels at the speed of light and propagates through a vacuum such as outer space.

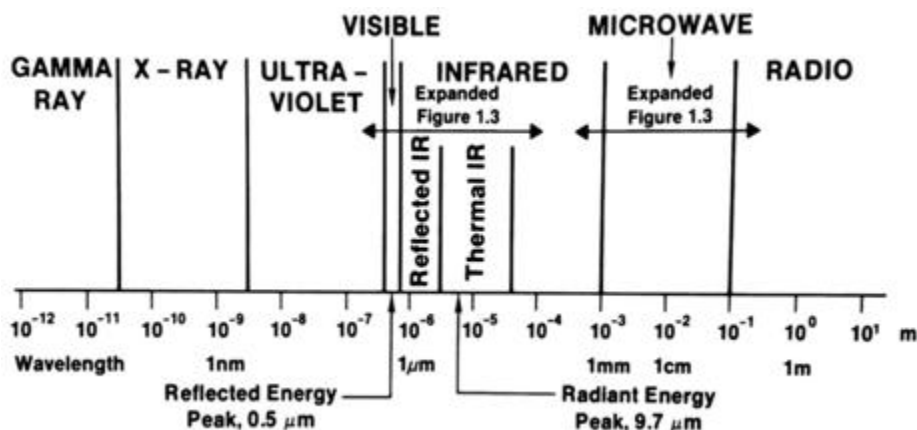

Fig.7.2 Electromagnetic Spectrum

Various regions of electromagnetic spectrum are given in Table 1. You can see that the cosmic rays have least wavelength and very high frequency. As we proceed to gamma rays, X-rays, UV, light, IR, MW and radio waves the wavelength increases and the corresponding frequency decreases. The radio waves have higher wavelengths but very low frequency.

Table 1. Electromagnetic Spectrum Chart

Rays	Wavelength	Frequency (cycle/sec) Hertz
Cosmic rays	$10^{-11}$ cm= X.U.	$10^{28}$
Γ- Gamma rays	$10^{-10}$ cm to $10^{-8}$ cm= $1\text{A}^0$	$6 \times 10^{20}$ to $6 \times 10^{18}$
X-rays	$10^{-9}$ cm to $10^{-5}$ cm	$6 \times 10^{19}$ to $6 \times 10^{15}$
Ultra violet	$1.4 \times 10^{-6}$ to $4 \times 10^{-5}$ cm	$2 \times 10^{16}$ to $8 \times 10^{14}$
Visible (light)	$4.0 \times 10^{-5}$ cm to $8 \times 10^{-5}$ cm	$8 \times 10^{14}$ to $4 \times 10^{14}$
Infra-red	$8.0 \times 10^{-5}$ cm to 0.04cm	$4 \times 10^{14}$ to $3 \times 10^{13}$
Microwaves	$10^{-1}$ cm to $10^2$ cm	300 Mhz to 300GHz
Radiowaves	$10^2$ cm to $10^7$ cm (1m to 100km)	300GHz to 3 KHz

**7.4.1.1. Characteristics of the various wavelength regions**

Radiations differing in wavelength ( $\lambda$ ) have different energy content. The shorter wavelengths have higher energy content while the longer wavelengths possess low energy content. You can see these characteristics in visible and near visible region and relate wavelength, frequency and energy content per photon as given in Table 2.

**Table 2. Characteristics of different regions of light**

Colour	$\lambda$ range (nm)	Representative $\lambda$	Frequency	Energy Ev/photon	Energy KCal/mol of photon
Ultra violet	< 400	254	$11.80 \times 10^{14}$	4.88	112.5
Violet	400-425	410	$7.31 \times 10^{14}$	3.02	69.7
Blue	425-490	460	$6.52 \times 10^{14}$	2.70	62.2
Green	490-560	520	$5.77 \times 10^{14}$	2.39	55.0
Yellow	560-585	580	$5.17 \times 10^{14}$	2.14	49.3
Orange	585-640	620	$4.84 \times 10^{14}$	2.00	46.2
Red	640-740	680	$4.41 \times 10^{14}$	1.82	42.1
Infra-red	> 740	1400	$2.14 \times 10^{14}$	0.88	20.4

Now it is clear to you that the lower wavelengths are characterised by higher frequency and high energy content per photon and higher wavelength have low frequency and low energy content per photon. The energy content in K Cal per mol of photon also decreases. The relative photon flux per unit wavelength interval of electromagnetic radiations in visible and nearly visible region is shown in Fig. 7.3.

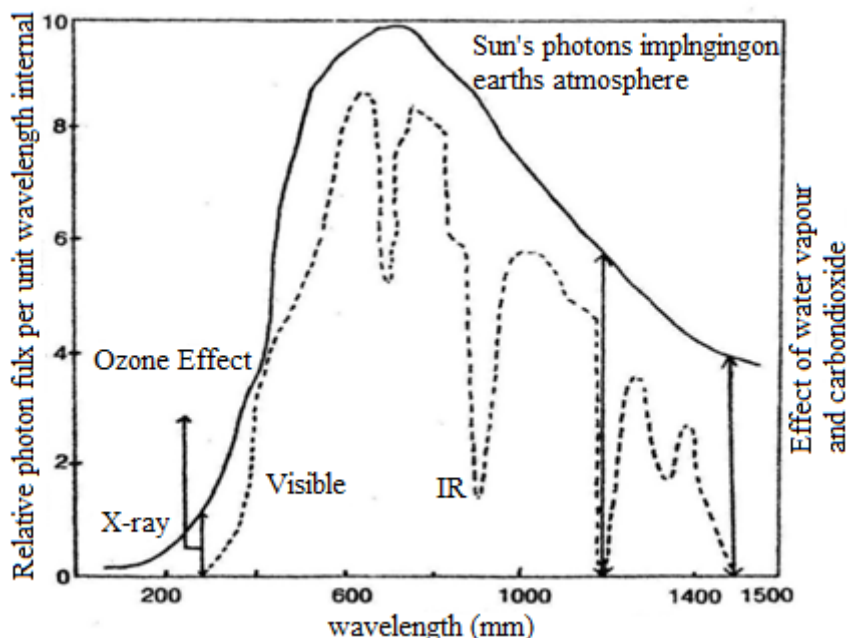

**Fig.7.3** It shows the relative number of sun’s photon incident on the earth atmosphere and reaching its surface as a function of wavelength

About 5% of the photons incident on the earth's surface are ultra violet (< 400nm), 28% in visible and, 68% in the infra red (beyond 740nm) region. Most of the ultraviolet fraction of sunlight incident on earth atmosphere is prevented to reach the surface by the ozone present in the stratosphere (18-32 km above the earth surface). Much of the infra red of the sun is absorbed by atmospheric water vapour and carbondioxide. Water absorbs strongly near 900nm, 1100nm and above 1200nm, having a major infra red absorption band at 1400nm (1.4 $\mu$ m). Because of the substantial absorption of UV and IR by atmospheric gases, the EMR at the earth surface has a larger fraction in the visible region than that incident at the outer atmosphere.

#### 7.4.1.2 Common terms used with electromagnetic radiations

1- *Radiant energy (Q)*: It is the energy carried by EMR. The unit of Q is joule.

2- *Radiant flux ( $\Phi$ )*: It is the time rate of flow of energy.

3- *Spectral Irradiance (E)*: Radiant flux received by a plane surface per unit area. It arrives at the surface from all directions within a hemisphere. The unit of spectral irradiance is  $Wm^{-2}$ .

4- *Emittance or Radiant exitance ( $\mathcal{E}$ )*: Radiant flux leaving a surface per unit area of the surface. The exitance may be in any one or at all directions within a hemisphere over the surface.

5- *Hemispherical reflectance, transmittance and absorbance*: When radiant energy falls on a surface it is either reflected back by the surface, transmitted through the surface or it is absorbed by the surface and transformed into some other form of energy. Thus hemispherical reflectance ( $\rho$  or rho) is the ratio of the reflected emittance from the plane to the irradiance on that plane.

$$\rho \text{ (reflectance)} = \text{reflected energy} / \text{total energy}$$

Similarly hemispherical transmittance ( $\tau$  or tau) is defined as the ratio of transmitted energy leaving the opposite side of the plane, to the irradiance.

$$\tau \text{ (transmittance)} = \text{transmitted energy} / \text{total energy}$$

The hemispherical absorbance ( $\alpha$  or alpha) denotes the fraction of the incident energy that is absorbed by the surface.

$$\alpha \text{ (absorbance)} = \text{absorbed energy} / \text{total energy}$$

Thus,  $Q = \rho + \tau + \alpha$  (where Q= radiant energy and  $\rho$ ,  $\tau$ ,  $\alpha$  are the reflectance, transmittance and absorbance. For an ideal black body  $\rho=0$ ,  $\tau=0$  and  $\alpha=1$  and for a perfectly white body  $\rho=1$ ,  $\tau=0$  and  $\alpha=0$ ).



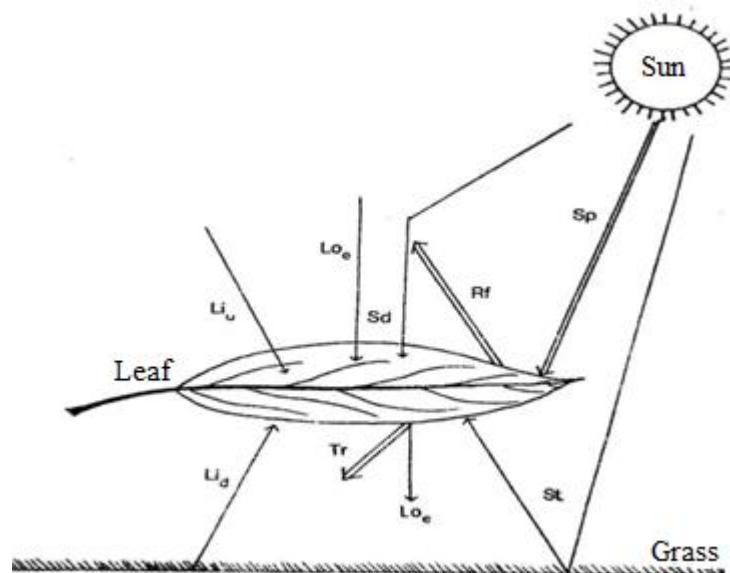

**Fig.7.4** Response of an object (leaf) towards the stream of radiant energy Sp-direct solar irradiance, Sd-diffuse sky irradiance, St- reflected short wave flux,  $Lo_e$ - long wave emittance from object surface, Rf-reflected radiation, Tr-transmitted radiations,  $li_u$ -long wave irradiance for the above facing surface,  $Li_d$ - long wave irradiance for down facing.

### 7.4.1.3. Production of electromagnetic radiations (EMR)

**i. Emission of EMR from gases.** It is due to atoms and molecules in the gases. You know atoms consist of a positively charged nucleus surrounded by orbiting electrons which have discrete energy states. Transition of electrons from one energy state to other leads the emission of radiations in discrete wavelength. The resulting spectrum is referred as *line spectrum*.

Molecules have two or more atoms joined together by orbiting electrons. Thus molecules encompass rotational and vibrational energy states, transition between which leads to emission of radiation in a band *spectrum*.

**ii. Emission of EMR from solids and liquids.** Solids and liquids when heated emit EMR in a *continuous spectrum*. This is known as thermal emission of radiation. It is the most important source of radiation from the view point of remote sensing.

The thermal emission is due to conversion of heat energy which is the kinetic energy of the random motion of the particles (of matter) into electromagnetic energy. Thermal emission of radiation depends upon absolute temperature and emissivity.

### 7.4.1.4. Characteristics of Solar Radiant Energy

You know the sun is the strongest and most important source of radiant energy for remote sensing. The solar spectrum extends approximately from 0.3 to 3.0  $\mu\text{m}$ . The maximum irradiance occurs at 0.47  $\mu\text{m}$ . The visible region from 0.4  $\mu\text{m}$  to 0.76  $\mu\text{m}$  carries about 46% of the total solar energy at earth surface.

## 7.4.2. Atmospheric Effects in Remote Sensing

The universal source of the EMR is sun. The earth receives a part of it. The reflected radiations are received by remote sensors. During this journey from sun to earth to remote sensors, the electromagnetic radiations interact with atmosphere. This EMR- atmosphere interaction is very important from the view point of remote sensing because (i) information carried by EMR reflected or emitted by earth surface is modified during the course of passage in the atmosphere and (ii) EMR-atmosphere interaction can be used to obtain the information about the atmosphere itself.

The electromagnetic radiations interact with the atmosphere in two ways viz., absorption and scattering. Both the phenomena depend upon the composition of the atmosphere and attenuate the radiant flux. The atmosphere is composed of pure gases and particulates.

The atmosphere primarily consists of pure gas molecules of which nitrogen, oxygen, and argon are predominant. Ozone forms an outer belt of the atmosphere in the stratospheric zone. Small traces of carbon dioxide and water vapours, etc. are also present. All these molecules block solar radiation

The atmosphere also consists of particles of various size, shape and density which originate from various sources for instance dust, haze, smoke, soil and rock debris, etc.

### 7.4.2.1. Atmospheric absorption

You know that the atmosphere comprise of various type of gas molecules including CO<sub>2</sub>, water vapours, ozone, etc. Radiations (EMR) passing through the atmosphere are absorbed strongly in certain spectral bands. These bands are not suitable for remote sensing. The atmosphere is transparent for other spectral bands and these are known as atmospheric windows. The atmospheric windows exist in visible and near infra-red region (0.4  $\mu\text{m}$ - 3.0  $\mu\text{m}$ ), middle infra-red (3.0  $\mu\text{m}$ - 5.3  $\mu\text{m}$ ) and thermal infra-red (9  $\mu\text{m}$  -16  $\mu\text{m}$ ) region. The atmosphere is transparent again beyond the wavelength region of 1mm which is used for microwave sensing (Fig.7.5).

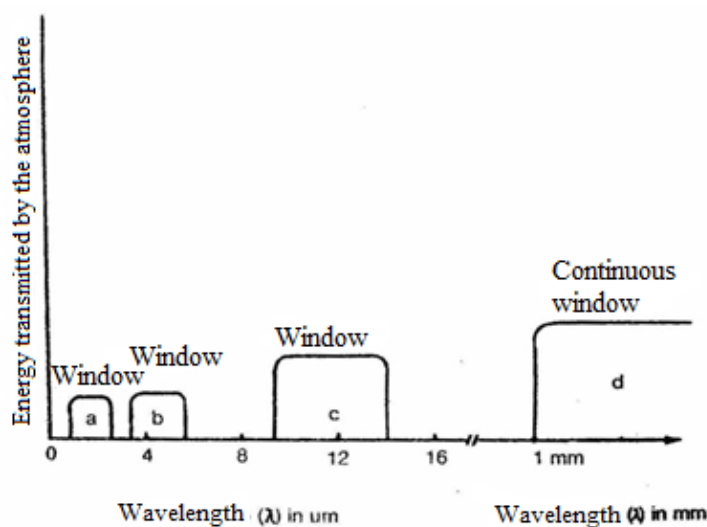

Fig.7.5 Atmospheric windows in visible and near infra red region

### 7.4.2.2. Scattering

When a beam of radiations hits a particle, molecule or aggregates of particles or molecules scattering occurs. Pure scattering occurs in the absence of all absorption; there is no loss of energy or no attenuation of EMR, only redirection of energy. Scattering of electromagnetic radiations within the atmosphere have two adverse effects in remote sensing. viz., it reduces the image contrast and, it changes the spectral signature of ground objects as perceived by the sensor. The scattering of electromagnetic radiations depends on the atmospheric composition and the radiation wavelength. The intensity of scattered radiation is directly proportional to the particle size, concentration, polarizability of molecules and, wavelength.

The particles present in the atmosphere vary in size while the gas molecules are of the order of 0.1 $\mu\text{m}$ . The size of haze particles (water droplets formed by the condensation of water vapour around particles of soluble substances) varies from 1.0 $\mu\text{m}$  to 10  $\mu\text{m}$  (0.01mm) depending upon the state of relative humidity. Table 3 depicts the three different type of scattering from particles of three size range.

**Table 3. Molecules and particle size and scattering of EMR**

S.No.	Particle type	Particle size	Wavelength dependent	Scattering phenomenon
1	Air/gas molecule	<1.0 $\mu\text{m}$	$\lambda^{-4}$ ( $10^{-4}\text{cm}$ )	Rayleigh
2	Smoke/haze	1.0 $\mu\text{m}$ to 10 $\mu\text{m}$	$\lambda^0 - \lambda^{-4}$	Mie
3	Dust/fog/clouds	>10 $\mu\text{m}$	$\lambda^0$	Non selective

#### i) Rayleigh Scattering

It is named after British physicist Lord Rayleigh. It is the elastic scattering of visible light ( $0.4 \mu\text{m} < \lambda < 0.8 \mu\text{m}$  or EMR) by particles and gas molecules in a clear atmosphere much smaller ( $\sim 10^{-4} \mu\text{m}$ ) than the wavelengths of the radiations. It accounts for example, for the blue colour of the sky, since blue light is scattered more efficiently than red. The scattering is strong in both forward as backward direction (Fig.7.6).

#### ii) Mie Scattering

It corresponds to the intermediate case when the particle size is comparable to the radiation wavelength (1 $\mu\text{m}$  -10 $\mu\text{m}$ ). The incident light is scattered mainly in the forward direction.

#### iii) Non selective Scattering

It occurs when the particle size is very much larger (10 $\mu\text{m}$  -100 $\mu\text{m}$ ) than the radiation wavelength for example water droplets and large dust particles. This scattering does not depend upon wavelengths of radiation. All wavelengths are attenuated equally (hence name). It results in fog, mist, clouds, etc., appearing white. It is because of equal scattering of red, green and blue wavelength.

The effects of the Rayleigh component of scattering can be eliminated by using minus blue filters. However, the effects of heavy haze, when all the wavelengths are scattered uniformly cannot be eliminated by using haze filters. The effects of haze are less pronounced in the thermal infra-red region. Microwave region radiations are completely immune to haze and can even penetrate clouds.

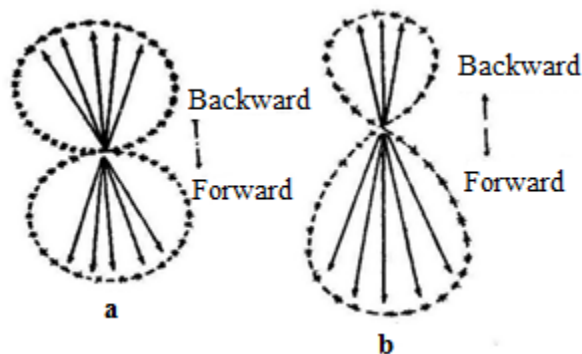
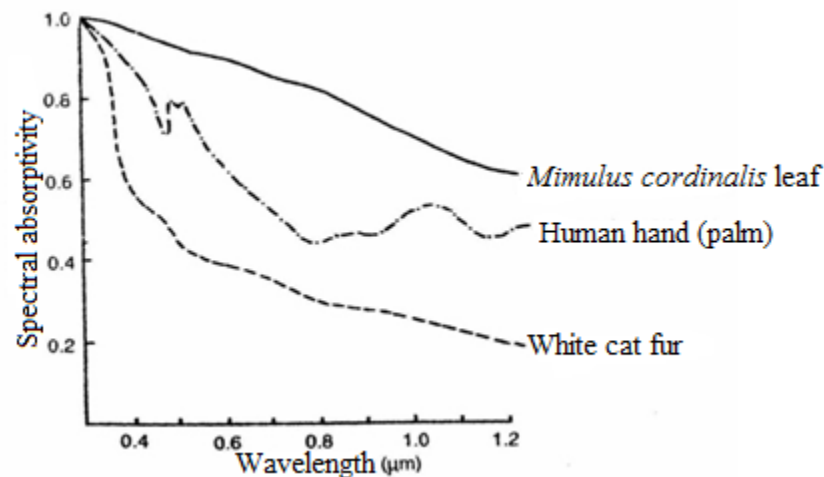

**Fig.7.6 Scattering of EMR by atmospheric particles (a) Rayleigh (b) Mie**

### 7.4.2.3. Spectral Signature

You very well know that different features on the earth reflect, absorb, transmit and emit electromagnetic energy which they receive from the sun. The difference in the reflectance/emittance characteristics of various objects with respect to wavelength (i.e., reflectance/emittance of  $\lambda$ ) is called spectral signature. In other words you can say that spectral signatures are specific combination of emitted, reflected or absorbed EMR at varying  $\lambda$  (wavelength) which can uniquely identify an object.

In remote sensing we normally measure reflected energy e.g., visible light, near infra-red, etc., coming from land and water surfaces. The amount of energy reflected from these surfaces is usually expressed as a percentage of the amount of energy striking the object. Reflectance is 100% if all of the light striking an object bounces off and detected by the sensor. If none of the light returns from the surface, reflectance is said to be zero per cent. In most cases the reflectance value of each object for each area of electromagnetic spectrum is somewhere between these two extremes. Across any range of wavelengths, the percent reflectance values for landscape features such as forests, roads, sand, water, etc., can be plotted and compared. Such plots are referred as spectral response curves or spectral signatures. Difference in spectral signature of natural or manmade ground objects are recorded in terms of tonal variation in multispectral photography or scanner imagery. Spectral signature differences of the objects form the basis of identification and discrimination among objects (Fig.7.7).



**Fig.7.7** Spectral absorptivity of natural surfaces as a function of wavelength (Courtesy: Gates, 1975)

The spectral reflectivity (short wave) of some natural objects is displayed in Table 4. Since atmospheric scattering is wavelength dependent, the spectral characteristics of ground features are modified when viewed by a sensor. For example, the general picture of the terrain looks more bluish hazy.

**Table 4. Short wave reflectivity (albedo) of soils and vegetation**

S. No.	Surface	Reflectivity
1	Dry soil (light colour)	0.32
2	Wheat crop (mature)	0.26
3	Grass	0.24
4	Maize	0.22
5	Deciduous forests	0.18
6	Coniferous forests	0.16
7	Sugar cane	0.15
8	Pine apple	0.15
9	Swamp forest	0.12
10	Open water	0.05

### 7.4.3. Interaction of EMR with earth's surface

The solar radiations strike the earth surface and get reflected, transmitted or absorbed by the surface. As a result of interaction, the EMR experiences a number of alterations in magnitude, direction, wavelength polarization and phase. These changes are perceived by the remote sensor and enable the analyst to obtain useful information about the object of interest. The remotely sensed data contains two type of information:

- i. Spatial information viz. size, shape and orientation
- ii. Spectral information viz., tone, colour and spectral signature

#### **7.4.3.1. Interaction Mechanism**

To understand the mechanism of interaction the visible and infra-red (optical) wavelengths from 0.3  $\mu\text{m}$ - 16  $\mu\text{m}$  can be divided into three regions:

- i. The spectral band from 0.3  $\mu\text{m}$  to 3.0  $\mu\text{m}$  is known as the reflective region. The radiations sensed by the sensor in the band come from the sun and reflected by the earth surface.
- ii. The band corresponding to atmospheric window between 9  $\mu\text{m}$  to 16  $\mu\text{m}$  is known as the thermal infra-red band. The energy available in this band for remote sensing is due to thermal emission from ground features.
- iii. Both reflection and self emission are important for the intermediate band (middle infra-red) from 3.0  $\mu\text{m}$ -5.5  $\mu\text{m}$ .
- iv. Besides these three spectral regions the microwave region (100 $\mu\text{m}$ - 1m) is also very important from the remote sensing view point. In this MW region of the spectrum, RADAR is an active sensor since it has its own source of energy. The EMR produced by the RADAR is transmitted to the earth surface and the reflected EMR from the surface is recorded and analysed. There are passive sensors also which utilize the radiations in microwave region i.e., microwave radiometers record the radiations emitted by the terrain in the microwave region.

Among all the EMR interaction, surface reflections are most useful and revealing in remote sensing applications.

#### **7.4.3.2. Intensity of reflected EMR**

The intensity of an electromagnetic wave reflected from a substance depends on a number of parameters such as surface roughness, wavelength, angle of incidence and polarization, in addition to characteristic reflecting properties of the medium. Surface roughness is a function of wavelengths of incident radiations. Surfaces may be grouped into three roughness classes.

- i. Smooth when all the energy is reflected specularly.
- ii. Rough when the energy is diffusely scattered at all angles.
- iii. Intermediate when a portion of the energy is reflected specularly and the rest diffusely scattered.

In a specular reflection the angle of incidence equals the angle of reflection. From the remote sensing point of view the specular reflections are not good as they produce solar glare e.g., water or any polished surface reflects specularly. When the surface is rough, the incident EMR is reflected in all directions irrespective of the angle of incidence. The natural features like sand, tilted soils and certain vegetation exhibit diffuse reflections. Besides there are mixed reflections in nature. Here the surface reflects the EMR both specularly and diffusely (Fig. 7.8).

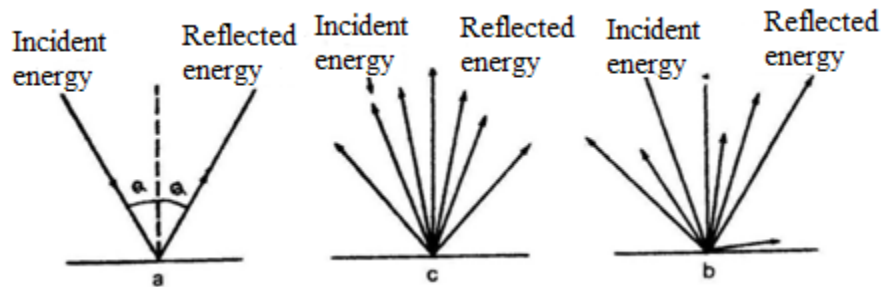

Fig.7.8 EMR reflection from various surfaces. (a) Specular (b) Diffuse (c) Mixed reflection

#### 7.4.3.3. Spectral Reflectance

Spectral Reflectance  $\rho(\lambda)$  is defined as the ratio of reflected energy to incident energy as a function of wavelength. The spectral reflectance characteristics vary with the surface of the object. Spectral reflectance is responsible for the colour or tone in the photographic image of an object. A wall appears white because it reflects all wavelengths. The shoes appear black as it absorbs all wavelengths. The vegetation appears green because it reflects most of the green wavelength band in the visible region.

Spectral reflectance can be easily measured and recorded by the instruments like spectrophotometers and spectroradiometers. Spectrophotometers measure the absolute spectral reflectance of a sample in the laboratory. The spectroradiometers are field instruments to measure the radiances.

#### 7.4.3.4. Interactions in the thermal infra-red region

Infra-red Sensors record the spectral exitance of objects by sensing the thermal emission of radiations. A thermal emission depends upon emissivity ( $\epsilon$ ), and the temperature ( $T$ ). Intensity of emitted EMR increases with the temperature. Change in existence arising due to changes in temperature can be sensed and utilized in identifying and differentiating between surface features. Thermal infra-red sensors sense an invisible world and interpretation of their imagery require special skills.

#### 7.4.4 Transmission of reflected EMR from the surface to sensor

The reflected energy from the ground features again pass through the atmosphere to reach a remote sensor and, during its return journey may undergo attenuation and modifications as the case may be. These energy signals are detected, recorded and interpreted. Sensors are the device that receives these energy signals and process them before recording.

The detection of electromagnetic energy is done either photographically or electronically. Photography is a process that involves chemical reactions on the surface of a light sensitive film and detects energy variations within a scene. Photographic system (chiefly used up to the

beginning of 20<sup>th</sup> century) offer many advantages as they are relatively simple and inexpensive besides providing spatial details and geometric reliability.

#### **7.4.4.1. Photographic Sensors**

These are widely used for the study of forest vegetation and ecological aspects. The photographic sensors comprise of various type of camera systems. The essential component of a camera system is lens, film and filter combination. The photography includes panchromatic photography (EMR of the order of 400-700 mille micron), infra-red photography (EMR range 700-900  $\mu\text{m}$ ), colour photography, false colour photography (colour infra-red), multispectral or additive colour aerial photography. In all these cases, blue green or red filters are used for true colour rendition. From these negative, positive transparencies are prepared which are projected using different coloured light. Actually this system combines spectrometric sensing with principles of photometry to enable detection of reflectance differences (spectral signature).

A camera gives a momentary image of the ground scene as a perspective projection. The picture has a scale  $f/H$  where  $f$  is the focal length and  $h$  is the flying height. Naturally the scale of the image can be altered by manipulating focal length or changing the flying height.

It is explicit that in the standard aerial photography, the photograph is the result of the reflectance in the entire visible band (including infra-red band in IR photography). However in multiband photography the ground reflectance is split up into narrow spectral bands. In fact the same ground scene is photographed to obtain four black and white negatives by the use of blue, green, red and infra-red filters. Diapositive can be reproduced from these negatives, and the four images can be seen in an additive colour viewer to develop a true or false colour image.

The aerial camera is mounted on helicopters, aeroplanes or drones in such a way that these can view the earth feature and obtain aerial photographs. In order to have stereo photographs two aerial cameras are mounted together.

#### **i. Sensor types**

There are two broad categories of basic sensor types such as passive and active. It refers to the illumination source of the system. Passive sensors measure light reflected or emitted naturally from surfaces and objects. The device (camera) merely observes, and depends primarily on solar energy as the ultimate radiation source illuminating surfaces and objects. Examples of remote passive sensors include film photography, infra-red, charge couple devices and radiometers. A camera with a flash gun is referred as an active sensor system since it has its own energy source so it first emits its energy and then measure the return of that energy after it has interacted with an object. RADAR and LIDAR are examples of active remote sensing where the time interval between emission and return is measured, establishing the location, velocity and shape/size of an object.

A sensor classified as passive, scanning and imaging method, is a camera, such as an aerial survey camera or a space camera. A sensor classified as a combination of passive, non-scanning and non-imaging system is a type of profile recorder for example, a microwave



radiometer. Sensors categorized as a combination of passive, scanning and imaging are further classified into image plane scanning sensors such as TV camera and solid state scanners and, object plane scanning sensors such as OMS (optical mechanical scanner), MSS (multispectral scanner) and scanning microwave radiometers.

The most popular sensors used in remote sensing are the camera, solid state scanner, such as the CCD (charge couple device) images, the multispectral scanner and the passive synthetic aperture radar. Laser sensors that have developed recently are frequently used for monitoring air pollution by laser spectrometers and, for the measurement of the distance by laser altimeters. The sensors which use lenses in the visible and reflective infra-red region are called optical sensors.

## ii. Photographic camera

It is a simple passive sensor. There are three basic elements of photographic camera system viz., lens, film and filters. **The lenses** in a camera are responsible for focussing and zooming of an object. Some time to minimise distortions associated with the use of single lenses, most camera lenses are usually composed of multiple lenses that work in concert to form an image on to film. The amount of image detail that can be recorded on film is directly related to focal length (f) i.e., distance between lenses and film. As the focal length increases, the details on the film are also enhanced. It is called zooming of an object.

**Film** in a camera is used to record the image that passes through the lens. A photographic film is composed of a durable base, which is coated with a light sensitive layer known as emulsion. During the short time when a camera shutter is open, light strikes the film and leaves a latent image on the emulsion. The image can be developed and printed.

The construction of most black and white film emulsions starts with the film base, typically a cellulose acetate which is tough, stable and typically non-inflammable. On the top of this, the emulsion of silver bromide grains in gelatine is attached with an adhesive layer. Gelatine is used because of its water solubility, its ability to hold grains in a fine, even dispersion and the fact that it swells when wetted allowing developers (developing solutions) to permeate through it. The emulsion is protected by a thin coating that resists scratching and an antihalation layer backs the film base to prevent unwanted light being reflected into the emulsions (Fig. 9). Different types of emulsions are used to make the film sensitive and thus the procured aerial photographs also vary. In colour film the emulsion is composed of three layers, each being sensitive to different wavelength of light, normally blue, green and red light. Film emulsions are generally limited to recording wavelength between 0.4-0.9 micro meters. Ordinarily, photographic emulsions are not sensitive to wavelengths beyond 1.2 micrometers, and other materials which are sensitive to thermal infrared radiations, cannot be used in a system working on the principle of a conventional camera.

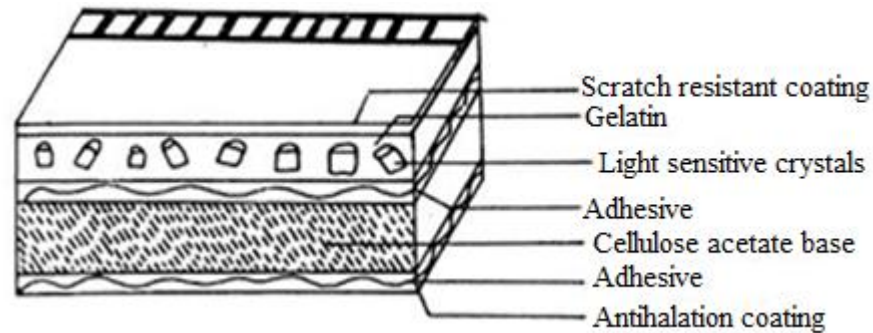

**Fig.7.9 Components of a film**

Panchromatic (black and white) film records the visible light in the range ( $0.4 - 0.75 \mu\text{m}$ ) of the electromagnetic radiations. These films have a low sensitivity in green region and a limitation against adverse atmospheric conditions such as haze, dust particles, clouds, darkness, etc.

Infra-red black and white film works well both in the visible light and near infra-red region viz.,  $0.4-0.9 \mu\text{m}$ . Since radiation with longer wavelength can penetrate haze better, IR film is recommended over panchromatic film in high altitude photography. The infra-red photography is also widely used for aerial surveying, long distance haze and for penetration surveillance and medical diagnosis. It is also used to distinguish between artificial and organic or dead and living substances.

The IR film is used in combination with a dark red filter that curtails all wavelengths below  $0.68 \mu\text{m}$ . The film is very suitable for the study of forests as its prints show a high tonal contrast between infra-red reflective objects (conifers) and infra-red absorbing objects (with surfaces and objects in shade).

Colour film is a three layer film sensitive to full visible range ( $0.40 - 0.75 \mu\text{m}$ ). It is exposed with a yellow filter which curtails ultra violet and some blue radiations. The three layers of colour film are sensitive to three primary colours blue, green and red. It is easy to distinguish and identify different diseases and species in colour photography. It has a limitation in haze and foggy conditions.

False colour (Infra-red colour) film differs from ordinary colour film in having sensitivity against green, red and infra-red region (blue is eliminated). A yellow orange filter is used. After exposure when the film is processed, the colours blue, green and red appear in the final photographs. The infra-red replaces red, the red replaces green and the green replaces blue. Thus there is a false rendition of colours; it is known as false colour photography.

The colour films with infra-red sensitivity produces false colour images that reveals heat variations with great accuracy. It is also easy to differentiate between manmade and natural objects, healthy and diseased vegetation with its background and, deciduous and green forests. The chlorophyll in plants reflects infra-red so strongly (40-45%) that healthy vegetation has a reddish caste, strikingly different from the expected green. In contrast the reflectance at blue green region is nearly 15-20% only.

Spectrazonal film possesses two layers of emulsions, one sensitive to visible colours (panchromatic) and other to near infra-red radiations (infra-chromatic). The film is exposed with yellow, orange or red filter.

Multiband or multispectral aerial photography is achieved by using several multiband camera (4 band I<sup>2</sup>S and 6 band ITEK camera). The film having infra-red aerographic emulsions is normally used in multispectral photography. Here separate filters are used to record photographic images in different bands on a single frame. All the four bands appear on a single format (23 x23 cm) with picture of each band in size equal to approximately 9 x9 cm.

Film speed is another quality of emulsions that is important for aerial photography. Film speed refers to the quantity of light that is required to expose the emulsion. False film requires less light than slow film to record the same image. For example if the camera platform is moving, one would like to use a high speed film to minimise the blurring effects of the moving camera.

Filters as referred above are also important as they restrict the light entering the camera. Colour filters work by absorbing a range of wavelengths while allowing other wavelength to pass through. Similarly the other filter type, known as neutral colour filters do not alter the spectral composition of light but instead reduce the amount of light of all wavelengths that pass through. The most common filter is antihaze filter. These filters absorb out ultra violet and blue wave lengths (shorter wavelength which are substantially scattered by particulates in the atmosphere). Another filter used for monitoring vegetation is an infra-red filter that absorbs visible light and permits only infra-red light to pass through.

Aerial photography is one of the conventional forms of remote sensing and is still used extensively today in spite of latest technological developments in this field in recent past. It is usually preferred if spatial details are required. For example, aerial photographs are used to identify individual tree species or taking measurements of individual trees by special photographic techniques. The aerial photographs are extensively used for mapping vegetation classes. Similarly, aerial photographs are used as a reconnaissance tool to provide information for a particular area. For instance if there is an outbreak of a disease in a forest of bamboo or teak, aerial photography using infra-red film can monitor areas and extent of the disease. The foliar canopy of the trees can easily be discerned.

### **Electro-optic radiometers**

A radiometer is a devise or instrument that is designed to measure the intensity of EMR in a set of wavelength bands ranging from ultraviolet to microwave region. Radiometers are similar in design to a camera. They have an aperture, lenses and mirror for the light to pass through but instead of film, radiometers have an electronic detector to record the intensity of electromagnetic energy. As incoming EMRs hits the detector a signal proportional to the incoming irradiance is processed to a digital or analogue output that can be recorded.

Detectors for radiometers measure wavelengths from 0.4  $\mu\text{m}$  to 1.4 $\mu\text{m}$ . Some radiometers detect the entire range while other are devised to measure selected wavelength band.

Multispectral radiometers measure more than one wavelength bands. These have prism, filters or other sophisticated devices to split the EMR into different wavelength bands.

#### 7.4.4.2. Non Photographic Sensors

There are several non-photographic remote sensors used for different type of studies. These include various scanner/detector/ recorder combinations in analogue or digital form. Scanner system working beyond the visible and near infra-red range of electromagnetic spectrum in thermal and microwave region are all non-photographic sensors.

The scanner use a rotating mirror to scan the ground scene line by line advancing in the direction of movement of the platform (vehicle). The mirror reflected ground image is then split up into narrow spectral bands by a grating and a detector converts this reflected energy into an electrical signal. These signals are then transmitted to earth receiving stations where the data are processed in a computer to obtain a hard copy image. These sensors are widely used in discerning the vegetation types, exploration of natural resources, delineation of drainage patterns and monitoring weather conditions, etc.

For the easy understanding of the students some of the non-photographic sensors and their data products are mentioned below.

- i. **Active Systems:** Radar imaging systems in microwave region (both synthetic aperture radar-SAR and side looking airborne radar-SLAR and, light detecting and ranging) Lidar (active optical) systems.
- ii. **Passive Systems:** Optical Mechanical Scanners (OMS); Multispectral Scanning Systems (MSS), Thematic Mapper (TM); Linear Array Sensors; High Resolution Visible (HRV) Imager, Multimodular Scanner (M<sup>2</sup>S).

#### Radar Imaging System in Microwave Region (Active Microwave)

Radar (radio detection and ranging) systems use microwaves (wavelengths ranging from 1mm to 1m). Microwaves pulses are transmitted at a target or surface, and the timing and intensity of the return signal is recorded. There are a number of devices available to produce microwaves. A low power device *Reflex Klystron* generates 10-500 MW and is suitable in the frequency range of 1000-3000MHz. *Cavity Magnetron* is a powerful device with operating frequencies from 1000MHz to 30,000MHz. Active systems like SAR and SLAR transmit their own energy and monitor the return.

**i. Radar Imaging Device:** As the name RADAR implies, it uses radio waves to detect objects at a considerable distance and to determine their position and direction of motion. At present a range between 8.6mm to 33mm is used in Radars. While panchromatic photography is superior for estimation of density and species identification, the Radar imageries are suitable for discerning vegetation types and delineating vegetation pattern.

The two primary factors that influence the transmission characteristics of the signals from any given radar system include the wavelength and the polarization of the energy pulse used. Table 5 given below lists the common wavelength bands used in pulse transmission. The letter

codes for various bands were originally selected arbitrarily to ensure military security during the early stages of the development of radar.

**Table 5. Radar bands and their characteristics**

Band name	Wavelength $\lambda$ (cm)	Frequency-MHz ( $10^6$ cycles $\text{sec}^{-1}$ )
K <sub>a</sub>	0.75 -1.1	40,000 – 26,500
K	1.1 -1.67	26,500 –18,000
K <sub>u</sub>	1.67 -2.4	18,000 –12,500
X	2.4 -3.75	12,500 – 8,000
C	3.75 -7.5	8,000 – 4,000
S	7.5 -15	4,000 – 2,000
L	15 -30	2,000 – 1,000
P	30 -100	1,000 -- 300

A radar system consists essentially of the following constituent parts and shown in Fig.7.10

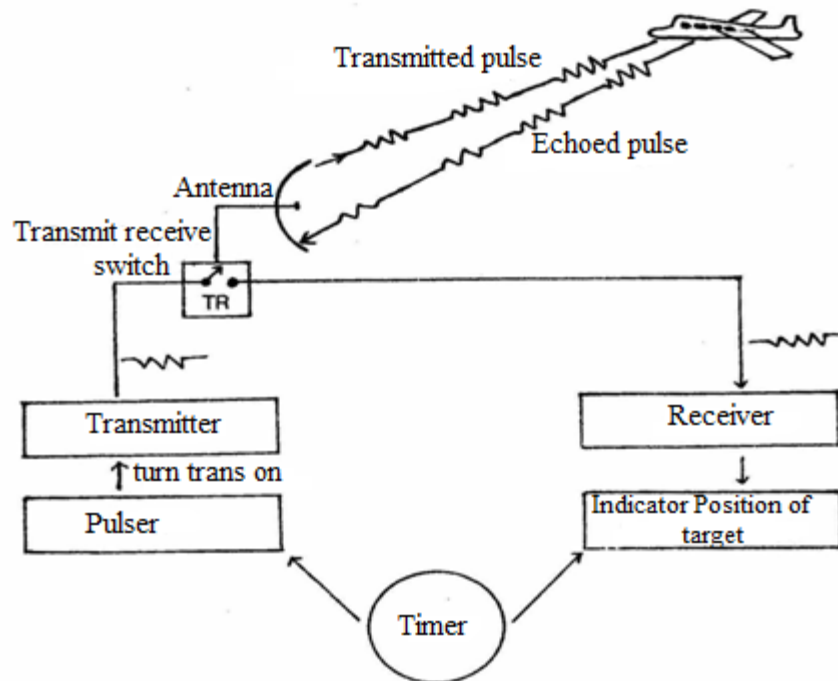

**Fig.7.10 Working of a Radar imaging system**

*Transmitter* consists of a high power magnetron, which generates very short radio pulses of only a few microseconds duration at exactly equal intervals. The output of transmitter is fed to the antenna system which sends out the radio energy over space. It also acts as a receiver of returning signals.

*TR switch or duplexer device* accomplish the alternate working of the transmitter and receiver. During the pulse time the TR switch connects the transmitter to the antenna which then sends a train of waves towards the target which are reflected and received by the same antenna. The TR switch in the mean time turns automatically to the *receive* position and guide to the echo pulse to the *Receiver*.

The *timer* controls the generations of pulses and ensures that a single pulse goes to the transmitter. The receiver can detect signals of very small power of the order of  $10^{-12}$  watts. The receiver output is fed to the *Indicator* which furnishes the information about the presence and position of target.

The radar imaging system is an active system since it produces the energy waves itself and then receives the reflected waves to determine the distance and position of target. The shape and orientation as well as the surface roughness of an object must be taken into account while evaluating the radar returns. A particularly bright response results from a corner reflector. Here adjacent smooth surfaces cause a double reflection that yields a very high return. Because corner reflectors generally cover small areas of the scene, they often appear as bright 'sparkles' on the image (Fig.7.11).

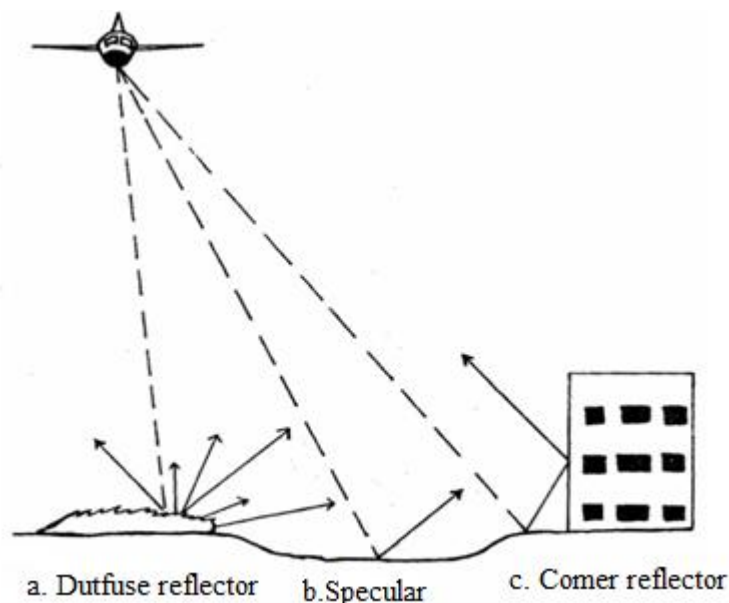

**Fig.7.11 Reflections from various surfaces and corner effect**

The radars have got a wide range of applications in various areas:

1. Radar is used to detect the presence of enemy aircrafts or ships in war time,
2. It is employed to control civilian traffic and to guide ships in the sea,
3. It is useful in mapping of the thunderstorms and other meteorological disturbances,
4. A number of radars have been deployed in the coastal areas of our country for coastal surveillance that warns the fishermen and coastal townships against storms well in advance, and
5. Fire control radars are now widely used in military airplanes and ships.

**ii. Side looking air borne radars (SLAR)**

Radar is a technique for detecting the presence and location of physical objects. SLAR is an air borne imaging system which is mounted on an air plane for the purpose of sensing the terrain. The sensing is achieved by transmitting a short pulse of electromagnetic energy towards the earth's surface from a radar transmitter on board the air craft and sensing the energy reflected from the ground or terrain features. The size and location of reflecting object is determined by the intensity of its echo (reflected energy), its direction and the time lapse between the initiation of a pulse and its return to the receiver.

**iii. Vidicon**

It is a photo electronic imaging device. Scene is focussed on a photo-emissive surface where it is stored as a charge pattern. A focussed electron beam scans this target and produces video signals.

**iv. Synthetic Aperture Radar**

The two basic systems are real aperture radar and synthetic aperture radar. These are active remote sensing systems and consist of a radio frequency generator and amplifier, a timer, a transmit-receiving (TR) switch, an antenna, a receiver and a cathode ray tube (CCT) oscilloscope. The data is recorded on CCT for processing and can be converted into images for visual interpretation.

The two basic systems differ primarily in the method each uses to achieve resolution in the azimuth direction. The real aperture system uses an antenna of the maximum practical length to produce a narrow angular beam width in the azimuth direction (flight direction).

**v. Lidar (active optical)**

Lidar (light detecting and ranging) systems use laser light as an illumination source. A short pulse of light is emitted from a laser and a detector receives the light energy (photon) after it has been reflected absorbed or remitted by an object or surface.

Lidar systems emit pulses at specific narrow wavelengths that depend on the type of laser transmitter used. The wavelengths range from 0.3-1.5  $\mu\text{m}$  which covers the ultraviolet, visible to near- infrared spectral range. The simplest lidar systems measure the to and fro travel time of a laser pulse which is directly related to the distance between the sensor and target.

Distance measuring lidars are often called as range finders or laser altimeters and deployed on an aircraft or satellite.

The lidar systems are used for atmospheric monitoring applications and measuring tree heights and vertical distribution of tree canopy layers with great accuracy and precision. Vegetation Canopy Lidar (VCL) and ice, cloud, and land elevation satellite (ICESat) lidar missions are being planned. Lidar systems can also be used in fluorescence measurement. You know fluorescence refers the process where a material absorbs radiant energy at one wavelength and emits it at a different wavelength (no conversion of radiant energy in thermal energy and

afterwards emission). Leaf fluorescence helps to identify plant species. Fluorescence data can identify and quantify the amount of plankton and pollutants in the marine environment.

### **Passive sensors in non-photographic Systems**

We know that in modern remote sensing, instruments other than photographic camera are also used. In earlier lines you have read about the active sensors which have their own illumination source. Now we shall learn about passive sensors which use sun's energy reflected from ground features. These sensors generally scan the earth's surface and are known as scanners. There are scanners which scan the earth line by line in many discrete bands of the spectrum. A scan line consists of several measurement values representing the reflected or emitted energy from the discrete block of the surface area. The values are recorded on the magnetic tapes which can be directly analysed through a computer.

These passive sensors have gradually evolved. Earlier remote sensing operations comprised of first and second generation of such sensors. Modern remote sensing techniques have latest sensor technology. Some of the non-photographic passive sensor and their technology is discussed here.

i. **Optical Mechanical Scanner:** It records the spectral information (reflectance) in the form of electrical signals. The OMS system has been devised to receive thermal infra-red energy. You know at this spectral band, photographic emulsion cannot be used hence non-photographic sensor. The scanner consists of three main parts:

- Optical head with the scanning mechanism
- Detector with associated amplifier electronics and,
- Recorder or display

The optical head consists of a rotating mirror which collects the electromagnetic radiations reflected by terrain and focussed it into a detector. The detector produces an electrical signal which is proportional to the amount of thermal radiation. The current drives a luminous spot that exposes a small area of a photographic film. This area is known as a picture element or a pixel. Consequently a pixel is the minimum size in the ground from which energy can be assembled in sensor. Thus the exposure of the film is proportional to the radiations emitted by the terrain.

As the mirror scans a line on the ground, a visible line is recorded on the photographic film. When one line is completed the rotating mirror begins to scan another line. Thus a continuous strip map of the terrain is generated. An air borne scanner scans the line perpendicular to the flight path of the aircraft.

ii. **Multispectral Scanner:** The multispectral scanner is an optical mechanical scanner which views the scene in a number of discrete bands from ultraviolet to visible to photographic infrared regions and into the thermal infrared. Here the optical head of the scanner is divided into spectral components using a prism. Different spectral bands are coupled to different detectors. In MSS,



the same area is recorded in all the bands. Hence the image can be superposed in additive colour viewing or otherwise compared readily in automated processing in a computer.

iii. **Thematic Mapper (TM):** There is a new sensor called Thematic Mapper in earlier NASA satellites viz., Landsat 4 and 5. It has seven spectral bands and ground resolution of 30 m for all but for thermal infra-red which is 120 m. It is also a line scan imager, however being a second generation line scanning sensor it is more superior to its predecessors in four ways.

- It has improved pointing accuracy and stability.
- It has higher resolution with new and more spectral bands.
- It has 16 days repetitive coverage with high scanning efficiency using two directional scanning and,
- Increased quantization level

A scan line character is introduced between the telescope and focal plane for the purpose of two directional scanning. The scan line character (SLC) ensures parallel lines of scanning in the forward and reverse direction.

All the above three scanners are referred as Whisk Broom Scanners. On the other hand the HRV and Linear Array Scanners are called Push Broom Scanners since the scanners use the forward motion of the satellite to sweep the array across the scene (Fig. 12).

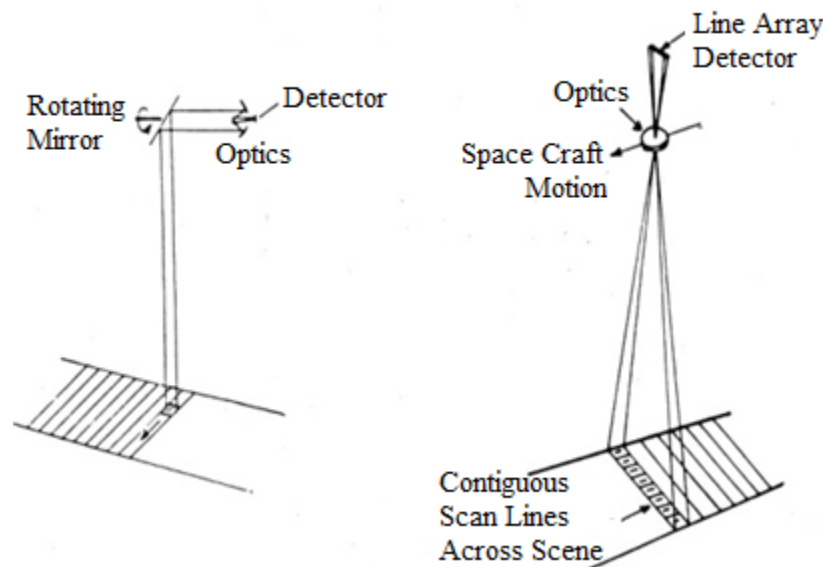

Fig.7.12 Whisk Broom (left) and Push Broom (right) Scanners

#### iv. High Resolution Visible Imager (HRV)

The French spacecrafts SPOT-1 carried two high resolution visible imagers which can be operated independently or in various coupled mode. HRV camera consists of charge couple device (CCD) array as the sensor instead of oscillating mirror design used in (LANDSAT imaging system). Each of the two imagers can be operated in either multispectral mode

(resolution of 20 m) or panchromatic (10 m) mode. The swath covered is 60 km and the camera can be set up to  $27^{\circ}$  on either side of the nadir. SPOT had stereo vision.

#### v. Linear Array Sensors

The system is also known as Charge Coupled Device (CCD). It consists of a series of several hundred light sensitive silicon cells. The silicon cells are capable of storing and transporting the electrical charge which results from exposure to radiations in the wavelength of 0.4-1.2  $\mu\text{m}$ . These sensors were employed in SPOT and IRS mission.

IRS (Indian Remote Sensing Satellite) 1A had two types of imaging sensors, one with a spatial resolution of 72.5m and designated as LISS I (Linear Imaging Self Scanning Sensor) and the other with two separate imaging sensors with a normal resolution of 36.25 m and referred as LISS II A and LISS II B. The LISS I offered a swath of 148 km while LISS II A and LISS II B provided a complete swath of 145 km. These imaging sensors operate in four spectral bands in the visible and infrared region. IRS 1C had stereo vision and a resolution of 7x7m.

### 7.4.5. Standard data output on computer compatible tapes for processing, analysis and interpretation (digital, graphic, hard copy)

#### i. Photographic data

The data output involves the detection of energy signals, recording and interpretation for extracting the useful information. The detection of electromagnetic energy can be carried out either photographically or electronically. You very well understand that the process of photography uses chemical reaction on the surface of a light sensitive film to detect energy variations within a scene. In remote sensing, the term photograph is used for images that are detected as well as recorded on film. Thus a photograph is a result of film, filter and lens combination of a camera. Photographic systems have many advantages; they are relatively simple and inexpensive and provide a high degree of spatial detail. The stereo photographs are helpful in providing 3-D information such as height or depth of an object. Classification of aerial photographs would be discussed in next chapter.

A number of devices are available to study photographic data products. These include lens and mirror stereoscopes, parallax bars, parallax wedges and micrometer wedges, planimeters, additive colour viewer, to name a few. The interpretation of aerial photographs has been a practical resource management tool for nearly a century. However, newer forms of remote sensing have been developed in last few decades and the new technologies are displaying their potentials in resource management, engineering, environmental monitoring and exploration, etc.

#### ii. Non photographic data products

Electronic sensors generate an electrical signal that corresponds to the energy variations in the original scene. The familiar examples are video camera and mobile phones. The electronic sensors are more complex and expensive however, they offer the advantage of a broader spectral

range of sensitivity, improved calibration potential and the ability to transmit the data electronically. The generic term image is used for any pictorial representation of image data. Thus a pictorial record from a thermal or microwave scanner (an electronic sensor) will be called a thermal or microwave imagery instead of thermal or microwave photograph. In short the imagery is a data product (pictorial representation) of non-photographic active or passive sensors.

All types of remote sensing images are routinely recorded in digital form. CCT or computer compatible tape is a magnetic tape on which the digital data for earlier sensors viz., multispectral scanner and thematic mapper images were recorded. The digital data recorded by sensors on board is electronically transmitted to ground receiving stations. These recorded data can be transformed into pictorial, graphic, tabular or any other information product based on the requirement of the user. The analysis and interpretation of all such digital data is under the scope of digital image processing. Digital image processing is the computer manipulation of the digital number values of an image.

---

## ***7.5 SUMMARY***

---

Remote sensing is a scientific tool to study the objects from a distance with the help of some devices. The conventional form of remote sensing is aerial photography. Different type of photographic data products are obtained for the study of the terrain, vegetation pattern and geological features. Stereo photographs are also obtained for studying the objects in 3-dimension e.g. height or depth, forest timber volume, etc. Similarly satellite data products obtained in digital form or imagery are required to have an understanding of earth resources. The chapter summarizes tools and techniques, applications and the physical basis of remote sensing.

---

## ***7.6 GLOSSARY***

---

- **Absorbance:** The ratio of the radiant energy absorbed by a substance to the energy it receives.
- **Aerial photograph:** Any photograph taken from the air borne or space borne platform. These are of different type depending upon the factors.
- **Albedo**Ratio of radiant energy (short wave reflectivity) reflected by earth/ target to the total energy incident.
- **Atmospheric window:** All spectral bands of EMR do not reach to earth surface. Some are absorbed or reflected by the atmospheric gases and particles. A few spectral bands which pass through atmosphere unhindered are called atmospheric windows.
- **Azimuth direction:** In RADAR images, the direction in which the aircraft is heading. **Band:** The specific wavelength interval in the electromagnetic spectrum.

- **Camera Aerial:** A camera specially designed for use in aerial platform for aerial photography.
- **Camera, Multiple lens:** A camera with two or more lenses.
- **Camera, Multiband:** A camera used to obtain simultaneous photograph in several portions of the spectrum.
- **Digital image:** An array of digital number arranged in rows and columns having the property of an intensity value and their locations.
- **Digital Number:** An intensity value of a pixel in a digital image.
- **Electromagnetic radiation (EMR):** The energy propagated through a space or a medium at a speed of light.
- **Emissivity:** Probability of a photon being emitted by a slab of unit thickness; equal to absorptivity for an opaque body.
- **Electromagnetic spectrum:** The continuum of EMR that varies from cosmic radiations (short wave, high frequency) to radio waves ( long wavelength, low frequency).
- **Film:** A thin flexible transparent sheet coated with light sensitive emulsion for photography.
- **Filter:** Filter is used in camera to absorb a certain part of EMR and prevent it to reach the sensitized film.
- **Image:** The permanent record of a scene comprising of natural or man made features and activities produced by photographic and non photographic means.
- **Imagery:** It is a data product (pictorial representation) of non photographic active or passive sensor.
- **Infra-red:** EMR longer than 750 milli micron and shorter than sub millimetric waves above the detection of human eye.
- **Mie scattering:** Relationship between scattering intensity and wavelength when the radiation wavelength is approximately equal to or shorter than the scatterer's diameter.
- **Photomap:** The vertical aerial photographs are also called photomaps since these can be substituted for maps.
- **Pixel:** Picture element. Each pixel has a numerical value called digital number (DN) that records the intensity of electromagnetic energy reflected from a unit area on ground.
- **Pulse:** Short burst of electromagnetic radiation transmitted by a radar antenna.
- **Radar:** An abbreviation for radio detection and ranging. Identification of distant objects by active sensing technique.
- **Radiant flux:** Rate of flow of electromagnetic radiations measured in watts per square centimetre.
- **Satellite:** An object in orbit around a celestial body.
- **Scattering:** Scattering of EMR refers to a phenomena where the incoming solar radiation are dispersed in all directions after interacting with the dust particles, haze, fog, clouds and gas molecules present in the atmosphere. It reduces the image contrast and alters the spectral signature.

- **Scene:** The ground area covered by an image or a photograph.
- **Sensor:** An imaging or non-imaging device that receives EMR and converts it into a signal that can be recorded and displayed as photograph or digital image.
- **Side-looking air borne radar (SLAR):** An airborne side scanning system for acquiring radar images.
- **Spectrum:** Energy dispersion of a variable as a function of frequency, wave number, etc.
- **Spectral signature:** Refers to the reflectance or reradiance ability of an object or ground feature. It helps in the identification of the object and discriminating between similar looking objects.
- **Specular:** Refers to the surface that is smooth with respect to the wave length of the incident energy.
- **Thematic mapper (TM):** Scanner deployed in Landsat that recorded seven bands of data from the visible through the thermal IR region.
- **UV:** Ultraviolet region of the electromagnetic spectrum ranging in wave length from 0.01 to 0.04  $\mu\text{m}$ .

---

## 7.7 SELF ASSESSMENT QUESTION

---

### 7.7.1 Fill in the blanks:

- 1-..... form of scattering in the atmosphere is not dependent of wavelength?
- 2-.....part of the spectrum is maximally reflected/ scattered by the green vegetation?
- 3-....., ..... is the most common wavelength band which electro- optical scanners work within.
- 4-.....is abbreviated as NRSA whereas IIRS is used for .....
- 5-.....is abbreviated as ISRO whereas NNRMS is used for.....
- 6- SLAR and LIDAR stand for..... and.....
- 7- Reflectivity in short wave region is known as.....
- 8- CO<sub>2</sub>, water vapours and few gases present in the atmosphere absorb EMR at infra-red region. This causes.....

**7.7.1 Answer Key:** 1- Non selective, 2- Near Infra-red, 3- 0.3-14  $\mu\text{m}$ , thermal infra-red, 4- National Remote Sensing Agency, Indian Institute of Remote Sensing, 5- Indian Space Research Organisation, National Natural Resource Management System, 6- Side Looking Airborne Radar and Light Detection and Ranging, 7- Albedo, 8- Greenhouse Effect

---

## 7.8 REFERENCES

---

- Curran, P.J. 1985. Principles of Remote Sensing. ELBS Longman Group, U.K.
- Gates, D. M. 1980. Biophysical Ecology. Springer- Verlag, New York.
- Lilles, T.M. and R. W. Kiefer 1994. Remote Sensing and Image Interpretation. John Wiley and Sons, New York.
- Rees, W. G. 1990. Physical Principles of Remote Sensing. Cambridge University Press, Cambridge, U.K.

---

## ***7.9 SUGGESTED READINGS***

---

- Drury, S.A. 1992. A Guide to Remote Sensing. Interpreting Images of the Earth. Oxford University Press, Oxford.
- Sabins, F.F. 1987. Remote Sensing. Principles and Interpretations. W. H. Freeman and Co. New York.

---

## ***7.10 TERMINAL QUESTIONS***

---

### **7.10.1 Short answer type question:**

- 1-Write short notes on atmospheric windows and spectral signature.
- 2-Is there any relationship between the wavelength and frequency of EMR?
- 3-The atmosphere is essential for life on earth, but it causes problems in remote sensing. How?
- 4-What are electromagnetic spectral regions? List them.
- 5-What relationship you see among metre, millimetre, micrometre and nanometre?
- 6-Why specular reflections are not considered good for remote sensing?
- 7-In hill top the amount of UV radiations is more than that of valleys. Why?
- 8-It is said that ozone depletion in stratosphere may cause various skin diseases. How?

### **7.10.2 Long answer type question:**

- 1-Describe the EMR- atmosphere interaction using the sun as energy source for satellite based remote sensing.
- 2-Define the terms Radiant energy, Radiant flux, transmittance, absorptance, Spectral reflectance and albedo.
- 3-What you can predict about the future of Remote Sensing?
- 4-What is electromagnetic spectrum? What is the major wavelength ranges used for remote sensing?

---

## **UNIT- 8 AERIAL AND SPACE PLATFORMS, AERIAL PHOTOGRAPHY AND PHOTOINTERPRETATION**

---

- 8.1 Objectives
- 8.2 Introduction
- 8.3 Aerial Platform
- 8.4 Space Platform
- 8.5 Aerial Photography
- 8.6 Photointerpretation
- 8.7 Summary
- 8.8 Glossary
- 8.9 Self Assessment Questions
- 8.10 References
- 8.11 Suggested Readings
- 8.12 Terminal Questions

---

## 8.1 OBJECTIVES

---

After reading this unit students will be able-

- to familiarize different platforms used in remote sensing,
- to know about Photographic data products
- to understand Basic elements of photo interpretation

---

## 8.2. INTRODUCTION

---

Platform signifies a raised level from the ground wherefrom one can have a detailed view of the objects, terrain or any other ground feature. Thus platforms may be ground borne, air borne and space borne. In short it can vary from stepladders to space stations. In the initial stage of aerial photography, hill tops and mounds etc. were used to photograph the ground features. Similarly the ground features can also be photographed by a camera on raised hand. This may be referred as ground borne platform. Ground based remote sensing systems are chiefly used for collecting ground truth data or for laboratory studies. The air borne platforms include balloons and kites, aircrafts, drones, helicopters to photograph the ground features. Today we use space borne platforms viz., satellites and spacecrafts to obtain an imagery or digital data. The sensors say a camera is operated through platform. Specific sensor/ platform combination is needed for a particular application.

---

## 8.3 AERIAL PLATFORMS

---

Air borne platforms are further classified into balloon borne and air craft based platforms. The use of balloons for remote sensing started in 19<sup>th</sup> century. Balloons going up to 49 km altitudes were developed for studying the earth surface, the atmosphere and the celestial bodies. Balloons are useful for testing the performance of sensors and vehicles at different altitudes. Wind velocity restricts the use of balloons for remote sensing purposes. Balloons used for remote sensing purposes fall into two classes; free balloons and tethered ones. Free balloons are designed according to the desired trajectory and specific applications. They may hover over a particular area, return to their starting point or move from one place to another along a predetermined route. Free balloons have been used to obtain high resolution photographs of the earth through remotely controlled astronomical telescopes.

*Tethered balloons* are kite like that is tied with a thread. These are connected to earth station by wires of high tensile strength and flexibility. The tether line serves the additional purpose of carrying the antenna, power line and gas tube. *Spherical balloons* are preferred when the wind velocity is less than 35 km/hour at an altitude of 8,000m. Naturally shaped balloons are used if the velocity of wind is 80 km per hour or less. Streamlined balloons have the capacity to



withstand a chosen wind pressure for a given payload, flight duration and anticipated life. Tethered balloons have been successfully used to support aerial cameras for mapping of archaeological sites.

### **8.3.1 Aircraft platforms**

Aircrafts and drones are commonly used as an aerial remote sensing platform for obtaining photographs and digital data. The aircraft should have maximum stability, least vibrations and oscillations and be capable of flying at a uniform velocity. Helicopters owing to their high vibrations are not preferred. Ceiling height is an important criterion. At a particular altitude of aircraft, images of different scales can be obtained with optimum ground resolution. The resolution of air craft data products is quite high as compared to satellites.

Aircraft operations are expensive. The activity is seasonally dependent as monsoon season poses many problems. Similarly cloudy weather and foggy valleys make the survey task difficult. For border areas photography clearance from defence is a time consuming affair hence needs long planning. Further aircraft photographic operations are restricted to the film length on spool. Digital recording system does not have such limitations. Flight parameters should adhere to the design values, as high fluctuations hinder the establishment of a stereo model.

The air craft should have a quality of short take off and landing so that any area can be easily photographed in remote regions. The other basic requirements an air craft should possess for aerial survey include Statoscope for reading earth camera station, horizon camera images for each exposure, Radar altimeter, Doppler, Recorder, Magnetometer and several other devices. For aerial survey work the aircrafts like AVRO, SESNA, CANBERA has been used.

---

## **8.5 SPACE PLATFORMS**

---

With the development in space science and technology, space vehicles and satellites are more frequently being used for space photography and imageries. Space platforms are not affected by the atmosphere, hence their orbits are defined. A satellite essentially consists of two parts, a bus (carrier or vehicle) and pay load (sensor). The satellites are of many types for example a geostationary satellite and, near polar sun synchronous satellite. All these satellites differ in sensing capability and resolution. Space borne platforms can also be used to view extra terrestrial bodies without any interference of earth's atmosphere. The initial development cost of satellite is very high, but taking into account the global repetitive service, space craft remote sensing is cheaper than air craft remote sensing.

Space borne platforms are divided into three classes: low altitude satellites (remote sensing satellites), high altitude satellites (geostationary satellites) and space shuttles. The low altitude satellites may be sun synchronous or near polar satellites and varies in their altitude from 500-800 Kms. Geostationary satellites are high altitude satellites stationed at 36,000 km or above

(Fig. 8.1). The satellite development and launching initiated in 1950s. Initially satellites were used for defence purposes. Later on scientists started using them for civil applications.

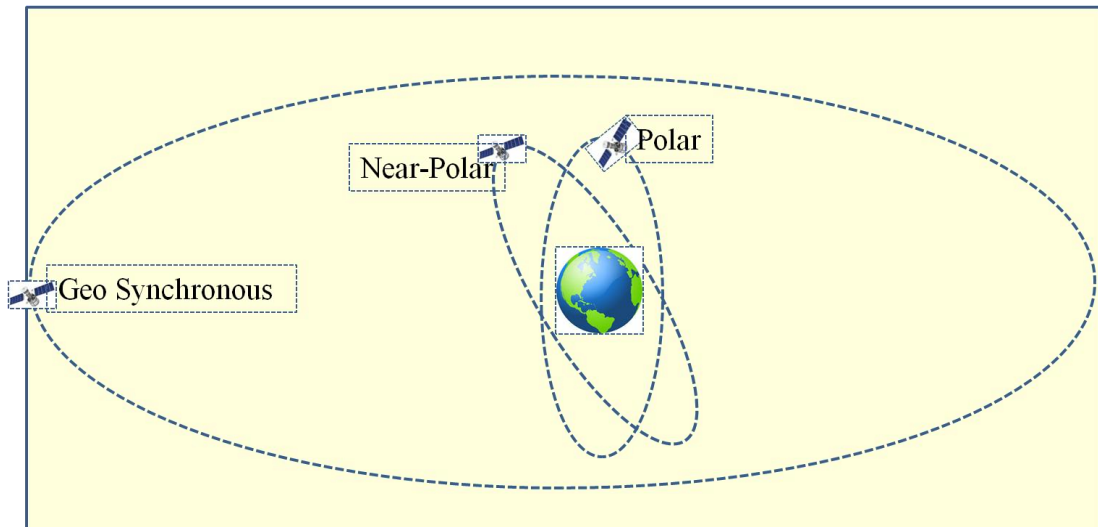

**Fig. 8.1 Satellites and their orbits**

### 8.5.1. Geostationary Satellites

These are also known as geosynchronous satellites. Since the altitude of an orbiting or geostationary satellite is very high (36,000 km above equator), the resolution is poor. In geostationary orbit the satellite synchronises with the earth's rotation. Its angular velocity equals to the rotational velocity of the earth at its axis and the satellite appears stationary for a ground observer (geostationary) making it suitable as a relay for communication, a 24 hour meteorological monitoring with accurate weather forecasting, storm warning and for telecasting TV and broadcasting radio programmes. These satellites are stationary over a certain area and continuously watch the entire hemispherical disc corresponding to one third of the entire earth. Since the coverage area is about one third of the earth; only three satellites are needed to cover the entire earth particularly for communication purpose.

Some of the important geostationary satellites are:

#### i. INSAT

The Indian National Satellite system or INSAT is a series of multipurpose geostationary satellites launched by Indian Space Research Organisation (ISRO) which combine communication, broadcasting, meteorological functions and, search and rescue operations. It is a joint venture of Department of Space, Department of Telecommunications, Indian Meteorological Department, All India Radio and Doordarshan.

The INSAT satellites are equipped with VHRR (Very High Resolution Radiometer) and CCD cameras for meteorological imaging. These incorporate transponders for receiving distress alert signals for search and rescue operations in Indian Ocean. The transponders in various bands

serve the television and communication needs of our country. INSAT system brought a revolution in Indian television and radio broadcasting, modern telecommunication facilities and in meteorological sector.

The INSAT system was commissioned with the launch of INSAT 1B in 1983. Since then, 24 satellites have been launched in INSAT programme of which 11 are functional and operative. A list of satellites in service is appended here. For details you can access Wikipedia.

INSAT- 2E; INSAT- 3A, INSAT- 3C, INSAT- 3D, INSAT- 3E, KALPANA-1, GSAT-2, Edusat; INSAT-4A, INSAT-4B, INSAT-4CR, INSAT- 4G/GSAT-8, GSAT- 10, GSAT-12, GSAT-16, INSAT-3DR

Five satellites were launched in INSAT-2 series. Earlier INSAT 1B was launched in August 1983, INSAT 2A in June 1992, INSAT 2b in July 1993, INSAT 2C in Dec. 1995, INSAT 2D in June 1997 and INSAT-2E from European Space Agency, Kourou in French Guiana.

INSAT 3B a communication satellite was launched in March 2000, followed by INSAT 3C a multipurpose satellite in Jan 2002 and INSAT 3A also a multipurpose satellite was launched by Ariane rocket in April 2003. Some of the INSATs also carry instruments for meteorological observations and data relay services. KALPANA-1 is exclusively a meteorological satellite.

INSAT 4A is the first one in INSAT 4 satellite series providing services in  $K_u$  and C frequency bands. At the time of launch it was the heaviest satellite India had produced and launched. INSAT 4B a communication satellite launched in March 2007 while INSAT 4CR is a communication satellite launched in Sept. 2007, INSAT 4D in Aug 2013; INSAT 4F (GSAT 7) a multiband communication satellite was launched in Aug. 2013. INSAT 3DR an Indian weather satellite was launched in Aug. 2016.

## ii. INTELSAT

It is an international satellite system for communication throughout the world. There is a series of such geostationary satellites for the telecommunication purpose. These can be classified as Generation 1-4 (1965-1978), Generation 5-6 (1980-1991), and Generation 7-10 (1993-2004). Out of these the satellites of 8-10 generation are still active. Among recent spacecrafts most of the satellites are functional. These include the satellites launched between 2009 and 2016 (Intelsat-14 to Intelsat-36). Besides, there are Intelsat satellites of other agencies, viz., Galaxy, Horizons, etc.

## iii. TDRS (Tracking and Data Relay Satellite)

It is a network of American communication satellite systems (operated by NASA, USA). TDRS spacecrafts are used for communication between NASA and spacecrafts including the space shuttle, Hubble Space Telescope and International Space Station. First generation TDRS satellites were launched between 1983 -1995 (TDRS-1 to TDRS-7), second generation (TDRS-8 to TDRS-10) between 2000- 2002 and, third generation (TDRS -11, 12, TDRS-M, TDRS-N)

between 2013- 2016. For details of launch date, rocket used, launching pad, and specific functions various sites may be visited.

#### **iv. GPS (Global Positioning System)**

Between 1978 and 2016, 72 Global Positioning System navigation satellites have been launched. The GPS satellites USA -132 to USA-266 launched between 1997 and 2016 are all operational. The minimum number of operational satellites for a full constellation is 24. Each GPS satellite has been assigned a serial number (Space vehicle number) and differentiates itself from other member satellites of the constellation. There are some reserve satellites which can be used to maintain the numbers. You all are aware of the importance of GPS system in our daily life.

### **8.5.2. Sun Synchronous Satellites**

These satellites are also called near polar satellite since they move from pole to pole. These are sun synchronous because the satellite orbit always faces towards sun. The remote sensing satellites fall in this category. These satellites complete one rotation in 90-100 minutes i.e. 14-16 orbits per day. As the orbit of the satellite is fixed while the earth is rotating, at every round it sees nearly 2500 km apart. The remote sensing satellites have a higher resolution.

Many countries have remote sensing satellite programmes for land resources survey, environmental impact assessment, and weather forecasting and, ocean science studies. METSAT satellite for weather monitoring and LANDSAT satellite for land resource survey launched by USA between 1960 and 1972 were a part of remote sensing satellite programmes. These two series of satellite programmes provided good remote sensing data source for a long time. France started an ambitious SPOT satellite series programme with the launching of SPOT 1 in 1986 and SPOT 2 in 1990. Japan had launched MOS (Marine observation satellite) in 1990 and Canada had launched RADARSAT in 1991. As you know our country had launched a number of experimental remote sensing satellites in seventh and eighth decade of last century viz., Bhaskar I (1979) and Bhaskar II (1981). Later in 1988, the second generation remote sensing satellite IRS-1A was launched followed by IRS 1B, 1C, IRS 2 with improved sensors in following years to provide continuity of data service to remote sensing user community. The Indian Remote Sensing Satellites are the main stay of National Natural Resource Management System (NNRMS). A list of these earth observation satellites is compiled for your knowledge.

**Past Satellites:** Aryabhata, 1975; Bhaskara I, 1979; Bhaskar II, 1981; Rohini series, 1980-1983; SROSS series, 1985-92, IRS-1A, 1988; IRS-PI, 1993.

**Present operational Satellites:** IRS-1B, 1991; IRS-P2, 1994; IRS-1C, 1995; IRS-P3, 1996; IRS-1D, 1997; IRS-P4 (Oceansat), 1999; IRS-P6 (Resourcesat-I), 2003; IRS-P5 (Cartosat-1), 2005; IRS-P7 (Cartosat-2), 2007; IRS P6 (Resourcesat-2), 2011; RISAT-1, 2012; Cartosat 2C (June 2016); SCATSAT-1, (Sept. 2016). You should visit ISRO website for updated information.

### 8.5.3. Characters of Satellites

Four type of information can be obtained from these satellites. These are spatial, spectral, radiometric and temporal resolution.

**i. Spatial Resolution:** The minimum detectable area of the ground viewed by a satellite is referred as spatial resolution. All sensors have a limit on how small an object on the earth surface can be seen by a sensor delineating it from its surroundings. This limit or the ability to distinguish between two closely spaced objects on earth is referred as spatial resolution of a sensor. In other way spatial resolution is a term that refers to the number of pixels utilized in the construction of a digital image. Images having higher spatial resolution are composed with a greater number of pixels than those of lower spatial resolution. Spatial resolution of sensors on board to some remote sensing satellites is given in Table 1.

**ii. Spectral Resolution:** It refers to the spectral qualities of a satellite sensor. It is the ability to resolve spectral features and bands into their separate components. The sensor can view a scene in different wavelength bands. The sensors have detectors that receive reflected energy of an object at various wave lengths and depending upon the magnitude of reflected EMR, certain numbers in digital form (DN or digital number) are generated. The visible band ranges from 0.4 $\mu$ m to 0.7  $\mu$ m which can be further split up into 0.4  $\mu$ m-0.5  $\mu$ m, 0.5  $\mu$ m-0.6  $\mu$ m and 0.6  $\mu$ m-0.7  $\mu$ m using blue green and red filters. Some sensors viz., Thematic Mapper on board LANDSAT 4 and 5 of USA had 7 bands (see table). There are 140 bands or channels in Earth Observation System satellite.

**Table1. Satellites, Sensors and, their resolutions**

Satellite	Sensor	Resolution			
		Spatial (m)	Spectral ( $\mu$ m)	Temporal	Radio metric
LANDSAT 1,2,3 USA	MSS	79 x 79	0.5-0.6 0.6-0.7 0.7-0.8 0.8-1.1	18 days	255 (8 bit)
LANDSAT 4,5 (USA)	TM	30 x 30	0.45- 0.52 0.52- 0.60 0.63- 0.69 0.76- 0.90 1.55-1.75 10.4-12.5	16 days	255 (8 bit)
SPOT-1, 2 (France)	Multispectral (MS) mode	20 x 20	0.50-0.59 0.61-0.68	26 days	255 (8 bit)

			0.79-0.89		
	Panchromatic Mode	10 x 10	0.51-0.73	26 days	255 (8 bit)
MOS-1 (Japan)	MESSR	50 x 50	0.51-0.59 0.61-0.69 0.72-0.80 0.80-1.11	17 days	
IRS 1A,1B	LISS I	72.5 x 72.5	0.45-0.52 0.52-0.59 0.62-0.68 0.79-0.86	22 days	128 (7 bit)
	LISS II	36.25 x 36.25	Same as above	Same as above	128 (7 bit)
IRS 1C,1D India	PAN LISS III VNIR  LISS III SWIR WiFS	5.8 x 5.8 23.5 x 23.5  70.5 x 70.5 188 x 188	0.50-0.75 0.52-0.59 0.62-0.68 0.77-0.86 1.55-1.70 0.62-0.68 0.77-0.86	24 days	128 (7 bit)
IRS P-5 (Cartosat-1)	PAN	2.5 x 2.5	0.50-0.85	126 days	12 bit
IRS P-6 (Resat-2)	PAN	0.65 x 0.65	0.50-0.85	8 days	12 bit
	AWiFS	56 x 56	0.52-0.59 0.62-0.68 0.77-0.86 1.55-1.70		1024
	LISS III	23.7x23.7	as above		1024
	LISS IV	5.8 x 5.8	0.52-0.59 0.62-0.68 0.77-0.86		(10 bit)
Cartosat 2c	PAN	0.65 x 0.65	0.50-0.85	4 days	12 bit

Cartosat 2C satellite proved to be a mile stone in Indian space Programme. On June 22, 2016 this earth observation satellite was launched by ISRO from Sriharikota Launching Pad, A.P. along with 21 other satellites. PSLV-C34 rocket was used for launching. This satellite has a

High Resolution Multispectral Optical Imager and capable of taking colour and panchromatic pictures and, also capable of capturing minute long video of a fixed spot as well. Along with other applications, the data products can also be used for defence purposes.

### **iii. Radiometric Resolution**

It is also known as tonal variation or a sequence of grey tones from black to white. As you know the grey level changes from black to white. A human eye can differentiate 10-12 shades (grades) between black and white. A satellite (sensor) eye on the other hand can see many more grades between black and white. This sensitivity of a sensor to incoming reflection is radiometric resolution. The detectors available in various satellites differ in their capability of radiometric resolution. Some are able to identify 0-64 grades, others 0-256 grades and some can identify 0-1024 grades (10 bit) between black and white. In other words higher the value (number of grades) better is the radiometric resolution.

### **iv. Temporal Resolution**

Temporal resolution (TR) refers to the precision of a measurement with respect to time. Thus it is the repetitive coverage of the entire globe by the satellite. For example LANDSAT views the entire globe in 16 days while IRS 1A and 1B take 22 days to view the entire planet. The temporal resolution of IRS 1C and 1D is 24 days and IRS P6 is 8 days. The repeat interval of Cartosat 2C is 4 days only.

---

## **8.5 AERIAL PHOTOGRAPHY**

---

The term aerial photography refers to obtain photographs of ground features from a height e.g., hill top, air or space. Gaspard Felix Tournachan took the first aerial photograph of a village near Paris from a balloon in 1858. Black and King photographed Boston (Massachusetts, USA) in 1880 from a balloon flying at a height of 350m. After the invention of aircrafts, the aerial photography became easier. During First World War there had been a tremendous development in the utility of aerial photographs. The art of photointerpretation for the military use developed during these years. After Second World War the science of aerial photography and photointerpretation found its expansion in forestry, geography, geology, soil science and engineering. The scientist trained for military purposes used their gained experience in their respective field of civil life.

Canadians (1920-30) pioneered the study and observations of their vegetation wealth using aerial photographic techniques as a tool. Sweden was the first European country to map its forest wealth and natural resources. In Asia, Myanmar (1924) initiated the aerial survey of vegetation of Irrawaddy delta and Japan (1930-40) completed the forest survey of Sakhalin islands. In our country Survey of India had started preparing topographical maps before independence. In 1963, the aerial photographs of Kulu valley were taken for a quick inventory

of forests. With the establishment of Forest Survey of India (FSI) innumerable information pertaining to the exploration of forest wealth and other aspects of forestry has been gathered through aerial surveys.

### **8.5.1. Applications of Aerial Photography**

Aerial photography is a form of remote sensing where air borne platforms viz., aircraft, balloon or helicopters are used with aerial cameras along with various lenses and film combination to record and collect information in the form of photographic images. The aerial photography has three major application viz., in all type of mapping jobs, as substitutes to maps and photomaps and, in interpretation of data.

### **8.5.2. Energy source and Atmospheric effects in Aerial Photography**

You should have learnt by now that sun as an energy source illuminates all earthly features in the visible and near infra red region of the electromagnetic spectrum. The reflected energy from the objects is recorded in the aerial camera with lens-filter- film combination. The atmosphere comprising of various gases and particles of different dimensions attenuate the EMR either by absorption or by scattering.

### **8.5.3. Factors affecting Aerial Photographic task**

There are a number of factors that influence the photographic task being undertaken.

- *Type of camera and lens used:* The aerial camera should be calibrated properly before final photography. The lens, filter and other accessories should be properly fitted to get good results. Focal length and resolution are important criteria for quality photography. Lens selection should be appropriate to prevent distortion in photographic products.
- *Flight direction:* It is worked out in such way that majority of the area is photographed in one flight.
- *Scale of photography:* Scale is a factor that varies with terrain relief even if the flight height is maintained accurately.
- *Atmospheric conditions:* Haze, fog, refraction of light and pollutant gases over industrialized cities influence adversely the quality of image.
- *Season and time of photography:* Photography should be done in proper season to achieve best results subject to the requirement. Similarly selection of time is also important as in early morning and late evening the shadows are long that may obscure the ground details.
- *Stereoscopic coverage:* A correct stereoscopic coverage provides a three dimensional view in the photograph and is helpful in the correct interpretation.

### **8.5.4. Classification of data products in Aerial Photography**

The aerial photographs can be classified on the basis of various criteria. These are enumerated below:



### 8.5.4.1. Direction of exposure

Direction refers to the deviation of the optical axis from the vertical. Thus the aerial photographs may have a vertical exposure or oblique exposure (Fig.8.2).

#### i. Vertical Photographs

The data products are obtained when the optical axis of camera is perpendicular to the horizontal plane. The degree of tilt (the angle between the terrain and photo plane at the time of aerial photography) never exceeds  $4^\circ$  for an exposure.

The vertical photographs cover a small area. However the scale is uniform throughout the picture and convenient for interpretation and mapping. The reasons for the suitability of vertical photographs are

- The vertical photographs are more accurate and can be used as a substitute to maps.
- An overlapping pair of vertical photograph gives a 3-dimensional picture if viewed under a mirror stereoscope.
- Height and depth of the objects can be perceived and measured.

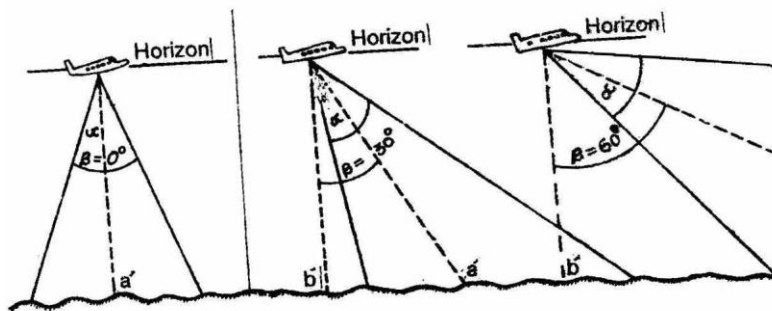

Fig. 8.2 a, b, c. Vertical, low oblique and high oblique directions of exposure

#### ii. Oblique Aerial Photographs

When the optical axis of the camera is tilted intentionally between the vertical and horizontal plane, the oblique photographs are obtained. These may be low oblique when the tilt is less than  $30^\circ$  and high oblique when the tilt is around  $60^\circ$ . These oblique photographs may be forward facing, rear facing or lateral facing depending upon the position of the camera in respect to the aircraft. The degree of tilt determines an oblique photograph low or high oblique.

The scale in an oblique photograph is variable thus you observe a distortion. The degree of distortion increases towards horizon. The distortion is more in high oblique photographs. The advantages of oblique photographs are.

- The coverage is more with an appreciable reduction in the number of photographs,
- These appear more normal since the relief is more apparent,
- These furnish supplement information for the interpretation of vertical photograph and,
- The oblique photographs are more economical and illustrative.

The characteristics of various photographic products are mentioned in Table 2.

**Table 2. Comparison of characteristics of photographic data products**

S. No.	Features	Vertical	Low oblique	High oblique
1	Tilt	2°-4°	4°- 30°	Above 30°
2	Horizon	No horizon	No horizon	Horizon seen
3	Coverage	Least	Less	More
4	Area	Rectangular	Trapezoidal	Trapezoidal
5	Scale	Uniform	Decreases from foreground to background	Decreases from foreground to background
6	View distortion	Least	Less	More
7	Advantage	Easy to map	Economic and illustrative	Economic

**8.5.4.2. Number and type of camera and lens used**

In aerial photography more than one camera may be used or at a time one camera with many lenses may be used. Thus different types of aerial photographs are obtained.

**i. Trimetrogon or 3-camera photography**

As obvious by the name three cameras are used, out of these, one is vertical, and the other two placed laterally are oblique. The field of view of three cameras overlap each other in such a way that a photographic strip is prepared horizon to horizon across the flight direction Fig. 8.3). These photographs are less expensive with a significantly high coverage. These are useful in survey work and reconnaissance. These are not suitable for vegetation mapping.

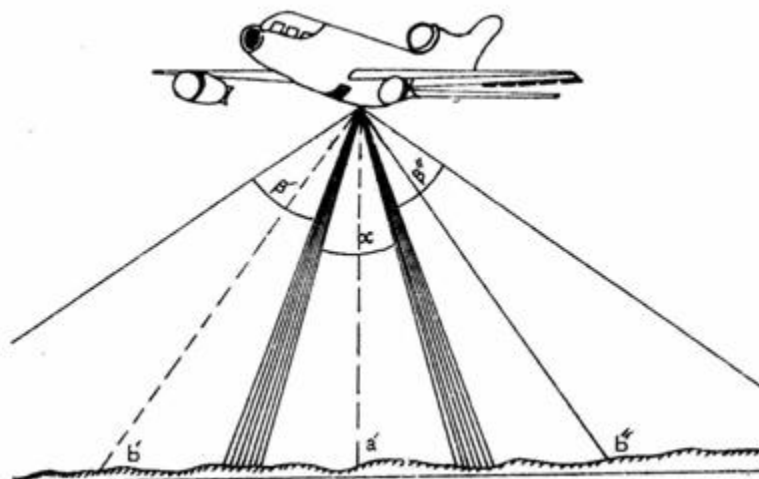

**Fig. 8.3. Trimetrogon photography displaying field of view of vertical and two adjacent scenes; a 'Optical axis of vertical camera, b' and b'' tilted optical axis of left and right camera. Shaded part exhibit overlapping area.**

## ii. Convergent photography

Here two cameras, one facing forward and other backward are tilted at a certain angle from vertical line in the direction of flight line (Fig.8.4). These are synchronised in such a way that the forward exposure of the first locality forms a stereopair with the backward exposure of the next coming locality. Thus by using convergent cameras, stereopairs with varying degree of overlap can be produced.

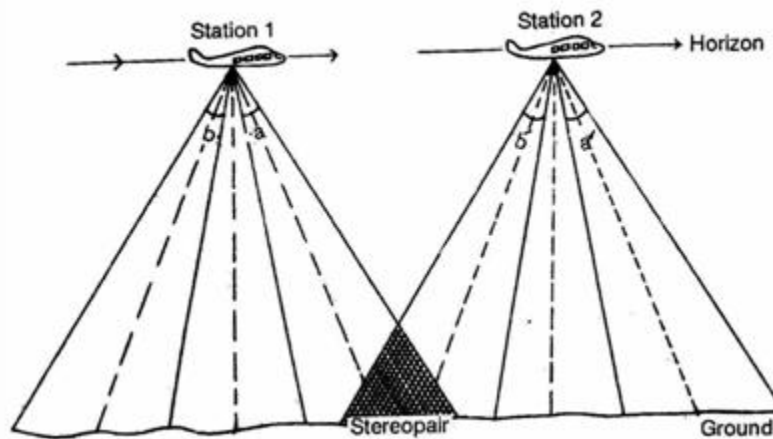

**Fig. 8.4. Convergent aerial photography.** a-a' denotes field of view of forward camera at two successive exposures; b-b' FoV of backfaced camera at two successive exposure. Shaded area indicates that the forward exposure of first station forms a stereopair with the backward exposure of second station.

## iii. Multiple lens photography

There is only one camera but equipped with many lenses and filters and, which can be exposed together. Photographs of the same scene are obtained in different wavelength bands.

## iv. Continuous strip photography

Continuous strip photography can be produced by the use of camera having no shutter. The altitude and speed of the plane are taken into account while determining the speed of the camera film. The camera is used for large scale photography.

### 8.5.4.3. Angle of coverage or Field of View of the Camera

Aerial photographs are of different type based on field of view of the camera. The field of view is the angle formed by the diagonal of the photoformat at the perspective centre. The focal length and the photoformat determine the field of view (FoV). Based on this aspect the aerial photographs are narrow angled, normal, wide angled and super wide angled (Fig.8.5).

**i. Narrow angle photography:** Here the FoV is of the order of less than  $60^\circ$ . The focal length is 21cm and the format is 18 x 18cm.

**ii. Normal angle or Standard photography:** Here the FoV is of the order of  $60^\circ$  or so. The other features are as above

**iii. Wide angle photography:** The field of view is of the order of  $90^\circ$  or so. The negative size is smaller (14 x 14cm) and the focal length is 10cm. Here the precision of height measurement is higher as compared to normal angled photography.

**iv. Super wide angle photography:** In super wide angled cameras the angle of field of view is of the order of  $120^\circ$  and the focal length is 9cm or less. Cameras designed for super wide angled photography has the highest precision of the height measurement.

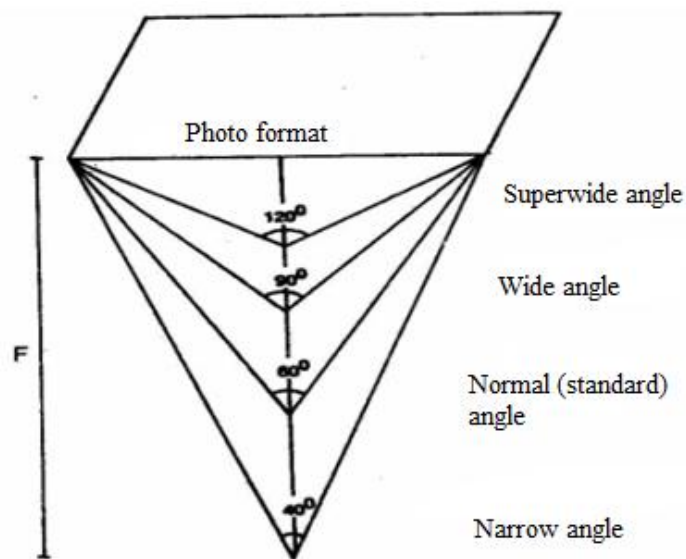
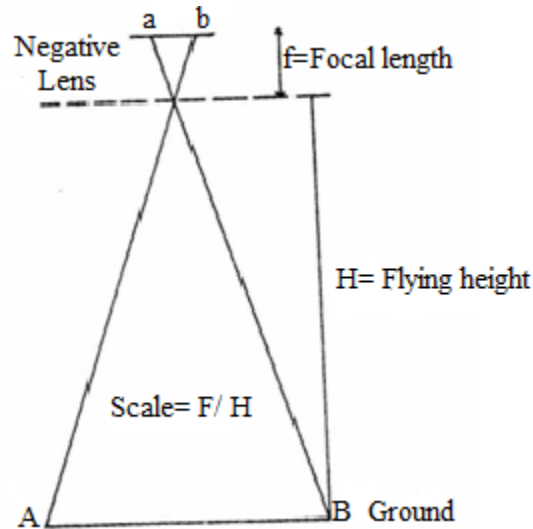

**Fig. 8.5. Angle of coverage, The field of view decreases with increase in focal length.**

Normal angle cameras are suitable for large scale photography in undulating areas. With a normal angle field of view, it is easier to see the ground through the tree canopy. Wide angle photography is convenient for topographic mapping of flat areas.

#### **8.5.4.4. Scale of Photography**

Based on the scale criterion the aerial photographs can be classified as small scale, medium scale and large scale aerial photographs. Scale is the ratio of the distances between two images on an aerial photograph and the actual distance between the same two points or objects on the ground. In other words scale is the ratio  $f/H$  where  $f$  is the focal length of the aerial camera and  $H$  is the flying height above the mean terrain (Fig. 8.6).



**Fig. 8.6, Relationship between focal length of aerial camera (f) and flying height (H) of aircraft above ground**

Since the flying height varies with the relief, the scale of a hill top would always be higher than the scale of a valley bottom. Similarly, with a change in flying height the scale is changed if the focal length is same (Fig.8.7).

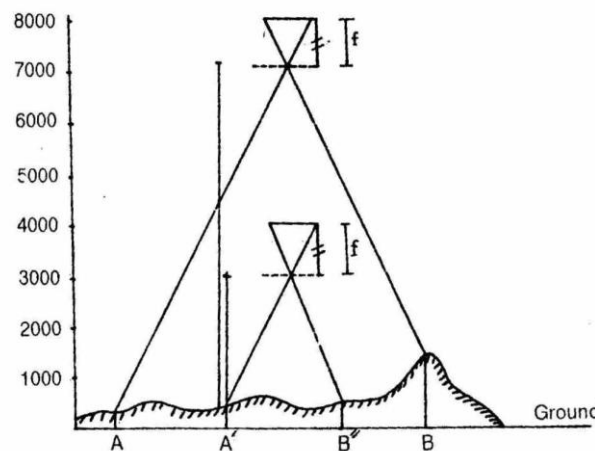

**Fig. 8.7, Relationship between flying height and scale, focal length (f) being same. (Courtesy Loetsch and Haller, 1964)**

The aerial photographs are classified into three broad categories.

- Small scale photograph : 1: 50,000 and above
- Medium scale photograph: 1: 50,000 – 1: 20,000
- Large scale photograph : 1: 20,000 – 1: 5,000

Based on the nature of work, we require photographs with varying scale. The small scale photography is suitable for weather monitoring (military applications, navigation, meteorology).

Small scale photographs are obtained by reducing the focal length or increasing flying height of aircraft (Table 3). For vegetation mapping we prefer a medium scale photograph. For detailed forest information viz., disease survey, insect damage survey, volume estimation, a large scale photograph is preferred. Large scale photographs are obtained by keeping the flying height low and using a normal lens camera. The large scale photography is very suitable in mapping, archaeological surveys, urban planning, road and railway planning, study of flood situation, etc. Very large scale photograph are used for wild life management, logging planning, traffic analysis, etc. In large and very large scale photographs the ground objects are clearer and the measurements can be made more accurately. The scale in the satellite imageries is very small.

**Table 3. Scale variations at two flying heights with varying focal length**

Flying height (m)	Focal length (mm)	Scale (f/H)	Classification
5,000	300	1: 16,667	Large scale
10,000	300	1: 33,333	Medium scale
5,000	210	1: 23,809	Medium scale
10,000	210	1: 47,610	Small scale
5,000	152	1: 32,894	Medium scale
10,000	152	1: 65,789	Small scale
5,000	100	1: 50,000	Small scale
10,000	100	1: 1,00,000	Very small scale

#### 8.5.4.5. Film Emulsions

A number of film types are used in aerial photography. A film is composed of a film base typically cellulose acetate which is tough, stable and non-flammable. On the top of this the emulsion of silver bromide grains in gelatine is attached with an adhesive layer. Gelatin is used because of its water solubility, its ability to hold grains in a fine, even dispersion and the fact that it swells (in developing solutions) to permeate through it. The emulsion is protected by a thin coating of scratch resistant and antihalation layer which also prevent unwanted light being reflected in emulsions (See Chap. 7). Different types of emulsions are used to make the film sensitive and thus the procured aerial photographs also vary.

##### i. Panchromatic photography

The panchromatic (black and white) film records the visible light in the range of 0.35-0.70  $\mu\text{m}$ . These films have a low sensitivity in the green region. It has a limitation against the adverse atmospheric conditions such as haze, dust particles, clouds and darkness, etc. the film is usually used in combination with minus blue or medium yellow filter which absorbs light with shorter wavelength than 0.50  $\mu\text{m}$ . This data product is used for most general purpose interpretation.

##### ii. Infra-red Black and white

The IR black and white film works well both in visible light and near infra red region. The IR film is used in combination with a dark filter that curtails all wavelengths below 0.68  $\mu\text{m}$ . You know radiation with longer wavelength can penetrate haze better therefore such film is recommended for high altitude photography. It is also used to distinguish between living and dead substances. The film is very suitable for the study of forests as its prints show a high tonal contrast between infra red reflective objects (conifers) and infra red absorbing object (surfaces and objects in shade). It is useful in soil moisture studies and delineation of water courses through vegetation.

### iii. Colour Photography

The colour film is a 3-layer film which is sensitive to full visible range (0.40  $\mu\text{m}$ -0.70  $\mu\text{m}$ ). It is exposed with a yellow filter which cuts out the ultra violet and some blue radiations. The three layers of emulsion are sensitive to three primary colours blue, green and red. Thus the colour film is an integral tri-pack. Colour photography is useful in distinguishing and identifying different diseases and species in forests and, in geology to bring out colours of rocks. However, it has limitation in haze and foggy conditions.

### iv. False Colour Photography

It is an infra-red colour film. The colour IR film is manufactured to record green, red and the photographic portion of IR (near infra red) i.e., 0.70  $\mu\text{m}$ -0.90  $\mu\text{m}$ . A yellow orange filter gives the most normal results. After exposure when the film is developed, the blue, green and red colours appear in the final photograph. The infra red replaces red, the red replaces green and the green replaces blue. Thus there is a false rendition of colours hence referred as false colour photography. The false colour images reveal heat variations with great accuracy. The chlorophyll in plants reflects infra-red so strongly (40-45%) that healthy vegetation has a reddish shed, strikingly different from the expected green. In contrast the reflectance at blue-green-red region is nearly 15-20% only. The film is used in forestry and vegetation surveys as healthy vegetation appears bright red in the image.

### v. Multiband or multispectral Aerial Photography

Multiband camera, viz., ITEK and I<sup>2</sup>S (International Imaging System) camera possess 4 lenses each with separate filters to record photographic images in different bands on a single format. All the four bands appear on a single format of size (23cm x 23cm) with picture of each band in size of 9cm x 9cm.

Band 1	0.4- 0.5 $\mu\text{m}$
Band 2	0.5- 0.6 $\mu\text{m}$
Band 3	0.6- 0.7 $\mu\text{m}$
Band 4	0.7 -0.9 $\mu\text{m}$

The film having infra-red Aerographic emulsions (Kodak 2424) is normally used in multispectral photography.

#### **8.5.4.6. Type of Photographic Paper**

Photographic paper is used to prepare positive print from negatives. A photographic paper differs from a film in that it is an opaque one and is viewed by reflected light. The photographic papers used for printing the negatives are of different kinds depending upon paper weight and paper surface characteristics i.e., texture, tint, grades. Etc.

#### **8.5.4.7. Aerial Photographs based on season and time**

Following classes can be identified:

##### **i. Autumn and winter Photography**

The photographs obtained in October-November (autumn) and December- February (winter) are best for forest photography to make distinction between broad leaved and coniferous trees.

##### **ii. Spring and Summer Photography**

Normally conducted during the months of March to June. This is good for distinguishing coniferous and broad leaved forests in montane zone in spring and, tropical moist evergreen forests from dry deciduous forests in summers.

##### **iii. Rainy season Photography**

Monsoon period aerial photography is restricted up flood studies and hydrological investigations. Due to cloudy weather it is not convenient to undertake aerial photographic operations for other purposes.

Time of the day for the photography is also important. Shadow factor should be kept in consideration while in tropics mid noon photography is not recommended because hot spots or sun spots obscure the objects on the photographs.

#### **8.5.4.8. Photographs based on the security**

The photographs of border areas and civil vital points are considered restricted. Similarly the operational photographs of defence (air force, army and navy) activities are also considered as top secret.

#### **8.5.5 Specifications for Aerial Photography**

Specification refers to the standards applied in surveying and interpretation of aerial photographs. There are many desirable as well as mandatory requirements to be followed. These include equipments, flight standard, photographic processing, documentation and quality of photographic (printing) paper. In addition camera lens, filters, film type, camera frame and mounts, tilt angle, air craft type platform and various auxiliary devices, processing techniques for colour and false colour films are also taken into account.



---

## **8.6 PHOTO-INTERPRETATION**

---

Photographic interpretation or image interpretation is the examination of photographic images for the purpose of detection, identification, measurement and evaluation of objects and assessing their significance. An image is the record of the reflected EMR from various objects.

Anyone who looks at a photograph or imagery in order to recognize the image is an interpreter. A forester, a geologist, a soil scientist or a planner can recognize the vertical view displayed by the ground objects on an aerial photograph or satellite imagery which enables him to detect many small features. The interpreter is a specialist trained in the study of photograph or imagery. In photo or image interpretation visual perception and mental acuity to analyse the image are two essential prerequisites.

### **8.6.1 Applications of an aerial photograph or imagery**

These data products have applicability to various fields for four basic reasons.

- It represents a larger area on earth from a perspective view and provides a format for the study of objects and their relationships.
- Certain type of aerial photographs and imagery can provide a 3-D view of objects.
- Characteristics of objects not visible to human eye can be transferred onto images, thermograms or radio photographs and lastly,
- It provides the observer with a permanent record of an object at any time.

### **8.6.2 Basic Principles for Photointerpretation**

An aerial image is a pictorial presentation of the pattern of a landscape. The pattern is composed of indicators of objects and events that relate to the physical, biological and cultural components of the landscape. Similar condition in similar circumstances and surroundings reflect similar pattern and, unlike conditions reflect unlike patterns. The type and amount of information that can be achieved is proportional to the knowledge, skill, experience of the interpreter and, the equipments and techniques used for interpretation.

### **8.6.3 Elements of Image Interpretation**

There are eight pictorial elements used for the identification of an object on a photograph or imagery. These are shape, size, shadow, tone texture, location, association and pattern.

**i. Shape:** Numerous components of the earth can be identified with reasonable certainty merely because of their shape. This is true for both natural and manmade features. The shape of the objects on an aerial photograph or imagery viewed by us is actually the top view to which we are not habituated. In oblique photographs the shapes can be identified easily. When you wish to identify tree objects by their shape, the important consideration to be kept in mind is season of photography. The shape of a tree may vary with spring, summer and autumn season. Trees with

persistent foliage as conifers can be easily identified by their shape in all season photographs. Thus the shape of a tree crown is important in tree species identification. Most conifers and young leaved broad species have an ovate shaped while those of mature broad leaved possess dome shaped (circular) crown.

**ii. Size:** The size of an object on photograph depends upon the object size, the scale of aerial photograph and the resolution of camera lens. You know 1mm would be equivalent to 15 m in a photograph of 1:15,000 scale. In forest measurements crown diameter of a tree is an important element. Suppose the diameter of a teak tree is 10m, it would appear as a point of 0.67 mm on the photograph. Similarly if the point in the photograph is of the order of 0.33m you will easily say that the crown of teak tree is 5m. Height and crown size are very helpful in the identification of trees in forest. A correlation can be established between crown size and basal area of trees and thus the volume of a tree or a given stand can also be estimated. Size also helps to differentiate between a highway and a rural road or a small residence and a school building.

**iii. Shadow:** Shadow of objects falling on ground gives an indication about objects. Shadows depend upon the time of photography and flight direction. By estimating shadow length the objects can also be measured accurately. It supplements in the correct identification of the objects. In dense forests shadows obscure the ground objects.

**iv. Tone:** Tone refers to the relative brightness of objects on photographs. You know the objects differ in their reflectivity and thus impart various shades on photographs. The relative darkness or whiteness of the image in a black and white photograph is tone. In a colour photograph, varying shades of the colour form the tone. In a photograph, tonal contrast draws the attention of interpreter and makes the interpretation task more accurate. Tonal contrast of object and its background is useful for the correct identification. On a black and white aerial photograph, tone varies from white (1) to black (10) with various grey shades in between. The tonal contrast is a function of amount of light reflected by an object, amount of incident light and, amount of light actually received by a sensor.

Tone permits the discrimination of many spatial variables for instance on land different crop types or at sea- water bodies of contrasting depth or temperatures. The term light medium and dark are used to describe tonal variations.

**v. Texture:** It refers to the degree of smoothness or roughness of an object. It is a microtonal variation within a tone. Texture is an important photographic characteristic closely associated with tone in the sense that it is a quality that permits two objects or areas of same tone to be differentiated on the basis of microtonal variations. Common photographic textures include smooth, rippled, mottled, lineated or irregular.

Texture is useful in accessing the approximate age of a stand in forest surveys and help in identification. Texture changes with a change in frequency and with the size of an object. Thus it

varies with a change in forest vegetation e.g., the bamboos culm displays a star shaped texture while *Cedrus* displays a unique deodar texture. Grazing lands exhibit a fine texture; young crops display a medium texture while mature crops exhibit coarse texture. Mature *Eucalyptus* forest presents a rough texture while badly lopped oak forest exhibit a mottled texture.

Texture also changes with scale. In woodland, level of objects contributing to texture alters with a change in scale as shown in Table 4.

**Table 4. Scale and texture relationship**

Scale	Objects contributing to texture	Texture
1: 5,000	Bunches of leaves and branches contribute	Coarse
1:10,000	Tree crown	Coarse
1:30,000	Group of trees	Medium
1:80,000	Entire forest or Plantation of stand	Smooth

**vi. Location:** Sometimes information about topographical location (site) and relative elevation supplement and help in identifying the objects. Without location no map or imagery can be worked out. You know in plane only certain plant species are found while in hills other certain species are found. Conifers, e.g., chir pine, deodar, fir and spruce occur at certain elevation on certain aspects.

There are two basic procedures to obtain precise location. Use of GPS instruments during field survey is relatively less expensive method to obtain the desired location of an object. The other way is to collect the remotely sensed geocoded data. Most aircrafts used to collect the remotely sensed data possess a GPS receiver.

**vii. Association:** Both location and association are not the features exhibited by the objects but they help the interpreter in knowing about immediate surroundings. Association may be with other species growing nearby. Certain tree species can be identified by recognition of other species that grow together. You know khair (*Acacia catechu*) and sisoo (*Dalbergiasissoo*) are associated with fresh alluvial deposits in riverine areas. Association may also be with the geological features displayed by the terrain or with the soil features e.g., chir pine (*Pinusroxburghii*) prefers to grow on quartzite, *Cupressustorulosa* prefers to grow on lime soils, blue pine (*Pinuswallichiana*) occur on mica schist and sal (*Shorearobusta*) grows on heavy or clayey soils. Thus knowledge of location and association helps an interpreter to identify an object quickly and reliably.

**viii. Pattern:** It is the arrangement of the object in space. The objects may be arranged randomly or systematically on a landscape. Spatial distribution of natural objects like forests, grazing lands, ridges, brooks, streams, drainage pattern on soil types can be easily delineated from manmade objects like orchard plantation, canal systems, hydro-electric projects. Thus pattern helps in distinguishing a natural forest from that of a planted forest.

After collecting the information of various pictorial elements from the aerial photographs, the interpretation is done manually or by electronically operated instruments. In manual method, the photographic images are measured with stereoscope and the photo interpreter uses his experiences, skill and intuition. The computers process the data products in a faster rate and extract information beyond the capacity of human interpreter.

#### **8.6.4 Techniques for photointerpretation**

Photointerpretation includes subjective judgement, deductive reasoning and an extensive background of training and experience. The photo interpreter arrives at a logical identification on the basis of inferences drawn from several clues and facts. For a quick and best probable identification following steps are considered:

**i. Features for identifying Aerial photographs and Imageries:** A number of features can be displayed in a data product that help in the probable identification for instance, drainage features, surface configuration, agriculture, non agriculture areas viz., wasteland, urban feature, industrial features help in arriving at a most probable identification.

**ii. From General to Specific:** This is the second step in photo interpretation. After first step we follow the second step. For example we first delineate a forest from an agriculture land or waste land. After marking a forest we go for other features to delineate vegetation types in the forest or identification of stands. Then we identify the species in the stand and finally we measure the density, crown, volume, etc.

**iii. From known to unknown:** This is the third step. On the basis of the presence, location, shape and size of the known objects, probable identification of associated unknown objects is done. Many clues gathered from known objects help in the identification of unknown object. If all or many clues are pointing out to same conclusion, the conclusion is probably correct. Infact, photo interpretation is an art and technique of the probabilities.

**iv. Efficient Search:** Systematic elimination of the non probable leads to quick and correct identification of the objects. The interpreter proceeds through a series of possible identification eliminating all the incorrect choices.

**v. Conference System:** There should be a continuous interaction among photointerpreters so that they exchange their views and experience. This is mandatory for the correct identification of unknown objects.

**vi. Information from analogous area:** The studies made and conclusion drawn would be correct only if the data products undertaken for studies are obtained under similar conditions.

**vii. Reference Materials:** A rich library with sufficient literature is inevitable. Similarly topo sheets are also necessary. Terrain information and contours are essential for correct identification of the object.

### 8.6.5. Basic Photointerpretation Equipment

Photointerpretation equipment generally serves three fundamental purposes: viewing photograph, making measurements on photograph and, transferring interpreted information to base map or digital data base.

The photointerpretation also involves stereoscopic viewing to provide a 3-D view of a terrain. A stereoscope facilitates the stereo viewing process. Carl Zeiss Stereocards are used to test stereoscopic vision with the help of *Lens stereoscope*. For viewing stereo pairs of aerial photographs (60% overlap) *Mirror Stereoscope* is used. With a mirror stereoscope, the interpreter can view all or most of the stereoscopic portion of a stereo pair without moving the photographs or stereoscope. Binoculars can be fitted to the eyepieces to provide a magnification of 2-4 power. Further measuring instruments like parallax bar can be conveniently used under the stereoscope. Then there is *Scanning Mirror Stereoscope* that has an in built provision for moving the field of view across the entire stereo overlap area of the photograph without moving the photograph or the stereoscope. Another equipment a *Zoom Stereoscope* gives a magnification of 2.5 to 10 times and is a precision device.

The aerial photographs or transparencies can be viewed using a stereoscope. Transparencies are placed on a *light table* for viewing. Here the light source is behind the transparency. For measuring the area of a feature *dot grid* is used. This grid composed of uniformly spaced dots, is superimposed over the aerial photograph. From knowledge of the dot density of the grid, the photo area of the region can be computed. *Polar planimeter* is an alternate device used to measure numerous regions. Areas may be determined most rapidly and accurately using an *Electronic Coordinate Digitizer*.

Once information has been interpreted from data products (aerial photographs), it is transferred to a base map. Sometimes base map is not of the same scale as the photograph, special optical devices are used to transfer the information. *Zoom Transfer Scope* is a device that optically superimposes a view of the photograph and the map. By adjusting the magnification of the two views, the aerial photograph can be matched to the scale of the map. The *Colour Additive Viewer* is a device that superimposes three multispectral photographs to generate a more interpretable colour composite. A Colour Additive Viewer and a ZTS can be used in combination so that interpretation made on colour additive viewer screen can be transferred to a map base of different scale.

### 8.6.6. Digital Image Processing

Image is a general term for any pictorial representation. It may be a photograph or imagery obtained from a photographic or non photographic sensor. Electro-optical sensor like

*Multispectral Scanner* produces images in digital form. You very well know that variations in photographs are in terms of brightness and grey shades while, in digital image, variations (of reflected energy) are represented as numbers- digital number (DN). A photographic film can be transformed to an equivalent digital image by a process of digitization; the device is *digitizer*. Similarly a digital image can be converted into a photograph by *film writer*.

All the scanners digitise the objects or ground features to produce a digital image. A digital image is an array of numbers. Each element in a digital image is called pixel (pel or picture element). Digital images have high radiometric quality and they do not deteriorate with age unlike a photograph.

The enormous information received from a satellite is recorded on a high density digital tape (HDDT). The HDDT has a capacity of 6250 bits per inch (BPI). The desired information is further transferred to computer compatible tapes (CCT) which have a capacity of 1600 bpi. The processing of data involves three steps viz., preprocessing, enhancement and classification or pattern recognition.

**i. Preprocessing of Image:** It involves the correction of radiometric and geometric errors at data collection centre. The raw image data is processed to correct radiometric distortions, calibrate and, finally eliminate the noise present in the data. This is also called *image rectification and restoration*. The process is based upon the sensor characteristics used to collect data.

**ii. Image Enhancement:** It is done to improve the quality of data (image). The image is modified to highlight certain details for the convenience of the interpreter. Enhancement technique includes linear stretching, square root stretching for rear details, square stretching for central details, histogram stretching and piece wise linear stretching for magnifying a particular detail. The digital images have a radiometric resolution of the order of 7 bit ( up to 128 grey levels) or more which is beyond the detection ability of a human interpreter. *Density slicing* converts the grey levels of an image in to a series of separate density intervals each corresponds to a separate colour or bounded by contour lines. Thus an interpreter can easily mark the grey scale differences. Next step is *filtering*. It is done to remove the image noise. Noise is any unwanted disturbance in image data that is due to sensor limitation, signal digitization or data recording process. Filtering helps to restore an image as close to an original scene as possible. *Band ratioing* or *spectral ratioing* is a method for image analysis considering two or more bands at a time. Ratio picture are useful because they highlight colour differences.

**iii. Image Classification:** Now the visual analysis of the image data has been replaced with other quantitative techniques to identify the features of a scene. The classification process based on the analysis of multispectral image data or on the spectral radiances is known as *spectral pattern recognition*. When the decision rules are based on the geometric shape, size and pattern present in the image data, it is referred as *spatial pattern recognition*. Thus the classification process categorizes all pixels in a digital image into several themes, finally to develop thematic maps.

The whole process of classification is undertaken on the basis of *Principal Component Analysis* and *Pattern Recognition*.

**iv. Data merging and GIS integration:** The image data for a given geographic area is combined with other geographically reference data set for e.g., soil, topographic, climatic and various other information. GIS or *Geographic Information System* is a system of hardware, software, data, people, and organizational arrangements for collecting, storing, analyzing and disseminating information about earth. Thus GIS is the ability to spatially interrelate multiple types of information from different sources.

Digital Image Processing and photointerpretation are two important ways of analyzing image data. Photointerpretation is a qualitative technique and it requires much of intuition and skill. It is time consuming with certain limitations. On the other hand digital image processing (computer processing of a digital image) is a quantitative technique. It is fast, accurate and repeatable.

---

## 8.7 SUMMARY

---

You should have learnt by now that remote sensing techniques and applications are highly diversified. Remote sensing techniques have developed enormously in last few decades and so its applications in various fields from resource survey, navigation, mineral and oil exploration, vegetation studies and forest survey, atmospheric monitoring, topographical mapping and military surveillance. Airborne platforms viz., balloons and aircrafts, accompanied by various type of aerial camera have been used to generate aerial photographs. These are used for interpretation in specific fields such as forestry, geology, hydrology, and military purposes. Gradually with the development of stereoscopy, it became easy to study the earth features in three dimensions and to extract more information. Non photographic sensors revolutionised the remote sensing techniques by overcoming the limitations of camera photography. The space borne platforms viz., sun synchronous and geosynchronous satellites equipped with sensors able to view the earth in most of the energy bands, have made possible to obtain desired information related to this planet with maximum accuracy. There are various photointerpretation instruments used for the visual interpretation of the images. Digital image processing is a technique to study the imageries with high reliability in minimum time.

---

## 8.8 GLOSSARY

---

- **Aerial photograph:** Any photograph taken from the air borne platform.
- **Albedo:** Ratio of radiant energy reflected by earth or target to the total incident energy.
- **Altitude:** Height above a datum. Usually refers to sea level.

- **Angle of tilt:** The angle subtended at the lens by rays to the principal point and the plumb point.
- **Aperture:** An opening in a lens diaphragm through which the light passes.
- **Base height ratio:** Ratio between air base and flying height of a stereoscopic pair of photograph.
- **Bit:** An abbreviation of a binary digit which refers to an exponent of two.
- **Byte:** A group of 8 bits of digital data. A byte represents digital number upto 255 adopted by most digital remote sensing system.
- **Camera station:** The point in air or space at the time of exposure; also called exposure station.
- **Charge Coupled Device (CCD):** A light sensitive capacitor whose charge is proportional to the intensity of illumination. They are able to be charged and discharged rapidly and are used in pushbroom scanners, spectro-radiometers and video cameras.
- **Colour composite:** True or false colour composite prepared from three bands.
- **Coverage:** Ground area represented on aerial photograph.
- **Digital Number (DN):** The value of a variable recorded for each pixel as an image as a binary integer usually in the range of 0-255.
- **Emmissivity:** Probability of a photon being emitted of unit thickness by a slab of unit thickness; equal to absorptivity for an opaque body.
- **Flying height (H):** Height of the lens (camera) above sea level at the time of exposure.
- **Format:** The size of the photo.
- **Focal length (f):** The distance from the lens along the optical axis to the focal point.
- **Focal plane:** The plane in which the film is held in the camera for photography.
- **Grid:** A system of lines superimposed on photographs and maps in respect to which points on ground are located.
- **Image:** It is a record of the intensity of reflected EMR from various objects; A general term for any pictorial presentation.
- **Imagery:** A data product of non photographic active or passive sensor.
- **Image interpretation:** Art of examining images for the purpose of efficient or effective identification of objects and assessing their significance.
- **Infra-red:** EMR longer than  $0.75\mu\text{m}$  and shorter than microwaves above the detection of human eye towards red.
- **Optical axis:** The line from the principle point through the centre of the lens. The optical axis is vertical to the photoplane.
- **Overlap:** The amount expressed in percentage by which the two photographs include the same area; Forward overlap between aerial photographs in the same flight strip and lateral overlap between photos of adjacent strip.
- **Payload:** It refers to the sensor system mounted on the bus of the satellite.



- **Pixel:** A single sample of data in a digital image having both a spatial attribute (its position in the image and usually a rectangular dimension on the ground) and a spectral attribute (the intensity of a particular waveband for that position (DN)).
- **Polar orbit:** An orbit that passes close to the poles (reference to remote sensing satellites).
- **Principal Component Analysis:** It refers to preprocessing and transformation that creates new images from the uncorrected values of the digital images. The transformation is done for the image enhancement and pattern recognition. The technique of PCA is used for the areas for which we have little information at the initial level.
- **Radiations:** Propagation of energy in the form of electromagnetic waves.
- **Radiometer:** Device for quantitative measurement of thermal radiation.
- **Relief Displacement:** Relief displacement or height distortion or geometric distortion is a character of terrain relief that causes image displacement.
- **Scale:** Photoscale is the ratio of photodistance to ground distance. It is also equal to the ratio of focal length of the camera lens and flying height above the terrain (amsl).
- **Scattering:** Scattering of EMR refers to a phenomenon where incoming solar radiations are dispersed in all directions after interacting with atmospheric particles, viz., dust, smoke, haze, fog, clouds and gas molecules. It reduces image contrast and alters the spectral signature of the objects.
- **Sensor:** A device that receives EMR and converts it into a signal that can be recorded and displayed as numerical data or an image.
- **Spectral reflectance:** Reflectance of EMR at specified wavelength intervals.
- **Spectral signature:** Reflectance ability of an object or ground feature. It is useful in discriminating between similar looking objects.
- **Stereocard:** Used for the perception of 3-dimensional vision.
- **Stereopair:** A pair of photograph with 60-70% overlap. It can be obtained by taking the photograph of the same scene from two different angles.
- **TDRS:** Tracking and Data Relay Satellite launched by USA into geostationary orbit for data transfer by LANDSAT
- **Thematic Mapper:** An imaging device carried by LANDSAT 4 and 5 that records 7-bands of data from visible to thermal IR.
- **Thermal IR:** Infra red region from 3-14  $\mu\text{m}$  used in remote sensing.
- **Tilt:** It is the angle between the optical axis and the plumb line.
- **Tone:** Each distinguishable shade of gray from white to black on a photograph.
- **Zenith:** The point immediately overhead. Opposite to nadir

---

## ***8.9 SELF ASSESSMENT QUESTIONS***

---

**8.9.1 Select the correct option:**

1. False colour photographs are:
 

(a) Panchromatic	(b) Black and white IR
(c) Colour	(d) Colour infra red
  
2. Aerial Photographs are a versatile and useful form of remote sensing for the reason:
  - (a) The film provides excellent spatial resolution and possesses high information content.
  - (b) Photographs cost relatively little;
  - (c) Different films provide a sensitivity range from ultra violet spectral region to visible and finally to infra red region;
  - (d) All of the above.

**8.9.2 True or False:**

1. Chlorophyll in green vegetation absorbs mainly in the visible region of the EMR spectrum.
2. The blue colour of sky is a result of scattering of blue colour waves.
3. Microwaves are more powerful than ultra violet waves.
4. The energy in one photon of blue wavelength band is more than red wavelength band Photon.
5. When an electron absorbs energy from a photon, it jumps to a low energy level.
6. Multiband photography is also called as multispectral photography.

**8.9.1 Answer Key:** 1. (d), 2. (d)

**8.9.2 Answer Key:** 1. True, 2. True, 3. False, 4. True, 5. False, 6. True

---

## **8.10 REFERENCES**

- Indian Institute of Remote Sensing. 1993. Lectures and practical notes on Photogrammetry, Aerial Photography, Image interpretation, Remote sensing and Digital image processing. Compiled by K.C. Bhagra. IIRS, Dehradun.
- Jenson, John, 2000. Remote Sensing of the Environment. Prentice Hall
- Lillesand, T. M and R. W. Kiefer, 1994. Remote Sensing and Image Interpretation. John Wiley and Sons. New York
- Sabins. F. Jr. 1987. Remote Sensing Principles and Interpretation. W. H. Freeman and Co. New York
- [https://en.wikipedia.org/wiki/Indian\\_National\\_Satellite\\_System](https://en.wikipedia.org/wiki/Indian_National_Satellite_System)

---

## **8.11 SUGGESTED READINGS**

- Colwell, R. N. 1997. Manual of Photographic Interpretation. American Society for Photogrammetry and Remote Sensing.

- Sharma, M.K. 1986. Remote Sensing and Forest Surveys. International Book distributors, Dehradun
- Tomar, M.S. and A.R. Maslekar, 1973. Aerial Photograph in Land use and Forest Surveys. Jugal Kishore & Co. Dehradun

---

## ***8.12. TERMINAL QUESTIONS***

---

### **8.12.1 Short Answer type Questions:**

1. Enlist various types of remote sensing platforms giving examples.
2. What is a near polar orbit? What are sun-synchronous and geo-synchronous orbits?
3. What is the difference among true colour, false colour and colour infra red?
4. What is the major difference between thermal infra-red remote sensing and, visible and near infra red based remote sensing?
5. What is FCC?
6. What do you mean by stereo data?
7. How spectral characteristics help in delineation of vegetation type.
8. Calculate the scale of aerial photograph acquired at a camera height of 3050 m with a 152 mm lens.

### **8.12.2 Long Answer type Questions:**

1. Discuss the types of remote sensing in terms of energy sources.
2. What is meant by radiometric resolution? What is the meaning of 7 bits? How many digital numbers one single pixel can have?
3. Write short notes on (i) Tonal variations and (ii) Sensors.

## **BLOCK-3 BIOSTATISTICS**

---

## **UNIT-9 METHODS OF GRAPHIC AND NON-GRAPHIC PRESENTATION OF DATA**

---

- 9.1- Objectives
- 9.2-Introduction
- 9.3- Importance of Statistics
- 9.4- Methods of graphic presentation of data
- 9.5- Methods of non-graphic presentation of data
- 9.6- Summary
- 9.7- Glossary
- 9.8-Self Assessment Question
- 9.9- References
- 9.10-Suggested Readings
- 9.11-Terminal Questions

---

## 9.1 OBJECTIVES

---

In this unit, student will be able to:

- learn the uses of statistics and procedure for analysing statistical enquiry.
- learn the term ‘Primary data’, ‘Secondary data’, ‘Grouped data’ and ‘Ungrouped data’
- discuss Frequency, cumulative frequency and frequency distribution.
- know about Continuous frequency distribution and discrete frequency distribution.
- know about the representation of data in the form of a frequency distribution.
- The graphical representation of the data and frequency distribution too.

---

## 9.2 INTRODUCTION

---

The naturalist, the biologist, the astronomers, the administrators, the businessmen, and the economists all make use of statistical methods and facts. Its scope has become so wide today that few statisticians, if any, are expert in all branches. Astronomy pioneered their use in making predictions about eclipses and Biology has equally appreciably utilized them in its generalization, for instance, in laws of variations and heredity. Metrology uses them for weather forecasts i.e., temperature, rainfall, barometrical pressure and force of the wind. To the political economists the statistician supplies the facts by which they test their theories or on which they base them.

---

## 9.3 IMPORTANCE OF STATISTICS

---

We now discuss briefly the importance of statistics in some different sectors and disciplines.

**Statistics and Economics:** Statistical data and techniques of statistical analysis have proved immensely useful in solving a variety of economic problems, such as wages, prices, consumption, production, distribution of income and wealth etc.

**Statistics and Business:** Statistics is an indispensable tool of production control also. Business executives are relying more and more on statistical techniques for studying the needs and the desires of the consumers and for many other purposes.

**Statistics and Biology, Astronomy and Medical Science:** The association between statistical methods, and biological theories was first studied by Francis Galton in his work in ‘Regression’. According to Prof. Karl Pearson, the whole ‘theory of heredity’ rests on statistical basis. He says, “The whole problem of evolution is a problem of vital statistics, a problem of longevity, of fertility, of health, of disease and it is impossible for the Registrar General to discuss the national mortality without an enumeration of the population, a classification of deaths and knowledge of statistical theory.”

In medical science, the efficiency of a manufactured drug or injection or medicine is tested by using the ‘tests of significance’.

**Statistics and War:** In war, the theory of ‘Decision functions’ can be of great assistance to military and technical personnel to plan ‘maximum destruction with minimum effort’.

Thus, we see that the science of statistics associated with almost all the sciences-social as well as physical. Bowley has rightly said, “A knowledge of statistics is like a knowledge of foreign language or of algebra; it may prove of use at any item under any circumstance.”

On the other hand, there are certain limitations to statistics. For example: consider the following statement:

‘75% of the people who drink alcohol dies before attaining the age of 70 years. Hence drinking is harmful for longevity of life.’

This statement is incorrect since nothing is mentioned about the number of persons who do not drink alcohol and die before attaining the age of 70 years. Thus, statistical arguments based on incomplete data often lead to fallacious conclusions.

**Remark:** Incomplete data usually leads to fallacious conclusions.

**9.3.1 The Statistical methods:** The statistical methods are devices by which complex and numerical data are so systematically treated as to present a comprehensible and intelligible view of them. In other words the statistical method is a technique used to obtain, analyse and present numerical data. The different steps that are included in the statistical methods are: Collection of data, Classification, Tabulation, Presentation, Analysis, Interpretation and Forecasting.

**9.3.2 Main Stages of a Statistical Enquiry:** A statistical enquiry passes through various stages which we mention in brief as follows:

- i. **Collection of Data:** The first task of a statistician is to collect and assemble his data. The data may be primary or secondary.
- ii. **Classification and Tabulation of Data:** When the data are obtained, we have to arrange and condense them into some suitable form.
- iii. **Analysis of Data:** First task of a statistician is over when he has arranged and tabulated his data.
- iv. **Interpretation of Data:** When the data have been analysed, we have to interpret them in order to draw inferences from them.

### **Population and Sample**

A population may be defined as the totality of all actual or conceivable objects under consideration. To speak more accurately, a population consists of numerical values connected

with these objects. The term 'universe' is also used for population. A population may be finite or infinite, existent or hypothetical.

A sample is defined as a selected number of individuals each of which is a member of the population. It is clear that a sample will not tell us everything about the parent population from which the sample has been drawn, but an attempt may be made to estimate certain constants of the parent population.

The information obtained in any investigation is generally numerical facts. The facts which can be presented in numerical forms are based on two types of characteristics-

**(i) Qualitative characteristics:** The characteristics which can-not be measured but only their presence or absence in a group of individual can be noted are called qualitative characteristics or attributes. Example: sex, nationality, education, eye-colour, blindness, etc.

**(ii) Quantitative characteristics:** The characteristics which can be counted or measured are known as quantitative characteristics or variables. Example: height, weight, salary, price, marks obtained, number of students, etc.

Quantitative characteristics which can take any of the prescribed value is known as variable. There are two types of variables: Continuous variable, Discontinuous (Discrete variable). Qualitative characteristics (attributes) are considered as non-orderable and countable variables or nominal variables.

Now, we understand the term '**data**' as follows:

The word 'data' means information in the form of numerical figures or a set of given facts. Data are of two types:

**Primary Data:** The information collected by the investigator himself or herself with a definite purpose in his or her mind is called primary data.

**Secondary Data:** The information gathered from a source which already had the information stored is called secondary data.

**Example 9.1-** Let us consider the number of children in 20 families of a locality:

2, 1, 3, 1, 2, 3, 2, 2, 4, 3, 2, 1, 5, 4, 3, 3, 2, 1, 2, 6

The data in this form is the raw data (**ungrouped** or **unclassified** data). Here, the number of children is the **variable** and each entry in the above is an observation (or **variate**).

Arranging the above data in ascending order, we get:

1, 1, 1, 1, 2, 2, 2, 2, 2, 2, 3, 3, 3, 3, 3, 4, 4, 5, 6



The data arranged in this form is called **arrayed data**. The presentation of data in this form gives better information, but it is quite tedious and time-consuming, especially when the number of observations is large.

**Example 9.2-** Consider the marks of 40 students, from 50 given below:

5, 6, 7, 8, 11, 15, 20, 8, 11, 25, 30, 15, 17, 11, 6, 22, 25, 20, 22, 15, 30, 32, 32, 8, 20, 25, 22, 22, 35, 37, 40, 20, 11, 25, 20, 10, 10, 15, 35, 42.

Now consider the data arranged in the following manner:

**Table 9.1**

Marks	Number of students
5	1
6	2
7	1
8	3
10	2
11	4
15	4
17	1
20	5
22	4
25	4
30	2
32	2
35	1
37	1
40	1
42	1

The above table is known as the frequency table, each mark is a variate and the number of student is the frequency. The sum of the frequencies is 40, the total number of students.

Next consider the following arrangement as under:

**Table 9.2**

Marks	No. of Students
0-5	0
5-10	7
10-15	6
15-20	5

20-25	9
25-30	4
30-35	4
35-40	3
40-45	2
45-50	0

The marks have been divided into classes with difference of 5 in each class, which is known as **class interval**. In the class interval, the figure on left side is called **lower limit** and that on right side is the **upper limit** of the class. For example **5-10**, **5** is **lower limit** and **10** is **upper limit**. The difference between upper limit and lower limit is known as **class size**. Mid value of the class interval is called **class mark**, act as a variate for that class interval.

In this grouped frequency distribution, the classes are non-overlapping but continuous. Such a frequency distribution is called **continuous (or exclusive) distribution**. In this distribution, the upper limit of one class coincides with the lower limit of next class.

**Example 9.3-** Consider the following distribution:

**Table 9.3**

Classes	frequency
1-5	2
6-10	7
11-15	8
16-20	6
21-25	2
total	25

In this example, the classes are non-overlapping but discontinuous. Such a frequency distribution is called **discrete (or inclusive) distribution**. In this distribution, the upper limit of one class does not coincide with the lower limit of the next class.

### **Converting discrete distribution to continuous distribution**

To convert discrete classes into continuous classes, we require some adjustment.

$$\text{adjustment factor} = \frac{\text{lower limit of one class} - \text{upper limit of previous class}}{2}$$

Subtract the adjustment factor from all the lower limits and add the adjustment factor to all of the upper limits. In above example,

$$\text{adjustment factor} = \frac{6 - 5}{2} = \frac{1}{2} = 0.5$$

Continuous frequency distribution is:

**Table 9.4**

Classes	Classes after adjustment	Frequency
1-5	0.5-5.5	2
6-10	5.5-10.5	7
11-15	10.5-15.5	8
16-20	15.5-20.5	6
21-25	20.5-25.5	2
Total		25

The **cumulative frequency** corresponding to a class is the total of all the frequencies upto and including that class. In the following example, the cumulative frequency of class 5-10 is the total of all frequencies upto (class 1-5) and including that class 5-10, i.e,  $2 + 7 = 9$ .

**Example 9.4-**

**Table 9.5**

Classes	Frequency	Cumulative frequency
0-5	2	2
5-10	7	$2 + 7 = 9$
10-15	8	$9 + 8 = 17$
15-20	6	$17 + 6 = 23$
20-25	2	$23 + 2 = 25$
Total	25	

The number of observations less than the upper class limit of a given class (i.e. the total number of the frequencies upto and including that class where classes are in ascending order) is called **less than type cumulative frequency**, and the distribution is called less than type cumulative frequency distribution. Consider the example, less than type cumulative frequency distribution is given by:

**Example 9.5 –**

**Table 9.6**

Classes	frequency	Less than	Cumulative frequency
0-5	2	<b>Less than 5</b>	2
5-10	7	<b>Less than 10</b>	$2 + 7 = 9$
10-15	8	<b>Less than 15</b>	$9 + 8 = 17$
15-20	6	<b>Less than 20</b>	$17 + 6 = 23$
20-25	2	<b>Less than 25</b>	$23 + 2 = 25$
Total	25		

The number of observations more than the lower limit (i.e. when the data are in the ascending order) of the class intervals is called **more than type cumulative frequency** and the distribution is called more than type cumulative frequency distribution. Consider the example:

**Example 9.6 –**

**Table 9.7**

Classes	frequency	More than	Cumulative frequency
0-5	2	<b>More than 0</b>	<b>25</b>
5-10	7	<b>Morethan 5</b>	<b>25 – 2 = 23</b>
10-15	8	<b>More than 10</b>	<b>23 – 7 = 16</b>
15-20	6	<b>Morethan 15</b>	<b>16 – 8 = 8</b>
20-25	2	<b>Morethan 20</b>	<b>8 – 6 = 2</b>
Total	25		

### 9.3.3 Characteristics of frequency distribution

To compare the distributions of the same type we study their four main characteristics which describe their nature in a general way. These characteristics are:

- (i) **Central tendency:** In most of the frequency distribution there is found a point around which largest numbers of observations tend to cluster. This point is called the central point of the frequency distribution. The tendency of the observations to concentrate around a central point is known as central tendency.
- (ii) **Dispersion:** Dispersion implies that within a group the observations are not uniform in their magnitude. Such scatteredness of the values from any fixed value (generally central value) is called dispersion or variation.
- (iii) **Skewness:** It means the lack of symmetry. It is of two types, positive skewness and negative skewness. It determines the nature and extent of the concentration of the observations towards the higher or lower values of the variable.
- (iv) **Kurtosis:** It refers to the shape of the top of its curve. Kurtosis is the degree of peakedness in a frequency distribution or the relative flatness of the top of the frequency curve. There are three forms of distributions based on kurtosis:
  - (a) Mesokurtic (b) Leptokurtic (c) Platykurtic.

We will discuss ‘Measure of central tendency’ and ‘Measure of dispersion’ in detail on the unit-10 and unit-11 respectively.

---

## 9.4 METHODS OF GRAPHIC REPRESENTATION OF DATA

---

The data in various forms may be represented by the graphs or diagrams. When data of two items are compared with one another it is always easier to compare through graphs. The following are the main diagrams-

- (i) Bar diagram
- (ii) Pie diagram
- (iii) Pictogram.

(i) **Bar diagrams:** When the comparison of simple magnitude of different item is done, the bar diagram are widely used. In bar diagrams equal base on horizontal lines are selected and rectangles of equal width are constructed with length proportional to the given data. The distance between two bars should be taken about one half of the width of a bar.

**Example 9.7** - Draw a bar diagram of the following data:

Years	1959	1960	1961	1962	1963
Wheat(in- quintals)	200	350	450	550	600

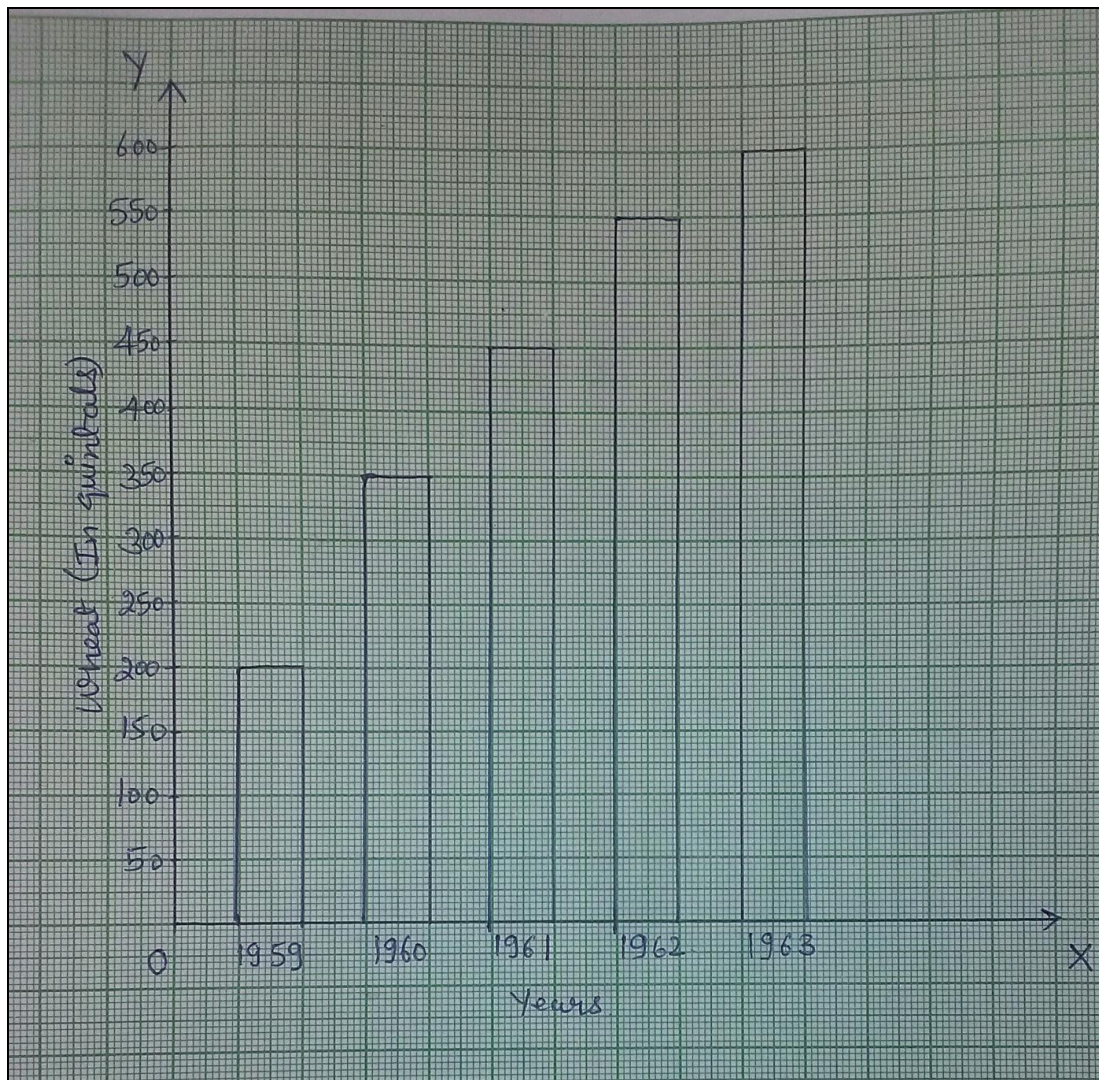

**Fig. 9.1**

**(ii) Pie Diagram:** Pie diagram are used when comparison of the component parts is done with another and total. The total value is equated to  $360^{\circ}$  and then the angles corresponding to component parts are calculated.

**Example 9.8** - Construct the pie-diagram for the following:

	Children	Adults	Old	Total
City A	250	450	200	900
City B	1000	2250	350	3600

Draw two circles. The angle corresponding to no. of children, adults and old is calculated as follows:

**For city A**

**Table 9.8**

No. of each component	Corresponding Angle = $\frac{\text{no. of component}}{\text{total}} \times 360$
No. of children	$= \frac{250}{900} \times 360 = 100$
No. of adults	$= \frac{450}{900} \times 360 = 180$
No. of olds	$= \frac{200}{900} \times 360 = 80$

**For city B**

**Table 9.9**

No. of each component	Corresponding Angle = $\frac{\text{no. of component}}{\text{total}} \times 360$
No. of children	$= \frac{1000}{3600} \times 360 = 100$
No. of adults	$= \frac{2250}{3600} \times 360 = 225$
No. of olds	$= \frac{350}{3600} \times 360 = 35$

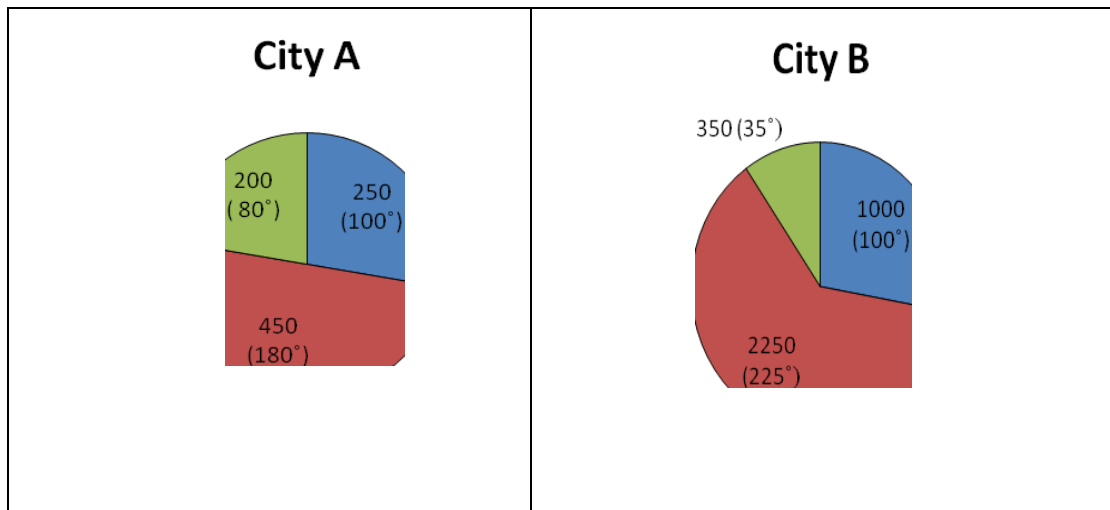

Fig. 9.2

(iii) **Pictograms:** When numerical data are represented by pictures, they give a more attractive representation. Such pictures are called pictograms.

**Example 9.9** - Suppose we are to compare the milk production of 3 districts

	A	B	C
In quintals	2000	3000	6500

Now suppose that the 1- picture ‘\*’ represents 500 quintals. Then pictogram representation of the above data:

Table 9.10

A	****
B	*****
C	*****

If the distribution is represented by the graphs, a clear visual conception of the distribution is obtained. Generally **the following types of graphs are used in representing frequency distribution (careful):**

- (i) Histograms
- (ii) Frequency Polygon
- (iii) Frequency Curves
- (iv) Cumulative Frequency Curves or the ogive.

**(i) Histograms**

A histogram is used to represent continuous grouped data. It consists of adjacent rectangles. Procedure to draw a histogram: (i) Firstly Mark the class limits along x-axis and take the breadth of a rectangle equal to a class size. (ii) Take the length of a rectangle equal to the frequency of that class and mark it along y-axis. (iii) Construct rectangles corresponding to each class.



**Example 9.10** - Draw a histogram for the following distribution:

Class	0-10	10-20	20-30	30-40	40-50	50-60	60-70	70-80	80-90	90-100
Freq.	2	4	10	4	3	8	1	5	11	2

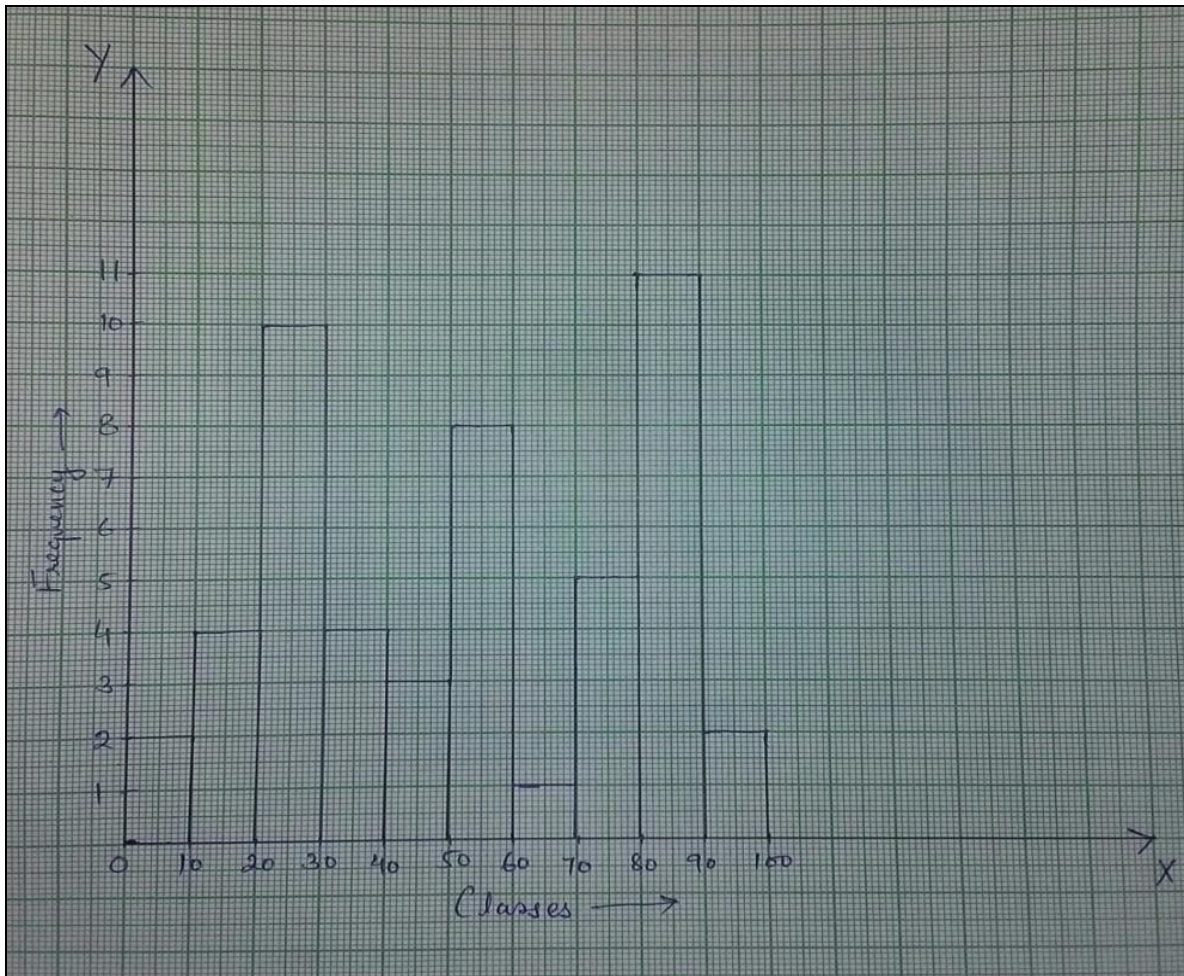

**Fig. 9.3**

### (ii) Frequency polygon

If the various points are obtained by plotting the central value of the class intervals as x-coordinates and the respective frequencies as the y-coordinates, and these points are joined by straight lines taken in order, they form a polygon called frequency polygon.

**Example 9.11** - Draw a frequency polygon for the following distribution:

Class	0-10	10-20	20-30	30-40	40-50	50-60	60-70	70-80	80-90	90-100
Freq.	2	4	10	4	3	8	1	5	11	2



First we find class-mark:

**Table 9.11**

Class	0-10	10-20	20-30	30-40	40-50	50-60	60-70	70-80	80-90	90-100
<b>x</b>	5	15	25	35	45	55	65	75	85	95
<b>Freq.</b>	2	4	10	4	3	8	1	5	11	2

The frequency polygon shown in following graph.

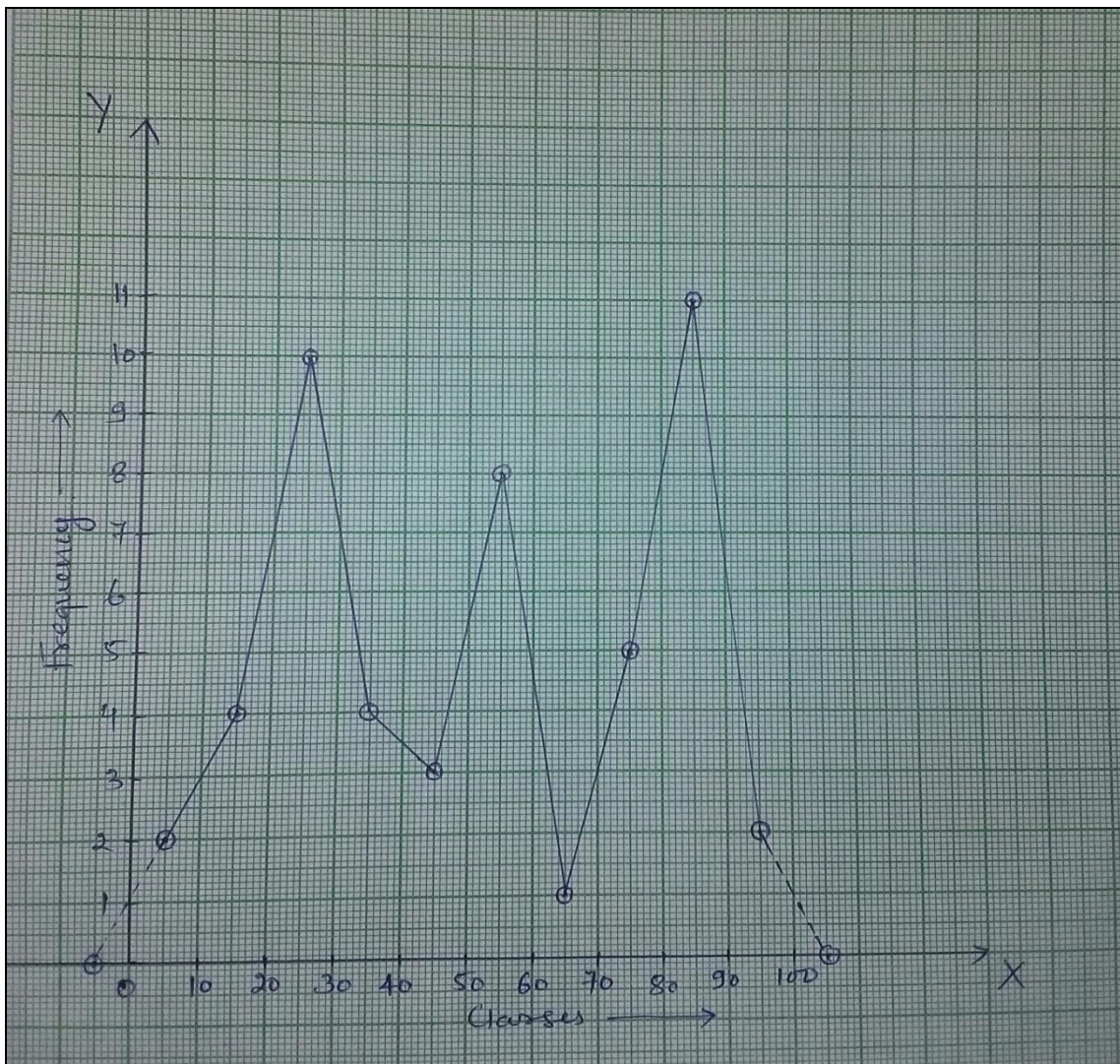

**Fig. 9.4**



### (iii) Frequency Curves

If through the vertices of a frequency polygon a smooth freehand curve is drawn we get the frequency curve. Consider the same example for which we have drawn frequency polygon. If we join the vertices of frequency polygon by freehand curve, we obtained frequency curve as:

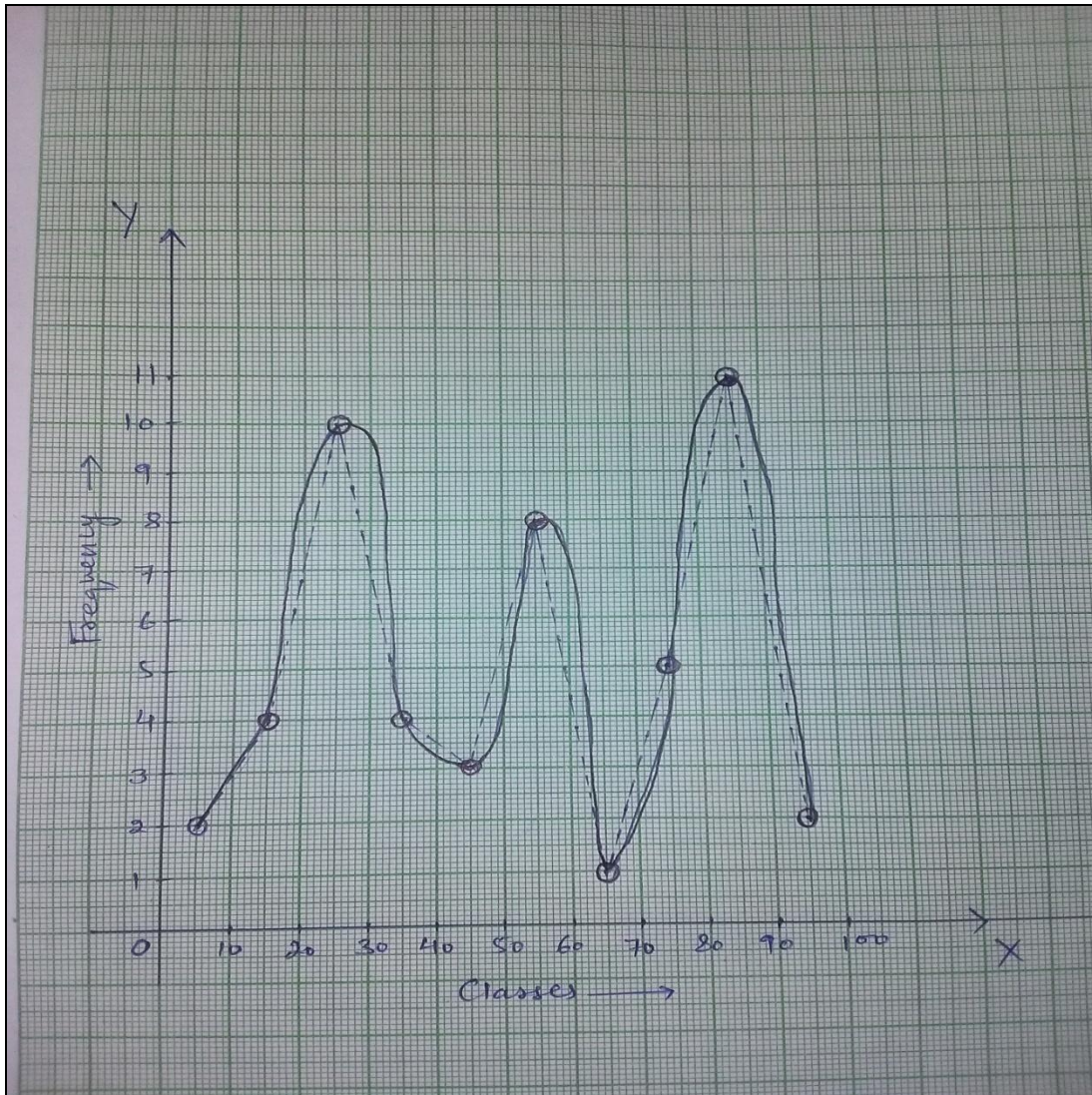

Fig. 9.5

### (iv) Cumulative frequency curves or ogives

If less than cumulative frequency is plotted against the corresponding upper limits of each class and the points plotted are joined by straight lines, we obtain less than type cumulative frequency polygon.

If more than cumulative frequency is plotted against the corresponding lower limits of each class and the points plotted are joined by straight lines, we obtain more than type cumulative frequency polygon.

When the points plotted are joined by a free hand smooth curve, we obtain cumulative frequency curve or ogive.

**Example 9.12** - Draw a less than type and a more than type ogive from the following distribution:

X	38-40	40-42	42-44	44-46	46-48	48-50	50-52
f	3	2	4	5	14	4	3

First, the less than type cumulative frequency distribution table is:

**Table 9.12**

<b>x</b>	<b>c. f</b>
Less than 40	3
Less than 42	$3 + 2 = 5$
Less than 44	$5 + 4 = 9$
Less than 46	$9 + 5 = 14$
Less than 48	$14 + 14 = 28$
Less than 50	$28 + 4 = 32$
Less than 52	$32 + 3 = 35$

When the points A(40, 3), B(42, 5), C(44, 9), D(46, 14), E(48, 28), F(50, 32) and G(52, 35) are plotted, and joined by the straight lines (or free hand), we obtain less than type ogive.

The more than type cumulative frequency distribution table is:

**Table 9.13**

<b>x</b>	<b>c. f</b>
More than 38	35
More than 40	$35 - 3 = 32$
More than 42	$32 - 2 = 30$
More than 44	$30 - 4 = 26$
More than 46	$26 - 5 = 21$
More than 48	$21 - 14 = 7$
More than 50	$7 - 4 = 3$



When the points P(38, 35), Q(40, 32), R(42, 30), S(44, 26), T(46, 21), U(48, 7) and V(50, 3) are plotted, and joined by the straight lines (or free hand), we obtain more than type ogive.

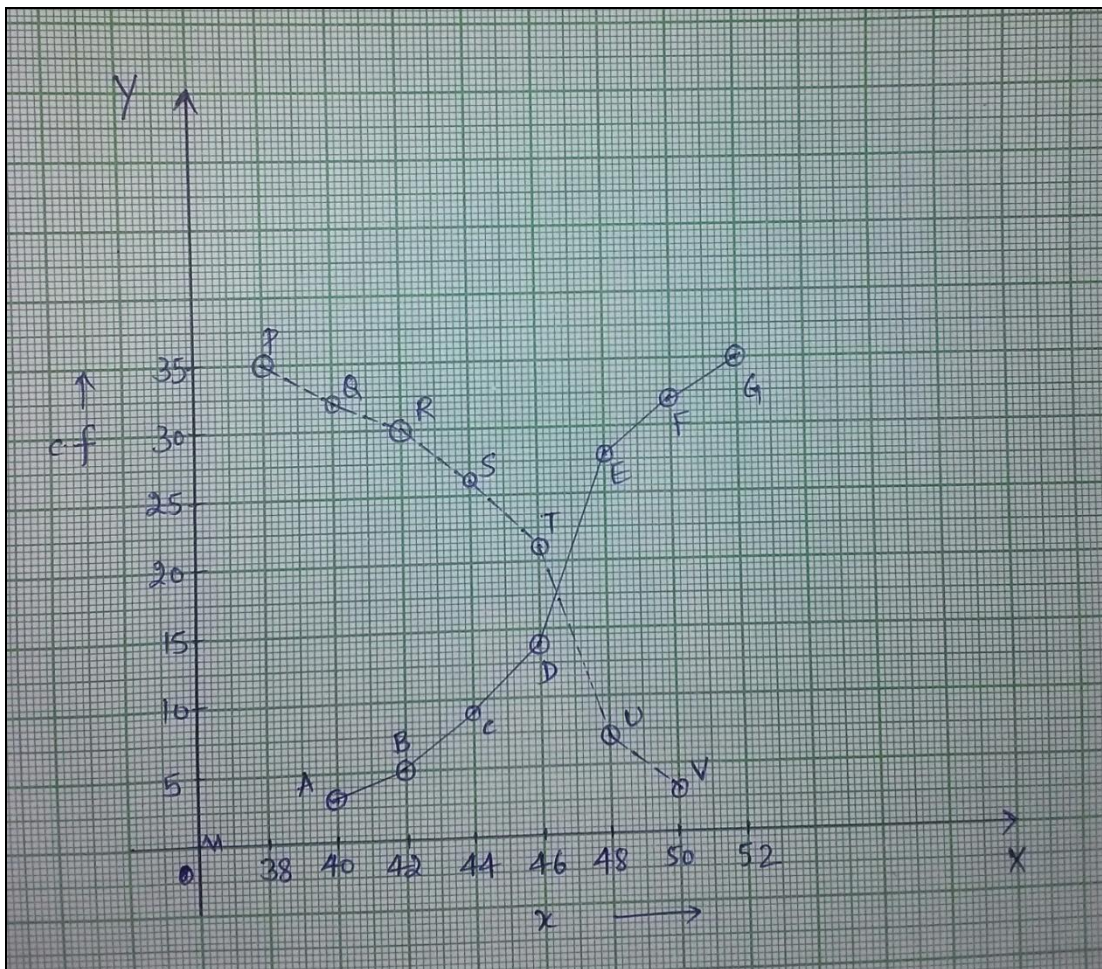

**Fig. 9.6**

In fig.9.6, curve ABCDEFGH shown in this graph is less than type ogive, and curve PQRSTU is more than type ogive.

In making grouped frequency table, we have taken classes of equal width. If the classes are of varying width, the different class frequencies will not be comparable. Comparable figures can be obtained by dividing the value of the frequencies by the corresponding widths of the class intervals. The ratios thus obtained are called ‘frequency densities’. Consider an example:

**Example 9.13** - Draw a histogram for the following frequency distributions-

Age	0-5	5-10	10-20	20-30	30-40	40-50	50-70	70-100
No. of persons	5	10	15	20	25	40	30	15

In this case, we use frequency density instead of frequency.

**Table 9.14**

Class	f	Width of class(w)	Frequency density(=f/w)
0-5	5	5	$= \frac{5}{5} = 1$
5-10	10	5	$= \frac{10}{5} = 2$
10-20	15	10	$= \frac{15}{10} = 1.5$
20-30	20	10	$= \frac{20}{10} = 2$
30-40	25	10	$= \frac{25}{10} = 2.5$
40-50	40	10	$= \frac{40}{10} = 4$
50-70	30	20	$= \frac{30}{20} = 1.5$
70-100	15	30	$= \frac{15}{30} = 0.5$

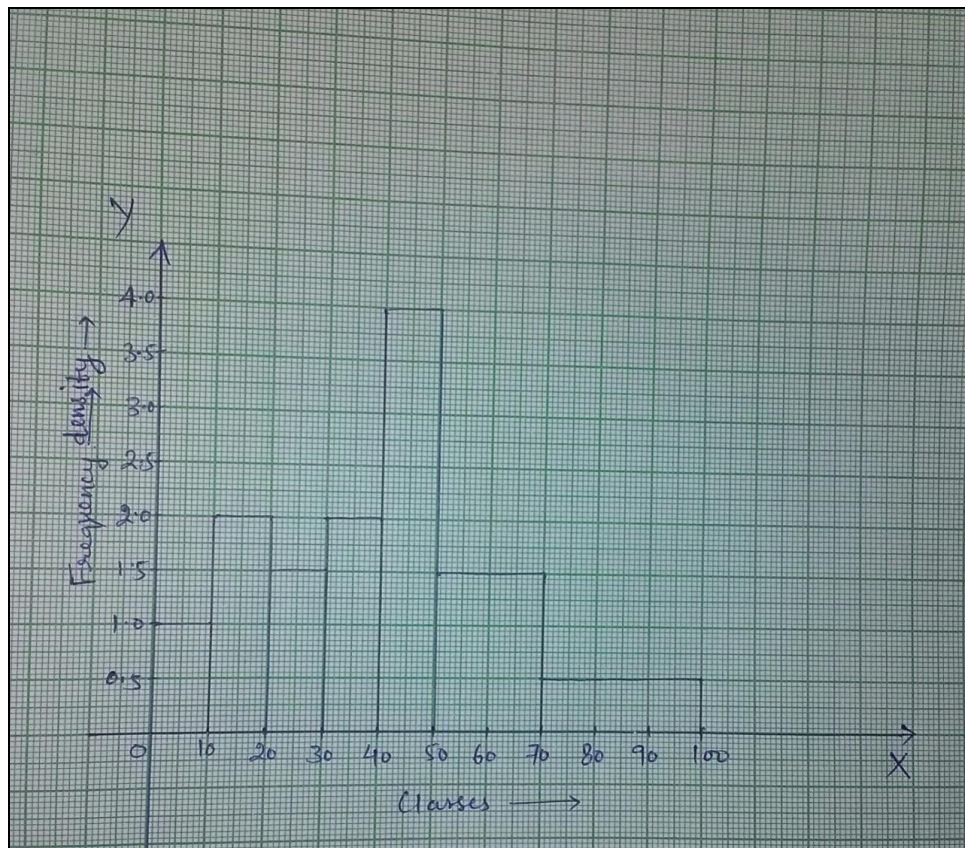

**Fig. 9.7**

## 9.5 METHODS OF NON-GRAPHIC REPRESENTATION OF DATA

Methods of non-graphic representation of data are frequency distribution table discussed above. An easy way to construct frequency distribution of a data is given by 'tally mark method'. Consider every observation and put it in the suitable class by drawing a vertical line. After every 4 vertical line cross it for the 5<sup>th</sup> entry and then a little space is left and then next vertical line is drawn.

**Example 9.14** - Consider the marks of 50 students in statistics:

19, 70, 75, 15, 0, 23, 59, 56, 27, 89, 56, 73, 56, 89, 75, 65, 85, 22, 3, 12, 41, 87, 82, 72, 50, 22, 87, 50, 89, 28, 89, 50, 40, 36, 40, 30, 28, 87, 81, 90, 22, 15, 30, 35.

The 'tally mark method' for frequency distribution is given by

**Table 9.15**

Marks Class	Tally Marks	Frequency
0-10		2
10-20		4
20-30		10
30-40		4
40-50		3
50-60		8
60-70		1
70-80		5
80-90		11
90-100		2
Total		50

Frequency distribution is also represented by the graphs as discussed above.

**Note:** The upper limit of a class counted in the next class.

**Example 9.14**-Compile a table showing the frequencies with which words of different number of letters occur in the extract reproduced below (omitting punctuation marked) treating as the variable the number of letters in each word

“ Success in the examination confers no absolute right to appointment, unless Government is satisfied, after such inquiry as may be considered necessary, that the candidate is suitable in all respects for appointment to the public service.”

**Solution:** We form table as follows:

**Table 9.16**

No. of letters	No. of words
2	9
3	6
4	2
5	2
6	2
7	4
8	3
9	3
10	2
11	3

---

## ***9.6 SUMMARY***

---

Originally, statistics was simply the collection of numerical data on some aspects of life of the people useful to the government. However, with the time, its scope broadened. Today, statistics means collection of facts or information concerning almost every aspect of life of the people with a definite purpose in the form of numerical data, organisation, summarisation and presentation of data by tables and graphs (Charts), analysing the data and drawing inferences (meaningful prediction) from the data. In this unit, we have seen that grouped frequency distribution gives a better idea of the data than an ungrouped one, and also if the distribution is represented by graphs, a clear visual conception of the distribution is obtained.

---

## ***9.7 GLOSSARY***

---

**Raw Data:** The numerical data recorded in its original form as it is collected by the investigator or received from some source is called raw data.

**Variable:** The quantitative characteristics which can assume any of a prescribed numerical value is known as variable. A quantity which is being measured in an experiment (or survey) is called a variable. Variables are of two types: Continuous variable and discontinuous variable.

**Continuous variable:** A variable which can take any value between two given values is called a continuous variable.

**Discontinuous variable:** A variable which cannot take all possible values between two given values is called a discontinuous or discrete variable.

**Range:** The difference between the maximum and minimum values of a variable is called its range.

**Variate:** A particular value of a variable is called variate (observation).

**Frequency:** The number of times a variate occurs in a given data set is called frequency of that variable.

**Frequency Distribution:** A tabular arrangement of given numerical data showing the frequency of different variates is called frequency distribution, and the table itself is called frequency distribution table.

**Population:** Any collection of individuals under study is said to be population (universe).

**Sample:** A part or small section selected from the population is called a sample and the process of such selection is called sampling.

**Parameters:** Statistical measures such as mean, variance etc. of the population are called as parameters.

**Statistic:** It is a statistical measure computed from sample observation alone.

---

## ***9.8 SELF ASSESSMENT QUESTION***

---

### **9.8.1 Indicate the correct answer:**

1. Which one of the following is a discrete variable?

- (a) The heights of the students of a college    (b) The weights of the students of a college  
(c) The number of students in a college        (d) None of the above

2. Which one of the following is a continuous variable?

- (a) The heights of the students of a college  
(b) The number of students in a college  
(c) The number of hairs on the body of a person  
(d) The number of shares sold in a share market

3. If less than cumulative frequency is plotted against the corresponding upper limits of each class and the points plotted are joined by straight lines, we obtain

- (a) More than type cumulative frequency polygon  
(b) Less than type cumulative frequency polygon  
(c) Both (a) and (b)  
(d) None of the above

4. If more than cumulative frequency is plotted against the corresponding lower limits of each class and the points plotted are joined by straight lines, we obtain

- (a) More than type cumulative frequency polygon.  
(b) Less than type cumulative frequency polygon.  
(c) Both (a) and (b).  
(d) None of the above.

5. The representation of frequency distribution by means a graph is useful:



- (a) For making the unwieldy data intelligible and convey to the eye the general run of the observations.  
 (b) Have a more lasting effect on the brain.  
 (c) For easier comparison of two items.  
 (d) All of the above.

6. The mean of the sample is

- (a) A parameter (b) A statistic  
 (c) Both a. and b. (d) None of these

7. The frequency of 2 in the data: 2, 3, 4, 5, 2, 2, 3, 4, 5, 2, 2 is

- (a) 5 (b) 4  
 (c) 3 (d) 1

8. Classes of type 15-19, 20-24, 25-29 etc., in which both the upper and lower limits are included are called

- (a) Exclusive classes (b) Inclusive classes  
 (c) None of the above (d) Both a. and b.

9. Classes in which the upper limits are excluded from the respective classes and are included in the immediate next class are known as

- (a) Exclusive classes (b) Inclusive classes  
 (c) None of the above (d) Both a. and b.

10. The class-mark of a class interval 10-20 is

- (a) 10 (b) 20  
 (c) 15 (d) None of these

### 9.8.1 Answer Key:

1. (c), 2. (a), 3.(b), 4. (a), 5. (d), 6.(a), 7.(a), 8. (b), 9. (b), 10. (c)

### 9.8.2 Long Answer Type Questions:

1. Draw histogram and frequency polygon for the following table-

Class interval	0-10	10-20	20-30	30-40	40-50
Frequency	2	4	6	8	4

2. Form a grouped frequency table of intervals 0-10,... etc. From the following-

5, 23, 49, 50, 38, 37, 25, 30, 29, 42, 37, 18, 12, 13, 9, 18, 27, 32, 50, 47, 48, 29, 30, 32, 37, 27, 41, 19, 32, 27.

3. Draw a less than type and a more than type ogive from the following distribution:

X	200-250	250-300	300-350	350-400	400-450	450-500	500-550	550-600
F	30	15	45	20	25	40	10	15

4. What is variable? Distinguish between discrete and continuous variable with examples.

5. Which one of the following is a discrete variable and which one is a continuous variable-

- (i) Number of shares sold in a share market.
- (ii) The temperature recorded at 1 hour interval.
- (iii) The average income of families in a city.
- (iv) The heights of the students of a college.
- (v) The quantity of water in a washing machine.
- (vi) The number of hairs on the body of a person.

---

## 9.9 REFERENCES

- Gupta S. C, Kapoor V. K., Fundamentals of mathematical statistics, Sultan Chand & Sons, India, 11 (2006).
- Gupta C.B., An Introduction to statistics methods, Vikss Publishing House Pvt Ltd, India, 9 (1981). Goyal J. K., Sharma J. N., Mathematical statistics, Krishna prakashan media (P) Ltd., India, 25 (2009).
- Kumar R., Statistics, Vardhman publications, Delhi, India, (2013).
- Ray M., Sharma H. S., Mathematical statistics, Ram prasad & sons, Agra, India, 11.
- Kothari, C.R., Research Methodology Methods and Techniques, New Age International (P) Ltd., New Delhi, (2004).

---

## 9.10 SUGGESTED READINGS

- S. C. Gupta and V. K. Kapoor: Fundamentals of Mathematical Statistics
- Ray, Sharma and Chaudhary: Mathematical Statistics
- tutorials.istudy.psu.edu.
- R. Kumar: Statistics
- <https://en.wikipedia.org/wiki/Wikipedia:Statistics>

- [bobhall.tamu.edu/FiniteMath/Module8/Introduction.html](http://bobhall.tamu.edu/FiniteMath/Module8/Introduction.html)

---

## 9.11 TERMINAL QUESTIONS

---

- 1- Write short notes on graphical representations of frequency distribution.
- 2- Draw histogram and frequency polygon of the following distribution:

X	0-5	5-10	10-15	15-20	20-25	25-30
f	3	5	9	20	15	6

- 3- The following table gives the country of origin of featured films exhibited in India in 1984-

Country	India	America	Britain	Germany	Others
No. of films	140	80	60	10	20

Represent them by a bar graph.

- 4- The electricity bills (in rupees) of 40 houses in a locality are given below. Construct a grouped frequency distribution table:

78, 87, 81, 52, 59, 65, 101, 108, 115, 95, 98, 65, 62, 121, 128, 63, 76, 84, 89, 91, 65, 101, 95, 81, 87, 105, 129, 92, 75, 105, 78, 72, 107, 116, 127, 100, 80, 82, 61, 118.

- 5- Explain the meaning of the following terms:

- (i) Variate
- (ii) Class size
- (iii) Class mark
- (iv) Class limits
- (v) Frequency of a class
- (vi) Cumulative frequency of a class

- 6- 100 students in a school have heights as tabulated below:

Height	121-130	131-140	141-150	151-160	161-170	171-180
No. of students	12	16	30	20	14	8

Draw frequency polygon of the above data.

---

# **UNIT-10      MEASUREMENTS      OF      CENTRAL TENDENCIES**

---

10.1- Objectives

10.2-Introduction

10.3-Mean

10.4-Median

10.5-Mode

10.6- Summary

10.7- Glossary

10.8-Self Assessment Question

10.9- References

10.10-Suggested Readings

10.11-Terminal Questions

---

## ***10.1 OBJECTIVES***

---

After reading this unit students will be able to understand:

- The measure of central tendency (or averages).
- The requisites of an ideal measure of central tendency.
- The mean, median and mode.
- The process of computation of the various measures of central tendency, viz., arithmetic mean, median, mode, geometric mean, and harmonic mean, for different types of data.
- Under what conditions which average is most appropriate to be used in our distribution.

---

## ***10.2 INTRODUCTION***

---

When we have two same types of frequency distributions, it is not enough to classify the observations and tabulate them. To study the data more comprehensively it is desirable to determine the characteristics of frequency distribution as quantitatively. There are four fundamental characteristics in which similar frequency distribution may differ. One of these characteristics is central tendency. They may differ in the value of the variate around which they cluster. Measures of this kind are generally known as Measure of Central tendency or averages.

### **Measure of Central tendency (Averages)**

Measures of central tendency tell us the point about which items have a tendency to cluster. It is the value of the variable which is the representative of entire distribution. The most important measures of central tendency that is common in use:

1. Arithmetic Mean or Simple Mean
2. Median
3. Mode
4. Geometric Mean
5. Harmonic Mean

Consider the statement “All People watches 3 hours of television per day”. It does not mean that everybody watches 3 hours of television each day, but that some watch more and some less. In this case we mean is that on the average. Clearly, the average is a value of the variable, so it has the same units as the variable. Thus the average height will be in the unit of height, the average of the percentages will be a percentage and the average marks will be a mark.

Averages are useful because they summaries a large amount of data to a single value and indicate that there is some variation around this single value within the original data.

According to Professor Yule, the following are the characteristics to be satisfied by an ideal measure of central tendency:

- (i) It should be rigidly defined.
- (ii) It should be readily comprehensible and easy to calculate.

- (iii) It should be based on all observations.
  - (iv) It should be suitable for further mathematical treatment. By this we mean that knowing the averages and size of the series, we should be able to calculate the average of the composite series obtained on combining the given series.
  - (v) It should be affected as little as possible by fluctuations of sampling.
- In addition to above criteria, we may add the following:  
 It should not be affected by the extreme values.  
 Now, we will study different types of averages one by one in the following sections.

### 10.3 MEAN

**10.3.1 Arithmetic Mean:** Arithmetic mean of a group of observations is the quotient obtained by dividing the sum of the all observations by their numbers. It is denoted by  $\bar{x}$ .

We consider all types of data sets and learn to calculate their arithmetic mean with the help of examples

**(i) For Ungrouped Data:** If the variable  $x$  takes the  $n$  values  $x_1, x_2, x_3, \dots, x_n$ , the arithmetic mean is given by

$$\bar{x} = \frac{\text{Sum of observations}}{\text{Number of observations}} = \frac{x_1+x_2+\dots+x_n}{n} = \frac{\sum_{i=1}^n x_i}{n} \tag{10.1}$$

**Example 10.1:** The heights of 5 boys in a group are: 152 cm, 170 cm, 156 cm, 164 cm and 158 cm.

Here,  $n = 5$ , and  $x_1 = 152 \text{ cm}$ ,  $x_2 = 170 \text{ cm}$ ,  $x_3 = 156 \text{ cm}$ ,  $x_4 = 164 \text{ cm}$ ,  $x_5 = 158 \text{ cm}$ .

$$\text{Mean Height } \bar{x} = \frac{x_1+x_2+x_3+x_4+x_5}{5} = \frac{152+170+156+164+158}{5} = \left(\frac{800}{5}\right) \text{ cm} = 160 \text{ cm}.$$

Hence, the mean height is 160 cm. **Note** that *mean height (160 cm) is not coincide with the actual height* of any of the 5 boys.

**(ii) For Discrete Frequency Distribution:** Let the frequencies of  $n$  observations  $x_1, x_2, \dots, x_n$  be  $f_1, f_2, \dots, f_n$  respectively.

Variable $x_i$	$x_1$	$x_2$	...	$x_n$
Frequency $f_i$	$f_1$	$f_2$	...	$f_n$

Then, **Arithmetic mean**  $\bar{x} = \frac{f_1 x_1 + f_2 x_2 + \dots + f_n x_n}{f_1 + f_2 + \dots + f_n} = \frac{\sum_{i=1}^n f_i x_i}{\sum_{i=1}^n f_i} = \frac{\sum_{i=1}^n f_i x_i}{N}$  (10.2)

where  $N = \sum_{i=1}^n f_i = f_1 + f_2 + \dots + f_n = \text{total frequency}$ .

**Example 10.2:** The heights of 72 plants in a garden are given below:

Height (in cm) $x_i$	58	60	62	64	66	68
Number of plants $f_i$	12	14	20	11	9	6

The mean height per plant calculated as follows:

**Table 10.1**

Height (in cm) $x_i$	Number of plants $f_i$	$f_i x_i$
58	12	$58 \times 12 = 696$
60	14	$60 \times 14 = 840$
62	20	$62 \times 20 = 1240$
64	11	$64 \times 11 = 704$
66	9	$66 \times 9 = 594$
68	6	$68 \times 6 = 408$
	$N = \sum_{i=1}^6 f_i = 72$	$\sum_{i=1}^6 f_i x_i = 4482$

$$\bar{x} = \frac{\sum_{i=1}^n f_i x_i}{N} = \frac{4482}{72} = 62.25 \text{ cm.}$$

Therefore, Mean Height per plant is 62.25 cm. The mean height is not the actual height of any plant.

**(iii) For Grouped Frequency Distribution:** In a grouped series the frequencies of a certain group are taken as if they are concentrated at the mid value of that group (Class mark ( $x_i$ )). Then the formula for discrete case is applied.

**Example 10.3:** The weight of 50 persons in a group is given below:

Weight (in Kg)	40-44	44-48	48-52	52-56	56-60
Number of Persons $f_i$	8	12	9	16	5

The mean weight per person calculated as follows:

**Table 10.2**

Weight (in Kg)	Number of Persons $f_i$	Class mark $x_i$	$f_i x_i$
40-44	8	42	$8 \times 42 = 336$
44-48	12	46	$12 \times 46 = 552$

48-52	9	50	$9 \times 50 = 450$
52-56	16	54	$16 \times 54 = 864$
56-60	5	58	$5 \times 58 = 290$
	$N = \sum_{i=1}^5 f_i = 50$		$\sum_{i=1}^5 f_i x_i = 2492$

Mean weight:

$$\bar{x} = \frac{\sum_{i=1}^n f_i x_i}{N} = \left(\frac{2492}{50}\right) Kg = 49.84 Kg.$$

Hence, the mean weight is 49.84 Kg.

If the values of  $x$  and  $f$  are large, the calculation of mean by Direct Method (formula (10.1)) is quite time-consuming and tedious. There are much more convenient methods for calculating arithmetic mean- (i) Short-Cut Method, and (ii) Step-Deviation Method.

Consider an example:

**Example 10.4:** The monthly income of 9 persons is (in Rs.) 480, 350, 650, 400, 430, 700, 400, 750, and 520. We know that arithmetic mean **by direct method** calculated as:

$$\bar{x} = \frac{\sum_{i=1}^n x_i}{n} = \frac{480 + 350 + 650 + 400 + 430 + 700 + 400 + 750 + 520}{9} = \frac{4680}{9} = Rs. 520.$$

Now we understand the procedures of calculating arithmetic mean **by Short-Cut Method** as follows:

Let  $x_i$  denote the monthly income. Let  $A$  be any assumed number (often called assumed mean). The difference of each  $x_i$  with  $A$  ( $d = x_i - A$ ) is called deviation of  $x_i$  from  $A$ . After summing all the deviations we get  $\sum d = \sum(x_i - A) = \sum x - A \sum 1 = \sum x - nA$

$$\Rightarrow \frac{\sum d}{n} = \frac{\sum x}{n} - A$$

$$\Rightarrow \frac{\sum x}{n} = A + \frac{\sum d}{n}$$

$$\Rightarrow \bar{x} = A + \frac{\sum d}{n} = A + \bar{d}.$$

$$\bar{x} = A \text{ (assumed mean)} + \bar{d} \text{ (mean of the deviations of } x_i \text{ from } A)$$

Again, coming to the above example let  $A = 500$  be assumed mean (note that the value of  $A$  may be different from individual observations  $x_i$ ).



**Table 10.3**

$x_i$	$A$	$d = x_i - A$
480	500	$480 - 500 = -20$
350	500	$350 - 500 = -150$
650	500	$650 - 500 = 150$
400	500	$400 - 500 = -100$
430	500	$430 - 500 = -70$
700	500	$700 - 500 = 200$
400	500	$400 - 500 = -100$
750	500	$750 - 500 = 250$
520	500	$520 - 500 = 20$
		$\sum d = 180$

Mean of deviations  $\bar{d} = \frac{\sum d}{n} = \frac{180}{9} = 20$ ,

Hence, Mean of observations:

$$\bar{x} = A + \bar{d} = 500 + 20 = 520.$$

Any number can serve the purpose of  $A$  but, usually, the value of  $x$  corresponding to the middle part of the distribution will much more convenient from the point of view of calculation.

The procedures of calculating arithmetic mean **by Step-Deviation Method** as follows:  
 Let  $x_i$  denote the monthly income. Let  $h$  denote any number (often called scale) and  $A$  be any assumed number. Then

$$\begin{aligned} u &= \frac{x - A}{h} \Rightarrow \sum u = \frac{\sum(x - A)}{h} \\ \Rightarrow \frac{\sum u}{n} &= \frac{\sum x}{nh} - \frac{nA}{nh} \\ \Rightarrow \frac{\sum u}{n} &= \frac{\sum x}{nh} - \frac{A}{h} \\ \Rightarrow \bar{u} &= \frac{\bar{x}}{h} - \frac{A}{h} \\ \Rightarrow h\bar{u} &= \bar{x} - A \\ \Rightarrow \bar{x} &= A + h\bar{u}. \end{aligned}$$

In above example, let  $A = 500$  be assumed mean and  $h = 10$  be scale factor.

**Table 10.4**

$x_i$	$A$	$d = x_i - A$	$u = \frac{x_i - A}{h}$
480	500	$480 - 500 = -20$	-2

350	500	$350 - 500 = -150$	-15
650	500	$650 - 500 = 150$	15
400	500	$400 - 500 = -100$	-10
430	500	$430 - 500 = -70$	-7
700	500	$700 - 500 = 200$	20
400	500	$400 - 500 = -100$	-10
750	500	$750 - 500 = 250$	25
520	500	$520 - 500 = 20$	2
			$\sum u = 18$

$$\bar{u} = \frac{18}{9} = 2$$

Hence, Arithmetic Mean  $\bar{x} = A + h\bar{u} = 500 + (10 \times 2) = 500 + 20 = 520$ .

**Remark:** To add or subtract a constant in the value of the variable is called change of origin. To divide or multiply a value by a constant is called change of scale. In Step-Deviation Method we take  $u = \frac{x-A}{h}$ , then it is the change of origin and scale both.

#### **When not to use the mean?**

Consider the wages of 10 staff members at sidkul factory, Rudrapur:

Staff	1	2	3	4	5	6	7	8	9	10
Salary(Rs.)	15000	18000	16000	14000	15000	15000	12000	17000	90000	95000

The mean salary for these ten staff is Rs. 30700. However, inspecting the data suggests that most workers have salaries in the Rs. 12000 to Rs. 18000 range. The mean is being skewed by two large salaries. In this case, arithmetic mean is not the appropriate measure of central tendency. We will find out later that median would be a better measure of central tendency in this situation.

---

## **10.4 MEDIAN**

---

Median of a distribution is the value of that variable which exceeds and is exceeded by the same number of observations. The median is thus a positional average. The median is less affected by the outliers and skewed data.

Now, we will understand (calculate) the median in each type of frequency distribution.

**(i) For ungrouped data:** First arrange the observations in ascending or descending order.

(a) If the number of observations ***N*** is **odd**,

$$\text{Median} = \left( \frac{N+1}{2} \right) \text{th value.}$$

(b) If the number of observations ***N*** is even,

$$\text{Median} = \text{average of 2 middlemost values} = \frac{\left(\frac{N}{2}\right) \text{th value} + \left(\frac{N}{2} + 1\right) \text{th value}}{2}$$

**Example 10.5:** The median of the values 25, 20, 15, 35, 18 is obtained by

(i) Arrange the observations into ascending order.

15, 18, 20, 25, 35

(ii) Here,  $N = 5$  (*odd*). Then

$$\text{Median} = \left(\frac{N + 1}{2}\right) \text{th value} = \left(\frac{6}{2}\right) \text{th value} = (3)\text{rd value} = 20.$$

**(ii) For discrete frequency distribution:** In this case, median is obtained by considering the cumulative frequencies. The steps for calculating median:

(a) Find  $\frac{N}{2}$ , where  $N = \sum f_i$ .

(b) See cumulative frequency (c.f.) just greater than  $\frac{N}{2}$ .

(c) The corresponding value of  $x$  is median.

**Example 10.6:** The median for the following distribution:

x	1	2	3	4	5	6	7	8	9
f	8	10	11	16	20	25	15	9	6

Firstly, we find cumulative frequency for the distribution.

**Table 10.5**

x	f	c.f
1	8	8
2	10	8 + 10 = 18
3	11	18 + 11 = 29
4	16	29 + 16 = 45
5	20	45 + 20 = 65
6	25	65 + 25 = 90
7	15	90 + 15 = 105
8	9	105 + 9 = 114
9	6	114 + 6 = 120
	N = 120	

$$\frac{N}{2} = \frac{120}{2} = 60$$

The cumulative frequency just greater than 60 is 65 and the value corresponding to 65 is 5. Therefore, median is 5.

(iii) **For Continuous frequency distribution:** In case of continuous frequency distribution, the *class corresponding to the c.f just greater than the  $\frac{N}{2}$*  is called the *median class* and the median is,

$$\text{Median} = l + \frac{h}{f} \left( \frac{N}{2} - c \right)$$

where  $l$  is the lower limit of the median class,

$f$  is the frequency of the median class,

$h$  is the magnitude of the median class,

$c$  is the cumulative frequency (c.f) of the class preceding the median class,

and  $N = \sum f$ .

**Example 10.7:** Consider a continuous frequency distribution:

x	2000-3000	3000-4000	4000-5000	5000-6000	6000-7000
f	3	5	20	10	5

First we find cumulative frequencies in the distribution.

**Table 10.6**

x	f	c.f
2000-3000	3	3
3000-4000	5	3 + 5 = 8
4000-5000	20	8 + 20 = 28
5000-6000	10	28 + 10 = 38
6000-7000	5	38 + 5 = 43
	<b><math>N = 43</math>.</b>	

$$\frac{N}{2} = \frac{43}{2} = 21.5$$

Median class = *cumulative frequency just greater than  $\left(\frac{N}{2}\right)$*  = 4000 – 5000..

Here,  $l$  = the lower limit of the median class = 4000,

$f$  = the frequency of the median class = 20,

$h$  = the magnitude of the median class = 5000 – 4000 = 1000,

$c$  = the cumulative frequency (c.f) of the class preceding the median class = 8,

Now,

$$\begin{aligned} \text{Median} &= l + \frac{h}{f} \left( \frac{N}{2} - c \right) = 4000 + \frac{1000}{20} \left( \frac{43}{2} - 8 \right) = 4000 + 50(21.5 - 8) \\ &= 4000 + 50(13.5) = 4000 + 675 = 4675. \end{aligned}$$

**Remark:** If we are given a frequency distribution in which classes are of ‘inclusion type’ with gaps, then it must be converted into a continuous ‘exclusive type’ frequency distribution without any gaps. As an illustration see the following example:

**Example 10.8:**

**Table 10.7**

x	11-15	16-20	21-25	26-30	31-35	36-40
f	3	5	6	9	10	7

We make these classes into a continuous type:

x	f	c.f
10.5-15.5	3	3
15.5-20.5	5	3 + 5 = 8
20.5-25.5	6	8 + 6 = 14
25.5-30.5	9	14 + 9 = 23
30.5-35.5	10	23 + 10 = 33
35.5-40.5	7	33 + 7 = 40
	$N = 40$	

$$\frac{N}{2} = \frac{40}{2} = 20$$

Median class = *cumulative frequency just greater than*  $\left( \frac{N}{2} \right) = 25.5 - 30.5..$

Here,  $l$  = the lower limit of the median class = 25.5,

$f$  = the frequency of the median class = 9,

$h$  = the magnitude of the median class = 30.5 - 25.5 = 5,

$c$  = the cumulative frequency (c.f) of the class preceding the median class = 14,

Now,

$$\begin{aligned} \text{Median} &= l + \frac{h}{f} \left( \frac{N}{2} - c \right) = 25.5 + \frac{5}{9} \left( \frac{40}{2} - 14 \right) = 25.5 + \frac{5}{9} (20 - 14) = 25.5 + \frac{5}{9} (6) \\ &= 25.5 + 3.33 = 28.83. \end{aligned}$$

## 10.5 MODE

Mode is the value which occurs most frequently in a set of observations. In other words, mode of a frequency distribution is the value of the variable corresponding to maximum frequency.

Consider each type of frequency distribution as follows:

**(a) For ungrouped data:** In this case, mode is defined as:

*mode = most frequent occurring value.*

Thus, for the data 18, 19, 21, 21, 22, the value 21 occurs twice, whereas all other values occur only once. So, 21 is the mode.

**(b) For discrete frequency distribution:** Mode is the value of variable corresponding to maximum frequency.

**Example 10.9:** In the following frequency distribution:

x	1	2	3	4	5	6	7	8	9
f	4	9	16	25	22	23	15	6	12

*Mode = Value of variable (x) corresponding to the maximum frequency = 4.*

**Remark:** Consider the following cases:

- (i) If the maximum frequency is repeated,
- (ii) If the maximum frequency occurs in the beginning or at the end of the distribution, and
- (iii) If there are irregularities in the distribution,

the value of mode is determined by the method of grouping which is illustrated below by an example:

**Example 10.10:**

x	4	5	6	7	8	9	10	11	12	13
f	2	5	8	9	12	14	14	15	11	13

**Table 10.8**

x	I	II	III	IV	V	VI
4	2	2 + 5 = 7		2 + 5 + 8 = 15		
5	5		5 + 8 = 13		5 + 8 + 9 = 22	

6	8	8 + 9 = 17				8 + 9 + 12 = 29
7	9		9 + 12 = 21	9 + 12 + 14 = 35		
8	12	12 + 14 = 26			12 + 14 + 14 = <b>40</b>	
9	14		14 + 14 = <b>28</b>			14 + 14 + 15 = <b>43</b>
10	14	14 + 15 = <b>29</b>		14 + 15 + 11 = <b>40</b>		
11	<b>15</b>		15 + 11 = 26		15 + 11 + 13 = 39	
12	11	11 + 13 = 24				
13	13					

In column II, the frequencies of column I are grouped by two's: 2 + 5 = 7, 8 + 9 = 17, 12 + 14 = 26, 14 + 15 = **29** and 11 + 13 = 24.

In column III, after leaving the first frequency 2, other frequencies are grouped by two's: 5 + 8 = 13, 9 + 12 = 21, 14 + 14 = **28**, and 15 + 11 = 26.

In column IV, the frequencies are written down after grouping the frequency of column I in three's starting from first frequency: 2 + 5 + 8 = 15, 9 + 12 + 14 = 35, and 14 + 15 + 11 = **40**.

In column V, after leaving the first frequency 2, the frequencies are grouped by three's: 5 + 8 + 9 = 22, 12 + 14 + 14 = **40**, and 15 + 11 + 13 = 39.

In column VI, the grouping in three's is done after leaving first two frequencies: 8 + 9 + 12 = 29, 14 + 14 + 15 = **43**.

**Table 10.9**

Column Number	Maximum Frequency	Value of x having maximum frequency
I	15	11
II	29	10, 11
III	28	9, 10
IV	40	10, 11, 12
V	40	8, 9, 10
VI	43	9, 10, 11

Here, 10 occurs maximum times. Hence, 10 is the mode.

**(c) For continuous frequency distribution:** A single class with maximum frequency is called *modal class*, and within this class mode is obtained by the following:

$$Mode M_0 = l + \left( \frac{f_1 - f_0}{2f_1 - f_0 - f_2} \times h \right)$$

Where, *l* = lower limit of the modal class,

$h$  = magnitude of the class interval,  
 $f_0$  = frequency of class preceding the modal class,  
 $f_1$  = frequency of the modal class, and  
 $f_2$  = frequency of class succeeding the modal class.

**Example 10.11:** Consider the following continuous distribution:

x	0-10	10-20	20-30	30-40	40-50	50-60	60-70	70-80
f	5	8	7	12	28	20	10	10

Modal Class = 40-50,

$l$  = lower limit of the modal class = 40,  
 $h$  = magnitude of the class interval = 50- 40 = 10,  
 $f_0$  = frequency of class preceding the modal class = 12,  
 $f_1$  = frequency of the modal class = 28,  
 $f_2$  = frequency of class succeeding the modal class = 20,

Now,

$$\text{Mode } M_0 = l + \left( \frac{f_1 - f_0}{2f_1 - f_0 - f_2} \times h \right)$$

$$= 40 + \left( \frac{28 - 12}{2 \times 28 - 12 - 20} \times 10 \right)$$

$$= 40 + 6.666 = 46.67 \text{ (approx.)}$$

**Remarks:** (i) If the values cluster at more than one class interval, we decide the modal class by grouping method. (ii) For symmetrical distribution, **Mean, Median and mode coincide**. (iii) For moderately asymmetrical, we use, **Mode = 3 × Median – 2 × Mean**.

Each measure of central tendency has some advantages and disadvantages. The advantages and disadvantages of various averages are discussed below:

### 10.5.1 Arithmetic Mean

#### Advantages

1. It is rigidly defined.
2. It is based on all the observations made and easily calculated from the data.
3. It is useful to algebraic treatment, i.e., we can obtain the mean of the composite series by using means and sizes of component series.



4. Of all averages, arithmetic mean is affected least by fluctuations of sampling. So, arithmetic mean is a stable average.

### **Disadvantages**

1. It cannot be determined by inspection nor it can be located graphically
2. It cannot be used if we are dealing with qualitative characteristics; such as, intelligence, honesty, beauty etc.
3. It is affected very much by extreme values.
4. It may lead to wrong conclusions if the details of the data from which it is computed are not given.
5. It cannot be calculated if the extreme class is open e.g. below 5 or above 50.
6. In extremely asymmetrical (skewed) distribution, usually arithmetic mean is not a suitable measure of location.

## **10.5.2 Median**

### **Advantages**

1. It is rigidly defined.
2. It is easy to calculate. In some classes it can be located merely by inspection.
3. It is not at all affected by extreme values.
4. It can be calculated for distribution with open end classes.

### **Disadvantages**

1. In case of even number of observations, it cannot be determined exactly.
2. It is not based on all of the observations. It is not so useful for further algebraic treatment.
3. It is affected much by fluctuation of samplings.

**Uses:** Median is the only average to be used while dealing with qualitative data. It is also be used for determining the typical problems concerning wages, distribution of wealth, etc.

## **10.5.3 Mode**

### **Advantages**

1. It is readily comprehensible and easy to calculate.
2. It is not at all affected by extreme values.

### **Disadvantages**

1. Mode is ill-defined. It is not always possible to find a clearly defined mode. In some cases, we may come across distribution with two modes. Such distribution is called bi-modal. If a distribution has more than two modes, it is said to be multi-modal.
2. It is not based upon all the observations.
3. It is not useful of further mathematical treatment.
4. It is affected to greater extent by fluctuations of sampling.

**Uses:** Mode is the average to be used to find ideal size, e.g., in business forecasting, in the manufacture of ready-made garments, shoes, etc.

Now we define two other measures of central tendency for appropriate situations, and will also discuss its advantages and disadvantages.

### 10.5.4 Geometric Mean:

**(a) For ungrouped data:** Let  $x_1, x_2, \dots, x_n$  be the (positive)  $n$  values, then the Geometric mean  $G$  is defined by

$$G = (x_1 \times x_2 \times \dots \times x_n)^{1/n}$$

**Example:** The geometric mean of 4, 8, and 16 is  $G = (4 \times 8 \times 16)^{1/3} = (2^9)^{1/3} = 2^3 = 8$ .

**Remark:** The geometric mean  $G$  can easily be solved by using logarithms as follows:

$$\log G = \frac{1}{n} (\log x_1 + \log x_2 + \dots + \log x_n) = \frac{1}{n} \sum_{i=1}^n \log x_i$$

**(b) For discrete series:** If  $x_1, x_2, \dots, x_n$  occur  $f_1, f_2, \dots, f_n$  times respectively, and  $N$  is total frequency. The geometric mean  $G$  is:

$$G = (x_1^{f_1} \times x_2^{f_2} \times \dots \times x_n^{f_n})^{1/N}, \quad \text{where } N = \sum_{i=1}^n f_i$$

Taking Logarithmic of both sides, we get

$$\log G = \frac{1}{N} (\log(x_1^{f_1} \times x_2^{f_2} \times \dots \times x_n^{f_n}))$$

$$\log G = \frac{1}{N} (f_1 \log x_1 + f_2 \log x_2 + \dots + f_n \log x_n)$$

$$\log G = \frac{1}{N} \left( \sum_{i=1}^n f_i \log x_i \right)$$

Clearly, Logarithmic of geometric mean is arithmetic mean of the logarithms of the given values. Now, geometric mean is:

$$G = \text{Antilog} \left( \frac{1}{N} \left( \sum_{i=1}^n f_i \log x_i \right) \right)$$

(c) **For continuous frequency distribution:** Take  $x$  is the mid value of the class intervals, and proceeds like discrete series.

**Example10.12:** Consider the following continuous distribution:

Class	0-10	10-20	20-30	30-40
f	5	8	3	4

Firstly, we find  $x$ , mid value of each class intervals as:

**Table 10.10**

Class	Mid value (x)	f	log x	f log x
0-10	5	5	log 5 = 0.6990	5 × 0.6990 = 3.4950
10-20	15	8	log 15 = 1.1761	8 × 1.1761 = 9.4088
20-30	25	3	log 25 = 1.3979	3 × 1.3979 = 4.1937
30-40	35	4	log 35 = 1.5541	4 × 1.5541 = 6.2164
		$\sum f = 20$		$\sum f \log x = 23.3139$

$$G = \text{antilog} \left( \frac{1}{N} \left( \sum_{i=1}^n f_i \log x_i \right) \right)$$

$$G = \text{antilog} \left( \frac{1}{20} \times 23.3139 \right) = \text{antilog} (1.1657) = 14.64.$$

### 10.5.5 Harmonic Mean

Harmonic mean of a series of positive values is defined as the reciprocal of the arithmetic mean of their reciprocals.

(a) **For ungrouped data:** Let  $x_1, x_2, \dots, x_n$  be the (positive) n values, the harmonic mean  $H$  is given by:

$$H = \frac{n}{\frac{1}{x_1} + \frac{1}{x_2} + \dots + \frac{1}{x_n}}$$

The harmonic mean of 4, 8 and 16 calculated as:

$$H = \frac{3}{\frac{1}{x_1} + \frac{1}{x_2} + \frac{1}{x_3}} = \frac{3}{\frac{1}{4} + \frac{1}{8} + \frac{1}{16}} = \frac{3}{0.25 + 0.125 + 0.0625} = \frac{3}{0.4375} = 6.855.$$

(b) **For discrete series:** Let  $x_1, x_2, \dots, x_n$  be the (positive)  $n$  values having frequencies  $f_1, f_2, \dots, f_n$  respectively, the harmonic mean is given by:

$$H = \frac{1}{\frac{1}{N} \left( \sum_{i=1}^n \left( \frac{f_i}{x_i} \right) \right)}, \text{ where } N = \sum_{i=1}^n f_i$$

(c) **For continuous frequency distribution:** Take  $x$  is the mid value of the class intervals, and proceeds like discrete series.

**Example 10.13:** Consider the following distribution:

**Table 10.11**

Class	2-4	4-6	6-8	8-10
f	20	40	30	10

Harmonic mean is calculated as follows:

Class	x	f	$\frac{1}{x}$	$f \times \frac{1}{x}$
2-4	3	20	0.3333	$20 \times 0.3333 = 6.666$
4-6	5	40	0.2000	$40 \times 0.2000 = 8.000$
6-8	7	30	0.1428	$30 \times 0.1428 = 4.284$
8-10	9	10	0.1111	$10 \times 0.1111 = 1.111$
		$\sum f = 100$		$\sum f \times \left( \frac{1}{x} \right) = 20.061$

$$\text{Harmonic mean, } H = \frac{1}{\frac{1}{N} \left( \sum_{i=1}^n \left( \frac{f_i}{x_i} \right) \right)} = \frac{1}{\frac{1}{100} (20.061)} = \frac{100}{20.061} = 4.985.$$

**Remarks:** (i) For two observations, we have  $AH = G^2$ , where  $A$  = arithmetic mean,  $H$  = harmonic mean, and  $G$  = geometric mean.

(ii) For  $n$  positive observations  $A \geq G \geq H$ . The sign of equality will hold if and only if the values of all observations are same.

### 10.5.6 Geometric mean

**Advantages**

1. It is rigidly defined.
2. It is based upon all the observations.
3. It is suitable for further mathematical treatment.
4. It is not affected much by fluctuations of sampling.
5. It gives comparatively more weight to small items.

**Disadvantages**

1. It is not easy to understand and to calculate for a non-mathematical person.
2. If any of the observation is zero, geometric mean becomes zero.
3. It cannot be calculated if the number of negative values is odd.

**Uses:** It is used to find the rate of population growth, the rate of the interest and also used in construction of index numbers.

**10.5.7 Harmonic Mean****Advantages**

1. It is rigidly defined.
2. It is based upon all of the observations.
3. It is capable of further algebraic treatment.

**Disadvantages**

1. Harmonic mean is not easily understood and is difficult to compute.

**Uses:** Harmonic mean is useful in cases like finding the average speed when the speed for different parts of the distance is given in distance per unit time.

It may be noted that arithmetic mean is the most convenient and widely used form of the average and should always be used unless there are strong reasons in some particular case against it.

---

**10.6 SUMMARY**

---

From the chapter discussion, it is evident that no single average is suitable for all practical purposes. Each one of the averages has its own merits and demerits and thus its own particular field of importance and utility. A judicious selection of the average depending upon the nature of the data is essential. For this, we discussed the three main measures of central tendency mean, median, and mode. However, of all the averages, arithmetic mean is affected least by fluctuations of sampling. In other words, Arithmetic mean is a stable average and satisfies all the properties for an ideal average. Median is the only average to be used while dealing with qualitative data. It is also be used for determining the typical value in the problems concerning wages, distribution

of wealth, etc. Mode is the average to be used to find ideal sizes, e.g., in business forecasting, in the manufacture of ready garments, shoes, etc.

---

## 10.7 GLOSSARY

---

**Frequency:** The number of occurrences of the variable is called its frequency.

**Frequency Distribution:** It is an arrangement of data according to the number (called frequency) possessing the individual or grouped values of the variable. In other words, a tabular form of the data in which the frequencies of the values of a variable are given along with them.

**Bimodal:** A curve has two modes (maxima).

**Multimodal:** A curve has more than two modes (maxima).

**Class mark:** Mid value of the class interval is class-mark.

**Fluctuations:** Rise or fall in quantities called fluctuations.

**Logarithmic:** The logarithm of a number is the exponent to which another fixed number, the *base*, must be raised to produce that number. We know that  $2^6 = 64$ , logarithmic of 64 is the exponent (6) to the base (2), i.e.,  $\log_2 64 = 6$ . The logarithmic to base 10 is called common logarithmic and logarithmic to base e (approx. 2.718) is natural logarithmic.

**Antilogarithmic:** If  $\log x = M$ , then antilog is defined as  $\text{Antilog}(M) = x$ .

---

## 10.8 SELF ASSESSMENT QUESTION

---

### 10.8.1 Indicate the correct answer:

1. The mean of first 10 natural numbers

- |         |        |
|---------|--------|
| (a) 8   | (b) 10 |
| (c) 5.5 | (d) 0  |

2. The mean of 100 observations is 50. What will be the new mean if 5 is added to each observation?

- |          |         |
|----------|---------|
| (a) 50   | (b) 55  |
| (c) 50.5 | (d) 250 |

3. The mean of 100 observations is 50. What will be the new mean if each observation is multiplied by 3?

- |         |   |
|---------|---|
| (a) 150 | (b) 300                                 |
| (c) 50  | (d) Data is insufficient for prediction |

4. The most stable measure of central tendency is

- |              |                   |
|--------------|-------------------|
| (a) The mean | (b) The median    |
| (c) The mode | (d) None of these |

5. The mean weight of 150 students in a certain class is 60 kilograms. The mean weight of boys in the class is 70 kilograms and that of the girls is 55 kilograms. The number of boys and number of girls in the class:

- (a) There are 50 boys and 100 girls in the class.
- (b) There are 100 boys and 50 girls in the class.
- (c) There are 75 boys and 75 girls in the class.
- (d) Data is insufficient for predicting the number of boys and girls.

6. The mean of 10 observations is 15. On checking it was found that two observations were wrongly copied as 3 and 6. If wrong observations are replaced by corrected values 8 and 4, then the corrected mean is ...

- (a) 15
- (b) 18
- (c) 15.3
- (d) 14.6

7. The geometric mean of 2, 4, 16, and 32 is ...

- (a) 2
- (b) 8
- (c) 16
- (d) 4

8. The point of intersection of the 'less than' and the 'more than' ogive corresponds to

- (a) The mean
- (b) The median
- (c) The geometric mean
- (d) None of these

9. The harmonic mean of  $n$  numbers is

- (a) 0
- (b) The reciprocal of the arithmetic mean of the numbers
- (c) The reciprocal of the arithmetic mean of the reciprocals of the numbers
- (d) None of these

10. Algebraic sum of the deviations of values 5, 6, 10, 10, 4 from their arithmetic mean is

- (a) 0
- (b) 1
- (c) -1
- (d) None of these

**10.8.1 Answer Key:** 1. (c), 2. (b), 3. (a), 4. (a), 5. (a), 6. (c), 7. (b), 8. (b), 9. (c), 10. (a)

### 10.8.2 Long Answer type Questions:

1. What is the arithmetic mean of first  $n$  natural numbers?
2. Find the geometric mean of 6, 12, and 24.

3. What are the main characteristics for satisfactory averages? Point out the special characteristics of arithmetic mean, median and mode.

4. Find the median from the following table-

Marks	0-10	10-20	20-30	30-40	40-50	50-60	60-70	70-80
No. of student	2	18	30	45	35	20	6	3

5. Write the relationship between mean, median and mode for a symmetrical distribution.

6. Give an example in which arithmetic mean is not the suitable measure of central tendency.

7. Give a frequency distribution that has bi-modal curve.

8. We know that arithmetic mean may or may not belong to the data set. Give an example for each case.

9. Give a frequency distribution in which arithmetic mean does not belong to data set. Calculate its median, also draw the graph showing median and mean. What do you observe about mean and median?

10. Calculate the arithmetic mean (A.M), geometric mean (G.M) and harmonic mean (H.M) in each case and show that  $A.M \geq G.M \geq H.M$ .

(i) 32, 35, 36, 37, 39, 41, 43.

(ii) 8, 8, 8, 8, 8, 8, 8, 8.

What do you observe in case (ii)?

---

## 10.9 REFERENCES

---

- Gupta S. C, Kapoor V. K., Fundamentals of mathematical statistics, Sultan Chand & Sons, India, 11 (2006).
- Gupta C.B., An Introduction to statistics methods, Viks Publishing House Pvt Ltd, India, 9 (1981). Goyal J. K., Sharma J. N., Mathematical statistics, Krishna prakashan media (P) Ltd., India, 25 (2009).
- Kumar R., Statistics, Vardhman publications, Delhi, India, (2013).
- Ray M., Sharma H. S., Mathematical statistics, Ram prasad& sons, Agra, India, 11.
- Kothari, C.R., Research Methodology Methods and Techniques, New Age International (P) Ltd., New Delhi, (2004).

---

## 10.10 SUGGESTED READINGS

---



- S. C. Gupta and V. K. Kapoor: Fundamentals of Mathematical Statistics
- Ray, Sharma and Chaudhary: Mathematical Statistics
- tutorials.istudy.psu.edu.
- R. Kumar: Statistics
- <https://en.wikipedia.org/wiki/Wikipedia:Statistics>
- [bobhall.tamu.edu/FiniteMath/Module8/Introduction.html](http://bobhall.tamu.edu/FiniteMath/Module8/Introduction.html)

### ***10.11 TERMINAL QUESTIONS***

1. Which measure is suitable to compare?

- i. Heights of students in two-classes.
- ii. Intelligence of students.
- iii. Size of agricultural holdings.

2. 10 is the mean of a set of 7 observations and 5 is the mean of a set of 3 observation. Find the mean of the combined set.

3. If the mean of the following distribution is 50, find the value of  $p$ .

x	10	30	50	70	90
f	17	28	32	$p$	19

4. The heights of plants (in cm) in a nursery are given below:

Height	28	30	32	34	36
No. of plants	36	47	80	58	72

Calculate the mean, median and mode.

---

# UNIT-11 MEASURES OF DISPERSIONS AND DEVIATIONS

---

11.1-Objectives

11.2-Introduction

11.3- Measures of dispersion

11.4- Measures of deviations

11.4.1-Range

11.4.2-Mean deviation

11.4.3-Standard deviation

11.5- Summary

11.6- Glossary

11.7-Self Assessment Question

11.8- References

11.9-Suggested Readings

11.10-Terminal Questions

---

## ***11.1 OBJECTIVES***

---

After reading this unit, students will be able:

- To understand the concept of dispersion and significance of measuring it.
- to learn to compute the different measures of dispersion, viz., range, mean deviation, and standard deviation, for different types of data.
- to discuss use of an appropriate measure of dispersion under different situations, and understand the use of measures of dispersion in comparing variability of different distribution.

---

## ***11.2 INTRODUCTION***

---

In the previous unit, we studied the various measure of central tendency of the given frequency distribution. Now, we understand how the values of the variate are dispersed about the central values. Let us consider the average income of a number of persons is Rs. 150 per day. It does not give an idea whether a large number among them are earning nearly this amount or some of them may be earning in thousands while a number of them very small amounts bringing the averages to Rs. 150. The measures of dispersion tell us about the distribution.

Averages give us an idea of the concentration of the observations about the central part of the distribution. If we know the average alone, we cannot form a complete idea about the distribution. For example consider the series (i) 1, 2, 3, 4, 5, (ii) 2, 3, 2, 3, 5, (iii) 1, 3, 3, 5, 3. In all three cases, number of observations are 5, and mean is 3. If we are given that mean of the 5 observations is 3, we cannot decide whether it is first series, or second series, or third series. Thus we observe that the measures of central tendency are inadequate to give us a complete idea of distribution. They must be supported and supplemented by some other measures. One such measure is Dispersion.

---

## ***11.3 MEASURES OF DISPERSION***

---

The property which denotes the extent to which the values are dispersed about the central value is termed as dispersion. In other words, the deviations from a measure of central tendency or any other fixed value are not uniform in their size. The scatteredness of these deviations is also referred to as dispersion.

According to Simpson and Kafka “The measure of scatteredness of the mass of the figures in a series about an average is called the measure of variation or dispersion.”

### **11.3.1 Characteristics for an ideal measure of Dispersion:**

1. It should be rigidly defined.
2. It should be easy to calculate and easy to understand.

3. It should be based on all of the observations.
4. It should be amenable to algebraic treatment.
5. It should be affected by as little as possible by fluctuations of samplings.

The commonly used measures of dispersion are

- i. Range
- ii. Quartile deviation
- iii. Mean deviation
- iv. Standard deviation

---

## 11.4 MEASURES OF DEVIATIONS

---

We will discuss Range, Mean deviation, and standard deviation one by one in the following section.

### 11.4.1- Range

The simplest measure of dispersion is the range which is the difference between the greatest and the least values of the variable.

*Range = greatest value – least value*

$$= x_{max} - x_{min}.$$

For the series: 8, 9, 14, 10, 12, 7, the *Range = greatest value – least value = 14 – 7 = 7*.

**Remarks:** Range is the simplest but it has some drawbacks. The range is subject to fluctuations of considerable magnitude from sample to sample. It takes into account only the extreme items. It is not a reliable measure of dispersion.

### 11.4.2- Mean deviation

Mean deviation about any point  $A$  is a mean of the all deviations (positive) from point  $A$ .

$$\text{Mean deviation} = \frac{1}{N} \sum |x - A|.$$

(i) **For ungrouped data:** Consider the data set- 2, 3, 3, 5, 3, the mean deviation about point 3 is mean of the all deviations from point 3.

In first step, we calculate the deviation (positive) from point  $A = 3$ , i.e.,  $|2 - 3| = 1, |3 - 3| = 0, |3 - 3| = 0, |5 - 3| = 2$ , and  $|3 - 3| = 0$ .

Then, take the mean of these deviations as follows:

$$\text{Mean deviation about point} = \frac{1 + 0 + 0 + 2 + 0}{5} = 0.60.$$

(ii) **For discrete series:** Let the frequencies of  $n$  observations  $x_1, x_2, \dots, x_n$  be  $f_1, f_2, \dots, f_n$  respectively.

Variable $x_i$	$x_1$	$x_2$	...	$x_n$
Frequency $f_i$	$f_1$	$f_2$	...	$f_n$

We calculate mean deviation about any point  $A$  in the following steps:

(i) Firstly, we calculate the positive deviations from  $A$ , i.e.,  $|x_i - A|$ .

(ii) then, find the mean of all deviations  $|x_i - A|$ , with frequencies  $f_i, (i = 1, 2, 3, \dots)$ , i.e.,

$$\text{Mean deviation about } A = \frac{1}{N} \sum_{i=1}^n f_i |x_i - A|, \quad \text{where } N = \sum_{i=1}^n f_i.$$

**Example 11.1:** Consider the following distribution:

X	6	12	18	24	30	36	42
f	4	7	9	18	15	10	5

Mean deviation about any point (*here, Let  $A = \text{median}$* ) is calculated as:

**Table 11.1**

x	F	c.f	$ x - A $	$f x - A $
6	4	4	18	72
12	7	11	12	84
18	9	20	6	54
24	18	38	0	0
30	15	53	6	90
36	10	63	12	120
42	5	68	18	90
<b>Total</b>	<b>68</b>			<b>510</b>

Firstly we calculate,  $A = \frac{N}{2} \text{th value} = \frac{68}{2} \text{th value} = 34 \text{th value}$   
 $= \text{the value corresponding to c.f just greater than } 34 = 24.$

Then,

$$\text{Mean deviation about } A = \frac{1}{N} \sum_{i=1}^n f_i |x_i - A| = \frac{1}{68} \times 510 = 7.5.$$

**Example 11.2:** Find the mean deviation from the arithmetic mean for the following data which represents the circumference (in cm) for the necks of set of students-

Circumference x	30	31.5	33	34.5	36	37.5	39	40.5
No. of students f	4	19	30	63	66	29	18	1

Solution:

**Table 11.2**

$x$	$f$	$d = x - A$	$fd$	$x - \bar{x}$	$f x - \bar{x} $
30	4	-6	-24	-5	20
31.5	19	-4.5	-85.5	-3.5	66.5
33	30	-3	-90	-2	60
34.5	63	-1.5	-94.5	-0.5	31.5
36	66	0	0	1	66
37.5	29	1.5	43.5	2.5	72.5
39	18	3.0	54	4	72
40.5	1	4.5	4.5	5.5	5.5
	$N = \sum f = 230$		$\sum fd = -192$		$\sum f x - \bar{x}  = 394$

Arithmetic Mean,  $\bar{x} = A + \frac{\sum fd}{N} = 36 - \frac{192}{230} = 36 - 0.84 = 35.16 = 35 \text{ cm}(\text{approx.})$ .

Mean deviation  $\frac{1}{N} \sum_{i=1}^n f_i |x_i - \bar{x}| = \frac{394}{230} = 1.713 \text{ cm}$ .

**(iii) For continuous frequency distribution:** In a grouped series the frequencies of a certain group are taken as if they are concentrated at the mid value of that group (Class mark ( $x_i$ )). Then the formula for discrete case is applied.

**Example 11.3:** Calculate mean deviation from the arithmetic mean of the following distribution-

Marks	0-10	10-20	20-30	30-40	40-50
No. of Students	5	8	15	16	6

Solutions:

**Table 11.3**

Class	Mid value $x$	Frequency $f$	$u = \frac{x - A}{i}$	$fu$	$x - M$	$f(x - M)$
0-10	5	5	-2	-10	-22	110

10-20	15	8	-1	-8	-12	96
20-30	25	15	0	0	-2	30
30-40	35	16	1	16	8	128
40-50	45	6	2	12	18	108
<b>Total</b>	-	<b>50</b>	-	<b>10</b>		<b>472</b>

Arithmetic mean,  $M = A + \frac{\sum fu}{N} \times i = 25 + \frac{10 \times 10}{50} = 25 + 2 = 27.$

Mean deviations from Mean,

$$\frac{1}{N} \sum_{i=1}^n f_i |x_i - A| = \frac{472}{50} = 9.44.$$

**Example 11.4:** Find the average deviation from mean of the following frequency distribution-

Class	0-6	6-12	12-18	18-24	24-30
Frequency	8	10	12	9	5

Class	Mid-value	$f$	$d = x - A$	$fd$	$x - M$	$f x - M $
0-6	3	8	-12	-96	-11	88
6-12	9	10	-6	-60	-5	50
12-18	15	12	0	0	1	12
18-24	21	9	6	54	7	63
24-30	27	5	12	60	13	65
<b>Total</b>		<b>44</b>		<b>-42</b>		<b>278</b>

**Table 11.4**

$$\text{Mean} = A + \frac{1}{N} \sum fd = 15 - \frac{42}{44} = 14.1 = 14 \text{ nearly.}$$

Average deviation from the mean

$$d = \frac{1}{N} \sum f|x - M| = \frac{278}{44} = 6.3.$$

**Remarks :**(i) Since mean deviation is based on the all of the observations, it is a better measure of dispersion than range. But the step of ignoring the signs of the deviations( $x_i - A$ ) creates artificially and renders it useless for further mathematical treatment.

(ii) Mean deviation is least when taken from median.

### 11.4.3- Standard deviation

Standard deviation ( $\sigma$ ), is the positive square root of the arithmetic mean of the squares of the given values from their arithmetic mean

We will calculate the standard deviation of the frequency distribution in the following steps:

**Step 1.** Firstly, we find arithmetic mean ( $\bar{x}$ ) of the given frequency distribution.

**Step 2.** Deviations of all variates from the arithmetic mean, i.e.,  $(x_i - \bar{x})$ .

**Step 3.** Square the deviations calculated in step 2, i.e.  $(x_i - \bar{x})^2$ .

**Step 4.** Arithmetic mean of these squared deviations.

**Step 5.** Square root of the mean calculated in step 4.

We will understand this procedure with an example.

(i) **For ungrouped data:** Consider the set of observations 3, 4, 9, 11, 13, 6, 8, and 10.

**Table 11.5**

$x$	$x - \bar{x}$	$(x - \bar{x})^2$
3	$3 - 8 = -5$	25
4	$4 - 8 = -4$	16
9	$9 - 8 = 1$	1
11	$11 - 8 = 3$	9
13	$13 - 8 = 5$	25
6	$6 - 8 = -2$	4
8	$8 - 8 = 0$	0
10	$10 - 8 = 2$	4
64		$\sum (x - \bar{x})^2 = 84.$

Step 1. Arithmetic mean ( $\bar{x}$ ) of the given frequency distribution is:

$$\bar{x} = \frac{1}{N} \sum x_i = \frac{1}{8} \times 64 = 8.$$

Step 2. Deviations of all variates from the arithmetic mean, i.e.,  $(x_i - \bar{x})$  are calculated in the second column of the above table.

Step 3. Squared deviations  $(x_i - \bar{x})^2$ , are in the third column of the table.

Step 4. Arithmetic mean of these squared deviations is given by:



$$\sigma^2 = \frac{1}{n} \sum (x_i - \bar{x})^2 = \frac{84}{8} = 10.5.$$

Step 5. Square root of the mean calculated in step 4 is standard deviation and given by:

$$\sigma = \sqrt{10.5} = 3.24.$$

**Note:** The Square of standard deviation is called the variance and is given by:

$$\text{variance} = \sigma^2 = \frac{1}{n} \sum (x_i - \bar{x})^2$$

**Note:** There are four Methods of calculating standard deviation:

1. Direct Method:  $\sigma = \sqrt{\frac{1}{N} \sum (x - \bar{x})^2}$ , where  $\bar{x}$  = arithmetic mean.

2. Without finding out deviation or taking deviation about origin

$$\sigma = \sqrt{\frac{1}{N} \sum x^2 - \left(\frac{\sum x}{N}\right)^2}$$

$$\sigma = \sqrt{\frac{1}{N} \sum x^2 - (\bar{x})^2}, \text{ where } \bar{x} = \text{arithmetic mean.}$$

3. By changing origin, deviations from any point A.

$$\sigma = \sqrt{\frac{1}{N} \sum d^2 - \left(\frac{\sum d}{n}\right)^2}, \text{ where } d = x - A$$

4. By changing origin and scale.

$$\sigma = h \sqrt{\frac{1}{N} \sum u^2 - \left(\frac{\sum u}{n}\right)^2}, \text{ where } u = \frac{(x - A)}{h}$$

**(ii) For discrete series:** The standard deviation for discrete series is given by

$$\sigma = \sqrt{\frac{1}{N} \sum f_i (x_i - \bar{x})^2}, \quad \text{where } N = \sum_{i=1}^n f_i.$$

**Note:** In case of discrete series, the formulae written in various forms as given below:

1. Direct Method:  $\sigma = \sqrt{\frac{1}{N} \sum f(x - \bar{x})^2}$ , where  $\bar{x}$  = arithmetic mean.

2. Without finding out deviation or taking deviation about origin

$$\sigma = \sqrt{\frac{1}{N} \sum fx^2 - \left(\frac{\sum fx}{N}\right)^2}$$

$$\sigma = \sqrt{\frac{1}{N} \sum fx^2 - (\bar{x})^2}, \text{ where } M = \text{arithmetic mean.}$$

3. By changing origin, deviations from any point A.

$$\sigma = \sqrt{\frac{1}{N} \sum fd^2 - \left(\frac{\sum fd}{N}\right)^2}, \text{ where } d = x - A$$

4. By changing origin and scale.

$$\sigma = h \sqrt{\frac{1}{N} \sum fu^2 - \left(\frac{\sum fu}{N}\right)^2}, \text{ where } u = \frac{(x - A)}{h}$$

Example 11.5: Consider an example of the following frequency distribution:

x	0	4	5	8	9	13
f	5	6	1	4	7	2

Firstly, we make table:

**Table 11.5**

x	f	fx	$x_i - \bar{x}$	$(x_i - \bar{x})^2$	$f_i(x_i - \bar{x})^2$
0	5	0	0 - 6 = -6	36	180
4	6	24	4 - 6 = -2	4	24
5	1	5	5 - 6 = -1	1	1
8	4	32	8 - 6 = 2	4	16
9	7	63	9 - 6 = 3	9	63
13	2	26	13 - 6 = 7	49	98
	$\sum f = 25$	$\sum fx = 150$			$\sum f_i(x_i - \bar{x})^2 = 382$

Arithmetic mean  $\bar{x} = \frac{\sum fx}{\sum f} = \frac{150}{25} = 6$ .

Standard deviation  $\sigma = \sqrt{\frac{1}{N} \sum f_i(x_i - \bar{x})^2} = \sqrt{\frac{1}{25} \times 382} = \sqrt{15.28} = 3.91$ .

(iii) **For continuous frequency distributions:** In a grouped series the frequencies of a certain group are taken as if they are concentrated at the mid value of that group (Class mark ( $x_i$ )). Then the formula for discrete case is applied.

**Example 11.6:** Calculate the standard deviation for the following frequency distribution-

Class	0-10	10-20	20-30	30-40	40-50	50-60	60-70	70-80
Frequency	5	10	20	40	30	20	10	5

**Solution:**

**Table 11.6**

Class	Mid-value	$f$	$u = \frac{x - 35}{10}$	$fu$	$fu^2$
0-10	5	5	-3	-15	45
10-20	15	10	-2	-20	40
20-30	25	20	-1	-20	20
30-40	35	40	0	0	0
40-50	45	30	1	30	30
50-60	55	20	2	40	80
60-70	65	10	3	30	90
70-80	75	5	4	20	80
<b>Total</b>		<b>140</b>		<b>65</b>	<b>385</b>

Assumed mean,  $A = 35$  and common factor  $h = 10$ .

$$\text{Mean, } M = A + h \frac{\sum fu}{N} = 35 + 10 \left( \frac{65}{140} \right) = 35 + 4.64 = 39.64$$

$$\text{Standard deviation, } \sigma = h \sqrt{\frac{\sum fu^2}{N} - \left( \frac{\sum fu}{N} \right)^2} = 10 \sqrt{\frac{385}{140} - (0.464)^2}$$

$$= 10 \sqrt{2.74 - 0.215}$$

$$= 10 \sqrt{2.535}$$

$$= 10 \times 1.59$$

$$= 15.9.$$

**Example 11.7:** Find the standard deviation of the following distribution-

Marks (above)	0	10	20	30	40	50	60	70
No. of students	100	90	75	50	25	15	5	0

Solutions:

Table 11.7

Class	Mid-value(x)	$f$	$u = \frac{x - 35}{10}$	$fu$	$fu^2$
0-10	5	$100 - 90 = 10$	-3	-30	90
10-20	15	$90 - 75 = 15$	-2	-30	60
20-30	25	$75 - 50 = 25$	-1	-25	25
30-40	35	$50 - 25 = 25$	0	0	0
40-50	45	$25 - 15 = 10$	1	10	10
50-60	55	$15 - 5 = 10$	2	20	40
60-70	65	$5 - 0 = 5$	3	15	45
Total		$\sum f = 100$		$\sum fu = -40$	$\sum fu^2 = 270$

Here, assumed mean,  $A = 35$ , and common factor,  $h = 10$ .

Standard deviation is given by

$$\sigma = h \sqrt{\frac{1}{N} \sum fu^2 - \left(\frac{\sum fu}{N}\right)^2} = 10 \sqrt{\frac{270}{100} - \left(\frac{-40}{100}\right)^2} = 10 \sqrt{2.7 - 0.16} = 10 \sqrt{2.54} = 15.94.$$

**Note:** Standard deviation is independent from the change of origin but dependent of the changing the scale.

**Remarks:** (i) The step of squaring the deviations  $(x_i - \bar{x})$  overcomes the drawback of ignoring the signs in mean deviation. Standard deviation is also suitable for further mathematical treatment. Moreover, of all the measures, standard deviation is affected least by fluctuations of sampling.

(ii) It is an ideal measure of dispersion except for calculating the square root which is not readily comprehensible for a non-mathematical person.

(iii) The root mean square deviation denoted by  $s$ , is defined as the positive square root of the mean of the square of the deviations from an arbitrary point. i.e.,  $s = \sqrt{\frac{1}{N} \sum f_i (x_i - A)^2}$ .

(iv) The relation between  $s$ , and  $\sigma$  is  $s^2 = \sigma^2 + d^2$ , where  $d = \bar{x} - A$ .

Now, we understand the term 'Quartile deviation' as follows:

There are the values of the variate which divides the total frequency into a number of equal parts. Some of them are quartiles, deciles and percentiles.

**Quartiles:** Quartiles are those values of the variate which divide the total frequency into four equal parts. Median is that value of the variate which divides total frequency into two equal parts. When the lower half before the median is divided into two equal parts the value of the dividing variate is called Lower Quartile and is denoted by  $Q_1$ . The value of the variate dividing the upper half is called the Upper Quartile and is denoted by  $Q_3$ . The formulae for computation are:

$$Q_1 = l + \frac{\left(\frac{1}{4}N - F\right)}{f} \times i$$

$$Q_3 = l + \frac{\left(\frac{3}{4}N - F\right)}{f} \times i$$

**Deciles:** Deciles are those values of the variate which divide the total frequency into 10 equal parts. Thus, the first decile is given by

$$D_1 = l + \frac{\left(\frac{1}{10}N - F\right)}{f} \times i,$$

The second decile is given by:

$$D_2 = l + \frac{\left(\frac{2}{10}N - F\right)}{f} \times i, \text{ etc.}$$

**Percentiles:** Percentiles are the values of the variate which divide the total frequency into 100 equal parts. Thus,

The first percentile is given by,

$$P_1 = l + \frac{\left(\frac{1}{100}N - F\right)}{f} \times i,$$

The second percentile is given by,

$$P_2 = l + \frac{\left(\frac{2}{100}N - F\right)}{f} \times i, \text{ etc.}$$

Where,  $l$  = lower limit of median class,

$f$  = frequency of median class,

$i$  = width of the median class,

$F$  = cumulative frequency of the class preceding the median class, that is, total of all frequencies before the median class.

$N$  = Total frequency.

**Example 11.8:** Calculate median, lower quartile and upper quartile for the following data-

Class	0-4	4-6	6-8	8-12	12-18	18-20
Frequency	4	6	8	12	7	2

Here, the class intervals are unequal. However, there is no need to make them equal

**Table 11.8**

Class	Frequency	Cumulative frequency
0 - 4	4	4
4 - 6	6	4 + 6 = 10
6 - 8	8	10 + 8 = 18
8 - 12	12	18 + 12 = 30
12 - 18	7	30 + 7 = 37
18 - 20	2	37 + 2 = 39
<b>Total</b>	<b>39</b>	

(i) For median,  $\frac{N}{2} = \frac{39}{2} = 19.5$

19.5<sup>th</sup> item lies in the class 8 – 12. Thus

$$\text{Median} = l + \frac{\left(\frac{N}{2} - F\right)}{f} \times i = 8 + \frac{19.5 - 18}{12} \times 4 = 8 + 0.5 = 8.5.$$

(ii) For lower quartile,  $\frac{N}{4} = \frac{39}{4} = 9.75$

9.75<sup>th</sup> item lies in the class 4 – 6. Thus

$$Q_1 = l + \frac{\left(\frac{1}{4}N - F\right)}{f} \times i = 4 + \frac{9.75 - 4}{6} \times 2 = 4 + 1.93 = 5.93.$$

(iii) For upper quartile,  $\frac{3N}{4} = 29.25$

29.5<sup>th</sup> item lies in the class 8 – 12. Thus

$$Q_3 = l + \frac{\left(\frac{3}{4}N - F\right)}{f} \times i = 8 + \frac{29.25 - 18}{12} \times 4 = 8 + 3.75 = 11.75.$$

### Quartile deviation or Semi-interquartile Range

The difference between the upper and lower quartiles, i.e.,  $Q_3 - Q_1$  is known as the **interquartile range** and the 50% of the total frequency lies in this range. Half of the interquartile range i.e., half of the difference  $Q_3 - Q_1$  is called the **semi-interquartile range or the quartile deviation**.

Thus, quartile deviation, denoted by Q. D., is given by

$$Q.D. = \frac{1}{2}(Q_3 - Q_1)$$

The quartile deviation is easily computed and is better measure of dispersion than range. However, it does not take into account all the items.

The difference between the ninth and the first decile is called as inter-decile range and 80% of total frequency lies in this range.

**Example 11.9:** Calculate range, interquartile range and quartile deviation for the marks of 63 students in statistics given below-

Marks-group	0-10	10-20	20-30	30-40	40-50	50-60	60-70	70-80	80-90	90-100
No. of Students	5	7	10	16	11	7	3	2	2	0

Solution:

**Table 11.9**

Marks	Frequency	Cumulative frequency
0-10	5	5
10-20	7	12
20-30	10	22
30-40	16	38
40-50	11	49
50-60	7	56
60-70	3	59
70-80	2	61
80-90	2	63
90-100	0	63
<b>Total</b>	<b>63</b>	

Smallest value = lower limit of the class interval 0-10 = 0,

Greatest value = upper limit of the class interval 90-100 = 100,

Range = greatest value – smallest value = 100 – 0 = 100.

$Q_1$  = The marks of  $\frac{(63+1)}{4}$ th student = The marks of 16<sup>th</sup> student are in 20-30 marks group.

$$Q_1 = l + \frac{\left(\frac{1}{4}N - F\right)}{f} \times i = 20 + \frac{(15.75 - 12)}{10} \times 10 = 23.75.$$

$Q_3$  = The marks of  $\frac{3}{4}(63 + 1)$ th student = The marks of 48<sup>th</sup> student are in 40-50 marks group.

$$Q_3 = l + \frac{\left(\frac{3}{4}N - F\right)}{f} \times i = 40 + \frac{(47.75 - 38)}{11} \times 10 = 48.4.$$

Interquartile range =  $Q_3 - Q_1 = 48.4 - 23.75 = 24.65$  marks.

Quartile deviation =  $Q.D. = \frac{1}{2}(Q_3 - Q_1) = \frac{1}{2}(48.4 - 23.75) = 12.325$ .

### Absolute and Relative Measures of Dispersion

The measures of dispersion given above, (Range, Interquartile Range, Quartile Deviation, Mean Deviation and Standard Deviation) are called absolute measures of dispersion. The absolute measures are expressed in terms of the units of the observations (Rs, cm, km, degree Celsius, etc). It is thus impossible to compare dispersion in different units. For example there is no comparison possible between centimeters and kilograms. Moreover the measures of dispersion depend on the measures of central tendency or any other point. For this reason it has been suggested that some measures which are independent of the units of measurements and can be adjusted for measures of central tendency should be used. Such measures are called relative measures of dispersion or coefficients of dispersion. They are pure numbers and are usually expressed as percentages. Thus these measures are useful for comparing two series expressed in different units and they are also useful when we are comparing the variations of two series which have quite different magnitudes even when the units of original measurements are same. The most common relative measures of dispersion are-

1. Range Coefficient of Dispersion =  $\frac{\text{Difference between extreme values}}{\text{Sum of the extreme values}} = \frac{x_{\max} - x_{\min}}{x_{\max} + x_{\min}}$
2. Quartile Coefficient of Dispersion =  $\frac{\left(\frac{Q_3 - Q_1}{2}\right)}{\left(\frac{Q_3 + Q_1}{2}\right)} = \frac{Q_3 - Q_1}{Q_3 + Q_1}$
3. Coefficient of Mean Dispersion =  $\frac{\text{Mean deviation about any point A}}{A}$

In place of any point A, we can take mean, median, mode etc.

4. Standard Coefficient of Dispersion or Coefficient of Variation

**Coefficient of variation** is the percentage variation in the mean, standard deviation being considered as the total variation in the mean.



$$\text{Coefficient of variation} = \frac{\sigma}{\bar{x}} \times 100$$

Where  $\sigma$  = standard deviation, and  $\bar{x}$  = mean of the distribution.

**Note:** For comparing the variability of two series, we calculate the coefficient of variations for each series. The series having greater C.V is said to be more variable than the other and the series having lesser C.V is said to be more consistent (or homogeneous) than the other.

**Example 11.10:** Calculate the standard deviation and coefficient of variation for the following frequency distribution-

Class	0-10	10-20	20-30	30-40	40-50	50-60	60-70	70-80
Frequency	5	10	20	40	30	20	10	5

See Example standard deviation = 15.9, Mean = 39.64.

$$\text{Coefficient of variation} = \frac{\sigma}{\bar{x}} \times 100 = \frac{15.9}{39.64} \times 100 = 40.11.$$

**Example 11.11:** Calculate the standard deviation of the following two series. Which shows greater deviations?

Series A	192	288	236	229	184	260	348	291	330	243
Series B	83	87	93	109	124	126	126	101	102	108

Solution:

For series A

**Table 11.10**

X	$d = x - 260$	$d^2$
192	-68	4624
288	28	784
236	-24	576
229	-31	961
184	-76	5776
260	0	0
348	88	7744
291	31	961
330	70	4900
243	-17	289
$\sum x = 2601$	$\sum d = 1$	$\sum d^2 = 26615$

$$\text{Mean } \bar{x} = \frac{\sum x}{N} = \frac{2601}{10} = 260.1$$

$$\text{Variance } \sigma^2 = \frac{1}{N} \sum d^2 - \left( \frac{\sum d}{N} \right)^2 = \frac{1}{10} \times 26615 - \left( \frac{1}{10} \right)^2 = 2661.5 - 0.01 = 2661.49.$$

$$\text{Standard deviation } \sigma = \sqrt{\frac{1}{N} \sum d^2 - \left( \frac{\sum d}{N} \right)^2} = \sqrt{2661.49} = 51.6.$$

$$\text{coefficient of variation} = \frac{\sigma}{\bar{x}} \times 100 = \frac{51.6}{260.1} \times 100 = 19.8.$$

For series B

**Table 11.11**

X	$d = y - 105$	$d^2$
83	-22	484
87	-18	324
93	-12	144
109	4	16
124	19	361
126	21	441
126	21	441
101	-4	16
102	-3	9
108	3	6
$\sum y = 1059$	$\sum d = 9$	$\sum d^2 = 2245$

$$\text{Mean } \bar{y} = \frac{\sum y}{N} = \frac{1059}{10} = 105.9$$

$$\text{Variance } \sigma^2 = \frac{1}{N} \sum d^2 - \left( \frac{\sum d}{N} \right)^2 = \frac{1}{10} \times 2245 - \left( \frac{9}{10} \right)^2 = 224.5 - 0.81 = 223.69.$$

$$\text{Standard deviation } \sigma = \sqrt{\frac{1}{N} \sum d^2 - \left( \frac{\sum d}{N} \right)^2} = \sqrt{223.69} = 14.96.$$

$$\text{coefficient of variation} = \frac{\sigma}{\bar{y}} \times 100 = \frac{14.96}{105.9} \times 100 = 14.1.$$

Since the coefficient of variation of series A is greater than that of B, the A series shows greater variation than B.

**Example 11.12:** Treating the number of letters in each word in the following passage as the variable x, prepare the frequency distribution table:

“The reliability of data must always be examined before any attempt is made to base conclusions upon them. This is true of all data, but particularly so of numerical data, which do not carry their quality written large on them. It is a waste of time to apply the refined theoretical methods of statistics to data which are suspect from the beginning.”

Find the mean, median, mode, variance and standard deviation of the distribution so formed.

Table 11.12

No. of letters	f	D	fd	$fd^2$
1	1	-3	-3	9
2	16	-2	-32	64
3	8	-1	-8	8
4	14	0	0	0
5	7	1	7	7
6	2	2	4	8
7	6	3	18	54
8	1	4	4	16
9	2	5	10	50
10	1	6	6	36
11	3	7	21	147
12	1	8	8	64
<b>Total</b>	<b>62</b>		<b>35</b>	<b>463</b>

$$\text{Mean} = 4 + (35/62) = 4 \frac{35}{62}$$

$$\text{Median} = \text{Mean of the } (n/2)\text{th and } (n-1)/2 \text{ th item} = \text{mean of the } 31^{\text{st}} \text{ and } 31.5^{\text{th}} \text{ item} = 4$$

$$\text{Variance, } \sigma^2 = \frac{1}{N} \sum d^2 - \left( \frac{\sum d}{N} \right)^2 = \frac{1}{62} \times 463 - \left( \frac{35}{62} \right)^2 = 7.149063$$

$$\text{Standard deviation} = \sqrt{\text{Variance}} = 2.673. \text{ For mode, we use grouping method as follows:}$$

Table 11.13

Size of item	f	I	II	III	IV	V	No. (max. freq.)
1	1	1 + 16 = 17		1 + 16 + 8 = 25			1
2	16		16 + 8 = 24		16 + 8 + 14 = 38		4
3	8	8 + 14 = 22				8 + 14 + 7 = 29	5
4	14		14 + 7 =	14 + 7 + 2			3

			21	= 23			
5	7	7 + 2 = 9			7 + 2 + 6 = 15		0
6	2		2 + 6 = 8			2 + 6 + 1 = 9	0
7	6	6 + 1 = 7		6 + 1 + 2 = 9			0
8	1		1 + 2 = 3		1 + 2 + 1 = 4		0
9	2	2 + 1 = 3				2 + 1 + 3 = 6	0
10	1		1 + 3 = 4	1 + 3 + 1 = 5			0
11	3	3 + 1 = 4					0
12	1						0

The mode is located at 3.

Now, we introduced new term “**Moments**”:

The  $r^{\text{th}}$  moment of  $x$  about any origin  $a$  is given by

$$\mu_r' = \frac{1}{N} \sum f_i (x_i - a)^r,$$

Where,  $r$  is positive integer and  $N = \sum f_i$ .

When the origin is taken at mean of the distribution, it is called a **central moment** and is denoted by

$$\mu_r = \frac{1}{N} \sum f_i (x_i - \bar{x})^r$$

Now,  $\mu_0' = \frac{1}{N} \sum f_i = 1 = \mu_0$

$$\mu_1' = \frac{1}{N} \sum f_i (x_i - a) = \frac{1}{N} \left[ \sum f_i x_i - a \sum f_i \right] = \bar{x} - a = d(\text{say})$$

$$\mu_1 = \frac{1}{N} \sum f_i (x_i - \bar{x}) = \bar{x} - \bar{x} = 0.$$

$$\mu_2 = \frac{1}{N} \sum f_i (x_i - \bar{x})^2 = \sigma^2.$$

**Note:**  $\mu_0 = 1$ ,  $\mu_1 = 0$ , and  $\mu_2 = \sigma^2$ , are of fundamental importance and should be committed to memory.

### Relation between Moments about Mean in terms of Moments about any point and vice versa

$$\mu_r = \mu_r' - {}^r C_1 \mu_{r-1}' \mu_1' + {}^r C_2 \mu_{r-2}' \mu_1'^2 - \dots + (-1)^r \mu_1'^r$$

In particular, on putting  $r = 2, 3$  and  $4$  and simplifying, we get

$$\mu_2 = \mu_2' - \mu_1'^2$$

$$\mu_3 = \mu_3' - 3\mu_2' \mu_1' + 2\mu_1'^3$$

$$\mu_4 = \mu_4' - 4\mu_3' \mu_1' + 6\mu_2' \mu_1'^2 - 3\mu_1'^4$$

### Sheppard's Correction for Moments:

In case of grouped frequency distribution, while calculating moments we assume that the frequencies are concentrated at the middle point of the class intervals. If the distribution is symmetrical or slightly symmetrical and the class intervals are not greater than one-twentieth of the range, this assumption is very nearly true. But since this assumption is not in general true, some error, called the grouping error, creeps into the calculation of the moments.

W. F. Sheppard proved that if (i) the frequency distribution is continuous, and (ii) the frequency tapers off to zero in both directions, the effect due to grouping at the mid-point of the intervals can be corrected by the following formulae:

$$\mu_2(\text{corrected}) = \mu_2 - \frac{h^2}{12}$$

$$\mu_3(\text{corrected}) = \mu_3$$

$$\mu_4(\text{corrected}) = \mu_4 - \frac{1}{2}h^2\mu_2 + \frac{7}{240}h^4$$

where  $h$  is the width of the class interval.

Karl Pearson defined the following four coefficients, based upon the first four moments about mean:

$$\beta_1 = \frac{\mu_3^2}{\mu_2^3}, \gamma_1 = +\sqrt{\beta_1} \quad \text{and} \quad \beta_2 = \frac{\mu_4}{\mu_2^2}, \gamma_2 = \beta_2 - 3$$

These coefficients are pure numbers independent of units of measurement. The practical utility of these coefficients is discussed below:

**Skewness:** Skewness means ‘lack of symmetry’. We study skewness to have an idea about the shape of the curve which we can draw with the help of the given data. A distribution is said to be skewed if –

- (i) Mean, median and mode fall at different points, i.e., Mean  $\neq$  Median  $\neq$  Mode;
- (ii) Quartiles are not equidistant from median; and
- (iii) The curve drawn with the help of the given data is not symmetrical but stretched more to one side than to other.

Prof. Karl Pearson gave the coefficient of skewness as follows:

$$S_k = \frac{(M - M_0)}{\sigma}, \quad \text{where } \sigma \text{ is the standard deviation of the distribution.}$$

If mode is ill-defined, then using empirical relation,  $M_0 = 3M_d - 2M$ , we get

$$S_k = \frac{3(M - M_d)}{\sigma}$$

We observe that  $S_k = 0$  if  $M = M_0 = M_d$ .

Hence for a symmetrical distribution, mean, median and mode coincide. Skewness is positive if  $M > M_0$  or  $M > M_d$ , and negative if  $M < M_0$  or  $M < M_d$ .

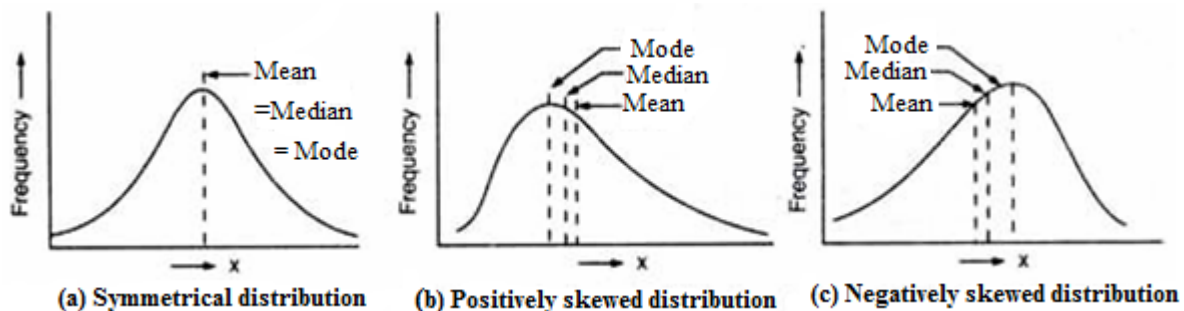

Fig. 11.1

**Kurtosis:** If we know the measures of central tendency, dispersion and skewness, we still cannot form a complete idea about the distribution as will be clear from the Fig. 11.2 in which all the three curves A, B and C are symmetrical about the mean ' $m$ ' and have the same range. In addition to these measures, we should know one more measure as ‘Convexity of the

Frequency Curve' or Kurtosis. Kurtosis enables us to have an idea about the 'flatness or peakedness' of the frequency curve. It is measured by the coefficient  $\beta_2$  or its derivation  $\gamma_2$

$$\beta_2 = \frac{\mu_4}{\mu_2^2}, \quad \gamma_2 = \beta_2 - 3$$

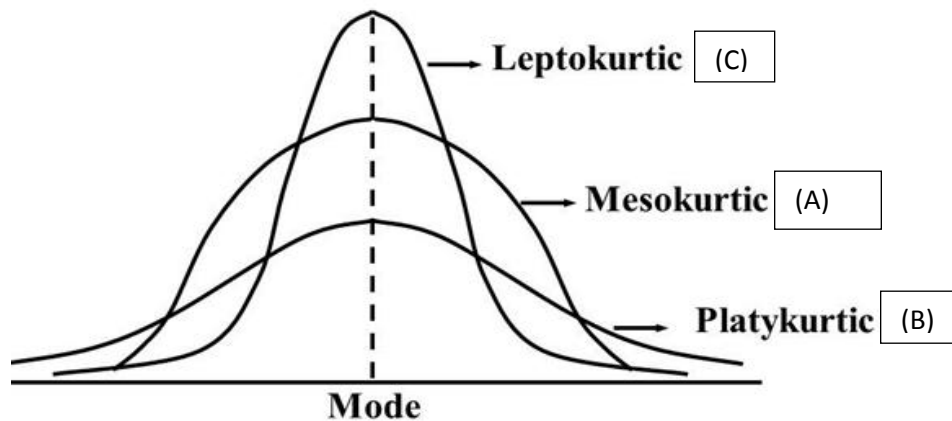

Fig. 11.2

Curve of the type 'A' which is neither flat nor peaked is called the normal curve or mesokurtic curve and for such a curve  $\beta_2 = 3$ , i.e.,  $\gamma_2 = 0$ .

Curve of the type 'B' which is flatter than the normal curve is known as platykurtic and for such a curve  $\beta_2 < 3$ , i.e.,  $\gamma_2 < 0$ .

Curve of the type 'C' which is more peaked than the normal curve is called leptokurtic and for such a curve  $\beta_2 > 3$ , i.e.,  $\gamma_2 > 0$ .

---

## 11.5 SUMMARY

---

In this unit, we studied the three main measure of dispersion and observed the standard deviation is the best among the two others. The standard deviation satisfies almost all the properties laid down for an ideal measure of dispersion except for the general nature of extracting the square root which is not readily comprehensible for a non – mathematical person. It gives greater weight to extreme values and as such has not found favor with economists who are not interested in the results of the modal class. Taking into consideration the wide applications of standard deviation in statistical theory, we regard standard deviation as the best and powerful measure of dispersion.

We also understand the use of moments for determining the various characteristics of the frequency curve. The first moment  $\mu_1$ (about the origin) gives the mean and is a measure of central tendency, second moment  $\mu_2$  about the mean is known as the variance and is a measure of dispersion. The third moment  $\mu_3$  about the mean indicates the symmetry or asymmetry of the

distribution, it being zero for a symmetrical distribution. The fourth moment  $\mu_4$  about the mean is a measure of kurtosis or the flatness of the frequency curve.

---

## 11.6 GLOSSARY

---

**Variable:** property of an object that can take on different values.

**Deviation:** The deviation of a value from a point is the difference between that value and the point.

**Range:** The difference between the greatest and least value of the variable is range.

**Quantitative:** a numerical value characterizes something.

**Variance:** The variance is a measure based on the deviations of individual values from the mean.

**Measure of variations:** Measures of variability provide information about the degree to which individual values are clustered about or deviate from the average value in a distribution.

**Bivariate:** Having or having to do with two variables.

**Association:** Two variables are associated if some of the variability of one can be accounted for by the other.

**Standard Variable:** Let  $X$  be a variable with mean  $M$  and standard deviation  $\sigma$ . Then  $z = \frac{X-M}{\sigma}$  is called standard variable whose mean is zero and variance is unity. It is considered for comparing the scores in various subjects.

---

## 11.7 SELF ASSESSMENT QUESTION

---

### 11.7.1 Indicate the correct answer:

1. Variance of the first 5 odd natural numbers is

- (a) 8 (b) 12  
(c) 9 (d) 5

(Hint: Find the variance of 1, 3, 5, 7, 9)

2. Variance of the first 5 even natural numbers is

- (a) 8 (b) 12  
(c) 9 (d) 5

(Hint: Find the variance of 2, 4, 6, 8, 10)

3. The relation between standard deviation and variance is

- (a) Variance = (standard deviation)<sup>1/2</sup> (b) Variance = (standard deviation)<sup>2</sup>  
(c) Standard deviation = (Variance)<sup>2</sup> (d) None of the above.

4. The coefficient of variation of A player is greater than that of B. Which statement is true from the given information:



- (a) Player A is better.  
 (b) Player A has more consistency in the number of attempts.  
 (c) Player B has more consistency in the number of attempts.  
 (d) Nothing can be said.
5. The standard deviation is:  
 (a) Independent of change of scale and origin of the variables.  
 (b) Independent of change of scale and dependent of origin of the variables.  
 (c) Independent of change of origin and dependent on the scale.  
 (d) Depends on both of change of scale and origin.
6. For a normal curve or mesokurtic curve  
 (a)  $\beta_2 = 3$ , i.e.,  $\gamma_2 = 0$ .  
 (b)  $\beta_2 < 3$ , i.e.,  $\gamma_2 < 0$ .  
 (c)  $\beta_2 > 3$ , i.e.,  $\gamma_2 > 0$ .  
 (d) None of these
7. For a curve  $\beta_2 < 3$ , i.e.,  $\gamma_2 < 0$ , then curve is  
 (a) Normal curve  
 (b) Mesokurtic curve  
 (c) Platykurtic curve  
 (d) Leptokurtic curve
8. The first moment about the origin is  
 (a) Mean  
 (b) A measure of central tendency  
 (c) Both a. and b.  
 (d) None of these
9. The fourth moment about the mean is a measure of  
 (a) Central tendency  
 (b) Kurtosis  
 (c) Variability  
 (d) None of these
10. The first four moments of a distribution about the mean are 0, 2, 0 and 16 respectively. What type of curve is formed?  
 (a) Platykurtic  
 (b) Mesokurtic  
 (c) Leptokurtic  
 (d) None of these

**11.7.1 Answer Key:** 1.(a), 2. (a), 3.(b), 4. (c), 5.(c), 6.(a), 7.(c), 8.(c), 9.(b), 10.(a)

### 11.7.2 Long Answer type Questions:

- Calculate, mean and standard deviation of the first 10 natural numbers.
- Calculate the mean, standard deviation, median and mode for the following:

x	15	20	25	30	35	40	45	50	55
---	----	----	----	----	----	----	----	----	----

F	2	22	19	14	3	4	6	1	1
---	---	----	----	----	---	---	---	---	---

3. The runs gained by two batsmen A and B in different innings are as follows:

A	24	79	31	114	14	02	68	01	110	07
B	05	18	42	53	09	47	52	17	81	56

(i) Which of the two batsmen is better run scorer?

(ii) Which of the two batsmen has more consistency in the number of runs?

4. Calculate range of the following distribution:

139, 150, 151, 151, 157, 158, 160, 161, 162, 173, and 175.

5. Marks obtained by four students are: 25, 35, 45, 55. Find the average deviation amount the mean, and also find Standard deviation of the series.

6. Standard deviation of 100 observations is 10 and mean is 50. What will be the new mean and standard deviation if

(i) 5 is added to each observation.

(ii) Each observation is multiplied by 3.

7. The mean and standard deviation of 20 items is found to be 10 and 2 respectively. At the time of checking it was found that one item 8 was incorrect. Calculate the mean and standard deviation if (i) the wrong items is omitted, and (ii) it is replaced by 12.

---

## ***11.8 REFERENCES***

---

- Gupta S. C, Kapoor V. K., Fundamentals of mathematical statistics, Sultan Chand & Sons, India, 11 (2006).
- Gupta C.B., An Introduction to statistics methods, Vikss Publishing House Pvt Ltd, India, 9 (1981).
- Goyal J. K., Sharma J. N., Mathematical statistics, Krishna prakashan media (P) Ltd., India, 25 (2009).
- Kumar R., Statistics, Vardhman publications, Delhi, India, (2013).
- Ray M., Sharma H. S., Mathematical statistics, Ram prasad& sons, Agra, India, 11.
- Kothari, C.R., Research Methodology Methods and Techniques, New Age International (P) Ltd., New Delhi, (2004).
- <http://youarticlelibrary.com>; <http://slideplayer.com>.

---

## ***11.9 SUGGESTED READINGS***

---

- S. C. Gupta and V. K. Kapoor: Fundamentals of Mathematical Statistics
- Ray, Sharma and Chaudhary: Mathematical Statistics
- tutorials.istudy.psu.edu.
- R. Kumar: Statistics
- <https://en.wikipedia.org/wiki/Wikipedia:Statistics>
- [bobhall.tamu.edu/FiniteMath/Module8/Introduction.html](http://bobhall.tamu.edu/FiniteMath/Module8/Introduction.html)

## 11.10 TERMINAL QUESTIONS

1. Find the standard deviation of the set of numbers 2, 4, 6, ..., 20.

2. Write short notes on:

- Range
- Mean deviation
- Root mean square deviation.

3. In a survey of 950 families in a village, the following distribution of number of children was obtained.

X	0-2	2-4	4-6	6-8	8-10	10-12
f	272	328	205	120	15	10

Calculate the standard deviation.

4. The scores of two golfers for 10 rounds each are:

A: 58, 59, 60, 54, 65, 66, 52, 75, 69, 52

B: 56, 87, 89, 78, 71, 73, 84, 65, 66, 46

Which of the two you would consider to be more consistent?

5. Compute the mean deviation from arithmetic mean, median and mode for the following frequency distribution:

Class	14-15	15-16	16-17	17-18	18-19	19-20
frequency	4	6	10	18	9	3

6. Compile a table showing the frequencies with which words of different lengths occur in this question, treating as the variable number of letters in each word. Obtain the median, the mode and the coefficient of variation of the distribution.

7. Compile a table, showing the frequencies with which words of different numbers of letters occur in the extract reproduced below (omitting punctuation marks treating as the variable) the numbers of letters in each word and obtain the mean, median, standard deviation and the coefficient of variation of the distribution.

“Success in the examination confers no absolute right to appointment, unless Government is satisfied after such enquiry as may be, considered necessary that the candidate is suitable in all respects for appointment to the public service.”

8. The scores of two golfers for 24 rounds each are:

A: 74, 75, 78, 78, 72, 77, 79, 78, 81, 76, 72, 72, 77, 74, 70, 78, 79, 80, 81, 74, 80, 75, 71, 73;

B: 86, 84, 80, 88, 89, 85, 86, 82, 82, 79, 76, 80, 82, 76, 86, 89, 87, 83, 80, 88, 86, 81, 84, 87.

Which may be considered to be more consistent player?

9. Calculate the standard deviation of the following-

<b>x</b> <b>above</b>	0	10	20	30	40	50	60	70	80
<b>f</b>	150	140	100	80	80	70	30	14	0

10. Find the standard deviation of the following series:

<b>Expenditure</b>	<b>No. of Students</b>
Below Rs. 5	6
Below Rs. 10	16
Below Rs. 15	28
Below Rs. 20	38
Below Rs. 25	46

---

## **UNIT-12 CORRELATION AND STATUTORY TEST**

---

- 12.1-Objectives
- 12.2-Introduction
- 12.3- Coefficient of correlation
- 12.4-Chi-square test
- 12.5-T-test
- 12.6- Summary
- 12.7- Glossary
- 12.8-Self Assessment Question
- 12.9- References
- 12.10-Suggested Readings
- 12.11-Terminal Questions

---

## 12.1 OBJECTIVES

---

After reading this unit, students will be able to:

- Understand the meaning of the term correlation and significance of its study.
- Learn to compute Karl Pearson's correlation coefficient,  $r$ .
- Understand the Karl Pearson's correlation coefficient and Spearman's rank correlation coefficient.
- Understand the use of chi-square test and t-test.

---

## 12.2 INTRODUCTION

---

Now our object is to discover whether there is any connection between two variables. We may find a change in one variable result in three ways:

- (i) Direct change in the other variable, or
- (ii) Inverse change in the other variable, or
- (iii) Does not have any effect on the second variable.

If the second variable is unaffected by a change in the first, they are said to be statistically independent, and if the second variable is affected by a change in the first, they are said to be statistically dependent (correlated).

Now, we define **correlation**:

Whenever two variables  $x$  and  $y$  are so related that a change in one is accompanied by a change in the other in such a way that an increase (or decrease) in the one is accompanied by an increase or decrease (or decrease or increase), in the other, then variables are said to be **correlated in the linear sense**. When an increase (or decrease) in one variate corresponds to an increase (or decrease) in the other, the correlation is said to be **positive**. It is **negative** when increase in one corresponds to decrease in the other or vice-versa.

The measure of this relation is measured by the coefficient of correlation given by the Karl Pearson (1857-1936).

---

## 12.3 COEFFICIENT OF CORRELATION

---

Before defining the coefficient of correlation, we will understand the term 'covariance of two variables'.

If  $\bar{x}$  and  $\bar{y}$  are means of the values of  $x$  and  $y$  respectively. Then the mean of the product of the deviations from mean of the variables  $(x - \bar{x})(y - \bar{y})$  is defined as **covariance** of  $x$  and  $y$ .

$$cov(x, y) = \frac{1}{N} \sum (x - \bar{x})(y - \bar{y}).$$

**Remarks:** (i) If  $x, y$  are small numbers, then it is easier to calculate  $cov(x, y)$  using the following formula

$$cov(x, y) = \frac{1}{N} \left[ \sum xy - \frac{1}{N} \sum x \sum y \right].$$

(ii) In case of assumed mean method, we can assume means  $A$  and  $B$ , use  $u = x - A, v = y - B$ , then

$$cov(x, y) = \frac{1}{N} \left[ \sum uv - \frac{1}{N} \sum u \sum v \right].$$

**Example 12.1:** Find  $cov(x, y)$  for the following data:

x	3	4	5	6	7
y	8	7	6	5	4

Here,  $N = 5$ ,

Construct the following table:

**Table 12.1**

x	y	xy
3	8	24
4	7	28
5	6	30
6	5	30
7	4	28
<b>25</b>	<b>30</b>	<b>140</b>

Here,  $\sum x = 25, \sum y = 30, \sum xy = 140$

$$cov(x, y) = \frac{1}{N} \left[ \sum xy - \frac{1}{N} \sum x \sum y \right] = \frac{1}{5} \left[ 140 - \frac{1}{5} (25)(30) \right] = -2$$

Hence, we see a negative relation between  $X$  and  $Y$ .

As a measure of linear relationship between two variables, **Karl Pearson's correlation coefficient  $r$** , between two variables  $x$  and  $y$  is defined as:

$$r = \frac{cov(x, y)}{\sqrt{var(x)var(y)}} = \frac{cov(x, y)}{\sigma_x \sigma_y}$$

In previous unit we studied,  $\sigma_x = \sqrt{\text{var}(x)} = \sqrt{\frac{1}{N} \sum (x - \bar{x})^2}$

Now,

$$r = \frac{\frac{1}{N} \sum (x - \bar{x})(y - \bar{y})}{\sqrt{\frac{1}{N} \sum (x - \bar{x})^2} \sqrt{\frac{1}{N} \sum (y - \bar{y})^2}}$$

$$= \frac{\frac{1}{N} \sum (x - \bar{x})(y - \bar{y})}{\frac{1}{N} \sqrt{\sum (x - \bar{x})^2} \sqrt{\sum (y - \bar{y})^2}}$$

$$r = \frac{\sum (x - \bar{x})(y - \bar{y})}{\sqrt{\sum (x - \bar{x})^2} \sqrt{\sum (y - \bar{y})^2}}$$

This coefficient is also called **the product moment correlation coefficient**.

Now, we understand the procedure of calculating the correlation coefficient with an example.

**Example 12.2** - Find the correlation coefficient for the following data:

x	1	2	3	4	5
y	5	4	3	2	6

Here, Mean,  $\bar{x} = \frac{15}{5} = 3$ , and  $\bar{y} = \frac{20}{5} = 4$ .

We form table as follows:

**Table 12.2**

x	y	$x - \bar{x}$	$y - \bar{y}$	$(x - \bar{x})^2$	$(y - \bar{y})^2$	$(x - \bar{x})(y - \bar{y})$
1	5	-2	1	4	1	-2
2	4	-1	0	1	0	0
3	3	0	-1	0	1	0
4	2	1	-2	1	4	-2
5	6	2	2	4	4	4
<b>15</b>	<b>20</b>			<b>10</b>	<b>10</b>	<b>0</b>

Coefficient of correlation

$$r = \frac{\sum (x - \bar{x})(y - \bar{y})}{\sqrt{\sum (x - \bar{x})^2} \sqrt{\sum (y - \bar{y})^2}} = \frac{0}{\sqrt{10} \sqrt{10}} = \frac{0}{10} = 0.$$

**Example 12.3** – Calculate coefficient of correlation from the following data:



x	12	13	14	15	16	17	18
y	14	17	18	19	20	24	28

Here, Mean,  $\bar{x} = \frac{105}{7} = 15$ , and  $\bar{y} = \frac{140}{7} = 20$ .

We construct the following table:

**Table 12.3**

x	$x - \bar{x}$	$(x - \bar{x})^2$	y	$y - \bar{y}$	$(y - \bar{y})^2$	$(x - \bar{x})(y - \bar{y})$
12	-3	9	14	-6	36	18
13	-2	4	17	-3	9	6
14	-1	1	18	-2	4	2
15	0	0	19	-1	1	0
16	1	1	20	0	0	0
17	2	4	24	4	16	8
18	3	9	28	8	64	24
<b>105</b>		<b>28</b>	<b>140</b>		<b>130</b>	<b>58</b>

Coefficient of correlation

$$r = \frac{\sum(x - \bar{x})(y - \bar{y})}{\sqrt{\sum(x - \bar{x})^2 \sum(y - \bar{y})^2}} = \frac{58}{\sqrt{28} \sqrt{130}} = \frac{58}{\sqrt{3640}} = 0.961.$$

### Assumptions Underlying Karl Pearson's Correlation Coefficient

Pearsonian correlation coefficient  $r$  is based on the following assumptions:

1. The variables  $X$  and  $Y$  under study are linearly related. In other words, the scatter diagram of the data will give a straight line curve.
2. Each of the variables is being affected by a large number of independent contributory causes of such a nature as to produce normal distribution. For example, the variables relating to ages, heights, weights, supply, price etc., conform to this assumption.
3. The forces so operating on each of the variable series are not independent of each other but are related in a casual fashion. In other words, cause and effect relationship exists between different forces operating on the items of the two variable series. These forces must be common to both the series. If the operating forces are entirely independent of each other and not related in any fashion, then there cannot be any correlation between the variables under study.

For example, the correlation coefficient between the series of heights and incomes of the individuals over a period of time should be zero, since the forces affecting the two variables are entirely independent of each other.

However, if in any such cases the value of  $r$  for a given set of data is not zero, then such correlation is termed as chance correlation or spurious or nonsense correlation.

### Some remarks regarding coefficient of correlation

1. The coefficient of correlation  $r$  has no units and is a mere number.
2. The value of  $r$  is independent of change of origin and scale, so we can choose any convenient origin and scale.
3. The correlation coefficient  $r$  between two variables lies between (-1) and (1), i.e.  $-1 \leq r \leq 1$ .
4. The square of  $r$  i.e.  $r^2$  is called coefficient of determination. Obviously  $0 \leq r^2 < 1$ . Variation between  $X$  and  $Y$  is indicated by  $r^2$  and not  $r$ . For example, if  $r = 0.9$ , there is strong positive relation between  $X$  and  $Y$ , but as  $r^2 = (0.9)^2 = 0.81$ , only 81% variation in  $Y$  is explained due to  $X$ .
5. Correlation is said to be high degree if  $\frac{3}{4} \leq |r| \leq 1$ , of moderate degree if  $\frac{1}{4} \leq |r| < \frac{3}{4}$  and of low degree if  $0 \leq |r| < \frac{1}{4}$ .
6. If  $X$  and  $Y$  are independent variables then  $cov(X, Y) = 0$  and coefficient of correlation  $r = 0$ . Inversely, if  $r = 0$ , then  $X$  and  $Y$  have no linear relation. However,  $Y$  may still have a curved relation with  $X$ .
7. Correlation coefficient is highly abused by the researchers and advertisers. It may or may not indicate cause and effect relationship. For example, in any school, we will find a high positive correlation between the children's shoe size and spelling ability. Does it mean that bigger feet lead to better brains or that if you learn to spell better, your feet will get bigger? May be a third factor, that is, the age of children, affects both these factors.

### Spearman's coefficient of rank correlation

Sometimes, it is difficult to give numerical values to a quality e.g. honesty, beauty, intelligence etc. Sometimes, though it may be possible to quantify the variable, we may choose to grade it in terms of the ranks, by using numbers  $1, 2, \dots, n$ . If two corresponding sets of values  $x$  and  $y$  are ranked in such manner, the Edward Spearman's coefficient of rank correlation, denoted by  $r_{rank}$ , or as  $r$ , is given by

$$r = 1 - \frac{6 \sum d^2}{n(n^2 - 1)}$$

Where  $d = \text{difference between the ranks of corresponding } x \text{ and } y$ ,  
 $n = \text{number of pairs of values } (x, y) \text{ in the data.}$

**Example 12.4:** Consider 5 students is ranked in Maths and Physics as

Student	A	B	C	D	E
Maths	1	2	3	4	5

Physics	1	2	3	4	5
---------	---	---	---	---	---

For each pair,  $d = 0$ , so  $r = +1$ .

Now, let us assume that the five students are given marks as follows in Maths and English:

**Table 12.4**

Student	A	B	C	D	E
Maths	90	80	70	60	50
English	90	70	80	60	50

To find Spearman's rank correlation, we have

**Table 12.5**

Student	Maths Marks	Rank in Maths (x)	English Marks	Rank in English(y)	Difference $d = x - y$	$d^2$
A	90	1	90	1	0	0
B	80	2	70	3	-1	1
C	70	3	80	2	1	1
D	60	4	60	4	0	0
E	50	5	50	5	0	0

Here,  $n = 5$ ,  $\sum d^2 = 2$

$$r = 1 - \frac{6 \sum d^2}{n(n^2 - 1)} = 1 - \frac{6(2)}{5(5^2 - 1)} = 0.9$$

Sometimes, either series  $x$  or  $y$  may have common ranks. Then we use average rank for these items, and add a correction to  $\sum d^2$  to calculate  $r$ . If  $m$  items have common rank, the correction  $\frac{1}{12}(m^3 - m)$  is added to  $\sum d^2$ . If more ties occur for ranks, more corrections are added. Consider an example:

**Example 12.5:** The marks in History and Science are:

Student	A	B	C	D	E
History	70	70	60	50	40
Science	80	80	80	60	60

Rank of both A and B for History is  $\frac{1+2}{2} = 1.5$ ;

Rank for Science for A, B, C is  $\frac{1+2+3}{3} = \frac{6}{3} = 2$ .

Rank for Science for D, E is  $\frac{4+5}{2} = \frac{9}{2} = 4.5$ .

The rank table:

Table 12.6

Student	History Marks	Rank in History(x)	Science Marks	Rank in Science(y)	Difference d = x - y	d <sup>2</sup>
A	70	1.5	80	2	-0.5	0.25
B	70	1.5	80	2	-0.5	0.25
C	60	3	80	2	1	1
D	50	4	60	4.5	-0.5	0.25
E	40	5	60	4.5	0.5	0.25

Here,  $n = 5$ ,  $\sum d^2 = 2$ , and we have to add 3 corrections due to 3 ties (2 in  $y$  (of 3 and 2 terms), and one in  $x$  (of 2 terms)), so

$$r = 1 - \frac{6 \left[ 2 + \frac{1}{12} (3^3 - 3) + \frac{1}{12} (2^3 - 2) + \frac{1}{12} (2^3 - 2) \right]}{5(5^2 - 1)}$$

$$= 1 - \frac{6(2 + 2 + 0.5 + 0.5)}{120} = 1 - \frac{30}{120} = 1 - 0.25 = 0.75.$$

---

## 12.4 CHI-SQUARE TEST

---

This test was given by Karl Pearson in 1900 for testing the significance of the discrepancy between theory and experiment. It enables us to find if the deviation of the experiment from theory is by chance or due to the inadequacy of the theory to fit the observed data. Chi-square test is used

- (i) To test the significance of sample variance.
- (ii) To test the independence of attributes in a contingency table.
- (iii) To compare a number of frequency distributions.
- (iv) To test the goodness of fit.

### Chi-square test for testing the significance of Sample Variance (Sample size $n \leq 30$ )

Suppose we want to test if a random sample has been drawn from a normal population with a specified variance  $\sigma_0^2$ .

Step 1- We assume, Null hypothesis is population variance =  $\sigma_0^2$ ,

Step 2- The chi-square statistic

$$\chi^2 = \sum_{i=1}^n \left[ \frac{(x_i - \bar{x})^2}{\sigma_0^2} \right] = \frac{1}{\sigma_0^2} \left[ \sum_{i=1}^n x_i^2 - \frac{(\sum x_i)^2}{n} \right] = \frac{ns^2}{\sigma_0^2}$$

follows chi-square distribution with  $(n - 1)$  degree of freedom.

Step 3- By comparing the calculated value with the tabulated value of the  $\chi^2$  for (n-1) degree of freedom at certain level of significance (usually 5%), we may retain or reject the null hypothesis.

If  $\chi^2(\text{calculated}) > \chi^2(\text{table value for } (n - 1)\text{degree of freedom})$ , then null hypothesis is rejected.

**Remark:** The above test can be applied only if the population from which the sample is drawn is normal.

**Example 12.6** - The standard deviation of a certain dimensions of articles produced by a machine is 7.5 over a long period. A random sample of 25 articles gave a standard deviation of 10. Is it justifiable to conclude that the variability has increased? Use 5% level of significance.

Null hypothesis: population variance = 7.5

The chi-square statistic

$$\chi^2 = \frac{ns^2}{\sigma^2} = \frac{25 \times 10 \times 10}{7.5 \times 7.5} = 44$$

$$\chi^2(\text{table value for } (n - 1)\text{degree of freedom}) = \chi^2(\text{ for } (24)\text{degree of freedom})$$

$$= 36.415 (\text{at } 0.05)$$

Since,  $\chi^2(\text{calculated}) > \chi^2(\text{table value for } (n - 1)\text{degree of freedom})$  so, null hypothesis is rejected. This means there is a justification for believing that the variability has increased.

### Chi-square test for testing the independence of attributes in a contingency table

We first understand the term ‘contingency table’.

Let us suppose that the data is divided into classes  $A_1, A_2, \dots, A_s$  according to attribute  $A$  and into  $t$  classes  $B_1, B_2, \dots, B_t$  according to attribute  $B$ . This table of  $s$  rows and  $t$  columns thus  $t \times s$  frequency cells. This is called  $t \times s$  contingency table. Let  $O_{ij}$  denote the observed frequency of the cell belonging to both the classes  $A_i$  and  $B_j$ .

Expected frequency to cell  $(i, j)$  to observed frequency  $O_{ij}$  is given by

$$E_{ij} = \frac{(A_i)(B_j)}{N}, \quad i = 1, 2, \dots, s; j = 1, 2, \dots, t;$$

Null hypothesis: Attributes are independent.

Chi-square statistic is calculated as follows:

$$\chi^2 = \sum_{i=1}^s \sum_{j=1}^t \left[ \frac{(O_{ij} - E_{ij})^2}{E_{ij}} \right] \sim \chi^2 \text{ with } (s-1)(t-1) \text{ degrees of freedom.}$$

If  $\chi^2(\text{calculated}) > \chi^2(\text{table value for } (s-1)(t-1) \text{ degree of freedom})$ , hypothesis of independence (null hypothesis) is rejected.

**Example 12.7** - Test the hypothesis that the flower colour is independent of flatness of leaf-

	Flat leaves	Curled leaves	Total
White flowers	99	36	135
Red flowers	20	5	25

Use the following table giving the values of  $\chi^2$  for one degree of freedom for different values of P-

P	.5	.1	.05
$\chi^2$	.455	2.706	3.841

Here, Null hypothesis is flower colour is independent of flatness of leaves, the expected frequency table are:

**Table 12.7**

	Flat leaves	Curled leaves	Total
White flowers	100.41 ( $E_{11}$ )	34.59 ( $E_{12}$ )	135( $A_1$ )
Red flowers	18.59( $E_{21}$ )	6.41( $E_{22}$ )	25( $A_2$ )
Total	119( $B_1$ )	41( $B_2$ )	160( $N$ )

Expected frequency

$$E_{11} = \frac{(A_1)(B_1)}{N} = \frac{(135 \times 119)}{160} = 100.41$$

$$E_{12} = \frac{(A_1)(B_2)}{N} = \frac{(135 \times 41)}{160} = 34.59$$

$$E_{21} = \frac{(A_2)(B_1)}{N} = \frac{(25 \times 119)}{160} = 18.59$$

$$E_{22} = \frac{(A_2)(B_2)}{N} = \frac{(25 \times 41)}{160} = 6.41$$

$$\chi^2 = \sum_{i=1}^2 \sum_{j=1}^2 \left[ \frac{(O_{ij} - E_{ij})^2}{E_{ij}} \right] = \frac{(O_{11} - E_{11})^2}{E_{11}} + \frac{(O_{12} - E_{12})^2}{E_{12}} + \frac{(O_{21} - E_{21})^2}{E_{21}} + \frac{(O_{22} - E_{22})^2}{E_{22}}$$

$$= \frac{(99 - 100.41)^2}{100.41} + \frac{(36 - 34.59)^2}{34.59} + \frac{(20 - 18.59)^2}{18.59} + \frac{(5 - 6.41)^2}{6.41} = 0.494.$$

The number of degree of freedom is =  $(2-1)(2-1) = 1$

$$\chi^2(\text{table value for 1 degree of freedom}) = 3.841 \text{ (at } P = 0.05)$$

Since,  $\chi^2(\text{calculated}) \ll \chi^2(\text{table value})$ , thus null hypothesis that the flower colour is independent of flatness of leaf is accepted.

### Chi-square test for testing the goodness of fit

If  $O_i$ , ( $i = 1, 2, \dots, n$ ) is a set of observed frequencies and  $E_i$ , ( $i = 1, 2, \dots, n$ ) is the corresponding set of expected frequencies. Then Chi-square is defined by

$$\chi^2 = \sum_{i=1}^n \left[ \frac{(O_i - E_i)^2}{E_i} \right], \text{ having } (n - 1) \text{ degree of freedom.}$$

If  $\chi^2(\text{calculated}) < \chi^2(\text{table value})$ , the fit is considered to be good, and

If  $\chi^2(\text{calculated}) > \chi^2(\text{table value})$ , the fit is considered to be poor.

**Example 12.8:** The demand for a particular spare part in a factory was found from day to day. In a sample study the following information was obtained:

Days	Mon.	Tues.	Wed.	Thurs.	Fri.	Sat.
No. of parts demanded	1124	1125	1110	1120	1126	1115

Test the hypothesis that the number of parts demanded does not depend on the day of the week. (Given: The values of chi-square significance at 5, 6, 7d.f are respectively 11.07, 12.59, 14.07 at the 5% level of significance.

Null Hypothesis: the number of parts demanded does not depend on the day of the week.

Under the null hypothesis, the expected frequencies of the spare part demanded on each of the six days would be:

$$\frac{1}{6} (1124 + 1125 + 1110 + 1120 + 1126 + 1115) = \frac{6720}{6} = 1120.$$

We form table as:

**Table 12.8**

Days	Observed $O_i$	Expected $E_i$	$(O_i - E_i)^2$	$\frac{(O_i - E_i)^2}{E_i}$
Mon.	1124	1120	16	0.014
Tues	1125	1120	25	0.022
Wed.	1110	1120	100	0.089
Thurs.	1120	1120	0	0
Fri.	1126	1120	36	0.032
Sat	1115	1120	25	0.022
<b>Total</b>	<b>6720</b>	<b>6720</b>		<b>0.179</b>

Number of degree of freedom = 6 - 1 = 5.

$$\chi^2 = \sum_{i=1}^n \left[ \frac{(O_i - E_i)^2}{E_i} \right] = 0.179.$$

Table value of  $\chi^2$  for 5 d.f = 11.07.

Since,  $\chi^2(\text{calculated}) < \chi^2(\text{table value})$ . Hence we conclude that the numbers of parts demanded are same over the 6-day period.

**Example 12.9:** In 120 throws of a single die, the following distribution of faces was obtained:

Faces	1	2	3	4	5	6	Total
$O_i$	30	25	18	10	22	15	120

Do these results constitute of reputation of equal probability null hypothesis?

On the basis of principle of equal probability  $p = \frac{1}{6}$ , the theoretical frequencies for each face is

$$Np = 120 \times \frac{1}{6} = 20. \text{ Thus we have}$$

**Table 12.9**

Faces	1	2	3	4	5	6	Total
$O_i$	30	25	18	10	22	15	120
$E_i$	20	20	20	20	20	20	120

Since no theoretical frequency is less than 10. Hence,



$$\begin{aligned}\chi^2 &= \sum_{i=1}^n \left[ \frac{(O_i - E_i)^2}{E_i} \right] \\ &= \frac{(30 - 20)^2}{20} + \frac{(25 - 20)^2}{20} + \frac{(18 - 20)^2}{20} + \frac{(10 - 20)^2}{20} + \frac{(22 - 20)^2}{20} \\ &\quad + \frac{(15 - 20)^2}{20} = \frac{1}{20} [100 + 25 + 4 + 100 + 4 + 25] = \frac{258}{20} = 12.9.\end{aligned}$$

Degree of freedom = 6 - 1 = 5.

$\chi^2(\text{table}) = 11.070$ .

Since,  $\chi^2(\text{calculated}) > \chi^2(\text{table value})$ , Null hypothesis of equal probability is rejected.

### Conditions for the validity of $\chi^2$ - test

$\chi^2$ - test is an approximate test for large value of  $n$ . For the validity of chi-square test of 'goodness of fit' between theory and experiment, the following conditions must be satisfied:

- i. The sample observations should be independent.
- ii. Constraints on the cell frequencies should be linear.
- iii.  $N$ , the total frequency should be reasonably large.
- iv. No theoretical cell frequency should be less than 5. (The chi square distribution is essentially a continuous distribution but it cannot maintain the character of continuity if cell frequency is less than 5.) If any theoretical cell frequency is less than 5, it is pooled with preceding or succeeding frequency so that pooled frequency is more than 5 and finally adjust the degree of freedom lost in pooling.

$\chi^2$ - test depends only on the set of observed and expected frequencies and on degree of freedom. It does not make any assumptions regarding the parent population from which the observations are taken. Since,  $\chi^2$  does not involve any population parameters, it is termed as a statistic and the test is known as Non-parametric test or Distribution free test.

## 12.5 T-test

The statistic t was introduced by W.S. Gosset in 1908 who wrote under the name 'Student'. That is why it is called Student's t. Later on its distribution was rigorously established by Prof. R.A. Fisher in 1926. The t- distribution is used to test the significance of

- (i) The mean of the sample.
- (ii) The difference between two means or to compare two samples.
- (iii) Sample coefficient of correlation.

(iv) Sample coefficient of regression.

The following assumptions are made in the Student's t-test:

1. The parent population from which the sample is drawn is normal.
2. The sample observations are independent, i.e., the sample is random.
3. The population standard deviation  $\sigma$  is unknown.

### t-test for testing the significance of sample mean

Null hypothesis: population mean ( $\mu$ ) = *sample mean* ( $\bar{x}$ )

Test statistic

$$t = \frac{\bar{x} - \mu}{\left(\frac{s}{\sqrt{n}}\right)}, \quad \text{where } s = \sqrt{\frac{1}{n-1} \sum_{i=1}^n (x_i - \bar{x})^2}$$

follows with (n-1) degree of freedom.

If  $t(\text{calculated}) < t(\text{table value})$ , we accept null hypothesis, and

if  $t(\text{calculated}) > t(\text{table value})$ , we reject null hypothesis.

**Example 12.10:** The nine items of a sample had the following values:

45, 47, 50, 52, 48, 47, 49, 53, 51.

Does the mean of the nine items differ significantly from the assumed population mean of 47.5 ?

Null hypothesis: The mean of the population from which sample is drawn is 47.5.

Calculate the mean of the given data by assumed mean method (refer unit 10) by taking  $A = 49$ .

$$\bar{x} = 49.11$$

$$\text{Calculate } s = \sqrt{\frac{1}{n-1} [\sum d^2 - \frac{1}{n} (\sum d)^2]} = 2.62$$

Where  $d = x - A$  (from assumed mean method)

Test statistic

$$t = \frac{\bar{x} - \mu}{\left(\frac{s}{\sqrt{n}}\right)} = \frac{49.11 - 47.5}{\left(\frac{2.62}{\sqrt{9}}\right)} = 1.85$$

Degree of freedom = 9-1= 8

$t(\text{table value}) = 2.31$ .

Since,  $t(\text{calculated}) < t(\text{table value})$ , we accept null hypothesis.

### t-test for testing the significance of difference between two means

We want to test the null hypothesis whether the two independent samples (with means  $\bar{x}$  and  $\bar{y}$  and sizes  $n_1$  and  $n_2$  respectively) have been drawn from the population with the same means.

Null hypothesis:  $\bar{x} = \bar{y}$

Test statistic:

$$t = \frac{(\bar{x} - \bar{y})}{s \sqrt{\frac{1}{n_1} + \frac{1}{n_2}}}, \quad \text{where } s = \sqrt{\frac{1}{n_1 + n_2 - 2} [\sum (x_i - \bar{x})^2 + \sum (y_i - \bar{y})^2]}$$

The significance of t for  $n_1 + n_2 - 2$  degree of freedom is tested.

If  $t(\text{calculated}) < t(\text{table value})$ , we accept null hypothesis, and

if  $t(\text{calculated}) > t(\text{table value})$ , we reject null hypothesis.

**Example 12.11:** In a rat feeding experiment, the following results were obtained:

Diet				Gain	in	Weight	in	gm				
High Protein	13	14	10	11	12	16	10	8	11	12	9	12
Low Protein	7	11	10	8	10	13	9					

Investigate if there is any evidence of superiority of one diet over the other. The value of  $t$  for 17 degrees of freedom at 5% level of significance = 2.11.

Table 12.10

High Protein			Low Protein		
$x$	$x - \bar{x}$	$(x - \bar{x})^2$	$y$	$y - \bar{y}$	$(y - \bar{y})^2$
13	1.5	2.25	7	$-2\frac{5}{7}$	$\frac{361}{49}$
14	2.5	6.25	11	$1\frac{2}{7}$	$\frac{81}{49}$
10	-1.5	2.25	10	$\frac{2}{7}$	$\frac{4}{49}$
11	-0.5	2.5	8	$-1\frac{5}{7}$	$\frac{144}{49}$
12	0.5	2.5	10	$\frac{2}{7}$	$\frac{4}{49}$
16	4.5	20.25	13	$3\frac{2}{7}$	$\frac{529}{49}$
10	-1.5	2.25	9	$-\frac{5}{7}$	$\frac{25}{49}$
8	-3.5	12.25			
11	-0.5	0.25			
12	0.5	0.25			
9	-2.5	6.25			
12	0.5	0.25			
<b>138</b>	<b>0</b>	<b>53.00</b>	<b>68</b>	<b>0</b>	<b><math>\frac{1148}{49}</math></b>

Mean gain in weight of High Protein =  $\bar{x} = \frac{138}{12} = \frac{23}{2} = 11.5$ .

Mean gain in weight of Low Protein =  $\bar{y} = \frac{68}{7} = 9\frac{5}{7}$ .

The standard error of this difference

$$s = \sqrt{\frac{1}{n_1 + n_2 - 2} [\sum (x_i - \bar{x})^2 + \sum (y_i - \bar{y})^2]} = \sqrt{\frac{1}{12 + 7 - 2} [53 + \frac{1148}{49}]} = \sqrt{\frac{535}{119}}$$

Test statistic:

$$t = \frac{(\bar{x} - \bar{y})}{s \sqrt{\frac{1}{n_1} + \frac{1}{n_2}}} = \frac{(\frac{23}{2} - \frac{68}{7})}{\sqrt{\frac{535}{119}} \sqrt{\frac{1}{12} + \frac{1}{7}}} = 1.77$$

The number of degree of freedom =  $12+7 - 2=17$ .

The value of  $t$  for 17 degree of freedom at 5% level of significance = 2.11.

Since,  $t(\text{calculated}) < t(\text{table value})$ , we accept null hypothesis, i.e., the difference is not significant.

### t-test for a Paired data

Suppose we have two samples of the same size  $n_1 = n_2 = n$ . We consider the increments  $d_i = x_i - y_i, i = 1, 2, \dots, n$ .

Null hypothesis: Increments are due to the fluctuations of the sampling.

Test statistic

$$t = \frac{\bar{d}}{\left(\frac{s}{\sqrt{n}}\right)} \text{ with } (n-1) \text{ degree of freedom, where } s = \sqrt{\frac{1}{n-1} \sum_{i=1}^n (d_i - \bar{d})^2}.$$

If  $t(\text{calculated}) < t(\text{table value})$ , we accept null hypothesis, and

if  $t(\text{calculated}) > t(\text{table value})$ , we reject null hypothesis.

**Example 12.12:** To test the desirability of a certain modification in typists desk, 9 typists were given two tests of as nearly as possible the same nature one on the desk in use and other on the new type. The following differences of word typed per minute were recorded:

Typists	A	B	C	D	E	F	G	H	I
Increased No. of words/min	2	4	0	3	-1	4	-3	2	5

Do the data indicate that the modification in desk promotes speed in typing? (5% value of  $t$  for degree of freedom 8 and 9 are respectively 2.31 and 2.26).

Null Hypothesis: The data does not indicate the modification in desk promotes speed in typing.

**Table 12.11**

Typists	Differences	Deviations from means $(d - \bar{d})$	$(d - \bar{d})^2$
A	2	$\frac{2}{9}$	$\frac{4}{81}$

B	4	$\frac{20}{9}$	$\frac{400}{81}$
C	0	$-\frac{16}{9}$	$\frac{256}{81}$
D	3	$\frac{11}{9}$	$\frac{121}{81}$
E	-1	$-\frac{25}{9}$	$\frac{625}{81}$
F	4	$\frac{20}{9}$	$\frac{400}{81}$
G	-3	$-\frac{43}{9}$	$\frac{1849}{81}$
H	2	$\frac{2}{9}$	$\frac{4}{81}$
I	5	$\frac{29}{9}$	$\frac{851}{81}$
<b>Total</b>	<b>16</b>		<b><math>\frac{4500}{81}</math></b>

Mean of the differences  $\bar{d} = \frac{16}{9} = 1\frac{7}{9}$ .

And,

$$s = \sqrt{\frac{1}{n-1} \sum_{i=1}^n (d_i - \bar{d})^2} = \sqrt{\frac{1}{8} \times \frac{4500}{81}} = \frac{5}{6} \sqrt{10}.$$

Assuming the difference in typing has no effect, i.e, mean of the difference is zero, then,

$$t = \frac{\bar{d} - 0}{\left(\frac{s}{\sqrt{n}}\right)} = \frac{\left(\frac{16}{9}\right)}{\left(\frac{5\sqrt{10}}{6\sqrt{9}}\right)} = 2.024.$$

This value of  $t$  is less than 5% value of  $t$  for degree of freedom = 8 which is 2.31.

Clearly, the difference is not significant.

### **t-test for testing the significance of correlation coefficient (Small samples)**

Let a random sample  $(x_1, y_1), (x_2, y_2), \dots, (x_n, y_n)$  be drawn from the joint distribution of bivariate normal population.

Null hypothesis: The population correlation coefficient is zero.

Test statistics:

$$t = \frac{r\sqrt{n-2}}{\sqrt{1-r^2}}, \text{ with } (n-2) \text{ degrees of freedom,}$$

$$\text{where } r = \text{sample correlation coefficient} = \frac{\sum(x - \bar{x})(y - \bar{y})}{\sqrt{\sum(x - \bar{x})^2 \sum(y - \bar{y})^2}}.$$

If  $t(\text{calculated}) < t(\text{table value})$ , we accept null hypothesis, and

if  $t(\text{calculated}) > t(\text{table value})$ , we reject null hypothesis.

**Example 12.13:** A random sample of size 15 from a bivariate normal population gave a correlation coefficient  $r = 0.5$ . Is this indicating the existence of correlation in the population?

Null hypothesis: The population correlation coefficient is zero.

Test statistics:

$$t = \frac{r\sqrt{n-2}}{\sqrt{1-r^2}}, \text{ with } (n-2) \text{ degrees of freedom}$$

$$= \frac{0.5\sqrt{15-2}}{\sqrt{1-0.5^2}}$$

$$t = \frac{0.5\sqrt{13}}{\sqrt{0.75}} = 2.082.$$

$t(\text{table value})$  for  $P = 0.05$  (13 degree of freedom) = 2.16.

Since,  $t(\text{calculated}) < t(\text{table value})$ , we accept null hypothesis. Thus, the sample correlation is not significant to warrant the existence of correlation in the population.

---

## 12.6 SUMMARY

---

There are a wide change of statistical tests. The decision of which statistical test to use depends on the research design, distribution of the data, and the type of the variable. In general, if the data is normally distributed, we use parametric tests. If the data is non-normal, we choose non-parametric test. In this unit we introduced hypothesis testing procedures based on the use of chi-square distribution and t-test. All these tests are based on the assumption of normality i.e., the

source of the data is considered to be normally distributed. Chi-square test as a parametric test is used for comparing a sample variance to a theoretical population variance and also for goodness of fit. T-test is used for significance of an observed sample correlation coefficient. These tests compare the sample results with those that are expected when the null hypothesis is true. The acceptance or rejection of the null hypothesis is based upon how 'close' the sample or observed results are to the expected results.

---

## 12.7 GLOSSARY

---

**Population:** Any collection of individuals under study is said to be population (universe).

**Sample:** A part or small section selected from the population is called a sample and the process of such selection is called sampling.

**Parameters:** Statistical measures such as mean, variance etc. of the population are called as parameters.

**Statistic:** It is a statistical measure computed from sample observation alone.

**Null hypothesis:** A hypothesis which is tested under the assumption that it is true is called a null hypothesis. A hypothesis which is tested for possible rejection under the assumption that it is true is known as null hypothesis.

**Alternate hypothesis:** The hypothesis which differs from a given null hypothesis, and accepted when null hypothesis is rejected is called alternate hypothesis.

**Test of significance:** Procedures which enables us to decide, on the basis of sample information whether to accept or reject the hypothesis or to determine whether observed sampling results differ significantly from expected results are called tests of significance.

**Critical Region:** The part of the sample space which amounts to rejection of null hypothesis  $H_0$ , is called critical region or region of rejection.

**Type I Error and Type II Error:** The wrong decision of rejecting a null hypothesis  $H_0$ , when it is true is called the Type I Error, i.e., we reject  $H_0$  when it is true.

The wrong decision of accepting the null hypothesis  $H_0$ , when it is not true is called the Type II Error, i.e., we accept  $H_0$  when  $H_1$  is true.

---

## 12.8 SELF ASSESSMENT QUESTIONS

---

### 12.8.1 Indicate the correct answer:

- The coefficient of correlation will have negative sign when
  - X is increasing and Y is decreasing
  - Both X and Y are increasing
  - Both a and b
  - There is no change in X and Y

- The coefficient of correlation



- (a) Cannot be positive  
(c) Is always positive
- (b) Cannot be negative  
(d) Can be both positive as well as negative
3. The coefficient of determination
- (a) Cannot be positive  
(b) Cannot be negative  
(c) Is positive (having magnitude less than one) and zero  
(d) Can be both positive as well as negative
4. The coefficient of correlation
- (a) Can take any value between -1 and +1.  
(c) Is always more than -1.
- (b) Is always less than -1.  
(d) Cannot be zero.
5. The coefficient of correlation
- (a) Independent of change of scale and origin of the variables.  
(b) Independent of change of scale and dependent of origin of the variables.  
(c) Independent of change of origin and dependent on the scale.  
(d) Depends on both of change of scale and origin.
6. The coefficient of correlation between two variables X and Y is 0.64. Their covariance is 16. The variance of X is 9, The standard deviation of Y-series is
- (a) 8  
(c) 8.33
- (b) 7  
(d) 0
7. The coefficient of correlation  $r = 0$  shows
- (a) Lack of linear relationship.  
(b) No relationship  
(c) There may be any other relation such as  $Y = X^2$ , but not linear relation.  
(d) Both a. and c.
8. For testing the significance of an observed sample correlation coefficient, we use
- (a) T- test  
(c) Both a. and b.
- (b) Chi-square test  
(d) None of these
9. To test the independence of attributes in a contingency table, we use
- (a) T- test  
(c) Both a and b
- (b) Chi-square test  
(d) None of these
10. Chi-square test of goodness of fit is

- (a) Parametric test  
 (b) Non-parametric test  
 (c) A test to determine if a hypothesized probability distribution for a population provides a good fit.  
 (d) Both b. and c.

**12.8.1 Answer Key:** 1. (a), 2.(d), 3. (c), 4. (a), 5.(a), 6.(c), 7.(d), 8.(a), 9.(b), 10.(d)

**12.8.2 Long Answer type Question:**

1. The students got the following percentage of marks in principles of Economics and Statistics:

Roll No.	1	2	3	4	5	6	7	8	9	10
Economics	78	36	98	25	75	82	90	62	65	39
Statistics	84	51	91	60	68	62	86	58	53	47

Calculate the coefficient of correlation.

2. Find the coefficient of correlation between the values of X and Y.

X	1	3	5	7	8	10
Y	8	12	15	17	18	20

3. A set of 15 observations gives mean = 68.57, standard deviation = 2.40, another of 7 observations gives mean = 64.14, standard deviation = 2.70. Use t- test to find whether two sets of data were drawn from populations with the same mean.
4. Calculate rank correlation coefficient for the following data:

X	81	78	73	73	69	68	62	58
Y	10	12	18	18	18	22	20	24

5. Find the covariance of the data given below:

(1, 5), (2, 7), (3, 9), (4, 11), (5, 10), (6, 9), (7, 8), (8, 7), (9, 6), (10,5).

---

## 12.9 REFERENCES

---

- Gupta S. C, Kapoor V. K., Fundamentals of mathematical statistics, Sultan Chand & Sons, India, 11 (2006).
- Gupta C.B., An Introduction to statistics methods, Vikas Publishing House Pvt Ltd, India, 9 (1981).
- Goyal J. K., Sharma J. N., Mathematical statistics, Krishna prakashan media (P) Ltd., India, 25 (2009).
- Kumar R., Statistics, Vardhman publications, Delhi, India, (2013).
- Ray M., Sharma H. S., Mathematical statistics, Ram prasad& sons, Agra, India, 11.
- Kothari, C.R., Research Methodology Methods and Techniques, New Age International (P) Ltd., New Delhi, (2004).

---

## 12.10 SUGGESTED READINGS

---

- S. C. Gupta and V. K. Kapoor: Fundamentals of Mathematical Statistics
- Ray, Sharma and Chaudhary: Mathematical Statistics
- tutorials.istudy.psu.edu.
- R. Kumar: Statistics
- <https://en.wikipedia.org/wiki/Wikipedia:Statistics>
- bobhall.tamu.edu/Finite Math/Module8/Introduction.html

---

## 12.11 TERMINAL QUESTIONS

---

1- Calculate the Karl Pearson's coefficient of correlation between X and Y series:

X	17	18	19	19	20	20	21	21	22	23
Y	12	16	14	11	15	19	22	16	15	20

2- Find the coefficient of correlation between the heights of fathers and sons:

Father	65	66	67	67	68	69	70	72
son	67	68	65	68	72	72	69	71

3- Calculate the coefficient of correlation for the following data:

X	48	53	64	50	58	60	63
Y	54	55	53	60	62	70	48

4- Discuss any two tests of significance based on t-distribution.

5- Calculate Spearman's rank correlation for the following data, and interpret the result.

Maths Marks	15	18	21	24	27	30	36	39	42	48
Statistics Marks	25	25	27	27	31	33	35	41	41	45

6- Calculate the coefficient of correlation from the following data:

x	12	13	14	15	16	17	18
y	14	17	18	19	20	24	28

7- From the following table, calculate y and the Karl Pearson's coefficient of correlation. Arithmetic means of X and Y series are 6 and 8 respectively.

X	6	2	10	4	8
Y	9	11	y	8	7

8- Calculate  $\chi^2$  for the following data:

Class	A	B	C	D	E
$F_0$	8	29	44	15	4
$F_e$	7	24	38	24	7

9- Two medicines A and B were treated to control a certain type of plant disease. The following results were obtained-

	Injected	Not injected
A	40	160
B	10	190

Is medicine B superior to A? Given that for 1 degree of freedom at 5% level of significance the value of  $\chi^2$  is 3.841.