

# S14 FlexMount Camera

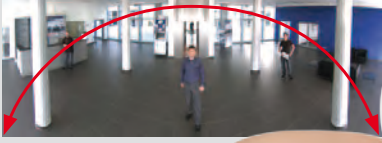

The HiRes Video Company

**MOBOTIX**



## Discreet. Flexible. Hemispheric.

### Two HiRes 180° Panorama

6MEGA double hemispheric camera with no blind spots

### Discreet Miniature Sensor Modules Incl. Microphone

Mountable up to two meters away from the camera housing

### Mobile-Ready (DIN EN 50155)

Certified for mobile use, for example, on buses and trains

### Weatherproof Professional Solution (IP65)

Robust and durable, suitable for day & night use

### Decentralized Complete System

On-board image processing, internal storage or on NAS

### Low Total Costs

Software included, PoE, no wearing mechanical parts



# S14D

Dual Camera System with up to  
6 Megapixel Resolution Dual Imaging



# S14M

Mono Camera System  
With Integrated Lens



# S14 FlexMount Camera

The HiRes Video Company

**MOBOTIX**

## THE WORLD'S FIRST DOUBLE HEMISPHERIC CAMERA

The compact S14D FlexMount is a universally deployable, easy concealable video system with a highly detailed resolution of up to six megapixels. The fully weatherproof IP camera has two miniature sensor modules, which are each connected to the camera housing with a two-meter cable. Thanks to the hemispheric dual lens, two separate rooms can be secured simultaneously without any blind spots.

### Two HiRes 180° Panorama

One S14D replaces up to eight standard cameras, with detailed, wall-to-wall panorama images of two connected or separate rooms.

### Discreet Miniature Sensor Modules Including Microphone

No visible camera housing for inconspicuous appearance. Flexible installation thanks to two-meter sensor cables.

### Mobile-Ready (DIN EN 50155)

For buses, trains and other types of vehicles. Increased security thanks to HiRes video and audio. With minimal technical requirements.

### Weatherproof Professional Solution (IP65)

Extremely robust and durable in indoor and outdoor environments. For day and night use, from -30 to +60° C (-22 to +140° F). No additional heating required.

### Decentralized Complete System

Camera with on-board image processing guarantees a minimal network load. Long-term storage on an internal SD card or externally on NAS.

### Low Total Costs

Low power consumption with under 5 watts (PoE supply). No wearing mechanical moving parts. Free-of-charge software for PC, tablet and smartphone.



## Technology Leader Of Network Cameras

MOBOTIX is known as the global market leader for high-resolution video systems. Each camera includes a high-speed processor as well as digital memory for long-term recording (decentralized MOBOTIX concept).

# The Decentralized MOBOTIX Concept



Original MOBOTIX camera image: Standard CIF compared to MOBOTIX HiRes

## HiRes Video Innovations And Technology Leader

The German company MOBOTIX AG is known as the leading pioneer in network camera technology since its founding in 1999, and its decentralized concept has made high-resolution video systems cost efficient.

MOBOTIX has been producing megapixel cameras exclusively for many years now and is regarded as **the global market leader for high-resolution video systems.**

## Why High-Resolution Systems?

The higher the resolution, the more accurate the detail in the image. With analog technology, a recorded image generally has no more than 0.1 megapixels (CIF). **One**

**single MOBOTIX camera with 3.1 megapixels records around 30 times more detail.** As a result, larger image areas with up to 360° allround views are possible, thus reducing the number of cameras, and therefore the costs. For example, four lanes of a gas station can be recorded with one MOBOTIX camera instead of four conventional cameras.

## Disadvantages Of The Centralized Solution

Usually, cameras only supply the images while the processing and recording is done later on a central PC using expensive video management software. This traditional centralized structure has many limitations, since it requires high network bandwidth and the PC processing power is not enough for several cameras. An HDTV MPEG4 film already puts considerable strain on a PC, so how can it be expected to process dozens of high-resolution live cameras? **Traditional centralized systems are therefore less suitable and unprofitable when compared with high-resolution systems due to the high number of PCs needed.**

Standard system requires an extra PC including software for analysis and storage



**Standard system**  
Storage bottleneck is pre-programmed



Recording software



PC as storage device

## Standardized Network Technology

The cameras are connected and supplied with power using a single network cable. A separate video cable is not required. This has the advantage that access can be granted from anywhere in the world using affordable standard fiber optic, copper and wireless components.

## The Decentralized MOBOTIX Concept

Unlike other systems, **with the decentralized MOBOTIX concept, a high-speed computer** and if necessary, digital **long-term memory (MicroSD Card)** is built into every camera, providing several days of recording time. The PC and the video control center now serve only for viewing and controlling the cameras (PTZ), not for analysis or recording. This makes it unnecessary to purchase expensive video management software, as the most important and computer-intensive functions are already integrated in the MOBOTIX cameras.



MOBOTIX systems are decentralized and secure, even without a PC for storage

## SD Card Memory Reduces Recording Costs

Events can be recorded internally (up to 64 GB) or externally to any PC, server or cost-efficient NAS drive on the network. Thanks to the high internal storage capacity and the option of recording only the sequences in which an event occurs, external storage devices such as hard drives are rarely required. This saves on recording devices and network infrastructure and reduces the maintenance cost of mechanical components in hard drives and fans. Internal storage is digital and does not use mechanical components, which makes it maintenance-free.

64 GB: Continuous two-week recording of four gas station lanes, four days of TV-quality video, 200,000 high-resolution ten-second clips, or two million single images

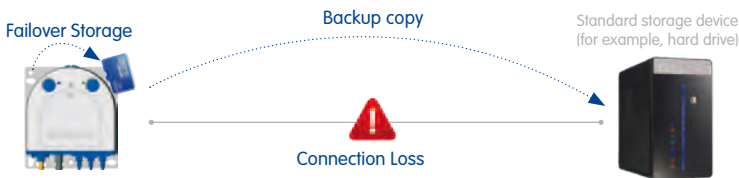

If the standard storage medium is disconnected or fails, the video stream is automatically diverted to the camera's internal storage until the problem is resolved

Even when external recording is preferable due to a vulnerable camera location, internal storage is used to buffer the video stream in case of bandwidth fluctuations or network failures. In any case, the decentralized approach serves to slim down the recording process. As a result, **10 times as many cameras** can be simultaneously recorded on a PC or server. Naturally, this is not just stamp-size video or stationary images but high-resolution HDTV video and audio.

Fewer storage devices, lower costs

## Custom-Tailored Control Room Software

In contrast to other software solutions, MxControlCenter supports the decentralized recording technology of the MOBOTIX cameras. It not only enhances performance, it also bridges network failures without any gaps in the recording stream.

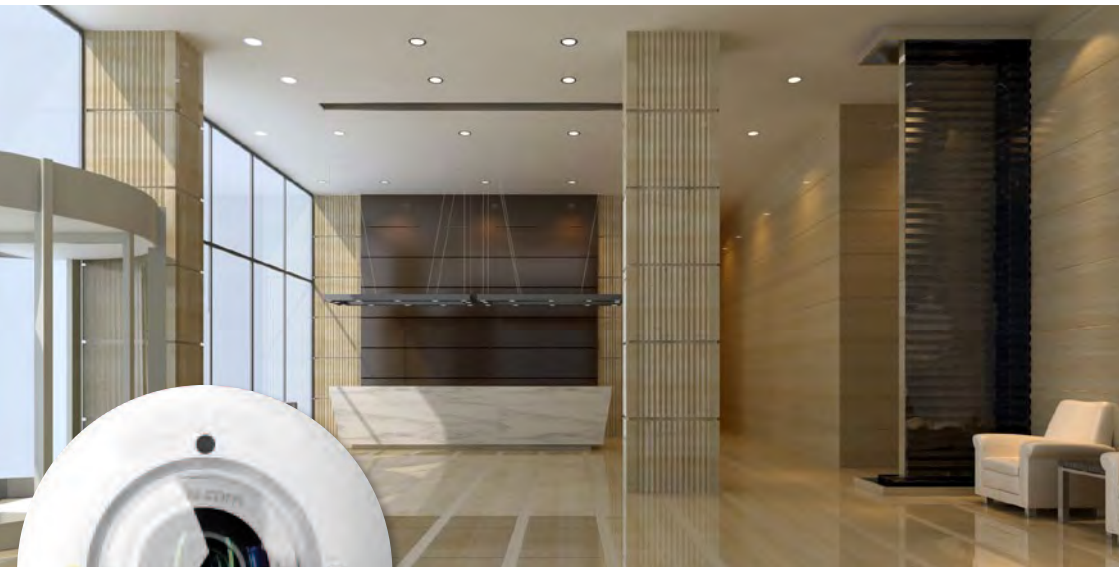

## A Camera Can Be This Discreet

In some application scenarios it is best if a surveillance camera is present but not visible. With the S14 FlexMount, MOBOTIX presents an IP video system with an especially discreet appearance, enabling a flexible range of applications. The inconspicuous appearance of this digital network camera makes it an ideal solution when unobtrusive design and appearance are important.

When in use, the S14 also remains inconspicuous as its lenses usually have a stationary focus that captures an entire room rather than following individual objects. Without mechanical moving parts, the camera requires low maintenance and it is silent when digitally panning and focusing on a specific image area.

Typical application scenarios for an S14 FlexMount are in hotels and restaurants, installations in public buildings, waiting rooms, sales rooms, parking garages, warehouses and exhibition booths, but also the installation in machines or devices such as ATMs is possible.

## Discreet Security

MOBOTIX is proud to present the S14 FlexMount, a camera characterized above all by its miniature sensor modules and huge range of application scenarios. The S14 additionally offers the option of using two hemispheric sensor modules simultaneously.

Image is actual size, diam. 50 mm

### High-Performance HiRes System With Mono Or Dual Lens System

The single lens version of this camera is the S14M (M = mono) with the lens directly screwed into the camera housing. The camera features a high-resolution 3 megapixel color sensor for daylight or a 1 megapixel black-and-white sensor for locations with low lighting. If needed, microphone and/or speaker units can be directly connected to the camera via suitable terminal connectors.



S14M

The dual lens version is, the S14D (D = dual). One or two compact sensor modules (with a diameter of just 50 mm) with integrated microphones are connected to the actual camera housing with one or two 2-meter long connector cables.



S14D with two sensor modules, each with 2 m cable

### Network Video

MOBOTIX has redefined video. Whether on the Internet, in traffic management, building surveillance or banking environments, the MOBOTIX camera is connected to the network like a printer and live and recorded images can then be retrieved from any PC without installing any software.

Concealed camera housing



2 m cable



Integrated microphone

Integrated microphone

## Concealed Camera Housing

The flat housing of the S14D FlexMount, including long-term flash memory (MicroSD card up to 64 GB) and all internal and external connectors (Ethernet, MiniUSB, MxBus, microphone, speaker), can be installed discreetly and with optimal protection behind a wall or ceiling panel so that only the lens units in their protective housings are visible in the room.

## Flexible Sensor Modules Available In Two Different Colors

The sensor modules with integrated lens, image sensor and microphone are shipped pre-assembled from the factory as a ceiling- or wall-mounting set that is easily connected to the camera housing by a quick connection plug. The color of the visible external part is either black or white, which makes it an outstanding fit within a broad range of installation environments, whether indoors or outdoors.



## Lowest Maintenance Costs

Fiberglass-reinforced, robust housing with fully concealed cabling and no mechanical moving parts guarantee long product life with virtually no need for maintenance.



### Network Connection Via Patch Or Installation Cable

Network connection is easy thanks to an up to ten-meter MOBOTIX patch cable that plugs directly into the housing. Alternatively, the eight individual strands of a standard installation cable (such as Cat5) can be attached to the LSA terminal integrated into the housing.

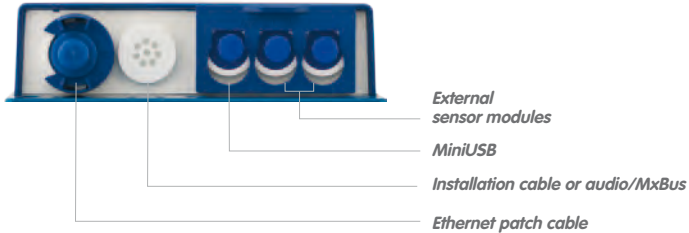

### Easy Replacement Of Sensor Modules

The system can easily be matched to suit the location requirements, thanks to a range of available sensor modules with lens aperture angles between 15° and 180° (S14D only).

Replacing the sensor modules at a later stage to change the focal lengths or upgrading from one to two sensor modules (mono/dual operation) is quick and easy.

### Configurable For All Lighting Conditions

Day and night versions are available for all sensor modules. If fitted with one day sensor and one night sensor, the S14D can simultaneously monitor a permanently light area (for example, hotel reception area) and a permanently dark area nearby (for example, storage room).

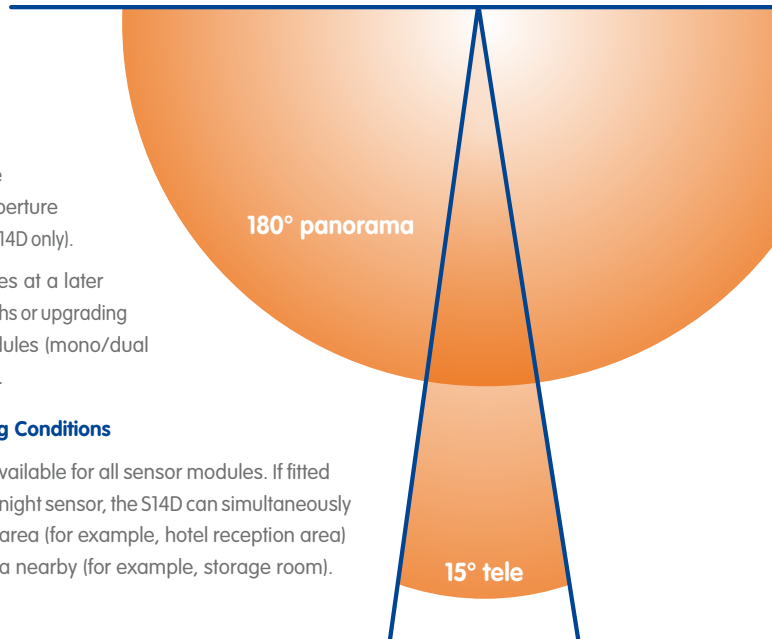

### Lowest Installation Costs

MOBOTIX cameras can be quickly and easily installed by any electrician with network experience or any IT technician – just like connecting a printer to a computer network.



### Unlimited Usage Possibilities

The camera is ideal for the most discreet installation locations thanks to the extremely small visible surface area of the S14D FlexMount and the separation of housing and sensor modules. Of course, the MOBOTIX S14 system is just as suitable for weatherproof installation in all kinds of devices (such as automated bank tellers) as a modern door spyhole, a research camera and many other scenarios. There are virtually no limits to your ideas with the S14.

### Vandalism Protection

The MOBOTIX S14 also demonstrates its advantages in more critical environments. The inconspicuous appearance and low-visibility contact surfaces of the sensor modules, combined with the inaccessible camera housing and connectors mounted behind a wall or cover panel, make acts of vandalism significantly more difficult than with conventional cameras.

### High-Resolution Digital Image Instead Of TV Quality

A megapixel sensor and integrated image processing generate sharp and court-evidence admissible images in a resolution higher than HDTV.

### Hard To Be Seen, But Sees Everything: S14M

Unlike the S14D, the S14M has just one lens, which does not have a flexible sensor cable but is directly connected to the camera housing. However, compared with conventional mono cameras, the S14M has a special feature:

The camera housing can be mounted completely out of view behind a wall up to 6 mm thick (wood paneling, stainless steel panel, etc.) with a small round opening measuring just 34 mm. The S14M can simply be fixed behind the wall, leaving only the tiny exposure area of the hemispheric lens visible.



*Mounting set without screws for the S14M with speaker and microphone behind stainless steel (MOBOTIX Accessories)*

#### **This allows the following installation options:**

- Wall- or ceiling-mounting behind correspondingly thin or countersunk panels/cover plates
- Individual mounting solutions such as installation in industrial equipment, paneling, air ducts, mail boxes, homemade mounts, etc.

### Low Power Costs, No Extra Heating

Anti-fogging without heating allows year-round usage of standard PoE technology to power the system via Ethernet or two-wire cable and saves the costs of power cabling (power consumption approx. 4 W).

# Hemispheric Dual Camera



**180° panorama – sensor module 1**

## The World's First Double Hemispheric Camera

As a world first, the S14D provides the option of using two hemispheric sensor modules within a single camera, featuring L11 fisheye sensors with a horizontal image angle of 180°. This means that the entire hemispheric area in front of each lens is captured, with no blind spots from wall to wall and floor to ceiling. Within fractions of a second, the microprocessor of the camera transforms the hemispheric image into an undistorted, wide-angle 180° panorama image.

Two entirely separate rooms – next to or on top of each other, indoors or outdoors – can be monitored simultaneously using the S14D with two hemispheric sensor modules.

## Virtual PTZ – No Motor, No Wear-And-Tear

The virtual PTZ feature allows you to move image sections within the hemisphere just like with a camera, yet without the need for mechanical moving parts. The live image from the camera can be continuously enlarged, while allowing users to zoom in on any section of the image using the mouse or a joystick. This provides the features of a mechanical PTZ camera without the disadvantages of maintenance and wear.



Unlike a normal PTZ camera, which is always focused on one section of a room and only records that section, the virtual PTZ also allows to pan to other areas at a

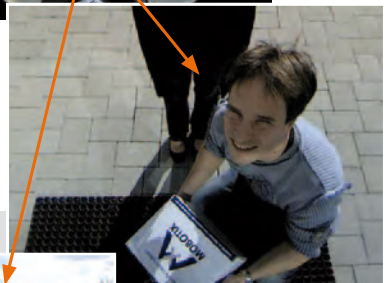



**180° panorama – sensor module 2**

later stage in the recording, since optional full image recording always captures the entire room within the hemispheric image.

**Automatic Adjustment For Changing Light Conditions**

MOBOTIX S14D is also the world's first hemispheric day-and-night camera. The black-and-white and color sensor modules are mounted directly next to each other so they cover the same area. The camera automatically chooses the best available mode depending on the lighting conditions: either the color sensor with daylight lens, or the black-and-white image sensor with infrared lens. The dual sensor system provides excellent colors in daylight as well as superb light sensitivity in dark environments.



**180° panorama – B/W sensor**

The difference between a MOBOTIX day-and-night camera and the standard versions is primarily that the MOBOTIX camera continuously uses two sensor modules rather than relying on a mechanical filter switch. In low light conditions, the hardware ensures an inherently better image quality, as a true infrared black-and-white image sensor is used instead of the usual color sensor with electronic color fade-out.

Dual FlexMount mounting aid from Q4/2012



**Hemispheric Technology For An Overview With No Blind Spots**







360° panorama view or 180° widescreen image with perspective correction; a single sensor module can monitor an entire room or area without any blind spots.

## S14M Lens

The S14M is available with an L11 lens and either a day sensor or night sensor.

## S14D Sensor Modules

The S14D is available with day or night sensor modules, each of which features a hemispheric L11 lens and any of the MOBOTIX L22 to L135 lenses (including a non-reflective protection layer made of tempered glass). All S14D sensor modules can be freely interchanged with each other.

Lenses	L11	L22	L32	L43	L65	L135
Original image						
35mm-equivalent focal length	11 mm	22 mm	32 mm	43 mm	65 mm	135 mm
Nominal focal length	1.8 mm	4 mm	6 mm	8 mm	12 mm	25 mm
Aperture	2.0	2.0	2.0	2.0	2.0	2.5
Horizontal image angle	180°	90°	60°	45°	31°	15°
Vertical image angle	160°	67°	45°	34°	23°	11°
<b>Distance 1 m</b>	<b>m</b>	<b>m</b>	<b>m</b>	<b>m</b>	<b>m</b>	<b>m</b>
Image width	infinite	2.0	1.1	0.8	0.5	0.3
Image height	11	1.3	0.8	0.6	0.4	0.2
<b>Distance 5 m</b>	<b>m</b>	<b>m</b>	<b>m</b>	<b>m</b>	<b>m</b>	<b>m</b>
Image width	infinite	10.0	5.7	4.1	2.7	1.3
Image height	55	6.6	4.1	3.0	2.0	1.0
<b>Distance 10 m</b>	<b>m</b>	<b>m</b>	<b>m</b>	<b>m</b>	<b>m</b>	<b>m</b>
Image width	infinite	20.0	11.5	8.2	5.5	2.6
Image height	110	13.3	8.2	6.1	4.0	1.9
<b>Distance 20 m</b>	<b>m</b>	<b>m</b>	<b>m</b>	<b>m</b>	<b>m</b>	<b>m</b>
Image width	infinite	40.0	23.0	16.4	11.0	5.2
Image height	220	26.6	16.4	12.2	8.0	3.8
<b>Distance 50 m</b>	<b>m</b>	<b>m</b>	<b>m</b>	<b>m</b>	<b>m</b>	<b>m</b>
Image width	not specified	100.0	57.5	41.0	27.5	13.0
Image height	not specified	66.0	41.0	30.5	20.0	9.5

S14D sensor modules can be freely interchanged

Sensor modules L22 through L135 provide a non-reflective protection layer made of **tempered glass**

## MOBOTIX Full Image Storage

It is always possible to record a full image, regardless of the live image stream that is being displayed. As a result, the recording always contains the maximum image data, even though the operator may have used the vPTZ features to zoom into the image.



180° panorama



180° panorama



180° panorama



full image



180° panorama



panorama focus

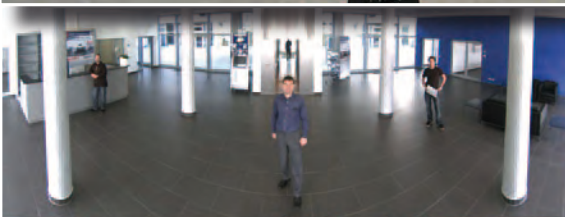

panorama focus

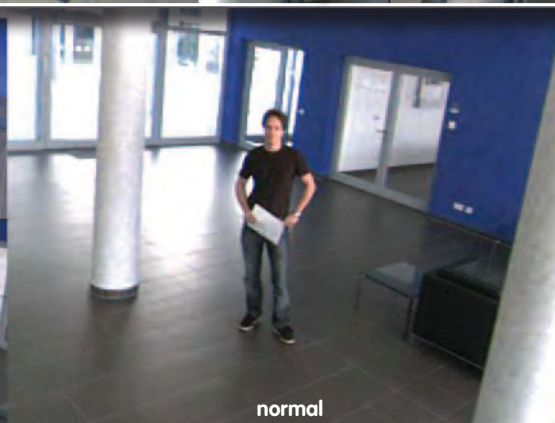

normal

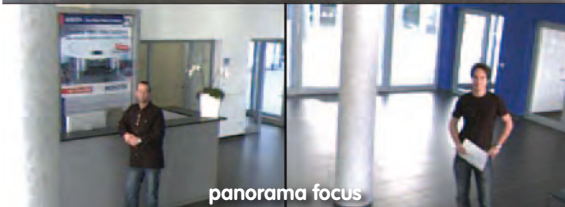

double panorama



panorama focus

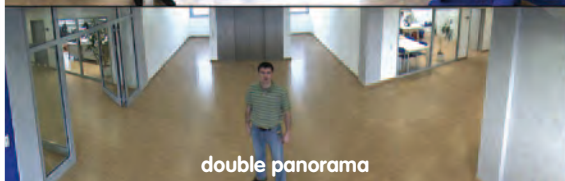

panorama focus

## Ceiling Installation

Indoor installation is mostly on suspended ceilings. The maximum distance between the two sensor modules of an S14D is four meters with the camera housing placed at the center. Such flexible installation options open up new application scenarios:

- Two adjacent areas separated by a dividing wall, shelves, floor ceiling or other form of screen can be captured with no blind spots using an S14D.

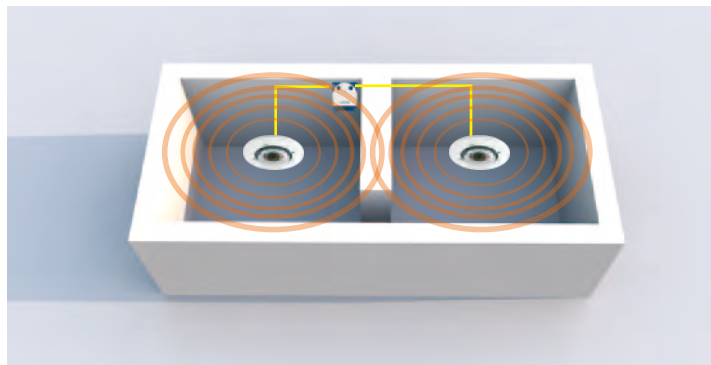

- In rooms that are especially long and narrow, installing two sensor modules at the center directly next to each other, but facing in opposite directions, produces a high-resolution dual hemispheric image without any blind spots at all.

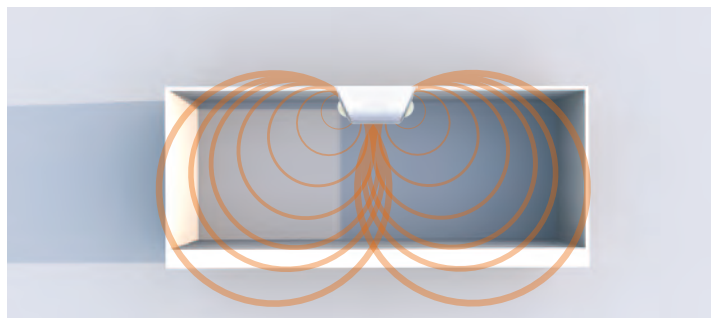

SurroundMount mounting aid (Accessories)



## Very Simple Installation

Screw in sensor module. Connect to housing. Plug in network cable or wireless module, done! Probably no other camera can be connected quicker or easier. And because fewer cameras are needed, the installation costs drop even further.



- The two sensor modules are simply positioned at a right angle on the center corner in L-shaped rooms, again enabling the S14D to capture the entire room without any blind spots.

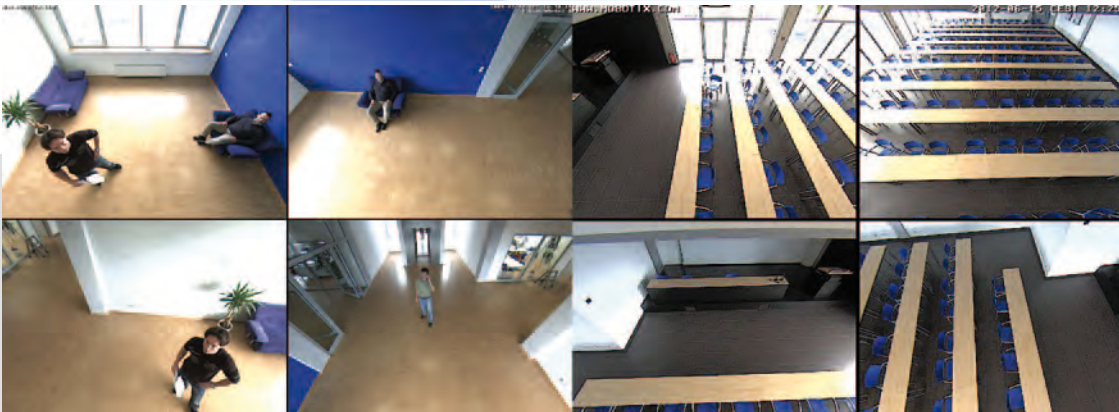
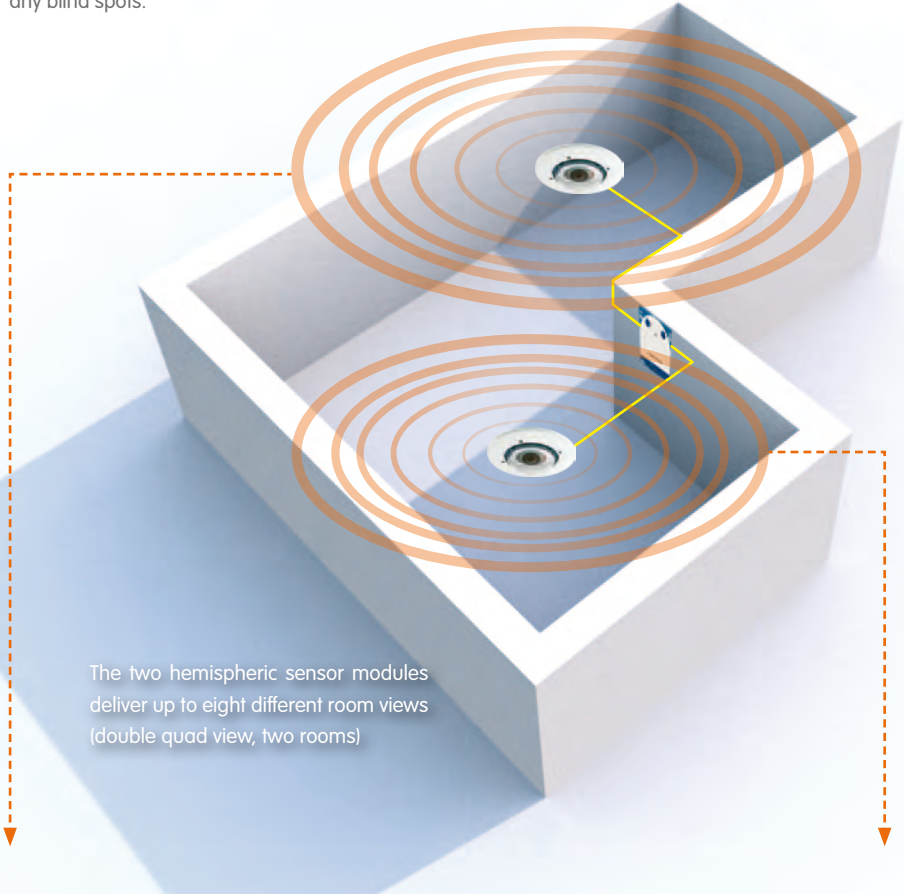

## Wall Installation

Installing an S14D sensor module on a wall, for example, on basic partition walls or fake walls with cavities behind the wall cover (minimum thickness of 15 mm), is just as easy as an installation on a ceiling. Drill a hole, insert the sensor module, fix from behind with a locknut and connect to the camera housing. Depending on the installation height and the required camera focus, the camera can be installed with or without the SlopeMount with 15° tilt, which is available as an accessory.

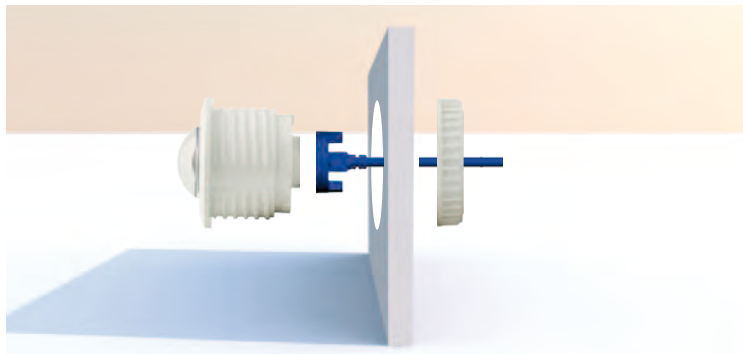

SlopeMount 15°  
mounting aid  
(Accessories)

Typically the sensor modules are mounted high enough (from 2.5 m) to protect them against direct access. Since the image quality and detail decrease with distance of an object from the camera focus (center of image), it is recommended to install the camera so that the focus is on the center of the event in the room, using the SlopeMount, a 15° inclined wall mounting.

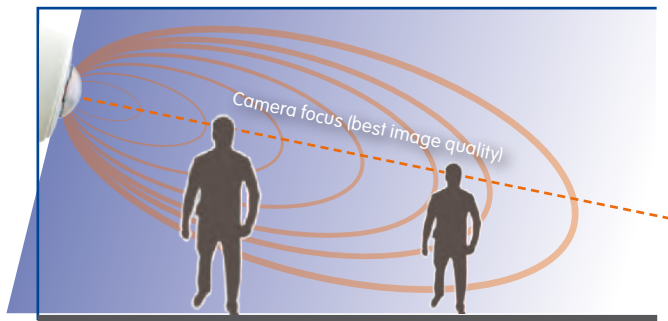

## Mounting On A Door

A sensor module on a door should always be fitted with SlopeMount. Thanks to the 15° lens angle, less important areas such as ceiling or sky are reduced and the areas in front of the door are captured with improved image clarity.

MOBOTIX also offer the appropriate installation accessories for mounting the sensor module on thicker walls. Longer “tunnel holes” through a wall can also be bridged using several extension pieces (each approx. 40 mm). The maximum wall thickness is therefore only limited by the length of the sensor cable in relation to the installation position of the camera housing.



### **Mixed Ceiling And Wall Installation**

By installing a sensor module on the ceiling of a room and at the same time attaching the second sensor module to an outside wall of the same room, both the inside and outside area can be captured with one single S14D at minimal installation cost.

### **Example: Kiosk**

Simultaneous capture of the entire sales floor and the area outside the entrance with stand-up cocktail tables.

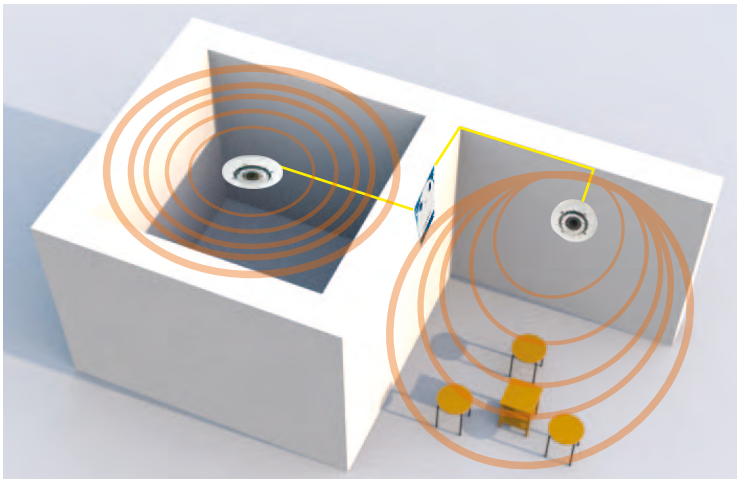

### **Robust And Maintenance-Free**

Fiberglass-reinforced composite housing with built-in cable protection and no mechanical moving parts (no auto iris) guarantee longevity.





## Security Is A Competitive Advantage

More than ever, operators of public and private transportation or commercial transport trucks must act on vandalism, theft and violence within and against their vehicles. This ensures their guests feel safe and that business remains viable in the long term. MOBOTIX' decentralized, high-resolution video security technology is perfect for these requirements. With the help of detailed wall-to-wall hemispheric images, offenders can be identified faster and more reliably than with conventional video systems.

"Video Surveillance by MOBOTIX" discourages offenders, and has been proven to increase the safety of passengers and staff alike. For a good number of years now, security technicians from all over the world have been most enthusiastic about the effectiveness and the outstanding image quality delivered by the MOBOTIX systems.

## Fully Suited To Mobile Use

The S14D and S14M models have been subjected to rigorous certification tests (DIN EN 50155), ensuring that even under the most challenging environmental conditions for mobile use, complete reliability is granted at all times.

## The S14 Is Also A Convincing Mobile Solution:

- Easy installation, very little space required
- Low material costs and no need for expensive, fragile recording devices
- Camera housing with integrated flash memory can be securely mounted out of sight
- Resistant to continuous vibration
- Resistant to temperature and humidity fluctuations
- Cost-efficient replacement of parts that are visible/subject to vandalism – only the sensor module needs to be replaced, not the entire camera; no recordings are lost
- Custom-tailored accessories for enhanced usage options

## Mobile Power Supply And Data Connection

With the MX-NPA-Box, and the upcoming MX-NPS3 alarm center (scheduled for Q4/2012), MOBOTIX is offering battery power for a single camera (12 - 57 V), and power plus UMTS network connection for up to three cameras.

### SurroundMount (Accessories)

Installing the two sensor modules pointing in opposite directions, which is suitable for particularly long, narrow spaces such as buses, planes or trains, delivers double hemispheric images of up to 6 megapixels. In terms of sharpness and detail, this significantly outperforms the results of a single hemispheric camera with just one lens. For these kinds of installations, MOBOTIX will be offering an appropriate mount as part of the range of accessories available for the S14 (SurroundMount). The slight downward tilt of the two sensor modules allows the area directly underneath them to be captured with no blind spots.

Available Q4/2012

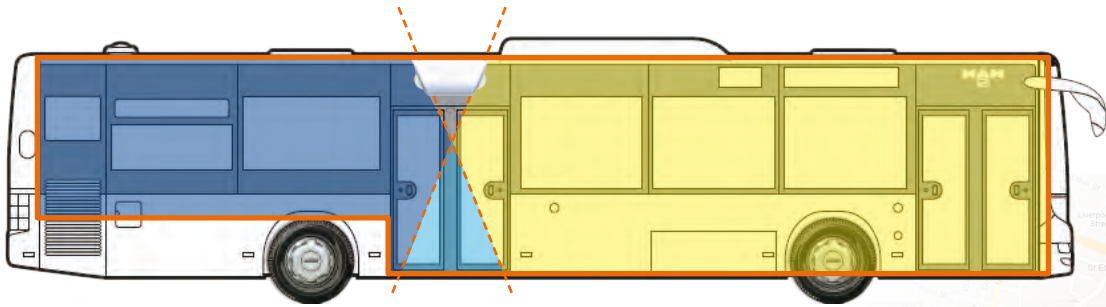
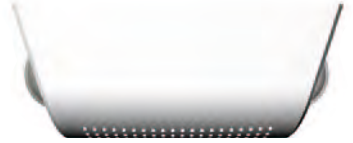

### MX-GPS-Box (Accessories)

Weatherproof GPS timer for MOBOTIX systems (protection class IP65, -30 to +60° C/-22 to +140° F) includes an exterior temperature sensor and a brightness sensor. Connection is provided by the MxBus two-wire cable of the S14 (for example, bell wire).

- Alarms whenever there is a change in position, speed, brightness or temperature
- Current GPS data can be transferred (wireless or cable network) at any time
- Maximum cable length between camera housing and MX-GPS-Box is 50 meters
- The box can also be mounted on the outside of the vehicle for the best GPS reception (for example, on the roof, rear of the truck cab, etc.)



### No Recording Gaps During Network Failures

Internal camera data storage (up to 64 GB) bridges even longer network failures or bandwidth fluctuations (primarily on wireless networks).

S14D Dimensions (values in mm)

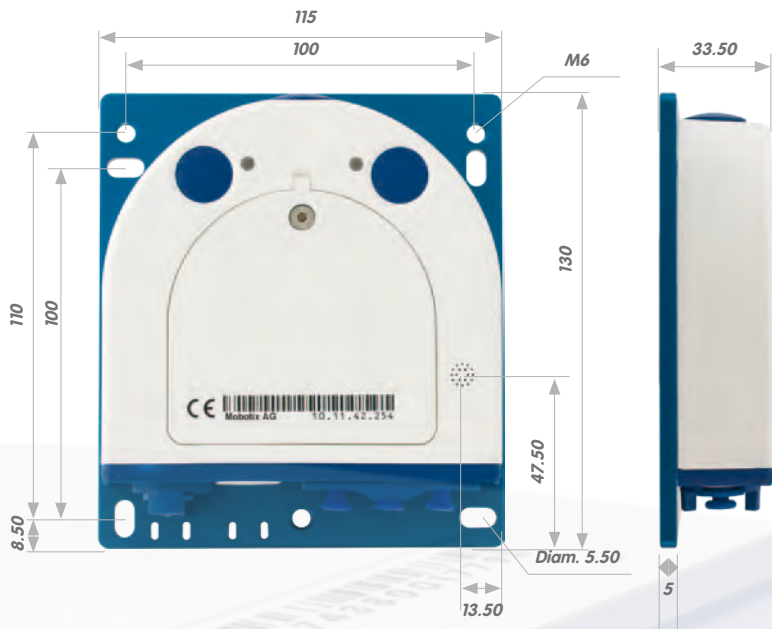

Dimensions of S14D L11 Sensor Module



## Maximum Reliability

Hundreds of thousands of MOBOTIX systems are successfully in use throughout the world. These cameras operate resiliently around the clock.

**S14M Dimensions (values in mm)**

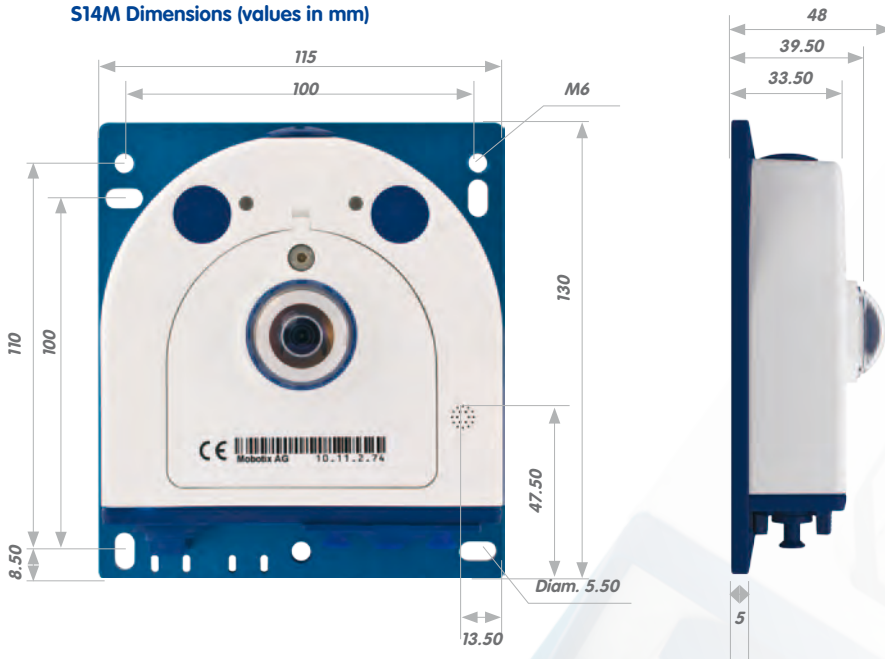

**S14D/S14M Connections**

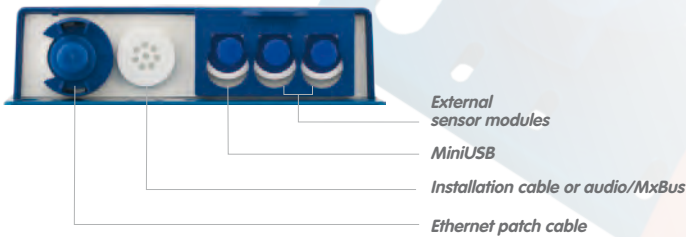

**MOBOTIX Stores Data Reliably**

Thanks to the lack of any mechanical moving parts, flash memory is particularly reliable and secure. The MOBOTIX FlashFile system (MxFFS) prevents unauthorized persons from reading or transferring the internally stored data, even if the card is stolen.



Technical Specifications S14D/S14M	
<b>Model versions</b>	MX-S14M-SEC (day), MX-S14M-SEC-NIGHT (night), MX-S14D-SEC (all combinations of day/night sensor modules)
<b>Sensor modules</b>	11 to 135 mm format, horizontal angle 180° to 15°
<b>Sensitivity</b>	Color sensor: 1 lux (t = 1/60 s), 0.05 lux (t = 1/1 s) Black-and-white sensor: 0.1 lux (t = 1/60 s), 0.005 lux (t = 1/1 s)
<b>Image sensor S14M/S14D (in sensor module)</b>	1/2" CMOS, progressive scan
<b>Max. image resolution (dual image)</b>	Color, color: 4096 × 1536 (6.2 MEGA) Color, black-and-white: 2048 × 1536, 1280 × 960 (4.3 MEGA) Black-and-white, black-and-white: 2560 × 960 (2.5 MEGA)
<b>Image formats (per sensor)</b>	User choice of image format, for example, 2048 × 1536 (3 MEGA), 1280 × 960 (MEGA), 1024 × 768, 800 × 600, 768 × 576 (DI-PAL), 704 × 576 (TV-PAL), 640 × 480, 384 × 288, 320 × 240, 160 × 120
<b>Max. frame rate M-JPEG (live/recording)</b>	VGA: 30 fps, MEGA: 10 fps, 3MEGA: 4 fps, 6MEGA: 2 fps
<b>Max. video rate MxPEG (live/recording/audio)</b>	VGA: 30 fps, MEGA: 30 fps, 3MEGA: 20 fps, 6MEGA: 8 fps
<b>Image compression</b>	MxPEG, M-JPEG, JPEG, H.264 (for SIP video only)
<b>Internal DVR</b>	MicroSD slot including 4 GB, max. 64 GB
<b>External video ring buffer</b>	Directly on NAS and PC/server without additional recording software
<b>Software (included)</b>	MxEasy video management software (full-scale S14 support in future versions), MxControlCenter control room software
<b>Image processing</b>	Backlight compensation, automatic white balance, image distortion correction, panorama correction, video sensor (motion detection)
<b>Virtual PTZ</b>	Digital pan/tilt/zoom, continuous 8× zoom
<b>Alarm/events</b>	Triggered by motion detection, external signals, temperature sensor, microphone, shock detector, notification via e-mail, FTP, IP telephony (VoIP, SIP), visual/acoustic alarms, pre- and post-alarm images
<b>Sound</b>	Microphone in sensor module (S14D only), S14M via external microphone, lip-synchronous audio, two-way communication, audio recording, external speaker can be connected directly

## Remote Camera Access Via The Internet

With MOBOTIX, a PC is not used to record, but for viewing and researching images in case of an event – from any location on earth with a network connection.





Technical Specifications S14D/S14M	
<b>Interfaces</b>	10/100 Ethernet, MiniUSB, MxBus (keypad RFID support in future software versions); inputs/outputs and RS232 via accessories
<b>Video telephony</b>	VoIP/SIP, two-way communication (with external speaker, not included), remote control via key code, event notification
<b>Security</b>	User/group management, HTTPS/SSL, IP address filter, IEEE 802.1x, intrusion detection, digital image signature
<b>Certifications</b>	EMC (EN 55022, CISPR 22, EN 55024, EN 61000-6-1+2, FCC Part 15B, AS/NZS3548), EN 50121-4, DIN EN 50155
<b>Power supply</b>	Year-round Power-over-Ethernet (IEEE 802.3af/t); variable PoE class, S14D: typ. 4.5 W, S14M: typ. 3 W
<b>Operating conditions</b>	IP65, -30 to +60° C (-22 to +140° F)
<b>Dimensions/weight S14M</b>	W × H × D: 115 × 130 × 39.4 mm (installation dimensions); weight: approx. 457 g (including lens)
<b>Dimensions/weight S14D</b>	W × H × D: 115 × 130 × 33 mm; weight: approx. 444 g (without sensor modules, see below)
<b>Dimensions/weight: L11 sensor module</b>	Diam. × H: 50 × 33.4 mm (installation dimensions); weight approx. 91 g (including lens)
<b>Standard delivery</b>	Housing (high-resistance composite, PBT), white, shock-resistant dome (transparent), mounting parts, Allen wrench, 50 cm patch cable, manual, software, 4 GB MicroSD card (built-in)





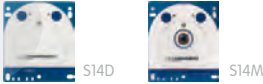

Minimal network load thanks to MicroSD card storage integrated into camera (weatherproof)

## No Storage Limit

There is no storage limit for the system as a whole, as each camera can optionally maintain its own terabyte storage system (NAS) over the network.

Product	Article number	Note	Price (€)
			
<b>Camera sets</b>			
S14D complete set 1, day	MX-S14D-Set1	Camera housing with one L11 day sensor module, one 2 m sensor cable, one extension set, 0.5 m ETH patch cable, one replacement dome, color: white	968
S14D complete set 2, day/day	MX-S14D-Set2	Camera housing with two L11 day sensor modules, two 2 m sensor cables, two extension sets, 0.5 m ETH patch cable, two replacement domes, color: white	1,318
S14D complete set 3, day/night	MX-S14D-Set3	Like Set 2 but with one L11 day sensor and one L11 night sensor	1,318
<b>Camera versions</b>			
			
S14D FlexMount (core)	MX-S14D-Sec	Camera housing without sensor module	648
S14M FlexMount, day	MX-S14M-Sec-D11	Mono camera including L11 lens and 3.1 megapixel (3MP) on-board color sensor	798
S14M FlexMount, night	MX-S14M-Sec-Night11	Mono camera including L11 lens and 1 megapixel (1MP) on-board black/white sensor	798
<b>Sensor modules</b>			
			
S14D L11 sensor module, day	MX-SM-D11-PW, MX-SM-D11-BL	Including L11 lens and 3.1 MP color sensor; color: white (PW) or black (BL)	298
S14D L11 sensor module, night	MX-SM-N11-PW, MX-SM-N11-BL	Including L11 lens and 1.3 MP black/white sensor; color: white (PW) or black (BL)	298
S14D L22 sensor module, day	MX-SM-D22-PW, MX-SM-D22-BL	Including L22 lens and 3.1 MP color sensor; color: white (PW) or black (BL)	248
S14D L22 sensor module, night	MX-SM-N22-PW, MX-SM-N22-BL	Including L22 lens and 1.3 MP black/white sensor; color: white (PW) or black (BL)	248

Product	Article number	Note	Price (€)
S14D L32 sensor module, day	MX-SM-D32-PW, MX-SM-D32-BL	Including L32 lens and 3.1 MP color sensor; color: white (PW) or black (BL)	248
S14D L32 sensor module, night	MX-SM-N32-PW, MX-SM-N32-BL	Including L32 lens and 1.3 MP black/white sensor; color: white (PW) or black (BL)	248
S14D L43 sensor module, day	MX-SM-D43-PW, MX-SM-D43-BL	Including L43 lens and 3.1 MP color sensor; color: white (PW) or black (BL)	248
S14D L43 sensor module, night	MX-SM-N43-PW, MX-SM-N43-BL	Including L43 lens and 1.3 MP black/white sensor; color: white (PW) or black (BL)	248
S14D L65 sensor module, day	MX-SM-D65-PW, MX-SM-D65-BL	Including L65 lens and 3.1 MP color sensor; color: white (PW) or black (BL)	248
S14D L65 sensor module, night	MX-SM-N65-PW, MX-SM-N65-BL	Including L65 lens and 1.3 MP black/white sensor; color: white (PW) or black (BL)	248
S14D L135 sensor module, day	MX-SM-D135-PW, MX-SM-D135-BL	Including L135 lens and 3.1 MP color sensor; color: white (PW) or black (BL)	248
S14D L135 sensor module, night	MX-SM-N135-PW, MX-SM-N135-BL	Including L135 lens and 1.3 MP black/white sensor; color: white (PW) or black (BL)	248
Replacement dome, hemispheric	MX-OPT-DK-L11	Protective screw-on dome for L11 lenses, suitable for S14M and S14D L11 sensor module	28
<b>Mounting aids</b>			
			
40 mm extension for S14D sensor module	MX-S14-OPT-MK-EX	For larger mounting depths; is directly plugged onto a sensor module or previously mounted extension	18
SlopeMount 15°	MX-S14-OPT-MK-CW	Complete set for mounting a sensor module to the ceiling or wall at a 15° inclination; including 40 mm extension, locknut and 15° wedges (white and black)	28
SurroundMount	MX-S14-OPT-SM-PW	Special ceiling mount for two S14D sensor modules; for allround view with no blind spots in long and narrow rooms	Q4/2012
Dual FlexMount	MX-S14-OPT-FM-PW	Special mount for fully parallel sensor module installation	Q4/2012

Product	Article number	Note	Price (€)
<b>Connection cables</b>			
 Sensor cable	 MiniUSB	 Patch cable	
S14D sensor cable	MX-S14-OPT-CBL-2	Two-meter cable for weatherproof connection (IP65) of one S14D sensor module	28
MiniUSB to MiniUSB cable	MX-CBL-MU-STR-5	Five-meter cable for weatherproof connection (IP65) of MOBOTIX extension modules (MX-232-IO-Box, ExtIO, CamIO, two straight plugs (STR))	18
Ethernet patch cable with bayonet catches	MX-OPT-CBL-LAN-1, MX-OPT-CBL-LAN-2, MX-OPT-CBL-LAN-5, MX-OPT-CBL-LAN-10	Patch cable with a length of 1, 2, 5 or 10 meters for weatherproof network connection (IP65) of the S14	from 8
<b>Accessories</b>			
 NPA-PoE set	 Mx2wire+		
NPA-PoE-Set EU	MX-NPA-PoE-EU-Set	Multifunctional PoE injector according to IEEE 802.3af; three RJ45 ports (network, camera/PoE device, PC), crossover function, EU version with EU power plug adapter	98
NPA-PoE-Set INT	MX-NPA-PoE-INT-Set	Multifunctional PoE injector according to IEEE 802.3af; three RJ45 ports (network, camera/PoE device, PC), crossover function, INT version with EU, US, UK, AUS power plug adapters	98
Battery cable for NPA-PoE-Set	MX-CBL-NPA-BAT-2	Battery cable for connecting the NPA-PoE injector to mobile power sources (12 to 42 V DC)	24
Mx2wire+ Media Converter Set	MX-2wirePlus-Set-PW	Complete set for installing an Ethernet network with PoE using conventional two-wire cables, length up to 500 meters; any existing coaxial cables from old analog video cameras, etc. can be used as two-wire cables for a high-resolution MOBOTIX S14	298

Product	Article number	Note	Price (€)	
<b>Accessories</b>				
				
Patch-Box	NPA-Box	GPS-Box	232-IO-Box	ExtIO
MX-Patch-Box	MX-OPT-Patch1-EXT	Weatherproof interface box (IP65); connects network installation cable (LSA terminal) to MOBOTIX patch cable (for camera/PoE device) or two MOBOTIX patch cables (for network and camera/PoE device)	48	
MX-NPA-Box	MX-OPT-NPA1-EXT	Weatherproof interface box (IP65); PoE injector according to IEEE 802.3af; connection screw clamp (+/-) for external power sources (12 to 57 V DC), network connection via MOBOTIX patch cable or LSA+	128	
MX-GPS-Box	MX-OPT-GPS1-EXT	Weatherproof interface box (IP65) for connecting to a MOBOTIX camera's MxBus interface; reports time and position; delivers GPS-based events (deviation from a fixed position, exceeding minimum/maximum speeds or temperatures)	178	
MX-232-IO-Box	MX-OPT-RS1-EXT	Weatherproof interface box (IP65) for connecting to a MOBOTIX camera's MxBus or MiniUSB interface; contains two signal inputs and outputs each plus a serial RS232 interface	148	
ExtIO expansion module	MX-ExtIO	Expansion module for connecting to a PoE switch or to a MiniUSB interface of a MOBOTIX camera; contains a high-performance loudspeaker, microphone, infrared motion sensor, external temperature sensor, two input contacts and two output contacts, two backlit buttons	198	



## MOBOTIX Software Free-Of-Charge

As is to be expected from MOBOTIX products, the entire setup and operating software is either integrated directly into the camera (web browser-controlled camera software) or can be downloaded for Windows/Mac from the MOBOTIX website free of charge (MxEasy and MxControlCenter: [www.mobotix.com](http://www.mobotix.com) > Support).



## MxControlCenter – Professional Video Management

Instead of using a web browser, you can download and install the free-of-charge MxControlCenter from the MOBOTIX website. This program allows live images from high-resolution MOBOTIX cameras to be displayed on one monitor with sound. In addition, MxControlCenter can activate alarms with lip-synchronous audio and also enables convenient event search. The integrated Layout Editor of MxControlCenter allows you to quickly create floor plans by simply dragging/dropping the cameras onto a background image. Load a floor plan as a background image, drag and drop the cameras and you're done.

## App With Integrated Bandwidth Optimization

Remote bandwidth optimization automatically adjusts the image size and frame rate to the available bandwidth. This not only applies to the live camera feed but also to recordings and image sections.

### MxEasy – Intuitive Application For Up To 16 Cameras

MxEasy aims at easy operation of the most important camera functions through its intuitive user interface, thus creating a new user experience when configuring and viewing MOBOTIX cameras. The clear design allows up to 16 cameras to be managed, and the application can show up to four cameras at the same time.

Future versions of MxEasy will provide full-scale support for the S14 FlexMount



### MOBOTIX App – Mobile Solution For The iPad, iPhone And iPod Touch

The MOBOTIX App allows you to enjoy a mobile security system from anywhere in the world. You can view live camera feeds and receive important additional information. What happened today while I was gone? When and why did the video motion detection of my camera trigger? You will be alerted by camera alarms in real-time, and you can view the events recorded by any connected camera from anywhere. The App provides access via WLAN (Wi-Fi) and UMTS (for slower connections) and it offers a fast remote search function with multi-view and fast forward/reverse for multiple cameras at a glance.

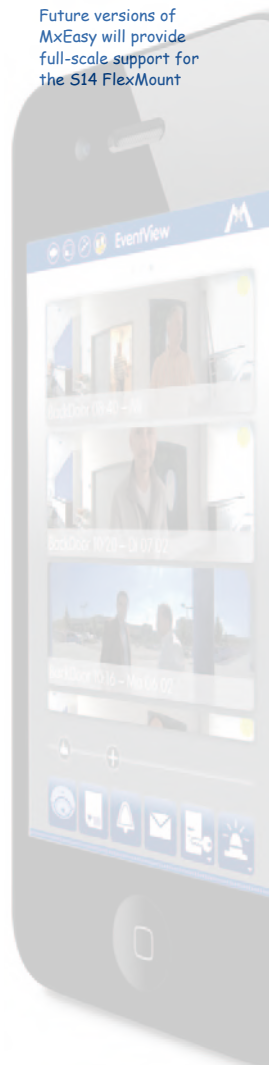

**DVR:** Abbreviation for Digital Video Recorder.

**Ethernet:** The most common technology for communication within a wired network. It facilitates data exchange between all devices (computers, printers, IP cameras, IP video phones, etc.) connected in a local network (LAN).

**Events:** An event refers to a situation when something happens or changes. In terms of video surveillance, this means a change in the status of an area that is being monitored. This may be movement of a person, a change in brightness, a drop in ambient temperature, the detection of a noise via a microphone, an electrical signal at a signal input, the manual operation of a button, etc.

**Flash memory:** See MicroSD card.

**Frame rate:** The frame rate specifies how many frames per second (fps) are generated and sent by the camera. 16 fps and higher is perceived by the human eye as a fluid video sequence.

**G.711:** G.711 refers to the process by which analog audio signals are encoded and decoded. This codec (= enCOder-DECOder) is used in classic telephone systems and IP telephony.

**H.264:** H.264 is the process by which the video image is encoded/compressed and decoded.

**HiRes:** Abbreviation for High Resolution. Refers to high-resolution images (above 1 megapixel).

**IP network:** Data network based on the Internet protocol (TCP/IP).

**IP telephone:** See VoIP.

**LED:** Abbreviation for Light Emitting Diode. An electronic semiconductor component built into MOBOTIX cameras and add-on modules that emits light when a current flows through the component in the correct direction.

**Megapixel:** Images that have more than one million pixels.

**MicroSD card:** SD Memory Card (Secure Digital Memory Card). A digital storage medium based on flash storage modules.

**Motion detection:** Action of detecting a movement within a particular area. MOBOTIX cameras use algorithmic methods to detect changes from image to image in predefined areas, while taking preset conditions into account. If a camera detects a movement, it signals an event and triggers an alarm.

**MxEasy:** Free MOBOTIX video management software for small and compact camera networks of up to 16 cameras/Door Stations.

**MxPEG:** Method developed by MOBOTIX to compress and store image and video data with low network load and high image quality. The MxPEG ActiveX control element allows video and audio data from MOBOTIX cameras to be displayed in other applications (including Internet Explorer).

### Domestic References

Commerzbank AG • Daimler AG • Deutsche Bahn Station & Service AG • EON Wasserkraft • Fraport AG • Le Méridien Parkhotel Frankfurt • MAN Logistics • Max-Planck-Institut for Chemical Ecology • Skoda Auto Deutschland GmbH • Spielbank Mainz, Trier, Bad Ems GmbH & Co. KG • World Cultural Heritage Site at the Völklingen Ironworks • etc.



**Network:** A group of end devices, such as computers, that are connected via various cables and share access to data and devices such as printers and IP cameras.

**PIR sensor:** Passive infrared sensor for motion detection.

**PoE:** Power over Ethernet. A technology for supplying network-enabled devices (for example, IP cameras) with power via the Ethernet cable.

**PTZ:** Abbreviation for Pan/Tilt/Zoom. Refers to the movement of a video camera to the left and right, up and down, and to the camera's ability to enlarge an image.

**Resolution:** Indicates the number of pixels used to produce an image. The more pixels an image has, the more recognizable the details remain when the image is enlarged. The resolution is expressed as the number of pixel columns by pixel rows or as a total number of pixels. A VGA image has 640 columns and 480 rows (640 × 480), which equals 307,200 pixels or approximately 0.3 megapixels.

**RFID:** Radio frequency identification.

**Router:** Network device that connects multiple networks with one another. The router establishes a physical connection between the devices in different networks (like a hub), analyzes the relevant data packets and forwards ("routes") these packets to the correct target network.

**Search:** Monitoring of recordings or searching for a particular event.

**SIP:** Session Initiation Protocol. Network protocol for setting up, controlling and terminating a communication connection via a computer network. SIP is frequently used in conjunction with IP telephony.

**Switch:** Hardware used to connect multiple network devices (computers, cameras, printers, etc.) within a network. A PoE switch can also supply the (door) cameras with power over an Ethernet cable.

**Transponder:** A transponder is a device used for wireless communication (for example, as a key tag or a check card). The device detects the incoming signal and automatically responds to it or forwards it. The term "transponder" is made up of the terms "transmitter" and "responder." Passive transponders do not require their own power source, but they only work over short distances.

**VoIP:** Voice over IP. Telephony using computer networks.

**WLAN (Wi-Fi):** Wireless local area network connection.

## International References

Bahrain Defense Hospital (Bahrain) • Donbass Arena UEFA 2012 (Ukraine) • Hudson River Park (New York) • Central Bank of the Philippines • Orange Mobile (Romania) • Police of Portofino (Italy) • Republic Polytechnic (Singapore) • Sderbank of Russia (Ukraine) • Vatican Apostolic Library (Vatican City) • etc.

## Complete HiRes Video Solutions

high-resolution, digital & cost-effective recording



### HiRes Video Innovations

The German company MOBOTIX AG is known as the leading pioneer in network camera technology since its founding in 1999, and its **decentralized concept has made high resolution video systems cost efficient**. Whether in embassies, airports, railway stations, ports, gas stations, hotels or highways, MOBOTIX video systems have been in operation on every continent for years.

### Technology Leader Of Network Cameras

In just a short time, MOBOTIX has climbed to the second place in European market share and fourth

place worldwide in terms of market share. MOBOTIX has exclusively produced megapixel cameras for years and is the **global leader for high-resolution video systems**. The **decentralized MOBOTIX concept** is characterized by the fact that a high-speed processor is built into every camera and, if required, a digital memory (MicroSD card) can also be integrated for long-term recording.

MOBOTIX cameras can make event-driven recordings even without a central PC or DVR and can digitally store videos long term with sound. This is why MOBOTIX solutions represent an unbeatably good value with their excellent image quality, even for small-scale installations.

### Free Consulting Service

Simply call us or send us an e-mail. We will get in touch with you promptly.

With MOBOTIX, you're in the best hands right from the start. Both our internal project managers and our experienced, highly specialized partners make sure that every system is planned and installed optimally. Our support specialists can help you with any technical questions you may have.

You can also consult  
your electrician  
or IT technician

## MOBOTIX Growth

Revenue In Fiscal Year (June 30)

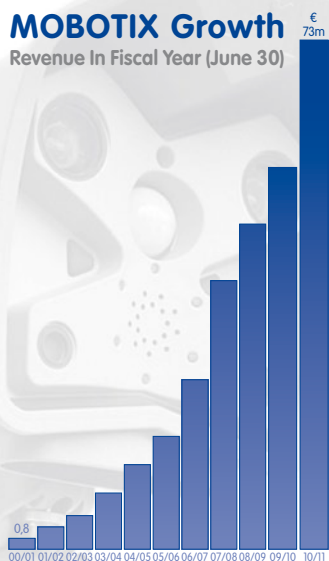

### MOBOTIX Trainings And Seminars

MOBOTIX has a high-tech training campus at the company headquarters in Langmeil, Germany, for all interested parties, customers, security companies and sales partners. For further information and online registration, please visit [www.mobotix.com](http://www.mobotix.com)



**MOBOTIX AG**  
Security-Vision-Systems  
Kaiserstrasse  
D-67722 Langmeil, Germany  
Tel: +49 6302 9816-103  
Fax: +49 6302 9816-190  
E-Mail: [sales@mobotix.com](mailto:sales@mobotix.com)  
[www.mobotix.com](http://www.mobotix.com)



# S14 FlexMount Camera



The HiRes Video Company

**MOBOTIX**



## Discreet. Flexible. Hemispheric.

### Two HiRes 180° Panorama

6MEGA double hemispheric camera with no blind spots

### Discreet Miniature Sensor Modules Incl. Microphone

Mountable up to two meters away from the camera housing

### Mobile-Ready (DIN EN 50155)

Certified for mobile use, for example, on buses and trains

### Weatherproof Professional Solution (IP65)

Robust and durable, suitable for day & night use

### Decentralized Complete System

On-board image processing, internal storage or on NAS

### Low Total Costs

Software included, PoE, no wearing mechanical parts



# MOBOTIX