

ACCESSORIES CATALOGUE 2016/17



Milwaukee®

Nothing but **HEAVY DUTY™**.

Milwaukee

Nothing but **HEAVY DUTY**.™



SHOCKWAVE
IMPACT DUTY

THUNDERWEB

RX4

SPEEDCROSS

SAWZALL

Contents		Page No.
Abrasives	- Coated - Abrasive Paper - Cutting and Grinding Discs - Flap Discs	108-110 102-103 104
Angle Grinder System Accessories / FIXTEC Nut		105-107
Band Saw Blades		139
Batteries & Chargers		149-150
Biscuit Jointer System Accessories		141
Caulk and Adhesive Gun System Accessories		147
Chisels & Special Application Tools	- SDS-Plus - SDS-Max - 21 mm K-Hex	22-24 25-26 / 29 27-29
Chucks	- Keyed & Keyless - Chuck Adaptors	84-85 83
Circular Saw Blades/System Accessories		136-138
Cores/Tunnel Bits - TCT	- SDS-Plus - SDS-Max - SDS-Max Vario Extension System	12 17-18 19
Diamond Blades/Diamond Cup Wheels		94-101
Diamond Core Bits	- Wet Core Bits/System Accessories - Dry Core Bits/System Accessories	86-88 89-93
Drill Bits ■ Concrete	- SDS-Plus M2 - SDS-Plus RX4 - SDS-Plus Contractor & Multipurpose - SDS-Max - 21 mm K-Hex	7-10 4-6 11 15-16 18
■ Concrete/Masonry (round shank)	- Concrete - Concrete Super	31 32
■ Multi Material	- Multi Material	33
■ Wood	- Auger Impact Rated - Auger - Cable - Flat Boring - Forstner - Lip & Spur	34 36 42 41 37 40
■ Selffeed Bits	- Switchblade™ Selffeed - Selffeed - Speed Feed™	38 39 42
■ Glass & Tile	- Glass & Tile	33
■ Metal	- HSS Annular Cutters - HSS-G-Cobalt DIN 338 - HSS-Ground DIN 1897 / Double Ended / DIN 340 - HSS-Ground THUNDERWEB - HSS-Rollforged - Step Drills	59 54-55 52-53 / 80 50-52 48-49 56-57
■ Contractor Sets		44
Drill Connect		20-21
Drilling System Accessories	- QUIK-LOK Cables/Side Handles/Right Angle Drill	69-70
Dust Absorption System Accessories		69-70 / 148
Expander Heads		141
Grease		11
HACKZALL Blades		128
Heated Jacket System Accessories		144
Hand Tools	- INKZALL Markers - Jobsite Scissors - Knives/Blades - Metal Snips - Plastic /PEX Cutter - Pliers - Saws - Screwdrivers - Staplers - Storage Solutions - Workboxes & Softside - Tape Measures - Wrenches	163 159 153-154 154 159 155-158 / 165 164 170 171 166-169 160-162 165
Holesaws	- Adjustable Hole Cutter - BIG HAWG™ - Bi-Metal Hole Dozer™ - Diamond Plus™ - Universal TCT - Shockwave Impact Holesaws	66 43 61-66 67 13-14 68
Impact Wrenches System Accessories		82
Inspection Camera System Accessories		144
Jigsaw Blades/System Accessories		129-135
Lamps and Bulbs		149
Knockout Punch System Accessories		146
Magnetic Drill Stand/System Accessories		60
Nibbler System Accessories		143
Multitool Accessories		140
Pipe Cutter/Cable Cutter System Accessories		143 / 146
Planer Accessories		138
Plate Shear System Accessories		142
Polishing Accessories		113-114
Press Jaws		145
Router System Accessories		141
Sanding System Accessories	- Belt Sanders - Delta Sanders - Orbital Sanders - Random Orbital Sanders	112 112 112 111
SAWZALL® Blades/System Accessories		115-127
Screwdriving System Accessories		82
Screwdriving	- Screwdriving Bits/Sets - Shockwave Bits/Sets - Shockwave Magnetic Nut Drivers - Shockwave Magnetic Bit Holder/Adaptors - Shockwave Metal Drill Bits HSS-Ground - Offset Attachment Knuckle™ - Offset Attachment OSD 2 - Shockwave Sockets	71-72 73-77 79 79 80 80 81 78
Stiletto® Titanium Tools		151-152
Straight Die Grinders System Accessories		142
Test & Measurement System Accessories		143
Transport Cases		166



LONGER THAN LIFE!

+ 50% LONGER LIFE TIME



Thanks to the optimum 4x90° symmetry, all four carbide cutting edges function evenly and do not jam up when hitting rebar.



Solid one piece carbide tip for outstanding lifetime.



Centering tip for straight forward spot drilling with pinpoint accuracy.



Four symmetrically spiral shoulders ensure low, uniform flute wear.

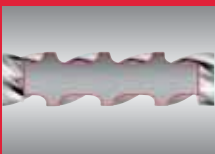

Thicker core body for low vibration and extra strength minimising drill bit breakages.



The PGM seal guarantees precisely fitting anchor application holes over the entire lifetime of the drill bit.



SDS-Plus RX4 drill bits - 4 cut



Embedded solid one piece carbide with centering tip for easy spot drilling and long lifetime.

Four symmetrical 90° cutting edges guarantee perfect round holes for anchor fixing as well as reduce the risk of the drill bit jamming when hitting rebar. The high volume flute geometry ensures optimum dust removal.

4 spiral flute design provides lowest vibration and low uniform flute wear.

Suitable for brick, concrete, reinforced concrete and natural stone.

Diameters > Ø 18 mm have a 3 pc carbide tip.

Made in Germany.

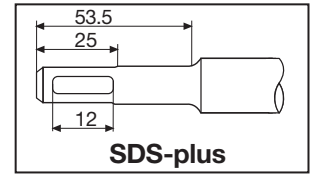

Ø (mm)	Total length A (mm)	Working length B (mm)	Pre-drill	Packed contents	Article Number	EAN Code	Price exc. VAT
5	110	50		1	4932352007	4002395366644	£6.13
5	160	100		1	4932352008	4002395368891	£6.50
5	260	200		1	4932430724	4002395383856	£11.99
5.5	110	50		1	4932352009	4002395368907	£6.37
5.5	160	100		1	4932352010	4002395368914	£6.73
6	110	50		1	4932352011	4002395368921	£6.65
6	160	100		1	4932352012	4002395368938	£6.82
6	210	150		1	4932352013	4002395366705	£8.64
6	260	200		1	4932352014	4002395366712	£10.69
6	310	250		1	4932352015	4002395366729	£14.80
6.5	160	100		1	4932430146	4002395378074	£9.29
6.5	210	150		1	4932352016	4002395366736	£11.77
6.5	260	200		1	4932352017	4002395366743	£14.88
6.5	310	250		1	4932352018	4002395366750	£17.50
7	110	50		1	4932352019	4002395366767	£7.99
7	160	100		1	4932352020	4002395366774	£8.50
8	110	50		1	4932352021	4002395366781	£7.20
8	160	100		1	4932352022	4002395366798	£7.63
8	210	150		1	4932352023	4002395366804	£8.79
8	260	200		1	4932352024	4002395366811	£11.85
8	310	250		1	4932352712	4002395373703	£15.86
8	450	400	✓	1	4932352713	4002395373710	£24.10
9	160	100		1	4932352944	4002395376025	£8.76
9	260	200		1	4932430409	4002395380701	£11.99
10	110	50		1	4932352025	4002395366828	£7.93
10	160	100		1	4932352026	4002395366835	£8.45
10	210	150		1	4932352027	4002395366842	£9.80
10	260	200		1	4932352028	4002395366859	£11.92
10	310	250		1	4932352029	4002395366866	£15.76
10	450	400	✓	1	4932352030	4002395366873	£23.67
10	600	540	✓	1	4932352945	4002395376032	£28.45
10	1000	940	✓	1	4932352946	4002395376049	£76.13
12	160	100		1	4932352031	4002395366880	£10.22
12	210	150		1	4932352032	4002395366897	£12.24
12	260	200		1	4932352033	4002395366903	£14.32
12	310	250		1	4932352034	4002395366910	£19.72
12	450	400	✓	1	4932352035	4002395366927	£25.72
12	600	540	✓	1	4932352947	4002395376056	£38.00
12	1000	940	✓	1	4932352948	4002395376063	£84.36
14	160	100		1	4932352036	4002395366934	£14.04
14	210	150		1	4932352037	4002395366941	£18.36
14	260	200		1	4932352949	4002395376070	£21.02
14	310	250		1	4932352038	4002395366958	£22.48
14	450	400	✓	1	4932352039	4002395366965	£29.31
14	600	540	✓	1	4932352950	4002395376087	£39.93
14	1000	940	✓	1	4932352951	4002395376094	£87.22
15	160	100		1	4932430725	4002395383863	£22.99
15	260	200		1	4932352952	4002395376100	£24.95
16	160	100		1	4932430726	4002395383870	£23.99
16	210	150		1	4932352953	4002395376117	£23.80
16	260	200	✓	1	4932352819	4002395374779	£26.90
16	310	250		1	4932352954	4002395376124	£27.90
16	450	400	✓	1	4932352820	4002395374786	£34.90

✓ Pre drill with a short drill bit of the same diameter.

SDS-Plus RX4 drill bits - 4 cut



✓ Pre drill with a short drill bit of the same diameter.

Ø (mm)	Total length A (mm)	Working length B (mm)	Pre-drill	Packed contents	Article Number	EAN Code	Price exc. VAT
16	600	540	✓	1	4932352955	4002395376131	£43.86
16	1000	940	✓	1	4932352956	4002395376148	£97.80
18	250	200		1	4932356502	4002395320950	£31.28
18	450	400	✓	1	4932356503	4002395320967	£42.14
20	250	200		1	4932356504	4002395320974	£35.45
20	450	400	✓	1	4932356505	4002395320981	£46.52
22	250	200		1	4932399332	4002395359608	£40.84
22	450	400	✓	1	4932356506	4002395320998	£55.00
24	250	200		1	4932356507	4002395321001	£52.59
24	450	400	✓	1	4932356508	4002395321018	£61.54
25	250	200		1	4932399333	4002395359615	£57.72
25	450	400	✓	1	4932356509	4002395321025	£67.96
28	250	200		1	4932399334	4002395359622	£66.50
28	450	400	✓	1	4932356510	4002395321032	£77.07
30	250	200		1	4932399335	4002395359639	£74.15
30	450	400	✓	1	4932356511	4002395321049	£84.74
32	450	400	✓	1	4932399336	4002395359646	£97.35

SDS-Plus RX4 drill bits - 4 cut / 10 pack



Ø (mm)	Total length A (mm)	Working length B (mm)	Packed contents	Article Number	EAN Code	Price exc. VAT
5	110	50	10	4932352040	4002395366972	£58.25
5.5	160	100	10	4932352041	4002395366989	£63.95
6	110	50	10	4932352042	4002395366996	£63.13
6	160	100	10	4932352043	4002395367009	£64.76
6	210	150	10	4932430234	4002395378951	£99.94
6.5	210	150	10	4932430235	4002395378968	£135.44
7	160	100	10	4932352044	4002395367016	£84.46
8	110	50	10	4932352045	4002395367023	£70.04
8	160	100	10	4932352046	4002395367030	£74.16
10	160	100	10	4932352047	4002395367047	£81.77
10	210	150	10	4932352048	4002395367054	£94.88
12	160	100	10	4932352049	4002395367061	£98.98
12	210	150	10	4932352050	4002395367078	£118.53

SDS-Plus RX4 drill bits - 4 cut / 50 pack



Ø (mm)	Total length A (mm)	Working length B (mm)	Packed contents	Article Number	EAN Code	Price exc. VAT
6	110	50	50	4932430437	4002395380985	£315.65
6	160	100	50	4932430438	4002395380992	£323.80
6	210	150	50	4932430462	4002395381234	£429.00
6.5	210	150	50	4932430463	4002395381241	£569.00
8	160	100	50	4932430439	4002395381005	£370.80
8	210	150	50	4932430440	4002395381012	£439.50
10	160	100	50	4932430441	4002395381029	£409.00
10	210	150	50	4932430442	4002395381036	£474.40
12	210	150	50	4932430443	4002395381043	£592.65

SDS-Plus RX4 - 4 cut / sets



Description	Supplied in	Packed contents	Order quantity	Article Number	EAN Code	Price exc. VAT
① SDS-Plus drill bit set (5 pcs). Ø 5 / 6 x 110 mm, Ø 6 / 8 / 10 x 160 mm.	Plastic container	5	1	4932352833	4002395374915	£39.99
① SDS-Plus drill bit set (5 pcs). Ø 5.5 x 110 mm, Ø 5.5 / 6 / 7 / 8 x 160 mm.	Plastic container	5	1	4932352835	4002395374939	£39.99
② SDS-Plus drill bit set (7 pcs). Ø 5 / 6 / 8 x 110 mm, Ø 6 / 8 / 10 / 12 x 160 mm.	Plastic cassette	7	1	4932352051	4002395367085	£59.47
③ Counter display. 6 x 7 pc SDS-plus RX4 set 4932352051.	Plastic cassette	6	1	4932352153	4002395368068	£356.82





FASTER THAN EVER



Breaker points

- 3 offset aggressive breaker points. These produce a “Demolition” effect and create micro cracks in the drilled material
- **+25% FASTER**



Centering tip

- Ensures immediate spot drilling with pin point accuracy
- Prevents skidding on smooth surfaces



Enlarged rebar chamfers

- Enlarged rebar chamfers
- Prevents side tip damage when hitting rebar
- Reduces the risk of the drill bit jamming when hitting rebar



Tapered shoulder design

- Thinner shoulder towards drill tip for less friction providing for greater speed
- Ideal for cordless hammers identified from its tapered shoulder geometry



Reinforced flute

- High volume flute geometry for optimum dust removal
- Reinforced flute design (thicker core) gives:
 - Full power transfer to the tip
 - Lower vibrations
 - Exceptional break resistance, less breakages and best durability

+25% FASTER

SDS-Plus drill bits - 2 cut



FASTEST: New aggressive tip geometry with 3 chip breakers demolishes the concrete quicker and a tapered shoulder design minimises friction enabling the M2 drill bit to deliver faster drilling speed.
DURABILITY: Rebar chamfers on the tip prevent side tip damage when hitting metal reinforcement and a thicker core body ensures higher power transfer, lower vibrations and less flute breakages.

Made in Germany.

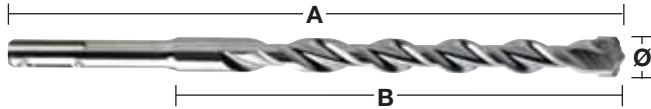
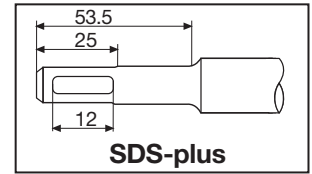

Ø (mm)	Total length A (mm)	Working length B (mm)	Pre-drill	Packed contents	Article Number	EAN Code	Price exc. VAT
3	110	50		1	4932352892	4002395375509	£5.90
3.5	110	50		1	4932373908	4002395353378	£5.90
4	110	50		1	4932339498	4002395304561	£4.13
4	160	100		1	4932399143	4002395357505	£4.60
4.8	110	50		1	4932352130	4002395367832	£5.50
5	110	50		1	4932307067	4002395308835	£2.98
5	160	100		1	4932399315	4002395359431	£3.89
5	210	150		1	4932399316	4002395359448	£4.98
5.5	110	50		1	4932339499	4002395304578	£3.28
5.5	160	100		1	4932340408	4002395311910	£3.88
5.5	210	150		1	4932399317	4002395359455	£5.89
5.5	260	200		1	4932399318	4002395359462	£8.20
5.5	310	250		1	4932399319	4002395359479	£12.81
5.5	410	350		1	4932399320	4002395359486	£15.42
6	110	50		1	4932307068	4002395308842	£2.98
6	160	100		1	4932307069	4002395308859	£3.27
6	210	150		1	4932373136	4002395346394	£4.96
6	260	200		1	4932353819	4002395320127	£6.20
6	310	250		1	4932399321	4002395359493	£12.89
6	460	400	✓	1	4932399322	4002395359509	£15.63
6.5	110	50		1	4932344292	4002395312276	£3.62
6.5	160	100		1	4932344293	4002395312269	£3.99
6.5	210	150		1	4932399147	4002395357574	£5.79
6.5	260	200		1	4932399148	4002395357581	£8.25
6.5	310	260		1	4932399323	4002395359516	£12.46
7	110	50		1	4932353820	4002395320134	£3.67
7	160	100		1	4932340409	4002395311927	£3.87
7	210	150		1	4932399222	4002395358366	£5.88
7	250	200		1	4932399324	4002395359523	£9.89
8	110	50		1	4932307070	4002395308866	£3.56
8	160	100		1	4932307071	4002395308873	£3.92
8	210	150		1	4932307072	4002395308880	£4.89
8	260	200		1	4932353821	4002395320141	£6.01
8	310	250		1	4932399325	4002395359530	£8.78
8	400	350		1	4932399326	4002395359547	£12.36
8	460	400	✓	1	4932367013	4002395336692	£12.50
8	600	550	✓	1	4932399327	4002395359554	£20.33
8	1000	950	✓	1	4932399328	4002395359561	£42.87
9	160	100		1	4932353823	4002395320165	£4.75
9	210	150		1	4932353822	4002395320158	£7.51
10	110	50		1	4932340410	4002395311934	£4.50
10	160	100		1	4932307073	4002395308897	£4.59
10	210	150		1	4932307074	4002395308903	£5.81
10	260	200		1	4932344295	4002395312252	£6.28
10	310	250		1	4932353824	4002395320172	£7.63
10	450	400	✓	1	4932344296	4002395312245	£12.69
10	600	550	✓	1	4932367014	4002395336708	£18.42
10	1000	950	✓	1	4932367015	4002395336715	£44.13

✓ Pre drill with a short drill bit of the same diameter.



SDS-Plus drill bits - 2 cut

Ø (mm)	Total length A (mm)	Working length B (mm)	Pre-drill	Packed contents	Article Number	EAN Code	Price exc. VAT
11	160	100		1	4932367066	4002395336722	£5.98
11	260	210		1	4932399329	4002395359578	£6.97
12	160	110		1	4932307075	4002395308910	£5.64
12	210	160		1	4932307076	4002395308927	£6.73
12	260	210		1	4932344297	4002395312238	£7.30
12	310	260		1	4932353825	4002395320189	£9.11
12	450	400	✓	1	4932307077	4002395308934	£13.89
12	600	550	✓	1	4932367068	4002395336746	£18.82
12	1000	950	✓	1	4932367017	4002395336760	£48.05
13	160	110		1	4932307946	4002395309054	£7.28
13	260	210		1	4932344298	4002395312221	£8.68
14	160	110		1	4932307078	4002395308941	£8.11
14	210	160		1	4932353826	4002395320196	£8.66
14	260	210		1	4932307079	4002395308958	£9.59
14	310	260		1	4932399330	4002395359585	£10.32
14	450	400	✓	1	4932307088	4002395309047	£15.45
14	600	550	✓	1	4932367018	4002395336777	£21.20
14	1000	950	✓	1	4932367019	4002395336784	£52.96
15	160	110		1	4932373910	4002395353392	£7.97
15	260	210		1	4932344300	4002395312207	£10.70
16	160	110		1	4932307080	4002395308965	£8.80
16	210	160		1	4932307081	4002395308972	£10.19
16	260	210		1	4932399331	4002395359592	£12.33
16	310	260		1	4932344301	4002395312191	£14.06
16	450	400	✓	1	4932307082	4002395308989	£18.50
16	600	550	✓	1	4932367069	4002395336791	£26.16
16	1000	950	✓	1	4932367021	4002395336814	£55.87
18	200	150		1	4932344303	4002395312177	£15.99
18	250	200		1	4932307083	4002395308996	£18.80
18	300	250		1	4932344304	4002395312160	£18.63
18	450	400	✓	1	4932340411	4002395311941	£24.17
18	600	550	✓	1	4932367022	4002395336821	£38.32
18	1000	950	✓	1	4932367024	4002395336845	£69.40
20	200	150		1	4932344305	4002395312153	£19.75
20	250	200		1	4932307084	4002395309009	£35.00
20	300	250		1	4932399027	4002395356126	£25.95
20	450	400	✓	1	4932307085	4002395309016	£28.85
20	600	550	✓	1	4932367025	4002395336876	£37.77
20	1000	950	✓	1	4932367026	4002395336883	£71.71
22	250	200		1	4932373911	4002395353408	£28.93
22	450	400	✓	1	4932344307	4002395312139	£33.97
22	600	550	✓	1	4932367027	4002395336890	£44.04
22	1000	950	✓	1	4932367029	4002395336913	£81.41
24	250	200		1	4932373922	4002395353521	£31.29
24	450	400	✓	1	4932307087	4002395309030	£37.81
25	250	200		1	4932344308	4002395312122	£33.67
25	450	400	✓	1	4932344309	4002395312115	£39.99
25	1000	950	✓	1	4932367030	4002395336975	£91.88
26	250	200		1	4932344310	4002395323814	£36.15
26	450	400	✓	1	4932344311	4002395312092	£41.22

✓ Pre drill with a short drill bit of the same diameter.

SDS-plus drill bits - 2 cut / counter displays



Description	Packed contents	Order quantity	Article Number	EAN Code	Price exc. VAT
① Counter display. 10 x 7 pc SDS-plus drill set 4932352339.	10	1	4932352341	4002395370009	£338.00
② Counter display. 10 x 10 pc SDS-plus drill set 4932352340.	10	1	4932352342	4002395370016	£479.00



SDS-Plus drill bits - 2 cut / 10 pack

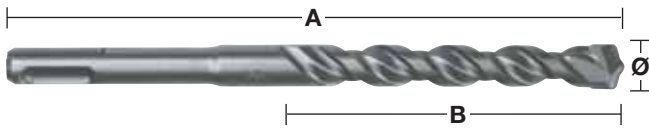

Ø (mm)	Total length A (mm)	Working length B (mm)	Packed contents	Article Number	EAN Code	Price exc. VAT
5	110	50	10	4932371702	4002395344017	£27.12
5	160	100	10	4932352520	4002395371785	£35.79
5.5	110	50	10	4932352521	4002395371792	£31.15
5.5	160	100	10	4932371703	4002395344024	£35.40
6	110	50	10	4932371704	4002395344031	£27.12
6	160	100	10	4932371705	4002395344048	£29.76
6	210	150	10	4932399337	4002395359653	£45.14
6.5	160	100	10	4932399338	4002395359660	£37.09
6.5	210	150	10	4932399339	4002395359677	£52.69
6.5	260	200	10	4932399340	4002395359684	£75.08
7	160	100	10	4932373225	4002395348619	£35.22
8	160	100	10	4932371706	4002395344055	£35.67
8	210	150	10	4932399341	4002395359691	£44.51
10	110	50	10	4932352522	4002395371808	£40.50
10	160	100	10	4932371708	4002395344079	£41.77
10	210	150	10	4932371709	4002395344086	£52.87
10	260	200	10	4932399342	4002395359707	£58.15
12	160	100	10	4932399343	4002395359714	£51.32
12	210	160	10	4932371710	4002395344093	£61.24
12	260	210	10	4932399344	4002395359721	£66.43
14	260	210	10	4932371711	4002395344109	£87.26

SDS-Plus drill bits - 2 cut / 50 pack



Ø (mm)	Total length A (mm)	Working length B (mm)	Packed contents	Article Number	EAN Code	Price exc. VAT
5	110	50	50	4932399176	4002395357833	£123.67
5.5	160	100	50	4932399177	4002395357840	£159.00
6	110	50	50	4932399178	4002395357857	£123.67
6	160	100	50	4932399179	4002395357864	£135.71
7	160	110	50	4932399181	4002395357888	£149.00
8	160	100	50	4932399182	4002395357895	£159.00
8	210	150	50	4932399183	4002395357901	£202.96
10	160	110	50	4932399345	4002395359738	£179.00
10	210	150	50	4932399184	4002395357918	£241.12
10	260	200	50	4932399185	4002395357925	£279.00
12	210	160	50	4932399186	4002395357932	£279.30

SDS-Plus drill bits - 2 cut / cassettes



Description	Packed contents	Order quantity	Article Number	EAN Code	Price exc. VAT
① Set of 5 SDS-plus hammer drill bits. Ø 5 / 6 x 110 mm and Ø 6 / 8 / 10 x 160 mm.	5	1	4932352338	4002395369973	£17.90
① Set of 5 SDS-plus hammer drill bits. Ø 5.5 x 110 mm and Ø 5.5 / 6 / 7 / 8 x 160 mm.	5	1	4932352834	4002395374922	£24.99
① Set of 5 SDS-plus hammer drill bits. Ø 10 / 12 / 14 / 16 / 20 x 450 mm.	5	1	4932352801	4002395374595	£99.00
② Set of 7 SDS-plus hammer drill bits. Ø 5 / 6 / 8 x 110 mm and Ø 6 / 8 / 10 / 12 x 160 mm.	7	1	4932352339	4002395369980	£33.80
③ Set of 10 SDS-plus hammer drill bits. Ø 5 / 6 / 6 x 110 mm and Ø 6 / 6 / 8 / 8 / 10 / 12 / 14 x 160 mm.	10	1	4932352340	4002395369997	£47.90
Chisel set (5 pcs). SDS-plus drill bits Ø 6 / 8 / 10 x 160 mm, pointed and flat chisel.	5	1	4932430002	4002395376636	£29.95



SDS-Plus contractor drill bits - 2 cut / 10 pack

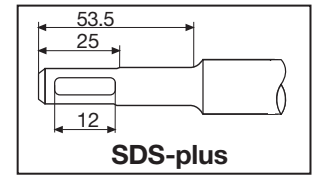
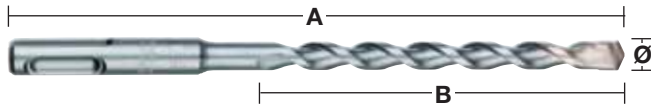

Ø (mm)	Total length A (mm)	Working length B (mm)	Packed contents	Article Number	EAN Code	Price exc. VAT
5.5	160	100	10	4932352695	4002395373536	£26.50
6	160	100	10	4932352696	4002395373543	£26.90
7	160	100	10	4932352697	4002395373550	£29.80
8	160	100	10	4932352698	4002395373567	£33.00
8	210	150	10	4932352699	4002395373574	£39.80
10	210	150	10	4932352700	4002395373581	£46.80

SDS-Plus TCT multipurpose drill bits

These drill bits will drill in metal, wood and stone but in rotary mode only. Hammer action cannot be used with these drill bits. Ideal for tradesmen who need to drill through a variety of materials in one go. Made in Germany.

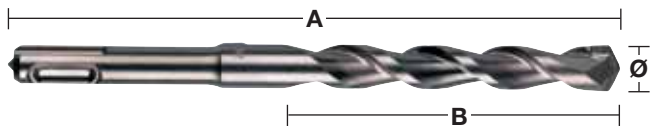

Ø (mm)	Total length A (mm)	Working length B (mm)	Packed contents	Article Number	EAN Code	Price exc. VAT
6	160	100	1	4932373918	4002395353484	£5.61
8	210	150	1	4932373919	4002395353491	£6.99
10	260	200	1	4932373920	4002395353507	£9.20
12	260	200	1	4932373921	4002395353514	£11.75

Grease

This grease has been especially formulated to lubricate and protect both the tool and accessories ensuring increased lifetime.

Apply sparingly directly onto the reception of the drill bit, chisel or core cutter, etc. Contains 50 grams.

Description	Packed contents	Order quantity	Article Number	EAN Code	Price exc. VAT
① Grease.	1	1	4932352273	4002395369324	£8.63
② Counter display with 15 x single grease tube 4932352273.	15	1	4932352274	4002395369331	£119.85

①



②



SDS-Plus TCT core cutters

Core cutters for rotary hammers up to 4 kg.
 All TCT cores have a M16 x 2 thread and fit to both SDS-Plus and Hex 11 arbors.
 Arbor and pilot drill bit required additionally.
 Made in Germany.

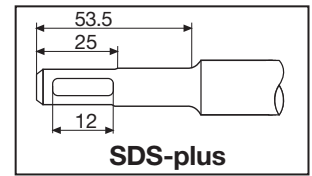

Ø (mm)	Total length A (mm)	Packed contents	Article Number	EAN Code	Price exc. VAT
35	58	1	4932344478	4002395312559	£66.89
50	58	1	4932344479	4002395312566	£75.46
65	50	1	4932344480	4002395312573	£89.72
68	50	1	4932399099	4002395357031	£97.41
82	50	1	4932344481	4002395312580	£105.36
90	50	1	4932344482	4002395312597	£124.39

SDS-Plus TCT core cutter - set

Set version includes: TCT core cutter, SDS-Plus arbor 105 mm length, TCT pilot drill bit Ø 8 x 120 mm and allen key.

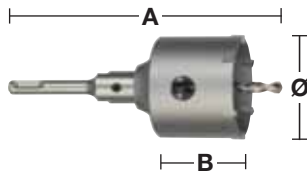

Ø (mm)	Total length A (mm)	Working length B (mm)	Packed contents	Article Number	EAN Code	Price exc. VAT
65	182	50	4	4932399295	4002395359097	£127.86
68	182	50	4	4932399296	4002395359103	£134.66
82	182	50	4	4932399297	4002395359110	£141.44

SDS-Plus TCT core cutter arbors

Both SDS-Plus and Hex arbors include an allen key and require a pilot drill bit additionally.

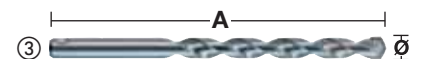
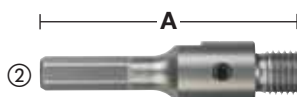
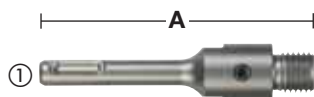

Description	Reception	Ø (mm)	Total length A (mm)	Packed contents	Article Number	EAN Code	Price exc. VAT
① SDS-plus arbor.	SDS-Plus		105	2	4932399966	4002395366255	£24.84
① SDS-plus arbor.	SDS-Plus		370	2	4932399967	4002395366262	£39.78
② Hex arbor.	11 mm Hex		90	2	4932399968	4002395366279	£22.45
③ TCT pilot drill bit for use in masonry, concrete, brick etc.		8	120	1	4932399125	4002395357291	£6.90
③ TCT pilot drill bit with conical shaft for old style arbors. NOT SUITABLE for above arbors.		10	100	1	4932399020	4002395356058	£5.90

TCT Universal Holesaws

TCT Universal Holesaws are ideal for electricians, carpenters, kitchen fitters and all related heating, ventilation and plumbing trades.

TCT Universal Holesaws are designed for use in a wide variety of materials such as:

- Bricks* – suitable for both solid bricks and bricks with cavities
- Aerated concrete blocks*, lightweight aggregate blocks and breeze blocks
- Soft density lime-sandstone building blocks upto hardness of 30 N/mm²
- Softwoods, chipboard, plywood, medium density fibreboard (MDF)
- Plastics and plastic coated board (Contiboard)
- Gypsum/plaster board

Application areas:

- Installation of electrical switch boxes and junction boxes.
- Fitting of spot and down lights.
- Through holes for cables, water and central heating pipes.
- Openings for ventilation and extractor pipework.

** Not suitable for use in hard materials such as concrete, granite, medium to hard density lime-sandstone block, natural stone and hard bricks over 30 N/mm² hardness.*

TCT Universal Holesaws can be used with pneumatic rotary hammers with SDS-plus reception and all rotary/percussion corded and cordless drills.

Important: the percussion/hammer action mode must be turned off when using these holesaws.



Features

① Robust and durable

Tungsten carbide teeth are dovetailed into the core body guaranteeing tougher material bonding and less tooth breakage.

② FIXTEC arbors

There are two types of arbor reception available, (1) standard Hex shaft for use with rotary/percussion drills or cordless tools and (2) SDS-plus reception for use with pneumatic rotary hammers.

Both arbors come with an innovative self locking FIXTEC mechanism for securing the pilot drill bit, eliminating the need for awkward grub screws. Spanner flats allow the core to be easily detached from the FIXTEC arbor.

③ Protection

TCT Universal Holesaws are only to be used without hammer action but in the event the hammer action is not deactivated when using the FIXTEC SDS-plus arbor, the holesaw will not be damaged.

The FIXTEC SDS-plus arbor has been especially designed with shorter than usual grooves so preventing the pneumatic hammer drill from hammering.

④ Material removal

Large dust chambers ensure effective and rapid material removal.

⑤ Core body

Lightweight thin wall design meets less resistance for faster cleaner drilling with less vibrations.

⑥ Pilot drill bit

This is available either in HSS for use in wood/plastics or carbide tipped for applications in masonry.

TCT Universal holesaws

All TCT Universal Holesaws have a M 16 thread and fit to both FIXTEC SDS-plus and Hex 11 reception arbors.

FIXTEC arbor and pilot drill required additionally.

Made in Germany.

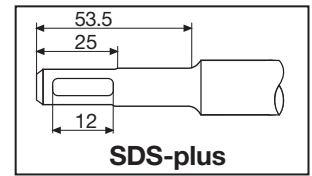

SDS-plus

Ø (mm)	Total length A (mm)	No. of teeth	Packed contents	Article Number	EAN Code	Price exc. VAT
25	60	3	1	4932399100	4002395357048	£36.52
30	60	3	1	4932399101	4002395357055	£36.74
35	60	3	1	4932399102	4002395357062	£39.75
40	60	3	1	4932399103	4002395357079	£46.00
45	60	3	1	4932399104	4002395357086	£48.53
50	60	3	1	4932399105	4002395357093	£49.91
55	60	3	1	4932399106	4002395357109	£53.60
60	60	5	1	4932399108	4002395357123	£56.85
63	60	5	1	4932399109	4002395357130	£57.79
65	60	5	1	4932399110	4002395357147	£58.92
68	60	5	1	4932399111	4002395357154	£57.07
70	60	5	1	4932399112	4002395357161	£71.64
74	60	5	1	4932399114	4002395357185	£73.96
76	60	5	1	4932399115	4002395357192	£76.27
80	60	5	1	4932399117	4002395357215	£78.58
85	60	5	1	4932399118	4002395357222	£85.50
90	60	5	1	4932399119	4002395357239	£88.75
105	60	6	1	4932399120	4002395357246	£113.70

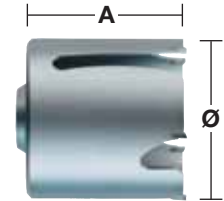

TCT Universal Holesaw set version

Set version includes: TCT universal holesaw, countersink, SDS-plus arbor 118 mm length and TCT pilot drill bit Ø 8 x 120 mm.

The countersink can be removed for use in wood and brick.

Ø (mm)	Total length A (mm)	Working length B (mm)	Packed contents	Article Number	EAN Code	Price exc. VAT
68	205	60	4	4932399298	4002395359127	£149.00

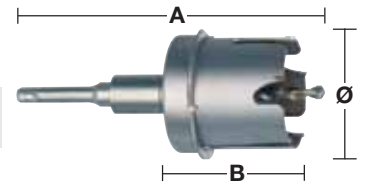

Countersink

Countersink - When fitted to the 68 mm holesaw it allows for the flush fitting of electrical switch boxes in drywall / plasterboard walls.

Ø (mm)	Max. cutting depth (mm)	No. of teeth	Packed contents	Article Number	EAN Code	Price exc. VAT
68	2	3	1	4932399127	4002395357314	£49.45



TCT Universal Holesaw system attachments

Both SDS-plus and Hex arbors require a pilot drill bit additionally.

Description	Shank reception	Ø (mm)	Total length A (mm)	Packed contents	Article Number	EAN Code	Price exc. VAT
① FIXTEC arbor.	SDS-Plus		118	1	4932399121	4002395357253	£41.86
① FIXTEC arbor.	SDS-Plus		220	1	4932399134	4002395357406	£48.38
① FIXTEC arbor.	SDS-Plus		370	1	4932399122	4002395357260	£53.82
② FIXTEC arbor.	11 mm Hex		118	1	4932399123	4002395357277	£42.42
② FIXTEC arbor.	11 mm Hex		370	1	4932399124	4002395357284	£56.29
③ TCT pilot drill bit for use in masonry, concrete, brick etc.		8	120	1	4932399125	4002395357291	£6.90
④ HSS pilot drill bit for use in wood and plastic.		7.4	120	1	4932399126	4002395357307	£7.20

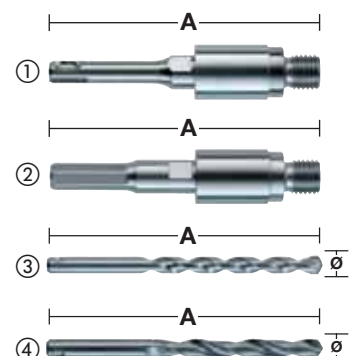

SDS-Max / 21 mm K-Hex 4 cut drill bits

Large carbide tip with patented rebar chamfers.

Ensures lower vibration and optimised drilling performance when hitting reinforced steel. Longer lifetime.



old



new

Innovative, unique carbide tip. With more carbide on all diameters and extra carbide on $\varnothing > 32$ mm.

Especially developed robust head geometry with optimum 4x90° symmetry of carbide tip.

Reduces jamming up on hitting reinforcing steel.



90°



Wear mark on both sides of primary cutter.

Guarantees diameter accuracy i.e. for anchor fittings. Life time indicator in warranty cases.

Centering point with 130° point angle.

Easy spot drilling with pinpoint accuracy and ensures optimum guidance during drilling.



Patented reinforced flute geometry.

Lower vibrations for smoother drilling. Stronger flute means less breakages. Better transfer of hammer energy to the tip.

Big, robust secondary cutter with dynamic, curved cutting edge.

Supports the primary cutter for faster drilling.

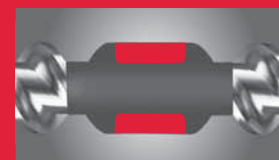

Deep flute shoulders.

High volume dust removal for optimum drilling speed less wear and heat build up.

Shorter spiral windings.



For faster transport of drilling dust from the head to the flute = Less wear and heat build up at the tip.



Low vibration drilling performance.

Comfortable drilling ensures less stress for man and machine.



Special surface treatment.

Shot blasting provides a smooth surface.

Densifies the surface structure and makes the bit more wear resistant.



PGM conformity.

Guarantees precise holes for anchor fitting over the entire lifetime of the drill bit.

SDS-Max drill bits - 4 cut

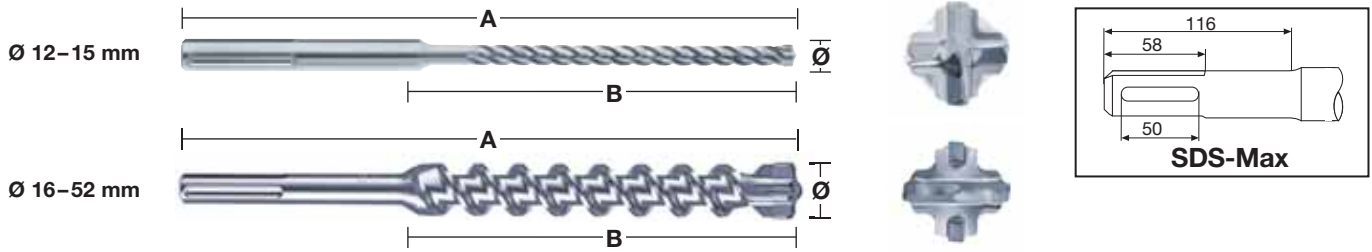

Ø (mm)	Total length A (mm)	Working length B (mm)	Pre-drill	Packed contents	Article Number	EAN Code	Price exc. VAT
12	340	200		1	4932352750	4002395374083	£38.59
12	540	400	✓	1	4932352751	4002395374090	£50.57
12	690	550		1	4932430727	4002395383887	£73.99
14	340	200		1	4932352752	4002395374106	£38.59
14	540	400	✓	1	4932352753	4002395374113	£51.11
15	340	200		1	4932352754	4002395374120	£42.86
15	540	400	✓	1	4932352755	4002395374137	£52.00
16	340	200		1	4932352756	4002395374144	£48.55
16	540	400	✓	1	4932352757	4002395374151	£62.60
16	940	800	✓	1	4932352758	4002395374168	£88.03
16	1320	1180	✓	1	4932352759	4002395374175	£189.00
18	340	200		1	4932352760	4002395374182	£48.55
18	540	400	✓	1	4932352761	4002395374199	£62.60
18	940	800	✓	1	4932352762	4002395374205	£99.98
18	1320	1180	✓	1	4932352763	4002395374212	£208.95
20	320	200		1	4932352764	4002395374229	£52.14
20	520	400	✓	1	4932352765	4002395374236	£65.47
20	920	800	✓	1	4932352766	4002395374243	£99.98
20	1320	1200	✓	1	4932352767	4002395374250	£219.00
22	320	200		1	4932352768	4002395374267	£57.90
22	520	400	✓	1	4932352769	4002395374274	£65.47
22	920	800	✓	1	4932352770	4002395374281	£109.98
22	1320	1200	✓	1	4932352771	4002395374298	£223.00
24	320	200		1	4932352772	4002395374304	£62.16
24	520	400	✓	1	4932352773	4002395374311	£79.53
25	320	200		1	4932352774	4002395374328	£68.00
25	520	400	✓	1	4932352775	4002395374335	£72.30
25	920	800	✓	1	4932352776	4002395374342	£119.00
25	1320	1200	✓	1	4932352777	4002395374359	£225.00
26	520	400		1	4932430728	4002395383894	£89.99
28	370	250		1	4932352778	4002395374366	£75.63
28	570	450	✓	1	4932352779	4002395374373	£85.19
28	670	550	✓	1	4932352780	4002395374380	£110.94
28	920	800	✓	1	4932352781	4002395374397	£139.00
28	1320	1200	✓	1	4932352782	4002395374403	£240.45
30	370	250		1	4932352783	4002395374410	£79.91
30	570	450		1	4932352784	4002395374427	£88.33
30	920	800		1	4932430729	4002395383900	£149.99
32	370	250		1	4932352785	4002395374434	£83.63
32	570	450		1	4932352786	4002395374441	£101.24
32	920	800	✓	1	4932352787	4002395374458	£159.00
32	1320	1200	✓	1	4932352788	4002395374465	£259.00
35	370	250		1	4932352789	4002395374472	£89.89
35	570	450		1	4932352790	4002395374489	£109.00
35	920	800	✓	1	4932352791	4002395374496	£188.36
38	370	250		1	4932352792	4002395374502	£107.47
38	570	450		1	4932352793	4002395374519	£138.72
40	370	250		1	4932352794	4002395374526	£131.10
40	570	450	✓	1	4932352795	4002395374533	£160.22
40	920	800	✓	1	4932352796	4002395374540	£216.84
40	1320	1200	✓	1	4932352797	4002395374557	£345.35
45	570	450		1	4932352798	4002395374564	£218.49
45	920	800		1	4932430730	4002395383917	£299.99
50	570	450		1	4932430731	4002395383924	£309.99
52	570	450		1	4932352799	4002395374571	£271.24
SDS-Max 5 pc drill bit set.		Ø 16 / 18 x 540 mm, Ø 20 / 22 / 25 x 520 mm.		5	4932352800	4002395374588	£345.35

SDS-Max TCT tunnel bits - One piece design

- One piece solid steel tool.
- Up to 30% faster than conventional 2 piece design tools.
- Increased lifetime.
- Suitable for all rotary hammers.
- Made in Germany.
- Vario tunnel bits (supplied with thread)

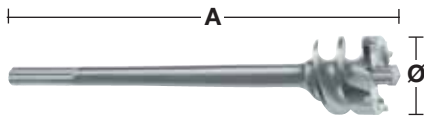
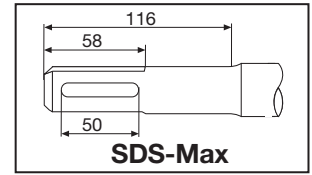

Ø (mm)	Total length A (mm)	Packed contents	Article Number	EAN Code	Price exc. VAT
45	310	1	4932399365	4002395359820	£224.28
45	550	1	4932373892	4002395353217	£222.62
45	990	1	4932399366	4002395359837	£311.44
55	310	1	4932399367	4002395359844	£258.39
55	550	1	4932373893	4002395353224	£260.52
55	990	1	4932399368	4002395359851	£350.94
65	310	1	4932399369	4002395359868	£284.58
65	550	1	4932373894	4002395353231	£279.46
65	990	1	4932399370	4002395359875	£379.03
80	310	1	4932399371	4002395359882	£321.15
80	550	1	4932373895	4002395353248	£470.83
80	990	1	4932399372	4002395359899	£470.83

SDS-Max TCT core cutters - One piece design

- One piece solid steel tool.
- Up to 30% faster than conventional 2 piece design tools.
- Increased lifetime.
- Supplied with pilot drill bit and ejector tool.
- Suitable for all rotary hammers.
- Made in Germany.

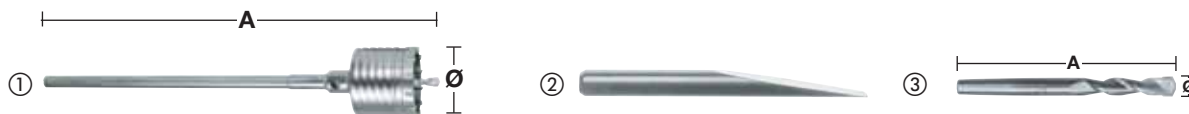

Description	Ø (mm)	Total length A (mm)	Packed contents	Article Number	EAN Code	Price exc. VAT
①	50	290	1	4932399373	4002395359905	£177.16
	50	550	1	4932373884	4002395353132	£205.09
	68	290	1	4932399374	4002395359912	£208.94
	68	550	1	4932373885	4002395353149	£227.78
	80	290	1	4932399375	4002395359929	£260.24
	80	550	1	4932373886	4002395353156	£276.27
	100	550	1	4932373888	4002395353170	£349.00
	125	550	1	4932373889	4002395353187	£425.00
	150	550	1	4932373890	4002395353194	£531.69
② Ejector tool.			1	4932399021	4002395356065	£11.78
③ Pilot drill bit.	11	120	1	4932245967	4002395307111	£8.00

SDS-Max TCT core cutters - Two piece design

Not suitable for rotary hammers > 10 kg.
Made in Germany.

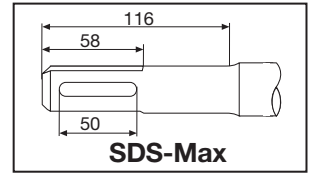
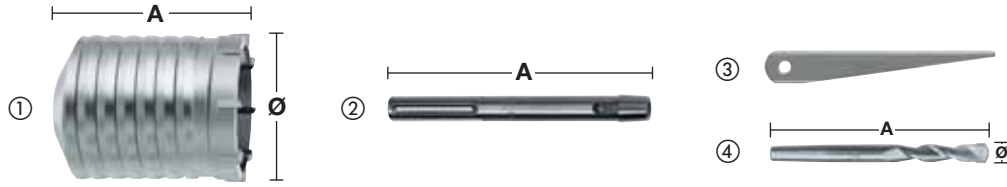

Description	Ø (mm)	Total length A (mm)	Packed contents	Article Number	EAN Code	Price exc. VAT
①	40	100	1	4932245992	4002395307180	£76.49
	50	100	1	4932430732	4002395383931	£99.99
	60	100	1	4932430733	4002395383948	£129.99
	65	100	1	4932245994	4002395307203	£119.31
	68	100	1	4932430734	4002395383955	£149.99
	80	100	1	4932245995	4002395307210	£150.89
	90	100	1	4932430735	4002395383962	£199.99
	100	100	1	4932367304	4002395336432	£189.89
	125	100	1	4932367306	4002395336456	£222.37
	150	100	1	4932367308	4002395336470	£346.39
② Arbor SDS-Max.		180	1	4932343667	4002395315932	£48.36
		450	1	4932343670	4002395315949	£88.21
③ Ejector tool.			1	4932604214	4002395311231	£7.55
④ Pilot drill bit.	11	120	1	4932245967	4002395307111	£8.00

Adaptor



Description	Tool reception	Drill reception	Packed contents	Article Number	EAN Code	Price exc. VAT
Adaptor.	SDS-Max	SDS-Plus	1	4932359490	4002395325795	£69.98

21 mm K-Hex drill bits - 4 cut

Easy centering: The special shaped tip design ensures accurate positioning and avoids skating on hard and smooth materials.

Optimal dust removal: The large entrance channels remove the dust quickly from the hole for less wear rate on the tip resulting higher performance and longer lifetime.

Precise round holes: Due to two extra carbide tips the drill bit will produce precise round holes and has also an excellent performance when hitting rebar.

High energy transfer: The patented KVS-flute design gives the best energy transfer from the tool reception to the drill bit tip and also lowest vibration.

Made in Germany.

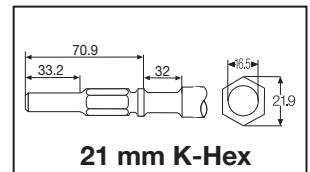
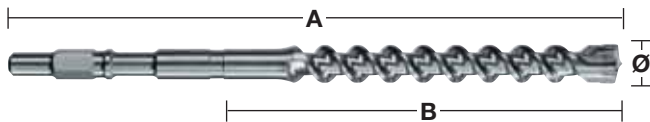

Ø (mm)	Total length A (mm)	Working length B (mm)	Pre-drill	Packed contents	Article Number	EAN Code	Price exc. VAT
16	570	400	✓	1	4932399560	4002395362141	£71.32
18	570	400	✓	1	4932399562	4002395362165	£74.09
20	570	400	✓	1	4932399564	4002395362189	£75.11
22	570	400	✓	1	4932399566	4002395362202	£82.93
25	570	400	✓	1	4932399569	4002395363216	£89.36
28	570	400	✓	1	4932399571	4002395362257	£99.48
30	570	400	✓	1	4932399572	4002395362264	£127.40
32	570	400	✓	1	4932399573	4002395362271	£127.40
32	1320	1200	✓	1	4932399040*	4002395356447	£127.40
35	570	400	✓	1	4932399574	4002395362288	£139.00

* while stocks last

SDS-Max vario extension system

- Flexible tool system: can be extended to variable lengths in combination with core cutters or tunnel bits. We recommend a maximum of 3 extensions.
- Cost effective: different drill sizes can be exchanged easily and fast with the threaded stud system.
- Suitable for rotary hammers up to 8 kg.
- Vario tunnel bits (supplied with thread)

Description	Ø (mm)	Total length A (mm)	Packed contents	Article Number	EAN Code	Price exc. VAT
① SDS-Max arbor with internal thread.		195	1	4932430736	4002395383979	£79.99
② Vario extension (incl. threaded stud)	25	280	1	4932430737	4002395383986	£129.99
③ Vario threaded stud.			1	4932430738	4002395383993	£29.99
④ Vario threaded stud with tapered end 1:8 for TCT core cutters.			1	4932430748	4002395384099	£99.99
⑤ TCT core cutter.	40	100	1	4932245992	4002395307180	£76.49
	50	100	1	4932430732	4002395383931	£99.99
	60	100	1	4932430733	4002395383948	£129.99
	65	100	1	4932245994	4002395307203	£119.31
	68	100	1	4932430734	4002395383955	£149.99
	80	100	1	4932245995	4002395307210	£150.89
	90	100	1	4932430735	4002395383962	£199.99
	100	100	1	4932367304	4002395336432	£189.89
	125	100	1	4932367306	4002395336456	£222.37
	150	100	1	4932367308	4002395336470	£346.39
⑥ Ejector tool.			1	4932604214	4002395311231	£7.55
⑦ Pilot drill bit.	11	120	1	4932245967	4002395307111	£8.00
⑧ Vario tunnel bits (supplied with thread)	30	150	1	4932430739	4002395384006	£199.99
	35	150	1	4932430740	4002395384013	£219.99
	40	150	1	4932430743	4002395384044	£229.99
	45	150	1	4932430744	4002395384051	£249.99
	55	150	1	4932430745	4002395384068	£299.99
	60	150	1	4932430741	4002395384020	£329.99
	68	150	1	4932430746	4002395384075	£349.99
	80	150	1	4932430747	4002395384082	£449.99
	90	150	1	4932430742	4002395384037	£549.99

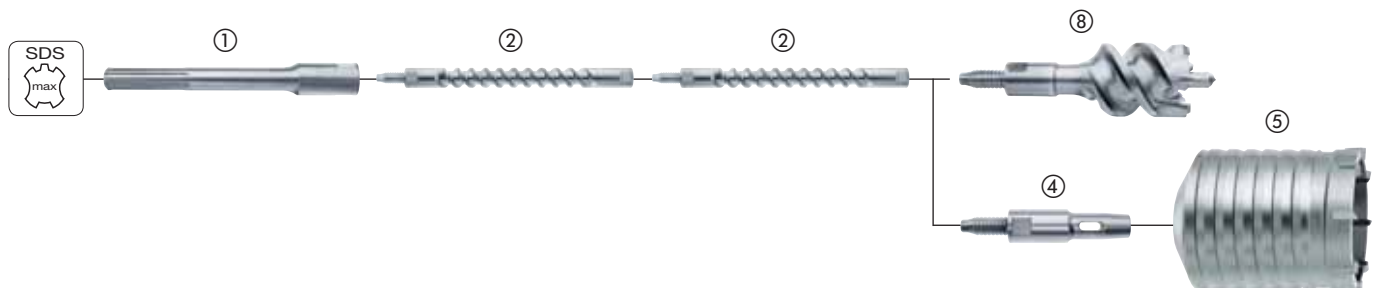
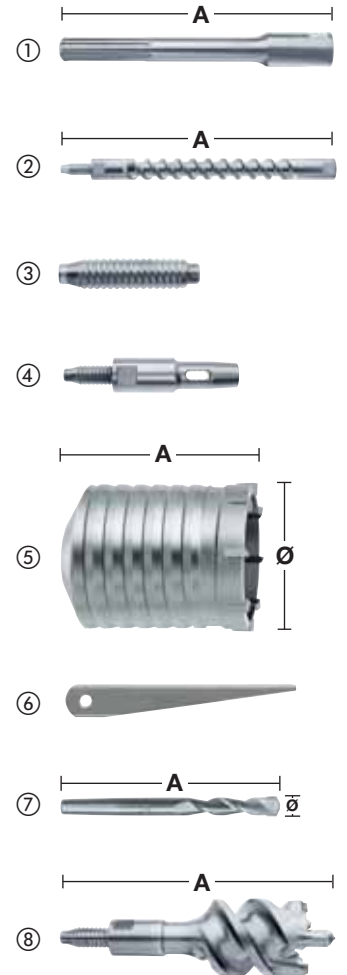



Nothing but **HEAVY DUTY.**[™]

Drill Connect

The innovative and patented Drill Connect System is the ultimate solution for those requiring maximum versatility with large diameter drilling tools.

Versatile:

Drill Connect acts as a link between machine and drilling tools. On one side the system is totally compatible to all SDS-Max reception drilling tools such as drill bits, tunnel bits and core cutters. On the opposite side between the rotary hammer and the Drill Connect attachment one can fit the extension piece with the desired length.

Universal:

The extension pieces are offered in a range of lengths fitting to rotary hammers with either SDS-Max, Spline or 19 mm Hex reception. Short or long – the choice is yours!

Cost effective:

Professional users always require both long and short length drill bits and depending on the application sometimes even of the same diameter. But now, one can reduce the total number of drilling tools with the help of the Drill Connect System which makes it possible to interchange the drilling tools diameter and length in one simple step. Therefore users can reap the benefits of purchasing the cheaper short length drill bits and extending the length with the economical extensions plus the flexibility of Drill Connect reduces the overall quantity of drill bits one must carry in their toolbox.



100% Power:

The Drill Connect attachment provides a quick and safe connection between drilling tool and extension piece and therefore ensures that 100% of the power is completely transmitted to the drill bit tip.



Less weight:

The combination of short drilling tools and 18 mm diameter extensions reduces the overall weight by up to 15%.

- We recommend that Drill Connect be cleaned of concrete dust and lubricated with grease at regular intervals (Grease – Part-no. 4932352273).
- Drill Connect is only suitable for drilling tools in excess of 32 mm diameter and limited for use with rotary hammers up to 8 kg in weight.

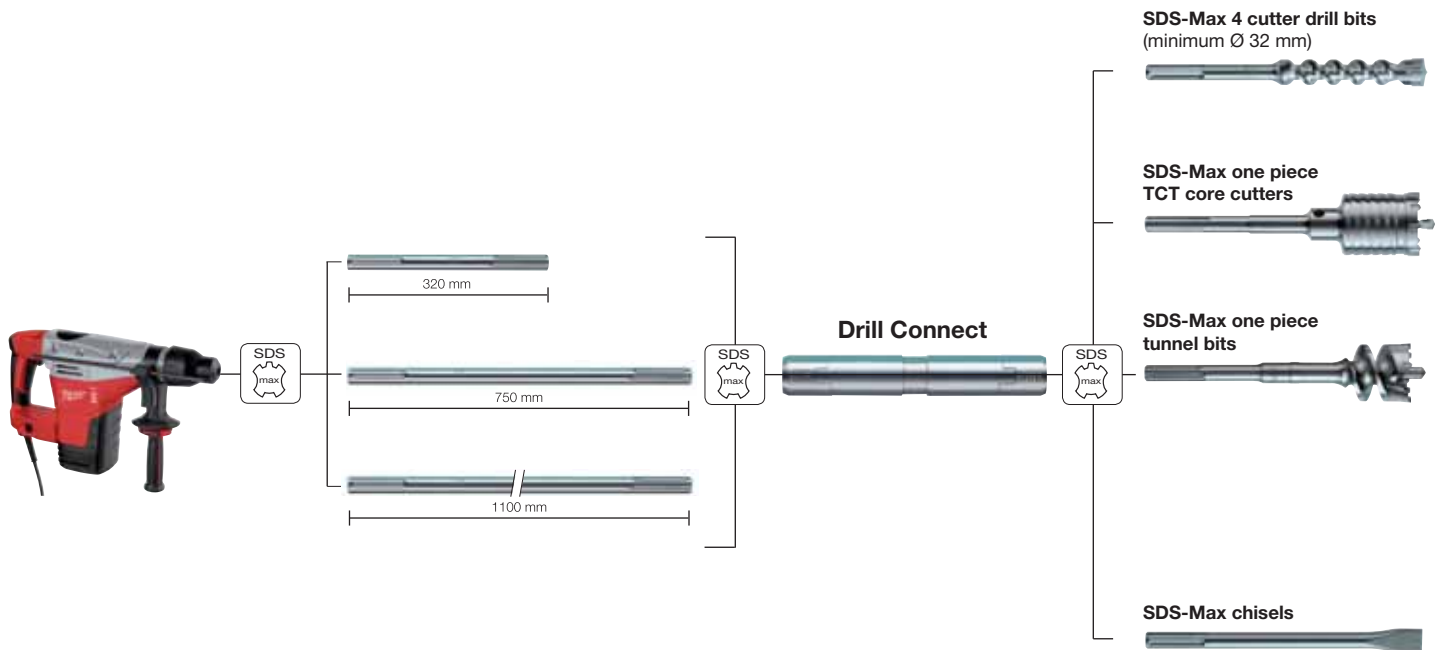

Drill Connect

Suitable for use with drilling tools with a Ø of 32 mm and above.
For use with rotary hammers up to 8 kg in weight.

Description	Tool reception	Drill connect reception	Total length A (mm)	Packed contents	Article Number	EAN Code	Price exc. VAT
Drill connect.	SDS-Max	SDS-Max	190	1	4932399128	4002395357321	£270.59



Extension pieces

Description	Tool reception	Drill connect reception	Length (mm)	Packed contents	Article Number	EAN Code	Price exc. VAT
SDS-Max extension.	SDS-Max	SDS-Max	320	1	4932399242	4002395358533	£39.23
SDS-Max extension.	SDS-Max	SDS-Max	750	1	4932399129	4002395357338	£49.14
SDS-Max extension.	SDS-Max	SDS-Max	1100	1	4932399243	4002395358540	£66.40



Grease

This grease has been especially formulated to lubricate and protect both the tool and accessories ensuring increased lifetime.
Apply sparingly directly onto the reception of the drill bit, chisel or core cutter, etc.
Contains 50 grams.

Description	Packed contents	Order quantity	Article Number	EAN Code	Price exc. VAT
① Grease.	1	1	4932352273	4002395369324	£8.63
② Counter display with 15 x single grease tube 4932352273.	15	1	4932352274	4002395369331	£119.85





Nothing but **HEAVY DUTY**.™

Chisels

Every chisel comes with 150 years experience in manufacturing expertise, we know what it takes to make the best chisel. A high quality chisel needs to withstand the daily routine of breaking and demolition on the worksite, this demands a chisel with a low wear rate, impact strength and elasticity to have a low risk of breaking.

With these objectives in mind great attention is placed on sourcing the correct raw materials and to use the most up to date manufacturing techniques.

For the base material a specifically defined alloy steel is chosen, then each chisel is crafted individually through the production process of forging, sharpening, hardening, tempering and finishing.

The chisels are precision formed using traditional forging skills coupled with sophisticated machinery for the specific tip design.

The heat treatment process is totally enclosed and computer controlled ensuring consistent results, this guarantees that the complete chisel is hardened throughout to 55 HRC. The tempering operation creates a uniform hardened surface across the complete chisel to give it impact strength, more wear resistance and the required elasticity.

The chisels then go through the final finishing process which gives the chisel a smooth grain flow surface and a special corrosion resistant treatment.

Finally for identification purposes the Milwaukee® logo is laser marked on the chisel.

To achieve long service life all our chisels can be resharpened time and time again.

These chisels stand for 100% quality – Made in Germany.

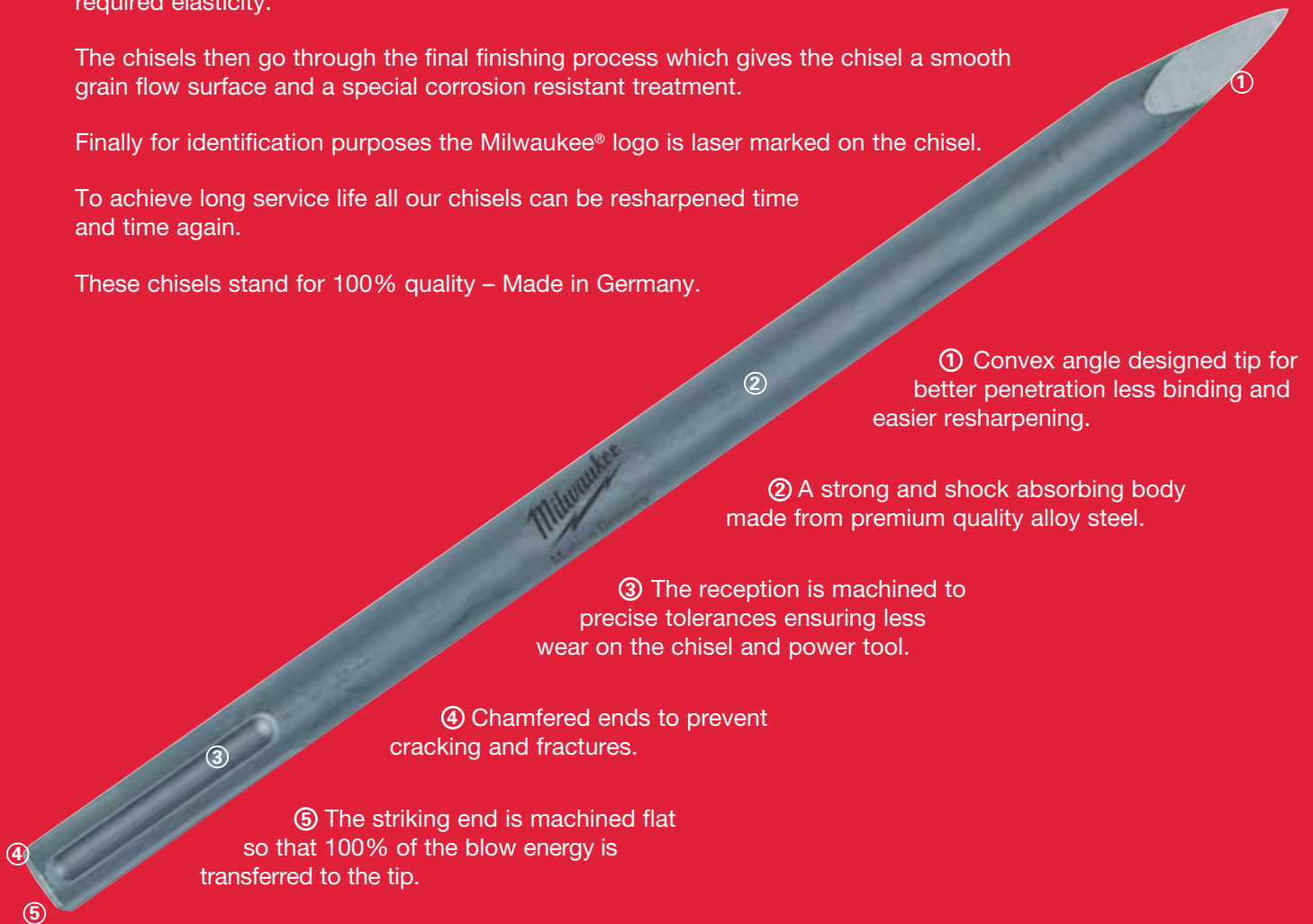

Maintenance Tips

1. Grease the reception regularly (Milwaukee® grease part no. 4932352273).
2. Keep receptions clean from dust.
3. Do not exert excessive side pressure on the chisel. Do not use as a crowbar.
4. Do not store chisels outdoors at temperatures below freezing, if so chisels should be warmed before use. Rusty chisels are more likely to suffer fatigue failure.

SDS-Plus chisels

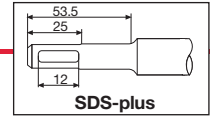

SDS-Plus pointed chisels

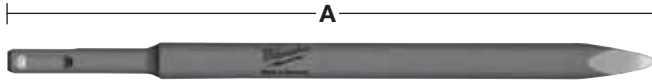

Total length A (mm)	Blade width (mm)	Packed contents	Article Number	EAN Code	Price exc. VAT
250	-	1	4932339625	4002395304813	£10.99

SDS-Plus flat chisels

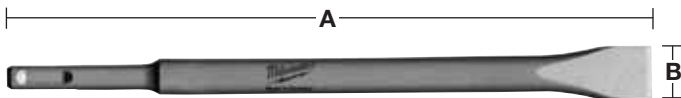

Total length A (mm)	Blade width (mm)	Packed contents	Article Number	EAN Code	Price exc. VAT
250	20	1	4932339626	4002395304820	£10.99

SDS-Plus wide chisels

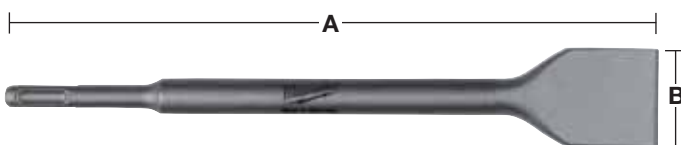

Total length A (mm)	Blade width (mm)	Packed contents	Article Number	EAN Code	Price exc. VAT
250	40	1	4932367146	4002395334377	£18.61

SDS-Plus chisel sets



Description	Packed contents	Order quantity	Article Number	EAN Code	Price exc. VAT
3 pc chisel set (250 mm length). 1 x Pointed chisel, 1 x Flat chisel, 1 x Wide chisel.	3	1	493240001	4002395376629	£37.50

SDS-Plus chisels

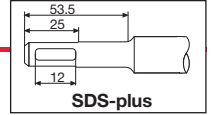

SDS-Plus tile removal chisels

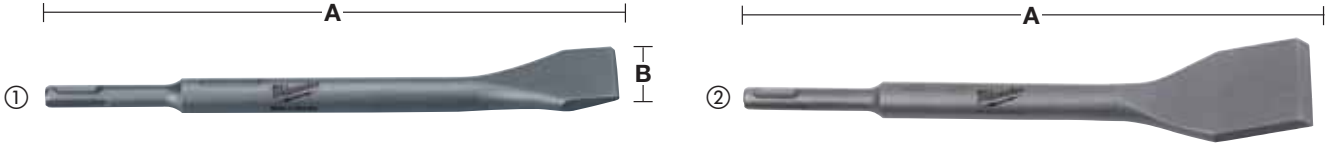

Angled head to prevent damage to walls when removing tiles.

	Total length A (mm)	Blade width (mm)	Packed contents	Article Number	EAN Code	Price exc. VAT
①	250	40	1	4932353424	4002395320202	£19.32
②	250	50	1	4932352343	4002395370023	£24.50

SDS-Plus gouge chisels

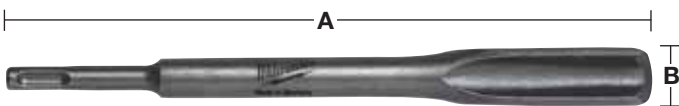

	Total length A (mm)	Blade width (mm)	Packed contents	Article Number	EAN Code	Price exc. VAT
	250	25	1	4932339627	4002395304837	£24.27

SDS-Plus plaster removal chisels

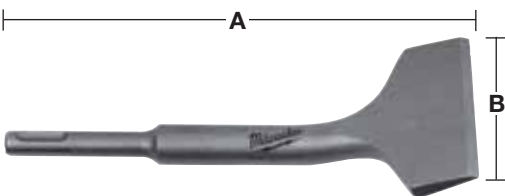

	Total length A (mm)	Blade width (mm)	Packed contents	Article Number	EAN Code	Price exc. VAT
	165	75	1	4932352344	4002395370030	£29.95

SDS-Plus floor / wall scrapers

For scraping adhesives, paint, scree and soft plaster.

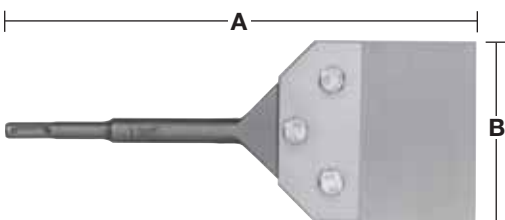

Description	Total length A (mm)	Width (mm)	Packed contents	Article Number	EAN Code	Price exc. VAT
Floor cleaning tool complete.	250	100	1	4932352919	4002395375776	£169.00
Spare 1 mm thick blade with 3 x bolts / nuts.			1	4932352920	4002395375783	£49.90

SDS-Max chisels

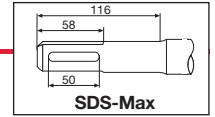

SDS-Max pointed chisels

Ideal for a wide range of breaking and demolition work of concrete or breeze block.



	Total length A (mm)	Blade width (mm)	Packed contents	Order quantity	Article Number	EAN Code	Price exc. VAT
①	280	-	1	1	4932343734	4002395317509	£12.68
②	380	-	1	1	4932399907	4002395365623	£15.98
①	400	-	1	1	4932343735	4002395317516	£14.60
①	400	-	20	1	4932399302	4002395359165	£262.71
①	600	-	1	1	4932343736	4002395317523	£18.69

SDS-Max flat chisels

Ideal for a wide range of breaking and cutting of concrete as well as demolition work.



	Total length A (mm)	Blade width (mm)	Packed contents	Order quantity	Article Number	EAN Code	Price exc. VAT
①	280	25	1	1	4932343737	4002395317530	£12.68
②	380	30	1	1	4932399908	4002395365630	£16.28
①	400	25	1	1	4932343738	4002395317547	£13.97
①	400	25	20	1	4932399303	4002395359172	£251.37
①	600	25	1	1	4932343739	4002395317554	£18.69

SDS-Max wide chisels

Stripping walls of plaster, ceramic tiles. Removing heavy deposits of rust and scale metal.

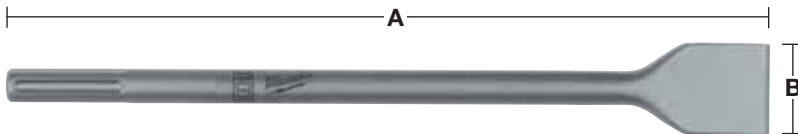

	Total length A (mm)	Blade width (mm)	Packed contents	Article Number	EAN Code	Price exc. VAT
	400	50	1	4932343743	4002395317592	£27.17
	300	80	1	4932343744	4002395317608	£30.65
	300	115	1	4932343745	4002395317615	£58.21

SDS-Max tile removal chisels

Cranked for stripping walls of plaster and ceramic tiles.

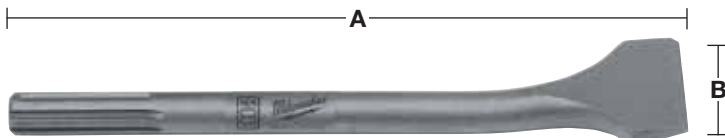

	Total length A (mm)	Blade width (mm)	Packed contents	Article Number	EAN Code	Price exc. VAT
	300	80	1	4932399234	4002395358489	£42.76

SDS-Max chisels

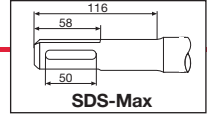

SDS-Max chasing gouge chisels

Cutting grooves into a wall surface to hold pipe work or electrical conduit. Suitable for brick, breeze block and concrete.

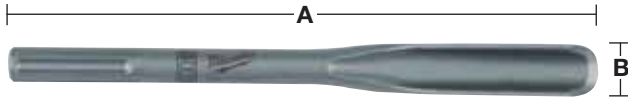

Total length A (mm)	Blade width (mm)	Packed contents	Article Number	EAN Code	Price exc. VAT
300	26	1	4932343740	4002395317561	£31.29

SDS-Max spade chisels

Pointed end for digging harder ground such as chalk, shingle or shale.

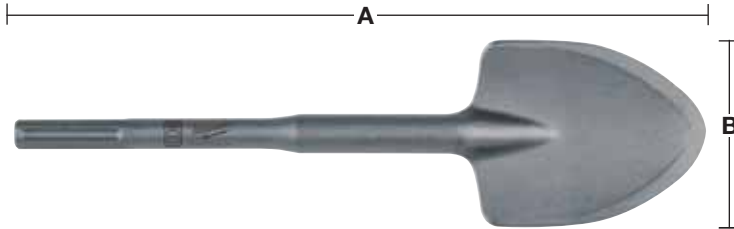

Total length A (mm)	Blade width (mm)	Packed contents	Article Number	EAN Code	Price exc. VAT
400	110	1	4932343747	4002395317639	£79.80

SDS-max surface treatment / bushing tools

For roughing up concrete before its surface coated ie. for pitted or uneven floors or walls must often be roughened up prior to covering with a new layer of coating.

16 teeth.

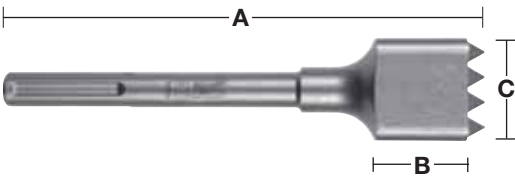

Total length A (mm)	Working length B (mm)	Working height (mm)	Packed contents	Article Number	EAN Code	Price exc. VAT
240	50	50	1	4932352918	4002395375769	£149.00

SDS-Max electrode / ground rod drivers

Suitable for driving hammering electrode / ground rods. Not suitable for driving rebar or steel rods.

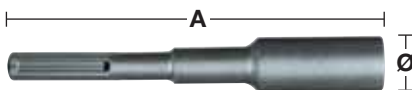

Ø (mm)	Total length A (mm)	Packed contents	Article Number	EAN Code	Price exc. VAT
13.3	220	1	4932451354	4002395159031	£54.99
16.6	220	1	4932451355	4002395159048	£54.99
22.2	220	1	4932451356	4002395159055	£79.99

21 mm K-Hexagon chisels

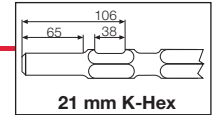

21 mm K-Hex pointed chisels

Ideal for a wide range of breaking and demolition work of concrete or breeze block.

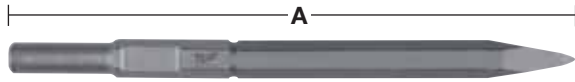

Total length A (mm)	Blade width (mm)	Packed contents	Article Number	EAN Code	Price exc. VAT
380	-	1	4932399251	4002395358632	£16.54
450	-	1	4932399252	4002395358649	£17.03
600	-	1	4932399253	4002395358656	£20.94

21 mm K-Hex flat chisels

Ideal for a wide range of breaking and cutting of concrete as well as demolition work.



Total length A (mm)	Blade width (mm)	Packed contents	Article Number	EAN Code	Price exc. VAT
380	25	1	4932399256	4002395358687	£15.62
450	25	1	4932399257	4002395358694	£16.08
600	25	1	4932399258	4002395358700	£19.78

21 mm K-Hex wide chisels

Suitable for stripping walls of plaster or ceramic tiles. Removing heavy deposits of rust and scale from metal.

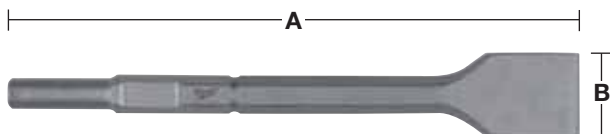

Total length A (mm)	Blade width (mm)	Packed contents	Article Number	EAN Code	Price exc. VAT
300	50	1	4932399260	4002395358724	£30.68
300	75	1	4932399261	4002395358731	£31.28

21 mm K-Hexagon chisels

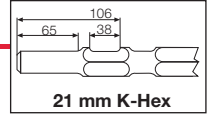

21 mm K-Hex spade chisels

Suitable for digging in all types of ground - clay, earth, chalk, shingle and shale. Also for digging in frozen ground. Not suitable for concrete.

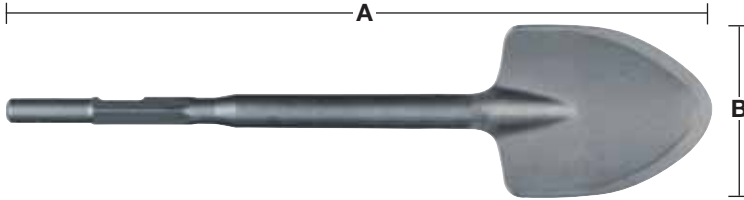

Total length A (mm)	Blade width (mm)	Packed contents	Article Number	EAN Code	Price exc. VAT
533	110	1	4932399264	4002395358762	£111.72

21 mm K-Hex electrode / ground rod drivers

Suitable for driving hammering electrode / ground rods. Not suitable for driving rebar or steel rods.

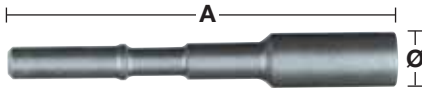

Ø (mm)	Total length A (mm)	Packed contents	Article Number	EAN Code	Price exc. VAT
12	222	1	4932399265	4002395358779	£131.25
16	222	1	4932399266	4002395358786	£139.59
25	222	1	4932399269	4002395358816	£138.82

Dust guard

Prevents dust and dirt entering the tool reception area when using spades and ground rod drivers.



Description	Packed contents	Article Number	EAN Code	Price exc. VAT
Dust guard cap.	1	9170086960	4002395565504	£4.22

21 mm K-Hex / SDS-Max special application tools

Tamping tools

Application: Suitable for compacting earth and ballast prior to pouring concrete. Tamping back-fill on ditches. Requires universal taper shank.

Description	Width (mm)	Working length B (mm)	Packed contents	Article Number	EAN Code	Price exc. VAT
Tamping plate.	120	120	1	4932399270	4002395358823	£89.00

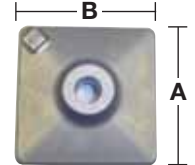

Surface treatment tools

Application: For roughing up concrete before its surface coated i.e. for pitted or uneven floors or walls must often be roughened prior to covering with a new layer of coating. Requires universal taper shank.

Description	Length (mm)	Width (mm)	Packed contents	Article Number	EAN Code	Price exc. VAT
Bushing head (16 teeth).	50	50	1	4932399279	4002395358915	£52.40

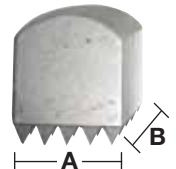

Floor cleaning tools

Application: For scraping floor tile adhesive, paint, scree and other floor coatings. Requires universal taper shank.

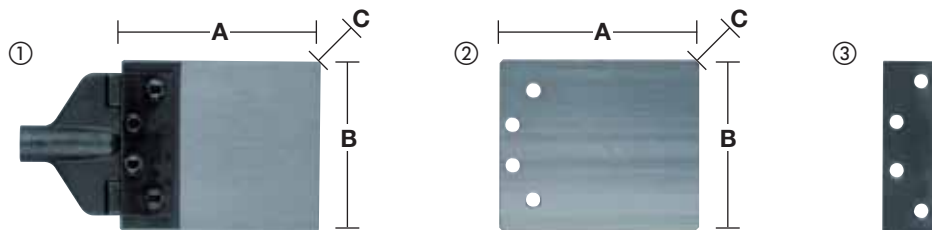

Description	Blade length (mm)	Blade width (mm)	Thickness (mm)	Packed contents	Article Number	EAN Code	Price exc. VAT
① Floor cleaning tool including 2 mm blade. Requires universal taper shank.	180	150	2	1	4932399272	4002395358847	£205.61
② Spare 2 mm blade.	180	150	2	1	4932399273	4002395358854	£35.75
③ Replacement clamping bracket.				1	4932399275	4002395358878	£31.28
Service set. 2 x gasket, 4 x nuts, 4 x screws, 8 x washers.				18	4932352300	4002395369591	£25.81

Universal taper shanks



Description	Total length A (mm)	Packed contents	Article Number	EAN Code	Price exc. VAT
① Universal taper shank SDS-Max.	300	1	4932343771	4002395317745	£52.64
② Universal taper shank 21 mm K-Hexagon.	300	1	4932399280	4002395358922	£17.20
	450	1	4932399281	4002395358939	£19.57

Name		Top view	Suitable for
① SDS-plus	drill		AEG, Milwaukee®, Bosch, Dewalt, Hilti, Hitachi, Kango, Makita, Ryobi
① SDS-plus	chisel		AEG, Milwaukee®, Bosch, Dewalt, Hilti, Hitachi, Kango, Makita, Ryobi
② SDS-Max	drill		AEG, Milwaukee®, Bosch, Dewalt, Hilti, Hitachi, Kango, Makita, Ryobi
② SDS-Max	chisel		AEG, Milwaukee®, Bosch, Dewalt, Hilti, Hitachi, Kango, Makita, Ryobi
③ Spline	drill		AEG, Milwaukee®, Bosch, Dewalt, Hilti, Hitachi, Kango, Makita, Metabo
④ Twisted spline	chisel		AEG, Milwaukee®, Bosch, Dewalt, Hilti, Hitachi, Kango, Makita, Metabo
⑤ 13 mm Hexagon	drill		Hitachi, Makita
⑥ 17 mm Hexagon	chisel		Hitachi, Makita
⑦ 19 mm K-Hexagon	chisel		Kango
⑧ 19 mm Hexagon	chisel		AEG, Milwaukee®, Bosch, Dewalt, Ryobi
⑨ 21 mm K-Hexagon	drill		Hitachi, Kango, Makita, Milwaukee®
⑩ 21 mm K-Hexagon	chisel		Hitachi, Kango, Makita, Milwaukee®
⑪ 28 mm Hexagon	chisel		AEG, Milwaukee®
⑫ 32 mm Hexagon	chisel		Atlas Copco, Kango, Milwaukee®

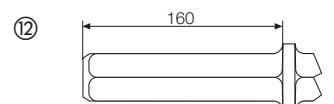
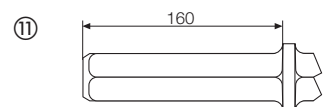
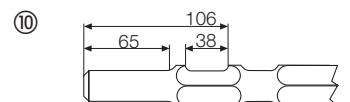
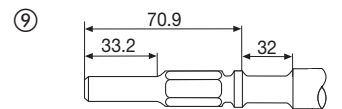
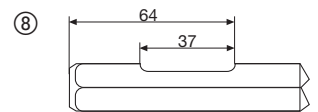
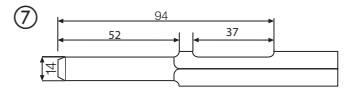
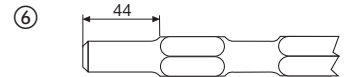
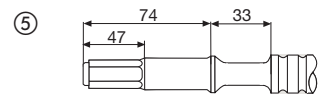
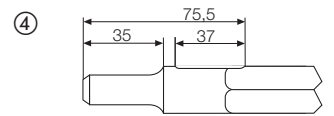
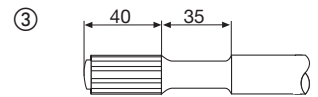
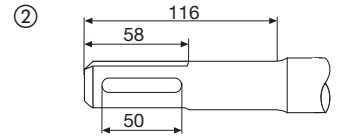
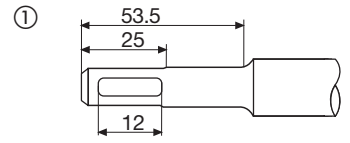

Concrete drill bits - round shank - DIN 8039

Diamond ground percussion carbide tip with two cutting edges.
 For drilling in brick, tile, ceramic, concrete, plaster, slate and aerated concrete blocks.
 Made in Germany.

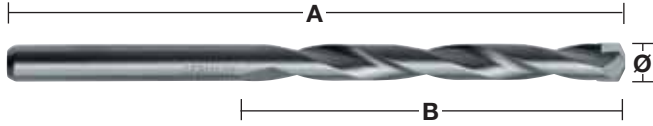

Ø (mm)	Total length A (mm)	Working length B (mm)	Packed contents	Article Number	EAN Code	Price exc. VAT
3	70	40	1	4932363630	4002395332007	£1.81
3.5	80	45	1	4932399916	4002395365746	£1.99
4	85	50	1	4932363631	4002395332014	£1.77
4.5	85	50	1	4932363632	4002395332021	£1.87
5	85	50	1	4932363633	4002395332038	£1.87
5	150	90	1	4932363634	4002395332045	£2.42
5.5	85	50	1	4932363635	4002395332052	£1.96
5.5	150	90	1	4932367035	4002395333998	£2.69
6	100	60	1	4932363636	4002395332069	£2.18
6	150	90	1	4932363637	4002395332076	£2.95
6	200	150	1	4932399383	4002395360000	£3.63
6	400	350	1	4932352505	4002395371631	£8.98
6	600	550	1	4932352506	4002395371648	£10.98
6.5	100	60	1	4932363638	4002395332083	£2.18
6.5	150	90	1	4932367036	4002395334605	£3.05
7	100	60	1	4932363639	4002395332090	£2.27
7	150	90	1	4932367037	4002395334612	£3.29
7.5	100	60	1	4932399917	4002395365753	£3.40
8	120	80	1	4932363640	4002395332106	£2.66
8	200	150	1	4932363641	4002395332113	£4.38
8	400	350	1	4932399384	4002395360017	£9.55
8	600	550	1	4932352507	4002395371655	£12.98
8.5	120	80	1	4932363642	4002395332120	£3.70
9	120	80	1	4932363643	4002395332137	£3.26
9.5	120	80	1	4932399919	4002395365777	£3.90
10	120	80	1	4932363644	4002395332144	£3.91
10	200	150	1	4932363645	4002395332151	£5.95
10	400	350	1	4932399385	4002395360024	£11.39
10	600	550	1	4932352508	4002395371662	£17.72
10	1000	950	1	4932352509*	4002395371679	£43.50
11	150	85	1	4932363646	4002395332168	£4.60
12	150	85	1	4932363647	4002395332175	£5.21
12	200	150	1	4932363648	4002395332182	£6.34
12	400	350	1	4932399386	4002395360031	£13.32
12	600	550	1	4932352510	4002395371686	£24.20
12	1000	950	1	4932352511*	4002395371693	£44.90
13	150	90	1	4932363649	4002395332199	£5.90
13	400	350	1	4932352512	4002395371709	£14.40
14	150	90	1	4932363650	4002395332205	£7.51
14	400	350	1	4932399387	4002395360048	£15.43
14	600	550	1	4932352513	4002395371716	£25.23
15	160	100	1	4932399380	4002395359974	£8.86
16	160	100	1	4932373914	4002395353446	£9.66
16	400	350	1	4932399388	4002395360055	£16.53
16	600	550	1	4932352514	4002395371723	£14.67
18	160	100	1	4932399229	4002395358434	£14.18
18	400	350	1	4932352515	4002395371730	£17.82
20	160	100	1	4932399230	4002395358441	£19.31
20	400	350	1	4932399389	4002395360062	£23.50
20	600	550	1	4932352516	4002395371747	£25.98
22	400	350	1	4932352517	4002395371754	£23.50
①	Concrete drill bit set (5 pcs). Ø 4 / 5 / 6 / 8 / 10 mm.		5	4932352333	4002395369928	£10.99
②	Concrete drill bit set (8 pcs). Ø 3 / 4 / 5 / 6 / 7 / 8 / 9 / 10 mm.		8	4932352334	4002395369935	£18.99

①



②



* while stocks last

Concrete super drill bits - round shank - DIN 8039

These high quality concrete drill bits have a unique shaped drill head with centering point and a H-spiral flute for maximum drilling speed and longer lifetime in hard materials such as concrete, aerated concrete blocks, masonry, natural stone, artificial stone, ceramic tile, slate and granite.

From Ø 12 mm the drill bits are supplied with a multi-flat shank to prevent the drill bit slipping in the chuck.

Made in Germany.

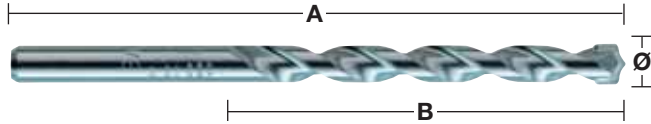

Ø (mm)	Total length A (mm)	Working length B (mm)	Packed contents	Article Number	EAN Code	Price exc. VAT
3	70	40	1	4932399394	4002395360116	£2.89
4	85	50	1	4932399395	4002395360123	£3.79
5	85	50	1	4932399396	4002395360130	£3.09
5.5	85	50	1	4932399397	4002395360147	£3.23
6	100	60	1	4932399398	4002395360154	£3.29
6.5	100	60	1	4932399399	4002395360161	£3.41
7	100	60	1	4932399400	4002395360178	£3.97
8	120	80	1	4932399401	4002395360185	£4.10
9	120	80	1	4932399402	4002395360192	£4.82
10	120	80	1	4932399403	4002395360208	£5.15
12	150	90*	1	4932399404	4002395360215	£6.65
14	150	90*	1	4932399405	4002395360222	£10.33
15	160	100*	1	4932399406	4002395360239	£12.92
16	160	100*	1	4932399407	4002395360246	£13.16
18	160	100*	1	4932399408	4002395360253	£17.25
20	160	100*	1	4932399409	4002395360260	£23.79
① Concrete Super drill bit set (5 pcs). Ø 4 / 5 / 6 / 8 / 10 mm.			5	4932352336	4002395369959	£21.90
② Concrete Super drill bit set (7 pcs). Ø 4 / 5 / 5.5 / 6 / 7 / 8 / 10 mm.			7	4932352337	4002395369966	£32.90

* with multi-flat shank

①



②



Multi material drill bits

These tungsten carbide tipped (TCT) drill bits will drill in metal, wood and stone rotary mode only. Hammer action cannot be used with these drill bits. Ideal for tradesmen who need to drill through a variety of materials in one go. Made in Germany.

①

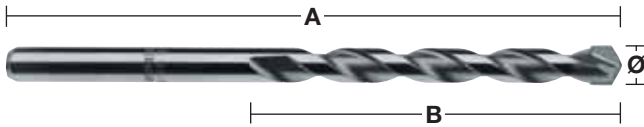

Ø (mm)	Total length A (mm)	Working length B (mm)	Packed contents	Article Number	EAN Code	Price exc. VAT
3	70	40	1	4932430147	4002395378081	£3.85
4	85	50	1	4932430148	4002395378098	£3.98
5	85	50	1	4932430149	4002395378104	£3.98
5.5	85	50	1	4932430150	4002395378111	£3.98
5.5	150	90	1	4932430151	4002395378128	£4.98
6	100	60	1	4932430152	4002395378135	£4.08
6	150	90	1	4932430153	4002395378142	£5.20
6	200	150	1	4932430154	4002395378159	£6.20
6.5	150	90	1	4932430155	4002395378166	£5.58
6.5	200	150	1	4932430156	4002395378173	£6.76
7	100	60	1	4932430157	4002395378180	£4.80
8	120	80	1	4932430158	4002395378197	£4.80
8	250	200	1	4932430159	4002395378203	£6.76
10	120	80	1	4932430160	4002395378210	£5.32
10	250	200	1	4932430161	4002395378227	£7.98
12	150	90	1	4932430162	4002395378234	£7.58
① Multi material drill bit set (7 pcs). Ø 3 / 4 / 5 / 6 / 6 / 8 / 10 mm.			7	4932352335	4002395369942	£29.99
Multi material drill bit set (7 pcs). Ø 4 / 5 / 5.5 / 6 / 7 / 8 / 10 mm.			7	4932352836	4002395374946	£34.99

Glass & tile bits

Suitable for glass, tiles, mirrors, ceramics. Made in Germany.

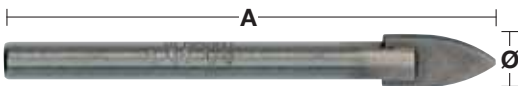

Ø (mm)	Total length A (mm)	Packed contents	Article Number	EAN Code	Price exc. VAT
3	90	1	4932399393	4002395360109	£3.69
4	90	1	4932363884	4002395333585	£3.79
5	90	1	4932363885	4002395333592	£3.98
6	90	1	4932363886	4002395333608	£4.75
8	95	1	4932363887	4002395333615	£5.88
10	100	1	4932363888	4002395333622	£7.18

Impact rated wood auger bits

Suitable for use with all types of corded / cordless drills including impact wrenches.

Drilling with an impact wrench enables drilling holes with less effort, one hand drilling, drilling up a ladder and above head height with less risk of injury from the tool clutching out.

Special zone hardening process ensures an extra hard shank, durable tip and perfectly flexible bit body.

New Milwaukee[®] Through-Center head geometry with the lead cutting edge lines up with the center of the feed screw.

This ensures efficient chip removal and allows for continuous feeding.

20° rake angle of the lead cutting edge creates a path for easy chip ejection.

Polished and powder coated flute design produces a non-stick surface for increased chip ejection, reduced chip clogging and higher selffeeding capability.

Milling marks are removed in the finishing process, creating a smooth surface.

Lewis flute with large, wide throat design for rapid chip removal.

Sharp ground cutting lips for smooth clean holes.

Resharpenable cutting lips.

With 7/16" shank. To fit square drive 1/2" impact wrenches the adaptor 48660061 is required.

Suitable for hard & soft wood, wet & treated wood, plywood, chipboard, WPC (wood plastic composite), laminated beams and panels, exotic and hard woods e.g. bongossi, iroko, teak, beech, oak, etc.



Short series

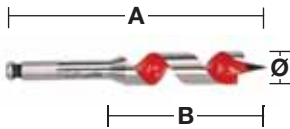

Special short design enables drilling in tight and normally non accessible places.

Ø (mm)	Total length A (mm)	Working length B (mm)	Shank reception	Packed contents	Article Number	EAN Code	Price exc. VAT
18	153	100	7/16" Hex	1	48130683	045242091379	£16.99
20	153	100	7/16" Hex	1	48130813	045242091522	£17.99
22	153	100	7/16" Hex	1	48130873	045242091638	£19.99
25	153	100	7/16" Hex	1	48131003	045242091782	£22.99
28	153	100	7/16" Hex	1	48131123	045242091935	£25.99
32	153	100	7/16" Hex	1	48131253	045242092031	£30.99

Long series

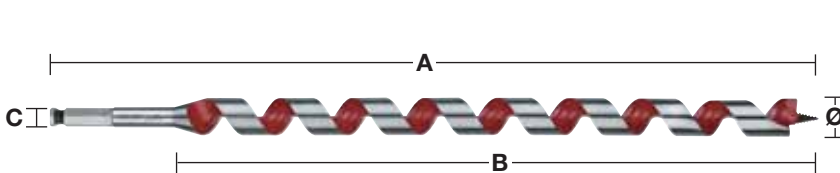

Ø (mm)	Total length A (mm)	Working length B (mm)	Shank reception	Packed contents	Article Number	EAN Code	Price exc. VAT
14	470	395	7/16" Hex	1	4932352275	4002395369348	£20.27
16	470	395	7/16" Hex	1	4932352276	4002395369355	£22.41
18	470	395	7/16" Hex	1	4932352277	4002395369362	£25.05
20	470	395	7/16" Hex	1	4932352278	4002395369379	£29.01
22	470	395	7/16" Hex	1	4932352279	4002395369386	£31.64
24	470	395	7/16" Hex	1	4932352280	4002395369393	£35.60
26	470	395	7/16" Hex	1	4932352281	4002395369409	£39.55
28	470	395	7/16" Hex	1	4932352282	4002395369416	£47.46
30	470	395	7/16" Hex	1	4932352283	4002395369423	£50.10
32	470	395	7/16" Hex	1	4932352284	4002395369430	£52.74

① 5 pc set in pouch.

Ø 14 / 16 / 18 / 20 / 22 x 470 mm.

5 4932352285 4002395369447 £125.43

System accessories

Description	Packed contents	Article Number	EAN Code	Price exc. VAT
Adaptor: 1/2" square drive to 7/16" and Hex 11 mm. For use with 7/16" selffeed bits and impact auger bits.	1	48660061	045242155118	£27.08



Wood drilling speeds

The following tables give recommended drilling speeds for the most efficient cutting speed. The tables should only be used as a guide and are dependant on the user and material being drilled.

Auger bits

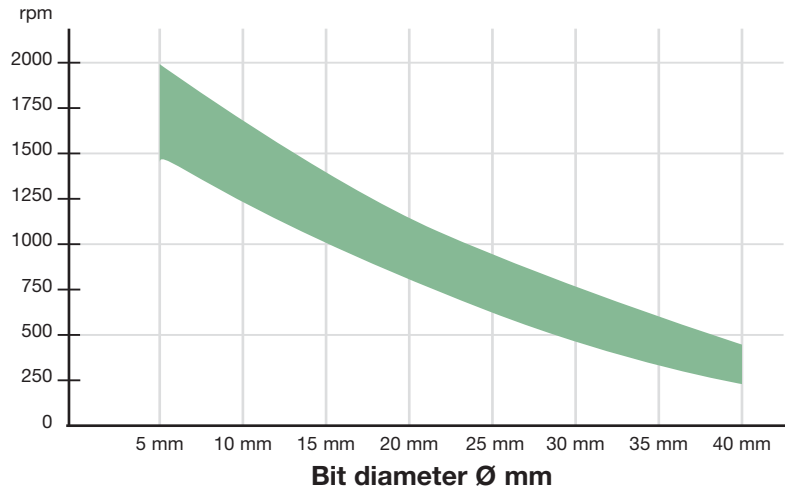

Optimum drilling speed range in rpm

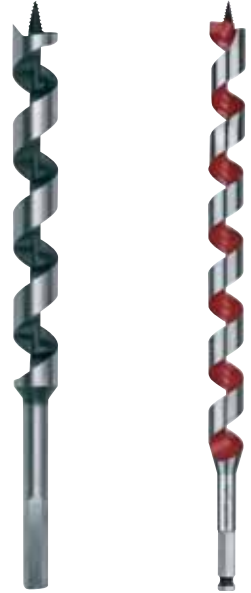

Forstner bits / Selffeed bits

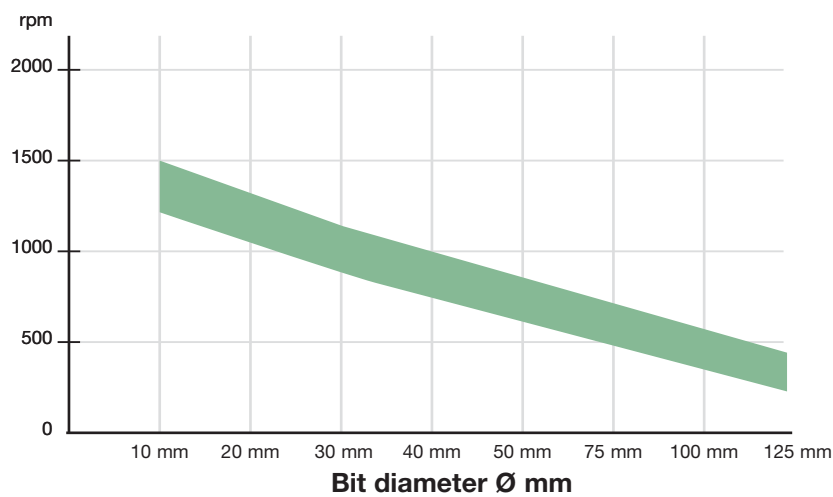

Optimum drilling speed range in rpm



Wood auger bits

For heavy duty, precision drilling in soft and hard wood, large section beams, joists, floor boarding, chipboard and plywood.
Lewis flute design for rapid chip removal.
With Hex shank for secure chuck grip.

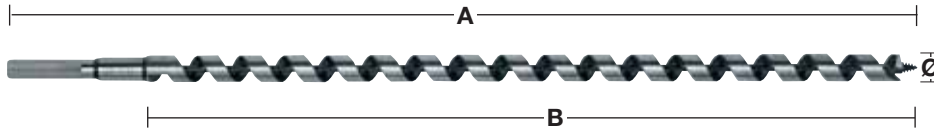

Ø (mm)	Total length A (mm)	Working length B (mm)	Shank reception	Packed contents	Article Number	EAN Code	Price exc. VAT	
6	230	155	6.5 mm Hex	1	4932430175	4002395378364	£6.90	
6	460	385	6.5 mm Hex	1	4932430176	4002395378371	£9.99	
8	230	155	6.5 mm Hex	1	4932363681	4002395331796	£7.42	
8	460	385	6.5 mm Hex	1	4932363688	4002395331710	£11.16	
10	230	155	8.5 mm Hex	1	4932363682	4002395331802	£7.90	
10	460	385	8.5 mm Hex	1	4932363689	4002395331727	£11.33	
10	600	530	8.5 mm Hex	1	4932363696	4002395331642	£16.35	
12	230	155	10 mm Hex	1	4932363683	4002395331819	£8.89	
12	460	385	10 mm Hex	1	4932363690	4002395331734	£12.78	
12	600	530	10 mm Hex	1	4932363697	4002395331659	£20.75	
14	230	155	11 mm Hex	1	4932363684	4002395331826	£9.38	
14	460	385	11 mm Hex	1	4932363691	4002395331741	£15.08	
14	600	530	11 mm Hex	1	4932363698	4002395331666	£22.87	
16	230	155	11 mm Hex	1	4932363685	4002395331833	£10.27	
16	460	385	11 mm Hex	1	4932363692	4002395331758	£16.86	
16	600	530	11 mm Hex	1	4932363699	4002395331673	£24.45	
18	230	155	11 mm Hex	1	4932363686	4002395331840	£11.37	
18	460	385	11 mm Hex	1	4932363693	4002395331765	£20.40	
18	600	530	11 mm Hex	1	4932363700	4002395331680	£28.78	
20	230	155	11 mm Hex	1	4932363687	4002395331857	£14.22	
20	460	385	11 mm Hex	1	4932363694	4002395331772	£22.94	
20	600	530	11 mm Hex	1	4932363701	4002395331697	£32.01	
22	230	155	11 mm Hex	1	4932373363	4002395347889	£15.83	
22	460	385	11 mm Hex	1	4932363695	4002395331789	£24.94	
22	600	530	11 mm Hex	1	4932363702	4002395331703	£37.85	
24	230	155	11 mm Hex	1	4932373364	4002395347896	£18.00	
24	460	385	11 mm Hex	1	4932373370	4002395348558	£30.60	
26	230	155	11 mm Hex	1	4932373365	4002395348503	£21.50	
26	460	385	11 mm Hex	1	4932373371	4002395348565	£35.07	
28	230	155	11 mm Hex	1	4932373366	4002395348510	£24.32	
28	460	385	11 mm Hex	1	4932373372	4002395348572	£39.81	
30	230	155	11 mm Hex	1	4932373367	4002395348527	£26.89	
30	460	385	11 mm Hex	1	4932373373	4002395348589	£44.34	
32	230	155	11 mm Hex	1	4932373368	4002395348534	£30.05	
32	460	385	11 mm Hex	1	4932373374	4002395348596	£49.46	
Wood auger bits 6 pcs. ① Ø 8 / 10 / 12 / 14 / 16 / 18 mm x 230 mm.				Wood case	6	4932373380	4002395349258	£68.09



Forstner bits

Centre point for precisely locating the bit, peripheral cutters ensure splinter free drilling in all natural soft and hard woods. Manufactured according to DIN 74836. Suitable for heavy-duty applications in all naturals, soft and hard woods.

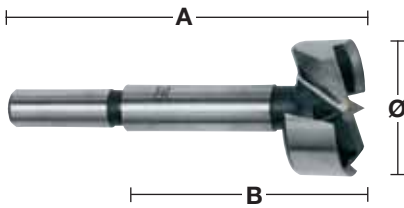

Ø (mm)	Total length A (mm)	Working length B (mm)	Shank reception	Packed contents	Article Number	EAN Code	Price exc. VAT
10	90	50	8 mm round shank	1	4932363703	4002395331468	£4.66
12	90	50	8 mm round shank	1	4932363704	4002395331475	£4.85
14	90	50	8 mm round shank	1	4932363705	4002395331482	£5.05
15	90	50	8 mm round shank	1	4932363883	4002395333738	£5.43
16	90	50	8 mm round shank	1	4932363706	4002395331499	£5.71
18	90	50	8 mm round shank	1	4932363707	4002395331505	£6.09
20	90	50	8 mm round shank	1	4932363708	4002395331512	£6.68
25	90	50	8 mm round shank	1	4932363711	4002395331543	£7.84
26	90	50	8 mm round shank	1	4932363712	4002395331550	£8.03
30	90	50	8 mm round shank	1	4932363714	4002395331574	£8.61
32	90	50	10 mm round shank	1	4932363715	4002395331581	£8.80
35	90	50	10 mm round shank	1	4932363717	4002395331604	£9.31
40	90	50	10 mm round shank	1	4932363720	4002395331635	£10.17
50	90	50	10 mm round shank	1	4932373923	4002395353538	£15.00
Forstner 5 piece drill bit set.							
①	Ø 15 / 20 / 25 / 30 / 35 mm.			5	4932373379	4002395349241	£37.15

SWITCHBLADE[™] Selffeed bits

- **Speed:** aggressive feed screw design allows the bit to pull through the wood faster and without effort, resulting in faster drilling.
- **Replaceable SWITCHBLADE[™]:** The SWITCHBLADE[™] replaceable blade system ensures your blade is always razor sharp. It increases productivity by eliminating resharpening downtime and it increases the overall life of the bit.
- **Application:** suitable for all general contractors, electricians, plumbers and HVAC engineers who require to drill through holes in wood for all types of pipe, vents and wire trunking.
- Each Selffeed bit is supplied with 2x blades, 2x replaceable feed screws, 2x set screws and 1x allen key.



Ø (mm)	Shank reception	Packed contents	Article Number	EAN Code	Price exc. VAT
35	7/16" Hex	1	48255120	045242157471	£30.96
38	7/16" Hex	1	48255125	045242157488	£32.43
51	7/16" Hex	1	48255135	045242157495	£38.89
54	7/16" Hex	1	48255140	045242157525	£42.41
57	7/16" Hex	1	48255143	045242225903	£42.41
65	7/16" Hex	1	48255150	045242157532	£47.80



SWITCHBLADE[™] 5 piece kit

Description	Packed contents	Article Number	EAN Code	Price exc. VAT
SWITCHBLADE[™] 5 pc set. 4 SWITCHBLADE [™] Selffeed bits: Ø 35 / 38 / 54 / 65 mm, QUIK-LOK extension 140 mm length, 4 x Replacement SWITCHBLADE [™] blades (1 for each size bit), 4 x Feed screws, 4 x Set screws, 1 x Allen key.	5	49225100	045242157686	£170.23



SWITCHBLADE[™] replacement blades

Ø (mm)	Packed contents	Article Number	EAN Code	Price exc. VAT
35	1	48255420	045242225842	£3.70
38	1	48255425	045242225859	£3.70
51	1	48255435	045242225866	£3.70
54	1	48255440	045242225873	£3.70
57	1	48255443	045242225880	£3.70
65	1	48255450	045242226474	£3.70

Service kit in storage container.

1 x feed screw, 2 x set screws, 1 x allen key, 1 x storage container also can store spare SWITCHBLADE[™].

5

48255280

045242225934

£5.91



Selfeed Bits

All sizes have removable and replaceable feed screws.
 Two feed screws supplied with each bit.
 Feed screw provides fast, effortless feeding even in gummy woods.
 Internal cutting plane shaves hole radius for clean, smooth holes without pressure.
 Each selfeed bit is supplied with 2 x feed screws, 1 x set screw and 1 x allen key.

Ø (mm)	Shank reception	Packed contents	Article Number	EAN Code	Price exc. VAT
25	7/16" Hex	1	48251002	045242119028	£14.25
29	7/16" Hex	1	48251122	045242119073	£15.68
32	7/16" Hex	1	48251252	045242119127	£18.53
35	7/16" Hex	1	48251372	045242119172	£19.95
38	7/16" Hex	1	48251502	045242119226	£21.38
44	7/16" Hex	1	48251752	045242119271	£22.81
51	7/16" Hex	1	48252002	045242119325	£24.23
54	7/16" Hex	1	48252122	045242119370	£25.66
57	7/16" Hex	1	48252252	045242119424	£28.51
65	7/16" Hex	1	48252562	045242119479	£31.36
Feed screw coarse thread 1/4".		1	48286870	045242122707	£1.43
Allen key 1/8" for all arbors.		1	49960060	045242221455	£1.89
Set screw for drills up to 65 mm.		1	06832625	-	£1.26



Large selffeed drills

Large selffeed drills in 76, 92 and 116 mm sizes have double internal cutter blades that shave hole radius for clean, smooth holes without pressure.
 Replaceable arbor.

Ø (mm)	Shank reception	Packed contents	Article Number	EAN Code	Price exc. VAT
76	3 milled flats	1	48253001	045242119509	£37.06
92	3 milled flats	1	48253621	045242119554	£42.76
116	3 milled flats	1	48254621	045242119608	£54.16
Replaceable arbor.		1	48070201	045242088904	£7.43
Feed screw regular thread.		1	48286880	045242122806	£3.85
Set screw for drills up over 76mm.		1	06833150	-	£0.88
Allen Key 3/32"		1	49960070	045242221554	£0.33



7-bit contractors kit

Description	Packed contents	Article Number	EAN Code	Price exc. VAT
7 pc contractors kit. Selffeed bits Ø 25 / 29 / 32 / 38 / 44 / 54 / 65 mm, extension 140 mm length and feed screws.	7	49220130	045242180301	£145.38



Shank extensions

For selffeed bits, auger bits and holesaws (25 mm / 1" diameter and larger) with 7/16" Hex shank.

	Total length A (mm)	Packed contents	Article Number	EAN Code	Price exc. VAT
①	140	1	48284001	045242122462	£17.10
	300	1	48284006	045242122516	£19.90
②	450	1	48284011	045242122561	£25.47
	600	1	48284016	045242122615	£28.77

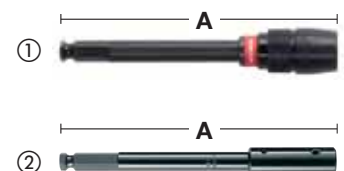

Lip & spur / brad point bits for wood - DIN 7487 E

Suitable for drilling hardboard, plywood, chipboard and all natural hard and soft wood.
Produced according to DIN 7487 E.

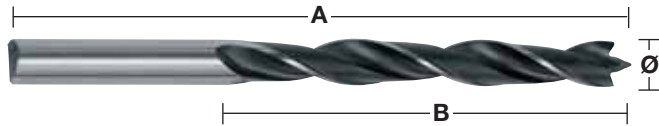

Ø (mm)	Total length A (mm)	Working length B (mm)	Shank reception	Packed contents	Article Number	EAN Code	Price exc. VAT
3	60	33	3 mm round shank	1	4932363651	4002395331307	£1.27
4	75	43	4 mm round shank	1	4932363652	4002395331314	£1.38
5	86	52	5 mm round shank	1	4932363653	4002395331321	£1.44
6	97	60	6 mm round shank	1	4932363654	4002395331338	£1.51
7	109	69	7 mm round shank	1	4932363655	4002395331345	£1.65
8	117	75	8 mm round shank	1	4932363656	4002395331352	£1.72
9	125	80	9 mm round shank	1	4932363657	4002395331369	£1.92
10	133	87	10 mm round shank	1	4932363658	4002395331376	£2.27
11	142	89	10 mm round shank	1	4932363659	4002395331383	£2.75
12	151	96	10 mm round shank	1	4932363660	4002395331390	£2.99
13	151	96	10 mm round shank	1	4932363661	4002395331406	£3.51
14	151	97	10 mm round shank	1	4932363662	4002395331413	£3.84
15	151	97	10 mm round shank	1	4932363663	4002395331420	£4.46
16	151	97	10 mm round shank	1	4932363664	4002395331437	£5.08
18	180	120	10 mm round shank	1	4932363665	4002395331444	£8.55
20	200	130	10 mm round shank	1	4932363666	4002395331451	£11.13
① Wood drill bit set 5 pcs. Ø 4 / 5 / 6 / 8 / 10 mm.			Plastic cassette	5	4932352465	4002395371242	£8.39
② Wood drill bit set 8 pcs. Ø 3 / 4 / 5 / 6 / 7 / 8 / 9 / 10 mm.			Plastic cassette	8	4932352466	4002395371259	£13.64

Flat boring bits

- Fast drilling of big diameters.
- Suitable for drilling in natural hard and softwood and chipboard.
- Ideal for door locks, morticing, electrical and plumbing work.
- 1/4" Hex shank reception (DIN E 6.3) for direct insertion into the power tool or for secure chuck grip.
- Ground centre point for accurate positioning and sharp wings for improved cutting performance.



Ø (mm)	Total length A (mm)	Packed contents	Article Number	EAN Code	Price exc. VAT
6	152	1	4932352487	4002395371457	£2.35
6	400	1	4932352488	4002395371464	£7.11
8	152	1	4932363130	4002395332618	£2.33
8	400	1	4932352489	4002395371471	£7.30
10	152	1	4932363131	4002395332625	£2.33
10	400	1	4932352490	4002395371488	£8.04
12	152	1	4932363132	4002395332632	£2.51
12	400	1	4932352491	4002395371495	£8.61
13	152	1	4932363133	4002395332649	£2.78
13	400	1	4932352492	4002395371501	£9.11
14	152	1	4932363134	4002395332656	£2.78
14	400	1	4932352493	4002395371518	£9.11
16	152	1	4932363135	4002395332663	£3.13
16	400	1	4932352494	4002395371525	£9.18
18	152	1	4932363136	4002395332670	£3.43
18	400	1	4932352495	4002395371532	£9.46
19	152	1	4932363137	4002395332687	£3.54
19	400	1	4932352496	4002395371549	£9.46
20	152	1	4932363138	4002395332694	£3.56
20	400	1	4932352497	4002395371556	£9.96
22	152	1	4932363139	4002395332700	£3.47
22	400	1	4932352498	4002395371563	£10.82
24	152	1	4932363140	4002395332717	£4.33
25	152	1	4932363141	4002395332724	£3.68
25	400	1	4932352499	4002395371570	£11.76
26	152	1	4932363142	4002395332731	£4.67
28	152	1	4932363143	4002395332748	£4.84
28	400	1	4932352500	4002395371587	£12.58
30	152	1	4932363144	4002395332755	£5.22
30	400	1	4932352501	4002395371594	£13.31
32	152	1	4932363145	4002395332762	£5.04
32	400	1	4932352502	4002395371600	£13.49
35	400	1	4932352503	4002395371617	£15.23
36	152	1	4932363146	4002395332779	£5.65
38	152	1	4932363147	4002395332786	£6.73
① 8 pc Flat bit set. Ø 12 / 16 / 18 / 20 / 22 / 25 / 28 / 32 x 152 mm length.		8	4932352504	4002395371624	£31.40

Extension

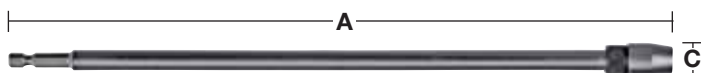

Description	Total length A (mm)	Shank reception	Tool reception	Packed contents	Article Number	EAN Code	Price exc. VAT
Extension.	305	1/4" Hex	1/4" Hex	1	4932363148	4002395332793	£10.67

SPEED FEED[™] wood drill bits

Step up from flat bit in quality and performance - faster drilling, higher lifetime and less jamming!
 Dual cutting edges for fast and aggressive cut - up to 10 times faster drilling vs. flat boring bit.
 Tapered design for reduced chip clogging, less friction and less jamming even in tough applications - results in less breakages.
 Feed screw with coarse thread increases selffeeding in all types of wood - soft & hard, wet & treated.
 Polished and powder coated flute design for increased chip ejection, reduced clogging and higher selffeeding capability.

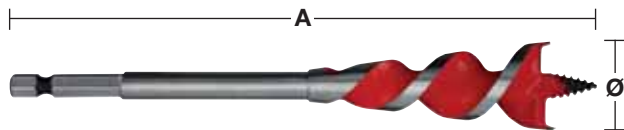

Dual cutting edges

Ø (mm)	Ø (inch)	Total length A (mm)	Shank reception	Packed contents	Article Number	EAN Code	Price exc. VAT
13	½"	165	¼" Hex	1	48130048	045242224807	£6.49
16	⅝"	165	¼" Hex	1	48130058	045242224814	£6.99
20	¾"	165	¼" Hex	1	48130068	045242224821	£7.89
22	⅞"	165	¼" Hex	1	48130078	045242224838	£8.99
25	1"	165	¼" Hex	1	48130088	045242224845	£9.59
32	1 ¼"	165	¼" Hex	1	48130108	045242224852	£11.99
4 pc set.				4	48130400	045242234448	£31.49
Ø 13 / 16 / 20 / 25 mm.							



Tapered design

HSS Cable bits - DIN 7490

Manufactured from HSS steel for increased lifetime. Suitable for drilling through holes in wood, plasterboard and metal channel.
 Manufactured according to DIN 7490 and conforming to the German Employer's Liability Insurance Association in terms of safety requirements for the building trade. The body of the drill bit is attached to the cylindrical shank by means of a thread, therefore eliminating the risk of breakage and guaranteeing absolute concentricity. The small twist angle and enlarged flutes ensure rapid and clog-free chip removal.
 Made in Germany.

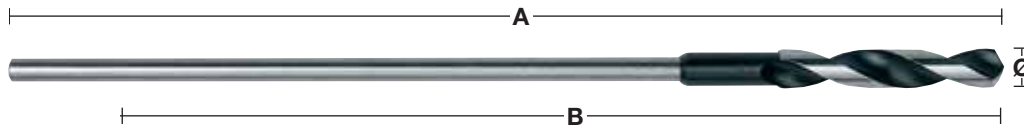

Ø (mm)	Total length A (mm)	Working length B (mm)	Shank reception	Packed contents	Article Number	EAN Code	Price exc. VAT
6	400	300	5 mm round shank	1	4932399672	4002395363223	£10.19
6	600	500	5 mm round shank	1	4932399675	4002395363254	£10.95
8	400	300	6 mm round shank	1	4932363667	4002395331932	£10.25
8	600	500	6 mm round shank	1	4932363674	4002395331864	£11.00
10	400	300	8 mm round shank	1	4932363668	4002395331949	£12.03
10	600	500	8 mm round shank	1	4932363675	4002395331871	£12.84
12	400	300	8 mm round shank	1	4932363669	4002395331956	£13.60
12	600	500	8 mm round shank	1	4932363676	4002395331888	£16.17
14	400	300	8 mm round shank	1	4932363670	4002395331963	£17.75
14	600	500	8 mm round shank	1	4932363677	4002395331895	£19.44
16	400	300	10 mm round shank	1	4932363671	4002395331970	£22.01
16	600	500	10 mm round shank	1	4932363678	4002395331901	£23.18
18	400	300	10 mm round shank	1	4932363672	4002395331987	£26.19
18	600	500	10 mm round shank	1	4932363679	4002395331918	£27.65
20	400	300	10 mm round shank	1	4932363673	4002395331994	£33.49
20	600	500	10 mm round shank	1	4932363680	4002395331925	£34.83
22	400	300	10 mm round shank	1	4932399673	4002395363230	£44.81
22	600	500	10 mm round shank	1	4932399676	4002395363261	£48.31
24	400	300	11 mm round shank	1	4932399674*	4002395363247	£52.78
24	600	500	11 mm round shank	1	4932399677*	4002395363278	£53.59

* while stocks last

BIG HAWG™

NEW

- Fast cutting: aggressive tooth geometry for up to 10x faster cutting than hole saws.
- Long life: cuts up to 600 holes in wood without needing to be resharpened.
- Easy plug removal: wide and deep gullets for easy plug removal.
- Super sharp: teeth can be resharpened with diamond file.



Suitability: softwoods, chipboard, medium density fibreboard (MDF), OSB board.

BIG HAWG™ Hole cutters

Ø (mm)	Max. cutting depth (mm)	No. of teeth	Packed contents	Article Number	EAN Code	Price exc. VAT
35	60	3	1	49568995	045242225378	£24.99
54	60	3	1	49569000	045242200467	£29.99
57	60	3	1	49569005	045242200474	£29.99
65	60	3	1	49569010	045242200481	£34.99
76	60	3	1	49569020	045242200504	£39.99
86	60	3	1	49569025	045242225385	£44.99
92	60	3	1	49569030	045242200511	£49.99
108	60	3	1	49569045	045242200535	£54.99
110	60	3	1	49569047	045242225392	£54.99
117	60	3	1	49569050	045242200542	£59.99
133	60	3	1	49569055	045242225408	£64.99
159	60	3	1	49569065	045242200559	£74.99



BIG HAWG™ Hole cutter 7 pc set

Description	Packed contents	Article Number	EAN Code	Price exc. VAT
7 pc Bighawg set	7	49569075	045242200566	£129.99
BIGHAWG™ hole cutter: 54, 65, 92 mm. Arbor with pilot drill, 2x additional pilot drills, diamond file, allen key.				



BIG HAWG™ System accessories

Description	Reception	Length (mm)	Packed contents	Article Number	EAN Code	Price exc. VAT
Arbor supplied with pilot flat drill bit.	11 mm Hex	75	1	49569105	045242200573	£24.99
Centre pilot flat drill bit 3/8"		110	1	48271401	045242121397	£3.99
Diamond file for resharpening teeth.			1	48095055	045242089369	£3.99

Contractor 50 pc set

Description	Packed contents	Article Number	EAN Code	Price exc. VAT
Contractor 50 pc set				
<p>HSS-G drill bits THUNDERWEB: 1 x 2.0 mm / 2 x 2.5 mm / 2 x 3.0 mm / 2 x 3.5 mm / 2 x 4.0 mm / 2 x 4.5 mm / 2 x 5.0 mm / 1 x 6.0 mm. Masonry drill bits: 1 x 4.0 mm / 1 x 5.0 mm / 1 x 5.5 mm / 2 x 6.0 mm / 1 x 7.0 mm / 2 x 8.0 mm / 1 x 9.0 mm / 1 x 10.0 mm. Screwdriving bits SHOCKWAVE: 25 mm length 1 x PH1 / 2 x PH2, 1 x PZ1 / 2 x PZ2 / 1 x PZ3, 2 x TX15 / 2 x TX20 / 2 x TX25 / 1 x TX30 / 1 x TX40 / 1 x TX50, 1 x Hex 4 mm / 1 x Hex 5 mm. 50 mm length 1 x PH2, 1 x PZ2, 1 x TX20. Nut drivers SHOCKWAVE: 1 x Hex 7 mm / 1 x Hex 8 mm / 1 x Hex 10 mm. 1 x magnetic drill bit holder SHOCKWAVE 60 mm length. 1 x QUIK-LOK extension 1/4" Hex 150 mm length.</p>	50	4932352863	4002395375219	£99.99



Contractor 100 pc set

Description	Packed contents	Article Number	EAN Code	Price exc. VAT
Contractor 100 pc set.				
<p>HSS-R drill bits: 1 x 2.0 mm / 2 x 2.5 mm / 2 x 3.0 mm / 2 x 3.5 mm / 2 x 4.0 mm / 2 x 4.5 mm / 2 x 5.0 mm / 1 x 6.0 mm. Masonry drill bits: 1 x 4.0 mm / 1 x 5.0 mm / 1 x 5.5 mm / 2 x 6.0 mm / 1 x 7.0 mm / 2 x 8.0 mm / 1 x 9.0 mm / 1 x 10.0 mm. Screwdriving bits: 25 mm length 2 x PH1 / 4 x PH2, 2 x PZ1 / 4 x PZ2 / 3 x PZ3, 1 x TX7 / 1 x TX8 / 1 x TX9 / 3 x TX10 / 4 x TX15 / 4 x TX20 / 4 x TX25 / 2 x TX30, 2 x Hex 3 mm / 2 x Hex 4 mm / 2 x Hex 5 mm / 2 x Hex 6 mm, 3 x SL 0.6 x 4.5 mm / 3 x SL 0.8 x 5.5 mm / 3 x SL 1.0 x 5.5 mm / 3 x SL 1.2 x 6.5 mm. 50 mm length 1 x PH1 / 1 x PH2, 1 x PZ1 / 1 x PZ2, 1 x TX10 / 1 x TX15 / 1 x TX20 / 1 x TX25. Nut drivers: 1 x Hex 6 mm / 1 x 9/16" / 1 x Hex 7 mm / 1 x Hex 8 mm / 1 x Hex 10 mm / 1 x Hex 13 mm. Wood drill bits: 1 x 3.0 mm / 1 x 4.0 mm / 1 x 5.0 mm / 1 x 6.0 mm / 1 x 7.0 mm. 1 x magnetic bit holder 60 mm length. 1 x socket adapter 1/4" Hex to 1/4" square drive. 1 x counter sink.</p>	100	4932352864	4002395375226	£99.99

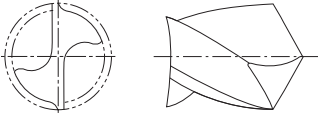
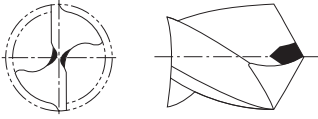
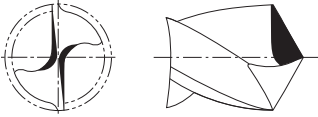
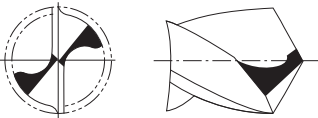
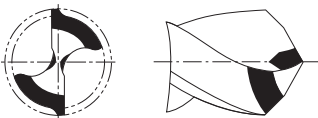
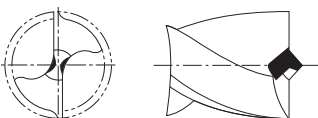
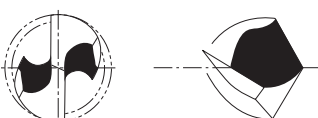

HSS Drill bit tip geometry

		Standard/Form	Application	Features
		Normal Standard Point	For standard drilling in ferrous/non ferrous metals and plastics	The wide cutting edge provides a drill bit that is robust and resistant to sideways pressure. Due to the wide cutting edge higher feed pressure is required. Can be easily resharpened.
		Chisel Edge Point DIN 1412 A	For drilling work in solid steel with large diameter drill bits.	Good and easy centering. Requires very low feed pressure – approx. 30% less than a normal point drill bit.
		Chisel Edge Point with corrected cutting edge DIN 1412 B	For drilling in high strength steel and high alloy steels. Also suitable for drilling thin sheet material.	Robust and resistant to sideways pressure.
		Split Point DIN 1412 C	For drilling in high strength steel and high alloy steels. Suitable for deep drilling bits.	Excellent chip removal makes this design ideal for deep drilling applications. Good centering. Low feed pressure required.
		Double Angle Point for Cast Iron DIN 1412 D	For drilling cast iron.	Extended major cutting edges reduce wear on the cutting corners for improved lifetime. Good heat conduction. Resistant to sideways pressure.
		Centre Point DIN 1412 E	For drilling thin sheet metal and soft materials.	Easy centering. Low feed pressure required. Does not snatch when drilling thin materials. Accurate and clean holes.
		U Point	For high performance drilling in high strength steels such as stainless and acid resistant steel.	Easy centering. Produces small metal chips ensuring low heat build up and quicker material resulting in faster drilling.

HSS Drill bit application guide





The following table gives recommended drilling speeds for the most efficient cutting speed. The tables should only be used as a guide and are dependant on the user and material being drilled. Coolants and lubricants will improve tool life by up to 5 times and workpiece finish.

Material class		Material type	Hardness/ Tensile Strength N/mm ²	Rockwell	Hole diameter Ø mm – RPM					Cooling agent
					Ø 1-2	Ø 3-5	Ø 6-10	Ø 11-15	Ø 16-20	
Steel	Speed	Non-alloyed construction steel, non-alloyed case hardened steel	< 400	< HRB 69	4770	1870	930	630	470	Drilling emulsion, cutting oil
			400-800	< HRC 21	4450	1770	870	580	430	
		Sheet Steel	< 800	< HRC 21	4450	1760	860	560	430	Drilling emulsion, ester oil
		Non-alloyed tool steel	< 800	< HRC 21	4440	1760	860	560	430	Drilling emulsion, cutting oil
		Alloyed tool steel	< 800	< HRC 21	3950	1550	780	520	390	Drilling emulsion, ester oil
			> 800	> HRC 21	1950	800	390	275	200	
	Alloyed hardened & tempered steel	< 1200	< HRC 37	2100	890	450	300	210	Drilling emulsion, ester oil	
> 1200		> HRC 38	1350	540	260	170	120			
Feed	Feed (mm/rev)				0.03	0.09	0.15	0.20	0.25	
Stainless steel	Speed	Stainless steel	< 1000	< HRC 30	2250	930	450	290	220	Rapeseed oil, cutting oil
		Stainless steel	1000-1200	HRC 30-37	1430	560	280	190	130	
	Feed	Feed (mm/rev)				0.02	0.06	0.13	0.18	0.24
Cast iron	Speed	Malleable cast iron	750	HRB 99	4700	2000	1100	800	600	Dry
		Soft	450	HRB 75	4500	1700	950	650	550	Drilling emulsion, cutting oil
		Hard	700	HRB 96	3450	1350	680	440	340	
	Feed	Feed (mm/rev)				0.05	0.10	0.16	0.20	0.25
Aluminium	Speed		< 350	< HRC 59	8700	3560	1720	1130	860	Drilling emulsion, cutting oil
	Feed	Feed (mm/rev)				0.02	0.08	0.13	0.18	0.23
Copper	Speed				5100	2000	990	670	500	Drilling emulsion, cutting oil
	Feed	Feed (mm/rev)				0.02	0.10	0.20	0.28	0.35
Bronze	Speed				7950	3190	1480	1010	770	Dry
	Feed	Feed (mm/rev)				0.02	0.11	0.21	0.32	0.35
Brass	Speed				7950	3190	1480	1010	770	Drilling emulsion
	Feed	Feed (mm/rev)				0.02	0.11	0.21	0.32	0.35
Magnesium	Speed				9550	3800	1900	1250	970	Dry
	Feed	Feed (mm/rev)				0.05	0.10	0.25	0.30	0.35
Plastics	Speed	PVC, Polyamide, Thermoplastics			3500	2500	1800	700	450	Water
	Feed	Feed (mm/rev)				0.05	0.10	0.16	0.21	0.23

RPM: The number of revolutions that a spindle/a cutting tool completes in one minute.

Feed: This is the linear distance at which the cutter is advanced against the workpiece during one rotation of the cutting tool. It is expressed in units of distance per revolution – millimetres per revolution.

HSS Drill bit application guide

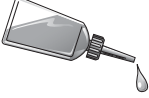
									
Material class	Material type	Hardness/ Tensile Strength N/mm ²	Rockwell	HSS-R DIN 338	HSS-G Thunderweb DIN 338 DIN 340 DIN 1897 Double Ended	HSS-G Cobalt DIN 338	HSS-G step drills 1/4 Hex reception	HSS-G cone drills 1/4 Hex reception	Cooling agent
Steel	Non-alloyed construction steel, non-alloyed case hardened steel	< 400	< HRB 69		●	●	●	●	Drilling emulsion, cutting oil
		400–800	< HRC 21	●	●	●	●		
	Sheet Steel	< 800	< HRC 21		●	●	●	●	Drilling emulsion, ester oil
	Non-alloyed tool steel	< 800	< HRC 21	●	●	●	●	●	Drilling emulsion, cutting oil
	Alloyed tool steel	< 800	< HRC 21		●	●	●	●	Drilling emulsion, ester oil
		> 800	> HRC 21		●	●	▲	▲	
Alloyed hardened & tempered steel	< 1200	< HRC 37				●	▲	▲	Drilling emulsion, ester oil
	> 1200	> HRC 38				●	▲	▲	
Stainless steel	Stainless steel	< 1000	< HRC 30		▲	●	▲	▲	Rapeseed oil, cutting oil
	Stainless steel	1000–1200	HRC 30–37			●	▲	▲	
Cast iron	Malleable cast iron	750	HRB 99	●	●	●	●	●	Dry
	Soft	450	HRB 75	●	●	●	●	●	Drilling emulsion, cutting oil
	Hard	700	HRB 96	●	●	●	●	●	
Aluminium		< 350	< HRC 59		▲	●	●	●	Drilling emulsion, cutting oil
Copper					▲	●	●	●	Drilling emulsion, cutting oil
Bronze				●	●	●	●	●	Dry
Brass				●	●	●	●	●	Drilling emulsion
Magnesium						●			Dry
Plastics	PVC, Polyamide, Thermoplastics				●	●	●	●	Water
Wood				●	●	●			Dry

● Most suitable. Recommended for these materials. ▲ Suitable. Recommended for intermittent use in these materials.

Metal drill bits HSS Rollforged - DIN 338 with reduced shank

High speed steel rollforged metal drill bits produced according to DIN 338.

Oxide coating enables quick swarf removal.

Normal point shaped cutting tip with 118° angle.

Type N flute normal angle.

Suitable for drilling in steel, cast iron, alloyed and non-alloyed material up to 800 N/mm².

Colour: black.

Ø 13.5 mm - Ø 16 mm = 10 mm shank / Ø 16.5 mm - Ø 20 mm = 13 mm shank.

Ø (mm)	Total length A (mm)	Working length B (mm)	Packed contents	Article Number	EAN Code	Price exc. VAT
13.5	160	108	1	4932373318	4002395348435	£7.23
14.0	160	108	1	4932373319	4002395348442	£7.23
14.5	169	108	1	4932373320	4002395348459	£8.74
15.0	169	114	1	4932373321	4002395348466	£8.74
15.5	178	120	1	4932373322	4002395348473	£10.85
16.0	178	120	1	4932373323	4002395348480	£10.85
16.5	184	125	1	4932373324	4002395348497	£18.78
17.0	184	125	1	4932373325	4002395349104	£18.78
17.5	191	130	1	4932373326	4002395349111	£21.60
18.0	191	130	1	4932373327	4002395349128	£21.60
18.5	198	135	1	4932373328	4002395349135	£24.91
19.0	198	135	1	4932373329	4002395349142	£24.91
19.5	205	140	1	4932373330	4002395349159	£28.29
20.0	205	140	1	4932373331	4002395349166	£28.29

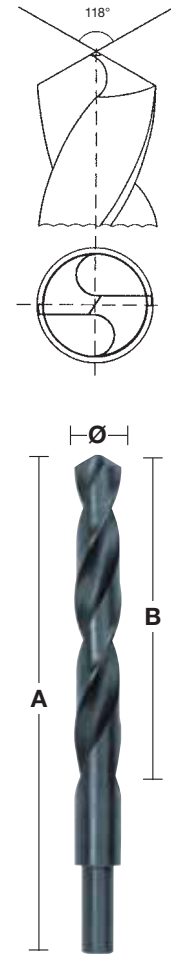

Metal drill bits HSS Rollforged - DIN 338 - cassettes

Description	Supplied in	Packed contents	Article Number	EAN Code	Price exc. VAT
HSS-R drill bit set (19 pcs).					
① Ø 1 / 1.5 / 2 / 2.5 / 3 / 3.5 / 4 / 4.5 / 5 / 5.5 / 6 / 6.5 / 7 / 7.5 / 8 / 8.5 / 9 / 9.5 / 10 mm.	Metal case	19	4932352468	4002395371273	£25.90
HSS-R drill bit set (25 pcs).					
② Ø 1 / 1.5 / 2 / 2.5 / 3 / 3.5 / 4 / 4.5 / 5 / 5.5 / 6 / 6.5 / 7 / 7.5 / 8 / 8.5 / 9 / 9.5 / 10 / 10.5 / 11 / 11.5 / 12 / 12.5 / 13 mm.	Metal case	25	4932352469	4002395371280	£46.40



Metal drill bits HSS Rollforged - DIN 338 - 5 and 10 pack

High speed steel rollforged metal drill bits produced according to DIN 338. Oxide coating enables quick swarf removal. Normal point shaped cutting tip with 118° angle. Type N flute normal angle. Suitable for drilling in steel, cast iron, alloyed and non-alloyed material up to 800 N/mm². Colour: black.

Ø (mm)	Total length A (mm)	Working length B (mm)	Packed contents	Article Number	EAN Code	Price exc. VAT
1.0	34	12	10	4932363444	4002395329458	£3.94
1.5	40	18	10	4932363449	4002395329502	£4.21
2.0	49	24	10	4932363454	4002395329557	£4.60
2.5	57	30	10	4932363459	4002395329601	£4.98
3.0	61	33	10	4932363464	4002395329656	£5.26
3.2	65	36	10	4932363466	4002395329670	£5.48
3.5	70	39	10	4932363469	4002395329700	£5.53
4.0	75	43	10	4932363474	4002395329755	£5.92
4.2	75	43	10	4932363476	4002395329779	£7.21
4.5	80	47	10	4932363479	4002395329809	£7.43
4.8	86	52	10	4932363482	4002395329830	£7.87
5.0	86	52	10	4932363484	4002395329854	£7.73
5.5	93	57	10	4932363489	4002395329908	£8.83
6.0	93	57	10	4932363494	4002395329953	£9.22
6.5	101	63	10	4932363499	4002395330003	£11.01
6.8	109	69	10	4932363502	4002395330034	£13.10
7.0	109	69	10	4932363504	4002395330058	£13.10
7.5	109	69	10	4932363509	4002395330102	£14.67
8.0	117	75	10	4932363514	4002395330157	£17.64
8.5	117	75	10	4932363519	4002395330201	£19.51
9.0	125	81	10	4932363524	4002395330256	£23.20
9.5	125	81	10	4932363529	4002395330300	£25.45
10.0	133	87	10	4932363534	4002395330355	£26.89
10.5	133	87	5	4932363539	4002395330409	£15.80
11.0	142	94	5	4932363544	4002395330454	£17.56
11.5	142	94	5	4932363549	4002395330508	£18.91
12.0	151	101	5	4932363554	4002395330553	£21.33
12.5	151	101	5	4932363559	4002395330607	£23.31
13.0	151	101	5	4932363564	4002395330652	£24.96



Metal drill bits HSS Rollforged - DIN 338 - 345 pc cabinet

Ø (mm)	Total length A (mm)	Working length B (mm)	Packed contents	Order quantity	Article Number	EAN Code	Price exc. VAT
Metal drill bit cabinet with HSS Rollforged metal drill bits (345 pcs).			345	1	4932352674	4002395373321	£548.55
1.0	34	12	20				
1.5	40	18	20				
2	49	24	20				
2.5	57	30	20				
3	61	33	20				
3.5	70	39	20				
4	75	43	20				
4.5	80	47	20				
5	86	52	20				
5.5	93	57	20				
6	93	57	20				
6.5	101	63	20				
7	109	69	10				
7.5	109	69	10				
8	117	75	20				
8.5	117	75	10				
9	125	81	10				
9.5	125	81	5				
10	133	87	10				
10.5	133	87	5				
11	142	94	5				
11.5	142	94	5				
12	151	101	5				
12.5	151	101	5				
13	151	101	5				



THUNDERWEB

Metal drill bits HSS Ground - DIN 338



THUNDERWEB

The **THUNDERWEB** design is characterised by a conical shaped web which gets thicker towards the back of the drill bit. The web is the internal core of the drill bit.

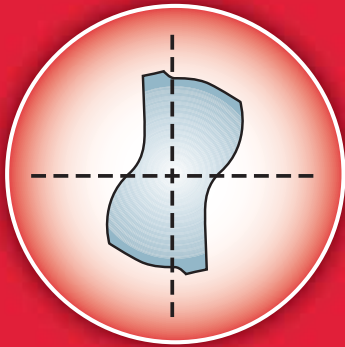

Parabolic web cross section

- Large web thickness. Strength built in.
- Accepts higher feed pressure and torque.
- Less breakages. Good for drilling deep holes and on curved surfaces.
- Long life.



Standard drill bit

The web on standard drill bits is a constant thickness throughout the length of the bit.

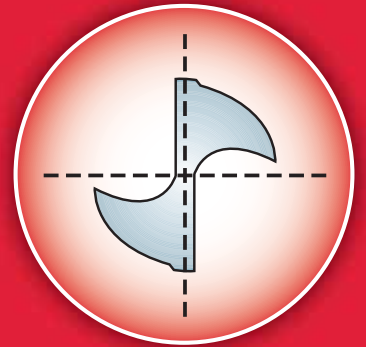

Conventional type web cross section

THUNDERWEB SPECIFICATION

FLUTE GEOMETRY

- **THUNDERWEB** flute form ejects hot chips rapidly. Dissepates heat better increasing lifetime.
- Open flute form reduces drill drawback when drilling deeper holes.
- Sharpened edges reduce binding for faster cleaner cuts.
- Flatter twist angle creates smaller chippings, ideal for drilling harder steels ie. stainless steel.

135° SPLIT POINT

- Precision starting, drill bit won't walk.
- Penetrates quickly.
- Good for drilling on curved surfaces.
- Requires less effort/feed pressure.
- Excellent for very hard materials.



THUNDERWEB - Metal drill bits HSS Ground - DIN338

Ø (mm)	Total length A (mm)	Working length B (mm)	Packed contents	Article Number	EAN Code	Price exc. VAT
1.0	34	12	2	4932352345	4002395370047	£1.22
1.5	40	18	2	4932352346	4002395370054	£1.32
2.0	49	24	2	4932352347	4002395370061	£1.39
2.5	57	30	2	4932352348	4002395370078	£1.49
3.0	61	33	2	4932352349	4002395370085	£1.76
3.2	65	36	2	4932352350	4002395370092	£1.98
3.5	70	39	2	4932352351	4002395370108	£1.98
4.0	75	43	2	4932352352	4002395370115	£2.08
4.2	75	43	1	4932352353	4002395370122	£1.49
4.5	80	47	1	4932352354	4002395370139	£1.49
4.8	86	52	1	4932352355	4002395370146	£1.66
5.0	86	52	1	4932352356	4002395370153	£1.66
5.5	93	57	1	4932352357	4002395370160	£2.13
6.0	93	57	1	4932352358	4002395370177	£2.32
6.5	101	63	1	4932352359	4002395370184	£2.54
6.8	109	69	1	4932352360	4002395370191	£2.91
7.0	109	69	1	4932352361	4002395370207	£2.96
7.5	109	69	1	4932352362	4002395370214	£3.37
8.0	117	75	1	4932352363	4002395370221	£4.18
8.5	117	75	1	4932352364	4002395370238	£4.45
9.0	125	81	1	4932352365	4002395370245	£5.23
9.5	125	81	1	4932352366	4002395370252	£5.64
10.0	133	87	1	4932352367	4002395370269	£6.60
10.5	133	87	1	4932352368	4002395370276	£7.16
11.0	142	94	1	4932352369	4002395370283	£8.21
11.5	142	94	1	4932352370	4002395370290	£8.94
12.0	151	101	1	4932352371	4002395370306	£10.16
12.5	151	101	1	4932352372	4002395370313	£11.02
13.0	151	101	1	4932352373	4002395370320	£11.85

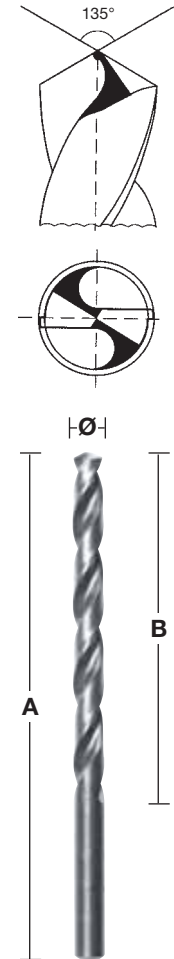

THUNDERWEB - DIN 338 - 5 and 10 pack

Ø (mm)	Total length A (mm)	Working length B (mm)	Packed contents	Article Number	EAN Code	Price exc. VAT
1.0	34	12	10	4932352377	4002395370368	£4.89
1.5	40	18	10	4932352378	4002395370375	£5.28
2.0	49	24	10	4932352379	4002395370382	£5.57
2.4	57	30	10	4932430569	4002395382309	£6.99
2.5	57	30	10	4932352380	4002395370399	£5.96
3.0	61	33	10	4932352381	4002395370405	£7.04
3.2	65	36	10	4932352382	4002395370412	£7.92
3.5	70	39	10	4932352383	4002395370429	£7.92
3.8	75	43	10	4932430547	4002395382088	£8.99
4.0	75	43	10	4932352384	4002395370436	£8.31
4.2	75	43	10	4932352385	4002395370443	£10.43
4.5	80	47	10	4932352386	4002395370450	£10.43
4.8	86	52	10	4932352387	4002395370467	£11.63
5.0	86	52	10	4932352388	4002395370474	£11.63
5.2	86	52	10	4932430548	4002395382095	£14.99
5.5	93	57	10	4932352389	4002395370481	£14.88
5.6	93	57	10	4932430570	4002395382316	£16.79
5.8	93	57	10	4932430549	4002395382101	£16.99
6.0	93	57	10	4932352390	4002395370498	£16.25
6.2	101	63	10	4932430550	4002395382118	£17.59
6.4	101	63	10	4932430571	4002395382323	£17.99
6.5	101	63	10	4932352391	4002395370504	£17.79
6.8	109	69	5	4932352392	4002395370511	£12.21
7.0	109	69	5	4932352393	4002395370528	£12.42
7.2	109	69	5	4932430551	4002395382125	£13.99



THUNDERWEB - DIN 338 - 5 and 10 pack

Ø (mm)	Total length A (mm)	Working length B (mm)	Packed contents	Article Number	EAN Code	Price exc. VAT
7.5	109	69	5	4932352394	4002395370535	£14.16
8.0	117	75	5	4932352395	4002395370542	£17.55
8.2	117	75	5	4932430552	4002395382132	£17.99
8.4	117	75	5	4932430553	4002395382149	£18.99
8.5	117	75	5	4932352396	4002395370559	£18.68
9.0	125	81	5	4932352397	4002395370566	£21.96
9.5	125	81	5	4932352398	4002395370573	£23.71
10.0	133	87	5	4932352399	4002395370580	£27.71
10.5	133	87	5	4932352400	4002395370597	£30.07
11.0	142	94	5	4932352401	4002395370603	£34.48
11.5	142	94	5	4932352402	4002395370610	£37.56
12.0	151	101	5	4932352403	4002395370627	£42.69
12.5	151	101	5	4932352404	4002395370634	£46.28
13.0	151	101	5	4932352405	4002395370641	£49.77



Metal drill bits THUNDERWEB - DIN 338 cassettes

Description	Supplied in	Packed contents	Order quantity	Article Number	EAN Code	Price exc. VAT
THUNDERWEB HSS-G Set (19 pcs).						
① Ø 1/1.5/2/2.5/3/3.5/4/4.5/5/5.5/6/6.5/7/7.5/8/8.5/9/9.5/10 mm.	Plastic cassette	19	1	4932352374	4002395370337	£59.00
② Counter display with 6 x 19 pc HSS-G drill set 4932352374.	-	6	1	4932352375	4002395370344	£354.00
THUNDERWEB HSS-G Set (25 pcs).						
③ Ø 1/1.5/2/2.5/3/3.5/4/4.5/5/5.5/6/6.5/7/7.5/8/8.5/9/9.5/10/10.5/11/11.5/12/12.5/13 mm.	Plastic cassette	25	1	4932352376	4002395370351	£89.00



Metal drill bits HSS Ground Long - DIN 340 / 5 and 10 pack

High quality high speed steel.
 Split point DIN 1412 C.
 Right hand cutting edge.
 135° angle for improved centering.
 Most suitable for drilling deep holes in channels or where there are hollow sections.
 Suitable for drilling steel, cast iron, alloyed and non alloyed material up to 900 N/mm².
 Also suitable for wood and plastics.

Ø (mm)	Total length A (mm)	Working length B (mm)	Packed contents	Article Number	EAN Code	Price exc. VAT
2.0	85	56	10	4932430328	4002395379897	£6.55
2.5	95	62	10	4932430329	4002395379903	£8.26
3.0	100	66	10	4932430330	4002395379910	£11.12
3.5	112	73	10	4932430331	4002395379927	£15.13
4.0	119	78	10	4932430332	4002395379934	£17.76
4.5	126	82	10	4932430333	4002395379941	£20.44
5.0	132	87	10	4932430334	4002395379958	£24.26
5.5	139	91	10	4932430335	4002395379965	£31.18
6.0	139	91	10	4932430336	4002395379972	£34.32
6.5	148	97	10	4932430337	4002395379989	£37.56
7.0	156	102	10	4932430338	4002395379996	£45.34
8.0	165	109	10	4932430339	4002395380008	£63.09
9.0	175	115	10	4932430340	4002395380015	£82.51
10.0	184	121	10	4932430341	4002395380022	£104.03
11.0	195	128	5	4932430342	4002395380039	£65.76
12.0	205	134	5	4932430343	4002395380046	£79.72
13.0	205	134	5	4932430344	4002395380053	£93.43

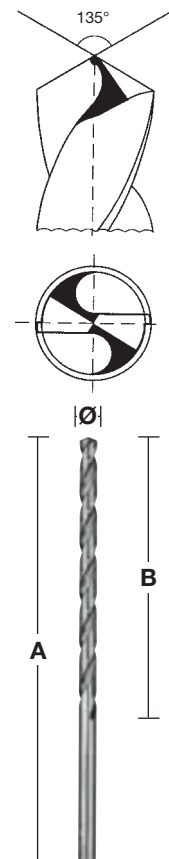

Metal drill bits HSS Ground Short - DIN 1897 - 5 and 10 pack

Drill bit quality: High quality high speed steel. Tip geometry: Split Point DIN 1412 C.
 Point angle: 118°. Tolerance: h8. Flute / Helix angle: Type N flute and normal 20 - 30° angle.
 Right hand cutting edge. Surface / Colour: Polished silver. Withstands high drill point pressure due to short overall length. Excellent concentricity. Polished type N flute with right hand cutting edge, eliminates binding for faster chip removal and faster cutting with less effort.
 Application: Most suited for drilling sheet and thin walled materials.
 Suitable for drilling in sheet steel, thin alloyed and non-alloyed material up to 900 N/mm².
 Also suitable for wood and plastics.

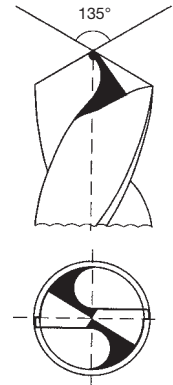

Ø (mm)	Total length A (mm)	Working length B (mm)	Packed contents	Article Number	EAN Code	Price exc. VAT
2.0	38	12	10	4932352200	4002395368532	£4.46
2.5	43	14	10	4932352201	4002395368549	£4.86
3.0	46	16	10	4932352202	4002395368556	£8.64
3.2	49	18	10	4932352203	4002395368563	£9.98
3.3	49	18	10	4932352204	4002395368570	£9.98
3.5	52	20	10	4932352205	4002395368587	£9.98
3.7	52	20	10	4932352206	4002395368594	£10.52
4.0	55	22	10	4932352207	4002395368600	£10.52
4.2	55	22	10	4932352208	4002395368617	£12.92
4.5	58	24	10	4932352209	4002395368624	£13.22
4.8	62	26	10	4932352210	4002395368631	£15.36
5.0	62	26	10	4932352211	4002395368648	£15.36
5.2	62	26	10	4932352212	4002395368655	£20.41
5.5	66	28	10	4932352213	4002395368662	£20.41
6.0	66	28	10	4932352214	4002395368679	£22.81
6.5	70	31	10	4932352215	4002395368686	£25.20
7.0	74	34	10	4932352216	4002395368693	£29.90
7.5	74	34	5	4932352217	4002395368709	£18.09
8.0	79	37	5	4932352218	4002395368716	£22.83
8.5	79	37	5	4932352219	4002395368723	£24.38
9.0	84	40	5	4932352220	4002395368730	£28.78
10.0	89	43	5	4932352221	4002395368747	£36.69

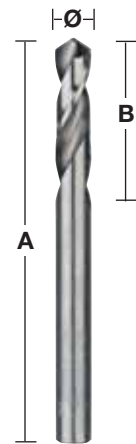

Metal drill bits HSS Ground - Double ended

Drill bit quality: High quality high speed steel. Tip geometry: Split Point DIN 1412 C. Point angle: 135°
 Tolerance: h8. Flute / Helix angle: Type N flute and normal 20 - 30° angle.
 Right hand cutting edge. Surface / Colour: Polished silver. Split point tip for good centering.
 Both ends can be used. Due to its short length it can be used with higher feed pressure without the risk of breakage. Excellent concentricity.
 Polished type N flute with right hand cutting edge, eliminates binding for faster chip removal and faster cutting with less effort.
 Application: Suitable drilling in steel, non-ferrous metals and plastic.
 Most suitable for thin sheet materials, e.g. rivet holes.

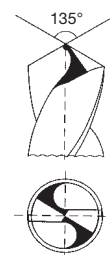

Ø (mm)	Total length A (mm)	Working length B (mm)	Packed contents	Article Number	EAN Code	Price exc. VAT
2.5	43	10	10	4932352222	4002395368754	£5.66
3.0	46	11	10	4932352223	4002395368761	£10.08
3.2	49	12	10	4932352224	4002395368778	£11.65
3.3	49	12	10	4932352225	4002395368785	£11.65
3.5	52	14	10	4932352226	4002395368792	£11.65
4.0	55	14	10	4932352227	4002395368808	£12.29
4.1	55	14	10	4932352228	4002395368815	£15.15
4.2	55	14	10	4932352229	4002395368822	£15.15
4.5	58	16	10	4932352230	4002395368839	£15.46
4.8	62	18	10	4932352231	4002395368846	£17.99
5.0	62	18	10	4932352232	4002395368853	£17.99
5.5	66	19	10	4932352233	4002395368860	£24.01
6.0	66	19	10	4932352234	4002395368877	£26.85

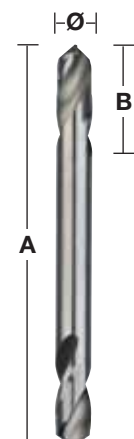

Metal drill bits HSS Ground Cobalt - DIN 338

Metal drill bits ground from solid extremely heat resistant cobalt-alloyed high speed steel produced according to DIN 338. Polished finish.

Split point shaped cutting tip with 135° angle for improved centering - no center punch required.

5% Cobalt content. Withstands high drilling heat.

Type N flute normal angle. Suitable for drilling high alloy content steels and metals with tensile strengths over 1000 N/mm² like heat and acid proof steels and stainless steel. Colour: bronze.

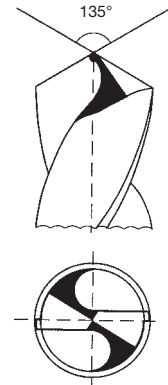

Ø (mm)	Total length A (mm)	Working length B (mm)	Packed contents	Article Number	EAN Code	Price exc. VAT
1.0	34	12	2	4932363248	4002395333080	£4.32
1.5	40	18	2	4932363249	4002395333097	£4.14
2.0	49	24	2	4932363250	4002395333103	£4.27
2.5	57	30	2	4932363251	4002395333110	£4.27
3.0	61	33	2	4932363253	4002395333134	£4.19
3.2	65	36	2	4932363254	4002395333141	£4.97
3.5	70	39	2	4932363256	4002395333165	£4.95
4.0	75	43	2	4932363258	4002395333189	£5.32
4.2	75	43	1	4932363260	4002395333202	£3.14
4.5	80	47	1	4932363262	4002395333226	£3.25
4.8	86	52	1	4932363263	4002395333233	£3.69
5.0	86	52	1	4932363264	4002395333240	£3.38
5.5	93	57	1	4932363267	4002395333271	£4.16
6.0	93	57	1	4932363268	4002395333288	£4.37
6.5	101	63	1	4932363269	4002395333295	£5.16
6.8	109	69	1	4932363270	4002395333301	£5.91
7.0	109	69	1	4932363271	4002395333318	£5.60
7.5	109	69	1	4932363272	4002395333325	£5.97
8.0	117	75	1	4932363274	4002395333349	£6.50
8.5	117	75	1	4932363276	4002395333363	£7.17
9.0	125	81	1	4932363277	4002395333370	£8.60
9.5	125	81	1	4932363278	4002395333387	£8.90
10.0	133	87	1	4932363279	4002395333394	£9.50
10.5	133	87	1	4932363281	4002395333417	£13.90
11.0	142	94	1	4932363282	4002395333424	£14.69
11.5	142	94	1	4932363283	4002395333431	£17.80
12.0	151	101	1	4932363284	4002395333448	£18.87
12.5	151	101	1	4932363285	4002395333455	£24.70
13.0	151	101	1	4932363286	4002395333462	£23.97



Metal drill bits HSS Ground Cobalt - DIN 338 - cassettes

Description	Supplied in	Packed contents	Article Number	EAN Code	Price exc. VAT
HSS-G Co drill bit set (19 pcs).					
① Ø 1 / 1.5 / 2 / 2.5 / 3 / 3.5 / 4 / 4.5 / 5 / 5.5 / 6 / 6.5 / 7 / 7.5 / 8 / 8.5 / 9 / 9.5 / 10 mm.	Plastic cassette	19	4932352470	4002395371297	£99.00
HSS-G Co drill bit set (25 pcs).					
② Ø 1 / 1.5 / 2 / 2.5 / 3 / 3.5 / 4 / 4.5 / 5 / 5.5 / 6 / 6.5 / 7 / 7.5 / 8 / 8.5 / 9 / 9.5 / 10 / 10.5 / 11 / 11.5 / 12 / 12.5 / 13 mm.	Plastic cassette	25	4932352471	4002395371303	£199.00



Metal drill bits HSS Ground Cobalt - DIN 338 - 5 and 10 pack

Metal drill bits ground from solid extremely heat resistant cobalt-alloyed high speed steel produced according to DIN 338.

Polished finish. Split point shaped cutting tip with 135° angle for improved centering - no center punch required.

5% Cobalt content withstands high drilling heat.

Type N flute normal angle. Suitable for drilling high alloy content steels and metals with tensile strengths over 1000 N/mm² like heat and acid proof steels and stainless steel.

Colour: bronze.

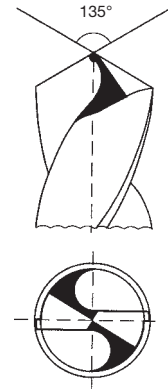

Ø (mm)	Total length A (mm)	Working length B (mm)	Packed contents	Article Number	EAN Code	Price exc. VAT
1.0	34	12	10	4932373332	4002395349173	£19.44
1.5	40	18	10	4932373333	4002395349180	£18.61
2.0	49	24	10	4932373334	4002395349197	£19.21
2.5	57	30	10	4932373335	4002395349807	£19.21
3.0	61	33	10	4932373336	4002395349814	£18.85
3.2	65	36	10	4932373337	4002395349821	£22.37
3.5	70	39	10	4932373338	4002395349838	£22.26
4.0	75	43	10	4932373339	4002395349845	£23.92
4.2	75	43	10	4932373340	4002395349852	£28.27
4.5	80	47	10	4932373341	4002395349869	£29.22
4.8	86	52	10	4932373342	4002395349876	£32.90
5.0	86	52	10	4932373343	4002395349883	£30.41
5.5	93	57	10	4932373344	4002395349890	£37.46
6.0	93	57	10	4932373345	4002395347100	£41.33
6.5	101	63	10	4932373346	4002395347117	£48.73
6.8	109	69	5	4932373347	4002395347124	£26.20
7.0	109	69	5	4932373348	4002395347131	£25.19
7.5	109	69	5	4932373349	4002395347148	£26.85
8.0	117	75	5	4932373350	4002395347155	£30.55
8.5	117	75	5	4932373351	4002395347162	£32.97
9.0	125	81	5	4932373352	4002395347179	£41.54
9.5	125	81	5	4932373353	4002395347186	£42.99
10.0	133	87	5	4932373354	4002395347193	£46.38
10.5	133	87	5	4932373355	4002395347803	£64.22
11.0	142	94	5	4932373356	4002395347810	£66.10
11.5	142	94	5	4932373357	4002395347827	£84.11
12.0	151	101	5	4932373358	4002395347834	£84.91
12.5	151	101	5	4932373359	4002395347841	£116.72
13.0	151	101	5	4932373360	4002395347858	£104.99



Step drills

NEW

- Step Drill advantages over conventional drill bits:
 - One drill bit to drill multiple sizes - Do more carry less!
 - Best option for enlarging existing holes.
 - More durable than twist drill bits, thick core resists breakage.
 - More accurate and less walking, tip starts on contact.
 - Clean burr free holes, less reaming required.
 - Drills plastic without splitting or cracking.

- Step drills are ideal for drilling into the following materials:
 - Ferrous & non-ferrous sheets metals, profiles and pipes.
 - Copper, brass and aluminium.
 - Stainless steel.
 - Plastics.
 - Maximum material thickness 4 mm.
 - To ensure best lifetime we recommend the use of a coolant.

- Trades:
 - Electrical: drilling of panels and cabinets for cable gland installation.
 - Plumbing / HVAC: access holes for pipework and installation.
 - Metal workers / fabrication: various sizes and hole enlargement.
 - Automotive: holes for cable installation (mobile telephones, antennas, re-directing electrical wiring).
 - Maintenance repair operations: various applications, sizes and hole enlargement.



Milwaukee[®] Advantages

Spot drill - Drill - Debur - All in one go

- ① Rapid Strike tip for improved centering - less walking and fast drilling without the need to punch or pre drill the material.
- ② Special tip and step geometry for jam-free performance - less risk of drill snagging when used with high speed cordless tools and also prevents deformation of the drilled material.
- ③ Optimised 2 flute ground sharpened edge geometry for 2 x faster and smoother cutting.
- ④ Produced from custom engineered steel with black oxide coating for 4 x longer life. Optimised for use with high speed cordless drills.
- ⑤ Laser engraved size markings for best long term visibility.
- ⑥ Each step is relief ground to drill and deburr automatically.
- ⑦ With 3 flat secure grip to prevent step drill from slipping in the chuck and ensure maximum transmission of torque.



UPTO
2x
FASTER

UPTO
4x
LIFE

UPTO
25%
MORE HOLES
PER CHARGE

	Description	Shank diameter (mm)	Overall length (mm)	No. of steps	Packed contents	Article Number	EAN Code	Price exc. VAT
①	PG 7 - PG 21	10	68	9	1	48899321	045242364060	£99.99
②	M 6 - M 32	10	92	13	1	48899332	045242344437	£129.99
③	4 - 12 mm / 1"	6	65	9	1	48899301	045242342532	£44.99
④	4 - 12 mm / 2"	6	65	5	1	48899302	045242342549	£49.99
⑤	4 - 20 mm	8	65	9	1	48899320	045242344406	£59.99
⑥	6 - 35 mm	10	90	14	1	48899335	045242344413	£129.99
⑦	Step drill set (3 pcs) Includes step drills no. 3, 5, 6.				3	48899399	045242344420	£219.00

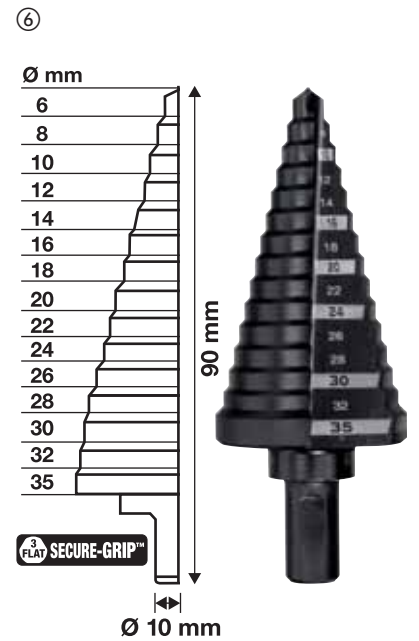
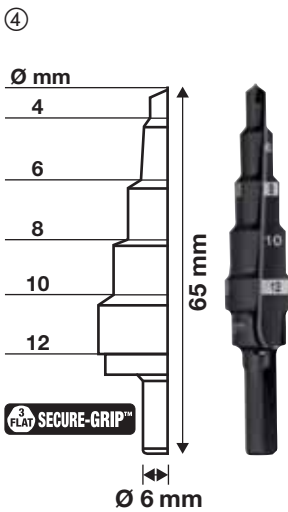
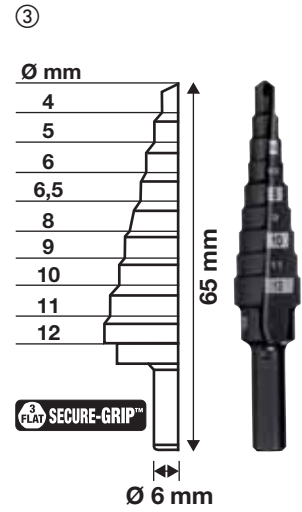
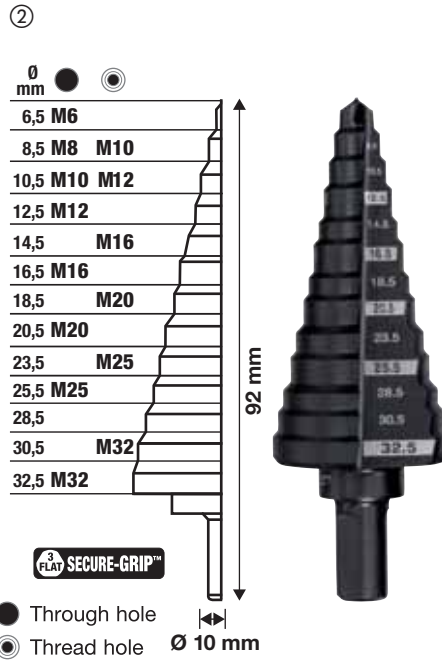

Magnetic Drilling

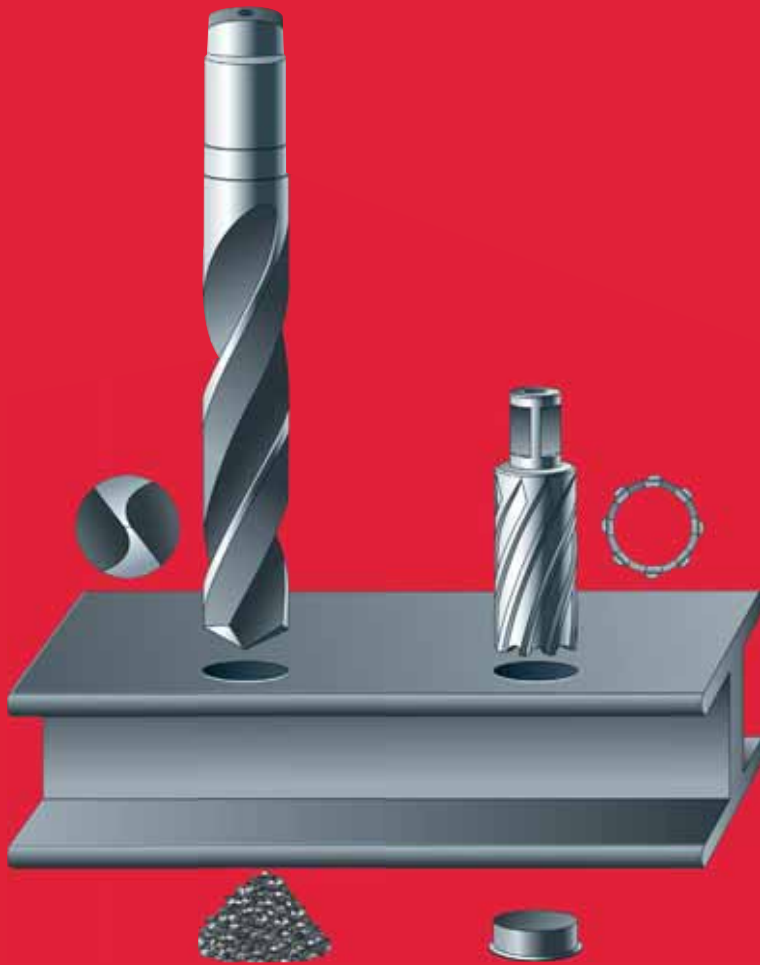

100% Faster

Speed and time savings are achieved due to the following factors. Firstly the annular cutter principle of only cutting material from the periphery of the hole as opposed to the twist drill which must cut the complete diameter of the hole. Secondly the benefit of two aggressive sharp angles per cutting edge help to achieve faster feed rates and lower cutting resistance.

30% More productivity

Because the annular cutter is only cutting material from the periphery of the hole.

Less motor energy and driving power is required.

The larger the drill diameter the greater the energy saving.

Longer lifetime

The annular cutters cutting edges do less work than the twist drill resulting in more holes between sharpening. Thick 6 mm body together with special tooth geometry ensures high stability and reduces to a minimum the risk of breakage due to overloading.

Speed chart

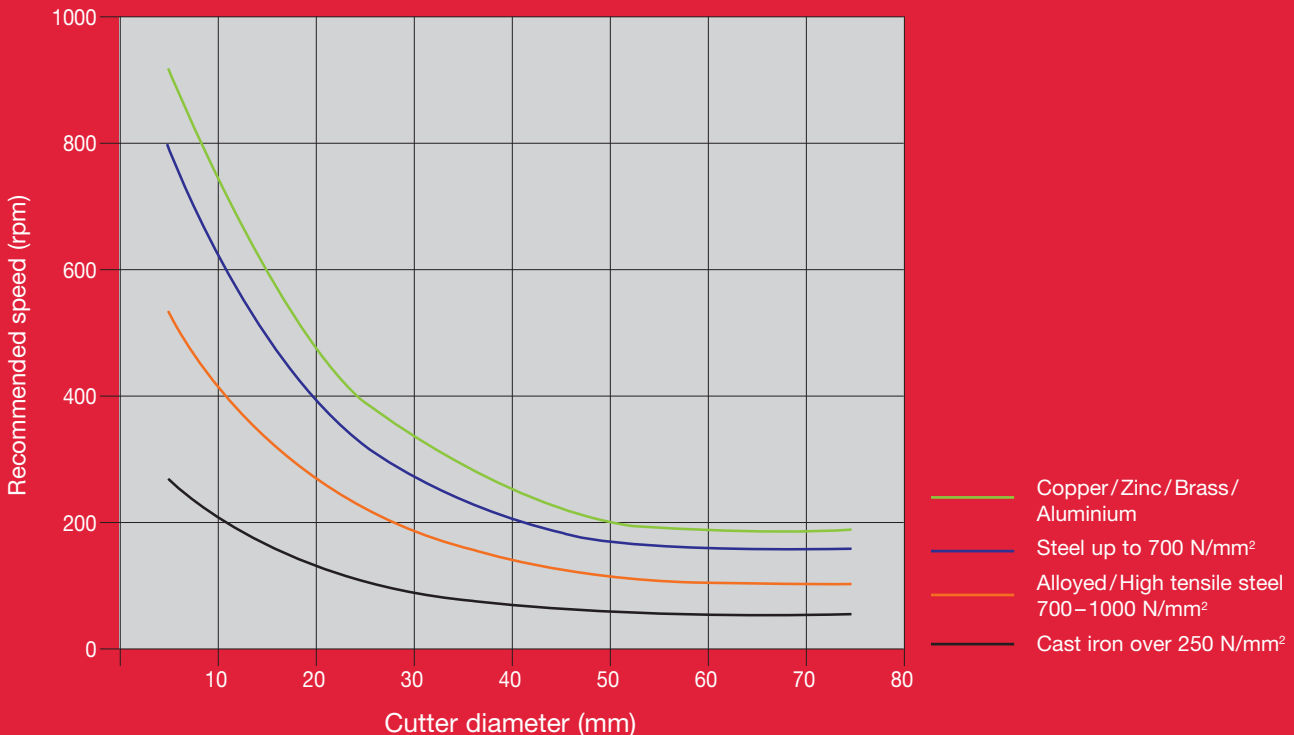

HSS annular cutters

Thick walled HSS annular cutters for increased durability and life time. With standard 19 mm Weldon reception.

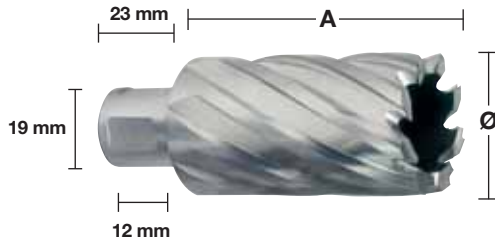

30 mm

Ø (mm)	Total length A (mm)	Packed contents	Article Number	EAN Code	Price exc. VAT
12	30	1	4932371740	4002395344161	£28.86
13	30	1	4932371741	4002395344178	£28.86
14	30	1	4932343270	4002395315130	£28.86
15	30	1	4932343271	4002395315147	£30.02
16	30	1	4932343272	4002395315154	£31.18
17	30	1	4932343273	4002395315161	£32.41
18	30	1	4932343274	4002395315178	£33.59
19	30	1	4932343275	4002395315185	£34.32
20	30	1	4932343276	4002395315192	£35.90
21	30	1	4932343277	4002395315208	£38.25
22	30	1	4932343278	4002395315215	£39.81
23	30	1	4932343279	4002395315222	£41.33
24	30	1	4932343280	4002395315239	£42.89
25	30	1	4932343281	4002395315246	£44.47
26	30	1	4932343282	4002395315253	£46.05
27	30	1	4932343283	4002395315260	£47.62
28	30	1	4932343284	4002395315277	£49.13
29	30	1	4932343285	4002395315284	£50.72
30	30	1	4932343286	4002395315291	£52.28
31	30	1	4932343287	4002395315307	£62.03
32	30	1	4932343288	4002395315314	£63.72
33	30	1	4932371742	4002395344185	£66.82
34	30	1	4932371743	4002395344192	£78.82
35	30	1	4932371744	4002395344208	£86.69
36	30	1	4932371745	4002395344215	£92.51
37	30	1	4932371746	4002395344222	£93.87
38	30	1	4932371747	4002395344239	£95.94
39	30	1	4932371748	4002395344246	£98.00
40	30	1	4932371749	4002395344253	£101.07
41	30	1	4932371750	4002395344260	£106.56
42	30	1	4932371751	4002395344277	£112.04
43	30	1	4932371752	4002395344284	£116.15
44	30	1	4932371753	4002395344291	£122.99
45	30	1	4932371754	4002395344307	£126.10
46	30	1	4932371755	4002395344314	£129.86
47	30	1	4932371756	4002395344321	£133.97
48	30	1	4932371757	4002395344338	£136.35
49	30	1	4932371758	4002395344345	£140.48
50	30	1	4932371759	4002395344352	£144.59

50 mm

Ø (mm)	Total length A (mm)	Packed contents	Article Number	EAN Code	Price exc. VAT
14	50	1	4932343289	4002395315352	£43.71
15	50	1	4932343290	4002395315369	£47.62
16	50	1	4932343291	4002395315376	£51.54
17	50	1	4932343292	4002395315383	£53.86
18	50	1	4932343293	4002395315390	£56.94
19	50	1	4932343294	4002395315406	£59.28
20	50	1	4932343295	4002395315413	£62.42
21	50	1	4932343296	4002395315420	£65.50
22	50	1	4932343297	4002395315437	£67.09
23	50	1	4932343298	4002395315444	£68.67
24	50	1	4932343299	4002395315451	£70.99
25	50	1	4932343300	4002395315468	£72.57
26	50	1	4932343301	4002395315475	£74.89
27	50	1	4932343302	4002395315482	£78.06
28	50	1	4932343303	4002395315499	£81.14
29	50	1	4932343304	4002395315505	£85.79
30	50	1	4932343305	4002395315512	£88.47
31	50	1	4932343306	4002395315529	£92.11
32	50	1	4932343307	4002395315536	£93.87
33	50	1	4932371760	4002395344369	£95.87
34	50	1	4932371761	4002395344376	£98.06
35	50	1	4932371762	4002395344383	£102.23
36	50	1	4932371763	4002395344390	£107.78
37	50	1	4932371764	4002395344406	£102.14
38	50	1	4932371765	4002395344413	£114.43
39	50	1	4932371766	4002395344420	£116.57
40	50	1	4932371767	4002395344437	£119.78
41	50	1	4932371768	4002395344444	£123.56
42	50	1	4932371769	4002395344451	£126.10
43	50	1	4932371770	4002395344468	£129.17
44	50	1	4932371771	4002395344475	£132.61
45	50	1	4932371772	4002395344482	£137.05
46	50	1	4932371773	4002395344499	£141.84
47	50	1	4932371774	4002395344505	£147.82
48	50	1	4932371775	4002395344512	£152.12
49	50	1	4932371776	4002395344529	£155.20
50	50	1	4932371777	4002395344536	£160.01

Description	Supplied in	Packed contents	Article Number	EAN Code	Price exc. VAT
Telescopic ejector pin for 30 mm cutters.		1	49590011	045242364039	
Telescopic ejector pin for 50 mm cutters.		1	49590012	045242364046	
6 pc HSS annular cutter set 19 mm Weldon reception and ejector pin short series - 30 mm.	Plastic case	6	4932372533	4002395345236	£194.48

① Ø 14 / 16 / 18 / 20 / 22 / 24 mm.

System accessories - Magnetic drill stands



4932604226

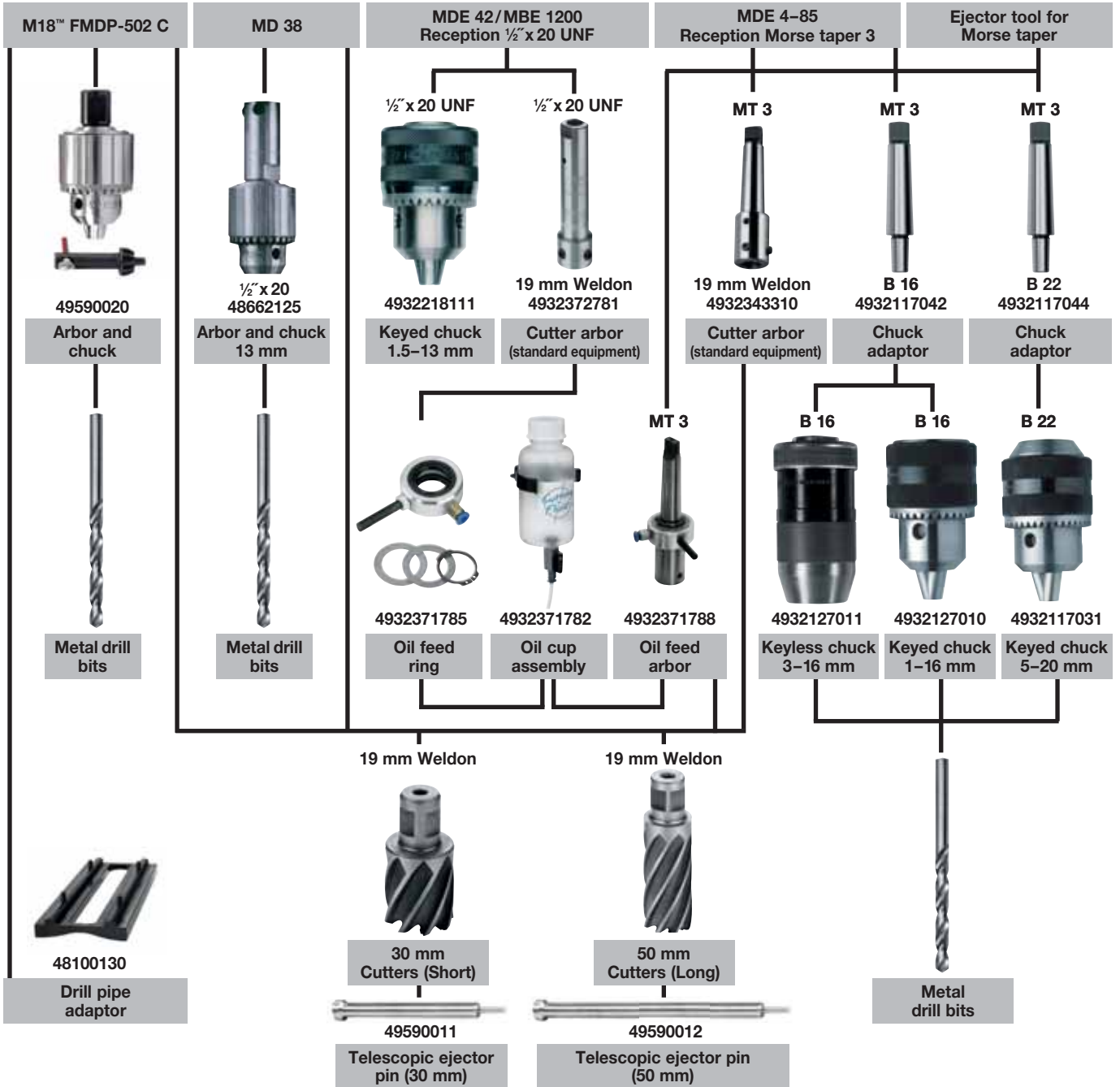

High Performance Bi-Metal Holesaws

HOLE DOZER™

The Milwaukee® *Hole Dozer™* is the jobsite workhorse that provides unstoppable durability through the most demanding applications.



Ø 19-37 mm



Ø 38-152 mm



Ø 152-210 mm

- Lifetime warranty against tooth breakage
- Rip guard tooth geometry provides for the most durable tooth form and best lifetime

PLUG JACK™

- Multiple leverage points to work cut material out of the holesaw for faster plug removal
 - Deepest access for thick plugs
 - Higher access for thin material
- Minimises downtime between cuts





Tooth design

A variable 4–6 teeth per inch tooth design with a positive 10° tooth angle provides the following benefits:

- Faster and more aggressive cut.
- Improved heat dispersion during cutting ensures that the teeth stay sharper for longer.
- Deeper curved gullets provide more efficient chip clearance preventing clogging and heat build up.
- Special shaped tooth angle has less tendency to snag on thinner materials.
- Teeth are alternate/side set to minimise binding and friction.
- Requires less feed pressure – This is achieved by the combination of aggressive tooth geometry and good chip clearance resulting in the requirement of less force during drilling.

Holesaw body

- 1.27 mm thick steel holesaw body is rigid to retain its shape but also has built in elasticity.
- Effective sawing depth is 41 mm.

Applications

- High quality manufacturing techniques ensure high rotational precision, therefore these holesaws are suitable for use both in hand and pillar drills (manual feed only).
- This high quality holesaw range is the perfect solution for cutting all types of materials:
 - Steel up to 1000 N/mm² strength
 - Stainless steel and acid resistant steel
 - Non-ferrous metals
 - Cast iron
 - Aluminium
 - Wood
 - Medium density fibreboard (MDF)
 - Gypsum plasterboard
 - Sandwich materials
 - PVC

Tooth material

- Type Matrix II premium high speed steel is used for the toothed area of the holesaw. Matrix II steel contains 8% cobalt allowing the teeth to retain the original tooth hardness even at high working temperatures when used in metal cutting applications.
- Bi-Metal construction – High speed steel teeth are laser welded onto a low alloy steel body. The teeth are then vacuum hardened to 65 HRC at a temperature of 600°C to give maximum durability and lifetime.
- Due to the high wear resistance of the Matrix II steel, these holesaws are ideal for cutting difficult and hard materials such as stainless steel and acid resistant steels as well as softer materials like wood.

Back plate design

- The back plates are constructed with thick steel thus the holes will not enlarge over time. Thick backs add strength and rigidity minimising vibrations.
- 4 drive pin holes for easier arbor location.
- Perfectly manufactured round back plate, especially important for the larger diameter holesaws.



FIXTEC arbors

① For holesaws Ø 14–30 mm

FIXTEC “twist release” quick change arbor. Prevents holesaw locking onto the arbor. Compatible to all manufacturers holesaws – no adapter required.

② For holesaws Ø 32–210 mm

The locking nut secures and locks the arbor drive plate against the back of the holesaw for a stable fit, eliminating holesaw wobble and vibration.



①



②

Hole Dozer™ holesaws: Recommended cutting speed in RPM

Ø mm	Ø Inch	Metal up to 700 N/mm ²	Cast iron	Stainless steel & metal up to 1000 N/mm ²	Non-ferrous metal	Aluminium	Wood	MDF
14	9/16	580	400	300	790	900	1500	750
16	5/8	550	365	275	730	825	1500	750
17	11/16	500	330	250	665	750	1500	750
19	3/4	460	300	230	600	690	1500	750
20	25/32	425	280	210	560	635	1500	750
21	13/16	425	280	210	560	635	1500	750
22	7/8	390	260	195	520	585	1500	750
23	29/32	370	250	185	500	550	1500	750
25	1	350	235	175	470	525	1500	750
27	1 1/16	325	215	160	435	480	1400	700
29	1 1/8	300	200	150	400	450	1400	700
30	1 3/16	285	190	145	380	425	1400	700
32	1 1/4	275	180	140	380	410	1400	700
33	1 5/16	260	175	135	345	390	1400	700
35	1 3/8	250	165	125	330	375	1400	700
37	1 7/16	240	160	120	315	360	1400	700
38	1 1/2	230	150	115	300	345	1400	700
40	1 9/16	220	145	110	290	330	1200	600
41	1 5/8	210	140	105	280	315	1200	600
43	1 11/16	205	135	100	270	305	1200	600
44	1 3/4	195	130	95	260	295	1200	600
46	1 13/16	190	125	95	250	285	1200	600
48	1 7/8	180	120	90	240	270	1200	600
50	1 31/32	175	120	85	230	260	1200	600
51	2	170	115	85	230	255	1200	600
52	2 1/16	165	110	80	220	245	1200	600
57	2 1/4	150	100	75	200	225	1000	500
58	2 19/32	145	100	75	195	225	1000	500
59	2 5/8	145	100	75	195	225	1000	500
60	2 3/8	140	95	70	190	220	1000	500
63	2 31/64	135	90	65	180	205	900	450
64	2 1/2	135	90	65	180	205	900	450
65	2 9/16	130	85	65	175	200	800	400
68	2 11/16	125	80	60	160	185	800	400
73	2 7/8	120	80	60	160	180	800	400
76	3	115	75	55	150	170	700	350
79	3 1/8	110	70	55	140	165	700	350
83	3 1/4	105	50	40	140	155	700	350
86	3 3/8	100	45	30	130	150	500	250
89	3 1/2	95	45	30	130	145	500	250
92	3 5/8	95	60	45	120	140	500	250
95	3 3/4	90	60	45	120	135	500	250
98	3 7/8	90	60	45	120	135	500	250
102	4	85	55	40	110	130	400	200
105	4 1/8	80	55	40	110	120	400	200
111	4 3/8	80	50	40	100	120	300	150
114	4 1/2	75	50	35	100	105	300	150
121	4 3/4	75	50	35	95	95	300	150
127	5	65	45	30	90	90	200	100
133	5 1/4	60	40	25	85	85	200	100
140	5 1/2	60	40	25	85	85	200	100
146	5 3/4	55	35	25	75	75	200	100
152	6	55	35	25	75	75	200	100
160	6 5/16	50	30	25	60	60	150	75
168	6 5/8	50	30	25	55	55	150	75
177	6 31/32	45	25	25	55	55	150	75
200	7 7/8	40	25	25	50	50	100	50
210	8 9/32	40	20	25	50	50	100	50



Cutting oil Dry Cutting oil Cutting oil Turpentine Dry Dry



Speed kills!

Operating at higher speeds than those recommended will shorten the life of the holesaw and produce very inefficient cutting.



Feed Pressure:

Variables in material, work configuration should be considered. Apply sufficient feed pressure to aid good chip re-removal. Reduce the pressure when the holesaw becomes hot or if the teeth start to clog with material. Insufficient feed pressure will dull tooth points prematurely but too much pressure can totally destroy teeth.



Cooling Lubricant:

Cutting oil serves two purposes when sawing in metals. It cools the saw and the work piece. It reduces heat and abrasion which can shorten cutting life. It also aids re-moving swarf from the cutting surface. Using a cooling lubricant will extend the life of your holesaw by 500%.

Hole Dozer[™] holesaws - A cut above the rest!

Ø (mm)	Ø (inch)	Max. cutting depth (mm)	Packed contents	Article Number	EAN Code	Price exc. VAT
14	9/16	41	1	49560002	045242271061	£10.98
16	5/8	41	1	49560012	045242192922	£8.45
17	11/16	41	1	49560014	045242193639	£8.45
19	3/4	41	1	49560023	045242192632	£8.45
20	25/32	41	1	49560024	045242271016	£8.45
21	13/16	41	1	49560027	045242192649	£8.45
22	7/8	41	1	49560032	045242192878	£8.69
24	15/16	41	1	49560037	045242192885	£9.69
25	1	41	1	49560043	045242192526	£10.38
27	1 1/16	41	1	49560047	045242192892	£10.98
29	1 1/8	41	1	49560052	045242192939	£11.80
30	1 3/16	41	1	49560057	045242192946	£12.37
32	1 1/4	41	1	49560062	045242192977	£12.37
33	1 3/16	41	1	49560067	045242192984	£12.58
35	1 3/8	41	1	49560072	045242192991	£13.54
37	1 7/16	41	1	49560077	045242193028	£13.82
38	1 1/2	41	1	49560082	045242193035	£13.54
40	1 9/16	41	1	49560087	045242193042	£14.59
41	1 5/8	41	1	49560092	045242193073	£14.70
43	1 11/16	41	1	49560097	045242193080	£14.95
44	1 3/4	41	1	49560102	045242193097	£14.75
46	1 13/16	41	1	49560107	045242193127	£15.32
48	1 7/8	41	1	49560112	045242193134	£15.32
50	1 31/32	41	1	49560113	045242271023	£15.40
51	2	41	1	49560117	045242193141	£14.95
52	2 1/16	41	1	49560122	045242193172	£15.25
54	2 1/8	41	1	49560127	045242193189	£15.25
57	2 1/4	41	1	49560132	045242193196	£15.95
59	2 3/16	41	1	49560137	045242193226	£17.50
60	2 3/8	41	1	49560142	045242193233	£17.50
64	2 1/2	41	1	49560147	045242193240	£17.61
65	2 5/16	41	1	49560153	045242193271	£18.27
67	2 3/8	41	1	49560158	045242193288	£18.55
68	2 11/16	41	1	49560159	045242271030	£18.60
70	2 3/4	41	1	49560163	045242193295	£18.60
73	2 7/8	41	1	49560167	045242193325	£18.60
76	3	41	1	49560173	045242193332	£18.90
79	3 1/8	41	1	49560177	045242193349	£19.77
83	3 1/4	41	1	49560183	045242193370	£20.49
86	3 3/8	41	1	49560187	045242193387	£22.44
89	3 1/2	41	1	49560193	045242193394	£21.83
92	3 5/8	41	1	49560197	045242193431	£23.12
95	3 3/4	41	1	49560203	045242193448	£24.67
98	3 7/8	41	1	49560207	045242193479	£22.86
102	4	41	1	49560213	045242193486	£21.76
105	4 1/8	41	1	49560217	045242193493	£27.44
111	4 3/8	41	1	49560227	045242193530	£32.60
114	4 1/2	41	1	49560233	045242193547	£33.90
121	4 3/4	41	1	49560237	045242193578	£36.00
127	5	41	1	49560243	045242193585	£38.90
133	5 1/4	41	1	49560244	045242271078	£42.03
140	5 1/2	41	1	49560247	045242193592	£44.21
152	6	41	1	49560253	045242193622	£49.88
160	6 3/16	38	1	4932399885	4002395365395	£64.00
168	6 3/8	38	1	4932399886	4002395365401	£71.00
177	6 31/32	38	1	4932399887	4002395365418	£72.00
200	7 7/8	38	1	4932399888	4002395365425	£89.00
210	8 3/16	38	1	4932399889	4002395365432	£99.00



Hole Dozer™ holesaw sets

Description	Packed contents	Article Number	EAN Code	Price exc. VAT
7 pc Hole Dozer Holesaw set.				
① Holesaws: Ø 19, 22, 25, 29, 32 mm. Arbor - for holesaws Ø 14 - 30 mm (ld. No. 49567010). Spacer and adaptor. 1/8" Hex allen key.	7	49224083	045242310760	£89.99
10 pc holesaw set.				
② Holesaws: Ø 25, 32, 40, 54, 68, 76 mm. Arbor - for holesaws Ø 14 - 30 mm (ld. No. 49567010). Arbor - for holesaws Ø 32 - 152 mm (ld. No. 49569100). 2 x Pilot drill bits, 1/8" Hex allen key.	10	49224201	045242348091	£159.99
14 pc holesaw set.				
③ Holesaws: Ø 19, 22, 25, 29, 32, 35, 38, 44, 51, 57 mm. Arbor - for holesaws Ø 14 - 30 mm (ld. No. 49567010). Arbor - for holesaws Ø 32 - 152 mm (ld. No. 49569100). 2 x Pilot drill bits, 1/8" ~ 3 mm allen key.	14	49224152	045242271047	£165.00
17 pc holesaw set.				
④ Holesaws: Ø 20, 22, 25, 32, 40, 44, 51, 57, 64, 65, 67, 68, 76 mm. Arbor - for holesaws Ø 14 - 30 mm (ld. No. 49567010). Arbor - for holesaws Ø 32 - 152 mm (ld. No. 49569100). 2 x Pilot drill bits, 1/8" allen key (ld. No. 49960060).	17	49224102	045242271054	£219.00
Holesaw kit box.				
⑤ Arbor with pilot drill (ld. No. 49567010). Arbor with pilot drill (ld. No. 49569100). 2 x Pilot drill bits, 1/8" allen key (ld. No. 49960060).	1	4932430327	4002395379880	£39.99



System accessories - Hole Dozer[™] holesaws

Description	Fits holesaw Ø	Shank reception	Holesaw or core reception	Packed contents	Article Number	EAN Code	Price exc. VAT
① Fixtec „Twist Release“ quick change arbor.	Ø 14-30 mm	9.5 mm Hex	½" x 20	1	49567210	045242225774	£29.99
② Arbor.	Ø 14-30 mm	9.5 mm Hex	½" x 20	1	49567010	045242200177	£8.60
③ Arbor.	Ø 32-210 mm	9.5 mm Hex	¾" x 18	1	49567250	045242225798	£13.95
④ Arbor.	Ø 32-210 mm	11 mm Hex	¾" x 18	1	49569100	045242200832	£13.95
⑤ Extension - 300 mm long.	-	9.5 mm Hex	-	1	48284008	045242225811	£19.90
⑥ Extension - 300 mm long.	-	11 mm Hex	-	1	48284006	045242122516	£19.90
Pilot drill bit fits to all arbors Ø 6 mm and 89 mm length.				1	49568010	045242200450	£19.90
⑦ Pilot drill long bit fits to all arbors Ø 6 mm and 100 mm length.				1	49568000	045242200351	£3.99
Allen key ½" for all arbors.				1	49960060	045242221455	£4.11
Grub screw for arbors.				1	06832712	4002395874354	£0.84



Adjustable hole cutter

NEW

For cutting large diameter holes for air conditioning pipes, fans, downlights and ceiling speakers. Dust collection shroud for 100% dust free work when overhead drilling. Diameter is adjustable from 51 mm to 178 mm in 6.4 mm steps. Laser marked preset diameters at 51 - 178 mm. Suitable for use on drywall (max. 25 mm) and ceiling tile. Not suitable for OSB wood boards.



Description	Packed contents	Article Number	EAN Code	Price exc. VAT
Adjustable hole cutter				
① Pilot drill, 2 blades, QL arbor and dust collection shroud.	1	49560260	045242350261	£32.99
② QL arbor with ½" Hex reception. 75 mm long.	1	48281000	045242122622	£9.99
Replacement blade and pilot drill set				
③ Pilot drill bit, 2 x blades and allen hex key.	1	49560290	045242346370	£13.99



Diamond Plus™ wet / dry drill bits and holesaws

Diamond grit edge drills and holesaws have been specially developed for professionals that need to drill in extremely hard materials such as porcelain/gres/quarry tiles, cast iron or fibreglass where it is increasingly difficult to drill with conventional holesaws. These holesaws guarantee excellent performance and superior life time even in the hardest of materials.

Water starved: These holesaws only require limited water supply unlike conventional diamond drills that require a continuous flow of water. Just dip the drill bit or holesaw into water at the start of each hole to be cut and thereafter every 5 second cut duration.

Clean holes: Drills clean, precise holes without any perimeter scratches.

Lifetime: To ensure long lifetime, we use high grade diamond for fast cutting and a superior brazed bond matrix to give best durability.

Durability: Tough alloy body which does not bend or distort easily.

Easy slug ejection: Offset slug ejection slots for greater leverage when removing tight slugs.

Versatile: Can be used either on angle grinders with relevant adaptor or with a drill.



Ø (mm)	Reception	Packed contents	Article Number	EAN Code	Price exc. VAT
5	1/8" Hex	1	49560503	045242223732	£21.49
6	1/8" Hex	1	49560505	045242223749	£22.79
8	1/8" Hex	1	49560507	045242223756	£23.99
10	1/8" Hex	1	49560509	045242223763	£24.49
12	1/8" Hex	1	49560511	045242223770	£28.99
15	1/8" Hex	1	49560513	045242223787	£32.99
20	1/8" Hex	1	49560515	045242223794	£36.50
25	1/8" Hex	1	49560517	045242223800	£39.95

Ø (mm)	Reception	Packed contents	Article Number	EAN Code	Price exc. VAT
22	1/2" x 20	1	49565605	045242308439	£26.29
29	1/2" x 20	1	49565615	045242308446	£29.49
32	3/4" x 18	1	49565620	045242308453	£30.99
35	3/4" x 18	1	49565625	045242308460	£32.95
38	3/4" x 18	1	49565630	045242308477	£35.99
44	3/4" x 18	1	49565640	045242308491	£40.29
51	3/4" x 18	1	49565645	045242308507	£42.95
68	3/4" x 18	1	49565664	045242337835	£51.79

Description	Fits holesaw Ø	Shank reception	Holesaw or core reception	Packed contents	Article Number	EAN Code	Price exc. VAT
Arbor.	Ø 14-30 mm	9.5 mm Hex	1/2" x 20	1	49567010	045242200177	£8.60
Arbor.	Ø 32-210 mm	9.5 mm Hex	3/4" x 18	1	49567250	045242225798	£13.95
Grinder adaptor.	Ø 22-29mm	M14	1/2" x 20	1	4932430464	4002395381258	£16.99
Grinder adaptor.	Ø 32-68mm	M14	3/4" x 18	1	4932430465	4002395381265	£16.99

How to use on an angle grinder:

1. Screw the grinder adaptor M14 to the holesaw and tighten firmly with a spanner. Then apply the spindle lock on the angle grinder and fit the adaptor directly onto the spindle; tighten firmly with a spanner.
2. If the tile is not fitted to a wall or floor ensure it is secured firmly with a clamp.
3. Dip the holesaw tips into water.
4. Switch on angle grinder to full speed. Slowly approach the tile with the holesaw at a 20-30° angle with light pressure to avoid skating on the tile. Once the holesaw starts to cut into the tile and forms a groove, gradually raise the holesaw so that it is horizontal with the tile.
5. Every 5 seconds dip the holesaw into water.
6. Apply light pressure and an oscillating circular motion during cutting to maximise tool life.

Application areas

Ceramic tiles – all types hard and soft:
Porcelain/Gres/Granite/Quarry/Terrazzo/
Artificial stone/Terracota/Agglomerate/Glazed

Cast iron

Fibreglass/GRP
(Glass reinforced plastic)/Perspex



Professional water cooling system

- Water feed system with water regulator to control water flow.
- Easy fixing and removal from surfaces due to vacuum fixing.

Description	Packed contents	Article Number	EAN Code	Price exc. VAT
Professional water cooling system.				
① Water pressure bottle with 1 litre capacity, water hose and water regulation unit.	3	4932352330*	4002395369898	£18.99
② Drilling guide for drills / holesaws Ø 19 - 68 mm.	1	4932352332	4002395369911	£47.99



* while stocks last

IMPACT HOLESAWS



Optimised for use with cordless tools



- ① Thin wall
 - 8 TPI = smooth burr free holes
 - 0.6 mm thick = less resistance
 - up to 40% faster
- ② Shallow cup optimised for drilling thin metal
- ③ 8% Cobalt Bi-Metal for best durability and lifetime
- ④ Ejection spring auto ejects slugs
- ⑤ Stop shoulder prevents over drilling
- ⑥ 1/4" Hex shank = impact driver compatible

Suitability

Max. 2 mm steel, aluminium and stainless steel (max. 1.5 mm)

Shockwave impact holesaws

NEW

	Ø (mm)	Packed contents	Article Number	EAN Code	Price exc. VAT	
	19	1	49569805	045242321094	£19.99	
	22	1	49569810	045242321100	£20.29	
	25	1	49569815	045242321117	£20.50	
①	29	1	49569820	045242321124	£21.39	
	32	1	49569825	045242321131	£21.99	
	35	1	49569830	045242321148	£22.29	
	38	1	49569835	045242321155	£22.59	
②	3 pc Shockwave impact set.					
	Ø 22 / 29 / 35 mm.		3	49224800	045242321162	£59.00
	Ejection spring and grub screw.		1	4932430466	4002395381272	£6.99
	Pilot drill bit with arbor.		1	4932430477	4002395381388	£12.99



M12 / M18 Dust extraction system attachments

Description	Fits Milwaukee dust absorption systems	Packed contents	Article Number	EAN Code	Price exc. VAT
① Drilling nozzle.	M18 CDEX / M18/28 CPDEX, M12 DE	2	49902301	045242337279	£26.99
② Filter.	M18 CDEX / M18/28 CPDEX, M12 DE	3	49902306	045242299454	£29.99
③ Crevice nozzle.	M12 DE	1	49902325*	045242297603	£15.99
④ 3 pc set. Filter box, filter, box lid.	M12 DE	3	49902340	045242299461	£34.99
⑤ M18 & M28 Dustbox with filter box, filter	M18 CDEX / M18/28 CPDEX	1	49902342	045242341948	£28.99
⑥ Dust thru-box to allow connection of the M12 DE to an independent dust extraction / vacuum cleaner. Outlet nozzle: Ø 37 mm outside / Ø 32 mm inside.		1	4932430479	4002395381401	£19.99



Side handles

Description	Packed contents	Article Number	EAN Code	Price exc. VAT
① Side handle with depth gauge for all drills and percussion drills with gear neck diameter 43 mm.	1	4932373725	4002395352647	£14.90
② Side handle with depth gauge for all drills and percussion drills with a short gear neck (13 mm) of diameter 43 mm.	1	4932364149	4002395342198	£28.20



QUIK-LOK cables

Cable length (m)	Country version	Packed contents	Article Number	EAN Code	Price exc. VAT
4	EU	1	4932373502	4002395351725	£23.49
10	EU	1	4932373503	4002395351732	£42.02
4	CH	1	4932373504	4002395351749	£24.77
4	GB	1	4932373508	4002395351787	£44.95
4	GB	1	4932373510	4002395351800	£44.95
6	EU	1	4932364483 ¹	4002395337620	£40.62
QUIK-LOK cable repair kit.		1	4931380758	4002395714551	£18.35



¹ Heavy duty and acid resistant, non repairable

* while stocks last

Dust extraction

Description	Packed contents	Article Number	EAN Code	Price exc. VAT
① Dust collection ring for collecting dust when overhead drilling. Suitable for Ø 5 - 8 mm.	1	4932265320	4002395302741	£8.01
Dust bag, cloth. For use with Clean Line dust system 345547.	1	4932346182	4002395313273	£58.64
② Extractor for dust collection on the wall or when overhead drilling. Maximum diameter drill bit Ø 28 mm. Fits to all industrial dust extraction units (universal reception Ø 26 - 41 mm).	1	4932430446	4002395381074	£18.99
③ Drilling shroud - PHDE72. For drilling and coring from Ø 6 - 72 mm. Brush insert to improve suction and extraction. Brushes to be removed for coring applications. Outlet nozzle: Ø 37 mm outside / Ø 32 mm inside. Replacement sealing lips (2 pcs): 4931448564. Replacement brush: 4931448565	1	4932430480	4002395381418	£39.99
DE16 - Vac assist universal extractor				
④ DE16 unit, 1 x side handle and 3 x neck collars-allows fitting to drills with gear neck from Ø 43 - 59 mm. 2 x drilling nozzles (49902301).	1	4932430835	4002395384976	£99.99



Universal right angle drill attachment

- Converts Milwaukee® HDE 13 RQD straight drill to angle drill.
- Used extensively for drilling between joists or in tight corners.
- Head and handle swivel 360°.
- Provides two speeds: 1. Low: speed decreases by 30% torque increases by 50%
2. High: speed increases by 50%

Description	Packed contents	Article Number	EAN Code	Price exc. VAT
Right angle drill attachment.	1	48062871	045242088812	£171.72

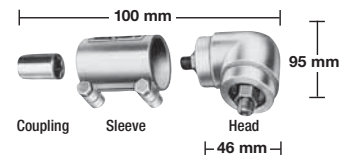

Head and handle swivel 360° and can be locked tight in any position.

Screwdriving bits





The ribs are cold formed to exact specification ensuring reduced wear from slippage. The tip is subjected to a special hardening process with temperatures up to 870°C.

The outcome is a bit with a hardness of 60 HRC. This extra hard tip ensures extra long life under constant use.

The body is manufactured from the highest quality S2 european steel.

The sign of „Quality“. All bits are laser marked with the Milwaukee® logo and tip reception for easy identification.

	Type	Total length A (mm)	Packed contents	Order quantity	Article Number	EAN Code	Price exc. VAT
 Phillips	PH 1	25	25	1	4932399586	4002395362363	£12.17
	PH 2	25	25	1	4932399587	4002395362370	£12.17
	PH 3	25	25	1	4932399588	4002395362387	£12.17
 PoziDrive	PZ 1	25	25	1	4932399589	4002395362394	£12.17
	PZ 2	25	25	1	4932399590	4002395362400	£11.90
	PZ 3	25	25	1	4932399591	4002395362417	£11.41
 Torx	TX 10	25	25	1	4932399594	4002395362448	£17.21
	TX 15	25	25	1	4932399595	4002395362455	£17.21
	TX 20	25	25	1	4932399596	4002395362462	£17.21
	TX 25	25	25	1	4932399597	4002395362479	£17.21
	TX 30	25	25	1	4932399599	4002395362493	£17.21
	TX 40	25	25	25	1	4932399600	4002395362509

Trade case - 35 pcs

Description	Packed contents	Order quantity	Article Number	EAN Code	Price exc. VAT
Screwdriving bit set.					
① Screwdriving bits 25 mm length: PH 1 x 2 / PH 2 x 3 / PH 3 x 2. PZ 1 x 2 / PZ 2 x 3 / PZ 3 x 2. TX 10 x 2 / TX 15 x 2 / TX 20 x 3. TX 25 x 3 / TX 30 x 2 / TX 40 x 2. Screwdriving bits 50 mm length: PH 1 x 1 / PH 2 x 1. PZ 1 x 1 / PZ 2 x 1. TX 20 x 1 / TX 25 x 1. Magnetic bit holder with 1/4" Hex reception x 1.	35	1	4932352068	4002395367214	£39.99
Counter display.					
② 6 x screwdriving bit set - 35 pc 4932352068.	6	1	4932352063	4002395366699	£239.94



Magnetic bit holders

Description	Packed contents	Article Number	EAN Code	Price exc. VAT
① Magnetic bit holder with quick release clutch. Total length 58 mm.	1	4932373483	4002395351060	£8.90
② Magnetic bit holder for drywall.	1	4932430179	4002395378401	£15.99



Compact screwdriving bit cassettes

- This high quality cassette aimed at the professional user is available in 3 different assortments.
- Slimline pocket design: 110 mm x 65 mm x 15 mm.
- Secure latch system - easy opening and safe closing.
- Extra side compartment accepts either 50 mm screwdriving bits or drill bits.
- Front window to protect bits from dust.
- High quality screwdriving bits with hardness of 60 HRC and 1/4" Hex reception. 25 mm bits manufactured according to DIN 3126 - C 6.3. 50 mm bits are manufactured according to DIN 3126 - E 6.3.
- HSS-G Metal drill bits are ground from one piece of solid high speed steel according to DIN 1412 C. Split point shaped cutting tip with 135° angle for improved centering. Type N flue design for fast chip removal. Reception manufactured according to DIN 3126 - E 6.3. Suitable for drilling in steel, cast iron, alloyed and non alloyed material up to 900 N/mm².
- Magnetic bit holder with quick release clutch.

Description	Packed contents	Order quantity	Article Number	EAN Code	Price exc. VAT
12 pc compact screwdriving bit set.					
① 25 mm: SL 0.8 x 5.5 mm x 1. 25 mm: PH 1 x 1 / PH 2 x 2 / PH 3 x 1. 25 mm: PZ 1 x 1 / PZ 2 x 2 / PZ 3 x 1. 50 mm: PH 2 x 1. 50 mm: PZ 2 x 1. Magnetic bit holder with quick release clutch.	12	1	4932399513	4002395361601	£34.76
12 pc compact screwdriving bit set TITANIUM.					
② 25 mm: PH 2 x 1. 25 mm: PZ 1 x 1 / PZ 2 x 1 / PZ 3 x 1. 25 mm: TX 15 x 1 / TX 20 x 1 / TX 25 x 1 / TX 30 x 1 / TX 40 x 1. HSS-G metal drill bit: 3.0 mm x 1 / 5.0 mm x 1. Magnetic bit holder with quick release clutch.	12	1	4932399514	4002395361618	£38.19
12 pc compact screwdriving set.					
③ 25 mm: SL 0.8 x 5.5 mm x 1. 25 mm: PH 1 x 1 / PH 2 x 2 / PH 3 x 1. 25 mm: TX 10 x 1 / TX 15 x 1 / TX 20 x 1 / TX 25 x 1. HSS-G metal drill bit: 3.0 mm x 1 / 4.2 mm x 1. Magnetic bit holder with quick release clutch.	12	1	4932399516	4002395361632	£34.76
Screwdriving bit set.					
④ 27 pc robust and compact with an extra big latch. PH 1 x 2 / PH 2 x 2 / PH 3 x 1. PZ 1 x 2 / PZ 2 x 4 / PZ 3 x 2. TX 10 x 2 / TX 15 x 3 / TX 20 x 3. TX 25 x 3 / TX 30 x 1 / TX 40 x 1. Magnetic bit holder with quick release clutch.	27	1	4932352747	4002395374052	£34.99

①



②



③



④



SHOCKWAVE IMPACT DUTY

Shockwave Impact Duty™ screwdriving bits

IMPACT

Designed for use with Impact Drivers the Shockwave Impact Duty™ accessory line is not only ideal for heavy duty impact applications, but also delivers a full system solution for all the user's drilling and fastening needs.

NEW

Shock Zone Geometry - Designed to Flex.

The larger optimized Shock Zone are reduces stress at the tip resulting in less tip breakages. The combination of the Shock Zone design and special heat treatment absorbs impacts and allows the bit to flex with spring like action.



Precision milled tip provides the best fit with screw head, reducing cam out and stripping, resulting in outstanding lifetime.

Custom engineered steel - Milwaukee® custom metal formula makes the Shockwave bits more resistant to shock from impacting.



A) 25 mm ¼" Hex - DIN 3126 - C 6.3
B) 50 mm ¼" Hex - DIN 3126 - E 6.3
C) 90 mm ¼" Hex - DIN 3126 - E 6.3



Type	Total length A (mm)	Supplied in	Packed contents	Order quantity	Article Number	EAN Code	Price exc. VAT	
Phillips 	PH 1	25	①	2	1	4932430850	4002395385126	£2.49
		90	①	1	1	4932430851	4002395385133	£2.99
	PH 2	25	①	2	1	4932430852	4002395385140	£2.49
		25	②	25	10	4932430853	4002395385157	£19.99
		50	①	1	1	4932430854	4002395385164	£2.49
		50	②	10	10	4932430855	4002395385171	£19.99
		90	①	1	1	4932430856	4002395385188	£2.99
	PH 3	25	①	2	1	4932430857	4002395385195	£2.49
		50	①	1	1	4932430858	4002395385201	£2.49
		90	①	1	1	4932430859	4002395385218	£2.99
Pozidrive 	PZ 1	25	①	2	1	4932430860	4002395385225	£2.49
		25	②	25	10	4932430861	4002395385232	£19.99
		90	①	1	1	4932430862	4002395385249	£2.99
	PZ 2	25	①	2	1	4932430863	4002395385256	£2.49
		25	②	25	10	4932430864	4002395385263	£19.99
		50	①	1	1	4932430865	4002395385270	£2.49
		50	②	10	10	4932430866	4002395385287	£19.99
		90	①	1	1	4932430867	4002395385294	£2.99
	PZ 3	25	①	2	1	4932430868	4002395385300	£2.49
		25	②	25	10	4932430869	4002395385317	£19.99
		50	①	1	1	4932430870	4002395385324	£2.49

Individual pieces can be ordered as well as the Counter display quantities illustrated

① Blister













② Storage container



Counter display



	Type	Total length A (mm)	Supplied in	Packed contents	Order quantity	Article Number	EAN Code	Price exc. VAT	
	TX 10	25	①	2	1	4932430871	4002395385331	£2.49	
		TX 15	25	①	2	1	4932430872	4002395385348	£2.49
			50	①	1	1	4932451286	4002395157440	£2.99
	TX 20	25	②	25	10	4932430873	4002395385355	£19.99	
		25	①	2	1	4932430874	4002395385362	£2.49	
		25	②	25	10	4932430875	4002395385379	£19.99	
		50	①	1	1	4932430876	4002395385386	£2.49	
		50	②	10	10	4932430877	4002395385393	£19.99	
		90	①	1	1	4932430878	4002395385409	£2.99	
	TX 25	25	①	2	1	4932430879	4002395385416	£2.49	
		25	②	25	10	4932430880	4002395385423	£19.99	
		50	①	1	1	4932430881	4002395385430	£2.49	
		50	②	10	10	4932430882	4002395385447	£19.99	
		90	①	1	1	4932430883	4002395385454	£2.99	
	TX 27	25	①	2	1	4932430884	4002395385461	£2.49	
	TX 30	25	①	2	1	4932430885	4002395385478	£2.49	
		25	②	25	10	4932430886	4002395385485	£19.99	
		50	①	1	1	4932430887	4002395385492	£2.49	
TX 40	25	①	2	1	4932430888	4002395385508	£2.49		
	25	②	25	10	4932430889	4002395385515	£19.99		
	50	①	1	1	4932430890	4002395385522	£2.49		
TX 50	25	①	2	1	4932430891	4002395385539	£2.69		
	25	②	25	10	4932430892	4002395385546	£19.99		
	Hex 2.5 	25	①	2	1	4932430893	4002395385553	£2.49	
	Hex 3 	25	①	2	1	4932430894	4002395385560	£2.49	
	Hex 4 	25	①	2	1	4932430895	4002395385577	£2.49	
	Hex 5 	25	①	2	1	4932430896	4002395385584	£2.49	
	Hex 6 	25	①	2	1	4932430897	4002395385591	£2.49	
	Hex 8 	25	①	2	1	4932430898	4002395385607	£2.99	
	Hex 10 	25	①	2	1	4932430899	4002395385614	£3.49	
	Hex 12 	25	①	2	1	4932430900	4002395385621	£3.99	
	SL 0.6 x 4.5	25	①	2	1	4932430901	4002395385638	£2.49	
	SL 0.8 x 5.5	25	①	2	1	4932430902	4002395385645	£2.49	
	SL 1.2 x 6.5	25	①	2	1	4932430903	4002395385652	£2.49	

NEW

① Blister



② Storage container



Counter display



Individual pieces can be ordered as well as the Counter display quantities illustrated

SHOCKWAVE IMPACT DUTY™

Shockwave Impact Duty™ sets

NEW

Description	Packed contents	Order quantity	Article Number	EAN Code	Price exc. VAT
15 pc Shockwave puck set. Available only as display.					
① Shockwave Impact Duty™ screwdriving bits: 15 x 25 mm length: 1 x PH1 / 2 x PH2, 1 x PZ1 / 2 x PZ2 / 1 x PZ3, 1 x TX10 / 2 x TX15 / 2 x TX20 / 1 x TX25 / 1 x TX30. 1 x magnetic bit holder 60 mm length.	15	10	4932430904	4002395385669	£19.99
33 pc Shockwave bits & nut drivers set - Counter display					
Shockwave Impact Duty™ screwdriving bits: 24 x 25 mm length 1 x PH1 / 2 x PH2 / 1 x PH3, 2 x PZ1 / 3 x PZ2 / 2 x PZ3, 2 x TX10 / 2 x TX15 / 3 x TX20 / 2 x TX25 / 2 x TX30 / 1 x TX40 / 1 x TX50. 5 x 50 mm length 1 x PH2 / 1 x PZ2, 1 x TX15 / 1 x TX20 / 1 x TX25. 3 x Shockwave Impact Duty™ magnetic nut drivers: 48 mm length 1 x Hex 7 mm / 1 x Hex 8 mm / 1 x Hex 10 mm. 1 x magnetic bit holder 60 mm length.	33	6	4932430905	4002395385676	£54.99



Individual pieces can be ordered as well as the Counter display quantities illustrated

Shockwave Impact Duty™ sets

NEW

Description	Packed contents	Order quantity	Article Number	EAN Code	Price exc. VAT
<p>48 pc Shockwave drill & drive set - Counter display</p> <p>Shockwave Impact Duty™ screwdriving bits: 32 x 25 mm length 2 x PH1 / 2 x PH2 / 1 x PH3, 2 x PZ1 / 3 x PZ2 / 1 x PZ3, 3 x TX10 / 3 x TX15 / 3 x TX20 / 3 x TX25 / 3 x TX30 / 1 x TX40, 1 x Hex 4 mm / 1 x Hex 5 mm, 1 x SL 0.6 x 4.5 / 1 x SL 0.8 x 5.5 / 1 x SL 1.2 x 6.5, 8 x 50 mm length 1 x PH1 / 1 x PH2, 1 x PZ1, 1 x TX10 / 1 x TX15 / 1 x TX20 / 1 x TX25 / 1 x TX30, 3 x 90 mm length 1 x PZ2, 1 x TX20 / 1 x TX25, 1 x magnetic bit holder 60 mm length, 4 x Shockwave Impact Duty™ 1/4" Hex drill bits: Ø 3 / 4 / 5 / 6 mm.</p>	48	6	4932430906	4002395385683	£64.99
<p>56 pc Shockwave drive set - Counter display</p> <p>Shockwave Impact Duty™ screwdriving bits: 48 x 25 mm length 2 x PH1 / 3 x PH2 / 1 x PH3, 3 x PZ1 / 4 x PZ2 / 2 x PZ3, 3 x TX10 / 3 x TX15 / 4 x TX20 / 4 x TX25 / 4 x TX30 / 3 x TX40 / 2 x TX50, 2 x Hex 4 mm / 2 x Hex 5 mm, 2 x SL 0.6 x 4.5 / 2 x SL 0.8 x 5.5 / 2 x SL 1.2 x 6.5, 7 x 50 mm length 1 x PH2, 1 x PZ1 / 1 x PZ2, 1 x TX10 / 1 x TX15 / 1 x TX20 / 1 x TX25, 1 x magnetic bit holder 60 mm length.</p>	56	6	4932430907	4002395385690	£59.99
<p>40 pc Shockwave drill & drive set - Counter display</p> <p>Shockwave Impact Duty™ screwdriving bits: 25 x 25 mm length 1 x PH1 / 2 x PH2, 1 x PZ1 / 3 x PZ2, 2 x TX10 / 2 x TX15 / 3 x TX20 / 2 x TX25 / 2 x TX30 / 1 x TX40 / 1 x TX50, 1 x Hex 4 mm / 1 x Hex 5 mm, 1 x SL 0.6 x 4.5 / 1 x SL 0.8 x 5.5 / 1 x SL 1.2 x 6.5, 8 x 50 mm length 1 x PH2, 1 x PZ1 / 1 x PZ2, 1 x TX10 / 1 x TX15 / 1 x TX20 / 1 x TX25 / 1 x TX30, 1 x magnetic bit holder 60 mm length, 1 x magnetic bit holder 152 mm length, 3 x Shockwave Impact Duty™ 1/4" Hex drill bits: Ø 3 / 4 / 5 mm, 2 x Shockwave Impact Duty™ magnetic nut drivers: 48 mm length 1 x Hex 8 mm / 1 x Hex 10 mm.</p>	40	6	4932430908	4002395385706	£74.99



Individual pieces can be ordered as well as the Counter display quantities illustrated

SHOCKWAVE IMPACT DUTY™

Shockwave Impact Duty™ drive guide cassettes

NEW

- Slimline pocket design.
- Drive Guide bit holder with extendable sleeve to hold long screws secure. Up to 110 mm total length.
- Front loading screwdriver handle.
- Metal wire stripper for Ø 0.75 / 1.0 / 1.5 / 2.5 mm².
- Wire loop maker up to 5 mm².



Description	Total length A (mm)	Packed contents	Order quantity	Article Number	EAN Code	Price exc. VAT
-------------	---------------------	-----------------	----------------	----------------	----------	----------------

Counter display.

① 1 x PH2, 1 x PZ1 / 2 x PZ2 / 1 x PZ3, 1 x TX20 / 1 x TX25, 1 x SL 0.6 x 4.5 mm / 1 x SL 0.8 x 5.5 mm, 1 x Hex 4 / 1 x Hex 5, 1 x drive guide bit holder 76 mm length.	25	12	10	4932430909	4002395385713	£24.90
---	----	----	----	------------	---------------	--------

①



Counter display.

② 1 x PH2, 1 x PZ1 / 2 x PZ2 / 1 x PZ3, 1 x TX15 / 1 x TX20 / 2 x TX25 / 1 x TX30 / 1 x TX40, 1 x drive guide bit holder 76 mm length.	25	12	10	4932430910	4002395385720	£24.90
--	----	----	----	------------	---------------	--------

②



Counter display.

③ 2 x TX10 / 3 x TX15 / 2 x TX20 / 2 x TX25 / 1 x TX30 / 1 x TX40, 1 x drive guide bit holder 76 mm length.	25	12	10	4932430911	4002395385737	£24.90
---	----	----	----	------------	---------------	--------

③



Individual pieces can be ordered as well as the Counter display quantities illustrated

1/2" Sockets

NEW

- Impact duty (Chrome-Molybdenum) steel is high quality alloy steel which provides ultimate strength and durability.
- Best fitting thanks to 6 gripping points.
- Recessed corners allow torque to be transferred across the flats of the socket rather than producing stress on the points or corners.
- Thin wall construction provides access to tight spaces.
- Deep wall construction provides clearance for protruding bolts.
- Laser etched size markings for easy identification and won't wear off.

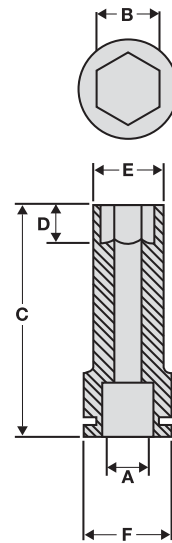

A (MM)	B (MM)	C (MM)	D (MM)	E (MM)	F (MM)	Packed contents	Article Number	EAN Code	Price exc. VAT
1/2" square	8	78	12	15	21.8	1	4932352847	4002395375059	£9.47
1/2" square	10	78	12	17	21.8	1	4932352848	4002395375066	£9.47
1/2" square	11	78	12	18	21.8	1	4932352849	4002395375073	£9.47
1/2" square	12	78	12	19	21.8	1	4932352850	4002395375080	£9.47
1/2" square	13	78	12	20	23.8	1	4932352851	4002395375097	£10.37
1/2" square	14	78	15	22	23.8	1	4932352852	4002395375103	£10.37
1/2" square	16	78	15	23.8	23.8	1	4932352853	4002395375110	£10.37
1/2" square	17	78	18	25.8	25.8	1	4932352854	4002395375127	£10.37
1/2" square	19	78	21	27.8	27.8	1	4932352855	4002395375134	£11.27
1/2" square	21	78	24	29.8	29.8	1	4932352856	4002395375141	£11.27
1/2" square	24	78	24	33.8	33.8	1	4932352857	4002395375158	£13.97
1/2" square	27	78	24	37.8	37.8	1	4932352858	4002395375165	£16.23
1/2" square	30	78	24	41.8	38	1	4932352859	4002395375172	£18.48
1/2" square	32	78	24	43.8	38	1	4932352860	4002395375189	£20.28



① 10 piece Shockwave Impact Duty™ 1/2" socket set.
 Contents: 8 / 10 / 11 / 12 / 13 / 14 / 16 / 17 / 19 / 21 mm. 10 4932352861 4002395375196 £99.95

1/4" Sockets

NEW

Description	Packed contents	Article Number	EAN Code	Price exc. VAT
-------------	-----------------	----------------	----------	----------------

20 pc Shockwave Impact Duty™ 1/4" socket set

① 12 x 1/4" sockets: 4 / 4.5 / 5 / 5.5 / 6 / 7 / 8 / 9 / 10 / 11 / 12 / 13 mm. 50 mm total length. 6 x screwdriving bits 25 mm in length: PH 2, PZ 2, TX 15, TX 20, TX 25, TX 30. 1 x socket adaptor 1/4" Hex > 1/4" square drive. 1 x bit adaptor 1/4" square (F) > 1/4" Hex. Magnetic bit holder for screwdriving bits. 20 4932352862 4002395375202 £99.95

A	B (MM)	C (MM)	D (MM)	E (MM)	F (MM)
1/4"	4	50	3	7.7	12.8
1/4"	4.5	50	3.5	8	12.8
1/4"	5	50	4	8.8	12.8
1/4"	5.5	50	4.5	9.5	12.8
1/4"	6	50	6	9.8	12.8
1/4"	7	50	6	11.4	12.8
1/4"	8	50	7.5	12.5	12.8
1/4"	9	50	7.5	13.8	13.8
1/4"	10	50	9	14.3	14.3
1/4"	11	50	11	16.8	16.8
1/4"	12	50	12	17.8	17.8
1/4"	13	50	12	18.8	18.8

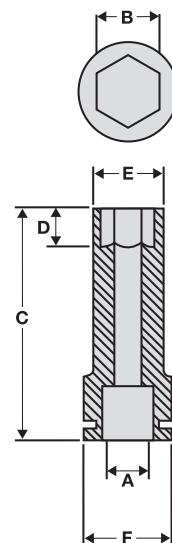



SHOCKWAVE IMPACT DUTY™

Magnetic bit holder

NEW

Custom engineered steel and heat treatment for maximum strength and flexibility.
Solid construction withstands abuse in impact applications.
Strong magnetic tip for secure grip.

Description	Total length A (mm)	Packed contents	Order quantity	Article Number	EAN Code	Price exc. VAT
① Magnetic bit holder with 1/4" Hex reception (DIN 3126 - E 6.3).	60	1	1	4932352406	4002395370658	£8.99
② 100 pcs bulk box. Orders are only possible in multiples of 100 pcs (i.e. 200, 300...). Minimum order quantity is 100 pcs.	60	100	1	4932430478	4002395381395	£8.99
③ 	152	1	1	48324511	045242301980	£9.99
④ 	305	1	1	48324512	045242301997	£12.99
③ Magnetic bit holders- long series 152 mm with 1/4" Hex reception (DIN 3126 - E 6.3).	152	1	1	48324511	045242301980	£9.99
④ Magnetic bit holders- long series 305 mm with 1/4" Hex reception (DIN 3126 - E 6.3).	305	1	1	48324512	045242301997	£12.99



Magnetic nut drivers

NEW

Custom engineered steel and heat treatment for maximum strength and extreme durability.
Strong magnetic tip for secure grip.
Reception: 1/4" Hex (DIN 3126 - E 6.3). Very suitable for high torque and impact applications.

Size AF (across flats) (mm)	For anchor rod thread size	Total length A (mm)	Packed contents	Article Number	EAN Code	Price exc. VAT
5.5	M3	65	1	4932352536	4002395371945	£9.99
6.0	M3.5	65	1	4932352537	4002395371952	£9.99
1/4"	-	65	1	4932352538	4002395371969	£9.99
7.0	M4	65	1	4932352539	4002395371976	£9.99
5/16"	-	65	1	4932352540	4002395371983	£9.99
8.0	M5	65	1	4932352541	4002395371990	£9.99
3/8"	-	65	1	4932352542	4002395372003	£9.99
10.0	M6	65	1	4932352543	4002395372010	£10.99
12.0	M7	65	1	4932352544	4002395372027	£10.99
13.0	M8	65	1	4932352545	4002395372034	£10.99
17.0	M10	65	1	4932352546	4002395372041	£13.99
① 5 piece Shockwave Impact Duty™ nut driver set. Ø 7 / 8 / 10 / 12 / 13 mm.			5	4932352822	4002395374809	£49.99



Socket and bit adaptors

NEW

Description	Total length A (mm)	Packed contents	Article Number	EAN Code	Price exc. VAT
① Socket adaptor: 1/4" Hex - 1/4" square drive. DIN 3126 - E 6.3.	50	1	48325030	045242195039	£7.99
② Socket adaptor: 1/4" Hex - 1/2" square drive. DIN 3126 - E 6.3.	50	1	48325032	045242195046	£7.99
③ Bit adaptor: 1/2" square drive - 1/4" F. To accept screwdriving bits.	50	1	48034410	045242195015	£24.73





Metal drill bits SHOCKWAVE™ HSS-Ground

NEW

Drill bit quality: High quality high speed steel ground from solid.

Tip geometry: Split point DIN 1412 C. Point angle: 135°.

Flute: Thunderweb design. Reception: 1/4" Hex (DIN 3126 - E 6.3).

Surface / Colour: black oxide. Right hand cutting edge.

Application: Suitable for drilling in steel, cast iron, alloyed and non-alloyed material up to 900 N/mm² and wood / plastics.

Thunderweb parabolic shaped web is characterised by larger web cross section for extra strength.

Accepts higher feed pressure and torque for longer lifetime.

Thunderweb flute is an open flute with flatter twist angle for smaller chippings, ideal for drilling harder steels i.e. stainless steel.

Ejects hot chips rapidly, dissipates heat better increasing lifetime.

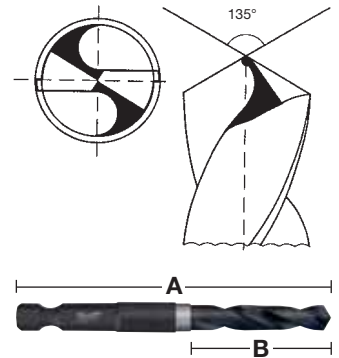

①

Ø (mm)	Total length A (mm)	Working length B (mm)	Packed contents	Article Number	EAN Code	Price exc. VAT
3	70	23	1	4932352448	4002395371075	£4.99
3.2	70	23	1	4932352606	4002395372645	£3.99
4	80	32	1	4932352449	4002395371082	£4.99
4.8	90	29	1	4932352607	4002395372652	£4.99
5	90	29	1	4932352450	4002395371099	£4.99
6	93	32	1	4932352451	4002395371105	£5.99
7	96	35	1	4932352452	4002395371112	£5.99
8	96	35	1	4932352453	4002395371129	£5.99

① 6 pc Shockwave Impact Duty™ set.

Ø 3 / 4 / 5 / 6 / 7 / 8 mm.

6

4932352454

4002395371136

£26.99

KNUCKLE™

Offset attachment for heavy duty impact applications.

- Impact rated. Can be used with both cordless and impact drills.
- Very compact offset attachment.
- Ideally suited to working in confined and limited spaces.
- Solid metal construction to absorb impact action.
- 0° and 30° positions.
- 1/4" Hex shank fits directly into the chuck preventing slippage.
- 0° and 30° positions. Solid metal construction to absorb impact action.
- Suitable for use with 1/4" Hex impact drivers up to 180 Nm torque.



* Height when 30° tilted 40 mm



①

Description	Packed contents	Order quantity	Article Number	EAN Code	Price exc. VAT
Knuckle™					
1 x Knuckle™, 1 x PH1 / 2 x PH2, 1 x PZ1 / 2 x PZ2 / 1 x PZ3, 1 x TX15 / 1 x TX20 / 1 x TX25.	11	1	4932352938	4002395375967	£34.90
① Counter display.					
10 x 11 pc set 4932352938.	10	1	4932352939	4002395375974	£299.90



OSD2 - Offset Screwdriver/ drill

The **OSD 2 screwdriver / drill angle attachment** is the ideal solution for all screwdriving and drilling applications in restricted areas.



1/4" magnetic Hex bit reception accepts both standard 25 mm (C 6.3) and ball end reception (E 6.3), with bit locking mechanism.

Metal gears and housing for smooth and precise running and excellent power transmission.

360° rotatable softgrip side handel for left and right hand use with 4 lock positions.

Two step Hex shaft to fit either 1/4" / (6 mm) Hex shaft or 10 mm Hex shaft.

Industrial quality designed for use with all cordless tools in applications up to 40 Nm torque and a maximum of 1750 rpm.

The OSD2 is capable of both drilling and screwdriving applications offering maximum versatility.

Only 51 mm in height for use in confined spaces.



Description	Packed contents	Order quantity	Article Number	EAN Code	Price exc. VAT
① OSD 2 Counter display.	1	1	4932352320	4002395369799	£79.99
② 6 x OSD 2 (single OSD 2 4932352320).	6	1	4932352321	4002395369805	£479.94



System attachments - Screwdrivers

Description	Fits corded screwdrivers	Packed contents	Article Number	EAN Code	Price exc. VAT
① Drywall sleeve assembly.	DWE 4000 Q, DWSE 4000 Q, TKSE 2500 Q, 6790, 6743	1	49261036	045242185245	£5.94
② Self drill sleeve assembly.	TKSE 2500 Q, 6790	1	49261082	045242185375	£5.94
Magnetic bit holder 1/4". Length 76 mm.	DWE 4000 Q, DWSE 4000 Q, 6743	1	48323065	045242128600	£13.48
Magnetic bit holder 1/4". Length 76 mm. Requires additionally 49261036 sleeve assembly.	TKSE 2500 Q, 6790	1	48323070	045242128655	£14.70
③ 3 piece Hexagon socket set. Ø 6 / 8 / 10 mm magnetic sockets.		3	49663004	045242207848	£36.47
④ M12 BDDX-OA Offset attachment for screwdriving applications. 12 fixing positions.		1	4932430432	4002395380930	£45.99
⑤ M12 BDDX-RAA Right angle attachment for drilling and screwdriving applications in confined spaces. 90° angle. 12 fixing positions. Direct bit reception.		1	4932430433	4002395380947	£58.99



System attachments - Sharp-Fire screwdrivers

Description	Fits corded screwdrivers	Packed contents	Article Number	EAN Code	Price exc. VAT
① Square drive bit. For use with Sharp-Fire magazine 48051000. 120 mm long.	DWE 4000 Q, SE 2500 LMQ, TKSE 2500 Q	1	48301526	045242124312	£9.19
① Square drive bit. For use with Sharp-Fire magazine 48051005. 140 mm long.	DWE 4000 Q, SE 2500 LMQ, TKSE 2500 Q	1	48301527	045242124329	£9.52
② Phillips drive bit. For use with Sharp-Fire magazine 48051005. 140 mm long.	DWE 4000 Q, SE 2500 LMQ, TKSE 2500 Q	1	48301528	045242124336	£12.69









System attachments - Impact wrenches

Description	Packed contents	Article Number	EAN Code	Price exc. VAT
Detent pin square type. Socket will not slip off unless detent pin is pressed in.	1	49170405	045242178919	£4.58
① Adaptor 1/2" square drive to 3/16" and Hex 11 mm. For use with 3/16" selffeed bits and impact auger bits.	1	48660061	045242155118	£27.08
② Rubber Sleeve for M18 CIW	1	49162754	045242320455	£40.00
② Rubber Sleeve for M18 CHIW & M28 CHIW	1	49162763	045242324255	£65.00



FIXTEC and SDS-plus chuck adaptors

Tool Drive	Reception	Id. No. 4932	EAN Code 4002395	Price exc. VAT	
① FIXTEC	SDS-plus	379877	346561	£30.32	① 
② FIXTEC	SDS-plus	399152	357628	£31.80	② 
③ FIXTEC	SDS-plus	352299	369584	£24.73	③ 
④ FIXTEC	1/2" x 20 UNF	371807	344710	£26.43	④ 
⑤ FIXTEC	1/2" x 20 UNF	399154	357635	£24.28	⑤ 
<p>Only suitable for PLH 16 QEX, V28 HX, V18 HX, PLH 26 QEX, PH 30 Power X, KH 26 XE, KH 24 XE, KH 28 Super XE, BH 26 LXE and PH 26 X.</p>					
⑥ SDS-plus	1/2" x 20 UNF	367438	337668	£30.41	⑥ 
<p>Chuck adaptor with direct bit reception (1/4" Hex) to accept screwdriving bits. Threaded housing enables adaptor to be tightened to the chuck resulting in no wobble.</p>					
⑦ SDS-plus	1/2" x 20 UNF	367166	334438	£12.52	⑦ 
<p>Chuck adaptor with retaining screw.</p>					

Keyed chucks

Chuck jaws open (mm)	Drill reception	Locking device	Safety screw	Rotary drill	Percussion drill	Battery drill	Chuck key	Packed contents	Article Number	EAN Code	Price exc. VAT
1.0-10	3/8" x 24	✓	✓	✓	✓	✓	A	1	4932373412	4002395349760	£16.91
1.0-10	1/2" x 20	✓	✓	✓	✓	✓	A	1	4932269401	4002395302932	£15.46
1.5-13	1/2" x 20			✓	✓	✓	A	1	4932218111	4002395300051	£15.54
1.5-13	1/2" x 20	✓	✓	✓	✓	✓	A	1	4932267980	4002395300488	£16.56
1.0-16	Taper B16			✓			C	1	4932127010	4002395306169	£82.95
3.0-16	M18x2.5	✓	✓	✓	✓		C	1	4932320014	40023953310784	£56.47
3.0-16	1/2" x 20			✓	✓		C	1	4932363753	4002395332953	£45.41
5.0-20	Taper B22			✓			E	1	4932117031	4002395305827	£104.01



Keyed chucks - machine specific

Chuck jaws open (mm)	Drill reception	Fits drill drivers	Safety screw	Chuck key	Packed contents	Article Number	EAN Code	Price exc. VAT
1.0-10	3/8" x 24	HDE 6 RQ	✓	H	1	48660817	045242155705	£33.47
1.0-10	3/8" x 20	HDE 10 RQ	✓	J	1	48662115*	045242157327	£62.85
2.0-13	1/2" x 20	HDE 13 RQD	✓	K	1	48661355	045242156542	£16.85



Keyed chucks with 1/4" Hex reception

Chuck jaws open (mm)	Drill reception	Battery drill	Chuck key	Packed contents	Article Number	EAN Code	Price exc. VAT
0.5-6.5	1/4" Hex	✓	D	1	4932314867	4002395300112	£28.67



Chuck keys

Description	Type	Ref. No.	Packed contents	Article Number	EAN Code	Price exc. VAT
① Chuck key	A	S2A	1	4932221378	4002395302765	£2.85
	B	S2AT	1	4932310612	4002395309177	£5.78
	C	S3T	1	4932221379	4002395306381	£6.71
	D	S14	1	4932304684	4002395300105	£4.21
	E	S4	1	4932221380	4002395306398	£15.11
	G	S2	1	4932319995	4002395303724	£2.56
	H		1	48663350	045242157600	£4.87
② Spanner (SW13) to remove chucks.	J		1	48663240	045242157501	£7.14
	K		1	48663280	045242157556	£6.03
③ Morse taper No. 3 adaptor for chucks with B16 taper.			1	4932315788	4002395302611	£0.71
	MT3 - B16		1	4932117042	4002395305834	£16.36
③ Morse taper No. 3 adaptor for chucks with B22 taper.	MT3 - B22		1	4932117044	4002395305841	£17.33
	Ejector tool DIN 317 size 3.		1	4932604226	4002395311248	£8.96

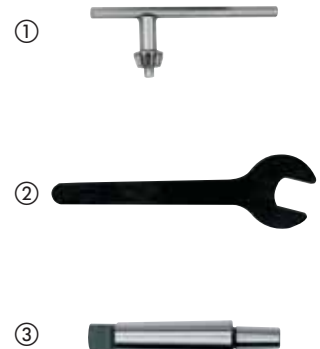

Keyless chucks

Chuck jaws open (mm)	Reception	Locking device	Safety screw	Rotary drill	Percussion drill	Battery drill	Packed contents	Article Number	EAN Code	Price exc. VAT
1.0-10	5/8" x 24		✓	✓		✓	1	4932349457	4002395318155	£30.87
1.0-10	1/2" x 20	✓	✓	✓	✓	✓	1	4932364382	4002395337675	£29.85
1.5-13	1/2" x 20	✓		✓	✓	✓	1	4932376531	4002395346332	£31.82
1.5-13	1/2" x 20	✓	✓	✓	✓	✓	1	4932376533	4002395346349	£32.74
1.5-13	1/2" x 20	✓		✓	✓	✓	1	4932364265	4002395334056	£36.69
1.5-13	1/2" x 20	✓	✓	✓	✓	✓	1	4932364267	4002395334070	£37.27



Keyless chucks for FIXTEC (spindle lock) machines

Chuck jaws open (mm)	Reception	Locking device	Safety screw	Rotary drill	Percussion drill	Battery drill	Packed contents	Article Number	EAN Code	Price exc. VAT
1.0-10	5/8" x 24	✓	✓	✓	✓	✓	1	4932371018	4002395339365	£30.28
1.0-10	1/2" x 20	✓	✓	✓	✓	✓	1	4932372443	4002395345458	£30.28
1.5-13	1/2" x 20	✓	✓	✓	✓	✓	1	4932371913	4002395345366	£39.60
1.5-13	5/8" x 24	✓	✓	✓	✓	✓	1	4932399492	4002395361137	£36.89



Industrial keyless chucks for percussion drills

Chuck jaws open (mm)	Reception	Locking device	Rotary drill	Percussion drill	Battery drill	Packed contents	Article Number	EAN Code	Price exc. VAT
1.0-13	1/2" x 20	✓	✓	✓	✓	1	4932364266	4002395334063	£90.59



Industrial keyless chucks for rotary drills

Chuck jaws open (mm)	Reception	Locking device	Rotary drill	Percussion drill	Battery drill	Packed contents	Article Number	EAN Code	Price exc. VAT
3.0-16	B16		✓			1	4932127011	4002395306176	£88.80



Keyless chucks - specific tool related chucks

Chuck jaws open (mm)	Reception	Machine specific	Locking device	Rotary drill	Safety screw	Packed contents	Article Number	EAN Code	Price exc. VAT
① 1.0-10	1/2" x 20	HDE 10 RQX			✓	1	48661520	045242156795	£51.72
① 1.5-13	1/2" x 20	HDE 13 RQX			✓	1	42660755	4002395891436	£38.74
② 1.5-13	FIXTEC		✓	✓		1	4932399214	4002395358236	£64.80
③ 1.0-10	FIXTEC	M12 BDDX		✓		1	4932430444	4002395381050	£23.99



Wet Diamond Drilling Cores

WCHP-SB
8–50 mm



- ① Standard 1/2" G reception
- ② Standard 1 1/4" UNC reception
- ③ Engraving of diameter and type on the core reception for longterm visibility
- ④ Laser welded segments guarantee against break off
- ④ 10 mm segment height for superior lifetime



WCHP-SB
52–152 mm



WCHP
52–350 mm



- Extra thin 2 mm segment for fast and aggressive drilling in reinforced concrete
- Closed ring segment for outstanding performance in tough applications

- Uniquely designed TURBO shaped segments
- Pre-grinded, for best performance right from the first hole
 - One outer and two inner slots enable improved cooling and increased material removal

Material	WCHP-SB WCHP
Aerated/breeze concrete blocks	✓
Artificial stone – hard	✗
Asphalt	✗
Concrete pipes	✓
Concrete reinforced – very abrasive: e.g. – with flint aggregate – with silex (flint) aggregate – soft/green concrete	◆
Concrete reinforced – low abrasive: e.g. – with limestone aggregate	✓
Concrete reinforced – with hard aggregates: e.g. – with granite aggregate – quartz sand aggregate	✓
Fireclay bricks	✗
Lime/sandstone blocks – very hard	✗
Lime/sandstone blocks – medium to hard	◆
Lime/sandstone blocks – soft/abrasive	◆
Granite	✗
Marble	◆
Porphyry	✗
Screed	✓
Stoneware/clay pipes	◆
Slate	◆
Tiles – hard	◆
Tiles – soft	◆

- ✓ Most suitable. Recommended for these materials.
- ◆ Limited suitability – recommended for intermittent use. Very good drilling characteristics, but reduced lifetime.
- ✗ Not suitable. Not recommended for these materials.

Wet diamond drilling cores

Ø (mm)	Description	Fits DD3-152	Fits DCM2-250C & DCM2-350C	Core reception	Working length B (mm)	Total length A (mm)	Packed contents	Article Number	EAN Code	Price exc. VAT
8	WCHP-SB 8	✓	◆	1/2 Gas	70	135	1	4932352072	4002395367269	£78.14
12	WCHP-SB 12	✓	◆	1/2 Gas	200	265	1	4932352074	4002395367283	£80.06
14	WCHP-SB 14	✓	◆	1/2 Gas	300	365	1	4932352075	4002395367290	£83.86
16	WCHP-SB 16	✓	◆	1/2 Gas	300	365	1	4932352077	4002395367313	£85.39
18	WCHP-SB 18	✓	◆	1/2 Gas	300	365	1	4932352078	4002395367320	£92.98
20	WCHP-SB 20	✓	◆	1/2 Gas	300	365	1	4932352079	4002395367337	£96.82
22	WCHP-SB 22	✓	◆	1/2 Gas	300	365	1	4932352080	4002395367344	£99.10
24	WCHP-SB 24	✓	◆	1/2 Gas	300	365	1	4932352081	4002395367351	£102.15
25	WCHP-SB 25	✓	◆	1/2 Gas	300	365	1	4932352082	4002395367368	£111.52
28	WCHP-SB 28	✓	◆	1/2 Gas	300	365	1	4932352083	4002395367375	£122.95
30	WCHP-SB 30	✓	◆	1/2 Gas	300	365	1	4932352084	4002395367382	£131.53
32	WCHP-SB 32	✓	◆	1/2 Gas	300	365	1	4932352085	4002395367399	£134.92
35	WCHP-SB 35	✓	◆	1/2 Gas	300	365	1	4932352086	4002395367405	£138.97
37	WCHP-SB 37	✓	◆	1/2 Gas	300	365	1	4932352087	4002395367412	£139.50
40	WCHP-SB 40	✓	◆	1/2 Gas	300	365	1	4932352088	4002395367429	£148.08
42	WCHP-SB 42	✓	◆	1/2 Gas	300	365	1	4932352089	4002395367436	£148.34
45	WCHP-SB 45	✓	◆	1/2 Gas	300	365	1	4932352090	4002395367443	£180.25
50	WCHP-SB 50	✓	◆	1/2 Gas	300	365	1	4932352092	4002395367467	£203.94
52	WCHP 52		✓	1 1/4 UNC	420	500	1	4932399707	4002395363582	£160.45
52	WCHP-SB 52	✓		1 1/4 UNC	420	500	1	4932352734	4002395373925	£160.45
62	WCHP 62		✓	1 1/4 UNC	420	500	1	4932399708	4002395363599	£175.78
62	WCHP-SB 62	✓		1 1/4 UNC	420	500	1	4932352735	4002395373932	£175.78
72	WCHP 72		✓	1 1/4 UNC	420	500	1	4932399709	4002395363605	£191.05
82	WCHP 82		✓	1 1/4 UNC	420	500	1	4932399710	4002395363612	£221.41
82	WCHP-SB 82	✓		1 1/4 UNC	420	500	1	4932352736	4002395373949	£221.41
92	WCHP 92		✓	1 1/4 UNC	420	500	1	4932399711	4002395363629	£248.95
92	WCHP-SB 92	✓		1 1/4 UNC	420	500	1	4932352737	4002395373956	£248.95
102	WCHP 102		✓	1 1/4 UNC	420	500	1	4932399712	4002395363636	£268.71
102	WCHP-SB 102	✓		1 1/4 UNC	420	500	1	4932352738	4002395373963	£268.71
112	WCHP 112		✓	1 1/4 UNC	420	500	1	4932399713	4002395363643	£281.15
112	WCHP-SB 112	✓		1 1/4 UNC	420	500	1	4932352739	4002395373970	£281.15
122	WCHP 122		✓	1 1/4 UNC	420	500	1	4932399714	4002395363650	£319.41
122	WCHP-SB 122	✓		1 1/4 UNC	420	500	1	4932352740	4002395373987	£319.41
132	WCHP 132		✓	1 1/4 UNC	420	500	1	4932399715	4002395363667	£337.81
132	WCHP-SB 132	✓		1 1/4 UNC	420	500	1	4932352741	4002395373994	£337.81
152	WCHP 152		✓	1 1/4 UNC	420	500	1	4932399716	4002395363674	£364.38
152	WCHP-SB 152	✓		1 1/4 UNC	420	500	1	4932352742	4002395374007	£364.38
162	WCHP 162		✓	1 1/4 UNC	420	500	1	4932399717	4002395363681	£400.53
172	WCHP 172		✓	1 1/4 UNC	420	500	1	4932352052	4002395367092	£427.09
182	WCHP 182		✓	1 1/4 UNC	420	500	1	4932399718	4002395363698	£448.33
202	WCHP 202		✓	1 1/4 UNC	420	500	1	4932399719	4002395363704	£513.97
225	WCHP 225		✓	1 1/4 UNC	420	500	1	4932399720	4002395363711	£678.37
250	WCHP 250		✓	1 1/4 UNC	420	500	1	4932399721	4002395363728	£747.07
300	WCHP 300		✓	1 1/4 UNC	420	500	1	4932399722	4002395363735	£812.67
350	WCHP 350		✓	1 1/4 UNC	420	500	1	4932399723	4002395363742	£901.25

✓ Most suitable

◆ Limited suitability

WCHP-SB
Ø 8–50 mm

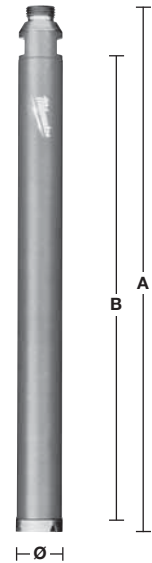

WCHP-SB
Ø 52–152 mm

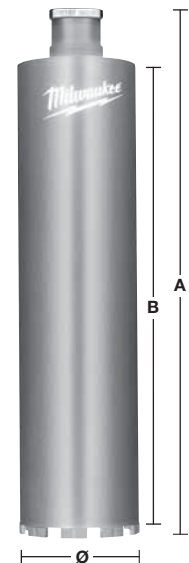

WCHP
Ø 52–350 mm

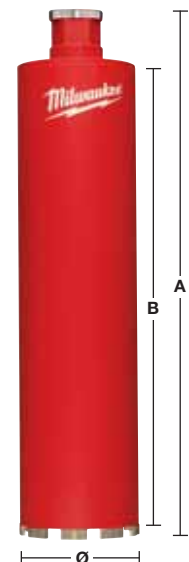

System attachments - wet diamond drilling

Description	Fits DD3-152	Fits DCM2-250C & DCM2-350C	Packed contents	Article Number	EAN Code	Price exc. VAT
Fixing kit. For exclusive use in concrete. Ø 16 mm drill bit is required to set the drop anchor.						
① Stud bolt, setting tool, wing nut, washer and 5 pcs M12™ drop anchor.	✓	✓	9	4932399731	4002395363827	£80.89
1 3/8" open ended spanner. For holding the motor output spindle while removing a core bit.		✓	1	49964705	04524222766	£24.15
32 mm ended spanner. For holding the motor output spindle while removing a core bit.	✓		1	4931428009	4002395844791	£12.95
41 mm open ended spanner. For removing the core bit from the motor spindle.	✓	✓	1	4931428010	4002395844807	£19.04
Fixtec release. Suitable for all diamond motors with 1 1/4" spindle reception. Prevents the core bit from locking itself too tight onto the machine spindle. The core bits can then be released and removed with minimum effort.	✓	✓	1	4932352053	4002395367108	£106.21
1 1/4" female to 1/2" female adaptor. To enable the connection of <50 mm diamond core bits on a 1 1/4" machine spindle thread.	✓	✓	1	4932352627	4002395372850	£29.02
1 1/4" female / male extension rod, length 300 mm.	✓	✓	1	4932399724	4002395363759	£103.44
③ 1 1/4" female / male extension rod, length 500 mm.	✓	✓	1	4932399725	4002395363766	£150.16
Telescopic extension. Extension pole used to fix drill rig to the ground instead of anchor bolts. Maximum load of 500 kg and adjustable extension height from 1.8-2.9 m.	✓	✓	1	4932399732	4002395363834	£620.61
⑤ Vacuum pump VP6. For fastening of the diamond drill rig on smooth and even surfaces. Suction capacity: 850 mbar. Max. vacuum pressure: 6 m³/h / 100 l/min. Rated voltage: 220-240 V.	✓	✓	1	4932352094	4002395367474	£1509.84
⑥ Vacuum plate. Replacement rubber seal 4931428665.	✓		1	4932352676	4002395373345	£213.84
⑦ WT 10 watertank. 10 liters capacity, steel, water tank with inside and outside polyester coating. Reliable brass pump with a max. pressure bar of 6 bar. 2.5 m hose with quick connection system fits direct to Milwaukee® diamond drills.	✓	✓	1	4932399726	4002395363773	£321.84
⑧ Water collection ring. For use with drill rig DR 152 T. For use with max. Ø 152 mm core bits.			1	4932352677	4002395373352	£286.20
Replacement rubber ring for DR 152 T.			1	4932352678	4002395373369	£31.92
⑨ Water collection ring. For use with drill rig DR 250 TV. For use with max. Ø 180 mm core bits.			1	4932399727	4002395363780	£421.20
Replacement rubber ring for DR 250 TV.			1	4932399729	4002395363803	£52.92
⑨ Water collection ring. For use with drill rig DR 350 T. For use with max. Ø 300 mm core bits.			1	4932399728	4002395363797	£466.52
Replacement rubber ring for DR 350 T.			1	4932399730	4002395363810	£55.05
⑩ Spacer block T = 50 mm. Needs to be mouted between drill rig and motor cores > 250 mm and max. 350 mm. Included in drill rig DR 350 T.		✓	1	4932399736	4002395363872	£216.91
Quick connection motor mounting plate. Included in both drill rigs DR 250 TV and DR 350 T.		✓	1	4932399733	4002395363841	£216.91

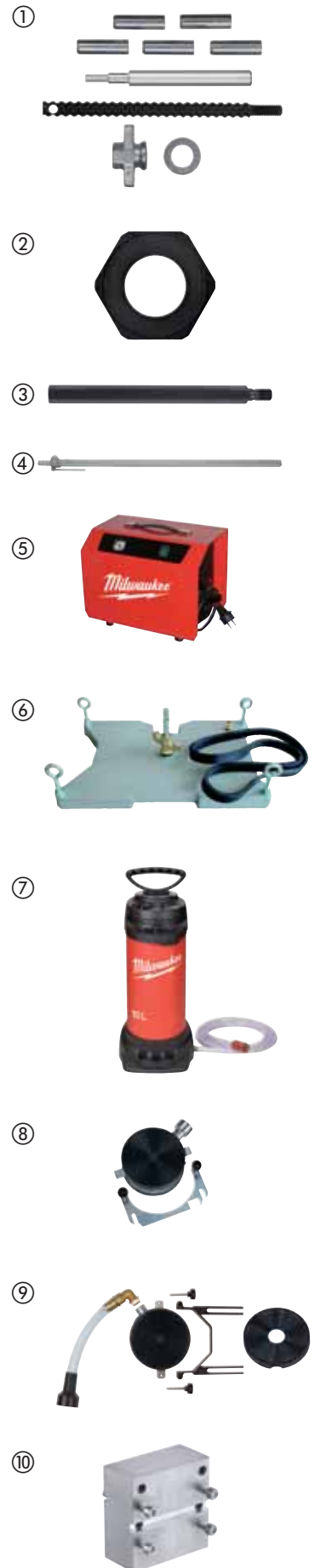

FIXTEC Diamond Core System

The patented Milwaukee® range of FIXTEC diamond core adaptors allows changing diamond cores in a matter of seconds without the use of extra tools.

The most common complaint with existing systems is that the diamond core locks itself tight onto the machine making it increasingly difficult to later remove the core, even with the aid of spanners and wrenches. However with the new FIXTEC adaptor solution from Milwaukee® this is a problem of the past, the cores can be unscrewed, removed and exchanged quite simply by hand – there is no need for spanners or wrenches.

The revolutionary FIXTEC adaptors are available with or without dust absorption and with different tool receptions making them compatible to other manufacturers tools.

The Past



The Future



FIXTEC solution

FIXTEC solution with dust extraction

FIXTEC Clean Liner Rotor (CLR) Fits to diamond cores with 1 ¼" UNC thread. The added advantage of dust absorption allows drilling speed to be increased and extends the lifetime of the diamond cores.

Description	Tool reception	Core reception	Packed contents	Article Number	EAN Code	Price exc. VAT
-------------	----------------	----------------	-----------------	----------------	----------	----------------

FIXTEC Clean Line Rotor (CLR).	M18 x 2.5	1 ¼" UNC	1	4932352172	4002395368242	£420.12
--------------------------------	-----------	----------	---	------------	---------------	---------



FIXTEC solution without dust extraction

FIXTEC adaptor Fits to diamond cores with M16 thread. As centering drill bit a standard SDS-plus drill bit can be used.

Description	Tool reception	Core reception	Packed contents	Article Number	EAN Code	Price exc. VAT
-------------	----------------	----------------	-----------------	----------------	----------	----------------

FIXTEC adaptor. Tool changing in seconds. No extra tool required.	M18 x 2.5	M16	1	4932399174	4002395357819	£128.52
	11 mm Hex	M16	1	4932399220	4002395358342	£139.32



Dry diamond cores with dust extraction - DCHXL

- 10 mm high segments for longer life.
- Laser welded segments for extra durability.
- Use with the machine set to rotary only, not suitable for hammer action.
- During pre-drilling the centering unit (centering stars, guide rod and SDS Plus pilot drill bit) must be used.

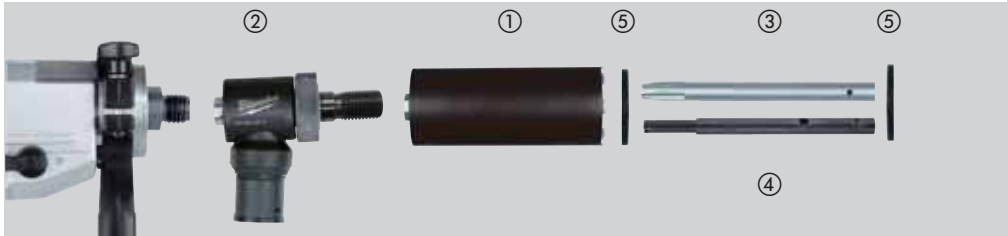

Material	DCHXL	Material	DCHXL
Aerated/breeze concrete blocks	◆	Granite	✘
Artificial stone – hard	✘	Lime/sandstone – hard	✓
Brick – very hard, engineering brick	✓	Lime/sandstone – soft/abrasive	◆
Brick – medium	✓	Marble	✘
Brick – soft	◆	Tiles	✘
Concrete	✘		

✓ Most suitable. Recommended for these materials.
✘ Not suitable. Not recommended for these materials.

◆ Limited suitability – recommended for intermittent use.
Very good in drilling characteristics, but reduced lifetime.

Description	Ø (mm)	Core reception	Working length B (mm)	Total length A (mm)	Packed contents	Article Number	EAN Code	Price exc. VAT
DCHXL 38*	38	1 1/4" UNC	420	490	1	4932399753	4002395364060	£137.81
DCHXL 52	52	1 1/4" UNC	420	490	1	4932399163	4002395357703	£165.37
DCHXL 68	68	1 1/4" UNC	420	490	1	4932399164	4002395357710	£183.75
DCHXL 82	82	1 1/4" UNC	420	490	1	4932399165	4002395357727	£206.71
DCHXL 102	102	1 1/4" UNC	420	490	1	4932399166	4002395357734	£268.73
DCHXL 107	107	1 1/4" UNC	420	490	1	4932399754	4002395364077	£277.92
① DCHXL 112	112	1 1/4" UNC	420	490	1	4932399167	4002395357741	£289.41
DCHXL 117	117	1 1/4" UNC	420	490	1	4932399755	4002395364084	£298.59
DCHXL 122	122	1 1/4" UNC	420	490	1	4932399168	4002395357758	£310.08
DCHXL 127	127	1 1/4" UNC	420	490	1	4932399169	4002395357765	£321.56
DCHXL 132	132	1 1/4" UNC	420	490	1	4932399170	4002395357772	£335.34
DCHXL 152	152	1 1/4" UNC	420	490	1	4932399171	4002395357789	£367.49
DCHXL 162	162	1 1/4" UNC	420	490	1	4932399172	4002395357796	£401.95

* During pre-drilling no centering star required.

Description	Tool reception	Core reception	Packed contents	Article Number	EAN Code	Price exc. VAT
FIXTEC Clean Line Rotor (CLR)	M18 x 2.5	1 1/4" UNC	1	4932352172	4002395368242	£420.12

Description	Packed contents	Article Number	EAN Code	Price exc. VAT
③ Guide rod for DD2-160. Supplied with locking screw (4931622432). Requires allen key (4931616044) and SDS-plus pilot drill bit (Ø 8 x 160 mm, 4932307071).	1	4932399173	4002395357802	£46.35
④ Guide rod for DD3-152. Requires SDS-plus pilot drill bit (Ø 8 x 110 mm, 4932307070).	1	4932352679	4002395373376	£129.00

Ø (mm)	Article Number	EAN Code	Price exc. VAT	Ø (mm)	Article Number	EAN Code	Price exc. VAT
52	4931393176	4002395358380	£6.62	117	4931403508	4002395364107	£8.96
68	4931393177	4002395358397	£6.82	122	4931393181	4002395780709	£9.84
82	4931393178	4002395358403	£7.61	127	4931393182	4002395780716	£11.10
⑤ 102	4931393179	4002395358410	£8.00	132	4931393183	4002395358458	£12.38
107	4931403507	4002395364091	£8.25	152	4931393184	4002395358465	£12.38
112	4931393180	4002395358427	£8.76	162	4931393185	4002395358472	£13.55



Dry diamond cores for electrical sockets with dust extraction - DCHX

- 10 mm high segments for longer life.
- Laser welded segments for extra durability.
- Suitable for installation of electrical sockets and junction boxes.
- Use with the machine set to rotary only, not suitable for hammer action.

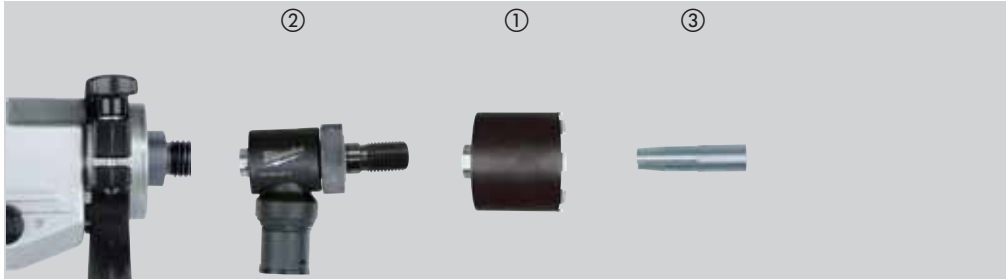

Material	DCHX	Material	DCHX
Aerated/breeze concrete blocks	◆	Granite	✘
Artificial stone – hard	✘	Lime/sandstone – hard	✓
Brick – very hard, engineering brick	✓	Lime/sandstone – soft/abrasive	◆
Brick – medium	✓	Marble	✘
Brick – soft	◆	Tiles	✘
Concrete	✘		

- ✓ Most suitable. Recommended for these materials.
- ◆ Limited suitability – recommended for intermittent use. Very good in drilling characteristics, but reduced lifetime.
- ✘ Not suitable. Not recommended for these materials.

Description	Ø (mm)	Core reception	Working length B (mm)	Total length A (mm)	Packed contents	Article Number	EAN Code	Price exc. VAT
① DCHX 68	68	1 1/4" UNC	60	130	1	4932399217	4002395358311	£108.09
DCHX 82	82	1 1/4" UNC	60	130	1	4932399218	4002395358328	£148.62

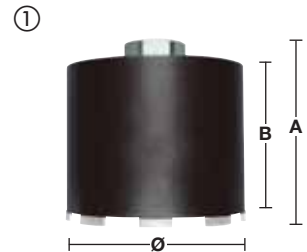

Description	Tool reception	Core reception	Packed contents	Article Number	EAN Code	Price exc. VAT
-------------	----------------	----------------	-----------------	----------------	----------	----------------



FIXTEC Clean Line Rotor (CLR)	M18 x 2.5	1 1/4" UNC	1	4932352172	4002395368242	£420.12
-------------------------------	-----------	------------	---	------------	---------------	---------

Description	Packed contents	Article Number	EAN Code	Price exc. VAT
-------------	-----------------	----------------	----------	----------------



③ Guide rod for DD2-160. Supplied with locking screw (4931622432). Requires allen key (4931616044) and SDS-plus pilot drill bit (Ø 8 x 160 mm, 4932307071).	1	4932399173	4002395357802	£46.35
---	---	------------	---------------	--------

④ Guide rod for DD3-152. Requires SDS-plus pilot drill bit (Ø 8 x 110 mm, 4932307070).	1	4932352679	4002395373376	£129.00
--	---	------------	---------------	---------

Dry diamond drilling for electrical sockets without dust extraction - DCU / DCH

- 7 mm high segments.
- Laser welded segments for extra durability.
- Suitable for installation of electrical sockets and junction boxes.
- Use with the machine set to rotary only, not suitable for hammer action.

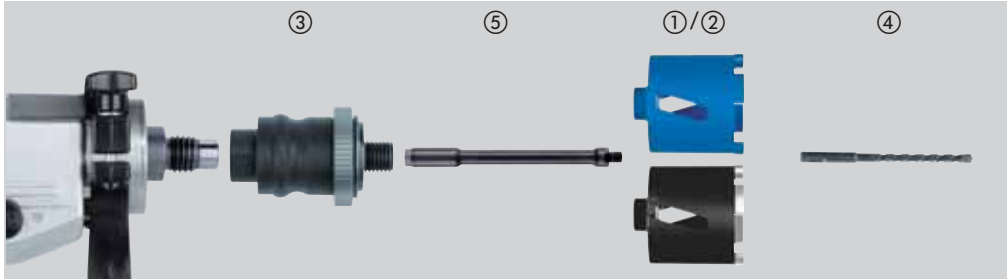

Material	DCU	DCH	Material	DCU	DCH
Aerated/breeze concrete blocks	◆	◆	Granite	✗	✗
Artificial stone – hard	✗	✗	Lime/sandstone – hard	◆	✓
Brick – very hard, engineering brick	◆	✓	Lime/sandstone – soft/abrasive	✓	◆
Brick – medium	✓	✓	Marble	✗	✗
Brick – soft	✓	◆	Tiles	✗	✗
Concrete	✗	✗			

- ✓ Most suitable. Recommended for these materials.
- ◆ Limited suitability – recommended for intermittent use. Very good in drilling characteristics, but reduced lifetime.
- ✗ Not suitable. Not recommended for these materials.

- ✓ Most suitable. Recommended for these materials.
- ◆ Limited suitability – recommended for intermittent use. Very good in drilling characteristics, but reduced lifetime.
- ✗ Not suitable. Not recommended for these materials.

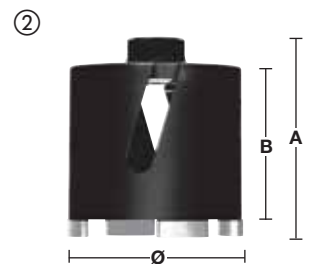
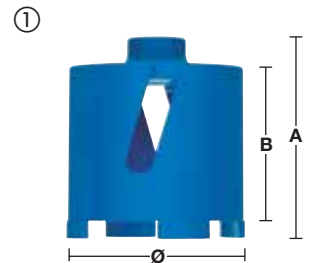

Description	Ø (mm)	Core reception	Working length B (mm)	Total length A (mm)	Packed contents	Article Number	EAN Code	Price exc. VAT
① DCU 68	68	M16	60	90	1	4932371978	4002395346035	£78.36
① DCU 82	82	M16	60	90	1	4932371979	4002395346042	£99.98
② DCH 68	68	M16	60	90	1	4932399579	4002395362080	£97.27
② DCH 82	82	M16	60	90	1	4932399580	4002395362097	£127.00

Description	Tool reception	Core reception	Packed contents	Article Number	EAN Code	Price exc. VAT
③ FIXTEC adaptor. Tool changing in seconds. No extra tool required.	M18 x 2.5	M16	1	4932399174	4002395357819	£128.52
	11 mm Hex	M16	1	4932399220	4002395358342	£139.32
④ Requires SDS-plus pilot drill bit (Ø 8 x 160 mm).			1	4932307071	4002395308873	£3.92



Description	Adaptor reception	Core reception	Total length A (mm)	Packed contents	Article Number	EAN Code	Price exc. VAT
⑤ Extention between FIXTEC adaptor and diamond core.	M16	M16	300	1	4932369736	4002395346028	£91.02



Dry diamond drilling without dust extraction - DCH 150

- 10 mm high segments.
- Laser welded segments for extra durability.
- Use with the machine set to rotary only, not suitable for hammer action.

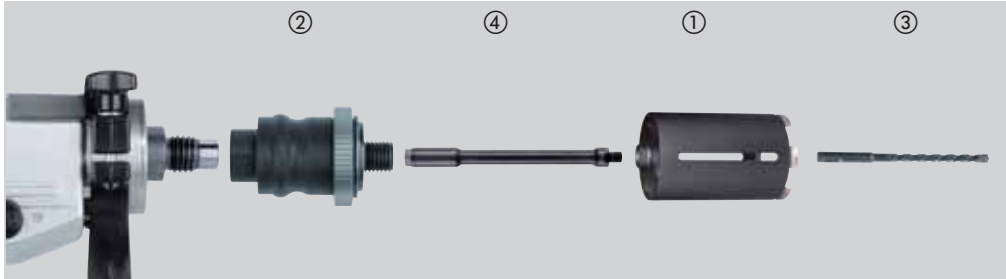

Material	DCH	Material	DCH
Aerated/breeze concrete blocks	◆	Granite	✘
Artificial stone – hard	✘	Lime/sandstone – hard	✓
Brick – very hard, engineering brick	✓	Lime/sandstone – soft/abrasive	◆
Brick – medium	✓	Marble	✘
Brick – soft	◆	Tiles	✘
Concrete	✘		

✓ Most suitable. Recommended for these materials.
 ◆ Limited suitability – recommended for intermittent use. Very good in drilling characteristics, but reduced lifetime.
 ✘ Not suitable. Not recommended for these materials.

Description	Ø (mm)	Core reception	Working length B (mm)	Total length A (mm)	Packed contents	Article Number	EAN Code	Price exc. VAT
DCH 150-52	52	M16	150	180	1	4932352628	4002395372867	£132.87
DCH 150-62	62	M16	150	180	1	4932352629	4002395372874	£149.35
DCH 150-68	68	M16	150	180	1	4932352630	4002395372881	£174.07
DCH 150-82	82	M16	150	180	1	4932352631	4002395372898	£182.31
DCH 150-102	102	M16	150	180	1	4932352632	4002395372904	£221.45
DCH 150-127	127	M16	150	180	1	4932352633	4002395372911	£235.87



Description	Tool reception	Core reception	Packed contents	Article Number	EAN Code	Price exc. VAT
② FIXTEC adaptor. Tool changing in seconds. No extra tool required.	M18 x 2.5	M16	1	4932399174	4002395357819	£128.52
③ Requires SDS-plus pilot drill bit (Ø 8 x 260 mm).	11 mm Hex	M16	1	4932399220	4002395358342	£139.32
			1	4932353821	4002395320141	£6.01



Description	Adaptor reception	Core reception	Total length A (mm)	Packed contents	Article Number	EAN Code	Price exc. VAT
⑤ Extension between FIXTEC adaptor and diamond core.	M16	M16	300	1	4932369736	4002395346028	£91.02

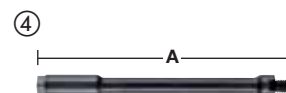



Nothing but **HEAVY DUTY.**[™]

SPEED

MILWAUKEE® SPEEDCROSS DIAMOND BLADES ARE ENGINEERED FOR ALL CONSTRUCTION SITE PROFESSIONALS WHO DEMAND ONLY THE BEST IN PERFORMANCE WHEN WORKING IN THE TOUGHEST ENVIRONMENTS.



Segments

10 mm segment height to ensure long lifetime. High diamond concentration with special aggressive geometry gives a high cutting performance. Laser welded segments for 100% user safety.

Precision engineered blade body

Pre-tensioned and hardened blade body for perfect concentration and maximum resistance to heat build up.

Cool cutting slots

The slots and holes improve the airflow keeping the cutting temperature of the segments to a minimum. This safeguards the segments from heat damage and allows the user to cut more and quicker.

Noise reduction qualities

Perfect balance and concentration suppress cutting noise.

Low vibration

The tensioned blade body eliminates wobble and minimises vibration.

Laser marked

All technical/safety information plus the direction of rotation arrow is laser marked for the complete life of the blade. Even when used in abrasive materials the information will not wear off.

**DIAMOND PREMIUM BLADES
MAXIMUM SPEED!**

Speedcross Blades

CROSS

**MAXIMUM SPEED,
LONG LIFE,
LOW VIBRATION!**

- Universal blades for a variety of materials
- Classed into two categories for maximum lifetime
- 10 mm segments height to ensure long lifetime
- Laser welded segments, so 100% user friendly
- Low vibration



**HUDD
HARD UNIVERSAL**



**AUDD
ABRASIVE UNIVERSAL**

Application areas

The Speedcross blades are both universal in application but their best performance is achieved at different ends of the spectrum. The HUDD is predominantly a blade for very hard to medium hard general building materials, the harder the material the better the performance. Alternatively the AUDD is most suitable for hard materials to soft/abrasive materials, its best performance is achieved when used in standard hardness concrete and general building materials.

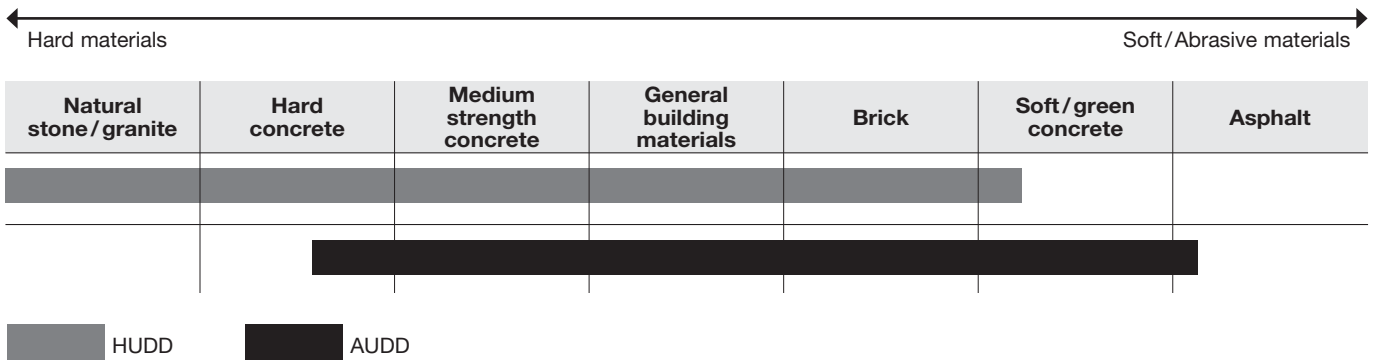

Speedcross HUDD

Type	Disc diameter (mm)	Bore size (mm)	Segment height (mm)	Cutting width (mm)	Packed contents	Article Number	EAN Code	Price exc. VAT
HUDD 115	115	22.23	10	2.6	1	4932399819	4002395364749	£102.99
HUDD 125	125	22.23	10	2.6	1	4932399820	4002395364756	£126.38
HUDD 150	150	22.23	10	2.6	1	4932399821	4002395364763	£148.31
HUDD 230	230	22.23	10	2.6	1	4932399822	4002395364770	£205.75



Speedcross AUDD

Type	Disc diameter (mm)	Bore size (mm)	Segment height (mm)	Cutting width (mm)	Packed contents	Article Number	EAN Code	Price exc. VAT
AUDD 115	115	22.23	10	2.6	1	4932399823	4002395364787	£123.24
AUDD 125	125	22.23	10	2.6	1	4932399824	4002395364794	£132.64
AUDD 150	150	22.23	10	2.6	1	4932399825	4002395364800	£155.62
AUDD 230	230	22.23	10	2.6	1	4932399826	4002395364817	£217.76



Diamond blades

Diamond blades DU

A general purpose blade offering good performance in speed and lifetime in a wide variety of construction materials.



Type	Disc diameter (mm)	Bore size (mm)	Segment height (mm)	Cutting width (mm)	Packed contents	Article Number	EAN Code	Price exc. VAT
DU 115	115	22.23	10	2.2	1	4932399521	4002395361687	£11.18
DU 125	125	22.23	10	2.3	1	4932399522	4002395361694	£14.48
DU 180	180	22.23	10	2.4	1	4932399523	4002395361700	£34.29
DU 230	230	22.23	10	2.6	1	4932399524	4002395361717	£48.77

Diamond blades DUT

A general purpose turbo rimmed blade for cutting a wide variety of general building materials. The turbo rim ensures clean chip free cuts.

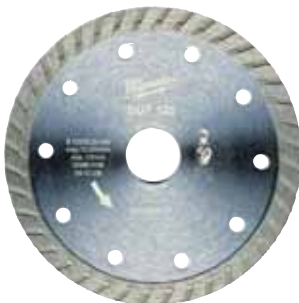

Type	Disc diameter (mm)	Bore size (mm)	Segment height (mm)	Cutting width (mm)	Packed contents	Article Number	EAN Code	Price exc. VAT
DUT 115	115	22.23	10	2.2	1	4932399526	4002395361731	£13.22
DUT 125	125	22.23	10	2.3	1	4932399527	4002395361748	£16.00
DUT 180	180	22.23	10	2.4	1	4932399528	4002395361755	£26.68
DUT 230	230	22.23	10	2.6	1	4932399529	4002395361762	£43.69

Diamond blades DUH

A trade laser welded quality blade with exceptional performance in hard materials such as hard concrete, block paviers and masonry products.



Type	Disc diameter (mm)	Bore size (mm)	Segment height (mm)	Cutting width (mm)	Packed contents	Article Number	EAN Code	Price exc. VAT
DUH 115	115	22.23	10	2.2	1	4932399539	4002395361861	£29.21
DUH 125	125	22.23	10	2.3	1	4932399540	4002395361878	£36.32
DUH 180	180	22.23	10	2.4	1	4932399541	4002395361885	£68.59
DUH 230	230	22.23	10	2.6	1	4932399542	4002395361892	£72.64

Diamond blades DHTS

A trade quality turbo blade with extra thin body (DHTS 115 = 1.7 mm, DHTS 125 / DHTS 230 = 1.8 mm) for very fast, precise and chip free cuts in thin materials such as granite, marble slabs and tiles (type: porcelain, gres, ceramic).

Due to the high quality of this blade it is also suitable for cutting most building materials.



Type	Disc diameter (mm)	Bore size (mm)	Segment height (mm)	Cutting width (mm)	Packed contents	Article Number	EAN Code	Price exc. VAT
DHTS 115	115	22.23	10	1.2	1	4932399145	4002395357550	£39.08
DHTS 125	125	22.23	10	1.2	1	4932399146	4002395357567	£46.41
DHTS 230	230	22.23	10	1.9	1	4932399550	4002395361977	£96.02

Diamond blades

Diamond blades DHTi

Specifically designed turbo rimmed blade for clean cut edges in ceramic tiles and thin natural stone tiles / slabs.



Type	Disc diameter (mm)	Bore size (mm)	Segment height (mm)	Cutting width (mm)	Packed contents	Article Number	EAN Code	Price exc. VAT
DHTi 115	115	22.23	8	2.0	1	4932399552	4002395361991	£10.87
DHTi 125	125	22.23	8	2.1	1	4932399553	4002395362004	£14.21
DHTi 230	230	22.23	8	2.6	1	4932399555	4002395362028	£35.05

Diamond blades DSU

A trade quality universal blade, specially designed for hard and abrasive materials.

Laser welded segments provide long lifetime and excellent cutting performance. Recommended for use with wall chasers.



Type	Disc diameter (mm)	Bore size (mm)	Segment height (mm)	Cutting width (mm)	Packed contents	Article Number	EAN Code	Price exc. VAT
DSU 125	125	22.23	10	2.4	1	4932373147	4002395346455	£81.21
DSU 150	150	22.23	10	2.4	1	4932373148	4002395346462	£110.65

Diamond blades: Which diamond cutting blade for which material?

Material	Type	Speedcross Premium		Professional					
		HUDD	AUDD	DU	DUT	DUH	DHTS	DHTi	DSU
Abrasive refractory materials		◆	✓						
Aerated concrete/breeze blocks		◆	✓	✓	✓	✓			◆
Artificial stone		✓			✓	✓			✓
Artificial stone – hard		✓				✓	✓	◆	✓
Asphalt			◆						
Basalt		✓	✓		✓	✓			✓
Brick – very hard, engineering brick		✓			◆	✓			✓
Brick – medium to hard		✓		◆	◆	✓			✓
Brick – medium to soft		✓	✓	◆	◆	◆			✓
Concrete – hard		✓	◆			✓			✓
Concrete – medium		✓	✓	✓	✓	✓			✓
Concrete – soft/green		◆	✓						◆
Concrete with flint aggregate		◆	✓						
Concrete with flint and rebar		◆	✓						
Concrete kerbstones		✓	✓			✓			✓
Concrete lintels		✓	◆			✓			✓
Concrete block paviers		✓	✓	◆	◆	✓			✓
Concrete tiles		✓	✓	✓	✓	✓	◆		✓
Concrete reinforced with rebar		✓	◆	◆	◆	✓			✓
Concrete slabs		✓	◆			✓			✓
Concrete slabs with aggregate		✓	✓		◆	✓			✓
Fireclay		✓	✓			✓			✓
General building materials		✓	✓	✓	✓	✓			✓
Gneiss		✓				◆			◆
Granite		✓			✓	✓			✓
Granite tiles/slabs		◆			✓	◆	✓		◆
Lime/sandstone blocks – hard		✓	✓			✓			✓
Lime/sandstone blocks – medium		✓	✓	◆	◆	✓			
Lime/sandstone – soft/abrasive		◆	✓	◆	◆	◆			◆
Marble tiles/slabs		◆			✓	◆	✓	◆	✓
Metal channel/profiles							◆		
Poroton		✓	✓	✓	✓	✓			✓
Porphyry		✓			◆	✓	✓		✓
Roof tiles – clay		✓	◆	◆	✓	◆	✓		✓
Roof tiles – concrete		✓	✓		✓	◆	✓		✓
Screed		◆	✓	◆	◆	◆			◆
Slate		✓	◆	◆	✓	✓	✓		◆
Stoneware/clay tiles		✓	✓		✓	✓			✓
Tiles – ceramic					◆		✓	✓	
Tiles – porcelain and gres type					◆		✓	◆	
Tiles – terrazo type		✓	◆		✓	✓	✓		✓

✓ Most suitable. Recommended for these materials. Very long service life and very good cutting characteristics.

◆ Suitable. Recommended for intermittent use in these materials. Good service life and cutting characteristics.

Combi-segment diamond cup wheels

All rounder in applications:

For quick grinding down of thick concrete layers.

For levelling of concrete, granite and natural stone surfaces.

For edge grinding applications e.g. grinding off high edges of concrete, granite, natural stone tiles.

For roughening prior to covering with a new layer of coating.

High quality diamonds and special soft bonding for low wear, especially in hard materials.

Large openings for better dust removal and segment cooling.

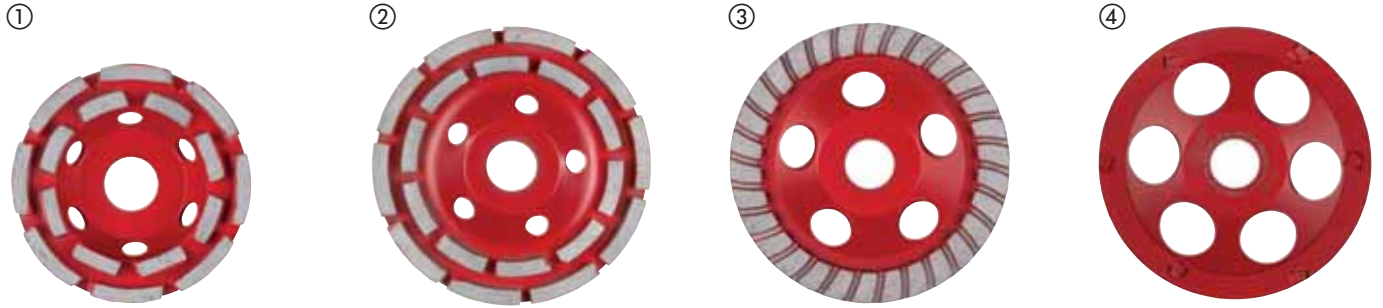

Type	Ø (mm)	Bore size (mm)	No. of segments	Cup wheel height (mm)	Segment height (mm)	Packed contents	Article Number	EAN Code	Price exc. VAT
DCWU 100									
① Universal wheel for grinding and levelling applications. High stock removal.	100	22.23	16	21	5	1	4932451185	4002395138739	£26.99
DCWU 125									
② Universal wheel for grinding and levelling applications. High stock removal.	125	22.23	20	21	5	1	4932451186	4002395138746	£46.99
DCWUT 125									
③ Turbo type segment for levelling, edge grinding and for smooth finishing. Fine finish for concrete and natural stone.	125	22.23	Turbo	21	5	1	4932451187	4002395138753	£99.99
DCWS 125									
④ PCD segment for removal of special substances: thermoplastic and epoxy based coatings, acrylic paint, lue, tile adhesive, screed, plaster.	125	22.23	6	18.5	4 / 7	1	4932451188	4002395138760	£219.99

	DCWU 100	DCWU 125	DCWUT 125	DCWS 125
Acrylic paint and coatings				✓
Aerated and breeze concrete blocks	✓	✓	✓	
Bitumen				✓
Concrete hard	✓	✓	✓	
Concrete soft or green	◆	◆	◆	
Epoxy resin coatings and glues				✓
Granite	◆	◆	◆	
Lime and sandstone blocks hard	✓	✓	✓	
Lime and sandstone blocks soft and abrasive	◆	◆	◆	◆
Marble	◆	◆	◆	
Plasterboard	◆	◆	◆	
Porphyry	◆	◆	◆	
Screed	◆	◆	◆	
Thermoplastic protective paint, glue				✓
Tile adhesive	◆	◆	◆	✓

✓ Most suitable.

◆ Suitable - for intermittent use.

System accessories - Wall chasers

AUDD blade is a perfect solution for 80% of wall chaser applications.

- 30% less loading on the machine
- 40% higher speed of cut

SPEEDCROSS

	① HUDD	② AUDD	③ DSU
Abrasive refractory materials	◆	✓	
Aerated and breeze concrete blocks	◆	✓	◆
Brick medium to soft	✓	✓	✓
Concrete medium	✓	✓	✓
Concrete reinforced with rebar	✓	◆	✓
Concrete with flint and rebar	◆	✓	
Fireclay	✓	✓	✓
General building materials	✓	✓	✓
Granite	✓		✓
Lime and sandstone blocks soft and abrasive	◆	✓	◆
Lime and sandstone blocks medium	✓	✓	
Screed	◆	✓	◆

✓ Maximum performance

◆ Limited suitability - recommended for intermittent use



Description	Fits wall chasers	Packed contents	Article Number	EAN Code	Price exc. VAT	
Transport case for wall chasers.	MFE 1500, MFE 1305, MF 1900	WCE 30, WCS 45, DME 30, DME 45	1	4932383357	4002395357390	£132.17
④ Pin spanner.	MFE 1500, MFE 1305, MF 1900	DME 30, DME 45, WCS 45, DME 65, WCE 65, WCE 30	1	4932367712	4002395338467	£4.95
⑤ T-handle key.	MFE 1500, MFE 1305, MF 1900	WCE 30, WCS 45, WCE 65, DME 30, DME 45, DME 65	1	4931362928	4002395661879	£5.38
Dust protection grille against entry of ground particles.	MFE 1500, MFE 1305, MF 1900	WCE 30, WCS 45, DME 30, DME 45	1	4932329397	4002395303892	£15.57
⑥ Dust protection grille against entry of ground particles.		WCE 65, DME 65	2	4932326525	4002395303311	£20.01
Extension hose Ø 35 mm / 4 m long. Requires adaptor (362778).	MFE 1500, MFE 1305, MF 1900	DME 30, WCE 30, DME 45, WCS 45, DME 65, WCE 65	1	4932330552	4002395312719	£104.31
Adaptor with bayonet fitting for direct connection of hose to machine.	MFE 1500, MFE 1305, MF 1900	WCE 30, WCS 45, WCE 65, DME 30, DME 45, DME 65	1	4932362778	4002395334285	£12.87
⑦ Side handle	MFE 1500, MFE 1305, MF 1900	WCE 30, WCS 45, DME 30, DME 45	1	4932409546	4002395370870	£5.23
Flange nut.	MFE 1305	DME 1300	1	4932334667	4002395304448	£21.64
Clamping flange.	MFE 1305	DME 1300	1	4932334706	4002395304455	£28.00
Spacer set. Contents 6 rings.	MFE 1305		6	4931334675	4002395762804	£33.48
Spacer set.		DME 30, DME 45, DME 65, WCE 30, WCE 65	5	4931362797	4002395764068	£42.12

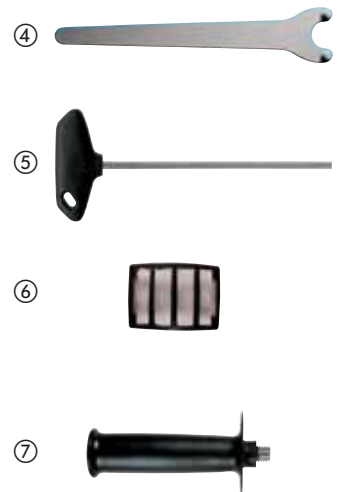

Cutting and grinding discs

NEW

Milwaukee® Type - how to find the right disc

SC 41 / 115

Material	Application	Design	Diameter	
S = Steel	C = Cutting	flat 41	mm	inches
C = Stone	G = Grinding	depressed 42	100	4
	CS = Cutting Slim	depressed 27	115	4½
	L = Flap	flap 50	125	5
	LC = Flap Ceramic		150	6
	CT = Cutting Thin		180	7
			230	9
			355	14



Extended life and moisture protection with PRO+**

■ **Special mixture delivers:**

Up to 20% longer lifetime.

Up to 20% less dust development.

The new formula HydroProtect prevents the age-related loss of performance and still provides almost the entire performance after months of storage.

■ **Benefits:**

Reduced costs per cut and shorter set up times.

Reduction of wheel deterioration during the storage interval.

Longer lasting high-performance.



**available on cutting and grinding discs with thickness 1, 1.5, 1.9 and 6 mm.

Thin metal cutting discs PRO+

Applications: Iron and sulphur free top line thin cut-off wheels for all steels. Best suitable for stainless and acid-resistant steel, hardox, heat-resistant cast steel, spring steel, mild and tool steel.

Characteristics: +30% more life, 50% less cutting time, 50% less dust. Lower material loss.



Type	Disc diameter (mm)	Thickness (mm)	Bore size (mm)	Packed contents	Order quantity	Article Number	EAN Code	Price exc. VAT	
41	SCS 41 / 115	115	1	22.2	50	50	4932451484	4002395163953	£1.99
	① Counter display (200 x SCS 41 / 115 discs).				200	1	4932451485	4002395163960	£369.99
	SCS 41 / 115	115	1.5	22.2	50	50	4932451486	4002395163977	£1.99
	SCS 41 / 125	125	1	22.2	50	50	4932451487	4002395163984	£2.49
	② Counter display (200 x SCS 41 / 125 discs).				200	1	4932451488	4002395163991	£399.99
	SCS 41 / 180	180	1.5	22.2	25	25	4932451489	4002395161300	£3.49
	SCS 41 / 230	230	1.9	22.2	25	25	4932451490	4002395161317	£4.49

*Orders are only possible in master cartons. Order quantities greater than the pack quantity are to be ordered in multiples (i.e. 50, 100, 150...)

Metal cutting discs PRO+

Applications: Great performance in cutting mild steel with medium strength, plain alloy tool steel, concrete reinforcing iron and steel rebar.

Characteristics: Efficient cutting properties in combination with high performance.

Type	Disc diameter (mm)	Thickness (mm)	Bore size (mm)	Packed contents	Order quantity	Article Number	EAN Code	Price exc. VAT	
41	SC 41 / 115	115	3	22.2	25	25	4932451491	4002395161324	£1.49
	SC 41 / 125	125	3	22.2	25	25	4932451492	4002395161331	£1.69
	SC 41 / 180	180	3	22.2	25	25	4932451493	4002395161348	£2.49
	SC 41 / 230	230	3	22.2	25	25	4932451494	4002395161362	£3.49
42	SC 42 / 115	115	3	22.2	25	25	4932451495	4002395161379	£1.49
	SC 42 / 125	125	3	22.2	25	25	4932451496	4002395161393	£1.69
	SC 42 / 180	180	3	22.2	25	25	4932451497	4002395162000	£2.49
	SC 42 / 230	230	3	22.2	25	25	4932451498	4002395162017	£3.49

*Orders are only possible in master cartons. Order quantities greater than the pack quantity are to be ordered in multiples (i.e. 50, 100, 150...)

Metal cutting discs for chop saws PRO+

Applications: For structural steels, tool steel, cast iron, hard high-grade steels and concrete reinforcing steel bars (rebar).
 Characteristics: Soft cutting wheel for chop saws.

	Type	Disc diameter (mm)	Thickness (mm)	Bore size (mm)	Packed contents	Order quantity	Article Number	EAN Code	Price exc. VAT
41	SC 41 / 355	355	2.5	25.4	10	10	4932451505	4002395162086	£12.99

*Orders are only possible in master cartons. Order quantities greater than the pack quantity are to be ordered in multiples (i.e. 50, 100, 150...)

Metal grinding discs PRO+

Applications: Sound performance in mild steel and non alloy tool steel.
 Characteristics: Provides good lifetime and efficient grinding characteristics.

	Type	Disc diameter (mm)	Thickness (mm)	Bore size (mm)	Packed contents	Order quantity	Article Number	EAN Code	Price exc. VAT
27	SG 27 / 115	115	6	22.2	25	25	4932451501	4002395162048	£2.49
	SG 27 / 125	125	6	22.2	25	25	4932451502	4002395162055	£2.69
	SG 27 / 180	180	6	22.2	10	10	4932451503	4002395162062	£3.99
	SG 27 / 230	230	6	22.2	10	10	4932451504	4002395162079	£7.99

*Orders are only possible in master cartons. Order quantities greater than the pack quantity are to be ordered in multiples (i.e. 50, 100, 150...)

Stone cutting discs PRO+

Applications: for concrete, masonry products and thin natural stone tiles.

	Type	Ø (mm)	Thickness (mm)	Bore size (mm)	Packed contents	Order quantity	Article Number	EAN Code	Price exc. VAT
42	CC 42 / 115	115	3	22.2	25	25	4932451499	4002395162024	£1.69
	CC 42 / 125	125	3	22.2	25	25	4932451500	4002395162031	£4.49

*Orders are only possible in master cartons. Order quantities greater than the pack quantity are to be ordered in multiples (i.e. 50, 100, 150...)

Flap discs



- Maximum productivity with CERA TURBO[™] 50% faster material removal 2x longer lifetime.
- Ceramic hybrid disc: grinds steel, stainless steel, bronze, titanium, aluminium.
- Ceramic grain: grinds and finishes in one step! Material removal like grit 40, finishing result like grit 60!
- Self trimming backing pad: allows grinding to the last grain!
- Natural fibre backing pad: low vibration & noise, no harmful dust.
- Highly flexible: perfectly adjusts to working piece.
- Low heat development: no metal discolouration, especially on stainless steel.
- Made in Germany.
- Ideal grinding speed: Ø115 mm: 7.000 - 8.000 rpm. Ø125 mm: 6.000 - 7.000 rpm.
- Applications: Ferrous metals, non-ferrous metals (aluminium, titan, etc.), stainless steel V2A (1.4301) / V4A (1.4401).

	Type	Disc diameter (mm)	Grit	Bore size (mm)	Backing pad material	Packed contents	Order quantity	Article Number	EAN Code	Price exc. VAT
50	SLC 50 / 115	115	Multigrain 40/60	22.2	Natural fibre	10	10	4932430407	4002395380688	£5.75
	SLC 50 / 125	125	Multigrain 40/60	22.2	Natural Fibre	10	10	4932430408	4002395380695	£6.65

Orders are only possible in master cartons (with 10 x 4932430407). Minimum order quantity is 10 x 4932430407 (= 1 master carton). Order quantities greater than 10 pcs are to be ordered in multiples of 10 pcs (ie. 20, 30, 40, 50 ...).

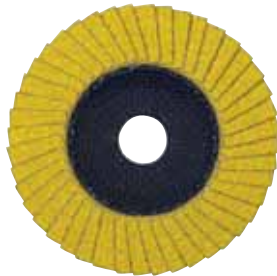

- High quality zirconium grain: longer lifetime on ferrous metals and stainless steel.
- Self trimming backing pad: allows grinding on the last grain!
- Natural fibre backing pad: low vibration & noise, no harmful dust.
- Highly flexible: perfectly adjusts to working piece.
- Low heat development: no metal discolouration, especially on stainless steel.
- Made in Germany
- Ideal grinding speed: Ø115 mm: 7.000 - 8.000 rpm. Ø125 mm: 6.000 - 7.000 rpm.
- Applications: Ferrous metals, stainless steel V2A (1.4301) / V4A (1.4401).

	Type	Disc diameter (mm)	Grit	Bore size (mm)	Backing pad material	Packed contents	Order quantity	Article Number	EAN Code	Price exc. VAT
50	SL 50 / 115	115	80	22.2	Natural Fibre	10	10	4932430412	4002395380732	£4.20
	SL 50 / 115	115	120	22.2	Natural Fibre	10	10	4932430413	4002395380749	£4.20
	SL 50 / 125	125	80	22.2	Natural Fibre	10	10	4932430414	4002395380756	£4.70
	SL 50 / 125	125	120	22.2	Natural Fibre	10	10	4932430415	4002395380763	£4.70

Orders are only possible in master cartons (with 10 x 4932430412). Minimum order quantity is 10 x 4932430412 (= 1 master carton). Order quantities greater than 10 pcs are to be ordered in multiples of 10 pcs (ie. 20, 30, 40, 50...).



FIXTEC Nut

- FIXTEC: Disc changing in seconds, no extra tools required.
- 12 seconds from removing the worn disc to fixing a new disc.
- Only 8 mm thin, enabling more surface of disc on the material.
- Compatible to all manufacturers angle grinders up to Ø 150 mm with standard M14 spindle thread.
- With integrated keyholes, for removal of the nut with a standard pin spanner in the event of the nut becoming too tight.



Description	Packed contents	Order quantity	Article Number	EAN Code	Price exc. VAT
FIXTEC nut - M14 thread. Counter display	12	12	4932352473	4002395371327	£21.59



WS-T1

- Cutting stand suitable for most angle grinders up to 230 mm with M14 spindle thread.
- Mitre cuts up to 45°, adjustable vice and angle guard.
- Additional spark protection.
- Solid cast iron base plate construction.
- Spring loaded protective guard.



Description	Packed contents	Article Number	EAN Code	Price exc. VAT
WS-T1	1	4932351790	4002395201372	£313.20

Technical data WS-T1

Description	
Vice opening	120 mm
Max. profile cuts with Ø disc 180 mm	30 x 110 mm
Max. pipe cuts with Ø disc 180 mm	40 mm
Max. profile cuts with Ø disc 230 mm	45 x 110 mm
Max. pipe cuts with Ø disc 230 mm	65 mm
Base plate	325 x 290 mm
Weight	13 kg
Supplied as standard: 2 clamping screws, spanner SW 17/21	



System attachments - Angle grinders

Description	Fits 115 mm angle grinders	Fits 125 mm angle grinders	Fits 150mm angle grinders	Fits 180mm angle grinders	Fits 230mm angle grinders	Packed contents	Article Number	EAN Code	Price exc. VAT
① Flange nut M14. Flange nut only for use on AG 25-230 Q.	✓	✓	✓	✓	✓	1	4932345628	4002395313105	£8.32
② Backing flange.	✓	✓	✓	✓	✓	1	4932263299	4002395307708	£3.11
③ Two hole spanner straight.	✓	✓	✓	✓	✓	1	4932367712	4002395338467	£4.95
④ Open-ended spanner. SW 17/24.	✓	✓	✓	✓	✓	1	4932345710	4002395307722	£10.47
⑤ Cranked two hole spanner for steel wire brushes.				✓	✓	1	4932371469	4002395342181	£5.62
⑥ Dust protection grille against entry of ground particles.		✓	✓			1	4932329397	4002395303892	£15.57
				✓	✓	2	4932326525	4002395303311	£20.01
Side handle	✓	✓	✓			1	4932409546	4002395370870	£5.23
				✓	✓	1	4931433531	4002395889259	£4.27
⑦ Anti-Vibration side handle.	✓	✓	✓	✓ ¹		1	4932399991	4002395366507	£24.30
				✓	✓	1	4932399992	4002395366514	£24.30
Hand protection guard.						1	4932378478	4002395347353	£6.43
Flange nut set. Only for AGV 16- 180 QXC.		Suitable for WS 2300 (Australia version)				1	4932351632	4002395321636	£71.43
Flange nut M14 (4932345629), backing flange (4932371404), large flange nut (4932367952).									

¹ Only for AGV 16-180 QXC.

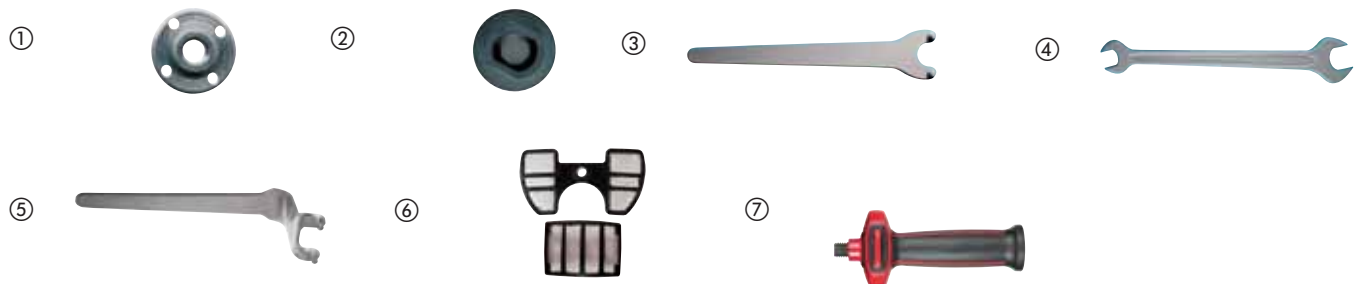

Flexible backing pads

Description	Bore size (mm)	Ø (mm)	Fits 115 mm angle grinders	Fits 125 mm angle grinders	Fits 180mm angle grinders	Fits 230mm angle grinders	Packed contents	Article Number	EAN Code	Price exc. VAT
Flexible backing pad.	14.2	110	✓				1	4932345760	4002395313488	£10.00
Flexible backing pad. Complete with flange nut M14 for all angle grinders.	14.2	125		✓			1	4932345761	4002395313495	£13.95
	14.2	170			✓		1	4932345758	4002395313501	£16.74
	22.2	170			✓		1	4932352744	4002395374021	£16.74
Replacement flange nut M14.			✓	✓	✓	✓	1	4932345627	4002395313112	£4.88

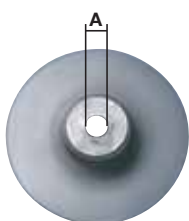

Cutting guards and dust extraction guards

Description	Fits 115 mm angle grinders	Fits 125 mm angle grinders	Fits 150mm angle grinders	Fits 180mm angle grinders	Fits 230mm angle grinders	Packed contents	Article Number	EAN Code	Price exc. VAT
① Guard with cutting guide. Fastening type: snap in clamping lever.	✓	✓				1	4932358948*	4002395325818	£73.30
② Dust extraction guard set. Fastening type: snap in. Not suitable for WS 2100, AG 22.					✓	1	4932399906	4002395365616	£104.31
Extension hose Ø 35 mm / 4 m long. Requires adaptor (362778).						1	4932330552	4002395312719	£104.31
③ Adaptor for direct connection of suction hose 330552.					✓	1	4932430833	4002395384952	



Dust guards

Description	Fits 115 mm angle grinders	Fits 125 mm angle grinders	Packed contents	Article Number	EAN Code	Price exc. VAT
① Dust guard for cutting - DEC 125. 100% tool free connection to Ø 115 - 125 mm AG(V) 12, AGV 15 series and FUEL™ grinders, keyless depth adjustment from 5 - 28 mm. Guide to prevent twisting during cutting. Dust guard fits to the Milwaukee® M-Class cleaners with unique „click-system“ adaptor supplied with the vacuum cleaner.	✓	✓	1	4932430467	4002395381289	£79.00
② Dust guard for surface conditioning - DEG 125. 100% tool free connection to Ø 125 mm AG(V) 12 and AGV 15 series grinders. Supplied with additional loop handle. Removable magnetic front cover to gain access to tight corners and edges when using a cup wheel. Dust guard fits to the Milwaukee® M-Class cleaners with unique „click-system“ adaptor supplied with the vacuum cleaner. Includes replaceable brush 4931448429.		✓	1	4932430468	4002395381296	£99.00



* while stocks last

Abrasive discs - Hook & Loop

Perforated sanding discs for wood, metal, paint, lacquer, plaster.

Grit type: fused alumina, half open.

Artificial resin-bonded on special tear resistant paper.

Sanding sheets for random orbital sanders Ø 125 mm - 8 holes

Grit	Paper size diameter (mm)	Packed contents	Article Number	EAN Code	Price exc. VAT
40	125	5	4932367740	4002395338610	£5.16
60	125	5	4932367741	4002395338627	£4.65
80	125	5	4932367742	4002395338634	£4.40
120	125	5	4932367743	4002395338641	£4.24
180	125	5	4932367744	4002395338658	£4.24
240	125	5	4932367745	4002395338665	£4.24
40	125	25	4932371470	4002395341870	£15.47
60	125	25	4932371396	4002395341665	£13.95
80	125	25	4932371397	4002395341672	£13.20
120	125	25	4932371398	4002395341689	£12.73
180	125	25	4932371399	4002395341696	£12.73
240	125	25	4932371400	4002395341702	£12.73



Sanding sheets for random orbital sanders Ø 150 mm - 6 holes

Grit	Paper size diameter (mm)	Packed contents	Article Number	EAN Code	Price exc. VAT
40	150	5	4932371590	4002395343171	£6.34
60	150	5	4932371591	4002395343188	£5.74
80	150	5	4932371592	4002395343195	£5.43
120	150	5	4932371593	4002395343201	£5.25
180	150	5	4932371594	4002395343218	£5.25
240	150	5	4932371595	4002395343225	£5.25
40	150	25	4932371596	4002395343232	£20.29
60	150	25	4932371597	4002395343249	£18.38
80	150	25	4932371598	4002395343256	£17.37
120	150	25	4932371599	4002395343263	£16.80
180	150	25	4932371600	4002395343270	£16.80
240	150	25	4932371601	4002395343287	£16.80

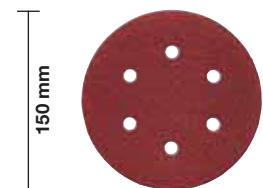

Abrasive sheets - Hook & Loop

Perforated sanding discs for wood, metal, paint, lacquer, plaster.

Grit type: fused alumina, half open.

Artificial resin-bonded on special tear resistant paper.

Sanding sheets for orbital sanders 80 x 133 mm

Grit	Paper size A x B (mm)	Packed contents	Article Number	EAN Code	Price exc. VAT
60	80 x 133	10	4932351666	4002395319305	£4.31
80	80 x 133	10	4932351667	4002395319312	£4.20
120	80 x 133	10	4932351668	4002395319329	£4.20
180	80 x 133	10	4932351669	4002395319336	£4.20
240	80 x 133	10	4932351670	4002395319343	£4.20

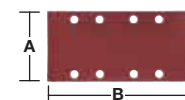

Sanding sheets for orbital sanders 93 x 185 mm

Grit	Paper size A x B (mm)	Packed contents	Article Number	EAN Code	Price exc. VAT
80	93 x 185	10	4932345103*	4002395312498	£8.80

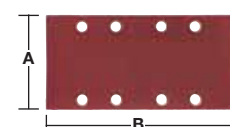

* while stocks last

Sanding sheets for orbital sanders 115 x 107 mm

Grit	Paper size A x B (mm)	Packed contents	Article Number	EAN Code
60	115 x 107	10	4932430815	4002395384761
80	115 x 107	10	4932430816	4002395384778
120	115 x 107	10	4932430817	4002395384785
240	115 x 107	10	4932430818	4002395384792

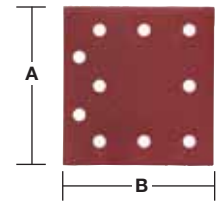

Abrasive sheets - Clamp type

Perforated sanding discs for wood, metal, paint, lacquer, plaster. Grit type: fused alumina, half open. Artificial resin-bonded on special tear resistant paper.

Sanding sheets for orbital sanders 93 x 230 mm

Grit	Paper size A x B (mm)	Packed contents	Article Number	EAN Code	Price exc. VAT
50	93 x 230	10	4932305176	4002395300006	£5.78
80	93 x 230	10	4932305177	4002395300013	£4.99
100	93 x 230	10	4932305178	4002395300020	£4.83
150	93 x 230	10	4932305179	4002395300037	£4.83

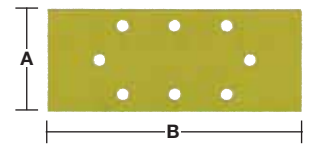

Sanding sheets for orbital sanders 115 x 140 mm

Grit	Paper size A x B (mm)	Packed contents	Article Number	EAN Code
60	115 x 140	10	4932430819	4002395384815
80	115 x 140	10	4932430820	4002395384822
120	115 x 140	10	4932430822	4002395384846
240	115 x 140	10	4932430821	4002395384839

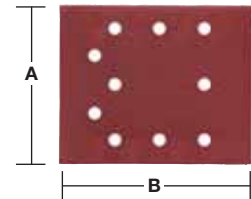

Abrasive sheets - Hook & Loop

Perforated sanding discs for wood, metal, paint, lacquer, plaster. Grit type: fused alumina, half open. Artificial resin-bonded on special tear resistant paper.

Sanding sheets for delta sanders 105 x 105 mm

Grit	Paper size A x B (mm)	Packed contents	Article Number	EAN Code	Price exc. VAT
60	105 x 105	5	4932358492	4002395324248	£4.10
80	105 x 105	5	4932358493	4002395324255	£4.03
120	105 x 105	5	4932358494	4002395324262	£3.97
180	105 x 105	5	4932358495	4002395324279	£3.97
240	105 x 105	5	4932358496	4002395324286	£3.97

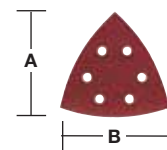

Sanding sheets for delta sanders 100 x 147 mm

Grit	Paper size A x B (mm)	Packed contents	Article Number	EAN Code	Price exc. VAT
60	100 x 147	10	4932355140	4002395319992	£15.95
80	100 x 147	10	4932355141	4002395320004	£15.83
120	100 x 147	10	4932355142	4002395320011	£15.68
180	100 x 147	10	4932355143	4002395320028	£15.68
240	100 x 147	10	4932355144	4002395320035	£15.68

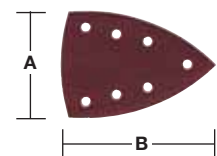

Sanding sheets for delta sanders 51 x 95 mm

Grit	Paper size A x B (mm)	Packed contents	Article Number	EAN Code	Price exc. VAT
60	51 x 95	5	4932358508*	4002395324163	£3.16
80	51 x 95	5	4932358509*	4002395324170	£2.99
120	51 x 95	5	4932358510*	4002395324187	£3.03

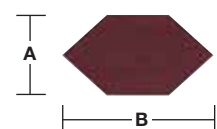

* while stocks last

Abrasive belts

Cloth sanding belts for wood, metal, paint, lacqueur, plaster.

Grit type: fused alumina, half open.

Artificial resin-bonded on special fabric.

Sanding belts 75 x 533 mm

Grit	Paper size A x B (mm)	Packed contents	Article Number	EAN Code	Price exc. VAT
40	75 x 533	5	4932312475	4002395301263	£11.33
60	75 x 533	5	4932312476	4002395301270	£10.99
80	75 x 533	5	4932312477	4002395301287	£10.80
100	75 x 533	5	4932312478	4002395301294	£10.65
150	75 x 533	5	4932312479	4002395301300	£10.65
240	75 x 533	5	4932312480	4002395301317	£10.65

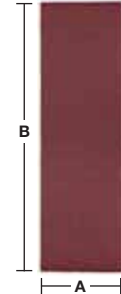

Sanding belts 100 x 560 mm

Grit	Paper size A x B (mm)	Packed contents	Article Number	EAN Code	Price exc. VAT
40	100 x 560	3	4932312099	4002395300419	£9.30
60	100 x 560	3	4932312100	4002395300426	£9.08
80	100 x 560	3	4932312101	4002395300433	£8.75
100	100 x 560	3	4932312102	4002395300440	£8.75
150	100 x 560	3	4932312103	4002395300457	£8.75
240	100 x 560	3	4932312104	4002395300464	£8.75

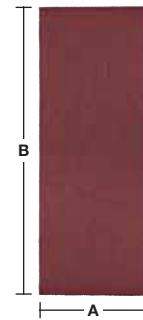

Sanding belts 100 x 610 mm

Grit	Paper size A x B (mm)	Packed contents	Article Number	EAN Code	Price exc. VAT
40	100 x 610	5	4932355066	4002395319824	£20.92
60	100 x 610	5	4932355067	4002395319831	£20.67
80	100 x 610	5	4932355068	4002395319848	£20.45
100	100 x 610	5	4932355069	4002395319855	£20.45
150	100 x 610	5	4932355070	4002395319862	£20.45
240	100 x 610	5	4932355071	4002395319879	£20.45

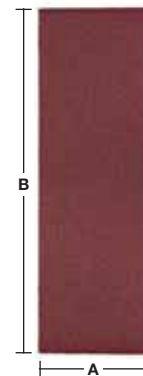

Sanding belts 100 x 620 mm

Grit	Paper size A x B (mm)	Packed contents	Article Number	EAN Code	Price exc. VAT
40	100 x 620	5	4932341610	4002395304882	£20.76
60	100 x 620	5	4932341611	4002395304899	£19.20
80	100 x 620	5	4932341612	4002395304905	£18.51
100	100 x 620	5	4932341613	4002395304912	£18.02
150	100 x 620	5	4932341614	4002395304929	£18.02
240	100 x 620	5	4932341615	4002395304936	£18.02

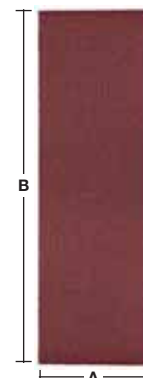

System accessories - Random orbital sanders

Description	Ø (mm)	Fits random orbital sanders	Packed contents	Article Number	EAN Code	Price exc. VAT
① Base plate Ø 125 mm, 8 holes. Complete with rubber ring as spare.	125	ROS 125 E	1	4932341268*	4002395305117	£31.32
				4932430091	4002395377527	£4.19
① Base plate Ø 150 mm, 6 holes. Complete with rubber ring as spare.	150	TXE 150,ROS 150 E	1	4932357591*	4002395343317	£30.61
		ROS 150 E		4932430145	4002395378067	£19.99
Clean Line System. Frame with dust bag.	125	ROS 125 E	1+1	4931435448	4002395889563	£4.19
	150	ROS 150	1+1	4931435911	4002395874729	£5.28
Spare paper bags for 4932345544.		TXE 150, TX 125, ROS 150 E	5	4931442873	4002395247882	£17.78
Frame holder for dust bag 4932313096.	125/150	ROS 150 E, TXE 150	1	4931329719	4002395610938	£8.10
Dust bag requires frame 4931329719.	125/150	TXE 150, TX 125, ROS 150 E	1	4932313096*	4002395302734	£27.91
② Lambswool polishing disc. Finishing high gloss polishing.	125	TX 125, ROS 125 E	1	4932373159*	4002395347919	£13.83
	150	ROS 150, ROS 150 E, TXE 150	1	4932373164	4002395347926	£19.14
③ Lambswool polishing disc. 100% natural lambswool. Premium quality with extremely high fibre density for longer lifetime. Integrated soft touch layer guarantees perfect adjustment to flat and curved profiles. For finishing old and fresh paint. Extremely good polishing of temperature sensitive clear lacquers thanks to heat resistant fibres, e.g. polishing car bumper.	135	TX 125, ROS 125 E	1	4932430395	4002395380565	£14.46
④ Polishing sponge hard. Polish up of weather-beaten lacquer, lacquer re-conditioning.	125	TX 125, ROS 125 E	1	4932373160*	4002395347933	£16.61
	150	TXE 150, ROS 150 E, ROS 150	1	4932373165	4002395347940	£22.95
⑤ Polishing sponge hard. Hard sponge with coarse foam structure. For maximum removal of the recondition-ing lacquer, removing deep scratches and polishing weather-beaten lacquer.	145	TX 125, ROS 125 E	1	4932430396	4002395380572	£22.95

①



②



③



④



⑤



System attachments - Orbital sanders

Description	Fits orbital sanders	Packed contents	Article Number	EAN Code	Price exc. VAT
① Dust bag with metal connector.		1	4932313096*	4002395302734	£27.91
② Spare paper bags for 4932345544.		5	4931442873	4002395247882	£17.78
③ Dust bag, cloth. For use with Clean Line dust system 345547.	VSS 20,VSSE 20,VSS 22,VSSE 22,VS 230,VSS 260,VSSE 260	1	4932346182*	4002395313273	£58.64
④ Extraction hose Ø 26 mm, 4 m. For connection to external extraction system.		1	4932278824	4002395308286	£96.12

①



②



③



④



System attachments - Delta sanders

Description	Fits delta sanders	Packed contents	Article Number	EAN Code	Price exc. VAT
Sanding plate delta 105 x 105 mm.	DSE 260	1	4932358439	4002395324231	£15.41
Hook & Loop sanding plate. 80 x 133 mm. Delta 100 x 147 mm.	VS 11 D,FS 2 D	1	4932351674*	4002395323067	£49.08
Dust bag made of sturdy fabric.	VS 11 D,FS 2,FS 2 D	1	4932351675	4002395320103	£25.21
Adaptor for hose Ø 26 mm.	FS 2,FS 2 D,VS 11 D	1	4932351999	4002395320110	£9.86
Extraction hose Ø 26 mm, 4 m. For connection to external extraction system.	FS 2,VS 11 D,FS 2 D	1	4932278824	4002395308286	£96.12

System attachments - Belt sanders

Description	Fits belt sanders	Packed contents	Article Number	EAN Code	Price exc. VAT
① Screw clamp (single piece) for stationary use on the work surface (2 units required).	BS 100 S,BS 100 LE	1	4932367730	4002395338566	£24.62
② Extraction hose Ø 26 mm, 4 m. For connection to external extraction system.	HBSE 75 S,BS 100 S,BS 100 LE	1	4932278824	4002395308286	£96.12
③ Dust bag (spare).	BS 100 S,BS 100 LE	1	4932336597	4002395311026	£20.33

①



②



③



Premium polishing accessories - Hook & Loop Ø 125 mm

Description	Ø (mm)	Height (mm)	Packed contents	Article Number	EAN Code	Price exc. VAT
<p>① Polishing backing pad with M14 thread. Very flat design with excellent flexibility. Low vibration allows precise work on any flat and curved profiles.</p>	125		1	4932430394	4002395380558	£32.99
<p>② Lambswool polishing disc. 100% natural lambswool. Premium quality with extremely high fibre density for longer lifetime. Integrated soft touch layer guarantees perfect adjustment to flat and curved profiles. For finishing old and fresh paint. Extremely good polishing of temperature sensitive clear lacquers thanks to heat resistant fibres, e.g. polishing car bumper.</p>	135	25	1	4932430395	4002395380565	£23.99
<p>③ Polishing sponge hard. Hard sponge with coarse foam structure. For maximum removal of the reconditioning lacquer, removing deep scratches and polishing weather-beaten lacquer.</p>	145	30	1	4932430396	4002395380572	£22.95
<p>④ Polishing sponge soft. Extremely soft sponge with fine foam structure. For fine polishing with polishing creams / wax compounds to remove very fine scratches and holograms (swirls).</p>	145	30	1	4932430397	4002395380589	£15.99
<p>⑤ Microfibre polishing cloth. Super-soft premium microfibre polishing cloth for finishing gloss polishing. With good absorption properties perfectly suited for final finishing and removing water spots from sensitive surfaces. Machine-washable with 30° without softener.</p>	400 x 400		1	4932430398	4002395380596	£19.99
<p>⑥ Polish M-Cut 1500 (250 ml). A coarse 1500 grit polish for removing deep scratches without damaging the lacquer. Suitable for removing dust grains, orange peel texture, lacquer/paints runs and deep scratches. Free of wax, silicone and roxic solvents. Recommended for use with polishing sponge hard (4932430396) and lambswool polishing disc (4932430395).</p>			1	4932430475	4002395381364	
<p>⑦ Polish M-Wax 6000 (250 ml). Premium high-tech wax with 6000 grit for removing fine scratches and sealing the paintwork in one step. Excellent performance in removing fine scratches / holograms / swirls. Contains the finest Brazilian Carnuba wax for long lasting mirror-like shine. Free of silicone. Recommended for use with polishing sponge soft (4932430397) and microfibre polishing cloth (4932430398).</p>			1	4932430476	4002395381371	



①



②



③



④



⑤



⑥



⑦

Polishing accessories - Hook & Loop Ø 125 / 150 mm

Description	Ø (mm)	Height (mm)	Packed contents	Article Number	EAN Code	Price exc. VAT
<p>Polishing backing pad. Application: Reception of felt / lambswool polishing discs and sponges. Characteristics: M14 thread, break resistant with integrated soft and flexible foam layer, Hook & Loop fixation.</p> <p>①</p>	150	25	1	4932373161	4002395347285	£30.82
<p>Felt polishing disc. Application: second polishing / finish of new lacquer work (spray mist and inclusion of dust), non ferrous metals and stainless steel, can also be used with polishing paste. Requires polishing backing.</p> <p>②</p>	125	50	1	4932373163	4002395347902	£10.30
<p>Lambswool polishing disc. Finishing high gloss polishing.</p> <p>③</p>	125	25	1	4932373159*	4002395347919	£13.83
	150	25	1	4932373164	4002395347926	£19.14
<p>Polishing sponge hard. Polish up of weather-beaten lacquer, lacquer re-conditioning.</p> <p>④</p>	125	50	1	4932373160*	4002395347933	£14.46
	150	50	1	4932373165	4002395347940	£16.61
<p>Polishing sponge soft. Second polish of lacquer, lacquer care.</p> <p>⑤</p>	125	50	1	4932373184*	4002395347957	£14.46
	150	50	1	4932373186	4002395347964	£16.61
<p>Polishing sponge, super-soft, profiled. Polish up of lacquer, lacquer reconditioning, polishing of acrylic glass.</p> <p>⑥</p>	125	25	1	4932373185*	4002395347971	£11.80
	150	25	1	4932373187*	4002395347988	£12.40



Polishing accessories - Spot polisher

Description	Ø (mm)	Height (mm)	Packed contents	Article Number	EAN Code	Price exc. VAT
<p>Polishing / Sanding backing pad. Thread: M9 x 0.75. Hook and loop fixation. For use with polishing sponges and abrasive paper.</p> <p>①</p>	76		1	4932430488	4002395381494	£8.99
<p>Polishing sponge - Hard (yellow). Hard sponge for use with more aggressive polish for removal of deep scratches. Hook and loop fixation. For use with polishing / sanding backing pad.</p> <p>②</p>	75	25	1	4932430489	4002395381500	£6.99
<p>Polishing sponge - Soft (white). Soft sponge for use with light polish for removal of small scratches. Hook and loop fixation. For use with polishing / sanding backing pad.</p> <p>③</p>	80	25	1	4932430490	4002395381517	£5.99
<p>Lambswool polishing pad. Hook and loop fixation. For use with polishing / sanding backing pad.</p> <p>④</p>	87		1	4932430491*	4002395381524	£7.99
	80		1	4932430838	4002395384990	
<p>Fibre disc backing pad. Thread: M9 x 0.75 to affix to tool. Knurled thread to fix coated abrasives and surface finishing products for coarse sanding applications, such as rust removal. Ideal for sanding small or awkward to reach areas such as pinch welds, door shuts and wheel arches.</p> <p>⑤</p>	46		1	4932430492	4002395381531	£7.99



* while stocks last

SAWZALL® blades

Shank reception



1/2" Universal shank

Suitable for the brands AEG, B&D, Bosch, DeWalt, Fein, Flex, Hilti, Makita, Metabo, Milwaukee®, Porter Cable, Ridgid, Rothenberger, Ryobi, Skil.

Material qualities

To ensure maximum performance and lifetime, a number of different raw materials are used in the production of sabre saw blades. The raw material depends on the eventual application.

Bi-Metal

■ Bi-Metal blade. With high quality M2 steel cutting edge for all Heavy Duty applications.

Bi-Metal, Co

■ Bi-Metal blade with 8% cobalt. With premium Matrix II steel cutting teeth (with 8% cobalt content), the ultimate in performance and lifetime.

HCS

■ High carbon steel. Mostly suited to cutting wood and plastics.

Stainless

■ Stainless steel. Corrosion resistant blade.

TC

■ Carbide grit. For cutting cast iron pipes and abrasive materials.

■ Carbide tipped teeth. Suitable for glass fibre reinforced products and soft building blocks.

Bi-Metal blades consist of a hardened high speed steel cutting edge electron-beam welded onto a flexible alloy steel back. Bi-Metal blades are tougher, flexible reducing breakages, faster cutting and last longer than conventional carbon and all high speed steel blades. Those blades with cobalt have even harder teeth and offer double the lifetime in metal cutting applications and five times the lifetime over conventional high carbon steel blades.

The Milwaukee® advantage

SAWZALL® Blades

- Up to 50% longer life
 - Unique cryogenic heat treatment process provides tougher teeth for extreme applications
 - Excellent cutting performance and lifetime in difficult materials such as stainless steel
- ✓ Upto 65 HRC tooth hardness with cobalt for the most demanding applications in all metals and high alloy steels.
 - ✓ The blade body has a high level of elasticity and significantly reduces the risk of blade breakage.
 - ✓ Matrix II Bi-Metal strip with 8% cobalt teeth can endure high wear rates and is very heat resistant ensuring longer life.

Comparative test in 100 mm steel pipe

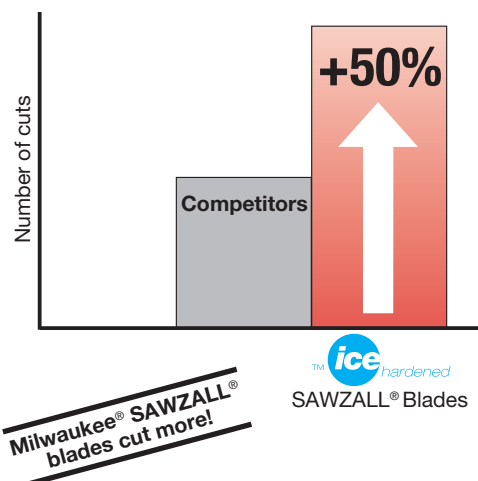

Blade shapes

SAWZALL[®] blades can be manufactured in many various shapes. The shape is adjusted to the application. The thickness of the blade depends on the required flexibility. More demanding applications like cutting tubes require thick blades, less demanding applications require thin, narrow blades.

The blade shapes can be divided into four different groups:

1. Universal blades



The universal blade is for general use. Its even width guarantees good cutting stability and excellent guidance. This enables straight edge cutting through many different materials.

3. Scroll blades



These blades are especially used for curve cutting. The more narrow the blade, the smaller a radius can be cut.

2. Sloped blades



Sloped blades are commonly used when cutting wood and demolition applications. The narrow tip allows for plunge cuts and curve cutting. This shape is rarely used when working in metal, since the tip does not have the necessary strength required for this application.

4. Special scroll blades



Special scroll blades were developed for both straight and curve cutting in soft material like plaster-board. The blade is wide at the rear (for straight cutting) and narrow at the front (for curve cutting).

Packaging

Our SAWZALL[®] blade packaging is totally language free, technical characteristics and applications are clearly illustrated for easy self-service. Blades are offered in two forms of packaging, a economic pack and for the industrial users a bulk pack container. Both forms of packaging can be reused as a storage facility for used blades.



Tooth geometry

The blade length (A) represents the complete length of the blade – A.
 The tooth pitch is shown in millimetres (mm) and in inches.

Tooth pitch in mm

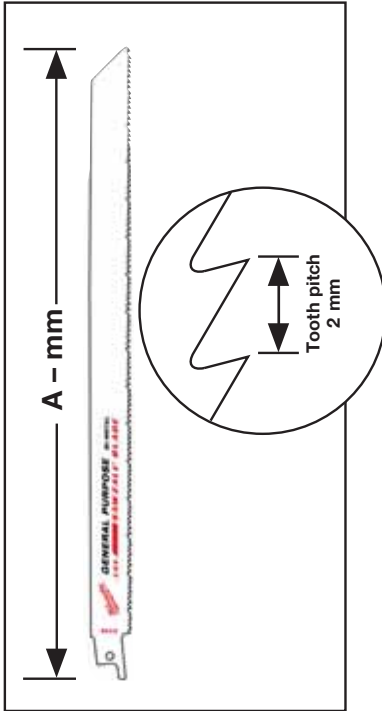

Teeth per inch

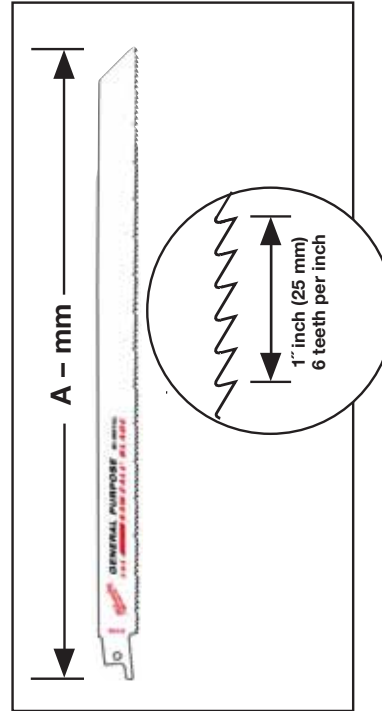

To attain the correct blade length, it is necessary to take the width of material to be cut and add an extra 80 mm. Selecting the correct tooth pitch for the material being cut is dependent on the thickness of the material being cut, this is extremely important when cutting metals to ensure the blade is used to its optimum performance. The golden rule is to have three teeth in contact with the material being cut at all times. When cutting wood the higher the tooth pitch in mm's (the lower in inches) the rougher and coarser the cut will be.









For cutting metal the following table can be used for guidance.

Material – All metals – Tubing/profiles/channels	Tooth pitch (mm)	Teeth per inch
Wall thickness 4.5 mm to 10 mm	1.8	14
Wall thickness 3.0 mm to 4.5 mm	1.4	18
Wall thickness less than 3 mm (thin materials)	1.0	24

Application guidelines











Cut Cool – Cut Faster – Cut Longer

To ensure longer life, it is recommended to use a cooling lubricant, which can result in extending the life of the saw blade by up to 500%.











Material	Coolant
  	Cutting oil
	Turpentine
	Compressed air
  	Water
	Dry

Cutting Speed Recommendation

The following table can be used as a rough guide, however the material wall thickness must also be considered when deciding on the correct speed.

Material	Speed – max. strokes per minute
 <p>Less than 600 N/mm² strength</p>	2000
 <p>Between 600 N/mm² – 800 N/mm² strength</p>	1500
  <p>Over 800 N/mm² strength</p>	500
 	1500
	1000
  	500
	2000 – 2800









Wood and plastics

Blade length (mm)	Tooth pitch (mm)	Teeth per inch	Material type	Ref. No.						Packed contents	Article Number	EAN Code	Price exc. VAT	
	150	4.2	6	HCS	S644D	6 - 100	-	6 - 100	No	Yes	3	48001075	045242079810	£7.69
	150	4.2	6	HCS	S744D	6-50	-	6-50	Yes	No	3	48001076	045242079827	£7.69
	230	4.2	6	Bi-Met,Co	-	6 - 190	6 - 190	6 - 100	No	Yes	5	48005016	045242082636	£29.46
	240	5.5/6	4/5	HCS	S1531L	15 - 190	15 - 190	-	No	No	3	48001077	045242079834	£16.99
	240	8.5	3	HCS	S1542K	15 - 190	-	-	No	No	3	48001078	045242079841	£22.32
	300	4.2	6	HCS	S1344D	6 - 250	-	-	No	No	3	48001079	045242079858	£13.70

Wood with nails: THIN KERF Demolition blades

- **FANG TIP™:** For faster plunge cutting and reaching into restricted areas.
- **NAIL GUARD™:** Protects the tooth during nail impacts for increased durability and lifetime.
- **Strong:** 1.25 mm thick blade body for good strength and blade life making it ideal for wood with nails or bolts.
- **Fast:** Aggressive 5 TPi geometry removes more material per stroke for faster cutting.
- **Sloped shape:** Excellent for plunge cutting and reaching into restricted areas.
- **Shatter resistant:** Bi-Metal construction allows the blade to bend and flex without breaking.



Blade length (mm)	Tooth pitch (mm)	Teeth per inch	Material type	Ref. No.							Packed contents	Article Number	EAN Code	Price exc. VAT	
	150	5	5	Bi-Met,Co	S611DF	10 - 100	10 - 100	Ø 10 - 100	10 - 50	Yes	Yes	5	48005035	045242082698	£20.32
	230	5	5	Bi-Met,Co	S1111DF	10 - 175	10 - 175	Ø 10 - 175	10 - 50	Yes	Yes	5	48005036	045242082704	£27.83
	300	5	5	Bi-Met,Co	S1411DF	10 - 250	10 - 250	Ø 10 - 250	10 - 50	No	Yes	5	48005037	045242082711	£35.45

Wood with nails: Heavy Duty AX Demolition blades

THE AX™



- **FANG TIP™:** For faster plunge cutting and reaching into restricted areas.
- **NAIL GUARD™:** Protects the tooth during nail impacts for increased durability and lifetime.
- **Strong:** Extra thick 1.60 mm body for maximum robustness and life making it ideal for wood with nails or bolts.
- **Fast:** Aggressive 5 Tpi tooth geometry removes more material per stroke for faster cutting.
- **Sloped shape:** Excellent for plunge cutting and reaching into restricted areas.
- **Shatter resistant:** Bi-Metal construction allows the blade to bend and flex without breaking.

Blade length (mm)	Tooth pitch (mm)	Teeth per inch	Material type	Ref. No.								Packed contents	Article Number	EAN Code	Price exc. VAT
150	5	5	Bi-Met,Co	-	10 - 100	10 - 100	Ø 10 - 100	10 - 50	Yes	Yes	Yes	5	48005021	045242082988	£22.66
												25	48008021	045242082285	£108.15
230	5	5	Bi-Met,Co	-	10 - 175	10 - 175	Ø 10 - 175	10 - 50	Yes	Yes	Yes	5	48005026	045242082995	£29.25
												25	48008026	045242082292	£139.00
300	5	5	Bi-Met,Co	-	10 - 250	10 - 250	Ø 10 - 250	10 - 50	Yes	Yes	Yes	5	48005027	045242083022	£39.28
												25	48008027	045242082308	£195.70

Wood / Metal / Plastic: Universal blades

Blade length (mm)	Tooth pitch (mm)	Teeth per inch	Material type	Ref. No.									Packed contents	Article Number	EAN Code	Price exc. VAT
150	2.5	10	Bi-Met,Co	-	3 - 10	3 - 10	5 - 50	3 - 10	5 - 50	No	Ø 3 - 50	10 - 50	5	48005092	045242082766	£13.07
150	2.5/1.8	10/14	Bi-Met,Co	SS922VF	3 - 10	3 - 10	5 - 100	3 - 10	5 - 100	No	Ø 3 - 100	10 - 50	5	48005292	045242084067	£17.50
													50	48016292	045242084081	£149.00
200	2.5/1.8	10/14	Bi-Met,Co	-	3 - 10	3 - 10	5 - 175	3 - 10	5 - 175	Yes	Ø 3 - 160	10 - 50	5	48005293	045242084074	£23.17
													50	48016293	045242084098	£208.84
300	2.5/1.8	10/14	Bi-Met,Co	-	3 - 10	3 - 10	5 - 250	3 - 10	5 - 250	Yes	Ø 3 - 250	10 - 50	5	48005194	045242082926	£31.37
150	3.2/2.1	8/12	Bi-Met,Co	-	3 - 10	3 - 10	5 - 100	3 - 10	5 - 100	No	Ø 3 - 100	10 - 50	5	48005091	045242082759	£18.80
													50	48016091	045242084685	£179.00
200	3.2/2.1	8/12	Bi-Met,Co	-	3 - 10	3 - 10	5 - 175	3 - 10	5 - 175	Yes	Ø 3 - 160	10 - 50	5	48005093	045242082773	£24.74
													50	48016093	045242084708	£222.83
													500	48016000	045242084951	£1917.15
300	3.2/2.1	8/12	Bi-Met,Co	-	3 - 10	3 - 10	5 - 250	3 - 10	5 - 250	Yes	Ø 3 - 250	10 - 50	5	48005094	045242082780	£34.03
													50	48016094	045242084715	£302.99

Metal: THIN KERF blades

**QUICKEST
THIN KERF**



STRONGEST



LONGEST

**DOUBLE
DUTY
UPGRADE**



Improved tooth geometry for best speed and double the lifetime. Bi-Metal quality cutting teeth with 8% Cobalt the ultimate in performance and lifetime.



Stamped indentations around the reception strengthens the blade at its weakest point.

THIN KERF



















Slim 0.90 mm thick blade body optimised for maximum speed and flexibility.



Unique cryogenic heat treatment process gives
– tougher teeth for cutting the hardest of metals
– up to 50% longer life.



Metal: THIN KERF blades

Blade length (mm)	Tooth pitch (mm)	Teeth per inch	Material type	Ref. No.	Material								Packed contents	Article Number	EAN Code	Price exc. VAT	
					METAL	METAL	METAL	Cu/Ni/Ms/Zn	STAINLESS-INOX / INRGITA	ALU							
	100	1	25	Bi-Met,Co	S522AF	0.5 - 3	0.5 - 3	Ø 8 - 50	0.5 - 3	0.5 - 3	-	No	No	5	48005185	045242082865	£14.90
	150	1	25	Bi-Met,Co	S922AF	0.5 - 3	0.5 - 3	Ø 8 - 100	0.5 - 3	0.5 - 3	-	No	No	5	48005186	045242082872	£16.71
	100	1.4	18	Bi-Met,Co	S522EF	1.5 - 4	1.5 - 4	Ø 10 - 50	1.5 - 4	1.5 - 4	-	No	No	5	48005183	045242082841	£19.16
	150	1.4	18	Bi-Met,Co	S922EF	1.5 - 4	1.5 - 4	Ø 10 - 100	1.5 - 4	1.5 - 4	-	No	No	5	48005184	045242082858	£16.60
	150	1.4	18	Bi-Met,Co	S922EF	1.5 - 4	1.5 - 4	Ø 10 - 100	1.5 - 4	1.5 - 4	-	No	No	50	48016184	045242084739	£144.55
	150	1.4	18	Bi-Met,Co	S922EF	1.5 - 4	1.5 - 4	Ø 10 - 100	1.5 - 4	1.5 - 4	-	No	No	5	48004184	045242081042	£20.07
	230	1.4	18	Bi-Met,Co	S1122EF	1.5 - 4	1.5 - 4	Ø 10 - 100	1.5 - 4	1.5 - 4	-	No	No	5	48005188	045242082896	£23.03
	230	1.4	18	Bi-Met,Co	S1122EF	1.5 - 4	1.5 - 4	Ø 10 - 100	1.5 - 4	1.5 - 4	-	No	No	50	48016188	045242084876	£207.55
	230	1.4	18	Bi-Met,Co	S1122EF	1.5 - 4	1.5 - 4	Ø 10 - 160	1.5 - 4	1.5 - 4	-	No	No	5	48004188	045242081066	£27.68
	300	1.4	18	Bi-Met,Co	-	1.5 - 4	1.5 - 4	Ø 10 - 180	1.5 - 4	1.5 - 4	-	No	Yes	5	48005189	045242082902	£30.72
	300	1.4	18	Bi-Met,Co	-	1.5 - 4	1.5 - 4	Ø 10 - 180	1.5 - 4	1.5 - 4	-	No	Yes	50	48016189	045242084883	£272.39
	90	1.8	14	Bi-Met,Co	S422BF	1.5 - 6	1.5 - 6	-	1.5 - 4	-	1.5 - 6	Yes	No	5	48005162	045242082803	£11.42
	100	1.8	14	Bi-Met,Co	S522BF	3 - 10	-	Ø 10 - 50	3 - 10	2 - 4	3 - 10	No	No	5	48005181	045242082827	£18.11
	150	1.8	14	Bi-Met,Co	S922BF	3 - 10	-	Ø 10 - 100	3 - 10	2 - 4	3 - 10	No	No	5	48005182	045242082834	£16.65
	150	1.8	14	Bi-Met,Co	S922BF	3 - 10	-	Ø 10 - 100	3 - 10	2 - 4	3 - 10	No	No	50	48016182	045242084722	£157.09
	150	1.8	14	Bi-Met,Co	S922BF	3 - 10	-	Ø 10 - 100	3 - 10	2 - 4	3 - 10	No	No	5	48004182	045242081035	£20.07
	230	1.8	14	Bi-Met,Co	S1122BF	3 - 10	-	Ø 10 - 160	3 - 10	2 - 4	3 - 10	No	No	5	48005187	045242082889	£22.92
	230	1.8	14	Bi-Met,Co	S1122BF	3 - 10	-	Ø 10 - 160	3 - 10	2 - 4	3 - 10	No	No	50	48016187	045242084869	£223.84
	230	1.8	14	Bi-Met,Co	S1122BF	3 - 10	-	Ø 10 - 160	3 - 10	2 - 4	3 - 10	No	No	5	48004187	045242080991	£27.68

Metal: Heavy Duty demolition blades



DOUBLE DUTY UPGRADE™



Improved tooth geometry for best speed and double the lifetime.
 Thick 1,06 mm robust blade body for precise cuts.
 25 mm blade height for improved stability and minimum vibration.
 Bi-Metal quality cutting teeth with 8 % Cobalt the ultimate in performance and lifetime.



Stamped indentations around the reception strengthens the blade at its weakest point.



A grid iron pattern is built into the blade to make it more rigid with less tendency to bend or buckle for best durability and straight cuts.



Unique cryogenic heat treatment process gives
 – tougher teeth for cutting the hardest of metals
 – up to 50% longer life.













Metal: Heavy Duty demolition blades

Blade length (mm)	Tooth pitch (mm)	Teeth per inch	Material type	Ref. No.						Packed contents	Article Number	EAN Code	Price exc. VAT	
					METAL	METAL	Cu/Ni/Ms/Zn	STAINLESS INOX NROSTA	WOOD					
150	1.4	18	Bi-Met,Co	-	2 - 8	Ø 10 - 100	2 - 8	2 - 4	No	Yes	5	48005784	045242083084	£23.03
											25	48008784	045242082407	£112.85
150	1.4	18	Bi-Met,Co	-	2 - 8	Ø 10 - 100	2 - 8	2 - 4	No	Yes	5	48004784	045242081110	£27.81
230	1.4	18	Bi-Met,Co	-	2 - 8	Ø 10 - 160	2 - 8	2 - 4	No	Yes	5	48005788	045242083091	£23.90
											25	48008788	045242082421	£118.31
230	1.4	18	Bi-Met,Co	-	2 - 8	Ø 10 - 160	2 - 8	2 - 4	No	Yes	5	48004788	045242081134	£35.15
300	1.4	18	Bi-Met,Co	-	2 - 8	Ø 10 - 180	2 - 8	2 - 4	No	Yes	5	48005789	045242083107	£33.34
											25	48008789	045242082438	£160.00
150	1.8	14	Bi-Met,Co	-	3 - 10	Ø 10 - 100	3 - 10	3 - 7	Yes	Yes	5	48005782	045242083060	£18.50
											25	48008782	045242082391	£92.00
150	1.8	14	Bi-Met,Co	-	3 - 10	Ø 10 - 100	3 - 10	3 - 7	Yes	Yes	5	48004782	045242081097	£27.81
230	1.8	14	Bi-Met,Co	-	3 - 10	Ø 10 - 160	3 - 10	3 - 7	Yes	Yes	5	48005787	045242083077	£29.22
											25	48008787	045242082414	£140.00
230	1.8	14	Bi-Met,Co	-	3 - 10	Ø 10 - 160	3 - 10	3 - 7	Yes	Yes	5	48004787	045242081127	£35.15
150	2.5	10	Bi-Met,Co	-	4 - 10	Ø 10 - 100	4 - 10	4 - 10	Yes	Yes	5	48005712	045242083039	£23.14
											25	48008712	045242082377	£110.00
150	2.5	10	Bi-Met,Co	-	4 - 10	Ø 10 - 100	4 - 10	4 - 10	Yes	Yes	5	48004712	045242081073	£27.81
230	2.5	10	Bi-Met,Co	-	4 - 10	Ø 10 - 160	4 - 10	4 - 10	Yes	Yes	5	48005713	045242083046	£29.30
											25	48008713	045242082384	£140.00
230	2.5	10	Bi-Met,Co	-	4 - 10	Ø 10 - 160	4 - 10	4 - 10	Yes	Yes	5	48004713	045242081080	£35.15

Metal: Extra Heavy Duty

THE WRECKER™

- Strong and precise: Extra thick 1.60 mm blade body.
- Bi-Metal construction: Excellent blade life and performance.
- Tooth geometry: Aggressive strengthened tooth tip design and uniform gullet depth allows for more material to be removed per stroke for faster cutting.
- Blade shape: Sloped - The sloped shape makes this blade ideal for plunge cutting. Most suited for cutting metal and for demolition applications (wood with nails).

Blade length (mm)	Tooth pitch (mm)	Teeth per inch	Material type	Ref. No.								Packed contents	Article Number	EAN Code	Price exc. VAT
 150	3.2	8	Bi-Met,Co	1	4 - 10	Ø 10 - 100	4 - 10	4 - 10	Yes	Yes	Yes	5	48005701	045242082476	£21.83
 230	3.2	8	Bi-Met,Co	1	4 - 10	Ø 10 - 160	4 - 10	4 - 10	Yes	Yes	Yes	5	48005706	045242082483	£34.89
 300	3.2	8	Bi-Met,Co	1	4 - 10	Ø 10 - 180	4 - 10	4 - 10	Yes	Yes	Yes	5	48005711	045242082490	£37.64











SAWZALL® sets

Description	Packed contents	Article Number	EAN Code	Price exc. VAT
Sawzall blade set (9 pcs).				
① 2 x Demolition - wood with nails 150 mm x 5 Tpi (48005035), 1 x Demolition - wood with nails 230 mm x 5 Tpi (48005036), 3 x Metal 3-10 mm 150 mm x 14 Tpi (48005182), 3 x Metal thin 0,5-3 mm 150 mm x 24 Tpi (48005186).	9	49221145	045242043521	£36.04
Sawzall blade set (12 pcs)				
② 2 x AX Demolition - wood with nails 150 mm x 5Tpi (48005021), 2 x AX Demolition - wood with nails 230 mm x 5Tpi (48005026), 2 x Wrecker Metal straight cuts 4-10 mm, 150 mm x 8Tpi (48005701), 2 x Torch Metal 3-10 mm, 230 mm x 14 TPI (48005787), 4 x Torch Metal 2-8 mm, 150 mm x 18 TPI (48005784).	12	49221129	045242180813	£57.67







SAWZALL® blades for special materials



Special application: cast iron / abrasive materials / fibreglass

Blade length (mm)	Tooth pitch (mm)	Teeth per inch	Material type	Ref. No.						Packed contents	Article Number	EAN Code	Price exc. VAT	
	230	Coarse grit	Diamond	-	Ø 10 - 160	Ø 10 - 160	3 - 175	-	-	1	48001450	045242187416	£23.53	
	150	Coarse grit	TC	-	Ø 10 - 100	Ø 10 - 100	3 - 100	-	-	3	48001420	045242081950	£15.50	
	230	Coarse grit	TC	S1130R	Ø 10 - 160	Ø 10 - 160	3 - 175	-	-	3	48001430	045242082001	£18.50	
	305	8.5	3	TC	S1241HM	-	-	6 - 150	10 - 250	-	1	48001080	045242079865	£44.57
	450	17.0	1.5	TC	-	-	-	6 - 150	10 - 350	10 - 350	1	48001460	045242235353	£51.49

Special application: insulation material / carton / foam

Blade length (mm)	Tooth pitch (mm)	Teeth per inch	Material type	Ref. No.					Packed contents	Article Number	EAN Code	Price exc. VAT	
	300	Wave knife	Wave knife	HCS	-	**▲	**▲	**▲	**▲	1	48001084	045242079902	£18.25

Special application: frozen materials

	300	4.2	6	Stainless	S1211K					1	48001082	045242079889	£20.11
	400	4.2	6	Stainless	-					1	48001083	045242079896	£25.70

Special Application: flush cut blade



- Flush cuts against floor - floor guard protects teeth from floor contact when cutting flush to the floor.
- Extra tall blade body - guides blade for straighter cuts ie. when cutting out doors and windows in wood construction.
- FANG TIP™ - for easy and quick plunging.
- Suitable for cutting all types of wood and nail embedded wood. Not suitable for brick, masonry or steel.

Blade length (mm)	Tooth pitch (mm)	Teeth per inch	Material type	Ref. No.	Packed contents	Article Number	EAN Code	Price exc. VAT
300	5	5	Bi-Met,Co	-	1	48001600	045242253272	£39.99

Special application: ductwork blade

- Plunge tip - fast plunging in materials < 0,6 mm. No need for extra tools.
- Versatility - tapered blade body profile allows for tight radius cutting and square cuts.
- Longlife - optimized tooth geometry 30 tpi for cutting thin material 0,6 - 1,5 mm. Most common spiral duct is 0,8 mm thick.



Blade length (mm)	Tooth pitch (mm)	Teeth per inch	Packed contents	Article Number	EAN Code	Price exc. VAT
85	0,8	30	5	48001630	045242300174	£29.99

Special application: drywall / plasterboard blade



- Precise depth of cut - only 63 mm long, protects from unintentional cuts in pipes or wiring.
- Double sided teeth - cuts in ALL directions - produces less dust than jobsaw handtool - cuts clean without ripping the drywall.
- Plunge tip - fast and effortless plunging.

Blade length (mm)	Tooth pitch (mm)	Teeth per inch	Yes	Yes	Packed contents	Article Number	EAN Code	Price exc. VAT
63	-	-	Yes	Yes	1	48001640	045242300181	£7.95
125	4.2	6	Yes	Yes	5	48005052	045242082735	£17.69

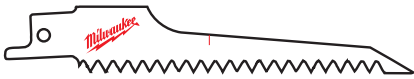









System accessories - SAWZALL®

Description	Fits SAWZALL	Packed contents	Article Number	EAN Code	Price exc. VAT
Heavy Duty cast iron pipe clamp with round fixing post (part no. 45160611). Capacity 4" / 110 mm.	SSE 1000 AVS, SSE 1000 SQ, SSE 1000 QX	1	49221012*	045242180394	£261.41
Heavy Duty cast iron pipe clamp with fixing post (part no. 45160613). Capacity 4" / 110 mm.	SSPE 1000 QX, SSH 800 QX Hatchet, PSH 18v hatchet	1	49221024*	045242180493	£294.36
Heavy Duty cast iron pipe clamp with fixing post (part no. 45160604). Capacity 4" / 110 mm.	SSPE 1300 QX, SSPE 1300 SQ, V18 SX, V28 SX, M18 FUEL™ SAWZALL, SSDE 1500 X, USE 980 X, SSPE 1500 X	1	49221016*	045242181445	£341.05
Conversion kit: to convert FIXTEC blade reception models to keyed blade reception to accept 20 mm reception blades.	SSE 1000 QX, SSPE 1000 QX, SSH 800 QX Hatchet, PSH 18v hatchet, V18 SX, SSPE 1300 QX, M18 FUEL™ SAWZALL, SSDE 1500 X, USE 980 X, V28 SX	1	42680685		£14.36
Screw.		1	06832976		£1.44
Allen Key 5/16"		1	49960070	045242221554	£0.33
Conversion kit: to convert FIXTEC blade reception models to keyed blade reception to accept 1/2" universal reception blades.	SSE 1000 QX, SSPE 1000 QX, SSH 800 QX Hatchet, PSH 18v hatchet, V18 SX, SSPE 1300 QX, M18 FUEL™ SAWZALL, SSDE 1500 X, USE 980 X, V28 SX	1	49225016	045242182060	£12.38
Screw.		1	06832976		£1.44
Allen Key 5/16"		1	49960070	045242221554	£0.33
Conversion kit: to convert standard 1/2" keyed blade reception models to keyed blade reception to accept 20 mm reception blades.	SSE 1000 AVS, SSE 1000 SQ, SSPE 1300 SQ	1	42680647		£18.75
Screw.		1	06832960		£2.78
Allen Key 5/16"		1	49960080	045242221608	£0.84
Transport case for sabre saws / SAWZALLS®.	SSE 1000 AVS, SSE 1000 SQ, SSE 1000 QX, SSPE 1000 QX, SSD 1100 X, SSPE 1300 QX, SSPE 1300 SQ, M18 FUEL™ SAWZALL, SSDE 1500 X, V18 SX, V28 SX	1	48556510	045242148424	£43.14
	V18 SX, V28 SX	1	201602001	4002395836383	£23.21
Cases supplied with latches and foam insert. Size 1 (L x W x H) 475 x 358 x 132 mm.	PSH 18v hatchet	1	4932378986	4002395349401	£64.03

* while stocks last

HACKZALL[™] Blades

- Especially engineered blades for exclusive use on 12 V HACKZALL[™].
- Bi-Metal construction for increased tooth durability.
- Optimised tooth form for aggressive and faster cutting.
- Thinner blade body for better speed of cut and 35% more cuts per charge.

Blade length (mm)	Tooth pitch (mm)	Teeth per inch	Material type	Material type						Packed contents	Article Number	EAN Code	Price exc. VAT	
				METAL	METAL	Cu/Ni/Ms/Zn	ALU	WOOD	P.V.C.					
	100	4.2	6	Bi-Met,Co	-	-	-	-	6 - 40	Ø 10 - 40	5	49005460	045242160273	£14.42
	150	1.8	14	Bi-Met,Co	3 - 6	Ø 10 - 32	3 - 6	3 - 6	-	Ø 10 - 50	5	49005614	045242160334	£15.73
	100	1.4	18	Bi-Met,Co	1.5 - 4	Ø 10 - 32	1.5 - 4	-	-	-	5	49005418	045242160341	£14.42
	100	1	25	Bi-Met,Co	0.5 - 3	Ø 8 - 32	0.5 - 3	-	-	-	5	49005424	045242160358	£14.42
	75	-	-	-	-	-	-	-	-	-	1	49005456	045242219476	£13.38
75 mm scraper: for removing strong adhesive silicon, caulk, paint and rust.														
	125	-	-	-	-	-	-	-	-	-	1	49005455	045242293421	£14.99
125 mm wide scraper: for removing glue, silicon, caulk, vinyl, rust, paint and wallpaper.														
	60	-	-	-	-	-	-	-	-	-	1	49005450	045242221066	£20.59
Grout removal blade: for removing damaged or moulded grout between tiles.														
	10 pc set 2 x 49005460, 3 x 49005614, 3 x 49005424, 2 x 49005418.										10	49220220	045242160365	£28.83

Jigsaw blades

Material qualities

HCS

- High Carbon Steel jigsaw blades are used for cutting all types of wood and plastics.

HSS

- High Speed Steel blades are suited to cutting metal, non ferrous metal and aluminium.

Carbide grit

- These blades have a tungsten carbide grit edge making them suitable for abrasive materials.

TC

- Blades with tungsten carbide tipped teeth are ideally suited to glassfibre reinforced products. Those blades with a continuous tungsten carbide tooth strip cutting edge are suitable for extremely hard materials such as stainless steel.

Bi-Metal

- Bi-Metal blades consist of high speed steel teeth electron beam welded onto a flexible alloy steel back. These blades offer maximum performance in the most demanding applications in both wood and metal.

Bi-Metal blades offer the following benefits:

- Flexible and shatter resistant
- Longer lifetime. Metal cutting blades offer double the lifetime and wood cutting blades more than 5 times the lifetime over conventional HCS and HSS blades.
- High wear rate and heat resistance ensure the teeth stay sharp longer.
- Faster cutting performance.

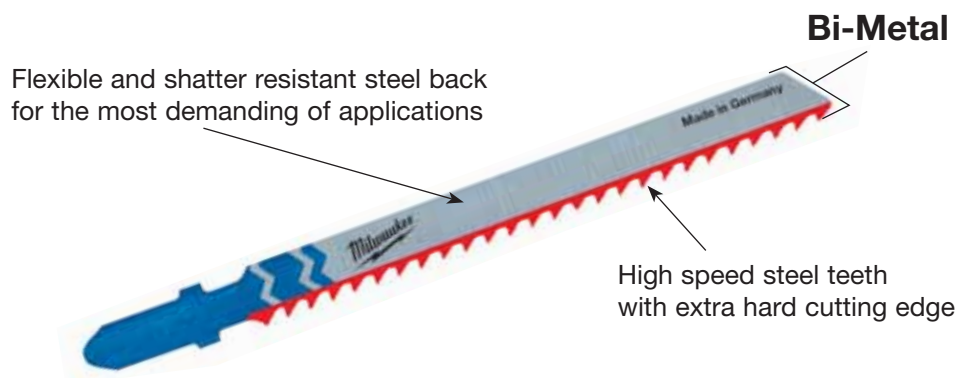

Blade colour code

Shank colour means application



= For all types of wood, laminated chipboard, chipboard, plywood, blockboard and plastics. Silver colour blade body.



= For all types of ferrous and non-ferrous metals, steel, aluminium, brass, copper, stainless steel, lead, tin and sandwich materials. Silver colour blade body.



= For cutting a range of products, carton, rubber, fibreglass, foam and abrasive materials. Black colour blade body.



= Bi-Metal blades come with a white body and then the corresponding colour shank; yellow for wood and blue for metal.

Shank receptions

T-Shank blades

- Suitable for most major brands.

AEG, Bosch, DeWalt, Festool, Hitachi, Hilti, Mafell, Makita, Metabo, Milwaukee®, Ryobi.



Special shank blades

- We do also offer a range of the most popular blades with either the Makita, or U-Shank reception.

U-Shank: for Black & Decker, Kress, Ryobi, Skil



Packaging



- Common blades are available in 5 and bulk 25 pack quantities. Our 25 pack packaging is reusable allowing for blades to be removed and returned easily.
- Our colour system on the blades is also featured on our packaging in conjunction with our pictograms to ensure you have the right blade for the application.

Technical tips

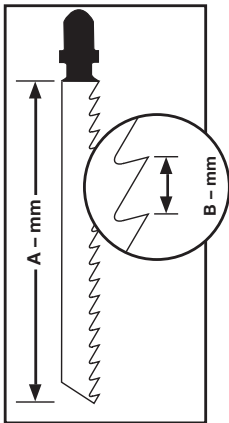

- The blade length represents the section of the blade with cutting teeth (A–mm). The tooth pitch is measured in millimetres (mm) from tooth point to tooth point (B–mm). Selecting the correct tooth pitch is dependent on the thickness of material being cut. The golden rule is to have three teeth in contact with the material being cut at all times; this is the optimum, as a guidance for thick material such as metals over 4 mm thickness a tooth pitch of 2 mm or more is recommended. For metals with a thickness of 1.5–3.5 mm a tooth pitch of 1.2 to 1.4 is desirable. When cutting thin metal sheet material below 1.5 mm a tooth pitch of 0.7 to 1.2 mm is recommended. The general rule when cutting wood is the higher the tooth pitch the faster and rougher / coarser the cut will be.
- When cutting extremely thin sheet material it is recommended to place the material onto a thicker backing to prevent the sheet material from breaking.
- We recommend the use of a cooling lubricant to extend the life of the saw blade when cutting metals and plastics.

Material	Coolant
	Cutting oil
	Turpentine
	Water

Jigsaw blades for wood and plastic



Traditional blades

Traditional blades that deliver good and solid performance.

Blade length (mm)	Tooth pitch (mm)	Ref. No.											Article Number	EAN Code	Price exc. VAT
50	2	T 119 B	< 20	-	< 20	Yes	-	No	No	No	No	5	4932274353	4002395301553	£5.39
75	3	T 111 C	5 - 50	-	< 40	-	Yes	No	No	No	No	5	4932254071	4002395301539	£4.59

Curve cutting blades

All of our curve cutting blades are characterised by a narrow blade body for improved manoeuvrability.

Jigsaw blade 4932265312 and 4932430143 has cutting teeth on both sides.

The teeth on the back of the blade allows one to cut tight and acute curves with simplicity.

For best results work without pendulum action when cutting tight curves.

50	1.35	T 101 A0	< 20	< 20	< 15	Yes	No	Yes	No	No	No	5	4932373392	4002395348879	£8.19
50	2	T 119 B0	< 20	-	< 20	Yes	No	Yes	No	No	No	5	4932274650	4002395301485	£6.75
75	2.5	Curve	< 30	< 20	< 20	Yes	No	Yes	No	Yes	Yes	5	4932430143	4002395378043	£12.22
75	4 / 1.2	Special	< 30	-	< 30	No	Yes	Yes	No	No	No	5	4932265312	4002395301478	£12.22
75	4	T 244 D	< 50	-	-	No	Yes	Yes	No	Yes	Yes	5	4932346078	4002395312375	£8.69
												25	4932373492	4002395349920	£38.65

Fast cut blades

The sharp and aggressive tooth geometry is ideal for very fast cutting of wood.

75	4	T 144 D	< 50	-	-	No	Yes	No	No	Yes	Yes	5	4932213116	4002395301492	£6.96
												25	4932373487	4002395349272	£30.90
												100	4932430461	4002395381227	£99.00
75	4	T 144 DF	< 50	-	-	No	Yes	No	No	Yes	Yes	5	4932373391	4002395348862	£13.06
105	4	T 344 D	< 80	-	-	No	Yes	No	No	Yes	Yes	5	4932311633	4002395301508	£16.88
155	4	T 744 D	5-125	-	-	No	Yes	No	No	Yes	Yes	5	4932354745	4002395324095	£42.88

Bi-Metal

Fast and clean cutting blades

Triple sharpened tooth geometry for fast and super clean splinter free cuts. Plunge tip for fast plunging.

Blade length (mm)	Tooth pitch (mm)	Ref. No.										Packed contents	Article Number	EAN Code	Price exc. VAT
3 cut 91	2.5	T 234 X	3 - 60	3 - 60	Yes	< 45	No	No	Yes	No	5	4932430141	4002395378029	£10.95	

Clean and splinter free cutting blades

The following blades have diagonally sharpened side teeth resulting in a very clear splinter free cut.

	75	2.5	T 101 B	< 30	< 60	No	< 30	Yes	No	No	No	5 25	4932254061 4932373489	4002395301522 4002395349296	£8.82 £40.17
Bi-Metal	75	2.5	T 101 BF	< 30	< 60	No	< 30	Yes	No	No	No	5	4932373390	4002395348855	£16.64
	75	4	T 101 D	< 50	< 60	No	< 45	Yes	No	No	No	5 25	4932274351 4932373490	4002395301515 4002395349906	£8.82 £40.17
	105	3	T 301 CD	< 80	< 60	No	-	Yes	No	No	No	5	4932399306	4002395359202	£15.80
	105	4	T 301 DL	< 80	< 80	No	< 50	Yes	No	No	No	5	4932346071	4002395312399	£15.80

Precise straight cutting blades: kitchen worktops

The following blades benefit from a thicker blade body guaranteeing extra stiffness and consequently a more accurate vertical cut. Ideal for those applications where a true square cut is necessary - i.e. kitchen worktops.

	75	4	T 101 DP	< 60	< 60	No	< 45	Yes	No	No	Yes	5	4932373080	4002395346073	£9.45
	105	4	T 101 DP sp.	< 80	< 80	No	< 50	Yes	No	No	Yes	5	4932373388	4002395348831	£20.70

Special application: kitchen worktops and laminated chipboard

These blades have a reversed tooth design, this means that the blade cuts on the downward stroke making them extremely suitable for clean and splinter free cuts in laminated chipboard and especially kitchen worktops in situ.

For best results work without pendulum action.

	75	2.5	T 101 BR	< 30	< 60	No	< 60	Yes	No	No	No	5	4932346079	4002395312382	£9.61
	105	2.5	T101BR sp.	< 50	< 80	No	< 80	Yes	No	No	No	5	4932348072	4002395313860	£18.38

Special application: laminated and parquet flooring

Blade 4932373392 is ideally suited for cutting curves and irregular shapes. Use blade 4932373083 for straight cuts.

	50	1.35	T 101 A0	< 20	No	< 20	< 15	Yes	No	Yes	No	5	4932373392	4002395348879	£8.19
	60	1.9	Special	3 - 20	Yes	Yes	-	Yes	No	No	No	5	4932373083	4002395346080	£19.07

Jigsaw blades for metal



Traditional blades

Blade reference 4939274652 is especially suited to cutting very thin sheet material because of its low 0.7 mm tooth pitch. For those professionals desiring extra lifetime and durability we recommend the use of Bi-Metal blades in conjunction with a suitable cooling lubricant, the blades lifetime is double that of non Bi-Metal blades.

Blade length (mm)	Tooth pitch (mm)	Ref. No.	METAL	Cu/Ni/Ms/Zn	STAINLESS-INOX INOXSTA	ALU	P.V.C.	PERSPEX®	Packed contents	Article Number	EAN Code	Price exc. VAT	
2746 52	0.7	T 118 G	0.5 - 2	0.5 - 2	-	-	-	-	No	5	4932274652	4002395301621	£8.23
2540 63	1.2	T 118 A	1.5 - 4	1.5 - 4	-	-	-	-	No	5	4932254063	4002395301614	£8.31
3400 11	1.2	T 118 AF	1.5 - 4	1.5 - 4	-	1.2 - 2	-	-	No	5	4932340011	4002395304684	£11.42
3458 26	1.2	T 118 A sp.	1.5 - 4	1.5 - 4	-	-	-	-	No	5	4932345826	4002395313464	£11.91
3993 07	1	T 318 A	1 - 4	1 - 4	< 85	-	-	-	No	5	4932399307	4002395359219	£13.86
2540 64	2	T 118 B	3 - 6	3 - 6	-	-	3 - 10	-	No	5	4932254064	4002395301591	£8.31
3400 12	2	T 118 BF	3 - 6	3 - 6	-	2 - 3	3 - 10	2 - 30	No	5	4932340012	4002395304691	£11.42
2746 51	2.5	T 101 A sp.	-	2 - 10	< 45	-	3 - 10	2 - 20	No	5	4932274651	4002395301577	£17.30

Universal application blades

These blades are suitable for cutting a wide variety of materials ranging from mild steel, aluminium, wood with nails, plastics and sandwich composites. Blade 4932373086 with its extra length (155 mm) is suitable for cutting thick corrugated sandwich material.

Bi-Metal TWIN CUT	4301 42	2.5 / 1.8	T 123 XF	2.5 - 10	3 - 10	< 50	-	4 - 10	-	-	No	5	4932430142	4002395378036	£10.75
Bi-Metal	2746 54	1.2	T 318 AF	1.5 - 4	1.5 - 4	< 85	-	-	-	-	No	5	4932274654	4002395301607	£15.47
Bi-Metal	2746 53	2	T 318 BF	3 - 6	3 - 6	< 85	-	3 - 10	4 - 30	-	No	5	4932274653	4002395301584	£15.47
Bi-Metal	3730 86	1	T 718 AF	1 - 4	1 - 4	< 125	-	-	-	-	No	5	4932373086	4002395346097	£23.20

Curve cutting blades

Especially narrower saw blade body allows one to cut tight curves in a range of metallic materials.

3460 82	55	1.2	T 218 A	1.5 - 4	1.5 - 4	-	-	-	-	-	Yes	5	4932346082	4002395312368	£10.08
3460 81	75	3	T 227 D	3.5 - 6	3.5 - 6	-	-	4 - 15	4 - 30	-	Yes	5	4932346081	4002395312351	£11.83

Special application: aluminium

Most traditional blades are also capable of cutting aluminium, however these two blades benefit from a larger tooth pitch and wider gullets offering better material removal which is an advantage when cutting aluminium.

When cutting curves or irregular shapes in aluminium we recommend the use of blade 4932346081.

Blade length (mm)	Tooth pitch (mm)	Ref. No.	METAL	Cu/Ni/Ms/Zn		STAINLESS+INOX NITROSTA	ALU	P.V.C.	Packed contents	Article Number	EAN Code	Price exc. VAT
75	3	T 127 D	3.5 - 6	3.5 - 6	-	-	4 - 15	4 - 30	5	4932274315	4002395301560	£9.26

Special application: stainless steel

This blades teeth consist of a carbide tipped strip making it the most suitable and durable blade for steels with a high alloy content such as stainless steel.

For best results work without pendulum action and use cutting oil as a lubricant.

50	1.1	T 118 AHM	1.5 - 3	1.5 - 3	-	1.5 - 3	-	-	2	4932373393	4002395348886	£33.89
50	1.4	T 118 EHM	2 - 5	2 - 5	-	2 - 5	-	-	2	4932373394	4002395348893	£33.89

Jigsaw blades for special materials

Special applications: fibreglass, reinforced plastics, acrylic glass

Blade 4932373387 has tungsten carbide teeth for longer lifetime in hard materials such as fibreglass.

Blade length (mm)	Tooth pitch (mm)	Ref. No.	Cu/Ni/Ms/Zn		P.V.C.	PERSPEX							Packed contents	Article Number	EAN Code	Price exc. VAT
75	2.5	T 101 A sp.	2 - 10	-	No	No	-	2 - 20	-	No	-	No	5	4932274651	4002395301577	£17.30
75	4.2	T 141 HM	-	-	No	No	5 - 20	-	5 - 20	No	-	Yes	1	4932399308	4002395359226	£17.00
105	4.2	T 341 HM	-	< 60	No	No	5 - 20	-	5 - 20	No	-	No	1	4932373387	4002395348824	£19.06

Special application: abrasive material and cast iron

54	Grain 30	T 130 Coarse grit	-	-	Yes	Yes	< 15	-	-	Yes	5 - 15	No	1	4932213231	4002395301645	£9.27
54	Grain 50	T 150 Fine	-	-	Yes	Yes	< 10	-	-	Yes	5 - 15	No	1	4932213232	4002395301652	£9.27

Special application: insulation material

Blade length (mm)	Tooth pitch (mm)	Ref. No.					Packed contents	Article Number	EAN Code	Price exc. VAT
155	Wave knife	T 313 AW	Yes	Yes	Yes	Yes	5	4932430144	4002395378050	£24.95

Jigsaw blade sets - T-Shank reception

Description	Packed contents	Article Number	EAN Code	Price exc. VAT
5 pc set on blister card. Suitable for applications in wood and metal.				
Jigsaw blade 4932213116, 4932254061, 4932254063, 4932254064, 4932254071.	5	4932345825	4002395314850	£8.76



System accessories - Jigsaws

Description	M12 JS HD18 JS/JSB BST 18 X LI JS 120 X JSPE 135 TX STEP 1200 BX/X JSPE 90 X FSPE 11 X BSPE 110 QX STEP 800 X ST 800 XE V28 JSB	STEP 70 STEP 75 ST 700 E STEP 90 X STEP 100 X FSPE 100 XL BSPE 100 XL	Packed contents	Article Number	EAN Code	Price exc. VAT
Gliding shoe for materials with delicate surfaces.	•		1	4932430356	4002395380176	£3.99
		•	1	4932430834	4002395384969	

①



U Shank jigsaw blades

Blade length (mm)	Tooth pitch (mm)	Ref. No.								Packed contents	Article Number	EAN Code	Price exc. VAT
75	4	A 2202	5 - 60	< 60	-	No	Yes	Yes		5	4932354508	4002395321070	£9.07
75	2.5	A5035/A5041	< 30	< 60	< 30	Yes	No	No		5	4932354506	4002395321056	£9.13

Circular saw blades for wood

Circular saw blades for portable tools

Blade diameter (mm)	Bore size (mm)	No. of teeth	Cutting width (kerf) (mm)	Solid wood	Chipboard	MDF and fibreboard	Laminated chipboard	Blockboard	Plywood & OSB boards	Plastics	Plasterboard, breezeblock, cemented plywood	Non ferrous metals profiles alu	Fine cut	Packed contents	Article Number	EAN Code	Price exc. VAT
160	20	12	2.4	✓	✓	✓					✓			1	4932327743	4002395312962	£25.75
		48	2.6	✓	✓	✓	✓	✓	✓		✓			1	4932248233	4002395307340	£50.47
		42	2.8	✓	✓		✓	✓	✓	✓	✓	✓	✓	1	4932346511	4002395318933	£81.37
165	20	24	2.6	✓	✓	✓	✓	✓	✓	✓	✓			1	4932352131	4002395367849	£44.29
		52	2.8	✓	✓	✓	✓	✓	✓	✓	✓		✓	1	4932352132	4002395367856	£79.31
165	30	24	1.8	✓	✓	✓	✓	✓	✓	✓	✓			1	4932399909	4002395365647	£44.29
		36	2.6	✓	✓	✓	✓	✓	✓	✓	✓		✓	1	4932352133	4002395367863	£71.07
184	30	24	1.8	✓	✓	✓	✓	✓	✓	✓	✓			1	4932352327	4002395369867	£37.08
		48	1.8	✓	✓	✓	✓	✓	✓	✓	✓		✓	1	4932352328	4002395369874	£54.59
		54	2.0	✓	✓	✓	✓	✓	✓	✓	✓	✓	✓	1	4932352329	4002395369881	£71.07
190	30	16	2.4	✓	✓	✓					✓			1	4932256387	4002395300709	£29.87
		24	2.4	✓	✓	✓	✓	✓	✓	✓	✓			1	4932327969	4002395319060	£35.02
		48	2.8	✓	✓	✓	✓	✓	✓	✓	✓		✓	1	4932256388	4002395300747	£50.47
		54	2.8	✓	✓		✓	✓	✓	✓	✓	✓	✓	1	4932346512	4002395318940	£77.25
210	30	16	2.4	✓	✓	✓					✓			1	4932259182	4002395300716	£33.99
		48	2.8	✓	✓	✓	✓	✓	✓		✓		✓	1	4932259136	4002395300754	£56.65
		54	2.8	✓	✓		✓	✓	✓	✓		✓	✓	1	4932346513	4002395318957	£87.55
230	30	48	3.0	✓	✓	✓	✓	✓	✓	✓			1	4932303099	4002395305285	£60.77	

Circular saw blades for cordless tools

140	20	18	1.3	✓	✓	✓	✓	✓	✓					1	4932430719	4002395383801	£24.99
165	15.87	24	1.6	✓	✓	✓	✓	✓	✓					1	4932352313	4002395369720	£24.99
165	15.87	40	1.6	✓	✓	✓	✓	✓	✓				✓	1	4932352314	4002395369737	£34.90
190	30	24	2.0	✓	✓	✓	✓	✓	✓					1	4932430430	4002395380916	£34.99

Circular saw blades for mitre saws

210	30	24	2.8	✓	✓	✓	✓	✓	✓					1	4932352135	4002395367887	£56.65
		48	2.8	✓	✓	✓	✓	✓	✓				✓	1	4932352136	4002395367894	£60.77
		54	2.8								✓		✓	✓	1	4932352137	4002395367900
216	30	24	2.8	✓	✓	✓	✓	✓	✓					1	4932352839	4002395374977	£49.89
		48	2.8	✓	✓	✓	✓	✓	✓				✓	1	4932352840	4002395374984	£69.00
		80	2.8								✓		✓	✓	1	4932352841	4002395374991
250	30	24	3.2	✓	✓	✓	✓	✓	✓					1	4932352138	4002395367917	£66.95
		48	3.2	✓	✓	✓	✓	✓	✓					1	4932352139	4002395367924	£91.67
		80	3.2	✓	✓	✓	✓	✓	✓				✓	1	4932361504	4002395337088	£143.17
		80	3.4								✓		✓	✓	1	4932352140	4002395367931
305	30	60	3.2	✓	✓	✓	✓	✓	✓					1	4932352141	4002395367948	£143.17
		100	3.2	✓	✓	✓	✓	✓	✓				✓	1	4932352142	4002395367955	£153.47
		96	3.2								✓		✓	✓	1	4932352143	4002395367962

Circular saw blades for metal

1. Engineered tooth geometry for optimum performance.
2. Top grade carbide and cermet tooth tips for superior lifetime.
3. Fully hardened and tensioned blade body for accurate cuts.
4. Deep gullets provide rapid and efficient chip removal.
5. Laser cut resin filled expansion slots for noise and vibration dampening.

- Cuts clean. Burr free edges reduce extra finishing processes.
- Cuts cool. The cut material can be handled immediately after cutting.
- Cuts fast. Quicker than all other conventional cutting methods.
- Cost cutter. Less expensive per cut than abrasive discs.
- Reduced noise.
- Reduced vibration.
- Total safety: no sparks, no coolants, cool to touch.

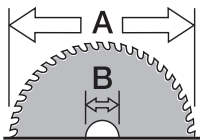

Blade diameter (mm)	Bore size (mm)	No. of teeth	Cutting width (kerf) (mm)	Material wall thickness (mm)	Mild steel	Sheet steel up to 2.5mm	Corrugated steel panels up to 2.5mm	Steel tube	Steel pipe	Angle iron	Steel channel	Stainless steel sheets	Cast iron	Copper	Aluminium	Rebar	Sandwich material (steel, foam, panels)	Packed contents	Article Number	EAN Code	Price exc. VAT
135	20	30	1.6	1-2.5	✓	✓	✓	✓	✓	✓	✓	✖	✖	✖	✖	✖	✓	1	48404070	045242233786	£89.99
		50	1.6	1-2.5	✖	✖	✖	✖	✖	✖	✖	✖	✖	✓	✓	✖	✖	1	48404075	045242233793	£109.00
165	15.87	48	1.6	1-2.5	✓	✓	✓	✓	✓	✓	✓	✖	✖	✖	✖	✖	✓	1	48404015	045242134298	£115.28
174	20	36	1.65	>2.5	✓	✖	✖	✓	✓	✓	✓	✖	✖	✖	✖	✖	✖	1	48404016	045242134120	£99.99
		50	1.65	1-2.5	✓	✓	✓	✓	✓	✓	✓	✖	✖	✖	✖	✖	✓	1	48404017	045242151738	£157.27
203	15.87	42	1.8	>2.5	✓	✖	✖	✓	✓	✓	✓	✖	✖	✖	✖	✖	✖	1	48404515	045242134465	£109.99
		50	1.8	1-2.5	✓	✓	✓	✓	✓	✓	✓	✖	✖	✖	✖	✖	✓	1	48404520	045242134472	£129.99

- ✓ Most suitable. Recommended for these materials.
- ✖ Not suitable. Not recommended for these materials.
- ◆ Suitable. Recommended for intermittent use in these materials.
- Very good cutting characteristics, but greatly reduced lifetime of the blade.

Optimising Blade Life

1. Clamp the workpiece securely to avoid vibration.
2. Do NOT stack or bundle cutting material. The gaps between layers allow for more opportunities to chip the teeth. The life of the blade is severely affected by this type of cutting.
3. Lower the blade to its maximum cutting capacity and allow the tool to come to full speed before applying the blade to the material.
4. Do NOT force the saw blade into the material. Start gently, then gradually apply enough pressure to avoid sparks.
5. Optimal cutting speed and pressure will produce little or no sparks. Sparking creates heat build up which shortens saw blade life.
6. Keep the cut straight. If following a cut line and you wander off the line, getting back on line may cause side loading of the blade and break teeth. Use an edge guide whenever possible.
7. Do NOT apply side pressure on the blade as this will cause chipping of the teeth.
8. Periodically allow the tool to run free of the cutting material to cool the blade and tool especially when making long cuts or cuts in thick material.

System accessories - Circular saws

Description	Fits circular saws	Packed contents	Article Number	EAN Code	Price exc. VAT
① Clean line system.	SCS 65 Q,CS 55	3	4932346123*	4002395313266	£40.05
② Cloth filter bag. Requires bag holder 4932346123.	SCS 65 Q,CS 55	1	4932346182*	4002395313273	£58.64
Dust absorption connector.	PCS 55	1	4932369282	4002395338412	£20.51
	CS 75,HKS 75,HK 75 A	1	4932259301*	4002395304158	£10.18
③ Extension hose Ø 35 mm / 4 m long. Requires adaptor (362778).	CS 55,CS 75,HKS 75,HK 75 A,HKS 85	1	4932330552	4002395312719	£104.31
④ Extraction hose Ø 26 mm, 4 m. For connection to external extraction system.	PCS 55,HK 46 N	1	4932278824	4002395308286	£96.12
Spanner for removing saw blade.	CS 55,HK 46 N,SCS 65 Q,CS 75,PCS 55,HKS 75,HK 75 A,HKS 85,PMS 18	1	4932371469	4002395342181	£5.62
	CS 75,CS 55,HKS 75,HK 75 A	1	4932276288	4002395308217	£8.48
Parallel guide / fence.	PMS 18	1	49221001	045242180417	£14.90
	SCS 65 Q	1	49224146	045242181896	£19.88
Plastic transport case.	SCS 65 Q	1	201672001	4002395840519	£24.91
⑤ Dust extraction hood for MS216 Mitre Saw.		1	4932430005	4002395376667	£69.98
⑥ Guide rail GRU 1400. 1400 mm long. Supplied with carry bag.		1	4932451265	4002395170197	£169.99
	Connector piece	1	4932352559	4002395372171	
For fixing guide rail to the work material.		1	4932451266	4002395170807	£129.99
Strip and rubber lip assembly set.		1	4931433774	4002395887620	£17.92



Planer blades

Description	Width (mm)	Fits planers	Packed contents	Article Number	EAN Code	Price exc. VAT
Tungsten carbide reversible blades. Two reversible blades, suitable for soft and hardwoods.	82 mm	H 500,H 750	2	4932273484	4002395300150	£12.04
	102 mm	HB 750,HBE 800	2	4932316243	4002395300167	£14.74



System accessories - Planers

Description	All planers 82 & 102mm	Packed contents	Article Number	EAN Code	Price exc. VAT
Hose connections. Suction sleeve for suction hoses 330552.	✓	1	4932316270	4002395302017	£9.31
Parallel guide.	✓	1	4932274071	4002395300358	£35.52
Folding rebate depth gauge. For all planers except H500 / PR 1.6-82 models.	✓	1	4932274069	4002395300129	£7.78
① Clamp (single piece). For planer / thicknesser bench mounting kit. 2 pieces required.	✓	1	4932367730	4002395338566	£24.62



Band saw blades

Choosing the right tooth geometry

10 Tpi Tooth pitch 2.5 mm	10/14 Tpi Tooth pitch 2.5/1.8 mm	14 Tpi Tooth pitch 1.8 mm	14/18 Tpi Tooth pitch 1.8/1.4 mm	18 Tpi Tooth pitch 1.4 mm	25 Tpi Tooth pitch 1 mm
FOR CUTTING STOCK 8 to 13 mm	FOR CUTTING STOCK 5 to 13 mm	FOR CUTTING STOCK 5 to 8 mm	FOR CUTTING STOCK 4 to 8 mm	FOR CUTTING STOCK 4 to 5 mm	FOR CUTTING STOCK < 4 mm

Bi-Metal blades with matrix II high speed steel teeth with 8% cobalt outlast conventional blades up to 3 times, requiring fewer blade changes.

Extremely hard and uniform tooth point is electron beam welded to a tough durable backing with high flex life for faster cutting, and longer blade life.

High speed cutting of aluminium, angle iron, bronze, brass, copper, galvanized pipe, mild steel.

Tougher steels including stainless, chrome, tungsten steel plus other problem materials at slow speed.

Blade length 1139.83 mm (corded & M18 FUEL™)

Material wall thickness (mm)	Tooth pitch (mm)	Teeth per inch	Packed contents	Article Number	EAN Code	Price exc. VAT
≥ 8	2.5	10	3	48390501	045242132096	£35.89
5 - 8	1.8	14	3	48390511	045242132164	£36.55
4 - 5	1.4	18	3	48390521	045242132263	£35.89
≤ 4	1.0	25	3	48390531	045242132362	£36.55

Blade length 898.52 mm (M18)

Material wall thickness (mm)	Tooth pitch (mm)	Teeth per inch	Packed contents	Article Number	EAN Code	Price exc. VAT
5 - 8	1.8	14	3	48390519	045242201594	£35.00
4 - 5	1.4	18	3	48390529	045242201747	£35.00
≤ 4	1.0	25	3	48390539	045242201815	£35.00

Blade length 687.57 mm (M12)

Material wall thickness (mm)	Tooth pitch (mm)	Teeth per inch	Packed contents	Article Number	EAN Code	Price exc. VAT
2.5 - 8	1.4	18	3	48390572	045242272341	£32.00

Bi-Metal multi-pitch blades

Designed with varying set angles and gullet depths to break up the harmonic vibrations generated in cutting, resulting in smoother, quieter cutting and longer blade life.

Designed for interrupted cutting applications (tubing, structurals, etc.).

Also production cutting of solids in variety of sizes or shapes.

Blade length 1139.83 mm

Material wall thickness (mm)	Tooth pitch (mm)	Teeth per inch	Packed contents	Article Number	EAN Code	Price exc. VAT
5 - 13	2.5 / 1.8	10 / 14	3	48390551	045242132461	£36.55
4 - 8	1.8 / 1.4	14 / 18	3	48390561	045242132560	£36.55

Multitool accessories

NEW

Universal blade reception makes Milwaukee® blades compatible with the most popular oscilating tools.

	Reception
AEG	✓
Bosch	✓
Fein	✓
Makita	✓
Milwaukee	✓
Ryobi	✓

Description	Teeth per inch	Width (mm)	Length (mm)	Packed contents	Article Number	EAN Code	Price exc. VAT
① 19 mm plunge cut blade. Plunge / recess / flush cutting in wood and PVC.	16	19	42	1	48900015	045242349005	£11.99
② 32 mm plunge cut blade. Plunge / recess / flush cutting in wood and PVC.	16	32	42	1	48900030	045242349036	£14.99
③ 32 mm fast cut Japanese tooth blade. For fast , clean cuts in soft and hard wood.	14	32	42	1	48900055	045242355228	£14.99
④ 64 mm Bi-Metal wide blade. For cuts in sheet metal, nail embedded wood, plastic and fibreglass.	18	64	42	1	48900050	045242353514	£14.99
⑤ 80 mm flush cut segmented blade. For accurate and flush cuts in wood and plastics.	18	80	20	1	48900045	045242349067	£22.99
⑥ 80 mm Titanium flush segmented blade. Titanium coating for best wear resistance and double the lifetime. For accurate and flush cuts in sheet metal, nail embedded wood, plastic and fibreglass.	18	80	20	1	48900035	045242349043	£32.99
⑦ Grout removal blade. For removing damaged grout between wall or floor tiles. Also good for cutting grooves in drywall.	Carbide grit	64		1	48900100	045242349074	£24.99
⑧ Flush cut carbide grit blade. For cutting grooves and slots in plaster, drywall and grout.	Carbide grit	30	20	1	48900110	045242349081	£22.99
⑨ Sanding pad	Grit	93	93	1	48902000	045242349098	£9.99
	60	93	93	8	48902060	045242349166	£8.99
⑩ Sanding paper. Hook & Loop. 8 pc pack.	80	93	93	8	48902080	045242349173	£9.99
	120	93	93	8	48902120	045242349135	£10.99
	240	93	93	8	48902240	045242366064	£11.99



Expander heads

Description	Pipe diameter (mm)	Pipe wall thickness (mm)	Pipe pressure (bar)	Suitable	Packed contents	Article Number	EAN Code	Price exc. VAT
PXPH9-144/8	9.9	1.1	4/8	M12, M18	1	4932430102	4002395377633	
PXPH12I-14	12	1.7/ 1.8/ 2	6-10	M12, M18	1	4932352716	4002395373741	£76.85
PXPH15N-14	14 / 15	2.5	6-10	M12, M18	1	4932352727	4002395373857	
PXPH16I-1406	16	1.5/ 1.8	6	M12, M18	1	4932430103	4002395377640	
PXPH16I-1410	16	1.8/ 2.0/ 2.2	10	M12, M18	1	4932352717	4002395373758	£80.35
PXPH18N-14	17 / 18	2.5	6-10	M12, M18	1	4932352728	4002395373864	
PXPH20I-1406	20	1.9/ 2.0/ 2.3	6, (8 bar - Ø 2.3 mm)	M12, M18	1	4932352718	4002395373765	£80.35
PXPH20I-1410	20	2.8	10	M12, M18	1	4932352719	4002395373772	£80.35
PXPH20I-2506	20	1.9/ 2.0/ 2.3	6, (8 bar - Ø 2.3 mm)	M18	1	4932352733	4002395373918	
PXPH20I-2510	20	2.8	10	M18	1	4932352748	4002395374069	
PXPH22N-14	22	3	6-10	M12, M18	1	4932352729	4002395373871	
PXPH25I-1406	25	2.3	6	M12, M18	1	4932352720	4002395373789	£87.69
PXPH25I-1410	25	3.5	10	M12, M18	1	4932352721	4002395373796	
PXPH25I-2506	25	2.3	6	M18	1	4932352722	4002395373802	
PXPH25I-2510	25	3.5	10	M18	1	4932352749	4002395374076	
PXPH28N-14	28	4	6-10	M12, M18	1	4932352730	4002395373888	
PXPH32I-1406	32	2.9	6	M12, M18	1	4932352723	4002395373819	
PXPH32I-25	32	2.9/ 4.4	6-10	M18	1	4932352724	4002395373826	
PXPH40I-2506	40	3.7	6	M18	1	4932352725	4002395373833	
Grease Tube contents 50 g. For lubrication of cone and expander heads.					1	4932352726	4002395373840	



System accessories - Routers

Description	Fits routers	Packed contents	Article Number	EAN Code	Price exc. VAT
Precision collet for router.					
High rotation accuracy.					
Ø 3 mm collet.	OFE 710,OFE 630	OFS 450	1	4932308974	4002395309092 £32.53
Ø 6.35 mm (1/4) collet.	OFE 710,OFE 630	OFS 450	1	4932313194	4002395302857 £18.08
Ø 6 mm collet.	OFE 710,OFE 630	OFS 450	1	4932313192	4002395302833 £17.34
Ø 6 mm collet.	OFE 650	OFSE 1000,OFSE 850,OFS 720	1	4932256210*	4002395306237 £31.11
Ø 6.35 mm (1/4) collet.	OFE 650	OFSE 1000,OFSE 850,OFS 720	1	4932249981*	4002395307517 £31.11
Ø 8 mm collet.	OFE 650	OFSE 1000,OFSE 850,OFS 720	1	4932256303*	4002395302703 £31.08
Ø 8 mm collet.	OFE 710,OFE 630	OFS 450	1	4932313190	4002395302840 £14.74
Screw clamp (single piece) for stationary use of routers when used with flexible shaft (2 pcs required)..	OFE 710,OFE 630,OFE 650	OFSE 1000,OFSE 850,OFS 720,OFS 450	1	4932367730	4002395338566 £24.62

①



②



System attachments - Biscuit jointers

Description	Fits biscuit jointers	Packed contents	Article Number	EAN Code	Price exc. VAT
Cutter	LF 650	PJ 710	1	4932361072	4002395326679 £44.83
Frame holder for dust bag 4931443872	LF 650	PJ 710	1	4931442872	4002395247899 £26.25
Spare paper bags for 4932345544.	LF 650	PJ 710	5	4931442873	4002395247882 £17.78
Two hole spanner.	LF 650	PJ 710	1	4932345712	4002395305551 £3.63



* while stocks last

System accessories - Straight die grinders

Description	Fits die grinders	Packed contents	Article Number	EAN Code	Price exc. VAT
Ø 3 mm collet.	DGL 34,DGL 30 E,DG 30 E, PSG 12,PSG 14.4 PP,HD18 SG	1	4932308974	4002395309092	£32.53
Ø 6 mm collet.	PSG 14.4 PP,HD18 SG,PSG 12, DG 30 E,DGL 30 E,DGL 34	1	4932313192	4002395302833	£17.34
Ø 6 mm collet.	DG 7 E	1	4931391453	4002395734818	£17.51
Ø 8 mm collet.	DGL 34,DGL 30 E,DG 30 E, PSG 12,PSG 14.4 PP,HD18 SG, V 28 SG	1	4932313190	4002395302840	£14.74
Ø 8 mm collet.	DG 7 E	1	4931391452	4002395734801	£23.18
Ø 6.35 mm (1/4") collet.	DGL 34,DGL 30 E,DG 30 E, PSG 12,PSG 14.4 PP,HD18 SG	1	4932313194	4002395302857	£18.08
Ø 6 mm collet.	DG 14-50 Q	1	48660978*	045242155620	£35.49
Ø 8 mm collet.	DG 14-50 Q	1	48660976*	045242156269	£35.49



System attachments - Plate shears

Description	Fits plate shears	Packed contents	Article Number	EAN Code	Price exc. VAT
Piston four sided blade.	PPS 12	1	4932308837	4002395311583	£46.82
Cutting table blade four sided blade.	KS 2.5,S 2.5	1	4932430171	4002395378326	£48.46
	PPS 12	1	4932308838	4002395309085	£48.46
Centre blade.	SMC 1.2 Q	1	48440150	045242140701	£51.16
Left blade.	SMC 1.2 Q	1	48440160	045242140756	£47.24
Right blade.	SMC 1.2 Q	1	48440170	045242140800	£47.24
Socket wrench 3/4".	SMC 1.2 Q	1	49960070	045242221554	£0.33
Replacement shear head assembly.	SMC 1.2 Q	1	48080500*	045242089253	£213.84



System accessories - Nibblers

Description	Fits nibblers	Packed contents	Article Number	EAN Code	Price exc. VAT	
Punch.	KN 2	PN 14.4,PN 12,N 2	1	4932430172	4002395378333	£110.08
Die.	KN 2	PN 14.4,PN 12,N 2	1	4932279565	4002395308521	£120.56
Special die. Especially designed for cutting corrugated steel. Max. cutting capacity 1.5 mm.	KN 2	PN 14.4,PN 12,N 2	1	4932279498	4002395308514	£139.60



System accessories - Pipe cutter / Cable cutter

Description	Packed contents	Article Number	EAN Code	Price exc. VAT
① Pipe cutter wheels. Suitable for copper pipe. Not suitable for plastic or stainless steel pipe.	2	48380010	045242159710	£15.99
② Cable cutter blade	1	4932430070	4002395377312	



System accessories - Electrical T&M

Description	Packed contents	Article Number	EAN Code	Price exc. VAT
① Electrical test probes (max. 1000 Volts/ 10 Amps) heads 125 mm long.	1	49771004	4002395806294	£12.40
② Electrical alligator clips (max. 1000 Volts/ 10 Amps).	1	49771005	4002395806287	£19.85



System accessories - Inspection cameras

All extension cables are water splash and dust proof.

Extensions are attached between the base camera unit and standard supplied camera cable.

Description	Cable length (m)	Cable diameter (mm)	Fits inspection cameras	Packed contents	Article Number	EAN Code	Price exc. VAT
Cable extension. Up to a maximum of 3 extensions can be fixed together.	0.9	17	C12 IC	1	48530110	045242157747	£86.39
Cable extension. Up to a maximum of 5 extensions can be fixed together.	0.9	17	C12 AVD,C12 AVA	1	48530141	045242216529	£86.39
Cable extension. Up to a maximum of 2 extensions can be fixed together.	2.4	17	C12 IC,C12 AVD,C12 AVA	1	48530140	045242195787	£128.52
Replacement digital camera cable.	0.9	17	C12 IC	1	4931411079	4002395907007	£129.80
Replacement digital camera cable.	0.9	17	C12 AVD,C12 AVA	1	4931419516	4002395828227	£140.39
Replacement analog camera cable.	0.9	9.5	C12 AVD,C12 AVA	1	4931419517	4002395828234	£151.19



System attachments - M12[™] heated jackets





- M18[™] USB Power Source - M18[™] USB PS HJ. Powers the jacket on M18[™] battery packs. USB charging port for MP3 player, mobile phone, digital camera, GPS.
- 12 V Car Plug - 12 V CP HJ. Powers the jacket on any 12 V cigarette style outlet.



Description	Packed contents	Article Number	EAN Code	Price exc. VAT
① M18 [™] USB controller (M18 [™] USB PS HJ).	1	4932430084	4002395377459	£39.98
② M12 [™] car plug (12 V CP HJ).	1	4932430085	4002395377466	£19.98



Press jaws

Jaw profile	Fits to following pipe systems suppliers	Nominal size	Tool suitability	Jaw model description	Id. No. 4932	EAN Code 4002395	Price ex. VAT			
M	Geberit: Mapress VSH: X-Press Eurotubi Raccorderie Metallique Rubinetteria Bresciane Sanha: Nirosoan Pegler Yorkshire	M12	M12	J12-M12	430243	379040	£311.22	 Jaw M profile		
		M12	M18	J18-M12	430244	379057	£352.54			
		M15	M12	J12-M15	430245	379064	£299.16			
		M15	M18	J18-M15	430246	379071	£341.40			
		M18	M12	J12-M18	430247	379088	£299.16			
		M18	M18	J18-M18	430248	379095	£341.40			
		M22	M12	J12-M22	430249	379101	£299.16			
		M22	M18	J18-M22	430250	379118	£341.40			
		M28	M12	J12-M28	430251	379125	£299.16			
		M28	M18	J18-M28	430252	379132	£341.40			
		M35	M12	J12-M35	430253	379149	£391.24			
		M35	M18	J18-M35	430254	379156	£341.40			
		M42	M18	RJ18-M42 (requires ring jaw adaptor RJA-1)	430255	379163	£1,108.67			
		M54	M18	RJ18-M54 (requires ring jaw adaptor RJA-1)	430256	379170	£1,143.88			
V	Viega Comap IBP Sanha: Nirosoan	V12	M12	J12-V12	430260	379217	£311.22	 Jaw V profile		
		V12	M18	J18-V12	430261	379224	£352.54			
		V15	M12	J12-V15	430262	379231	£299.16			
		V15	M18	J18-V15	430263	379248	£341.40			
		V18	M12	J12-V18	430264	379255	£299.16			
		V18	M18	J18-V18	430265	379262	£341.40			
		V22	M12	J12-V22	430266	379279	£299.16			
		V22	M18	J18-V22	430267	379286	£341.40			
		V28	M12	J12-V28	430268	379293	£299.16			
		V28	M18	J18-V28	430269	379309	£341.40			
		V35	M12	J12-V35	430270	379316	£391.24			
		V35	M18	J18-V35	430271	379323	£341.40			
		V42	M18	RJ18-V42 (requires ring jaw adaptor RJA-1)	430272	379330	£1,108.67			
		V54	M18	RJ18-V54 (requires ring jaw adaptor RJA-1)	430273	379347	£1,143.88			
TH	ALB Comap Fränkische Henco (TH14 - TH25 only) IPA Sanha Tiemme	TH14	M12	J12-TH14	430274	379354	£311.22	 Jaw TH profile		
		TH14	M18	J18-TH14	430275	379361	£352.54			
		TH16	M12	J12-TH16	430276	379378	£299.16			
		TH16	M18	J18-TH16	430277	379385	£341.40			
		TH18	M12	J12-TH18	430278	379392	£311.22			
		TH18	M18	J18-TH18	430279	379408	£352.54			
		TH20	M12	J12-TH20	430280	379415	£299.16			
		TH20	M18	J18-TH20	430281	379422	£341.40			
		TH25	M12	J12-TH25	430282	379439	£299.16			
		TH25	M18	J18-TH25	430355	380169	£106.56			
		TH26	M12	J12-TH26	430283	379446	£299.16			
		TH26	M18	J18-TH26	430284	379453	£341.40			
		TH32	M12	J12-TH32	430285	379460	£299.16			
		TH32	M18	J18-TH32	430286	379477	£341.40			
		TH40	M12	J12-TH40	430287	379484	£417.78			
		TH40	M18	RJ18-TH40 (requires ring jaw adaptor RJA-1)	430288	379491	£944.86			
		TH50	M18	RJ18-TH50 (requires ring jaw adaptor RJA-1)	430289	379507	£965.88			
		TH63	M18	RJ18-TH63 (requires ring jaw adaptor RJA-1)	430290	379514	£1,133.61			
U	ALB Uponor: Unipipe, Airpipe Kann: Kann-therm Wavin: Press-Systeme Fränkische: Alpex F50 Profi DW Verbundrohr: Multitubo IBP: >B< Flex KE Kelit: Kelit Kelox Jupiter: Heizsystem	U14	M12	J12-U14	430291	379521	£311.22	 Jaw U profile		
		U14	M18	J18-U14	430292	379538	£352.97			
		U16	M12	J12-U16	430293	379545	£299.16			
		U16	M18	J18-U16	430294	379552	£341.40			
		U18	M12	J12-U18	430295	379569	£311.22			
		U18	M18	J18-U18	430296	379576	£352.97			
		U20	M12	J12-U20	430297	379583	£299.16			
		U20	M18	J18-U20	430298	379590	£341.40			
		U25	M12	J12-U25	430299	379606	£299.16			
		U25	M18	J18-U25	430300	379613	£341.40			
		U32	M12	J12-U32	430301	379620	£299.16			
		U32	M18	J18-U32	430302	379637	£341.40			
		U40	M12	J12-U40	430303	379644	£417.78			
		U40	M18	RJ18-U40 (requires ring jaw adaptor RJA-1)	430304	379651	£944.86			
		U50	M18	RJ18-U50 (requires ring jaw adaptor RJA-1)	430305	379668	£965.88			
		U63	M18	RJ18-U63 (requires ring jaw adaptor RJA-1)	430306	379675	£1,133.61			
		① Ring jaw adaptor			RJA-1	430307	379682		£783.08	 Ring jaw adaptor

System accessories - Knockout punch and dies

NEW

- Suitable for mild steel and aluminium up to a thickness of 3 mm.
- Also suitable for stainless steel max. 2.5 mm.



Ø (mm)	Standard PG size	Standard ISO metric size	Punch			Die		
			Article Number	EAN Code	Price exc. VAT	Article Number	EAN Code	Price exc. VAT
16.2		M 16	4932430841	4002395385034	£49.99	4932430913	4002395385751	£39.99
20.4	PG 13.5	M 20	4932430842	4002395385041	£49.99	4932430914	4002395385768	£39.99
22.5	PG 16 $\frac{1}{2}$ "		4932430843	4002395385058	£49.99	4932430915	4002395385775	£39.99
25.4		M 25	4932430844	4002395385065	£49.99	4932430916	4002395385782	£39.99
28.3	PG 21 $\frac{1}{4}$ "		4932430845	4002395385072	£49.99	4932430917	4002395385799	£39.99
32.5		M 32	4932430846	4002395385089	£59.99	4932430918	4002395385805	£39.99
40.5		M 40	4932430847	4002395385096	£69.99	4932430919	4002395385812	£44.99
50.5		M 50	4932430848	4002395385102	£79.99	4932430920	4002395385829	£49.99
63.5		M 63	4932430849	4002395385119	£89.99	4932430921	4002395385836	£59.99

Draw stud bolt 49162680 Ø 11,1 mm: requires pre-drilling with Ø 11.3 - 11.5 mm drill bit / step drill.

Draw stud bolt 49162681 Ø 19 mm: requires pre-drilling with Ø 19.5 - 20 mm drill bit / step drill.

Description	Packed contents	Article Number	EAN Code	Price exc. VAT
Adaptor to allow the Milwaukee® tool to use competitors punches and dies ie. Klauke®, Greenlee® and Alfa®.	1	49162685	045242337965	£44.99
Adaptor to allow use of original Milwaukee® punches and dies with competitor tools ie. Klauke®, Greenlee® and Alfa®.	1	49162684	045242337958	£44.99

System accessories - Cable Cutter Blades suitable for M18[™] HCCAC / M18[™] HCCS

NEW

Description	Packed contents	Article Number	EAN Code	Price exc. VAT
① Cable cutter jaw and blade set for cutting steel. ACSS-aluminium conductor steel supported cable and ACSR-aluminium conductor steel reinforced cable i.e. 477 ACSR. Guy wire / tensioned cable utility grade up to thickness Ø 9.5 mm. Not suitable for armoured cable.	1	49162773	045242350070	£299.00
② Replacement cable cutter blades for steel. Guy wire / tensioned cable utility grade upto thickness Ø 9.5 mm. Not suitable for armoured cable.	1	48440412	045242355235	£99.00
① Cable cutter jaw and blade set for cutting copper / aluminium. Copper / aluminium standard stranded cable up to 4 x 50 mm ² , 1 x 100 mm ² .	1	4932430839	4002395385010	£299.00
② Replacement cable cutter blades for copper and aluminium.	1	4932430840	4002395385027	£129.00



System accessories - Caulk and adhesive guns

Description	Fits caulk guns	Packed contents	Article Number	EAN Code	Price exc. VAT
310 ml standard carriage. Accepts all standard 250 ml and 310 ml tubes/cartridges. Requires plunger rod 49520600.	PCG 14 / 300,PCG 14 / 600	1	48081075	045242087938	£71.30
310 ml standard carriage. Accepts all standard 250 ml and 310 ml tubes/cartridges.	C18 PCG	1	48081076	045242263127	£59.99
310 ml standard carriage. Accepts all standard 250 ml and 310 ml tubes/cartridges.	C12 PCG	1	48080900	045242286355	£59.98
310 ml aluminium sausage tube barrel. Accepts standard 310 ml "sausage style" material packs and 380 ml cartridges. Requires plunger rod 49520660.	PCG 14 / 300,PCG 14 / 600	1	48081085	045242089246	£80.36
400 ml aluminium sausage tube barrel. Accepts standard 400 ml "sausage style" material packs (includes 2 end cups). Requires plunger rod (48091090) and piston (44700375).	C18 PCG,C12 PCG	1	4932352844	4002395375028	£29.99
600 ml aluminium sausage tube barrel. Accepts standard 600 ml "sausage style" material packs. Requires plunger rod 49520660.	PCG 14 / 600,PCG 14 / 300	1	48081090	045242087952	£96.58
600 ml aluminium sausage tube barrel. Accepts standard 600 ml "sausage style" material packs (includes 2 end cups). Requires plunger rod (48091091) and piston (44700375).	C18 PCG,C12 PCG	1	4932352845	4002395375035	£39.99
400 ml transparent sausage tube barrel. Accepts standard 400 ml "sausage style" material packs (includes 2 end cups). Requires plunger rod (48091090) and piston (44700375).	C18 PCG,C12 PCG	1	4932352842	4002395375004	£69.99
600 ml transparent sausage tube barrel. Accepts standard 600 ml "sausage style" material packs (includes 2 end cups). Requires plunger rod (48091091) and piston (44700375).	C18 PCG,C12 PCG	1	4932352843	4002395375011	£89.99
Plunger rod assembly for 310 ml cartridges. For use with: 48081076 310 ml standard carriage.	C18 PCG	1	4932352937	4002395375950	£21.99
Plunger rod assembly for 310 ml carriage. For use with: 48080900 310 ml standard carriage.	C12 PCG	1	4932430099	4002395377602	£19.98
Plunger rod short (340 mm long). For use with: 48081075 carriage and 48081085 „sausage style“ barrel.	PCG 14 / 300,PCG 14 / 600	1	49520600	045242190201	£67.91
Plunger rod assembly for 400 ml sausage tube barrel. For use with: 4932352844 400 ml aluminium sausage tube barrel. 4932352842 400 ml transparent sausage tube barrel.	C18 PCG	1	48091090	045242263158	£23.99
Plunger rod assembly for 400 ml sausage tube barrel. For use with: 4932352844 400 ml aluminium sausage tube barrel. 4932352842 400 ml transparent sausage tube barrel.	C12 PCG	1	4932430100	4002395377619	£20.98
Plunger rod assembly long (480 mm long). For use with 48081090.	PCG 14 / 300,PCG 14 / 600	1	49520660	045242190164	£137.56
Plunger rod assembly for 600 ml sausage tube barrel. For use with: 4932352845 600 ml aluminium sausage tube barrel. 4932352843 600 ml transparent sausage tube barrel.	C18 PCG	1	48091091	045242263165	£25.99
Plunger rod assembly for 600 ml sausage tube barrel. For use with: 4932352845 600 ml aluminium sausage tube barrel. 4932352843 600 ml transparent sausage tube barrel.	C12 PCG	1	4932430101	4002395377626	£22.98
Piston for carriage assemblies.	C18 PCG,C12 PCG	1	44700330	045242260928	£2.99
Piston for sausage tube barrels.	C18 PCG,C12 PCG	1	44700375	045242277438	£3.70
Replacement nozzle.	PCG 14 / 300,PCG 14 / 600, C18 PCG,C12 PCG	1	45760525	4002395775323	£3.24

System accessories for dust absorption systems

	Description	Fits Milwaukee dust absorption systems	Packed contents	Article Number	EAN Code	Price exc. VAT
System Ø 26 mm	Extraction hose Ø 26 mm, 4 m. For connection to external extraction system.	WDC 1400 A,AS 1,AS 2 C,AS 3 W	1	4932278824*	4002395308286	£96.12
	Extraction hose, anti static. 4 m long 36 mm diameter with tool adaptor.	AS 300 ELCP,AS 500 ELCP, AS 300 EMAC	1	4932352311	4002395369706	£150.12
	Extraction hose. 3.5 m long 32 mm diameter with tool adaptor.	AS 250 ECP	1	4932352312	4002395369713	£85.32
	Adaptor for direct connection of suction hose 330552.	AS 1,AS 2 C	1	4932326528	4002395310937	£9.71
	Universal adaptor Ø 35 / 33 / 27 mm.	WDC 1400 A,AS 1,AS 2 C, AS 3 W,ASE 1400,ASM 1400	1	4932369282	4002395338412	£20.51
System Ø 35 mm	Ø 35 mm suction tube 50 cm plastic.	ASE 1400,AS 1,AS 2 C,ASM 1400	1	4932346620	4002395319503	£16.01
	Ø 35 mm carpet nozzle.	WDC 1400 A,ASE 1400,AS 1, AS 2 C,AS 3 W,ASM 1400	1	4932272584	4002395303243	£41.30
	Ø 35 mm gap nozzle.	WDC 1400 A,ASE 1400,AS 1, AS 2 C,AS 3 W,ASM 1400	1	4932276048	4002395303250	£10.40
	Extension hose Ø 35 mm / 4 m long. Requires adaptor (362778).	WDC 1400 A,ASE 1400,AS 1, AS 2 C,AS 3 W,ASM 1400	1	4932330552*	4002395312719	£104.31
	Extraction hose Ø 35 mm / 5 m.	ASE 1400,ASM 1400	1	4932373626	4002395351534	£86.19
	Extraction hose Ø 50 mm / 3 m.	NT 1200,NT 1500 A,NT 900	1	4932300171	4002395308576	£69.11
System Ø 50 mm	Ø 50 mm wide gap nozzle.	ASE 1400,AS 1,AS 2 C,ASM 1400	1	4932316070	4002395310449	£10.76
	Ø 50 mm suction tube.	ASE 1400,AS 1,AS 2 C,ASM 1400	1	4932316069	4002395310432	£16.89
	Ø 50 mm to Ø 35 mm reduction sleeve.	ASE 1400,AS 1,AS 2 C,ASM 1400	1	4932316074	4002395310456	£7.16
	4 x fleece filter bags, 1 x fleece wet filter with rubber band.	AS 250 ECP	5	4932352306	4002395369652	£21.47
	5 x 30 l fleece filter bags.	AS 300 ELCP	5	4932352307	4002395369669	£43.02
	5 x 50 l fleece filter bags.	AS 500 ELCP	5	4932352308	4002395369676	£59.15
	Filter bags: 5 x plastic bags, 30 l.	AS 250 ECP,AS 300 ELCP, AS 300 EMAC	5	4932352309	4002395369683	£38.88
	Filter bags: 5 x plastic bags, 50 l.	AS 500 ELCP	5	4932352310	4002395369690	£42.12
	5 x 10 l paper bags.	AS 1 ¹	5	4932346619	4002395319428	£19.22
	Filter bag for RSE +AS2C, light duty	AS 1,AS 2 C,AS 3 W	1	4932346812	4002395319534	£7.72
Filter bags	Filter bags. Light duty. 3 x 18 l paper bags.	NT 1500 A	3	4932340125	4002395305445	£19.80
	Filter bags. Heavy duty. 3 x 18 l paper bags.	NT 1500 A	1	4932373669	4002395351824	£28.94
	Filter bags. Heavy duty. 5 x 25 l paper bags.	AS 2 C,AS 3 W	5	4932346585	4002395319442	£50.51
	Filter bags. Heavy duty. 5 x 25 l paper bags.	RSE 1400	5	4932373852	4002395352821	£51.93
	Filter bags. Heavy duty. 5 x 50 l paper bags.	ASE 1400,ASM 1400	5	4932373621	4002395351503	£69.94
	3 x paper bag.	NT 900	3	4932316045	4002395302598	£20.37
	Filter bags: cloth.	NT 900	1	4932276019	4002395303267	£11.68
	Filter bags. Suitable for fine concrete dust. Conforms to dust classification M & H EN 60335-2-69. Only suitable for ASM1400. 3 x 25 l plastic bags.	ASE 1400,ASM 1400	3	4932399502	4002395361595	£170.16
	Filter cartridge.	AS 250 ECP	1	4932352303	4002395369621	£38.85
	Filter cartridge.	AS 250 ECP,AS 300 ELCP	1	4932352304	4002395369638	£52.58
	Filter cartridge.	AS 500 ELCP	1	4932352305	4002395369645	£80.88
	Filter cartridge, 3600 cm ² , BIA usage Cat. C.	AS 1	1	4932346587	4002395319466	£43.47
Filters	SR Filter cartridge, self cleaning 6800 cm ² , BIA usage Cat. C.	AS 2 C	1	4932346338	4002395313778	£206.24
	Filter cartridge, 7000 cm ² , BIA usage Cat. C.	AS 3 W	1	4932346588	4002395319473	£61.51
	Filter cartridge, 7200 cm ² .	RSE	1	4932327205	4002395303885	£96.84
	Filter cartridge.	NT 1200,NT 1500 A	1	4932340124	4002395305452	£29.60
	Flat folded polyester filter cartridge, 2 pcs.	ASE 1400,ASM 1400	1	4932373623	4002395351510	£139.03

¹ In combination with 4932346812 bag adapter and filter cartridge 4932346587.

* while stocks last

Chargers



Description	System	Charging range	Charging time	For battery type NiCd	For battery type NiMH	For battery type Li-Ion	Article Number	EAN Code	Price exc. VAT
① M4 C	M4	4 V	30 min	-	-	Yes	4932352958	4002395376162	*
② C12 C	M12	12 V	40/80 min	-	-	Yes	4931431190	4002395856459	£39.00
③ M12 C4	M12	12 V	40/80 min	-	-	Yes	4932430555	4002395382163	£99.00
④ M12-18C	M12,M18,M14	12 - 18 V	40/80/100 min	-	-	Yes	4932352959	4002395376179	*
⑤ M12-18 FC	M12,M18	12 - 18 V	26/47/59 min	-	-	Yes	4932451080	4002395810598	£99.00
⑥ M1418 C6	M14,M18	14.4 V - 18 V	40/80/100 min	-	-	Yes	4932430087	4002395377480	£129.00
⑦ M28 C	M28	28 V	60/90 min	-	-	Yes	4932352525	4002395371839	£60.00

*Not available in the UK

Lamps & bulbs



Description	Voltage (V)	Battery type	System	Battery compatibility	Bulb type	Article Number	EAN Code	Price exc. VAT
① M12 TLED-0	12	Li-ion	M12	All Milwaukee® M12™ batteries	LED	4932430360	4002395380213	£35.00
② M12 SLED-0	12	Li-ion	M12	All Milwaukee® M12™ batteries	LED	4933451261	4002395170159	£69.00
③ M12 SL-0	12	Li-ion	M12	All Milwaukee® M12™ batteries	LED	4932430178	4002395378395	£46.00
④ M12 LL-0	12	Li-ion	M12	All Milwaukee® M12™ batteries	LED	4932430562	4002395382231	£59.00
⑤ M18 TLED-0	18	Li-ion	M18	All Milwaukee® M18™ batteries	LED	4932430361	4002395380220	£45.00
⑥ M18 AL-0	18	Li-ion	M18	All Milwaukee® M18™ batteries	LED	4932430392	4002395380534	£99.00
⑦ M18 LL-0	18	Li-ion	M18	All Milwaukee® M18™ batteries	LED	4932430563	4002395382248	£79.00
⑧ M18 IL-0	18	Li-ion	M18	All Milwaukee® M18™ batteries	LED	4932430564	4002395382255	£69.00
⑨ M18 SAL-0	18	Li-ion	M18	All Milwaukee® M18™ batteries	LED	4933451246	4002395167708	£199.00
⑩ M28 WL-0	28	Li-ion	M28	All Milwaukee® M28™ batteries	Xeon	4932352526	4002395371846	£45.00
⑪ M28 WL LED-0	28	Li-ion	M28	All Milwaukee® M28™ batteries	LED	4932352527	4002395371853	£59.00

Batteries



Description	System	Battery type	Voltage (V)	Battery pack capacity (Ah)	Article Number	EAN Code	Price exc. VAT
① M4 B2	M4	Li-ion	4	2.0	4932430098	4002395377596	*
② M12 B2	M12	Li-ion	12	2.0	4932430064	4002395377251	£49.00
③ M12 B4	M12	Li-ion	12	4.0	4932430065	4002395377268	£89.00
④ M14 B	M14	Li-ion	14.4	1.5	4932352665	4002395373239	*
⑤ M14 B4	M4	Li-ion	14.4	4.0	4932430323	4002395379842	*
⑥ M18 B2	M18	Li-ion	18	2.0	4932430062	4002395377237	£69.00
⑦ M18 B4	M18	Li-ion	18	4.0	4932430063	4002395377244	£129.00
⑧ M18 B5	M18	Li-ion	18	5.0	4932430483	4002395381449	£149.00
⑨ M18 B6	M18	Li-ion	18	6.0	4932451244	4002395167661	£169.00
⑩ M18 B9	M18	Li-ion	18	9.0	4932451245	4002395167678	£199.00
⑪ M28 BX	M28	Li-ion	28	3.0	4932352732	4002395373901	£149.00
⑫ M28 B5	M28	Li-ion	28	5.0	4932430484	4002395381456	£169.00

*Not available in the UK



TITANIUM TOOLS

Since 1849 Stiletto® tools has been renowned worldwide from premium quality professional tools. Stiletto® was the first company to introduce Titanium hammers, the product line of today combines the latest technology in materials, design and balance to give professional users extra power, effortless striking and overall higher productivity.

Durability: More flexible and fracture resistant than steel. Accepts harder impacts without distorting the overall shape of the hammer. One-piece design – strength built in from the head right through to the handle providing for best stability.

Rust resistant: Hammers are predominantly used outdoors. Titanium is 100% corrosion resistant.

Less fatigue: Titanium weighs 45% less than steel. Titanium has the highest strength to weight ratio of any metal. Less weight allows one to swing the hammer faster creating greater head speed resulting in more power. Titanium hammers drive 30% more nails with the same effort. Light hammer can be swung faster, it puts less strain on the body without compromising work efficiency.

Less arm pain and vibration: Titanium provides 10 times greater dampening of harmful recoil shock vibrations compared to steel. Excessive hammer use can cause long term damage to the arm.

More productivity: Drives up to 30% more nails with the same effort.

100% Titanium TiBone™ hammers

Strongest handle: All titanium one piece frame. 200% stronger than wood.

Longer lifetime: Replaceable faces instead of replacing the complete hammer.

Pulls nails easier: Patented 180° side nail puller.

Magnetic nail starter: Helps to start nails in difficult to reach places.

Description	Weight (oz)	Weight (g)	Replaceable face	Face type	Length (mm)	Packed contents	Article Number	EAN Code	Price exc. VAT
① TB 15 MC + TBM-SR.	15	425	Yes	Supplied with milled and smooth face	457	1	4932352578	4002395372362	£249.95
② TBM 14 RMC + TBM-SR.	14	397	Yes	Supplied with milled and smooth face	388	1	4932352579	4002395372379	£249.95



Titanium hammers with wood handles

Traditional hickory wood handle: Strong curved axe type grip for comfortable handling.
 Magnetic nail starter: Helps to start nails in difficult to reach places.
 Low weight: Due to the natural wood handle a very lightweight hammer but still incredibly powerful.

Description	Weight (oz)	Weight (g)	Face type	Length (mm)	Packed contents	Article Number	EAN Code	Price exc. VAT
① Ti 14MC-H18	14	397	Milled	457	1	4932352583	4002395372416	£115.95
② Ti 14SC-H18	14	397	Smooth	457	1	4932352584	4002395372423	£114.95
③ Ti 14MC-H16	14	397	Milled	406	1	4932352585	4002395372430	£113.95
④ Ti 14SC-H16	14	397	Smooth	406	1	4932352586	4002395372447	£113.48

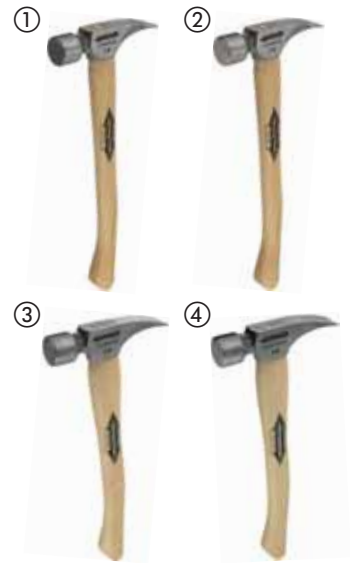

Clawbar nail puller

- 100% titanium construction - 5 times stronger than steel.
- 295 mm long for good leverage.
- Weighs only 225 grams. 50% lighter than steel.
- Two claws.
- Dimpler: When positioned over the nail head and struck with a hammer, it creates a recess around the nail allowing then the claws to slide underneath the head of the nail for easy removal without damaging the surrounding wood.
- 'W' Beam structure for less weight and added strength.

Description	Weight (g)	Total length A (mm)	Packed contents	Article Number	EAN Code	Price exc. VAT
Ti CLW-12	225	295	1	4932352703*	4002395373611	£89.95



Stainless steel bar SSFB15

- Durable stainless steel construction: Rust proof.
- Long and compact: For better leverage.
- 50% cost advantage over titanium.
- Less weight than steel.
- Multifunctional: 2 claws - for nail and staples, bottle opener.

Description	Weight (g)	Length (mm)	Packed contents	Article Number	EAN Code	Price exc. VAT
SSFB-15	792	400	1	4932430089*	4002395377503	£44.98



Spare parts

Description	Packed contents	Article Number	EAN Code	Price exc. VAT
① TBM-MR	3 oz Steel milled replacement face for TB15MC and TBM14RMC.	4931428165	4002395835003	£26.75
② TBM-SR	3 oz Steel smooth replacement face for TB15MC and TBM14RMC.	4931428166	4002395835010	£27.30
TBR-B	Replacement bolt kit for TB15MC and TBM14RMC. 1 x bolt, 1 x washer, 1 x allen key, 1 x loctite tube, 1 x instruction manual.	4931428167	4002395835027	£10.92
Handle H18"	18" hickory replacement curved handle for 14 oz heads.	4931428170	4002395835058	£17.22
Handle H16"	16" hickory replacement curved handle for 14 oz heads.	4931428171	4002395835065	£16.15



* while stocks last

Hand Tools

FASTBACK™ flip utility knife

- One handed blade opening. User can flip open the blade with one hand for easy activation.
- Integrated gut hook. Allows users to make cuts without exposing the blade.
- Tool free blade change. Less down time in the field for blade changes.
- Wire stripper. Eliminates the need to look for another tool in user's bag.
- Thin body design. Tool is easily stored in user's pocket.
- Belt clip for easy storage.



6 pcs master carton



2

Description	Packed contents	Order quantity	Article Number	EAN Code	Price exc. VAT
① FASTBACK™ knife	6	6	48229901	045242367047	£16.99
② FASTBACK™ knife with blade storage	1	1	48221902	045242292547	£17.99

Sliding utility knife

- Side blade activation: Reduces the risk of exposing the blade accidentally.
- Wire stripper: Eliminates the need for another tool in the users bag.
- Tool free blade change: Saves time changing blades.
- Blade storage: Magnetic holder for 5 blades.
- Heavy Duty: Full metal body with rubber overmould for increased comfort and reduced hand slippage.



1

6 pcs master carton

Description	Packed contents	Order quantity	Article Number	EAN Code	Price exc. VAT
① Sliding utility knife	6	6	48229910	045242367054	£12.99

Self-retracting safety knife

- Self-retract mechanism: Retracts blade when the button is released.
- Two blade positions allows user to control cutting depth.
- Blade storage holds up to 5 blades conveniently inside the handle.
- Tool-free blade change: Saves time changing blades. Thumb-screw mechanism allows to change the blade quickly and without any extra tools.
- Heavy Duty: Durable full metal body.
- Wire Stripper: Eliminates the need to look for another tool in users's bag. Cut up the wire up to Ø 5 mm².



Description	Packed contents	Order quantity	Article Number	EAN Code	Price exc. VAT
Self-retracting safety knife	1	1	48221915	045242296873	£15.99

General purpose utility blades

- Iron carbide deposited metal for longer lifetime.
- Optimised cutting angle geometry for sharpness.
- Extra ground cutting edge for cleaner cuts.
- Blades are protected and easily accessible from storage box.

Description	Total length A (mm)	Height (mm)	Packed contents	Order quantity	Article Number	EAN Code	Price exc. VAT
① General purpose utility knife blades	62	19	50	1	48221950	045242344444	£21.99
② Hook utility knife blades	62	19	50	1	48221952	045242286980	£29.99
③ Carton utility knife blades (rounded).	62	19	5	1	48221934	045242286942	£1.99



Rasping jab saw

- 150 mm plaster / drywall blade. Extra strong thicker blade making it more resistant for plunge cuts. Coated for corrosion protection.
- Coated for corrosion protection.
- Rubber overmould. Increased comfort and reduced hand slippage.
- Built in rasping holes. Allows user to rapidly expand holes or smooth rough edges.



Description	Packed contents	Order quantity	Article Number	EAN Code	Price exc. VAT
Rasping jab saw	6	6	48229304	045242480555	£9.99



6 pcs master carton

Snap knives

- Metal lock* for maximum durability and longer lifetime.
- Lock with a speed thread* that allows faster blade adjustment.
- Auto-lock slide** for faster blade adjustment.
- Snap-off cap pocket clip** snaps off blade segments.
- Overmolded handle offers a slip resistant grip and is an acetone resistant.
- Iron carbide blade for longer lifetime, increased sharpness and clean cut finish.
- * 18 mm / 25 mm snap knives
- ** 9 mm snap knives



Description	Blade width (mm)	No. blade points	Packed contents	Order quantity	Article Number	EAN Code	Price exc. VAT
① Snap knife 9 mm	9	13	1	1	48221960	045242296811	£4.99
② Snap knife 18 mm	18	8	1	1	48221961	045242296798	£6.99
③ Snap knife 25 mm	25	7	1	1	48221962	045242296828	£8.99

Snap blades

- Robust re-usable storage dispenser with easy access to blades.
- Optimized cutting angle geometry for sharpness and improved cutting precision.
- Iron carbide metal for longer life.
- Precise ground cutting edges for cleaner cuts.

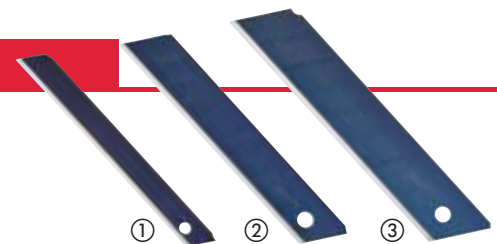

Description	Blade width (mm)	No. blade points	Packed contents	Order quantity	Article Number	EAN Code	Price exc. VAT
① Snap blades 9 mm	9	13	10	1	48229109	045242288649	£3.99
② Snap blades 18 mm	18	8	10	1	48229118	045242288656	£5.99
③ Snap blades 25 mm	25	7	10	1	48229125	045242288663	£7.99

Metal snips

- Thumb and forefinger slots for increased comfort and less fatigue. Allows user to push through sheet metal with ease with less risk of cutting oneself.
- Serrated cutting edges prevent slippage when cutting.
- Less hand fatigue when cutting thicker materials. Design with compound leverage action.
- Torsion spring opens jaws automatic during cutting for faster cutting action and less fatigue work.
- Chrome plated rust protected forged blades for increased lifetime. Extra hardened to 65 HRC.
- Made from forged alloy steel for best durability – Cr Steel.
- One hand locking mechanism.
- Flush slimline design for non-snagging in material.
- Triple cutting direction identification – on the head, handle and by colour coded handle.
- Ergonomic and durable overmoulded grips add comfort and last longer.
- Aviation snips: For short, straight and shaped cuts. Ideal for narrow radius cuts and notch cuts.
- Offset snips: For long continuous straight or curved cuts. 45° offset keeps users hand away from the cutting material.
- Extra long aviation snips: for longer and straighter cuts in one go.



Cutting direction	Total length A (mm)	Edge length (mm)	Max. cutting capacity aluminium (mm)	Max. cutting capacity stainless steel (mm)	Weight (g)	Packed contents	Order quantity	Article Number	EAN Code	Price exc. VAT
① Aviation snips: For short, straight and shaped cuts. Ideal for narrow radius cuts and notch cuts.										
Straight (yellow)	260	31	1.0	0.6	430	1	1	48224030	045242251339	£17.99
Right (green)	260	31	1.0	0.6	430	1	1	48224020	045242251315	£17.99
Left (red)	260	31	1.0	0.6	430	1	1	48224010	045242251292	£17.99
② Offset snips: For long continuous straight or curved cuts. 45° offset keeps users hand away from the cutting material.										
Straight (yellow)	260	37	1.0	0.6	430	1	1	48224032	045242288144	£21.99
Right (green)	260	30	1.0	0.6	430	1	1	48224022	045242288120	£21.99
Left (red)	260	30	1.0	0.6	430	1	1	48224012	045242288137	£21.99
③ Extra long aviation snips: for longer and straighter cuts in one go.										
Straight (yellow)	310	76	1.0	0.6	450	1	1	48224037	045242332083	£24.99
Left (offset)	290	63	1.0	0.6	450	1	1	48224038	045242332090	£24.99

Long nose pliers with wire stripper - 6 in 1 tool

- Long nose pliers – specially suitable for gripping, bending and adjusting in restricted areas.
- Wire stripper – strips 3 sizes of wire: 0,5 – 0,75 / 1,5 / 2,5 mm².
- Wire cutter – cuts wire up to 2.5 mm.
- Deburrer – Deburring ribs on head for up to 20 mm pipe. No need for extra tools.
- Nail puller – powerful gripping and high leverage.
- Loop maker: built in loop maker function for wire up to 6.6 mm² / Ø 2.9 mm.
- Crosswise serrated jaws for better grip and excellent control.
- Laser hardened durable cutting edges. Extra hardened to 64 HRC.
- Made from Chrome Vanadium for best durability and good rust protection.
- Ergonomic and durable overmoulded grips add comfort and last longer.
- Serrated jaws for better grip and excellent control.



Total length A (mm)	Cut cap. in hard wire (mm)	Max. cutting capacity cable (mm)	Jaw length (mm)	Weight (g)	Deburring head max. Ø (mm)	Packed contents	Order quantity	Article Number	EAN Code	Price exc. VAT
210	2.5	6.0	51	255	18	1	1	48226101	045242342211	£29.99

Combination pliers with wire stripper - 6 in 1 tool

- Pliers – specially suitable for gripping, bending and adjusting in restricted areas.
- Wire stripper – strips 5 sizes of wire: 0,5 – 0,75 / 1,0 / 1,5 / 2,5 / 4,0 mm².
- Wire cutter – cuts wire up to 2.5 mm.
- Deburrer – deburring ribs on head for up to 25 mm pipe. No need for extra tools.
- Bolt cutter – cuts M3 and M4 size threaded bolts.
- Loop maker: built in loop maker function for wire up to 6.6 mm² / Ø 2.9 mm.
- Crosswise serrated jaws for better grip and excellent control.
- Laser hardened durable cutting edges. Extra hardened to 50 HRC.
- Made from Chrome Vanadium steel for best durability and good rust protection.
- Slim nose design to reach restricted areas.
- Ergonomic and durable overmoulded grips add comfort and last longer.
- One handed locking mechanism, tool remains closed while in pouch, spring loaded but easy opening.



Stripping capacities (mm ²)	Cut cap. in hard wire (mm)	Max. cutting capacity cable (mm)	Total length A (mm)	Jaw thickness (mm)	Weight (g)	Deburring head max. Ø (mm)	Packed contents	Order quantity	Article Number	EAN Code	Price exc. VAT
0.5 - 0.75 / 1.0 / 1.5 / 2.5 / 4.0	2.5	6.0	190	4	270	25	1	1	48229069	045242271252	£29.99

Heavy Duty Lineman's pliers

NEW

- For universal gripping, cutting applications.
- High leverage design – long handles for maximum cutting power and leverage.
- Deburrer – Deburring ribs on head for up to 25 mm pipe. No need for extra tools.
- Nail puller – powerful gripping and high leverage.
- Laser hardened durable cutting edges: cuts wire, bolts, screws and nails. Extra hardened jaws to 64 HRC.
- Serrated gripping zone for strong gripping and pulling.
- Made from Chrome Vanadium steel for best durability and good rust protection.
- Ergonomic and durable overmoulded grips add comfort and last longer.
- With crimping facility.



Cut cap. in hard wire (mm)	Cutting capacity soft wire (mm)	Total length A (mm)	Weight (g)	Deburring head max. Ø (mm)	Packed contents	Order quantity	Article Number	EAN Code	Price exc. VAT
3.0	4.6	250	480	25	1	1	48226100	045242342228	£29.99

Diagonal pliers

NEW

- For all around cutting use.
- Tip protection – tips are off set ground to protect cutting edges from damage when dropped.
- High leverage design – long handles for maximum cutting power and leverage.
- Deburrer – Deburring ribs on head for up to 25 mm pipe. No need for extra tools.
- 15° offset head allows flush cutting, can be used as a nail puller for easier and quicker prying and pulling.
- Laser hardened durable cutting edges. Extra hardened to 64 HRC. Cuts wire, bolts, screws and nails.
- Made from forged alloy Chrome Vanadium steel for best durability and good rust protection.
- Ergonomic and durable overmoulded grips add comfort and last longer.



Total length A (mm)	Cut cap. in hard wire (mm)	Cutting capacity soft wire (mm)	Jaw length (mm)	Weight (g)	Packed contents	Order quantity	Article Number	EAN Code	Price exc. VAT
160	2.5	4.0	22	195	1	1	48226106	045242342181	£22.99
180	3.0	4.0	26	246	1	1	48226107	045242342198	£24.99

Quick adjust water pump pliers

NEW

- For gripping, fastening and holding work pieces.
- One hand push button adjustment for fast and firm grip.
- Fine scale adjustment positions for precise grip. Less downtime and more efficiency.
- Self locking button for fast and firm adjustment.
- V-groove jaws with profile for firmer grip, more precise fit and reduced slipping. Special teeth hardening 60 HRC.
- Made from Nickel and Chrome forged alloy steel for best durability and good rust protection.
- Ergonomic and durable overmoulded grips add comfort and last longer.
- Deburring head and handle design. No need for extra tools.
- Available in 3 lengths for optimum leverage.
- Ergonomic slim design to allow access in confined areas.



Total length A (mm)	Total length (inch)	Max. cutting capacity nut size/ AF (mm)	Max. cutting capacity tubes/ pipes Ø (mm)	Weight (g)	Deburring head max. Ø (mm)	Deburring handles max. Ø (mm)	Packed contents	Order quantity	Article Number	EAN Code	Price exc. VAT
200	8	30	32	250	38	25	1	1	48226208	045242342235	£21.99
250	10	36	42	425	51	25	1	1	48226210	045242342242	£24.99
300	12	50	60	660	70	25	1	1	48226212	045242342259	£29.99

TORQUE LOCK™ locking pliers

- TORQUE LOCK™: Faster set up and easy release when clamping flat and round material. Extra force can be applied to the TORQUE LOCK™ screw for better and more secure grip. Can also be used for hanging / storage purposes.
- Hardened jaws: better grip force on jobsite material.
- Rust protection: chrome plated tool increases life by reducing corrosion.
- Lever release design: traditional release lever for jobsite convenience.

	Total length A (mm)	Total length (inch)	Jaw type	Jaw capacity flat (mm)	Jaw opening capacity for pipe (mm)	Packed contents	Order quantity	Article Number	EAN Code	Price exc. VAT
①	250	10	curved	-	51	1	1	48223420	045242325276	£14.99
②	250	10	flat	30	-	1	1	48223510	045242324996	£14.99
③	150	6	flat long nose	61	-	1	1	48223406	045242325030	£16.99



TORQUE LOCK™ locking C clamps

- TORQUE LOCK™: Faster set up and easy release when clamping flat and round materials for welding. Extra force can be applied to the TORQUE LOCK™ screw for better and more secure grip. Can also be used for hanging / storage purposes.
- Hardened jaws: better grip force on jobsite material.
- Rust protection: chrome plated tool increases life by reducing corrosion.
- Lever release design: traditional release lever for jobsite convenience.

	Total length A (mm)	Total length (inch)	Jaw type	Jaw size (mm)	Packed contents	Order quantity	Article Number	EAN Code	Price exc. VAT
①	280	11	swivel pads	100	1	1	48223521	045242325054	£19.99
②	280	11	regular pointed pads	90	1	1	48223531	045242325115	£19.99



STOP LOCK™ hand clamps

- STOP LOCK™: Single handed clamp. Maximum holding force in one pressing.
- Overmoulded grip: maximum grip for comfort and performance.
- Optimised pad design: non marking swivel pads for clamping on a variety of jobsite work surfaces.

	Total length A (mm)	Total length (inch)	Jaw size (mm)	Packed contents	Order quantity	Article Number	EAN Code	Price exc. VAT
①	200	8	50	12	12	48223022*	045242348039	£7.49
②	240	9½	100	12	12	48223024*	045242348046	£9.49



* while stocks last

Jobsite scissors

- Iron carbide cutting edge for maximum durability. Longer lifetime vs. stainless steel.
- Chrome plated blades for maximum rust protection.
- All metal core: full metal handle construction to protect from drops and handle breakage.
- Bolt lock technology protects blades from loosening to ensure precise cutting.
- Large handle loops for use with gloves.
- Index finger groove for more comfort.
- Laser edged ruler markings on the blade allows to measure and cut in one go.
- Jobsite offset scissors with micro-serrated blades for maximum durability and better grip.
- Jobsite offset scissors with 60°-offset head allows to keep hand above cutting material.

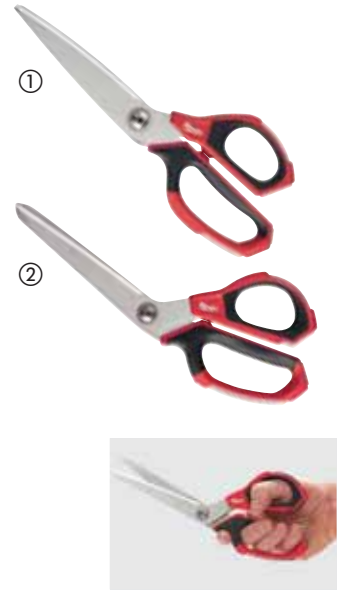

Description	Total length A (mm)	Blade length (mm)	Weight (g)	Packed contents	Order quantity	Article Number	EAN Code	Price exc. VAT
① Straight scissors	230	95	180	1	1	48224044	045242347483	£21.99
② Offset scissors	240	115	230	1	1	48224043	045242347476	£24.99

Plastic cutter

- Cuts PEX, PB, MDP, PE, plastic electrical conduits, pneumatic pipe, plastic overflow pipe, rubber hoses, silicon hoses up to Ø 25 mm.
- V-shaped blade allows quick and straight cuts; prevents crushing of material.
- Replaceable stainless steel blade.
- Robust construction – metal core from the head to the handles for maximum lifetime.
- Grooves on the head allows stripping of couplings.
- Corrosion resistant head.
- One handed locking mechanism, tool remains closed while in pouch, spring loaded but easy opening.
- Ergonomic and durable overmoulded grips add comfort and last longer.



Description	Max. cutting capacity tubes/ pipes Ø (mm)	Packed contents	Order quantity	Article Number	EAN Code	Price exc. VAT
Plastic cutter	25	1	1	48224202	045242343133	£34.99
Replaceable blade		1	1	48224201*	045242268085	£3.99
				48224203	045242343140	£6.99

Cable cutter

NEW

- Best-in-class cut quality: beveled jaw heads. Accurate, smooth cable shearing.
- Comfort grips: more comfortable than dipped plastic. Grips will not peel.
- Forged design: tool durability in abusive environments.
- Rust protection: black oxide finish protects from rust.



Description	Packed contents	Order quantity	Article Number	EAN Code	Price exc. VAT
Cable cutter	1	1	48226104	045242356140	£25.99

* while stocks last

Tape measures



- Double sided nylon bond blade protection for extreme tape durability against dust, dirt, debris and water.
- Non reflective blade coating makes the tape anti-glare and easier to read in bright sunlight.
- Finger stop for comfortable hold and finger protection when the blades retracts.
- Dual magnets: one magnet holds the hook in front; a second magnet prevents roll off on the material e.g. on steel studs, pipes. Not applicable to NON magnetic tapes.
- 2-sided scale printing: horizontal measuring scale on the front side; vertical measuring scale on back side for increased readability.
- Premium quality with 27 mm blade width.
- 5-point reinforced frame for job site durability.
- Wire belt clip: clips on easily without fraying and tearing clothing.
- Extra large 360° grip hook: can be hooked on the material from any side with ease.
- Architect scale: is integrated for easy calculating of scaled drawings (ISO 5455). Enables to measure distances and calculate material demand directly on construction site. 5 m & 8 m tape measures: 1:20 and 1:50 scales. 5 m / 16 ft & 8 m / 26 ft tape measures: 1/8" to 1 and 1/4" to 1 scales.
- Overmould gripping area for extra comfort and durability. Class II accuracy.



Finger stop



5-point reinforced frame

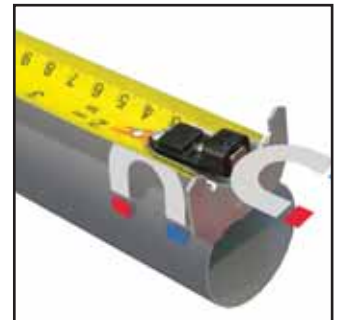

Dual magnets*



2-sided scale printing

Magnetic tape measures

Description	Length [m]	Packed contents	Order quantity	Article Number	EAN Code	Price exc. VAT
5 m metric	5	6	6	48225305	045242317677	£19.99
8 m metric	8	6	6	48225308	045242317684	£23.99
10 m metric	10	6	6	48225411	045242347421	£39.99
5 m / 16 ft metric & imperial	5 / 16'	6	6	48225216	045242296903	£19.99
8 m / 26 ft metric & imperial	8 / 26'	6	6	48225225	045242296910	£23.99
10 m / 33 ft metric & imperial	10 / 33'	6	6	48225233	045242317707	£39.99

NON magnetic tape measures

Description	Length [m]	Packed contents	Order quantity	Article Number	EAN Code	Price exc. VAT
5 m NON magnetic	5	6	6	48225306	045242317608	£19.99
8 m NON magnetic	8	6	6	48225309	045242317639	£23.99
5 m / 16' NON magnetic	5 / 16'	6	6	48225217	045242317592	£19.99
8 m / 26' NON magnetic	8 / 26'	6	6	48225226	045242317622	£23.99

Orders are only possible in master cartons (with 6 x 48225305). Minimum order quantity is 6 x 48225305 (= 1 master carton). Order quantities greater than 6 pcs are to be ordered in multiples of 6 pcs (ie. 12, 18, 24, 30, ...).



Contractor Series Tape Measures

NEW

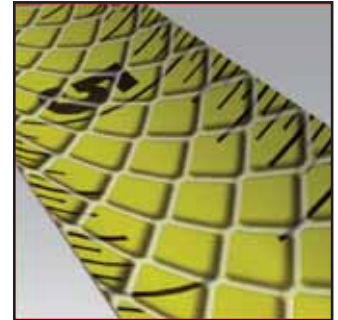

Nylon coating



5-point reinforced frame



41 mm wide base

- Double sided nylon bond blade protection for extreme tape durability against dust, dirt, debris and water.
- Non reflective blade coating makes the tape anti-glare and easier to read in bright sunlight.
- Extra wide base 41 mm.
- Premium quality with 27 mm blade width.
- 5-point reinforced frame for job site durability.
- Wire belt clip: clips on easily without fraying and tearing clothing.
- Extra large 360° grip hook: can be hooked on the material from any side with ease.
- Overmould gripping area for extra comfort and durability.
- Class II accuracy.

Description	Length [m]	Packed contents	Order quantity	Article Number	EAN Code	Price exc. VAT
Metric	5	6	6	48225705	045242350551	£17.99
Metric	8	6	6	48225708	045242350568	£21.99
Metric & Imperial	5 / 16'	6	6	48225616	045242350575	£17.99
Metric & Imperial	8 / 26'	6	6	48225625	045242350582	£21.99
Metric & Imperial	10 / 33'	6	6	48225633	045242467327	£32.99

Orders are only possible in master cartons.

Minimum order quantity is 6 pieces.

Order quantities greater than 6 pcs are to be ordered in multiples of 6 pcs (i.e. 12, 18, 24, 30...).



Tape measure - 2 m / 6'

NEW

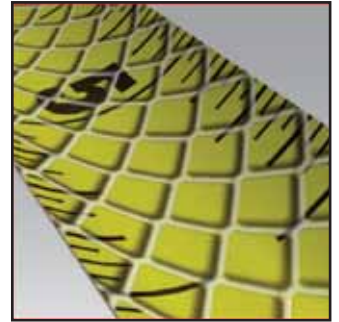

Nylon coating

- 5-point reinforced frame for job site durability.
- Heavy Duty blade with 13 mm blade width.
- Double sided nylon bond blade protection for extreme tape durability against dust, dirt, debris and water.
- Compact design and overmould gripping area for extra comfort and durability.
- Bull packed, order in multiples of 12 pcs.

Description	Length [m]	Packed contents	Order quantity	Article Number	EAN Code	Price exc. VAT
2 m / 6 ft NON magnetic metric & imperial	2 / 6	12	12	48225502	045242468034	£4.99

INKZALL™ markers

- Stays sharp, doesn't mushroom or push back under pressure.
- Acrylic nib ideal for rough surfaces such as OSB and concrete.
- Marker continues to write after 72+ hours of cap off time.
- For use on concrete, wood, metal, plywood, OSB, plastic.
- Can be used on wet, oily, dusty, rusty, with debris surfaces.
- Quick dry time – reduced smearing markings on PVC, metal surfaces.
- Thin body for use in restricted areas.
- Helmet clip – can be clipped to the construction site cap, trousers, overalls.
- Easy open cap for one hand operation.
- Lanyard Hole, e.g. to attach the pen to the tough screen device.
- Anti-Roll design – body design for better grip.

Description	Tip	Packed contents	Order quantity	Article Number	EAN Code	Price exc. VAT
① Fine point marker*	1 mm	36	36	48223100	045242319473	£1.29
② Fine point marker with stylus	1 mm	1	1	48223101	045242297436	£8.99
③ Chisel point marker with stylus	1- 4.8 mm	1	1	48223103	045242333608	£2.99
④ Fine tip colour marker Blue, red, green and black	1 mm	4	1	48223106	045242333585	£5.99

Fine tip* - Orders are only possible in master cartons (contains 36 x 48223100). Minum order quantity is 36 pcs (= 1 master carton). Order quantities greater than 36 pcs are to be ordered in multiples of 36 pcs (i.e. 72, 108, 144, 180...).



PVC saw

NEW

- All-metal handle design for best-in-class durability.
- Tool free blade change: up to 10x faster blade change.
- Overmold handle for increased comfort.
- Compact design.

Description	Packed contents	Order quantity	Article Number	EAN Code	Price exc. VAT
PVC saw	1	1	48220212	045242467518	£29.99
PVC saw replacement blade	1	1	48220222	045242467532	£14.99



Compact Hacksaw

NEW

- Tool free blade change for changing blades up to 10x faster.
- Compact design, ideal for versatile cutting in tight spaces.
- Adjustable blade length for easier flush cutting.
- Rubber overmould grip for increased comfort.
- Accepts 12" blades.

Description	Packed contents	Order quantity	Article Number	EAN Code	Price exc. VAT
Compact Hacksaw	1	1	48220012	045242204571	£19.99



Folding jabsaw

NEW

- Tool free blade change - change blades up to 10x faster.
- Folding blade - easier and safer storage.
- Rubber overmould grip - increased comfort.
- Accepts all Sawzall[®] blades - increased versatility.
- Supplied with 18 TPI , 150 mm blade.

Description	Blade length (mm)	Packed contents	Order quantity	Article Number	EAN Code	Price exc. VAT
Folding jabsaw	150	1	1	48220305	045242204618	£26.99



Hacksaw

NEW

- Tough metal frame, supports higher tension (25,000 PSI / 250 lbs).
- Overmould handle ensures secure grip and user comfort.
- Internal blade storage for extra blades.
- Supplied with 12" / 24 Tpi blade.

Description	Packed contents	Order quantity	Article Number	EAN Code	Price exc. VAT
Hacksaw	1	1	48220050	045242362226	£44.99



Nipping pliers

NEW

- Iron carbide edge: longer blade life.
- Comfort grips: more comfortable than dipped plastic. Grips will not peel.
- Smooth head. Will not mark surface during pull / pry applications.
- Forged design: tool durability in abusive environments.
- Rust protection: black oxide finish protect from rust.



Description	Length (mm)	Packed contents	Order quantity	Article Number	EAN Code	Price exc. VAT
Nipping pliers	180	1	1	48226407	045242356096	£22.99

Basin wrench

NEW

- Ratchet-compatible design: accepts 3/8" ratchet.
- Hi-leverage design: achieve break-away torque on stuck fasteners.
- Door-knob handle: more comfortable than square.
- Easy to adjust handle: best-in-class adjustability.



Description	Jaw size (mm)	Packed contents	Order quantity	Article Number	EAN Code	Price exc. VAT
Basin wrench compact	10 - 32	1	1	48227001	045242366170	£44.99
Basin wrench	32 - 65	1	1	48227002	045242366187	£54.99

Jobsite organiser

NEW

- Mountable bins: 10 removable bins for jobsite materials organisation, screws, nails, washers, seals, etc.
 - Full access when stacked: organisers stack and clip together for easier transport. Full access to ALL organisers even when stacked & clipped together.
 - Up to 20% more capacity: more storage than competitive organisers.
 - Weather seal: prevents water / dust ingress and rust. Stainless steel hinges and latches - fully rust protected.
 - No-travel bin seal lid: Polycarbonate virtually unbreakable lid. Seals each bin, preventing contents from shifting between bins during transport. Seals even when some bins are removed.
 - Reinforcing rib: strengthens box and allows for hand tool / drill bit storage.
- Dimensions: 455 x 360 x 110 mm.



Description	Dimensions (mm)	Packed contents	Order quantity	Article Number	EAN Code	Price exc. VAT
Jobsite Organiser	455 x 360 x 110	3	3	4932451416	4002395161904	£69.99



Transport cases

NEW

Description		Metal/ Plastic	Packed contents	Article Number	EAN Code	Price exc. VAT	
Transport case for hammers.	K 900, K 950	Plastic case	1	4931375502	4002395752881	£50.07	
Transport case for sabre saws / SAWZALLS [®] .	SSE 1000 AVS, SSE 1000 SQ, SSE 1000 QX, SSPE 1000 QX, SSD 1100 X, SSPE 1300 QX, SSPE 1300 SQ, M18 FUEL [™] SAWZALL, SSDE 1500 X, V18 SX, V28 SX	Plastic case	1	48556510	045242148424	£43.14	
Transport case for wall chasers.	WCE 30, WCS 45, DME 30, DME 45	MFE 1500, MFE 1305, MF 1900	Metal case	1	4932383357	4002395357390	£132.17



Heavy Duty boxes

NEW

■ Cases supplied with latches and foam.

HD Box Size	Dimensions (mm)	Packed contents	Order quantity	Article Number	EAN Code	Price exc. VAT
Cases supplied with latches and foam.						
1	475 x 358 x 132	1	1	4932453385	4002395146376	
2	475 x 358 x 192	1	1	4932449767	4002395146383	
3	475 x 358 x 195	1	1	4932453386	4002395143634	
Accessories HD Box organisers		1	1	4932451545	4002395146581	
Spare latches.		2	1	4932373252	4002395347247	£7.99

Inserts for Heavy Duty boxes

NEW

HD Box Insert	Packed contents	Order quantity	Article Number	EAN Code
1	1	1	4932440936	4002395147588
2	1	1	4932449686	4002395147595
3	1	1	4932453379	4002395148202
4	1	1	4932456391	4002395148219
5	1	1	4932456392	4002395148226
6	1	1	4932456393	4002395148233
7	1	1	4932456394	4002395148240
8	1	1	4932453508	4002395146390
9	1	1	4932453507	4002395143603
10	1	1	4932453509	4002395143610
11	1	1	4932453510	4002395143627
HD Box accessories insert	1	1	4932451546	4002395146598



	HD Box Size	HD Box Insert
M18 CDD-202X	1	1
M18 CDD-502X	1	1
M18 CPD-202X	1	1
M18 CPD-502X	1	1
M18 CIW12-502X	1	1
M18 CID-202X	1	1
M18 CID-502X	1	1
M18 CAG125XPDB-502X	2	2
M18 CAG115XPDB-502X	2	2
M18 FDD-202X	1	3
M18 FDD-502X	1	3
M18 FPD-202X	1	3
M18 FPD-502X	1	3
M18 FTPD-502X	1	3
M18 FTDD-502X	1	3
M18 CCS55-502X	2	4
M18 CSX-502X	2	5
M18 CHPX-502X	2	6
M18 CHX-502X	2	7
M18 CHIWF12-502X	1	8
M18 CHIWF34-502X	1	8
M18 CAG-115 X-502X	1	9
M18 CAG-125 X-502X	1	9
M18 CAG-125 XPD-502X	1	9
M18 CHIWP12-502X	1	8
M18 CRAD-502X	1	10
M18 FIWF12-502X	1	11
M18 FID-502X	1	11
M18 FTID-502X	1	11
M18 FTIWP12-502X	1	11
M18 FTIWF12-502X	1	11

Electricians pouch

- Robust construction, made from 1680D ballistic nylon.
- Double stitched, up to 4x stronger riveted seams.
- Integrated handle allows easy transport and provides an easy mounting point on common jobsite materials.
- Solid base allows bag to stand-up, even when fully loaded.
- Integrated belt loops allow bag to be worn on a tool belt.
- Center mounted metal D-rings allow bag to hang evenly from shoulder strap.
- Metal tape measure clip securely stores tape for easy access.



Description	Packed contents	Order quantity	Article Number	EAN Code	Price exc. VAT
Electricians pouch	1	1	48228100	045242333929	£65.00

Zippered pouches - 3 pcs

- Heavy duty zipper withstands jobsite abuse and is up to 2x more durable than competitive zippered pouches.
- Heavy duty canvas construction; breathable and durable for a lifetime of use.
- Water resistant stand up base protects contents from water damage and allows the bag to stand-up for easy viewing of contents.
- Integrated hand pocket provides quick access storage for the most commonly needed items.
- Webbing loop allows bags to be hooked together or to a bag.



Description	Packed contents	Order quantity	Article Number	EAN Code	Price exc. VAT
Zippered pouches - 3 pcs	3	1	48228193	045242344611	£26.99

Electricians belt

- Robust construction, made from 1680D ballistic nylon.
- Double stitched, up to 4x stronger riveted seams.
- Integrated handles allow easy transport of the pouch and provides easy mounting point on common jobsite materials.
- Padded, breathable belt for ultimate comfort and jobsite performance.
- Metal suspender attachments allow suspenders to be added.
- Metal tape measure clip securely stores tape for easy acces.



Description	Packed contents	Order quantity	Article Number	EAN Code	Price exc. VAT
Electricians belt	1	1	48228110	045242333936	£129.00

Contractor rig

- Robust construction, made from 1680D ballistic nylon.
- Double stitched, up to 4x stronger riveted seams.
- Padded 4-point harness distributes weight for all day comfort.
- Padded, breathable belt for ultimate comfort and jobsite performance.
- Integrated handle allows easy transport of the pouch and provides easy mounting point on common jobsite materials.
- Metal suspender attachments allow suspenders to be added.



Description	Packed contents	Order quantity	Article Number	EAN Code	Price exc. VAT
Contractor rig	1	1	48228120	045242333974	£159.00

Jobsite backpack

- Durable construction, made from 1680D ballistic nylon.
- Hard moulded base allows bag to stand-up and provides ultimate all-weather protection.
- Padded, breathable straps for ultimate comfort and jobsite performance.
- Large storage - 35 pockets in total.
- Fold down front pocket for easier access and storage of larger items. Side water bottle pocket.
- Vertical tool wall maximizes storage space while allowing for bulk storage space.
- Laptop pocket allows protected storage for laptops/tablets and personal goods.
- Exterior daisy chains allow clip on storage.



Description	Packed contents	Order quantity	Article Number	EAN Code	Price exc. VAT
Jobsite backpack	1	1	48228200	045242333943	£155.00



10 in 1 Ratchet Multi-Bit screwdriver

NEW

- Ergonomic 152 mm long screwdriver with 1/4" Hex nut driver (in reception) and built in wire stripper and loop maker.
- Full metal high torque ratchet for 2 x driving speed and control.
- 88 mm long power groove bits, power tool compatibility.
- Precision hardened bit tips: durable driving tips for secure fitment and long life.
- Revolver style bit storage in handle.
- Chrome plated marine grade rust protected bits.



Description	Packed contents	Order quantity	Article Number	EAN Code	Price exc. VAT
10 in 1 Ratchet Multi-Bit screwdriver - universal					
PH1 / PH2 / PZ1 / PZ2 / TX15 / TX20 / Slotted 0.8 x 5.5 mm.	12	12	48222311	045242352135	£24.99
10 in 1 Ratchet Multi-Bit screwdriver - Hex					
Hex 1.5 mm / Hex 2 mm / Hex 2.5 mm / Hex 3 mm / Hex 4 mm / Hex 5 mm / Hex 6 mm	12	12	48229306	045242467310	£24.99



Hollowcore[™] magnetic nut drivers

NEW

- Hollowcore[™] unlimited depth in long bolts and threaded rod applications (patent pending).
- Magnetic retention driver heads for secure fitment in fastening applications.
- NEW TO WORLD universal driver head fits 4 x more fasteners - square, 12 point, 8 point, Hex.
- Removes rusted and stripped bolts.
- Color coded ID markings allow for quick tool identification on jobsite.
- Wrench ready Hex shanks deliver additional leverage.
- Chrome plated for maximum durability.
- Forged steel shanks provide longer life and more durability.



	Size (mm)	Colour code	For anchor rod thread size	Packed contents	Order quantity	Article Number	EAN Code	Price exc. VAT
①	5	Black		1	1	48222531	045242294428	£9.99
②	5.5	Brown	M3	1	1	48222532	045242294435	£9.99
③	6	Red	M3.5	1	1	48222533	045242294442	£9.99
④	7	Orange	M4	1	1	48222534	045242294459	£9.99
⑤	8	Yellow	M5	1	1	48222535	045242294466	£9.99
⑥	10	Blue	M6	1	1	48222536	045242294473	£9.99
⑦	13	Orange	M8	1	1	48222537	045242294480	£9.99

Staple gun

- Dual mode power switch: - Up to 75% more driving power. - High power drives staples flush in jobsite material. - Low power for driving control.
- 30 degree beveled driving edge: - Easy firing leverage and drives staples flush, even when stapler is held at an angle.
- Integrated staple puller: - Removes proud staples from work surface.
- Flush drive surface: - Allows users to safely drive staples with the rear of the tool.
- Belt clip: Easily store on pouch, belt, bag or ladder.
- Staples 6 / 8 / 10 / 12 / 14 mm (10.6 mm wide)
- Type 50 / Rapid No. 140 - Arrow T50 - Novus Type 11 G - Tacwise Type 140 - Stanley Type G
- Nails 12 / 16 mm (18 gauge / 1.02 mm thick)
- Arrow BN 1810 - Novus Typ J E - Stanley



Description	Packed contents	Order quantity	Article Number	EAN Code	Price exc. VAT
Staple gun	1	1	48221010	045242323807	£39.99

Hammer tacker

- Up to 3 x longer life: - Longer tool life vs. leading competitor.
- Reinforced frame: - Durable construction survives repeated drops from 10 ft.
- Protected staple magazine: - Easy access for re-loading. - Protects magazine from damage. - Fast reloading and easy jam clearance.
- Integrated staple puller: Removes proud staples from work surface.
- Flush drive surface: - Allows users to safely drive staples with the rear of the tool.
- Staples 8 / 10 / 12 mm (10.6 mm wide)
- Type 50 / Rapid No. 53 - Arrow T50 - Novus Type 11 G - Tacwise Type 140 - Stanley Type G



Description	Packed contents	Order quantity	Article Number	EAN Code	Price exc. VAT
Hammer tacker	1	1	48221020	045242323814	£59.99



Nothing but **HEAVY DUTY.**[™]

Accessories Merchandising Solutions



Whatever the space, we have the solution...

Milwaukee® offers a comprehensive range of merchandising systems to ensure the optimum display of accessories in store. 1 m rows offer a great solution that is easy to implement straight from delivery and the new Red Rack system fits on most merchandising walls and allows for effective category management of accessories.



A wide range of counter displays offer a flexible solution at point of purchase, or can be placed on the base shelves of the wall units.

SDS-plus RX4 4 cut drill bits 1 metre row



Pos	Ø mm	A mm	B mm	Quantity	Id. No. 4932	EAN Code 4002395
1	5	110	50	5	352007	366644
2	6	110	50	5	352011	368921
3	6	160	100	5	352012	368938
4	6	210	150	5	352013	366705
5	6	260	200	5	352014	366712
6	8	110	50	5	352021	366781
7	8	160	100	5	352022	366798
8	8	210	150	5	352023	366804
9	8	260	200	5	352024	366811
10	10	110	50	5	352025	366828
11	10	160	100	5	352026	366835
12	10	210	150	5	352027	366842
13	10	260	200	5	352028	366859
14	12	160	100	5	352031	366880
15	12	210	150	5	352032	366897
16	12	260	200	5	352033	366903
17	14	160	100	5	352036	366934
18	14	210	150	5	352037	366941

4932 430493
4002395 381548

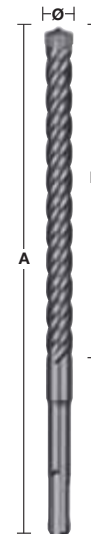

Pos	Display material	Quantity	Id. No. 4939	EAN Code 4002395
1	1 m Assembled row	1	434656	557967
2	Euro hook (short)	18	434650	557905
3	Milwaukee® header strip	1	510100	900596
4	Barcode label strip RX4 drill bits EU	1	565571	937516
5	Carton	1	4931373861	734399

SDS-plus 2 cut drill bits 1 metre row

Pos	Ø mm	A mm	B mm	Quantity	Id. No. 4932	EAN Code 4002395
1	4	110	50	5	339498	304561
2	5	110	50	5	307067	308835
3	6	110	50	5	307068	308842
4	6	160	100	5	307069	308859
5	6	260	200	5	353819	320127
6	8	110	50	5	307070	308866
7	8	160	100	5	307071	308873
8	8	210	150	5	307072	308880
9	8	260	200	5	353821	320141
10	10	110	50	5	340410	311934
11	10	160	100	5	307073	308897
12	10	210	150	5	307074	308903
13	10	260	200	5	344295	312252
14	12	160	100	5	307075	308910
15	12	210	150	5	307076	308927
16	14	160	100	5	307078	308941
17	16	210	150	5	307081	308972
18	18	210	150	3	344303	312177
19	20	210	150	3	344305	312153

4932 430494
4002395 381555

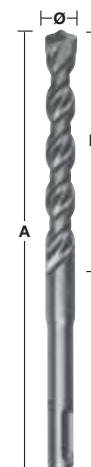

Pos	Display material	Quantity	Id. No. 4939	EAN Code 4002395
1	1 m Assembled row	1	434656	557967
2	Euro hook (short)	19	434650	557905
3	Milwaukee® header strip	1	510100	900596
4	Barcode label strip SDS-plus drill bits EU	1	530434	914135
5	Carton	1	4931373861	734399

SDS-plus 2 cut drill bits long 1 metre row

Pos	Ø mm	A mm	B mm	Quantity	Id. No. 4932	EAN Code 4002395
1	8	460	400	5	367013	336692
2	10	310	250	5	353824	320172
3	10	450	400	5	344296	312245
4	12	260	200	5	344297	312238
5	12	450	400	5	307077	308934
6	14	260	200	5	307079	308958
7	14	450	400	5	307088	309047
8	15	260	200	5	344300	312207
9	16	310	250	5	344301	312191
10	16	450	400	5	307082	308989
11	18	250	200	3	307083	308996
12	18	450	400	3	340411	311941
13	20	250	200	3	307084	309009
14	20	450	400	2	307085	309016
15	22	450	400	3	344307	312139
16	24	450	400	3	307087	309030

Pos	Display material	Quantity	Id. No. 4939	EAN Code 4002395
1	1 m Assembled row	1	434656	557967
2	Euro hook (short)	16	434650	557905
3	Milwaukee® header strip	1	510100	900596
4	Barcode label strip SDS-plus drill bits long EU	1	530436	914135
5	Carton	1	4931373861	734399

4932 430495
4002395 381562

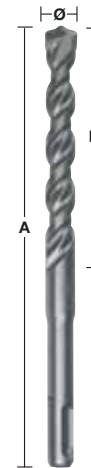
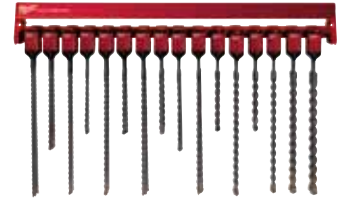

SDS-plus 2 cut drill bits & chisels 1 metre row

Pos	Ø mm	A mm	B mm	Quantity	Id. No. 4932	EAN Code 4002395
① 1	5	110	50	5	307067	308835
2	6	110	50	5	307068	308842
3	6	160	100	5	307069	308859
4	8	110	50	5	307070	308866
5	8	160	100	5	307071	308873
6	8	210	150	5	307072	308880
7	10	160	100	5	307073	308897
8	10	210	150	5	307074	308903
9	12	160	100	5	307075	308910
10	14	160	100	5	307078	308941
11	16	210	150	5	307081	308972
12	18	210	150	3	344303	312177
13	20	210	150	3	344305	312153

② 14	7pc SDS-plus 2 cut set with Ø 5/6/8x110 mm and Ø 6/8/10/12x160 mm			3	352339	369980
③ 15	Pointed chisel	250	-	5	339625	304813
④ 16	Wide chisel	250	40	5	367146	334377
⑤ 17	Flat chisel	250	20	5	339626	304820

Pos	Display material	Quantity	Id. No. 4939	EAN Code 4002395
1	1 m Assembled row	1	434656	557967
2	Euro hook (short)	17	434650	557905
3	Milwaukee® header strip	1	510100	900596
4	Barcode label strip SDS-plus drill bits & chisels EU	1	530442	914005
5	Carton	1	4931373861	734399

4932 430496
4002395 381579

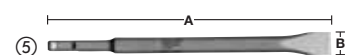
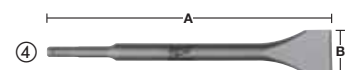
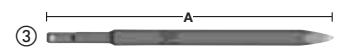

SDS-Max drill bits & chisels 1 metre row

Pos	Ø mm	A mm	B mm	Quantity	Id. No. 4932	EAN Code 4002395
① 1	16	340	200	3	352756	374144
2	16	540	400	2	352757	374151
3	18	540	400	3	352761	374199
4	20	520	400	3	352765	374236
5	22	520	400	3	352769	374274
6	24	520	400	2	352773	374311
7	25	520	400	2	352775	374335
8	28	570	450	2	352779	374373
9	30	570	450	2	352784	374427
10	32	570	450	1	352786	374441
11	35	570	450	2	352790	374489
② 12	Pointed chisel	280	-	3	343734	317509
13	Pointed chisel	400	-	3	343735	317516
③ 14	Flat chisel	280	25	3	343737	317530
15	Flat chisel	400	25	3	343738	317547
④ 16	Wide chisel	400	50	3	343743	317592
17	Wide chisel	300	80	3	343744	317608

Pos	Display material	Quantity	Id. No. 4939	EAN Code 4002395
1	1 m Assembled row	1	434656	557967
2	Euro hook (short)	6	434650	557905
3	Single hook (short)	11	434652	557929
4	Milwaukee® header strip	1	510100	900596
5	Barcode label strip SDS-Max drill bits & chisels EU	1	530294	914838
6	Carton	1	4931373861	734399

4932 430497
4002395 381586

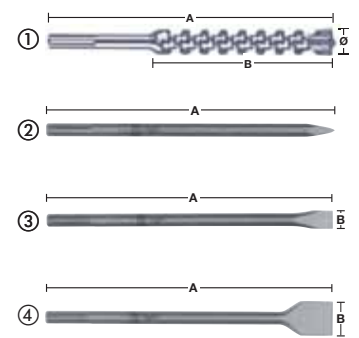

SDS-plus & SDS-Max chisels 1 metre row

Pos	Type	A mm	B mm	Quantity	Id. No. 4932	EAN Code 4002395
SDS-plus						
① 1	Pointed chisel	250	-	5	339625	304813
② 2	Wide chisel	250	40	5	367146	334377
③ 3	Flat chisel	250	20	5	339626	304820
④ 4	Chasing goug. chisel	250	25	3	339627	304837
⑤ 5	Tile chisel	250	40	3	353424	320202
SDS-Max						
① 6	Pointed chisel	280	-	4	343734	317509
① 7	Pointed chisel	400	-	4	343735	317516
① 8	Pointed chisel	600	-	3	343736	317523
② 9	Flat chisel	280	25	5	343737	317530
③ 10	Flat chisel	400	25	5	343738	317547
③ 11	Flat chisel	600	25	3	343739	317554
② 12	Wide chisel	400	50	4	343743	317592
② 13	Wide chisel	300	80	4	343744	317608
② 14	Wide chisel	300	115	3	343745	317615

Pos	Display material	Quantity	Id. No. 4939	EAN Code 4002395
1	1 m Assembled row	1	434656	557967
2	Euro hook (short)	14	434650	557905
3	Milwaukee® header strip	1	510100	900596
4	Barcode label strip SDS-plus & SDS-Max chisels EU	1	530297	914807
5	Carton	1	4931373861	734399

4932 430498
4002395 381593

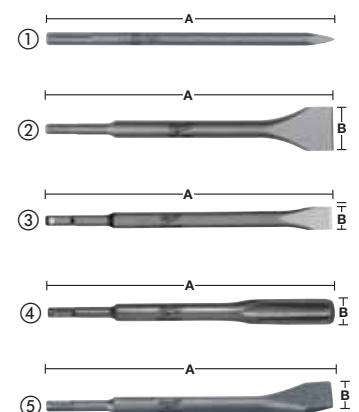

Concrete drill bits round shank - DIN 8039 - 1 metre row

Pos	Ø mm	A mm	B mm	Quantity	Id. No. 4932	EAN Code 4002395	
①	1	4	85	50	5	363631	332014
	2	5	85	50	5	363633	332038
	3	5	150	90	5	363634	332045
	4	6	100	60	5	363636	332069
	5	6	150	90	5	363637	332076
	6	8	120	80	5	363640	332106
	7	8	200	150	5	363641	332113
	8	9	120	80	5	363643	332137
	9	10	120	80	5	363644	332144
	10	10	200	150	5	363645	332151
	11	12	150	85	5	363647	332175
	12	12	200	150	5	363648	332182
	13	14	150	90	5	363650	332205
②	14	8pc concrete bit round shank set with Ø 3/4/5/6/7/8/9/10 mm		3	352334	369935	

Pos	Display material	Quantity	Id. No. 4939	EAN Code 4002395
1	1 m Assembled row	1	434656	557967
2	Euro hook (short)	14	434650	557905
3	Milwaukee® header strip	1	510100	900596
4	Barcode label strip concrete drill bits EU	1	530391	914364
5	Carton	1	4931373861	734399

4932 430499
4002395 381609

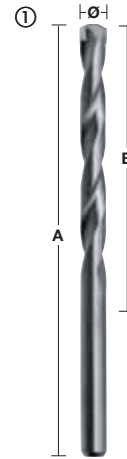

THUNDERWEB Metal drill bits HSS Ground - DIN 338 - 1 metre row

Pos	Ø mm	A mm	B mm	Quantity	Id. No. 4932	EAN Code 4002395
1	1,0	34	12	5	352345	370047
2	1,5	40	18	5	352346	370054
3	2,0	49	24	5	352347	370061
4	2,5	57	30	5	352348	370078
5	3,0	61	33	5	352349	370085
6	3,2	65	36	5	352350	370092
7	3,5	70	39	5	352351	370108
8	4,0	75	43	5	352352	370115
9	4,5	80	47	5	352354	370139
10	5,0	86	52	5	352356	370153
11	6,0	93	57	5	352358	370177
12	7,0	109	69	5	352361	370207
13	8,0	117	75	5	352363	370221
14	9,0	125	81	5	352365	370245
15	10,0	133	87	5	352367	370269
16	11,0	142	94	5	352369	370283
17	12,0	151	101	5	352371	370306
18	13,0	151	101	5	352373	370320

Pos	Display material	Quantity	Id. No. 4939	EAN Code 4002395
1	1 m Assembled row	1	434656	557967
2	Euro hook (short)	18	434650	557905
3	Milwaukee® header strip	1	510100	900596
4	Barcode label strip HSS-G drill bits EU	1	530356	914722
5	Carton	1	4931373861	734399

4932 430500
4002395 381616

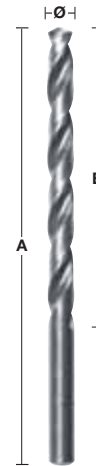

Metal drill bits HSS-G Cobalt - DIN 338 - 1 metre row

Pos	Ø mm	A mm	B mm	Quantity	Id. No. 4932	EAN Code 4002395
1	1,0	34	12	5	363248	333080
2	1,5	40	18	5	363249	333097
3	2,0	49	24	5	363250	333103
4	2,5	57	30	5	363251	333110
5	3,0	61	33	5	363253	333134
6	3,2	65	36	5	363254	333141
7	3,5	70	39	5	363256	333165
8	4,0	75	43	5	363258	333189
9	4,5	80	47	5	363262	333226
10	5,0	86	52	5	363264	333240
11	5,5	93	57	5	363267	333271
12	6,0	93	57	5	363268	333288
13	6,5	101	63	5	363269	333295
14	7,0	109	69	5	363271	333318
15	8,0	117	75	5	363274	333349
16	8,5	117	75	5	363276	333363
17	9,0	125	81	5	363277	333370
18	10,0	133	87	5	363279	333394
19	11,0	142	94	5	363282	333424
20	12,0	151	101	5	363284	333448
21	13,0	151	101	5	363286	333462

Pos	Display material	Quantity	Id. No. 4939	EAN Code 4002395
1	1 m Assembled row	1	434656	557967
2	Euro hook (short)	21	434650	557905
3	Milwaukee® header strip	1	510100	900596
4	Barcode label strip HSS-Co drill bits EU	1	530366	914623
5	Carton	1	4931373861	734399

4932 430501
4002395 381623



Wood auger bits 230 mm 1 metre row

Pos	Ø mm	A mm	B mm	C mm	Quantity	Id. No. 4932	EAN Code 4002395
1	8	230	155	6,5	3	363681	331796
2	10	230	155	8,5	3	363682	331802
3	12	230	155	10	3	363683	331819
4	14	230	155	11	3	363684	331826
5	16	230	155	11	3	363685	331833
6	18	230	155	11	3	363686	331840
7	20	230	155	11	3	363687	331857
8	22	230	155	11	3	373363	347889
9	24	230	155	11	3	373364	347896
10	26	230	155	11	3	373365	348503
11	28	230	155	11	3	373366	348510
12	30	230	155	11	3	373367	348527
13	32	230	155	11	2	373368	348534

Pos	Display material	Quantity	Id. No. 4939	EAN Code 4002395
1	1 m Assembled row	1	434656	557967
2	Euro hook (short)	13	434650	557905
3	Milwaukee® header strip	1	510100	900596
4	Barcode label strip wood auger bits 230 mm EU	1	530395	914326
5	Carton	1	4931373861	734399

4932 430502
4002395 381630



Wood auger bits 460 mm 1 metre row

Pos	Ø mm	A mm	B mm	C mm	Quantity	Id. No. 4932	EAN Code 4002395
1	8	460	385	6,5	3	363688	331710
2	10	460	385	8,5	3	363689	331727
3	12	460	385	10	3	363690	331734
4	14	460	385	11	3	363691	331741
5	16	460	385	11	3	363692	331758
6	18	460	385	11	3	363693	331765
7	20	460	385	11	3	363694	331772
8	22	460	385	11	3	363695	331789
9	24	460	385	11	3	373370	348558
10	26	460	385	11	3	373371	348565
11	28	460	385	11	3	373372	348572
12	30	460	385	11	3	373373	348589
13	32	460	385	11	2	373374	348596

Pos	Display material	Quantity	Id. No. 4939	EAN Code 4002395
1	1 m Assembled row	1	434656	557967
2	Euro hook (short)	13	434650	557905
3	Milwaukee® header strip	1	510100	900596
4	Barcode label strip wood auger bits 460 mm EU	1	530256	914852
5	Carton	1	4931373861	734399

4932 430503
4002395 381647



Brad point drill bits for wood - DIN 7487 E - 1 metre row

Pos	Ø mm	A mm	B mm	C mm	Quantity	Id. No. 4932	EAN Code 4002395
1	3	60	33	3	5	363651	331307
2	4	75	43	4	5	363652	331314
3	5	86	52	5	5	363653	331321
4	6	97	60	6	5	363654	331338
5	7	109	69	7	5	363655	331345
6	8	117	75	8	5	363656	331352
7	9	125	80	9	5	363657	331369
8	10	133	87	10	5	363658	331376
9	11	142	89	10	5	363659	331383
10	12	151	96	10	5	363660	331390
11	13	151	96	10	5	363661	331406
12	14	151	97	10	5	363662	331413
13	15	151	97	10	5	363663	331420
14	16	151	97	10	5	363664	331437
15	18	180	120	10	5	363665	331444
16	20	200	130	10	5	363666	331451

Pos	Display material	Quantity	Id. No. 4939	EAN Code 4002395
1	1 m Assembled row	1	434656	557967
2	Euro hook (short)	16	434650	557905
3	Milwaukee® header strip	1	510100	900596
4	Barcode label strip brad point drill bits for wood EU	1	530261	914890
5	Carton	1	4931373861	734399

4932 430504
4002395 381654



Flat boring bits 160 mm 1 metre row

Pos	Ø mm	A mm	Quantity	Id. No. 4932	EAN Code 4002395
1	8	160	5	363130	332618
2	10	160	5	363131	332625
3	12	160	5	363132	332632
4	13	160	5	363133	332649
5	14	160	5	363134	332656
6	16	160	5	363135	332663
7	18	160	5	363136	332670
8	19	160	5	363137	332687
9	20	160	5	363138	332694
10	22	160	5	363139	332700
11	24	160	5	363140	332717
12	25	160	5	363141	332724
13	26	160	5	363142	332731
14	28	160	5	363143	332748
15	30	160	5	363144	332755
16	32	160	5	363145	332762
17	36	160	5	363146	332779
18	38	160	5	363147	332786

Pos	Display material	Quantity	Id. No. 4939	EAN Code 4002395
1	1 m Assembled row	1	434656	557967
2	Euro hook (short)	18	434650	557905
3	Milwaukee® header strip	1	510100	900596
4	Barcode label strip flat boring bits 160 mm EU	1	530259	914883
5	Carton	1	4931373861	734399

4932 430505
4002395 381661

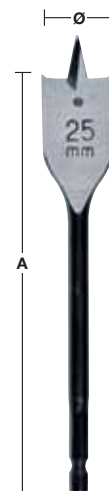

SHOCKWAVE Impact Duty™ drilling & driving - 1 metre row

Pos	Size	A mm	Quantity	Id. No. 4932	EAN Code 4002395
① 1	PH 1	25	5	430850	385126
2	PH 2	25	5	430852	385140
3	PH 2	50	5	430854	385164
4	PZ 1	25	5	430860	385225
5	PZ 2	25	5	430863	385256
6	PZ 2	50	5	430865	385270
7	PZ 3	25	5	430868	385300
8	TX 15	25	5	430872	385348
9	TX 20	25	5	430874	385362
10	TX 25	25	5	430879	385416
11	TX 30	25	5	430885	385478

② 12	Magnetic bit holder 60 mm length		5	352406	370658
③	Magnetic nut drivers				
13	Hex 8	65	4	352541	370726
14	Hex 10	65	4	352543	370740
15	Hex 13	65	4	352545	370764

④ 16	6pc Shockwave Impact Duty™ drill bit set with Ø 3/4/5/6/7/8 mm		3	352454	371136
------	--	--	---	--------	--------

Pos	Display material	Quantity	Id. No. 4939	EAN Code 4002395
1	1 m Assembled row	1	434656	557967
2	Euro hook (short)	16	434650	557905
3	Milwaukee® header strip	1	510100	900596
4	Barcode label strip SHOCKWAVE EU	1	434828	192038
5	Carton	1	4931373861	734399

4932 451316
4002395 151981

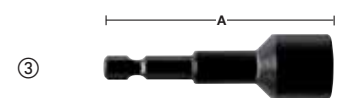

Chucks 1 metre row

Pos	Item	Reception	Quantity	Id. No. 4932	EAN Code 4002395
1	Three jaw chuck	3/8" x 24 1,0-10	1	373412	349760
2	Three jaw chuck	1/2" x 20 1,0-10	2	269401	302932
3	Three jaw chuck	1/2" x 20 1,5-13	2	218111	300051
4	Three jaw chuck	1/2" x 20 1,5-13	2	267980	300488
5	Three jaw chuck	M18 x 2,5 3,0-16	1	320014	310784
6	Quick action chuck	FIXTEC 1,5-13	1	371913	345366
7	Keyless chuck	3/8" x 24 1,0-10	1	349457	318155
8	Keyless chuck	1/2" x 20 1,0-10	1	364382	337675
9	Keyless chuck	1/2" x 20 1,0-13	1	364266	334063
10	Quick action chuck	1/2" x 20 1,5-13	1	376533	346349
11	Keyless chuck	1/2" x 20 1,5-13	1	364267	334070
12	Chuck key	1/2" x 20	5	221378	302765

Pos	Display material	Quantity	Id. No. 4939	EAN Code 4002395
1	1 m Assembled row	1	434656	557967
2	Euro hook (short)	12	434650	557905
3	Milwaukee® header strip	1	510100	900596
4	Barcode label strip chucks EU	1	530273	915002
5	Carton	1	4931373861	734399

4932 430507
4002395 381685



Jigsaw blades for wood, plastics & metal - 1 metre row

Pos	Blade length (toothed) mm	Tooth pitch mm	Ref. No.	Quantity	Id. No. 4932	EAN Code 4002395
1	55	1,2	T 118 A	5	254063	301614
2	91	2,5/1,8	T 123 XF	5	430142	378036
3	75	3,0	T 127 D	5	274315	301560
4	75	4,0	T 144 D	5	213116	301492
5	75	2,5	T 101 B	5	254061	301522
6	75	4,0	T 101 D	5	274351	301515
7	75	2,5	Curve	5	430143	378043
8	91	2,5	T 234 X	5	430141	378029
9	105	4,0	T 344 D	5	311633	301508
10	5pc jigsaw blade set with 213116, 254061, 254063, 254064, 254071			5	345825	314850

Pos	Display material	Quantity	Id. No. 4939	EAN Code 4002395
1	1 m Assembled row	1	434656	557967
2	Euro hook (short)	10	434650	557905
3	Milwaukee® header strip	1	510100	900596
4	Barcode label strip jigsaw blades top line EU	1	530372	914555
5	Carton	1	4931373861	734399

4932 430508
4002395 381692



Jigsaw blades for wood & plastics 1 metre row

Pos	Blade length (toothed) mm	Tooth pitch mm	Ref. No.	Quantity	Id. No. 4932	EAN Code 4002395
1	75	4,0	T 144 D	5	213116	301492
2	75	2,5	T 101 B	5	254061	301522
3	105	4,0	T 301 DL	5	346071	312399
4	75	4,0	T 101 D	5	274351	301515
5	91	2,5	T 234 X	5	430141	378029
6	75	2,5	T 101 BR	5	346079	312382
7	75	2,5/1,2	Curve	5	430143	378043
8	105	4,0	T 344 D	5	311633	301508
9	75	3,0	T 111 C	5	254071	301539
10	5pc jigsaw blade set with 213116, 254061, 254063, 254064, 254071			5	345825	314850

Pos	Display material	Quantity	Id. No. 4939	EAN Code 4002395
1	1 m Assembled row	1	434656	557967
2	Euro hook (short)	10	434650	557905
3	Milwaukee® header strip	1	510100	900596
4	Barcode label strip jigsaw blades for wood & plastics EU	1	530376	914517
5	Carton	1	4931373861	734399

4932 430509
4002395 381708



Jigsaw blades for metal 1 metre row

Pos	Blade length (toothed) mm	Tooth pitch mm	Ref. No.	Quantity	Id. No. 4932	EAN Code 4002395
1	55	1,2	T 118 A	5	254063	301614
2	55	2,0	T 118 B	5	254064	301591
3	75	3,0	T 127 D	5	274315	301560
4	75	1,2	T 118 AF	5	340011	304684
5	91	2,5/1,8	T 123 XF	5	430142	378036
6	75	1,2	T 118 A sp.	5	345826	313464
7	75	0,7	T 118 G	5	274652	301621
8	105	1,2	T 318 AF	5	274654	301607
9	105	2,0	T 318 BF	5	274653	301584
10	5pc jigsaw blade set with 213116, 254061, 254063, 254064, 254071			5	345825	314850

Pos	Display material	Quantity	Id. No. 4939	EAN Code 4002395
1	1 m Assembled row	1	434656	557967
2	Euro hook (short)	10	434650	557905
3	Milwaukee® header strip	1	510100	900596
4	Barcode label strip jigsaw blades for metal EU	1	530379	914487
5	Carton	1	4931373861	734399

4932 430510
4002395 381715



Abrasive paper - Hook & Loop 100x147 mm - 1 metre row

Pos	Grit	Paper size mm A x B	Quantity	Id. No. 4932	EAN Code 4002395
1	60	100x147	3	355140	319992
2	60	100x147	3	355140	319992
3	80	100x147	3	355141	320004
4	80	100x147	3	355141	320004
5	120	100x147	3	355142	320011
6	180	100x147	3	355143	320028
7	240	100x147	3	355144	320035

Pos	Display material	Quantity	Id. No. 4939	EAN Code 4002395
1	1 m Assembled row	1	434656	557967
2	Euro hook (short)	7	434650	557905
3	Milwaukee® header strip	1	510100	900596
4	Barcode label strip abrasive paper 100x147 mm EU	1	530281	915071
5	Carton	1	4931373861	734399

4932 430511
4002395 381722

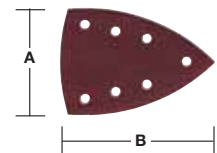

Abrasive paper - Hook & Loop 105x105 mm - 1 metre row

Pos	Grit	Paper size mm A x B	Quantity	Id. No. 4932	EAN Code 4002395
1	60	105 x 105	3	358492	324248
2	60	105 x 105	3	358492	324248
3	80	105 x 105	3	358493	324255
4	80	105 x 105	3	358493	324255
5	120	105 x 105	3	358494	324262
6	180	105 x 105	3	358495	324279
7	240	105 x 105	3	358496	324286

Pos	Display material	Quantity	Id. No. 4939	EAN Code 4002395
1	1 m Assembled row	1	434656	557967
2	Euro hook (short)	8	434650	557905
3	Milwaukee® header strip	1	510100	900596
4	Barcode label strip abrasive paper 105x105 mm EU	1	530285	915118
5	Carton	1	4931373861	734399

4932 430557
4002395 382187

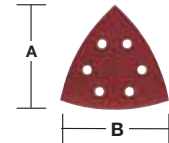

Abrasive paper - Hook & Loop Ø 125 mm 8 holes - 1 metre row

Pos	Grit	Paper size mm Ø	Quantity	Id. No. 4932	EAN Code 4002395
1	40	125	3	367740	338610
2	60	125	3	367741	338627
3	60	125	3	367741	338627
4	80	125	3	367742	338634
5	120	125	3	367743	338641
6	180	125	3	367744	338658
7	240	125	3	367745	338665

Pos	Display material	Quantity	Id. No. 4939	EAN Code 4002395
1	1 m Assembled row	1	434656	557967
2	Euro hook (short)	7	434650	557905
3	Milwaukee® header strip	1	510100	900596
4	Barcode label strip abrasive paper Ø 125 mm EU	1	530422	914258
5	Carton	1	4931373861	734399

4932 430512
4002395 381739

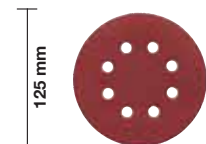

Abrasive paper - Hook & Loop Ø 150 mm - 6 holes 1 metre row

Pos	Grit	Paper size mm Ø	Quantity	Id. No. 4932	EAN Code 4002395
1	40	150	3	371590	343171
2	60	150	3	371591	343188
3	80	150	3	371592	343195
4	120	150	3	371593	343201
5	180	150	3	371594	343218
6	240	150	3	371595	343225

Pos	Display material	Quantity	Id. No. 4939	EAN Code 4002395
1	1 m Assembled row	1	434656	557967
2	Euro hook (short)	6	434650	557905
3	Milwaukee® header strip	1	510100	900596
4	Barcode label strip abrasive paper Ø 150 mm EU	1	530399	914289
5	Carton	1	4931373861	734399

4932 430513
4002395 381746

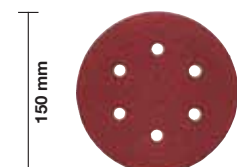

Abrasive belts - 100x620 mm 1 metre row

Pos	Grit	Paper size mm A x B	Quantity	Id. No. 4932	EAN Code 4002395
1	40	100 x 620	2	341610	304882
2	60	100 x 620	2	341611	304899
3	60	100 x 620	2	341611	304899
4	80	100 x 620	2	341612	304905
5	100	100 x 620	2	341613	304912
6	150	100 x 620	2	341614	304929
7	240	100 x 620	2	341615	304936

Pos	Display material	Quantity	Id. No. 4939	EAN Code 4002395
1	1 m Assembled row	1	434656	557967
2	Euro hook (short)	7	434650	557905
3	Milwaukee® header strip	1	510100	900596
4	Barcode label strip abrasive belts 100x620 mm EU	1	530425	914227
5	Carton	1	4931373861	734399

4932 430558
4002395 382194

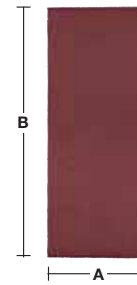

Abrasive belts - 100x610 mm 1 metre row

Pos	Grit	Paper size mm A x B	Quantity	Id. No. 4932	EAN Code 4002395
1	40	100 x 610	2	355066	319824
2	60	100 x 610	2	355067	319831
3	60	100 x 610	2	355067	319831
4	80	100 x 610	2	355068	319848
5	100	100 x 610	2	355069	319855
6	150	100 x 610	2	355070	319862
7	240	100 x 610	2	355071	319879

Pos	Display material	Quantity	Id. No. 4939	EAN Code 4002395
1	1 m Assembled row	1	434656	557967
2	Euro hook (short)	7	434650	557905
3	Milwaukee® header strip	1	510100	900596
4	Barcode label strip abrasive belts 100x610 mm EU	1	530428	914227
5	Carton	1	4931373861	734399

4932 430559
4002395 382200

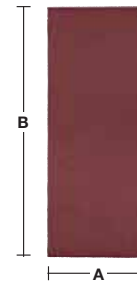

Abrasive belts - 75x533 mm 1 metre row

Pos	Grit	Paper size mm A x B	Quantity	Id. No. 4932	EAN Code 4002395
1	40	75 x 533	2	312475	301263
2	60	75 x 533	2	312476	301270
3	60	75 x 533	2	312476	301270
4	80	75 x 533	2	312477	301287
5	80	75 x 533	2	312477	301287
6	100	75 x 533	2	312478	301294
7	100	75 x 533	2	312478	301294
8	150	75 x 533	2	312479	301300
9	240	75 x 533	2	312480	301317

Pos	Display material	Quantity	Id. No. 4939	EAN Code 4002395
1	1 m Assembled row	1	434656	557967
2	Euro hook (short)	9	434650	557905
3	Milwaukee® header strip	1	510100	900596
4	Barcode label strip abrasive belts 75x533 mm EU	1	530429	914180
5	Carton	1	4931373861	734399

4932 430514
4002395 381753

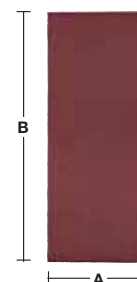

SAWZALL® blades for wood/ demolition/universal - 1 metre row

Pos	Blade length	Teeth per inch	Application	Quantity	Id. No.	UPC Code 45242
1	230	6	Wood	5	48005016	082636
2	300	6	Wood	5	48001079	079858
3	150	5	Demolition	5	48005035	082698
4	230	5	Demolition	5	48005036	082704
5	300	5	Demolition	5	48005037	082711
6	150	5	Demolition AX	5	48005021	082988
7	230	5	Demolition AX	5	48005026	082995
8	300	5	Demolition AX	5	48005027	083022
9	150	10/14	Universal	5	48005292	084067
10	200	10/14	Universal	5	48005293	084074
11	150	8/12	Universal	5	48005091	082759
12	200	8/12	Universal	5	48005093	082773
13	300	8/12	Universal	5	48005094	082780
14	300	knife	Insulation mat.	5	48001084	079902
15	125	6	Drywall	5	48005052	082735

Pos	Display material	Quantity	Id. No. 4939	EAN Code 4002395
1	1 m Assembled row	1	434656	557967
2	Euro hook (short)	15	434650	557905
3	Milwaukee® header strip	1	510100	900596
4	Barcode label strip SAWZALL® blades for wood/demolition/universal	1	565538	936236
5	Carton	1	4931373861	734399

4932 430515
4002395 381760



SAWZALL® blades for wood/metal demolition/universal - 1 metre row

Pos	Blade length	Teeth per inch	Application	Quantity	Id. No.	UPC Code 45242
1	300	6	Wood	5	48001079	079858
2	150	6	Demolition	5	48005035	082698
3	230	6	Demolition	5	48005036	082704
4	300	6	Demolition	5	48005037	082711
5	200	10/14	Universal	5	48005293	084074
6	200	8/12	Universal	5	48005093	082773
7	300	8/12	Universal	5	48005094	082780
8	150	18	Metal	5	48005184	082858
9	230	18	Metal	5	48005188	082896
10	300	18	Metal	5	48005189	082902
11	150	14	Metal	5	48005182	082834
12	230	14	Metal	5	48005187	082889
13	230	18	Metal – Torch	5	48005788	083091
14	230	14	Metal – Torch	5	48005787	083077
15	230	10	Metal – Torch	5	48005713	083046
16	230		Cast iron – Coarse grit	5	48001430	082001

Pos	Display material	Quantity	Id. No. 4939	EAN Code 4002395
1	1 m Assembled row	1	434656	557967
2	Euro hook (short)	16	434650	557905
3	Milwaukee® header strip	1	510100	900596
4	Barcode label strip SAWZALL® blades top line EU	1	565539	936243
5	Carton	1	4931373861	734399

4932 430516
4002395 381777

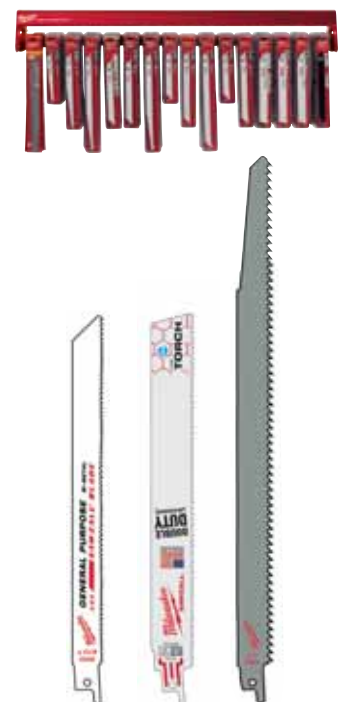

SAWZALL® blades for metal 1 metre row

Pos	Blade length	Teeth per inch	Application	Quantity	Id. No.	UPC Code 45242
1	150	25	Metal	5	48005186	082872
2	150	18	Metal	5	48005184	082858
3	230	18	Metal	5	48005188	082896
4	300	18	Metal	5	48005189	082902
5	150	14	Metal	5	48005182	082834
6	230	14	Metal	5	48005187	082889
7	150	18	Metal – Torch	5	48005784	083084
8	230	18	Metal – Torch	5	48005788	083091
9	300	18	Metal – Torch	5	48005789	083107
10	150	14	Metal – Torch	5	48005782	083060
11	230	14	Metal – Torch	5	48005787	083077
12	150	10	Metal – Torch	5	48005712	083039
13	230	10	Metal – Torch	5	48005713	083046
14	150		Cast iron – Coarse grit	5	48001420	081950
15	230		Cast iron – Coarse grit	5	48001430	082001

Pos	Display material	Quantity	Id. No. 4939	EAN Code 4002395
1	1 m Assembled row	1	434656	557967
2	Euro hook (short)	15	434650	557905
3	Milwaukee® header strip	1	510100	900596
4	Barcode label strip SAWZALL® blades for metal	1	565540	936250
5	Carton	1	4931373861	734399

4932 430517
4002395 381784



SAWZALL® blades for metal – top line 1 metre row

Pos	Blade length	Teeth per inch	Application	Quantity	Id. No.	UPC Code 45242
1	150	18	Metal – Ice Hardened	5	48004184	081042
2	230	18	Metal – Ice Hardened	5	48004188	081066
3	150	14	Metal – Ice Hardened	5	48004182	081035
4	230	14	Metal – Ice Hardened	5	48004187	080991
5	150	18	Metal – Torch Ice Hardened	5	48004784	081110
6	230	18	Metal – Torch Ice Hardened	5	48004788	081134
7	150	14	Metal – Torch Ice Hardened	5	48004782	081097
8	230	14	Metal – Torch Ice Hardened	5	48004787	081127
9	150	10	Metal – Torch Ice Hardened	5	48004712	081073
10	230	10	Metal – Torch Ice Hardened	5	48004713	081080
11	150	8	Metal – Wrecker	5	48005701	082476
12	230	8	Metal – Wrecker	5	48005706	082483
13	300	8	Metal – Wrecker	5	48005711	082490

Pos	Display material	Quantity	Id. No. 4939	EAN Code 4002395
1	1 m Assembled row	1	434656	557967
2	Euro hook (short)	13	434650	557905
3	Milwaukee® header strip	1	510100	900596
4	Barcode label strip SAWZALL® blades metal top line	1	565541	936267
5	Carton	1	4931373861	734399

4932 430518
4002395 381791



SDS-plus RX4 4 cut drill bits & chisels - Red Rack



Pos	Ø mm	A mm	B mm	Quantity	Id. No. 4932	EAN Code 4002395	
①	1	5	110	5	352007	366644	
	2	6	110	5	352011	368921	
	3	6	160	5	352012	368938	
	4	6	210	5	352013	366705	
	5	6	260	5	352014	366712	
	6	8	110	5	352021	366781	
	7	8	160	5	352022	366798	
	8	8	210	5	352023	366804	
	9	8	260	5	352024	366811	
	10	10	110	5	352025	366828	
	11	10	160	5	352026	366835	
	12	10	210	5	352027	366842	
	13	10	260	5	352028	366859	
	14	12	160	5	352031	366880	
	15	12	210	5	352032	366897	
	16	12	260	5	352033	366903	
	17	14	160	5	352036	366934	
	18	14	210	5	352037	366941	
②	19	Pointed chisel	250	-	5	339625	304813
③	20	Wide chisel	250	40	5	367146	334377
④	21	7pc SDS-plus RX4 drill bit set with Ø 5/6/8x110 mm and Ø 6/8/10/12x160 mm		3	352051	367085	

4932 352637
4002395 372959

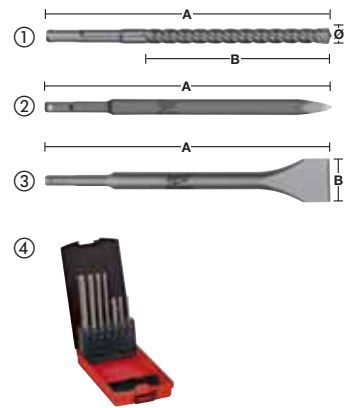

Pos	Display material	Quantity	Id. No. 4939	EAN Code 4002395
1	Red Rack/Header Card	1	434075	930852
2	Euro hook (short)	20	434076	920655
3	Euro hook (long)	1	434077	920662
4	Re Order Tag Set (10pcs)	3	434080	920648
5	Barcode label set SDS-plus RX4 drill bits/chisels	1	434082	920563
6	Planogram SDS-plus RX4 drill bits/chisels (EU)	1	434169	923892

SDS-plus 2 cut drill bits & chisels Red Rack

Pos	Ø mm	A mm	B mm	Quantity	Id. No. 4932	EAN Code 4002395	
①	1	5	110	5	307067	308835	
	2	6	110	5	307068	308842	
	3	6	160	5	307069	308859	
	4	6	210	5	373136	346394	
	5	6	260	5	353819	320127	
	6	8	110	5	307070	308866	
	7	8	160	5	307071	308873	
	8	8	210	5	307072	308880	
	9	8	260	5	353821	320141	
②	10	Pointed chisel	250	-	5	339625	304813
③	11	Wide chisel	250	40	5	367146	334377
	12	10	160	100	5	307073	308897
	13	10	210	150	5	307074	308903
	14	10	260	200	5	344295	312252
	15	12	160	100	5	307075	308910
	16	12	210	150	5	307076	308927
	17	14	160	100	5	307078	308941
	18	14	260	200	5	307079	308958
④	19	7pc SDS-plus drill bit set with Ø 5/6/8x110 mm and Ø 6/8/10/12x160 mm		4	352339	369980	

4932 352634
4002395 372928

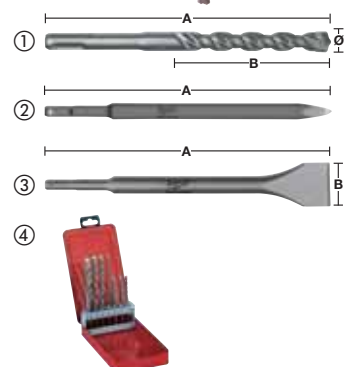

Pos	Display material	Quantity	Id. No. 4939	EAN Code 4002395
1	Red Rack/Header Card	1	434075	930852
2	Euro hook (short)	18	434076	920655
3	Euro hook (long)	1	434077	920662
4	Re Order Tag Set (10pcs)	2	434080	920648
5	Barcode label set SDS-plus drill bits/chisels	1	434081	920556
6	Planogram SDS-plus drill bits/chisels (EU)	1	434166	923861

Concrete & multipurpose drill bits Red Rack

Pos	Ø mm	A mm	B mm	Quantity	Id. No. 4932	EAN Code 4002395
Concrete drill bits						
① 1	4	85	50	5	363631	332014
2	5	85	50	5	363633	332038
3	5	150	90	5	363634	332045
4	6	100	60	5	363636	332069
5	6	150	90	5	363637	332076
6	8	120	80	5	363640	332106
7	8	200	150	5	363641	332113
8	9	120	80	5	363643	332137
9	10	120	80	5	363644	332144
10	12	150	85	5	363647	332175
11	14	150	90	5	363650	332205
② 12	5pc concrete drill bit set with Ø 4/5/6/8/10 mm			5	352333	369928
③ 13	8pc concrete drill bit set with Ø 3/4/5/6/7/8/9/10 mm			5	352334	369935
Multipurpose drill bits						
④ 14	7pc multipurpose drill bit set with Ø 3/4/5/6/6/8/10 mm			5	352335	369942
⑤ 15	4	85	50	5	430148	378098
16	5	85	50	5	430149	378104
17	6	100	60	5	430152	378135
18	8	120	80	5	430158	378197
19	10	120	80	5	430160	378210

Pos	Display material	Quantity	Id. No. 4939	EAN Code 4002395
1	Red Rack/ Header Card	1	434075	930852
2	Euro hook (short)	16	434076	920655
3	Euro hook (long)	3	434077	920662
4	Re Order Tag Set (10pcs)	2	434080	920648
5	Barcode label set concrete & multipurpose drill bits	1	434085	920594
6	Planogram concrete & multipurpose drill bits (EU)	1	434172	923922

4932 352640
4002395 372980

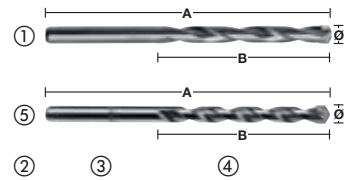

Wood auger bits 230 mm Red Rack

Pos	Ø mm	A mm	B mm	C mm	Quantity	Id. No. 4932	EAN Code 4002395
① 1	8	230	155	6.5	3	363681	331796
2	10	230	155	8.5	3	363682	331802
3	12	230	155	10	3	363683	331819
4	14	230	155	11	3	363684	331826
5	16	230	155	11	3	363685	331833
6	18	230	155	11	3	363686	331840
7	20	230	155	11	3	363687	331857
② 8	5pc impact wood auger bit set with Ø 14/16/18/20/22x470 mm			3	352285	369447	
9	22	230	155	11	3	373363	347889
10	24	230	155	11	3	373364	347896
11	26	230	155	11	3	373365	348503
12	28	230	155	11	3	373366	348510
13	30	230	155	11	3	373367	348527
14	32	230	155	11	2	373368	348534

Pos	Display material	Quantity	Id. No. 4939	EAN Code 4002395
1	Red Rack/ Header Card	1	434075	930852
2	Euro hook (short)	13	434076	920655
3	Euro hook (long)	2	434077	920662
4	Re Order Tag Set (10pcs)	2	434080	920648
5	Barcode label set wood auger bits 230 mm	1	434086	920600
6	Planogram wood auger bits 230 mm	1	434175	923953

4932 352643
4002395 373017

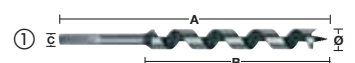

THUNDERWEB Metal drill bits HSS-Ground - DIN 338 - Red Rack

Pos	Ø mm	A mm	B mm	Quantity	Id. No. 4932	EAN Code 4002395
① 1	1,0	34	12	5	352345	370047
2	1,5	40	18	5	352346	370054
3	2,0	49	24	2	352347	370061
4	2,5	57	30	2	352348	370078
5	3,0	61	33	2	352349	370085
6	3,2	65	36	2	352350	370092
7	3,5	70	39	5	352351	370108
8	4,0	75	43	5	352352	370115
9	4,5	80	47	5	352354	370139
10	4,8	86	52	5	352355	370146
11	5,0	86	52	5	352356	370153
12	6,0	93	57	5	352358	370177
13	7,0	109	69	5	352361	370207
14	8,0	117	75	5	352363	370221
15	9,0	125	81	5	352365	370245
16	10,0	133	87	5	352367	370269
17	11,0	142	94	5	352369	370283
18	12,0	151	101	5	352371	370306
② 19	25pc HSS-G metal drill bit set			3	352376	370351
③ 20	19pc HSS-G metal drill bit set			4	352374	370337
21	13,0	151	101	5	352373	370320

Pos	Display material	Quantity	Id. No. 4939	EAN Code 4002395
1	Red Rack/Header Card	1	434075	930852
2	Euro hook (short)	19	434076	920655
3	Euro hook (long)	4	434077	920662
4	Re Order Tag Set (10pcs)	3	434080	920648
5	Barcode label set HSS-G metal drill bits	1	434084	920587
6	Planogram HSS-G metal drill bits	1	434177	923977

4932 352645
4002395 373031

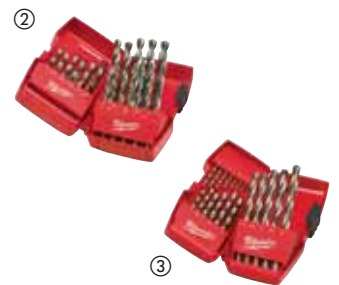
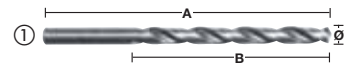

SAWZALL® blades Red Rack

Pos	Blade length	Teeth per inch	Application	Quantity	Id. No.	UPC Code 45242
1	230	6	Wood	5	48005016	082636
2	150	5	Demolition AX	5	48005021	082988
3	230	5	Demolition AX	5	48005026	082995
4	300	5	Demolition AX	5	48005027	083022
5	230	5	Demolition AX	5	48005036	082704
6	200	10/14	Universal	5	48005293	084074
7	150	8/12	Universal	5	48005091	082759
8	200	8/12	Universal	5	48005093	082773
9	230		Cast iron - Diamond grit	3	48001450	187416
10	450	2,1	Brick	3	48001460	235353
11	150	18	Metal	5	48005184	082858
12	230	18	Metal	5	48005188	082896
13	230	14	Metal	5	48005187	082889
14	150	14	Metal	5	48005182	082834
15	230	14	Metal - Torch	5	48005787	083077
16	150	14	Metal - Torch	5	48005782	083060
17	300	18	Metal	5	48005189	082902

Pos	Display material	Quantity	Id. No. 4939	EAN Code 4002395
1	Red Rack/Header Card	1	434075	930852
2	Euro hook (short)	17	434076	920655
3	Euro hook (long)	2	434080	920648
4	Barcode label set SAWZALL® blades	1	434087	920617
5	Planogram SAWZALL® blades	1	434179	923991

4932 352647
4002395 373055



Jigsaw blades Red Rack

Pos	Blade length (toothed) mm	Tooth pitch mm	Ref. No.	Quantity	Id. No. 4932	EAN Code 4002395
1	75	4,0	T 144 D	5	213116	301492
2	55	2,0	T 118 B	5	254064	301591
3	75	2,5	T 101 B	5	254061	301522
4	75	4,0	T 101 D	5	274351	301515
5	75	3,0	T 111 C	5	254071	301539
6	91	2,5	T 234 X	5	430141	378029
7	75	4,0	Special	5	265312	301478
8	75	2,5	T 101 BR	5	346079	312382
9	105	4,0	T 344 D	5	311633	301508
10	105	4,0	T 301 DL	5	346071	312399
11	5pc jigsaw blade set with 213116, 254061, 254063, 254064, 254071			5	345825	314850
12	55	0,7	T 118 G	5	274652	301621
13	55	1,2	T 118 A	5	254063	301614
14	75	1,2	T 118 A	5	345826	313464
15	91	2,5/1,8	T 123 XF	5	430142	378036
16	55	1,2	T 118 AF	5	340011	304684
17	55	2,0	T 118 BF	5	340012	304691
18	105	2,0	T 318 BF	5	274653	301584

Pos	Display material	Quantity	Id. No. 4939	EAN Code 4002395
1	Red Rack/Header Card	1	434075	930852
2	Euro hook (short)	18	434076	920655
3	Euro hook (long)	2	434080	920648
4	Barcode label set jigsaw blades	1	434089	920631
5	Planogram jigsaw blades	1	434180	924004

4932 352648
4002395 373062



Holesaws Red Rack

Pos	Application	Quantity	Id. No.	UPC Code 45242
1	Holesaw 19 mm	2	49560023	192632
2	Holesaw 20 mm	2	49560024	271016
3	Holesaw 22 mm	2	49560032	192878
4	Holesaw 25 mm	2	49560043	192526
5	Holesaw 32 mm	2	49560062	192977
6	Holesaw 35 mm	2	49560072	192991
7	Holesaw 40 mm	2	49560087	193042
8	Holesaw 44 mm	2	49560102	193097
9	Holesaw 52 mm	2	49560122	193172
10	Holesaw 54 mm	2	49560127	193189
11	Holesaw 60 mm	2	49560142	193233
12	Holesaw 65 mm	2	49560153	193271
13	Holesaw 67 mm	2	49560158	193288
14	Holesaw 76 mm	1	49560173	193332
15	Holesaw 86 mm	1	49560187	193387
16	Holesaw 102 mm	1	49560213	193486
17	Holesaw 111 mm	1	49560227	193530
18	Arbor 9.5 mm / 14-30 mm	2	49567010	200177
19	Arbor 9,5 mm / 32-210 mm	2	49567250	225798
20	Arbor 11 mm / 32-210 mm	2	49569100	200832
21	Pilot drill 6x89	5	49568010	200450
22	Holesaw 4/6 Set-17pcs	1	49224102	271054

Pos	Display material	Quantity	Id. No. 4939	EAN Code 4002395
1	Red Rack/Header Card	1	434075	930852
2	Euro hook (short)	6	434076	920655
3	Euro hook (long)	15	434077	920662
4	Re Order Tag (10pcs)	3	434080	920648
5	EAN LB	1	434409	551521

4932 430177
4002395 378388



SHOCKWAVE Impact Duty™ Drilling & Driving - Red Rack

NEW

4932 451317
4002395 151998

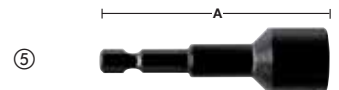

Pos	Size Ø mm	A mm	Quantity	Id. No. 4932	EAN Code 4002395
① Screwdriving bits					
1	PH 1	25	5	430850	385126
2	PH 2	25	5	430852	385140
3	PZ1	25	5	430860	385225
4	PZ 2	25	5	430863	385256
5	PZ 3	25	5	430868	385300
6	TX 10	25	5	430871	385331
7	TX 15	25	5	430872	385348
8	TX 20	25	5	430874	385362
9	TX 25	25	5	430879	385416
10	TX 30	25	5	430885	385478
11	Hex 4 mm	25	5	430895	385577
12	Hex 5 mm	25	5	430896	385584
13	PH 2	50	5	430854	385164
14	PZ 2	50	5	430865	385270
15	TX 20	50	5	430876	385386
16	TX 25	50	5	430881	385430
②	Magnetic bit holder	65	8	352406	370658
18	Magnetic bit holder	152	5	48324511	45242301980
③	PH 2 (25pc box)	25	3	430853	385157
20	PZ 2 (25pc box)	25	3	430864	385263
21	TX 20 (25pc box)	25	3	430875	385379
22	TX 25 (25pc box)	25	3	430880	385423
④ Metal drill bits HSS-G ¼" Hex reception					
23	3,0	70	5	352448	371075
24	4,0	80	5	352449	371082
25	5,0	90	5	352450	371099
26	6,0	93	5	352451	371105
⑤ Magnetic nut drivers					
27	7,0	65	5	352539	371976
28	8,0	65	5	352541	371990
29	10,0	65	4	352543	372010
30	13,0	65	4	352545	372034
⑥	31	6pc Shockwave Impact Duty™ drill bit set with Ø 3/4/5/6/7/8 mm	3	352454	371136
⑦	32	48pc Shockwave Impact Duty™ drill & drive set	3	430906	385683

Pos	Display material	Quantity	Id. No. 4939	EAN Code 4002395
1	Red Rack/ Header Card	1	434075	930852
2	Euro hook (short)	26	434076	920655
3	Euro hook (long)	7	434077	920662
4	Re Order Tag Set (10pcs)	4	434080	920648
5	Barcode label set Shockwave Impact Duty™ Accessories	1	434088	920624
6	Planogram Shockwave Impact Duty™ Accessories	1	434178	923984



Nothing but **HEAVY DUTY.**[™]

Techtronic Industries UK Ltd

Ground Floor

Unit 3 Globeside Business Park

Fieldhouse Lane

Marlow

Bucks SL7 1HZ

Tel: +44 (0) 1628 894400

Fax: +44 (0) 1628 894401

Distributed by: