



ELECTRICAL FITTINGS & SUPPLIES



TOPAZ[®]

Friendly Service... Powerful Solutions[™]



Friendly Service... Powerful Solutions™



STANDARDS

PRODUCT GROUP	UL STANDARD NUMBER	UL FILE NUMBER	US FED SPEC NUMBER	NEMA/ANSI STANDARD	MILITARY SPEC NUMBER
Liquid-Tight Fittings	UL 514B	E148716	A-A-50552	FB-1	*
Insulating Bushings	UL 514B	E148716	A-A-50552	FB-1	*
EMT Fittings	UL 514B	E148716	A-A-50553	FB-1	*
Service Entrance Cable Fittings	UL 514B	E26593	A-A-50552	FB-1	*
Armored Cable Connectors	UL 514B	E170258	A-A-50552	FB-1	*
Conduit Bodies	UL 514B	E170258	A-A-50563	FB-1	*
MC Cable Connectors	UL 514B	E18716	A-A-50552	FB-1	*
Rigid Conduit Fittings	UL 514B	E148716	A-A-50553	FB-1	*
Grounding and Bonding Equipment	UL 467	E170258	A-A-50552	FB-1	*
Tubular Products	UL 514B	E223147	A-A-50552	FB-1	*
Flexible Cord Connectors	UL 514B	E148715	A-A-50552	FB-1	*

* Military Specs: W-F-406D
W-F-406E
W-F-408D
W-S-610D

TABLE OF CONTENTS

EMT CONDUIT	1
LIQUID TIGHT	2
BX-FLEX-MC	3
NM CABLE	4
SERVICE ENTRANCE	5
CONDUIT BODIES	6
CONDUIT SUPPORT	7
RIGID-IMC CONDUIT	8
TUBULAR PRODUCTS	9
FLEXIBLE CORD	10
NYLON PRODUCTS	11
GROUNDING	12
WIRE ACCESSORIES	13
BOX ACCESSORIES	14
FIXTURE ACCESSORIES	15
HANGING & SUPPORT DEVICES	16
PVC - SCHEDULE 40	17
HVAC	18
WEATHERPROOF	19
TEMPORARY LIGHTING	20
MISCELLANEOUS	21
INDEX	22

TABLE OF CONTENTS

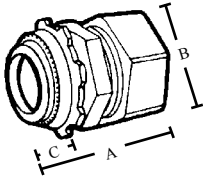

CAT#	A	B	C
651/651i	1.26	1.10	.420
652/652i	1.34	1.31	.420
653/653i	1.49	1.67	.525
654/654i	1.67	2.10	.630
655/655i	1.87	2.30	.620
656/656i	2.01	2.85	.680
657/657i	2.63	3.70	.860
658/658i	2.77	4.49	1.01
659/659i	2.77	5.06	.94
660/660i	2.77	5.63	1.00

EMT CONNECTORS COMPRESSION TYPE

• CONCRETE TIGHT 1/2" - 4"

ZINC DIE CAST

TOPAZ CAT #	UPC#	SIZE	UNIT CTN	SHIP CASE	WT/ CASE
651	16590	1/2"	50	500	50
652	16600	3/4"	25	250	35
653	16610	1"	50	200	40
654	16620	1 1/4"	—	25	10
655	16630	1 1/2"	—	20	11
656	16640	2"	—	15	12
657	16650	2 1/2"	—	12	13
658	16660	3"	—	12	16
659	16670	3 1/2"	—	10	18
660	16680	4"	—	6	12



1/2"-2"
2 1/2"-4"

E148720
E148716

INSULATED THROAT

651i	16690	1/2"	50	200	50
652i	16700	3/4"	25	250	35
653i	16710	1"	50	200	40
654i	16720	1 1/4"	—	25	10
655i	16730	1 1/2"	—	20	11
656i	16740	2"	—	15	12
657i	16750	2 1/2"	—	12	13
658i	16760	3"	—	12	16
659i	16770	3 1/2"	—	10	18
660i	16780	4"	—	6	12



1/2"-2"
2 1/2"-4"

E148720
E148716

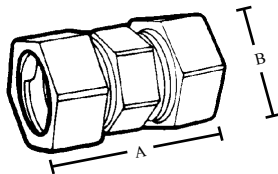

CAT#	A	B
661	1.50	1.10
662	1.62	1.31
663	1.84	1.67
664	2.05	2.10
665	2.47	2.30
666	2.56	2.85
667	3.29	3.70
668	3.42	4.49
669	3.51	5.06
670	3.54	5.63

EMT COUPLINGS COMPRESSION TYPE

• CONCRETE TIGHT 1/2" - 4"

ZINC DIE CAST

TOPAZ CAT #	UPC#	SIZE	UNIT CTN	SHIP CASE	WT/ CASE
661	16910	1/2"	50	500	60
662	16920	3/4"	25	250	48
663	16930	1"	50	200	56
664	16940	1 1/4"	—	25	11
665	16950	1 1/2"	—	20	14
666	16960	2"	—	15	14
667	16970	2 1/2"	—	12	16
668	16980	3"	—	12	21
669	16990	3 1/2"	—	10	22
670	17000	4"	—	6	15



1/2"-2"
2 1/2"-4"

E148720
E148716

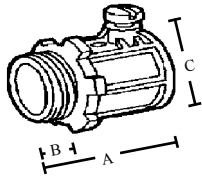

CAT#	A	B	C
631/631i	1.16	.400	1.06
632/632i	1.39	.400	1.30
633/633i	1.55	.520	1.52
634/634i	1.93	.560	1.95
635/635i	2.28	.720	1.18
636/636i	2.50	.730	2.64
637/637i	3.08	.920	3.27
638/638i	3.37	1.050	3.91
639/639i	3.46	1.050	4.46
640/640i	3.75	1.050	4.99

1/2"-1" 1 SCREW
1 1/4"-4" 2 SCREW

EMT CONNECTORS SET SCREW TYPE

• CONCRETE TIGHT WHEN TAPED

ZINC DIE CAST

TOPAZ CAT #	UPC#	SIZE	UNIT CTN	SHIP CASE	WT/ CASE
631	16290	1/2"	50	500	35
632	16300	3/4"	25	250	25
633	16310	1"	—	50	30
634	16320	1 1/4"	—	25	8
635	16330	1 1/2"	—	25	10
636	16340	2"	—	20	11
637*	16350	2 1/2"	—	12	10
638*	16360	3"	—	12	12
639*	16370	3 1/2"	—	10	13
640*	16380	4"	—	6	9

*EMT & RIGID



INSULATED THROAT

631i	16390	1/2"	50	500	35
632i	16400	3/4"	25	250	25
633i	16410	1"	50	200	30
634i	16420	1 1/4"	—	25	8
635i	16430	1 1/2"	—	25	10
636i	16440	2"	—	20	11
637i*	16450	2 1/2"	—	12	10
638i*	16460	3"	—	12	12
639i*	16470	3 1/2"	—	10	13
640i*	16480	4"	—	6	8

*EMT & RIGID

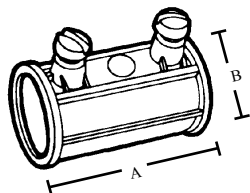
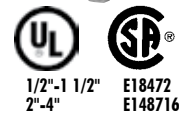

CAT#	A	B
641	1.53	0.93
642	1.92	1.16
643	1.00	1.44
644	2.52	1.84
645	2.85	2.05
646	3.41	2.51
647	4.21	3.30
648	4.67	4.01
649	4.85	4.52
650	5.47	5.01

1/2"-1" 2 SCREW
1 1/4"-4" 4 SCREW

EMT COUPLINGS SET SCREW TYPE

• CONCRETE TIGHT WHEN TAPED

ZINC DIE CAST

TOPAZ CAT #	UPC#	SIZE	UNIT CTN	SHIP CASE	WT/ CASE
641	16490	1/2"	50	500	35
642	16500	3/4"	25	250	25
643	16510	1"	50	200	28
644	16520	1 1/4"	—	25	8
645	16530	1 1/2"	—	25	15
646	16540	2"	—	20	11
647*	16550	2 1/2"	—	12	9
648*	16560	3"	—	12	12
649*	16570	3 1/2"	—	10	12
650*	16580	4"	—	6	10

*EMT & RIGID

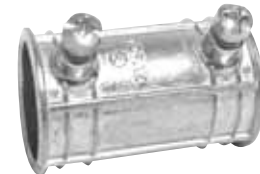

EMT CONNECTORS COMPRESSION TYPE

• CONCRETE TIGHT

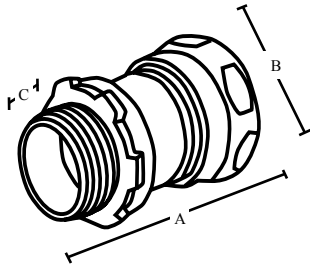

CAT#	A	B	C
651S/Si	1.750	1.250	.406
652S/Si	1.813	1.563	.406
653S/Si	2.000	1.813	.406
654S/Si	2.750	2.188	.500
655S/Si	3.000	2.438	.500
656S/Si	3.188	2.938	.688
657S/Si	3.875	3.688	.750
658S/Si	4.375	4.313	.938
659S/Si	4.500	4.875	.938
660S/Si	4.750	5.375	.938

STEEL

TOPAZ CAT #	UPC#	SIZE	UNIT CTN	SHIP CASE	WT/ CASE
651S	16790	1/2"	25	250	30
652S	16800	3/4"	25	250	43
653S	16810	1"	10	100	25
654S	16820	1 1/4"	—	25	12
655S	16830	1 1/2"	—	20	12
656S	16840	2"	—	15	15
657S	16841	2 1/2"	—	12	19
658S	16842	3"	—	6	15
659S	16843	3 1/2"	—	6	16
660S	16844	4"	—	6	21



INSULATED THROAT

651Si	16850	1/2"	25	250	30
652Si	16860	3/4"	25	250	43
653Si	16870	1"	10	100	25
654Si	16880	1 1/4"	—	25	12
655Si	16890	1 1/2"	—	20	12
656Si	16900	2"	—	15	15
657Si	16901	2 1/2"	—	12	19
658Si	16902	3"	—	6	15
659Si	16903	3 1/2"	—	6	16
660Si	16904	4"	—	6	21

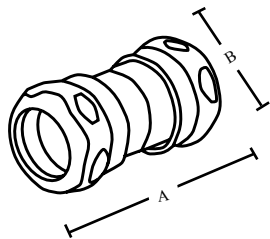

CAT#	A	B
661S	1.688	1.250
662S	2.000	1.563
663S	2.125	1.813
664S	3.063	2.188
665S	3.125	2.438
666S	3.375	2.938
667S	4.875	3.688
668S	5.250	4.313
669S	5.500	4.875
670S	5.750	5.375

EMT COUPLINGS COMPRESSION TYPE

• CONCRETE TIGHT

STEEL

TOPAZ CAT #	UPC#	SIZE	UNIT CTN	SHIP CASE	WT/ CASE
661S	17010	1/2"	25	250	32
662S	17020	3/4"	25	250	40
663S	17030	1"	10	100	31
664S	17040	1 1/4"	—	25	15
665S	17050	1 1/2"	—	20	15
666S	17060	2"	—	15	18
667S	17061	2 1/2"	—	6	14
668S	17062	3"	—	6	19
669S	17063	3 1/2"	—	6	21
670S	17064	4"	—	3	15



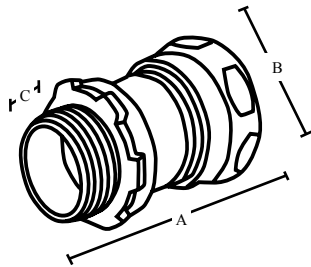

CAT#	A	B	C
651SRT	1.063	1.125	.438
652SRT	1.125	1.375	.438
653SRT	1.187	1.687	.500
654SRT	1.562	2.062	.625
655SRT	1.687	2.062	.625
656SRT	1.812	2.750	.687
657SRT	2.437	3.625	.750
658SRT	2.562	4.250	.875
659SRT	2.750	4.687	.937
660SRT	2.750	5.187	.937

651SIRT	1.125	1.125	.500
652SIRT	1.187	1.375	.500
653SIRT	1.25	1.687	.562
654SIRT	1.625	2.062	.687
655SIRT	1.75	2.25	.687
656SIRT	1.875	2.75	.750
657SIRT	2.50	3.625	.812
658SIRT	2.625	4.25	.937
659SIRT	2.812	4.687	1.00
660SIRT	2.812	5.187	1.00

EMT CONNECTORS

COMPRESSION TYPE

RAINTIGHT

• CONCRETE TIGHT

TOPAZ CAT #	UPC#	SIZE	UNIT CTN	SHIP CASE	STEEL WT/ CASE
651SRT	83059	1/2"	25	250	30
652SRT	83060	3/4"	25	250	43
653SRT	83061	1"	10	100	25
654SRT	83062	1 1/4"	—	25	12
655SRT	83063	1 1/2"	—	20	12
656SRT	83064	2"	—	15	15
657SRT	83598	2 1/2"	—	12	19
658SRT	83599	3"	—	12	15
659SRT	83600	3 1/2"	—	5	16
660SRT	83659	4"	—	3	21



E170258

INSULATED THROAT

651SIRT	83006	1/2"	25	250	30
652SIRT	83007	3/4"	25	250	43
653SIRT	83008	1"	10	100	25
654SIRT	83009	1 1/4"	—	25	12
655SIRT	83010	1 1/2"	—	20	12
656SIRT	83011	2"	—	15	15
657SIRT	83512	2 1/2"	—	12	19
658SIRT	83513	3"	—	6	15
659SIRT	83614	3 1/2"	—	5	16
660SIRT	83615	4"	—	3	21



E170258

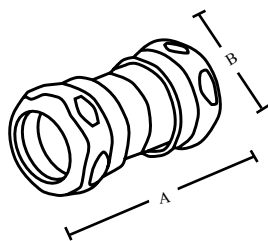

CAT#	A	B
661SRT	1.625	1.125
662SRT	1.750	1.375
663SRT	1.875	1.687
664SRT	2.250	2.062
665SRT	2.250	2.250
666SRT	2.375	2.750
667SRT	3.875	3.625
668SRT	4.000	4.250
669SRT	4.687	4.687
670SRT	4.937	5.187

EMT COUPLINGS

RAINTIGHT

COMPRESSION TYPE

• CONCRETE TIGHT

TOPAZ CAT #	UPC#	SIZE	UNIT CTN	SHIP CASE	STEEL WT/ CASE
661SRT	83071	1/2"	25	250	35
662SRT	83072	3/4"	25	250	25
663SRT	83073	1"	10	100	28
664SRT	83074	1 1/4"	—	25	15
665SRT	83075	1 1/2"	—	20	15
666SRT	83076	2"	—	15	18
667SRT	83602	2 1/2"	—	12	14
668SRT	83603	3"	—	6	19
669SRT	83604	3 1/2"	—	5	21
670SRT	83605	4"	—	6	15



E170258

EMT CONNECTORS SET SCREW TYPE

• CONCRETE TIGHT WHEN TAPED

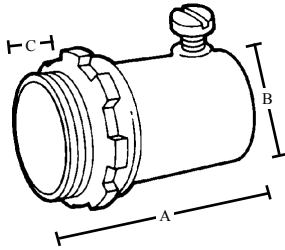

CAT#	A	B	C
631S/Si	1.469	1.063	.406
632S/Si	1.531	1.313	.438
633S/Si	1.625	1.563	.469
634S/Si	2.250	1.938	.563
635S/Si	2.500	2.250	.563
636S/Si	2.750	2.750	.563
637S/Si	3.313	3.563	.750
638S/Si	3.813	4.188	.938
639S/Si	3.938	4.688	.938
640S/Si	4.188	5.188	1.000

1/2"-1" 1 SCREW
1 1/4"-4" 2 SCREW

STEEL

TOPAZ CAT #	UPC#	SIZE	UNIT CTN	SHIP CASE	WT/ CASE
631S	23000	1/2"	50	500	50
632S	23010	3/4"	25	250	35
633S	23020	1"	50	200	46
634S	23030	1 1/4"	—	25	10
635S	23040	1 1/2"	—	25	14
636S	23050	2"	—	20	16
637S*	23060	2 1/2"	—	12	17
638S*	23070	3"	—	12	22
639S*	23080	3 1/2"	—	6	15
640S*	23090	4"	—	6	17

*EMT & RIGID

INSULATED THROAT

631Si	23100	1/2"	50	500	50
632Si	23110	3/4"	25	250	35
633Si	23120	1"	50	200	46
634Si	23130	1 1/4"	—	25	10
635Si	23140	1 1/2"	—	25	14
636Si	23150	2"	—	20	16
637Si*	23160	2 1/2"	—	12	17
638Si*	23170	3"	—	12	22
639Si*	23180	3 1/2"	—	6	15
640Si*	23190	4"	—	6	17

*EMT & RIGID



1/2-2" E148720
2 1/2-4" E148716



1/2-2" E148720
2 1/2-4" E148716

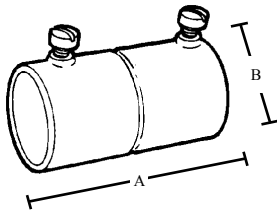

CAT#	A	B
641S	1.750	.88
642S	2.125	1.06
643S	2.500	1.31
644S	3.25	1.69
645S	3.75	1.94
646S	4.00	2.38
647S	4.25	3.19
648S	4.50	3.19
649S	4.75	4.31
650S	5.00	4.81

1/2"-1" 2 SCREW
1 1/4"-4" 4 SCREW

EMT COUPLINGS SET SCREW TYPE

• CONCRETE TIGHT WHEN TAPED

STEEL

TOPAZ CAT #	UPC#	SIZE	UNIT CTN	SHIP CASE	WT/ CASE
641S	23200	1/2"	50	500	50
642S	23210	3/4"	25	250	38
643S	23220	1"	10	100	24
644S	23230	1 1/4"	—	25	11
645S	23240	1 1/2"	—	25	17
646S	23250	2"	—	20	18
647S*	23260	2 1/2"	—	12	19
648S*	23270	3"	—	12	26
649S*	23280	3 1/2"	—	6	15
650S*	23290	4"	—	6	17

*EMT & RIGID



1/2-2" E148720
2 1/2-4" E148716

EMT OFFSET CONNECTORS, EMT TO BOX

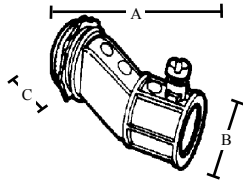

CAT#	A	B	C
771	2.10	.94	.52
772	3.00	1.16	.52
773	3.16	1.42	.67

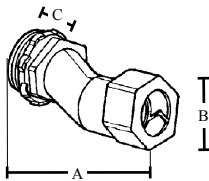

CAT#	A	B	C
781	2.13	1.00	.48
782	2.90	1.19	.54
783	3.08	1.49	.64

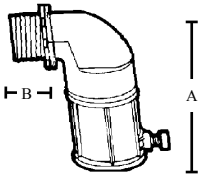

CAT#	A	B
161	1.66	.52
162	1.98	.52

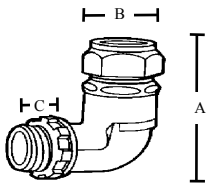

CAT#	A	B	C
431	1.75	.83	.52
432	1.86	.95	.52
433	2.21	1.12	.67

ZINC DIE CAST

TOPAZ CAT #	UPC#	SIZE	UNIT CTN	SHIP CASE	WT/ CASE
SET SCREW TYPE					
• CONCRETE TIGHT WHEN TAPED					
771	17960	1/2"	10	100	12
772	17970	3/4"	10	100	19
773	17980	1"	10	100	25



E148720

COMPRESSION TYPE

TOPAZ CAT #	UPC#	SIZE	UNIT CTN	SHIP CASE	WT/ CASE
• CONCRETE TIGHT					
781	17990	1/2"	20	200	26
782	18000	3/4"	10	100	21
783	18010	1"	10	100	31



E148720

EMT 90° ANGLE CONNECTORS

ZINC DIE CAST

TOPAZ CAT #	UPC#	SIZE	UNIT CTN	SHIP CASE	WT/ CASE
SET SCREW TYPE					
• CONCRETE TIGHT WHEN TAPED					
161	11350	1/2"	25	250	40
162	11360	3/4"	20	200	50



E148720

COMPRESSION TYPE

TOPAZ CAT #	UPC#	SIZE	UNIT CTN	SHIP CASE	WT/ CASE
431	13960	1/2"	25	250	50
432	13970	3/4"	20	200	52
433	13980	1"	10	100	46



E148720

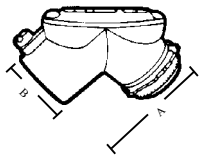

CAT#	A	B
371	1.31	.93
372	1.47	1.22

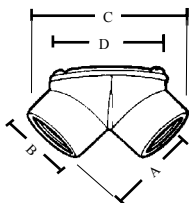

CAT#	A	B	C	D
361SS	1.31	1.09	2.40	1.80
362SS	1.47	1.29	2.66	2.14
363SS	2.80	1.60	3.66	3.16
364SS	3.13	1.96	5.16	3.24

351SS	1.31	1.09	2.50	1.78
352SS	1.43	1.29	2.76	2.13
353SS	1.95	1.59	3.86	3.17
354SS	2.26	1.97	4.56	3.25

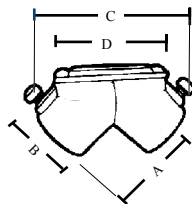

CAT#	A	B	C	D
381	1.31	1.09	2.50	1.78
382	1.43	1.29	2.76	2.13
383	1.95	1.59	3.86	3.17
384	2.26	1.97	4.56	3.25

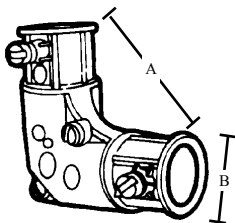

CAT#	A	B
341	1.81	1.00
342	2.00	1.25

90° EMT PULL ELBOWS SET SCREW TYPE

ZINC DIE CAST

TOPAZ CAT #	UPC#	SIZE	UNIT CTN	SHIP CASE	WT/ CASE
EMT TO BOX					
371	13610	1/2"	10	100	22
372	13620	3/4"	5	50	17

• SET SCREW AND THREADED

361SS	85034	1/2"	10	100	31
362SS	85035	3/4"	5	50	18
363SS	85036	1"	—	25	21
364SS	85037	1 1/4"	—	20	25

EMT TO RIGID

• SET SCREW AND THREADED

351SS	85030	1/2"	10	100	28
352SS	85031	3/4"	5	50	17
353SS	85032	1"	—	25	16
354SS	85033	1 1/4"	—	20	18

EMT TO EMT

381	13630	1/2"	10	100	24
382	13640	3/4"	5	50	19
383	13650	1"	—	25	16
384	13660	1 1/4"	—	20	20

EMT TO EMT, INSIDE CORNER

341	13470	1/2"	10	100	20
342	13480	3/4"	5	50	15



E148716



E148716



E148716



E148720



E148720

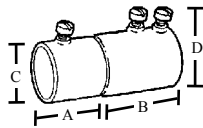

CAT#	A	B	C	D	SCREWS
391S	0.850	1.200	0.720	0.855	2
392S	1.000	1.310	0.940	1.065	2
393S	1.270	1.530	1.170	1.320	3

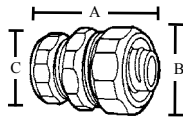

CAT#	A	B	C
271	1.64	1.39	1.09
272	1.75	1.72	1.30
273	2.00	1.75	1.50

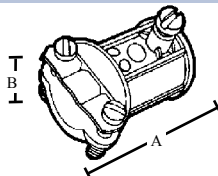

CAT#	A	B (Min)	B (Max)
180	1.35	0.17	0.63

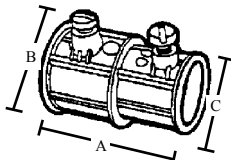

CAT#	A	B	C
590	1.25	0.93	0.78

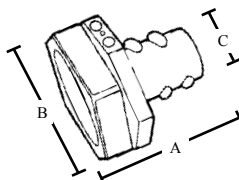

CAT#	A	B	C
131	1.660	1.000	.723
132	1.680	1.180	.931
133	1.895	1.625	1.070

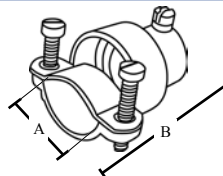

CAT#	A (Min)	A (Max)	B
181	.75	.95	1.65
182	.75	1.20	1.93
182A	.75	1.40	2.00

COMBINATION COUPLINGS

TOPAZ CAT #	UPC#	SIZE	UNIT CTN	SHIP CASE	STEEL WT/CASE
EMT TO RIGID					
• SET SCREW TYPE					
391S	70210	1/2" - 1/2"	25	250	33
392S	70220	3/4" - 3/4"	10	100	25
393S	70230	1" - 1"	10	100	33



E170258

EMT TO LIQUID TIGHT

TOPAZ CAT #	UPC#	SIZE	UNIT CTN	SHIP CASE	WT/CASE
• COMPRESSION TYPE					
• FOR USE WITH METALLIC & NON METALLIC CONDUIT					
271	12260	1/2" - 1/2"	25	250	20
272	12270	3/4" - 3/4"	20	200	14
273	12280	1" - 1"	10	100	16



1/2" - 3/4"-1"

E148716
E170258

EMT TO BX OR NM CABLE

TOPAZ CAT #	UPC#	SIZE	UNIT CTN	SHIP CASE	ZINC DIE CAST WT/CASE
• SET SCREW TO CLAMP TYPE					
180	11410	1/2" - 3/8"	50	500	40



E170258

EMT TO BX

TOPAZ CAT #	UPC#	SIZE	UNIT CTN	SHIP CASE	WT/CASE
• SET SCREW TYPE					
590	15780	1/2" - 3/8"	25	250	15



E170258

EMT COMPRESSION TO FLEX

TOPAZ CAT #	UPC#	SIZE	UNIT CTN	SHIP CASE	WT/CASE
• SCREW-IN TYPE					
131	10840	1/2" - 1/2"	50	500	40
132	10850	3/4" - 3/4"	25	250	28
133	10860	1" - 1"	25	250	58



E148716

EMT TO FLEX

TOPAZ CAT #	UPC#	SIZE	UNIT CTN	SHIP CASE	WT/CASE
• SET SCREW TO CLAMP TYPE					
181	11420	1/2" - 1/2"	25	250	25
182	11430	3/4" - 3/4"	—	100	15
182A	11431	1" - 1"	—	50	13



EMT STRAPS SNAP-ON TYPE

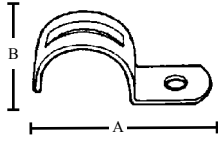

CAT#	A	B
511	1.79	.57
512	1.96	.62
513	2.25	.75
514	2.85	.88
515	3.16	.99
516	3.93	1.10
517	5.00	1.28
518	5.55	1.28
519	6.37	1.28
520	6.87	1.28
520A	8.75	5.00
520B	10.25	6.00

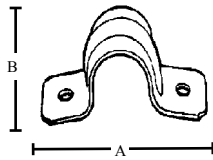

CAT#	A	B
521	2.20	.56
522	2.67	.62
523	2.97	.68
524	3.67	.75
525	4.22	.88
526	4.91	1.00
527	5.91	1.00
528	6.71	1.00
529	7.51	1.00
530	8.31	1.00
530A	12.00	5.25
530B	12.50	7.75

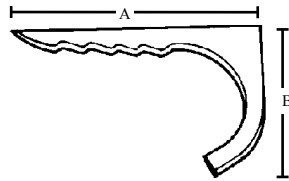

CAT#	A	B
DS1	2.13	1.10
DS2	2.13	1.20
DS3	2.25	1.50

STEEL

TOPAZ CAT #	UPC#	SIZE	UNIT CTN	SHIP CASE	WT/ CASE
ONE HOLE					
511	15610	1/2"	100	1000	25
512	15620	3/4"	100	1000	30
513	15630	1"50	500	25	
514	15640	1 1/4"	25	250	20
515	15650	1 1/2"	10	100	12
516	15660	2"10	100	16	
517*	15670	2 1/2"	-	50	21
518*	15680	3"	-	25	13
519*	15690	3 1/2"	-	25	18
520*	15700	4"	-	25	20
520A*	15702	5"	-	10	5
520B*	15704	6"	-	10	6

*EMT & RIGID

TWO HOLE

521	14950	1/2"	50	500	10
522	14960	3/4"	50	500	10
523	14970	1"	50	500	15
524	14980	1 1/4"	20	200	12
525	14990	1 1/2"	20	200	16
526	15000	2"	-	50	7
527*	15010	2 1/2"	-	25	6
528*	15020	3"	-	25	7
529*	15030	3 1/2"	-	25	8
530*	15040	4"	-	25	7
530A*	15042	5"	-	10	5
530B*	15044	6"	-	10	6

*EMT & RIGID



EMT DRIVE STRAPS FLAT TYPE

STEEL

TOPAZ CAT #	UPC#	SIZE	UNIT CTN	SHIP CASE	WT/ CASE
DS1	20380	1/2"	100	1000	10
DS2	20390	3/4"	100	1000	18
DS3	20400	1"	100	1000	23



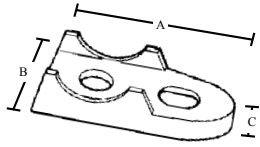

CAT#	A	B	C
481	2.06	1.00	.50
482	2.38	1.06	.50
483	2.94	1.25	.56
484	3.50	1.88	.75
485	3.81	1.44	.81
486	4.75	1.94	1.00
487	5.75	2.44	.75
488	6.69	2.63	.88
489	7.13	2.88	1.06
489A	8.88	3.06	1.06
489B	10.13	3.75	.60
489C	12.19	4.00	.75

EMT/RIGID CLAMP BACKS

MALLEABLE IRON

TOPAZ CAT #	UPC#	SIZE	UNIT CTN	SHIP CASE	WT/ CASE
481	14510	1/2"	25	250	16
482	14520	3/4"	25	250	22
483	14530	1"	25	250	35
484	14540	1 1/4"	10	100	21
485	14550	1 1/2"	10	100	27
486	14560	2"	5	50	22
487	14570	2 1/2"	—	25	14
488	14580	3"	—	10	9
489	14590	3 1/2"	—	10	14
489A	14600	4"	—	10	18
489B	14601	5"	—	10	25
489C	14602	6"	—	10	30

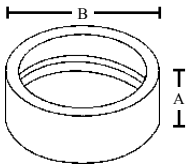

CAT#	A	B
1661	.522	.570
1662	.538	.764
1663	.614	.954
1664	.620	1.26
1665	.620	1.44
1666	.619	1.86
1667	1.12	2.34
1668	1.19	2.78
1669	1.22	3.27
1670	1.22	3.71

EMT INSULATING BUSHING

6/6 NYLON

TOPAZ CAT #	UPC#	SIZE	UNIT CTN	SHIP CASE	WT/ CASE
1661	18451	1/2"	100	1000	5
1662	18452	3/4"	100	1000	6
1663	18453	1"	50	500	5
1664	18454	1 1/4"	25	250	4
1665	18455	1 1/2"	25	250	5
1666	18456	2"	20	200	5
1667*	18457	2 1/2"	—	25	1
1668*	18458	3"	—	25	2
1669*	18459	3 1/2"	—	25	2
1670*	18460	4"	—	25	2



*EMT & RIGID

LIQUID TIGHT CONNECTORS

COMPONENT TYPE

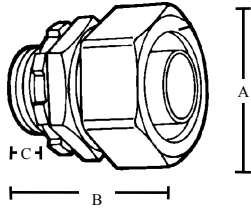

CAT#	A	B	C
470/470i	1.446	1.260	.400
471/471i	1.500	1.385	.420
472/472i	1.603	1.720	.420
473/473i	1.792	1.900	.550
474/474i	1.900	2.290	.546
475/475i	1.737	2.633	.520
476/476i	2.080	3.156	.585
477	3.025	4.205	.775
478	3.530	4.910	.920
479	3.660	5.470	.920
480	3.875	5.925	.987

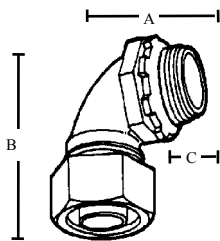

CAT#	A	B	C
490/490i	2.062	2.340	.52
491/491i	2.220	2.340	.52
492/492i	2.550	3.550	.68
493/493i	2.820	3.785	.67
494/494i	3.362	3.960	.70
495/495i	3.450	4.130	.70
496/496i	4.036	4.700	.57
497	5.215	5.375	.77
498	6.100	6.500	1.10
499	6.715	7.450	1.10
500	6.780	8.00	1.10

ZINC DIE CAST

TOPAZ CAT #	UPC#	CONDUIT SIZE	UNIT CTN	SHIP CASE	WT/ CASE
STRAIGHT					
470	14250	3/8" 1/2" KO	20	200	36
471	14260	1/2"	20	200	40
472	14270	3/4"	10	100	23
473	14280	1"	5	50	20
474	14290	1 1/4"	5	50	30
475	14300	1 1/2"	2	20	15
476	14310	2"	2	20	24
477*	14320	2 1/2"	—	1	1
478*	14330	3"	—	1	2
479*	14340	3 1/2"	—	1	3
480*	14350	4"	—	1	4

STRAIGHT WITH INSULATED THROAT

470i	14360	3/8" 1/2" KO	20	200	40
471i	14370	1/2"	20	200	34
472i	14380	3/4"	10	100	25
473i	14390	1"	5	50	22
474i	14400	1 1/4"	5	50	34
475i	14410	1 1/2"	2	20	18
476i	14420	2"	2	20	28

90° ANGLE

490	14610	3/8" 1/2" KO	10	100	27
491	14620	1/2"	10	100	28
492	14630	3/4"	10	100	38
493	14640	1"	5	50	32
494	14650	1 1/4"	2	20	20
495	14660	1 1/2"	2	20	26
496	14670	2"	1	10	19
497*	14680	2 1/2"	—	1	4
498*	14690	3"	—	1	5
499*	14700	3 1/2"	—	1	6
500*	14710	4"	—	1	7

90° ANGLE WITH INSULATED THROAT

490i	14720	3/8" 1/2" KO	10	100	30
491i	14730	1/2"	10	100	27
492i	14740	3/4"	10	100	39
493i	14750	1"	5	50	33
494i	14760	1 1/4"	2	20	21
495i	14770	1 1/2"	2	20	26
496i	14780	2"	1	10	20

*2 1/2" - 4" Straight and 90° all insulated throat



E170258



E170258



E170258



E170258

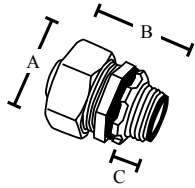

CAT#	A	B	C
470S	1.38	.56	1.69
471S	1.38	.59	1.69
472S	1.64	.63	1.81
473S	1.91	.75	2.13
474S	2.44	.78	2.19
475S	2.72	.91	2.44
476S	3.25	1.00	2.88
477S	4.00	1.50	3.25
478S	4.63	1.50	3.88
479S	5.50	1.50	4.00
480S	5.82	1.63	4.00

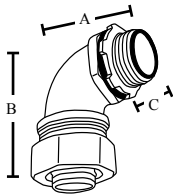

CAT#	A	B	C
490S	1.31	1.81	.50
491S	1.41	1.88	.50
492S	1.63	2.06	.53
493S	2.06	2.25	.69
494S	2.13	2.75	.72
495S	2.69	3.13	.84
496S	2.94	3.88	.94
497S	6.00	6.50	1.50
498S	6.50	7.00	1.50
500S	9.00	9.50	1.50

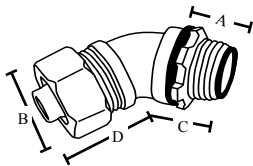

CAT#	A	B	C	D
230S	.50	1.38	1.38	1.00
231S	.50	1.38	1.38	1.06
232S	.53	1.64	1.50	1.19
233S	.69	1.91	1.69	1.38
234S	.72	2.44	1.94	1.63
235S	.84	2.72	2.25	1.81
236S	.94	3.25	2.75	1.94
237S	1.50	4.00	4.00	3.50
238S	1.50	4.63	4.50	4.00
239S	1.63	5.81	5.00	4.50
240S	1.63	5.81	5.00	4.50

LIQUID TIGHT CONNECTORS

INSULATED THROAT-COMPONENT TYPE

MALLEABLE IRON

TOPAZ CAT #	UPC#	CONDUIT SIZE	UNIT CTN	SHIP CASE	WT/ CASE
STRAIGHT					
470S	14430	3/8" 1/2" KO	25	250	25
471S	14440	1/2"	20	200	26
472S	14450	3/4"	10	100	18
473S	14460	1"	5	50	16
474S	33620	1 1/4"	5	50	37
475S	33630	1 1/2"	2	20	21
476S	33640	2"	2	20	33
477S	33650	2 1/2"	—	1	3
478S	33660	3"	—	1	4
479S	33670	3 1/2"	—	1	4
480S	33680	4"	—	1	5



E148716

90° ANGLE

490S	14790	3/8" 1/2" KO	10	100	26
491S	14800	1/2"	10	100	26
492S	14810	3/4"	10	100	24
493S	14820	1"	5	50	34
494S	33690	1 1/4"	2	20	24
495S	33700	1 1/2"	2	20	40
496S	33710	2"	1	20	28
497S	33720	2 1/2"	—	1	7
498S	33730	3"	—	1	11
500S	33750	4"	—	1	10



E170258

45° ANGLE

230S	11960	3/8" 1/2" KO	10	100	24
231S	11970	1/2"	10	100	28
232S	11980	3/4"	10	100	42
233S	11990	1"	5	50	32
234S	33550	1 1/4"	2	20	22
235S	33560	1 1/2"	2	20	32
236S	33570	2"	2	20	49
237S	33580	2 1/2"	—	1	5
238S	33590	3"	—	1	7
239S	33591	3 1/2"	—	1	10
240S	33610	4"	—	1	12



E148716

UL rated suitable for hazardous locations.

Class I, Div. 2; Class II, Div. 1 and 2; Class III, Div. 1 and 2;
NEC 501-4(b), 502-4(a) (2), 503-3(a)

LIQUID TIGHT CONNECTORS

COMPONENT TYPE FOR FLEXIBLE
NONMETALLIC LIQUID TIGHT TUBING

125° 6/6 NYLON

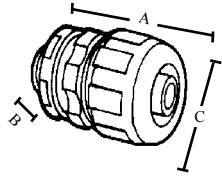

CAT#	A	B	C
P470/B	2.00	.44	1.09
P471/B	2.00	.44	1.09
P472/B	2.03	.46	1.30
P473/B	2.25	.57	1.50
P474/B	2.00	.57	2.40
P475/B	2.25	.57	2.68
P476/B	2.50	.57	3.31

TOPAZ CAT #	UPC#	CONDUIT SIZE	UNIT CTN	SHIP CASE	WT/ CASE
STRAIGHT - GRAY					
P470	21570	3/8" 1/2" KO	25	100	7
P471	21580	1/2"	25	100	6
P472	21590	3/4"	10	100	8
P473	21600	1"	5	50	12
P474	21602	1 1/4"	5	50	12
P475	21604	1 1/2"	5	20	14
P476	21606	2"	2	20	9



E148716

STRAIGHT - BLACK

P470B	21610	3/8" 1/2" KO	25	100	7
P471B	21620	1/2"	25	100	6
P472B	21630	3/4"	10	100	8
P473B	21640	1"	5	50	12
P474B	21721	1 1/4"	5	50	12
P475B	21722	1 1/2"	5	50	14
P476B	21723	2"	2	20	9



E148716

90° ANGLE - GRAY

P490	21650	3/8" 1/2" KO	10	100	9
P491	21660	1/2"	10	100	8
P492	21670	3/4"	10	100	11
P493	21680	1"	5	50	8
P494	21681	1 1/4"	2	20	8
P495	21682	1 1/2"	2	20	10
P496	21683	2"	1	10	9

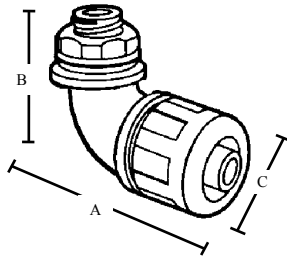

E148716

CAT#	A	B	C
P490/B	2.56	2.14	1.09
P491/B	2.56	2.14	1.09
P492/B	2.84	2.38	1.30
P493/B	2.25	2.81	1.50
P494/B	3.96	3.36	2.40
P495/B	4.13	3.45	2.68
P496/B	4.68	4.04	3.31

90° ANGLE - BLACK

P490B	21690	3/8" 1/2" KO	10	100	9
P491B	21700	1/2"	10	100	8
P492B	21710	3/4"	10	100	11
P493B	21720	1"	5	50	8
P494B	21724	1 1/4"	2	20	8
P495B	21725	1 1/2"	2	20	10
P496B	21726	2"	1	10	9



E148716

TOP-FLEX I CONDUIT



TRADE SIZE	PART DIMENSIONS (inches)				
	OUTSIDE DIAMETER		INSIDE DIAMETER		WALL THICKNESS
	MIN.	MAX.	MIN.	MAX.	
3/8	.690	.710	.484	.504	.21
1/2	.820	.840	.622	.642	.21
3/4	1.030	1.050	.820	.840	.21
1	1.290	1.315	1.041	1.066	.25
1 1/4	1.630	1.660	1.380	1.410	.25
1 1/2	1.865	1.900	1.575	1.600	.30
2	2.340	2.375	2.020	2.045	.33

GREY					
TOPAZ CAT #	UPC#	SIZE	UNIT CTN	SHIP CASE	WT/ CASE
HF138	30000	3/8"	—	100'	10
HF112	30010	1/2"	—	100'	13
HF112R	30015	1/2"	REEL	1000'	130
HF134	30020	3/4"	—	100'	18
HF134R	30025	3/4"	REEL	800'	144
HF11	30030	1"	—	100'	25
HF1114	30040	1 1/4"	—	100'	33
HF1112	30050	1 1/2"	—	50'	23
HF12	30060	2"	—	50'	30



E170258

UL TYPE B FLEXIBLE NONMETALLIC LIQUID TIGHT CONDUIT

- 3/8" THRU 2" TRADE SIZES
- USE WITH TOP-FLEX NYLON CONNECTORS STRAIGHT OR RIGHT ANGLE
- MAY ALSO BE USED WITH TOPAZ DIE-CAST CONNECTORS FOR LIQUID TIGHT CONDUIT
- RESISTS CORROSION, ABRASION, OIL, WATER, ACID, METAL SHAVINGS, AND ROUGH ENVIRONMENTS
- RESISTS ABUSE, PULL, AND CRUSHING
- SMOOTH INSIDE FOR EASIER WIRE PULLING, NO HAZARDOUS SHARP EDGES OR BURRS; WILL NOT DAMAGE CONDUCTORS
- FOR DIRECT BURIAL/POURED CONCRETE
- LIGHTWEIGHT AND LOWER INSTALLED COST
- QUICK INSTALLATION, CUTS WITH UTILITY KNIFE OR PVC CUTTER (CATALOG #VF28)
- INTEGRAL RIGID AND FLEXIBLE PVC CONSTRUCTION
- SUITABLE FOR INDOOR/OUTDOOR USE: HVAC EQUIPMENT, MACHINE TOOLS, MOTORS AND CONTROLS, MARINE EQUIPMENT, PRINTING EQUIPMENT, PUMPS, REFRIGERATION EQUIPMENT
- UV RATED
- 80° C



TRADE SIZE	PART DIMENSIONS (inches)				
	OUTSIDE DIAMETER		INSIDE DIAMETER		WALL THICKNESS
	MIN.	MAX.	MIN.	MAX.	
1/4	.560	.575	.385	.405	.17
3/8	.690	.710	.484	.504	.21
1/2	.820	.840	.622	.642	.21
3/4	1.030	1.050	.820	.840	.21
1	1.290	1.315	1.041	1.066	.25
1 1/4	1.630	1.660	1.380	1.410	.25
1 1/2	1.865	1.900	1.575	1.600	.30
2	2.340	2.375	2.020	2.045	.33

TOP-FLEX II TUBING

BLACK					
TOPAZ CAT #	UPC#	SIZE	UNIT CTN	SHIP CASE	WT/ CASE
STRAIGHT					
HF214	30065	1/4"	—	100'	4
HF238	30070	3/8"	—	100'	6
HF212	30080	1/2"	—	100'	8
HF234	30090	3/4"	—	100'	10
HF21	30100	1"	—	100'	15
HF2114	23412	1 1/4"	—	100'	19
HF2112	23415	1 1/2"	—	50'	22
HF22	23416	2"	—	50'	60



FLEXIBLE NONMETALLIC LIQUID ELECTRICAL TUBING

- 1/4" THRU 1" TRADE SIZES, CONSULT TOPAZ FOR 1 1/4", 1 1/2", AND 2" SIZES
- USE WITH TOP-FLEX NYLON CONNECTORS - STRAIGHT OR RIGHT ANGLE
- RESISTS CORROSION, OIL AND WATER
- MAXIMUM FLEXIBILITY, CAN BE USED IN EXTREMELY TIGHT QUARTERS
- SMOOTH INSIDE FOR EASIER WIRE PULLING
- LIGHTWEIGHT AND LOWER INSTALLED COST
- QUICK INSTALLATION, CUTS WITH UTILITY KNIFE OR PVC CUTTER (CATALOG #VF28)
- INTEGRAL RIGID AND FLEXIBLE PVC CONSTRUCTION
- IDEAL FOR FIBER OPTIC CABLE PROTECTION
- SUITABLE FOR USE IN HIGH VIBRATION OR FLEXIBLE APPLICATIONS: AUTOMOTIVE EQUIPMENT, COMPUTERS AND PERIPHERALS, FIBER OPTICS LAB EQUIPMENT, LASERS, OFFICE EQUIPMENT, PROCESSING CONTROLS AND MONITORING EQUIPMENT, ROBOTICS
- 70° C

CUTTING TOOL

- FOR TOP-FLEX I CONDUIT AND TOP-FLEX II TUBING
- CUTS CLEANLY AND EVENLY
- CUTS UP TO 1 1/4" PVC

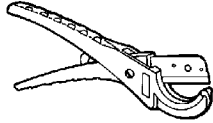

TOPAZ CAT #	UPC#	UNIT CTN	SHIP CASE	WT/ CASE
VF28	30105	1	1	0.4



FLEXIBLE LIQUID TIGHT METALLIC CONDUIT

- CORROSION RESISTANT STEEL CORE FOR LASTING MECHANICAL PROTECTION
- COIL

EF PVC JACKET, STEEL CORE

PART DIMENSIONS (inches)		
CAT #	INSIDE DIAMETER	OUTSIDE DIAMETER
6100	.0504	.709
6101	.642	.839
6102	.835	1.051
6103	1.055	1.315
6104	1.394	1.661
6105	1.598	1.902
6106	2.043	2.374
6107	2.504	2.874
6108	3.102	3.500
6109	3.540	4.000
6110	4.039	4.500

TOPAZ CAT #	UPC#	SIZE	FEET COIL	UNIT CTN	SHIP CASE	WT/ CASE
6100	80414	3/8"	100'	—	100	16
6101	80415	1/2"	100'	—	100	26
6102	80417	3/4"	100'	—	100	31
6103	80419	1"	100'	—	100	44
6104	80421	1-1/4"	50'	—	50	46
6105	80423	1-1/2"	50'	—	50	35
6106	80425	2"	25'	—	25	22
6107	80427	2-1/2"	25'	—	25	42
6108	80429	3"	25'	—	25	53
6109	80430	3-1/2"	25'	—	25	55
6110	80431	4"	25'	—	25	57



FLEXIBLE LIQUID TIGHT METALLIC CONDUIT

- CORROSION RESISTANT STEEL CORE FOR LASTING MECHANICAL PROTECTION
- REEL

EF PVC JACKET, STEEL CORE

PART DIMENSIONS (inches)		
CAT #	INSIDE DIAMETER	OUTSIDE DIAMETER
6100R	.0504	.709
6101R	.642	.839
6102R	.835	1.051
6103R	1.055	1.315
6104R	1.394	1.661
6105R/R150	1.598	2.374
6106R	2.043	2.874

TOPAZ CAT #	UPC#	SIZE	FEET REEL	UNIT CTN	SHIP CASE	WT/ CASE
6100R	85588	3/8"	1000	—	1000	182
6101R	82021	1/2"	1000	—	1000	296
6102R	85247	3/4"	500	—	500	148
6103R	85248	1"	200	—	200	96
6104R	85249	1-1/4"	200	—	200	192
6105R	85250	1-1/2"	100	—	100	79
6105R150	85527	1-1/2"	150	—	150	120
6106R	85251	2"	100	—	100	96



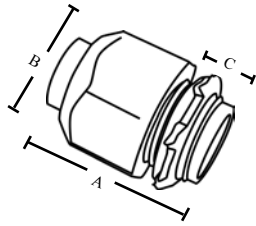

CAT#	A	B	C
1501	1.750	.500	1.250
1502	1.800	.625	1.500

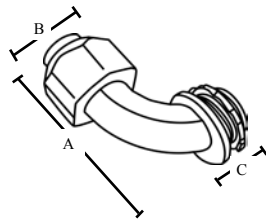

CAT#	A	B	C
1521	1.875	.500	3.125
1522	2.375	.625	3.500

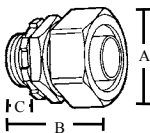

CAT#	A	B	C
470ST	1.09	1.19	.63
471ST	1.19	1.34	.63
472ST	1.43	1.43	.63
473ST	1.75	1.63	.66
474ST	2.16	1.84	.67
475ST	2.38	2.00	.72
476ST	2.88	2.13	.72

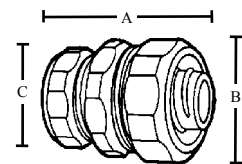

CAT#	A	B	C
271	1.64	1.39	1.09
272	1.75	1.72	1.30
273	2.00	1.75	1.50

LIQUID TIGHT CONNECTORS

ONE PIECE TYPE

TOPAZ CAT #	UPC#	SIZE	UNIT CTN	SHIP CASE	PVC WT/ CASE
-------------	------	------	----------	-----------	--------------

STRAIGHT - GRAY

1501	83022	1/2"	25	100	20
1502	83023	3/4"	25	100	28



90° ANGLE - GRAY

1521	83024	1/2"	10	100	28
1522	83025	3/4"	10	100	30

STEEL

470ST	14439	3/8" 1/2" KO	20	200	26
471ST	14441	1/2"	20	200	26
472ST	14451	3/4"	10	100	18
473ST	14461	1"	5	50	16
474ST	14471	1 1/4"	5	50	37
475ST	14481	1 1/2"	2	20	21
476ST	14491	2"	2	20	3



COMBINATION COUPLINGS

EMT TO LIQUID TIGHT

- COMPRESSION TYPE
- FOR USE WITH METALLIC AND NONMETALLIC CONDUIT

STEEL

TOPAZ CAT #	UPC#	SIZE	UNIT CTN	SHIP CASE	WT/ CASE
271	12260	1/2" - 1/2"	25	250	20
272	12270	3/4" - 3/4"	20	200	14
273	12280	1" - 1"	10	100	16



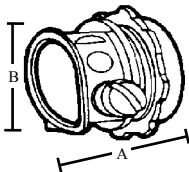

CAT#	A	B	RANGE
130	.84	.64	.38 - .63

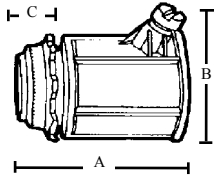

CAT#	A	B	C
121	1.38	1.26	.380
121A	1.54	1.50	.406

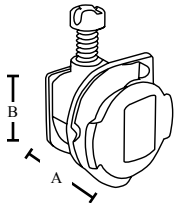

CAT#	A	B	RANGE
130SNP	.84	.64	.38 - .63

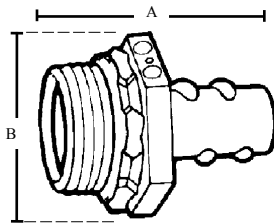

CAT#	A	B
450/450i	1.31	.92
451/451i	1.38	.92
452/452i	1.63	1.10
453/453i	1.94	1.38
454/454i	2.12	1.75
455/455i	2.31	2.13
456/456i	2.58	2.67

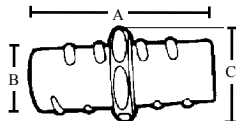

CAT#	A	B	C
461	1.80	.92	1.062
462	2.09	1.12	1.372
463	2.41	1.37	1.687
464	2.74	1.81	2.125
465	3.05	2.12	2.375
466	3.27	2.67	2.937

BX-FLEX CONNECTORS

SET SCREW TYPE ZINC DIE CAST

TOPAZ CAT #	UPC#	BX SIZE	KO	UNIT CTN	SHIP CASE	WT/ CASE
130	10830	3/8"	1/2"	100	1000	50
121	10700	1/2"	1/2"	25	250	25
121A	10701	3/4"	3/4"	25	250	25

BX SNAP IN

130SNP	85167	3/8"	1/2"	25	250	15
--------	-------	------	------	----	-----	----

BX-FLEX CONNECTORS

SCREW IN TYPE ZINC DIE CAST

TOPAZ CAT #	UPC#	BX SIZE	KO SIZE	UNIT CTN	SHIP CASE	WT/ CASE
450	14030	3/8"	1/2"	50	500	30
451	14040	1/2"		50	500	30
452	14050	3/4"		25	250	25
453	14060	1"		25	250	40
454	14070	1 1/4"		10	100	28
455	14080	1 1/2"		10	40	15
456	14090	2"		10	40	25

INSULATED THROAT

450i	14100	3/8"	1/2"	50	500	30
451i	14110	1/2"		50	500	30
452i	14120	3/4"		25	250	25
453i	14130	1"		25	250	40
454i	14140	1 1/4"		10	100	28
455i	14150	1 1/2"		10	40	15
456i	14160	2"		10	40	25

FLEX COUPLINGS

SCREW IN TYPE ZINC DIE CAST

TOPAZ CAT #	UPC#	CONDUIT SIZE	UNIT CTN	SHIP CASE	WT/ CASE
461	14190	1/2"	50	500	30
462	14200	3/4"	25	250	23
463	14210	1"	25	250	38
464	14220	1 1/4"	10	100	25
465	14230	1 1/2"	10	40	16
466	14240	2"	10	40	24



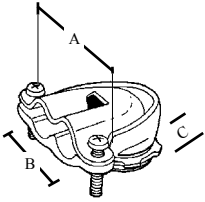

CAT#	A	B	C
561A	1.5	.858	.380
561ADC	2.016	---	1.087

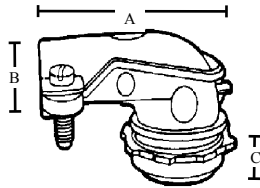

CAT#	A	B (Min-Max)	C	SCREWS
100/i	1.740	0.43-0.72	.370	2
101/i	2.110	0.64-1.03	.400	2
102/i	2.400	0.76-1.15	.400	2
103/i	2.870	1.09-1.73	.540	2
104/i	4.000	1.34-1.97	.640	2
105/i	6.000	1.65-2.61	.750	2
106/i	6.000	1.54-2.54	.740	2
107	7.187	2.45-2.98	.875	4
108	7.875	2.93-3.45	1.031	4
109	9.400	3.28-3.95	1.031	4
110	10.200	3.68-4.43	1.031	4
100M	1.750	0.78-0.95	.440	2
101M	1.750	0.78-0.95	.440	2
102M	1.810	0.91-1.02	.440	2
103M	2.060	1.25-1.38	.560	2
104M	2.810	1.41-1.63	.560	2
105M	3.810	1.75-2.00	.560	2
106M	4.750	2.19-2.44	.690	2
107M	6.250	2.75-3.00	.880	4
108M	7.250	3.25-3.50	1.000	4
109M	10.250	3.70-4.16	1.250	4
110M	13.000	4.11-4.56	1.250	4
101Mi	1.750	0.78-0.95	.440	2
102Mi	1.810	0.91-1.02	.440	2
103Mi	2.060	1.25-1.38	.560	2
104Mi	2.810	1.41-1.63	.560	2
105Mi	3.810	1.75-2.00	.560	2
106Mi	4.750	2.19-2.44	.690	2
107Mi	6.250	2.75-3.00	.880	4
108Mi	7.250	3.25-3.50	1.000	4
109Mi	10.250	3.70-4.16	1.250	4
110Mi	13.000	4.11-4.56	1.250	4

DUPLEX CONNECTOR

90° ANGLE ZINC/MALLEABLE IRON

TOPAZ CAT #	UPC#	BX-FLEX SIZE	KO SIZE	UNIT CTN	SHIP CASE	WT/ CASE
561A	15341	3/8"	1/2"	25	250	37
561ADC	86339	3/8"	1/2"	25	250	30

BX-FLEX CONNECTORS

SQUEEZE TYPE 90° ANGLE

ZINC DIE CAST

TOPAZ CAT #	UPC#	CONDUIT SIZE	UNIT CTN	SHIP CASE	WT/ CASE
100	10340	3/8" 1/2" KO	50	500	45
101	10350	1/2"	25	250	35
102	10360	3/4"	10	100	20
103	10370	1"	5	50	19
104	10380	1 1/4"	10	40	20
105	10390	1 1/2"	—	5	5
106	10400	2"	—	5	6
107	10410	2 1/2"	—	5	18
108	10420	3"	—	2	9
109	10430	3 1/2"	—	1	9
110	10440	4"	—	1	10

INSULATED THROAT

100i	10341	3/8" 1/2" KO	50	500	45
101i	10351	1/2"	25	250	35
102i	10361	3/4"	10	100	20
103i	10371	1"	5	50	19
104i	10381	1 1/4"	10	40	20
105i	10391	1 1/2"	—	5	5
106i	10401	2"	—	5	6

MALLEABLE IRON

100M	85239	3/8"	25	250	40
101M	10510	1/2"	25	250	40
102M	10520	3/4"	10	100	30
103M	10530	1"	5	50	30
104M	10540	1 1/4"	—	50	38
105M	10550	1 1/2"	—	5	5
106M	10560	2"	—	5	10
107M	10570	2 1/2"	—	5	16
108M	10580	3"	—	2	9
109M	10590	3 1/2"	—	1	14
110M	10600	4"	—	1	24

INSULATED THROAT

101Mi	10511	1/2"	25	250	16
102Mi	10521	3/4"	10	100	30
103Mi	10531	1"	5	50	60
104Mi	10541	1 1/4"	5	50	76
105Mi	10551	1 1/2"	—	5	100
106Mi	10561	2"	—	5	200
107Mi	10571	2 1/2"	—	5	320
108Mi	10581	3"	—	2	450
109Mi	10591	3 1/2"	—	1	1400
110Mi	10601	4"	—	1	2400



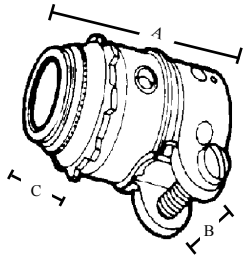

CAT#	A	B (Min-Max)	C	SCREWS
150	1.00	0.58-0.61	.370	1
151/i	1.47	0.74-0.95	.400	1
152/i	1.58	0.88-1.11	.400	1
153/i	1.75	1.14-1.38	.540	1
154/i	1.91	1.42-1.65	.640	1
155/i	2.09	1.68-1.94	.750	1
156/i	2.34	2.08-2.56	.740	1
157	2.81	2.85-3.25	.875	2
158	3.84	3.33-3.63	1.03	2
159	4.19	3.75-4.10	1.03	2
160	4.56	4.18-4.58	1.03	2

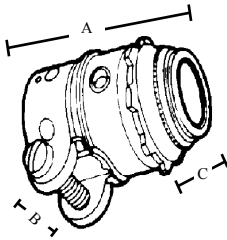

CAT#	A	B (Min-Max)	C	SCREWS
150M	0.93	0.55-0.60	0.50	1
151M	0.94	0.78-0.94	0.50	1
152M	1.13	0.91-1.08	0.50	1
153M	1.19	1.28-1.44	0.56	1
154M	1.25	1.44-1.63	0.63	1
155M	1.88	1.63-1.88	0.69	1
156M	2.00	2.19-2.38	0.75	1
157M	2.06	2.70-2.95	0.94	2
158M	2.25	3.13-3.50	0.94	2
159M	3.56	3.72-4.00	1.25	2
160M	3.69	4.06-4.44	1.25	2

151Mi	0.94	0.78-0.94	0.50	1
152Mi	1.13	0.91-1.08	0.50	1
153Mi	1.19	1.28-1.44	0.56	1
154Mi	1.25	1.44-1.63	0.63	1
155Mi	1.88	1.63-1.88	0.69	1
156Mi	2.00	2.19-2.38	0.75	1
157Mi	2.06	2.70-2.95	0.94	2
158Mi	2.25	3.13-3.50	0.94	2
159Mi	3.56	3.72-4.00	1.25	2
160Mi	3.69	4.06-4.44	1.25	2

BX-FLEX CONNECTORS

SQUEEZE TYPE

ZINC DIE CAST

TOPAZ CAT #	UPC#	CONDUIT SIZE	UNIT CTN	SHIP CASE	WT/ CASE
STRAIGHT					
150	10990	3/8" 1/2" KO	50	500	35
151	11000	1/2"	25	250	25
152	11010	3/4"	25	250	32
153	11020	1"	10	100	20
154	11030	1 1/4"	10	100	29
155	11040	1 1/2"	5	50	20
156	11050	2"	10	40	21
157	11060	2 1/2"	—	10	9
158	11070	3"	—	10	17
159	11080	3 1/2"	—	1	3
160	11090	4"	—	1	3



INSULATED THROAT

151i	11001	1/2"	25	250	25
152i	11011	3/4"	25	250	32
153i	11021	1"	10	100	20
154i	11031	1 1/4"	10	100	29
155i	11041	1 1/2"	5	50	20
156i	11051	2"	10	40	21



MALLEABLE IRON

150M	83748	3/8"	25	250	40
151M	11100	1/2"	25	250	30
152M	11110	3/4"	25	250	48
153M	11120	1"	10	100	26
154M	11130	1 1/4"	10	100	39
155M	11140	1 1/2"	5	50	33
156M	11150	2"	—	20	21
157M	11160	2 1/2"	—	10	14
158M	11170	3"	—	2	4
159M	11180	3 1/2"	—	1	5
160M	11190	4"	—	1	7



INSULATED THROAT

151Mi	11101	1/2"	25	250	12
152Mi	11111	3/4"	25	250	19
153Mi	11121	1"	10	100	26
154Mi	11131	1 1/4"	10	100	39
155Mi	11141	1 1/2"	5	50	66
156Mi	11151	2"	—	20	105
157Mi	11161	2 1/2"	—	10	150
158Mi	11171	3"	—	2	200
159Mi	11181	3 1/2"	—	1	500
160Mi	11191	4"	—	1	700



BX-FLEX CONNECTORS

SQUEEZE TYPE 45° ANGLE

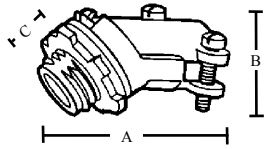

CAT#	A	B	C
390	1.588	1.132	.382

ZINC DIE CAST

TOPAZ CAT #	UPC#	CONDUIT SIZE	KO SIZE	UNIT CTN	SHIP CASE	WT/ CASE
390	13670	3/8"	1/2"	50	500	45

FITS MC RANGE .620 - .780



BX-FLEX, NM AND MC CABLE CONNECTORS

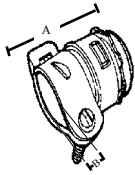

CAT#	A	B (Min-Max)
191	1.413	.620-.780

ZINC DIE CAST

TOPAZ CAT #	UPC#	BX-FLEX SIZE	KO SIZE	UNIT CTN	SHIP CASE	WT/ CASE
191	11530		1/2"	25	250	25

• SQUEEZE STRAP TYPE

• 2 SCREW CLAMP TYPE

140	10920	3/8"	1/2"	100	1000	60
-----	-------	------	------	-----	------	----

FITS MC RANGE .400 - .500



CAT#	A	B (RANGE)
140	1.192	.18-.63

• SADDLE TYPE

170	11380	3/8"	1/2"	50	500	40
-----	-------	------	------	----	-----	----

FITS ALUMINUM, STEEL SMOOTH EXTRUDED MC

171	11381	1/2"	1/2"	25	250	11
-----	-------	------	------	----	-----	----

172	11382	3/4"	3/4"	20	200	16
-----	-------	------	------	----	-----	----

173	11383	1"	1"	10	100	25
-----	-------	----	----	----	-----	----

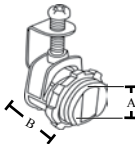

CAT#	A (Min)	A (Max)	B
170	.400	.500	.935
171	.660	.990	1.356
172	.700	1.150	1.520
173	1.100	1.400	1.680

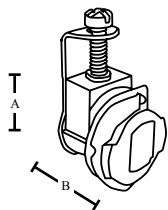

CAT#	A (Min)	A (Max)	B
170SNP	.400	.500	.935

• SADDLE TYPE SNAP IN

170SNP	85169	3/8"	1/2"	25	250	25
--------	-------	------	------	----	-----	----

• SNAP-IN SET SCREW TYPE W/INSULATED THROAT

STEEL

AMC1	33370	1/2"	50	500	38
------	-------	------	----	-----	----

AMC2	33771	3/4"	25	250	48
------	-------	------	----	-----	----

AMC12*	33772	1/2"	20	200	14
--------	-------	------	----	-----	----

*DUPLICATE AMC12

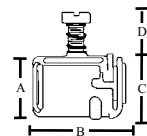

CAT#	A	B	C	D
AMC1	14/2-10/2	1.390	.844	.846
AMC2	10/4-6/3	1.630	1.88	.522
AMC12	14/2-12/2	1.520	.916	.868



COMBINATION COUPLINGS

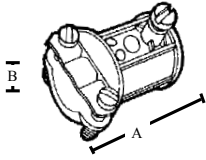

CAT#	A	B(Min)	B(Max)
180	1.35	0.17	0.63

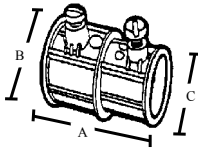

CAT#	A	B	C
590	1.25	.93	.78

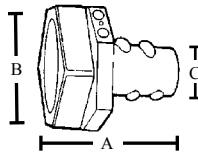

CAT#	A	B	C
131	1.660	1.000	.723
132	1.680	1.180	.931
133	1.895	1.625	1.070

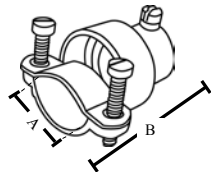

CAT#	A(Min)	A(Max)	B
181	0.75	0.95	1.65
182	0.75	1.20	1.93
182A	0.75	1.40	2.00

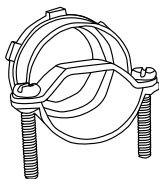

CAT#	A(Min) Cable Diameter	A(Max)
TA50	.68	.85
TA75	.94	1.08
TA100	1.15	1.25
TA125	1.34	1.45
TA150	1.7	1.845
TA200	2.07	2.18

ZINC DIE CAST

TOPAZ CAT #	UPC#	SIZE	UNIT CTN	SHIP CASE	WT/ CASE
-------------	------	------	----------	-----------	----------

EMT TO BX OR NM CABLE

• SET SCREW TO CLAMP TYPE

180	11410	1/2"-3/8"	50	500	40
-----	-------	-----------	----	-----	----

EMT TO BX

• SET SCREW TYPE

590	15780	1/2"-3/8"	25	250	15
-----	-------	-----------	----	-----	----

EMT COMPRESSION TO FLEX

• SCREW-IN TYPE

131	10840	1/2"-1/2"	50	500	40
132	10850	3/4"-3/4"	25	250	28
133	10860	1"-1"	25	250	58

EMT TO FLEX

• SET SCREW TO CLAMP TYPE

181	11420	1/2"-1/2"	25	250	25
182	11430	3/4"-3/4"	—	100	15
182A	11431	1"-1"	—	50	13

TAKE ALL CONNECTORS

MC, AC, NM SE ROUND

- REVERSABLE STEEL STRAP FOR MULTIPLE APPLICATIONS
- TRI-COMBINATION SCREW HEAD

ZINC DIE CAST BODY/LOCKNUT

TOPAZ CAT #	UPC#	SIZE	UNIT CTN	SHIP CASE	WT/ CASE
TA50	86341	1/2"	25	250	18
TA75	86342	3/4"	20	200	20
TA100	86343	1"	10	100	14
TA125	86344	1-1/4"	10	100	21
TA150	86345	1-1/2"	5	50	14
TA200	86346	2"	5	50	19



E148716



E170258



E148716



E18176

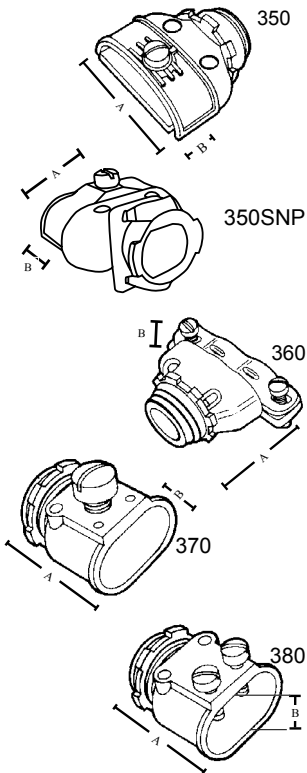

CAT#	A	B (Min)	B (Max)
350	1.57	.13	.65
360	1.59	.24	.63
350SNP	1.57	.13	.65

CAT#	A	B (Min)	C
370	1.42	.63	---
380	1.42	.63	---

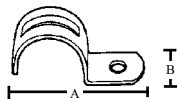

CAT#	A	B
510BX	1.25	.48
1101TC	.625	.5
1105TC	.75	.562
1106TC	1.00	.625

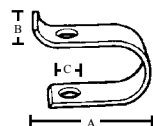

CAT#	A	B	C
90	1.200	.670	.175

DUPLEX CONNECTORS

ZINC DIE CAST

TOPAZ CAT #	UPC#	SIZE	KO	UNIT CTN	SHIP CASE	WT/ CASE
-------------	------	------	----	----------	-----------	----------

FOR BX-FLEX, NM & MC CABLE

• 1 SCREW CLAMP TYPE

350	13490	3/8"	1/2"	25	250	32
-----	-------	------	------	----	-----	----

FITS ALUMINUM SMOOTH EXTRUDED MC RANGE .210-.500

• 1 SCREW CLAMP TYPE

• SNAP LOCK

350SNP	85168	3/8"		10	100	14
--------	-------	------	--	----	-----	----

• 2 SCREW CLAMP TYPE

360	13500	3/8"	1/2"	25	250	32
-----	-------	------	------	----	-----	----

FITS ALUMINUM SMOOTH EXTRUDED MC RANGE .210-.500

FOR BX-FLEX

• 1 SCREW SET SCREW TYPE

370	13590	3/8"	1/2"	25	250	28
-----	-------	------	------	----	-----	----

• 2 SCREW SET SCREW TYPE

380	13600	3/8"	1/2"	25	250	25
-----	-------	------	------	----	-----	----

BX STRAP

ONE HOLE

STEEL

TOPAZ CAT #	UPC#	SIZE	UNIT CTN	SHIP CASE	WT/ CASE
510BX	15590	14/2 TO 10/3	100	1000	14
1101TC	14868	1/4" MINI	100	1000	13
1105TC	14872	1/2"	50	100	14
1106TC	14871	9/16"	50	100	16

BX-FLEX U-CLIP

STEEL

TOPAZ CAT #	UPC#	SIZE	UNIT CTN	SHIP CASE	WT/ CASE
90	10320	3/8" FLEXIBLE	—	500	5



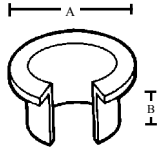

CAT#	A	B
0/0B	.550	.595
1/1B	.66	.67
2/2B	.845	.610
3/3B	.94	.680
4/4B	1.16	.775

CAT#	Fits Cable
0/0B	14/2, 14/3, 12/2, 12/3
1/1B	14/4, 6/1, 4/1
2/2B	12/4, 10/2, 10/3, 2/1
3/3B	10/4, 8/2, 8/3, 1/1
4/4B	8/4, 6/2, 6/3, 6/4, 4/2, 4/3

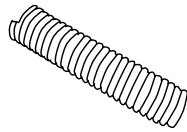

CAT#	Diameter	
	INNER	OUTER
5200/5250	.376	.571
5201	.634	.866
5202	.846	1.063
5203/C50	1.059	1.299
5204	1.343	1.535
5205/C25	1.520	1.850
5206	2.075	2.362
5207	2.559	2.953
5208	3.110	3.504
5209	3.551	3.957
5210	4.154	4.508

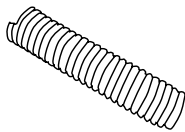

CAT#	Diameter	
	INNER	OUTER
5200R	.376	.571
5201R/RL	.634	.866
5202R/R500	.846	1.063
5203R/R300	1.059	1.299
5204R/R400	1.343	1.535
5205R	1.520	1.850
5206R	2.075	2.362

ANTI-SHORT BUSHINGS

PLASTIC

TOPAZ CAT #	UPC#	SIZE	FLEX SIZE	PER BAG	SHIP CASE	WT/ CASE
0	10000	0	5/16"	35	500 BAGS	15
1	10010	1	3/8"	35	400 BAGS	12
2	10020	2	7/16"	35	300 BAGS	18
3	10030	3	1/2"	20	200 BAGS	16
4	10040	4	3/4"	16	100 BAGS	9

BULK						
TOPAZ CAT #	UPC#	SIZE	FLEX SIZE	PER BAG	SHIP CASE	WT/ CASE
0B	10041	0	5/16"	-	5000	3
1B	10042	1	3/8"	-	5000	3
2B	10043	2	7/16"	-	2000	4
3B	10044	3	1/2"	-	2000	4
4B	10045	4	3/4"	-	1000	3



FLEXIBLE STEEL CONDUIT

- SMOOTH INTERIOR FOR EASY WIRE PULL THROUGH
- COIL

STEEL

TOPAZ CAT #	UPC#	SIZE	FEET COIL	UNIT CTN	SHIP CASE	WT/ CASE
5200	80341	3/8"	100'	-	100	15
5250	85482	3/8"	250'	-	250	37
5201	80342	1/2"	100'	-	100	21
5202	80343	3/4"	100'	-	100	25
5203	80345	1"	100'	-	100	45
5203C50	85524	1"	50'	-	50	24
5204	82011	1-1/4"	50'	-	50	24
5205	80346	1-1/2"	50'	-	50	30
5205C25	85526	1-1/2"	25'	-	25	16
5206	80347	2"	25'	-	25	19
5207	80348	2-1/2"	25'	-	25	26
5208	80349	3"	25'	-	25	31
5209	80350	3-1/2"	25'	-	25	34
5210	80351	4"	25'	-	25	34



FLEXIBLE STEEL CONDUIT

- SMOOTH INTERIOR FOR EASY WIRE PULL THROUGH
- REEL

STEEL

TOPAZ CAT #	UPC#	SIZE	FEET REEL	UNIT CTN	SHIP CASE	WT/ CASE
5200R	85240	3/8"	1000'	-	1000	159
5201R	85241	1/2"	500'	-	500	80
5201RL	85508	1/2"	1000'	-	1000	160
5202R	85242	3/4"	300'	-	300	48
5202R500	85523	3/4"	500'	-	500	80
5203R	85243	1"	200'	-	200	99
5203R300	85525	1"	300'	-	300	150
5204R	85244	1-1/4"	200'	-	200	104
5204R400	85589	1-1/4"	400'	-	400	52
5205R	85245	1-1/2"	100'	-	100	63
5206R	85246	2"	100'	-	100	81



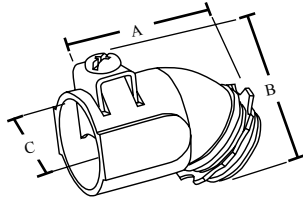

CAT#	A	B	C
230TBS	1.81	1.75	.938
231TBS	2.13	2.13	1.26
232TBS	2.38	2.313	1.44

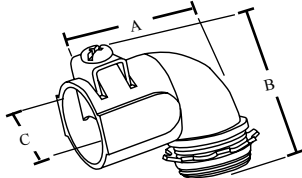

CAT#	A	B	C
490TBS	1.75	2.06	1.00
491TBS	2.13	2.25	1.25
492TBS	2.50	2.50	1.38
493TBS	2.81	2.88	1.69

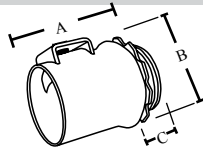

CAT#	A	B	C
630TBS	1.19	1.25	.500
631TBS	1.38	1.25	.438
632TBS	1.38	1.44	.438
633TBS	1.56	1.81	.500
634TBS	2.19	2.13	.625
635TBS	2.43	2.50	.625
636TBS	2.56	3.00	.625
637TBS	2.69	3.26	.813
638TBS	2.81	4.25	.938
639TBS	2.94	4.75	1.00
640TBS	3.00	5.81	1.03

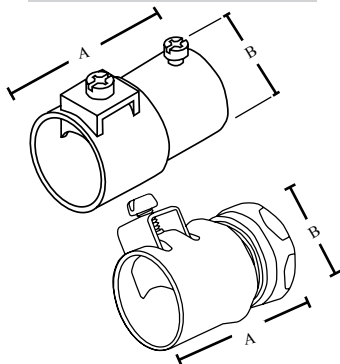

CAT#	A	B
420TBS	1.563	.875
421TBS	2.000	.875
422TBS	2.125	1.125
430TBS	1.375	1.250
431TBS	1.563	1.250
432TBS	1.563	1.438

TOP BITE CONNECTORS

SADDLE TYPE CONNECTORS

- SET SCREW TYPE
- INSULATED THROAT

				MALLEABLE IRON		
TOPAZ CAT #	UPC#	SIZE	KO SIZE	UNIT CTN	SHIP CASE	WT/ CASE
230TBS	85183	3/8"	1/2"	50	300	46
231TBS	85184	1/2"	1/2"	25	150	39
232TBS	85185	3/4"	3/4"	20	120	38

				MALLEABLE IRON		
TOPAZ CAT #	UPC#	SIZE	KO SIZE	UNIT CTN	SHIP CASE	WT/ CASE
490TBS	85186	3/8"	1/2"	50	300	54
491TBS	85187	1/2"	1/2"	25	150	43
492TBS	85188	3/4"	3/4"	20	120	43
493TBS	85189	1"	1"	5	60	34

				STEEL		
TOPAZ CAT #	UPC#	SIZE	KO SIZE	UNIT CTN	SHIP CASE	WT/ CASE
630TBS	85172	3/8"	1/2"	25	100	10
631TBS	85173	1/2"	1/2"	25	100	15
632TBS	85174	3/4"	3/4"	10	50	9
633TBS	85175	1"	1"	5	25	9
634TBS	85176	1-1/4"	1-1/4"	5	25	14
635TBS	85177	1-1/2"	1-1/2"	2	10	8
636TBS	85178	2"	2"	-	5	5
637TBS	85179	2-1/2"	2-1/2"	-	4	6
638TBS	85180	3"	3"	-	5	11
639TBS	85181	3-1/2"	3-1/2"	-	1	3
640TBS	85182	4"	4"	-	1	3

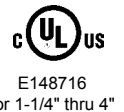

COMBINATION COUPLINGS

SADDLE TYPE

- EMT SET SCREW TYPE TO FLEX

				STEEL		
TOPAZ CAT #	UPC#	SIZE	UNIT CTN	SHIP CASE	WT/ CASE	
420TBS	85193	3/8"	50	250	21	
421TBS	85194	1/2"	25	125	17	
422TBS	85195	3/4"	10	100	18	

- EMT COMPRESSION TYPE TO FLEX

				STEEL		
TOPAZ CAT #	UPC#	SIZE	UNIT CTN	SHIP CASE	WT/ CASE	
430TBS	85190	3/8"	25	125	17	
431TBS	85191	1/2"	25	125	22	
432TBS	85192	3/4"	20	100	20	



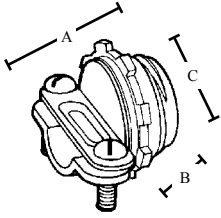

CAT#	A	B	C
120	.814	.44	.92

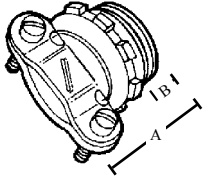

CAT#	A	B
952	1.03	.42
953	1.20	.57
954	1.32	.64
955	1.32	.60
956	1.55	.71

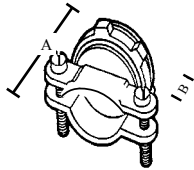

CAT#	A	B
143R	1.190	.645
144R	1.330	.660
145R	1.470	.740
146R	1.620	.750

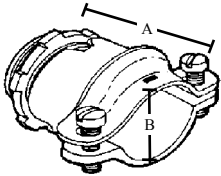

CAT#	A	B(Min)	B(Max)
971	1.87	.40	0.95
972	1.84	.50	1.10
973	2.00	.62	1.40
974	2.28	.50	1.38
975	2.49	.75	1.61
976	3.35	.90	2.04

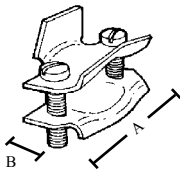

CAT#	A	B
441	1.310	.640
442	1.750	.765
444	2.120	.765
445	2.500	.780

NM CLAMP TYPE CONNECTORS

- NON-WATERTIGHT
- TWO SCREWS

TOPAZ				ZINC DIE CAST		
CAT #	UPC#	SIZE	FITS CABLE	UNIT CTN	SHIP CASE	WT/ CASE
3/8" NM CABLE						
120	10690	1/2"	NM CABLE FROM 2#14-2 W/GROUND AND 2#12-2 W/GROUND	100	1000	50

FOR OVAL NM CABLE

952	19500	3/4"	OVAL NM 8-2 TO 6-3	25	250	25
953	19510	1"	OVAL NM 8-3 TO 4-3	25	250	37
954	19520	1 1/4"	OVAL NM 4-3 TO 1-3	10	100	24
955	19530	1 1/2"	OVAL NM 1-3 TO 1/0-3	10	100	34
956	19540	2"	OVAL NM 1/0-3 TO 4/0-3	5	50	45

All above take 2 cables

FOR NM & SE CABLE

• ROUND CABLE						
143R	10950	1"	SE CABLE 6-3, 4-3, 4-2, 2-2 NM CABLE 12-3, 12-4, 10-3, 10-4 8-3, 8-2, 6-2, 4-2	25	250	37
144R	10960	1 1/4"	SE CABLE 10-2, 8-2, 6-2, 4-2 NM CABLE 8-3, 6-3, 4-3, 2-3	10	100	24
145R	10970	1 1/2"	SE CABLES 3-3, 3-2, 3-1	5	50	34
146R	10980	2"	SE CABLES 3-4/0	5	50	23

FOR NM & ROUND SE CABLE

• TAKE-ALL TYPE						
971	19580	1/2"	ROUND NM .630-.810	25	250	25
972	19590	3/4"	ROUND NM 8-2 TO 6-3	20	200	20
973	19600	1"	ROUND NM 8-3 TO 4-3	10	100	15
974	19610	1 1/4"	ROUND NM 4-3 TO 1-3	10	100	25
975	19620	1 1/2"	ROUND NM 1-3 TO 1/0-3	5	50	34
976	19630	2"	ROUND NM 1/0-3 TO 4/0-3	—	50	45

NM BOX CONNECTORS

- TWO PIECE CLAMP BUTTERFLY TYPE

				STEEL		
TOPAZ CAT #	UPC#	SIZE	FITS CABLE	UNIT CTN	SHIP CASE	WT/ CASE
441	13990	3/8" TO 1/2"	2 OR 3#14, 12, 10, 8	100	1000	50
442	14000	3/4" TO 1"	2 OR 3#8, 6, 4	50	500	35
444	14010	1 1/4"	#2/0	25	250	25
445	14020	1 1/2"	#3/0, #4/0	25	250	40



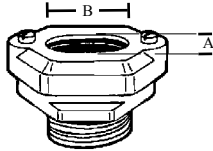

CAT#	FITS CABLE	GROMMET OPENING	
		A	B
873C	2#2	.625 X	1.00
874C	3#2	.625 X	1.00
875C	3#2	.625 X	1.00
876E	3#4/0	.830 X	1.415

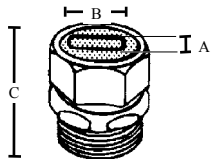

CAT#	FITS CABLE	GROMMET OPENING		
		A	B	C
873	3#8	.410 X	.650	1.875
873A	3#6	.460 X	.715	1.875
873B	3#4	.530 X	.850	1.875
874	3#3	.550 X	.910	1.937
874A	3#2	.580 X	.960	1.937
874B	3#1	.660 X	1.120	1.937
875	3#1/0	.705 X	1.195	2.375
875A	3#2/0	.740 X	1.235	2.375
876	3#1/0	.890 X	1.540	2.250
876A	3#2/0	.750 X	1.195	2.250
876B	3#3/0	.740 X	1.235	2.250
876C	3#4/0	.830 X	1.415	2.250
876D	3#4/0	.995 X	1.580	2.250

871/S	2#14	.220 X	.440	1.437
872/S	3#14	.220 X	.660	1.750

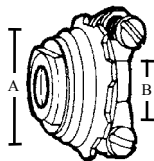

CAT#	A	B (RANGE)
140	1.192	.18-.63

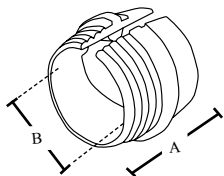

CAT#	A	B
RCR50	.93	.50
RCR75	.92	.75

WATER TIGHT CONNECTORS

ZINC DIE CAST

TOPAZ CAT #	UPC#	WIRE SIZE	SIZE	UNIT CTN	SHIP CASE	WT/ CASE
-------------	------	-----------	------	----------	-----------	----------

FOR TYPE SE, STYLE U FLAT
2 INSULATING CONDUCTORS, 1 BARE

• 2 SCREW TYPE

873C	18749	2#2 2 screw	1"	10	100	20
874C	18801	3#2 2 screw	1 1/4"	10	100	52
875C	18823	3#2	1 1/2"	5	50	44
876E	18871	3#4/0	2"	5	50	44

• COMPRESSION TYPE

873	18750	3#8	1"	10	100	34
873A	18760	3#6	1"	10	100	34
873B	18770	3#4	1"	10	100	34
874	18780	3#3	1 1/4"	10	100	52
874A	18790	3#2	1 1/4"	10	100	52
874B	18800	3#1	1 1/4"	10	100	52
875	18810	3#1/0	1 1/2"	5	50	33
875A	18820	3#2/0	1 1/2"	5	50	32
876	18830	3#1/0	2"	5	50	44
876A	18840	3#2/0	2"	5	50	44
876B	18850	3#3/0	2"	5	50	44
876C	18860	3#4/0	2"	5	50	44
876D	18870	3#4/0	2"	5	50	44

FOR UF CABLE

871	18730	14-2 12-2 10-2	1/2"	25	250	43
872	18740	14-3 12-3 10-3	3/4"	25	250	65
871S	18731	14-2 12-2	1/2" STEEL	25	250	30
872S	18741	14-3 12-3 10-3	3/4" STEEL	25	250	45

COMBINATION CONNECTORS

ZINC DIE CAST

TOPAZ CAT #	UPC#	BX-FLEX SIZE	KO SIZE	UNIT CTN	SHIP CASE	WT/ CASE
-------------	------	--------------	---------	----------	-----------	----------

FOR BX-FLEX, NM, AND MC CABLE

• 2 SCREW CLAMP TYPE

140	10920	3/8"	1/2"	100	1000	60
-----	-------	------	------	-----	------	----

FITS MC RANGE
.400-.500

CABLE CONNECTORS

• NM Sheathed

PLASTIC

TOPAZ CAT #	UPC#	SIZE	UNIT CTN	SHIP CASE	WT/ CASE
RCR50	85170	1/2"	100	1000	4.1
RCR75	85171	3/4"	50	500	3.3



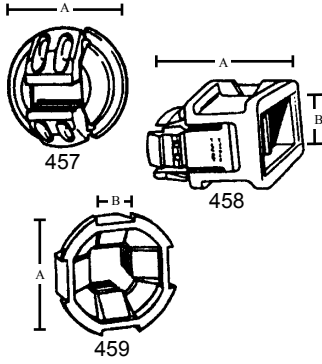

CAT#	A	B
457	1.00	—
458	1.25	.25
459	1.0938	.375

NM SNAP-IN CONNECTORS

GREY		PLASTIC			
TOPAZ CAT #	UPC#	KO SIZE	UNIT CTN	SHIP CASE	WT/ CASE
457	14091	1/2" 14/2 & 12/2	100	1000	1.38
458	14092	1/2" 2-WIRE TWO: 14/2 OR 12/2 ONE: 14/2 OR 12/2 ONE: 14/2 OR 10/2 ONE: 12/2 OR 10/2	50	500	.14
459	14093	3/4" ONE: 14/3 OR 12/3 ONE: 10/2, 8/3 OR 6/3	50	500	.44

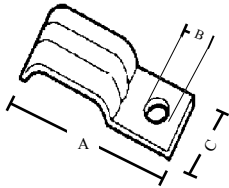
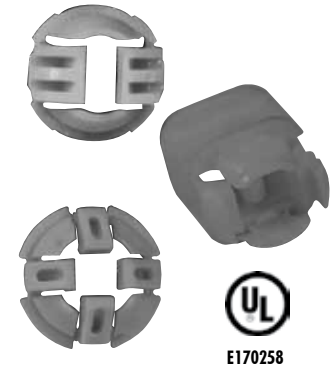

CAT#	A	B	C
510RX	1.08	.28	.50

NM STRAP

• ONE HOLE		STEEL			
TOPAZ CAT #	UPC#	SIZE	UNIT CTN	SHIP CASE	WT/ CASE
510RX	15600	14/2, 12/2	100	1000	14

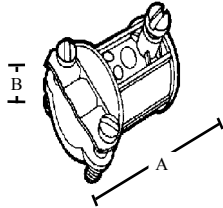

CAT#	A	B (MIN)	B (MAX)
180	1.35	.17	.63

COMBINATION COUPLINGS

		ZINC DIE CAST			
TOPAZ CAT #	UPC#	SIZE	UNIT CTN	SHIP CASE	WT/ CASE
EMT TO BX OR NM					
• SET SCREW CLAMP TYPE					
180	11410	1/2" - 3/8"	50	500	40

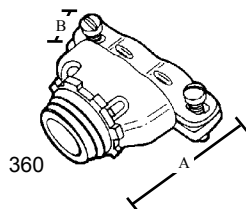
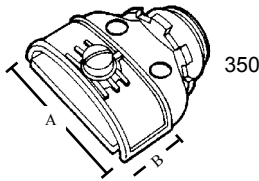
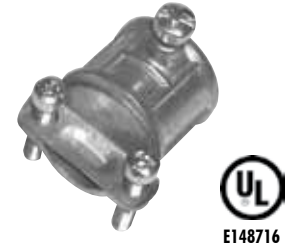

CAT#	A	B (MIN)	B (MAX)
350	1.57	.13	.650
360	1.59	.24	.630

DUPLEX CONNECTORS

		ZINC DIE CAST				
TOPAZ CAT #	UPC#	SIZE	KO SIZE	UNIT CTN	SHIP CASE	WT/ CASE
FOR BX-FLEX, NM, AND MC CABLE*						
• 1 SCREW CLAMP TYPE						
350	13490	3/8"	1/2"	25	250	32
FITS MC RANGE .210-.500						
• 2 SCREW CLAMP TYPE						
360	13500	3/8"	1/2"	25	250	32
FITS MC RANGE .210-.500						

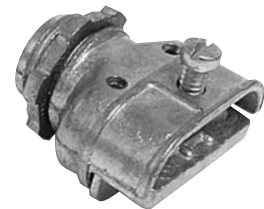

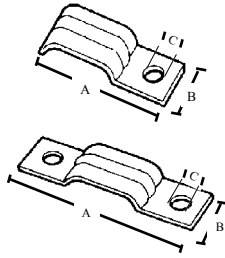

CAT#	A	B	C
501	1.695	.570	.25
502	1.950	.580	.25
503	2.480	1.000	.35
504	2.795	1.010	.35
506	2.395	.750	.25
507	2.740	.750	.25
508	3.150	.750	.25
509	3.485	.750	.25

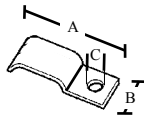

CAT#	A	B	C
232A	2.0625	.625	.25
282A	2.625	.75	.26
284A	2.9375	1.0	.32

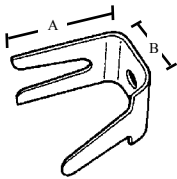

CAT#	A	B
135	1.420	.750
136	1.52	.750
137	1.620	.780
138	1.82	.890
139	2.20	1.000

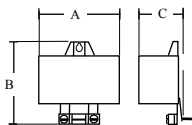

CAT#	A	B	C
709	4.25	5.00	2.00
710	6.00	5.19	2.50

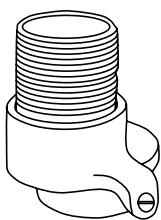

SE STRAPS

ONE HOLE				STEEL	
TOPAZ CAT #	UPC#	SIZE	UNIT CTN	SHIP CASE	WT/ CASE
501	14870	3#8,6,4	100	1000	20
502	14880	3#3,2	100	1000	20
503	14890	3#1,1/0,2/0	25	250	18
504	14900	3#3/0,4/0	25	250	20

TWO HOLE					
TOPAZ CAT #	UPC#	SIZE	UNIT CTN	SHIP CASE	WT/ CASE
506	14910	3#8,6,4	100	1000	26
507	14920	3#3,2	100	1000	28
508	14930	3#1/0,2/0	25	250	11
509	14940	3#3/0,4/0	25	250	10

ONE HOLE			ALUMINUM		
TOPAZ CAT #	UPC#	SIZE	UNIT CTN	SHIP CASE	WT/ CASE
232A	12015	3# 8-4	100	1000	2
282A	12055	3# 1/0-2/0 SE	50	500	5
284A	12056	3# 3/0-4/0 SE	50	500	5

SE LOCK OVER CLIPS

ALUMINUM					
TOPAZ CAT #	UPC#	SIZE	UNIT CTN	SHIP CASE	WT/ CASE
135	10870	6/3	100	1000	8
136	10880	4/3	100	1000	10
137	10890	2/3	100	1000	15
138	10900	2/0	50	500	20
139	10910	4/0	50	500	25

SERVICE ENTRANCE HOODS

PVC					
TOPAZ CAT #	UPC#	SIZE	UNIT CTN	SHIP CASE	WT/ CASE
709	17432	3#3-1	-	10	28
710	17434	3#2/0-4/0	-	10	54

RIGID OFFSET REDUCER

ALUMINUM					
TOPAZ CAT #	UPC#	SIZE	UNIT CTN	SHIP CASE	WT/ CASE
1203	23386	2" x 1 1/4"	-	50	15



E170258



E170258



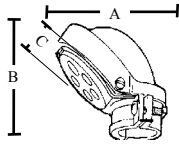

CAT#	A	B	C
731	2.93	2.62	2.00
732	3.25	2.75	2.37
733	3.50	3.25	2.62
734	4.50	3.25	3.00
735	5.00	4.75	3.31
736	6.75	6.00	4.62
737	10.50	7.50	6.00
738	11.50	9.00	8.00
739	12.00	9.00	8.00
740	12.00	9.00	8.00

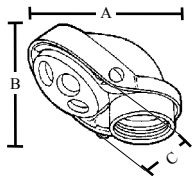

CAT#	A	B	C
741	2.68	2.60	2.00
742	3.80	2.72	2.37
743	3.32	3.11	2.62
744	4.46	3.20	3.00
745	4.85	4.34	3.31
746	6.62	5.44	4.62
747	9.74	7.80	6.00
748	10.50	8.00	8.00
749	13.02	9.39	8.00
750	13.14	8.54	8.00
750A	11.28	8.77	8.25
750B	12.25	9.76	8.25

SERVICE ENTRANCE CAPS

ALUMINUM

TOPAZ CAT #	UPC#	SIZE	INS. HOLE SIZE	# HOLES	UNIT CTN	SHIP CASE	WT/ CASE
CLAMP ON TYPE							
731	17640	1/2"	19/64	4	10	50	12
732	17650	3/4"	3/8 13/32	2 3	10	50	15
733	17660	1"	7/16 1/2	2 3	5	25	8
734	17670	1 1/4"	27/64 5/8	2 3	5	25	10
735	17680	1 1/2"	19/32 7/16 3/4	2 1 3	3	15	11
736	17690	2"	17/32 3/4 1	1 2 3	-	5	9
737	17700	2 1/2"	7/8 1 1 5/16	3 1 3	-	1	4
738	17710	3"	7/8 1 1 5/16	3 1 3	-	1	6
739	17720	3 1/2"	1 1/8 1 3/4	4 3	-	1	6
740	17730	4"	1 1/8 1 3/4	4 3	-	1	7



THREADED TYPE

ALUMINUM

TOPAZ CAT #	UPC#	SIZE	INS. HOLE SIZE	# HOLES	UNIT CTN	SHIP CASE	WT/ CASE
741	17740	1/2"	19/64	4	5	50	12
742	17750	3/4"	3/8 13/32	2 3	5	50	15
743	17760	1"	7/16 1/2	2 3	-	50	15
744	17770	1 1/4"	27/64 5/8	2 3	-	20	10
745	17780	1 1/2"	19/32 7/16 3/4	2 1 3	-	10	7
746	17790	2"	17/32 3/4 1	1 2 3	-	5	4
747	17800	2 1/2"	7/8 1 1 5/16	3 1 3	-	2	8
748	17810	3"	7/8 1 1 5/16	3 1 3	-	1	6
749	17820	3 1/2"	1 1/8 1 3/4	4 3	-	1	6
750	17830	4"	1 1/8 1 3/4	2 4	-	1	7
750A	17840	5"	1 1/8 1 3/4	2 4	-	1	12
750B	17850	6"	1 1/8 1 3/4	2 4	-	1	14



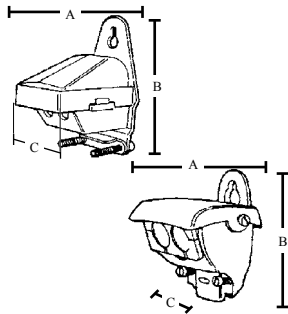

CAT#	A	B	C
727	2.75	2.75	1.87
728	4.25	4.25	3.00
729	4.25	4.25	3.00
707	2.37	2.25	2.25
708	4.93	3.12	3.75

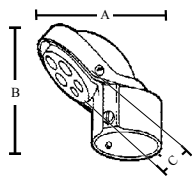

CAT#	A	B	C
704	4.75	4.00	3.12
705	5.25	4.00	3.00
706	7.00	5.50	4.50

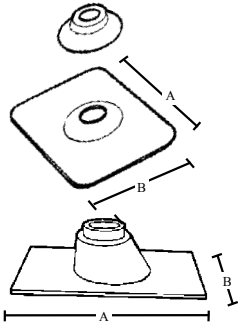

CAT#	A	B
984	12.50	8.75
985	12.50	8.75
986	14.50	10.75
987	14.50	10.75
994	11.50	9.00
995	11.50	9.00
996	11.50	9.00
997	13.50	10.00

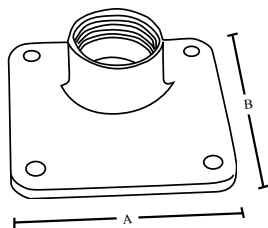

CAT#	A	B
9663	3.25	3.25
9674	3.25	3.25
9685	3.25	3.25
9696	3.25	3.25
9707	3.25	3.25

SERVICE ENTRANCE CAPS

THERMOPLASTIC

TOPAZ CAT #	UPC#	FITS CABLE	UNIT CTN	SHIP CASE	WT/ CASE
727	17610	2/3	—	30	8
728	17620	1/0,2/0	—	10	7
729	17630	3#2/0,#4/0	—	10	11

WITH SPLIT INSULATOR

ZINC DIE CAST

TOPAZ CAT #	UPC#	FITS CABLE	UNIT CTN	SHIP CASE	WT/ CASE
707	17400	3#8 TO 3#1	—	20	8
708	17430	1/0 TO 4/0	—	10	11



E170258



SET SCREW TYPE

ALUMINUM

TOPAZ CAT #	UPC#	PIPE SIZE	HEAD SIZE	UNIT CTN	SHIP CASE	WT/ CASE
704	17390	2"	1 1/4"	—	10	10
705	17400	2 1/2"	1 1/4"	—	10	20
706	17410	2 1/2"	2"	—	10	20



E170258

ROOF FLASHINGS

GALVANIZED WITH NEOPRENE SEAL

TOPAZ CAT #	UPC#	SIZE	UNIT CTN	SHIP CASE	WT/ CASE
984	19660	1 1/4"	—	25	9
985	19670	1 1/2"	—	25	9
986	19680	2"	—	25	12
987	19690	2 1/2"	—	25	14

NEOPRENE

TOPAZ CAT #	UPC#	SIZE	UNIT CTN	SHIP CASE	WT/ CASE
994	19730	1 1/4" - 1 1/2"	—	12	9
995	19740	2"	—	12	8
996	19750	2 1/2"	—	12	9
997	19760	3"	—	12	12

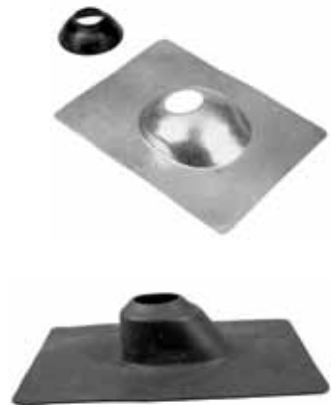

METER HUBS

ZINC DIE CAST

TOPAZ CAT #	UPC#	SIZE	UNIT CTN	SHIP CASE	WT/ CASE
9663	85021	1"	—	10	2.5
9674	85022	1 1/4"	—	10	2.3
9685	85023	1 1/2"	—	10	2.1
9696	85024	2"	—	10	2.0
9707	85025	2 1/2"	—	10	2.0



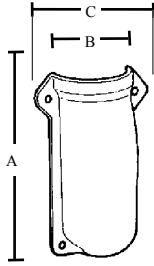

CAT#	A	B	C
591	2.37	1.00	2.61
593	2.50	1.25	3.00
594	2.61	1.56	3.76
595	3.580	1.738	3.568
596	5.81	1.88	3.48
596A	4.20	2.29	4.76

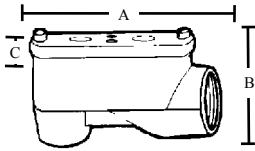
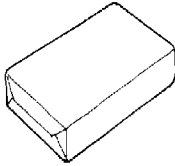

CAT#	A	B	WITH C
211	3.155	1.187	1.375
212	3.470	1.360	1.625
213	4.180	1.720	1.9375
214	5.515	2.178	2.4375
215	6.095	2.410	2.6875
216	6.595	2.846	3.0625
214XL	7.91	2.75	2.75
215XL	7.74	3.88	3.375

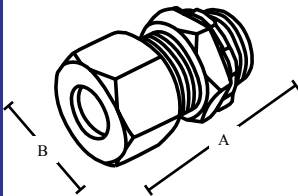

CAT#	A	B
1750	1.75	1.0625
1751	1.75	1.0625
1752	1.75	1.0625
1753	1.75	1.0625
1754	1.75	1.0625
1755	1.75	1.0625
1756	1.75	1.0625
1757	1.75	1.0625
1758	1.75	1.0625
1759	1.75	1.0625

SILL PLATES WITH SEALING COMPOUND AND SCREWS

ALUMINUM

TOPAZ CAT #	UPC#	SIZE	UNIT CTN	SHIP CASE	WT/ CASE
591	15790	1/2" EMT & 3/4" EMT	10	100	10
593	15800	1" EMT & 3/3 SEU	10	100	40
594	15810	1 1/4" EMT & 2/3 SEU	—	25	15
595	15811	1 1/2" EMT	—	25	11
596	15820	4/0 SEU	—	20	17
596A	15821	2" EMT	—	25	16



DUCT-SEAL WEATHERPROOF COMPOUND

GRAY, ASBESTOS FREE

- PERMANENTLY SOFT
- NON-CORROSIVE TO METALS OR PLASTIC

TOPAZ CAT #	UPC#	SIZE	UNIT CTN	SHIP CASE	WT/ CASE
961	19550	1 LB.	—	50	50
965	19560	5 LB.	—	10	50



R11374

SERVICE ENTRANCE ELLS-SLB

COPPER FREE ALUMINUM

TOPAZ CAT #	UPC#	SIZE	UNIT CTN	SHIP CASE	WT/ CASE
211	11650	1/2"	10	50	13
212	11660	3/4"	10	50	16
213	11670	1"	5	25	12
214	11680	1 1/4"	2	10	8
214XL	11682	1 1/4" LONG	—	2	3
215	11690	1 1/2"	1	5	6
216	11700	2"	1	5	10
216XL	11702	2" LONG	—	1	3



E170258

KENNY CLAMP

BRASS

TOPAZ CAT #	UPC#	SIZE	KO SIZE	UNIT CTN	SHIP CASE	WT/ CASE
1750	83964	3/0 Stranded	1/2"	10	80	20
1751	83965	2/0 Stranded	1/2"	10	80	20
1752	83966	1/0 Stranded	1/2"	10	80	20
1753	83967	2 Stranded	1/2"	10	80	20
1754	83968	4 Solid	1/2"	10	80	20
1755	83969	4 Stranded	1/2"	10	80	20
1756	83970	6 Solid	1/2"	10	80	20
1757	83971	6 Stranded	1/2"	10	80	20
1758	83972	8 Solid	1/2"	10	80	20
1759	83973	8 Stranded	1/2"	10	80	20



E170258

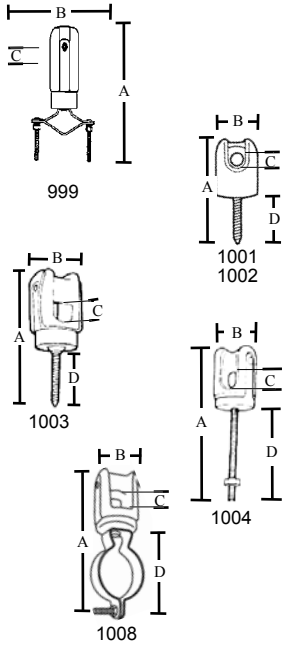

CAT#	Opening			
	A	B	C	D
999	7.62	5.60	1.0 x .875	---
1001	3.0625	1.375	.5 x .375	1.687
1002	5.25	1.968	.5 x .375	2.25
1003	6.1563	1.875	1.0 x .875	2.25
1004	8.1563	1.875	1.0 x .875	5.00
1008	6.416	1.875	1.0 x .875	3.375

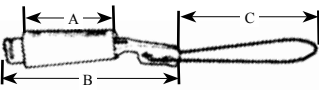

CAT#	A	B	C
1005	3.00	6.07	5.45
1006	3.75	7.26	5.45
1007	3.75	7.28	5.45

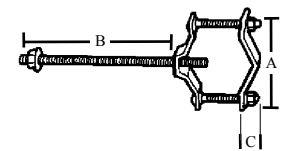

CAT#	A	B	C
998	4.125	9.75	1.25

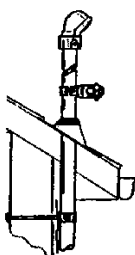

WIREHOLDERS

PORCELAIN, STEEL

TOPAZ CAT #	UPC#	SIZE	UNIT CTN	SHIP CASE	WT/ CASE
ADJUSTABLE					
999	70240	1 1/4" - 3"	-	20	34
LIGHT DUTY					
• LAG SCREW					
LAG					
1001	70260	1-11/16"	10	100	25
MEDIUM DUTY					
1002	70270	2 1/4"	-	50	32
HEAVY DUTY					
PORCELAIN, STEEL REINFORCED					
• LAG SCREW					
LAG					
1003	70280	2 1/4"	-	50	34
• BOLT & NUT					
BOLT SIZE					
1004	70290	3/8" X 5"	-	25	22
HANGER					
1008	70322	2"	-	25	31

WEDGE GRIP CLAMPS

• WITH SOLID 6 1/2" STAINLESS STEEL BAIL

ALUMINUM

TOPAZ CAT #	UPC#	SIZE	UNIT CTN	SHIP CASE	WT/ CASE
1005	70300	6 ACSR - 2 ACSR	-	50	8
1006	70310	4 ACSR - 1/0 ACSR	-	25	7
1007	70320	2/0 ACSR - 4/0 ACSR	-	25	8

Aluminum Conductor Steel Reinforced

UNIVERSAL PIPE SUPPORT

• WITH 10" BOLT

STEEL

TOPAZ CAT #	UPC#	SIZE	BOLT SIZE	UNIT CTN	SHIP CASE	WT/ CASE
998	19761	1 1/4" - 3"	1/2"	-	20	18

SE MAST KIT

TOPAZ CAT #	UPC#	PIPE SIZE	HEAD SIZE	UNIT CTN	SHIP CASE	WT/ CASE
1514	19717	2"	1 1/4"	-	1	5
Consists of 704, 986, (2) 1000, 1203, 1008						
1517	85114	2"	2"	-	1	8
Consists of 736, 986, 1008, (2) #546						
1515	19718	2 1/2"	2"	-	1	6
Consists of 706, 999, 987, (2) 998						



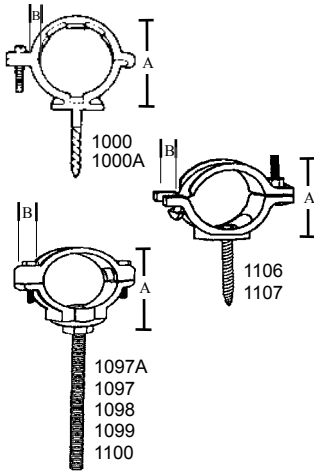

CAT#	A	B
1000	2.875	.875
1000A	3.30	.875
1106	2.70	.985
1107	3.295	1.080
1097A	2.70	.985
1097	3.33	1.071
1098	4.50	1.040
1099	5.125	1.075
1100	5.593	1.075

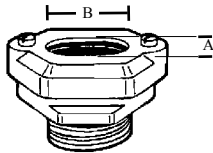

CAT#	FITS CABLE	GROMMET OPENING	
		A	B
873C	2#2	.625 X	1.00
874C	3#2	.625 X	1.00
875C	3#2	.625 X	1.00
876E	3#4/0	.830 X	1.415

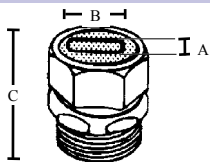

CAT#	FITS CABLE	GROMMET OPENING		
		A	B	C
873	3#8	.410 X	.650	1.875
873A	3#6	.460 X	.715	1.875
873B	3#4	.530 X	.850	1.875
874	3#3	.550 X	.910	1.937
874A	3#2	.580 X	.960	1.937
874B	3#1	.660 X	1.120	1.937
875	3#1/0	.705 X	1.195	2.375
875A	3#2/0	.740 X	1.235	2.375
876	3#1/0	.890 X	1.540	2.250
876A	3#2/0	.750 X	1.195	2.250
876B	3#3/0	.740 X	1.235	2.250
876C	3#4/0	.830 X	1.415	2.250
876D	3#4/0	.995 X	1.580	2.250
871/S	2#14	.220 X	.440	1.437
872/S	3#14	.220 X	.660	1.750

CONDUIT SUPPORTS

2 1/2" LAG SCREW TYPE				ALUMINUM		
TOPAZ CAT #	UPC#	CONDUIT SIZE	LAG	UNIT CTN	SHIP CASE	WT/ CASE
1000	70250	2"	2.375	-	25	8
1000A	70251	2 1/2"	2.375	-	25	10
				MALLEABLE IRON		
1106	19715	2"	2.375	-	25	37
1107	19716	2 1/2"	2.375	-	35	87

SPLIT RING

		BOLT SIZE				
TOPAZ CAT #	UPC#	CONDUIT SIZE	BOLT SIZE	UNIT CTN	SHIP CASE	WT/ CASE
1097A	83597	2"	1/2"-10"	-	25	12
1097	19711	2 1/2"	1/2"-10"	-	25	13
1098	19712	3"	5/8"-13"	-	10	25
1099	19713	3 1/2"	5/8"-13"	-	10	27
1100	19714	4"	5/8"-13"	-	10	28

WATER TIGHT CONNECTORS

				ZINC DIE CAST		
TOPAZ CAT #	UPC#	WIRE SIZE	SIZE	UNIT CTN	SHIP CASE	WT/ CASE

FOR TYPE SE, STYLE U FLAT 2 INSULATING CONDUCTORS, 1 BARE

• 2 SCREW TYPE						
873C	18749	2#2	2 screw	1"	10	100 20
874C	18801	3#2	2 screw	1 1/4"	10	100 52
875C	18823	3#2		1 1/2"	5	50 44
876E	18871	3#4/0		2"	5	50 44

• COMPRESSION TYPE						
873	18750	3#8		1"	10	100 34
873A	18760	3#6		1"	10	100 34
873B	18770	3#4		1"	10	100 34
874	18780	3#3		1 1/4"	10	100 52
874A	18790	3#2		1 1/4"	10	100 52
874B	18800	3#1		1 1/4"	10	100 52
875	18810	3#1/0		1 1/2"	5	50 33
875A	18820	3#2/0		1 1/2"	5	50 32
876	18830	3#1/0		2"	5	50 44
876A	18840	3#2/0		2"	5	50 44
876B	18850	3#3/0		2"	5	50 44
876C	18860	3#4/0		2"	5	50 44
876D	18870	3#4/0		2"	5	50 44

FOR UF CABLE

871	18730	14-2	12-2	10-2	1/2"	25 250 43
872	18740	14-3	12-3	10-3	3/4"	25 250 65
871S	18731	14-2	12-2		1/2" STEEL	25 250 30
872S	18741	14-3	12-3	10-3	3/4" STEEL	25 250 45



E170258



E148711



E148711

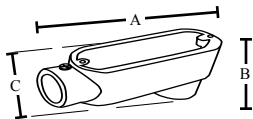

CAT#	A	B	C
ELB1	4.295	2.150	1.330
ELB2	5.090	2.430	1.540
ELB3	5.915	2.765	1.740
ELB4	7.894	3.665	2.490
ELB5	7.894	3.665	2.490
ELB6	10.134	4.275	3.100
ELB7	12.500	5.437	4.450
ELB8	12.500	5.657	4.450
ELB9	15.500	6.922	5.500
ELB10	15.500	6.922	5.500

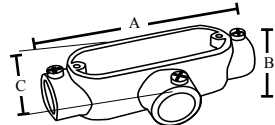

CAT#	A	B	C
ET1	4.720	1.370	2.030
ET2	5.570	1.625	2.335
ET3	6.460	1.900	2.705
ET4	8.528	2.770	3.630
ET5	8.528	2.770	3.630
ET6	10.831	3.335	3.980
ET7	13.500	4.060	5.825
ET8	13.500	4.685	5.825
ET9	15.937	5.450	7.060
ET10	15.937	5.450	7.060

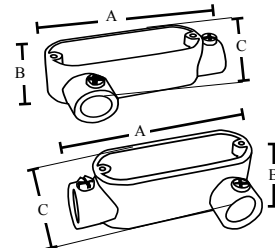

CAT#	A	B	C
ELR1/ELL1	4.295	1.370	2.030
ELR2/ELL2	5.090	1.625	2.330
ELR3/ELL3	5.915	1.900	2.650
ELR4/ELL4	7.894	2.770	3.385
ELR5/ELL5	7.894	2.770	3.385
ELR6/ELL6	10.134	3.335	3.810
ELR7/ELL7	12.500	5.437	4.450
ELR8/ELL8	12.500	5.657	4.450
ELR9/ELL9	15.500	6.922	5.500
ELR10/ELL10	15.500	6.922	5.500

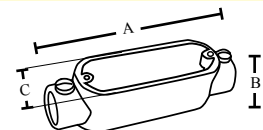

CAT#	A	B	C
EC1	4.720	1.370	1.330
EC2	5.570	1.625	1.540
EC3	6.460	1.900	1.740
EC4	8.528	2.770	2.490
EC5	8.528	2.770	2.490
EC6	10.831	3.335	3.100
EC7	13.000	4.063	5.709
EC8	12.500	4.682	5.506
EC9	15.500	5.452	6.171
EC10	15.500	5.452	6.171

CONDUIT BODIES

EMT SET SCREW TYPE

COPPER FREE ALUMINUM

TOPAZ CAT #	UPC#	SIZE	MAX # CONDUCTORS	UNIT CTN	SHIP CASE	WT/ CASE
EMT LB TYPE						
ELB1	20470	1/2"	1# 6AWG	10	100	28
ELB2	20480	3/4"	2# 6AWG	10	50	19
ELB3	20490	1"	3# 6AWG	5	25	20
ELB4	20500	1 1/4"	3# 2AWG	2	10	13
ELB5	20510	1 1/2"	3# 2AWG	2	10	14
ELB6	20520	2"	3# 2/OAWG	1	5	13
ELB7	20530	2 1/2"	3# 2/OAWG	-	1	6
ELB8	20540	3"	3# 4/OAWG	-	1	6
ELB9	20550	3 1/2"	3# 500MCM	-	1	8
ELB10	20560	4"	3# 500MCM	-	1	8



EMT T TYPE

ET1	20690	1/2"	1# 6AWG	10	100	32
ET2	20700	3/4"	2# 6AWG	10	50	30
ET3	20710	1"	3# 6AWG	5	25	15
ET4	20720	1 1/4"	3# 2AWG	2	10	17
ET5	20730	1 1/2"	3# 2AWG	2	10	19
ET6	20740	2"	3# 2/OAWG	-	2	5
ET7	20781	2 1/2"	3# 4/OAWG	-	1	7
ET8	20782	3"	3# 250MCM	-	1	7
ET9	20783	3 1/2"	3# 350MCM	-	1	9
ET10	20784	4"	4# 350MCM	-	1	9



EMT LR TYPE

ELR1	20630	1/2"	1# 6AWG	10	100	30
ELR2	20640	3/4"	2# 6AWG	10	50	24
ELR3	20650	1"	3# 6AWG	5	25	16
ELR4	20660	1 1/4"	3# 2AWG	2	10	14
ELR5	20670	1 1/2"	3# 2AWG	2	10	17
ELR6	20680	2"	3# 2/OAWG	1	5	14
ELR7	20681	2 1/2"	3# 4/OAWG	-	1	6
ELR8	20682	3"	3# 250MCM	-	1	6
ELR9	20683	3 1/2"	3# 350MCM	-	1	8
ELR10	20684	4"	4# 350MCM	-	1	8



EMT LL TYPE

ELL1	20570	1/2"	1# 6AWG	10	100	30
ELL2	20580	3/4"	2# 6AWG	10	50	23
ELL3	20590	1"	3# 6AWG	5	25	18
ELL4	20600	1 1/4"	3# 2AWG	2	10	14
ELL5	20610	1 1/2"	3# 2AWG	2	10	16
ELL6	20620	2"	3# 2/OAWG	1	5	14
ELL7	20621	2 1/2"	3# 4/OAWG	-	1	6
ELL8	20622	3"	3# 250MCM	-	1	6
ELL9	20623	3 1/2"	3# 350MCM	-	1	8
ELL10	20624	4"	4# 350MCM	-	1	8



EMT C TYPE

EC1	20410	1/2"	1# 6AWG	10	100	24
EC2	20420	3/4"	2# 6AWG	10	50	21
EC3	20430	1"	3# 6AWG	5	25	25
EC4	20440	1 1/4"	3# 2AWG	2	10	15
EC5	20450	1 1/2"	3# 2AWG	2	10	17
EC6	20460	2"	3# 2/OAWG	1	5	13
EC7	20461	2 1/2"	3# 4/OAWG	-	1	6
EC8	20462	3"	3# 250MCM	-	1	7
EC9	20463	3 1/2"	3# 350MCM	-	1	8
EC10	20464	4"	4# 350MCM	-	1	8



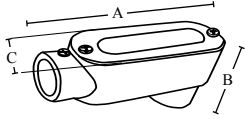

CAT#	A	B	C
ELB1CG	4.295	2.150	1.330
ELB2CG	5.090	2.430	1.540
ELB3CG	5.915	2.765	1.740
ELB4CG	7.894	3.665	2.490
ELB5CG	7.894	3.665	2.490
ELB6CG	10.134	4.275	3.100
ELB7CG	12.500	5.437	4.450
ELB8CG	12.500	5.657	4.450
ELB9CG	15.500	6.922	5.500
ELB10CG	15.500	6.922	5.500

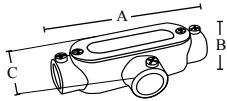

CAT#	A	B	C
ET1CG	4.720	1.370	2.030
ET2CG	5.570	1.625	2.335
ET3CG	6.460	1.900	2.705
ET4CG	8.528	2.770	3.630
ET5CG	8.528	2.770	3.630
ET6CG	10.831	3.335	3.980
ET7CG	13.500	4.060	5.825
ET8CG	13.500	4.685	5.825
ET9CG	15.937	5.450	7.060
ET10CG	15.937	5.450	7.060

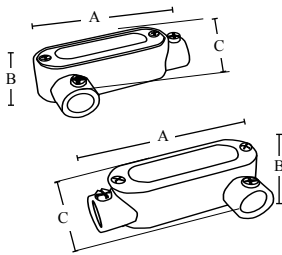

CAT#	A	B	C
ELR1CG/ELL1CG	4.295	1.370	2.030
ELR2CG/ELL2CG	5.090	1.625	2.330
ELR3CG/ELL3CG	5.915	1.900	2.650
ELR4CG/ELL4CG	7.894	2.770	3.385
ELR5CG/ELL5CG	7.894	2.770	3.385
ELR6CG/ELL6CG	10.134	3.335	3.810
ELR7CG/ELL7CG	12.500	5.437	4.450
ELR8CG/ELL8CG	12.500	5.657	4.450
ELR9CG/ELL9CG	15.500	6.922	5.500
ELR10CG/ELL10CG	15.500	6.922	5.500

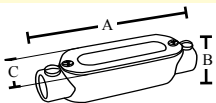

CAT#	A	B	C
EC1CG	4.720	1.370	1.330
EC2CG	5.570	1.625	1.540
EC3CG	6.460	1.900	1.740
EC4CG	8.528	2.770	2.490
EC5CG	8.528	2.770	2.490
EC6CG	10.831	3.335	3.100
EC7CG	13.00	4.063	5.709
EC8CG	12.50	4.682	5.506
EC9CG	15.50	5.452	6.171
EC10CG	15.50	5.452	6.171

CONDUIT BODIES WITH COVERS & GASKETS

EMT SET SCREW TYPE

COPPER FREE ALUMINUM

TOPAZ CAT #	UPC#	SIZE	MAX # CONDUCTORS	UNIT CTN	SHIP CASE	WT/ CASE
EMT LB TYPE						
ELB1CG	20471	1/2"	1# 6AWG	10	100	32
ELB2CG	20481	3/4"	2# 6AWG	10	50	23
ELB3CG	20491	1"	3# 6AWG	5	25	19
ELB4CG	20501	1 1/4"	3# 2AWG	2	10	14
ELB5CG	20511	1 1/2"	3# 2AWG	2	10	15
ELB6CG	20521	2"	3# 2/OAWG	1	5	14
ELB7CG	20531	2 1/2"	3# 2/OAWG	-	1	7
ELB8CG	20541	3"	3# 4/OAWG	-	1	7
ELB9CG	20551	3 1/2"	3# 500MCM	-	1	10
ELB10CG	20561	4"	3# 500MCM	-	1	10



E170258



E170258



E170258



E170258



E170258

EMT T TYPE

ET1CG	20691	1/2"	1# 6AWG	5	50	38
ET2CG	20701	3/4"	2# 6AWG	10	50	30
ET3CG	20711	1"	3# 6AWG	5	25	20
ET4CG	20721	1 1/4"	3# 2AWG	2	10	19
ET5CG	20731	1 1/2"	3# 2AWG	2	10	21
ET6CG	20745	2"	3# 2/OAWG	-	2	5
ET7CG	20744	2 1/2"	3# 4/OAWG	-	1	8
ET8CG	20747	3"	3# 250MCM	-	1	8
ET9CG	20748	3 1/2"	3# 350MCM	-	1	11
ET10CG	20749	4"	4# 350MCM	-	1	11

EMT LR TYPE

ELR1CG	20631	1/2"	1# 6AWG	10	100	36
ELR2CG	20641	3/4"	2# 6AWG	5	10	28
ELR3CG	20651	1"	3# 6AWG	5	25	17
ELR4CG	20661	1 1/4"	3# 2AWG	2	10	15
ELR5CG	20671	1 1/2"	3# 2AWG	2	10	18
ELR6CG	20685	2"	3# 2/OAWG	1	5	14
ELR7CG	20686	2 1/2"	3# 4/OAWG	-	1	7
ELR8CG	20687	3"	3# 250MCM	-	1	7
ELR9CG	20688	3 1/2"	3# 350MCM	-	1	10
ELR10CG	20689	4"	4# 350MCM	-	1	10

EMT LL TYPE

ELL1CG	20571	1/2"	1# 6AWG	10	100	30
ELL2CG	20581	3/4"	2# 6AWG	5	50	23
ELL3CG	20591	1"	3# 6AWG	5	25	18
ELL4CG	20601	1 1/4"	3# 2AWG	2	10	14
ELL5CG	20611	1 1/2"	3# 2AWG	2	10	16
ELL6CG	20625	2"	3# 2/OAWG	1	5	14
ELL7CG	20626	2 1/2"	3# 4/OAWG	-	1	6
ELL8CG	20627	3"	3# 250MCM	-	1	6
ELL9CG	20628	3 1/2"	3# 350MCM	-	1	8
ELL10CG	20629	4"	4# 350MCM	-	1	8

EMT C TYPE

EC1CG	20411	1/2"	1# 6AWG	10	100	24
EC2CG	20421	3/4"	2# 6AWG	5	50	21
EC3CG	20431	1"	3# 6AWG	5	25	25
EC4CG	20441	1 1/4"	3# 2AWG	5	25	15
EC5CG	20451	1 1/2"	3# 2AWG	5	10	17
EC6CG	20465	2"	3# 2/OAWG	1	5	13
EC7CG	20466	2 1/2"	3# 4/OAWG	-	1	6
EC8CG	20467	3"	3# 250MCM	-	1	6
EC9CG	20468	3 1/2"	3# 350MCM	-	1	8
EC10CG	20469	4"	4# 350MCM	-	1	8

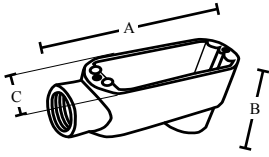

CAT#	A	B	C
LB1	4.295	2.150	1.330
LB2	5.090	2.430	1.540
LB3	5.915	2.765	1.740
LB4	7.894	3.665	2.490
LB5	7.894	3.665	2.490
LB6	10.134	4.275	3.100
LB7	12.500	5.437	4.450
LB8	12.500	5.675	4.450
LB9	15.500	6.922	5.500
LB10	15.500	6.922	5.500

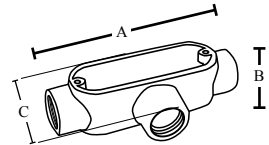

CAT#	A	B	C
T1	4.720	1.370	2.030
T2	5.570	1.625	2.335
T3	6.460	1.900	2.705
T4	8.528	2.770	3.630
T5	8.528	2.770	3.630
T6	10.831	3.335	3.980
T7	13.500	4.060	5.825
T8	13.000	4.685	5.825
T9	15.937	5.450	7.060
T10	15.937	5.450	7.060

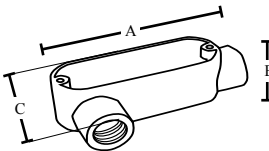

CAT#	A	B	C
LR1	4.295	1.370	2.030
LR2	5.090	1.625	2.330
LR3	5.915	1.900	2.650
LR4	7.894	2.770	3.385
LR5	7.894	2.770	3.385
LR6	10.134	3.335	3.810
LR7	13.000	4.063	5.709
LR8	12.750	4.682	5.506
LR9	15.500	5.452	6.171
LR10	15.500	5.452	6.171

CONDUIT BODIES

RIGID THREADED TYPE

COPPER FREE ALUMINUM

TOPAZ CAT #	UPC#	SIZE	MAX # CONDUCTORS	UNIT CTN	SHIP CASE	WT/ CASE
LB1	20840	1/2"	1#6AWG	10	100	28
LB2	20850	3/4"	2#6AWG	10	50	19
LB3	20860	1"	3#6AWG	5	25	18
LB4	20870	1 1/4"	3#2AWG	2	10	13
LB5	20880	1 1/2"	3#2AWG	2	10	14
LB6	20890	2"	3#2/0AWG	1	5	13
LB7	20900	2 1/2"	3#2/0AWG	—	1	6
LB8	20910	3"	3#4/0AWG	—	1	6
LB9	20920	3 1/2"	3#500MCM	—	1	8
LB10	20930	4"	3#500MCM	—	1	8



E170258

RIGID T TYPE

T1	21730	1/2"	1#6AWG	10	100	32
T2	21740	3/4"	2#6AWG	10	50	26
T3	21750	1"	3#6AWG	5	25	18
T4	21760	1 1/4"	3#2AWG	2	10	17
T5	21770	1 1/2"	3#2AWG	2	10	19
T6	21780	2"	3#2/0AWG	—	2	5
T7	21790	2 1/2"	3#4/0AWG	—	1	7
T8	21800	3"	3#250MCM	—	1	7
T9	21810	3 1/2"	3#350MCM	—	1	9
T10	21820	4"	4#350MCM	—	1	9



E170258

RIGID LR TYPE

LR1	21240	1/2"	1#6AWG	10	100	29
LR2	21250	3/4"	2#6AWG	10	50	24
LR3	21260	1"	3#6AWG	5	25	19
LR4	21270	1 1/4"	3#2AWG	2	10	14
LR5	21280	1 1/2"	3#2AWG	2	10	17
LR6	21290	2"	3#2/0AWG	1	5	14
LR7	21300	2 1/2"	3#4/0AWG	—	1	6
LR8	21310	3"	3#250MCM	—	1	6
LR9	21320	3 1/2"	3#350MCM	—	1	8
LR10	21330	4"	4#350MCM	—	1	8



E170258

CONDUIT BODIES RIGID THREADED TYPE

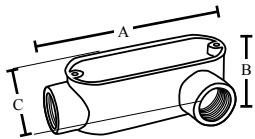

CAT#	A	B	C
LL1	4.295	1.370	2.030
LL2	5.090	1.625	2.330
LL3	5.915	1.900	2.650
LL4	7.894	2.770	3.385
LL5	7.894	2.770	3.385
LL6	10.134	3.335	3.810
LL7	13.000	4.063	5.709
LL8	12.750	4.682	5.506
LL9	15.500	5.452	6.171
LL10	15.500	5.452	6.171

COPPER FREE ALUMINUM

TOPAZ CAT #	UPC#	SIZE	MAX # CONDUCTORS	UNIT CTN	SHIP CASE	WT/ CASE
RIGID LL TYPE						
LL1	21040	1/2"	1#6AWG	10	100	28
LL2	21050	3/4"	2#6AWG	10	50	23
LL3	21060	1"	3#6AWG	5	25	18
LL4	21070	1 1/4"	3#2AWG	2	10	14
LL5	21080	1 1/2"	3#2AWG	2	10	16
LL6	21090	2"	3#2/OAWG	1	5	14
LL7	21100	2 1/2"	3#4/OAWG	—	1	6
LL8	21110	3"	3#250MCM	—	1	6
LL9	21120	3 1/2"	3#350MCM	—	1	8
LL10	21130	4"	4#350MCM	—	1	8

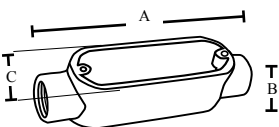

CAT#	A	B	C
C1	4.720	1.370	1.330
C2	5.570	1.625	1.540
C3	6.460	1.900	1.740
C4	8.528	2.770	2.490
C5	8.528	2.770	2.490
C6	10.831	3.335	3.100
C7	13.500	4.060	4.450
C8	13.000	4.685	4.450
C9	15.937	5.450	5.500
C10	15.937	5.450	5.500

RIGID C TYPE

TOPAZ CAT #	UPC#	SIZE	MAX # CONDUCTORS	UNIT CTN	SHIP CASE	WT/ CASE
RIGID C TYPE						
C1	19900	1/2"	1#6AWG	10	100	24
C2	19910	3/4"	2#6AWG	10	50	21
C3	19920	1"	3#6AWG	5	25	15
C4	19930	1 1/4"	3#2AWG	2	10	15
C5	19940	1 1/2"	3#2AWG	2	10	17
C6	19950	2"	3#2/OAWG	1	5	13
C7	19960	2 1/2"	3#4/OAWG	—	1	6
C8	19970	3"	3#250MCM	—	1	6
C9	19980	3 1/2"	3#350MCM	—	1	8
C10	19990	4"	4#350MCM	—	1	8

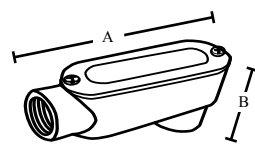

CAT#	A	B
MLBCG4	10.19	4.06
MLBCG5	15.54	4.88
MLBCG6	15.54	4.88
MLBCG7	17.88	8.00
MLBCG8	21.06	10.00
MLBCG9	24.31	10.25
MLBCG10	27.50	12.50

MOGUL CONDUIT BODIES WITH COVERS & GASKETS

RIGID LB TYPE

MALLEABLE IRON

TOPAZ CAT #	UPC#	SIZE	UNIT CTN	SHIP CASE	WT/ CASE
MLBCG4	32110	1 1/4"	—	5	8
MLBCG5	32120	1 1/2"	—	2	10
MLBCG6	32130	2"	—	2	9
MLBCG7	32131	2 1/2"	—	1	26
MLBCG8	32132	3"	—	1	34
MLBCG9	32133	3 1/2"	—	1	74
MLBCG10	32134	4"	—	1	74



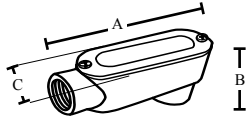

CAT#	A	B	C
LB1CG	4.295	2.150	1.330
LB2CG	5.090	2.430	1.540
LB3CG	5.915	2.765	1.740
LB4CG	7.894	3.665	2.490
LB5CG	7.894	3.665	2.490
LB6CG	10.134	4.275	3.100
LB7CG	12.500	5.437	4.450
LB8CG	12.500	5.675	4.450
LB9CG	15.500	6.922	5.500
LB10CG	15.500	6.922	5.500

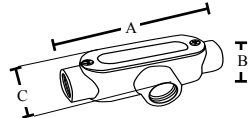

CAT#	A	B	C
T1CG	4.720	1.370	1.330
T2CG	5.570	1.625	1.540
T3CG	6.460	1.900	1.740
T4CG	8.528	2.770	2.490
T5CG	8.528	2.770	2.490
T6CG	10.831	3.335	3.100
T7CG	13.500	4.060	5.825
T8CG	13.000	4.685	5.825
T9CG	15.937	5.450	7.060
T10CG	15.937	5.450	7.060

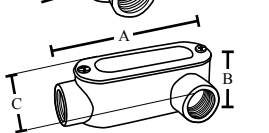
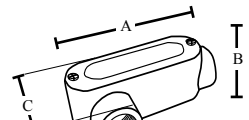

CAT#	A	B	C
LR1CG/LL1CG	4.295	1.370	2.030
LR2CG/LL2CG	5.090	1.625	2.330
LR3CG/LL3CG	5.915	1.900	2.650
LR4CG/LL4CG	7.894	2.770	3.385
LR5CG/LL5CG	7.894	2.770	3.385
LR6CG/LL6CG	10.134	3.335	3.810
LR7CG/LL7CG	13.000	4.063	5.709
LR8CG/LL8CG	12.750	4.682	5.506
LR9CG/LL9CG	15.500	5.452	6.171
LR10CG/LL10CG	15.500	5.452	6.171

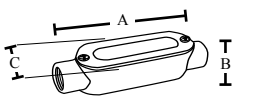

CAT#	A	B	C
C1CG	4.720	1.370	1.330
C2CG	5.570	1.625	1.540
C3CG	6.460	1.900	1.740
C4CG	8.528	2.770	2.490
C5CG	8.528	2.770	2.490
C6CG	10.831	3.335	3.100
C7CG	13.500	4.060	4.450
C8CG	13.000	4.685	4.450
C9CG	15.937	5.450	5.500
C10CG	15.937	5.450	5.500

CONDUIT BODIES WITH COVERS & GASKETS

RIGID THREADED TYPE

COPPER FREE ALUMINUM

TOPAZ CAT #	UPC#	SIZE	MAX # CONDUCTORS	UNIT CTN	SHIP CASE	WT/ CASE
RIGID LB TYPE						
LB1CG	20841	1/2"	1#6AWG	10	100	34
LB2CG	20851	3/4"	2#6AWG	10	50	23
LB3CG	20861	1"	3#6AWG	5	25	19
LB4CG	20871	1 1/4"	3#2AWG	2	10	14
LB5CG	20881	1 1/2"	3#2AWG	2	10	15
LB6CG	20891	2"	3#2/OAWG	1	5	14
LB7CG	20901	2 1/2"	3#2/OAWG	-	1	7
LB8CG	20911	3"	3#4/OAWG	-	1	7
LB9CG	20921	3 1/2"	3#500MCM	-	1	10
LB10CG	20931	4"	3#500MCM	-	1	10

RIGID T TYPE

T1CG	21731	1/2"	1#6AWG	10	100	38
T2CG	21741	3/4"	2#6AWG	10	50	30
T3CG	21751	1"	3#6AWG	5	25	20
T4CG	21761	1 1/4"	3#2AWG	2	10	19
T5CG	21771	1 1/2"	3#2AWG	2	10	21
T6CG	21781	2"	3#2/OAWG	-	2	5
T7CG	21791	2 1/2"	3#4/OAWG	-	1	8
T8CG	21801	3"	3#250MCM	-	1	8
T9CG	21811	3 1/2"	3#350MCM	-	1	11
T10CG	21821	4"	4#350MCM	-	1	11

RIGID LR TYPE

LR1CG	21241	1/2"	1#6AWG	10	100	36
LR2CG	21251	3/4"	2#6AWG	10	50	28
LR3CG	21261	1"	3#6AWG	5	25	17
LR4CG	21271	1 1/4"	3#2AWG	2	10	15
LR5CG	21281	1 1/2"	3#2AWG	2	10	18
LR6CG	21291	2"	3#2/OAWG	1	5	14
LR7CG	21301	2 1/2"	3#4/OAWG	-	1	7
LR8CG	21311	3"	3#250MCM	-	1	7
LR9CG	21321	3 1/2"	3#350MCM	-	1	10
LR10CG	21331	4"	4#350MCM	-	1	10

RIGID LL TYPE

LL1CG	21041	1/2"	1#6AWG	10	100	36
LL2CG	21051	3/4"	2#6AWG	10	50	23
LL3CG	21061	1"	3#6AWG	5	25	19
LL4CG	21071	1 1/4"	3#2AWG	2	10	15
LL5CG	21081	1 1/2"	3#2AWG	2	10	16
LL6CG	21091	2"	3#2/OAWG	1	5	14
LL7CG	21101	2 1/2"	3#4/OAWG	-	1	7
LL8CG	21111	3"	3#250MCM	-	1	7
LL9CG	21121	3 1/2"	3#350MCM	-	1	10
LL10CG	21131	4"	4#350MCM	-	1	10

RIGID C TYPE

C1CG	19901	1/2"	1#6AWG	10	100	30
C2CG	19911	3/4"	2#6AWG	10	50	25
C3CG	19921	1"	3#6AWG	5	25	18
C4CG	19931	1 1/4"	3#2AWG	2	10	17
C5CG	19941	1 1/2"	3#2AWG	2	10	19
C6CG	19951	2"	3#2/OAWG	1	5	14
C7CG	19961	2 1/2"	3#4/OAWG	-	1	7
C8CG	19971	3"	3#250MCM	-	1	7
C9CG	19981	3 1/2"	3#350MCM	-	1	10
C10CG	19991	4"	4#350MCM	-	1	10



E170258



E170258



E170258



E170258



E170258

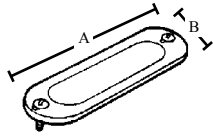

CAT#	A	B	SCREW SIZE
571	3.875	1.310	8/32 X 3/8
572	4.625	1.520	8/32 X 3/8
573	5.315	1.710	8/32 X 3/8
574	7.240	2.510	12/24 X 3/8
576	9.484	3.110	12/24 X 3/8
577	12.187	4.440	5/16 X 3/8
579	14.937	5.500	5/16 X 3/8

CAT#	A	B	SCREW SIZE
571P	3.875	1.310	8/32 X 3/8
572P	4.625	1.520	8/32 X 3/8
573P	5.315	1.710	8/32 X 3/8
574P	7.240	2.510	12/24 X 3/8
576P	9.484	3.110	12/24 X 3/8
577P	12.187	4.440	5/16 X 3/8
579P	14.937	5.500	5/16 X 3/8

CAT#	A	B	SCREW SIZE
571S	3.875	1.310	8/32 X 3/8
572S	4.625	1.520	8/32 X 3/8
573S	5.315	1.710	8/32 X 3/8
574S	7.240	2.510	12/24 X 3/8
576S	9.484	3.110	12/24 X 3/8
577S	12.187	4.440	5/16 X 3/8
579S	14.937	5.500	5/16 X 3/8

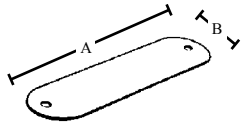

CAT#	A	B
581	3.935	1.360
582	4.600	1.550
583	5.370	1.760
584	7.250	2.500
586	9.500	3.070
587	12.125	4.355
589	14.812	5.400

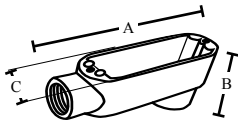

CAT#	A	B	C
LB1M	4.56	2.06	1.31
LB2M	5.31	2.37	1.48
LB3M	6.25	2.63	1.75
LB4M	8.22	3.50	2.40
LB5M	8.22	3.75	2.40
LB6M	10.48	4.31	3.05
LB7M	13.75	4.45	4.38
LB8M	13.75	4.45	4.38
LB9M	16.75	5.80	5.63
LB10M	16.75	5.80	5.63

CONDUIT BODY COVERS

WITH SCREWS

TOPAZ CAT #	UPC#	SIZE	UNIT CTN	SHIP CASE	ALUMINUM WT/ CASE
571	15450	1/2"	25	250	15
572	15460	3/4"	25	250	20
573	15470	1"	10	100	9
574	15480	1 1/4"-1 1/2"	—	25	4
576	15490	2"	—	25	7
577	15500	2 1/2"-3"	—	10	8
579	15510	3 1/2"-4"	—	5	7



PAINTED

TOPAZ CAT #	UPC#	SIZE	UNIT CTN	SHIP CASE	PAINTED WT/ CASE
571P	51160	1/2"	25	250	17.5
572P	51177	3/4"	25	250	22.5
573P	51184	1"	10	100	10
574P	51191	1 1/4"-1 1/2"	25	25	4.25
576P	51207	2"	25	25	6.25
577P	51214	2 1/2"-3"	10	10	7.20
579P	51221	3 1/2"-4"	5	5	9.5



STEEL ZINC PLATED

TOPAZ CAT #	UPC#	SIZE	UNIT CTN	SHIP CASE	STEEL ZINC PLATED WT/ CASE
571S	15520	1/2"	25	250	15
572S	15530	3/4"	25	250	20
573S	15540	1"	10	100	8
574S	15550	1 1/4"-1 1/2"	—	25	4
576S	15560	2"	—	25	7
577S	15570	2 1/2"-3"	—	10	7
579S	15580	3 1/2"-4"	—	5	9



CONDUIT BODY GASKETS

NEOPRENE

TOPAZ CAT #	UPC#	SIZE	UNIT CTN	SHIP CASE	NEOPRENE WT/ CASE
581	15710	1/2"	50	500	1
582	15720	3/4"	50	500	1
583	15730	1"	25	500	2
584	15740	1 1/4"-1 1/2"	25	500	2
586	15750	2"	25	250	2
587	15760	2 1/2"-3"	10	100	2
589	15770	3 1/2"-4"	5	50	2



All Covers and Gaskets fit LB, LL, LR, C and T's, Aluminum and Malleable, Set Screw and Rigid Bodies

CONDUIT BODIES

RIGID THREADED TYPE

TOPAZ CAT #	UPC#	SIZE	UNIT CTN	SHIP CASE	MALLEABLE IRON WT/ CASE
LB1M	20940	1/2"	—	10	7
LB2M	20950	3/4"	—	10	9
LB3M	20960	1"	—	5	6
LB4M	20970	1 1/4"	—	10	23
LB5M	20980	1 1/2"	—	10	26
LB6M	20990	2"	—	5	26
LB7M	21000	2 1/2"	—	1	10
LB8M	21010	3"	—	1	13
LB9M	21020	3 1/2"	—	1	22
LB10M	21030	4"	—	1	24



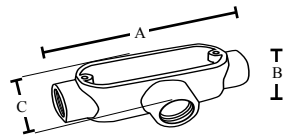

CAT#	A	B	C
T1M	5.35	1.31	2.02
T2M	6.00	1.62	2.22
T3M	7.06	1.88	2.56
T4M	7.25	2.50	3.50
T5M	9.25	2.67	3.50
T6M	11.50	3.29	4.25
T7M	15.00	3.9375	5.718
T8M	15.125	4.75	5.875
T9M	18.125	5.2031	6.812
T10M	18.125	5.5625	7.203

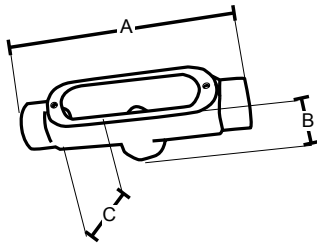

CAT#	A	B	C
TB1M	5.25	1.9375	1.9375
TB2M	6.0625	1.5625	1.5625
TB3M	7.125	1.8125	1.8125
TB4M	9.3125	2.4375	3.75
TB5M	9.3125	2.4375	3.75
TB6M	11.8125	3.8125	4.125

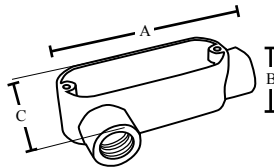

CAT#	A	B	C
LR1M	4.56	1.31	2.06
LR2M	5.31	1.62	2.23
LR3M	6.25	1.88	2.50
LR4M	8.22	2.50	3.40
LR5M	8.22	2.67	3.48
LR6M	10.48	3.29	4.07
LR7M	13.75	4.45	4.38
LR8M	13.75	4.45	4.38
LR9M	16.75	5.80	5.63
LR10M	16.75	5.80	5.63

CONDUIT BODIES

RIGID THREADED TYPE

MALLEABLE IRON

TOPAZ CAT #	UPC#	SIZE	UNIT CTN	SHIP CASE	WT/ CASE
RIGID T TYPE					
T1M	21830	1/2"	—	10	7
T2M	21840	3/4"	—	5	10
T3M	21850	1"	—	10	16
T4M	21860	1 1/4"	—	10	28
T5M	21870	1 1/2"	—	10	29
T6M	21880	2"	—	2	12
T7M	21890	2 1/2"	—	1	12
T8M	21900	3"	—	1	15
T9M	21910	3 1/2"	—	1	27
T10M	21920	4"	—	1	28



RIGID TB TYPE

TB1M	17545	1/2"	—	10	9
TB2M	17546	3/4"	—	10	11
TB3M	17547	1"	—	10	21
TB4M	17548	1 1/4"	—	5	18
TB5M	17549	1 1/2"	—	5	21
TB6M	17550	2"	—	2	14



RIGID LR TYPE

LR1M	21340	1/2"	—	10	7
LR2M	21350	3/4"	—	10	9
LR3M	21360	1"	—	5	6
LR4M	21370	1 1/4"	—	10	23
LR5M	21380	1 1/2"	—	10	26
LR6M	21390	2"	—	5	26
LR7M	21400	2 1/2"	—	1	10
LR8M	21410	3"	—	1	13
LR9M	21420	3 1/2"	—	1	22
LR10M	21430	4"	—	1	24



CONDUIT BODIES RIGID THREADED TYPE

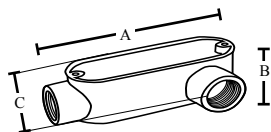

CAT#	A	B	C
LL1M	4.56	1.31	2.06
LL2M	5.31	1.62	2.23
LL3M	6.25	1.88	2.50
LL4M	8.22	2.50	3.40
LL5M	8.22	2.67	3.48
LL6M	10.48	3.29	4.07
LL7M	13.6094	3.9063	5.718
LL8M	13.875	4.75	5.875
LL9M	16.50	6.8125	7.125
LL10M	16.50	7.1875	7.125

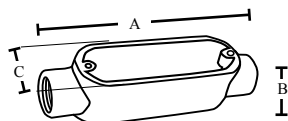

CAT#	A	B	C
C1M	5.35	1.31	1.31
C2M	6.00	1.62	1.48
C3M	7.06	1.88	1.75
C4M	9.25	2.50	2.40
C5M	9.25	2.67	2.40
C6M	11.50	3.29	3.05
C7M	15.00	3.9063	4.312
C8M	15.125	4.75	4.312
C9M	18.125	5.1875	4.875
C10M	18.125	5.5625	4.875

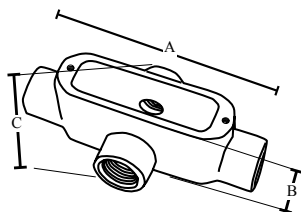

CAT#	A	B	C
X1M	5.25	1.75	2.8125
X2M	6.0625	2.00	2.9375
X3M	7.125	2.25	3.5625
X4M	9.125	2.5625	4.4375
X5M	9.125	2.75	4.4375
X6M	11.75	3.4375	5.375

MALLEABLE IRON

TOPAZ CAT #	UPC#	SIZE	UNIT CTN	SHIP CASE	WT/ CASE
RIGID LL TYPE					
LL1M	21140	1/2"	—	10	7
LL2M	21150	3/4"	—	10	9
LL3M	21160	1"	—	5	6
LL4M	21170	1 1/4"	—	10	23
LL5M	21180	1 1/2"	—	10	26
LL6M	21190	2"	—	5	26
LL7M	21200	2 1/2"	—	1	10
LL8M	21210	3"	—	1	13
LL9M	21220	3 1/2"	—	1	22
LL10M	21230	4"	—	1	24



RIGID C TYPE

C1M	20000	1/2"	—	10	7
C2M	20010	3/4"	5	25	23
C3M	20020	1"	—	5	6
C4M	20030	1 1/4"	—	10	23
C5M	20040	1 1/2"	—	10	26
C6M	20050	2"	—	5	26
C7M	20051	2 1/2"	—	5	10
C8M	20052	3"	—	1	12
C9M	20053	3 1/2"	—	1	21
C10M	20054	4"	—	1	23



RIGID X TYPE

X1M	17551	1/2"	—	10	14
X2M	17552	3/4"	—	10	18
X3M	17553	1"	—	10	25
X4M	17554	1 1/4"	—	5	23
X5M	17555	1 1/2"	—	5	26
X6M	17556	2"	—	2	17



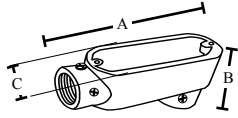

CAT#	A	B	C
LB1SS	4.56	2.06	1.31
LB2SS	5.31	2.37	1.48
LB3SS	6.25	2.63	1.75
LB4SS	8.22	3.50	2.40
LB5SS	8.22	3.75	2.40
LB6SS	10.13	4.13	3.10

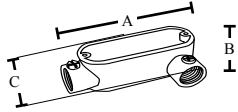

CAT#	A	B	C
LL1SS	4.56	1.31	2.06
LL2SS	5.31	1.62	2.23
LL3SS	6.25	1.88	2.50
LL4SS	8.22	2.50	3.40
LL5SS	8.22	2.67	3.48
LL6SS	10.48	3.29	4.07

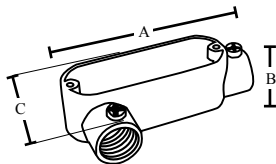

CAT#	A	B	C
LR1SS	4.56	1.31	2.06
LR2SS	5.31	1.62	2.23
LR3SS	6.25	1.88	2.50
LR4SS	8.22	2.50	3.40
LR5SS	8.22	2.67	3.48
LR6SS	10.48	3.29	4.07

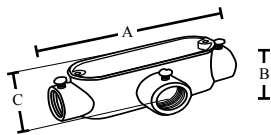

CAT#	A	B	C
T1SS	5.35	1.31	2.02
T2SS	6.00	1.62	2.22
T3SS	7.06	1.88	2.56
T4SS	7.25	2.50	3.50
T5SS	9.25	2.67	3.50
T6SS	11.50	3.29	4.25

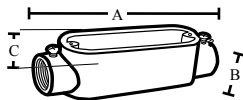

CAT#	A	B	C
C1SS	5.35	1.31	1.31
C2SS	6.00	1.62	1.48
C3CS	7.06	1.88	1.75
C4SS	9.25	2.50	2.40
C5SS	9.25	2.67	2.40
C6SS	11.50	3.29	3.05

CONDUIT BODIES

EMT AND RIGID COMBINATION

		ALUMINUM				
TOPAZ CAT #	UPC#	SIZE	MAX # CONDUCTORS	UNIT CTN	SHIP CASE	WT/ CASE
EMT & RIGID LB TYPE						
LB1SS	20842	1/2"	1#6AWG	10	100	28
LB2SS	20852	3/4"	2#6AWG	10	50	19
LB3SS	20862	1"	3#6AWG	5	25	18
LB4SS	20872	1 1/4"	3#2AWG	2	10	13
LB5SS	20882	1 1/2"	3#2AWG	2	10	14
LB6SS	20892	2"	3#2/OAWG	-	5	13

EMT & RIGID LL TYPE						
LL1SS	21042	1/2"	1#6AWG	10	100	28
LL2SS	21052	3/4"	2#6AWG	10	50	23
LL3SS	21062	1"	3#6AWG	5	25	18
LL4SS	21072	1 1/4"	3#2AWG	2	10	14
LL5SS	21082	1 1/2"	3#2AWG	2	10	16
LL6SS	21092	2"	3#2/O	-	5	14

EMT & RIGID LR TYPE						
LR1SS	21242	1/2"	1#6AWG	10	100	29
LR2SS	21252	3/4"	2#6AWG	10	50	24
LR3SS	21262	1"	3#6AWG	5	25	19
LR4SS	21272	1 1/4"	3#2AWG	2	10	14
LR5SS	21282	1 1/2"	3#2AWG	2	10	17
LR6SS	21292	2"	3#2/OAWG	-	5	4

EMT & RIGID T TYPE						
T1SS	21732	1/2"	1#6AWG	10	100	32
T2SS	21742	3/4"	2#6AWG	10	50	26
T3SS	21752	1"	3#6AWG	5	25	18
T4SS	21762	1 1/4"	3#2AWG	2	10	17
T5SS	21772	1 1/2"	3#2AWG	2	10	19
T6SS	21782	2"	3#2/OAWG	-	5	5

EMT & RIGID C TYPE						
C1SS	19902	1/2"	1#6AWG	10	100	24
C2SS	19912	3/4"	2#6AWG	10	50	21
C3SS	19922	1"	3#6AWG	5	25	15
C4SS	19932	1 1/4"	3#2AWG	2	10	15
C5SS	19942	1 1/2"	3#2AWG	2	10	17
C6SS	19952	2"	3#2/OAWG	-	5	13



E170258

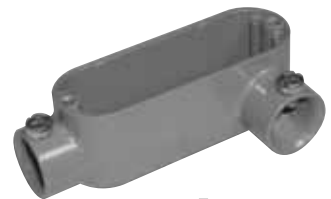

E170258



E170258



E170258



E170258

CONDUIT BODIES WITH COVERS & GASKETS

EMT AND RIGID COMBINATION

• POWDER COATED BODY & COVER **ALUMINUM**

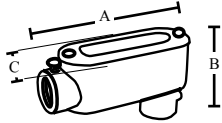

CAT#	A	B	C
LB1SSCG	4.56	2.06	1.31
LB2SSCG	5.31	2.37	1.48
LB3SSCG	6.25	2.63	1.75
LB4SSCG	8.22	3.50	2.40
LB5SSCG	8.22	3.75	2.40
LB6SSCG	10.13	4.28	3.10

TOPAZ CAT #	UPC#	SIZE	MAX # CONDUCTORS	UNIT CTN	SHIP CASE	WT/ CASE
EMT & RIGID LB TYPE						
LB1SSCG	83768	1/2"	1#6AWG	10	100	34
LB2SSCG	83769	3/4"	2#6AWG	10	50	23
LB3SSCG	83770	1"	3#6AWG	5	25	19
LB4SSCG	83771	1 1/4"	3#2AWG	2	10	14
LB5SSCG	83772	1 1/2"	3#2AWG	2	10	15
LB6SSCG	83773	2"	3#2/OAWG	—	5	14

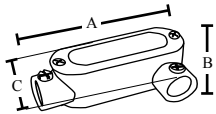

CAT#	A	B	C
LL1SSCG	4.56	1.31	2.06
LL2SSCG	5.31	1.62	2.23
LL3SSCG	6.25	1.88	2.50
LL4SSCG	8.22	2.50	3.40
LL5SSCG	8.22	2.67	3.48
LL6SSCG	10.48	3.29	4.07

EMT & RIGID LL TYPE

LL1SSCG	83774	1/2"	1#6AWG	10	100	36
LL2SSCG	83775	3/4"	2#6AWG	10	50	23
LL3SSCG	83776	1"	3#6AWG	5	25	19
LL4SSCG	83777	1 1/4"	3#2AWG	2	10	15
LL5SSCG	83778	1 1/2"	3#2AWG	2	10	16
LL6SSCG	83779	2"	3#2/OAWG	—	5	14

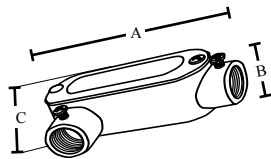

CAT#	A	B	C
LR1SSCG	4.56	1.31	2.06
LR2SSCG	5.31	1.62	2.23
LR3SSCG	6.25	1.88	2.50
LR4SSCG	8.22	2.50	3.40
LR5SSCG	8.22	2.67	3.48
LR6SSCG	10.48	3.29	4.07

EMT & RIGID LR TYPE

LR1SSCG	83780	1/2"	1#6AWG	10	100	36
LR2SSCG	83781	3/4"	2#6AWG	10	50	28
LR3SSCG	83782	1"	3#6AWG	5	25	17
LR4SSCG	83783	1 1/4"	3#2AWG	2	10	15
LR5SSCG	83784	1 1/2"	3#2AWG	2	10	18
LR6SSCG	83785	2"	3#2/OAWG	—	5	14



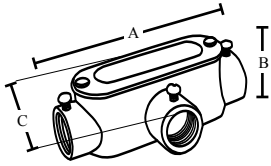

CAT#	A	B	C
T1SSCG	5.35	1.31	2.02
T2SSCG	6.00	1.62	2.22
T3SSCG	7.06	1.88	2.56
T4SSCG	7.25	2.50	3.50
T5SSCG	9.25	2.67	3.50
T6SSCG	11.50	3.29	4.25

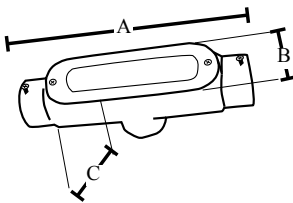

CAT#	A	B	C
TB1SSCG	5.35	1.31	2.02
TB2SSCG	6.00	1.62	2.22
TB3SSCG	7.06	1.88	2.56
TB4SSCG	7.25	2.50	3.50
TB5SSCG	9.25	2.67	3.50
TB6SSCG	11.50	3.29	4.25

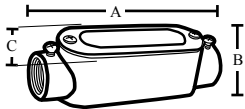

CAT#	A	B	C
C1SSCG	5.35	1.31	1.31
C2SSCG	6.00	1.62	1.48
C3SSCG	7.06	1.88	1.75
C4SSCG	9.25	2.50	2.40
C5SSCG	9.25	2.67	2.40
C6SSCG	11.50	3.29	3.05

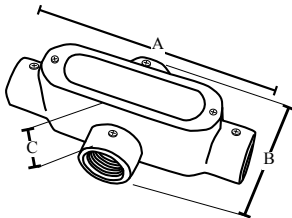

CAT#	A	B	C
X1SSCG	4.75	2.6875	1.625
X2SSCG	5.50	3.00	1.875
X3SSCG	6.50	3.50	2.125
X4SSCG	8.25	4.50	2.75
X5SSCG	8.25	4.50	2.75
X6SSCG	10.50	5.3750	3.625

CONDUIT BODIES WITH COVERS & GASKETS

EMT AND RIGID COMBINATION

• POWDER COATED BODY & COVER **ALUMINUM**

TOPAZ CAT #	UPC#	SIZE	MAX # CONDUCTORS	UNIT CTN	SHIP CASE	WT/ CASE
EMT & RIGID T TYPE						
T1SSCG	83792	1/2"	1# 6AWG	10	100	38
T2SSCG	83793	3/4"	2# 6AWG	10	50	30
T3SSCG	83794	1"	3# 6AWG	5	25	20
T4SSCG	83795	1 1/4"	3# 2AWG	2	10	19
T5SSCG	83796	1 1/2"	3# 2AWG	2	10	21
T6SSCG	83797	2"	3# 2/OAWG	-	5	5



E170258

EMT & RIGID TB TYPE

TB1SSCG	17572	1/2"	1# 6AWG	10	100	38
TB2SSCG	17573	3/4"	2# 6AWG	10	50	30
TB3SSCG	17574	1"	3# 6AWG	5	25	18
TB4SSCG	17575	1 1/4"	3# 2AWG	2	10	17
TB5SSCG	17576	1 1/2"	3# 2AWG	2	10	19
TB6SSCG	17577	2"	3# 2/OAWG	-	5	14



E170258

EMT & RIGID C TYPE

C1SSCG	83786	1/2"	1# 6AWG	10	100	30
C2SSCG	83787	3/4"	2# 6AWG	10	50	25
C3SSCG	83788	1"	3# 6AWG	5	25	18
C4SSCG	83789	1 1/4"	3# 2AWG	2	10	17
C5SSCG	83790	1 1/2"	3# 2AWG	2	10	19
C6SSCG	83791	2"	3# 2/OAWG	-	5	14



E170258

EMT & RIGID X TYPE

X1SSCG	17566	1/2"	1# 6AWG	5	50	20
X2SSCG	17567	3/4"	2# 6AWG	5	25	16
X3SSCG	17568	1"	3# 6AWG	2	10	7
X4SSCG	17569	1 1/4"	3# 2AWG	1	5	9
X5SSCG	17570	1 1/2"	3# 2AWG	1	5	10
X6SSCG	17571	2"	3# 2/OAWG	1	2	6



E170258

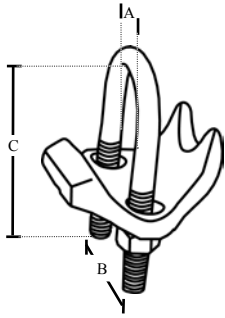

CAT#	A	B	C
1550	.820	1.00	1.12
1551	1.00	1.25	2.50
1552	1.125	1.125	2.8125
1553	1.375	1.375	3.0625
1554	1.75	1.75	3.1875
1555	2.00	2.375	3.50
1556	2.50	2.50	4.50
1557	3.00	3.00	4.875
1558	3.625	3.875	5.375
1559	4.0625	4.5625	5.875
1559A	4.6875	5.0625	6.6875

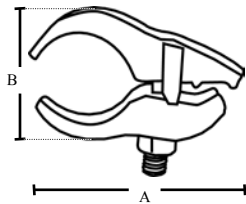

CAT#	A	B
1560	2.00	1.370
1561	2.875	1.4375
1562	3.0625	1.6875
1563	3.25	2.00
1564	3.625	2.125
1565	3.875	2.1875
1566	4.625	2.875
1567	5.25	3.25
1568	5.875	3.875
1569	6.3125	4.3125
1570	6.8125	4.8125



CAT#	A	B
1571	2.8125	2.125
1572	2.9375	2.375
1573	3.0625	2.625
1574	3.0625	3.0625
1575	3.9375	3.25
1576	4.50	4.0625
1577	5.125	4.625
1578	5.75	5.25

RIGHT ANGLE CONDUIT SUPPORT

MALLEABLE IRON

TOPAZ CAT #	UPC#	SIZE	UNIT CTN	SHIP CASE	WT/ CASE
1550	52001	3/8"	-	50	25
1551	52002	1/2"	-	50	40
1552	52003	3/4"	-	50	43
1553	52004	1"	-	50	48
1554	52005	1 1/4"	-	50	53
1555	52006	1 1/2"	-	50	58
1556	52007	2"	-	50	85
1557	52008	2 1/2"	-	25	106
1558	52009	3"	-	25	110
1559	52011	3 1/2"	-	25	128
1559A	52010	4"	-	25	140



PARALLEL CONDUIT SUPPORT

MALLEABLE IRON

TOPAZ CAT #	UPC#	SIZE	UNIT CTN	SHIP CASE	WT/ CASE
1560	52012	3/8"	-	50	32
1561	52013	1/2"	-	50	58
1562	52014	3/4"	-	50	64
1563	52015	1"	-	50	70
1564	52016	1 1/4"	-	25	72
1565	52017	1 1/2"	-	25	93
1566	52018	2"	-	25	100
1567	52019	2 1/2"	-	25	135
1568	52020	3"	-	10	155
1569	52021	3 1/2"	-	10	190
1570	52022	4"	-	10	205



EDGE TYPE CONDUIT SUPPORT

MALLEABLE IRON

TOPAZ CAT #	UPC#	SIZE	UNIT CTN	SHIP CASE	WT/ CASE
1571	52023	1/2"	-	50	67
1572	52024	3/4"	-	50	71
1573	52025	1"	-	25	85
1574	52066	1 1/4"	-	25	91
1575	52027	1 1/2"	-	25	115
1576	52028	2"	-	25	135
1577	52029	2 1/2"	-	10	183
1578	52030	3"	-	10	230



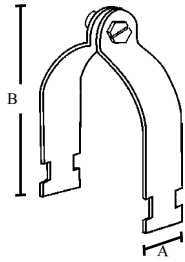

CAT#	A	B
2101	1.24	2.30
2102	1.24	2.46
2103	1.24	2.68
2104	1.24	3.21
2105	1.24	3.42
2106	1.24	4.00
2107	1.24	5.00
2108	1.24	5.55
2109	1.24	6.00
2110	1.24	6.50

STRUT CLAMP

EMT & RIGID

TOPAZ CAT #	UPC#	SIZE	UNIT CTN	SHIP CASE	WT/ CASE
2101	41031	1/2"	-	100	19
2102	41032	3/4"	-	100	21
2103	41033	1"	-	100	23
2104	41034	1 1/4"	-	100	26
2105	41035	1 1/2"	-	50	26
2106	41036	2"	-	50	31
2107	41037	2 1/2"	-	50	32
2108	41038	3"	-	25	18
2109	41039	3 1/2"	-	25	21
2110	41040	4"	-	25	25

ALL SCREWS - 5/16" X 1-1/4" SLOTTED HEX HEAD

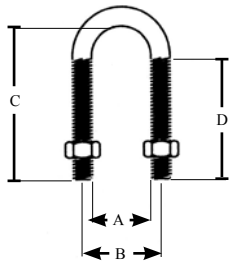

CAT#	A	B	C	D
761	1	1-1/4	2-1/2	1-13/16
762	1-1/8	1-3/8	2-13/16	1-13/16
763	1-3/8	1-5/8	3-1/16	1-13/16
764	1-3/4	2	3-3/16	1-13/16
765	2	2-3/8	3-1/2	1-13/16
766	2-1/2	2-1/2	4-1/2	2-5/8
767	3	3-1/4	4-7/8	2-5/8
768	3-5/8	3-7/8	5-3/8	2-5/8
769	4-1/16	4-9/16	5-7/8	2-5/8
770	4-11/16	5-1/16	6-11/16	2-5/8

U-BOLTS

RIGID, IMC & EMT

TOPAZ CAT #	UPC#	SIZE	BOLT SIZE	UNIT CTN	SHIP CASE	WT/ CASE
761	82541	1/2"	5/16"-18	25	250	13
762	82542	3/4"	5/16"-18	25	250	16
763	82543	1"	5/16"-18	25	250	16
764	82544	1 1/4"	5/16"-18	20	200	16
765	82545	1 1/2"	5/16"-18	20	200	19
766	82546	2"	3/8"-16	20	200	31
767	82547	2 1/2"	3/8"-16	-	10	31
768	82548	3"	3/8"-16	-	10	38
769	82549	3 1/2"	1/2"-16	-	10	41
770	82550	4"	1/2"-16	-	10	43

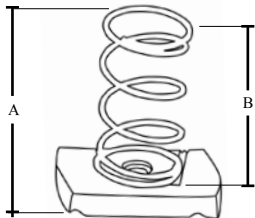

CAT#	A	B
2111	1.50	1.30
2112	1.77	1.35
2113	1.77	1.35

SPRING NUTS

ZINC PLATED STEEL

TOPAZ CAT #	UPC#	SIZE	UNIT CTN	SHIP CASE	WT/ CASE
2111	83691	1/4-20	-	100	7
2112	83692	3/8-16	-	100	10
2113	83693	1/2-13	-	100	12



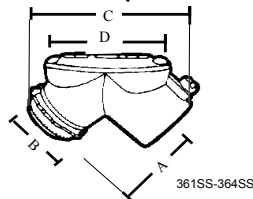
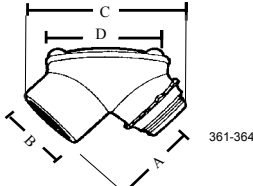
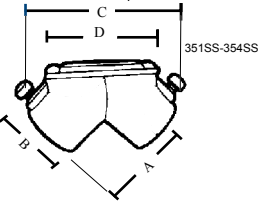

CAT#	A	B	C	D
351/SS	1.31	1.09	2.50	1.78
352/SS	1.43	1.29	2.76	2.13
353/SS	1.95	1.59	3.86	3.17
354/SS	2.26	1.97	4.56	3.25

361/SS	1.31	1.09	2.40	1.80
362/SS	1.47	1.29	2.66	2.14
363/SS	2.80	1.60	3.66	3.16
364/SS	3.13	1.96	5.16	3.24

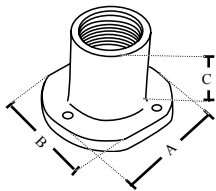

CAT#	A	B	C
1791	1.5	1.75	1.25
1792	2.75	2	1.75
1793	2.5	3.25	1.50

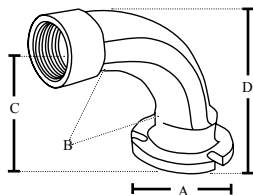

CAT#	A	B	C	D
1891	1.5	1.75	3.12	3.62
1892	2.75	2	3.06	3.68
1893	2.5	3.75	2.93	3.68

RIGID PULL ELBOWS WITH GASKET

TOPAZ CAT #	UPC#	SIZE	UNIT CTN	SHIP CASE	WT/ CASE
ZINC DIE CAST					
RIGID TO RIGID					
351	13510	1/2"	10	100	28
352	13520	3/4"	5	50	17
353	13530	1"	—	25	16
354	13540	1 1/4"	—	20	18

TOPAZ CAT #	UPC#	SIZE	UNIT CTN	SHIP CASE	WT/ CASE
RIGID AND EMT COMBO					
• SET SCREW AND THREADED					
351SS	85030	1/2"	10	100	28
352SS	85031	3/4"	5	50	17
353SS	85032	1"	—	25	16
354SS	85033	1 1/4"	—	20	18

TOPAZ CAT #	UPC#	SIZE	UNIT CTN	SHIP CASE	WT/ CASE
RIGID TO BOX					
361	13550	1/2"	10	100	31
362	13560	3/4"	5	50	18
363	13570	1"	—	25	21
364	13580	1 1/4"	—	20	25

TOPAZ CAT #	UPC#	SIZE	UNIT CTN	SHIP CASE	WT/ CASE
RIGID AND EMT COMBO					
• SET SCREW AND THREADED					
361SS	85034	1/2"	10	100	31
362SS	85035	3/4"	5	50	18
363SS	85036	1"	—	25	21
364SS	85037	1 1/4"	—	20	25



CONCRETE SLAB INSERTS FOR THREADED RIGID CONDUIT

TOPAZ CAT #	UPC#	SIZE	UNIT CTN	SHIP CASE	WT/ CASE
MALLEABLE IRON					
STRAIGHT					
1791	85040	1/2"	—	20	4
1792	85041	3/4"	—	20	4
1793	85042	1"	—	10	6

90°					
1891	85043	1/2"	—	20	13
1892	85044	3/4"	—	20	16
1893	85045	1"	—	10	10



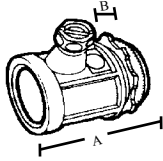

CAT#	A	B
671	1.34	.39
672	1.44	.45

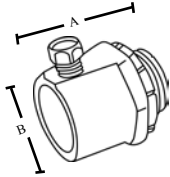

CAT#	A	B
671S/Si	1.125	1.125
672S/Si	1.25	1.375
673S/Si	1.5	1.625
674S/Si	1.75	2
675S/Si	1.875	2.25
676S/Si	2	2.75

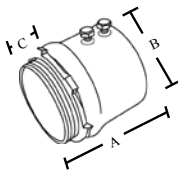

CAT#	A	B	C
637S	3.313	3.563	.750
638S	3.813	4.188	.938
639S	3.938	4.688	.938
640S	4.188	5.188	1.000

2 SCREW

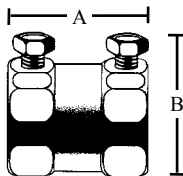

CAT#	A	B
647S	4.25	3.19
648S	4.50	3.19
649S	4.75	4.31
650S	5.00	4.81

681S	1.5	1.125
682S	1.5	1.375
683S	1.875	1.625
684S	2.1875	2
685S	2.625	2.25
686S	2.75	2.75

RIGID CONNECTORS SET SCREW TYPE

- NO THREAD
- CONCRETE TIGHT WHEN TAPED

TOPAZ CAT #	UPC#	SIZE	UNIT CTN	SHIP CASE	WT/ CASE
671	17110	1/2"	50	500	50
672	17120	3/4"	25	250	38

MALLEABLE IRON					
TOPAZ CAT #	UPC#	SIZE	UNIT CTN	SHIP CASE	WT/ CASE
671S	17135	1/2"	25	250	42
672S	17136	3/4"	25	250	22
673S	17137	1"	25	100	27
674S	17138	1 1/4"	5	50	12
675S	17139	1 1/2"	5	50	7
676S	17140	2"	—	20	10

INSULATED THROAT

671Si	17112	1/2"	25	250	42
672Si	17122	3/4"	25	250	22
673Si	17132	1"	25	100	27
674Si	17142	1 1/4"	5	50	12
675Si	17152	1 1/2"	5	50	7
676Si	17162	2"	—	20	10

STEEL					
TOPAZ CAT #	UPC#	SIZE	UNIT CTN	SHIP CASE	WT/ CASE
637S*	23060	2 1/2"	—	12	17
638S*	23070	3"	—	12	22
639S*	23080	3 1/2"	—	6	15
640S*	23090	4"	—	6	17

*EMT & RIGID

RIGID COUPLINGS SET SCREW TYPE

- NO THREAD

STEEL					
TOPAZ CAT #	UPC#	SIZE	UNIT CTN	SHIP CASE	WT/ CASE
647S	23260	2 1/2"	—	12	19
648S	23270	3"	—	12	26
649S	23280	3 1/2"	—	6	15
650S	23290	4"	—	6	17

MALLEABLE IRON					
TOPAZ CAT #	UPC#	SIZE	UNIT CTN	SHIP CASE	WT/ CASE
681S	17150	1/2"	25	250	43
682S	17151	3/4"	25	250	25
683S	17152	1"	25	100	28
684S	17153	1 1/4"	5	50	15
685S	17154	1 1/2"	5	50	9
686S	17155	2"	—	20	12



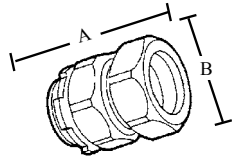

CAT#	A	B
261/i	1.35	1.17
262/i	1.48	1.43
263/i	1.58	1.75
264/i	1.86	2.15
265/i	1.94	2.38
266/i	2.49	3.38

261M	1.50	1.50
262M	1.50	1.63
263M	1.687	2.00
264M	2.00	2.38
265M	2.0625	2.63
266M	2.25	3.31

267/i	3.00	3.75
268/i	3.125	4.25
269/i	3.187	4.75
270/i	3.437	5.312

RIGID CONNECTORS COMPRESSION TYPE

- NO THREAD
- CONCRETE TIGHT

TOPAZ CAT #	UPC#	SIZE	UNIT CTN	SHIP CASE	STEEL WT/ CASE
261	12200	1/2"	20	200	26
262	12210	3/4"	10	100	20
263	12220	1"	5	50	18
264	12230	1 1/4"	5	50	32
265	12240	1 1/2"	—	12	11
266	12250	2"	—	12	14

INSULATED THROAT	STEEL
261i	12201 1/2" 20 200 26
262i	12211 3/4" 10 100 20
263i	12221 1" 5 50 18
264i	12231 1 1/4" 5 50 32
265i	12241 1 1/2" — 12 11
266i	12251 2" — 12 14
267i	12255 2 1/2" — 5 14
268i	12256 3" — 3 13
269i	12257 3 1/2" — 2 13
270i	12258 4" — 2 13

MALLEABLE IRON	
261M	85534 1/2" 20 200 13
262M	85535 3/4" 10 100 20
263M	85536 1" 5 50 36
264M	85537 1 1/4" 5 50 64
265M	85538 1 1/2" — 12 92
266M	85539 2" — 12 117
267	12251 2 1/2" — 5 14
268	12252 3" — 3 13
269	12253 3 1/2" — 2 13
270	12254 4" — 2 13

RIGID COUPLINGS COMPRESSION TYPE

- NO THREAD
- CONCRETE TIGHT

STEEL	
251	12140 1/2" 10 100 16
252	12150 3/4" 10 100 24
253	12160 1" 5 50 24
254	12170 1 1/4" 5 50 43
255	12180 1 1/2" — 12 15
256	12190 2" — 5 8

MALLEABLE IRON	
251M	85528 1/2" 10 100 16
252M	85529 3/4" 10 100 24
253M	85530 1" 5 50 48
254M	85531 1 1/4" 5 50 86
255M	85532 1 1/2" — 12 125
256M	85533 2" — 5 160
257	12131 2 1/2" — 5 260
258	12141 3" — 3 300
259	12151 3 1/2" — 2 350
260	12161 4" — 2 400

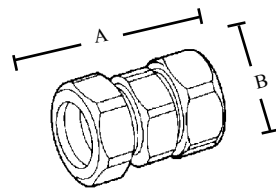

CAT#	A	B
251	1.74	1.17
252	1.82	1.43
253	1.95	1.75
254	2.65	2.15
255	2.70	2.37
256	2.93	3.38

251M	1.81	1.50
252M	1.87	1.62
253M	2.18	2.00
254M	2.62	2.37
255M	2.68	2.62
256M	3.00	3.31
257	5.75	3.93
258	5.72	4.66
259	6.00	5.20
260	6.81	5.75



E170258



E170258



E170258



E170258



E170258

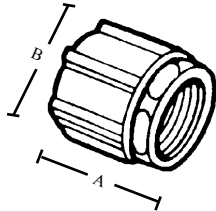

CAT#	A	B
851	1.43	1.36
852	1.63	1.58
853	1.81	1.89
854	2.19	2.38
855	2.31	2.83
856	2.44	3.29

857	2.52	4.03
858	2.58	4.62
859	2.65	5.35
860	3.42	5.87
860A	4.38	7.00
860B	4.38	8.25

851S	1.43	1.31
852S	1.52	1.61
853S	1.70	2.13
854S	2.13	2.40
855S	2.18	2.89
856S	2.36	3.40

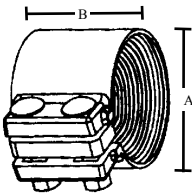

CAT#	A	B
76	1.95	3.35
77	3.25	4.75
78	3.25	5.50
79	3.35	5.75
80	3.40	6.25

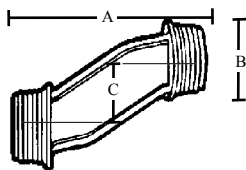

CAT#	A	B	C
111/i	2.460	1.000	.750
112/i	2.560	1.220	.750
113/i	2.560	1.525	.750
114/i	2.910	1.910	.750
115/i	3.080	2.125	.750
116/i	3.145	2.665	.750
117	3.970	3.280	.750
118	4.420	3.795	.750

RIGID COUPLINGS

THREE PIECE TYPE

MALLEABLE IRON

TOPAZ CAT #	UPC#	SIZE	UNIT CTN	SHIP CASE	WT/ CASE
851	18630	1/2"	20	200	40
852	18640	3/4"	10	100	30
853	18650	1"	5	50	23
854	18660	1 1/4"	5	50	55
855	18670	1 1/2"	3	30	44
856	18680	2"	—	20	44

857	18690	2 1/2"	—	10	37
858	18700	3"	—	5	20
859	18710	3 1/2"	—	5	29
860	18720	4"	—	2	18
860A	18722	5"	—	1	12
860B	18724	6"	—	1	21

STEEL					
TOPAZ CAT #	UPC#	SIZE	UNIT CTN	SHIP CASE	WT/ CASE
851S	18631	1/2"	20	200	20
852S	18641	3/4"	10	100	30
853S	18651	1"	5	50	46
854S	18661	1 1/4"	5	50	110
855S	18671	1 1/2"	3	30	147
856S	18681	2"	—	20	220

SLIP-ON TYPE

MALLEABLE IRON

76*	70400	2"	5	25	26
77*	70410	2 1/2"	2	10	23
78*	70420	3"	2	10	30
79*	70430	3 1/2"	1	5	19
80*	70440	4"	1	5	20

*A neoprene gasket makes a concrete tight seal. Used when conduit cannot be turned.

RIGID OFFSET NIPPLES

3/4" OFFSET

ZINC DIE CAST

TOPAZ CAT #	UPC#	SIZE	UNIT CTN	SHIP CASE	WT/ CASE
111	10610	1/2"	10	100	12
112	10620	3/4"	10	100	16
113	10630	1"	10	100	22
114	10640	1 1/4"	5	50	17
115	10650	1 1/2"	5	50	23
116	10660	2"	2	20	13
117	10670	2 1/2"	—	2	13
118	10680	3"	—	2	6

INSULATED THROAT

111i	10611	1/2"	10	100	12
112i	10621	3/4"	10	100	16
113i	10631	1"	10	100	22
114i	10641	1 1/4"	5	50	17
115i	10651	1 1/2"	5	50	23
116i	10661	2"	2	20	13



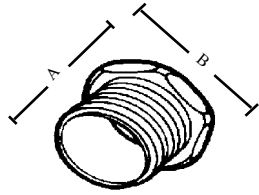

CAT#	A	B
751/751i	.68	1.02
751A	1.00	1.02
752A	1.00	1.29
752/752i	.75	1.29
753/753i	.87	1.53
754/754i	.94	1.89
755/755i	.91	2.30
756/756i	1.07	2.88
757/757i	1.38	3.39
758/758i	1.44	4.06
759/759i	1.47	4.61
760/760i	1.47	5.15

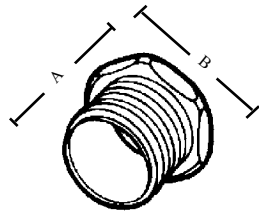

CAT#	A	B
751M/751Mi	.68	1.02
752M/752Mi	.75	1.29
753M/753Mi	.87	1.53
754M/754Mi	.94	1.89
755M/755Mi	.91	2.30
756M/756Mi	1.07	2.88
757M/757Mi	1.38	3.39
758M/758Mi	1.44	4.06
759M/759Mi	1.47	4.61
760M/760Mi	1.47	5.15
760A	2.352	6.0
760B	2.180	7.0

RIGID CONDUIT NIPPLES

ZINC DIE CAST

TOPAZ CAT #	UPC#	SIZE	UNIT CTN	SHIP CASE	WT/ CASE
751	17860	1/2"	100	1000	40
751A	17859	1/2" x 1" L	—	100	5
752	17870	3/4"	50	500	30
752A	17851	3/4" x 1" L	—	50	25
753	17880	1"	25	250	25
754	17890	1 1/4"	25	250	35
755	17900	1 1/2"	25	100	20
756	17910	2"	10	40	13
757	17920	2 1/2"	10	40	17
758	17930	3"	10	40	22
759	17940	3 1/2"	10	40	27
760	17950	4"	5	20	14

INSULATED THROAT

751i	17861	1/2"	100	1000	40
752i	17871	3/4"	50	500	30
753i	17881	1"	25	250	25
754i	17891	1 1/4"	25	250	35
755i	17901	1 1/2"	25	100	20
756i	17911	2"	10	40	13
757i	17921	2 1/2"	10	40	17
758i	17931	3"	10	40	22
759i	17941	3 1/2"	10	40	27
760i	17951	4"	5	20	14

MALLEABLE IRON

751M	17862	1/2"	100	1000	5
752M	17872	3/4"	50	500	7
753M	17882	1"	25	250	12
754M	17892	1 1/4"	25	250	15
755M	17902	1 1/2"	25	250	22
756M	17912	2"	10	40	35
757M	17922	2 1/2"	10	40	76
758M	17932	3"	10	40	101
759M	17942	3 1/2"	10	40	124
760M	17943	4"	5	20	200
760A	17952	5"	—	1	75
760B	17953	6"	—	1	65

INSULATED THROAT

751Mi	17863	1/2"	100	1000	7
752Mi	17873	3/4"	50	500	7
753Mi	17883	1"	25	250	12
754Mi	17893	1 1/4"	25	250	15
755Mi	17903	1 1/2"	25	250	22
756Mi	17913	2"	10	40	35
757Mi	17923	2 1/2"	10	40	76
758Mi	17933	3"	10	40	101
759Mi	17943	3 1/2"	10	40	124
760Mi	17944	4"	5	20	200



E148716



E148716



E148716



E148716

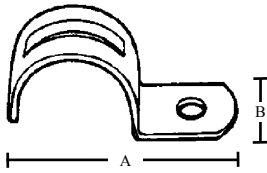

CAT#	A	B
531A	1.51	.562
531B	1.81	.562
531	1.91	.625
532	2.21	.750
533	2.57	.875
534	2.79	.880
535	3.69	.899
536	4.17	1.140
517	5.00	1.280
518	5.55	1.280
519	6.37	1.280
520	6.87	1.280
520A	9.00	1.500
520B	10.35	1.50

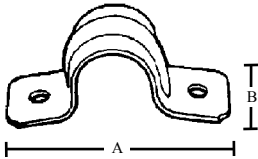

CAT#	A	B
541A	2.15	.562
541B	2.20	.562
541	2.43	.625
542	2.81	.685
543	3.28	.750
544	4.02	.875
545	4.58	1.00
546	5.22	1.00
527	5.91	1.00
528	6.71	1.00
529	7.51	1.00
530	8.31	1.00
530A	10.60	1.25
530B	11.85	1.25

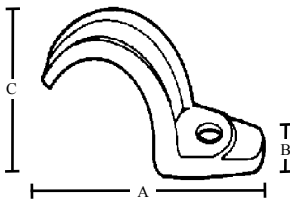

CAT#	A	B	C
561	2.250	.660	.94
562	2.560	.750	1.22
563	3.060	.810	1.50
564	3.690	.880	1.88
565	4.000	1.00	2.06
566	5.060	1.130	2.56
567	5.940	1.380	3.06
568	7.440	1.630	3.81
569	8.190	1.810	4.38
570	8.690	2.000	5.00
570A	9.3750	2.68750	6.00
570B	10.375	3.1250	7.00

RIGID STRAPS

TOPAZ CAT #	UPC#	SIZE	UNIT CTN	SHIP CASE	WT/ CASE
STEEL					
ONE HOLE					
• SNAP-ON TYPE 1/2" - 2"					
531A	15041	1/4"	100	1000	20
531B	15045	3/8"	100	1000	20
531	15050	1/2"	50	500	21
532	15060	3/4"	50	500	15
533	15070	1"	25	250	25
534	15080	1 1/4"	20	200	20
535	15090	1 1/2"	20	200	32
536	15100	2"	10	100	22
517*	15670	2 1/2"	—	50	21
518*	15680	3"	—	25	13
519*	15690	3 1/2"	—	25	18
520*	15700	4"	—	25	20
520A*	15702	5"	—	10	5
520B*	15704	6"	—	10	6

* EMT & RIGID

TWO HOLE

541A	15043	1/4"	100	1000	18
541B	15046	3/8"	100	1000	18
541	15150	1/2"	50	500	13
542	15160	3/4"	50	500	16
543	15170	1"	25	250	12
544	15180	1 1/4"	20	200	13
545	15190	1 1/2"	10	100	12
546	15200	2"	—	50	7
527*	15010	2 1/2"	—	25	6
528*	15020	3"	—	25	7
529*	15030	3 1/2"	—	25	8
530*	15040	4"	—	25	7
530A*	15042	5"	—	10	5
530B*	15044	6"	—	10	6

* EMT & RIGID

ONE HOLE MALLEABLE IRON ZINC PLATED

561	15350	1/2"	100	1000	40
562	15360	3/4"	50	500	25
563	15370	1"	25	250	20
564	15380	1 1/4"	20	200	20
565	15390	1 1/2"	10	100	16
566	15400	2"	—	25	9
567	15410	2 1/2"	—	25	17
568	15420	3"	—	25	25
569	15430	3 1/2"	—	10	15
570	15440	4"	—	10	22
570A	15441	5"	—	10	35
570B	15442	6"	—	10	45



E170258



E170258



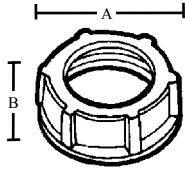

CAT#	A	B
301	1.053	.37
302	1.327	.37
303	1.584	.47
304	1.952	.50
305	2.201	.52
306	2.693	.52
307	3.235	.85
308	3.855	.85
309	4.359	.85
310	5.011	.85

301M	1.223	.48
302M	1.498	.49
303M	1.818	.56
304M	2.423	.61
305M	2.512	.68
306M	3.053	.68
307M	3.624	.85
308M	4.172	.91
309M	4.767	1.00
310M	5.321	1.06
310AM	6.15	1.30
310BM	7.19	1.30

301CB	1.053	.37
302CB	1.327	.37
303CB	1.584	.37
304CB	1.952	.50
305CB	2.201	.52
306CB	2.093	.52
307CB	3.235	.85
308CB	3.855	.85
309CB	4.359	.85
310CB	5.011	.85
310ACB	6.15	1.30
310BCB	7.25	1.125

RIGID CONDUIT BUSHINGS

ZINC DIE CAST

TOPAZ CAT #	UPC#	SIZE	UNIT CTN	SHIP CASE	WT/ CASE
301	12530	1/2"	100	1000	30
302	12540	3/4"	100	1000	50
303	12550	1"	50	500	30
304	12560	1 1/4"	25	250	25
305	12570	1 1/2"	25	250	38
306	12580	2"	25	100	17
307	12590	2 1/2"	10	100	36
308	12600	3"	—	10	5
309	12610	3 1/2"	—	10	6
310	12620	4"	—	10	7



MALLEABLE IRON

301M	12630	1/2"	100	1000	50
302M	12640	3/4"	50	500	30
303M	12650	1"	50	500	24
304M	12660	1 1/4"	25	250	30
305M	12670	1 1/2"	—	25	22
306M	12680	2"	—	25	35
307M	12690	2 1/2"	—	15	20
308M	12700	3"	—	10	10
309M	12710	3 1/2"	—	10	13
310M	12720	4"	—	10	20
310AM	12622	5"	—	10	25
310BM	12623	6"	—	10	35



RIGID CAPPED BUSHINGS

STEEL CAP

ZINC DIE CAST

TOPAZ CAT #	UPC#	SIZE	UNIT CTN	SHIP CASE	WT/ CASE
301CB	12531	1/2"	100	1000	5
302CB	12541	3/4"	100	1000	7
303CB	12551	1"	50	500	11
304CB	12561	1 1/4"	25	250	17
305CB	12571	1 1/2"	25	250	21
306CB	12581	2"	25	1000	34
307CB	12591	2 1/2"	10	100	48
308CB	12601	3"	10	100	61
309CB	12611	3 1/2"	—	10	70
310CB	12631	4"	—	10	125
310ACB	12621	5"	—	10	78
310BCB	85152	6"	—	10	85



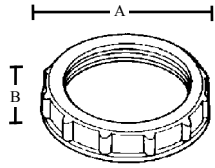

INSULATING PLASTIC BUSHINGS

105°C FLAME RETARDANT

THERMOPLASTIC

CAT#	A	B
831	1.06	.43
832	1.31	.43
833	1.59	.48
834	1.96	.56
835	2.18	.56
836	2.68	.59
837	3.25	.72
838	3.87	.75
839	4.37	.77
840	5.00	.77
840A	6.25	1.00
840B	7.50	1.00

TOPAZ CAT #	UPC#	SIZE	UNIT CTN	SHIP CASE	WT/ CASE
831	18450	1/2"	100	1000	6
832	18460	3/4"	100	1000	9
833	18470	1"	50	500	11
834	18480	1 1/4"	25	250	5
835	18490	1 1/2"	25	250	7
836	18500	2"	20	200	12
837	18510	2 1/2"	—	50	5
838	18520	3"	—	25	3
839	18530	3 1/2"	—	25	5
840	18540	4"	—	10	7
840A	18550	5"	—	10	3
840B	18560	6"	—	10	4

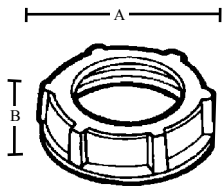

RIGID BUSHINGS

INSULATED

• 105° C. THERMOPLASTIC LINERS

ZINC DIE CAST

CAT#	A	B
311	1.053	.394
312	1.327	.394
313	1.584	.477
314	1.952	.503
315	2.201	.522
316	2.693	.564
317	3.235	.866
318	3.855	.866
319	4.359	.866
320	5.011	.866

TOPAZ CAT #	UPC#	SIZE	UNIT CTN	SHIP CASE	WT/ CASE
311	12730	1/2"	100	1000	30
312	12740	3/4"	50	500	20
313	12750	1"	50	500	40
314	12760	1 1/4"	25	250	25
315	12770	1 1/2"	25	250	30
316	12780	2"	—	100	14
317	12790	2 1/2"	—	50	20
318	12800	3"	—	25	12
319	12810	3 1/2"	—	25	14
320	12820	4"	—	10	6



CAT#	A	B
311M	1.223	.506
312M	1.498	.547
313M	1.818	.662
314M	2.423	.735
315M	2.512	.808
316M	3.053	.808
317M	3.624	.958
318M	4.172	1.052
319M	4.767	1.169
320M	5.321	1.178
320AM	6.15	1.30
320BM	7.19	1.30

MALLEABLE IRON

CAT#	UPC#	SIZE	UNIT CTN	SHIP CASE	WT/ CASE
311M	12830	1/2"	100	1000	20
312M	12840	3/4"	50	500	20
313M	12850	1"	50	500	40
314M	12860	1 1/4"	25	250	43
315M	12870	1 1/2"	25	100	25
316M	12880	2"	10	100	30
317M	12890	2 1/2"	—	50	20
318M	12900	3"	—	25	13
319M	12910	3 1/2"	—	25	18
320M	12920	4"	—	10	10
320AM	12922	5"	—	10	25
320BM	12924	6"	—	10	35



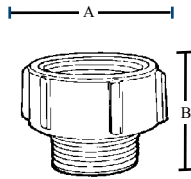

CAT#	A	B
981	1.35	1.40
982	1.62	1.40

RIGID MALE ENLARGERS

ZINC DIE CAST

TOPAZ CAT #	UPC#	SIZE	UNIT CTN	SHIP CASE	WT/ CASE
981	19640	1/2"M x 3/4"F	25	250	50
982	19650	3/4"M x 1"F	10	100	12

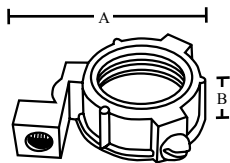

CAT#	A	B
321	1.25	.50
322	1.50	.50
323	1.75	.56
324	2.12	.62
325	2.37	.75
326	2.81	.75
327	3.62	.93
328	4.18	.93
329	4.68	.93
330	5.25	.93
321M	1.25	.50
322M	1.48	.54
323M	1.80	.65
324M	2.40	.73
325M	2.50	.80
326M	3.03	.80
327M	3.60	.95
328M	4.16	1.03
329M	4.75	1.15
330M	5.30	1.17
330AM	6.15	1.130
330BM	7.19	1.130

INSULATED METALLIC GROUNDING BUSHINGS WITH ALUMINUM LUG

- FOR COPPER OR ALUMINUM BARE GROUND WIRE
- 105° C. THERMOPLASTIC LINERS

ZINC DIE CAST

TOPAZ CAT #	UPC#	SIZE	GROUNDING LUG WIRE SIZE		UNIT CTN	SHIP CASE	WT/ CASE
			MIN	MAX			
321	12930	1/2"	14	4	50	500	25
322	12940	3/4"	14	4	50	500	35
323	12950	1"	14	4	25	250	30
324	12960	1 1/4"	14	4	20	200	34
325	12970	1 1/2"	14	2	10	100	20
326	12980	2"	14	2	10	100	35
327	12990	2 1/2"	14	1/0	—	50	25
328	13000	3"	14	1/0	—	10	6
329	13010	3 1/2"	14	2/0	—	10	7
330	13020	4"	6	250 MCM	—	10	8



E148716

MALLEABLE IRON

321M	13030	1/2"	14	4	50	500	25
322M	13040	3/4"	14	4	50	500	30
323M	13050	1"	14	4	25	250	23
324M	13060	1 1/4"	14	4	20	200	34
325M	13070	1 1/2"	14	2	25	250	53
326M	13080	2"	14	2	25	250	78
327M	13090	2 1/2"	14	1/0	—	10	4
328M	13100	3"	14	1/0	—	10	5
329M	13110	3 1/2"	14	2/0	—	10	15
330M	13120	4"	14	2/0	—	10	20
330AM	13122	5"	6	250 MCM	—	10	25
330BM	13124	6"	6	250 MCM	—	10	35



E170258

INSULATED METALLIC GROUNDING BUSHINGS WITH ALUMINUM LAY-IN LUG

- 105° C. THERMOPLASTIC LINERS
 - FOR COPPER OR ALUMINUM BARE GROUND CONNECTOR
- ZINC DIE CAST**

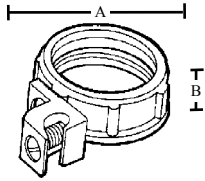

CAT#	A	B
331	1.25	.50
332	1.50	.50
333	1.75	.56
334	2.12	.62
334A	2.12	.62
335	2.37	.75
335A	2.37	.75
336	2.81	.75
336A	2.81	.75
337	3.62	.93
337A	3.62	.93
338	4.18	.93
338A	4.18	.93
339	4.68	.93
339A	4.68	.93
340	5.25	.93
340A	5.25	.93

331M	1.25	.50
332M	1.48	.54
333M	1.80	.65
334M	2.40	.73
334AM	2.40	.73
335M	2.50	.80
335AM	2.50	.80
336M	3.03	.80
336AM	3.03	.80
337M	3.60	.95
337AM	3.60	.95
338M	4.16	1.03
338AM	4.16	1.03
339M	4.75	1.15
339AM	4.75	1.15
340M	5.30	1.17
340AM	6.15	1.30
340ALM	6.15	1.30
340BLM	7.19	1.30

331MSS	1.25	.50
332MSS	1.48	.54
333MSS	1.80	.65
334MSS	2.40	.73
335MSS	2.50	.80
336MSS	3.03	.80
337MSS	3.60	.95
338MSS	4.16	1.03
339MSS	4.75	1.15
340MSS	5.30	1.17
340AMSS	6.15	1.30
340BMSS	7.19	1.30

GROUNDING LUG

TOPAZ CAT #	UPC#	SIZE	WIRE SIZE MIN	WIRE SIZE MAX	UNIT CTN	SHIP CASE	WT/ CASE
331	13130	1/2"	14	4	50	500	30
332	13140	3/4"	14	4	50	500	35
333	13150	1"	14	4	25	250	23
334	13160	1 1/4"	14	4	20	200	26
334A	13170	1 1/4"	14	1/0	20	200	26
335	13180	1 1/2"	14	4	10	100	16
335A	13190	1 1/2"	14	1/0	10	100	16
336	13200	2"	14	4	10	100	21
336A	13210	2"	14	1/0	10	100	21
337	13220	2 1/2"	14	1/0	—	50	20
337A	13230	2 1/2"	6	250 MCM	—	50	20
338	13240	3"	14	1/0	—	50	29
338A	13250	3"	6	250 MCM	—	50	29
339	13260	3 1/2"	14	1/0	—	10	15
339A	13270	3 1/2"	6	250 MCM	—	10	15
340	13280	4"	14	1/0	—	10	20
340A	13290	4"	6	250 MCM	—	10	20

MALLEABLE IRON

331M	13300	1/2"	14	4	50	500	45
332M	13310	3/4"	14	4	50	500	50
333M	13320	1"	14	4	25	250	40
334M	13330	1 1/4"	14	4	20	200	35
334AM	13340	1 1/4"	14	1/0	20	200	35
335M	13350	1 1/2"	14	4	10	100	25
335AM	13360	1 1/2"	14	1/0	10	100	25
336M	13370	2"	14	4	10	100	30
336AM	13380	2"	14	1/0	10	100	30
337M	13390	2 1/2"	14	1/0	—	50	25
337AM	13400	2 1/2"	6	250 MCM	—	50	25
338M	13410	3"	14	1/0	—	25	18
338AM	13420	3"	6	250 MCM	—	25	18
339M	13430	3 1/2"	14	1/0	—	10	20
339AM	13440	3 1/2"	6	250 MCM	—	10	20
340M	13450	4"	14	1/0	—	10	25
340AM	13460	4"	6	250 MCM	—	10	25
340ALM	13462	5"	6	250 MCM	—	10	25
340BLM	13463	6"	6	250 MCM	—	10	35

SET SCREW NO THREAD

331MSS	13321	1/2"	14	4	50	500	25
332MSS	13331	3/4"	14	4	50	500	30
333MSS	13341	1"	14	4	25	250	23
334MSS	13351	1 1/4"	14	4	20	200	30
335MSS	13361	1 1/2"	14	4	10	100	25
336MSS	13371	2"	14	4	10	100	30
337MSS	13391	2 1/2"	14	1/0	5	50	38
338MSS	13411	3"	14	1/0	—	25	35
339MSS	13431	3 1/2"	14	1/0	—	10	15
340MSS	13451	4"	14	1/0	—	10	20
340AMSS	13461	5"	6	250MCM	—	10	25
340BMSS	13471	6"	6	250MCM	—	10	35



E170258



E170258



E170258

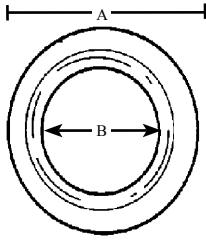

CAT#	A	B
900	1.420	.870
901	1.710	.870
902	1.710	1.060
903	2.080	.870
904	2.080	1.125
905	2.080	1.380
906	2.635	.870
907	2.635	1.060
908	2.635	1.335
909	2.635	1.690
910	3.265	.870
911	3.265	1.060
912	3.265	1.335
913	3.265	1.690
914	3.265	1.935
915	3.265	.870
916	3.265	1.060
917	3.265	1.370
918	3.265	1.750
919	3.265	1.995
920	3.265	2.425
921	4.490	.870
922	4.490	1.060
923	4.490	1.360
924	4.490	1.750
925	4.490	1.995
926	4.490	2.400
927	4.490	2.940
928	5.000	.870
929	5.000	1.060
930	5.000	1.380
931	5.000	1.710
932	5.000	1.980
933	5.000	2.435
934	5.000	2.920
935	5.000	3.560
936	5.500	.870
937	5.500	1.060
938	5.500	1.380
939	5.500	1.715
940	5.500	1.970
941	5.500	2.435
942	5.500	2.920
943	5.500	3.560
944	5.500	4.050

REDUCING WASHERS

TOPAZ CAT #	UPC#	SIZE	UNIT CTN	SHIP CASE	STEEL WT/ CASE
900	19050	3/4" x 1/2"	100	100	2
901	19060	1" x 1/2"	100	100	2
902	19070	1" x 3/4"	100	100	2
903	19080	1 1/4" x 1/2"	50	50	2
904	19090	1 1/4" x 3/4"	50	50	2
905	19100	1 1/4" x 1"	50	50	1
906	19110	1 1/2" x 1/2"	50	50	2
907	19120	1 1/2" x 3/4"	50	50	4
908	19130	1 1/2" x 1"	50	50	4
909	19140	1 1/2" x 1 1/4"	50	50	2
910	19150	2" x 1/2"	25	25	2
911	19160	2" x 3/4"	25	25	2
912	19170	2" x 1"	25	25	2
913	19180	2" x 1 1/4"	25	25	2
914	19190	2" x 1 1/2"	25	25	2
915	19200	2 1/2" x 1/2"	25	25	2
916	19210	2 1/2" x 3/4"	25	25	2
917	19220	2 1/2" x 1"	25	25	2
918	19230	2 1/2" x 1 1/4"	25	25	2
919	19240	2 1/2" x 1 1/2"	25	25	1
920	19250	2 1/2" x 2"	25	25	1
921	19260	3" x 1/2"	25	25	6
922	19270	3" x 3/4"	25	25	5
923	19280	3" x 1"	25	25	5
924	19290	3" x 1 1/4"	25	25	4
925	19300	3" x 1 1/2"	25	25	3
926	19310	3" x 2"	25	25	2
927	19320	3" x 2 1/2"	25	25	2
928	19330	3 1/2" x 1/2"	10	10	3
929	19340	3 1/2" x 3/4"	10	10	3
930	19350	3 1/2" x 1"	10	10	3
931	19360	3 1/2" x 1 1/4"	10	10	3
932	19370	3 1/2" x 1 1/2"	10	10	3
933	19380	3 1/2" x 2"	10	10	3
934	19390	3 1/2" x 2 1/2"	10	10	2
935	19400	3 1/2" x 3"	10	10	2
936	19410	4" x 1/2"	10	10	3
937	19420	4" x 3/4"	10	10	3
938	19430	4" x 1"	10	10	3
939	19440	4" x 1 1/4"	10	10	2
940	19450	4" x 1 1/2"	10	10	2
941	19460	4" x 2"	10	10	2
942	19470	4" x 2 1/2"	10	10	2
943	19480	4" x 3"	10	10	2
944	19490	4" x 3 1/2"	10	10	1



REDUCING BUSHINGS

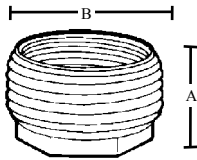

CAT#	A	B
RB1	.563	.750
RB2	.650	.920
RB3	.715	1.125
RB4	.715	1.125
RB5	.820	1.470
RB6	.820	1.470
RB7	.820	1.470
RB8	.850	1.700
RB9	.850	1.700
RB10	.850	1.700
RB11	.850	1.700
RB12	.970	2.230
RB13	.970	2.230
RB14	.970	2.230
RB15	.970	2.230
RB16	.970	2.230
RB17	1.563	2.750
RB18	2.090	2.845
RB19	1.125	2.820
RB20	1.200	3.485
RB21	2.100	3.445
RB22	2.020	3.460
RB23	2.000	3.380
RB24	1.390	4.395
RB25	1.905	4.575
RB26	1.905	4.575
RB27	2.020	3.945
RB28	1.385	4.920
RB29	2.070	5.220
RB30	2.070	5.220
RB31	1.775	5.250
RB32	1.400	5.250

		STEEL			
TOPAZ CAT #	UPC#	SIZE	UNIT CTN	SHIP CASE	WT/ CASE
RB1	20060	1/2" x 3/8"	—	100	4
RB2	20070	3/4" x 1/2"	—	100	4
RB3	20080	1" x 1/2"	—	50	6
RB4	20090	1" x 3/4"	—	50	3
RB5	20100	1 1/4" x 1/2"	—	25	7
RB6	20110	1 1/4" x 3/4"	—	25	6
RB7	20120	1 1/4" x 1"	—	25	4
RB8	20130	1 1/2" x 1/2"	—	25	10
RB9	20140	1 1/2" x 3/4"	—	25	9
RB10	20150	1 1/2" x 1"	—	25	7
RB11	20160	1 1/2" x 1 1/4"	—	25	3
RB12	20170	2" x 1/2"	—	10	5
RB13	20180	2" x 3/4"	—	10	8
RB14	20190	2" x 1"	—	10	7
RB15	20200	2" x 1 1/4"	—	10	5
RB16	20210	2" x 1 1/2"	—	10	4



		MALLEABLE IRON			
TOPAZ CAT #	UPC#	SIZE	UNIT CTN	SHIP CASE	WT/ CASE
RB17	20220	2 1/2" x 1"	—	10	9
RB18	20230	2 1/2" x 1 1/4"	—	10	9
RB19	20240	2 1/2" x 1 1/2"	—	10	8
RB20	20250	2 1/2" x 2"	—	10	5
RB21	20260	3" x 1 1/4"	—	10	11
RB22	20270	3" x 1 1/2"	—	10	11
RB23	20280	3" x 2"	—	10	11
RB24	20290	3" x 2 1/2"	—	10	10
RB25	20300	3 1/2" x 1 1/2"	—	10	20
RB26	20310	3 1/2" x 2"	—	10	10
RB27	20320	3 1/2" x 2 1/2"	—	10	9
RB28	20330	3 1/2" x 3"	—	10	15
RB29	20340	4" x 2"	—	10	11
RB30	20350	4" x 2 1/2"	—	10	15
RB31	20360	4" x 3"	—	10	13
RB32	20370	4" x 3 1/2"	—	10	13



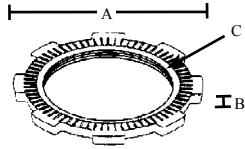

CAT#	A	B	C
241	1.12	.15	.787-.797
242	1.33	.15	.999-1.009
243	1.68	.19	1.250-1.260
244	2.15	.19	1.595-1.605
245	2.35	.19	1.837-1.847
246	2.89	.19	2.307-2.317
247	3.43	.25	2.777-2.788
248	4.12	.25	3.403-3.414
249	4.67	.27	3.892-3.904
250	5.25	.27	4.399-4.411

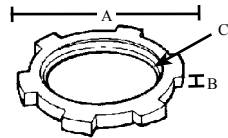

CAT#	A	B	C
281	1.15	.110	.787-.797
282	1.45	.115	.999-1.009
283	1.75	.140	1.250-1.260
284	2.10	.140	1.595-1.605
285	2.40	.140	1.837-1.847
286	2.95	.140	2.307-2.317
287	3.55	.185	2.777-2.788
288	3.55	.190	3.403-3.414
289	4.20	.190	3.892-3.904
290	4.75	.190	4.399-4.411
290A	6.67	.900	5.488-5.500
290B	7.93	.400	6.545-6.557

C=THREAD PITCH DIAMETER

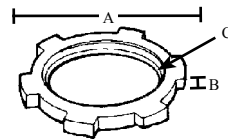

CAT#	A	B	C
281UL	1.115	.125	.787-.797
282UL	1.375	.125	.999-1.009
283UL	1.6875	.170	1.250-1.260
284UL	2.050	.170	1.595-1.605
285UL	2.345	.170	1.837-1.847
286UL	2.845	.170	2.307-2.317
287UL	3.520	.170	2.777-2.788
288UL	4.215	.170	3.403-3.414
289UL	4.735	.170	3.892-3.904
290UL	5.275	.170	4.399-4.411

C=THREAD PITCH DIAMETER

RIGID LOCKNUTS

ZINC DIE CAST

TOPAZ CAT #	UPC#	SIZE	THREADS PER INCH	UNIT CTN	SHIP CASE	WT/ CASE
241	12040	1/2"	14	200	2000	20
242	12050	3/4"	14	100	1000	20
243	12060	1"	11 1/2	100	1000	20
244	12070	1 1/4"	11 1/2	50	500	20
245	12080	1 1/2"	11 1/2	50	500	20
246	12090	2"	11 1/2	50	200	12
247	12100	2 1/2"	8	25	100	13
248	12110	3"	8	25	100	18
249	12120	3 1/2"	8	10	40	13
250	12130	4"	8	10	40	15



E148716

STEEL

281	12300	1/2"	14	100	2000	20
282	12310	3/4"	14	100	1000	20
283	12320	1"	11 1/2	100	1000	30
284	12330	1 1/4"	11 1/2	50	500	20
285	12340	1 1/2"	11 1/2	50	500	30
286	12350	2"	11 1/2	25	250	20
287	12360	2 1/2"	8	—	50	6
288	12370	3"	8	—	50	9
289	12380	3 1/2"	8	—	25	6
290	12390	4"	8	—	25	7
290A	12400	5"	8	—	10	5
290B	12410	6"	8	—	10	8



281UL	86392	1/2"	14	200	2000	23
282UL	86393	3/4"	14	100	1000	23
283UL	86394	1"	11 1/2	100	1000	33
284UL	86395	1 1/4"	11 1/2	50	500	23
285UL	86396	1 1/2"	11 1/2	50	500	33
286UL	86397	2"	11 1/2	25	250	23
287UL	86398	2 1/2"	8	—	50	8
288UL	86399	3"	8	—	50	12
289UL	86400	3 1/2"	8	—	25	9
290UL	86401	4"	8	—	25	10



SEALING LOCKNUTS

• ZINC PLATED WITH PVC MOLDED GASKET

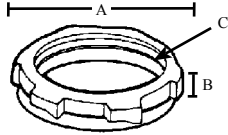

CAT#	A	B	C
711	1.12	.26	.787-.797
712	1.37	.27	.999-1.009
713	1.75	.28	1.250-1.260
714	2.06	.32	1.595-1.605
715	2.37	.32	1.837-1.847
716	2.87	.32	2.307-2.317
717	3.43	.32	2.777-2.788
718	4.12	.32	3.403-3.414
719	4.62	.32	3.892-3.904
720	5.18	.32	4.399-4.411
720A	6.67	.50	5.488-5.500
720B	7.83	.52	6.545-6.567

C=THREAD PITCH DIAMETER

TOPAZ CAT #	UPC#	SIZE	THREADS PER INCH	UNIT CTN	SHIP CASE	WT/ CASE
711	17450	1/2"	14	50	500	10
712	17460	3/4"	14	50	500	16
713	17470	1"	11 1/2	25	250	4
714	17480	1 1/4"	11 1/2	10	100	8
715	17490	1 1/2"	11 1/2	10	100	8
716	17500	2"	11 1/2	10	100	12
717	17510	2 1/2"	8	—	25	5
718	17520	3"	8	—	25	5
719	17530	3 1/2"	8	—	25	6
720	17540	4"	8	—	25	6
720A	85017	5"	8	—	5	6
720B	17542	6"	8	—	5	10

STEEL



E321980

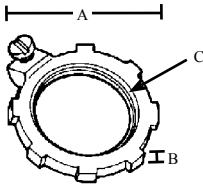

CAT#	A	B	C
551	1.15	.110	.787-.797
552	1.45	.115	.999-1.009
553	1.75	.140	1.250-1.260
554	2.10	.140	1.595-1.605
555	2.40	.140	1.837-1.847
556	2.95	.140	2.307-2.317
557	3.55	.185	2.777-2.788
558	3.55	.190	3.403-3.414
559	4.20	.190	3.892-3.904
560	4.75	.190	4.399-4.411

C=THREAD PITCH DIAMETER

GROUNDING LOCKNUTS

TOPAZ CAT #	UPC#	SIZE	THREADS PER INCH	UNIT CTN	SHIP CASE	WT/ CASE
551	15250	1/2"	14	100	1000	30
552	15260	3/4"	14	100	1000	30
553	15270	1"	11 1/2	50	500	25
554	15280	1 1/4"	11 1/2	50	500	30
555	15290	1 1/2"	11 1/2	25	250	22
556	15300	2"	11 1/2	20	200	28
557	15310	2 1/2"	8	—	50	8
558	15320	3"	8	—	50	14
559	15330	3 1/2"	8	—	25	9
560	15340	4"	8	—	25	10

STEEL



E323726

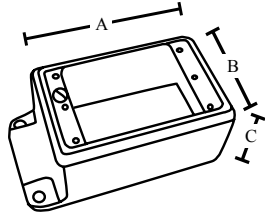

CAT#	A	B	C
FS1M	5.25	2.93	2.125
FS2M	5.25	2.93	2.125
FS3M	5.25	2.93	2.125

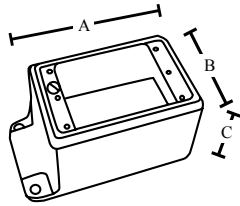

CAT#	A	B	C
FSD1M	5.25	3	2.875
FSD2M	5.25	3	2.875
FSD3M	5.25	3	2.875

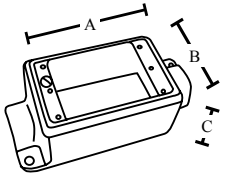

CAT#	A	B	C
FSCS1M	6.0625	2.9375	2.125
FSCS2M	6.0625	2.9375	2.125
FSCS3M	6.0625	2.9375	2.125

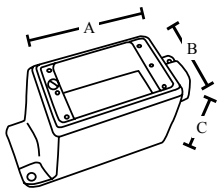

CAT#	A	B	C
FSDD1M	6.0625	3	2.875
FSDD2M	6.0625	3	2.875
FSDD3M	6.0625	3	2.875

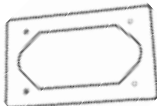

FS & FD CAST DEVICE BOXES

MALLEABLE IRON

TOPAZ CAT #	UPC#	SIZE	UNIT CTN	SHIP CASE	WT/ CASE
FS TYPE					
• SINGLE HUB					
FS1M	85196	1/2"	—	5	11
FS2M	85197	3/4"	—	5	12
FS3M	85198	1"	—	5	12



E195124

FD TYPE

- SINGLE HUB
- DEEP

FSD1M	85199	1/2"	—	5	14
FSD2M	85200	3/4"	—	5	14
FSD3M	85201	1"	—	5	14



E195124

FSC TYPE

- DUEL HUB

FSCS1M	85202	1/2"	—	5	11
FSCS2M	85203	3/4"	—	5	12
FSCS3M	85204	1"	—	5	12



E195124

FDC TYPE

- DUEL HUB
- DEEP

FSDD1M	85205	1/2"	—	5	14
FSDD2M	85206	3/4"	—	5	15
FSDD3M	85207	1"	—	5	15



E195124

FS & FD CAST DEVICE BOX GASKET

NEOPRENE RUBBER

TOPAZ CAT #	UPC#	UNIT CTN	SHIP CASE	WT/ CASE
FSFDCG	17564	—	25	1



FS & FD CAST DEVICE BOX COVERS

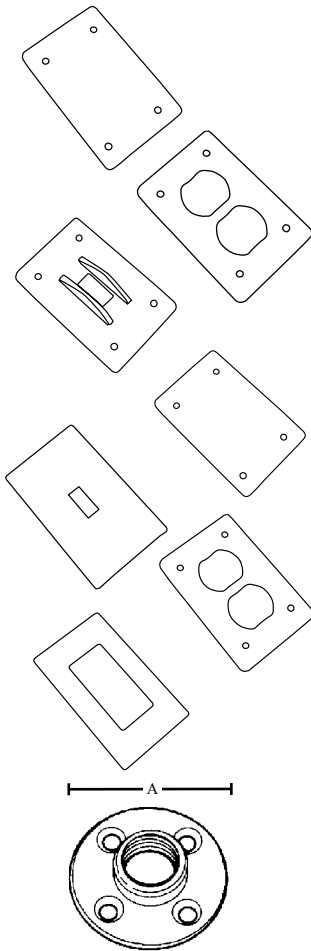

CAT#	A
291	3.000
292	3.375
293	3.625
294	4.000
295	4.375
296	4.875

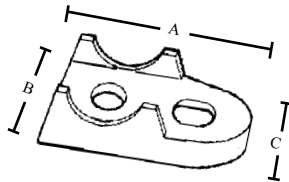

CAT#	A	B	C
481	2.06	1.00	.50
482	2.38	1.06	.50
483	2.94	1.25	.56
484	3.50	1.88	.75
485	3.81	1.44	.81
486	4.75	1.94	1.00
487	5.75	2.44	.75
488	6.69	2.63	.88
489	7.13	2.88	1.06
489A	8.88	3.06	1.06
489B	10.13	3.75	.60
489C	12.19	4.00	.75

MALLEABLE IRON

TOPAZ CAT #	UPC#	UNIT CTN	SHIP CASE	WT/ CASE
• BLANK FSCM	17557	—	25	14
• DUPLEX FSDRM	17559	—	25	14
• GUARDED SQUARE SWITCH FSGSM	17558	—	25	16
STEEL				
• BLANK FSCS	17560	—	25	5
• UNGUARDED SQUARE SWITCH FSGSS	17561	—	25	4
• DUPLEX FSDRS	17562	—	25	4
• GFI FSGFIS	17563	—	25	3



RIGID FLOOR FLANGE PLATES

MALLEABLE IRON

TOPAZ CAT #	UPC#	SIZE	UNIT CTN	SHIP CASE	WT/ CASE
291	12420	1/2"	—	50	23
292	12430	3/4"	—	50	25
293	12440	1"	—	50	43
294	12450	1 1/4"	—	25	20
295	12460	1 1/2"	—	25	32
296	12470	2"	—	25	27



EMT/RIGID CLAMP BACKS

MALLEABLE IRON

TOPAZ CAT #	UPC#	SIZE	UNIT CTN	SHIP CASE	WT/ CASE
481	14510	1/2"	25	250	16
482	14520	3/4"	25	250	22
483	14530	1"	25	250	35
484	14540	1 1/4"	10	100	21
485	14550	1 1/2"	10	100	27
486	14560	2"	5	50	22
487	14570	2 1/2"	—	25	14
488	14580	3"	—	10	9
489	14590	3 1/2"	—	10	14
489A	14600	4"	—	10	18
489B	14601	5"	—	10	25
489C	14602	6"	—	10	30



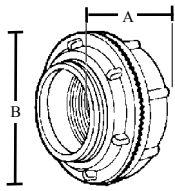

RIGID WATERTIGHT HUBS INSULATED THROAT

• NEMA 2 3R, 4, 4X, 5, 12, 13

CAT#	A	B
201M	1.31	1.54
202M	1.37	1.73
203M	1.59	2.04
204M	1.59	2.42
205M	1.59	2.79
206M	1.59	3.30
207M	2.44	3.70
208M	2.44	4.39
209M	2.44	4.88
210M	2.44	5.50
210MA	3.50	6.80
210MB	3.59	8.18

201	1.31	1.54
202	1.37	1.73
203	1.59	2.04
204	1.59	2.42
205	1.59	2.79
206	1.59	3.30
207	2.44	3.70
208	2.44	4.39
209	2.44	4.88
210	2.44	5.50

201B	1.31	1.54
202B	1.37	1.73
203B	1.59	2.04
204B	1.59	2.42
205B	1.59	2.79
206B	1.59	3.30
207B	2.44	3.70
208B	2.44	4.39
209B	2.44	4.88
210B	2.44	5.50

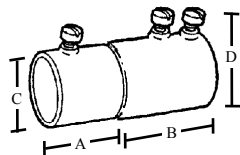

CAT#	A	B	C	D	SCREWS
391S	.850	1.200	.720	.855	2
392S	1.000	1.310	.940	1.065	2
393S	1.270	1.530	1.170	1.320	3

MALLEABLE IRON

TOPAZ CAT #	UPC#	SIZE	UNIT CTN	SHIP CASE	WT/ CASE
201M	11552	1/2"	25	250	49
202M	11562	3/4"	10	100	29
203M	11572	1"	10	100	29
204M	11582	1 1/4"	2	20	15
205M	11592	1 1/2"	2	20	16
206M	11602	2"	2	20	18
207M	11612	2 1/2"	—	2	4
208M	11622	3"	—	2	5
209M	11623	3 1/2"	—	1	5
210M	11632	4"	—	1	6
210MA	85555	5"	—	1	3
210MB	85556	6"	—	1	6

ZINC DIE CAST

201	11550	1/2"	25	250	47
202	11560	3/4"	10	100	27
203	11570	1"	10	100	40
204	11580	1 1/4"	2	20	10
205	11590	1 1/2"	2	20	13
206	11600	2"	2	20	17
207	11610	2 1/2"	—	2	3
208	11620	3"	—	2	4
209	11630	3 1/2"	—	1	4
210	11640	4"	—	1	5

W/BONDING SCREW

201B	11551	1/2"	25	250	19
202B	11561	3/4"	10	100	27
203B	11571	1"	10	100	40
204B	11581	1 1/4"	2	20	11
205B	11591	1 1/2"	2	20	14
206B	11601	2"	2	20	18
207B	11611	2 1/2"	—	2	3
208B	11621	3"	—	2	4
209B	11631	3 1/2"	—	1	4
210B	11641	4"	—	1	5

COMBINATION COUPLINGS

EMT TO RIGID
• SET SCREW TYPE

STEEL

TOPAZ CAT #	UPC#	SIZE	UNIT CTN	SHIP CASE	WT/ CASE
391S	70210	1/2"-1/2"	25	250	40
392S	70220	3/4"-3/4"	10	100	23
393S	70230	1"-1"	10	100	40



E148716



E148716



E148716



E170258

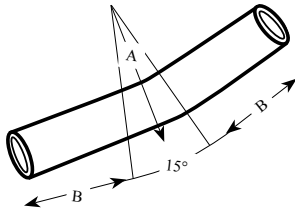

CAT#	A	B
8415	7.25	2.781
8515	8.25	2.781
8615	9.5	2.781
8715	10.5	3
8815	13	3.125
8915	15	3.281
89A15	16	3.375

A=MIN. UL RADIUS
B=STRAIGHT LEG EACH END

EMT 15° ELBOW

GALVANIZED STEEL

TOPAZ CAT #	UPC#	SIZE	UNIT CTN	SHIP CASE	WT/ CASE
8415	83896	1 1/4"	—	20	16
8515	83897	1 1/2"	—	20	22
8615	83898	2"	—	10	16
8715	83899	2 1/2"	—	1	3
8815	83815	3"	—	1	4
8915	83901	3 1/2"	—	1	6
89A15	83902	4"	—	1	7

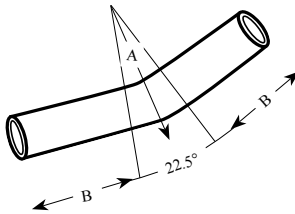

CAT#	A	B
8422	7.25	2.781
8522	8.25	2.781
8622	9.5	2.781
8722	10.5	3
8822	13	3.125
8922	15	3.281
89A22	16	3.375

A=MIN. UL RADIUS
B=STRAIGHT LEG EACH END

EMT 22 1/2° ELBOW

GALVANIZED STEEL

TOPAZ CAT #	UPC#	SIZE	UNIT CTN	SHIP CASE	WT/ CASE
8422	83889	1 1/4"	—	20	17
8522	83890	1 1/2"	—	20	24
8622	83891	2"	—	10	18
8722	83892	2 1/2"	—	1	3
8822	83893	3"	—	1	5
8922	83994	3 1/2"	—	1	6
89A22	83995	4"	—	1	8

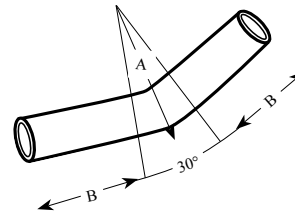

CAT#	A	B
8430	7.25	2.781
8530	8.25	2.781
8630	9.5	2.781
8730	10.5	3
8830	13	3.125
8930	15	3.281
89A30	16	3.375

A=MIN. UL RADIUS
B=STRAIGHT LEG EACH END

EMT 30° ELBOW

GALVANIZED STEEL

TOPAZ CAT #	UPC#	SIZE	UNIT CTN	SHIP CASE	WT/ CASE
8430	83903	1 1/4"	—	20	19
8530	83893	1 1/2"	—	20	25
8630	83905	2"	—	10	20
8730	83906	2 1/2"	—	1	3
8830	83907	3"	—	1	5
8930	83908	3 1/2"	—	1	7
89A30	83909	4"	—	1	8



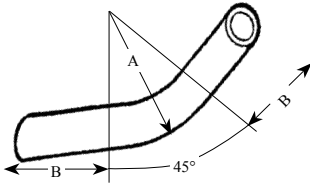

CAT#	A	B
21	4.000	2.875
22	4.500	2.875
23	5.750	3.00
24	7.250	3.25
25	8.250	3.625
26	9.500	4.1875
27	10.500	5.25
28	13.000	5.8125
29	15.000	6.75
30	16.000	6.9375

A=MIN. UL RADIUS
B=STRAIGHT LEG EACH END

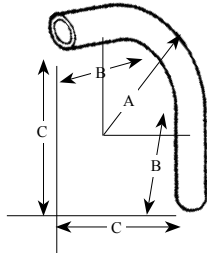

CAT#	A	B	C
81	4.000	2.875	6.343
82	4.500	2.875	6.781
83	5.750	3.00	8.901
84	7.250	3.25	10.25
85	8.250	3.625	11.937
86	9.500	4.1875	14.031
87	10.500	5.25	16.00
88	13.000	5.8125	18.947
89	15.000	6.75	22.218
89A	16.000	6.9375	23.437



EMT 45° ELBOW

GALVANIZED STEEL

TOPAZ CAT #	UPC#	SIZE	UNIT CTN	SHIP CASE	WT/ CASE
21	33400	1/2"	—	50	11
22	33410	3/4"	—	50	19
23	33420	1"	—	35	25
24	33430	1 1/4"	—	30	30
25	33440	1 1/2"	—	15	44
26	33450	2"	—	15	31
27	33460	2 1/2"	—	1	5
28	33470	3"	—	1	7
29	33480	3 1/2"	—	1	9
30	33490	4"	—	1	12



E197604

EMT 90° ELBOW

GALVANIZED STEEL

TOPAZ CAT #	UPC#	SIZE	UNIT CTN	SHIP CASE	WT/ CASE
81	30420	1/2"	—	50	14
82	30430	3/4"	—	50	23
83	30440	1"	—	25	16
84	30450	1 1/4"	—	20	30
85	30460	1 1/2"	—	20	20
86	30470	2"	—	10	30
87	30480	2 1/2"	—	1	6
88	30490	3"	—	1	9
89	30500	3 1/2"	—	1	11
89A	30510	4"	—	1	15



E197604

EMT SPECIAL RADIUS ELBOW

GALVANIZED STEEL

TOPAZ CAT #	UPC#	SIZE	DEGREES	UNIT CTN	SHIP CASE	WT/ CASE
2624	86273	2	45	24	1	7
2636	86274	2	45	36	1	9
8624	85544	2	90	24	1	14
8636	81734	2	90	36	1	22
8836	30494	3	90	36	1	45
8848	86275	3	90	48	1	57
8924	85367	3-1/2	90	30	1	42
8936	86276	3-1/2	90	36	1	54
8948	86277	3-1/2	90	48	1	69
3036	81735	4	45	36	1	24
3042	86278	4	45	42	1	28
3048	86279	4	45	48	1	31
89A36	86280	4	90	36	1	64
89A42	85296	4	90	42	1	73
89A48	81983	4	90	48	1	81



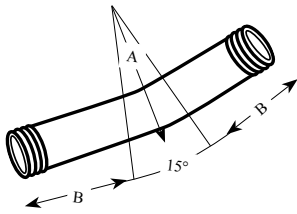

CAT#	A	B
6415	7.25	2.781
6515	8.25	2.781
6615	9.5	2.781
6715	10.5	3
6815	13	3.125
6915	15	3.281
7015	16	3.375

A=MIN. UL RADIUS
B=STRAIGHT LEG EACH END

RIGID 15° ELBOW

GALVANIZED STEEL

TOPAZ CAT #	UPC#	SIZE	UNIT CTN	SHIP CASE	WT/ CASE
6415	83917	1 1/4"	—	20	32
6515	83918	1 1/2"	—	15	34
6615	83919	2"	—	10	33
6715	83920	2 1/2"	—	1	7
6815	83921	3"	—	1	10
6915	83922	3 1/2"	—	1	13
7015	83923	4"	—	1	17



E223147

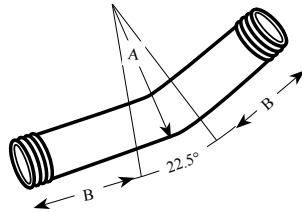

CAT#	A	B
6422	7.25	2.781
6522	8.25	2.781
6622	9.5	2.781
6722	10.5	3
6822	13	3.125
6922	15	3.281
7022	16	3.375

A=MIN. UL RADIUS
B=STRAIGHT LEG EACH END

RIGID 22 1/2° ELBOW

GALVANIZED STEEL

TOPAZ CAT #	UPC#	SIZE	UNIT CTN	SHIP CASE	WT/ CASE
6422	83910	1 1/4"	—	20	34
6522	83911	1 1/2"	—	15	36
6622	83912	2"	—	10	38
6722	83913	2 1/2"	—	1	8
6822	83914	3"	—	1	11
6922	83915	3 1/2"	—	1	14
7022	83916	4"	—	1	18



E223147

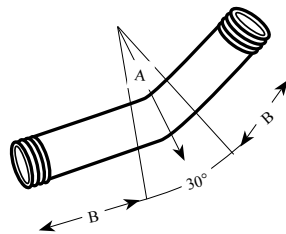

CAT#	A	B
6430	7.25	2.781
6530	8.25	2.781
6630	9.5	2.781
6730	10.5	3
6830	13	3.125
6930	15	3.281
7030	16	3.375

A=MIN. UL RADIUS
B=STRAIGHT LEG EACH END

RIGID 30° ELBOW

GALVANIZED STEEL

TOPAZ CAT #	UPC#	SIZE	UNIT CTN	SHIP CASE	WT/ CASE
6430	83924	1 1/4"	—	20	40
6530	83925	1 1/2"	—	15	39
6630	83926	2"	—	10	42
6730	83927	2 1/2"	—	1	8
6830	83928	3"	—	1	12
6930	83929	3 1/2"	—	1	17
7030	83930	4"	—	1	20



E223147

RIGID 45° ELBOW

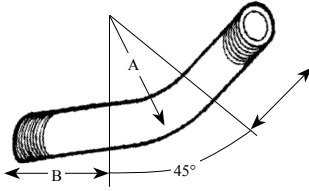

CAT#	A	B
11	4.000	2.875
12	4.500	2.875
13	5.750	3.00
14	7.250	3.25
15	8.250	3.625
16	9.500	4.1875
17	10.500	5.25
18	13.000	5.8125
19	15.000	6.75
20	16.000	6.9375

A=MIN. UL RADIUS
B=STRAIGHT LEG EACH END

GALVANIZED STEEL

TOPAZ CAT #	UPC#	SIZE	UNIT CTN	SHIP CASE	WT/ CASE
11	33300	1/2"	—	50	26
12	33310	3/4"	—	50	38
13	33320	1"	—	35	45
14	33330	1 1/4"	—	30	60
15	33340	1 1/2"	—	15	45
16	33350	2"	—	15	68
17	33360	2 1/2"	—	1	8
18	33370	3"	—	1	13
19	33380	3 1/2"	—	1	16
20	33390	4"	—	1	22



E223147

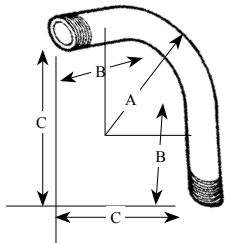

CAT#	A	B	C
61	4.000	2.875	6.343
62	4.500	2.875	6.781
63	5.750	3	8.901
64	7.250	3.25	10.25
65	8.250	3.625	11.937
66	9.500	4.1875	14.031
67	10.500	5.25	16.00
68	13.000	5.8125	18.947
69	15.000	6.75	22.218
70	16.000	6.9375	23.437
70A	24.000	11.125	36.156
70B	30.000	12.4375	41.460

A=MIN. UL RADIUS B=STRAIGHT
C=OFFSET

RIGID 90° ELBOW

GALVANIZED STEEL

TOPAZ CAT #	UPC#	SIZE	UNIT CTN	SHIP CASE	WT/ CASE
61	31030	1/2"	—	50	40
62	31040	3/4"	—	50	54
63	31050	1"	—	20	40
64	31060	1 1/4"	—	20	60
65	31070	1 1/2"	—	10	42
66	31080	2"	—	10	68
67	31090	2 1/2"	—	1	13
68	31100	3"	—	1	18
69	31110	3 1/2"	—	1	26
70	31120	4"	—	1	33
70A	31127	5"	—	1	45
70B	31128	6"	—	1	48



E223147

RIGID SPECIAL RADIUS ELBOW

• NPT THREAD WITH END CAP ON EACH END

GALVANIZED STEEL

TOPAZ CAT #	UPC#	PIPE SIZE	DEGREES	SHIP CASE	WT/ CASE
6624	31082	2	90	1	17
6630SR	86281	2	90	1	20
6636	31084	2	90	1	22
6642	31085	2	90	1	25
6648	31086	2	90	1	29
6724	31092	2-1/2	90	1	26
6730SR	86282	2-1/2	90	1	30
6736	31094	2-1/2	90	1	34
6742	31095	2-1/2	90	1	39
6748	31096	2-1/2	90	1	45
6824	31102	3	90	1	33
6830SR	83928	3	90	1	38
6836	31104	3	90	1	43
6842	31105	3	90	1	54
6848	31106	3	90	1	60
6924	31112	3-1/2	90	1	41
6930SR	86283	3-1/2	90	1	47
6936	31114	3-1/2	90	1	53
6942	31115	3-1/2	90	1	62
6948	31116	3-1/2	90	1	66
7018	86284	4	90	1	40
7024	31122	4	90	1	47
7030SR	86285	4	90	1	54
7036	31124	4	90	1	62
7042	31125	4	90	1	72
7048	31126	4	90	1	81
7060	86286	4	90	1	88
70A36	31129	5	90	1	83
70A42	86287	5	90	1	98
70A48	86288	5	90	1	108
70A60	86289	5	90	1	122
70B36	82488	6	90	1	120
70B42	86290	6	90	1	135
70B48	86291	6	90	1	145
70B60	86292	6	90	1	165





CONDUIT NIPPLES



GALVANIZED STEEL

TOPAZ CAT #	UPC#	CONDUIT SIZE	LENGTH INCHES	SHIP CASE	WT/100
6451	31130	1/2"	CLOSE	25	6
6451112	31140	1/2"	1 1/2	25	8
64512	31150	1/2"	2	25	12
6451212	31160	1/2"	2 1/2	25	15
64513	31170	1/2"	3	25	26
6451312	31180	1/2"	3 1/2	25	6
64514	31190	1/2"	4	25	26
64515	31200	1/2"	5	25	33
64516	31210	1/2"	6	25	40
64518	31220	1/2"	8	1	54
645110	31230	1/2"	10	1	68
645112	31240	1/2"	12	1	82
6452	31250	3/4"	CLOSE	25	9
6452112	31251	3/4"	1 1/2	25	10
64522	31260	3/4"	2	25	14
6452212	31270	3/4"	2 1/2	25	19
64523	31280	3/4"	3	25	26
6452312	31290	3/4"	3 1/2	25	28
64524	31300	3/4"	4	25	34
64525	31310	3/4"	5	25	43
64526	31320	3/4"	6	25	52
64528	31330	3/4"	8	1	73
645210	31340	3/4"	10	1	89
645212	31350	3/4"	12	1	109
6453	31360	1"	CLOSE	25	16
64532	31370	1"	2	25	22
6453212	31380	1"	2 1/2	25	28
64533	31390	1"	3	25	26
6453312	31400	1"	3 1/2	25	43
64534	31410	1"	4	25	49
64535	31420	1"	5	25	64
64536	31430	1"	6	25	20
64538	31440	1"	8	1	1
645310	31450	1"	10	1	1
645312	31460	1"	12	1	2

TOPAZ CAT #	UPC#	CONDUIT SIZE	LENGTH INCHES	SHIP CASE	WT/100
6454	31470	1 1/4"	CLOSE	25	22
64542	31480	1 1/4"	2	25	28
6454212	31490	1 1/4"	2 1/2	25	37
64543	31500	1 1/4"	3	25	25
6454312	31510	1 1/4"	3 1/2	25	55
64544	31520	1 1/4"	4	25	66
64545	31530	1 1/4"	5	25	84
64546	31540	1 1/4"	6	25	25
64548	31550	1 1/4"	8	1	1
645410	31560	1 1/4"	10	1	2
645412	31570	1 1/4"	12	1	2
6455	31580	1 1/2"	CLOSE	25	28
64552	31590	1 1/2"	2	25	34
6455212	31600	1 1/2"	2 1/2	25	44
64553	31610	1 1/2"	3	25	25
6455312	31620	1 1/2"	3 1/2	25	68
64554	31630	1 1/2"	4	25	80
64555	31640	1 1/2"	5	25	103
64556	31650	1 1/2"	6	25	31
64558	31660	1 1/2"	8	1	2
645510	31670	1 1/2"	10	1	2
645512	31680	1 1/2"	12	1	3
6456	31690	2"	CLOSE	25	44
6456212	31700	2"	2 1/2	25	15
64563	31710	2"	3	25	25
6456312	31720	2"	3 1/2	25	88
64564	31730	2"	4	25	103
64565	31740	2"	5	25	132
64566	31750	2"	6	25	25
64568	31760	2"	8	1	2
645610	31770	2"	10	1	3
645612	31780	2"	12	1	3

Continued on next page



CONDUIT NIPPLES

GALVANIZED STEEL

TOPAZ CAT #	UPC#	CONDUIT SIZE	LENGTH INCHES	SHIP CASE	WT/100
6457	31790	2 1/2"	CLOSE	1	84
64573	31800	2 1/2"	3	1	1
6457312	31810	2 1/2"	3 1/2	1	12
64574	31820	2 1/2"	4	1	150
64575	31830	2 1/2"	5	1	197
64576	31840	2 1/2"	6	1	3
64578	31850	2 1/2"	8	1	3
645710	31860	2 1/2"	10	1	4
645712	31870	2 1/2"	12	1	5
6458	31880	3"	CLOSE	1	1
64583	31890	3"	3	1	1
6458312	31900	3"	3 1/2	1	2
64584	31910	3"	4	1	2
64585	31920	3"	5	1	3
64586	31930	3"	6	1	3
64588	31940	3"	8	1	4
645810	31950	3"	10	1	5
645812	31960	3"	12	1	6

TOPAZ CAT #	UPC#	CONDUIT SIZE	LENGTH INCHES	SHIP CASE	WT/CASE
6459	31970	3 1/2"	CLOSE	1	2
64594	31980	3 1/2"	4	1	2
64595	31990	3 1/2"	5	1	3
64596	32000	3 1/2"	6	1	4
64598	32010	3 1/2"	8	1	5
645910	32020	3 1/2"	10	1	7
645912	32030	3 1/2"	12	1	8
6410	32040	4"	CLOSE	1	2
64104	32050	4"	4	1	3
64105	32060	4"	5	1	4
64106	32070	4"	6	1	4
64108	32080	4"	8	1	6
641010	32090	4"	10	1	8
641012	32100	4"	12	1	9

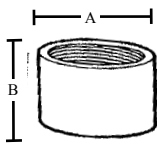

RIGID COUPLINGS TUBULAR THREADED TYPE

GALVANIZED STEEL

CAT#	A	B
51	1.010	1.563
52	1.250	1.625
53	1.525	2.000
54	1.869	2.063
55	2.155	2.063
56	2.650	2.125
57	3.250	3.125
58	3.870	3.250
59	4.500	3.375
60	4.875	3.500
60A	6.000	3.750
60B	7.200	4.000

TOPAZ CAT #	UPC#	SIZE	THREADS PER INCH	UNIT CTN	SHIP CASE	WT/CASE
51	10130	1/2"	14	—	100	13
52	10140	3/4"	14	—	50	10
53	10150	1"	11 1/2	—	30	11
54	10160	1 1/4"	11 1/2	—	25	11
55	10170	1 1/2"	11 1/2	—	25	14
56	10180	2"	11 1/2	—	20	15
57	10190	2 1/2"	8	—	12	22
58	10200	3"	8	—	8	18
59	10210	3 1/2"	8	—	4	15
60	10220	4"	8	—	4	12
60A	10230	5"	8	—	2	10
60B	10240	6"	8	—	1	8



LIQUID TIGHT CORD GRIPS

- LIQUID TIGHT AT UP TO 70 P.S.I. WATER PRESSURE
- LOCKNUTS MUST BE ORDERED SEPARATELY

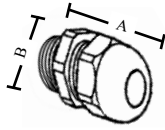

CAT#	A	B
LTF38	1.48	.87
RLTF38	1.48	.87
LTF12	1.53	.93
LTF34	1.78	1.31
RLTF34	1.78	1.31
LTF1	2.15	1.65

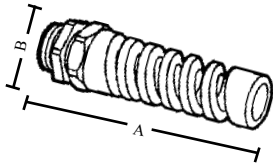

CAT#	A	B
FLEXLTF38	3.09	.87
FLEXRLTF38	3.09	.87
FLEXLTF12	4.03	.93
FLEXRLTF12	4.03	.93
FLEXLTF34	5.09	1.31
FLEXRLTF34	5.09	1.31

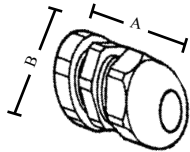

CAT#	A	B
LTF7	1.12	.59
LTF9	1.20	.75
LTF11	1.29	.87
LTF13	1.41	.95
LTF16	1.50	1.07
LTF21	1.66	1.30
LTF29	1.94	1.66

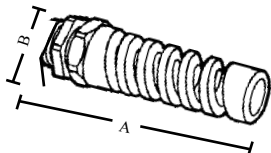

CAT#	A	B
FLEXLTF7	2.46	.59
FLEXLTF9	2.80	.75
FLEXLTF11	3.40	.87
FLEXLTF13	3.89	.95
FLEXLTF16	4.36	1.07
FLEXLTF21	4.95	1.30

6/6 NYLON

TOPAZ CAT #	UPC#	SIZE	CABLE DIAMETER MIN	CABLE DIAMETER MAX	UNIT CTN	SHIP CASE	WT/ CASE
NPT HUBS							
LTF38	30110	3/8"	.19"	.31"	25	100	2
RLTF38	30120	3/8"	.08"	.23"	25	100	2
LTF12	30130	1/2"	.17"	.47"	25	100	3
LTF34	30150	3/4"	.55"	.70"	10	100	5
RLTF34	30160	3/4"	.36"	.63"	10	100	5
LTF1	30170	1"	.71"	1.0"	10	100	6



E170258

FLEX NPT HUBS

FLEXLTF38	30300	3/8"	.19"	.31"	25	100	2
FLEXRLTF38	30310	3/8"	.08"	.23"	25	100	2
FLEXLTF12	30320	1/2"	.27"	.48"	25	100	3
FLEXRLTF12	30330	1/2"	.20"	.35"	25	100	3
FLEXLTF34	30340	3/4"	.55"	.70"	10	100	11
FLEXRLTF34	30350	3/4"	.36"	.63"	10	100	11



E170258

PG HUBS

- PG THREADS ARE STEEL CONDUIT THREADS PER DIN 40430
- LOCKNUTS INCLUDED

LTF7	30230	PG7	.09"	.26"	25	100	1
LTF9	30240	PG9	.20"	.30"	25	100	2
LTF11	30250	PG11	.23"	.39"	25	100	3
LTF13	30260	PG13	.27"	.48"	25	100	3
LTF16	30270	PG16	.43"	.655"	10	100	4
LTF21	30280	PG21	.55"	.70"	10	100	6
LTF29	30290	PG29	.70"	1.0"	10	100	6



E170258

FLEX PG HUBS

FLEXLTF7	30360	PG7	.09"	.26"	25	100	2
FLEXLTF9	30370	PG9	.20"	.30"	25	100	2
FLEXLTF11	30380	PG11	.23"	.39"	25	100	4
FLEXLTF13	30390	PG13	.27"	.48"	25	100	5
FLEXLTF16	30400	PG16	.43"	.55"	10	100	10
FLEXLTF21	30410	PG21	.55"	.70"	10	100	11



E170258

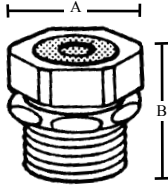

FLEXIBLE CORD CONNECTORS

• STRAIN RELIEF

ZINC DIE CAST

CAT #	A	B	RANGE	
			MIN.	MAX.
881	.96	1.30	.190	.260
881A	.96	1.30	.260	.375
881B	.96	1.30	.375	.500
882	1.20	1.32	.440	.500
882A	1.20	1.32	.500	.625
882B	1.20	1.32	.625	.725
883	1.51	1.58	.375	.500
883A	1.51	1.58	.500	.625
883B	1.51	1.58	.625	.750
883C	1.51	1.58	.750	.880
883D	1.51	1.58	.875	.985

TOPAZ CAT #	UPC#	SIZE	CABLE RANGE	UNIT CTN	SHIP CASE	WT/ CASE
881	18880	1/2"	.190 TO .260	25	250	43
881A	18890	1/2"	.260 TO .375	25	250	43
881B	18900	1/2"	.375 TO .500	25	250	43
882	18910	3/4"	.375 TO .500	25	250	65
882A	18920	3/4"	.500 TO .625	25	250	65
882B	18930	3/4"	.625 TO .750	25	250	65
883	18939	1"	.375 TO .500	10	100	34
883A	18940	1"	.500 TO .625	10	100	34
883B	18950	1"	.625 TO .750	10	100	34
883C	18960	1"	.750 TO .880	10	100	34
883D	18970	1"	.880 TO .985	10	100	34

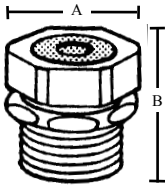

CAT #	A	B	GROMMET COLOR
50A250	.975	1.937	RED
50A350	.975	1.937	WHITE
50A450	.975	1.937	BLUE
50A560	.975	1.937	GREEN
50A650	.975	1.937	BROWN
75A250	1.220	1.937	RED
75A350	1.220	1.937	WHITE
75A450	1.220	1.937	BLUE
75A550	1.220	1.937	GREEN
75A650	1.220	1.937	BROWN
75B750	1.220	1.562	YELLOW
75B850	1.220	1.562	PURPLE
100B560	1.50	1.75	GREEN
100B650	1.50	1.75	BROWN
100B750	1.50	1.75	YELLOW
100B850	1.50	1.75	PURPLE
100C950	1.50	1.875	GRAY
100C1050	1.50	1.875	BLACK

TOPAZ CAT #	UPC#	SIZE	CABLE RANGE	UNIT CTN	SHIP CASE	WT/ CASE
50A250	10080	1/2"	.15" TO .25"	—	25	3
50A350	10090	1/2"	.25" TO .35"	—	25	3
50A450	10100	1/2"	.35" TO .45"	—	25	3
50A560	10110	1/2"	.45" TO .56"	—	25	3
50A650	10120	1/2"	.55" TO .65"	—	25	3
75A250	10250	3/4"	.15" TO .25"	—	25	3
75A350	10260	3/4"	.25" TO .35"	—	25	3
75A450	10270	3/4"	.35" TO .45"	—	25	3
75A560	10280	3/4"	.45" TO .55"	—	25	3
75A650	10290	3/4"	.55" TO .65"	—	25	3
75B750	10300	3/4"	.65" TO .75"	—	25	3
75B850	10310	3/4"	.75" TO .85"	—	25	3
100B560	10450	1"	.45" TO .56"	10	100	28
100B650	10460	1"	.55" TO .65"	10	100	28
100B750	10470	1"	.65" TO .75"	10	100	28
100B850	10480	1"	.75" TO .85"	10	100	28
100C950	10490	1"	.85" TO .95"	10	100	28
100C1050	10500	1"	.95" TO 1.05"	10	100	28



LARGER SIZES AVAILABLE
SEE SPECIFICATIONS ON NEXT PAGE

FLEXIBLE CORD CONNECTORS - CONT'D

TOPAZ CAT #	SIZE	CABLE RANGE		FOR TYPES S, SO, ST, & STO	FOR TYPES SJ, STO, SJT SJTO, SVO, AND BUS DROP	FOR VNTC TYPE TRAY CABLE
		MIN	MAX			
50A250	1/2"	.150	.250		18-2,3 SVO	
50A350	1/2"	.250	.350		18-2,3 SJT 18-2,3,4 SJO 16-2,3 SJO	18-3,4 & 5 16-3 & 4 14-3
50A450	1/2"	.350	.450	18-2,3,4 16-2,3,4	16-4 SJO 14-2,3,4 SJO 12-2 SJO 14-3 Bus Drop	18-6 to 18-11 16-5 to 16-8 14-4 to 14-7 12-3 & 4 also Composite Cables 3 # 16 & 4 # 14
50A560	1/2"	.450	.560	18-5,6,7 16-5,6 14-2,3	12-3 SJO 12-3 & 10-3 Bus Drop	18-10 to 18-16 16-9 to 16-12 14-8 to 14-9 12-5 & 12-7 10-3 to 10-4 also Composite Cables 3 # 12 & 4 # 14 3 # 10 & 4 # 14
50A650	1/2"	.550	.650	18-8,10 16-7,8 14-4 12-2,3 10-2		18-17 to 18-23 16-13 to 16-19 14-10 to 14-14 12-8 & 9 10-5 to 10-7 8-2 to 8-4 also Composite Cables 3 # 8 & 4 # 14 3 # 10 & 4 # 12
75A250	3/4"	.150	.250		18-2,3 SVO	
75A350	3/4"	.250	.350		18-2,3 SJT 18-2,3,4 SJO 16-2,3 SJO	18-3,4 & 5 16-3,4 14-3
75A450	3/4"	.350	.450	18-2,3,4 16-2,3,4	16-4 SJO 14-2,3,4 SJO 12-2 SJO 14-3 Bus Drop	18-6 to 18-11 16-5 to 16-8 14-4 to 14-7 12-3 & 4 also Composite Cables 3 # 16 & 4 # 14
75A560	3/4"	.450	.560	18-5,6,7 16-5,6 14-2,3	12-3 SJO 12-3 & 10-3 Bus Drop	18-10 to 18-16 16-9 to 16-12 14-8 to 14-9 12-5 to 12-7 10-3 to 10-4 also Composite Cables 3 # 12 & 4 # 14 3 # 10 & 4 # 14
75A650	3/4"	.550	.650	18-8,10 16-7,8 14-4 12-2,3 10-2		18-17 to 18-23 16-13 to 16-19 14-10 to 14-14 12-8 & 9 10-5 to 10-7 8-2 to 8-4 also Composite Cables 3 # 8 & 4 # 14 3 # 10 & 4 # 12
75B750	3/4"	.650	.750	18-12,14 16-10,12 14-5,6,7 12-4,5 10-3,4 8-2	8-3 Bus Drop	18-24 to 18-37 16-20 to 16-27 14-15 to 14-21 12-5 to 12-7 10-3 to 10-4 also Composite Cables 3 # 6 & 4 # 14 3 # 8 & 4 # 12
75B850	3/4"	.750	.850	18-16,18,20 16-14,16,18 14-8 12-6,7,8 10-5 8-3,4 6-2	6-3 Bus Drop	16-28 to 16-33 14-22 to 14-26 12-15 to 12-19 10-10 to 10-11 6-4 4-2 also Composite Cables 3 # 6 & 4 12 3 # 6 & 6 # 14 3 # 6 & 6 # 12
100B560	1"	.450	.560	18-5,6,7 16-5,6 14-2,3	12-3 SJO 12-3 & 10-3 Bus Drop	18-10 to 18-16 16-9 to 16-12 14-8 to 14-9 12-5 to 12-7 10-3 to 10-4 also Composite Cables 3 # 12 & 4 # 14 3 # 10 & 4 # 14
100B650	1"	.550	.650	18-8,10 16-7,8 14-4 12-2,3 10-2		18-17 to 18-23 16-13 to 16-19 14-10 to 14-14 12-8,9 10-5 to 10-7 8-2 to 8-4 also Composite Cables 3 # 8 & 4 # 14 3 # 10 & 4 # 12
100B750	1"	.650	.750	18-2,14 16-10,12 14-5,6,7 12-4,5 10-3,4 8-2	8-3 Bus Drop	18-24 to 18-37 16-20 to 16-27 14-15 to 14-21 12-10 to 12-14 10-8 to 10-9 6-3 also Composite Cables 3 # 6 & 4 # 14 3 # 8 & 4 # 12
100B850	1"	.750	.850	18-16,18,20 16-14,16,18 14-8 12-6,7,8 10-5 8-3,4 6-2	6-3 Bus Drop	16-28 to 16-33 14-22 to 14-26 12-15 to 12-19 10-10 to 10-11 6-4 to 4-2 also Composite Cables 3 # 6 & 4 # 12 3 # 6 & 6 # 14 3 # 6 & 6 # 12
100C950	1"	.850	.950	18-22,24,26 16-20,22,24 14-10,12 10-6,7,8 6-3,4	4-3 Bus Drop	16-34 to 16-37 14-27 to 14-33 12-20 to 12-23 10-12 4-3 also Composite Cables 3 # 4 & 4 # 14 3 # 4 & 4 # 12
100C1050	1"	.950	1.050	18-30 16-26 14-14,16 12-10 4-3		14-34 to 14-37 12-24 to 12-30 4-4 2-2 2-3 also Composite Cables 3 # 2 & 4 # 14 3 # 2 & 4 # 12 3 # 2 & 6 # 14

KNOCK-OUT BUSHINGS

SUITABLE FOR USE WITH
ELECTRICAL KNOCKOUT

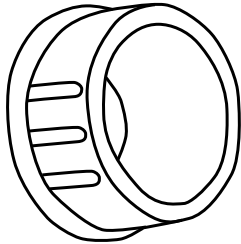

						6/6 NYLON
TOPAZ CAT #	UPC#	INSIDE DIAMETER	K.O. SIZE	UNIT CTN	SHIP CASE	WT/ CASE
SB8756	32620	3/8"	1/2"	100	1000	4
SB8757	32630	7/16"	1/2"	100	1000	4
SB8758	32640	1/2"	1/2"	100	1000	4
SB8759	32650	9/16"	1/2"	100	1000	4
SB87510	32660	5/8"	1/2"	100	1000	4
SB87511	32670	11/16"	1/2"	100	1000	4
SB109313	32690	13/16"	3/4"	100	1000	6
SB109314	32700	7/8"	3/4"	100	1000	6
SB109315	32710	15/16"	3/4"	100	1000	6
SB137514	32760	7/8"	1"	100	1000	8
SB137516	32770	1"	1"	100	1000	8
SB175022	32810	1-3/8"	1 1/4"	50	500	6
SB200026	32820	1-5/8"	1 1/2"	50	500	7
SB2.531	32840	1-31/32"	2"	10	100	4
SB3.039	32850	2-15/32"	2 1/2"	10	100	4
SB3.547	32860	2-15/16"	3"	10	100	4
SB4.055	32870	3-7/16"	3 1/2"	10	100	4



STUD GROMMETS

				6/6 NYLON	
TOPAZ CAT #	UPC#	SIZE	UNIT CTN	SHIP CASE	WT/ CASE
45	14172	UNIVERSAL*	—	200	5

*Fits all stud hole sizes.

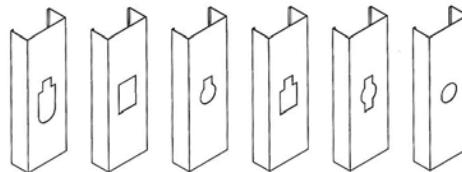
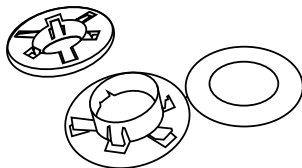

Common hole configurations in metal studs.

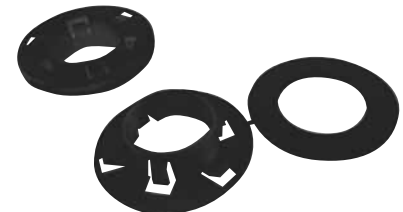

HEAVY DUTY CABLE CLAMPS

- 1/2" WIDE, .08" THICK, #8 SCREW
- For clamping cable or tubing securely into place
- Resists corrosion, salt water, weak acids, gasoline, alcohol, oil, grease and common solvents

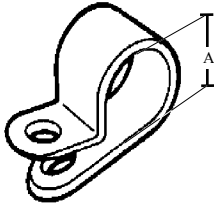

CAT#	A (in.)	A (mm)
CCH18(W&B)	.125	3.2
CCH316(W&B)	.187	4.7
CCH14(W&B)	.250	6.4
CCH516(W&B)	.312	7.9
CCH38(W&B)	.375	9.5
CCH716(W&B)	.437	11.1
CH12(W&B)	.500	12.7
CCH916(W&B)	.562	14.3
CCH58(W&B)	.625	15.9
CCH1116(W&B)	.687	17.4
CCH34(W&B)	.750	19.1
CCH1316(W&B)	.812	20.6
CCH78(W&B)	.875	22.2
CCH1(W&B)	1.000	25.4
CCH118(W&B)	1.125	28.6
CCH1916(W&B)	1.187	30.1
CCH114(W&B)	1.250	31.8
CCH138(W&B)	1.375	34.9
CCH112(W&B)	1.500	38.1

6/6 NYLON

TOPAZ CAT #	UPC#	SIZE	UNIT CTN	SHIP CASE	WT/ CASE
WHITE					
CCH18W	32900	1/8"	100	1000	2
CCH316W	32910	3/16"	100	1000	2
CCH14W	32920	1/4"	100	1000	2
CCH516W	32930	5/16"	100	1000	2
CCH38W	32940	3/8"	100	1000	3
CCH716W	32950	7/16"	100	1000	3
CCH12W	32960	1/2"	100	1000	3
CCH916W	32970	9/16"	100	1000	3
CCH58W	32980	5/8"	100	1000	3
CCH1116W	32990	11/16"	100	1000	3
CCH34W	33000	3/4"	100	1000	4
CCH1316W	33010	13/16"	50	500	3
CCH78W	33020	7/8"	50	500	3
CCH1W	33030	1"	50	500	3
CCH118W	33040	1 1/8"	50	500	3
CCH1916W	33050	1 3/16"	50	500	3
CCH114W	33060	1 1/4"	50	500	4
CCH138W	33070	1 3/8"	50	500	4
CCH112W	33080	1 1/2"	50	500	4

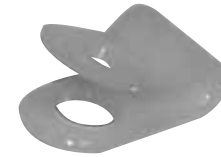

BLACK

CCH18B	30690	1/8"	100	1000	2
CCH316B	30700	3/16"	100	1000	2
CCH14B	30710	1/4"	100	1000	2
CCH516B	30720	5/16"	100	1000	2
CCH38B	30730	3/8"	100	1000	3
CCH716B	30740	7/16"	100	1000	3
CCH12B	30750	1/2"	100	1000	3
CCH916B	30760	9/16"	100	1000	3
CCH58B	30770	5/8"	100	1000	3
CCH1116B	30780	11/16"	100	1000	3
CCH34B	30790	3/4"	100	1000	4
CCH1316B	30800	13/16"	50	500	3
CCH78B	30810	7/8"	50	500	3
CCH1B	30820	1"	50	500	3
CCH118B	30830	1 1/8"	50	500	3
CCH1916B	30840	1 3/16"	50	500	3
CCH114B	30850	1 1/4"	50	500	4
CCH138B	30860	1 3/8"	50	500	4
CCH112B	30870	1 1/2"	50	500	4



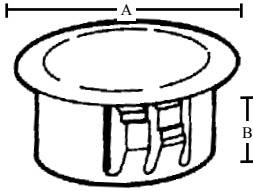

CAT#	A	B
PK050	1.016	.453
PK051	1.219	.453
PK052	1.500	.453
PK053	1.906	.453
PK054	2.141	.453
PK055	2.750	.750

KNOCK-OUT SEALS

GRAY

6/6 NYLON

TOPAZ CAT #	UPC#	SIZE	UNIT CTN	SHIP CASE	WT/ CASE
PK050	30890	1/2"	100	1000	5
PK051	30900	3/4"	100	1000	6
PK052	30910	1"	100	1000	9
PK053	30920	1 1/4"	50	500	7
PK054	30930	1 1/2"	50	500	8
PK055	30940	2"	10	100	11

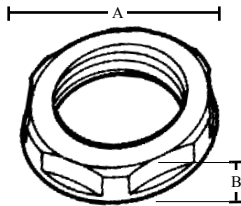

CAT#	A	B
NLN38B	1.078	.266
NLN12B	1.078	.266
NLN34B	1.313	.266
NLN1B	1.625	.266

NPT LOCKNUTS

6/6 NYLON

TOPAZ CAT #	UPC#	SIZE	UNIT CTN	SHIP CASE	WT/ CASE
BLACK					
NLN38B	30950	3/8"	100	1000	5
NLN12B	30970	1/2"	100	1000	5
NLN34B	30990	3/4"	50	500	3
NLN1B	31010	1"	50	200	3



NLN38G	1.078	.266
NLN12G	1.078	.266
NLN34G	1.313	.266
NLN1G	1.625	.266

GRAY

NLN38G	30960	3/8"	100	1000	5
NLN12G	30980	1/2"	100	1000	5
NLN34G	31000	3/4"	50	500	3
NLN1G	31020	1"	50	200	3

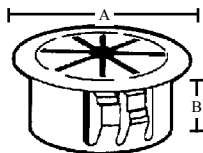

CAT#	A	B	Max Inside DIAM
UB625	.719	.406	.437
UB750	.859	.391	.500
UB812	.859	.391	.500
UB875	.938	.453	.562
UB1000	1.063	.453	.750
UB1093	1.156	.453	.812
UB1375	1.438	.453	1.000

UNIVERSAL BUSHINGS

• .125 MAXIMUM THICKNESS

BLACK

6/6 NYLON

TOPAZ CAT #	UPC#	MOUNTING HOLE DIAMETER	KO	UNIT CTN	SHIP CASE	WT/ CASE
UB625	30620	0.625		100	1000	4
UB750	30630	0.750		100	1000	4
UB812	30640	0.812		100	1000	4
UB875	30650	0.875	1/2"	100	1000	4
UB1000	30660	1.000		100	1000	5
UB1093	30670	1.093	3/4"	100	1000	5
UB1375	30680	1.375	1"	100	1000	5



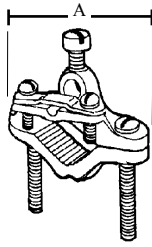

CAT#	A
630B	2.30
630	3.60
630DB	2.30

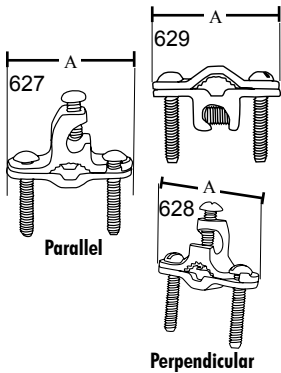
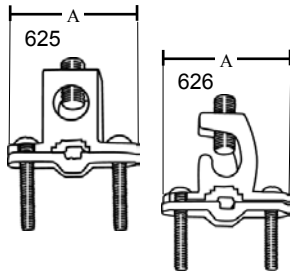

CAT#	A
625	2.36
626	2.52
627	2.28
628	2.28
629	2.28

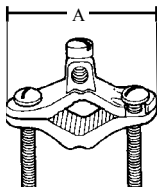

CAT#	A
620Z	2.22
620BP	2.22
626A	2.43
626BS	2.43
626B	3.60
626C	6.35
626D	8.50
620DB	2.28

GROUND CLAMPS

• FITS 8, 6, OR 4 BARE ARMORED GROUND WIRE COPPER

BRASS					
TOPAZ CAT #	UPC#	SIZE	UNIT CTN	SHIP CASE	WT/ CASE
FOR ARMORED GROUND WIRE					
630B	16240	1/2" TO 1"	10	100	20
630	16250	1 1/4" TO 2"	5	50	30

FOR DIRECT BURIAL

BRONZE					
630DB	16260	1/2" TO 1"	10	100	20

GROUND CLAMPS

FOR DIRECT BURIAL STAINLESS STEEL SCREWS

• FITS 8 STR TO 4/0 STR AWG COPPER

BRONZE					
TOPAZ CAT #	UPC#	SIZE	UNIT CTN	SHIP CASE	WT/ CASE
625	81968	1/2" TO 1"	10	100	30
626	81969	1/2" TO 1"	10	100	30
629	85209	1/2" TO 1"	10	100	21

3/8 To 1" Rebar 1/2" To 1" Water Pipe, Copperwater Pipe and Ground Rod

FOR DIRECT BURIAL BRASS SCREWS

• FITS 10 SOL TO 2 STR AWG COPPER

BRASS					
TOPAZ CAT #	UPC#	SIZE	UNIT CTN	SHIP CASE	WT/ CASE
627	83694	1/2" TO 1"	10	100	23
628	85208	1/2" TO 1"	10	100	23

3/8 To 1" Rebar 1/2" To 1" Water Pipe, Copperwater Pipe and Ground Rod

GROUND CLAMPS

• FITS NO. 10, 8, 6, 4, & 2 AWG COPPER ZINC DIE CAST

BRASS PLATED					
TOPAZ CAT #	UPC#	SIZE	UNIT CTN	SHIP CASE	WT/ CASE
FOR BARE WIRE					
620Z*	16100	1/2" TO 1"	25	250	43
620BP**	16110	1/2" TO 1"	25	250	43

*For Copper and Aluminum Wire

**Non UL

BRASS					
TOPAZ CAT #	UPC#	SIZE	UNIT CTN	SHIP CASE	WT/ CASE
626A	16050	1/2" TO 1"	10	100	19
626BS	16060	1/2" TO 1"	10	100	20

W/BRASS SCREWS

626B	16070	1 1/4" TO 2"	5	50	19
626C	16080	2 1/2" TO 4"	—	10	10
626D	16082	5" TO 6"	—	10	15

FOR DIRECT BURIAL

BRONZE					
620DB	16090	1/2" TO 1"	10	100	20

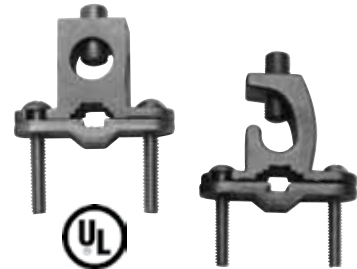

E170258

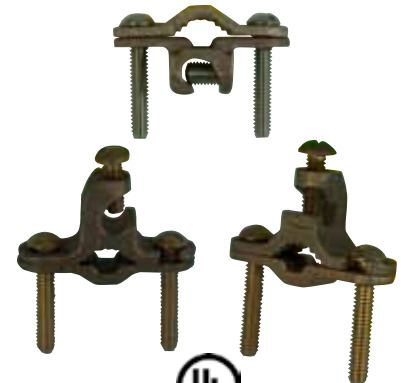

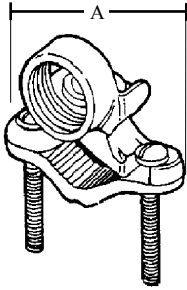

CAT#	A
621	2.250
622	3.600
623	6.340
624	8.500

621A	2.250
622A	3.600
623A	6.340
624A	8.500

621B	2.250
622B	3.600
623B	6.340
624B	8.500

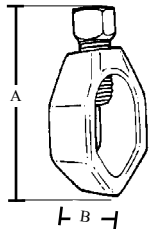

CAT#	A	B	WIRE SIZE MIN MAX
411	1.22	.75	10 SOL 2STR
412	1.41	.90	10 SOL 2STR
413	1.47	1.00	10 SOL 2STR

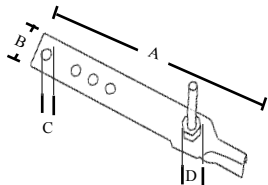

CAT#	A	B	C	D
GS1	5.810	.75	.25	1/4-20 X 1 1/4

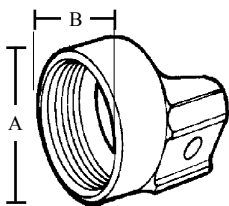

CAT#	A	B
31	1.15	1.07
32	1.30	1.28
33	1.56	1.50

GROUND CLAMPS WITH THREADED HUBS FOR CONDUIT PIPE

BRASS

TOPAZ CAT #	UPC#	SIZE	UNIT CTN	SHIP CASE	WT/ CASE
WITH 1/2" HUBS					
621	16120	1/2" TO 1"	10	100	26
622	16130	1 1/4" TO 2"	5	50	35
623	16140	2 1/2" TO 4"	—	10	15
624	16150	5" TO 6"	—	10	20

WITH 3/4" HUBS

621A	16160	1/2" TO 1"	5	50	20
622A	16170	1 1/4" TO 2"	5	50	37
623A	16180	2 1/2" TO 4"	—	10	12
624A	16190	5" TO 6"	—	10	21

WITH 1" HUBS

621B	16200	1/2" TO 1"	—	10	9
622B	16210	1 1/4" TO 2"	—	10	10
623B	16220	2 1/2" TO 4"	—	10	21
624B	16230	5" TO 6"	—	10	28



GROUND ROD CLAMPS FOR DIRECT BURIAL W/BRONZE OR STAINLESS SCREWS

BRONZE

TOPAZ CAT #	UPC#	SIZE	UNIT CTN	SHIP CASE	WT/ CASE
411	13820	1/2"	—	100	9
412	13830	5/8"	—	100	18
413	13840	3/4"	—	50	12



GROUND STRAP

• 16 GAUGE

SOLID COPPER

TOPAZ CAT #	UPC#	SIZE	UNIT CTN	SHIP CASE	WT/ CASE
GS1	20760	1/2" TO 1"	—	100	5

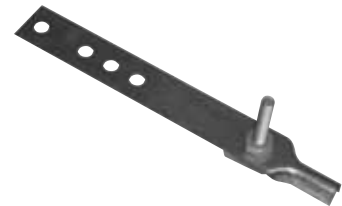

CONDUIT HUBS

BRASS

TOPAZ CAT #	UPC#	SIZE	UNIT CTN	SHIP CASE	WT/ CASE
31	10050	1/2"	—	25	3
32	10060	3/4"	—	25	5
33	10070	1"	—	25	6



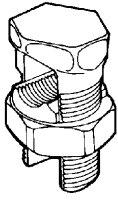

SPLIT BOLT CONNECTORS

SOLDERLESS

COPPER ALLOY

CAT#	WIRE RANGE MAIN AND TAP	
	MIN.	MAX.
690	16 STR	10 STR
691	12 STR	8 STR
692	10 SOL	6 SOL
693	8 SOL	4 SOL
694	6 SOL	2 SOL
695	6 SOL	2 STR
696	4 SOL	1/0 STR
697	2 SOL	2/0 STR
698	2 SOL	3/0 STR
699	4/0 SOL	250 MCM
700	4/0 STR	350 MCM
701	250 MCM	500 MCM
702	350 MCM	750 MCM
703	500 MCM	1000 MCM

TOPAZ CAT #	UPC#	SIZE	UNIT CTN	SHIP CASE	WT/ CASE
FOR COPPER AND COPPERWELD WIRE					
690	17250	10	—	100	2
691	17260	8	—	100	3
692	17270	6	—	100	5
693	17280	4	—	100	6
694	17290	3	—	100	8
695	17300	2	—	100	11
696	17310	1/0	—	50	8
697	17320	2/0	—	25	7
698	17330	3/0	—	25	8
699	17340	4/0-250 MCM	—	25	10
700	17350	350 MCM	—	6	5
701	17360	500 MCM	—	6	5
702	17370	750 MCM	—	3	5
703	17380	1000 MCM	—	4	10



E155861

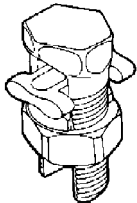

WITH SPACER BAR

• ELECTRO-TINNED BODY, NUT, SPACER, & PRESSURE BAR

FOR COPPER TO COPPER (1,2)

CAT#	WIRE RANGE MAIN AND TAP	
	MIN.	MAX.
790	16 STR	10 STR
791	16 STR	8 STR
792	14 STR	6 SOL
793	10 STR	4 SOL
794	8 SOL	3 STR
795	8 SOL	2 STR
796	6 SOL	1/0 STR
797	6 STR	2/0 STR
798	4 STR	3/0 STR
799	4 STR	250 MCM
800	3/0 STR	350 MCM
801	3/0 STR	500 MCM
802	250 MCM	750 MCM
803	350 MCM	1000 MCM

790	18020	10	—	100	4
791	18030	8	—	100	4

FOR COPPER TO COPPER, COPPER TO ALUMINUM, ALUMINUM TO ALUMINUM (2)

792	18040	6	—	100	7
793	18050	4	—	100	8
794	18060	3	—	100	11
795	18070	2	—	100	15



E170258

FOR COPPER TO COPPER (1,2)

796	18080	1/0	—	50	10
797	18090	2/0	—	25	5
798	18100	3/0	—	25	15
799	18110	4/0-250 MCM	—	25	15
800	18120	350 MCM	—	6	5
801	18130	500 MCM	—	6	7
802	18140	750 MCM	—	4	7
803	18150	1000 MCM	—	2	6

(1) USABLE WITH ALUMINUM CONDUCTOR, HOWEVER NOT UL LISTED FOR THAT APPLICATION.

(2) WHEN MAKING CONNECTIONS WITH ALUMINUM OR ACSR (ALUMINUM CONDUCTOR STEEL REINFORCED) MAKE CERTAIN TO USE AN OXIDE INHIBITING COMPOUND.

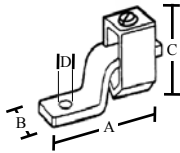

CAT#	A	B	C	D
820	1.00	.3125	.6875	.125
821	1.1875	.375	.75	.1875
822	1.3125	.50	.8125	.25
823	1.5313	.50	1.00	.25
824	1.9688	.625	1.375	.25
825	2.1875	.75	1.5625	.375
826	2.625	1.00	2.00	.3125
827	3.1875	1.00	2.625	.375
828	4.25	1.50	2.75	.375
829	4.625	2.00	3.6875	.50

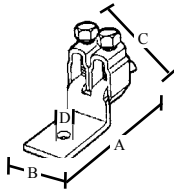

CAT#	A	B	C	D
814	3.375	1.50	2.00	.375
815	3.625	2.75	2.75	.375
816	4.4375	2.00	2.5625	.500

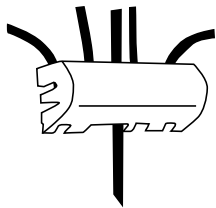

SOLDERLESS LUGS

COPPER

TOPAZ CAT #	UPC#	AMP RATING	RECOMMENDED TORQUE IN LBS	WIRE RANGE MIN-MAX	BOLT SIZE	SHIP WT/ CASE	WT/ CASE
SINGLE HOLE							
• OFFSET TANG							
820	18270	25	20	14-10	1/8	250	3
821	18280	35-50	45	14-6	3/16	250	6
822	18290	70	50	14-4	1/4	200	6
823	18300	70-90	50	12-2	1/4	200	9
824	18310	125	50	8-1/0	1/4	100	11
825	18320	175	124	4-3/0	3/8	25	3
826	18330	225	204	6-4/0	5/16	25	6
827	18340	300	325	1/0-350 MCM	3/8	20	10
828	18350	400	375	4/0-500 MCM	3/8	10	7
829	18360	650	500	600MCM-1000 MCM	1/2	4	7



E170258



E170258

DUPLEX TERMINAL LUGS

814	18240	400	-	2#1/0-2#4/0	3/8	10	5
815	18250	600	-	2#1/0-2#350 MCM	3/8	5	5
816	18260	800	-	2#4/0-2#500 MCM	1/2	4	6

GROUNDING BRIDGE

COPPER

INTERSYSTEM BONDING BRIDGE
Meets requirements of 2008 NEC Article 250.49

TOPAZ CAT #	UPC#	WIRE RANGE MIN-MAX	UNIT CTN	SHIP WT/ CASE	WT/ CASE
813	17544	6-2 AWG	1	10	6



E170258

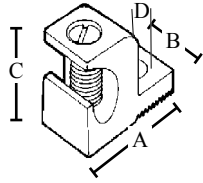

CAT#	A	B	C	D
810	1.0981	.3906	.75	.193
811	1.50	1.6099	1.4375	.25
812	2.2031	2.2031	1.7031	.3125

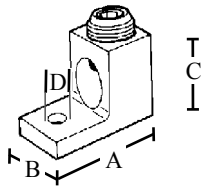

CAT#	A	B	C	D
805	1.0625	.50	.50	.25
806	1.1563	.50	.5625	.25
807	1.4088	.625	.8125	.25
808	1.4688	.625	.8125	.25
809	2.00	.9375	1.0625	.3125
1810	2.00	.8275	1.0625	.3125
817	2.25	1.125	1.25	.3125
818	2.75	1.125	1.50	.375
1818	2.75	1.375	1.50	.375
819	3.50	1.50	1.75	.50
1820	3.50	1.50	1.25	.50

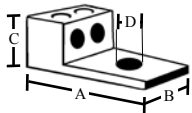

CAT#	A	B	C	D
2807	1.50	1.1875	.8125	.25
2808	1.50	1.1875	.8125	.25
2809	2.5625	1.625	1.1875	.375
2817	2.875	2.9375	1.25	.50
2818	3.125	2.375	1.5625	.50
2819	3.50	2.8125	1.6875	.625
2820	3.50	2.8125	1.6875	.625

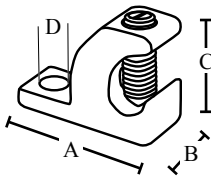

CAT#	A	B	C	D
810DB	1.1417	.38	.8464	.19

SOLDERLESS LUGS

LAY-IN TYPE

• TEMPERATURE RATING 90° C

Used with copper or alum. conductor **ALUMINUM**

TOPAZ CAT #	UPC#	RECOMMENDED TORQUE IN LBS	WIRE RANGE MIN-MAX	BOLT SIZE	UNIT CTN	SHIP CASE	WT/ CASE
810	18210	35	14-4	1/4	-	250	2
811	18220	50	8-1/0	1/4	-	100	6
812	18230	275	6-250 MCM	5/16	-	50	7

SINGLE HOLE

805	18160	35	14-6	1/4	-	100	2
806	18170	50	14-2	1/4	-	100	2
807	18180	180	14-1/0	1/4	-	50	6
808	18190	120	14-2/0	1/4	-	50	5
809	18200	325	6-4/0	5/16	-	25	3
1810	18269	325	6-300 MCM	5/16	10	100	25
817	18201	325	6-350 MCM	5/16	-	25	3
818	18202	375	4-500 MCM	5/16	-	10	2
1818	18271	500	9-600 MCM	3/8	5	50	35
819	18203	500	350 MCM-800 MCM	3/8	-	5	2
1820	18272	600	500 MCM-10000 MCM	5/8	6	60	46

DOUBLE

• TEMPERATURE RATING 90° C

2807	81830	50	14	1/0	10	100	23
2808	81831	50	14	2/0	10	100	24
2809	81832	275	6	250 MCM	10	100	26
2817	81833	275	6	350 MCM	4	40	20
2818	81834	375	2	600 MCM	4	40	19
2819	81835	375	300 MCM	800 MCM	2	20	14
2820	81836	375	500 MCM	1000 MCM	2	20	15

SOLAR LAY IN LUG

COPPER, TINPLATED, STAINLESS STEEL SCREW

TOPAZ CAT #	UPC#	RECOMMENDED TORQUE IN LBS	WIRE RANGE MIN-MAX	BOLT SIZE	UNIT CTN	SHIP CASE	WT/ CASE
810DB	86341	35	14-4	1/4	-	100	7

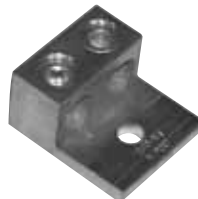
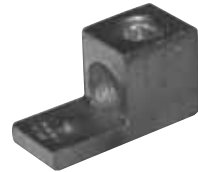

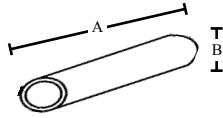

CAT#	A	B
3101	1.75	.20
3102	1.75	.20
3103	1.75	.25
3105	1.90	.31
3106	2.20	.39
3107	2.25	.44
3108	2.25	.49
3109	2.75	.55
3109A	3.25	.59
3109B	3.50	.66
3110	3.75	.70
3110A	3.75	.76
3111	4.25	.83
3111A	4.50	.93
3112	4.75	1.03

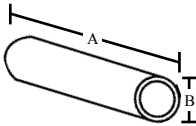

CAT#	A	B
3301	.90	.17
3302	1.00	.20
3303	1.00	.25
3305	1.25	.31
3305A	1.60	.39
3306	1.75	.44
3307	1.75	.49
3308	1.90	.55
3309	2.00	.59
3309A	2.10	.66
3310	2.10	.70
3310A	2.30	.76
3311	2.50	.83
3311A	2.50	.93
3312	3.21	1.03

COMPRESSION SPLICES

UL LISTED PER 486A UP TO 35KV

TOPAZ CAT #	UPC#	WIRE SIZE	COLOR CODE	UNIT CTN	SHIP CASE	WT/ CASE	COPPER
LONG BARREL							
3101	41080	8	RED	100	1000	32	
3102	41081	6	BLUE	100	1000	32	
3103	41082	4	GRAY	100	1000	32	
3105	41084	2	BROWN	100	1000	32	
3106	41085	1/0	PINK	50	1000	18	
3107	41086	2/0	BLACK	50	1000	18	
3108	41087	3/0	ORANGE	50	1000	18	
3109	41088	4/0	PURPLE	25	250	10	
3109A	41089	250 MCM	YELLOW	25	250	10	
3109B	41090	300 MCM	WHITE	25	250	10	
3110	41091	350 MCM	RED	25	250	12	
3110A	41092	400 MCM	BLUE	25	250	12	
3111	41093	500 MCM	BROWN	25	250	12	
3111A	81810	600 MCM	GREEN	25	250	14	
3112	81811	750 MCM	BLACK	25	250	14	

TOPAZ CAT #	UPC#	WIRE SIZE	COLOR CODE	UNIT CTN	SHIP CASE	WT/ CASE	COPPER
SHORT BARREL							
3301	81599	8	RED	100	1000	11	
3302	81600	6	BLUE	100	1000	12	
3303	81601	4	GRAY	100	1000	14	
3305	81602	2	BROWN	100	1000	19	
3305A	81603	1	GREEN	100	1000	33	
3306	81604	1/0	PINK	100	1000	39	
3307	81605	2/0	ORANGE	50	500	39	
3308	81606	3/0	PURPLE	50	500	37	
3309	81607	4/0	YELLOW	50	500	26	
3309A	81608	250 MCM	WHITE	50	500	27	
3310	81609	350 MCM	RED	50	500	27	
3310A	81610	400 MCM	BLUE	50	500	20	
3311	81611	500 MCM	BROWN	50	500	21	
3311A	81612	600 MCM	GREEN	50	500	17	
3312	81613	750 MCM	BLACK	20	200	22	



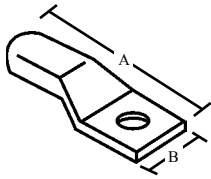

CAT#	A	B
2901	1.20	.42
2901A	1.20	.42
2902	1.50	.42
2902A	1.50	.42
2903	1.50	.71
2903A	1.50	.71
2903B	1.50	.71
2905	1.80	.83
2905A	1.83	.67
2906	1.83	.74
2907	2.24	.81
2907A	2.24	.81
2908	2.36	.90
2909	2.36	1.00
2909A	2.48	1.09
2909B	2.49	1.19
2910	2.61	1.28
2910A	3.95	1.39
2911	3.28	1.54
2911A	3.50	1.72
2912	4.37	1.90

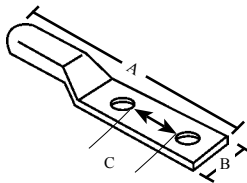

CAT#	A	B	C
2921	2.50	.45	.625
2922	2.56	.45	.625
2923	2.34	.50	.625
2925	2.58	.61	.75
2925A	3.05	.61	.75
2926	3.14	.75	.875
2927	3.24	.83	1.75
2927A	4.17	.83	1.75
2928	4.25	.91	1.75
2929	4.28	1.02	1.75
2929A	4.41	1.11	1.75
2929B	4.53	1.24	1.75
2930	4.53	1.24	1.75
2931	4.81	1.34	1.75
2932	4.88	1.52	1.75
2933	4.49	1.73	1.75
2934	4.79	1.89	1.75

COMPRESSION LUGS

UL LISTED PER 486A UP TO 35KV

COPPER

TOPAZ CAT #	UPC#	WIRE SIZE	COLOR CODE	BOLT SIZE	UNIT CTN	SHIP CASE	WT/ CASE
-------------	------	-----------	------------	-----------	----------	-----------	----------

ONE HOLE SHORT BARREL

2901	81614	8	RED	10	100	1000	14
2901A	81615	8	RED	1/4"	100	1000	13
2902	81616	6	BLUE	1/4"	100	1000	17
2902A	81617	6	BLUE	5/16"	100	1000	18
2903	81618	4	GRAY	1/4"	100	1000	20
2903A	81619	4	GRAY	5/16"	100	1000	18
2903B	81620	4	GRAY	3/8"	100	1000	19
2905	81621	2	BROWN	3/8"	100	1000	24
2905A	81622	1	GREEN	3/8"	100	1000	31
2906	81623	1/0	PINK	3/8"	100	1000	24
2907	81624	2/0	BLACK	3/8"	100	1000	34
2907A	81625	2/0	BLACK	1/2"	100	1000	27
2908	81626	3/0	ORANGE	3/8"	100	1000	33
2909	81627	4/0	PURPLE	1/2"	50	500	27
2909A	81804	250 MCM	YELLOW	1/2"	50	500	27
2909B	81805	300 MCM	WHITE	1/2"	50	500	27
2910	81628	350 MCM	RED	1/2"	50	500	36
2910A	81629	400 MCM	BLUE	1/2"	50	500	26
2911	81606	500 MCM	BROWN	5/8"	20	200	26
2911A	81807	600 MCM	GREEN	5/8"	20	200	26
2912	81630	750 MCM	BLACK	5/8"	20	200	26



TWO HOLE SHORT BARREL

2921	81813	8	RED	10	100	1000	18
2922	81814	6	BLUE	1/4"	100	1000	26
2923	81815	4	GRAY	1/4"	100	1000	20
2925	81816	2	BROWN	5/16"	100	1000	18
2925A	81817	2	BROWN	3/8"	100	1000	21
2926	81818	1/0	PINK	5/16"	100	1000	21
2927	81819	2/0	BLACK	3/8"	100	1000	21
2927A	81820	2/0	BLACK	1/2"	100	1000	21
2928	81821	3/0	ORANGE	1/2"	50	500	28
2929	81822	4/0	PURPLE	1/2"	50	500	19
2929A	81803	250 MCM	YELLOW	1/2"	50	500	23
2929B	81804	300 MCM	WHITE	1/2"	50	500	26
2930	81825	350 MCM	RED	1/2"	50	500	26
2931	81826	400 MCM	BLUE	1/2"	20	200	26
2932	81807	500 MCM	BROWN	1/2"	20	200	26
2933	81808	600 MCM	GREEN	3/8"	20	200	26
2934	81839	750 MCM	BLACK	1/2"	20	200	26



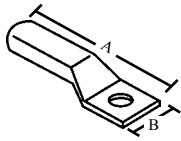

COMPRESSION LUGS (Cont'd)

UL LISTED PER 486A UP TO 35KV **COPPER**

TOPAZ CAT #	UPC#	WIRE SIZE	COLOR CODE	BOLT SIZE	UNIT CTN	SHIP CASE	WT/ CASE
-------------	------	-----------	------------	-----------	----------	-----------	----------

ONE HOLE LONG BARREL

3001	41050	8	RED	1/4"	100	1000	32
3002	41051	6	BLUE	1/4"	100	1000	32
3003	41052	4	GRAY	1/4"	100	1000	32
3005	41054	2	BROWN	3/8"	100	1000	32
3005A	81808	1	GREEN	3/8"	100	1000	32
3006	41055	1/0	PINK	3/8"	50	500	18
3007	41056	2/0	BLACK	3/8"	50	500	18
3008	41057	3/0	ORANGE	3/8"	50	500	10
3008A	81809	3/0	ORANGE	1/2"	50	500	10
3009	41058	4/0	PURPLE	1/2"	25	250	10
3009A	41059	250 MCM	YELLOW	1/2"	25	250	10
3009B	41061	300 MCM	WHITE	1/2"	25	250	10
3010	41062	350 MCM	RED	1/2"	20	200	8
3010A	41063	400 MCM	BLUE	1/2"	20	200	8
3011	41064	500 MCM	BROWN	1/2"	20	200	8
3011A	41065	600 MCM	GREEN	5/8"	20	200	8
3012	41066	750 MCM	BLACK	5/8"	20	200	8



E155861

CAT#	A	B
3001	1.70	.38
3002	1.77	.38
3003	1.77	.50
3005	2.00	.67
3005A	2.09	.67
3006	2.20	.75
3007	2.80	.75
3008	2.80	.87
3008A	2.80	.87
3009	2.80	1.00
3009A	3.03	1.13
3009B	3.39	1.13
3010	3.50	1.13
3010A	3.74	1.34
3011	4.02	1.50
3011A	4.25	1.75
3012	5.16	1.87

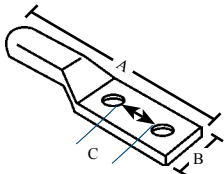

TWO HOLE LONG BARREL

3201	81812	8	RED	1/4"	100	1000	20
3202	81633	6	BLUE	1/4"	100	1000	21
3203	81635	4	GRAY	1/4"	100	1000	21
3205	81636	2	BROWN	1/2"	100	1000	29
3206	81638	1/0	PINK	1/2"	100	1000	30
3207	81640	2/0	BLACK	1/2"	100	1000	25
3208	81701	3/0	ORANGE	1/2"	50	500	19
3209	81641	4/0	PURPLE	1/2"	50	500	19
3209A	81642	250 MCM	YELLOW	1/2"	50	500	27
3209B	81643	300 MCM	WHITE	1/2"	50	500	29
3210	81644	350 MCM	RED	1/2"	50	500	37
3210A	81645	400 MCM	BLUE	1/2"	20	200	39
3211	81646	500 MCM	BROWN	1/2"	20	200	32
3211A	81647	600 MCM	GREEN	1/2"	20	200	41
3212	81648	750 MCM	BLACK	1/2"	20	200	43



E155861

CAT#	A	B	C
3201	2.24	.42	.625
3202	2.24	.42	.625
3203	2.36	.49	.625
3205	2.87	.50	.75
3206	4.40	.74	.875
3207	4.61	.81	1.75
3208	4.69	.90	1.75
3209	4.72	1.00	1.75
3209A	4.95	1.09	1.75
3209B	5.31	1.19	1.75
3210	5.39	1.28	1.75
3210A	5.47	1.39	1.75
3211	5.79	1.72	1.75
3211A	5.79	1.72	1.75
3212	6.30	1.90	1.75

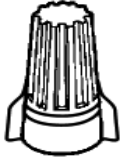

CAT#	WIRE RANGE		VOLTS
	MIN.	MAX.	
WY1	2#18	3#12	600V
WY2	2#18	3#12	600V
WR1	2#14	5#12	600V
WR2	2#14	5#12	600V
WB1	3#12	1#6 & 2#8	600V
WB2	3#12	1#6 & 2#8	600V
WG1	2#14	5#12	600V
WG2	2#14	5#12	600V
WT1	3#22	3#10	600V
WT2	3#22	3#10	600V



CAT#	WIRE RANGE		VOLTS
	MIN.	MAX.	
W81G1	2#22	2#16	300V
W82G2	2#22	2#16	300V
W82B1	2#18	3#16	300V
W82B2	2#18	3#16	300V
W83O1	2#18	2#14	600V
W83O2	2#18	2#14	600V
W84Y1	3#18	4#14&1#18	600V
W84Y2	3#18	4#14&1#18	600V
W86R1	2#14	4#12	600V
W86R2	2#14	4#12	600V

WIRE CONNECTORS

- EASY ASSEMBLY
- COLOR CODED FOR EASY SIZE AND CAPACITY IDENTIFICATION
- TEMPERATURE RATING OF 105° C.
- SQUARE WIRE SPRING INSERT FOR SECURE CONNECTIONS

POLYPROPYLENE

TOPAZ CAT #	UPC#	COLOR	UNIT CTN	SHIP CASE	WT/ CASE
-------------	------	-------	----------	-----------	----------

WINGED

- JOINS #18 THRU #10 AWG

WY1	21930	YELLOW	100/BOX	5000	16
WY2	21940	YELLOW	500/BAG	5000	16

- JOINS #18 THRU #10 AWG

WR1	21950	RED	100/BOX	5000	27
WR2	21960	RED	500/BAG	5000	27

- JOINS #14 THRU #6 AWG

WB1	21970	BLUE	50/BOX	1000	13
WB2	21980	BLUE	250/BAG	1000	13

- JOINS #14 THRU #10 AWG

WG1	21993	GREEN	100/BOX	5000	16
WG2	21990	GREEN	500/BAG	5000	16

- JOINS #22 THRU #8 AWG

WT1	21992	TAN	100/BOX	1000	13
WT2	21991	TAN	500/BAG	1000	35

FLUTED BODY

- JOINS #22 THRU #14 AWG

W81G1	30520	GRAY	100/BOX	5000	4
W81G2	30530	GRAY	500/BAG	5000	4

- JOINS #22 THRU #14 AWG

W82B1	30540	BLUE	100/BOX	5000	5
W82B2	30550	BLUE	500/BAG	5000	5

- JOINS #22 THRU #14 AWG

W83O1	30560	ORANGE	100/BOX	5000	13
W83O2	30570	ORANGE	500/BAG	5000	13

- JOINS #18 THRU #10 AWG

W84Y1	30580	YELLOW	100/BOX	5000	24
W84Y2	30590	YELLOW	500/BAG	5000	24

- JOINS #18 THRU #8 AWG

W86R1	30600	RED	100/BOX	5000	52
W86R2	30610	RED	500/BAG	5000	52

(1) UL RATED AT 300 VOLTS.

(2) UL RATED AT 600 VOLTS, EXCEPT FIXTURES AND SIGNS-1,000 VOLTS.



E155861



E155861

PLASTIC ELECTRICAL TAPE

• 7 MIL

PVC



TOPAZ CAT #	UPC#	SIZE	COLOR	UNIT CTN	SHIP CASE	WT/ CASE
830T	18370	3/4" X 30'	BLACK	10	500	41
860T	18380	3/4" X 60'	BLACK	10	200	21
866T	18410	3/4" X 66'	BLACK	—	100	20
866BLU	18411	3/4" X 66'	BLUE	—	100	20
866BRN	18412	3/4" X 66'	BROWN	—	100	20
866GRN	18413	3/4" X 66'	GREEN	—	100	20
866GRY	18414	3/4" X 66'	GRAY	—	100	20
866ORN	18415	3/4" X 66'	ORANGE	—	100	20
866RED	18417	3/4" X 66'	RED	—	100	20
866WHT	18418	3/4" X 66'	WHITE	—	100	20
866YEL	18419	3/4" X 66'	YELLOW	—	100	20
867T	18440	1 1/2" X 66'	BLACK	—	100	40



TAPE

TOPAZ CAT #	UPC#	SIZE	COLOR		SHIP CASE	WT/ CASE
830BLU	18371	1/2" X 20'	BLUE	Phasing Tape	7	8
830BRN	18372	1/2" X 20'	BROWN	Phasing Tape	7	8
830GRN	18373	1/2" X 20'	GREEN	Phasing Tape	7	8
830GRY	18374	1/2" X 20'	GRAY	Phasing Tape	7	8
830ORN	18375	1/2" X 20'	ORANGE	Phasing Tape	7	8
830PUR	18376	1/2" X 20'	PURPLE	Phasing Tape	7	8
830RED	18377	1/2" X 20'	RED	Phasing Tape	7	8
830WHT	18378	1/2" X 20'	WHITE	Phasing Tape	7	8
830YEL	18379	1/2" X 20'	YELLOW	Phasing Tape	7	8
861	18381	2" X 36 YD	WHITE	Vinyl Tape	24	20
869	18421	3/4" X 60 YD	BLACK	Friction Tape	100	35
870	18420	3/4" X 22 YD	BLACK	Rubber Tape	100	20
870C	18396	2" X 22 YD	BLACK	Rubber Tape	50	25
870T	18423	2" X 55 YD	CLEAR	Film Tape	36	7
871C	18402	2" X 110 YD	CLEAR	Sealing Tape	36	14



CAUTION TAPE

• NON-DETECTABLE

TOPAZ CAT #	UPC#	COLOR	UNIT CTN	SHIP CASE	WT/ CASE
1591	83029	3" x 300' YELLOW "CAUTION"	—	16	16
1592	83030	3" x 1000' YELLOW "CAUTION"	—	8	40
1593	83031	3" x 200' RED "CAUTION BURIED ELECTRIC LINE BELOW"	—	16	16
1594	83032	3" x 1000' RED "CAUTION BURIED ELECTRIC LINE BELOW"	—	8	40
1595	83033	6" x 1000' RED "CAUTION BURIED ELECTRIC LINE BELOW"	—	4	60

• DETECTABLE

1596	83034	2" x 1000' RED "CAUTION BURIED ELECTRIC LINE BELOW"	—	12	60
1597	83035	3" x 1000' RED "CAUTION BURIED ELECTRIC LINE BELOW"	—	8	64
1598	83036	6" x 1000' RED "CAUTION BURIED ELECTRIC LINE BELOW"	—	4	64



CAT#	MIL	
1591	4	Non-Detectable
1592	4	Non-Detectable
1593	4	Non-Detectable
1594	4	Non-Detectable
1595	4	Non-Detectable
1596	5	Detectable
1597	5	Detectable
1598	5	Detectable



HEAVY DUTY CABLE LUBRICANT

TOPAZ CAT #	UPC#	SIZE	UNIT CTN	SHIP CASE	WT/ CASE
1200	19762	1 QUART	—	10	13
1201	19763	1 GALLON	—	4	25
1202	19764	5 GALLON PAIL	—	1	30

Water-based gel, Non-toxicity - Non-flammable. Compatible with all cables. Complete cleanup with water.

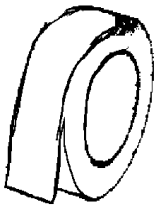

DUCT TAPE

TOPAZ CAT #	UPC#	SIZE	UNIT CTN	SHIP CASE	WT/ CASE
868	33760	2" X 60 YARDS	—	24	42
868F	18422	2" X 50 YD FOIL TAPE	—	24	51



ANTIOX CONTACT COMPOUND

TOPAZ CAT #	UPC#	SIZE	UNIT CTN	SHIP CASE	WT/ CASE
1209	19765	4 OUNCE BOTTLE	—	12	3
1210	19766	8 OUNCE BOTTLE	—	12	6

Prevents oxidation of Aluminum to Aluminum & Aluminum to Copper Electrical Conductors. Used for all types of connections, split-bolt and wire connectors. Non conductive

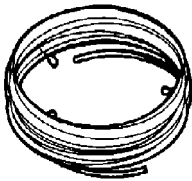

FISH WIRE

- INDIVIDUALLY BAGGED
- REPLACEMENT FOR REWINDERS

SPRING STEEL

TOPAZ CAT #	UPC#	SIZE	UNIT CTN	SHIP CASE	WT/ CASE
890	18980	1/8" X .060" X 25'	—	20	7
891	18990	1/8" X .060" X 50'	—	20	25
892	19000	1/8" X .060" X 100'	—	10	25
893	19010	1/8" X .060" X 200'	—	5	25
895	19020	1/4" X .060" X 50'	—	10	25
896	19030	1/4" X .060" X 100'	—	10	50
897	19040	1/4" X .060" X 200'	—	5	50



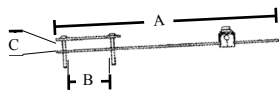

CAT#	OPENINGS			
	A	B (MIN)	B (MAX)	C (MAX)
CBS	11.00	1.00	2.25	1.25

CEILING BOX SUPPORT

STEEL

TOPAZ CAT #	UPC#	SIZE	UNIT CTN	SHIP CASE	WT/ CASE
CBS	19891	1"- 2"	-	50	1

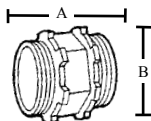

CAT#	A	B
141	1.12	.40
141A	1.12	.95

BOX SPACING CONNECTOR WITH TWIN LOCKNUTS

ZINC DIE CAST

TOPAZ CAT #	UPC#	SIZE	UNIT CTN	SHIP CASE	WT/ CASE
141	10930	1/2"	50	500	40
141A	10932	3/4"	25	250	24



E155861

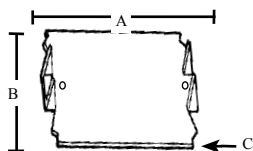

CAT#	A	B	C
187	6.00	1.50	.0598
188	5.00	1.50	.0598
189	2.50	1.50	.0598
189B	2.50	1.50	.0598
189-100	2.50	1.50	.0598

NAIL PLATE WITH PRONGS

- 16 GAUGE
- NAIL HOLES

STEEL

TOPAZ CAT #	UPC#	SIZE	UNIT CTN	SHIP CASE	WT/ CASE
187	11497	1 1/2" X 6"	-	100	49
188	11498	1 1/2" X 5"	-	100	30
189	11500	1 1/2" X 2 1/2"	-	200	20
189B	11501	1 1/2" X 2 1/2" X 1/16"	50	200	20
189-100	11499	1 1/2" X 2 1/2" X 1/16"	-	100	20

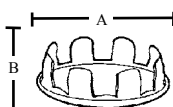

CAT#	A	B
K050	1.07	.37
K051	1.24	.31
K052	1.48	.34
K053	1.80	.31
K054	2.22	.37
K055	2.68	.36

KNOCK-OUT SEALS

STEEL

TOPAZ CAT #	UPC#	SIZE	UNIT CTN	SHIP CASE	WT/ CASE
K050	20780	1/2"	100	1000	10
K051	20790	3/4"	100	1000	20
K052	20800	1"	50	500	9
K053	20810	1 1/4"	50	500	10
K054	20820	1 1/2"	50	500	20
K055	20830	2"	10	100	5

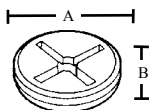

CAT#	A	B
WP50	.79	.33
WP75	1.00	.30
WP100	1.23	.28

CLOSURE PLUGS

ZINC DIE CAST

TOPAZ CAT #	UPC#	SIZE	UNIT CTN	SHIP CASE	WT/ CASE
WP50	19700	1/2"	-	100	2
WP75	19710	3/4"	-	50	2
WP100	19720	1"	-	25	2



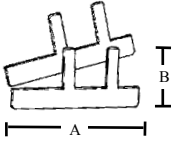

CAT#	A	B
199	5.125	2.250

BOX SUPPORTS

TOPAZ		STEEL			
CAT #	UPC#	UNIT	SHIP	WT/	
		CTN	CASE	CASE	
199	11540	SOLD IN PAIRS	50 PR	500 PR	25

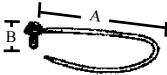
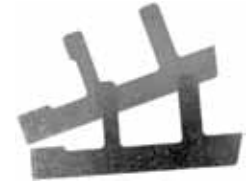

CAT#	A	B
49	7 1/2	10-32 x 3/8
50	7 1/2	10-32 x 3/8

GREEN PIGTAIL W/SLOTTED HEX GROUND SCREW

TOPAZ		COPPER			
CAT #	UPC#	SIZE	UNIT	SHIP	WT/
			CTN	CASE	CASE
49	33505	7 1/2" 12GA. SOLID	-	100	24
50	33506	7 1/2" 14GA. SOLID	-	100	23

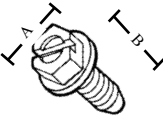

CAT#	A	B
48	.375	.625

GREEN GROUND SCREW

TOPAZ		STEEL			
CAT #	UPC#	SIZE	UNIT	SHIP	WT/
			CTN	CASE	CASE
48	33500	10/32" X 3/8"	-	100	1



CAT#	A	B
GC99	.24	.65

GREEN GROUND CLIP

TOPAZ		STEEL			
CAT #	UPC#	SIZE	UNIT	SHIP	WT/
			CTN	CASE	CASE
GC99	20770	#14 & #12	100	1000	3



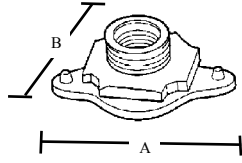

CAT#	A	B
277	1.752	.654

NO BOLT FIXTURE STUD

ZINC DIE CAST

TOPAZ CAT #	UPC#	SIZE	UNIT CTN	SHIP CASE	WT/ CASE
277	17730	1/8" F X 3/8" M	—	100	3

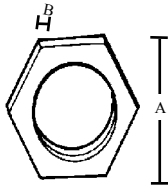

CAT#	A	B
278	.625	.20
279	.715	.20
280	1.00	.22

FIXTURE LOCKNUTS

STEEL

TOPAZ CAT #	UPC#	SIZE	UNIT CTN	SHIP CASE	WT/ CASE
278	11710	1/8"	100	1000	1
279	11720	1/4"	100	1000	1
280	12290	3/8" SQUARE - HEAVY	—	200	5

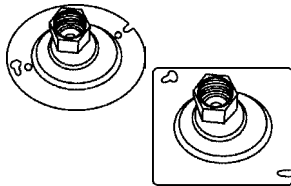

CAT#	
33R	FITS 4" OCTAGON
34S	FITS 4" SQUARE

FLEXIBLE FIXTURE HANGERS

20° SWING FROM VERTICAL

- SUPPORTS WEIGHT 50 LBS.
- BALL TYPE SWIVEL

STEEL

TOPAZ CAT #	UPC#	SIZE	UNIT CTN	SHIP CASE	WT/ CASE
33R	10071	1/2" OR 3/4" ROUND	—	25	15
34S	10072	1/2" OR 3/4" SQUARE	—	25	18

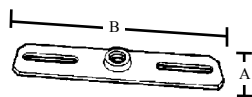

CAT#	A	B
46	1.00	4.12

FIXTURE HANGER

- WITH GREEN GROUND SCREW
- CROSS BAR FITS ALL STANDARD SWITCH BOXES & 3-1/4" & 4" OUTLET BOXES

STEEL

TOPAZ CAT #	UPC#	SIZE	UNIT CTN	SHIP CASE	WT/ CASE
46	14170	1/8" FEMALE	—	100	4

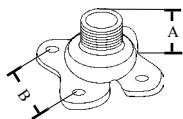

CAT#	A	B
47	1.00	1.10

MALLEABLE IRON					
TOPAZ CAT #	UPC#	SIZE	UNIT CTN	SHIP CASE	WT/ CASE
47	14171	CROWS FOOT	25	250	8



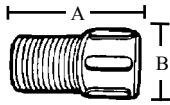

CAT#	A	B
190	1.000	.776
200	1.375	.780

FIXTURE EXTENSIONS

ZINC DIE CAST

TOPAZ CAT #	UPC#	SIZE	UNIT CTN	SHIP CASE	WT/ CASE
190	11510	3/8" M X 1" F	100	1000	50
200	11520	3/8" M X 1 3/8" F	100	1000	60

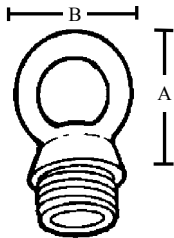

CAT#	A	B
71	1.27	1.12

FIXTURE LOOP

ZINC DIE CAST

TOPAZ CAT #	UPC#	SIZE	UNIT CTN	SHIP CASE	WT/ CASE
71	17440	1/2" MALE	25	250	15

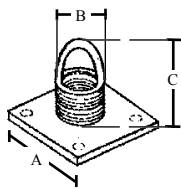

CAT#	A	B	C
71A	1.39	.57 (Opening)	1.12

STUD LOOP & HANGER

ZINC DIE CAST

TOPAZ CAT #	UPC#	SIZE	UNIT CTN	SHIP CASE	WT/ CASE
71A	17442	1/2"	-	100	7



LAMP HOLDER

PLASTIC

TOPAZ CAT #	UPC#	SIZE	UNIT CTN	SHIP CASE	WT/ CASE
P2	84005	Medium Base	1	50	25

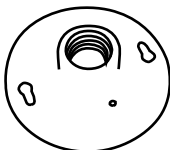

LAMP HOLDER

PORCELAIN

TOPAZ CAT #	UPC#	SIZE	UNIT CTN	SHIP CASE	WT/ CASE
PORI	84006	Medium Base	24	100	10



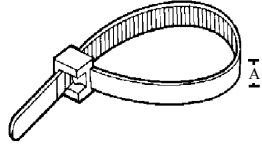

CAT#	BUNDLE DIAMETER		A
	MIN	MAX	
NT0418	.0625	.875	.98
NT0530	.0625	1.378	.98
NT0618	.0625	1.378	.98
NT0640	.0625	1.535	.142
NT0750	.0625	1.75	.187
NT0818	.0625	2.00	.100
NT0840	.0625	2.00	.130
NT08120	.0625	2.00	.300
NT1150	.0625	3.00	.187
NT1450	.0625	4.00	.187
NT24175	.1875	7.20	.345
NT30175	.1875	9.30	.35
NT34175	.1875	7.20	.345

BT0418	.0625	.875	.100
BT0530	.0625	1.378	.98
BT0618	.0625	1.378	.98
BT0750	.0625	1.75	.187
BT0818	.0625	2.00	.100
BT0840	.0625	2.00	.130
BT1150	.0625	3.00	.187
BT1450	.0625	4.00	.187
BT24175	.1875	7.20	.345
BT34175	.1875	7.20	.345

CABLE TIES

6/6 NYLON

TOPAZ CAT #	UPC#	SIZE	MIN TENSILE STRENGTH	PER BAG	SHIP CASE	WT/ 100
NATURAL WHITE						
NT0418	21440	4"	18	100	1000	.10
NT0530	21450	5"	30	100	1000	.10
NT0618	21451	6 1/2"	18	100	1000	.41
NT0640	21452	6"	40	100	1000	.41
NT0750	21460	7"	50	100	1000	.42
NT0818	21470	8"	18	100	1000	.34
NT0840	21480	8"	40	100	1000	.38
NT08120	21490	8"	120	100	1000	.43
NT1150	21500	11"	50	100	1000	.54
NT1450	21510	14"	50	100	1000	.69
NT24175	21530	24"	175	50	500	2.82
NT30175	21532	30"	175	50	500	3.22
NT34175	21550	34"	175	50	500	4.20

BLACK

BT0418	19770	4"	18	100	1000	.10
BT0530	19780	5"	30	100	1000	.10
BT0618	19781	6 1/2"	18	100	1000	.41
BT0750	19790	7"	50	100	1000	.42
BT0818	19800	8"	18	100	1000	.34
BT0840	19810	8"	40	100	1000	.38
BT1150	19830	11"	50	100	1000	.54
BT1450	19840	14"	50	100	1000	.69
BT24175	19860	24"	175	50	500	2.82
BT34175	19890	34"	175	50	500	4.20



OPERATING TEMPERATURES

MIN -40°F MAX 185°F

UL Flame Rating 94V-2.

OPERATING TEMPERATURES

MIN -40°F MAX 185°F

UL Flame Rating 94V-2.
UV Resistance

AIR HANDLING CABLE TIES

6/6 NYLON

TOPAZ CAT #	UPC#	SIZE	COLOR	MIN TENSILE STRENGTH	PER BAG	SHIP CASE	WT/ 100
PTB0750	83642	7 1/2"	BURGUNDY	50	100	1000	.42
PTB1150	83644	11"	BURGUNDY	50	100	1000	.54
PTB1450	83646	14 1/2"	BURGUNDY	50	100	1000	.69

- Applications: Air Handling Spaces, above drop ceilings and below raised flooring.
- Meets UL 1565 low smoke generation, low heat release, and mechanical strength test.
- UL Listed suitable for use in Air Handling Spaces in accordance with the Section 300.00 (C) and (D) of the National Electrical Code and Rules 12-010 (3), (4), and (5) and 12-020 of the Canadian Electrical Code, Part 1.
- Strong and Pure manufactured from filtered nylon 6/6 reducing particle contamination.
- Mounting Hole Style secures and positions wire bundles, cables, etc. to surfaces with one mechanical fastener.
- Low Profile Style reduced head height increases safety, eliminates snags, cuts, and abrasions to cables, surrounding products, and users.

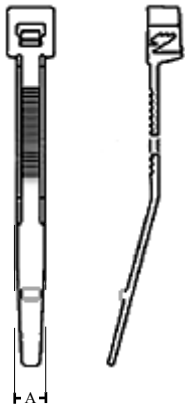

CAT#	BUNDLE DIAMETER		A
	MIN	MAX	
PTB0750	.0625	1.875	.180
PTB1150	.0625	3.062	.180
PTB1450	.0625	4.125	.180



CONDUIT HANGERS

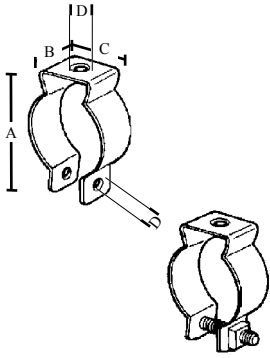

CAT#	A	B	C	D
611/601	1.875	.750	.725	.25
612/602	2.125	.750	.850	.25
613/603	2.437	.875	.975	.25
614/604	2.75	.875	.975	.25
614A/604A	2.875	.875	1.050	.25
615/605	3.125	1.000	1.125	.25
616/606	3.875	1.000	1.145	.25
617/607	4.625	1.250	1.225	.3125
618/608	5.500	1.250	1.275	.3125
619/609	5.750	1.250	1.275	.3125
620/610	6.250	1.250	1.275	.3125

STEEL							
TOPAZ CAT #	UPC#	TRADE SIZE	FOR RIGID	FOR EMT	BOLT SIZE	SHIP CASE	WT/ CASE
WITH BOLTS & NUTS ATTACHED							
601	15830	0	3/8"-1/2"	1/2"	1/4-20	100	6
602	15840	1	3/4"	3/4"	1/4-20	100	8
603	15850	2	1"	1"	1/4-20	100	8
604	15860	3	1 1/4"	1 1/2"	1/4-20	100	10
604A	15870	2 1/2	---	1 1/4"	1/2-20	100	10
605	15880	4	1 1/2"	---	1/2-20	100	18
606	15890	5	2"	2"	1/2-20	50	10
607	15900	6	2 1/2"	2 1/2"	5/16-18	50	11
608	15910	7	3"	3"	5/16-18	25	6
609	15920	8	3 1/2"	3 1/2"	5/16-18	25	8
610	15930	9	4"	4"	5/16-18	25	12



E170258

WITHOUT BOLTS & NUTS

611	15940	0	3/8"-1/2"	1/2"	---	100	5
612	15950	1	3/4"	3/4"	---	100	7
613	15960	2	1"	1"	---	100	7
614	15970	3	1 1/4"	1 1/2"	---	100	9
614A	15980	2 1/2	---	1 1/4"	---	100	9
615	15990	4	1 1/2"	---	---	100	17
616	16000	5	2"	2"	---	50	9
617	16010	6	2 1/2"	2 1/2"	---	50	11
618	16020	7	3"	3"	---	25	5
619	16030	8	3 1/2"	3 1/2"	---	25	7
620	16040	9	4"	4"	---	25	11



E170258



CAT#	WORKLOAD LIMITS
FC1	50 LBS.

FLUORESCENT CHAIN

STEEL							
TOPAZ CAT #	UPC#	SIZE	UNIT CTN	SHIP CASE	WT/ CASE		
FC1	20750	1 YARD LENGTHS	1 YD.	100	35		

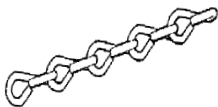
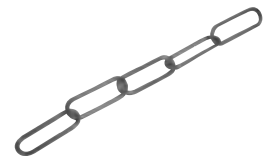

CAT#	WORKLOAD LIMITS
297	16 LBS.
298	29 LBS.
298S	29 LBS.
299	29 LBS.
299B	43 LBS.

JACK CHAIN

• ZINC PLATED

STEEL							
TOPAZ CAT #	UPC#	SIZE	UNIT CTN	SHIP CASE	WT/ CASE		
297	12480	14 GAUGE - LIGHT	100 FT.HANKS	10	50		
298	12490	12 GAUGE - STANDARD	50 FT.HANKS	10	30		
298S	12500	12 GAUGE - STANDARD	100 FT.SPOOLS	4	48		
299	12501	12 GAUGE - STANDARD	250 FT.SPOOLS	4	60		
299B	12505	10 GAUGE - HEAVY	100 FT.HANKS	1	18		



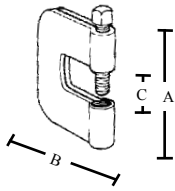

CAT#	A	B	C
126	2.40	2.49	.73

I-BEAM CLAMP C CLAMP

• CLAMP IS TAPPED FOR ROD

STEEL

TOPAZ CAT #	UPC#	SIZE	TAPPING	UNIT CTN	SHIP CASE	WT/ CASE
126	10820	3/4"	3/8" - 16	10	100	30

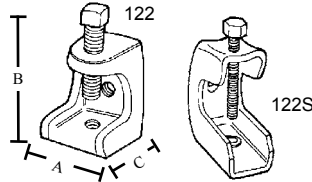

CAT#	A	B	C	TIGHTEN TORQUE
122	1.130	1.400	1.390	60
123	1.990	1.755	1.890	125
123A	1.130	1.400	1.390	60
124	2.530	2.140	2.500	250

BEAM CLAMPS

MALLEABLE IRON

TOPAZ CAT #	UPC#	JAW OPENING	TAPPING	LOAD CAPACITY	UNIT CTN	SHIP CASE	WT/ CASE
122	10710	3/4"	1/4" - 20	125 LBS.	—	50	11
123	10720	7/8"	3/8" - 16	300 LBS.	—	50	23
123A	10721	3/4"	3/8" - 16	300 LBS.	—	50	18
124	10730	1 1/8"	1/2" - 13	800 LBS.	—	25	40

STEEL

122S	10740	11/16"	1/4" - 20	50 LBS.	—	100	22
123S	10750	1"	3/8" - 16	100 LBS.	—	50	20

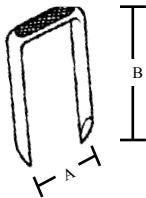

CAT#	A	B
183	.500	1.0
183i	.500	1.0
184	.500	1.0
184i	.500	1.0
185	.500	1.0
185i	.500	1.0
193	.500	1.25
194	.500	1.25
195	.5005	1.25
196	.82	1.40
197	.82	1.40
186	1.0625	1.4375
198	1.3438	1.875

CABLE STAPLES

STEEL

TOPAZ CAT #	UPC#	SIZE	UNIT CTN	SHIP CASE	WT/ CASE
FOR NMC 2 WIRE #14-12					
183	11440	1/2"	100	5000	25
183i*	11441	1/2"	100	5000	26
184	11450	1/2"	500	5000	25
184i*	11442	1/2"	500	5000	26
185	11460	1/2"	BUCKET	5000	26
185i*	11445	1/2"	BUCKET	2500	13
FOR NMC AND ARMORED 3 WIRE #14-12-10					
193	11470	9/16"	100	5000	33
194	11480	9/16"	500	5000	31
195	11490	9/16"	BUCKET	5000	35
FOR SEU TO 3 #6					
196	11492	13/16"	100	5000	61
197	11494	13/16"	500	5000	61
186	11443	1-11/16"	100	1000	15
198	11444	1-11/32"	100	1000	32

*Insulated





COVER PLATE

- BAKED WHITE ENAMEL
- 2-8/32" SCREWS

CAT#	
175	3 1/2" Screw Separation
176	2 3/4" Screw Separation

STEEL					
TOPAZ CAT #	UPC#	SIZE	UNIT CTN	SHIP CASE	WT/ CASE
175	33510	5"	1 PER BAG	100	18
176	33511	5"	1 PER BAG	100	18

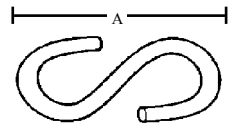
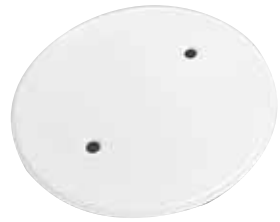

S HOOKS

- ZINC PLATED

CAT#	G	WORKLOAD LIMITS	
		A	
300	14 GA	.96	16 LBS.
300A	12 GA	1.23	29 LBS.
300B	10 GA	1.48	43 LBS.

STEEL						
TOPAZ CAT #	UPC#	SIZE	DUTY	UNIT CTN	SHIP CASE	WT/ CASE
300	12510	14 GAUGE	LIGHT	100	1000	11
300A	12520	12 GAUGE	MEDIUM	100	1000	15
300B	12525	10 GAUGE	HEAVY	100	1000	19

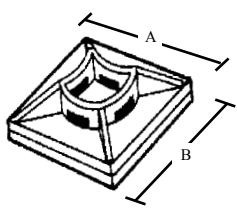

CABLE TIE MOUNTING PLATFORMS

CAT#	MOUNTING HEAD		HEIGHT	HOLE	FLAT SCREW
	A	B			
MP4A	1.00	1.00	.157	.197	#6
MP4S	1.00	1.00	.157	.197	#6
MP4AB	1.00	1.00	.157	.197	#6
MP4SB	1.00	1.00	.157	.197	#6

NYLON					
TOPAZ CAT #	UPC#	SIZE	UNIT CTN	SHIP CASE	WT/ CASE
NATURAL WHITE					
MP4A	32270	4 WAY ADHESIVE BASE	100	1000	5
MP4S	32280	4 WAY SCREW MOUNT	100	1000	5

BLACK					
TOPAZ CAT #	UPC#	SIZE	UNIT CTN	SHIP CASE	WT/ CASE
MP4AB	32320	4 WAY ADHESIVE BASE	100	1000	5
MP4SB	32330	4 WAY SCREW MOUNT	100	1000	5

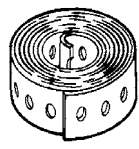

PERFORATED BAND IRON

- 20 GA

CAT#	
962	1/4" HOLES ON 1/2" CENTER

STEEL					
TOPAZ CAT #	UPC#	SIZE	UNIT CTN	SHIP CASE	WT/ CASE
962	19570	3/4" x 10'	—	50	30



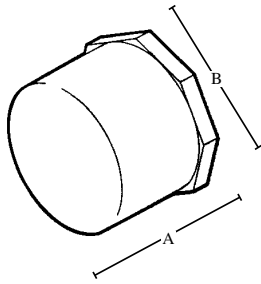

CAT#	A	B
1081	1.00	1.0625
1082	1.25	1.3125
1083	1.4375	1.625
1084	1.50	2.00
1085	1.625	2.25
1086	1.75	2.75
1087	2.125	3.50
1088	2.25	4.00
1089	2.3125	4.625
1090	2.50	5.0625
1090A	2.50	6.125
1090B	3.3125	7.25

END CAPS

TOPAZ CAT #	UPC#	SIZE	UNIT CTN	SHIP CASE	PVC WT/ CASE
1081	23407	1/2"	—	100	2
1082	23091	3/4"	—	100	5
1083	23092	1"	—	50	8
1084	23093	1 1/4"	—	25	8
1085	23094	1 1/2"	—	25	12
1086	23095	2"	—	50	18
1087	23096	2 1/2"	—	25	32
1088	23097	3"	—	25	52
1089	23098	3 1/2"	—	25	68
1090	23099	4"	—	25	88
1090A	23102	5"	—	25	104
1090B	23101	6"	—	10	108



E170258

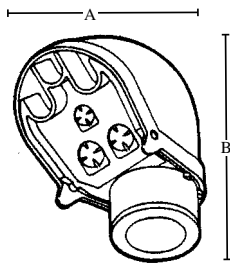

CAT#	A	B
1111	3.00	3.00
1112	3.00	3.00
1113	3.50	3.50
1114	5.25	4.25
1115	6.75	5.75
1116	6.75	5.75
1117	14.00	9.00
1118	14.00	9.00
1119	---	---
1120	17.00	13.50

SERVICE ENTRANCE CAPS

TOPAZ CAT #	UPC#	SIZE	UNIT CTN	SHIP CASE	PVC WT/ CASE
1111	23104	1/2"	—	10	10
1112	23105	3/4"	—	10	10
1113	23106	1"	—	20	20
1114	23107	1 1/4"	—	20	40
1115	23108	1 1/2"	—	20	50
1116	23109	2"	—	5	100
1117	23408	2 1/2"	—	5	500
1118	23111	3"	—	5	500
1119	23112	3 1/2"	—	5	420
1120	23113	4"	—	1	1500



E170258

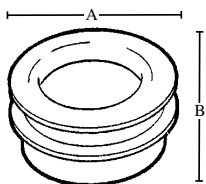

CAT#	A	B
1121	1.25	.75
1122	1.50	1.00
1123	1.75	1.25
1124	2.125	1.3125
1125	2.50	1.5625
1126	2.8125	1.5625
1127	3.375	1.875
1128	4.125	2.0625
1129	4.625	2.25
1130	5.125	2.375
1130A	6.375	2.4375
1130B	7.375	2.875

END BELLS

TOPAZ CAT #	UPC#	SIZE	UNIT CTN	SHIP CASE	PVC WT/ CASE
1121	23409	1/2"	—	100	2
1122	23131	3/4"	—	100	3
1123	23132	1"	—	50	4
1124	23133	1 1/4"	—	50	4
1125	23134	1 1/2"	—	50	8
1126	23135	2"	—	40	8
1127	23436	2 1/2"	—	30	14
1128	23137	3"	—	50	16
1129	23138	3 1/2"	—	50	26
1130	23139	4"	—	50	32
1130A	23372	5"	—	25	36
1130B	23373	6"	—	15	63



E170258

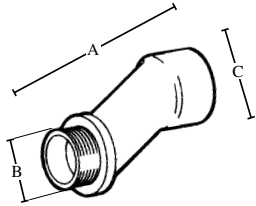

CAT#	A	B	C
1094	3.50	1.625	2.00
1096	3.50	2.3125	2.1875

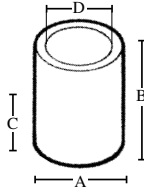

CAT #	A	B	C	D
1011	1.0625	1.50	.625	.875
1012	1.3125	1.5625	.625	1.062
1013	1.625	2.00	1.00	1.3125
1014	2.00	2.125	1.00	1.6875
1015	2.25	2.375	1.125	1.9375
1016	2.6875	2.4375	1.25	2.375
1017	3.25	3.50	1.75	2.875
1018	4.00	3.875	1.8125	3.50
1019	4.125	4.00	1.9375	4.00
1020	5.00	4.1875	2.00	4.50
1020A	6.125	5.375	2.50	5.625
1020B	7.25	6.375	3.00	6.625

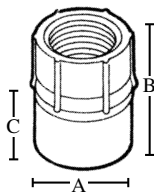

CAT #	A	B	C
1021	1.00	1.4375	.6875
1022	1.25	1.625	.6875
1023	1.5625	1.875	.8750
1024	2.00	1.9375	.9375
1025	2.25	2.125	.9375
1026	2.6875	2.125	.9375
1027	3.3125	3.00	1.3125
1028	4.00	3.0625	1.25
1029	4.50	3.00	1.1875
1030	5.00	3.25	1.375
1030A	7.25	4.375	1.625
1030B	9.3125	7.00	2.25

METER OFFSET

TOPAZ CAT #	UPC#	SIZE	UNIT CTN	SHIP CASE	PVC WT/ CASE
1094	23116	1 1/4"	—	25	8
1096	23117	2"	—	8	24



E170258

COUPLINGS

TOPAZ CAT #	UPC#	SIZE	UNIT CTN	SHIP CASE	PVC WT/ CASE
1011	23001	1/2"	—	200	4
1012	23002	3/4"	—	125	5
1013	23003	1"	—	70	6
1014	23004	1 1/4"	—	40	7
1015	23005	1 1/2"	—	30	10
1016	23006	2"	—	40	14
1017	23007	2 1/2"	—	20	35
1018	23008	3"	—	40	50
1019	23009	3 1/2"	—	30	70
1020	23401	4"	—	20	90
1020A	23011	5"	—	10	140
1020B	23012	6"	—	8	185



E170258

FEMALE ADAPTERS

TOPAZ CAT #	UPC#	SIZE	UNIT CTN	SHIP CASE	PVC WT/ CASE
1021	23013	1/2"	—	200	3
1022	23014	3/4"	—	125	4
1023	23015	1"	—	70	5
1024	23016	1 1/4"	—	40	10
1025	23017	1 1/2"	—	30	11
1026	23018	2"	—	40	15
1027	23019	2 1/2"	—	20	40
1028	23402	3"	—	40	47
1029	23021	3 1/2"	—	30	65
1030	23022	4"	—	20	85
1030A	23023	5"	—	10	140
1030B	23024	6"	—	8	185



E170258

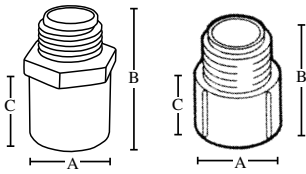

CAT #	A	B	C
1031	1.0625	1.6875	1.125
1032	1.25	1.75	1.1875
1033	2.1875	1.625	1.50
1034	2.00	2.125	1.3125
1035	2.00	2.0625	1.3125
1036	2.6875	2.1875	1.375
1037	3.3125	2.875	2.00
1038	3.9375	3.00	2.1875
1039	4.50	3.1875	2.5625
1040	5.00	3.4375	2.5625
1040A	6.25	4.75	3.00
1040B	7.3125	4.9375	2.6875

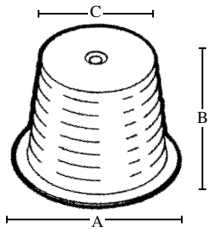

CAT #	A	B	C
1206	2.50	3.00	1.875
1207	3.50	3.75	2.625
1208	4.375	3.875	3.75
1208A	5.75	3.875	3.875
1208B	6.75	3.75	5.75

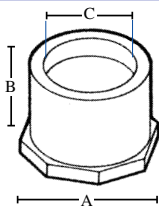

CAT #	A	B	C
1132	1.050	1.00	.852
1133	1.315	1.18	1.064
1134	1.660	1.42	1.330
1135	1.900	1.37	1.677
1136	2.375	1.60	1.918
1137	2.875	1.90	2.393
1138	3.50	2.25	2.890
1139	4.50	2.60	3.515
1140	4.50	2.60	4.015

TERMINAL ADAPTERS

TOPAZ CAT #	UPC#	SIZE	UNIT CTN	SHIP CASE	WT/ CASE
1031	23025	1/2"	—	200	3
1032	23026	3/4"	—	125	6
1033	23027	1"	—	70	5
1034	23028	1 1/4"	—	40	8
1035	23029	1 1/2"	—	30	7
1036	23403	2"	—	40	12
1037	23031	2 1/2"	—	20	25
1038	23032	3"	—	40	40
1039	23033	3 1/2"	—	30	59
1040	23034	4"	—	20	60
1040A	23035	5"	—	10	150
1040B	23036	6"	—	8	125



POLY PLUGS

TOPAZ CAT #	UPC#	SIZE	UNIT CTN	SHIP CASE	WT/ CASE
1206	23142	2"	—	70	6
1207	23143	3"	—	70	10
1208	23144	4"	—	90	19
1208A	23145	5"	—	45	14
1208B	23146	6"	—	30	10



REDUCERS

TOPAZ CAT #	UPC#	SIZE	UNIT CTN	SHIP CASE	WT/ CASE
1132	23081	3/4" x 1/2"	—	100	2
1133	23082	1" x 3/4"	—	100	3
1134	23083	1 1/4" x 1"	—	50	2
1135	23084	1 1/2" x 1 1/4"	—	50	6
1136	23085	2" x 1 1/2"	—	25	12
1137	23086	2 1/2" x 2"	—	25	20
1138	23087	3" x 2 1/2"	—	25	36
1139	23088	4" x 3"	—	20	55
1140	23089	4" x 3 1/2"	—	20	36



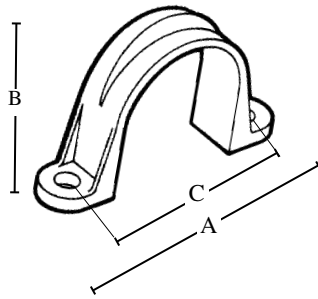

CAT #	A	B	C
1061	2.1875	1.00	1.6875
1062	2.50	1.25	2.00
1063	2.8125	1.50	2.00
1064	3.125	1.8125	2.50
1065	3.375	2.125	2.6875
1066	4.00	2.5625	3.3125
1067	5.50	3.00	4.5625
1068	6.00	3.5625	5.125
1070	7.00	4.625	6.00

TWO-HOLE PIPE STRAPS

TOPAZ CAT #	UPC#	SIZE	UNIT CTN	SHIP CASE	WT/ CASE
1061	23063	1/2"	—	300	.68
1062	23064	3/4"	—	200	1.20
1063	23065	1"	—	200	1.80
1064	23066	1 1/4"	—	200	2.30
1065	23067	1 1/2"	—	200	2.50
1066	23068	2"	—	200	3.50
1067	23069	2 1/2"	—	100	8.35
1068	23406	3"	—	100	10.50
1070	23071	4"	—	100	12.80



BOX ADAPTERS

TOPAZ CAT #	UPC#	SIZE	UNIT CTN	SHIP CASE	WT/ CASE
1211	23025	1/2"	—	100	1.65
1212	23026	3/4"	—	100	3.05
1213	23027	1"	—	100	3.60
1214	23028	1 1/4"	—	50	5.00
1215	23029	1 1/2"	—	50	6.00
1216	23030	2"	—	25	10.40
1217	23403	2 1/2"	—	10	23.00
1218	23032	3"	—	10	35.80
1219	23033	3 1/2"	—	10	46.50
1220	23034	4"	—	10	45.80

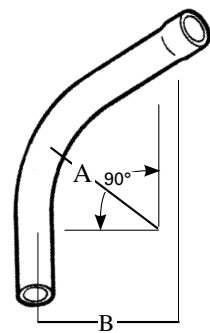
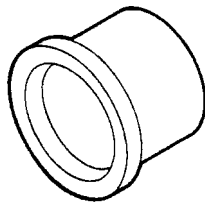

CAT #	A	B
1241	4.00	4.00
1242	4.50	4.50
1243	5.75	5.75
1244	7.25	7.25
1245	8.25	8.25
1246	9.50	9.50
1247	10.50	10.50
1248	13.00	13.00
1249	15.00	15.00
1250	16.00	16.00
1250A	24.00	24.00
1250B	30.00	30.00

90° ELBOWS BELL END

TOPAZ CAT #	UPC#	SIZE	UNIT CTN	SHIP CASE	PVC WT/ CASE
1241	23164	1/2"	—	50	12
1242	23165	3/4"	—	35	18
1243	23166	1"	—	20	40
1244	23167	1 1/4"	—	30	53
1245	23168	1 1/2"	—	30	70
1246	23169	2"	—	15	123
1247	23174	2 1/2"	—	18	200
1248	23171	3"	—	14	322
1249	23172	3 1/2"	—	12	435
1250	23173	4"	—	10	640
1250A	23174	5"	—	1	1033
1250B	23175	6"	—	1	1700



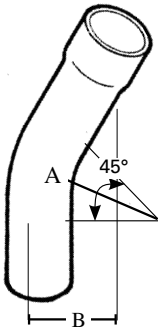

45° ELBOWS BELL END

TOPAZ CAT #	UPC#	SIZE	UNIT CTN	SHIP CASE	WT/ CASE
1251	23176	1/2"	—	50	10
1252	23177	3/4"	—	25	12
1253	23178	1"	—	25	20
1254	23179	1 1/4"	—	25	36
1255	23375	1 1/2"	—	20	45
1256	23181	2"	—	10	80
1257	23182	2 1/2"	—	20	140
1258	23183	3"	—	8	192
1259	23184	3 1/2"	—	5	280
1260	23185	4"	—	20	395
1260A	23186	5"	—	1	600
1260B	23187	6"	—	1	900

CAT #	A	B
1251	4.00	1.1875
1252	4.50	1.3125
1253	5.75	1.6875
1254	7.25	2.125
1255	8.25	2.4375
1256	9.50	2.8125
1257	10.50	3.0625
1258	13.00	3.8125
1259	15.00	4.375
1260	16.00	4.6875
1260A	24.00	7.00
1260B	30.00	8.875

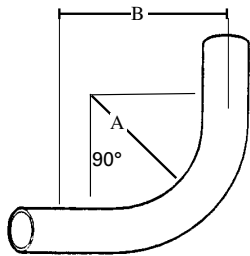

90° ELBOWS PLAIN END

TOPAZ CAT #	UPC#	SIZE	UNIT CTN	SHIP CASE	WT/ CASE
1041	23038	1/2"	—	50	10
1042	23039	3/4"	—	35	17
1043	23404	1"	—	20	30
1044	23041	1 1/4"	—	30	45
1045	23042	1 1/2"	—	30	69
1046	23043	2"	—	15	125
1047	23044	2 1/2"	—	18	230
1048	23045	3"	—	14	370
1049	23046	3 1/2"	—	12	505
1050	23047	4"	—	10	720
1050A	23048	5"	—	1	1297
1050B	23049	6"	—	1	2080

CAT #	A	B
1041	4.00	4.00
1042	4.50	4.50
1043	5.75	5.75
1044	7.25	7.25
1045	8.25	8.25
1046	9.50	9.50
1047	10.50	10.50
1048	13.00	13.00
1049	15.00	15.00
1050	16.00	16.00
1050A	24.00	24.00
1050B	30.00	30.00

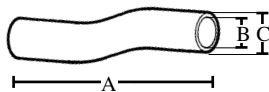

PVC OFFSETS

TOPAZ CAT #	UPC#	SIZE	UNIT CTN	SHIP CASE	WT/ CASE
1101	23118	1/2"	—	25	8
1102	23119	3/4"	—	25	12

CAT #	A	B	C
1101	6.375	.625	.875
1102	6.375	.75	1.0625



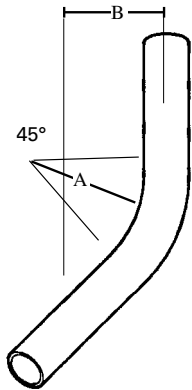

45° ELBOWS PLAIN END

PVC

TOPAZ CAT #	UPC#	SIZE	UNIT CTN	SHIP CASE	WT/ CASE
1051	23051	1/2"	—	50	5
1052	23052	3/4"	—	25	8
1053	23053	1"	—	20	15
1054	23054	1 1/4"	—	25	28
1055	23055	1 1/2"	—	20	35
1056	23056	2"	—	10	40
1057	23057	2 1/2"	—	20	105
1058	23058	3"	—	8	180
1059	23059	3 1/2"	—	5	260
1060	23405	4"	—	20	345
1060A	23061	5"	—	1	650
1060B	23062	6"	—	1	950



CAT #	A	B
1051	4.00	4.00
1052	4.50	4.50
1053	5.75	5.75
1054	7.25	7.25
1055	8.25	8.25
1056	9.50	9.50
1057	10.50	10.50
1058	13.00	13.00
1059	15.00	15.00
1060	16.00	16.00
1060A	24.00	24.00
1060B	30.00	30.00

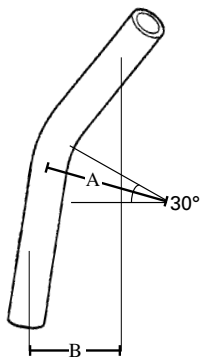

30° ELBOWS PLAIN END

TOPAZ CAT #	UPC#	SIZE	UNIT CTN	SHIP CASE	WT/ CASE
1261	23188	1/2"	—	50	5
1262	23189	3/4"	—	25	9
1263	23376	1"	—	20	15
1264	23191	1 1/4"	—	25	27
1265	23192	1 1/2"	—	20	1
1266	23193	2"	—	10	1
1267	23194	2 1/2"	—	20	108
1268	23195	3"	—	8	16
1269	23196	3 1/2"	—	5	265
1270	23197	4"	—	20	275
1270A	23198	5"	—	30	800
1270B	23199	6"	—	25	1300



CAT #	A	B
1261	4.00	.50
1262	4.50	.625
1263	5.75	.75
1264	7.25	1.00
1265	8.25	1.0625
1266	9.50	1.25
1267	10.50	1.4375
1268	13.00	1.75
1269	15.00	2.00
1270	16.00	2.0625
1270A	24.00	3.1875
1270B	30.00	4.00

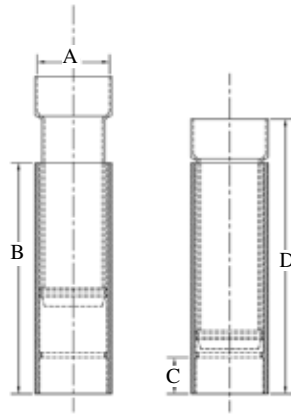

CAT#	A	B	C	D
1071	.875	7.00	.6875	8.125
1072	1.0625	7.00	.875	8.125
1073	1.3125	7.0625	1.00	8.375
1074	1.6875	7.625	1.00	9.00
1075	1.9375	7.5625	1.125	9.00
1076	2.375	7.6875	1.1875	9.25
1077	2.875	12.00	1.875	14.9375
1078	3.50	12.00	1.875	14.3125
1079	4.00	12.375	2.00	14.875
1080	4.50	12.3125	2.125	14.875

EXPANSION COUPLINGS TWO PIECE

TOPAZ CAT #	UPC#	SIZE	UNIT CTN	SHIP CASE	WT/ CASE
1071	23152	1/2"	—	25	12
1072	23153	3/4"	—	10	4
1073	23154	1"	—	10	8
1074	23155	1 1/4"	—	5	5
1075	23156	1 1/2"	—	5	7
1076	23157	2"	—	25	51
1077	23158	2 1/2"	—	12	44
1078	23159	3"	—	12	37
1079	23373	3 1/2"	—	9	51
1080	23161	4"	—	6	28

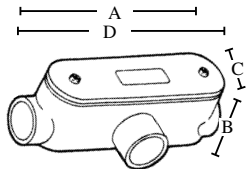

CAT #	A	B	C	D
1171	4.00	1.50	1.3125	4.625
1172	4.625	1.6875	1.50	5.375
1173	5.375	2.00	1.75	6.5625
1174	7.1875	2.50	2.50	8.1875
1175	8.00	2.8125	2.625	9.25
1176	9.50	3.375	3.125	10.375
1177	12.875	4.625	4.625	19.00
1178	12.875	4.625	4.625	19.00
1179	13.75	5.5625	5.5625	20.375
1180	13.875	5.5625	5.5625	20.1875

TYPE T

TOPAZ CAT #	UPC#	SIZE	UNIT CTN	SHIP CASE	WT/ CASE	PVC
1171	23383	1/2"	—	25	20	
1172	23231	3/4"	—	15	25	
1173	23232	1"	—	10	40	
1174	23233	1 1/4"	—	10	70	
1175	23234	1 1/2"	—	10	90	
1176	23235	2"	—	5	180	
1177	23236	2 1/2"	—	2	550	
1178	23237	3"	—	2	500	
1179	23238	3 1/2"	—	1	1000	
1180	23239	4"	—	1	800	

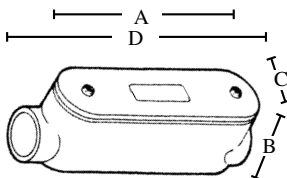

CAT #	A	B	C	D
1181	4.00	1.50	1.3125	4.625
1182	4.625	1.6875	1.50	5.375
1183	5.375	2.00	1.75	6.5625
1184	7.1875	2.50	2.50	8.1875
1185	8.00	2.8125	2.625	9.25
1186	9.50	3.375	3.125	10.375
1187	12.875	4.625	4.625	19.00
1188	12.875	4.625	4.625	19.00
1189	13.75	5.5625	5.5625	20.375
1190	13.875	5.5625	5.5625	20.1875

TYPE C

TOPAZ CAT #	UPC#	SIZE	UNIT CTN	SHIP CASE	WT/ CASE
1181	23384	1/2"	—	25	20
1182	23241	3/4"	—	15	25
1183	23242	1"	—	10	40
1184	23243	1 1/4"	—	10	70
1185	23244	1 1/2"	—	10	90
1186	23245	2"	—	5	160
1187	23246	2 1/2"	—	5	550
1188	23247	3"	—	5	460
1189	23248	3 1/2"	—	4	725
1190	23249	4"	—	4	650



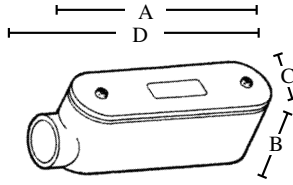

CAT #	A	B	C	D
1191	4.00	1.4375	1.3125	4.25
1192	4.625	1.625	1.50	4.9375
1193	5.375	2.00	1.75	6.00
1194	7.1875	2.4375	2.4375	7.625
1195	8.00	2.8125	2.625	8.5625
1196	9.50	3.4375	3.0625	9.875
1197	12.75	4.625	4.625	14.9375
1198	12.8125	4.625	4.625	15.00
1199	12.8125	5.50	5.625	16.1875
1199A	12.8125	5.50	5.625	15.9375

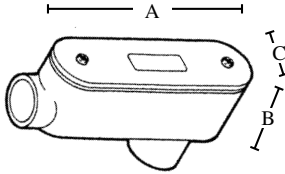

CAT #	A	B	C
1141	4.1875	1.4375	1.3125
1142	4.9375	1.625	1.50
1143	5.875	2.00	1.75
1144	7.5625	2.375	2.50
1145	8.5625	2.75	2.625
1146	9.8125	3.375	3.125
1147	15.00	4.5625	4.625
1148	15.0625	4.5625	4.625
1149	16.1875	5.50	5.625
1150	16.1875	5.50	5.625

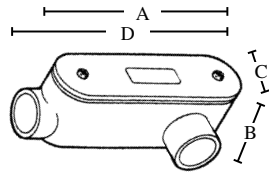

CAT #	A	B	C	D
1151	4.25	1.4375	1.3125	4.00
1152	4.9375	1.625	1.50	4.625
1153	6.00	2.00	1.75	5.375
1154	7.625	2.4375	2.4375	7.1875
1155	8.5625	2.8125	2.625	8.00
1156	9.875	3.4375	3.0625	9.50
1157	14.9375	4.625	4.625	12.75
1158	15.00	4.625	4.625	12.8125
1159	16.1875	5.50	5.625	12.8125
1160	15.9375	5.50	5.625	12.8125

TYPE E

TOPAZ CAT #	UPC#	SIZE	UNIT CTN	SHIP CASE	WT/ CASE
1191	23385	1/2"	—	25	20
1192	23251	3/4"	—	15	28
1193	23252	1"	—	10	30
1194	23253	1 1/4"	—	10	70
1195	23254	1 1/2"	—	10	90
1196	23255	2"	—	5	160
1197	23256	2 1/2"	—	5	168
1198	23257	3"	—	5	380
1199	23258	3 1/2"	—	4	575
1199A	23259	4"	—	4	675



E170258

TYPE LB

TOPAZ CAT #	UPC#	SIZE	UNIT CTN	SHIP CASE	WT/ CASE
1141	23377	1/2"	—	25	26
1142	23201	3/4"	—	15	27
1143	23202	1"	—	10	30
1144	23203	1 1/4"	—	10	70
1145	23204	1 1/2"	—	10	90
1146	23205	2"	—	5	160
1147	23206	2 1/2"	—	5	460
1148	23207	3"	—	5	465
1149	23208	3 1/2"	—	4	700
1150	23209	4"	—	4	625



E170258

TYPE LL

TOPAZ CAT #	UPC#	SIZE	UNIT CTN	SHIP CASE	WT/ CASE	PVC
1151	23381	1/2"	—	25	20	
1152	23211	3/4"	—	15	25	
1153	23212	1"	—	10	40	
1154	23213	1 1/4"	—	10	40	
1155	23214	1 1/2"	—	10	90	
1156	23215	2"	—	5	160	
1157	23216	2 1/2"	—	5	500	
1158	23217	3"	—	5	380	
1159	23218	3 1/2"	—	4	725	
1160	23219	4"	—	4	500	



E170258

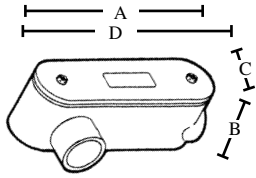

CAT #	A	B	C	D
1161	4.00	1.4375	1.3125	4.25
1162	4.625	1.625	1.50	4.9375
1163	5.375	2.00	1.75	6.00
1164	7.1875	2.4375	2.4375	7.625
1165	8.00	2.8125	2.625	8.5625
1166	9.50	3.4375	3.0625	9.875
1167	12.75	4.625	4.625	14.9375
1168	12.8125	4.625	4.625	15.00
1169	12.8125	5.50	5.625	15.9375
1170	12.8125	5.50	5.625	16.1875

TYPE LR

TOPAZ CAT #	UPC#	SIZE	UNIT CTN	SHIP CASE	WT/ CASE
1161	23382	1/2"	—	25	20
1162	23221	3/4"	—	15	25
1163	23222	1"	—	10	40
1164	23223	1 1/4"	—	10	70
1165	23224	1 1/2"	—	10	90
1166	23225	2"	—	5	160
1167	23226	2 1/2"	—	5	500
1168	23227	3"	—	5	500
1169	23228	3 1/2"	—	4	725
1170	23229	4"	—	4	650



E170258

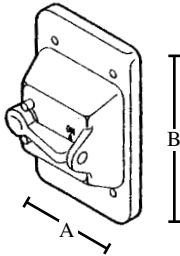

CAT #	A	B
1316	2.8125	4.5625

TOGGLE SWITCH COVER SINGLE

TOPAZ CAT #	UPC#	SIZE	UNIT CTN	SHIP CASE	WT/ CASE
1316	23115	—	—	10	29



E170258

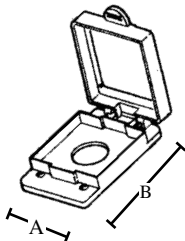

CAT #	A	B
1317	2.8125	4.5625
1318	2.8125	4.5625
1319	2.8125	4.5625
1320	2.8125	4.5625

RECEPTACLE COVER SINGLE

TOPAZ CAT #	UPC#	SIZE	Hole Diameter	UNIT CTN	SHIP CASE	WT/ CASE
1317	23316	15 amp	1.375	—	10	32
1318	23317	20 amp	1.625	—	10	29
1319	23318	30 amp	1.722	—	10	29
1320	23319	50 amp	2.187	—	10	29



E170258

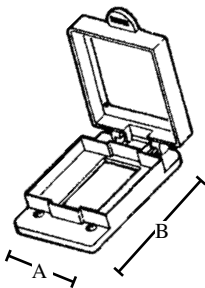

CAT #	A	B
1321	2.8125	4.5625

GFI RECEPTACLE COVER SINGLE

TOPAZ CAT #	UPC#	SIZE	UNIT CTN	SHIP CASE	WT/ CASE
1321	23320	—	—	10	31



E170258

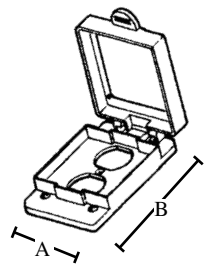

CAT #	A	B
1323	2.8125	4.5625

DUPLEX RECEPTACLE COVER

TOPAZ CAT #	UPC#	SIZE	UNIT CTN	SHIP CASE	WT/ CASE	PVC
1323	23383	—	—	10	32	

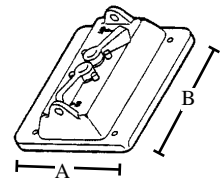

CAT #	A	B
1324	4.5625	4.5625

DOUBLE TOGGLE SWITCH COVER

TOPAZ CAT #	UPC#	SIZE	UNIT CTN	SHIP CASE	WT/ CASE
1324	23384	—	—	10	41

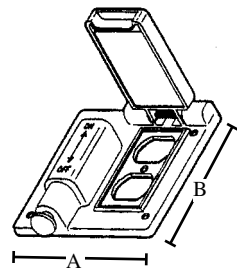

CAT #	A	B
1325	4.5625	4.5625

DUPLEX & PLUNGER SWITCH COVER

TOPAZ CAT #	UPC#	SIZE	UNIT CTN	SHIP CASE	WT/ CASE
1325	23384	—	—	10	46

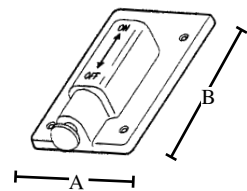

CAT #	A	B
1326	2.8125	4.5625

PLUNGER SWITCH COVER

TOPAZ CAT #	UPC#	SIZE	UNIT CTN	SHIP CASE	WT/ CASE
1326	23384	—	—	10	29

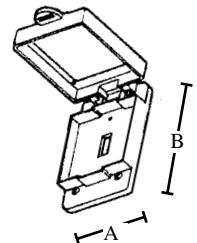

CAT #	A	B
1315	2.8125	4.5625

SWITCH COVER

TOPAZ CAT #	UPC#	SIZE	UNIT CTN	SHIP CASE	WT/ CASE
1315	23384	—	—	10	33



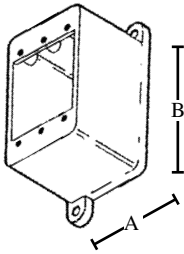

CAT #	A	B
1280	4.5625	4.5625
1281	2.8125	4.5625

TYPE FD-BLANK SINGLE

TOPAZ CAT #	UPC#	SIZE	UNIT CTN	SHIP CASE	WT/CASE	PVC
1280	23279	DOUBLE GANG	—	10	24	
1281	23391	SINGLE GANG	—	10	13	

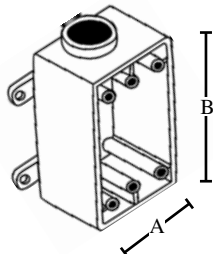

CAT #	A	B
1282	2.875	4.5625
1283	2.875	4.5625
1284	2.875	4.5625

TYPE FSE SINGLE

TOPAZ CAT #	UPC#	SIZE	UNIT CTN	SHIP CASE	WT/CASE
1282	23281	1/2"	—	10	43
1283	23282	3/4"	—	10	43
1284	23283	1"	—	10	40

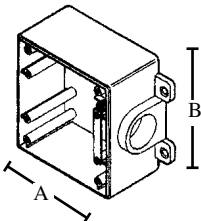

CAT #	A	B
1285	4.5625	4.5625
1286	4.5625	4.5625
1287	4.5625	4.5625

TYPE FSE DOUBLE

TOPAZ CAT #	UPC#	SIZE	UNIT CTN	SHIP CASE	WT/CASE
1285	23284	1/2"	—	5	91
1286	23285	3/4"	—	5	91
1287	23286	1"	—	5	91

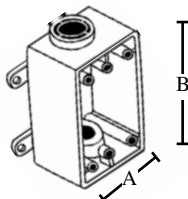

CAT #	A	B
1288	2.875	4.5625
1289	2.875	4.5625
1290	2.875	4.5625

TYPE FSC SINGLE

TOPAZ CAT #	UPC#	SIZE	UNIT CTN	SHIP CASE	WT/CASE
1288	23287	1/2"	—	10	48
1289	23288	3/4"	—	10	45
1290	23289	1"	—	10	42

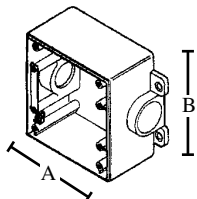

CAT #	A	B
1291	4.5625	4.5625
1292	4.5625	4.5625
1293	4.5625	4.5625

TYPE FSC DOUBLE

TOPAZ CAT #	UPC#	SIZE	UNIT CTN	SHIP CASE	WT/CASE
1291	23392	1/2"	—	5	88
1292	23291	3/4"	—	5	88
1293	23292	1"	—	5	88



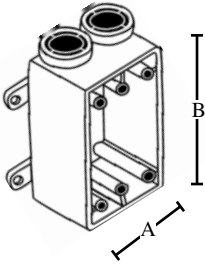

CAT #	A	B
1294	2.875	4.5625
1295	2.875	4.5625
1296	2.875	4.5625

TYPE FSS SINGLE

TOPAZ CAT #	UPC#	SIZE	UNIT CTN	SHIP CASE	PVC WT/ CASE
1294	23293	1/2"	—	10	88
1295	23294	3/4"	—	10	88
1296	23295	1"	—	10	88

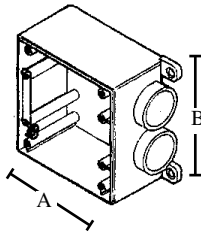

CAT #	A	B
1297	4.5625	4.5625
1298	4.5625	4.5625
1299	4.5625	4.5625

TYPE FSS DOUBLE

TOPAZ CAT #	UPC#	SIZE	UNIT CTN	SHIP CASE	WT/ CASE
1297	23296	1/2"	—	5	88
1298	23297	3/4"	—	5	88
1299	23298	1"	—	5	88

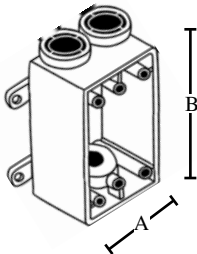

CAT #	A	B
1301	2.875	4.5625
1302	2.875	4.5625
1303	2.875	4.5625

TYPE FSCC SINGLE

TOPAZ CAT #	UPC#	SIZE	UNIT CTN	SHIP CASE	WT/ CASE
1301	23299	1/2"	—	10	50
1302	23300	3/4"	—	10	46
1303	23301	1"	—	10	42

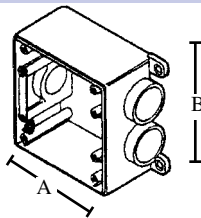

CAT #	A	B
1304	4.5625	4.5625
1305	4.5625	4.5625
1306	4.5625	4.5625

TYPE FSCC DOUBLE

TOPAZ CAT #	UPC#	SIZE	UNIT CTN	SHIP CASE	WT/ CASE
1304	23302	1/2"	—	5	52
1305	23303	3/4"	—	5	48
1306	23304	1"	—	5	45

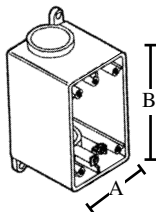

CAT #	A	B
1307	2.875	4.5625
1308	2.875	4.5625
1309	2.875	4.5625

TYPE FDC SINGLE

TOPAZ CAT #	UPC#	SIZE	UNIT CTN	SHIP CASE	WT/ CASE
1307	23306	1/2"	—	10	59
1308	23307	3/4"	—	10	59
1309	23308	1"	—	10	59



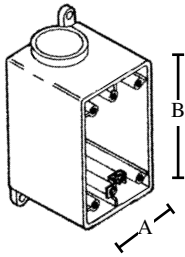

CAT #	A	B
1310	2.875	4.5625
1311	2.875	4.5625
1312	2.875	4.5625

TYPE FDS SINGLE

TOPAZ CAT #	UPC#	SIZE	UNIT CTN	SHIP CASE	PVC WT/ CASE
1310	23309	1/2"	—	10	59
1311	23310	3/4"	—	10	59
1312	23311	1"	—	10	59

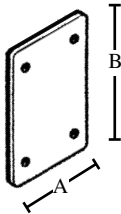

CAT #	A	B
1313	2.875	4.5625

BLANK COVER SINGLE

TOPAZ CAT #	UPC#	SIZE	UNIT CTN	SHIP CASE	WT/ CASE
1313	23393	—	—	50	9

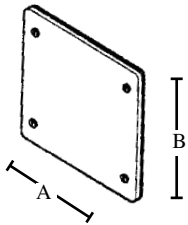

CAT #	A	B
1314	4.5625	4.5625

BLANK COVER DOUBLE

TOPAZ CAT #	UPC#	SIZE	UNIT CTN	SHIP CASE	WT/ CASE
1314	23313	—	—	25	18

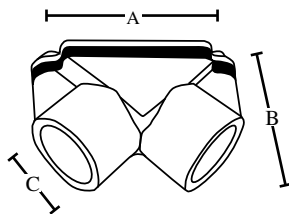

CAT #	A	B	C
1091	2.125	1.50	.875
1092	2.50	1.625	1.0625

PULL ELBOWS

TOPAZ CAT #	UPC#	SIZE	UNIT CTN	SHIP CASE	WT/ CASE
1091	23114	1/2"	—	75	8
1092	23115	3/4"	—	50	12

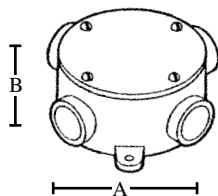

CAT #	A	B
1239	4.0625	1.875

ROUND JUNCTION BOX

TOPAZ CAT #	UPC#	SIZE	UNIT CTN	SHIP CASE	WT/ CASE
1239	23275	1/2" & 3/4"	—	15	90



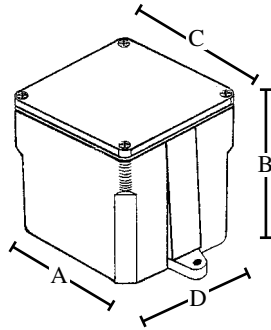

CAT #	A	B	C	D
1221	4.375	2.375	4.375	4.375
1222	4.25	4.375	4.25	4.25
1223	4.25	6.3125	4.25	4.25
1224	5.25	2.3125	5.25	5.25
1225	6.375	4.375	6.75	6.375
1226	6.375	6.3125	6.6875	6.375
1227	8.50	4.50	8.875	8.50
1228	8.3125	6.4375	9.00	8.3125
1229	8.75	7.75	9.00	8.75
1230	12.50	4.4375	12.875	12.50
1231	12.375	6.50	12.875	12.375
1232	16.75	6.75	17.125 X 15.125	14.75
1233	24.125	8.25	24.25 X 18.75	18.25
1234	24.25	8.25	24.1875	24.25
1235	24.25	8.25	24.25 X 36.25	36.25

JUNCTION BOX

NEMA 3 RATED

TOPAZ CAT #	UPC#	INSIDE DIMENSION	UNIT CTN	SHIP CASE	WT/ CASE	PVC
1221	23387	4" X 4" X 2"	—	10	8	
1222	23261	4" X 4" X 4"	—	10	10	
1223	23262	4" X 4" X 6"	—	10	15	
1224	23263	5" X 5" X 2"	—	10	10	
1225	23388	6" X 6" X 4"	—	10	20	
1226	23265	6" X 6" X 6"	—	5	11	
1227	23266	8" X 8" X 4"	—	5	16	
1228	23267	8" X 8" X 6"	—	4	15	
1229	23268	8" X 8" X 7"	—	4	20	
1230	23269	12" X 12" X 4"	—	2	14	
1231	23389	12" X 12" X 6"	—	2	15	
1232	23271	16" X 14" X 6"	—	1	11	
1233*	23272	24" X 18" X 8"	—	1	20	
1234†	23273	24" X 24" X 8"	—	1	24	
1235†	23274	36" X 24" X 8"	—	1	45	

* UL Listed with only a Type 1 NEMA rating

† Not UL listed



DUPLEX BOXES & COVER

TOPAZ CAT #	UPC#	SIZE	UNIT CTN	SHIP CASE	WT/ CASE	PVC
1236	23276	FLOOR BASE BOX (4) 3/4" HUBS (4) 3/4" TO 1/2" REDUCERS LEVEL RING & POUR COVER UL LISTED	—	9	175	
1237	23277	FLOOR BASE BOX (2) 3/4" HUBS (2) 1" HUBS (2) 3/4" TO 1/2" REDUCERS LEVEL RING & POUR COVER UL LISTED	—	9	175	
1238	23278	PVC-DUPLEX COVER-BRONZE	—	10	40	

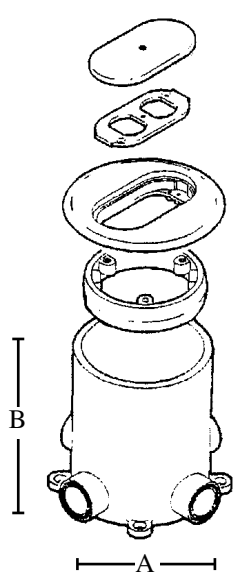

CAT #	A	B
1236	6.4375	6.00
1237	6.4375	6.00
1238	---	---

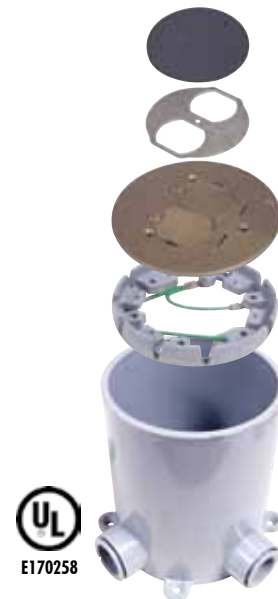

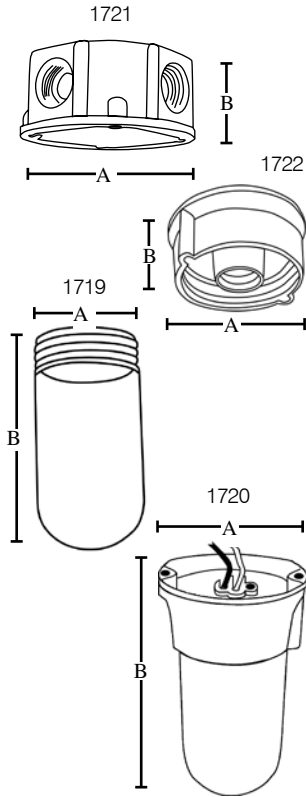

CAT #	A	B
1721	4.125	1.875
1722	4.125	1.875
1718	4.125	1.875
1719	4.125	6.25
1720	4.125	7.50

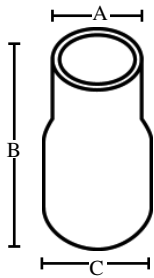

CAT #	A	B	C
1480	2.375	6.625	2.890
1481	2.375	7.125	3.515
1482	2.875	7.50	3.515
1483	3.500	7.375	4.515
1484	4.500	11.625	5.593
1485	5.563	11.50	6.658

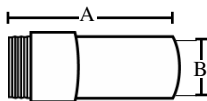

CAT #	A	B
1486	26.625	2.375
1487	23.6875	3.375
1488	24.00	4.00
1490	25.00	5.125

NM OUTLET BOX

TOPAZ CAT #	UPC#	KO SIZE	UNIT CTN	SHIP CASE	PVC WT/ CASE
1721	83931	1/2"	-	12	70
1722	83935	3/4"	-	12	70

FIXTURE

1718	83932	4" SOCKET	-	12	60
------	-------	-----------	---	----	----

GLOBE

1719	83933	6 1/4" POLY	-	12	30
------	-------	-------------	---	----	----

COMPLETE FIXTURE

1720	83934	7 1/2" CLEAR POLY	-	12	90
------	-------	-------------------	---	----	----

Suitable for wet location
60 Watt maximum



SWEDGED REDUCER BELL TO PLAIN END

TOPAZ CAT #	UPC#	SIZE	UNIT CTN	SHIP CASE	PVC WT/ CASE
1480	82522	2-1/2" x 2"	-	20	20
1481	82523	3" x 2"	-	25	31
1482	82524	3" x 2-1/2"	-	25	9
1483	82525	4" x 3"	-	15	17
1484	82526	5" x 4"	-	8	17
1485	82527	6" x 5"	-	4	8



EXPANSION JOINT (METER RISER) SCHEDULE 40

TOPAZ CAT #	UPC#	SIZE	UNIT CTN	SHIP CASE	PVC WT/ CASE
1486	50106	2"	28"	140	696
1487	50108	2 1/2"	28"	135	1075
1488	50109	3"	28"	81	933
1490	50110	4"	28"	51	839



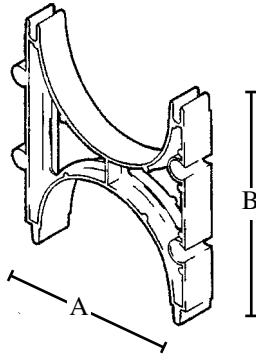

CAT #	A	B
1331	22	18
1332	22	18
1334	22	18
1335	22	18
1336	22	18
1337	22	18
1338	22	18
1339	22	18
1340	22	18
1341	22	18
1342	22	18
1343	22	18
1344	22	18
1345	22	18
1346	22	18

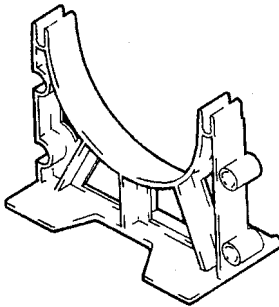

CAT #	A	B
1347	22	18
1348	22	18
1349	22	18
1350	22	18
1351	22	18
1352	22	18
1353	22	18
1354	22	18
1355	22	18
1356	22	18
1357	22	18
1358	22	18
1359	22	18
1360	22	18
1361	22	18
1362	22	18



INTERMEDIATE SPACERS

TOPAZ CAT #	UPC#	PIPE SIZE	SEPARATION	UNIT CTN	SHIP CASE	WT/ CASE
1331	23326	4	1"	—	200	18
1332	23327	2	1 1/2"	—	350	9
1333	23328	3	1 1/2"	—	225	14
1334	23329	4	1 1/2"	—	150	20
1335	23330	5	1 1/2"	—	100	28
1336	23331	6	1 1/2"	—	100	30
1337	23332	2	2"	—	300	10
1338	23333	3	2"	—	200	15
1339	23334	4	2"	—	125	22
1340	23335	5	2"	—	100	27
1341	23336	6	2"	—	90	34
1342	23337	2	3"	—	200	13
1343	23338	3	3"	—	125	18
1344	23339	4	3"	—	90	27
1345	23340	5	3"	—	80	29
1346	23341	6	3"	—	70	31



E170258

BASE SPACERS

TOPAZ CAT #	UPC#	PIPE SIZE	SEPARATION	UNIT CTN	SHIP CASE	WT/ CASE
1347	23342	4	1"	—	175	20
1348	23343	2	1 1/2"	—	250	12
1349	23344	3	1 1/2"	—	175	18
1350	23345	4	1 1/2"	—	140	28
1351	23346	5	1 1/2"	—	120	35
1352	23347	6	1 1/2"	—	100	32
1353	23348	2	2"	—	225	15
1354	23349	3	2"	—	155	18
1355	23350	4	2"	—	140	30
1356	23351	5	2"	—	120	38
1357	23352	6	2"	—	100	41
1358	23353	2	3"	—	225	16
1359	23354	3	3"	—	150	21
1360	23355	4	3"	—	120	36
1361	23356	5	3"	—	100	38
1362	23357	6	3"	—	95	40



E170258

CONDUIT CEMENT

TOPAZ CAT #	UPC#	SIZE	UNIT CTN	SHIP CASE	WT/ CASE
1327	23358	1/2 PINT	—	24	56
1328	23359	PINT	—	12	104
1329	23360	QUART	—	12	200
1329H	23371	QUART - HEAVY SET	—	12	200
1363	83766	PINT COLD WEATHER	—	12	120
1364	83767	QUART COLD WEATHER	—	12	224



PVC PRIMER/CLEANER

TOPAZ CAT #	UPC#	SIZE	UNIT CTN	SHIP CASE	WT/ CASE
1328P	81877	PINT	—	12	104
1329P	81875	QUART	—	12	200

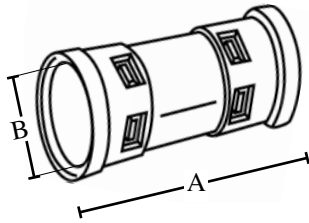

CAT #	A	B
1491	1.400	.860
1492	2.035	1.060
1493	2.350	1.330

ENT COUPLINGS

TOPAZ CAT #	UPC#	SIZE	UNIT CTN	SHIP CASE	PVC WT/ CASE
1491	82528	1/2"	—	200	9
1492	82529	3/4"	—	200	16
1493	82530	1"	—	100	14



E170258

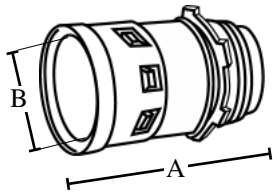

CAT #	A	B
1511	1.045	.860
1512	1.105	1.060
1513	1.220	1.330

ENT TERMINAL ADAPTERS THREADED

TOPAZ CAT #	UPC#	SIZE	UNIT CTN	SHIP CASE	WT/ CASE
1511	82531	1/2"	—	200	.40
1512	82532	3/4"	—	200	.40
1513	82533	1"	—	100	.40



E170258

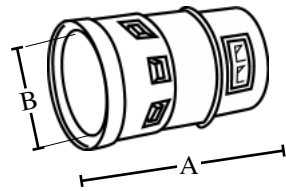

CAT #	A	B
1611	1.045	.860
1612	1.105	1.060
1613	1.220	1.330

ENT TERMINAL ADAPTERS SNAP-IN

TOPAZ CAT #	UPC#	SIZE	UNIT CTN	SHIP CASE	WT/ CASE
1611	82534	1/2"	—	200	.40
1612	82535	3/4"	—	200	.40
1613	82536	1"	—	100	.40



E170258

ENT CONDUIT COILS

• COIL

TOPAZ CAT #	UPC#	SIZE	FEET PER COIL	UNIT CTN	FEET PER PACK	WT/ FOOT
1621	82537	1/2"	200	—	400	.12
1622	82538	3/4"	100	—	200	.14
1623	82539	1"	100	—	100	.17

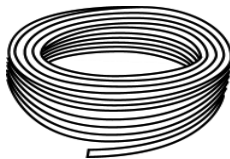

• REEL

TOPAZ CAT #	UPC#	SIZE	FEET PER REEL	UNIT CTN	FEET PER PACK	WT/ FOOT
1621R	83682	1/2"	1500	—	1500	.12
1622R	83680	3/4"	1000	—	1000	.14
1623R	83681	1"	750	—	750	.17

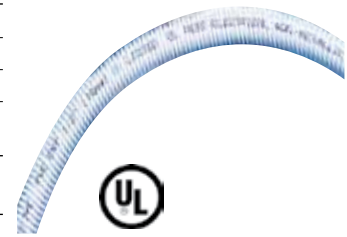

E170258

PVC SPECIAL RADIUS ELBOWS

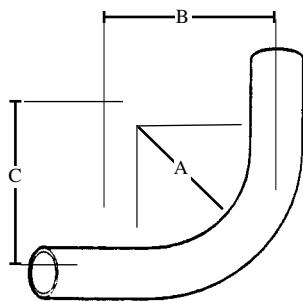

TOPAZ CAT #	UPC#	SIZE	UNIT CTN	SHIP CASE	PVC WT/ CASE
1377	50001	1" x 90° x 18"	—	1	84
1378	50002	1" x 90° x 24"	—	1	111
1379	50003	1" x 90° x 36"	—	1	140
1380	50004	1" x 90° x 48"	—	1	211
1381	50005	1" x 45° x 18"	—	1	46
1382	50006	1" x 45° x 24"	—	1	57
1383	50007	1" x 45° x 36"	—	1	65
1384	50008	1" x 45° x 48"	—	1	108
1385	50009	1" x 30° x 18"	—	1	33
1386	50010	1" x 30° x 24"	—	1	40
1387	50011	1" x 30° x 36"	—	1	49
1388	50012	1" x 30° x 48"	—	1	54
1389	50013	1-1/4" x 90° x 18"	—	1	125
1390	50014	1-1/4" x 90° x 24"	—	1	160
1391	50015	1-1/4" x 90° x 36"	—	1	201
1392	50016	1-1/4" x 90° x 48"	—	1	307
1393	50017	1-1/4" x 45° x 18"	—	1	68
1394	50018	1-1/4" x 45° x 24"	—	1	86
1395	50019	1-1/4" x 45° x 36"	—	1	94
1396	50020	1-1/4" x 45° x 48"	—	1	160
1397	50021	1-1/4" x 30° x 18"	—	1	51
1398	50022	1-1/4" x 30° x 24"	—	1	62
1399	50023	1-1/4" x 30° x 36"	—	1	89
1400	50024	1-1/4" x 30° x 48"	—	1	113
1401	50025	1-1/2" x 90° x 18"	—	1	149
1402	50026	1-1/2" x 90° x 24"	—	1	191
1403	50027	1-1/2" x 90° x 36"	—	1	280
1404	50028	1-1/2" x 90° x 48"	—	1	368
1405	50029	1-1/2" x 45° x 18"	—	1	84
1406	50030	1-1/2" x 45° x 24"	—	1	103
1407	50031	1-1/2" x 45° x 36"	—	1	175
1408	50032	1-1/2" x 45° x 48"	—	1	191
1409	50033	1-1/2" x 30° x 18"	—	1	61
1410	50034	1-1/2" x 30° x 24"	—	1	75
1411	50035	1-1/2" x 30° x 36"	—	1	95
1412	50036	1-1/2" x 30° x 48"	—	1	136
1413	50037	2" x 90° x 18"	—	1	206
1414	50038	2" x 90° x 24"	—	1	623
1415	50039	2" x 90° x 36"	—	1	262
1416	50040	2" x 90° x 48"	—	1	500
1417	50041	2" x 45° x 18"	—	1	119
1418	50042	2" x 45° x 24"	—	1	144
1419	50043	2" x 45° x 36"	—	1	206
1420	50044	2" x 45° x 48"	—	1	263
1421	50045	2" x 30° x 18"	—	1	88
1422	50046	2" x 30° x 24"	—	1	106
1423	50045	2" x 30° x 36"	—	1	206
1424	50046	2" x 30° x 48"	—	1	188
1425	50049	2-1/2" x 90° x 18"	—	1	337
1426	50050	2-1/2" x 90° x 24"	—	1	426
1427	50051	2-1/2" x 90° x 36"	—	1	614
1428	50052	2-1/2" x 90° x 48"	—	1	803

PVC SPECIAL RADIUS ELBOWS - CONT'D

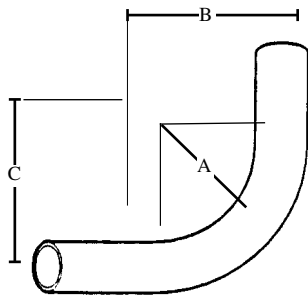

E331760

TOPAZ CAT #	UPC#	SIZE	UNIT CTN	SHIP CASE	PVC WT/ CASE
1429	50053	2-1/2" x 45° x 18"	—	1	199
1430	50054	2-1/2" x 45° x 24"	—	1	238
1431	50055	2-1/2" x 45° x 36"	—	1	337
1432	50056	2-1/2" x 45° x 48"	—	1	426
1433	50057	2-1/2" x 30° x 18"	—	1	149
1434	50058	2-1/2" x 30° x 24"	—	1	178
1435	50059	2-1/2" x 30° x 36"	—	1	280
1436	50060	2-1/2" x 30° x 48"	—	1	390
1437	50061	3" x 90° x 18"	—	1	477
1438	50062	3" x 90° x 24"	—	1	599
1439	50063	3" x 90° x 36"	—	1	881
1440	50064	3" x 90° x 48"	—	1	1115
1441	50065	3" x 45° x 18"	—	1	286
1442	50066	3" x 45° x 24"	—	1	340
1443	50067	3" x 45° x 36"	—	1	476
1444	50068	3" x 45° x 48"	—	1	599
1445	50069	3" x 30° x 18"	—	1	218
1446	50070	3" x 30° x 24"	—	1	258
1447	50071	3" x 30° x 36"	—	1	325
1448	50072	3" x 30° x 48"	—	1	435
1449	50073	3-1/2" x 90° x 24"	—	1	737
1450	50074	3-1/2" x 90° x 36"	—	1	1047
1451	50075	3-1/2" x 90° x 48"	—	1	1358
1452	50076	3-1/2" x 45° x 24"	—	1	631
1453	50077	3-1/2" x 45° x 36"	—	1	589
1454	50078	3-1/2" x 45° x 48"	—	1	736
1455	50079	3-1/2" x 30° x 24"	—	1	325
1456	50080	3-1/2" x 30° x 36"	—	1	426
1457	50081	3-1/2" x 30° x 48"	—	1	640
1458	50082	4" x 90° x 24"	—	1	892
1459	50083	4" x 90° x 36"	—	1	1260
1460	50084	4" x 90° x 48"	—	1	1628
1461	50085	4" x 45° x 24"	—	1	523
1462	50086	4" x 45° x 36"	—	1	717
1463	50087	4" x 45° x 48"	—	1	892
1464	50088	4" x 30° x 24"	—	1	407
1465	50089	4" x 30° x 36"	—	1	510
1466	50090	4" x 30° x 48"	—	1	659
1467	50091	5" x 90° x 36"	—	1	1760
1468	50092	5" x 90° x 48"	—	1	2260
1469	50093	5" x 45° x 36"	—	1	1025
1470	50094	5" x 45° x 48"	—	1	1261
1471	50095	5" x 30° x 36"	—	1	1110
1472	50096	5" x 30° x 48"	—	1	1104
1473	50097	6" x 90° x 36"	—	1	2354
1474	50098	6" x 90° x 48"	—	1	2865
1475	50099	6" x 45° x 36"	—	1	1399
1476	50100	6" x 45° x 48"	—	1	1706
1477	50101	6" x 30° x 36"	—	1	1040
1478	50102	6" x 30° x 48"	—	1	1296

SCHEDULE 80 PVC SPECIAL RADIUS ELBOWS

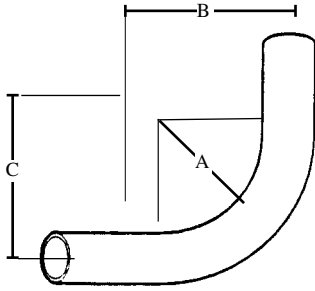

CAT #	A	B	C
141480	24.00	24.00	24.00
141580	36.00	36.00	36.00
141680	48.00	48.00	48.00
143980	36.00	36.00	36.00
144080	48.00	48.00	48.00
145980	36.00	36.00	36.00
146080	48.00	48.00	48.00
146780	36.00	36.00	36.00
146880	48.00	48.00	48.00
147380	36.00	36.00	36.00

TOPAZ CAT #	UPC#	SIZE	CTN	UNIT CASE	SHIPWT/ CASE
141480	85046	2" x 90° x 24"	—	1	156
141580	85047	2" x 90° x 36"	—	1	159
141680	85048	2" x 90° x 48"	—	1	163
143980	85049	3" x 90° x 36"	—	1	380
144080	85050	3" x 90° x 48"	—	1	410
145980	85051	4" x 90° x 36"	—	1	930
146080	85052	4" x 90° x 48"	—	1	950
146780	85053	5" x 90° x 36"	—	1	1767
146880	85054	5" x 90° x 48"	—	1	1780
147380	85055	6" x 90° x 36"	—	1	7260



E331760

SCHEDULE 80 UNIVERSAL NIPPLES

•PVC Running Thread

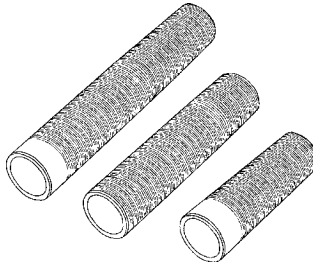

CAT #	SIZE
1684	1 1/4" x 22"
1685	1 1/2" x 22"
1686	2" x 22"
1687	2 1/2" x 22"
1688	3" x 22"
1690	4" x 22"
1694	1 1/4" x 8"
1695	1 1/2" x 8"
1696	2" x 8"
1697	2 1/2" x 8"
1704	1 1/4" x 16"
1705	1 1/2" x 16"
1706	2" x 16"
1707	2 1/2" x 16"
1708	3" x 16"
1710	4" x 16"

TOPAZ CAT #	UPC#	SIZE	UNIT CTN	SHIP CASE	WT/ CASE
1684	83749	1 1/4" x 22"	—	12	8
1685	83750	1 1/2" x 22"	—	9	9
1686	83751	2" x 22"	—	25	38
1687	83752	2 1/2" x 22"	—	16	33
1688	83753	3" x 22"	—	16	49
1690	83754	4" x 22"	—	9	44
1694	83755	1 1/4" x 8"	—	25	9
1695	83756	1 1/2" x 8"	—	16	6
1696	83757	2" x 8"	—	12	7
1697	83758	2 1/2" x 8"	—	32	24
1704	83759	1 1/4" x 16"	—	25	16
1705	83760	1 1/2" x 16"	—	16	13
1706	83761	2" x 16"	—	25	30
1707	83762	2 1/2" x 16"	—	16	26
1708	83763	3" x 16"	—	25	58
1710	83764	4" x 16"	—	12	43



Commercial Length 16"

Length 22"

Brick Length 8"



E170258 Patented

AC DISCONNECT

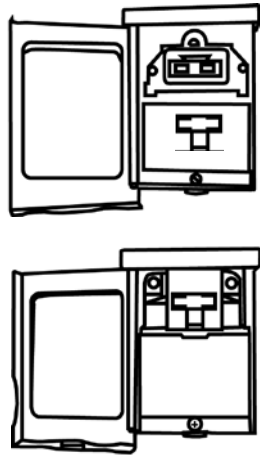

CAT#	CABINET SIZE		
	H	W	D
ACD48	6 1/24	4 7/8	2 3/4
ACD49	6 1/2	4 7/8	2 3/4
ACD50	9	4 7/8	2 3/4
ACD51	9	4 7/8	2 3/4
ACD52	10 1/2	6 1/2	3 3/8
ACD53	10 1/2	6 1/2	3 3/8

TOPAZ CAT #	UPC#	SIZE	VOLTAGE	SHIP CASE	WT/ CASE
ACD48	33781	60 AMP SWITCHABLE	120/240	6	20
ACD49	33773	60 AMP NON-FUSED PULLOUT	120/240	6	20
ACD50	33774	30 AMP FUSED	120/240	6	20
ACD51	33775	60 AMP FUSED	120/240	6	20
ACD52	33776	60 AMP NON-FUSED PULLOUT W/15 AMP GFCI RECP	120/240	6	30
ACD53	33777	60 AMP SWITCHABLE W/15 AMP GFCI RECP	120/240	6	30



WIRE RANGE DATA: CONNECTORS	COPPER		LUG TIGHTENING TORQUE (lb-in) SCREW TYPE	WIRE SIZE	TORQUE
	SOL	STR.			
LINE	14-10	14-3	SLOTTED	8	36-40
LOAD	14-10	14-3		6-4	41-35
EQUIP.GRD.	12-10	12-4		3-2	45-50

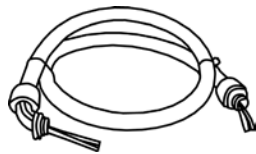

CAT#	LENGTH	WIRE REDUCING	
		SIZE	WASHER
ACW10	4	#10	1/2 X 3/4
ACW11	6	#10	1/2 X 3/4
ACW12	4	#8	3/4 X 1
ACW13	6	#8	3/4 X 1

AC WHIPS

TOPAZ CAT #	UPC#	CONNECTORS	CONDUIT SIZE	UNIT CTN	SHIP CASE	WT/ CASE
ACW10	33782	1/2" ST. 1/2" 90°	1/2"	-	12PK	400
ACW11	33783	1/2" ST. 1/2" 90°	1/2"	-	12PK	400
ACW12	33778	3/4" ST. 3/4" 90°	3/4"	-	12PK	400
ACW13	33779	3/4" ST. 3/4" 90°	3/4"	-	12PK	400



WITH ST. & 90° NM CONNECTORS



MAGNETIC CIRCUIT BREAKER LABELS CBL

TOPAZ CAT #	UPC#	PREPRINTED	BLANK	UNIT CTN	SHIP CASE	WT/ CASE
CBL	19949	42	6	-	24	1

HANGS ON A POINT OF PURCHASE DISPLAY. 12 PER DISPLAY.



WEATHERPROOF COVERS

• GREY

COPPER FREE ALUMINUM

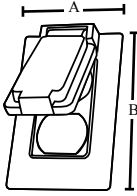

CAT#	A	B
WCV1DUP	2.81	4.56

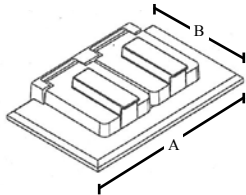

CAT#	A	B
WCH1DUP/B/W	4.56	2.81



CAT#	A	B
WCV11	2.77	4.52

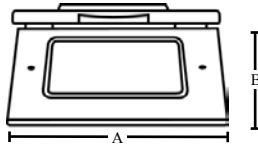

CAT#	A	B
WCH1GFI/W	4.56	2.81

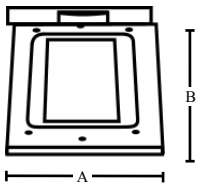

CAT#	A	B
WCV1GFI/W	2.81	4.56

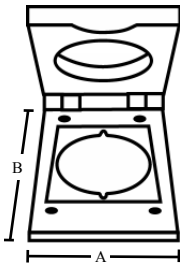

CAT#	A	B
WCV11.625	2.81	4.56
WCV12.125	2.81	4.56

SINGLE GANG DUPLEX VERTICAL

TOPAZ CAT #	UPC#	SHIP CASE	WT/ CASE
WCV1DUP	85098	50	25

SINGLE GANG DUPLEX RECEPTACLE

WCH1DUP	81892	50	35
WCH1DUPB*	85575	50	35
WCH1DUPW**	85574	50	35

*BRONZE

** WHITE

SINGLE GANG-/SINGLE RECEPTACLE SWITCH

WCV11	81893	50	16
-------	-------	----	----

SINGLE GANG HORIZONTAL-GFCI

WCH1GFI	81895	50	20
WCH1GFIW**	85576	50	20

** WHITE

SINGLE GANG VERTICAL-GFCI

WCV1GFI	81896	50	20
WCV1GFIW**	85577	50	20

** WHITE

SINGLE GANG-20A/30A RECEPTACLE

WCV11.625	81898	50	16
-----------	-------	----	----

SINGLE GANG-30A/50A RECEPTACLE

WCV12.125	85113	50	16
-----------	-------	----	----



E170258



E170258



E170258



E170258



E170258



E170258

WEATHERPROOF COVERS

• GREY

ALUMINUM

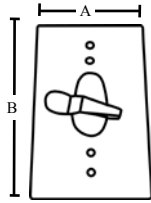

CAT#	A	B
WSC1	2.81	4.50

TOPAZ CAT #	UPC#	SHIP CASE	WT/ CASE
SINGLE GANG-30AMP SWITCH COVER			
WSC1	85103	50	11

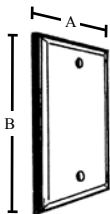

CAT#	A	B
WC1B/BB	2.77	4.54

SINGLE GANG - BLANK

WC1B	81901	100	5
WC1BB*	85573	100	5

* BRONZE

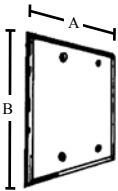

CAT#	A	B
WC2B	4.62	4.57

DOUBLE GANG - BLANK

WC2B	81902	100	11
------	-------	-----	----

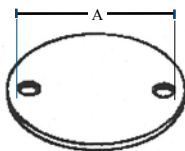

CAT#	A
WRCB	4.08

ROUND - BLANK

WRCB	81903	100	8
------	-------	-----	---



ALL COVERS COME WITH GASKETS AND SCREWS

WEATHERPROOF IN USE COVER

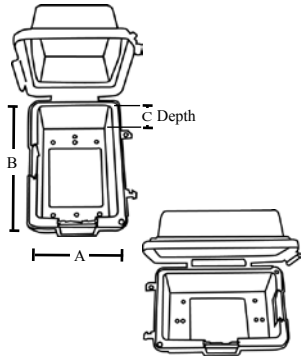

SINGLE GANG Vertical & Horizontal

- CLEAR COVER
- 14 IN I

PLASTIC

TOPAZ CAT #	UPC#	SHIP CASE	WT/ CASE
WCIU1	83687	10	3

CAT#	A	B	Depth C
WCIU1	2.81	4.56	2.75

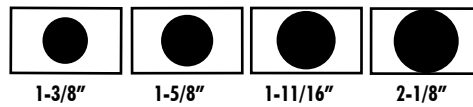
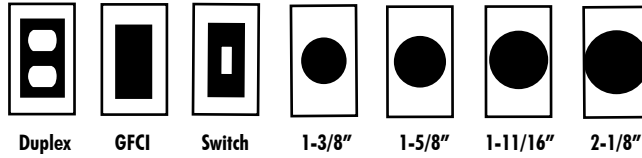

E170258

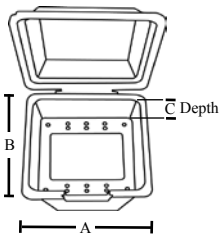

DOUBLE GANG - DUPLEX

- CLEAR COVER
- 31 IN I

PLASTIC

TOPAZ CAT #	UPC#	SHIP CASE	WT/ CASE
WCIU2	83688	10	5

CAT#	A	B	Depth C
WCIU2	4.40	4.54	3.5

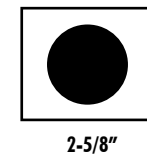
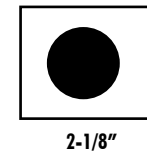
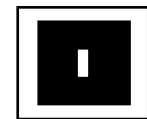
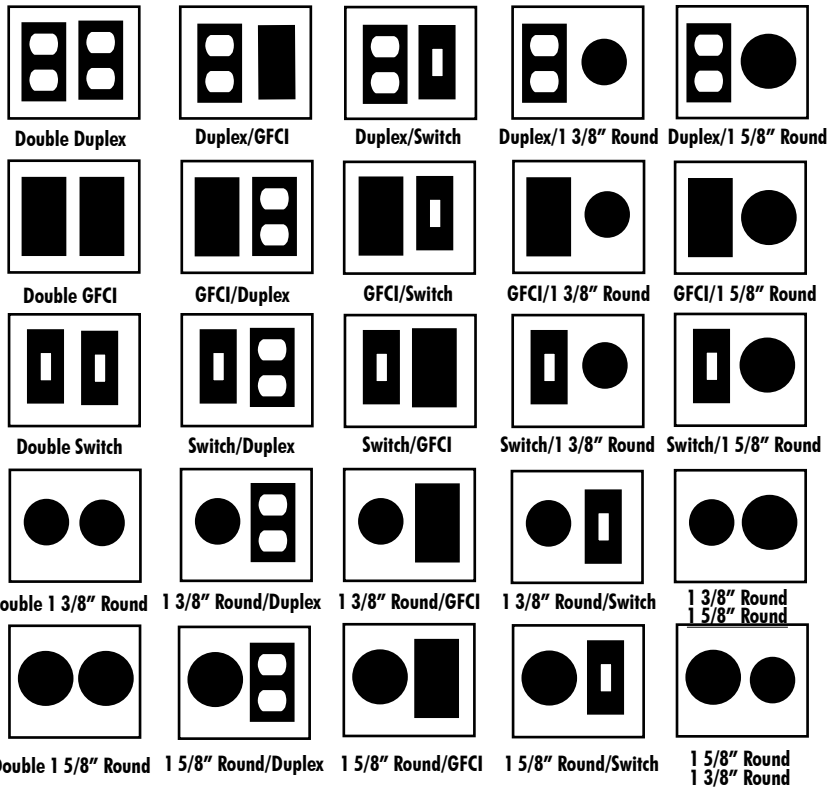
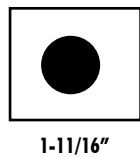
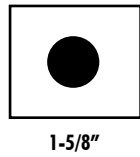
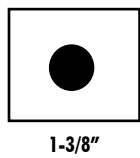

E170258

WEATHERPROOF COVERS

• GREY

COPPER FREE ALUMINUM

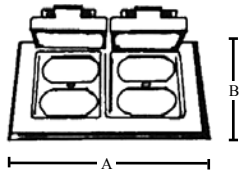

CAT#	A	B
WCV2DUP	4.54	4.54

TOPAZ CAT #	UPC#	SHIP CASE	WT/CASE
DOUBLE GANG - DUPLEX			
WCV2DUP	81894	25	15

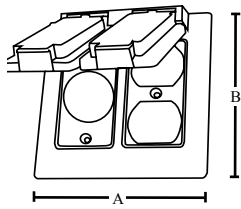

CAT#	A	B
WCV2SDUP	4.54	4.54

DOUBLE GANG - DUPLEX & SWITCH

WCV2SDUP	85101	25	16
----------	-------	----	----

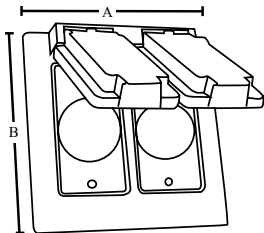

CAT#	A	B
WCV21515	4.54	4.54

DOUBLE GANG - 15 AMP SWITCH

WCV21515	85100	25	16
----------	-------	----	----

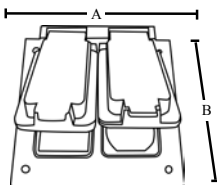

CAT#	A	B
WCV2DUPGFI	4.54	4.54

DOUBLE GANG - DUPLEX-GFCI

WCV2DUPGFI	85099	25	12
------------	-------	----	----



WEATHERPROOF COVERS

• GREY

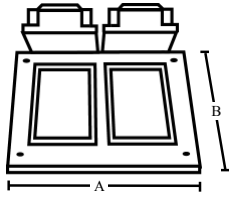

CAT#	A	B
WCV2GFI	4.54	4.54

COPPER FREE ALUMINUM

TOPAZ CAT #	UPC#	SHIP CASE	WT/ CASE
DOUBLE GANG - VERTICAL GFCI			
WCV2GFI	81897	50	35

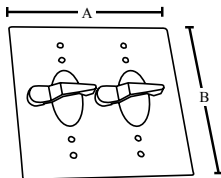

CAT#	A	B
WSC22S	4.54	4.54

DOUBLE GANG - 30 AMP SWITCH COVER ALUMINUM

WSC22S	85104	30	10
--------	-------	----	----

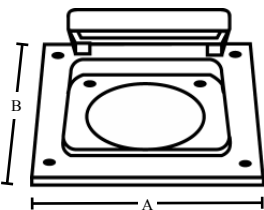

CAT#	A & B Hole Diameter
WCV22.125	4.54 2.125
WCV22.64	4.54 2.64

DOUBLE GANG - 20/30/50 AMP POWER OUTLET

WCV22.125	81899	8	7
WCV22.64	81900	8	7



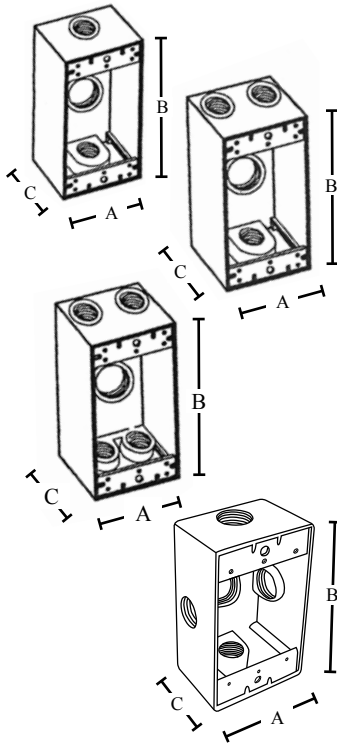

CAT#	A	B	C
WB1350/B	2.81	4.56	2
WB1375	2.81	4.56	2
WB13100	2.81	4.56	2
WB1450	2.81	4.56	2
WB1475	2.81	4.56	2
WB1550	2.81	4.56	2
WB1575	2.81	4.56	2
WB15100	2.81	4.56	2
WB1550X	2.81	4.56	2
WB1575X	2.81	4.56	2
WB15100X	2.81	4.56	2

SINGLE GANG BOXES

- 18 CUBIC INCH CAPACITY
- GREY

COPPER FREE ALUMINUM

TOPAZ CAT #	UPC#	K.O.	SHIP CASE	WT/ CASE
3 HOLES				
WB1350	81878	1/2"	25	15
WB1350B*	85572	1/2"	25	15
WB1375	81879	3/4"	25	15
WB13100	83999	1"	25	13

4 HOLES

WB1450	81880	1/2"	25	14
WB1475	81881	3/4"	25	14

5 HOLES

WB1550	81882	1/2"	25	13
WB1575	81883	3/4"	25	13
WB15100	84001	1"	20	13

5 HOLES

- SIDE OPENING

WB1550X	85258	1/2"	25	13
WB1575X	85259	3/4"	25	13
WB15100X	85260	1"	20	13

* BRONZE



E170258



E170258



E170258



E170258

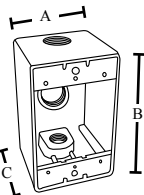

CAT#	A	B	C
WDB1350	2.81	4.56	2.62
WDB1375	2.81	4.56	2.62
WDB13100	2.81	4.56	2.62

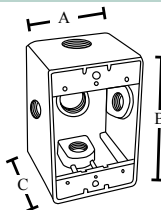

CAT#	A	B	C
WDB1550X	2.81	4.56	2.62
WDB1575X	2.81	4.56	2.62
WDB15100X	2.81	4.56	2.62

SINGLE GANG DEEP BOXES

- 28 CUBIC INCH CAPACITY
- GREY

COPPER FREE ALUMINUM

TOPAZ CAT #	UPC#	K.O.	SHIP CASE	WT/ CASE
3 HOLES				
WDB1350	85107	1/2"	20	16
WDB1375	85078	3/4"	20	16
WDB13100	85079	1"	20	16

5 HOLES SIDE OPENING

WDB1550X	85080	1/2"	20	15
WDB1575X	85081	3/4"	20	15
WDB15100X	85082	1"	20	15

ALL BOXES COME WITH MOUNTING LUGS, CLOSURE PLUGS AND GREEN GROUNDING SCREW # 10/32



E170258



E170258

DOUBLE GANG BOXES

- 30 CUBIC INCH CAPACITY
- GREY

COPPER FREE ALUMINUM

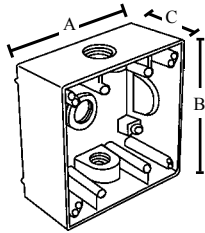

TOPAZ CAT #	UPC#	K.O.	SHIP CASE	WT/CASE
3 HOLES				
WB2350	81884	1/2"	10	22
WB2375	81885	3/4"	10	22
WB23100	84002	1"	10	22

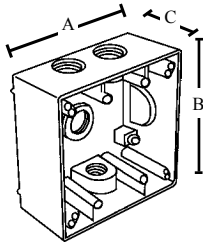

4 HOLES				
WB2450	81886	1/2"	10	21
WB2475	81887	3/4"	10	21

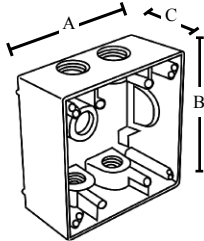

5 HOLES				
WB2550	81888	1/2"	10	20
WB2575	81889	3/4"	10	20
WB25100	84004	1"	10	20

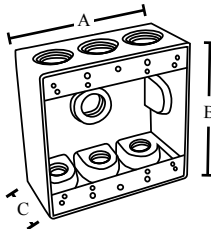

7 HOLES				
WB2750	85091	1/2"	10	20
WB2775	85092	3/4"	10	20



CAT#	A	B	C
WB2350	4.56	4.56	2.00
WB2375	4.56	4.56	2.00
WB23100	4.56	4.56	2.00
WB2450	4.56	4.56	2.00
WB2475	4.56	4.56	2.00
WB2550	4.56	4.56	2.00
WB2575	4.56	4.56	2.00
WB25100	4.56	4.56	2.00
WB2750	4.56	4.56	2.00
WB2775	4.56	4.56	2.00

ALL BOXES COME WITH MOUNTING LUGS, CLOSURE PLUGS AND GROUNDING SCREWS

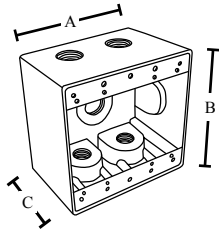

CAT#	A	B	C
WDB2550	4.56	4.56	2.62
WDB2575	4.56	4.56	2.62
WDB25100	4.56	4.56	2.62

DOUBLE GANG DEEP BOXES

- 40 CUBIC INCH CAPACITY
- GREY

5 HOLES

COPPER FREE ALUMINUM

TOPAZ CAT #	UPC#	K.O.	SHIP CASE	WT/ CASE
WDB2550	85086	1/2"	10	21
WDB2575	85087	3/4"	10	21
WDB25100	85088	1"	10	21

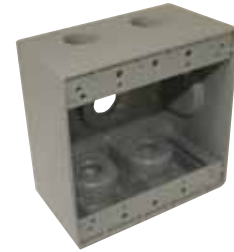

DOUBLE GANG BOXES SIDE OPENING

- 30 CUBIC INCH CAPACITY
- GREY

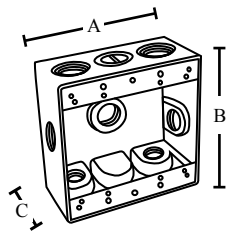
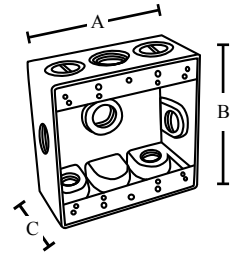
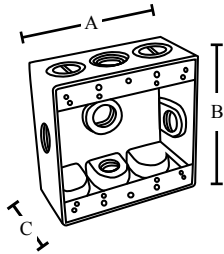

CAT#	A	B	C
WB2550X	4.56	4.56	2.00
WB2575X	4.56	4.56	2.00
WB25100X	4.56	4.56	2.00
WB2650X	4.56	4.56	2.00
WB2675X	4.56	4.56	2.00
WB2750X	4.56	4.56	2.00
WB2775X	4.56	4.56	2.00

COPPER FREE ALUMINUM

TOPAZ CAT #	UPC#	K.O.	SHIP CASE	WT/ CASE
5 HOLES				
WB2550X	85083	1/2"	10	20
WB2575X	85084	3/4"	10	20
WB25100X	85085	1"	10	22

6 HOLES

WB2650X	84089	1/2"	10	19
WB2675X	84090	3/4"	10	19

7 HOLES

WB2750X	85093	1/2"	10	19
WB2775X	84094	3/4"	10	19

ALL BOXES COME WITH MOUNTING LUGS, CLOSURE PLUGS AND GREEN GROUNDING SCREW



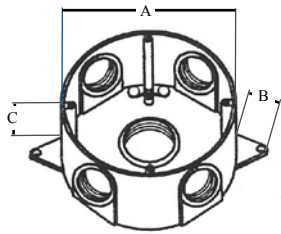

CAT#	A	B	C
WRB1550/B	4.31	0.65	1.58
WRB1550W	4.31	0.65	1.58
WRB1575	4.31	0.65	1.58
WRB1575W	4.31	0.65	1.58

4" ROUND BOX

- 17.2 CUBIC INCH CAPACITY
- GREY

5 HOLES

COPPER FREE ALUMINUM

TOPAZ CAT #	UPC#	K.O.	SHIP CASE	WT/ CASE
WRB1550	81890	1/2"	25	14
WRB1550B*	85580	1/2"	25	14
WRB1550W**	83631	1/2"	25	14
WRB1575	81891	3/4"	25	14
WRB1575W**	83632	3/4"	25	14

*BRONZE

**WHITE

USED WITH ALL STANDARD OUTLET BOX AND LAMPHOLDER COVERS.
INCLUDES FOUR CLOSURE PLUGS AND GROUNDING SCREWS.



E170258

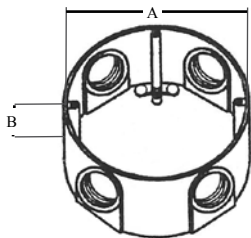

CAT#	A	B
WRB450EXT	4.31	1.58
WRB475EXT	4.31	1.58

4" ROUND EXTENSION

- GREY

4 HOLES

COPPER FREE ALUMINUM

TOPAZ CAT #	UPC#	K.O.	SHIP CASE	WT/ CASE
WRB450EXT	83576	1/2"	10	6
WRB475EXT	83577	3/4"	10	6



E170258

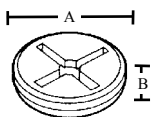

CAT#	A	B
WP50	.79	.33
WP75	1.00	.30
WP100	1.23	.28

CLOSURE PLUGS

ZINC DIE CAST

TOPAZ CAT #	UPC#	SIZE	UNIT CTN	SHIP CASE	WT/ CASE
WP50	19700	1/2"	—	100	2
WP75	19710	3/4"	—	50	2
WP100	19720	1"	—	25	2



E170258

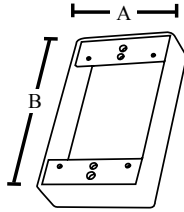

WB1EXT

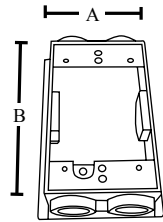

WB1450EXT

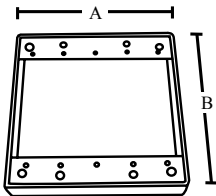

WB2EXT

CAT#	A	B
WB1EXT	2.81	4.56
WB1450EXT	2.81	4.56
WB2EXT	4.56	4.56

RECTANGLE EXTENSION SINGLE GANG

- GREY

COPPER FREE ALUMINUM

TOPAZ CAT #	UPC#	K.O.	SHIP CASE	WT/ CASE
WB1EXT	85111	----	24	7
WB1450EXT	85096	1/2"	25	10

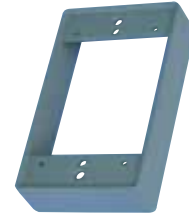

RECTANGLE EXTENSION DOUBLE GANG

- GREY

COPPER FREE ALUMINUM

TOPAZ CAT #	UPC#	K.O.	SHIP CASE	WT/ CASE
WB2EXT	85097	----	25	25



PAR LAMP HOLDER

- MEDIUM BASE
- GREY

COPPER FREE ALUMINUM

TOPAZ CAT #	UPC#	K.O.	SHIP CASE	WT/ CASE
WPAR50	80868	1/2"	50	22
WPAR50B*	85579	1/2"	50	22
WPAR50W**	83633	1/2"	50	22

*BRONZE

**WHITE

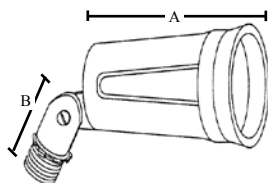

CAT#	A	B
WPAR50	2.57	2.00
WPAR50B	2.57	2.00
WPAR50W	2.57	2.00



E170258

COMES WITH 1/2" LOCKNUT AND GASKET. 150 WATTS MAX.
PAR 38 SWIVELS 180°.

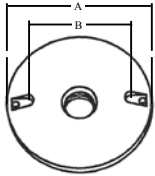

CAT#	A	B	C
WRC150	4.50	3.5	.875
WRC250	4.50	3.5	.875
WRC350/B	4.50	3.5	.875
WRC150W	4.50	3.5	.875
WRC250W	4.50	3.5	.875
WRC350W	4.50	3.5	.875

ROUND COVERS

• GREY

COPPER FREE ALUMINUM

TOPAZ CAT #	UPC#	# HOLES	K.O.	SHIP CASE	WT/ CASE
WRC150	81132	1	1/2"	100	30
WRC250	81133	2	1/2"	100	30
WRC350	81134	3	1/2"	100	30
WRC350B*	85582	3	1/2"	100	30
WRC150W**	83616	1	1/2"	100	30
WRC250W**	83617	2	1/2"	100	30
WRC350W**	83618	3	1/2"	100	30

* BRONZE

** WHITE



E170258



E170258



E170258

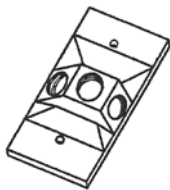
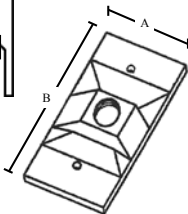

CAT#	A	B	C
WCR1150	2.79	4.55	.99
WCR1350	2.79	4.55	.99
WCR1150W	2.79	4.55	.99
WCR1350W	2.79	4.55	.99

RECTANGULAR COVERS

• GREY

COPPER FREE ALUMINUM

TOPAZ CAT #	UPC#	# HOLES	K.O.	SHIP CASE	WT/ CASE
WCR1150	81943	1	1/2"	50	14
WCR1350	80916	3	1/2"	50	14
WCR1150W*	83629	1	1/2"	50	14
WCR1350W*	83630	3	1/2"	50	14

* WHITE

ALL COVERS COME WITH GASKET AND SCREWS.



E170258



E170258

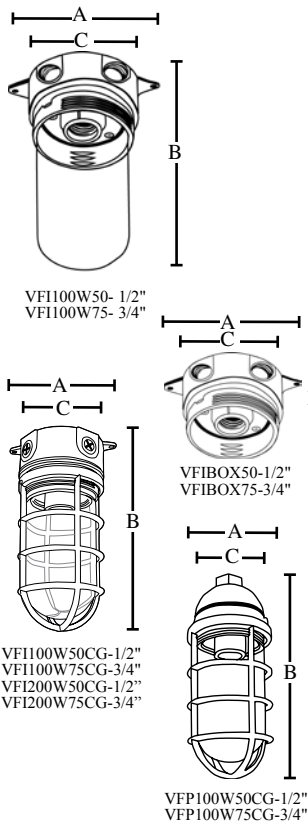

VAPOR PROOF FIXTURE

• GREY		COPPER FREE ALUMINUM			
TOPAZ CAT #	UPC#	# HOLES	THREAD SIZE	SHIP CASE	WT/ CASE
VF1100W50	83868	5	1/2"	6	13
VF1100W75	83869	5	3/4"	6	13
VF1100W50CG	85156	5	1/2"	6	16
VF1100W75CG	85157	5	3/4"	6	16
VF1200W50CG	85561	5	1/2"	6	16
VF1200W75CG	85562	5	3/4"	6	16
VFIBOX50	83872	5	1/2"	12	13
VFIBOX75	83871	5	3/4"	12	13
VFP100W50CG	85235	-	1/2"	6	17
VFP100W75CG	85236	-	3/4"	6	17
VFW100W50CG	85237	5	1/2"	6	19
VFW100W75CG	85238	5	3/4"	6	19



VAPOR PROOF 7" GLOBE

• CLEAR		SHIP CASE	WT/ CASE
TOPAZ CAT #	UPC#		
POLY			
VFIGGC	83870	6	5
GLASS			
VFIGLS	85155	6	6

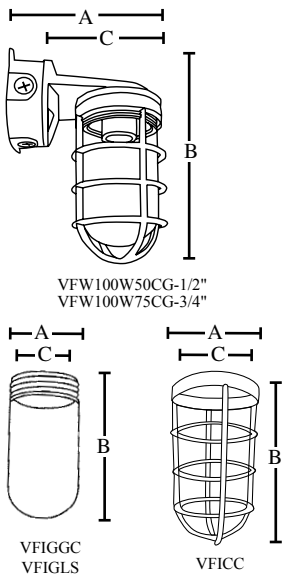

CAT#	A	B	C
VF1100W50	5.25	8.5	3.25
VF1100W75	5.25	8.5	3.25
VF1100W50CG	5.25	9.0	4.13
VF1100W75CG	5.25	9.0	4.13
VF1200W50CG	5.25	11.50	5.15
VF1200W75CG	5.25	11.50	5.15
VFIBOX50	5.25	3.5	4.13
VFIBOX75	5.25	3.5	4.13
VFP100W50CG	4.13	10.25	3.88
VFP100W75CG	4.13	10.25	3.88
VFW100W50CG	7.25	10.00	4.13
VFW100W75CG	7.25	10.00	4.13
VFIGGC	3.25	7.00	3.00
VFIGLS	3.25	7.00	3.00
VFICC	4.25	7.25	4.13

CAST CAGE

• THREAD ON		SHIP CASE	WT/ CASE
TOPAZ CAT #	UPC#		
VFICC	83936	16	18



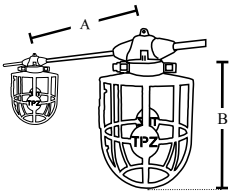

CAT#	A	B
1782	10.00'	6.00

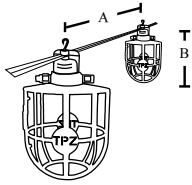

CAT#	A	B
1783	10.00'	6.00

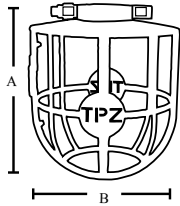

CAT#	A	B
1780	6.00	5.125

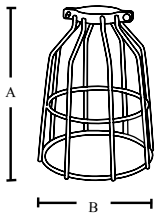

CAT#	A	B
1781	6.04	4.50

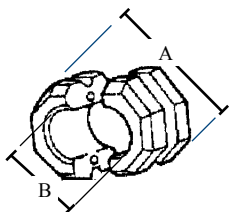

CAT#	A	B
V22	2.125	1.00
V38	3.00	1.500



CAT#	
T124/L	14GA 6" LONG PIGTAIL

TEMPORARY LIGHTING

14-2 MOLDED CORD

- CAGE 10 FEET ON CENTER
- 14-2 AVAILABLE WITH GROUND (USE PART #1784)

TOPAZ CAT #	UPC#	SIZE	UNIT CTN	SHIP CASE	WT/ CASE
1782	84010	14-2	1	100 FT	11

TEMPORARY LIGHTING

14-2 FLAT WIRE

- CAGE 10 FEET ON CENTER
- 14-2 AVAILABLE WITH GROUND (USE PART #1784)

TOPAZ CAT #	UPC#	SIZE	UNIT CTN	SHIP CASE	WT/ CASE
1783	84011	14-2	1	100 FT	10

BIRDCAGE

- YELLOW

TOPAZ CAT #	UPC#	UNIT CTN	SHIP CASE	WT/ CASE
1780	84008	100	100	15

OPEN BIRDCAGE

- COATED

TOPAZ CAT #	UPC#	UNIT CTN	SHIP CASE	WT/ CASE
1781	84009	20	20	11

VICTOR SPLIT KNOB

- FOR RUNNING TEMPORARY LIGHTING

TOPAZ CAT #	UPC#	SIZE	UNIT CTN	SHIP CASE	WT/ CASE
V22	33515	1"	—	100	38
V38	33516	1 1/2"	—	50	104

PIGTAIL SOCKET

- RIGHT HANDED THREAD
- LEFT HANDED THREAD
- #14 STRANDED
- 60/600V

TOPAZ CAT #	UPC#	SIZE	UNIT CTN	SHIP CASE	WT/ CASE
T124	33517	6" LONG	25	250	32
T124L	85697	6" LONG Left Hand	25	250	32



OSHA APPROVED



OSHA APPROVED



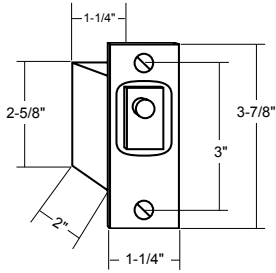

DOOR LIGHT SWITCH

TOPAZ CAT #	UPC#	DESCRIPTION	UNIT CTN	SHIP CASE	WT/ CASE
SD1	84007	DOOR SWITCH	1	100	50



TUBEGUARDS

• WITH END CAPS

TOPAZ CAT #	UPC#	DESCRIPTION	UNIT CTN	SHIP CASE	WT/ CASE
TGF40T12	83651	4' T12	24	24	6
TGF96T12	83652	8' T12	24	24	12
TGFP28T5	85145	4' T5 CLEAR	125	125	18
TGF032T8	83653	4' T8	24	24	10
TGF096T8	83654	8' T8	24	24	12
TGENDCAPS12	83655	T12 BLACK	48	48	35
TGENDCAPS5	85146	T5 BLACK	50	50	1
TGENDCAPS8	83656	T8 BLACK	48	48	35

Colors Available: Amber, Blue, Pink, Green, Red. End caps are made of high heat polypropylene and are included in each carton of tubes.

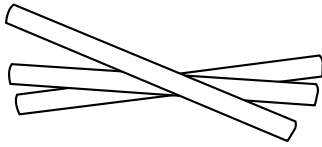

ALPHA-NUMERIC LISTING BY CATALOG NUMBER

0.....	3-7	61.....	9-4	103i.....	3-2	137.....	5-1
0B.....	3-7	62.....	9-4	103M.....	3-2	138.....	5-1
1.....	3-7	63.....	9-4	103Mi.....	3-2	139.....	5-1
1B.....	3-7	64.....	9-4	104.....	3-2	140.....	3-4,4-2
2.....	3-7	65.....	9-4	104i.....	3-2	141.....	14-1
2B.....	3-7	66.....	9-4	104M.....	3-2	141A.....	14-1
3.....	3-7	67.....	9-4	104Mi.....	3-2	143R.....	4-1
3B.....	3-7	68.....	9-4	105.....	3-2	144R.....	4-1
4.....	3-7	69.....	9-4	105i.....	3-2	145R.....	4-1
4B.....	3-7	70.....	9-4	105M.....	3-2	146R.....	4-1
11.....	9-4	70A.....	9-4	105Mi.....	3-2	150.....	3-3
12.....	9-4	70B.....	9-4	106.....	3-2	150M.....	3-3
13.....	9-4	71.....	15-2	106i.....	3-2	151.....	3-3
14.....	9-4	71A.....	15-2	106M.....	3-2	151i.....	3-3
15.....	9-4	75A250.....	10-2	106Mi.....	3-2	151M.....	3-3
16.....	9-4	75A350.....	10-2	107.....	3-2	151Mi.....	3-3
17.....	9-4	75A450.....	10-2	107M.....	3-2	152.....	3-3
18.....	9-4	75A560.....	10-2	107Mi.....	3-2	152i.....	3-3
19.....	9-4	75A650.....	10-2	108.....	3-2	152M.....	3-3
20.....	9-4	75B750.....	10-2	108M.....	3-2	152Mi.....	3-3
21.....	9-2	75B850.....	10-2	108Mi.....	3-2	153.....	3-3
22.....	9-2	76.....	8-4	109.....	3-2	153i.....	3-3
23.....	9-2	77.....	8-4	109M.....	3-2	153M.....	3-3
24.....	9-2	78.....	8-4	109Mi.....	3-2	153Mi.....	3-3
25.....	9-2	79.....	8-4	110.....	3-2	154.....	3-3
26.....	9-2	80.....	8-4	110M.....	3-2	154i.....	3-3
27.....	9-2	81.....	9-2	110Mi.....	3-2	154M.....	3-3
28.....	9-2	82.....	9-2	111.....	8-4	154Mi.....	3-3
29.....	9-2	83.....	9-2	111i.....	8-4	155.....	3-3
30.....	9-2	84.....	9-2	112.....	8-4	155i.....	3-3
31.....	12-2	85.....	9-2	112i.....	8-4	155M.....	3-3
32.....	12-2	86.....	9-2	113.....	8-4	155Mi.....	3-3
33.....	12-2	87.....	9-2	113i.....	8-4	156.....	3-3
33R.....	15-1	88.....	9-2	114.....	8-4	156i.....	3-3
34S.....	15-1	89.....	9-2	114i.....	8-4	156M.....	3-3
45.....	11-1	89A.....	9-2	115.....	8-4	156Mi.....	3-3
46.....	15-1	89A36.....	9-2	115i.....	8-4	157.....	3-3
47.....	15-1	89A42.....	9-2	116.....	8-4	157M.....	3-3
48.....	14-2	89A48.....	9-2	116i.....	8-4	157Mi.....	3-3
49.....	14-2	90.....	3-6	117.....	8-4	158.....	3-3
50.....	14-2	100.....	3-2	118.....	8-4	158M.....	3-3
50A250.....	10-2	100B560.....	10-2	120.....	4-1	158Mi.....	3-3
50A350.....	10-2	100B650.....	10-2	121.....	3-1	159.....	3-3
50A450.....	10-2	100B750.....	10-2	121A.....	3-1	159M.....	3-3
50A560.....	10-2	100B850.....	10-2	122.....	16-3	159Mi.....	3-3
50A650.....	10-2	100C950.....	10-2	122S.....	16-3	160.....	3-3
51.....	9-7	100C1050.....	10-2	123.....	16-3	160M.....	3-3
52.....	9-7	100M.....	3-2	123A.....	16-3	160Mi.....	3-3
53.....	9-7	100i.....	3-2	123S.....	16-3	161.....	1-6
54.....	9-7	101.....	3-2	124.....	16-3	162.....	1-6
55.....	9-7	101i.....	3-2	126.....	16-3	170.....	3-4
56.....	9-7	101M.....	3-2	130.....	3-1	170SNP.....	3-4
57.....	9-7	101Mi.....	3-2	130SNP.....	3-1	171.....	3-4
58.....	9-7	102.....	3-2	131.....	1-8,3-5	172.....	3-4
59.....	9-7	102i.....	3-2	132.....	1-8,3-5	173.....	3-4
60.....	9-7	102M.....	3-2	133.....	1-8,3-5	175.....	16-4
60A.....	9-7	102Mi.....	3-2	135.....	5-1	176.....	16-4
60B.....	9-7	103.....	3-2	136.....	5-1	180.....	1-8,3-5,4-3

ALPHA-NUMERIC LISTING BY CATALOG NUMBER

181	1-8,3-5	212	5-4	264i	8-3	300	16-4
182	1-8,3-5	213	5-4	264M	8-3	300A	16-4
182A	1-8,3-5	214	5-4	265	8-3	300B	16-4
183	16-3	214XL	5-4	265i	8-3	301	8-7
183i	16-3	215	5-4	265M	8-3	301CB	8-7
184	16-3	216	5-4	266	8-3	301M	8-7
184i	16-3	216XL	5-4	266i	8-3	302	8-7
185	16-3	230S	2-2	266M	8-3	302CB	8-7
185i	16-3	230TBS	3-8	267	8-3	302M	8-7
186	16-3	231S	2-2	267i	8-3	303	8-7
187	14-1	231TBS	3-8	268	8-3	303CB	8-7
188	14-1	232A	5-1	268i	8-3	303M	8-7
189	14-1	232S	2-2	269	8-3	304	8-7
189B	14-1	232TBS	3-8	269i	8-3	304CB	8-7
189-100	14-1	233S	2-2	270	8-3	304M	8-7
190	15-2	234S	2-2	270i	8-3	305	8-7
191	3-4	235S	2-2	271	1-8,2-6	305CB	8-7
193	16-3	236S	2-2	272	1-8,2-6	305M	8-7
194	16-3	237S	2-2	273	1-8,2-6	306	8-7
195	16-3	238S	2-2	277	15-1	306CB	8-7
196	16-3	239S	2-2	278	15-1	306M	8-7
197	16-3	240S	2-2	279	15-1	307	8-7
198	16-3	241	8-13	280	15-1	307CB	8-7
199	14-2	242	8-13	281	8-13	307M	8-7
200	15-2	243	8-13	281UL	8-13	308	8-7
201	8-17	244	8-13	282	8-13	308CB	8-7
201B	8-17	245	8-13	282A	5-1	308M	8-7
201M	8-17	246	8-13	282UL	8-13	309	8-7
202	8-17	247	8-13	283	8-13	309CB	8-7
202B	8-17	248	8-13	283UL	8-13	309M	8-7
202M	8-17	249	8-13	284	8-13	310	8-7
203	8-17	250	8-13	284A	5-1	310ACB	8-7
203B	8-17	251	8-3	284UL	8-13	310AM	8-7
203M	8-17	251M	8-3	285	8-13	310BCB	8-7
204	8-17	252	8-3	285UL	8-13	310BM	8-7
204B	8-17	252M	8-3	286	8-13	310CB	8-7
204M	8-17	253	8-3	286UL	8-13	310M	8-7
205	8-17	253M	8-3	287	8-13	311	8-8
205B	8-17	254	8-3	287UL	8-13	311M	8-8
205M	8-17	254M	8-3	288	8-13	312	8-8
206	8-17	255	8-3	288UL	8-13	312M	8-8
206B	8-17	255M	8-3	289	8-13	313	8-8
206M	8-17	256	8-3	289UL	8-13	313M	8-8
207	8-17	256M	8-3	290	8-13	314	8-8
207B	8-17	257	8-3	290A	8-13	314M	8-8
207M	8-17	258	8-3	290B	8-13	315	8-8
208	8-17	259	8-3	290UL	8-13	315M	8-8
208B	8-17	260	8-3	291	8-16	316	8-8
208M	8-17	261	8-3	292	8-16	316M	8-8
209	8-17	261i	8-3	293	8-16	317	8-8
209B	8-17	261M	8-3	294	8-16	317M	8-8
209M	8-17	262	8-3	295	8-16	318	8-8
210	8-17	262i	8-3	296	8-16	318M	8-8
210B	8-17	262M	8-3	297	16-2	319	8-8
210M	8-17	263	8-3	298	16-2	319M	8-8
210MA	8-17	263i	8-3	298S	16-2	320	8-8
210MB	8-17	263M	8-3	299	16-2	320AM	8-8
211	5-4	264	8-3	299B	16-2	320BM	8-8

ALPHA-NUMERIC LISTING BY CATALOG NUMBER

320M.....	8-8	339A.....	8-10	441.....	4-1	478S.....	2-2
321.....	8-9	339AM.....	8-10	442.....	4-1	479.....	2-1
321M.....	8-9	339M.....	8-10	444.....	4-1	479S.....	2-2
322.....	8-9	339MSS.....	8-10	445.....	4-1	480.....	2-1
322M.....	8-9	340.....	8-10	450.....	3-1	480S.....	2-2
323.....	8-9	340A.....	8-10	450i.....	3-1	481.....	1-10,8-16
323M.....	8-9	340ALM.....	8-10	451.....	3-1	482.....	1-10,8-16
324.....	8-9	340AM.....	8-10	451i.....	3-1	483.....	1-10,8-16
324M.....	8-9	340AMSS.....	8-10	452.....	3-1	484.....	1-10,8-16
325.....	8-9	340BLM.....	8-10	452i.....	3-1	485.....	1-10,8-16
325M.....	8-9	340BMSS.....	8-10	453.....	3-1	486.....	1-10,8-16
326.....	8-9	340M.....	8-10	453i.....	3-1	487.....	1-10,8-16
326M.....	8-9	340MSS.....	8-10	454.....	3-1	488.....	1-10,8-16
327.....	8-9	341.....	1-7	454i.....	3-1	489.....	1-10,8-16
327M.....	8-9	342.....	1-7	455.....	3-1	489A.....	1-10,8-16
328.....	8-9	350.....	3-6,4-3	455i.....	3-1	489B.....	1-10,8-16
328M.....	8-9	350SNP.....	3-6	456.....	3-1	489C.....	1-10,8-16
329.....	8-9	351.....	8-1	456i.....	3-1	490.....	2-1
329M.....	8-9	351SS.....	1-7,8-1	457.....	4-3	490i.....	2-1
330.....	8-9	352.....	8-1	458.....	4-3	490S.....	2-2
330AM.....	8-9	352SS.....	1-7,8-1	459.....	4-3	490TBS.....	3-8
330BM.....	8-9	353.....	8-1	461.....	3-1	491.....	2-1
330M.....	8-9	353SS.....	1-7,8-1	462.....	3-1	491i.....	2-1
331.....	8-10	354.....	8-1	463.....	3-1	491S.....	2-2
331M.....	8-10	354SS.....	1-7,8-1	464.....	3-1	491TBS.....	3-8
331MSS.....	8-10	360.....	3-6,4-3	465.....	3-1	492.....	2-1
332.....	8-10	361.....	8-1	466.....	3-1	492i.....	2-1
332M.....	8-10	361SS.....	1-7,8-1	470.....	2-1	492S.....	2-2
332MSS.....	8-10	362.....	8-1	470i.....	2-1	492TBS.....	3-8
333.....	8-10	362SS.....	1-7,8-1	470S.....	2-2	493.....	2-1
333M.....	8-10	363.....	8-1	470ST.....	2-6	493i.....	2-1
333MSS.....	8-10	363SS.....	1-7,8-1	471.....	2-1	493S.....	2-2
334.....	8-10	364.....	8-1	471i.....	2-1	493TBS.....	3-8
334A.....	8-10	364SS.....	1-7,8-1	471S.....	2-2	494.....	2-1
334AM.....	8-10	370.....	3-6	471ST.....	2-6	494i.....	2-1
334M.....	8-10	371.....	1-7	472.....	2-1	494S.....	2-2
334MSS.....	8-10	372.....	1-7	472i.....	2-1	495.....	2-1
335.....	8-10	380.....	3-6	472S.....	2-2	495i.....	2-1
335A.....	8-10	381.....	1-7	472ST.....	2-6	495S.....	2-2
335AM.....	8-10	382.....	1-7	473.....	2-1	496.....	2-1
335M.....	8-10	383.....	1-7	473i.....	2-1	496i.....	2-1
335MSS.....	8-10	384.....	1-7	473S.....	2-2	496S.....	2-2
336.....	8-10	390.....	3-4	473ST.....	2-6	497.....	2-1
336A.....	8-10	391S.....	1-8,8-17	474.....	2-1	497S.....	2-2
336AM.....	8-10	392S.....	1-8,8-17	474i.....	2-1	498.....	2-1
336M.....	8-10	393S.....	1-8,8-17	474S.....	2-2	498S.....	2-2
336MSS.....	8-10	411.....	12-2	474ST.....	2-6	499.....	2-1
337.....	8-10	412.....	12-2	475.....	2-1	499S.....	2-2
337A.....	8-10	413.....	12-2	475i.....	2-1	500.....	2-1
337AM.....	8-10	420TBS.....	3-8	475S.....	2-2	500S.....	2-2
337M.....	8-10	421TBS.....	3-8	475ST.....	2-6	501.....	5-1
337MSS.....	8-10	422TBS.....	3-8	476.....	2-1	502.....	5-1
338.....	8-10	430TBS.....	3-8	476i.....	2-1	503.....	5-1
338A.....	8-10	431.....	1-6	476S.....	2-2	504.....	5-1
338AM.....	8-10	431TBS.....	3-8	476ST.....	2-6	506.....	5-1
338M.....	8-10	432.....	1-6	477.....	2-1	507.....	5-1
338MSS.....	8-10	432TBS.....	3-8	477S.....	2-2	508.....	5-1
339.....	8-10	433.....	1-6	478.....	2-1	509.....	5-1

ALPHA-NUMERIC LISTING BY CATALOG NUMBER

510BX.....	3-6	565.....	8-6	614A.....	16-2	635S.....	1-5
510RX.....	4-3	566.....	8-6	615.....	16-2	635Si.....	1-5
511.....	1-9	567.....	8-6	616.....	16-2	635TBS.....	3-8
512.....	1-9	568.....	8-6	617.....	16-2	636.....	1-2
513.....	1-9	569.....	8-6	618.....	16-2	636i.....	1-2
514.....	1-9	570.....	8-6	619.....	16-2	636S.....	1-5
515.....	1-9	570A.....	8-6	620.....	16-2	636Si.....	1-5
516.....	1-9	570B.....	8-6	620BP.....	12-1	636TBS.....	3-8
517.....	1-9,8-6	571.....	6-6	620DB.....	12-1	637.....	1-2
518.....	1-9,8-6	571P.....	6-6	620Z.....	12-1	637i.....	1-2
519.....	1-9,8-6	571S.....	6-6	621.....	12-2	637S.....	1-5,8-2
520.....	1-9,8-6	572.....	6-6	621A.....	12-2	637Si.....	1-5
520A.....	1-9,8-6	572P.....	6-6	621B.....	12-2	637TBS.....	3-8
520B.....	1-9,8-6	572S.....	6-6	622.....	12-2	638.....	1-2
521.....	1-9	573.....	6-6	622A.....	12-2	638i.....	1-2
522.....	1-9	573P.....	6-6	622B.....	12-2	638S.....	1-5,8-2
523.....	1-9	573S.....	6-6	623.....	12-2	638Si.....	1-5
524.....	1-9	574.....	6-6	623A.....	12-2	638TBS.....	3-8
525.....	1-9	574P.....	6-6	623B.....	12-2	639.....	1-2
526.....	1-9	574S.....	6-6	624.....	12-2	639i.....	1-2
527.....	1-9,8-6	576.....	6-6	624A.....	12-2	639S.....	1-5,8-2
528.....	1-9,8-6	576P.....	6-6	624B.....	12-2	639Si.....	1-5
529.....	1-9,8-6	576S.....	6-6	625.....	12-1	639TBS.....	3-8
530.....	1-9,8-6	577.....	6-6	626.....	12-1	640.....	1-2
530A.....	1-9,8-6	577P.....	6-6	626A.....	12-1	640i.....	1-2
530B.....	1-9,8-6	577S.....	6-6	626B.....	12-1	640S.....	1-5,8-2
531.....	8-6	579.....	6-6	626BS.....	12-1	640Si.....	1-5
531A.....	8-6	579P.....	6-6	626C.....	12-1	640TBS.....	3-8
531B.....	8-6	579S.....	6-6	626D.....	12-1	641.....	1-2
532.....	8-6	581.....	6-6	627.....	12-1	641S.....	1-5
533.....	8-6	582.....	6-6	628.....	12-1	642.....	1-2
534.....	8-6	583.....	6-6	629.....	12-1	642S.....	1-5
535.....	8-6	584.....	6-6	630.....	12-1	643.....	1-2
536.....	8-6	586.....	6-6	630B.....	12-1	643S.....	1-5
541.....	8-6	587.....	6-6	630DB.....	12-1	644.....	1-2
541A.....	8-6	589.....	6-6	630TBS.....	3-8	644S.....	1-5
541B.....	8-6	590.....	1-8,3-5	631.....	1-2	645.....	1-2
542.....	8-6	591.....	5-4	631i.....	1-2	645S.....	1-5
543.....	8-6	593.....	5-4	631S.....	1-5	646.....	1-2
544.....	8-6	594.....	5-4	631Si.....	1-5	646S.....	1-5
545.....	8-6	595.....	5-4	631TBS.....	3-8	647.....	1-2
546.....	8-6	596.....	5-4	632.....	1-2	647S.....	1-5,8-2
551.....	8-14	596A.....	5-4	632i.....	1-2	648.....	1-2
552.....	8-14	601.....	16-2	632S.....	1-5	648S.....	1-5,8-2
553.....	8-14	602.....	16-2	632Si.....	1-5	649.....	1-2
554.....	8-14	603.....	16-2	632TBS.....	3-8	649S.....	1-5,8-2
555.....	8-14	604.....	16-2	633.....	1-2	650.....	1-2
556.....	8-14	604A.....	16-2	633i.....	1-2	650S.....	1-5,8-2
557.....	8-14	605.....	16-2	633S.....	1-5	651.....	1-1
558.....	8-14	606.....	16-2	633Si.....	1-5	651i.....	1-1
559.....	8-14	607.....	16-2	633TBS.....	3-8	651S.....	1-3
560.....	8-14	608.....	16-2	634.....	1-2	651Si.....	1-3
561.....	8-6	609.....	16-2	634i.....	1-2	651SRT.....	1-4
561A.....	3-2	610.....	16-2	634S.....	1-5	651SiRT.....	1-4
561ADC.....	3-2	611.....	16-2	634Si.....	1-5	652.....	1-1
562.....	8-6	612.....	16-2	634TBS.....	3-8	652i.....	1-1
563.....	8-6	613.....	16-2	635.....	1-2	652S.....	1-3
564.....	8-6	614.....	16-2	635i.....	1-2	652Si.....	1-3

ALPHA-NUMERIC LISTING BY CATALOG NUMBER

652SRT.....	1-4	663SRT.....	1-4	706.....	5-3	754M.....	8-5
652SiRT.....	1-4	664.....	1-1	707.....	5-3	754Mi.....	8-5
653.....	1-1	664S.....	1-3	708.....	5-3	755.....	8-5
653i.....	1-1	664SRT.....	1-4	709.....	5-1	755i.....	8-5
653S.....	1-3	665.....	1-1	710.....	5-1	755M.....	8-5
653Si.....	1-3	665S.....	1-3	711.....	8-14	755Mi.....	8-5
653SRT.....	1-4	665SRT.....	1-4	712.....	8-14	756.....	8-5
653SiRT.....	1-4	666.....	1-1	713.....	8-14	756i.....	8-5
654.....	1-1	666S.....	1-3	714.....	8-14	756M.....	8-5
654i.....	1-1	666SRT.....	1-4	715.....	8-14	756Mi.....	8-5
654S.....	1-3	667.....	1-1	716.....	8-14	757.....	8-5
654Si.....	1-3	667S.....	1-3	717.....	8-14	757i.....	8-5
654SRT.....	1-4	667SRT.....	1-4	718.....	8-14	757M.....	8-5
654SiRT.....	1-4	668.....	1-1	719.....	8-14	757Mi.....	8-5
655.....	1-1	668S.....	1-3	720.....	8-14	758.....	8-5
655i.....	1-1	668SRT.....	1-4	720A.....	8-14	758i.....	8-5
655S.....	1-3	669.....	1-1	720B.....	8-14	758M.....	8-5
655Si.....	1-3	669S.....	1-3	727.....	5-3	758Mi.....	8-5
655SRT.....	1-4	669SRT.....	1-4	728.....	5-3	759.....	8-5
655SiRT.....	1-4	670.....	1-1	729.....	5-3	759i.....	8-5
656.....	1-1	670S.....	1-3	731.....	5-2	759M.....	8-5
656i.....	1-1	670SRT.....	1-4	732.....	5-2	759Mi.....	8-5
656S.....	1-3	671.....	8-2	733.....	5-2	760.....	8-5
656Si.....	1-3	671S.....	8-2	734.....	5-2	760A.....	8-5
656SRT.....	1-4	671Si.....	8-2	735.....	5-2	760B.....	8-5
656SiRT.....	1-4	672.....	8-2	736.....	5-2	760i.....	8-5
657.....	1-1	672S.....	8-2	737.....	5-2	760M.....	8-5
657i.....	1-1	672Si.....	8-2	738.....	5-2	760Mi.....	8-5
657S.....	1-3	673S.....	8-2	739.....	5-2	761.....	7-2
657Si.....	1-3	673Si.....	8-2	740.....	5-2	762.....	7-2
657SRT.....	1-4	674S.....	8-2	741.....	5-2	763.....	7-2
657SiRT.....	1-4	674Si.....	8-2	742.....	5-2	764.....	7-2
658.....	1-1	675S.....	8-2	743.....	5-2	765.....	7-2
658i.....	1-1	675Si.....	8-2	744.....	5-2	766.....	7-2
658S.....	1-3	676S.....	8-2	745.....	5-2	767.....	7-2
658Si.....	1-3	676Si.....	8-2	746.....	5-2	768.....	7-2
658SRT.....	1-4	681S.....	8-2	747.....	5-2	769.....	7-2
658SiRT.....	1-4	682S.....	8-2	748.....	5-2	770.....	7-2
659.....	1-1	683S.....	8-2	749.....	5-2	771.....	1-6
659i.....	1-1	684S.....	8-2	750.....	5-2	772.....	1-6
659S.....	1-3	685S.....	8-2	750A.....	5-2	773.....	1-6
659Si.....	1-3	686S.....	8-2	750B.....	5-2	781.....	1-6
659SRT.....	1-4	690.....	13-1	751.....	8-5	782.....	1-6
659SiRT.....	1-4	691.....	13-1	751A.....	8-5	783.....	1-6
660.....	1-1	692.....	13-1	751i.....	8-5	790.....	13-1
660i.....	1-1	693.....	13-1	751M.....	8-5	791.....	13-1
660S.....	1-3	694.....	13-1	751Mi.....	8-5	792.....	13-1
660Si.....	1-3	695.....	13-1	752.....	8-5	793.....	13-1
660SRT.....	1-4	696.....	13-1	752A.....	8-5	794.....	13-1
660SiRT.....	1-4	697.....	13-1	752i.....	8-5	795.....	13-1
661.....	1-1	698.....	13-1	752M.....	8-5	796.....	13-1
661S.....	1-3	699.....	13-1	752Mi.....	8-5	797.....	13-1
661SRT.....	1-4	700.....	13-1	753.....	8-5	798.....	13-1
662.....	1-1	701.....	13-1	753i.....	8-5	799.....	13-1
662S.....	1-3	702.....	13-1	753M.....	8-5	800.....	13-1
662SRT.....	1-4	703.....	13-1	753Mi.....	8-5	801.....	13-1
663.....	1-1	704.....	5-3	754.....	8-5	802.....	13-1
663S.....	1-3	705.....	5-3	754i.....	8-5	803.....	13-1

ALPHA-NUMERIC LISTING BY CATALOG NUMBER

805.....	13-3	856.....	8-4	883D.....	10-2	961.....	5-4
806.....	13-3	856S.....	8-4	890.....	13-9	962.....	16-4
807.....	13-3	857.....	8-4	891.....	13-9	965.....	5-4
808.....	13-3	858.....	8-4	892.....	13-9	971.....	4-1
809.....	13-3	859.....	8-4	893.....	13-9	972.....	4-1
810.....	13-3	860.....	8-4	895.....	13-9	973.....	4-1
810DB.....	13-3	860A.....	8-4	896.....	13-9	974.....	4-1
811.....	13-3	860B.....	8-4	897.....	13-9	975.....	4-1
812.....	13-3	860T.....	13-8	900.....	8-11	976.....	4-1
813.....	13-2	861.....	13-8	901.....	8-11	981.....	8-9
814.....	13-2	866BLU.....	13-8	902.....	8-11	982.....	8-9
815.....	13-2	866BRN.....	13-8	903.....	8-11	984.....	5-3
816.....	13-2	866GRN.....	13-8	904.....	8-11	985.....	5-3
817.....	13-3	866GRY.....	13-8	905.....	8-11	986.....	5-3
818.....	13-3	866ORN.....	13-8	906.....	8-11	987.....	5-3
819.....	13-3	866RED.....	13-8	907.....	8-11	994.....	5-3
820.....	13-2	866T.....	13-8	908.....	8-11	995.....	5-3
821.....	13-2	866WHT.....	13-8	909.....	8-11	996.....	5-3
822.....	13-2	866YEL.....	13-8	910.....	8-11	997.....	5-3
823.....	13-2	867T.....	13-8	911.....	8-11	998.....	5-5
824.....	13-2	868.....	13-9	912.....	8-11	999.....	5-5
825.....	13-2	868F.....	13-9	913.....	8-11	1000.....	5-6
826.....	13-2	869.....	13-8	914.....	8-11	1000A.....	5-6
827.....	13-2	870.....	13-8	915.....	8-11	1001.....	5-5
828.....	13-2	870C.....	13-8	916.....	8-11	1002.....	5-5
829.....	13-2	870T.....	13-8	917.....	8-11	1003.....	5-5
830BLU.....	13-8	871.....	4-2,5-6	918.....	8-11	1004.....	5-5
830BRN.....	13-8	871C.....	13-8	919.....	8-11	1005.....	5-5
830GRN.....	13-8	871S.....	4-2,5-6	920.....	8-11	1006.....	5-5
830GRY.....	13-8	872.....	4-2,5-6	921.....	8-11	1007.....	5-5
830ORN.....	13-8	872S.....	4-2,5-6	922.....	8-11	1008.....	5-5
830PUR.....	13-8	873.....	4-2,5-6	923.....	8-11	1011.....	17-2
830RED.....	13-8	873A.....	4-2,5-6	924.....	8-11	1012.....	17-2
830WHT.....	13-8	873B.....	4-2,5-6	925.....	8-11	1013.....	17-2
830YEL.....	13-8	873C.....	4-2,5-6	926.....	8-11	1014.....	17-2
830T.....	13-8	874.....	4-2,5-6	927.....	8-11	1015.....	17-2
831.....	8-8	874A.....	4-2,5-6	928.....	8-11	1016.....	17-2
832.....	8-8	874B.....	4-2,5-6	929.....	8-11	1017.....	17-2
833.....	8-8	874C.....	4-2,5-6	930.....	8-11	1018.....	17-2
834.....	8-8	875.....	4-2,5-6	931.....	8-11	1019.....	17-2
835.....	8-8	875A.....	4-2,5-6	932.....	8-11	1020.....	17-2
836.....	8-8	875C.....	4-2,5-6	933.....	8-11	1020A.....	17-2
837.....	8-8	876.....	4-2,5-6	934.....	8-11	1020B.....	17-2
838.....	8-8	876A.....	4-2,5-6	935.....	8-11	1021.....	17-2
839.....	8-8	876B.....	4-2,5-6	936.....	8-11	1022.....	17-2
840.....	8-8	876C.....	4-2,5-6	937.....	8-11	1023.....	17-2
840A.....	8-8	876D.....	4-2,5-6	938.....	8-11	1024.....	17-2
840B.....	8-8	876E.....	4-2,5-6	939.....	8-11	1025.....	17-2
851.....	8-4	881.....	10-2	940.....	8-11	1026.....	17-2
851S.....	8-4	881A.....	10-2	941.....	8-11	1027.....	17-2
852.....	8-4	881B.....	10-2	942.....	8-11	1028.....	17-2
852S.....	8-4	882.....	10-2	943.....	8-11	1029.....	17-2
853.....	8-4	882A.....	10-2	944.....	8-11	1030.....	17-2
853S.....	8-4	882B.....	10-2	952.....	4-1	1030A.....	17-2
854.....	8-4	883.....	10-2	953.....	4-1	1030B.....	17-2
854S.....	8-4	883A.....	10-2	954.....	4-1	1031.....	17-3
855.....	8-4	883B.....	10-2	955.....	4-1	1032.....	17-3
855S.....	8-4	883C.....	10-2	956.....	4-1	1033.....	17-3

ALPHA-NUMERIC LISTING BY CATALOG NUMBER

1034.....	17-3	1087.....	17-1	1146.....	17-8	1203.....	5-1
1035.....	17-3	1088.....	17-1	1147.....	17-8	1206.....	17-3
1036.....	17-3	1089.....	17-1	1148.....	17-8	1207.....	17-3
1037.....	17-3	1090.....	17-1	1149.....	17-8	1208.....	17-3
1038.....	17-3	1090A.....	17-1	1150.....	17-8	1208A.....	17-3
1039.....	17-3	1090B.....	17-1	1151.....	17-8	1208B.....	17-3
1040.....	17-3	1091.....	17-13	1152.....	17-8	1209.....	13-9
1040A.....	17-3	1092.....	17-13	1153.....	17-8	1210.....	13-9
1040B.....	17-3	1094.....	17-2	1154.....	17-8	1211.....	17-4
1041.....	17-5	1096.....	17-2	1155.....	17-8	1212.....	17-4
1042.....	17-5	1097.....	5-6	1156.....	17-8	1213.....	17-4
1043.....	17-5	1097A.....	5-6	1157.....	17-8	1214.....	17-4
1044.....	17-5	1098.....	5-6	1158.....	17-8	1215.....	17-4
1045.....	17-5	1099.....	5-6	1159.....	17-8	1216.....	17-4
1046.....	17-5	1100.....	5-6	1160.....	17-8	1217.....	17-4
1047.....	17-5	1101.....	17-5	1161.....	17-9	1218.....	17-4
1048.....	17-5	1101TC.....	3-6	1162.....	17-9	1219.....	17-4
1049.....	17-5	1102.....	17-5	1163.....	17-9	1220.....	17-4
1050.....	17-5	1105TC.....	3-6	1164.....	17-9	1221.....	17-14
1050A.....	17-5	1106.....	5-6	1165.....	17-9	1222.....	17-14
1050B.....	17-5	1106TC.....	3-6	1166.....	17-9	1223.....	17-14
1051.....	17-6	1107.....	5-6	1167.....	17-9	1224.....	17-14
1052.....	17-6	1111.....	17-1	1168.....	17-9	1225.....	17-14
1053.....	17-6	1112.....	17-1	1169.....	17-9	1226.....	17-14
1054.....	17-6	1113.....	17-1	1170.....	17-9	1227.....	17-14
1055.....	17-6	1114.....	17-1	1171.....	17-7	1228.....	17-14
1056.....	17-6	1115.....	17-1	1172.....	17-7	1229.....	17-14
1057.....	17-6	1116.....	17-1	1173.....	17-7	1230.....	17-14
1058.....	17-6	1117.....	17-1	1174.....	17-7	1231.....	17-14
1059.....	17-6	1118.....	17-1	1175.....	17-7	1232.....	17-14
1060.....	17-6	1119.....	17-1	1176.....	17-7	1233.....	17-14
1060A.....	17-6	1120.....	17-1	1177.....	17-7	1234.....	17-14
1060B.....	17-6	1121.....	17-1	1178.....	17-7	1235.....	17-14
1061.....	17-4	1122.....	17-1	1179.....	17-7	1236.....	17-14
1062.....	17-4	1123.....	17-1	1180.....	17-7	1237.....	17-14
1063.....	17-4	1124.....	17-1	1181.....	17-7	1238.....	17-14
1064.....	17-4	1125.....	17-1	1182.....	17-7	1239.....	17-13
1065.....	17-4	1126.....	17-1	1183.....	17-7	1241.....	17-4
1066.....	17-4	1127.....	17-1	1184.....	17-7	1242.....	17-4
1067.....	17-4	1128.....	17-1	1185.....	17-7	1243.....	17-4
1068.....	17-4	1129.....	17-1	1186.....	17-7	1244.....	17-4
1070.....	17-4	1130.....	17-1	1187.....	17-7	1245.....	17-4
1071.....	17-7	1130A.....	17-1	1188.....	17-7	1246.....	17-4
1072.....	17-7	1130B.....	17-1	1189.....	17-7	1247.....	17-4
1073.....	17-7	1132.....	17-3	1190.....	17-7	1248.....	17-4
1074.....	17-7	1133.....	17-3	1191.....	17-8	1249.....	17-4
1075.....	17-7	1134.....	17-3	1192.....	17-8	1250.....	17-4
1076.....	17-7	1135.....	17-3	1193.....	17-8	1250A.....	17-4
1077.....	17-7	1136.....	17-3	1194.....	17-8	1250B.....	17-4
1078.....	17-7	1137.....	17-3	1195.....	17-8	1251.....	17-5
1079.....	17-7	1138.....	17-3	1196.....	17-8	1252.....	17-5
1080.....	17-7	1139.....	17-3	1197.....	17-8	1253.....	17-5
1081.....	17-1	1140.....	17-3	1198.....	17-8	1254.....	17-5
1082.....	17-1	1141.....	17-8	1199.....	17-8	1255.....	17-5
1083.....	17-1	1142.....	17-8	1199A.....	17-8	1256.....	17-5
1084.....	17-1	1143.....	17-8	1200.....	13-9	1257.....	17-5
1085.....	17-1	1144.....	17-8	1201.....	13-9	1258.....	17-5
1086.....	17-1	1145.....	17-8	1202.....	13-9	1259.....	17-5

ALPHA-NUMERIC LISTING BY CATALOG NUMBER

1260.....	17-5	1325.....	17-10	1393.....	17-18	1451.....	17-19
1260A.....	17-5	1326.....	17-10	1394.....	17-18	1452.....	17-19
1260B.....	17-5	1327.....	17-16	1395.....	17-18	1453.....	17-19
1261.....	17-6	1328.....	17-16	1396.....	17-18	1454.....	17-19
1262.....	17-6	1328P.....	17-16	1397.....	17-18	1455.....	17-19
1263.....	17-6	1329.....	17-16	1398.....	17-18	1456.....	17-19
1264.....	17-6	1329H.....	17-16	1399.....	17-18	1457.....	17-19
1265.....	17-6	1329P.....	17-16	1400.....	17-18	1458.....	17-19
1266.....	17-6	1331.....	17-16	1401.....	17-18	1459.....	17-19
1267.....	17-6	1332.....	17-16	1402.....	17-18	1460.....	17-19
1268.....	17-6	1333.....	17-16	1403.....	17-18	1461.....	17-19
1269.....	17-6	1334.....	17-16	1404.....	17-18	1462.....	17-19
1270.....	17-6	1335.....	17-16	1405.....	17-18	1463.....	17-19
1270A.....	17-6	1336.....	17-16	1406.....	17-18	1464.....	17-19
1270B.....	17-6	1337.....	17-16	1407.....	17-18	1465.....	17-19
1280.....	17-11	1338.....	17-16	1408.....	17-18	1466.....	17-19
1281.....	17-11	1339.....	17-16	1409.....	17-18	1467.....	17-19
1282.....	17-11	1340.....	17-16	1410.....	17-18	1468.....	17-19
1283.....	17-11	1341.....	17-16	1411.....	17-18	1469.....	17-19
1284.....	17-11	1342.....	17-16	1412.....	17-18	1470.....	17-19
1285.....	17-11	1343.....	17-16	1413.....	17-18	1471.....	17-19
1286.....	17-11	1344.....	17-16	1414.....	17-18	1472.....	17-19
1287.....	17-11	1345.....	17-16	1415.....	17-18	1473.....	17-19
1288.....	17-11	1346.....	17-16	1416.....	17-18	1474.....	17-19
1289.....	17-11	1347.....	17-16	1417.....	17-18	1475.....	17-19
1290.....	17-11	1348.....	17-16	1418.....	17-18	1476.....	17-19
1291.....	17-11	1349.....	17-16	1419.....	17-18	1477.....	17-19
1292.....	17-11	1350.....	17-16	1420.....	17-18	1478.....	17-19
1293.....	17-11	1351.....	17-16	1421.....	17-18	1480.....	17-15
1294.....	17-12	1352.....	17-16	1422.....	17-18	1481.....	17-15
1295.....	17-12	1353.....	17-16	1423.....	17-18	1482.....	17-15
1296.....	17-12	1354.....	17-16	1424.....	17-18	1483.....	17-15
1297.....	17-12	1355.....	17-16	1425.....	17-18	1484.....	17-15
1298.....	17-12	1356.....	17-16	1426.....	17-18	1485.....	17-15
1299.....	17-12	1357.....	17-16	1427.....	17-18	1486.....	17-15
1301.....	17-12	1358.....	17-16	1428.....	17-18	1487.....	17-15
1302.....	17-12	1359.....	17-16	1429.....	17-19	1488.....	17-15
1303.....	17-12	1360.....	17-16	1430.....	17-19	1490.....	17-15
1304.....	17-12	1361.....	17-16	1431.....	17-19	1491.....	17-17
1305.....	17-12	1362.....	17-16	1432.....	17-19	1492.....	17-17
1306.....	17-12	1363.....	17-16	1433.....	17-19	1493.....	17-17
1307.....	17-12	1364.....	17-16	1434.....	17-19	1501.....	2-6
1308.....	17-12	1377.....	17-18	1435.....	17-19	1502.....	2-6
1309.....	17-12	1378.....	17-18	1436.....	17-19	1511.....	17-17
1310.....	17-13	1379.....	17-18	1437.....	17-19	1512.....	17-17
1311.....	17-13	1380.....	17-18	1438.....	17-19	1513.....	17-17
1312.....	17-13	1381.....	17-18	1439.....	17-19	1514.....	5-5
1313.....	17-13	1382.....	17-18	1440.....	17-19	1515.....	5-5
1314.....	17-13	1383.....	17-18	1441.....	17-19	1517.....	5-5
1315.....	17-10	1384.....	17-18	1442.....	17-19	1521.....	2-6
1316.....	17-9	1385.....	17-18	1443.....	17-19	1522.....	2-6
1317.....	17-9	1386.....	17-18	1444.....	17-19	1550.....	7-1
1318.....	17-9	1387.....	17-18	1445.....	17-19	1551.....	7-1
1319.....	17-9	1388.....	17-18	1446.....	17-19	1552.....	7-1
1320.....	17-9	1389.....	17-18	1447.....	17-19	1553.....	7-1
1321.....	17-9	1390.....	17-18	1448.....	17-19	1554.....	7-1
1323.....	17-10	1391.....	17-18	1449.....	17-19	1555.....	7-1
1324.....	17-10	1392.....	17-18	1450.....	17-19	1556.....	7-1

ALPHA-NUMERIC LISTING BY CATALOG NUMBER

1557.....	7-1	1696.....	17-20	2901.....	13-5	3102.....	13-4
1558.....	7-1	1697.....	17-20	2901A.....	13-5	3103.....	13-4
1559.....	7-1	1704.....	17-20	2902.....	13-5	3105.....	13-4
1559A.....	7-1	1705.....	17-20	2902A.....	13-5	3106.....	13-4
1560.....	7-1	1706.....	17-20	2903.....	13-5	3107.....	13-4
1561.....	7-1	1707.....	17-20	2903A.....	13-5	3108.....	13-4
1562.....	7-1	1708.....	17-20	2903B.....	13-5	3109.....	13-4
1563.....	7-1	1710.....	17-20	2905.....	13-5	3109A.....	13-4
1564.....	7-1	1718.....	17-15	2905A.....	13-5	3109B.....	13-4
1565.....	7-1	1719.....	17-15	2906.....	13-5	3110.....	13-4
1566.....	7-1	1720.....	17-15	2907.....	13-5	3110A.....	13-4
1567.....	7-1	1721.....	17-15	2907A.....	13-5	3111.....	13-4
1568.....	7-1	1722.....	17-15	2908.....	13-5	3111A.....	13-4
1569.....	7-1	1750.....	5-4	2909.....	13-5	3112.....	13-4
1570.....	7-1	1751.....	5-4	2909A.....	13-5	3201.....	13-6
1571.....	7-1	1752.....	5-4	2909B.....	13-5	3202.....	13-6
1572.....	7-1	1753.....	5-4	2910.....	13-5	3203.....	13-6
1573.....	7-1	1754.....	5-4	2910A.....	13-5	3205.....	13-6
1574.....	7-1	1755.....	5-4	2911.....	13-5	3206.....	13-6
1575.....	7-1	1756.....	5-4	2911A.....	13-5	3207.....	13-6
1576.....	7-1	1757.....	5-4	2912.....	13-5	3208.....	13-6
1577.....	7-1	1758.....	5-4	2921.....	13-5	3209.....	13-6
1578.....	7-1	1759.....	5-4	2922.....	13-5	3209A.....	13-6
1591.....	13-8	1780.....	20-1	2923.....	13-5	3209B.....	13-6
1592.....	13-8	1781.....	20-1	2925.....	13-5	3210.....	13-6
1593.....	13-8	1782.....	20-1	2925A.....	13-5	3210A.....	13-6
1594.....	13-8	1783.....	20-1	2926.....	13-5	3211.....	13-6
1595.....	13-8	1791.....	8-1	2927.....	13-5	3211A.....	13-6
1596.....	13-8	1792.....	8-1	2927A.....	13-5	3212.....	13-6
1597.....	13-8	1793.....	8-1	2928.....	13-5	3301.....	13-4
1598.....	13-8	1810.....	13-3	2929.....	13-5	3302.....	13-4
1611.....	17-17	1818.....	13-3	2929A.....	13-5	3303.....	13-4
1612.....	17-17	1820.....	13-3	2929B.....	13-5	3305.....	13-4
1613.....	17-17	1891.....	8-1	2930.....	13-5	3305A.....	13-4
1621.....	17-17	1892.....	8-1	2931.....	13-5	3306.....	13-4
1621R.....	17-17	1893.....	8-1	2932.....	13-5	3307.....	13-4
1622.....	17-17	2101.....	7-2	2933.....	13-5	3308.....	13-4
1622R.....	17-17	2102.....	7-2	2934.....	13-5	3309.....	13-4
1623.....	17-17	2103.....	7-2	3001.....	13-6	3309A.....	13-4
1623R.....	17-17	2104.....	7-2	3002.....	13-6	3310.....	13-4
1661.....	1-10	2105.....	7-2	3003.....	13-6	3310A.....	13-4
1662.....	1-10	2106.....	7-2	3005.....	13-6	3311.....	13-4
1663.....	1-10	2107.....	7-2	3005A.....	13-6	3311A.....	13-4
1664.....	1-10	2108.....	7-2	3006.....	13-6	3312.....	13-4
1665.....	1-10	2109.....	7-2	3007.....	13-6	5200.....	3-7
1666.....	1-10	2110.....	7-2	3008.....	13-6	5200R.....	3-7
1667.....	1-10	2111.....	7-2	3008A.....	13-6	5201.....	3-7
1668.....	1-10	2112.....	7-2	3009.....	13-6	5201R.....	3-7
1669.....	1-10	2113.....	7-2	3009A.....	13-6	5202.....	3-7
1670.....	1-10	2624.....	9-2	3009B.....	13-6	5202R.....	3-7
1684.....	17-20	2636.....	9-2	3010.....	13-6	5202R500.....	3-7
1685.....	17-20	2807.....	13-3	3010A.....	13-6	5203.....	3-7
1686.....	17-20	2808.....	13-3	3011.....	13-6	5203C50.....	3-7
1687.....	17-20	2809.....	13-3	3011A.....	13-6	5203R.....	3-7
1688.....	17-20	2817.....	13-3	3012.....	13-6	5203R300.....	3-7
1690.....	17-20	2818.....	13-3	3036.....	9-2	5204.....	3-7
1694.....	17-20	2819.....	13-3	3048.....	9-2	5204R.....	3-7
1695.....	17-20	2820.....	13-3	3101.....	13-4	5204R400.....	3-7

ALPHA-NUMERIC LISTING BY CATALOG NUMBER

5205.....	3-7	7030.....	9-3	64544.....	9-6	645912.....	9-7
5205C25.....	3-7	8415.....	9-1	64545.....	9-6	6451112.....	9-6
5205R.....	3-7	8422.....	9-1	64546.....	9-6	6451212.....	9-6
5206.....	3-7	8430.....	9-1	64548.....	9-6	6451312.....	9-6
5206R.....	3-7	8515.....	9-1	64552.....	9-6	6452112.....	9-6
5207.....	3-7	8522.....	9-1	64553.....	9-6	6452212.....	9-6
5208.....	3-7	8530.....	9-1	64554.....	9-6	6452312.....	9-6
5209.....	3-7	8615.....	9-1	64555.....	9-6	6453212.....	9-6
5210.....	3-7	8622.....	9-1	64556.....	9-6	6453312.....	9-6
6100.....	2-5	8624.....	9-2	64558.....	9-6	6454212.....	9-6
6100R.....	2-5	8630.....	9-1	64563.....	9-6	6454312.....	9-6
6101.....	2-5	8636.....	9-2	64564.....	9-6	6455212.....	9-6
6101R.....	2-5	8715.....	9-1	64565.....	9-6	6455312.....	9-6
6102.....	2-5	8722.....	9-1	64566.....	9-6	6456212.....	9-6
6102R.....	2-5	8730.....	9-1	64568.....	9-6	6456312.....	9-6
6103.....	2-5	8815.....	9-1	64573.....	9-7	6457312.....	9-7
6103R.....	2-5	8822.....	9-1	64574.....	9-7	6458312.....	9-7
6104.....	2-5	8830.....	9-1	64575.....	9-7	ACD48.....	18-1
6104R.....	2-5	8836.....	9-2	64576.....	9-7	ACD49.....	18-1
6105.....	2-5	8848.....	9-2	64578.....	9-7	ACD50.....	18-1
6105R.....	2-5	8915.....	9-1	64583.....	9-7	ACD51.....	18-1
6105R150.....	2-5	8922.....	9-1	64584.....	9-7	ACD52.....	18-1
6106.....	2-5	8924.....	9-2	64585.....	9-7	ACD53.....	18-1
6106R.....	2-5	8930.....	9-1	64586.....	9-7	ACW10.....	18-1
6107.....	2-5	8936.....	9-2	64588.....	9-7	ACW11.....	18-1
6108.....	2-5	8948.....	9-2	64594.....	9-7	ACW12.....	18-1
6109.....	2-5	89A15.....	9-1	64595.....	9-7	ACW13.....	18-1
6110.....	2-5	89A22.....	9-1	64596.....	9-7	AMC1.....	3-4
6410.....	9-7	89A30.....	9-1	64598.....	9-7	AMC2.....	3-4
6415.....	9-3	9663.....	5-3	141480.....	17-20	AMC12.....	3-4
6422.....	9-3	9674.....	5-3	141580.....	17-20	BT0418.....	16-1
6430.....	9-3	9685.....	5-3	141680.....	17-20	BT0530.....	16-1
6451.....	9-6	9696.....	5-3	143980.....	17-20	BT0618.....	16-1
6452.....	9-6	9707.....	5-3	144080.....	17-20	BT0750.....	16-1
6453.....	9-6	64104.....	9-7	145980.....	17-20	BT0818.....	16-1
6454.....	9-6	64105.....	9-7	146080.....	17-20	BT0840.....	16-1
6455.....	9-6	64106.....	9-7	146780.....	17-20	BT1150.....	16-1
6456.....	9-6	64108.....	9-7	146880.....	17-20	BT1250.....	16-1
6457.....	9-7	64512.....	9-6	147380.....	17-20	BT1450.....	16-1
6458.....	9-7	64513.....	9-6	641010.....	9-7	BT24175.....	16-1
6459.....	9-7	64514.....	9-6	641012.....	9-7	BT34175.....	16-1
6515.....	9-3	64515.....	9-6	645110.....	9-6	C1.....	6-4
6522.....	9-3	64516.....	9-6	645112.....	9-6	C1CG.....	6-5
6530.....	9-3	64518.....	9-6	645210.....	9-6	C1M.....	6-8
6615.....	9-3	64522.....	9-6	645212.....	9-6	C1SS.....	6-9
6622.....	9-3	64523.....	9-6	645310.....	9-6	C1SSCG.....	6-11
6630.....	9-3	64524.....	9-6	645312.....	9-6	C2.....	6-4
6715.....	9-3	64525.....	9-6	645410.....	9-6	C2CG.....	6-5
6722.....	9-3	64526.....	9-6	645412.....	9-6	C2M.....	6-8
6730.....	9-3	64528.....	9-6	645510.....	9-6	C2SS.....	6-9
6815.....	9-3	64532.....	9-6	645512.....	9-6	C2SSCG.....	6-11
6822.....	9-3	64533.....	9-6	645610.....	9-6	C3.....	6-4
6830.....	9-3	64534.....	9-6	645612.....	9-6	C3CG.....	6-5
6915.....	9-3	64535.....	9-6	645710.....	9-7	C3M.....	6-8
6922.....	9-3	64536.....	9-6	645712.....	9-7	C3SS.....	6-9
6930.....	9-3	64538.....	9-6	645810.....	9-7	C3SSCG.....	6-11
7015.....	9-3	64542.....	9-6	645812.....	9-7	C4.....	6-4
7022.....	9-3	64543.....	9-6	645910.....	9-7	C4CG.....	6-5

ALPHA-NUMERIC LISTING BY CATALOG NUMBER

C4M.....	6-8	CCH916W.....	11-2	ELL5.....	6-1	FLEXLTF16.....	10-1
C4SS.....	6-9	CCH1116B.....	11-2	ELL5CG.....	6-2	FLEXLTF21.....	10-1
C4SSCG.....	6-11	CCH1116W.....	11-2	ELL6.....	6-1	FLEXLTF34.....	10-1
C5.....	6-4	CCH1316B.....	11-2	ELL6CG.....	6-2	FLEXLTF38.....	10-1
C5CG.....	6-5	CCH1316W.....	11-2	ELL7.....	6-1	FLEXRLTF12.....	10-1
C5M.....	6-8	CCH1916B.....	11-2	ELL7CG.....	6-2	FLEXRLTF34.....	10-1
C5SS.....	6-9	CCH1916W.....	11-2	ELL8.....	6-1	FLEXRLTF38.....	10-1
C5SSCG.....	6-11	DS1.....	1-9	ELL8CG.....	6-2	FS1M.....	8-15
C6.....	6-4	DS2.....	1-9	ELL9.....	6-1	FS2M.....	8-15
C6CG.....	6-5	DS3.....	1-9	ELL9CG.....	6-2	FS3M.....	8-15
C6M.....	6-8	EC1.....	6-1	ELL10.....	6-1	FSBCM.....	8-16
C6SS.....	6-9	EC1CG.....	6-2	ELL10CG.....	6-2	FSBCS.....	8-16
C6SSCG.....	6-11	EC2.....	6-1	ELR1.....	6-1	FSCS1M.....	8-15
C7.....	6-4	EC2CG.....	6-2	ELR1CG.....	6-2	FSCS2M.....	8-15
C7CG.....	6-5	EC3.....	6-1	ELR2.....	6-1	FSCS3M.....	8-15
C7M.....	6-8	EC3CG.....	6-2	ELR2CG.....	6-2	FSD1M.....	8-15
C8.....	6-4	EC4.....	6-1	ELR3.....	6-1	FSD2M.....	8-15
C8CG.....	6-5	EC4CG.....	6-2	ELR3CG.....	6-2	FSD3M.....	8-15
C8M.....	6-8	EC5.....	6-1	ELR4.....	6-1	FSDD1M.....	8-15
C9.....	6-4	EC5CG.....	6-2	ELR4CG.....	6-2	FSDD2M.....	8-15
C9CG.....	6-5	EC6.....	6-1	ELR5.....	6-1	FSDD3M.....	8-15
C9M.....	6-8	EC6CG.....	6-2	ELR5CG.....	6-2	FSDRM.....	8-16
C10.....	6-4	EC7.....	6-1	ELR6.....	6-1	FSDRS.....	8-16
C10CG.....	6-5	EC7CG.....	6-2	ELR6CG.....	6-2	FSFDCG.....	8-15
C10M.....	6-8	EC8.....	6-1	ELR7.....	6-1	FSGF1S.....	8-16
CBL.....	18-1	EC8CG.....	6-2	ELR7CG.....	6-2	FSGSM.....	8-16
CBS.....	14-1	EC9.....	6-1	ELR8.....	6-1	FSGSS.....	8-16
CCH1B.....	11-2	EC9CG.....	6-2	ELR8CG.....	6-2	GC99.....	14-2
CCH1W.....	11-2	EC10.....	6-1	ELR9.....	6-1	GS1.....	12-2
CCH12B.....	11-2	EC10CG.....	6-2	ELR9CG.....	6-2	HF11.....	2-4
CCH12W.....	11-2	ELB1.....	6-1	ELR10.....	6-1	HF12.....	2-4
CCH14B.....	11-2	ELB1CG.....	6-2	ELR10CG.....	6-2	HF21.....	2-4
CCH14W.....	11-2	ELB2.....	6-1	ET1.....	6-1	HF22.....	2-4
CCH18B.....	11-2	ELB2CG.....	6-2	ET1CG.....	6-2	HF112.....	2-4
CCH18W.....	11-2	ELB3.....	6-1	ET2.....	6-1	HF112R.....	2-4
CCH34B.....	11-2	ELB3CG.....	6-2	ET2CG.....	6-2	HF134.....	2-4
CCH34W.....	11-2	ELB4.....	6-1	ET3.....	6-1	HF134R.....	2-4
CCH38B.....	11-2	ELB4CG.....	6-2	ET3CG.....	6-2	HF138.....	2-4
CCH38W.....	11-2	ELB5.....	6-1	ET4.....	6-1	HF212.....	2-4
CCH58B.....	11-2	ELB5CG.....	6-2	ET4CG.....	6-2	HF214.....	2-4
CCH58W.....	11-2	ELB6.....	6-1	ET5.....	6-1	HF234.....	2-4
CCH78B.....	11-2	ELB6CG.....	6-2	ET5CG.....	6-2	HF238.....	2-4
CCH78W.....	11-2	ELB7.....	6-1	ET6.....	6-1	HF1112.....	2-4
CCH112B.....	11-2	ELB7CG.....	6-2	ET6CG.....	6-2	HF1114.....	2-4
CCH112W.....	11-2	ELB8.....	6-1	ET7.....	6-1	HF2112.....	2-4
CCH114B.....	11-2	ELB8CG.....	6-2	ET7CG.....	6-2	HF2114.....	2-4
CCH114W.....	11-2	ELB9.....	6-1	ET8.....	6-1	KO50.....	14-1
CCH118B.....	11-2	ELB9CG.....	6-2	ET8CG.....	6-2	KO51.....	14-1
CCH118W.....	11-2	ELB10.....	6-1	ET9.....	6-1	KO52.....	14-1
CCH138B.....	11-2	ELB10CG.....	6-2	ET9CG.....	6-2	KO53.....	14-1
CCH138W.....	11-2	ELL1.....	6-1	ET10.....	6-1	KO54.....	14-1
CCH316B.....	11-2	ELL1CG.....	6-2	ET10CG.....	6-2	KO55.....	14-1
CCH316W.....	11-2	ELL2.....	6-1	FC1.....	16-2	LB1.....	6-3
CCH516B.....	11-2	ELL2CG.....	6-2	FLEXLTF7.....	10-1	LB1CG.....	6-5
CCH516W.....	11-2	ELL3.....	6-1	FLEXLTF9.....	10-1	LB1M.....	6-6
CCH716B.....	11-2	ELL3CG.....	6-2	FLEXLTF11.....	10-1	LB1SS.....	6-9
CCH716W.....	11-2	ELL4.....	6-1	FLEXLTF12.....	10-1	LB1SSCG.....	6-10
CCH916B.....	11-2	ELL4CG.....	6-2	FLEXLTF13.....	10-1	LB2.....	6-3

ALPHA-NUMERIC LISTING BY CATALOG NUMBER

LB2CG.....	6-5	LL5SSCG.....	6-10	LTF1.....	10-1	P490B.....	2-3
LB2M.....	6-6	LL6.....	6-4	LTF7.....	10-1	P491.....	2-3
LB2SS.....	6-9	LL6CG.....	6-5	LTF9.....	10-1	P491B.....	2-3
LB2SSCG.....	6-10	LL6M.....	6-8	LTF11.....	10-1	P492.....	2-3
LB3.....	6-3	LL6SS.....	6-9	LTF12.....	10-1	P492B.....	2-3
LB3CG.....	6-5	LL6SSCG.....	6-10	LTF13.....	10-1	P493.....	2-3
LB3M.....	6-6	LL7.....	6-4	LTF16.....	10-1	P493B.....	2-3
LB3SS.....	6-9	LL7CG.....	6-5	LTF21.....	10-1	P494.....	2-3
LB3SSCG.....	6-10	LL7M.....	6-8	LTF29.....	10-1	P494B.....	2-3
LB4.....	6-3	LL8.....	6-4	LTF34.....	10-1	P495.....	2-3
LB4CG.....	6-5	LL8CG.....	6-5	LTF38.....	10-1	P495B.....	2-3
LB4M.....	6-6	LL8M.....	6-8	MLBCG4.....	6-4	P496.....	2-3
LB4SS.....	6-9	LL9.....	6-4	MLBCG5.....	6-4	P496B.....	2-3
LB4SSCG.....	6-10	LL9CG.....	6-5	MLBCG6.....	6-4	PK050.....	11-3
LB5.....	6-3	LL9M.....	6-8	MLBCG7.....	6-4	PK051.....	11-3
LB5CG.....	6-5	LL10.....	6-4	MLBCG8.....	6-4	PK052.....	11-3
LB5M.....	6-6	LL10CG.....	6-5	MLBCG9.....	6-4	PK053.....	11-3
LB5SS.....	6-9	LL10M.....	6-8	MLBCG10.....	6-4	PK054.....	11-3
LB5SSCG.....	6-10	LR1.....	6-3	MP4A.....	16-4	PK055.....	11-3
LB6.....	6-3	LR1CG.....	6-5	MP4S.....	16-4	POR1.....	15-2
LB6CG.....	6-5	LR1M.....	6-7	MP4AB.....	16-4	PTB0750.....	16-1
LB6M.....	6-6	LR1SS.....	6-9	MP4SB.....	16-4	PTB1150.....	16-1
LB6SS.....	6-9	LR1SSCG.....	6-10	NLN1B.....	11-3	PTB1450.....	16-1
LB6SSCG.....	6-10	LR2.....	6-3	NLN1G.....	11-3	RB1.....	8-12
LB7.....	6-3	LR2CG.....	6-5	NLN12B.....	11-3	RB2.....	8-12
LB7CG.....	6-5	LR2M.....	6-7	NLN12G.....	11-3	RB3.....	8-12
LB7M.....	6-6	LR2SS.....	6-9	NLN34B.....	11-3	RB4.....	8-12
LB8.....	6-3	LR2SSCG.....	6-10	NLN34G.....	11-3	RB5.....	8-12
LB8CG.....	6-5	LR3.....	6-3	NLN38B.....	11-3	RB6.....	8-12
LB8M.....	6-6	LR3CG.....	6-5	NLN38G.....	11-3	RB7.....	8-12
LB9.....	6-3	LR3M.....	6-7	NT0418.....	16-1	RB8.....	8-12
LB9CG.....	6-5	LR3SS.....	6-9	NT0530.....	16-1	RB9.....	8-12
LB9M.....	6-6	LR3SSCG.....	6-10	NT0618.....	16-1	RB10.....	8-12
LB10.....	6-3	LR4.....	6-3	NT0640.....	16-1	RB11.....	8-12
LB10CG.....	6-5	LR4CG.....	6-5	NT0750.....	16-1	RB12.....	8-12
LB10M.....	6-6	LR4M.....	6-7	NT0818.....	16-1	RB13.....	8-12
LL1.....	6-4	LR4SS.....	6-9	NT0840.....	16-1	RB14.....	8-12
LL1CG.....	6-5	LR4SSCG.....	6-10	NT08120.....	16-1	RB15.....	8-12
LL1M.....	6-8	LR5.....	6-3	NT1150.....	16-1	RB16.....	8-12
LL1SS.....	6-9	LR5CG.....	6-5	NT1450.....	16-1	RB17.....	8-12
LL1SSCG.....	6-10	LR5M.....	6-7	NT24175.....	16-1	RB18.....	8-12
LL2.....	6-4	LR5SS.....	6-9	NT30175.....	16-1	RB19.....	8-12
LL2CG.....	6-5	LR5SSCG.....	6-10	NT32120.....	16-1	RB20.....	8-12
LL2M.....	6-8	LR6.....	6-3	NT34175.....	16-1	RB21.....	8-12
LL2SS.....	6-9	LR6CG.....	6-5	P2.....	15-2	RB22.....	8-12
LL2SSCG.....	6-10	LR6M.....	6-7	P470.....	2-3	RB23.....	8-12
LL3.....	6-4	LR6SS.....	6-9	P470B.....	2-3	RB24.....	8-12
LL3CG.....	6-5	LR6SSCG.....	6-10	P471.....	2-3	RB25.....	8-12
LL3M.....	6-8	LR7.....	6-3	P471B.....	2-3	RB26.....	8-12
LL3SS.....	6-9	LR7CG.....	6-5	P472.....	2-3	RB27.....	8-12
LL3SSCG.....	6-10	LR7M.....	6-7	P472B.....	2-3	RB28.....	8-12
LL4.....	6-4	LR8.....	6-3	P473.....	2-3	RB29.....	8-12
LL4CG.....	6-5	LR8CG.....	6-5	P473B.....	2-3	RB30.....	8-12
LL4M.....	6-8	LR8M.....	6-7	P474.....	2-3	RB31.....	8-12
LL4SS.....	6-9	LR9.....	6-3	P474B.....	2-3	RB32.....	8-12
LL4SSCG.....	6-10	LR9CG.....	6-5	P475.....	2-3	RCR50.....	4-2
LL5.....	6-4	LR9M.....	6-7	P475B.....	2-3	RCR75.....	4-2
LL5CG.....	6-5	LR10.....	6-3	P476.....	2-3	RLTF34.....	10-1
LL5M.....	6-8	LR10CG.....	6-5	P476B.....	2-3	RLTF38.....	10-1
LL5SS.....	6-9	LR10M.....	6-7	P490.....	2-3	SB8756.....	11-1

ALPHA-NUMERIC LISTING BY CATALOG NUMBER

SB8757.....	11-1	T8M.....	6-7	WB1.....	13-7	WCV2SDUP.....	19-4
SB8758.....	11-1	T9.....	6-3	WB1EXT.....	19-10	WDB1350.....	19-6
SB8759.....	11-1	T9CG.....	6-5	WB1450EXT.....	19-10	WDB1375.....	19-6
SB87510.....	11-1	T9M.....	6-7	WB1350.....	19-6	WDB13100.....	19-6
SB87511.....	11-1	T10.....	6-3	WB1350B.....	19-6	WDB1550X.....	19-6
SB109313.....	11-1	T10CG.....	6-5	WB1375.....	19-6	WDB1575X.....	19-6
SB109314.....	11-1	T10M.....	6-7	WB13100.....	19-6	WDB15100X.....	19-6
SB109315.....	11-1	TB1M.....	6-7	WB1450.....	19-6	WDB2550.....	19-8
SB137514.....	11-1	TB1SSCG.....	6-11	WB1475.....	19-6	WDB2575.....	19-8
SB137516.....	11-1	TB2M.....	6-7	WB1550.....	19-6	WDB25100.....	19-8
SB175022.....	11-1	TB2SSCG.....	6-11	WB1550X.....	19-6	WG1.....	13-7
SB200026.....	11-1	TB3M.....	6-7	WB1575.....	19-6	WG2.....	13-7
SB2.531.....	11-1	TB3SSCG.....	6-11	WB1575X.....	19-6	WP50.....	14-1,19-9
SB3.039.....	11-1	TB4M.....	6-7	WB15100.....	19-6	WP75.....	14-1,19-9
SB3.547.....	11-1	TB4SSCG.....	6-11	WB15100X.....	19-6	WP100.....	14-1,19-9
SB4.055.....	11-1	TB5M.....	6-7	WB2.....	13-7	WPAR50.....	19-10
SD1.....	21-1	TB5SSCG.....	6-11	WB2EXT.....	19-10	WPAR50B.....	19-10
TA50.....	3-5	TB6M.....	6-7	WB2350.....	19-7	WPAR50W.....	19-10
TA75.....	3-5	TB6SSCG.....	6-11	WB2375.....	19-7	WR1.....	13-7
TA100.....	3-5	TGENDCAPS5.....	21-1	WB23100.....	19-7	WR2.....	13-7
TA125.....	3-5	TGENDCAPS12.....	21-1	WB2450.....	19-7	WRB1550.....	19-9
TA150.....	3-5	TGENDCAPS8.....	21-1	WB2475.....	19-7	WRB1550B.....	19-9
TA200.....	3-5	TGF40T12.....	21-1	WB2550.....	19-7	WRB1550W.....	19-9
T1.....	6-3	TGF96T12.....	21-1	WB2550X.....	19-8	WRB1575.....	19-9
T124.....	20-1	TGF032T8.....	21-1	WB2575.....	19-7	WRB1575W.....	19-9
T124L.....	20-1	TGF096T8.....	21-1	WB2575X.....	19-8	WRB450EXT.....	19-9
T1CG.....	6-5	TGFP28T5.....	21-1	WB25100.....	19-7	WRB475EXT.....	19-9
T1M.....	6-7	UB625.....	11-3	WB25100X.....	19-8	WRC150.....	19-11
T1SS.....	6-9	UB750.....	11-3	WB2650X.....	19-8	WRC150W.....	19-11
T1SSCG.....	6-11	UB812.....	11-3	WB2675X.....	19-8	WRC250.....	19-11
T2.....	6-3	UB875.....	11-3	WB2750.....	19-7	WRC250W.....	19-11
T2CG.....	6-5	UB1000.....	11-3	WB2750X.....	19-8	WRC350.....	19-11
T2M.....	6-7	UB1093.....	11-3	WB2775.....	19-7	WRC350B.....	19-11
T2SS.....	6-9	UB1375.....	11-3	WB2775X.....	19-8	WRC350W.....	19-11
T2SSCG.....	6-11	V22.....	20-1	WC1B.....	19-2	WRCB.....	19-2
T3.....	6-3	V38.....	20-1	WC1BB.....	19-2	WSC1.....	19-2
T3CG.....	6-5	VF28.....	2-5	WC2B.....	19-2	WSC22S.....	19-5
T3M.....	6-7	VF1100W50.....	19-12	WCH1DUP.....	19-1	WT1.....	13-7
T3SS.....	6-9	VF1100W50CG.....	19-12	WCH1DUPB.....	19-1	WT2.....	13-7
T3SSCG.....	6-11	VF1100W75.....	19-12	WCH1DUPW.....	19-1	WY1.....	13-7
T4.....	6-3	VF1100W75CG.....	19-12	WCH1GFI.....	19-1	WY2.....	13-7
T4CG.....	6-5	VFIBOX50.....	19-12	WCH1GFI W.....	19-1	X1M.....	6-8
T4M.....	6-7	VFIBOX75.....	19-12	WCIU1.....	19-3	X1SSCG.....	6-11
T4SS.....	6-9	VFICC.....	19-12	WCIU2.....	19-3	X2M.....	6-8
T4SSCG.....	6-11	VFIGGC.....	19-12	WCR1150.....	19-11	X2SSCG.....	6-11
T5.....	6-3	VFIGLS.....	19-12	WCR1150W.....	19-11	X3M.....	6-8
T5CG.....	6-5	VFP100W50CG.....	19-12	WCR1350.....	19-11	X3SSCG.....	6-11
T5M.....	6-7	VFP100W75CG.....	19-12	WCR1350W.....	19-11	X4M.....	6-8
T5SS.....	6-9	VFW100W50CG.....	19-12	WCV11.....	19-1	X4SSCG.....	6-11
T5SSCG.....	6-11	VFW100W75CG.....	19-12	WCV11.625.....	19-1	X5M.....	6-8
T6.....	6-3	W81G1.....	13-7	WCV12.125.....	19-1	X5SSCG.....	6-11
T6CG.....	6-5	W81G2.....	13-7	WCV1DUP.....	19-1	X6M.....	6-8
T6M.....	6-7	W82B1.....	13-7	WCV1GFI.....	19-1	X6SSCG.....	6-11
T6SS.....	6-9	W82B2.....	13-7	WCV1GFI W.....	19-1		
T6SSCG.....	6-11	W83O1.....	13-7	WCV21515.....	19-4		
T7.....	6-3	W83O2.....	13-7	WCV22.125.....	19-5		
T7CG.....	6-5	W84Y1.....	13-7	WCV22.64.....	19-5		
T7M.....	6-7	W84Y2.....	13-7	WCV2DUP.....	19-4		
T8.....	6-3	W86R1.....	13-7	WCV2DUPGFI.....	19-4		
T8CG.....	6-5	W86R2.....	13-7	WCV2GFI.....	19-5		

TERMS AND CONDITIONS OF SALE

TERMS: 2% cash discount 10th proximo, net end of month. Cash discount will be allowed if invoices are paid on or before the 10th of the following month. Invoices not discounted are due in full on the last day of the month following the month in which the invoice was dated. Invoices dated after the 25th of the month will be considered as being dated the first of the following month and due accordingly.

All orders are accepted subject to credit approval.

MINIMUM CHARGE: Due to the cost of processing small orders a minimum charge of \$100.00 will be applied for each invoice regardless of the dollar value.

FREIGHT: All product is sold F.O.B. factory. Full freight allowed on shipments weighing 750 lbs. or invoiced at \$1,200.00 within the continental United States. To Alaska and Hawaii freight is allowed to the West Coast. If meeting export minimums, freight will be prepaid to port of exit. All prepaid shipments will be routed by TOPAZ.

TOPAZ will not be responsible for any loss or damage which might occur during shipment. Buyer is responsible once freight is delivered to the first carrier.

TAXES: Liability for all taxes, excise tax, duties, revenues, imports, licenses, or other fees imposed upon products, sale shipment, or use of the company's products shall be assumed and paid for by the buyer, and buyer shall indemnify TOPAZ against any such liability.

PRICES: All prices are subject to change without notice. Orders shall be invoiced at prices in effect at time of shipment. Written quotations will be protected for 15 days from day of quote.

CLAIMS: All claims for shortages or defects must be made to TOPAZ within 15 days from receipt of merchandise.

CANCELLATIONS AND RETURNS: Orders may not be cancelled without prior written consent of TOPAZ. Returning product for credit is permitted only if an R.G.A. (return goods authorization) is issued by TOPAZ. All freight charges will be borne by buyer and a restocking fee of 20% will be charged. **All items returned must be in sellable condition or credit will not be given.**

WARRANTY

TOPAZ ELECTRIC UTILIZES A DOUBLE CHECK INSPECTION SYSTEM IN ORDER TO MINIMIZE THE POSSIBILITY OF DEFECTIVE GOODS LEAVING OUR FACILITY. TOPAZ PRODUCTS ARE WARRANTED AGAINST DEFECTS IN WORKMANSHIP AND MATERIALS AT THE TIME OF SHIPMENT. TOPAZ WILL REPLACE FREE OF CHARGE ANY PART IT DETERMINES TO BE DEFECTIVE IN MATERIAL OR WORKMANSHIP PROVIDED THAT:

1. A CLAIM IS MADE WITHIN ONE YEAR AFTER RECEIVING SHIPMENT.
2. THE PART HAS NOT BEEN PHYSICALLY DAMAGED OR OTHERWISE ABUSED.

THERE ARE NO EXPRESS OR IMPLIED WARRANTIES OF MERCHANTABILITY OR FITNESS FOR A PARTICULAR PURPOSE, AND ANY SUCH WARRANTIES ARE SPECIFICALLY DISCLAIMED. NO OTHER LIABILITIES ARE INCLUDED, SUCH AS THE COST OF REMOVAL AND REPLACEMENT OF DEFECTIVE PARTS, LABOR COSTS, LOSS OF ANTICIPATED PROFITS, CLAIMS OF BUYER'S CUSTOMERS, OR CONSEQUENTIAL DAMAGES OF ANY KIND. THE LIMITED WARRANTY CONTAINED IN THE PRECEDING PARAGRAPH IS THE SOLE AND ONLY WARRANTY OFFERED BY TOPAZ.

SOME STATES DO NOT ALLOW LIMITATIONS AS TO HOW LONG AN IMPLIED WARRANTY LASTS, OR THE EXCLUSION OR LIMITATION OF INCIDENTAL OR CONSEQUENTIAL DAMAGES, SO THE LIMITATIONS OR EXCLUSIONS MAY NOT APPLY TO YOU.

ALTHOUGH THIS WARRANTY GIVES YOU SPECIFIC LEGAL RIGHTS, YOU MAY ALSO HAVE OTHER RIGHTS THAT VARY FROM STATE TO STATE.



TOPAZ is committed to delivering the highest quality products to our customers, but not without regard for the environment.

This is why we participate in the RoHS European Directive 2002/95/EG, which was established to restrict six hazardous substances in electrical and electronic equipment.

TOPAZ ELECTRIC PRODUCTS ARE MANUFACTURED FOR NEC INSTALLATION ON LISTED RACEWAYS.

Product listed by Underwriters Laboratories and certified by the Canadian Standards Association are indicated accordingly. All listings are as of the publication date of this catalog. Updated listings are available upon request.



Underwriters Laboratories, Inc.



Canadian Standards Association

APPLICABLE THIRD PARTY STANDARDS

TOPAZ ELECTRIC products are manufactured in compliance with Federal Specifications W-F-406D and W-F-408D, ANSI/NEMA-FB1-1993, UL 514-B, UL 467 and CSA C222 No. 18-1987, C222 No. 41-1987.



General Services Administration



CITY OF NEW YORK DEPARTMENT OF GENERAL SERVICES

Member:



Uniform Code Council (UCC) manufacturer number= **751338**. This prefix in conjunction with the 5 digit number listed for each item throughout the catalog provides the complete Universal Product Code (UPC) number.



Friendly Service... Powerful Solutions™

NEW YORK

925 Waverly Avenue
Holtsville, NY 11742
800-666-2852
Fax: 800-333-3488

CALIFORNIA

225 Parkside Drive
San Fernando, CA 91340
888-551-2852
Fax: 888-690-2852

FLORIDA

2020 West 26th Street
Jacksonville, FL 32209
800-666-2852
Fax: 800-333-3488