

SPORT EQUIPMENT MADE IN GERMANY



VINDICO

SPORT

YEAR 2023 / 2024
...more than sports!



**BAYERISCHER
FUSSBALL-VERBAND**



**international
SOCCA
federation**

WHO IS VINDICO?

Vindico Sport GmbH is a young, innovative and dynamic team. It specializes in production, sales and installation of all kinds of sport equipment. We set ourselves the standard to improve our products every single day. Our ideas have no limits and if you want a custom made product, please do not hesitate to contact us. We will gladly accept your suggestions and try to implement them for you.



Our company stands for elaborateness, consistent customer care and quality. Vindico focuses on the customers needs and wishes. After an intensive consultation with our team which has years of experience in the sport equipment industry. We will take every step with our customers from planning the sport ground to the first step on the ground. Gladly, we will take over the installation and give advice to our customers.

VINDICO

SPORT

FOLLOW us on



INDEX

02	About Vindico	85	Baseball
04	Construction service / repair service	86 - 87	Table tennis
05	Special solutions		
06	Football rules		
07	Net suspensions of Vindico		
08	Football	88	Soccercourts / Padel Court
09 - 10	Competition goals „Competition“	89	Sport cage „Panna Field“
11	Ground frame „Players Protect“	90	Mini playing fields
12 - 13	Ground frame „High Class“	91 - 92	Simple Line „Soccercourt“
14	Football goal fully welded	93	Simple Line Strong „Soccercourt“
15	Football goal „All in one“	94	Pro Line „Soccercourt“
16	Football goal Simplex/Socca/Futsal goal	95 - 97	Omnistadium „Soccercourt“
17	Swing goals	98	Hard Line „Soccercourt“
18	International goal types	99	Padel Court
19	Recreational goal		
20 - 21	Mini goals	100	Track and field
22 - 23	Pipe mesh gates	101 - 105	Long jump
24	Ground socket „Safety“	106 - 107	Shot put throw
25	Ground socket „Safety Pro“	108	Hammer throw / Jawelin
26	Football accessory / ground socket	109	Athletics accessories
27	Safety warning Goals	110 - 111	Safety cage
28-29	Football accessory „weights“	112 - 115	Running disciplines
30 - 31	Transport trolley	116 - 121	High jump
32	Line markers	122 - 126	Pole vault
33 - 35	Sport facility accessories	127 - 129	Safety covers landing mats
36 - 37	Training accessories		
38 - 39	Nets	130	Outdoor Workout
40 - 41	Field Barrier	131 - 133	Outdoor Workout
42 - 47	Ball catching constructions	134	Calisthenics League
48	Players tunnel	135	Parkour
49	Turf Cleaning systems	136 - 137	Outdoor Fitness
		138	Slackline / equipment box
50	Players cabin	139	Beachsport
51	Players cabin „Basic“	140 - 143	Beachsport (Soccer, Handball, Volleyball etc.)
52	Players cabin „Pro“	144 - 145	Beach Borders
53	Players cabin „League“		
54	Players cabin „Strong“ + „Double“	146	Show washing systems
55	Players cabin „Royal“ + „special Solutions“	147 - 148	Washing system Type A
55 - 57	Players cabin accessories	149 - 151	Washing system Type B
58 - 61	Grandstand elements	152 - 153	Washing system Type C
		154	Washing system Type D
		155 - 156	Washing system Type SC
		157	Shoe wash system
		158 - 159	Washing systems accessories
62	Ball games	160	Construction built-in parts
63 - 65	Handball	160 - 167	Construction built-in parts
66 - 67	Hockey		
68 - 73	Volleyball	168	Notes
74 - 80	Basketball	168	Terms and concitions
81	Tennis	169	Warranty
82	Pickleball	170	References
83	Badminton / Rugby	171	Contact Persons
84	American Football		

DO YOU KNOW...



Please contact us for more information

... our installation service?

We are not only producing a wide range of sports equipment but are additionally offering a complete installation service.

Our technical service staff is very skilled and has the technical know how to set up your sports ground according to valid regulations.

- **complete installation after excavation**
- **initial installation**
- **Installations for new acquisitions**
- **repair service**
even if the sports equipment originates from another manufacturer
- **partner service**
for earth-works through our landscape and horticulture specialist



Equipment does not have to be defect!

REPAIRING YOUR SPORTS EQUIPMENT

We can rebuild your broken equipment!

Due to our long-lasting experience in the sports equipment industry, we have acquired the technical know-how and ability to rebuild any sports equipment e.g. track and field equipment or football goals. If something needs to be rebuilt – we are the first choice!

We also offer the following service:

- **procurement of new equipment: mostly out of our own production**
- **installation & assembly service**
- **validation of outdoor sports facilities according to current DIN-requirements**

VINDICO...

...more than sports

Vindico supports your projects. From the first idea, to the implementation, production and installation – we are the perfect service partner. Just send us a request and we will be glad to support your project.

mobile run-up bar for athletics disciplines

starting platform for athletics competition outside

- Pole vault
- Long jump
- Sprint track
- High jump

Properties:

- Production on request incl. running track covering (EPDM or Mondo)
- height adjustable
- incl. pole vault box
- incl. long jump take off board
- Length: as required
- element length approx. 200 cm, element width approx. 122 cm
- Edge support for 5 cm white element as track marking
- Height approx. 20 cm with support for adjustable legs
- completely made of aluminium
- fully welded



Send us your project! It will be a pleasure to help you.

Advertising banner frame

- Completely made out of aluminium
- All around with lugs for a tight fit of the advertising banner
- Manufactured according to your desired size.



Safety wall construction

Production of a safety wall construction made of aluminium for running tracks

- completely made of aluminium
- including safety pads for indoor and outdoor use



SOCCER RULES IN GERMANY

Dimensions of the playing field for international matches:

Length (side-line): min. 100 m/ max. 110 m
 Width (goal-line): min. 64m / max. 75 m

Football goals have to be white. The frame of the goal must not exceed 12 cm in width and depth. The natural silver colour of aluminum goals is permitted.

According to FIFA the distance between the inner edges of the posts must be 7,32m. The lower edge of the crossbar is 2,44m away from the ground (8 feet x 8 yards). This corresponds to a ratio of 1:3. The minimum size of the corner flags must be 1,5m and they are not allowed to be spiky at the top.

Additional explanation of the DFB:

To avoid accidents, mobile goals (small and big goals) have to be secured in such way that the goals are prevented from tipping over. (See page 27).



under 7's - expedition for small explorers!

team size: 2 vs 2 or 3 vs 3
 age: have not reached age 7 yet
 pitch: 16 x 20 up to 28 x 22 meter
 ball: size 3 or a light ball size 4 (290 grams)
 goal width: 1,80 x 1,20 meter

under 9's - equal game shares for everyone!

team size: 3 vs 3 up to 5 vs 5
 age: completed their 7th or 8th years of age
 pitch: 35 x 25 meter (3 vs 3) up to 40 x 35 Meter (5 vs 5)
 ball: size 4 or a light ball size 5 (290 grams)
 goal width: Minitor or 5x2 meter (has to be secured against tilting)

under 11's - encounter in small groups on the country level!

team size: 7 vs 7 (including a goal keeper)
 age: completed their 9th or 10th years of age
 pitch: 55 x 35 meter
 ball: size 4 or a light ball size 5 (290 grams)
 goal width: 5 x 2 meter (has to be secured against tilting)

under 13's - 9 vs 9 is what counts!

team size: 9 vs 9 (including a goal keeper)
 age: completed their 11th or 12th years of age
 pitch: 70 x 50 meter
 ball: size 4 oder a light ball size 5 (350 Gramm)
 goal width: 5 x 2 Meter (has to be secured against tilting)

under 15's - first experience in 11 vs 11!

team size: 11 vs 11
 age: completed their 13th or 14th years of age
 pitch: approx. 100 x 70 meter
 ball: size 5
 goal width: 7,32 x 2,44 meter

under 17's - choosing the right system for the development!

team size: 11 vs 11
 age: completed their 15th or 16th years of age
 pitch: approx. 100 x 70 meter
 ball: size 5
 goal width: 7,32 x 2,44 meter

under 19's - promote the final step into senior football!

team size: 11 vs 11
 age: completed their 17th or 18th years of age
 pitch: approx. 100 x 70 meter
 ball: size 5
 goal width: 7,32 x 2,44 meter

senior football - everything counts!

team size: 11 vs 11
 age: older than 18 years
 pitch: approx. 100 x 70 meter
 ball: size 5
 goal width: 7,32 x 2,44 meter

OUR NETSUSPENSION

These net suspensions are possible for goal posts and ground frames

Netsuspension „Basic“

- Twin hooks
- Recessed plastic hooks
- Applicable by click system
- Easy, quick insertion of the net
- No snapping of the net hooks
- Quick replacement possible
- Tight fit of the net



Netsuspension „Smart“

- Indented net suspension
- Can be retrofitted
- All mesh sizes possible
- Not visible on the border line
- Tight fit of the net
- The seam is held tightly



Netsuspension „Smart“ with additional safety bar

- net is additionally secured
- net with anti-theft protections
- a very closed look
- only the net strand appears



FOOTBALL



FOOTBALL GOAL

„COMPETITION I“ 7,32 x 2,44 m

Competition goal Competition I / Type I:

- Football goal made of aluminum in ground sockets
- 7,32m x 2,44 m, goal profil 120/100 mm
- internal corner connectors
- ncl. 2 pieces of steel tension rods with rope clamp
- white powder coated or aluminum
- according to FIFA - standard / DIN-EN 748
- „Basic“ = plastic net hook
- „Smart“ = milled aluminum net suspension

Ground frame:

- floor frame with embedded net suspension
- solid floor frame joint
- floor frame can be folded up
- form-fitting on the goal frame
- no twisting possible
- height adjustable



Art.-No. product specification

Competition goal (goal frame with tension rods)

2001240	Competition I - „Basic“ Aluminium blank
2001246	Competition I - „Smart“ Aluminium blank
2001242	Competition I - „Basic“ white powder coated
2001247	Competition I - „Smart“ white powder coated

Ground frame for competition goals

2001262	„Basic“ (2,00 m; 7,32 m lenght)
2001265	„Smart“ (2,00 m; 7,32 m lenght)

individual parts for competition goals

2001245	Tension rod made of round tube Ø60 mm with rope clamp
---------	---



ground sockets for Competition goals on page 26.
nets on page 38/39.

Safety pad net tension rods

- PU-foam core for 60 mm net tension rods
- Tarpaulin cover (colour freely selectable)
- Continuous velcro tape
- According to FIFA standards

Art.-No. product specification

Safety pad net tension rods

4001240	safety pad net tension rods
---------	-----------------------------



FOOTBALL GOAL

„COMPETITION II“ 7,32x2,44 m/5,00x2,00 m



Competition goals II 7,32 x 2,44 m

Art.-No. product specification

Competition goals II 7,32 x 2,44 m
(goal frame with net hanger)

2001250	Competition II - „Basic“ Aluminium blank
2001254	Competition II - „Smart“ Aluminium blank
2001252	Competition II - „Basic“ white powder coated
2001255	Competition II - „Smart“ white powder coated

Ground frames for competition goals 7,23 m

2001260	„Basic“ (1,50 m; 7,32 m length)
2001264	„Smart“ (1,50 m; 7,32 m length)
2001262	„Basic“ (2,00 m; 7,32 m length)
2001265	„Smart“ (2,00 m; 7,32 m length)

Junior Competition goals 5,00 x 2,00 m

Art.-No. product specification

Junior goals 5,00 x 2,00 m
(goal frame with net hanger)

2001150	Competition II - „Basic“ Aluminium blank
2001154	Competition II - „Smart“ Aluminium blank
2001152	Competition II - „Basic“ white powder coated
2001155	Competition II - „Smart“ white powder coated

Ground frames for competition goals 5,00 m

2001260	„Basic“ (1,50 m; 5,00 m length)
2001264	„Smart“ (1,50 m; 5,00 m length)

Competition II / Typ II:

- Football goal made of aluminum in ground sockets
- 7,32m x 2,44 m, goal profil 120/100 mm
- internal corner connectors
- incl. upper „pre-tensioned“ net hanger, 40mm
- white powder coated or aluminum
- according DIN-EN 748
- „Basic“ = plastic net hook
- „Smart“ = milled aluminum net suspension

Ground frame:

- floor frame with embedded net suspension
- solid floor frame joint
- floor frame can be folded up
- form-fitting on the goal frame
- no twisting possible
- height adjustable

GROUND FRAME „PLAYERS PROTECT“

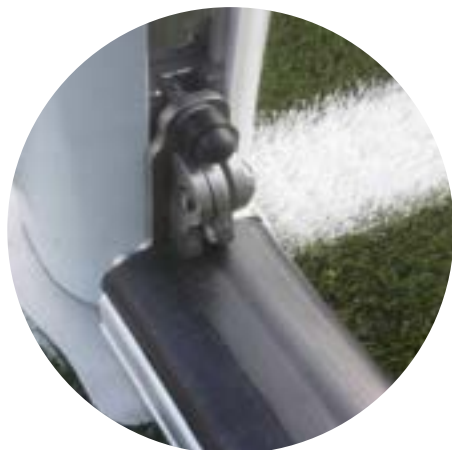

What is Players Protect?

- is an impact protection combined with a specially designed flat aluminium floor
- guarantees due to the special shape and inner chamber a significant reduction of force in case of an impact
- forms a homogeneous unit with the aluminium floor frame
- made of a newly developed rubber profile which is UV-resistant and weatherproof
- unique security feature for football goals

Why Players Protect?

- makes the handling with football goals safer
- minimises the risk of injuries
- protects the player in the goal arena from an impact on the floor frame
- convinces by a high-quality workmanship and beautiful design

Therefore Players Protect ground frame!

- after FIFA and DFB- regulations
- construction referred to DIN EN 748
- low risk for injuries
- net suspension with plastic double net hooks

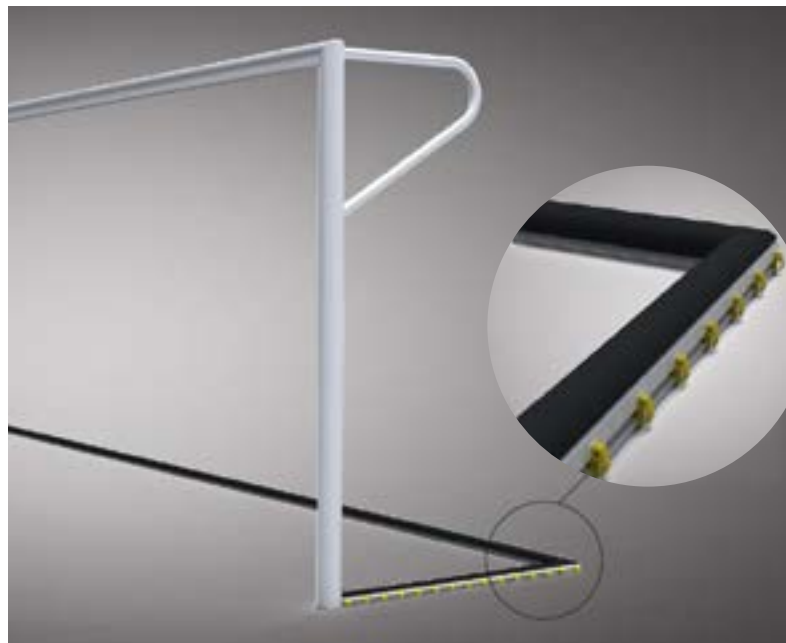

On request we are also offering fully welded football goals with „Players Protect“ (training goals, youth goals and mini goals)

Players Protect for stadium football goals protects the players. Prevents injuries in hot goal scenes and is nearly invisible for spectators on the stands.

art.-no.	products specification
4900362	display 1,50 m
4900363	display 2,00 m

PlayersProtect.
A cooperation with...



DEEP GROUND FRAMED „HIGH CLASS“

Top edge of the socket with an elastic layer
>>> No metal frame!



With the recessed ground frame socket you are getting a high tech solution for your football goals. The ground frame is at the same level with the ground-surface, thereby preventing possible accidents and injuries. This optically appealing solution is very easy to take care of. Special inlays can be used as a replacement for the ground frame – enabling easy lawn maintenance. For the installation of the recessed ground frame, no concrete is needed so that there is no interference with the underfloor heating. The ground frame can be moved easily because it is dismantlable in individual parts. The individual elements are fastened by their own weight. The recessed ground frame socket is suitable only for goals with a display of 2 meters.



Advantages for the processor

- no cement for the installation needed
- fixation by dead weight & humus layer
- due to the low height the under soil heating can stay and does not have to be displaced / moved

Advantages for the end user

- low risk of injuries
- no cement on the under soil heating needed
- low-maintenance
- suitable for stadiums

Art.-No. product specification

Ground frame „High Class“

2001267	ground frame bracket „High Class“
2001268	inlays recessed ground frame



VINDICO - TIP

We recommend, that the installation is carried out by our trained installation service team as any adjustments to the existing ground sockets are required.



DEEP GROUND FRAMED WITH NET SUSPENSION

Smart (old version)



Basic (old version)



FOOTBALL GOAL

FULLY WELDED, MOBILE



TÜV NORD tested only in connection with anti-tipping devices according to DIN EN 748



- net suspension in the complete goal- and ground frame
- corner welded
- lateral grips

Anti-tilting devices for goals can be found on page 27. nets on page 38/39.

Training and junior goal

- football goal made of aluminium
- reinforced in the goal profile
- goal frame from 120 / 100 mm oval profile
- ground frame from 80 / 40 mm rectangle profile
- ground frame with inverted net suspension
- net hanger from 60 mm round tube
- No tensioning rope in the ground frame necessary!



Art.-Nro product specification

Training goal 7,32 x 2,44 m

2001202	Display 80 / 150 cm - „Basic“, Aluminium blank
2001206	Display 80 / 150 cm - „Smart“, Aluminium blank
2001204	Display 80 / 200 cm - „Basic“, Aluminium blank
2001207	Display 80 / 200 cm - „Smart“, Aluminium blank

Junior goal 5,00 x 2,00 m

2001100	Display 80 / 100 cm - „Basic“, Aluminium blank
2001106	Display 80 / 100 cm - „Smart“, Aluminium blank
2001102	Display 80 / 150 cm - „Basic“, Aluminium blank
2001107	Display 80 / 150 cm - „Smart“, Aluminium blank
2001104	Display 80 / 200 cm - „Basic“, Aluminium blank
2001108	Display 80 / 200 cm - „Smart“, Aluminium blank

Accessories

2001605	Surcharge kit for on the side wheels (1 set)
2001603	Surcharge for extended goal post
2001600	Adapter for goal post
2001299	Surcharge for white goal frame for training goals
2001199	Surcharge for white goal frame for junior goals
2001600	Surcharge for sliding latches



FOOTBALL GOAL

„ALL IN ONE“ WEIGHTED, MOBILE

Meets tilting weight according to DIN 748

- net suspension in the complete goal- and ground frame
- corner welded
- lateral grips
- Integrated weight according to DIN 748

Training and junior goal „All In One“

- Football goal made of aluminium
- Reinforced in the goal profile
- Goal frame from 120 / 100 mm oval profile
- Ground frame from 80 / 40 mm rectangle profile
- Ground frame with inverted net suspension
- Foam wheels with solid welded-on wheel holder
- Net hanger from 60 mm round tube
- No tensioning rope in the ground frame necessary!

Art.-No. product specification

Training goal „All In One“ 7,32 x 2,44 m aluminium blank

2001222	Display 80 / 150 cm - „Basic“, 170 kg in the floor frame
2001226	Display 80 / 150 cm - „Smart“, 170 kg in the floor frame
2001224	Display 80 / 200 cm - „Basic“, 100 kg in the floor frame
2001227	Display 80 / 200 cm - „Smart“, 100 kg in the floor frame

Junior goal „All In One“ 5,00 x 2,00 m Aluminium blank

2001120	Display 80 / 100 cm - „Basic“, 200 kg in the floor frame
2001135	Display 80 / 100 cm - „Smart“, 200 kg in the floor frame
2001122	Display 80 / 150 cm - „Basic“, 125 kg in the floor frame
2001136	Display 80 / 150 cm - „Smart“, 125 kg in the floor frame
2001124	Display 80 / 200 cm - „Basic“, 100 kg in the floor frame
2001137	Display 80 / 200 cm - „Smart“, 100 kg in the floor frame

Accessories

2001299	Surcharge for white goal frame for training goals
2001199	Surcharge for white goal frame for junior goals



Training goal „All In One“ Display 200 cm



Junior goal „All In One“ Display 150 cm



Integrated weight for „All In One“ goals

FOOTBALL GOAL „SIMPLEX“



THE SIMPLE FOOTBALL GOAL

football goal „Simplex“

- football goal made of aluminium
- fully welded
- goal frame from 120 / 100 mm oval profile
- ground frame from 80 / 40 mm rectangle profile
- goal and ground frame with inverted net suspension „Basic“
- on the side foamed wheels, screwed to the net hanger
- net hanger from 60 mm round tube
- No tensioning rope in the ground frame necessary!

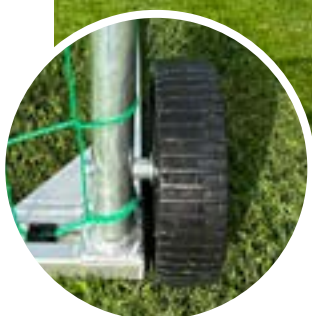

Art.-No.	product specification
2001214	Training goal „Simplex“ 7,32 x 2,44 m Display 80 / 200 cm

2001112	Junior goal „Simplex“ 5,00 x 2,00 m Display 80 / 150 cm
---------	--

Anti-tilting devices for goals can be found on page 27.
Nets on page 38/39.

FOOTBALL GOAL „SOCCA / FUTSAL GOAL“



- Futsal/Socca goal according international standards
- Football goal made of Aluminium blank
- Fully welded
- Goal frame from 80/80 mm oval profile
- Ground frame from 80/40 mm rectangle profile
- Net hoops made of 60 mm round tube
- Goal and ground frame with inverted net suspension „Basic“
- For dwelling on the ground
- Alternatively with extended posts for insertion in

Art.-No.	product specification
2001215	Socca Tor, aluminium blank
4510420	Net for Socca Tor, white, 4mm, PP

Art.-No.	product specification
2001006	Futsal Tor, aluminium blank
4310401	Net for Futsal goal, white, 4mm, PP,

FOOTBALL GOAL

„SWING GOAL“



Football goal „Swing goal“

- football goal made of aluminium
- corner reinforced in the goal profile
- goal frame from 120 / 100 mm oval profile
- rear post construction with variable articulated arms
- display from safety stand post up to 4,50 m
- securing the goals against unauthorized use
- side display made out of round aluminium tubes including eyes for upper and lower net tensioning rope

NOTE

for the rear connection, 2 additional adapters installed in foundations outside the playground are required..

- lateral foldable
- corner reinforcement
- variable hinges

art.-no. product specification

football goal „Swing goal“ 7,32 x 2,44m
aluminium blank

- | | |
|---------|-----------------------------|
| 2001230 | swing training goal „Basic“ |
| 2001232 | swing training goal „Smart“ |

football goal „Swing junior goal“ 5,00 x 2,00m
aluminium blank

- | | |
|---------|---------------------------|
| 2001130 | swing junior goal „Basic“ |
| 2001132 | swing junior goal „Smart“ |

accessories

- | | |
|---------|---|
| 2001604 | adapter for swing goal included bolt for fixation |
| 2001238 | rear cross pipe for training goal, foldable, including insertion tube and hinge |
| 2001138 | rear cross pipe for junior goal, foldable, including insertion tube and hinge |
| 2001299 | surcharge for white goal frame for training goals |
| 2001199 | surcharge for white goal frame for junior goals |



FOOTBALL GOAL „INTERNATIONAL“



Junior goal „Austria“ 3.00 x 1.60 m



- display 100 / 100 cm
- fully welded
- goal frame from 120 / 100 mm oval profile
- ground frame from 80 / 40 mm rectangle profile

art.-no. product specification

Junior goal „Austria“

2001126 Junior goal „Austria“, 3,00 x 1,60 m, 100 / 100 cm



Junior goal „France“ 6.00 x 2.10 m



- Football goal made of aluminium, display 80/180 cm
- Goal profile with reinforced corners
- Goal frame from 120 / 100 mm oval profile
- Ground frame from 80 / 40 mm rectangle profile
- Goal and ground frame with inverted net suspension Basic“

art.-no. productspecification

Football goal „France“

2001127 Junior goal „France“, 6,00 x 2,10 m, 80 / 180 cm



Football goal „Swiss“
extended display
(use of anti-tilting devices)



- Training goal 7.32 x 2.44 m, 80/220 cm display
- Youth goal 5.00 x 2.00 m, display 80/180 cm (for net 80/150 cm display)
- incl. holes for steel rope at 150 or 200 cm
- fully welded
- Goal frame made of 120 / 100 mm aluminium oval profile
- Ground frame profile made of 80 / 40 mm aluminium Rectangular profile
- Net hoop made of 60 mm round tube

art.-no. product specification

Football goal „Swiss“

2001180 Junior goal „Swiss“, „Basic“, display 80 / 180 cm
 2001181 Junior goal „Swiss“, „Smart“, display 80 / 180 cm
 2001280 Training goal „Swiss“, „Basic“, display 80 / 220 cm
 2001281 Training goal „Swiss“, „Smart“, display 80 / 220 cm

FOOTBALL GOAL

„RECREATIONAL GOAL“



- completely made of aluminium
- fully welded
- goal frame from 120 / 100 mm oval profile
- ground frame from 80 / 40 mm rectangle profile
- goal and ground frame with inverted net suspension

art.-no. product specification

Recreational goal 3,00 x 2,00 m

2001000	display 80/100 cm - „Basic“, aluminium blank
2001071	display 80/100 cm - „Smart“, aluminium blank
2001002	display 80/150 cm - „Basic“, aluminium blank
2001072	display 80/150 cm - „Smart“, aluminium blank
2001004	display 80/200 cm - „Basic“, aluminium blank
2001073	display 80/200 cm - „Smart“, aluminium blank

ground sockets / anchoring

1050395	standard ground socket, recreational goal
1050450	special ground socket, recreational goal
1111210	ground anchors

Accessories

2001603	surcharge for extended goal post
2001014	surcharge for attachment of vandalism-proof net
2001009	surcharge for basketball attachment, no display
2001008	surcharge for basketball attachment, 60cm display
2001099	surcharge white goal frame 3,00 x 2,00m



illustration image basketball attachment, 60 cm display



Dralo net

- 3,00 x 2,00 m, display 90 x 90 cm, inside hanging
- quadratic mesh
- mesh width approx. 100 mm, approx. 3 mm strong
- tensioning rod montage set included

Art.-No. product specification

Dralo Net

4406401	Dralo net, galvanised steel cable 100x100 cm Display
4406402	Dralo net, galvanised steel cable 100x100 cm Display
4406403	Dralo net, galvanised steel cable 100x100 cm Display



Herkules net

- 3,00 x 2,00 m, display 90 x 90 cm, inside hanging
- diagonal mesh, PA-covered
- mesh width approx. 100 mm, approx. 2,5 / 5 mm strong, colour: Grün

Art.-No. product specification

Herkules net with steel insertion

4466401	Herkules net with steel insertion, 3x2m
A4466402	Herkules net with steel insertion, 4x2m
4466403	Herkules net with steel insertion, 5x2m

MINI GOAL



illustration image mini goal 120 / 80 cm and 180 / 120 cm



illustration image mini goal 120 / 80 cm, foldable



illustration image mini goal 180 / 120 cm

Mini goal

- mini goal made of aluminium
- fully welded or foldable
- goal frame from 80 / 80 mm rectangle profile
- net suspension with „Basic“ plastic net hooks
- display 50 / 50 cm

Art.-no. product specification

mini goal 120 / 80 cm

- | | |
|---------|----------------------------------|
| 1111240 | fully welded, display 50 / 50 cm |
| 1111250 | foldable, display 50 / 50 cm |

accessories for mini goals 120 / 80 cm

- | | |
|---------|--|
| 4120842 | goal net, 4 mm, green, mesh width 100 |
| 4120832 | goal net, 4 mm, white, mesh width 100 |
| 2001603 | surcharge for extended goalposts |
| 2111264 | surcharge integrated weights and wheels |
| 2111261 | surcharge goal frame from oval profile, fully welded |

mini goal 180 / 120 cm

- | | |
|---------|----------------------------------|
| 1111270 | fully welded, display 50 / 50 cm |
| 1111280 | foldable, display 50 / 50 cm |

accessories for mini goal 180 / 120 cm

- | | |
|---------|--|
| 4120842 | goal net, 4 mm, green, mesh width 100 |
| 4120832 | goal net, 4 mm, white, mesh width 100 |
| 2001603 | surcharge for extended goalposts |
| 2111264 | surcharge integrated weights and wheels |
| 2111261 | surcharge goal frame from oval profile, fully welded |

mini goal 240 / 160 cm

- | | |
|---------|------------------------------------|
| 2111263 | fully welded, display 100 / 100 cm |
|---------|------------------------------------|

accessories for mini goal 240 / 160 cm

- | | |
|---------|--|
| 4122001 | goal net, 4 mm, green or white, mesh width 100 |
| 2111266 | surcharge integrated weights and wheels |

MINI GOAL „SPEZIAL“

Mini goal stackable

- Goal frame made of 120 / 100 mm aluminium profile with inverted net suspension „Basic“
- Ground frame made of 80 / 40 mm aluminium rectangular profile with inverted net suspension „Basic“

Art.-no. product specification

Mini goal stackable

1111241	Fully welded, 120 x 80 cm, display 50 / 50 cm
1111271	Fully welded, 180 x 120 cm, display 50 / 50 cm
1111272	Fully welded, 300 x 100 cm, display 100 / 100 cm



illustration image mini goal 300 x 100 cm, stackable

Mini turnable goal

- on both sides goal frame from 120 / 100 mm aluminium profile with inverted net suspension „Basic“
- dual use by turning over

Art.-no. product specification

Mini turnable goal

2111260	turnable goal
---------	---------------

accessories mini turnable goal

4122500	Net for turnable goal, green
---------	------------------------------



Mini turnable goal

FOOTBALL GOAL „PIPE MESH GOAL PRISONWALL“



Note! Pipe mesh goals with basketball attachment must be secured with ground anchors on the rear!



Pipe mesh goal 3,00 x 2,00 m, display 70 / 100 cm



Pipe mesh goal 3,00 x 2,00 m, display 70 / 100 cm with Basketball attachment



Pipe mesh goal 3,00 x 2,00 m, Display 100 / 100 cm, goal-shooting walls

Pipe mesh goal „Prisonwall“

- completely made of aluminium
- fully welded
- strut spacing after DIN EN 1176-1
- goal frame profile 120 x 100 mm
- back and side wall made from Ø 40 mm round tubes
- display 70 / 100 cm or 100 / 100 cm
- prepared for ground anchoring
- TÜV GS certificated

Referred to DIN EN 15312 multi-sportequipment

Art.-no. product specification

Pipe mesh goal „Prisonwall“

2001010	3,00 x 2,00 m, display 70 / 100 cm
2001012	5,00 x 2,00 m, display 70 / 100 cm
2001015	3,00 x 2,00 m, display 100 / 100 cm
2001016	5,00 x 2,00 m, display 100 / 100 cm

Pipe mesh goal with basketball

- Basketball attachment 60 cm display with TÜV GS certification
- Backboard 120 x 90 cm included
- Red basketball rim according to DIN and 6 mm nylon net included
- Rim height 3,05 m

art.-no. productspecification

Pipe mesh goal with basketball attachment

2001021	3,00 x 2,00 m, display 70 / 100 cm, BB-display 60 cm
2001022	5,00 x 2,00 m, display 70 / 100 cm, BB-display 60 cm
2001023	3,00 x 2,00 m, display 100 / 100 cm, BB-display 60 cm
2001024	5,00 x 2,00 m, display 100 / 100 cm, BB-display 60 cm
2001025	3,00 x 2,00 m, display 70 / 100 cm, no BB-display
2001026	5,00 x 2,00 m, display 70 / 100 cm, no BB-display
2001027	3,00 x 2,00 m, display 100 / 100 cm, no BB-display
2001028	5,00 x 2,00 m, display 100 / 100 cm, no BB-display

Accessories

2001011	Surcharge sand filling of the round tubes, 3,00 m goal
2001013	Surcharge sand filling of the round tubes, 5,00 m goal
2001603	Surcharge for extended goal post
2001600	Adapter for goal post
2001606	Surcharge for integrated goal-shooting walls

mini pipe mesh goal

- completely made of aluminium
- fully welded
- strut spacing after DIN EN 1176-1 (<89mm)
- goal frame profile 120 x 100 mm
- back and side wall made from Ø 40 mm round tubes
- display 50 / 50 cm
- prepared for ground anchoring

art.-no. productspecification**Mini recreational goal**

2001030 Recteational goal 120x80 cm



FOOTBALL GOAL

„RECREATIONAL GOAL UND STEEL



Struts are not butt-welded but embedded in cross tubes and then welded.
That makes the goal extremely stable.

Steel recreational goal**„Strong Line“**

- fully welded goal made out of steel
- hot galvanised with curing
- goal frame made out of 60Ø mm round pipe
- with recessed steel strut
- already prepared for ground anchoring
- net hanger out of 42mm round pipe
- TÜV tested according to DIN EN 15312

according to
DIN 15312 /
DIN EN 1176

art.-no. productspecification**Steel recreational goal**

2001041	5,00 x 2,00 m, display 70 / 100 cm
2001040	3,00 x 2,00 m, display 70 / 100 cm
2001046	1,80 x 1,20 m, display 50 / 50 cm
2001047	1,20 x 0,80 m, display 50 / 50 cm
2001042	Surcharge for goal wall

Ground anchoring for recreational goal

1111210	Ground anchors
---------	----------------



GROUND SOCKET „SAFETY“

Injuries at the socket head are a thing of the past !



Ground frame sockets for football goals and corner flags are usually made of Aluminum. The problem with all known ground sockets is the fact that if there is no post in the socket, the socket head represents a risk of injury for the athlete and the lawn care equipment can be damaged during mowing.

The new ground socket „safety“ avoids these risks completely.

Advantages compared to other ground sockets

- No ground socket edge in natural / artificial turf
- Elastic socket head
- Risk of injuries avoided
- Protection of lawn care equipment
- Serves as mowing edge for natural turf
- Socket insert for corner flag serves as sealing cap



Football ground socket



Tension ground socket



Corner flag socket

Art.-No.	product specification
Safety ground socket	
1110155	Football ground socket
1110156	Oval sleeve insert with rubber head
1110165	Tension ground socket
1110495	Corner flag socket with reversible insert for 50 mm Corner flag poles

Substitute for „Safety“ socket	
1110496	Substitute rubber head
1110499	Adhesive for „Safety“ rubber head



GROUND SOCKET „SAFETY PRO“ -

THE BEST GROUND SLEEVE FOR OUTDOOR SPORTS EQUIPMENT



Good is not good enough. That is why we have taken our safety ground socket as a basis and developed a new ground socket that offers a perfect solution for football and other sports..

Many clubs take thier competition goals out of the ground sockets after every match and store them next to the playground. The problem is that due to dirt, incorrect handling or slight damages at the ground sockets, the goals can no longer be pulled out of the ground sockets - or only with great effort. The friction of aluminium on aluminium makes this situation even more difficult. Thanks to our new „Safety PRO“ ground sleeve, this is now a thing of the past.

Advantages compared to other ground sockets

- Basic body made of aluminum square profile 150x150mm
- elastic sleeve head (also post sleeve)
- Plastic inner profile with an upper and lower contact surface of only 3cm (hardly any friction)
- Completely replaceable interior if necessary
- Ground sleeve can be produced for all profiles by all manufacturers (e.g. oval, round, square, sail mast)



The insertion depth is adjusted, NOT the sleeve head like with other products



Advantage 1:
elastic safety head



Advantage 2:
Aluminum profile runs in plastic.
Only 3.00cm contact surface



Advantage 3:
straight offset edge for installation



Advantage 4:
Interchangeable interior



Advantage 5:
Optionally with height adjustment
(-1cm to +4cm)



Advantage 6:
Production possible for all profiles
(Fig. 80x80mm)

Art.-No. product specification

ground socket „Safety Pro“

1110500	Ground socket „safety PRO“, Ovalprofil
1110510	Ground socket „safety PRO“, Ovalprofil, with height adjustment
1110512	Additional charge for recess for safety PRO sleeve for recessed floor frame “High Class”

FOOTBALL ACCESSORIES



Standard socket toe rod

Special socket tie rod

Standard ground socket

Standard ground socket with Bitumen

Special ground socket

Safety ground socket

Ground sockets

- completely made out of aluminium
- football socket: length 50 cm, insert depth 40 cm
- tie rod socket: length 45 cm, insert depth 35 cm
- standard socket comes with loose lid

Art.-no.	product specification
----------	-----------------------

Ground sockets football goals

1110140	standard ground socket, football
1110150	special ground socket, football
1110155	Safety ground socket
2001601	surcharge bitumen sealing

Ground sockets tie rod for Competition I

1110160	standard ground socket, tie rod
1110170	special ground socket, tie rod
1110165	Safety ground socket
2001601	surcharge bitumen sealing



Protective base ring

- Protection against dirt (soft ground = earth and grass) (artificial ground = rubber granulate)
- With natural turf - no direct overgrowth

Art.-no.	product specification
----------	-----------------------

Protective base ring

2001244	Protective base ring
---------	----------------------

Net safety bar

- made of aluminium
- screws included
- set is always for one frame



Art.-No.	product specification
----------	-----------------------

Net safety bar

2001248	safety bar for goal frame 7,32 x 2,44 m
2001146	safety bar for goal frame 5,00 x 2,00 m
2001048	safety bar for goal frame 3,00 x 2,00 m
on request	safety bar for goal frame

Goal post accessories

Height adjustment for all competition goals

- exact setting of the competition goals of 2.44 m
- easy adjustment through a back nut

Inclination adjustment for „Competition I“ goals

- pre-tensioning of the goals to the field
- net tension cord to the tie rod leads that the goal post will become exactly straight
- can be also used as a compensator if the ground sleeves have been set incorrectly



Art.-no.	product specification
----------	-----------------------

Goal post accessories

2001256	Height adjustment
2001257	Inclination adjustment

FOOTBALL ACCESSORY

„WEIGHTS“



Safety first! Our products are manufactured according this slogan:

The DIN and GuV say that a goal by itself must be tilt-proof. That's why we recommend our mobile „all in one“ football goals (see page 15). This type of goal has a steel filling in the bottom frame which makes tilting impossible - confirmed by a TÜV certificate. Your previous gates are not yet protected from tilting? No Problem!

Our goal weights type „Small“ and „Big“ can be adapted to any ground frame. Note, that lay on weights no longer get TÜV since january 2018 because they are not permanently connected with the goal.

WICH WEIGHT IS REQUIRED:

To make sure your future goal weights fit and that the counterweight matches the requirements, we created this little help for you.

Step 1:

Please measure the size of your goal frame. For this please take the internal dimensions.

Step 2:

Please measure the top and the bottom display of the goal. These are colour coded/indicated in the graphic. For this please start measuring at the rear edge of the goal post up to the net hanger.

Step 3:

The goal frame can be either round, oval or rectangular. Measure the height and the width of the goal frame.

We have to know these details to select the right goal weight for you.

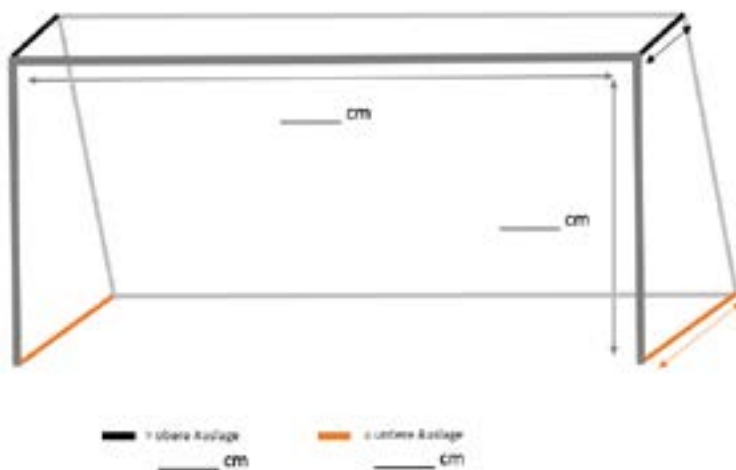

Needed weights after DIN EN 748

7,32 x 2,44 m, mit 2,00 m Display = 100kg

7,32 x 2,44 m, mit 1,50 m Display = 170kg

5,00 x 2,00 m, mit 2,00 m Display = 100kg

5,00 x 2,00 m, mit 1,50 m Display = 125kg

5,00 x 2,00 m, mit 1,00 m Display = 200kg

FOOTBALL ACCESSORIES



„WEIGHTS“

Spiral anchor

The spiral anchors are only used to prevent the slipping of the goals. The tilt safety is not guaranteed and also depends on the ground surface.



Art.-no.	Product specification
4000047	spiral anchor (Set = 4 pieces)

Clamping ground socket for mobile gates

new clamping ground socket for securing free-standing football goals



- made of aluminium
- Clamping unit can be completely embedded in the floor
- Clamping base sleeve is closed during clamping
- no additional tools are required for clamping
- with stainless steel threaded spindle
- Clamping via knurled nut
- Clamping for profiles up to 12cm
- Clamping lever can be moved lengthwise up to 7cm
- Lid can be coated with plastic / lined with artificial turf

Ground sleeve adapter for goals

- to prevent the mobile gates from tipping over
- for installation in standard or special ground sockets
- for insertion into the goal and into the ground socket
- **Advantage:** This means goals can be placed freely at any time!



Art.-no.	Product specification
2001600	adapter for goal post 120/100 mm gr. socket
2001602	adapter for goal post 115/100 mm gr. socket
2001607	adapter for goal post 80/80 mm gr. socket

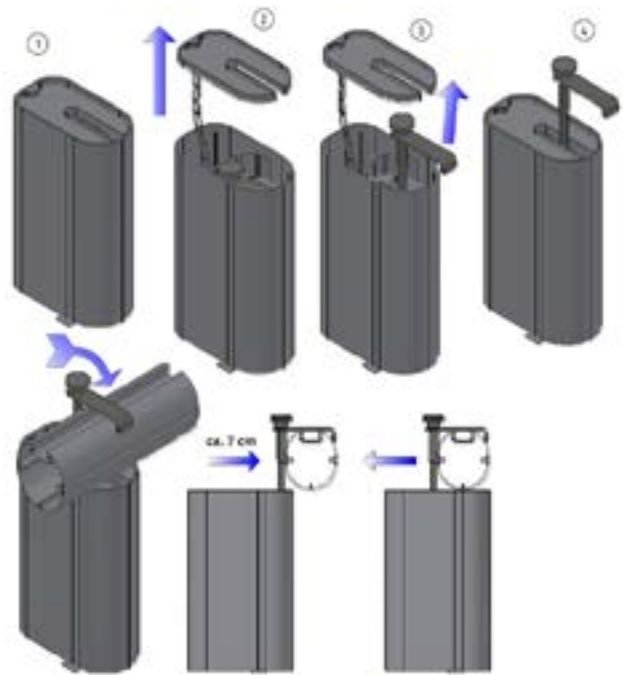

clamping ground socket
1110200 clamping ground socket

FOOTBALL ACCESSORIES

„WEIGHTS“



Weights for retrofitting „Big“

- with big, frothed wheels
- weight approx. 125 kg
- retrofitting for all ground frames
- concrete weights are included
- Tightly screwed with the ground frame

Art.-no.	product specification
Weights for retrofitting „Big“	
2014016	weight for retrofitting „Big“, frothed wheels, backwards movable
2014017	weight for retrofitting „Big“, frothed wheels, lateral movable



Lay on weights „Small“

- weight to put on the ground frame
- can be filled with approx. 70kg of sand
- retrofitting for all ground frames

Art.-no.	productspecification
Lay on weights „Small“	
2014012	Lay on weights with Polyamid (only for artificial turf / hard courts)



Transport and weight trolley „All in one“

- solid combi goal trolley for fully welded training goals or junior goals
- width corresponding to the length of the goal
- with 4 polyamide swivel castors - 2 of them can be locked
- Construction fixes the ground frame to the anti-tilting device
- Goal can be easily placed on the trolley
- Fixing of the installation and transport position with one bolt

Art.-no.	product specification
Transport and weight trolley „All in one“	
2014020	Transport & weight trolley for training goal 7.32 m
2014025	Transport & weight trolley for training goal 5.00 m
2014030	Surcharge for pneumatic castors



Weights for retrofitting „Small“

- with big wheels
- individual weight approx. 65 kg
- TÜV-certificated



Art.-no.	productspecification
Weights for retrofitting „Small“	
2014610	Retrofit weight „SMALL“, Polyamid wheels (only for artificial Turf / hard courts)
2014014	Retrofit weight „SMALL“, Wheels

TRANSPORT TROLLEY FOR GOAL



Transport trolley with big guide rollers



Transport trolley with big small rollers

Transport trolley „Basic“ for fully welded goals

- Transport trolley with recessed admission
- Four guide rollers (small or big)
- Two pieces are needed per goal
- Perfect for light-weight goals

Art.-no. productspecification

Transport trolley „Basic“

2014002	Transport trolley „Basic“ with small guide rollers
2014009	Transport trolley „Basic“ with big guide rollers

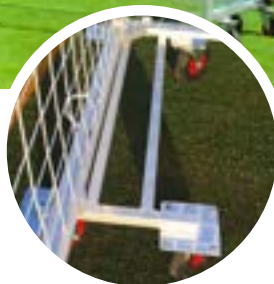

Transport trolley „Herkules“ for weighted goals

- 1 set includes a couple of transport trolleys
- with big frothed wheels
- pivoting wheels can be locked with bolts
- toggle leveller can be used as a drawbar for towing vehicles

Art.-no. product specification

Transport trolley „Herkules“

2014001	Transport trolley „Herkules“ for training goals
2014004	Transport trolley „Herkules“ for junior goals
2014003	toggle leveller for transport trolley „Herkules“

TRANSPORT TROLLEY FOR GOAL



Transport trolley „Professional“ in the goal



Transport trolley „Professional“

Transport trolley „Professional“

- Goal transport and lifting trolley for competition goals
- Goal holders can be raised via toothed racks
- Trolley completely made of aluminium
- four large swiveling wheels with bandage wheels
- with stopper for goal posts

Art.-no. product specification

Transport trolley „Professional“

2014011

Goal transport trolley „Professional“



Transport trolley and storage platform for competition goals

- size 7,80 x 1,60 m
- can hold up one pair of pluggable 7,32m goals
- central storage for tensioning rods, nets, etc.
- on both sides with towing eye and drawbar
- four pieces tipping sleeves lockable



Art.-no. product specification

Goal transport trolley

2014005

Goal transport trolley for „Competition“ goals

MARKING MACHINE



Marking machine „Simple Liner“

- linewidth form 5 cm up to 12 cm
- firm carriage with frothed wheels
- handle bar is vertically adjustable

Art.-no. productspecification

Marking machine „Simple Liner“

- | | |
|---------|-----------------------------------|
| 4008000 | Marking machsine „Simple Liner“ |
| 4008001 | spray cans (6 pieces / cartonage) |



Marking machine „Jet Liner“

- function: battery, pump and round cone nozzle
- vortex function: the grass is sprayed all-around
- colour can be in the machine without rinsing
- due to low weight easy to handle

Art.-no. productspecification

Marking machine „Jet Liner“

- | | |
|---------|--|
| 4010001 | Marking machine „Jet Liner“ |
| 4010006 | arena white marking colour, 18,5 kg bucket |



Marking machine „Roll Liner“

- Aluminium pressure wheel for homogeneous distribution of the marking color by rolling it off
- Lawn-protecting, viibration-damping pneumatics wheels
- Dirt rejection system
- Filling capacity: 12l

Art.-no. product specification

Marking machine „Roll Liner“

- | | |
|---------|--|
| 4110760 | Marking machine „Roll Liner“ |
| 4107600 | white marking colour „Protect 200“ 10 ltr. |



Marking machine „Supermatic GM10“

- patented spraying technology
- Adjustable pressure 1.5 - 2.5 bar
- Marking without electricity, fuel etc.
- High pressure hose pump is run by a wheel shaft

Art.-no. product specification

Marking machine „Supermatic GM10“ - new Edition“

- | | |
|---------|--|
| 4110761 | Marking machine „GM10 - new Edition“ |
| 4107600 | white marking colour „Protect 200“ 10 ltr. |

SPORT FACILITY ACCESSORIES

„CORNER FLAGS“

Corner flag pole

- Corner flag pole diameter 50 mm
- Made of accident-preventing material
- According to FIFA standards
- With and without tilt joint

Art.-no. product specification

Corner flag pole

4030101	Corner flag pole fixed, white
4030102	Corner flag pole fixed, yellow
4030121	Corner flag pole tilting, white
4030122	Corner flag pole tilting, yellow



Corner flag pole yellow tilting



Corner flag pole white fixed

Corner flags

- Corner flag made of polyester
- Wind, water and UV resistant
- For corner flag pole \varnothing 50mm
- Size 45 x 45 cm plus hem
- Various colors
- Flag with club logo (one-sided)

Art.-no. product specification

Corner flag

4030401	Corner flag, colour: neon yellow
4030402	Corner flag, colour: neon orange
4030451	Corner flag checkered yellow/orange
4030452	Corner flag with club logo imprinted
4030454	Corner flag with club logo vaporized
4030453	Corner flag, two coloured



neon yellow



checkered



two coloured



High quality print

Art.-no. product specification

Corner flag ground socket and accessories

1110495	Corner flag „Safety“ ground socket incl. turning insert
1110490	Aluminium special socket incl. reducing insert
1110491	Aluminium standard socket incl. reducing insert
4011050	Plastic socket with snap-on lid
4030205	Flag retaining clip
4011051	Corner flag insert, reduced from 60 to 50 mm
4011052	Corner flag base, round, for 50 mm poles
4030125	Surcharge for integrated lifting hook (ATTENTION! Only for tilting corner flagpoles)



„Safety“ Ground socket



Plastic socket with snap-on lid



Flag retaining clip



Corner flag base

Linieman flag set

Art.-no. product specification

Linieman flag set (2 flags and case included)

4030312	Linieman flag set
---------	-------------------



SPORTS GROUND ACCESSORIES

Lawn sprinkler

- robust chassis, hot-dip galvanised, 3 pneumatic wheels
- 100 m quality hose 1 1/4" with fabric insert
- 100 m pull cord with fastening peg
- infinitely adjustable driving speed
- automatic limit stop
- Irrigated area width 28 - 44 m
- Running speed 10 - 25 m/hour
- Required pressure 4 - 8 bar
- Water consumption 3.8 - 8.5 m³/h

Art.-no.	product specification
----------	-----------------------

4121030	Lawn sprinkler
---------	----------------



measuring help „Simple“

The set includes:

- 25 pcs. marking tufts of the same color
- Includes three different insertion tools
- Tube with safety cap to drive the marking tufts into the ground
- T-handle for manual insertion/removal of marking tufts
- Insert for a standard cordless screwdriver for inserting/removing the marking tufts
- easy-to-understand instructions



Art.-no.	product specification
----------	-----------------------

4121006	white
4121008	red

Marking template

- Marking of:
 - Penalty point (diameter 23 cm)
 - Corner quadrant Radius 100 cm, width 120 cm
 - Recess for tracing the goal line at the post
- Template made of solid HPL board (8 mm)
- screwed-on frame for corner flag radius on the underside for better colour gradient
- two aluminium handles
- total size approx. 110 x 110 cm

Alternative:

- steel marking template
- foldable

Art.-no.	product specification
----------	-----------------------

1001980	Marking template of HPL with Aluminium handles
1001981	Marking template foldable



Goal lifting device for „Competition goals“

- made of aluminium
- suitable for oval goal posts
- welded handles



Art.-no.	product specification
----------	-----------------------

2001610	goal lifting device
---------	---------------------

SPORT FACILITY ACCESSORIES

Net hooks

- Hooks for net fixture
- UV-stable plastic

Art.-no. product specification

Net hooks for different goal types

1001000	Net hook Vindico single hook
1001020	Net hook Vindico twin hook
1001001	Net hook Typ 2 (for 8 mm slot)
1001002	Net hook Typ 2 (for 10 mm slot)
1001003	Net hook Typ 3
1001004	Net hook Typ 4
1001005	Net hook Typ 5
1001006	Net hook Typ 6
1001007	Net hook Typ 7
1001008	Net hook Typ 8
1001009	Net hook Typ 9



Vindico single hook

Vindico twin hook

Typ 2



Typ 3

Typ 4

Typ 5



Typ 6

Typ 7

Typ 8

Typ 9

Clip bolt with slot stone

Art.-no. product specification

Clip bolt with slot stone

1001010	Clip bolt with slot stone
---------	---------------------------



Note:
Hook bolts are no longer permitted according to current regulations

Suspension bracket

- incl. counterplate
- completely made of aluminium
- inner pad with Teflon tape

Art.-no. product specification

Suspension bracket for goals

2607015	suspension bracket
---------	--------------------



Safety pad for flood light pole

- Standard height 200 cm
- Flood light pole Ø: 30 cm (Standard)
- Pad strength: 10 cm (Standard), total pad strength Ø 50 cm
- Many colours available

Art.-no. product specification

Safety pad for flood light pole

4321010	Safety pad for flood light pole in the standard measurements
---------	--



TRAINING ACCESSORIES

„FREE KICK WALL“



Free kick wall „Strong“

- mobile and fully made out of aluminium
- foamed wheels (2x stiff / 2x pivoted)
- welded handles
- ball opening at the bottom

Art.-no. product specification

Free kick wall „Strong“
2003030 Free kick wall „Strong“



Free kick wall „Champion“

- Mobile with drawbar
- Ball opening at the bottom
- Heads are hinged and rotatable
- Frame completely made out of aluminium
- Body and heads made of HPL-plates
- coating with logo and preferred colour
- frothed wheels

Art.-no. product specification

Free kick wall „Champion“
2003031 Free kick wall „Champion“

TRAINING ACCESSORIES

Pendulum header on one side

- Aluminium-oval-standpipe
- Display on one side 165 cm
- Including reel, rope, balls and weights
- For embedding in concrete or with ground socket
- Height 500 cm



Pendulum header on both side

- Aluminium-oval-standpipe
- Display on both sides 250 cm
- Height 600 cm
- Including reel, rope, balls and weights



Art.-no. product specification

Pendulum header one side

2015001 On one side incl. pendulum ball

Art.-no. product specification

Pendulum header doppel side

2015002 On both sides incl. pendulum ball

Training dummy „Air Body“

- high-strength foil
- special weldtechnique, for a higher tear strength
- fabric reinforced base, extremely resilient
- tank can be filled with sand, pebble or water
- fast assembly and disassembly due to special valve technology (within 30s)

Art.-no. produc specification

Training dummy „Air Body“

4007009 Training dummy „185“, height 1,91 m

4007010 Training dummy „Junior“, height 1,56 m



TRAINING AIDS

- Free kick wall
- Rebounder
- Cones
- Speed agility ladder
- Slalom poles



FOOTBALL ACCESSORIES

„NET“

Net for football goals

- Nets available in all sizes
- in 3 / 4 / 5 mm strength, standard 4 mm
- All colours / multi-coloured possible
- All displays / sizes available
- Special / irregular sizes only on request
- On request with club logo
- Nets made of polypropylene

Art.-no. product specification

Nets
for goal frame 7,32 x 2,44 m, display 200/200 cm

4722401	display 200/200 cm, 4 mm, colour: white
4722402	display 200/200 cm, 4 mm, colour: green
4722412	display 200/200 cm, 4 mm, colour: green / white
4722413	display 200/200 cm, 4 mm, colour: black / white
4722414	display 200/200 cm, 4 mm, colour: blue / white
4722415	display 200/200 cm, 4 mm, colour: red / white

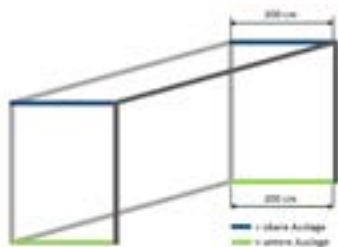

Art.-no. product specification

Nets
for goal frame 7,32 x 2,44 m, display 80/200 cm

4720302	display 80/200 cm, 3 mm, colour: green
4720401	display 80/200 cm, 4 mm, colour: white
4720402	display 80/200 cm, 4 mm, colour: green
4720412	display 80/200 cm, 4 mm, colour: green / white
4720413	display 80/200 cm, 4 mm, colour: black / white
4720414	display 80/200 cm, 4 mm, colour: blue / white
4720415	display 80/200 cm, 4 mm, colour: red / white

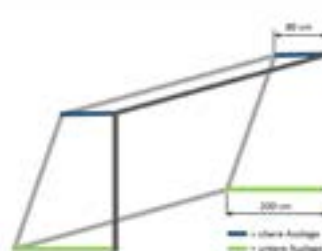

Art.-no. product specification

Nets
for goal frame 7,32 x 2,44 m, display 80/150 cm

4715302	display 80/150 cm, 3 mm, colour: green
4715401	display 80/150 cm, 4 mm, colour: white
4715402	display 80/150 cm, 4 mm, colour: green
4715412	display 80/150 cm, 4 mm, colour: green / white
4715413	display 80/150 cm, 4 mm, colour: black / white
4715414	display 80/150 cm, 4 mm, colour: blue / white
4715415	display 80/150 cm, 4 mm, colour: red / white
4715436	display 80/150 cm, 4 mm, colour: black / yellow

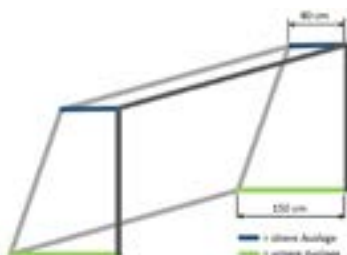

Art.-no. product specification

Junior goal nets
for goal frame 5,00 x 2,00 m, display 80/200 cm

4520302	display 80/200 cm, 3 mm, colour: green
4520401	display 80/200 cm, 4 mm, colour: white
4520402	display 80/200 cm, 4 mm, colour: green
4520412	display 80/200 cm, 4 mm, colour: green / white
4520413	display 80/200 cm, 4 mm, colour: black / white
4520414	display 80/200 cm, 4 mm, colour: blue / white
4520415	display 80/200 cm, 4 mm, colour: red / white

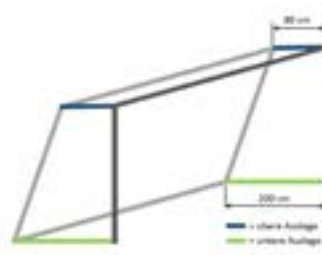

Art.-no. product specification

**Junior goal nets
for goal frame 5,00 x 2,00 m, display 80/150 cm**

4515302	display 80/150 cm, 3 mm, colour: green
4515401	display 80/150 cm, 4 mm, colour: white
4515402	display 80/150 cm, 4 mm, colour: green
4515412	display 80/150 cm, 4 mm, colour: green / white
4515413	display 80/150 cm, 4 mm, colour: black / white
4515414	display 80/150 cm, 4 mm, colour: blue / white
4515415	display 80/150 cm, 4 mm, colour: red / white

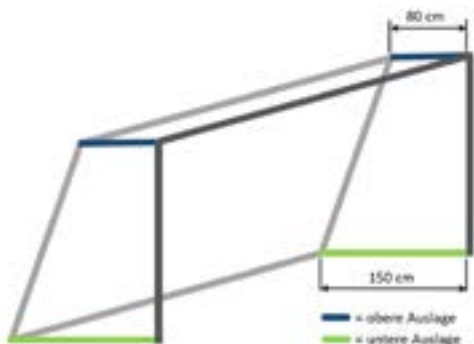

Art.-no. product specification

**Junior goal nets
for goal frame 5,00 x 2,00 m, display 80/100 cm**

4510302	display 80/100 cm, 3 mm, colour: green
4510401	display 80/100 cm, 4 mm, colour: white
4510402	display 80/100 cm, 4 mm, colour: green
4510412	display 80/100 cm, 4 mm, colour: green / white
4510413	display 80/100 cm, 4 mm, colour: black / white
4510414	display 80/100 cm, 4 mm, colour: blue / white
4510415	display 80/100 cm, 4 mm, colour: red / white

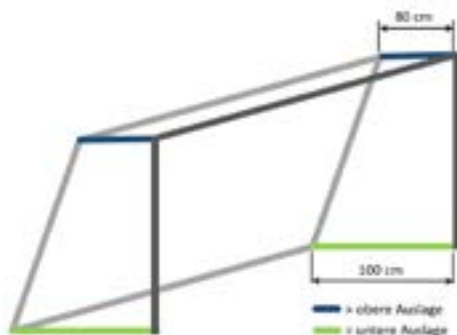

Art.-no. product specification

**Handball / recreational goal nets
for goal frame 3,00 x 2,00 m, display 80/100 cm**

4310302	display 80/100 cm, 3 mm, colour: green
4310402	display 80/100 cm, 4 mm, colour: green
4310401	display 80/100 cm, 4 mm, colour: white

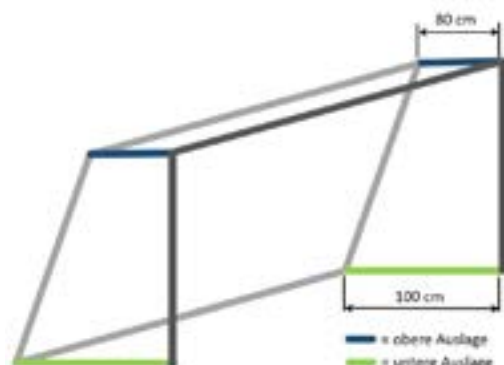

Camera optimized net

The white side which lines in sight with the pitch shows a clear contour for the players. The black side directed at the spectators allows an optimal view not only for the spectators but also for the cameras.



Art.-no. product specification

camera optimized football goal net

4310133	Football goal net 7,32 x 2,44 m display 200/200 cm, honeycombed
4301088	Handball goal net 3,00 x 2,00 m display 80/100 cm, honeycombed

Printed football goal nets with club logo

For printed goal nets, the mesh size must be at least 60x60mm in order to achieve a good result in terms of visibility etc. The narrower the mesh size, the better the eye perceives the logo.

Before the network goes to print, we will send you a proof for print approval.



Art.-no. product specification

printed nets

4310001	Additional charge for printing costs with club logo
---------	---

SPORT FIELD BARRIERS



aluminium barrier



Barrier anthracite powder-coated



90° bow



T-connection

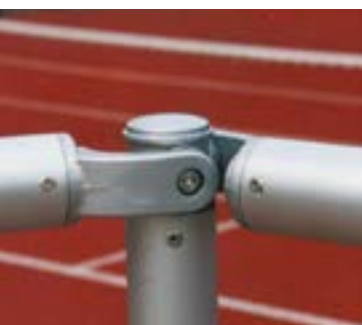

double hinge



slide in tube

Barrier made of aluminium:

The handrail and the support posts are made from 60x2.5mm aluminum profile. The length of the handrail is 2.50 meters, so a post must be placed every 2.50 meters. The support posts are 1.50 meters long. The height after installation is 1.10 meters. The scope of delivery includes support posts, handrails, T-connectors and blind rivets.

- Barrier made of anodized aluminum
- Installation height 1.50m
- Visibility height 1.10m
- 60mm post and handrail
- Post spacing 2.50m
- including external aluminum T-connectors

Barrier made of steel:

The handrail and the support posts are made of 60x2.0 mm tubular steel and hot-dip galvanized. The length of the handrail is 2.50 meters, so a post must be placed every 2.50 meters. The support posts are 1.50 meters long. The height after installation is 1.10 meters. The scope of delivery includes support posts, handrails, T-connectors and blind rivets.

- Barrier made of hot-dip galvanized steel
- Installation height 1.50m
- Visibility height 1.10m
- 60mm post and handrail
- Post spacing 2.50m
- including external aluminum T-connectors

Art.-no. product specification

Aluminium Barriers

1160000	Aluminium Barriers, complete per rm
1160005	Steel barrier, complete per running meter (50m minimum purchase)
2607016	Surcharge for barrier powder-coated in RAL

Art.-no. product specification

Accessories

1160100	90° bow for barriers
1160101	T-connection
4901306	double hinge
1160001	hand railing for barriers, length 2,5 m
1160002	Stand post for barriers, length 1,5 m
2160102	slide in tube 3,00m, with grip

BARRIERS BANNER HOLDER

Perimeter advertising elements for existing barriers

- for endless assembly in any length
- Height of the advertising boards 75 cm (visible area approx. 70 cm)
- Fastening set with clamps for Ø 60 mm and screwing material
- particularly robust and durable
- suitable for 24 mm thick elements
- Top/Bottom bordered with aluminum advertising hoarding handrail
- incl. fixing kit
- made of aluminum and stainless steel for existing barriers
- only corrosion-resistant parts
- particularly quiet thanks to the special clamping system

Art.-no. product specification

Advertising panel-elements

4901360 Advertising panel-elements for existing barriers



Perimeter advertising elements with standpipes

- particularly robust and durable
- Edged at the top and bottom with an aluminum profile
- Particularly quiet thanks to the special shape of the profile
- Support tubes made of round aluminum tubes Ø 60 mm with plastic caps, approx. 1.00 m above ground, distance 2.5 m
- Includes fastening set with clamps and screw fastening material
- Advertising hoarding completely enclosed with end pieces made from advertising hoarding profile
- the panels are free in the profile and can expand
- no deformation of the advertising boards
- Impact-resistant and weatherproof
- stable, durable, dimensionally stable and physiologically harmless

Art.-no. product specification

Advertising panel-elements

490135 Advertising panel-elements with stand pipes and hard foam board



“easy” advertising banner holder

- Holder made of bright aluminum
- Solid rubber sealing lip on both sides
- Advertising board thickness between 6-8 mm possible
- U-connectors between the rails
- very quiet. The board is rubber-mounted all around

art.-no. productspecification

Advertising barrier holder „J.B. Simple“

4138401 Advertising barrier holder „J.B. Simple“, per rm

4138405 PVC rigid foam board, height 90cm, 8mm thick

Firm cling and protection against dirt.

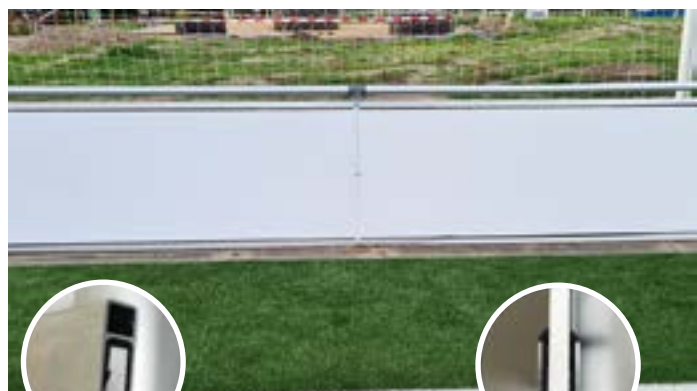

Fig. upper rail with rubber seal

Fig. lower rail with rubber seal



Ball catching construction

Our ball catching constructions are designed and manufactured according to your requirements (for aluminium max. 8m, for steel up to 10 m)

- ball catching construction in all lengths possible
- facility with crossbar or oblique support
- posts made out of aluminium or steel
- height up to 10 m
- on request with passage door
- bar grate mats along the bottom are possible

We manufacture your ball catching construction according to your requested dimensions!

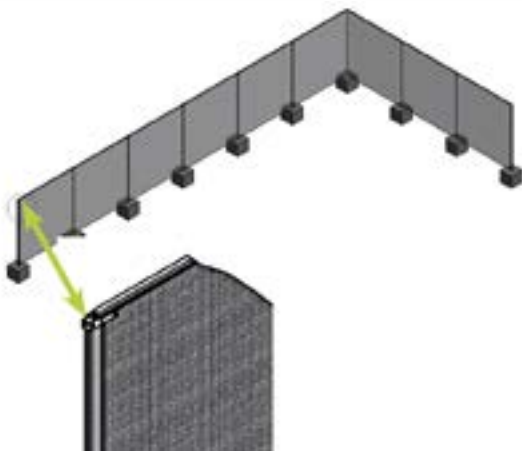

Ball catching construction with crossbars

Standard distance = 5,00 m

Foundation size up to 4.50m = 60 x 60 x 55 cm
Foundation size from 4.50m = 80 x 80 x 75 cm

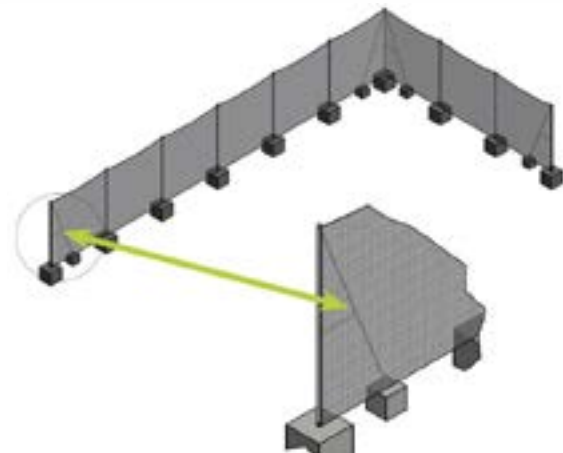

Ball catching construction with oblique support

Standard distance = 5,00 m

Foundation size up to 4.50m = 60 x 60 x 55 cm
Foundation size from 4.50m = 80 x 80 x 75 cm



VINDICO-TIP

For higher stability we recommend crossbars between each pair of posts. This increases the stability of the construction and makes it more appealing.

Height	aluminium	aluminium	aluminium	aluminium	steel	steel
	Ø 60 x 5 mm	80x80x2,5 mm	120x100x2,5 mm	120x100x4/6 mm	100x100x3 mm	150x150x3 mm
	insertion depth: 35cm	insertion depth: 25 cm	insertion depth: 40 cm	insertion depth: 40 cm	insertion depth: 60 cm	insertion depth: 60 cm

with welded eyes and hooks



with slot for net hooks 3 pieces / rm included



with slot for net hooks 3 pieces / rm included



with welded eyes and hooks



with welded eyes and hooks



with welded eyes and hooks



3,00 m	Art. 2606030	Art. 2608030	Art. 2601030	Art. 2601230	Art. 2601430	Art. 2601530
3,50 m	Art. 2606035	Art. 2608035	Art. 2601035	Art. 2601235	Art. 2601435	Art. 2601535
4,00 m	Art. 2606040	Art. 2608040	Art. 2601040	Art. 2601240	Art. 2601440	Art. 2601540
4,50 m	Art. 2606045	Art. 2608045	Art. 2601045	Art. 2601245	Art. 2601445	Art. 2601545
5,00 m	Art. 2606050	Art. 2608050	Art. 2601050	Art. 2601250	Art. 2601450	Art. 2601550
5,50 m			Art. 2601055	Art. 2601255	Art. 2601455	Art. 2601555
6,00 m			Art. 2601060	Art. 2601260	Art. 2601460	Art. 2601560
6,50 m			Art. 2601065	Art. 2601265	Art. 2601465	Art. 2601565
7,00 m				Art. 2601270	Art. 2601470	Art. 2601570
7,50 m				Art. 2601275		Art. 2601575
8,00 m				Art. 2601280		Art. 2601580
8,50 m						Art. 2601585
9,00 m						Art. 2601590
9,50 m						Art. 2601595
10,00 m						Art. 2601510



Sockets and post accessories

art.-no. productspecification

Sockets and post accessories

2607001	crossbar, standard length 5,00m, made of aluminium with plastic net hooks
2607002	crossbar, standard length 5,00m, made of aluminium with welded net hooks
2607003	Surcharge for u-socket for crossbar for aluminium post
2607004	Surcharge for u-socket for crossbar for



BALL CATCHING ACCESSORIES

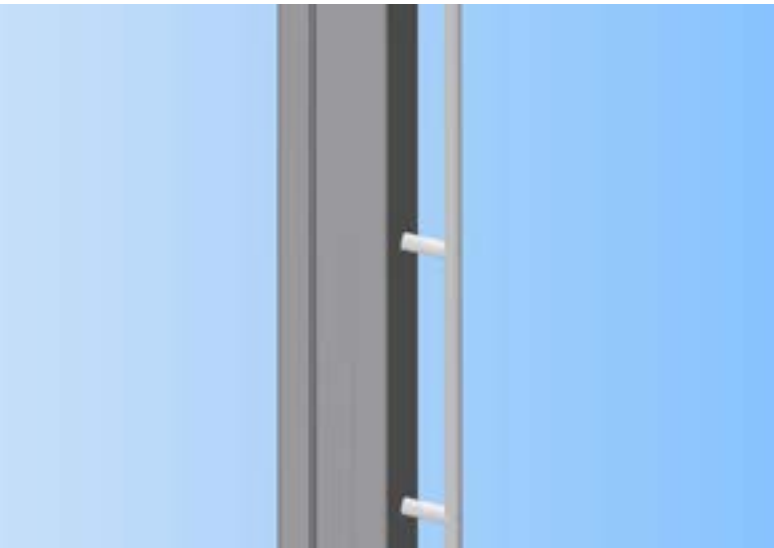

welded-on railing

Oblique support / railing

Art.-no. product specification

Oblique support

- 2607005 oblique support made from aluminium with horizontal strut & ground socket adapter
- 2607006 surcharge welded railing Ø 10mm

Art.-no. product specification

Inner reinforcement

- 2607007 surcharge internal reinforcement with steel height 2,00 m for 120 x 100 or 80 x 80 mm
- 2607008 surcharge internal reinforcement with steel height 2,00 m for 120 x 100mm, 4/6mm profile



Passage door

Art.-no. product specification

Passage door

- 2607009 passage door made of aluminium, fully welded, for the connection with a post
- 2607010 passage door made of steel, 203 x 100 cm, frame left and right filling of double rod mats 8/8/6mm incl. cover strips for double bar mat connection incl. mortise lock

Ball catching post powder coated

Art.-no. product specification

Powder coating

- 2607011 ball catching post powder coated in RAL-colour as surcharge

Standard ground sockets

Art.-no. product specification

Standard ground sockets

- 1110160 Standard sockets Ø 60 mm, insert depth 350 mm
- 1110140 Standard sockets 120/100 mm, insert depth 400 mm
- 1070070 Standard sockets 80/80 mm, insert depth 250 mm
- 4050058 steel post socket 100 x 100 mm, insert depth 600 mm
- 4050059 steel post socket 150 x 150 mm, insert depth 600 mm



BALL CATCHING „NETS“

Ball catching nets
made of polypropylene, knotless



art.-no. product specification

Ø 3 mm, MW 45

4045301	ball catching net, Ø 3 mm, MW 45, colour: white
4045302	ball catching net, Ø 3 mm, MW 45, colour: green
4045303	ball catching net, Ø 3 mm, MW 45, colour: black

art.-no. product specification

Ø 4 mm, MW 45

4045401	ball catching net, Ø 4 mm, MW 45, colour: white
4045402	ball catching net, Ø 4 mm, MW 45, colour: green
4045403	ball catching net, Ø 4 mm, MW 45, colour: black

art.-no. product specification

Ø 3 mm, MW 100

4100301	ball catching net, Ø 3 mm, MW 100, colour: white
4100302	ball catching net, Ø 3 mm, MW 100, colour: green
4100303	ball catching net, Ø 3 mm, MW 100, colour: black

art.-no. product specification

Ø 4 mm, MW 100

4100401	ball catching net, Ø 4 mm, MW 100, colour: white
4100402	ball catching net, Ø 4 mm, MW 100, colour: green
4100403	ball catching net, Ø 4 mm, MW 100, colour: black

Art.-no. product specification

Double rod grid mat

2607012	bar grate pad 2,50 m length, 2,00 m height, MW 50/200 mm, 8/8/6 mm
2607022	bar grate pad 2,50 m length, 1,00 m height, MW 50/200 mm, 8/8/6 mm
2607014	intermediate post for double grate pads made out of steel, height 2,00 m
2607013	intermediate post for double grated pads made out of aluminium, height 200 cm profile 80x80 mm,



Bar grade pad
can also be
mounted in the



Surcharge for filling finish of the net with a lead line

Art.-no. product specification

Weighing down

4050050	lead line with a belt strap attached onto the net, 200 g
4050051	lead line with a belt strap attached onto the net, 400 g
4050052	lead line with a belt strap attached onto the net, 600 g

BALL CATCHING ACCESSORIES



Use steel ropes with PVC sheathing to



Art.-no. product specification
Tension rod accessories

- 4050056 Carabiner hook
- 4050055 Snap hook for eyelet
- 4050054 Rope thimble
- 4050053 Rope clamp for 4 mm rope
- 4050057 Open nylon ring suspension for the nets (3 pieces per rm)
- 4050045 Steel wire rope, galvanised 4mm strong, PVC coated

Art.-no. product specification
Tension rod

- 4050044 tension cable set for 4mm stell ropes consists of:
 - 1 stk. Carabiner hook
 - 2 stk. Rope thimble
 - 2 stk. Snap hook
 - 4 stk. Rope clamp



BALL CATCHING „STADION“

Ball catching „Stadion“

Ball catching nets for large stadiums must always be adapted to the local conditions. The nets can be fastened with ball catcher posts or suspended from the stadium roof. The appropriate solution depends on the existing conditions in the Stadium. Our nets comply with the current standards and requirements. We would be happy to take over the installation of the ball catcher net. We look forward to your enquiry!

We also supply and install individual ball catcher net systems for your stadium!



Ball catching Voith Arena Heidenheim

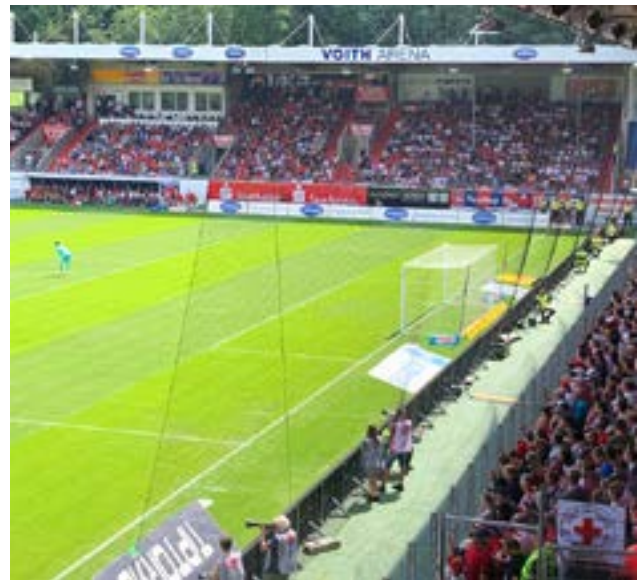

Ball catching Voith Arena Heidenheim



Steel plate for net weighting



Net with fire protection expertise

PLAYERS TUNNEL „LIGHT UND STRONG“



Players tunnel „Light“



Players tunnel „Light“



Players tunnel „Strong“

Players tunnel „Light“

The foldable players' tunnel is made of high quality materials and is manufactured according to your specifications or the conditions on site. The construction consists of aluminum profiles. Each standard module is 1 meter long and has lateral pantographs made of aluminum (height 150cm) with clamping elements. The roof is made of class 2, hardly inflammable.

PVC-tarpaulin, 650g/m² (standard colour is white, other colors available on request).

Each module has its individual tarpaulin, which is inserted into the grooves of the aluminum profiles. The tunnel has nylon wheels. On request, it can also be equipped with pressured tires. Module length: 1,00m, width max: 3,00m. Side height max 2,40m.

- extendible players tunnel
- height up to a max. of 400 cm,
- width up to a max. of 800 cm
- all forms and sizes are possible
- assembly on the wall and ground are available
- PVC - coated tarpaulin
- element width 100 cm

Art.-no. product specification

Players tunnel „Light“

4050000	Players tunnel, foldable
4050001	Club logo print

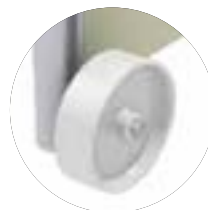

Nylon wheels (Standard)



Running rails



Rubber wheels

Players tunnel „Strong“

- players tunnel made out of aluminium, completely welded
- disguised with unbreakable and impact resistant polycarbonate glass, colourless
- multi-piece
- telescopic
- can be adjusted trough big rollers
- tunnel height approx. 2,60 m
- Length, width and construction of the tunnel can match the local conditions

Art.-no. product specification

Players tunnel „Strong“

on demand	Players tunnel „Strong“
-----------	-------------------------

CARING DEVICES

Dragging mat for artificial turf

- edged rubber mat
- galvanised steel frame
- size approx. 150 x 200 x 7 cm
- chain with shackle to pull the mat

Art.-no.	product specification
Dragging mat for artificial turf	
2199999	Dragging mat for artificial turf



Care brush for artificial turf

- Hot galvanised steel frame, approx. 80kg
- Robust 3 mm Starke Nylonborsten

Art.-no.	product specification
Care brush for artificial turf	
4028000	Care brush 250 x 80 cm rectangle shape
4028002	Care brush 250 x 80 cm triangular shape
4028005	Surcharge for 3 point-suspension



Triangular broom for artificial turf

- To strip down artificial plastic fibres
- Consistent equalizing the surface
- Towing bar with changeable draw gear
- For transport rolls for an easy handling
- Working width 1,60 m
- Overall size W 185 x B 124 x D 27 cm

Art.-no.	product specification
Triangular broom	
2199998	triangular broom „Light“
2199997	triangular broom „Strong“ with wheels and draw gear



Turf cleaning systems

We are pleased to offer you the maintenance and care equipment from SMG. Since 1975 Fa. SMG develops and manufactures devices for the care of artificial turf and sports floors. With more than 10 different caring- and cleaning devices, we provide a wide selection of different products. Starting with hand-guided devices for mini soccer courts, to ride-on machines of various sizes. Not to forget different add-on devices for municipal-tractors. These machines are available, according to our customer's requirements.



PLAYER CABIN



PLAYER CABIN „BASIC“

Player cabin „Basic“

- Player cabin made from aluminium
- Fully welded
- made of non-breakable and UV-resistant 3 mm polycarbonate plates
- one-piece up to 6 m (incl.), from 7 m two-parts
- sloping roof
- bench and backrest made of hardwood
- optionally available with plastic seats

Length 2,00 - 12,00m (sizable lengths on request)

Glazing all the way with polycarbonate plates

Seating Douglas wood, seats on request

Size lower depth: 97 cm
roof overhang: 28 cm

Art.-no. product specification

Player cabin „Basic“

2010102	length 2,00m, one-piece, for approx. 3-4 persons
2010103	length 3,00m, one-piece, for approx. 5-6 persons
2010104	length 4,00m, one-piece, for approx. 7-8 persons
2010105	length 5,00m, one-piece, for approx. 9-10 persons
2010106	length 6,00m, one-piece, for approx. 11-12 persons
2010107	length 7,00m, two parts, for approx. 13-14 persons
2010108	length 8,00m, two parts, for approx. 15-16 persons
2010109	length 9,00m, two parts, for approx. 17-18 persons
2010110	length 10,00m, two parts, for approx. 19-20 persons
2010111	length 11,00m, two parts, for approx. 21-22 persons
2010112	length 12,00m, two parts, for approx. 23-24 persons

Art.-no. product specification

Surcharge Player cabin „Basic“ with 4mm polycarbonate with 5mm polycarbonate

2010131	length 2,00m	2010152	length 2,00m
2010132	length 3,00m	2010153	length 3,00m
2010133	length 4,00m	2010154	length 4,00m
2010134	length 5,00m	2010155	length 5,00m
2010135	length 6,00m	2010156	length 6,00m
2010136	length 7,00m	2010157	length 7,00m
2010137	length 8,00m	2010158	length 8,00m
2010138	length 9,00m	2010159	length 9,00m
2010139	length 10,00m	2010160	length 10,00m
2010140	length 11,00m	2010161	length 11,00m
2010141	length 12,00m	2010162	length 12,00m

Art.-no. product specification

Accessories

2010003	Surcharge for aluminium foot rest
---------	-----------------------------------



Also available with 4 or 5mm polycarbonate glass!

Fig. player cabin Basic with bucket seats, Protective padding and foiled upon request



PLAYER CABIN „PRO“



Also available with 4 or 5mm polycarbonate glass!



Player cabin „Pro“

- Player cabin made from aluminium
- fully welded
- at the bottom with aluminium profile
- upper area made of non-breakable and UV resistant 3 mm polycarbonate plates
- one-piece up to 6 m (incl.), from 7 m two-parts
- sloping roof
- bench and backrest made of hardwood
- carrying handles at both sides
- incl. aluminium footrest
- optionally available with plastic seats

Length 2,00 - 12,00m (sizable lengths on request)

Glazing at the bottom aluminium profile, at the top polycarbonate plates 3mm

Seating Douglas wood, seats on request

Size lower depth: 99 cm
roof overhang: 28 cm

Art.-no. product specification

Player cabin „Pro“

2020202	length 2,00m, one-piece, for approx. 3-4 persons
2020203	length 3,00m, one-piece, for approx. 5-6 persons
2020204	length 4,00m, one-piece, for approx. 7-8 persons
2020205	length 5,00m, one-piece, for approx. 9-10 persons
2020206	length 6,00m, one-piece, for approx. 11-12 persons
2020207	length 7,00m, two parts, for approx. 13-14 persons
2020208	length 8,00m, two parts, for approx. 15-16 persons
2020209	length 9,00m, two parts, for approx. 17-18 persons
2020200	length 10,00m, two parts, for approx. 19-20 persons
2020211	length 11,00m, two parts, for approx. 21-22 persons
2020212	length 12,00m, two parts, for approx. 23-24 persons

Art.-no. product specification

Surcharge Player cabin „Pro“

with 4mm polycarbonate with 5mm polycarbonate

2010131	length 2,00m	2010152	length 2,00m
2010132	length 3,00m	2010153	length 3,00m
2010133	length 4,00m	2010154	length 4,00m
2010134	length 5,00m	2010155	length 5,00m
2010135	length 6,00m	2010156	length 6,00m
2010136	length 7,00m	2010157	length 7,00m
2010137	length 8,00m	2010158	length 8,00m
2010138	length 9,00m	2010159	length 9,00m
2010139	length 10,00m	2010160	length 10,00m
2010140	length 11,00m	2010161	length 11,00m
2010141	length 12,00m	2010162	length 12,00m

PLAYER CABIN „LEAGUE“

We create our “League” player cabins according to your specifications for your stadium. No matter what length and features. Together we will find a solution.

Special solution for your stadium - We would be pleased to submit an offer

- Player cabin according to DFL standards
- Mobile seat bases for easy seat removal
- Shape and length can be freely designed
- Integrated weather protection on the front
- High-quality leather seats including seat heating (various types & manufacturers)
- Manufacture with electrical connections (LAN / power)
- upon request including foiling
- Protective padding with club logo/advertising partners

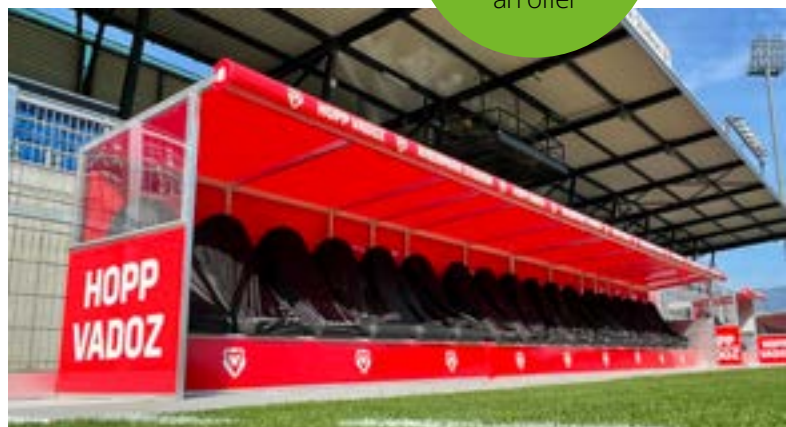

PLAYER CABIN „STRONG“

Optional
without side
windows



Fig. "Strong" player cabin, length 4.00 m with side windows and multiplex panels

Player cabin „Strong“

players cabin made from aluminium, fully welded, straight roof version, bottom with aluminium profile, side window made of polycarbonate plates, break

Length 2,00 - 3,00m (sizable lengths on request)

Glazing Roof, side windows & upper partition wall made of 3 mm polycarbonate plates

Seating Douglas wood, seats on request

Size Lower depth: 99 cm
Roof overhang: 28 cm

Art.-no. product specification

Player cabin „Strong“

2050502 Length 2,00m
2050503 Length 3,00m
2050504 Length 4,00m

PLAYER CABIN „DOUBLE“



Player cabin „Double“

players cabin made from aluminium, usable on both sides, fully welded, curved roof version, side windows and upper partition wall made of break and impact resistant polycarbonate plates. Lower partition wall made of aluminium profiles..

Length 3,00 - 5,00m (sizable lengths on request)

Glazing Roof, side windows & upper partition wall made of 3 mm polycarbonate plates

Seating Douglas wood, seats on request

Size Lower depth: 99 cm
Roof overhang: 28 cm
Leading edge: 218 cm

Art.-no. product specification

Player cabin „Double“

2060603 Länge 3,00 m
2060604 Länge 4,00 m
2060605 Länge 5,00 m

PLAYER CABIN „ROYAL“

player cabin „Royal“

- Player cabin with 18 seats
- Only 4 m long!
- Depth on the bottom 2,00 m
- Height with roof 2,65 m
- With or without plastic seats
- On the side you have a corridor to get in
- At the top you are save from heavy rain (with roof)
- Can be used as a replacement for spectator stand

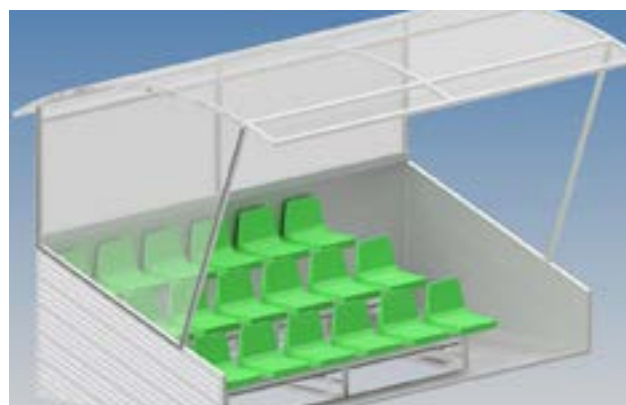

Art.-no. product specification

Player cabin „Royal“,
Length 4,00 m, without seats

- | | |
|---------|--------------|
| 2040404 | with roof |
| 2040405 | without roof |

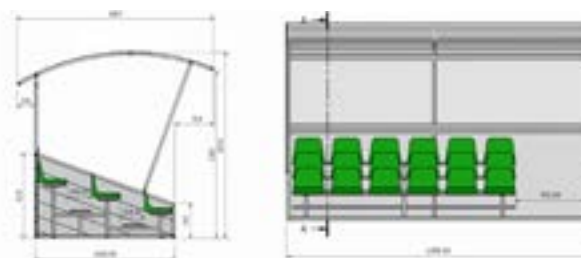

PLAYER CABIN „SPECIAL CONSTRUCTION“

Player cabin „Special construction“

Our high-quality player cabins with different standards are also available as customized products in almost any size and design.

- Round or square
- Cabin length and cabin depth
- Cladding in polycarbonate or aluminium
- Various seating surfaces
- Colours
- Various accessories such as coat hooks etc.



PLAYER CABIN „ACCESSORIES“

Transport trolley for player cabin „Pro“

- Completely made of aluminium
- The trolley is hooked into the side handles
- With swivel wheels
- The player cabin is lifted to be moved

Art.-no. product specification

Transport trolley for player cabin „Pro“

- | | |
|---------|-------------------|
| 2014008 | Transport trolley |
|---------|-------------------|



PLAYER CABIN „ACCESSORIES“

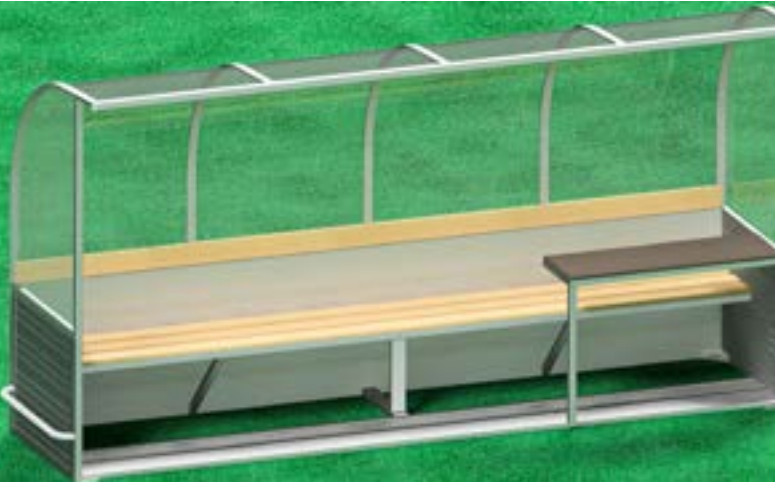

Table for cabin

- can be integrated in every cabin
- construction made of aluminium
- table top made of multiplex panel
- standard size 1,20 x 0,40 m
- other sizes on request

Art.-no.	product specification
Table for cabin	
2060702	Surcharge for table



Imitation leather seats

- embroidered logo incl.
- one or two colors
- with seat heating possible
- three heating levels, adjustable by every user

Art.-no.	product specification
Imitation leather seats	
2060703	with heated seats
2060704	without heated seats



Original „Recaro“ stadium seats

- Model „Players cabin“
- completely padded with leatherette
- RECARO Logo on the front and the back of the

Art.-no.	product specification
Recaro seats	
2060700	with heated seats
2060701	without heated seats

PLAYER CABIN „ACCESSORIES“

Plastic seats in standard RAL colours

During the cold months of the year, concrete elements are unpleasantly cold and damp. Give your supporters a treat to watch the game on comfortably heated seats. A water drainage slit in the seats makes sure, that there will be no puddles or water-logging.
All grandstand seats can be used indoors and outdoors.
For a small surcharge, the seats can be numbered.



Art.-no. product specification

Plastic seat
2010001 with back rest in standard RAL-colours

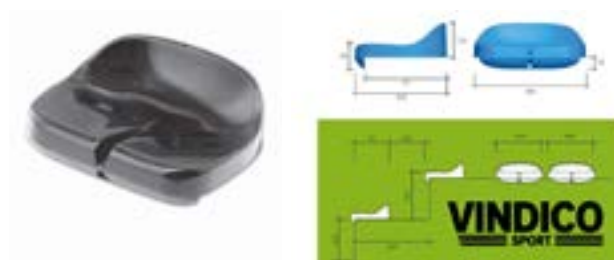

Art.-no. product specification

Plastic seat
2010001 with back rest in standard RAL-colours



Protective padding for cabin roofs

- Protective padding made of RG 28/70
- Individual lengths 100 cm
- Individually printed with 510 g tarpaulin fabric
- weatherproof
- B1 certified
- for complete player cabin (please specify length)
- continuous tarpaulin fabric
- including desired print

Art.-no. product specification

Protective pad for cabin roof
2010002 Protective pad



SPECTATOR STAND



Spectator stand „Easy“, movable with plastic seats



Spectator stand „Easy“



Spectator stand „Easy“

- three rows made of aluminium
- Length 3,00 m
- Space for approx. 18 persons
- Height: 0,83 m, Depth: 1,80 m
- dismantlable elements

Art.-no.	product specification
----------	-----------------------

Spectator stand „Easy“	
------------------------	--

- | | |
|---------|--|
| 1130040 | Spectator stand „easy“ length 3,00 m |
| 1130041 | Surcharge for backrest |
| 1130042 | Surcharge for handrail all around |
| 1130043 | Surcharge for handrail sideward |
| 1130044 | Surcharge for movable spectator stand |
| 1130045 | Surcharge for 18 plastic seats with backrest |



Spectator stand „Pro“, with 50 seats, three rows

The new spectator stand for all outdoor sports has 50 comfortable seats in three rows, as well as a central entrance and railing (9,19 m x 2,13m). The flooring construction is made out of steel section tubes together with heavy grillage. All steel elements are hot galvanized and are weatherproof. The UV-resistant shell type seats provide seating comfort. They can be delivered in various colours. The spectator stand will be delivered in 4 modules in a width of 2m with 16 seats as well as a staircase module with a width of 1.2m and 2 seats to dispose of easy assembly. The stand also matches the DIN 13200 requirements. This spectator stand system with 50 seats can be extended to your requirements. Likewise custom build designs with the 2 m modules and the staircase modules are

Length	9,20 m
Depth	2,13 m
Height	1,52 m
Seat height	approx. 45 cm
Capacity	50 places
Material stand	Steel, hot galvanized
Material seat:	sprayed polypropylene, impact resistant,

Art.-no.	product specification
----------	-----------------------

Spectator stand „Pro“	
-----------------------	--

4040985	with 50 seats
---------	---------------

STAND ELEMENTS

Determine the dimensions or the incline conditions of the construction

The use of rectangular elements as sitting and standing steps elements are not new to this world. Many years of experience with various constructions show that the rectangular elements have the best value for its money.

Planning

Get in touch with us as soon as possible. The elements are only produced to order. Please plan longer delivery times.

Construction

Self-compacting flowing concrete, reinforced, formwork smooth, cement grey or blasted (front and tread area), completely enclosed. Mass according to the adjacent drawing.

Stand elements

Concrete, formwork smooth with abraded surface, cement grey, with one-sided chamfer on the appearance of 2cm. Maximum length 200cm. Since the height of the staircase and depth must be half of the sitting and standing elements. Therefore the stair elements are available in variable sizes. The front and tread surface are also available as sand-blasted which lowers the risk of slipping.

Extension in concrete elements

approx. 0.3 mm per cm, with 30° C temperature difference.

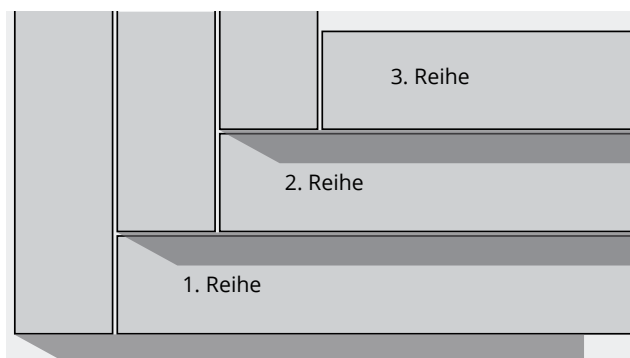

Corner 90°, with normal and finish elements

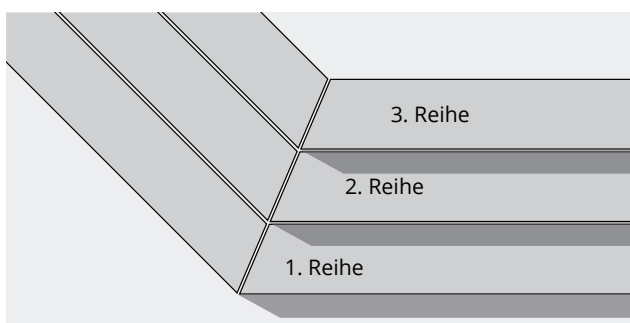

Corner 45°, with special elements (on commission/order)



Planning note stand elements / seat ele-

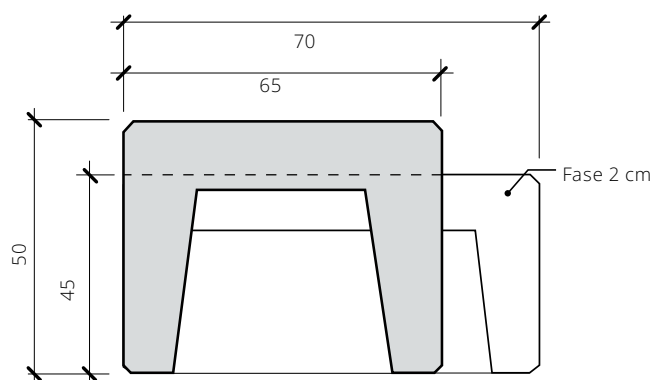
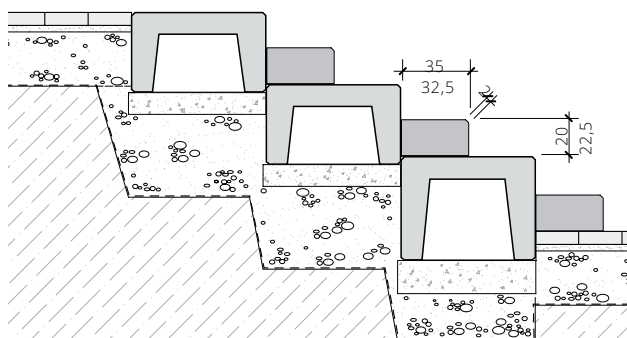

Corner construction

For rectangular corners there are no special corner elements used. All elements are closed on the side. For 45° corner are special elements needed which are available on request. Contact us, we will advise you, give you the technical details and prices for the product.

Transfer

The elements are delivered by us. The unloading takes place on site (forklift etc.). For transfer, we recommend the use of a vacuum device.

STAND ELEMENTS

„SEAT AND FLOOR ELEMENTS TYPE SD“



Seat and floor element type SD, smooth
Closed on both sides, width 65 cm, height 50 cm

Art.-no. product specification

Seat and floor element
Typ „SD“

3320100	Lenght 100 cm, weight 348 kg
3320105	Lenght 150 cm, weight 522 kg
3320110	Lenght 200 cm, weight 696 kg
3320115	Lenght 250 cm, weight 870 kg
3320120	Lenght 300 cm, weight 1044 kg

Seat and floor element type SD, smooth
Closed on both sides, width 70 cm, height 45 cm

Art.-No. product specification

Seat and floor element
Typ „SD“

3320200	Lenght 100 cm, weight 340 kg
3320201	Lenght 140 cm, weight 470 kg
3320206	Lenght 200 cm, weight 670 kg
3320211	Lenght 240 cm, weight 800 kg
3320215	Lenght 280 cm, weight 940 kg
3320220	Lenght 300 cm, weight 990 kg

Seat and floor element type SD, blasted
Closed on both sides, width 65 cm, height 50 cm

Art.-no. product specification

Seat and floor element
Typ „SD“

3320150	Lenght 100 cm, weight 350 kg
3320155	Lenght 150 cm, weight 522 kg
3320160	Lenght 200 cm, weight 696 kg
3320165	Lenght 250 cm, weight 870 kg
3320170	Lenght 300 cm, weight 1045 kg

Seat and floor element type SD, blasted
Closed on both sides, width 70 cm, height 45 cm

Art.-no. product specification

Seat and floor element
Typ „SD“

3320250	Lenght 100 cm, weight 340 kg
3320251	Lenght 140 cm, weight 470 kg
3320256	Lenght 200 cm, weight 670 kg
3320261	Lenght 240 cm, weight 800 kg
3320265	Lenght 280 cm, weight 940 kg
3320270	Lenght 300 cm, weight 990 kg

STAND ELEMENTS

„BLOCK LEVEL TYP

We recommend the use of a vacuum device for the

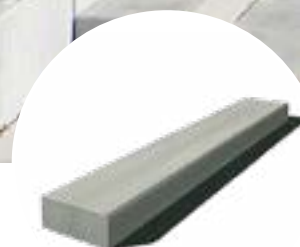

Block level type SD, stair element,
Length 100 cm

Width 35 cm, height 20 cm or width 35 cm,

Art.-no. **product specification**

Block level
Typ „SD“

3302194 smooth, weight 156 kg
3320191 structured, weight 156 kg

Block level type SD, stair element,
Length 200 cm

Width 35 cm, height 20 cm or width 35 cm,

Art.-no. **product specification**

Block level
Typ „SD“

3320195 smooth, weight 312 kg
3320190 structured, weight 312 kg





BALL SPORTS

HANDBALL GOALS

„FULLY WELDED“

Handball goals „Fully welded“

Our handball goals can be used indoors as well as outdoors on multi-sport facilities. The goal area has an internal dimension of 3.00 x 2,00 m. Fully welded handball goals made of aluminium are extremely robust and durable.

- handball goals are fully welded
- 3,00 x 2,00 m, 80/80 mm profile
- completely made of aluminium
- welded net hangers
- of contrasting colour
- on request with an additional catching net
- ground frame with inverted net hooks
- corner reinforced

Art.-no. product specification

Handball goal „fully welded“
can be fixed into the ground or with adapters for
ground sockets

2002000	Handball goal fully welded 80/100 cm display, „Basic“
2002004	Handball goal fully welded 80/100 cm display, „Smart“
2002001	Handball goal fully welded 125/140 cm display, „Basic“
2002005	Handball goal fully welded 125/140 cm display, „Smart“

Art.-no. product specification

Handball goal „fully welded“
with extended goal posts, for insertion in ground
sockets

2002010	Handball goal fully welded display 80/100 cm, with extended goal posts, „Basic“
2002014	Handball goal fully welded display 80/100 cm, with extended goal posts, „Smart“
2002011	Handball goal fully welded display 125/140 cm, with extended goal posts, „Basic“
2002015	Handball goal fully welded display 125/140 cm, with extended goal posts, „Smart“

Art.-no. product specification

Handball goal „fully welded“
Accessories

2111268	Surcharge for int. weight, incl. side wheels
---------	--



Handball goals in all colour combinations and with club logo available!

HANDBALL GOALS

„COMPETITION“ UND „FOLDABLE“



Handball goal „Competition“



Handball goal „Foldable“



Handball Goal „Demountable“

Handballgoal „Competition“

- Handball goal made of aluminium, for insertion in ground sockets
- Ground frame with inverted net hooks
- Upper pre-tensioned net hangers, display 80 cm
- Foldable ground frame
- 3,00 x 2,00 m, 80/80 mm profile
- Completely made out of aluminium
- Of contrasting colour

Art.-no. product specification

Handball goal „Competition“

2002020	Handball goal „Competition“ with upper net hanger „Basic“, without ground frame
2002026	Handball goal „Competition“ with upper net hanger „Smart“, without ground frame
2002021	Ground frame for handball goal „Competition“, Display 100 cm, „Basic“
2002016	Ground frame for handball goal „Competition“, Display 100 cm, „Smart“

Handball goal „Foldable“

Art.-no. product specification

Handball goal, foldable, with net hanger, display 80/100 cm, can be fixed into the ground or with adapters for ground sockets

2002022	Handball goal foldable, „Basic“
2002025	Handball goal foldable, „Smart“
2014010	Transport trolley for foldable handball goals

Handball goal „Demountable“

Art.-no. product specification

Handball goal, demountable, with net hanger, display 125/125 cm, can be fixed into the ground or with adapters for ground sockets

1070010	Handball goal demountable, „Basic“
2070021	Handball goal demountable, „Smart“

HANDBALL GOAL „ACCESSORIES“

Adapter for goal

- for setting in ground socket and goal

Art.-no.	product specification
Adapter	
2001607	adapter for goal post and ground sockets 80/80 mm



Ground sockets for handball

- Completely made of aluminium
- Handball ground socket, length 35 cm, insertion depth 25 cm
- Standard ground socket with a loose lid
- Special ground socket with aluminium lid and lid chamber

Art.-no.	product specification
Ground sockets for handball	
1070070	standard ground socket for 80/80 mm posts
1070150	special ground socket for 80/80 mm posts



Standardhülse

Spezialhülse

Gym anchoring

Art.-no.	product specification
Gym anchoring	
1070180	Foorplate with screw made of aluminium
4900416	Screw with rubber for a lower injury risk



Chain weights

Art.-no.	product specification
chain weights with plastic sleeve	
4810174	weight approx. 800 g/1fm, length 5,00 m, display 100 cm

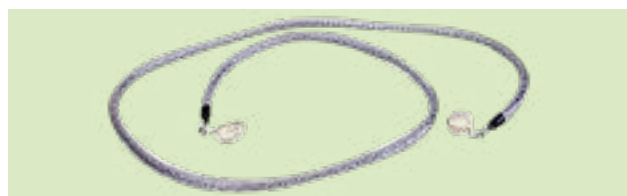

Goal net for handball

Art.-no.	product specification
Goal net for 3,00 x 2,00 m goal frame	
4310302	Handball goal net, display 80/100 cm, 3 mm, colour: green
4310402	Handball goal net, display 80/100 cm, 4 mm, colour: green
4310401	Handball goal net, display 80/100 cm, 4 mm, colour: white
Camera optimized net	
4301088	Handball goal net, display 80/100 cm, honeycombed, white inside, black outside



HOCKEY

„FIELD AND INDOOR HOCKEY“



Field and indoor hockey

- hockey goal 3,66 x 2,14 m
- display 90 / 120 cm
- EPDM covered at the bottom
- net is hanging free in the goal frame
- dismantlable
- welded double transport rolls

art.-no.	productspecification
Field and indoor hockey	
1090090	Hockey goal, 3,66 x 2,14 m, demountable
4361202	Hockey goal net, display 90/120 cm, 4 mm



Field and indoor hockey

- Hockey goal „league“ 3,66 x 2,14 m
- Goal frame fully welded, thick walled profile
- Welded barrier, made from very tough aluminium side profile
- With a wooden filling, very longlasting
- Slot for net hooks
- Big aluminium net hanger Ø 50 mm
- Free net suspension
- Screwed with goal frame and barrier
- Inside 8 mm thick polyurethane coating
- According to DIN EN 750

art.-no.	productspecification
Field and indoor hockey	
4900453	hockey goal, 3,66 x 2,14 m, goal frame white, according to international rules
4900460	hockey goal, 3,66 x 2,14 m, goal frame aluminium blank
4900454	surcharge for two additional wheels welded
4361202	hockey goal net, display 90/120 cm, 4 mm



HOCKEY „ROLLER- AND RINK-HOCKEY“

Roller hockey goal

- Fully welded goal made of steel
- Internal dimension 170 x 105 cm
- Round goal frame, slanted goal corners
- Net reling around the goal
- Ball baffle on the ground
- Completely powder coated
- Goal frame in fluorescent orange

art.-no. productspecification

Roller hockey

2003010	Roller hockey goal 170 x 105 cm
2003011	Transport trolley for roller hockey
4131102	Goal net 4 mm for roller hockey goal including catch net

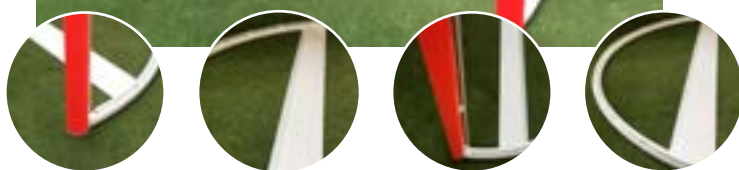

Street hockey

- Fully welded street hockey goal made of steel
- Internal dimension 170 x 105 cm
- Net reling around the goal
- Free net suspension
- Completely powder coated in fire-red
- Can be fixed to the ground

art.-no. productspecification

Street hockey

2003020	Street hockey goal 170 x 105 cm
4000099	Goal net 4 mm for street hockey goal, MW 40 mm



Impact protection plank

- For hockey fields to fasten either on a barrier or a fence system
- made of aluminium hollow profile 205 mm high, 35 mm thick
- including connectors
- with a smooth aluminium surface or with 10 mm thickend sound-absorbing rubber profile

art.-no. productspecification

Impact protection plank

4900456	Impact protection plank made of aluminium
4900556	Impact protection plank with sound absorbing
4900557	Mounting kit for barriers
4000099	Mounting kit for bar grad mat



VOLLEYBALLSYSTEM „COMPETITION“

TÜV-GS certified according to DIN 1271 CLASS A



Volleyball

„Competition“ TÜV-GS certified according to DIN 1271 Class A

The height of the “Competition” volleyball system can be adjusted when the net is taut. The height is adjusted on the back with a crank using an internal solid trapezoidal threaded rod.

Features of the Volleyball “Competition” facility:

- oval aluminum profile 120x100 mm
- Wall thickness 4/6 mm
- complete mechanics inside
- Height adjustment on the back with removable crank using a trapezoidal threaded rod
- Mains tension via removable crank using a second trapezoidal threaded rod
- a crank for height adjustment & mains tension
- for net tension cable lengths from 11.20m to max. 12.50m
- Infinitely variable height adjustment when the net is tensioned
- Aluminum post, powder-coated black
- on request in blank aluminum

Our volleyball “Competition” system can be set as standard for the following heights (Heights from 200-250 cm):

- 2.43m height = volleyball men
- 2.35m height = volleyball mixed & male youth U18 years
- 2.24m height = volleyball women & men youth U16
- 2.20m height = volleyball female youth U16 & students up to 14 years



Art.-no. product specification

Volleyball facility „Competition“

1800320	Volleyballsystem, „Competition“, black powder-coated
4800310	Lower price in aluminium blank
4800305	Surcharge for powder coating in a RAL colour of your choice

VOLLEYBALLSYSTEM „MORE COMPETITION“

TÜV-GS certified according to DIN 1271 CLASS A

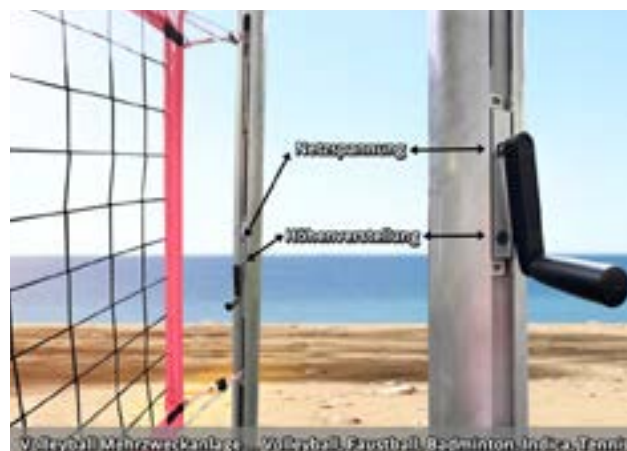

Features Volleyball “More Competition”

- oval aluminum profile 120x100 mm
- Wall thickness 4/6 mm
- complete mechanics inside
- Height adjustment via “centrifugal clutch”. removable crank
- Mains voltage via removable crank Trapezoidal thread rod
- a crank for height adjustment and mains tension
- for net tension cable lengths 11.20m to max. 12.50m
- Infinitely variable height adjustment when the net is tensioned
- Aluminum post, powder-coated black
- on request in blank aluminum

Volleyball „more Competition“ TÜV-GS certified according to DIN 1271 Class A

The volleyball multi-purpose system can be adjusted in height when the net is tensioned. Thanks to an integrated centrifugal clutch, the height slider can be moved more or less easily depending on the crank speed. In volleyball systems with a “screw version” for height adjustment, the height slider can slip down abruptly and cause damage to the volleyball system or even injuries to the operator. To eliminate this problem, the centrifugal clutch brakes the elevator when it is released.

Our volleyball “More Competition” multi-purpose facility can be used as standard for the following sports (heights from 151-250 cm):

- 2.43m height = volleyball men
- 2.35m height = volleyball mixed & male youth U18 years
- 2.24m height = volleyball women & men youth U16
- 2.20m height = volleyball female youth U16 & students up to 14 years & footvolley
- 2.02m height = fistball max.
- 1.85m height = India approx
- 1.78m height = fistball min.
- 1.55m height = badminton



Art.-no. product specification

Volleyballanlage „more Competition“

1800325	Volleyballsystem, „more Competition“ multi-purpose
4800310	Lower price in aluminium blank
4800305	Surcharge for powder coating in a RAL colour of your choice

VOLLEYBALL LEISURE AND SCHOOL „PRO“

TÜV-GS certified according to DIN 1271 CLASS C



Volleyball Leisure and school „Pro“ with pulley technology

With the “Pro” leisure volleyball system, the net can be tensioned without tools or a crank. This means that the desired height can be set in a very short time.

This eliminates the need to search for the crank or the appropriate tool.

Characteristics:

- Profile selectable 120/100 mm or 80/80 mm
- height adjustable using external slide
- **Mains voltage with pulley mechanism**
- 6-point suspension possible
- for network tension cable lengths from 11.20 to max. 12.00m
- Posts made of black powder-coated aluminum
- pulley mechanism located inside in a closed Aluminum profile

Our volleyball leisure “Pro” system can be used as standard for the following sports
(Heights from 107-260 cm):

- 2.43m height = volleyball men
- 2.35m height = volleyball mixed and male youth U18
- 2.24m height = volleyball women and men youth U16
- 2.20m height = volleyball female youth U16 and students up to 14 years and foot volley
- 2.02m height = fistball max.
- 1.85m height = India approx
- 1.78m height = fistball min.
- 1.55m height = badminton
- 1.07m height = tennis



Art.-no. product specification

Volleyball Leisure and school „Pro“ black powder coating

1050205	Volleyball leisure and school „Pro“, 120/100 mm
1050206	Volleyball leisure and school „Pro“, 80/80 mm
4800310	Lower price in aluminium blank
4800305	Surcharge for powder coating in a RAL colour of your choice

VOLLEYBALL LEISURE AND SCHOOL „Basic“

according to DIN 1271 CLASS C

Volleyball Leisure and school „Basic“ with threaded spindle

Characteristics:

- Profile selectable 120/100 mm or 80/80 mm
- Height adjustable using external slider
- **Mains voltage via threaded spindle and crank**
- for network tension cable lengths from 11.20 m to max. 12.00 m
- 6-point suspension possible
- Posts made of black powder-coated aluminum

Our volleyball leisure “Basic” facility can be used as standard for the following sports can be used (heights from 107-260 cm):

- 2.43m height = volleyball men
- 2.35m height = volleyball mixed and male youth U18 years
- 2.24m height = volleyball women and men youth U16
- 2.20m height = volleyball female youth U16 and students up to 14 years and foot volley
- 2.02m height = fistball max.
- 1.85m height = India approx
- 1.78m height = fistball min.
- 1.55m height = badminton
- 1.07m height = tennis



Art.-no. product specification

Volleyball Leisure and school „Basic“

1050201	Volleyball leisure facility „Basic“, 120/100 mm
1050202	Volleyball leisure facility „Basic“, 80/80 mm
4800305	Surcharge for powder coating in a RAL colour of your choice
4800310	Lower price in aluminium blank
4900269	Replacement crank for volleyball leisure facility “Basic”

VOLLEYBALL „INTEGRAL“

according to DIN 1271 CLASS C AND DW1



- according to DIN EN 1271 and DW 1
- made of sturdy special aluminum profile
- 98x142mm sail mast profile
- matt silver anodized
- Net height infinitely adjustable
- Safety tensioning device integrated into the post
- particularly robust



Profil 98x142

Available in two versions.

Art.-no. product specification

Volleyball net posts „Integral, DW 1“

4901045	Volleyball construction DW 1
4901046	Volleyball construction BW-Standard multipurpose (z.B. volleyball, tennis, badminton, fistball)
4900233	Standard ground socket without lid, 98x142 mm, for DW I
4900280	Spezial ground socket, 98x142 mm, for DW I

VOLLEYBALL CONSTRUCTION „STEEL LINE“



Volleyball „Steel Line“ with steel net

Volleyball „Steel Line“

- Posts made of sturdy, hot-dip galvanized steel
- 150 x 150 mm
- Net height 2.43 m
- very robust system
- Standard steel ground sockets
- without a network (we recommend a Dralo net-

art.-no. product specification

Volleyball construction „Steel Line“

4901074	Volleyball construction „Steel Line“
4901183	Standard ground socket Stahl verzinkt, 450 mm
4901186	Standard Beach-Bodenhülse, 900 mm

VINDICO TIP:

We recommend using a steel net for the “Steel Line” volleyball system. This makes the system almost vandal-proof.



Art.-no. product specification

Steel volleyball net

4640741	Dralo-Volleyball net, made of galvanised steel wire ropes 2mm, MW 100 mm, net size 1,00 x 9,50 m
---------	--

VOLLEYBALL BASE FRAME „MOBILE“



- mobile base frame for volleyball posts
- for 80x80 mm posts
- weighted to prevent tipping, weight 120 kg
- Steel base frame, coated green
- particularly stable and stable
- side drum wheels
- can be used outdoors as well as indoors

DANGER:

Delivery without volleyball posts. We recommend Volleyball facility “Pro”, item # 1050206



Art.-no. product specification

Volleyball „Mobile“

1050210	mobile pedestal (1 pair) for 80/80 mm
---------	---------------------------------------

VOLLEYBALL „ACCESSORIES“

Volleyball ground sleeves with inclination

Our special sleeves come with an inclination Factory-made

Art.-no. product specification

Ground socket

1050395	standard ground socket 120/100 mm, length 35 cm
1050451	special ground socket 120/100 mm, length 35 cm
1070070	standard ground socket 80/80 mm, length 35 cm
1070151	special ground socket 80/80 mm, length 35 cm



Standard socket



Spezial socket Oval

Volleyball Net / Antenna

Art.-no. product specification

Net

4850133	volleyball net „spare time“, 3 mm, colour: black
4850143	volleyball net „competition“, 4 mm, colour: black

Antenna

4600502	volleyball antenna made of fibre glass, one piece with holding pocket, length 1,80 m
4800099	volleyball antenna made of fibre glass, two pieces with holding pocket



Abb. Volleyballnetz „Comp.“



Volleyballantenne

Dralo net

4640742	dralo volleyball net made of galvanised steel cable with pvc cover 1,8 / 2,5 mm, green
---------	--



Volleyball Dralonetz



Volleyball Stahlnetz

Steel volleyball net

4640741	Dralo-Volleyball net made of galvanised steel wire ropes 2mm, MW 100 mm, net size 1,00 x 9,50 m
---------	---

Safety pad & Net hanger

art.-no. product specification

Safety pad

4321100	Safety pad Ø 80 mm inside, 200 cm, 20 mm wall thickness
4321000	Safety pad Ø 120 mm inside, 200 cm, 50 mm wall thickness

Net hanger

4600530	Net hanger for rolling up the volleyball nets
---------	---



Schutzpolster



Netzbügel

BASKETBALL „MADE OF ALUMINIUM“



Baskets are bolted to the target board and target board bracket. This prevents the baskets from moving out and the target boards from breaking.

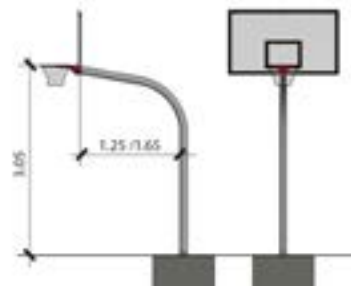

Basketball construction made of Aluminium „Edgy Version“

- Made of Aluminium
- mast made of 120/100 mm profile, wall thickness 4/6 mm
- Basketball backboard with aluminium base frame
- Basket connected to display mast and base frame
- GRP target board 180x105 cm incl.
- Red basketball hoop & nylon net incl.

Basketball construction made of Aluminium „Curved Version“

- Made of Aluminium
- mast made of 120/100 mm profile, wall thickness 4/6 mm
- Basketball backboard with aluminium base frame
- Basket connected to display mast and base frame
- GRP target board 180x105 cm incl.
- Red basketball hoop & nylon net incl.

Art.-no. product specification

Art.-no.	product specification
Basketball construction aluminium rectangular	
2004012	1- mast, display 1,25 m
2004013	1- mast, display 1,65 m
2004022	2- mast, display 1,65 m
2004023	2- mast, display 2,25 m

Art.-no. product specification

Art.-no.	product specification
Basketball construction Aluminium curved	
2004010	1- mast, display 1,25 m
2004011	1- mast, display 1,65 m
2004020	2- mast, display 1,65 m
2004021	2- mast, display 2,25 m



Basketball 1-Mast, edgy



Basketball 2-Mast, edgy



Basketball 2-Mast, curved



Basketball 1-Mast, curved

BASKETBALL „SCHOOL“

Aluminum basketball „School“

- Aluminium system
- Standing posts made of oval profile 120/100 mm, Wall thickness 4/6mm profile
- Backboard with aluminum base frame
- Basket connected to display pole and base frame
- incl. GRP backboard 120x90 cm
- Includes red basketball hoop & nylon net



fig.
50cm
Display



fig.
without
Display



Basketball practice facility with 50 cm display, height-adjustable screwed onto the foundation

Art.-no.	product specification
Basketball construction aluminium training	
2004061	50 cm display, 305 cm
2004063	50 cm display, heightadjustable 260 - 305 cm
2004060	no display, 305 cm
2004062	no display, heightadjustable 260 - 305 cm

BASKETBALL „STEEL LINE“

- Basketball stand made of steel, 1-mast
- Backboard incl.
- screwed on bolted frame, which has to be embedded in concrete
- post and display made of galvanised steel tube
- incl. backboard 180x105 cm, made of GRP, with hoop made of powder-coated steel in orange and net made of nylon
- without bolted frame for mounting

Art.-no.	product specification
Basketball stand „Steel-Line“	
4001015	Display 165 cm
4001016	Display 225 cm
4001017	Screwed frame for embedding in concrete, with internal thread
4001018	extended version (60 cm)



screwedframe



BASKETBALL MADE OF STEEL

„HULK“ 150x150x4MM



Basketball „Hulk“ Single, Display 2,25m



Fig. „Hulk“ Duo



Fig. „Hulk“ Quattro

Basketball construction made of steel

„Hulk“ 150x150x4mm

- According to DIN EN 7899 and DIN EN 1270
- 150x150 mm facilities more solid and even more robust!
- Hoop heights variably adjustable
- Displays 120, 165 and 225 cm are possible

New and exclusive:

Internal, covered clamping device (for systems in ground sleeves)

- lift-out safe
- low-noise

incl. safety backboard made of steel grid, with mesh width 60x8 mm with surrounding steel frame

- torsion-resistant
- absolutely low-noise
- very good playability
- Basketball facility made of hot-dip galvanized steel
- hoop heights variably adjustable
- safe against vandalism
- noise reduced thanks to back board made of steel grid (ball contact area is very small)
- backboard made of hot-dip galvanized wire mesh, 120 x 90 cm
- hoop made of hot-dip galvanized solid steel, incl. galvanized chain net
- can be mounted in ground socket or with dowelling
- delivery incl. ground socket (length 60 cm, ET 50 cm) or welded flange plate

Art.-no. product specification

Basketball „Hulk“ Single

4901116	Display 1,20 m, 150x150x4mm, in ground socket
4901117	Display 1,20 m, 150x150x4mm, for dowelling
4901118	Display 1,65 m, 150x150x4mm, in ground socket
4901119	Display 1,65 m, 150x150x4mm, for dowelling
4901120	Display 2,25 m, 150x150x4mm, in ground socket
4901121	Display 2,25 m, 150x150x4mm, for dwelling

Basketball „Hulk“ Duo

4901122	Display 1,20/1,20m, 150x150x4mm, in ground socket
4901123	Display 1,20/1,20m, 150x150x4mm, for dowelling
4901124	Display 1,65/1,65m, 150x150x4mm, in ground socket
4901125	Display 1,65/1,65m, 150x150x4mm, for dowelling

Basketball „Hulk“ Quattro

4901126	Display 4x1,20m, 150x150x4mm, in ground socket
4901127	Display 4x1,20m, 150x150x4mm, for dowelling
4901128	Display 4x1,65m, 150x150x4mm, in ground socket
4901129	Display 4x1,65m, 150x150x4mm, for dowelling

BASKETBALL MADE OF STEEL

„HOOLIGAN“ 100x100x3MM



Basketball construction made of steel
„Hooligan“ 100x100x3mm

- according to DIN EN 7899 and DIN EN 1270
- 150x150 mm facilities more solid and even more robust!
- Hoop heights variably adjustable
- Displays 120 and 165 cm are possible

New and exclusive:

Internal, covered clamping device (for systems in ground sleeves)

- lift-out safe
- low-noise

incl. safety backboard made of steel grid, with mesh width 60x8 mm with surrounding steel frame

- torsion-resistant
- absolutely low-noise
- very good playability
- Basketball facility made of hot-dip galvanized steel
- Hoop heights variably adjustable
- Safe against vandalism
- Noise reduced thanks to back board made of steel grid (ball contact area is very small)
- Backboard made of hot-dip galvanized wire mesh, 120 x 90 cm
- Hoop made of hot-dip galvanized solid steel, incl. galvanized chain net
- Can be mounted in ground socket or with dowelling
- Delivery incl. ground socket (length 60 cm, ET 50 cm) or welded flange plate



Abb. Basketball „Hooligan“ Duo

art.-no. product specification

Basketball „Hooligan“ Single

4901110	Display 1,20 m, 100x100x3mm, in ground socket
4901111	Display 1,20 m, 100x100x3mm, for dowelling
4901112	Display 1,65 m, 100x100x3mm, in ground socket
4901113	Display 1,65 m, 100x100x3mm, for dowelling

Basketball „Hooligan“ Duo

4901114	Display 1,20/1,20m, 100x100x3mm, in ground socket
4901115	Display 1,20/1,20m, 100x100x3mm, for dowelling



Basketball „Hooligan“ Single, with Aluminium backboard



Advantages basketball facility „Holligan“ and „Hulk“

- Internal clamping device (ground socket)
- Low-noise backboard with small mesh width
- Flexible height adjustment through clamping screws
- Backboard with pre-assembly help



Vermontage-Hilfe



BASKETBALL WALL CONSTRUCTION

Basketball „Wall construction“ made of aluminium

- Wall construction made of aluminium
- Rigid or height adjustable
- incl. target board 120 x 90 cm
- including hoop and nylon net
- excl. fixing screws and dowels

Art.-no.	product specification
Basketball wall construction	
2004050	Wall construction, 50 cm display
2004051	Wall construction, 50 cm display, height adjustable



BASKETBALL „MOBILE“



Art.-no.	product specification
Basketball made of aluminium „Mobile“	
2004040	Basketball stand mobile (without weight, without lift roller)
4000061	Safety pad for basketball stand mobile
4004040	Lift roller for mobile basketball stand

- Display 1.65 m, foldable
- Backboard made of GRP 180x105cm
- incl. Basketballbasket & net
- Backboard can be tilted when not in use or when there is a risk of storms
- easy to move with lifting roller

Anti-tip protection is provided with 12 discount stones 100/25/8 cm or 5 high curb stones 100/30/15 cm. (Weights not included)

BASKETBALL „ACCESSORIES“

Accessories for basketball steel construction „Hooligan and Hulk“

Art.-no.	product specification
Accessories	
4901178	Safety pad for 100x100 mm post
4901179	Safety pad for 150x150 mm post
4901182	Ground socket 100x100 mm post
4901184	Ground socket 150x150 mm post
4001017	Screw frame for embedding in concrete with internal thread
4901148	Additional for backboard height adjustment for „Hulk“ systems



Screw frame



Welded-on base plate for screwing on the stand column

Basketball Backboards

Art.-no.	product specification
Backboards	
4901130	backboard 120 x 90 cm, made of GRP with reinforcement
4901153	backboard 180 x 105 cm, made of GRP with reinforcement
4004061	aluminium backboard, aluminium blank, 120 x 90 cm
4004062	aluminium backboard, aluminium blank, 180 x 105 cm
4901145	grid backboard 120 x 90 cm, MW 40/40 mm
4901175	grid backboard 180 x 105 cm, MW 40/40 mm
4901146	grid backboard 120x90 cm, MW 60x8 mm
4901147	grid backboard 180x105 cm, MW 60x8 mm
4004075	backboard 120 x 90 cm, macrolon transparent
4004052	backboard 180 x 105 cm, macrolon transparent

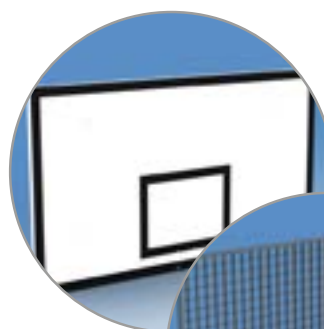

backboard 180 x 105 cm, made of GRP with reinforcement

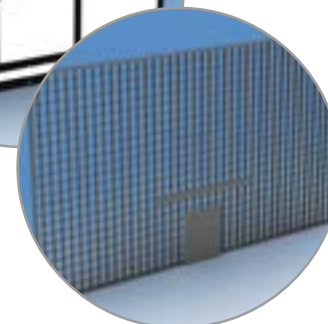

Grid target board MW 40/40mm

Basketball net

Art.-no.	product specification
Basketball net	
4001041	chain net, galvanised, 12 point suspension
4061201	basketball net made of nylon, 12 point suspension
4046771	basketball net vandalism-proof „Herkules“ steel insertion 5 mm



Basketball net „vandalism-proof“

BASKETBALL „ACCESSORIES“



Basketball hoop, red powder coated



Basketball hoop, hot-dip galvanised, reinforced

Hoops with DIN hole pattern 11x9cm / DIN EN 1270

art.-no.	productspecification
----------	----------------------

Hoops with DIN hole pattern	
-----------------------------	--

4001012	Basketball hoop, orange powder coated, reinforced
4001025	Basketball hoop, steel powder coated, foldable, 105 kg
4001013	Basketball hoop, hot-dip galvanised, reinforced, with 12 point chain net fastening



Spezial ground sockets, 2-mast

Ground sockets

Art.-no.	product specification
----------	-----------------------

Basketball ground sockets	
---------------------------	--

1100470	Standard ground sockets, 120 x 100 mm, 1-mast
1100472	Standard ground sockets, 120 x 100 mm, 2-mast
1100480	Special ground sockets, 120 x 100 mm, 1-mast
1100482	Special ground sockets, 120 x 100 mm, 2-mast



Basketball, Safety Pad

Basketball Safety Pad

- Protective padding with continuous Velcro tab
- Height 200 cm
- 50 mm wall thickness
- completely sewn into tarpaulin fabric

Art.-no.	product specification
----------	-----------------------

Safety pad	
------------	--

4000060	Safety pad, height 200 cm, 50mm strong, for oval profile
4901178	Safety pad for 100x100 mm post
4901179	Safety pad for 150x150 mm post



Height adjustment

Our basketball facilities can optionally be equipped with a separate one, Construction for height adjustment can be delivered.

The board can be infinitely adjusted in the basket height range from 260 to 305 cm using a self-locking threaded rod. The height is adjusted from the ground using a removable crank (one crank per two systems included).

Solid aluminum construction, guides using Plastic liners.

Art.-no.	product specification
----------	-----------------------

Height adjustment	
-------------------	--

1100245	Surcharge for height-adjustable target board, 305 - 260 cm
---------	--

TENNIS

POSTS, NET AND ACCESSORIES

Tennis post

- tennis post made of 80x80 mm
- aluminium special profile
- interior clamping unit
- exterior net pole
- inclusive crank

art.-no. productspecification

Tennis post

4080080	Tennis post, aluminium blank
4080081	Tennis post, white powder coated
4080082	Tennis post, green powder coated
4080083	Tennis post, black powder coated

Ground socket tennis

2006000	Standard ground socket tennis
2006001	Special ground socket tennis

art.-no. productspecification

Tennis net

4121353	tennis net with double rows PET tennis net made of a 3 mm strong polyethylene rope, with 5 continuous double rows (hand made). colour black
4121403	tennis net without double rows, 4 mm, PP very strong, knotless tennis net for the highest claims, in a proven knotless technology made of polypropylene ca. 4 mm strong, all around edged colour black



Tennis post

Tennis post inner parts

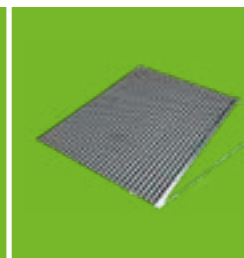
Tennis Lining
Art.No. 4040365Ground anchor sleeve-
Art.No. 4040760Belt strap with
plastic clip
Art.No. 4040720Umpire chair
Art.No. 4040800Sand Smoother
Art.Nr. 4040081Drag net
Art.No. 4410301

Art.-no. product specification

Tennis net accessories

4040760	Aluminum ground anchor recessed sleeve for regulating tape
4040720	Webbing made of high-quality nylon fabric Plastic buckle, Velcro fastener and Carabiner hook
2006002	Single aluminum support
4040721	Net weight

Art.-no. product specification

Accessories for the place

4040365	Tennis lining special made of flexible hard PVC profile. 4 mm wide cross slots at 28 mm intervals, anchoring with 18 ground dowels (included), complete set for a tennis court Color white
4040800	Referee chair made of aluminum according to DIN EN 131 Anchoring with 18 ground dowels (included) Stable thanks to stable rung ladder UV-resistant, red plastic bucket seat
4040081	Aluminum sand smoother for tennis courts, 150 cm wide, without stem
4410301	Aluminum trawl net special simple, 200 cm wide, 150 cm deep



PICKLEBALL

Pickleball is a ball sport that combines elements of badminton, tennis and table tennis.

The sport originated in the USA. The differences to the three other ball sports lie in the size of the court, the speed of the ball and the flow of the game. The game was originally played with a wooden racket, but now with plastic rackets. The plastic play balls are perforated.

The size of the playing field corresponds to that of the badminton court (13.40 x 6.10 m). The game is played with 2 or 4 people. The facilities comply with the specifications of the U.S.A.P.A (USA Pickleball Association) and the specifications of the German Pickleball Association (DPB).

Pickleball „Simple“



- high-quality aluminum profiles and wide feet
- Mains tensioning system for optimal mains voltage
- including center rod
- quick assembly
- can be stowed away to save space
- weight of only 6,8kg allows an easy transport
- consisting of five slightly curved, pluggable connecting elements
- Net posts are attached to the standing feet
- Delivery including network

Technical data:

- Foot width: 60 cm
- Connecting element individually: 138cm x 4cm x 3cm
- Total length: 670 cm
- Height: approx. 86.5 cm
- Weight: 6.8kg

Art.-no. product specification

Pickleball „Simple“

4404231 Pickleball „Simple“

4404238 Replacement net for pickleball „Simple“ with side insertion tabs, 670 x 80 cm

Pickleball „Pro“



- Heavy mobile tournament system “Made in Germany”
- Aluminum frame made of 80x80 mm profile
- completely black powder-coated
- with clamping mechanism (internal) for adjusting the desired height
- two diagonal supports for optimal stability
- Easy webbing attachment to the existing hanging loop
- Standard dimensions 670 x 86.5cm

Technical data:

- Profile: 80x80 mm
- Color: Black
- Weight: approx. 100 kg
- Post height: approx. 93 cm
- Total length: approx. 681 cm

Pickleball net “Pro”:

- approx. 3 mm PE braided line
- hand-knotted
- black
- Double mesh enclosure
- black plastic surround
- Incl. two fiberglass rods

Art.-no. product specification

Pickleball „Pro“

4404233 Pickleball „Pro“

4404230 Net for Pickleball „Pro“

BADMINTON „SIMPLE“

Badminton post „Simple“

- Badminton post made of aluminium oval profile 120 / 100 mm
- Simple, manual exterior adjustment
- Tension height 1,55 cm

Art.-no.	product specification
Badminton post „Simple“	
2060080	Badminton post „Simple“
1050396	Standard ground socket badminton „Simple“
4602076	Badminton net „Competition“



RUGBY GOAL

Rugby goal

- Rugby goal fully made of aluminium
- With internal reinforcement
- White or aluminium blank
- Surcharge for wind vane
- 5,6 m internal dimension
- 3,0 m crossbar height

Art.-no.	product specification
Rugby goal	
2700000	Rugby goal 8,5 m
2700001	Rugby goal 8,5 m, white powder coated
2700002	Rugby goal 12,0 m
2700003	Rugbytor 12,0 m, white powder coated
2700004	wind vane, positioned on a post
4000060	Safety pad



AMERICAN FOOTBALL GOAL „STEEL SWIVELLING“

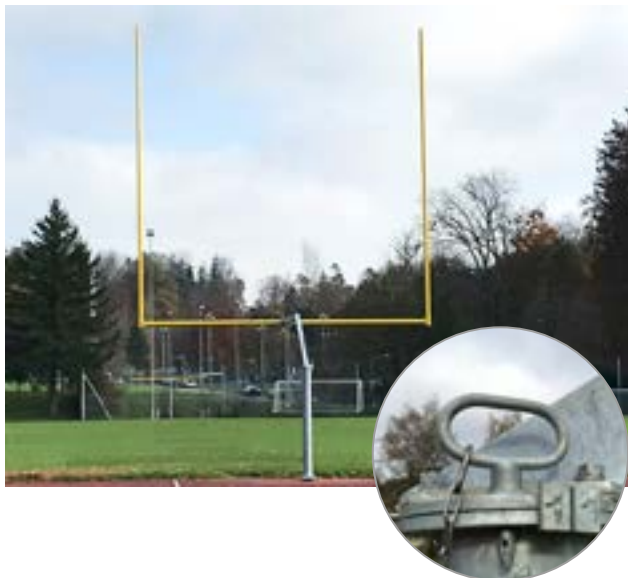
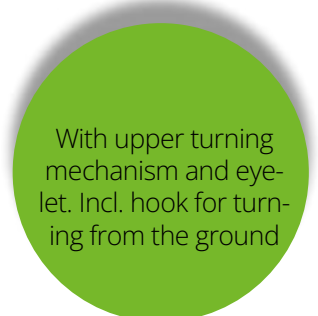

**American Football Goal
„Steel and swivel“**

- Upright and cross tube made of galvanised steel, $\varnothing 168.3$ mm
- Cross tube made of galvanised steel 80/120 mm, wet-laquered
- Uprights made of aluminium round tubes $\varnothing 75$ mm, wet-laquered in RAL colour (on request)
- Distance between the uprights 5.64 m, maximum height of the uprights 13.716 m
- Height of upper edge of cross tube 305 cm
- Display variable, up to max. 4.00 m -
- Football goal assembled or not assembled

Art.-no. product specification

American Football goal	
2701100	American Football goal made of steel, swivelling
2701101	Screwed frame to set in concrete for American football goal posts

AMERICAN FOOTBALL „ALUMINIUM AND STEEL“



American Football goal of „rigid aluminium“

- Posts made of solid aluminium oval profile
- Dismountable (mast, crossbar and uprights)
- Complete device in blank aluminium (uprights can also be powder-coated with surcharge)
- Total height 9,00 m from ground
- Crossbar width 5,64 m (inside dimension)
- Display 1,50 m, angular

Art.-no. product specification

American Football goal	
2701002	American Football goal, 9,00 m height, aluminium blank, angular
2701001	Safety pad for football goal
2700004	wind vane, positioned on a post

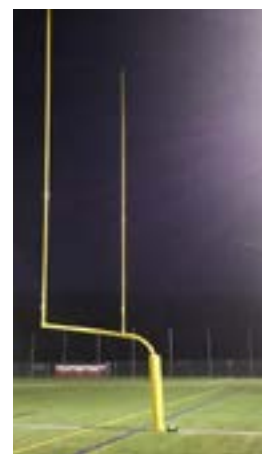

American Football goal of „rigid aluminium“

- American football goal made of aluminium
- According to NFL guidelines 2016
- Rounded pole
- Uprights in yellow
- Overall height 13,716 m

Art.-no. product specification

American Football goal	
2701000	American Football goal, 13,716 m height, steel round tubes, yellow
2701001	Safety pad for football goal
2700004	wind vane, positioned on a post

BASEBALL

VINDICO Sport has a wide range of baseball field equipment in its delivery range.

This includes: bases, double base (softball), home plates, pitcher plates, batting cages.

L-screens with and without rotating top part, screen for infield / outfield, backstop nets (ball catchers)

Foul poles (vertical marking foul lines) and dugout (players' bench).

You can find more information on our homepage: www.vindico-sport.de

- Bases set of 3
- Size 15 inches (38x38 cm)
- Heavy duty molded rubber cover with quilted pattern
- thick, foam-padded core
- Bottom with metal base
- including small square ground sleeve and sealing plug
- Professional style anchor system



Art.-no. product specification

Baseball Bases

4009000 Bases, Set of 3, including steel base and sleeve

- Softball double first base
- White-orange cover
- Rubber cover, one-piece construction
- Heavy duty molded rubber cover with quilted pattern
- thick, foam-padded core
- Incl. double bottom sleeve with sealing plug
- Anchor system with removable rubber insert



Art.-no. product specification

Softball Double First Bases

4009005 Doublebases, incl. double sleeve

- white homeplate rubber plate with beveled edge
- Underside with recessed threaded sockets for spikes
- Delivery includes three spikes made of nickel-plated steel
- Length 17 inches (43.18 cm)
- Side edge 8 ½ inches (21.5 cm)
- Pointed sides 12 inches (30.5 cm) each



Art.-no. product specification

Homeplate

4009001 Homeplate incl. three massive spikes

- Pitcher plate rubber plate
- Single white area
- Underside with recessed threaded sockets for spikes
- Delivery includes three spikes made of nickel-plated steel
- Size: 61x15 cm

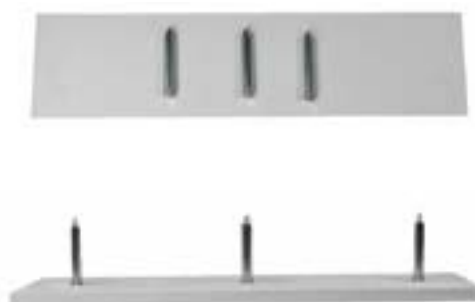

Art.-no. product specification

Pitcherplate

4009003 Pitcher plate including three massive spikes

TABLE TENNIS

Design

Table plate and base made of reinforced concrete, smooth and impregnated, incl. 4 set screws for level compensation and threaded sleeves for net type 3.

Construction

Table plate and base are produced in one element

Dimensions (LxWxH) and weight

274 x 152.5 x 73 cm, approx. 900 kg

Feet diameter 10 cm



Table tennis table Type 1

- color concrete grey
- Surface formwork smooth
- without table tennis field marking
- Weight: 900 kg

Table tennis table Type 1R

- Color concrete grey
- Corners rounded, radius 6.8 cm
- Surface formwork smooth
- Without table tennis field marking
- Weight: 900 kg

Art.-no.	product specification
Table tennis table Type 1	
3006001	Table tennis table Type 1
3006011	Table tennis table Type 1R



Fig. Typ 1A corners square

Table tennis table Type 1A

- Color concrete grey
- Surface formwork smooth
- With painted on table tennis field marking in black
- Weight: 900 kg

Table tennis table Type 1AR

- Color concrete grey
- Corners rounded, radius 6.8 cm
- Surface formwork smooth
- With painted on table tennis field marking in black
- Weight: 900 kg

Art.-no.	product specification
Table tennis table type 1A	
3006008	Table tennis table Type 1A
3006018	Table tennis table Type 1AR



Fig. Typ 1AR corners round

TABLE TENNIS

Table tennis type 2 - 4, surface made of synthetic resin, with white playing field markings, weight 900 kg

Table tennis table type 2

- Color green
- Surface synthetic resin board

Table tennis table type 2R

- Color green
- Corners rounded, radius 6.8 cm

Art.-no. product specification

Table tennis table Type 2

3006006	Table tennis table Type 2
3006016	Table tennis table Type 2R



Table tennis table type 3

- Color blue
- Surface synthetic resin board

Table tennis table type 3R

- Color blue
- Corners rounded, radius 6.8 cm

Art.-no. product specification

Table tennis table Type 3

3006007	Table tennis table Type 3
3006017	Table tennis table Type 3R



Table tennis table type 4

- Color anthracite
- Surface synthetic resin board

Table tennis table type 4R

- Color anthracite
- Corners rounded, radius 6.8 cm

Art.-no. product specification

Table tennis table Type 4

3006009	Table tennis table Type 4
3006019	Table tennis table Type 4R



Metall net type 3

- Table thickness from min. 50mm
- Aluminium
- Grey, aluminium coloured
- For screwing into existing threaded sleeves
- Weight 3,6 kg
- Very robust design

Art.-no. product specification

Table tennis net

3006004	Net Type 3
---------	------------



SOCCERCOURTS



SOCCERCOURT „PANNA FIELD“



The rectangular "Panna Field" has been developed in close cooperation with Nike. It requires great tactical and technical skills to handle the football inside the boundary of the playing field. Furthermore, the "Panna Field" is vandalism-proof and made out of sturdy, galvanized steel and lattice materials – assuring low maintenance requirements.

The cost-effective playing field can be used for a large variety of different sports and be installed on asphalt or concrete. In addition, it is possible to lay up 50x50 cm large floor panels. It is also possible to install the "Panna Field" on artificial turf using concrete sockets.

Advantages

- joy of playing for a low price
- cool design (developed with NIKE)

Application possibilities

- educational institutions
- Educational institutions
- sport clubs
- playground operators
- public places

Execution

- „Panna Field“ 4 x 6 m, required area: 7 x 4,3m
- „Panna Field“ 10 x 7 m, required area: 11 x 7,3m
- „Panna Field“ 13 x 9 m, required area: 14 x 9,3m
- dimensions according to your choice (using standard elements)

Material

- steel, hot galvanised (can be powder coated on request)

Colours

- Stand: standard RAL 9005 black
- Grid and goals: hot galvanised (can be powder coated on request)

art.-no. productspecification

Soccercourt
„Panna Field“

4006007	Size 4,00 x 6,00 m
4006008	Size 10,00 x 7,00 m
4006009	Size 13,00 x 9,00 m

MINI PITCH „FAST PLAY“



... FUN & ACTION ON THE SMALLEST AREA!

“Fast Play” is the ultimate sports device for schools or public places. No matter whether the small playing field is used by schools, companies, clubs or hotels – the fast game is fun for players and spectators alike. The compact football field is ideal for 1 on 1 or 2 on 2 plays.

Soccer Court „Fast Play“

- Height 2,30 m incl. nets mesh size 100mm
- Individual segments with 1 m high impact-resistant white plastic panels
- Plastic nets are suspended in the upper area in special aluminium profiles
- 2 opposite segments with goals 1m x 0.5 m x 0.5 m and nets
- 1 segment with an access door
- Optional 20 cm high, integrated advertising white KU board with aluminium substructure
- Optional also with ceiling net

Art.-no.	product specification
Soccer Court „Fast Play“	
4909300	approx. 5,00 m diameter (10-teilig)
4909301	approx. 6,00 m diameter (12-teilig)

MINI PITCH „ARENA PLAY“



Mini pitch „Arena Play“

suitable for all age groups in sports clubs, schools, leisure facilities, hotels, social and cultural facilities as well as on public squares and in business areas.

Soccer Court „Arena Play“

- robust, permanent perimeter system in octagonal shape - weatherproof and low-noise
- approx. 6.5m diameter, suitable for „1-against-1“ or „2-against-2“
- basic construction made of corrosion-free aluminium
- fixing straps on the intermediate posts (for ground anchoring)
- construction according to DIN EN 15312
- 2 mini-goals 1.0 x 0.5 x 0.5 m, incl. high-quality goal nets
- 1 segment with an access door
- the boards are perfect as advertising space for sponsoring

Art.-no.	product specification
Soccer Court „Arena Play“	
4901401	Court „Arena Play“
4901402	Surcharge for surrounding net, height 3m, mesh width 100 mm
4901403	Surcharge for surrounding net, height 3m, mesh width 45 mm
4901404	Surcharge for ceiling net, mesh width 120 mm

SOCCER COURT „SIMPLE LINE“



All pitch sizes possible, contact us!



Soccercourt „Simple Line“

- Version 1: detached inclusive weights
- Version 2: in included ground sockets
- Version 3: for dowelling onto concrete foundations
- barrier element out of sandwich-panels, Standard white / gray
- with aluminium U-profile edged
- ending riveted
- stand legs made of rectangular profile 80x80x3 mm with display
- hand railing made of 50x50x3 mm with slot
- goal size 3,00 x 2,00 m, access dors on the side of the goals
- alternative goal sizes:
5,00 x 2,00 m / 1,80 x 1,20 m / 1,20 x 0,80 m
- ball catching nets all around is a possibility
- With perimeter advertising on request (club/company logo, sponsors)



Art.-no. product specification

Soccercourt „Simple Line“

2050010	Perimeter „Simple Line“, element length 2,50m per rm
2050016	Perimeter „Simple Line“, element length 5,00m per rm
2050310	Goal for soccer court 3,00 x 2,00 m incl. access door
4180188	Net for band goal 3.00 x 2.00 m with door cut-out
2050011	Surcharge for gang in mobile version
2050012	Surcharge for dowel-mounted band per post element
2050013	Ball catcher elevation 1.00m above rail
2050014	Ball catcher elevation 2,00m above rail
2050015	Ball catcher elevation 3,00m above rail
2050017	Gangaccess door 1,00m
2050018	Hinge door 2,50 m, 1-flüglig
2050019	Perimeter service door, 4,00 m, 2-winged



SOCCER COURT „SIMPLE LINE STRONG“



Perimeter court „Simple Line Strong“

- Highest quality, stability and durability
- Almost indestructible construction
- Permanent installation at one location
- Extended posts, firmly anchored in the ground by means of foundations
- incl. elaboration of a plan for the foundations that exactly matches the project
- Robust, weatherproof, low-noise
- Many optional extras for example, ceiling protection nets, basketball, volleyball, ...

Basic equipment

- Closed, surrounding perimeter board system, approx. 100 cm high and approx. 4 cm thick
- Perimeter boards made in sandwich construction with steel-covered PU hard foam (one side green, one side grey/white)
- Basic construction made of corrosion-free aluminium
- Optional: aluminium ball catching fence above the perimeter boards, instead of nets
- Fully welded tubular mesh goals with one side-access door per goal
- Distance between the ball catching tubes according to the latest standards: 85 mm

Art.-no.	product specification
Soccer Court „Simple Line Strong“	
4901101	Perimeter 10x7 m, with 2,40 x 1,60 m-goals (1 m deep)
4901102	Perimeter 14x7 m, with 2,40 x 1,60 m-goals (1 m deep)
4901103	Perimeter 15x10 m, with 3,00 x 2,00 m-goals (1 m deep)
4901104	Perimeter 20x13 m, with 3,00 x 2,00 m-goals (1 m deep)
4901105	Perimeter 25x14 m, with 4,00 x 2,00 m-goals (1 m deep)
4901106	Perimeter 30 x 15 m, with 3,00 x 2,00 m-goals (1 m deep)
4901107	Perimeter 30 x 15 m, with 4,00 x 2,00 m-goals (1 m deep)
4901108	Perimeter 40 x 20 m, with 3,00 x 2,00 m-goals (1 m deep)
4901075	Surcharge surrounding aluminium fence, total height 3m
4901076	Surcharge surrounding aluminium fence, total height 4m
4901077	Surcharge for end aluminium fence, total height 3m
4901078	Surcharge for front aluminium fence, total height 4m

SOCCER COURT „PRO LINE“

All pitch sizes possible, contact

Soccercourt „Pro Line“

- Perimeter element out of HPL-panels, standard colour is white (other colours are possible)
- Perimeter element length 2,50 m
- construction made of aluminium
- stand legs out of 80 x 80 x 3 mm
- hand rail profile 80 x 80 x 3 mm with internal slot, only on the ball catching version
- goal size 3,00 x 2,00 m, access doors on the side of the goals
- alternative goal sizes:
5,00 x 2,00 m / 1,80 x 1,20 m / 1,20 x 0,80 m
- ball catching net all around is possible
- roof nets are also possible

Art.-no. product specification

Soccercourt „Pro Line“

2005020 Soccer Court „Pro Line“

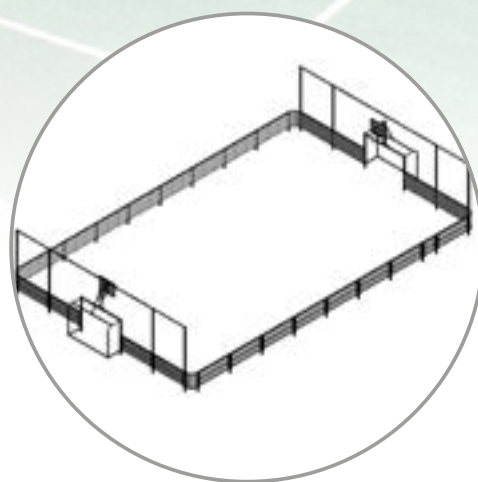

MULTI-PURPOSE FIELDS

„OMNISTADIUM“



TÜV tested and with
noise
protection certificate



Why is this „Omnistadium“ the ultimativ multi-purpose playground?

- Playing in the „Omnistadium“ is a special feeling
- Low noise (noise certificate) by means of noise-reducing grid clamps and a funnel-shaped design, modular construction
- Design your own sports field with appropriate length, width and wall height. Select the sports to be played and the desired design (e.g. colour, background, etc.)
- Durable design: 10 years warranty
- Suitable options for small and large budgets
- Vibration-free pressed grids, no use of rubber material, use of grid clamps and shear bolts

The „Omnistadium“ is a sports meeting point without ball or noise disturbance and therefore suitable for any location

- Public areas and parks in residential areas or city centers
- Recreational locations
- School yards
- Sport clubs
- Play grounds

Soccer court „Omnistadium“ construction

- Posts of square profile (90x90 mm), hot-dip galvanized / standard coating RAL 9005 (deep black)
- Pressed grids with very high rigidity, hot-dip galvanized, with coating in RAL colour of your choice
- Roof panel grids in thermally galvanized version.

Advantages of this soccer court

- High quality
- Modular construction / different designs are possible
- Noise certificate incl.
- 10 years warranty on the construction



Court A
13,2 x 24,7m
height 1m
art.-no.:
4006001



Court B
13,2 x 24,7m
height 2m
art.-no.:
4006002



Court C
13,2 x 24,7m
height 3m
art.-no.: 4006003



Court D
13,2 x 24,7m
height 3/2/1m
art.-no.:
4006004



Court E
13,2 x 24,7m
height 4m
art.-no.:
4006005



Court F
13,2 x 24,7m
height 4m
with roof
art.-no.:
4006006



MULTI-PURPOSE FIELDS „OMNISTADIUM“



Full rebound and low noise using:

- Vibration-free grid panels
- Noise-damping grid clamps
- Funnel-shaped design

Modular design:

From a small playing field to a complete stadium with various options for sports and games - suitable solutions for small and large budgets



Entrance



Entrance opening



Entrance opening



Entrance opening





Soccercourt „Hard Line“

Usage:

The robust, low-noise concrete elements are to be favored in public areas due to the high requirements (vandalism). The elements can be placed on top of existing floor coverings

Finish:

- Reinforced concrete, concrete grey, smooth formwork or sandblasted
- Ball catching posts and cross struts made of aluminium profiles
- Polypropylene ball catching net
- Goals integrated in the perimeter elements, 3.00 x 2.00m with side-access doors
- Size selectable according to your requirements



Art.-no. product specification

Soccercourt „Hard Line“

3700600

Soccer Court „Hard Line“

PADEL COURT „SERIE B“

Two different court types. "Basic" and "Pano".

In the color of your choice, RAL6005 green, RAL5017 blue, RAL7016 dark gray, RAL9004 black
Individual accessories such as floodlights, access doors, benches, game displays, etc. are available

All padel courts have the following features:

- Corners of the overall construction are decorated with panels
- CE certificate EN-1090
- Dimensions: 20 x 10 x 3/4 meters (LxWxH)
- large open entrances in the middle of the square according to WPT
- all connecting parts are made of stainless A4 steel
- the entire construction is made of carbon steel S235JRH (EN 10219)
- All steel parts are completely hot-dip galvanized
- Grid frame made of 40x40x2 mm tube, with 48x48x4 mm wire mesh, reinforced with 40x40x2 mm tubes
- electro-welded wire mesh, flush with the glass (no edges)
- open entrances according to type WPT (World Padel Tour)
- electrostatic coating using thermoset polyester paint
- Delivery including net posts and a competition net of the highest quality

Hardened glass:

Complies with the standards of the International Padel Federation.

Tempered glass (EN 12150) with 10 or 12 mm thickness (12 mm for Pano-Court) with flat polished edge, perfect planimetry and full homology.



Padel Court Typ „Basic“

The Padel Court "Basic" is a high-quality basic court. The court is made of high quality materials and is designed for official competitions.

Construction consists of tubular steel frame (120x80mm). Rear support posts made of 80 x 80 x 2 mm



Art.-no. product specification

Padel Court „Basic“

3700600 Padel Court „Basic“ (without glass)

Padel Court Typ „Pano“

Impressive panoramic court, especially for professional players. Unbeatably aesthetic design that widens the viewer's perspective. The Pano type requires 12mm glazing. The construction consists of a tubular steel frame (120x80mm). The frame of the Pano glass is made of steel tubes 120x60x2 mm.



Art.-no. product specification

Padel Court „Pano“

4003210 Padel Court „Pano“ (without glass)

Comprehensive accessories available for every court:

Art.-no. product specification

Accessories Padel Court

4003211	Surcharge for padel court "Series B" free-standing
4003220	Panes made of safety glass with CE marking, 10mm
4003230	Panes made of safety glass with CE marking, 12mm
4003260	LED lighting club 150W (leisure), 8 pieces per system.
4003265	LED lighting Master 200W (competition), 8 pieces per system.
4003240	Light pole straight shape from 3.00 to 6.00m (4 pieces)
4003241	Light pole, bent shape (V shape) from 3.00 to 6.00m
4003242	Light pole curved shape (C shape) from 3.00 to 6.00m
4003250	Additional charge for double zinc layer, extra zinc primer



ATHLETICS



LONGJUMP

„FOUNDATION TRAY“

Foundation tray „Standard“

- entirely made of aluminum
- beveled on both sides of the contact surface
- Delivery including spacer boards
- WA certified

Art.-no. product specification

Foundation tray „Standard“

1040030	Foundation tray, 122 / 34 / 10 cm
1040070	Foundation tray, 122 / 20 / 10 cm
1040031	Foundation tray, 122 / 30 / 10 cm



Foundation tray „Standard“ 122/34/10

Foundation tray „Height adjustable“

- fully welded from aluminum
- open floor with three walkways
- beveled on both sides of the contact surface
- Delivery including spacer boards
- height adjustable using adjusting screws
- precise adjustment of the height
- WA certified

Art.-no. product specification

Foundation tray „Height adjustable“

4902003	Foundation tray, height adjustable, 122 / 34 / 10 cm
4902002	Foundation tray, height adjustable, 122 / 30 / 10 cm



Foundation tray „Height adjustable“



Foundation tray „Concrete block“

- Cast concrete block
- No concrete work needed on-site
- With anchor lugs for transport
- WA-Zertifiziert

Art.-no. productspecification

Foundation tray „Concrete block“

4902005	Foundation tray, 122 / 34 / 10 cm
4902007	Foundation tray, height adjustable, 122/34/10 cm
4902006	Foundation tray, height adjustable, 122/30/10 cm
4902008	Foundation tray, height adjustable, 122/30/10 cm

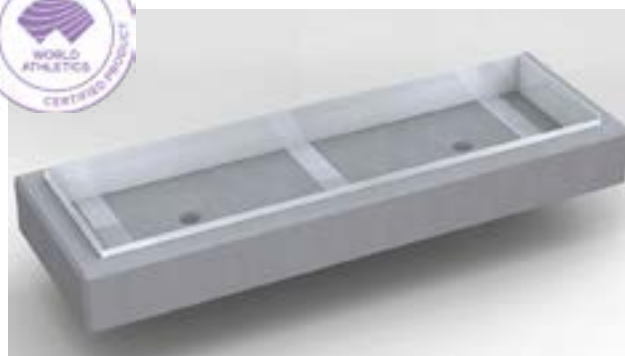

Foundation tray „Concrete block“

LONGJUMP „TAKE-OFF BOARD“



take-off board "Plastic", 1-sided

- Jump bar made of solid rubber
- absolutely weatherproof
- Incl. Rubber insert strips
- No swelling, fraying or splintering
- WA certified

Art.-no. product specification

take-off board "Plastic", 1-sided

4902110 take-off board "Plastic" 122 / 34 / 10 cm



take-off board "Plastic", 2-sided

- incl. clamping device
- double-sided take-off area
- Stainless steel clamping device
- including rubber insert profile
- WA certified

Art.-no. product specification

take-off board "Plastic", 2-sided

4902112 take-off board "Plastic", 2-sided, 122 / 34 / 10 cm

4902113 take-off board "Plastic", 2-sided, 122 / 34 / 10 cm



Wettkampf Absprung- / Wendebeilken "Hartholz"

Art. Nr. 1040132

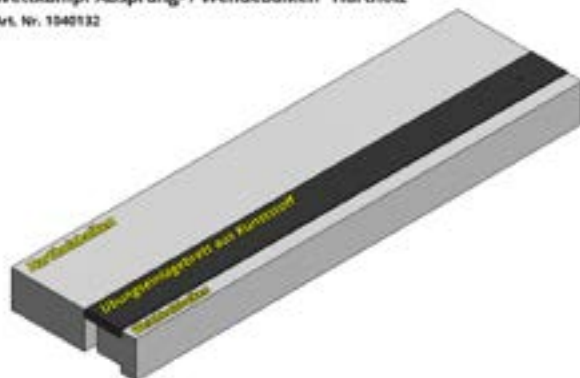

Wettkampf Absprung- / Wendebeilken "Weichholz"

Art. Nr. 1040130

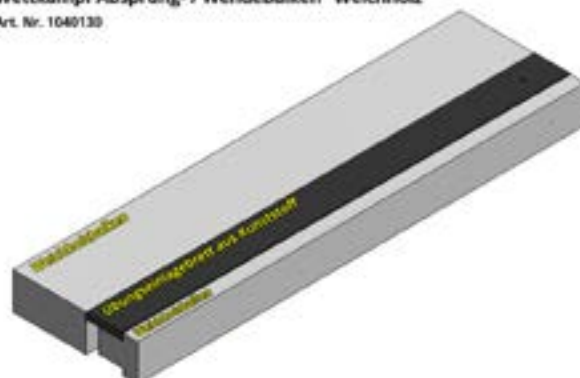

Take-off board „Wood“ for competition

- Competition take-off board 122x34x10 cm
- Two-part construction with clamping screws to ensure a perfect fitting in the foundation tray
- Including exercise board made of plastic
- Robust and durable hardwood take off board
- Softwood take off board for an easy penetration of the spikes
- Completely white lacquered
- Double-sided take off surface
- WA certified

Art.-no. product specification

Take-off board „Wood“

1040130 Softwood take off board, 122 / 34 / 10 cm

1040132 Hardwood take-off board, 122 / 34 / 10 cm

1040131 Softwood take off board, 122 / 30 / 10 cm

1040133 Hardwood take-off board, 122 / 30 / 10 cm

Take-off board „Wood“ for school sport

- School sports take off board 122x20x10 cm
- Durable and robust hardwood take off board
- Softwood take off board for an easy spike penetration
- Completely white lacquered
- Double-sided take off surface

Art.-no. product specification

Take-off board „Wood“

1040135 Softwood take off board, 122 / 20 / 10 cm

1040137 Hardwood take-off board, 122 / 20 / 10 cm

LONGJUMP „TAKE-OFF BOARD“

Take-off board „Two in One“

- Core out of aluminium profile
- One-sided plastic white for long jump
- The other side running track coloured for Triple Jump
- **Advantage:** low weight and high stability

Art.-no. product specification

Take-off board „Two in One“

4902128	Take-off board „Two in One“, 122 / 34 / 10 cm
4902124	Take-off board „Two in One“, 122 / 30 / 10 cm
4902126	Take-off board „Two in One“, 122 / 20 / 10 cm

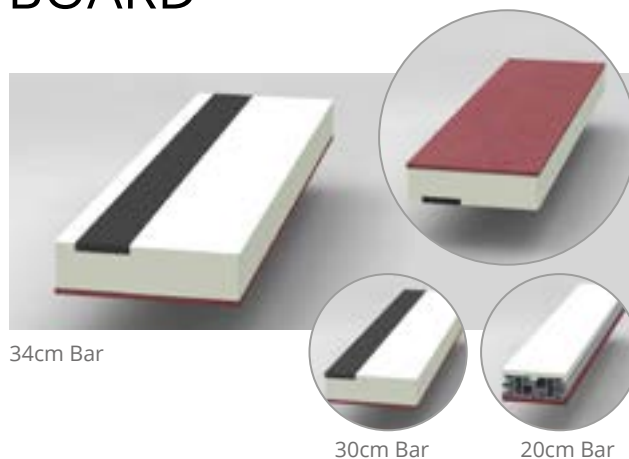

Jump bar „Three in One“

- Design as „Two in One“, but in 2 parts
- can be used for school sports, competitions and Blind beam
- one side of white plastic for long jump
- one side of plastic in track color for triple jump
- **Advantage:** low weight with maximum stability
- WA certified

Art.-no. product specification

Take-off board „Three in One“

4902129	Take-off board „Three in One“, 122 / 34 / 10 cm
4902127	Take-off board „Three in One“, 122 / 30 / 10 cm



Take-off board „Blank board“

- Core made of aluminum profiles
- Height adjustable with 6 adjustable feet
- Can be coated with running track surface
- with locking mechanism on request

Art.-no. product specification

Take-off board „Blank board“

1040010	blank board, uncoated 122 / 34 / 10 cm
1040011	blank board, uncoated 122 / 30 / 10 cm
1040010	Additional charge for side locking

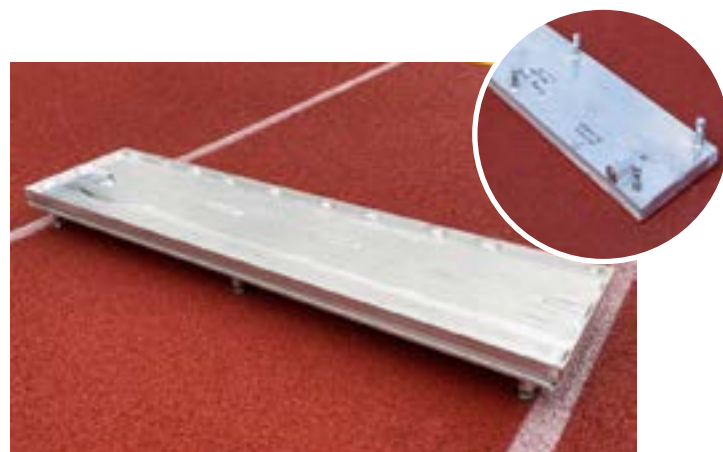

LONGJUMP „ACCESSORIES“

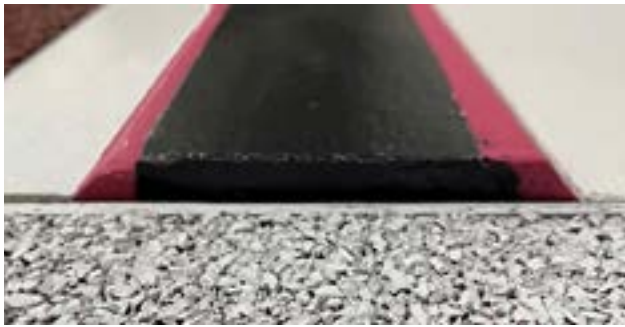

Insert board all plastic

- aluminium core
- cast with polyurethane
- including plasticine
- WA certified

Art.-no.	product specification
Insert board all plastic	
1040090	Insert board with polyurethane
4007164	Plasticine strip set for a control strip



Distance measuring panel

- made of aluminium
- white powder coated
- with metric scale

Art.-no.	product specification
Distance measuring panel	
1040190	Distance measuring panel 3-9 m or 13-19 m



Box template for control strips

- Wooden template
- 45° angle (old rules)
- 90° angle (new rules)

Art.-no.	product specification
Box template for insert boards	
1040120	Template control strip 45°
1040121	Template control strip 90



Control strips made of „Wood“

- Made of glued screen printing plates
- Recess for plasticine
- Without plasticine

Art.-no.	product specification
Control strips made of „Wood“	
4902118	Control strips made of „Wood“



Indicator boards

Art.-no.	product specification
Insertion boards for take-off boards	
4040100	Insert board, plastic, gray
4902146	Insert board, hardwood
4902147	Insert board, rubber

Insert board, plastic, gray

SANDPIT COVER



Jump pit cover

Material:

PVC coated mesh, weatherproof, tear-resistant, UV-stable, approx. 250 g/m²

Color:

green or black

Size:

individually according to your requirements

Execution:

The side edges of the cover are hemmed all around

When covering with lead tape, the straps and holding loops (width: 45 mm) are welded along the outer edges as shown in the sketch and additionally fixed with rivets. All welds are carried out using high frequency technology. A lead tape (400 g/m) is inserted into the hem on four sides.

Art.-no.	product specification
Sandpit cover	
4300020	Sandpit cover, loose, with chain
4300030	Sandpit cover, loose, with steel rope
4300000	Sandpit cover, loose, with lead tape

Art.-no.	product specification
Accessories for sandpit cover	
1030166	Standard ground socket with support to install a carabiner hook

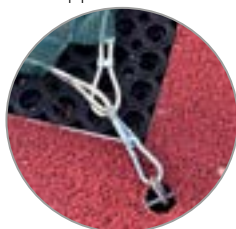

Cover with chain, all around



- Stable mesh web, all around with hemstitch
- Colour: moss-green
- All around chain (6 mm, hot galvanised) for weighting the cover
- 4 open corners with carabiner hooks for installing

Cover with steel rope, all around



- stable mesh web, all around with hemstitch
- Colour: moss-green
- all around steel rope (4 mm, hot galvanised and PVC-coated) worked into the seam
- 4 open corners with carabiner hooks for installing

Art.-no.	product specification
Cover fixed with lead tape	
4030010	Cover, fixed overlapping, with lead tape
4030012	Weighting rod made of aluminum per linear meter
1110200	Clamping base sleeve



Aluminum diving pit cover



- Tongue & groove profile
- with upstand for coating with EPDM covering
- Cover size variable up to 7.40 m wide
- Width per plank without tongue and groove = 17cm

Art.-no.	product specification
Aluminum diving pit cover	
4300040	Aluminum cover for diving pits,
4300045	support brackets per linear meter

SHOT PUT- & DISCUS RING



concrete element

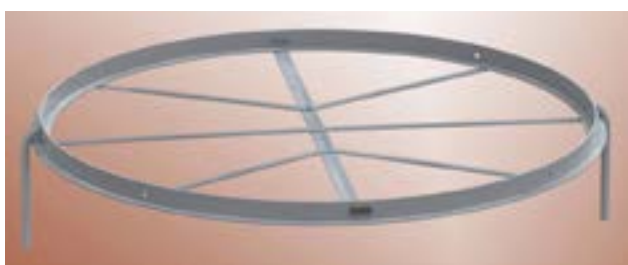

Shot put & Discus ring



Shot put ring handicapped accessible inkl. two additional sleeves and anchor bars

All shot put & discus rings comply with the WA regulations. The rings are made of dimensionally stable aluminium T-profiles.

Advantages of a shot put ring as a precast concrete element:

In-situ concrete solutions often do not meet the requirements. The dimensionally stable precast concrete element with concrete surface is functional for sport, offers an accurate workmanship (top surface and ring height) and is easy to install.

Shot put / discus ring

- Ring of special aluminium t-profile
- Diameter 2,135 m / 2,500 m for setting in concrete on site
- Perfect form stability
- Two-piece
- Stabilizing bars welded in

Shot put ring / discus ring suitable for athletes with disabilities

- Same properties as for rings but with six inspection shafts with integrated drainage and bar for belt fastening

Shot put ring / discus ring as a precast concrete element

- Same properties as for rings but as precast concrete element of special hardened concrete
- Throwing circle surface not smooth
- Incl. 2 threaded sleeves with transport loops

Art.-no.	product specification
Shot put ring	
1030210	Shot put ring made of aluminium
2030210	Shot put ring handicapped accessible, with 6 fixing points (two of them as revision shaft)
4030210	Shot put ring concrete element, with two processes

Art.-no.	product specification
Ring accessories	
1030160	Inspection shaft for shot-put ring with bar
1030162	Anchor bars for handicapped throwing disciplines

Art.-no.	product specification
Discus ring	
1030200	Discus ring made of aluminium
2030200	Discus ring handicapped accessible, with 6 fixing points (two of them as revision shaft)
4030200	Discus ring concrete element, with two processes

Art.-no.	product specification
Ring accessories	
1030160	Inspection shaft for shot-put ring with bar
1030162	Anchor bars for handicapped throwing disciplines

SHOT PUT

„BOARD & ACCESSORIES“

Shot put board

Wood

- Solid wood beam
- White lacquered
- Perfect form stability
- Incl. installation set
- WA certified

Plastic

- Made of solid plastic, particularly robust
- White
- Incl. installation set
- WA certified

Art.-no. product specification

Shot put board / Stone impact beam

1030430	Shot put board, wood
4902312	Shot put board, plastic
2030435	Stone bumper, aluminium, length 4m



Ring cover

- Ring cover for ball & hammer throwing rings
- Two-piece
- Completely made of aluminium
- Welded handles

Art.-no. product specification

Ring cover

1030340	Ring cover made of aluminium
---------	------------------------------

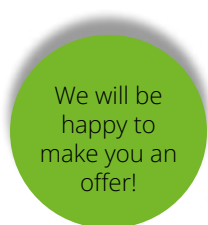

Shot put accessories

We also have other shot put accessories in our product range

- Competition & training shot put balls
- Indoor balls
- Transport trolleys
- Roll-back ramps
- Indoor mats for shot put



HAMMERTHROW

„HAMMERTHROW INSERT RING“



Hammerthrow

Hammer throw rings can be found in the shot put or discus section. For the hammer throw you use the same ring diameter (2.135 m) as for the shot put throw.

If discus and hammer throw are to be carried out in the same protective grid, a discus ring (2.50 m) and a hammer throw insert ring which reduces the diameter from 2.50 to 2.135m is needed.

Hammerthrow insert ring

- Reduces the ring diameter from 250 cm to 213,5 cm
- Consists of four elements
- Made of galvanised, powder coated steel

Art.-no.	product specification
1030140	Hammerthrow insert ring

Hammerthrow insert ring

1030140 Hammerthrow insert ring

JAVELIN THROW



Javelin throw

- Made of flat aluminium, white lacquered
- Length 4.00 m, arch with R = 8.00 m
- Width 70 mm, height 8 mm
- Including spikes for track surface

Art.-no.	product specification
4902401	Javelin bow

Javelin bow

4902401 Javelin bow

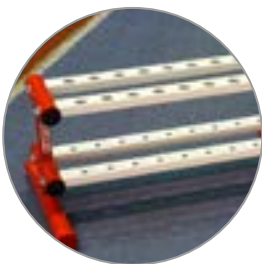

Javelin accessories

We also have other javelin accessories in our product range

- Training & competition javelin
- Transport trolley

We will be happy to make you an offer!

ATHLETICS ACCESSORIES

Distance markers

- Triangular, made of glass fibre, inclusive numbers
- Upper handle cutout
- Stackable

Art.-no.	product specification
Distance markers	
1031800	Distance marker (1 piece)
1031810	Distance markers (14 pieces for long throws)
1031820	Distance markers (26 pieces for long throws)
1031830	Distance markers (16 pieces for shot put)



Timekeepers stand

- made of aluminium, fully welded, Alu-natur
- extra wide plastic wheels
- inclusive plastic seats and lift roller

Art.-no.	product specification
Timekeepers Stand	
1010040	stairs, 6 persons, with seats
1010060	stairs, 8 persons, with seats
1010080	stairs, 12 persons, with seats, decomposed



Starting numbers

- rectangular, made of glass fibre, inclusive numbers, height 45 cm
- upper handle cutout
- yellow and red flaps for false start

Art.-no.	product specification
Starting numbers	
1010580	Lane marker box (for one lane)
1010581	Lane marker box (for four lanes)
1010582	Lane marker box (for six lanes)
1010583	Lane marker box (for eight lanes)
1010584	Lane marker box (for ten lanes)



Mobile bench for athletes

- Length 2,5 m / height 2,1 m
- Mobile with handles and wheels

Art.-no.	product specification
Mobile bench for athletes	
1011220	Mobile bench for athletes



SAFETYCAGE

„DISCUS & HAMMERTHROW CAGE 7/10 M“



Discus & Hammerthrow cage

- 10 aluminium profile posts 120/100 mm, 4/6 mm
- No turning in the ground socket
- Gallows with rope guide
- Lowerable carrier
- Two adjustable hatches with lowerable carrier
- Incl. rope reels at the posts
- High quality safety net made of PP 5 mm, 45 mm MW
- According to EN 1263-1 rhombic mesh

Art.-no. product specification

Discus & Hammerthrow cage

1030290 Discus and hammerthrow cage 7/10 m, incl. net

Art.-no. product specification

Discus cage accessories

1030076 Surcharge for all around net crossbars 7/10 m
 1030291 Bar spacer per post (demand 10 pieces)
 1030100 Standard ground socket discus / hammerthrow
 1030120 Special ground socket discus / hammerthrow

SAFETYCAGE

„DISCUS CAGE“



Discus cage

- 7 Stk aluminium profile posts 120/100 mm
- No turning in the ground socket
- Gallows with rope guide
- Incl. rope reels on the stand posts
- High-quality safety net made of PP 5mm, 45mm MW
- In accordance with EN 1263-1 rhombic mesh

Art.-no. product specification

Discus cage

1030070	Discus cage 4 m
1030071	Discus cage 5,5 m
1030072	Discus cage 4/6 m
1030073	Discus cage 6,0 m (according to new standard)

Art.-no. product specification

Diskus cage accessories

1030075	Surcharge for all around net crossbars
1030291	Bar spacer per post (demand 7 pieces)
1030100	Standard ground socket discus / hammerthrow
1030120	Special ground socket discus / hammerthrow



HURDLES



Competition hurdles



Trainings hurdles



Transporttrolley for 20 hurdles



Competition hurdles with advertising

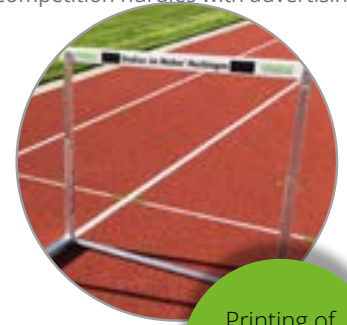

Printing of the hurdle bars on request!

Competition hurdles

- Competition hurdles made of aluminium
- 6-fold height adjustable
- Fully welded
- Height adjustment via snap push button
- Movable and snap-in counterweights in the hurdle base
- heights: 0,685 m; 0,762 m; 0,838 m; 0,914 m; 0,991 m; 1,067 m
- Incl. flexible wooden bar, in contrasting color
- WA certified

Training hurdle

- Exercise hurdle made of aluminium
- 4-fold height adjustment
- Fully welded
- Height adjustment via snap push button
- With plastic tube as hurdle bar

Art.-no. product specification

Art.-no.	product specification
Hurdles	
1010470	Competition hurdle
1010490	Training hurdle
4900271	Replacement wooden hurdle bars

Other hurdle width? Simply specify when ordering

Transport trolley for 20 hurdles

- Completely made of aluminium
- For up to 20 hurdles
- All around with pivoting wheels
- Incl. drawbar
- For hurdle widths 1.16 - 1.21 cm (outer edge to outer edge)

Transport trolley for 30 hurdles

- Completely made of aluminium
- For up to 30 hurdles
- Hurdles would be pushed on and loaded from behind
- In the front with foam-covered swivel wheels
- Incl. drawbar
- For hurdle widths 1.16 - 1.21 cm (outer border to outer border)

Art.-no. product specification

Art.-no.	product specification
Transport trolley for hurdles	
1010520	Transport trolley for 20 hurdles
1010525	Transport trolley for 30 hurdles

HURDLES / BARRIER

Barrier without crossbar

- Height adjustable (0,762 m / 0,838 m / 0,914m)
- Completely made of aluminium, wooden beam
- Internal weights in the frame

Art.-no. product specification

Barrier without crossbar

1010390	Barrier without crossbar, 3,96 m
1010350	Barrier without crossbar, 5,00 m
2010390	crossbar as substitute 3,96 m
2010350	crossbar as substitute 5,00 m



Barrier without crossbar

Barrier with crossbar

- Crossbar for a higher stability
- Height adjustable (0,762 m / 0,838 m / 0,914m)
- Completely made of aluminium, wooden beam
- Internal weights in the frame
- WA certified

Art.-no. product specification

Barrier with crossbar

1100370	Barrier with crossbar, 3,96 m
1010360	Barrier with crossbar, 5,00 m
2010390	crossbar as substitute 3,96 m
2010350	crossbar as substitute 5,00 m



Barrier with crossbar

Barrier transport trolley

- Transport trolley for 4 barriers
- Polyamid wheel
- With drawbar

Art.-no. product specification

Barrier transport trolley

1010400	Transport trolley for four barriers
---------	-------------------------------------



WATER JUMP PIT



Water jump barrier

- height adjustable (0,762 m women / 0,914 m men)
- pedestal made of 80x80 mm aluminium profile, wooden beams
- WA certified

Art.-no.	product specification
Water jump barrier	
1010410	Water jump barrier
1010330	Standard ground socket water jump barrier
1010340	Special ground socket water jump barrier
2010410	Crossbar as substitute 3,66 m

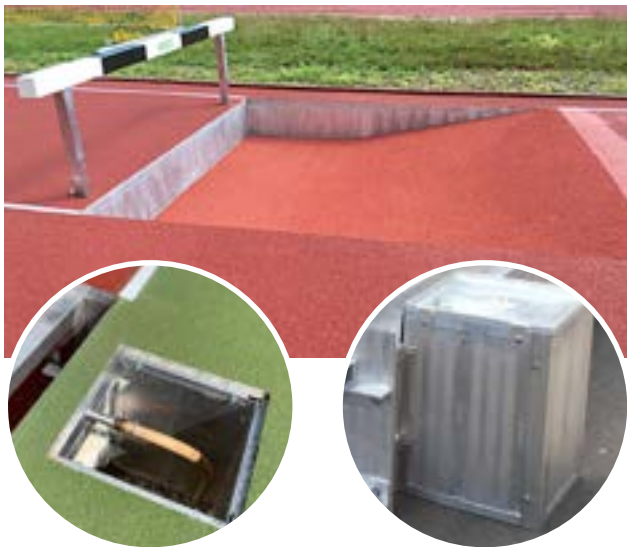

Water jump pit

- 3-parted construction kit
- Aluminium double hollow chamber profile
- Including front cross brace
- Surcharge for supply shaft

Art.-no.	product specification
Water jump pit	
1010285	Water jump pit construction kit
1010280	Water jump pit supply shaft

Art.-no.	product specification
Welded ground socket for water jump pit	
1010330	Standard ground socket for water jump barrier
1010340	Special ground socket for water jump barrier



Water jump pit cover / support bracket

- Cover made of aluminium
- Slot and spring profile
- coatable

Art.-no.	product specification
Water jump pit cover	
1010310	Support bracket for water jump pit cover (2 pieces required)
1010270	Coatable water jump pit cover

RUN

Starter block „Olympic“

- suitable for young athletes
- work angle is adjustable
- distance between the logs is adjustable
- made of steel, with coating, very wear-resistant

Art.-no. product specification

Starter block „Olympic“

1010550 Starter block „Olympic“

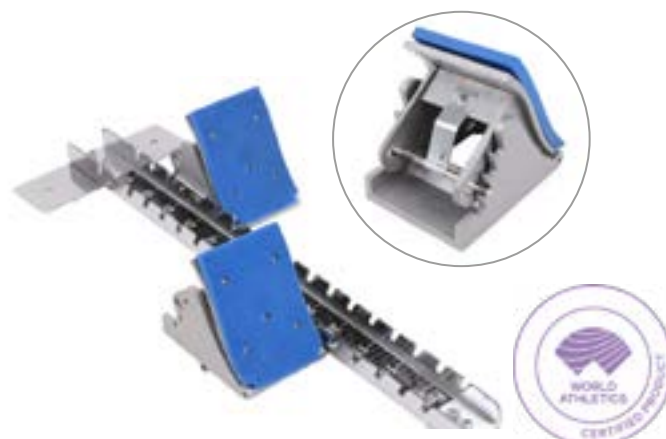

Starter block „New Olympic“

- big start rails and big pedals
- work angle is adjustable
- distance between the logs is adjustable
- made of aluminium, with rubber flooring, very good stop
- WA certified

Art.-no. product specification

Starter block „New Olympic“

1010560 Starter block „New Olympic“



Transport trolley for starter blocks

- Transport trolley for ten starter blocks
- Made of steel tubes
- Powder coated
- Mobile and steerable due to a swivel axel
- With handle

Art.-no. product specification

Transport trolley

4902458 Transport trolley for starter blocks



Curbing

- curbing made of special anodised aluminium profile
- Set for 400 m running track (170 m straight and 230 m curved profiles incl. all connectors)
- Straight and curved elements
- Standard radius 36,50 m
- Integrated connectors and fixing pins
- Can also be used as a mobile track barrier
- Powder-coated in RAL colours on request
- WA certified

Art.-no. product specification

Curbing

1011260 Curbing radius 36,5m



HIGHT JUMP MAT

Hight jump mat „Basic“

With integrated wear mat. The mono block system creates a harder landing. The high jump mat „basic“ is suitable for school sports, as falling height is much lower.

Application

- School sport

Kernel

- Mono block system RG 18

Wear mat

- solid PUR foam RG 20, 100 mm

Cover

single piece cover with weather proof plastic zipper, protective mesh web (spike proof) integrated in the cover, spike proof mesh web throughout the complete landing area guarantees the best possible air circulation, on the sides PVC-tarpaulin

Ground

- Anti-slid PVC tarpaulin
- Black PVC tarpaulin and green mesh fabric (available in other colours)



Hight jump mat „Simple“

The high jump mat „simple“ is suitable for school and club sport. The hollow block system creates a soft landing. The air can flow quickly through the integrated channels. The wear mat is separated from the hollow foam blocks due to a intermediate base..

Application

- School sport & club sport

Kernel

- double hollow foam block RG 23

Wear mat

- solid PUR foam RG 20

Intermediate base

- PVC-tarpaulin

Cover

two pieced cover with intermediate base and weather proof zipper, protective mesh web (spike proof) integrated in the cover, spike proof mesh web throughout the complete landing area guarantees the best possible air circulation, on the sides PVC-tarpaulin

Ground

- Anti-slid PVC tarpaulin
- Black PVC tarpaulin and green mesh fabric



Hight jump mat „Pro“

The high jump mat „pro“ is suitable for the more ambitious users. The double hollow kernel system creates one of the softest landings. The foam blocks are additionally single covered. The wear mat is separated from the hollow foam blocks due to a intermediate base.

Application

- Club sport & competition

Kernel

- Double hollow foam block RG 23

Wear mat

- solid PUR foam RG 20

Intermediate base

- PVC-tarpaulin



Cover

two pieced cover with intermediate base and weather proof zipper, protective mesh web (spike proof) integrated in the cover, spike proof mesh web throughout the complete landing area guarantees the best possible air circulation, on the sides PVC-tarpaulin

Ground

- Anti-slid PVC tarpaulin



HIGHT JUMP MAT

Art.-no. „Basic“	Width	Depth	Height
4404340	400 cm	300 cm	40 cm
4404350	400 cm	300 cm	50 cm
4404360	400 cm	300 cm	60 cm
4405340	500 cm	300 cm	40 cm
4405350	500 cm	300 cm	50 cm
4405360	500 cm	300 cm	60 cm
4405440	500 cm	400 cm	40 cm
4405450	500 cm	400 cm	50 cm
4405460	500 cm	400 cm	60 cm
4406340	600 cm	300 cm	40 cm
4406350	600 cm	300 cm	50 cm
4406360	600 cm	300 cm	60 cm
4406450	600 cm	400 cm	50 cm
4406460	600 cm	400 cm	60 cm

Art.-no. „Simple“	Width	Depth	Height
4414340	400 cm	300 cm	40 cm
4414350	400 cm	300 cm	50 cm
4414360	400 cm	300 cm	60 cm
4415340	500 cm	300 cm	40 cm
4415350	500 cm	300 cm	50 cm
4415360	500 cm	300 cm	60 cm
4415440	500 cm	400 cm	40 cm
4415450	500 cm	400 cm	50 cm
4415460	500 cm	400 cm	60 cm
4416340	600 cm	300 cm	40 cm
4416350	600 cm	300 cm	50 cm
4416360	600 cm	300 cm	60 cm
4416450	600 cm	400 cm	50 cm
4416460	600 cm	400 cm	60 cm

Art.-no. „Pro“	Width	Depth	Height	
4424340	400 cm	300 cm	40 cm	
4424350	400 cm	300 cm	50 cm	
4424360	400 cm	300 cm	60 cm	
4425340	500 cm	300 cm	40 cm	
4425350	500 cm	300 cm	50 cm	
4425360	500 cm	300 cm	60 cm	
4425440	500 cm	400 cm	40 cm	
4425450	500 cm	400 cm	50 cm	
4425460	500 cm	400 cm	60 cm	
4426340	600 cm	300 cm	40 cm	
4426350	600 cm	300 cm	50 cm	
4426360	600 cm	300 cm	60 cm	
4426450	600 cm	400 cm	50 cm	
4426460	WA-certified	600 cm	400 cm	60 cm



RAIN COVER FOR „HIGH JUMP MAT“

Colour
according
to customer
requirements
in standard
RAL colours



Rain cover for high jump mat

- Made of heavy PVC tarpaulin
- Completely welded
- With four tensioning ropes at the corners to hook at the mat or the grid

Art.-no. „Rain cover“	Width	Depth	Height
4434340	400 cm	300 cm	40 cm
4434350	400 cm	300 cm	50 cm
4434360	400 cm	300 cm	60 cm
4435340	500 cm	300 cm	40 cm
4435350	500 cm	300 cm	50 cm
4435360	500 cm	300 cm	60 cm
4435440	500 cm	400 cm	40 cm
4435450	500 cm	400 cm	50 cm
4435460	500 cm	400 cm	60 cm
4436340	600 cm	300 cm	40 cm
4436350	600 cm	300 cm	50 cm
4436360	600 cm	300 cm	60 cm
4436450	600 cm	400 cm	50 cm
4436460	600 cm	400 cm	60 cm
4436470	600 cm	400 cm	70 cm

HIGH JUMP MAT & SUPPORT GRID

High jump mat, foldable

- Hollow chamber system
- Cover made of polyester-reinforced tarpaulin fabric
- bottom side made of anti-slipping gym mat fabric

Art.-no. product specification

High jump mat, foldable

4217000	High jump mat foldable 600 x 300 x 60 cm
4217050	Rain cover high jump mat foldable 600 x 300 x 60 cm
4217060	Rain cover high jump mat foldable 600 x 150 x 120 cm
4217100	High jump mat foldable 500 x 300 x 60 cm
4217150	Rain cover high jump mat foldable 500 x 300 x 60 cm
4217160	Rain cover high jump mat foldable 500 x 150 x 120 cm



Support gride high jump mat

- support grid made completely of aluminium
- consisting of 2 screwable parts
- complete height 10 cm
- slatted frame made of 20 cm wide aluminium profiles
- incl. 4 brackets (back and sides) to prevent the mat from slipping

Available as well as mobile version with removable wheels (only used for transport)

ADVANTAGE: The high jump mat can be quickly moved.

PE support grid

- „ALL“ mats can be produced with an integrated PE support grid:
- Polyethylene grid
- 10 cm height- additional protection for the rails

Advantages of a PE support grid

- Fixed position, as the support grid is integrated in the mat
- No risk of injury
- Space-saving during storage

Art.-no. product specification

Support grid high jump mat

2236013	Support grid high jump mat 5x3 m
2236014	Support grid high jump mat 6x4 m
2236016	Surcharge for mobile support grid, high jump
4222222	Surcharge for an integrated support grid



Integrated grid



Support grid made of aluminium



Support wheel for mobile grid

HIGH JUMP BAR



High jump crossbar, 3-point

- light yellow competition and training high jump crossbar
- 3-fold fibreglass reinforced
- excellent background contrast effect
- extremely low deflection
- solid and durable
- heavy support ends for maximal possible frictional resistance
- length 400 cm
- according to World Athletics-Certification requirements



High jump crossbar, 5-point

- dark yellow, heavy competition high jump crossbar
- 5-fold matrix reinforced polyester
- excellent background contrast effect
- lowest deflection
- solid and nearly indestructible
- heavy support ends for maximal possible frictional resistance
- length 400 cm
- according to World Athletics-Certification requirements

Art.-no.	product specification
4025400	High jump bar 5-point, WA-certified
4024400	High jump bar 3-point

High jump bar

4025400 High jump bar 5-point, WA-certified

4024400 High jump bar 3-point



High jump measuring bar

- Measuring range from 0,6 - 3,0 m
- Millimeter precise, coated measuring tape
- Telescopic elements made of round aluminium
- Circular bubble incl.
- Aluminium flat on the top as an overlap on the high jump bar

Art.-no.	product specification
4024405	High jump measuring bar

High jump measuring bar

4024405 High jump measuring bar

High JUMP UPRIGHTS



Details und Zubehör

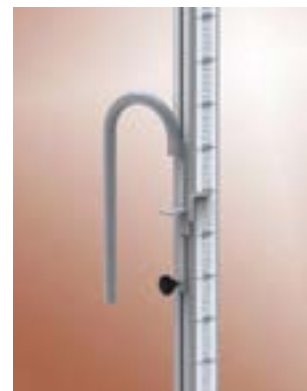
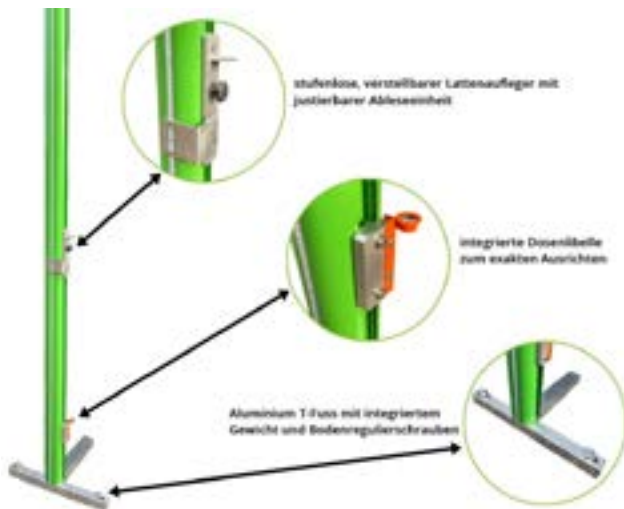

Lattenumlenkbügel



Mehrfachaufleger

High jump uprights „Pro“

- High jump uprights made of Aluminium oval profiles 120x100mm
- Aluminium T-foot with integrated weights
- Integrated ground screws for a perfect adjustment of the uprights
- Height adjustable from 50 - 250 cm infinitely variable
- Surcharge for bar support that can be moved infinitely variable
- Integrated circular bubble to control the correct alignment
- Surcharge for bar deflection bracket
- multiple bar support, 5-fold every 10 cm
- WA certified

Art.-no. product specification

Art.-no.	product specification
High jump uprights „Pro“	
1020570	High jump uprights "Pro" 0,5 - 2,5 m, green powder-coated
2012001	Surcharge for multiple bar support
2012002	Surcharge bar deflection bracket

High jump uprights

- High jump stands made of aluminium including t-foot standing leg with integrated weights
- Rounded edges
- height from 50 - 250 cm, or from 50 - 300 cm
- Adjustment elements – infinitely variable

Art.-no. product specification

Art.-no.	product specification
High jump uprights	
1020510	High jump uprights 0,5 - 2,5 m, Alu-natur
1020560	High jump uprights 0,5 - 3,0 m, Alu-natur, IAAF Zertifiziert
2012001	Fivefold supports for the bars
2012002	Deflection bow
2012003	Vertical control
2012004	Surcharge for ground levelling element at the T-foot





POLE VAULT BOX

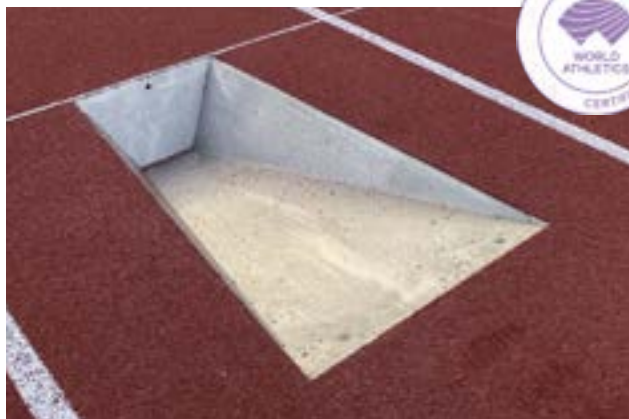

Pole vault puncture box „Default“

- Stainless steel puncture box
- Includes two drainage openings
- Aluminum cover can be coated
- Cover with guide pins for locking • Cover can be fitted with two additional screws be secured
- WA certified

Art.-no. product specification

Pole vault box „Standard“	
1020290	Pole vault box standard
1020310	Insertion block for pole vault box standard, coatable

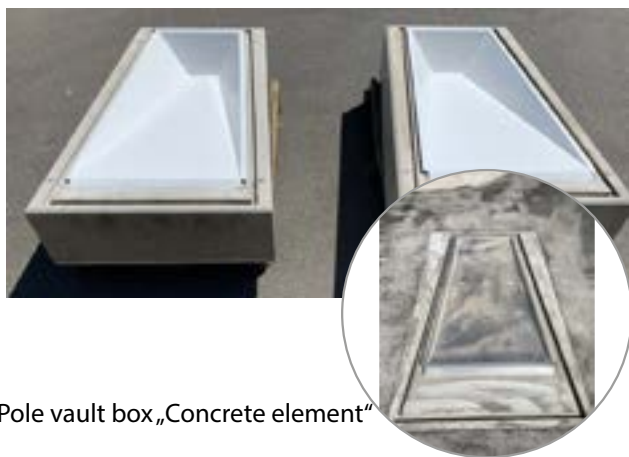

Pole vault box „Concrete element“

- With inspection shaft
- White powder coated on the inside
- With loops for transport
- Just install and align

Art.-no. product specification

Pole vault box „Concrete element“	
4902705	Pole vault box concrete element
4902706	Surcharge for locking device
4902707	Surcharge for additional inspection shaft

POLE VAULT UPRIGHTS „PRO“

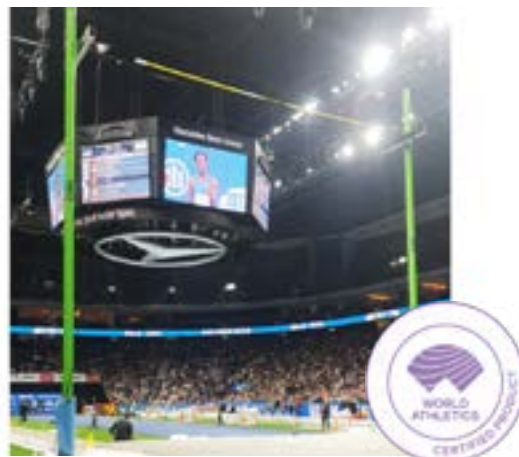

Our newly developed pole vault stands are equipped with many details

- Internal gearbox
- Display can be adjusted horizontally (+/- 5 cm).
- Extra larger adjustment options (+/- 80cm).
- Display with mechanical, integrated brake in the Hibernate state. This means that the slat support can be in the do not adjust jump mode independently
- The carriage of the slat spreader moves completely through sealed deep groove ball bearings
- Slatted support adjustable in depth and height
- Adjustment of the delivery using external ropes
- WA certified

optional features

- adjustable cable guide
- Display adjustment
- colored pole vault facility

Features of the “Pro” pole vault stands

- Aluminum construction made of oval profile 120x100 mm
- all connecting elements made of stainless steel materials
- Slatted support height adjustable from 160 to 645 cm
- with toothed belt system and removable crank
- Direct reading of the jump heights internal strap on the reading window
- very good scale on the boom for direct reading Delivery from 0-80cm
- injury-neutral, without entering the jumping area



Art.-no. product specification

Pole vault uprights „Pro“	
1020040	pole vault uprights “Pro”
1020041	Additional charge for adjustable cable guide
1020042	Additional charge for boom adjustment up to 80m
1020044	Additional charge for powder coating in RAL color

POLE VAULT UPRIGHTS „COMOFRT“



Pole vault stand „Comfort“ in rails

- Aluminium construction made of special profile 98 x 142 mm
- All functional parts made of stainless materials
- In the tension range up to 10 mm thick, white powder-coated
- Slide and ground socket welded
- Carriage is guided on high quality polyamide rollers in the guide rail
- Slat runners in the guide on the boom adjustable according to the rules
- Slatted height adjustable from 150 to 650 cm
- With toothed belt system and crank

Art.-no. product specification

Pole vault stand

1020010	Pole vault stand in rails
1020020	Rails (requirement 2 pieces)

Pole vault stand „Comfort“ in ground socket

- Aluminium construction made of special profile 98 x 142 mm
- All functional parts made of stainless materials
- In the tension range up to 10 mm thick, white powder-coated
- With standard ground socket and lid
- Slat runners in the guide on the boom adjustable according to the rules
- Slatted height adjustable from 150 to 650 cm
- With toothed belt system and crank
- Direct reading of jump heights
- Reading window with fine adjustment with regard to staff and take-off level
- Injury-neutral, without any components penetrating into the jump space
- WA certified

Art.-no. product specification

Pole vault stand

4902613	Pole vault construction „Comfort“
4901109	Surcharge for coatable special ground socket
4902615	Same as Art. 4902613, but self standing with weights
4382930	Safety pad for pole vault stand

POLE VALUT MAT

Pole valut mat

Optimal execution for club sports and national competitions. The integrated cross and longitudinal channels allow the air to escape very quickly. This hollow chamber system guarantees one of the softest landings. The spike mesh fabric is particularly skin-friendly and extremely tear-resistant.

Grid protection material

- Particularly skin-friendly
- Extremely tear resistant
- Athlete is protected of friction burn

Pole vault mat „Basic“

With integrated wear mat. The mono block system creates a harder landing. The pole vault mat „basic“ is suitable for school sports, as falling height is much lower.

Application

- School sport

Kernel

- Mono block system RG 18



Wear mat

- solid PUR foam RG 20, 100 mm

Pole vault mat „Simple“

The pole vault mat „simple“ is suitable for school and club sport. The hollow block system creates a soft landing. The air can flow quickly through the integrated channels. The wear mat is separated from the hollow foam blocks due to a intermediate base.

Application

- School & club sport

Kernel

- Double hollow foam block RG 23



Wear mat

- solid PUR foam RG 20

Pole vault mat „Pro“

The pole vault mat „pro“ is suitable for the more ambitious applications and users. The double hollow kernel system creates one of the softest landings. The foam blocks are single covered additionally. The wear mat is separated from the hollow foam blocks due to a intermediate base.

Application

- Club sport & competition

Kernel

- Double hollow foam block RG 23



- Perfect ventilation
- Black tarpaulin and green mesh fabric
- Also available in other colours

Accessories

- Additional side protection pads for rails
- Attachment blocks in different sizes
- High density foam blocks for the vault box area
- Protection pads for the pole vault uprights

Cover

single piece cover with weather proof plastic zipper, protective mesh web (spike proof) integrated in the cover, spike proof mesh web throughout the complete landing area guarantees the best possible air circulation, on the sides PVC-tarpaulin

Ground

- PVC-tarpaulin, non-slip

Intermediate base

- PVC-tarpaulin

Cover

two pieced cover with intermediate base and weather proof zipper, protective mesh web (spike proof) integrated in the cover, spike proof mesh web throughout the complete landing area guarantees the best possible air circulation, on the sides PVC-tarpaulin

Ground

- PVC-tarpaulin, non-slip

Mear mat

- solid PUR foam RG 20

Intermediate base

- PVC-tarpaulin

Cover

two pieced cover with intermediate base and weather proof zipper, protective mesh web (spike proof) integrated in the cover, spike proof mesh web throughout the complete landing area guarantees the best possible air circulation, on the sides PVC-tarpaulin

Ground

- PVC-tarpaulin, non-slip

POLE VALUT MAT



Art.-no. „Basic“	Depth	Width	Height	Norm
4446558	650 cm	500 cm	80 cm	Training mat
4447058	700 cm	500 cm	80 cm	DLV Norm
4448068	800 cm	600 cm	80 cm	IAAF / WA Norm

Art.-no. „Simple“	Depth	Width	Height	Norm
4456558	650 cm	500 cm	80 cm	Training mat
4457058	700 cm	500 cm	80 cm	DLV Norm
4458068	800 cm	600 cm	80 cm	IAAF / WA Norm

Art.-no. „Pro“	Depth	Width	Height	Norm
4466558	650 cm	500 cm	80 cm	Training mat
4467058	700 cm	500 cm	80 cm	DLV Norm
4468068	800 cm	600 cm	80 cm	IAAF / WA Norm

POLE VALUT MAT „RAIN COVER“

Colour according to customer requirements in standard



Pole valut mat „Rain cover“

- Made of heavy PVC tarpaulin
- Completely welded
- With four tensioning ropes at the corners to hook at the mat or the grid
- With or without recess in the pole vault box area

Art.-no. „Rain Cover“	Depth	Width	Height	Norm
4446558	650 cm	500 cm	80 cm	Training mat
4447058	700 cm	500 cm	80 cm	DLV Norm
4448068	800 cm	600 cm	80 cm	IAAF / WA Norm

POLE VAULT



Pole vault crossbar, 3-point

- light yellow competition and training high jump crossbar
- 3-fold fibreglass reinforced
- excellent background contrast effect
- extremely low deflection
- solid and durable
- heavy support ends for maximal possible frictional resistance
- length 400 cm
- according to World Athletics-Certification requirements

Pole vault crossbar, 5-point

- dark yellow, heavy competition high jump crossbar
- 5-fold matrix reinforced polyester
- excellent background contrast effect
- lowest deflection
- solid and nearly indestructible
- heavy support ends for maximal possible frictional resistance
- length 400 cm
- WA-certified

art.-no.	product specification
----------	-----------------------

Pole vault crossbar	
---------------------	--

4025400	Pole vault crossbar 5-point
4024400	Pole vault crossbar 3-point



Pole vault measuring bar up to 8,00 m

- measuring range from 1.53 - 8.00 m
- millimeter exact coatable measuring tape
- adjusted height settings cannot shift (clamping screws)
- incl. circular bubble
- aluminium flat on the upper side as an angle at the crossbar

Art.-no.	product specification
----------	-----------------------

Pole vault measuring rod up to 8 m	
------------------------------------	--

4024410	Pole vault measuring stick
---------	----------------------------



Support grid for pole vault mat

Support grid made of aluminium

- Support grid made of aluminium
- Consisting of 2 screwable parts
- Complete height 10 cm
- Slatted frame made of 20 cm wide aluminium profiles
- Incl. 4 brackets (back and sides) to prevent the mat from slipping

Available as well as mobile version with removable wheels (only used for transport)

ADVANTAGE: The high jump mat can be quickly moved.

PE support grid

- „ALL“ mats can be produced with an integrated PE support grid:
- Polyethylene grid
- 10 cm height- additional protection for the rails

Advantages of a PE support grid

- Fixed position, as the support grid is integrated in the mat
- No risk of injury
- Space-saving during storage

Art.-no.	product specification
----------	-----------------------

Support grid for pole vault mat	
---------------------------------	--

2236000	Support grid for pole vault mat 6,50 x 5,00m
2236011	Support grid for pole vault mat 8,00 x 6,00m
2236019	Support grid for pole vault mat 7,00 x 5,00m
2236018	Surcharge for mobile grid, pole vault
4222222	Surcharge for integrated support grid

SAFETY COVER „BASIC“

Safety cover „Basic“

Mobile safety cover for high jump and pole vault

- ground frame made of aluminium, fully welded
- lateral aluminium cassettes
- roof construction made of aluminium board wall profiles
- surface accessible
- big covered plastic wheel for an easy movement
- delivery in two or three parts
- elements are connected with clamping levellers
- lockable (excluding lock)
- with big stiff wheels

art.-no. product specification

Safety cover „Basic“

4902680	Safety cover „basic“ for high jump
4902685	Safety cover „basic“ for pole vault
4902698	Surcharge for lowerable construction (without ill.)
4902690	Surcharge for two steering wheels per element (high jump)
4902695	Surcharge for two steering wheels per element (pole vault)
4902696	surcharge for folding mechanism on one side of the stripe if the safety cover can only be moved

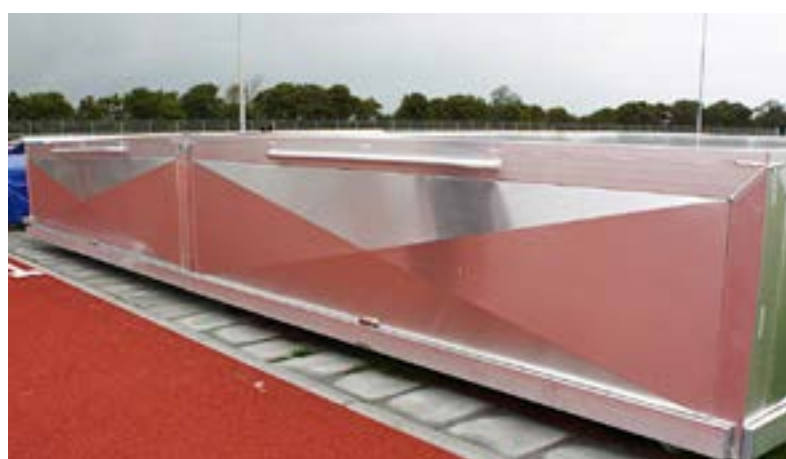

SAFETY COVER „STRONG“

Safety cover „Strong“

- When lowered, the cover rests directly on the floor all around. So, the mat is protected from vandalism and rodents.
- Minimum pressure on athletic track. Imprints caused by rollers do not occur.
- The cover is made of aluminium and is completely welded
- The special interlocking, sealed board wall profiles prevent the penetration of water.
- The steerable version (high jump 2-parts, pole vault 3-parts) can be manoeuvred around its own axis
- The cover is manufactured under pretension and can therefore withstand high loads



Essential advantages of the lowerable safety cover

Features of the safety cover „Strong“

- Fully welded construction made of aluminium
- Pre-stressed, curved roof shape (snow load)
- Lowering- without surcharge
- Full surface contact limits the risk of material damages on the track (EPDM-flooring)
- Incl. welded-on handles
- Lowering via spindle with crank
- Internal, broad drum wheels

SAFETY COVER „STRONG“



High jump safety cover „Strong“ two-piece, lowerable, movable and steerable

- Closed fronts
- Incl. lateral brass spigots and counter support to connect the elements
- Guide pins as connectors
- Individual elements steerable (hand cart principle)
- Integrated gutter for water drainage between the elements
- No lock is needed when the elements are connected

Art.-no.	product specification
2236021	High jump safety cover, steerable



High jump safety cover „Strong“ one-piece, can be lowered, can be moved backwards and forwards



High jump safety cover „Strong“ one-piece, lowerable and movable to the rear and to the front

- 2-part construction, inner joint surfaces screwed and sealed with silicone
- Front side with a hatch incl. handle
- Hatch is opened by gas pressure springs

Art.-no.	product specification
2236020	High jump cover with hatch, one-sided
2236024	Surcharge for an additional hatch (on request)

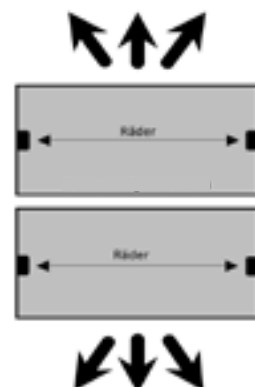

High jump safety cover „Strong“ two-piece, Lowerable, mobile and steerable

Safety cover „Strong“ for folding high jump mat

- Stationary safety cover for folding mat or as storage space
- Complete fully welded construction made of aluminium
- Pre-stressed, arched roof (snow load)
- For dowelling on foundations
- With two door wings including support wheels
- Opening for ventilation in the upper rear area (approx. 30 mm wide)

Art.-no.	product specification
9999998	cover on demand (Size according to individual requirements)

SAFETY COVER „STRONG“

Attention!
With a 1-piece
cover only
mobile, not

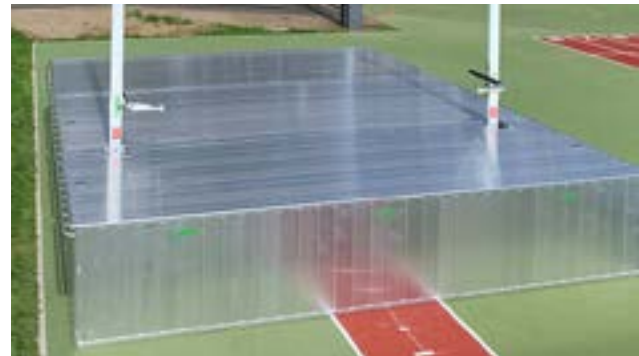
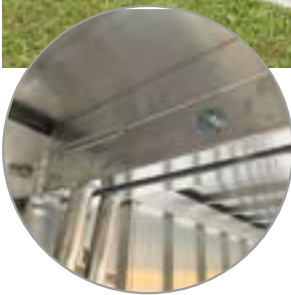

Pole vault cover „Strong“ 1-piece, lowerable, movable to the rear and to the front

- Delivery in 3 pieces, inner joint surfaces screwed and sealed with silicone
- Front side with a hatch incl. handle
- Hatch is opened by gas pressure springs

Art.-no. product specification

Pole vault cover „Strong“ 1-piece

2236022 Pole vault cover with hatch one-sided

2236024 Surcharge for additional hatch (on demand)

Pole vault cover „Strong“ 3-pieces
movable and steerable

- Closed fronts
- Incl. lateral brass spigot and counter support to connect the elements
- Guide pins as connectors
- Individual elements steerable (handcart principle)
- Gutter integrated between the elements for water drainage
- No lock is needed when the elements are connected

Art.-no. product specification

Pole vault cover „Strong“ 3-piece

2236023 Pole vault cover, steerable



Pole vault cover „Strong“ 1-piece, lowerable, movable to the rear and front

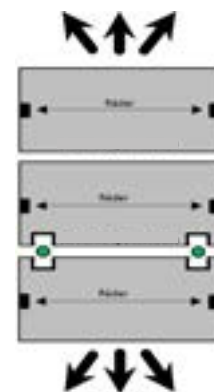

Pole vault cover „Strong“ 3-pieces, lowerable, movable and steerable

OUTDOOR WORKOUT



WORKOUT „SMALL“

The workout combinations can be combined as desired. Just ask!

Workout „Small“

- according to „DIN EN 1176“ (playground equipment) (only for type Small & Medium)
- according to „DIN EN 16630“ (outdoor fitness equipment) (all types)
- steel hot galvanised and powder coated
- attachment through foundation, alternative plugs
- posts made of 80 x 80 x 3 mm, standard in RAL 9005 deep black
- brace made of 60 x 60 x 3 mm, standard in RAL 6018 yellow-green
- grip rods made of Ø 33,7 x 3,2 mm, standard in RAL 6018 yellow-green
- other RAL-colours on request

According to DIN EN 1176

- max. fall height 2300 mm
- Required area 49,5 m² (6,1 x 8,1 m)

According to DIN EN 16630

- max. fall height 1300 mm
- Required area 42 m² (5,6 x 7,5 m)

- Length 4480 mm
- Width 2610 mm
- Height 2400 mm

- 2x Pull Up Bars, different heights
- 1x Double Parallel Bars
- 1x Swedish Wall

Art.-no. product specification

Workout „Small“

- | | |
|---------|------------|
| 4600010 | foundation |
| 4600011 | plugs |



WORKOUT „MEDIUM“

The workout combinations can be combined as desired. Just ask!



Workout „Medium“

- according to „DIN EN 1176“ (playground equipment) (only for type Small & Medium)
- according to „DIN EN 16630“ (outdoor fitness equipment) (all types)
- steel hot galvanised and powder coated
- attachment through foundation, alternative plugs
- posts made of 80 x 80 x 3 mm, standard in RAL 9005 deep black
- brace made of 60 x 60 x 3 mm, standard in RAL 6018 yellow-green
- grip rods made of Ø 33,7 x 3,2 mm, standard in RAL 6018 yellow-green
- other RAL-colours on request

According to DIN EN 1176

- max. fall height 2300 mm
- Required area 80 m² (8,9 x 9,0 m)

According to DIN EN 16630

- max. fall height 1300 mm
- Required area 66 m² (8,5 x 7,7 m)

- Length 5560 mm
- Width 4760 mm
- Height 2400 mm

- 5x Pull Up Bars, different heights
- 1x Double Parallel Bars
- 1x Swedish Wall
- 1x Monkey Bar



Art.-no. product specification

Workout „Medium“

4600020	Foundation
4600021	Plugs

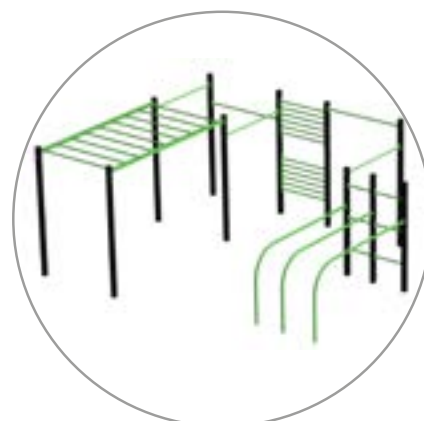

WORKOUT „LARGE“

Workout „Large“

- according to „DIN EN 1176“ (playground equipment) (only for type Small & Medium)
- according to „DIN EN 16630“ (outdoor fitness equipment) (all types)
- steel hot galvanised and powder coated
- attachment through foundation, alternative plugs
- posts made of 80 x 80 x 3 mm, standard in RAL 9005 deep black
- brace made of 60 x 60 x 3 mm, standard in RAL 6018 yellow-green
- grip rods made of Ø 33,7 x 3,2 mm, standard in RAL 6018 yellow-green
- other RAL-colours on request

According to DIN EN 1176

- max. fall height 2300 mm
- Required area 107 m² (13,6 x 7,9)

- Length 10570 mm
- Width 4880 mm
- Height 2400 mm

- 12x Pull Up Bars, different heights
- 2x Double Parallel Bars
- 2x Swedish Wall
- 1x Monkey Bar
- 2x Push Up bars

Art.-no. product specification

Workout „Large“

- | | |
|---------|------------|
| 4600030 | Foundation |
| 4600031 | Plugs |

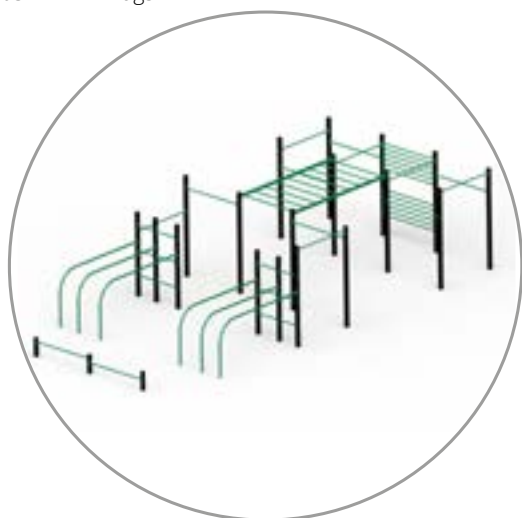

CALISTHENICS LEAGUE

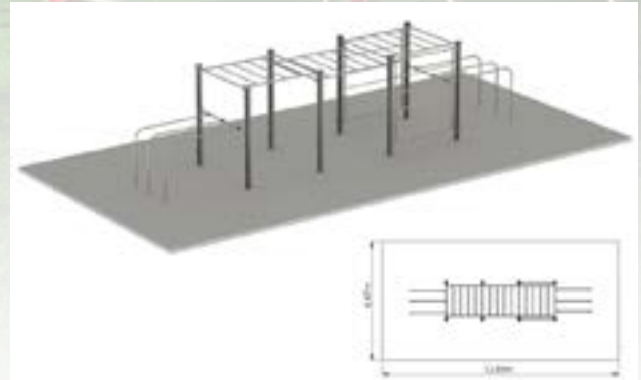
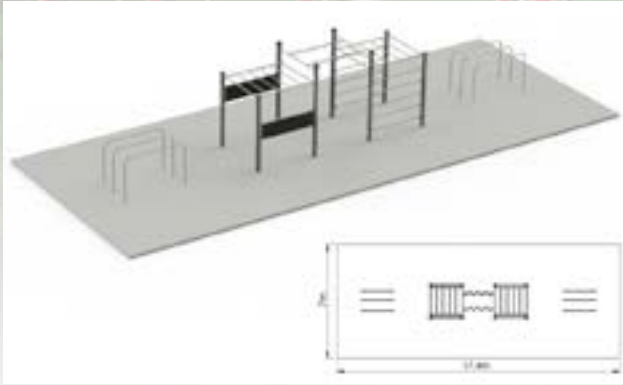

Calisthenics League

- Multifunctional, cross-shaped upright profile
- Clamp fastening system for cross braces
- Stainless steel posts
- Grip rods etc. made of brushed stainless steel
- Incl. TÜV GS seal
- In accordance with DIN EN 16630:2015-06 (outdoor fitness equipment)
- According to DIN EN 1176-1:2017-12 (playgrounds)

League Typ 1

- 4 Stk. post, height 250cm
- 4 Stk. post, height 300cm
- 2 Stk. Swedish Walls consisting of five bars Ø 33 mm
- 2 Stk. Monkey ladders/ wall bars, 6 bars
- 1 Stk. monkey ladder with grips and balls (Obstacle Course Races)
- 2 Stk. wall elements, multi-purpose basic wall (base/parkour)
- 2 Stk. 3-piece bar, free-standing for setting in concrete, Ø 42 mm
- 4 Stk. multi-purpose clamps to fix Battle Ropes etc.
- incl. fixing kit (anchor rods and injection mortar)
- incl. manufacturer's plate, assembly and installation instructions, maintenance instructions

Art.-no. product specification

Calisthenics League „Type 1“
4600040 Calisthenics League Type 1

Calisthenics League

- Multifunctional, cross-shaped post profile
- Clamp fastening system for cross braces
- Stainless steel posts
- Grip rods etc. made of brushed stainless steel
- Incl. TÜV GS seal
- In accordance with DIN EN 16630:2015-06 (outdoor fitness equipment)
- According to DIN EN 1176-1:2017-12 (playgrounds)

League Typ 2

- 8 Stk. post, height 250cm
- 2 Stk. Swedish Wall, 6 bars
- 3 Stk. monkey ladders/ wall bars, 6 bars
- 2 Stk. monkey ladders/ wall bars, 6 bars
- 2 Stk. 3-piece bar, free-standing for setting in concrete, Ø 42 mm
- 8 Stk. multi-purpose clamps to fix Battle Ropes etc.
- incl. fixing kit (anchor rods and injection mortar)
- incl. manufacturer's plate, assembly and installation instructions, maintenance instructions

Art.-no. product specification

Calisthenics League „Type 2“
4600040 Calisthenics League Type 2

PARKOUR - CONCRETE ELEMENTS

There are currently 24 parkour standard elements available. These can be used to plan countless systems. If you have your own ideas for elements, we may be able to realize them. Just talk to us.

- Concrete stone according to DIN EN 13198
- Concrete quality at least C25/30 XC4 XF1
- structurally reinforced
- Formed surface with chamfered edges
- Exposed concrete class SB 2
- sandblasted
- Slip resistance according to BGR 181, class at least R11
- Color gray
- including 2 shaft anchors for attachment to the foundation

Parkour Musteranlage

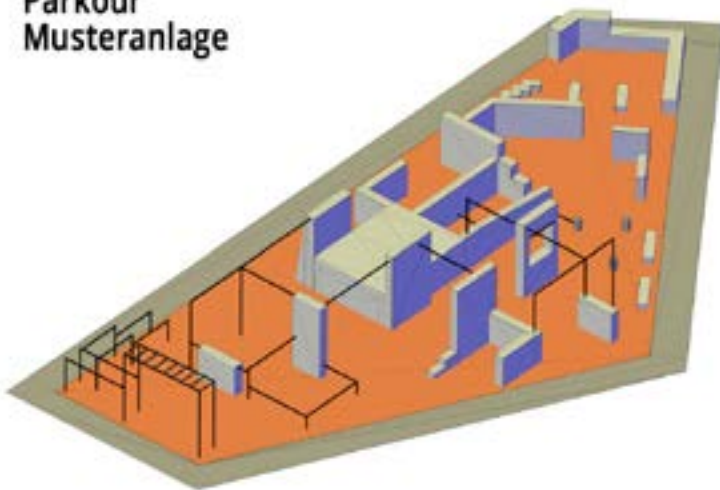

With us you will find the perfect opportunity to individually upgrade your open space. Our facilities comply with DIN EN 16899 "Sports and leisure facilities – Parkour facilities"

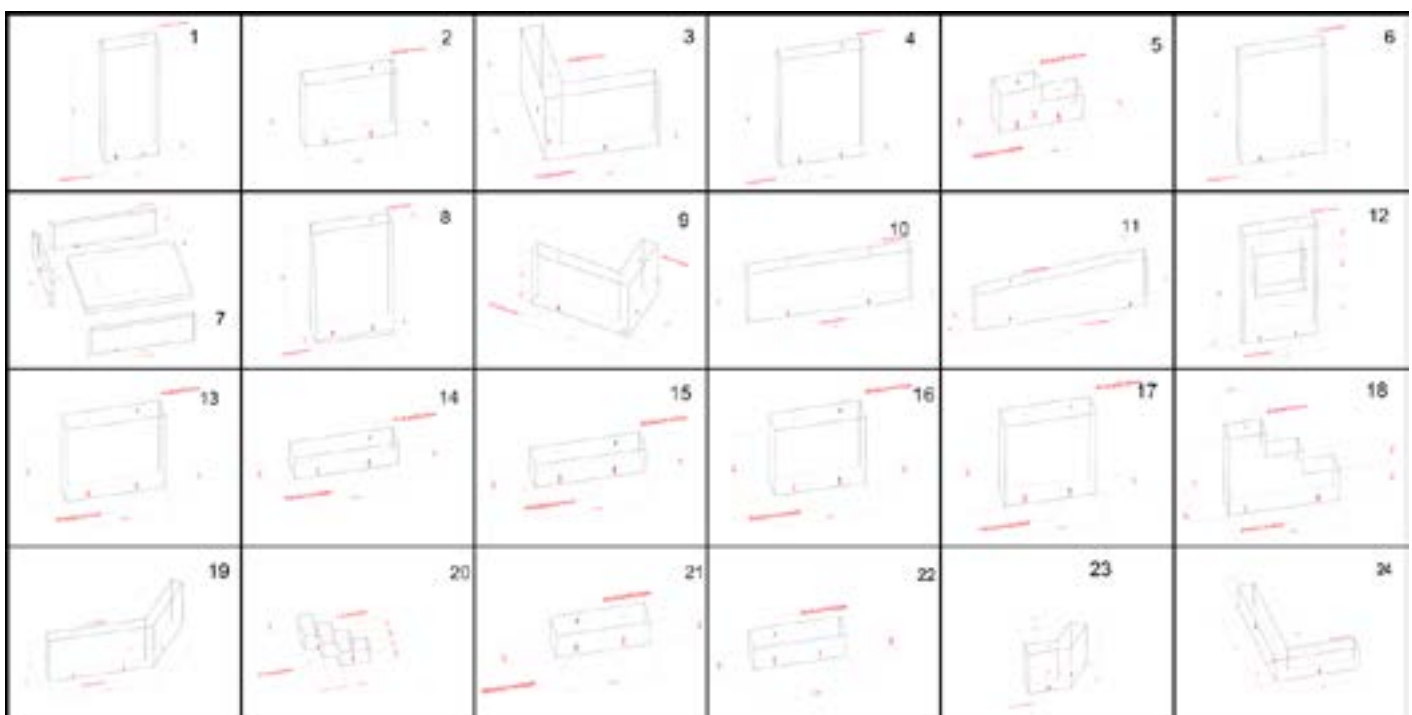

OUTDOOR FITNESS EQUIPMENT



Outdoor health training - the modern training spots for parks and jogging routes.

The numerous positive health effects of a calisthenics outdoor training are proved scientifically. Dr. Wolff's multifunctional training devices have been developed according to a sports science outdoor trainings concept.

Different and cost-effective:

The multifunctional Dr. Wolff training spots integrate harmoniously in parks and green areas.

An efficient solution for small spaces with a double advantage:

The walker finds a comfortable place to sit – the fitness athlete finds his perfect training medium for the workout.

Discover the new form of a varied and health-oriented outdoor training in your favorite places.

The advantages in view - training with movement quality

- Sports science training concept from experienced supplier
- Complete training programs can be performed on each device.
- Medical fitness: Different trunk muscle exercises to avoid back pain
- Target group specific programs via QR code and video: Back circuit training, abdomen/legs/ buttocks, total body workout

High quality product!

Stable and robust even under intensive load thanks to clever frame construction made of stainless steel. 100 % Made in Germany: long-lasting, sustainable and almost maintenance-free.

Outdoor Multi-Trainer

- complies with DIN EN 16630:2015 and DIN EN 1176-1:2008

Outdoor Multi-Trainer

- The perfect training station for small spaces - less is sometimes more!
- No cost-intensive training facility with elaborate landscaping
- No fall protection necessary
- Easy assembly - optionally pre-fabricated foundation
- No challenging calisthenics exercises
- Health training for everyone
- Enormous exercise variety

Multi Trainer Art. # 4600801

Dimensions: W: 126 D: 141 H: 98 cm
Falling range: 426 x 441 cm
Fall height: 98 cm

Prefabricated Art. # 4602800

For the assembling of all outdoor fitness devices, M10 screws are needed.
(Screws not included in the scope of delivery)



Information plate

Art.-no.	product specification
Outdoor Multi-Trainer	
4600801	Outdoor Multi-Trainer
4601801	Information plate Multi-Trainer
4601800	Optional pre-fabricated foundation



Outdoor fitness bench

- Probably the most sporty park bench in the world!
- Unique design - a real eye-catcher in your garden or in the park:
- Very comfortable seat made of stainless steel with high-quality perforated design
- Compact and robust stainless steel construction for high training loads
- Multi-functional: it offers over 20 different fitness exercises

Outdoor fitness bench Art. # 4600800
 Dimensions: W: 126 D: 124 H: 98 cm
 Falling area: 425 x 427 cm
 Free fall height: 98 cm

Prefabricated foundation Art. # 4602800
 For the assembling of all outdoor fitness devices, M10 screws are needed.
 (Screws not included in delivery)

Art.-no.	product specification
Outdoor fitness bench	
4600800	Outdoor gitness bench
4601800	Sign fitness park bench
4602800	Optional pre-fabricated foundation

Outdoor back trainer

- Suitable for strengthening the back muscles to avoid back pain
- the modern version of an outdoor back training
- 2 different starting positions for small and tall persons
- designed for fitness- and physiotherapy exercises

Back trainer Art. # 4600802
 Dimensions: B: 105 T: 32 H: 89 cm
 Falling area: 333 x 404 cm
 Free fall height: 89 cm

Pre-fabricated foundation Art. # 4602800
 For the assembling of all outdoor fitness devices, M10 screws are needed.
 (Screws not included in delivery)

Art.-no.	product specification
Outdoor back trainer	
4600802	Outdoor back trainer
4601802	Sign back trainer
4601800	Optional pre-fabricated foundation

SLACKLINE



Slackline

- Slackline post made of aluminium
- 120x100 mm profile, reinforced with steel
- Total length 160 cm, visible length 120 cm
- Studs at 50, 75 and 100 cm
- Optional slackline posts with platform with welded aluminium support plate with screen printing plate ø60 cm

Art.-no.	product specification
----------	-----------------------

Slackline	
------------------	--

2901000	Slackline posts, aluminium with steel core
2901003	Surcharge for slackline platform
2901001	Special socket for slackline posts
2901002	Standard socket for slackline posts
4001000	Slackline Classic, length 15m

Concrete slackline systems - the original from BLOACS

- Dimensions: approx. 1.8 m x 0.6 m x 0.58 m (L x W x H)
- Weight: each block approx. 1.5 tons
- Exposed concrete quality SB3 grey/smooth
- Concrete grade C35/45
- Seat surface with anti-slip structure
- Blocks are chamfered on all sides
- Edge protection edging on the front edge
- Shaft with anchor point for protected attachment of the ratchet



Art.-no.	product specification
----------	-----------------------

Slackline Concrete Element	
-----------------------------------	--

4002005	Basic system (2x foundation blocks, 1x slackline 3-6m / red, black or blue, 4x graphic panels)
4002010	Expansion set (1x foundation block, 1x slackline 3-6m / red, black or blue, 2x graphic panels)

STORAGE BOX

Outdoor storage box

Storage box made of aluminium hollow chamber profile, fully welded, in the base area with 4 welded-on lugs, with holes for ground anchors, lid with hinge, handle, gas pressure spring, all sizes possible.

Art.-no.	product specification
----------	-----------------------

Storage box	
--------------------	--

2530506	Size 300 / 50 / 60 cm
2535506	Size 350 / 50 / 60 cm
2540506	Size 400 / 50 / 60 cm
2550001	Post holder 1 pair
2550002	Post holder 2 pair
2550003	Handles bei 50 cm width
2550004	Handles bei 100 cm width
2550005	Surcharge movable with 4 swivel rolls



BEACHSPORT



BEACHSOCCER / BEACHHANDBALL



Beach soccer goal

Beach soccer goal "fully welded"

- Size 5.50 m x 2.20 m
- Goal frame made of 120x100 mm Aluminium profile
- fully welded
- Goal frame coated yellow
- Display 80/150 cm

Beach soccer goal "can be plugged into ground sockets"

- Size 5.50 m x 2.20 m
- Goal frame made of 120x100 mm Aluminium profile
- fully welded
- Goal frame coated yellow
- Display 80/150 cm
- upper pre-tensioned net brackets
- Display 80 cm

Art.-no. product specification

Beach Soccertor	
2800201	Beach soccer goal, fully welded, „Basic“
2800203	Beach soccer goal, fully welded, „Smart“
2801201	Beach soccer goal, pluggable, „Basic“
2801203	Beach soccer goal, pluggable, „Smart“

Art.-no. product specification

Accessories Beach Soccer	
4810175	chain weights for beach soccer goals, display 150 cm, length 8,70 m
4810151	beach soccer net, 4 mm, blue

Beach handball goal

Beach handball goal "fully welded"

- Size 3.00 m x 2.00 m
- Goal frame made of 80x80 mm aluminum profil
- fully welded
- Goal frame coated yellow
- Display 80/100 cm

Beach handball goal "can be plugged into ground sockets"

- Size 5.50 m x 2.20 m
- Goal frame made of 120x100 mm Aluminium profile
- fully welded
- Goal frame coated yellow
- Display 80/150 cm
- upper pre-tensioned net brackets
- Display 80 cm

Art.-no. product specification

Beach handball goal	
2800101	beach handball goal, fully welded, „Basic“
2800103	beach handball goal, fully welded, „Smart“
2801101	beach handball goal, pluggable, „Basic“
2801103	beach handball goal, pluggable, „Smart“

Art.-no. product specification

Accessories Beach Handball	
4810175	chain weights for beach handball goals, display 100 cm, length 5,00 m
4810151	beach handball net, 4 mm, yellow

BEACHVOLLEYBALL



“Competition”

TÜV certified according to DIN 1271 Class A



- oval aluminum profile 120x100 mm
- Wall thickness 4/6 mm
- complete mechanics inside
- Height adjustment on the back with removable Bare crank with trapezoidal threaded rod
- Mains voltage via removable crank a second trapezoidal threaded rod
- a crank for height adjustment & mains tension
- for net tension lengths from 11.20 to max. 12.50m
- Continuous height adjustment when the net is tensioned
- Aluminum post, powder-coated black
- on request in blank aluminum

Art.-no. product specification

Art.-no.	product specification
	Volleyball „Competition“
1800320	Volleyball, “Competition” facility,
4800310	Reduced price in blank aluminum
4800305	Additional charge for powder coating in RAL desired color

“More Competition” multi-purpose facility -

TÜV certified according to DIN 1271 Class A



- oval aluminum profile 120x100 mm
- Wall thickness 4/6 mm
- complete mechanics inside
- Height adjustment via “centrifugal clutch”. removable crank NEW DEVELOPMENT!
- Mains voltage via removable crank Trapezoidal thread rod
- a crank for height adjustment & mains tension
- for net tension lengths from 11.20 to max. 12.50m
- Continuous height adjustment when the net is tensioned
- Aluminum post, powder-coated black
- on request in blank aluminum

Art.-no. product specification

Art.-no.	product specification
	Volleyball „more Competition“
1800325	Volleyball, “more competition” multi-purpose
4800310	Reduced price in blank aluminum
4800305	Additional charge for powder coating in RAL desired color



Volleyball leisure and school “Basic” with threaded spindle - according to DIN EN 1270 Class C

- Aluminum profile made of 120x100 mm or 80x80 mm
- Height adjustable using external slider
- Mains voltage via threaded spindle and crank
- Posts in bright aluminum

art.-no. productspecification

art.-no.	productspecification
	Beachvolleyball Leisure and school „Basic“
2800301	Beach volleyball, „free time“ 120 x 100 mm
2800309	Beach volleyball, „free time“ 80 x 80 mm
2800312	Beach Volleyball Leisure facility „Basic“, 120 x 100 mm / deeper installation
2800313	Beach Volleyball Leisure facility „Basic“, 80 x 80 mm / deeper installation
4800305	Surcharge for powder coating in a RAL colour of your choice
4900269	Replacement crank for volleyball leisure facility “Basic”

BEACH- VOLLEYBALL / BADMINTON / TENNIS



Beach volleyball leisure and school „Pro“ with pulley - TÜV certified according to DIN 1271 Class C

- Aluminium profile 120/100 mm or 80/80 mm
- Height adjustable by external adjuster
- Net tensioning by means of a pulley (no crank necessary!)
- For net tensioning rope lengths from 11.20 m to max. 12.00 m
- Pulley mechanism inside a closed aluminium profile
- For volleyball (men, women, juniors and pupils) fist ball, indiaca and badminton



art.-no.	productspecification
----------	----------------------

art.-no.	productspecification
Beachvolleyball leisure fand school „Pro“	
2800315	Beach volleyball leisure facility „Pro“ 120 x 100 mm
2800316	Beach volleyball leisure facility „Pro“ 80 x 80 mm
2800317	Beach volleyball leisure facility „Pro“ 120 x 100 mm / deeper installation
2800318	Beach volleyball leisure facility „Pro“ 80 x 80 mm / deeper installation
4800310	surcharge for aluminium blank
4800305	surcharge for powder coating in a RAL-colour of your choice



Beach - Badminton

- Aluminium profile 120 x 100 mm
- External height adjustment
- Posts in aluminium blank
- Tension height 155 cm

Art.-no.	product specification
----------	-----------------------

Art.-no.	product specification
Beach Badminton	
2800301	beach badminton, tension height 155 cm



Beach - Tennis

- Aluminium profile 120 x 100 mm
- External height adjustment
- Posts in aluminium blank

Art.-no.	product specification
----------	-----------------------

Art.-no.	product specification
Beach Tennis	
2800301	Beach Tennis

BEACH SPORTS ACCESSORIES

Beach cover

- sturdy mesh web, all over with hemstitches
- colour: moss-green
- all around chain (6 mm, hot galvanised) for weightening the cover
- 4 open corners with carabiner hooks for installing

Art.-no. product specification

Beach cover

4030020 Cover, loose, with chain



Beach - net and antennas

art.-no. productspecification

Beach net and antenna

4850906 beach volleyball net, 2 mm, yellow PVC band, 9,50 x 1,00 m, Line 11,70 m
 4805044 beach volleyball net tournament, 3 mm, DVV, neonpink
 4800606 beach badminton nete, 1 mm, 6,00 x 0,76 m, yellow
 4800509 beach antenna one-piece, DVV certificated, yellow
 4805029 beach antenna two-piece, length 1,80 m



Beach - safety pad

Art.-no. product specification

Beach safety pad

4801000 Safety pad 120/100 mm, with Velcrotape
 4801100 Safety pad 80/80 mm, with Velcrotape



Beach - sleeves

Art.-Nr. Produktbeschreibung

Beach Bodenhülse

2800308 Beach volleyball sleeve reversible adapter oval
 2800307 Beach volleyball sleeve reversible adapter square

 2800303 Beach volleyball ground socket, 120/100 mm
 2800305 Beach volleyball ground socket, 80/80 mm
 2800304 Beach volleyball deeper installation with base ring, 120/100 mm
 2800306 Beach volleyball deeper installation with base ring, 80/80 mm

 2800502 Beach volleyball anchor plate, steel, „School“ posts, 120/100 mm
 2800505 Beach volleyball anchor plate, steel, „School“ posts, 80/80 mm
 2800504 Beach anchor plate for beach Soccer / Handball, no tilting
 2800503 Beach volleyball anchor plate, steel, „Competition“ posts, 120/100 mm

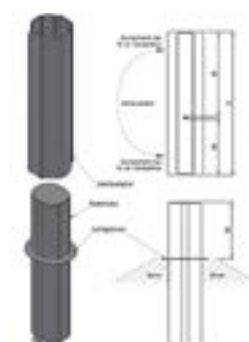

BEACH COURT EDGE ELEMENTS

ABSORBED SOLUTION „TYPE 2000“



Beachcourt - edge element „Type 2000“, absorbed solution

beach edge type 2000, «absorbee solution», consists of guide and stabilising element made of hot galvanised steel and polyurethane bound rubber granules (not colour resistant)

- Beach pitch 22 x 14 m (internal measurement) for one volleyball field
- Beach pitch 26 x 22 m (internal measurement) for one double volleyball field
- Beach pitch 39 x 28 m (internal measurement) for one soccer field

Materials:

- 1. normal element, rubber granules, polyurethane-bound, red, green, black or grey.
- 2. corner element, rubber granules, polyurethane-bound, red, green, black or grey.
- 3. Guide and stabilisingelement, steel, hot galvanised, length 300 cm.



Art.-no. product specification

Beachcourt edge element „Type 2000“

3030005	stabilising element 200 cm
3030100	normal element red
3030101	corner element red
3030110	normal element green
3030111	corner element green
3030115	installation template
3621420	PUR glue red
3621421	PUR glue green

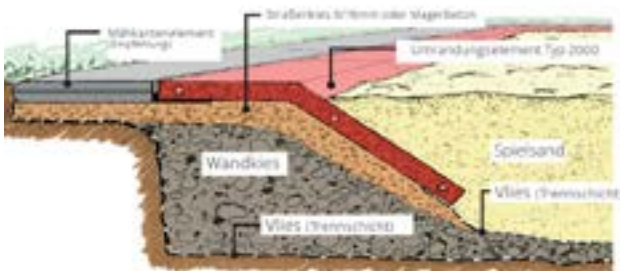

- Materialien:
- 1. Normalelement, Gummigranulat, polyurethan gebunden, rot, grün, schwarz oder grau.
 - 2. Eckschalen, Gummigranulat, polyurethan gebunden, rot, grün, schwarz oder grau.
 - 3. Führungs- und Stabilisierungselement, Stahlblech, verzinkt, 300 cm.

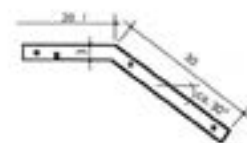

BEACH COURT EDGE ELEMENTS

RAISED SOLUTION „TYPE 98“

Beachcourt - edge element „Typ 98“, raised solution

beach court edge type 98, «raised solution», elements made of galvanised steel, 2 mm thick; corner and connection elements made of chrome steel; stabilising elements made of hot galvanised steel; rust free tensioning and assembly materials.

- Beach pitch 22 x 14 m (internal measurement) for one volleyball field
- Beach pitch 26 x 22 m (internal measurement) for one double volleyball field
- Beach pitch 39 x 28 m (internal measurement) for one soccer field

Art.-no. product specification

Beach edge element „Typ 98“

3030002	fitting element 274 cm without guide
3030003	corner element type 98, chromed 200cm
3030004	connection element
3030005	stabilising element 200 cm
3030006	corner element type 98, side length 108/108cm, steel
3030007	fitting element 74 cm without guide
3030009	tension set simple system
3030010	assembly material simple system
3030011	length variable
3130001	normal element type 98 left
3130009	tension set double system
3130010	assembly material double system
3230001	normal element type 98 right

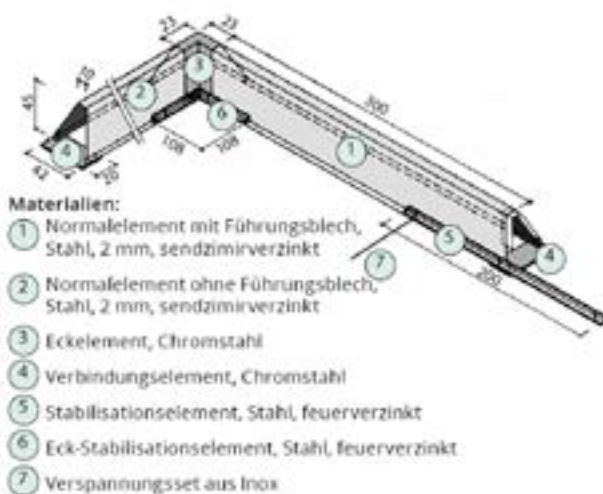

Beachcourt- edge element „Typ 08“, raised solution

Design and construction of type 98 and type 08 are similar. Type 08, however, has a vertical external side, suitable for a connection with a ball catching system. Type 08 and type 98 can be combined.



SHOE CLEANING SYSTEMS



SHOE WASH SYSTEMS „TYPE A“

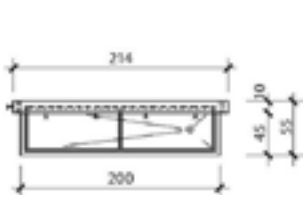

Shoe wash systems Type A1

- 1 wash trough concrete element type A, incl. 2 grillages
- 1 washing hanger type A1
- 4 taps, plain chromed

art.-no. product specification

Shoe wash systems Type A1
3005180 Shoe wash system complete type A1

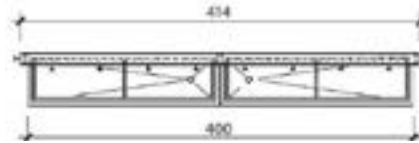

Shoe wash systems Type A2

- 2 wash trough concrete element type A, incl. 2 grillages
- 1 washing hanger type A2
- 8 taps, plain chromed

art.-no. product specification

Shoe wash systems Type A2
3005181 Waschtrog komplett Typ A2

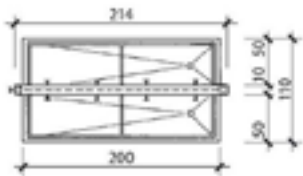
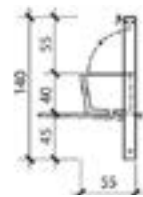

Shoe wash systems Type A3

- 2 wash trough concrete element type A, incl. 2 grillage
- 1 washing hanger type A3
- 8 taps, plain chromed

art.-no. product specification

Shoe wash systems Type A3
3005182 Shoe wash system complete type A3

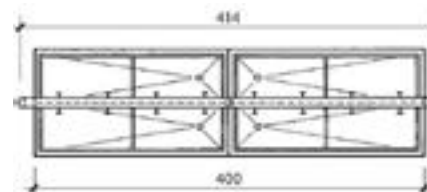
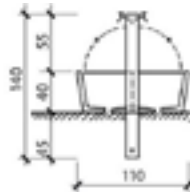

Shoe wash systems Type A4

- 4 wash trough concrete element type A, incl. 2 grillage
- 1 washing hanger type A4
- 16 taps, plain chromed

art.-no. product specification

Shoe wash systems Type A4
3005184 Shoe wash system complete type A4

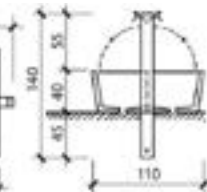

Wash hanger type A1

- usable from one side, length 214 cm, 4 fittings for

art.-no. product specification

Wash hanger type A1
3005090 Wash hanger type A1

Wash hanger type A2

- usable from one side, length 414 cm, 8 fittings for

art.-no. product specification

Wash hanger type A2
3005091 Wash hanger type A2

Wash hanger type A3

- usable from both sides, length 214 cm, 8 fittings for

art.-no. product specification

Wash hanger type A3
3005092 Wash hanger type A3

Wash hanger type A4

- usable from both sides, length 414 cm, 16 fittings for

art.-no. product specification

Wash hanger type A4
3005093 Wash hanger type A4

SHOE WASH SYSTEMS „TYPE B“

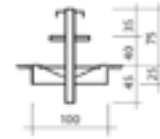
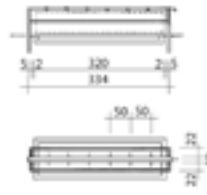
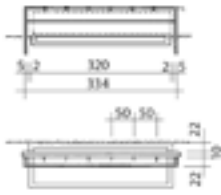

Shoe wash system type B11

- 1 wash trough concrete element type B10 incl. 3 grillages
- 1 wash hanger type B11
- 6 taps , plain chromed
- 1 hose fitting

art.-no. product specification

Show wash system type B11

3005204 Wash trough complete type B11

Shoe wash system type B12

- 1 wash trough concrete element type B10 incl. 3 grillages
- 1 wash hanger type B12
- 12 taps, plain chromed
- 1 hose fitting

art.-no. product specification

Show wash system type B12

3005205 Wash trough complete type B12

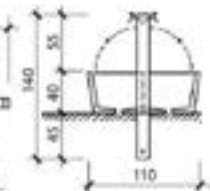
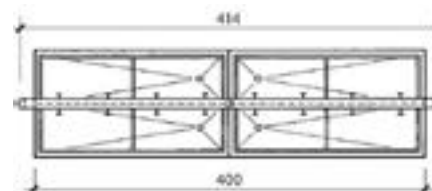
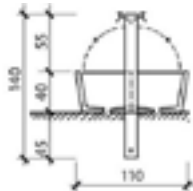
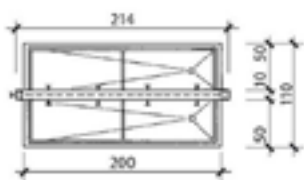

Shoe wash system type B13

- 2 wash trough concrete element type B10 incl. 6 grillages
- 1 wash hanger type B13
- 12 taps , plain chromed
- 1 hose fitting

art.-no. product specification

Show wash system type B13

3005206 Wash trough complete type B13

Shoe wash system type B14

- 2 wash trough concrete element type B10 incl. 6 grillages
- 1 wash hanger type B14
- 24 taps , plain chromed
- 1 hose fitting

art.-no. product specification

Show wash system type B14

3005204 Wash trough complete type B14

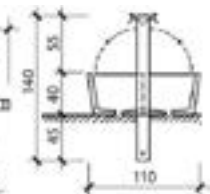
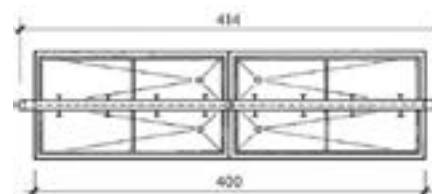
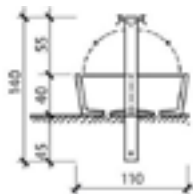
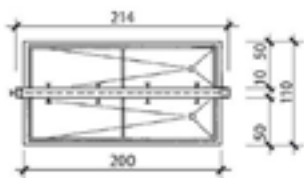

Shoe wash system type B21

- 1 wash trough concrete element type B20 incl. 2 grillages
- 1 wash hanger type B21
- 4 taps , plain chromed
- 1 hose fitting

art.-no. product specification

Show wash system type B21

3005208 Wash trough complete type B21

Shoe wash system type B22

- 1 wash trough concrete element type B20 incl. 2 grillages
- 1 wash hanger type B22
- 8 taps , plain chromed
- 1 hose fitting

art.-no. product specification

Show wash system type B22

3005204 Wash trough complete type B22

SHOE WAS SYSTEMS „TYPE B“

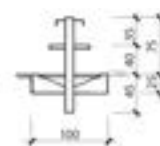
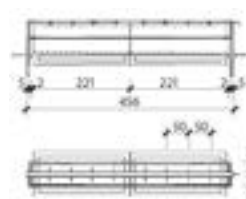
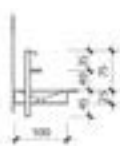

Shoe wash system type B23

- 2 wash trough concrete element type B20 incl. 4 grillages
- 1 wash hanger type B23
- 8 taps, plain chromed
- 1 hose fitting

art.-no. product specification

Show wash system type B23

3005210 Wash trough complete type B23

Shoe wash system type B24

- 2 wash trough concrete element type B20 incl. 4 grillages
- 1 wash hanger type B24
- 16 taps, plain chromed
- 1 hose fitting

art.-no. product specification

Show wash system type B24

3005211 Wash trough complete type B24

Wash hanger type B11

- Usable on one side, length 334 cm, 6 fittings for taps, weight 55 kg.

art.-no. product specification

Wash hanger type B11

3005214 Wash hanger type B11

Wash hanger type B12

- Usable from both sides, length 334 cm, 12 fittings for taps, weight 68 kg.

art.-no. product specification

Wash hanger type B12

3005215 Wash hanger type B12

Wash hanger type B13

- Usable on one side, length 654 cm, 12 fittings for taps, weight 96 kg.

art.-no. product specification

Wash hanger type A3

3005216 Wash hanger type B13

Wash hanger type B14

- Usable from both sides, length 654 cm, 24 fittings for taps, weight 120 kg.

art.-no. product specification

Wash hanger type B14

3005217 Wash hanger type B14

Wash hanger type B21

- Usable on one side, length 234 cm, 4 fittings for taps, weight 37 kg.

art.-no. product specification

Wash hanger type B21

3005224 Wash hanger type B21

Wash hanger type B22

- Usable from both sides, length 234 cm, 8 fittings for taps, weight 45 kg.

art.-no. product specification

Wash hanger type B22

3005093 Wash hanger type B22

Wash hanger type B23

- Usable on one side, length 454 cm, 8 fittings for taps, weight 64 kg.

art.-no. product specification

Wash hanger type B23

3005226 Wash hanger type B23

Wash hanger type B24

- Usable from both sides, length 454 cm, 16 fittings for taps, weight 80 kg.

art.-no. product specification

Wash hanger type B24

3005227 Wash hanger type B24

SHOE WASH SYSTEM „TYPE C“



Shoe wash system „Type C“,
The solution with concrete trough

Design

concrete element, grey, formwork smooth, reinforced including drain (shaft lining NW 100) and removable grillage cover. The water pipe with faucet connections ½" is inserted in concrete element. Shoe support bar is made of steel profiles.

Design „frost-proof“

Identical to the standard design but with a free space in the rear wall to add the parts for the frost-proof version. The frost-proof version is delivered „without“ sanitary parts. Insulated water pipes and connections on site.

Transfer

The following work must be performed on site: foundation / support, water connection and discharge with mud collector.

Note

When ordering we need the information whether the drain is desired to be left or right as well as the water connection (please refer to the drawings)

Positioning process on customer's request (standard: infeed) Type C3 and C4 have two drains.

Normalausführung

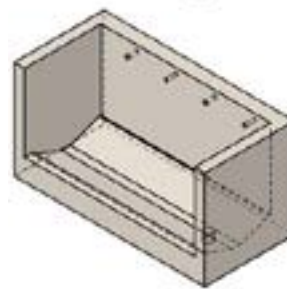

Ausführung frostsicher

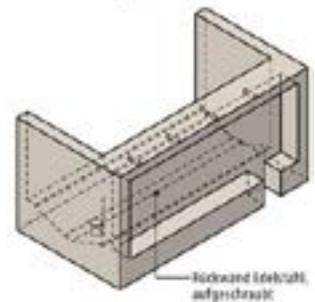

Querschnitt (Normalausführung)

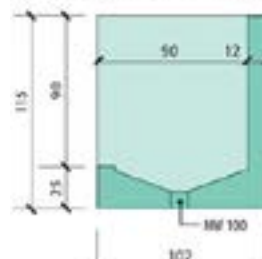

Querschnitt (Ausführung frostsicher)

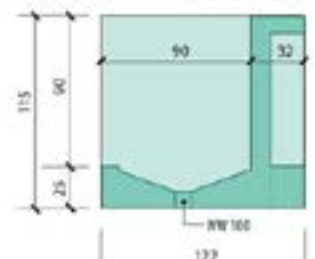

SHOE WASH SYSTEM „TYPE C“

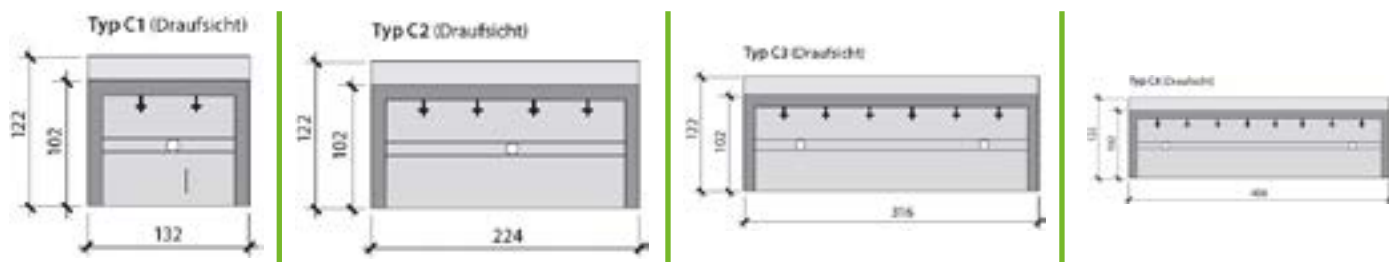

Art.-Nr.	Type	Version	Height	Depth	Length	Weight	Taps
3005810	C1	Standard version	115 cm	102 cm	132 cm	1525 kg	2
3005820	C2	Standard version	115 cm	102 cm	224 cm	2225 kg	4
3005825	C2	Frost-proof	115 cm	122 cm**	224 cm	2620 kg	4
3005830	C3	Standard version	115 cm	102 cm	316 cm	2925 kg	6
3005835	C3	Frost-proof	115 cm	122 cm**	316 cm	2925 kg	6
3005840	C4	Standard version	115 cm	102 cm	408 cm	3575 kg	8
3005845	C4	Frost-proof	115 cm	122 cm**	408 cm	4350 kg	8

exkl. roof, **exkl. back

WASH SYSTEM „TYPE C“ ROOF

Version A, for example type C2

We are also supplying shoe wash systems with roof and lighting. Plan with us!!

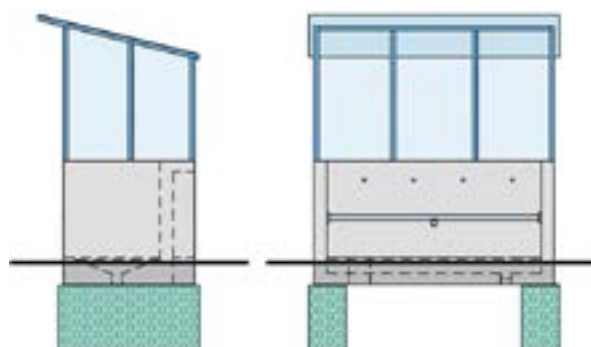

Version B, for example type C2

We are also supplying shoe wash systems with roof and lighting. Plan with us!

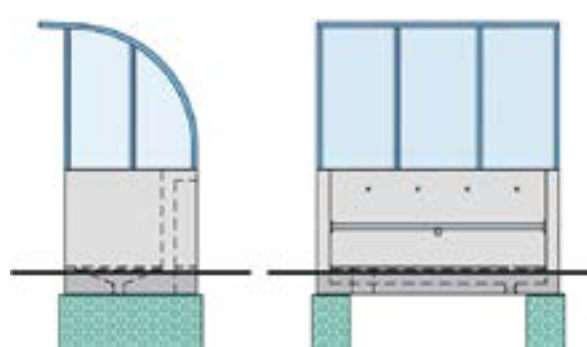

SHOE WASH SYSTEM „TYPE D“

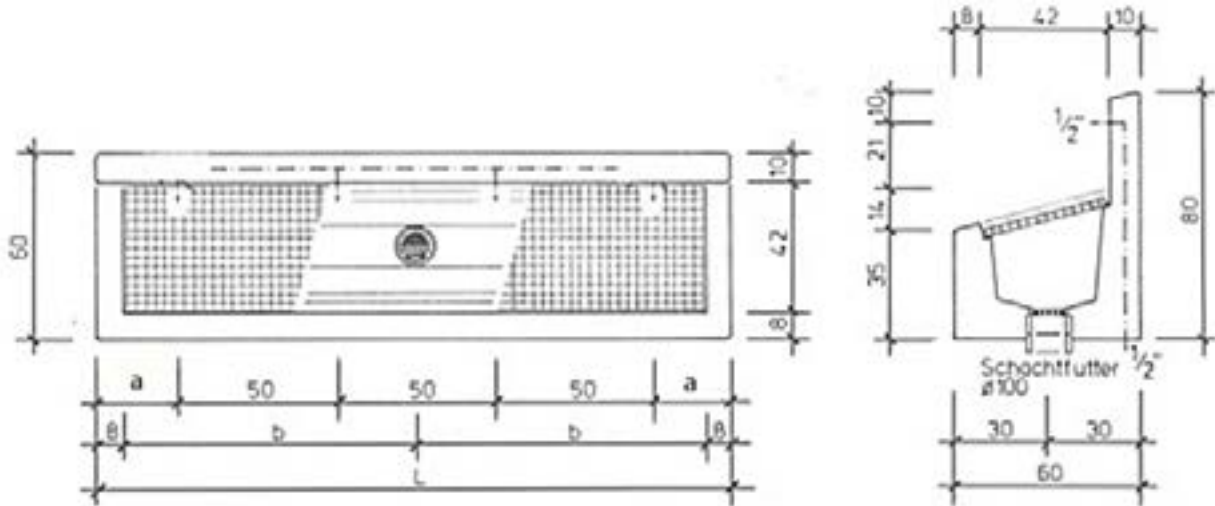

Shoe wash system „Typ D“,
The raised solution with integrated back

concrete wash trough with integrated back, grey, smooth surface, chamfered edges, incl. Supply line (for an additional charge you can freely select, distance 10 cm) and grillage, flow 100mm.

Type D1, fitting for 2 taps

art.-no. product specification

Type D1, fitting for 2 taps

3902001 Length 140 cm, width 60 cm, height 80 cm,
Weight 600 kg, without taps



Type D2, fitting for 4 taps

art.-no. product specification

Type D2, fitting for 4 taps

3902011 Length 200 cm, width 60 cm, height 80 cm,
weight 900 kg, without taps

Type D3, fitting for 5 taps

art.-no. product specification

Type D3, fitting for 5 taps

3902611 Length 260 cm, width 60 cm, height 80 cm,
weight 1200 kg, without taps

SHOE WASH SYSTEM „TYPE SC“

Shoe wash system „Typ SC“,
Single units for easy use

Application / use

- School- and sports facilities
- Sports halls and gymnasia
- Leisure facilities
- Factory premises
- Army barracks
- Police, fire brigade
- Camping sites
- Riding centers
- Restaurants/hotels
- Private areas
- Construction sites, industrial areas
- Municipalities, schools, day-care centers
- Gardens and workshops
- Agriculture and forestry

All-round cleaning

- With the 3-brush system all sides of the shoes are cleaned at the same time

Flexible

- The long bristles adapt to any shoe size

Self-cleaning

- When the long bristles spring back, the dirt particles clear away of the bristles

Robust and functional

- The system meets the high quality requirements and guarantees the function

Solutions with convincing advantages

- „lay-on“ version, type SC-1: for refitting
- „recessed“ version, type SC-2: for use on the same level
- „recessed“ version, TYPE SC-3: with wet cleaning

Shoe wash system Typ SC-1 „lay-on“

Fixing on the ground is not necessary, but advisable. Suitable for retrofitting. Hot-dip galvanized metal grillage and 3 brushes (exchangeable), weight 3 kg.

art.-no.	product specification
Show wash system Typ SC-1 „lay-on“	
3005520	Type SC-1
3005523	Replacement brushes set – 3 pcs

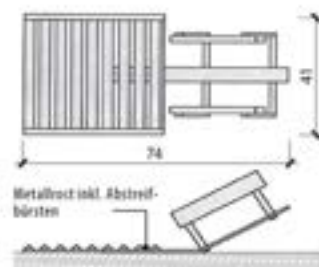

Shoe wash system type SC-2 „recessed“

The grillage is loosely placed into concrete element. For cleaning just lift out the grillage. The stripping brushes are firmly connected to the grillage. Concrete element, hot-galvanised grillage, 3 brushes (interchangeable). Weight 61 kg

art.-no.	product specification
Shoe wash system type SC-2	
3005521	Type SC-2
3005523	Replacement brushes set – 3 pcs

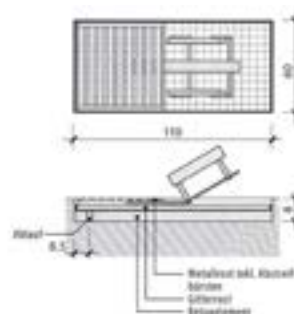

SHOE WASH SYSTEM „TYPE SC-3“

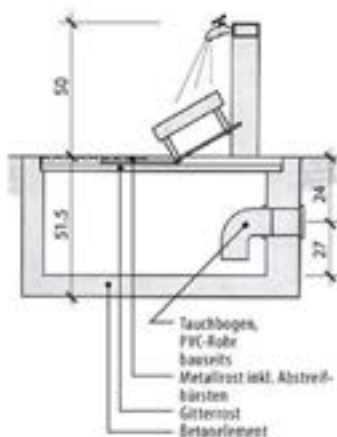
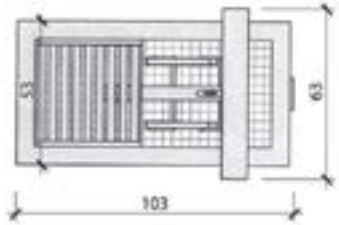

Shoe wash system type SC-3 „Recessed with wet cleaning“

Trough / Grillage

Concrete element, grey, smooth, reinforced, incl. Shaft lining for PVC pipe NW100, metal frame and removable grillage cover with 3 stripping brushes (interchangeable)

Wash hanger

Steel profile 100 x 50mm, hot-dip galvanised, with water supply and water tap connection 1/2.

Transfer

The following work must be performed on site: Foundation / support, water connection and discharge with mud collector.

- 1 concrete element type SC-3
- 1 grillage with
- 3 stripping brushes
- 1 wash hanger type SC-3
- 1, resp. 2 tap(s)
- Weight 501 kg

art.-no. productspecification

Show wash system type SC-3

3005525	concrete element incl. grillage and stripping brushes
3005526	Wash hanger usable on one side
3005527	Wash hanger usable on both sides
3005523	Bristles (set contains 3 pieces)

Shoe cleaner „Ideal“

- Shoe cleaner made of hot-galvanised steel
- High quality bristles
- Measurements 49,5 x 29,5 x 18 cm

art.-no. productspecification

Show cleaner „Ideal“

4041284	Shoe cleaner „Ideal“
---------	----------------------

WASH SYSTEM „ACCESSORIES“

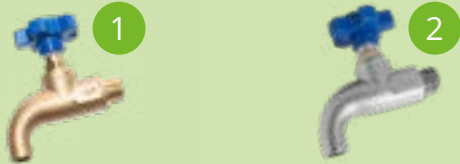

Tap simple

Art.-no. product specification

Tap simple

3005600 ① Version red brass

3005601 ② Version chromed



Tap with hose fitting

Art.-no. product specification

Tap with hose fitting

3005602 ③ Version red brass with plastic wheel

3005603 ④ Version chromed with metal wheel

3005606 ⑤ Version red brass with socket wrench

3005605 ⑥ Version chromed with socket wrench



Tap self-locking

Art.-no. product specification

Tap self closing

3005607 ⑦ Version chromed



Tap self-locking, with hose fitting

Art.-no. product specification

Tap self-locking, with hose fitting

3005608 ⑧ Version chromed



Rosette for water tap

• We recommend to use tap rosettes for wash system type C and D because the water taps are in direct

Art.-no. product specification

Rosette

3005609 Rosette for water tap

WASH SYSTEM „ACCESSORIES“

Cleaning brush

- Made of plastic, red, with stable bristles, connection

Art.-no.	product specification
Cleaning brush	
3005218	Connection 1/2"
3005219	Connection 3/4"



Brush bracket

- Made of steel hot-galvanised, suspension on wash

Art.-no.	product specification
Brush bracket	
3005604	Suspension on one side
3005605	Suspension on both sides



Spare parts compensatory bristles for type SC-1/2/3

Art.-no.	product specification
Compensatory bristles for type SC-1/2/3	
3005523	bristles (set contains 3 pieces)



Bench for show wash systems

- suitable for systems type A, B, C and D

Art.-no.	product specification
Bench for show wash systems	
3005510	Type A bench to cemente in
3005511	Type B bench to screw on

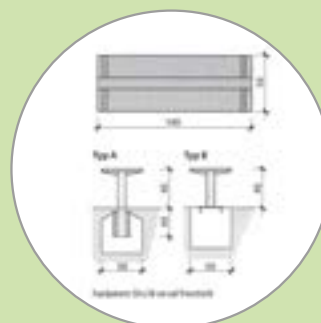

INSTALLATION PARTS „ELASTIC CURBING“ MADE OF HARD CONCRETE

Elastic curbing

Sport arenas and training facilities must be equipped with curbing to prevent injuries. The elastic curbings are high quality installation parts to make sports fields safe. They are used as border elements for shot put and long jump training areas, all-weather pitches or other play areas.

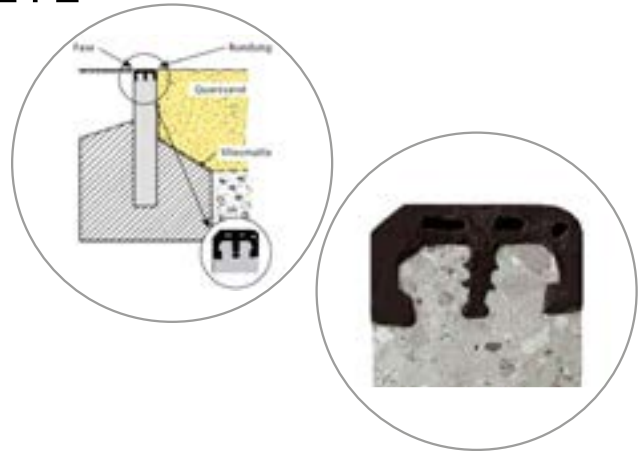

Elastic curbing made of hard concrete

Material

- Hard concrete, grey with rubber profile in black

Dimesions

- All types available in length 100 cm

Installation

- In continuous concrete foundation with a joint of

art.-no. productspecification

Elastic border element made of hard concrete with black rubber cover

3002084	Standard element G1-20, LxWxH: 100,00 x 20,00 x 6,00 cm
3002090	Standard element G1-30, LxWxH: 100,00 x 30,00 x 6,00 cm
3002092	Standard element G1-40, LxWxH: 100,00 x 40,00 x 6,00 cm

art.-no. productspecification

Elastic border element, hard concrete, edge 90° complete

3002102	Edge element complete G1-20, LxWxH: 50,00/50,00 x 20,00 x 6,00 cm
3002104	Edge element complete G1-30, LxWxH: 50,00/50,00 x 30,00 x 6,00 cm
3002106	Edge element complete G1-40, LxWxH: 100,00 x 40,00 x 6,00 cm

art.-no. productspecification

Elastic border element, hard concrete, edge 90° 2-piece

3002086	Edge element 2-piece G1-20, LxWxH: 100,00/100,00 x 20,00 x 6,00 cm
3002094	Edge element 2-piece G1-30, LxWxH: 100,00/100,00 x 30,00 x 6,00 cm
3002096	Edge element 2-piece G1-40, LxWxH: 100,00/100,00 x 40,00 x 6,00 cm

art.-no. productspecification

Elastic curbing made of hard concrete Radius element (inner radius 100 cm)

3002107	Edge element/radius element G1-40, LxWxH: 157,00 x 40,00 x 6,00 m
---------	--

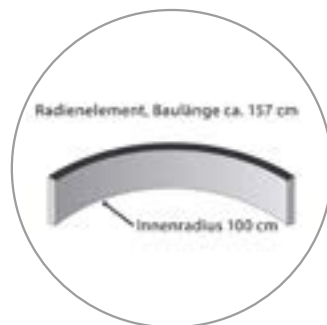
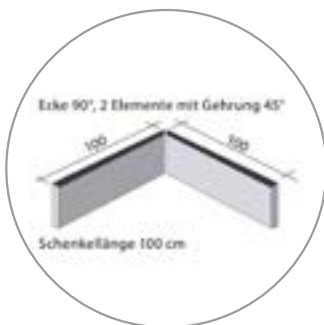
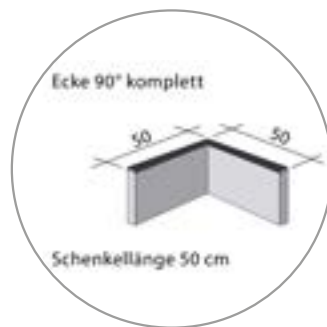
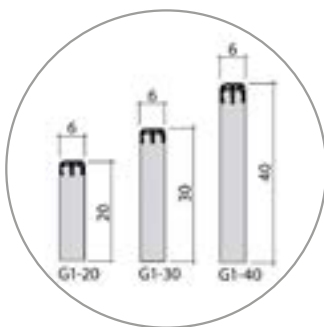

INSTALLATIONPARTS „ELASTIC CURBING“ MADE OF POLYMER CONCRETE



Elastic curbing made of polymer concrete

Elastic curbing made of polymer concrete with white or black rubber profile (EPDM).

The rubber profile is firmly cast in the lower part of the polymer concrete. The integrated air chamber

art.-no.	productspecification
Elastic curbing black rubber edge	
5001573	Elastic curbing, black, LxWxH: 50,00 x 6,00 x 30,00 cm
5001574	Elastic curbing, black, LxWxH: 50,00 x 6,00 x 40,00 cm
5001773	Elastic curbing, black, LxWxH: 100,00 x 10,00 x 20,00 cm
5001774	Elastic curbing, black, LxWxH: 100,00 x 10,00 x 25,00 cm
5001690	Elastic curbing, black, LxWxH: 100,00 x 5,00 x 20,00 cm
5001035	Elastic curbing, black, LxWxH: 100,00 x 5,00 x 25,00 cm
5001034	Elastic curbing, black, LxWxH: 100,00 x 6,00 x 20,00 cm
5001036	Elastic curbing, black, LxWxH: 100,00 x 6,00 x 30,00 cm
5001037	Elastic curbing, black, LxWxH: 100,00 x 6,00 x 40,00 cm

art.-no.	productspecification
Elastik curbing white rubber edge	
5001689	Elastic curbing, white, LxWxH: 100,00 x 5,00 x 20,00 cm
5000962	Elastic curbing, white, LxWxH: 100,00 x 5,00 x 25,00 cm
5000961	Elastic curbing, white, LxWxH: 100,00 x 6,00 x 20,00 cm
5000963	Elastic curbing, white, LxWxH: 100,00 x 6,00 x 30,00 cm
5000964	Elastic curbing, white, LxWxH: 100,00 x 6,00 x 40,00 cm
5001571	Elastic curbing, white, LxWxH: 50,00 x 6,00 x 30,00 cm
5001572	Elastic curbing, white, LxWxH: 50,00 x 6,00 x 40,00 cm

art.-no.	productspecification
Elastik curbing corner elements	
5000968	Elastic curbing, white, LxBxH: 25,00/25,00 x 5,00 x 25,00 cm
5001381	Elastic curbing, white, LxBxH: 25,00/25,00 x 6,00 x 30,00 cm
5000969	Elastic curbing, white, LxBxH: 25,00/25,00 x 6,00 x 40,00 cm
5001041	Elastic curbing, black, LxBxH: 25,00/25,00 x 5,00 x 25,00 cm
5001380	Elastic curbing, black, LxBxH: 100,00 x 5,00 x 20,00 cm
5001042	Elastic curbing, black, LxBxH: 25,00/25,00 x 6,00 x 40,00 cm

SAND-TRAP CHANNEL

Sand-trap channel

The benefit of sand trap elements around long jump pits is uncontested. We offer different solutions.

sand-trap channel grate and rubber mat

- Base made of frost-resistant polymer concrete
- Cover of anti-slip galvanized metal grillage with locked rubber mat to protect against injuries
- Metal edge for a perfect contact with the plastic cover
- Pre-forming for connection piece DN 100 in the bottom for opening a channel line
- Internal channels as construction elements for a double-row installation to increase the installation width as required.
- Compensating pieces of 56 cm
- Smooth inner surface for an easy cleaning



art.-no.	productspecification
Sand-trap channel grate and rubber mat	
5001475	Elastic sand-trap channel - outer chase 100 cm
5001477	Elastic sand-trap channel - outer chase 56 cm
5001474	Elastic sand-trap channel - inner chase 100 cm
5001476	Elastic sand-trap channel - inner chase 56 cm



Sand trap-element Typ B - Concrete element with rubber border

- Sand is „deposited“ in the recesses of the rubber mat
- Concrete element with rubber border on one side (black) and black perforated rubber mat
- Dimensions (L x W x H): 100 x 52 x 9 cm
- Corner and end element consisting of concrete element with rubber border (black) and perforated black rubber mat
- Dimension (L x W x H): 52 x 52 x 9 cm

art.-no.	productspecification
Sand trap - element	
3002110	Stand element
3002112	Corner and final element
3002114	Surcharge for cutting short lengths



Sand trap-element Typ C - with aluminium tray

- Consisting of an aluminium tray (metal thickness 2.0 mm)
- Incl. galvanized metal grillage and perforated black rubber mat
- Dimensions (L x W x H): 100 x 50 x 15 cm
- In case of type C, no concrete additives must be added to the lean concrete because the Aluminium surfaces could be affected

art.-no.	productspecification
Sand trap - element	
3002140	Standard element
3002111	End element (aluminium plate)

ARTIFICIAL TURF „FINISHING ELEMENT“

Plastic flooring - end element

We recommend the alu-liner for small solutions (visible aluminium- profile: 3 mm) price-performance ratio. Although material costs for the alu-liner are higher, the end price of this solution is lower, caused by lower labour costs with a smaller installation depth.

Material and measurements

- Aluminium
- Construction height: 15 cm
- Total width at the top: 23 mm
- Visible width at the top: 3 mm
- Construction length: 5 metre
- Weight approx.: 7.5 kg / element, 1.5 kg/ml

Installation

Installation of the alu-liner is equal to top edge in a continuous concrete foundation with a gap of 2 mm. To increase the bonding between aluminium and concrete, we recommend to clean the contact surfaces and to prime the aluminium.

Radii of > 4.00 m can be created on site by bending the material. We recommend that you mark the radius on the subsoil and place metal pickets as a stabilization measure before placing the concrete foundation. These pickets can be removed after the hardening process (foundation concrete).

art.-no.	productspecification
Aluliner	
3002700	Normal element with connection, length 500 cm
3002701	Corner 90° sawed on mitter and welded, side length 50 cm (construction length 100 cm).
3002702	Corner variable two-parted, sawed on mitter, side length 50 cm (construction length 100 cm).
3002705	Surcharge for short lengths under 500 cm

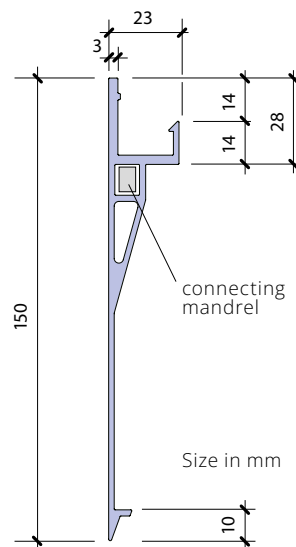

The connection thorn is fixed in



The necessary gap of 2 mm (material expansion) can be ensured with a match.

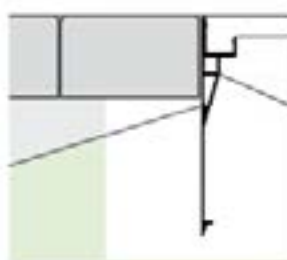
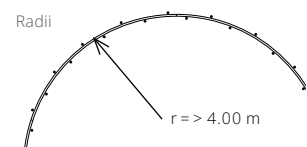
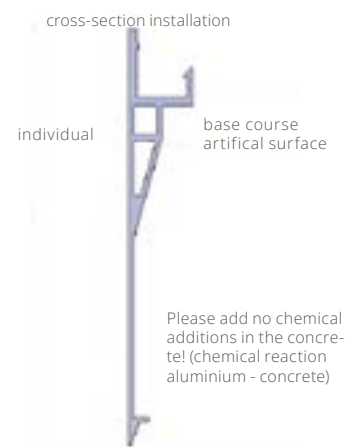

Border (individual surfaces)

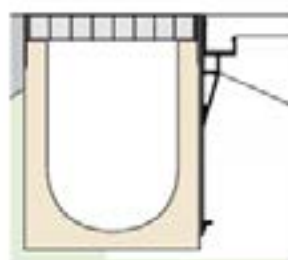

Border to a drainage gutter

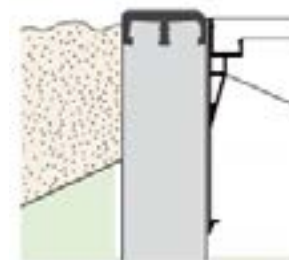

Border with curbing

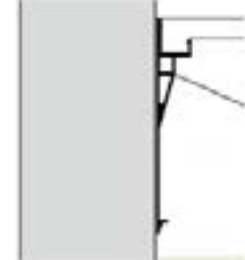

Border with wall

SPORTS SURFACE CURB

„ARTIFICIAL GROUND FINISHING ELEMENT“

The foundation concrete must not be accompanied by additives.

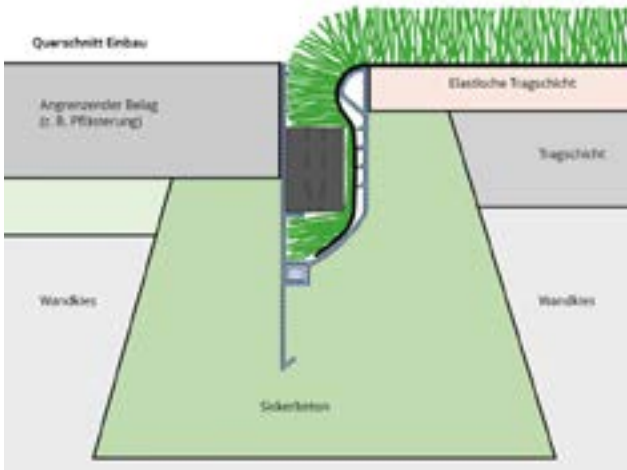

long pile artificial turf



short pile artificial turf



Arguments for artificial turf finishing elements

- Element installation length 5 M > quicker, cheaper
- „Turning radius“ (15mm) for artificial turf > better aesthetics and lowers risk of fracture for the turf
- Big storage space for artificial turf > reserve for post-tensioning
- Easy fastening method (screw cap with clamping action > higher draw resistance, allows easy tensioning or disassembly)

Technical data

Normal element

- Aluminium, tolerance according to EN 755-9 standards
- Installation length: 500 cm
- Weight: ca. 10 kg/element, 2 kg/ml

Distance element

- wood (length ca. 2 – 4 m)
- Is inserted before the installation of adjacent materials and removed before fixing the artificial turf. (Prevents the penetration of foreign parts until the artificial turf is laid).

Fastening element

- plastic HDPE (every 50 cm one element)

Connection element

- Aluminium (installation length (every 5 m one

Artificial turf - finishing element

- Made of aluminium
- Installation length 500 cm
- Incl. connection-, distance-, and fastening elements

Corner element 90° for artificial turf - finishing element

- completely welded
- side length 50 cm (handling 100 cm)

art.-no. productspecification

Artificial turf - finishing element

3002800 Artificial turf - finishing element

art.-no. productspecification

Corner element 90°

3002801 Corner element 90°

ARTIFICIAL TURF „FINISHING ELEMENT“



THE CONNECTING ELEMENT IS INSERTED INTO THE INDIVIDUAL ELEMENTS.

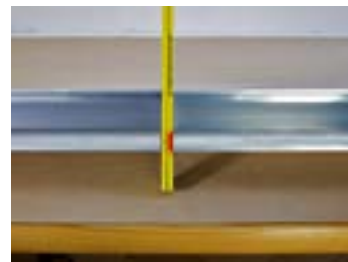

(top view)

THE REQUIRED ELEMENT SPACING OF APPROX. 6 MM CAN BE ENSURED, FOR EXAMPLE, WITH A COMMERCIALY AVAILABLE METRE MASS (DOUBLE THICKNESS). THE GAP IS NECESSARY FOR THE EXPANSION OF THE MATERIAL AND ALSO ENSURES THAT THE WATER CAN FLOW THROUGH THE PERMEABLE CONCRETE INTO THE GROUND.

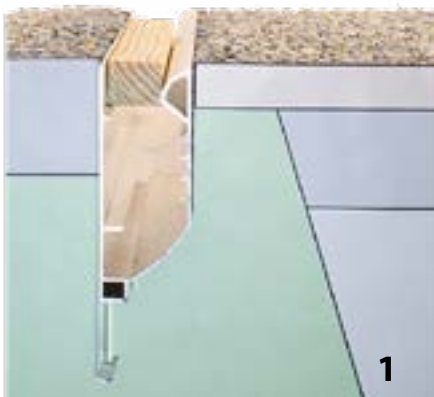

1 Before you mount the permeable concrete and the surrounding surface you will need to put the distance elements into the mounting element.



2 The artificial turf is laid overlapping onto the built-in artificial turf installation element and cut to the length of installation (temperature-dependent).



3 The artificial turf is inserted into the mounting element.



4 The mounting element is inserted with the install key into the built-in element.



5 After insertion up until raising and locking the installation key is raised. The fixation, which is made at a distance of about 50 cm, ensures that the artificial turf withstands the tractive forces.



ARTIFICIAL TURF

„FINISHING ELEMENT“

Guide after installation of the silisport synthetic turf finishing elements™ (installation element) and laying of the artificial turf.



Removing the cistance elements (to be disposed of by the customer).



The artificial turf is cut to the right length.



The artificial grass is pressed into the installation element.



For thick or high-pile artificial turf aids such as seated iron can be used.



The fixing element is inserted into the installation element by means of the installation key, down to the lower web (note the pictures on the previous pages).



Install position

End position



The fastener is turned over the curve by 90 ° and the installation key pulled out.



Covering / artificial turf (in order to increase the surface area a metal strip (flat steel) was used here).



Paving stones / artificial turf (The artificial turf closing elements, which are set lower than the paving stones, are not visible).



Artificial turf (use of two elements)

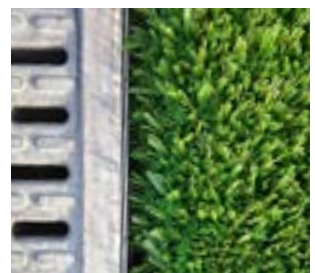

Drainage channel / artificial turf

Tension, loosen and removal artificial turf

- If necessary, carry out coarse cleaning using a high-pressure cleaning device. Insert the key into the fastening element
- Turn fastener 90° using built-in key and insert installation key from mounting element
- After cutting and / or retightening the synthetic turf > installation according to specifications fixing technique (pictures 3-5)

ARTIFICIAL TURF

„FINISHING ELEMENT MOBILE“

Technical Data

Material

- Sheet steel, hot-galvanised, strength approx. 1.5 mm

Measurement

- according to the adjacent drawing
- installation length: 298 cm (on request also shorter construction length possible)

Weight

- approx. 7.5 kg / element

With the mobile artificial turf finishing element, artificial turf surfaces can be enclosed on existing surfaces. The dead load ensures the stability. The fastening technology prevents the movement of the artificial turf. The system can be used for low and high pile artificial turf. The edging element can be anchored into the ground (screwed on).

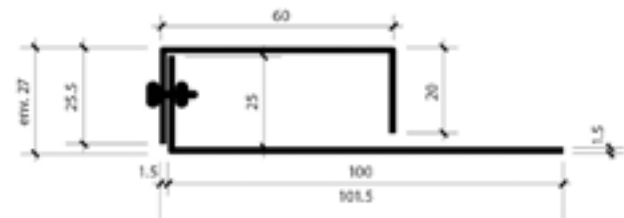

Artificial turf - finishing element mobile

- made of sheet steel, hot-galvanised

art.-no. product specification

Artificial turf - finishing element mobile

3002850 Artificial turf - finishing element mobile

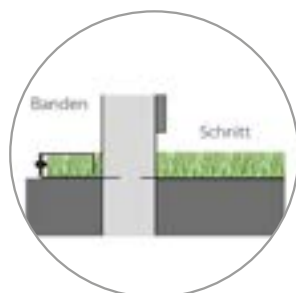

Edge/Cross section



Top view

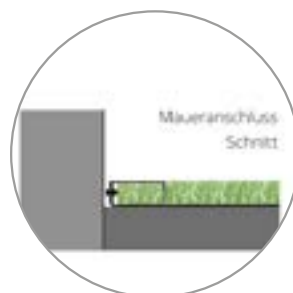

Wall connection cross section

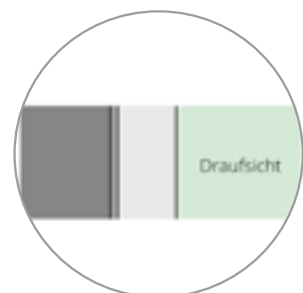

Top view

Allgemeine Geschäfts- und Verkaufsbedingungen

§ 1 Allgemeines:

Für alle Lieferungen und Leistungen gelten ausschließlich die nachstehenden Verkaufs- und Lieferbedingungen. Abweichende Bedingungen des Käufers, die von der Vindico Sport GmbH nicht ausdrücklich schriftlich anerkannt werden, sind unverbindlich, auch wenn wir ihnen nicht speziell widersprechen. Einbeziehung und Auslegung dieser Verkaufs- und Lieferbedingungen regeln sich ebenso wie Abschluss und Auslegung der Rechtsgeschäfte mit dem Käufer selbst ausschließlich nach dem Recht der Bundesrepublik Deutschland. Die Anwendungen des „Einheitlichen Gesetzes über den Abschluss von internationalen Kaufverträgen über bewegliche Sachen“ und des „Einheitlichen Gesetzes über den internationalen Kauf beweglicher Sachen“ des UN-Verkaufsrechts sind ausgeschlossen.

§ 2 Angebote / Leistungen / Vertragsabschluss:

Angebote von Vindico Sport GmbH sind stets freibleibend und sind max. 2 Monate gültig ab Angebotsdatum bzw. nach der im Angebot angegebenen Frist. Ein Liefer- und Leistungsvertrag kommt erst mit der schriftlichen Auftragsbestätigung zustande. Der Vertragsabschluss wird mit der Vindico Sport GmbH abgeschlossen. Die mit dem Angebot oder der Auftragsbestätigung zugrunde liegenden Unterlagen wie Abbildungen, Zeichnungen, und Gewichtsangaben sind in der Regel nur als Annäherungswerte zu verstehen, sofern sie nicht ausdrücklich als verbindlich bezeichnet werden. geringfügige Abweichungen in Farbe, Größe und Form sind zulässig, soweit sie für den Besteller zumutbar sind. Vindico Sport GmbH behält sich das Recht vor technische Änderungen umzusetzen. Eigentums- und Urheberrechte für sämtliche Abbildungen, Kalkulationen, Zeichnungen, Kataloginhalte sowie andere Verkaufs- und Werbematerialien liegen ausschließlich bei der Vindico Sport GmbH. Sie dürfen nur mit ausdrücklicher schriftlicher Zustimmung der Vindico Sport GmbH für eigene oder andere Zwecke verwendet werden.

§ 3 Preise:

Alle Preise sind in Euro ab Werk D-73463 Westhausen zzgl. der zum Zeitpunkt gültigen Mehrwertsteuer. Verpackungskosten, Frachtkosten und evtl. Transportversicherungen werden separat in Rechnung gestellt. Die Verpackung wird nur zurück genommen, wenn wir kraft zwingender gesetzlicher Regelung hierzu verpflichtet sind.

§ 4 Zahlungsbedingungen:

Ist nichts anderes vereinbart sind Rechnungen innerhalb von 7 Tagen mit 2 % Skonto bzw. innerhalb von 14 Tagen ohne Abzug fällig und zahlbar. Voraussetzung für Skontoabzug ist, dass alle vorhergehenden Rechnungen bezahlt sind. Rechnungen für Dienst- oder Montageleistungen sind sofort ohne Abzug netto zu zahlen. Im Falle von Teillieferungen behält sich Vindico Sport GmbH anteilige Fakturierungen vor. In begründeten Fällen behält sich Vindico Sport GmbH eine Lieferung auf Vorkasse vor. Bei Zahlungsverzug, steht es der Firma Vindico Sport GmbH frei, die weitere Erfüllung des Vertrages abzulehnen. Vindico Sport GmbH behält sich das Recht vor, bei Überschreitung des Zahlungsziels, Verzugszinsen in Höhe von 5 % über dem Basiszinssatz, soweit der Besteller kein Verbraucher ist, von 8 % über dem Basiszinssatz zu fordern. Bei vereinbarten Teilzahlungen, welche nicht fristgerecht geleistet werden, wird umgehend der Gesamtbetrag zur sofortigen Zahlung fällig. Bei Sonderanfertigungen in Verbindung mit Fremdartikeln gelten folgende Zahlungsbedingungen: sofortige Zahlung von der Hälfte der Auftragssumme bei Vertragsabschluss, Restsumme nach Auslieferung mit den in Punkt 4 genannten Zahlungskonditionen.

§ 5 Lieferfrist / Lieferbedingungen:

Die angegebenen Liefertermine, soweit sie nicht explizit als Fixtermin vereinbart worden sind, sind als unverbindliche annähernde Termine zu betrachten. Im Voraus müssen alle technischen Fragen geklärt sein. Nachträgliche Änderungen bzw. Ergänzungen können zu Veränderungen des Liefertermins führen. Im Rahmen von Arbeitskämpfen (Streik), Lieferverzögerung von Vorlieferanten, Verkehrs- und Betriebsstörungen, Werkstoff- oder Energiemangel etc. bei welchem sich unverhältnismäßig lange Lieferverzögerungen abzeichnen, sind wir berechtigt, vom Vertrag zurückzutreten. Eine Haftung für Lieferverzug wird ausgeschlossen.

§ 6 Versand und Gefahrenübergang:

Lieferungen erfolgen „unabgeladen, frei Bordsteinkante“. Achtung: Transportschäden bitten wir sofort dem Spediteur bzw. Transporteur zur Schadensfeststellung zu melden und auf dem Lieferschein des Anlieferers zu vermerken. Nur wenn eine Schadensfeststellung vorliegt, deckt die Versicherung den Verlust ab. Der Gefahrenübergang für die Liefergegenstände geht auf den Käufer über, sobald wir die Ware dem Käufer zur Verfügung gestellt und dies dem Käufer angezeigt haben. Der Versand erfolgt stets auf Rechnung und auf Gefahr des Käufers bzw. des Empfängers.

§ 7 Eigentumsvorbehalt:

Die gelieferte Ware bleibt bis zur vollständigen Bezahlung Eigentum der Firma Vindico Sport GmbH. Der Eigentumsvorbehalt gilt auch, bis sämtliche, auch künftige und bedingte Forderungen aus der Geschäftsverbindung zwischen dem Käufer und der Vindico Sport GmbH erfüllt sind. Der Käufer ist zur Sicherungsübereignung oder Verpfändung der Ware nicht befugt, er ist jedoch zur Weiterveräußerung der Vorbehaltsware im geordneten Geschäftsgang berechtigt. Die hieraus gegenüber seinen Geschäftspartnern entstehenden Forderungen tritt er hiermit an Vindico Sport GmbH ab. Wird die Ware vom Käufer be- oder verarbeitet, so erstreckt sich der Eigentumsvorbehalt auch auf die gesamte neue Sache. Der Käufer erwirbt Miteigentum zu dem Bruchteil, der dem Verhältnis des Wertes seiner Ware, zu dem, der von der Vindico Sport GmbH gelieferten Ware entspricht. Wir sind berechtigt, die Eigentumsvorbehaltsrechte geltend zu machen, ohne vom Vertrag zurückzutreten. Falls konkrete Gefahr für unsere Ansprüche besteht, sind wir oder ein Beauftragter berechtigt, Zugriff auf die Ware am Lagerort zu nehmen. Wir sind berechtigt, bei Zahlungsverzug die Forderung an Dritte, zum Beispiel an ein Inkassobüro, abzutreten. Der Besteller verpflichtet sich, die ihm überlassene Ware auf eigene Kosten gegen Schadensrisiken (z.B. Feuer, Wasser, Diebstahl) ausreichend zu versichern. Leistungen, die von der Firma Vindico Sport GmbH dem Käufer zur Verfügung gestellt wurden und die nicht Bestandteil der Werkleistung als solcher sind (z.B. Entwürfe, Konstruktionszeichnungen, Werkzeuge etc.), bleiben im Eigentum der Firma Vindico Sport GmbH.

§ 8 Gewährleistung

Die Vindico Sport GmbH übernimmt folgende Gewährleistungsfristen: Bei neu hergestellten Sportgeräten der Firma Vindico Sport GmbH zwei Jahre, bei gebrauchten, überarbeiteten Sportgeräten ein Jahr. Ist der Besteller Unternehmer, eine juristische Person des öffentlichen Rechts, so beträgt die Gewährleistung ein Jahr. Die Waren und Leistungen sind nach Erhalt bzw. Ausführung unverzüglich auf Mängel hin zu prüfen. Reklamationen sind der Vindico Sport GmbH spätestens innerhalb von 10 Tagen nach Erhalt bzw. Ausführung schriftlich zu melden. Sie berechtigen nicht zur Zurückhaltung oder Kürzung von Zahlungen. Die Mängelansprüche sind auf Nacherfüllung (Nachbesserung) durch die Vindico Sport GmbH beschränkt. Nur wenn diese durch die Vindico Sport GmbH nicht möglich ist, darf nach Abstimmung ein autorisierter Dritter hinzugezogen werden. Gewährleistungsansprüche sind ausgeschlossen, wenn nicht fristgerecht informiert wurde und der Vindico Sport GmbH keine Gelegenheit zur Nachbesserung gegeben wurde. Ausgeschlossen sind natürliche Abnutzung und unsachgemäße Behandlung der Ware sowie vorsätzliche oder grob fahrlässige oder vorsätzliche Schadensverursachung. Eine nachträgliche Rüge von Mängeln bei Montageleistungen wird ausgeschlossen, sofern diese beim Abnahmetermin schon feststellbar waren.

§ 9 Erfüllungsort, Gerichtsstand, Teilunwirksamkeit:

Erfüllungsort für alle sich mittelbar oder unmittelbar aus diesem Vertragsverhältnis ergebenden Verpflichtungen, einschließlich der Zahlungspflicht, ist „Westhausen“ (D-73463). Diese Vereinbarung gilt auch für Unternehmer, eine juristische Person des öffentlichen Rechts. Die Unwirksamkeit einzelner Bestimmungen dieses Vertrags oder seiner Bestandteile lässt die Wirksamkeit der übrigen Regelungen unberührt. Für sämtliche Streitigkeiten wird D-73430 Aalen als Gerichtsstand vereinbart, sofern der Kunde Kaufmann ist.

UNSERE 8-JAHRES-GARANTIE

Vindico Sport bietet auf einige Artikel eine 8-Jahres-Garantie, die über die gesetzliche Gewährleistung von zwei Jahren hinausgeht.

Wer kann die 8-Jahres Garantie erwerben?

Die 8-Jahres-Garantie gilt für alle Kunden, die direkt bei der Vindico Sport GmbH die Artikel erworben haben. Die 8-Jahres-Garantie gilt nicht für Unternehmer, eine juristische Person des öffentlichen Rechts oder Wiederverkäufer. Sollte die Garantie für diese Kunden weiterhin gültig sein, so muss diese zuvor mit einer schriftlichen Vereinbarung mit den jeweiligen Unternehmern / Wiederverkäufern / Handelspartnern geregelt werden.

Was beinhaltet die Garantie?

Die 8-Jahres-Garantie beinhaltet nachfolgende Produkte:

- vollverschweißte Aluminiumprofile Fußballtore Competition I und II
- vollverschweißte Aluminiumprofile Trainings- / Jugend- & Bolzplatztore*
- vollverschweißte Aluminiumprofile Handball- & Minitore*
- vollverschweißte Aluminiumprofile Konstruktionen von Basketballanlagen
- vollverschweißte Aluminiumprofile Sicherheitsabdeckungen für Hochsprungmatten
- vollverschweißte Aluminiumprofile Sicherheitsabdeckungen für Stabhochsprungmatten

Vindico kann, je nach Ermessen des Schadens, eine Reparatur oder eine Ersatzlieferung veranlassen.

* Sind Tore mit Kippsicherungen ausgestattet (z.B. integriert, montiert oder aufgelegt) oder in Verbindung mit Rädern gilt die Garantie nicht. (Ausgeschlossen sind ebenfalls Verschleißteile wie Netze, Mechaniken, Beschichtungen, Holz und PU Materialien etc.)

Wie lange dauert die Garantie?

Die Garantie beginnt am Tag der Übergabe. Die gesetzliche Garantie/Gewährleistungspflicht ist hiervon nicht betroffen.

Garantieverlust

Folgende Kriterien führen dazu, dass die 8-Jahres-Garantie erlischt. Diese wären wie folgt:

- Produkt ist nicht mehr im Originalzustand
- Produkt wurde verändert oder modifiziert
- Produkt wird nicht zum sinngemäßen Gebrauch benutzt
- Falsche Handhabung / Bedienung

- Gewaltanwendung, Vandalismus oder natürlicher Verschleiß
- Benutzung mit Kippsicherungen
- Sonderanfertigungen auf Kundenwunsch sind komplett ausgeschlossen
- Entfernung von Hinweisen auf das Herstellungsjahr
- Abweichungen von Form und Farbe sind ausgeschlossen



VINDICO - MORE THAN SPORTS

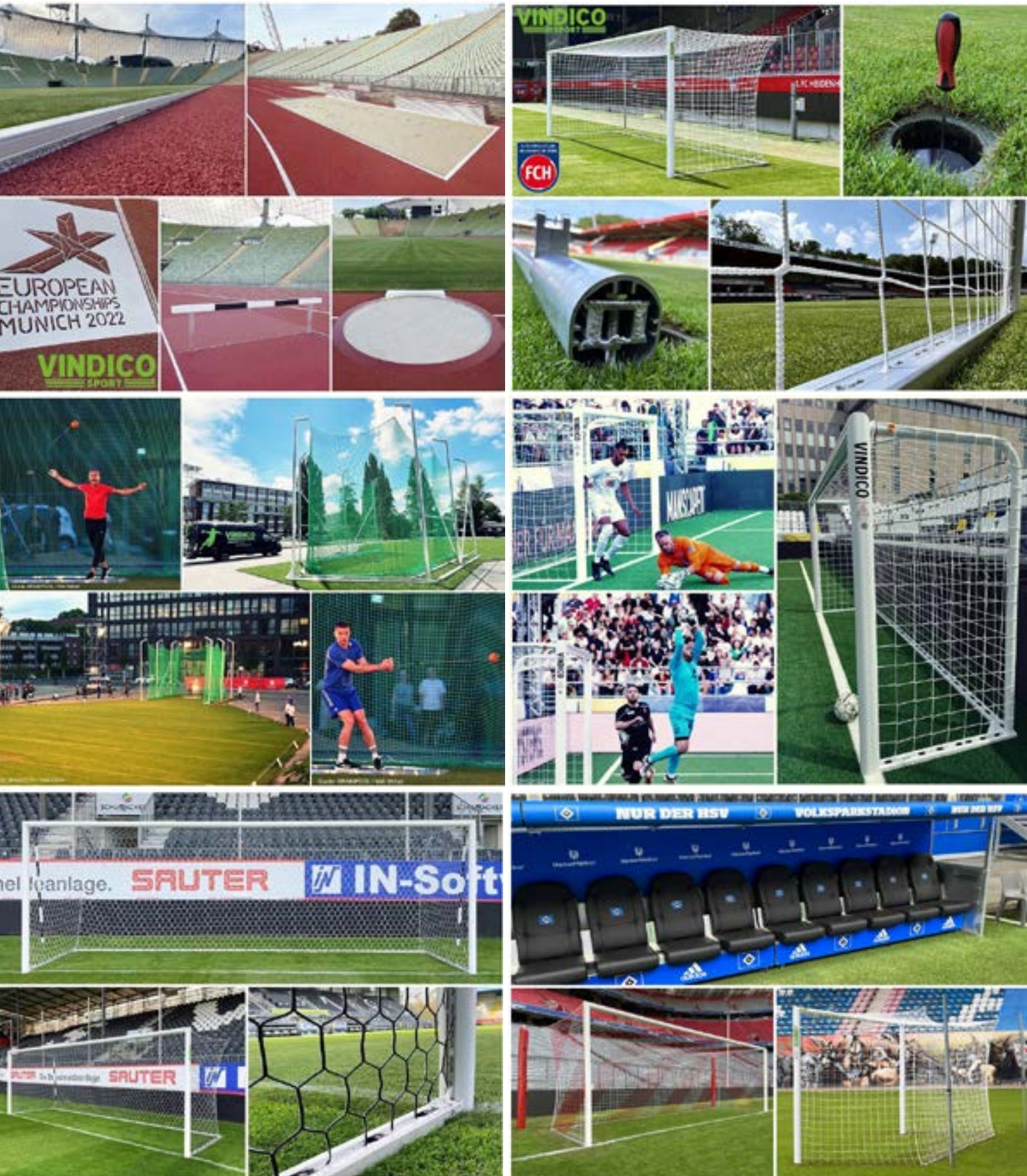

OUR VINDICO TEAM

CONTACT PERSON VINDICO

MICHAEL STARZ

POSITION: CEO / Head of Sales
TELEFON: +49 (0)7363 / 40902-80
HANDY: +49 (0)173 / 597 35 47
E-MAIL: m.starz@vindico-sport.de

KLAUS ATTENBERGER

POSITION: CEO / Accounting
TELEFON: +49 (0)7363 / 40902-90
E-MAIL: buchhaltung@vindico-sport.de

THOMAS PFITZENMAIER

POSITION: Technical Director
TELEFON: +49 (0)7363 / 40902-70
E-MAIL: t.pfitzenmaier@vindico-sport.de

DANIEL HÄNLE

POSITION: Commercial Operations Director
TELEFON: +49 (0)7363 / 40902-55
E-MAIL: d.haenle@vindico-sport.de

ANDREAS KURZ

POSITION: Purchasing & Project management
TELEFON: +49 (0)7363 / 40902-60
E-MAIL: a.kurz@vindico-sport.de

VERONIKA KNAUER

POSITION: Project management
TELEFON: +49 (0)7363 / 40902-65
E-MAIL: v.knauer@vindico-sport.de

FRANZISKA DRAHT

POSITION: Technical / Project management
TELEFON: +49 (0)7363 / 40902-40
E-MAIL: f.draht@vindico-sport.de

ELENA SCHOPPE

POSITION: Project management
TELEFON: +49 (0)7363 / 40902-75
E-MAIL: e.schoppe@vindico-sport.de

SALES PARTNER GERMANY

SALES SOUTH GERMANY

Baden-Württemberg, Bayern, Hessen, Saarland, Rheinland-Pfalz

VINDICO SPORT GmbH
Deutschordenstraße 38
73463 Westhausen

Telefon +49 (0) 73 63 / 40 90 2 - 0
Telefax +49 (0) 73 63 / 40 90 2 - 99
email info@vindico-sport.de

SALES WEST & EAST GERMANY

Nordrhein-Westfalen, Thüringen, Sachsen, Sachsen-Anhalt, Brandenburg, Berlin

VINDICO SPORT GmbH
Deutschordenstraße 38
73463 Westhausen

CINI WOHKITTEL

Telefon +49 (0) 73 63 / 40 90 2 - 0
Telefax +49 (0) 73 63 / 40 90 2 - 99
Mobil +49 (0) 151 / 560 560 16
email c.wohkittel@vindico-sport.de

SALES NORTH GERMANY

Schleswig Holstein, Niedersachsen, Bremen, Mecklenburg Vorpommern, Hamburg

HENNING HILDENER

Telefon +49 (0) 4221 / 925 457
Telefax +49 (0) 171 / 215 14 01
email henning@hildener.info

 **HENNING HILDENER**
Handelsvertretung für Sportbau

SALES PARTNER INTERNATIONAL



silidur ag

SCHWEIZ

silidur ag
Niederfeldstrasse 5
CH - 8450 Andelfingen

Tel.: +41 (0) 52 / 305 22 11
Fax: +41 (0) 52 / 305 22 12
E-mail: info@silidur.ch



ITALIEN (NORDITALIEN)

SPORTBAU GmbH

SPORTBAU GmbH
Sigmundskron 43
I - 39100 Bozen

Tel.: +39 (0) 471 / 66 31 58
Fax: +39 (0) 471 / 66 36 32
E-mail: info@sportbau.it



ÖSTERREICH

Sportbau Walser Ges. mbH
Bauern 21
AT - 6844 ALTACH

Tel.: +43 (0) 5576 / 72 611
Fax: +43 (0) 5576 / 72 611-18
E-mail: office@sportbau.at



DÄNEMARK

TF SPORT & FRITID ApS
Lumbyvej 11D
DNK - 5000 Odense C

Tel.: +40 (0)731 / 955 144
E-mail: info@TFsport-fritid.dk



BELGIEN

Sportimpex 2.0 BV
Gentsesteenweg 17 bus2
BEL - 9520 Sint Lievens Houtem

Tel.: +32 (0)53 59 02 05
E-mail: info@sportimpex.be



FRANKREICH

Playgones
Amenageur Urbain Sports et Loisirs
7 impasse Gutenberg
FR - 38110 ROCHETOIRIN

E-Mail: info@playgones.com

SALES INTERNATIONAL



LUXEMBURG

Point Solutions S.à r.l.
25 rue de la Sûre
L-6484 Echternach

Tel: +352 26721310 - 1
E-Mail: info@pointsolutions.lu
Bruno Reicherts
E-Mail: reicherts@pointsolutions.lu
Tel: +352 26721310 - 22

SALES INTERNATIONAL

ZENTRAL- & OSTEUROPE

(Polen, Ungarn, Slowakei, Slowenien, Kroatien, Bosnien und Herzegowina, Serbien, Montenegro, Albanien, Nordmazedonien, Kosovo, Rumänien, Bulgarien, Griechenland, Moldawien)

European Sport Installation SRL
39th Matei Basarab str.
RO - 30671, Romania

Alex Bobeica
Tel: +49 171 4638409
E-Mail: alex@sportconstructionsgroup.com
www.sportconstructionsgroup.com



VINDICO

SPORT

WWW.VINDICO-SPORT.DE

Vindico Sport GmbH
Deutschordenstraße 38
73463 Westhausen
Germany

Tel. +49 (0)7363 / 40 90 2 - 0
Fax. +49 (0)7363 / 40 90 2 - 99
E-Mail: info@vindico-sport.de
www.vindico-sport.de