

SPORT EQUIPMENT **MADE IN GERMANY**



VINDICO

SPORT

JAHR **2021**

...more than sports!



**BAYERISCHER
FUSSBALL-VERBAND**

www.vindico-sport.de

WHO IS **VINDICO?**

Vindico Sport GmbH is a young, innovative and dynamic team. It specializes in production, sales and installation of all kinds of sport equipment. We set ourselves the standard to improve our products every single day. Our ideas have no limits and if you want a custom made product, please do not hesitate to contact us. We will gladly accept your suggestions and try to implement them for you.



Our company stands for elaborateness, consistent customer care and quality. Vindico focuses on the customers needs and wishes. After an intensive consultation with our team which has years of experience in the sport equipment industry. We will take every step with our customers from planning the sport ground to the first step on the ground. Gladly, we will take over the installation and give advice to our customers.

VINDICO

SPORT

FOLLOW US ON



INDEX

02 About Vindico

- 04 Construction service / repair service
- 05 Special solutions
- 06 Football rules
- 07 Net suspensions of Vindico

08 Football

- 09 - 10 Competition goals „Competition“
- 11 Ground frame „Players Protect“
- 12 - 13 Ground frame „High Class“
- 14 Ground socket „Safety“
- 15 Football goal accessories
- 16 Football goal fully welded
- 17 Goals „all in one“
- 18 Football goal Simplex/Socca/Futsal goal
- 19 Swing goals
- 20 International goal types
- 21 Recreational goal
- 22 - 23 Mini goals
- 24 - 27 Round tube goals
- 28 Anti-tilting safety device
- 29 Football accessory „weights“
- 30 - 31 Transportrolley
- 32 Line markers
- 33 - 35 Sport facility accessories
- 36 - 37 Training accessories
- 38 - 39 Nets
- 40 - 41 Barrier
- 42 - 47 Ball catching constructions
- 48 Players tunnel
- 49 Caring devices

50 Players cabin

- 51 Players cabin „Basic“
- 52 Players cabin „Pro“
- 53 Spielerkabinen „League“
- 54 Spielerkabinen „Strong“ + „Double“
- 55 Players cabin „Royal“ + „Sonderanfertigung“
- 56 - 57 players cabin accessories
- 58 - 61 Spectator stand

62 Ball games

- 63 - 65 Handball
- 66 - 67 Hockey
- 68 - 73 Volleyball
- 74 - 80 Basketball
- 81 Badminton
- 82 Tennis
- 83 Baseball / Rugby
- 84 American football
- 85 - 87 Table tennis

88 Playing fields

- 89 „Panna Field“
- 90 Soccer egg
- 91 Mini playing fields
- 92 - 93 Simple Line
- 94 Simple Line Strong
- 95 Pro Line
- 96 - 98 Omnistadium
- 99 Hard Line

100 Athletics

- 101 - 105 Long jump
- 106 - 107 Shot put throw
- 108 Hammer throw
- 109 Athletics accessories
- 110 - 111 Safety cage
- 112 - 115 Running disciplines
- 116 - 121 High jump
- 122 - 127 Pole vault
- 127 - 129 safety cages

130 Outdoor workout

- 130 Outdoor workout
- 131 - 133 Workout
- 134 Power Wall
- 135 Calisthenics League
- 136 - 137 outdoor fitness
- 138 Slackline / equipment box

139 Beach sports

- 140 - 143 Beach sports
- 144 - 145 Beach edge element

146 Show washing systems

- 147 - 148 Washing system type A
- 149 - 151 Washing system type Typ B
- 152 - 153 Washing system type Typ C
- 154 Washing system type Typ D
- 155 - 156 Washing system type Typ SC
- 157 Shoe wash system
- 158 - 159 Washing systems accessories

160 Element

- 160 - 167 Element

168 Notes

- 168 Terms and conditions
- 169 Warranty
- 170 References
- 171 Contact

DO YOU KNOW...



Please contact us for more information.

... our installation service?

We are not only producing a wide range of sports equipment but are additionally offering a complete installation service.

Our technical service staff is very skilled and has the technical know how to set up your sports ground according to valid regulations.

- complete installation after excavation
- initial installation
- Installations for new acquisitions
- repair service - even if the sports equipment originates from another manufacturer
- partner service - for earth-works through our landscape and horticulture specialist



Equipment does not have to be defect!

REPAIRING YOUR SPORT EQUIPMENT

We can rebuild your broken equipment!

Due to our long-lasting experience in the sports equipment industry, we have acquired the technical know-how and ability to rebuild any sports equipment e.g. track and field equipment or football goals. If something needs to be rebuilt – we are the first choice!

We also offer the following service:

- procurement of new equipment: mostly out of our own production
- installation & assembly service
- validation of outdoor sports facilities according to current DIN-requirements



VINDICO...

...more than sports

Vindico supports your projects. From the first idea, to the implementation, production and installation – we are the perfect service partner. Just send us a request and we will be glad to support your project.

mobile run-up bar for athletics disciplines

starting platform for athletics competition outside

- Pole vault
- Long jump
- Sprint track
- High jump

Properties:

- Production on request incl. running track covering (EPDM or Mondo)
- height adjustable
- incl. pole vault box
- incl. long jump take off board
- Length: as required
- element length approx. 200 cm, element width approx. 122 cm
- Edge support for 5 cm white element as track marking
- Height approx. 20 cm with support for adjustable legs
- completely made of aluminium
- fully welded

Send us your project! It will be a pleasure to help you.

Advertising banner frame

- Completely made out of aluminium
- All around with lugs for a tight sit of the advertising banner
- Manufactured according to your desired size.

Safety wall construction

Production of a safety wall construction made of aluminium for running tracks

- completely made of aluminium
- including safety pads for indoor and outdoor use



SOCCER RULES IN GERMANY

Dimensions of the playing field for international matches:

Length (side-line): min. 100 m/ max. 110 m
 Width (goal-line): min. 64m / max. 75 m

Football goals have to be white. The frame of the goal must not exceed 12 cm in width and depth. The natural silver colour of aluminum goals is permitted.

According to FIFA the distance between the inner edges of the posts must be 7,32m. The lower edge of the crossbar is 2,44m away from the ground (8 feet x 8 yards). This corresponds to a ratio of 1:3. The minimum size of the corner flags must be 1,5m and they are not allowed to be spiky at the top.

Additional explanation of the DFB:

To avoid accidents, mobile goals (small and big goals) have to be secured in such way that the goals are prevented from tipping over. (See page 28).

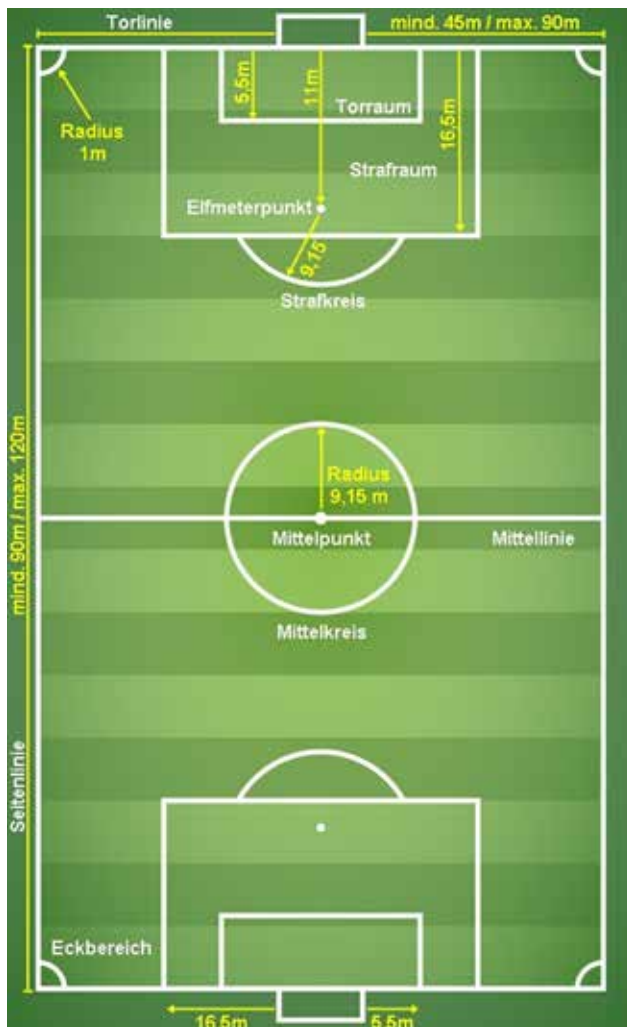

under 7's - expedition for small explorers!

team size: 2 vs 2 or 3 vs 3
 age: have not reached age 7 yet
 pitch: 16 x 20 up to 28 x 22 meter
 ball: size 3 or a light ball size 4 (290 grams)
 goal width: 1,80 x 1,20 meter

under 9's - equal game shares for everyone!

team size: 3 vs 3 up to 5 vs 5
 age: completed their 7th or 8th years of age
 pitch: 35 x 25 meter (3 vs 3) up to 40 x 35 Meter (5 vs 5)
 ball: size 4 or a light ball size 5 (290 grams)
 goal width: Minitor or 5x2 meter (has to be secured against tilting)

under 11's - encounter in small groups on the country level!

team size: 7 vs 7 (including a goal keeper)
 age: completed their 9th or 10th years of age
 pitch: 55 x 35 meter
 ball: size 4 or a light ball size 5 (290 grams)
 goal width: 5 x 2 meter (has to be secured against tilting)

under 13's - 9 vs 9 is what counts!

team size: 9 vs 9 (including a goal keeper)
 age: completed their 11th or 12th years of age
 pitch: 70 x 50 meter
 ball: size 4 oder a light ball size 5 (350 Gramm)
 goal width: 5 x 2 Meter (has to be secured against tilting)

under 15's - first experience in 11 vs 11!

team size: 11 vs 11
 age: completed their 13th or 14th years of age
 pitch: approx. 100 x 70 meter
 ball: size 5
 goal width: 7,32 x 2,44 meter

under 17's - choosing the right system for the development!

team size: 11 vs 11
 age: completed their 15th or 16th years of age
 pitch: approx. 100 x 70 meter
 ball: size 5
 goal width: 7,32 x 2,44 meter

under 19's - promote the final step into senior football!

team size: 11 vs 11
 age: completed their 17th or 18th years of age
 pitch: approx. 100 x 70 meter
 ball: size 5
 goal width: 7,32 x 2,44 meter

senior football - everything counts!

team size: 11 vs 11
 age: older than 18 years
 pitch: approx. 100 x 70 meter
 ball: size 5
 goal width: 7,32 x 2,44 meter

OUR NETSUSPENSION

Diese Netzaufhängungen sind für Torpfosten und Bodenrahmen möglich!

Netsuspension „Basic“

- Twin hooks
- Recessed plastic hooks
- Applicable by click system
- Easy, quick insertion of the net
- No snapping of the net hooks
- Quick replacement possible
- Tight fit of the net



Netsuspension „Smart“

- Indented net suspension
- Can be retrofitted
- All mesh sizes possible
- Not visible on the border line
- Tight fit of the net
- The seam is held tightly



Netsuspension „Smart“ with additional safety bar

- net is additionally secured
- net with anti-theft protections
- a very closed look
- only the net strand appears



FOOTBALL



FOOTBALL GOAL

„COMPETITION I“ 7,32 x 2,44 M

- Ground frame reinforced
- with two tension rods
- solid ground frame hinge



art.-no. productspecification

Competition goal (goal frame with tension rods)

2001240	competition I - „Basic“ aluminium blank
2001246	competition I - „Smart“ aluminium blank
2001242	competition I - „Basic“ white powder coated
2001247	competition I - „Smart“ white powder coated

Ground frame for competition goals

2001262	„Basic“ (2,00 m; 7,32 m length)
2001265	„Smart“ (2,00 m; 7,32 m length)



ground sockets for Competition goals on page 15.
nets on page 38/39.

Safety pad net tension rods

- PU-foam core for 60 mm net tension rods
- Tarpaulin cover (colour freely selectable)
- Continuous velcro tape
- According to FIFA standards

art.-no. productspecification

Safety pad net tension rods

4001240	safety pad net tension rods
---------	-----------------------------



FOOTBALL GOAL

„COMPETITION II“ 7,32 x 2,44 m / 5,00 x 2,00 m



- ground frame reinforced
- pre-tensioned net hanger construction
- solid groundframe hinge



Art.-Nr. Produktbeschreibung

Competition goals 7,32 x 2,44 m
(goal frame with net hanger)

- | | |
|---------|--|
| 2001250 | competition II - „Basic“ aluminium blank |
| 2001254 | competition II - „Smart“ aluminium blank |
| 2001252 | competition II - „Basic“ white powder coated |
| 2001255 | competition II - „Smart“ white powder coated |

Ground frames for competition goals 7,23 m

- | | |
|---------|---------------------------------|
| 2001260 | „Basic“ (1,50 m; 7,32 m length) |
| 2001264 | „Smart“ (1,50 m; 7,32 m length) |
| 2001262 | „Basic“ (2,00 m; 7,32 m length) |
| 2001265 | „Smart“ (2,00 m; 7,32 m length) |

Junior goals 5,00 x 2,00 m (goal frame with net hanger)

- | | |
|---------|--|
| 2001150 | competition II - „Basic“ aluminium blank |
| 2001154 | competition II - „Smart“ aluminium blank |
| 2001152 | competition II - „Basic“ white powder coated |
| 2001155 | competition II - „Smart“ white powder coated |

Ground frame for junior goals 5,00 m

- | | |
|---------|---------------------------------|
| 2001260 | „Basic“ (1,50 m; 5,00 m length) |
| 2001264 | „Smart“ (1,50 m; 5,00 m length) |
| 2001262 | „Basic“ (2,00 m; 5,00 m length) |
| 2001265 | „Smart“ (2,00 m; 5,00 m length) |

Competition II

- Football goal made of aluminium, in ground sockets
- Ground frame with recessed net suspension
- 7,32 x 2,44 m, goal profile 120/100 mm
- 2 pcs. aluminium tension rods incl.
- White powder coated or aluminium blank
- Ground frame can be folded up
- According to FIFA standards
- Display 80/150 cm or 80/200 cm
- upper „pre-tensioned“ net hanger
- tensioning rope in the ground frame not necessary

GROUND FRAME „PLAYERS PROTECT“



What is Players Protect?

- is an impact protection combined with a specially designed flat aluminium floor
- guarantees due to the special shape and inner chamber a significant reduction of force in case of an impact
- forms a homogeneous unit with the aluminium floor frame
- made of a newly developed rubber profile which is UV-resistant and weatherproof
- unique security feature for football goals

Why Players Protect?

- makes the handling with football goals safer
- minimises the risk of injuries
- protects the player in the goal arena from an impact on the floor frame
- convinces by a high-quality workmanship and beautiful design

Therefore Players Protect ground frame!

- after FIFA and DFB- regulations
- construction referred to DIN EN 748
- low risk for injuries
- net suspension with plastic double net hooks

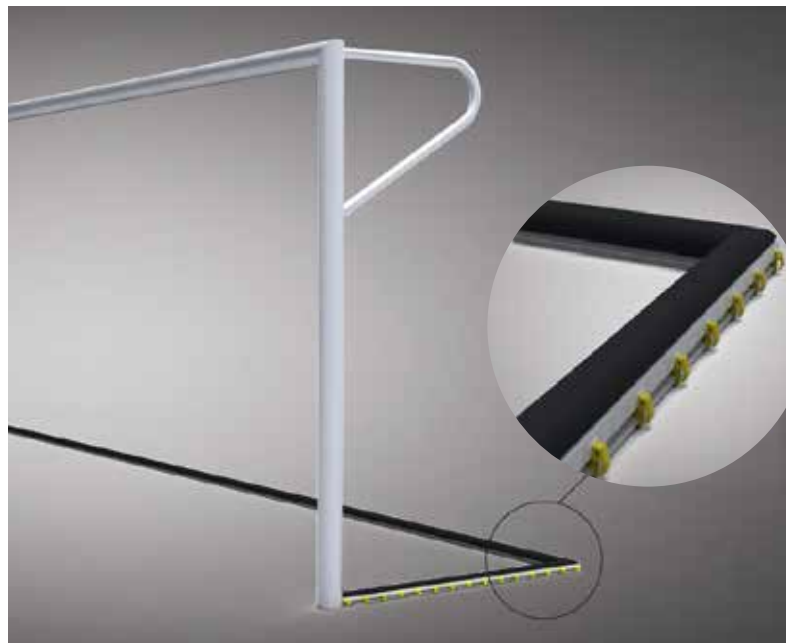

On request we are also offering fully welded football goals with „Players Protect“ (Training goals, youth goals and mini goals)

Players Protect for stadium football goals protects the players. Prevents injuries in hot goal scenes and is nearly invisible for spectators on the stands.

art.-no. productspecification

Ground frame „Players Protect“, length 7,32 m

4900362	display 1,50 m
4900363	display 2,00 m

PlayersProtect.
A cooperation with...



RECESSED MOUNT FOR GROUND FRAMES „HIGH CLASS“

Top edge of the socket with an elastic layer
>>> No metal frame!



With the recessed ground frame socket you are getting a high tech solution for your football goals. The ground frame is at the same level with the ground-surface, thereby preventing possible accidents and injuries. This optically appealing solution is very easy to take care of. Special inlays can be used as a replacement for the ground frame – enabling easy lawn maintenance. For the installation of the recessed ground frame, no concrete is needed so that there is no interference with the underfloor heating. The ground frame can be moved easily because it is dismountable in individual parts. The individual elements are fastened by their own weight. The recessed ground frame socket is suitable only for goals with a display of 2 meters.



Advantages for the processor

- no cement for the installation needed
- fixation by dead weight & humus layer
- due to the low height the under soil heating can stay
- and does not have to be displaced / moved

Advantages for the end user

- low risk of injuries
- no cement on the under soil heating needed
- low-maintenance
- suitable for stadiums

Art.-Nr. Produktbeschreibung
Ground frame „High Class“

2001267	ground frame „High Class“
2001268	Inlays recessed ground frame

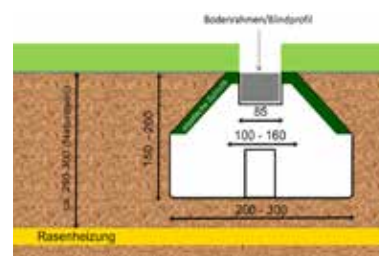

VINDICO - TIP

We recommend, that the installation is carried out by our trained installation service team as any adjustments to the existing ground sockets are required.



Recessed ground frame with net suspension

Smart



Basic



GROUND SOCKET „SAFETY“

Injuries at the socket head are a thing of the past !



Ground frame sockets for football goals and corner flags are usually made of Aluminum. The problem with all known ground sockets is the fact that if there is no post in the socket, the socket head represents a risk of injury for the athlete and the lawn care equipment can be damaged during mowing.

The new ground socket „safety“ avoids these risks completely.

Advantages compared to other ground sockets

- No ground socket edge in natural / artificial turf
- Elastic socket head
- Risk of injuries avoided
- Protection of lawn care equipment
- Serves as mowing edge for natural turf
- Socket insert for corner flag serves as sealing cap



Football ground socket

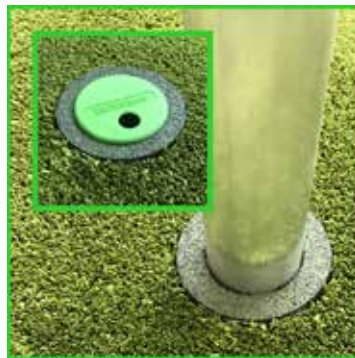

Tension ground socket



Corner flag socket

art.-no. productspecification

Football ground socket

1110155 Football ground socket

Corner flag socket

1110495 Corner flag socket with reversible insert for 50 mm Corner flag poles

Tension ground socket

1110165 Tension ground socket

Substitute for „Safety“ socket

1110496 Substitute rubber head
1110499 Adhesive for „Safety“ rubber head

FOOTBALL ACCESSORIES



standard socket
tie rod

special socket
tie rod

standard ground socket

standard ground socket with
bitumen

special ground socket

Safety ground socket

Ground sockets

- completely made out of aluminium
- football socket: length 50 cm, insert depth 40 cm
- tie rod socket: length 45 cm, insert depth 35 cm
- standard socket comes with loose lid
- special socket with aluminium lid and lid chamber

art.-no. productspecification

Ground sockets football goals

1110140	standard ground socket, football
1110150	special ground socket, football
1110155	Safety ground socket
2001601	surcharge bitumen sealing

Ground sockets tie rod for Competition I

1110160	standard ground socket, tie rod
1110170	special ground socket, tie rod
1110165	Safety ground socket
2001601	surcharge bitumen sealing

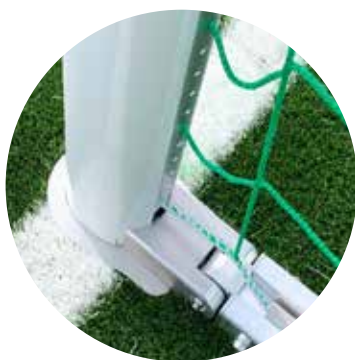

Protective base ring

- Protection against dirt (soft ground = earth and grass) (artificial ground = rubber granulate)
- With natural turf - no direct overgrowth
- Upgrade on all VINDICO goals possible

art.-no. productspecification

Protective base ring

2001244	Protective base ring
---------	----------------------

Net safety bar

- made of aluminium
- screws included
- set is always for one frame

Art.-Nr. Produktbeschreibung

Net safety bar

2001248	safety bar for goal frame 7,32 x 2,44 m
2001146	safety bar for goal frame 5,00 x 2,00 m
2001048	safety bar for goal frame 3,00 x 2,00 m
on request	safety bar for goal frame



Goal post accessories

Height adjustment for all competition goals

- exact setting of the competition goals of 2.44 m
- easy adjustment through a back nut

Inclination adjustment for „Competition I“ goals

- pre-tensioning of the goals to the field
- net tension cord to the tie rod leads that the goal post will become exactly straight
- can be also used as a compensator if the ground sleeves have been set incorrectly

art.-no. productspecification

Goal post accessories

2001256	Height adjustment
2001257	Inclination adjustment

FOOTBALL GOAL

FULLY WELDED, MOBILE



TÜV NORD tested only in connection with anti-tipping devices according to DIN EN 748



- net suspension in the complete goal- and ground frame
- corner welded
- lateral grips

Anti-tilting devices for goals can be found on page 28. nets on page 38/39.

Training and junior goal

- football goal made of aluminium
- reinforced in the goal profile
- goal frame from 120 / 100 mm oval profile
- ground frame from 80 / 40 mm rectangle profile
- ground frame with inverted net suspension
- net hanger from 60 mm round tube
- No tensioning rope in the ground frame necessary!



art.-no. productspecification

Training goal 7,32 x 2,44 m

2001202	Display 80 / 150 cm - „Basic“, aluminium blank
2001206	Display 80 / 150 cm - „Smart“, aluminium blank
2001204	Display 80 / 200 cm - „Basic“, aluminium blank
2001207	Display 80 / 200 cm - „Smart“, aluminium blank

Junior goal 5,00 x 2,00 m

2001100	Display 80 / 100 cm - „Basic“, aluminium blank
2001106	Display 80 / 100 cm - „Smart“, aluminium blank
2001102	Display 80 / 150 cm - „Basic“, aluminium blank
2001107	Display 80 / 150 cm - „Smart“, aluminium blank
2001104	Display 80 / 200 cm - „Basic“, aluminium blank
2001108	Display 80 / 200 cm - „Smart“, aluminium blank

Accessories

2001605	Surcharge kit for on the side frosted wheels (1 set)
2001603	Surcharge for extended goal post
2001600	Adapter for goal post
2001299	Surcharge for white goal frame for training goals
2001199	Surcharge for white goal frame for junior goals
2001600	Surcharge for sliding latches





FOOTBALL GOAL

„ALL IN ONE“ WEIGHTED, MOBILE

Fulfills the tilting weight regulation DEN EN 748, TÜV GS proofed

- net suspension in the complete goal- and ground frame
- corner welded
- lateral grips

Training and junior goal „All In One“

- Football goal made of aluminium
- Reinforced in the goal profile
- Goal frame from 120 / 100 mm oval profile
- Ground frame from 80 / 40 mm rectangle profile
- Ground frame with inverted net suspension
- Foam wheels with solid welded-on wheel holder
- Net hanger from 60 mm round tube
- No tensioning rope in the ground frame necessary!

art.-no. productspecification

Training goal „All In One“ 7,32 x 2,44 m
aluminium blank

2001222	Display 80 / 150 cm - „Basic“, 170 kg in the floor frame
2001226	Display 80 / 150 cm - „Smart“, 170 kg in the floor frame
2001224	Display 80 / 200 cm - „Basic“, 100 kg in the floor frame
2001227	Display 80 / 200 cm - „Smart“, 100 kg in the floor frame

Junior goal „All In One“ 5,00 x 2,00 m
aluminium blank

2001120	Display 80 / 100 cm - „Basic“, 200 kg in the floor frame
2001135	Display 80 / 100 cm - „Smart“, 200 kg in the floor frame
2001122	Display 80 / 150 cm - „Basic“, 125 kg in the floor frame
2001136	Display 80 / 150 cm - „Smart“, 125 kg in the floor frame
2001124	Display 80 / 200 cm - „Basic“, 100 kg in the floor frame
2001137	Display 80 / 200 cm - „Smart“, 100 kg in the floor frame

Accessories

2001299	Surcharge for white goal frame for training goals
2001199	Surcharge for white goal frame for junior goals



training goal „All In One“ display 200 cm



Junior goal „All In One“ display 100 cm



Integrated weight for „all in one“ goals



FOOTBALL GOAL „SIMPLEX“ THE SIMPLE FOOTBALL GOAL

football goal „Simplex“

- football goal made of aluminium
- fully welded
- goal frame from 120 / 100 mm oval profile
- ground frame from 80 / 40 mm rectangle profile
- goal and ground frame with inverted net suspension „Basic“
- on the side foamed wheels, screwed to the net hanger
- net hanger from 60 mm round tube
- No tensioning rope in the ground frame necessary!



art.-no. productspecification

Training goal „Simplex“ 7,32 x 2,44 m
aluminium blank

2001214 display 80 / 200 cm

Junior goal „Simplex“ 5,00 x 2,00 m
aluminium blank

2001112 display 80 / 150 cm

Anti-tilting devices for goals
can be found on page 28.
Nets on page 38/39.

FOORBALL GOAL „SOCCA / FUTSAL TOR“



- Futsal/Socca goal according international standards
- Football goal made of Aluminium blank
- Fully welded
- Goal frame from 80/80 mm oval profile
- Ground frame from 80/40 mm rectangle profile
- Net hoops made of 60 mm round tube
- Goal and ground frame with inverted net suspension „Basic“
- For dowelling on the ground
- Alternatively with extended posts for insertion in ground sockets or with int. weight

art.-no. productspecification

Socca Tor

2001215 Socca goal, aluminium blank
4510420 Net for Socca goal, white, 4mm, PP,
MW 120 mm

art.-no. productspecification

Futsal Tor

2001006 Futsal goal, aluminium blank
4310401 Net for Futsal goal, white, 4mm, PP,

FOOTBALL GOAL

„SWING GOAL“



Football goal „Swing goal“

- football goal made of aluminium
- corner reinforced in the goal profile
- goal frame from 120 / 100 mm oval profile
- rear post construction with variable articulated arms
- display from safety stand post up to 4,50 m
- securing the goals against unauthorized use
- side display made out of round aluminium tubes including eyes for upper and lower net tensioning rope

art.-no. productspecification

football goal „Swing goal“ 7,32 x 2,44m
aluminium blank

2001230 swing training goal „Basic“
2001232 swing training goal „Smart“

football goal „Swing junior goal“ 5,00 x 2,00m
aluminium blank

2001130 swing junior goal „Basic“
2001132 swing junior goal „Smart“

accessories

2001604 adapter for swing goal included bolt for fixation
2001238 rear cross pipe for training goal, foldable,
including insertion tube and hinge
2001138 rear cross pipe for junior goal, foldable, including
insertion tube and hinge
2001299 surcharge for white goal frame for training goals
2001199 surcharge for white goal frame for junior goals

NOTE

additionally you will find need for the rear binding two adapter with a fundament which a fundament are out of the pitch.

- lateral foldable
- corner reinforcement
- variable hinges



FOOTBALL GOAL „INTERNATIONAL“



Junior goal „Austria“ 3.00 x 1.60 m



- display 100 / 100 cm
- fully welded
- goal frame from 120 / 100 mm oval profile
- ground frame from 80 / 40 mm rectangle profile
- goal and ground frame with inverted net suspension

art.-no. productspecification

Junior goal „Austria“

2001126 Junior goal „Austria“, 3,00 x 1,60 m, 100 / 100 cm



Junior goal „France“ 6.00 x 2.10 m



- Football goal made of aluminium, display 80/180 cm
- Goal profile with reinforced corners
- Goal frame from 120 / 100 mm oval profile
- Ground frame from 80 / 40 mm rectangle profile
- Goal and ground frame with inverted net suspension Basic“
- Net hoop of 60 mm round tube

art.-no. productspecification

Football goal „France“

2001127 Junior goal „France“, 6,00 x 2,10 m, 80 / 180 cm



Football goal „Swiss“ extended display (use of anti-tilting devices)



- Training goal 7.32 x 2.44 m, 80/220 cm display
- Youth goal 5.00 x 2.00 m, display 80/180 cm (for net 80/150 cm display)
- incl. holes for steel rope at 150 or 200 cm
- fully welded
- Goal frame made of 120 / 100 mm aluminium oval profile
- Ground frame profile made of 80 / 40 mm aluminium Rectangular profile
- Net hoop made of 60 mm round tube
- Net hoop at 150 or 200 cm

art.-no. productspecification

Football goal „Swiss“

2001180 Junior goal „Swiss“, „Basic“, display 80 / 180 cm
 2001181 Junior goal „Swiss“, „Smart“, display 80 / 180 cm
 2001280 Training goal „Swiss“, „Basic“, display 80 / 220 cm
 2001281 Training goal „Swiss“, „Smart“, display 80 / 220 cm

FOOTBALL GOAL

„RECREATIONAL GOAL“



- completely made of aluminium
- fully welded
- goal frame from 120 / 100 mm oval profile
- ground frame from 80 / 40 mm rectangle profile
- goal and ground frame with inverted net suspension „Basic“

art.-no. productspecification

Recreational goal 3,00 x 2,00 m

2001000	display 80/100 cm - „Basic“, aluminium blank
2001071	display 80/100 cm - „Smart“, aluminium blank
2001002	display 80/150 cm - „Basic“, aluminium blank
2001072	display 80/150 cm - „Smart“, aluminium blank
2001004	display 80/200 cm - „Basic“, aluminium blank
2001073	display 80/200 cm - „Smart“, aluminium blank

ground sockets / anchoring

1050395	standard ground socket, recreational goal
1050450	special ground socket, recreational goal
1111210	ground anchors

Accessories

2001603	surcharge for extended goal post
2001014	surcharge for attachment of vandalism-proof net
2001009	surcharge for basketball attachment, no display
2001008	surcharge for basketball attachment, 60cm display



illustration image basketball attachment, 60 cm display



Dralo net

- 3,00 x 2,00 m, display 90 x 90 cm, inside hanging
- quadratic mesh
- mesh width approx. 100 mm, approx. 3 mm strong
- tensioning rod montage set included

art.-no. productspecification

Dralo net

4406401	Dralo net, galvanised steel cable
---------	-----------------------------------

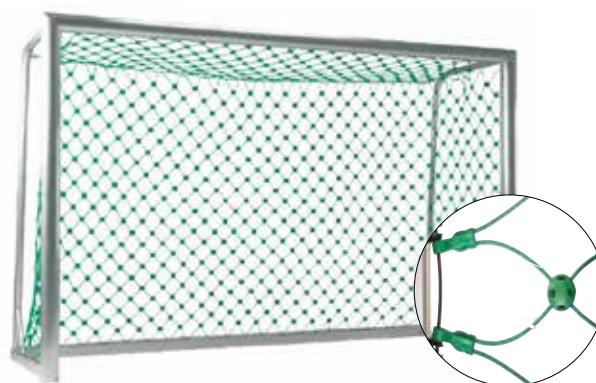

Herkules net

- 3,00 x 2,00 m, display 90 x 90 cm, inside hanging
- diagonal mesh, PA-covered
- mesh width approx. 100 mm, approx. 2,5 / 5 mm strong, colour: Grün
- tensioning rod montage set included

art.-no. productspecification

Herkules net with steel insertion

4466401	Herkules net with steel insertion
---------	-----------------------------------

MINI GOAL



illustration image mini goal 120 / 80 cm and 180 / 120 cm



illustration image mini goal 120 / 80 cm, foldable



illustration image mini goal 180 / 120 cm

Mini goal

- mini goal made of aluminium
- fully welded or foldable
- goal frame from 80 / 80 mm rectangle profile
- net suspension with „Basic“ plastic net hooks
- display 50 / 50 cm
- folding function with mounted net possible

art.-no. productspecification

mini goal 120 / 80 cm

- | | |
|---------|----------------------------------|
| 1111240 | fully welded, display 50 / 50 cm |
| 1111250 | foldable, display 50 / 50 cm |

accessories for mini goals 120 / 80 cm

- | | |
|---------|--|
| 4120842 | goal net, 4 mm, green, mesh width 100 |
| 4120832 | goal net, 4 mm, white, mesh width 100 |
| 2001603 | surcharge for extended goalposts |
| 2111264 | surcharge integrated weights and wheels |
| 2111261 | surcharge goal frame from oval profile, fully welded |

mini goal 180 / 120 cm

- | | |
|---------|----------------------------------|
| 1111270 | fully welded, display 50 / 50 cm |
| 1111280 | foldable, display 50 / 50 cm |

accessories for mini goal 180 / 120 cm

- | | |
|---------|--|
| 4120842 | goal net, 4 mm, green, mesh width 100 |
| 4120832 | goal net, 4 mm, white, mesh width 100 |
| 2001603 | surcharge for extended goalposts |
| 2111264 | surcharge integrated weights and wheels |
| 2111261 | surcharge goal frame from oval profile, fully welded |

mini goal 240 / 160 cm

- | | |
|---------|------------------------------------|
| 2111263 | fully welded, display 100 / 100 cm |
|---------|------------------------------------|

accessories for mini goal 240 / 160 cm

- | | |
|---------|--|
| 4122001 | goal net, 4 mm, green or white, mesh width 100 |
| 2111266 | surcharge integrated weights and wheels |

MINI GOAL „SPECIAL“



Mini goal stackable

- Goal frame made of 120 / 100 mm aluminium profile with inverted net suspension „Basic“
- Ground frame made of 80 / 40 mm aluminium rectangular profile with inverted net suspension „Basic“
- Net hoop made of 60 mm round tube

art.-no. productspecification

Mini goal stackable

1111241	Fully welded, 120 x 80 cm, display 50 / 50 cm
1111271	Fully welded, 180 x 120 cm, display 50 / 50 cm
1111272	Fully welded, 300 x 100 cm, display 100 / 100 cm
4122005	Net, 300 x 100 cm, 4 mm, green, mesh width 100cm



illustration image mini goal 300 x 100 cm, stackable

Mini turnable goal

- on both sides goal frame from 120 / 100 mm aluminium profile with inverted net suspension „Basic“
- dual use by turning over
- 120 / 80 cm or 120 / 60 cm, fully welded

art.-no. productspecification

Mini turnable goal

2111260	turnable goal
---------	---------------

accessories mini turnable goal

4122500	Net for turnable goal, green
---------	------------------------------



Mini turnable goal

FOOTBALL GOAL „RECREATIONAL GOAL PRISONWALL“



Note! Recreational goals with basketball attachment must be secured with ground anchors on the rear!



illustration image recreational goal 3,00 x 2,00 m, Auslage 70 / 100 cm

Referred to DIN EN 15312 multi-sportequipment

Recreational goal „Prisonwall“

- completely made of aluminium
- fully welded
- strut spacing after DIN EN 1176-1
- goal frame profile 120 x 100 mm
- back and side wall made from Ø 40 mm round tubes
- display 70 / 100 cm or 100 / 100 cm
- prepared for ground anchoring
- TÜV GS certificated

art.-no. productspecification

Recreational goal „Prisonwall“

2001010	3,00 x 2,00 m, display 70 / 100 cm
2001012	5,00 x 2,00 m, display 70 / 100 cm
2001015	3,00 x 2,00 m, display 100 / 100 cm
2001016	5,00 x 2,00 m, display 100 / 100 cm

Recreational goal with basketball

- Basketball attachment 60 cm display with TÜV GS certification
- Backboard 120 x 90 cm included
- Red basketball rim according to DIN and 6 mm nylon net included
- Rim height 3,05 m

art.-no. productspecification

Recreational goal with basketball attachment

2001021	3,00 x 2,00 m, display 70 / 100 cm, BB-display 60 cm
2001022	5,00 x 2,00 m, display 70 / 100 cm, BB-display 60 cm
2001023	3,00 x 2,00 m, display 100 / 100 cm, BB-display 60 cm
2001024	5,00 x 2,00 m, display 100 / 100 cm, BB-display 60 cm
2001025	3,00 x 2,00 m, display 70 / 100 cm, no BB-display
2001026	5,00 x 2,00 m, display 70 / 100 cm, no BB-display
2001027	3,00 x 2,00 m, display 100 / 100 cm, no BB-display
2001028	5,00 x 2,00 m, display 100 / 100 cm, no BB-display



illustration image recreational goal with basketball attachment



Accessories

2001011	Surcharge sand filling of the round tubes, 3,00 m goal
2001013	Surcharge sand filling of the round tubes, 5,00 m goal
2001603	Surcharge for extended goal post
2001600	Adapter for goal post
2001606	Surcharge for integrated goal-shooting walls

FOOTBALL GOAL

„RECREATIONAL GOAL HARDIOLA“



Note! Recreational goals with basketball attachment must be secured with ground anchors on the rear!

Recreational goal „Hardiola“

- completely made of aluminium
- fully welded
- strut spacing after DIN EN 1176-1 (<89mm)
- goal frame profile 120 x 100 mm
- back and side wall made from Ø 40 mm round tubes
- round display
- prepared for ground anchoring
- TÜV GS certificated

art.-no. productspecification

Recreational goal „Hardiola“

2001017	3,00 x 2,00 m
2001018	5,00 x 2,00 m

Recreational goal „Hardiola“ with basketball attachment

2001019	3,00 x 2,00 m, BB-display 60 cm
2001032	5,00 x 2,00 m, BB-display 60 cm
2001020	3,00 x 2,00 m, no BB-display
2001033	5,00 x 2,00 m, no BB-display

Accessories

2001011	Surcharge sand filling of the round tubes, 3,00 m goal
2001013	Surcharge sand filling of the round tubes, 5,00 m goal
2001603	Surcharge for extended goal post
2001600	Adapter for goal post
2001606	Surcharge for integrated goal wall



Referred to DIN EN 15312 multi-sportequipment

Recreational goal 3,00 x 2,00 m, with basketball attachment

mini recreational goal

- completely made of aluminium
- fully welded
- strut spacing after DIN EN 1176-1 (<89mm)
- goal frame profile 120 x 100 mm
- back and side wall made from Ø 40 mm round tubes
- display 50 / 50 cm
- prepared for ground anchoring
- TÜV GS certificated

art.-no. productspecification

Mini recreational goal

2001030	Recreational goal 120x80 cm
2001031	Recreational goal 180x120 cm

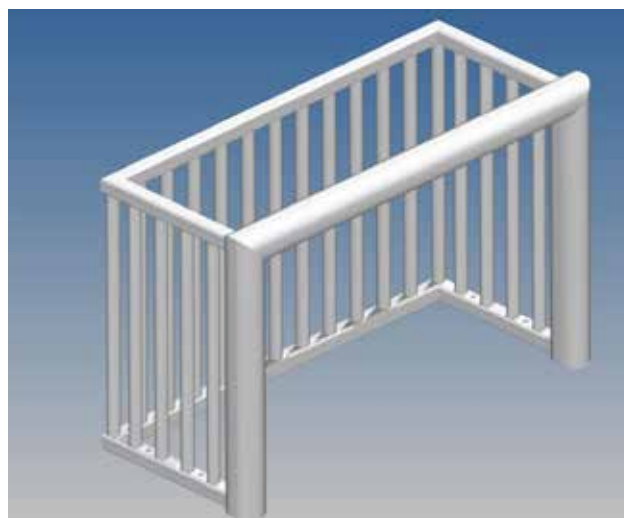

FOOTBALL GOAL

„RECREATIONAL GOAL UND STEEL GOAL“



The strut are not dulled welded but rather are the cross pipes are recessed and then „all around“ fully welded making the goal extremely resilient!

Steel recreational goal „Strong Line“

- fully welded goal made out of steel
- hot galvanised with curing
- goal frame made out of 60Ø mm round pipe
- with recessed steel strut
- already prepared for ground anchoring
- net hanger out of 42mm round pipe
- TÜV tested according to DIN EN 15312

after
DIN 15312 /
DIN EN 1176



art.-no. productspecification

Steel recreational goal

2001041	5,00 x 2,00 m, display 70 / 100 cm
2001040	3,00 x 2,00 m, display 70 / 100 cm
2001046	1,80 x 1,20 m, display 50 / 50 cm
2001047	1,20 x 0,80 m, display 50 / 50 cm
2001042	Surcharge for goal wall

Ground anchoring for recreational goal

1111210	Ground anchors
---------	----------------



„Omnigoal“ mit schwarzen Gittermatten

Steel goal „Omnigoal“

- resilient, vandal-proof design
- noise protection construction, residents are not disturbed by any sound
- stable and robust grates
- thermal galvanised (optional in RAL- colour of your choice)
- thermal galvanised standard coating in RAL 9005 jet black
- goal frame made out of 90x90 mm steel profile
- 10 year warranty on these solids high-quality goals
- TÜV GS certificated

art.-no. productspecification

steel goal „Omnigoal“ made of grid

4005001	„Omnigoal Standard“ (B) 2,73 x (H) 2,03 x (T) 0,73 m
4005002	„Omnigoal XL“ (B) 4,81 x (H) 2,03 x (T) 0,73 m

FOOTBALL GOAL

„MINI STEEL GOAL“

Mini steel goal „Chico“

Playing fields for confined spaces require smart solutions. Especially in residential areas there is often not enough space for wide sports fields. Furthermore, noise levels have to be kept at a minimum. Our steel goal „Chico“ has been specially developed for these kind of environment. It is resilient and vandal-proof. The mini steel goal „Chico“ is available in a wide selection of different colors.

- resilient and compact
- can be installed on all grounds
- steel, galvanised or an alternative is powder-coating
- already prepared for floor anchoring
- available in two sizes
- TÜV GS certified

art.-no. productspecification

steel goal „Chico“ (W)1,90 x (H)0,99 x (D)0,99m

4005003	steel galvanised
4005004	steel galvanised or alternativ powder coated (standard RAL-colours)

steel goal „Chico XL“ (W)2,84 x (H)0,99 x (D)0,99m

4005005	steel galvanised
4005006	steel galvanised or alternativ powder coated (standard RAL-colours)



Mini steel goal „Chica“

The mini goal „Chica“ is a small but versatile goal. The unusual design and shape gives this goal an unique appearance. This makes it ideal for schoolyards, campsites, sports- or training grounds. Although the goal can be used for different ball games, it is most suitable for street hockey.

- suitable for street-hockey/ hockey
- available in two versions: with galvanised or powder coated steel
- prepared for ground anchoring
- (W) 1,25 x (H) 0,82 x (D) 0,58m (external dimensions)
- TÜV GS certified

art.-no. productspecification

steel goal „Chica“

4005007	steel galvanised
4005008	steel galvanised or alternativ powder coated (standard RAL-colours)



FOOTBALL ACCESSORIES

„TILTING SAFETY DEVICE“

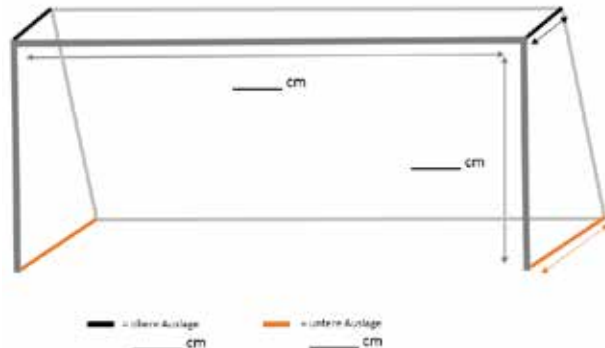

Safety first! Our products are manufactured after this slogan:

The DIN and GuV indicate that a goal on its own has to be safe against tilting. That's why we are recommending our mobile "all in one" football goals (see page 15). The "all in one" features a steel filling in the bottom frame which prevents any tilting of the goal. The "all in one" has a TÜV certificate. Your present goals are not secured against tilting yet? That is not a problem! Our goal weights type „Small“ and „Big“ can be adapted for every ground frame.

Lay on weights do not get any TÜV since January 2018 onwards because they are not permanently attached to the goal.

WICH WEIGHT IS REQUIRED.

To make sure your future goal weights fit and that the counterweight matches the requirements we created this little help for you.

Step 1: Please measure the size of your goal frame. For this please take the internal dimensions.

Step 2: Please measure the top and the bottom display of the goal. These are colour coded/indicated in the graphic. For this please start measuring at the rear edge of the goal post up to the net hanger.

Step 3: The goal frame can be either round, oval or rectangular. Measure the height and the width of the goal frame.

We have to know these details to select the right goal weight for you.

Needed weights after DIN EN 748

training goal

7,32 x 2,44m, mit 2,00m display = 100kg

training goal

7,32 x 2,44m, mit 1,50m display = 170kg

junior goal

5,00 x 2,00m, mit 2,00m display = 100kg

junior goal

5,00 x 2,00m, mit 1,50m display = 125kg

junior goal

5,00 x 2,00m, mit 1,00m display = 200kg

The spiral anchor are only used to prevent the slipping of the goals. The tilt safety is not guaranteed and it also depends on the ground surface.

art.-no.	productspecification
spiral anchor	
4000047	spiral anchor (Set = 4 pieces)
adapter for goals	
2001600	adapter for goal post 120/100 mm gr. socket
2001602	adapter for goal post 115/100 mm gr. socket
2001607	adapter for goal post 80/80 mm gr. socket



FOOTBALL ACCESSORIES

„WEIGHTS“



Weights for retrofitting „Big“

- with big, frothed wheels
- weight approx. 125 kg
- retrofitting for all ground frames
- concrete weights are included
- Tightly screwed with the ground frame

art.-no. productspecification

Weights for retrofitting „Big“

2014016	weight for retrofitting „Big“, frothed wheels, backwards movable
2014017	weight for retrofitting „Big“, frothed wheels, lateral movable



Lay on weights „Small“

- weight to put on the ground frame
- can be filled with approx. 70kg of sand
- retrofitting for all ground frames

art.-no. productspecification

Lay on weights „Small“

2014012	Auflegegewicht (nur bei Kunstrasen / Hartplatz einsetzbar)
---------	---



Transport and weight trolley „All in one“

- solid combi goal trolley for fully welded training goals or junior goals
- width corresponding to the length of the goal
- with 4 polyamide swivel castors - 2 of them can be locked
- Construction fixes the ground frame to the anti-tilting device
- Goal can be easily placed on the trolley
- Fixing of the installation and transport position with one bolt

art.-no. productspecification

Transport and weight trolley „All in one“

2014020	Transport & weight trolley for training goal 7.32 m
2014025	Transport & weight trolley for training goal 5.00 m
2014030	Surcharge for pneumatic castors



Weights for retrofitting „Small“

- with big wheels
- individual weight approx. 65 kg

art.-no. productspecification

Weights for retrofitting „Small“

2014610	Nachrüstgewicht „SMALL“, Polyamidräder (nur bei Kunstrasen / Hartplatz einsetzbar)
2014014	Nachrüstgewicht „SMALL“, ausgeschäumte Räder

TRANSPORT TROLLEY FOR GOAL



Transport trolley with big guide rollers



Transport trolley with big small rollers

Transport trolley „Basic“, for fully welded goals

- Transport trolley with recessed admission
- Four guide rollers (small or big)
- Two pieces are needed per goal
- Perfect for light-weight goals

art.-no. productspecification

Transport trolley „Basic“

- | | |
|---------|--|
| 2014002 | Transport trolley „Basic“ with small guide rollers |
| 2014009 | Transport trolley „Basic“ with big guide rollers |



toggle leveller

Transport trolley „Herkules“, for weighted goals

- 1 set includes a couple of transport trolleys
- with big frothed wheels
- pivoting wheels can be locked with bolts
- toggle leveller can be used as a drawbar for towing vehicles

art.-no. productspecification

Transport trolley „Herkules“

- | | |
|---------|--|
| 2014001 | Transport trolley „Herkules“ for training goals |
| 2014004 | Transport trolley „Herkules“ for junior goals |
| 2014003 | toggle leveller for transport trolley „Herkules“ |

TRANSPORT TROLLEY FOR GOAL



Transport trolley „Professional“ in the goal



Transport trolley „Professional“

Transport trolley „Professional“

- Goal transport and lifting trolley for competition goals
- Goal holders can be raised via toothed racks
- Trolley completely made of aluminium
- four large swiveling wheels with bandage wheels
- with stopper for goal posts
- Belt fixation during transport

art.-no. productspecification

Transport trolley „Professional“

2014011 Goal transport trolley „Professional“



Transport trolley and storage platform for competition goals

- size 7,80 x 1,60 m
- can hold up one pair of pluggable 7,32m goals
- central storage for tensioning rods, nets, etc.
- on both sides with towing eye and drawbar
- four pieces tipping sleeves lockable
- big pneumatic tyres



art.-no. productspecification

Goal transport trolley

2014005 Goal transport trolley for „Competition“ goals

MARKING MACHINE



Marking machine „Simple Liner“

- linewidth form 5 cm up to 12 cm
- firm carriage with frothed wheels
- handle bar is vertically adjustable
- can hold up to 6 spray cans

art.-no. productspecification

Marking machine „Simple Liner“

4008000	Marking machsine „Simple Liner“
4008001	spray cans (6 pieces / cartonage)



Marking machine „Roll Liner“

- Aluminium-Druckrad zur gleichmäßigen Verteilung der Markierfarbe durch einfaches Abrollen
- Rasenschonende, vibrationsdämpfende Lufträder
- Schmutzabweiser
- filling capacity: 12 l

art.-no. productspecification

Marking machine „Roll Liner“

4110760	Marking machine „Roll Liner“
4107600	white marking colour „Protect 200“ 10 ltr.



Marking machine „Jet Liner“

- function: battery, pump and round cone nozzle
- vortex function: the grass is sprayed all-around
- colour can be in the machine without rinsing
- due to low weight easy to handle
- line width can be adjusted

art.-no. productspecification

Marking machine „Jet Liner“

4010001	Marking machine „Jet Liner“
4010006	arena white marking colour, 18,5 kg bucket



Marking machine „Supermatic GM10“

- patented spraying technology
- Adjustable pressure 1.5 - 2.5 bar
- Marking without electricity, fuel etc.
- High pressure hose pump is run by a wheel shaft

art.-no. productspecification

Marking machine „Supermatic GM10“

4010001	Marking machine „Jet Liner“
4010006	arena white marking colour, 18,5 kg bucket

SPORT FACILITY ACCESSORIES

„CORNER FLAGS“

Corner flag pole

- Corner flag pole diameter 50 mm
- Made of accident-preventing material
- According to FIFA standards
- With and without tilt joint
- Colors white and yellow

art.-no. productspecification

Corner flag pole

4030101	Corner flag pole fixed, white
4030102	Corner flag pole fixed, yellow
4030121	Corner flag pole tilting, white
4030122	Corner flag pole tilting, yellow

Corner flags

- Corner flag made of polyester
- Wind, water and UV resistant
- For corner flag pole ø 50mm
- Size 45 x 45 cm plus hem
- Various colors
- Flag with club logo (one-sided)
- High quality 4c digital print on request

art.-no. productspecification

Corner flag

4030401	Corner flag, colour: neon yellow
4030402	Corner flag, colour: neon orange
4030451	Corner flag checkered yellow/orange
4030452	Corner flag with club logo imprinted
4030453	Corner flag, two coloured

art.-no. productspecification

Corner flag ground socket and accessories

1110495	Corner flag „Safety“ ground socket incl. turning insert
1110490	Aluminium special socket incl. reducing insert
1110491	Aluminium standard socket incl. reducing insert
4011050	Plastic socket with snap-on lid
4030205	Flag retaining clip
4011051	Corner flag insert, reduced from 60 to 50 mm
4011052	Corner flag base, round, for 50 mm poles
4030125	Surcharge for integrated lifting hook (ATTENTION! Only for tilting corner flagpoles)

Linesman flag set

art.-no. productspecification

Linesman flag set (2 flags and case included)

4030312	Linesman flag set
---------	-------------------



Corner flag pole yellow tilting



Corner flag pole white fixed



neon yellow



checkered



two coloured



High quality print



„Safety“ Ground socket



Plastic socket with snap-on lid



Flag retaining clip



Corner flag base



SPORTS GROUND ACCESSORIES

Lawn sprinkler

- robust chassis, hot-dip galvanised, 3 pneumatic wheels
- 100 m quality hose 1 1/4" with fabric insert
- 100 m pull cord with fastening peg
- infinitely adjustable driving speed
- automatic limit stop
- Irrigated area width 28 - 44 m
- Running speed 10 - 25 m/hour
- Required pressure 4 - 8 bar
- Water consumption 3.8 - 8.5 m³/h

art.-no. productspecification

Lawn sprinkler

4121030 Lawn sprinkler



measuring help „Plifix“

- Artificial turf implant for playing field marking
- 1 set of Plifix marking aids (25 pieces), sufficient for one soccer field
- Total length 17 cm
- Length (screw): 10 cm
- Length (turf implant/bunch): 7 cm
- Incl. impact bar



art.-no. productspecification

measuring help „Plifix“

- 4121006 Plifix - white
- 4121004 Plifix - green
- 4121005 Plifix - orange
- 4121007 Plifix - yellow
- 4121008 Plifix - red
- 4121009 Plifix - blue

Marking template

- Marking of:
 - Penalty point (diameter 23 cm)
 - Corner quadrant Radius 100 cm, width 120 cm
 - Recess for tracing the goal line at the post
- Template made of solid HPL board (8 mm)
- screwed-on frame for corner flag radius on the underside for better colour gradient
- two aluminium handles
- total size approx. 110 x 110 cm

Alternative:

- steel marking template
- foldable

art.-no. productspecification

Markierschablone

- 1001980 Marking template of HPL with Aluminium handles
- 1001981 Marking template foldable



Goal lifting device for „Competition goals“

- made of aluminium
- suitable for oval goal posts
- welded handles
- openable



art.-no. productspecification

goal lifting device

- 2001610 goal lifting device

SPORT FACILITY ACCESSORIES

Net hooks

- Hooks for net fixture
- UV-stable plastic

art.-no. productspecification

Net hooks for different goal types

1001000	Net hook Vindico single hook
1001020	Net hook Vindico twin hook
1001001	Net hook Typ 2 (for 8 mm slot)
1001002	Net hook Typ 2 (for 10 mm slot)
1001003	Net hook Typ 3
1001004	Net hook Typ 4
1001005	Net hook Typ 5
1001006	Net hook Typ 6
1001007	Net hook Typ 7
1001008	Net hook Typ 8
1001009	Net hook Typ 9



Clip bolt with slot stone

art.-no. productspecification

Clip bolt with slot stone

1001010	Clip bolt with slot stone
---------	---------------------------



Note:
Hook bolts are no longer permitted according to current regulations

Suspension bracket

- incl. counterplate
- completely made of aluminium
- inner pad with Teflon tape

art.-no. productspecification

Suspension bracket for goals

2607015	suspension bracket
---------	--------------------



Safety pad for flood light pole

- Standard height 200 cm
- Flood light pole Ø: 30 cm (Standard)
- Pad strength: 10 cm (Standard), total pad strength Ø 50 cm
- Many colours available
- Size can be adjusted to your requirement (on request)

art.-no. productspecification

Safety pad for flood light pole

4321010	Safety pad for flood light pole in the standard measurements
---------	--



TRAINING ACCESSORIES

„FREE KICK WALL“



Free kick wall „Strong“

- mobile and fully made out of aluminium
- foamed wheels (2x stiff / 2x pivoted)
- welded handles
- ball opening at the bottom
- size: approx. (W) 2,60 x (H) 2,25 m (other sizes available!)

art.-no.	productspecification
2003030	Free kick wall „Strong“



Free kick wall „Champion“

- Mobile with drawbar
- Ball opening at the bottom
- Heads are hinged and rotatable
- Frame completely made out of aluminium
- Body and heads made out of HPL-plates
- coating with logo and preferred colour
- frothed wheels
- size: approx. (W) 2,75 x (H) 2,30 m (other size available!)

art.-no.	productspecification
2003031	Free kick wall „Champion“

TRAINING ACCESSORIES

Pendulum header on one side

- Aluminium-oval-standpipe
- Display on one side 165 cm
- Including reel, rope, balls and weights
- For embedding in concrete or with ground socket
- Height 500 cm (Display 250 cm)



art.-no. productspecification

Pendulum header

2015001 On one side incl. pendulum ball

Pendulum header on both side

- Aluminium-oval-standpipe
- Display on both sides 250 cm
- Height 600 cm
- Including reel, rope, balls and weights
- For embedding in concrete



art.-no. productspecification

Pendulum header

2015002 On both sides incl. pendulum ball

Training dummy „Air Body“

- High-strength foil
- special weldtechnique, for a higher tear strength
- fabric reinforced base, extremely resilient
- tank can be filled with sand, pebble or water
- fast assembly and disassembly due to special valve technology (within 30s)
- can be subsequently increased (2,11 m & 2,31 m)

art.-no. productspecification

Training dummy „Air Body“

4007009 Training dummy „185“, height 1,91 m
4007010 Training dummy „Junior“, height 1,56 m



We have a wide spectrum of

TRAINING AIDS

- Free kick wall
- Rebounder
- Cones
- Speed agility ladder
- Slalom poles
- Marking cones

Do not hesitate to contact us!



FOOTBALL ACCESSORIES

„NET“

Net for football goals

- Nets available in all sizes
- in 3 / 4 / 5 mm strength, standard 4 mm
- All colours / multi-coloured possible
- All displays / sizes available
- Special / irregular sizes only on request
- On request with club logo
- Nets made of polypropylene

art.-no. productspecification

Nets
for goal frame 7,32 x 2,44 m, display 200/200 cm

4722401	display 200/200 cm, 4 mm, colour: white
4722402	display 200/200 cm, 4 mm, colour: green
4722412	display 200/200 cm, 4 mm, colour: green / white
4722413	display 200/200 cm, 4 mm, colour: black / white
4722414	display 200/200 cm, 4 mm, colour: blue / white
4722415	display 200/200 cm, 4 mm, colour: red / white

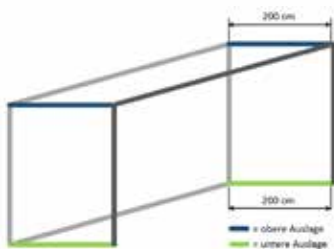

art.-no. productspecification

Nets
for goal frame 7,32 x 2,44 m, display 80/200 cm

4720302	display 80/200 cm, 3 mm, colour: green
4720401	display 80/200 cm, 4 mm, colour: white
4720402	display 80/200 cm, 4 mm, colour: green
4720412	display 80/200 cm, 4 mm, colour: green / white
4720413	display 80/200 cm, 4 mm, colour: black / white
4720414	display 80/200 cm, 4 mm, colour: blue / white
4720415	display 80/200 cm, 4 mm, colour: red / white

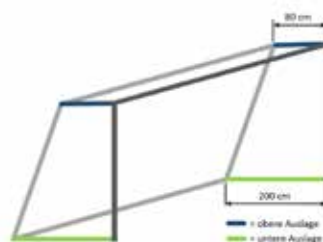

art.-no. productspecification

Nets
for goal frame 7,32 x 2,44 m, display 80/150 cm

4715302	display 80/150 cm, 3 mm, colour: green
4715401	display 80/150 cm, 4 mm, colour: white
4715402	display 80/150 cm, 4 mm, colour: green
4715412	display 80/150 cm, 4 mm, colour: green / white
4715413	display 80/150 cm, 4 mm, colour: black / white
4715414	display 80/150 cm, 4 mm, colour: blue / white
4715415	display 80/150 cm, 4 mm, colour: red / white
4715436	display 80/150 cm, 4 mm, colour: black / yellow

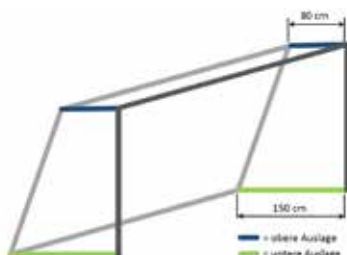

art.-no. productspecification

Junior goal nets
for goal frame 5,00 x 2,00 m, display 80/200 cm

4520302	display 80/200 cm, 3 mm, colour: green
4520401	display 80/200 cm, 4 mm, colour: white
4520402	display 80/200 cm, 4 mm, colour: green
4520412	display 80/200 cm, 4 mm, colour: green / white
4520413	display 80/200 cm, 4 mm, colour: black / white
4520414	display 80/200 cm, 4 mm, colour: blue / white
4520415	display 80/200 cm, 4 mm, colour: red / white

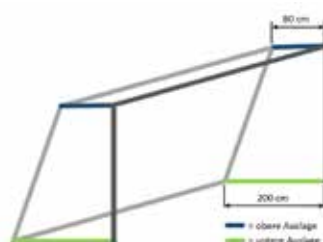

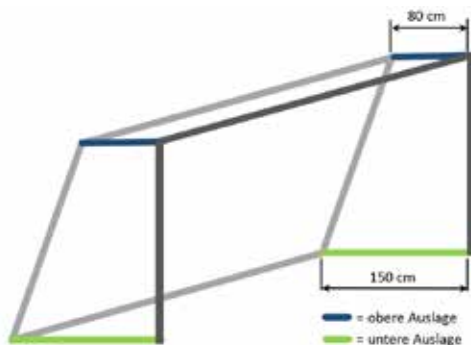

art.-no. productspecification

Junior goal nets
for goal frame 5,00 x 2,00 m, display 80/150 cm

- 4515302 display 80/150 cm, 3 mm, colour: green
- 4515401 display 80/150 cm, 4 mm, colour: white
- 4515402 display 80/150 cm, 4 mm, colour: green
- 4515412 display 80/150 cm, 4 mm, colour: green / white
- 4515413 display 80/150 cm, 4 mm, colour: black / white
- 4515414 display 80/150 cm, 4 mm, colour: blue / white
- 4515415 display 80/150 cm, 4 mm, colour: red / white

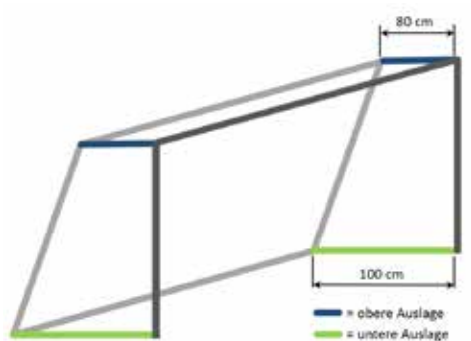

art.-no. productspecification

Junior goal nets
for goal frame 5,00 x 2,00 m, display 80/100 cm

- 4510302 display 80/100 cm, 3 mm, colour: green
- 4510401 display 80/100 cm, 4 mm, colour: white
- 4510402 display 80/100 cm, 4 mm, colour: green
- 4510412 display 80/100 cm, 4 mm, colour: green / white
- 4510413 display 80/100 cm, 4 mm, colour: black / white
- 4510414 display 80/100 cm, 4 mm, colour: blue / white
- 4510415 display 80/100 cm, 4 mm, colour: red / white

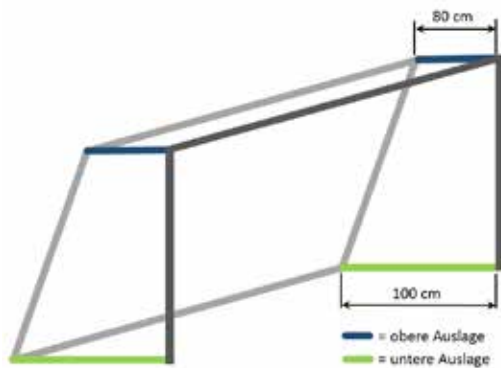

art.-no. productspecification

Handball / recreational goal nets
for goal frame 3,00 x 2,00 m, display 80/100 cm

- 4310302 display 80/100 cm, 3 mm, colour: green
- 4310402 display 80/100 cm, 4 mm, colour: green
- 4310401 display 80/100 cm, 4 mm, colour: white
- 4310412 display 80/100 cm, 4 mm, colour: green / white
- 4310413 display 80/100 cm, 4 mm, colour: black / white
- 4310414 display 80/150 cm, 4 mm, colour: blue / white
- 4310415 display 80/100 cm, 4 mm, colour: red / white
- 4715436 display 80/100 cm, 4 mm, colour: blue / white

Camera optimized net

The white side which lines in sight with the pitch shows a clear contour for the players. The black side directed at the spectators allows an optimal view not only for the spectators but also for the cameras.

art.-no. productspecification

camera optimized football goal net

- 4310133 Football goal net 7,32 x 2,44 m
display 200/200 cm, honeycombed
- 4301088 Handball goal net 3,00 x 2,00 m
display 80/100 cm, honeycombed



BARRIERS



Barriers made of aluminium

- Barriers made out of anodised aluminium
- Installation height 1,10 m
- 60 mm post and handrail
- Post distance 2,5 m
- Including external t-connection

art.-no. productspecification

Aluminium Barriers

1160000 Aluminium Barriers, complete per rm



90° bow



T-connection



double hinge



slide in tube

art.-no. productspecification

Accessories

1160100 90° bow for barriers
 1160101 T-connection
 4901306 double hinge
 1160001 hand railing for barriers, length 2,5 m
 1160002 Stand post for barriers, length 1,5 m
 2160102 slide in tube 3,00m, with grip

Firm cling and protection against dirt.



Fig. upper rail with rubber seal



Fig. lower rail with rubber seal

Advertising barrier holder „J.B. Simple“

- holder made out of aluminium (anodised on request)
- double sided „massive“ rubber sealing lip
- Advertising panel strength between 6-8 mm possible
- U-connector between the rails
- very quiet, the whole advertising panel is rubber-cushioned

art.-no. productspecification

Advertising barrier holder „J.B. Simple“

4138401 Advertising barrier holder „J.B. Simple“, per rm

BARRIERS

Advertising panel-elements for existing barriers

- very resilient and durable
- Height of the advertising banners 75 cm (visible area approx. 70 cm)
- Fastening set with clamps for Ø 60 mm and bolting material
- Very resilient and durable
- Suitable for 24 mm elements
- Top/bottom surrounded with advertising hand railing made out of aluminium
- Including fastening set
- Completely made out of aluminium and high-grade steel for already existing barriers
- No party can rot
- Noise-damped through a specific clamping system

art.-no. productspecification

Advertising panel-elements

4901360 Advertising panel-elements for existing barriers

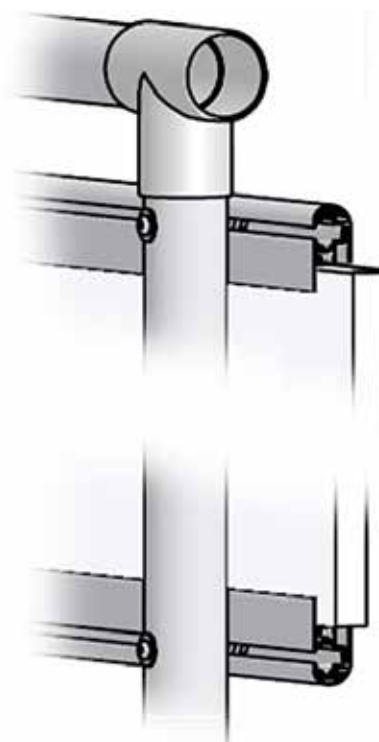

Advertising panel-elements with stand pipe

- very resilient and durable
- top/bottom surrounded with advertising hand railing made out of aluminium
- Particularly noise reduced due to the special shape of the profile
- Support tubes made of aluminium round tube Ø 60 mm with KU caps, approx. 1.0 m above ground, distance 2.5 m
- incl. fastening set with clamps and bolting material
- Advertising hoarding completely bordered with special end pieces made of advertising hoarding profile
- The panels are freely positioned in the profile and can expand, so no deformation of the advertising hoardings.
- impact resistant and weatherproof
- stable, long-lasting and physiologically harmless

art.-no. productspecification

Advertising panel-elements

4901350 Advertising panel-elements with stand pipes and hard foam board

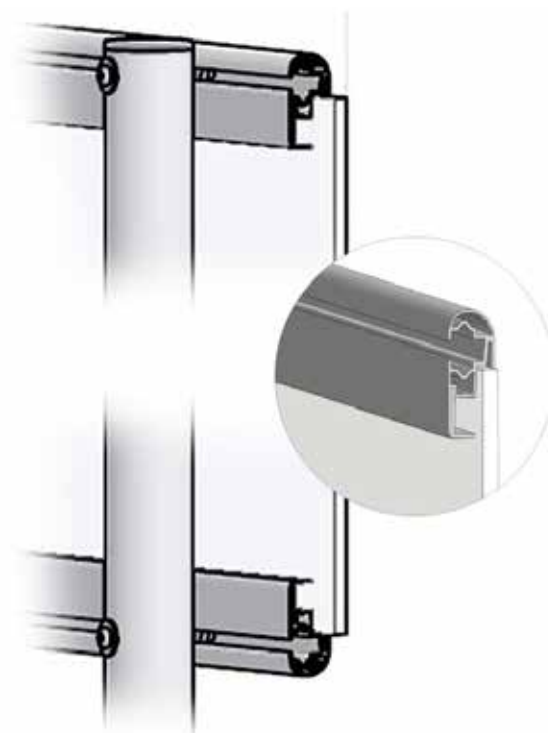



Ball catching construction

Our ball catching constructions are designed and manufactured according to your requirements (for aluminium max. 8m, for steel up to 10 m)

- ball catching construction in all lengths possible
- facility with crossbar or oblique support
- posts made out of aluminium or steel
- height up to 10 m
- on request with passage door
- bar grate mats along the bottom are possible
- nets in different colours and mesh width are possible

We manufacture your ball catching construction according to your requested dimensions!

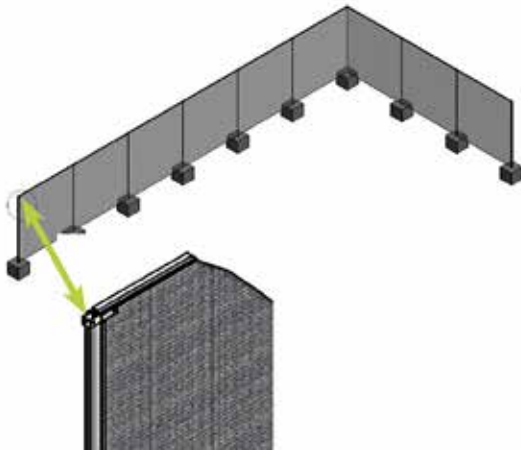

Ball catching construction with crossbars

Standard distance = 5,00 m

Foundation size up to 4.50m = 60 x 60 x 55 cm
Foundation size from 4.50m = 80 x 80 x 75 cm

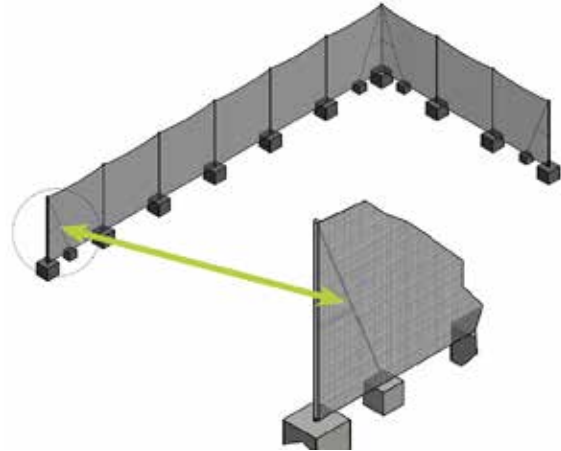

Ball catching construction with oblique support

Standard distance = 5,00 m

Foundation size up to 4.50m = 60 x 60 x 55 cm
Foundation size from 4.50m = 80 x 80 x 75 cm



VINDICO-TIPP

For higher stability we recommend crossbars between each pair of posts. This increases the stability of the construction and makes it more appealing.

Height	aluminium	aluminium	aluminium	aluminium	steel	steel
	Ø 60 x 5 mm	80x80x2,5 mm	120x100x2,5 mm	120x100x4/6 mm	100x100x3 mm	150x150x3 mm
	insertion depth: 35cm	insertion depth: 25 cm	insertion depth: 40 cm	insertion depth: 40 cm	insertion depth: 60 cm	insertion depth: 60 cm

with welded eyes and hooks



with slot for net hooks 3 pieces / rm included



with slot for net hooks 3 pieces / rm included



with welded eyes and hooks



with welded eyes and hooks



with welded eyes and hooks



3,00 m	Art. 2606030	Art. 2608030	Art. 2601030	Art. 2601230	Art. 2601430	Art. 2601530
3,50 m	Art. 2606035	Art. 2608035	Art. 2601035	Art. 2601235	Art. 2601435	Art. 2601535
4,00 m	Art. 2606040	Art. 2608040	Art. 2601040	Art. 2601240	Art. 2601440	Art. 2601540
4,50 m	Art. 2606045	Art. 2608045	Art. 2601045	Art. 2601245	Art. 2601445	Art. 2601545
5,00 m	Art. 2606050	Art. 2608050	Art. 2601050	Art. 2601250	Art. 2601450	Art. 2601550
5,50 m			Art. 2601055	Art. 2601255	Art. 2601455	Art. 2601555
6,00 m			Art. 2601060	Art. 2601260	Art. 2601460	Art. 2601560
6,50 m			Art. 2601065	Art. 2601265	Art. 2601465	Art. 2601565
7,00 m				Art. 2601270	Art. 2601470	Art. 2601570
7,50 m				Art. 2601275		Art. 2601575
8,00 m				Art. 2601280		Art. 2601580
8,50 m						Art. 2601585
9,00 m						Art. 2601590
9,50 m						Art. 2601595
10,00 m						Art. 2601510

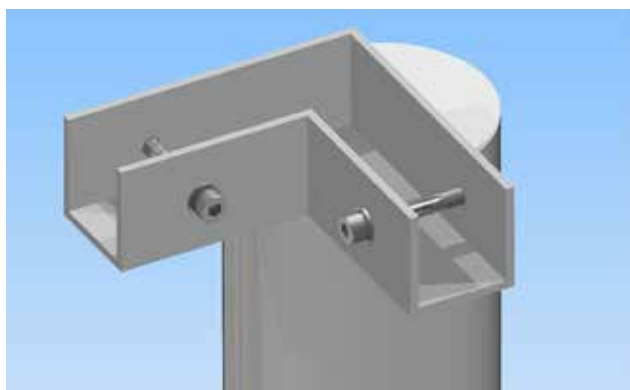

Sockets and post accessories

art.-no. productspecification

Sockets and post accessories

2607001	crossbar, standard length 5,00m, made of aluminium with plastic net hooks
2607002	crossbar, standard length 5,00m, made of aluminium with welded net hooks
2607003	Surcharge for u-socket for crossbar for aluminium post
2607004	Surcharge for u-socket for crossbar for aluminium post, corner version



BALL CATCHING ACCESSORIES

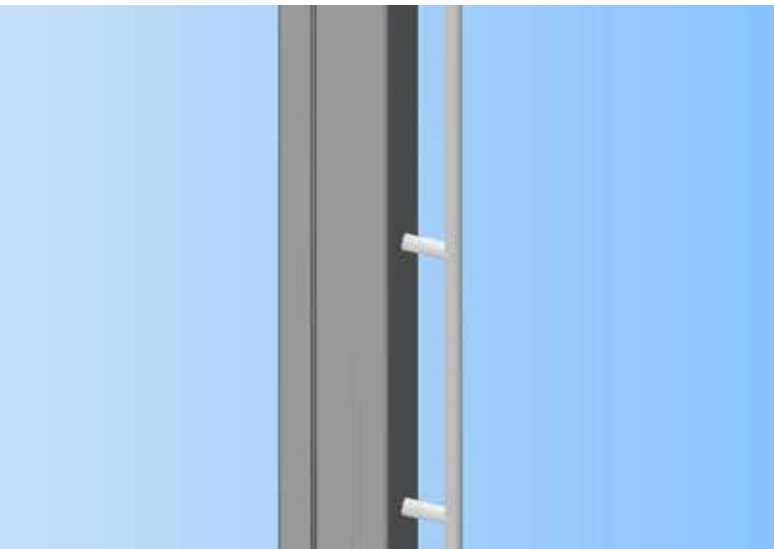

angeschweißte Reeling

Oblique support / Reeling

art.-no. productspecification

Oblique support

- 2607005 oblique support made from aluminium with horizontal strut & ground socket adapter
- 2607006 surcharge welded reeling Ø 10mm

art.-no. productspecification

Inner reinforcement

- 2607007 surcharge internal reinforcement with steel height 2,00 m for 120 x 100 or 80 x 80 mm
- 2607008 surcharge internal reinforcement with steel height 2,00 m for 120 x 100mm, 4/6mm profile



Passage door

art.-no. productspecification

Passage door

- 2607009 passage door made of aluminium, fully welded, for the connection with a post
- 2607010 passage door made of steel, 203 x 100 cm, frame left and right filling of double rod mats 8/8/6mm incl. cover strips for double bar mat connection incl. mortise lock

Ball catching post powder coated

art.-no. productspecification

Powder coating

- 2607011 ball catching post powder coated in RAL-colour as surcharge



Standard ground sockets

art.-no. productspecification

Standard ground sockets

- 1110160 Standard sockets Ø 60 mm, insert depth 350 mm
- 1110140 Standard sockets 120/100 mm, insert depth 400 mm
- 1070070 Standard sockets 80/80 mm, insert depth 250 mm
- 4050058 steel post socket 100 x 100 mm, insert depth 600 mm
- 4050059 steel post socket 150 x 150 mm, insert depth 600 mm

BALL CATCHING „NETS“

Ball catching nets made of polypropylene, knotless version

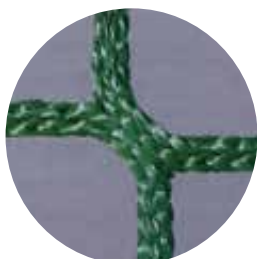

art.-no. productspecification

Ø 3 mm, MW 45

- 4045301 ball catching net, Ø 3 mm, MW 45, colour: white
- 4045302 ball catching net, Ø 3 mm, MW 45, colour: green
- 4045303 ball catching net, Ø 3 mm, MW 45, colour: black

art.-no. productspecification

Ø 4 mm, MW 45

- 4045401 ball catching net, Ø 4 mm, MW 45, colour: white
- 4045402 ball catching net, Ø 4 mm, MW 45, colour: green
- 4045403 ball catching net, Ø 4 mm, MW 45, colour: black

art.-no. productspecification

Ø 3 mm, MW 100

- 4100301 ball catching net, Ø 3 mm, MW 100, colour: white
- 4100302 ball catching net, Ø 3 mm, MW 100, colour: green
- 4100303 ball catching net, Ø 3 mm, MW 100, colour: black

art.-no. productspecification

Ø 4 mm, MW 100

- 4100401 ball catching net, Ø 4 mm, MW 100, colour: white
- 4100402 ball catching net, Ø 4 mm, MW 100, colour: green
- 4100403 ball catching net, Ø 4 mm, MW 100, colour: black

art.-no. productspecification

Double rod grid mat

- 2607012 bar grate pad 2,50 m length, 2,00 m height, MW 50/200 mm, 8/8/6 mm
- 2607014 intermediate post for double grate pads made out of steel, height 2,00 m
- 2607013 intermediate post for double grated pads made out of aluminium, height 200 cm profile 80x80 mm, including cover strip, screws and aluminium cover

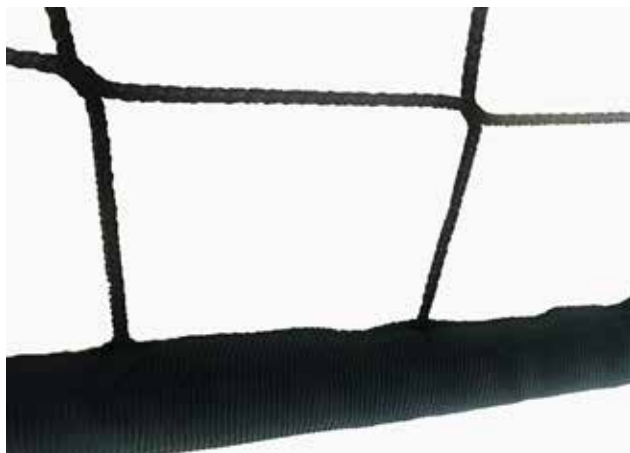

Bar grate pad can also be mounted in the lower part

Surcharge for filling finish of the net with a lead line

art.-no. productspecification

Weighing down

- 4050050 lead line with a belt strap attached onto the net, 200 g
- 4050051 lead line with a belt strap attached onto the net, 400 g
- 4050052 lead line with a belt strap attached onto the net, 600 g

BALL CATCHING ACCESSORIES



Use steel ropes with PVC sheathing to avoid chafing!

Spannschloss
Art. # 4050056



Stahlseil Ø 4/5 mm
Art. # 4050045



Karabinerhaken
Art. # 4050055



Nylonring
Art. # 4050057



Seilkausche
Art. # 4050054



Seilklemme
Art. # 4050053

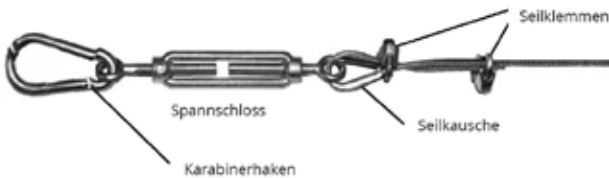

art.-no. productspecification

Tension rod accessories

- 4050056 Carabiner hook
- 4050055 Snap hook for eyelet
- 4050054 Rope thimble
- 4050053 Rope clamp for 4 mm rope
- 4050057 Open nylon ring suspension for the nets (3 pieces per rm)
- 4050045 Steel wire rope, galvanised 4mm strong, PVC coated

art.-no. productspecification

Tension rod

- 4050044 tension cable set for 4mm stell ropes consists of:
 - 1 stk. Carabiner hook
 - 2 stk. Rope thimble
 - 2 stk. Snap hook
 - 4 stk. Rope clamp



BALL CATCHING „STADION“

Ball catching „Stadion“

Ball catching nets for large stadiums must always be adapted to the local conditions. The nets can be fastened with ball catcher posts or suspended from the stadium roof. The appropriate solution depends on the existing conditions in the Stadium. Our nets comply with the current standards and requirements. We would be happy to take over the installation of the ball catcher net. We look forward to your enquiry!

We also supply and install individual ball catcher net systems for your stadium!



Ball catching Voith Arena Heidenheim



Ball catching Voith Arena Heidenheim



Steel plate for net weighting



Net with fire protection expertise

PLAYERS TUNNEL „LIGHT UND STRONG“



Spielertunnel „Light“



Players tunnel „Light“



Players tunnel „Strong“

Players tunnel „Light“

The foldable players' tunnel is made of high quality materials and is manufactured according to your specifications or the conditions on site. The construction consists of aluminum profiles. Each standard module is 1 meter long and has lateral pantographs made of aluminum (height 150cm) with clamping elements. The roof is made of class 2, hardly inflammable.

PVC-tarpaulin, 650g/m² (standard colour is white, other colors available on request).

Each module has its individual tarpaulin, which is inserted into the grooves of the aluminum profiles. The tunnel has nylon wheels. On request, it can also be equipped with pressured tires. Module length: 1,00m, width max: 3,00m. Side height max 2,40m.

- extendible players tunnel
- height up to a max. of 400 cm,
- width up to a max. of 800 cm
- all forms and sizes are possible
- assembly on the wall and ground are available
- PVC - coated tarpaulin
- element width 100 cm

art.-no. productspecification

Players tunnel „Light“

4050000	Players tunnel, foldable
4050001	Club logo print



Nylon wheels (Standard)



Running rails



Rubber wheels

Players tunnel „Strong“

- players tunnel made out of aluminium, completely welded
- disguised with unbreakable and impact resistant polycarbonate glass, colourless
- multi-piece
- telescopic
- can be adjusted trough big rollers
- tunnel height approx. 2,60 m
- Length, width and construction of the tunnel can match the local conditions

art.-no. productspecification

Players tunnel „Strong“

on demand	Players tunnel „Strong“
-----------	-------------------------

CARING DEVICES

Dragging mat for artificial turf

- edged rubber mat
- galvanised steel frame
- size approx. 150 x 200 x 7 cm
- chain with shackle to pull the mat

art.-no. productspecification

Dragging mat for artificial turf

2199999 Dragging mat for artificial turf



Care brush for artificial turf

- Hot galvanised steel frame, approx. 80kg
- Robust 3 mm Starke Nylonborsten

art.-no. productspecification

Care brush for artificial turf

4028000 Care brush 250 x 80 cm rectangle shape
 4028002 Care brush 250 x 80 cm triangular shape
 4028005 Surcharge for 3 point-suspension



Triangular broom for artificial turf

- To strip down artificial plastic fibres
- Consistent equalizing the surface
- Towing bar with changeable draw gear
- For transport rolls for an easy handling
- Working width 1,60 m
- Overall size W 185 x B 124 x D 27 cm

art.-no. productspecification

Triangular broom

2199998 triangular broom „Light“
 2199997 triangular broom „Strong“ with wheels and draw gear



Caring devices

We are pleased to offer you the maintenance and care equipment from SMG. Since 1975 Fa. SMG develops and manufactures devices for the care of artificial turf and sports floors. With more than 10 different caring- and cleaning devices, we provide a wide selection of different products. Starting with hand-guided devices for mini soccer courts, to ride-on machines of various sizes. Not to forget different add-on devices for municipal-tractors. These machines are available, according to our customer's requirements.

Gladly we will send you more information!



passion for sports grounds



PLAYER CABIN



PLAYER CABIN „BASIC“

Player cabin „Basic“

- Player cabin made from aluminium
- Fully welded
- made of non-breakable and UV-resistant 3 mm polycarbonate plates
- one-piece up to 6 m (incl.), from 7 m two-parts
- sloping roof
- bench and backrest made of hardwood
- optionally available with plastic seats

Length 2,00 - 12,00m (sizable lengths on request)

Glazing all the way with polycarbonate plates

Seating Douglas wood, seats on request

Size lower depth: 97 cm
roof overhang: 28 cm
leading edge: 213 cm

art.-no. productspecification

Player cabin „Basic“

2010102	length 2,00m, one-piece, for approx. 3-4 persons
2010103	length 3,00m, one-piece, for approx. 5-6 persons
2010104	length 4,00m, one-piece, for approx. 7-8 persons
2010105	length 5,00m, one-piece, for approx. 9-10 persons
2010106	length 6,00m, one-piece, for approx. 11-12 persons
2010107	length 7,00m, two parts, for approx. 13-14 persons
2010108	length 8,00m, two parts, for approx. 15-16 persons
2010109	length 9,00m, two parts, for approx. 17-18 persons
2010110	length 10,00m, two parts, for approx. 19-20 persons
2010111	length 11,00m, two parts, for approx. 21-22 persons
2010112	length 12,00m, two parts, for approx. 23-24 persons

art.-no. productspecification

Surcharge Player cabin „Basic“ with 4mm polycarbonate with 5mm polycarbonate

2010131	length 2,00m	2010152	length 2,00m
2010132	length 3,00m	2010153	length 3,00m
2010133	length 4,00m	2010154	length 4,00m
2010134	length 5,00m	2010155	length 5,00m
2010135	length 6,00m	2010156	length 6,00m
2010136	length 7,00m	2010157	length 7,00m
2010137	length 8,00m	2010158	length 8,00m
2010138	length 9,00m	2010159	length 9,00m
2010139	length 10,00m	2010160	length 10,00m
2010140	length 11,00m	2010161	length 11,00m
2010141	length 12,00m	2010162	length 12,00m

art.-no. productspecification

Accessories

2010003 Surcharge for aluminium foot rest



Also available with 4 or 5mm polycarbonate glass!



PLAYER CABIN

„PRO“

Player cabin „Pro“

- Player cabin made from aluminium
- fully welded
- at the bottom with aluminium profile
- upper area made of non-breakable and UV resistant 3 mm polycarbonate plates
- one-piece up to 6 m (incl.), from 7 m two-parts
- sloping roof
- bench and backrest made of hardwood
- carrying handles at both sides
- incl. aluminium footrest
- optionally available with plastic seats

Also available with 4 or 5mm polycarbonate glass!

Length 2,00 - 12,00m (sizable lengths on request)

Glazing at the bottom aluminium profile, at the top polycarbonate plates 3mm

Seating Douglas wood, seats on request

Size lower depth: 99 cm
roof overhang: 28 cm
leading edge: 213 cm

art.-no. productspecification

Player cabin „Pro“

2020202	length 2,00m, one-piece, for approx. 3-4 persons
2020203	length 3,00m, one-piece, for approx. 5-6 persons
2020204	length 4,00m, one-piece, for approx. 7-8 persons
2020205	length 5,00m, one-piece, for approx. 9-10 persons
2020206	length 6,00m, one-piece, for approx. 11-12 persons
2020207	length 7,00m, two parts, for approx. 13-14 persons
2020208	length 8,00m, two parts, for approx. 15-16 persons
2020209	length 9,00m, two parts, for approx. 17-18 persons
2020200	length 10,00m, two parts, for approx. 19-20 persons
2020211	length 11,00m, two parts, for approx. 21-22 persons
2020212	length 12,00m, two parts, for approx. 23-24 persons

art.-no. productspecification

Surcharge Player cabin „Pro“ with 4mm polycarbonate with 5mm polycarbonate

2010131	length 2,00m	2010152	length 2,00m
2010132	length 3,00m	2010153	length 3,00m
2010133	length 4,00m	2010154	length 4,00m
2010134	length 5,00m	2010155	length 5,00m
2010135	length 6,00m	2010156	length 6,00m
2010136	length 7,00m	2010157	length 7,00m
2010137	length 8,00m	2010158	length 8,00m
2010138	length 9,00m	2010159	length 9,00m
2010139	length 10,00m	2010160	length 10,00m
2010140	length 11,00m	2010161	length 11,00m
2010141	length 12,00m	2010162	length 12,00m



PLAYER CABIN „LEAGUE“

Special solution
for your stadium -
We would be
pleased to submit
an offer

Player cabin „League“

- Player cabin according to DFL standard
- movable seat bases for an easy removing of the seats
- Shape and length is customisable
- integrated weather protection
- Seats incl. seat heating (various types)
- Incl. electrical connection (LAN / power)



Bildquelle: FCH

PLAYER CABIN „STRONG“

Optional
without side
windows



Player cabin „Strong“

players cabin made from aluminium, fully welded, straight roof version, bottom with aluminium profile, side window made of polycarbonate plates, break and impact resistant.

Length 2,00 - 3,00m (sizable lengths on request)

Glazing Roof, side windows & upper partition wall made of 3 mm polycarbonate plates

Seating Douglas wood, seats on request

Size Lower depth: 99 cm
Roof overhang: 28 cm
Leading edge: 218 cm

art.-no. productspecification

Player cabin „Strong“

2050502 Length 2,00m

2050503 Length 3,00m

PLAYER CABIN „DOUBLE“



Player cabin „Double“

players cabin made from aluminium, usable on both sides, fully welded, curved roof version, side windows and upper partition wall made of break and impact resistant polycarbonate plates. Lower partition wall made of aluminium profiles.

Length 3,00 - 5,00m (sizable lengths on request)

Glazing Roof, side windows & upper partition wall made of 3 mm polycarbonate plates

Seating Douglas wood, seats on request

Size Lower depth: 99 cm
Roof overhang: 28 cm
Leading edge: 218 cm

art.-no. productspecification

Player cabin „Double“

2060603 Length 3,00m

2060604 Length 4,00m

2060605 Length 5,00m

PLAYER CABIN „ROYAL“

player cabin „Royal“

- Player cabin with 18 seats
- Only 4 m long!
- Depth on the bottom 2,00 m
- Height with roof 2,65 m
- With or without plastic seats
- On the side you have a corridor to get in
- At the top you are save from heavy rain (with roof)
- Can be used as a replacement for spectator stand

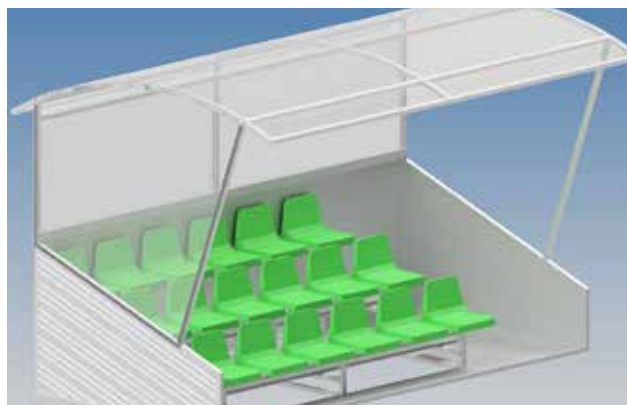

art.-no. productspecification

Player cabin „Royal“,
Length 4,00 m, without seats

- | | |
|---------|--------------|
| 2040404 | with roof |
| 2040405 | without roof |

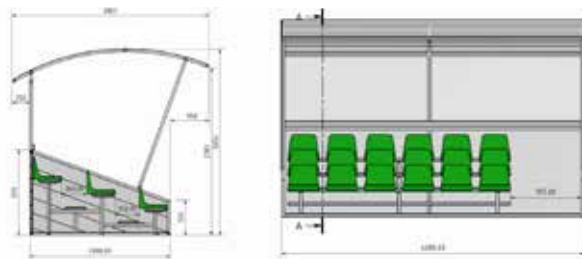

PLAYER CABIN „SPECIAL CONSTRUCTION“

Player cabin „Special construction“

Our high-quality player cabins with different standards are also available as customized products in almost any size and design.

- Round or square
- Cabin length and cabin depth
- Cladding in polycarbonate or aluminium
- Various seating surfaces
- Colours
- Various accessories such as coat hooks etc.



PLAYER CABIN „ACCESSORIES“

Transport trolley for player cabin „Pro“

- Completely made of aluminium
- The trolley is hooked into the side handles
- With swivel wheels
- The player cabin is lifted to be moved

art.-no. productspecification

Transport trolley for player cabin „Pro“

- | | |
|---------|-------------------|
| 2014008 | Transport trolley |
|---------|-------------------|



PLAYER CABIN „ACCESSORIES“

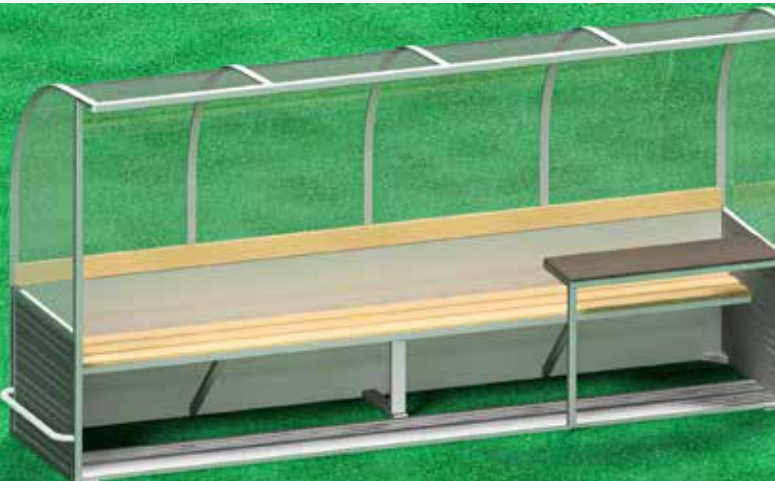

Table for cabin

- can be integrated in every cabin
- construction made of aluminium
- table top made of multiplex panel
- standard size 1,20 x 0,40 m
- other sizes on request

art.-no. productspecification

Table for cabin

2060702 Surcharge for table



Imitation leather seats

- embroidered logo incl.
- one or two colors
- with seat heating possible
- three heating levels, adjustable by every user

art.-no. productspecification

Imitation leather seats

2060703 with heated seats
2060704 without heated seats



Original „Recaro“ stadium seats

- Model „Players cabin“
- completely padded with leatherette
- RECARO Logo on the front and the back of the headrest

art.-no. productspecification

Recaro seats

2060700 with heated seats
2060701 without heated seats

PLAYER CABIN

„ACCESSORIES“

Plastic seats in standard RAL colours

During the cold months of the year, concrete elements are unpleasantly cold and damp. Give your supporters a treat to watch the game on comfortably heated seats. A water drainage slit in the seats makes sure, that there will be no puddles or water-logging.

All grandstand seats can be used indoors and outdoors.

For a small surcharge, the seats can be numbered.



art.-no. productspecification

Plastic seat

2010001 with back rest in standard RAL-colours

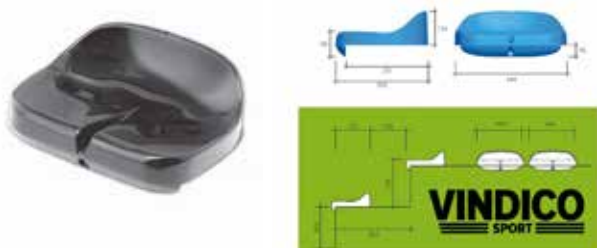

art.-no. productspecification

Plastic seat

2010004 without back rest in standard RAL-colours

Protective pad for cabin roof

- Standard RAL-colours
- PU-foam core
- durable tarpaulin cover
- mounting with Velcro

art.-no. productspecification

Protective pad for cabin roof

2010002 Protective pad



SPECTATOR STAND



Spectator stand „Easy“, movable with plastic seats



Spectator stand „Easy“



Spectator stand „Easy“

- three rows made of aluminium
- Length 3,00 m
- Space for approx. 18 persons
- Height: 0,83 m, Depth: 1,80 m
- dismantlable elements

art.-no. productspecification

Spectator stand „Easy“

1130040	Spectator stand „easy“ length 3,00 m
1130041	Surcharge for backrest
1130042	Surcharge for handrail all around
1130043	Surcharge for handrail sideward
1130044	Surcharge for movable spectator stand
1130045	Surcharge for 18 plastic seats with backrest

Spectator stand „Pro“, with 50 seats, three rows

The new spectator stand for all outdoor sports has 50 comfortable seats in three rows, as well as a central entrance and railing (9,19 m x 2,13m). The flooring construction is made out of steel section tubes together with heavy grillage. All steel elements are hot galvanized and are weatherproof. The UV-resistant shell type seats provide seating comfort. They can be delivered in various colours. The spectator stand will be delivered in 4 modules in a width of 2m with 16 seats as well as a staircase module with a width of 1.2m and 2 seats to dispose of easy assembly. The stand also matches the DIN 13200 requirements. This spectator stand system with 50 seats can be extended to your requirements. Likewise custom build designs with the 2 m modules and the staircase modules are possible. There should be a solid surface.

Length	9,20 m
Depth	2,13 m
Height	1,52 m
Seat height	approx. 45 cm
Capacity	50 places
Material stand	Steel, hot galvanized
Material seat:	sprayed polypropylene, impact resistant, UV-resistand according to DIN 4102B1

art.-no. productspecification

Spectator stand „Pro“

4040985	with 50 seats
---------	---------------



STAND ELEMENTS



Planning note stand elements / seat elements type SD

Determine the dimensions or the incline conditions of the construction

The use of rectangular elements as sitting and standing steps elements are not new to this world. Many years of experience with various constructions show that the rectangular elements have the best value for its money.

Planning

Get in touch with us as soon as possible. The elements are only produced to order. Please plan longer delivery times.

Construction

Self-compacting flowing concrete, reinforced, formwork smooth, cement grey or blasted (front and tread area), completely enclosed. Mass according to the adjacent drawing.

Stand elements

Concrete, formwork smooth with abraded surface, cement grey, with one-sided chamfer on the appearance of 2cm. Maximum length 200cm. Since the height of the staircase and depth must be half of the sitting and standing elements. Therefore the stair elements are available in variable sizes. The front and tread surface are also available as sand-blasted which lowers the risk of slipping.

Extension in concrete elements

approx. 0.3 mm per cm, with 30° C temperature difference.

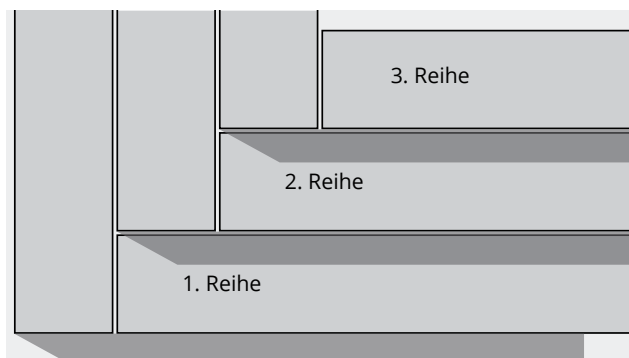
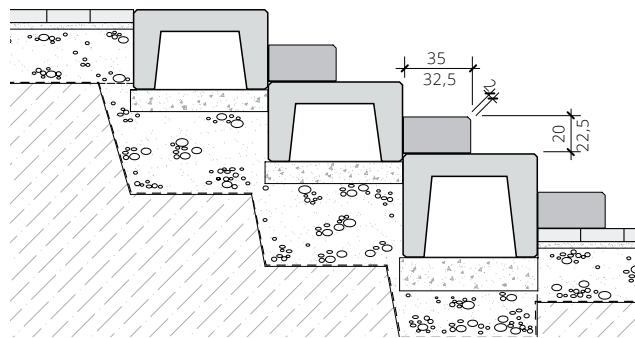

Corner 90°, with normal and finish elements

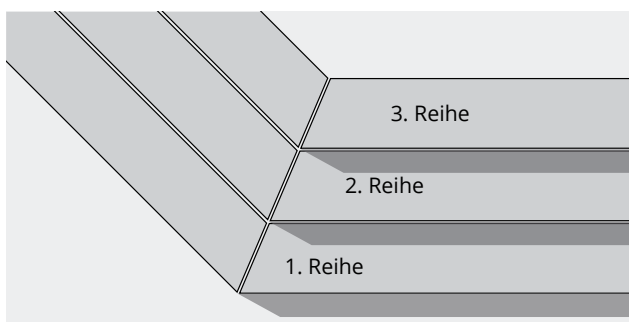

Corner 45°, with special elements (on commission/order)

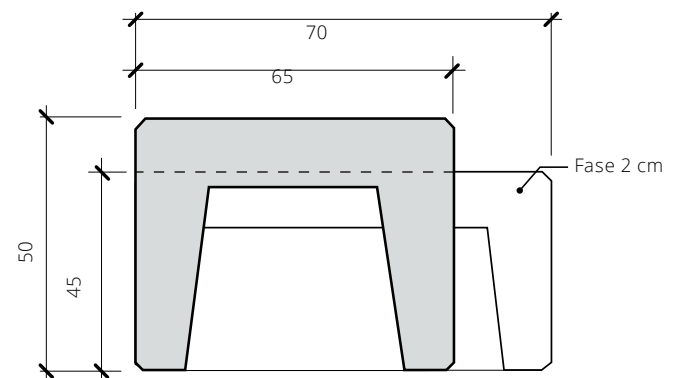

Corner construction

For rectangular corners there are no special corner elements used. All elements are closed on the side. For 45° corner are special elements needed which are available on request. Contact us, we will advise you, give you the technical details and prices for the product.

Transfer

The elements are delivered by us. The unloading takes place on site (forklift etc.). For transfer, we recommend the use of a vacuum device.

STAND ELEMENTS

„SEAT AND FLOOR ELEMENTS TYPE SD“



Seat and floor element type SD, smooth

Closed on both sides, width 65 cm, height 50 cm

art.-no. productspecification

Seat and floor element
Typ „SD“

3320100	Length 100 cm, Weight 348 kg
3320105	Length 150 cm, Weight 522 kg
3320110	Length 200 cm, Weight 696 kg
3320115	Length 250 cm, Weight 870 kg
3320120	Length 300 cm, Weight 1044 kg

Seat and floor element type SD, smooth

Closed on both sides, width 70 cm, height 45 cm

art.-no. productspecification

Seat and floor element
Typ „SD“

3320201	Length 140 cm, Weight 504 kg
3320206	Length 200 cm, Weight 672 kg
3320211	Length 240 cm, Weight 840 kg
3320215	Length 280 cm, Weight 1008 kg

Seat and floor element type SD, blasted

Closed on both sides, width 65 cm, height 50 cm

art.-no. productspecification

Seat and floor element
Typ „SD“

3320150	Length 100 cm, Weight 348 kg
3320155	Length 150 cm, Weight 522 kg
3320160	Length 200 cm, Weight 696 kg
3320165	Length 250 cm, Weight 870 kg
3320170	Length 300 cm, Weight 1044 kg

Seat and floor element type SD, blasted

Closed on both sides, width 70 cm, height 45 cm

art.-no. productspecification

Seat and floor element
Typ „SD“

3320251	Length 140 cm, Weight 504 kg
3320256	Length 200 cm, Weight 672 kg
3320261	Length 240 cm, Weight 840 kg
3320265	Length 280 cm, Weight 1008 kg

STAND ELEMENTS „BLOCK LEVEL TYP SD“

We recommend the use of a vacuum device for the transfer.



Block level type SD, stair element, Length 100 cm

Width 35 cm, height 20 cm or width 35 cm,
Height 25,5 cm, stairs structured.

art.-no. productspecification

Block level
Typ „SD“

3302194 smooth, weight 156 kg
3320191 structured, weight 156 kg

Block level type SD, stair element, Length 200 cm

Width 35 cm, height 20 cm or width 35 cm,
Height 25,5 cm, stairs structured.

art.-no. productspecification

Block level
Typ „SD“

3320195 smooth, weight 312 kg
3320190 structured, weight 312 kg



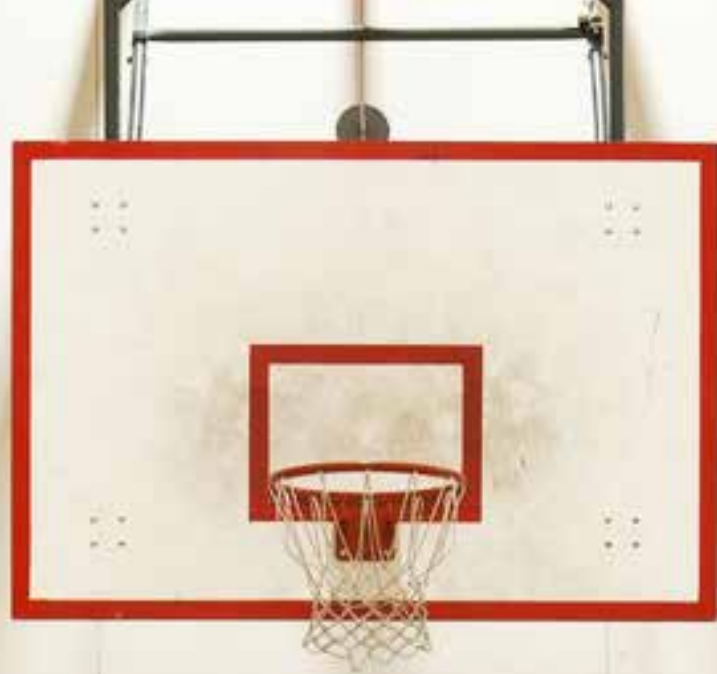

BALL SPORTS

HANDBALL GOALS

„FULLY WELDED“

Handball goals „Fully welded“

Our handball goals can be used indoors as well as outdoors on multi-sport facilities. The goal area has an internal dimension of 3.00 x 2,00 m. Fully welded handball goals made of aluminium are extremely robust and durable.

- handball goals are fully welded
- 3,00 x 2,00 m, 80/80 mm profile
- completely made of aluminium
- welded net hangers
- of contrasting colour
- on request with an additional catching net
- ground frame with inverted net hooks
- corner reinforced

art.-no. productspecification

Handball goal „fully welded“ can be fixed into the ground or with adapters for ground sockets

2002000	Handball goal fully welded 80/100 cm display, „Basic“
2002004	Handball goal fully welded 80/100 cm display, „Smart“
2002001	Handball goal fully welded 125/140 cm display, „Basic“
2002005	Handball goal fully welded 125/140 cm display, „Smart“

art.-no. productspecification

Handball goal „fully welded“ with extended goal posts, for insertion in ground sockets

2002010	Handball goal fully welded display 80/100 cm, with extended goal posts, „Basic“
2002014	Handball goal fully welded display 80/100 cm, with extended goal posts, „Smart“
2002011	Handball goal fully welded display 125/140 cm, with extended goal posts, „Basic“
2002015	Handball goal fully welded display 125/140 cm, with extended goal posts, „Smart“

art.-no. productspecification

Handball goal „fully welded“ Accessories

2111268	Surcharge for int. weight, incl. side wheels
---------	--

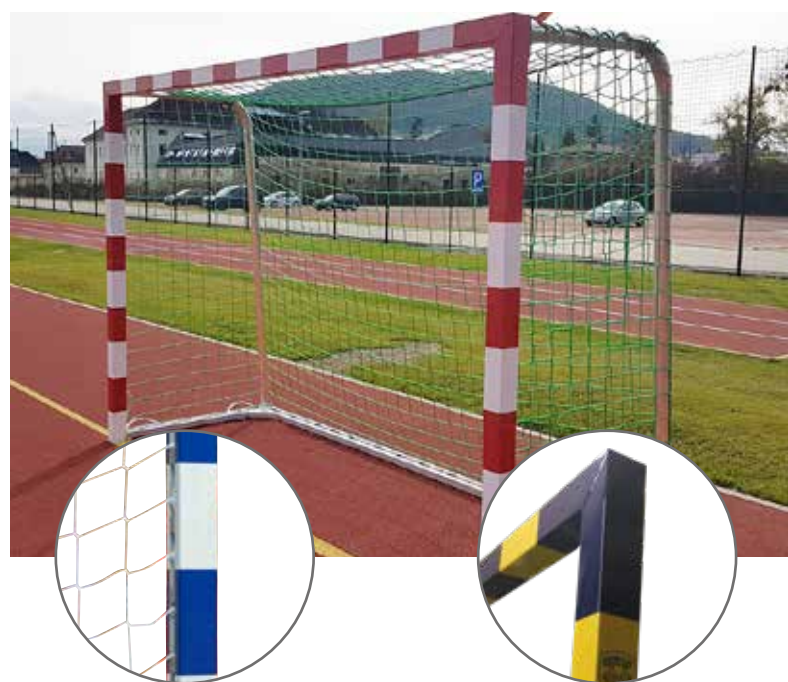

Handball goals in all colour combinations and with club logo available!



HANDBALL GOALS

„COMPETITION“ UND „FOLDABLE“



Handball goal „Competition“



Handball goal „Foldable“

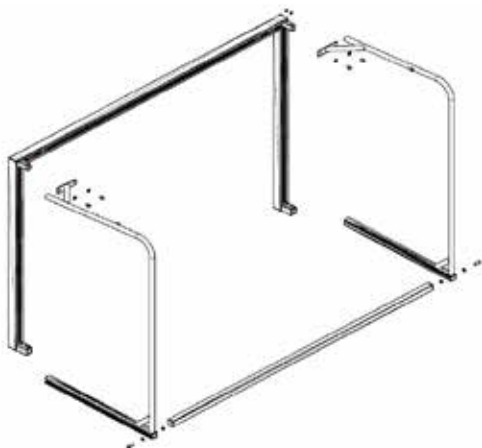

Handballtor „Zerlegbar“

Handballtore „Competition“, mit Netzbügel

- Handball goal made of aluminium, for insertion in ground sockets
- Ground frame with inverted net hooks
- Upper pre-tensioned net hangers, display 80 cm
- Foldable ground frame
- 3,00 x 2,00 m, 80/80 mm profile
- Completely made out of aluminium
- Of contrasting colour

art.-no. productspecification

Handball goal „Competition“

2002020	Handball goal „Competition“ with upper net hanger „Basic“, without ground frame
2002026	Handball goal „Competition“ with upper net hanger „Smart“, without ground frame
2002021	Ground frame for handball goal „Competition“, Display 100 cm, „Basic“
2002016	Ground frame for handball goal „Competition“, Display 100 cm, „Smart“

Handball goal „Foldable“

art.-no. productspecification

Handball goal, foldable, with net hanger, display 80/100 cm, can be fixed into the ground or with adapters for ground sockets

2002022	Handball goal foldable, „Basic“
2002025	Handball goal foldable, „Smart“
2014010	Transport trolley for foldable handball goals

Handball goal „Demountable“

art.-no. productspecification

Handball goal, demountable, with net hanger, display 125/125 cm, can be fixed into the ground or with adapters for ground sockets

1070010	Handball goal demountable, „Basic“
2070021	Handball goal demountable, „Smart“

HANDBALL GOAL „ACCESSORIES“

Adapter for goal

- for setting in ground socket and goal

art.-no. productspecification

Adapter

2001607 adapter for goal post and ground sockets 80/80 mm



Ground sockets for handball

- Completely made of aluminium
- Handball ground socket, length 35 cm, insertion depth 25 cm
- Standard ground socket with a loose lid
- Special ground socket with aluminium lid and lid chamber

art.-no. productspecification

Ground sockets for handball

1070070 standard ground socket for 80/80 mm posts

1070150 special ground socket for 80/80 mm posts



Standardhülse



Spezialhülse

Gym anchoring

art.-no. productspecification

Gym anchoring

1070180 Floorplate with screw made of aluminium

4900416 Screw with rubber for a lower injury risk



Chain weights

art.-no. productspecification

chain weights with plastic sleeve

4810174 weight approx. 800 g/lfm, length 5,00 m, display 100 cm

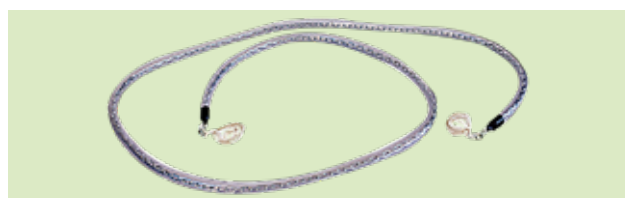

Goal net for handball

art.-no. productspecification

Goal net for 3,00 x 2,00 m goal frame

4310302 Handball goal net, display 80/100 cm, 3 mm, colour: green

4310402 Handball goal net, display 80/100 cm, 4 mm, colour: green

4310401 Handball goal net, display 80/100 cm, 4 mm, colour: white

art.-no. productspecification

Camera optimized net

4301088 Handball goal net, display 80/100 cm, honeycombed, white inside, black outside



HOCKEY

„FIELD AND INDOOR HOCKEY“



Field and indoor hockey

- hockey goal 3,66 x 2,14 m
- display 90 / 120 cm
- EPDM covered at the bottom
- net is hanging free in the goal frame
- dismantlable
- welded double transport rolls

art.-no. productspecification

Field and indoor hockey

- | | |
|---------|--|
| 1090090 | Hockey goal, 3,66 x 2,14 m, demountable |
| 4361202 | Hockey goal net, display 90/120 cm, 4 mm |



Field and indoor hockey

- Hockey goal „league“ 3,66 x 2,14 m
- Goal frame fully welded, thick walled profile
- Welded barrier, made from very tough aluminium side profile
- With a wooden filling, very longlasting
- Slot for net hooks
- Big aluminium net hanger Ø 50 mm
- Free net suspension
- Screwed with goal frame and barrier
- Inside 8 mm thick polyurethane coating
- According to DIN EN 750

art.-no. productspecification

Field and indoor hockey

- | | |
|---------|--|
| 4900453 | hockey goal, 3,66 x 2,14 m, goal frame white, according to international rules |
| 4900460 | hockey goal, 3,66 x 2,14 m, goal frame aluminium blank |
| 4900454 | surcharge for two additional wheels welded |
| 4361202 | hockey goal net, display 90/120 cm, 4 mm |



HOCKEY „ROLLER- AND RINK-HOCKEY“

Roller hockey goal

- Fully welded goal made of steel
- Internal dimension 170 x 105 cm
- Round goal frame, slanted goal corners
- Net reling around the goal
- Ball baffle on the ground
- Completely powder coated
- Goal frame in fluorescent orange

art.-no. productspecification

Roller hockey

2003010	Roller hockey goal 170 x 105 cm
2003011	Transport trolley for roller hockey
4131102	Goal net 4 mm for roller hockey goal including catch net



Produced according to international rules of roller hockey.

Street hockey

- Fully welded street hockey goal made of steel
- Internal dimension 170 x 105 cm
- Net reling around the goal
- Free net suspension
- Completely powder coated in fire-red
- Can be fixed to the ground

art.-no. productspecification

Street hockey

2003020	Street hockey goal 170 x 105 cm
4000099	Goal net 4 mm for street hockey goal, MW 40 mm



Impact protection plank

- For hockey fields to fasten either on a barrier or a fence system
- made of aluminium hollow profile 205 mm high, 35 mm thick
- including connectors
- with a smooth aluminium surface or with 10 mm thickend sound-absorbing rubber profile

art.-no. productspecification

Impact protection plank

4900456	Impact protection plank made of aluminium
4900556	Impact protection plank with sound absorbing
4900557	Mounting kit for barriers
4000099	Mounting kit for bar grad mat

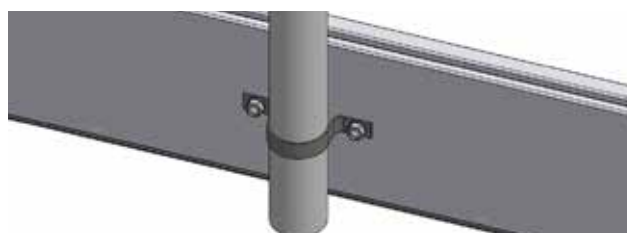
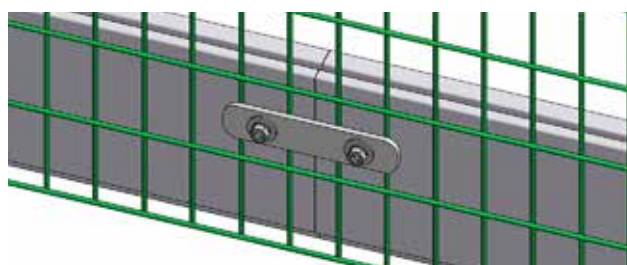

VOLLEYBALL WETTKAMPF FACILITY

„COMPETITION“ ACCORDING DIN 1271 CLASS A



Volleyball competition facility

„Competition“ according to DIN 1271 class A

The height of the volleyball „Competition“ facility can be adjusted when the net is tensioned. The adjustment is made on the backside with a crank by means of a solid trapezoidal threaded rod.

Our Volleyball „Competition“ system offers the following standard heights (heights from 200-250 cm):

- 2,43 m height = Volleyball men
- 2,35 m height = Volleyball mixed and boys U18 years
- 2,24 m height = Volleyball women and boys U16
- 2,20 m height = Volleyball girls U16 and pupil up to 14 years

Characteristics of the volleyball facility „Competition“

- oval aluminium profile 120x100 mm
- wall thickness 4/6 mm
- complete mechanism inside
- height adjustment on the backside with removable crank by means of a trapezoidal threaded rod
- Height adjustment with non-tensioned net
- Net tensioning with a removable crank by means of a second trapezoidal threaded rod
- one crank for height adjustment and net tensioning
- for net tensioning rope lengths from 11.20 m to max. 12.50 m
- infinitely variable height adjustment with tensioned net
- posts made of black powder coated aluminium
- on request in blank aluminium



art.-no. productspecification

Volleyball facility „Competition“

1800320	Volleyball, „Competition“ Anlage, black powder-coated
4800310	Lower price in aluminium blank
4800305	Surcharge for powder coating in a RAL colour of your choice

Volleyball construction „Mobile“

- Mobile pedestal
- Weighted as a tilt safety device
- On the side rubber wheels
- For 80 x 80 mm posts
- Incl. posts, height 3,00 m (for volleyball, fistball, badminton, tennis, etc.)

art.-no. productspecification

Volleyball construction „Mobile“

1050210	mobile pedestal (1 pair) for 80/80 mm
---------	---------------------------------------



VOLLEYBALL MULTI-PURPOSE

„MORE COMPETITION“ ACCORDING DIN 1271 CLASS A



Multi-purpose volleyball facility „more Competition“ according DIN 1271 Class A

The height of the multi-purpose volleyball facility „more Competition“ can be adjusted when the net is tensioned. With an integrated centrifugal clutch, the height adjuster can be moved more or less easily, depending on the crank speed. For volleyball facilities with a „screw version“ as a height adjustment, the height adjuster can slide down abruptly and cause damage to the volleyball facility or even injure the user. To avoid this problem, the centrifugal clutch brakes the height adjuster when it is released.

Our volleyball multi-purpose facility „more Competition“ can be used standardly for the following sports (heights from 151-250 cm):

- 2,43 m height = volleyball men
- 2,35 m height = volleyball mixed and boys U18 years
- 2,24 m height = volleyball Women and boys U16
- 2,20 m height = volleyball women girls U16 and pupils up to 14 years and foot-volley
- 2,02 m height = fist-ball max. standard
- 1,85 m height = indica
- 1,78 m height = fist-ball min.
- 1,55 m height = badminton

Characteristics of the multi-purpose volleyball facility „more Competition“

- oval aluminium profile 120x100 mm
- wall thickness 4/6 mm
- complete mechanics inside
- height adjustment via „centrifugal clutch“ with removable crank - **NEW DEVELOPMENT!**
- height adjustment with non-tensioned net
- net tensioning with a removable crank by means of a trapezoidal threaded rod
- one crank for height adjustment & net tensioning
- for net tensioning lengths from 11.20 m to max. 12.50 m
- infinitely variable height adjustment with tensioned net
- posts made of black powder-coated aluminium
- on request in blank aluminium



Volleyball Mehrzweckanlage ... Volleyball, Faustball, Badminton, Indica, Tennis

art.-no. productspecification

Volleyballanlage „Competition“

1800325	Volleyball, „more Competition“ multi-purpose
4800310	Lower price in aluminium blank
4800305	Surcharge for powder coating in a RAL colour of your choice

VOLLEYBALL FACILITY

„LEISURE AND SCHOOL“ ACCORDING DIN 1271



Volleyball leisure facility „Basic“ with threaded spindle - according to DIN EN 1270 class C

- profile selectable 120/100 mm or 80/80 mm
- height adjustable by external adjuster
- net tensioning by means of a threaded spindle and a crank
- for net tensioning rope lengths from 11.20 m to max. 12.00 m
- 6-point suspension possible
- Posts in blue aluminium

Our volleyball leisure facility „Basic“ can be used standardly for the following sports (heights from 107-260 cm):

- 2,43 m height = volleyball men
- 2,35 m height = volleyball mixed and boys U18
- 2,24 m height = volleyball women and boys U16
- 2,20 m height = volleyball girls U16 and pupils up to 14 years and foot-volley
- 2,02 m height = fist ball max.
- 1,85 m height = indiacca
- 1,78 m height = fist-ball min.
- 1,55 m height = badminton
- 1,07 m height = tennis

art.-no. productspecification

Volleyball leisure facility „Basic“

1050201	Volleyball leisure facility „Basic“, 120/100 mm
1050202	Volleyball leisure facility „Basic“, 80/80 mm
4800305	Surcharge for powder coating in a RAL colour of your choice
4900269	Replacement crank for volleyball leisure facility „Basic“



Volleyball leisure facility „Pro“ with pulley - according to DIN EN 1270 class C

- profile selectable 120/100 mm or 80/80 mm
- height adjustable by external adjuster
- net tensioning by means of a pulley (no crank necessary!)
- for net tensioning rope lengths from 11.20 m to max. 12.00 m
- 6-point suspension possible
- Posts in black powder aluminium

Our volleyball leisure facility „Basic“ can be used standardly for the following sports (heights from 107-260 cm):

- 2,43 m height = volleyball men
- 2,35 m height = volleyball mixed and boys U18
- 2,24 m height = volleyball women and boys U16
- 2,20 m height = volleyball girls U16 and pupils up to 14 years and foot-volley
- 2,02 m height = fist ball max.
- 1,85 m height = indiacca
- 1,78 m height = fist-ball min.
- 1,55 m height = badminton
- 1,07 m height = tennis

art.-no. productspecification

Volleyballanlage Freizeit „Pro“
black powder coating

1050205	Volleyball leisure and school facility „Pro“, 120/100 mm
1050206	Volleyball leisure and school facility „Pro“, 80/80 mm
4800310	Lower price in aluminium blank
4800305	Surcharge for powder coating in a RAL colour of your choice

VOLLEYBALL CONSTRUCTION

„MOBILE“ AND „ACCESSORIES“

Volleyball net post „Integral, DWV 1“

- According to DIN EN 1271 and DWV 1
- Made of solid aluminium special profile
- Net vertical adjustment infinitely variable
- Interiorly special-safety tensioning device

art.-no. productspecification

Volleyball net posts „Integral, DWV 1“

4901045	Volleyball construction DWV 1
4901046	Volleyball construction BW-Standard multipurpose (z.B. volleyball, tennis, badminton, fistball)
4900233	Standard ground socket without lid, 98x142 mm, for DWV I
4900280	Spezial ground socket, 98x142 mm, for DWV I

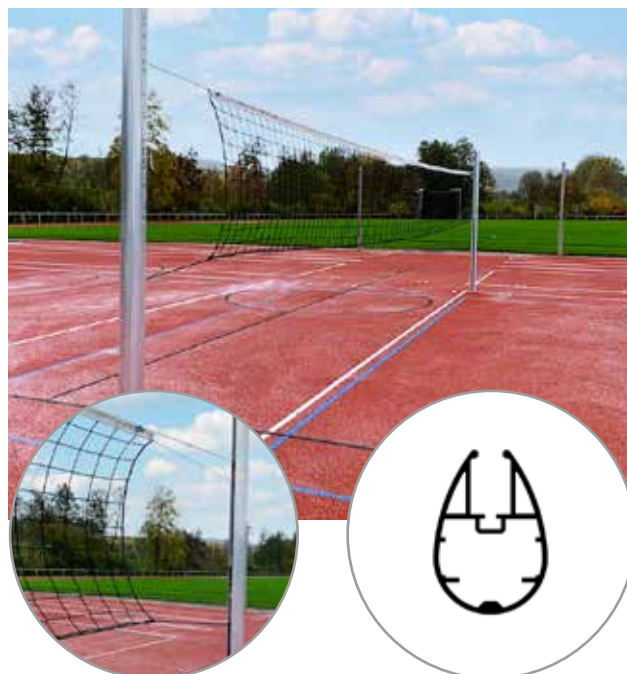

Profil 98x142

Volleyball net post „Integral, DWV II“

- According to DIN EN 1271 and DWV II
- Made from a stable aluminium profile
- Matt silver anodised
- Interiorly special-safety tensioning device
- Net vertical adjustment infinitely variable
- No deformation under net tension
- Extremely resilient

art.-no. productspecification

Volleyball construction / post „DWV II“

4901040	Profile 80x80 mm
4901042	Profile 80x80 mm, multipurpose (e.g. volleyball, tennis, badminton, fistball)
4901041	Profile Ø 83 mm
4901043	Profile Ø 83 mm, multipurpose (e.g. volleyball, tennis, badminton, fistball)
4901021	Profile 98x142 mm
4901026	Profile 98x142 mm, multipurpose (e.g. volleyball, tennis, badminton, fistball)

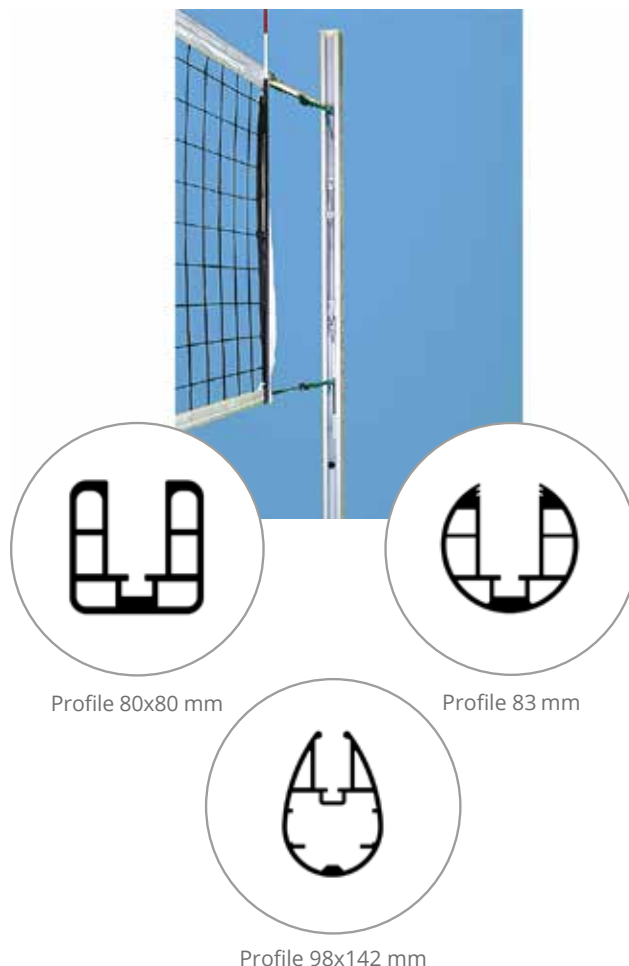

Profile 80x80 mm

Profile 83 mm

Profile 98x142 mm

art.-no. productspecification

Volleyball Standard ground socket for Ppost „DWV II“

4900234	Standard ground socket without lid, 80x80 mm
4900239	Standard ground socket without lid, Ø 83 mm
4900233	Standard ground socket without lid, 98x142 mm

VOLLEYBALL

„NET POST & CONSTRUCTION“



Volleyball net post „Standard“

- 80 x 80 mm, made from a stable aluminium-profile
- Net vertically adjustment infinitely variable
- with external safety tensioning device
- cost-effective alternative for school sport and training

art.-no. productspecification

Standard net post

4901020	Volleyball construction standard
4901025	Volleyball sonstruction standard multipurpose (z.B. volleyball, tennis, badminton, fistball)
4901034	standard ground socket without lid, vollyball standard



Volleyball construction „Steel Line“

- Post 150 x 150 mm, stable zinc-dipped steel
- Net height 2,43 m
- With rope tensioner
- Very resilient construction
- Including standard ground socket made of steel
- Without net

art.-no. productspecification

Volleyball construction „Steel Line“

4901074	Volleyball construction „Steel Line“
4901183	Standard ground socket Stahl verzinkt, 450 mm
4901186	Standard Beach-Bodenhülse, 900 mm

Steel volleyball net

art.-no. productspecification

Steel volleyball net

4640741	dralo volleyball net, made of galvanised steel cable 2mm, mesh width 100 mm, net size 1,00 x 9,50 m
---------	---

Volleyballanlage „Steel Line“ mit Stahlvolleyballnetz

VOLLEYBALL

„ACCESSORIES“

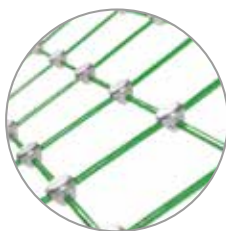

Dralo net

art.-no. productspecification

Dralo net

4640742 dralo volleyball net made of galvanised steel cable with pvc cover, 1,8 / 2,5 mm, green



Steel volleyball net

art.-no. productspecification

Steel volleyball net

4640741 Dralo-Volleyball net, made of galvanised steel wire ropes 2mm, MW 100 mm, net size 1,00 x 9,50 m

Net & antenna

art.-no. productspecification

Net

4850133 volleyball net „spare time“, 3 mm, colour: black
4850143 volleyball net „competition“, 4 mm, colour: black

Antenna

4600502 volleyball antenna made of fibre glass, one piece with holding pocket, length 1,80 m
4800099 volleyball antenna made of fibre glass, two pieces with holding pocket



Volleyball net



Volleyball antenna

Safety pad & Net hanger

art.-no. productspecification

Safety pad

4321100 Safety pad Ø 80 mm inside, 200 cm, 20 mm wall thickness
4321000 Safety pad Ø 120 mm inside, 200 cm, 50 mm wall thickness

Net hanger

4600530 Net hanger for rolling up the volleyball nets



Safety pad



Net hanger

Ground socket with slope

art.-no. productspecification

Ground socket

1050395 standard ground socket 120/100 mm, length 35 cm
1050451 special ground socket 120/100 mm, length 35 cm
1070070 standard ground socket 80/80 mm, length 35 cm
1070151 special ground socket 80/80 mm, length 35 cm



Standard ground socket



Spezial ground sokcet

BASKETBALL „MADE OF ALUMINIUM“



Basket are bolted to the target board and target board bracket. Prevents the baskets from moving out and the target boards from breaking.

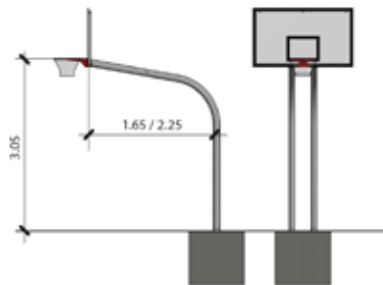
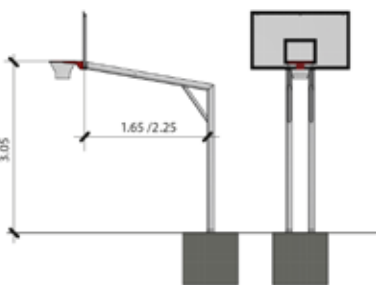
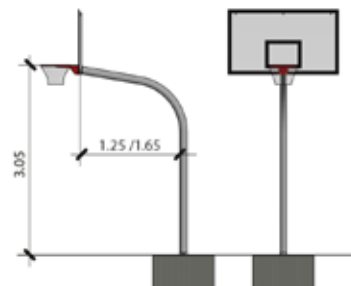
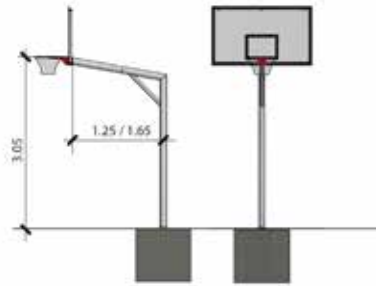

Basketball construction made of Aluminium „Rectangular Version“

- Made of Aluminium
- mast made of 120/100 mm profile, wall thickness 4/6 mm
- Basketball backboard with aluminium base frame
- Basket connected to display mast and base frame
- GRP target board 180x105 cm incl.
- Red basketball hoop & nylon net incl.

Basketball construction made of Aluminium „Curved Version“

- Made of Aluminium
- mast made of 120/100 mm profile, wall thickness 4/6 mm
- Basketball backboard with aluminium base frame
- Basket connected to display mast and base frame
- GRP target board 180x105 cm incl.
- Red basketball hoop & nylon net incl.

art.-no. productspecification

Basketball construction aluminium rectangular

2004012	1- mast, display 1,25 m
2004013	1- mast, display 1,65 m
2004022	2- mast, display 1,65 m
2004023	2- mast, display 2,25 m

art.-no. productspecification

Basketball construction Aluminium gebogen

2004010	1- mast, display 1,25 m
2004011	1- mast, display 1,65 m
2004020	2- mast, display 1,65 m
2004021	2- mast, display 2,25 m



BASKETBALL

„MADE OF ALUMINIUM AND STEEL“

Basketball made of aluminium „Training construction“

- Construction made of aluminium
- mast made of 120/100 mm, wall thickness 4/6mm
- Basketball Backboard with aluminium base frame
- Basket connected to display mast and base frame
- GRP target board 120x90 cm incl.
- Red basketball hoop & nylon net incl.

art.-no. productspecification

Basketball construction aluminium training

2004061	50 cm display, 305 cm
2004063	50 cm display, heightadjustable 260 - 305 cm
2004060	no display, 305 cm
2004062	no display, heightadjustable 260 - 305 cm

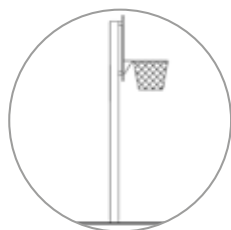

Basketball made of steel „Steel-Line“

- Basketball stand made of steel, 1-mast
- Backboard incl.
- screwed on bolted frame, which has to be embedded in concrete
- post and display made of galvanised steel tube
- incl. backboard 180x105 cm, made of GRP, with hoop made of powder-coated steel in orange and net made of nylon
- without bolted frame for mounting

art.-no. productspecification

Basketball stand „Steel-Line“

4001015	Display 165 cm
4001016	Display 225 cm
4001017	Screw frame for embedding in concrete, with internal thread
4001018	extended version (60 cm)



Screwed frame



BASKETBALL FACILITY MADE OF STEEL

„HULK“ 150x150x4MM



Basketball facility „Hulk“ Single

Basketballanlage aus Stahl „Hulk“ 150x150x4mm

- According to DIN EN 7899 and DIN EN 1270
- 150x150 mm facilities more solid and even more robust!
- Hoop heights variably adjustable
- Displays 120, 165 and 225 cm are possible

New and exclusive:

Internal, covered clamping device (for systems in ground sleeves)

- lift-out safe
- low-noise

incl. safety backboard made of steel grid, with mesh width 60x8 mm with surrounding steel frame

- torsion-resistant
- absolutely low-noise
- very good playability
- Basketball facility made of hot-dip galvanized steel
- hoop heights variably adjustable
- safe against vandalism
- noise reduced thanks to back board made of steel grid (ball contact area is very small)
- backboard made of hot-dip galvanized wire mesh, 120 x 90 cm
- hoop made of hot-dip galvanized solid steel, incl. galvanized chain net
- can be mounted in ground socket or with dowelling
- delivery incl. ground socket (length 60 cm, ET 50 cm) or welded flange plate

art.-no. productspecification

Basketball facility „Hulk“ Single

4901116	Display 1,20 m, 150x150x4mm, in ground socket
4901117	Display 1,20 m, 150x150x4mm, for dowelling
4901118	Display 1,65 m, 150x150x4mm, in ground socket
4901119	Display 1,65 m, 150x150x4mm, for dowelling
4901120	Display 2,25 m, 150x150x4mm, in ground socket
4901121	Display 2,25 m, 150x150x4mm, for dowelling

Basketball facility „Hulk“ Duo

4901122	Display 1,20/1,20m, 150x150x4mm, in ground socket
4901123	Display 1,20/1,20m, 150x150x4mm, for dowelling
4901124	Display 1,65/1,65m, 150x150x4mm, in ground socket
4901125	Display 1,65/1,65m, 150x150x4mm, for dowelling

Basketball facility „Hulk“ Quattro

4901126	Display 4x1,20m, 150x150x4mm, in ground socket
4901127	Display 4x1,20m, 150x150x4mm, for dowelling
4901128	Display 4x1,65m, 150x150x4mm, in ground socket
4901129	Display 4x1,65m, 150x150x4mm, for dowelling



„Hulk“ Duo



„Hulk“ Quattro

BASKETBALL FACILITY MADE OF STEEL

„Hooligan“ 100x100x3mm



Basketball facility made of steel „Hooligan“ 100x100x3mm

- according to DIN EN 7899 and DIN EN 1270
- 150x150 mm facilities more solid and even more robust!
- Hoop heights variably adjustable
- Displays 120 and 165 cm are possible

New and exclusive:

Internal, covered clamping device (for systems in ground sleeves)

- lift-out safe
- low-noise

incl. safety backboard made of steel grid, with mesh width 60x8 mm with surrounding steel frame

- torsion-resistant
- absolutely low-noise
- very good playability
- Basketball facility made of hot-dip galvanized steel
- Hoop heights variably adjustable
- Safe against vandalism
- Noise reduced thanks to back board made of steel grid (ball contact area is very small)
- Backboard made of hot-dip galvanized wire mesh, 120 x 90 cm
- Hoop made of hot-dip galvanized solid steel, incl. galvanized chain net
- Can be mounted in ground socket or with dowelling
- Delivery incl. ground socket (length 60 cm, ET 50 cm) or welded flange plate

art.-no. productspecification

Basketball facility „Hooligan“ Single

4901110	Display 1,20 m, 100x100x3mm, in ground socket
4901111	Display 1,20 m, 100x100x3mm, for dowelling
4901112	Display 1,65 m, 100x100x3mm, in ground socket
4901113	Display 1,65 m, 100x100x3mm, for dowelling

Basketball facility „Hooligan“ Duo

4901114	Display 1,20/1,20m, 100x100x3mm, in ground socket
4901115	Display 1,20/1,20m, 100x100x3mm, for dowelling



Basketballanlage „Hooligan“ Single Anlage



Basketballanlage „Hooligan“ Duo Anlage

Advantages basketball facility „Holligan“ and „Hulk“

- Internal clamping device (ground socket)
- Low-noise backboard with small mesh width
- Flexible height adjustment through clamping screws
- Backboard with pre-assembly help



Pre-assembly help



BASKETBALL WALL CONSTRUCTION

Basketball made of aluminium „Wall construction“

- Wall construction made of aluminium
- Rigid or height adjustable
- incl. target board 120 x 90 cm
- including hoop and nylon net
- excl. fixing screws and dowels

art.-no. productspecification

Basketball wall construction

2004050	Wall construction, 50 cm display
2004051	Wall construction, 50 cm display, height adjustable



BASKETBALL CONSTRUCTION MOBILE



Basketball made of aluminium „Mobile“

- Display 1,65 m, can be folded down
- backboard made of GRP
- including hoop and nylon net
- backboard can be folded, due to storm danger or if not in use
- easy movable with lift roller

art.-no. productspecification

Basketball made of aluminium „Mobile“

2004040	Basketball stand mobile (without weight, without lift roller)
4000061	Safety pad for basketball stand mobile
4004040	Lift roller for mobile basketball stand

BASKETBALL ACCESSORIES

Accessories for basketball steel construction „Hooligan and Hulk“

art.-no. productspecification

Accessories

4901178	Safety pad for 100x100 mm post
4901179	Safety pad for 150x150 mm post
4901182	Ground socket 100x100 mm post
4901184	Ground socket 150x150 mm post
4901146	Grid backboard 120x90 cm, MW 60x8mm
4901147	Grid backboard 180x105 cm, MW 60x8mm
4001017	Screw frame for embedding in concrete with internal thread



Screwed frame

Welded-on base plate for screwing on the stand column

Backboards

art.-no. productspecification

Backboards

4004074	backboard 120 x 90 cm, laminated fibre glass, 8 mm
4004051	backboard 180 x 105 cm, laminated fibre glass, 8 mm
4004075	backboard 120 x 90 cm, macrolon transparent
4004052	backboard 180 x 105 cm, macrolon transparent
4901145	grid backboard 120 x 90 cm, MW 40/40 mm
4901175	grid backboard 180 x 105 cm, MW 40/40 mm
4004061	aluminium backboard, aluminium blank, 120 x 90 cm
4004062	aluminium backboard, aluminium blank, 180 x 105 cm
4901130	backboard 120 x 90 cm, made of GRP with reinforcement
4901153	backboard 180 x 105 cm, made of GRP with reinforcement
4901146	Grid target board 120x90 cm, MW 60x8mm
4901147	Grid target board 180x105 cm, MW 60x8mm

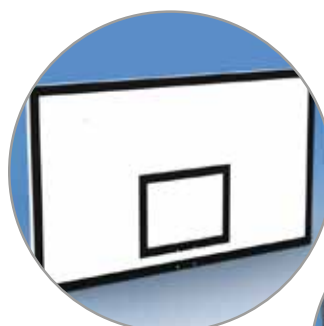

backboard 180 x 105 cm, made of GRP with reinforcement

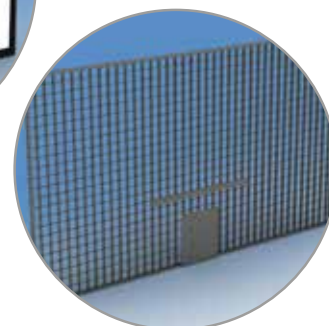

Grid target board
MW 60x8mm

Basketball net

art.-no. productspecification

Basketball net

4001041	chain net, galvanised, 12 point suspension
4061201	basketball net made of nylon, 12 point suspension
4046771	basketball net vandalism-proof „Herkules“ steel insertion 5 mm



Basketball net „Vandalismussicher“

BASKETBALL „ACCESSORIES“



Basketball hoop,
red powder coated



Basketball hoop,
hot-dip galvanised,
reinforced

Hoops with DIN hole pattern

art.-no. productspecification

Hoops with DIN hole pattern

- | | |
|---------|--|
| 4001012 | Basketball hoop, orange powder coated, reinforced |
| 4001025 | Basketball hoop, steel powder coated, foldable, 105 kg |
| 4001013 | Basketball hoop, hot-dip galvanised, reinforced, with 12 point chain net fastening |



Spezial ground sockets, 2-mast

Ground sockets

art.-no. productspecification

Basketball ground sockets

- | | |
|---------|---|
| 1100470 | Standard ground sockets, 120 x 100 mm, 1-mast |
| 1100472 | Standard ground sockets, 120 x 100 mm, 2-mast |
| 1100480 | Special ground sockets, 120 x 100 mm, 1-mast |
| 1100482 | Special ground sockets, 120 x 100 mm, 2-mast |
| 4901182 | Ground sockets, 100 x 100 mm post |
| 4901184 | Ground sockets, 150 x 150 mm post |



Basketball, safety pad

Safety pad

art.-no. productspecification

Safety pad

- | | |
|---------|--|
| 4000060 | Safety pad, height 200 cm, 50mm strong, for oval profile |
| 4901178 | Safety pad for 100x100 mm post |
| 4901179 | Safety pad for 150x150 mm post |

Height adjustment

art.-no. productspecification

Height adjustment

- | | |
|---------|--|
| 1100245 | Surcharge for height-adjustable target board, 305 - 260 cm |
|---------|--|

BADMINTON

„BASIC“ AND „SIMPLE“

Badminton post „Basic“

- Simple badminton post, 40 x 40 mm
- With upper deflection roller
- Net tension with ratchet

art.-no. productspecification

Badminton post „Basic“

1060080	Badminton post „Basic“
1060090	Standard ground socket badminton „Basic“
4602076	Badminton net „Competition“



Badminton post „Simple“

- Badminton post made of aluminium oval profile 120 / 100 mm
- Simple, manual exterior adjustment
- Tension height 1,55 cm

art.-no. productspecification

Badminton post „Simple“

2060080	Badminton post „Simple“
1050396	Standard ground socket badminton „Simple“
4602076	Badminton net „Competition“



TENNIS

„POST, NET AND ACCESSORIES“



Tennis post

Tennis post inner parts

Tennis post

- tennis post made of 80x80 mm
- aluminium special profile
- interior clamping unit
- exterior net pole
- inclusive crank

art.-no. productspecification

Tennis post

- | | |
|---------|----------------------------------|
| 4080080 | Tennis post, aluminium blank |
| 4080081 | Tennis post, white powder coated |
| 4080082 | Tennis post, green powder coated |
| 4080083 | Tennis post, black powder coated |

art.-no. productspecification

Ground socket tennis

- | | |
|---------|-------------------------------|
| 2006000 | Standard ground socket tennis |
| 2006001 | Special ground socket tennis |

art.-no. productspecification

Tennis net

- | | |
|---------|--|
| 4121353 | tennis net with double rows
PET tennis net made of a 3 mm strong polyethylene rope, with 5 continuous doublerows (hand made). colour black |
| 4121403 | tennis net without double rows, 4 mm, PP very strong, knotless tennis net for the highest claims, in a proven knotless technology made of polypropylene ca. 4 mm strong, all around edged colour black |

Accessories tennis net

art.-no. productspecification

Accessories tennis net

- | | |
|---------|---|
| 4040365 | Tennis lining special <ul style="list-style-type: none"> • made of flexible hard PVC • 4 mm wide cross slit, in distances of 28 mm • anchoring with 18 plugs (inclusive) • 4 rolls à 24 m = 4 cm wide 1 roll à 22 m = 4 cm wide 1 roll à 17 m = 4 cm wide 1 roll à 13 m = 5 cm wide • colour: white |
| 4040760 | Ground anchor for belt strap made of aluminium |
| 4040720 | Belt strap made of high quality nylonmesh with plastic clip, velcro fastener and snap hook |
| 2006002 | Single support made of aluminium |

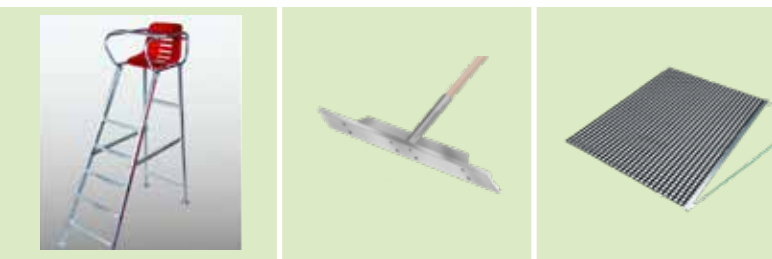
Tennis lining
Art.Nr. 4040365Ground anchor sleeve
Art.Nr. 4040760Belt strap with plastic clip
Art.Nr. 4040720Umpire chair
Art.Nr. 4040800Sand smoother for tennis
Art.Nr. 4040081Drag net
Art.Nr. 4410301

Accessories for the square

art.-no. productspecification

Accessories for the square

- | | |
|---------|--|
| 4040800 | umpire chair court royal tournament <ul style="list-style-type: none"> • umpire chair made of aluminium DIN EN 131 • stable rung ladder. • red plastic seat which is UV-resistant |
| 4040081 | aluminium sand smoother, 150 cm width, without stick |
| 4410301 | aluminium drag net „special“, simple handling |

BASEBALL

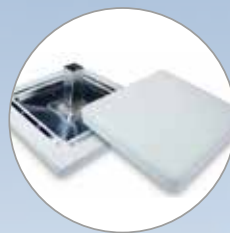

bases



homeplate



pitcherplate



Baseball

art.-no. productspecification

Baseball player cabin „Basic“

4009000	Bases
4009001	Homeplates
4009003	Pitcherplate

RUGBY

„RUGBY GOAL“

On request:
Special design
e.g. with logo of
the protective
pads

Rugby goal

- Rugby goal fully made of aluminium
- With internal reinforcement
- White or aluminium blank
- Surcharge for wind vane
- 5,6 m internal dimension
- 3,0 m crossbar height

art.-no. productspecification

Rugby goal

2700000	Rugby goal 8,5 m
2700001	Rugby goal 8,5 m, white powder coated
2700002	Rugby goal 12,0 m
2700003	Rugbytor 12,0 m, white powder coated
2700004	wind vane, positioned on a post
4000060	Safety pad



AMERICAN FOOTBALL GOAL „STEEL SWIVELLING“

With upper turning mechanism and eyelet. Incl. hook for turning from the ground



American Footballtor „Stahl und Schwenkbar“

- Upright and cross tube made of galvanised steel, $\varnothing 168.3$ mm
- Cross tube made of galvanised steel 80/120 mm, wet-laquered
- Uprights made of aluminium round tubes $\varnothing 75$ mm, wet-laquered in RAL colour (on request)
- Distance between the uprights 5.64 m, maximum height of the uprights 13.716 m
- Height of upper edge of cross tube 305 cm
- Display variable, up to max. 4.00 m -
- Football goal assembled or not assembled

art.-no. productspecification

American Footballtor

2701100	American Football goal made of steel, swivelling
2701101	Screwed frame to set in concrete for American football goal posts

AMERICAN FOOTBALL „ALUMINIUM AND STEEL“



American Football goal of „rigid aluminium“

- Posts made of solid aluminium oval profile
- Dismountable (mast, crossbar and uprights)
- Complete device in blank aluminium (uprights can also be powder-coated with surcharge)
- Total height 9,00 m from ground
- Crossbar width 5,64 m (inside dimension)
- Display 1,50 m, angular

art.-no. productspecification

American Football goal

2701002	American Football goal, 9,00 m height, aluminium blank, angular
2701001	Safety pad for football goal
2700004	wind vane, positioned on a post



American Football goal of „rigid aluminium“

- American football goal made of aluminium
- According to NFL guidelines 2016
- Rounded pole
- Uprights in yellow
- Overall height 13,716 m
- Crossbar width 5,64 m

art.-no. productspecification

American Football goal

2701000	American Football goal, 13,716 m height, steel round tubes, yellow
2701001	Schutzpolster für Footballtor
2700004	wind vane, positioned on a post



TABLE TENNIS



Concrete table tennis tables Proven on over 2000 outdoor facilities!

Design

Table plate and base made of reinforced concrete, smooth and impregnated, incl. 4 set screws for level compensation and threaded sleeves for net type 3.

Construction

Table plate and base are produced in one element

Dimensions (LxWxH) and weight
274 x 152.5 x 73 cm, approx. 900 kg
Feet diameter 10 cm

Attention!

Concrete table tennis tables must be placed on a solid underground.

Delivery and assembly

Delivery is by lorry transport. In the area of the four support points (see dimensional sketch) the underground must be solid. The exact height adjustment (max. 5 cm) is made with the set screws in the plinths. If the table tennis table is placed on a bituminous surface, e.g. metal plates can be put underneath the 4 support points; if not there is a risk that the adjustable feet will sink in.

Table tennis table Type 1

- color concrete grey
- Surface formwork smooth
- without table tennis field marking
- Weight: 900 kg

Table tennis table Type 1R

- Color concrete grey
- Corners rounded, radius 6.8 cm
- Surface formwork smooth
- Without table tennis field marking
- Weight: 900 kg

art.-no. productspecification

Table tennis table Type 1

3006001 Table tennis table Type 1
3006011 Table tennis table Type 1R



Alternative zu Typ 1,
Ecken rechteckig

Ecken abgerundet

TABLE TENNIS



Typ 1A Ecken rechteckig

Table tennis table Type 1A

- Color concrete grey
- Surface formwork smooth
- With painted on table tennis field marking in black
- Weight: 900 kg

Table tennis table Type 1AR

- Color concrete grey
- Corners rounded, radius 6.8 cm
- Surface formwork smooth
- With painted on table tennis field marking in black
- Weight: 900 kg



Typ 1AR Ecken abgerundet

art.-no. productspecification

Table tennis table type 1A

3006008	Table tennis table Type 1A
3006018	Table tennis table Type 1AR

You can find the fitting nets on the next page!

Table tennis table Type 2

- Color green
- Surface synthetic resin plate
- With table tennis field marking in white
- Weight: 900 kg

Table tennis table Type 2R

- Color green
- Corners rounded, radius 6.8 cm
- Surface synthetic resin plate
- With table tennis field marking in white
- Weight: 900 kg

art.-no. productspecification

Table tennis table Type 2

3006006	Table tennis table Type 2
3006016	Table tennis table Type 2R



TABLE TENNIS



Table tennis table Type 4

- Color charcoal grey
- Surface synthetic resin plate
- with table tennis field marking in white
- Weight: 900 kg

Table tennis table Type 4R

- Color green
- Corners rounded, radius 6.8 cm
- Surface synthetic resin plate
- With table tennis field marking in white
- Weight: 900 kg

art.-no. productspecification

Table tennis table Type 4

3006009	Table tennis table Type 4
3006019	Table tennis table Type 4R



Table tennis table Type 3

- Color blue
- Surface synthetic resin plate
- With table tennis field marking in white
- Weight: 900 kg

Table tennis table Type 3R

- Color blue
- Corners rounded, radius 6.8 cm
- Surface synthetic resin plate
- With center and side lines in white
- Weight: 900 kg

art.-no. productspecification

Table tennis table Type 3

3006007	Table tennis table Type 3
3006017	Table tennis table Type 3R

Metall net Type 1

- Clamping range up to 90mm
- Promat galvanized
- Painted in green (RAL 9006) or white aluminium (RAL9006)
- For screwing on
- Weight 5,8 kg

Metall net Type 3

- Table thickness from min. 50mm
- Aluminium
- Grey, aluminium coloured
- For screwing into existing threaded sleeves
- Weight 3,6 kg
- Very robust design

art.-no. productspecification

Table tennis net

3006002	Net Type 1 green
3006012	Net Type 1 white aluminium
3006004	Net Type 3

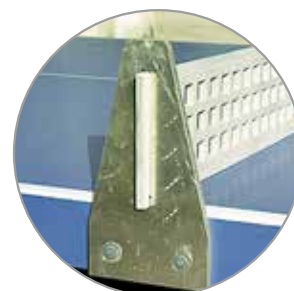
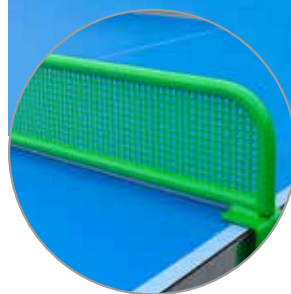

SOCCERCOURTS



SOCCEFCOURT „PANNA FIELD“

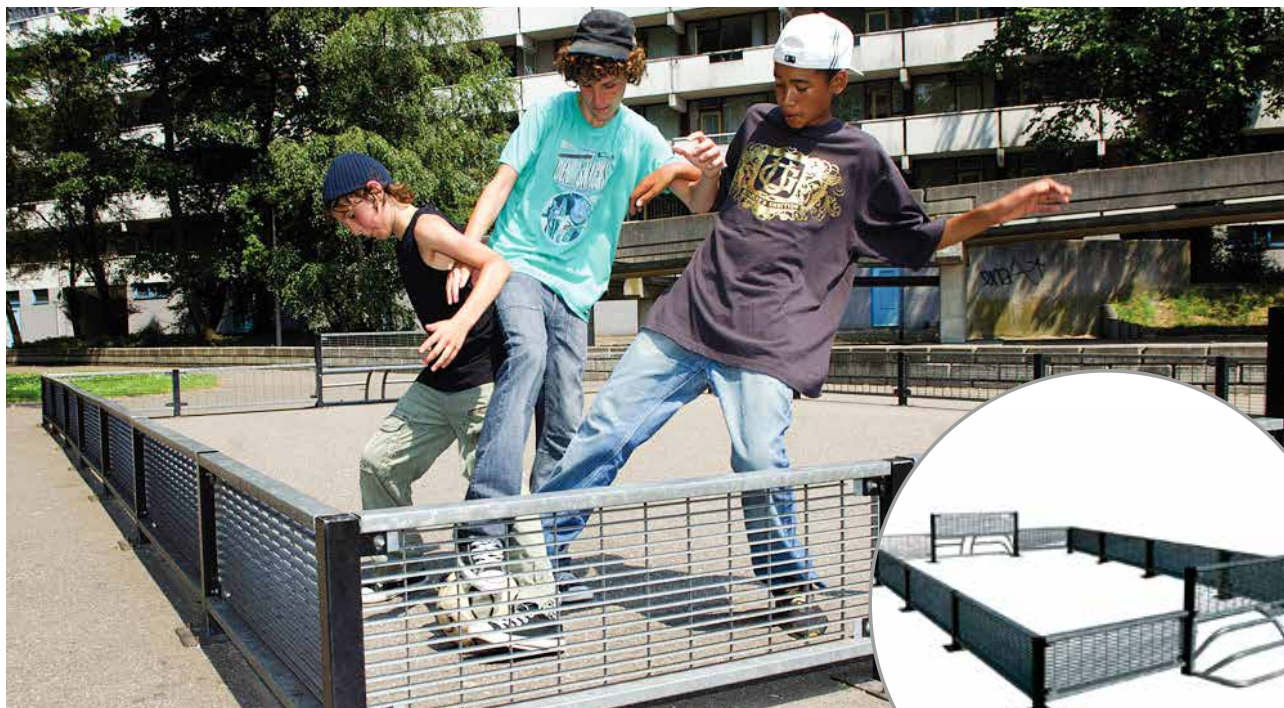

The rectangular "Panna Field" has been developed in close cooperation with Nike. It requires great tactical and technical skills to handle the football inside the boundary of the playing field. Furthermore, the "Panna Field" is vandalism-proof and made out of sturdy, galvanized steel and lattice materials – assuring low maintenance requirements.

The cost-effective playing field can be used for a large variety of different sports and be installed on asphalt or concrete. In addition, it is possible to lay up 50x50 cm large floor panels. It is also possible to install the "Panna Field" on artificial turf using concrete sockets.

art.-no. productspecification

Soccercourt
„Panna Field“

4006007	Size 4,00 x 6,00 m
4006008	Size 10,00 x 7,00 m
4006009	Size 13,00 x 9,00 m

Advantages

- joy of playing for a low price
- cool design (developed with NIKE)

Application possibilites

- educational institutions
- Educational institutions
- sport clubs
- playground operators
- public places

Execution

- „Panna Field“ 4 x 6 m, required area: 7 x 4,3m
- „Panna Field“ 10 x 7 m, required area: 11 x 7,3m
- „Panna Field“ 13 x 9 m, required area: 14 x 9,3m
- dimensions according to your choice (using standardelements)

Material

- steel, hot galvanised (can be powder coated on request)

Colours

- Stand: standard RAL 9005 black
- Grid and goals: hot galvanised (can be powder coated on request)

LITTLE-COURT ARENA „SOCCER EGG“



One Goal Arena

The "One-Goal Arena" is made out of one goal and 8 edge elements which are put together. It almost fits in any garden, every driveway or in bad weather you can put it in the garage.

„One Goal Arena“ ca. 3,0 x 3,0m consisting of:

- 1 Stk. mini goal 120/80 cm, incl. net
- 8 edge elements, height 60 cm, length 100 cm
- 7 feet

art.-no. productspecification

One Goal Arena

4701001 One Goal Arena



Little-Court Arena

The "Little Court Arena" is a small closed version of the Soccer Egg with two goals. It consist of 2 mini-goals and then 10 edge elements. The storage package between the two opposite goals need a place of 1,25m x 0,85m x 0,55m and that fits onto a euro-pallet.

„Little-Court Arena“ ca. 4,5 x 3,0m consisting of:

- 2 Stk. minit goals 120/80 cm, incl. net
- 10 edge elements, height 60 cm, length 100 cm
- 8 feet

art.-no. productspecification

Little-Court Arena

4701002 Little-Court Arena



Next Generation

The Next Generation consist of two goals and attached with 18 edge elements. Ideal for children up to the age of 12 years.

„Next Generation“ ca. 7,0 x 5,0m consisting of:

- 2 Stk. mini goal 120/80 cm, inkl. Netz
- 18 edge elements, height 60 cm, length 100 cm
- 16 feet

art.-no. productspecification

Next Generation Arena

4701003 Next Generation Arena



Funny-Field Arena

The "Funny-Field Arena" consist of two mini-goals but the 14 edge elements make the playing field compared to the "Little-Court-Arena" bigger. The "Funny-Field Arena" also fits exactly onto a euro-pallet. The storage package between the two opposite goals need a place of 1,25m x 0,85m x 0,75m.

„Funny-Field Arena“ ca. 6,5 x 4,0m consisting of:

- 2 Stk. mini goals 120/80 cm, incl. nets
- 14 edge elements, height 60 cm, length 100 cm
- 12 feet

art.-no. productspecification

Funny-Field Arena

4701004 Funny-Field Arena

MINI PITCH „FAST PLAY“



... FUN & ACTION ON THE SMALLEST AREA!

“Fast Play” is the ultimate sports device for schools or public places. No matter whether the small playing field is used by schools, companies, clubs or hotels – the fast game is fun for players and spectators alike. The compact football field is ideal for 1 on 1 or 2 on 2 plays.

Soccer Court „Fast Play“

- Height 2,30 m incl. nets mesh size 100mm
- Individual segments with 1 m high impact-resistant white plastic panels
- Plastic nets are suspended in the upper area in special aluminium profiles
- 2 opposite segments with goals 1m x 0.5 m x 0.5 m and nets
- 1 segment with an access door
- Optional 20 cm high, integrated advertising white KU board with aluminium substructure
- Optional also with ceiling net

art.-no. productspecification

Soccer Court
„Fast Play“

4909300	approx. 5,00 m diameter (10-teilig)
4909301	approx. 6,00 m diameter (12-teilig)

MINI PITCH „ARENA PLAY“



Mini pitch „Arena Play“

suitable for all age groups in sports clubs, schools, leisure facilities, hotels, social and cultural facilities as well as on public squares and in business areas.

Soccer Court „Arena Play“

- robust, permanent perimeter system in octagonal shape - weatherproof and low-noise
- approx. 6.5m diameter, suitable for „1-against-1“ or „2-against-2“
- basic construction made of corrosion-free aluminium
- fixing straps on the intermediate posts (for ground anchoring)
- construction according to DIN EN 15312
- 2 mini-goals 1.0 x 0.5 x 0.5 m, incl. high-quality goal nets
- 1 segment with an access door
- the boards are perfect as advertising space for sponsoring

art.-no. productspecification

Soccer Court
„Arena Play“

4901401	Court „Arena Play“
4901402	Surcharge for surrounding net, height 3m, mesh width 100 mm
4901403	Surcharge for surrounding net, height 3m, mesh width 45 mm
4901404	Surcharge for ceiling net, mesh width 120 mm

SOCCERCOURT „SIMPLE LINE“



All pitch sizes possible, contact us!



Soccercourt „Simple Line“

- Version 1: detached inclusive weights
- Version 2: in included ground sockets
- Version 3: for dowelling onto concrete foundations
- barrier element out of sandwich-panels, Standard white / gray
- with aluminium U-profile edged
- ending riveted
- stand legs made of rectangular profile 80x80x3 mm with display
- hand railing made of 50x50x3 mm with slot
- goal size 3,00 x 2,00 m, access doors on the side of the goals
- alternative goal sizes:
5,00 x 2,00 m / 1,80 x 1,20 m / 1,20 x 0,80 m
- ball catching nets all around is a possibility
- With perimeter advertising on request (club/company logo, sponsors)



art.-no. productspecification

Soccercourt „Simple Line“

2050010	Perimeter „Simple Line“, element length 2,50m per m
2050016	Perimeter „Simple Line“, element length 5,00m per m
2050310	Goal for soccer court 3,00 x 2,00 m incl. access door
4180188	Net for band goal 3.00 x 2.00 m with door cut-out
2050011	Surcharge for gang in mobile version
2050012	Surcharge for dowel-mounted band per post element
2050013	Ball catcher elevation 1.00m above rail
2050014	Ball catcher elevation 2,00m above rail
2050015	Ball catcher elevation 3,00m above rail
2050017	Gangaccess door 1,00m
2050018	Hinge door 2,50 m, 1-flüglig
2050019	Perimeter service door, 4,00 m, 2-winged



PERIMETER COURT „SIMPLE LINE STRONG“



Perimeter court „Simple Line Strong“

- Highest quality, stability and durability
- Almost indestructible construction
- Permanent installation at one location
- Extended posts, firmly anchored in the ground by means of foundations
- incl. elaboration of a plan for the foundations that exactly matches the project
- Robust, weatherproof, low-noise
- Many optional extras for example, ceiling protection nets, basketball, volleyball, ...

Basic equipment

- Closed, surrounding perimeter board system, approx. 100 cm high and approx. 4 cm thick
- Perimeter boards made in sandwich construction with steel-covered PU hard foam (one side green, one side grey/white)
- Basic construction made of corrosion-free aluminium
- Optional: aluminium ball catching fence above the perimeter boards, instead of nets
- Fully welded tubular mesh goals with one side-access door per goal
- Distance between the ball catching tubes according to the latest standards: 85 mm

art.-no. productspecification

Bandenspielfeld „Simple Line Strong“

4901101	Perimeter 10x7 m, with 2,40 x 1,60 m-goals (1 m deep)
4901102	Perimeter 14x7 m, with 2,40 x 1,60 m-goals (1 m deep)
4901103	Perimeter 15x10 m, with 3,00 x 2,00 m-goals (1 m deep)
4901104	Perimeter 20x13 m, with 3,00 x 2,00 m-goals (1 m deep)
4901105	Perimeter 25x14 m, with 4,00 x 2,00 m-goals (1 m deep)
4901106	Perimeter 30 x 15 m, with 3,00 x 2,00 m-goals (1 m deep)
4901107	Perimeter 30 x 15 m, with 4,00 x 2,00 m-goals (1 m deep)
4901108	Perimeter 40 x 20 m, with 3,00 x 2,00 m-goals (1 m deep)
4901075	Surcharge surrounding aluminium fence, total height 3m
4901076	Surcharge surrounding aluminium fence, total height 4m
4901077	Surcharge for end aluminium fence, total height 3m
4901078	Surcharge for front aluminium fence, total height 4m
4901079	Surcharge for basketball extension

SOCCERCOURT „PRO LINE“

All pitch sizes possible, contact us!

Soccercourt „Pro Line“

- Perimeter element out of HPL-panels, standard colour is white (other colours are possible)
- Perimeter element length 2,50 m
- construction made of aluminium
- stand legs out of 80 x 80 x 3 mm
- hand rail profile 80 x 80 x 3 mm with internal slot, only on the ball catching version
- goal size 3,00 x 2,00 m, access doors on the side of the goals
- alternative goal sizes:
5,00 x 2,00 m / 1,80 x 1,20 m / 1,20 x 0,80 m
- ball catching net all around is possible
- roof nets are also possible
- corners optional with radii formed

art.-no. productspecification

Soccercourt „Pro Line“

2005020

Soccer Court „Pro Line“

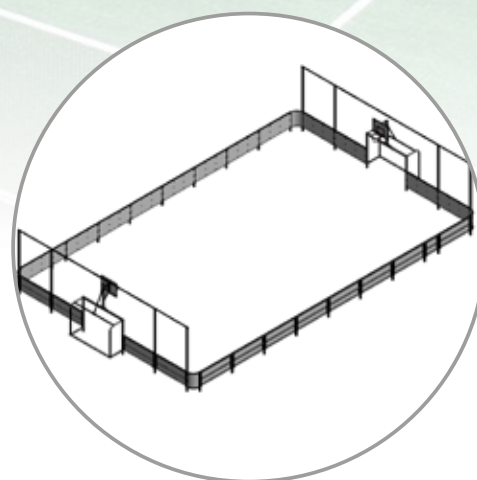

MULTI-PURPOSE FIELDS

„OMNISTADIUM“



TÜV tested and with noise protection certificate



Warum ist das „Omnistadium“ das ultimative Mehrzweck-Sportfeld?

- Playing in the „Omnistadium“ is a special feeling
- Low noise (noise certificate) by means of noise-reducing grid clamps and a funnel-shaped design, modular construction
- Design your own sports field with appropriate length, width and wall height. Select the sports to be played and the desired design (e.g. colour, background, etc.)
- Durable design: 10 years warranty
- Suitable options for small and large budgets
- Vibration-free pressed grids, no use of rubber material, use of grid clamps and shear bolts

The „Omnistadium“ is a sports meeting point without ball or noise disturbance and therefore suitable for any location

- Public areas and parks in residential areas or city centers
- Recreational locations
- School yards

- Sport clubs
- Play grounds

Soccer court „Omnistadium“ construction

- Posts of square profile (90x90 mm), hot-dip galvanized / standard coating RAL 9005 (deep black)
- Pressed grids with very high rigidity, hot-dip galvanized, with coating in RAL colour of your choice
- Roof panel grids in thermally galvanized version.

Advantages of this soccer court

- High quality
- Modular construction / different designs are possible
- Noise certificate incl.
- 10 years warranty on the construction



Court A
13,2 x 24,7m
height 1m
art.-no.:
4006001



Court B
13,2 x 24,7m
height 2m
art.-no.:
4006002



Court C
13,2 x 24,7m
height 3m
art.-no.: 4006003



Court D
13,2 x 24,7m
height 3/2/1m
art.-no.:
4006004



Court E
13,2 x 24,7m
height 4m
art.-no.:
4006005



Court F
13,2 x 24,7m
height 4m
with roof
art.-no.:
4006006



MULTI-PURPOSE FIELDS „OMNISTADIUM“



Full rebound and low noise using:

- Vibration-free grid panels
- Noise-damping grid clamps
- Funnel-shaped design

Modular design:

From a small playing field to a complete stadium with various options for sports and games - suitable solutions for small and large budgets



Entrance



Entrance opening



Maintenance entrance



Locking door



SOCCERCOURT „HARD LINE“

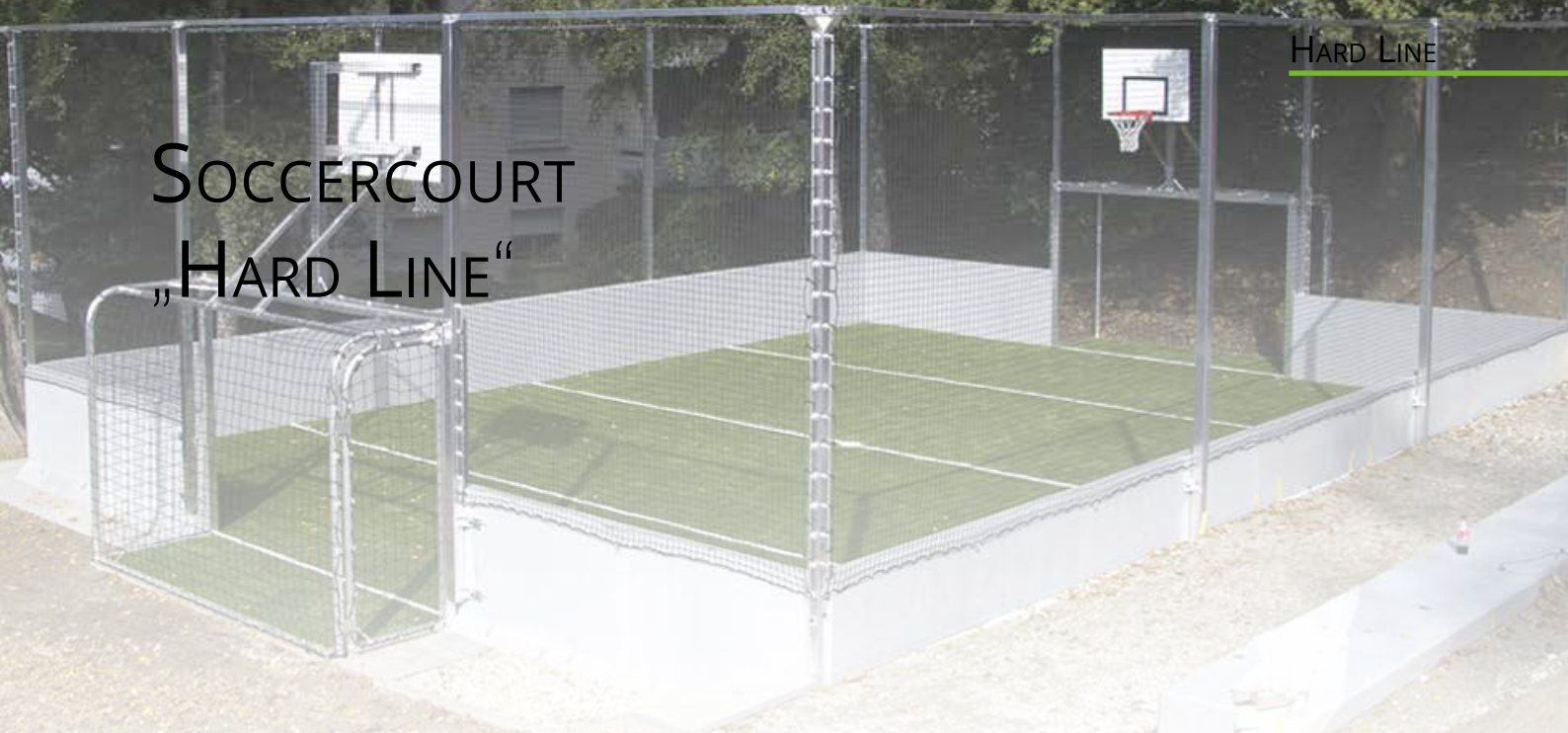

Soccercourt „Hard Line“

Usage:

The robust, low-noise concrete elements are to be favored in public areas due to the high requirements (vandalism). The elements can be placed on top of existing floor coverings

Finish:

- Reinforced concrete, concrete grey, smooth formwork or sandblasted
- Ball catching posts and cross struts made of aluminium profiles
- Polypropylene ball catching net
- Goals integrated in the perimeter elements, 3.00 x 2.00m with side-access doors
- Size selectable according to your requirements



art.-no. productspecification
Soccercourt „Hard Line“

3700600

Soccer Court „Hard Line“

ATHLETICS



LONGJUMP

„FOUNDATION TRAY“

Rake, sand smoother and sand trap on request!

Foundation tray „Standard“

- completely made of aluminium
- frontal claw nut
- on the side with folded claw nut
- on both sides bevelled for an even contact with the running surface

art.-no. productspecification

Foundation tray „Standard“

1040030	Foundation tray, 122 / 34 / 10 cm
1040070	Foundation tray, 122 / 20 / 10 cm
1040031	Foundation tray, 122 / 30 / 10 cm

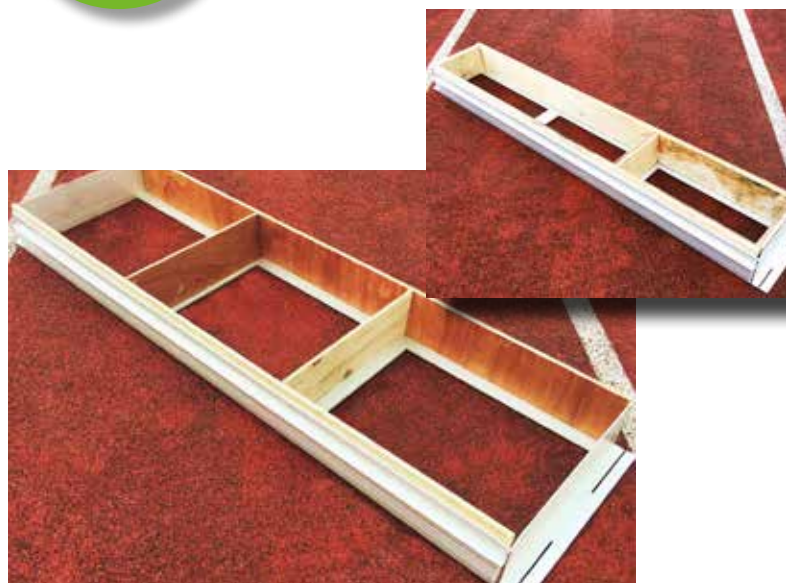

Foundation tray „Standard“ 122/34/10 cm

Foundation tray „Height adjustable“

- completely made of aluminium
- alongside the run-up tapered

art.-no. productspecification

Foundation tray „Height adjustable“

4902003	Foundation tray, height adjustable, 122 / 34 / 10 cm
4902002	Foundation tray, height adjustable, 122 / 30 / 10 cm



Foundation „Height adjustable“

Foundation tray „Concrete block“

- Cast concrete block
- No concrete work needed on-site
- With anchor lugs for transport

art.-no. productspecification

Foundation tray „Concrete block“

4902005	Foundation tray „concrete block“, 122 / 34 / 10 cm
4902007	foundation tray „concrete block“, height adjustable, 122 / 34 / 10 cm
4902006	Foundation tray „concrete block“, height adjustable, 122 / 30 / 10 cm
4902008	Foundation tray „concrete block“, height adjustable, 122 / 30 / 10 cm

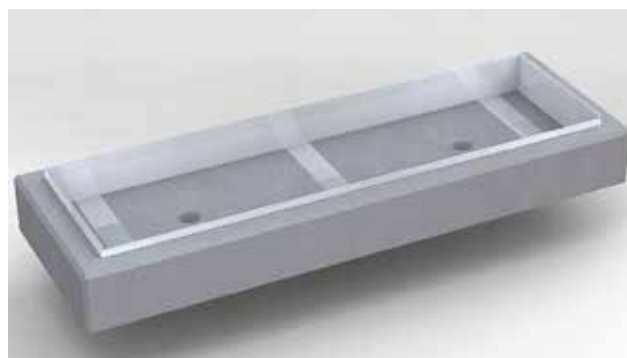

Foundation „Concrete block“

LONGJUMP „TAKE-OFF BOARD“

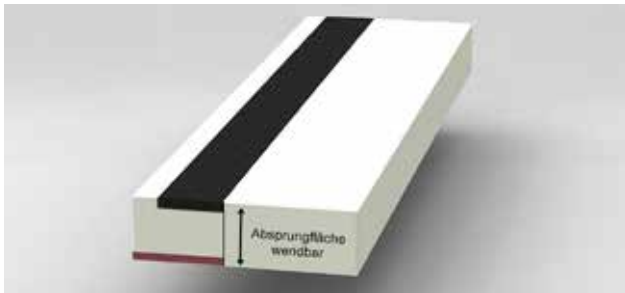

Take-off board „Plastic“ bilateral

- Including clamping device
- Double-sided take-off surface
- Clamping device out of high-grade steel
- Including rubber insertion profilel

art.-no. productspecification

Take-off board „Plastic“ bilateral

- | | |
|---------|--|
| 4902112 | Take-off board plastic, bilateral 122 / 34 / 10 cm |
| 4902113 | Take-off board plastic, bilateral 122 / 30 / 10 cm |

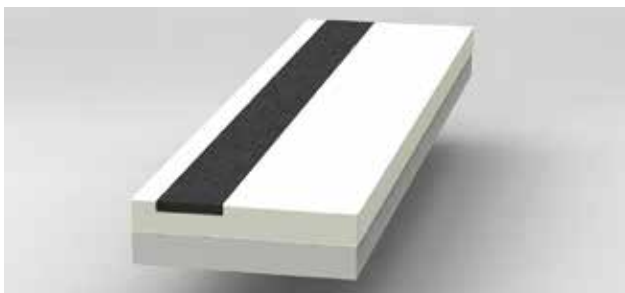

Take-off board „Plastic“ one-sided

- Core out of GRP
- Take-off surface fully plastic
- Including rubber insertion profile

art.-no. productspecification

Take-off board „Plastic“ one-sided

- | | |
|---------|--|
| 4902110 | Take-off board „Plastic“, 122 / 34 / 10 cm |
|---------|--|

Wettkampf Absprung- / Wendebalken "Weichholz"
Art. Nr. 1040130

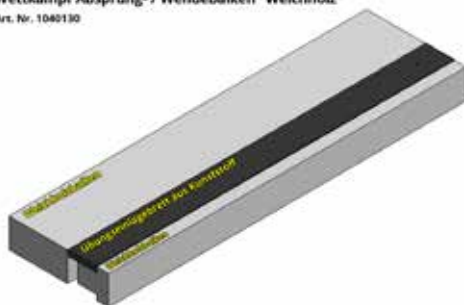

Take-off board „Wood“ for school sport

- School sports take off board 122x20x10 cm
- Durable and robust hardwood take off board
- Softwood take off board for an easy spike penetration
- Completely white lacquered
- Double-sided take off surface

art.-no. productspecification

Take-off board „Wood“

- | | |
|---------|---|
| 1040135 | Softwood take off board, 122 / 20 / 10 cm |
| 1040137 | Hardwood take-off board, 122 / 20 / 10 cm |

Wettkampf Absprung- / Wendebalken "Hartholz"
Art. Nr. 1040132

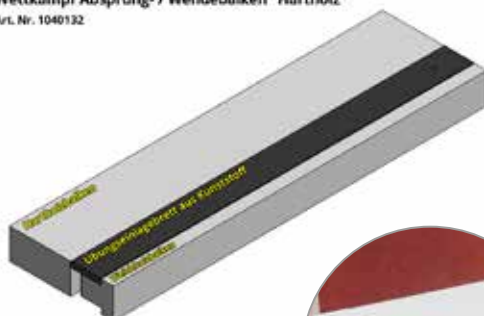

Take-off board „Wood“ for competition

- Competition take-off board 122x34x10 cm
- Two-part construction with clamping screws to ensure a perfect fitting in the foundation tray
- Including exercise board made of plastic
- Robust and durable hardwood take off board
- Softwood take off board for an easy penetration of the spikes
- Completely white lacquered
- Double-sided take off surface

art.-no. productspecification

Take-off board „Wood“

- | | |
|---------|---|
| 1040130 | Softwood take off board, 122 / 34 / 10 cm |
| 1040132 | Hardwood take-off board, 122 / 34 / 10 cm |
| 1040131 | Softwood take off board, 122 / 30 / 10 cm |
| 1040133 | Hardwood take-off board, 122 / 30 / 10 cm |



LONGJUMP „TAKE-OFF BOARD“

Take-off board „Two in One“

- Core out of aluminium profile
- One-sided plastic white for long jump
- The other side running track coloured for Triple Jump
- **Advantage:** low weight and high stability

art.-no. productspecification

Take-off board „Two in One“

4902128	Take-off board „Two in One“, 122 / 34 / 10 cm
4902126	Take-off board „Two in One“, 122 / 20 / 10 cm

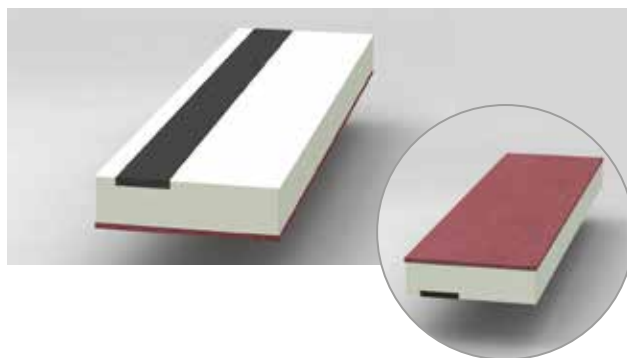

Take-off board „Three in One“

- Similar to take-off board „two in one“, but two pieces
- Can be used for school sports, competitions and as dummy board
- One side white plastic for long jump
- One side plastic in colour of the track for triple jump
- **Advantage:** low weight with highest stability

art.-no. productspecification

Take-off board „Three in One“

4902129	Take-off board „Three in One“, 122 / 34 / 10 cm
4902127	Take-off board „Three in One“, 122 / 30 / 10 cm

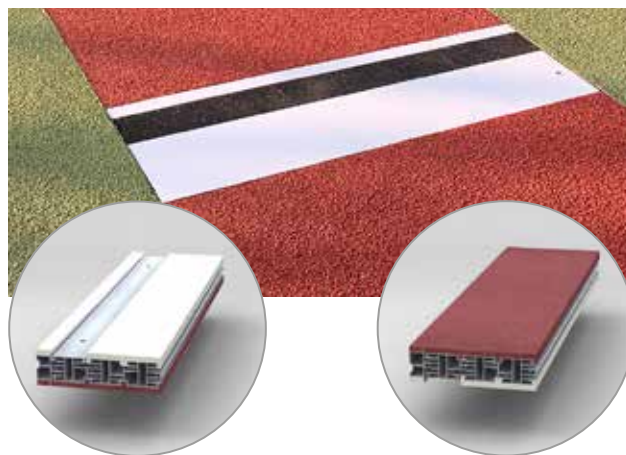

Take-off board „Blank board“

- Aluminium core
- Made of aluminium
- Height adjustable with six adjustable feet
- cCoatable

art.-no. productspecification

Take-off board „Blank board“

1040010	blank board, uncoated 122 / 34 / 10 cm
---------	--



LONGJUMP „ACCESSORIES“

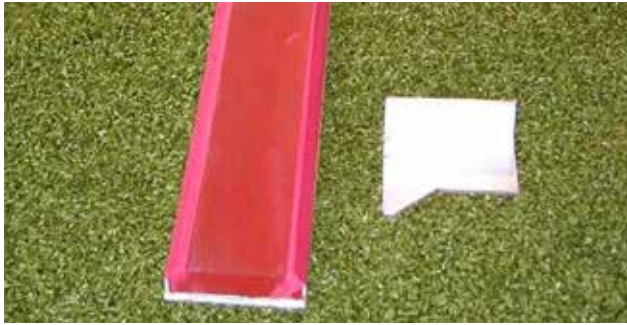

Insert board all plastic

- aluminium core
- cast with polyurethane
- including plasticine

art.-no. productspecification

Insert board all plastic

1040090 Insert board with polyurethane



Distance measuring panel

- made of aluminium
- white powder coated
- with metric scale

art.-no. productspecification

Distance measuring panel

1040190 Distance measuring panel 3-9 m or 13-19 m



Box template for insert boards

- Box template made of wood
- 45° angle

art.-no. productspecification

Box template for insert boards

1040120 Box template for insert boards
4007164 Plasticine strip-set for a insert board



Control strips made of „Wood“

- Made of glued screen printing plates
- Recess for plasticine
- Without plasticine

art.-no. productspecification

Control strips made of „Wood“

4902118 Control strips made of „Wood“



Indicator boards

art.-no. productspecification

Einlegebretter für Absprungbalken

4040100 Indicator board, plastic, grey
1040100 Indicator board, blue, PU coated
4902146 Indicator board, hardwood
4902147 Indicator board, rubber

Indicator board, blue, PU coated

SANDPIT COVER

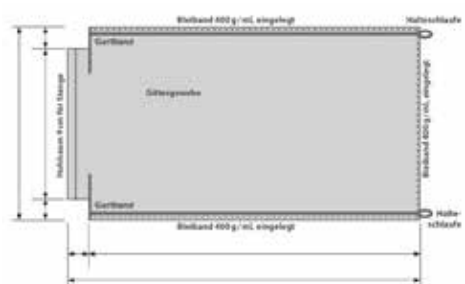
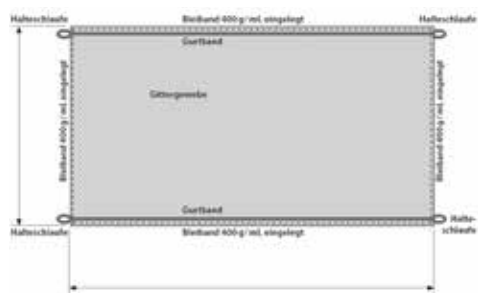

Sandpit cover

Material:

PVC - coated netting, weather resistant, tear proof, UV-stable, approx. 250 g/m²

Colour:

Green or black

Size:

Can be made individually after your demands

Design:

The side edges of the cover are hemmed all around

The belts and holding straps (width 45mm) are along the outer edge and according to the sketch continuously welded and with rivets additionally fixed. The weald seams are conducted using high-frequency technology. In the seam a lead band (400g/lfm) is inserted on four sides.

art.-no. productspecification

Sandpit cover

4300020	Sandpit cover, loose, with chain
4300030	Sandpit cover, loose, with steel rope

art.-no. productspecification

Sandpit cover with lead band

4300000	Sandpit cover, overlapping loose, with lead band
4030010	Sandpit cover, overlapping fixed, with lead band

Cover with chain, all around



- Stable mesh web, all around with hemstitch
- Colour: moss-green
- All around chain (6 mm, hot galvanised) for weighting the cover
- 4 open corners with carabiner hooks for installing

Cover with steel rope, all around



- stable mesh web, all around with hemstitch
- Colour: moss-green
- all around steel rope (4 mm, hot galvanised and PVC-coated) worked into the seam
- 4 open corners with carabiner hooks for installing

art.-no. productspecification

Accessories for sandpit cover

1030166	Standard ground socket with support to install a carabiner hook
---------	---

SHOT PUT- & DISCUS RING



concrete element



Shot put & Discus ring



Shot put ring handicapped accessible inkl. two additional sleeves and anchor bars

All shot put & discus rings comply with the WA regulations. The rings are made of dimensionally stable aluminium T-profiles.

Advantages of a shot put ring as a precast concrete element:

In-situ concrete solutions often do not meet the requirements.

The dimensionally stable precast concrete element with concrete surface is functional for sport, offers an accurate workmanship (top surface and ring height) and is easy to install.

Shot put / discus ring

- Ring of special aluminium t-profile
- Diameter 2,135 m / 2,500 m for setting in concrete on site
- Perfect form stability
- Two-piece
- Stabilizing bars welded in

Shot put ring / discus ring suitable for athletes with disabilities

- Same properties as for rings but with six inspection shafts with integrated drainage and bar for belt fastening

Shot put ring / discus ring as a precast concrete element

- Same properties as for rings but as precast concrete element of special hardened concrete
- Throwing circle surface not smooth
- Incl. 2 threaded sleeves with transport loops

art.-no. productspecification

Shot put ring

1030210	Shot put ring made of aluminium
2030210	Shot put ring handicapped accessible, with 6 fixing points (two of them as revision shaft)
4030210	Shot put ring concrete element, with two processes

art.-no. productspecification

Ring accessories

1030160	Inspection shaft for shot-put ring with bar
1030162	Anchor bars for handicapped throwing disciplines

art.-no. productspecification

Discus ring

1030200	Discus ring made of aluminium
2030200	Discus ring handicapped accessible, with 6 fixing points (two of them as revision shaft)
4030200	Discus ring concrete element, with two processes

art.-no. productspecification

Ring accessories

1030160	Inspection shaft for shot-put ring with bar
1030162	Anchor bars for handicapped throwing disciplines

SHOT PUT „BOARD & ACCESSORIES“

Shot put board

Wood

- Solid wood beam
- White lacquered
- Perfect form stability
- Incl. fastening set

Plastic

- Made of solid plastic, particularly robust
- White
- Incl. fastening set

nach IAAF / WA

art.-no. productspecification

Shot put board / Stone impact beam

1030430	Shot put board, wood
4902312	Shot put board, plastic
2030435	Stone bumper, aluminium, length 4m



Ring cover

- Ring cover for ball & hammer throwing rings
- Two-piece
- Completely made of aluminium
- Welded handles

art.-no. productspecification

Ring cover

1030340	Ring cover made of aluminium
---------	------------------------------

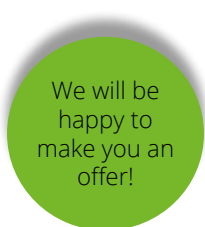

Shot put accessories

We also have other shot put accessories in our product range

- Competition & training shot put balls
- Indoor balls
- Transport trolleys
- Roll-back ramps
- Indoor mats for shot put



Stoßkugeln aller Art



Transportwagen starr oder fahrbar



Transportwagen aus Aluminium



Rückrollrampe für Stoßkugeln

HAMMERTHROW

„HAMMERTHROW INSERT RING“



Hammerthrow

Hammer throw rings can be found in the shot put or discus section.

For the hammer throw you use the same ring diameter (2.135 m) as for the shot put throw.

If discus and hammer throw are to be carried out in the same protective grid, a discus ring (2.50 m) and a hammer throw insert ring which reduces the diameter from 2.50 to 2.135m is needed.

Hammerthrow insert ring

- Reduces the ring diameter from 250 cm to 213,5 cm
- Consists of four elements
- Made of galvanised, powder coated steel

art.-no. productspecification

Hammerthrow insert ring

1030140

Hammerthrow insert ring

JAVELIN THROW



Javelin throw

- Made of flat aluminium, white lacquered
- Length 4.00 m, arch with R = 8.00 m
- Width 70 mm, height 8 mm
- Including spikes for track surface

art.-no. productspecification

Javelin bow

4902401

Javelin bow

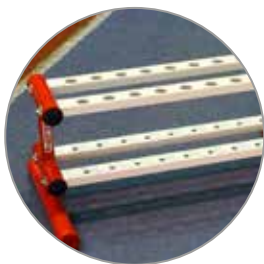

Speereständer



Speere aller Art

Javelin accessories

We also have other javelin accessories in our product range

- Training & competition javelin
- Transport trolley

We will be happy to make you an offer!

ATHLETICS ACCESSORIES

Distance markers

- Triangular, made of glass fibre, inclusive numbers
- Upper handle cutout
- Stackable

art.-no. productspecification

Distance markers

1031800	Distance marker (1 piece)
1031810	Distance markers (14 pieces for long throws)
1031820	Distance markers (26 pieces for long throws)
1031830	Distance markers (16 pieces for shot put)



Timekeepers stand

- made of aluminium, fully welded, Alu-natur
- extra wide plastic wheels
- inclusive plastic seats and lift roller

art.-no. productspecification

Zielrichter- & Zeitnehmertreppe

1010040	stairs, 6 persons, with seats
1010060	stairs, 8 persons, with seats
1010080	stairs, 12 persons, with seats, decomposed



Starting numbers

- rectangular, made of glass fibre, inclusive numbers, height 45 cm
- upper handle cutout
- yellow and red flaps for false start
- stackable

art.-no. productspecification

Starting numbers

1010580	Lane marker box (for one lane)
1010581	Lane marker box (for four lanes)
1010582	Lane marker box (for six lanes)
1010583	Lane marker box (for eight lanes)
1010584	Lane marker box (for ten lanes)



Mobile bench for athletes

- Length 2,5 m / height 2,1 m
- Mobile with handles and wheels
- foldable roof

art.-no. productspecification

Mobile bench for athletes

1011220	Mobile bench for athletes
---------	---------------------------



SAFETYCAGE

„DISCUS & HAMMERTHROW CAGE 7/10 M“



SafetyCage

- 10 aluminium profile posts 120/100 mm, 4/6 mm
- No turning in the ground socket
- Gallows with rope guide
- Lowerable carrier
- Two adjustable hatches with lowerable carrier
- Incl. rope reels at the posts
- High quality safety net made of PP 5 mm, 45 mm MW
- According to EN 1263-1 rhombic mesh

art.-no. productspecification

Diskus & Hammerthrow cage

1030290 Diskus and hammerthrow cage 7/10 m, incl. net

art.-no. productspecification

Diskus cage accessories

1030076 Surcharge for all around net crossbars 7/10 m
 1030291 Bar spacer per post (demand 10 pieces)
 1030100 Standard ground socket discus / hammerthrow
 1030120 Special ground socket discus / hammerthrow

SAFETYCAGE

„DISCUS CAGE“

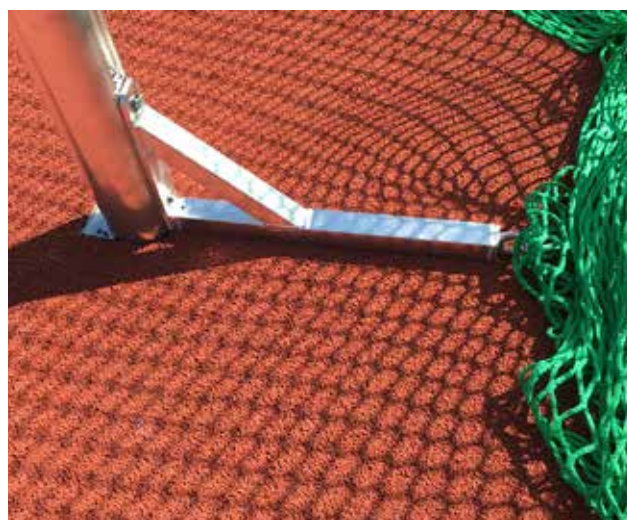

Discus cage

- 7 Stk aluminium profile posts 120/100 mm
- No turning in the ground socket
- Gallows with rope guide
- Incl. rope reels on the stand posts
- High-quality safety net made of PP 5mm, 45mm MW
- In accordance with EN 1263-1 rhombic mesh

art.-no. productspecification

Discus cage

1030070	Discus cage 4 m
1030071	Discus cage 5,5 m
1030072	Discus cage 4/6 m
1030073	Discus cage 6,0 m (according to new standard)

art.-no. productspecification

Diskus cage accessories

1030075	Surcharge for all around net crossbars
1030291	Bar spacer per post (demand 7 pieces)
1030100	Standard ground socket discus / hammerthrow
1030120	Special ground socket discus / hammerthrow

HURDLES



Competition hurdles



Trainings hurdles



Transporttrolley for 20 hurdles



Transporttrolley for 30 hurdles

Competition hurdles with advertising



Printing of the hurdle bars on request!

Competition hurdles

- Competition hurdles made of aluminium
- 6-fold height adjustable
- Fully welded
- Height adjustment via snap push button
- Movable and snap-in counterweights in the hurdle base
- heights: 0,685 m; 0,762 m; 0,838 m; 0,914 m; 0,991 m; 1,067 m
- Incl. flexible wooden bar, in contrasting color

Training hurdle

- Exercise hurdle made of aluminium
- 4-fold height adjustment
- Fully welded
- Height adjustment via snap push button
- With plastic tube as hurdle bar

art.-no. productspecification

Hurdles

1010470	Competition hurdle
1010490	Training hurdle
4900271	Replacement wooden hurdle bars

Other hurdle width? Simply specify when ordering

Transport trolley for 20 hurdles

- Completely made of aluminium
- For up to 20 hurdles
- All around with pivoting wheels
- Incl. drawbar
- For hurdle widths 1.16 - 1.21 cm (outer edge to outer edge)

Transport trolley for 30 hurdles

- Completely made of aluminium
- For up to 30 hurdles
- Hurdles would be pushed on and loaded from behind
- In the front with foam-covered swivel wheels
- Incl. drawbar
- For hurdle widths 1.16 - 1.21 cm (outer border to outer border)

art.-no. productspecification

Transport trolley for hurdles

1010520	Transport trolley for 20 hurdles
1010525	Transport trolley for 30 hurdles

HURDLES / BARRIER

Barrier without crossbar

- Height adjustable (0,762 m / 0,838 m / 0,914m)
- Completely made of aluminium, wooden beam
- Internal weights in the frame

art.-no. productspecification

Barrier without crossbar

1010390	Barrier without crossbar, 3,96 m
1010350	Barrier without crossbar, 5,00 m
2010390	crossbar as substitute 3,96 m
2010350	crossbar as substitute 5,00 m



Barrier without crossbar

Barrier with crossbar

- Crossbar for a higher stability
- Height adjustable (0,762 m / 0,838 m / 0,914m)
- Completely made of aluminium, wooden beam
- Internal weights in the frame

art.-no. productspecification

Barrier with crossbar

1100370	Barrier with crossbar, 3,96 m
1010360	Barrier with crossbar, 5,00 m
2010390	crossbar as substitute 3,96 m
2010350	crossbar as substitute 5,00 m



Barrier with crossbar

Barrier transport trolley

- Transport trolley for 4 barriers
- Polyamid wheel
- With drawbar

art.-no. productspecification

Barrier transport trolley

1010400	Transport trolley for four barriers
---------	-------------------------------------



Barrier transport trolley

WATER JUMP PIT



Water jump barrier

- height adjustable (0,762 m women / 0,914 m men)
- pedestal made of 80x80 mm aluminium profile, wooden beams

art.-no. productspecification

Water jump barrier

1010410	Water jump barrier
1010330	Standard ground socket water jump barrier
1010340	Special ground socket water jump barrier
2010410	Crossbar as substitute 3,66 m

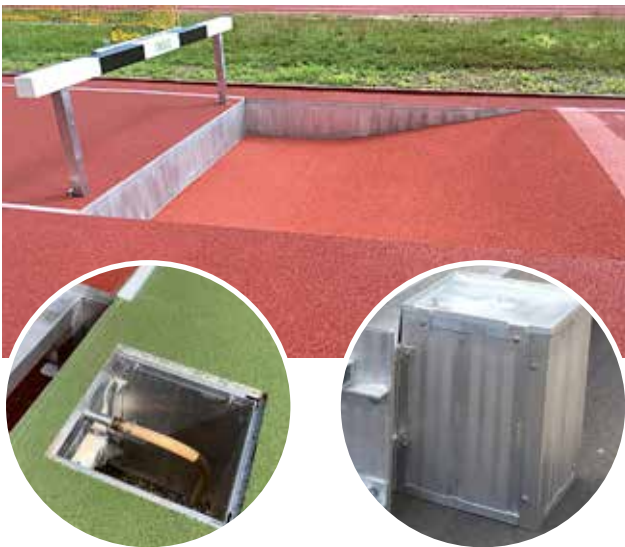

Water jump pit

- 3-parted construction kit
- Aluminium double hollow chamber profile
- Including front cross brace
- Surcharge for supply shaft

art.-no. productspecification

Water jump pit

1010285	Water jump pit construction kit
1010280	Water jump pit supply shaft

art.-no. productspecification

Welded ground socket for water jump pit

1010330	Standard ground socket for water jump barrier
1010340	Special ground socket for water jump barrier



Water jump pit cover / support bracket

- Cover made of aluminium
- Slot and spring profile
- coatable
- Support bracket in height and length adjustable

art.-no. productspecification

Water jump pit cover

1010310	Support bracket for water jump pit cover (2 pieces required)
1010270	Coatable water jump pit cover

RUN

Starter block „Olympic“

- suitable for young athletes
- work angle is adjustable
- distance between the logs is adjustable
- made of steel, with coating, very wear-resistant

art.-no. productspecification

Starter block „Olympic“

1010550 Starter block „Olympic“

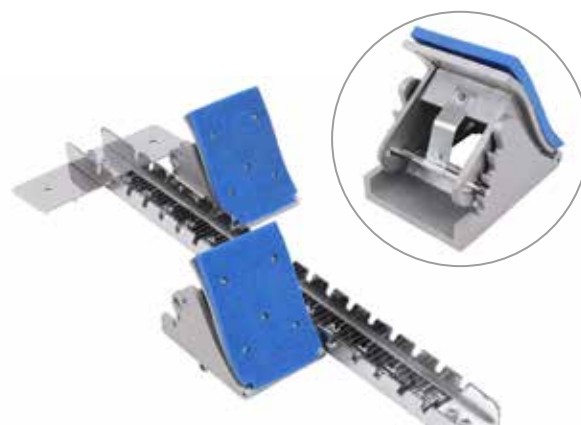

Starter block „New Olympic“

- big start rails and big pedals
- work angle is adjustable
- distance between the logs is adjustable
- made of aluminium, with rubber flooring, very good stop

art.-no. productspecification

Starter block „New Olympic“

1010560 Starter block „New Olympic“

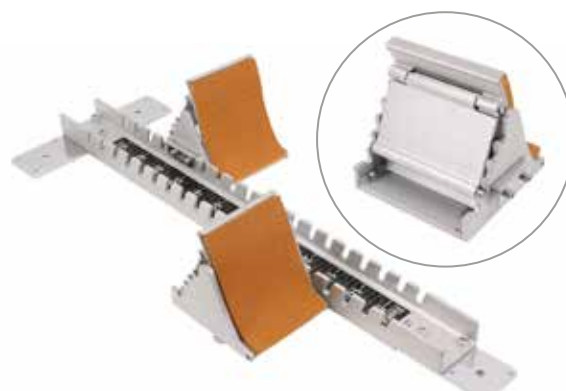

Transport trolley for starter blocks

- Transport trolley for ten starter blocks
- Made of steel tubes
- Powder coated
- Mobile and steerable due to a swivel axel
- With handle

art.-no. productspecification

Transport trolley

4902458 Transport trolley for starter blocks



Curbing

- curbing made of special anodised aluminium profile
- Set for 400 m running track (170 m straight and 230 m curved profiles incl. all connectors)
- Straight and curved elements
- Standard radius 36,50 m
- Integrated connectors and fixing pins
- Can also be used as a mobile track barrier
- Powder-coated in RAL colours on request

art.-no. productspecification

Curbing

1011260 Curbing radius 36,5m

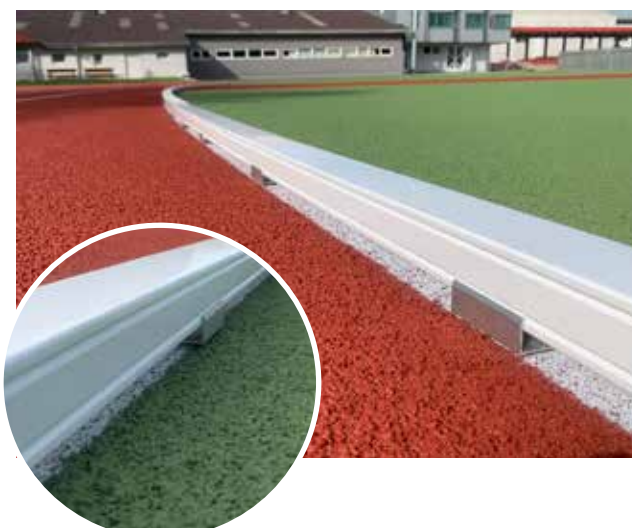

HIGHT JUMP MAT

Hight jump mat „Basic“

With integrated wear mat. The mono block system creates a harder landing. The high jump mat “basic” is suitable for school sports, as falling height is much lower.

Application

- School sport

Kernel

- Mono block system RG 18

Wear mat

- solid PUR foam RG 20, 100 mm

Cover

single piece cover with weather proof plastic zipper, protective mesh web (spike proof) integrated in the cover, spike proof mesh web throughout the complete landing area guarantees the best possible air circulation, on the sides PVC-tarpaulin

Ground

- Anti-slid PVC tarpaulin
- Black PVC tarpaulin and green mesh fabric (available in other colours)



Hight jump mat „Simple“

The high jump mat „simple“ is suitable for school and club sport. The hollow block system creates a soft landing. The air can flow quickly through the integrated channels. The wear mat is separated from the hollow foam blocks due to a intermediate base..

Application

- School sport & club sport

Kernel

- double hollow foam block RG 23

Wear mat

- solid PUR foam RG 20

Intermediate base

- PVC-tarpaulin

Cover

two pieced cover with intermediate base and weather proof zipper, protective mesh web (spike proof) integrated in the cover, spike proof mesh web throughout the complete landing area guarantees the best possible air circulation, on the sides PVC-tarpaulin

Ground

- Anti-slid PVC tarpaulin
- Black PVC tarpaulin and green mesh fabric (available in other colours)



Hight jump mat „Pro“

The high jump mat „pro“ is suitable for the more ambitious users. The double hollow kernel system creates one of the softest landings. The foam blocks are additionally single covered. The wear mat is separated from the hollow foam blocks due to a intermediate base.

Application

- Club sport & competition

Kernel

- Double hollow foam block RG 23

Wear mat

- solid PUR foam RG 20

Intermediate base

- PVC-tarpaulin



Cover

two pieced cover with intermediate base and weather proof zipper, protective mesh web (spike proof) integrated in the cover, spike proof mesh web throughout the complete landing area guarantees the best possible air circulation, on the sides PVC-tarpaulin

Ground

- Anti-slid PVC tarpaulin
- Black PVC tarpaulin and green mesh fabric (available in other colours)



HIGHT JUMP MAT

Art.-no. „Basic“	Width	Depth	Height
4404340	400 cm	300 cm	40 cm
4404350	400 cm	300 cm	50 cm
4404360	400 cm	300 cm	60 cm
4405340	500 cm	300 cm	40 cm
4405350	500 cm	300 cm	50 cm
4405360	500 cm	300 cm	60 cm
4405440	500 cm	400 cm	40 cm
4405450	500 cm	400 cm	50 cm
4405460	500 cm	400 cm	60 cm
4406340	600 cm	300 cm	40 cm
4406350	600 cm	300 cm	50 cm
4406360	600 cm	300 cm	60 cm
4406450	600 cm	400 cm	50 cm
4406460	600 cm	400 cm	60 cm
4406470	600 cm	400 cm	60 cm

Art.-no. „Simple“	Width	Depth	Height
4414340	400 cm	300 cm	40 cm
4414350	400 cm	300 cm	50 cm
4414360	400 cm	300 cm	60 cm
4415340	500 cm	300 cm	40 cm
4415350	500 cm	300 cm	50 cm
4415360	500 cm	300 cm	60 cm
4415440	500 cm	400 cm	40 cm
4415450	500 cm	400 cm	50 cm
4415460	500 cm	400 cm	60 cm
4416340	600 cm	300 cm	40 cm
4416350	600 cm	300 cm	50 cm
4416360	600 cm	300 cm	60 cm
4416450	600 cm	400 cm	50 cm
4416460	600 cm	400 cm	60 cm
4416470	600 cm	400 cm	60 cm

Art.-no. „Pro“	Width	Depth	Height
4424340	400 cm	300 cm	40 cm
4424350	400 cm	300 cm	50 cm
4424360	400 cm	300 cm	60 cm
4425340	500 cm	300 cm	40 cm
4425350	500 cm	300 cm	50 cm
4425360	500 cm	300 cm	60 cm
4425440	500 cm	400 cm	40 cm
4425450	500 cm	400 cm	50 cm
4425460	500 cm	400 cm	60 cm
4426340	600 cm	300 cm	40 cm
4426350	600 cm	300 cm	50 cm
4426360	600 cm	300 cm	60 cm
4426450	600 cm	400 cm	50 cm
4426460	600 cm	400 cm	60 cm
4426470	600 cm	400 cm	60 cm

RAIN COVER FOR „HIGH JUMP MAT“

Colour
according
to customer
requirements
in standard
RAL colours



Rain cover for high jump mat

- Made of heavy PVC tarpaulin
- Completely welded
- With four tensioning ropes at the corners to hook at the mat or the grid

Art.-no. „Rain cover“	Width	Depth	Height
4434340	400 cm	300 cm	40 cm
4434350	400 cm	300 cm	50 cm
4434360	400 cm	300 cm	60 cm
4435340	500 cm	300 cm	40 cm
4435350	500 cm	300 cm	50 cm
4435360	500 cm	300 cm	60 cm
4435440	500 cm	400 cm	40 cm
4435450	500 cm	400 cm	50 cm
4435460	500 cm	400 cm	60 cm
4436340	600 cm	300 cm	40 cm
4436350	600 cm	300 cm	50 cm
4436360	600 cm	300 cm	60 cm
4436450	600 cm	400 cm	50 cm
4436460	600 cm	400 cm	60 cm
4436470	600 cm	400 cm	60 cm

HIGH JUMP MAT & SUPPORT GRID

High jump mat, foldable

- Hollow chamber system
- Cover made of polyester-reinforced tarpaulin fabric
- bottom side made of anti-slipping gym mat fabric

art.-no. productspecification

High jump mat, foldable

4217000	High jump mat foldable 600 x 300 x 60 cm
4217050	Rain cover high jump mat foldable 600 x 300 x 60 cm
4217060	Rain cover high jump mat foldable 600 x 150 x 120 cm
4217100	High jump mat foldable 500 x 300 x 60 cm
4217150	Rain cover high jump mat foldable 500 x 300 x 60 cm
4217160	Rain cover high jump mat foldable 500 x 150 x 120 cm



Support gride high jump mat

- support grid made completely of aluminium
- consisting of 2 screwable parts
- complete height 10 cm
- slatted frame made of 20 cm wide aluminium profiles
- incl. 4 brackets (back and sides) to prevent the mat from slipping

Available as well as mobile version with removable wheels (only used for transport)

ADVANTAGE: The high jump mat can be quickly moved.

PE support grid

- „ALL“ mats can be produced with an integrated PE support grid:
- Polyethylene grid
- 10 cm height- additional protection for the rails

Advantages of a PE support grid

- Fixed position, as the support grid is integrated in the mat
- No risk of injury
- Space-saving during storage

art.-no. productspecification

Support grid high jump mat

2236013	Support grid high jump mat 5x3 m
2236014	Support grid high jump mat 6x4 m
2236016	Surcharge for mobile support grid, high jump
4222222	Surcharge for an integrated support grid



Integrated grid



Support grid made of aluminium



Support wheel for mobile grid

HIGH JUMP BAR



High jump crossbar, 3-point

- light yellow competition and training high jump crossbar
- 3-fold fibreglass reinforced
- excellent background contrast effect
- extremely low deflection
- solid and durable
- heavy support ends for maximal possible frictional resistance
- length 400 cm
- according to World Athletics-Certification requirements



High jump crossbar, 5-point

- dark yellow, heavy competition high jump crossbar
- 5-fold matrix reinforced polyester
- excellent background contrast effect
- lowest deflection
- solid and nearly indestructible
- heavy support ends for maximal possible frictional resistance
- length 400 cm
- according to World Athletics-Certification requirements

art.-no. productspecification

High jump bar

- | | |
|---------|-----------------------|
| 4025400 | High jump bar 5-point |
| 4024400 | High jump bar 3-point |



High jump measuring bar

- Measuring range from 0,6 - 3,0 m
- Millimeter precise, coated measuring tape
- Telescopic elements made of round aluminium
- Circular bubble incl.
- Aluminium flat on the top as an overlap on the high jump bar

art.-no. productspecification

High jump measuring bar

- | | |
|---------|-------------------------|
| 4024405 | High jump measuring bar |
|---------|-------------------------|

HIGH JUMP UPRIGHTS

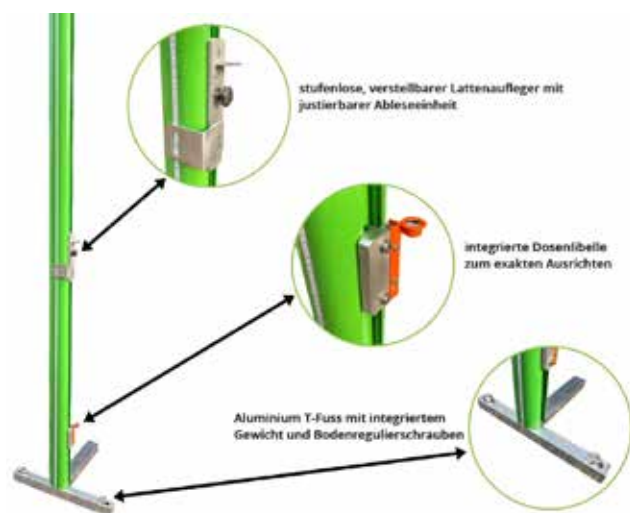

Details und Zubehör



Lattenumlenkbügel



Mehrfachaufleger

High jump uprights „Pro“

- High jump uprights made of Aluminium oval profiles 120x100mm
- Aluminium T-foot with integrated weights
- Integrated ground screws for a perfect adjustment of the uprights
- Height adjustable from 50 - 250 cm infinitely variable
- Surcharge for bar support that can be moved infinitely variable
- Integrated circular bubble to control the correct alignment
- Surcharge for bar deflection bracket
- multiple bar support, 5-fold every 10 cm

art.-no. productspecification

High jump uprights „Pro“

1020570	High jump uprights "Pro" 0,5 - 2,5 m, green powder-coated
2012001	Surcharge for multiple bar support
2012002	Surcharge bar deflection bracket

High jump uprights

- High jump stands made of aluminium including t-foot standing leg with integrated weights
- Rounded edges
- height from 50 - 250 cm, or from 50 - 300 cm
- Adjustment elements – infinitely variable
- Surcharge for bar deflection bracket, 5-fold every 10 cm

art.-no. productspecification

High jump uprights

1020510	High jump uprights 0,5 - 2,5 m, Alu-natur
1020560	High jump uprights 0,5 - 3,0 m, Alu-natur, IAAF Zertifiziert
2012001	Fivefold supports for the bars
2012002	Deflection bow
2012003	Vertical control
2012004	Surcharge for ground levelling element at the T-foot



POLE VAULT

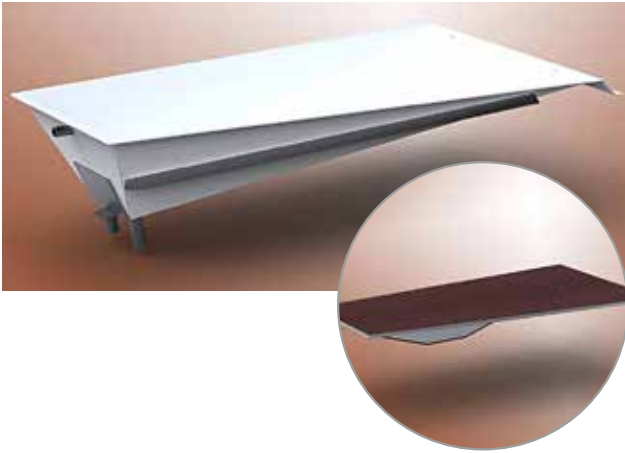

Pole vault box „Standard“

- Pole vault box made of stainless steel
- With two drainage pipes
- Insertion block, made of aluminium, coatable

art.-no. productspecification

Pole vault box „Standard“

1020290	Pole vault box standard
1020310	Insertion block for pole vault box standard, coatable

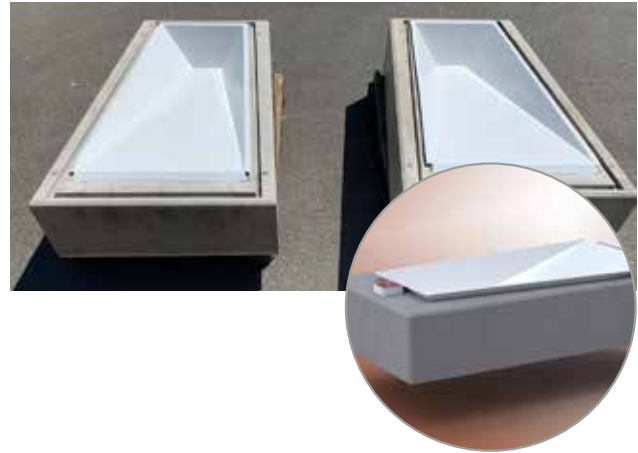

Pole vault box „Concrete element“

- With inspection shaft
- White powder coated on the inside
- With loops for transport
- Just install and align

art.-no. productspecification

Pole vault box „Concrete element“

4902705	Pole vault box concrete element
4902706	Surcharge for locking device
4902707	Surcharge for additional inspection shaft



Pole vault rack

- Completely made of aluminium
- Store sections for 20 jump sticks
- For poles and crossbars
- Coloured against surcharge

art.-no. productspecification

Pole vault rack

1020590	Pole vault rack
---------	-----------------



Pole vault measuring bar up to 8,00 m

- Measuring range from 1.53 - 8.0 m
- Millimeter exact coatable measuring tape
- Adjusted height settings cannot shift (clamping screws)
- Incl. circular bubble
- Aluminium flat on the upper side as an angle at the cross bar

art.-no. productspecification

Pole vault telescopic measuring bar up to 8,00 m

4024410	Pole vault measuring bar
---------	--------------------------

POLE VAULT STAND



Pole vault stand „Comfort“ in rails

- Aluminium construction made of special profile 98 x 142 mm
- All functional parts made of stainless materials
- In the tension range up to 10 mm thick, white powder-coated
- Slide and ground socket welded
- Carriage is guided on high quality polyamide rollers in the guide rail
- Slat runners in the guide on the boom adjustable according to the rules
- Slatted height adjustable from 150 to 650 cm
- With toothed belt system and crank

art.-no. productspecification

Pole vault stand

1020010	Pole vault stand in rails
1020020	Rails (requirement 2 pieces)

Pole vault stand „Comfort“ in ground socket

- Aluminium construction made of special profile 98 x 142 mm
- All functional parts made of stainless materials
- In the tension range up to 10 mm thick, white powder-coated
- With standard ground socket and lid
- Slat runners in the guide on the boom adjustable according to the rules
- Slatted height adjustable from 150 to 650 cm
- With toothed belt system and crank
- Direct reading of jump heights
- Reading window with fine adjustment with regard to staff and take-off level
- Injury-neutral, without any components penetrating into the jump space

art.-no. productspecification

Pole vault stand

4902613	Pole vault construction „Comfort“
4901109	Surcharge for coatable special ground socket
4902615	Same as Art. 4902613, but self standing with weights
4382930	Safety pad for pole vault stand

POLE VALUT MAT

Pole valut mat

Optimal execution for club sports and national competitions. The integrated cross and longitudinal channels allow the air to escape very quickly. This hollow chamber system guarantees one of the softest landings. The spike mesh fabric is particularly skin-friendly and extremely tear-resistant.

Grid protection material

- Particularly skin-friendly
- Extremely tear resistant
- Athlete is protected of friction burn

- Perfect ventilation
- Black tarpaulin and green mesh fabric
- Also available in other colours

Accessories

- Additional side protection pads for rails
- Attachment blocks in different sizes
- High density foam blocks for the vault box area
- Protection pads for the pole vault uprights

Pole vault mat „Basic“

With integrated wear mat. The mono block system creates a harder landing. The pole vault mat „basic“ is suitable for school sports, as falling height is much lower.

Application

- School sport

Kernel

- Mono block system RG 18



Wear mat

- solid PUR foam RG 20, 100 mm

Cover

single piece cover with weather proof plastic zipper, protective mesh web (spike proof) integrated in the cover, spike proof mesh web throughout the complete landing area guarantees the best possible air circulation, on the sides PVC-tarpaulin

Ground

- PVC-tarpaulin, non-slip

Pole vault mat „Simple“

The pole vault mat „simple“ is suitable for school and club sport. The hollow block system creates a soft landing. The air can flow quickly through the integrated channels. The wear mat is separated from the hollow foam blocks due to a intermediate base.

Application

- School & club sport

Kernel

- Double hollow foam block RG 23



Wear mat

- solid PUR foam RG 20

Intermediate base

- PVC-tarpaulin

Cover

two pieced cover with intermediate base and weather proof zipper, protective mesh web (spike proof) integrated in the cover, spike proof mesh web throughout the complete landing area guarantees the best possible air circulation, on the sides PVC-tarpaulin

Ground

- PVC-tarpaulin, non-slip

Pole vault mat „Pro“

The pole vault mat „pro“ is suitable for the more ambitious applications and users. The double hollow kernel system creates one of the softest landings. The foam blocks are single covered additionally. The wear mat is separated from the hollow foam blocks due to a intermediate base.

Application

- Club sport & competition

Kernel

- Double hollow foam block RG 23



Mear mat

- solid PUR foam RG 20

Intermediate base

- PVC-tarpaulin

Cover

two pieced cover with intermediate base and weather proof zipper, protective mesh web (spike proof) integrated in the cover, spike proof mesh web throughout the complete landing area guarantees the best possible air circulation, on the sides PVC-tarpaulin

Unterboden

- PVC-tarpaulin, non-slip

POLE VALUT MAT

Art.-no. „Basic“	Depth	Width	Height	Norm
4446558	650 cm	500 cm	80 cm	Training mat
4447058	700 cm	500 cm	80 cm	DLV Norm
4448068	800 cm	600 cm	80 cm	IAAF / WA Norm

Art.-no. „Simple“	Depth	Width	Height	Norm
4456558	650 cm	500 cm	80 cm	Training mat
4457058	700 cm	500 cm	80 cm	DLV Norm
4458068	800 cm	600 cm	80 cm	IAAF / WA Norm

Art.-no. „Pro“	Depth	Width	Height	Norm
4466558	650 cm	500 cm	80 cm	Training mat
4467058	700 cm	500 cm	80 cm	DLV Norm
4468068	800 cm	600 cm	80 cm	IAAF / WA Norm

POLE VALUT MAT „RAIN COVER“

Colour according to customer requirements in standard RAL colours



Pole valut mat „Rain cover“

- Made of heavy PVC tarpaulin
- Completely welded
- With four tensioning ropes at the corners to hook at the mat or the grid
- With or without recess in the pole vault box area

Art.-no. „Basic“	Depth	Width	Height	Norm
4446558	650 cm	500 cm	80 cm	Training mat
4447058	700 cm	500 cm	80 cm	DLV Norm
4448068	800 cm	600 cm	80 cm	IAAF / WA Norm

POLE VALUT



Pole vault crossbar, 3-point

- light yellow competition and training high jump crossbar
- 3-fold fibreglass reinforced
- excellent background contrast effect
- extremely low deflection
- solid and durable
- heavy support ends for maximal possible frictional resistance
- length 400 cm
- according to World Athletics-Certification requirements

Pole vault crossbar, 5-point

- dark yellow, heavy competition high jump crossbar
- 5-fold matrix reinforced polyester
- excellent background contrast effect
- lowest deflection
- solid and nearly indestructible
- heavy support ends for maximal possible frictional resistance
- length 400 cm
- according to World Athletics-Certification requirements

art.-no. productspecification

Pole vault crossbar

4025400	Pole vault crossbar 5-point
4024400	Pole vault crossbar 3-point



Support grid for pole vault mat

Support grid made of aluminium

- Support grid made of aluminium
- Consisting of 2 screwable parts
- Complete height 10 cm
- Slatted frame made of 20 cm wide aluminium profiles
- Incl. 4 brackets (back and sides) to prevent the mat from slipping

Available as well as mobile version with removable wheels (only used for transport)

ADVANTAGE: The high jump mat can be quickly moved.

PE support grid

- „ALL“ mats can be produced with an integrated PE support grid:
- Polyethylene grid
- 10 cm height- additional protection for the rails

Advantages of a PE support grid

- Fixed position, as the support grid is integrated in the mat
- No risk of injury
- Space-saving during storage

art.-no. productspecification

Support grid for pole vault mat

2236013	Support grid for pole vault mat 5x3 m
2236014	Support grid for pole vault mat 6x4 m
2236016	Surcharge for mobile grid, high jump
4222222	Surcharge for integrated support grid

SAFETY COVER

„BASIC“

Safety cover „Basic“

Mobile safety cover for high jump and pole vault

- ground frame made of aluminium, fully welded
- lateral aluminium cassettes
- roof construction made of aluminium board wall profiles
- surface accessible
- big covered plastic wheel for an easy movement
- delivery in two or three parts
- elements are connected with clamping levellers
- lockable (excluding lock)
- with big stiff wheels

art.-no. productspecification

Safety cover „Basic“

4902680	Safety cover „basic“ for high jump
4902685	Safety cover „basic“ for pole vault
4902698	Surcharge for lowerable construction (without ill.)
4902690	Surcharge for two steering wheels per element (high jump)
4902695	Surcharge for two steering wheels per element (pole vault)
4902696	surcharge for folding mechanism on one side of the stripe if the safety cover can only be moved to one side

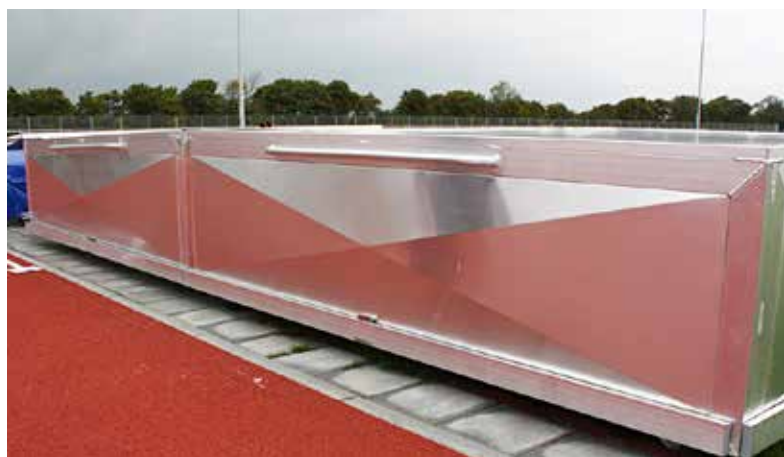

SAFETY COVER

„STRONG“

Safety cover „Strong“

- When lowered, the cover rests directly on the floor all around. So, the mat is protected from vandalism and rodents.
- Minimum pressure on athletic track. Imprints caused by rollers do not occur.
- The cover is made of aluminium and is completely welded
- The special interlocking, sealed board wall profiles prevent the penetration of water.
- The steerable version (high jump 2-parts, pole vault 3-parts) can be manoeuvred around its own axis
- The cover is manufactured under pretension and can therefore withstand high loads



Essential advantages of the lowerable safety cover „Strong“

Features of the safety cover „Strong“

- Fully welded construction made of aluminium
- Pre-stressed, curved roof shape (snow load)
- Lowering- without surcharge
- Full surface contact limits the risk of material damages on the track (EPDM-flooring)
- Incl. welded-on handles
- Lowering via spindle with crank
- Internal, broad drum wheels

SAFETY COVER „STRONG“



High jump safety cover „Strong“ two-piece, lowerable, movable and steerable

- Closed fronts
- Incl. lateral brass spigots and counter support to connect the elements
- Guide pins as connectors
- Individual elements steerable (hand cart principle)
- Integrated gutter for water drainage between the elements
- No lock is needed when the elements are connected

art.-no. productspecification High jump safety cover „Strong“ two-piece

2236021 High jump safety cover, steerable



High jump safety cover „Strong“ one-piece, absenkbar, fahrbar nach hinten und vorne



High jump safety cover „Strong“ one-piece, lowerable and movable to the rear and to the front

- 2-part construction, inner joint surfaces screwed and sealed with silicone
- Front side with a hatch incl. handle
- Hatch is opened by gas pressure springs

art.-no. productspecification High jump cover „Strong“ 1-piece

2236020 High jump cover with hatch, one-sided
2236024 Surcharge for an additional hatch (on request)

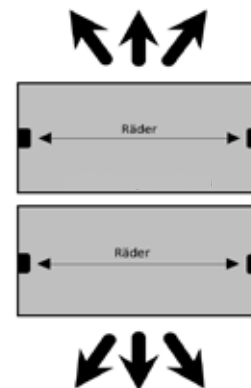

High jump safety cover „Strong“ two-piece, absenkbar, fahrbar und lenkbar

Safety cover „Strong“ for folding high jump mat

- Stationary safety cover for folding mat or as storage space
- Complete fully welded construction made of aluminium
- Pre-stressed, arched roof (snow load)
- For dowelling on foundations
- With two door wings including support wheels
- Opening for ventilation in the upper rear area (approx. 30 mm wide)

art.-no. productspecification stationary safety cover

9999998 cover on demand
(Size according to individual requirements)

SAFETY COVER „STRONG“

Attention!
With a 1-piece
cover only
mobile, not
steerable!

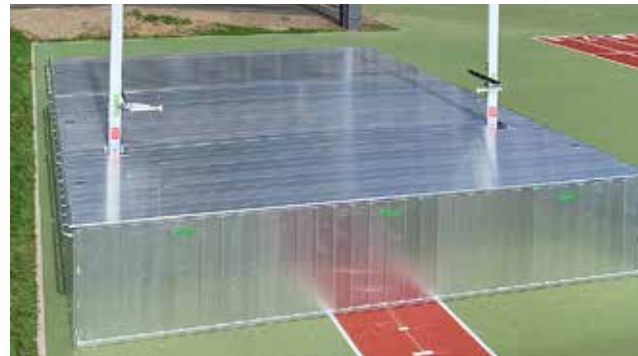

Pole vault cover „Strong“ 1-piece, lowerable, movable to the rear and to the front

- Delivery in 3 pieces, inner joint surfaces screwed and sealed with silicone
- Front side with a hatch incl. handle
- Hatch is opened by gas pressure springs

art.-no. productspecification

Pole vault cover „Strong“ 1-piece

2236022	Pole vault cover with hatch one-sided
2236024	Surcharge for additional hatch (on demand)

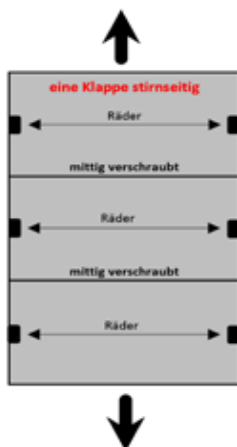

Pole vault cover „Strong“ 1-piece, lowerable, movable to the rear and front

Pole vault cover „Strong“ 3-pieces movable and steerable

- Closed fronts
- Incl. lateral brass spigot and counter support to connect the elements
- Guide pins as connectors
- Individual elements steerable (handcart principle)
- Gutter integrated between the elements for water drainage
- No lock is needed when the elements are connected

art.-no. productspecification

Pole vault cover „Strong“ 3-piece

2236023	Pole vault cover, steerable
---------	-----------------------------

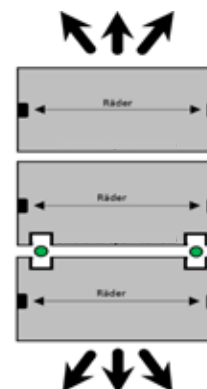

Pole vault cover „Strong“ 3-pieces, lowerable, movable and steerable

OUTDOOR WORKOUT



WORKOUT „SMALL“

Die Workout-
kombinationen
können Be-
liebig kombini-
ert werden. Einfach
Anfragen!

Workout „Small“

- according to „DIN EN 1176“ (playground equipment) (only for type Small & Medium)
- according to „DIN EN 16630“ (outdoor fitness equipment) (all types)
- steel hot galvanised and powder coated
- attachment through foundation, alternative plugs
- posts made of 80 x 80 x 3 mm, standard in RAL 9005 deep black
- brace made of 60 x 60 x 3 mm, standard in RAL 6018 yellow-green
- grip rods made of Ø 33,7 x 3,2 mm, standard in RAL 6018 yellow-green
- other RAL-colours on request

According to DIN EN 1176

- max. fall height 2300 mm
- Required area 49,5 m² (6,1 x 8,1 m)

According to DIN EN 16630

- max. fall height 1300 mm
- Required area 42 m² (5,6 x 7,5 m)

- Length 4480 mm
- Width 2610 mm
- Height 2400 mm

- 2x Pull Up Bars, different heights
- 1x Double Parallel Bars
- 1x Swedish Wall

art.-no. productspecification

Workout „Small“

- | | |
|---------|------------|
| 4600010 | foundation |
| 4600011 | plugs |

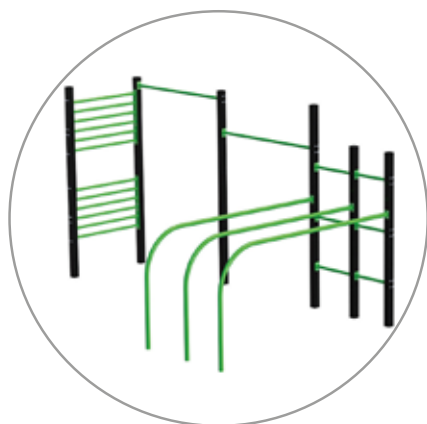

WORKOUT „MEDIUM“

Die Workout-
kombinationen
können Be-
liebig kombiniert
werden. Einfach
Anfragen!



Workout „Medium“

- according to „DIN EN 1176“ (playground equipment) (only for type Small & Medium)
- according to „DIN EN 16630“ (outdoor fitness equipment) (all types)
- steel hot galvanised and powder coated
- attachment through foundation, alternative plugs
- posts made of 80 x 80 x 3 mm, standard in RAL 9005 deep black
- brace made of 60 x 60 x 3 mm, standard in RAL 6018 yellow-green
- grip rods made of Ø 33,7 x 3,2 mm, standard in RAL 6018 yellow-green
- other RAL-colours on request



According to DIN EN 1176

- max. fall height 2300 mm
- Required area 80 m² (8,9 x 9,0 m)

According to DIN EN 16630

- max. fall height 1300 mm
- Required area 66 m² (8,5 x 7,7 m)

- Length 5560 mm
- Width 4760 mm
- Height 2400 mm

- 5x Pull Up Bars, different heights
- 1x Double Parallel Bars
- 1x Swedish Wall
- 1x Monkey Bar

art.-no. productspecification

Workout „Medium“

- | | |
|---------|------------|
| 4600020 | Foundation |
| 4600021 | Plugs |

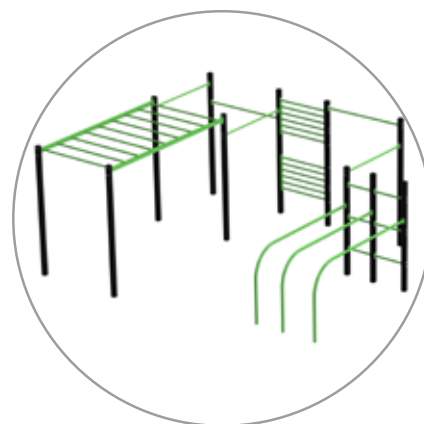

WORKOUT „LARGE“

Workout „Large“

- according to „DIN EN 1176“ (playground equipment) (only for type Small & Medium)
- according to „DIN EN 16630“ (outdoor fitness equipment) (all types)
- steel hot galvanised and powder coated
- attachment through foundation, alternative plugs
- posts made of 80 x 80 x 3 mm, standard in RAL 9005 deep black
- brace made of 60 x 60 x 3 mm, standard in RAL 6018 yellow-green
- grip rods made of Ø 33,7 x 3,2 mm, standard in RAL 6018 yellow-green
- other RAL-colours on request

According to DIN EN 1176

- max. fall height 2300 mm
- Required area 107 m² (13,6 x 7,9)

- Length 10570 mm
- Width 4880 mm
- Height 2400 mm

- 12x Pull Up Bars, different heights
- 2x Double Parallel Bars
- 2x Swedish Wall
- 1x Monkey Bar
- 2x Push Up bars

art.-no. productspecification

Workout „Large“

- | | |
|---------|------------|
| 4600030 | Foundation |
| 4600031 | Plugs |

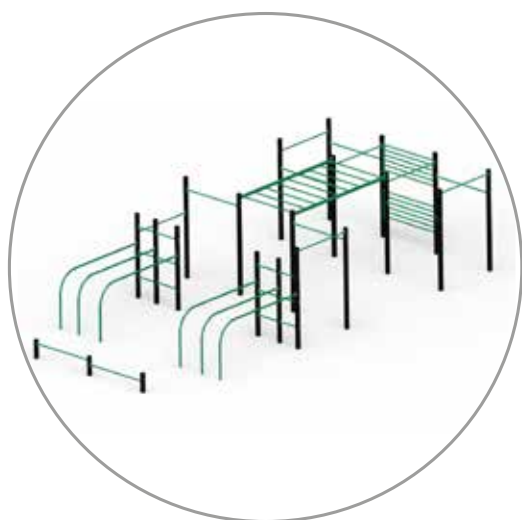

POWER WALL

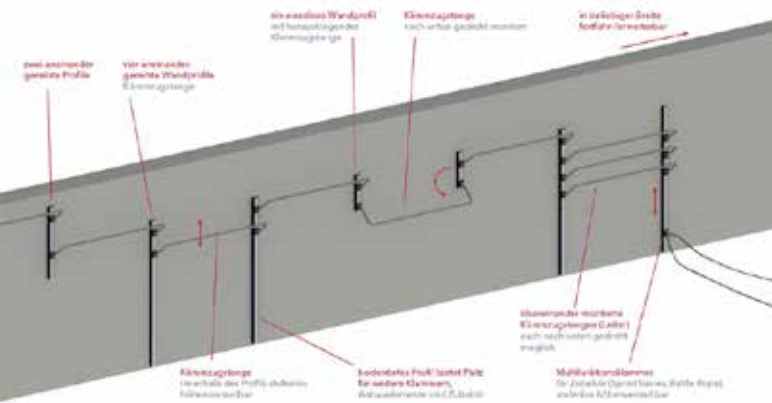

Power Wall „Type A“

- Wall version – using the retaining/concrete walls or Power Hills
- The length of the wall profiles is an example and can also be uniformly short/long

art.-no. productspecification

Power Wall „Type A“

4600010 for setting in concrete

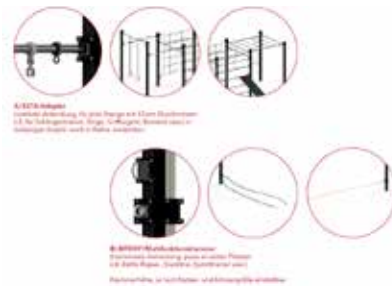

Details of possible accessories for all Power Wall types

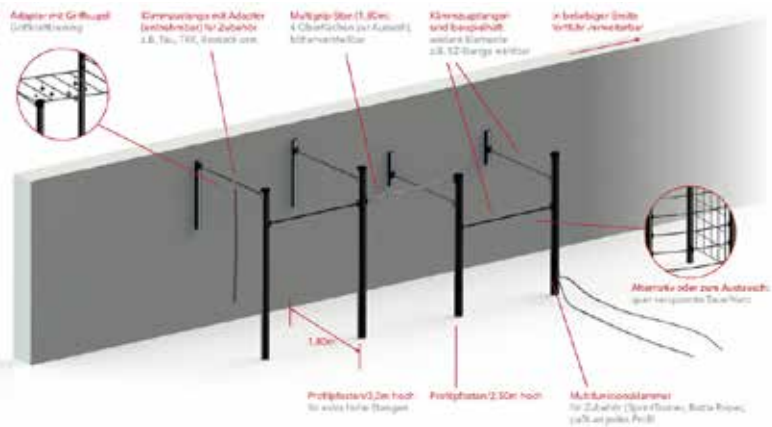

Power Wall „Type B“

- Wall version - using the retaining/concrete walls or Power Hills
- 1.80 m design grid for maximum flexibility
- The selected bars are an example. Also imaginable are wall bars, snake ladders, ergonomic SZ or innovative OCR pole

art.-no. productspecification

Power Wall „Type B“

4600010 for setting in concrete

Power Wall „Type C“

- Wall version - using the retaining/concrete walls or Power Hills
- Despite the space-saving 1.0 m special dimension for the poles intruding in the room, the 1.80 m grid remains the same
- Alternatively, bouldering wall modules, ball throwing wall or physiotherapeutic equipment (fascia roller) are available

art.-no. productspecification

Power Wall „Type C“

4600010 for setting in concrete



CALISTHENICS LEAGUE

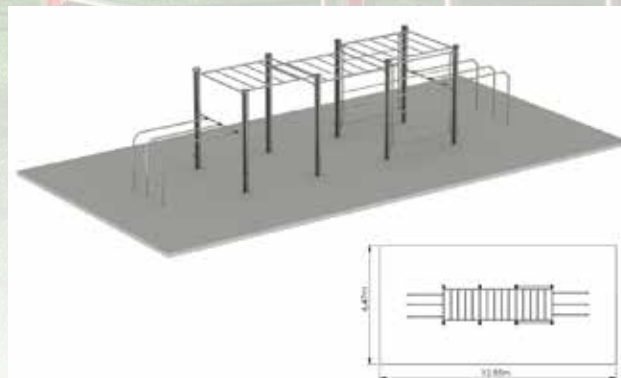
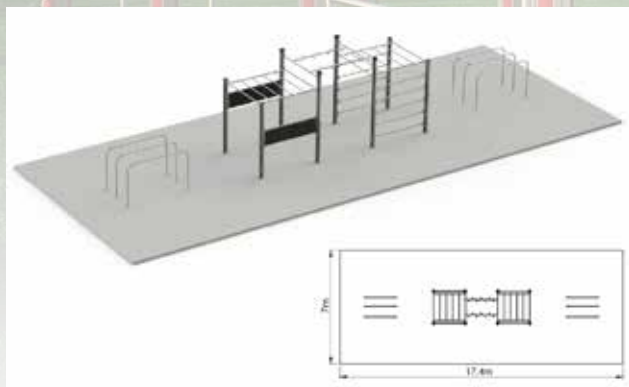

Calisthenics League

- Multifunctional, cross-shaped upright profile
- Clamp fastening system for cross braces
- Stainless steel posts
- Grip rods etc. made of brushed stainless steel
- Incl. TÜV GS seal
- In accordance with DIN EN 16630:2015-06 (outdoor fitness equipment)
- According to DIN EN 1176-1:2017-12 (playgrounds)

League Typ 1

- 4 Stk. post, height 250cm
- 4 Stk. post, height 300cm
- 2 Stk. Swedish Walls consisting of five bars Ø 33 mm
- 2 Stk. Monkey ladders/ wall bars, 6 bars
- 1 Stk. monkey ladder with grips and balls (Obstacle Course Races)
- 2 Stk. wall elements, multi-purpose basic wall (base/parkour)
- 2 Stk. 3-piece bar, free-standing for setting in concrete, Ø 42 mm
- 4 Stk. multi-purpose clamps to fix Battle Ropes etc.
- incl. fixing kit (anchor rods and injection mortar)
- incl. manufacturer's plate, assembly and installation instructions, maintenance instructions

art.-no. productspecification

Calisthenics League „Type 1“

4600040 Calisthenics League Type 1

Calisthenics League

- Multifunctional, cross-shaped post profile
- Clamp fastening system for cross braces
- Stainless steel posts
- Grip rods etc. made of brushed stainless steel
- Incl. TÜV GS seal
- In accordance with DIN EN 16630:2015-06 (outdoor fitness equipment)
- According to DIN EN 1176-1:2017-12 (playgrounds)

League Typ 2

- 8 Stk. post, height 250cm
- 2 Stk. Swedish Wall, 6 bars
- 3 Stk. monkey ladders/ wall bars, 6 bars
- 2 Stk. monkey ladders/ wall bars, 6 bars
- 2 Stk. 3-piece bar, free-standing for setting in concrete, Ø 42 mm
- 8 Stk. multi-purpose clamps to fix Battle Ropes etc.
- incl. fixing kit (anchor rods and injection mortar)
- incl. manufacturer's plate, assembly and installation instructions, maintenance instructions

art.-no. productspecification

Calisthenics League „Type 2“

4600040 Calisthenics League Type 2

OUTDOOR FITNESS EQUIPMENT



Outdoor health training - the modern training spots for parks and jogging routes.

The numerous positive health effects of a calisthenics outdoor training are proved scientifically. Dr. Wolff's multifunctional training devices have been developed according to a sports science outdoor trainings concept.

Different and cost-effective:

The multifunctional Dr. Wolff training spots integrate harmoniously in parks and green areas.

An efficient solution for small spaces with a double advantage:

The walker finds a comfortable place to sit – the fitness athlete finds his perfect training medium for the workout.

Discover the new form of a varied and health-oriented outdoor training in your favorite places.

The advantages in view - training with movement quality

- Sports science training concept from experienced supplier
- Complete training programs can be performed on each device.
- Medical fitness: Different trunk muscle exercises to avoid back pain
- Target group specific programs via QR code and video: Back circuit training, abdomen/legs/ buttocks, total body workout

High quality product!

Stable and robust even under intensive load thanks to clever frame construction made of stainless steel. 100 % Made in Germany: long-lasting, sustainable and almost maintenance-free.

Outdoor Multi-Trainer

- complies with DIN EN 16630:2015 and DIN EN 1176-1:2008
- TÜV GS seal, ISO certificate



Outdoor Multi-Trainer

- The perfect training station for small spaces - less is sometimes more!
- No cost-intensive training facility with elaborate landscaping
- No fall protection necessary
- Easy assembly - optionally pre-fabricated foundation
- No challenging calisthenics exercises
- Health training for everyone
- Enormous exercise variety

Multi Trainer Art. # 4600801

Dimensions: W: 126 D: 141 H: 98 cm
Falling range: 426 x 441 cm
Fall height: 98 cm

Prefabricated Art. # 4602800

For the assembling of all outdoor fitness devices, M10 screws are needed.
(Screws not included in the scope of delivery)



Information plate

art.-no.	productspecification
4600801	Outdoor Multi-Trainer
4601801	Information plate Multi-Trainer
4601800	Optional pre-fabricated foundation



Outdoor fitness bench

- Probably the most sporty park bench in the world!
- Unique design - a real eye-catcher in your garden or in the park:
- Very comfortable seat made of stainless steel with high-quality perforated design
- Compact and robust stainless steel construction for high training loads
- Multi-functional: it offers over 20 different fitness exercises

Outdoor fitness bench Art. # 4600800

Dimensions: W: 126 D: 124 H: 98 cm
 Falling area: 425 x 427 cm
 Free fall height: 98 cm

Prefabricated foundation Art. # 4602800

For the assembling of all outdoor fitness devices, M10 screws are needed.
 (Screws not included in delivery)

Outdoor back trainer

- Suitable for strengthening the back muscles to avoid back pain
- the modern version of an outdoor back training
- 2 different starting positions for small and tall persons
- designed for fitness- and physiotherapy exercises

Back trainer Art. # 4600802

Dimensions: B: 105 T: 32 H: 89 cm
 Falling area: 333 x 404 cm
 Free fall height: 89 cm

Pre-fabricated foundation Art. # 4602800

For the assembling of all outdoor fitness devices, M10 screws are needed.
 (Screws not included in delivery)

art.-no. productspecification

Outdoor fitness bench

4600800	Outdoor fitness bench
4601800	Sign fitness park bench
4602800	Optional pre-fabricated foundation

art.-no. productspecification

Outdoor back trainer

4600802	Outdoor back trainer
4601802	Sign back trainer
4601800	Optional pre-fabricated foundation

SLACKLINE



Slackline

- Slackline post made of aluminium
- 120x100 mm profile, reinforced with steel
- Total length 160 cm, visible length 120 cm
- Studs at 50, 75 and 100 cm
- Optional slackline posts with platform with welded aluminium support plate with screen printing plate ø60 cm

art.-no.	productspecification
Slackline	
2901000	Slackline posts, aluminium with steel core
2901003	Surcharge for slackline platform
2901001	Special socket for slackline posts
2901002	Standard socket for slackline posts
4001000	Slackline Classic, length 15m



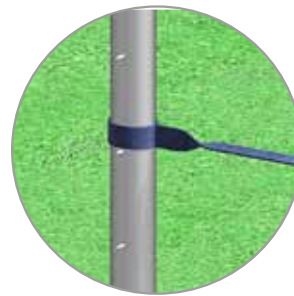

OUTDOOR STORAGE BOX

Outdoor storage box

Storage box made of aluminium hollow chamber profile, fully welded, in the base area with 4 welded-on lugs, with holes for ground anchors, lid with hinge, handle, gas pressure spring, all sizes possible.

art.-no.	productspecification
Storage box	
2530506	Size 300 / 50 / 60 cm
2535506	Size 350 / 50 / 60 cm
2540506	Size 400 / 50 / 60 cm
2550001	Post holder 1 pair
2550002	Post holder 2 pair
2550003	Handles bei 50 cm width
2550004	Handles bei 100 cm width
2550005	Surcharge movable with 4 swivel rolls



BEACH SPORTS



BEACH SPORTS



Beach Soccer

Beach Soccer „fully welded“

- Size 5,50 m x 2,20 m
- Goal frame made of 120x100 mm aluminium oval profile
- Fully welded
- Yellow powder coated
- Display 80/150 cm

Beach Soccer „pluggable in ground sockets“

- Size 5,50 m x 2,20 m
- Goal frame made of 120 x 100 cm aluminium oval profile
- Fully welded
- Yellow powder coated
- Display 80/150 cm
- On top net hoops – preloaded
- Display 80 cm

art.-no. productspecification

Beach Soccer

2800201	Beach soccer goal, fully welded, „Basic“
2800203	Beach soccer goal, fully welded, „Smart“
2801201	Beach soccer goal, pluggable, „Basic“
2801203	Beach soccer goal, pluggable, „Smart“



Beach handball goal

Beach Handball goal „fully welded“

- Size 3,00 m x 2,00 m
- Goal frame made of 80 x 80 mm aluminium square profile
- Fully welded
- Yellow powder coated
- Display 80/150 cm

Beach handball goal „pluggable in ground sockets“

- Size 5,50 m x 2,20 m
- Goal frame made of 120x100 mm aluminium oval profile
- Fully welded
- Yellow powder coated
- Display 80/150 cm
- On top net hoops – preloaded
- Display 80 cm

art.-no. productspecification

Beach handball goal

2800101	beach handball goal, fully welded, „Basic“
2800103	beach handball goal, fully welded, „Smart“
2801101	beach handball goal, pluggable, „Basic“
2801103	beach handball goal, pluggable, „Smart“

Accessories Beach sports

art.-no. productspecification

Accessories Beach Soccer

4810175	chain weights for beach soccer goals, display 150 cm, length 8,70 m
4810151	beach soccer net, 4 mm, blue

art.-no. productspecification

Accessories Beach Handball

4810175	chain weights for beach handball goals, display 100 cm, length 5,00 m
4810151	beach handball net, 4 mm, yellow

BEACH VOLLEYBALL



„Competition“ construction

- Aluminium profile 120x100 mm
- Wall thickness 4/6 mm
- Complete mechanism located inside
- Height adjustment on the backside with removable crank by means of a trapezoidal threaded rod
- Height adjustment with non-tensioned net
- Net tensioning with a removable crank by means of a second trapezoidal threaded rod
- One crank for height adjustment and net tensioning
- for net tensioning rope lengths from 11.20 m to max. 12.50 m
- Infinitely variable height adjustment with tensioned net
- Posts made of black powder coated aluminium
- On request in blank aluminium

„more Competition“

- Aluminium profile 120x100 mm
- Wall thickness 4/6 mm
- Complete mechanism located inside
- Height adjustment via „centrifugal clutch“ with removable crank - NEW DEVELOPMENT!
- Height adjustment with non-tensioned net
- Net tensioning with a removable crank by means of a second trapezoidal threaded rod
- One crank for height adjustment and net tensioning
- For net tensioning rope lengths from 11.20 m to max. 12.50 m
- Infinitely variable height adjustment with tensioned net
- Posts made of black powder coated aluminium
- On request in blank aluminium

art.-no. productspecification

Volleyball construction „Competition“

1800320	Volleyball, „Competition“ device, black powder coated
4800310	Lower price in aluminium blank
4800305	Surcharge for powder coating in a RAL colour of your choice

art.-no. productspecification

Volleyball construction „more Competition“

1800325	Volleyball multi-purpose facility „more Competition“
4800310	Lower price in aluminium blank
4800305	Surcharge for powder coating in a RAL colour of your choice

Volleyball free time „Basic“ with threaded spindle - according to DIN EN 1270 class C

- Aluminium profile 120x100 mm or 80x80 mm
- External height adjustment
- Net tensioning by means of a threaded spindle and a crank
- Posts in aluminium blank

art.-no. productspecification

Beachvolleyball construction free time „Basic“

2800301	Beach volleyball, „free time“ 120 x 100 mm
2800309	Beach volleyball, „free time“ 80 x 80 mm
2800312	Beach Volleyball Leisure facility „Basic“, 120 x 100 mm / deeper installation
2800313	Beach Volleyball Leisure facility „Basic“, 80 x 80 mm / deeper installation
4800305	Surcharge for powder coating in a RAL colour of your choice
4900269	Replacement crank for volleyball leisure facility „Basic“



BEACHSPORT



Beach volleyball leisure facility „Pro“ with pulley - according to DIN EN 1270 class C

- Aluminium profile 120/100 mm or 80/80 mm
- Height adjustable by external adjuster
- Net tensioning by means of a pulley (no crank necessary!)
- For net tensioning rope lengths from 11.20 m to max. 12.00 m
- Pulley mechanism inside a closed aluminium profile
- For volleyball (men, women, juniors and pupils) fist ball, indiacca and badminton

art.-no. productspecification

Beach volleyball leisure facility „Pro“

2800315	Beach volleyball leisure facility „Pro“ 120 x 100 mm
2800316	Beach volleyball leisure facility „Pro“ 80 x 80 mm
2800317	Beach volleyball leisure facility „Pro“ 120 x 100 mm / deeper installation
2800318	Beach volleyball leisure facility „Pro“ 80 x 80 mm / deeper installation
4800310	surcharge for aluminium blank
4800305	surcharge for powder coating in a RAL-colour of your choice

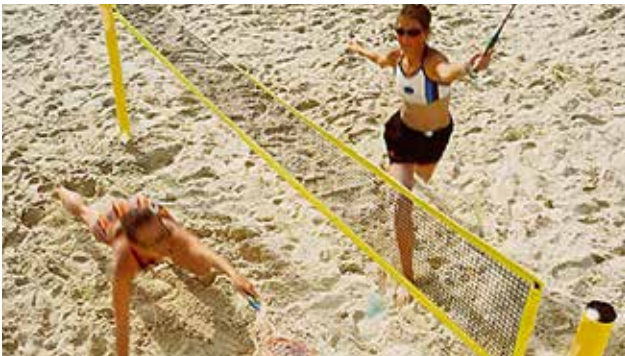

Beach - Badminton

- Aluminium profile 120 x 100 mm
- External height adjustment
- Posts in aluminium blank
- Tension height 155 cm

art.-no. productspecification

Beach Badminton

2800301	beach badminton, tension height 155 cm
---------	--



Beach - Tennis

- Aluminium profile 120 x 100 mm
- External height adjustment
- Posts in aluminium blank

art.-no. productspecification

Beach Tennis

2800301	Beach Tennis
---------	--------------

BEACH SPORTS & ACCESSORIES

Beach cover

- sturdy mesh web, all over with hemstitches
- colour: moss-green
- all around chain (6 mm, hot galvanised) for weightening the cover
- 4 open corners with carabiner hooks for installing

art.-no. productspecification

Beach cover

4030020 Cover, loose, with chain



Beach - net and antennas

art.-no. productspecification

Beach net and antenna

4850906 beach volleyball net, 2 mm, yellow PVC band, 9,50 x 1,00 m, Line 11,70 m
 4805044 beach volleyball net tournament, 3 mm, DWV, neonpink
 4800606 beach badminton nete, 1 mm, 6,00 x 0,76 m, yellow
 4800509 beach antenna one-piece, DWV certificated, yellow
 4805029 beach antenna two-piece, length 1,80 m



Beach - safety pad

art.-no. productspecification

Beach safety pad

4801000 Safety pad 120/100 mm, with Velcrotape
 4801100 Safety pad 80/80 mm, with Velcrotape



Beach - ground sockets

art.-no. productspecification

Beach ground sockets

2800303 Beach volleyball ground socket, 120/100 mm
 2800305 Beach volleyball ground socket, 80/80 mm
 2800304 Beach volleyball deeper installation with base ring, 120/100 mm
 2800306 Beach volleyball deeper installation with base ring, 80/80 mm
 2800502 Beach volleyball anchor plate, steel, „free time“ posts, 120/100 mm
 2800505 Beach volleyball anchor plate, steel, „free time“ posts, 80/80 mm
 2800504 Beach anchor plate for beach Soccer / Handball, no tilting



BEACH EDGE ELEMENT ABSORBED SOLUTION „TYPE 2000“



Beach - edge element „Type 2000“, absorbed solution

beach edge type 2000, «absorbee solution», consists of guide and stabilising element made of hot galvanised steel and polyurethane bound rubber granules (not colour resistant)

- Beach pitch 22 x 14 m (internal measurement) for one volleyball field
- Beach pitch 26 x 22 m (internal measurement) for one double volleyball field
- Beach pitch 39 x 28 m (internal measurement) for one soccer field

Materials:

- 1. normal element, rubber granules, polyurethane-bound, red, green, black or grey.
- 2. corner element, rubber granules, polyurethane-bound, red, green, black or grey.
- 3. Guide and stabilisingelement, steel, hot galvanised, length 300 cm.

art.-no. productspecification

Beach edge element „Type 2000“

3030005	stabilising element 200 cm
3030100	normal element red
3030101	corner element red
3030110	normal element green
3030111	corner element green
3030115	installation template
3621420	PUR glue red
3621421	PUR glue green

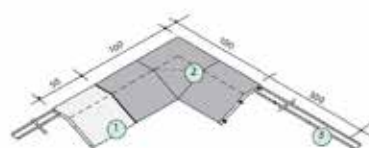
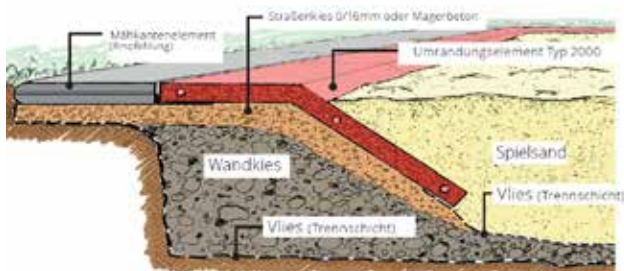

- Materialien:
1. Normalelement, Gummigranulat, polyurethan gebunden, rot, grün, schwarz oder grau.
 2. Eckelement, Gummigranulat, polyurethan gebunden, rot, grün, schwarz oder grau.
 3. Führungs- und Stabilisierungselement, Stahlblech, sandstrahlverzinkt, BL 300 cm.

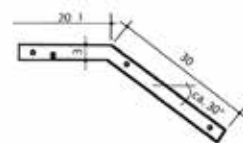

BEACH EDGE ELEMENT

RAISED SOLUTION „TYPE 98“

Beach - edge element „Typ 98“, raised solution

beach edge type 98, «raised solution», elements made of galvanised steel, 2 mm thick; corner and connection elements made of chrome steel; stabilising elements made of hot galvanised steel; rust free tensioning and assembly materials.

- Beach pitch 22 x 14 m (internal measurement) for one volleyball field
- Beach pitch 26 x 22 m (internal measurement) for one double volleyball field
- Beach pitch 39 x 28 m (internal measurement) for one soccer field

art.-no. productspecification

Beach edge elemnt „Typ 98“

3030002	fitting element 274 cm without guide
3030003	corner element type 98, chromed 200cm
3030004	connection element
3030005	stabilising element 200 cm
3030006	corner elemen type 98, side length 108/108cm, steel
3030007	fitting element 74 cm without guide
3030009	tension set simple system
3030010	assembly material simple system
3030011	length variable
3130001	normal element type 98 left
3130009	tension set double system
3130010	assembly material double system
3230001	normal element type 98 right

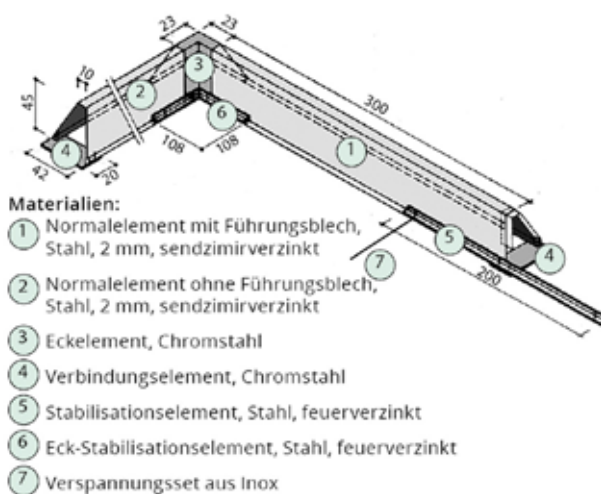

Beach - edge element „Typ 08“, raised solution

Design and construction of type 98 and type 08 are similar. Type 08, however, has a vertical external side, suitable for a connection with a ball catching system. Type 08 and type 98 can be combined.



SHOE WASHING SYSTEMS

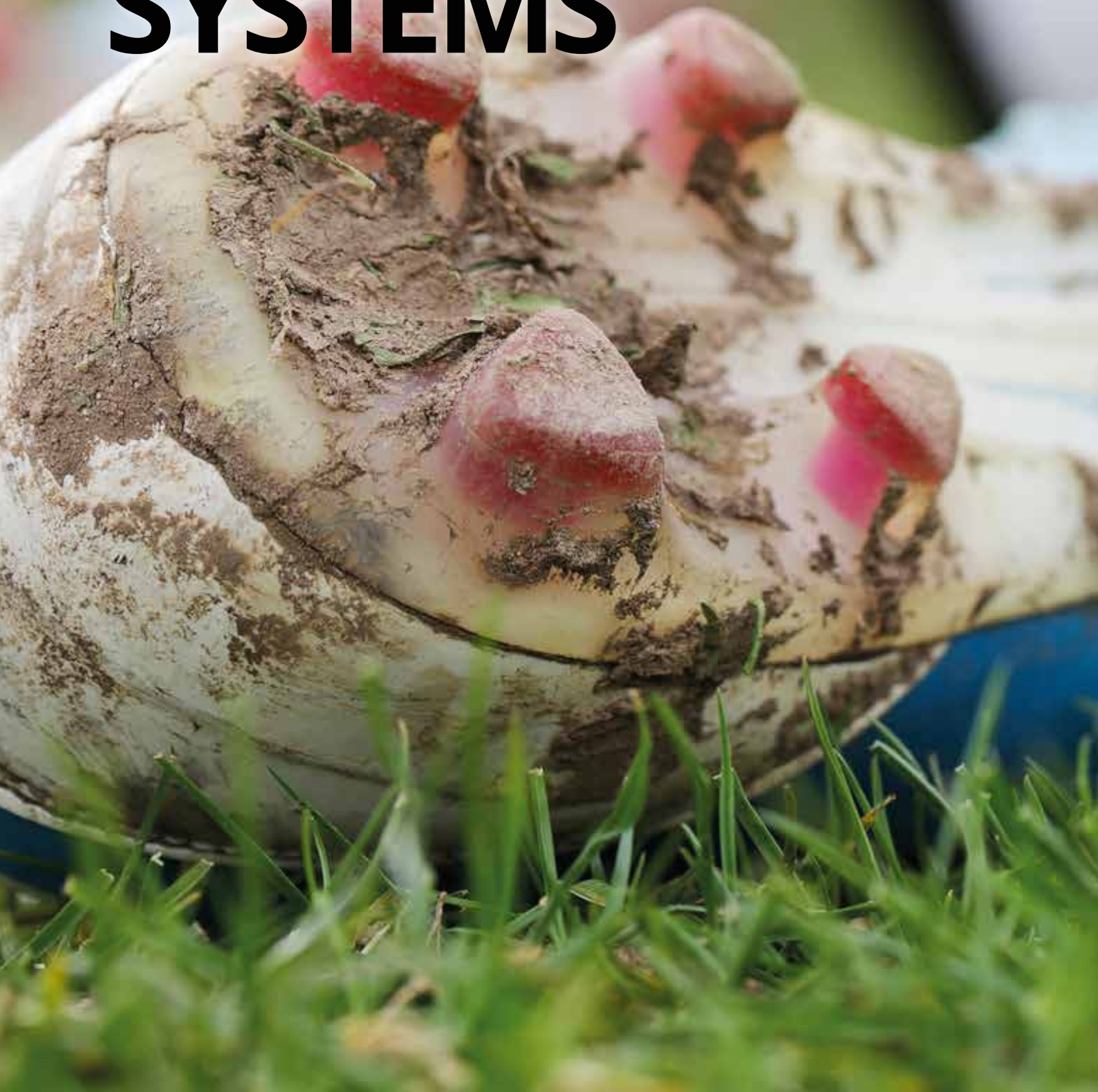

SHOE WASH SYSTEMS „TYPE A“



Shoe washing system „Type A“, the raised solution for shoe and device cleaning

Wash trough

concrete, formwork smooth, reinforced with edge protection-angled iron, hot-galvanised, 2 – parted folding grillage, mesh width 31/31mm, bar-height 25mm. drain Ø4,5cm, left or right (from the user side), incl. plugs. content: 250l, weight approx. 380kg

Washing hanger

Steel profiles 100 x 50 mm, hot-galvanised, water bearing, ½ incl. faucet connections ¾ and LW 16 water connection nozzles 1". (Welded, galvanised)

Transfer

The following work must be performed on site: foundation / support, water connection and drain with sludge collector

Note

When ordering we need the information whether the drain is desired to be left or right as well as the water connection (please refer to the drawings).

Annotation

The trough can also be recessed.
Top edge trough = trough ground.

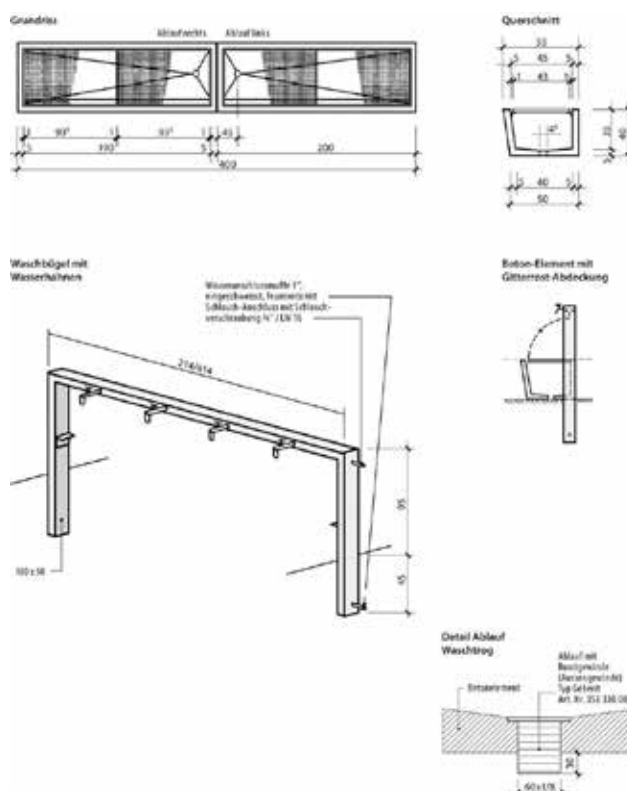

Wash trough, concrete element Type A

- grey, incl. grillage, weight 380 kg

art.-no. productspecification

Wash trough, concrete element Type A

3005100

Wash trough concrete element Type A

SHOE WASH SYSTEMS „TYPE A“

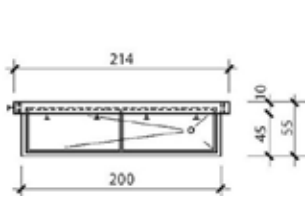

Shoe wash systems Type A1

- 1 wash trough concrete element type A, incl. 2 grillages
- 1 washing hanger type A1
- 4 taps, plain chromed
- 1 hose fitting

art.-no. productspecification

Shoe wash systems Type A1

3005180 Shoe wash system complete type A1

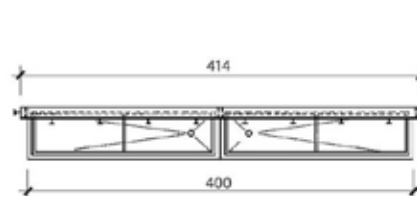

Shoe wash systems Type A2

- 2 wash trough concrete element type A, incl. 2 grillages
- 1 washing hanger type A2
- 8 taps, plain chromed
- 1 hose fitting

art.-no. productspecification

Shoe wash systems Type A2

3005181 Waschtrog komplett Typ A2

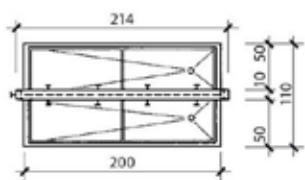
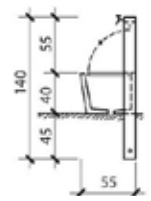

Shoe wash systems Type A3

- 2 wash trough concrete element type A, incl. 2 grillage
- 1 washing hanger type A3
- 8 taps, plain chromed
- 1 hose fitting

art.-no. productspecification

Shoe wash systems Type A3

3005182 Shoe wash system complete type A3

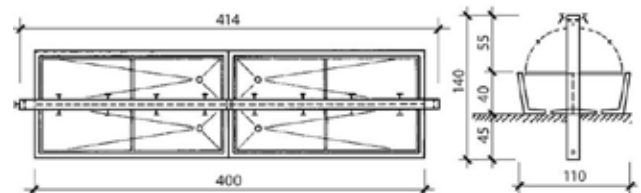
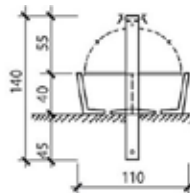

Shoe wash systems Type A4

- 4 wash trough concrete element type A, incl. 2 grillage
- 1 washing hanger type A4
- 16 taps, plain chromed
- 1 hose fitting

art.-no. productspecification

Shoe wash systems Type A4

3005184 Shoe wash system complete type A4

Wash hanger type A1

- usable from one side, length 214 cm, 4 fittings for taps, weight 43 kg.

art.-no. productspecification

Wash hanger type A1

3005090 Wash hanger type A1

Wash hanger type A2

- usable from one side, length 414 cm, 8 fittings for taps, weight 70 kg.

art.-no. productspecification

Wash hanger type A2

3005091 Wash hanger type A2

Wash hanger type A3

- usable from both sides, length 214 cm, 8 fittings for taps, weight 51 kg.

art.-no. productspecification

Wash hanger type A3

3005092 Wash hanger type A3

Wash hanger type A4

- usable from both sides, length 414 cm, 16 fittings for taps, weight 85 kg.

art.-no. productspecification

Wash hanger type A4

3005093 Wash hanger type A4

SHOE WASH SYSTEMS „TYPE B“

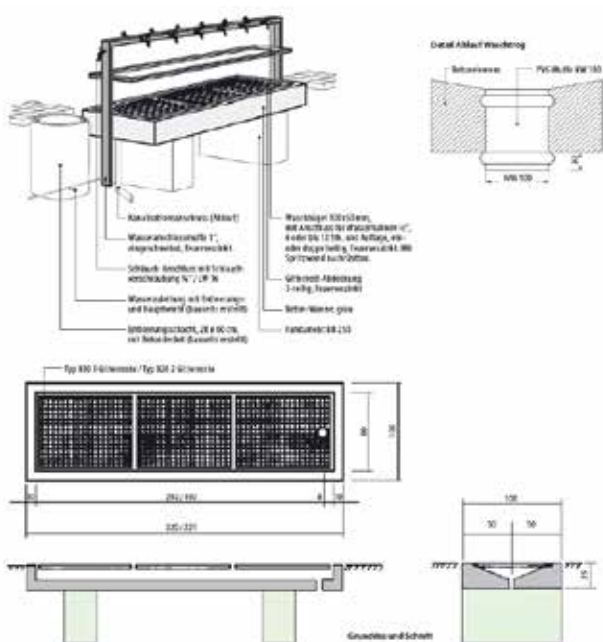

**Shoe wash systems „Type B“,
The recessed solution for shoe and device
cleaning**

Trough / Grillage

concrete-element, grey, formwork smooth, reinforced, incl. shaft lining for PVC-pipe NW 100 and removable grillage cover.

Wash hanger

steel profiles 100 x 50 mm, hot-galvanised, with water supply, incl. support bracket for shoes, faucet connection 1/2", hose connection with hose fitting 3/4" / LW 16 and water connection nozzles 1" (welded, hot-galvanised).

Transfer

The following work must be performed on site: Foundation/Support, water connection and discharge with mud collector.

Note

When ordering we need the information whether the drain is desired to be left or right as well as the water connection (please refer to the drawings)

Wash trough, concrete element Type B10

• Length 320cm, grey, incl. grillages, weight 1430 kg

art.-no. productspecification
Wash trough, concrete element Type B10

3005200 Wash trough concrete element Type B10

Wash trough, concrete element Type B20

• Length 221cm, grey, incl. grillage, weight 953kg

art.-no. productspecification
Wash trough, concrete element Type B20

3005201 Wash trough concrete element Type B20

SHOE WASH SYSTEMS „TYPE B“

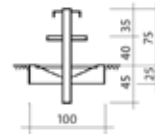
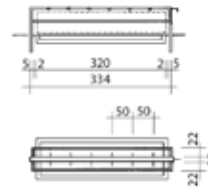
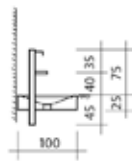
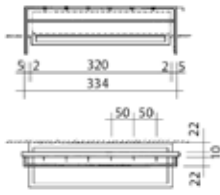

Shoe wash system type B11

- 1 wash trough concrete element type B10 incl. 3 grillages
- 1 wash hanger type B11
- 6 taps , plain chromed
- 1 hose fitting

art.-no. productspecification

Show wash system type B11

3005204 Wash trough complete type B11

Shoe wash system type B12

- 1 wash trough concrete element type B10 incl. 3 grillages
- 1 wash hanger type B12
- 12 taps, plain chromed
- 1 hose fitting

art.-no. productspecification

Show wash system type B12

3005205 Wash trough complete type B12

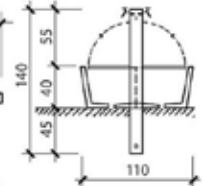
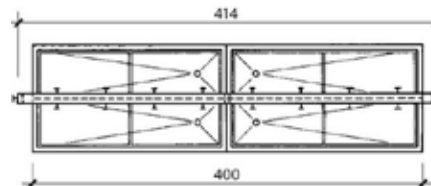
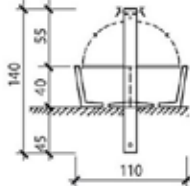
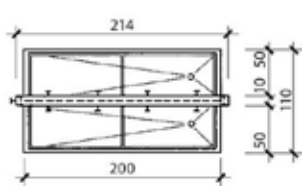

Shoe wash system type B13

- 2 wash trough concrete element type B10 incl. 6 grillages
- 1 wash hanger type B13
- 12 taps , plain chromed
- 1 hose fitting

art.-no. productspecification

Show wash system type B13

3005206 Wash trough complete type B13

Shoe wash system type B14

- 2 wash trough concrete element type B10 incl. 6 grillages
- 1 wash hanger type B14
- 24 taps , plain chromed
- 1 hose fitting

art.-no. productspecification

Show wash system type B14

3005204 Wash trough complete type B14

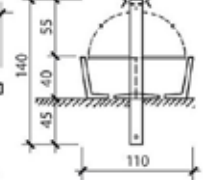
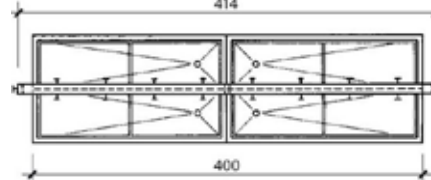
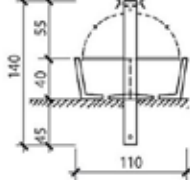
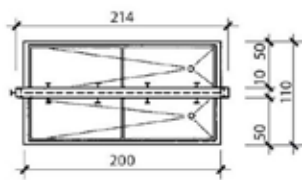

Shoe wash system type B21

- 1 wash trough concrete element type B20 incl. 2 grillages
- 1 wash hanger type B21
- 4 taps , plain chromed
- 1 hose fitting

art.-no. productspecification

Show wash system type B21

3005208 Wash trough complete type B21

Shoe wash system type B22

- 1 wash trough concrete element type B20 incl. 2 grillages
- 1 wash hanger type B22
- 8 taps , plain chromed
- 1 hose fitting

art.-no. productspecification

Show wash system type B22

3005204 Wash trough complete type B22

SHOE WAS SYSTEMS „TYPE B“

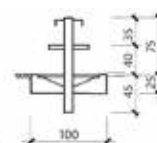
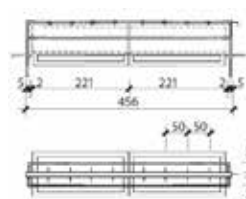
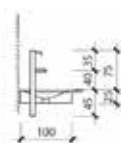

Shoe wash system type B23

- 2 wash trough concrete element type B20 incl. 4 grillages
- 1 wash hanger type B23
- 8 taps, plain chromed
- 1 hose fitting

art.-no. productspecification

Show wash system type B23

3005210 Wash trough complete type B23

Shoe wash system type B24

- 2 wash trough concrete element type B20 incl. 4 grillages
- 1 wash hanger type B24
- 16 taps, plain chromed
- 1 hose fitting

art.-no. productspecification

Show wash system type B24

3005211 Wash trough complete type B24

Wash hanger type B11

- Usable on one side, length 334 cm, 6 fittings for taps, weight 55 kg.

art.-no. productspecification

Wash hanger type B11

3005214 Wash hanger type B11

Wash hanger type B12

- Usable from both sides, length 334 cm, 12 fittings for taps, weight 68 kg.

art.-no. productspecification

Wash hanger type B12

3005215 Wash hanger type B12

Wash hanger type B13

- Usable on one side, length 654 cm, 12 fittings for taps, weight 96 kg.

art.-no. productspecification

Wash hanger type A3

3005216 Wash hanger type B13

Wash hanger type B14

- Usable from both sides, length 654 cm, 24 fittings for taps, weight 120 kg.

art.-no. productspecification

Wash hanger type B14

3005217 Wash hanger type B14

Wash hanger type B21

- Usable on one side, length 234 cm, 4 fittings for taps, weight 37 kg.

art.-no. productspecification

Wash hanger type B21

3005224 Wash hanger type B21

Wash hanger type B22

- Usable from both sides, length 234 cm, 8 fittings for taps, weight 45 kg.

art.-no. productspecification

Wash hanger type B22

3005093 Wash hanger type B22

Wash hanger type B23

- Usable on one side, length 454 cm, 8 fittings for taps, weight 64 kg.

art.-no. productspecification

Wash hanger type B23

3005226 Wash hanger type B23

Wash hanger type B24

- Usable from both sides, length 454 cm, 16 fittings for taps, weight 80 kg.

art.-no. productspecification

Wash hanger type B24

3005227 Wash hanger type B24

SHOE WASH SYSTEM „TYPE C“



Shoe wash system „Type C“, The solution with concrete trough

Design

concrete element, grey, formwork smooth, reinforced including drain (shaft lining NW 100) and removable grillage cover. The water pipe with faucet connections ½" is inserted in concrete element. Shoe support bar is made of steel profiles.

Design „frost-proof“

Identical to the standard design but with a free space in the rear wall to add the parts for the frost-proof version. The frost-proof version is delivered „without“ sanitary parts. Insulated water pipes and connections on site.

Transfer

The following work must be performed on site: foundation / support, water connection and discharge with mud collector.

Note

When ordering we need the information whether the drain is desired to be left or right as well as the water connection (please refer to the drawings)

Positioning process on customer's request (standard: infeed) Type C3 and C4 have two drains.

Normalausführung

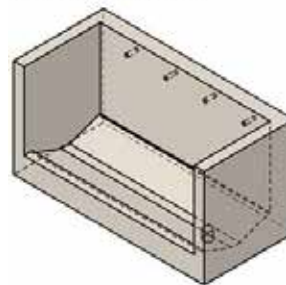

Ausführung frostsicher

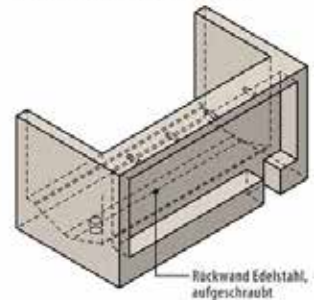

Querschnitt (Normalausführung)

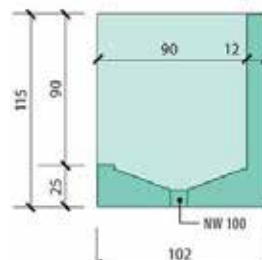

Querschnitt (Ausführung frostsicher)

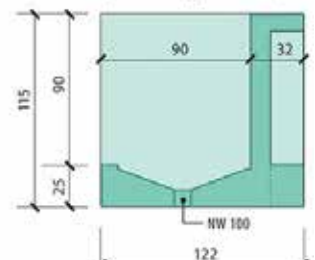

Wash trough concrete element type B20

- Length 221cm, grey, incl. grillages, weight 953kg

art.-no. productspecification

Wash trough concrete element type B20

3005201

Wash trough concrete element type B20

SHOE WASH SYSTEM „TYPE C“

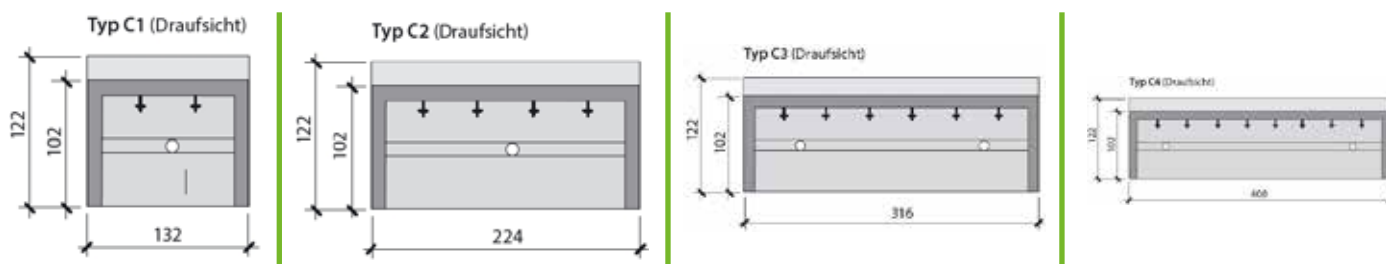

Art.-Nr.	Type	Version	Height	Depth	Length	Weight	Taps
3005810	C1	Standard version	115 cm	102 cm	132 cm	1525 kg	2
3005815	C1	Frost-proof	115 cm	122 cm**	132 cm	1825 kg	2
Art.-Nr.	Typ	Version	Height	Depth	Length	Weight	Taps
3005820	C2	Standard version	115 cm	102 cm	224 cm	2225 kg	4
3005825	C2	Frost-proof	115 cm	122 cm**	224 cm	2620 kg	4
Art.-Nr.	Typ	Version	Height	Depth	Length	Weight	Taps
3005830	C3	Standard version	115 cm	102 cm	316 cm	2925 kg	6
3005835	C3	Frost-proof	115 cm	122 cm**	316 cm	2925 kg	6
Art.-Nr.	Typ	Version	Height	Depth	Length	Weight	Taps
3005840	C4	Standard version	115 cm	102 cm	408 cm	3575 kg	8
3005845	C4	Frost-proof	115 cm	122 cm**	408 cm	4350 kg	8

exkl. roof, **exkl. back

WASH SYSTEM „TYPE C“ ROOF

Version A, for example type C2

We are also supplying shoe wash systems with roof and lighting. Plan with us!!

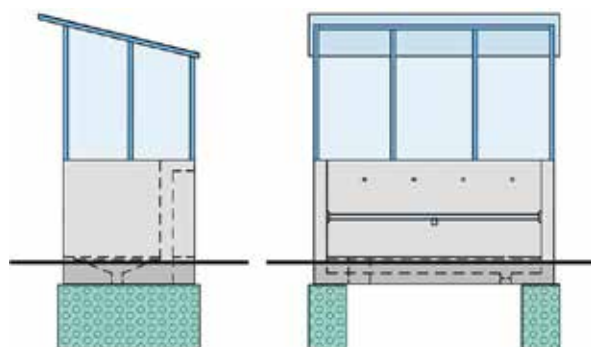

Version B, for example type C2

We are also supplying shoe wash systems with roof and lighting. Plan with us!

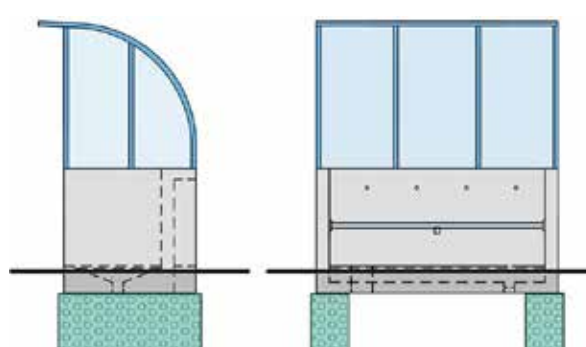

SHOE WASH SYSTEM „TYPE D“

Surcharge
for frost-
proof with
electric
heating.

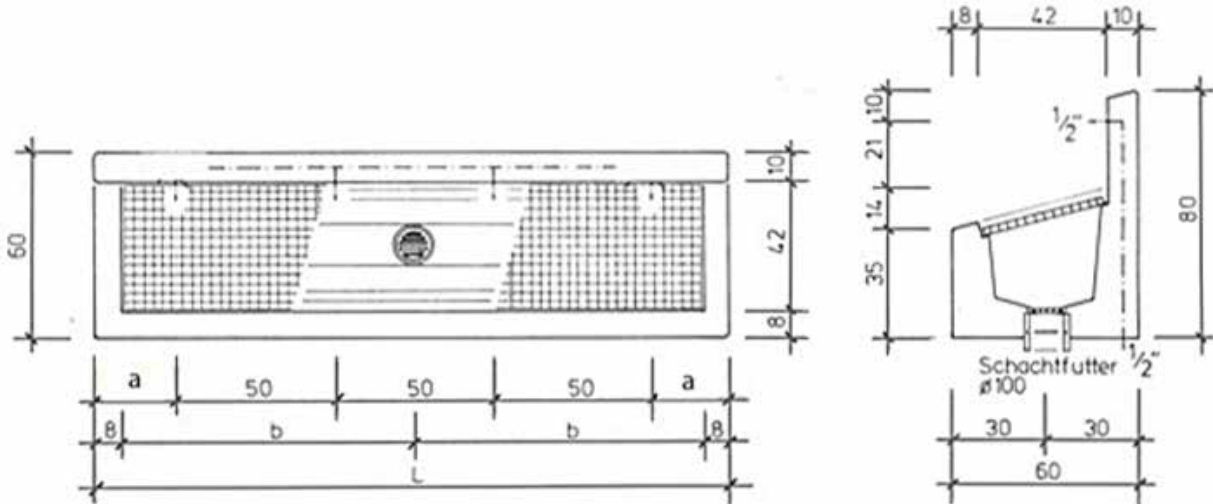

Shoe wash system „Type D“, The raised solution with integrated back

concrete wash trough with integrated back, grey, smooth surface, chamfered edges, incl. Supply line (for an additional charge you can freely select, distance 10 cm) and grillage, flow 100mm.

Type D1, fitting for 2 taps

art.-no. productspecification

Type D1, fitting for 2 taps

3902001 Length 140 cm, width 60 cm, height 80 cm,
Weight 600 kg, without taps



Type D2, fitting for 4 taps

art.-no. productspecification

Type D2, fitting for 4 taps

3902011 Length 200 cm, width 60 cm, height 80 cm,
weight 900 kg, without taps

Type D3, fitting for 5 taps

art.-no. productspecification

Type D3, fitting for 5 taps

3902611 Length 260 cm, width 60 cm, height 80 cm,
weight 1200 kg, without taps

SHOE WASH SYSTEM „TYPE SC“

Shoe wash system „Typ SC“, Single units for easy use

Application / use

- School- and sports facilities
- Sports halls and gymnasia
- Leisure facilities
- Factory premises
- Army barracks
- Police, fire brigade
- Camping sites
- Riding centers
- Restaurants/hotels
- Private areas
- Construction sites, industrial areas
- Municipalities, schools, day-care centers
- Gardens and workshops
- Agriculture and forestry

All-round cleaning

- With the 3-brush system all sides of the shoes are cleaned at the same time

Flexible

- The long bristles adapt to any shoe size

Self-cleaning

- When the long bristles spring back, the dirt particles clear away of the bristles

Robust and functional

- The system meets the high quality requirements and guarantees the function

Solutions with convincing advantages

- „lay-on“ version, type SC-1: for refitting
- „recessed“ version, type SC-2: for use on the same level
- „recessed“ version, TYPE SC-3: with wet cleaning

Shoe wash system Typ SC-1 „lay-on“

Fixing on the ground is not necessary, but advisable. Suitable for retrofitting. Hot-dip galvanized metal grillage and 3 brushes (exchangeable), weight 3 kg.

art.-no. productspecification

Show wash system Typ SC-1 „lay-on“

3005520	Type SC-1
3005523	Replacement brushes set – 3 pcs

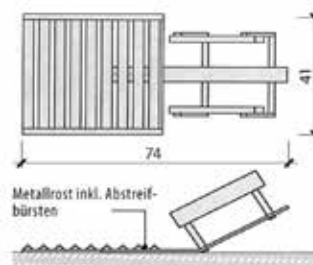

Shoe wash system type SC-2 „recessed“

The grillage is loosely placed into concrete element. For cleaning just lift out the grillage. The stripping brushes are firmly connected to the grillage. Concrete element, hot-galvanized grillage, 3 brushes (interchangeable). Weight 61 kg

art.-no. productspecification

Show wash system type SC-2

3005521	Type SC-2
3005523	Replacement brushes set – 3 pcs

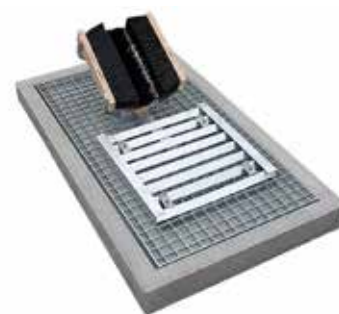
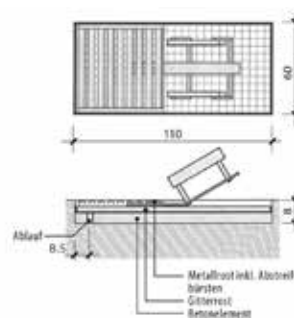

SHOE WASH SYSTEM „TYPE SC-3“

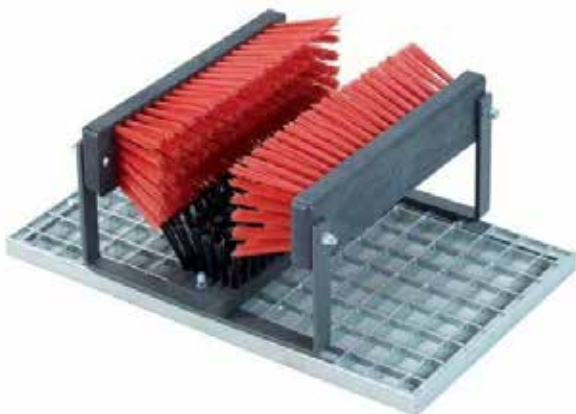
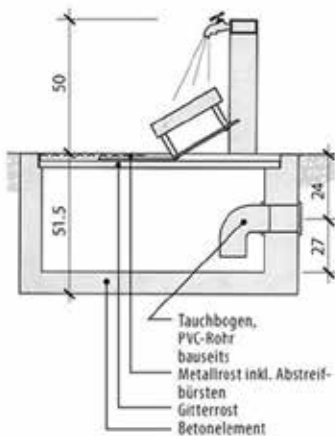
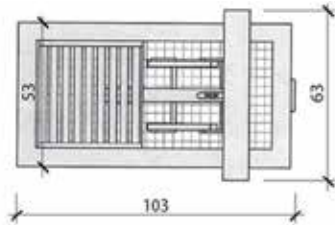

Shoe wash system type SC-3 „Recessed with wet cleaning“

Trough / Grillage

Concrete element, grey, smooth, reinforced, incl. Shaft lining for PVC pipe NW100, metal frame and removable grillage cover with 3 stripping brushes (interchangeable)

Wash hanger

Steel profile 100 x 50mm, hot-dip galvanised, with water supply and water tap connection 1/2.

Transfer

The following work must be performed on site: Foundation / support, water connection and discharge with mud collector.

- 1 concrete element type SC-3
- 1 grillage with
- 3 stripping brushes
- 1 wash hanger type SC-3
- 1, resp. 2 tap(s)
- Weight 501 kg

art.-no. productspecification

Show wash system type SC-3

3005525	concrete element incl. grillage and stripping brushes
3005526	Wash hanger usable on one side
3005527	Wash hanger usable on both sides
3005523	Bristles (set contains 3 pieces)

Shoe cleaner „Ideal“

- Shoe cleaner made of hot-galvanised steel
- High quality bristles
- Measurements 49,5 x 29,5 x 18 cm

art.-no. productspecification

Show cleaner „Ideal“

4041284	Shoe cleaner „Ideal“
---------	----------------------

SHOE AND BOOT CLEANING SYSTEM

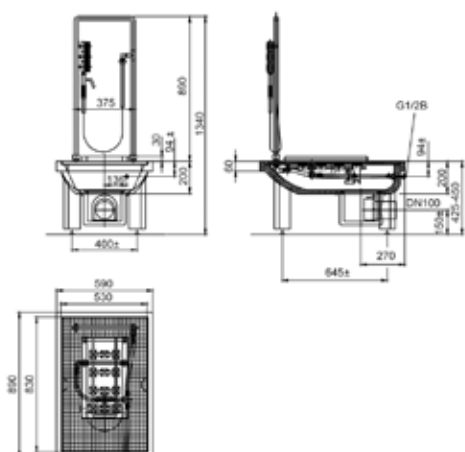

Boot cleaning system

Made of resin-bonded mineral material with a smooth, non-porous surface. Colour anthracite. With levelling feet, galvanised grate, hand brush with lifting valve, hand support bar, sole cleaning brushes, spray bars and foot valve DN15. Resin Boundary Solid surface material is largely resistant to acids and alkalis. Limited resistance to paint remover and all ketone compounds. In case of doubt, please request chemical resistance table. Production-related minor deviations may occur.

Size 600 x 425-450 x 900 mm (B x H x T)

Technical Data

- Total depth 900.00 mm
- Total height 1,340.00 mm
- Total width 600.00 mm
- Material: Mineral material
- Type of material: Miranit

- Ground installation
- Drain in the middle
- Incl. brushes: hand and sole brushes
- Drain size DN 100
- Incl. mud collector and siphon
- One washing place
- Connection size G 1/2 B

Synthetic resin-bonded mineral material is largely resistant to acids and alkalis. Limited resistance to paint remover and all ketone compounds. In case of doubt, please ask for the chemical resistance table. Slight dimensional deviations may occur due to the manufacturing process.

art.-no. productspecification

Stiefelreinigungsanlage

3105523

With drain body DN 100, mud collector and siphon

WASH SYSTEM „ACCESSORIES“

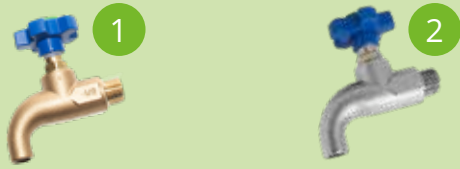

Tap simple

- Connection 1/2", with plastic wheel

art.-no. productspecification

Tap simple

- 3005600 1 Version red brass
- 3005601 2 Version chromed



Tap with hose fitting

- Connection 1/2", hose fitting 3/4", tap with check valve

art.-no. productspecification

Tap with hose fitting

- 3005602 3 Version red brass with plastic wheel
- 3005603 4 Version chromed with metal wheel
- 3005606 5 Version red brass with socket wrench
- 3005605 6 Version chromed with socket wrench



Tap self-locking

- Connection 1/2"

art.-no. productspecification

Wasserhahn selbstschliessend

- 3005607 7 Version chromed



Tap self-locking, with hose fitting

- Connection 1/2", hose fitting 1/2"

art.-no. productspecification

Tap self-locking, with hose fitting

- 3005608 8 Version chromed



Rosette for water tap

- We recommend to use tap rosettes for wash system type C and D because the water taps are in direct contact with the concrete.

art.-no. productspecification

Rosette

- 3005609 9 Rosette for water tap

WASH SYSTEM „ACCESSORIES“

Cleaning brush

- Made of plastic, red, with stable bristles, connection for tap and hose fitting, incl. 1 m hose.

art.-no. productspecification

Cleaning brush

3005218	Connection 1/2"
3005219	Connection 3/4"



Brush bracket

- Made of steel hot-galvanised, suspension on wash hanger for cleaning brush.

art.-no. productspecification

Brush bracket

3005604	Suspension on one side
3005605	Suspension on both sides



Spare parts compensatory bristles for type SC-1/2/3

- A set contains 3 pieces.

art.-no. productspecification

Compensatory bristles for type SC-1/2/3

3005523	bristles (set contains 3 pieces)
---------	----------------------------------

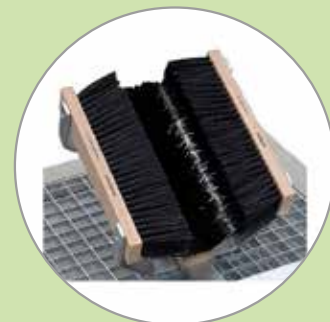

Bench for show wash systems

- suitable for systems type A, B, C and D
weight 45 kg.

art.-no. productspecification

Bench for show wash systems

3005510	Type A bench to cemente in
3005511	Type B bench to screw on

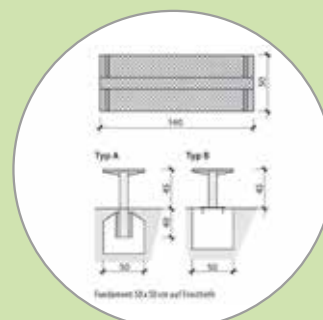

INSTALLATION PARTS „ELASTIC CURBING“ MADE OF HARD CONCRETE

Elastic curbing

Sport arenas and training facilities must be equipped with curbing to prevent injuries. The elastic curbings are high quality installation parts to make sports fields safe. They are used as border elements for shot put and long jump training areas, all-weather pitches or other play areas.

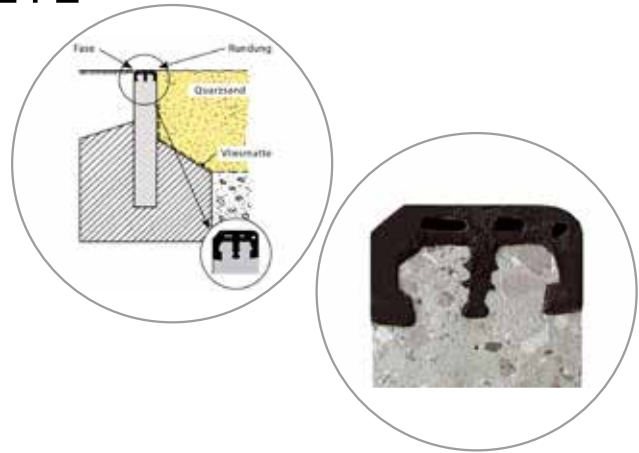

Elastic curbing made of hard concrete

Material

- Hard concrete, grey with rubber profile in black

Dimensions

- All types available in length 100 cm

Installation

- In continuous concrete foundation with a joint of approx. 2mm

art.-no. productspecification

Elastic border element made of hard concrete with black rubber cover

3002084	Standard element G1-20, LxWxH: 100,00 x 20,00 x 6,00 cm
3002090	Standard element G1-30, LxWxH: 100,00 x 30,00 x 6,00 cm
3002092	Standard element G1-40, LxWxH: 100,00 x 40,00 x 6,00 cm

art.-no. productspecification

Elastic border element, hard concrete, edge 90° complete

3002102	Edge element complete G1-20, LxWxH: 50,00/50,00 x 20,00 x 6,00 cm
3002104	Edge element complete G1-30, LxWxH: 50,00/50,00 x 30,00 x 6,00 cm
3002106	Edge element complete G1-40, LxWxH: 100,00 x 40,00 x 6,00 cm

art.-no. productspecification

Elastic border element, hard concrete, edge 90° 2-piece

3002086	Edge element 2-piece G1-20, LxWxH: 100,00/100,00 x 20,00 x 6,00 cm
3002094	Edge element 2-piece G1-30, LxWxH: 100,00/100,00 x 30,00 x 6,00 cm
3002096	Edge element 2-piece G1-40, LxWxH: 100,00/100,00 x 40,00 x 6,00 cm

art.-no. productspecification

Elastic curbing made of hard concrete Radius element (inner radius 100 cm)

3002107	Edge element/radius element G1-40, LxWxH: 157,00 x 40,00 x 6,00 m
---------	--

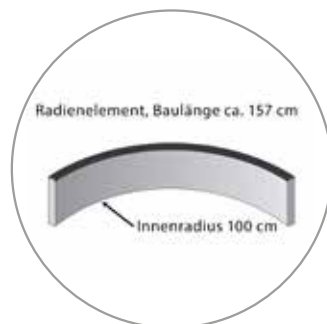
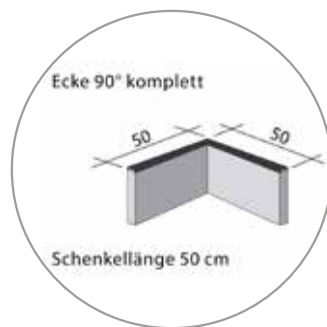
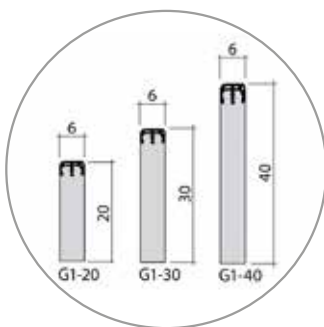

INSTALLATIONPARTS „ELASTIC CURBING“ MADE OF POLYMER CONCRETE



Elastic curbing made of polymer concrete

Elastic curbing made of polymer concrete with white or black rubber profile (EPDM).

The rubber profile is firmly cast in the lower part of the polymer concrete. The integrated air chamber ensures high elasticity and maximum safety.

art.-no. productspecification

Elastic curbing black rubber edge

5001573	Elastic curbing, black, LxWxH: 50,00 x 6,00 x 30,00 cm
5001574	Elastic curbing, black, LxWxH: 50,00 x 6,00 x 40,00 cm
5001773	Elastic curbing, black, LxWxH: 100,00 x 10,00 x 20,00 cm
5001774	Elastic curbing, black, LxWxH: 100,00 x 10,00 x 25,00 cm
5001690	Elastic curbing, black, LxWxH: 100,00 x 5,00 x 20,00 cm
5001035	Elastic curbing, black, LxWxH: 100,00 x 5,00 x 25,00 cm
5001034	Elastic curbing, black, LxWxH: 100,00 x 6,00 x 20,00 cm
5001036	Elastic curbing, black, LxWxH: 100,00 x 6,00 x 30,00 cm
5001037	Elastic curbing, black, LxWxH: 100,00 x 6,00 x 40,00 cm

art.-no. productspecification

Elastik Randstein white rubber edge

5001689	Elastic curbing, white, LxWxH: 100,00 x 5,00 x 20,00 cm
5000962	Elastic curbing, white, LxWxH: 100,00 x 5,00 x 25,00 cm
5000961	Elastic curbing, white, LxWxH: 100,00 x 6,00 x 20,00 cm
5000963	Elastic curbing, white, LxWxH: 100,00 x 6,00 x 30,00 cm
5000964	Elastic curbing, white, LxWxH: 100,00 x 6,00 x 40,00 cm
5001571	Elastic curbing, white, LxWxH: 50,00 x 6,00 x 30,00 cm
5001572	Elastic curbing, white, LxWxH: 50,00 x 6,00 x 40,00 cm

art.-no. productspecification

Elastik Randstein corner elements

5000968	Elastic curbing, white, LxBxH: 25,00/25,00 x 5,00 x 25,00 cm
5001381	Elastic curbing, white, LxBxH: 25,00/25,00 x 6,00 x 30,00 cm
5000969	Elastic curbing, white, LxBxH: 25,00/25,00 x 6,00 x 40,00 cm
5001041	Elastic curbing, black, LxBxH: 25,00/25,00 x 5,00 x 25,00 cm
5001380	Elastic curbing, black, LxBxH: 100,00 x 5,00 x 20,00 cm
5001042	Elastic curbing, black, LxBxH: 25,00/25,00 x 6,00 x 40,00 cm

SAND-TRAP CHANNEL

Sand-trap channel

The benefit of sand trap elements around long jump pits is uncontested. We offer different solutions.

sand-trap channel grate and rubber mat

- Base made of frost-resistant polymer concrete
- Cover of anti-slip galvanized metal grillage with locked rubber mat to protect against injuries
- Metal edge for a perfect contact with the plastic cover
- Pre-forming for connection piece DN 100 in the bottom for opening a channel line
- Internal channels as construction elements for a double-row installation to increase the installation width as required.
- Compensating pieces of 56 cm
- Smooth inner surface for an easy cleaning



art.-no. productspecification

Sand-trap channel grate and rubber mat

5001475	Elastic sand-trap channel - outer chase 100 cm
5001477	Elastic sand-trap channel - outer chase 56 cm
5001474	Elastic sand-trap channel - inner chase 100 cm
5001476	Elastic sand-trap channel - inner chase 56 cm



Sand trap-element Typ B - Concrete element with rubber border

- Sand is „deposited“ in the recesses of the rubber mat
- Concrete element with rubber border on one side (black) and black perforated rubber mat
- Dimensions (L x W x H): 100 x 52 x 9 cm
- Corner and end element consisting of concrete element with rubber border (black) and perforated black rubber mat
- Dimension (L x W x H): 52 x 52 x 9 cm

art.-no. productspecification

Sand trap - element

3002110	Stand element
3002112	Corner and final element
3002114	Surcharge for cutting short lengths



Sand trap-element Typ C - with aluminium tray

- Consisting of an aluminium tray (metal thickness 2.0 mm)
- Incl. galvanized metal grillage and perforated black rubber mat
- Dimensions (L x W x H): 100 x 50 x 15 cm
- In case of type C, no concrete additives must be added to the lean concrete because the Aluminium surfaces could be affected

art.-no. productspecification

Sand trap - element

3002140	Standard element
3002111	End element (aluminium plate)

ARTIFICIAL TURF „FINISHING ELEMENT“

Plastic flooring - end element

We recommend the alu-liner for small solutions (visible aluminium- profile: 3 mm) price-performance ratio. Although material costs for the alu-liner are higher, the end price of this solution is lower, caused by lower labour costs with a smaller installation depth.

Material and measurements

- Aluminium
- Construction height: 15 cm
- Total width at the top: 23 mm
- Visible width at the top: 3 mm
- Construction length: 5 metre
- Weight approx.: 7.5 kg / element, 1.5 kg/ml

Installation

Installation of the alu-liner is equal to top edge in a continuous concrete foundation with a gap of 2 mm. To increase the bonding between aluminium and concrete, we recommend to clean the contact surfaces and to prime the aluminium.

Radii of > 4.00 m can be created on site by bending the material. We recommend that you mark the radius on the subsoil and place metal pickets as a stabilization measure before placing the concrete foundation. These pickets can be removed after the hardening process (foundation concrete).

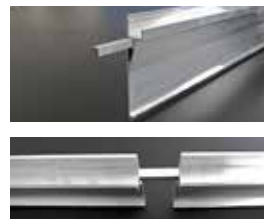
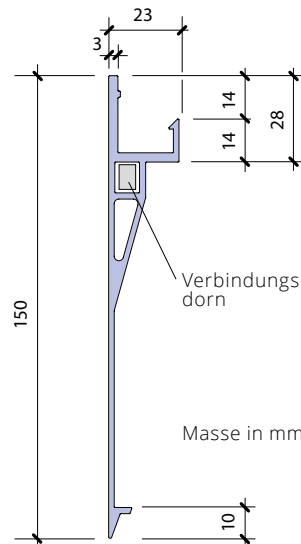

The connection thorn is fixed in the element.



The necessary gap of 2 mm (material expansion) can be ensured with a match.

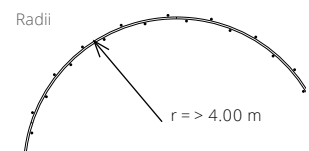
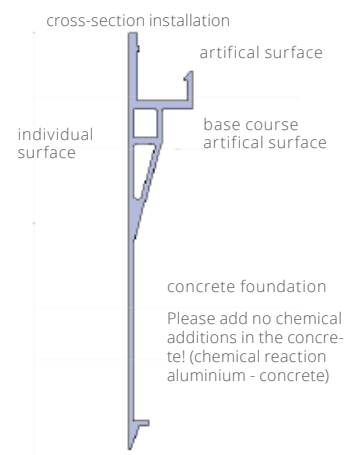

art.-no. productspecification

Aluliner

3002700	Normal element with connection thorn, length 500 cm
3002701	Corner 90° sawed on mitter and welded, side length 50 cm (construction length 100 cm).
3002702	Corner variable two-parted, sawed on mitter, side length 50 cm (construction length 100 cm).
3002705	Surcharge for short lengths under 500 cm

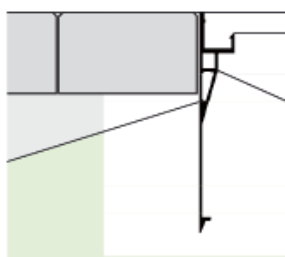

Border (individual surfaces)

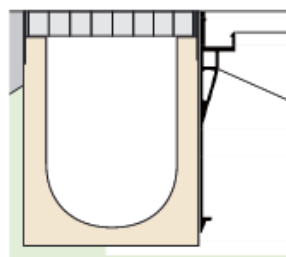

Border to a drainage gutter

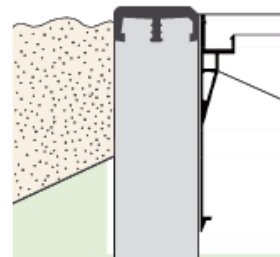

Border with curbing

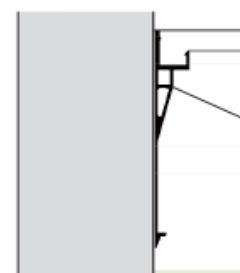

Border with wall

SPORTS SURFACE CURB

„ARTIFICIAL GROUND FINISHING ELEMENT“

The foundation concrete must not be accompanied by additives.

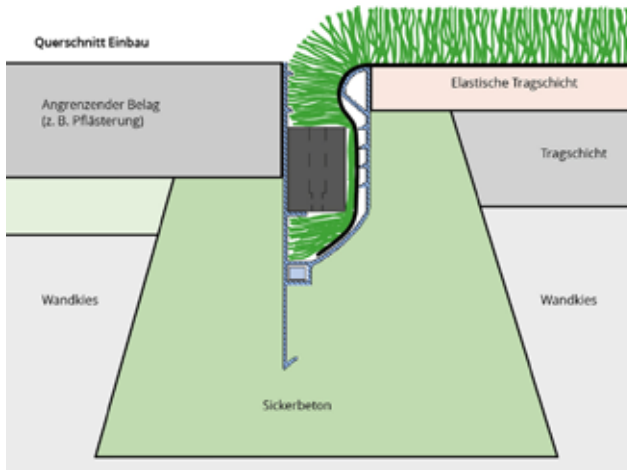

long pile artificial turf



short pile artificial turf



Artificial turf - finishing element

- Made of aluminium
- Installation length 500 cm
- Incl. connection-, distance-, and fastening elements and install key

art.-no. productspecification

Artificial turf - finishing element

3002800 Artificial turf - finishing element

Arguments for artificial turf finishing elements

- Element installation length 5 M > quicker, cheaper
- „Turning radius“ (15mm) for artificial turf > better aesthetics and lowers risk of fracture for the turf
- Big storage space for artificial turf > reserve for post-tensioning
- Easy fastening method (screw cap with clamping action > higher draw resistance, allows easy tensioning or disassembly)
- Corrosion resistant elements > long lifespan

Technical data

Normal element

- Aluminium, tolerance according to EN 755-9 standards
- Installation length: 500 cm
- Weight: ca. 10 kg/element, 2 kg/ml

Distance element

- wood (length ca. 2 – 4 m)
- Is inserted before the installation of adjacent materials and removed before fixing the artificial turf. (Prevents the penetration of foreign parts until the artificial turf is laid).

Fastening element

- plastic HDPE (every 50 cm one element)

Connection element

- Aluminium (installation length (every 5 m one element))

Corner element 90° for artificial turf - finishing element

- completely welded
- side length 50 cm (handling 100 cm)
- incl. connection and fastening elements

art.-no. productspecification

Corner element 90°

3002801 Corner element 90°

ARTIFICIAL TURF „FINISHING ELEMENT“

Connection element

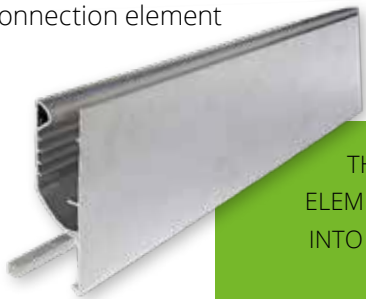

THE CONNECTING
ELEMENT IS INSERTED
INTO THE INDIVIDUAL
ELEMENTS.

Gap (element distance):

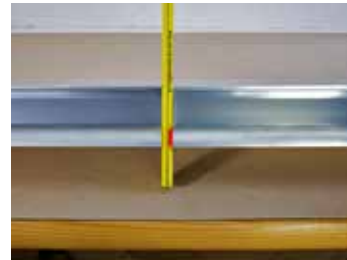

(top view)

THE REQUIRED ELEMENT SPACING OF APPROX. 6 MM CAN BE ENSURED, FOR EXAMPLE, WITH A COMMERCIALY AVAILABLE METRE MASS (DOUBLE THICKNESS). THE GAP IS NECESSARY FOR THE EXPANSION OF THE MATERIAL AND ALSO ENSURES THAT THE WATER CAN FLOW THROUGH THE PERMEABLE CONCRETE INTO THE GROUND.

Fastening technique artificial turf

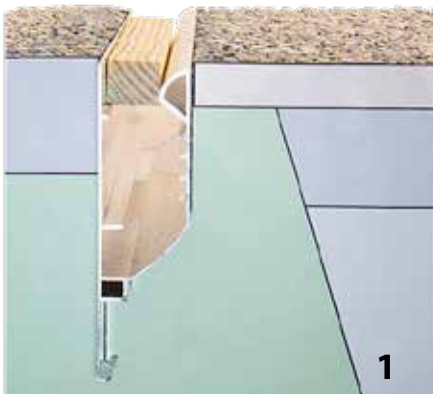

1 Before you mount the permeable concrete and the surrounding surface you will need to put the distance elements into the mounting element.



2 The artificial turf is laid overlapping onto the built-in artificial turf installation element and cut to the length of installation (temperature-dependent).



3 The artificial turf is inserted into the mounting element.



4 The mounting element is inserted with the install key into the built-in element.



5 After insertion up until raising and locking the installation key is raised. The fixation, which is made at a distance of about 50 cm, ensures that the artificial turf withstands the tractive forces.



ARTIFICIAL TURF

„FINISHING ELEMENT“

Guide after installation of the silisport synthetic turf finishing elements™ (installation element) and laying of the artificial turf.



Removing the distance elements (to be disposed of by the customer).



The artificial turf is cut to the right length.



The artificial grass is pressed into the installation element.



For thick or high-pile artificial turf aids such as seated iron can be used.



The fixing element is inserted into the installation element by means of the installation key, down to the lower web (note the pictures on the previous pages).



Install position

End position



The fastener is turned over the curve by 90 ° and the installation key pulled out.



Covering / artificial turf (in order to increase the surface area a metal strip (flat steel) was used here).



Paving stones / artificial turf (The artificial turf closing elements, which are set lower than the paving stones, are not visible).



Artificial turf (use of two elements)



Drainage channel / artificial turf

Tension, loosen and removal artificial turf

- If necessary, carry out coarse cleaning using a high-pressure cleaning device. Insert the key into the fastening element
- Turn fastener 90° using built-in key and insert installation key from mounting element
- After cutting and / or retightening the synthetic turf > installation according to specifications fixing technique (pictures 3-5)

ARTIFICIAL TURF

„FINISHING ELEMENT MOBILE“

Technical Data

Material

- Sheet steel, hot-galvanised, strenght approx. 1.5 mm

Measurement

- according to the adjacent drawing
- installation length: 298 cm (on request also shorter construction length possible)

Weight

- approx. 7.5 kg / element

With the mobile artificial turf finishing element, artificial turf surfaces can be enclosed on existing surfaces. The dead load ensures the stability. The fastening technology prevents the movement of the artificial turf. The system can be used for low and high pile artificial turf. The edging element can be anchored into the ground (screwed on).

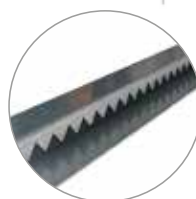
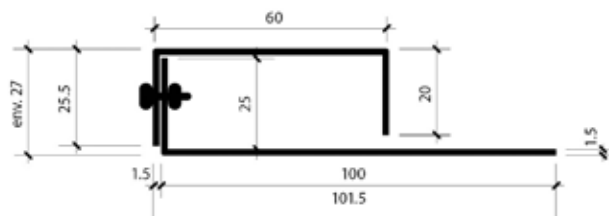

Technique with dead load



Technique with anchors

Artificial turf - finishing element mobile

- made of sheet steel, hot-galvanised
- installation length 298 cm

art.-no. productspecification

Artificial turf - finishing element mobile

3002850 Artificial turf - finishing element mobile

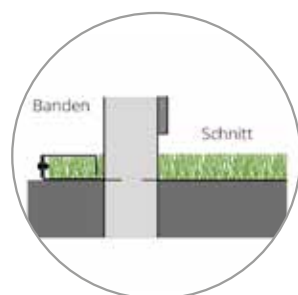

Edge/Cross section



Top view

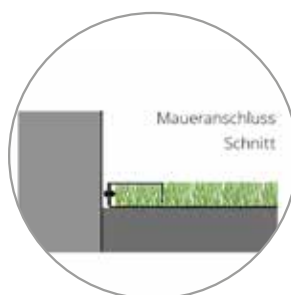

Wall connection cross section

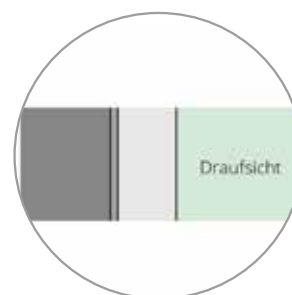

Top view

AGB'S

AGB - Allgemeine Geschäfts- und Verkaufsbedingungen

§ 1 Allgemeines:

Für alle Lieferungen und Leistungen gelten ausschließlich die nachstehenden Verkaufs- und Lieferbedingungen. Abweichende Bedingungen des Käufers, die von der Vindico Sport GmbH nicht ausdrücklich schriftlich anerkannt werden, sind unverbindlich, auch wenn wir ihnen nicht speziell widersprechen. Einbeziehung und Auslegung dieser Verkaufs- und Lieferbedingungen regeln sich ebenso wie Abschluss und Auslegung der Rechtsgeschäfte mit dem Käufer selbst ausschließlich nach dem Recht der Bundesrepublik Deutschland. Die Anwendungen des „Einheitlichen Gesetzes über den Abschluss von internationalen Kaufverträgen über bewegliche Sachen“ und des „Einheitlichen Gesetzes über den internationalen Kauf beweglicher Sachen“ des UN-Verkaufsrechts sind ausgeschlossen.

§ 2 Angebote / Leistungen / Vertragsabschluss:

Angebote von Vindico Sport GmbH sind stets freibleibend und sind max. 2 Monate gültig ab Angebotsdatum bzw. nach der im Angebot angegebenen Frist. Ein Liefer- und Leistungsvertrag kommt erst mit der schriftlichen Auftragsbestätigung zustande. Der Vertragsabschluss wird mit der Vindico Sport GmbH abgeschlossen. Die mit dem Angebot oder der Auftragsbestätigung zugrunde liegenden Unterlagen wie Abbildungen, Zeichnungen, und Gewichtsangaben sind in der Regel nur als Annäherungswerte zu verstehen, sofern sie nicht ausdrücklich als verbindlich bezeichnet werden. geringfügige Abweichungen in Farbe, Größe und Form sind zulässig, soweit sie für den Besteller zumutbar sind. Vindico Sport GmbH behält sich das Recht vor technische Änderungen umzusetzen. Eigentums- und Urheberrechte für sämtliche Abbildungen, Kalkulationen, Zeichnungen, Kataloginhalte sowie andere Verkaufs- und Werbematerialien liegen ausschließlich bei der Vindico Sport GmbH. Sie dürfen nur mit ausdrücklicher schriftlicher Zustimmung der Vindico Sport GmbH für eigene oder andere Zwecke verwendet werden.

§ 3 Preise:

Alle Preise sind in Euro ab Werk D-73463 Westhausen zzgl. der zum Zeitpunkt gültigen Mehrwertsteuer. Verpackungskosten, Frachtkosten und evtl. Transportversicherungen werden separat in Rechnung gestellt. Die Verpackung wird nur zurück genommen, wenn wir kraft zwingender gesetzlicher Regelung hierzu verpflichtet sind.

§ 4 Zahlungsbedingungen:

Ist nichts anderes vereinbart sind Rechnungen innerhalb von 7 Tagen mit 2 % Skonto bzw. innerhalb von 14 Tagen ohne Abzug fällig und zahlbar. Voraussetzung für Skontoabzug ist, dass alle vorhergehenden Rechnungen bezahlt sind. Rechnungen für Dienst- oder Montageleistungen sind sofort ohne Abzug netto zu zahlen. Im Falle von Teillieferungen behält sich Vindico Sport GmbH anteilige Fakturierungen vor. In begründeten Fällen behält sich Vindico Sport GmbH eine Lieferung auf Vorkasse vor. Bei Zahlungsverzug, steht es der Firma Vindico Sport GmbH frei, die weitere Erfüllung des Vertrages abzulehnen. Vindico Sport GmbH behält sich das Recht vor, bei Überschreitung des Zahlungsziels, Verzugszinsen in Höhe von 5 % über dem Basiszinssatz, soweit der Besteller kein Verbraucher ist, von 8 % über dem Basiszinssatz zu fordern. Bei vereinbarten Teilzahlungen, welche nicht fristgerecht geleistet werden, wird umgehend der Gesamtbetrag zur sofortigen Zahlung fällig. Bei Sonderanfertigungen in Verbindung mit Fremdartikeln gelten folgende Zahlungsbedingungen: sofortige Zahlung von der Hälfte der Auftragssumme bei Vertragsabschluss, Restsumme nach Auslieferung mit den in Punkt 4 genannten Zahlungskonditionen.

§ 5 Lieferfrist / Lieferbedingungen:

Die angegebenen Liefertermine, soweit sie nicht explizit als Fixtermin vereinbart worden sind, sind als unverbindliche annähernde Termine zu betrachten. Im Voraus müssen alle technischen Fragen geklärt sein. Nachträgliche Änderungen bzw. Ergänzungen können zu Veränderungen des Liefertermins führen. Im Rahmen von Arbeitskämpfen (Streik), Lieferverzögerung von Vorlieferanten, Verkehrs- und Betriebsstörungen, Werkstoff- oder Energiemangel etc. bei welchem sich unverhältnismäßig lange Lieferver-

zögerungen abzeichnen, sind wir berechtigt, vom Vertrag zurückzutreten. Eine Haftung für Lieferverzug wird ausgeschlossen.

§ 6 Versand und Gefahrenübergang:

Lieferungen erfolgen „unabgeladen, frei Bordsteinkante“. Achtung: Transportschäden bitten wir sofort dem Spediteur bzw. Transporteur zur Schadensfeststellung zu melden und auf dem Lieferschein des Anlieferers zu vermerken. Nur wenn eine Schadensfeststellung vorliegt, deckt die Versicherung den Verlust ab. Der Gefahrenübergang für die Liefergegenstände geht auf den Käufer über, sobald wir die Ware dem Käufer zur Verfügung gestellt und dies dem Käufer angezeigt haben. Der Versand erfolgt stets auf Rechnung und auf Gefahr des Käufers bzw. des Empfängers.

§ 7 Eigentumsvorbehalt:

Die gelieferte Ware bleibt bis zur vollständigen Bezahlung Eigentum der Firma Vindico Sport GmbH. Der Eigentumsvorbehalt gilt auch, bis sämtliche, auch künftige und bedingte Forderungen aus der Geschäftsverbindung zwischen dem Käufer und der Vindico Sport GmbH erfüllt sind. Der Käufer ist zur Sicherungsübereignung oder Verpfändung der Ware nicht befugt, er ist jedoch zur Weiterveräußerung der Vorbehaltsware im geordneten Geschäftsgang berechtigt. Die hieraus gegenüber seinen Geschäftspartnern entstehenden Forderungen tritt er hiermit an Vindico Sport GmbH ab. Wird die Ware vom Käufer be- oder verarbeitet, so erstreckt sich der Eigentumsvorbehalt auch auf die gesamte neue Sache. Der Käufer erwirbt Miteigentum zu dem Bruchteil, der dem Verhältnis des Wertes seiner Ware, zu dem, der von der Vindico Sport GmbH gelieferten Ware entspricht. Wir sind berechtigt, die Eigentumsvorbehaltsrechte geltend zu machen, ohne vom Vertrag zurückzutreten. Falls konkrete Gefahr für unsere Ansprüche besteht, sind wir oder ein Beauftragter berechtigt, Zugriff auf die Ware am Lagerort zu nehmen. Wir sind berechtigt, bei Zahlungsverzug die Forderung an Dritte, zum Beispiel an ein Inkassobüro, abzutreten. Der Besteller verpflichtet sich, die ihm überlassene Ware auf eigene Kosten gegen Schadensrisiken (z.B. Feuer, Wasser, Diebstahl) ausreichend zu versichern. Leistungen, die von der Firma Vindico Sport GmbH dem Käufer zur Verfügung gestellt wurden und die nicht Bestandteil der Werkleistung als solcher sind (z.B. Entwürfe, Konstruktionszeichnungen, Werkzeuge etc.), bleiben im Eigentum der Firma Vindico Sport GmbH.

§ 8 Gewährleistung

Die Vindico Sport GmbH übernimmt folgende Gewährleistungsfristen: Bei neu hergestellten Sportgeräten der Firma Vindico Sport GmbH zwei Jahre, bei gebrauchten, überarbeiteten Sportgeräten ein Jahr. Ist der Besteller Unternehmer, eine juristische Person des öffentlichen Rechts, so beträgt die Gewährleistung ein Jahr. Die Waren und Leistungen sind nach Erhalt bzw. Ausführung unverzüglich auf Mängel hin zu prüfen. Reklamationen sind der Vindico Sport GmbH spätestens innerhalb von 10 Tagen nach Erhalt bzw. Ausführung schriftlich zu melden. Sie berechtigen nicht zur Zurückhaltung oder Kürzung von Zahlungen. Die Mängelansprüche sind auf Nacherfüllung (Nachbesserung) durch die Vindico Sport GmbH beschränkt. Nur wenn diese durch die Vindico Sport GmbH nicht möglich ist, darf nach Abstimmung ein autorisierter Dritter hinzugezogen werden. Gewährleistungsansprüche sind ausgeschlossen, wenn nicht fristgerecht informiert wurde und der Vindico Sport GmbH keine Gelegenheit zur Nachbesserung gegeben wurde. Ausgeschlossen sind natürliche Abnutzung und unsachgemäße Behandlung der Ware sowie vorsätzliche oder grob fahrlässige oder vorsätzliche Schadensverursachung. Eine nachträgliche Rüge von Mängeln bei Montageleistungen wird ausgeschlossen, sofern diese beim Abnahmetermin schon feststellbar waren.

§ 9 Erfüllungsort, Gerichtsstand, Teilunwirksamkeit:

Erfüllungsort für alle sich mittelbar oder unmittelbar aus diesem Vertragsverhältnis ergebenden Verpflichtungen, einschließlich der Zahlungspflicht, ist „Westhausen“ (D-73463). Diese Vereinbarung gilt auch für Unternehmer, eine juristische Person des öffentlichen Rechts. Die Unwirksamkeit einzelner Bestimmungen dieses Vertrags oder seiner Bestandteile lässt die Wirksamkeit der übrigen Regelungen unberührt. Für sämtliche Streitigkeiten wird D-73430 Aalen als Gerichtsstand vereinbart, sofern der Kunde Kaufmann ist.

UNSERE 8-JAHRES-GARANTIE

Vindico Sport bietet auf einige Artikel eine 8-Jahres-Garantie, die über die gesetzliche Gewährleistung von zwei Jahren hinausgeht.

Wer kann die 8-Jahres Garantie erwerben?

Die 8-Jahres-Garantie gilt für alle Kunden, die direkt bei der Firma Vindico Sport die Artikel erworben haben. Die 8-Jahres-Garantie gilt nicht für Unternehmer, eine juristische Person des öffentlichen Rechts oder Wiederverkäufer. Sollte die Garantie für diese Kunden weiterhin gültig sein, so muss diese zuvor mit einer schriftlichen Vereinbarung mit den jeweiligen Unternehmern / Wiederverkäufern / Handelspartnern geregelt werden.

Was beinhaltet die Garantie?

Die 8-Jahres-Garantie beinhaltet nachfolgende Produkte:

- vollverschweißte Aluminiumprofile Fußballtore Competition I und II
- vollverschweißte Aluminiumprofile Trainings- / Jugend- & Bolzplatztore*
- vollverschweißte Aluminiumprofile Handball- & Minitorer*
- vollverschweißte Aluminiumprofile Konstruktionen von Basketballanlagen
- vollverschweißte Aluminiumprofile Sicherheitsabdeckungen für Hochsprungmatten
- vollverschweißte Aluminiumprofile Sicherheitsabdeckungen für Stabhochsprungmatten

Vindico kann, je nach Ermessen des Schadens, eine Reparatur oder eine Ersatzlieferung veranlassen.

* Sind Tore mit Kippsicherungen ausgestattet (z.B. integriert, montiert oder aufgelegt) oder in Verbindung mit Rädern gilt die Garantie nicht. (Ausgeschlossen sind ebenfalls Verschleißteile wie Netze, Mechaniken, Beschichtungen, Holz und PU Materialien etc.)

Wie lange dauert die Garantie?

Die Garantie beginnt am Tag der Übergabe. Die gesetzliche Garantie/Gewährleistungspflicht ist hiervon nicht betroffen.

Garantieverlust

Folgende Kriterien führen dazu, dass die 8-Jahres-Garantie erlischt. Diese wären wie folgt:

- Produkt ist nicht mehr im Originalzustand
- Produkt wurde verändert oder modifiziert
- Produkt wird nicht zum sinngemäßen Gebrauch benutzt
- Falsche Handhabung / Bedienung

- Gewaltanwendung, Vandalismus oder natürlicher Verschleiß
- Benutzung mit Kippsicherungen
- Sonderanfertigungen auf Kundenwunsch sind komplett ausgeschlossen
- Entfernung von Hinweisen auf das Herstellungsjahr
- Abweichungen von Form und Farbe sind ausgeschlossen



REFERENZEN

Deutschland

Aalen		Trainingsgelände, Fußballtore
Abtsgmünd		Omnistadium
Augsburg		Stadiontore, Trainingsgelände
Bremen		Trainingsgelände, Fußballtore
Düsseldorf		Stadiontore
Ellwangen		Fußballtore, Kabinen
Essen		Bandenspielfeld
Gunzesried, Allgäuer Berghof Hotel		Bandenspielfeld
Hamburg		Sportanlagen
Hechingen	Weiherstadion	Kampfbahn Typ B
Heidenheim		Stadiontore
Heilbronn	Frankenstadion	Leichtathletik
Ingolstadt		Freistoßmauer, Trainingstore
Künzelsau		Bandenspielfeld
Leipzig		Fußballtrainingsgeräte
Mannheim		Spielerkabinen
München		Fußballtore
München		Trainingsgelände, Fußballtore
Renningen		Fußballtore / Spielerkabinen
Sindelfingen	Stadion	Leichtathletik / Kunstrasenplatz
Stuttgart		Stadiontore
Unterhaching		Stadiontore
Waldshut		
Wangen	Allgäustadion	Fußballtore, Kabinen
Winterbach		Bandenspielfeld
Winterbach	Stadion	Kampfbahn Typ B
Würzburg		Trainingsgelände, Fußballtore
Würzburg		Fußballtore

Veranstaltungen

Berlin fliegt	Anlaufpodest
---------------	--------------

Österreich

Dornbirn	Stadiontore
Götzis	Leichtathletik, Wassergraben
Linz	Leichtathletik Hallenausstattung
Lustenau	Fußballtore
Styr	Bandenspielfeld
Völkermarkt	Kleinspielfeld, Leichtathletik
Wagram	Kleinspielfeld, Leichtathletik
Wien	Leichtathletik

Russland

Leningraf-region	Leichtathletik
------------------	----------------

Oman

Muscat	Sportgeräte
--------	-------------

Großbritannien

Swanley Village	Basketballanlagen
-----------------	-------------------

Hawai

Guadeloupe	Beachsoccer, Beachvolleyball
------------	------------------------------

Partner WFV | BFV | 1. FC Heidenheim 1846 | FC Ingolstadt 04 e.V. | IAKS | international socca federation

UNSERE MANNSCHAFT

ANSPRECHPARTNER

ANSPRECHPARTNER BEI VINDICO

MICHAEL STARZ

POSITION: Geschäftsführung / Vertrieb
TELEFON: +49 (0)7363 / 40902-80
HANDY: +49 (0)173 / 597 35 47
E-MAIL: m.starz@vindico-sport.de

KLAUS ATTENBERGER

POSITION: Geschäftsführung /
Rechnungswesen
TELEFON: +49 (0)7363 / 40902-0
E-MAIL: info@vindico-sport.de

THOMAS PFITZENMAIER

POSITION: Technischer Betriebsleiter
TELEFON: +49 (0)7363 / 40902-70
E-MAIL: t.pfitzenmaier@vindico-sport.de

TOMASZ ZELASKO

POSITION: Vertrieb & Projektabwicklung
TELEFON: +49 (0)7363 / 40902-50
E-MAIL: t.zelasko@vindico-sport.de

RALPH HALMAGHI

POSITION: Einkauf & Projektabwicklung
TELEFON: +49 (0)7363 / 40902-60
E-MAIL: r.halmaghi@vindico-sport.de

HANNAH GRAF

POSITION: Projektabwicklung
TELEFON: +49 (0)7363 / 40902-40
E-MAIL: h.graf@vindico-sport.de

VERTRIEBSPARTNER DEUTSCHLAND

HENNING HILDENER

Handelsvertretungen für Sportbau
(Schleswig Holstein, Niedersachsen,
Bremen, Mecklenburg Vorpommern,
Hamburg)

TELEFON: +49 (0) 4221 / 925 457
HANDY: +49 (0) 171 / 215 14 01
E-MAIL: henning@hildener.info



STRÖBL GMBH

Industrieververtretungen
(Bayern)

TELEFON: +49 (0) 89 / 89 7777-0
FAX: +49 (0) 89 / 89 7777-77
E-MAIL: info@stroebel.com



GS SPORTSERVICE GMBH

Geräte - Sicherheit - Sport - Service
(Nordrhein Westfalen / Hessen)

Am Breiten Weg 2 - 36132 Eiterfeld
TELEFON: +49 (0) 6676 / 918 68 65
FAX: +49 (0) 6676 / 918 68 64
E-MAIL: info@gs-sportservice.de
www.gs-sportservice.de



KREATIVITÄT IN BEWEGUNG

Ariane Hölscher
(Sachsen Anhalt / Sachsen)

Nedderfeldstraße 24 - 30451 Hannover
TELEFON: +49 (0) 511 / 897 37 72
E-MAIL: info@KiB-Hoelscher.de
www.KiB-Hölscher.de

VERTRIEBSPARTNER INTERNATIONAL



SCHWEIZ



silisport ag

silisport ag

Niederfeldstrasse 5
CH - 8450 Andelfingen

Tel.: +41 (0) 52 / 396 70 70
Fax: +41 (0) 52 / 396 70 80
E-mail: kontakt@silisport.com



ITALIEN
(NORDITALIEN)



SPORTBAU
GmbH

SPORTBAU GmbH

Sigmundskron 43
I - 39100 Bozen

Tel.: +39 (0) 471/ 66 31 58
Fax: +39 (0) 471/ 66 36 32
E-mail: info@sportbau.it



ÖSTERREICH



Sportbau Walser
Gesellschaft m.b.H.

Sportbau Walser Gesellschaft m.b.H.

Bauern 21
AT - 6844 ALTACH

Tel.: +43 (0) 5576 / 72 611
Fax: +43 (0) 5576 / 72 611-18
E-mail: office@sportbau.at



RUMÄNIEN

Der Service Gaertner

Hauptstrasse 19
D - 65510 Idstein-Woersdorf

Tel.: +40 (0) 731 / 955 144
E-mail: ralphleuschner@mail.com



FRANKREICH



Playgones

Amenageur Urbain Sports et Loisirs
7 impasse Gutenberg
FR - 38110 ROCHETOIRIN

Fixe: 04.74.28.38.14
E-Mail: info@playgones.com
https://www.playgones.com





VINDICO

SPORT

WWW.VINDICO-SPORT.DE

Vindico Sport GmbH

Deutschordenstraße 38
73463 Westhausen
Germany

Tel. +49 (0)7363 / 40 90 2-0
Fax. +49 (0)7363 / 40 90 299
E-Mail: info@vindico-sport.de
www.vindico-sport.de