

BASIC FISHING METHODS

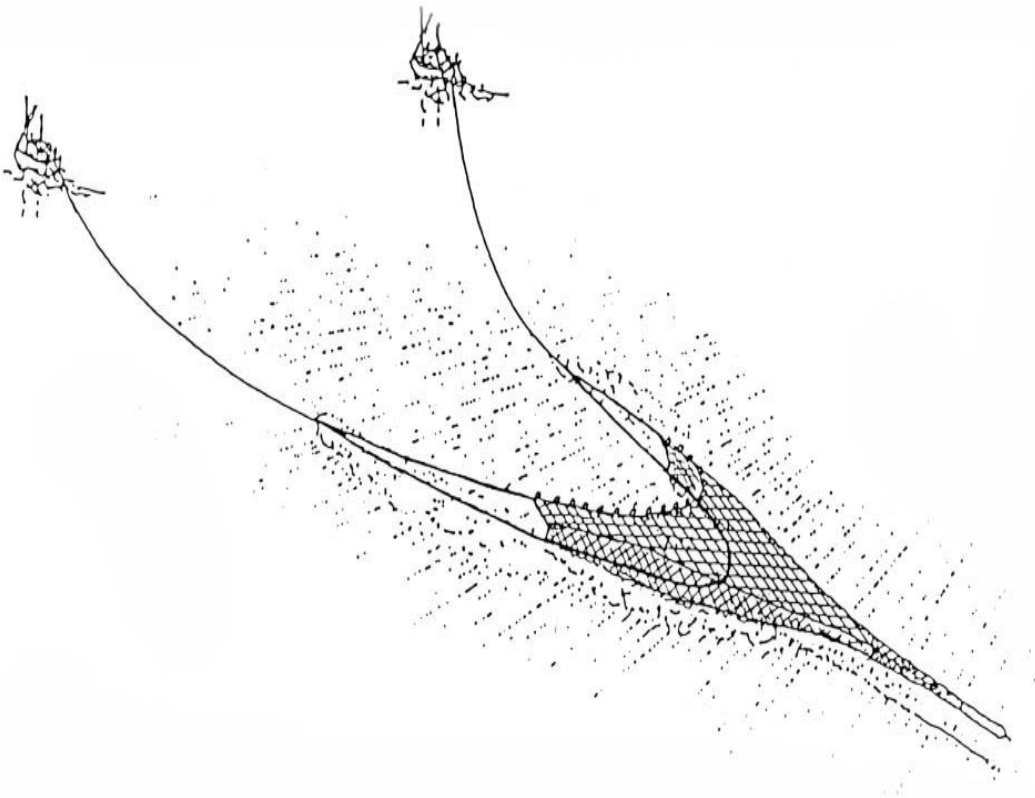

**SEAFISH FLUME TANK
Manchester Street
Hull
APRIL 2005**

CLASSIFICATION OF FISHING GEAR

Surrounding nets	Purse nets Ring nets
Seine nets	Beach seines Scottish seines Anchor seines Pair seines
Trawls	Beam trawl Otter trawl Pair trawl Multi rig trawls Pelagic trawls Pelagic pair trawls
Dredges	Scallop dredges
Gill nets	Gill nets Trammel nets Drift nets
Traps	Pots and creels Fyke nets
Hooks and lines	Long lines Jigging Trolling Pole lines
Miscellaneous	Lift nets Cast nets Harpoons Fish pumps

GEAR DESCRIPTIONS

ENCIRCLING

RING NET	Net operated by surrounding a shoal of pelagic fish with a “wall” of netting, often operated by two boats.
PURSE SEINE	A large net used to surround a shoal of pelagic fish, the bottom of which is then drawn together to enclose them
BEACH SEINE	An encircling net shot from a small boat then drawn ashore by ropes.
ANCHOR SEINE	An encircling net shot in the open sea using very long ropes to lay out the net and ropes on the seabed prior to hauling from a boat at anchor. Sometimes called Danish seine.
SCOTTISH SEINE	An encircling net shot in the open sea using very long ropes to lay out the net and ropes on the seabed prior to towing the net closed and hauling from a boat under its own power. Sometimes called fly dragging or fly shooting.

TOWED GEAR

BEAM TRAWL	Trawl towed on the seabed in which the net is held open by a wood or steel beam.
OTTER TRAWL	Trawl towed on the seabed, held open by a pair of otter boards (trawl doors). It is usually a much larger net than a beam trawl.
PAIR TRAWL	Trawl towed between two boats, either on the seabed or in mid-water, held open by the distance apart of the two vessels.
TWIN RIG TRAWL	Method of towing two otter trawls side by side.
MULTI RIG TRAWL	Method of towing two or more otter trawls side by side.
DREDGE-	Rigid structure towed on the seabed usually for shellfish.

STATIC GEAR

FIXED NETS	Sheets of thin netting anchored in the water to catch fish by enmeshing or entangling them.
DRIFT NETS	Sheets of thin netting allowed to drift with the tide or current to catch fish by enmeshing or entangling them
LONG LINES	Extremely long lines that can be anchored or drifting. with numerous baited hooks.
TRAPS	Structures into which fish are guided or enticed through funnels that encourage entry but limit escape. Pots, creels, fish traps etc.

DEVELOPMENT OF FISHING GEAR

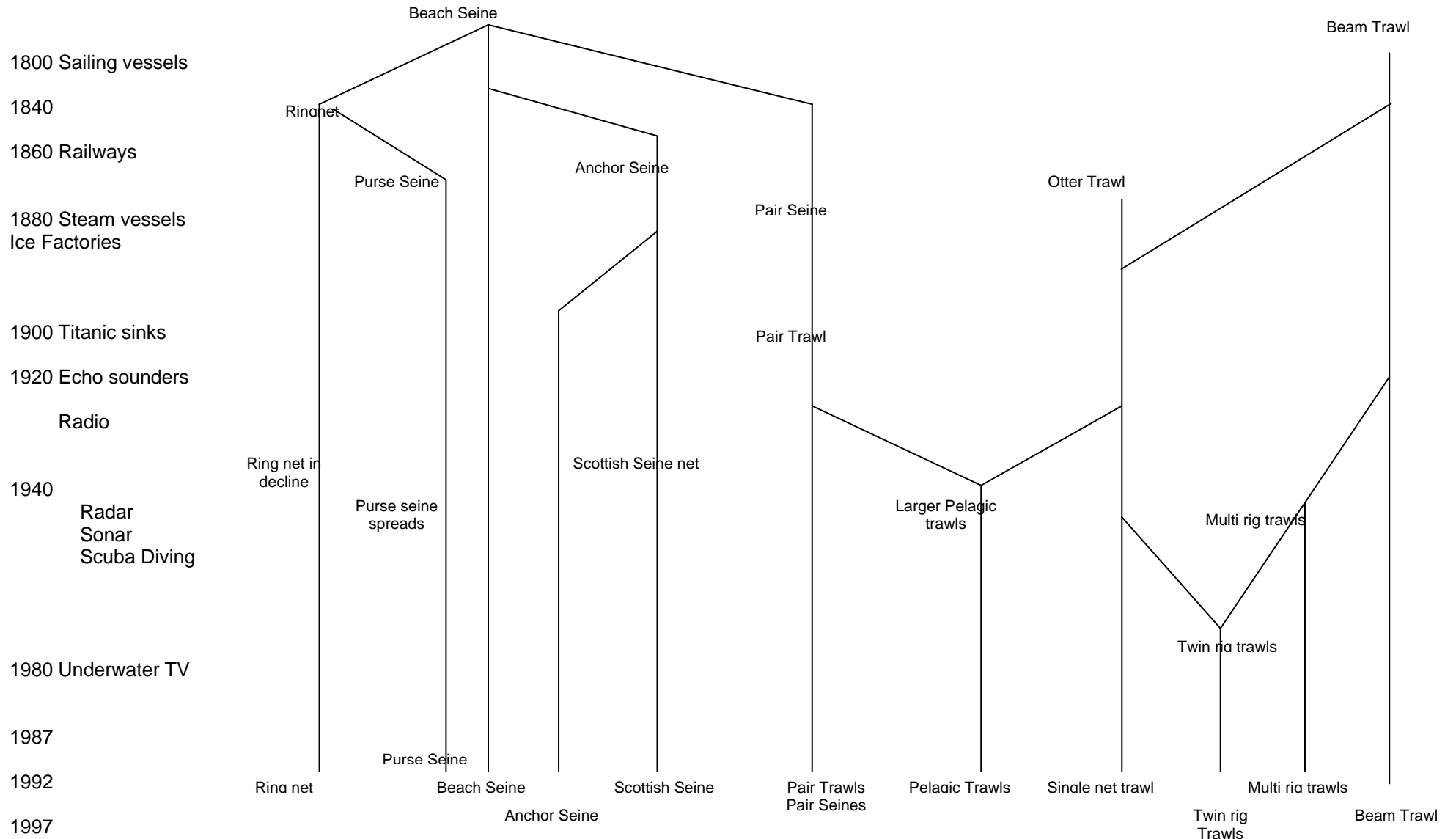

GEARS IN THE WATER COLUMN

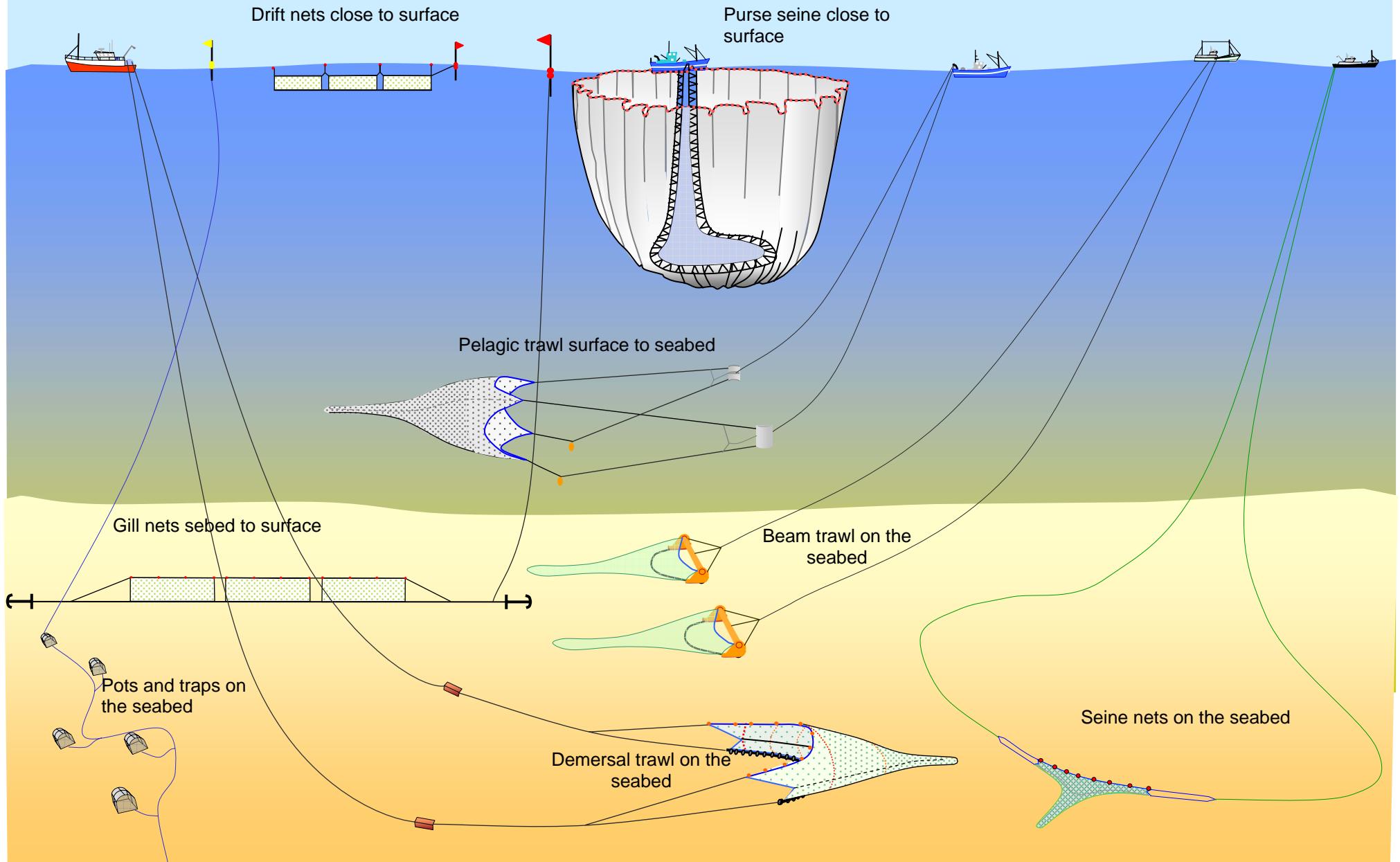

FISH SPECIES IN THE WATER COLUMN

SURFACE

SURFACE



mackerel

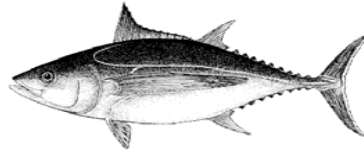

tuna



scad

PELAGIC



herring



sardine



sprat

DEMERSAAL



John dory



bass



hake



cod



saithe



haddock



whiting

ON THE SEA BED



megrin



brill

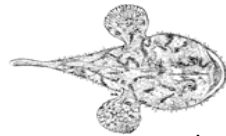

monk

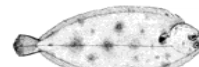

Dover sole



turbot

Skate and rays



halibut



shrimp



scallop



lobster



prawns



Norway lobster



crab

BEAM TRAWL

EVOLUTION

The beam trawl is one of the earliest forms of towed fishing gear, being used in the Southern North Sea by the sailing smacks from Grimsby and Lowestoft in the latter part of the 19th century. The net is held open by a rigid framework ensuring it maintains its shape and effectiveness despite changes in towing speed. This made it ideal for towing behind early sailing boats with their unpredictable course and speed. As diesel engines were developed along with mechanised hauling methods the gear was made larger and towed at faster speeds in an effort to improve catches. In the early days of beam trawling only one net was towed from the stern of the boat. Nowadays most commercial beam trawlers tow two beam trawls from long derricks projecting over each side of the vessel.

GEAR

The beam trawl consists of a heavy steel beam, of tubular section, supported by steel beam heads at each end. These beam heads have wide shoes at the bottom to which slide over the seabed. The beam and beam heads form a rigid framework that keeps the trawl open and supports the net. On the early beam trawls and modern day small scale trawls the timber was used for the beam. The cone shaped net is towed from this framework with the headrope attached to the beam and each end of the footrope connected to the bases of the shoes. As the gear is towed over the seabed the footrope forms a 'U' shape curve behind the beam and shoes with the net and codend behind this. The headline height of the trawl is limited to the height of the beam off the seabed. The beam is usually towed using a chain bridle arrangement from both shoes and the centre of the beam to the end of the trawl warp leading to the vessel

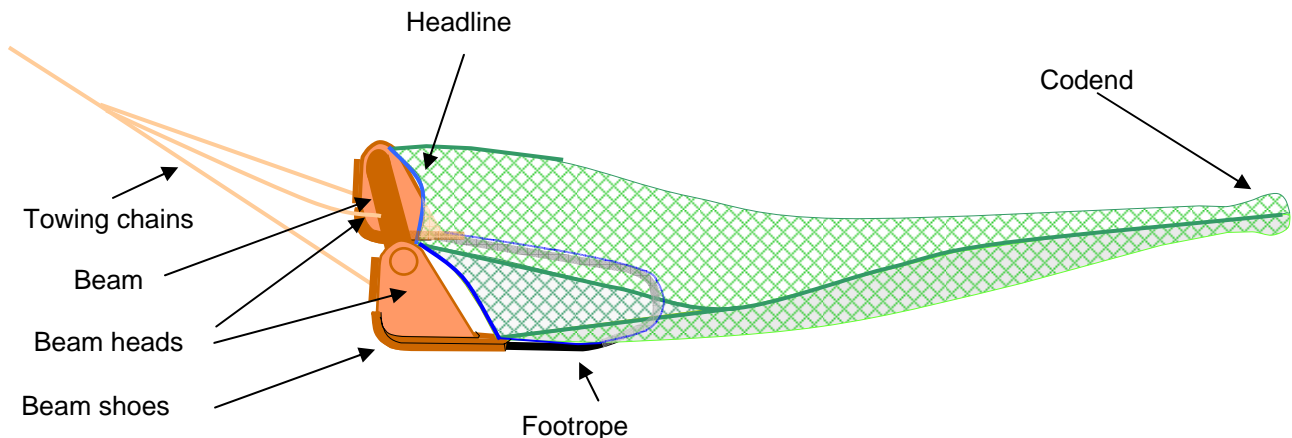

There are two common types of beam trawl, referred to as 'open gear' and 'chain mat gear'. Open gear is a lighter rig with several chains, called ticklers, towed on the seabed across the mouth of the net. These ticklers help to disturb the fish from the muddy seabed, causing them to rise and be caught by the net. This rig is used on clean soft ground (seabeds). The chain mat gear is used for towing over harder, rockier areas of seabed, more commonly used by the bigger class of beamers. In this rig there is a lattice work of chains towed from the back of the beam sloping down to the footrope of the net. The purpose of this is to guide the trawl over any rough ground and boulders on the seabed, thereby minimising damage to the netting. Some beam trawls are also fitted with 'flip up ropes' to prevent stones from entering the net and damaging it. This is a rope mesh fence towed ahead of the footrope to lift the footrope over any obstacles on the seabed.

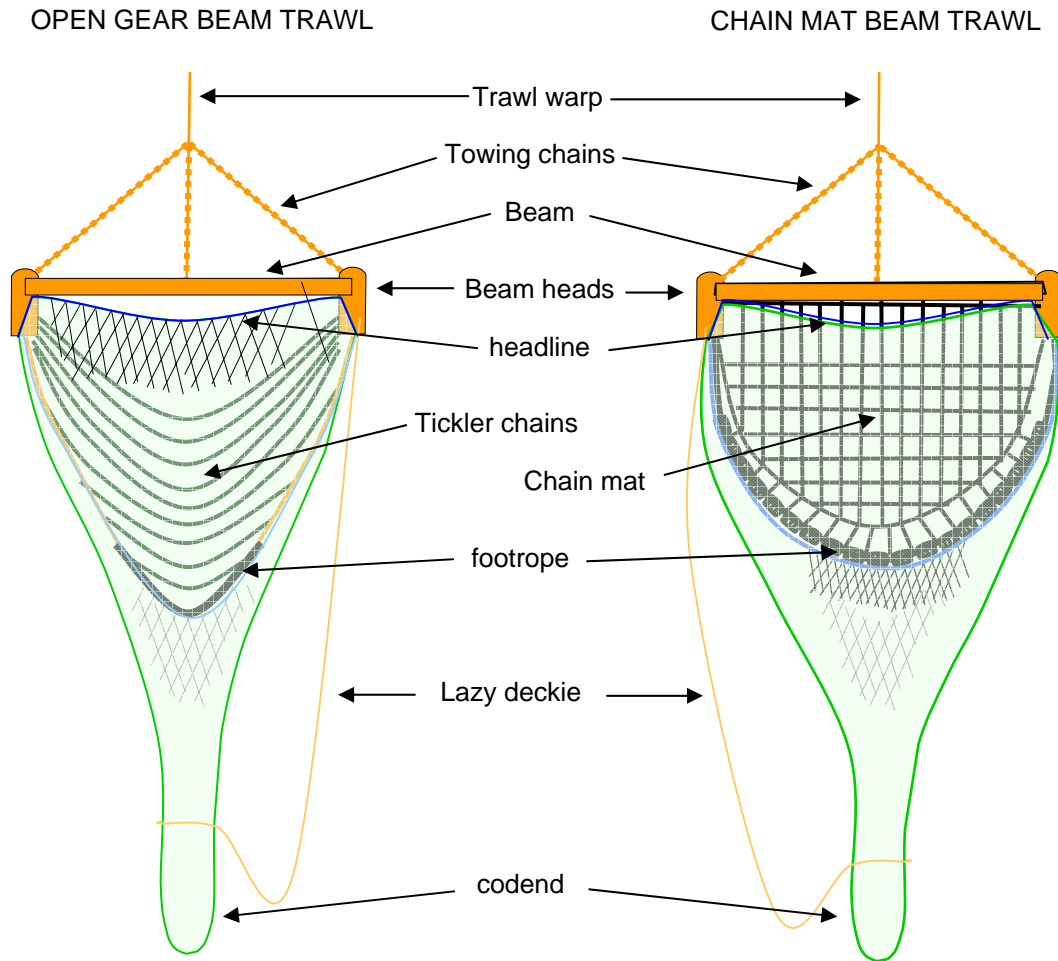

TYPICAL VESSELS

The largest class of beam trawlers are around 25 – 40metres long, generally have in excess of 1000 horse power, towing two beam trawls 12 metres wide. This size of beam trawl can weigh up to 9 tonne each enabling the trawler to tow at speeds up to 7 knots. The medium class of beamers, from 12–18 metres usually have between 300- 500 horsepower to tow 4–7 metre beams. Many of the vessels under this size tow one trawl from the stern of the vessel. The size of beams towed and the horsepower of many vessels is restricted by fishery regulations in the area that they fish.



TARGET SPECIES

The target species are Dover sole, plaice, shrimp, lemon sole, skate, with megrims and monkfish being caught in deeper water.

BOTTOM TRAWL

EVOLUTION

Bottom trawling is a direct descendant of the original beam trawl. The early forms of towed fishing gear used by sailing boats with their unreliable towing power involved the use of beam trawls. The size of the nets being restricted by the limited power available and the length of beam that could be stowed aboard the vessel. With the coming of steam powered vessels and later diesel propulsion, otterboards were developed to spread the nets in place of the rigid beam of the beam trawl. This allowed nets to be made much larger. To begin with the otterboards or trawl doors, as they are more commonly called nowadays, were attached to the wingends of the nets. Later with the understanding that certain species of fish could be herded into the path of the net, short bridles were added between the wingend, and the doors allowing a larger area of seabed to be swept by the net. Nowadays the bridles can range from none at all right up to 300 metres depending upon the target species and the type of seabed fished.

GEAR

A basic trawl is made up from two shaped panels of netting laced together at each side to form an elongated funnel shaped bag. This funnel tapers down to the cod-end where the fish are collected until the net is hauled. The remaining cut edges of the netting, at the mouth of the net are strengthened by lacing them to ropes. The rope along the upper edge of the net is called the headline, the one along the lower edge the footrope or fishing line, and the side ropes called the winglines or gables. The headrope has floats attached to it to lift it clear of the seabed and hold the net open in a vertical direction. The footrope usually has some form of weighted 'groundgear' attached to it.

The wings of the net are attached to a set of trawl doors by wires called bridles or sweeps.

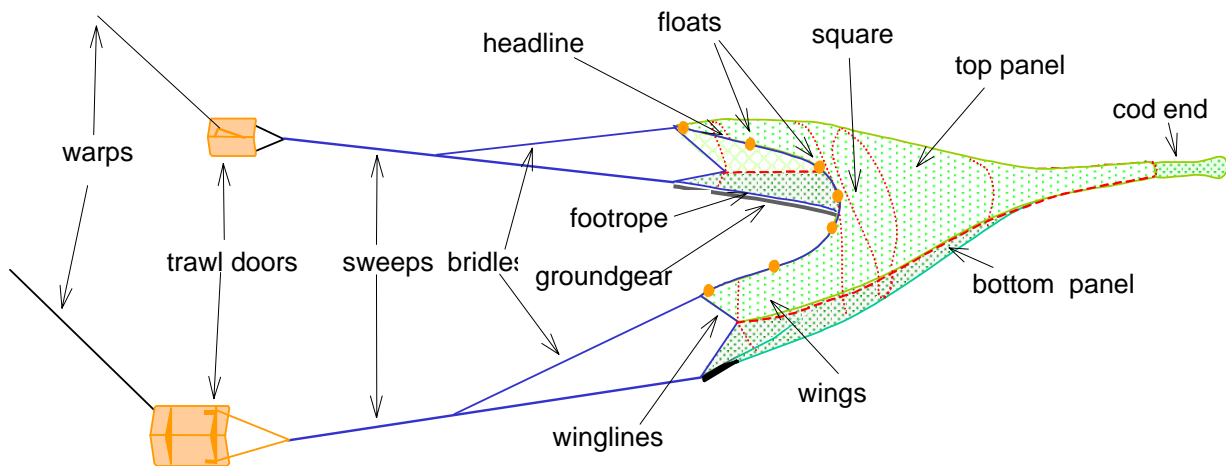

The trawl doors, made of steel or wood, are designed to flow through the water at an angle causing them to spread away from each other opening the net in a horizontal direction. The trawl doors in turn are attached to the boat by trawl warps.

As well as spreading the net the otterboards have to be heavy enough to keep the gear on the seabed as it is towed along by the trawler. As the trawl doors are towed along the seabed they kick up large sand clouds that initiate the herding process.

The early trawl doors were flat rectangular shaped objects made from timber with steel reinforcing. These simple doors are still used today in some fisheries, but many boats use steel doors with the plates bent into a 'V' shape. Recently many manufacturers of trawl doors have introduced new designs of doors using curved plates and foil type sections in an attempt to be more hydrodynamically efficient. The more elaborate designs tend to be more intricate to use well. The correct weight distribution and towing chain lengths are critical to get a trawl door to spread the trawl gear effectively.

Some of the more common types of trawl doors;-

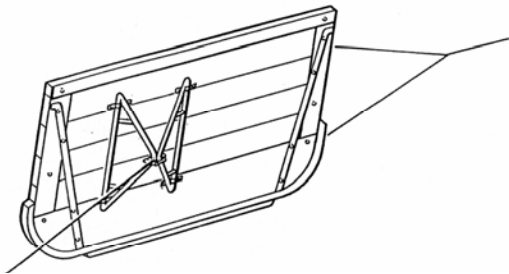

Common flat wooden door. This is one of the earliest known designs of otterboards. Nowadays in the UK it is used mainly by smaller trawlers towing in shallow water. They are easily constructed and easy to maintain.

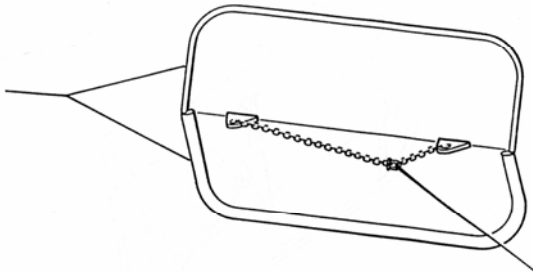

Steel 'vee' door. Probably the most commonly used otterboard in the UK fishing fleet today. Theoretically not the most efficient otterboard but they are cheap to construct and easy to work

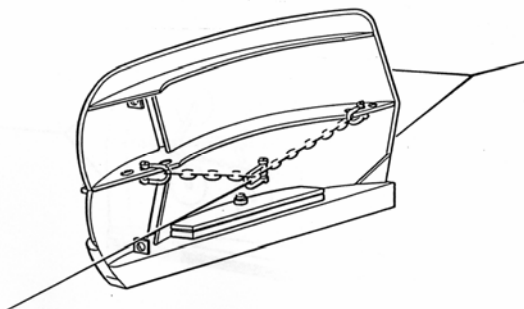

A cambered 'v' otterboard. The idea of the curved plate is to improve water flow around the otterboard thereby improving efficiency.

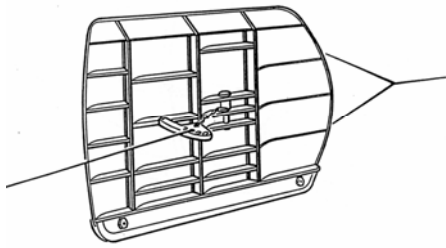

'Bison' otterboard using four curved foils to reduce drag and improve performance

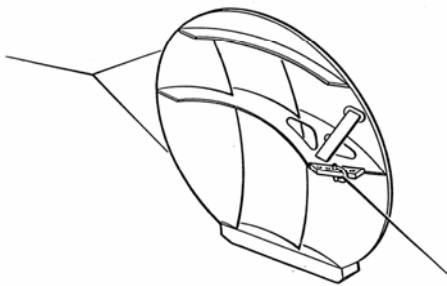

Danish 'Lindholmen' otterboards. Mainly used by the North Sea Nephrops trawlers.

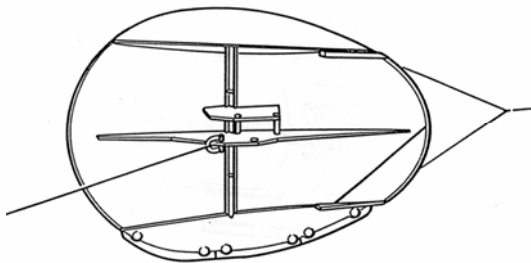

Oval shaped doors favoured by the deep sea fleet. Particularly suitable for fishing over rough seabeds.

Generally, immediately behind the otterboard there is a length of single wire referred to as the sweep or single sweep, this in turn is connected to the bridles, which are then attached to the net. The top bridle, usually of lighter weight material, to the headline of the net and the bottom bridle to the fishing line and groundgear.

The sweeps and bridles between the net and the otterboards can be made up using wire, combination wire or chain. The choice depends upon the size of gear and the type of seabed that is being trawled over. The bigger fishing vessels tend to use thick wire and chain and the smaller inshore boats using thin wire and combination on the softer seabeds. The length of these bridles varies with the type of net being used. A net with a low headline will only have short bridles, a higher standing net needs longer bridles to allow it to open up fully. These sweeps and bridles can range from 2 metres long to as much as 300 metres. As they are towed over the seabed they create a sand cloud that helps to herd the fish into the mouth of the net. The length and the angle that the sweeps and bridles are towed at varies with the type of fish targeted by the skipper.

The mesh size used in a demersal trawl varies with the type of trawl. In the larger nets targeting round fish the mesh size may vary from 150-300mm in the top wings with slightly less in the lower wings, decreasing towards the cod end where it is usually from 70mm to 110mm, dictated by the official regulations concerning the species to be caught and the area to be fished. In nets used for catching bottom fish and prawns the complete net may be made from these smaller mesh sizes.

Along the lower edge of the trawl is the ground gear. The purpose of this groundgear is to maintain trawl gear in contact with the seabed and also protect the relatively fragile netting from damage on the seabed.

These groundgears come in many different forms depending on the type of seabed that the trawl is towed over.

On soft sand and mud, light chain is used but when fishing stony, rougher bottoms various heavier ground gears are attached below this fishing line. The heaviest ground gears are made up of rubber discs and wheels threaded onto chains and wires all chosen to be tough and hard wearing to ease the relatively fragile advancing net over any stones and boulders that may be in its track.

TRAWLER AND ITS GEAR

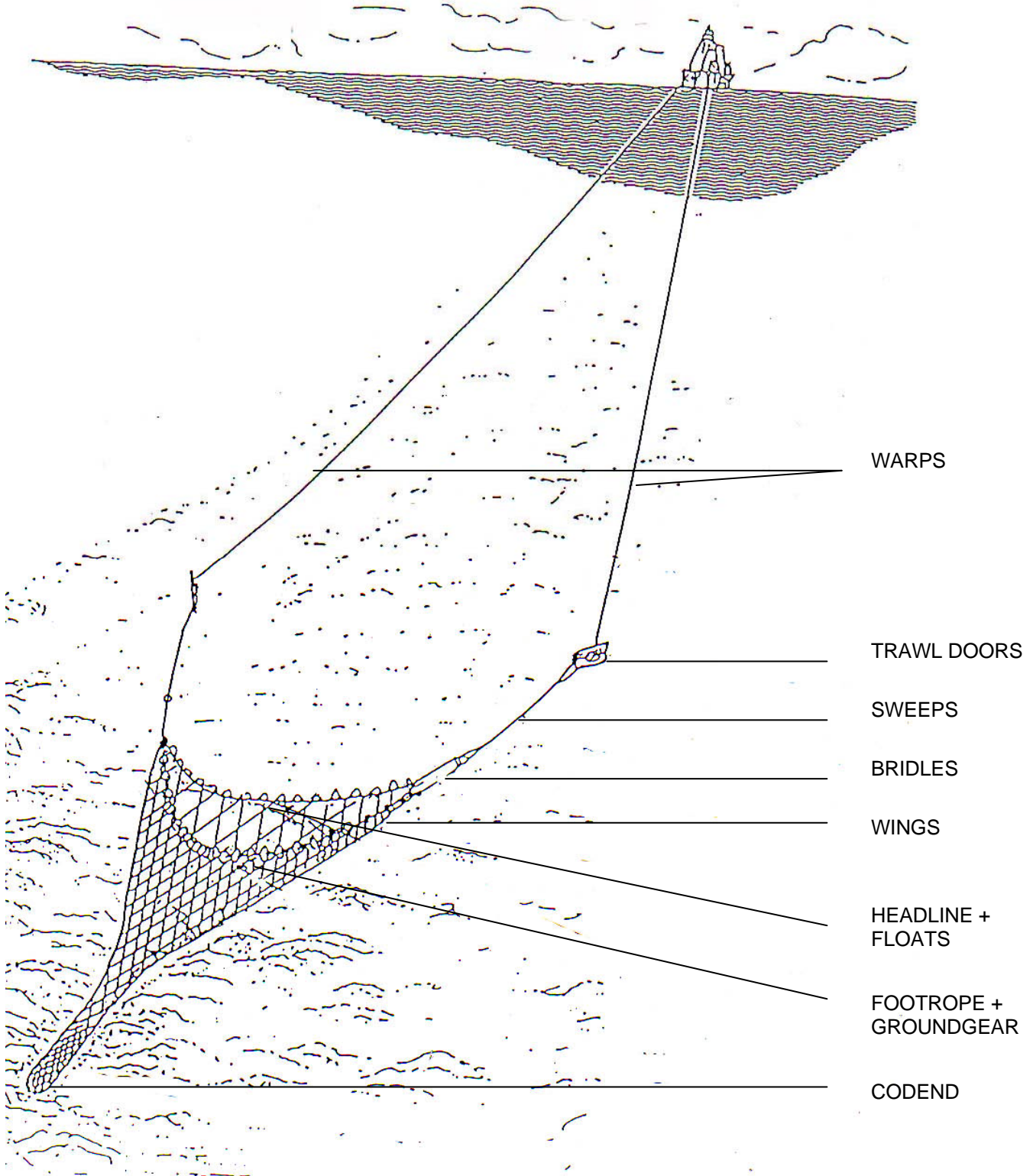

SELECTION OF TRAWL DESIGNS

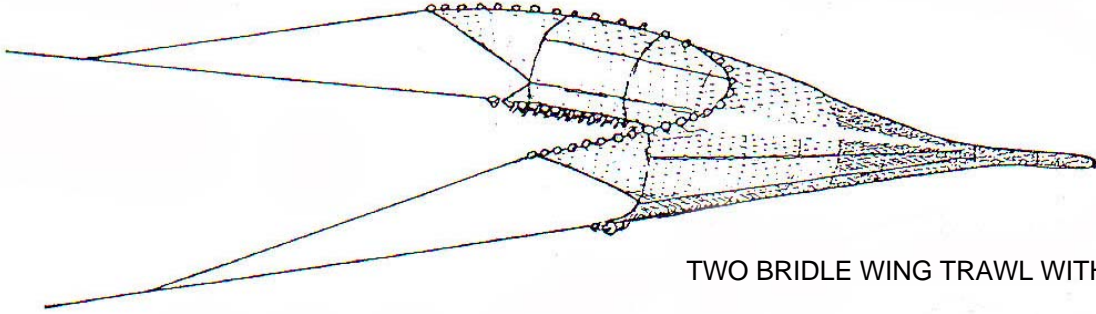

TWO BRIDLE WING TRAWL WITH SIDE PANELS

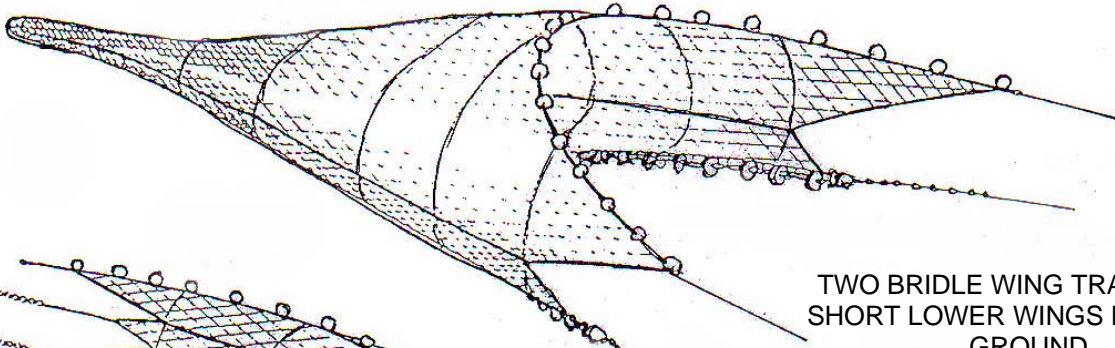

TWO BRIDLE WING TRAWL WITH SHORT LOWER WINGS FOR HARD GROUND

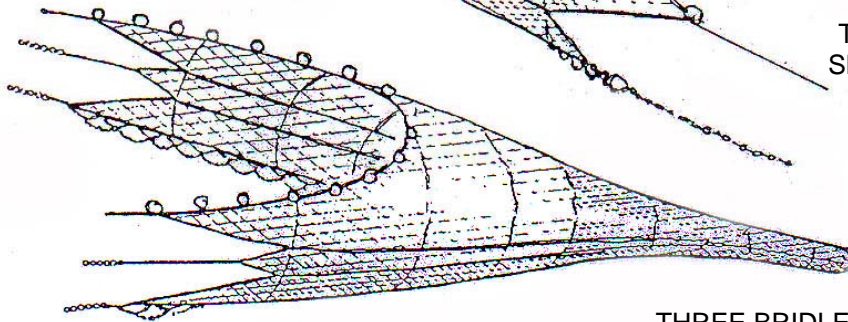

THREE BRIDLE WING TRAWL WITH SIDE PANEL

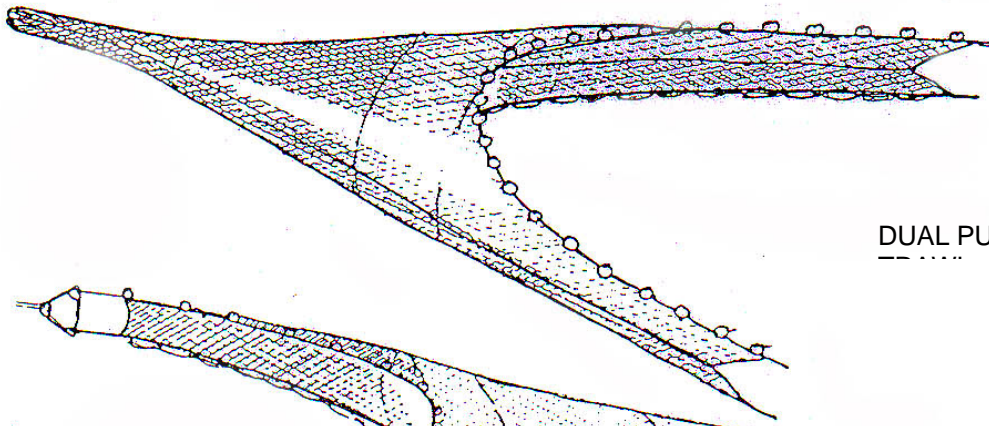

DUAL PURPOSE GROUND FISH

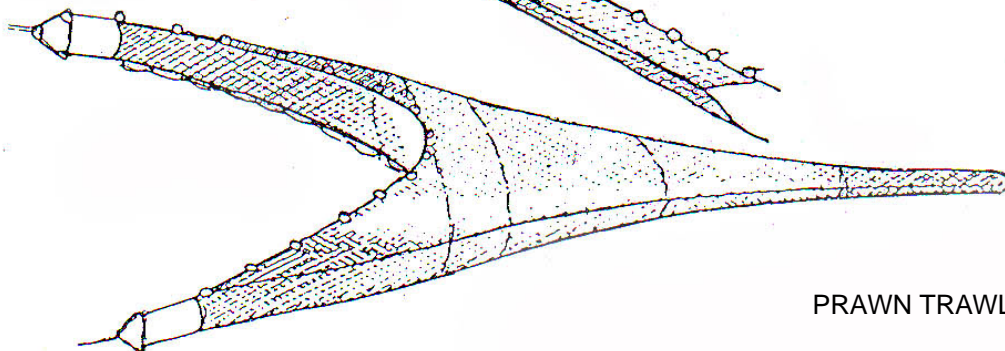

PRAWN TRAWL WITH LONG WINGS

EXAMPLES OF TRAWL GROUND GEAR RIGS

RIGS FOR SOFT SEABEDS

RIGS FOR FIRMER SEABEDS

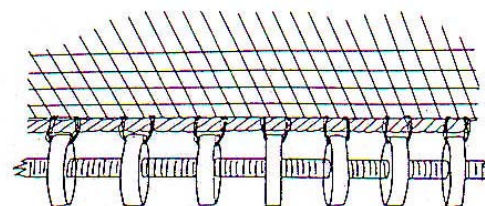
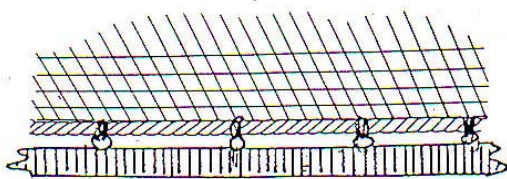
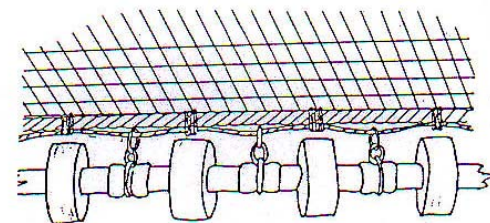
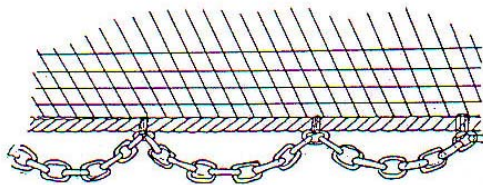
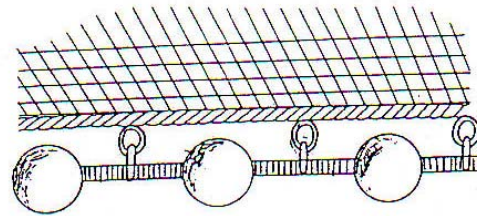
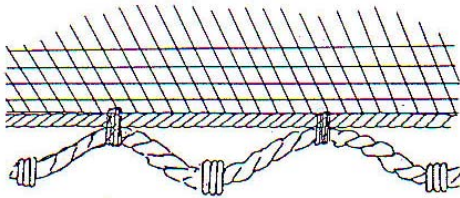
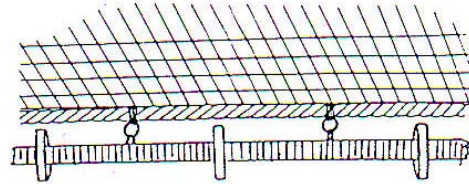
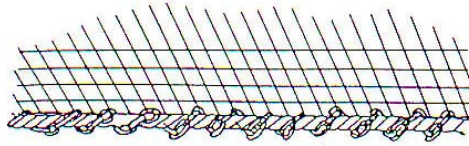

PAIR TRAWL (DEMERSAL)

In this method a bottom trawl is towed simultaneously by two boats. The basic net differs very little from that of a single trawl but there are no trawl doors, the distance between the vessels ensures that the horizontal opening of the net is maintained. The net and bridles are connected directly to the trawl warps. The weight of the doors is replaced either by a clump weight or a length of heavy wire (150-300metres) to help keep the gear on the seabed.

Because there are no doors, the total drag on the gear is less, enabling two trawlers to tow a very large trawl. In pair trawling a considerable length of warp is shot (between 4 and 6 times the depth of water) some of which (the heavy wire) drags along the seabed acting like a bridle to herd fish towards the net. Additionally in shallow water the propeller noise does not disturb the fish before the passage of the trawl but helps the herding effect of the gear.

The gear is handled in the same way as a single net with one boat shooting and hauling the net while the other takes one side of the net when towing. Usually each boat only carries one net because of its increased size and weight.

PAIR SEINE

This is very similar to pair trawling but longer lengths (as much as 3500metres) of seine net ropes and combination wire are used instead of trawl warp. It is usually used to sweep vast areas of clean ground, whereas pair trawl covers smaller areas of harder seabeds.

One of the problems of both methods is that the two vessels have to come close together to pass the tails of the net across. This can be hazardous in poor weather.

DEMERSAL PAIR TRAWL

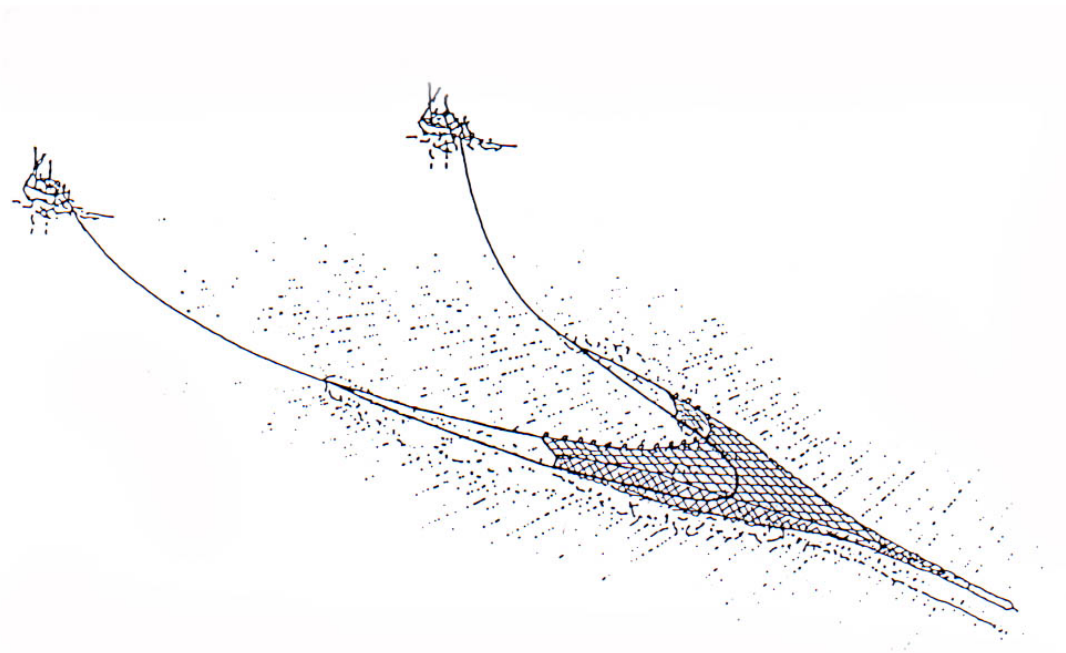

COMPARISON OF SWEEPED AREAS OF DIFFERENT TOWED GEARS

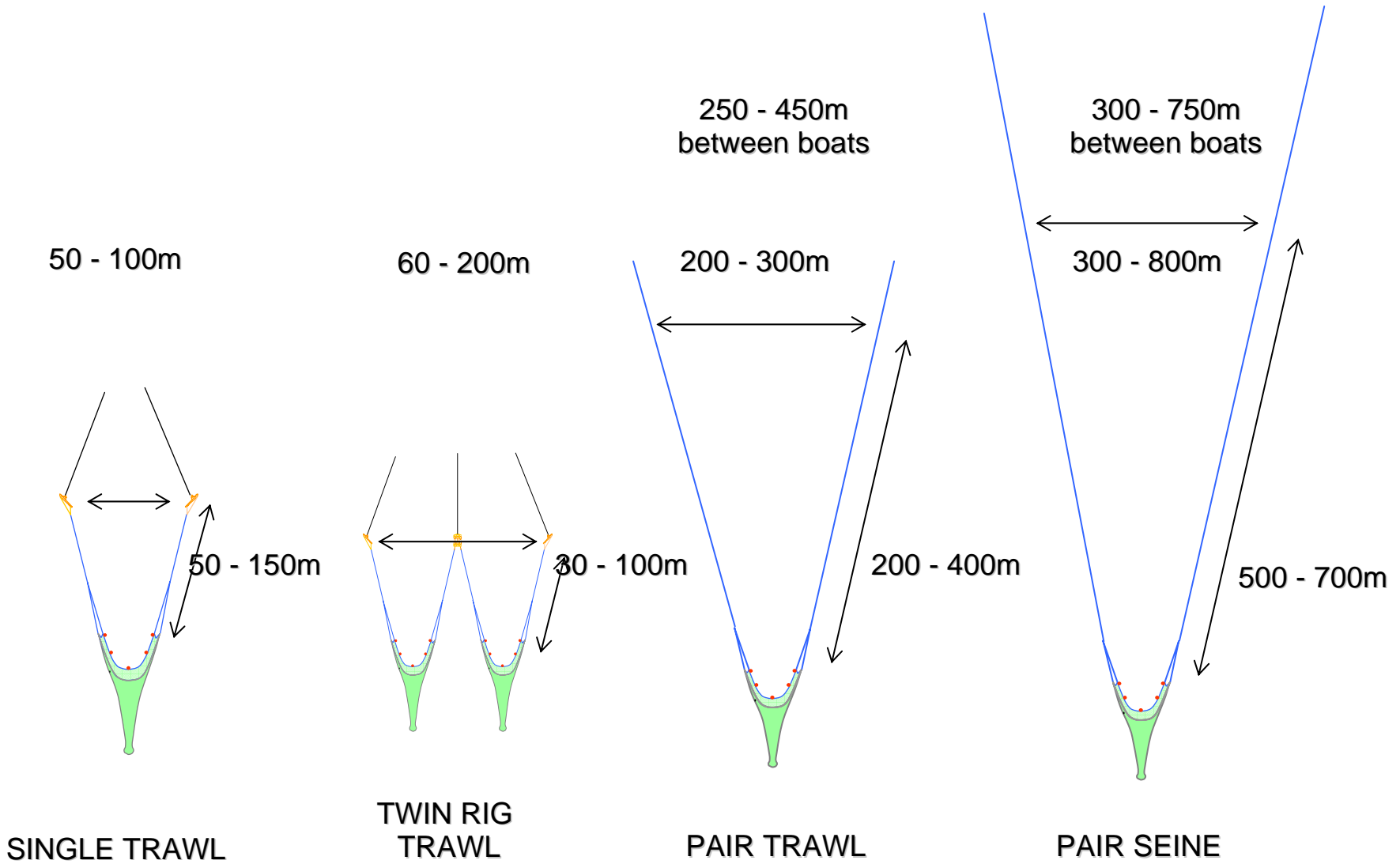

MULTI RIG / TWIN RIG BOTTOM TRAWL

Multi-rig fishing techniques have been used extensively in overseas fisheries for many years and proved very efficient. In Australia and Mexico as many as five nets are towed using outriggers for prawn and shrimps.

MEXICAN MULTI-RIG SYSTEM

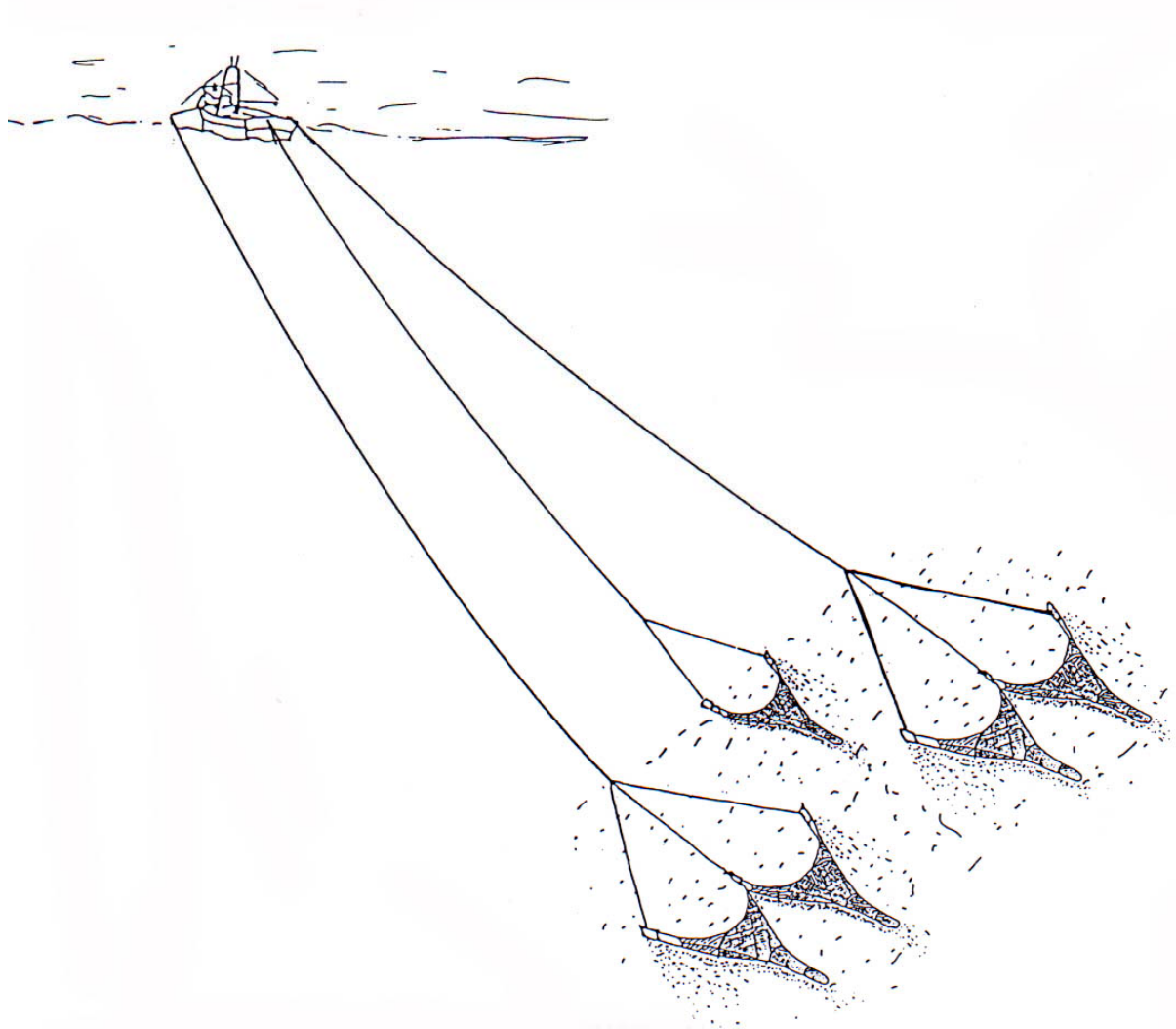

In the early 1980s this method was successfully adopted using only two nets in the Danish prawn and shrimp industry. The English trawlers copied this method for targeting soles using both twin and triple rigs. The prawn (*Nephrops*) trawlers in Scotland also followed the Danish trend and it spread to the vessels targeting bottom living fish.

The idea behind the technique of multi-rig trawling is that a larger area of seabed can be covered by allowing a wider spread of ground gear to be worked without towing the increased area of netting of one large single trawl to give similar coverage. The type of fish targeted by this method do not react well to herding, so the catch is more dependant upon the area of seabed covered by the ground gear of the net, the centre section (the bosom) in particular.

TWIN-RIG FOR SOLES

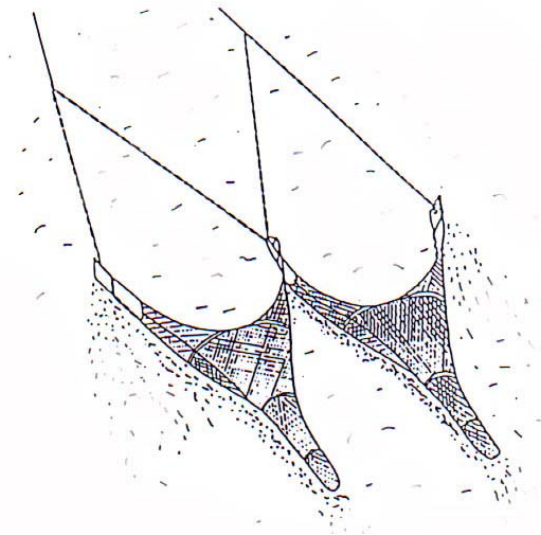

TRIPLE-RIG FOR SOLES

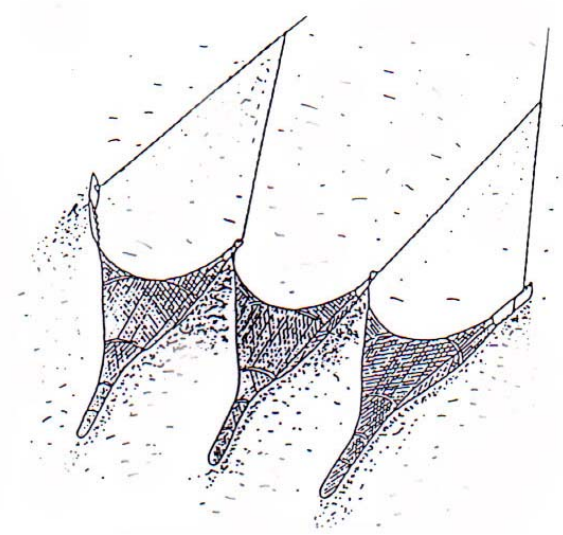

TWO WARP TWIN-RIG SYSTEM

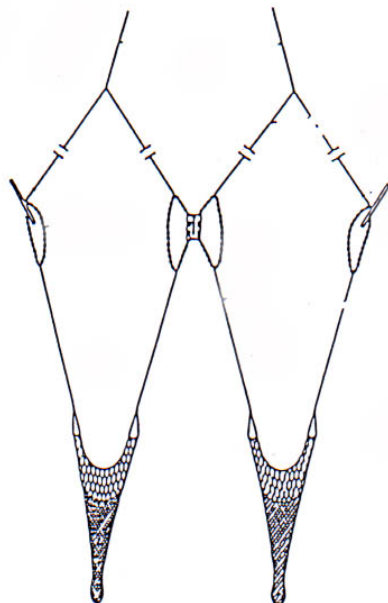

As the method developed it was found to be effective with short sweeps, for several species of ground fish (monks, megrims etc). In recent years with the comparative decline in value of the main demersal species such as haddock and, fishermen have started targeting the high value species such as monkfish and megrim which are found close to the bottom. These species, unlike haddock and whiting, tend to herd only short distances. With a small sweep angle and a large area of seabed swept by the two sets of ground gear this method of bottom trawling is very effective for ground hugging species but because of an increased area swept between the trawl doors it is still very effective for round fish (haddock, cod etc).

Multi-rig trawls can be towed with either a 2 or 3 warp system depending upon the capabilities of the vessel's winch. Although the 2 warp system is very effective, it has its problems; the 3 wire system is more versatile and probably easier to work, particularly when problems develop.

The basic rig is, similar to a single net rig, with trawl doors on each outside warp to spread the gear and a form of clump weight on the tail of the centre warp to keep the gear in contact with the seabed. Behind the doors and weight two nets are towed side by side. The amount of bridle (sweep) between the net and doors and net and weight depends on the type of seabed worked and the target species. The centre weight can range from a simple clump of heavy chain to a specialist depressor style weight and is usually about 25%-50% heavier than one door. To keep both nets square and in their most efficient mode, the centre wire has to be shortened slightly. The amount depends on the length of wire between the doors and the vessel and the door spread.

TWIN RIG USING THREE WIRES

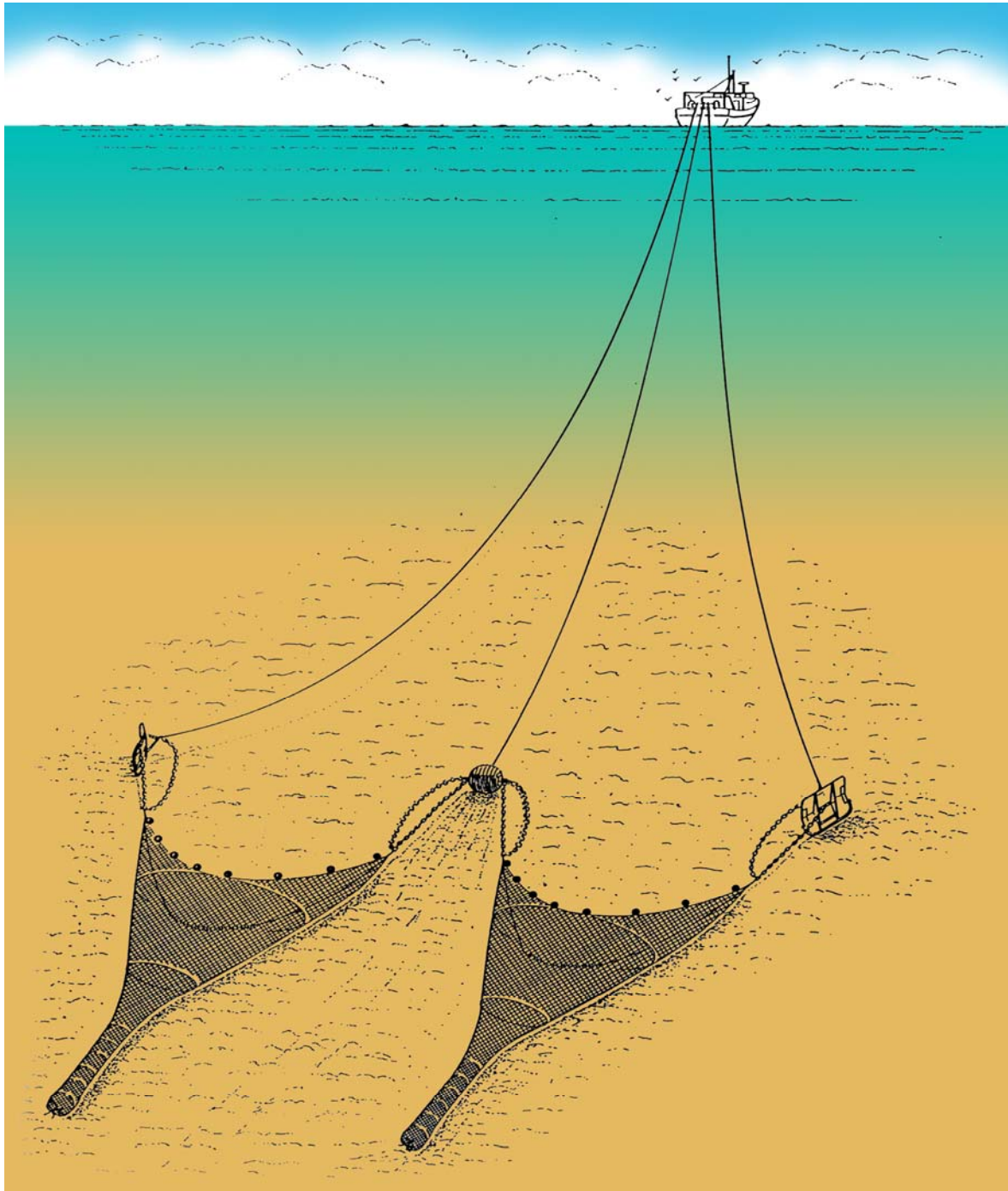

PELAGIC TRAWL (SINGLE AND PAIR)

Pelagic trawling is a method of fishing for targeting fish between the surface and seabed. The main target species are mackerel, herring and sprats, in some areas white fish are also caught using pelagic or semi pelagic gear. With the improvement of sonar, echo sounders and fishlupes enabling the vessel to actually locate and track schools of pelagic fish it became more apparent to fishermen that, at certain times, large amounts of fish could be caught in the layers of water off the seabed.

Pelagic or midwater trawls are generally much larger than bottom trawls with the forward sections of the net usually comprising of very large meshes (5-120m) or ropes that herd the shoals of fish towards the main body of the trawl.

These large meshes are effective for these types of fish as they are schooling fish, i.e. when one fish strikes danger (the net) the whole shoal moves clear of it as one. It also allows much larger nets to be used effectively filtering a much larger volume of water. The position of the net between the surface and seabed is usually monitored using electronic sensors on the headline to give a depth for both top and bottom of the net allowing the skipper to position his net in line with the shoal. These nets can be as big as 160 metres deep and 240 metres wide.

The nets for single and pair trawling are basically the same but the bridle arrangement differs.

Single trawl - this net is towed by one vessel using a set of midwater doors to open the net horizontally. The net is opened vertically by the use of a chain clump on each lower wing end and floats on the headline. This position within the water column is controlled by the speed of the vessel and the amount of weight on the wing ends.

SINGLE BOAT PELAGIC TRAWL

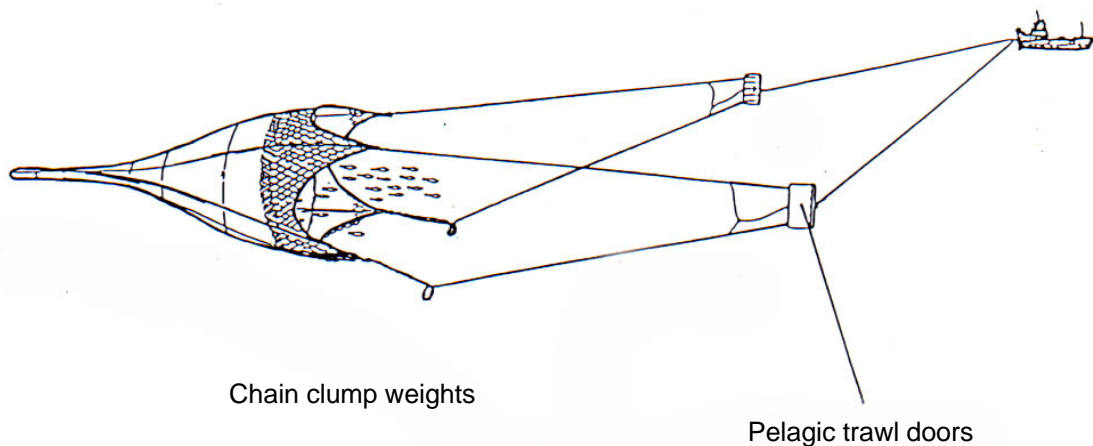

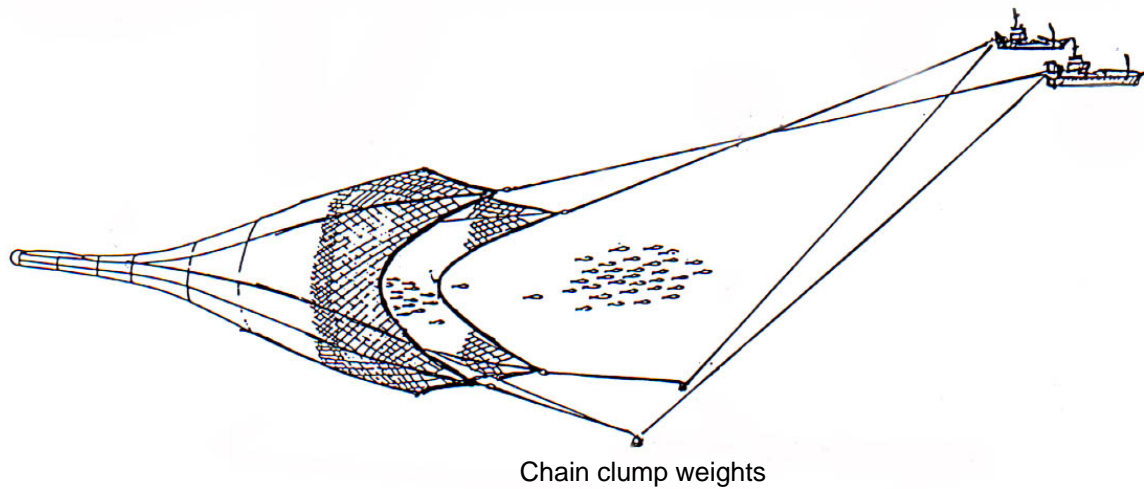

The nets in both methods are handled exactly the same as bottom trawls except that the larger pelagic boats usually pump their fish aboard in the same manner as purse seiners rather than lifting the full cod end aboard. Some of the larger vessels are capable of catching several hundred tons in one haul.

A wide variety of vessels use both these methods of fishing, from under 10metres in length vessels fishing pelagic gear close inshore at certain times of the year right up to 30-60metres in length specialist pelagic vessels with RSW tanks and even bigger (as long as 140m) 'supertrawler' class with freezing capabilities for up to 5400 tonnes of fish.

PELAGIC TRAWL DOORS

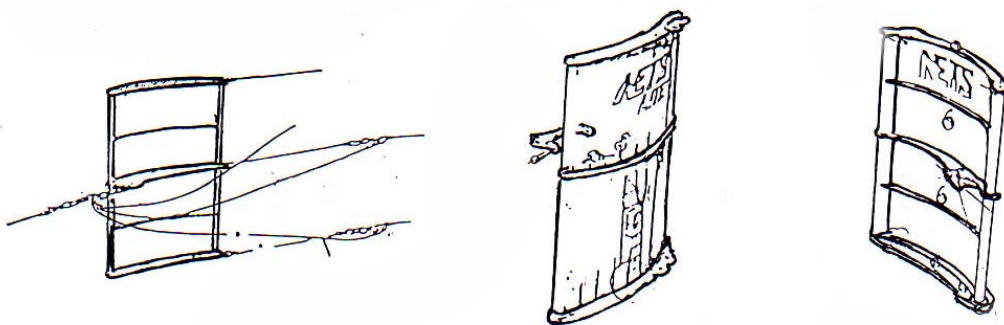

SEINE NET

The seine net method of fishing dates from around 1848 in Denmark where it was first used to catch plaice. The principle of the operation of seine net was that of using ropes to keep the net open and herd the fish towards the net. It originates from the beach seine, then shot from an anchored sail boat with longer ropes which were all hauled by hand.

With the coming of power driven boats with winches aboard, longer ropes and larger nets could be worked with smaller crews. In the 1920s Danish anchor seining was introduced to Scotland but they quickly dispensed with the anchor by using the vessel's own power to maintain its position while hauling the ropes and net. This method called fly shooting, proved more successful for catching round fish (whiting, haddock, cod etc).

Fly dragging is a very skilful operation requiring extensive knowledge in locating fish within the grounds, accurate rigging of the gear and consideration of tidal streams with relation to the gear throughout the shooting, towing and hauling operation.

The modern seine net vessel can work anything up to 16 coils of rope each side of the net. Each coil consists of 120 fathoms (220m) of lead cored, abrasion resistant rope, from 19mm up to 32mm diameter depending on the size of vessel. One end of the ropes is shot, with a dhan [buoy] attached. The vessel then steams round in a triangular shaped course shooting one side of the ropes, dropping the net half way round before shooting the second side of ropes, finishing close to the dhan, picking it up, leading both ropes to the winch and starting to tow the gear. The vessel will tow until strain is on both ropes, then engage the winch to begin heaving slowly. At this stage the vessel is moving ahead at about one or two knots, the winch speed is gradually increased from 50ft per minute to begin with to about 300 ft per minute, when around half the ropes are in and the gear has closed up. At this stage the vessel is maintaining its position or getting hauled astern by the net.

When all the ropes are in, the net is usually hauled aboard using a power block, the fish emptied into a deck pound or hopper and the gear made ready for the next shot.

Originally the ropes were coiled on deck but nowadays they are usually stored on large reels. When the vessels had open decks with coils of rope snaking across the deck and over the side this was a fairly dangerous method of fishing but with the advent of rope reels and shelter decks, allowing the ropes to be shot well clear of the crew, safety has been dramatically improved.

It is a more fuel-efficient method than trawling and usually yields a better quality of end product due to the short time that the fish are in the net before being taken aboard the boat.

As it becomes more mechanised with rope reels, more powerful winches and power blocks and improved rope construction, the skippers are tending to work harder bottoms and deeper water in an attempt to improve catches.

With the current trends toward targeting bottom fish in deeper water the number of vessels pursuing this type of fishing have declined in recent years.

SEINE NET VESSELS

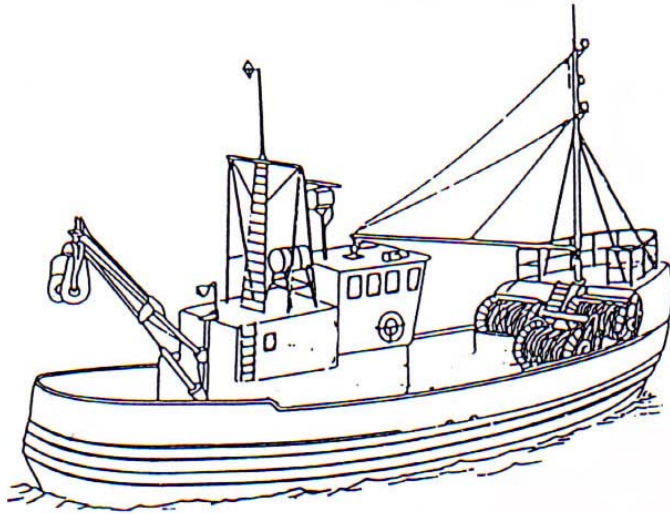

60ft Open Deck Seine Net Boat with three rope reels

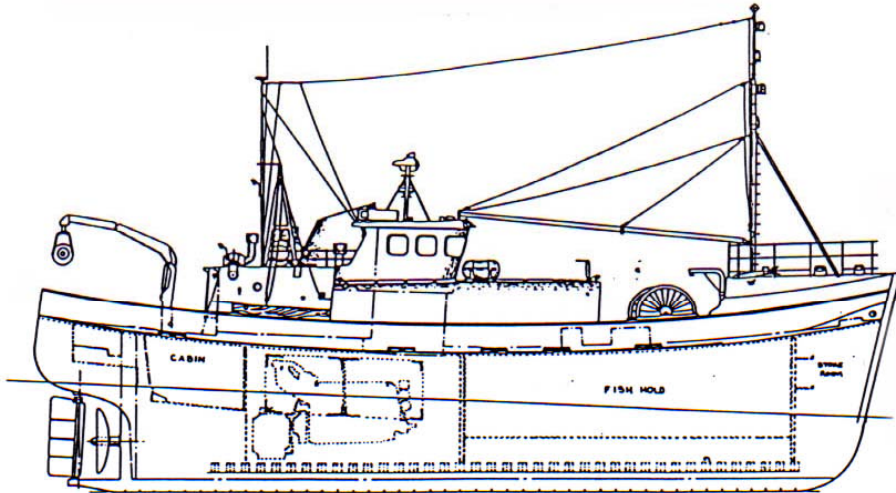

85ft Seine Net Boat with half length shelter-deck and 2 rope reels

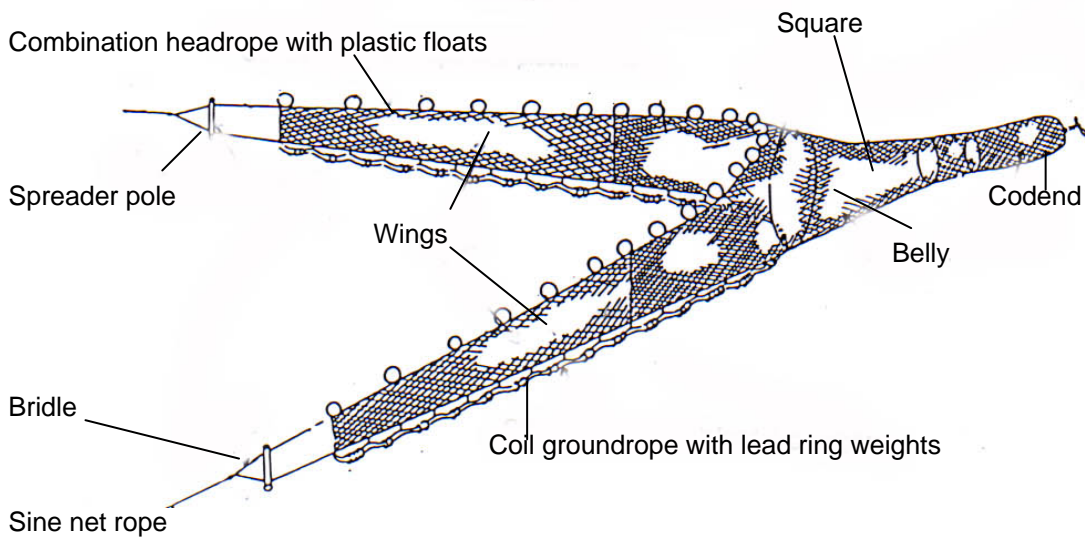

SHOOTING AND HAULING OF SEINE NET

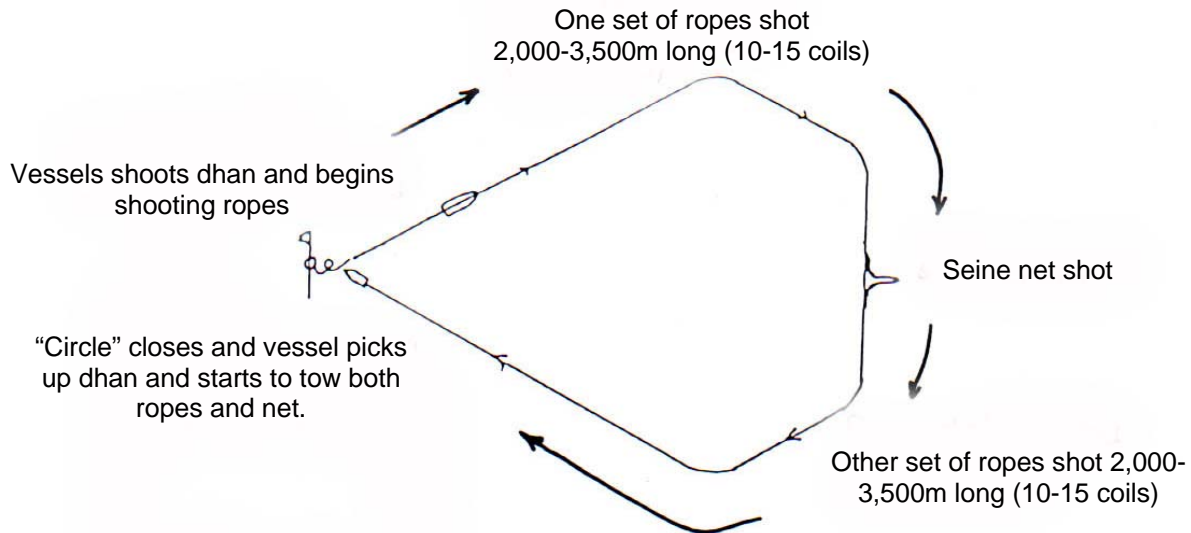

1. Ropes and net are shot
2. Starting to tow
3. Hauling the ropes slowly
4. Hauling speeded up and net beginning to close
5. Net completely closed, ready to be hauled aboard.

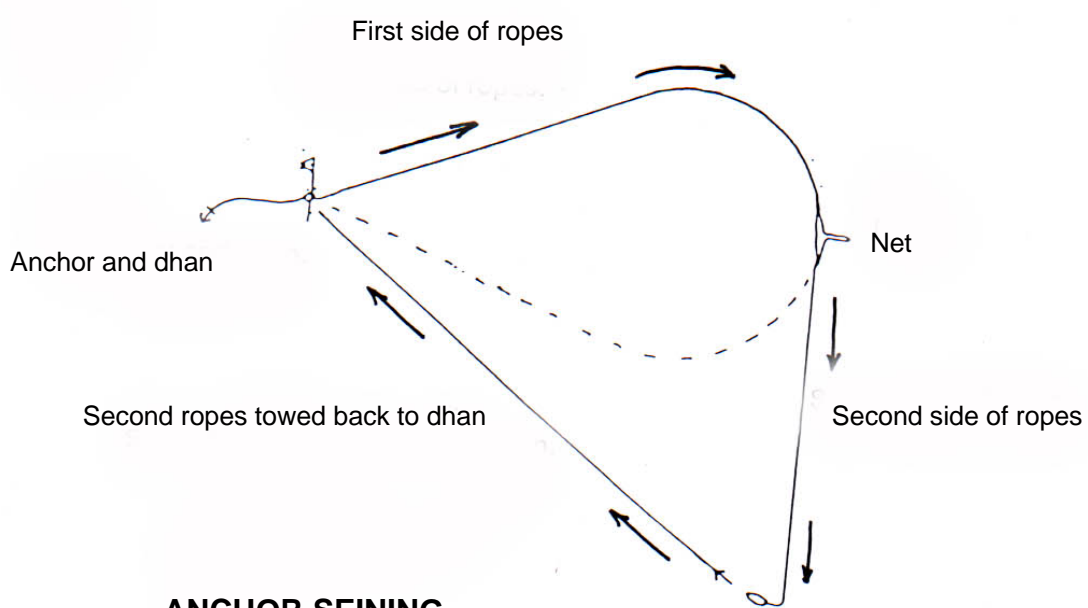
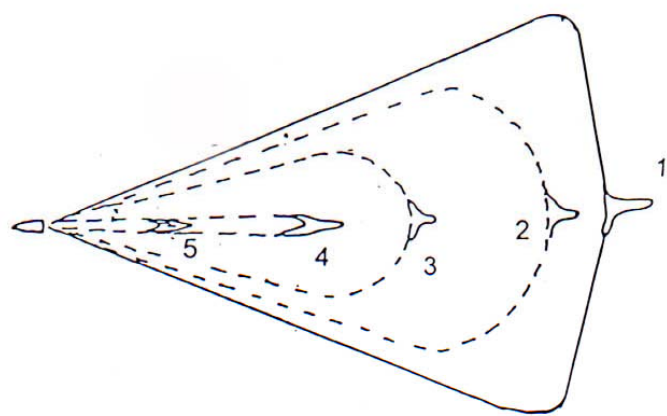

ANCHOR SEINING

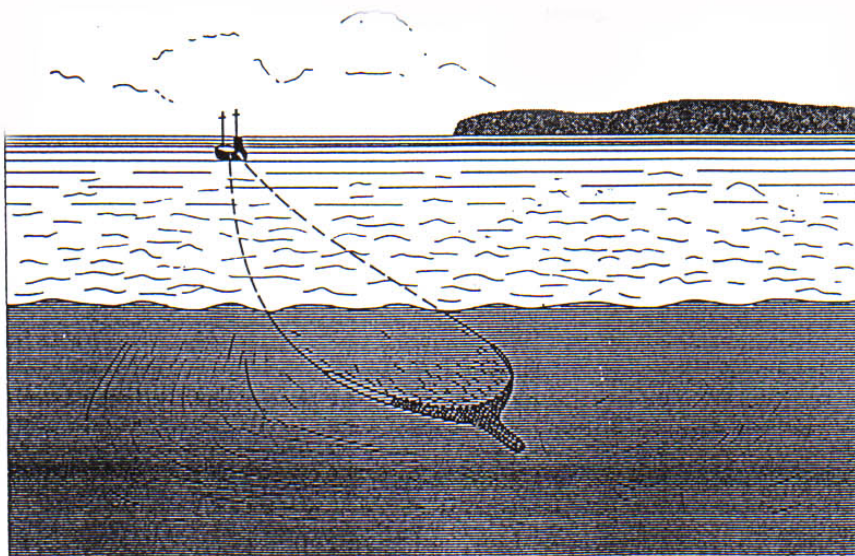
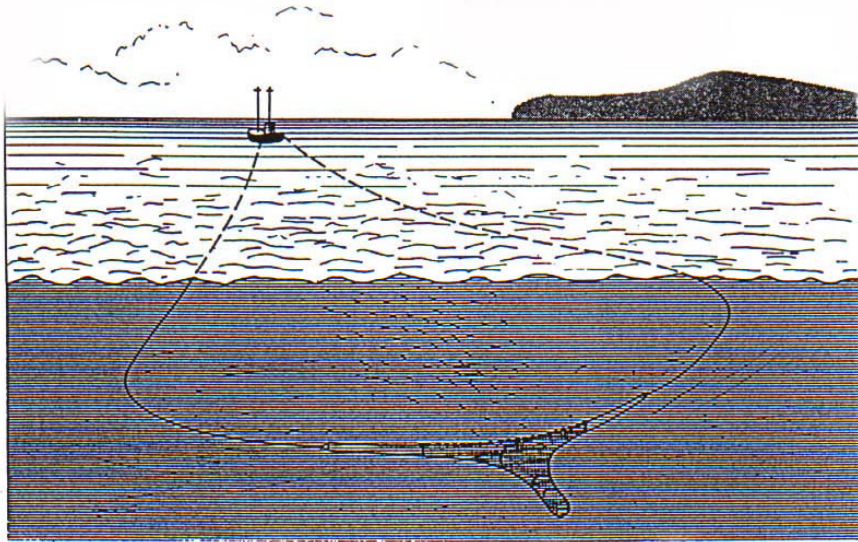
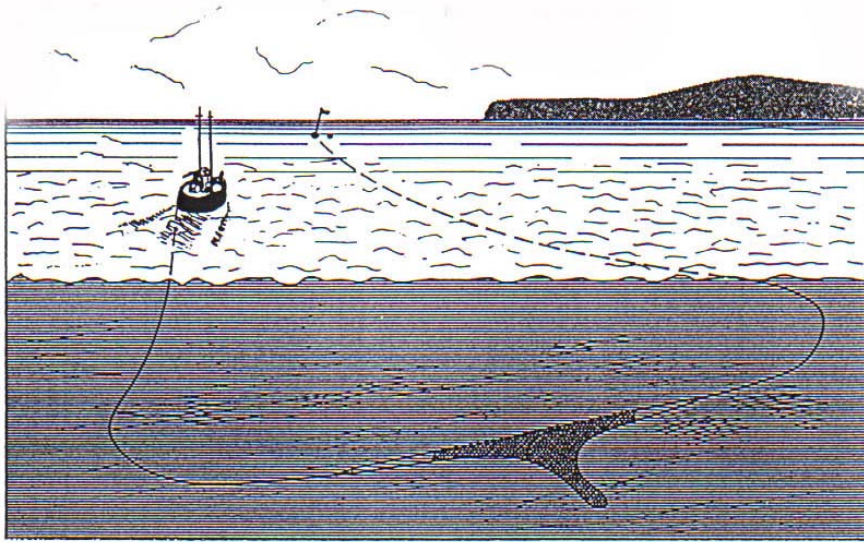

PURSE SEINE

The purse seine is used mainly for catching dense, mobile schools of pelagic fish and includes all the elements of searching, hunting down and capture. The schools of fish are surrounded and impounded by means of large pursed surround nets called either ring nets or purse seines according to design. A purse seine is a wall of netting with a mesh size to suit the target species and a headrope carrying numerous floats to keep the net on the surface. The net is equipped with rings (purse rings) along its lower edge through which a special cable (purse wire) is passed to enable the fisherman to close off the space surrounded by the purse seine from below, preventing the fish from escaping downwards and forming a bowl-like shape of net in the water containing the fish.

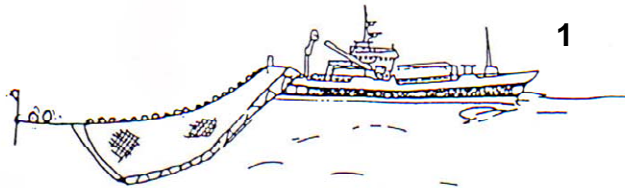

1 Setting -- The net is set from the after deck, purse rings being stowed on the bar forward of the stowed net and sliding off as the net is shot

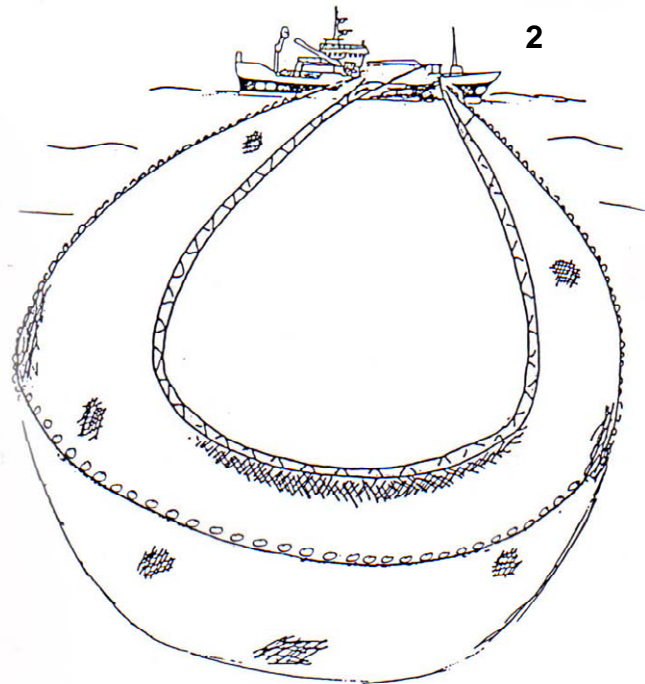

2 Pursing – The dhan has been retrieved, the purse wire is being hauled using the winch on the foredeck.

3 Hauling – Pursing complete, the net is led over the power block, onto the transport roller and into the net bin, stowed ready for the next shot. The purse rings are passed aft from the pursing davit via a wire to be stowed alongside the net on a bar

4 Pumping – The fish pump is lifted into the net by a crane and the fish are pumped into a water separator before being channelled into the RSW tanks below deck.

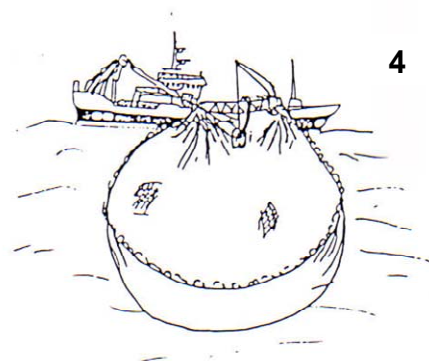
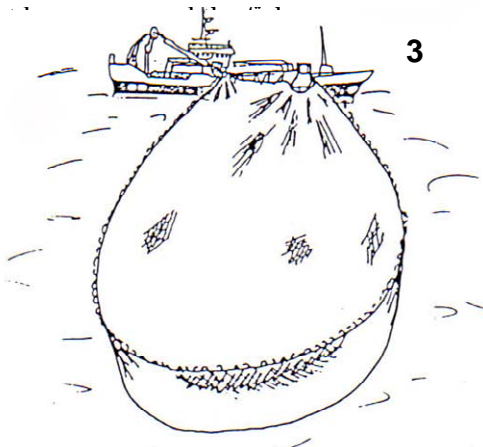

PURSE NET SHOT AND STARTING TO HEAVE IN THE PURSE WIRE

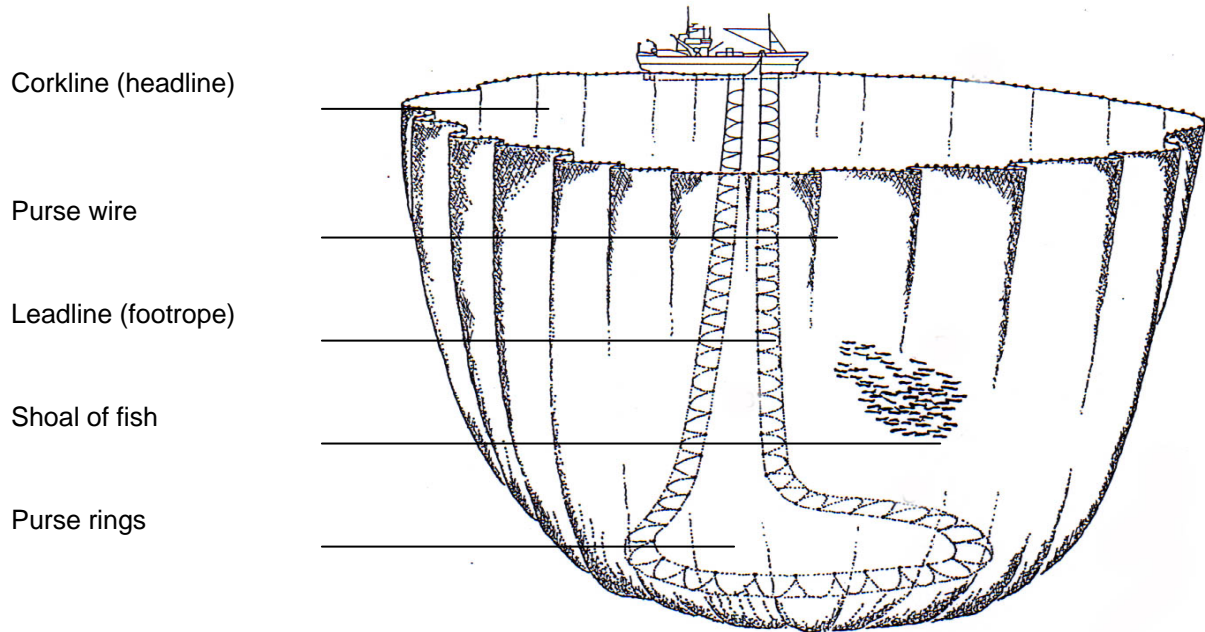

After the closure of the net by hauling in the purse line the net is gradually hauled aboard using a power block and net stacking system. The size of the bowl like shape is slowly reduced leaving the captured fish to accumulate in the strengthened part of the net (the bunt) ready to be taken aboard the vessel using a brail or more commonly nowadays a pumping system. While the fish are being pumped aboard, the vessel is kept clear of the net using side thrusters or towed clear of the net by another vessel because as the net is hauled there is a tendency for the boat to be hauled into the middle of the net. Once all the fish are aboard the vessel, the net is hauled aboard and made ready for the next shot.

The origins of the purse can be traced back to one of the most basic types of fishing gear, the beach seine, which has been used through the ages almost all over the world. A deep beach seine operated offshore could be regarded as an early ring net, made deeper still and fitted with primitive purse rings and purse line it could be regarded as an early purse seine.

Purse seines are operated throughout the world by vessels of almost any size, from large canoes (6m long) in Israel and Africa right up to ocean going tuna seines (100m long) with the size of net adapted to suit the vessel size, degree of mechanisation and target species. Both nets and boats have evolved to suit local conditions.

MODERN NORTH SEA PURSE SEINER



The pursers in Northern Europe (Scotland, Ireland, Norway etc) mainly target mackerel, herring and scad, further south in the Mediterranean they are commonly used to catch sardine, anchovy and tuna. In the tropical waters of the Atlantic and Indian Oceans large ocean going seiners, based mainly in France and Spain, target tuna.

Modern vessels tend to be designed to deliver a quality product rather than excessive quantity to the market. They are built with the ability to steam faster to reach the best markets as quickly as possible storing the catch in refrigerated seawater tanks (RSW) to keep them in good condition. The latest class of seiners are designed to be more versatile with the ability to pelagic trawl as well as purse to cope with the changing behaviour patterns of the fish.

STATIC GEAR

Pots - Creels

Traps in various forms of cages or baskets are used throughout the UK for the capture of crabs, lobsters, crayfish, *Nephrops*, shrimps, cuttlefish and several other species in lesser numbers. These pots differ in shape, size and construction materials according to the target species, and local practices. They all have one or more 'funnel' style entrance making it easy for the shellfish to get in but very difficult to escape again. They are usually baited and set on the bottom singly or in strings with a marker buoy at each end.

SELECTION OF POTS AND CREELS

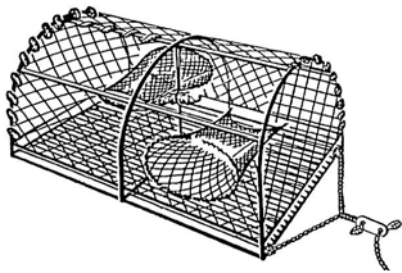

Lobster creel with two 'soft' entrances

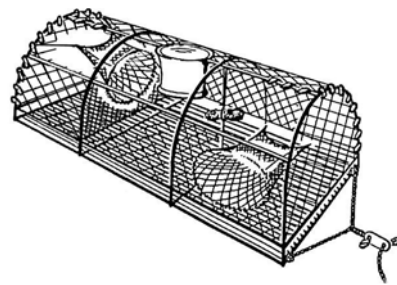

'Parlour' lobster creel with one soft entrance and one plastic spout entrance

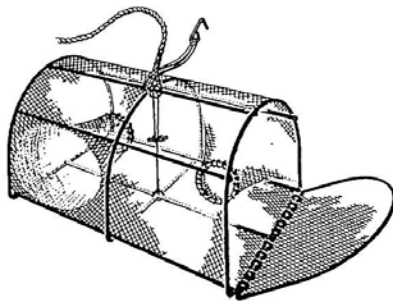

Nephrops creel

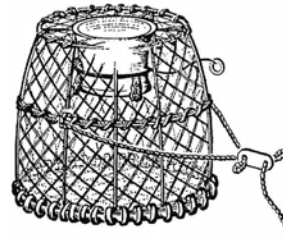

Inkwell pot with one plastic spout entrance

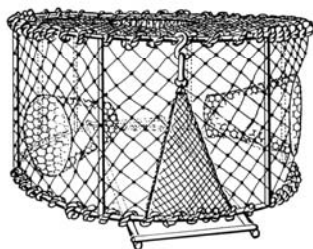

Cuttlefish trap

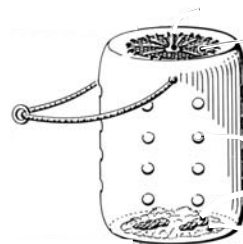

Whelk pot

Vessels working this method need to have a large open deck area to enable them to carry large amounts of pots. They are fitted with a powerful creel hauler winch specially adapted to take the main rope with pots being lifted clear as they pass the winch. Some vessels are fitted with a chute to guide the pots over the boats side when shooting the gear. The pots are usually hauled each day with the catch being stored in vivier tanks (circulating sea water tanks) or in boxes covered with hessian to keep them alive until they are landed to the processor.

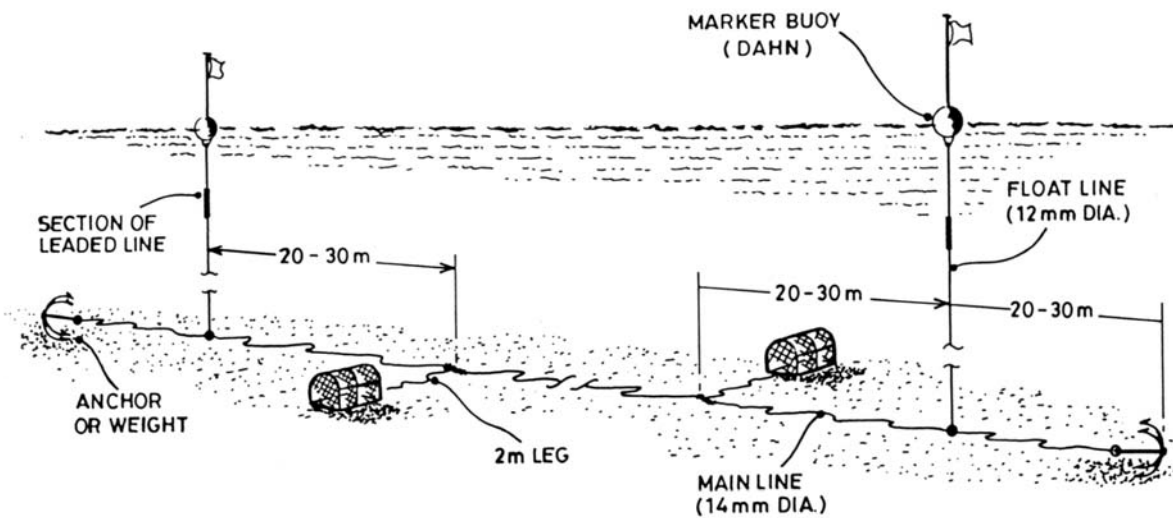

A fleet of creels to suit a small potter

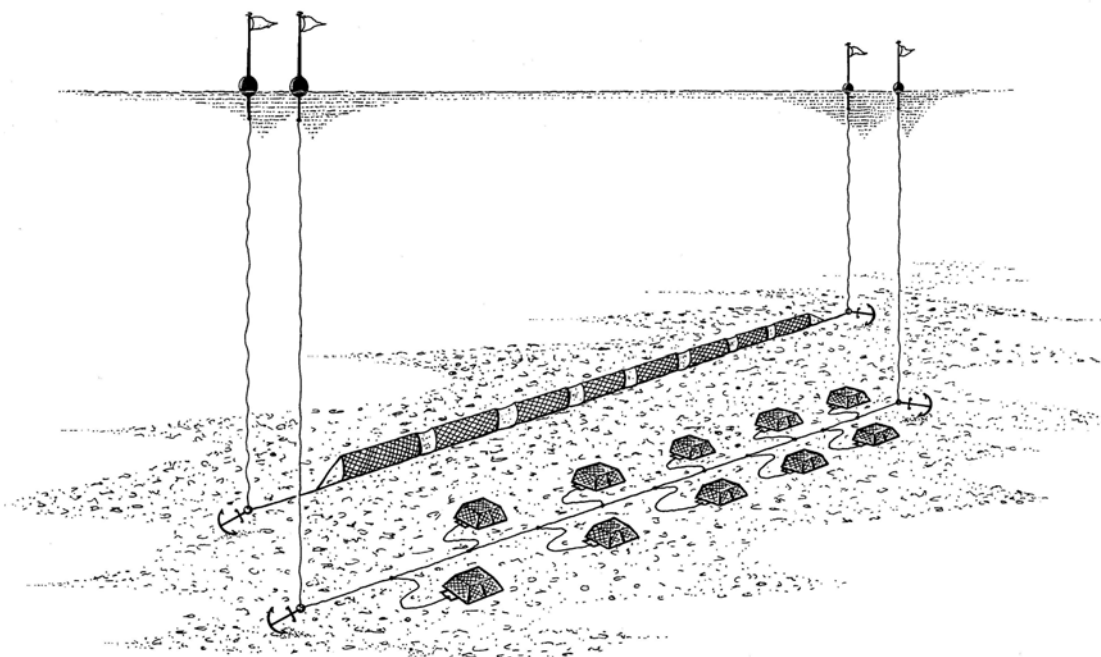

A fleet of gill nets and a fleet of pots on the seabed

LINES

Bottom set longlines are set along the seabed and anchored at each end. The main line, which may be several kilometres in length, comprise of ropes of different thickness' with the snoods of lighter material spaced out over its length. The ropes, often monofilament nowadays, thickness and snoods spacing is determined by the target species, the fishing conditions and the onboard handling machinery.

Most commercial longline operations use a mechanised system for handling the lines. This usually operates in successive phases:

- 1 hauling the longline and unhooking the fish;
- 2 cleaning the hooks;
- 3 storage of mainline snoods and hooks;
- 4 baiting the hooks; and
- 5 shooting the lines.

The degree of automation can vary with some of the smaller vessels using only a mechanised line hauler and cleaning, baiting and stowing hooks by hand, right up to the more modern deep sea liners with a fully automated system.

The catch of a liner is usually in better condition than that of a trawler, thereby selling for a better price. The size of fish being regulated by the hook size and species to a certain extent by the bait used.

In some operations the gear is rigged so that some hooks are slightly above the seabed to be more effective for target species.

BOTTOM SET LONG LINES

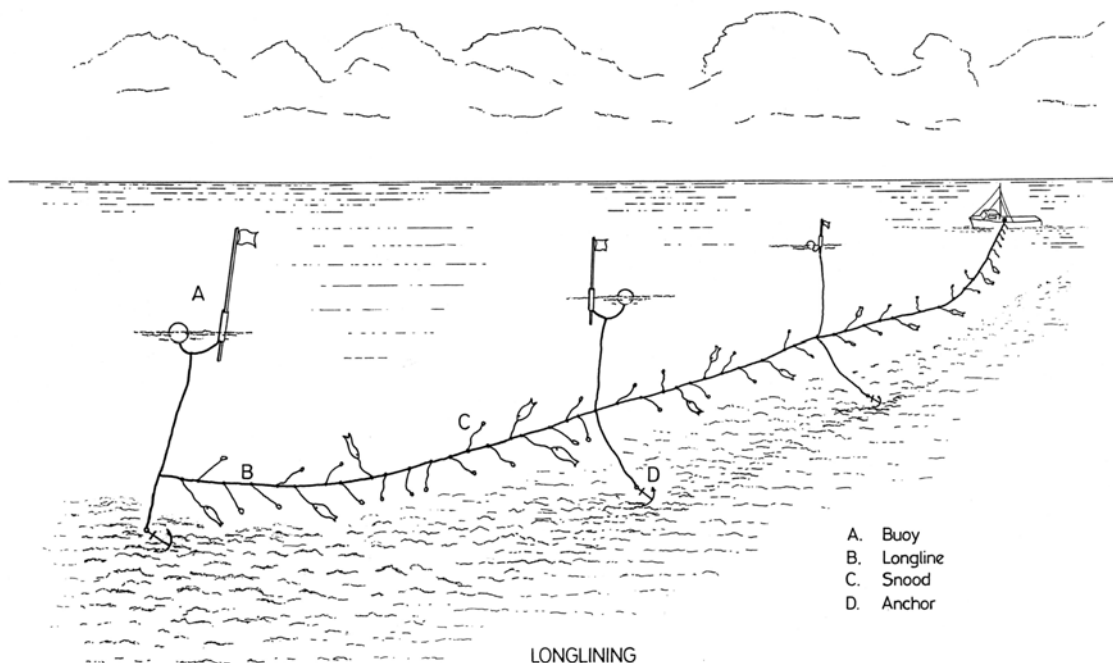

GILL NET

Gill nets are usually rectangular sheets of netting hung like a curtain in the water to catch fish by enmeshing or entangling them as they swim into the net.

A true gill net actually catches fish by the gills as they try to swim through individual meshes of the net. Trammel and tangle nets are types of gill nets but are made in such a way that the fish become entangled by several meshes when hitting the net. Gill nets may be anchored to the seabed (fixed nets) or allowed to drift with the tide or current.

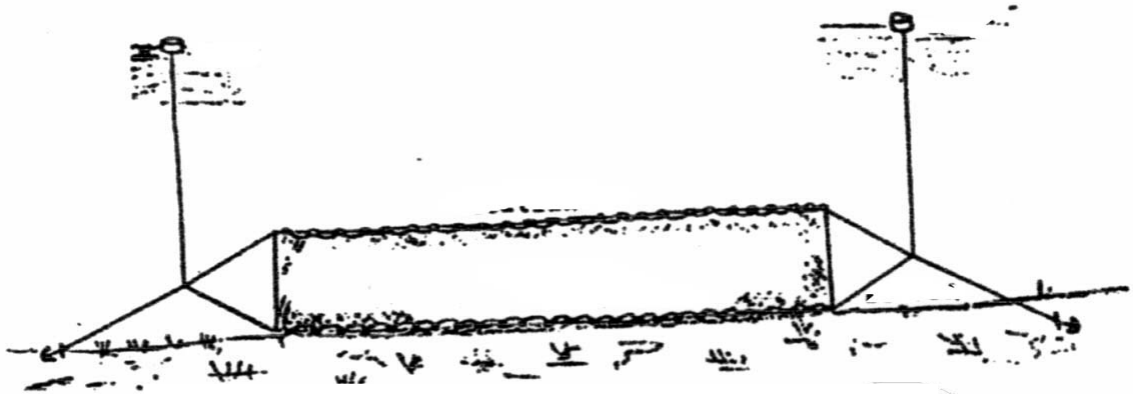

A bottom set gill net

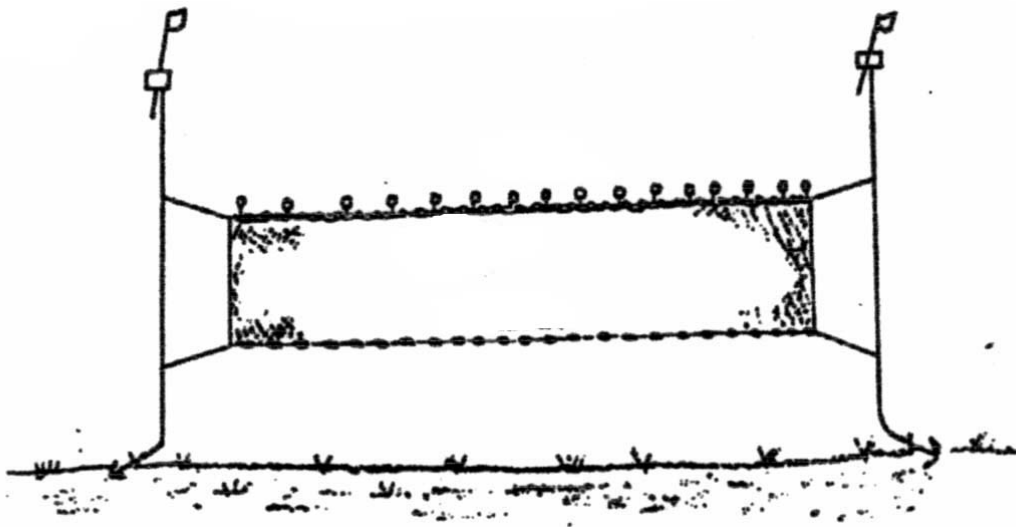

A mid water gill net

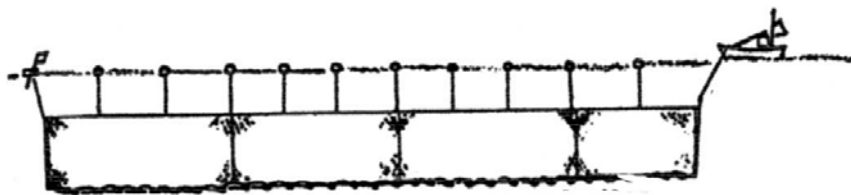

A surface set gill net or drift net

GILL NETS

The net consists of a single wall of netting weighted at the bottom and supported at the top by floats attached to a headline so that it hangs vertically in the water column. Floats are attached to the headline the number and distance apart depending on the floatation required the footrope is weighted either with individual lead weights or by a continuous braided sheath.

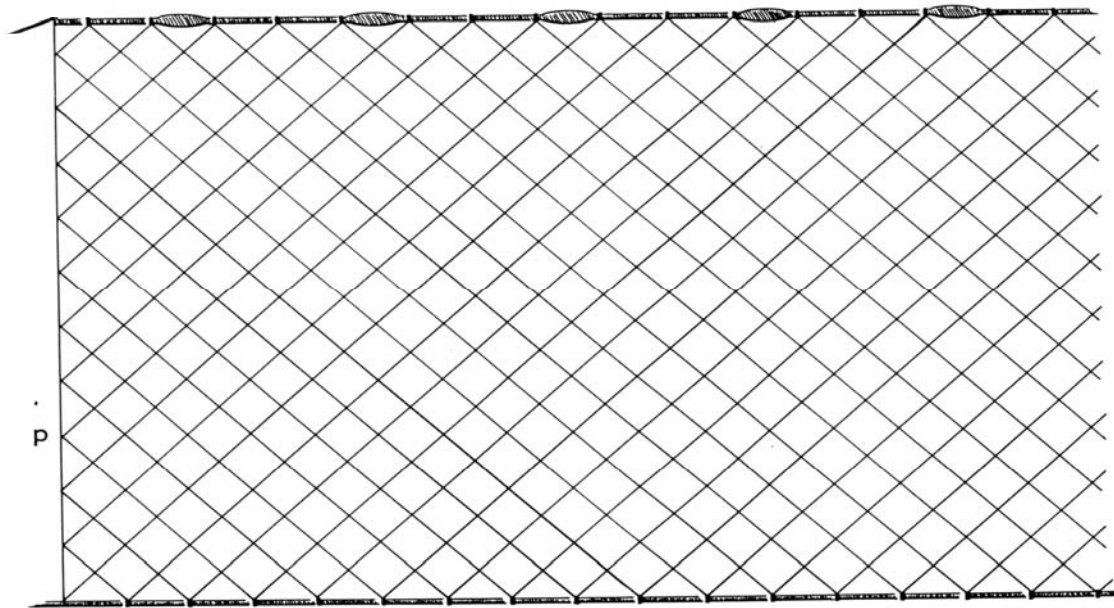

A section of a gill net showing the float line at the top and the leaded footrope at the bottom

TANGLE NETS (Single walled nets)

In areas where tangle nets are used, such as the monk, turbot, ray and crawfish fisheries, the nets resemble gill nets in their design. The main differences are the greater amount of slack netting set onto the headline, less floatation and a smaller vertical height of netting, the result is a much more loosely hung net and effectively entangles species with protruding spines such as rays and monkfish etc.

TRAMMEL NETS (Three walled nets)

This is a much more efficient general purpose net, which can be used to catch a much wider variety of species ranging from cod and monk to soles and plaice. This net consists of three walls of netting in which the small fine meshed inner net is sandwiched between two outer layers of footrope so that all three hang vertically in the water. Slack netting is ensured by setting the netting loosely on to the headline and footrope and by having the inner net depth measuring approximately twice the outer net depth. This ensures that there is always plenty of slack net for the fish to become entangled in.

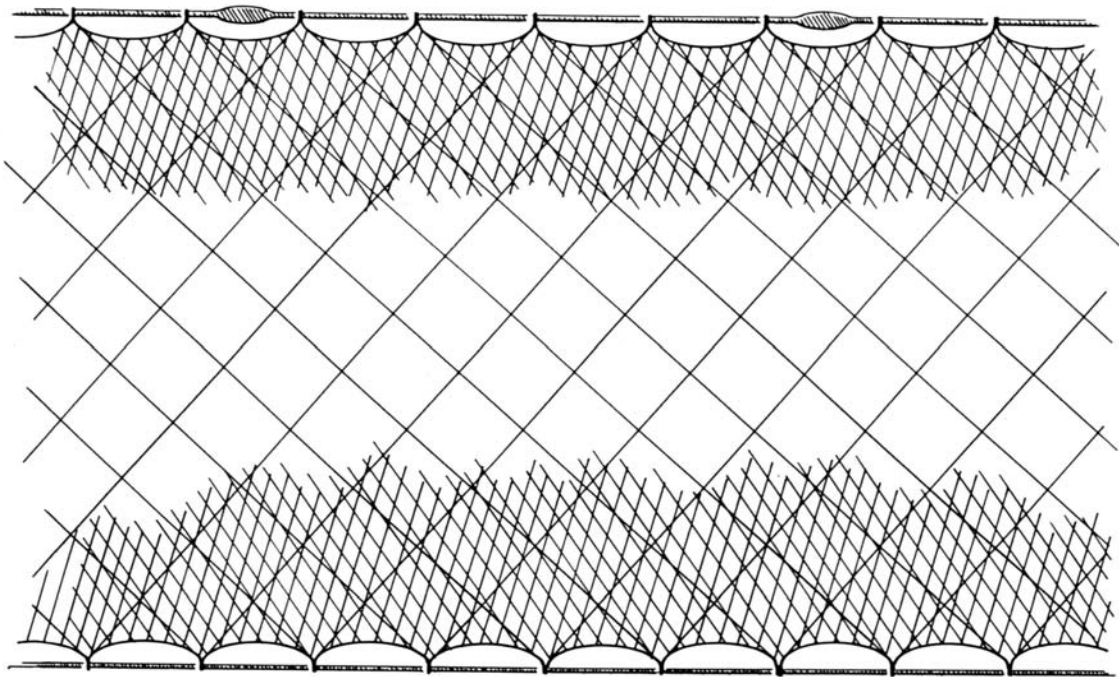

A section of a trammel net showing the three layers of netting

METHOD OF FISHING

The procedure used when fishing fixed nets is similar whether gill, trammel or tangle nets are being used. The nets are usually fished in groups (or fleets as they are widely known) with the end of each fleet attached by bridles to a heavy weight or anchor on the seabed. Each weight or anchor is secured to a marker buoy or dhan flag on the surface by a length of rope equal to about twice the depth of water. Depths of water fished can be from 15 metres to 140 meters, with some fisheries going as deep as 1800 metres (deep-water monk and tangle nets).

Length of nets can vary from 50 metres to 200 metres and length of fleets from 300 metres to 2000 metres. The amount of netting being fished (set on the seabed) at any one time can range between 2 kilometres and 30 kilometres and soak times (the time a fleet is left on the seabed to fish) can range from a 6 hour tidal soak to 72 hours. These figures are dependent on which species are being targeted and whether there is any conflict with other boats using mobile fishing gear in the area.

The nets are shot whilst steaming into the tide and are fished along the direction of the tidal stream, rather than across it (there are some exceptions to this). This reduces the chances of the nets being swept over or tangled in the strong tidal conditions found in many areas of the UK. The dhan is thrown

overboard and the vessel steams away from it paying out the rope until it reaches the anchor which is quickly dropped overboard. The fleet of nets follows until the full length of netting has run out and the second anchor and dhan follow. Retrieval of the gear is carried out in the same order with first the dhan, then the anchor and net followed by the remaining anchor and dhan. Virtually all boats now use net haulers to help them retrieve the gear. The basic design consists of a rotating drum covered with rubber, which is driven by a hydraulic system run off the main engine. The rubber grips the net, allowing the hauler to take the strain of the net and pull it aboard. Variations on the basic design include belts or rubber spheres, which exert pressure on top of the netting creating more friction with the lower drum and the netting making it easier to haul the net.

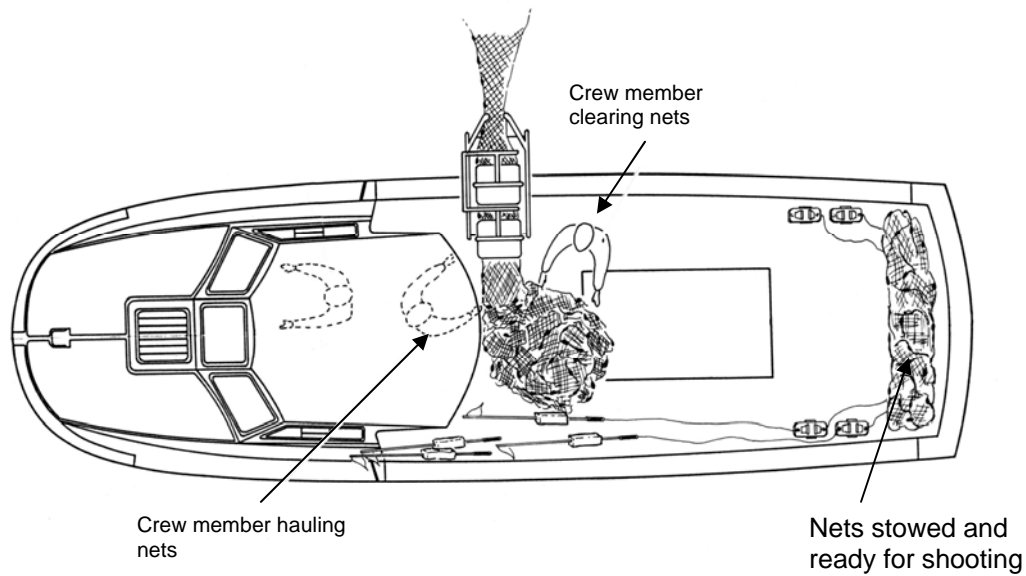

Layout of forward wheelhouse vessel

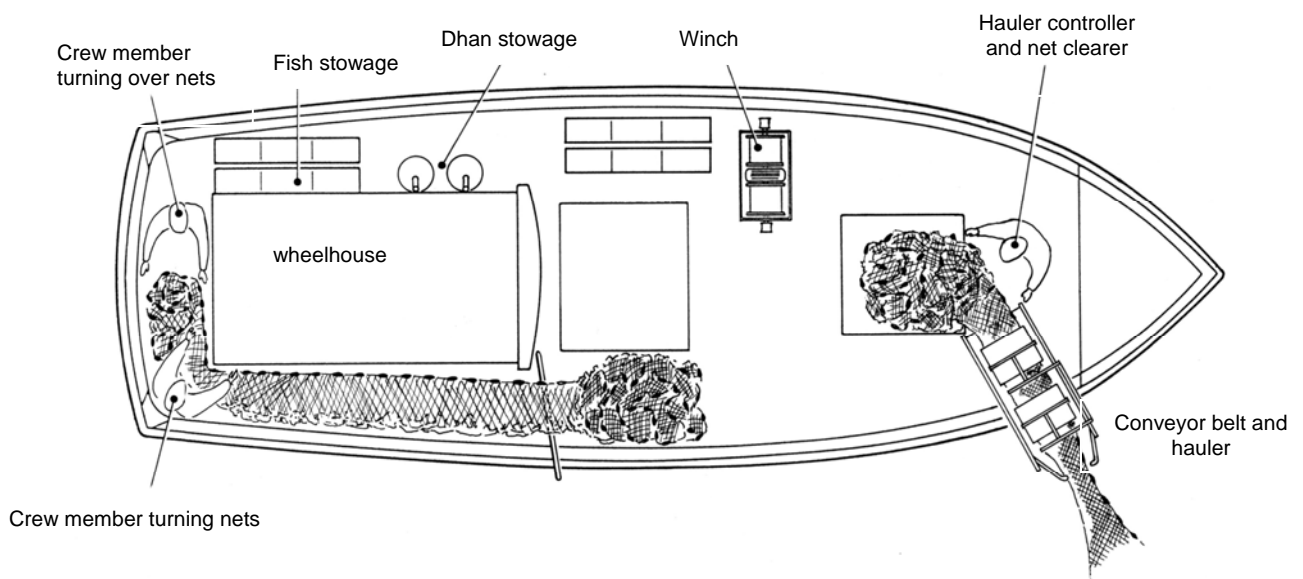

Layout of aft wheel house vessel

DREDGES

Used mainly in the UK for scallops. The vessels and rigging are very similar to that of beam trawling with the beam trawls being replaced by multiple dredges. The dredges consist of a frame and a toothed bar at the front to dig the scallops out of the sand with a collecting bag behind it. This bag is made of chain links forming a chain mesh on the bottom and usually netting on the top.

Several of these dredges are towed behind a heavy spreading bar, usually one from each side of the vessel. The length of bar and number of dredges is dictated by the power of the vessel and its length of side deck to work the dredges over. The number can vary from 3 or 4 on a small 10m boat up to 18-20 on a 30m vessel with 1500hp

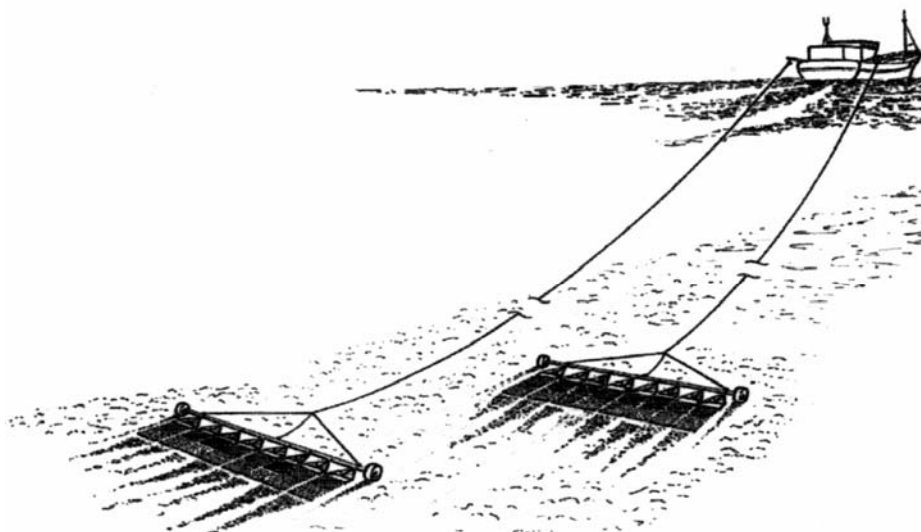

Scallop dredger towing 8 dredges each side

Fishing Terminology

Anchor seining	Seine net fishing with the vessel at anchor to haul the gear. Danish seining.
Beam	Beam used to keep mouth of a beam trawl open
Brail	Large netting basket used to lift fish
Buoy	Float for marking position of fishing gear.
Chain bridle	Chains on the leading edge of a beam trawl for attaching the warp to.
Chain mat	Network of chains to prevent stones entering the net (usually in beam trawls). Stone mat
Clean ground	Soft sand and muddy seabeds with no stones to damage nets.
Cod end	End of a towed net where the catch collects
Coil	Measurement used for ropes equal to 120 fathoms (220 metres).
Corkline	Rope along the to edge of a net to hold the floats usually refers to a purse net.
Deck pound	Area on boat with built up sides for emptying the catch into when it is taken aboard the boat
Dhan	Buoy with a flag on it
Fathom	Unit of length equal to 6 feet used by seamen.
Fishing Line	Lower frame rope of a net. Footrope, groundrope.
Flip-up ropes	Framework of ropes across the mouth of a net to prevent stones entering the net.
Fly dragging	Scottish seine netting. Fly shooting.
Fly shooting	Fly dragging. Scottish seine netting.
Frame rope	Ropes to which sheets of netting are attached at their edges to form the shape of the net.
Ground rope	General term for lower frame rope of a net. Fishing line. Footrope
Ground gear	Part of a net designed to be n contact with the seabed, to which the fishing line is attached.
Hard ground	Seabed made up of stones and rock
Headline	General term for upper frame rope of a net. Headrope.
Hopper	Large 'box' for receiving the catch from the net on the deck of a boat
Mesh size	The distance between two opposite knots in the same mesh.
Mesh	One of the closed spaces bounded by twine in a piece of netting

Net drum	Large capacity winch for winding nets onto.
Otterboards	Shearing device, two of which hold open horizontally, the mouth of a trawl. Trawl doors. Boards.
Outrigger boom	Booms on either side of a beam trawler to tow the nets from. Booms
Powerblock	Large rubber covered roller powered by hydraulics for hauling nets.
R.S.W.	Refrigerated seawater tanks
Round fish	Demersal fish other than flat fish e.g. Cod, haddock, whiting.
Shoes	Steel frame used to support the beam on a beam trawl. Beam shoes.
Stern ramp	Ramp set into the stern of a vessel for pulling heavy nets up.
Tickler chain	Chain towed ahead of the groundrope to disturb fish on the seabed.
Trawl doors	Otter boards
Warp	Wire used for towing fishing gear.

For any further information please contact Mike Montgomerie at the Seafish Fisheries Development Centre: Tel: 01482 327837, E-Mail M_Montgomerie@seafish.co.uk