



STANDARD PRODUCTS



**ELECTRICAL HEATING AND COOLING
SOLUTIONS
FOR THE INDUSTRY**



VULCANIC

The Vulcanic group has been designing and manufacturing electrical process heating and temperature control solutions since 1973. Employing 550 people across 8 manufacturing locations, Vulcanic currently services 30 000 customers in 100 different countries across the globe and is an ISO 9001 v 2008 accredited company.



**You have an issue... let us solve it !
Vulcanic your worldwide local partner !**



Advice

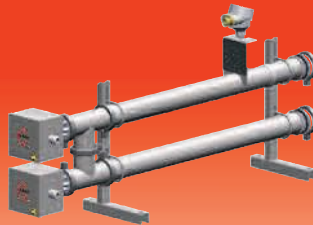

Design



Manufacturing

All in One Solutions

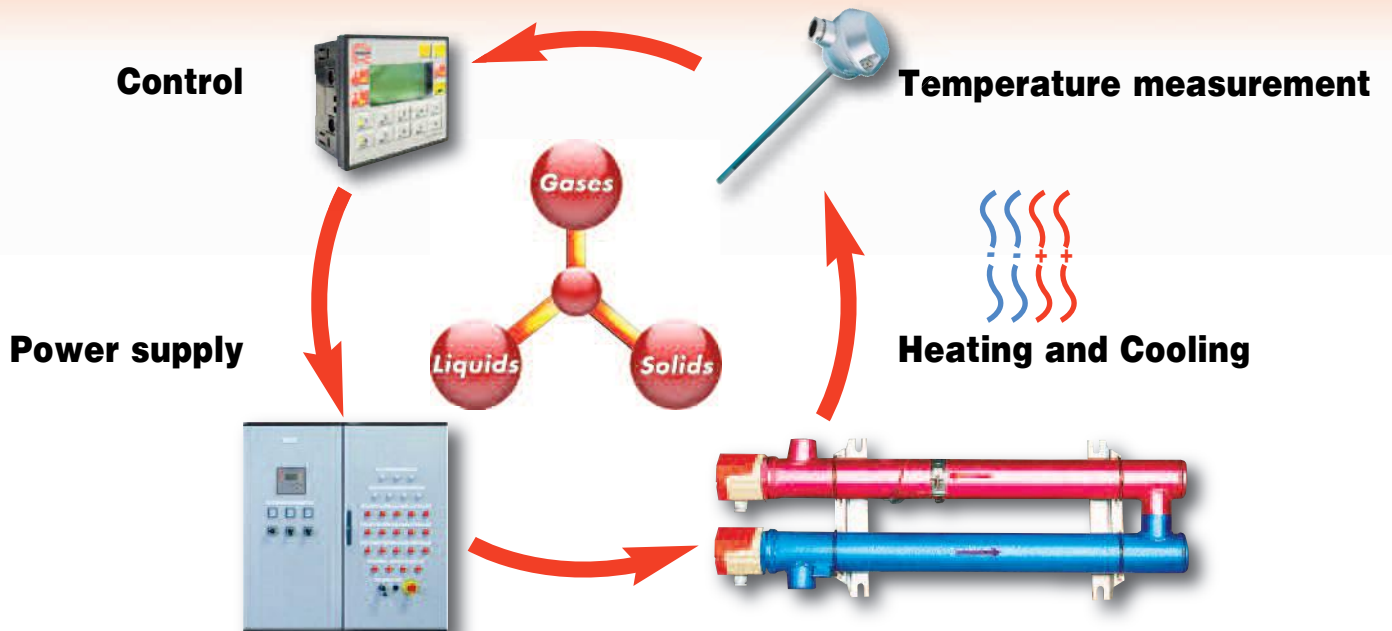



SERVED MARKETS



DESIGN EXPERTISE AND CODES

Vulcanic design teams support our partners from conceptual design and feasibility study throughout the life of the equipment. Our design capabilities include:

- Electrical design
- Mechanical design
- Thermal design
- Electronic design (hardware and software)
- Hydraulic design
- Automation
- Communication protocols
- Hazardous area certification



- AD 2000
- ASME
- CODAP
- EN 286

- PD 5500
- RCC-M / RCC-E
- STOOMWEZEN
- GOST



MANUFACTURING

Vulcanic offers the benefits of integrated "in house" manufacturing processes, using "state of the art" equipment to manufacture almost all components utilised within our product ranges. With only minimal dependance upon subcontractors, we remain in full control of Quality and Production schedules while maintaining a high level of know how in house.



Heating element manufacturing



CNC machining



Sensor manufacturing



Welding



Wiring

CERTIFICATION



- ISO 9001 : 2008
- PED 97/23/EC cat I-IV
- ATEX 94/9/EC
- IECEx
- TR CU
- CCOE
- VDE
- UL
- DNV
- INMETRO





VULCANIC GROUP

VULCANIC SAS
ZI des Chanoux
48, rue Louis Ampère
F-93330 Neuilly sur Marne
France
Tel. : +33 1 49 44 49 20



VULCANIC SAS
ZI la Saunière
F-89600 Saint Florentin
France
Tel. : +33 1 49 44 49 20



VULCANIC UK Ltd
South Green Park
Entreprise Centre, Mattishall
NR20 3JY, Dereham Norfolk
United Kingdom
Tel. : +44 1603 340015



LOREME SAS
12, rue des Potiers d'Etain
Actipôle Borny
F-57071 Metz
France
Tel. : +33 3 87 76 32 51



VULCANIC SA
Heilig Hartstraat, 14
B-2600 Berchem
Belgium
Tel. : +32 3 286 70 30



RS ISOLSEC SAS
45, avenue des acacias
F-45120 Cepoy
France
Tel. : +33 2 38 85 62 62



VULCANIC TERMOELÉCTRICA SLU
Ctra. a Viérnoles, 32
E-39300 Torrelavega
Spain
Tel. : +34 942 80 35 35



VULCANIC GmbH
Donaustraße 21
D-63542 Hanau
Germany
Tel. : +49 6181 9503 0



RS ISOLSEC SLU
Ave Riu Mogent, 5
E-08170 Montornes del valles
Spain
Tel. : +34 93 568 73 10



VULCANIC Russia
105005 Moscow
radio street
house 24 building 1
Russia
Tel. : + 7 (903) 967-95-68



VULCANIC TRIATHERM GmbH
Flurstraße 9
D-96515 Sonneberg
Germany
Tel. : +49 3675 4083-0





Page 6

Atex marking

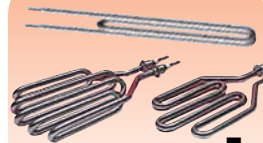

Page 7

Heating elements

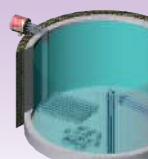

Page 12

Selecting an immersion heater

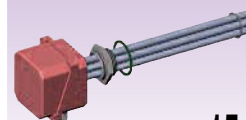

Page 15

Screw plug immersion heaters



Page 32

Flange immersion heaters

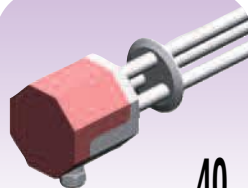

Page 40

Clamp flange immersion heaters



Page 41

Ceramic core elements

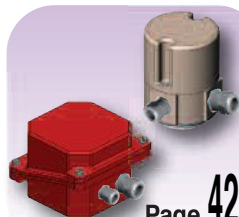

Page 42

Junction boxes for immersion heaters



Page 44

Control thermostats for immersion heaters

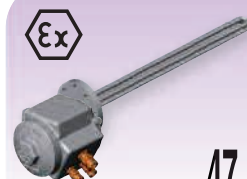

Page 47

Atex screw plug and flange immersion heaters

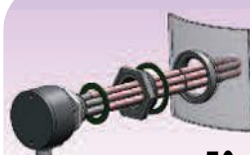

Page 56

Accessories for immersion heaters



Page 57

Removable immersion heaters



Page 59

Drum heaters

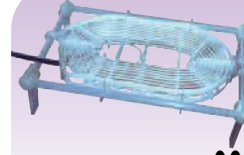

Page 60

Fluorated immersion heaters



Page 62

Fluid circulation heaters



Page 68

Heating hoses

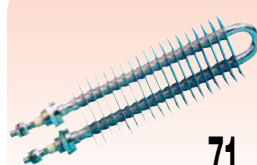

Page 71

Finned strip heaters

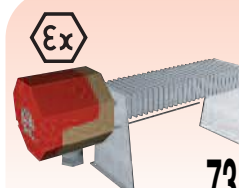

Page 73

Anti-condensation cabinet heaters



Page 74

Radiators

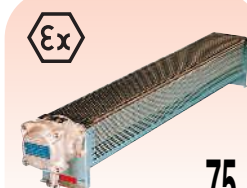

Page 75

Atex radiators



Page 76

Fan heaters and convectors



Page 78

Hot air generators



Page 79

Circular air duct heaters



Page 80

Rectangular and flange air duct heaters



Page 85

Cartridges Vulstar®



Indicates the presence of ATEX certified products in the chapter



Page 89

Accessories for Vulstar®



Page 90

Sheathed mica ring and strip heaters



Page 91

PTC resistors



Page 92

Band heaters



Page 94

Heat tracing



Page 97

Accessories for heat tracing



Page 100

Silicone heating panels



Page 102

Infrared generators



Page 107

Control thermostats and safety temperature cut out



Page 111

Electromechanical thermostats

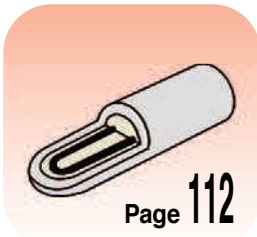

Page 112

Selecting a temperature sensor

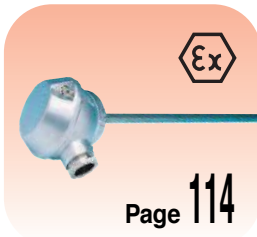

Page 114

PT 100 sensors

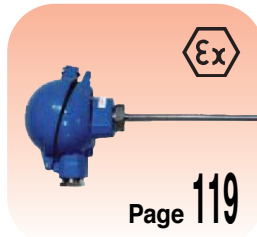

Page 119

Thermocouples

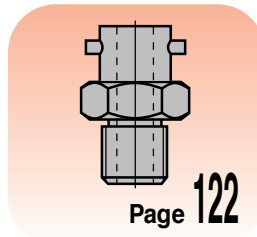

Page 122

Accessories for temperature sensors



Page 123

Converters



Page 124

Sealing glands



Page 126

Temperature displays and controllers



Page 128

Static power units



Page 130

Cabinets



Page 132

Isolators and wires for cabling



Page 134

Temperature control units Vulcatherm® Water



Page 141

Temperature control units Vulcatherm® Thermal Oil



Page 146

Air conditioning units



Page 146

Liquid chillers



Page 147

Dehumidifiers Edenair®

Indicates the presence of ATEX certified products in the chapter



CE 0080 **II 2 G**

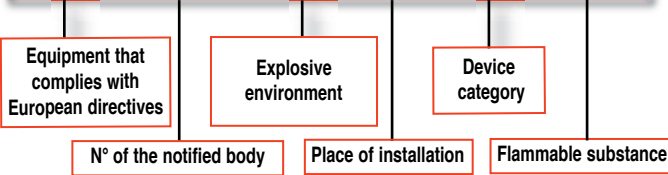

• N° of the notified body

0081	France	LCIE
0080	France	INERIS
0102	Germany	IBExU
0722	Spain	LOM

• Place of installation

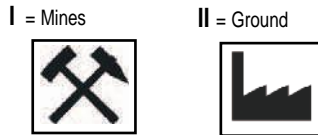

• Device category

		Risk of explosion		Time
1	Zones 0	Gas	HIGH	Continuously present
	Zones 20	Dust		
2	Zones 1	Gas	MEDIUM	Often present
	Zones 21	Dust		
3	Zones 2	Gas	LOW	Accidentally present
	Zones 22	Dust		

• Flammable substance
G = Gas
D = Dust

Ex d IIC T4 Gb

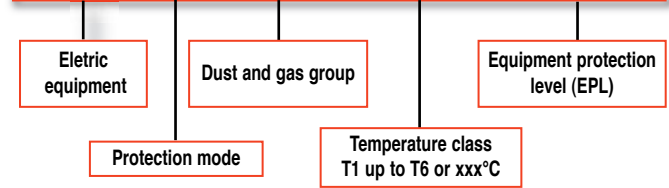

• Protection mode

d	Explosion-proof		Prevent the transmission of the explosion to the environment
e	Increased safety		Prevent excessive temperature and sparks from electrical equipment
de	Explosion-proof and increased safety		Prevent both transmission of the explosion and electric spark
ia	Intrinsic safety		Limited electrical energy below the level of self ignition

• Dust and gas group

Gas group	Place of installation	Typical gas	Energy of self ignition
I	Mines	Methane	E ≥ 300 μJ
IIA	Ground	Propane, butane, benzene, acetone, alcohol, kerosene, Gasoline, Petrol	E ≥ 240 μJ
IIB		Ethylene, diethyl ether	E ≥ 70 μJ
IIC		Hydrogen, acetylene	E ≥ 17 μJ

Dust group	Place of installation	Hazard	Size	Resistivity
IIIA	Ground	Combustible flyings	∅ ≥ 0,5 mm	
IIIB		None-conductive dust	∅ < 0,5 mm	R > 1000Ωm
IIIC		Conductive dust	∅ < 0,5 mm	R < 1000Ωm

• Temperature class

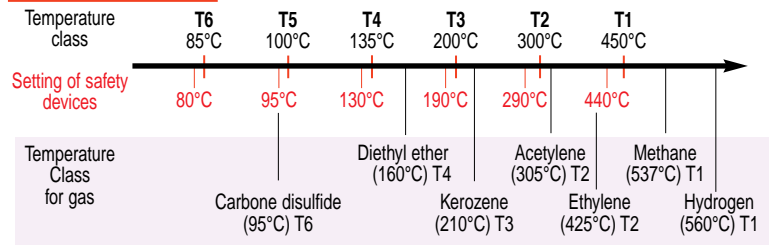

• Equipment protection level (EPL)

Group II - Gas area			Group II - Dust area		
Category	Zone	EPL	Catégorie	Zone	EPL
II 1 G	0	Ga	II 1 D	20	Da
II 2 G	1	Gb	II 2 D	21	Db
II 3 G	2	Gc	II 3 D	22	Dc

Applications : Tubular sheathed elements are quasi universal solution used to heat up solids, liquids or gas through the JOULE EFFECT up to about 800°C. Depending on their use, they transfer their energy by natural or forced convection, by conduction or induction.

SEALING

WP+: Waterproof resin sealing. The most standard one. Excellent sealing that guarantees insulation in case of prolonged storage or application in moisture conditions. Maximum admitted connection temperature of 160°C.

TM : Silicon cost effective solution operational up to a connection temperature of 350 °C in environment exempt from moisture.

HT : Cement high temperature, no water-tight sealing, operational up to a connection temperature of 450°C. Using in atmospheres without moisture.

TUBE Ø
6,5 - 6,8 - 8 - 8,5
10,2 - 16 - 18 - 22
(mm)

LENGTH
up to 6 m

SURFACE LOAD
up to 20 W/cm²

VOLTAGE
up to 750 V

CONNECTIONS
Threaded terminals
M4 or M6 for Ø8
M5 for Ø8,5
M5 or M6 for Ø10,2
M6 for Ø16
Spade terminal
Clamping screw
Copper lead
Nickel lead

FASTENINGS
Three-piece union
Crimped threaded union
Brazed threaded union
Welded threaded union
Hooks

MATERIALS	SURFACE LOAD	APPLICATION
Carbon steel	2 W/cm ²	Oil, fuel oil, heat transfer fluid
AISI 321/Din 1.4541	2 W/cm ²	Air, gas, solids
Carbon steel	4 W/cm ²	Circulating light oil
AISI 321/Din 1.4541	4 W/cm ²	Air, circulating fluids, solids
AISI 316L/Din 1.4404	6 W/cm ²	Process heating water
Incoloy 800/Din 1.4876	10 W/cm ²	Air, gas, solids
Incoloy 825/Din 2.4858	10 W/cm ²	Sanitary water
Copper	10 W/cm ²	Circulating fresh water
AISI 904L/Din 1.4539	12 W/cm ²	Circulating water

BENT TO SHAPE

Tubular heating elements can be shaped to suit your requirements. We can manufacture and deliver special elements quickly and cost-effectively.

DETERMINATION OF REQUIRED POWER

To heat a volume V (solid, liquid or gas) in a given time T (without state modification).

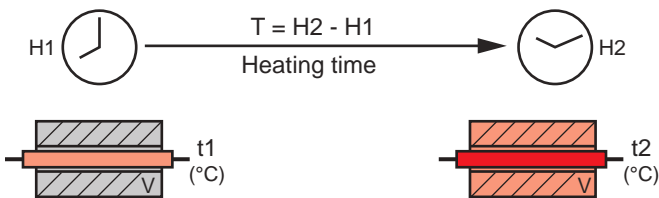

Units to be known

- V : Volume in liter or dm³
- ρ : Density en kg/dm³
- V x ρ : Mass to be heated in kg
- t1 : Initial temperature in °C
- t2 : Final temperature in °C
- Cp : Specific heat kcal/kg.°C
- T : Heating time in hours.

Result : P = Power to be installed in kW

1,2 : safety factor taking into account the tolerances on voltage supply and ohmic value of the heating element.

$$P = \frac{V \times \rho \times Cp \times (t2 - t1) \times 1,2}{860 \times T}$$

Vaporization of a mass M (liquid) in a given time T when the liquid is already at its boiling temperature.

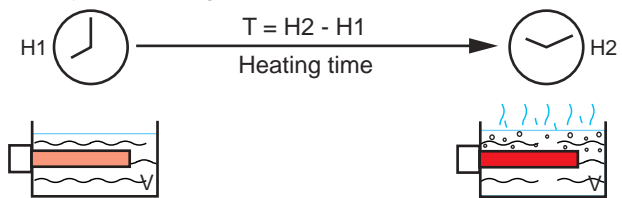

Units to be known

- M : Weight of the liquid in kg.
- L : Latent heat of vaporization in kcal/kg
- T : Heating time in hour.

Result : P = Power to be installed in kW

1,2 : safety factor taking into account the tolerances on voltage supply and ohmic value of the heating element.

$$P = \frac{M \times L \times 1,2}{860 \times T}$$

STANDARD STRAIGHT TUBULAR HEATING ELEMENTS

Connection by M6 threaded steel rod.
The elements are annealed, so that they can be bent them to shape.

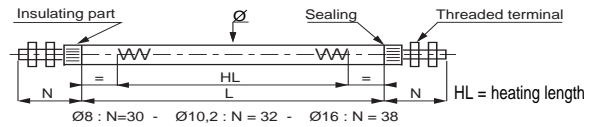

Ø 8 mm in AISI 321/Din 1.4541 - 2 W/cm² – TM seals

P/N.	Power +5 -10%	Voltage 1P	L (mm)	HL (mm)	Weight (kg)
27501-21	250 W	230 V	760	500	0,2
27501-22	500 W	230 V	1260	1000	0,3
27501-23	1000 W	230 V	2250	1990	0,5
27501-24	1500 W	230 V	3250	2990	0,8
27501-25	2000 W	230 V	4240	3980	1,0

Ø 10,2 mm in AISI 321/Din 1.4541 - 2 W/cm² TM seals

P/N.	Power +5 -10%	Voltage 1P	L (mm)	HL (mm)	Weight (kg)
27501-11	250 W	230 V	650	390	0,23
27501-12	500 W	230 V	1040	780	0,4
27501-13	1000 W	230 V	1820	1560	0,7
27501-14	1500 W	230 V	2600	2340	0,94
27501-15	2000 W	230 V	3380	3120	1,2
27501-16	3000 W	230 V	4940	4680	1,8

Ø 10,2 mm in VLY/AISI 904L/Din 1.4539 - 4 W/cm² WP+ seals

P/N.	Power +5 -10%	Voltage 1P	L (mm)	HL (mm)	Weight (kg)
26501-40	250 W	230 V	355	195	0,15
26501-41	500 W	230 V	550	390	0,2
26501-42	750 W	230 V	745	585	0,27
26501-43	1000 W	230 V	940	780	0,34
26501-44	1500 W	230 V	1330	1170	0,5
26501-45	2000 W	230 V	1720	1560	0,62
26501-46	3000 W	230 V	2500	2340	0,9

Ø 16 mm in AISI 321/Din 1.4541 - 2 W/cm² – TM seals

P/N.	Power +5 -10%	Voltage 1P	L (mm)	HL (mm)	Weight (kg)
27501-01	500 W	230 V	760	500	0,6
27501-02	1000 W	230 V	1260	1000	1,1
27501-03	1500 W	230 V	1750	1490	1,5
27501-04	2000 W	230 V	2250	1990	1,9
27501-05	3000 W	230 V	3250	2990	2,8
27501-06	4000 W	230 V	4240	3980	3,6
27501-07	5000 W	230 V	5240	4980	4,5

Ø 8 mm in Incoloy 800/Din 1.4876 - 6 W/cm²- TM seals

P/N.	Power +5 -10%	Voltage 1P	L (mm)	HL (mm)	Weight (kg)
28501-51	500 W	230 V	630	330	0,15
28501-52	1000 W	230 V	960	660	0,23
28501-53	2000 W	230 V	1630	1330	0,4
28501-54	3000 W	230 V	2290	1990	0,5
28501-55	4500 W	230 V	3290	2990	0,8
28501-56	6000 W	400 V	4280	3980	1,0
28501-57	8000 W	400 V	5610	5310	1,3

Ø 10,2 mm in VLY/AISI 904L/Din 1.4539 - 2 W/cm² - TM seals

P/N.	Power +5 -10%	Voltage 1P	L (mm)	HL (mm)	Weight (kg)
26501-30	250 W	230 V	550	390	0,2
26501-31	500 W	230 V	940	780	0,34
26501-32	750 W	230 V	1330	1170	0,5
26501-33	1000 W	230 V	1720	1560	0,62
26501-34	1500 W	230 V	2500	2340	0,9

Ø 10,2 mm in Incoloy 800/Din 1.4876- 6 W/cm² TM seals

P/N.	Power +5 -10%	Voltage 1P	L (mm)	HL (mm)	Weight (kg)
28501-41	500 W	230 V	560	260	0,2
28501-42	1000 W	230 V	820	520	0,3
28501-43	2000 W	230 V	1340	1040	0,5
28501-44	3000 W	230 V	1860	1560	0,7
28501-45	4500 W	230 V	2640	2340	1,0
28501-46	6000 W	400 V	3420	3120	1,2
28501-47	8000 W	400 V	4460	4160	1,6
28501-48	10000 W	400 V	5500	5200	2,0

Ø 16 mm in AISI 321/Din 1.4541 - 4 W/cm² – TM seals

P/N.	Power +5 -10%	Voltage 1P	L (mm)	HL (mm)	Weight (kg)
27501-62	1000 W	230 V	760	500	0,6
27501-63	2000 W	230 V	1260	1000	1,1
27501-64	3000 W	230 V	1750	1490	1,5
27501-65	4500 W	230 V	2500	2240	2,1
27501-66	6000 W	400 V	3250	2990	2,8
27501-67	7500 W	400 V	3990	3730	3,4
27501-68	9000 W	400 V	4740	4480	4,0

Ø 8 mm in AISI 321/Din 1.4541 - 4 W/cm² – WP+ seals

P/N.	Power +5 -10%	Voltage 1P	L (mm)	HL (mm)	Weight (kg)
27501-81	500 W	230 V	760	500	0,2
27501-82	1000 W	230 V	1260	1000	0,3
27501-83	2000 W	230 V	2250	1990	0,5
27501-84	3000 W	230 V	3250	2990	0,8
27501-85	4500 W	230 V	4740	4480	1,1

Ø 10,2 mm in AISI 321/Din 1.4541 - 4 W/cm² – TM seals

No.	Power +5 -10%	Voltage 1P	L (mm)	HL (mm)	Weight (kg)
27501-71	500 W	230 V	650	390	0,23
27501-72	1000 W	230 V	1040	780	0,4
27501-73	2000 W	230 V	1820	1560	0,7
27501-74	3000 W	230 V	2600	2340	0,94
27501-75	4500 W	230 V	3770	3510	1,4
27501-76	6000 W	400 V	4940	4680	1,8

Ø 10,2 mm in VLY/AISI 904L/Din 1.4539 - 7 W/cm²- WP+ seals

P/N.	Power +5 -10%	Voltage 1P	L (mm)	HL (mm)	Weight (kg)
26501-10	500 W	230 V	385	225	0,14
26501-11	750 W	230 V	495	335	0,18
26501-12	1000 W	230 V	605	445	0,22
26501-13	1500 W	230 V	830	670	0,3
26501-14	2000 W	230 V	1050	890	0,38
26501-15	3000 W	230 V	1500	1340	0,54
26501-16	4500 W	400 V	2170	2010	0,8
26501-17	6500 W	400 V	3060	2900	1,1
26501-18	9000 W	400 V	4180	4020	1,5
26501-19	13500 W	400 V	6185	6025	2,2

Ø 16 mm in Incoloy 800/Din 1.4876 - 6 W/cm² TM seals

P/N.	Power +5 -10%	Voltage 1P	L (mm)	HL (mm)	Weight (kg)
28501-31	500 W	230 V	470	170	0,4
28501-32	1000 W	230 V	630	330	0,5
28501-33	2000 W	230 V	960	660	0,8
28501-34	3000 W	230 V	1300	1000	1,1
28501-35	4500 W	230 V	1790	1490	1,5
28501-36	6000 W	400 V	2290	1990	1,9
28501-37	8000 W	400 V	2950	2650	2,5
28501-38	10000 W	400 V	3620	3320	3,1
28501-39	12000 W	400 V	4280	3980	3,6
28501-40	15000 W	400 V	5280	4980	4,5

Examples of shaped heating elements

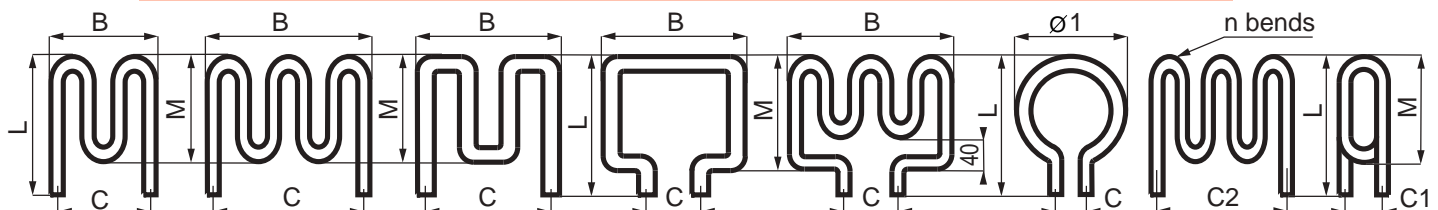

U-SHAPED TUBULAR HEATING ELEMENTS

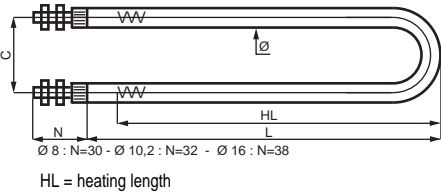

Electrical connections with steel threaded terminals M6

On request
Connection by carbon steel crimped threaded rod : order xx514 instead of xx504.

Ø 8 mm in Incoloy 800 / Din 1.4876 - 10 W/cm² WP+, C = 30

P/N.	Power +5 -10%	Voltage 1P	L (mm)	HL (mm)	Weight (kg)
28504-81	500 W	230 V	200	100	0,1
28504-82	1000 W	230 V	300	200	0,15
28504-83	2000 W	230 V	500	400	0,24
28504-84	3000 W	230 V	695	595	0,33
28504-85	4500 W	230 V	995	895	0,5
28504-86	6000 W	400 V	1295	1195	0,6
28504-87	8000 W	400 V	1690	1590	0,8
28504-88	10000 W	400 V	2090	1990	1

Ø 10,2 mm in AISI 321/Din 1.4541- 2 W/cm², TM, C = 29

P/N.	Power +5 -10%	Voltage 1P	L (mm)	HL (mm)	Weight (kg)
27504-11	250 W	230 V	325	195	0,2
27504-12	500 W	230 V	520	390	0,4
27504-13	1000 W	230 V	910	780	0,7
27504-14	1500 W	230 V	1300	1170	0,9
27504-15	2000 W	230 V	1690	1560	1,2
27504-16	3000 W	230 V	2470	2340	1,8

Ø 10,2 mm in Incoloy 800 / Din 1.4876 - 6 W/cm², WP+, C = 45

P/N.	Power +5 -10%	Voltage 1P	L (mm)	HL (mm)	Weight (kg)
28504-41	500 W	230 V	280	130	0,2
28504-42	1000 W	230 V	410	260	0,3
28504-43	2000 W	230 V	670	520	0,5
28504-44	3000 W	230 V	930	780	0,7
28504-45	4500 W	230 V	1320	1170	1
28504-46	6000 W	400 V	1710	1560	1,2
28504-47	8000 W	400 V	2230	2080	1,6
28504-48	10000 W	400 V	2750	2600	2

Ø 10,2 mm in AISI 904L / Din 1.4539 - 12 W/cm², WP+, C = 45

P/N.	Power +5 -10%	Voltage 1P	L (mm)	HL (mm)	Weight (kg)
26504-59	6000 W	230 V	910	780	0,7
26504-60	7000 W	230 V	1015	885	0,8
26504-61	8000 W	230 V	1165	1035	0,9
26504-63	10000 W	400 V	1415	1285	1,1
26504-65	12000 W	400 V	1660	1530	1,3
26504-69	15000 W	400 V	2060	1930	1,6

Ø 16 mm in AISI 316L/Din 1.4404 SP* - 6 W/cm², WP+, C = 45

P/N.	Power +5 -10%	Voltage 1P	L (mm)	HL (mm)	Weight (kg)
28504-01	500 W	230 V	235	185	0,4
28504-02	1000 W	230 V	315	165	0,5
28504-03	2000 W	230 V	480	330	0,8
28504-04	3000 W	230 V	650	500	1,1
28504-05	4500 W	230 V	895	745	1,5
28504-06	6000 W	400 V	1145	995	1,9
28504-07	8000 W	400 V	1475	1325	2,5
28504-08	10000 W	400 V	1810	1660	3,1
28504-09	12000 W	400 V	2140	1990	3,6
28504-10	15000 W	400 V	2640	2490	4,5

Ø 8 mm in AISI 316L / Din 1.4404 SP* - 6 W/cm², WP+, C = 25

P/N.	Power +5 -10%	Voltage 1P	L (mm)	HL (mm)	Weight (kg)
28504-21	500 W	230 V	315	165	0,15
28504-22	1000 W	230 V	480	330	0,23
28504-23	2000 W	230 V	815	665	0,4
28504-24	3000 W	230 V	1145	995	0,55
28504-25	4500 W	230 V	1645	1495	0,8
28504-26	6000 W	400 V	2140	1990	1
28504-27	8000 W	400 V	2805	2655	1,3

Ø 10,2 mm in AISI 904L / Din 1.4539 - 2 W/cm², WP+, C = 45

P/N.	Power +5 -10%	Voltage 1P	L (mm)	HL (mm)	Weight (kg)
26504-31	500 W	230 V	465	385	0,4
26504-33	1000 W	230 V	855	775	0,7
26504-34	1500 W	230 V	1245	1165	1,0
26504-35	2000 W	230 V	1635	1555	1,2
26504-36	3000 W	230 V	2415	2335	1,8

Ø 10,2 mm in AISI 316L/Din 1.4404 SP* - 6 W/cm², WP+, C=29

P/N.	Power +5 -10%	Voltage 1P	L (mm)	HL (mm)	Weight (kg)
28504-11	500 W	230 V	280	130	0,2
28504-12	1000 W	230 V	410	260	0,3
28504-13	2000 W	230 V	670	520	0,5
28504-14	3000 W	230 V	930	780	0,7
28504-15	4500 W	230 V	1320	1170	1
28504-16	6000 W	400 V	1710	1560	1,2
28504-17	8000 W	400 V	2230	2080	1,6
28504-18	10000 W	400 V	2750	2600	2

Ø 10,2 mm in AISI 904L / Din 1.4539 - 12 W/cm², WP+, C = 45

P/N.	Power +5 -10%	Voltage 1P	L (mm)	HL (mm)	Weight (kg)
26504-51	1000 W	230 V	255	125	0,2
26504-52	1500 W	230 V	320	190	0,2
26504-53	2000 W	230 V	385	255	0,3
26504-55	3000 W	230 V	515	385	0,4
26504-57	4000 W	230 V	645	515	0,5
26504-58	5000 W	230 V	775	645	0,6

Ø 16 mm in Incoloy 800 / Din 1.4876 - 6 W/cm², WP+, C = 65

P/N.	Power +5 -10%	Voltage 1P	L (mm)	HL (mm)	Weight (kg)
28504-31	500 W	230 V	235	185	0,4
28504-32	1000 W	230 V	315	165	0,5
28504-33	2000 W	230 V	480	330	0,8
28504-34	3000 W	230 V	650	500	1,1
28504-35	4500 W	230 V	895	745	1,5
28504-36	6000 W	400 V	1145	995	1,9
28504-37	8000 W	400 V	1475	1325	2,5
28504-38	10000 W	400 V	1810	1660	3,1
28504-39	12000 W	400 V	2140	1990	3,6
28504-40	15000 W	400 V	2640	2490	4,5

Ø 8 mm in AISI 312 / Din 1.4541 - 2 W/cm², TM, C = 25

P/N.	Power +5 -10%	Voltage 1P	L (mm)	HL (mm)	Weight (kg)
27504-21	250 W	230 V	380	250	0,2
27504-22	500 W	230 V	630	500	0,3
27504-23	1000 W	230 V	1125	995	0,5
27504-24	1500 W	230 V	1625	1495	0,8
27504-25	2000 W	230 V	2120	1990	1

Ø 8 mm in Incoloy 800 / Din 1.4876 - 6 W/cm², WP+, C = 30

P/N.	Power +5 -10%	Voltage 1P	L (mm)	HL (mm)	Weight (kg)
28504-51	500 W	230 V	315	165	0,2
28504-52	1000 W	230 V	480	330	0,2
28504-53	2000 W	230 V	815	665	0,4
28504-54	3000 W	230 V	1145	995	0,5
28504-55	4500 W	230 V	1645	1495	0,8
28504-56	6000 W	400 V	2140	1990	1
28504-57	8000 W	400 V	2805	2655	1,3

Ø 10,2 mm in AISI 904L / Din 1.4539 - 4 W/cm², WP+, C = 45

P/N.	Power +5 -10%	Voltage 1P	L (mm)	HL (mm)	Weight (kg)
26504-41	500 W	230 V	270	190	0,2
26504-43	1000 W	230 V	465	385	0,34
26504-44	1500 W	230 V	660	580	0,5
26504-45	2000 W	230 V	855	775	0,62
26504-46	3000 W	230 V	1245	1165	0,9
26504-47	4500 W	230 V	1830	1750	1,3
26504-48	6000 W	230 V	2415	2335	1,73

Ø 10,2 mm in Incoloy 800 / Din 1.4876 - 10 W/cm² WP+, C = 45

P/N.	Power +5 -10%	Voltage 1P	L (mm)	HL (mm)	Weight (kg)
28504-71	500 W	230 V	180	80	0,13
28504-72	1000 W	230 V	255	155	0,2
28504-73	2000 W	230 V	410	310	0,3
28504-74	3000 W	230 V	570	470	0,4
28504-75	4500 W	230 V	805	705	0,6
28504-76	6000 W	400 V	1035	935	0,75
28504-77	8000 W	400 V	1350	1250	1
28504-78	10000 W	400 V	1660	1560	1,2
28504-79	15000 W	400 V	2440	2340	1,8

Ø 16 mm in AISI 321/Din 1.4541 - 2 W/cm², TM, C = 45

P/N.	Power +5 -10%	Voltage 1P	L (mm)	HL (mm)	Weight (kg)
27504-01	500 W	230 V	380	250	0,65
27504-02	1000 W	230 V	630	500	1,1
27504-03	1500 W	230 V	875	745	1,5
27504-04	2000 W	230 V	1125	995	1,9
27504-05	3000 W	230 V	1625	1495	2,8
27504-06	4000 W	230 V	2120	1990	3,6
27504-07	5000 W	230 V	2620	2490	4,5

Ø 16 mm in Incoloy 800 / Din 1.4876 - 10W/cm², WP+, C = 65

P/N.	Power +5 -10%	Voltage 1P	L (mm)	HL (mm)	Weight (kg)
28504-61	1000 W	230 V	200	100	0,34
28504-62	2000 W	230 V	300	200	0,5
28504-63	3000 W	230 V	400	300	0,7
28504-64	4500 W	230 V	550	450	0,9
28504-65	6000 W	400 V	695	595	1,2
28504-66	8000 W	400 V	895	795	1,5
28504-67	10000 W	400 V	1095	995	1,9
28504-68	12000 W	400 V	1295	1195	2,2
28504-69	15000 W	400 V	1595	1495	2,7
28504-70	20000 W	400 V	2090	1990	3,6

* SP = scoured and passivated

FIXING ACCESSORIES

Threaded nipples allow a watertight fixing of tube 26501 and 26504. Supplied with nut and gasket. Max. pressure : 10 bar

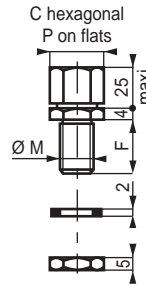

P/N.	Tube Ø (mm)	Ø M	C (mm)	P (mm)	F (mm)	P/N.in pack	Weight (kg)
55144-04	6.5/6.8	14 x 1,5	22	19	14	4	0,26
55145-04	8	14 x 1,5	22	19	14	4	0,25
55146-04	10.2	16 x 1,5	25,5	22	14	4	0,30
55147-04	16	20 x 1,5	31,2	27	14	4	0,39
55148-04	20	24 x 1,5	37	32	14	4	0,52

Inside Ø of fixing = Ø Tube

Fixing brackets in chrome-plated steel:

These brackets allow elements to be fixed to flat or slightly convex surfaces and permit expansion.

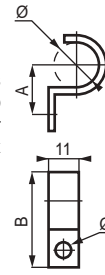

P/N.	Tube Ø (mm)	A (mm)	B (mm)	P/N.in pack	Weight (kg)
55140-10	6.5/6.8	11	22	10	0,02
55140-99	6.5/6.8	11	22	100	0,20
55141-10	8	12	23	10	0,03
55141-99	8	12	23	100	0,30
55142-10	10.2	12	25	10	0,04
55142-99	10.2	12	25	100	0,40
55143-10	16	15	30	10	0,05
55143-99	16	15	30	100	0,50

HEATING ELEMENTS FOR INDUSTRIAL OVENS

Heat-resistant stainless steel sheathed elements for industrial ovens and drying cabinets up to 300°C. Heating by natural convection (air) or radiation (solids).

Supply voltage: 230V single phase. Connection by M6 threaded terminals and M6 ground terminal.

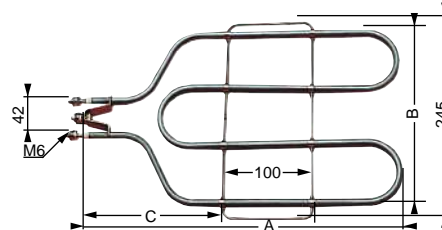

P/N.	Power +5 -10%	A (mm)	B (mm)	C (mm)	Weight (kg)
4501-20	1000 W	272	173	125	0,180
4501-21	1250 W	302	218	145	0,200
4501-22	1500 W	356	218	155	0,220

TUBULAR ELEMENTS FOR HOTPLATES

Stainless-steel sheathed element in a flat circular shape to heat solids up to 300°C by conduction (2 heating stages from 1000W upwards). Supply voltage : 230V single phase. Connection by flat terminals with calliper.

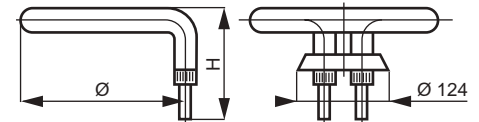

P/N.	Power +5 -10%	Ø (mm)	H (mm)	Weight (kg)	Fig.
4501-01	500 W	109	60	0,160	A
4501-02	1000 W	145	75	0,400	B
4501-03	1400 W	180	75	0,600	B
4501-04	2000 W	220	75	0,700	B

Accessories :

Clips for models 4501-01 (Weight 0,040 kg)



P/N. 4501-08 - 2 holes, 86 mm between centres

P/N. 4501-09 - 2 holes, 138 mm between centres

SQUARE-SECTION HEATING ELEMENTS

Especially suited to heat flat and cylindrical surfaces, their square cross-section allows a large area of contact with the object to be heated. This enables large transfers of heat and high temperatures (max. 700°C on the heating element).

Sheathed elements are available either straight or shaped to your requirements (minimum bend radius = 19 mm)

Tubes of 5x5 or 7,1x7,1 section are in stainless steel.

Connection at one end by 60cm cable with earth wire protected by metal braid.

HT seals.

The heating element is retained in a groove.

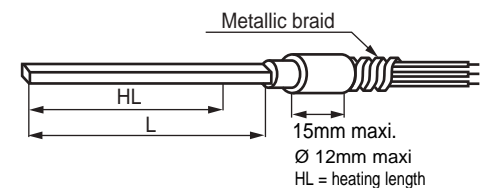

P/N.	Load 2 W/cm ²				
	Power +5 -10% single phase	Voltage	Section (mm)	L (mm)	HL (mm)
26680-21	250 W	230 V	5X5	690	640
26680-22	500 W	230 V	5X5	1290	1250
26681-21	250 W	230 V	7,1X7,1	490	450
26681-22	500 W	230 V	7,1X7,1	940	900
26681-23	750 W	230 V	7,1X7,1	1380	1340
26681-24	1000 W	230 V	7,1X7,1	1840	1800
26681-25	1500 W	230 V	7,1X7,1	2720	2680

P/N.	Load 4 W/cm ²				
	Power +5 -10% single phase	Voltage	Section (mm)	L (mm)	HL (mm)
26680-41	250 W	230 V	5x5	360	320
26680-42	500 W	230 V	5x5	665	625
26680-43	750 W	230 V	5x5	1040	1000
26681-41	1000 W	230 V	5x5	1290	1250
26681-42	250 W	230 V	7,1x7,1	381	230
26681-43	500 W	230 V	7,1x7,1	584	450
26681-44	750 W	230 V	7,1x7,1	762	670
26681-45	1000 W	230 V	7,1x7,1	965	900
26681-46	1500 W	230 V	7,1x7,1	1371	1350
26681-47	2000 W	230 V	7,1x7,1	1854	1800
26681-48	2500 W	230 V	7,1x7,1	2743	2300

P/N.	Load 6 W/cm ²				
	Power +5 -10% single phase	Voltage	Section (mm)	L (mm)	HL (mm)
26680-61	250 W	230 V	5x5	250	210
26680-62	500 W	230 V	5x5	460	420
26680-63	750 W	230 V	5x5	665	625
26681-61	250 W	230 V	7,1x7,1	190	150
26681-62	500 W	230 V	7,1x7,1	381	300
26681-63	750 W	230 V	7,1x7,1	457	450
26681-64	1000 W	230 V	7,1x7,1	660	600
26681-65	1500 W	230 V	7,1x7,1	965	900
26681-66	2000 W	230 V	7,1x7,1	1270	1200
26681-67	2500 W	230 V	7,1x7,1	1540	1500

FLUIDS HEATING

Screw plug immersion heaters



VULCALOY flange immersion heaters

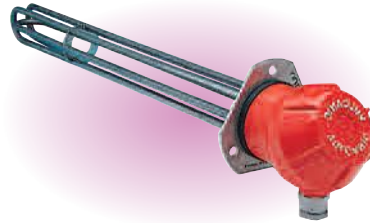

Flange immersion heaters

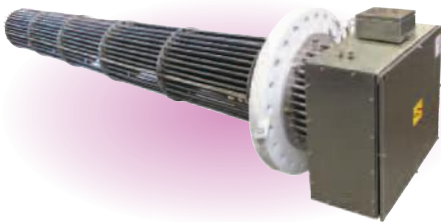

Clamp flange immersion heaters

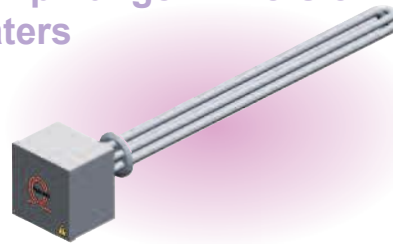

Ceramic core elements

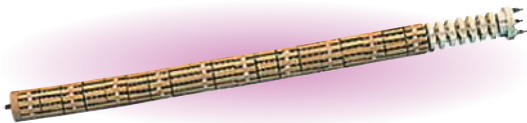

ATEX screw plug and flange immersion heaters



Removable immersion heaters

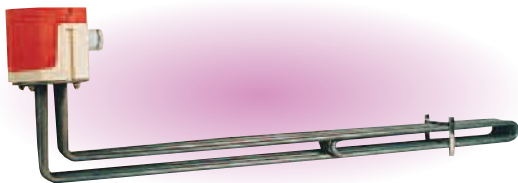

Drum heaters



Fluorated tank bottom heaters

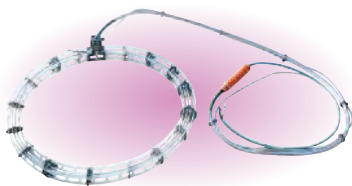

Fluid circulation heaters

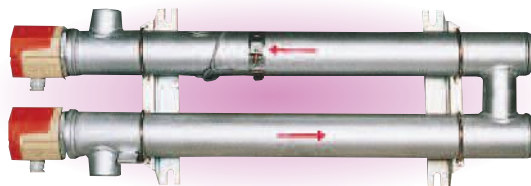

Heating hoses



APPLICATION: Electric immersion heaters are suited to heat up fluids (liquids and gas) by natural (static fluids) or forced convection (fluids in circulation). They are designed to heat up trough heating elements (pins, monotubes or ceramic cores) in direct contact with the fluid to be heated. Heating elements layout enables the optimization of heat transfers.

R

EQUIREMENTS:

Immersion heater requirements ?

- Type of fluid ?
- Volume of liquid to be heated ?
- Start temperature (before heating) (t₁) ?
- Target temperature. (t₂) ?
- Heating time ?
- Pressure ?
- Available space (Internal and external)
- Mounting interface
- With or without control
- With or without safety probes ?

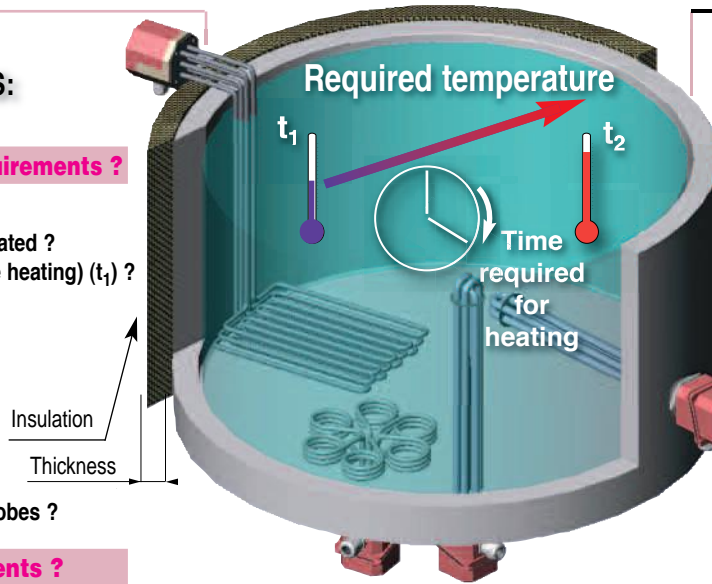

S

OLUTIONS :

See table page 13

- Suitable materials (Heating elements, flanges...)
- Specific load

Liquid (Static)	Specific load
Water	10 W/cm ² Max
Oil	2 W/cm ² Max
Other liquids contact us.	

- Power of the immersion heater
- Type of immersion heater

Pressure	Type of immersion heaters
Atmospheric	Removable, screw plug or flange
15 bar Max	Screw plug or flange
50 bar Max	Flange
Over 50 bar	Contact us

Power requirements ?

$$P_{ch} \text{ (power to heat)} + P_{th} \text{ (thermal losses)} = P \text{ total power requirements (kW)}$$

Power requirements?

- Weight of liquid : m (kg)
- Specific heat : Cp (kcal/kg x °C)
- Start temperature : t₁ (°C)
- Target temperature: t₂ (°C)
- Heating time : T (hour)

$$P_{ch} \text{ (kW)} = \frac{m \times C_p \times (t_2 - t_1) \times 1,2}{860 \times T}$$

$$m = V \times \rho$$

V

V = π x Ø²/4 x H
 Ø = Internal diameter(dm)
 H = Height of liquid (dm)

V = l x L x H
 L = length (dm)
 l = Width (dm)
 H = Height of liquid (dm)

	ρ	Cp
Paraffins	0,88	0,52
Mineral oil	0,9	0,5
Water	1	1
Glycol	1,1	0,67
Acetic acid	1,1	0,51
Formic acid	1,2	0,39
Hydrochloric acid	1,2	0,60
Sulphuric acid	1,8	0,33

Thermal losses ?

- Vessel surface area: S (m²)
- Room temperature : t_a (°C)
- Target temperature : t₂ (°C)
- Exchange coefficient : K (kcal/h x m² x °C)
- Thickness of insulation :(mm)

$$P_{th} = \frac{S \times (t_2 - t_a) \times K}{860}$$

S

Exchange surface (m²)

S = (π x Ø x H) + (π x Ø²/4)
 Ø = External diameter (m)
 H = Height of tank (m)

S = [2 x H x (l + L)] + (l x L)
 L = Tank's length (m)
 l = Tank's width (m)
 H = Tank's height (m)

K

Exchange factor (kcal/h x m² x °C)

	Thickness of insulation			
	without	25 mm	50 mm	100 mm
External underground tank	9	1,7	1	0,55
External sheltered tank - wind ≤ 10 km/h	30	2,1	1,1	0,59
External underground tank - wind ≤ 45 km/h	30	2,3	1,2	0,61
External underground tank - wind ≤ 90 km/h	45	2,9	2,5	1

CAUTION : An inappropriate immersion heater may result in :

- **Excessive Heating time :** too low power. **Too short heating time :** electric installation over dimensioned.
- **Alteration or even destruction of the fluid to be heated :** The fluid doesn't withstand the power load of the heater (W/cm²).
- **Destruction of the immersion heater :** The material of the heater doesn't fit with the fluid to be heated. The heater gets quickly corroded.

SELECTING SUITABLE SHEATHED MATERIALS

• The recommendations in this table are only indicative and do not involve the responsibility of Vulcanic.
The customer must verify the suitability of the material chosen with the thermal process.

x = not suitable < = Possible under certain conditions << = recommended

Fluids to be heated	Soldering	Welding	Carbon Steel	Scoured copper	Stainless steel 321	Stainless steel 316	904L Vulcaloy	Incoloy 800	Incoloy 825	PTFE
DIN number (For food and beverage applications, contact us)			E235+N	SFCu	1.4541	1.4404	1.4539	1.4876	2.4858	
WATER										
Softened water	<<	<<	x	x	<	<<	<<	<<	<<	<<
Boric water	x	<<	x	x	<	<<	<<	<	<<	<<
Desalinated water	x	<<	x	x	<	<<	<<	<	<<	<<
Deionised water	x	<<	x	x	<	<<	<<	<	<<	<<
Distilled water	x	<<	x	x	x	<<	<<	x	<<	<<
Hydrochloric sodium	<<	<	x	x	x	x	x	x	x	<<
Seawater	<<	<<	x	<	x	<	<<	<	<<	<<
Swimming-bath water	<<	<<	x	<	x	x	<<	x	x	<<
Treated water	<<	<<	x	<<	<<	<<	<<	<	x	x
Process water TH ≤ 10	<<	<<	x	<<	<	<<	<<	<	<<	x
Process water 10 < TH < 25	<<	<<	x	<<	x	<	<<	x	<<	x
Process water	<<	<<	x	<<	x	<	<<	x	<<	x
OILS										
Animal oil	<<	<<	<<	<	<<	<<	<<	<<	<<	<<
Lubricant	<<	<<	<<	<	<<	<<	<<	<<	<<	<<
Mineral oil (max. 90°C)	<<	<<	<<	<	<<	<<	<<	<<	<<	<<
Plant oil(200°C)	<<	<<	<<	x	<<	<<	<<	<<	<<	<<
Drilling oil	<<	<<	<	x	<<	<<	<<	<<	<<	<<
ACIDS										
Acetic acid										
5 to 20% < 20°C	x	<<	x	x	x	<<	<<	x	<<	<<
20 to 100% < 20°C	x	<<	x	x	x	<<	<<	x	<<	<<
5 to 50% < 100°C	x	<<	x	x	x	<<	<<	x	<<	<<
5 to 50% and boiling 120°C	x	<<	x	x	x	<<	x	x	<<	x
Hydrochloric acid (HCl)	x	<<	x	x	x	x	x	x	x	<<
Citric acid										
< 50% < 40°C	x	<<	x	x	<<	<<	<<	<<	<<	<<
< 50% and boiling	x	<<	x	x	x	<<	<<	x	<<	<<
Formic acid										
< 25% < 90°C	x	<<	x	<	x	<<	<<	x	<<	<<
10 to 90% < 90°C	x	<<	x	<	x	<	<	x	<<	<<
Oxalic acid										
< 40% < 75°C	x	<<	x	<	x	<<	<<	x	<<	<<
< 90% < 100°C	x	<<	x	x	x	x	x	x	x	<<
Phosphoric acid										
< 45% < 100°C	x	<<	x	<	x	<<	<<	x	<<	<<
≤ 100°C and boiling	x	<<	x	x	x	x	x	x	x	<<
Sulphuric acid										
< 3% < 20°C	x	<<	x	x	x	<<	<<	x	<<	<<
≥ 3% < 20% < 50°C	x	<<	x	x	x	<<	<<	x	<<	<<
> 10% < 50°C	x	<<	x	x	x	<	<	x	<<	<<
< 40% < 20°C	x	<<	x	x	x	<<	<<	x	<<	<<
≥ 50% ≤ 70% All Temp.	x	<<	x	x	x	x	<	x	x	<<
≤ 80% ≤ 20°C	x	<<	x	x	x	<<	<<	x	<<	<<
ALKALINE BATHS										
Bath lubrication										
Alcali or Anodic	x	<<	<<	x	x	x	x	x	x	x
Electrolytic	x	<<	<<	x	<	<<	<<	<	<<	x
Phosphoric baths	x	<<	<<	x	x	<<	<<	x	<<	x
Paint	x	<<	<<	<<	<<	<<	<<	<<	<<	x
Soap + water (In solution)	x	<<	<<	<	<<	<<	<<	<<	<<	<<
Caustic soda										
< 50% < 50°C	x	<<	<<	x	<	<<	<<	<	<<	<<
< 70% < 60°C	x	<<	<<	x	<	<<	<<	<	<<	<<
< 50% < 110°C	x	<<	<<	x	<	<<	<<	<	<<	<<
> 50% > 100°C	x	<<	<<	x	x	<	<	x	<	x
HIGH VISCOSITY LIQUIDS										
Asphalt	<<	<	<<	x	<<	<<	<<	<<	<<	x
Wax (Hot water bath)	<<	<	<<	x	<<	<<	<<	<<	<<	x
Heavy fuel	<<	<	<<	<<	<<	<<	x	<<	<<	<

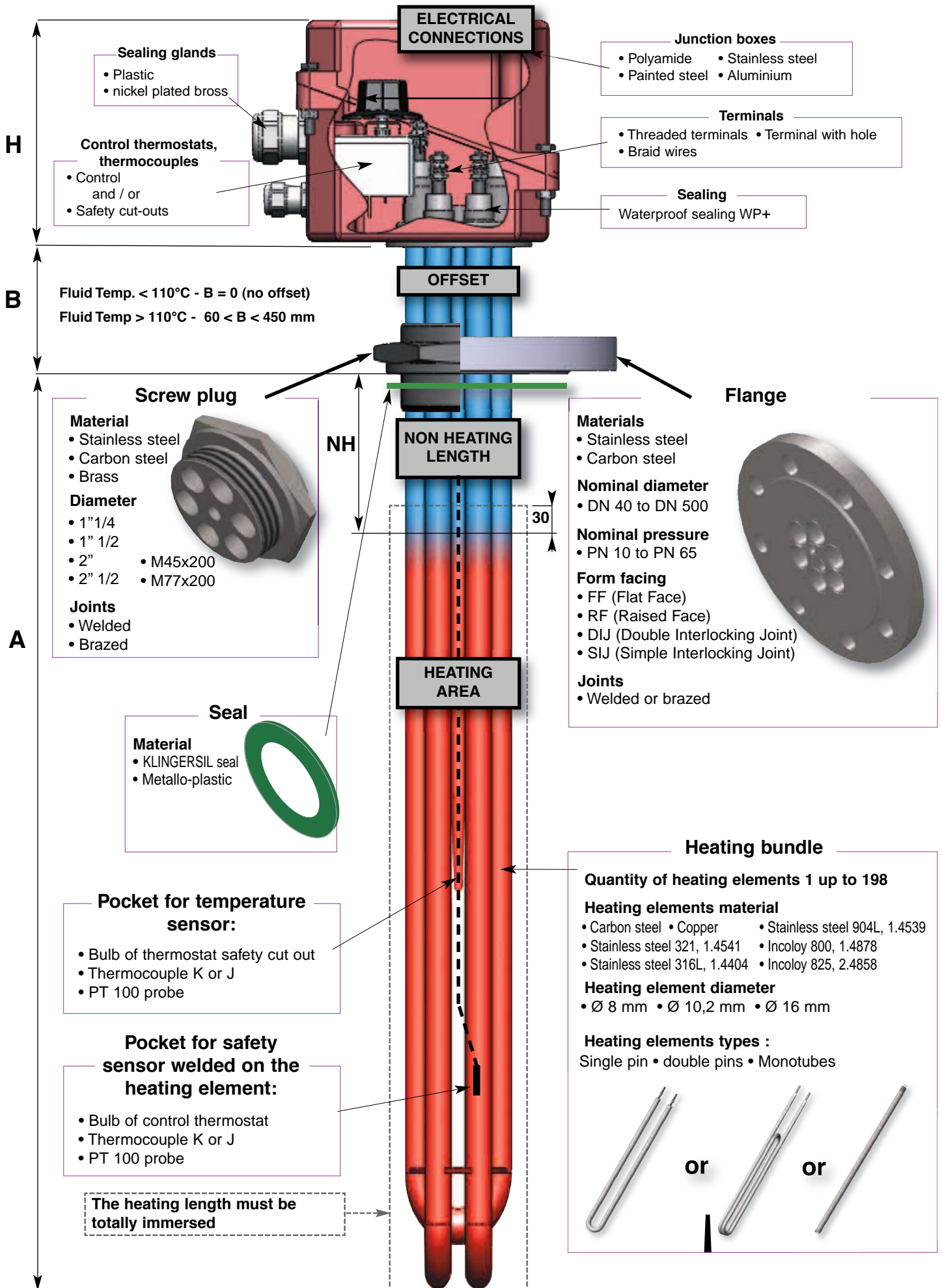

1 1/4 BSPP - 1 1/2 BSPP - ISO M45X200 SCREW PLUG HEATER SPECIFICATIONS

TYPE		2300						
SCREW PLUG		Ø Thread	1 1/4		1 1/2 or M45x200		M45x200	
MAXIMUM PRESSURE								
	Brazed joint		15 bar	15 bar	15 bar	15 bar	15 bar	
	Welded joint		20 bar	20 bar	20 bar	20 bar	20 bar	
JUNCTION BOX								
	Without control thermostat		H1 A1	Q1 G1	H1 A1			
	With control thermostat		-	Q2 K2 G2	-			
CONNECTIONS - COUPLING								
	Sealing		Resin WP+	Resin WP+	Resin WP+			
Ø Heating elements	6,8 mm		M4 M6 BW	-	-			
	8 mm		M4 M6 BW	M4 BW	M4 BW			
	10,2 mm		-	M4 M5 BW	M4 M5 BW			
	Coupling		Single phase (Parallel, Series), 3 phases (Star, Delta)					
OFFSET - MAXI TEMPERATURE								
	Without offset B = 0		110°C	110°C	110°C			
	Offset B = 60 mm		200°C	200°C	200°C			
	Offset B = 120 mm Brazed joint		250°C	250°C	250°C			
	Offset B = 120 mm Welded joint		300°C	300°C	300°C			
SCREW PLUG								
	Ø Thread		1 1/4	1 1/2 or M45x200	M45x200			
	Width across flats (mm)		60	60	60			
	Material		Carbon steel - Stainless steel - Copper brass					
HEATING ELEMENTS								
	Ø (mm)		6,8	8	8	10,2	8	10,2
	Qty		1 to 3		1 to 3		1 to 3	
Material	Z2 316L/DIN 1.4404		X	X	X	X	X	X
	Z6 321/DIN 1.4541		X	X	X	X	X	X
	Incoloy 800/DIN 1.4876		X	X	X	X	X	X
	Incoloy 825/DIN 2.4858		X	X	X	X	X	X
	Copper		X	X	X	X	X	X
	Carbon steel				X			X
	Sheath treatment		Without - Scoured - Scoured passivated - Electropolished					
Dimensions (mm)	A Maxi		1900	1900	1900	3000	1900	3000
	A Mini without thermowell		80	80	80	100	80	100
	A Mini with thermowell		150	150	150	200	150	200
	Tolerance on dimensions A		-2% +0 with mini -10 mm					
	LC Mini (Heating length)		40	40	40	60	40	60
	NC Mini (Non heating length)		40	40	40	40	40	40
	Ø Maxi bundle		37	37	42	42	42	42
Electrical parameters	Specific load - W/cm ²		Depending on customer application					
	Maximum current - A		16	16	16	26 / 45	16	26 / 45
	Maximum voltage - V		400	400	400	500	400	500
POCKET (Option)								
	Dimensions (mm)		Stainless steel					
	Ø Thermostat temperature sensor		6 or 8					
	T Maxi (Thermostat or temperature sensor)		A - 30					
	T Mini (Thermostat)		NH +10 + Bulb length					
	T Mini (Temperature sensor)		NH + 30					
	Temperature measurement device (Fluid)		Sensor PT100	Thermostat	Sensor PT100			
	Safety sensor on heating element		Thermocouple TC J or TC K					

Connections
M4 - Threaded terminal M4
M5 - Threaded terminal M5
M6 - Threaded terminal M6
BW - Threaded terminal

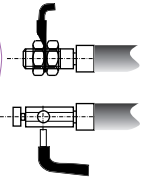

See range of junction boxes pages 42-43

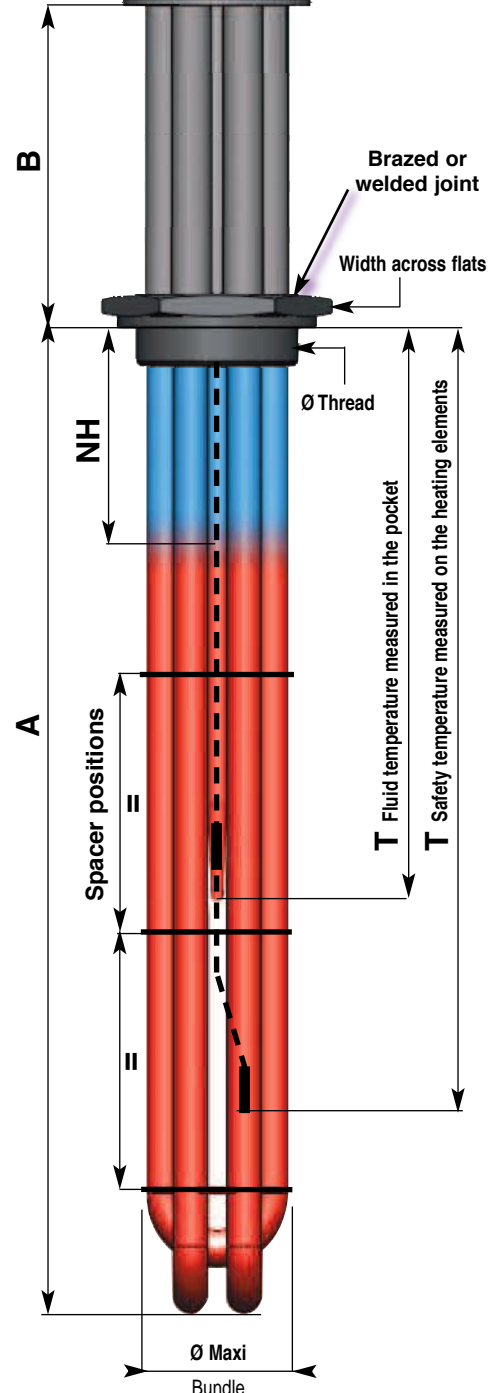
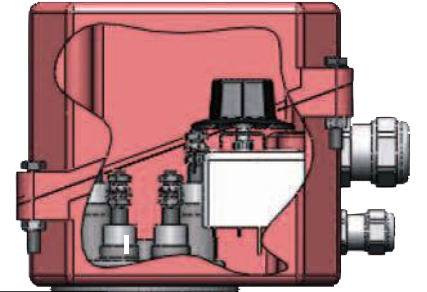

1 1/2 BSPP AND ISO M45x200 SCREW PLUG HEATERS WITH OFFSET FOR WATER AND OIL FROST PROTECTION

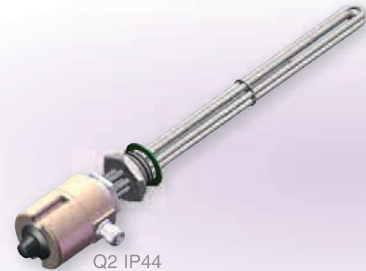

Q2 IP44
P/n. 2216-xx
P/n. 3216-xx
Control thermostat -20/+40°C P/n. 9030-71
External setting button



Q2 IP54
P/n. 2217-xx
P/n. 3217-xx
Control thermostat -20/+40°C P/n. 9030-71
Internal setting button

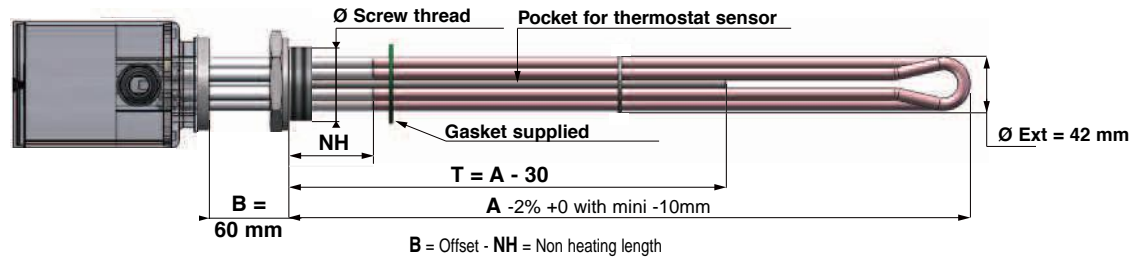

Junction box (See on pages 42-43)	Type	Q2	Q2
	IP	44	54
	Thermostat setting	External	Internal
	Material	Polyamide	
	Cable gland	P ≤ 3kW 1 CG ISO20 P > 3kW 1 CG ISO20 + 1 CG ISO25	
	Control thermostat	-20/+40°C 1 Change over contact - 16A / 230V	

WATER FROST PROTECTION

3 Heating elements						\varnothing 8 - Incoloy 825 - Without treatment	
Screw plug						Copper brass - Without treatment - Brazed	
\varnothing Screw thread	Power (kW) +5/-10%	Voltage (V)	Load (W/cm ²)	A (mm)	NH (mm)	P/N.	P/N.
1 1/2 BSPP	2	230-1P	5	300	40	2216-50	2217-50
	3	230-1P	5	480	40	2216-51	2217-51
	4,5	400-3P	5	670	40	2216-52	2217-52
	6	400-3P	5	960	40	2216-53	2217-53
M45 x 200	2	230-1p	5	300	40	3216-50	3217-50
	3	230-1P	5	480	40	3216-51	3217-51
	4,5	400-3P	5	670	40	3216-52	3217-52
	6	400-3P	5	960	40	3216-53	3217-53

OIL FROST PROTECTION

3 Heating elements						\varnothing 8 - Stainless steel 316L - Without treatment	
Screw plug						Carbon steel - Without treatment - Brazed	
\varnothing Screw thread	Power (kW) +5/-10%	Voltage (V)	Load (W/cm ²)	A (mm)	NH (mm)	P/N.	P/N.
1 1/2 BSPP	2	230-1P	1	1160	40	2216-60	2217-60
	3	230-1P	1,7	1160	40	2216-61	2217-61
M45 x 200	2	230-1p	1	1160	40	3216-60	3217-60
	3	230-1P	1,7	1160	40	3216-61	3217-61

• See optional accessories on page 56

1 1/2 BSPP AND ISO M45x200 SCREW PLUG TO HEAT OIL UP TO 95°C

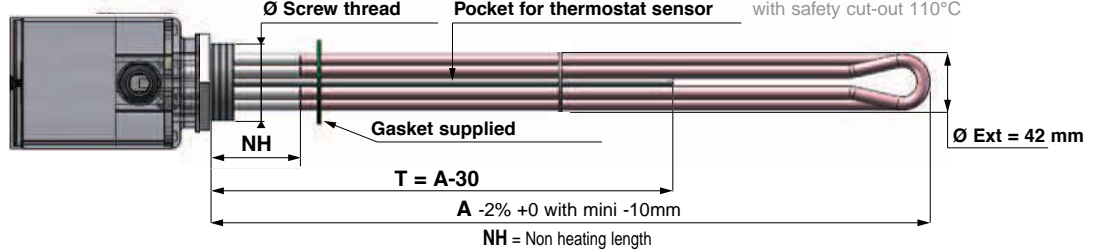
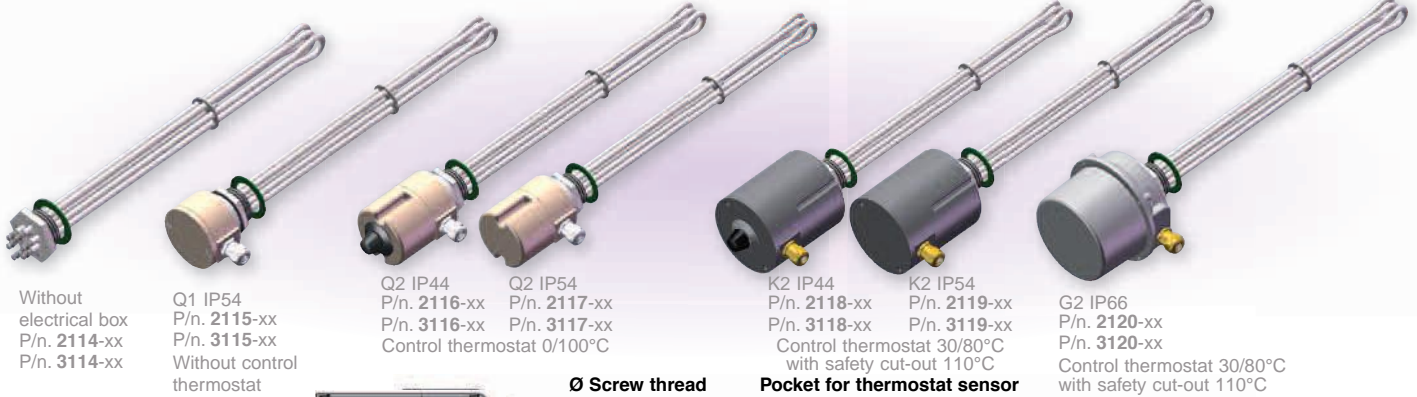

Junction box (See on pages 42-43)	Type	Without	Q1	Q2	Q2	K2	K2	G2	
	IP	Without	54	44	54	44	54	66	
	Thermostat setting	Without	Without	External	Internal	External	Internal	Internal	
	Material	Without	Polyamide						Alu.
	Cable gland	Without	P ≤ 3kW 1 CG ISO20		P > 3kW 1CG ISO20 + 1 CG ISO25				
	Control thermostat	Without	0/100°C 1 Change over contact 16A / 230 V			30/80°C 3 Contacts - 20A / 400V Safety 110°C reset manual			

STATIC OIL

3 Heating elements						Ø8 - Stainless steel 316L - Without treatment						
Screw plug						Carbon steel - Without treatment - Brazed						
Ø Screw thread	Power (kW) +5/-10%	Voltage (V)	Load (W/cm ²)	A (mm)	NH (mm)	P/N.	P/N.	P/N.	P/N.	P/N.	P/N.	P/N.
1 1/2 BSPP	1	230-1P	2	370	40	2114-01	2115-01	2116-01	2117-01	2118-01	2119-01	2120-01
	1,5	230-1P	2	540	40	2114-02	2115-02	2116-02	2117-02	2118-02	2119-02	2120-02
	2	230-1P	2	700	40	2114-03	2115-03	2116-03	2117-03	2118-03	2119-03	2120-03
	3	230-1P	2	1040	40	2114-04	2115-04	2116-04	2117-04	2118-04	2119-04	2120-04
M45 X200	1	230-1P	2	370	40	3114-01	3115-01	3116-01	3117-01	3118-01	3119-01	3120-01
	1,5	230-1P	2	540	40	3114-02	3115-02	3116-02	3117-02	3118-02	3119-02	3120-02
	2	230-1P	2	700	40	3114-03	3115-03	3116-03	3117-03	3118-03	3119-03	3120-03
	3	230-1P	2	1040	40	3114-04	3115-04	3116-04	3117-04	3118-04	3119-04	3120-04

CIRCULATING OIL (speed mini = 2m/s)

3 Heating elements						Ø8 - Stainless steel 316L - Without treatment						
Screw plug						Carbon steel - Without treatment - Brazed						
Ø Screw thread	Power (kW) +5/-10%	Voltage (V)	Load (W/cm ²)	A (mm)	NH (mm)	P/N.	P/N.	P/N.	P/N.	P/N.	P/N.	P/N.
1 1/2 BSPP	2	230-1P	5	300	40	2114-06	2115-06	2116-06	2117-06	2118-06	2119-06	2120-06
	3	230-1P	5	480	40	2114-07	2115-07	2116-07	2117-07	2118-07	2119-07	2120-07
	4,5	400-3P	5	670	40	2114-08	2115-08	2116-08	2117-08	2118-08	2119-08	2120-08
	6	400-3P	5	960	40	2114-09	2115-09	2116-09	2117-09	2118-09	2119-09	2120-09
M45 X 200	2	230-1P	5	300	40	3114-06	3115-06	3116-06	3117-06	3118-06	3119-06	3120-06
	3	230-1P	5	480	40	3114-07	3115-07	3116-07	3117-07	3118-07	3119-07	3120-07
	4,5	400-3P	5	670	40	3114-08	3115-08	3116-08	3117-08	3118-08	3119-08	3120-08
	6	400-3P	5	960	40	3114-09	3115-09	3116-09	3117-09	3118-09	3119-09	3120-09

• See optional accessories on page 56

1 1/2 BSPP AND ISO M45x200 SCREW PLUG WITH OFFSET TO HEAT OIL UP TO 200°C

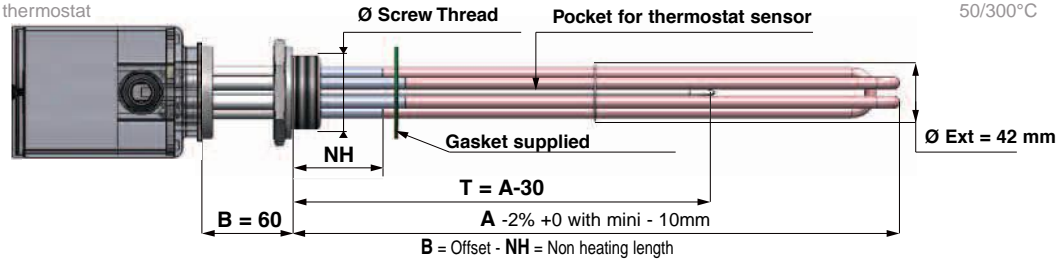
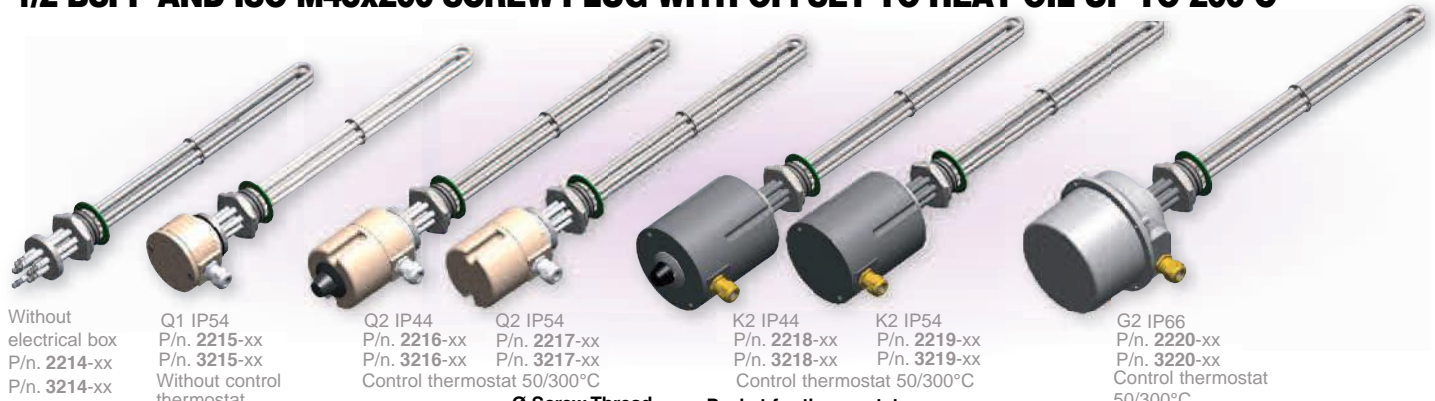

Junction box (See on pages 42-43)	Type	Without	Q1	Q2	Q2	K2	K2	G2	
	IP	Without	54	44	54	44	54	66	
	Thermostat setting	Without	Without	External	Internal	External	Internal	Internal	
	Material	Without	Polyamide						Alu.
	Cable gland	Without	P ≤ 3kW 1 CG ISO20 P > 3kW 1CG ISO20 + 1 CG ISO25						
	Control thermostat	Without	50/300°C 1 Change over contact 16A / 230V						

STATIC OIL

3 Heating elements						Ø8 - Stainless steel 316L - Without treatment						
Screw plug						Carbon steel - Without treatment - Welded						
Ø Screw Thread	Power (kW) +5/-10%	Voltage (V)	Load (W/cm ²)	A (mm)	NH (mm)	P/N.	P/N.	P/N.	P/N.	P/N.	P/N.	P/N.
1 1/2 BSPP	1	230-1P	2	370	40	2214-01	2215-01	2216-01	2217-01	2218-01	2219-01	2220-01
	1,5	230-1P	2	540	40	2214-02	2215-02	2216-02	2217-02	2218-02	2219-02	2220-02
	2	230-1P	2	700	40	2214-03	2215-03	2216-03	2217-03	2218-03	2219-03	2220-03
	3	230-1P	2	1040	40	2214-04	2215-04	2216-04	2217-04	2218-04	2219-04	2220-04
M45 X 200	1	230-1P	2	370	40	3214-01	3215-01	3216-01	3217-01	3218-01	3219-01	3220-01
	1,5	230-1P	2	540	40	3214-02	3215-02	3216-02	3217-02	3218-02	3219-02	3220-02
	2	230-1P	2	700	40	3214-03	3215-03	3216-03	3217-03	3218-03	3219-03	3220-03
	3	230-1P	2	1040	40	3214-04	3215-04	3216-04	3217-04	3218-04	3219-04	3220-04

CIRCULATING OIL SPEED MINI = 2m/s

3 Heating elements						Ø8 - Stainless steel 316L - Without treatment						
Screw plug						Carbon steel - Without treatment - Welded						
Ø Screw Thread	Power (kW) +5/-10%	Voltage (V)	Load (W/cm ²)	A (mm)	NH (mm)	P/N.	P/N.	P/N.	P/N.	P/N.	P/N.	P/N.
1 1/2 BSPP	2	230-1P	5	300	40	2214-06	2215-06	2216-06	2217-06	2218-06	2219-06	2220-06
	3	230-1P	5	480	40	2214-07	2215-07	2216-07	2217-07	2218-07	2219-07	2220-07
	4,5	400-3P	5	670	40	2214-08	2215-08	2216-08	2217-08	2218-08	2219-08	2220-08
	6	400-3P	5	960	40	2214-09	2215-09	2216-09	2217-09	2218-09	2219-09	2220-09
M45 X 200	2	230-1P	5	300	40	3214-06	3215-06	3216-06	3217-06	3218-06	3219-06	3220-06
	3	230-1P	5	480	40	3214-07	3215-07	3216-07	3217-07	3218-07	3219-07	3220-07
	4,5	400-3P	5	670	40	3214-08	3215-08	3216-08	3217-08	3218-08	3219-08	3220-08
	6	400-3P	5	960	40	3214-09	3215-09	3216-09	3217-09	3218-09	3219-09	3220-09

• See optional accessories on page 56

ISO M45X200 SCREW PLUG TO HEAT OIL FROM 110°C UP TO 200°C

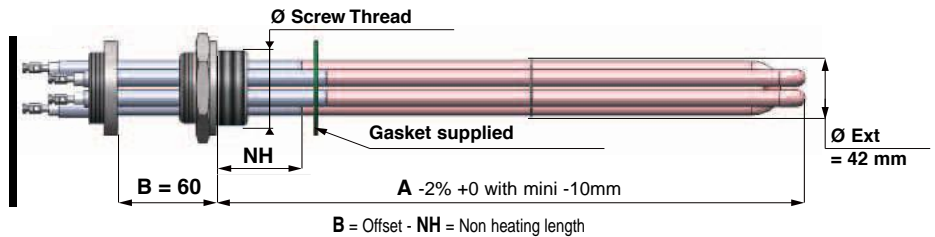
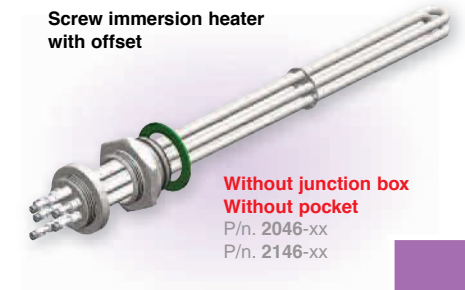
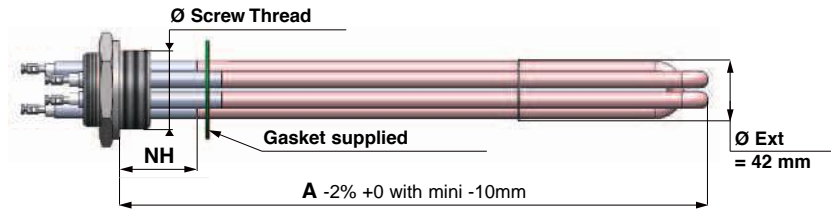
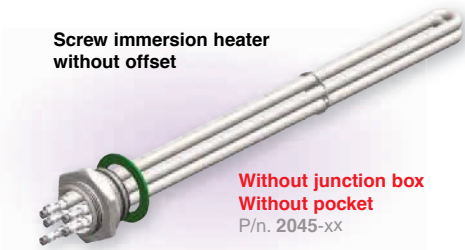

3 Heating elements	\varnothing 10,2 - Coated carbon steel
Screw plug	Coated carbon steel - Brazed

STATIC OIL UP TO 110°C (screw immersion heater without offset)

\varnothing Screw thread	Power (kW) +5/-10%	Voltage (V)	Load (W/cm ²)	A (mm)	NH (mm)	P/N.
M45 x 200	1	230/400	2	315	30	2045-01
	1,5	230/400	2	450	30	2045-02
	2	230/400	2	590	30	2045-03
	3	230/400	2	860	30	2045-04

STATIC OIL UP TO 200°C (screw immersion heater with offset B = 60)

\varnothing Screw thread	Power (kW) +5/-10%	Voltage (V)	Load (W/cm ²)	A (mm)	NH (mm)	P/N.
M45 x 200	1,5	230/400	2	450	30	2046-02
	2	230/400	2	590	30	2046-03
M45 x 200	1,5	230/400	2	460	70	2146-01
	3	230/400	2	865	85	2146-02
	4,5	230/400	2	1260	85	2146-03

• Junction box on option, see on pages 42-43 • See optional accessories on page 56

1"1/4 BSPP SCREW PLUG TO HEAT AQUEOUS LIQUIDS UP TO 95°C

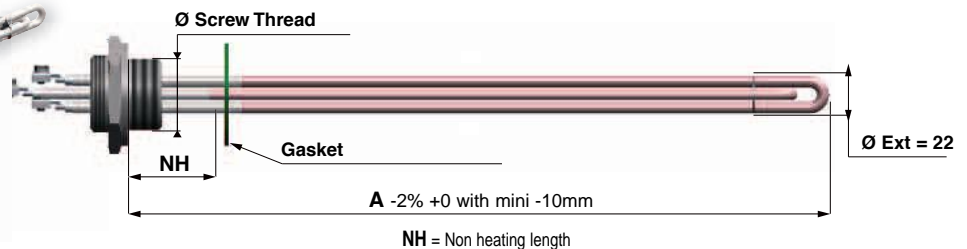

2 Heating elements	\varnothing 6,8 - Stainless steel 321 - Without treatment
Screw plug	Coated carbon steel - Brazed

\varnothing Thread screw	Power (kW) +5/-10%	Voltage (V)	Load (W/cm ²)	A (mm)	NH (mm)	P/N.
1"1/4 BSPP	0,75	230-1P	5	205	30	2041-01
	1	230-1P	5	250	30	2041-02
	1,5	230-1P	5	400	30	2041-03
	2	230-1P	5	500	30	2041-04
	3	230-1P	5	750	30	2041-05

• Junction box option, see P/N 9621-02 and P/N 9621-10 pages 43 • See optional accessories on page 56

1 1/2 BSPP AND ISO M45x200 SCREW PLUG TO HEAT AQUEOUS LIQUIDS UP TO 95°C

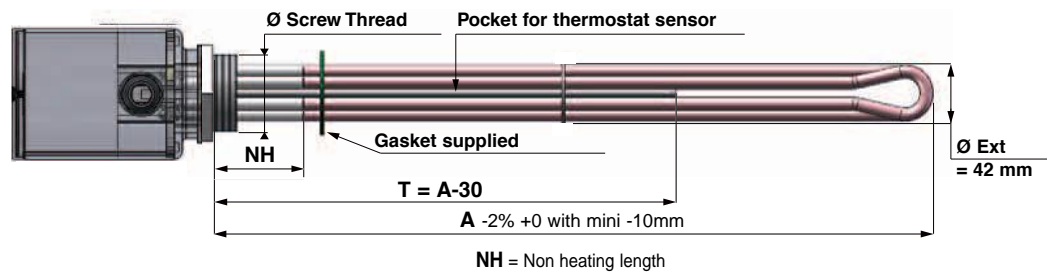

WATER

Junction box (See on pages 42-43)		Type	Without	Q1	Q2	Q2	K2	K2	G2			
		IP	Without	54	44	54	44	54	66			
		Thermostat setting	Without	Without	External	Internal	External	Internal	Internal			
		Material	Without	Polyamide						Alu.		
		Cable gland	Without	P ≤ 3kW 1 CG ISO20			P > 3kW 1CG ISO20 + 1 CG ISO25					
		Control thermostat	Without	0/100°C 1 change over contact 16A / 230V		30/80°C 3 Contacts - 20A / 400V Safety cut-out 110°C (manual reset)						
3 Heating elements			Ø8 - Stainless steel 316L - Without treatment									
Screw plug			Copper brass - Without treatment - Brazed									
Ø Screw Thread	Power(kW) +5/-10%	Voltage (V)	Load (W/cm ²)	A (mm)	NH (mm)	P/N.	P/N.	P/N.	P/N.	P/N.	P/N.	P/N.
1 1/2 BSPP	2	230-1P	10	170	40	2114-10	2115-10	2116-10	2117-10	2118-10	2119-10	2120-10
	3	230-1P	10	230	40	2114-11	2115-11	2116-11	2117-11	2118-11	2119-11	2120-11
	4,5	400-3P	10	330	40	2114-12	2115-12	2116-12	2117-12	2118-12	2119-12	2120-12
	6	400-3P	10	430	40	2114-13	2115-13	2116-13	2117-13	2118-13	2119-13	2120-13
	7,5	400-3P	9	600	40	2114-14	2115-14	2116-14	2117-14	2118-14	2119-14	2120-14
	9	400-3P	9	750	40	2114-15	2115-15	2116-15	2117-15	2118-15	2119-15	2120-15
M45 x 200	2	230-1P	10	170	40	3114-10	3115-10	3116-10	3117-10	3118-10	3119-10	3120-10
	3	230-1P	10	230	40	3114-11	3115-11	3116-11	3117-11	3118-11	3119-11	3120-11
	4,5	400-3P	10	330	40	3114-12	3115-12	3116-12	3117-12	3118-12	3119-12	3120-12
	6	400-3P	10	430	40	3114-13	3115-13	3116-13	3117-13	3118-13	3119-13	3120-13
	7,5	400-3P	9	600	40	3114-14	3115-14	3116-14	3117-14	3118-14	3119-14	3120-14
	9	400-3P	9	750	40	3114-15	3115-15	3116-15	3117-15	3118-15	3119-15	3120-15

• See optional accessories on page 56

1 1/2 BSPP AND ISO M45x200 SCREW PLUG TO HEAT AQUEOUS LIQUIDS UP TO 95°C

POTABLE WATER CONTAINED IN A METAL TANK

Junction box (See on pages 42-43)						Type	Without	Q1	Q2	Q2	K2	K2	G2	
						IP	Without	54	44	54	44	54	66	
						Thermostat setting	Without	Without	External	Internal	External	Internal	Internal	
						Material	Without	Polyamide						Alu.
						Cable gland	Without	P ≤ 3kW 1 CG ISO20			P > 3kW 1CG ISO20 + 1 CG ISO25			
						Control thermostat	Without	0/100°C 1 change over contact 16A / 230V			30/80°C 3 Contacts - 20A / 400V Safety cut-out 110°C (manual reset)			
3 Heating elements						Ø8 - Incoloy 825 - Without treatment								
Screw plug						Copper brass - Without treatment - Brazed								
Ø Screw thread	Power(kW) +5/-10%	Voltage (V)	Load (W/cm ²)	A (mm)	NH (mm)	P/N.	P/N.	P/N.	P/N.	P/N.	P/N.	P/N.		
1 1/2 BSPP	2	230-1P	6	470	100	2114-16	2115-16	2116-16	2117-16	2118-16	2119-16	2120-16		
	3	230-1P	7	380	100	2114-17	2115-17	2116-17	2117-17	2118-17	2119-17	2120-17		
	4,5	400-3P	8	470	100	2114-18	2115-18	2116-18	2117-18	2118-18	2119-18	2120-18		
	6	400-3P	11	470	100	2114-19	2115-19	2116-19	2117-19	2118-19	2119-19	2120-19		
	7,5	400-3P	10	600	100	2114-20	2115-20	2116-20	2117-20	2118-20	2119-20	2120-20		
	9	400-3P	10	690	100	2114-21	2115-21	2116-21	2117-21	2118-21	2119-21	2120-21		
M45 x 200	2	230-1P	6	470	100	3114-16	3115-16	3116-16	3117-16	3118-16	3119-16	3120-16		
	3	230-1P	7	380	100	3114-17	3115-17	3116-17	3117-17	3118-17	3119-17	3120-17		
	4,5	400-3P	8	470	100	3114-18	3115-18	3116-18	3117-18	3118-18	3119-18	3120-18		
	6	400-3P	11	470	100	3114-19	3115-19	3116-19	3117-19	3118-19	3119-19	3120-19		
	7,5	400-3P	10	600	100	3114-20	3115-20	3116-20	3117-20	3118-20	3119-20	3120-20		
	9	400-3P	10	690	100	3114-21	3115-21	3116-21	3117-21	3118-21	3119-21	3120-21		

POTABLE WATER CONTAINED IN AN ENAMELLED TANK (heating elements insulated from the screw)

Junction box (See on pages 42-43)						Type	Without	Q1	Q2	Q2	K2	K2	G2	
						IP	Without	54	44	54	44	54	66	
						Thermostat setting	Without	Without	External	Internal	External	Internal	Internal	
						Material	Without	Polyamide						Alu.
						Cable gland	Without	P ≤ 3kW 1 CG ISO20			P > 3kW 1CG ISO20 + 1 CG ISO25			
						Control thermostat	Sans	0/100°C 1 change over contact 16A / 230V			30/80°C 3 Contacts - 20A / 400V Safety cut-out 110°C (manual reset)			
3 Heating elements						Ø8 - Incoloy 825 - Without treatment								
Screw plug						Copper brass - Without treatment - Brazed								
Ø Screw thread	Power(kW) +5/-10%	Voltage (V)	Load (W/cm ²)	A (mm)	NH (mm)	P/N.	P/N.	P/N.	P/N.	P/N.	P/N.	P/N.		
1 1/2 BSPP	2	230-1P	6	470	100	-	2115-35	2116-35	2117-35	2118-35	2119-35	2120-35		
	3	230-1P	7	380	100	-	2115-36	2116-36	2117-36	2118-36	2119-36	2120-36		
	4,5	400-3P	8	470	100	-	2115-37	2116-37	2117-37	2118-37	2119-37	2120-37		
	6	400-3P	11	470	100	-	2115-38	2116-38	2117-38	2118-38	2119-38	2120-38		
	7,5	400-3P	10	600	100	-	2115-39	2116-39	2117-39	2118-39	2119-39	2120-39		
	9	400-3P	10	690	100	-	2115-40	2116-40	2117-40	2118-40	2119-40	2120-40		
M45 x 200	2	230-1P	6	470	100	-	3115-35	3116-35	3117-35	3118-35	3119-35	3120-35		
	3	230-1P	7	380	100	-	3115-36	3116-36	3117-36	3118-36	3119-36	3120-36		
	4,5	400-3P	8	470	100	-	3115-37	3116-37	3117-37	3118-37	3119-37	3120-37		
	6	400-3P	11	470	100	-	3115-38	3116-38	3117-38	3118-38	3119-38	3120-38		
	7,5	400-3P	10	600	100	-	3115-39	3116-39	3117-39	3118-39	3119-39	3120-39		
	9	400-3P	10	690	100	-	3115-40	3116-40	3117-40	3118-40	3119-40	3120-40		

• See optional accessories on page 56

1 1/2 BSPP AND ISO M45x200 SCREW PLUG TO HEAT AGGRESSIVE LIQUIDS UP TO 95°C

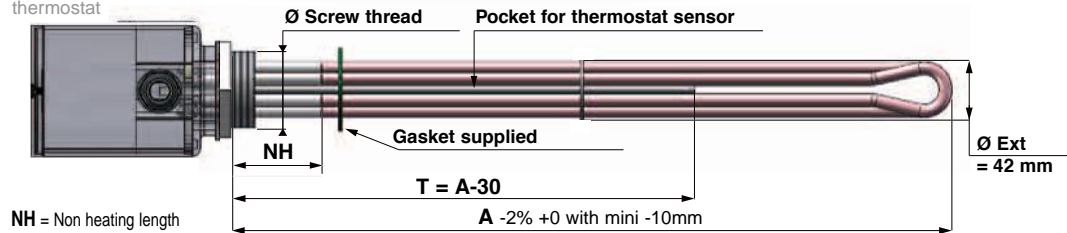

Junction box (See on pages 42-43)	Type	Without	Q1	Q2	Q2	K2	K2	G2
	IP	Without	54	44	54	44	54	66
	Thermostat setting	Without	Without	External	Internal	External	Internal	Internal
	Material	Without	Polyamide					Alu.
	Cable gland	Without	P ≤ 3kW 1 CG ISO20		P > 3kW 1CG ISO20 + 1 CG ISO25			
	Control thermostat	Without	0/100°C 1 change over contact 16A / 230V			30/80°C 3 Contacts - 20A / 400V Safety cut out 110°C manual reset		

AGGRESSIVE AQUEOUS LIQUIDS (chlorinated water)

3 Heating elements						Ø8 - Incoloy 825 - Without treatment						
Screw plug						Stainless steel - Without treatment - Welded						
Ø Screw thread	Power(kW) +5/-10%	Voltage (V)	Load (W/cm ²)	A (mm)	NH (mm)	P/N.	P/N.	P/N.	P/N.	P/N.	P/N.	P/N.
1 1/2 BSPP	3	230-1P	6	380	40	2114-28	2115-28	2116-28	2117-28	2118-28	2119-28	2120-28
	4,5	230-1P	7	470	40	2114-29	2115-29	2116-29	2117-29	2118-29	2119-29	2120-29
	6	400-3P	10	470	40	2114-30	2115-30	2116-30	2117-30	2118-30	2119-30	2120-30
	7,5	400-3P	10	600	40	2114-31	2115-31	2116-31	2117-31	2118-31	2119-31	2120-31
M45 x 200	3	230-1P	6	380	40	3114-28	3115-28	3116-28	3117-28	3118-28	3119-28	3120-28
	4,5	230-1P	7	470	40	3114-29	3115-29	3116-29	3117-29	3118-29	3119-29	3120-29
	6	400-3P	10	470	40	3114-30	3115-30	3116-30	3117-30	3118-30	3119-30	3120-30
	7,5	400-3P	10	600	40	3114-31	3115-31	3116-31	3117-31	3118-31	3119-31	3120-31
M45 x 200	9	400-3P	10	690	40	3114-32	3115-32	3116-32	3117-32	3118-32	3119-32	3120-32

DEMINERALIZED LIQUIDS

3 Heating elements						Ø8 - Stainless steel 316L - Without treatment						
Screw plug						Stainless steel - Without treatment - Welded						
Ø Screw thread	Power(kW) +5/-10%	Voltage (V)	Specific load (W/cm ²)	A (mm)	NH (mm)	P/N.	P/N.	P/N.	P/N.	P/N.	P/N.	P/N.
1 1/2 BSPP	0,75	230-1P	4	230	40	2114-22	2115-22	2116-22	2117-22	2118-22	2119-22	2120-22
	3	230-1P	10	230	40	2114-23	2115-23	2116-23	2117-23	2118-23	2119-23	2120-23
	4,5	400-3P	11	330	40	2114-24	2115-24	2116-24	2117-24	2118-24	2119-24	2120-24
	6	400-3P	11	430	40	2114-25	2115-25	2116-25	2117-25	2118-25	2119-25	2120-25
	7,5	400-3P	10	600	40	2114-26	2115-26	2116-26	2117-26	2118-26	2119-26	2120-26
M45 x 200	9	400-3P	9	750	40	2114-27	2115-27	2116-27	2117-27	2118-27	2119-27	2120-27
	0,75	230-1P	4	230	40	3114-22	3115-22	3116-22	3117-22	3118-22	3119-22	3120-22
	3	230-1P	10	230	40	3114-23	3115-23	3116-23	3117-23	3118-23	3119-23	3120-23
	4,5	400-3P	11	330	40	3114-24	3115-24	3116-24	3117-24	3118-24	3119-24	3120-24
	6	400-3P	11	430	40	3114-25	3115-25	3116-25	3117-25	3118-25	3119-25	3120-25
M45 x 200	7,5	400-3P	10	600	40	3114-26	3115-26	3116-26	3117-26	3118-26	3119-26	3120-26
	9	400-3P	9	750	40	3114-27	3115-27	3116-27	3117-27	3118-27	3119-27	3120-27

• See optional accessories on page 56

ISO M45x200 SCREW PLUG TO HEAT AQUEOUS LIQUIDS UP TO 110°C



Without junction box
Without pocket
P/n. 2045-xx
P/n. 2145-xx

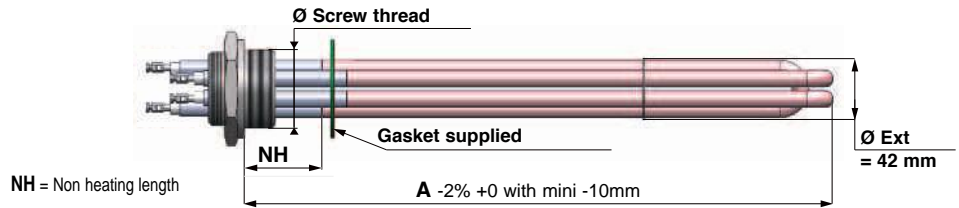

3 Heating elements						Ø10,2 - Stainless steel 316L - Scoured passivated
Screw plug						Coated carbon steel - Brazed
Ø Screw thread	Power(kW) +5/-10%	Voltage (V)	Load (W/cm ²)	A (mm)	NH (mm)	P/N.
M45 x 200	1	230/400	4	180	30	2045-11
	2	230/400	4	320	30	2045-12
	3	230/400	4	450	30	2045-13
	3	230/400	4	460	70	2145-11
	4,5	230/400	4	660	30	2045-14
	6	230/400	4	860	30	2045-15
	6	230/400	4	865	85	2145-12
	9	230/400	4	1260	85	2145-13
	12	230/400	4	1650	85	2145-14

3 Heating elements						Ø8 - Stainless steel 316L - Scoured passivated
Screw plug						Copper brass - Without treatment - Brazed
Ø Screw thread	Power(kW) +5/-10%	Voltage (V)	Load (W/cm ²)	A (mm)	NH (mm)	P/N.
M45 x 200	1	230/400	5	170	30	2045-71
	2	230/400	5	300	30	2045-72
	3	230/400	5	440	40	2045-73
	4	230/400	5	600	60	2045-74
	6	230/400	5	860	70	2045-75

3 Heating elements						Ø8 - Copper - Scoured passivated
Screw plug						Copper brass - Without treatment - Brazed
Ø Screw thread	Power(kW) +5/-10%	Voltage (V)	Load (W/cm ²)	A (mm)	NH (mm)	P/N.
M45 x 200	1	230/400	8	130	30	2045-20
	2	230/400	8	215	30	2045-21
	3	230/400	8	300	30	2045-22
	4,5	230/400	8	425	30	2045-23
	6	230/400	8	550	30	2045-24

• Junction box option, see on pages 42-43 • See optional accessories on page 56

ISO M45x200 SCREW PLUG WITH OFFSET TO HEAT AQUEOUS LIQUIDS UP TO 200°C



Without junction box
Without pocket
P/n. 2046-xx

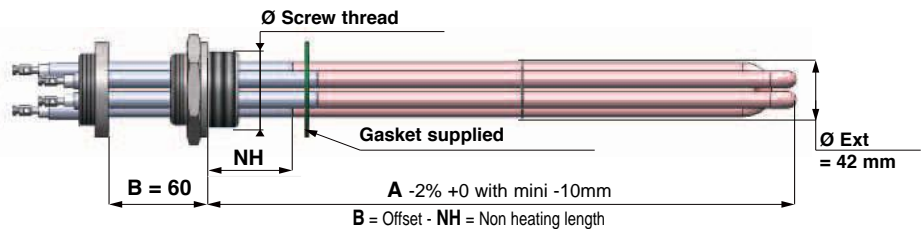

3 Heating elements						Ø10,2 - Stainless steel 316L - Scoured passivated
Screw plug						Coated carbon steel - Brazed
Ø Screw thread	Power(kW) +5/-10%	Voltage (V)	Load (W/cm ²)	A (mm)	NH (mm)	P/N.
M45 x 200	2	230/400	4	320	30	2046-12
	3	230/400	4	450	30	2046-13
	4,5	230/400	4	680	30	2046-14

• Junction box option, see on pages 42-43 • See optional accessories on page 56

1 1/2 BSPP AND ISO M45x200 SCREW PLUG TO HEAT POTABLE WATER OR HEAT PUMP



Capot IP44

P/n. 2048-xx Control thermostat 30/75°C with safety cut out 98°C
 P/n. 2049-xx Control thermostat 30/85°C with safety cut out 110°C

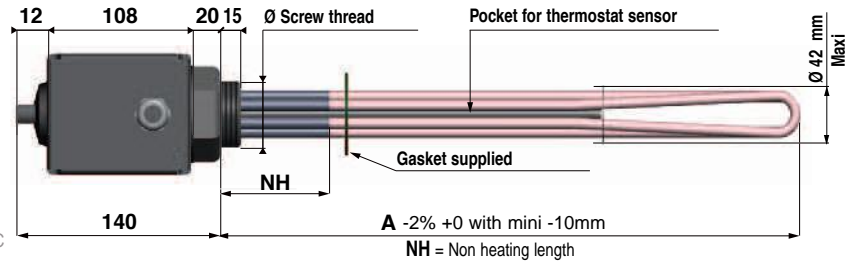

Junction box (See pages 42-43)		IP		44				
		Material		Polyamide				
		Cable gland		1 CG ISO20				
		Control thermostat		30/75°C 3 Contacts - 20A / 400V Safety cut out 98°C manual reset	30/80°C 3 Contacts - 20A / 400V Safety cut out 110°C manual reset			
3 Heating elements		Ø8,5 - Incoloy 825 - Without treatment						
Screw plug		Stainless steel - Without treatment - Brazed						
Ø Screw thread	Power(kW) +5/-10%	Voltage (V)	Coupling	Load (W/cm ²)	A (mm)	NH (mm)	P/N.	P/N.
1 1/2 BSPP	2	230/400	Star	6,2	250	50	2048-01	2049-01
	3	230/400	Star	9,4	250	50	2048-02	2049-02
	4,5	230/400	Star	11	350	100	2048-03	2049-03
	6	230/400	Star	10,7	450	100	2048-04	2049-04
	7,5	230/400	Star	10,4	550	100	2048-05	2049-05
	9	230/400	Star	10,2	650	100	2048-06	2049-06
	12	400-3P	Delta	11,5	750	100	2048-07	2049-07
M45 x 200	2	230/400	Star	6,2	250	50	2048-11	2049-11
	3	230/400	Star	9,4	250	50	2048-12	2049-12
	4,5	230/400	Star	11	350	100	2048-13	2049-13
	6	230/400	Star	10,7	450	100	2048-14	2049-14
	7,5	230/400	Star	10,4	550	100	2048-15	2049-15
	9	230/400	Star	10,2	650	100	2048-16	2049-16
	12	400-3P	Delta	11,5	750	100	2048-17	2049-17

• See optional accessories on page 56

TANK BOTTOM IMMERSION HEATERS ISO M45 AND M77X200 TO HEAT AQUEOUS LIQUIDS UP TO 110°C

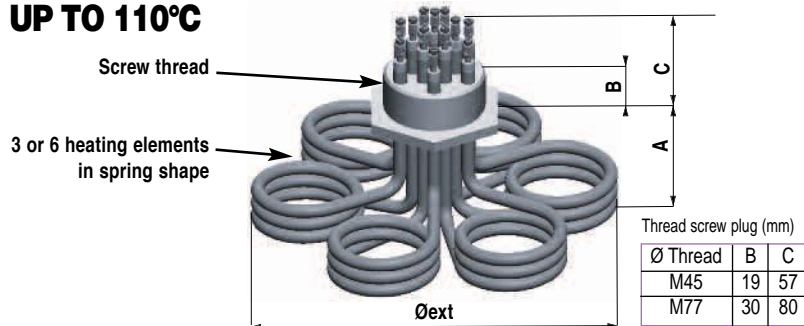

3 Heating elements		Ø8 - Stainless steel 316L Scoured passivated	
Screw plug		Stainless steel - Brazed	
Ø Screw thread	Power(kW) +5/-10%	Voltage (V)	P/N.
M45 x 200	2	230/400	4300-11
M45 x 200	3	230/400	4300-12
6 Heating elements		Ø10,2 - Stainless steel 316L Scoured passivated	
Screw plug		Stainless steel - Brazed	
Ø Screw thread	Power(kW) +5/-10%	Voltage (V)	P/N.
M77x 200	4	230/400	4300-51
M77x 200	6	230/400	4300-52

3 Heating elements		Ø8 - Copper - Scoured	
Screw plug		Copper brass - Brazed	
Ø Screw thread	Power(kW) +5/-10%	Voltage (V)	P/N.
M45 x 200	2	230/400	4300-01
	4,5	230/400	4300-02
	3	230/400	4300-03
	6	230/400	4300-04
	7,5	230/400	4300-05
	9	230/400	4300-06
	12	230/400	4300-07

6 Heating elements		Ø10,2 - Copper - Scoured	
Screw plug		Copper brass - Brazed	
Ø Screw thread	Power(kW) +5/-10%	Voltage (V)	P/N.
M77x 200	15	230/400	4300-61
	18	230/400	4300-62
	24	230/400	4300-63

• Junction box option, see on pages 42-43
 • See optional accessories on page 56

2" BSPP - 2"1/2 BSPP - ISO M77x200 SCREW IMMERSION HEATER SPECIFICATIONS

TYPE		2300														
SCREW PLUG	Ø Thread	2"			2"1/2			M77								
MAXIMUM PRESSURE		Brazed joint (up to 200°C) Welded joint (up to 300°C)			15 bar 25 bar			15 bar 25 bar			15 bar 25 bar					
JUNCTION BOX		Without control thermostat			H1 - A2			H1 - A2 - A3			With control thermostat			G2 - K2		
CONNECTION COUPLING		Ø Heating elements		8	10,2	8	10,2	16	8	10,2	16	Resine WP+160				
		Sealing		M4 M5 M4 M5 M6 M4 M5 M6												
		Connections		M4			M5			M6			FIL - Threaded terminal			
		Coupling		Single phase (Parallel, Series), 3 phases (Star, Delta)												
OFFSET - MAXI TEMPERATURE		Ø Heating elements		8	10,2	8	10,2	16	8	10,2	16					
		Without offset B = 0mm		110°C			110°C			110°C			110°C			
		With offset B = 60mm		200°C			200°C			200°C			200°C			
		Offset B = 120mm Brazed joint		250°C			250°C			250°C			250°C			
		Offset B = 120mm Welded joint		300°C			300°C			300°C			300°C			
		Offset B = 225mm Welded joint		-			-			400°C			-			
SCREW PLUG		Ø Thread		2"			2"1/2			M77						
		Across flats		95			95			95						
		Material		Carbon steel - Stainless steel - Copper brass												
HEATING ELEMENTS		Ø		8	10,2	8	10,2	16	8	10,2	16					
		Qty		1 to 6	1 to 3	1 to 6	1 to 3	1 to 3	1 to 6	1 to 3	1 to 3					
Material		Z2 316L/DIN	1.4404	X	X	X	X	X	X	X	X	X	X	X		
		Z6 321/DIN	1.4541	X	X	X	X	X	X	X	X	X	X	X		
		Incoloy 800/DIN	1.4876	X		X			X			X				
		Incoloy 825/DIN	2.4858	X		X			X			X				
		Stainless steel			X		X			X		X		X		
		Vulcaloy 904L/DIN	1.4539		X		X			X		X		X		
		Copper		X	X	X	X	X	X	X	X	X	X	X		
Sheath Treatment		Without - Scoured - Scoured passivated - Electropolished														
Dimensions (mm)		A Maxi		1900	3000	1900	3000	3000	1900	3000	3000					
		A Mini without pocket		80	100	80	100	150	80	100	150					
		A Mini with pocket		150	200	150	200	200	150	200	200					
		Width across flats A		-2% +0 with mini -10mm												
		LC Mini (Heating length)		40	60	40	60	90	40	60	90					
		NC Mini (Non heating length)		40	40	40	40	60	40	40	60					
		Ø Maxi bundle		55	55	70	70	70	70	70	70					
		Distance between spacers :		400	650	400	650	1000	400	650	1000					
Electrical parameters		Specific load - W/cm ²		Depending on customer application												
		Maximum current - A		16	26 / 45	16	26 / 45	60	16	26 / 45	60					
		Maximum voltage - V		400	500	400	500	750	400	500	750					
POCKET (Option)		Material		Stainless steel												
		Ø Thermostat temperature sensor		Ø6 or Ø8 central position - Ø6 peripheral position												
		T Maxi (Thermostat or temperature sensor)		A - 30												
		T Mini (Thermostat)		NH + 10 + Bulb length												
		T Mini (Temperature sensor)		NH + 30												
		Temperature measurement device (Fluid)		Thermostat or sensor PT100												
		Safety sensor on heating element		Thermocouple TC J or TC K												

Connections

- M4 - Threaded terminal M4
- M5 - Threaded terminal M5
- M6 - Threaded terminal M6
- FIL - Threaded terminal

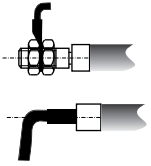

See range of junction boxes pages 42-43

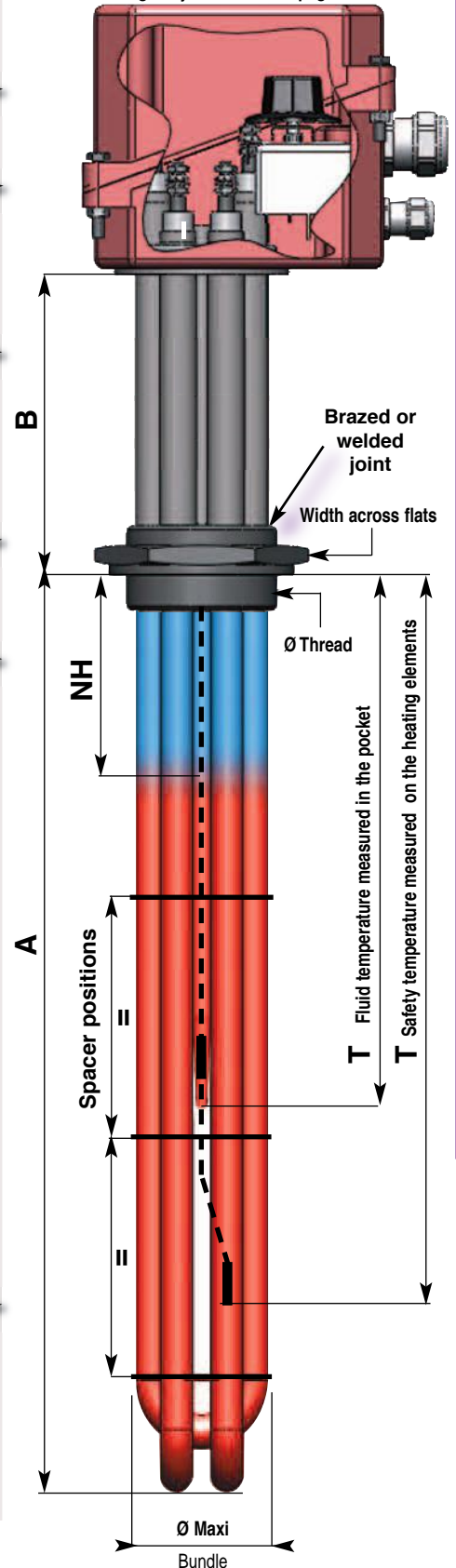

ISO M77x200 SCREW PLUG TO HEAT OIL UP TO 110°C

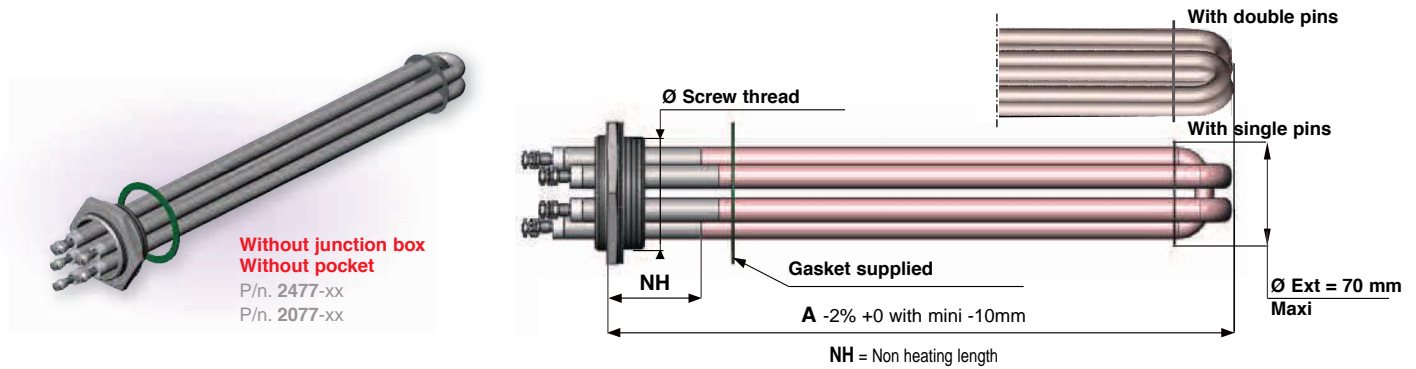

3 Heating elements						Ø10,2 - Coated Carbon steel	
Screw plug						Coated carbon steel - Brazed	
Ø Screw thread	Power (kW) +5/-10%	Voltage (V)	Load (W/cm ²)	A (mm)	NH (mm)	P/N.	
With single heating pins	M77 x 200	0,33	400-1P	0,7	315	30	2477-51
		0,5	400-1P	0,7	445	30	2477-52
		0,66	400-1P	0,7	580	30	2477-53
		1	400-1P	0,7	860	30	2477-54
With single heating pins	M77 x 200	1	230/400	2	180	50	2077-00
		2	230/400	2	305	50	2077-01
		3	230/400	2	460	50	2077-02
		4,5	230/400	2	670	50	2077-03
		6	230/400	2	870	50	2077-04
		9	230/400	2	1250	50	2077-05
12	230/400	2	1650	50	2077-06		

• Junction box option, see on pages 42-43 • See optional accessories on page 56

ISO M77x200 SCREW PLUG TO HEAT OIL UP TO 200°C

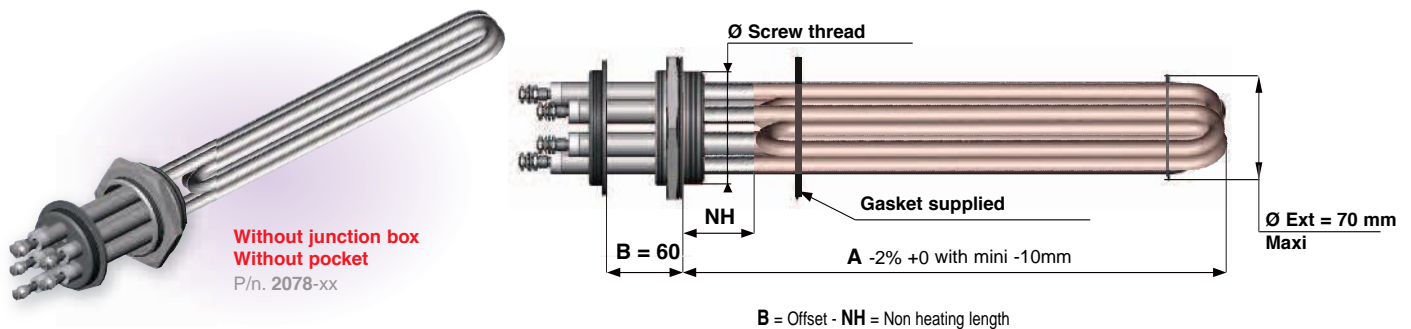

3 Heating elements in double pin						Ø10,2 - Coated Carbon steel
Screw plug						Coated carbon steel - Brazed
Ø Screw thread	Power (kW) +5/-10%	Voltage (V)	Load (W/cm ²)	A (mm)	NH (mm)	P/N.
M77 x 200	2	230/400	2	315	50	2078-01
	3	230/400	2	460	50	2078-02
	4,5	230/400	2	670	50	2078-03
	6	230/400	2	870	50	2078-04
	9	230/400	2	1250	50	2078-05
	12	230/400	2	1650	50	2078-06

• Junction box option, see on pages 42-43 • See optional accessories on page 56

ISO M77x200 AND 2 1/2 BSPP SCREW PLUG TO HEAT WATER OR AQUEOUS LIQUIDS UP TO 110°C

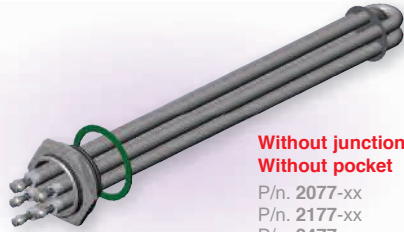

Without junction box
Without pocket
P/n. 2077-xx
P/n. 2177-xx
P/n. 2477-xx

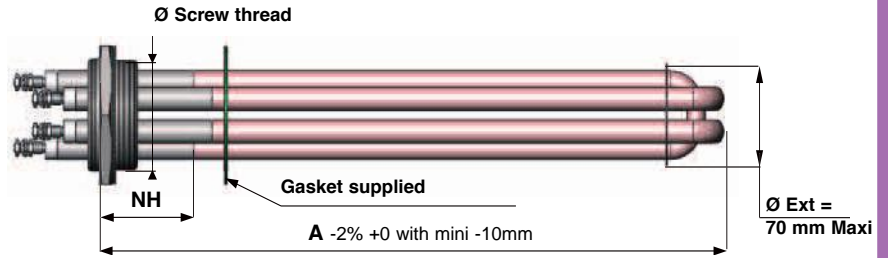

4 W/cm²

3 Heating elements			Ø16 - Stainless steel 316L Scoured passivated		
Screw plug			Copper brass - Without treatment - Brazed		
Ø Screw thread			M77 x 200		
Power (kW) +5/-10%	Voltage (V)	Load (W/cm ²)	A (mm)	NH (mm)	P.N.
3	230/400	4	300	50	2177-71
4,5	230/400	4	430	50	2177-72
6	230/400	4	550	50	2177-73
9	230/400	4	800	50	2177-74
12	230/400	4	1050	50	2177-75

5 W/cm²

3 Heating elements			Ø16 - Stainless steel 316L - Scoured passivated				
Screw plug			Coated carbon steel - Brazed				
Ø Screw thread			M77 x 200		2 1/2 BSPP		
Power (kW) +5/-10%	Voltage (V)	Load (W/cm ²)	A (mm)	NH (mm)	P.N.	NH (mm)	P.N.
3	230/400	5	250	70	2077-11	50	2077-51
4,5	230/400	5	360	70	2077-12	50	2077-52
6	230/400	5	460	70	2077-13	50	2077-53
9	230/400	5	670	70	2077-14	50	2077-54
12	230/400	5	870	70	2077-15	50	2077-55

NH = Non heating length

8 W/cm²

3 Heating elements			Ø16 - Incoloy 825 - Without treatment			
Screw plug			Copper brass - Without treatment - Brazed			
Ø Screw thread			M77 x 200		2 1/2 BSPP	
Power (kW) +5/-10%	Voltage (V)	Load (W/cm ²)	A (mm)	NH (mm)	P.N.	P.N.
3	230/400	8	170	50	2077-77	-
4,5	230/400	8	225	50	2077-78	-
6	230/400	8	295	50	2077-79	2077-88
8	230/400	8	385	50	2077-80	-
9	230/400	8	420	50	2077-81	2077-89
12	230/400	8	545	50	2077-82	2077-90
15	230/400	8	670	50	2077-83	-
18	230/400	8	850	50	2077-84	2077-91
20	230/400	8	880	50	2077-85	-
24	230/400	8	1100	50	2077-86	2077-92
30	400-3P	8	1305	50	2077-87	-

10 W/cm²

3 Heating elements			Ø16 - Incoloy 825			
Screw plug			Copper brass - Without treatment - Brazed			
Ø Screw thread			M77 x 200			
Power (kW) +5/-10%	Voltage (V)	Load (W/cm ²)	A (mm)	NH (mm)	P.N.	
4	230/400	10	200	50	2477-60	
6	230/400	10	260	50	2477-61	
8	230/400	10	330	50	2477-62	
10	230/400	10	400	50	2477-63	
12	230/400	10	460	50	2477-64	
15	230/400	10	560	50	2477-65	
18	230/400	10	660	50	2477-66	
20	230/400	10	750	50	2477-67	
24	230/400	10	880	50	2477-68	
30	400-3P	10	1070	50	2477-69	
35	400-3P	10	1240	50	2477-70	

• Junction box option, see on pages 42-43 • See optional accessories on page 56

ISO M77x200 SCREW PLUG WITH OFFSET TO HEAT WATER OR AQUEOUS LIQUIDS UP TO 200°C



Without junction box
Without pocket
P/n. 2078-xx

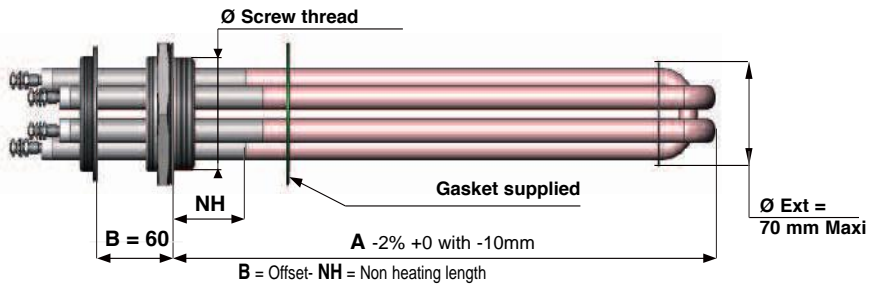

B = Offset- NH = Non heating length

3 Heating elements			Ø16 - Stainless steel 316L - Scoured passivated			
Screw plug			Coated carbon steel - Brazed			
Ø Screw Thread	Power (kW) +5/-10%	Voltage (V)	Load (W/cm ²)	A (mm)	NH (mm)	P.N.
M77 x 200	3	230/400	5	250	70	2078-11
	4,5	230/400	5	360	70	2078-12
	6	230/400	5	460	70	2078-13
	9	230/400	5	670	70	2078-14
	12	230/400	5	870	70	2078-15

• Junction box option, see on pages 42-43 • See optional accessories on page 56

ISO M77x200 SCREW PLUG WITH POCKET TO HEAT OIL OR AQUEOUS LIQUIDS UP TO 200°C

Screw plug heater without offset



Without junction box
With pocket
P/n. 2277-xx
P/n. 2477-xx

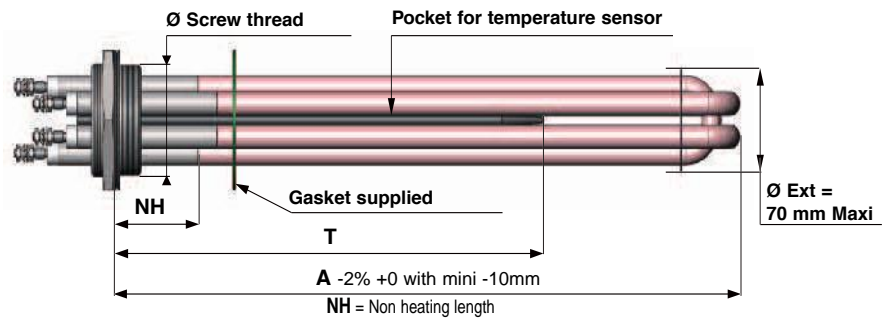

Screw plug heater with offset

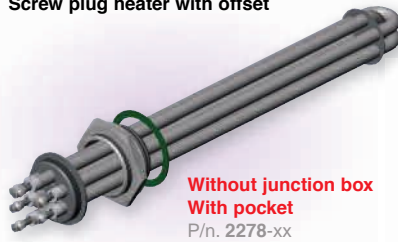

Without junction box
With pocket
P/n. 2278-xx

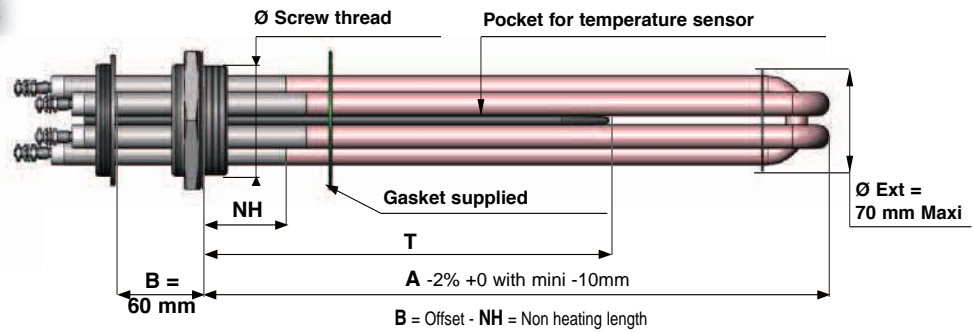

Liquid temperature							< 110°C			< 200°C		
Screw plug heater							Without offset			Offset B = 60		
3 Heating elements							Ø16 - Stainless steel 316L Scoured passivated		Ø16 - Incoloy 825 Without treatment		Ø16 - Stainless steel 316L Scoured passivated	
Screw plug							Stainless steel - Welded Without treatment	Copper brass - Brazed Without treatment	Stainless steel - Welded Without treatment		Stainless steel - Welded Without treatment	
Pocket (center of bundle)							Internal Ø = 8,5 mm					
Ø Screw Thread	Power (kW) +5/-10%	Voltage (V)	Load (W/cm ²)	A (mm)	NH (mm)	T (mm)	P/N.	P/N.	P/N.	T (mm)	P/N.	
OIL HEATING												
M77 x 200	1	230/400	2	220	50	145	2277-11			150	2278-11	
	2	230/400	2	400	50	145	2277-12			300	2278-12	
	3	230/400	2	570	50	355	2277-13			300	2278-13	
	4,5	230/400	2	820	50	355	2277-14			410	2278-14	
	6	230/400	2	1070	50	355	2277-15			530	2278-15	
	7,5	230/400	2	1320	50	505	2277-16			660	2278-16	
	9	230/400	2	1570	50	505	2277-17			780	2278-17	
AQUEOUS LIQUIDS HEATING												
M77 x 200	3	230/400	4	300	50	145	2277-31			230	2278-31	
	4,5	230/400	4	450	50	145	2277-32			300	2278-32	
	6	230/400	4	560	50	355	2277-33			300	2278-33	
	9	230/400	4	820	50	355	2277-34			410	2278-34	
	12	230/400	4	1200	50	505	2277-35			600	2278-35	
	15	230/400	4	1320	50	505	2277-36			660	2278-36	
	18	230/400	4	1520	50	505	2277-37			760	2278-37	
	6	230/400	8	295	50	145	2277-80	2278-85		145	2278-80	
	9	230/400	8	420	50	145	2277-81	2278-86		145	2278-81	
	12	230/400	8	545	50	355	2277-82	2278-87		355	2278-82	
	15	230/400	8	670	50	355	2277-83	2278-88		355	2278-83	
	18	230/400	8	850	50	355	2277-84	2278-89		355	2278-84	
	4	230/400	12	210	70	140			2477-11			
	6	230/400	12	260	70	190			2477-12			
	9	230/400	12	350	70	280			2477-13			
	12	230/400	12	440	70	300			2477-14			
	15	230/400	12	520	70	300			2477-15			
	20	230/400	12	670	70	335			2477-16			
	24	230/400	12	780	70	400			2477-17			
30	400 - 3P	12	960	70	480			2477-18				
35	400 - 3P	12	1100	70	550			2477-19				

•Junction box option, see on pages 42-43 • See optional accessories on page 56

ISO M77x200 AND 2"1/2 BSPP SCREW PLUG WITH REMOVABLE MONOTUBES AND CONTROL TO HEAT OIL OR AQUEOUS LIQUIDS UP TO 200°C

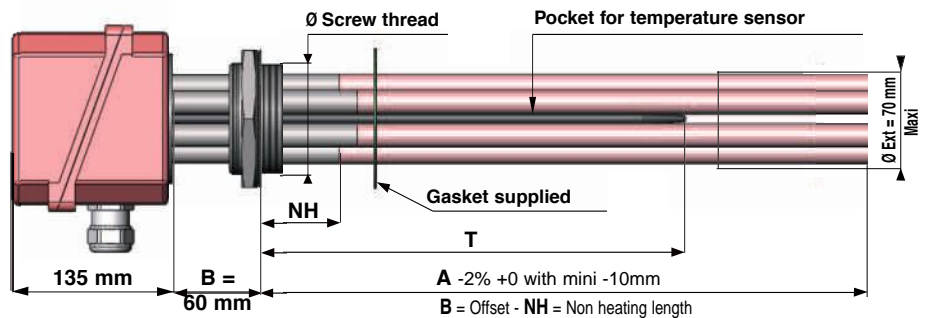
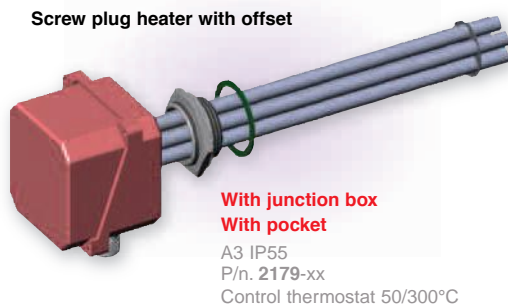
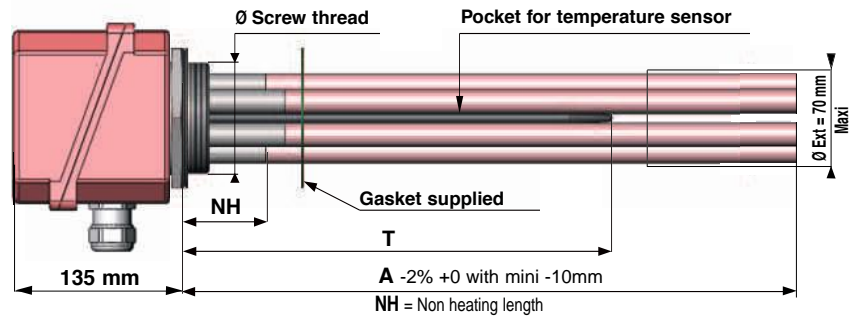
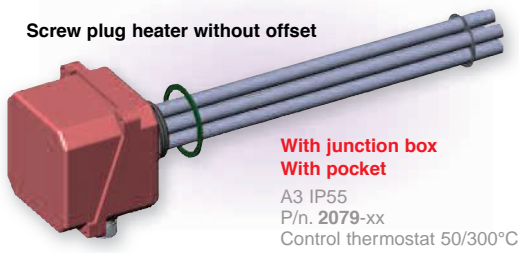

The junction boxes of screw plug heaters with heating power > 3kW, are equipped with 2 cables glands and one additional relay.

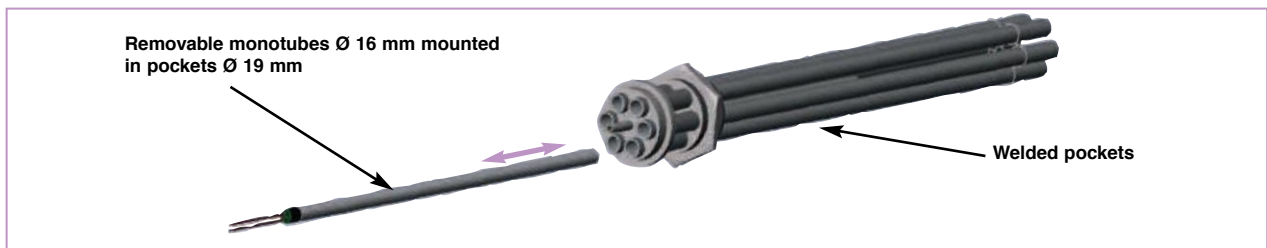

AQUEOUS LIQUIDS OR OIL HEATING

Junction box (see on pages 42-43)		Type	A3							
		IP	55							
		Material	Aluminium							
Cable gland		P ≤ 3kW 1 CG ISO20		P > 3kW 1 CG ISO20 + 1 CG ISO25						
Control thermostat		50/300°C - 1 Change over contact - 16A / 230V								
Ø Screw Thread		M77x200		2"1/2 BSPP						
Liquid temperature		<110°C	<200°C	<110°C	<200°C					
Screw plug heaters		Without offset	Offset B = 60	Without offset	Offset B = 60					
Screw plug material		Stainless steel - Without treatment - Welded		Stainless steel - Without treatment - Welded						
Removable monotubes mounted in pockets		Ø19 - Stainless steel 316L - Scoured passivated		Ø19 - Stainless steel 316L - Scoured passivated						
Power (kW) +5/-10%	Voltage (V)	Load (W/cm ²)	A (mm)	NH (mm)	T (mm)	P/N.	P/N.	P/N.	P/N.	
3 Monotubes	1	230-1P	2	345	50	100	2079-31	2179-31	2079-51	2179-51
	2	230-1P	2	640	50	350	2079-32	2179-32	2079-52	2179-52
	3	230-1P	2	950	50	500	2079-33	2179-33	2079-53	2179-53
6 Monotubes	3	230-1P	2	490	50	270	2079-34	2179-34	2079-63	2179-63
	6	400-3P	2	950	50	500	2079-35	2179-35	2079-64	2179-64
	9	400-3P	2	1370	50	710	2079-36	2179-36	2079-65	2179-65
	12	400-3P	2	1870	50	960	2079-37	2179-37	2079-66	2179-66
	15	400-3P	2	2250	50	1150	2079-38	2179-38	2079-67	2179-67

• See optional accessories on page 56

ISO M77x200 SCREW PLUG WITH CONTROL THERMOSTAT TO HEAT OIL OR AQUEOUS LIQUIDS UP TO 200°C

Screw plug heater without offset

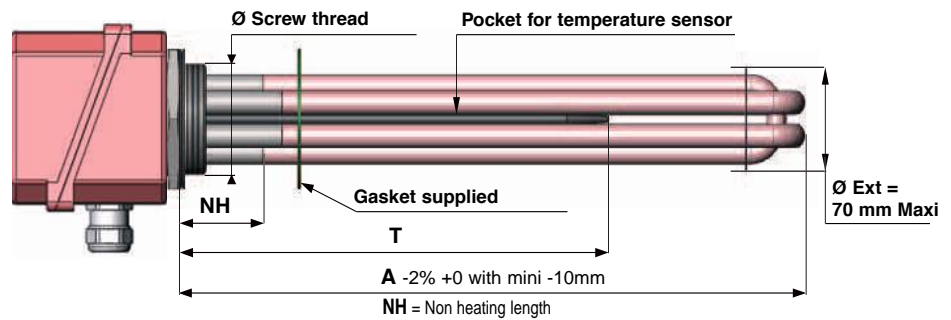
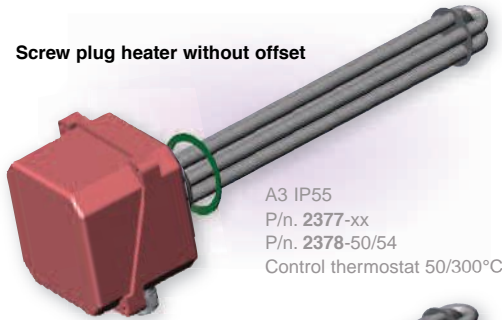

Screw plug heater with offset

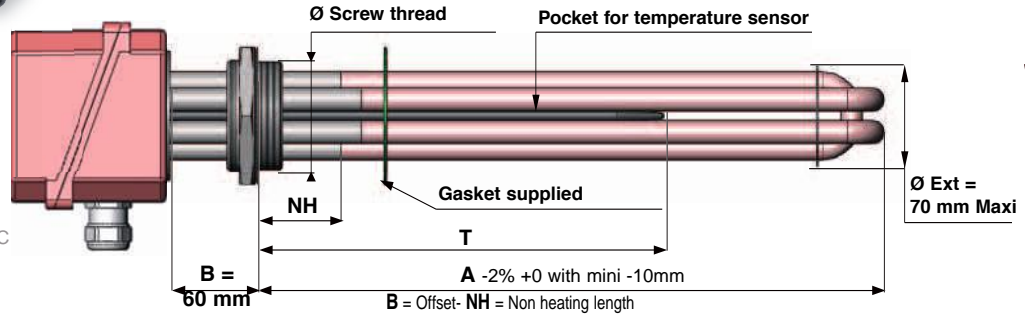
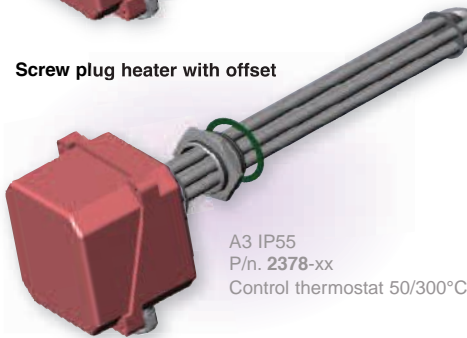

Junction box	Type A3 - IP55 - Aluminium			
Control thermostat	50/300°C - 1 Change over contact - 20A / 230V			
Liquid temperature	< 110°C		< 200°C	
Screw plug heater	Without offset		Offset B = 60	
3 Heating elements	Ø16 - Stainless steel 316L Scoured passivated	Ø16 - Incoloy 825 Without treatment	Ø16 - Stainless steel 316L Scoured passivated	
Screw plug	Stainless steel - Welded Without treatment	Copper brass - Brazed Without treatment	Stainless steel - Welded Without treatment	Stainless steel - Welded Without treatment

Ø Screw Thread	Power (kW) +5/-10%	Voltage (V)	Load (W/cm²)	A (mm)	NH (mm)	T (mm)	P.N.	P.N.	P.N.	T (mm)	P.N.
OIL HEATING											
M77 x 200	1	230-1P	2	220	50	145	2377-31			150	2378-11
	2	230-1P	2	400	50	145	2377-32			300	2378-12
	3	230-1P	2	570	50	355	2377-33			300	2378-13
	4,5	400-3P	2	820	50	355	2377-34			410	2378-14
	6	400-3P	2	1070	50	355	2377-35			530	2378-15
	7,5	400-3P	2	1320	50	505	2377-36			660	2378-16
	9	400-3P	2	1570	50	505	2377-37			780	2378-17
AQUEOUS LIQUIDS HEATING											
M77 x 200	3	230-1P	4	300	50	145	2377-41			230	2378-31
	4,5	400-3P	4	450	50	145	2377-42			300	2378-32
	6	400-3P	4	560	50	355	2377-43			300	2378-33
	9	400-3P	4	820	50	355	2377-44			410	2378-34
	12	400-3P	4	1200	50	505	2377-45			600	2378-35
	15	400-3P	4	1320	50	505	2377-46			660	2378-36
	18	400-3P	4	1520	50	505	2377-47			760	2378-37
	6	400-3P	8	295	50	145	2377-80	2378-50		145	2378-40
	9	400-3P	8	420	50	145	2377-81	2378-51		145	2378-41
	12	400-3P	8	545	50	355	2377-82	2378-52		355	2378-42
	15	400-3P	8	670	50	355	2377-83	2378-53		355	2378-43
	18	400-3P	8	850	50	355	2377-84	2378-54		355	2378-44
	4	400-3P	12	210	70	140			2377-91		
	6	400-3P	12	260	70	190			2377-92		
	9	400-3P	12	350	70	280			2377-93		
	12	400-3P	12	440	70	300			2377-94		
	15	400-3P	12	520	70	300			2377-95		
	20	400-3P	12	670	70	335			2377-96		
	24	400-3P	12	780	70	400			2377-97		
30	400-3P	12	960	70	480			2377-98			
35	400-3P	12	1100	70	550			2377-99			

• See optional accessories on page 56

2" 1/2 SCREW PLUG WITH CONTROL THERMOSTAT TO HEAT OIL OR AQUEOUS LIQUIDS UP TO 200°C

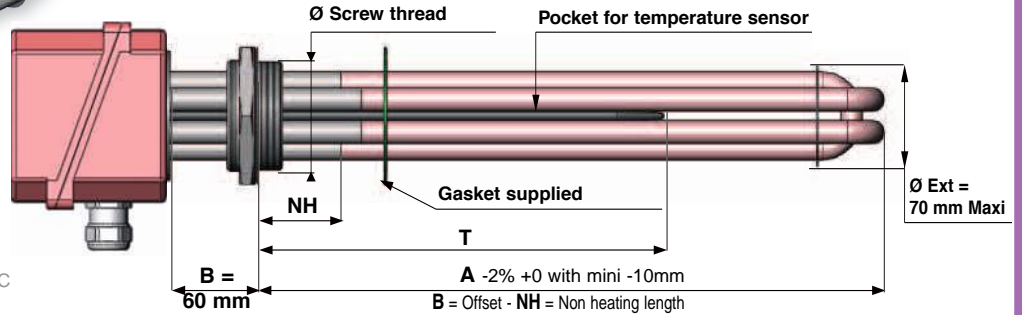
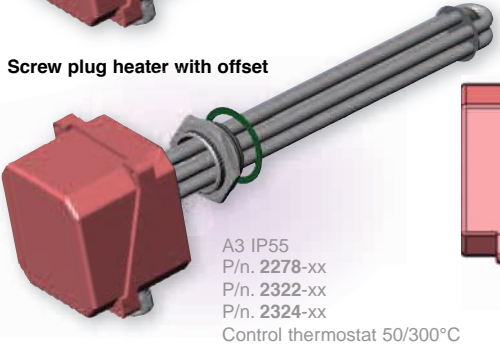
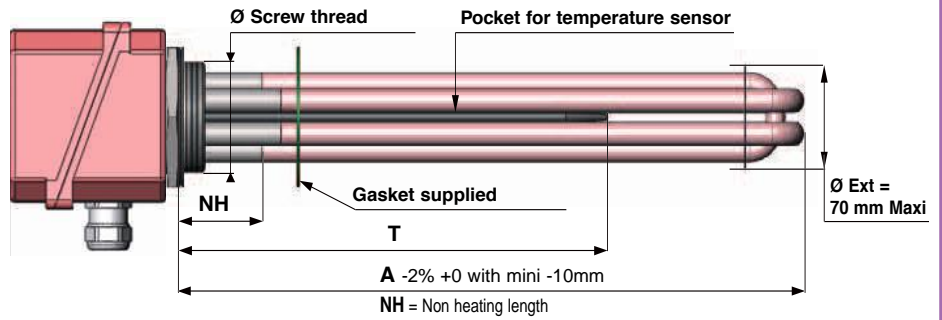
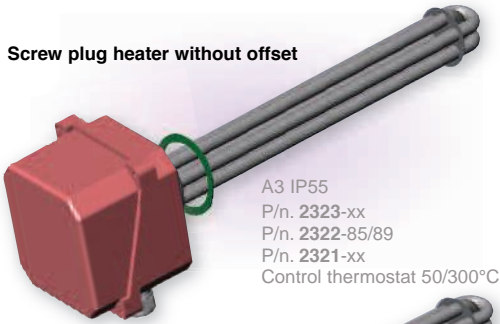

Junction box		Type A3 - IP55 - Aluminium				Without							
Control thermostat		50/300°C - 1 Change over contact - 16A / 230V				Without							
Liquid temperature		< 110°C				< 200°C							
Screw plug heater		Without offset				Offset B = 60							
3 Heating elements		Ø16 - Stainless steel 316L Scoured passivated		Ø16 - Incoloy 825 Without treatment		Ø16 - Stainless steel 316L Scoured passivated							
Screw plug		Stainless steel - Welded Without treatment		Copper brass - Brazed Without treatment		Stainless steel - Welded Without treatment							
Ø Screw thread	Power (kW) +5/-10%	Voltage (V)	Load (W/cm ²)	A (mm)	NH (mm)	T (mm)	P/N.	P/N.	P/N.	P/N.	T (mm)	P/N.	P/N.

OIL HEATING													
2" 1/2	1	230-1P	2	220	50	145	2323-01	2321-01			150	2322-11	2324-11
	2	230-1P	2	400	50	145	2323-02	2321-02			300	2322-12	2324-12
	3	230-1P	2	570	50	355	2323-03	2321-03			300	2322-13	2324-13
	4,5	400-3P	2	820	50	355	2323-04	2321-04			410	2322-14	2324-14
	6	400-3P	2	1070	50	355	2323-05	2321-05			530	2322-15	2324-15
	7,5	400-3P	2	1320	50	505	2323-06	2321-06			660	2322-16	2324-16
	9	400-3P	2	1570	50	505	2323-07	2321-07			780	2322-17	2324-17

AQUEOUS LIQUIDS HEATING													
2" 1/2	3	230-1P	4	300	50	145	2323-31	2321-31			230	2322-31	2324-31
	4,5	400-3P	4	450	50	145	2323-32	2321-32			300	2322-32	2324-32
	6	400-3P	4	560	50	355	2323-33	2321-33			300	2322-33	2324-33
	9	400-3P	4	820	50	355	2323-34	2321-34			410	2322-34	2324-34
	12	400-3P	4	1200	50	505	2323-35	2321-35			600	2322-35	2324-35
	15	400-3P	4	1320	50	505	2323-36	2321-36			660	2322-36	2324-36
	18	400-3P	4	1520	50	505	2323-37	2321-37			760	2322-37	2324-37
2" 1/2	6	400-3P	8	295	50	145	2323-80	2321-80	2322-85		145	2322-80	2324-80
	9	400-3P	8	420	50	145	2323-81	2321-81	2322-86		145	2322-81	2324-81
	12	400-3P	8	545	50	355	2323-82	2321-82	2322-87		355	2322-82	2324-82
	15	400-3P	8	670	50	355	2323-83	2321-83	2322-88		355	2322-83	2324-83
	18	400-3P	8	850	50	355	2323-84	2321-84	2322-89		355	2322-84	2324-84
	4	400-3P	12	210	70	140				2321-11			
	6	400-3P	12	260	70	190				2321-12			
9	400-3P	12	350	70	280				2321-13				
12	400-3P	12	440	70	300				2321-14				
15	400-3P	12	520	70	300				2321-15				
20	400-3P	12	670	70	335				2321-16				
24	400-3P	12	780	70	400				2321-17				
30	400-3P	12	960	70	480				2321-18				
35	400-3P	12	1100	70	550				2321-19				

• See optional accessories on page 56

DN 32 TO DN 65 FLANGE IMMERSION HEATERS SPECIFICATIONS

TYPE		2400							
FLANGE	Norms 1092-1 DN Standard B16.5 NPS	32 1"1/4	40 1"1/2	50 2"	65 2"1/2				
MAXIMUM PRESSURE		Depending on operating temperature and pressure							
JUNCTION BOX		Without control thermostat: H1-A1, Q1-H1-A1, H1-A2, H1 - A2 - A3 With control thermostat: -, Q2-G2-K2, G2-K2, G2 - K2 - A3							
CONNECTION COUPLING		Ø Heating elements: 8, 8, 10,2, 8, 10,2, 8, 10,2, 16 Connections: M4, M4, M5, M4, M5, M4, M5, M6 Sealing Coupling: Resin WP+160 Single phase (Parallel, Series), 3 phases (Star, Delta)							
OFFSET - MAXI TEMPERATURE		Ø Heating elements: 8, 8, 10,2, 8, 10,2, 8, 10,2, 16 Without offset B = 0mm: 110°C, 110°C, 110°C, 110°C With offset B = 60mm: 200°C, 200°C, 200°C, 200°C Offset B = 120mm: 250°C, 300°C, 300°C, 300°C Offset B = 245mm: -, 400°C, 400°C, 400°C							
FLANGE		According norms 1092-1 DN NP (Nominal pressure) Bar: 32, 40, 50, 65 According standard B16.5 NPS Class lbs: 1"1/4, 1"1/2, 2", 2"1/2 Form facing Material: FF (Flat face) - RF (raised face) SIJ - DIJ Carbon steel - Stainless steel 304L - 316L							
HEATING ELEMENTS		Ø: 8, 8, 10,2, 8, 10,2, 8, 10,2, 16 Joint: Brazed, Brazed - Welded, Welded, Welded Qty Maxi: 1, 2, 3, 1, 2, 3, 1, 2, 3, 3, 6, 3, 3, 6, 3, 3 Material: Z2 316L/DIN 1.4404, Z6 321/DIN 1.4541, Incoloy 825/DIN 2.4858, Incoloy 800/DIN 1.4876, Carbon steel, Vulcaloy 904L/DIN 1.4539 Sheath treatment: Without - Scoured - Scoured passivated - Electropolished Dimensions (mm): A Maxi (1900, 1900, 3000, 1900, 3000, 1900, 3000, 3000, 3000), A Mini without pocket (80, 80, 100, 80, 100, 80, 100, 150), A Mini with pocket (150, 150, 200, 150, 200, 150, 200, 200), Tolerance on length A (-2% +0 with mini -10mm), Ø Maxi bundle (37, 37, 42, 52, 52, 67, 67, 67) Electrical parameters: Specific load - W/cm ² (16, 16, 26 / 45, 16, 26 / 45, 16, 26 / 45, 60), Maximum current - A (400, 400, 500, 400, 500, 400, 500, 750), Maximum voltage - V (400, 400, 500, 400, 500, 400, 500, 750) POCKET (Option): Dimensions (mm) Material (Stainless steel), Ø Thermostat temperature sensor (Ø6 or Ø8 central position - Ø6 peripheral position), T Maxi (Thermostat or temperature sensor) (A - 30), T Mini (Thermostat) (NH + 10 + Bulb length), T Mini (Temperature sensor) (NH + 30), Temperature measurement device (Thermostat or sensor PT100), Temperature measurement on heating element (Thermocouple TC J or TC K)							

Connections

- M4 - Threaded terminal M4
- M5 - Threaded terminal M5
- M6 - Threaded terminal M6

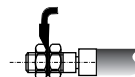

See range of junction boxes on pages 42-43

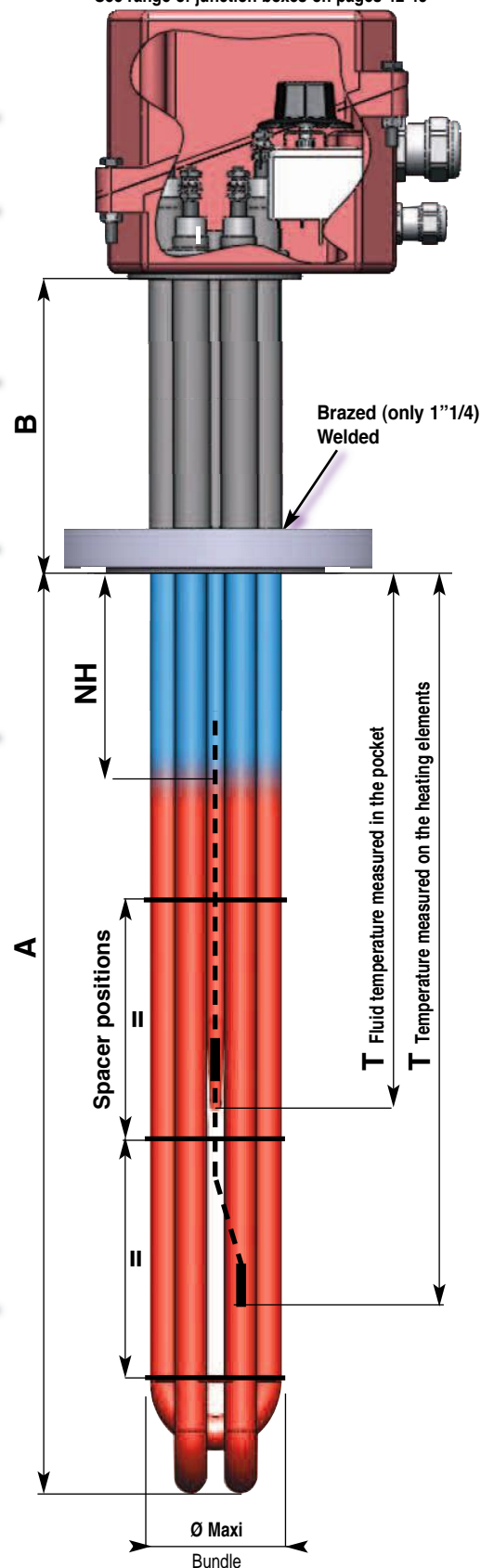

DIJ: Double interlocking joint - SIJ: Simple interlocking joint

DN 80 AND DN 100 FLANGE IMMERSION HEATERS SPECIFICATIONS

TYPE		2400					
FLANGE	Norms 1092-1 DN	80			100		
	Standard B16.5 NPS	3"			4"		
MAXIMUM PRESSURE		Depending on operating temperature and pressure					
JUNCTION BOX		<div style="display: flex; justify-content: space-between;"> Without control thermostat H1 - A2 - A3 H1 - A2 - A3 </div> <div style="display: flex; justify-content: space-between;"> With control thermostat G2 - K2 - A3 C2 </div>					
CONNECTION COUPLING	Ø Heating elements	8	10,2	16	8	10,2	16
	Connections	M4	M5	M6	M4	M5	M6
Sealing Coupling		Resin WP+160 Single phase (Parallel, Series), 3 phases (Star, Delta)					
OFFSET - MAXI TEMPERATURE		<div style="display: flex; justify-content: space-between;"> Ø Heating elements 8 10,2 16 8 10,2 16 </div> <div style="display: flex; justify-content: space-between;"> Without offset B = 0mm 110°C 110°C </div> <div style="display: flex; justify-content: space-between;"> With offset B = 60mm 200°C 200°C </div> <div style="display: flex; justify-content: space-between;"> Offset B = 120mm 300°C 300°C </div> <div style="display: flex; justify-content: space-between;"> Offset B = 245mm 400°C 400°C </div>					
FLANGE	According norms 1092-1 DN	80			100		
	NP (Nominal pressure) Bar	16 - 20 - 25 - 40 - 50 - 63			16 - 20 - 25 - 40 - 50 - 63		
	According standard B16.5 NPS	3"			4"		
	Class lbs	150 - 300			150 - 300		
Form facing Material		FF (Flat face) - RF (raised face) SIJ - DIJ Carbon steel - Stainless steel 304L - 316L					
HEATING ELEMENTS		<div style="display: flex; justify-content: space-between;"> Ø 8 10,2 16 8 10,2 16 </div> <div style="display: flex; justify-content: space-between;"> Joint Welded Welded </div> <div style="display: flex; justify-content: space-between;"> Qty maxi 3, 6, 9 3, 6 3 3, 6, 9 3, 6, 9 3, 6 </div>					
Material	Z2 316L/DIN 1.4404	X	X	X	X	X	X
	Z6 321/DIN 1.4541	X	X	X	X	X	X
	Incoloy 825/DIN 2.4858	X			X	X	X
	Incoloy 800/DIN 1.4876	X			X	X	X
	Stainless steel		X	X			X
	Vulcaloy 904L/DIN 1.4539		X			X	
Sheath Treatment		Without - Scoured - Scoured passivated - Electropolished					
Dimensions (mm)	A Maxi	1900	3000	3000	1900	3000	3000
	A Mini without pocket	80	100	150	80	100	150
	A Mini with pocket	150	200	200	150	200	200
	Tolerance on length A	-2% +0 with mini -10mm					
	Ø Maxi bundle	78	78	78	102	102	102
Electrical parameters	Specific load - W/cm ²	Depending on customer application					
	Maximum current - A	16	45	60	16	45	60
	Maximum voltage - V	400	500	750	400	500	750
POCKET (Option)		<div style="display: flex; justify-content: space-between;"> Material Stainless steel </div> <div style="display: flex; justify-content: space-between;"> Ø Thermostat temperature sensor Ø6 or Ø8 central position - Ø6 peripheral position </div> <div style="display: flex; justify-content: space-between;"> T Maxi (Thermostat or temperature sensor) A - 30 </div> <div style="display: flex; justify-content: space-between;"> T Mini (Thermostat) NH + 10 + Bulb length </div> <div style="display: flex; justify-content: space-between;"> T Mini (Temperature sensor) NH + 150 </div> <div style="display: flex; justify-content: space-between;"> Temperature measurement device Thermostat or sensor PT100 </div> <div style="display: flex; justify-content: space-between;"> Temperature measurement on heating element Thermocouple TC J or TC K </div>					

Connections

M4 - Threaded terminal M4

M5 - Threaded terminal M5

M6 - Threaded terminal M6

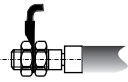

See range of junction boxes on pages 42-43

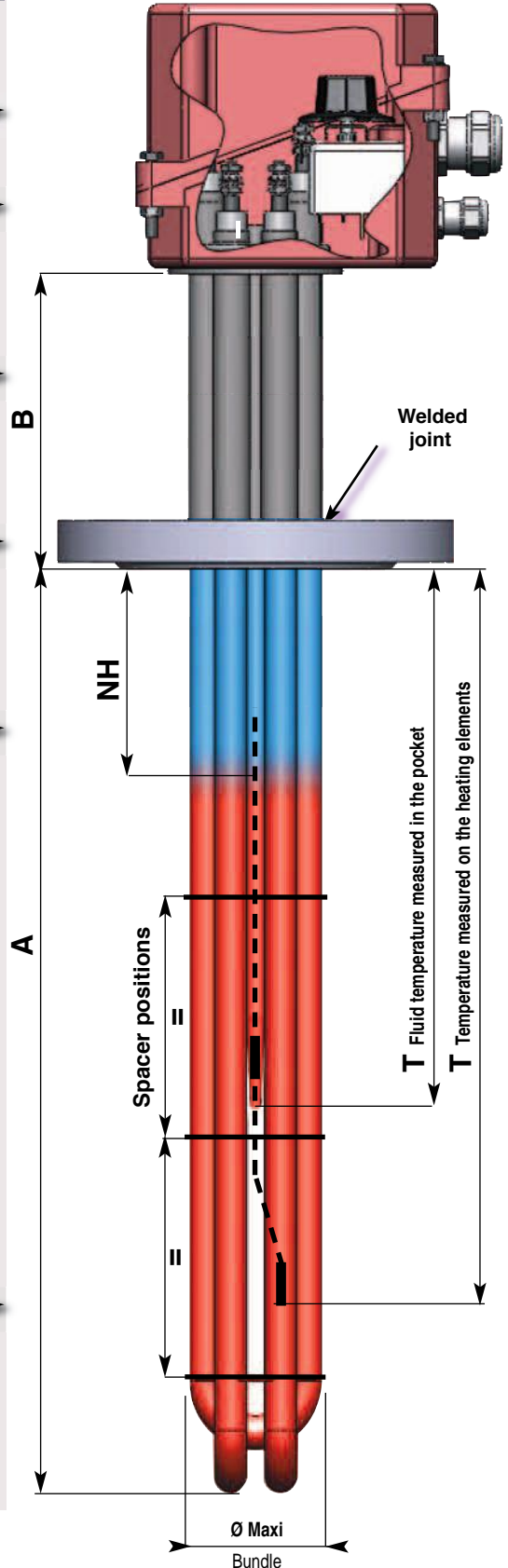

DIJ: Double interlocking joint - SIJ: Simple interlocking joint

DN 80 - 3"- FLANGE WITH CONTROL THERMOSTAT TO HEAT OIL OR AQUEOUS LIQUIDS UP TO 200°C

Flange immersion heater without offset

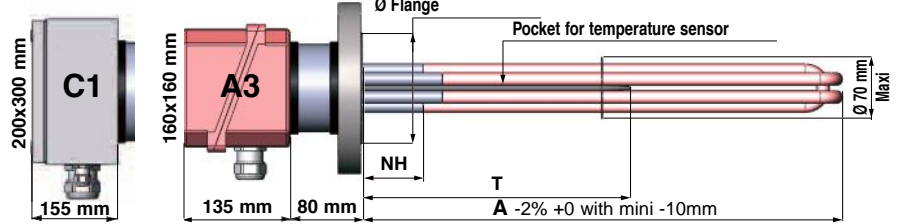
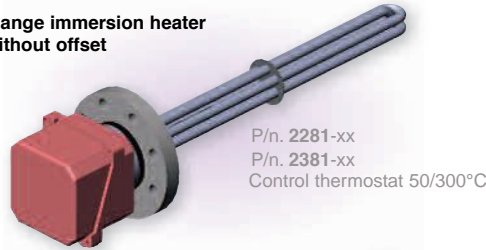

Flange immersion heater with offset

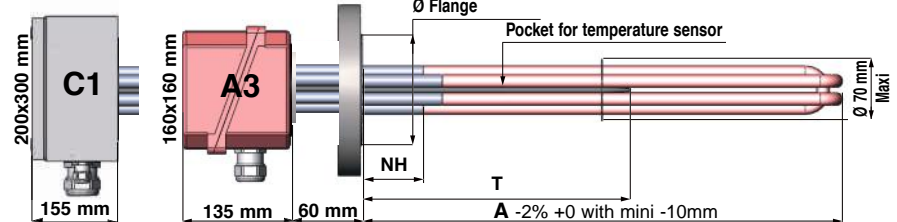
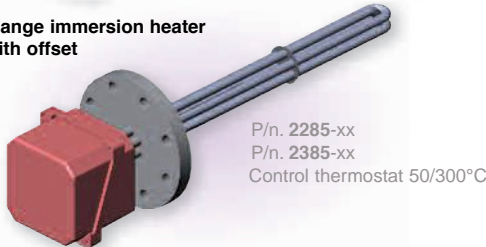

B = Offset - NH = Non heating length

Junction box (see on pages 42-43)	Type	A3 or C1 according to the power
	IP	without offset A3 / C1 IP44 - with offset A3 IP55 / C1 IP66
	Material	A3 Aluminium or C1 Coated carbon steel
Cable glands (CG)	P ≤ 3kW 1 CG ISO20 - P > 3kW 1 CG ISO20 + 1 CG according to the heating power	
Control thermostat	50/300°C - 1 Change over contact - 16A / 230V	

OIL HEATING

3 heating elements						Ø16 - Coated Carbon steel			
Flange						Coated carbon steel - Welded			
Liquid temperature						DN80 NP16 FS (EN 1092-1)		3" 150 lbs RF (Standard B16.5)	
Offset B						<110°C	<200°C	<110°C	<110°C
Power (kW)						Without	B = 60	Without	B = 60
Voltage (V)						P/N.	P/N.	P/N.	P/N.
Load (W/cm²)						2281-11	2285-11	2381-11	2385-11
A (mm)						2281-12	2285-12	2381-12	2385-12
NH (mm)						2281-03	2285-03	2381-03	2385-03
T (mm)						2281-04	2285-04	2381-04	2385-04
						2281-14	2285-14	2381-14	2385-14
						2281-05	2285-05	2381-05	2385-05
						2281-15	2285-15	2381-15	2385-15

AQUEOUS LIQUIDS HEATING

3 Heating elements						Ø16 - Stainless steel 316L - Scoured passivated			
Flange						Stainless steel 304L - Without treatment - Welded			
Liquid temperature						DN80 NP16 FS (EN 1092-1)		3" 150 lbs RF (Standard B16.5)	
Offset B						<110°C	<200°C	<110°C	<200°C
Power (kW)						Without	B = 60	Without	B = 60
Voltage (V)						P/N.	P/N.	P/N.	P/N.
Load (W/cm²)						2281-51	2285-51	2381-51	2385-51
A (mm)						2281-52	2285-52	2381-52	2385-52
NH (mm)						2281-53	2285-53	2381-53	2385-53
T (mm)						2281-54	2285-54	2381-54	2385-54
						2281-55	2285-55	2381-55	2385-55
						2281-56	2285-56	2381-56	2385-56
						2281-57	2285-57	2381-57	2385-57
Junction box C1						2281-58	2285-58	2381-58	2385-58
						2281-59	2285-59	2381-59	2385-59

						2281-76	2285-76	2381-76	2385-76
						2281-77	2285-77	2381-77	2385-77
						2281-78	2285-78	2381-78	2385-78
						2281-79	2285-79	2381-79	2385-79
						2281-80	2285-80	2381-80	2385-80
						2281-81	2285-81	2381-81	2385-81
						2281-82	2285-82	2381-82	2385-82
Junction box C1						2281-83	2285-83	2381-83	2385-83
						2281-84	2285-84	2381-84	2385-84
						2281-85	2285-85	2381-85	2385-85
						2281-86	2285-86	2381-86	2385-86
						2281-87	2285-87	2381-87	2385-87

DN 100 - 4" AND DN 125 - 5" FLANGE WITH CONTROL THERMOSTAT TO HEAT OIL OR AQUEOUS LIQUIDS UP TO 200°C

Flange immersion heater without offset

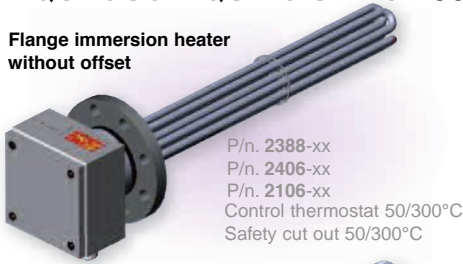

P/n. 2388-xx
P/n. 2406-xx
P/n. 2106-xx
Control thermostat 50/300°C
Safety cut out 50/300°C

Flange immersion heater with offset

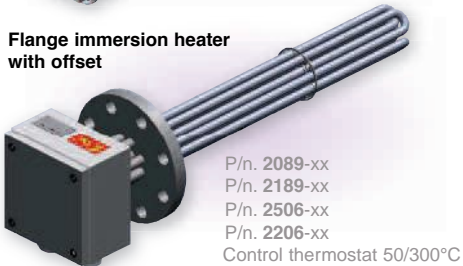

P/n. 2089-xx
P/n. 2189-xx
P/n. 2506-xx
P/n. 2206-xx
Control thermostat 50/300°C
Safety cut out 50/300°C

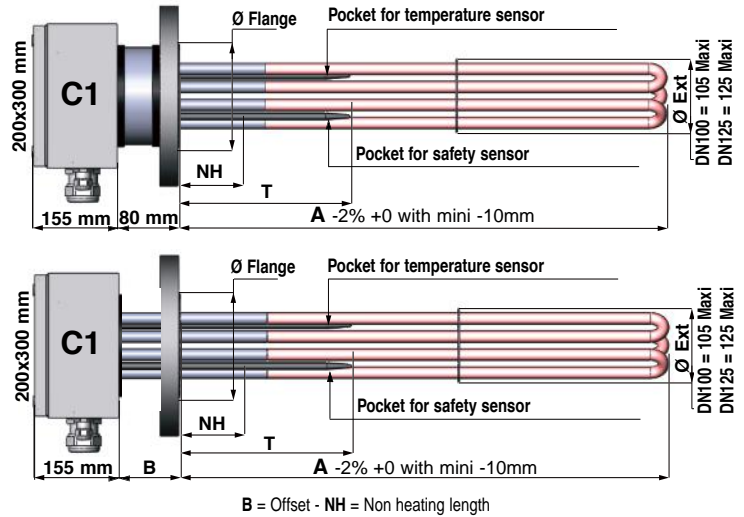

Junction box (See on pages 42-43)	Type	C1, C3 according to the power			
	IP	IP44 (without offset) IP66 (with offset)			
	Material	Coated carbon steel			
Cable glands (CG)	1 CG ISO20 t + 1 CG according selection on page 43				
2 Thermostats	Control : 50/300°C - 1 Change over contact - 16A / 230V + Safety cut out : 50/300°C - 16A / 230V manual reset				
Flange	DN100 NP16 FS (EN1092-1) or 4" 150lbs RF (standard B16.5)		Flange DN125 NP16 FS (EN1092-1) or 5" 150lbs RF (standard B16.5)		
Liquid temperature	<110°C	<200°C	Liquid temperature	<110°C <200°C	
Offset B	Without	B = 60	Offset B	Without B = 60	

OIL HEATING

Flange		Coated carbon steel - Welded								Flange		Coated carbon steel - Welded							
6 Heating elements		Ø16 - Coated carbon steel								6 Heating elements		Ø16 - Coated carbon steel							
Power (kW) +5/-10%	Voltage (V)	Load (W/cm ²)	A (mm)	NH (mm)	T (mm)	P/N. DN100	P/N. 4"	P/N. DN100	P/N. 4"	Power (kW) +5/-10%	Voltage (V)	Load (W/cm ²)	A (mm)	NH (mm)	T (mm)	P/N. DN125	P/N. 5"	P/N. DN125	P/N. 5"
6	400-3P	2	650	150	400	2088-11	2388-11	2089-11	2389-11	6	400-3P	2	650	150	400	2106-01	2406-01	2206-01	2506-01
10	400-3P	2	950	150	550	2088-12	2388-12	2089-12	2389-12	10	400-3P	2	950	150	550	2106-02	2406-02	2206-02	2506-02
12	400-3P	2	1150	150	650	2088-03	2388-03	2089-03	2389-03	12	400-3P	2	1150	150	650	2106-03	2406-03	2206-03	2506-03
16	400-3P	2	1500	150	825	2088-04	2388-04	2089-04	2389-04	16	400-3P	2	1500	150	825	2106-04	2406-04	2206-04	2506-04
18	400-3P	2	1650	150	900	2088-14	2388-14	2089-14	2389-14	18	400-3P	2	1650	150	900	2106-05	2406-05	2206-05	2506-05
21	400-3P	2	1900	150	1025	2088-05	2388-05	2089-05	2389-05	21	400-3P	2	1900	150	1025	2106-06	2406-06	2206-06	2506-06
24	400-3P	2	2150	150	1150	2088-15	2388-15	2089-15	2389-15	24	400-3P	2	2150	150	1150	2106-07	2406-07	2206-07	2506-07
27	400-3P	2	2400	150	1275	2088-06	2388-06	2089-06	2389-06	27	400-3P	2	2400	150	1275	2106-08	2406-08	2206-08	2506-08

AQUEOUS LIQUIDS HEATING

Flange		304L - Without treatment - Welded								Flange		304L - Without treatment - Welded							
6 Heating elements		Ø16 - Stainless steel 316L - Scoured passivated								6 Heating elements		Ø16 - Stainless steel 316L - Scoured passivated							
Power (kW) +5/-10%	Voltage (V)	Load (W/cm ²)	A (mm)	NH (mm)	T (mm)	P/N. DN100	P/N. 4"	P/N. DN100	P/N. 4"	Power (kW) +5/-10%	Voltage (V)	Load (W/cm ²)	A (mm)	NH (mm)	T (mm)	P/N. DN125	P/N. 5"	P/N. DN125	P/N. 5"
6	400-3P	4	460	150	275	2188-51	2388-51	2189-51	2389-51	6	400-3P	4	460	150	275	2106-51	2406-51	2206-51	2506-51
9	400-3P	4	550	150	335	2188-52	2388-52	2189-52	2389-52	9	400-3P	4	550	150	335	2106-52	2406-52	2206-52	2506-52
12	400-3P	4	650	150	400	2188-53	2388-53	2189-53	2389-53	12	400-3P	4	650	150	400	2106-53	2406-53	2206-53	2506-53
18	400-3P	4	950	150	525	2188-54	2388-54	2189-54	2389-54	18	400-3P	4	950	150	525	2106-54	2406-54	2206-54	2506-54
24	400-3P	4	1150	150	650	2188-55	2388-55	2189-55	2389-55	24	400-3P	4	1150	150	650	2106-55	2406-55	2206-55	2506-55
30	400-3P	4	1400	150	775	2188-56	2388-56	2189-56	2389-56	30	400-3P	4	1400	150	775	2106-56	2406-56	2206-56	2506-56
36	400-3P	4	1650	150	900	2188-57	2388-57	2189-57	2389-57	36	400-3P	4	1650	150	900	2106-57	2406-57	2206-57	2506-57
42	400-3P	4	1900	150	1010	2188-58	2388-58	2189-58	2389-58	42	400-3P	4	1900	150	1010	2106-58	2406-58	2206-58	2506-58
48	400-3P	4	2150	150	1150	2188-59	2388-59	2189-59	2389-59	48	400-3P	4	2150	150	1150	2106-59	2406-59	2206-59	2506-59
6	400-3P	8	275	150	215	2188-76	2388-76	2189-76	2389-76	6	400-3P	8	275	150	215	2106-76	2406-76	2206-76	2506-76
9	400-3P	8	335	150	245	2188-77	2388-77	2189-77	2389-77	9	400-3P	8	335	150	245	2106-77	2406-77	2206-77	2506-77
12	400-3P	8	400	150	275	2188-78	2388-78	2189-78	2389-78	12	400-3P	8	400	150	275	2106-78	2406-78	2206-78	2506-78
18	400-3P	8	525	150	335	2188-79	2388-79	2189-79	2389-79	18	400-3P	8	525	150	335	2106-79	2406-79	2206-79	2506-79
24	400-3P	8	650	150	400	2188-80	2388-80	2189-80	2389-80	24	400-3P	8	650	150	400	2106-80	2406-80	2206-80	2506-80
30	400-3P	8	775	150	465	2188-81	2388-81	2189-81	2389-81	30	400-3P	8	775	150	465	2106-81	2406-81	2206-81	2506-81
36	400-3P	8	900	150	525	2188-82	2388-82	2189-82	2389-82	36	400-3P	8	900	150	525	2106-82	2406-82	2206-82	2506-82
42	400-3P	8	1020	150	585	2188-83	2388-83	2189-83	2389-83	42	400-3P	8	1020	150	585	2106-83	2406-83	2206-83	2506-83
48	400-3P	8	1150	150	650	2188-84	2388-84	2189-84	2389-84	48	400-3P	8	1150	150	650	2106-84	2406-84	2206-84	2506-84
60	400-3P	8	1390	150	770	2188-85	2388-85	2189-85	2389-85	60	400-3P	8	1390	150	770	2106-85	2406-85	2206-85	2506-85

DN 80 - 3"- DN100 - 4"- DN 125 - 5"- FLANGE WITH OFFSET AND REMOVABLE MONOTUBES TO HEAT WATER OR OIL UP TO 200°C

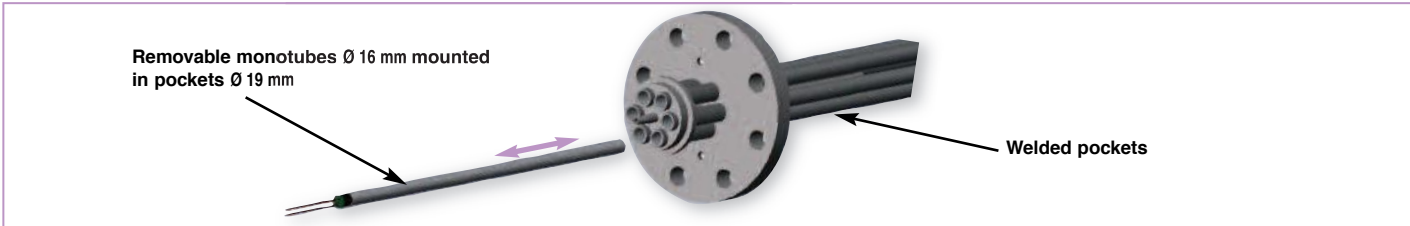
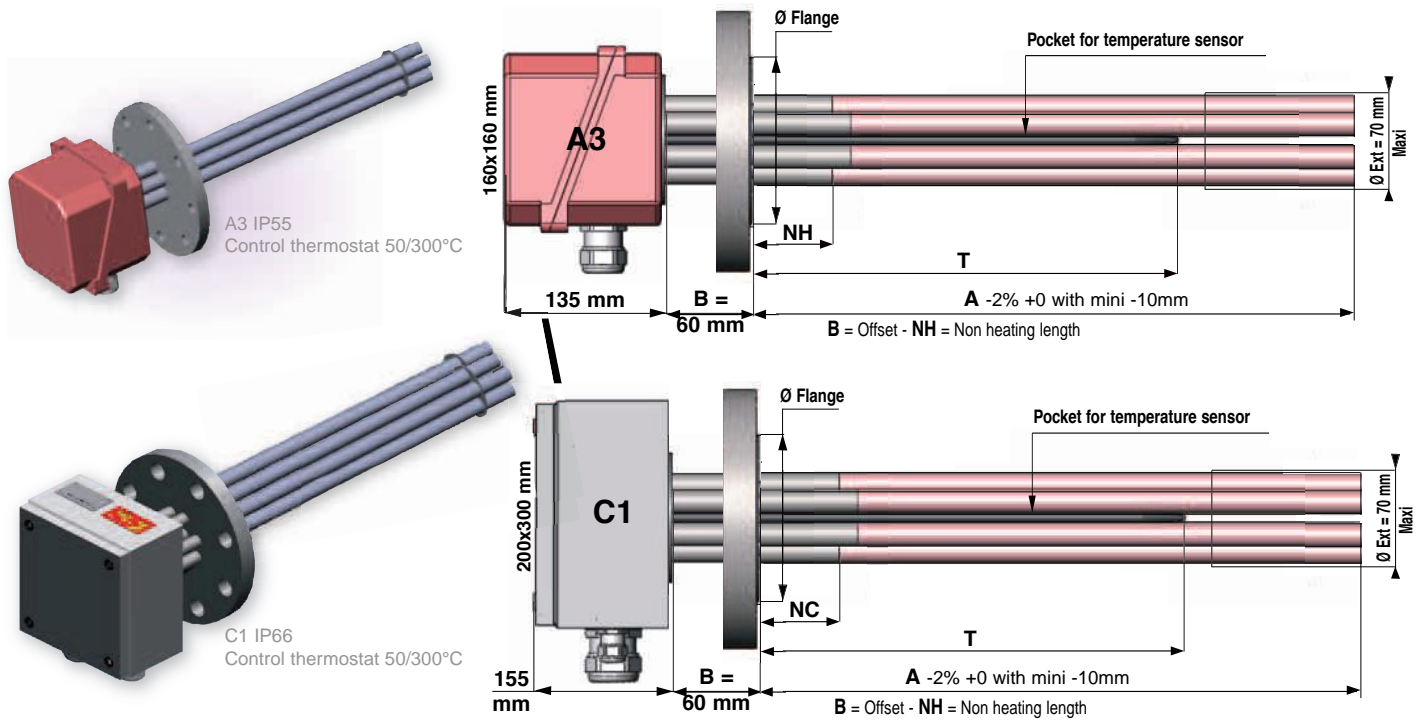

OIL OR AQUEOUS LIQUIDS HEATING UP TO 200°C

Junction box (See on pages 42-43)		Type	A3		C1										
		IP	55		66										
		Material	Aluminium		Coated carbon steel										
Cable gland		P ≤ 3kW 1 PE ISO20		P > 3kW 1PE ISO20 + 1 PE ISO25											
Control thermostat		50/300°C - 1 Change over contact - 16A / 230V (See optional safety cut out on page 44)													
Heating elements		Qty	6 Monotubes in pocket Ø19		9 Monotubes in pocket Ø19		12 Monotubes in pocket Ø19								
		Material	Sainless steel 316L		Sainless steel 316L		Sainless steel 316L								
Flange		Stainless steel - Without treatment - Welded		Stainless steel - Without treatment - Welded		Stainless steel - Without treatment - Welded									
		EN (1092-1) Standard B16.5		EN (1092-1) Standard B16.5		EN (1092-1) Standard B16.5									
		DN80 PN16 FS 3" 150lbs RF		DN100 PN16 FS 4" 150lbs RF		DN125 PN16 FS 5" 150lbs RF									
Power (kW) +5/-10%	Voltage (V)	Load (W/cm ²)	NH (mm)	A (mm)	T (mm)	P/N.	P/N.	A (mm)	T (mm)	P/N.	P/N.	A (mm)	T (mm)	P/N.	P/N.
3	400-3P	2	50	490	300	2279-01	2279-41								
6	400-3P	2	50	930	500	2279-02	2279-42								
9	400-3P	2	50	1370	800	2279-03	2279-43	1050	930	2279-10	2279-51				
12	400-3P	2	50	1870	1000	2279-04	2279-44	1400	1160	2279-12	2279-52	1050	930	2279-22	2279-61
15	400-3P	2	50					1750	1450	2279-13	2279-53	1300	1160	2279-23	2279-62
18	400-3P	2	50					2000	1870	2279-14	2279-54	1550	1370	2279-24	2279-63
20	400-3P	2	50					2300	1950	2279-15	2279-55	1700	1450	2279-25	2279-64
22	400-3P	2	50									1850	1640	2279-26	2279-65
25	400-3P	2	50									2100	1870	2279-27	2279-66

VULCALOY® : 3 POINT DELTA FLANGE TO HEAT SANITARY WATER UP TO 110°C

P/n. 1789-xx

Without control thermostat

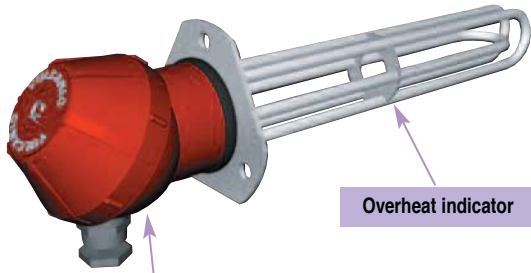

Overheat indicator

Quick electrical coupling :

- Star/Delta connector
- Easy connection
- Quick voltage adaptator for heating power up to 24 kW

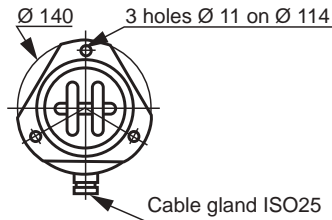
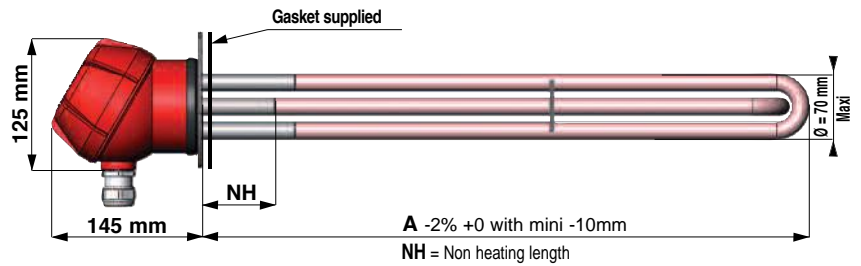

CIRCULATING OR STAGNANT WATER UP TO 110°C/10 bar

12 W/cm²

3 POINT DELTA FLANGE					Stainless steel 304L - without treatment
3 removable Heating elements					Ø10,2 - Stainless steel 904L Without treatment
Power (kW) +5/-10%	Voltage (V)	Load (W/cm ²)	A (mm)	NH (mm)	P/N.
3	230/400	12	240	95	1789-01
4,5	230/400	12	305	95	1789-02
6	230/400	12	370	95	1789-03
9	230/400	12	500	95	1789-05
12	230/400	12	630	95	1789-06
15	230/400	12	760	95	1789-07
18	230/400	12	900	95	1789-08
21	230/400	12	1000	95	1789-09
24	230/400	12	1150	95	1789-10
30	400 - 3P	12	1400	95	1789-12
36	400 - 3P	12	1650	95	1789-14
45	400 - 3P	12	2050	95	1789-17

8 W/cm²

3 POINT DELTA FLANGE					Stainless steel 304L - without treatment
3 welded Heating elements					Ø16 - Incoloy 825 Without treatment
Power (kW) +5/-10%	Voltage (V)	Load (W/cm ²)	A (mm)	NH (mm)	P/N.
3	230/400	8	240	120	1789-51
4,5	230/400	8	305	120	1789-52
6	230/400	8	370	120	1789-53
9	230/400	8	500	120	1789-55
12	230/400	8	630	120	1789-56
15	230/400	8	760	120	1789-57
18	230/400	8	900	120	1789-58
21	230/400	8	1000	120	1789-59
24	230/400	8	1150	120	1789-60
30	400 - 3P	8	1400	120	1789-62
36	400 - 3P	8	1650	120	1789-64
45	400 - 3P	8	2050	120	1789-67

ACCESSORIES :

• Welding type swivelling adaptor

Ø Screw thread (mm)	Material	P/N.
Ø78 mm	Stainless steel	1789-96
Ø78 mm	Coated Carbon steel	1789-97

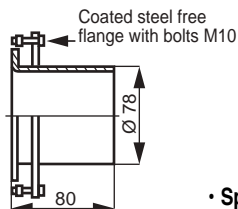

• Screw type swivelling adaptor

Ø Screw thread	Material	P/N.
M77x200	Coated Carbon steel	1789-98
2"1/2 BSPP	Coated Carbon steel	1789-99
M77x200	Stainless steel	1789-88
2"1/2 BSPP	Stainless steel	1789-89

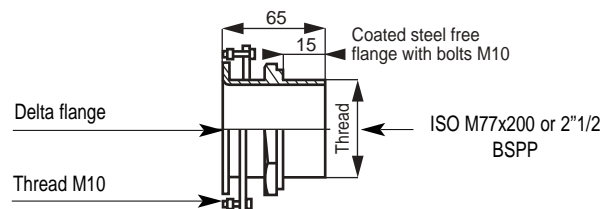

• Spare parts

Description	Material	P/N.
Reversible Star/delta connector	Pa6	1789-94
Set of 10 EPDM Gaskets	EPDM	1789-93
Spare Junction box with cable gland ISO 25	Polyamide	1789-90



DN 125 UP TO DN 500 FLANGE IMMERSION HEATERS SPECIFICATIONS

TYPE	2006									
FLANGE	DN125 5"	DN150 6"	DN200 8"	DN250 10"	DN300 12"	DN350 14"	DN400 16"	DN450 18"	DN500 20"	
MAXIMUM PRESSURE	Depending on operating temperature and pressure									
JUNCTION BOX	→									
Coated Carbon steel without offset B = 0	C2		C5			C6		C8		C9
Coated Carbon steel with Offset B > 0	C3		C6			C7		C8		C9
Stainless steel	C3		C7			C7		C8		C9
Protection	IP66									
CONNECTION COUPLING	→									
Heating elements										
Pins Ø10,2 mm	Threaded M5 M6									
Pins Ø16 mm	Threaded M6									
Monotubes Ø16 mm	Wire									
Sealing	Resin WP+160									
Connections	3 phases (Star, Delta)									
Wiring	Connection 4mm ² to 70mm ² - Copper bar 100mm ² to 250mm ²									
OFFSET B	→									
	100 mm < B < 450 mm									
	Depending on liquids, heating temperature, and operating conditions and whether the flange immersion heater is mounted horizontally or vertically,									
FLANGE	→									
Material	Carbon steel - Stainless steel 304L - 316L - 316Ti									
Flange norm 1092-1 NP Bar	DN125	DN150	DN200	DN250	DN300	DN350	DN400	DN450	DN500	
	NP10 to NP63									
Flange Standard B16.5 NPS Class lbs	5"	6"	8"	10"	12"	14"	16"	18"	20"	
	150 - 300 - 400 - 600									
Facing flange	FF (Flat Face) RF (Raised Face) GF (Groove face) MF (Male face) FM (Female face)									
HEATING ELEMENTS	→									
Maxi Qty	DN125	DN150	DN200	DN250	DN300	DN350	DN400	DN450	DN500	
Pins Ø10,2	9	15	27	45	66	78	102	165	174	
Pins Ø16	6	9	18	27	39	51	57	90	99	
Monotubes Ø16	12	18	36	54	78	102	114	180	198	
Ø Maxi(Bundle)	122	151	197	245	290	317	362	416	460	
Material										
DN 150 to 500	Pins Ø10,2		Pins Ø16			Monotubes Ø16				
Z2 Stainless steel 316L/DIN 1.4404	X		X			X				
Z6 Stainless steel 321/DIN 1.4541	X		X			X				
Incoloy 800/DIN 1.4876	X		X			X				
Incoloy 825/DIN 2.4858	X		X			X				
Carbon steel	X		X			X				
Stainless steel 904L/DIN 1.4539	X		X			X				
Treatment	Without - Scoured - Scoured passivated - Electropolished									
Dimension (mm)	DN125	DN150	DN200	DN250	DN300	DN350	DN400	DN450	DN500	
Tolerance on dimensions A	-2% +0 with mini -10mm									
Maxi length = A + B (mm)	3200mm (Pins Ø10,2 - Ø16) - 2500mm (Monotubes Ø16) (Others length on request)									
A Mini	300	375	500	625	750	875	1000	1125	1250	
NH Mini	60	75	100	125	150	175	200	225	250	
Specific load - W/cm ²	Depending on customer application									
Maxi Voltage	500 V (Pin Ø10,2 and monotube Ø16) - 750 V (Pin Ø16)									
TEMPERATURE CONTROL AND SAFETY DEVICES	→									
Sensor	Mounting		Tmini (mm)			Tmaxi (mm)				
RTD PT100	Mounted in pocket		NH + 30			A - 30				
RTD PT100	Welded on heating element		NH + 50			A - 30				
Thermocouple	Mounted in pocket		NH + 30			A - 30				
Thermocouple	Welded on heating element		NH + 50			A - 30				
Control Thermostat	Mounted in pocket		NH + 50 + Lg bulb			T maxi = capillary length - 100 - B				
Control Thermostat	Welded on heating element		NH + 50 + Lg bulb			T maxi = capillary length - 100 - B				
	Caution : For gas heating, a thermocouple welded on the heating element is highly recommended									

Junction box dimensions L x H x P	
C2 = 300x300x120	C6 = 500x500x210
C3 = 300x300x210	C7 = 500x500x300
C4 = 380x380x210	C8 = 600x600x210
C5 = 400x400x120	C9 = 760x760x300

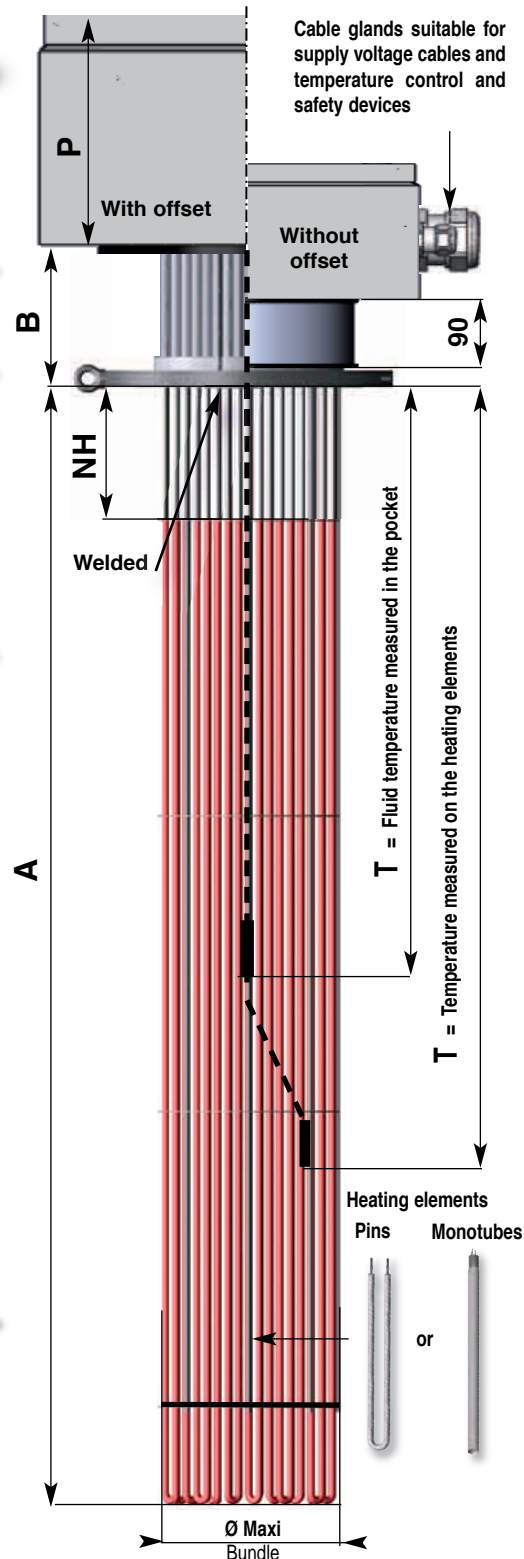

DN 150 UP TO DN 500 FLANGE TO HEAT OIL AND ACQUEOUS LIQUIDS UP TO 200°C

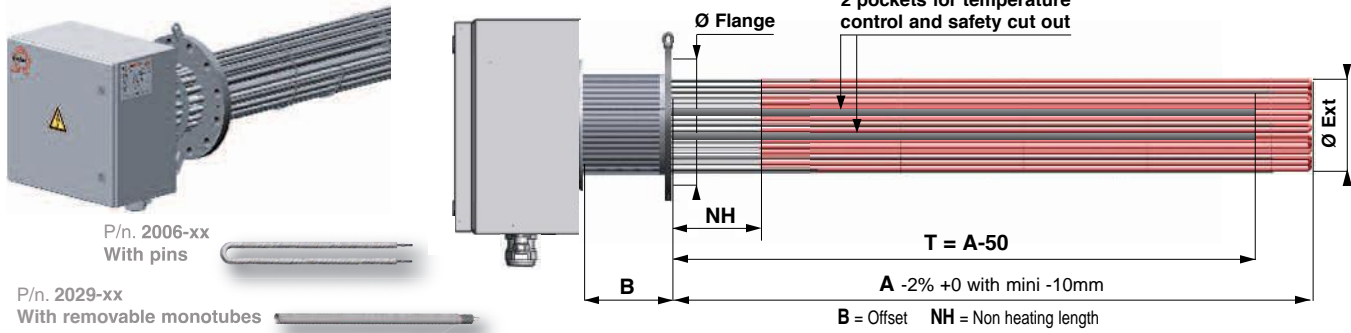

Removable monotubes Ø 16 mm mounted in pockets Ø 19 mm

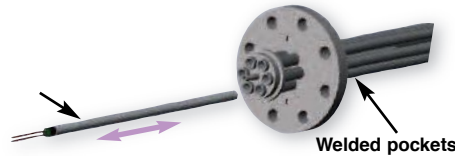

Liquid temperature	≤ 200°C
Flange	Stainless steel - Scoured passivated - welded
Pins Ø16 or monotubes in pockets Ø19 mm	Stainless steel 316L - Scoured passivated
Safety cut out	Thermocouple K in a pocket
Control thermostat	50/300°C - 1 Change over contact - 10A / 230V

Qty Heating elements	Liquid	Junction box	Power (kW) +5/-10%	Voltage (V)	Load (W/cm ²)	A (mm)	NH (mm)	B (mm)	ØExt Maxi (mm)	Ø FLANGE NP16 FS EN1092-1	P/N.	Ø FLANGE 150lbs RF Standard B16.5	P/N.
Pins 9 pins	Oil	C3	43	400	1,9	2600	150	250	151	150	2006-01	6"	2006-31
	Water		90	400	4	2600	150	250	151		2006-02		2006-32
	Water		135	400	6	2600	150	250	151		2006-03		2006-33
18 pins	Oil	C3	90	400	1,9	2600	150	250	197	200	2006-04	8"	2006-34
	Water		170	400	4	2600	150	250	197		2006-05		2006-35
	Water		180	400	6	1900	150	250	197		2006-06		2006-36
27 pins	Oil	C6	130	400	1,9	2600	150	250	245	250	2006-07	10"	2006-37
	Water		260	400	4	2600	150	250	245		2006-08		2006-38
	Water		290	400	6	2000	150	250	245		2006-09		2006-39
39 pins	Oil	C6	190	400	1,9	2600	150	250	290	300	2006-11	12"	2006-40
	Water		290	400	4	2100	150	250	290		2006-12		2006-41
	Water		290	400	6	1500	150	250	290		2006-13		2006-42
51 pins	Oil	C7	245	400	1,9	2600	200	250	317	350	2006-14	14"	2006-70
	Water		435	400	4	2300	200	250	317		2006-15		2006-71
	Water		435	400	6	1700	200	250	317		2006-16		2006-72
57 pins	Oil	C7	290	400	1,9	2600	200	250	362	400	2006-17	16"	2006-73
	Water		435	400	4	2100	200	250	362		2006-18		2006-74
	Water		435	400	6	1500	200	250	362		2006-19		2006-76
99 pins	Oil	C9	490	400	1,9	2600	250	250	460	500	2006-20	20"	2006-77
	Water		700	400	4	2000	250	250	460		2006-21		2006-78
	Water		700	400	6	1400	250	250	460		2006-22		2006-79
Removable monotubes 18 monotubes	Oil	C3	6,5	400	1	750	150	250	151	150	2029-01	6"	2029-31
			10	400	1	1050	150	250	151		2029-02		2029-32
			13	400	1	1350	150	250	151		2029-03		2029-33
			19	400	1	1950	150	250	151		2029-04		2029-34
			24,5	400	1	2450	150	250	151		2029-05		2029-35
			30	400	1	2950	150	250	151		2029-06		2029-36
36 monotubes	Oil	C3	19	400	1	1050	150	250	197	200	2029-07	8"	2029-37
			25	400	1	1350	150	250	197		2029-08		2029-38
			38	400	1	1950	150	250	197		2029-09		2029-39
			49	400	1	2450	150	250	197		2029-10		2029-40
			60	400	1	2950	150	250	197		2029-11		2029-41
			54 monotubes	Oil	C6	38	400	1	1350		150		250
57	400	1	1950	150	250	245	2029-13	2029-43					
74	400	1	2450	150	250	245	2029-14	2029-44					
90	400	1	2950	150	250	245	2029-15	2029-45					
78 monotubes	Oil	C6	55	400	1	1350	150	250	290	300	2029-16	12"	2029-46
			83	400	1	1950	150	250	290		2029-17		2029-47
			106	400	1	2450	150	250	290		2029-18		2029-48
			130	400	1	2950	150	250	290		2029-19		2029-49
102 monotubes	Oil	C7	105	400	1	1950	200	250	317	350	2029-20	14"	2029-50
			136	400	1	2450	200	250	317		2029-21		2029-51
			166	400	1	2950	200	250	317		2029-22		2029-52
114 monotubes	Oil	C7	118	400	1	1950	200	250	362	400	2029-23	16"	2029-53
			152	400	1	2450	200	250	362		2029-24		2029-54
			186	400	1	2950	200	250	362		2029-25		2029-55
198 monotubes	Oil	C9	258	400	1	2450	250	250	460	500	2029-28	20"	2029-58
			317	400	1	2950	250	250	460		2029-29		2029-59

Pharmaceutical, Chemical and Food & Beverage industries favour the installation of stations called **Cleaning in Place (CIP)** or **Sterilization in place (SIP)** for their **Aseptic production** line. These cleaning processes for fixed or mobiles stations need a heating system in compliance with applicable requirements.

Main requirements:

- **NO RETENTION ZONE** through the fluid flow (interface connection with tri-clamps...)
- **MATERIALS QUALITY** in contact with the fluid (stainless steel 316L, gasket approved by FDA/USP class VI, ...)
- **SURFACE QUALITY** of components in contact with the fluid $0,6 \leq Ra \leq 0,8$ (Heating pin or monotube according the value of Ra expected)
- **FULL TRACEABILITY** of the product with 3.1 certificate - Components **COMPLY WITH CUSTOMER'S STANDARD** (ASME BPE, SMS, ISO, ...)

FLANGE IMMERSION HEATERS

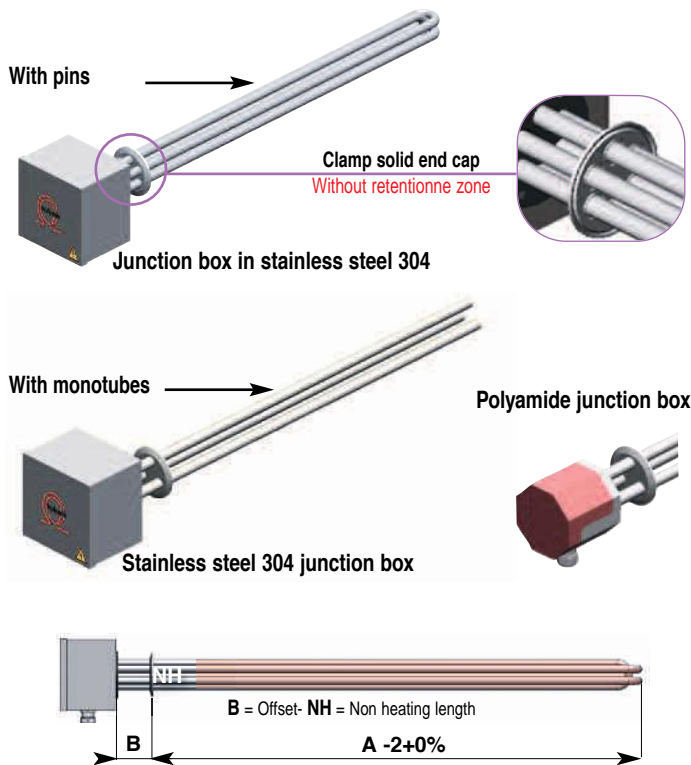

Specifications		
Heating power	≤ 25 kW	
Supply voltage	single or 3 phase	
Process temperature	70 up to 90°C	
Flange	Type	Clamp
	∅	maxi 6"
	Material	Stainless steel 316L
	Joint	Welded
	Surface quality	Ra ≤ 0,6 or Ra ≤ 0,8
Norms	Customer standards (SMS, ASME, BPE, ISO ...)	
Gasket	Material	EPDM, Silicone, Viton
	Compliance	FDA, USP ClassVI (other on request)
Heating Elements	Material	Inox 316L
	Type	Pins (surface quality Ra ≤ 0,8) Monotubes (surface quality Ra ≤ 0,6)
Specific load	up to 10W/cm ²	
Surface treatment	Mechanical polishing and electrolytic, passivated	
Junction box	Stainless steel 304 or Polyamide	
	IP	55
Cable gland on request	Polyamide	
	Stainless steel cable gland (suitable to junction box)	
Dimensions	A maxi	1100 mm
	B maxi	80 mm

LIQUIDS CIRCULATION HEATERS

In line heater 1 Body

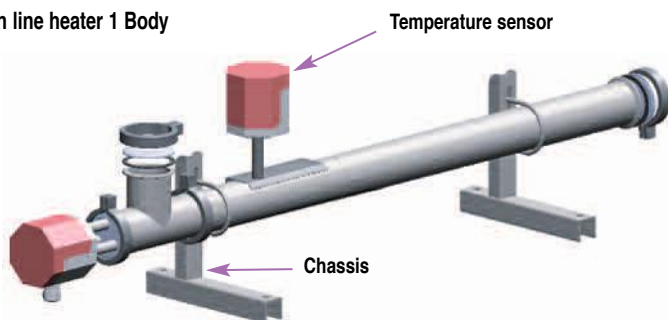

In line heater 2 Bodies

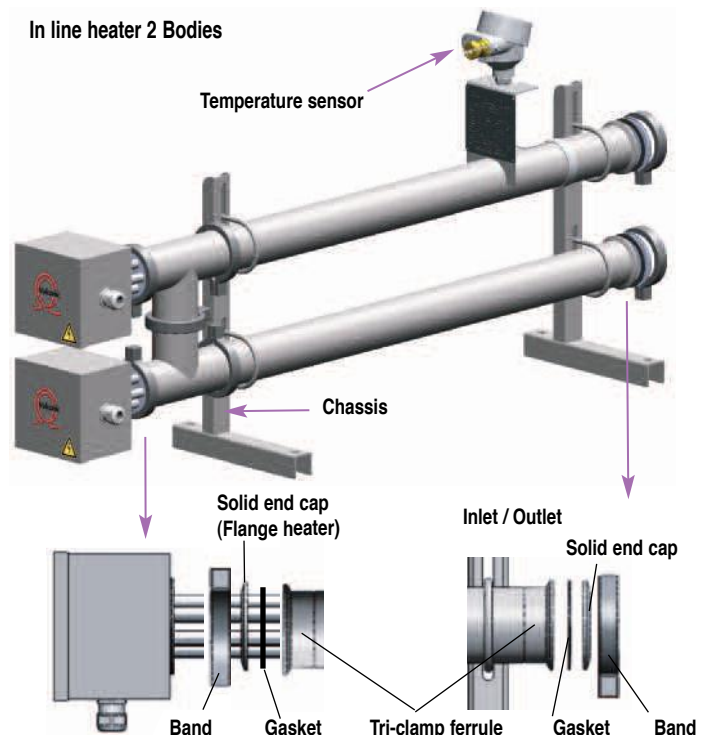

Heating power	≤ 50 kW	
Process temperature	70 up to 90°C	
Length max.	1200 mm	
Vessel	Pressure	NP16
	∅ Vessel	up to 3"
	Material	Stainless steel 316L
	Inlet/Outlet	Tri-clamp ferrule
	Norms	Customer standards (SMS, ASME BPE, ISO ...)
Support	Material	Stainless steel 304
Vessel temperature safety device	RTD PT100, control thermostat, thermocouple with stainless steel or polyamide junction box	

FLANGE IMMERSION HEATERS WITH CERAMIC CORE ELEMENTS TO HEAT LIQUIDS

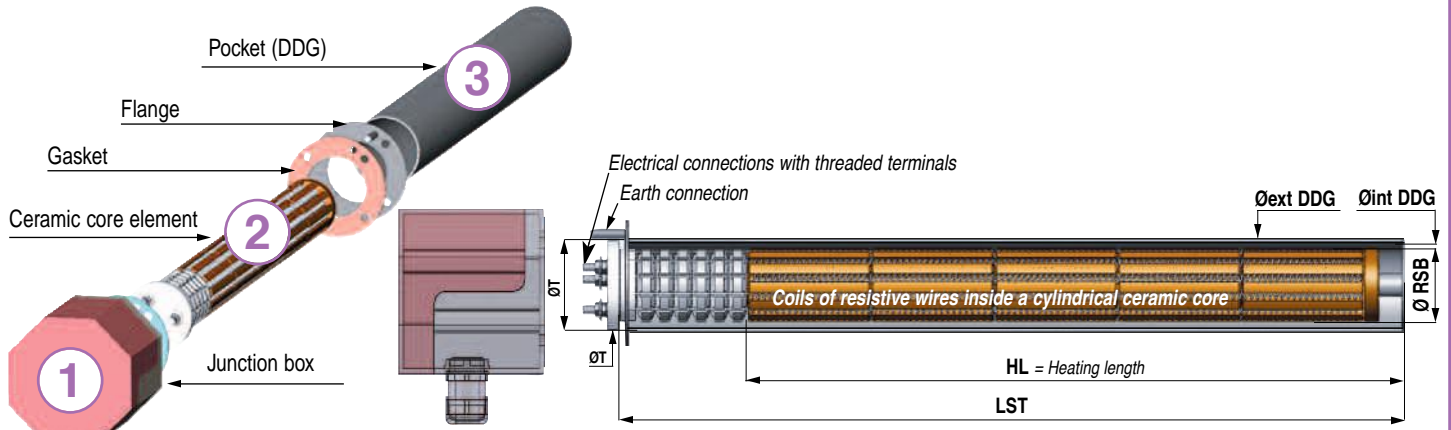

CERAMIC CORE ELEMENTS

Power (kW) +5/-10%	Voltage (V)	Load (W/cm ²)	Ø Cer. core (mm)	Ø int ddg (mm)	Ø T (mm)	LST (mm)	HL (mm)	P/N.
1	230 - 1P	2,5	47	48	57	440	300	1103-11
2	230 - 1P	2,5	47	48	57	690	550	1103-12
3	230 - 1P	2,5	47	48	57	890	700	1103-13
2	230 - 1P	4	47	48	57	440	300	1103-14
3	230 - 1P	4	47	48	57	690	500	1103-15
4	230 - 3P	4	47	48	57	890	650	1103-16
4	400 - 3P	4	47	48	57	890	650	1103-17
2	230 - 1P	4	58	60	67	451	280	1101-01
3	230 - 1P	4	58	60	67	691	400	1101-02
4	230 - 3P	4,5	58	60	67	891	520	1101-03
4	400 - 3P	4,5	58	60	67	891	520	1101-05
6	400 - 3P	4	58	60	67	971	800	1101-04

Junction box in polyamide 6/6

Including:
1 Junction box
1 Cable gland in polyamide
1 Gasket

Suitable Cer. core Ø (mm)	IP	Cable Gland	P/N.
47	55	ISO 20 Bis	1199-00
58	55	ISO 25 Bis	2081-99

Set of pocket in stainless steel 304 L

Including:
1 Pocket,
1 Flange
1 Gasket

Pocket Øint (mm)	Pocket Øext (mm)	L (mm)	Ø Flange (mm)	P/N.
48	51	920	85	5711-00
60	63,5	990	101	5710-00
60	63,5	1015	101	5710-01

Caution : All the parts are supplied separately, the customer has to cut the pocket at the length required, weld the flange and join the parts together.

Preparing and assembling parts

Cut the pipe at the right length L_g DDG

$$L_g DDG = (LST \times 1,02) + 25$$

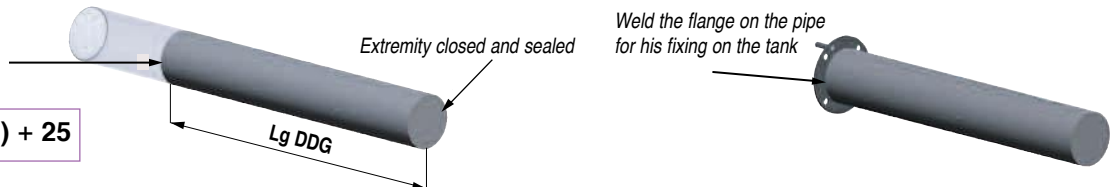

Available installations

Welded on the vessel:

The pocket is welded directly on the tank

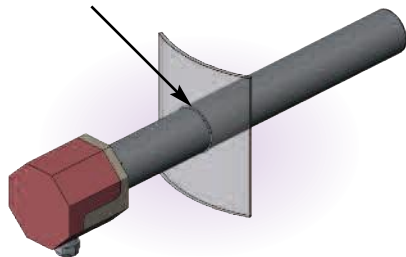

Screw plug ISO M77x200 and BSPP 2"1/2 :

A stainless steel ISO M77 screw plug is welded on the pocket

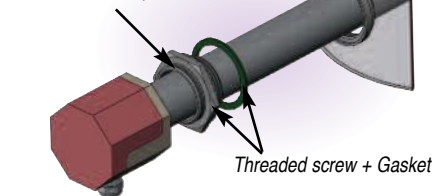

Description	Material	P/N.
Screw plug M77x200 + Gasket Ø78 (Klingerite)	Inox. 316L	9624-06
Screw plug 2" 1/2 BSPP + Gasket Ø 2" 1/2 (Klingerite)	Klingerite	9624-07
Sleeve for welding M77	Inox. 316L	9624-04
Sleeve for welding 2" 1/2 BSPP	Inox. 316L	9624-05

Flange DN80 :

A stainless steel DN 80 Flange is welded on the pocket

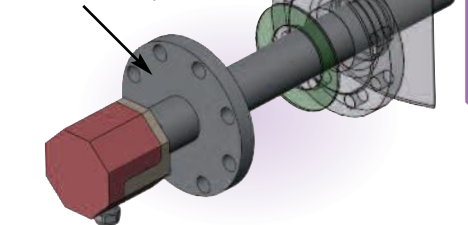

Description	Material	P/N.
Flange ND80 NP16 RF	S. Steel 316L	9624-08

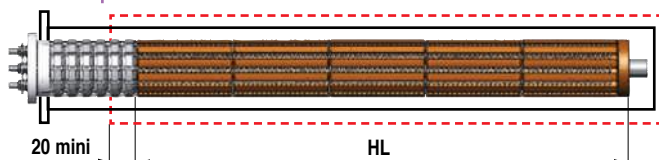

← This part must be totally immersed in the liquid

JUNCTION BOXES FOR SCREW PLUG AND FLANGE IMMERSION HEATERS UP TO DN 125

SPECIFICATIONS : **WITH CONTROL THERMOSTAT** (A cable gland ISO 16 is recommended on junction box from a heating power > 3kW)
 WITH THERMOCOUPLE PROBE OR RTD PT100 (An additional cable gland ISO 16 is recommended on the junction box)

Cable gland, gasket and fixing parts are supplied with each junction box.

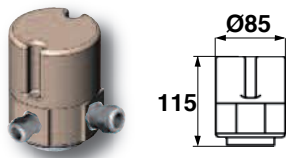
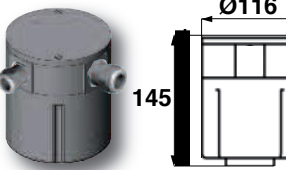
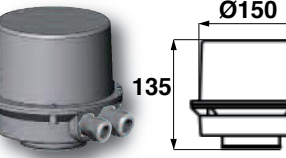
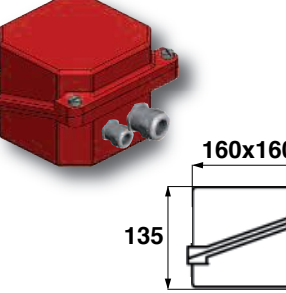
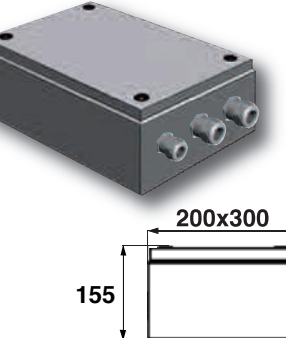
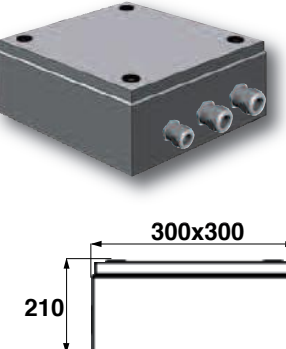
Type	Material IP	Screw plug heater Ø	Flange immersion heater DN	Mounting	Cable gland	P/N.					
Q2 	Plastic IP54**	maxi 1 control thermostat with bulb			ISO 20 + ISO 25	9643-01					
		1"1/4 - 1"1/2 - M45	1"1/4 - 1"1/2 DN32 - DN40	With or without offset							
K2 	Plastic IP54**	maxi 1 control thermostat with maxi 2 bulbs or maxi 2 control thermostats with 1 bulb			ISO 20 + ISO 20 ISO 20 + ISO 25 ISO 20 + ISO 20 ISO 20 + ISO 25	9645-01 9645-02 9645-11 9645-12					
		M45 - 1" 1/2	1"1/4 - 1"1/2	With or without offset							
		2"	DN32-DN40-DN50	With or without offset							
				With offset							
G2 	Aluminium IP66	maxi 1 control thermostat with maxi 2 bulbs or maxi 2 control thermostats with 1 bulb			ISO 20 + ISO 20 ISO 20 + ISO 25 ISO 20 + ISO 20 ISO 20 + ISO 25 ISO 25	9644-01 9644-02 9644-11 9644-12 9644-13					
		1"1/4 - 1"1/2 - M45	1"1/4 - 1"1/2 - 2" - 2"1/2	With or without offset							
		2" - 2"1/2 - M77	1"1/4 - 1"1/2 - 2" - 2"1/2	With or without offset							
			DN32-DN40-DN50 DN65-DN80	With offset							
A3 	Aluminium IP55	maxi 1 control thermostat with maxi 2 bulbs or maxi 2 control thermostats with 1 bulb			ISO 25 ISO 32 ISO 20 + ISO 25 ISO 20 + ISO 32 ISO 20 + ISO 40 ISO 25 ISO 32 ISO 20 + ISO 25 ISO 20 + ISO 32 ISO 20 + ISO 40	9631-01 9631-02 9631-14 9631-15 9631-20 9631-10 9631-11 9631-12 9631-13 9631-21					
		2"1/2 M77		With or without offset							
							DN65 DN80	With offset			
		C1 	Painted Carbon steel IP66	1 thermostat maxi à 2 bulbes ou 2 thermostats maxi à 1 bulbe			ISO 25 ISO 32 ISO 20 + ISO 25 ISO 20 + ISO 32 ISO 20 + ISO 40 2 x ISO 25	9646-01 9646-02 9646-03 9646-04 9646-20 9646-05			
				DN80 - DN100 DN125					With offset		
										ISO 20 + 2 x ISO 25	
				Stainless steel IP66					DN80 - DN100 DN125		With offset
			ISO 32								
ISO 20 + ISO 25											
ISO 20 + ISO 40											
C3 	Painted Carbon steel IP66		1 thermostat maxi à 2 bulbes ou 2 thermostats maxi à 1 bulbe			2 x ISO 25 ISO 20 + 2 x ISO 25 ISO 50 ISO 63 ISO 20 + ISO 50 ISO 20 + ISO 63 2 x ISO 20 + ISO 50 2 x ISO 20 + ISO 63	9646-15 9646-16 9746-01 9746-02 9746-03 9746-04 9746-05 9746-06				
			DN100 DN125	With offset							
		ISO 50									
			Stainless steel IP66	DN100 DN125	With offset						
								ISO 63			
		ISO 20 + ISO 50									







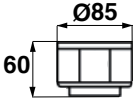

JUNCTION BOXES FOR SCREW PLUG AND FLANGE IMMERSION HEATERS UP TO DN 125

SPECIFICATIONS :

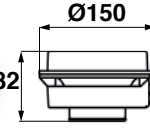
WITHOUT CONTROL THERMOSTAT

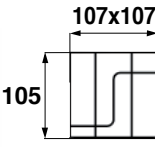
WITH THERMOCOUPLE PROBE OR RTD PT100 (An additional cable gland ISO 16 is recommended on the junction box)

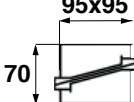
Cable gland, gasket and fixing parts are supplied with each junction box.

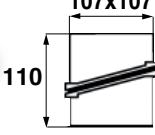
Type	Material IP	Screw plug heater Ø	Flange immersion heater DN	Mounting	Cable gland	P/N.		
Q1  	Plastic IP54	1"1/4 - 1"1/2 - M45		With or without offset	ISO 20	9641-01		
			ND32 - ND40 1"1/4 - 1"1/2	With offset	ISO 20 ISO 25	9641-01 9641-02		
G1  	Aluminium IP66	1"1/2 - M45	DN32 - DN40 1"1/4 - 1"1/2	With or without offset	ISO 20 ISO 25	9642-01 9642-02		
			DN32 - DN40 - DN50 1"1/4 - 1"1/2 - 2"	With offset	ISO 20 ISO 25	9642-10 9642-11		
H1  	Polyamide IP55	M45		With or without offset	ISO 25	2045-99		
				With or without offset	ISO 16 BIS + ISO 25 ISO 32	2077-97 2077-98		
		DN80	Without offset	ISO 25	2081-99			
			With offset	ISO 16 BIS + ISO 25 ISO 16 + ISO 25 ISO 32 ISO 25	2081-97 2077-97 2077-98 2077-99			
		A1  	Aluminium IP55	1"1/4 M45		With or without offset	ISO 20 ISO 25	9621-02 9621-10
A2  	Aluminium IP55	2" - 2"1/2 - M77		With or without offset	ISO 25	9622-01		
				With offset	ISO 25	9622-10		

** Q2 and K2 specifications : Junction boxes with control thermostats

Protection IP depending on external or internal temperature setting

Junction box IP44 with external adjustable knob

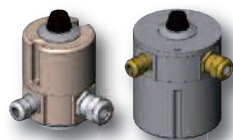

Junction box IP54 with internal adjustable knob

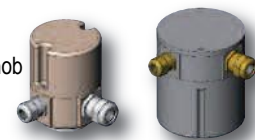

SELECTING A CABLE GLAND

Polyamide cable glands									
Maxi Ø cable clamping (mm)	8	10	13	15	19	25	32	38	44
Size Ø	ISO 16	ISO 16bis	ISO 20	ISO 20bis	ISO 25	ISO 32	ISO 40	ISO 50	ISO 63
P/N.	9671-01	9671-02	9671-03	9671-04	9671-05	9671-06	9671-07	9671-08	9671-09



Cable gland supplied with gaskets

CONTROL THERMOSTATS & SAFETY CUT-OUTS

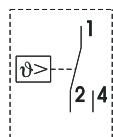

Layout 1

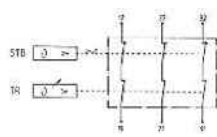

Layout 2

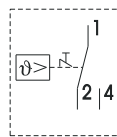

Layout 3

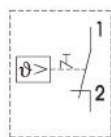

Layout 4

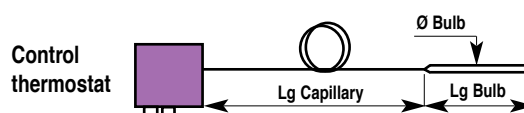

CONTROL THERMOSTAT WITH AUTOMATIC RESET TYPE TR (layout 1)

P/N.	Range	Ø Bulb	Length Bulb(Lg)	Lg Capillary	I (A)	Contacts	Junction boxes suitable with control thermostats					
							Q2	K2	G2	A3	C1	C3
9030-02	0 / +100°C	Ø6	160 mm	1000 mm	16A / 230V	1 Change over contact	•	•	•	•	•	•
9031-12	0 / +100°C	Ø6	160 mm	2000 mm	16A / 230V	1 Change over contact	•	•	•	•	•	•
9030-03	+50 / +300°C	Ø6	90 mm	1000 mm	16A / 230V	1 Change over contact	•	•	•	•	•	•
9031-13	+50 / +300°C	Ø6	87 mm	2000 mm	16A / 230V	1 Change over contact	•	•	•	•	•	•
9030-01	0 / +70°C	Ø6	130 mm	1000 mm	10A / 230V	1 Change over contact	•	•	•	•	•	•
9031-11	0 / +70°C	Ø6	130 mm	2000 mm	10A / 230V	1 Change over contact	•	•	•	•	•	•
9030-71	-20 / +40°C	Ø8	150 mm	2000 mm	16A / 230V	1 Change over contact	•	•	•	•	•	•

SAFETY CUT-OUT WITH MANUAL RESET TYPE TB (layout 3)

P/N.	Range	Ø Bulbe	Lg Bulbe	Lg Capillary	I (A)	Contacts	Q2	K2	G2	A3	C1	C3
9031-08	0 / +200°C	Ø6	100 mm	1000 mm	16A / 230V	1 Change over contact	•	•	•	•	•	•

SAFETY CUT-OUT WITH MANUAL RESET TYPE TB (layout 4)

P/N.	Range	Ø Bulbe	Lg Bulbe	Lg Capillary	I (A)	Contacts	Q2	K2	G2	A3	C1	C3
9030-05	+50 / +300°C	Ø6	88 mm	1000 mm	16A / 230V	1 Single pole normally closed contact	•	•	•	•	•	•

CONTROL THERMOSTAT WITH SAFETY CUT OUT WITH MANUAL RESET TYPE TR + STB (layout 2)

P/N.	Range	Cut out temp	2 Bulbs Ø	Length Bulb(Lg)	Lg Capillary	I (A)	Contacts	Q2	K2	G2	A3	C1	C3
9014-13	+30 / +80°C	110°C	Ø6 Control Ø6 Safety	130 mm 100 mm	800 mm 800 mm	20A / 400V	Triple pole normally closed contact	•	•	•	•	•	•
9014-15	+30 / +75°C	98°C	Ø6 Control Ø4 Safety	130 mm 110 mm	520 mm 400 mm	20A / 400V	Triple pole normally closed contact	•	•	•	•	•	•



SET WITH POCKET, TEMPERATURE PROBE, COUPLING AND CABLE

It allows fast disassembly of the probe or thermocouple without needing to drain the customers piping or tank.

1 SET =



+

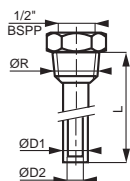

+

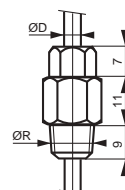

+



Temperature probe ØD = 6 mm

Pocket

Bicone union

Extension cable

KIT P/N.	Probe	Temp maxi. measured (°C)	Temp maxi. junction (°C)	Length (mm)	Length (mm)	Ø (mm)	Thread ØR	Thread ØR	P/N.	P/N.
2062-01	PT100	350	80	200	100	8	1/2" BSPT	1/2" BSPP	31672-00	31452-10
2062-03	PT 100	350	80	250	200	8	1/2" BSPT	1/2" BSPP	31672-00	31452-10
2062-05	PT 100	350	80	200	150	8	3/8" BSPT	1/2" BSPP	31672-00	31452-10
2062-06	TC J	450	80	200	150	8	3/8" BSPT	1/2" BSPP	31672-00	31621-10
2062-07	TC K	450	80	200	150	8	3/8" BSPT	1/2" BSPP	31672-00	31620-10

LEVEL INDICATOR

Float type magnetic level sensor for horizontal installation in liquids of relative density $\geq 0,8$ output on 2 A/250 VAC configurable for opening or closing. PVC cable 1,5 m length. Brass body and stainless steel float. Maxi working temperature : + 110°C. Maxi working pressure : 16 bar. Protection : IP 65

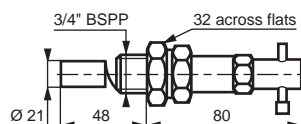
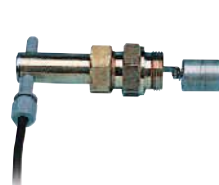

Description	P/N.
Magnetic level indicator	32020-01

CONTROL UNITS FOR SCREW PLUG IMMERSION HEATERS - IP 55

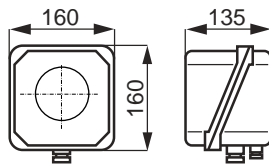

ONLY SUITABLE TO SCREW PLUG HEATERS WITH POCKET

M77 or 2"1/2 screw plug without offset

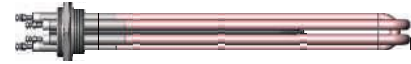

M77 or 2"1/2 screw plug with offset



Material: painted aluminium

These control units are designed to simplify the installation of ISO M77 or 2"1/2 immersion heaters with pocket. Heating is switched on/off by an integrated control thermostat. Comprises a sealed aluminium IP 55 IK 5 junction box fitted with a thermostat and/or a temperature safety cut out. The solution for small and medium-sized installations.

Maxi Power (kW)	Voltage (V)	Junction IP	Control thermostat				P/N.
			Rang	Safety	Qty Contact	Reset.	
13	400 - 3P	55	30/85°C	110°C	3	manual	9027-51
8	400 - 3P	55	0/300°C	-	2	-	9027-52
8	400 - 3P	55	0/100°C	-	2	-	9027-53
8	400 - 3P	55	50/200°C	-	2	-	9027-54
2	230 - 1P	55	110/550°C	-	1	-	9027-55
3	230 - 1P	55	-	90/110°C	1	manual	9027-61
5	400 - 3P	55	-	50/300°C	1	manual	9027-62
5	400 - 3P	55	-	20/500°C	1	manual	9027-63

CONTROL UNIT WITH SAFETY CUT OUT AND RELAY UP TO 30 kW - IP 55



Dimensions (mm) :
160 x 240 x 170



ONLY SUITABLE TO IMMERSION HEATERS WITH POCKET

2", M77, 2"1/2 screw plug heaters without offset



2", M77, 2"1/2 screw plug heaters with offset



DN80 Flange immersion heaters without offset

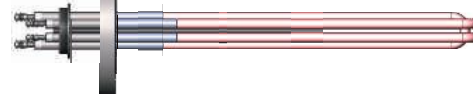

These control units are designed to simplify the installation of ISO M77, 2", 2"1/2 ou ND80 immersion heaters with pocket. Comprise a sealed plastic IP 55 junction box fitted with a control thermostat and a temperature safety cut out, a remote control and an electromechanical relay suitable up to 30 kW. Thermostat temperature range : 0-100°C. Adjustment of thermostat by interior knob. Cut-out temperature range 50 up to 300°C. ON/OFF pilot ligh under a transparent cover. Box equipped with 2 sealing glands.ISO 40 and ISO 20

Material: plastic

Maxi Power 400V tri	IP	Control thermostat		Safety cut out		Cable	Cable	P/N.
		Range	Contact	Range	Contact	Gland 1	Gland 2	
30kW	55	0/+100°C	2	+50/+300°C	2	ISO 40	ISO 20	9027-10

On request : READY TO USE

Vulcanic provides also the control unit directly mounted and cabled on your immersion heaters from the P/N: 9027-11



Option	P/N.
Assembly on screw plug	9027-11

DIGITAL CONTROL UNIT WITH WATERPROOF JUNCTION BOX IP 66

Description	P/N.
Digital temperature controller under waterproof junction box	9028-01
Sensor PT100 Ohms Ø 4 mm lg= 50 mm Cable lg = 5 m	9028-02

Waterproof polycarbonate junction box IP66

Temperature controller « On/Off », compact, easy to use, suitable to control immersions heaters, heating cables, or silicone heating panels up to 3,5 kW. Controlling an heating power over 3,5 kW requires an installation with an electromechanical relay.

Dimensions
200 x 160 x 110 (mm)

Polyamide cable glands

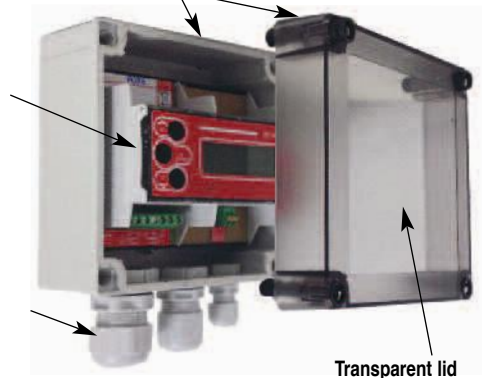

Transparent lid

Main specifications :

- Temperature measured, setting point, relay output position are indicated by digits.
- Input temperature PT100 2 wires (-50°C.....+250°C), with long length compensation integrated.
- Message « Err LO/Hi » in case of temperature sensor broken or in short circuit .
- Very easy to configurate with push button **temp +/temp-**; setting of hysteresis and short cycle protection.
- Relay output with close contact when temperature measured is lower the set temperature. Breaking capacity 16A/230V single phase.
- Waterproof and transparent casing IP 66. Resistant against shock and vibration.
- Cable glands suitable to supply voltage cables from Ø6 up to 13 mm.



CE 0080 **II 2 G**

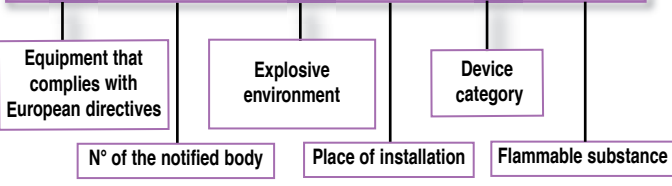

• N° of the notified body

0081	France	LCIE
0080	France	INERIS
0102	Germany	IBExU
0722	Spain	LOM

• Place of installation

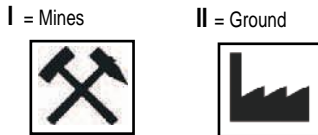

• Device category

		Risk of explosion		Time
1	Zones 0	Gas	HIGH	Continuously present
	Zones 20	Dust		
2	Zones 1	Gas	MEDIUM	Often present
	Zones 21	Dust		
3	Zones 2	Gas	LOW	Accidentally present
	Zones 22	Dust		

• Flammable substance

G = Gas
D = Dust

Ex d IIC T4 Gb

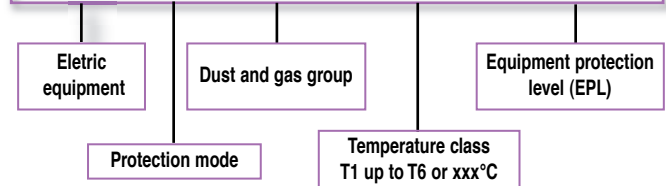

• Protection mode

d	Explosion-proof		Prevent the transmission of the explosion to the environment
e	Increased safety		Prevent excessive temperature and sparks from electrical equipment
de	Explosion-proof and increased safety		Prevent both transmission of the explosion and electric spark
ia	Intrinsic safety		Limited electrical energy

• Dust and gas group

Gas group	Place of installation	Typical gas	Energy of self ignition
I	Mines	Methane	E ≥ 300 μJ
IIA	Ground	Propane, butane, benzene, acetone, alcohol, kerosene, Gasoline, Petrol	E ≥ 240 μJ
IIB		Ethylene, diethyl ether	E ≥ 70 μJ
IIC		Hydrogen, acetylene	E ≥ 17 μJ

Dust group	Place of installation	Hazard	Size	Resistivity
IIIA	Ground	Combustible flyings	∅ ≥ 0,5 mm	
IIIB		None-conductive dust	∅ < 0,5 mm	R > 1000Ωm
IIIC		Conductive dust	∅ < 0,5 mm	R < 1000Ωm

• Temperature class

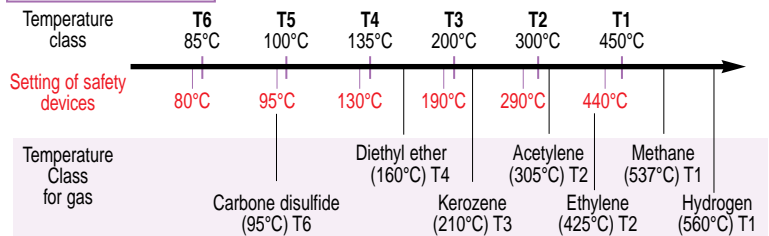

• Equipment protection level (EPL)

Group II - Gas area			Group II - Dust area		
Catégorie	Zone	EPL	Catégorie	Zone	EPL
II 1 G	0	Ga	II 1 D	20	Da
II 2 G	1	Gb	II 2 D	21	Db
II 3 G	2	Gc	II 3 D	22	Dc

SPECIFICATIONS : DN40 (1"1/2) UP TO DN125 (5")

Screw plug immersion heater	1"1/2 - M45 - 2"		2"1/2 - M77									
	2011 - 2012		2011 - 2012									
Flange immersion heaters	DN40 - DN50		DN65 - DN80		DN100		DN125					
	1"1/2 - 2"		2"1/2 - 3"		4"		5"					
		2015 - 2016		2015 - 2016		2015 - 2016		2010				
JUNCTION BOX												
Protection modes	Ex		d	d	e	de	d	e	de			
Cast-iron			•	•		•	•		•			
Aluminium			•	•		•	•		•			
Carbon steel					•		•	•	•			
Sainless steel					•	•	•	•	•			
TERMINALS												
Pins Ø8 or 8,5 mm	M4		M4		M4		M4					
Pins Ø10,2 mm	M5		M5		M5		M5					
Pins Ø16 mm			M6		M6		M6					
Rod Ø16 mm			Wire		Wire		Wire					
Sealing	WP+160		WP+160		WP+160		WP+160					
Coupling			1P (Parallel, Serial), 3P (Delta or star)									
OFFSET B												
Offset mini B = 100 mm.												
SCREW PLUG OR FLANGE												
Material	Carbon steel - Stainless steel 304L - 316L											
SCREW PLUG												
Ø	1"1/2	M45	2"	2"1/2	M77							
FLANGE : EN 1092-1												
Ø NP bar	DN40	DN50	DN65	DN80	DN100	DN100		DN125				
	NP10 to NP63		NP10 to NP63		NP10 to NP63		NP10 to NP63					
FLANGE : ASME B16.5												
Ø Class lbs	1"1/2	2"	2"1/2	3"	4"	4"		5"				
	150 to 600		150 to 600		150 to 600		150 to 600					
End flange facings												
Flate face - Raised face Male face - Female face - Groove face												
HEATING ELEMENTS												
Quantity												
Pins Ø8 or 8,5 mm	3	3	6	6	9	9		12				
Pins Ø10,2 mm	3	3	3	3	6	9		9				
Pins Ø16 mm				3	3	6		6				
Monotubes Ø16 mm				6	6	12		12				
Ø Max of the bundle	42	42	52	42	67	78	78	72	102	102	122	122
Material												
	Pins Ø8 - 8,5			Pins Ø10,2			Pins Ø16		Monotubes Ø16			
Z2 316L/DIN 1.4404	X			X			X		X			
Z6 321/DIN 1.4541	X			X			X		X			
Incoloy 800/DIN 1.4876							X					
Incoloy 825/DIN 2.4858							X					
Carbon steel				X			X		X			
Vulcaloy 904L/DIN 1.4539				X								
Treatment	Without - scoured - scoured and passivated - Electro polished											
Sizes (mm)												
	1"1/2	M45	2"	2"1/2	M77	DN100		DN125				
DN40	DN40		DN50	DN65	DN80	DN100		DN125				
Max length = A + B (mm)	1800mm (Pins Ø8) - 3200mm (Pins Ø10,2 - Ø16) - 2500mm (monotubes Ø16)											
Tolerance on A	-2% +0 with mini -10											
A Min	200mm (pins) - 300mm (monotubes)											
NH Min	75mm											
Maxi specif.load - W/cm ²	12	12	12	12	12	12		12				
Max voltage												
	400 V (Pins Ø8-8,5)			500 V (Pins Ø10,2 and monotubes Ø16) - 750 V (Pins Ø16)								
SAFETY DEVICES												
Fluid	Class		Probe			Assembly						
Liquid	T1 or T2		Thermocouple			mounted in a pocket						
			Thermocouple			welded on heating element						
			Fuse probe			mounted in a pocket						
Liquid	T3 to T6		Thermocouple			mounted in a pocket						
			Thermocouple			welded on heating element						
			Thermostat 50/300°C			mounted in a pocket						
			Thermostat 50/300°C			welded on heating element						
Gas	T1 to T6		Thermocouple			welded on heating element						

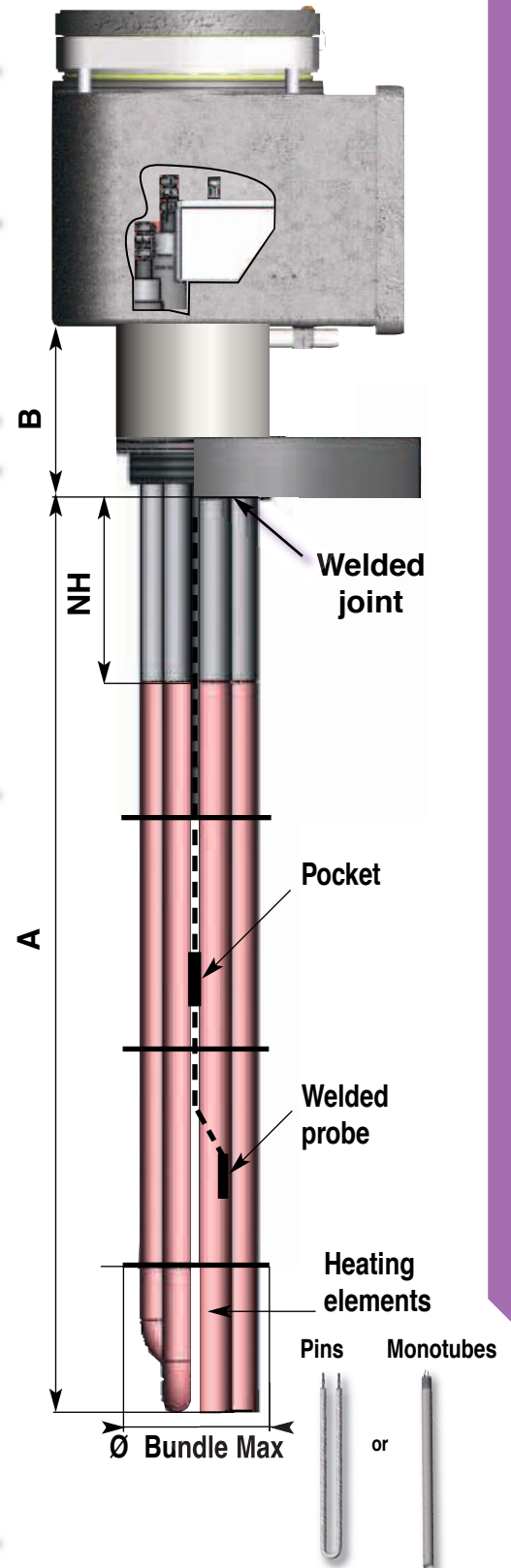



SCREW PLUG 1 1/2 BSPP, M77x200, 2 1/2 BSPP AND FLANGE DN80 II 2 G Ex d IIC TO HEAT OIL OR AQUEOUS LIQUIDS UP TO 65°C

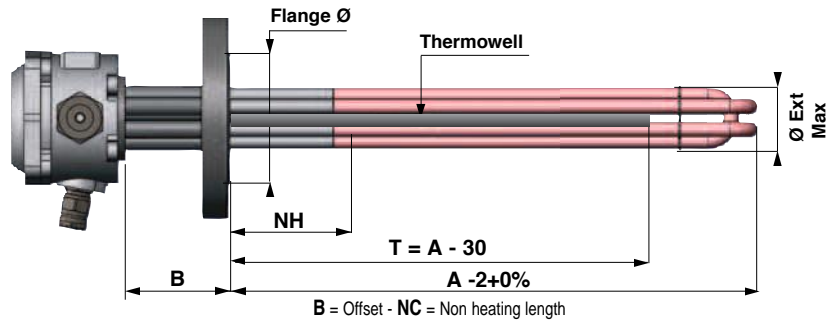
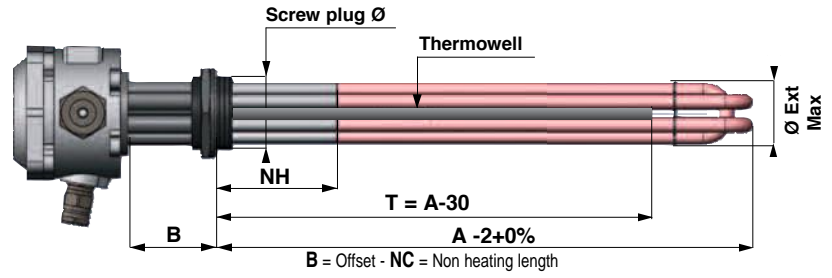
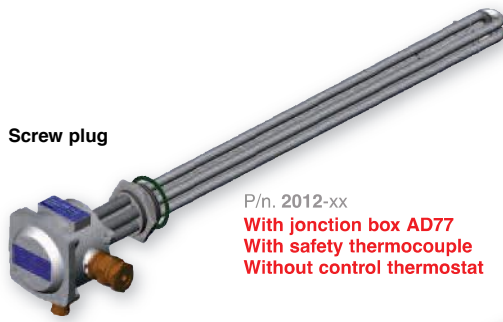

Junction box	AD77 IP 54 (option IP66) Aluminium (available in cast-iron)
Marking	II 2 G Ex d IIC T (1,2,3... see the table)
Room temperature	-20°C up to 40°C (Other on request)
Relative humidity	95% Max
Screw plug or flange material	Stainless steel - scoured and passivated - welded
Heating elements	Stainless steel 316L - scoured and passivated
Safety temperature cut out	Thermocouple (B)

	Qty	Ø screw plug Ø Flange	Power (kW) +5/-10%	Voltage (V)	Marking Temp.	Load (W/cm²)	A (mm)	NH (mm)	B (mm)	Pins Ø (mm)	ØExt Max (mm)	Fluid	P/N.	
Screw plug	3 pins	1 1/2 BSPP	0,5	230	T4	1	400	100	100	10,2	42	Oil	2012-01	
			0,9	230	T6	1,5	400	100	100	10,2	42	Oil	2012-02	
			1,1	230	T6	1,9	400	100	100	10,2	42	Oil	2012-03	
			3,45	230	T6	6	400	100	100	10,2	42	Oil	2012-04	
		3 pins	2" BSPP	0,75	230	T4	1	500	100	100	10,2	42	Oil	2012-05
				1,15	230	T6	1,5	500	100	100	10,2	42	Oil	2012-06
				1,45	230	T6	1,9	500	100	100	10,2	42	Oil	2012-07
				4,6	230	T6	6	500	100	100	10,2	42	Oil	2012-08
	3 pins	2 1/2 BSPP	1,05	230	T4	1	650	100	100	10,2	42	Oil	2012-10	
			1,6	230	T6	1,5	650	100	100	10,2	42	Oil	2012-11	
			2	400	T4	1,9	650	100	100	10,2	42	Oil	2012-12	
			6,4	400	T3	6	650	100	100	10,2	42	Water	2012-13	
	3 pins	M77 x 200	1,6	400	T6	1	650	100	100	16	72	Oil	2012-20	
			2,5	400	T6	1,5	650	100	100	16	72	Oil	2012-21	
			3,2	400	T4	1,9	650	100	100	16	72	Oil	2012-22	
			10	400	T4	6	650	100	100	16	72	Water	2012-23	
3 pins	DN80 3"	1,6	400	T6	1	950	100	100	16	72	Oil	2012-30		
		2,5	400	T6	1,5	950	100	100	16	72	Oil	2012-31		
		3,2	400	T4	1,9	950	100	100	16	72	Oil	2012-32		
		10	400	T4	6	950	100	100	16	72	Water	2012-33		
Flange	3 pins	DN80 3"	2,5	400	T6	1	950	100	100	16	72	Oil	Flange DN80 PN16 FS 2016-01	
			3,9	400	T6	1,5	950	100	100	16	72	Oil	2016-02	
			4,9	400	T4	1,9	950	100	100	16	72	Oil	EN1092-1 2016-03	
			15,3	400	T4	6	950	100	100	16	72	Water	2016-04	
												Flange Ø 3" 150lbs RF Standard B16.5	P/N. 2017-01 2017-02 2017-03 2017-04	

1 1/2 BSPP, M77x200, 2 1/2 BSPP SCREW PLUG AND DN 80 FLANGE II 2 G Ex d IIC WITH REMOVABLE MONOTUBES TO HEAT OIL UP TO 65°C

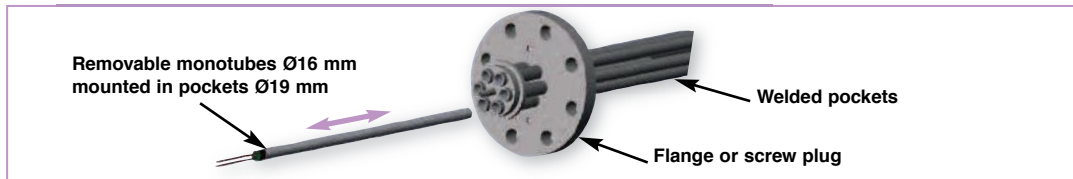
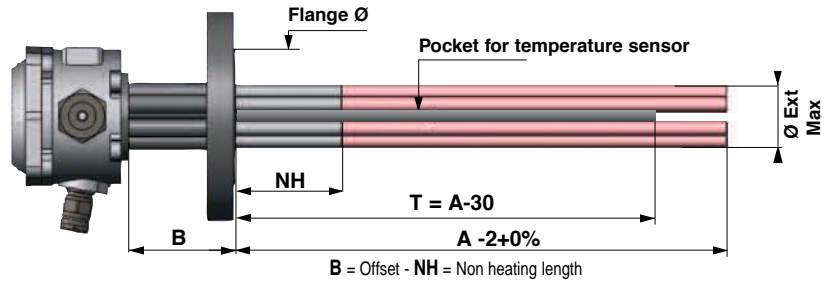
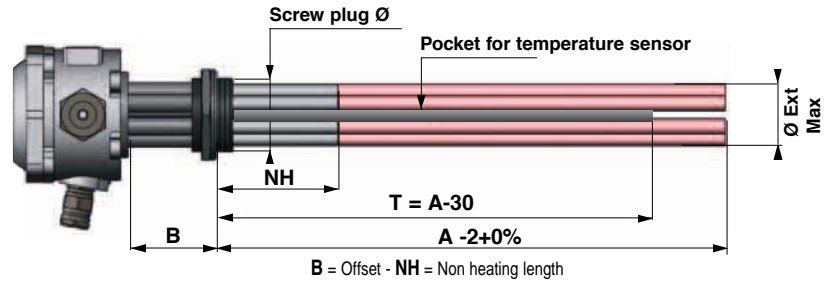
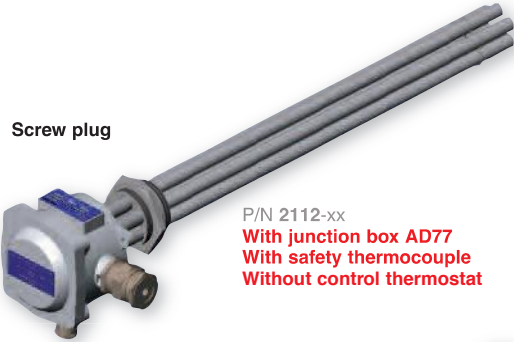

Junction box	AD77 IP 54 Aluminium (available in cast-iron)
Marking	II 2 G Ex d IIC T6
Room temperature	-20°C up to 40°C (Other on request)
Relative humidity	95% Max
Screw plug or flange material	Stainless steel - scoured and passivated - welded
Removable monotubes mounted in pockets	Stainless steel 316L - scoured and passivated
Safety cut out	Thermocouple (B)

	Qty	Ø screw plug Ø Flange	Power (kW) +5/-10%	Voltage (V)	Marking Temp.	Load (W/cm ²)	A (mm)	NH (mm)	B (mm)	ØExt Max (mm)	Fluid	P/N.	
Screw plug	6 monotubes	2 1/2 BSPP	2	400	T6	1	650	100	100	72	Oil	3002-06	
			3	400	T6	1	950	100	100	72	Oil	3002-07	
			4	400	T6	1	1200	100	100	72	Oil	3002-08	
			5	400	T6	1	1450	100	100	72	Oil	3002-09	
			6	400	T6	1	1850	100	100	72	Oil	3002-10	
			6 monotubes	M77 x 200	2	400	T6	1	650	100	100	72	Oil
	3	400			T6	1	950	100	100	72	Oil	3002-12	
	4	400			T6	1	1200	100	100	72	Oil	3002-13	
	5	400			T6	1	1450	100	100	72	Oil	3002-14	
	6	400			T6	1	1850	100	100	72	Oil	3002-15	
	Flange	6 monotubes			DN80 3"	2	400	T6	1	650	100	100	72
			3	400		T6	1	950	100	100	72	Oil	DN80 3002-18
4			400	T6		1	1200	100	100	72	Oil	PN16 FS 3002-19	
5			400	T6		1	1450	100	100	72	Oil	EN1092-1 3002-20	
6			400	T6		1	1850	100	100	72	Oil	3002-21	
											Flange	Flange	
											Ø 3"	Ø 3"	
											150lbs RF	150lbs RF	
											Standard B16.3	Standard B16.3	
											3003-17	3003-17	
											3003-18	3003-18	
											3003-19	3003-19	
											3003-20	3003-20	
											3003-21	3003-21	

EC type examination certificate : LCIE 03 ATEX 6283X



SCREW PLUG 1 1/2 BSPP, M77x200, 2 1/2 BSPP AND FLANGE ND80, ND100 II 2 G Ex d IIC TO HEAT OIL OR AQUEOUS LIQUIDS UP TO 65°C

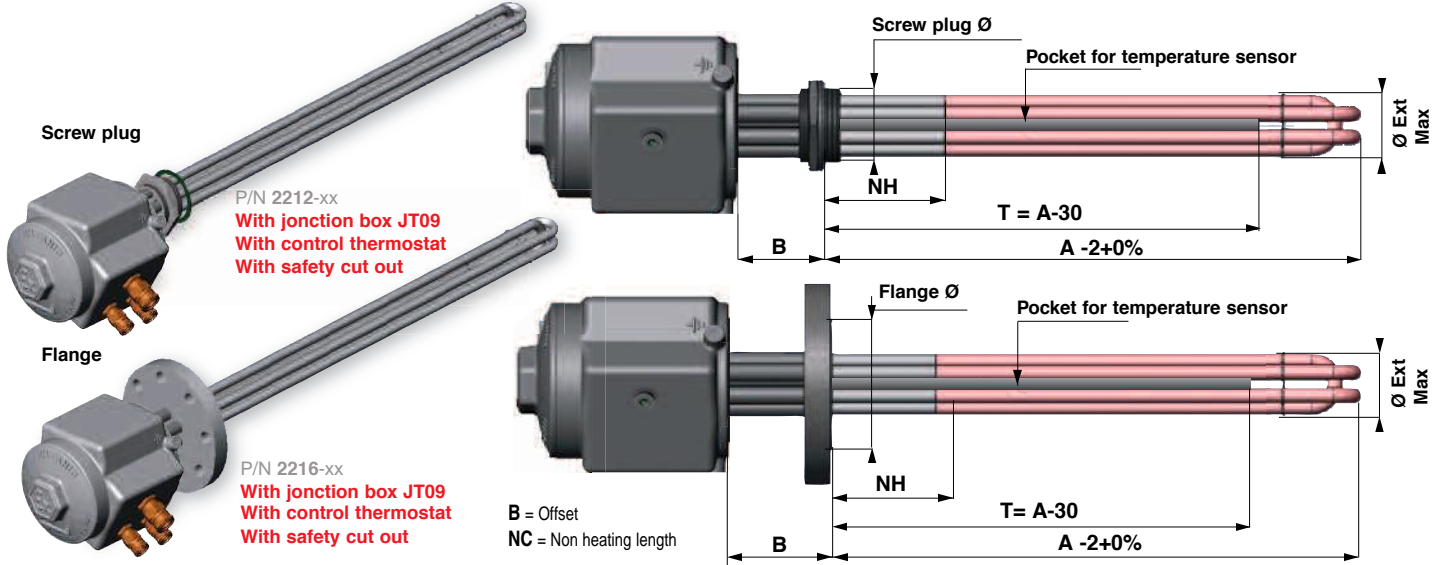

Junction box	JT09 IP 54 (option IP 66) Aluminium (available in cast-iron)
Marking	II 2 G Ex d IIC T (1,2,3... see the table)
Room temperature	-20°C up to 40°C (Other on request)
Relative humidity	95% Max
Screw plug or flange material	Stainless steel - scoured and passivated - welded
Heating elements	Stainless steel 316L - scoured and passivated
Control thermostat	0/70°C - Single pole double-throw contacts - 10A / 230V
Safety cut out (manual reset)	50/300°C - Single pole double-throw contacts - 16A / 230V

	Qty	Ø Screw plug Ø Flange	Power (kW) +5/-10%	Voltage (V)	Marking Temp.	Load (W/cm²)	A (mm)	NH (mm)	B (mm)	Pins Ø (mm)	ØExt Max (mm)	Fluid	P/N.		
Screw plug	3 pins	1 1/2 BSPP	0,5	230	T4	1	400	100	100	10,2	42	Oil	2012-40		
			0,9	230	T6	1,5	400	100	100	10,2	42	Oil	2012-41		
			1,1	230	T6	1,9	400	100	100	10,2	42	Oil	2012-42		
			3,45	230	T6	6	400	100	100	10,2	42	Oil	2012-43		
	6 pins	2" BSPP	0,75	230	T4	1	500	100	100	10,2	42	Oil	2012-44		
			1,15	230	T6	1,5	500	100	100	10,2	42	Oil	2012-45		
			1,45	230	T6	1,9	500	100	100	10,2	42	Oil	2012-46		
			4,6	230	T6	6	500	100	100	10,2	42	Oil	2012-47		
	6 pins	2 1/2 BSPP	1,65	230	T4	1	650	100	100	8	52	Oil	2012-50		
			2,5	230	T6	1,5	650	100	100	8	52	Oil	2012-51		
			3,15	400	T4	1,9	650	100	100	8	52	Oil	2012-52		
			10	400	T3	6	650	100	100	8	52	Water	2012-53		
6 pins	M77 x 200	2,15	400	T6	1	650	100	100	10,2	78	Oil	2012-55			
		3,15	400	T6	1,5	650	100	100	10,2	78	Oil	2012-56			
		4	400	T4	1,9	650	100	100	10,2	78	Oil	2012-57			
		12,7	400	T4	6	650	100	100	10,2	78	Water	2012-58			
6 pins	DN80 3"	2,15	400	T6	1	650	100	100	10,2	78	Oil	2012-60			
		3,15	400	T6	1,5	650	100	100	10,2	78	Oil	2012-61			
		4	400	T4	1,9	650	100	100	10,2	78	Oil	2012-62			
		12,7	400	T4	6	650	100	100	10,2	78	Water	2012-63			
Flange	6 pins	DN80 3"	3,25	400	T6	1	950	100	100	10,2	78	Oil	Flange 2016-10	Flange 2017-10	
			4,9	400	T6	1,5	950	100	100	10,2	78	Oil	DN80 2016-11	Ø 3" 2017-11	
			6,2	400	T4	1,9	950	100	100	10,2	78	Oil	PN16 FS 2016-12	150lbs RF 2017-12	
			19,6	400	T4	6	950	100	100	10,2	78	Water	EN1092-1 2016-13	Standard B16.5 2017-13	
	6 pins	DN100 4"	5,1	400	T4	1	950	100	100	16	102	Oil	2016-15	2017-15	
			7,7	400	T6	1,5	950	100	100	16	102	Oil	DN100 2016-16	Ø 4" 2017-16	
			9,75	400	T4	1,9	950	100	100	16	102	Oil	PN16 FS 2016-17	150lbs RF 2017-17	
			30,75	400	T3	6	950	100	100	16	102	Water	EN1092-1 2016-18	Standard B16.5 2017-18	
	6 pins	DN125 5"	5,1	400	T4	1	950	100	100	16	122	Oil	2016-20	2017-20	
			7,7	400	T6	1,5	950	100	100	16	122	Oil	DN125 2016-21	Ø 5" 2017-21	
			9,75	400	T4	1,9	950	100	100	16	122	Oil	PN16 FS 2016-22	150lbs RF 2017-22	
			30,75	400	T3	6	950	100	100	16	122	Water	EN1092-1 2016-23	Standard B16.5 2017-23	

EC type examination certificate : LCIE 03 ATEX 6283X

1 1/2 BSPP, M77x200, 2 1/2 BSPP SCREW PLUG AND DN 80 FLANGE II 2 G Ex d IIC WITH REMOVABLE MONOTUBES TO HEAT OIL UP TO 65°C

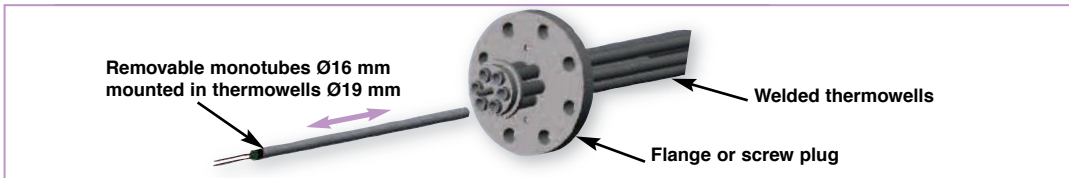
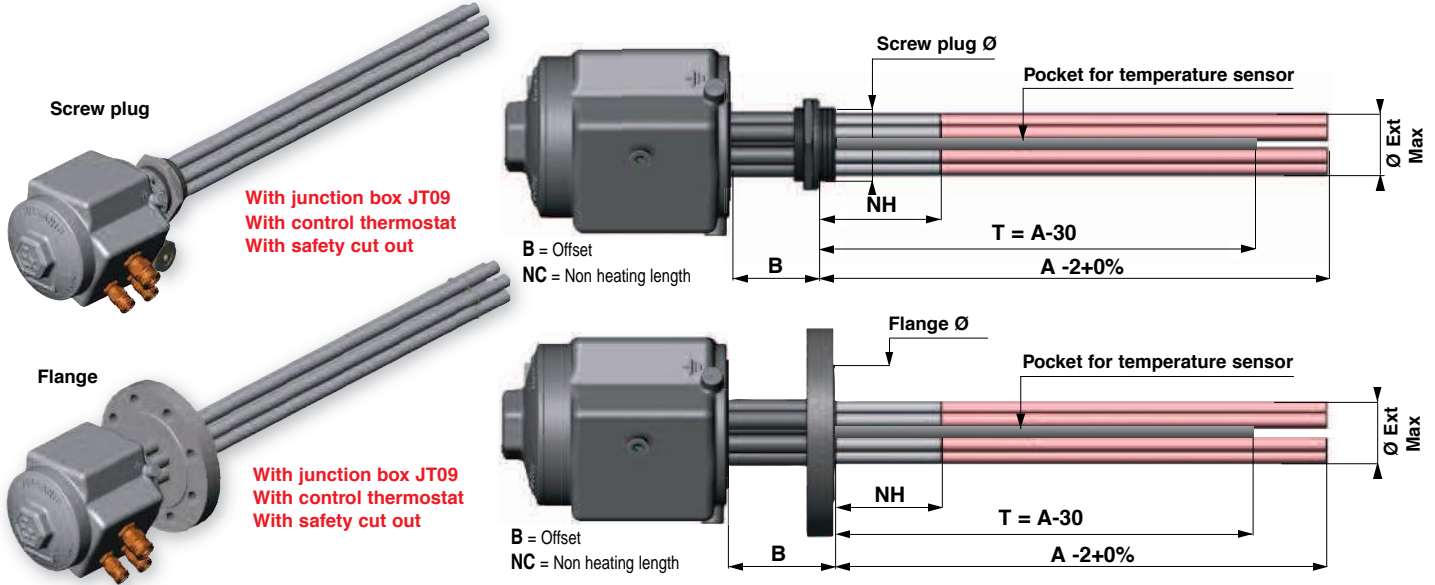

Junction box	JT09 IP 54 (option IP66) Aluminium (available in cast-iron)
Marking	II 2 G Ex d IIC T6
Room temperature	-20°C up to 40°C (Other on request)
Relative humidity	95% Max
Screw plug or flange material	stainless steel - scoured and passivated - welded
Removable monotubes mounted in pockets	316L - scoured and passivated
Control thermostat	0/70°C - Single pole double-throw contacts - 10A / 230V
Safety cut out (manual reset)	50/300°C - Single pole double-throw contacts - 16A / 230V

Qty	Ø Screw plug Ø Flange	Power (kW) +5/-10%	Voltage (V)	Marking Temp.	Load (W/cm ²)	A (mm)	NH (mm)	B (mm)	ØExt Max (mm)	Fluid	P/N.		
Screw plug	6 monotubes	2 1/2 BSPP	2	400	T6	1	650	100	100	72	Oil	3002-34	
			3	400	T6	1	950	100	100	72	Oil	3002-35	
			4	400	T6	1	1200	100	100	72	Oil	3002-36	
			5	400	T6	1	1450	100	100	72	Oil	3002-37	
			6	400	T6	1	1850	100	100	72	Oil	3002-38	
			M77 x 200	2	400	T6	1	650	100	100	72	Oil	3002-40
	3	400	T6	1	950	100	100	72	Oil	3002-41			
	4	400	T6	1	1200	100	100	72	Oil	3002-42			
	5	400	T6	1	1450	100	100	72	Oil	3002-43			
	6	400	T6	1	1850	100	100	72	Oil	3002-44			
	Flange	6 monotubes	DN80 3"	2	400	T6	1	650	100	100	72	Oil	Flange 3002-46
				3	400	T6	1	950	100	100	72	Oil	DN80 3002-47
4				400	T6	1	1200	100	100	72	Oil	PN16 FS 3002-48	
5				400	T6	1	1450	100	100	72	Oil	EN1092-1 3002-49	
6				400	T6	1	1850	100	100	72	Oil	3002-50	
150lbs RF Standard B16.5				Ø 3"	3003-46								
DN100 4"		5	400	T6	1	800	100	100	102	Oil	DN100 3002-52		
		6	400	T6	1	1220	100	100	102	Oil	PN16 FS 3002-53		
		9	400	T6	1	1770	100	100	102	Oil	EN1092-1 3002-54		
		150lbs RF Standard B16.5	Ø 4"	3003-52									
		DN125 5"	5	400	T6	1	800	100	100	122	Oil	DN125 3002-56	
			6	400	T6	1	1220	100	100	122	Oil	PN16 FS 3002-57	
9	400		T6	1	1770	100	100	122	Oil	EN1092-1 3002-58			
150lbs RF Standard B16.5	Ø 5"	3003-56											

EC type examination certificate : LUIE 03 ATEX 6283X



SCREW PLUG 1 1/2 BSPP, M77x200, 2 1/2 BSPP AND FLANGE ND80, ND100, ND125 II 2 G Ex de IIC TO HEAT OIL OR AQUEOUS LIQUIDS UP TO 65°C

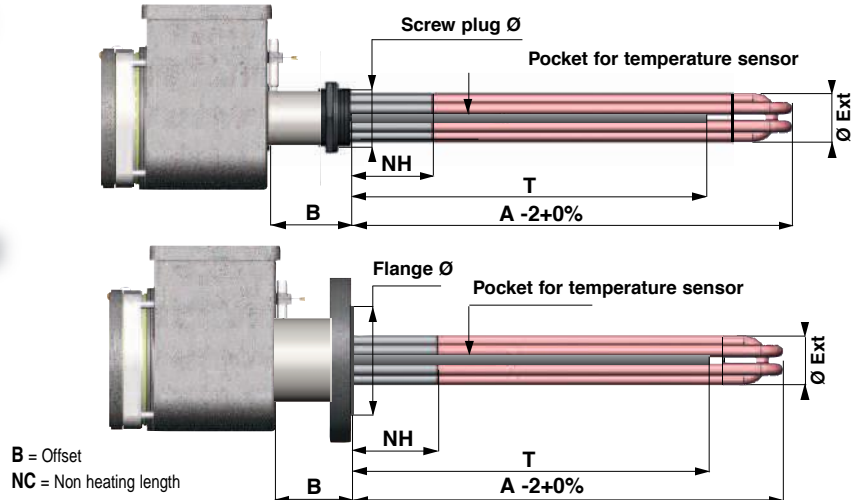
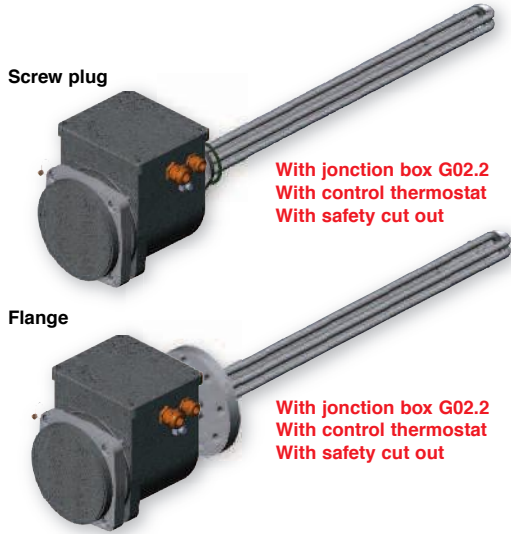

Junction box	G02.2 IP 66 Cast-iron
Marking	II 2 G Ex de IIC T (1,2,3... see the table)
Room temperature	-20°C up to 40°C (Others on request)
Relative humidity	95% Max
Screw plug or flange material	Stainless steel - scoured and passivated - welded
Heating elements	Stainless steel 316L - scoured and passivated
Control thermostat	0/70°C - Single pole double-throw contacts - 10A / 230V
Safety cut out (manual reset)	50/300°C - Single pole double-throw contacts - 16A / 230V

	Qty	Ø Screw plug Ø Flange	Power (kW) +5/-10%	Voltage (V)	Marking. Temp.	Load (W/cm²)	A (mm)	NH (mm)	B (mm)	Pins Ø (mm)	ØExt Max (mm)	Fluid	P/N.	
													Flange	Flange
Screw plug	3 pins	1 1/2 BSPP	0,5	230	T4	1	400	100	100	10,2	42	Oil	2012-70	
			0,9	230	T6	1,5	400	100	100	10,2	42	Oil	2012-71	
			1,1	230	T6	1,9	400	100	100	10,2	42	Oil	2012-72	
			3,45	230	T6	6	400	100	100	10,2	42	Oil	2012-73	
			0,75	230	T4	1	500	100	100	10,2	42	Oil	2012-74	
			1,15	230	T6	1,5	500	100	100	10,2	42	Oil	2012-75	
			1,45	230	T6	1,9	500	100	100	10,2	42	Oil	2012-76	
	4,6	230	T6	6	500	100	100	10,2	42	Oil	2012-77			
	6 pins	2" BSPP	1,65	230	T4	1	650	100	100	8	52	Oil	2012-80	
			2,5	230	T6	1,5	650	100	100	8	52	Oil	2012-81	
			3,15	400	T4	1,9	650	100	100	8	52	Oil	2012-82	
			10	400	T3	6	650	100	100	8	52	Water	2012-83	
6 pins	2 1/2 BSPP	2,15	400	T6	1	650	100	100	10,2	78	Oil	2012-85		
		3,15	400	T6	1,5	650	100	100	10,2	78	Oil	2012-86		
		4	400	T4	1,9	650	100	100	10,2	78	Oil	2012-87		
		12,7	400	T4	6	650	100	100	10,2	78	Water	2012-88		
6 pins	M77 x 200	2,15	400	T6	1	650	100	100	10,2	78	Oil	2012-90		
		3,15	400	T6	1,5	650	100	100	10,2	78	Oil	2012-91		
		4	400	T4	1,9	650	100	100	10,2	78	Oil	2012-92		
		12,7	400	T4	6	650	100	100	10,2	78	Water	2012-93		
Flange	6 pins	DN80 3"	3,25	400	T6	1	950	100	100	10,2	78	Oil	Flange 2016-30	Flange 2017-30
			4,9	400	T6	1,5	950	100	100	10,2	78	Oil	DN80 2016-31	Ø 3" 2017-31
			6,2	400	T4	1,9	950	100	100	10,2	78	Oil	PN16 FS 2016-32	150lbs RF 2017-32
			19,6	400	T4	6	950	100	100	10,2	78	Water	EN1092-1 2016-33	Standard B16.5 2017-33
	6 pins	DN100 4"	5,1	400	T4	1	950	100	100	16	102	Oil	2016-40	2017-40
			7,7	400	T6	1,5	950	100	100	16	102	Oil	DN100 2016-41	Ø 4" 2017-41
			9,75	400	T4	1,9	950	100	100	16	102	Oil	PN16 FS 2016-42	150lbs RF 2017-42
			30,75	400	T3	6	950	100	100	16	102	Water	EN1092-1 2016-43	Standard B16.5 2017-43
	6 pins	DN125 5"	5,1	400	T4	1	950	100	100	16	122	Oil	2016-50	2017-50
			7,7	400	T6	1,5	950	100	100	16	122	Oil	DN125 2016-51	Ø 5" 2017-51
			9,75	400	T4	1,9	950	100	100	16	122	Oil	PN16 FS 2016-52	150lbs RF 2017-52
			30,75	400	T3	6	950	100	100	16	122	Water	EN1092-1 2016-53	Standard B16.5 2017-53

EC type examination certificate : IBExU 07 ATEX 1164X

1 1/2 BSPP, M77x200, 2 1/2 BSPP SCREW PLUG AND DN 80, DN100, DN125 FLANGE II 2 G Ex de IIC WITH REMOVABLE MONOTUBES TO HEAT OIL UP TO 65°C

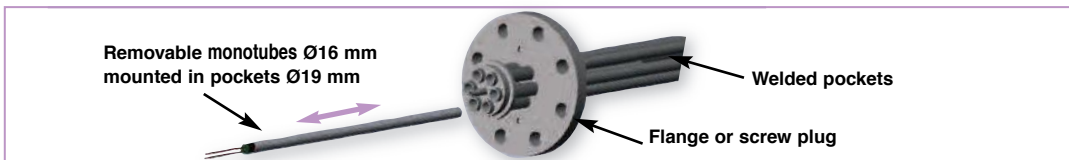
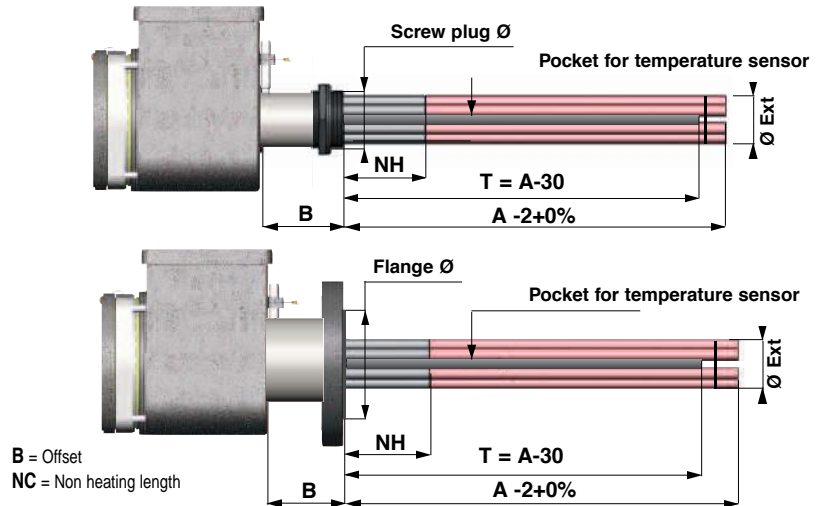

Junction box	G02.2 IP 66 Cast-iron
Marking	II 2 G Ex de IIC T (1,2,3... see the table)
Room temperature	-20°C up to 40°C (Others on request)
Relative humidity	95% Max
Screw plug or flange material	Stainless steel - scoured and passivated - welded
Removable monotubes mounted in pockets	Stainless steel 316L - scoured and passivated
Control thermostat	0/70°C - Single pole double-throw contacts - 10A / 230V
Safety cut out (manual reset)	50/300°C - Single pole double-throw contacts - 16A / 230V

	Qty	Ø screw plug Ø flange	Power (kW) +5/-10%	Voltage (V)	Marking. Marquage	Load (W/cm²)	A (mm)	NH (mm)	B (mm)	ØExt Max (mm)	Liquid	P/N.		
Screw plug	6 monotubes	2 1/2 BSPP	2	400	T6	1	650	100	100	72	Oil	3002-54		
			3	400	T6	1	950	100	100	72	Oil	3002-55		
			4	400	T6	1	1200	100	100	72	Oil	3002-56		
			5	400	T6	1	1450	100	100	72	Oil	3002-57		
			6	400	T6	1	1850	100	100	72	Oil	3002-58		
			6 monotubes	M77 x 200	2	400	T6	1	650	100	100	72	Oil	3002-60
	3	400			T6	1	950	100	100	72	Oil	3002-61		
	4	400			T6	1	1200	100	100	72	Oil	3002-62		
	5	400			T6	1	1450	100	100	72	Oil	3002-63		
	6	400			T6	1	1850	100	100	72	Oil	3002-64		
	Flange	6 monotubes			DN80 3"	2	400	T6	1	650	100	100	72	Oil
			3	400		T6	1	950	100	100	72	Oil	Flange 3002-67	Flange 3003-67
4			400	T6		1	1200	100	100	72	Oil	Flange 3002-68	Flange 3003-68	
5			400	T6		1	1450	100	100	72	Oil	PN16 FS 3002-69	150lbs RF 3003-69	
6			400	T6		1	1850	100	100	72	Oil	EN1092-1 3002-70	Standard B16.5 3003-70	
6 monotubes			DN100 4"	5		400	T6	1	800	100	100	102	Oil	DN100 3002-72
		6		400	T6	1	1220	100	100	102	Oil	PN16 FS 3002-73	150lbs RF 3003-73	
		9		400	T6	1	1770	100	100	102	Oil	EN1092-1 3002-74	Standard B16.5 3003-74	
		DN125 5"	5	400	T6	1	800	100	100	122	Oil	DN125 3002-76	Ø 5" 3003-76	
			6	400	T6	1	1220	100	100	122	Oil	PN16 FS 3002-77	150lbs RF 3003-77	
			9	400	T6	1	1770	100	100	122	Oil	EN1092-1 3002-78	Standard B16.5 3003-78	

EC type examination certificate : IBExU 07 ATEX 1164X



SPECIFICATIONS: DN150 (6") UP TO DN500 (20")

FLANGE		DN150	DN200	DN250	DN300	DN350	DN400	DN450	DN500	
		6"	8"	10"	12"	14"	16"	18"	20"	
Type		2010								
JUNCTION BOX										
Protection modes Ex		d	e	de	d	e	de	d	e	de
Cast iron										
Aluminium										
Steel										
Stainless steel										
TERMINALS										
Heating elements										
Pins Ø10,2 mm		M5		M5		M5				
Pins Ø16 mm		M6		M6		M6				
Monotubes Ø16 mm		Wire		Wire		Wire				
Sealing		WP+160		WP+160		WP+160				
Coupling		3P (Delta or star)								
OFFSET B										
B = 250 (mm)		Horizontal immersion heater - Temperature class T6 up to T3								
B = 450 (mm)		Horizontal immersion heater - Temperature class T1 à T2								
		In the case of an immersion heater has vertical or inclined mounting, contact us.								
FLANGE										
Material		Carbon steel - Stainless steel 304L - 316L - 316Ti								
Flange: EN 1092-1 NP bar		DN150	DN200	DN250	DN300	DN350	DN400	DN450	DN500	
		NP10 to NP63								
Flange: ASME B16.5 ND Class lbs		6"	8"	10"	12"	14"	16"	18"	20"	
		150 - 300 - 400 - 600								
End flange facings		Flate face - Raised face Male face - Female face - Groove face								
HEATING ELEMENTS										
Quantity		DN150	DN200	DN250	DN300	DN350	DN400	DN450	DN500	
Pins Ø10,2 mm		15	27	45	66	78	102	165	174	
Pins Ø16 mm		9	18	27	39	51	57	90	99	
Monotubes Ø16 mm		18	36	54	78	102	114	180	198	
Ø Max of the bundle (mm)		151	197	245	290	317	362	416	460	
Material DN 150 to 500		Pins 10,2		Pins 16		Monotubes 16				
Z2 316L/DIN 1.4404		X		X		X				
Z6 321/DIN 1.4541		X		X		X				
Incoloy 800/DIN 1.4876				X						
Incoloy 825/DIN 2.4858				X						
Steel		X		X		X				
904L/DIN 1.4539		X								
Treatment		Without - scoured - scoured and passivated - Electro polished								
Dimensions (mm)		DN150	DN200	DN250	DN300	DN350	DN400	DN450	DN500	
Tolerance on A length Max = A + B		-2% +0 with mini -10								
		3200mm (Pins Ø10,2 - Ø16) - 2500mm (Monotubes Ø16) (Other leght contact us)								
A Min		450	550	650	750	900	1000	1150	1250	
NC Min		150	150	150	150	200	200	250	250	
Specific load Max - W/Cm ²		Depending on customers application								
Voltage Max		500 V (Pins Ø10,2 and monotubes Ø16) - 750 V (Pins Ø16)								
SAFETY DEVICES										
Fluid	Class	Probe			Assembly					
Liquid	T1 or T2	Thermocouple			mounted in a pocket					
		Thermocouple			welded on heating element					
Liquid	T3 to T6	Fuse probe			mounted in a pocket					
		Thermocouple			mounted in a pocket					
		Thermocouple			welded on heating element					
		Thermostat 50/300°C			mounted in a pocket					
Gas	T1 to T6	Thermostat 50/300°C			welded on heating element					
		Thermocouple			welded on heating element					

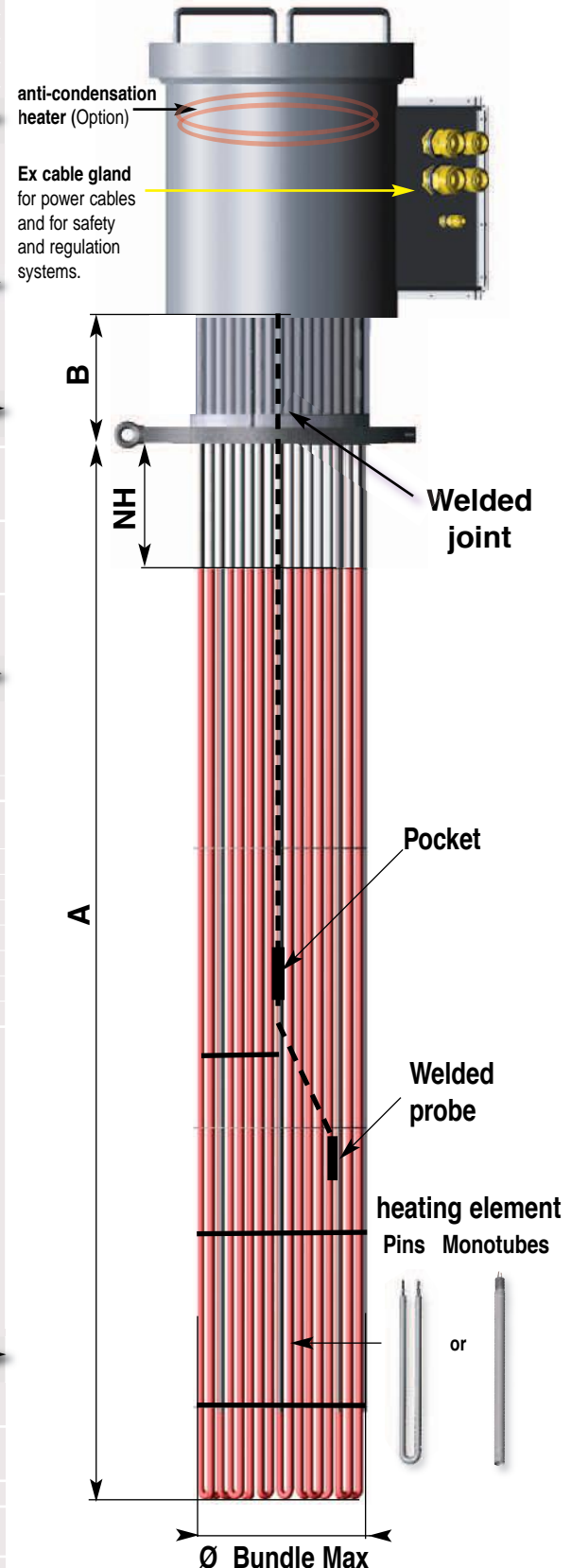

DN 150 UP TO DN 500 FLANGE TO HEAT OIL UP TO 65°C II 2 G Ex de IIC

P/N 2010-xx with pins
P/N 2019-xx with removable monotubes
Junction box Ex de with control thermostat and safety cut out



B = Offset NH = Non heating length

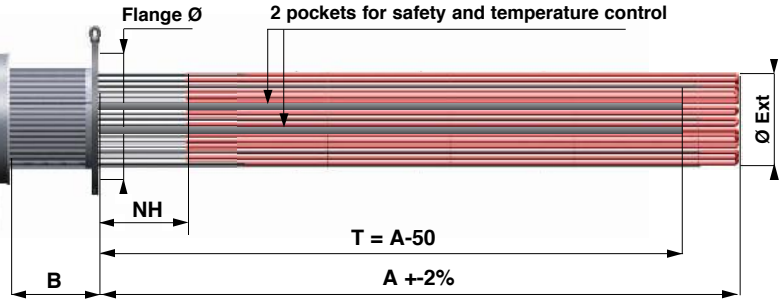

Flange DN150 up to DN500
NP16 RF (EN1092-1)
Flange DN6" to DN20"
150lbs RF (Standard B16.5)

Marking	II 2 G Ex de IIC T (1,2,3... see table)
Room temperature - Relative humidity (Hr)	-20°C up to 40°C (other on request) - Hr = 95% Max
Flange	Stainless steel - scoured and passivated - welded
Pins Ø16 or monotubes mounted in pockets Ø19	Stainless steel 316L - scoured and passivated
Control thermostat	0/70°C - Single pole double-throw contacts - 10A / 230V
Safety cut out (manual reset)	50/300°C - Single pole double-throw contacts - 16A / 230V

Quantity of heating elements	Liquid	Power (kW) +5/-10%	Voltage (V)	Marking	Load (W/cm ²)	A (mm)	NH (mm)	B (mm)	ØExt Max (mm)	Ø flange	P/N.	Ø flange	P/N.				
Pins	Oil	10	400	T6	1,9	750	150	250	151	DN150	2010-05	6"	2010-55				
		15	400	T6	1,9	1050	150	250	151		2010-06		2010-56				
		20	400	T6	1,9	1350	150	250	151		2010-07		2010-57				
		31	400	T6	1,9	1950	150	250	151		2010-08		2010-58				
		39	400	T6	1,9	2450	150	250	151		2010-09		2010-59				
		48	400	T6	1,9	2950	150	250	151		2010-10		2010-60				
		18	Oil	31	400	T6	1,9	1050	150		250		197	DN200	2010-11	8"	2010-61
				41	400	T6	1,9	1350	150		250		197		2010-12		2010-62
				61	400	T6	1,9	1950	150		250		197		2010-13		2010-63
	27	Oil	62	400	T6	1,9	1350	150	250	245	DN250	2010-16	10"	2010-66			
			93	400	T6	1,9	1950	150	250	245		2010-17		2010-67			
			118	400	T6	1,9	2450	150	250	245		2010-18		2010-68			
	39	Oil	144	400	T6	1,9	2950	150	250	245	DN250	2010-19	10"	2010-69			
			89	400	T6	1,9	1350	150	250	290		DN300		2010-20	12"	2010-70	
			134	400	T6	1,9	1950	150	250	290				2010-21		2010-71	
	171	400	T6	1,9	2450	150	250	290	2010-22	2010-72							
	208	400	T6	1,9	2950	150	250	290	2010-23	2010-73							
	51	Oil	170	400	T6	1,9	1950	200	250	317	DN350	2010-24	14"	2010-74			
219			400	T6	1,9	2450	200	250	317	2010-25		2010-75					
268			400	T6	1,9	2950	200	250	317	2010-26		2010-76					
57	Oil	190	400	T6	1,9	1950	200	250	362	DN400	2010-27	16"	2010-77				
		245	400	T6	1,9	2450	200	250	362		2010-28		2010-78				
		299	400	T6	1,9	2950	200	250	362		2010-29		2010-79				
99	Oil	416	400	T6	1,9	2450	250	250	460	DN500	2010-30	20"	2010-80				
		510	400	T6	1,9	2950	250	250	460		2010-31		2010-81				
		Removable monotubes	Oil	6,5	400	T6	1	750	150		250		151	DN150	2019-01	6"	2019-51
10	400			T6	1	1050	150	250	151	2019-02	2019-52						
13	400			T6	1	1350	150	250	151	2019-03	2019-53						
19	400			T6	1	1950	150	250	151	2019-04	2019-54						
24,5	400			T6	1	2450	150	250	151	2019-05	2019-55						
30	400			T6	1	2950	150	250	151	2019-06	2019-56						
36	Oil		19	400	T6	1	1050	150	250	197	DN200	2019-07	8"	2019-57			
			25	400	T6	1	1350	150	250	197		2019-08		2019-58			
			38	400	T6	1	1950	150	250	197		2019-09		2019-59			
49	400		T6	1	2450	150	250	197	2019-10	2019-60							
60	400		T6	1	2950	150	250	197	2019-11	2019-61							
54	Oil		38	400	T6	1	1350	150	250	245	DN250	2019-12	10"	2019-62			
			57	400	T6	1	1950	150	250	245		2019-13		2019-63			
			74	400	T6	1	2450	150	250	245		2019-14		2019-64			
90	400		T6	1	2950	150	250	245	2019-15	2019-65							
78	Oil		55	400	T6	1	1350	150	250	290	DN300	2019-16	12"	2019-66			
			83	400	T6	1	1950	150	250	290		2019-17		2019-67			
			106	400	T6	1	2450	150	250	290		2019-18		2019-68			
130	400	T6	1	2950	150	250	290	2019-19	2019-69								
102	Oil	105	400	T6	1	1950	200	250	317	DN350	2019-20	14"	2019-70				
		136	400	T6	1	2450	200	250	317		2019-21		2019-71				
		166	400	T6	1	2950	200	250	317		2019-22		2019-72				
114	Oil	118	400	T6	1	1950	200	250	362	DN400	2019-23	16"	2019-73				
		152	400	T6	1	2450	200	250	362		2019-24		2019-74				
		186	400	T6	1	2950	200	250	362		2019-25		2019-75				
198	Oil	258	400	T6	1	2450	250	250	460	DN500	2019-28	20"	2019-76				
		317	400	T6	1	2950	250	250	460		2019-29		2019-77				

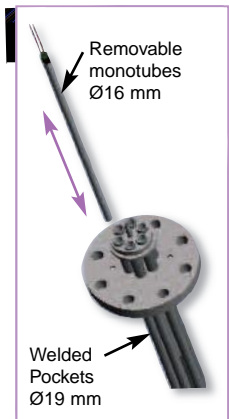

ACCESSORIES FOR SCREW PLUG AND FLANGE IMMERSION HEATERS

Wave stop LID
Avoid the distortion due to the welding assembly
Screw the wave stop LID before welding

Ø Thread	P/N.	Description
M45 x200	9639-00	Carbon steel lid
	9639-01	304L lid
M77 x200	9640-00	Carbon steel lid
	9640-01	316L lid

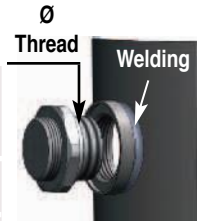

SPANNER WIDTH	
P/N.	Description
M77 2"1/2	4510-99 96 Pipe wrench
1"1/2 - 2" M45	4509-99 62 Pipe wrench
M77 2"1/2	4511-99 96 Pipe wrench
1"1/2 - 2" M45	4512-99 62 openend spanner

Only for screw plug without junction box



Mounting on welding sleeve

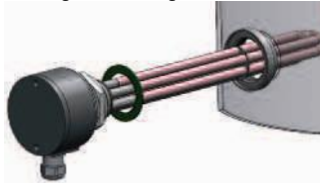

Mounting with reduction sleeve

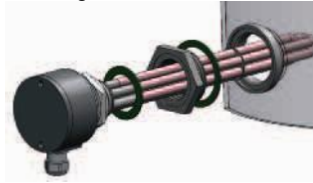

Mounting on flange threaded

Allows to transform a screw plug heater M77 in flange immersion heater

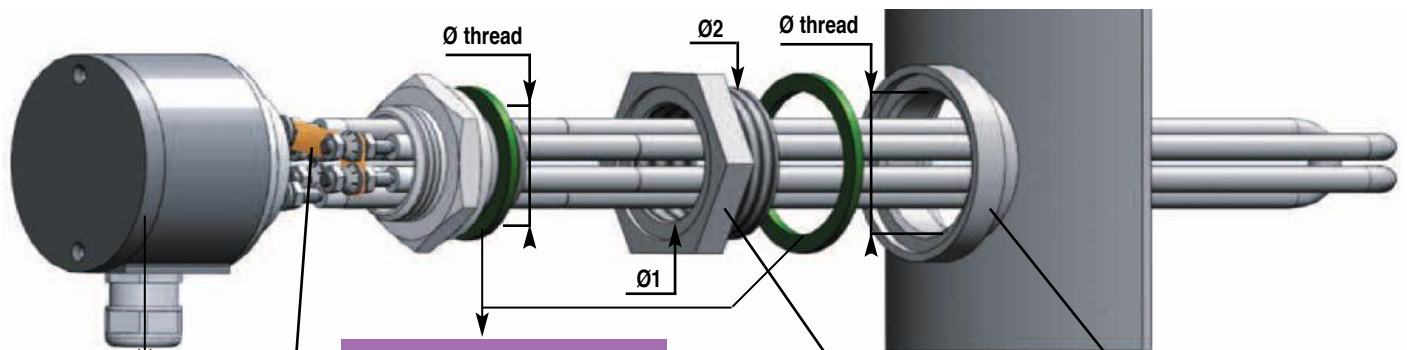
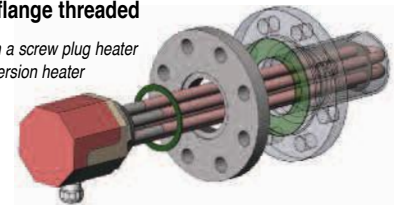

JUNCTION BOX CONTROL THERMOSTAT CABLE GLAND
SEE ON PAGES 41-42-43

GASKET		
Ø Thread	P/N.	Description
1/4" BSPP	51931-10	Set of 10 Metalo Plastic gasket
	52073-01	1 Copper gasket
1"1/2 BSPP	51935-10	Set 10 Metalo plastic gasket
	52074-01	1 Copper gasket
2" BSPP	51937-10	Set of 10 Klingersil gasket
	51939-10	Set of 10 Klingersil gasket
2"1/2 BSPP	51934-10	Set of 10 Klingersil gasket
	51954-10	Set of 10 Metalo plastic gasket
M45 x200	51938-10	Set of 10 Klingersil gasket
	51958-10	Set of 10 Metalo plastic gasket
M77 x200	51938-10	Set of 10 Klingersil gasket
	51958-10	Set of 10 Metalo plastic gasket

REDUCTION SLEEVE THREADED			
Ø1	P/N.	Material	Ø2
1"1/2 BSPP	52078-01	Copper brass	2" BSPP
M45 x200	4527-01	Carbon steel	M77 x200
	4527-08	Stainless steel	

REDUCTION FLANGE THREADED			
Transform a screw plug in flange imm. heater			
Ø1	P/N.	Description	DN
M77 x200	2081-89	Flange NP16 FS Carbon steel A37	DN80
	2081-88	Flange NP16 FS 316L	DN80
	2081-87	Flange NP16 FS 316L	DN100

WELDING SLEEVE		
Ø Thread	P/N.	Description
1"1/2 BSPP	52079-01	Sleeve 304L
	52080-01	Sleeve 316L
	52081-01	Sleeve Carbon steel
M45 x200	9623-01	Sleeve Carbon steel
	9623-03	Sleeve 304L
M77 x200	9624-01	Sleeve Carbon steel
	9624-03	Sleeve 304L
	9624-04	Sleeve 316L

Copper connections clips	
52732-01	3 heating elements
52732-02	6 heating elements
52732-03	9 heating elements
Ø8 mm with threaded terminals M4	
52732-10	3 heating elements
52732-11	6 heating elements
52732-12	9 heating elements
Ø10,2 mm with threaded terminals M5	
52732-23	3 heating elements
52732-26	6 heating elements
Ø16 mm with threaded terminals M6	

Each set contains right-angled connection clips for cross pattern circuits in single or triple phases with delta, star or parallell coupling according the instruction manual supplied with the immersion heater.

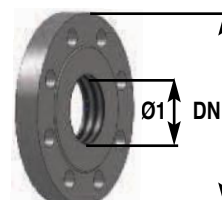

SELECTING YOUR REMOVABLE IMMERSION HEATER

Removable immersion heaters are the best way to heat up liquids in open containers.

The application of an immersion heater determines its shape and dimensions.

Therefore, it is necessary to know the properties of the liquid to be heated, the volume of the tank, the time required for the rise in temperature, and the minimum depth of liquid in the tank. On the basis of this information your Vulcanic expert will be able to select you the right immersion heater.

The diagrams opposite, show a selection of VULCANIC products range and shapes.

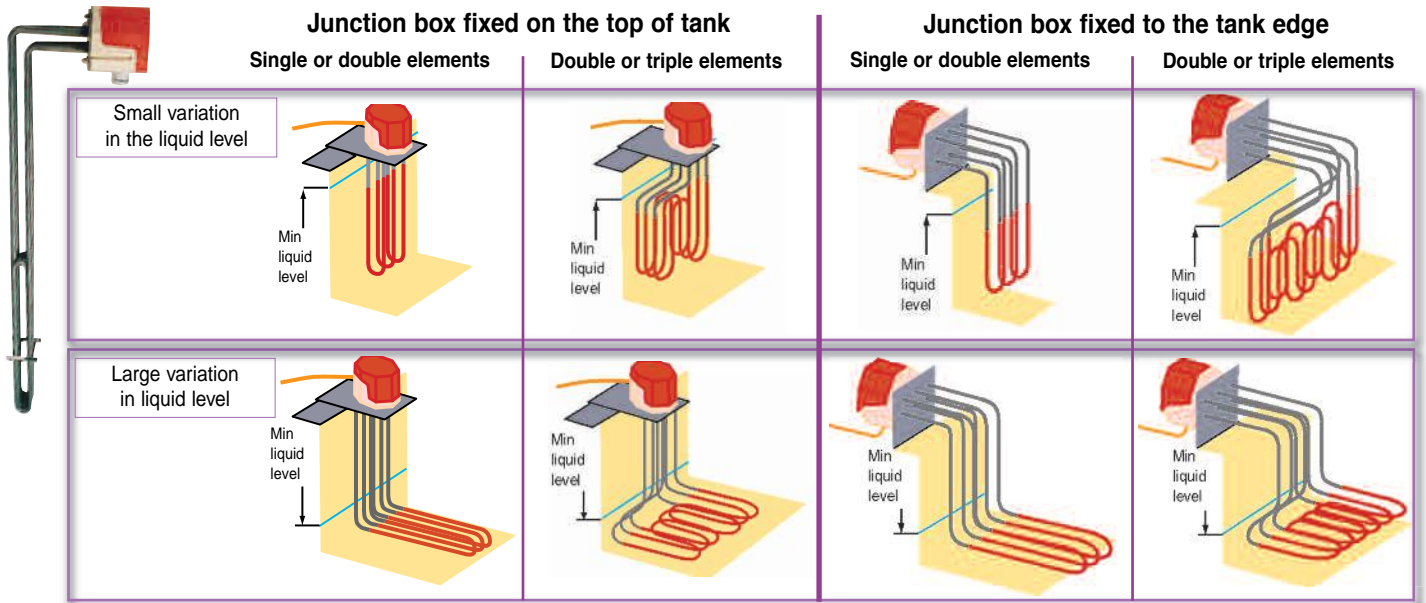

CARBON STEEL WITH ALUMINIUM COATING



For Oil (2 W/cm²), water and alkaline baths.

Consists of a ceramic core element in an aluminium plated steel tube, with IP 55 IK5 junction box in fiberglass reinforced polyamide and cable gland Iso 20 bis.

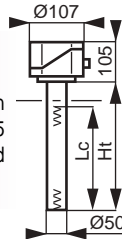

P/N.	Power. +5 -10%	Voltage	Specific load (W/cm ²)	Ht (mm)	Lc (mm)	Weight (kg)
5005-01	1000 W	230V mono	2	450	350	2
5005-07	2000 W	230V mono.	4	450	350	2
5005-02	2000 W	230V mono	2	700	600	3
5005-08	3000 W	230V mono	4	700	550	3
5005-03	3000 W	230V mono	2	900	750	3,5
5005-09	4000 W	230V Tri	4	900	700	3,5

Accessories for types 5005 and 5150 :

- Stainless steel fixing bracket for horizontal tank edge fitting. P/N. 5090-01 (weight 0,04 Kg)



STAINLESS STEEL 304L/DIN 1.4306



For water and very dilute acids.

Consists of a ceramic core element in a stainless steel tube with IP 55 IK5 junction box in fiberglass reinforced polyamide 6/6 and cable gland ISO 20 bis.

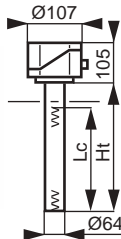

P/N.	Power. +5 -10%	Voltage	Specific load (W/cm ²)	Ht (mm)	Lc (mm)	Weight (kg)
5150-01	1000 W	230V mono	2	450	350	2
5150-04	2000 W	230V mono	4	450	350	2
5150-02	2000 W	230V mono	2	700	600	3
5150-05	3000 W	230V mono	4	700	500	3
5150-03	3000 W	230V mono	2	900	750	3,5
5150-06	4000 W	230V Tri	4	900	600	3,5

Stainless steel fixing bracket for horizontal tank edge fitting. P/N.5145-01

- (weight 0,04 Kg)

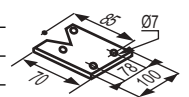

TITANIUM



For chrome baths.

Consists of a ceramic core element in a titanium tube with sealed neoprene junction box. Connection by cable, length approx. 1,5 m.

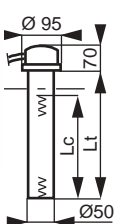

P/N.	Power. +5 -10%	Voltage	Specific load (W/cm ²)	Ht (mm)	Lc (mm)	Weight (kg)
5126-01	1000 W	230V mono	1,8	450	350	2,2
5126-04	2000 W	230V mono	3,6	450	350	2,2
5126-02	2000 W	230V mono	1,8	700	600	2,9
5126-05	3000 W	230V mono	3,6	700	550	2,9
5126-03	3000 W	230V mono	1,8	900	750	3,6
5126-06	4000 W	230V Tri	3,6	900	700	3,6
5126-07	4000 W	400V Tri	3,6	900	700	3,6

Accessories for types 5126-5019 :

- Stainless steel fixingbracket P/N. 9652-01 (weight 0,135 kg)

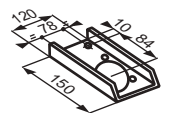

HEATING BELTS FOR DRUMS

Leakproof models allowing the heating of viscous products in drums, such as wax, grease, pomade, gelatin, organic acids, tar, asphalt, coal-tar... Light, easy to install, robust, these heating belts avoid all carbonization of the product because of its large surface (load 1w/cm²). To be installed on the bottom. Male and female plugs supplied. Voltage : 230V 1P. Height 120mm. For drums 50 to 500 litres up to 200°C Supply voltage : 230 VAC. 1P
On request : Supply voltage 110 VAC, Other thermostat -5 to 40 °C

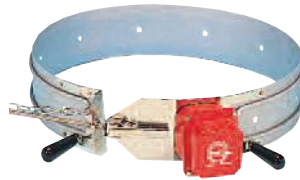

Option: Thermostat range 0 /+ 200°C, controls the temperature of the product to be heated.

P/N. without Thermostat	P/N. with Thermostat	Power. +5 -10%	Ø Range (mm)	Weight (kg)
7507-01	7507-02	2500 W	570-615	6,3
7507-15	7507-16	1000 W	350-370	4,2
7507-13	7507-14	1000 W	370-395	4,4
7507-11	7507-12	1250 W	395-420	4,8
7507-09	7507-10	1250 W	420-445	5,1
7507-07	7507-08	1500 W	445-490	5,4
7507-05	7507-06	1750 W	490-530	6,0
7507-03	7507-04	2000 W	530-570	6,4
7507-17	7507-18	2500 W	610-650	7,3
7507-19	7507-20	2500 W	650-710	7,8

FLEXIBLE HEATING BELTS FOR DRUMS

Flexible models with high mechanical strength fitted with an adjustable thermostat 20/120°C. Designed to heat drums from 25 to 200 litres according to the model, these belts consist of a heating element embedded in a flexible silicone panel. Power supply cable length : 2m.
Voltage : 230V 1P. Electrical box : 115 x 70 x 60 - Protection class : IP 43



Spare part : Female connector P/N. 9565-01 (weight 0,04 kg).
Control thermostat (IP 42 IK 7) : 7507-99.

DRUM HEATERS FOR PLASTIC DRUMS

The heaters are specifically designed to melt or reduce the viscosity of soap, fats, varnishes and oil based type of products. This drum heater is stitched into an insulated jacket made from a water-resistant Teflon/Polyester material, insulated with glass filament complete, with quick release buckles for ease of installation and removal. The heating elements are made of double insulated construction for safety. Each heater is fitted with a control thermostat (0/90°C). Flexible tough rubber sheathed supply cable, length 3 m.
Supply voltage : 230 VAC. 1P
On request : Supply voltage 110 VAC, Other thermostat -5 to 40 °C



P/N.	Ø range (mm)	Height (mm)	Capacity (l)	Power. +5-10%	Weight (kg)
7531-01	577/605	125	200	1000 W	2,2
7531-02	463/490	125	120	800 W	2
7531-03	320/330	125	55	500 W	1,5
7531-04	275/285	125	25	300 W	2,2
7531-05	350/360	125	60	600 W	1,5
7531-10	577/605	180	200	1000 W	2,2
7531-15	577/605	180	200	1500 W	2,2

GAS BOTTLE HEATER

This gas bottle heater is designed with a flexible heating red face and an insulated blue face. Temperature maintenance up to 55°C max, by compensating the bottle cooling down due to the gas expansion, and thus to avoid the pressure fall which prevents gas from flowing out the bottle.
• 2 heating sections which are regulated separately.
• Protection : IP54.
• Main supply length : 3000 mm.



P/N.	Circumference (mm)	Height (mm)	Capacity (l)	Power +5-10%
7535-05	1020	400	25	200 W
7535-07	1250	460	50	250 W
7535-08	1650	370	105	400 W
7535-06	1950	450	200	450 W

CONTAINER HEATERS

The container heaters are designed to heat products stored in 1000 litre intermediate bulk containers. Two types of heaters are available.
• The 7540-01/ 02 is a silicone mat heater for placement **below** the container liner before filling. An insulation jacket covering four sides and the lid is also available to aid warming up time.
Performance : - water temp. from 15°C to 70°C in 42 hours (without insulated jacket)
- water temp. from 15°C to 70°C in 30 hours (with insulated jacket)
• The 7540-03/ 04, an insulated nylon heater jacket, which covers all four sides and has an optional insulated lid.
Performance : - water temp. from 15°C to 55°C in 56 hours (without insulated lid)
- water temp. from 15°C to 80°C in 56 hours (with insulated lid)
On request (7540-03/04) : - supply voltage 110 VAC
- other thermostat -5 / + 40 °C



P/N.	Power. +5-10%	Voltage (V)	Thermostat	Jacket Insulated
7540-01	2700 W	230	0/90°C	no
7540-02	2700 W	230	0/90°C	yes

P/N.	Power. +5-10%	Voltage (V)	Thermostat	Jacket Insulated	Lid Insulated
7540-03	2x1000 W	240	0/90°C	yes	no
7540-04	2x1000 W	240	0/90°C	yes	yes

DRUM WRAPPING HEATERS

These wrapping heating systems are especially designed to heat drums, allow to liquefy products such as asphalt, grease, resin... Composed of a metal base plate, protected by a high temperature coating with a diameter of 600 mm, this heater especially designed for the 200 litre drums. The heated plate is equipped with a thermostat 0 / 150 ° C
Supply cable length = 2 m
Dimensions plate: Ø = 600mm H = 70mm
Overall dimensions L = 880mm s = 600 mm H = 105 mm

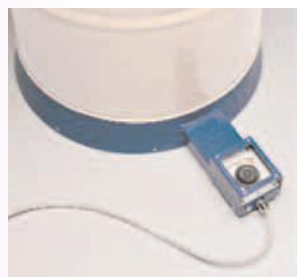

P/N.	Power +5-10%	Voltage (V)	Weight (kg)	Description
7535-55	900 W	230 mono	20	base

CIRCULAR PTFE TANK BOTTOM HEATERS

Especially suited for frost protection and made of fluoropolymer, the circular heaters allows heating or maintenance of temperature of corrosive chemical baths in storage tanks.

The flexible heating element is fixed to a flexible circular support. This form allows insertion into a tank through a 'manhole'.

Diam 200mm min. with models A to F

Diam 500mm .min with models G to K.

Circular PTFE heaters offer a simple, economical solution for heating liquids in storage tanks.

Made of Teflon®

Load 1 W/cm², max. temperature 90°C, without gland.

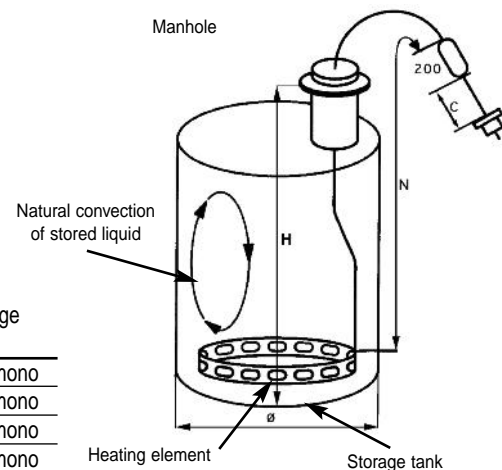

Model	Ø Element (mm)	Power (kW)	Voltage (V)
A	600	1	230 mono
B	600	2	230 mono
C	900	1	230 mono
D	900	3	230 mono
E	1100	1	230 mono
F	1100	6	400 Tri
G	1500	2	230 mono
H	1500	9	400 Tri
J	1900	3	230 mono
K	1900	12	400 Tri

No	Type	Coating	Frame in
26495		FEP	PVDF
26458		PFA	PVDF
26497		FEP	PP
26468		PFA	PP

Important : Types 26458 A to K are supplied without gland (90°C max.) ; other models can be operated up to 100°C when fitted with a sealing gland. Other options on request : single phase or three phase voltage, intermediate powers and loads, cable entry via gland or flange. Teflon® -coated PT 100 probe or TC/J thermocouple positioned on the descending supply cable. Dimensions N and C are tailor made.

When ordering state : PTFE immersion heater : Type :Model : - Frame in : PVDF or PP
Power (kW) : - Voltage (V) : - Dimension N (mm) : - Dimension C (mm) : - Dimension H (mm) :
IMPORTANT : Dimension N is the length of cable between the heating element and the connection. It must be long enough for the connector to be clear of vapour.

Polytetrafluoroethylene (PTFE) is a fluoropolymer. Other polymers with similar composition are known under the Teflon name: **Fluorinated ethylene-propylene (FEP)** and **perfluoroalkoxy polymer resin (PFA)**. They retain the useful properties of PTFE.
Polypropylene (PP) is a thermoplastic polymer.

CYLINDRICAL PTFE IMMERSION HEATERS

When ordering state :

PTFE immersion heater : Type :

Model : - Frame in : PVDF or PP

Power (kW) : - Voltage (V) :

Dimension N (mm) : - Dimension C (mm) : - Dimension X (mm)

Horizontal or vertical fitting.

IMPORTANT : Dimension N is the length of cable between the heating element and the connection. It must be long enough for the connector to be clear of vapor.

Horizontal fitting			
No	Type	Coating	Frame in
26477		FEP	PVDF
26456		PFA	PVDF
26487		FEP	PP
26466		PFA	PP
Vertical fitting			
No	Type	Coating	Frame in
26475		FEP 1 couche	PVDF
26451		PFA 2 couches	PVDF
26485		FEP 1 couche	PP
26461		PFA 2 couches	PP

Dimensions N, C et X are made to order

Model	Power ± 10%	Voltage (V)	A (mm)	ØD (mm)
A	1000 W	230 mono	280	85
B	2000 W	230 mono	410	85
C	3000 W	230 mono	650	85
D	4000 W	230 mono	780	85
E	4500 W	400 Tri	630	120
F	6000 W	400 Tri	1140	85
G	9000 W	400 Tri	1200	120
H	12000 W	400 Tri	1395	120

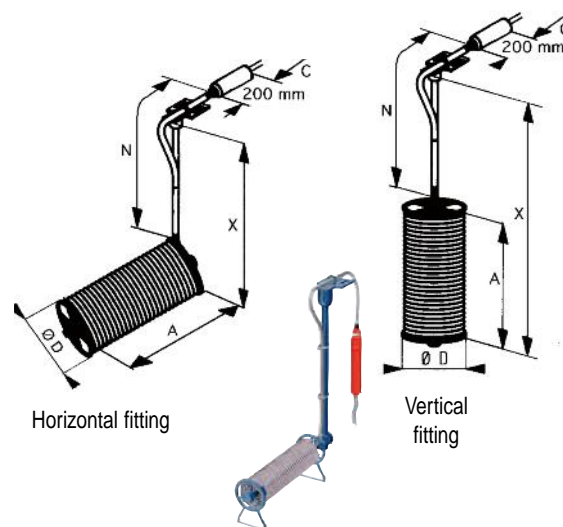

IMPORTANT : The heating area must be covered by at least 20 cm of liquid.

TEFLON® COATED PT100 PROBES

These probes mounted on a holder in PVDF are an essential accessory for the PTFE immersion heaters. Designed to be mounted on the tank edge. They allow to measure the temperature of the heated fluid. Several models are available to fit on different tanks. Connection leads : 1m.

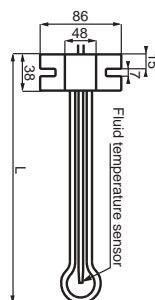

P/N.	L (m)
31170-01	0,5
31170-02	1,0
31170-03	1,5
31170-04	2,0



RIGID TEMPERATURE PROBES

Thermocouples or PT100 Teflon coated probes mounted on plunger with a sealing gland in PVDF or in PP. Standard length 0,5 m available up to 5m. Connection leads : 1m.

P/N.	Plonger material	Type of probe
31981-02	PVDF	Pt 100 ohms - 3 wires
31981-04	PVDF	TC/J
31981-05	PVDF	TC/K
31981-07	PP	Pt 100 ohms - 3 wires
31981-09	PP	TC/J
31981-10	PP	TC/K

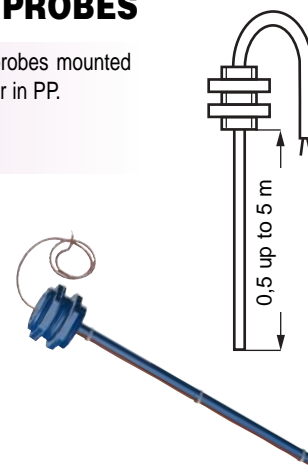

HORIZONTAL OR VERTICAL PTFE IMMERSION HEATERS

Horizontal fitting			
No	Type	Coating	Frame in
26477	FEP	1 couche	PVDF
26456	PFA	2 couches	PVDF
26487	FEP	1 couche	PP
26466	PFA	2 couches	PP

Vertical fitting			
No	Type	Coating	Frame in
26475	FEP	1 couche	PVDF
26451	PFA	2 couches	PVDF
26485	FEP	1 couche	PP
26461	PFA	2 couches	PP

Model	Power. ± 10%	voltage (V)	J (mm)	K (mm)
A	1000 W	230 mono	240	250
B	1000 W	230 mono	185	305
C	2000 W	230 mono	295	315
D	2000 W	230 mono	210	420
E	3000 W	230 mono	385	395
F	3000 W	230 mono	265	470
G	4000 W	230 mono	405	420
H	4000 W	230 mono	285	475
J	4500 W	400 Tri	420	440
K	4500 W	400 Tri	305	480
L	6000 W	400 Tri	475	540
M	6000 W	400 Tri	350	550
N	9000 W	400 Tri	600	675
P	9000 W	400 Tri	425	685
R	12000 W	400 Tri	585	785
S	12000 W	400 Tri	425	800

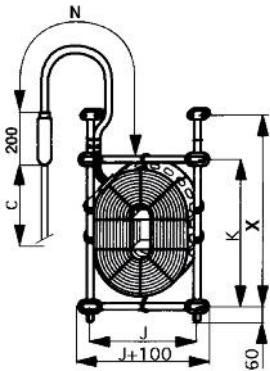
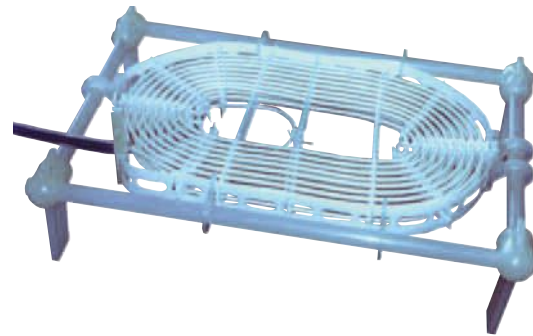

Dimensions **N**, **C** and **X** are made to order :

X = height of immersion heater fixing arms on tank edge
< height of tank.

N = Length of supply cable descending into tank.

This dimension must be large enough for the connector to be clear of vapour.

C = Length of electric supply cable.

Caution : Frame size = $(J + 100) \times (K + 100)$

When ordering state :

PTFE immersion heater : Type : 26450/453/460/463/472/474/482 or 484

Model : - Frame in : PVDF or PP

Coating : FEP (1 coat) or PFA (2 coats)

Power (kW) : - Voltage (V):

Dimension **N** (mm) : - Dimension **C** (mm): - Dimension **X** (mm):

Application : horizontal or vertical.

IMPORTANT : Dimension **N** is the length of cable between the heating element and the connection. It must be long enough for the connector to be clear of vapour.

For horizontal fitting, add feet : in PVDF , **P/N. 26450-03**,
in PP **P/N. 26450-53**.

Accessories :

- Outdoor frame bracket in PVDF. P/N. **26450.01**, in PP P/N. **26450-51**
- 4 feet, height 100 mm, in PVDF. P/N. **26450-03**, in PP P/N. **26450-53**

Needed for horizontal fitting as tank bottom heater

- Protective grid in PP. Type 26452 +type code (A, B, C ...)
- Teflon® -coated temperature probe Pt100, length 8 m. P/N. **26216-01**
(see section " Temperature probes")
- Pt 100 temperature probe, fixing to immersion heater, length 1,5 m P/N. **26250-98**, length 3,5 m P/N. **26450-97**
- TC J probe, fixing to immersion heater : length 1,5 m P/N. **26250-97**
length 3,5 m P/N. **26450-95**

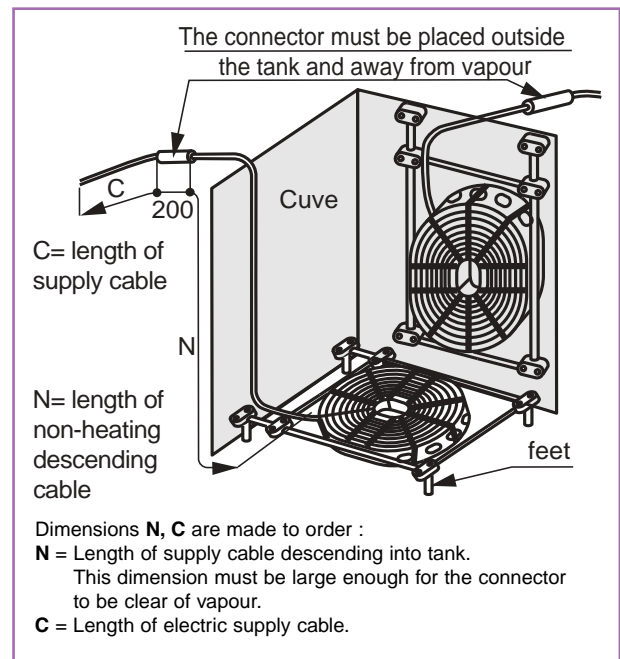

Polytetrafluoroethylene (PTFE) is a fluoropolymer. Other polymers with similar composition are known under the Teflon name: **Fluorinated ethylene-propylene (FEP)** and **perfluoroalkoxy polymer resin (PFA)**. They retain the useful properties of PTFE. **Polypropylene (PP)** is a thermoplastic polymer.

These appliances are used to heat circulating fluids such as water, fuel oil, as well as air or gases in general at up to 15 bar max. They are fitted with a screw plug immersion heater and a safety thermostat.

Fluid circulation heaters can be connected hydraulically in series, which allows a very large heating power to be achieved.

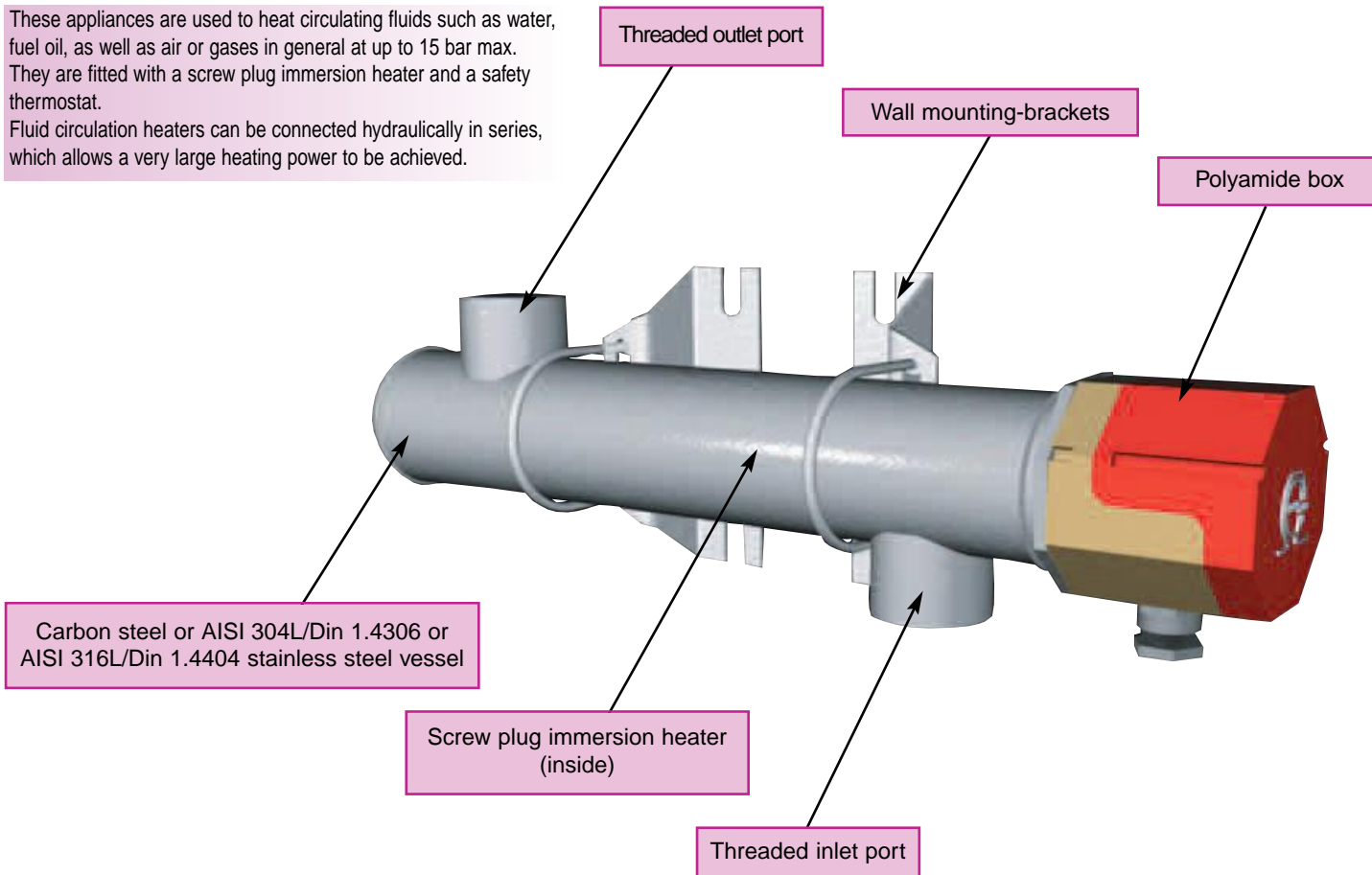

ALL COMPONENTS FROM ONE SOURCE.

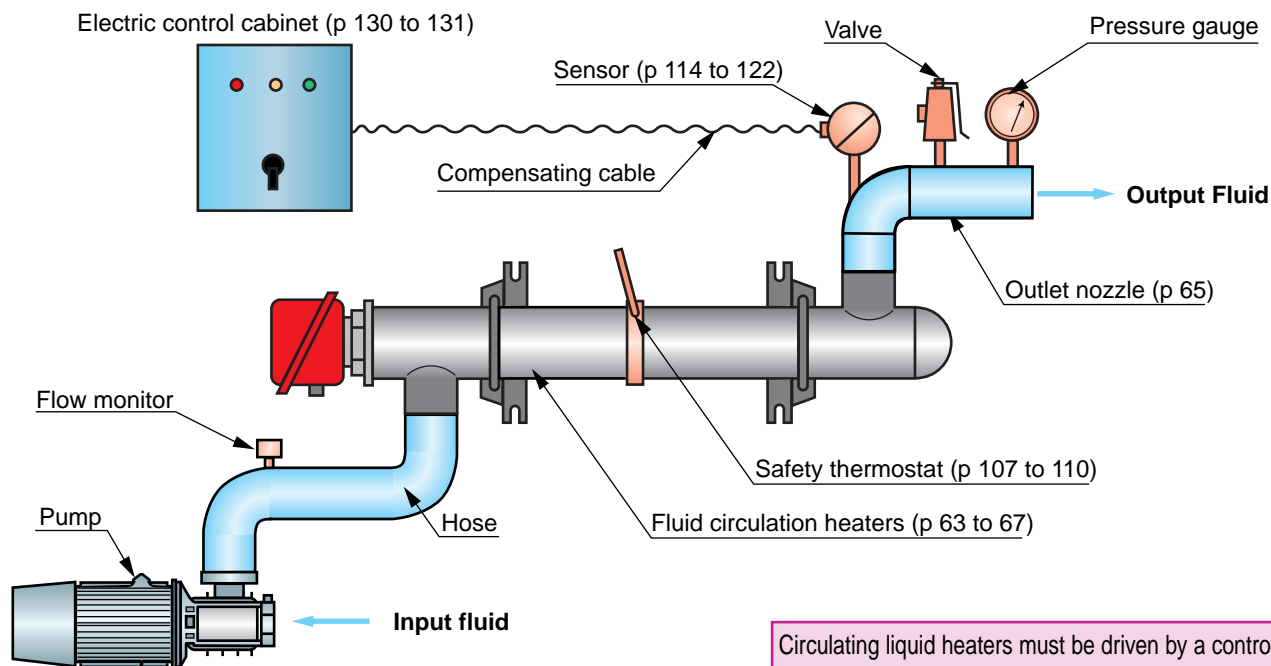

Circulating liquid heaters must be driven by a control system which is independent from the safety system and measures the fluid output temperature.

DN 20 TO DN 40 LOW FLOW FLUID INLINE HEATERS

Appliances conform to DESP 97/23/CE article 3 § 3.

To heat air, water or oil in open or closed circuits, at a maximum pressure of 10 bar.

Vessel in stainless steel AISI 316L/Din 1.4044 with BSP threaded inlet/ outlet. With cartridge in stainless steel (AISI 321/Din 1.4541), fitted with type K thermocouple.

The heaters are to be installed in series on rigid pipework. No other fixing needed for connecting the heater to the pipework.

For fluid output temperatures > 60°C, thermal insulation is needed.

AVAILABLE IN 3 VERSIONS :

- Connection by leads, without temperature sensor
- With connection box and PT100 temperature sensor
- With connection box and TC/J temperature sensor

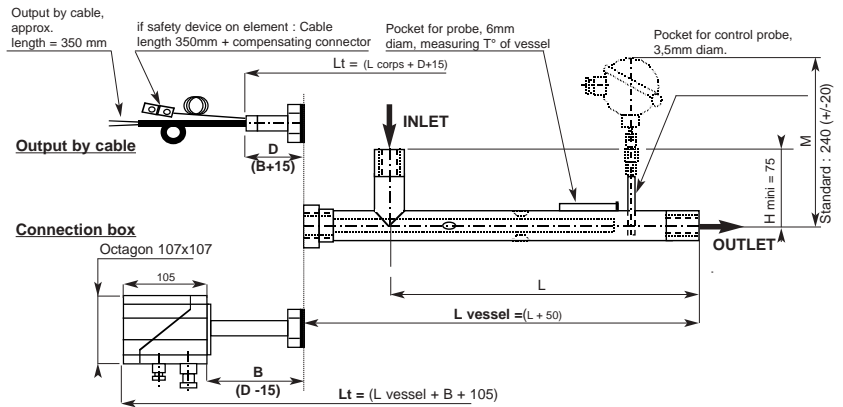

Models without connection box or temperature sensor

Max. output temperature	P/N.	Power +5/-10%	Voltage (V)	Min. output	Max. recommended	Pressure loss mm of WC*	Lt (mm)	D (mm)	L (mm)	H Vessel inside (mm)	Vessel inside Ø (mm)	I/O BSPP	Spare. element No	Weight (kg)
Models for gas (air, nitrogen) 350°C max	10706-01	500 W	230 1 p	20 kg/h	60 kg/h	300 at 5 bar	770	245	460	150	23,7	1/2"	60301-00	1,3
	10706-02	1000 W	230 1 p	40 kg/h	120 kg/h	250 at 5 bar	1130	245	820	150	29,7	3/4"	60302-00	2,7
	10706-03	2000 W	230 1 p	80 kg/h	240 kg/h	200 at 5 bar	1720	245	1410	150	40,9	1 1/4"	60303-00	8,8
Models for softened or treated water 140°C max.	10706-31	2000 W	230 1 p	0,2 m³/h	1 m³/h	300	580	55	460	150	23,7	1/2"	4500226-00	1,2
	10706-32	3000 W	230 1 P	0,5 m³/h	2,5 m³/h	300	750	55	630	150	29,7	3/4"	4500227-00	1,5
	10706-33	5500 W	400 3 P	1 m³/h	5 m³/h	300	1050	55	930	150	40,9	1 1/4"	4500228-00	2,2
Models for oil 200°C max.	10706-41	500 W	230 1 P	0,2m³/h	0,8 m³/h	250 at 100°C**	730	135	530	150	23,7	1/2"	60307-00	1,3
	10706-42	1000 W	230 1 P	0,6 m³/h	2,4 m³/h	300 at 100°C**	1130	135	930	150	29,7	3/4"	60308-00	2,2
	10706-43	2000 W	230 1 P	1,2 m³/h	5 m³/h	350 at 100°C**	1590	135	1390	150	40,9	1 1/4"	4500229-00	2,2

Accessories : TC/J temperature sensor, length 200mm with cable, length 2000mm P/N. 31080-31 or Pt100 Ø 3,5 length 160mm P/N. 31042-31* and extension cable (see probes section).

Models with connection box and temperature sensor (Pt 100 in thermowell on outlet)

Max. output temperature	P/N.	Power +5/-10%	Voltage (V)	Min. output	Max. recommended	Pressure loss mm of WC*	Lt (mm)	B (mm)	L (mm)	H Vessel inside (mm)	Vessel inside Ø (mm)	I/O BSPP	Spare. element No	Weight (kg)
Models for gas (air, nitrogen) 350°C max	10706-74	500 W	230 1 P	20 kg/h	60 kg/h	300 at 5 bar	845	230	460	150	23,7	1/2"	60301-01	1,3
	10706-75	1000 W	230 1 P	40 kg/h	120 kg/h	250 at 5 bar	1205	230	820	150	29,7	3/4"	60302-01	2,7
	10706-76	2000 W	230 1 P	80 kg/h	240 kg/h	200 at 5 bar	1795	230	1410	150	40,9	1 1/4"	60303-01	8,8
Models for softened or treated water 140°C max.	10706-54	2000 W	230 1 P	0,2 m³/h	1 m³/h	300	655	40	460	150	23,7	1/2"	4500226-01	1,2
	10706-55	3000 W	230 1 P	0,5 m³/h	2,5 m³/h	300	825	40	630	150	29,7	3/4"	4500227-01	1,5
	10706-56	5500 W	400 3 P	1 m³/h	5 m³/h	300	1125	40	930	150	40,9	1 1/4"	4500228-01	2,2
Models for oil 200°C max.	10706-64	500 W	230 1 P	0,2 m³/h	0,8 m³/h	250 at 100°C**	805	120	530	150	23,7	1/2"	60307-01	1,3
	10706-65	1000 W	230 1 P	0,6 m³/h	2,4 m³/h	300 at 100°C**	1205	120	930	150	29,7	3/4"	60308-01	2,2
	10706-66	2000 W	230 1 P	1,2 m³/h	5 m³/h	350 at 100°C**	1665	120	1390	150	40,9	1 1/4"	4500229-01	2,2

Accessories : Spare Pt100 temperature sensor Ø 3,5, length 160 P/N. 31042-31 and extension cable (see probes section)

Models with connection box and temperature sensor (type J thermocouple in thermowell on outlet)

Max. output temperature	P/N.	Power +5/-10%	Voltage (V)	Min. output	Max. recommended	Pressure loss mm of WC*	Lt (mm)	B (mm)	L (mm)	H Vessel inside (mm)	Vessel inside Ø (mm)	I/O BSPP	Spare. element No	Weight (kg)
Models for gas (air, nitrogen) 350°C max	10707-51	500 W	230 1 P	20 kg/h	60 kg/h	300 at 5 bar	845	230	460	150	23,7	1/2"	60301-01	1,3
	10707-52	1000 W	230 1 P	40 kg/h	120 kg/h	250 at 5 bar	1205	230	820	150	29,7	3/4"	60302-01	2,7
	10707-53	2000 W	230 1 P	80 kg/h	240 kg/h	200 at 5 bar	1795	230	1410	150	40,9	1 1/4"	60303-01	8,8
Models for softened or treated water 140°C max.	10707-81	2000 W	230 1 P	0,2 m³/h	1 m³/h	300	655	40	460	150	23,7	1/2"	4500226-01	1,2
	10707-82	3000 W	230 1 P	0,5m³/h	2,5 m³/h	300	825	40	630	150	29,7	3/4"	4500227-01	1,5
	10707-83	5500 W	400 3 P	1 m³/h	5 m³/h	300	1125	40	930	150	40,9	1 1/4"	4500228-01	2,2
Models for oil 200°C max.	10707-91	500 W	230 1 P	0,2 m³/h	0,8 m³/h	250 at 100°C**	805	120	530	150	23,7	1/2"	60307-01	1,3
	10707-92	1000 W	230 1 P	0,6 m³/h	2,4 m³/h	300 at 100°C**	1205	120	930	150	29,7	3/4"	60308-01	2,2
	10707-93	2000 W	230 1 P	1,2 m³/h	5 m³/h	350 at 100°C**	1665	120	1390	150	40,9	1 1/4"	4500229-01	2,2

Accessories : Spare TC/J temperature sensor, length 200 mm with cable, length 2000 mm P/N. 31080-31 and extension cable (see probes section).

* Pressure loss depends according to the fluid on the flow, the viscosity and the gas pressure - Consult us

**For Iso VG 32 oil.

Control unit for these heaters (see section control units):

Power control ready to use, for power supply and temperature control panels of low flow heaters

Fitted with a main controller with inputs for Pt100, TC/J or TC/K, and a safety controller with TC/K input, which guarantees protection against element damage due to overheating.



P/N.	Max. power(kW)	Input	Controller	Power unit	Temperature Range
32045-54	5	TC/J	PID	Static relay	0/400°C
32045-55	5	PT100	PID	Static relay	0/300°C

The model with TC/J input can be configured on site in a TC/K input.

DN 50 LIQUID CIRCULATION HEATERS

Appliances conform to DESP 97/23/CE article 3 § 3.

To heat water, fuel or oil circulating in pipework up to 15 bar max. These heaters are made of one or two DN 50 vessels in painted carbon steel, M45 screw plug immersion heaters, and a safety thermostat with automatic reset fixed at up to 115°C, or adjustable from 0°C to 300°C.

Horizontal wall mounting by an adjustable supports supplied with Non-insulated models (optional wall brackets not fixed to insulated models).

Voltage: 230/400 V 3P.

Swivelling box IP55.

* SP= scoured and passivated



Non-insulated 2 vessels circulating heater

Single vessel circulating HEATERS

Heaters for **recycled or waste water** up to 110°C max., 15 bar. Fitted with nickel-plated copper heating elements, brazed brass screw plug. Min. flow 1 m³/h.

P/N. without insulation	P/N. with insulation	Power +5/-10%	Load (W/cm²)	Control box P/N.	LN (mm)	Spare element	Weight without/with insulation (kg)
10631-12	10641-12	4,5 kW	8	32065-07	460	2145-21	8 15
10631-13	10641-13	9 kW	8	32065-13	900	2145-22	12 23
10631-14	10641-14	12 kW	8	32065-13	1390	2145-23	18 32

Heaters for **aqueous liquids** up to 110°C max., 15 bar. Fitted with AISI 316L/Din 1.4404 stainless steel heating elements SP*, brazed protected carbon steel screw plug. Min. flow 1 m³/h.

P/N. without insulation	P/N. with insulation	Power +5/-10%	Load (W/cm²)	Control box P/N.	LN (mm)	Spare element	Weight without/with insulation (kg)
10631-15	10641-15	3 kW	4	32065-07	460	2145-11	7 13
10631-16	10641-16	6 kW	4	32065-07	900	2145-12	11 22
10631-17	10641-17	9 kW	4	32065-13	1390	2145-13	18 32
10631-18	10641-18	12 kW	4	32065-13	2050	2145-14	23 43

Heaters for **oil and fuel** up to 200°C max., 15 bar. Fitted with oiled carbon steel heating elements, offset, brazed protected carbon steel screw plug. Min. flow 1 m³/h.

P/N. without insulation	P/N. with insulation	Power +5/-10%	Load (W/cm²)	Control box P/N.	LN (mm)	Spare element	Weight without/with insulation (kg)
10631-19	10641-19	1,5 kW	2	32065-07	460	2146-01	6,5 12
10631-20	10641-20	3 kW	2	32065-07	900	2146-02	10 21
10631-21	10641-21	4,5 kW	2	32065-07	1390	2146-03	18 32
10631-22	10641-22	6 kW	2	32065-07	2050	2146-04	23 43

Double vessel circulating HEATERS

Heaters for **recycled or waste water** up to 110°C max., 15 bar. Fitted with nickel-plated copper heating elements, brazed brass screw plugs. Min. flow 1 m³/h.

P/N. without insulation	P/N. with insulation	Power +5/-10%	Load (W/cm²)	Control box P/N.	LN (mm)	Spare element	Weight without/with insulation (kg)
10632-12	10642-12	9 kW	8	32065-16	460	2145-21	16 30
10632-13	10642-13	18 kW	8	32065-26	900	2145-22	24 46
10632-14	10642-14	24 kW	8	32065-26	1390	2145-23	36 64

Heaters for **aqueous liquids** up to 110°C max., 15 bar. Fitted with stainless steel AISI 316L/Din 1.4404 heating elements SP*, brazed protected carbon steel screw plugs. Min. flow 1 m³/h.

P/N. without insulation	P/N. with insulation	Power +5/-10%	Load (W/cm²)	Control box P/N.	LN (mm)	Spare element	Weight without/with insulation (kg)
10632-15	10642-15	6 kW	4	32065-16	460	2145-11	14 26
10632-16	10642-16	12 kW	4	32065-16	900	2145-12	22 44
10632-17	10642-17	18 kW	4	32065-26	1390	2145-13	36 64
10632-18	10642-18	24 kW	4	32065-26	2050	2145-14	46 86

Heaters for **oil and fuel** up to 200°C max., 15 bar. Fitted with oiled carbon steel heating elements, offset, brazed protected carbon steel screw plugs. Min. flow 1 m³/h

P/N. without insulation	P/N. with insulation	Power +5/-10%	Load (W/cm²)	Control box P/N.	LN (mm)	Spare element	Weight without/with insulation (kg)
10632-19	10642-19	3 kW	2	32065-16	460	2146-01	13 24
10632-20	10642-20	6 kW	2	32065-16	900	2146-02	20 42
10632-21	10642-21	9 kW	2	32065-16	1390	2146-03	36 64
10632-22	10642-22	12 kW	2	32065-26	2050	2146-04	46 86

Non-insulated models

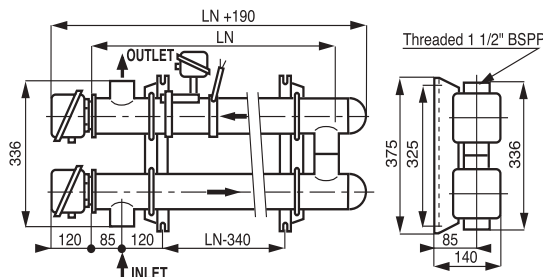
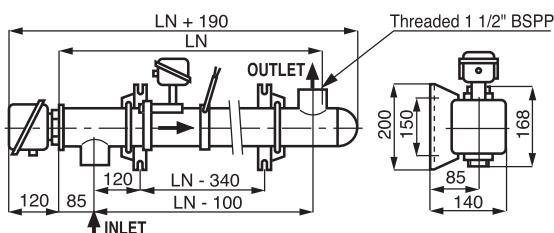

Insulated models

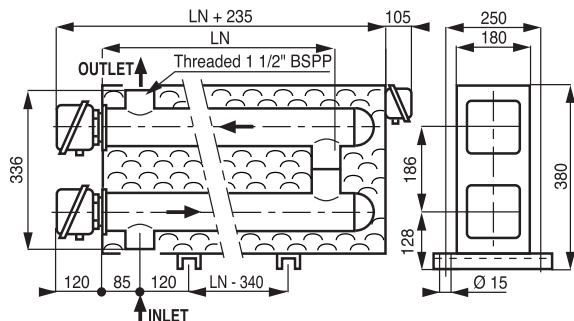
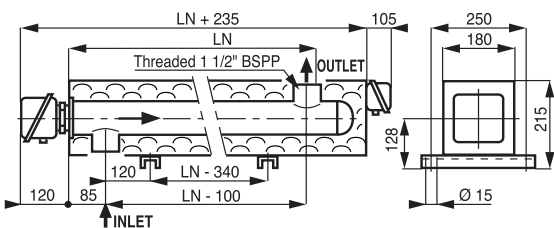

Heater with offset for vessel temperature > 110°C

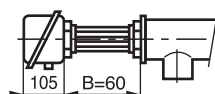

DN 80 LIQUID CIRCULATION HEATERS FOR DOMESTIC WATER

Consisting of a DN 80 vessel in painted steel, a VULCALOY® flanged immersion heater with a 115°C safety thermostat with automatic reset.

To heat waste or recycled domestic water, circulating in pipework, up to 110°C max. and up to 10 bar.

The heating elements are in AISI 904L/ Din 1.4539 stainless steel which is particularly resistant to scale formation and corrosion. Load 12 W/cm².



Non-insulated models



Insulated models

Non-insulated models

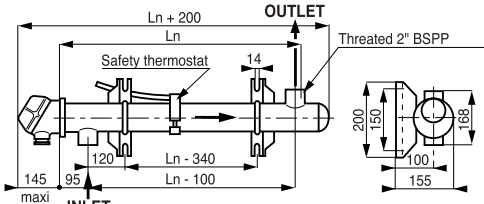

Insulated models

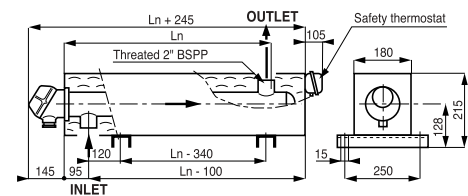

Appliances conform to DESP 97/23/CE article 3 § 3.

P/N. without Insulation	P/N. with Insulation	Power +5 /-10%	Voltage (V)	Control box	LN (mm)	Spare heater	Min. flow (m ³ /h)	Weight (kg)
10705-01	10745-01	3 kW	230/400 3 P	32065-07	460	1789-01	1	8/15
10705-02	10745-02	4,5 kW	230/400 3 P	32065-07	460	1789-02	1	8/15
10705-03	10745-03	6 kW	230/400 3 P	32065-07	460	1789-03	1	8/15
10705-05	10745-05	9 kW	230/400 3 P	32065-13	900	1789-05	1	12/23
10705-06	10745-06	12 kW	230/400 3 P	32065-13	900	1789-06	1	12/23
10705-07	10745-07	15 kW	230/400 3 P	32065-23	900	1789-07	1	12/23
10705-08	10745-08	18 kW	230/400 3 P	32065-23	900	1789-08	1	12/23
10705-09	10745-09	21 kW	230/400 3 P	32065-23	1390	1789-09	1	17/31
10705-10	10745-10	24 kW	230/400 3 P	32065-23	1390	1789-10	1	17/31
10705-12	10745-12	30 kW	400 3 P	32065-43	1390	1789-12	1	17/31
10705-14	10745-14	36 kW	400 3 P	32065-43	2050	1789-14	1	20/34
10705-17	10745-17	45 kW	400 3 P	32065-63	2050	1789-17	1	21/35

AIR AND GAS CIRCULATION HEATERS

Spare thermostat P/N 9031-01

Designed to heat air or nitrogen up to 150°C, up to 15 bar maximum pressure.

Consisting of a DN 80 vessel in painted steel, Ø 77 screw plug immersion heater and a 300°C adjustable safety thermostat. Stainless steel heating elements. Wall mounting by means of adjustable supports.

Supply voltage : 10901-03 : 400 V 1P
10901-06 and -07 : 230 V 1P or 3P or 400 V 3P.
Inlet temperature : min. +5°C, max. 110°C.

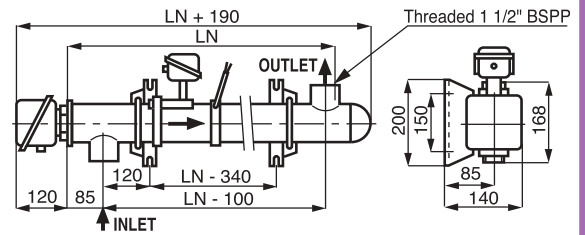

Spare parts :

- Type 2077 immersion heaters : see 'immersion heaters' section.
- 300°C adjustable safety thermostat P/N. 9032-01 (Weight 1 kg).

NEW P/N.	Old P/N.	Power +5 /-10%	LN (mm)	Min. flow (kg/h)	Spare element	Wiring	Weight (kg)
10901-03	10711-03	2000 W	460	120	2077-13	Serie 400 1P	8
10901-06	10711-06	4500 W	460	350	2077-12	400 3 P/Δ 230 3 P	8
10901-07	10711-07	6000 W	460	350	2077-13	400 3 P/Δ 230 3 P	8

OUTLET ELBOW FOR LIQUID CIRCULATION HEATERS

Outlet elbow with tapping for safety valve, air bleed valve and temperature measuring probe. Supplied with blanking plugs.

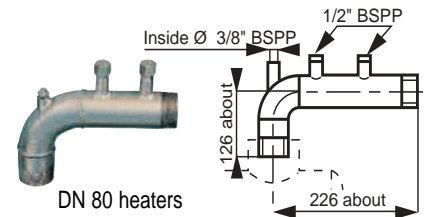
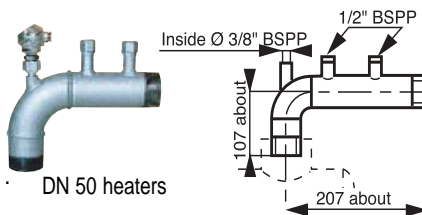

P/N.	Description for DN 50 heater	Material	Max. temp.
10630-98	With blanking plugs only	AISI316L/ Din 1.4404	450°C
10630-99	With blanking plugs only	Painted steel	300°C
10630-90	With PT100 sensor in aluminium box P/N. 31042-01 + thermowell P/N. 31396-50	Painted steel	110°C
10630-95	With PT100 sensor in alu box P/N. 31042-02 + connector P/N. 31672-00 + thermowell P/N. 31396-50	Painted steel	250°C
P/N.	Description for DN 80 heater	Material	Max. temp.
53824-01	With blanking plugs only	AISI 316L / Din1.4404	450°C
53804-01	With blanking plugs only	Painted steel	300°C
10700-90	With PT100 sensor in aluminium box P/N. 31042-01 + thermowell P/N. 31396-50	Painted steel	110°C
10700-95	With PT100 sensor in aluminium box P/N. 31042-02 + connector P/N. 31672-00	Painted steel	250°C

WALL MOUNTING BRACKETS FOR DN 50 and DN 80 HEATERS

- Pair of wall brackets for insulated heater P/N. 6048-01

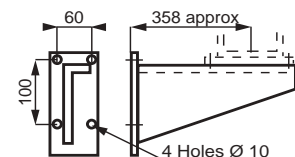

ND80 LIQUID CIRCULATION HEATERS

According PED 97/23/CE article 3.3.



To heat water, fuel or oil circulating in pipework at 15 bar max. Consisting of 1, 2 or 4 DN 80 vessels, in painted carbon steel, M77 screw plug immersion heaters and a safety thermostat with automatic reset, set at 115°C for water and adjustable between 0° and 300°C for oil. Horizontal wall mounting by adjustable brackets (non-insulated models).
SP* = Scoured and passived

SINGLE VESSEL

DOUBLE VESSEL

FOUR VESSEL

Non-insulated models

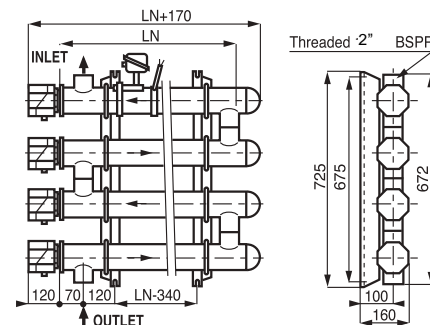
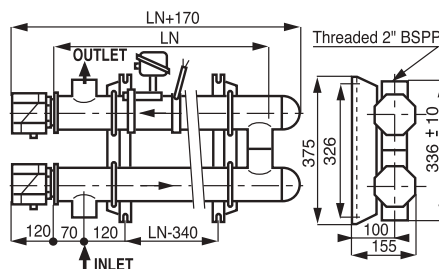
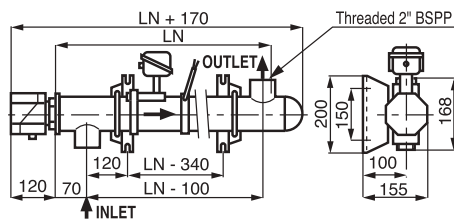

Insulated models

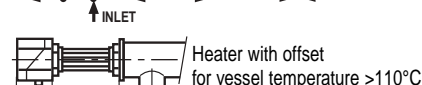
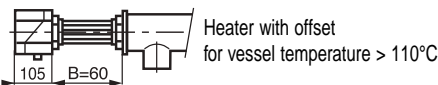
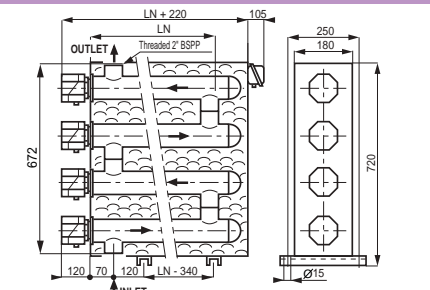
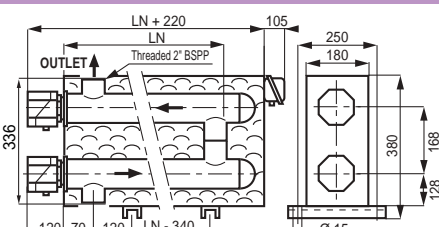
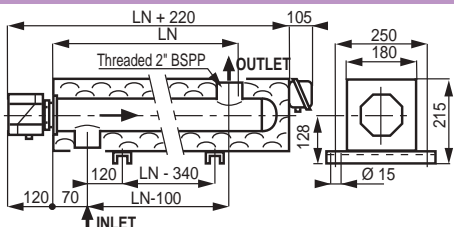

SINGLE VESSEL

Heaters for recycled or waste water up to 110°C, 15 bar. Nickel-plated copper heating elements, brazed brass screw plugs. Load 8 W/cm². Min. flow 2 m³/h.

Painted carbon steel vessel.

P/N without insulation	P/N.with insulation	Power +5/-10%	Voltage (V)	P/N. control box	LN (mm)	Spare element
10701-08	10741-08	6 kW	230/400 3 P	32065-07	460	2077-31
10701-10	10741-10	9 kW	230/400 3 P	32065-13	460	2077-32
10701-16	10741-16	12 kW	230/400 3 P	32065-13	900	2077-33
10701-17	10741-17	18 kW	230/400 3 P	32065-23	900	2077-34
10701-18	10741-18	24 kW	230/400 3 P	32065-23	1390	2077-35
10701-19	10741-19	36 kW	400 3 P	32065-43	2050	2077-36

Spare thermostat P/N. 9031-01 for Non-insulated models - all LN, and insulated models up to LN 1390
Spare thermostat P/N. 9031-02 for insulated models LN 2050.

Heaters for aqueous liquids up to 110°C, 15 bar. AISI 316L/ Din 1.4404 stainless steel heating elements SP*, brazed protected carbon steel screw plugs. Load 5 W/cm² about. Min. flow 2 m³/h. **Painted carbon steel vessel.**

P/N without insulation	P/N.with insulation	Power +5/-10%	Voltage (V)	P/N. control box	LN (mm)	Spare element
10701-03	10741-03	3 kW	230/400 3 P	32065-07	460	2077-11
10701-05	10741-05	4,5 kW	230/400 3 P	32065-07	460	2077-12
10701-07	10741-07	6 kW	230/400 3 P	32065-07	460	2077-13
10701-13	10741-13	9 kW	230/400 3 P	32065-13	900	2077-14
10701-14	10741-14	12 kW	230/400 3 P	32065-13	900	2077-15

Spare thermostat P/N. 9031-01 for all models.

Liquid circulation heaters must be controlled by a system which is independent from the safety system and measures the fluid output temperature.

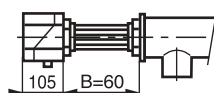

Heater with offset immersion heaters for vessel temperature > 110°C

Heaters for heavy fuel and oil up to 200°C, 15 bar. Fitted with oiled carbon steel heating elements, offset, brazed protected carbon steel screw plug, load 2 W/cm². Min. flow 2 m³/h. **Painted carbon steel vessel.**

P/N. without insulation	P/N.with insulation	Power +5/-10%	Voltage (V)	P/N. control box	LN (mm)	Spare element
10701-65	10741-65	2 kW	230/400 3 P	32065-07	460	2178-02
10701-66	10741-66	3 kW	230/400 3 P	32065-07	900	2178-03
10701-67	10741-67	4,5 kW	230/400 3 P	32065-07	900	2178-04
10701-68	10741-68	6 kW	230/400 3 P	32065-07	1390	2178-05

Spare thermostat P/N. 9032-01 for all non-insulated models. Spare thermostat P/N. 9014-03 for all insulated models. See also 2- and 4-tube models, to achieve higher powers.

Heaters for aqueous liquids up to 200°C, 15 bar. AISI 316L/ Din 1.4404 stainless steel heating elements SP*, welded 304L stainless steel screw plug. Min. flow 2 m³/h. **304L**

Stainless steel vessel.

Specific load 4 W/cm²

P/N. without insulation	P/N.with insulation	Power +5/-10%	Voltage (V)	P/N. control box	LN (mm)	Spare element
10701-80	10741-80	4,5 kW	230/400 Tri	32065-07	460	2378-80
10701-81	10741-81	10 kW	230/400 Tri	32065-13	900	2378-81
10701-82	10741-82	16 kW	230/400 Tri	32065-23	1390	2378-82
10701-83	10741-83	24 kW	230/400 Tri	32065-23	2050	2378-83

Specific load 6 W/cm²

P/N. without insulation	P/N.with insulation	Power +5/-10%	Voltage (V)	P/N. control box	LN (mm)	Spare element
10701-84	10741-84	7 kW	230/400 Tri	32065-07	460	2378-84
10701-85	10741-85	15 kW	230/400 Tri	32065-23	900	2378-85
10701-86	10741-86	24 kW	230/400 Tri	32065-23	1390	2378-86
10701-87	10741-87	36 kW	400 Tri	32065-43	2050	2378-87

Specific load 10 W/cm²

P/N. without insulation	P/N.with insulation	Power +5/-10%	Voltage (V)	P/N. control box	LN (mm)	Spare element
10701-88	10741-88	11,5 kW	230/400 Tri	32065-13	460	2378-88
10701-89	10741-89	25 kW	230/400 Tri	32065-23	900	2378-89
10701-90	10741-90	40 kW	230/400 Tri	32065-43	1390	2378-90
10701-91	10741-91	60 kW	400 Tri	32065-63	2050	2378-91

DOUBLE VESSEL

Heaters for **recycled or waste water up to 110°C**, 15 bar. Fitted with nickel-plated copper heating elements brazed brass screw plugs. Load 8 W/cm². Min. flow 2 m³/h. **Painted carbon steel vessel.**

P/N.without insulation	P/N.with insulation	Power +5/-10%	Voltage (V)	P/N. control box	LN (mm)	Spare element
10702-31	10742-31	36 kW	230/400 3 P	32065-46	900	2077-34
10702-32	10742-32	48 kW	230/400 3 P	32065-66	1390	2077-35
10702-34	10742-34	72 kW	400 3 P	32065-96	2050	2077-36

Spare thermostat P/N. 9031-01 for Non-insulated models - all LN, and insulated models up to LN 900
Spare thermostat P/N. 9031-02 for insulated models LN 1390 and longer.

Heaters for **aqueous liquids up to 110°C**, 15 bar. Fitted with stainless steel AISI 316L/Din 1.4404 heating elements SP*, brazed protected carbon steel screw plugs. Load 5 W/cm². Min. flow 2 m³/h. **Painted carbon steel vessel.**

P/N.without insulation	P/N.with insulation	Power +5/-10%	Voltage (V)	P/N. control box	LN (mm)	Spare element
10702-10	10742-10	18 kW	230/400 3 P	32065-26	900	2077-14
10702-11	10742-11	24 kW	230/400 3 P	32065-26	900	2077-15

Spare thermostat P/N. 9031-01 for all models.

Heaters for **heavy fuel and oil up to 200°C**, 15 bar. Fitted with oiled carbon steel heating elements, offset, brazed protected steel screw plugs. Load 2 W/cm². Min. flow 2 m³/h. **Painted carbon steel vessel.**

P/N.without insulation	P/N.with insulation	Power +5/-10%	Voltage (V)	P/N. control box	LN (mm)	Spare element
10702-54	10742-54	9 kW	230/400 3 P	32065-16	900	2178-04
10702-55	10742-55	12 kW	230/400 3 P	32065-16	1390	2178-05

According to PED, these appliances must not be used with dangerous fluids group 1.
Spare thermostat P/N. 9032-01 for all non-insulated models. Spare thermostat P/N. 9014-03 for all insulated models. See also 2- and 4-vessel models, to achieve higher powers.

Heaters for **aqueous liquids up to 200°C**, 15 bar. AISI 316L/ Din 1.4404 stainless steel heating elements SP*, welded 304L stainless steel screw plug. Min. flow 2 m³/h. **304L Stainless steel vessel.**

Specific load 4 W/cm²

P/N.without insulation	P/N.with insulation	Power +5/-10%	Voltage (V)	P/N. control box	LN (mm)	Spare element
10702-80	10742-80	9,5 kW	230/400 Tri	32065-16	460	2378-80
10702-81	10742-81	20 kW	230/400 Tri	32065-26	900	2378-81
10702-82	10742-82	32 kW	230/400 Tri	32065-46	1390	2378-82
10702-83	10742-83	48 kW	230/400 Tri	32065-66	2050	2378-83

Specific load 6 W/cm²

P/N.without insulation	P/N.with insulation	Power +5/-10%	Voltage (V)	P/N. control box	LN (mm)	Spare element
10702-84	10742-84	14 kW	230/400 Tri	32065-16	460	2378-84
10702-85	10742-85	30 kW	230/400 Tri	32065-46	900	2378-85
10702-86	10742-86	48 kW	230/400 Tri	32065-66	1390	2378-86
10702-87	10742-87	72 kW	400 Tri	32065-96	2050	2378-87

Specific load 10 W/cm²

P/N.without insulation	P/N.with insulation	Power +5/-10%	Voltage (V)	P/N. control box	LN (mm)	Spare element
10702-88	10742-88	23 kW	230/400 Tri	32065-26	460	2378-88
10702-89	10742-89	50 kW	230/400 Tri	32065-66	900	2378-89
10702-90	10742-90	80 kW	230/400 Tri	32065-96	1390	2378-90
10702-91	10742-91	120 kW	400 Tri	32065-82	2050	2378-91

FOUR VESSEL

Heaters for **recycled or waste water up to 110°C**, 15 bar. Fitted with nickel-plated copper heating elements brazed brass screw plugs. Load 8 W/cm². Min. flow 2 m³/h. **Painted carbon steel vessel.**

P/N.without insulation	P/N.with insulation	Power +5/-10%	Voltage (V)	Control box	LN (mm)	Spare element
10704-31	10744-31	72 kW	230/400 3 P	32065-99	900	2077-34
10704-32	10744-32	96 kW	230/400 3 P	32065-99	1390	2077-35
10704-34	10744-34	144 kW	400 3 P	32065-83	2050	2077-36

Spare thermostat P/N. 9031-01 for non-insulated models, all LN, and insulated models up to LN 900. Spare thermostat P/N. 9031-02 or insulated models LN 1390 and longer.

Heaters for **aqueous liquids up to 110°C**, 15 bar. Fitted with AISI 316L/ Din 1.4404 stainless steel heating elements SP*, brazed protected carbon steel screw plugs. Load 5 W/cm² about. Min. flow 2 m³/h. **Painted carbon steel vessel.**

P/N.without insulation	P/N.with insulation	Power +5/-10%	Voltage (V)	Control box	LN (mm)	Spare element
10704-10	10744-10	36 kW	230/400 3 P	32065-49	900	2077-14
10704-11	10744-11	48 kW	230/400 3 P	32065-69	900	2077-15

Spare thermostat P/N. 9031-01 for all models.

Heaters for **heavy fuel and oil up to 200°C**, 15 bar. Fitted with oiled carbon steel heating elements, offset, brazed protected carbon steel screw plugs. Load 2 W/cm². Min. flow 2 m³/h. **Painted carbon steel vessel.**

P/N.without insulation	P/N.with insulation	Power +5/-10%	Voltage (V)	Control box	LN (mm)	Spare element
10704-54	10744-54	18 kW	230/400 3 P	32065-29	900	2178-04
10704-55	10744-55	24 kW	230/400 3 P	32065-29	1390	2178-05

According to PED, these appliances must not be used with dangerous fluids group 1.
Spare thermostat P/N. 9032-01 for all non-insulated models
Spare thermostat P/N. 9014-03 for all insulated models.

Heaters for **aqueous liquids up to 200°C**, 15 bar. AISI 316L/ Din 1.4404 stainless steel heating elements SP*, welded 304L stainless steel screw plug. Min. flow 2 m³/h. **304L Stainless steel vessel.**

Specific load 4 W/cm²

P/N.without insulation	P/N.with insulation	Power +5/-10%	Voltage (V)	Control box	LN (mm)	Spare element
10704-80	10744-80	19 kW	230/400 Tri	32065-23	460	2378-80
10704-81	10744-81	40 kW	230/400 Tri	32065-46	900	2378-81
10704-82	10744-82	64 kW	230/400 Tri	32065-66	1390	2378-82
10704-83	10744-83	96 kW	230/400 Tri	32065-96	2050	2378-83

Specific load 6 W/cm²

P/N.without insulation	P/N.with insulation	Power +5/-10%	Voltage (V)	Control box	LN (mm)	Spare element
10704-84	10744-84	28 kW	230/400 Tri	32065-43	460	2378-84
10704-85	10744-85	60 kW	230/400 Tri	32065-66	900	2378-85
10704-86	10744-86	96 kW	230/400 Tri	32065-96	1390	2378-86
10704-87	10744-87	144 kW	400 Tri	32065-83	2050	2378-87

Specific load 10 W/cm²

P/N.without insulation	P/N.with insulation	Power +5/-10%	Voltage (V)	Control box	LN (mm)	Spare element
10704-88	10744-88	46 kW	230/400 Tri	32065-43	460	2378-88
10704-89	10744-89	100 kW	230/400 Tri	32065-99	900	2378-89
10704-90	10744-90	159 kW	230/400 Tri	on request	1390	2378-90
10704-91	10744-91	238 kW	400 Tri	on request	2050	2378-91

Liquid circulation heaters must be controlled by a system which is independent from the safety system and measures the fluid output temperature.

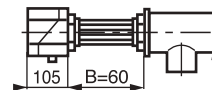

Heater with offset immersion heaters for vessel temperature > 110°C

ND 80 CIRCULATING LIQUID HEATERS WITH ND 80 FLANGE (in and outlet)

To heat circulating water, fuel or oil. Made of a ND 80 vessel in painted carbon steel or stainless steel AISI 316L/Din 1.4404, insulated or Non-insulated, DN 80 PN16 FS inlet and outlet, a ND 80 flange immersion heater, and a safety thermostat with automatic reset, adjustable between 0°C and 300°C. Fitted with a 1/4" BSP threaded thermowell on the outlet pipe, for a control sensor.

ON REQUEST

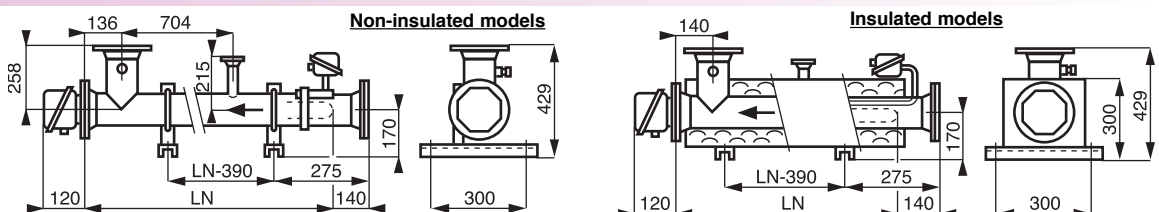

HEATING HOSES TYPE 26177

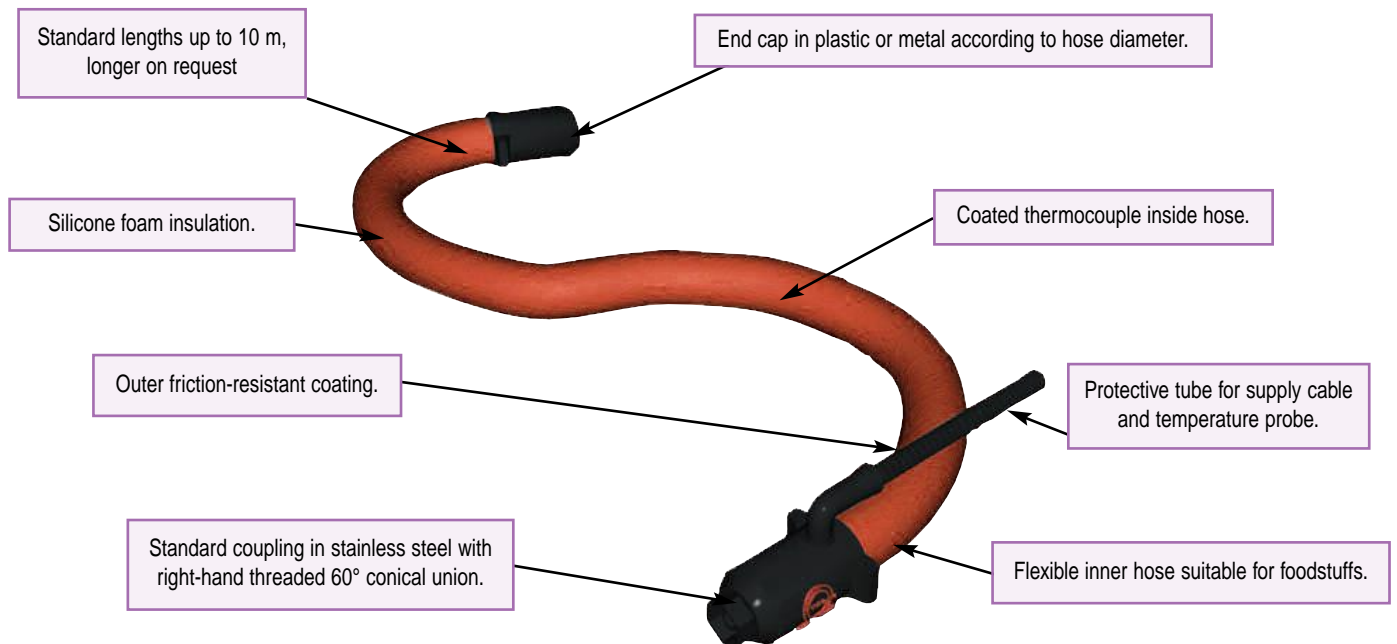

FLEXIBLE HEATING PIPE TYPE 26177

To maintain the temperature of liquids or gases between 5°C to 350°C (for special models in stainless steel) up to 200 bar during routing from the heating system to the point of use, or for keeping them free from freezing.

Application areas : foam bitumen, glue, oil, greases, wax, resin, paint, process gas, food products, molten metals....

Protection of certain liquids against freezing.

Protection of certain gases against condensation.

Link between fixed and mobile installations.

Control of viscous product pouring capability.

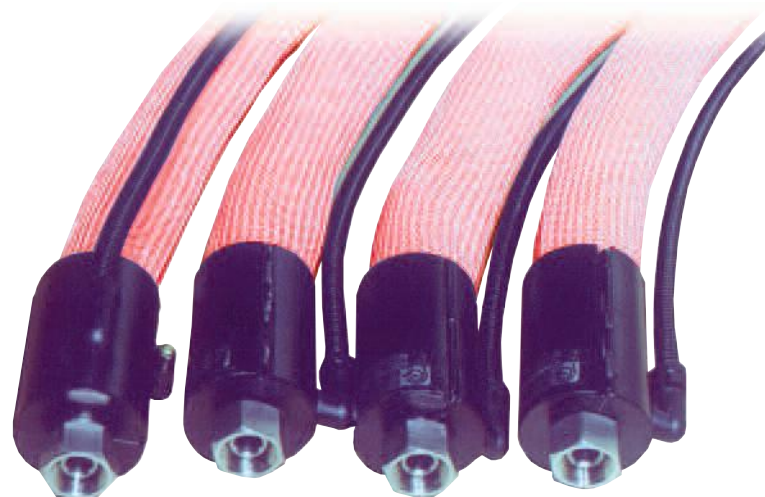

Special models of heating hose

ADVANTAGES :

These pipes are extremely flexible and can be installed quickly and easily.

Even distribution of temperature.

Quality materials in contact with fluid (usable for food and pharmaceutical industries).

Surface temperature control to guarantee long life duration.



Min. bend radius = 12 x Nominal Ø

COMPOSITION :

Smooth PTFE flexible pipe or corrugated AISI 321/ Din 1.4541 stainless steel with external braid of AISI 304 / Din 1.4301 stainless steel fitted with end coupling of steel, protected, or of AISI 304 / Din 1.4301 stainless steel. Resistive wire, spiral wound and held by a glass woven tape. Heat insulation adapted to conditions of use, in ceramic fiber or silicone foam, lined with end pieces in molded plastic .

Surface temperature sensor type PT 100 (3 wires) or thermocouple (J, K) placed in the heating part (on the electrical connection side).

Electric connection at one end, by sealed PTFE flexible wires grouped together in a silicone glass silk sheath (maximum temperature 250°C).

MADE-TO-MEASURE HEATING HOSES

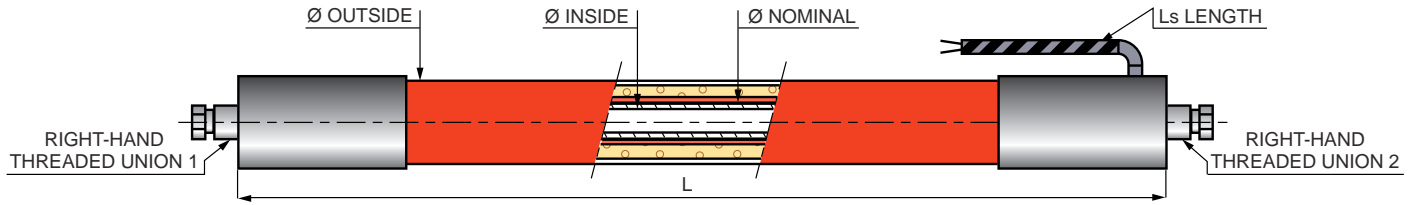

Sectional drawing of a heating hose

CHARACTERISTICS :

- Inside nominal diameters (mm) : **ND 6 to ND 25.**
- Interior lining of PTFE (200°C max. or stainless steel of about 350°C max.).
- Exterior lining tolerating 170°C max.
- Minimum of the neutral fiber curve radius : 20 x ND (mm) for PTFE and 16 x ND (mm) for stainless steel.
- Length between ends : from **0,5 to 25 meters.**
- Tolerance on Length = +/- 2%.
- Standard power supply voltage : 230 VAC 1 P
- Maximum power : 3600 W.
- Dielectric strength : 1800 V. Insulation resistance : 100 Megohms.
- Power supply cable length : 0,5 m to 5 m.

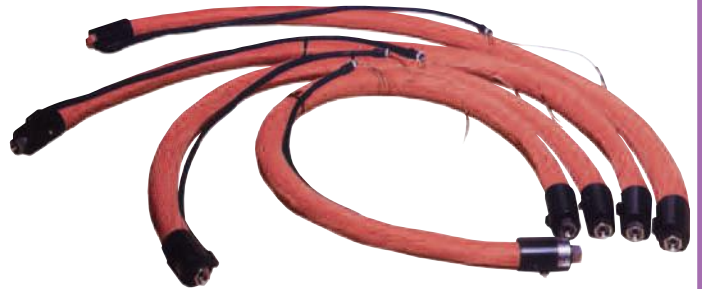

Nominal Diameter ND (mm)	6	8	10	13	16	20	25
Recommended linear power (W/m) per 100°C(*) for Δ-t	60	70	80	100	110	135	170
PTFE flexible line for 200°C maxi :							
Interior diameter (mm)	6	7	9,1	10	15	18	24
Exterior diameter (mm)	34	42	42	42	50	50	50
Max pressure at 200°C (bar)	156	130	123	97	71	52	36
Stainless steel flexible line for 350°C maxi :							
Interior diameter (mm)			10,5	13	16	19	25
Exterior diameter (mm)			43	50	50	50	50
Max pressure at 350°C (bar)			53	51	49	36	30

CONDITIONS OF USE :

The linear power of a standardised flexible pipe type 26177 will not allow the fluid temperature to be raised but only compensate for losses through the heat insulation. Connect the measurement probes to a regulator or an electronic thermostat capable of maintaining the temperature at the surface of the flexible hose to the maximum set point accepted by the sheath and the liquid being conveyed. It is preferable to position the power supply cable on the stationary coupling side. Avoid excessive mechanical stresses (compression, traction and twisting).

OTHER MANUFACTURING POSSIBILITIES :

- Other diameters : 5, 32, 38 and 50 mm and other lengths (up to 100 m).
- Other power supply voltages from 24 to 230 VAC.
- Power levels greater than 3600 W for 230 VAC.
- Other temperature sensors.
- Higher service pressures, smaller curve radius.
- Stainless steel external corrugated braid or sheath for strength and mechanical protection.
- Other hydraulic coupling : male, bent, flanges, clamps, all will be in AISI 316L/ Din 1.4404 stainless steel.
- Electric connection by plug-in connector.
- Flexible hoses of PTFE without end coupling for over-heating without pressure over smooth piping.
- Heated flexible pipes for use in explosive atmosphere (ATEX zone 1).
- Multiple flexible pipes for the transport of several components.
- Self-limiting flexible hoses for low temperature applications.

To order a made-to-measure heating hose please state:

- | | | |
|---------------------------------------|--|-------------------------|
| Heating hose type: 26177 | - Application : | |
| - Inside diameter (mm): | - Hose length (m) : | - Max. pressure (bar) : |
| - Connection 1 : | - Connection 2 (can be different from 1) : | - Power(W) : |
| - Desired constant temperature (°C) : | - Temperature probe (PT100, J-type or K-type thermocouple) | - Voltage (V) : |

AIR HEATING

Twisted finned elements

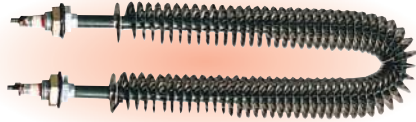

Finned elements

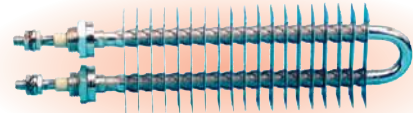

Anti-condensation cabinet heaters

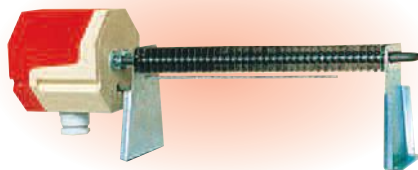

Radiators

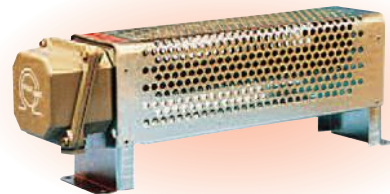

ATEX radiators

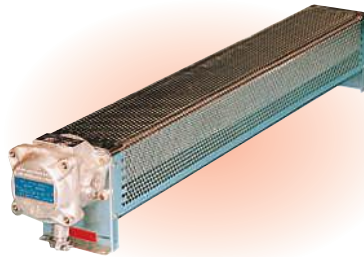

Wall-mounted air heaters



High temperature generators

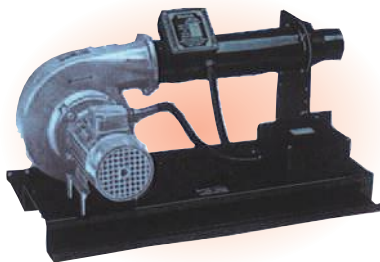

Circular air duct heaters



Industrial air duct heaters

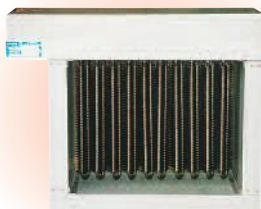

Flange air heaters



To heat air or gases by natural or forced convection, one possible solution are finned elements.
 Heat transfer from tubular heating elements for heating gaseous media is increased by a metal strip wrapped around the element.
 Through turbulence created in the medium, finned elements can be loaded up to 2 or 3 times more than unfinned elements.
 With lower surface temperatures and smaller dimensions, finned elements are particularly suitable for convection heating, air heaters, industrial ovens, drying cabinets, paint-drying installations, air-conditioning appliances, etc.

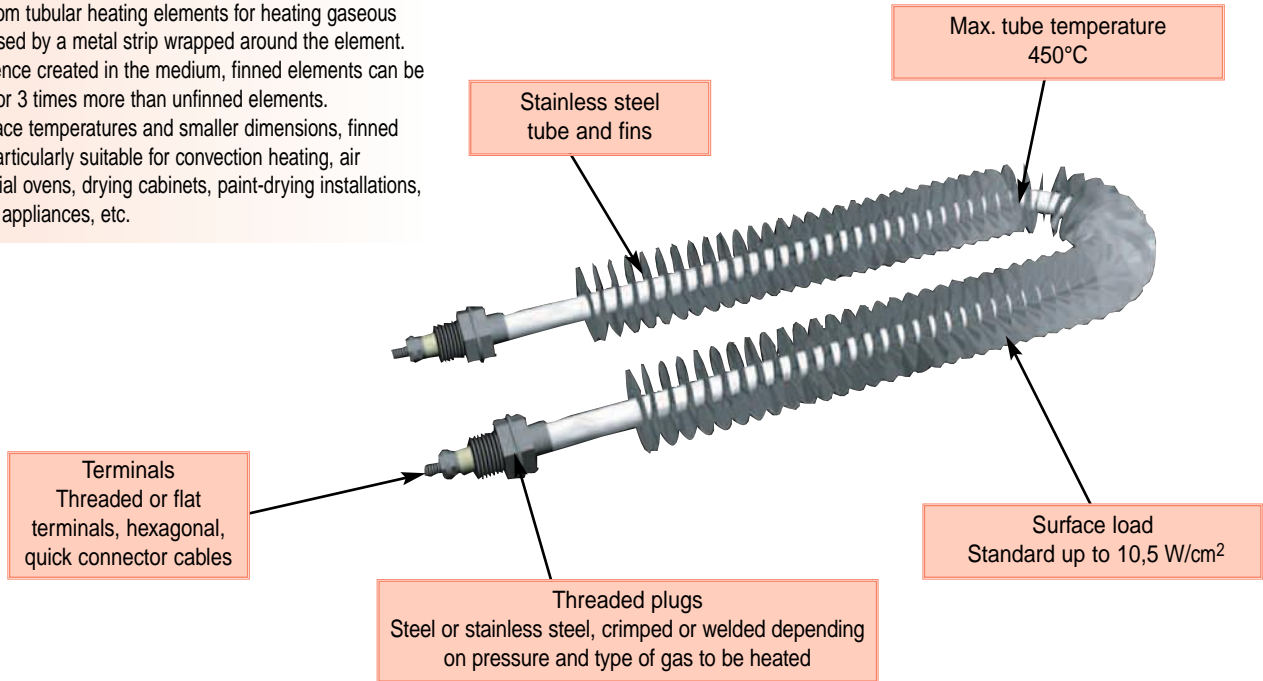

AVAILABLE SHAPES :
 Fig.1 - straight, completely finned
 Fig.2 - U-shaped, completely finned
 Fig.3 - U-form, bent area not finned
 Fig.4 - W-shaped, completely finned

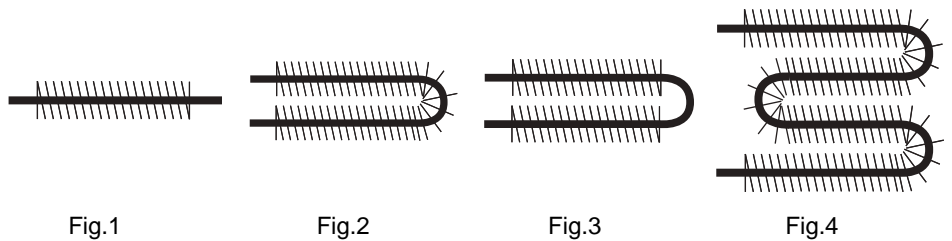

STAINLESS STEEL FINNED ELEMENTS

Temperatures up to 300°C, min.air speed 5 m/s.
 Supply voltage: 230 V single phase.
 Supplied bent, with crimped M 14 x 1,5 x 12 mm threaded plugs.
 AISI 321/Din 1.4541 tube,
 AISI 304L/Din 1.4306 fins,
 Crimped M14 x 150 threaded plugs in protected carbon steel (max. pressure : 100 mm WC) + sealing rings,
 M6 threaded terminals in protected carbon steel,
 TM seals (max. connection temperature : 200 °C).

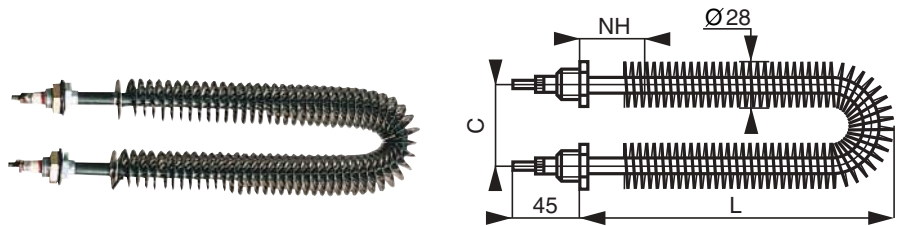

NH = Non-heating length
 V = 230 V 1P

P/N.-	Power +5 -10% (W/cm ²)	Load (mm)	LNH (mm)	Weight (kg)
6094-51	1000 W	9,5	280	0,45
6094-52	2000 W	8,5	530	0,65
6094-53	3000 W	8,5	780	0,9
6094-54	4000 W	9,5	920	1,1
6094-55	5000 W	9,0	1180	1,2
6094-56	6000 W	10,5	1230	1,3

c = 70

P/N.-	Power +5 -10% (W/cm ²)	Load (mm)	LNH (mm)	Weight (kg)
6094-01	400 W	4 240	50	0,3
6094-02	1000 W	4 490	50	0,58
6094-03	1500 W	4 740	50	0,8
6094-04	2000 W	4 990	50	1,1
6094-05	2500 W	41240	50	1,3
6094-06	3000 W	41490	50	1,5
6094-10	650 W	6 240	50	0,3
6094-11	1400 W	6 490	50	0,58
6094-12	2250 W	6 740	50	0,8

c = 40

P/N.-	Power +5 -10% (W/cm ²)	NH (mm)	Weight (kg)
6094-13	3000 W	6 990	1,1
6094-14	3750 W	61240	1,3
6094-15	4500 W	61490	1,5
6094-20	850 W	8240	0,3
6094-21	2000 W	8 490	0,58
6094-22	3000 W	8 740	0,8
6094-23	4000 W	8 990	1,1
6094-24	5000 W	81240	1,3
6094-25	6000 W	81490	1,5

c = 40

To heat air or gases by natural or forced convection, one possible solution are finned element. The required power, operating temperature, and flow speed of the gas to be heated will guide you in choosing your specific item.

VULCANIC finned elements are based on sheathed heating elements to which fins are attached. These square-finned elements are available in U-shaped form.

Fins in ferric or austenitic stainless steel

Protected carbon steel max. tube temperature 400°C
stainless steel max. tube temperature 650°C

Threaded plugs in steel or stainless steel, crimped or brazed depending on pressure and type of gas to be heated

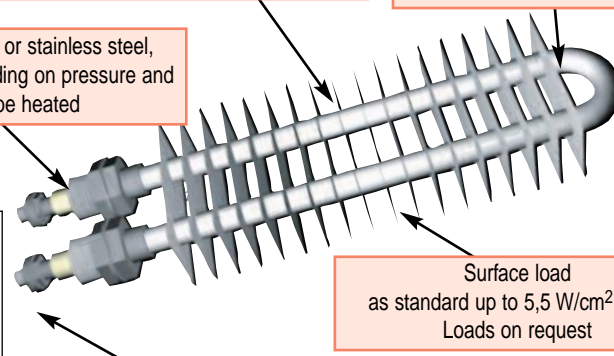

Surface load as standard up to 5,5 W/cm² higher Loads on request

Terminals : threaded, flat, hexagonal, Faston or cables

Application :

Natural convection

Ambient air temp. maxi	Load maxi.
80°C	5W/Cm ²
140°C	4W/Cm ²
200°C	2,7W/Cm ²

Forced convection for ambient air at 200°C Maxi

Low flow	Load maxi.
2m/s	4W/Cm ²
3m/s	5W/Cm ²

STAINLESS STEEL 25 x 50 FINNED STRIP HEATERS

AISI 321/Din 1.4541 tube, 25x50 fins in AISI 430, crimped M14 x 150 threaded plugs in protected steel (max. pressure : 100 mm WC + sealing rings, M6 threaded terminals in protected carbon steel, WP⁺ "waterproof" sealing (max. temperature at terminals : 160 °C).

Type 6024

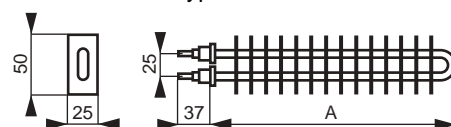

P/N.	Power +5 -10%	Voltage 1P	A (mm)	Load (W/cm ²)	Weight (kg)
6024-01	235 W	127 V	170	0,225	0,225
6024-00	235 W	230 V	170	0,225	0,225
6024-11	525 W	127 V	320	0,400	0,400
6024-10	525 W	230 V	320	0,400	0,400
6024-13	450 W	230 V	395	2,7	0,500
6024-90	450 W	230 V	226	0,290	0,290
6024-12	525 W	400 V	320	0,400	0,400
6024-73	550 W	230 V	470	2,7	0,560

P/N.	Power +5 -10%	Voltage 1P	A (mm)	Load (W/cm ²)	Weight (kg)
6024-20	725 W	230 V	420	0,510	0,510
6024-91	650 W	230 V	326	0,405	0,405
6024-30	950 W	230 V	520	0,610	0,610
6024-33	950 W	230 V	760	2,7	0,850
6024-92	950 W	230 V	426	0,515	0,515
6024-32	950 W	400 V	520	0,610	0,610
6024-40	1450 W	230 V	770	0,900	0,900

P/N.	Power +5 -10%	Voltage 1P	A (mm)	Load (W/cm ²)	Weight (kg)
6024-43	1325 W	230 V	1045	2,7	1,300
6024-42	1450 W	400 V	770	0,900	0,900
6024-50	1950 W	230 V	1020	41,200	41,200
6024-93	1950 W	230 V	816	0,950	0,950
6024-52	1950 W	400 V	1020	41,200	41,200
6024-60	2950 W	230 V	1520	41,900	41,900
6024-62	2950 W	400 V	1520	41,900	41,900

OTHER MANUFACTURING OPTIONS WITH SHORT DELIVERY TIMES : power, voltage, length of element (Dimension A), tube material (AISI 316L/Din 1.4404), fin material (stainless steel AISI 304L/Din 1.4306), threaded plug material (stainless steel) and their means of fastening to the tube (brazed for 50 bar max. pressure), seals (HT "high temperature" or TM "moderated temperature" and terminals (cables, flat terminals, hexagonal terminals, Faston terminals or threaded stainless steel terminals).

OTHER POSSIBLE SHAPES

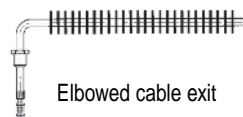

Elbowed cable exit



Bent element

Type 6114 : same as 6024 but with ferrules

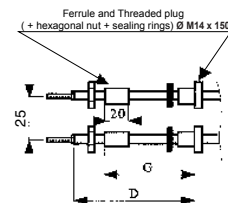

STAINLESS STEEL 40 X 80 FINNED STRIP HEATERS

AISI 321/Din 1.4541 tube, 40x80 fins in AISI 430 stainless steel, crimped M20 x 150 threaded plugs in protected steel (max. pressure :100 mm WC) + sealing rings, M6 threaded terminals in protected carbon steel, TM seals (max. temperature at terminals : 200 °C).

P/N.	Power +5 -10%	Voltage 1P	A (mm)	Load (W/cm ²)	Weight (kg)
6033-00	1250 W	230 V	420	4,5	1,15
6033-03	1500 W	230 V	470	5,15	1,15
6033-20	2000 W	230 V	610	4,5	1,65

P/N.	Power +5 -10%	Voltage 1P	A (mm)	Load (W/cm ²)	Weight (kg)
6033-30	2500 W	230 V	783	4,5	2,40
6033-50	4000 W	230 V	1162	4,5	3,20
6033-90	6000 W	230 V	1570	4,5	4,70

Type 6123 : same as 6013 but with ferrules

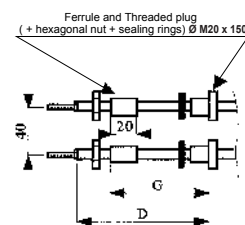

OTHER MANUFACTURING OPTIONS WITH SHORT DELIVERY TIMES : power, voltage, length of element (Dimension A), tube material (AISI 316L/Din 1.4404), fin material (stainless steel AISI 304L/Din 1.4306), threaded plug material (stainless steel) and their means of fastening to the tube (brazed for 50 bar max. pressure), seals (HT "high temperature" or TM "moderated temperature" and terminals (cables, flat terminals, hexagonal terminals, Faston terminals or threaded stainless steel terminals).

ACCESSORIES

For Finned strip heaters 25 x 50

- IP 55 IK5 polyamid connection box equipped with sealing gland ISO 20 - Max using temperature: 120°C - P/N. 6004-99 (Weight 0.4 kg).
- Pair of protected steel brackets for horizontal use P/N : 6004-81 . (Weight 0.22 kg).

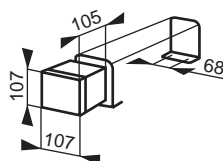

For Finned strip heaters 40 x 80

- IP 55 IK5 polyamid connection box equipped with sealing gland ISO 20 BIS - Max using temperature: 120°C P/N 6013-99 (Weight 0.4 kg).
- Pair of protected steel brackets for horizontal use P/N 6002-81 (Weight 0.22 kg).

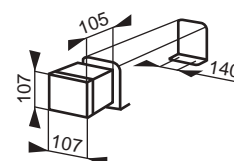

SWITCH CABINET HEATERS

Heaters with integral thermostat for warming electrical switch cabinets. Made of one or two finned strip heaters mounted in a polyamide 6/6 box, with IP42 cover, 0/120°C thermostat in a thermowell, mounted on two brackets, with ISO 25 gland. Same characteristics as stainless steel 25x50 finned strip heaters type 6004.

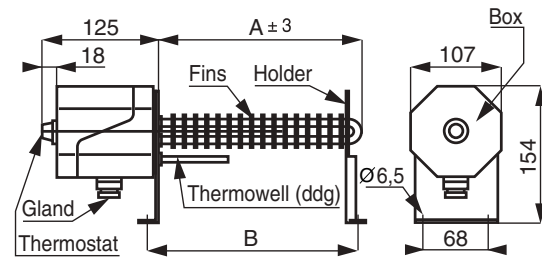
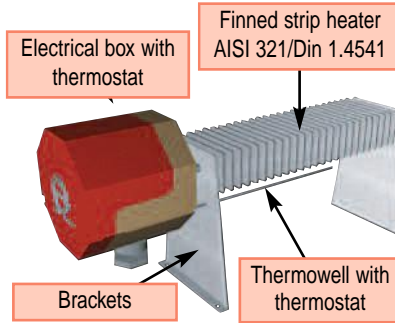

Version with 1 finned strip heater

P/N.	Power	Voltage	A		Load	B Spare	Weight
	+5 -10%	1P	(mm)	(mm)	(W/cm ²)	element	(kg)
6108-01	115 W	110 V	395	399	0,6	6004-13	3,15
6108-02	150 W	110 V	470	474	0,6	6004-73	3,21
6108-03	230 W	110 V	760	764	0,6	6004-33	3,50
6108-04	340 W	110 V	1045	1049	0,6	6004-43	3,95
6108-05	150 W	127 V	395	399	0,8	6004-13	3,15
6108-06	220 W	127 V	470	474	0,8	6004-73	3,21
6108-07	300 W	127 V	760	764	0,8	6004-33	3,50
6108-08	450 W	127 V	1045	1049	0,8	6004-43	3,95
6108-09	500 W	230 V	395	399	2,7	6004-13	3,15
6108-10	670 W	230 V	470	474	2,7	6004-73	3,21
6108-11	1000 W	230 V	760	764	2,7	6004-33	3,50
6108-12	1500 W	230 V	1045	1049	2,7	6004-43	3,95

Version with 2 finned strip heaters

P/N.	Power	Voltage	A		Load	B Spare	Weight
	+5 -10%	1P	(mm)	(mm)	(W/cm ²)	element	(kg)
6108-51	230 W	110 V	395	399	0,6	6004-13	3,65
6108-52	300 W	110 V	470	474	0,6	6004-73	3,77
6108-53	460 W	110 V	760	764	0,6	6004-33	4,35
6108-54	680 W	110 V	1045	1049	0,6	6004-43	5,25
6108-55	300 W	127 V	395	399	0,8	6004-13	3,65
6108-56	440 W	127 V	470	474	0,8	6004-73	3,77
6108-57	610 W	127 V	760	764	0,8	6004-33	4,35
6108-58	900 W	127 V	1045	1049	0,8	6004-43	5,25
6108-59	1000 W	230 V	395	399	2,7	6004-13	3,65
6108-60	1340 W	230 V	470	474	2,7	6004-73	3,77
6108-61	2000 W	230 V	760	764	2,7	6004-33	4,35
6108-62	3000W	230 V	1045	1049	2,7	6004-43	5,25

ATEX ENCLOSURES HEATERS - Ex e

These extra flat heaters (20 mm) are designed for electrical cabinets. Consist in stainless steel (316L) frames containing a self regulating cable, ATEX certified, allows a high level of frost protection and prevents the condensation of moisture. They can be fitted in all positions and are vibration resistant. ATEX marking: 2 GD Ex e II CT 3 Gb and II 2 GD Ex e II CT 6 Gb

Certificate: **LCIE 13 ATEX 3091**

Hygrostat or ATEX thermostat controlled (option)

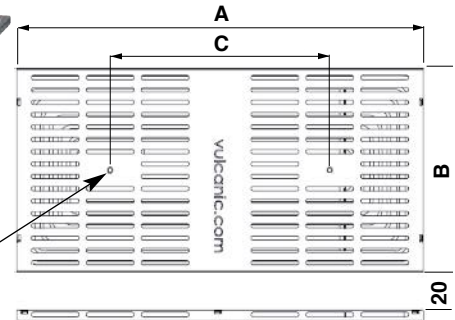
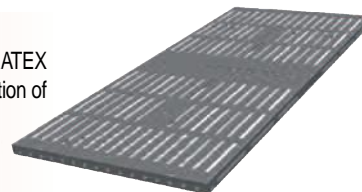

Ref. 9014-98 page 98



Ref. 6023-02/04 page 98

Temperature class T3

P/N.	Power	Tension	A		B	Marking
	+5 -10%	mono	(mm)	(mm)	(mm)	
6032-01	50 W	110 V	220	140	90	T3
6032-02	100 W	110 V	330	170	180	T3
6032-03	200W	110 V	660	170	360	T3
6032-04	500 W	110 V	740	330	450	T3
6032-05	50 W	230 V	220	140	90	T3
6032-06	100 W	230 V	330	170	180	T3
6032-07	200W	230 V	660	170	360	T3
6032-08	500 W	230 V	740	330	450	T3

Temperature class T6

P/N.	Power	voltage	A		B	Marking
	+5 -10%	mono	(mm)	(mm)	(mm)	
6032-10	50 W	110 V	220	140	90	T6
6032-11	100 W	110 V	330	170	180	T6
6032-12	200W	110 V	660	170	360	T6
6032-13	500 W	110 V	740	330	450	T6
6032-14	50 W	230 V	220	140	90	T6
6032-15	100 W	230 V	330	170	180	T6
6032-16	200W	230 V	660	170	360	T6
6032-17	500 W	230 V	740	330	450	T6

ANTI-CONDENSATION CABINET HEATERS

Heaters to keep wiring or switch cabinets free of frost, or to prevent condensation from forming in electric cabinet. Finned aluminium elements with safety thermostat to limit the surface temperature to 70°C. Fitted with 3-cores 0,75m² supply cable, length 0.3m. Can be mounted on 35mm DIN rails. Voltage : 230 V single phase.

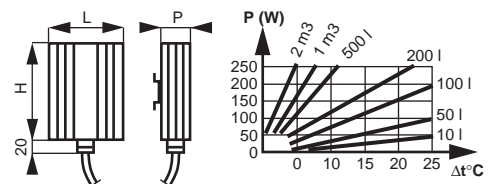

P/N.	P/N.	Power	H x L x P	Weight
IP 30	IP 55	+5 -10%	(mm)	(kg)
6006-00	6006-90	20 W	110x88x37	0,60
6006-01	6006-91	50 W	110x88x37	0,60
6006-02	6006-92	100 W	165x120x64	0,95
6006-03	6006-93	250 W	200x120x64	1,30



RADIATORS

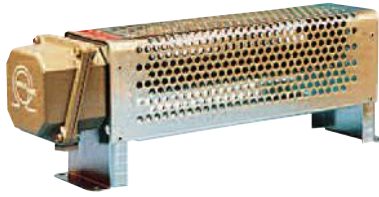

The thermostat setting knob is located on the outside of the unit.

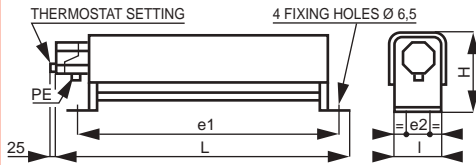

Steel radiator : Stainless steel heating element, F17 stainless steel fins, housing and support in protected steel, painted aluminium terminal box.

Stainless steel radiator : AISI 321/Din 1.4541 stainless steel heating element, stainless steel fins AISI 304L/Din 1.4305 stainless steel housing and brackets, painted aluminium terminal box.

These particularly robust appliances have been designed to provide reliable heating for industrial and technical premises, control rooms and mobile site cabins. Connection via gland to a IP55 IK7 aluminium terminal box. Available with an integral control thermostat, adjustable from 0 to 50°C. Horizontal fitting.

IP 55 IK 7 connection box for radiators without thermostat and IP 42 IK 7 for radiators with thermostat.

Models 6007.xx and 6103.xx H = 150, l = 90, e 2 = 68, e1=L - 70 (without thermostat), e1=L - 105 (with thermostat)

Spare thermostat : **P/N. 6099-01**

Models 6008.xx and 6104.xx H = 200 , l = 165, e 1 = L - 85, e 2 = 136 Spare thermostat: **P/N. 6099-02**

Steel models

P/N. without thermostat (mm)	P/N. with thermostat (mm)	L (mm)	Power +5 -10%	Spare element	Weight (kg)	
6007-01	430	6007-21	465	500 W	6004-10	3,0
6007-02	530	6007-22	565	750 W	6004-20	3,5
6007-03	630	6007-23	665	1000 W	6004-30	4,0
6008-01	520	6008-21	520	1500 W	6004-13	6,0
6008-02	595	6008-22	595	2000 W	6004-73	6,5
6008-03	886	6008-23	886	3000 W	6004-33	9,0
6008-04	1171	6008-24	1171	4500 W	6004-43	12,0

Stainless steel models

P/N. without thermostat (mm)	P/N. with thermostat (mm)	L (mm)	Power +5 -10%	Spare element	Weight (kg)
6103-21	500 W	465	6004-15	3,0	
6103-22	750 W	565	6004-25	3,5	
6103-23	1000 W	665	6004-35	4,0	
6104-21	1500 W	520	6004-18	6,0	
6104-22	2000 W	595	6004-28	6,5	
6104-23	3000 W	885	6004-38	9,0	
6104-24	4500 W	1170	6004-48	12,0	

Power supply : Type 6007-xx and 6103-xx : 230V 1P

Type 6008-xx and 6104-xx : supplied coupled 400V 3P - possibility of coupling 230V 1P (except 4500W) and 230V 3P.

Other manufacturing options : special powers and voltages

RADIATORS FOR PUBLIC PREMISES

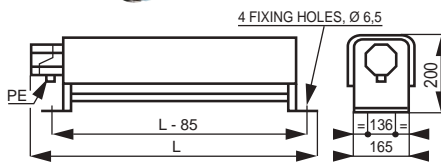

Low surface temperature suitable for public premises (reception halls, shops, waiting rooms, etc.)

Certified Class A by VERITAS (provided the appliances are wall-mounted) for use in merchant navy ships.

Include a safety thermostat with manual reset and no control thermostat. Connection via gland to a IP 55 IK7 box in black anodised aluminium. Supplied with a set of brackets 6008-20 (see accessories for radiators).

Supply voltage : 230 V 1P. Max. surface temperature on the housing : 85°C at an ambient temperature of 25°C.

P/N.	Power +5 -10%	L (mm)	Spare element	Weight (kg)
6021-01	500 W	520	6004-21	6,8
6021-02	1000 W	886	6004-22	9,6
6021-03	1500 W	1171	6004-23	12,2

Spare thermostat **P/N.6099-03**

ACCESSORIES FOR RADIATORS

Accessories for radiator type 6007 :

Pair of protected steel brackets for wall mounting

P/N. 6006-20 (weight 0,47 kg).

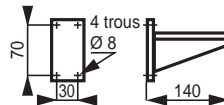

Accessories for radiator type 6008, 6010, 6021

Pair of protected steel brackets for wall mounting.

P/N. 6008-20 (weight 0,9 kg).

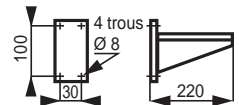

ATEX RADIATORS FOR DUSTY ENVIRONMENT - Ex d

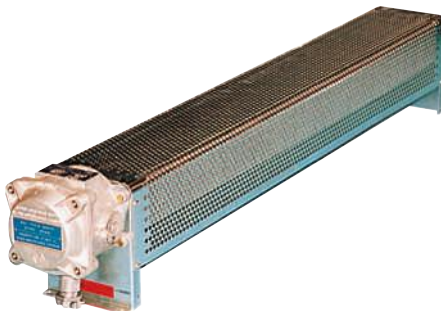

These particularly robust appliances have been designed to provide reliable heating at 40°C in explosive ambient with conductive dust. and max. skin temperature of heating element located inside the vessel 195°C, at an ambient temperature from - 20°C up to 40°C.

Connection via gland to an Ex t IIIC box IP66 equipped with ground terminal for equipotential connection; protected steel brackets and housing. Horizontal fixing.

Marking II 2 D Ex t IIIC T₅ 195°C Db IP 66
Certificate : LCIE 11 ATEX 3059X

Particular precautions must be taken to secure the operation of this product. Consult us or read the instruction manual.

Others possibilities : -20 up to +60 °C

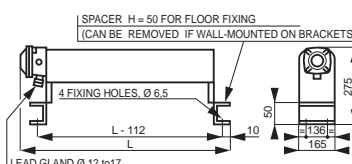

Supply voltage: 230 V 1P

P/N.	Power +0 -10%	L (mm)	Weight (kg)
6110-42	465 W	612	12
6110-43	790 W	902	18
6110-45	1110 W	1187	24
6110-47	1675 W	1687	27

Supply voltage: 230 V 3P

P/N.	Power +0 -10%	L (mm)	Weight (kg)
6110-52	465 W	612	12
6110-53	790 W	902	18
6110-55	1110 W	1187	24
6110-57	1675 W	1687	27

Supply voltage : 400V 3P

P/N.	Power +0 -10%	Lt (mm)	Weight (kg)
6110-02	465 W	612	12
6110-03	790 W	902	18
6110-05	1110 W	1187	24
6110-07	1675 W	1687	27

ATEX RADIATORS WITHOUT CONTROL THERMOSTAT - Ex d

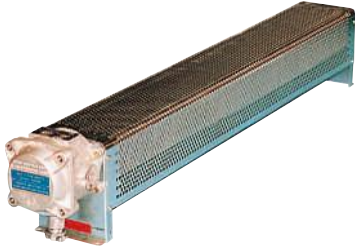

Room radiator ATEX 94/9/CE certified, for heating of ATEX hazardous atmospheres (ambient temperature from -20°C up to 40°C, maximum humidity 95%)- Built with a set of **heating pins ø 16 mm** mounted in a coated steel housing.

- Aluminium junction box IP 55 IK 7 with cable gland .
- **Explosion-proof equipment** of category 2 for surface industries usable in risk areas 1 and 2, in gas environment of the group IIC whose temperature of self ignition is higher than 200°C.

We recommend the use of a thermostat allowing an optimal control of ambient temperature in the room :

Atex control thermostat Ex de IIC T6 reference 6023-02.

Special precautions must be taken to ensure a safe and appropriate use of this equipment. Please consult us or read the instruction manual previously.

Atex marking : II 2 G Ex d IIC T3 Gb.
EC type examination certificate :
INERIS 11 ATEX0046



IECEX EPS 13.0046
EPS 11ATEX1354

Model Ex d IIC T3 (skin temperature of maxi 200°C on the heating element inside the steel casing with an ambient temperature from -20°C up to +40°C).

Temperature class T3

Power. +5 -10%	L (mm)	Weight (kg)	Voltage	P/N.	Voltage	P/N.	Voltage	P/N.
600 W	902	13	230V Mono	6410-43	230V Tri	6410-53	400V Tri	6410-03
800 W	1187	16	230V Mono	6410-45	230V Tri	6410-55	400V Tri	6410-05
1200 W	1687	24	230V Mono	6410-47	230V Tri	6410-57	400V Tri	6410-07

Ambient thermostat ATEX -20/+40°C - Protection : Ex de IIC T6 junction box IP64 - 10A/230VAC - Réf. 6023-02.

ATEX RADIATORS WITH CONTROL THERMOSTAT - Ex d

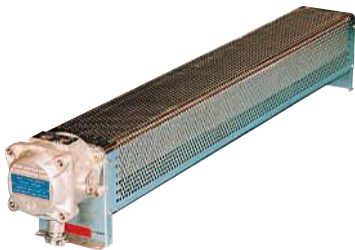

Room radiator type 6010 ATEX 94/9/CE certified, for heating of ATEX hazardous atmospheres (ambient temperature from -20°C up to 40°C, maximum humidity 95%). Built with a set of **heating monotubes mounted in a pocket** mounted in a coated steel housing.

- Control thermostat from 0 up to 50°C.
- Aluminium junction box IP 55 IK 7 with cable gland .
- **Explosion-proof equipment** of category 2 for surface industries usable in risk areas 1 and 2, in gas environment of the group IIC whose temperature of self ignition is higher than 135°C (T4) or 200°C.

Special precautions must be taken to ensure a safe and appropriate use of this equipment.

Please consult us or read the instruction manual previously.

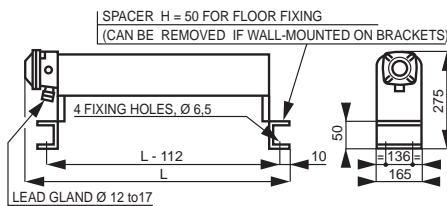

Atex marking II 2 G Ex d IIC T3 and T4
EC type examination certificate : LCIE 03 ATEX 6282X

Model Ex d IIC T3 (skin temperature of maxi 200°C on the heating element inside the steel casing with an ambient temperature from -20°C up to +40°C).

Model Ex d IIC T4 (skin temperature of maxi 135°C on the heating element inside the steel casing with an ambient temperature from -20°C up to +40°C).

Temperature class T3

Power. +5 -10%	L (mm)	Weight (kg)	Voltage	P/N.	Voltage	P/N.	Voltage	P/N.
500 W	612	10	230V Mono	6010-55				
750 W	612	12	230V Mono	6010-65	230V Tri	6010-68	400V Tri	6010-62
1250 W	902	18	230V Mono	6010-66	230V Tri	6010-69	400V Tri	6010-63
2000 W	1187	24	230V Mono	6010-67	230V tri	6010-70	400V Tri	6010-64

Temperature class T4

Power +5 -10%	L (mm)	Weight (kg)	Voltage	P/N.	Voltage	P/N.	Voltage	P/N
375 W	612	12	230V Mono	6010-35	230V Tri	6010-38	400V Tri	6010-42
650 W	902	18	230V Mono	6010-36	230V Tri	6010-39	400V Tri	6010-43
900 W	1187	24	230V Mono	6010-37	230V tri	6010-40	400V Tri	6010-44

ATEX RADIATORS WITH CONTROL THERMOSTAT AND SAFETY CUT OUT - Ex de



Room radiator type 6022 ATEX 94/9/CE certified, for heating of ATEX hazardous atmospheres (ambient temperature from -20°C up to 60°C, maximum humidity 95%). Built with a set of **heating pins ø 8,5 mm** mounted in a coated steel housing.

- Junction box IP 66 in painted cast-iron with cable gland.
- Control thermostat from 0 up to 50°C and safety cut-out.

Explosion-proof and increased safety equipment of category 2 for surface industries usable in risk areas 1 and 2, in gas environment of the group IIC whose temperature of self ignition is higher than 200°C(T3).

On request, this range of Atex radiators is also available in compliance with temperature class from T1 up to T6.

Special precautions must be taken to ensure a safe and appropriate use of this equipment. Please consult us or read the instruction manual previously.

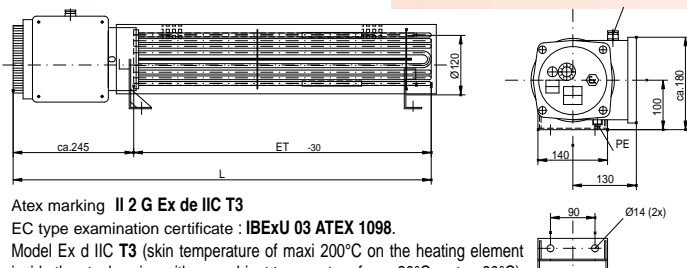

Atex marking II 2 G Ex de IIC T3
EC type examination certificate : IBExU 03 ATEX 1098.

Model Ex d IIC T3 (skin temperature of maxi 200°C on the heating element inside the steel casing with an ambient temperature from -20°C up to +60°C).

Temperature class T3

Power. +5 -10%	L (mm)	ET (mm)	Voltage	P/N.	Voltage	P/N.
500 W	510	250	230V Mono	6022-01	400V Tri	
1000 W	660	400	230V Mono	6022-02	400V Tri	
1500 W	860	600	230V Mono	6022-03	400V Tri	
2000 W	960	700	230V Mono	6022-04	400V Tri	
3000 W	1260	1000	230V Mono		400V Tri	6022-05
4000 W	1760	1500	230V Mono		400V Tri	6022-06

FAN HEATERS

Fan heaters for wall mounting, or mounted on castors to heat premises with recirculated air (case in electro-galvanised steel, painted and stove-dried – double layer of thermal insulation).
Thermal safety device. protective grille and air deflector.
Switch and thermostat on front panel with power on/off switch. Sound level at 1 m = 55 db(A).
IP 33.
Delivered with pair of wall brackets.



Dimensions : H = 480 mm - L = 400 mm
P = 400 mm (6 kW), 535 mm (12 kW), 670 mm (18 kW).

Accessories :

• Pair of wall brackets in painted sheet steel

P/N. 6046-98 L = 622 (6 -12 kW)

P/N. 6046-99 L = 690 (18 kW)

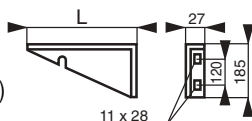

Mobile wheeled support P/N. 6041-98 (weight 9 kg)



Supply voltage : 400 V 3P.

P/N.	Power +5 -10%	Stages	Max. output (m ³ /h)	Weight (kg)
6046-06	6 kW	1/1	950	24
6046-12	12 kW	1/2 + 1/2	950	29
6046-18	18 kW	1/3 + 2/3	1750	34

Standard model to order.

Supply voltage : 230/400 V3P

P/N.	Power +5 -10%	Stages	Max. output (m ³ /h)	Weight (kg)
6046-56	6 kW	1/1	950	24
6046-62	12 kW	1/2 + 1/2	950	29
6046-68	18 kW	1/3 + 2/3	1750	34

Ambient thermostat for remote control of temperature :

P/N. 9014-20 • (see 'thermostats' section)

PORTABLE FAN HEATERS 2 to 15 kW

Portable floor-level fan heaters. Ideal top-up heating for industrial or agricultural sites.

Quick to set up (simply plug in), they can be moved quickly as the need arises.

This range of robust appliances at a competitive price meets the needs of many users while offering a quality technical specification.

2 switchable speeds on all modules : half/ full power switch, and integral blind ambient thermostat adjustable between 0° to 40°C without range.

IP 54.



P/N.	Max. power +5 -10%	Voltage (V)	Air output (m ³ /h)	Weight (kg)
6120-22	2 kW	230 1P	300	5,0
6120-25	5 kW	400 3P	400	8,0
6120-29	9 kW	400 3P	1300	13,5
6120-35	15 kW	400 3P	1300	15,5

Dimensions

6120-22	230 x 200 x 330
6120-25	250 x 250 x 420
6120-29	350 x 380 x 600
6120-35	350 x 440 x 600

WALL-MOUNTED FAN HEATERS 6 to 15 kW

Perfectly suited for the industrial environment, these fan heaters are designed to heat thermally insulated areas with little air change. In epoxy-coated steel sheet protected by a coat of lacquer, front panel in matt anodised aluminium.

These fan heaters are fitted with an ingenious wall mounting device which allows a choice of three fixing angles.

A 'quick fit' plug allows easy connection to a remote control (see accessories).

6 kW models : 1 heating speed + ventilation only.

9 to 15 kW models : 2 heating speeds + ventilation only.

Protection level : IP34.

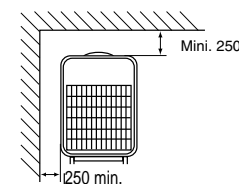
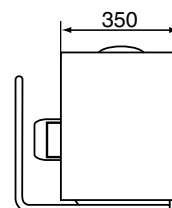
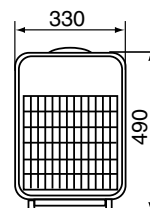

Installation :
Minimum distance (mm)

Reference P/N. follows Voltage

Power +5 -10%	230 V 3P	400 V 3P + N	400 V 3 P	440 V 3 P	Air output (m ³ /h)	Weight (kg)
6 kW	6129-11	6129-01	6129-21	6129-31	840	14,5
9 kW	6129-12	6129-02	6129-22	6129-32	840	14,5
12 kW	6129-13	6129-03	6129-23	6129-33	1050	16,5
15 kW	-	6129-04	6129-24	6129-34	1050	16,5

Accessories :

P/N : 6129-97

Remote digital electronic control allows the connection of a maximum of 6 air-blow heaters to select and see the temperature room (35 °C max), to start up the fan only or to start up the power with the fan together (2 speeds) and select the operating time from 1h to 9 hours.



INDUSTRIAL FAN HEATERS WITHOUT REGULATION

Fan heaters of simple and robust design for heating recirculated air in areas such as workshops, factory shopfloors, warehouses, refectories, sports halls, garages, shops, greenhouse... These appliances are not fitted with any control system. Max. working temperature : 45°C.

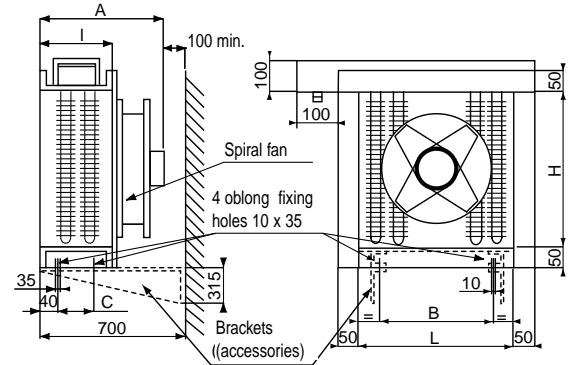

Specification of listed models with short delivery time :

Body in protected steel sheet. Stainless steel finned strip heaters (tube in AISI 312/Din 1.4541, fins in Z8 C17). Spiral fan with large blades, and motor (1000 or 1500 rpm, depending on model) with IP55 connection box. Safety thermostat set at 110°C, automatic reset. Connection of two power stages and safety thermostat in an IP30 box with 3 glands (2 for the power stages and 1 for the safety device).

P/N.	Power +5 -10%	Voltage (V Tri)	over heating (°C)	L (mm)	H (mm)	I (mm)	A (mm)	B (mm)	C (mm)	Stages (kW)	ØFan (mm)	Speed (t/mn)	run. output (m³/h)	Weight (kg)
6016-01	4,5	400		358	440	284	500	280	150	2,25+2,25	300	1000	1250	24
6016-02	6,75	400	12	355	440	334	550	280	200	2,25+4,50	300	1000	1200	27
6016-03		400	9 16	355	440	334	550	280	200	2,25+6,75	300	1000	1150	30
6016-04	11,25	400	20	355	440	334	550	280	200	4,50+6,75	300	1000	1100	32
6016-05	15,75	400	28	355	440	384	600	280	250	4,50+11,25	300	1000	1050	36
6016-06	18	400	32	355	540	384	600	280	250	6 +12	300	1000	1000	38
6016-07	21	400	26	395	540	384	605	280	250	6 +15	350	1500	1500	49
6016-08	24	400	30	395	540	384	605	280	250	9 +15	350	1500	1300	52
6016-09	27	400	12	435	540	384	605	350	250	9 +15	400	1500	2750	56
6016-10	30	400	13	435	540	384	615	350	250	12 +18	400	1500	2500	58
6016-11	33	400	14	435	540	434	665	350	300	12 +21	400	1500	2250	61
6016-12	36	400	16	435	540	434	665	350	300	12 +24	400	1500	2000	66
6016-13	40,5	400	13	515	790	384	675	350	250	13,50+27	450	1500	4000	74
6016-14	45	400	14	515	790	384	675	350	250	13,50+31,50	450	1500	3800	79
6016-15	49,5	400	16	515	790	384	675	350	250	18 +31,50	450	1500	3600	83
6016-16	54	400	17	515	790	384	675	350	250	18 +36	450	1500	3400	87
6016-17	58,5	400	15	555	790	384	695	350	250	22,50+36	500	1500	5200	99
6016-18	63	400	16	555	790	434	695	350	300	22,50+40,50	500	1500	5000	104
6016-19	67,5	400	17	555	790	434	695	350	300	22,50+45	500	1500	4800	109

Accessory : Pair of wall fixing brackets : P/N. 6059-01 for 30kW max.power models (Weight : 9 kg).

Other manufacturing options : Power, Voltage, number of stages, body material (stainless steel), sealing of the IP55 terminal box, etc.

CONVECTOR HEATERS

Convector heaters designed for heating houses, offices or technical sites open to the public. They are robust, pleasant to look at, and comply with European standards. Fitted with an on/off switch and an electronic ambient thermostat measuring the temperature at the air entry point, with the option of mechanical locking to a temperature range or to one set temperature. 'Frost guard' position set to approx. 7°C. Supply voltage: 230 V single phase.



P/N.	Power +5 -10%	L (mm)	H (mm)	D (mm)	Weight (kg)
6045-10	1000 W	420	430	83	4,6
6045-15	1500 W	580	430	83	6
6045-20	2000 W	740	430	83	7,6

All these convector heaters are double insulated (class 2) , and can be installed near water draw-off points as defined in regulations.

Electronic ambient air control : see 'thermostats' section.

HOT AIR CURTAINS 3kW

Economical hot air curtains suitable for single doorways. The heater can be wall - or ceiling -mounted at a height between 1,8m and 3m above floor level and a minimum of 300mm from adjacent walls . Hot air curtains set up a thermal barrier between two places of very different temperature. They help to save heating and air-conditioning in the protected area. Mounting kit included.

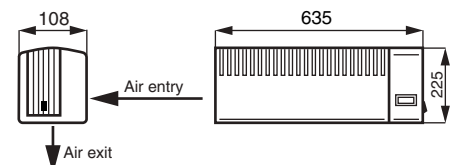
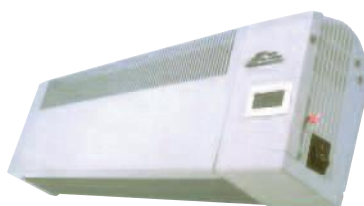

P/N.	Power +5 -10%	Voltage	No of stages	LOutput ³/h m	Weight (kg)
6122-01	3 kW	230		250	
6122-02	as 6122-01 but with electronic thermostat.				

HIGH TEMPERATURE HOT AIR GENERATORS

Bare-wire hot air generator. A method of heating dry air. A bare heating wire is in direct contact with the air. This reduces the start-up time of the heater considerably (working temperature is reached in a few seconds) and allows high temperatures to be achieved from a small appliance.

Supplied with or without a suitable blower, the appliance reliably produces the desired result.

Generators can be used in

- an open circuit (sending out hot air) or in a closed circuit (to heat another system via a heat exchanger or a double-skinned casing).
- Closed-circuit models are fitted with fans and an offset motor, so as to withstand a high return temperature. In open-circuit use, we recommend an air filter at the turbine entry, to prolong the life of the heater (by reducing accumulation of dirt, and corrosion of the heater).

Maximum output air temperature for generators : 250°C

Suction fans are designed to operate in open or closed circuit with an air inlet temperature of 160 ° C max

SUCTION FAN



HEATERS



GENERATOR



HEATERS

SUCTION FAN (50Hz)

P/N.	Power +5 -10%	Voltage (V)	Ø int (mm)	Length (mm)	P/N.	Power (kW)	Voltage (V)	Run. output (m ³ /h)
10755-01	1,5 kW	230 -1P	50	271	10746-01	0,4	220/380	360
10755-02	3 kW	230 -1P	50	271	10746-01	0,4	220/380	360
10756-01	3 kW	230 -1P	100	368	10747-01	0,75	220/380	900
10756-02	6 kW	230 -1P	100	368	10747-01	0,75	220/380	900
10756-03	3 kW	400 -3P	100	368	10747-01	0,75	220/380	900
10756-04	6 kW	400 -3P	100	368	10747-01	0,75	220/380	900
10756-05	9 kW	400 -3P	100	368	10747-01	0,75	220/380	900
10756-06	12 kW	400 -3P	100	368	10747-01	0,75	220/380	900
10757-01	18 kW	400 -3P	195	489	10748-01	3,7	220/380	2100
10757-02	24 kW	400 -3P	195	489	10748-01	3,7	220/380	2100
10757-03	36 kW	400 -3P	195	489	10748-01	3,7	220/380	2100

Accessories :

P/N.: 10748-02

Adapters to connect the motor fan type 10748 to "high power" heater type 10757

HOT AIR GENERATORS

These hot air generators are ideal for heating, drying, heat-shrinking or polymerisation.

Designed for industrial use, the AISI 321/Din 1.4541 stainless steel heating element heats air to a maximum of 90°C, propelled by the fan.

The heating part of these appliances is completely insulated.

Two models are available :

- fully equipped model, ready for use with temperature control and safety systems.

The PID controller drives a power unit, allowing a steady, precise output air temperature.

- unregulated model with safety system. A Pt100 ohms probe and a safety thermostat measure the output air temperature. The installer has to add an external control system (controller with Pt 100 input + power unit).

Minimum inlet temperature: 10°C.

Maximum outlet temperature: 90°C.

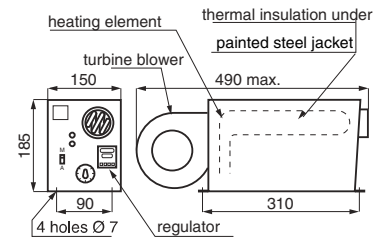

P/N.	Power +5 -10%	Voltage (V)	Regulator
10712-01	700 W	230 1P	Yes
10712-51	700 W	230 1P	No

Ø of outlet pipework : 50 mm (about)

Temperature rise is inversely proportional to output, which depends upon pressure loss in the receiver (tube + nozzle installed by the user).

Temperature rise inlet / outlet (°C)	80	70	60	50	45	40
Air output (m ³ /h)	23	26	30	37	41	46
Pressure loss in receiver (mm of CE)	90	85	70	50	25	0

To increase the air outlet temperature, it is therefore sometimes necessary to reduce the diameter of the outlet pipework.

PORTABLE HOT AIR GENERATORS

Portable equipment for heating and drying various parts, treatment of heat shrink to achieve bonding and welding of plastics.

Continuous adjustment using an electronic mounted in the handle

Supply voltage: 230 V 1P.

Power wire length = 3 m.

P/N 6042-02



P/N 6042-03



P/N.	Power. +5 -10%	Length (mm)	Air output (l/min)	Temp. (°C)	Weight (kg)
6042-02	3400 W	320	500 maxi	+20/+650	1,5
6042-03	1600 W	340	230 maxi	+20/+700	1,3

Blowing accessories:
Consult us



AIR HEATERS FOR CIRCULAR DUCTS

Electric duct heaters, for heating air to approx. 40°C in round air-conditioning ducts (diameter from 125 to 630mm) to a maximum pressure of 100mm WC and a minimum air speed of 2 m/s. Tubular sheathed elements stainless steel tube AISI 321/Din1.4541 in flat panel shape, mounted on an IP 30 cover in galvanised steel sheet.

2 sealing glands ISO 16 and ISO 20 Bis.

Supply voltage : 230 V 1P, 230 V 3P, 400 V 3Pi

In accordance with coupling and power selected.

Equipped with temperature limiter, bimetallic expansion type, with automatic reset preset to 90°C

Options :

- Stainless steel vessel.
 - Temperature limiter, bimetallic expansion type, with manual reset preset to 120°C
 - 2 temperature limiters, bimetallic expansion type, for air temperature alarms with 1 manual reset preset to 120°C and other one automatic reset preset to 90°C
- Diameter up to 600 mm-Power up to 27 kW with Longer length

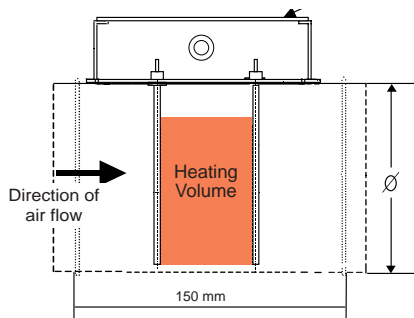

Standard models (supplied with connecting clips) :

Power +5/-10 % (kW)	Duct diameter Ø (mm)								
	125	160	200	250	315	355	400	450	500
0,5	60155-01	60255-01	60355-01	<input type="checkbox"/>	<input type="checkbox"/>				
0,75	60155-02	60255-02	60355-02	60455-02	60555-02				
1,00		60255-03	60355-03	60455-03	60555-03	60655-03	<input type="checkbox"/>		
1,25				60455-04	60555-04	60655-04	<input type="checkbox"/>		
1,50		60255-05 60255-06	60355-05 60355-06	60455-05	60555-05 <input type="checkbox"/>	60655-05	60755-05	60855-05	
1,75					60555-07	60655-07	60755-07	60855-07	<input type="checkbox"/>
2,00				60455-08	60555-08	60655-08	60755-08	60855-08	60955-08
2,25			60355-09	60455-09	60555-09				
2,50				60455-10	60555-10	60655-10	<input type="checkbox"/>	<input type="checkbox"/>	<input type="checkbox"/>
2,66							60755-11	60855-11	60955-11
3,00			60355-13	60455-13	60555-13	60655-12 60655-13	<input type="checkbox"/>	60855-12	<input type="checkbox"/>
3,50				60455-14	<input type="checkbox"/>	<input type="checkbox"/>	60755-14	60855-14	60955-14
3,75				60455-15	60555-15	60655-15	<input type="checkbox"/>		
4,00					60555-16	60655-16	60755-16	60855-16	60955-16
4,50					60555-17	60655-17	60755-17	60855-17	60955-17
5,30					60555-18	60655-18	60755-18	60855-18	<input type="checkbox"/>
6,00					60555-19	60655-19	60755-19	60855-19	60955-19
7,50						60655-20			<input type="checkbox"/>
8,00							60755-21	60855-21	60955-21
9,00						60655-22	<input type="checkbox"/>	<input type="checkbox"/>	<input type="checkbox"/>
10,50								60855-23	60955-23
12,00								60855-24	60955-24
13,50									60955-25

Available on request

Single phase : Main power in single phase, Duct heater with 1, 2 or 3 heating elements in 230V.
3 phases : Main power in 3 phases, Duct heater with 3 heating elements in 230V..

CENTRIFUGAL FANS FOR CIRCULAR DUCTS

Range of very compact fans (in galvanised steel) for round ducts. They can be installed at any point along a duct. IP 44.

They connect directly to standard ducting. Easy assembly and dismantling by means of fixing clamps supplied.

Supply voltage : 230 V 1P 50 Hz.

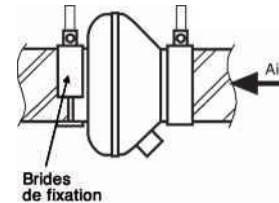
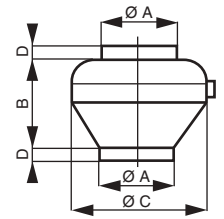

P/N	ØA (mm)	Output* (m³/h)	Output under Δp (m³/h)	Δp (Pa)	Max. (°C)	Dimensions (mm)		Power	Weight (kg)	
						B	C	D(W)		
60541-99	200	820	600	150	60°C	172	344	25	100	4,1
60541-98	200	960	500	300	60°C	172	344	25	146	4,8
60542-99	250	1100	580	300	55°C	172	344	25	210	5,0
60543-99	315	1115	680	300	50°C	172	402	30	224	5,7
60540-99	125	350	200	150	60°C	146	242	20	73	2,5
60540-98	160	490	300	150	60°C	130	272	25	75	2,8
60540-97	160	700	400	200	60°C	172	344	25	95	3,9

*Output to free air, with zero pressure loss

AIR DUCT HEATERS FOR RECTANGULAR DUCTS

Electric duct heater, for heating air to approx. 40 °C in rectangular ventilation ducts, with a maximum pressure of 100 mm WC and a minimum air flow speed of 2 m/s. These appliances are made of stainless steel finned strip heaters type 6004 (25 x 50) for model 6051 or type 6013 (40 x 80) for model 6052, mounted on a base plate with an IP 30 IK 7 cover in galvanised steel.

- a 90/100 °C safety thermostat with automatic reset.
- 3 entry points for cable, diameter 5 to 20 mm.

Wiring for 1 or 2 heating stages depending on model. Supply voltage : 230 V 1P, 230 V 3P or 400 V 3P depending on connection and power required.

For large heaters, reinforce the internal edges with metal strips.

Model with 25 x 50 fins
Type 6051

Model with 40 x 80 fins :
Type 6052

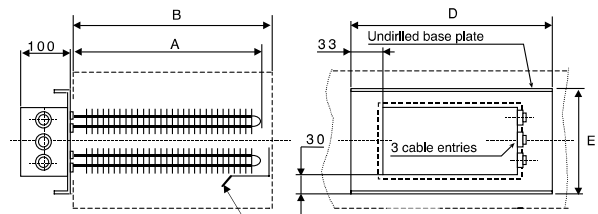
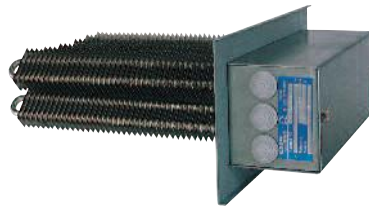

Shallow duct fixing

Tall duct fixing

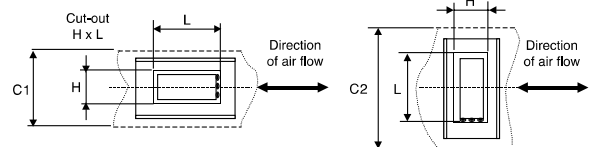

Appliances in stock :

Supplied unwired with instruction sheet and connection device allowing various combinations of power and voltage. Element voltage 230V 1P.

P/N	Max. power +5 -10%	Unitary. power of pins +5 -10%	A (mm)	Weigh (kg)
60512-08	2,25 kW	250 W	170	4,8
60512-19	6,00 kW	500 W	320	7,4
60513-28	11,25 kW	750 W	420	11
60513-39	18,00 kW	1000 W	520	14,4

Other manufacturing options : power, voltage, IP55 connection box, vessel in stainless steel...

Short delivery time :

Supplied wired.

Réf.	ExD	HxL	C1	C2
60511-xx	170x235	120x140	150	250
60512-xx	170x395	120x300	150	400
60513-xx	220x395	170x300	200	400
60521-xx	170x373	110x290	150	400
60522-xx	220x373	160x290	200	400
60523-xx	285x373	225x290	265	400

P/N.	Puissance (kW)															
	Pins P. unit		Duct P. maxi		Pins P. unit		Duct P. maxi		Pins P. unit		Duct P. maxi		Pins P. unit		Duct P. maxi	
60511-xx	0,25		1	0,5		2,75									1	4
60512-xx	0,25		3	0,5		6,75					12				1,5	18
60513-xx	0,25	4,5	0,5			9,75	13,5				18			1	1,5	27
60521-xx			1,25	3,75							2	2,5	7,5			
60522-xx			1,25	7,5						12	2	2,5	15			
60523-xx			1,25	11,25						18	2	2,5	22,5			
B mm	200		350		450		500		550		650		800			

These heaters are mounted on a duct of minimum depth B through a rectangular cut-out H x L (drawer method).

Spare parts :

Spare heating elements : see page finned strip heaters.

Safety thermostat, automatic resetting air limiter for temperature alarm 90°C, breaking capacity 10 A / 250 VAC, switch hysteresis 12°C. P/N. 53691-01.

PT 100 SENSORS WITH IP54 ALUMINIUM HEAD AND FLANGE

PT 100 ohm at 0°C class B sensing element, inside a AISI 316L /Din 1.4404 stainless steel sheath. Electrical connection by a 3 poles terminal block inside an IP 54 offset aluminium head, epoxy painted

Temperature range : - 50 to + 500°C (element)

The fitting flange is sliding.



P/N.	Ø D (mm)	Weight (kg)
31118-01	260	0,1
31118-02	560	0,15

RECTANGULAR AIR DUCT HEATERS APPLICATIONS

Rectangular duct heaters offer a means of raising the temperature of air duct in circulation and are used in industrial processes or in building air-conditioning applications.

When the circuit is closed (recycled air), the temperature rise generated by the rectangular duct heater is limited to a few degrees.

When the circuit is open (lost air), this rise can be up to 400°C.

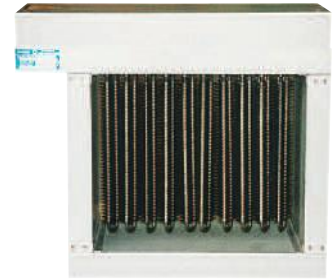

DEFINING YOUR RECTANGULAR AIR DUCT HEATER

Our standardised duct heaters are designed for heating dry or slightly humid, clean or slightly polluted air at a maximum pressure of 100 mm head. If our standardised duct heaters do not have all the criteria required for your application, we will build one specially for you.

List of main parameters needed to define a duct heater

- 1 – Rectangular duct heater model case drawer
- 2 – Quality of air to be heated dry air slightly damp there air not polluted
 air slightly polluted
- 3 – Air circulation : lost air recycled air
 recycled air with fresh air inlet temperature

4 – Min. air inlet temperature : _____ Maxi air outlet temperature : _____

5 – Nominal air flow (specifying the unit, m³/h, Nm³/h, kg/h...): _____

6 – Duct heater power (W) : _____

If you do not know the power to be installed, the following formula will help you to determine it, mainly for open circuit (lost air) applications :

$$P = 0,349 \times Mq \times \Delta t$$

P = Power to be installed in W (allowing for a safety factor of 1,2)

Mq = Mass flowrate (kg/h) = flow volume (m³/h) x mass volume at desired temperature (kg/m³)

Δt = temperature rise between inlet and outlet of rectangular duct heater in °C

In case of closed circuit operation (lost air), although the same formula applies identically, the temperature rise is gradual and not in one go. When Δt is not known, to estimate the power to be installed, it is necessary to take the following parameters into consideration : specific calorific losses of enclosure, volume of air and mass of rooms to be heated, temperature rise time etc. ...

7 – Number of power stages : _____

8 – Power supply voltage (specify single phase or three phase) : _____

9 – Air passage section (Width in mm x height in mm) : _____

_____ depth if required (mm) : _____

10 – Maximum operating pressure (while specifying the unit : mm de WC, Pa, mBar...): _____

11 – Maximum permissible load losses in battery :

12 – Material of housing : protected steel
 304L Stainless steel

13 – Tightness of the battery case : IP 55 IP 30

IDENTIFICATION OF THE RECTANGULAR DUCT HEATER MODELS BY TYPE NUMBER

Operating temperature	dry air	slightly damp or polluted air
temp. ≤ 110°C	6531/6532	6533/6096
110°C < temp. ≤ 200°C	6534	6534
110°C < temp. ≤ 300°C	6097	6097
Temp. > 300°C	consult us	consult us

Note : Compact rectangular duct heater type 6096 and 6097 have a high-power/ volume ratio.

The particular positioning of the heating elements considerably improves thermal exchanges.

Type P/N. of case model	Pwr min (kW)	Pwr maxi (kW)	heated by	Type P/N. of drawer model	L (mm)	H (mm)	Min. air vessel (m/s)	Max. air vessel (m/s)	Geometry	Tightness IP of terminal box
6531	0,25	171	Finned strip heaters 25 X 50	6535	75 to 1635	190 to 1540	1,5		Rectangular	30 or 55
6532	1,25	285	Finned strip heaters 40 X 80	6536	130 to 1755	350 to 1510	2		Rectangular	30 or 55
6533	0,25	228	tubular elements Ø 10,2	6537	75 to 1795	210 to 1300	2,5	3	Rectangular	30 or 55
6534	0,25	228	tubular elements Ø 10,2	6538	75 to 1795	250 to 1620	2,5	2	Rectangular	20 or 55
6096	1,35	368	tubular elements Ø 16		125 to 1725	500 to 1500	2,5	3	Rectangular	30
6097	1,125	368	tubular elements Ø 16		125 to 1725	500 to 1500	2,5	2,5	Rectangular	20 or 55

All our standard rectangular duct heaters have a safety thermostat with automatic reset in a thermowell, a stuffing box per power stage and a stuffing box for the safety thermostat. Customer electric connection is directly to the coupling bars of the heating elements except for the 6096 and 6097 models of high-power levels where connection is to a terminal block. Boxed models can be mounted in a horizontal or vertical airflow duct. The drawer type rectangular duct heater can be assembled preferably with the heating elements in the vertical position. The attaching flanges of the boxed rectangular duct heater and drawers rectangular duct heater on supporting plate are not drilled. Counter drilling will be performed on site. All our models have a protected steel or stainless steel carcass.

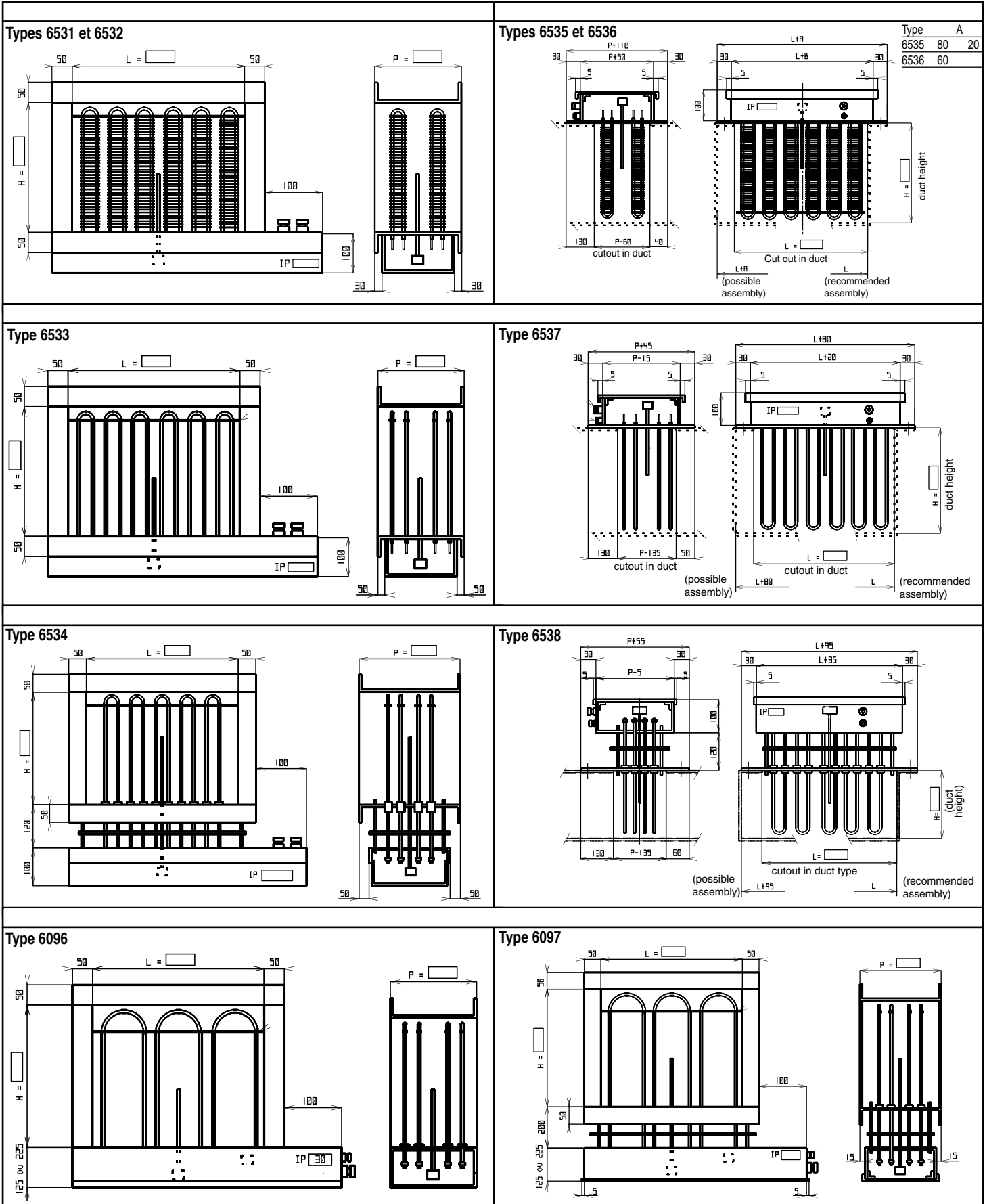

RECTANGULAR AIR DUCT HEATERS

KS = 0 mm, T < 80°C

KS = 150 mm, 80°C < T < 150 °C

KS = 300 mm, T > 150 °C

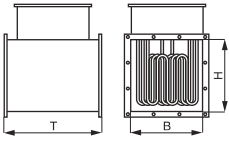

Type 6545

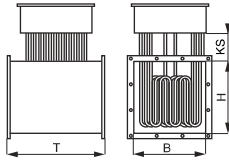

Tubular heating elements, diameter 10,2 mm, material AISI 316 L / DIN 1.4404

Inlet / Outlet flange : circumferential flange, width 40 mm

Metric threaded cable entry glands, Cover : IP 52

Supply voltage 230/400 V

2 sensor thermowells, diameter 7,5 x 0,5 mm (material AISI 316 L/ DIN 1.4435),

one connected to a heating element by a heat-transfer bridge

Max. working pressure 0,02 bar

All materials without certificate

Max. output temperature without cooling stretch (KS), 80 °C. (T> 80 °C with cooling stretch installed KS = 0 up to 80°C max.) ; KS = 150 mm 80°C < T < 150 °C KS= 300 mm, T > 150 °C.

FLANGE AIR HEATERS

Designed for heating air or gas up to 150°C, depending on the selected material and the cooling stretch, minimum speed 3m/s, maxi operating pressure 0,2 bar. Duct heaters made in stainless steel AISI 304/DIN1.

4301 as EN 1092 standard flanges form F, DN 100 or 150, PN 10. Designed for horizontal mounting.

IP52 connection box fitted with a 30 / 300 °C adjustable thermostat and a safety cut out preset to 500°C.

Voltage : 400V 3P



KS = 0 mm, T < 80°C

KS = 150 mm, 80°C < T < 150 °C

KS = 300 mm, T > 150 °C

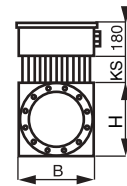
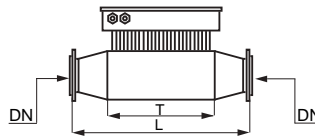

CLR 210 x 210 DN 150

Type 6546

H x B: 210 x 210				Load n (W/cm ²)			
(mm)	Rows of elements (mm)	Nbr. of elements	L	1	1,5	3	6
				Power (kW)	Power (kW)	Power (kW)	Power (kW)
300	900	3	3	0,7	1,0	2,0	4,0
300	900	6	6	1,4	2,0	4,0	8,0
300	900	9	9	2,1	3,0	6,0	12,0
500	1100	12	12	2,8	4,0	8,0	16,0
500	1100	15	15	3,8	5,0	10,0	20,0
500	1100	18	18	4,2	6,0	12,0	24,0
750	1350	24	24	5,6	8,0	16,0	32,0
750	1350	30	30	7,6	10,0	16,0	40,0
750	1350	36	36	8,4	12,0	24,0	48,0
1000	1600	39	39	8,8	13,0	26,0	52,0
1000	1600	42	42	9,5	14,0	28,0	56,0
1000	1600	48	48	11,2	16,0	32,0	64,0

CLR 285 x 285 DN150

Type 6547

H x B: 285 x 285				Load n (W/cm ²)			
(mm)	Rows of elements (mm)	Nbr. of elements	L	1	1,5	3	6
				Power (kW)	Power (kW)	Power (kW)	Power (kW)
300	900	3	135	2,2	2,5	9,0	
300	900	6	360	4,5	9,0	18,0	
300	900	9	495	6,7	13,5	27,0	
500	1100	12	6,0	9,0	18,0	36,0	
500	1100	15	7,5	11,2	22,5	45,0	
500	1100	18	9,0	13,4	27,0	54,0	
750	1350	24	12,0	18,0	36,0	72,0	
750	1350	30	15,0	22,4	45,0	90,0	
750	1350	36	18,0	27,0	54,0	108,0	
1000	1600	39	19,5	29,0	58,0	117,0	
1000	1600	42	21,0	31,5	63,0	126,0	
1000	1600	48	24,0	36,0	72,0	144,0	

CLR 400 x 400 DN 250

Type 6548

H x B: 400 x 400				Load n (W/cm ²)			
(mm)	Rows of elements (mm)	Nbr. of elements	L	1	1,5	3	6
				Power (kW)	Power (kW)	Power (kW)	Power (kW)
300	900	3	33,0	4,5	9,0	18,0	
300	900	6	66,0	9,0	18,0	36,0	
300	900	9	99,0	13,5	27,0	54,0	
500	1100	12	12,0	18,0	36,0	72,0	
500	1100	15	15,0	22,5	45,0	90,0	
500	1100	18	18,0	27,0	54,0	108,0	
750	1350	24	24,0	35,0	72,0	144,0	
750	1350	30	30,0	45,0	90,0	180,0	
750	1350	36	36,0	54,0	108,0	216,0	
1000	1600	39	39,0	59,0	117,0	234,0	
1000	1600	42	42,0	63,0	126,0	252,0	
1000	1600	48	48,0	70,0	144,0	288,0	

CLR 550 x 550 DN 400

Type 6549

H x B: 550 x 550				Load n (W/cm ²)			
(mm)	Rows of elements (mm)	Nbr. of elements	L	1	1,5	3	6
				Power (kW)	Power (kW)	Power (kW)	Power (kW)
300	900	3	660	9,0	18,0	36,0	
300	900	6	12,0	18,0	36,0	72,0	
300	900	9	18,0	27,0	54,0	108,0	
500	1100	12	24,0	36,0	72,0	144,0	
500	1100	15	30,0	45,0	90,0	180,0	
500	1100	18	36,0	54,0	108,0	216,0	
750	1350	24	48,0	72,0	144,0	288,0	
750	1350	30	60,0	90,0	180,0	360,0	
750	1350	36	72,0	108,0	216,0	432,0	
1000	1600	39	78,0	117,0	234,0	468,0	
1000	1600	42	84,0	126,0	252,0	504,0	
1000	1600	48	96,0	144,0	288,0	576,0	

Tubular heating elements diameter 10,2 mm, material AISI 316 L / DIN 1.4404

Inlet / Outlet flange : Form F flanges, DN 100 or 150, PN 10

Metric threaded cable entry glands.

Cover : IP 52

Supply voltage 230/400 V

2 sensor thermowells, diameter 7,5 x 0,5 mm (material 1.4435),

one connected to the heating element by a heat-transfer bridge

Max. working pressure 0,02 bar

All materials without certificate

Max. output temperature without cooling stretch(KS), 80 °C (T> 80 °C only with cooling stretch).

SOLIDS HEATING

Vulstar® cartridges

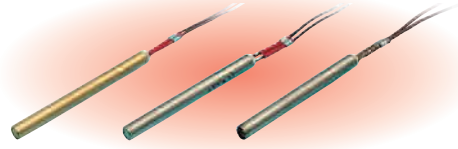

High-power heating rods

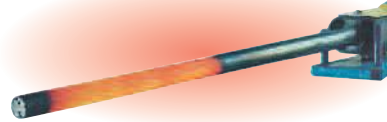

Ceramic core elements



Strip heaters

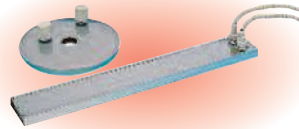

PTC resistors

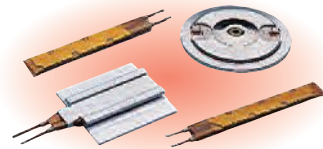

Band heaters

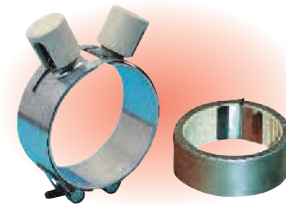

Heat tracing



Accessories for heat tracing



Silicone heating panels

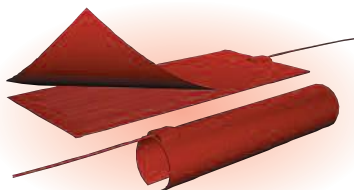

Infrared generators

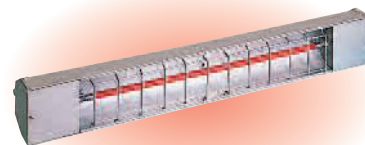

APPLICATIONS

Vulstar® cartridges are used to heat metal like moulds, dies, plates and bolts or liquid. They can be provided with a thermocouple.



VULSTAR® cartridge with thermocouple

VULSTAR® must be inserted in a drilling with an H7 allowance, pre-lubricated with an anti-corrosion product to facilitate installation and removal. Where possible, this drilling must be extended by a hole through the other side for insertion of an extractor. Length L must be fully in contact with the medium to be heated. The high heat flow of VULSTAR® cartridges requires efficient temperature control with a probe (usually a J- or K-type thermocouple) installed close to the heating section.

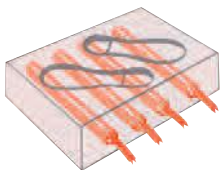

Mould

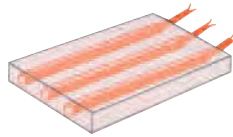

hotplates

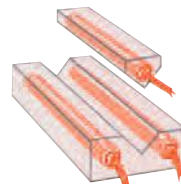

shaping dies

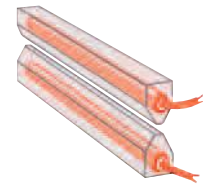

heat sealing



Marking appliances

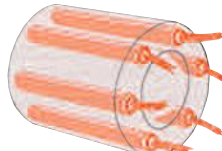

band heaters

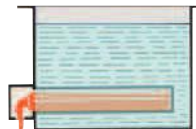

liquid heating

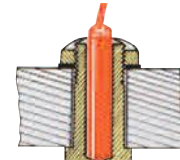

bolt heaters

Supply voltage up to 450 V 1P or 3P.
Load up to 40 W/cm².
Length from 25 mm to 2500 mm depending on diameter.
Diameter from 6,35 mm (1/4") up to 31,8 mm (2" 1/4).
Different types of connection to fit with the ambient temperature.

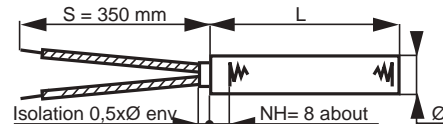

NH=Non Heating length

Compliance with VDE standards.

Connecting leads

Standard length S = 350mm.

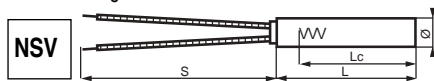

2 flexible braided nickel leads, silicone-coated glass fibre insulation (max. temperature 350°C).

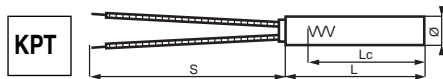

2 flexible braided nickel leads, kapton insulation (max. temperature 400°C).

Lc = Heating length

Fitting devices

Reversed plug

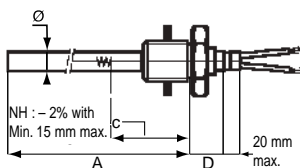

Plug

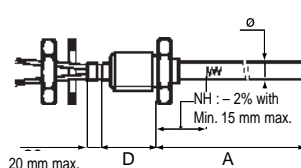

Fixed stop

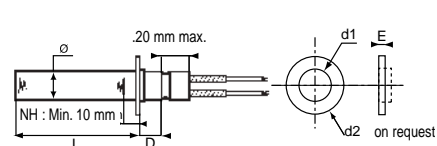

Different types of seals

WP+ (WaterProof Plus): For connection temperature up to 160°C.

MT (Medium Temperature): Sealed for connection temperature up to 220°C in low pollution environments with low humidity and no sudden temperature changes.

HT (High Temperature): Most frequently used. Non-waterproof seal for connection temperature up to 350°C, in a humidity-free atmosphere

Protection of connecting leads

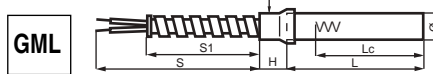

2 flexible NSV or KPT leads, mechanically protected by a flexible metal sheath attached axially.

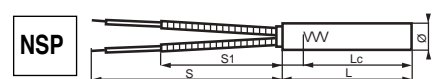

2 flexible braided nickel leads, thermally protected by ceramic beads (max. temperature 450°C).

GMAL

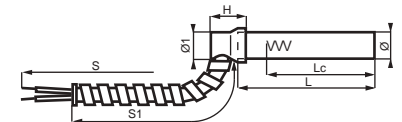

2 flexible NSV or KPT leads, mechanically protected by a flexible metal sheath attached radially.

SEALED

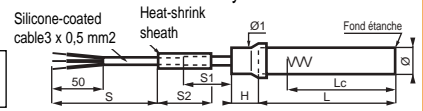

One 3-core cable, encased in resin to ensure a watertight connection.

HIGH LOAD VULSTAR® CARTRIDGES

High load VULSTAR® cartridges are especially suitable where space is at a minimum.

Cartridges in AISI 321/Din 1.4541 stainless steel. Filled with high-temperature (HT), non-watertight thermal cement.

Supply voltage 230V 1 P.

2 flexible braided nickel leads with silicone-coated fiber glass insulation (max. connection temperature 350°C).

Tolerance on length : 2,5 mm min.

Ø (mm)	P/N.			Power +5% -10%	Load (W/cm ²)	L (mm)	Weight (kg)
	WITHOUT TC	WITH TC/J	WITH TC/K				
6,5	10163-12	20163-12	20263-12	125 W	21	40	0,010
	10163-14	20163-14	20263-14	200 W	33	40	0,010
	10163-21	20163-21	20263-21	100 W	13	50	0,010
	10163-23	20163-23	20263-23	150 W	19	50	0,010
	10163-25	20163-25	20263-25	250 W	31	50	0,010
	10163-36	20163-36	20263-36	300 W	30	60	0,010
	10163-54	20163-54	20263-54	200 W	11	100	0,015
	10163-56	20163-56	20263-56	300 W	17	100	0,015
	10164-11	20164-11	20264-11	100 W	13	40	0,010
	10164-13	20164-13	20264-13	150 W	20	40	0,010
8	10164-15	20164-15	20264-15	250 W	33	40	0,010
	10164-24	20164-24	20264-24	200 W	20	50	0,010
	10164-26	20164-26	20264-26	300 W	30	50	0,010
	10164-31	20164-31	20264-31	100 W	13	60	0,010
	10164-33	20164-33	20264-33	150 W	12	60	0,010
	10164-35	20164-35	20264-35	250 W	20	60	0,010
	10164-42	20164-42	20264-42	125 W	12	80	0,015
	10164-44	20164-44	20264-44	200 W	11	80	0,015
	10164-46	20164-46	20264-46	300 W	17	80	0,015
	10164-55	20164-55	20264-55	250 W	11	100	0,015
10	10164-57	20164-57	20264-57	400 W	18	100	0,015
	10164-66	20164-66	20264-66	300 W	10	130	0,030
	10164-68	20164-68	20264-68	450 W	15	130	0,030
	10165-13	20165-13	20265-13	200 W	21	40	0,020
	10165-15	20165-15	20265-15	300 W	32	40	0,020
	10165-21	20165-21	20265-21	100 W	13	50	0,025
	10165-26	20165-26	20265-26	400 W	32	50	0,025
	10165-31	20165-31	20265-31	125 W	13	60	0,030
	10165-33	20165-33	20265-33	200 W	13	60	0,030
	10165-36	20165-36	20265-36	450 W	29	60	0,030
12,5	10165-44	20165-44	20265-44	250 W	11	80	0,035
	10165-46	20165-46	20265-46	400 W	18	80	0,035
	10165-47	20165-47	20265-47	600 W	27	80	0,035
	10165-54	20165-54	20265-54	250 W	11	100	0,040
	10165-56	20165-56	20265-56	400 W	14	100	0,040
	10165-57	20165-57	20265-57	600 W	21	100	0,040
	10165-59	20165-59	20265-59	800 W	28	100	0,040
	10165-66	20165-66	20265-66	400 W	11	130	0,050
	10165-67	20165-67	20265-67	600 W	16	130	0,050
	10165-69	20165-69	20265-69	800 W	21	130	0,050
12,5	10165-76	20165-76	20265-76	450 W	10	160	0,060
	10165-78	20165-78	20265-78	700 W	16	160	0,060
	10165-70	20165-70	20265-70	1000 W	23	160	0,060
	10166-21	20166-21	20266-21	125 W	13	50	0,035
	10166-22	20166-22	20266-22	200 W	13	50	0,035
	10166-23	20166-23	20266-23	300 W	19	50	0,035
	10166-25	20166-25	20266-25	450 W	29	50	0,035
	10166-42	20166-42	20266-42	250 W	11	80	0,050
	10166-44	20166-44	20266-44	400 W	15	80	0,050
	10166-46	20166-46	20266-46	600 W	22	80	0,050
12,5	10166-48	20166-48	20266-48	800 W	29	80	0,050
	10166-76	20166-76	20266-76	600 W	10	160	0,085
	10166-55	20166-55	20266-55	450 W	13	100	0,060
	10166-59	20166-59	20266-59	1000 W	28	100	0,060
	10166-65	20166-65	20266-65	450 W	10	130	0,075
	10166-67	20166-67	20266-67	700 W	15	130	0,075
	10166-69	20166-69	20266-69	1000 W	21	130	0,075

Model without Thermocouple (TC K/J)

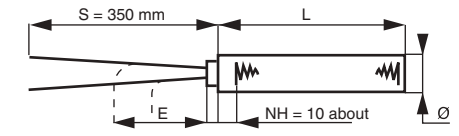

Model with Thermocouple (TC K/J)

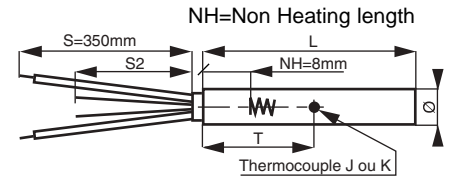

Ø (mm)	P/N.			Power +5% -10%	Load (W/cm ²)	L (mm)	Weight (kg)
	WITHOUT TC	WITH TC/J	WITH TC/K				
12,5	10166-78	20166-78	20266-78	800 W	14	160	0,085
	10166-96	20166-96	20266-96	600 W	8	200	0,095
	10166-90	20166-90	20266-90	1250 W	17	200	0,095
	10167-11	20167-11	20267-11	150 W	6	60	0,065
	10167-13	20167-13	20267-13	400 W	16	60	0,06
	10167-22	20167-22	20267-22	300 W	9	80	0,080
	10167-33	20167-33	20267-33	400 W	9	100	0,105
	10167-36	20167-36	20267-36	800 W	18	100	0,105
	10167-44	20167-44	20267-44	600 W	10	130	0,125
	10167-46	20167-46	20267-46	800 W	13	130	0,125
16	10167-57	20167-57	20267-57	1000 W	13	160	0,145
	10167-69	20167-69	20267-69	1500 W	18	180	0,160
	10167-76	20167-76	20267-76	800 W	8	200	0,175
	10167-78	20167-78	20267-78	1250 W	13	200	0,175
	10167-88	20167-88	20267-88	1250 W	10	250	0,220
	10167-80	20167-80	20267-80	2000 W	17	250	0,220
	10167-99	20167-99	20267-99	1500 W	10	300	0,260
	10168-23	20168-23	20268-23	800 W	11	130	0,180
	10168-38	20168-38	20268-38	2500 W	27	160	0,210
	10168-47	20168-47	20268-47	2000 W	17	200	0,260
10168-59	20168-59	20268-59	3150 W	21	250	0,320	



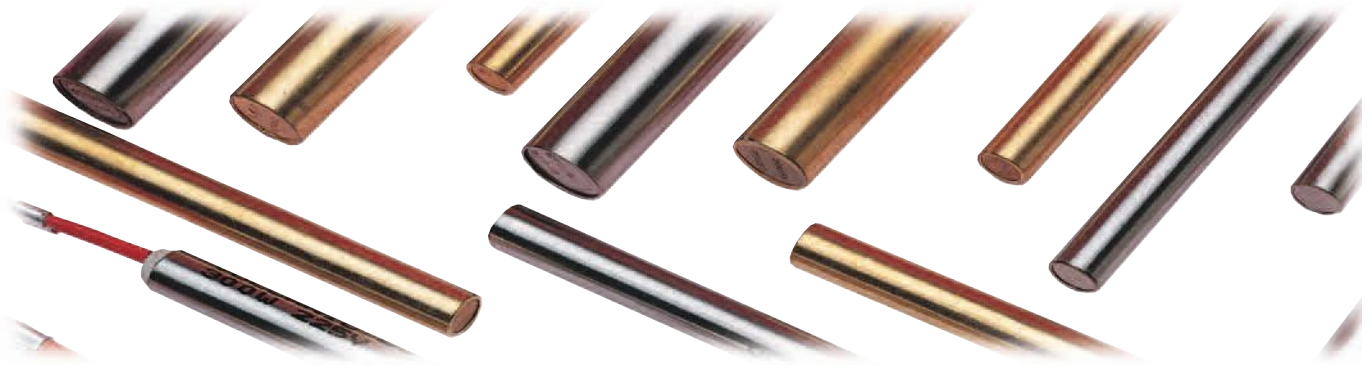

Ø (mm)	P/N.		Power +5% -10%	Load (W/cm ²)	L (mm)	Weight (kg)
	WITHOUT TC	WITH TC/J				
1/4" 6,35	10183-12	20183-12	125 W	22	38,1	0,005
	10183-14	20183-14	200 W	36	38,1	0,005
	10183-21	20183-21	100 W	12	50,8	0,010
	10183-23	20183-23	150 W	18	50,8	0,010
	10183-25	20183-25	250 W	31	50,8	0,010
	10183-32	20183-32	125 W	12	63,5	0,010
	10183-34	20183-34	200 W	19	63,5	0,010
	10183-36	20183-36	300 W	28	63,5	0,010
	10183-47	20183-47	400 W	30	76,2	0,015
	10183-56	20183-56	300 W	16	101,6	0,015
3/8" 9,52	10185-13	20185-13	200 W	24	38,1	0,020
	10185-15	20185-15	300 W	36	38,1	0,020
	10185-24	20185-24	250 W	21	50,8	0,025
	10185-42	20185-42	150 W		87,6	0,035
	10185-44	20185-44	250 W	13	76,2	0,035
	10185-46	20185-46	400 W	20	76,2	0,035
	10185-47	20185-47	600 W	30	76,2	0,035
	10185-54	20185-54	250 W		101,6	0,040
	10185-56	20185-56	400 W	15	101,6	0,040
	10185-57	20185-57	600 W	22	101,6	0,040
10185-66	20185-66	400 W	11	127	0,050	
10185-67	20185-67	600 W	17	127	0,050	
10185-76	20185-76	450 W	11	152,4	0,060	

Ø (mm)	P/N.		Power +5% -10%	Load (W/cm ²)	L (mm)	Weight (kg)
	WITHOUT TC	WITH TC/J				
1/2" 12,7	10186-21	20186-21	125 W		50,8	0,035
	10186-23	20186-23	300 W	18	50,8	0,035
	10186-25	20186-25	450 W	28	50,8	0,035
	10186-42	20186-42	250 W		97,6	0,050
	10186-44	20186-44	400 W	15	76,2	0,050
	10186-46	20186-46	600 W	23	76,2	0,050
	10186-48	20186-48	800 W	30	76,2	0,050
	10186-53	20186-53	300 W		101,6	0,060
	10186-55	20186-55	450 W	12	101,6	0,060
	10186-57	20186-57	700 W	19	101,6	0,060
5/8" 15,87	10186-65	20186-65	450 W	10	127	0,075
	10186-67	20186-67	700 W	15	127	0,075
	10186-78	20186-78	800 W	14	152,4	0,090
	10186-87	20186-87	700 W	10	177,8	0,100
	10186-89	20186-89	1000 W	15	177,8	0,100
	10186-98	20186-99	800 W	10	203,2	0,110
	10187-02	20187-02	250 W	12	50,8	0,060
	10187-03	20187-03	400 W	20	50,8	0,060
	10187-23	20187-23	450 W	14	76,2	0,080
	10187-36	20187-36	800 W	18	101,6	0,095

LOW LOAD VULSTAR® CARTRIDGES

These AISI 321/ Din 1.4541 stainless steel or brass heaters, with loads between 2 and 3,7 W/cm², offer a good solution for heating metal blocks and small containers to a temperature not exceeding 300°C (350°C for stainless steel models)

Sealing = HT

Supply voltage 230 V 1 P.

Flexible nickel braid leads with glass fiber isolation (bending possible; min. E = 15 mm).

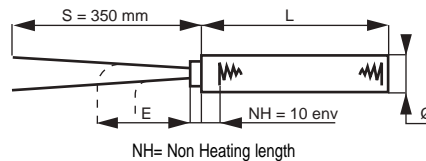

Tolerance on length : 0/ -2,5 % min. of 2,5 mm.

P/N.	Power +5 -10%	Ø (mm)	L (mm)	Material	Weight (kg)
1004-01	100 W	9,5	100	Stainless steel	0,025
1004-02	150 W	9,5	150	Stainless steel	0,035
1004-03	150 W	14,7	100	Brass	0,060
1004-04	150 W	14,7	150	Brass	0,075
1004-05	175 W	14,7	150	Brass	0,075
1004-06	200 W	14,7	200	Brass	0,100

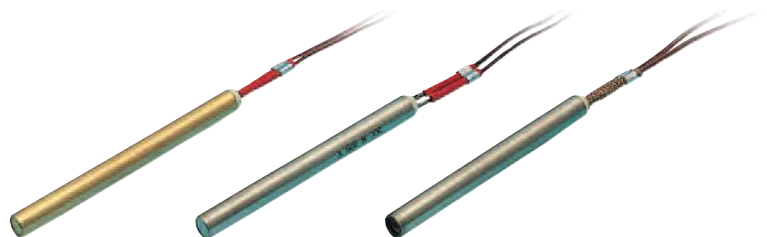

VULSTAR® MEDIUM LOAD CARTRIDGES

These cartridges have a very wide range of applications. Their 7 W/cm² load and their high temperature resistance (700°C on the sheath surface) allow a fast heating of metal blocks and small containers. The connection temperature must not exceed 300°C. Sealing = HT
Supply voltage 230 V 1 P.
Nickel braid leads with glass fiber isolation, length 350mm
Bending possible : min. 40mm

P/N.	Power(W) +5 -10%	Ø (mm)	Length L (mm)	Weight (kg)	P/N.	Power(W) +5 -10%	Ø (mm)	Length L (mm)	Weight (kg)
1008-90	50 W	6,35	50	0,010	1007-23	180 W	12,7	70	0,032
1008-93	70 W	6,35	70	0,012	1007-24	220 W	12,7	80	0,036
1008-94	80 W	6,35	80	0,013	1007-25	320 W	12,7	120	0,050
1008-91	110 W	6,35	100	0,015	1007-06	380 W	12,7	150	0,060
1007-01	80 W	9,52	50	0,015	1007-26	550 W	12,7	200	0,075
1007-18	100 W	9,52	60	0,018	1007-08	320 W	15,87	100	0,065
1007-02	180 W	9,52	100	0,025	1007-28	400 W	15,87	120	0,075
1007-21	250 W	9,52	120	0,030	1007-29	650 W	15,87	200	0,120
1007-03	300 W	9,52	150	0,040	1007-11	1000 W	25,4	200	0,290
					1007-12	1500 W	25,4	300	0,420

EXTRA-LONG VULSTAR® CARTRIDGES

To heat liquids or solids over great lengths. They are made of AISI 321 /Din 1.4544 or AISI 316L / Din 1.4406 stainless steel tube and loads up to 16 W/cm². Fixing devices available on request.

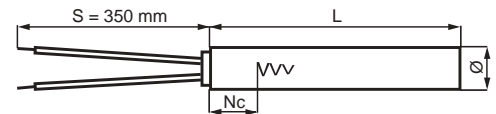
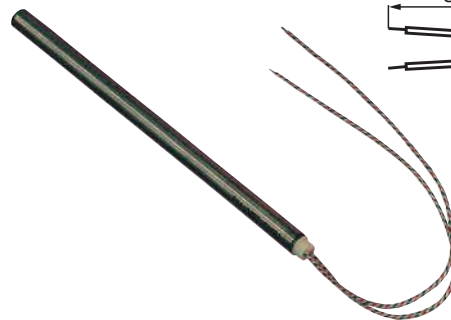

Diameter tolerance
1021 : ± 0,1 mm
1024 : -0,02 / -0,12 mm

Models listed below are made of AISI 321 / Din 1.4541 tube allowing a surface temperature up to 750°C, with copper braid leads 350 mm, waterproof seals (connection temperature up to 160°C). They are fitted with J- or K-type thermocouple (diameter 1mm).

P/N.	Ø (mm)	Power (W) +5/-10%	Voltage (V)	Load (W/cm ²)	LNH (mm)	Weight (kg)
1021-11	10	500	230 1 P	5	418	100 0,2
1021-12	10	1500	400 1 P	5	1055	100 0,4
1021-13	10	2000	400 1P	5	1374	100 0,5
1024-11	10	350	230 1P	5	323	100 0,1
1024-12	10	700	230 1 P	5	546	100 0,2
1021-21	10,2	500	230 1 P	5	412	100 0,1
1021-22	10,2	1500	400 1 P	5	1037	100 0,4
1021-23	10,2	2000	400 1 P	5	1349	100 0,5
1021-70	12,7	500	230 1 P	5	400	100 0,1
1021-71	12,7	1000	230 1 P	5	600	100 0,3
1021-72	12,7	1500	230 1 P	5	1000	100 0,5
1021-31	15,87	1000	230 1 P	5	501	100 0,4
1021-32	15,87	2000	230 1 P	5	903	100 0,8
1021-33	15,87	3000	230 1 P	5	1304	100 1,1
1021-34	15,87	4000	400 1 P	5	1705	100 1,4
1021-35	15,87	5000	400 1 P	5	2107	100 1,8
1024-31	15,87	750	230 1 P	5	401	100 0,3
1024-32	15,87	1500	230 1 P	5	702	100 0,6

P/N.	Ø (mm)	Power (W) +5/-10%	Voltage (V)	Load (W/cm ²)	LNH (mm)	Weight (kg)
1021-35	15,87	5000	400 1 P	5	2107	100 1,8
1024-31	15,87	750	230 1 P	5	401	100 0,3
1024-32	15,87	1500	230 1 P	5	702	100 0,6
1021-41	16	1000	230 1 P	5	498	100 0,4
1021-42	16	2000	230 1 P	5	896	100 0,8
1021-43	16	3000	230 1 P	5	1294	100 1,1
1021-44	16	4500	400 1 P	5	1891	100 1,6
1021-45	16	6000	400 1 P	5	2489	100 2,1
1021-51	20	1000	230 1 P	5	418	100 0,5
1021-52	20	2000	230 1 P	5	737	100 0,9
1021-53	20	4000	230 1 P	5	1374	100 1,7
1021-54	20	4000	230 3 P	13	547	67 0,8
1021-55	20	4000	400 3 P	13	547	67 0,8
1021-56	20	6000	230 3 P	20	547	67 0,8
1021-57	20	6000	400 3 P	20	547	67 0,8
1021-58	20	7000	230 3 P	23	547	67 0,8
1021-59	20	7000	400 3 P	23	547	67 0,8
1024-51	20	1250	230 1 P	5	498	100 0,6
1024-52	20	2500	230 1 P	5	896	100 1,1

HIGH POWER HEATING RODS

For heating liquids by forced convection from -200°C to 800°C with loads up to 100 W/cm². These heating rods are generally equipped with a thermowell inside the internal tube. AISI 316 L / Din1.4404 or AISI 321 / Din 1;4541 stainless steel tube. The tube surface is either smooth or corrugated to optimise exchange. Outside diameter 19 mm +0,15 /+0.mm.

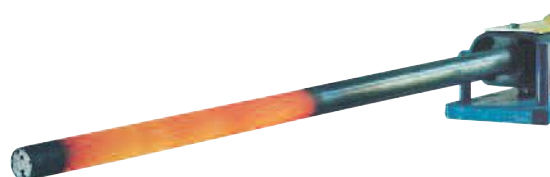

ON REQUEST

ELECTRICAL BOXES FOR CARTRIDGE HEATERS

Electrical box for VULSTAR® cartridge in a drilling, P/N. 1092-01

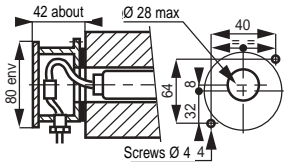

Allows sealed connections.
includes : Ø 80mm cast iron cover
- ISO 16 bis gland n°
- 10A ceramic connection block,
- 59 x 46 gasket,



Electrical box for VULSTAR® cartridge in a thermowell, P/N. 9625-01

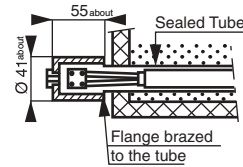

Allows sealed connections.
Includes : Ø 41 mm cover,
- 1 flange to be brazed on the tube
(max. Ø 30mm)

HIGH TEMPERATURE LUBRICANT PASTE AND SPRAY CANS



P/N.	Operating temperature	Weight (kg)
1026-01	solid above 200°C	0,180/ 400ml



P/N.	Operating temperature	Weight (kg)
1050-01	-30/+1200°C	0,06

Dry lubrication from 200°C upwards, resists up to 1200°C

ADVANTAGES / APPLICATIONS

- Good lubrication of parts subjected to sliding or rolling friction.
- Simplifies installation of pressed or screwed assemblies.

- Good protection against static friction.
- Allows dismantling of screwed or jointed assemblies without binding.

CERAMIC CORE ELEMENTS

For heating liquids (when mounted in a pocket) or solids up to 450°C (load : 2,5 W/cm²) when fitted into a drilling.

Comprises coils of resistive wire inside a cylindrical ceramic core. Connection by threaded terminals on a shouldered spigot.

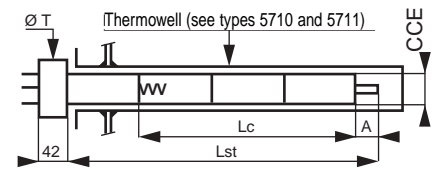

A=25 for CCE Ø47
A=35 for CCE Ø58

Lc= Heating length

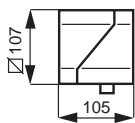

IP 555 polyamide 6/6 cover for CCE Ø 47
P/N. 1199-00 (weight 0,4 kg) with gasket and gland ISO 25 Bis

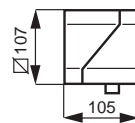

IP 555 polyamide 6/6 cover for CCE Ø 58
P/N. 2081-99 (weight 0,5 kg) with gasket and gland ISO 25 Bis

P/N.	Power +5 -10%	Lst (mm)	Lc (mm)	Ø CCE (mm)	TW inside Ø.	Ø T (mm)	Load (W/cm ²)	Voltage	Weight (kg)
1103-11	1000 W	440	300	47	48	57	2,5	230 V 1P	1
1103-12	2000 W	690	550	47	48	57	2,5	230 V 1P	1,6
1103-13	3000 W	890	700	47	48	57	2,5	230 V 1P	1,8
1103-14	2000 W	440	300	47	48	57		4230 V 1P	1,2
1103-15	3000 W	690	500	47	48	57		4230 V 1P	1,6
1103-16	4000 W	890	650	47	48	57		4230 V 3P	2
1103-17	4000 W	890	650	47	48	57		4400 V 3 P	2
1101-01	2000 W	451	280	58	60	67		4230 V 1P	1,6
1101-02	3000 W	691	400	58	60	67		4230 V 1P	2,4
1101-03	4000 W	891	520	58	60	67	4,5	230 V 3 P	3,2
1101-05	4000 W	891	520	58	60	67	4,5	400 V 3 P	3,2
1101-04	6000 W	971	800	58	60	67		4400 V 3P	3,5

SHEATHED RING HEATERS

To heat circular tank bottoms up to 300°C.

A coil of resistive wire supported by ceramic insulators inside a stainless steel casing.

Loads : 4 to 6 W/cm².

They can equally be used to heat large surfaces by grouping several heaters side by side.

Supply voltage : 230V 1P.

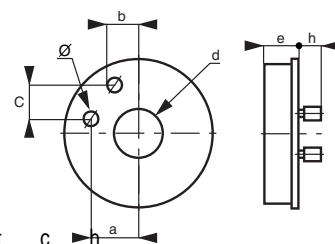
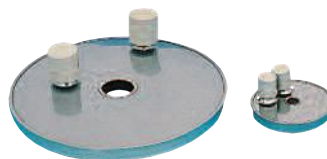

P/N.	Power +5 -10%	Ø (mm)	d (mm)	e (mm)	a (mm)	Weight (kg)			
8033-01	250 W	72	10	12	21	12	18	23	0,155
8033-02	300 W	88	25	12	25,5	23	20	23	0,145
8033-03	400 W	100	45	10	38	32,5	20	23	0,150
8033-04	500 W	112	21	14	28	38	17	23	0,315
8033-05	1000 W	187	28	17	76	0	48	34	0,390
8033-06	2000 W	252	40	18	106	0	41,5	34	1,990

Supply voltage : 230 V 1 P
Connection by Threaded Terminals, Ø 4 (T 4 for 250 to 500 W) or Ø 7 (T 7 for 1000 and 2000 W) with protective steatite cap.
T T = Threaded Terminals

SHEATHED MICA STRIP HEATERS

To heat flat surfaces up to 300°C (hotplates, tanks, moulds, tools). Load 4 W/cm².

Must be firmly clamped to the heated surface (along the entire heated length, Lc).

With protective steatite caps.

Supply voltage : 230V 1P.

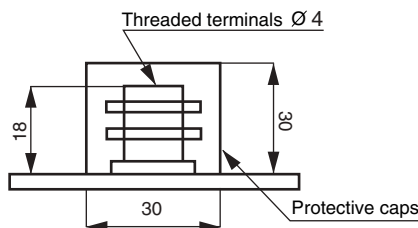
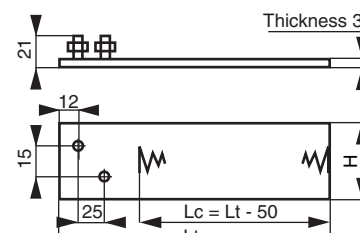

P/N.	Power +5 -10%	Lt (mm)	H (mm)	Weight (kg)
4027-05	200 W	200	40	0,090
4027-01	300 W	400	40	0,170
4027-02	400 W	500	40	0,220
4027-03	700 W	600	60	0,350
4027-04	800 W	700	60	0,390

Supply voltage : 230 V 1 P
Connection by Ø 4 threaded terminals

SHEATHED STEATITE-INSULATED STRIP HEATERS

To heat flat surfaces up to 600°C (300°C for models with threaded terminals).

These ceramic-insulated elements have in a stainless steel sheath

Supply voltage : 230V 1P

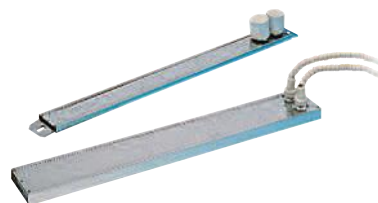

Nickel Braids with Bead insulation (N B B) depending on power length 500mm.

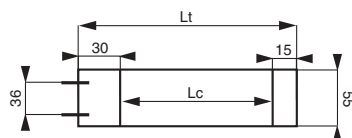

P/N.	Power +5 -10%	Lt (mm)	Lc (mm)	H (mm)	Connection TT	Weight (kg)
4033-01	250 W	225	165	38	7 T T 7	0,220
4033-02	500 W	390	330	38	7 T T 7	0,320
4033-03	750 W	390	340	55	15 N B B	0,870
4033-04	1000 W	500	450	55	15 N B B	1,070
4033-05	1500 W	730	680	55	15 N B B	1,600
4033-06	2000 W	950	900	55	15 N B B	2,000
4033-51	400 W	160	100	38	7 T T 7	0,2
4033-52	500 W	260	200	38	7 T T 7	0,3
4033-53	750 W	450	390	38	7 T T 7	1,0
4033-54	1000 W	560	500	38	7 T T 7	1,3
4033-55	1250 W	725	665	38	7 T T 7	2,3
4033-56	1500 W	930	870	38	7 T T 7	3,9

Connection by Ø 7 Threaded Terminals (T T 7) with protective steatite cap

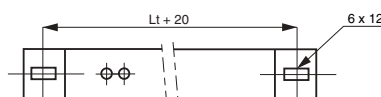
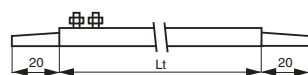
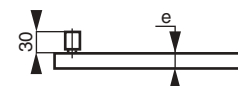
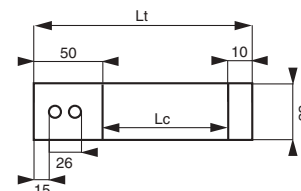

Hole of fitting for 4033-01 and 4033-02 up to 300°C
Fixing only with 1 hole

PTC RESISTORS

PTC resistors combine two technologies: electric heating and temperature limitation. These resistors have a high conductivity at low temperatures, but at a particular value known as the 'Curie bend', their resistance increases considerably. This technology allows automatic temperature limitation independently of the supply voltage.

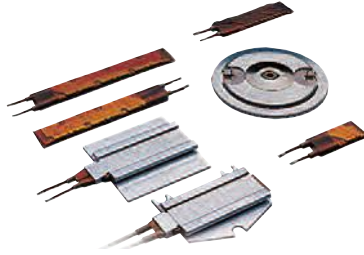

Economical use, compact, and protected against overheating. According to VDE, CEE, UL, and CSA standards. Their maximum surface temperature is lower than the 'Curie point', which is set according to the size of the device and the prevalent heat-transfer conditions. Connecting several PTC elements in parallel allows warm-up time to be reduced without influencing the total power dissipated at the regulation point.

Resistor bare, for fitting in a 'sandwich' of two metal plates. Supply voltage 120 up to 240V. Connection by leads, reinforced along the first 30mm.

P/N.	Nominal Curie point.	Max. power at 230 V	Starting power	Weight (kg)
3941-21	50°C	60 W	240 W	0,01
3941-24	110°C	110 W	460 W	0,01
3941-27	180°C	170 W	520 W	0,01
3941-28	220°C	200 W	660 W	0,01

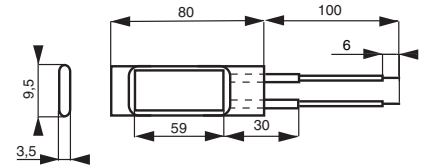

Flat circular resistor in aluminium sheath with central fixing point. Supply voltage 100 up to 240V. Connection by Two 6,35mm FASTON terminals.

P/N.	Nominal Curie point.	Max. power at 230 V	Starting power	Weight (kg)
3942-41	60°C	150 W	448 W	0,065
3942-43	120°C	270 W	820 W	0,065
3942-44	180°C	170 W	505 W	0,065
3942-45	230°C	200 W	550 W	0,065

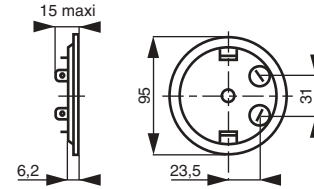

Flat rectangular resistor in aluminium sheath, with three fixing holes. Supply voltage 120 up to 240V. Connection by leads, reinforced along the first 50mm.

P/N.	Nominal Curie point.	Max. power at 230 V	Starting power	Weight (kg)
3943-41	60°C	110 W	448 W	0,065
3943-43	120°C	210 W	820 W	0,065
3943-44	180°C	150 W	505 W	0,065
3943-45	230°C	180 W	550 W	0,065
3943-46	270°C	275 W	700 W	0,065

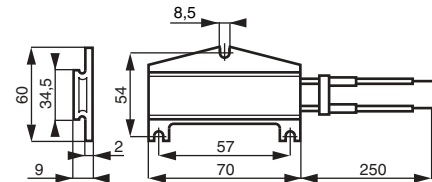

PTC DUCT HEATER FOR AIR

To heat a circulating air flow of up to 165 m³/h approx. in a duct of 100x100 cross-section, with automatic surface temperature limitation.

This modern technology ensures completely safe automatic control of the dissipated power.

Models comply with VDE, UL, and IEC standards.

Dimensions : 120,5 x 107 x 17,5 mm

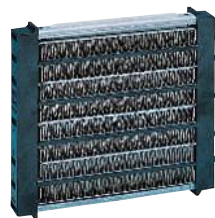

$\Delta p = 8\text{mm WC for } 165\text{m}^3/\text{h}$

P/N.	Max. surface temp.	Max. power	Starting power	Weight (kg)
3944-01	230°C	1750 W	2400 W	0,22

Connection by FASTON terminals. PTC operating principle described above. Supply voltage : 230 V 1 P.

Air flow in m ³ /h	20	40	60	80	100
Δt input/ outlet	120°C	80°C	60°C	50°C	40°C

CAST-IRON PLATES

These rugged cast-iron plates comprise two circuits of sheathed metal tubes encased in cast iron. The outer 1300W circuit and the inner 1100W circuit ensure an even temperature distribution. Several plates can be fitted side by side to make a heating table for foodstuffs or materials, up to 450°C.



P/N.	Power +5 -10%	Weight (kg)
8560-02	2400 W	11

Dimensions (mm) : width 400, height 120, thickness 45. Supply current : 230 V 1 P. Connection by spade terminals.

SEALED MICA BAND HEATERS

Ideally suited for heating cylindrical shapes in damp environments, in the presence of fatty matter, molten plastic, rubber, etc. (350°C maximum). Provided with brass or stainless profile shielding, brazed connection cover and clamping device offering compact overall dimensions.

Power supply voltage: 230 V 1P.

Output is by a flexible metal braid 1 m long protecting the two power supply conductors with one ground wire.

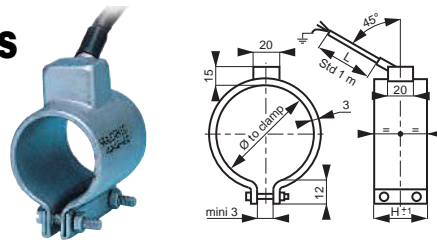

P/N.	Power. +5 -10%	Ø Nom. (mm)	Ø Clamp. (mm)	H (mm)	Weight (kg)
4040-60	100 W	29	28 to 30	25	0,115
4040-61	120 W	29	28 to 30	30	0,120
4040-62	160 W	29	28 to 30	40	0,130
4040-63	135 W	32	31 to 33	30	0,120
4040-64	150 W	35	34 to 38	30	0,125
4040-65	200 W	35	34 to 38	40	0,135
4040-66	140 W	40	39 to 43	25	0,130
4040-67	170 W	40	39 to 43	30	0,130

MICA BAND HEATERS

These collars resolve all heating problems for cylindrical shapes up to a temperature of 350°C. They are loaded to a maximum of 4W/cm². The heating element is enclosed in a sheet metal structure; the fast coupling system allows easy assembly and disassembly. Power supply voltage: 230 V 1P. Outputs are by M5 or M7 (starting from 350 W) threaded terminals.

Our technical advice :

Taking precautions, it is possible to open Mica collars with diameters ≥ 100 mm. This operation must only be performed once, taking care not to damage the heating part. Finalise tightening when the collar reaches its working temperature. They are delivered without caps.

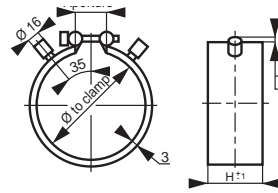

P/N.	Power. +5 -10%	Ø Nom. (mm)	Ø Clamp. (mm)	H (mm)	Weight (kg)
4020-01	120 W	32	31 to 33	30	0,090
4020-02	130 W	35	34 to 38	30	0,095
4020-03	190 W	40	39 to 43	40	0,120
4020-04	210 W	45	44 to 48	40	0,125
4020-05	240 W	50	49 to 53	40	0,130
4020-06	270 W	56	54 to 60	40	0,140

P/N.	Power. +5 -10%	Ø Nom. (mm)	Ø Clamp. (mm)	H (mm)	Weight (kg)
4040-68	225 W	40	39 to 43	40	0,170
4040-69	160 W	45	44 to 48	25	0,130
4040-70	190 W	45	44 to 48	30	0,140
4040-71	225 W	45	44 to 48	40	0,180
4040-72	175 W	50	49 to 53	25	0,135
4040-73	210 W	50	49 to 53	30	0,150
4040-74	280 W	50	49 to 53	40	0,170
4040-75	350 W	50	49 to 53	50	0,190
4040-76	200 W	56	54 to 61	25	0,140
4040-77	235 W	56	54 to 61	30	0,155
4040-78	310 W	56	54 to 61	40	0,195
4040-79	390 W	56	54 to 61	50	0,225
4040-80	260 W	63	62 to 67	30	0,160
4040-81	300 W	70	68 to 76	30	0,170
4040-82	400 W	70	68 to 76	40	0,200
4040-83	450 W	80	77 to 86	40	0,210

P/N.	Power. +5 -10%	Ø Nom. (mm)	Ø Clamp. (mm)	H (mm)	Weight (kg)
4020-07	300 W	63	62 to 67	40	0,160
4020-08	350 W	70	74 to 79	40	0,180
4020-23	375 W	75	74 to 79	40	0,190
4020-09	400 W	80	80 to 86	40	0,205
4020-10	450 W	90	88 to 96	40	0,230
4020-11	500 W	100	98 to 106	40	0,255
4020-12	560 W	110	108 to 117	40	0,285
4020-13	575 W	120	118 to 122	40	0,305
4020-14	750 W	125	123 to 127	50	0,360
4020-15	800 W	130	128 to 137	50	0,370
4020-16	850 W	140	138 to 147	50	0,395
4020-17	875 W	150	148 to 157	50	0,420
4020-18	900 W	160	158 to 167	50	0,445
4020-19	1000 W	170	168 to 177	50	0,460
4020-20	1100 W	180	178 to 187	50	0,470
4020-21	1200 W	190	188 to 197	50	0,492
4020-22	1300 W	200	198 to 207	50	0,520

ARTICULATED CERAMIC BAND HEATERS

Collars allowing the heating of cylindrical shapes up to maximum of 700°C depending on load, consisting of a nickel-chrome resistive wire mounted on steatite elements. These articulated elements make the assembly particularly flexible. Electrical connection is by threaded terminals.

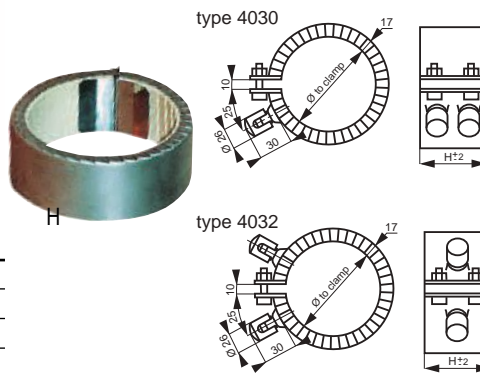

P/N.	Power (W) +5 -10%	U (V)	Load (W/cm ²)	Ø (mm)	
4030-13	990	230	2	300	55
4030-14	1350	230	2	410	55
4030-15	1650	230	2	500	55
4030-16	2520	230	2	760	55
4030-22	660	230	4	100	55
4030-27	990	230	4	150	55
4030-29	1200	230	4	180	55
4030-30	1320	230	4	200	55
4030-31	1530	230	4	230	55
4030-32	1650	230	4	250	55
4030-33	1980	230	4	300	55
4030-34	2700	230	4	410	55
4030-35	3300	230	4	500	55
4030-42	990	230	6	100	55
4030-44	1200	230	6	120	55
4030-47	1500	230	6	150	55
4030-49	1770	230	6	180	55
4030-50	1980	230	6	200	55
4030-51	2280	230	6	230	55
4030-52	2490	230	6	250	55
4030-53	2970	230	6	300	55
4030-54	4050	230	6	410	55
4030-55	4950	230	6	500	55

GENERAL MANUFACTURING CHARACTERISTICS

Diameter	: all diameters from 90 mm to 3600 mm
Height	: 32 - 44 - 55 - 78 mm
Power	: depending on the exchange surface (specific load up to 10 W/cm ²)
Voltage	: any voltage up to 400 V
Current	: 4 Min - Max depending on availabilities 60A
Outputs	: Cover and metal duct up to 300°C (without external lagging)
	: Threaded terminals Ø. 7 up to 500°C (without external lagging)
	: Threaded terminals Ø. 7 up to 300°C (without external lagging)
	: Nickels beads for high temperatures

No.	Power (W) +5 -10%	U (V)	Load (W/cm ²)	Ø (mm)	
4032-10	930	230	2	200	78
4032-11	1100	230	2	230	78
4032-12	1170	230	2	250	78
4032-13	1410	230	2	300	78
4032-14	1920	230	2	410	78
4032-15	2340	230	2	500	78
4032-22	930	230	4	100	78
4032-24	1120	230	4	120	78
4032-27	1410	230	4	150	78
4032-29	1680	230	4	180	78
4032-30	1860	230	4	200	78
4032-31	2160	230	4	230	78
4032-32	2340	230	4	250	78
4032-33	2820	230	4	300	78
4032-34	3840	230	4	410	78
4032-35	4680	230	4	500	78
4032-42	1410	230	6	100	78
4032-44	1680	230	6	120	78
4032-47	2100	230	6	150	78
4032-49	2520	230	6	180	78
4032-50	2820	230	6	200	78
4032-51	3240	230	6	230	78
4032-52	3510	230	6	250	78
4032-53	4200	230	6	300	78
4032-54	5760	230	6	410	78
4032-55	7020	230	6	500	78

SHEATHED BAND HEATERS

For heating cylindrical shapes up to 450°C in harsh conditions (vibration, humidity, dripping water, etc.) They consist in stainless steel tubular heating element in a flat cylindrical shape, held in place by an external clamping band which acts as a reflector. They have a higher efficiency than mica band heaters.

Supply voltage: 230 V - single phase.

Diameters available (Ø Clamp):

Ø60 to Ø200 mm with sheathed band heaters or symmetrical half-bands depending of your piping (side access only).

Ø > 200 mm solution available on request with symmetrical half-bands. **Bands height : 20 à 120 mm**

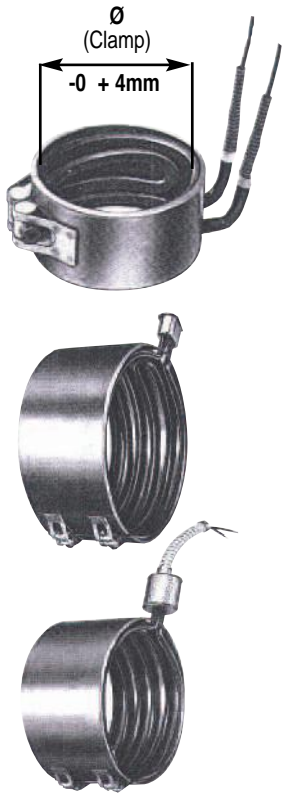

Electrical connections available on request

• **Glass fibre sheathing**

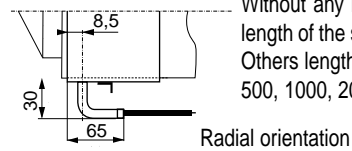
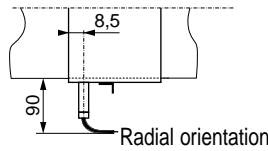

Without any information, the standard length of the sheath gains is 1500 mm. Others length available on request: 500, 1000, 2000 mm.

• **Threaded terminals**

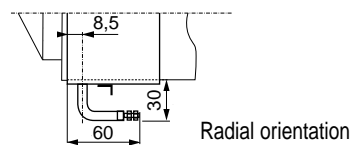
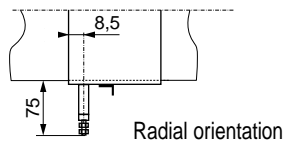

• **Electric spit**

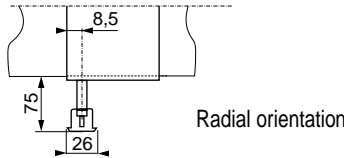

• **Flexible metal cover**

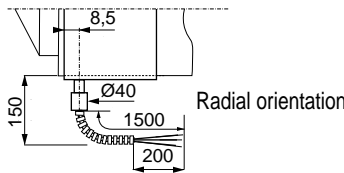

Without any information, the standard length of the sheath gains is 1500 mm. Others length available on request: 500, 1000, 2000 mm.

SEALED SHEATHED BAND HEATERS

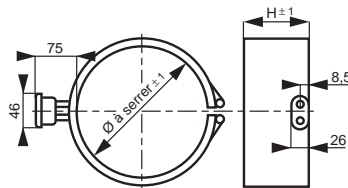

Female extension plug P/N. 9565-01

REF.	Power +5 -10%	Ø Noml (mm)	Ø Clamp (mm)	H (mm)	Weight (kg)
4750-10	620 W	100	96 to 105	40	0,38
4750-11	620 W	110	106 to 115	40	0,42
4750-12	620 W	120	116 to 125	40	0,45

REF.	Puiss. +5 -10%	Ø Nom.	Ø Clamp	H	Weight
		(mm)	(mm)	(mm)	(kg)
4750-13	800 W	130	126 to 135	40	0,49
4750-14	800 W	140	136 to 145	40	0,53
4750-15	1000 W	150	146 to 155	40	0,57
4750-16	1000 W	160	156 to 165	40	0,60

REF.	Power +5 -10%	Ø Nom.	Ø Clamp	H	Masse
		(mm)	(mm)	(mm)	(kg)
4750-17	1000 W	170	166 to 175	40	0,65
4750-18	1250 W	180	176 to 185	50	0,69
4750-19	1250 W	190	186 to 195	50	0,73
4750-20	1250 W	200	196 to 205	50	0,77

SEALED SHEATHED BAND HEATERS IN TWO HALVES

Built in the same way as the preceding heaters, they are made of two symmetrical half-bands, allowing them to be fitted to cylinders where access is only possible from one side.

Supply voltage: 230 V 1 P.

P/N.	Power +5 -10%	Ø Nom.	Ø Clamp	H	Weight
		(mm)	(mm)	(mm)	(kg)
4755-13	800 W	130	126 to 135	50	0,51
4755-14	800 W	140	136 to 145	50	0,55
4755-15	1000 W	150	146 to 155	50	0,59
4755-16	1000 W	160	156 to 165	50	0,63
4755-17	1000 W	170	166 to 175	50	0,66
4755-18	1240 W	180	176 to 185	50	0,70

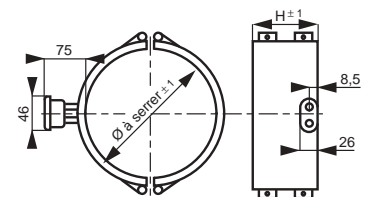

Female extension plug P/N. 9565-01

P/N.	Power +5 -10%	Ø Clamp	H	Weight
		(mm)	(mm)	(kg)
4755-19	1240 W	190	186 to 195	0,74
4755-20	1240 W	200	196 to 205	0,78

← Power available for 2 half-bands →



APPLICATIONS FOR HEAT TRACING

FROST PROTECTION, TEMPERATURE MAINTENANCE, HEATING of fluids in pipework, vessels and ANTICONDENSATION of enclosures (electrical cabinets...)

Use	FROST PROTECTION				TEMPERATURE MAINTENANCE or HEATING					
	Material pipework, tank : Metal									
Maxi Temperature	Material pipework, tank : PVC									
	35°C	45°C	65°C	85°C	120°C	150°C	200°C	250°C	450°C	900°C
Technologies										
Self regulating	Pipework									
Constant wattage	Pipework - Vessel									
Insulated mineral cables					Pipework - Vessel					
Fibre glass braided insulation					Pipework - Vessel					
Insulated mineral panels					Vessel					

HVAC	Frost protection and condensate discharge pipes. Glass demisting of refrigerating cabinets.
Buildings - roads	Frost protection of domestic waters pipe, garages, gardens, roofspaces, and parking areas, loading bays, sprinkler systems, Temperature retention of bitumen for road construction, sanitary water, water protection against legionella.
Industry - Petrochemical Medical care - Food and beverage	Temperature maintenance of petrochemical processes, oil and gas pipework, corrosive liquids including in hazardous areas, heating of pharmaceutical and cosmetics products sensitive to cold temperatures. Anti-condensation of electrical cabinets, engine start-up, including in hazardous areas temperature retention for gluing processes, polymers mouldings, and food preparations (Chocolates, ...).

TECHNOLOGY

Self regulating (120°C max)



The heating cable core is made with conductive plastic. Two parallel conductive wires distribute the current to a sheath of semi-conductive polymers insulated by an external insulation. The self regulating technology enables you to cross the cables or overlap without any danger. The self regulating cable in combination with an ambient thermostat will be more energy efficient during the winter periods (500 hours / year maxi vs 8700 hours / year without thermostat). **CAUTION:** a C curve circuit breaker must be used.

Operational principle

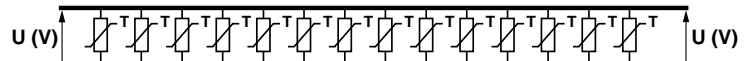

Self regulating cables performances P/N.	Cable Temperature																					
	5	10	15	20	25	30	35	40	45	50	55	60	65	70	75	80	85	90	95	100	105	110 °C
26157-00	15																					
26153-10	15	14	13	12	11	10	9															
26155-20 26183-10	26	24	22	20	19	17	15															
26170-30	30	28	27	26	25	24	23	22	21	20	17											
26165-10 26170-00	30	29	29	28	27	26	26	25	24	23	21	20	20	19	18							
26165-00	40	39	38	37	36	35	34	33	32	31	30	29	28	27	26	25	24	23	22	21	20	20
26174-50	50	49	48	46	45	44	43	41	40	39	35	34	33	32	30	29	28	27	26	24	23	22

Constant wattage (120°C max)

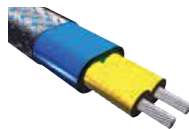

Constant wattage, no variation of the efficiency, 2 conductive wires are insulated and connected at regular intervals to a coiled resistive element. The constant current is provided between 2 fixed points on the conductive wires (W/m). **Caution:** these cables must be controlled by a thermostat, and their technology doesn't allow any contact by crossing or overlap.

Operational principle

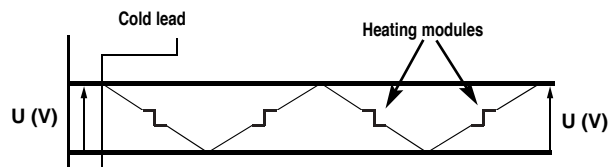

Insulated mineral heating cables (450°C max)



The cable consists of Kumanal conductor insulated by a compacted magnesium oxide and by stainless steel outer sleeve. Through their high power (15 up to 65W/m) and metallic sleeves, these cables with mineral insulation offer optimum heat transfer. They are supplied at set length with a cold section at each end parts and two power supplies terminal. They must be controlled by a thermostat device (see on pages 97-98)

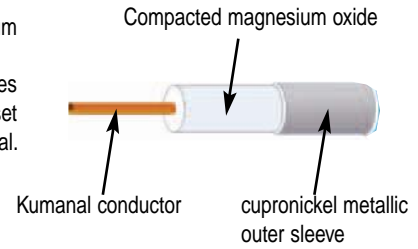

Heating cables with fibre glass braided insulation (900°C max)



The heating cables maintaining a constant power are used to apply a strong concentration of heat within a reduced time and in a dry atmosphere. They are isolated by a fibre glass twine (not waterproof). Powerful, ready for use. Very flexible, these heating cables are only available in defined lengths and must be controlled by a temperature control device.

Why use a thermostat or humidistat with heating cables ?



Heating cables are automatically controlled by a thermostat or humidistat with a set temperature or relative humidity. This will enable their electrical consumption to be reduced and their life extended. (see thermostat and humidistat range for heating cables on pages 97 and 98).

Installation of heating cables on pipes

Power requirements per meter > Heating cable power output:

CONFIGURATION WITH CABLE TWISTED IN SPIRAL

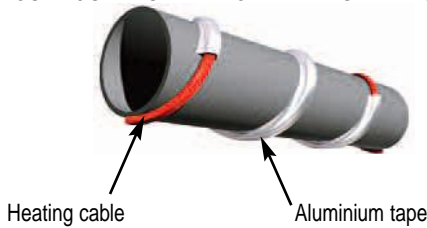

Power requirements per meter ≤ Heating cable power output:

CONFIGURATION WITH CABLE IN LINE

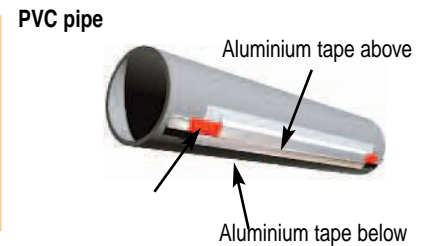
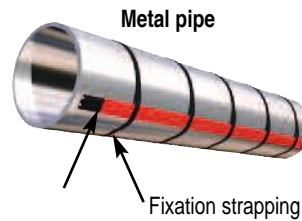

It is best to apply two heating cables in line for a better warm exchange and easy of installation

FROST PROTECTION OF PIPES

(Make sure that the trace piping installation is protected by a 30 mA circuit breaker (C curve))

Technology heating cable	Piping material	NON ATEX and ATEX 	Power at 5°C	Lg Mini	LG Maxi (W/m)	Temp. Maxi voltage (m)	Temp. Maxi voltage (m)	Braid on	Outer jacket off	P/N.		
Self regulating (Power output according temperature. See performance table on page 94)	Metal or Plastic	NON ATEX CSTB	15	5	70	45°C	65°C	x	x	26157-00		
		NON ATEX CSTB	15	5	110	65°C	75°C	✓	x	26153-10	Without outer jacket FEP With stainless steel braid	
	Metal	 II 2 GD Ex e IIC T6 Gb	26	5	110	65°C	75°C	✓	✓	26155-20	With outer Fluoro-polymere (High resistance to chemicals.)	
Constant wattage	Metal	NON ATEX	20	5	110	45°C	125°C	x	x	26281-00	Transparent sheath to locate easily the heating modules and cable cutting.	
Constant wattage (thermostat set at 3°C) Ready to use	Metal or Plastic Ø1" mini	NON ATEX	15	1						26178-01	 Equipped with an earth wire conductor	
			15	2						26178-02		
			15	4						26178-04		
			15	8			65°C		x	x		26178-08
			15	10								26178-10
			15	18								26178-18
			15	24								26178-24
15	37							26178-37				

CAUTION : PVC piping must be equipped with an earth wire conductor.



TEMPERATURE MAINTENANCE OF PIPES

Temperature maintenance Maxi	Technology Heating cable	Piping material	NON ATEX and ATEX	Power at 5°C (W/m)	Lg Mini (m)	LG Maxi (m)	Temp. Maxi (volatge on)	Temp. Maxi (Voltage off)	Braid	Outer jacket	P/N.			
35°C	Self regulating (Power output according temperature. See performance table on page 94)	Metal	II 2 GD Ex e IIC T6 Gb	26	5	110	65°C	75°C	✓	✓	26155-20	without outer jacket FEP		
			NON ATEX CSTB	26		5110	65°C	75°C	✓	x	26183-10			
65°C			NON ATEX CSTB	30		5110	85°C	125°C	✓	x	26170-30	With outer jacket FEP		
85°C			NON ATEX	30		5110	120°C	200°C	✓	x	26170-00			
85°C			II 2 GD Ex e IIC T6 Gb	30	5	110	120°C	200°C	✓	✓	26165-10			
85°C			NON ATEX	50		5110	120°C	200°C	✓	✓	26174-50			
120°C			II 2 GD Ex e IIC T3 Gb	40	5	65	120°C	205°C	✓	✓	26165-00	Fluoropolymer High resistance to chemicals.		
120°C			Constant wattage Extra flat (400V on request)	Metal	NON ATEX	30		5110	120°C	260°C	✓	x	26182-00	Transparent sheath to locate easily the heating modules and cable cutting.
105°C			Constant wattage	Metal	NON ATEX	30	1		105°C	200°C	Without braid Silicon sheath Section 9,75 x 5,25 mm		26175-03	Silicone heating tapes
						30	2	26175-06						
	30	3				26175-09								
	30	4				26175-12								
	30	5				26175-15								
	30	6				26175-18								

TEMPERATURE MAINTENANCE AND HEATING OF TANK AND PIPES

Temperature maintenance Maxi	Technology Heating cable	Raw material piping	NON ATEX and ATEX	Power in at 5°C (W)	Lc Mini (m)	Outer sheath	P/N.	
250°C	Insulated mineral cable (constant wattage)	Metal	NON ATEX	880	60	Cupronickel sheathed	26107-02	Fitted with a 1m long cold lead at both ends, with a sealed grommet to connect to an IP55 box. Ref 9650-02 (see accessories on page 97)
				1150	45		26107-05	
				1500	55		26108-05	
				1650	60		26106-25	
				1800	55		26106-26	
				2000	50		26106-27	
				2200	45		26106-28	
				2500	40		26106-29	
				2850	35		26106-30	
				450°C	Insulated fiber glass braided Non waterproof IP20		Metal	
250	1	26158-02						
375	1,5	26158-03						
500	2	26158-05						
750	3	26158-07						
450°C	900°C (without voltage)			180	0,5	26159-01		
540				1,5	26159-05			
760				2	26159-07			
900°C				930	2,5	26159-08		

INSULATED MINERAL PANELS: TEMPERATURE MAINTENANCE OR HEATING OF TANKS

Temperature maintenance Maxi	Technology Heating cable	Tank material	Power in at 5°C (W)	Dimensions (mm)	Outer sheath	P/N.	
200°C	Insulated mineral cable Fixed to a perforated zinc-coated steel sheet	Metal	600	500 x 1000	Cupronickel Sheathed	26160-01	Insulated mineral panels are shown installed on a tank, with a red electrical control box visible.
			600	750 x 1000		26160-02	
			960	750 x 1000		26160-03	
			600	1000 x 1000		26160-04	
			960	1000 x 1000		26160-05	
			960	1500 x 1000		26160-06	
			1750	1500 x 1000		26160-07	
			1100	2000 x 1000		26160-08	
			1750	2000 x 1000		26160-09	
			2200	2000 x 1000		26170-01	
			3800	2000 x 1000		26170-02	

ACCESSORIES FOR HEATING CABLES

REF.	Description		REF.	Description	
26181-99	Universal set for lead and junction (replace Ref. 26179-90) • Supply voltage connection: 2 thermoshrinkable sleeve Ø3mm, lg 40 mm • Wires insulation: 1 thermoshrinkable sleeve 60x12 mm to fix the outer jacket on the junction side, 1 thermoshrinkable sleeve 60x12 mm to insulate the leads end, 2 thermoshrinkable sleeve 40x12 mm and 1 silicone sleeve with a silicone tube also usable for leads on the jobsite (Atex zone).		9671-05	Standard polyamide cable gland ISO 25 for supply voltage (gasket, nuts and oblong silicone gasket).	
26179-92	Quick connector to plug 1 heating cable to the supply voltage 230V or to interlink 2 heating cables. <i>Gaskets supplied suitable heating cables with or without outer jacket.</i>		26179-75	Ex e cable gland ISO 25 suitable to Ex e junction box ref 9649.20, and connection to ATEX heating cable with outer jacket and braid.	
26179-93	Quick connector to plug 2 heating cable to the supply voltage 230V or to interlink 3 heating cables. <i>Gaskets supplied suitable heating cables with or without outer jacket.</i>		26179-13	Kit with an insulation bulkhead fitting + 1 cable gland ISO 20 + oblong silicone gasket suitable to heating cables with or without outer jacket and junction boxes.	
26179-50	Standard polyamide cable gland ISO 20 + oblong silicone gasket suitable cables with or without outer jacket.		26179-95	Aluminium adhesive tape for cable installation in piping (Temp. maxi -50/+150°C).	
26181.95	Universal silicone sleeve 100 x 15 mm. Mandatory for ATEX zone.		26180-05	Pack of 10 aluminium standard labels.	
			26179-20	Silicone tube for filling the sleeve on the lead opposite to the supply voltage, 3 fillings max (respect the polymerization time). Mandatory with ATEX zone.	

NON ATEX AND ATEX JUNCTION BOXES - Ex e

P/N.	Connection	Description		P/N.	Connection	Description	
9649-00	1 inlet for supply voltage + 2 outlets max for heating cables	Polyamide junction box IP55 107x107x105 mm with mounting brackets + 2 cable glands ISO 20 + 1 cable gland ISO 25 for supply voltage. One ceramic terminal block + 2 gaskets for cable with outer jacket + 2 gaskets for cable without outer jacket.		9649-20	1 inlet for supply voltage + 3 outlets max for heating cables	ATEX junction box, polyester-fiberglass, protection Ex e IP55 121x121x75 mm with mounting brackets + 4 cable glands ISO 25 with suitable gaskets + 3 polyamide lids in case of only 2 heating cables connected. Ceramic terminal block (Ex d junction box available on request).	
9650-02	1 inlet for supply voltage + 2 outlets max for heating cables	Aluminium junction box IP55 95 x 95 x 70 mm with mounting brackets + 2 cable glands ISO 16 BIS + 2 outlets for insulated mineral cables connection or PAMI equipped with ceramic block with threaded terminal.					

DIGITAL CONTROL UNIT WITH WATERPROOF JUNCTION BOX IP 66

Description	P/N.
Digital temperature controller under waterproof junction box	9028-01
Sensor PT100 Ohms Ø 4 mm lg= 50 mm Cable lg = 5 m	9028-02

Temperature controller « On/Off », compact, easy to use, suitable to control immersions heaters, heating cables, or silicone heating panels **up to 3,5 kW**.
Controlling a heating power over 3,5 kW requires an installation with an electromechanical relay.

Main specifications:

- Temperature measured, setting point, relay output position are indicated by digits.
- Input temperature PT100 2 wires (-50°C.....+250°C), with long length compensation integrated.
- Message « Err LO/Hi » in case of temperature sensor broken or in short circuit.
- Very easy to configurate with push button **temp +/temp-**; setting of hysteresis and short cycle protection.
- Relay output with close contact when temperature measured is lower the set temperature. Breaking capacity 16A/230V single phase.
- Waterproof and transparent casing IP 66. Resistant against shock and vibration.
- Cable glands suitable to supply voltage cables from Ø6 up to 13 mm.

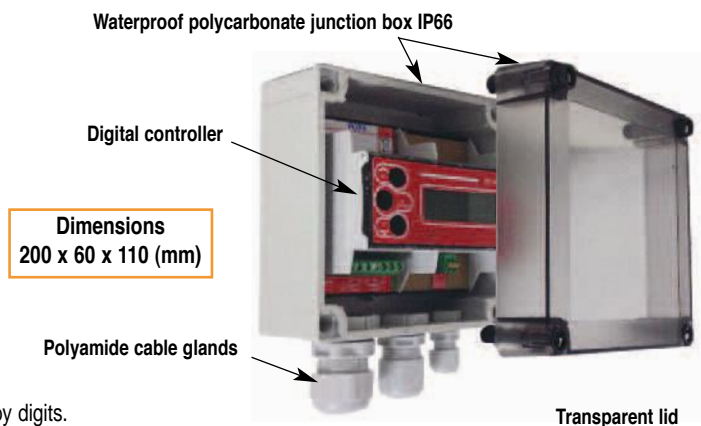

NON ATEX AND ATEX CONTROL THERMOSTATS

AMBIENT AIR CONTROL THERMOSTAT - IP 55

This outdoor control thermostat IP55 allows to reduce energy consumption with the power off or power on of heating cables used for frost protection (self regulating cables) during the winter time (500 hours/year vs 8700 hours/year).



P/N.	Applications	Description
9014-50	<ul style="list-style-type: none"> Outdoor installation. Frost protection of water tanks, pipework, mechanical processes, vessels, and pools.... 	Thermostat range: - 5 up to 30°C Sealable IP 55 cover Change over contact, breaking capacity 10A/250VAC. Normally closed contact Hysteresis 3°C Dimensions: 122x 120x55 mm

CONTROL THERMO-HUMIDISTATS ANTI-CONDENSATION - IP 30



P/N.	Applications	Description
9014-98	Control of a self regulating heating cable by a humidistat (relative humidity HR %) avoids condensation in electrical cabinets, enclosures and rooms.	Humidistat range 35% up to 100% . (HR %) Change over contact, breaking capacity 5A/230VAC . Dimensions: 75x 75x27 mm



P/N.	Applications	Description
9014-99	Control of a self regulating heating cable by a thermo-humidistat (ambient temperature + relative humidity HR %) avoids condensation in electrical cabinets and enclosures and rooms.	Thermo-humidistat range 10 °C up to 35°C – 35% up to 100% . (HR %). Change over contact, breaking capacity 5A/230V (humidistat) Change over contact, breaking capacity 10A/230V (thermostat). Dimensions: 127,5x 75x27 mm

CONTROL THERMOSTATS FOR HEATING CABLES - IP 55



P/N.	P/N spare part thermostat	Range (°C)	Ø bulb (mm)	B (mm)	Capillary length (mm)	Weight (kg)
9014-11	9014-31	+30 / +110	8	90	1000	2
9014-12	9014-32	-20 / +30	8	143	1000	2

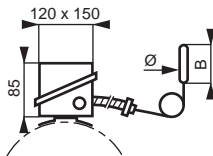

Liquid expansion type thermostat for heating cables, in an IP 55 box fitted with fixing lugs on the insulating cover, with copper capillary.
 Single-pole double-throw open contact, breaking capacity 16 A /400 VAC.
 Cable glands: ISO 16 bis and ISO 20 bis.

ATEX CONTROL THERMOSTATS CERTIFIED FOR DUST AND GAS - Ex de - IP 65



Ambiance

P/N.	Range (°C)	Capillary length (mm)	Type	Weight (kg)
6023-02	-20 / +40 (T6)	70	Ambient	0,6
6023-03	0 / +50 (T6)	1000	Contact/surface	0,6
6023-04	0 / +120 (T4)	1000	Contact/surface	0,6



Contact/surface

These ATEX thermostats are certified for zone 1 with an ambient temperature from -40°C up to 40°C (T6) or -40°C à +50°C (T4).

Protection: Ex de IIC T6 (T3 on request)

Junction box: IP 65

Dimensions: 122x120x90 mm

Breaking capacity: 10A/230VAC

Atex marking: II 2 G Ex d e IIC T6 Gb or II 2 G Ex d e IIC T4 Gb for hazardous atmospheres

and II 2 D Ex tb IIC T85° Db et II 2 D Ex IIC T130 Db for explosive ambient with conductive dust.

Certificate: EPS 11 ATEX 1 354

HEATING CABLE PREPARATION

Constant wattage

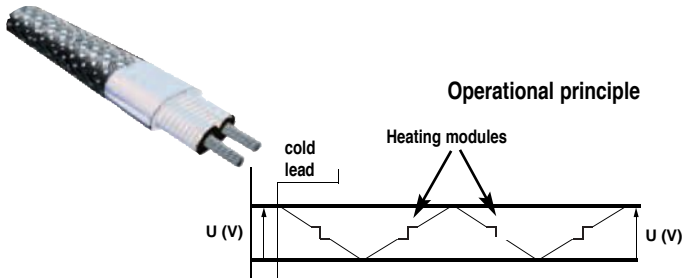

Side joint connection

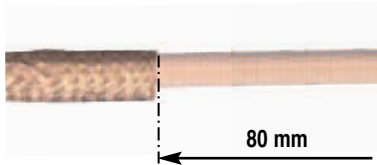

Locate through the transparent silicone sleeve, the beginning of the heating modules, depending of the desired cold length required. cut the heating cable and push back on the twine 80mm approximately.

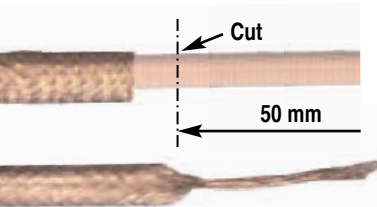

Cut the heating cable 50mm approximately and peel back the twine in order to splice it on 15mm long.

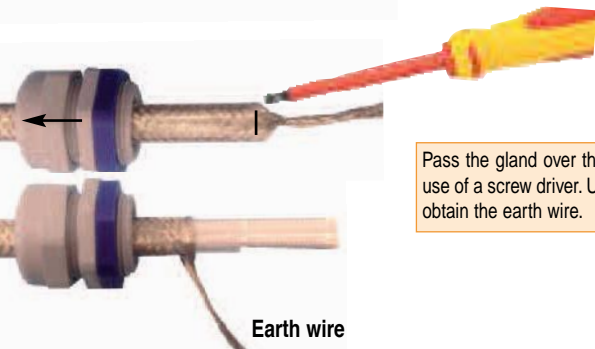

Pass the gland over the cable with the use of a screw driver. Undo the twine to obtain the earth wire.

Earth wire



Separate the two wires in the direction of the length with the use of scissors and strip back 15mm approximately.

Cable end

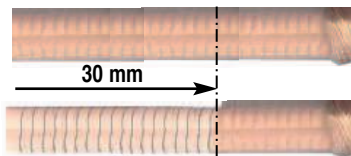

Strip the outer sleeve back 30mm with the help a wire cutter/ stripper, taking care not to damage the insulation of the two conductors located underneath.



Strip the sleeving from the two conductors and cut flat against the isolating sleeve. do not attempt to reconnect them again



Cut one of the two conductors shorter than the other one, to avoid any contact



Fill the sleeve with silicone and slip it over the cable end. Leave to dry before use.



Self regulating

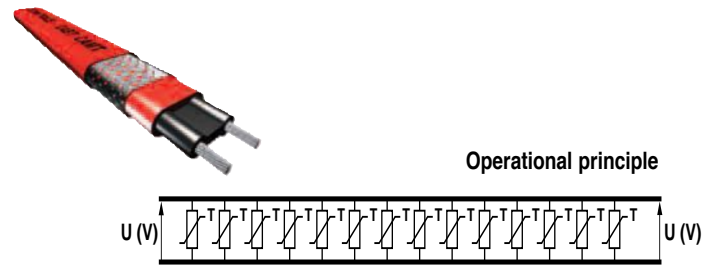

Side joint connection

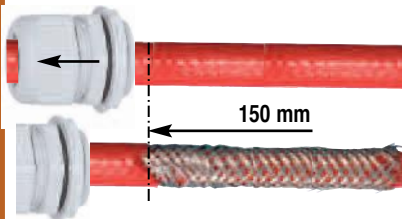

Pass the gland over the cable. Then cut the sleeve back 150mm approx.



Splice the stainless steel braid.



Earth conductor

Strip the outer sleeving taking care not to damage the insulation of the two conductors underneath.



Strip the conductors with a thermal stripper for a few seconds in the black area (zone) semi conductor. This helps to easily strip the conductors with the use of wire stripper/pliers.



Separate the two conductors with insulation tape, then maintain the braiding on the sheath with the use of another piece of insulation tape.



Two thermo retractable sleeves make it possible to insulate the conductors right up to the power connector if necessary.



Cable end

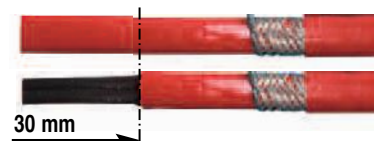

Strip the outer sleeve back 30mm with the use of a cutter/blade. taking care not to damage the insulation of the 2 conductors underneath.



With the use of wire cutters. Cut the end diagonally.



Fill the sleeve with silicone and slip over the cable end. Leave to dry before use.



APPLICATIONS

Heating and maintaining temperature of flat, cylindrical or conical components. For use especially when even temperature distribution is required (no hot spot) or when the heating system has to be very compact (thickness: about 4 mm).

Hot vulcanisation of the 2 surfaces = permanently bonded

Heating wires

Cylinder formed during vulcanisation

Connection mould also available with connections within the thickness of the panel.

200°C max.

Load up to 0,7 W/cm²
(moreover depending on heat exchange)

Protection code: IP21 - IP55 on request

Ex-stock silicone heating panels have a load of 0,7 W/cm² max

For cable leads within the panel thickness instead of on a mould, consult us.

An excellent way to heat flat surfaces up to 180°C. Rugged, flexible, and compact, silicone heating panels solve many problems of heating or maintaining temperature.

Listed models are available with a self-adhesive surface for permanent fixing, and with Pt100 probes.

Voltage: 230V 1 P.
Length of leads = 500 mm.

Ensure secure fixing with self-adhesive aluminium tape, P/N. 4550-00

Connection cable on the panel thickness 9 mm approximately

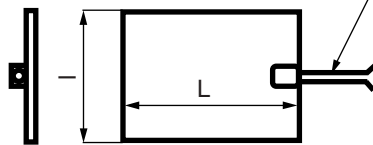

Connection cable on the panel, thickness 9 mm approximately

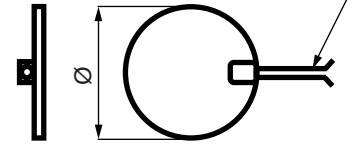

RECTANGULAR SILICONE HEATING PANELS

P/N.	Shape	Self-adhesive	Power. (W) +5-10%	Voltage (V)	Dim (mm) L x l	Temperature sensor
26156-03	Rectangular	Yes	1,25	12V 1 P	25 x 49	Non
26156-04	Rectangular	Yes	2,5	12V 1 P	50 x 49	Non
26156-05	Rectangular	Yes	3,75	12V 1 P	50 x 74	Non
26156-06	Rectangular	Yes	5,0	12V 1 P	50 x 99	Non
26156-07	Rectangular	Yes	7,5	12V 1 P	75 x 99	Non
26156-08	Rectangular	Yes	80,0	12V 1 P	200 x 399	Non
26156-13	Rectangular	Yes	50	230V 1 P	100 x 149	Non
26156-14	Rectangular	Yes	100	230V 1 P	100 x 149	Non
26156-15	Rectangular	Yes	100	230V 1 P	200 x 149	Non
26156-16	Rectangular	Yes	200	230V 1 P	200 x 249	Non
26156-17	Rectangular	Yes	400	230V 1 P	200 x 299	Non
26156-01	Rectangular	No	440	230V 1 P	200 x 280	Non
26156-18	Rectangular	Yes	533	230V 1 P	200 x 399	Non
26156-02	Rectangular	No	1000	230V 1 P	304 x 497	Non
26156-11	Rectangular	Yes	440	230V 1 P	200 x 280	Non
26156-12	Rectangular	Yes	1000	230V 1 P	304 x 497	Non
26156-42	Rectangular	Yes	1000	230V 1 P	304 x 497	PT 100

Models are bored in the centre to install a temperature limiter.

CIRCULAR SILICONE HEATING PANELS

P/N.	Shape	Self-adhesive	Power. (W) +5-10%	Voltage (V)	Dim (mm) Ø	Temperature sensor
26156-51	Circular	No	60	230V 1 P	Ø 100	Non
26156-52	Circular	No	310	230V 1 P	Ø 200	Non
26156-61	Circular	Yes	60	230V 1 P	Ø 100	Non
26156-62	Circular	Yes	310	230V 1 P	Ø 200	Non
26156-81	Circular	No	60	230V 1 P	Ø 100	PT 100
26156-82	Circular	No	310	230V 1 P	Ø 200	PT 100
26156-91	Circular	Yes	60	230V 1 P	Ø 100	PT 100
26156-92	Circular	Yes	310	230V 1 P	Ø 200	PT 100

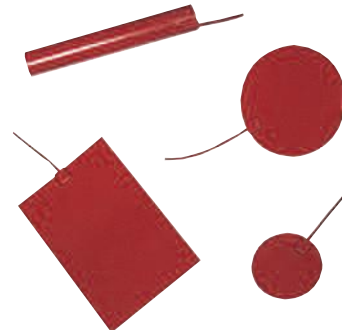

SILICONE HEATING PANELS WITH LEADS IN THE PANEL THICKNESS

Connection cables in panel thickness, max. thickness 4 mm

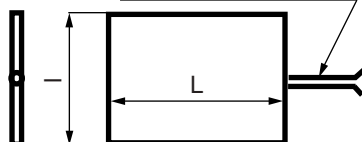

Connection cable in panel thickness, max. thickness 4 mm

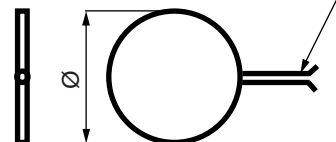

MADE-TO-MEASURE SILICONE HEATING PANELS

In addition to rectangular shapes, silicone heating panels can quickly be made into all kinds of irregular shapes with holes and cuts-outs.

It is therefore possible to heat flat, cylindrical and conical surfaces, as well as pipework, up to 180°C.

Maximum peak temperature 200°C.

Rugged, flexible, and compact, silicone heating panels solve many problems of heating or maintaining temperature.

A self-adhesive surface can be added to one or two sides of the panel for permanent fixing.

The panels can optionally be fitted with a temperature limiter (I max. = 10 A / 230 VAC), a Pt100 probe, or a J- or K-type thermocouple.

Voltage 230V 1 P.

For other voltage or other phases consult us.

I max. = 17 A / phase.

Connection lead length = 1 m on standard model.

Max. dimensions = 2000 x 900 mm

To describe a panel made to measure, use the boxes below.



Consult us with your plans

To order a made-to-measure silicone heating panel, state:

Silicone heating panel, rectangular type 26156 or circular type 26166

Shape and dimensions: Rectangular mm x mm or circular Ø mm, or provide a drawing

Power: (not to exceed 0,7 W/cm² on metals and 0,3 W/cm² on polypropylene and PVC)

Voltage: (max. 400V 1 P or 400V 3 P)

With temperature limiter: Yes / No (cut-out temperature, °C) or with a Pt100 probe or a J- or K-type thermocouple

With a self-adhesive surface: Yes / No

To order a made-to-measure cylindrical silicone heating panel, state :

Cylindrical silicone heating panel type 26176

Minimum size : Inside diameter : 12 mm ; Length : 150 mm

Maximum size : Inside diameter : 150 mm ; Length : 900 mm

Power: (not to exceed 0,7 W/cm²)

Voltage: (max. 400V 1 P or 400V 3 P)

With temperature limiter : Yes / No pre-set to °C or with a Pt100 probe or a J- or K-type thermocouple

etched foil possibility

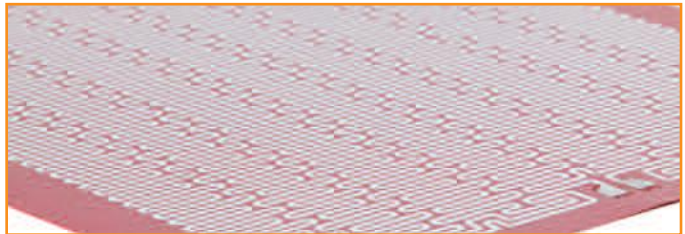

ACCESSORIES FOR SILICONE HEATING PANELS

- Special **silicone glue** to fix these panels to metal or plastic. Suitable for most materials. Available in two versions, to be used according to the prevalent temperature constraints: 200°C max. or 250°C max. Note: using primer **P/N. 26156-95** improves adhesion to metals and protects them from corrosion by the acetic acid released by the glue as it hardens.

- **Aluminium adhesive tape.** A simple and effective solution to fix silicone heating panels, whether flat or cylindrical. It ensures the protection of the heating panel whilst improving heat transfer.

- **Fixing belts for cylindrical heaters.** If cylindrical heaters need to be easily dismantled, we suggest the use of silicone belts. They are made of the same material as the heating panels, and fitted at one end with two metal rings for fastening. Belts should be placed at 100 mm maximum intervals along the cylinder.



P/N.	Description	Amount
26156-94	Glue Max. temp. 250°C	90 cm ³
26156-95	Primer for metal surfaces	90 cm ³
4550-00	Aluminium adhesive tape	5 cm x 50 m
26156-97	Fixing belt	Length 500mm
26156-98	Fixing belt	Length 1000mm

HOW TO SELECT YOUR INFRARED GENERATOR

400°C / 4,31µm

650°C / 3,14µm

1200°C / 1,97µm

3000°C / 0,89µm

LONG WAVE

MID WAVE

SHORT WAVE

Wavelength	LONG WAVE	MID WAVE	SHORT WAVE
Operating temperature range(°C)	from 400 to 500°C	from 750 to 850°C	from 2100 to 3000°C
Wavelength range	from 4,3 to 3,8 µm	from 2,6 to 2,8 µm	from 0,9 to 1,2 µm
Emitter source	Resistive wire encapsulated in ceramic	Sheathed tubular element	Filament under halogen into quartz pipe
Thermal inertia	2-5 min	1-2 min	0,5-1 sec
Max. installed power density	20 kW/m ²	50 kW/m ²	300 kW/m ²
Applications	Homogeneous heating. Suitable for thick products (several mm).	Superficial heating. Suitable for humid product.	Superficial heating. Suitable for thin product.

LONG WAVE INFRARED SOURCES :

Different technologies are available for those sources. Nevertheless mainly the ceramics are used in industry. They are made of heating elements bedded in ceramic. The resistances raise the ceramic surface temperature from 300 to 700°C. Thermal inertia is high (>3-5 min.)

MID WAVE INFRARED SOURCES :

They are made of resistances raised at temperatures between 700 and 1 000°C; the resistances are placed within a quartz/silica or metal sheathed tubular element to protect them. They emit lighting waves (red). Inertia is more consequent than shortwave (minutes), but they do not need cooling.

SHORT WAVE INFRARED SOURCES :

Those sources are lamps or tubes under vacuum or neutral gas; heating elements (emitter) are tungsten filaments raised at temperature higher than 2 000°C. They emit light (clear yellow) and allow very intensive power densities with low inertia (second). It's often necessary to cool them.

CERAMIC LONG WAVE INFRARED ELEMENTS

Infrared ceramic emitters provide longwave radiation ideally suitable for the preheating and thermoforming of plastics, rubber and synthetic fibers in addition to skin and blister packaging processes.

Advantages :

- No maintenance required
- No deviation of temperatures or wave lengths
- Appliance with water and acid
- Visual thermal indicator

FEATURES :

Radiation distances recommended from 100 to 200 mm. The element is encapsulated in ceramic coil and withstands high thermal shocks.

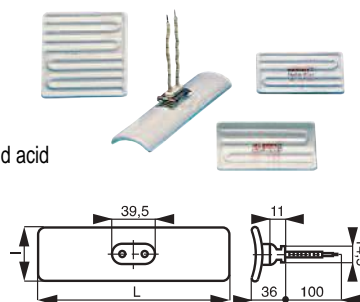

REF.	Power ± 10%	L (mm)	l (mm)	Curved or flat	Temp. (°C)	Weight (kg)
6020-00	125 W	122	60	C	370	0,13
6020-01	250 W	245	60	C	370	0,26
6020-03	500 W	245	60	C	500	0,26
6020-06	200 W	122	60	C	460	0,16
6020-09	500 W	245	60	F	500	0,25
6020-12	300 W	122	122	F	400	0,25
6020-13	500 W	122	122	F	500	0,25

Supply voltage : 230 V single phase
Interchangeable with English models FTE/HTE/SFE and German models FSR/FSR-2/HFS.

CERAMIC LONG WAVE INFRARED LAMPS

Lamp adaptable to all applications of the long IR and, in particular, to the poultry industry. Screwed into a lamp socket ceramic suspension (E27 base) equipped with an aluminium reflector at high reflecting power. Supply voltage : 230 V single phase

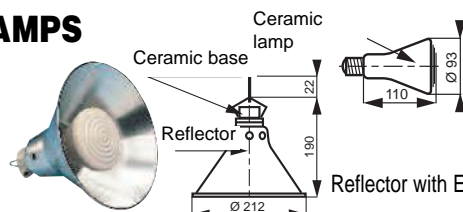

P/N.	Power ± 10%	Temp. (°C)	λ (µm)	Weight (kg)
6020-35	150 W	280	5,3	0,18
6020-36	250 W	370	4,4	0,18

Reflector with E27 socket : P/N. 6020-33 (Weight 0,28 kg)

ACCESSORIES FOR CERAMIC LONG WAVE INFRARED ELEMENTS

These sets of accessories allow the achievement of infrared heating panels, using ceramic generators. Particularly suitable for high ambient temperatures, they are made of :

- Aluminium reflector (avoiding overheating behind the element);
- Stainless steel bus bars (for electrical connection);
- High-temperature ceramic terminal blocks;
- Sets of spacers (for fixing reflectors);
- Protective grid to suit the reflector ; can be used on all our in-line infrared generators, long, medium or short wave.

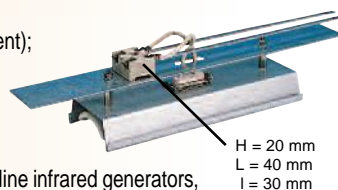

P/N.	Description	Weight (kg)
6020-34	Aluminium reflector (248 mm)	0,27
6020-42	10 spacers (M5 x 12 mm)	0,01
6020-40	Ceramic terminal block	0,05
6020-41	Bus bar (8x2) length 1,25 m	0,16
6014-17	Protective grid length 240 mm	0,15

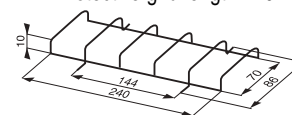

MEDIUM WAVE INFRARED GENERATORS

APPLICATION :

Straight medium wavelength infra-red generator able to solve all your needs of industrial drying, cooking, polymerisation...

ADVANTAGES :

Rugged and careful build. Easy to install vertically or horizontally in an environment at 200°C max. Double electrical insulation. High reflecting power of reflector and long life of heating elements allows an universal use.

FEATURES :

Incoloy 800 triangulated section sheathed element fitted at the heart of a high efficiency aluminium parabolic reflector, mounted in a rigid light alloy profile provided with an adjustable attaching bolts.

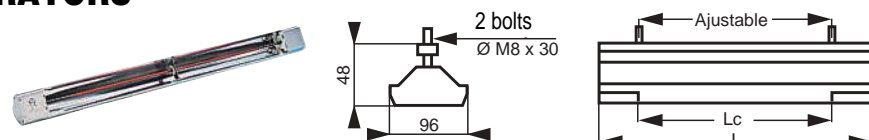

P/N. in 230 V	P/N. in 400 V	Power +5-10%	L (mm)	Lc (mm)	P/N. 230V	Spare elements 400V	Weight (kg)
6341-08	6341-09	800 W	622	412	6341-58	6341-59	2,6
6341-11	6341-12	1100 W	777	564	6341-61	6341-62	3
6341-18	6341-19	1800 W	1187	970	6341-68	6341-69	4
6341-25	6341-26	2500 W	1557	1330	6341-75	6341-76	5,2
6341-30	6341-31	3000 W	1872	1640	6341-80	6341-81	6,2
6341-36	6341-37	3600 W	2177	1944	6341-86	6341-87	7,1
6014-17	Protective grid length 240 mm						0,15

Supplied with 2 adjustable attaching bolts. See: electronic power controllers on page 82, connection wires with KAPTON insulator on page 117.

MEDIUM WAVE INFRARED UNITS

Using similar technology than the short-wave infrared units, these appliances are made of sheathed medium-wave infrared elements fixed in front of a flat highly-reflective dimpled reflector, in a metal surround with integral cooling. Robust and non-polluting these metal heating elements can be install vertically or horizontally. These panels are suited to applications, such as drying powder coatings on metal components, coil-coating, food processing, etc. Specific temperature surface are available on request. Multizone power supply available

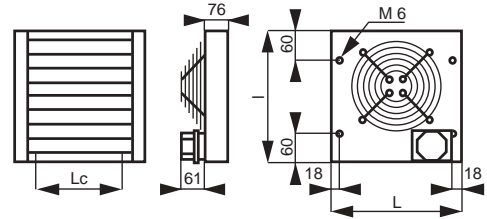

Can be fixed in any position.

Optional accessories :

- Counter-reflectors.
- Vitroceramic kit and protective brackets.
- Units also available without cooling.

P/N.	Power +5 -10%	Voltage (V)	I (mm)	Lc (mm)	L (mm)	Cooling wiring	Spare element	Unit power
6015-01	2,4 kW	230 1P	180	412	630	separated	6341-58	800 W
6015-02	7,2 kW	230/400 3P	540	412	630	separated	6341-58	800 W
6015-03	3,3 kW	230 1P	180	564	780	separated	6341-61	1100 W
6015-04	9,9 kW	230/400 3P	540	564	780	separated	6341-61	1100 W
6015-05	16,2 kW	230/400 3P	540	970	1190	separated	6341-68	1800 W
6015-06	32,4 kW	230/400 3P	1080	970	1190	separated	6341-68	1800 W

Standard models : Emitters for step 60mm

MEDIUM WAVE INFRARED TIGHT GENERATOR "U" SHAPE

FEATURES :

6091 type is made of a tubular sheathed element pin-bended and an aluminum plated steel reflector. Electrical connections are through IP55 waterproof terminal box.

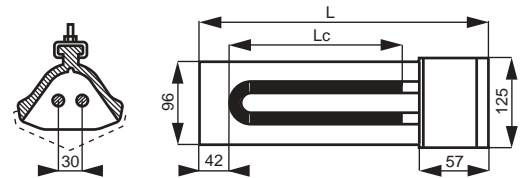

Supplied with 2 adjustable clamps, see :

- Electronic power distributors.
- KAPTON –insulated connection leads.
- Protective grilles (P/N. 6014-17).

P/N. in 230 V	P/N. in 400 V	Power +5 -10%	L (mm)	Lc (mm)	P/N. 230V	Spare elements 400V
6091-08	6091-09	800 W	390	255	6091-58	6091-59
6091-11	6091-12	1100 W	485	350	6091-61	6091-62
6091-18	6091-19	1800 W	710	575	6091-68	6091-69
6091-25	6091-26	2500 W	935	800	6091-75	6091-76
6091-30	6091-31	3000 W	1095	960	6091-80	6091-81
6091-36	6091-37	3600 W	1290	1155	6091-86	6091-87

SHORT WAVE INFRARED GENERATORS

APPLICATIONS :

Radiation heating for textile, paper, cardboard, plastic and film industries and all applications requiring near zero inertia.

ADVANTAGES :

Immediate turning on and off. High power density. Reflector guaranteeing maximum reflection and high resistance to corrosion. Practically no maintenance. Emitter tube easily replacable. This emitter makes it possible to focus on a line from 10 to 60 mm width, giving densities up to 300 kW/m².

FEATURES :

Coiled tungsten filament mounted under a neutral gas in a quartz pipe. Matt black extruded aluminium holder serving as heat sink with an adjustable central hook-on lug.

DON'T TOUCH THE HEATING ELEMENT :

Avoid contact with the heating element; avoid also vibrations of the emitter when powered on. Place the generator horizontally at a distance from 60 to 300 mm from the part to be heated, according to the required power density. Some atmospheres require forced ventilation. It is possible to install several generators side by side.

CLEAR QUARTZ LAMP



P/N.	Power +5 -10%	L (mm)	Lc (mm)	Spare element P/N	Weight (kg)
6014-21	500 W	245	170	6014-35	2,0
6014-22	1000 W	358	270	6014-32	2,3

Elements P/N.6014-32 and 35, connection by sockets, for horizontal fitting only (+/- 15°)

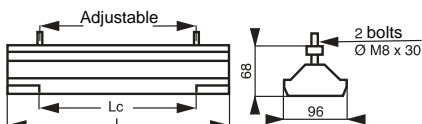

2 fixing clamps.
Connection by 2 nickel leads, length 250 mm.

RUBY QUARTZ LAMP



P/N.	Power +5 -10%	L (mm)	Lc (mm)	Weight (kg)
6114-22	1000 W	358	270	2,3

Spare elements P/N. 6114-32, connection trough sockets, for fitting in any position

Optional accessories :

- Electronic power distributors.
- KAPTON – insulated connection leads, see accessories
- Protective grids P/N. 6014-17.

SHORT WAVE INFRARED UNITS

APPLICATION :

Models with separately cabled ventilation. This will allow continuous ventilation even after tubes extension. Ideally suitable when a power control is needed or for high temperature treatments.

ADVANTAGES :

- Accurate control system.
- Well designed for wide applications.
- Easy maintenance.
- Light weighted and compact.

RUBY QUARTZ LAMP



P/N.	Power +5 -10%	Voltage (V)	I (mm)	Lc (mm)	L (mm)	Spare element	power Unit	Weight (kg)
6114-67	3 kW	230 1P	120	265	360	6114-32	1000 W	3,1
6114-63	9 kW	230/400 3P	360	265	360	6114-32	1000 W	7,2

Spare elements P/N.6114-32, connection trough sockets, fitting in any position

P/N.	Power +5 -10%	Voltage (V)	I (mm)	Lc (mm)	L (mm)	Spare element	Power Unit	Weight (kg)
6014-67	3 kW	230 1P	120	265	360	6014-32	1000 W	3,1
6014-63	9 kW	230/400 3P	360	265	360	6014-32	1000 W	7,2
6014-77	6,6 kW	230 1P	120	285	400	6014-34	2200 W	3,6
6014-73	19,8 kW	230/400 3P	360	285	400	6014-34	2200 W	8
6014-87	1,5 kW	230 1P	120	170	280	6014-35	500 W	2,6
6014-83	4,5 kW	230/400 3P	360	170	280	6014-35	500 W	5,8

Elements P/N.6014-32 and 35, connection through sockets, for horizontal fitting only (+/- 15°)

Elements P/N.6014-34, connection by leads, also for vertical fitting

Units also available without cooling.
For controls, see below.

Optional accessories :

- Counter-reflectors.
- Vitroceramic kit and protective brackets.

CLEAR QUARTZ LAMP



Standard models :
elements step 40mm

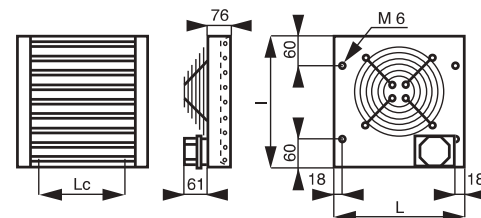

TEMPERATURE CONTROLLER WITH TWO USER CALIBRATION POINTS INFRARED TEMPERATURE SENSORS

The **auto-tuned PID** controller with digital display (96x103) format includes a J-type thermocouple input, an analogue 0-20mA heating output, and an alarm relay output.

This infrared **sensor** allows you to regulate the temperature of a static or production-line product in an open space without touching it, especially in infrared heating installations. It measures the radiation emitted by the product (target) and converts it into a configurable signal controller.



Regulator P/N : 30882-01



Sensor P/N: 31200.74

CONTROLLER MAIN FEATURES :

- Supply voltage : 85 to 264 VAC - 10W.
- Two user calibration points.**

SENSOR MAIN FEATURES :

- Temperature range: 40 to 600°C (25 to 600°C with J type thermocouple)
- Optical resolution: 10:1
- Adjustable emissivity
- Configurable output signals: analogue 4-20 mA, 0-20 mA, 0-5 V, J or K type thermocouples
- Supply voltage: 11 to 26 V DC ; 100 mA
- Probe cooling envelope must be connected to compressed air supply, for ambient temperatures up to 150°C
- IP65 offset connecting box (to be placed in an area of 60°C max.) with 1 m cable for probe connection.

PULSE CONTROL OR PHASE ANGLE POWER DISTRIBUTORS

APPLICATION :

Electronic controllers provide control of the heating elements power range from 0 to 100% of their max. value.

ADVANTAGES :

These models are particularly suited to the control of the infrared generators. Flexibility and easy to use.

FEATURES :

- A scaled potentiometer indicates the setting.
- A pulse control modulated output for resistive loads with low temperature coefficient.
- Phase angle output for resistive loads with high temperature coefficient as short waves IR

Din Rail



Wall fixing



REF.	Power. maxi	Voltage 1P	Intensy maxi	Control device	Installation	Weight (kg)
30302-12	8000 W	230 V	35A	Pulse control	DIN Rail	1,7
30302-16	8000 W	400 V	35A	Pulse control	DIN Rail	1,7
30302-14	8000 W	230 V	35A	Phase angle	DIN Rail	1,7
30302-15	8000 W	400 V	35A	Phase angle	DIN Rail	1,7
30302-13	6000 W	230 V	25 A	Pulse control	On wall	1,8
30302-18	6000 W	230 V	25 A	Phase angle	On wall	1,8
30302-17	7 kW/ 12 kW	230 /400V	30 A	Pulse control	On wall	1,8

CERAMIC LONG WAVE INFRARED GENERATORS

These models are suitable for the **heating of people in houses**, workshops or offices. They are fitted with ceramic long-wave infrared elements.

They do not emit any visible light and have a very high efficiency. They do not heat the air and so are ideally suited to places which are difficult to heat, such as buildings which are badly insulated, are draughty, or have high ceilings.

These appliances must be fixed to a ceiling or to a wall at a minimum height of 1.9 meters.



Supply voltage : 230 V 1P.
Supplied with swivelling fixing brackets.
Other powers to order.
Spare parts :
500 W ceramic element P/N. 6020-03.

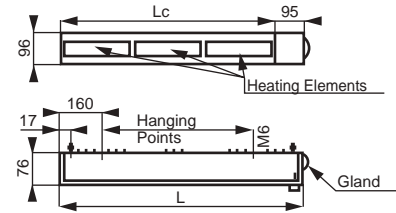

P/N.	Power ± 10%	L (mm)	Lc. (mm)	Weight (kg)
6014-91	1000 W	600	505	2,45
6014-92	1500 W	850	755	3,45
6014-93	2000 W	1100	1005	4,4

CERAMIC LONG WAVE INFRARED GENERATORS

This ceramic long-wave infrared generator, mounted on a mobile support, is particularly suited to the **localised heating of people and workplaces**.

The stable, robust, 2 m high support allows economical and instant heating of the required places only, with no emitted light.

Supply voltage : 230 V 1P.

Floor-standing appliance, working on the same principle as the preceding models. Their compact size and light weight suits them for auxiliary heating of large-volume buildings. Short warm-up time, no emitted light.

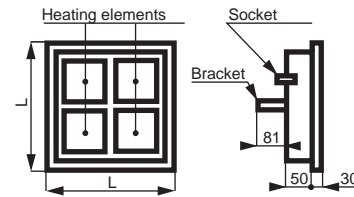

P/N.	Power ±10%	L (mm)	Spare element	Weight (kg)
6014-95	2000 W	322	6020-13	3,35
6014-96	Mobile support, 1m height			

METALLIC MEDIUM WAVE INFRARED GENERATORS

This medium-wave infrared generator is suitable for the heating of people in covered places where conditions are particularly harsh in industrial premises or warehouses. Solidly built and fitted with WP+ seals, it can tolerate long pause periods without damage to its insulation.

These appliances must be fixed to a ceiling or to a wall at a minimum height of 2,5 m up to 4 m

Limit the heating flux on the ground at 300 W/m².



Supply voltage : 230 V single phase.
Supplied with swivelling fixing brackets.

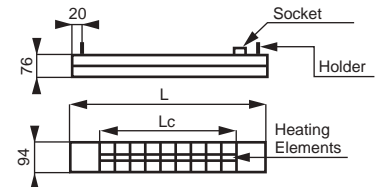

P/N.	Power ±10%	L (mm)	Lc. (mm)	Spare element	Weight (kg)
6014-04	1000 W	790	610	6014-14	2,4
6014-05	1500 W	1050	870	6014-15	3,1
6014-06	2000 W	1310	1130	6014-16	3,8

QUARTZ SHORT WAVE INFRARED GENERATORS

These appliances are the best solution for heating people in large buildings such as warehouses, sports halls, churches, loading docks, workplaces, etc.

Main Advantages : fast heat, swivelling reflector giving heat to the desired area only. Neutral or ruby light reduce dazzle.

Features :

Epoxy-coated.

Supply voltage : 230 V single phase.

Spare lamp : P/N. 6117-90

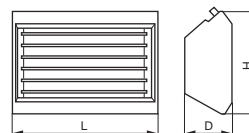

Power to be installed, in W/m ²	
Workshop	135
Church	270
Warehouse	135
Shop/ exhibition hall	270
Loading dock	200
Sports hall	100

Fixed models

P/N.	Power (W)	Dimensions (L x H x D mm)	Min. fixing height	Weight (kg)
6117-21	1500 W	405 x 190 x 72	2,2 m	1,75
6117-23	3000 W	405 x 345 x 72	2,5 m	2,75
6117-24	4500 W	405 x 495 x 72	3,0 m	3,5

TEMPERATURE MEASUREMENT AND CONTROL

Thermostats and temperature safety cut outs

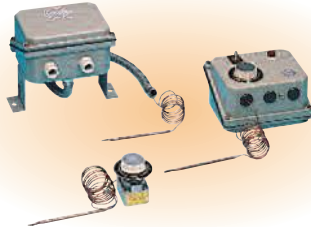

Hydrometers

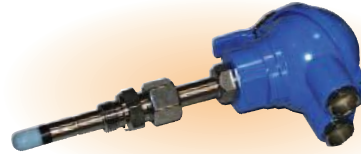

Electromechanical thermostats



PT 100 Sensors

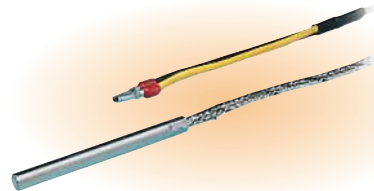

Thermocouple probes



Converters



Sealing glands



Controllers and displays



Solids state relays



Control units



notes :
 - The NC contacts open when the temperature rises, while the NO contacts close when the temperature rises.
 - The differential is the temperature difference between the operating point of the thermostat and the level where the contacts return to their original state.

THERMOSTATS WITHOUT FITTINGS

Liquid expansion type, copper capillary and bulb.
 Double-pole double-throw contacts,
 16 A at 400 VAC.
 Accuracy $\pm 1\%$ of full scale.
 Differential 2,5% of full scale.

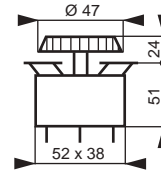

P/N.	Range (°C)	BulbØ (mm)	Bulb length (mm)	Capillary length (mm)	Weight (kg)
9014-04	0-100	8	100	1500	0,16
9014-05	50-200	5	150	1500	0,16
9014-03	0-300	5	100	1500	0,16
9014-07	0-300	5	120	3000	0,17

Steam pressure thermostats, with stainless steel 1m long capillary.
 Single-pole double-throw contacts, 16A at 250 VAC
 6mm Ø bulb. Small in size but with an excellent breaking capacity, these thermostats fit easily into control boxes.
 They are the most cost-effective solution for temperature control.

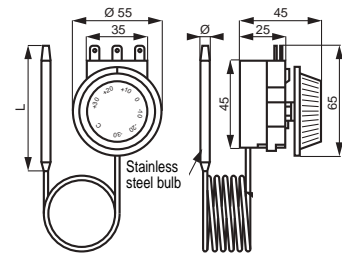

P/N.	Range (°C)	Accuracy (°C)	Differential (°C)	Bulb Ø (mm)	L (mm)	Weight (kg)
9030-51	-30/+30	+/-4	4	6	130	0,1
9030-52	0/120	+/-5	4	5	80	0,1

P/N.	Range (°C)	Accuracy (°C)	Differential (°C)	Bulb Ø (mm)	L (mm)	Weight (kg)
9030-53	0/200	+/-5	10	5	90	0,1
9030-54	50/320	+/-15	10	3	160	0,1

Capillary thermostats.
 Single-pole double-throw contacts, breaking capacity 16A at 400V .
 Copper bulb, Ø 6 mm.
 Copper capillary, length 1000mm.
 * % of full scale.

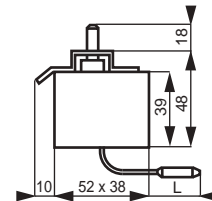

P/N.	Range (°C)	Differential (%)	Bulb length (mm)	Weight (kg)
9030-02	0-100	2,5	140	0,23
9030-03	50-300	2,5	90	0,23

Identical model but without setting knob or stem. Adjustment by screw driver.

P/N.	Range (°C)	Differential* (%)	Bulb length L(mm)	Weight (kg)
9030-08	0-100	2,5	140	0,23

Liquid expansion type, copper bulb and capillary.
 Single-pole double-throw contacts, 10 A at 230 VAC.
 Accuracy $\pm 1\%$ of full scale.

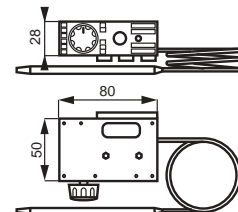
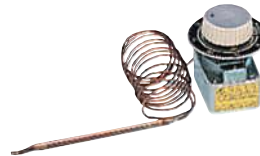

P/N.	Range (°C)	BulbØ (mm)	Bulb length (mm)	Capillary length (mm)	Weight (kg)
9030-07	110/550	4	120	1470	0,16

Capillary thermostat.
 Single-pole double-throw contacts, breaking capacity 10 A at 250V.
 Copper bulb, Ø 6 mm.
 Copper capillary, length 1 m.
 * % of full scale.

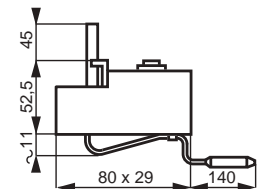
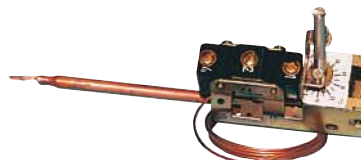

P/N.	Range (°C)	Differential (%)	Weight (kg)
9030-01	0-70	4	0,15

POSITIVE SAFETY TEMPERATURE CUT-OUTS WITH ADJUSTABLE THRESHOLD

Designed to protect water-heating installations against overheating, these temperature cut-outs are adjustable between 90° to 110°C and are manually reset.

They are fitted with a 1m long capillary and a 6,5x90 mm bulb.

Circuit is open if the sensor is broken.

Single-pole normally close contacts, breaking capacity 15A at 230V.

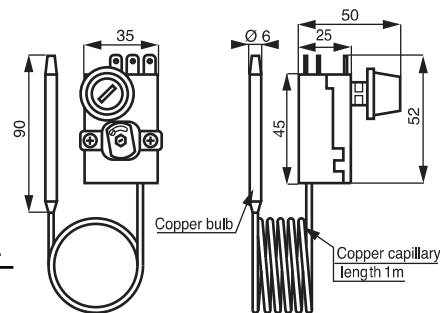
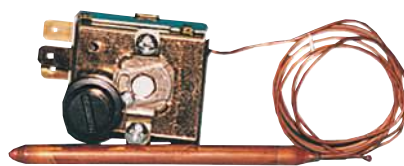

P/N.	Cut-out temp.	Cut-out tolerance	Max. bulb temp.
9030-31	90/110°C	+0°C/-6°C	120°C

THREE PHASE SAFETY TEMPERATURE CUT-OUT THERMOSTAT

Liquid expansion type thermostat including a safety temperature cut-out function with manual reset.

Temperature range +15°C to +85°C.

Safety temperature pre-set to 110°C.

Triple-pole normally close contacts, breaking capacity 3x20A at 400V.

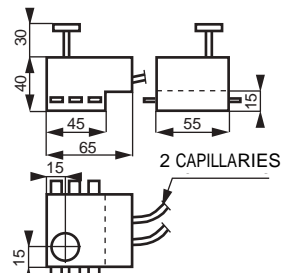

P/N.	Thermostat	Range (°C)	Bulb Ø (mm)	Bulb length (mm)	Capillary length (mm)
9014-13	Thermostat	+15/+85	6	95	900
	Safety temp	Fixed at 110°C	6	120	900

ENCLOSED ROD-TYPE THERMOSTATS

Simple to install and use, these box-mounted liquid-expansion thermostats are fixed to the tank (or pipe) and heated via the supplied copper thermowell.

IP40 box.

Copper probe, length 95mm.

Single-pole double-throw contacts, breaking capacity 15A at 250VAC, 10A at 400VAC.

Differential 6°K,

Accuracy ±3°C,

Max. working pressure: 10 bar.

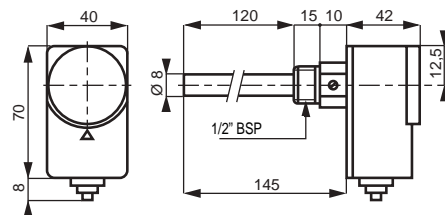
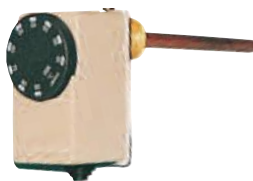

P/N.	Range (°C)	Max. bulb temp.
9030-11	10/90	120
9030-12	40/120	150

ENCLOSED ROD-TYPE POSITIVE SAFETY TEMPERATURE CUT-OUTS

These positive safety temperature cut-outs, (box mounted), with manual reset, are used to protect water heating systems against overheating. Circuit is open if the sensor is broken.

Simple to install and use, these box-mounted liquid-expansion thermostats are fixed to the tank (or pipe) and heated via the supplied copper thermowell.

IP40 box.

Copper probe, length 95mm.

Single-pole double-throw contacts, breaking capacity 15A at 250V, 10A at 400V

Differential 6°K, . Max. working pressure : 10 bar.

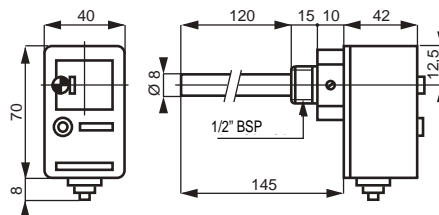

P/N.	Cut-out temp.	Cut-out Accuracy	Max. bulb temp.
9030-21	100°C	+0°C/-6°C	120°C

ENCLOSED THERMOSTATS AND POSITIVE SAFETY TEMPERATURE CUT-OUTS

Box containing a adjustable thermostat between 10°C to 90°C and a temperature cut-out, pre-set to 100°C, with manual reset.

Circuit is open if the sensor is broken.

Simple to install and use, these box-mounted liquid-expansion thermostats are fixed to the tank (or pipe) and heated via the supplied copper thermowell.

IP40 box.

Copper probe, length 95mm.

Thermostat : single-pole double-throw contacts, breaking capacity 15A at 250V, 10A at 400V.

Cut-out : normally close contact

Differential 6°K, Max. working pressure : 10 bar.

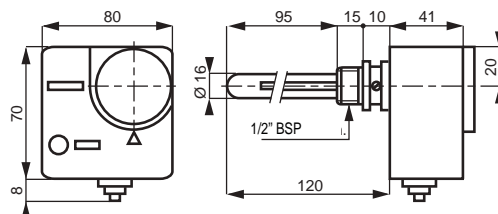
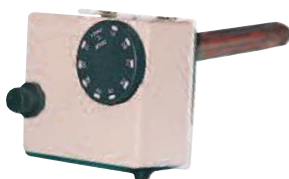

P/N.	Cut-out temp.	Cut-out tolerance	Max. bulb temp.
9030-41	100°C	+0°C/-6°C	120°C

ENCLOSED THERMOSTATS

Liquid expansion type, copper bulb and capillary.
Double-pole double throw contacts, 16A at 400VAC.
Accuracy $\pm 1\%$ of full scale.
Differential 2,5% of full scale.
Adjusting knob accessible by removal of the cover.

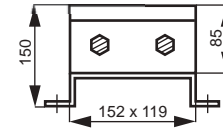

P/N.	Range (°C)	Bulb Ø (mm)	Bulb length (mm)	Capillary length (mm)	Weight (kg)
9019-02	0-100	8	100	1500	2
9019-03	50-200	5	150	1500	2
9019-01	0-300	5	100	1500	2

Protected enclosed models, with double-poles double-throw switch and heating indicator light.
Voltage 230V 1P (3500W max.).
Optional 230V 3P supply (6000W max.).

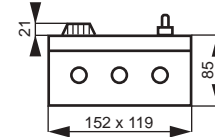

P/N.	Range (°C)	Bulb Ø (mm)	Bulb length (mm)	Capillary length (mm)	Weight (kg)
9014-06	0-100	8	100	1500	1
9014-08	50-200	5	150	1500	1
9014-09	0-300	5	100	1500	1

THERMOSTATS FOR HEATING TAPES

Liquid expansion type thermostat for heating cables, in an IP 55 box fitted with fixing lugs on the insulating cover, with copper capillary.
Single-pole double-throw open contact, 16A at 400VAC. Gland : ISO 16 BIS and ISO 20 BIS

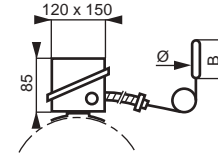

P/N.	Range (°C)	Ø (mm)	B (mm)	Capillary length (mm)	Weight (kg)
9014-11	+30 +110	8	90	1000	2
9014-12	-20 +30	8	143	1000	2

Spare thermostats:

P/N.	Range (°C)	Ø (mm)	B (mm)	Capillary length (mm)	Weight (kg)
9014-31	+30 +110	8	90	1000	2
9014-32	-20 +30	8	143	1000	2

ATEX/IECEX AMBIENT AIR THERMOSTAT «GAS AND DUST» - Ex de - IP65

These ATEX thermostats are certified for zone 1 with an ambient temperature from -40°C up to 40°C (T6) or -40°C à +50°C (T4).

Protection: Ex de IIC T6 (T3 on request)

Junction box: IP 65

Dimensions: 122x120x90 mm

Breaking capacity: 10A/230VAC

Atex marking: II 2 G Ex d e IIC T6 Gb or II 2 G Ex d e IIC T4 Gb for hazardous atmospheres and II 2 D Ex tb IIIC T85° Db et II 2 D Ex IIC T130 Db for explosive ambient with conductive dust.

Certificate: EPS 11 ATEX 1 354



Ambiance

Contact/surface

P/N.	Range (°C)	Ø (mm)	Type	Weight (kg)
6023-02	-20/+40 (T6)	70	Ambient	0,6
6023-03	0/+50 (T6)	1000	Contact/surface	0,6
6023-04	0/+120 (T4)	1000	Contact/surface	0,6

EXTRA-LONG THERMOSTATS

Extra-long steam pressure thermostat in a stainless steel thermowell, with IP 55 cover.

Double-pole double-throw contacts, breaking capacity 16A at 400VAC.

Specially designed for type 4910 suction filter heaters, see immersion heater section

Accuracy $\pm 3\%$ of full scale.

Supplied with a fixing gland.

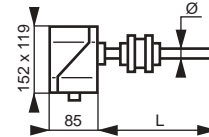

P/N.	Range (°C)	Ø (mm)	L (mm)	Weight (kg)
9010-01	0-300	12	3000	3

Note : Cutting to length L can be done within a short delivery time to suit the exactly dimensions of your tank

ROD TYPE THERMOSTATS

Liquid expansion type thermostat with a 6mm Ø probe in a removable stainless steel thermowell, with an IP 54 cover.

Differential 2,5% of full scale.

Double-pole double-throw contacts, 10A at 230V.

To install these thermostats you need only a 1/2" BSP threaded hole in the recipient tank. The sealable cover is fixed to the thermowell by a retaining screw, and the bulb can easily be removed.

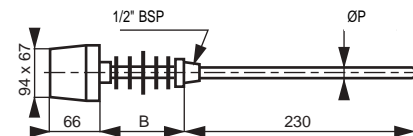

P/N.	Range (°C)	ØP (mm)	B (mm)	Weight (kg)	Fig.
9008-11	0-100	8	19	0,56	I
9008-12	0-150	8	19	0,56	I
9008-13	50-300	8	84	0,76	J

AMBIENT AIR THERMOSTATS

Simple model designed for temperature control in rooms or air-conditioned enclosures. Normally close contact, breaking capacity 10A at 250VAC. Differential 0,6°C.

Suitable for outdoor use, for frost protection of water tanks, pipes, pools... Sealable IP 55 cover. Normally close contact, breaking capacity 10A at 250VAC. Differential 3°C.

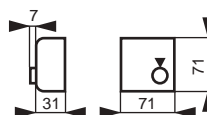

P/N.	Range (°C)	Weight (kg)
9014-20	5/30	0,12

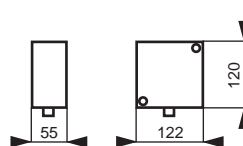

P/N.	Range (°C)	Weight (kg)
9014-23	-20 / +30	0,41

SAFETY CUT-OUTS WITH ADJUSTABLE THRESHOLD

Temperature limiter, liquid expansion type with capillary. Single-pole double-throw contacts, breaking capacity 16A at 400VAC. Manual reset. Stainless steel capillary, length 1 m and stainless steel bulb, diameter 6 mm.

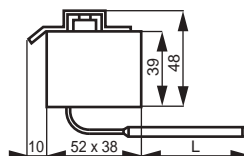
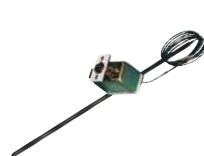

P/N.	Range (°C)	Bulb L (mm)	Weight (kg)
9030-05	+50 +300	85	0,15
9030-06	+20 +500	300	0,15

PRE-SET SAFETY TEMPERATURE LIMITERS

Temperature limiter, bimetallic expansion type with automatic reset, for air temperature alarms. Normally close contact, breaking capacity 10A at 250VAC. Differential 12°C.

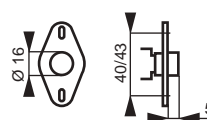

P/N.	Cut-out temp.	Weight (kg)
53691-01	90°C	0,01
9009-01	110°C	0,01

Temperature limiter, positive safety steam pressure type, with automatic or manual reset. Capillary Ø 1,9 mm, length 1 m. Normally close contact, breaking capacity 16A at 250VAC. Differential 12°C.

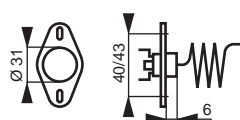

P/N.	Cut-out temp.	Reset	Weight (kg)
54229-01	90°C	auto.	0,05
53710-01	90°C	manu.	0,05

TIMERS

This timer allows two electrical appliances to be switched on and off independently according to a daily and weekly cycle. 42 switching orders can be programmed for any time over a maximum period of a week. Minimum programming interval : 1 minute. Digital display giving hour, working state and programming.

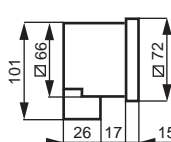

P/N.	Voltage (V)	Weight (kg)
9025-12	230V 50 Hz	0,2

Quick summer/winter time changeover. Backup in case of power cuts : 150 hours max.
double throw open contacts : 16A at 250VAC
Resistive load.

THERMO HYGROMETER

Humidity transmitter 40 HRG for air duct heater, robust design, measures the relative humidity and provides information through an output signal of 4/20 mA with 2 wires. HRG 40 is suitable for use in harsh environments (saline atmosphere and nitric acids, sulfuric, hydrochloric up to 75000 ppm). Max operating Humidity 93% Digital measurement (sensor included) ensures excellent repeatability and excellent performance characteristics

- Cast aluminium box with epoxy coating with sealing gland.
- Closing by clip or screw closure (IP 54 or 65)
- Stainless steel 316 dipping tube (Ø = 13,5mm)
- Pressure holding: 2 bars.
- Humidity hysteresis : +/- 1,5%
- Supply voltage 9 to 36 Vdc by 2 wires with protection against reverse polarity.
- Possibility to unplug the sensitive element
- Version with display is available on request (LCD 4 digits- 10000 points resolution)



P/N.	Max Temp.	Screw plug sliding
30746-01	60 °C	1/2" BSPP
30746-02	60 °C	1/2" BSPT
30746-01	60 °C	1/2" NPT

ELECTRO-MECHANICAL THERMOSTATS WITH FIXING FLANGE

These thermostats can easily be fixed to ventilation ducts and oven walls to monitor air and gas temperatures.

Max. pressure : 100 mm WC

Breaking capacity on resistive load :

- 5/8" models:

10 A at 115 VCA, 5A at 230 VCA, 2 A at 115 VCC.

- 1/2" models:

5 A at 115 VCA, 3 A at 230 VCA, 1 A at 115 VCC.

- 1/4" models:

1A at 115 VCA

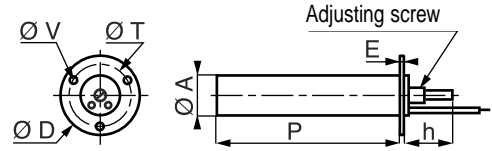

Not pre-set

P/N	Ø A	Temp. Range	Contact	P (mm)	h (mm)	E (mm)	Ø D (mm)	Ø T (mm)	Ø V (mm)	Model	Type
8310-00	5/8"	-70/+315°C	NC	84,1	27	1,6	44,5	31,8	4	Standard	8311
8320-00	5/8"	-70/+315°C	NO	84,1	27	1,6	44,5	31,8	4	Standard	8321
8330-00	1/2"	-70/+315°C	NC	58,7	23,9	1,6	44,5	31,8	4	Standard	8331
8340-00	1/2"	-70/+315°C	NO	58,7	23,9	1,6	44,5	31,8	4	Standard	8341

To order a pre-set thermostat state type P/N. followed by the required temperature.

Example : Type 8311 pre-set to130°C.

ELECTRO-MECHANICAL THERMOSTATS IN IP65 SEALED BOX - 1 OR 2 GLANDS

These thermostats are ideally suited to applications involving liquids, solids or gases where the measuring side and the connection side have to be sealed.

Max. pressure : 20 bar.

Breaking capacity on resistive load :

- 5/8" models:

10 A at 115 VCA, 5A at 230 VCA, 2 A at 115 VCC.

- 1/2" models:

5 A at 115 VCA, 3 A at 230 VCA, 1 A at 115 VCC.

Aluminium alloy box with N°16 gland for cables of min.Ø 10 mm, max.Ø 15 mm.

Closure by captive screw.

Options :

Epoxy-coated box.

Protective resistance.

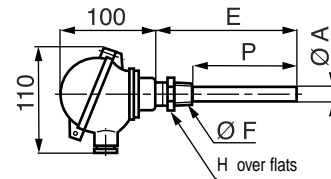

Not pre-set

Models with only one gland

P/N.	Ø A	Temp. Range	Contact	P (mm)	E (mm)	Ø F	H (mm)	Model	Type
8350-00	5/8"	-70/+315°C	NC	76,2	100	1/2" NPT	23	Standard	8351
8360-00	5/8"	-70/+315°C	NO	76,2	100	1/2" NPT	23	Standard	8361

The 2nd gland allows series or parallel connection of several thermostats.

Not pre-set

Models with 2 glands

P/N.	Ø A	Temp. range	Contact	P (mm)	E (mm)	Ø F	H (mm)	Model	Type
8410-00	5/8"	-70/+315°C	NC	76,2	100	1/2" NPT	23	Standard	8411
8420-00	5/8"	-70/+315°C	NO	76,2	100	1/2" NPT	23	Standard	8421

To order a pre-set thermostat state type P/N. followed by the required temperature.

Example : Type 8351 pre-set to130°C.

ELECTRO-MECHANICAL THERMOSTATS - Ex d - IP65 - 1 or 2 GLANDS

These thermostats are ideally suited for use in hazardous atmospheres, gas or liquids.

Marking : .II 2 G Ex d IIC T1 to T6 .

Breaking capacity on resistive load :

- 5/8" models:

10 A at 115 VCA, 5A at 230 VCA, 2 A at 115 VCC.

- 1/2" models:

5 A at 115 VCA, 3 A at 230 VCA, 1 A at 115 VCC.

Aluminium alloy box with integral ADF gland for cables of min.Ø 10 mm, max.Ø 19 mm.

Option :

Epoxy-coated box.

Earth terminal.

Protective resistance.

Certificate LCIE 03 ATEX 6339

Usable in hazardous areas (ambient temperature mini -20°C, relative humidity 95 % maximum).

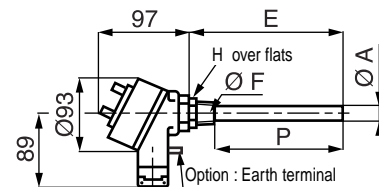

ATEX : CE 0081 Ex II 2 G Ex d IIC T1 to T6

Not pre-set

Models with only one gland

P/N.	Ø A	Temp. range	Contact	P (mm)	E (mm)	Ø F	H (mm)	Model	Type
8450-00	5/8"	-70/+315°C	NC	76,2	100	1/2" NPT	23	Standard	8451
8460-00	5/8"	-70/+315°C	NO	76,2	100	1/2" NPT	23	Standard	8461

Not pre-set

Models with 2 glands

P/N.	Ø A	Temp. range	Contact	P (mm)	E (mm)	Ø F	H (mm)	Model	Type
8452-00	5/8"	-70/+315°C	NC	76,2	100	1/2" NPT	23	Standard	8453
8462-00	5/8"	-70/+315°C	NO	76,2	100	1/2" NPT	23	Standard	8463

To order a pre-set thermostat state type P/N. followed by the required temperature.

Example : Type 8453 pre-set to130°C.

A temperature sensor is generally a small diameter cylinder (between 0.5 and 8 mm), varying in length (between 50 mm and several meters), rigid or deformable and immersed in the media to be measured : solid, liquid or gas. The choice depends on the following criteria: temperature range, precision, response time, media to be measured, overall dimensions, pressure, corrosion, attachment and connection.

The NTC technology (thermistor) is used predominantly for domestic applications based on the ambient temperature (-80° to 150°C).

The PTC technology (PT 100) is suited to industrial applications between -50°C and 500°C, in the absence of excessive vibration.

The thermocouple technology allows very short response times and high temperatures but with a lower precision (+/- 2°C on average).

The electrical connection of the sensors is made either using flexible cables or connectors, or on a terminal block inside a small standardised metal case referred to as the "probe head". When the cable is particularly long, it is advisable to use a 4/20 mA measurement converter installed in the probe head.

Some connection devices are ATEX certified in the "d", "e" or "ia" protection modes in a G (gas) or D (dust) environment.

The fastening of a sensor is done by a welded or swaged coupling, a sliding flange or by a bracket integrated in a case.

The use of a thermowell allows easy replacement of the sensor, its use in particularly corrosive environments and better resistance to high-pressure levels.

The mineral insulated cables are deformable. Generally long, they can be shrunk at the ends to benefit from a better response time.

PTC TECHNOLOGY (PT 100)

A PT 100 probe is a resistor whose value in ohm (Ω) increases in proportion to the temperature (100 Ω at 0°C).

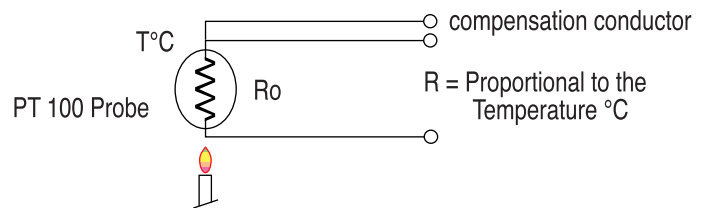

The resistance measurement is carried out by the current circulation generated by a measuring device or a regulator, through copper interconnecting wires.

The compensation for the interconnection conductor resistance is obtained by an artifice which consists in connecting a third wire (industrial applications) or even a fourth wire (laboratory applications).

The colours of the wires (white and red), the resistance variation and the precision class are defined in EN 60751 standard:

Class A (1/2 class B) : +/- (0.15°C + 0.0025.t)

Class B : +/- (0.3°C + 0.005.t)

1/10 class B : (0.03°C + 0.0005.t)

t = temperature measured in °C.

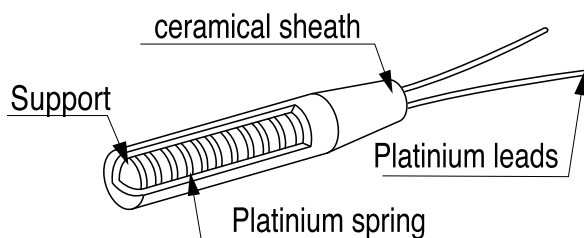

The sensitive element is inserted into a rigid sheath having a minimum diameter of **3 mm** and a minimum length of **30 mm**, and then extended by wires, a flexible cable or a cable with a mineral insulator.

The customary diameters of the rigid sheaths for probes are 4, 5, 6 and 8 mm. The customary diameters of deformable probes consisting of cables with mineral insulators are 3, 4, 5 and 6 mm.

Metallic protection sheaths are generally of AISI 316L/ DIN 1.4404 stainless steel when immersed in a fluid and AISI 304 L / DIN 1.4306 stainless steel when inserted into a thermometer well.

The response time of a probe depends on its diameter (approximately 4 sec in water for 3 mm diameter and 11 sec for 8 mm diameter).

The interconnection cables (one white conductor and two red conductors) provide a way of connecting the probes to a measuring or regulating device. Considering the low level of the transmitted signal, it is preferable to use shielded cables.

THERMOCOUPLE

A thermocouple is a soldered joint between 2 wires of different metals (known as "hot soldering") across the terminals of which an electrical voltage is generated proportional to the measured temperature.

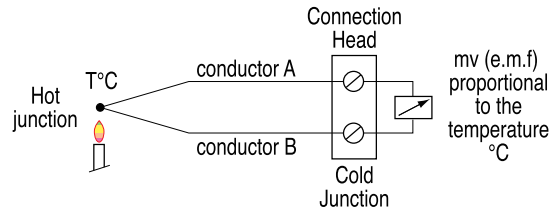

Analysis of this signal must be carried out by instrumentation and suitable interconnection wires compensating for the errors caused by the nature and temperature of the different connecting parts. For each type of thermocouple, the metal forming the conductors, the colour of the wires, the electromotive force and the precision class are defined by standards EN 60584-1 and EN 60584-2, of which the main types are:

Code	Nominal scale	Polarity	Colour	Precision	
				Class 1	Class 2
J	-40°C to +750°C	Fe +	Black	± 1,5°C	± 2,5°C
		Cst -	White	or ± -0,004.t	or ± -0,0075.t °C
K	-40°C to +1200°C	NiCr +--	Green	± 1,5°C	± 2,5°C
		NiAl --	White	or ± 0,004.t	o ± 0,0075.t °C
N	-40°C to +1200°C	NiCr +--	Pink	± 1,5°C	± 1,5°C
		Nis --	White	or ± 0,004.t	or ± 0,0075.t °C
R	0°C to 1600°C	Pt +	Orange	± 1°C	± 1,5°C
		PtRh13	White	or ± 0,0015.t	or ± 0,0025.t °C
S	0°C to 1600°C	Pt +	Orange	± 1°C	± 1,5°C
		PtRh10 +	White	or ± 0,0015.t	± 0,0025.t °C
T	-40°C to 350°C	Cu +	Brown	± 0,5°C	± 1°C
		Cst -	White	or ± 0,004.t°C	± 0,0075.t °C

There are several thermocouple technologies:

- Bare wires, if necessary protected by insulating beads and inserted into a rigid tube with customary diameters of: 3 or 4 or 5 or 6 mm.
- Mineral insulated cables are defined by standard EN 61515 with customary diameters of: 0.5 , 1, 2, 3, 4.5, 6 or 8 mm.

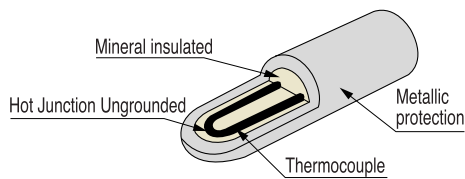

When the installation is by the measuring device or the regulator, the hot soldered joint can be connected to ground to reduce the sensor response time.

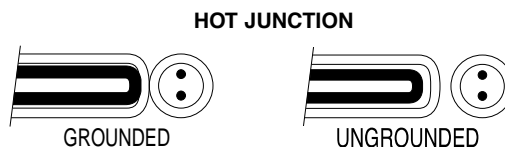

Metallic protection sheaths are generally of AISI 316L/ Din 1.4404 stainless steel for type J and of Inconel 600 for type K (when immersed in a fluid) or AISI 304 L/ Din 1.4306 stainless steel (when inserted into a thermometer well). The response time of a thermocouple depends on its diameter (approximately 0.05 sec in water for 0.5 mm diameter and 5 sec for 8 mm diameter). Divide these values by two when the hot soldered joint is connected to ground. The extension cables (conductors of the same type as those of the couple) or compensation cables (conductors of different types from those of the couple) are governed by standard IEC 584-3. They are indispensable for connecting thermocouples to a measuring or regulating device. Considering the low level of the transmitted signal (a few mV), it is preferable to use shielded cables. Compensated connectors are necessary for the connection of these cables.

PT100 SENSORS WITH PVC CABLE

PT 100 ohm at 0°C class B sensing element, inside a 316L stainless steel sheath, with sealed end and 3 wire PVC insulated cable with connection thimbles, with or without shielding.

Temperature range : - 30 to + 90°C.

Other manufacturing capabilities : accuracy from class A up to 1/10 class B ,diameter 5 or 6 mm, total sheath length from 50 up to 1000 mm, other cable length, other types of electrical connections, 4 wires circuit.

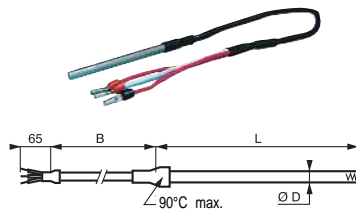

P/N.	Ø D (mm)	braided sheath	L (mm)	B (mm)	Weight (kg)
31030-09	5	without	50	5000	0,04
31030-10	5	without	100	5000	0,08
31030-11	5	without	150	5000	0,12
31030-12	6	with	50	5000	0,04
31030-13	6	with	100	5000	0,08
31030-02	6	with	150	5000	0,12
31030-04	6	with	250	5000	0,18
31030-05	6	with	300	5000	0,24
31030-06	6	with	550	5000	0,321

PT100 SENSORS WITH FEP SHIELDED CABLE

PT 100 ohm at 0°C class B sensing element, inside a AISI 316L/ Din 1.4404 stainless steel sheath, with sealed end and 3 wires FEP insulated cable with connection thimbles and shielding.

Temperature range : - 60 to + 200°C.

Other manufacturing capabilities : accuracy from class A up to 1/10 class B ,diameter 5 or 6 mm total sheath length from 50 up to 1000 mm, other cable length, other types of electrical connections, 4 wires circuit.

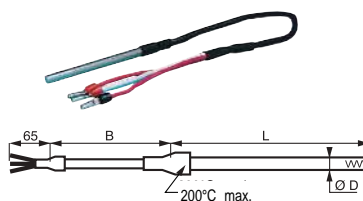

P/N.	Ø D (mm)	L (mm)	B (mm)	Weight (kg)
31035-11	6	30	5000	0,03
31035-14	6	50	5000	0,04
31035-15	6	100	5000	0,1
31035-12	6	150	5000	0,15
31035-13	6	300	5000	0,28

FLEXIBLE MINERAL INSULATED PT100 SENSORS WITH PVC SHIELDED CABLE

PT 100 ohm at 0°C class B sensing element, inside a 316L flexible stainless steel sheath, with sealed end and 3 wires PVC insulated cable with connection thimbles and shielding. A coiled spring protects the lead wires against sharp bends in the transition area.

Temperature range : - 50 to + 500°C (element).
- 30 to + 90°C (cable)

Other manufacturing capabilities : accuracy from class A up to 1/10 class B ,diameter 4,5 or 6 mm, total sheath length from 100 up to 5000 mm, other cable length, other types of electrical connections, 4 wires circuit, adjustable compression fitting type 31271.

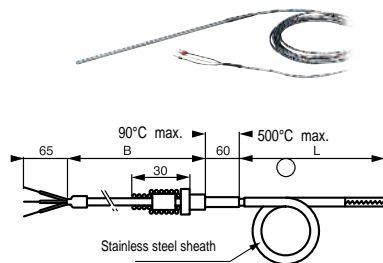

P/N.	Ø D (mm)	L (mm)	B (mm)	Weight (kg)
31048-01	4,5	150	5000	0,13
31048-02	4,5	250	5000	0,17
31048-03	4,5	350	5000	0,27
31048-04	4,5	500	5000	0,34
31048-05	4,5	1000	5000	0,61

PT100 SENSORS WITH HIGH TEMPERATURE CABLE

PT 100 ohm at 0°C class B sensing element, inside a AISI 316L/Din 4404 no flexible stainless steel sheath, with sealed end and 3 wires fibreglass insulated cable (350°C maxi) with connection thimbles and metallic overbraid. A coiled spring protects the lead wires against sharp bends in the transition area.

Temperature range : - 50 to +500°C .

Other manufacturing capabilities : accuracy from class A up to 1/10 class B, diameter 4,5 or 6 mm, total sheath length from 100 up to 5000 mm, other cable length, other types of electrical connections, 4 wire circuit, adjustable compression fitting type 31271.

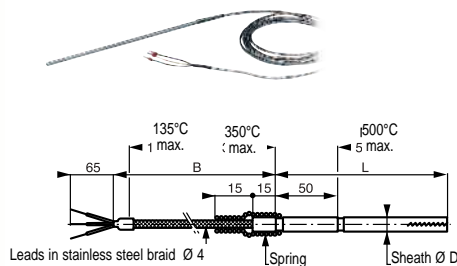

P/N.	Ø D (mm)	L (mm)	B (mm)	Weight (kg)
31032-03	4,5	100	2500	0,09
31032-01	4,5	200	2500	0,15
31032-04	4,5	300	2500	0,26
31032-05	6	150	2500	0,10
31032-02	6	250	2500	0,18
31032-06	6	300	2500	0,20
31032-07	6	550	2500	0,35

PT100 SENSORS WITH IP66 HEAD

PT 100 ohm at 0°C class B sensing element, inside a AISI 316L/Din 1.4404 stainless steel sheath - Ø 9 mm thickness 1 mm.

Temperature range : - 50 to + 500°C (sensor).

Threaded fitting below the head (DAN-V) in Epoxy coated alloy, hinged cover fixed by screws (IP66) .Sealing gland for leads (8mm) is provided

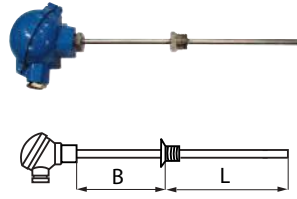

P/N.	Ø D (mm)	B (mm)	L (mm)	Weigh (kg)
31117-01	3/8"BSPT	0	100	0,1
31117-02	1/2"BSPP	0	100	0,1
31117-03	1/2"BSPP	0	250	0,2
31117-04	1/2"BSPP	145	100	0,2
31117-05	1/2"BSPP	145	250	0,3
31117-06	3/8"BSPT	145	100	0,1

PT100 SENSORS WITH IP54 HEAD AND FLANGE FITTING

PT 100 ohm at 0°C class B sensing element, inside a AISI 316L/Din 1.4404 stainless steel sheath - Ø 6 mm the lectrical connection is done by a 3 poles terminal block inside an IP54 aluminium head, epoxy painted.

Temperature range : - 50 to + 500°C (sensor).

Fitting by Flange stainless steel sliding.



P/N.	Ø D (mm)	L (mm)	Weigh (kg)
31118-01	6	250	0,1
31118-02	6	500	0,15

PT100 SENSORS WITH MINIATURE IP54 ALUMINIUM HEAD

PT 100 ohm at 0°C class B sensing element, inside a AISI 316L/Din 1.4404 stainless steel sheath. Electrical connection by a 3 poles terminal block inside an IP54 miniature aluminium head, epoxy painted, with compression gland ISO 16. Supplied with or without a 1/2" BSPT threaded fitting, welded below the head.

Temperature range : - 50 to + 500°C (sensor)
- 50 to + 80°C (box)

Other manufacturing capabilities : accuracy from class A up to 1/10 class B ,diameter 5 or 6 mm, total sheath length from 50 up to 1000 mm, 4 wires circuit, fastening by sliding flange.

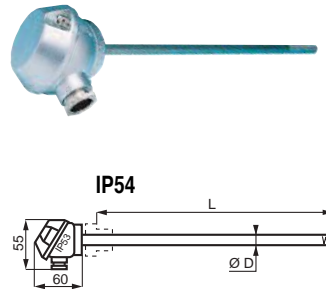

P/N.	ØD (mm)	L (mm)	Connector	Weight (kg)
31042-08	6	100	without	0,1
31042-01	6	100	with	0,16
31042-04	6	150	without	0,11
31042-09	6	150	with	0,2
31042-02	6	200	without	0,13
31042-10	6	200	with	0,24
31042-05	6	250	without	0,16

FLEXIBLE MINERAL INSULATED PT100 SENSORS WITH IP65 ALUMINIUM HEAD

Single PT sensor, 100 ohm at 0°C, class B, in a flexible stainless steel sheath with sealed end and 3 terminals in a miniature box (80°C max.) with a ISO 16 gland.

Temperature range : - 50 to + 500°C (element)
- 10 to + 80°C (head)

Other manufacturing capabilities : accuracy from class A up to 1/10 class B ,diameter 4,5 or 6 mm, total sheath length from 100 up to 5000 mm, 4 wires circuit, fastening by compression fitting type 31271. or mounting flange.

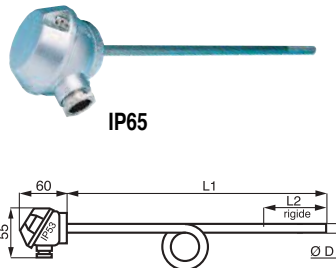

P/N.	D (mm)	L1 (mm)	L2 (mm)	Weight (kg)
31023-07	4,5	100	30	0,08
31023-08	4,5	200	30	0,12
31023-09	4,5	300	30	0,17
31023-10	6	300	30	0,25
31023-11	6	400	30	0,30
31023-12	6	500	30	0,35

FLEXIBLE MINERAL INSULATED PT100 SENSORS WITH IP65 ALUMINIUM HEAD

PT 100 ohm at 0°C class B sensing element, inside a AISI 316L/ Din 1.4404 flexible stainless steel sheath. Electrical connection by a 3 poles terminal block inside an IP 65 aluminium head, epoxy painted, with compression gland for cable dia 4 to 15 mm.

Temperature range : - 50 to + 500°C (element)
- 10 to + 80°C (head)

Other manufacturing capabilities : accuracy from class A up to 1/10 class B ,diameter 4,5 or 6 mm, total sheath length from 100 up to 5000 mm, 4 wires circuit, fastening by compression fitting type 31721, 4/20 mA transmitter installed inside the head.

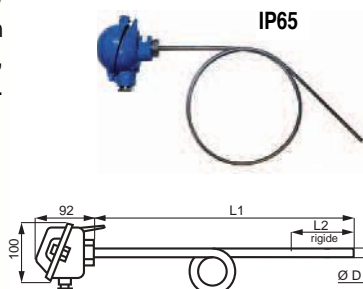

P/N.	Ø D (mm)	L1 (mm)	L2 (mm)	Weight (kg)
31022-01	4,5	150	30	0,12
31022-02	4,5	200	30	0,16
31022-03	4,5	300	30	0,24
31022-04	4,5	350	30	0,30
31022-05	4,5	500	30	0,34
31022-06	4,5	550	30	0,36



PT 100 SENSORS WITH IP65 OFFSET ALUMINIUM HEAD

PT 100 ohm at 0°C class B sensing element, inside a AISI 304L /Din 1.4306 stainless steel sheath. Electrical connection by a 3 poles terminal block inside an IP 65 offset aluminium head, epoxy painted, with compression gland for cable dia 4 to 15 mm. Spring loaded terminals, with a 8 mm clearance (the L dimension is corresponding to the half compression of the spring) Offset AISI316 L /Din 1.4404 nipple 1/2" NPT threaded fitting

Temperature range : - 50 to + 500°C (element)
- 50 to + 80°C (head)

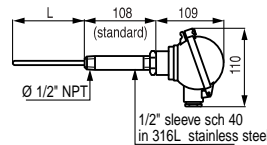

P/N.	Ø D (mm)	L1 (mm)
31045-01	4,5	100
31045-02	4,5	200
31045-03	4,5	300
31045-04	6	100
31045-05	6	200
31045-06	6	300

Other manufacturing capabilities : accuracy from class A up to 1/10 class B, total sheath length from 50 up to 1000 mm, offset nipple length 58 or 108 mm, 4 wires circuit, possible fixing nipple union, ATEX approval Ex ia or Ex e, 4/20 mA transmitter installed inside the head.

FLEXIBLE PT 100 SENSORS WITH IP65 STAINLESS STEEL HEAD

PT 100 ohm at 0°C class B sensing element, inside a flexible AISI 316L/Din 1.4404 stainless steel sheath. Electrical connection by a 3 poles terminal block inside an IP 65 stainless steel AISI 316L/Din 1.4404 head, epoxy painted, with compression gland for cable dia 4 up to 15 mm.

1/2" NPT threaded fitting welded below the head
Temperature range : - 50 to + 500°C (element)
- 50 to + 80°C (head)

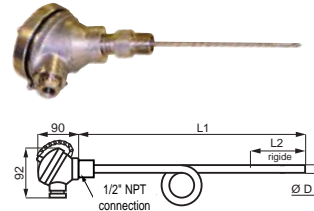

P/N.	Ø D (mm)	L1 (mm)
31043-10	6	100
31043-11	6	200
31043-12	6	300
31043-13	6	400

Other manufacturing capabilities : accuracy from class A up to 1/10 class B , diameter 6 mm, total sheath length from 100 up to 5000 mm, 4 wire circuits, 4/20 mA transmitter installed inside the head.

FLEXIBLE PT 100 SENSORS WITH ATEX HEAD - Ex d - IP65

PT 100 ohm at 0°C class B sensing element, inside a flexible AISI 316L/Din1.4404 stainless steel sheath. Electrical connection by a 3 poles terminal block inside an IP 65 EXPLOSION PROOF head with a compression gland for cable dia 8 mm.

1/2" NPT threaded fitting welded below the head.
temperature range: - 50 to + 500°C (element)
- 20 to + 80°C (head)

Usable in hazardous areas (ambient temperature from -20 °C up to 80°C, relative humidity 95 % maximum).

Certificate: **LCIE 02 ATEX 6097X** some precautions must be taken for using this device. Consult us or read the instruction manual

Other manufacturing capabilities : accuracy from class A up to 1/10 class B, diameter 6 mm, total sheath length from 100 up to 1000 mm, 4 wire circuits, 4/20 mA transmitter installed inside the head.

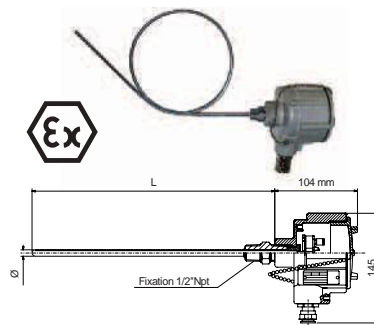

P/N.	Ø D (mm)	L1 (mm)
31043-15	6	100
31043-16	6	150
31043-17	6	200
31043-18	6	250
31043-19	6	300
31043-20	6	400

PT 100 SENSORS WITH ATEX HEAD - Ex d - IP65

PT 100 ohm at 0°C class B sensing element, inside a AISI 304L/ Din 1.4306 stainless steel sheath. Electrical connection by a 3 poles terminal block inside an IP 65 offset EXPLOSION PROOF head with compression gland for cable dia 8 mm. Spring loaded terminals, with a 8 mm clearance (the L dimension is corresponding to the half compression of the spring) Offset AISI316 L/Din 1.4406 nipple 1/2" NPT threaded fitting

Temperature range : - 50 to + 500°C (element)
- 20 to + 80°C (head)



Usable in hazardous areas (ambient temperature from -20 °C up to 80°C, relative humidity 95 % maximum).

Certificate: **LCIE 02 ATEX 6097X** some precautions must be taken for using this device. Consult us or read the instruction manual

Other manufacturing capabilities : accuracy from class A up to 1/10 class B, total sheath length from 50 up to 1000 mm, offset nipple of 58 or 108 mm, 4 wires circuit, fastening nipple union, 4/20 mA.

P/N.	Ø D (mm)	L1 (mm)	L2 (mm)
31045-07	4,5	100	108
31045-08	4,5	200	108
31045-09	4,5	300	108
31045-10	6	100	108
31045-11	6	200	108
31045-12	6	300	108

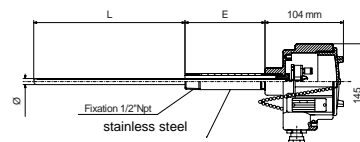

Options : transmitter installed inside the head.

E-mail : catalogue-vulcanic@vulcanic.com

FLEXIBLE PT 100 SENSORS WITH ATEX HEAD - Ex d - IP65

PT 100 ohm at 0°C class B sensing element, inside a flexible AISI 316L/ Din 1.4404 stainless steel sheath. Electrical connection by a 3 poles terminal block inside a miniature EXPLOSION PROOF head IP 65 marking II 2 G Ex d IIC T6, with compression gland for cable dia 6 up to 9 mm. :
 Temperature range : -50 to + 500°C (element)
 - 20 to + 80°C (head)



Other manufacturing capabilities : accuracy from class A up to 1/10 class B diameter 4,5 or 6 mm, total sheath length from 100 up to 5000 mm, 4 wires circuit, fastening by compression fitting type 31721.

P/N.	Ø D (mm)	L (mm)
31026-01	4,5	200
31026-06	4,5	300
31026-07	6	300
31026-08	6	400

Usable in hazardous areas (ambient temperature from -20 °C up to 80°C, relative humidity 95 % maximum).
 Certificate: **LCIE 02 ATEX 6097X** some precautions must be taken for using this device. Consult us or read the instruction manual

PT 100 SENSORS WITH PTFE SHEATH AND FEP LEADS

PT 100 ohm at 0°C class B sensing element, inside a PTFE sheath, with sealed end and 3 wires FEP insulated leads with connection thimbles. Supplied with 3 terminals for electrical connection on 2,5 mm² wires.
 Special design to be used with PTFE heating panel (see immersion heaters section).



P/N.	Max. temp.	Weight (kg)
26216-01	105°C	0,10

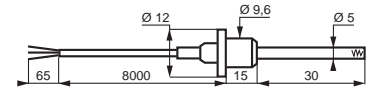

PT 100 SENSORS FOR SKIN TEMPERATURE MEASUREMENT

PT 100 ohm at 0°C class B sensing element, inside a AISI 316L/Din 1.4404 stainless steel sheath, flattened to measure the skin temperature of hoses, with sealed end and 3 wires PFE insulated cable with connection thimbles and shielding.



P/N.	Max. temp.	B (mm)	Weight (kg)
31180-01	200°C	1000	0,2
31180-02	200°C	3000	0,4
31180-03	200°C	5000	0,7

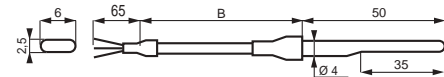

RING LUG PROBES

Mainly intended for the measure of surfaces temperature on machine contact or thermic dissipators. Sensing element mounted in a terminal ring lug connector
 Insulated conductors teflon/teflon cable length 1m.
 2 Cables for TC or 3 conductive isolated wires for RTD 100



REF.	Probet	Ø D (mm)	Rqng (°C)
31711-05	PT100 sensor	10,2	-50/+200
31711-02	Thermocouple K	5	-50/+280

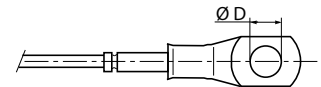

On request :
 Others fixing diameter
 Available for Atex areas (dust or gas)

SCREW PLUG PT100 SENSORS

Compact probe for direct screwing in the part to measure.
 PT 100 ohm at 0°C class B sensing element inside a AISI 316 L/Din 1.4404 screw. 3 wires PTFE insulated cable with connection thimbles.
 Temperature range : - 80 to + 200°C



P/N.	Ø D	Length threaded (mm)
31109-01	1/4"-20 UNF	11
31109-02	M8 ISO	16
31109-03	M10 ISO	16

ROOM AND OUTSIDE AMBIENT AIR TEMPERATURE PT 100 SENSORS

Room sensor : **P/N. 31055-01**
 PT 100 ohm at 0°C class B sensing element inside a holed plastic box to IP 20, for wall mounting.
 Temperature range : - 40 to + 85°C
 Electrical connection by a 2, 3 or 4 poles terminal block through the bulkhead.

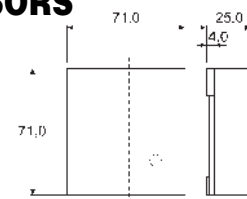

Outside ambient sensor : **P/N. 31055-02**
 PT 100 ohm at 0°C class B sensing element inside a plastic box to IP 65, for wall mounting.
 Temperature range : - 50 to + 100°C
 Electrical connection by a 2, 3 or 4 poles terminal bloc, with compression gland.

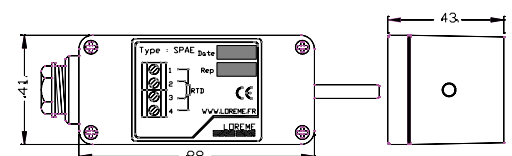

LAMINAR PLATINUM PROBES 7,6 MMX7,6 MM

Sensing element Pt 100 Ω, Class B.
 AWG 28 wire outputs Teflon lined
 One adhesive side for attachment.
 Thickness : 0,5 mm on element - 0,7 mm on wires.
 Options on request :
 • Without adhesive (-200°C / +200°C).
 • Wire length > 1000 mm.



P/N.	Sensor	Accuracy.	Nr of wires	Isolator	Time constant	Temperature range
31132-51 •	Pt 100 Ω to 0°C	±0,12 Ω	3	Polymide insulated + Alu face	0,15 s	-20/+177°C*
31132-52 •	Pt 100 Ω to 0°C	±0,12 Ω	4	Polymide insulated + Alu face	0,15 s	-20/+177°C*
31132-53 •	Pt 100 Ω to 0°C	±0,12 Ω	2	Polymide insulated + Alu face	0,15 s	-20/+177°C*

* For assembly without adhesive, operating temperature range : -200°C/+200°C

LAMINAR PLATINUM PROBES 5 MM X 15 MM

Sensing element Pt 100 Ω or Pt 1000Ω
 AWG 26 wire outputs Teflon lined
 One adhesive side for attachment.
 Thickness : 2 mm
 Options on request :
 • Without adhesive (-50°C / +200°C).
 • Wire length > 1000 mm.

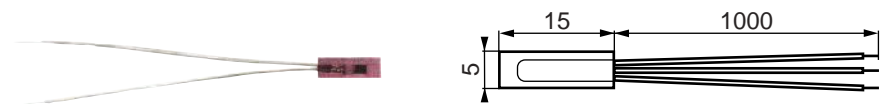

P/N.	Sensor	Accuracy.	Nr of wires	Isolator	Time constant	Temperature range
31132-01 •	Pt 100 Ω to 0°C	±0,12 Ω	3	Polymide insulated	1 s	-20/+177°C*
31132-02 •	Pt 100 Ω to 0°C	±0,12 Ω	4	Polymide insulated	1 s	-20/+177°C**

* For assembly without adhesive, operating temperature : -50°C/+200°C

MINIATURE FLANGED PLATINUM PROBES Ø 4,8 X 6,4 MM

Sensing element: PT 100 ohm at 0°C Class B
 Vessel of tinned light alloy
 Output by insulated wire with PTFE length 900 mm
 These probes can be used whenever space is at a premium.
 Other possibilities on request
 Wire outputs without shielding braid
 Copper probes 100 ohm
 Nickel probes 120 ohm
 Miniature sensors equipped with an antifriction end.
 In this case, the load temperatures become:
 Resistance probe: -50/+260°C
 Wire outputs: without shielding braid
 Wire length >900 mm

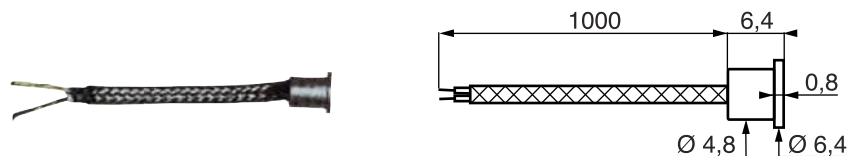

P/N.	Captor	Accuracy.	Probe	Temperature range	Nr lead	Section of lead mm²	Time constant
31123-04 •	Platinum 100 Ω to 0°C	±0,12 Ω	Simple	-50/+150°C	1 x 3	0,227	4 s
31123-09 •	Platinum 100 Ω to 0°C	±0,12 Ω	Double	-50/+150°C	2 x 3	0,089	4 s

Recommended installation:
 Use spring P/N 31123-99 and clip P/N 31123-98 or P/N 31123-97 to retain the miniature flanged probe in its hole

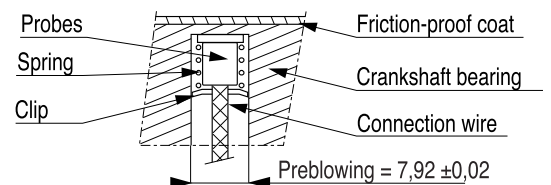

FASTENING ACCESSORIES

Spring P/N 31123-99
 -Stainless steel
 - Compressed length: 5.6 mm

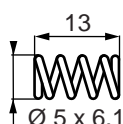

Clip P/N: 31123-98 for single or double sensors with Teflon wire
 - Anticorrosion-treated carbon steel
 - To be used for drilling diameter: 7.92 + 0.2 mm



Clip P/N: 31123-97 for single or double sensors with Teflon wires + shielding braid
 - Anticorrosion treated carbon steel
 - To be used on drilling diameter: 7.92 + 0.2 mm



THERMOCOUPLES WITH HIGH TEMPERATURE EXTENSION CABLE

Class 2 thermocouples with ungrounded hot junctions, inside 316 L stainless steel sheath, with sealed end and 2 wires high temperature cable with metallic overbraid and connection thimbles
Maximum operation temperature : 350°C.

Other manufacturing capabilities : accuracy class 1, total sheath length from 50 up to 1000 mm, other cable length, bended sensor, possible fixing by compression fitting or mounting flange, other thermocouple type R, S, T...

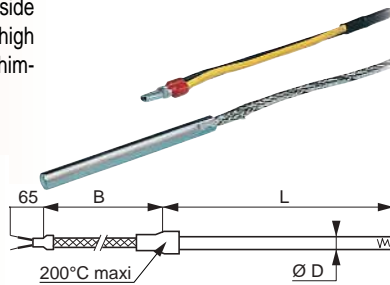

P/N. J type	P/N. K type	Ø D (mm)	L (mm)	B (mm)	Weight (kg)
31066-01	31066-11	4,5	50	2500	0,05
31066-03	31066-13	4,5	100	2500	0,1
31066-04	31066-14	4,5	200	2500	0,2
31066-05	31066-15	4,5	300	2500	0,3
31066-02	31066-12	6	150	2500	0,07
31066-06	31066-16	6	250	2500	0,12
31066-07	31066-17	6	550	2500	0,25

Other L or B lengths to order

FLEXIBLE MINERAL INSULATED THERMOCOUPLES WITH PVC EXTENSION CABLE

Class 2 thermocouples with ungrounded hot junctions, inside flexible mineral insulated 316L stainless steel sheath, with sealed end and 2 wires PVC insulated cable (90°C maxi) and connection thimbles

Other manufacturing capabilities : accuracy class 1, diameter 0,5 or 1 or 2 or 3 or 4,5 or 6 or 8 mm, total flexible sheath length from 100 up to 5000 mm, other cable length, adjustable compression fitting type 31271, other thermocouple types R, S, T..., ATEX approval EEx ia.

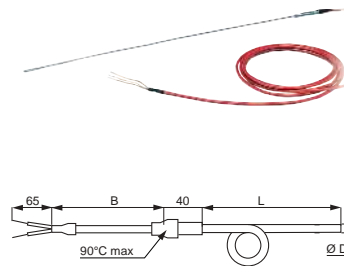

P/N.	T/C type	Ø D (mm)	Max. temp. (°C)	B (mm)	L (mm)	Weight (kg)
31061-01	K	3	1100°C	2500	500	0,07
31061-02	K	3	1100°C	2500	1000	0,1
31061-09	J	1	750°C	2500	500	0,05
31061-10	J	1	750°C	2500	1000	0,09
31061-12	J	2	750°C	2500	500	0,05
31061-11	J	2	750°C	2500	1000	0,1
31061-19	K	1	750°C	2500	500	0,05
31061-20	K	1	750°C	2500	1000	0,09
31061-22	K	2	750°C	2500	500	0,05
31061-21	K	2	750°C	2500	1000	0,1

FLEXIBLE MINERAL INSULATED THERMOCOUPLES WITH HIGH TEMPERATURE EXTENSION CABLE

Class 2 thermocouples with ungrounded hot junctions inside flexible mineral insulated 316L (Type J) or Inconel 600 (Type K) stainless steel sheath, with sealed end and high temperature extension cable with metallic overbraid.

Max. temperature: 600°C (J type) and 1000°C (K type).
Max. cable temperature: 200°C. Fastening: use a type 31271 compression fitting.

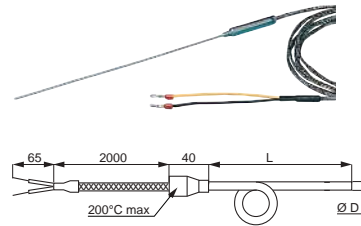

P/N.TCJ	P/N.TCK	ØD (mm)	L (mm)
31080-02	31214-02	0,5	150
31080-11	31214-11	1	200
31080-12	31214-12	1	250
31080-18	31214-18	1,5	150
31080-20	31214-20	1,5	250
31080-23	31214-23	2	200
31080-24	31214-24	2	250
31080-31	31214-31	3	200
31080-32	31214-32	3	250

Other manufacturing capabilities : accuracy class 1, diameter 0,5 or 1 or 2 or 3 or 4,5 or 6 or 8 mm, total flexible sheath length from 100 up to 5000 mm, other cable length, adjustable compression fitting type 31271.. R S T thermocouple type EExia, other thermocouple types R, S, T..., ATEX approval EEx ia.

FLEXIBLE MINERAL INSULATED THERMOCOUPLES WITH CONNECTOR AND PVC EXTENSION CABLE

Class 2 thermocouples with ungrounded hot junctions inside flexible mineral insulated 316L (Type J) or Inconel 600 (Type K) stainless steel sheath, with an electrical plug, and with an optional shielded PVC extension cable.
Maximum operation temperature : 600°C (TC J) or 1000°C (TCK), 200°C on the connector and 90°C on the cable.

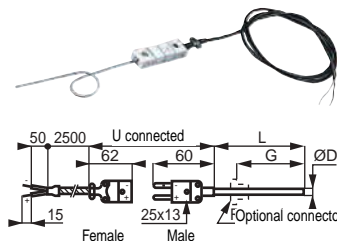

P/N.TCJ	P/N.TCK	ØD (mm)	A (mm)	U (mm)	Optional connector	Weight (kg)
31064-01	31064-11	3	500	106	with	0,09
31064-02	31064-12	3	1000	106	with	0,11
31064-03	31064-13	3	1500	106	with	0,13
31064-04	31064-08	3	100	0	without	0,09
31064-05	31064-09	3	200	0	without	0,09
31064-06	31064-10	3	300	0	without	0,09
31064-07	31064-14	3	400	0	without	0,10
31064-19	31064-15	6	100	0	without	0,09
31064-20	31064-16	6	200	0	without	0,09
31064-23	31064-17	6	300	0	without	0,10
31064-25	31064-18	6	400	0	without	0,10

A = "L" if there is no connector.
A = "G" if there is connector.

THERMOCOUPLES WITH IP65 OFFSET ALUMINIUM HEAD

Class 2 thermocouples with ungrounded hot junctions inside 304L (Type J) or Inconel 600 (Type K) stainless steel sheath. Electrical connection by 2 poles terminal blocks inside an IP 65 offset aluminium head, epoxy painted, with compression gland for cable dia 4 to 15 mm. Spring loaded terminals, with a 8 mm clearance (the L1 dimension is corresponding to the half compression of the spring) Offset 316 L nipple 1/2" NPT threaded fitting
Max operating temperature : 600°C (TC J) or 1000°C (TCK), and 80°C on the head

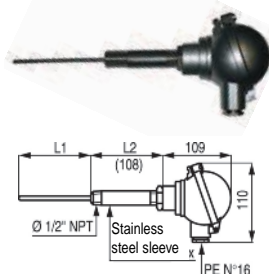

P/N. J type	P/N. K type	Ø D (mm)	L1 (mm)	L2 (mm)
31075-01	31075-05	3	100	108
31075-02	31075-06	3	150	108
31075-03	31075-07	3	200	108
31075-04	31075-08	3	250	108
	31075-09	6	100	108
	31075-10	6	150	108
	31075-11	6	200	108
	31075-12	6	250	108



FLEXIBLE MINERAL INSULATED THERMOCOUPLES - Ex d - IP65

Class 2 thermocouples with ungrounded hot junctions inside flexible mineral insulated 316L (Type J) or Inconel 600 (Type K) stainless steel sheath. Electrical connection by 2 poles terminal blocks inside an IP65 EXPLOSION PROOF head Marking : II 2 G Ex d IIC T6 with a compression gland for cable dia 8 mm. 1/2" NPT threaded fitting welded below the head
 Maximum operating temperature : 600°C (TC J) or 1000°C (TC K),
 Temperature range : - 20 to + 80°C on the head
 Other manufacturing capabilities : accuracy class 1, diameter 3 or 4,5 or 6 or 8 mm, total flexible sheath length from 100 up to 1000 mm, other thermocouple types R,S,T..., 4/20 mA transmitter installed inside the head.

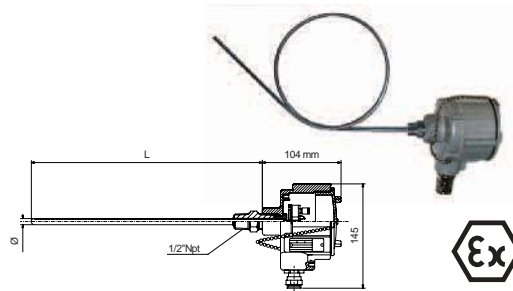

P/N. J type	P/N. K type	Ø D (mm)	L (mm)
31068-10	31068-13	3	100
31068-11	31068-14	3	150
31068-12	31068-15	3	200
	31068-16	6	100
	31068-17	6	150
	31068-18	6	200

Usable in hazardous areas (ambient temperature from -20 °C up to 80°C, relative humidity 95 % maximum).
 Certificate: **LCIE 02 ATEX 6097X** some precautions must be taken for using this device. Consult us or read the instruction manual

THERMOCOUPLES WITH OFFSET - Ex d - IP65

Class 2 thermocouples with ungrounded hot junctions inside 304L (Type J) or Inconel 600 (Type K) stainless steel sheath. Electrical connection by 2 poles terminal blocks inside an IP 65 EXPLOSION PROOF head Marking : II 2 G Ex d IIC T6 with a compression gland for cable dia 8 mm.
 Offset 316 L nipple 1/2" NPT threaded fitting
 Maximum operating temperature : 600°C (TCJ) or 1000°C (TCK),
 Temperature range : - 20 to + 80°C on the head
 Other manufacturing capabilities : accuracy class 1, diameter 3 or 4,5 or 6 or 8 mm, total flexible sheath length from 100 up to 1000 mm, other thermocouple types R,S,T..., 4/20 mA transmitter installed inside the head.

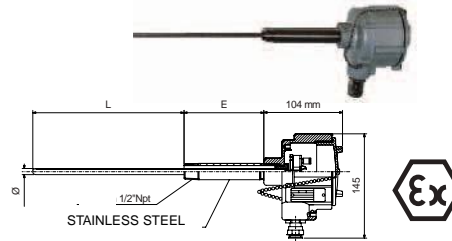

P/N. J type	P/N. K type	Ø D (mm)	L1 (mm)	L2 (mm)
31075-13	31075-17	3	100	108
31075-14	31075-18	3	150	108
31075-15	31075-19	3	200	108
31075-16	31075-20	3	250	108
	31075-21	6	100	108
	31075-22	6	150	108
	31075-23	6	200	108
	31075-24	6	250	108

Usable in hazardous areas (ambient temperature from -20 °C up to 80°C, relative humidity 95 % maximum).
 Certificate: **LCIE 02 ATEX 6097X** some precautions must be taken for using this device. Consult us or read the instruction manual

THERMOCOUPLES WITH MINIATURE IP54 ALUMINIUM HEAD

Class 2 thermocouples with ungrounded hot junctions inside 316L (Type J) or Inconel 600 (Type K) stainless steel sheath. Electrical connection by 2 pole terminal blocks inside an IP54 miniature aluminium head, epoxy painted, with compression gland N°9.
 Maximum operating temperature : 600°C (TC J) or 1000°C (TCK) and 80°C on the head.

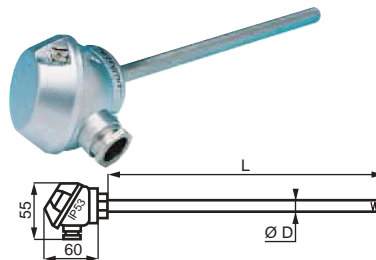

P/N. J type	P/N. K type	Ø D (mm)	L (mm)	Weight (kg)
31067-01	31067-03	8	150	0,13
31067-05	31067-13	8	250	0,15
31067-02	31067-04	8	300	0,17
31067-11	31067-14	8	350	0,19
31067-12	31067-15	8	550	0,31

FLEXIBLE MINERAL INSULATED THERMOCOUPLES WITH IP65 ALUMINIUM HEAD

Class 2 thermocouples with ungrounded hot junctions inside 316L (Type J) or Inconel 600 (Type K) stainless steel sheath. Electrical connection by 2 pole terminal blocks inside an IP 65 aluminium head, epoxy painted, with compression gland for cable dia 4 to 15 mm.
 Maximum operation temperature : 600°C (TC J) or 1000°C (TCK) and 80°C on the head
 Other manufacturing capabilities : accuracy class 1, diameter 3 or 4,5 or 6 or 8 mm, total flexible sheath length from 100 up to 5000 mm, adjustable compression fitting type 31271, other thermocouple types R, S, T. ATEX approval Ex ia. or Ex e, 4/20 mA transmitter installed inside the head.

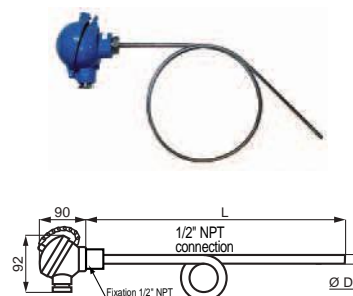

P/N. K type	Ø D (mm)	L (mm)	Weight (kg)
31068-61	4,5	150	0,06
31068-62	4,5	300	0,12
31068-63	4,5	550	0,2
31068-64	6	150	0,07
31068-65	6	200	0,09
31068-66	6	250	0,11
31068-67	6	300	0,14
31068-68	6	350	0,17
31068-69	6	550	0,26

CLAMPING PROBES FOR SURFACE TEMPERATURE MEASUREMENT

These sensors are dedicated to the temperature measurement of pipes (eg : for heating systems). Protective sheath in stainless steel 316L, diameter 5 mm, end thinned for a best contact. 2 wires (for TC) or 3 (for PT100) insulated conductors teflon / teflon, 1 m length

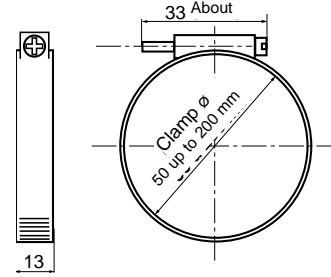

On request :
Other clamping diameters up to 2 meters.
Available in ATEX Gas and Dust.

REF.	Sensort	Range (°C)
31711-03	PT100 probe	-50/+200
31711-04	Thermocouple K	-50/+400

ADJUSTABLE FASTENING FLANGES and FASTENING CLAMP

Flange for fastening 2 to 8 mm Ø probes to a duct wall or an insulating jacket. 3 fixing holes, Ø 5mm.

Clamp for fastening a 6 mm Ø probe to the flat wall of a low-pressure air duct. AISI 304L=Din 1.4306

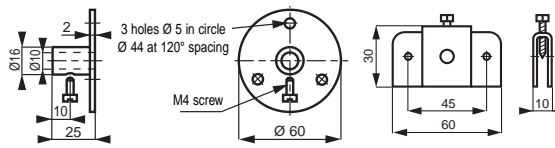

To be sealed after assembly with a heat-resistant silicone mastic.

P/N.	Article	Material
31979-01	Flange	Painted steel
31979-11	Flange	Stainless steel 304 L
31678-00	Clamp	Stainless steel 304 L

EXTENSION CABLES FOR PLATINUM-PLATED PROBES

Flexible multicore cables for connecting PT probes to temperature controllers. Type 31455 is covered in metal braid. Supplied in 25`m rolls.

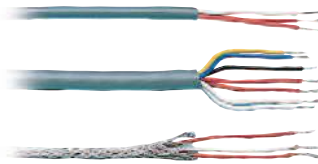

P/N.	Nrr. of wires	Section (mm ²)	Max. ambient	Outside Ø (mm)	Insulator	Weight (kg)
31450-25	3	0,14	80°C	3	PVC	0,25
31452-25	3	0,22	80°C	4	PVC	0,5
31454-25	7	0,22	80°C	6	PVC	1,0
31455-25	3	0,22	220°C	3	GSV	0,4
31459-25	3	0,5	400°C	7,2	FIB/SIL	0,7

STANDARD COMPENSATED PLUGS FOR THERMOCOUPLES

Allow a plugged connection between two thermocouple cables without measurement error, because their contacts are out of the same material as the sensor. The cable clamp fits the male and female plugs.

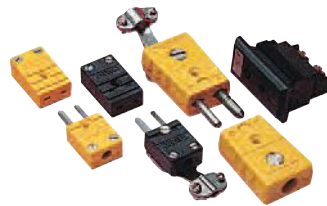

P/N.	T/C type	Description	Weight (kg)
31100-01	K	Standard male	0,020
31100-02	J	plug	0,020
31100-03	K	Standard female	0,015
31100-04	J	plug	0,015
31100-05	K	Standard female	0,015
31100-06	J	built-in plug	0,015
31100-07	K	Miniature male	0,005
31100-08	J	plug	0,005
31100-09	K	Miniature female	0,007
31100-10	J	plug	0,007
31100-11	K	Miniature female	0,005
31100-12	J	built-in plug	0,005
31100-13		Cable clamp for standard plug	0,010
31100-14		Cable clamp for miniature plug	0,008

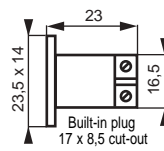
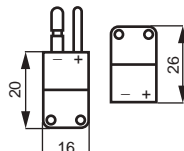
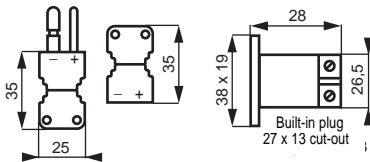

Standard plugs

Miniature plugs

3-PIN PLUGS FOR PT 100 ohm/ 0°C PROBES

Allow a plugged connection between two three-core copper extension cables for 100 ohm/ 0°C platinum-plated probes. Max. operating temperature 175°C.



P/N.	Description	Colour	Weight (kg)
31101-01	Miniature male plug	White	0,009
31101-02	Miniature female plug	White	0,008
31101-03	Miniature female built-in plug	White	0,008
31101-04	Standard male plug	White	0,030
31101-05	Standard female plug	White	0,025
31101-06	Cable clamp for miniature plug		0,008
31101-07	Cable clamp for standard plug		0,010

STAINLESS STEEL PROBE POCKETS, 3/8" AND 1/2" BSP

For easy dismantling of probes and thermocouples on liquid circulation heaters and pipe.

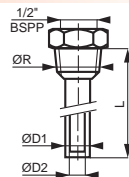

P/N.	Ø R	ØD1 (mm)	ØD2 (mm)	L (mm)	Material
31601-20	1/2" BSPT	13,5	8,9	100	304L/ 1.4306
31340-21	1/2" BSPT	13,5	8,9	200	304L/ 1.4306
31341-20	1/2" BSPT	9	7	100	304L/ 1.4306
31605-21	1/2" BSPT	9	7	200	304L/ 1.4306
31342-20	1/2" BSPT	9	7	300	304L/ 1.4306
31605-22	1/2" BSPT	9	7	500	304L/ 1.4306
31605-23	3/8" BSPT	9	7	200	304L/ 1.4306
31343-20	3/8" BSPT	13,5	8,9	150	304L/ 1.4306
31605-70	3/8" BSPT	9	7	150	304L/ 1.4306

P/N.	Ø R	ØD1 (mm)	ØD2 (mm)	L (mm)	Material
31390-21	1/2" BSPT	13,5	8,9	100	316L/1.4404
31391-21	1/2" BSPT	13,5	8,9	200	316L/1.4404
31392-20	1/2" BSPT	9	7	100	316L/1.4404
31393-20	1/2" BSPT	9	7	200	316L/1.4404
31394-20	1/2" BSPT	9	7	300	316L/1.4404
31395-20	1/2" BSPT	9	7	500	316L/1.4404
31396-20	3/8" BSPT	9	7	200	316L/1.4404
31396-70	3/8" BSPT	9	7	150	316L/1.4404
31397-20	3/8" BSPT	13,5	8,9	150	316L/1.4404

BRASS PROBE POCKETS

These models are especially suited to three phases safety temperature thermostats, P/N. 9014-13.

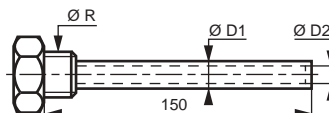

P/N.	Ø R	ØD1 (mm)	ØD2 (mm)	L (mm)	Material
9014-10	3/8" BSPP	9,5	8,5	150	Brass

Weight: 0,06 kg

BICONE UNIONS

For sealed fixing of rigid or flexible probes by crimping on a sliding 3-piece union.

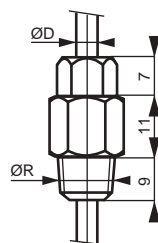

P/N.	Material	Ø D (mm)	Ø R
31664-00	316L / Din 1.4404	1	M 4 x 70
31656-00	brass	1	M 8 x 125
31446-00	316L / Din 1.4404	1,2	M 4 x 70
31447-00	brass	1,2	M 8 x 125
31665-00	316L / Din 1.4404	1,5	M 4 x 70
31657-00	brass	1,5	M 8 x 125
31666-00	316L / Din 1.4404	2	M 8 x 125
31658-00	brass	2	M 8 x 125
31448-00	316L / Din 1.4404	2,5	M 8 x 125
31449-00	brass	2,5	M 8 x 125
31667-00	316L / Din 1.4404	3	M 8 x 125

P/N.	Material	Ø D (mm)	Ø R
31659-00	brass	3	M 8 x 125
31659-01	316 L stainless steel	3,2	M8 x 125
31668-00	316L / Din 1.4404	3,5	M 8 x 125
31660-00	brass	3,5	M 8 x 125
31669-00	316L / Din 1.4404	4,5	M 8 x 125
31661-67	steel	4,5	1/4" BSPP
31670-00	316L / Din 1.4404	6	1/4" BSPT
31671-00	316L / Din 1.4404	6	3/8" BSPT
31672-00	316L / Din 1.4404	6	1/2" BSPP
31662-67	steel	6	1/2" BSPP
31673-00	316L / Din 1.4404	8	1/2" BSPP
31663-67	steel	8	1/2" BSPP

BAYONET CONNECTORS

MALE BAYONET FITTINGS, nickel-plated brass, 2 pins Ø 3 mm. For fixing probe types 31065 and 31083

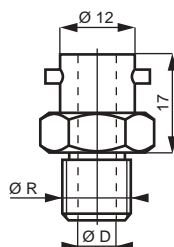

P/N.	Ø D (mm)	Ø R
31645-68	6,5	M 10 x 100
31871-68	6,5	M 10 x 150
31872-68	8,3	M 12 x 150
31873-68	8,3	M 12 x 175
31874-68	8,3	M 14 x 150
31875-68	8,3	M 14 x 200
31876-68	8,3	1/4" BSPP

LONG MALE BAYONET FITTINGS, nickel-plated brass. For fixing probe types 31065 and 31083

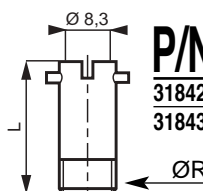

P/N.	L (mm)	Ø R
31842-68	35	M 12 x 100
31843-68	60	M 12 x 100

THREADED WELD-ON BOSSES

For sealed fixing of rigid or flexible probes
AISI 304L = Din 1.4306
AISI 316L = Din 1.4404

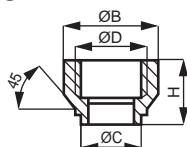

P/N.	P/N.	P/N.	ØB (mm)	ØC (mm)	ØD (mm)	H (mm)	Weight (kg)
31978-01	31978-11	31978-21	25,5	14	1/4" BSPP	30	0,085
31978-02	31978-12	31978-22	32	17,5	3/8" BSPP	30	0,113
31978-03	31978-13	31978-23	41	21,6	1/2" BSPP	33,5	0,141

POWER SUPPLIES FOR CONVERTER P/N.30713-01

These power supplies are particularly suitable for the implementation of converters with 2 wires (loop powered 4-20 mA)..
The isolation between each output eliminates ground loop problems that can disturb the measurement
The coupling in serial or parallel increases the current or voltage output .

- Assembly : DIN rail unit .
- Outputs : from 1 up to 8, presetting voltage 24 Vdc, 30 mA (other voltages are available).
- Permanent protection against short circuits.
- Insulation voltage between 1500 to 3000 V.
- Green LED when the power is switch on.

Input: 230Vac + / - 10% (other voltages available from 11 to 265 V AC or DC).

Output: on request from 0 to 24V DC (power 1watt/sortie), higher voltage is possible with parallel outputs (maximum 8x24V).



PROGRAMMABLE CONVERTERS FOR ROD HEAD P/N. 31712-00

31712-00 type are digital converters for a rod head using the 2-wire technique

Input : PT 100 ohm or thermocouple J K T R S B or mv

Output : 4/20 mA programmable for scale, response time and input type

Linearization, cold solder compensation and line resistance compensation incorporated into the converter.

Power supply between 9 and 40 Vdc with load resistance at 24 Vdc 750 ohm

Operating temperature range: -30 °C + 85 °C

Attaching centre distance 33 mm, 7 mm central role to accommodate sensor wires

Connection by screw-on terminal with 2.5 mm² capacity.

Indication of power supply presence by LED

Protection against polarity reversal

Protection from shock and vibration (silicone coating resin)



Other production : version with galvanic insulation, hart protocol

PROGRAMMABLE FIELD CONVERTERS WITH LOCAL DISPLAY P/N.31713-00

31713-00 type are 4/20 mA programmable converters using the two-wire technique with a local display assembled in an IP 65 epoxy painted aluminum case

Input : thermocouple JKTRSB with PT 100 Ohm probe .

Output : 4/20 mA programmable for scale, response time and input type

LCD display of extended temperature (4 digits) Resolution 10 000 points

Linearization, cold solder compensation and line resistance compensation incorporated into the converter.

Power supply between 12 and 40 Vdc with load resistance at 24 Vdc 550 ohm.

Operating temperature range: -20 °C + 60 °C

Connection by screw-on terminal with 2.5 mm² capacity. Protection against polarity reversal

IP 65 epoxy painted aluminum case with electrical output by PG 16 g cable gland for 7/12 mm

Process assembly by 1/2" cylindrical gas threading



MULTI GENERAL MEASUREMENT UNITS TYPE 31714

Assembly : - plug-in type, case 96 x 96 x 150 mm

Configurable inputs : - : 4,8,12 inputs, according to the P/N above (identical configuration for all the channels).

- Pt100 2 or 3 wires, linearised
- Compensated and linearised thermocouple
- mV, mA, ohm

Configurable alarms : - 2 configurable alarms for each channels

- detection of probe breakage and of measurement threshold

Relays : - 2 relays for all the channels

- inverter relay, potential free

Display : - 4 digits LCD 7 segments, 10 000 points

- display of measurement, fixed point, scrolling, alarm threshold adjustments

Power supply : - 230 Vac: other voltage to be defined on order

Insulation : - power supply/input/relay 1500 Vac

- input/output 250 Vac

Parameter settings : - RS232 link (cord not supplied, on request)



P/N. Input nbr.

31714-04	4
31714-08	8
31714-12	12

Application: centralised supervision and monitoring of temperature

Advantage: compact, low cost.

GENERAL-PURPOSE DIGITAL CONVERTERS P/N.31715-00

Assembly : - DIN rail unit: 23 x 100 x 120 mm

Configurable input : - Pt100, thermocouple

- mV, V, mA, ohm

- sensor power supply, potentiometer, stress gauge

- frequency: TTL, Namur, NPN, PNP,

Special functions :

- square root extraction

- customised linearisation

Configurable output : - 1 current output 0...4.... 20 mA, voltage 0 to 10 V

Second isolated output : - option (CNL 35L/S2)

Configurable relays (as an option) : - max 4 relays, potential free

- detection of probe breakage and of measurement threshold

Power supply : - 20 to 265 Vac-dc, or 9 to 30 Vdc on request

Insulation : - input/output 1500 Vac power supply

Parameter settings : - RS232 link or front panel



Application: measurement of industrial signals, temperature, speed, weight, position, flow rate, etc

Advantage: wide range of applications fully configurable by the user

APPLICATIONS

- Power
- Testing
- Instrumentation
- Regulation

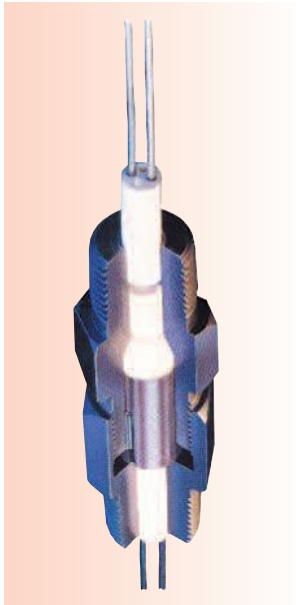

USES

-240°C to + 870°C

Liquid



690 bar*

Gas



690 bar*



-5.10⁻⁶ Hg

31270 TYPE

This type Glands seal a single tube or probe. Featuring a metal-to-metal seal rather than our standard soft sealing technology, glands are used where a joint must be opened and released in the same setting. Their unique design forms the seal well within the vessel housing to provide superior performance in high vibration applications.

Metal to metal tube and probe sealing.



Multiple sensors and probe glands



31272 TYPE

Glands enable multiple thermocouples, thermistor probes, RTD's, tubes or other sensors to pass through a single gland. Each probe is electrically isolated and its immersion length is adjustable. Elements may be individually adjusted, removed and replaced.

Multiple sensors and probe glands, for non-standard sizes and custom configurations - glands



31273 TYPE

Can often be used when the other type of probe glands are not suitable - they can be customized to accommodate non-standard sizes and a mixture of element sizes, for special hole patterns and for a higher density of elements than can be accommodated by other types of sealing assemblies.

Single and multiple sensor glands with split internal components



31171/31172 TYPE

These glands are used when the elements to be sealed can pass through the gland vessel but not through the internal components. Their process ends may be of a larger diameter than at the sealing points, there may be connectors to pass through the gland, elements may be long and difficult to handle, or, there are other installation constraints.

31275 TYPE

These power lead glands have kapton insulated copper wire in a number of wire sizes. They are used to feed through power leads to autoclaves and sterilisers, transformers, motors and heaters. Wires are individually marked at both ends and are easily installed or replaced.

Insulated wire sealing



Single electrode with ceramic insulators 31277 glands; and with Teflon insulator/sealing - 31278 glands

31277/31278 TYPE

These single conductor sealing glands are used for high voltage and/or high current feedthroughs to vacuum chambers, autoclaves, transformers, motor enclosures, reactor vessels and environmental chambers. Type 31277 are available with a choice of sealants and have ceramic insulators. Max.rating 2kV/400A. Type 31278 glands employ a single-piece, Teflon, combined insulator/sealant component to surround the electrode. Max.rating 8kV/525A..



High density, mechanically sealed, wire feedthroughs using single or multiple probe glands



31173 TYPE

These feedthrough assemblies comprise a high-density, wire feedthrough mounted in a sealing gland. A Teflon-lined, stainless steel tube is swaged over 12, 24, 40 or 60, solid, Teflon-coated, copper and/or thermocouple material wires to make the continuous wire feedthrough for thermocouples, RTD's and low voltage instrumentation.

- SEALS A SINGLE ELEMENT - USUALLY A TUBE, PROBE OR SENSOR
- FOR GAS OR LIQUID APPLICATIONS
- PRESSURE : Vacuum to 690 bar
- TEMPERATURE : -240°C to +870°C
- FIELD ADJUSTABLE
- REPLACEABLE SEALANT FOR REPEATED USE OF FITTING
- STAINLESS STEEL BODY, CAP AND FOLLOWER
- SIMPLE ASSEMBLY - INSERT ELEMENT, TORQUE CAP

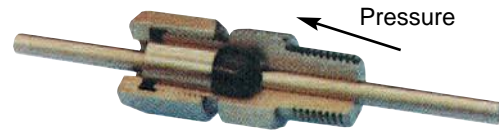

TYPE 31271

SEALANT SELECTION GUIDE

31271 type glands are designed for sealing a single element, usually a tube or a probe, where it crosses a pressure or environmental boundary. Glands are available to carry elements.

Applications for glands include :
Pressure and vacuum sealing of thermocouples, RTD's, dial-type thermometers, thermistor probes, glass thermometers, thermowells (pockets) including those made from fragile materials, capillary tubes and other sensor elements.

Sealant (sealant code)	Temperature range	Pressure range at 20°C
Neoprene (N)	-40°C to +93°C	Vacuum to 345 bar
Viton (V)	-20°C to +232°C	Vacuum to 690 bar
Teflon (T)	-185°C to + 232°C	Vacuum to 220 bar
Lava (L)	-185°C to +870°C	1bar to 690 bar
Grafoil (G)	-240°C to +495°C (to +1650°C in a reducing atmos.)	Vacuum to 690 bar

Diameter of element of seal thread**	Gland mounting thread	Pressure rating by Sealant*					L (mm)		Body Hex size (mm)
		Neoprene	Viton	Teflon	Lava	Grafoil	1 screw	2 screw	
		N	V	T	L	G			
0,5	1/16"	-	-	220	550	-	23,81	-	9
1	1/16"	-	-	220	550	-	23,81	-	9
1,5	1/16"	-	-	220	550	-	23,81	-	9
1	1/8"	165	220	275	385	-	30,2	39,7	13
1,5	1/8"	165	220	275	275	345	30,2	39,7	13
2	1/8"	165	165	220	275	345	30,2	39,7	13
2,5	1/8"	165	165	165	275	345	30,2	39,7	13
3	1/8"	165	165	165	275	345	30,2	39,7	13
3,5	1/8"	80	100	100	275	275	30,2	39,7	13
4	1/8"	80	100	100	275	275	30,2	39,7	13
4,5	1/8"	80	100	100	275	275	30,2	39,7	13
3	1/4"	345	690	220	690	690	50,8	60,4	19
3,5	1/4"	220	310	65	690	345	50,8	60,4	19
4	1/4"	220	310	165	690	345	50,8	60,4	19
4,5	1/4"	220	310	165	690	345	50,8	60,4	19
5	1/4"	165	205	80	690	275	50,8	60,4	19
5,5	1/4"	165	205	80	690	275	50,8	60,4	19
6	1/4"	165	205	80	690	275	50,8	60,4	19
5	1/2"	100	100	165	690	345	63,5	82,5	26
6	1/2"	100	100	165	690	345	63,5	82,5	26
7	1/2"	80	80	135	690	345	63,5	82,5	26
8	1/2"	80	80	135	690	345	63,5	82,5	26
9	1/2"	80	35	95	690	220	63,5	82,5	26
9,52	1/2"	80	35	95	690	220	63,5	82,5	26
12,7	3/4"	60	60	100	345	165	73	92	38
13	3/4"	55	55	55	275	165	73	92	38
14	3/4"	55	55	55	275	165	73	92	38
15	3/4"	55	55	55	275	165	73	92	38
15,87	3/4"	55	55	55	275	165	73	92	38
16	3/4"	55	55	55	275	165	73	92	38
17	3/4"	55	55	55	275	165	73	92	38

* All pressure and vacuum rating are determined at 20°C
**Tolerance of tube or probes diameter ± 0,127mm

How to order 31271 TYPE

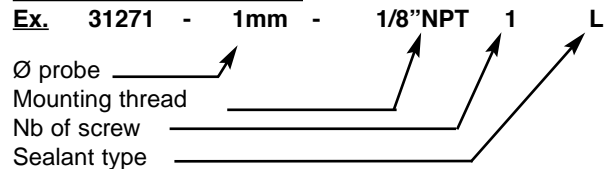

Ex. 31271- 1mm 1/8" NPT 1L

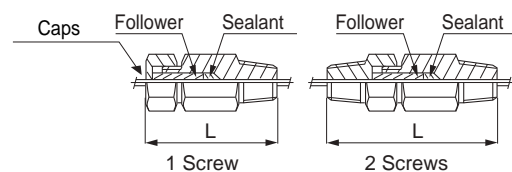

Sealant material	Torque table Nm						
	Ø Gland mounting thread NPT						
	1/16"	1/8"	1/4"	1/2"	3/4"	1"	1"1/4
Neoprene	-	6,21 6,78	40,8 47,6	74,8 81,6	74,8 81,6	-	-
Viton	-	6,21 6,78	40,8 47,6	74,8 81,6	74,8 81,6	-	-
Teflon	0,79	6,21	20,4	74,8	122	407	407
Lava	1,02	6,78	27,2	81,6	136	441	441
Grafoil	-	6,21 6,78	46,6 54,4	122 136	122 136	-	-

CHOOSING A CONTROLLER

The VULCANIC range of controllers covers the great majority of industry requirements. Following steps will help you to define the right controller.

- 1) define the desired control precision: if $\pm 5^{\circ}\text{C}$, choose an 'ON/OFF' controller ; for greater precision, consider a 'PID' appliance.
- 2) Know what kind of temperature input is used : PT100 - Thermocouple - Current - Voltage.
- 3) Know what kind of power supply device is to be driven, so as to choose the type of control output (usually called 'Output P/N.1'):
 - for a contactor, choose a controller with a 'relay' output
 - for a power unit, choose a controller with a "numeric" output
 - for a device with an analogic input (eg : motorised valve) choose a controller with an "Analogic" output.
- 4) Know what use will be made of the auxiliary outputs (usually called 'Output N°2 and N°3') : choose a "Relay" output to drive an alarm, "Current or Voltage" for a measurement repeater, and/or "Cold" output 2 to drive an ON/OFF valve for a cooling system.

48x48 ON/OFF CONTROLLERS WITH 3-DIGIT DISPLAY

Class 0,2 controllers, large-size 3 digit display, lockable setting, configurable input (PT100 - J-, K-, T-type thermocouples), panel mounted or fastened to DIN rail. Supplied pre-set.

1 relay output, double-throw contacts, 2A/240V.

Supply voltage : 90 to 264 V - 50/60 Hz.

Weight 0,2 kg.



Depth : 100mm.

P/N.	Input	Temperature Range (°C)
30633-01	PT 100	-50 to 100°C
30633-51	PT 100	0 to 100°
30633-41	PT 100	-50 to 300°C
30633-12	TC/J	0 to 200°C
30633-22	TC/J	0 to 400°C
30633-02	TC/J	0 to 600°C
30633-03	TC/K	0 to 800°C

48x48 AUTOTUNE CONFIGURABLE PID TEMPERATURE CONTROLLERS

Autotune PID temperature controllers with 3 outputs.

Configurable input : RTD (PT100) or thermocouples type B/J/K/L/M/R/S/T, or analogic voltage 0/10 V , 2/10 V, 0/5 V, 1/5 V, 0 / 50 mV, 1/50 mV, or loop powered analogic current 0/20 mA, 4/20 mA.

Main output on request : SPDT relay 2 A / 240 VAC (on a resistive load) and pulse wave modulation 0/10 VDC for SSR (period 0,25 to 512 seconds / 20 mA max) configurable by strap, analog voltage 0/5 V, 0/10 V, 2/10 V or analogic current 0/20 mA, 4/20 mA (powered in 24 VDC).

Output 2 and 3 on request : same as output 1. Optional circuit board A : see table hereafter.

On/off optional control with adjustable differential, simultaneous display of measurement (red LED 8 mm high) and setpoint (green LED 6 mm high).

Selftuning available during switch on operation.

Supply voltage 100 to 240 VAC +/- 10% 50/60 Hz. Class 0,1.

Front panel to IP 66. Mass 0,21 kg.

Removable casing depth 110 mm, for cutting 45 X 45 mm.



Depth : 100mm.

P/N.	Old P/N.	Input	Temp.* range (°C)	Control output	Output 2	Output 3
30656-01	30655-01	PT 100	-50 to 350	Relay	Alarm	-
30656-02	30655-02	PT 100	-50 to 350	Logic	Alarm	-
30656-03	30655-03	PT 100	-50 to 350	Relay	Cold Relay	Alarm
30656-04	30655-04	PT 100	-50 to 350	Logic	Cold Relay	Alarm
30656-13	30655-13	TC/J	0 to 450	Relay	Alarm	-
30656-14	30655-14	TC/J	0 to 450	Relay	Cold Relay	Alarm
30656-15	30655-15	TC/J	0 to 450	Logic	Alarm	-
30656-16	30655-16	TC/J	0 to 450	Logic	Cold Relay	Alarm
30656-21	30655-21	TC/K	0 to 1200	Relay	Alarm	-
30656-23	30655-23	TC/K	0 to 1200	Logic	Alarm	-
30656-05	-	PT100	-50 to 350	Analogic	Alarm	-
30656-17	-	TC/J	0 to 450	Analogic	Alarm	-
30656-24	-	TC/K	0 to 1200	Analogic	Alarm	-

Microcards for reconfiguring the appliance (they are used for PID controllers type 30656 or 30881)

30656-92	SPDT relay and PWM circuit board for main output
30656-96	Analog circuit board for main output (voltage or current)
30656-90	SPDT relay circuit board for output 2 and 3
30656-91	Analog circuit board for output 2 or 3 (voltage or current)
30656-99	PWM circuit board for output 2 or 3
30656-93	RS 485 circuit board, MODBUS or ASCII for option A
30656-97	Remote analog setpoint 0/5 VDC or 0/10 VDC or 2/10 VDC or 0/20mA or 4/20mA, for option A
30656-95	Setpoint selection by single pole contact for option A
30656-98	Power supply 24 VDC / 20 mA for cooled output

48x96 AUTOTUNE CONFIGURABLE PID TEMPERATURE CONTROLLERS

Autotune PID temperature controllers with 3 outputs.

Configurable input : RTD (PT100) or thermocouples type B/J/K/L/M/R/S/T, or analog voltage 0/10 V , 2/10 V, 0/5 V, 1/5 V, 0 / 50 mV, 1/50 mV, or loop powered analogic current 0/20 mA, 4/20 mA.

Main output on request : SPDT relay 2 A / 240 VAC (on a resistive load) and pulse wave modulation 0/10 VDC for SSR (period 0,25 to 512 seconds / 20 mA max) configurable by strap, analog voltage 0/5 V, 0/10 V, 2/10 V or analogic current 0/20 mA, 4/20 mA (powered in 24 VDC).

Output 2 and 3 on request : same as output 1.

Optional circuit boards A and B : see table above.

On/off optional control with adjustable differential, simultaneous display of measurement (red LED 8 mm high) and setpoint (green LED 6 mm high).

Selftuning available during switch on operation.

Supply voltage 100 to 240 VAC +/- 10% 50/60 Hz. Class 0,1.

Front panel to IP 66. Mass 0,27 kg.

Removable casing depth 100 mm, for cutting 45 X 92 mm.



P/N.	Input	Temperature range (°C)	Control output	Output 2	Output 3
30881-01	PT 100	-50 to 350	Relay	Alarm	-
30881-02	PT 100	-50 to 350	Logic	Alarm	-
30881-03	PT 100	-50 to 350	Relay	Cold Relay	Alarm
30881-04	PT 100	-50 to 350	Logic	Cold Relay	Alarm
30881-05	PT 100	-50 to 350	Analogic	Alarm	-
30881-13	TC/J	0 to 450	Relay	Alarm	-
30881-14	TC/J	0 to 450	Relay	Cold Relay	Alarm
30881-15	TC/J	0 to 450	Logic	Alarm	-
30881-16	TC/J	0 to 450	Logic	Cold Relay	Alarm
30881-17	TC/J	0 to 450	Analogic	Alarm	-
30881-21	TC/K	0 to 1200	Relay	Alarm	-
30881-23	TC/K	0 to 1200	Logic	Alarm	-
30881-24	TC/K	0 to 1200	Analogic	Alarm	-

Microcards for reconfiguring the appliance

30881-90 Circuit board for analogic remote setpoint : 0/5 VDC, 0/10 VDC, 2/10 VDC or 0/ 20 mA or 4/ 20 mA for option B, with local / remote switching by contact out of potential.

48 x 24 NUMERIC TEMPERATURE INDICATOR

Process magnitude or temperature indicators.

Input configurable for current :

(active or passive, zero assessed 20mA, 4/20 mA or other)

For low-level voltage (mV up to 2000) or high-level voltage (V up to 200, 0/10 V for instance), Potentiometer (200 ohm minimum), Stress gauges (5 V)

Frequency (0.25 Hz to 100 kHz), PT100 (2 or 3 or 4 wires) and thermocouples (B, E, J, K, R, S, T, N, W3 and W5)

Option 2 threshold alarm outputs by 260V/1A resistive inverter relay

Analogue measurement copy option, galvanic installation: current-configurable (active 0/20 mA, 4/20 mA or other) or for low-level voltage 0/10V (or other).

Display of four red digits + unit (configurable for °C, bar, rpm, lpm)

General-purpose power supply, 20 to 265 Vac or

DC. Connection to screw-on plug-in terminals



Depth: 84 mm, weight 0.18 kg, designed for recessing into a cutout measuring 92.5 x 42.5 mm.

P/N.

30828-01 basic model without options

30828-02 model equipped with an analogue output

30828-03 model equipped with two alarm outputs and one analogue output

30828-04 kit: IP65 flexible protection

IP40 front panel: convertible to IP65 by the addition of flexible protection.

Other manufacturing possibilities: MODBUS / PROFIBUS instead of analogic output.

48x48 DIGITAL ON/OFF CONTROLLER

These indicators are smaller than the 48x96 devices but still offer similar functions to the larger models. Supplied pre-set and ready for use (as are most of our measuring devices), they can be reconfigured by the user if necessary. Universal thermocouple input, PT 100, mA and mV inputs.

Large red 4-digits display, 2 alarms on SPDT 2A at 120/240 VAC relays and measurement repeater (4/20mA) on certain models.

IP65 front face, supply voltage: 100 to 240 VAC.

Alarm status shown by LEDs on the front face.



Depth : 110mm.

P/N.

P/N.	Input	Scale (°C)	Repeater	L (mm)	Weight (kg)
30848-01	T/C J	0 +761	No	110	0,2
30848-02	T/C K	-200 +1373	No	110	0,2
30848-03	PT 100	0 +800	No	110	0,2
30848-04	4/20mA	user-configured	No	110	0,2
30848-11	T/C J	0 +761	Yes	110	0,2
30848-12	T/C K	-200 +1373	Yes	110	0,2
30848-13	PT 100	0 +800	Yes	110	0,2
30848-14	4/20mA	user-configured	Yes	110	0,2

Temperature range can be altered by rekeying

48 x 96 TEMPERATURE CONTROLLER

Temperature indicators with 3 Digitals ON/OFF. Red 4-digit display and alarm indicators. Supplied pre-set (except P/N. 30856-1), but can be reconfigured by the user if necessary.

Alarm relays with SPDT contacts, 2A 120/240VAC, supply voltage 100 to 240 VAC

IP66 front face

ACCURACY ± 1unit 0,25% of the range



Depth : 100mm.

P/N.

P/N.	Input	Temp. range* (°C)	Alarms Configurable	Weight (kg)
30856-51	Configurable	-200/+1373	3	0,6
30856-61	T/C J	0 / +761	3	0,4
30856-62	T/C K	-200 / +1373	3	0,4
30856-63	PT 100	0 / +800	3	0,4
30880-91	Analogue card for measurement repeater			

Temperature range can be altered by rekeying

48 x 48 PID TEMPERATURE CONTROLLER

Programmer with the same control characteristics as the 30656 models. Memory capacity for four programs of 16 chainable subroutines. Programming by speed or by time, in hours / minutes or minutes / seconds. Delayed start function. Program cycles can be set from 1 to 9999. Weight : 0,2 kg

Voltage: 100 to 240 VAC IP66



Depth : 110mm.

P/N.

P/N.	Input	Temp. range* (°C)	Control output	Output 2	Output 3
30635-01	PT 100	0/+800	Relay	Alarm	Alarm
30635-02	PT 100	0/+800	Logic	Alarm	Alarm
30635-13	TC/J	0/761	Relay	Alarm	Alarm
30635-15	TC/J	0/761	Logic	Alarm	Alarm
30635-21	TC K	-20/+1371	Relay	Alarm	Alarm
30635-23	TC K	-20/+1371	Logic	Alarm	Alarm

Temperature range can be altered by rekeying

IP65 PROTECTIVE FRONT FACES FOR CONTROLLERS and ADAPTOR PLATES

IP 65 front faces for 48x48 and 48x96 controllers and 96x48 indicators. These panels have transparent hinges and covers and allow upgrading to IP65 of any appliance which fits a standard aperture of 45 x 45 (for 48 x 48 models) or 45 x 92 (for 48 x 96 models).

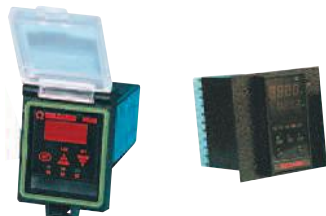

P/N.

P/N.	Purpose	Original fitting	Controller format
34848-99	protection		48x48
34896-99	protection		48x96
34896-48	adaptor	48x96 --->	48x48
39696-48	adaptor	96x96 --->	48x48
39696-96	adaptor	96x96 --->	48x96

CONNECTION PRINCIPLE FOR SOLID STATE RELAYS

Nominal powers given in the table are valid for an ambient temperature of 45°C max. They take into account the power accuracy of heating elements and variations in power supply voltage.

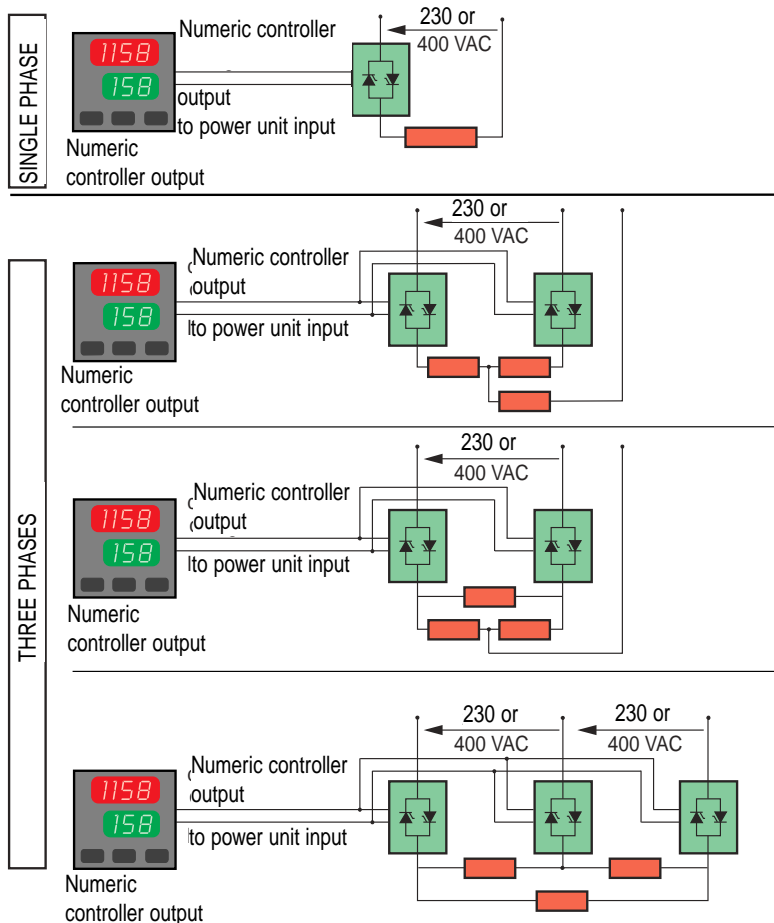

	Max. current UP	Nominal power	
		Single phase	Three phase
115 V	15 A	1,4 kW	2,5 kW
	25 A	2,4 kW	4,1 kW
	45 A	4,3 kW	7,5 kW
	75 A	7,2 kW	12,4 kW
	125 A	12,0 kW	20,7 kW
	200 A	19,2 kW	33,2 kW
	275 A	26,4 kW	45,6 kW
	400 A	38,3 kW	66,3 kW
230 V	15 A	3,0 kW	5,0 kW
	25 A	5,0 kW	8,3 kW
	45 A	8,6 kW	14,9 kW
	75 A	14,4 kW	24,9 kW
	125 A	24,0 kW	41,5 kW
	200 A	38,3 kW	66,3 kW
	275 A	52,7 kW	91,2 kW
	400 A	76,7 kW	132,7 kW
400 V	15 A	5,0 kW	8,6 kW
	25 A	8,3 kW	14,3 kW
	45 A	15,0 kW	25,7 kW
	75 A	25,0 kW	43,0 kW
	125 A	41,7 kW	72,0 kW
	200 A	66,7 kW	115,0 kW
	275 A	91,7 kW	158,0 kW
	400 A	133,3 kW	230,0 kW
500 A	166,7 kW	288,0 kW	

15, 25 and 45 A SINGLE PHASE SOLID STATE RELAYS

Single phase thyristor power units designed to drive resistive loads of up to 45 A.

A range of compact appliances meeting present-day industry requirements, fitting to symmetrical DIN rail. Much better suited than contactors to drive electric heaters, power units have no moving parts, no wear, and no maintenance; they have a higher switching rate, allowing better control of the output power.

Steering signal : 0/4 to 0/30VDC numeric input from a controller with numeric output.

Operating principle: pulse control. The thyristors start conducting when the voltage is 0V and stop when current is at zero (no interference).

Thyristor protection by RC circuit + varistor and ultra-fast fuse supplied.

Operating voltage :40 to 440VAC at 47 to 70 Hz.

A 24 V generator is needed to polarise the steering signal for power units with 4/20 mA analogic input.



Steering signal: 0/4 to 30 VDC numeric input, to be driven by a controller with numeric output, for single and three phase use.

P/N.	Max. current	L (mm)
30330-15	15 A	30
30330-25	25 A	30
30330-45	45 A	52

Pack of 5 spare ultra-fast fuses

P/N.	Current
30330-97	15 A
30330-98	25 A
30330-99	45 A

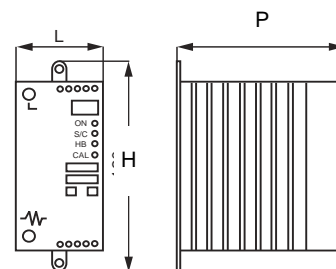

Steering signal: 4/20 mA analogic input from a controller with 4/20 mA output,

for breaking off only 1 phase

P/N.	Max. current	L/H/P (mm)
30330-65	15 A	52x120x120
30330-75	25 A	52x120x120
30330-95	45 A	52x120x120

For breaking off 2 phases

P/N.	Max. current	L/H/P (mm)
30330-66	15 A	95x120x120
30330-76	25 A	95x120x120
30330-86	35 A	148x120x123
30330-96	45 A	148x120x159

For breaking off 3 phases

P/N.	Max. current	L/H/P (mm)
30330-67	15 A	123x120x120
30330-77	30 A	148x120x123
30330-87	45 A	148x138x123

THREE PHASE STATIC POWER UNITS FROM 75 à 500 A

These are thyristorized units capable of controlling 3-phase resistive load current levels according to a numeric input (0/5 à 0/30 VDC) or analogic input (0/10 VDC - 4/20 mA - 0/2,2 kohms), of a regulator.

Attaching to the back of the panel at a maximum temperature of 45°C.

Conduction by wave trains with energising at zero voltage and deenergizing at zero current without interference.

Load voltage : 24 à 440 VAC maxi.

These units have forced ventilation and a control card requiring a 230VAC single phase auxiliary power supply.

All the equipment is supplied with integrated ultrafast fuses.

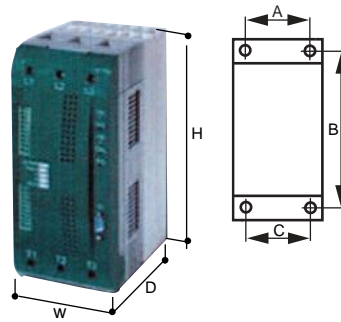

	Fixing distant		
	A	B	C
75A et 125A	96	290	104
200A	60	335	60
275A à 500A	222	495	222

Models equipped with load monitoring come with an integrated current sensor. They trip a contact in the event of an anomaly affecting a fuse, thyristor, phase, load.

P/N. with logic input	P/N. with configurable analogue input and load monitoring	I max	P.Nominal at 400 V 3P at 45°C	Size H x W x D (mm)	Weight (kg)
30250-01	30250-41	75 A	43 kW	316 x 116 x 187	5
30250-02	30250-42	125 A	72 kW	316 x 116 x 187	5
30250-03	30250-43	200 A	115 kW	350 x 116 x 220	6,5
30250-04	30250-44	275 A	158 kW	520 x 262 x 270	15
30250-05	30250-45	400 A	230 kW	520 x 262 x 270	15
30250-06	30250-46	500 A	288 kW	520 x 262 x 270	15

Ultra fast spare fuses for power units : (bag of two)

P/N.	I max (A)	For P/N
30251-01	120	30250-x1
30251-02	200	30250-x2
30251-03	315	30250-x3
30251-04	315	30250-x4
30251-05	550	30250-x5
30251-06	315x2	30250-x6

If you need a power input with an analog input without load monitoring, order a logic input family unit and a signal converter reference. P/N. 30290-01

ELECTROMECHANICAL POWER PROPORTION DEVICES

This device operates by the successive opening and closing of the power supply circuit with a period of around 20 seconds and a psychic ratio that is adjustable by a knob graduated from 0 to 100%. 230VAC single phase

Power supply $\pm 10\%$ (2800 W maximum on resistive load) with voltage output and terminals for the connection of a display indicator light.

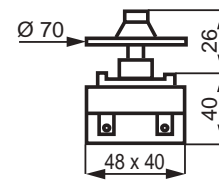

Bare model
P/N. 9014-01
(weight 0,11 kg).

Fig. A

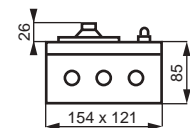

Model P/N.9014-02 • in protected case of aluminium alloy with the same properties as shown in A. fitted with switch and indicator light displaying the power supply of the load (weight 1kg).

ELECTRONIC POWER PROPORTIONER AND CONVERTER

The power proportioner P/N. 30290-03 is capable of controlling any type of static power unit of prosthetic relayed by means of a 0/100% potentiometer.

Output signal : logic 0/10 VDC.

Power supply : 240 VAC.



The signal converter P/N. 30290-01 using an analog signal (4/20mA, 0.20VDC, 0/10VDC, 2,2k Ω), can generate a logic signal with a variable cyclic ratio of 0 to 100% to control power units or static relays.

Output signal : 0/10 VDC logic

Power supply : 240 VAC.

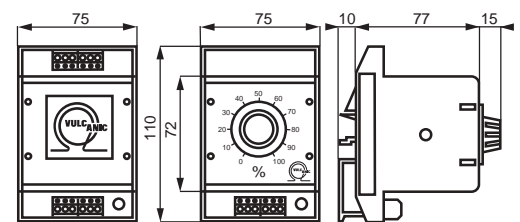

Power supply voltage : 240 VAC +10% -15% 50/60 Hz.

P/N.	Model
30290-03	Power proportioner
30290-01	Converter

READY TO USE POWER SUPPLY AND CONTROL UNITS

Why reinvent something that VULCANIC, the specialist, has already designed? Why design and build when VULCANIC has already done it for you. You save time and money, and you get a guaranteed result. Our power supply and control units are easy to install, quick to commission, and perfectly suited to our heating systems. Don't hesitate : choose the appliance which suits your installation – a few datas are enough to choose the right model :

- Supply voltage
- Power to be delivered
- Control mode: ON/OFF or PID
- Power supply device: contactor or PU (power unit: silent, and better suited to heating elements).
- Number of outputs : number of appliances to be connected in parallel. Delivered with drawing and usual manual

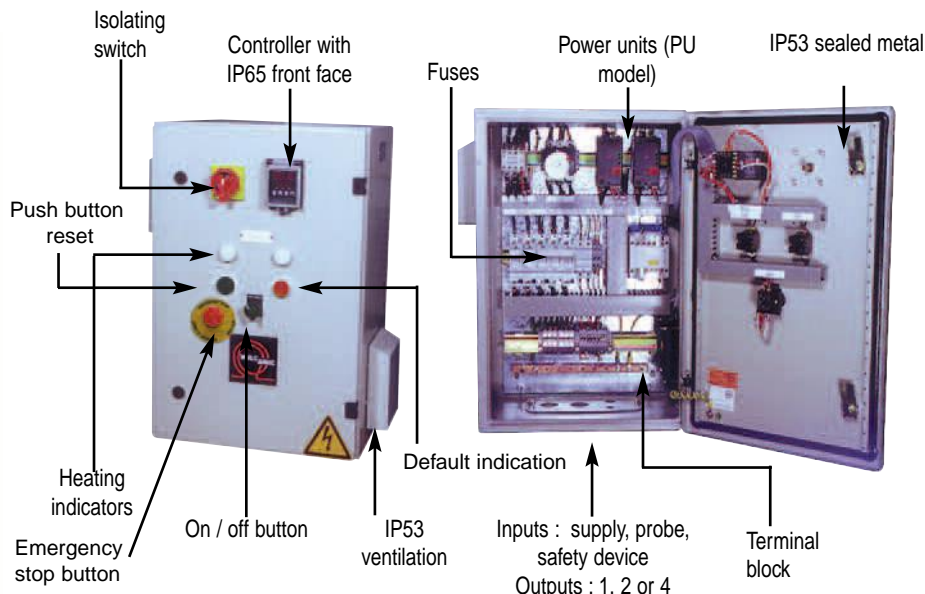

CONTROL UNITS CUSTOMIZED

VULCANIC offers you, at a very competitive price, a number of standard control units, some of which are available on stock within 24 hours. If in spite of everything you can't find the unit which suits your application in the following pages, describe it using the adjacent form and send the details to our control specialist, who will do the calculations.

Use:
Power: kW - **Voltage:** V single / three phases – **Number of control zones:** 1 / 2 / 3 / 4 and more
Control mode: on/off / PID / programmer - **Input:** Pt100 / J-type thermocouple / K-type thermocouple / current / voltage
Power supply device : Contactor / Power unit – **Number of outputs:** 1 / 2 / 3 / 4 and more.
Connected to a motor-pump or motor-fan unit: yes / no
-> Power: kW - **Voltage:** V single / three phases
Labelling and documentation in: French / English / German

CONTROL UNITS, PID 200W / 230V SINGLE PHASE/ 1A

Ready-to-use units for power supply and temperature control silicone heating panels, flexible heating elements, cartridge heaters, etc. These units are supplied in an IP53 metal box for wall mounting. They include a controller with IP65 front face, an on / off button with integral indicator light and load protection by fuse. Heating elements and probe are connected to a terminal block. Glands supplied.



Dimensions (mm): L =200- H = 250 - D = 136.

P/N.	Input	Controller	Temp range
32032-11	Pt100	PID	0/+300°C
32032-12	TC/J	PID	0/+450°C
32032-13	TC/K	PID	0/+1200°C

CONTROL UNITS, 3 AND 5 KW / 230V SINGLE PHASE

Ready-to-use units for power supply and temperature control silicone heating panels, flexible heating elements, cartridge heaters, etc. These units are supplied in an IP55 polyamid box. They are equipped with an auto-adaptive PID controller type 30656 class 0.2 with a alarm available, a remote controle and have 2 terminals for external safety circuit



These units are supplied in an IP55 metal box for wall mounting. They include a controller with IP65 front face, an on / off button with integral indicator light and load protection by fuse. Heating elements and probe are connected to a terminal block. Glands supplied. The simple control unit have 2 terminals for external safety circuit.

The control unit with integral safety temperature cut-out have 2 terminals for external safety circuit, and a safety temperature cut-out (K-type thermocouple input) to protect the heating elements from damage due to overheating.

Dimensions (mm): L = 400 - H = 400 - D = 200.

Technical advice: Solid-state relay models are preferable.

P/N.	P max. (kW)	Input	Controller	Supply device	Temp. range
32045-20	3	TC/J	PID	UP SSR	0/+450°C
32045-21	3	TC/K	PID	UP SSR	0/+1200°C
32045-22	3	Pt100	PID	UP SSR	-50/+350°C
P/N.	P max. (kW)	Input	Controller	Supply device	Temp. range
32045-03	3	TC/J	PID	Solid-state relay	0/450°C
32045-12	3	Pt100	PID	Solid-state relay	0/300°C
32045-51	5	TC/J	ON/OFF	Contactor	0/450°C
32045-53	5	TC/J	PID	Solid-state relay	0/450°C
32045-61	5	Pt100	PID	Contactor	0/300°C
32045-62	5	Pt100	PID	Solid-state relay	0/300°C

WITH INTEGRAL SAFETY TEMPERATURE CUT-OUT

Only for heating systems fitted with a safety K-type thermocouple

P/N.	P max. (kW)	Input	Controller	Device	Temp. range
32045-54	5	TC/J	PID	Solid-state relay	0/450°C
32045-55	5	Pt100	PID	Solid-state relay	0/300°C

The model with a J-type thermocouple input can be reconfigured on plant to a K-type input.

THERMOSTAT CONTROL UNITS

Ready-to-use units for power supply and temperature control silicone heating panels, flexible heating elements, cartridge heaters, etc. These units are supplied in an IP55 metal box for wall mounting. They include front face an on / off button with integral indicator light and load protection by fuse. Heating elements are connected to a terminal block. Glands supplied.



P/N.	P max. (kW)	Voltage 3P	Supply device	Dimensions (mm)		
				Width	Height	Depth
32032-01	18	400	Contactor	300	400	200
32032-02	45	400	Contactor	400	400	200

CONTROL UNITS, 8,6 kW to 158 kW at 400V, 3 phases with controller

Control units for temperature control of circulation liquid heaters, immersion heaters, fan heaters and duct heaters. Metal IP53 case.

They comprise a controller with IP65 front face, an isolating switch + fuses + power supply device (and its safety device, if a static power unit) + on / off indication + heating indications + safety fuses + emergency stop button + red default indicator + reset push button.

2 terminals for external safety circuit.

External safety module on 2 inputs terminal.

Pre-set controller.

Heating elements and probe are connected to a terminal block. Cable entry to box via supplied glands.

PART NUMBERS			Max. Power	Voltage (V)	Controller	Supply device	Dimensions		
PT100	J-type T/C	K-type T/C					Width	Height	Depth
32065-05	32066-05	32067-05	8,6 kW	400 3 P	ON/OFF	Contactor	1	400	600 300
32065-07	32066-07	32067-07	8,6 kW	400 3 P	PID	Solid-state relay	1	400	600 300
32065-11	32066-11	32067-11	14,3 kW	400 3 P	ON/OFF	Contactor	1	400	600 300
32065-13	32066-13	32067-13	14,3 kW	400 3 P	PID	Solid-state relay	1	400	600 300
32065-14	32066-14	32067-14	14,3 kW	400 3 P	ON/OFF	Contactor	2	400	600 300
32065-16	32066-16	32067-16	14,3 kW	400 3 P	PID	Solid-state relay	2	400	600 300
32065-21	32066-21	32067-21	25,7 kW	400 3 P	ON/OFF	Contactor	1	400	600 300
32065-23	32066-23	32067-23	25,7 kW	400 3 P	PID	Solid-state relay	1	400	600 300
32065-24	32066-24	32067-25	25,7 kW	400 3 P	ON/OFF	Contactor	2	400	600 300
32065-26	32066-26	32067-26	25,7 kW	400 3 P	PID	Solid-state relay	2	400	600 300
32065-27	32066-27	32067-27	25,7 kW	400 3 P	ON/OFF	Contactor	4	600	800 300
32065-29	32066-29	32067-29	25,7 kW	400 3 P	PID	Solid-state relay	4	600	800 300
32065-41	32066-41	32067-41	43 kW	400 3 P	ON/OFF	Contactor	1	600	800 300
32065-43	32066-43	32067-43	43 kW	400 3 P	PID	Solid-state relay	1	600	800 300
32065-44	32066-44	32067-44	43 kW	400 3 P	ON/OFF	Contactor	2	600	800 300
32065-46	32066-46	32067-46	43 kW	400 3 P	PID	Solid-state relay	2	600	800 300
32065-47	32066-47	32067-47	43 kW	400 3 P	ON/OFF	Contactor	4	600	800 300
32065-49	32066-49	32067-49	43 kW	400 3 P	PID	Solid-state relay	4	600	800 300
32065-61	32066-61	32067-61	72 kW	400 3 P	ON/OFF	Contactor	1	600	800 300
32065-63	32066-63	32067-63	72 kW	400 3 P	PID	Solid-state relay	1	600	1200 300
32065-64	32066-64	32067-64	72 kW	400 3 P	ON/OFF	Contactor	2	600	800 300
32065-66	32066-66	32067-66	72 kW	400 3 P	PID	Solid-state relay	2	600	1200 300
32065-67	32066-67	32067-67	72 kW	400 3 P	ON/OFF	Contactor	4	600	1200 300
32065-69	32066-69	32067-69	72 kW	400 3 P	PID	Solid-state relay	4	600	1200 300
32065-91	32066-91	32067-91	115 kW	400 3 P	ON/OFF	Contactor	1	600	1200 300
32065-93	32066-93	32067-93	115 kW	400 3 P	PID	Solid-state relay	1	600	1200 300
32065-94	32066-94	32067-94	115 kW	400 3 P	ON/OFF	Contactor	2	600	1200 300
32065-96	32066-96	32067-96	115 kW	400 3 P	PID	Solid-state relay	2	600	1200 300
32065-97	32066-97	32067-97	115 kW	400 3 P	ON/OFF	Contactor	4	600	1200 300
32065-99	32066-99	32067-99	115 kW	400 3 P	PID	Solid-state relay	4	600	1200 300
32065-81	32066-81	32067-81	158 kW	400 3 P	PID	Solid-state relay	1	800	2000 400
32065-82	32066-82	32067-82	158 kW	400 3 P	PID	Solid-state relay	2	800	2000 400
32065-83	32066-83	32067-83	158 kW	400 3 P	PID	Solid-state relay	4	800	2000 400



Temperature ranges

Factory set, user-configurable

Input	Control mode	Range
PT100	ON/OFF	-50/150
PT100	PID	0/300
TC J	ON/OFF	0/400
TC J	PID	0/450
TC K	ON/OFF	0/800
TC K	PID	0/1371

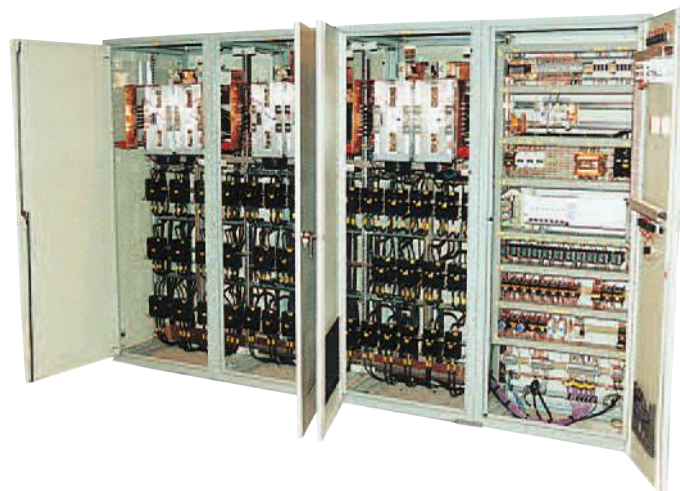

NICKEL-CHROME RESISTANCE WIRE

Resistive wires for making up wire-bare heating elements. They are generally used for making coil-wound heating elements and their resistivity of $1,08 \Omega \text{ mm}^2/\text{m}$ hardly changes at all with temperature. Their ends should be welded to steel or stainless steel pins which act as unheated conductors ; they can equally well be doubled and twisted.



These reference numbers are for 10m lengths.
Order x P/N. to receive x times 10 m of wire.

GLASS FIBRE SHEATHING

This sheathing is made of 1 or 2 overlapping layers, silicone treated to avoid fragility, and is suited for insulating conductors at an ambient temperature up to 250°C (300°C peak temperature).

P/N. P/N. 2510-01 is not silicone treated (.2513- XX is double thickness.)



STRANDED COPPER WIRE IN A GLASS FIBRE SHEATH

These conductors are made of small-diameter copper wires and are suited for connecting electrical heating elements at ambient temperatures up to 150°C (200°C peak temperature).



STRANDED NICKEL WIRE IN A GLASS FIBRE SHEATH

These conductors are made of 0,3 mm Ø pure nickel wires surrounded by an insulating sheath and are suited for connecting electrical heating elements at ambient temperatures up to 300°C (350°C peak temperature).



STRANDED NICKEL WIRE IN A KAPTON SHEATH

These conductors are made of 0,3 mm Ø pure nickel wires surrounded by an insulating sheath and are suited for connecting electrical heating elements at ambient temperatures up to 350°C (400°C peak temperature).



EYELET TERMINALS IN PURE NICKEL

Allow nickel or copper leads to be connected to threaded terminals at an ambient temperature up to 650°C. Fixing by brazing or crimping



STEATITE BEADS

Steatite beads allowing insulation of bare stranded ropes or under fibreglass insulator sheath or under kapton sheath, in 350 to 450°C environment.



To make an extension cord for infrared emitters type 6020, use the beads P/N 2530-03. A similar extension cord can be made up from beads P/N 2530-05 for ceramic insulated strip heaters type 4033.

CERAMIC TERMINALS

Enable the interconnection between two conductors (often inside protective boxes) at ambient temperatures up to 200°C. Bipolar models for single phase and tripolar models for 3 phases or single phase + earth.



P/N.	Wire Ø (mm)	Resistance Ω/m ±5%	Weight (kg)
4503-06	0,40	8,59	0,010
4503-07	0,50	5,5	0,016
4503-08	0,56	4,38	0,020
4503-09	0,63	3,46	0,026
4503-10	0,71	2,73	0,033
4503-11	0,80	2,15	0,042
4503-12	0,90	1,7	0,053
4503-13		11,36	0,065
4503-14	1,12	1,1	0,082
4503-15	1,25	0,88	0,102
4503-16	1,40	0,702	0,128
4503-17	1,60	0,537	0,167

P/N.	Inside Ø (mm)	Outside Ø (mm)	Length (m)	Weight (kg)
2510-01	1,5		1003	0,44
2511-01		3	50	0,088
2512-01		5	50	1,46
2513-01		80	50	0,86
2513-02	12	14	20	1,20

P/N.	Section (mm ²)	Outside Ø wire (mm)	Inside Ø sheath (mm)	Roll length (m)	I _{max} at 80°C (A)	Weight (kg)
2520-03	0,5	0,9	2,1	20	3,5	0,20
2520-05	0,75	1,2	2,3	20		0,246
2520-01	1,5	1,6	2,7	20	12	0,39
2520-04	2,5		2,3,2	20	16	0,59
2521-01		42,6		20 4	20	1,01
2521-02		63,6	4,8	20	27	1,30

P/N.	Section (mm ²)	Outside Ø wire (mm)	Inside Ø sheath (mm)	Roll length (m)	I _{max} at 80°C (A)	Weight (kg)
2525-01	0,42	0,9	1,5	20	3,9	0,20
2525-02	0,75	1,2	2,6	20		0,277
2526-01	1,5	1,6	2,9	20	11	0,40
2526-02	2,5	2,0	3,4	20	15	0,60
2526-03		4 2,6	4,2	20	22	0,90

P/N.	Section (mm ²)	Outside Ø wire (mm)	Inside Ø sheath (mm)	Roll length (m)	I _{max} at 80°C (A)	Weight (kg)
2527-01	2,5		2,52	20	15	0,625
2527-02		4 2,6		20	22	1,060

P/N.	Terminal Ø (mm)	Section (mm ²)	Pack of	Weight (kg)
55340-10		1,25 à 2,5	10	0,012
55341-10		1,25 à 2,5	10	0,016
55342-10		3 à 6	10	0,015
55343-10		3 à 6	10	0,020

P/N.	Ø inner (mm)	Ø outer (mm)	Length unit. (mm)	Nb of beads per m.	Nb of beads per packet	Weight (kg)
2530-01		1		390	4000	0,3 3
2530-02	1,5		4	280	3300	0,3
2530-03	2,2		5	260	3750	0,6
2530-04	3,2	6,5		260	2460	0,6
2530-05	3,8		7,7	200	2500	1
2530-06	4,7	8,5	9,5	150	1600	1
2530-07	6,7	10,5		940	1150	1

P/N.	Type (mm)	Dimensions (mm ²)	Section (mm)	Ø max (A)	Packaging	Weight (kg)
52486-10	2 poles	24x21x17	4	10	par 10 p.	0,16
52487-10	3 poles	35x21x17	4	10	par 10 p.	0,21
52488-05	2 poles	35x30x23	10	30	par 5 p.	0,24
52489-05	3 poles	51x30x23	10	30	par 5 p.	0,37

TEMPERATURE CONTROL UNITS

VULCATHERM®

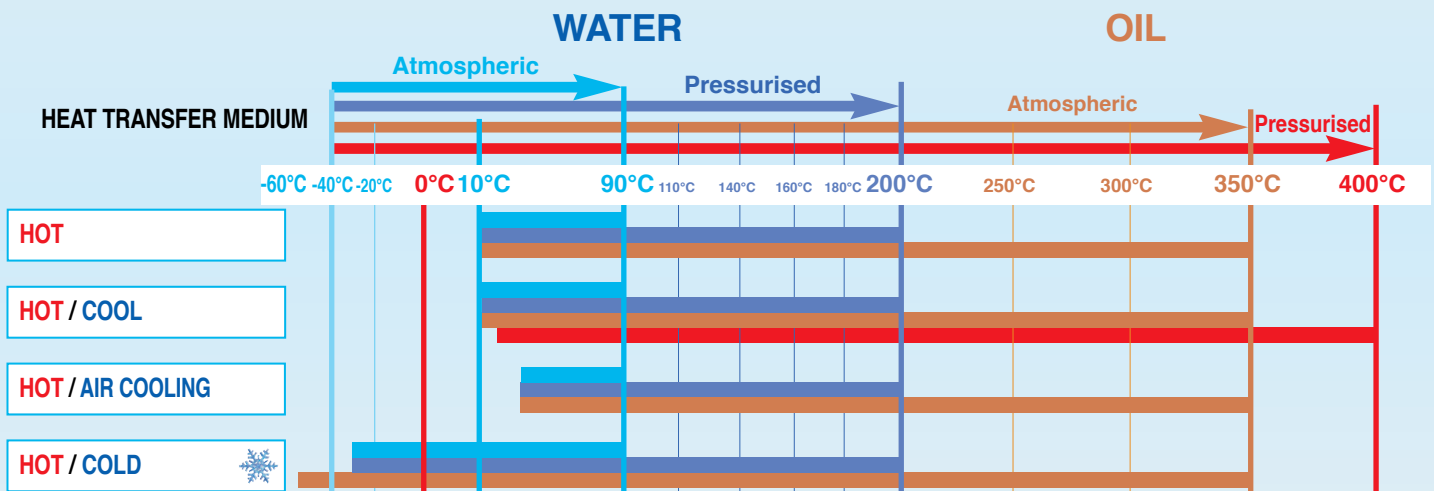

Sensors on heating elements guarantee long life service and performance of fluids

Lowest inertia for quick response time



Installation in ATEX Area see on page 144

High-energy efficiency and accurate temperature control with central management system (C.M.S/SGC)

Cooling control by Solenoid valve on/off or proportional

Easy opening and reduced maintenance



Heating control by 100% thyristor units or step control (combination of relays and thyristors)

Remote control with analogical or numerical signals (RS, IP)

ATMOSPHERIC : WATER 90°C MAX

Vulcatherm® HOT

Heat, cool and control a closed fluid loop (hot water 90°C maxi)

10811

Atmospheric
in closed loop

Money saving - Heavy duty
Reduced maintenance

Applications :

- Elastomer moulding
- Polymer moulding
- Thermoforming
- Thermo-compression
- Tracing...



Characteristics :

- 1 electrical heater with temperature sensors
- 1 pump
- 1 atmospheric expansion tank
- 1 electrical cabinet with integrated central management system (CMS/SGC ECO)
- Sensors for control and safety
- Painted frame equipped with castors

Features :

- Automatic filling by water network supply
- Automatic air bleeding
- Electrical supply 400VAC 3 Phases + E

Layout

Vulcatherm® HOT / COLD

Heat, cool and control a closed fluid loop (hot water 90°C maxi).
Hot water in process is cooled by heat exchanger connector to industrial water network.

10800

Atmospheric
in open loop

Money saving - Heavy duty
Stable control

Applications :

- Process with high frequency tools rotation
- Process with vacuum system
- Extrusion and injection of polymers...



Characteristics :

- 1 electrical heater
- 1 heat exchanger (for cooling)
- 1 immersible pump
- 1 atmospheric tank
- 1 electrical cabinet with integrated controller
- Sensors for control and safety
- Painted frame equipped with castors

Features :

- Automatic filling by water network supply
- Self priming and automatic air bleeding
- Electrical supply 400VAC 3 Phases + E

10801

Atmospheric
in closed loop

Accurate - Fast
Reduced maintenance

Applications :

- Elastomer moulding
- Polymer moulding
- Injection, extrusion
- Heating jacket
- Tracing...



Characteristics :

- 1 electrical heater with temperature sensors
- 1 heat exchanger (for cooling)
- 1 pump
- 1 atmospheric expansion tank
- 1 electrical cabinet with integrated central management system (CMS/SGC ECO)
- Sensors for control and safety
- Painted frame equipped with castors

Features :

- Automatic filling by water network supply
- Automatic air bleeding
- Electrical supply 400VAC 3 Phases + E

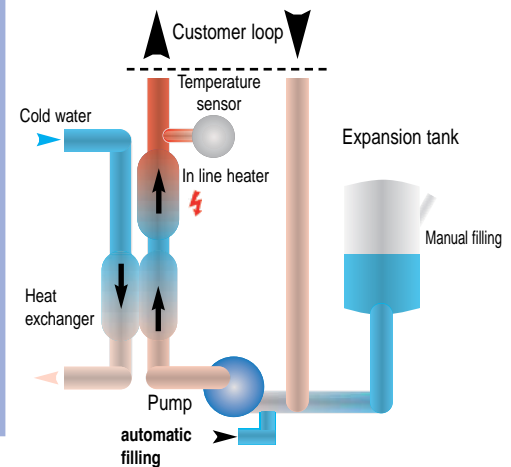
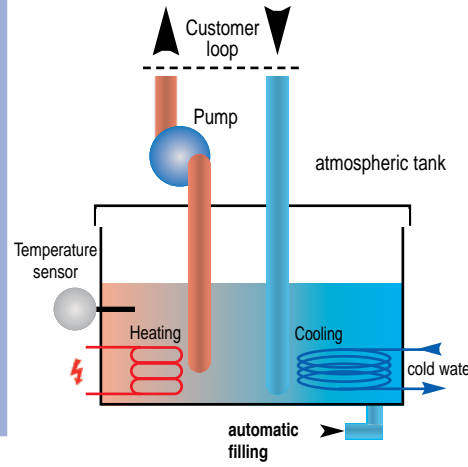
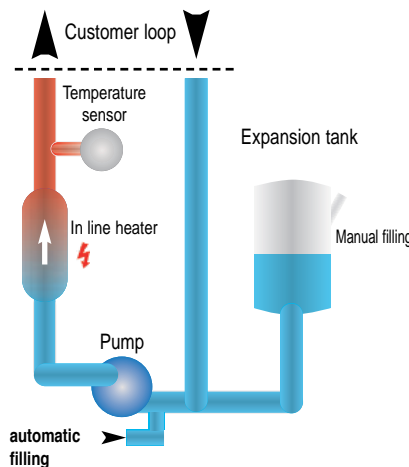

VULCATHERM®					HOT		HOT / COLD		
Heating temperature up to					90°C		90°C		
Maximum pressure allowed in the circuit					10 bar		8 bar (10800) 10 bar (10801)		
Δt between the thermal fluid and cooling water					-		Δt = 65°C Maxi		
Heating Power +5/-10% (kW)	Nominal Flow (m³/h)	Δp Maxi (bar)	Expansion volume V (litre)	Dimensions L x H x P (mm)	Weight (kg)	REF.	Cooling power (kW)	Weight (kg)	REF.
3,3	0,5	2	3,7	340 x 580 x 680	55	10811-03	10	60	10801-03
6	0,9	3	3,7	340 x 580 x 680	55	10811-06	16	60	10801-06
6	2,4	3	4	340 x 600 x 650	60	-	16	60	10800-06
9	2,4	3	4	340 x 600 x 650	60	-	18	60	10800-09
10	1,5	3	3,7	340 x 580 x 680	55	10811-10	18	60	10801-10
14	2,1	3	10	400 x 780 x 860	80	10811-14	45	85	10801-14
20	3	3	10	400 x 780 x 860	150	10811-20	60	120	10801-20
30	4,5	3	19	500 x 1180 x 950	200	10811-30	90	210	10801-30
40	6	3	19	500 x 1180 x 950	200	10811-40	120	210	10801-40
60	9	3	28	600 x 1600 x 1000	240	10811-60	180	210	10801-60

Customised solutions :

- Power : 75 up to 245 kW
- Centrifugal pump with magnetic seal
- Pump with high flow rate
- See all options on page 144



TEMPERATURE CONTROL UNITS VULCATHERM® WATER MEDIUM

ATMOSPHERIC : WATER 90°C MAX Vulcatherm® HOT / AIR COOLED 10831

Atmospheric
in closed loop

High performance - Compact - Accurate
Fast - Reduced maintenance

Heat, cool and control a water closed loop from 40°C to 90°C. Hot water in process is cooled through an air exchanger + fan.
Fully available and designed for process without water supply.



Applications :

- Elastomer moulding
- Polymer moulding
- Injection, extrusion
- Heating jacket
- Tracing ...

Features :

- Water loop
- Electrical supply 400VAC 3 Phases + N + E

Characteristics:

- 1 electrical heater with sensor
- 1 air exchanger (air 32°C maxi)
- 1 pump
- 1 atmospheric expansion tank
- 1 central management system (CMS/SGC ECO)
- Sensors for control and safety
- Painted frame equipped with castors

VULCATHERM®					HOT / AIR COOLED		
Heating temperature up to					90°C		
Maximum pressure allowed in the circuit					10 bar		
Heating Power +5/-10% (kW)	Nominal Flow (m³/h)	Δp Maxi (bar)	Expansion Volume V (litre)	Dimensions L x H x P (mm)	Cooling Power (kW)	Δt Maxi (°C)	REF.
4	0,5		3 3,8	400 x 980 x 860	10	68	10831-04
6	0,9		3 3,8	400 x 980 x 860	10	68	10831-06
10	1,5		3 3,8	400 x 980 x 860	10	68	10831-10
14	2,1		3 10	800 x 1200 x 800	20	68	10831-14
20	3		3 14	800 x 1200 x 800	20	68	10831-20
30	4,5		3 14	950 x 1660 x 900	50	68	10831-30
40	6		3 14	950 x 1660 x 900	50	68	10831-40
60	9	3	21	1000 x 2050 x 1600	100	68	10831-60

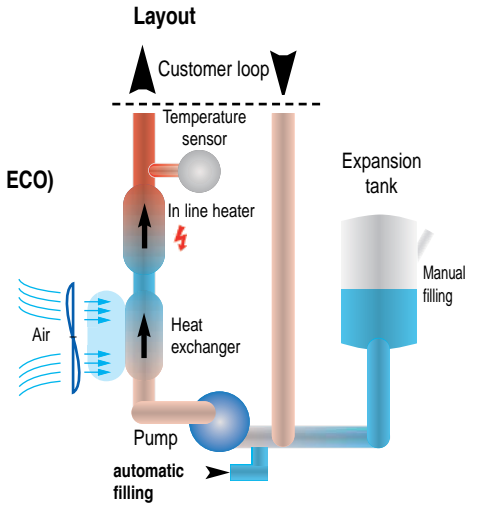

Customised solutions :

- Power : 75 up to 245 kW
- Centrifugal pump with magnetic seal
- Pump with high flow rate
- See all options on page 144

Vulcatherm® HOT / COLD 10821 ❄️

Atmospheric
in closed loop

High performance - Compact - Accurate
Fast - Reduced maintenance

Heat, cool and control a water + glycol loop from -20°C to 90°C. Hot water in process is cooled by integrated refrigerating unit.

Applications :

- Process with a wide temperature range
- Crystallizer
- Chemical reactor
- Climatic chamber
- Test benches

Characteristics :

- 1 electrical heaters with sensor
- 1 evaporator exchanger
- 1 condenser water cooled
- 1 pump
- 1 refrigerating compressor
- Electronic expansion valve
- 1 atmospheric expansion tank
- 1 central management system (CMS/SGC V2)
- Sensors for control and safety
- Painted frame equipped with castors

Type Air
Condenser
Ref. 10841-xx

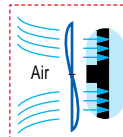

Type Water
Condenser
Ref. 10821-xx

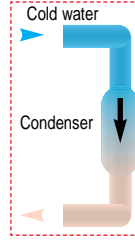

Layout

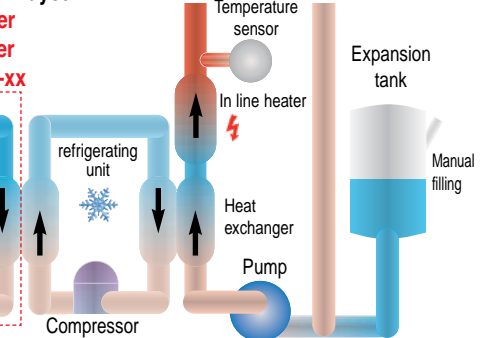

Water + glycol -20 to 90°C

VULCATHERM®					HOT / COLD			
Maximum pressure allowed in the circuit					10 bar			
Heating Power +5/-10% (kW)	Nominal Flow (m³/h)	Δp Maxi (bar)	Expansion Volume V (litre)	Dimensions L x H x P (mm)	Cooling power (kW)			REF.
					-20°C	-10°C	0°C	
4	0,5		2 3,8	800 x 1200 x 800	-	1,3	2	10821-01
4	0,5		3 3,8	800 x 1200 x 800	-	2,6	4	10821-03
6	0,9		3 3,8	800 x 1200 x 800	-	3,8	6	10821-05
10	1,5		3 3,8	800 x 1200 x 800	-	6,4	10	10821-09
20		3	14 3	800 x 1200 x 800	-	12,8	20	10821-19
4	0,5		3 3,8	800 x 1200 x 800	0,7	1,3	2	10821-02
4	0,5		3 3,8	800 x 1200 x 800	1,4	2,6	4	10821-04
6	0,9		3 3,8	800 x 1200 x 800	2,1	3,8	6	10821-06
10	1,5		3 3,8	800 x 1200 x 800	3,5	6,4	10	10821-10
20		3	14 3	800 x 1200 x 800	7	12,8	20	10821-20



Features :

- Water + glycol loop
- Manual filling
- Condenser cooled by industrial water network.
- Electrical supply 400VAC 3 Phases + E

Customised solutions :

- Power up to 125 kW hot / 80kW cold.
- Wide temperature range up to -30°C
- See all options on page 144
- Pressurised expansion tank (see next 10826 p.139)
- Air condenser (32°C maxi) with helicoid or centrifugal fan

PRESSURISED WITH EXPANSION IN WATER NETWORK : WATER 90°C MAXI

Vulcatherm® HOT

10814

*Pressurisation and expansion
in customer water network*

*Money saving - Compact
Reduced maintenance*

Vulcatherm® HOT / COLD

10804

*Pressurisation and expansion
in customer water network*

*Money saving
Compact - Accurate*

FOR TOOLS WORKING UNDER PRESSURE

Heat and control a water closed loop (water 90°C maxi).

Applications :

- Elasmoter moulding
- Polymer moulding
- Thermoforming
- Thermo-compression
- Tracing ...

Characteristics :

- 1 electrical heater
- 1 pump
- 1 electrical cabinet with integrated PID controller
- Sensors for control and safety
- Painted frame equipped with castors

Features :

- Automatic filling by water network
- Automatic air bleeding
- Electrical supply 400VAC 3 Phases + E
- Connection to pressurised water network can be achieved via our ref **10804-99** supplied as an option



Heat and control a closed water loop (hot water 90°C maxi). Hot water in process is cooled by an exchanger connected to water network supply.

Applications :

- Elasmoter moulding
- Polymer moulding
- Thermoforming
- Tools working under pressure ...

Characteristics :

- 1 electrical heater
- 1 exchanger hot cold (water / water)
- 1 pump
- 1 electrical cabinet with integrated PID controller
- Sensors for control and safety
- Painted frame equipped with castors



Features :

- Automatic filling by water network
- Automatic air bleeding
- Electrical supply 400VAC 3 Phases + E
- Connection to pressurised water network can be achieved via our ref **10804-99** supplied as an option

Layout

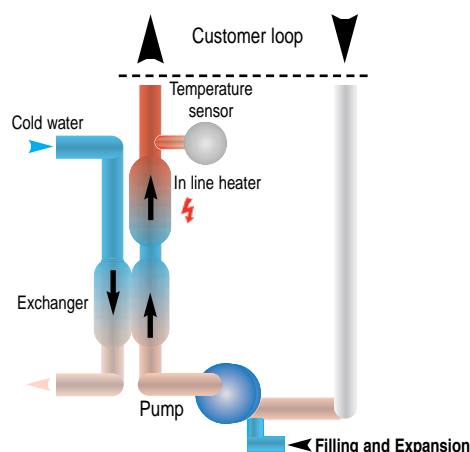
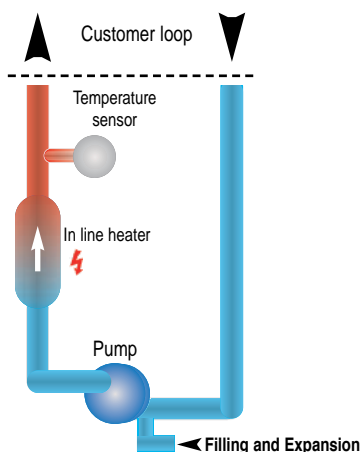

VULCATHERM®				HOT		HOT / COOL			
Heating temperature up to				90°C		90°C			
Maximum pressure allowed in the circuit				12 bar		12 bar			
Heating Power +5/-10% (kW)	Nominal Flow (m³/h)	Δp Maxi (bar)	Dimensions L x H x P (mm)	Weight (kg)	REF.	Cooling Power (kW)	Δt Maxi (°C)	Weight (kg)	REF.
3,3	0,5		2 300 x 500 x 570	40	10814-03	10	65	40	10804-03
6	0,9		3 300 x 500 x 570	40	10814-06	16	65	40	10804-06
10	1,5		3 300 x 500 x 570	40	10814-10	18	65	40	10804-10

Customised solutions :

- Remote control
- Temperature measurement by external sensor

- Stainless steel box
- All options on page 144

PRESSURISED AND EXPANSION CONTROL : WATER 110°C AND 140°C MAXI

Vulcatherm® HOT

10815
10812

Pressurisation and expansion
in customer water network

Money saving - High
performance - Heavy duty

Heat and control a closed water loop (hot water up to 140°C).

Applications :

- Autoclave, steriliser
- Mixer, melter ...
- Tools available to work under pressure 3 to 6 bar mini

Characteristics :

- 1 electrical heater with sensor
- 1 accumulator for expansion
- 1 centrifugal pump • 1 pressure reducer
- 1 safety valve (3 up to 7 bar)
- 1 electrical cabinet with integrated central management system (CMS/SGC ECO)
- Sensors for control and safety



Features :

- Automatic filling and pressurisation by customer water network (mini 1 bar)
- Electrical supply 400VAC 3 Phases + E

Vulcatherm® HOT / COLD

10805
10802

Pressurisation and expansion
in customer water network

Money saving - High
performance - Heavy duty

Heat and control a closed water loop (hot water up to 140°C). Hot water in process is cooled by a heat exchanger connected to water network supply.

Applications :

- Elastomer moulding
- Polymer moulding
- Thermoforming
- Tools available to work under pressure from 3 to 6 bar mini

Characteristics :

- 1 electrical heater with sensor
- 1 accumulator (for expansion)
- 1 exchanger hot/cold or direct injection (see table below)
- 1 pump • 1 pressure reducer
- 1 safety valve (3 up to 7 bar)
- 1 electrical cabinet with integrated central management system (CMS/SGC ECO)
- Sensors for control and safety
- Painted frame equipped with castors



Features :

- Automatic filling and pressurisation on customer water network (mini 3 bar)
- Automatic air bleeding
- Electrical supply 400VAC 3 Phases + E

Layout

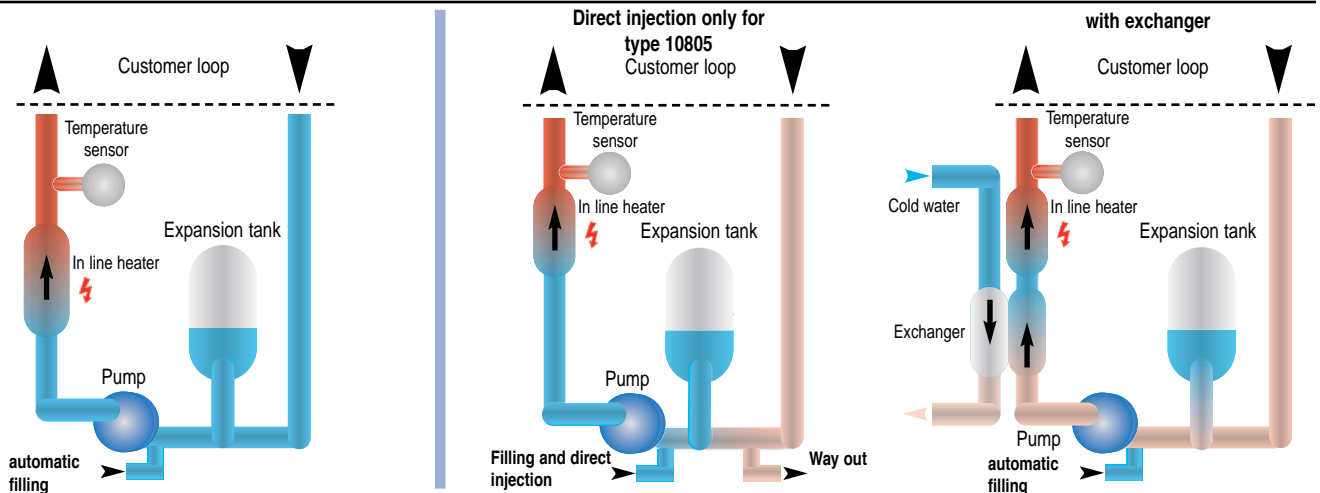

VULCATHERM®				HOT				HOT / COOL						
Maximum pressure in the circuit				12 bar				12 bar						
Cooling power according a Δt of				→				80°C			110°C			
Heating temperature up to				110°C		140°C		110°C			140°C			
Heating Power +5/-10%	Nominal Flow (m³/h)	Dimensions L x H x P (mm)	Weight (kg)	Δp Maxi (bar)	REF.	Δp Maxi (bar)	REF.	Cooling Power (kW)	Δp Maxi (bar)	REF. With exchanger	REF. Without exchanger (direct injection)	Cooling Power (kW)	Δp Maxi (bar)	REF.
3,3	0,5	340 x 580 x 680	70		-		-	10	2	10805-03	-	10	3	10802-03
3,3	0,5	340 x 580 x 680	70		-		-	10	3	-	10805-04			-
6	0,9	340 x 580 x 680	70		310815-06	3	10812-06	20	3	10805-06	10805-07	20	3	10802-06
10	1,5	340 x 580 x 680	70		310815-10	3	10812-10	22	3	10805-10	10805-11	22	3	10802-10
14	2,1	400 x 780 x 860	100		310815-14	3	10812-14	45	3	10805-14	10805-15	45	2	10802-14
20	3	400 x 780 x 860	100		310815-20		10812-20	60	3	10805-20	10805-21	60		10802-20
30	4,5	500 x 1320 x 950	170		310815-30			90	3	10805-30	10805-31			
40	6	500 x 1320 x 950	170		310815-40			120	3	10805-40	10805-41			
60	9	600 x 1600 x 1000	180	3	10815-60			180	3	10805-60	10805-61			

Customised solutions :

• Others power available from 75 up to 245 kW

• All options on page 144

ELECTRICAL PRESSURISATION AND EXPANSION : WATER 110°C, 140°C AND 160°C MAXI

Vulcatherm® **HOT**

10816

*Pressurisation and expansion
in customer water network*

*Money saving - Compact
Reduced maintenance*

Heat and control a closed water loop (hot water up to 110°C and over heated water up to 160°C maxi).

Applications :

- Autoclave, steriliser
- Mixer, melter...
- Tools available to work under pressure 3 to 6 bar mini

Characteristics:

- 1 electrical heater with sensor
- 1 pressurised tank
- 1 tank for filling and atmospheric expansion
- 2 pumps
- 1 solenoid valve for pressure reducing
- 1 safety valve
- 1 electrical cabinet with integrated central management (**CMS/SGC ECO**)
- Sensors for control and safety
- Painted frame equipped with castors

Features :

- Automatic filling by water network
- Pressurisation, expansion and automatic air bleeding
- Electrical supply 400VAC 3 Phases + E



Vulcatherm® **HOT / COLD**

10806

*Pressurisation and expansion
in customer water network*

*Money saving - Compact
Reduced maintenance*

Heat, cool and control a closed water loop (hot water). The closed water loop is cooled down in a exchanger working under the customer water network.

Applications :

- Elastomer moulding
- Polymer moulding
- Thermoforming
- Tools available to work under pressure 3 to 6 bar mini

Characteristics :

- 1 electrical heater with sensor
- 1 pressurised tank
- 1 exchanger hot cold (reverse counter current) or direct injection (see table below)
- 1 filling and expansion tank
- 2 pumps
- 2 solenoid valves with 1 for pressure reducing
- 1 safety valve
- 1 electrical cabinet with integrated central management (**CMS/SGC ECO**)
- Sensors for control and safety
- Painted frame equipped with castors

Features :

- Automatic filling by water network
- Pressurisation, expansion and automatic air bleeding
- Electrical supply 400VAC 3 Phases + E



Layout

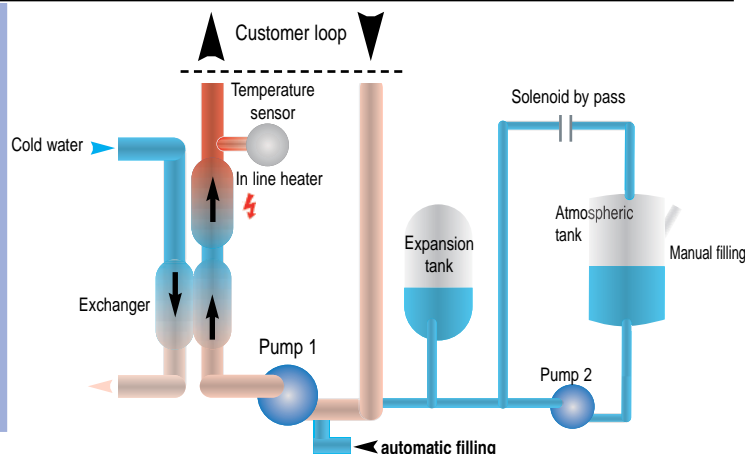
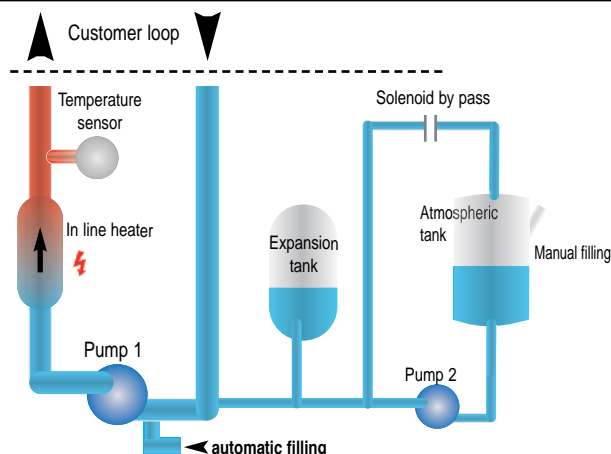

VULCATHERM®				HOT						HOT / COOL								
Maximum pressure in the circuit				12 bar						12 bar								
Cooling power for a Δt of				→						80°C			110°C			130°C		
Heating temperature up to				110°C / 1 bar		140°C / 3 bar		160°C / 6 bar		110°C / 1 bar			140°C / 3 bar			160°C / 6 bar		
Heating Power +5/-10%	Nom. Flow (m³/h)	Dimensions L x H x P (mm)	Weight (kg)	Δp Maxi (bar)	REF.	Δp Maxi (bar)	REF.	Δp Maxi (bar)	REF.	Cooling Power (kW)	Ap Maxi (bar)	REF.	Cooling Power (kW)	Ap Maxi (bar)	REF.	Cooling Power (kW)	Ap Maxi (bar)	REF.
4	0,5				--		--		-	10	3	10806-02	10	2,8	10806-03	10	3	10806-04
6	0,9	400 x 780 x 860	60		30816-05	3	10816-06	3	10816-07	20	3	10806-05	20	2,8	10806-06	20	3	10806-07
10	1,5	400 x 780 x 860	60		30816-09	3	10816-10	3	10816-11	22	3	10806-09	22	2,8	10806-10	22	3	10806-11
14	2,1	400 x 780 x 860	85		30816-13	3	10816-14	3	10816-15	45	3	10806-13	45	2,8	10806-14	45	3	10806-15
20	3	400 x 780 x 860	120		30816-19	3	10816-20	3	10816-21	60	3	10806-19	60	2,8	10806-20	60	3	10806-21
30	4,5	500 x 1320 x 950	210		30816-29	3	10816-30	3	10816-31	90	3	10806-29	90	2,8	10806-30	90	3	10806-31
40	6	500 x 1320 x 950	210		30816-39	3	10816-40	3	10816-41	120	3	10806-39	120	2,8	10806-40	120	3	10806-41
60	9	600 x 1600 x 1000	250	3	10816-59	3	10816-60	3	10816-61	180	3	10806-59	180	2,8	10806-60	180	3	10806-61

Dimensions = 400 x 780 x 860

Customised solutions : • Others power available from 75 up to 245 kW • Models 180°C and 200°C • See all options on page 144

ELECTRICAL PRESSURISATION AND EXPANSION : WATER 110°C AND 140°C MAXI

Vulcatherm® HOT / REFRIGERATED 10826 - 10846

Electrical pressurisation and expansion

High performance - Compact - Accurate
Fast - Reduced maintenance

Heat, cool and control a water + glycol closed loop from -20°C to +140°C. Process fluid cooled by evaporator connected to refrigerating unit.



Water condenser

Applications :

- Wide temperature range process
- Crystallizer
- Chemical reactor
- Climatic chamber
- Test benches

Features :

- Water + glycol loop
- Manual filling
- Condenser cooled by air or water
- Electrical supply 400VAC 3 Phases + E (+ Neutral for air condenser)

Characteristics :

- 1 electrical heater with sensor
- 1 evaporator
- 1 condenser cooled by air or water
- 2 pumps
- 1 pressurisation tank
- 1 compressor
- 1 electronic expansion valve
- 1 atmospheric expansion tank
- 1 electrical cabinet with integrated central management (CMS/SGC V2)
- Sensors for control and safety
- Painted frame equipped with castor



Air condenser

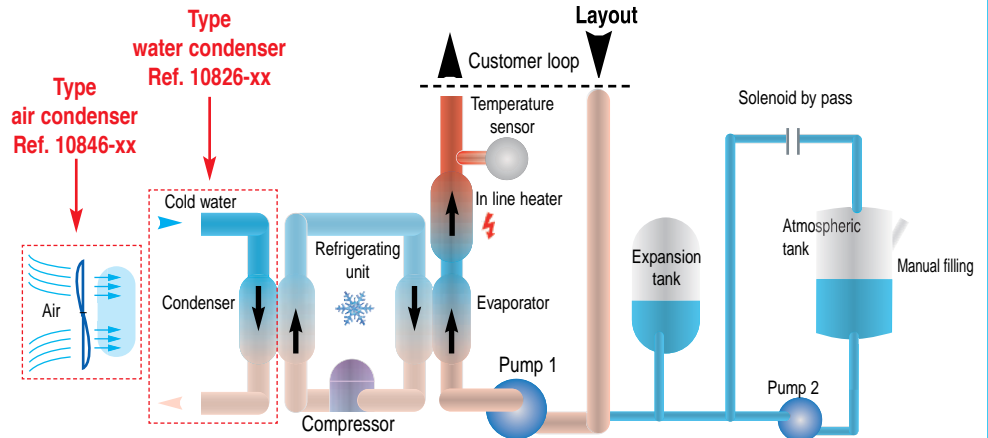

Water + glycol -20 to 140°C

VULCATHERM®				HOT / COLD WATER CONDENSER 25°C Maxi						
Maximum pressure allowed in the circuit				12 to 14 bar						
Heating temperature up to									110°C	140°C
Heating Power +5/-10% (kW)	Nominal Flow (m³/h)	Δp Maxi (bar)	Dimensions L x H x P (mm)	Cooling power (kW)					REF.	REF.
				-20°C	-10°C	0°C	+10°C	+20°C		
4	0,6	3	800 x 1200 x 800	1	2,4	4	6	8	10826-02	10826-03
6	0,9		800 x 1200 x 800	1,5	3,6	6	9	12	10826-05	10826-06
10	1,5		800 x 1200 x 800	2,5	6	10	15	20	10826-09	10826-10
14	2,1		950 x 1660 x 900	3,5	8,4	14	21	28	10826-13	10826-14
20	3		950x 1660 x 900	5	12	20	30	40	10826-19	10826-20
30	4,5	3	800 x 1730 x 1500	7,5	18	30	45	60	10826-29	10826-30
40	6		800 x 1730 x 1500	10	24	40	60	80	10826-39	10826-40
60	9		800x 1730 x 1800	15	36	60	90	120	10826-59	10826-60

VULCATHERM®				HOT / COLD CONDENSER A AIR 32°C Maxi						
Maximum pressure allowed in the circuit				12 to 14 bar						
Heating temperature up to									110°C	140°C
Heating Power +5/-10% (kW)	Nominal Flow (m³/h)	Δp Maxi (bar)	Dimensions L x H x P (mm)	Cooling power (kW)					REF.	REF.
				-20°C	-10°C	0°C	+10°C	+20°C		
4	0,6	3	800 x 1200 x 800	1	2,4	4	6	8	10846-02	10846-03
6	0,9		800 x 1200 x 800	1,5	3,6	6	9	12	10846-05	10846-06
10	1,5		950 x 1660 x 900	2,5	6	10	15	20	10846-09	10846-10
14	2,1		950 x 1660 x 900	3,5	8,4	14	21	28	10846-13	10846-14
20	3		950x 1660 x 900	5	12	20	30	40	10846-19	10846-20
30	4,5	3	1000 x 2050 x 1600	7,5	18	30	45	60	10846-29	10846-30
40	6		1000 x 2050 x 2300	10	24	40	60	80	10846-39	10846-40
60	9		1000 x 2050 x 3000	15	36	60	90	120	10846-59	10846-60

Customised solutions :
 • Others power available from 125 kW hot / 80kW cooling
 • Centrifugal fan
 • Temperatures available from -30°C up to +160°C
 • See all options on page 144

ELECTRICAL PRESSURISATION AND EXPANSION : WATER 110°C MAXI

Vulcatherm® HOT / AIR COOLING 10836

Electrical pressurisation
and expansion

High performance - Compact - Accurate - Fast
Wide temperature range - Reduced maintenance

Heat, cool and control a closed water loop from 40°C to 110°C. Hot process fluid is cooled through an air exchanger and a fan. **Designed for process without water supply**



Applications :

- Elastomer moulding
- Polymer moulding
- Injection, extrusion
- Jacket heat
- Tracing ...

Features :

- Water loop
- Electrical supply 400VAC 3 Phases + E

Characteristics :

- 1 electrical heater with temperature sensor
- 1 to 6 hot exchanger / air cold
- 1 to 3 helicoid fan
- 1 expansion tank
- 2 pumps
- 1 safety valve
- 1 electrical cabinet with integrated central management (CMS/SGC ECO)
- Sensors for control and safety
- Painted frame equipped with castors

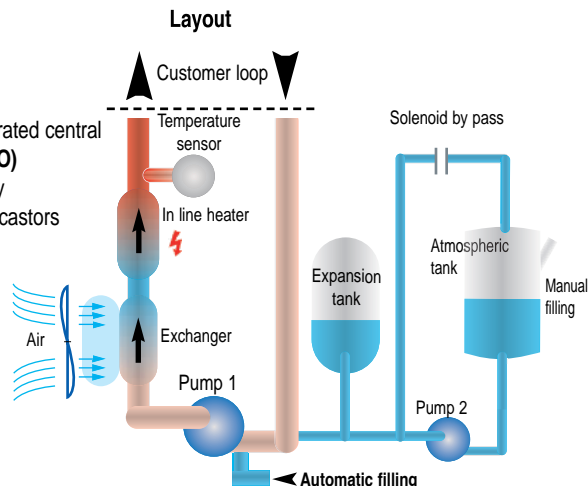

Customised solutions :

- Power : 75 up to 245 kW
- See all options on page 144

VULCATHERM®					HOT / AIR COOLING			
Heating temperature up to					110°C			
Maximum pressure allowed in the circuit					8 to 10 bar			
Heating Power +5/-10% (kW)	Nominal Flow (m³/h)	Δp Maxi (bar)	Expansion volume V (litre)	Dimensions L x H x P (mm)	Heating Power (kW)	Δt Maxi (°C)	Weight (kg)	REF.
4	0,5		2	400x 1000 x 860	10	68	110	10836-02
6	0,9		3	400x 1000 x 860	10	68	110	10836-05
10	1,5		3	400x 1000 x 860	10	68	115	10836-09
14	2,1		3	800x 1200 x 800	20	68	170	10836-13
20	3		3	800x 1200 x 800	20	68	170	10836-19
30	4,5		3	800x 1200 x 800	50	68	180	10836-29
40	6		3	800x 1200 x 800	50	68	180	10836-39
60	9	3	11	1000 x 2050 x 1600	100	68	230	10836-59

ELECTRICAL PRESSURISATION AND EXPANSION : WATER 160°C MAXI

Heat, cool and control a water + glycol closed loop from 40°C to 160°C. Hot process fluid is cooled through an air exchanger and a fan.

Designed for process without water supply.



Applications :

- Elastomer moulding
- Polymer moulding
- Injection, extrusion
- Jacket heat
- Tracing ...

Features :

- Water loop
- Electrical supply 400VAC 3 Phases + E

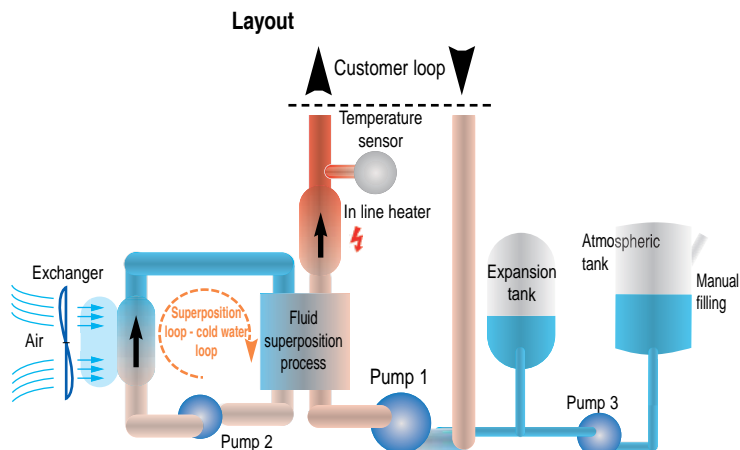

Characteristics :

- 1 electrical heater with sensor
- 1 tank for pressurisation
- 1 to 6 hot exchangers / air cold
- 1 to 3 helicoid fans
- 1 expansion tank
- 3 pumps + pressurisation + fluid superposition
- 1 solenoid valve
- 1 expansion valve
- 1 safety valve
- 1 electrical cabinet with integrated central management (CMS/SGC V3)
- Sensors for control and safety
- Painted frame equipped with castors

VULCATHERM®					HOT / AIR COOLING			
Heating temperature up to					160°C			
Maximum pressure allowed in the circuit					12 to 14 bar			
Heating Power +5/-10% (kW)	Nominal Flow (m³/h)	Δp Maxi (bar)	Expansion volume V (litre)	Dimensions L x H x P (mm)	Cooling Power (kW)	Δt Maxi (°C)	Weight (kg)	REF.
4	0,5		2 10	400 x 1000 x 860	10	68	130	10836-04
6	0,9		3 10	400 x 1000 x 860	10	68	130	10836-06
10	1,5		3 10	400 x 1000 x 860	10	68	135	10836-10
14	2,1		3 10	800 x 1200 x 800	20	68	200	10836-14
20	3		3 10	800 x 1200 x 800	20	68	200	10836-20
30	4,5		3 15	800 x 1200 x 800	50	68	210	10836-30
40	6		3 19	800 x 1200 x 800	50	68	210	10836-40
60	9	3	21	1000 x 2050 x 1600	100	68	240	10836-60

Customised solutions : • Power : 75 up to 245 kW • Temperature up to 180°C • Centrifugal fan • See all options on page 144

ATMOSPHERIC : OIL 180°C, 250°C AND 300°C MAXI

Vulcatherm® HOT 10813

Atmospheric closed loop

Money saving - High performance
Heavy duty - Reduced maintenance

Heat and control a thermal fluid closed loop (synthetic or mineral oil up to 300°C).

Applications :

- Industrial process with high temperature and low pressure
- Reactor
- Press moulding
- Composite moulding ...

Features :

- Mineral oil ISO32 up to 250°C
Synthetic oil up to 350°C
- Manual filling
- Electrical supply 400VAC 3 Phases + E

Characteristics :

- 1 electrical heater with sensor
- 1 exchanger
- 1 pump
- 1 electrical cabinet with integrated central management (CMS/SGC ECO)
- Sensors for control and safety
- Painted frame equipped with castors

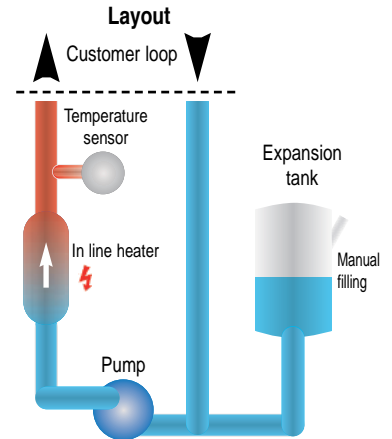

VULCATHERM®				HOT							
Maximum pressure				10 bar							
Heating temperature up to				180°C		250°C		300°C			
Heating Power +5/-10% (kW)	Nom. Flow (m³/h)	Δp Maxi (bar)	Dimensions L x H x P (mm)	REF.	Δp Maxi (bar)	Dimensions L x H x P (mm)	REF.	Δp Maxi (bar)	Dimensions L x H x P (mm)	REF.	
4	0,6	3,1	400 x 730 x 860	10813-04							
6	0,9	2,6	400 x 730 x 860	10813-06							
7					2,6	400 x 730 x 860	10813-07				
10	1,5	3,9	400 x 730 x 860	10813-10	3,7	400 x 780 x 860	10813-11	3,7	500 x 1320 x 950	10813-12	
14	2,1	3,1	400 x 730 x 860	10813-14	3	400 x 780 x 860	10813-15	3	500 x 1320 x 950	10813-16	
20	3,2	2,4	500 x 1320 x 950	10813-19	4	500 x 1320 x 950	10813-20	4	500 x 1320 x 950	10813-21	
30	4,5	2,7	500 x 1320 x 950	10813-29	3,9	600 x 1600 x 1000	10813-30	4	600 x 1600 x 1000	10813-31	
40	6,3	3,1	500 x 1320 x 950	10813-39	3,2	600 x 1600 x 1000	10813-40	3,2	600 x 1600 x 1000	10813-41	
60	9	3,7	600 x 1600 x 1000	10813-59	3,5	600 x 1600 x 1000	10813-60	3,5	600 x 1600 x 1000	10813-61	

- Customised solutions :**
- Power : 75 up to 245 kW
 - Temperature up to 350°C
 - Centrifugal pump with magnetic seal
 - Pump with high flow rate
 - See all options on page 144

Vulcatherm® HOT / COOL 10803

Atmospheric closed loop

High performance - Safe for fluid
Accurate - Heavy duty

Heat, cool and control a closed fluid loop (Synthetic or mineral oil up to 180°C). Hot oil from process is cooled by an heat exchanger connected to water network.

Applications :

- Industrial process with high temperature and low pressure
- Reactor
- Press moulding
- Composite moulding...

Features :

- Mineral oil ISO32 up to 250°C
Synthetic oil up to 350°C
- Manual filling
- Electrical supply 400VAC 3 Phases + E

Characteristics :

- 1 electrical heater with sensor
- 1 exchanger
- 1 atmospheric expansion tank
- 1 pump
- 1 electrical cabinet with integrated central management (CMS/SGC ECO)
- Sensors for control and safety
- Painted frame equipped with castors

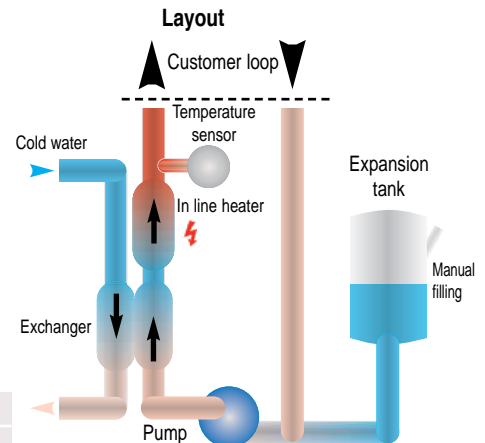

VULCATHERM®				HOT / COOL		
Maximum pressure				10 bar		
Δt				140°C Maxi		
Heating temperature up to				180°C		
Heating Power +5/-10% (kW)	Cooling Power (kW)	Nom. Flow (m³/h)	Δp Maxi (bar)	Dimensions L x H x P (mm)	REF.	
4	8	0,6	3,1	400 x 730 x 860	10803-04	
6	12	0,9	2,6	400 x 730 x 860	10803-06	
10	20	1,5	3,3	400 x 730 x 860	10803-10	
14	28	2,1	2,6	400 x 730 x 860	10803-14	
20	40	3	3,3	3500 x 1320 x 950	10803-19	
30	60	4,5	3,3	500 x 1320 x 950	10803-29	
40	80	6	3,7	500 x 1320 x 950	10803-39	
60	120	9	3,1	600 x 1600 x 1000	10803-59	

- Customised solutions :**
- Power : 75 up to 245 kW
 - Temperature up to 350°C
 - Centrifugal pump with magnetic seal
 - Pump with high flow rate
 - See all options on page 144



TEMPERATURE CONTROL UNITS VULCATHERM® OIL MEDIUM



ATMOSPHERIC : OIL 180°C, 250°C AND 300°C MAXI

Vulcatherm® HOT / COLD 10803

FLUID SUPERPOSITION

Atmospheric closed loop

High performance - Safe for fluid
Accurate - Heavy duty

Heat, cool and control a closed fluid loop (Synthetic or mineral oil up to 180°C). Hot oil from process is cooled by a heat exchanger connected to water network.

Applications :

- Industrial process with high temperature and low pressure
- Reactor
- Press moulding
- Composite moulding...

Features :

- Mineral oil ISO32 up to 250°C
Synthetic oil up to 350°C
- Manual filling
- Electrical supply 400VAC 3 Phases + E

Characteristics :

- 1 electrical heater with sensor
- 1 hot oil exchanger
- 1 atmospheric expansion tank
- 2 pumps
- 1 electrical cabinet with integrated central management (CMS/SGC V2)
- Sensors for control and safety
- Painted frame equipped with castors

Layout

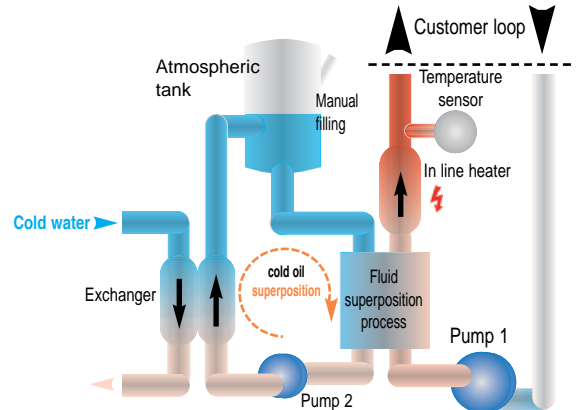

VULCATHERM®		HOT / COLD fluid superposition							
Maximum pressure		10 bar							
Δt		205°C Maxi				240°C Maxi			
Heating temperature up to		250°C				300°C			
Heating Power +5/-10% (kW)	Cooling Power (kW)	Nom. Flow (m³/h)	Δp Maxi (bar)	Dimensions L x H x P (mm)	REF.	Δp Maxi (bar)	Dimensions L x H x P (mm)	REF.	
7	14	1,05	2,6	400 x 780 x 860	10803-07				
10	20	1,5	3,7	400 x 780 x 860	10803-11	3,3	500 x 1320 x 950	10803-12	
14	28	2,1	3	500 x 1320 x 950	10803-15	3,1	500 x 1320 x 950	10803-16	
20	40	3	3	4500 x 1320 x 950	10803-20	3,3	500 x 1320 x 950	10803-21	
30	60	4,5	3,9	600 x 1600 x 1000	10803-30	3,3	600 x 1600 x 1000	10803-31	
40	80	6	3,2	600 x 1600 x 1000	10803-40	3,3	600 x 1600 x 1000	10803-41	
60	120	9	3,5	600 x 1600 x 1000	10803-60	3,3	600 x 1600 x 1000	10803-61	

- Customised solutions :**
- Power : 75 up to 245 kW
 - Temperature up to 350°C
 - Centrifugal pump with magnetic seal
 - Pump with high flow rate
 - See all options on page 144

Vulcatherm® HOT / AIR COOLED 10833

FLUID SUPERPOSITION

Atmospheric closed loop

High performance -
Wide temperature range

Heat, cool and control a closed oil loop (synthetic or mineral oil up to 180°C). Hot oil from process is cooled through an air exchanger and a fan. Fully available and designed for process without water network.

Applications :

- Elastomer moulding
- Polymer moulding
- Injection, extrusion
- Jacket heat
- Tracing ...

Features :

- Mineral oil ISO32
- Electrical supply 400VAC Tri + N + T

Characteristics :

- 1 electrical heater with temperature sensor
- 1 to 6 hot oil exchanger / cold air
- 1 to 3 helicoid fans
- 1 pump
- 1 atmospheric expansion tank
- 1 electrical cabinet with integrated central management (CMS/SGC V2)
- Sensors for control and safety
- Painted frame equipped with castors

Layout

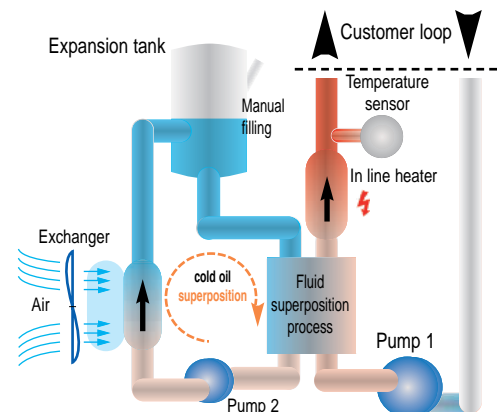

VULCATHERM®		HOT / AIR COOLING							
Heating temperature up to		180°C							
Maximum pressure		10 bar							
Heating Power +5/-10% (kW)	Nom. Flow (m³/h)	Δp Maxi (bar)	Volume expansion V (litre)	Dimensions L x H x P (mm)	Cooling Power (kW)	Δt Maxi (°C)	Weight (kg)	REF.	
4	0,6	3,1	9,4	400 x 980 x 860	10	130	130	10833-04	
6	0,9	2,6	9,4	400 x 980 x 860	10	130	130	10833-06	
10	1,5	3,8	9,4	400 x 980 x 860	10	130	135	10833-10	
14	2,1	3,2	10	800 x 1200 x 800	20	130	200	10833-14	
20	3	2,6	10	800 x 1200 x 800	20	130	200	10833-20	
30	4,5	3	14	950 x 1660 x 900	50	130	210	10833-30	
40	6	2,5	14	950 x 1660 x 900	50	130	210	10833-40	
60	9	3,7	24	1000 x 2050 x 1600	100	130	240	10833-60	

- Customised solutions :**
- Power : 75 up to 245 kW
 - Temperature up to 300°C
 - Centrifugal pump with magnetic seal
 - Pump with high flow rate
 - See all options on page 144

ATMOSPHERIC : OIL 180°C AND 250°C MAXI

Vulcatherm® **HOT / COLD** 10823 / 10843

Atmospheric
closed loop

High performance - Accurate
Wide temperature range - Reduced maintenance



Applications :

- Wide temperature range process
- Crystallizer
- Test benches
- Chemical reactor

Features :

- Loop with synthetic oil
- Manual filling
- Condenser cooled by water network
- Electrical supply 400VAC 3 Phases + E (+ Neutral with air condenser)

Characteristics :

- 1 electrical heater with sensor
- 1 hot oil exchanger / evaporator
- 1 condenser with water
- 1 pump
- 1 atmospheric expansion tank
- 1 electrical cabinet with integrated central management (**CMS/SGC V3**)
- Sensors for control and safety
- Painted frame equipped with castors

Customised solutions :

- **Wide temperature range available :**
from -55°C up to 180°C, from -30°C up to 260°C or from 0°C up to 300°C
- **Power : 125 kW hot / 80 kW cold**
- Pressurised expansion tank
- Air condenser (maxi 32°C) and centrifugal or helicoid fan
- See all options on page 144

Type
air condenser
Ref. 10843-xx

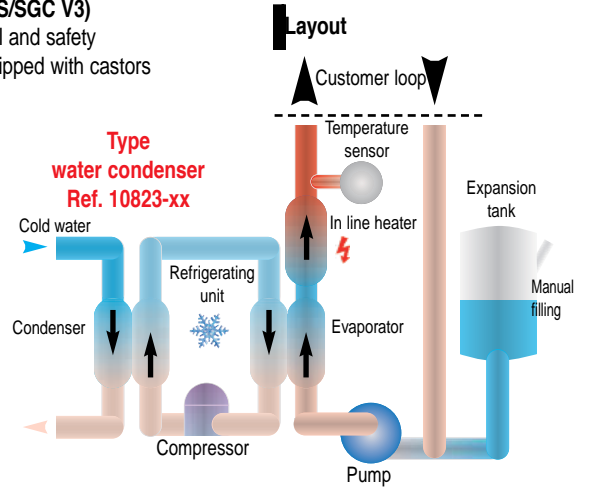
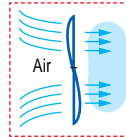

VULCATHERM®			HOT / COLD									
Maximum pressure			10 bar									
Heating temperature up to			180°C			250°C						
Thermal process			Fluid superposition			Fluid superposition						
Heating Power +5/-10% (kW)	Nom. Flow (m³/h)	Dimensions L x H x P (mm)	Cooling power (kW)			REF. Water condenser	REF. Air condenseur	Cooling power (kW)			REF. Water condenser	REF. Air condenseur
			-20°C	-10°C	0°C			-20°C	-10°C	0°C		
4	0,6	800 x 1200 x 800		2,4	4	10823-03	10843-03				-	-
6	0,9	800 x 1200 x 800		3,6	6	10823-05	10843-05				-	-
7	1	800 x 1200 x 800				-	-	3,6	6	10823-07	10843-07	
10	1,5	800 x 1200 x 800		6	10	10823-09	10843-09	6	10	10823-11	10843-11	
20	3	800 x 1200 x 800		12,8	20	10823-19	10843-19	12,8	20	10823-21	10843-21	
4	0,6	800 x 1200 x 800	1,2	2,4	4	10823-04	10843-04				-	-
6	0,9	800 x 1200 x 800	1,8	3,6	6	10823-06	10843-06				-	-
7	1	800 x 1200 x 800				-	-	1,8	3,6	6	10823-08	10843-08
10	1,5	800 x 1200 x 800	3,1	6	10	10823-10	10843-10	3,1	6	10	10823-12	10843-12
20	3	800 x 1200 x 800	6,2	12	20	10823-20	10843-20	6,2	12	20	10823-22	10843-22

CMS - CENTRAL MANAGEMENT SYSTEM

CMS's are smart controllers, able to manage elaborated control of process and feed back about measurements (temperature, pressure, flow rate...). Our 3 references are specially designed for specific requirements of thermoregulation.



SGC.v2



SGC.eco



SGC.v3 touch screen



In/out
module

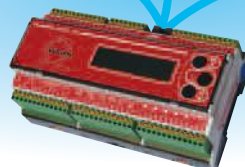

COMMUNICATION

- I-Pack analog in current 4...20 mA : set point (passive) + 1 measurement feedback (active).
- Pack digital ModBus RS 485 (RTU) Pack digital Profibus DP on gateway (internal electric box on SubD).
- Pack digital V485 (protocol ASCII Vulcanic)
- Pack numeric loop 0-20mA (Engel, Arburg...)
- Pack Ethernet (included Modbus IP except if other digital communication active)

EXTERNAL MEASUREMENT

- External temperature sensor PT100, TCJ, TCK, Analogic 4...20mA (passive).

SOFTWARE

- Cascade control by dual-loop (Master/Slave).
- Profil generator (16 steps).
- Programmable timer.
- Remote monitoring by GPRS network (GSM).
- Log (shortened max 2400 lines) on Ethernet (needs Pack Ethernet).

CMS UP-GRADE

- SGC.eco, SGC.v2 et SGC.v3 touch screen.

HYDRAULIC

- Increased cooling with fluid superposition.
- Automatic by-pass with 2-ways proportional valve.
- Flow rate control with 3-ways valve + flow meter.
- Piping in stainless steel...

MANUFACTURING

- Stainless steel housing.
- Removable retention tank.
- Replacement of castors by pads.
- Lifting rings.

ATEX TEMPERATURE CONTROL UNITS

Power available from 4 to 60 kW

- Water from 10°C to 140°C hot and hot/cold.
- Oil 10°C to 180°C hot/Cold.
- Oil 10°C to 300°C hot.
- Ambient atmospheric gas group IIA, or IIB or IIC.
- Operating temperature classification from T1 up to T6.
- Atex area 1 or area 2.
- Electrical cabinet and pumps Ex d protected or Ex e (possible other protection modes available).
- Electrical flow heater and heating elements available with protection modes Ex d or Ex e.



AIR CONDITIONING UNITS CHILLERS VULCAFROID® DEHUMIDIFIERS EDENAIR®



AIR-CONDITIONING UNITS FOR CABINETS

Cooling power : from 360 to 2500 W
(L35/L35 according to DIN 3168).

To be fixed either on the front door or side panel or top panel of a cabinet.

Factory pre-set to achieve an average cabinet temperature of 35°C max..

+ Customer's advantages

- One single cut-out for cabinets from 850 to 2500 W.
- **Powerless** condensation evaporating device.
- Electronic control with alarms and safety values (high pressure, cabinet opened, cabinet temperature, fan and compressor's thermal breakers).
- Ventilated hermetic compressor.
- Standard spare parts for all models.



Top mounted version



Standard electronic controller



Wall mounted air conditioners

TYPE	REF.	Cooling power (W)	Voltage (V/ph/Hz)	H (mm)	H (mm)	(mm)	Weight (kg)
CA 35 ME	80740-00	360	230/1/50	376	400	215	20
CA 85 ME	80812-08	850	230/1/50	800	400	215	34
CA 85 ME	80814-08	850	400/1/50	800	400	215	35
CA 120 ME	80812-12	1260	230/1/50	900	400	215	42
CA 120 TE	80834-12	1180	400/440/3/50/60	900	400	215	42
CA 170 ME	80812-17	1760	230/1/50	950	400	215	46
CA 170 TE	80834-17	1700	400/440/3/50/60	950	400	215	46
CA 210 ME	80812-21	2100	230/1/50	990	400	262	50
CA 210 TE	80834-21	2100	400/440/3/50/60	990	400	262	50
CA 250 TE	80834-25	2500	400/440/3/50/60	990	400	262	52

Top mounted

TYPE	REF.	Cooling power (W)	Voltage (V/ph/Hz)	H (mm)	H (mm)	(mm)	Weight (kg)
CAH 150 ME	80799-00	1460	230/1/50	400	600	400	49
CAH 150 TE	80745-00	1460	400/440/3/50/60	400	600	400	39

AIR / WATER EXCHANGERS

Cooling power : from 3900 to 6000 W
(W10/L35 according to DIN 3168).

To be fixed either on the front door or side panel of a cabinet.

Factory pre-set to achieve an average cabinet temperature of 35°C max..

Cooling power at nominal water flow (W).

Heat-transfer liquid temp.	RO400				RO600				
	10°C	15°C	20°C	25°C	10°C	15°C	20°C	25°C	
	430 l/h				690 l/h				
Cabinet temperature	30°C	3100	2100	1500	800	4800	3200	2300	1300
	35°C	3900	3800	2300	1700	6000	4300	3500	2600
	40°C	4700	3500	3000	2600	7200	5400	4600	3900

TYPE	REF.	Voltage (V/ph/Hz)	H (mm)	L (mm)	Weight (kg)	
RO 400	80705-40	400/1/50/60	850	400	160	20
RO 600	80705-60	400/1/50/60	1250	600	160	30

SELF-CONTAINED INDUSTRIAL CHILLERS VULCAFROID®

Chillers designed to cool down industrial process through a refrigerated water circulating in a closed loop (water with 5 % added glycol or ISO VG2 heat-transfer oil). Standard cooling power available from 1,6 to 30 kW.

On request : other powers and medium temperatures.



P/N.	Power (W)	Voltage (V/ph/Hz)	H (mm)	H (mm)	L (mm)	Weight (kg)	P
99002-16	1600*	230/1/50	395	400	780	65	
99002-66	1600*	400/3/50	395	400	780	65	
99002-25	2500*	230/1/50	395	400	780	65	
99002-75	2500*	400/3/50	395	400	780	65	
99003-03	3500**	230/1/50	1130	580	830	110	
99003-04	3500**	400/3/50	1130	580	830	110	
99003-05	5000**	400/3/50	1130	580	830	120	
99003-08	8000**	400/3/50	1600	780	1020	225	
99003-12	12000**	400/3/50	1600	780	1020	240	
99003-16	16000**	400/3/50	2400	900	1020	350	
99003-22	22000**	400/3/50	2400	900	1020	360	
99003-30	30000**	400/3/50	2400	900	1020	400	

Power (W) ** for W10/L35 * for W20/L35

According to DIN 3168 / "W10" = water temperature at 10°C / "L35" = Air condensing temperature at 35°C

LIQUID CHILLER STL 200/250



These chillers are a self-contained cooling system for liquids, mobile and autonomus.

Applications :

- Hot sources Pelletier
- Lasers
- Optical systems

Features :

- Rubber feet.
- Handle for transport.
- Electronic PID controller.
- Adjustable high set point for safety temperature.
- Special and non corrosion treatment on heat exchanger.
- Internal liquid tank.
- Front mounted level control.
- Centrifugal pump with magnetic seal.

- Inlet and outlet for pipes Ø 8x10mm.
- Hermetic cooling compressor.
- Air condensing unit.

Options :

- Flow switch 0,4 l/min or 1 l/min.
- Flow rate control with low flow safety contact.
- Water condenser.
- Electrical heating.
- Painted box with castors.

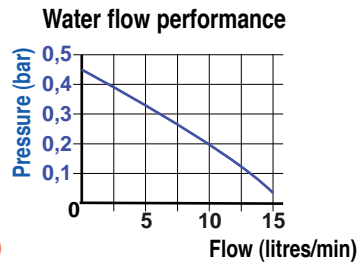
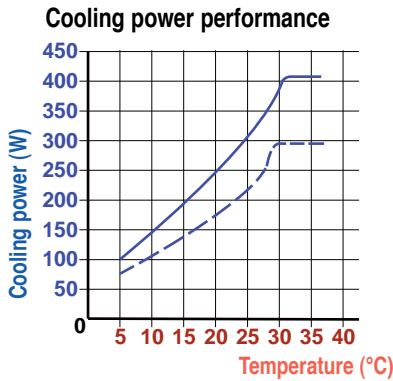

Characteristics	TYPE	
	STL 250	STL 200
Hermetic cooling compressor	1/6 CV - 120 W 1/6 HP - 120 W	1/5 CV - 150 W 1/5 HP - 150 W
Cooling power (liquid 20°C Air 25°C)	180 W	230 W
Air flow	120 m³/h **	150 m³/h **
Supply voltage (50Hz)	230 V - 1ph	230 V - 1ph
Current output	2A	2A
Average power consumption (20°C - 80% HR)	160 W/h	180 W/h
Refrigerant gas	R134 a	R134 a
Water flow output (20°C - 0,25 bar)	6 l/min	6 l/min
Reserve capacity	1,5 liters	1,5 liters
Dimensions : P/L/H (mm)	370 x 290 x 460	370 x 290 x 460
Weight	23 Kg	24 Kg
Working capabilities	5°C up to 35°C - ambient 15°C up to 35°C	

DEHUMIDIFIER EDENAIR® DP 1200, 3500, 5000 AND 10000



Applications :

- Warehouses
- Swimming pools
- Cellars
- Underground shelters
- Laboratories
- Drying processes : (buildings, wood, food and beverage, clothes...)
- Archives
- Green houses
- Gymnasium
- Covered stadium

Features :

- Easily changeable air filter.
- Automatic defrosting.
- Two functions : ventilation only / ventilation and dehumidification.
- Adjustable controller from 0 up to 20°C, cut out the dehumidifier at low temperature.
- Cooper lined cold exchanger with protection against corrosion

Options :

- Remote control with moisture controller. and 3 position cut out controller.
- Transformer incorporated (remote control 24 V).
- Electrical heating.
- Hot water heating exchanger.

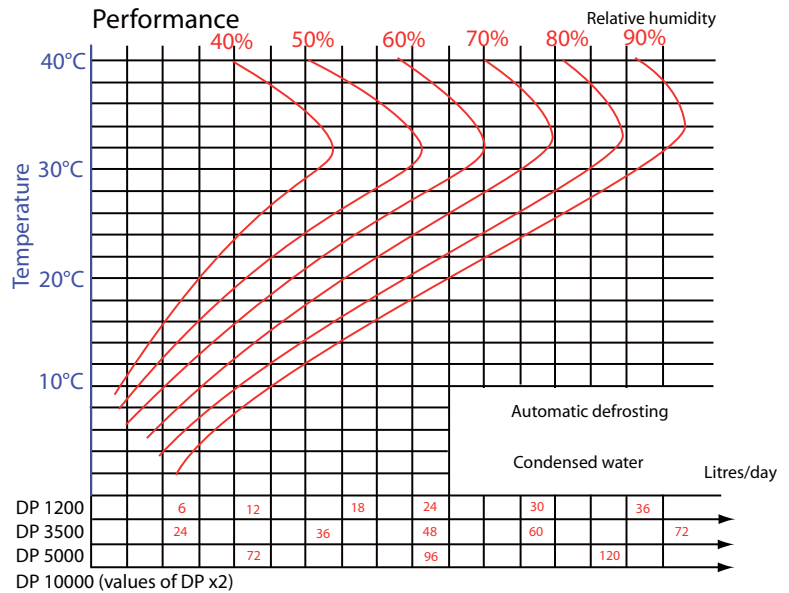

Characteristics	TYPE			
	DP 1200	DP 3500	DP 5000	DP 10000
Hermetic cooling compressor	0,5 CV - 380 W 0,5 HP - 380 W	1,25 CV - 930 W 1,25 HP - 930 W	2 CV - 1500 W 2 HP - 1500 W	4 CV - 3000 W 4 HP - 3000 W
Cooling power (liquid 20°C Air 25°C)	1400 W	3800 W	5250 W	11000 W
Air flow	360 m³/h **	900 m³/h **	1500 m³/h **	3000 m³/h **
Supply voltage (50Hz)*	230 V - 1ph ou 400V - 3ph	230 V - 1ph ou 400V - 3ph	230 V - 1ph ou 400V - 3ph	230 V - 1ph ou 400V - 3ph
Electrical power consumption (20°C - 80% HR)	730 W	1500 W	2500 W	4200 W
Power connexion :	3 x 1,5 ²	3 x 2,5 ² or 4 x 1,5 ²	3 x 1,5 ² or 4 x 1,5 ²	3 x 1,5 ² or 4 x 1,5 ²
Remote control	4 x 1 ²	4 x 1 ²	4 x 1 ²	4 x 1 ²
Condensed water outlet (mm)	Ø20	Ø20	Ø20	Ø20
Dimensions : P/L/H (mm)	630 x 425 x 305	845 x 530 x 472	850 x 610 x 572	850 x 1120 x 572
Weight	40 Kg	85 Kg	110 Kg	210 Kg
Volume treated	100 to 400m ³	300 to 900m ³	750 to 1750m ³	1000 to 3500m ³

* Others voltages and frequencies available for specific requirements ** Test bench CETIAT *** Value in DP 500 X2

DEHUMIDIFIERS EDENAIR® VDM 750, 1200, 3500, 5000 AND 10000



Applications :

- Warehouses
- Swimming pools
- Cellars
- Underground shelters
- Laboratories
- Drying processes : (buildings, wood, food and beverage, clothes...)
- Archives
- Green houses
- Gymnasium
- Covered stadium

Features :

- Casing adaptor for air duct connection.
- Designed in two parts for easy maintenance and handling during transport.
- Automatic defrosting allows temperature up to 0°C for VMD 750/1200 and 5°C for VMD 3500/5000 and 10000.
- Adjustable thermostat from -5°C up to 15°C in air inlet to switch off dehumidifier at low temperature.
- Cooper lined cold exchanger with protection against corrosion.

Options :

- Remote controller with hygostat and 3 positions switch : ventilation on, ventilation+ dehumidification and off.
- Internal transformer 24 V.
- Electrical heating with temperature controller.
- High pressure available reinforced at 10 mmCE for VMD 750/1200
- High pressure available reinforced at 20 mmCE for VMD 3500/5000/10000.
- Hot water heat exchanger without controller.
- Water condenser.

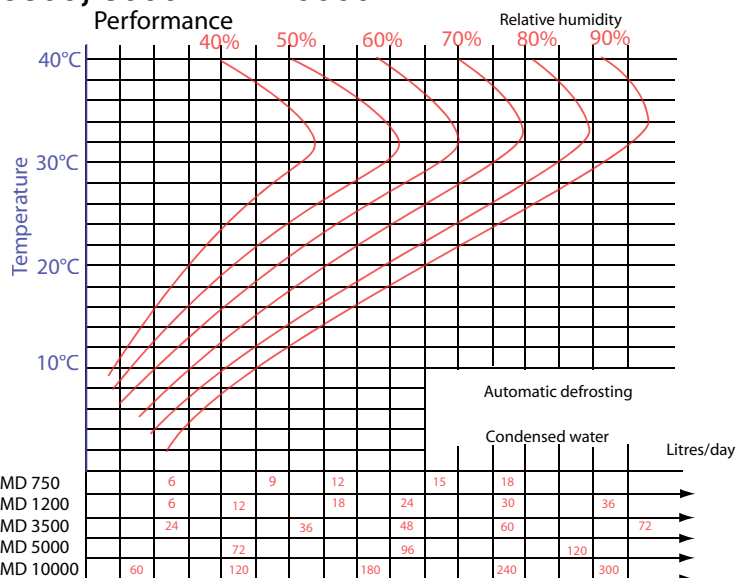

CHARACTERISTICS	TYPE				
	VDM 750	VDM 1200	VDM 3500	VDM 5000	VDM 10000
Hermetic cooling compressor	1,3 CV - 380 W	1,3 CV - 930 W	1,25 CV - 930 W	2 CV - 1500 W	4 CV - 3000 W
Refrigerant gas	R134 a	R407 c	R407 c	R407 c	R407c
Cooling power (liquid 20°C Air 25°C)	870 W	1400 W	3800 W	5300 W	11000 W
Air flow treated	300 m³/h	400 m³/h	900 m³/h	1500 m³/h	3000 m³/h
Pressure available (CE)	5mm	5mm	10mm	10mm	10mm
Air duct inlet outlet	250/250	250/250			
Power supply (50Hz)*	230 V - 1ph	230 V - 1ph	230 V - 1ph or 400V - 3ph	230 V - 1ph or 400V - 3ph	230 V - 1ph or 400V - 3ph
Electrical power consumption (20°C - 80% HR)	8/550 W	85/900 W	300/1500 W	450/2200 W	900/4200 W
Water condensed outlet (mm)	Ø16	Ø16	Ø20	Ø20	2 x Ø20
Dimensions : P/L/H (mm)	850 x 440 x 310	850 x 440 x 310	1110 x 540 x 475	1240 x 630 x 575	1240 x 1300 x 575
Weight	34 Kg	41 Kg	90 Kg	120 Kg	200 Kg
Heating power	1000 W	1000 W	2250 W	4500 W	9000 W
Volume of the room to be treated	100 m³	100 to 400 m³	400 to 900 m³	750 to 1750 m³	1000 to 3500 m³
Temperature and humidity range	0°C to 37°C - 30% to 100% HR		5°C to 37°C - 30% to 100% HR		

DEHUMIDIFIERS EDENAIR® T 750 AND 1200



Applications :

- Cellars
- Libraries
- Archives
- Photocopy centers
- Residences
- Restaurants
- Clothes dryers
- Boats
- Museums
- Green houses

Features :

- Wheels.
- Easy access Air filter - Efficiency 50%.
- Hygostat control - Accuracy +/- 7%
- Hot gas defrosting with automatic and thermostatic timer.
- Level control contact safety.
- High pressure contact safety.
- Hydraulic adapter for water connection on the customer network.
- May be built-in (on specific request).
- Cooper lined cold exchanger with protection against corrosion.

Options :

- Pump for condensed water.
- Centrifugal fan for air duct network 50 Pa (5 mm CE).
- Water exchanger.
- Electrical heater.

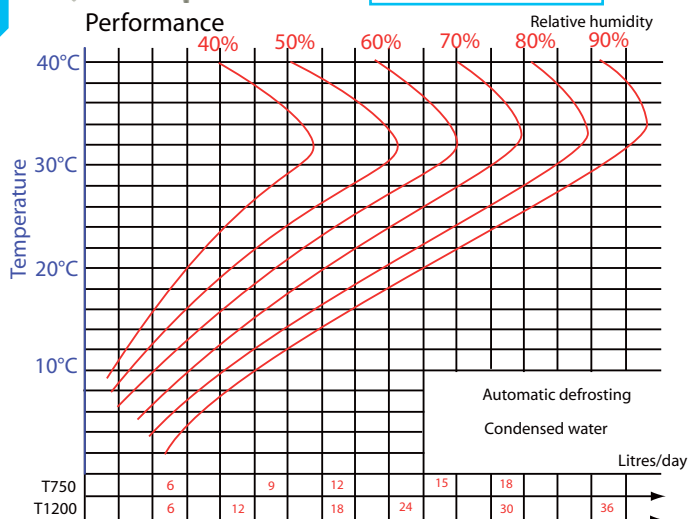

CHARACTERISTICS	TYPE	
	T 750	T1200
Hermetic cooling compressor	1/3 CV - 250 W 1/3 HP - 250 W	1/2 CV - 930 W 1/2 HP - 380 W
Cooling power (liquid 20°C Air 25°C)	870 W 2900 BTU	1400 W 4750 BTU
Air flow treated	300 m³/h **	400 m³/h **
Power supply (50Hz)	230 V - 1ph	230 V - 1ph
Electrical power consumption (20°C - 80% HR)	450 W	730 W
Refrigerant gas	R134 c	R407 c
Heating power 20°C - 80% HR	800 W	1200 W
Tank for condensate	10 litre	20 litre
Dimensions : P/L/H (mm)	420 x 410 x 650	470 x 140 x 780
Weight	38 Kg	50 Kg

* Others voltages and frequencies available for specific requirement ** Test bench CETIAT

DEHUMIDIFIERS EDENAIR® T 3500 AND 5000



- Applications :**
- Warehouses
 - Swimming pools
 - Cellars
 - Tanks
 - Underground shelters
 - Silos
 - Laboratories
 - Drying proceses (wood, plaster, buildings, food and beverage)
 - Librairies
 - Archives
 - Photocopy centers
 - Residences
 - Restaurants
 - Clothes dryers...

- Features :**
- Wheels.
 - Easy access air filter - Efficiency 50%.
 - Hygrostat control - Accuracy +/- 7%
 - Hot gas defrosting with automatic and thermostatic timer.
 - **Cooper lined cold exchanger with protection against corrosion.**

- Options**
- Pump for condensed water.
 - Centrifugal fan for air duct network 50 Pa (5 mm CE).
 - Water exchanger.
 - Electrical heater.
 - Water tank of 2 liters with automatic switch off.

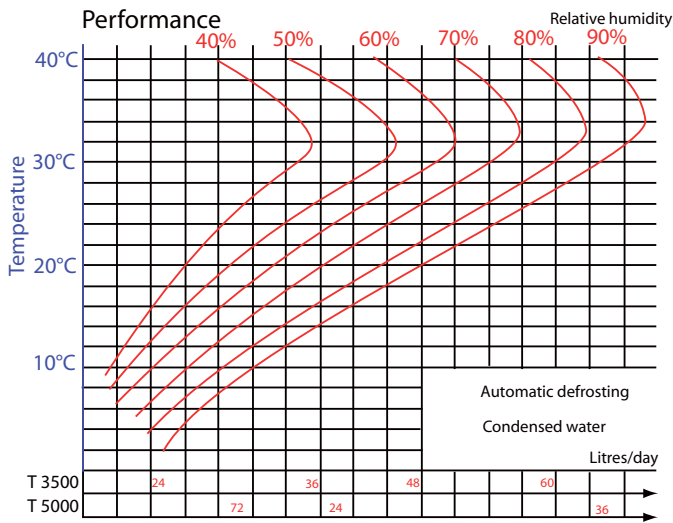

CHARACTERISTICS	TYPE	
	T 3500	T 5000
Hermetic cooling compressor	1,25 CV - 930 W 1,25 HP - 930 W	2 CV - 1500 W 2 HP - 1500 W
Cooling power (liquid 20°C Air 25°C)	3800 W 13000 BTU	5250 W 18000 BTU
Air flow treated	1000 m³/h **	1500 m³/h **
Power supply (50Hz)	230 V - 1ph 400 V - 3ph	230 V - 1ph 400 V - 3ph
Electrical power consumption (20°C - 80% HR)	1500 W	2200 W
Refrigerant gas	R407 c	R407 c
Heat output 20°C - 80%HR	2600 W	4000 W
Water condensed outlet (mm)	Ø16	Ø16
Dimensions : P/L/H (mm)	555 x 555 x 1080	655 x 655 x 1280
Weight	100 Kg	130 Kg
Volume of the room to be treated	100 to 900 m³	750 to 1750 m³
Temperature and humidity range	5°C to 35°C	30% to 100% H

* Others voltages and frequencies available for specific requirements ** Test bench CETIAT

DEHUMIDIFIERS EDENAIR® T 10000 AND 20000



- Applications :**
- Warehouses
 - Swimming pools
 - Cellars
 - Tanks
 - Underground shelters
 - Silos
 - Laboratories
 - Drying proceses (wood, plaster, buildings, food and beverage)
 - Librairies
 - Archives
 - Photocopy centers
 - Residences
 - Restaurants
 - Clothes dryers
 - Small workshops
 - Boats
 - Museums

- Features :**
- Wheels.
 - Air filter easy access - Efficiency 50%.
 - Hygrostat control - Accuracy +/- 7%
 - Hot gas defrosting with automatic and thermostatic timer.
 - **Cooper lined cold exchanger with protection against corrosion.**

- Options :**
- Pump for condensed water.
 - Centrifugal fan for air duct network 50 Pa (5 mm CE).
 - Water exchanger.
 - Electrical heater.

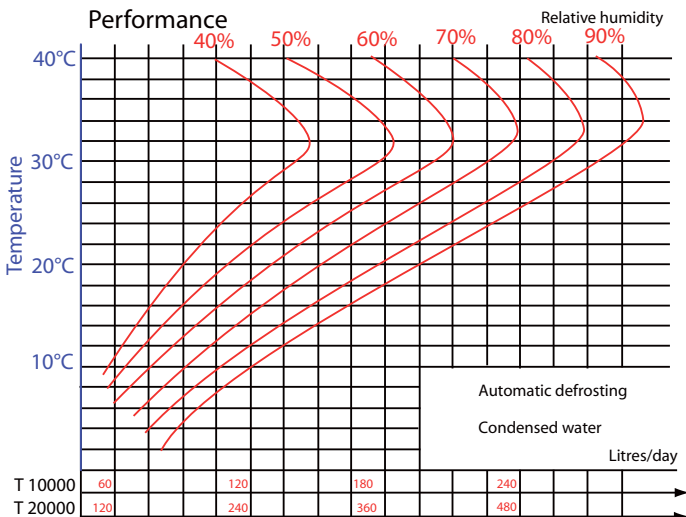

CHARACTERISTICS	TYPE	
	T 10000	T 20000
Hermetic cooling compressor	1x4 CV - 4 kW	2x4 CV - 6 kW 2x4 HP - 2X3 kW
Cooling power (liquid 20°C Air 25°C)	9500 W 32400 BTU	19250 W 65600 BTU
Air flow treated	3000 m³/h **	5300 m³/h **
Power supply (50Hz)	400 V - 3ph	400 V - 3ph
Electrical power consumption (20°C - 80% HR)	4000 W	7500 W
Refrigerant gas	R407 c	R407 c
Heat output 20°C - 80%HR	7000 W	15000 W
Water condensed outlet (mm)	Ø20	Ø20
Dimensions : P/L/H (mm)	1110 x 660 x 900	1350 x 1350 x 1000
Weight	250 Kg	450 Kg
Volume of the room to be treated	1500 to 3500 m³	3500 to 8000 m³
Temperature and humidity range	5°C to 35°C	30% to 100% H

* Others voltages or frequency available on specific requirement ** Test bench CETIAT

INDEX REFERENCE



P/N.	to	P/N.	Page	P/N.	to	P/N.	Page	P/N.	to	P/N.	Page	P/N.	to	P/N.	Page
6096	-	81	2029-31	2029-59	39	2206-76	2206-85	35	3003-66	3003-70	53	4548-01	4548-15	58	
6097	-	81	2041-01	2041-05	19	2214-01	2214-09	18	3003-72	3003-74	53	4550-00	-	101	
6531	-	81	2045-01	2045-04	19	2215-01	2215-09	18	3003-76	3003-78	53	4750-10	4750-20	93	
6532	-	81	2045-11	2045-15	23	2216-01	2216-09	18	3114-01	3114-09	17	4755-13	4755-20	93	
6533	-	81	2045-20	2045-24	23	2216-50	2216-53	16	3114-10	3114-15	20	5005-01	5005-09	57	
6534	-	81	2045-71	2045-75	23	2216-60	2216-61	16	3114-16	3114-21	21	5019-04	-	58	
6546	6549	83	2045-99	-	43	2217-01	2217-09	18	3114-22	3114-32	22	5090-01	-	57	
8310	8311	111	2046-02	2046-03	19	2217-50	2217-53	16	3114-35	3114-40	21	5126-01	5126-07	57	
8320	8321	111	2046-12	2046-14	23	2217-60	2217-61	16	3115-01	3115-09	17	5144-01	-	58	
8330	8331	111	2048-01	2048-17	24	2218-01	2218-09	18	3115-10	3115-15	20	5145-01	-	57	
8340	8341	111	2049-01	2049-17	24	2219-01	2219-09	18	3115-16	3115-21	21	5150-01	5150-06	57	
8350	8351	111	2062-01	2062-07	44	2220-01	2220-09	18	3115-22	3115-32	22	5516-01	5516-02	91	
8360	8361	111	2077-00	2077-06	26	2277-11	2277-17	28	3115-35	3115-40	21	5710-00	5710-01	41	
8420	8421	111	2077-11	2077-15	27	2277-31	2277-37	28	3116-01	3116-09	17	5711-00	-	41	
8450	8451	111	2077-11	2077-15	66	2277-80	2277-84	28	3116-10	3116-15	20	6002-81	-	72	
8452	8453	111	2077-14	2077-15	67	2278-11	2278-17	28	3116-16	3116-21	21	6004-10	-	74	
8460	8461	111	2077-31	2077-36	66	2278-31	2278-37	28	3116-22	3116-32	22	6004-13	-	73	
8462	8463	111	2077-34	2077-36	67	2278-80	2278-84	28	3116-35	3116-40	21	6004-13	-	74	
26450	-	61	2077-51	2077-55	27	2278-80	2278-91	66	3117-01	3117-09	17	6004-15	-	74	
26451	-	60	2077-71	2077-87	27	2278-80	2278-87	67	3117-10	3117-15	20	6004-18	-	74	
26452	-	61	2077-97	2077-99	43	2278-85	2278-89	28	3117-16	3117-21	21	6004-20	6004-25	74	
26453	-	61	2078-01	2078-06	26	2279-01	2279-04	36	3117-22	3117-32	22	6004-28	-	74	
26456	-	60	2078-11	2078-15	27	2279-10	2279-15	36	3117-35	3117-40	21	6004-30	-	74	
26458	-	60	2079-31	2179-38	29	2279-22	2279-27	36	3118-01	3118-09	17	6004-33	-	73	
26460	-	61	2079-51	2079-67	29	2279-41	2279-44	36	3118-01	3118-02	80	6004-33	-	74	
26461	-	60	2081-11	2081-15	34	2279-51	2279-55	36	3118-10	3118-15	20	6004-35	-	74	
26463	-	61	2081-87	2081-89	56	2279-61	2279-66	36	3118-16	3118-21	21	6004-38	-	74	
26466	-	60	2081-97	-	43	2321-01	2321-07	31	3118-22	3118-32	22	6004-43	-	73	
26472	-	61	2081-99	-	41	2321-11	2321-19	31	3118-35	3118-40	21	6004-43	-	74	
26474	-	61	2081-99	-	43	2321-31	2321-37	31	3119-01	3119-09	17	6004-48	-	74	
26475	-	60	2085-11	2085-15	34	2321-80	2321-84	31	3119-10	3119-15	20	6004-73	-	73	
26477	-	60	2088-03	2088-06	35	2322-11	2322-17	31	3119-16	3119-21	21	6004-73	-	74	
26482	-	61	2088-11	2088-15	35	2322-31	2322-37	31	3119-22	3119-32	22	6004-99	-	72	
26484	-	61	2089-03	2089-06	35	2322-80	2322-84	31	3119-35	3119-40	21	6006-00	6006-03	73	
26485	-	60	2089-11	2089-15	35	2377-01	2377-07	30	3120-01	3120-09	17	6006-20	-	74	
26487	-	60	2106-01	2106-08	35	2377-41	2377-47	30	3120-10	3120-15	20	6006-90	6006-93	73	
26495	-	60	2106-51	2106-59	35	2377-80	2377-84	30	3120-16	3120-21	21	6007-01	6007-03	74	
26497	-	60	2106-76	2106-85	35	2377-91	2377-99	30	3120-22	3120-32	22	6007-21	6007-23	74	
31171	-	124	2114-01	2114-09	17	2378-11	2378-17	30	3120-35	3120-40	21	6008-01	6008-04	74	
31172	-	124	2114-10	2114-15	20	2378-31	2378-37	30	3214-01	3214-09	18	6008-20	6008-24	74	
31270	-	124	2114-16	2114-21	21	2378-40	2378-44	30	3215-01	3215-09	18	6010-34	6010-40	75	
31272	-	124	2114-22	2114-32	22	2378-85	2378-89	30	3216-01	3216-09	18	6010-42	6010-44	75	
31273	-	124	2115-01	2115-09	17	2381-11	2381-15	34	3216-50	3216-53	16	6010-55	-	75	
31273	-	124	2115-10	2115-15	20	2381-51	2381-59	34	3216-60	3216-61	16	6010-62	6010-70	75	
31275	-	124	2115-16	2115-21	21	2381-76	2381-87	34	3217-01	3217-09	18	6013-99	-	72	
31277	-	124	2115-22	2115-32	22	2385-11	2385-15	34	3217-50	3217-53	16	6014-04	6014-06	105	
31278	-	124	2115-35	2115-40	21	2385-51	2385-59	34	3217-60	3217-61	16	6014-17	-	103	
60511	60253	80	2116-01	2116-09	17	2385-76	2385-87	34	3218-01	3218-09	18	6014-21	6014-22	103	
1004-01	1004-06	87	2116-10	2116-15	20	2388-03	2388-06	35	3219-01	3219-09	18	6014-32	6014-35	103	
1007-01	1007-29	88	2116-16	2116-21	21	2388-11	2388-15	35	3220-01	3220-09	18	6014-32	-	104	
1008-90	1008-94	88	2116-22	2116-32	22	2388-51	2388-59	35	3941-21	-	91	6014-34	-	104	
1021-11	1021-59	88	2116-35	2116-40	21	2388-76	2388-85	35	3941-24	-	91	6014-35	-	104	
1024-11	1024-12	88	2117-01	2117-09	17	2389-03	2389-06	35	3941-27	-	91	6014-63	-	104	
1024-31	1024-32	88	2117-10	2117-15	20	2389-11	2389-15	35	3941-28	-	91	6014-67	-	104	
1024-51	1024-52	88	2117-16	2117-21	21	2389-51	2389-59	35	3942-41	3942-45	91	6014-73	-	104	
1026-01	-	89	2117-22	2117-32	22	2389-76	2389-85	35	3943-41	3943-46	91	6014-77	-	104	
1050-01	-	89	2117-35	2117-40	21	2406-01	2406-08	35	3944-01	-	91	6014-83	-	104	
1092-01	-	89	2118-01	2118-09	17	2406-51	2406-59	35	4020-01	4020-23	92	6014-87	-	104	
1101-01	1101-05	41	2118-10	2118-15	20	2406-76	2406-85	35	4027-01	4027-05	90	6014-91	6014-96	105	
1103-11	1103-17	41	2118-16	2118-21	21	2477-11	2477-19	28	4030-13	4030-16	92	6015-01	6015-06	103	
1199-00	-	41	2118-22	2118-32	22	2477-51	2477-54	26	4030-22	-	92	6016-01	6016-19	77	
1789-01	1789-17	37	2118-35	2118-40	21	2477-60	2477-70	27	4030-27	-	92	6020-01	6020-13	102	
1789-01	1789-17	65	2119-01	2119-09	17	2506-01	2506-08	35	4030-29	4030-35	92	6020-34	6020-36	102	
1789-51	1789-67	37	2119-10	2119-15	20	2506-51	2506-59	35	4030-42	-	92	6020-40	6020-41	102	
1789-88	1789-89	37	2119-16	2119-21	21	2506-76	2506-85	35	4030-44	-	92	6021-01	6021-03	74	
1789-90	1789-94	37	2119-22	2119-32	22	2510-01	-	132	4030-47	-	92	6022-01	6022-06	75	
1789-96	1789-99	37	2119-35	2119-40	21	2511-01	-	132	4030-49	4030-55	92	6023-01	-	75	
2006-01	2006-22	39	2120-01	2120-09	17	2512-01	-	132	4032-10	4032-15	92	6023-02	6023-03	98	
2006-31	2006-42	39	2120-10	2120-15	20	2513-01	2513-02	132	4032-22	-	92	6024-00	6024-01	72	
2006-70	2006-79	39	2120-16	2120-21	21	2520-01	2520-05	132	4032-24	-	92	6024-10	6024-13	72	
2010-05	2010-31	55	2120-22	2120-32	22	2521-01	2521-02	132	4032-27	-	92	6024-30	-	72	
2010-55	2010-81	55	2120-35	2120-40	21	2525-01	2525-02	132	4032-29	4032-35	92	6024-32	6024-33	72	
2012-01	2012-33	48	2145-11	2145-15	23	2526-01	2526-03	132	4032-42	-	92	6024-40	-	72	
2012-40	2012-63	50	2145-11	2145-14	64	2527-01	2527-02	132	4032-44	-	92	6024-42	6024-43	72	
2012-70	2012-93	52	2145-21	2145-23	64	2530-01	2530-07	132	4032-47	-	92	6024-50	-	72	
2016-01	2016-04	48	2146-01	2146-03	19	3002-06	3002-21	49	4032-49	4032-55	92	6024-52	-	72	
2016-10	2016-13	50	2146-01	2146-04	64	3002-34	3002-38	51	4033-01	4033-06	90	6024-52	-	72	
2016-15	2016-18	50	2178-02	2178-05	66	3002-40	3002-44	51	4033-51	4033-56	90	6024-60	-	72	
2016-20	2016-23	50	2178-04	2178-05	67	3002-46	3002-50	51	4040-60	4040-83	92	6024-62	-	72	
2016-30	2016-33	52	2179-51	2179-67	29	3002-52	3002-54	51	4300-01	4300-07	24	6024-73	-	72	
2016-40	2016-43	52	2181-51	2181-59	34	3002-54	3002-58	53	4300-11	4300-12	24	6024-81	-	72	
2017-01	2017-04	48	2181-76	2181-87											



INDEX REFERENCES

P/N.	to	P/N.	Page	P/N.	to	P/N.	Page	P/N.	to	P/N.	Page	P/N.	to	P/N.	Page	P/N.	to	P/N.	Page
6041-98	-	-	76	9014-08	-	-	109	10700-90	-	-	65	10804-06	-	-	136	10846-13	10846-14	139	139
6042-01	-	-	78	9014-09	-	-	109	10700-95	-	-	65	10804-10	-	-	136	10846-19	10846-20	139	139
6042-03	-	-	78	9014-11	9014-12	98	10701-03	-	-	66	10805-03	10805-07	137	10846-29	10846-30	139	139	139	139
6045-10	-	-	77	9014-11	9014-12	109	10701-05	-	-	66	10805-10	10805-11	137	10846-39	10846-40	139	139	139	139
6045-15	-	-	77	9014-13	-	-	44	10701-07	-	-	66	10805-14	10805-15	137	10846-59	10846-60	139	139	139
6045-20	-	-	77	9014-13	-	-	108	10701-08	-	-	66	10805-20	10805-21	137	10901-03	-	65	65	65
6046-06	-	-	76	9014-15	-	-	44	10701-10	-	-	66	10805-30	10805-31	137	10901-06	-	65	65	65
6046-12	-	-	76	9014-20	-	-	110	10701-13	10701-14	66	10805-40	10805-41	137	10901-07	-	65	65	65	
6046-18	-	-	76	9014-23	-	-	110	10701-16	10701-19	66	10805-60	10805-61	137	20163-12	20163-56	86	86	86	86
6046-56	-	-	76	9014-31	9014-32	98	10701-65	10701-68	66	10806-02	10806-07	138	20164-11	20164-68	86	86	86	86	
6046-62	-	-	76	9014-31	9014-32	109	10701-80	10701-91	66	10806-09	10806-11	138	20165-13	20165-78	86	86	86	86	
6046-68	-	-	76	9014-50	-	-	98	10702-10	10702-11	67	10806-13	10806-15	138	20166-21	20166-96	86	86	86	86
6046-98	6046-99	76	9014-98	9014-99	98	10702-31	10702-32	67	10806-19	10806-21	138	20167-11	20167-99	86	86	86	86	86	86
6048-01	-	65	9017-20	-	109	10702-34	-	67	10806-29	10806-31	138	20168-23	20168-59	86	86	86	86	86	86
6091-08	6091-09	103	9017-99	-	109	10702-54	10702-55	67	10806-59	10806-61	138	20174-20	2017-23	50	50	50	50	50	50
6091-11	6091-12	103	9019-01	9019-03	109	10702-80	10702-91	67	10811-03	-	134	20179-31	2179-38	29	29	29	29	29	29
6091-18	6091-19	103	9025-12	-	110	10704-10	10704-11	67	10811-06	-	134	20183-12	20183-56	87	87	87	87	87	87
6091-25	6091-26	103	9027-10	9027-11	45	10704-31	10704-32	67	10811-10	-	134	20185-13	20185-76	87	87	87	87	87	87
6091-30	6091-31	103	9027-51	9027-55	45	10704-34	-	67	10811-14	-	134	20186-21	20186-99	87	87	87	87	87	87
6091-36	6091-37	103	9027-61	9027-63	45	10704-54	10704-55	67	10811-20	-	134	20187-02	20187-36	87	87	87	87	87	87
6091-58	6091-59	103	9028-01	9028-02	45	10704-80	10704-91	67	10811-30	-	134	20263-12	20263-56	86	86	86	86	86	86
6091-61	6091-62	103	9028-01	9028-02	97	10705-01	10705-17	65	10811-40	-	134	20264-11	20264-68	86	86	86	86	86	86
6091-68	6091-69	103	9030-01	9030-03	44	10706-01	10706-03	63	10811-60	-	134	20265-13	20265-78	86	86	86	86	86	86
6091-75	6091-76	103	9030-01	9030-03	107	10706-31	10706-33	63	10812-06	-	137	20266-21	20266-96	86	86	86	86	86	86
6091-80	6091-81	103	9030-05	-	44	10706-41	10706-43	63	10812-10	-	137	20267-11	20267-99	86	86	86	86	86	86
6091-86	6091-87	103	9030-05	9030-06	110	10706-54	10706-56	63	10812-14	-	137	20268-23	20268-59	86	86	86	86	86	86
6094-01	6094-06	71	9030-07	9030-08	107	10706-64	10706-66	63	10812-20	-	137	20283-12	20283-56	87	87	87	87	87	87
6094-10	6094-15	71	9030-08	-	44	10706-74	10706-76	63	10813-04	10813-07	141	20285-13	20285-76	87	87	87	87	87	87
6094-20	6094-25	71	9030-11	9030-12	108	10707-51	10707-53	63	10813-10	10813-16	141	20286-21	20286-99	87	87	87	87	87	87
6094-51	6094-56	71	9030-21	-	108	10707-81	10707-83	63	10813-19	10813-21	141	20287-02	20287-36	87	87	87	87	87	87
6099-02	-	74	9030-31	-	108	10707-91	10707-93	63	10813-29	10813-31	141	21454-25	-	121	121	121	121	121	121
6099-03	-	74	9030-41	-	108	10712-01	-	78	10813-39	10813-41	141	26106-25	26106-30	96	96	96	96	96	96
6103-21	6103-23	74	9030-51	9030-54	107	10712-51	-	78	10813-59	10813-61	141	26107-02	26107-05	96	96	96	96	96	96
6104-21	6104-24	74	9030-71	-	44	10741-03	-	66	10814-03	-	136	26108-05	-	96	96	96	96	96	96
6108-01	6108-12	73	9031-01	-	65	10741-05	-	66	10814-06	-	136	26153-10	-	95	95	95	95	95	95
6108-51	6108-62	73	9031-01	-	66	10741-07	-	66	10814-10	-	136	26155-20	-	95	95	95	95	95	95
6110-02	6110-07	74	9031-08	-	44	10741-08	-	66	10815-06	-	137	26155-20	-	96	96	96	96	96	96
6110-42	6110-47	74	9031-11	9031-13	44	10741-10	-	66	10815-10	-	137	26156-01	26156-08	100	100	100	100	100	100
6110-52	6110-57	74	9032-01	-	65	10741-13	10741-14	66	10815-14	-	137	26156-11	26156-18	100	100	100	100	100	100
6114-22	-	103	9032-01	-	66	10741-16	10741-19	66	10815-20	-	137	26156-42	-	100	100	100	100	100	100
6114-32	-	103	9032-01	-	67	10741-65	10741-68	66	10815-30	-	137	26156-51	26156-52	100	100	100	100	100	100
6114-32	-	104	9621-01	-	43	10741-80	10741-91	66	10815-40	-	137	26156-61	26156-62	100	100	100	100	100	100
6114-63	-	104	9621-10	-	43	10742-10	10742-11	67	10815-60	-	137	26156-81	26156-82	100	100	100	100	100	100
6114-67	-	104	9622-01	-	43	10742-31	10742-32	67	10816-05	10816-07	138	26156-91	26156-92	100	100	100	100	100	100
6117-21	6117-24	105	9622-10	-	43	10742-34	-	67	10816-09	10816-11	138	26156-94	26156-98	101	101	101	101	101	101
6120-22	-	76	9623-01	-	56	10742-54	10742-55	67	10816-13	10816-15	138	26157-00	-	95	95	95	95	95	95
6120-25	-	76	9623-03	-	56	10742-80	10742-91	67	10816-19	10816-21	138	26158-01	26158-07	96	96	96	96	96	96
6120-29	-	76	9624-01	-	56	10744-10	10744-11	67	10816-29	10816-31	138	26159-01	26159-08	96	96	96	96	96	96
6120-35	-	76	9624-02	9624-03	56	10744-31	10744-32	67	10816-39	10816-41	138	26160-01	26160-09	96	96	96	96	96	96
6122-01	6122-02	77	9625-01	-	89	10744-34	-	67	10816-59	10816-61	138	26165-00	-	96	96	96	96	96	96
6129-01	6129-04	76	9631-01	9631-02	42	10744-54	10744-55	67	10821-01	10821-06	135	26165-10	-	96	96	96	96	96	96
6129-11	6129-13	76	9631-10	9631-13	42	10744-80	10744-91	67	10821-09	10821-10	135	26170-00	-	96	96	96	96	96	96
6129-21	6129-24	76	9631-14	9631-15	42	10745-01	10745-17	65	10821-19	10821-20	135	26170-01	26170-02	96	96	96	96	96	96
6129-31	6129-34	76	9641-01	9641-02	43	10746-01	-	78	10823-03	10823-12	143	26170-30	-	96	96	96	96	96	96
6129-97	-	76	9641-10	9641-11	43	10747-01	-	78	10823-19	10823-22	143	26174-50	-	96	96	96	96	96	96
6341-08	6341-09	102	9642-01	9642-02	43	10748-01	-	78	10826-02	10826-03	139	26175-03	26175-18	96	96	96	96	96	96
6341-11	6341-12	102	9642-10	9642-11	43	10755-01	10755-02	78	10826-05	10826-06	139	26178-01	26178-37	95	95	95	95	95	95
6341-18	6341-19	102	9643-01	-	42	10756-01	10756-06	78	10826-09	10826-10	139	26179-13	-	97	97	97	97	97	97
6341-25	6341-26	102	9643-10	-	42	10757-01	10757-03	78	10826-13	10826-14	139	26179-20	-	97	97	97	97	97	97
6341-30	6341-31	102	9644-01	9644-02	42	10800-06	-	134	10826-19	10826-20	139	26179-50	26179-52	97	97	97	97	97	97
6341-36	6341-37	102	9644-11	9644-13	42	10800-09	-	134	10826-29	10826-30	139	26179-70	-	97	97	97	97	97	97
6341-58	6341-59	102	9645-01	9645-02	42	10801-03	-	134	10826-39	10826-40	139	26179-75	-	97	97	97	97	97	97
6341-61	6341-62	102	9645-11	9645-12	42	10801-06	-	134	10826-59	10826-60	139	26179-76	-	97	97	97	97	97	97
6341-68	6341-69	102	9646-01	9646-06	42	10801-10	-	134	10831-04	-	135	26179-92	26179-95	97	97	97	97	97	97
6341-75	6341-76	102	9646-11	9446-16	42	10801-14	-	134	10831-06	-	135	26180-05	-</						

INDEX REFERENCES



P/N.	to	P/N.	Page	P/N.	to	P/N.	Page	P/N.	to	P/N.	Page	P/N.	to	P/N.	Page	P/N.	to	P/N.	Page
26681-61		26681-67	10	31080-31		31080-32	119	32020-01		-	44	32067-41		-	131	60655-07		60655-08	79
27501-01		27501-07	8	31100-01		31100-14	121	32032-01		32032-02	131	32067-43		-	131	60655-10		-	79
27501-11		27501-16	8	31101-01		31101-07	121	32032-11		32032-13	130	32067-44		-	131	60655-12		60655-13	79
27501-21		27501-25	8	31109-01		31109-03	117	32045-03		-	130	32067-46		-	131	60655-15		60655-20	79
27501-62		27501-68	8	31117-01		31117-06	115	32045-12		-	130	32067-47		-	131	60655-22		-	79
27501-71		27501-76	8	31118-01		31118-02	115	32045-20		32045-23	130	32067-49		-	131	60755-05		60755-08	79
27501-81		27501-85	8	31123-04		-	118	32045-51		-	130	32067-61		-	131	60755-11		-	79
27504-01		27504-07	9	31123-09		-	118	32045-53		-	130	32067-63		-	131	60755-14		-	79
27504-11		27504-16	9	31132-01		31132-02	118	32045-54		-	130	32067-64		-	131	60755-16		60755-19	79
27504-21		27504-25	9	31132-51		31132-53	118	32045-55		-	130	32067-66		-	131	60755-21		-	79
28501-31		28501-48	8	31170-01		31170-04	60	32045-61		-	130	32067-67		-	131	60855-05		60855-08	79
28501-51		28501-57	8	31180-01		31180-03	117	32045-62		-	130	32067-69		-	131	60855-11		60855-12	79
28504-01		28504-18	9	31200-74		-	104	32065-05		-	131	32067-81		-	131	60855-14		-	79
28504-21		28504-27	9	31340-11		-	122	32065-07		-	131	32067-82		-	131	60855-16		60855-21	79
28504-31		28504-57	9	31341-10		-	122	32065-11		-	131	32067-83		-	131	60855-23		60855-24	79
28504-61		28504-88	9	31342-10		-	122	32065-13		-	131	32067-91		-	131	60955-08		-	79
30250-01		30250-06	129	31343-10		-	122	32065-14		-	131	32067-93		-	131	60955-11		-	79
30250-41		30250-46	129	31390-11		-	122	32065-16		-	131	32067-94		-	131	60955-14		-	79
30251-01		30251-06	129	31391-11		-	122	32065-21		-	131	32067-96		-	131	60955-19		-	79
30290-01		-	129	31392-10		-	122	32065-23		-	131	32067-97		-	131	60955-21		-	79
30290-03		-	129	31393-10		-	122	32065-24		-	131	32067-99		-	131	60955-23		60955-25	79
30302-12		30302-18	104	31394-10		-	122	32065-26		-	131	34848-99		-	127	80705-40		-	146
30330-15		-	128	31395-10		-	122	32065-27		-	131	34896-48		-	127	80705-60		-	146
30330-25		-	128	31396-10		-	122	32065-29		-	131	34896-99		-	127	80740-00		-	146
30330-45		-	128	31396-60		-	122	32065-41		-	131	39696-48		-	127	80745-00		-	146
30330-65		30330-67	128	31397-10		-	122	32065-43		-	131	39696-96		-	127	80799-00		-	146
30330-75		30330-77	128	31446-00		-	122	32065-44		-	131	51931-10		-	56	80812-08		-	146
30330-86		30330-87	128	31447-00		-	122	32065-46		-	131	51934-10		-	56	80812-12		-	146
30330-95		30330-99	128	31448-00		-	122	32065-47		-	131	51935-10		-	56	80812-17		-	146
30633-01		30633-03	126	31449-00		-	122	32065-49		-	131	51937-10		-	56	80812-21		-	146
30633-12		-	126	31450-25		-	121	32065-61		-	131	51938-10		-	56	80814-08		-	146
30633-22		-	126	31452-10		-	44	32065-63		-	131	51939-10		-	56	80834-12		-	146
30633-41		-	126	31452-25		-	121	32065-64		-	131	51954-10		-	56	80834-17		-	146
30633-51		-	126	31455-25		-	121	32065-66		-	131	51958-10		-	56	80834-21		-	146
30635-01		30635-02	127	31459-25		-	121	32065-67		-	131	52073-01		-	56	80834-25		-	146
30635-13		30635-15	127	31601-10		-	122	32065-69		-	131	52074-01		-	56	99002-16		-	146
30635-21		30635-23	127	31605-11		-	122	32065-81		-	131	52078-01		-	56	99002-25		-	146
30655-01		30655-04	126	31605-12		-	122	32065-82		-	131	52079-01		-	56	99002-66		-	146
30655-13		30655-16	126	31605-13		-	122	32065-83		-	131	52080-01		-	56	99002-75		-	146
30655-21		30655-23	126	31605-60		-	122	32065-91		-	131	52081-01		-	56	99003-03		99003-05	146
30656-01		30656-05	126	31620-10		-	44	32065-93		-	131	52486-10		-	132	99003-08		-	146
30656-13		30656-17	126	31621-10		-	44	32065-94		-	131	52487-10		-	132	99003-12		-	146
30656-21		-	126	31645-68		-	122	32065-96		-	131	52488-10		-	132	99003-16		-	146
30656-23		30656-24	126	31656-00		-	122	32065-97		-	131	52489-10		-	132	99003-22		-	146
30656-90		30656-99	126	31657-00		-	122	32065-99		-	131	52732-01		52732-03	56	99003-30		-	146
30713-01		-	122	31658-00		-	122	32066-05		-	131	53691-01		-	110	4500226-01		-	63
30746-01		30746-03	110	31659-00		-	122	32066-07		-	131	53710-01		-	110	4500227-01		-	63
30828-01		30828-04	127	31659-01		-	122	32066-11		-	131	53804-01		-	65	4500228-01		-	63
30848-01		30848-04	127	31660-00		-	122	32066-13		-	131	53824-01		-	65	4500229-01		-	63
30848-11		30848-14	127	31661-67		-	122	32066-14		-	131	54229-01		-	110	60542-99		-	80
30856-51		-	127	31662-67		-	122	32066-16		-	131	55140-10		-	10	DP10000		-	147
30856-61		30856-63	127	31663-67		-	122	32066-21		-	131	55140-99		-	10	DP1200		-	147
30880-91		-	127	31664-00		-	122	32066-23		-	131	55141-10		-	10	DP3500		-	147
30881-01		30881-05	126	31665-00		-	122	32066-24		-	131	55141-99		-	10	DP5000		-	147
30881-13		30881-17	126	31666-00		-	122	32066-26		-	131	55142-10		-	10	STL200		-	147
30881-21		30881-24	126	31667-00		-	122	32066-27		-	131	55142-99		-	10	STL250		-	147
30881-90		-	126	31668-00		-	122	32066-29		-	131	55143-10		-	10	VDM 10000		-	148
30882-01		-	104	31669-00		-	122	32066-41		-	131	55143-99		-	10	VDM 3500		-	148
31022-01		31022-06	115	31670-00		-	122	32066-43		-	131	55144-04		-	10	VDM 750		-	148
31023-07		31023-12	115	31671-00		-	122	32066-44		-	131	55145-04		-	10	VDM1200		-	148
31026-01		-	117	31672-00		-	44	32066-46		-	131	55146-04		-	10	VDM5000		-	148
31026-06		31026-08	117	31672-00		-	122	32066-47		-	131	55147-04		-	10	T 10000		-	149
31030-02		31030-06	114	31673-00		-	122	32066-49		-	131	55148-04		-	10	T 1200		-	148
31030-09		31030-13	114	31678-00		-	121	32066-61		-	131	55340-10		-	132	T 20000		-	149
31032-01		31032-07	114	31711-02		-	117	32066-63		-	131	55341-10		-	132	T 3500		-	149
31035-11		31035-13	114	31711-03		31711-04	121	32066-64		-	131	55342-10		-	132	T 5000		-	149
31042-01		31042-02	115	31711-05		-	117	32066-66		-	131	55343-10		-	132	T 750		-	148
31042-04		31042-05	115	31712-00		-	123	32066-67		-	131	60155-01		60155-02	79				
31042-08		31042-10	115	31713-00		-	123	32066-69		-	131	60255-01		60255-06	79				
31043-10		31043-20	116	31714-04		-	123	32066-81		-	131	60301-00		60303-00	63				
31045-01		31045-06	116	31714-08		-	123	32066-82		-	131	60307-00		60308-00	63				
31045-07		31045-12	116	31714-12		-	123	32066-83		-	131	60355-01		60355-03	79				
31048-01		31048-05	114	31715-00		-	123	32066-91		-	131	60355-05		60355-06	79				
31055-01		31055-02	117	31842-68		-	122	32066-93		-	131	60355-09		-	79				
31061-01		31061-02	119	31843-68		-	122	32066-94		-	131	60355-13		-	79				
31061-09		31																	



**ELECTRICAL HEATING AND COOLING
SOLUTIONS
FOR THE INDUSTRY**

VULCANIC SAS
ZI des Chanoux
48, rue Louis Ampère
F-93330 Neuilly sur Marne
France
Tel. : +33 1 49 44 49 20



VULCANIC SAS
ZI la Saunière
F-89600 Saint Florentin
France
Tel. : +33 1 49 44 49 20



VULCANIC UK Ltd
South Green Park Entreprise
Centre, Mattishall
NR20 3JY, Dereham Norfolk
United Kingdom
Tel. : +44 1603 340015



LOREME SAS
12, rue des Potiers d'Étain
Actipôle Borny
F-57071 Metz
France
Tel. : +33 3 87 76 32 51



VULCANIC SA
Heilig Hartstraat, 14
B-2600 Berchem
Belgium
Tel. : +32 3 286 70 30



RS ISOLSEC SAS
45, avenue des acacias
F-45120 Cepoy
France
Tel. : +33 2 38 85 62 62



VULCANIC TERMOELÉCTRICA SLU
Ctra. a Viérnoles, 32
E-39300 Torrelavega
Spain
Tel. : +34 942 80 35 35



VULCANIC GmbH
Donaustraße 21
D-63542 Hanau
Germany
Tel. : +49 6181 9503 0



RS ISOLSEC SLU
Ave Riu Mogent, 5
E-08170 Montornes del valles
Spain
Tel. : +34 93 568 73 10



VULCANIC Russia
105005 Moscow
radio street
house 24 building 1
Russia
Tel. : + 7 (903) 967-95-68



VULCANIC TRIATHERM GmbH
Flurstraße 9
D-96515 Sonneberg
Germany
Tel. : +49 3675 4083-0



www.vulcanic.com

