

Index

A

Axle & Nut Assemblies	22
Axle Sets	22
Axles	22

B

Bars, Handle	12,13
Basket Fittings	10
Baskets	7,8,9,10
Bolts, Binder	15
Bolts, Expander	15
Bolts, Fork Crown	17
Bolts & Nuts, Assorted	21
Bolts & Nuts, Coaster Brake Strap	21
Bolts & Nuts, Fender	3
Bolts & Nuts, Seat Post	19
Bolts & Nuts, Kickstand	6
Braces	3
Brackets, Fender Angle	3
Brackets, Reflector (basket mounted)	10
Bridge Clips, Fender Back Stay	3
Bushings, Seat Post	19
Bushings, Stem	15

C

Chain Guard Clamps	5
Chain Guards	5
Coaster Brake Straps	21
Cone Sets, Crank	18
Cones, Crank	18
Cones, Head	17
Crank Fitting Sets	18
Crank Sets	18
Cranks	18
Cups, Crank	18
Cups, Head	17

D

Dust Caps	21
-----------	----

F

Fender Fittings	3
Fenders	2
Flashlight Holders	21
Fork Front Wheel Retaining Clips	16
Forks	16

H

Handlebars	12,13
Head Sets	17
Hubs, Front	22

K

Kickstands	6
------------	---

L

Lugs, Stem Expander Bolt	15
--------------------------	----

N

Nuts, Axle (Flange)	23
Nuts, Crank Lock	18
Nuts, Head Lock	17

P

Pedal Bolt Fittings	11
Pedals	11

R

Racks, Rear	6
Reflector Brackets (basket mounted)	10
Repair Tags	21
Retainers, Ball	24

S

Seat Posts	19
Snap-on Caps	11
Splash Guards	2
Sprockets	20
Stands	6
Steel Balls	24
Stems, Handlebar	14

T

Training Wheel Fittings	5
Training Wheel Sets	4
Training Wheels	5

W

Washers, Axle	23
Washers, Crank Spacer	18
Washers, Key	17,18
Washers, Spring Lock	23
Washers, Star Lock	6
Wrenches, Open End	20
Wrenches, Spoke	20

Wald Manufacturing Co., Inc.

©1999 Wald Inc.

AN AMERICAN MANUFACTURER
QUALITY, SERVICE AND DESIGN SINCE 1905

GENERAL INFORMATION

ORDERING	Please specify the WALD NO. Minimum ordering quantity for any item is standard carton packing.
FREIGHT	All shipments are made F.O.B. Maysville, Kentucky, which is 63 miles east of Cincinnati, Ohio.
PRICES	A separate confidential price list is available <u>only to our distributors</u> .
DAMAGE OR LOSS CLAIMS	For merchandise lost or damaged in transit, please make claims direct to the carrier.
RETURN GOODS	Under no circumstances will we accept merchandise returned to us without our written consent.
PATENTS	Many items in this catalog are the subject of issued mechanical or design patents or pending patent applications.
BAR CODING	All Wald shipping carton labels, and some selected individual items, contain our UPC bar code.
PRODUCT SPECIFICATIONS	Specifications subject to change without notice.





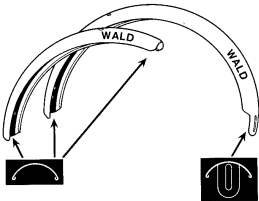
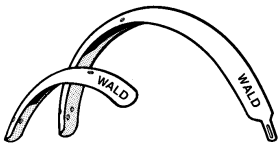
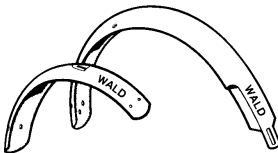
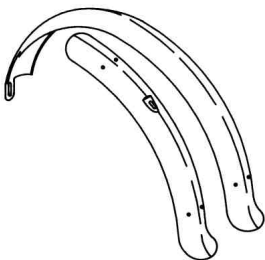
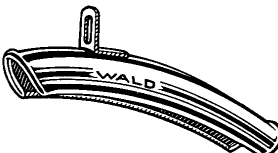

Fenders

All Wald Fender Sets Include Braces & Hardware

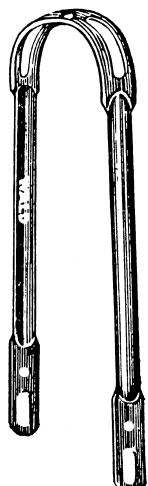
	WALD NO.	BICYCLE SIZE	FITS TIRE WIDTH	PACKING	WT/CRTN
	CHROME LIGHTWEIGHT CRESCENT				
	89-26	26"	1 1/4 or 1 3/8"	1 set/bag, 5 sets/crtn.	11
	CHROME MIDDLEWEIGHT				
	952-26	26"	1 1/2 or 1 3/4"	1 set/bag, 5 sets/crtn.	13 1/2
	952-24	24"	1 1/2 or 1 3/4"	1 set/bag, 5 sets/crtn.	13
	952-20	20"	1 1/2 or 1 3/4"	1 set/bag, 5 sets/crtn.	10 1/2
	952-16	16"	1 1/2 or 1 3/4"	1 set/bag, 5 sets/crtn.	9
	CHROME & BLACK BALLOON				
	962-26 Chrome	26"	2 or 2 1/8"	1 set/bag, 5 sets/crtn.	18
	962-26GB Black	26"	2 or 2 1/8"	1 set/bag, 5 sets/crtn.	18
	962-24 Chrome	24"	2 or 2 1/8"	1 set/bag, 5 sets/crtn.	16
	962-20 Chrome	20"	2 or 2 1/8"	1 set/bag, 5 sets/crtn.	13
	CHROME BALLOON - FLARED				
	972-26	26"	2 or 2 1/8"	1 set/bag, 5 sets/crtn.	18
	972-24	24"	2 or 2 1/8"	1 set/bag, 5 sets/crtn.	16
	972-20	20"	2 or 2 1/8"	1 set/bag, 5 sets/crtn.	13
	SPLASH GUARDS fit front or rear				
	80 Chrome	26/27" Ltw.	1 1/4 or 1 3/8"	1/bag, 10/crtn.	2 1/2
	90 Chrome	20,24,26" Mdw/Balloon	1 1/2, 1 3/4, 2 or 2 1/8"	1/bag, 10/crtn.	3
	90BL Black	20,24,26" Mdw/Balloon	1 1/2, 1 3/4, 2 or 2 1/8"	1/bag, 10/crtn.	3

Braces Fender Fittings

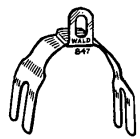
All Wald Braces are plated, marked with size and include bolts and nuts

WALD NO.	BICYCLE SIZE	PACKING	WT/CRTN	
BRACES				
MIDDLEWEIGHT				
322-26	26"	10/bag, 10 bags/crtn.	27	
322-24	24"	10/bag, 10 bags/crtn.	25	
322-20	20"	10/bag, 10 bags/crtn.	22	
322-16	16"	10/bag, 10 bags/crtn.	18 1/2	
BALLOON				
324-26	26"	10/bag, 10 bags/crtn.	28	
324-24	24"	10/bag, 10 bags/crtn.	26	
324-20	20"	10/bag, 10 bags/crtn.	23	
LIGHTWEIGHT CRESCENT				
121-26	26"	10/bag, 10 bags/crtn.	27	
FENDER BOLTS AND NUTS No. 8-32 thread, truss head, 13/32" diameter				
283-3/8 (3/8" long)		100/box, 1000/crtn.	7	
FENDER ANGLE BRACKETS				
827F		10/bag, 10 bags/crtn.	1 1/2	
FENDER BACK STAY BRIDGE CLIPS				
847		10/bag, 10 bags/crtn.	6 1/2	
FENDER FITTINGS Includes back stay bridge clip, angle bracket, and bolt & nut in bag.				
447		1/bag, 10 bags/pkg., 10 pkgs/crtn.	11 1/2	



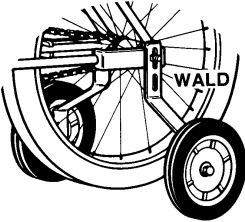
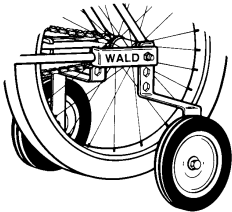
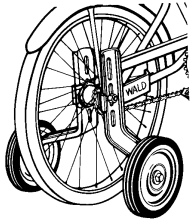
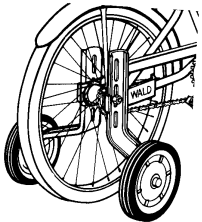
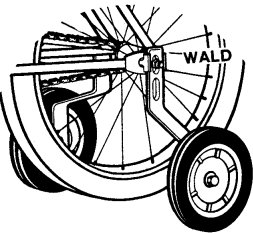

Training Wheels

FOR SINGLE SPEED BICYCLES



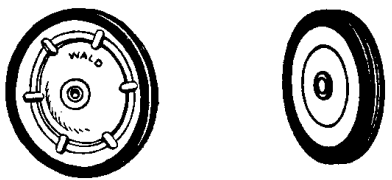

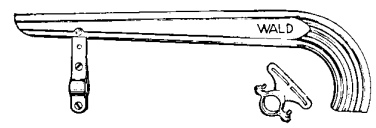

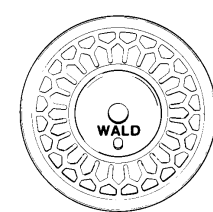
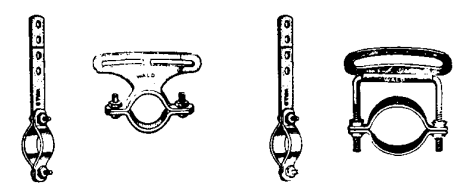
	WALD NO.	BICYCLE SIZE	WHEELS	PACKING	WT/CRTN
	Maximum rider weight 100 lbs.				
	252	Fits 16" thru 20"	5 1/2" diameter plated steel wheels with tires and 3/8" axle hole	1 set/box, 10 sets/crtn.	37
	10252	Fits 16" thru 20" WITH 1" REAR FRAME	5 1/2" diameter plated steel wheels with tires and 3/8" axle hole	1 set/box, 10 sets/crtn.	38
	Maximum rider weight 75 lbs.				
	632	Fits 12" thru 16"	5" diameter plastic wheels with tires and 3/8" axle hole	1 set/box, 10 sets/crtn.	30 1/2
	Maximum rider weight 125 lbs.				
	642	Fits 16", 20", 24" or 26"	5" diameter plastic wheels with tires and 3/8" axle hole	1 set/bag, 10 sets/crtn.	29
	Maximum rider weight 125 lbs.				
	742	Fits 16", 20", 24" or 26"	5 1/2" diameter plated steel wheels with tires and 3/8" axle hole	1 set/box, 10 sets/crtn.	37 1/2
	Maximum rider weight 75 lbs.				
	1216	Fits 12" thru 16"	5 1/2" diameter plated steel wheels with tires and 3/8" axle hole	1 set/box, 10 sets/crtn.	31

Training Wheel Parts

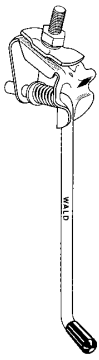
Chain Guards

WALD NO.	BICYCLE SIZE	PACKING	WT/CRTN	
TRAINING WHEEL PARTS				
REPLACEMENT WHEELS (for all Wald training wheel sets)				
1162 (Steel – 5 1/2" dia.)		20/crtn.	12 1/2	
1132 (Plastic – 5" dia.)		20/crtn.	6 1/2	
REPLACEMENT FITTINGS (for Wald training wheel sets)				
216 (for 1216)		10 bags/crtn.	2	
2622 (for 252 & 10252)		10 bags/crtn.	2	
3632 (for 632)		10 bags/crtn.	3	
3642 (for 642)		10 bags/crtn.	3 1/2	
3742 (for 742)		10 bags/crtn.	3 1/2	
CHAIN GUARDS Chrome Plated				
616	16"	1/bag, 10 bags/crtn.	5	
620	20"	1/bag, 10 bags/crtn.	5 1/2	
656	24/26"	1/bag, 10 bags/crtn.	6	
602	20"	1/bag, 10 bags/crtn.	6	
600	24/26"	1/bag, 10 bags/crtn.	6 1/2	
685 Circular	For 1 piece crank, 8 1/2" dia.	1/bag, 10 bags/crtn.	4 1/2	
CHAIN GUARD CLAMPS Plated (sets include both front & rear clamps)				
426	(for 616, 620, 656)	1 set/bag, 10 bags/crtn.	2	
427	(for 600 & 602)	1 set/bag, 10 bags/crtn.	2 1/2	

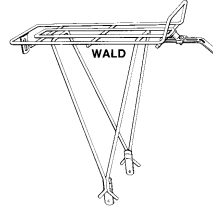
Kickstands Racks

	WALD NO.	BICYCLE SIZE	DESCRIPTION	PACKING	WT/ CRTN
	KICKSTANDS				
	78	Extra Long	Most Lightweight, Middleweight & Balloon	10/crtn.	11 1/2
	77-27	27"		10/crtn.	11 1/2
	76-26	24/26"		10/crtn.	11
	73-20	Most 20"	Also fits frames with weld-on mounting plate	10/crtn.	10 1/2
	70-20	Some 16/20"		10/crtn.	10
	74-16	Most 16"		10/crtn.	9
	67-24	24"	Rear Axle Mounting For <u>3/8"</u> axle	10/crtn.	8
	67-20	20"		10/crtn.	7 1/2
	67-20BL (Black)	20"		1/bag, 10/crtn.	7 1/2
	67-16	16"		10/crtn.	6 1/2
	1467-24	24"	Rear Axle Mounting For <u>14mm</u> axle	10/crtn.	8
	1467-20	20"		10/crtn.	7 1/2
	1467-20BL (Black)	20"		1/bag, 10/crtn.	7 1/2
	1467-16	16"		10/crtn.	6 1/2
	KICKSTAND BOLTS, NUTS & WASHERS (UNASSEMBLED)				
	516		5/16 x 1 1/2" bolt	10/bag, 10 bags/crtn.	5 1/2
	STAR LOCK WASHERS (FOR WALD REAR AXLE KICKSTANDS)				
	422		.422" dia. axle hole	10/bag, 10 bags/crtn.	1/2
	REAR RACKS				
	215	Chrome Plated	Adjustable mounting to brake bolt – fits 26 & 27"	5/crtn.	12
	215BL	Black		1/bag, 5/crtn.	13
	215F	Plated	Adjustable mounting bracket, screws & nuts	10 bags/crtn.	2

NOTE: Black and White Finish items are polyester powder coated, providing excellent durability and UV/weather resistance.

Baskets

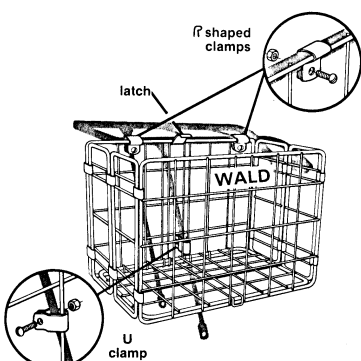
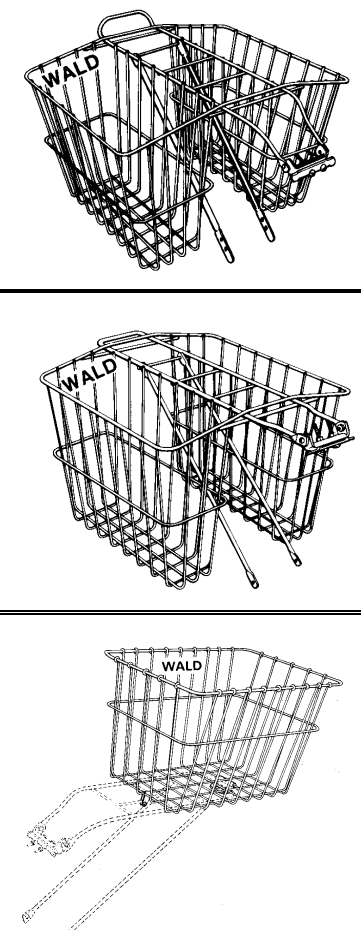
WALD NO.	FINISH	DESCRIPTION	PACKING	WT/CRTN	
FOLDING BICYCLE BASKETS for rear racks					
582	Plated	12 3/4 x 7 1/4 x 8 1/2" Sized for grocery bag	1/bag, 10/crtn.	28	
582BL	Black	About 1" thick when folded		28 1/2	
582WH	White			28 1/2	
REAR WIRE BASKETS					
520	Plated	13 1/2 x 6 1/4 x 11" Twin Carrier	5/crtn.	29	
535	Plated	18 x 7 1/2 x 12" Twin Carrier	5/crtn.	41	
570	Plated	13 1/2 x 5 x 10" Twin Carrier for 26 & 27" lightweights	5/crtn.	25	
585	Plated	14 1/2 x 9 1/2 x 9" Fits most rear racks Sized for grocery bag	5/crtn.	9	

Baskets

NOTE: Black and White Finish items are polyester powder coated, providing excellent durability and UV/weather resistance.

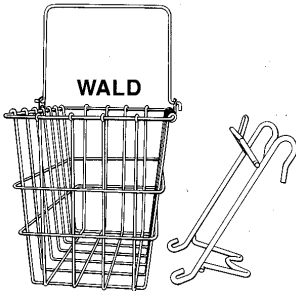
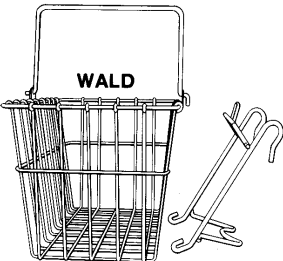
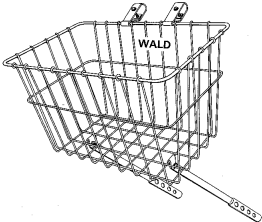
	WALD NO.	FINISH	DESCRIPTION	PACKING	WT/CRTN
	FRONT WIRE BASKETS				
	114WH 114GB	White Gloss Black	11 3/4 x 8 x 9" Compact Style Basket & Holder	5/crtn.	11 1/2
	133WH 133GB	White Gloss Black	14 1/2 x 9 1/2 x 9" Basket & Holder	5/crtn.	13
	124GB	Gloss Black with black legs	11 3/4 x 8 x 9" Compact Style	5/crtn.	10 1/2
	135 135BL 135WH	Plated Black with black legs White with white legs	14 1/2 x 9 1/2 x 9" Deep-sized for grocery bag	5/crtn.	11 1/2
	137 137GB	Plated Gloss Black with black legs	15 x 10 x 4 3/4" Standard	5/crtn.	11
	139 139GB	Plated Gloss Black with black legs	18 x 13 x 6" Standard	5/crtn.	13





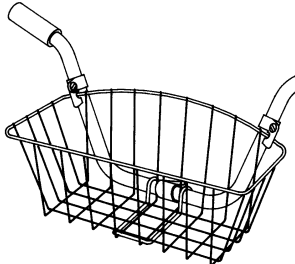
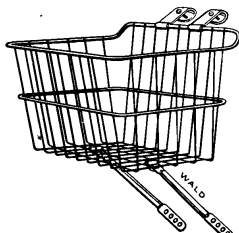
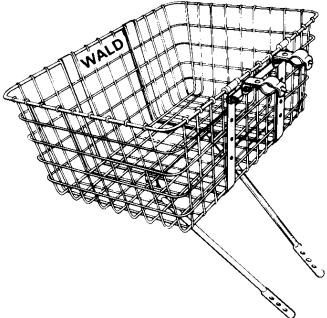
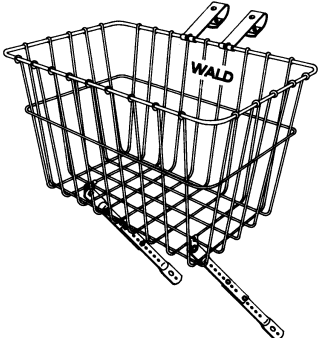



NOTE: Black and White Finish items are polyester powder coated, providing excellent durability and UV/weather resistance.

Baskets



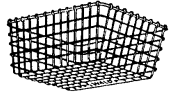

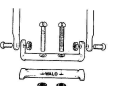
WALD NO.	FINISH	DESCRIPTION	PACKING	WT/CRTN	
FRONT WIRE BASKETS					
145WH	White	12 x 5 1/2 x 5" Fits high rise style handlebars	5/crtn.	5	
151	Plated	14 x 9 x 7" Drop Top Style	5/crtn.	11	
157B	Plated	21 x 15 x 9" Giant Delivery	5/crtn.	39	
198GB	Gloss Black	14 1/2 x 9 1/2 x 9" Multi-Fit <ul style="list-style-type: none"> • 2-piece adjustable legs • Extended handlebar clamps • 2 lower leg mounting holes 	5/crtn.	13 1/2	

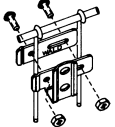
Baskets/Fittings

NOTE: Black and White Finish items are polyester powder coated, providing excellent durability and UV/weather resistance.

	WALD NO.	FINISH	DESCRIPTION	PACKING	WT/CRTN
BASKETS WITHOUT FITTINGS					
	35 35WH	Plated White	14 1/2 x 9 1/2 x 9" Same as No. 135	10/crtn. 5/crtn.	16 8 1/2
	42	Plated	18 x 13 x 6" Same as No. 139	10/crtn.	18 1/2
	57	Plated	21 x 15 x 9" Same as No. 157B	5/crtn.	28
	433	Plated	13 1/2 x 6 1/2 x 10"	10/crtn.	16
	1275 1275WH	Plated White	21 x 15 x 9" Same as No. 157B Without Bands	5/crtn. 9/crtn.	20 35
BASKET FITTINGS					
	1014WH 1014GB 1033WH 1033GB	White Gloss Black White Gloss Black	Holder/Tag for No. 114WH Holder/Tag for No. 114GB Holder/Tag for No. 133WH Holder/Tag for No. 133GB	1/bag, 10/crtn.	8
	552	Plated	2 hole Neck Clamp & Fittings for No. 520,535	1/bag, 10/crtn.	1 1/2
	570F	Plated	Neck Clamp Assembly for No. 570 Baskets	1/bag, 10/crtn.	2 1/2
	5820	Plated	Strap and Clamps for one No. 582 Basket	1/bag, 10/crtn.	1
	101	Plated	Basket Mounted Reflector Brackets Attaches to most front & rear wire bicycle baskets Accepts most push-on or screw- on style reflectors and LED lights	1/bag, 10 bags/pkg, 10 pkgs/crtn.	9
	135F 135X 157F 157X 198GBX	Plated	Bolts & Nuts for Nos. 135,151,124GB,137GB & 139GB Leg for Nos. 135,151 and 124GB Handlebar Fittings for No. 157B Basket Legs & Brace Support for No. 157B Basket Fittings for No. 198GB Basket	1/bag,10/crtn 10/crtn. 25/crtn. 24/crtn. 1/bag,10/crtn	1 1/2 1/2 25 26 6 1/2







Pedals/Snap Caps

WALD NO.	FINISH	DESCRIPTION	PACKING	WT/CRTN	
BICYCLE PEDALS					
912	Plated	1/2" Axle Ball Bearing Block Style With reflectors to meet C.P.S.C. Standards	1 pr./bag, 20 pr./crtn.	24 1/2	
VELOCIPEDE PEDALS					
72709	Plated	Fits most tricycles with 7/16" diameter crank 2 each 717 pedals, 462 snap-on caps, washers and 7/16" sleeves per pair.	1 pr./ header bag, 10 pr./crtn.	6 1/2	
VELOCIPEDE PEDAL BOLT FITTINGS					
7130	Plated	2 each bolts, nuts, washers & star washers per poly bag, unassembled.	10 bags/ crtn.	5 1/2	
SNAP-ON CAPS					
462		7/16"	10/bag,	1	
474		1/4"	10 bags/ crtn.	1/2	
476		5/16"		1/2	
2462		7/16"	2/bag,	2 1/2	
2474		1/4"	10 bags/ pkg.,	1 1/2	
2476		5/16"	10 pkgs/ crtn.	1 1/2	

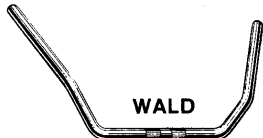
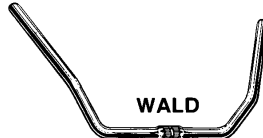
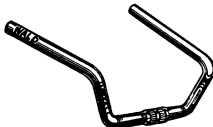
Handlebars

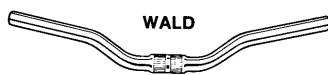
Handlebars with 1" center feature a heavy steel reinforcement inside the knurled section to insure maximum strength and a finished appearance.





Black Finish items are polyester powder coated, providing excellent durability and UV/weather resistance.

	WALD NO.	FINISH	CENTER	WIDTH	RISE	PACKING	WT/CRTN
	REGULAR / CRUISER STYLE						
	828	Chrome	7/8"	28"	3"	10/crtn.	19
	872	Chrome	1"	24"	3"	10/crtn.	14
	896	Chrome	1"	26"	3"	10/crtn.	18
	898	Chrome	1"	28"	3"	10/crtn.	20
	867	Chrome	1"	20"	4"	10/crtn.	14
	MOUNTAIN / CITY STYLE						
	823	Chrome	7/8"	27"	5 1/4"	10/crtn.	16
	803	Chrome	1"	27"	5 1/4"	10/crtn.	17
	803BL	Black				1/bag, 10/crtn.	
	8038GB	Gloss Black	1"	30" (with 8" handles)	5 1/4"	1/bag, 10/crtn.	19
	808	Chrome	1"	26"	2 1/4"	10/crtn.	14
	808BL	Black				1/bag, 10/crtn.	
	8003	Chrome	1"	23 3/4"	0	10/crtn.	12 1/2
	8003BL	Black				1/bag, 10/crtn.	
	TOURING STYLE						
	815	Chrome	1"	20 1/4"	2"	10/crtn.	9
	8095	Chrome	1"	22 3/4"	2 1/2"	10/crtn.	13

Handlebars

Handlebars with 1" center feature a heavy steel reinforcement inside the knurled section to insure maximum strength and a finished appearance.

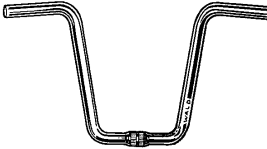
Black Finish items are polyester powder coated, providing excellent durability and UV/weather resistance.

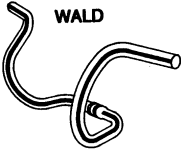
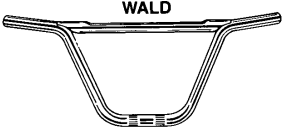
WALD NO.	FINISH	CENTER	WIDTH	RISE	PACKING	WT/CRTN	
HIGH-RISE STYLE							
870	Chrome	1"	24 1/4"	9 1/2"	10/crtn.	18	
880	Chrome	1"	23 1/4"	10 1/2"	10/crtn.	23	
1066	Chrome	1"	19 1/2"	6 1/2"	10/crtn.	15	
869	Chrome	1"	23 1/2"	10 3/4"	10/crtn.	23	
8069	Chrome	1"	24 1/2"	13"	10/crtn.	23	
805 805BL	Chrome Black	1"	25 1/2"	8" with 6" Forward Extension	10/crtn. 1/bag, 10/crtn.	24	
832 832BL	Chrome Black	1"	24 1/2"	7 3/8" with 5 7/8" Forward Extension	10/crtn. 1/bag, 10/crtn.	22	
BMX STYLE							
812	Chrome	7/8"	26 1/2"	8 1/2"	10/crtn.	22 1/2	
8001	Chrome	7/8"	26 1/2"	8 1/2"	10/crtn.	21 1/2	

Handlebar Stems

Most bicycles made in U.S.A. have .833" Max. Down Stem Diameter to fit 14 gage fork stems.

To assemble a Wald handlebar stem into a 16 gage (.875" I.D.) fork stem, use the Wald #905 bushing.

NOTE: 16 gage fork stems for 22.2mm handlebar stems are common on imports.

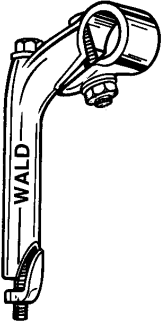
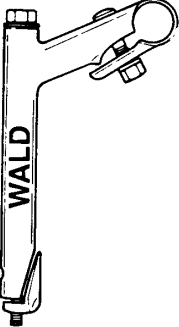
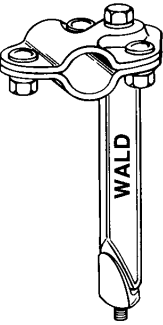
	WALD NO.	FINISH	DESCRIPTION	PACKING	WT/CRTN
	Recommended for use with handlebars having 1" diameter center, including those up to 14" rise.				
	4	Chrome	Down Stem Length: 5" Down Stem Dia.: .833" Max. Bar Hole Size: 1"	50/crtn.	49 1/2
	Recommended for use with handlebars having 1" diameter center, including those up to 10" rise.				
	550	Chrome	Down Stem Length: 6" Down Stem Dia.: .833" Max. Bar Hole Size: 1"	10/crtn.	11
	550BL	Black	Down Stem Length: 6" Down Stem Dia.: .833" Max. Bar Hole Size: 1"	1/bag, 10/crtn.	11
	511	Chrome	Down Stem Length: 11" Down Stem Dia.: .833" Max. Bar Hole Size: 1"	10/crtn.	14 1/2
	Recommended for use with handlebars having 7/8" diameter center, including those up to 10" rise.				
	4820C	Chrome	Down Stem Length: 5" Down Stem Dia.: .833" Max. Bar Hole Size: 7/8"	1/header bag, 10/crtn.	14
	4820	Black & Chrome			

Stem Fittings





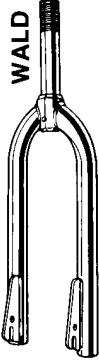
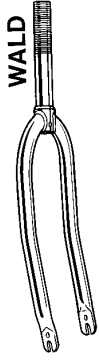
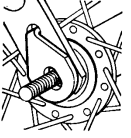

WALD NO.	FINISH	DESCRIPTION	PACKING	WT/CRTN	
EXPANDER BOLTS					
230-5 7/8	Plated	(for most Wald stems)	10/bag, 10 bags/crtn.	12	
230-12	Plated		10/bag, 10 bags/crtn.	23	
2350	Plated	1 each 230-5 7/8" bolt, 232 lug & 111 washer per bag	1/bag, 10 bags/pkg., 10 pkgs/crtn.	18 1/2	
2370	Plated	1 each 230-7 1/2" bolt, 232 lug & 111 washer per bag	1/bag, 10 bags/pkg., 10 pkgs/crtn.	20	
STEM BUSHINGS					
905	Plated	For assembling .833" diameter handlebar stems into .875" diameter forks. <i>NOTE: This bushing is also for assembling 13/16" seat posts into 7/8" masts.</i>	10/bag, 10 bags/crtn.	4	
SPLIT EXPANDER LUGS					
232	Plated	(for all Wald stems)	10/bag, 10 bags/crtn.	6	
BINDER BOLTS, NUTS & WASHERS					
239-1 7/8	Plated	Unassembled	10/bag, 10 bags/crtn.	8	
249 (1 7/8")	Plated	Unassembled (for Wald 550/511 stems)	10/bag, 10 bags/crtn.	8	

Forks



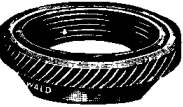

Wald forks have a caliper brake hole and 14 gage fork stem tubing.

	WALD NO.	BICYCLE SIZE	FINISH	PACKING	WT/CRTN
	TUBULAR FORKS (7" STEM) These Wald forks include a 593 cone and two 1420 fork clips, 1" x 24 thread stem.				
	1636C	26"	Chrome	1/bag, 5/crtn.	15 1/2
	1634C	24"	Chrome	1/bag, 5/crtn.	14 1/2
	1630C	20"	Chrome	1/bag, 5/crtn.	14
	1616C	16"	Chrome	1/bag, 5/crtn.	12
	TUBULAR FORKS (7" STEM) These Wald forks include a 593 cone, 398 bolt and two 1420 fork clips, 1" x 24 thread stem. (FOR MIDDLEWEIGHT OR BALLOON – easily accepts fenders and braces) Contour Leg Style				
	1826C	26"	Chrome	1/bag, 5/crtn.	13 1/2
	1824C	24"	Chrome	1/bag, 5/crtn.	13
	1820C	20"	Chrome	1/bag, 5/crtn.	12 1/2
	FRONT WHEEL RETAINING CLIPS (for all Wald forks)				
	1420		Plated	10/bag, 10/crtn.	1 1/2



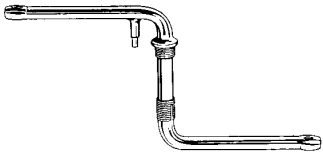
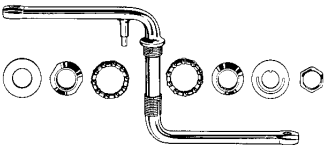

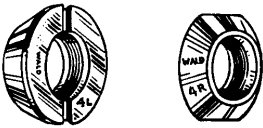
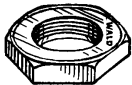
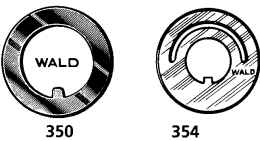

Head Fittings

WALD NO.	FINISH	DESCRIPTION	PACKING	WT/CRTN	
HEAD LOCK NUTS					
220	Plated	1" x 24 thread	10/bag, 10 bags/crtn.	6 1/2	
HEAD KEY WASHERS					
351	Plated	1" size	10/bag, 10 bags/crtn.	2	
HEAD SETS					
4080	Plated	(1 each 390 cone, 593 cone, 220 nut, 351 washer & 2 each 401 cups, 52 retainers per bag)	1/bag, 10 bags/pkg., 10 pkgs/crtn.	32 1/2	
HEAD CUPS					
401	Plated	fits most bicycles	10/bag, 10 bags/crtn.	6	
HEAD STATIONARY CONES					
593	Plated	fits any standard fork	10/bag, 10 bags/crtn.	2	
UPPER HEAD ADJUSTING CONES					
390	Plated	1" x 24 thread	10/bag, 10 bags/crtn.	7 1/2	
FORK CROWN BOLTS					
398	Plated	1/4" x 20 thread	10/bag, 10 bags/crtn.	1	



Cranks

	WALD NO.	BICYCLE SIZE	FINISH	PACKING	WT/CRTN
	CRANKS, BULK				
	6224-6 1/2	26" fits single to triple chainrings	Chrome	20/crtn.	43 1/2
	5224-5 1/2	24"			37
	5224-4 1/2	20" fits single or double chainrings			34
	CRANK SETS, WITH RETAINERS				
	626-6 1/2	26" fits single to triple chainrings	Chrome	1/bag, 20/crtn.	52
	526-5 1/2	24"			46
	526-4 1/2	20" fits single or double chainrings			42
	CRANK CONE SETS				
	1940	(1 each 194 R & L cones, 193 nut, 354 washer, 367 washer and 2 each 66 retainers)	Plated	1/bag, 10 bags/pkg., 10 pkgs/crtn.	38 1/2
	CRANK FITTING SETS				
	1990	(1 each 194 R & L cones, 193 nut, 354 washer, 367 washer and 2 each 290 cups & 66 retainers)	Plated	1/bag, 10 bags/pkg., 10 pkgs/crtn.	60 1/2
	CRANK CONES				
	194R (Right) 194L (Left)	24 thread	Plated	10/bag, 10 bags/crtn.	8 1/2 7 1/2
	CRANK LOCK NUTS				
	193	24 thread	Plated	10/bag, 10 bags/crtn.	3
	CRANK KEY WASHERS				
	350 (7/8") 354 (7/8")		Plated	10/bag, 10 bags/crtn.	1 1/2 3 1/2
	CRANK CUPS				
	290		Plated	10/bag, 10 bags/crtn.	13
	CRANK SPACER WASHERS				
	367		Plated	10/bag, 10 bags/crtn.	6 1/2





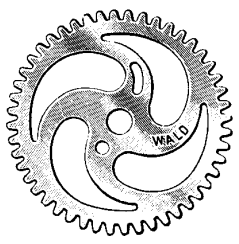
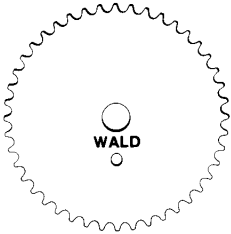
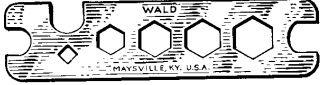

Seat Posts

WALD NO.	FINISH	LENGTH	PACKING	WT/CRTN	
SEAT POSTS 1" diameter mast with 7/8" top					
901-10	Plated	10"	10/crtn.	5	
901-15	Plated	15"	10/crtn.	7 1/2	
SEAT POSTS 13/16" diameter mast with 5/8" top					
920-9	Plated	9"	25/crtn.	11	
920-9C	Chrome Plated	9"	25/crtn.	11	
920-15	Plated	15"	25/crtn.	17	
920-15C	Chrome Plated	15"	25/crtn.	17	
920-18	Plated	18"	25/crtn.	20	
920-18C	Chrome Plated	18"	25/crtn.	20	
SEAT POSTS 13/16" diameter mast with 7/8" top furnished WITH #905 bushing					
950-10 1/2	Plated	10 1/2"	10/crtn.	5	
955-15 1/2	Plated	15 1/2"	10/crtn.	7	
SEAT POSTS 13/16" diameter mast with 7/8" top WITHOUT #905 bushing					
940-10 1/2	Plated	10 1/2"	10/crtn.	5	
945-15 1/2	Plated	15 1/2"	10/crtn.	7	
SEAT POST BUSHINGS For assembling 13/16" seat posts into 7/8" masts.					
905	Plated	NOTE: This bushing is also for assembling .833" dia. handlebar stems into .875" dia. forks.	10/bag, 10 bags/crtn.	4	
SEAT POST BOLTS & NUTS (unassembled)					
902	Plated	Hex Head Bolt, 1 3/4" long	10/bag, 10 bags/crtn.	6 1/2	



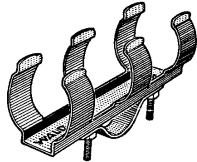
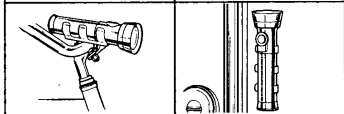

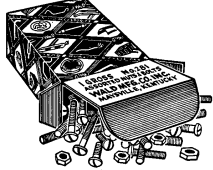
Sprockets/Tools

	WALD NO.	TOOTH	FINISH / DESCRIPTION	PACKING	WT/CRTN
	SPROCKETS 1/2" pitch x 1/8"				
	536	36	Chrome Plated	1/bag, 20/crtn.	10 1/2
	540	40	Chrome Plated	1/bag, 20/crtn.	13
	542	42	Chrome Plated	1/bag, 20/crtn.	14 1/2
	544	44	Chrome Plated	1/bag, 20/crtn.	14 1/2
	DISK SPROCKETS 1/2" pitch x 1/8"				
	5044	44	Chrome Plated	1/bag, 20/crtn.	22
	OPEN-END WRENCHES				
	500		Plated Eight openings: .575", .606", .512", .704" Hex., .640" Hex., .606" Hex, .512" Hex, .276" Square	100/crtn.	17
	SPOKE WRENCHES				
	76 760		Plated Plated	10/bag, 10 bags/crtn. 1/bag, 10 bags/pkg., 10 pkgs/crtn.	5 5 1/2





Parts

WALD NO.	FINISH	DESCRIPTION	PACKING	WT/CRTN	
COASTER BRAKE STRAPS (includes bolt & nut, unassembled)					
603	Plated		100/box, 10 boxes/crtn.	27 1/2	
6003	Plated		1/bag, 10 bags/pkg., 10 pkgs/crtn.	3 1/2	
COASTER BRAKE STRAP BOLTS & NUTS (unassembled)					
284	Plated		100/bag, 5 bags/crtn.	5	
FLASHLIGHT HOLDERS					 For Bicycle, Home or Shop 
40	Plated		1/bag, 10 bags/pkg., 10 pkgs/crtn.	15	
40GB	Gloss Black		1/bag, 10 bags/pkg., 10 pkgs/crtn.	15	
40409	White		1/header bag, 10/crtn.	2	
REPAIR TAGS					
700		Serially numbered on both tag and claim check	500/box, 10,000/crtn.	50	
ASSORTED BOLTS AND NUTS					
281	Plated	No. 8 and 10 bolts and nuts Standard Thread	1 gross/box, 10 BOX MINIMUM	1 1/2	
DUST CAPS					
161	Plated	For metric axle	100/box, 1,000/crtn.	1	



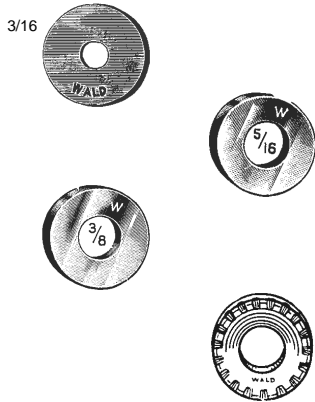

Hubs, Axles Axle Sets

	WALD NO.	FINISH	DESCRIPTION	PACKING	WT/CRTN
	FRONT HUBS (Two #4158 axle nuts per hub, packaged separately, 300/crtn.)				
	736	Plated	36 holes	150/crtn.	47 1/2
	728	Plated	28 holes	150/crtn.	48
	720	Plated	20 holes	150/crtn.	48
	AXLES				
	262 (Front)	Plated	5/16 x 24 x 5 1/2" standard	25/box, 250/crtn.	25
	282 (Rear)	Plated	3/8 x 24 x 6 1/2" standard	25/box, 250/crtn.	44
 <p>Front Axle Cone Used with Wald Axle Set</p>  <p>58</p>	FRONT AXLE SETS				
	188	Plated	For all Wald front hubs and others Two each 58 cones, 4158 flange nuts, 5 retainers and one 262 front axle	1 set/bag, 10 bags/pkg., 10 pkgs/crtn.	22
	FRONT AXLE & NUT ASSEMBLIES				
	9082	Plated	5/16 x 24 x 5 1/2" standard front axle Two 4158 flange nuts and one 262 front axle	1 set/bag, 10 bags/pkg., 10 pkgs/crtn.	14 1/2
	REAR AXLE & NUT ASSEMBLIES				
9094	Plated	3/8 x 24 x 6 1/2" standard rear axle Two 4155 flange nuts and one 282 rear axle	1 set/bag, 10 bags/pkg., 10 pkgs/crtn.	21 1/2	

Axle Nuts, Washers

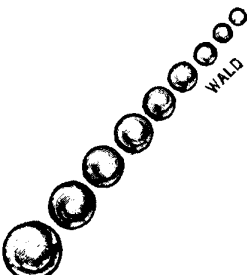
WALD NO.	FINISH	DESCRIPTION	PACKING	WT/CRTN	
FRONT FLANGE NUTS					
4158	Plated	5/16 x 24 thread 1/2" hexagon 5/16" thick	10/bag, 10 bags/pkg., 10 pkgs/crtn.	13 1/2	
24158	Plated		2/bag, 10 bags/pkg., 10 pkgs/crtn.	3	
4526	Plated	5/16 x 26 thread 1/2" hexagon 5/16" thick	10/bag, 10 bags/pkg., 10 pkgs/crtn.	13 1/2	
REAR FLANGE NUTS					
4155	Plated	3/8 x 24 thread 9/16" hexagon 3/8" thick	10/bag, 10 bags/pkg., 10 pkgs/crtn.	18 1/2	
24155	Plated		2/bag, 10 bags/pkg., 10 pkgs/crtn.	4	
4826	Plated	3/8 x 26 thread 9/16" hexagon 3/8" thick	10/bag, 10 bags/pkg., 10 pkgs/crtn.	18 1/2	
AXLE WASHERS					
340	Plated	3/16" Fender Reinforcement	100/bag, 10 bags/crtn.	5	
362	Plated	5/16" Front Axle	100/bag, 10 bags/crtn.	5	
364 365	Plated Plated	3/8" Rear Axle 3/8" Heavy Rear Axle	100/bag, 10 bags/crtn. 100/box, 10 boxes/crtn.	6 16 1/2	
318	Plated	Serrated Rear Axle, .422" dia. axle hole	100/box, 10 boxes/crtn.	14	
308	Plated	Serrated Front Axle, .345" dia. axle hole	100/box, 10 boxes/crtn.	10	
SPRING LOCK WASHERS					
3/16W	Plated	3/16"	100/bag, 10 bags/crtn.	1	
1/4W	Plated	1/4"	100/bag, 10 bags/crtn.	2	

Steel Balls Retainers

	WALD NO.	SIZE BALLS	DESCRIPTION	PACKING	WT/CRTN	
	STEEL BALLS					
		1/8	1/8"		100/bag, 10 bags/crtn.	1/2
		5/32	5/32"		100/bag, 10 bags/crtn.	1
		3/16	3/16"		100/bag, 10 bags/crtn.	1
		1/4	1/4"		100/bag, 10 bags/crtn.	3
  	FRONT HUB RETAINERS					
		5	7 – 3/16"	For Wald and most other front hubs with 5/16" axle	10/bag, 10 bags/crtn.	2
		250	7 – 3/16"		2/bag, 10 bags/pkg., 10 pkgs/crtn.	2 1/2
	HEAD RETAINERS					
		52	15 – 3/16"		10/bag, 10 bags/crtn.	3
		252R	15 – 3/16"		2/bag, 10 bags/pkg., 10 pkgs/crtn.	5
	CRANK RETAINERS					
		66	10 – 5/16"		10/bag, 10 bags/crtn.	7
		266	10 – 5/16"		2/bag, 10 bags/pkg., 10 pkgs/crtn.	13 1/2

Notes