



westfalia
AUTOMOTIVE

*It all starts
with the towbar.*



CATALOGUE **2023**



WESTFALIA-AUTOMOTIVE – MOVES LIFE!



westfalia-automotive.com

Products by Westfalia-Automotive:

TOWBARS

- Accurate fitting
- Millions sold
- OE quality



WIRING KITS

- Easy to install
- High reliability
- Full functionality by connection to the board net



CODING - AUTOCODE-REMOTE

- Easy handling
- Fast connection



CYCLE CARRIERS

- Easy handling
- High payload
- Foldable



POWER SPRINGS

- Improved driving style
- Increased driving safety
- Less wearing of chassis parts

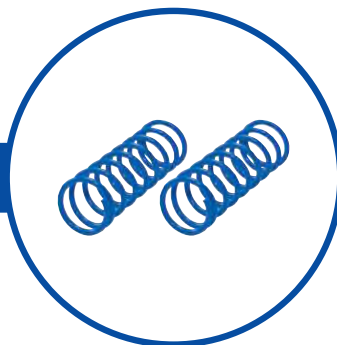



WESTFALIA-AUTOMOTIVE

Products create trust

EVERYTHING STARTS WITH THE ORIGINAL TOWBAR BY WESTFALIA-AUTOMOTIVE - LEISURE, SPORTS, PROFESSION

Security and reliability. We offer more than 1700 vehicle-specifically types of towbars of highest precision for over 85 years. In addition, you receive suitable wiring kits and coding-tools. The portfolio is rounded off with strong carrier systems for the towbar and the roof as well as power springs and accessories.

As part of the horizon global corporation (NYSE: HZN) Westfalia-Automotive operates globally. Due to this, you benefit from a global network, comprehensive know-how and the latest technologies. Westfalia-Automotive makes your work easier and safer. With constant innovation, highest quality and economical solutions.

DISCOVER NOW:

towbars | wiring-kits | bike-carrier | power springs | coding tools



[westfalia-automotive.com](https://www.westfalia-automotive.com)



COMPANY HISTORY

As the inventor of the towbar with worldwide patents, Westfalia-Automotive can naturally claim leadership in its sector since 1932. The birth of this genius idea characterizes the foundations on which the success of more than 85 years has been based: continuous innovation /// highest quality /// maximum safety /// consistent customer orientation. An additional engine of success is the targeted expansion of the product range, with which new markets, target groups and partners from the automotive industry are continually being won.

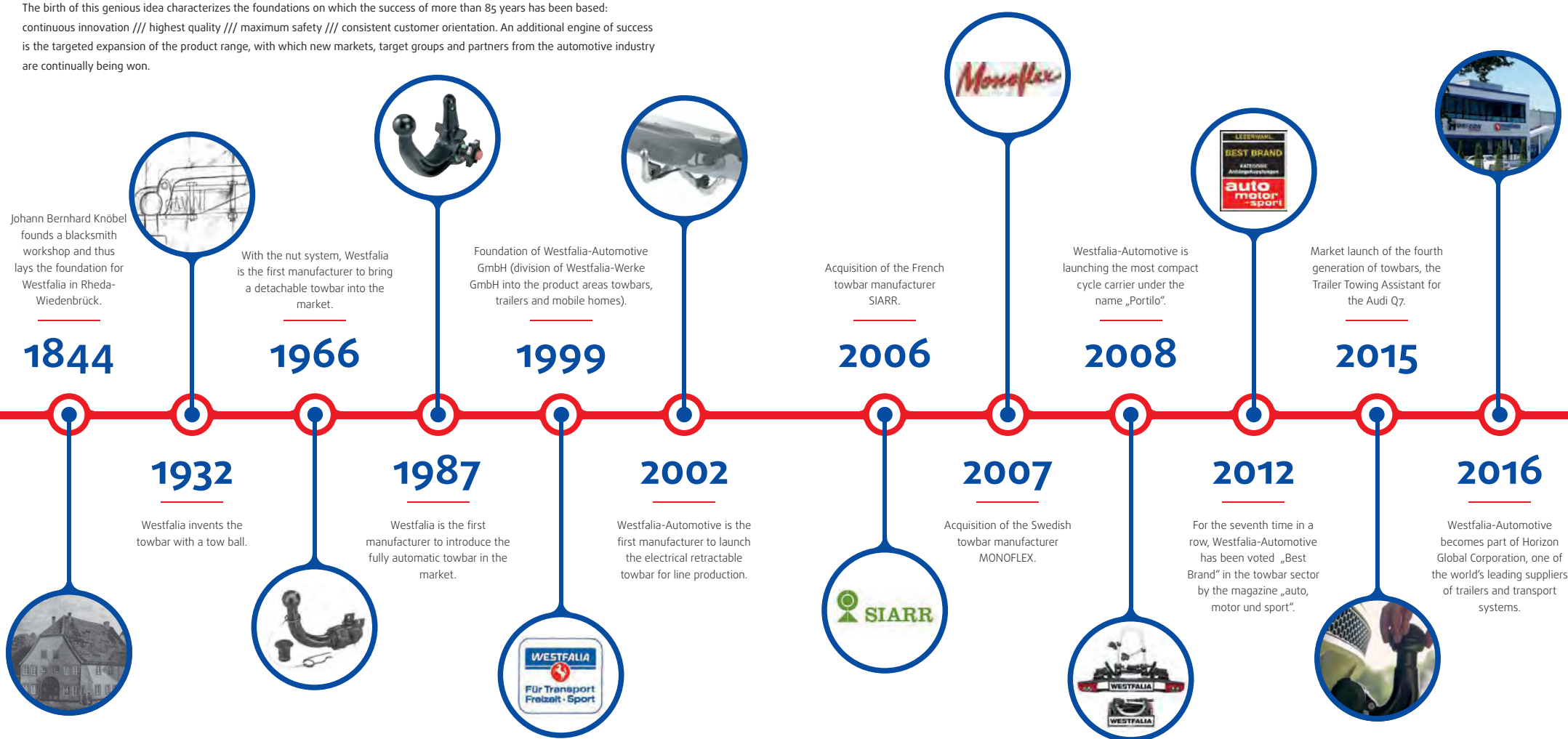



CYCLE CARRIER

The talented all-rounder

The bike carrier by Westfalia-Automotive is able to present a new changed rear cross member and an innovative design. Discover your multifunctional transport system for leisure, sports and profession. Easy to install, extremely compact and particularly safe with the mentality of a test winner.



maximum load up to 60 kg

E-Bike compatible

lockable



foldable



modern LED-lights
(not bikelander classic)



flexible, rubberized claws

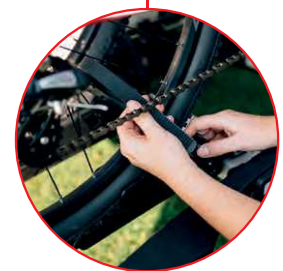

long tensioning belts

TESTED:



IT'S GENIUS: The bikelander can be easily supplemented with a box or a platform. The box offers a fast additional storage space of 220 liters. Wet, dirty or odorous things can be carried comfortably outside the vehicle. On the handy platform, you can stow bulky materials and sports equipment safely. Further useful accessories complete the range.



KITS

The perfect combination

Towbars and wiring kits by Westfalia-Automotive build the perfect partnership. Perfect fitting due to an own development and production, the system offers highest security. The involvement into the wiring system is particularly easy.

ideal connection

perfect fit

economic assembly

TOWBAR

- retractable, detachable or fixed
- reliable
- original manufacturer quality
- perfect fitting
- user-friendly
- millions sold
- EC-approved

VEHICLE-SPECIFIC WIRING KIT

- use of original parts
- easy assembly
- extremely reliable
- complete product portfolio
- full functionality through involvement into the wiring system

IT'S GENIUS: With only one article number and only one ordering process, you benefit from a real price advantage with our kits.

**Top marks again and again**

Westfalia-Automotive "Best Brand" seven times running! When choosing their "Best Brand", readers of the magazine "auto motor und sport" voted Westfalia-Automotive the winner in the "towbar" category.

RETRACTABLE TOWBAR

Always ready to use – the R10

The retractable towbar is the luxury version of towbars. Just one push on the button and it is available – no matter if you want to take a tour with your cycle carrier or if you want to go on vacation with your caravan.

PRACTICAL | SAFE | COMFORTABLE

Comfortable handling

Perfect fit and
easy to install

Maintenance-free

THE TOWBAR OFFERS

- Safe locking thanks to optical and acoustic signals
- System works independently -> no additional programming of the swivel module is necessary
- Safety chain hole easily accessible on the neck (ECE R55 approved)
- 13 pin car specific wiring kit included
- Integrated socket holder on the towball neck
- EC approved

IT'S GENIUS: The towball can become invisible without having to be removed and stowed away. So you can never lose it!



VEHICLE CODING

AUTOCODE-REMOTE

Vehicle coding has never been so easy.

After successful registration, you connect your Autocode-Remote to the OBD port of the vehicle, open our portal on a device of your choice and select your coding.

The price will be displayed without any additional costs. The coding itself is done remotely by a team of experts, almost as if the technician was sitting next to you. „Remote Diagnostics“ from Westfalia-Automotive for a wide range of models and applications and successful vehicle coding.

Remote Diagnostics

Remote coding by experienced experts

Easy to use

Vehicle coding almost at the push of a button

One solution for all

An enormous range of applications covered

Full cost transparency and control

No hidden costs





POWER SPRINGS

At last something stopping you going “weak at the knees”

Simple and effective. Under extreme conditions like a sudden evasive actions, a heavily loaded vehicle performs better with additional power springs. A significant improvement for caravans and commercial vans. The power springs are the ideal supplement to a towbar by Westfalia-Automotive, because through a joint shoring in the workshop synergy effects will occur.

Improved safety
with heavy loads

Low costs

TÜV-tested*

*by German Technical Inspection Authority

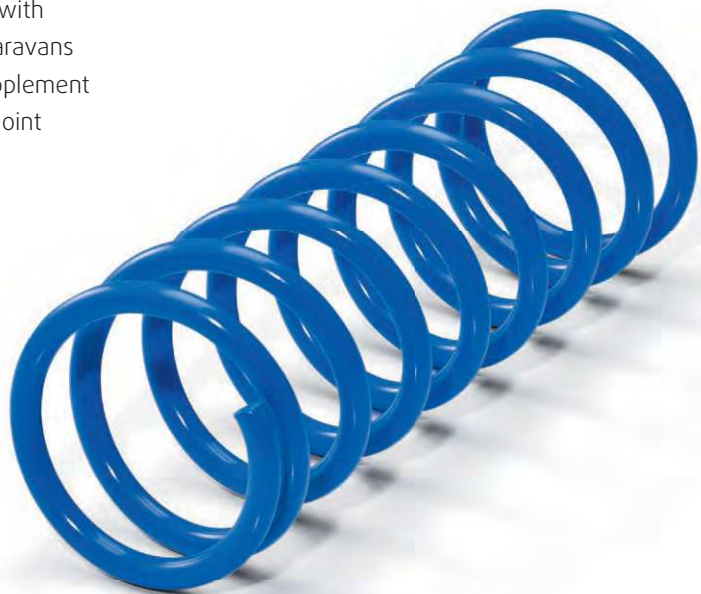

SLALOM AND OBSTACLE AVOIDANCE TEST WITH 300 KG LOAD IN BOOT.

WITHOUT POWER SPRINGS (image left)

Heavy loads can be too much for the standard suspension system of a vehicle – “bringing it to its knees” so to speak at the rear. The result: longer braking distances, risk of skidding and even possibly fishtailing in curves with crosswinds or during overtaking. This is caused by rough or uneven roads and potholes. All reasons to reinforce your vehicle’s original suspension system when driving with heavy loads.

WITHOUT POWER SPRINGS (image right)

Power springs from Westfalia-Automotive are designed to be simple and effective. Their extra boost of power is what’s needed to keep your vehicle “off its knees”. They provide extra on-road stability and offer better grip for the front tyres to keep braking distances short. You can tow heavy loads more easily while minimizing the risk of trailers or caravans fishtailing.

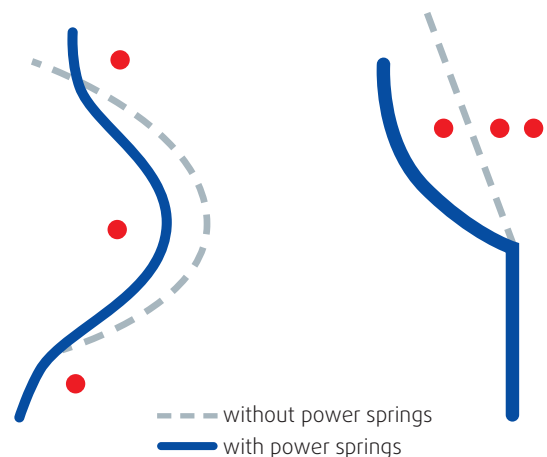



WAM-NET

Always right up to date

Who is informed, is always one step ahead.
In the Westfalia Internet you will find the right answer to almost every question. Just try it.

many assembly tips

sales promotion

availability check



TEST NOW AND BE IMPRESSED.

Create a customer account free of charge and take advantage for example of:

Newsletter-registration:

Monthly information about the latest products, product modifications and news

Availability query for products:

Always informed about what is in stock at the central warehouse

Fitting instructions:

Opportunity to download the latest versions workshop marketing: sales promotion, tips and tricks, FAQs



Key for towbars

		KIT												
--	--	-----	--	--	--	--	--	--	--	--	--	--	--	--

Vehicle	Phase-out model	D value kN
Year of manufacture	Visible cut-out	Vertical load
Towbar + vehicle-specific wiring kit	Invisible cut-out	Towed load
Towbar system	Installation time	
Part No. towbar	Assembly weight	

A40H detachable automatic system horizontal	A40V detachable automatic system vertical	A50 detachable small automatic system	A10H detachable small automatic system
F20 fixed screwed design	F10 fixed welded design	F40 towing bracket for ball plate (4 screws)	F30 towing bracket for ball plate (2 screws)
R10 schwenkbar elektrische Auslösung			

Key for wiring kits

											R/L/B
--	--	--	--	--	--	--	--	--	--	--	-------

Phase-out model	Parking aid shut-off
Additional information for wiring kits	E1 Parking aid shut-off (universal without preliminary set-up)
S Wiring kit vehicle-specific No. ...1.7 = 7-pins	E2 Parking aid shut-off (button on dashboard) if available
-- Wiring kit universal No. ...1.3 = 13-pins	-- No parking aid shut-off
C2 Indicator monitoring C2 indicator light	D Permanent plus included
A Indicator monitoring acoustic	D1 Permanent plus optional (extension kit 300027300113)
CAN Indicator monitoring CAN	-- No Permanent plus
FRE Indicator monitoring blink frequency	L Charging cable included
C Coding/activation necessary	L1 Charging cable optional (extension kit 300028300113)
C1 Possible without coding -> Indicator monitoring C2 via buzzer	-- No charging cable
-- Coding/activation not necessary	V Connection front
	H Connection rear
	Installation time
	R Right hand drive
	L Left hand drive
	B Both

Dear customer,

You now have the new 2023 Westfalia-Automotive catalogue covering towbars, electrical kits, bicycle racks and spare parts. We have made every effort to incorporate the suggestions and modifications that you have provided us with to further enhance this catalogue. This catalogue provides a wealth of important information and is designed to help you develop and promote your towbar fitting business.

Please note the following:

Legend

The legend for the columns in this catalogue can be found on the first pages of the catalogue..

KIT = Towbar + 13-pin electrical kit

Our KIT program has been further enhanced with the introduction of additional references. You will now find a KIT for nearly all of our towbar range which is supplied complete with a vehicle specific wiring kit. You can identify these KITs by the last figures of the part number: ... 900013.

Installation times

The specified installation times should only be used as an indication for our products of the time required to carry out an installation. The length of time required to complete this will depend on a number of factors, the condition of the vehicle and/or the skills and experience of the individual carrying out the work. In certain circumstances, the specification of a vehicle may vary significantly, such as when an automatic CD changer has to be removed in order to install the electrical equipment, then the required assembly time may increase considerably. Where possible, always try and ascertain the full specification of the vehicle. Limit the troubleshooting to approximately 0.5 hours for mechanical or 0.75 hours for electrical work in case of assembly or functional problems. In case of assembly or functional problems, contact Westfalia customer service.

Vehicles with parking sensors:

When mounting permanently attached towbars, the towball may in some instances activate the vehicles rear parking sensors. This problem can be overcome by fitting a detachable towbar where the neck can be removed from the vehicle when not required for towing. Some vehicles do come with cut off switches for the rear parking sensors but you should check with the customer to confirm that this is an acceptable solution.

The following is valid before assembling a towbar and an electrical kit:

Always observe the instructions of the vehicle manufacturer in the operating manual of the vehicle.



















Towing capacity

Please check whether a towing capacity is entered in the vehicle documents. If not the installation of a towbar is not approved by the vehicle manufacturer and is therefore not permitted. Always check the VIN plate or the vehicle handbook to verify the towing capacity of the vehicle.







Please visit our website [westfalia-automotive.com](https://www.westfalia-automotive.com) to find our current product finder, further information and frequently asked questions about our products.













Towbars and wiring kits

Alfa Romeo







Alfa 159 Saloon exc. GTA - 250 HP	09/06-10/11			306 356 600 001		120	25.0	9.9	100	1800		306 220 300 113	→		S	FRE	--	E	D	L1	H	90
		KIT		306 356 900 113	→		120	27.0	9.9	100	1800		included in the KIT 306 220 300 113	→		S	FRE	--	E	D	L1	H
Alfa 159 Sportwagon	03/06-10/11			306 356 600 001		120	25.0	9.9	100	1800		306 220 300 113	→		S	FRE	--	E	D	L1	H	90
		KIT		306 356 900 113	→		120	27.0	9.9	100	1800		included in the KIT 306 220 300 113	→		S	FRE	--	E	D	L1	H
Alfa Giulia exc. Quadrifoglio	05/16-			306 387 600 001		90	23.0	9.2	100	1600		306 471 300 113			S	FRE	--	E	D	L1	H	90
		KIT		306 387 900 113			90	24.1	9.2	100	1600		included in the KIT 306 471 300 113			S	FRE	--	E	D	L1	H
Alfa Giulietta	04/10-12/20			306 372 600 001		90	25.0	7.7	90	1500		306 371 300 113			S	FRE	--	E	D1	L1	V	105
Alfa Mito	09/08-07/18			306 375 600 001		90	19.0	6.7	75	1100		306 606 300 113	→		S	FRE	--	E	D1	L1	V	105
				306 374 600 001		90	19.0	6.7	75	1100												



















Audi

Audi A3 Convertible without preliminary setup exc. Quattro Attention: Depending on the engine variation it may be necessary to change the cooling system of the vehicle.	03/14-06/14	KIT 	317 131 900 113		60	21.0	10.3	85	2000		included in the KIT 305 406 300 113		-06/14 without preliminary setup	S	CAN	C	E	D	L1	V	150
Audi A3 Convertible exc. Quattro Please order spoiler inc. cover for bumper cutout at Audi-dealers. Attention: Depending on the engine variation it may be necessary to change the cooling system of the vehicle.	03/14-05/16		317 132 600 001		60	19.0	10.3	85	2000		305 403 300 107 305 403 300 113 305 406 300 113 305 407 300 113 305 408 300 107 305 408 300 113	→ 	-06/14 with preliminary setup -06/14 with preliminary setup -06/14 without preliminary setup 06/14- with preliminary setup 06/14- without preliminary setup 06/14- without preliminary setup	S	CAN	C	E	--	--	H	45
Audi A3 Convertible exc. Quattro Attention: Depending on the engine variation it may be necessary to change the cooling system of the vehicle.	03/14-05/16		317 131 600 001		60	19.0	10.3	85	2000		305 403 300 107 305 403 300 113 305 406 300 113 305 407 300 113 305 408 300 107 305 408 300 113	→ 	-06/14 with preliminary setup -06/14 with preliminary setup -06/14 without preliminary setup 06/14- with preliminary setup 06/14- without preliminary setup 06/14- without preliminary setup	S	CAN	C	E	--	--	H	45







Audi A3 Convertible without preliminary setup exc. Quattro Please order spoiler inc. cover for bumper cutout at Audi-dealers. Attention: Depending on the engine variation it may be necessary to change the cooling system of the vehicle.	06/14-05/16	KIT		305 409 900 113		60	21.0	10.3	85	2000		included in the KIT 305 408 300 113	06/14- without preliminary setup	S	CAN	C	E	D	L	V	60
Audi A3 Convertible without preliminary setup exc. Quattro Attention: Depending on the engine variation it may be necessary to change the cooling system of the vehicle.	06/14-05/16	KIT		305 408 900 113		60	19.0	10.3	85	2000		included in the KIT 305 408 300 113	06/14- without preliminary setup	S	CAN	C	E	D	L	V	60
Audi A3 Convertible with preliminary setup exc. Quattro Please order spoiler inc. cover for bumper cutout at Audi-dealers. Attention: Depending on the engine variation it may be necessary to change the cooling system of the vehicle.	06/14-05/16	KIT		317 155 900 113		60	20.5	10.3	85	2000		included in the KIT 305 407 300 113	06/14- with preliminary setup	S	CAN	C	E	D	L	H	30
Audi A3 Convertible with preliminary setup exc. Quattro Attention: Depending on the engine variation it may be necessary to change the cooling system of the vehicle.	06/14-05/16	KIT		317 154 900 113		60	20.5	10.3	85	2000		included in the KIT 305 407 300 113	06/14- with preliminary setup	S	CAN	C	E	D	L	H	30
Audi A3 Saloon without preliminary setup Please order spoiler inc. cover for bumper cutout at Audi-dealers. Attention: Depending on the engine variation it may be necessary to change the cooling system of the vehicle.	09/13-06/14	KIT		317 132 900 113		60	21.0	10.3	85	2000		included in the KIT 305 406 300 113	-06/14 without preliminary setup	S	CAN	C	E	D	L1	V	150
Audi A3 Saloon without preliminary setup Attention: Depending on the engine variation it may be necessary to change the cooling system of the vehicle.	09/13-06/14	KIT		317 131 900 113		60	21.0	10.3	85	2000		included in the KIT 305 406 300 113	-06/14 without preliminary setup	S	CAN	C	E	D	L1	V	150











Audi

Audi A3 Saloon Attention: Depending on the engine variation it may be necessary to change the cooling system of the vehicle.	09/13-05/16		317 131 600 001		60	19.0	10.3	85	2000	305 403 300 107	→	-06/14 with preliminary setup	S	CAN	C	E	--	--	H	45	
										305 403 300 113		-06/14 with preliminary setup	S	CAN	C	E	D	L1	H	45	
										305 406 300 113		-06/14 without preliminary setup	S	CAN	C	E	D	L1	V	150	
										305 407 300 113		06/14-11/19 with preliminary setup	S	CAN	C	E	D	L	H	30	
										305 408 300 107		06/14-11/19 without preliminary setup	S	CAN	C	E	--	--	V	60	
										305 408 300 113		06/14-11/19 without preliminary setup	S	CAN	C	E	D	L	V	60	
Audi A3 Saloon Please order spoiler inc. cover for bumper cutout at Audi-dealers. Attention: Depending on the engine variation it may be necessary to change the cooling system of the vehicle.	09/13-05/16		317 132 600 001		60	19.0	10.3	85	2000	305 403 300 107	→	-06/14 with preliminary setup	S	CAN	C	E	--	--	H	45	
										305 403 300 113		-06/14 with preliminary setup	S	CAN	C	E	D	L1	H	45	
										305 406 300 113		-06/14 without preliminary setup	S	CAN	C	E	D	L1	V	150	
										305 407 300 113		06/14-11/19 with preliminary setup	S	CAN	C	E	D	L	H	30	
										305 408 300 107		06/14-11/19 without preliminary setup	S	CAN	C	E	--	--	V	60	
										305 408 300 113		06/14-11/19 without preliminary setup	S	CAN	C	E	D	L	V	60	
Audi A3 Saloon without preliminary setup Please order spoiler inc. cover for bumper cutout at Audi-dealers. Attention: Depending on the engine variation it may be necessary to change the cooling system of the vehicle.	06/14-05/16	KIT		305 409 900 113		60	21.0	10.3	85	2000	included in the KIT 305 408 300 113		06/14-11/19 without preliminary setup	S	CAN	C	E	D	L	V	60



















Audi A3 Saloon without preliminary setup Attention: Depending on the engine variation it may be necessary to change the cooling system of the vehicle.	06/14-05/16	KIT		305 408 900 113		60	19.0	10.3	85	2000		included in the KIT 305 408 300 113		06/14-11/19 without preliminary setup	S	CAN	C	E	D	L	V	60
Audi A3 Saloon with preliminary setup Please order spoiler inc. cover for bumper cutout at Audi-dealers. Attention: Depending on the engine variation it may be necessary to change the cooling system of the vehicle.	06/14-05/16	KIT		317 155 900 113		60	20.5	10.3	85	2000		included in the KIT 305 407 300 113		06/14-11/19 with preliminary setup	S	CAN	C	E	D	L	H	30
Audi A3 Saloon with preliminary setup Attention: Depending on the engine variation it may be necessary to change the cooling system of the vehicle.	06/14-05/16	KIT		317 154 900 113		60	20.5	10.3	85	2000		included in the KIT 305 407 300 113		06/14-11/19 with preliminary setup	S	CAN	C	E	D	L	H	30
Audi A3 Saloon (8Y) inc. S-Line inc. AdBlue inc. Hybrid	04/20-			322 094 600 001		60	17.7	12.3	150	2500		322 080 300 113		without preliminary setup	S	CAN	C	E	D	L	V	120
		KIT		305 625 900 113		60	31.7	10.1	120	2000		included in the KIT 300 006 300 153		not available individually	S	CAN	C	E	D	L	H	90
Audi A3 Saloon (8Y) without preliminary setup inc. S-Line inc. AdBlue inc. Hybrid	04/20-	KIT		322 094 900 113		60	19.6	12.3	150	2500		included in the KIT 322 080 300 113		without preliminary setup	S	CAN	C	E	D	L	V	120
Audi A3 Sportback inc. Quattro, V6 3,2 l (250 HP), Facelift 06/08- models S3 04/08-: Please check if the vehicle is homologated for towing trailers by the vehicle manufacturer.	09/04-01/13			305 299 600 001		120	16.5	9.7	100	1800		305 256 300 113			S	CAN	C	E	D1	--	V	120
Audi A3 Sportback inc. Quattro, S-Line, V6 3,2 l (250 HP), Facelift 06/08- models S3 04/08-: Please check if the vehicle is homologated for towing trailers by the vehicle manufacturer. For optimal fit, order spoiler and cover at Audi dealers.	09/04-01/13			305 300 600 001		120	17.5	9.7	100	1800		305 256 300 113			S	CAN	C	E	D1	--	V	120
		KIT		305 300 900 113		120	18.5	9.7	100	1800		included in the KIT 305 256 300 113			S	CAN	C	E	D1	--	V	120







Audi

Audi A3 Sportback without preliminary setup Attention: Depending on the engine variation it may be necessary to change the cooling system of the vehicle.	02/13-06/14	KIT		317 131 900 113			60	21.0	10.3	85	2000		included in the KIT 305 406 300 113		-06/14 without preliminary setup	S	CAN	C	E	D	L1	V	150
Audi A3 Sportback without preliminary setup Please order spoiler inc. cover for bumper cutout at Audi-dealers. Attention: Depending on the engine variation it may be necessary to change the cooling system of the vehicle.	02/13-06/14	KIT		317 132 900 113			60	21.0	10.3	85	2000		included in the KIT 305 406 300 113		-06/14 without preliminary setup	S	CAN	C	E	D	L1	V	150
Audi A3 Sportback Please order spoiler inc. cover for bumper cutout at Audi-dealers. Attention: Depending on the engine variation it may be necessary to change the cooling system of the vehicle.	02/13-06/16			317 132 600 001			60	19.0	10.3	85	2000		305 403 300 107 →		-06/14 with preliminary setup	S	CAN	C	E	--	--	H	45
													305 403 300 113		-06/14 with preliminary setup	S	CAN	C	E	D	L1	H	45
													305 406 300 113		-06/14 without preliminary setup	S	CAN	C	E	D	L1	V	150
													305 407 300 113		06/14- with preliminary setup	S	CAN	C	E	D	L	H	30
													305 408 300 107		06/14-11/19 without preliminary setup	S	CAN	C	E	--	--	V	60
													305 408 300 113		06/14-11/19 without preliminary setup	S	CAN	C	E	D	L	V	60













Audi A3 Sportback (8V) inc. vehicles 07/16- Attention: Depending on the engine variation it may be necessary to change the cooling system of the vehicle.	02/13-11/19		317 131 600 001		60	19.0	10.3	85	2000		305 403 300 107	→	-06/14 with preliminary setup	S	CAN	C	E	--	--	H	45	
											305 403 300 113		-06/14 with preliminary setup	S	CAN	C	E	D	L1	H	45	
											305 406 300 113		-06/14 without preliminary setup	S	CAN	C	E	D	L1	V	150	
											305 407 300 113		06/14- with preliminary setup	S	CAN	C	E	D	L	H	30	
											305 408 300 107		06/14-11/19 without preliminary setup	S	CAN	C	E	--	--	V	60	
											305 408 300 113		06/14-11/19 without preliminary setup	S	CAN	C	E	D	L	V	60	
Audi A3 Sportback without preliminary setup Please order spoiler inc. cover for bumper cutout at Audi-dealers. Attention: Depending on the engine variation it may be necessary to change the cooling system of the vehicle.	06/14-06/16	KIT		305 409 900 113		60	21.0	10.3	85	2000		included in the KIT 305 408 300 113		06/14-11/19 without preliminary setup	S	CAN	C	E	D	L	V	60
Audi A3 Sportback with preliminary setup Please order spoiler inc. cover for bumper cutout at Audi-dealers. Attention: Depending on the engine variation it may be necessary to change the cooling system of the vehicle.	06/14-06/16	KIT		317 155 900 113		60	20.5	10.3	85	2000		included in the KIT 305 407 300 113		06/14- with preliminary setup	S	CAN	C	E	D	L	H	30
Audi A3 Sportback (8V) without preliminary setup inc. vehicles 07/16- Attention: Depending on the engine variation it may be necessary to change the cooling system of the vehicle.	06/14-11/19	KIT		305 408 900 113		60	19.0	10.3	85	2000		included in the KIT 305 408 300 113		06/14-11/19 without preliminary setup	S	CAN	C	E	D	L	V	60
Audi A3 Sportback (8V) with preliminary setup inc. vehicles 07/16- Attention: Depending on the engine variation it may be necessary to change the cooling system of the vehicle.	06/14-11/19	KIT		317 154 900 113		60	20.5	10.3	85	2000		included in the KIT 305 407 300 113		06/14- with preliminary setup	S	CAN	C	E	D	L	H	30





























Audi

Audi A3 Sportback (8V) Attention: Depending on the engine variation it may be necessary to change the cooling system of the vehicle.	07/16-11/19		305 551 600 001		180	29.0	9.9	85	1900		305 407 300 113	06/14- with preliminary setup	S	CAN	C	E	D	L	H	30
			305 555 600 001		60	17.9	9.0	109	2100		305 408 300 107	06/14-11/19 without preliminary setup	S	CAN	C	E	--	--	V	60
											305 408 300 113	06/14-11/19 without preliminary setup	S	CAN	C	E	D	L	V	60
Audi A3 Sportback (8V) without preliminary setup Attention: Depending on the engine variation it may be necessary to change the cooling system of the vehicle.	07/16-11/19	KIT		305 555 900 113		60	19.4	9.0	109	2100	included in the KIT 305 408 300 113	06/14-11/19 without preliminary setup	S	CAN	C	E	D	L	V	60
Audi A3 Sportback (8V) without preliminary setup Attention: Depending on the engine variation it may be necessary to change the cooling system of the vehicle.	07/16-11/19	KIT		305 556 900 113		60	19.4	9.0	109	2100	included in the KIT 305 407 300 113	06/14- with preliminary setup	S	CAN	C	E	D	L	H	30
Audi A3 Sportback (8Y) inc. S-Line inc. AdBlue inc. Hybrid	11/19-	KIT		305 625 900 113		60	31.7	10.1	120	2000	included in the KIT 300 006 300 153	not available individually	S	CAN	C	E	D	L	H	90
Audi A3, 3 doors front wheel drive inc. Quattro, inc. S3 04/06-, inc. V6 3,2 l, 250 HP models S3 04/08-: Please check if the vehicle is allowed for towing trailers by the car manufacturer.	05/03-04/12	KIT		321 865 600 001		60	17.0	9.4	100	1800	305 256 300 113		S	CAN	C	E	D1	--	V	120
				305 389 900 113		60	19.0	9.4	100	1800	included in the KIT 305 256 300 113		S	CAN	C	E	D1	--	V	120
Audi A3, 3 doors front wheel drive inc. Quattro, inc. S-Line and S3 04/06-, inc. V6 3,2 l, 250 HP models S3 04/08-: Please check if the vehicle is allowed for towing trailers by the car manufacturer. Please order separately spoiler inc. cover at Audi dealers.	05/03-04/12	KIT		321 885 600 001		60	17.0	9.4	100	1800	305 256 300 113		S	CAN	C	E	D1	--	V	120
				305 390 900 113		60	19.0	9.4	100	1800	included in the KIT 305 256 300 113		S	CAN	C	E	D1	--	V	120
Audi A3, 3 doors without preliminary setup inc. S-Line, exc. S3 Attention: Depending on the engine variation it may be necessary to change the cooling system of the vehicle.	05/12-06/14	KIT		317 131 900 113		60	21.0	10.3	85	2000	included in the KIT 305 406 300 113	-06/14 without preliminary setup	S	CAN	C	E	D	L1	V	150





















Audi A3, 3 doors without preliminary setup Please order spoiler inc. cover for bumper cutout at Audi-dealers. Attention: Depending on the engine variation it may be necessary to change the cooling system of the vehicle.	05/12-06/14	KIT		317 132 900 113		60	21.0	10.3	85	2000		included in the KIT 305 406 300 113		-06/14 without preliminary setup	S	CAN	C	E	D	L1	V	150
Audi A3, 3 doors inc. S-Line, exc. S3 inc. facelift 07/16- Attention: Depending on the engine variation it may be necessary to change the cooling system of the vehicle.	05/12-11/19			317 131 600 001		60	19.0	10.3	85	2000		305 403 300 107	→	-06/14 with preliminary setup	S	CAN	C	E	--	--	H	45
Audi A3, 3 doors inc. S-Line, exc. S3 inc. facelift 07/16- Please order spoiler inc. cover for bumper cutout at Audi-dealers. Attention: Depending on the engine variation it may be necessary to change the cooling system of the vehicle.	05/12-11/19			317 132 600 001		60	19.0	10.3	85	2000		305 403 300 107	→	-06/14 with preliminary setup	S	CAN	C	E	--	--	H	45
												305 403 300 113		-06/14 with preliminary setup	S	CAN	C	E	D	L1	H	45
												305 406 300 113		-06/14 without preliminary setup	S	CAN	C	E	D	L1	V	150
												305 407 300 113		06/14-11/19 with preliminary setup	S	CAN	C	E	D	L	H	30
												305 408 300 107		06/14- without preliminary setup	S	CAN	C	E	--	--	V	60
												305 408 300 113		06/14- without preliminary setup	S	CAN	C	E	D	L	V	60





























Audi

Audi A3, 3 doors without preliminary setup Please order spoiler inc. cover for bumper cutout at Audi-dealers. inc. S-Line, exc. S3 Attention: Depending on the engine variation it may be necessary to change the cooling system of the vehicle.	06/14-05/16	KIT		305 409 900 113		60	21.0	10.3	85	2000		included in the KIT 305 408 300 113		06/14- without preliminary setup	S	CAN	C	E	D	L	V	60
Audi A3, 3 doors with preliminary setup Please order spoiler inc. cover for bumper cutout at Audi-dealers. inc. S-Line, exc. S3 Attention: Depending on the engine variation it may be necessary to change the cooling system of the vehicle.	06/14-05/16	KIT		317 155 900 113		60	20.5	10.3	85	2000		included in the KIT 305 407 300 113		06/14-11/19 with preliminary setup	S	CAN	C	E	D	L	H	30
Audi A3, 3 doors without preliminary setup inc. S-Line, exc. S3 inc. facelift 07/16- Attention: Depending on the engine variation it may be necessary to change the cooling system of the vehicle.	06/14-11/19	KIT		305 408 900 113		60	19.0	10.3	85	2000		included in the KIT 305 408 300 113		06/14- without preliminary setup	S	CAN	C	E	D	L	V	60
Audi A3, 3 doors with preliminary setup inc. S-Line, exc. S3 inc. facelift 07/16- Attention: Depending on the engine variation it may be necessary to change the cooling system of the vehicle.	06/14-11/19	KIT		317 154 900 113		60	20.5	10.3	85	2000		included in the KIT 305 407 300 113		06/14-11/19 with preliminary setup	S	CAN	C	E	D	L	H	30
Audi A4 Allroad Quattro B8 Attention: Depending on the engine variation it may be necessary to change the cooling system of the vehicle. RECEPTION TUBE FOR TOWBALL VISIBLE	06/09-12/15			305 571 600 001		90	25.1	11.1	90	2100		305 214 300 113			S	CAN	C	E	D	L1	H	60
		KIT		305 571 900 113		90	26.8	11.1	90	2100		included in the KIT 305 214 300 113			S	CAN	C	E	D	L1	H	60

Audi A4 Allroad Quattro B9	01/16-			305 450 600 001		90	24.0	11.2	85	2100		305 417 300 113	→		S	A	C1	E2	D	L1	H	60	
				305 447 600 001		90	25.5	11.2	85	2100		305 437 300 113			S	CAN	C	E	D	L	H	60	
													305 447 300 113			S	CAN	C	E	D	L1	H	60
		KIT		305 531 900 113		90	25.1	11.2	85	2100		included in the KIT 305 437 300 113			S	CAN	C	E	D	L	H	60	
		KIT		305 532 900 113		90	26.6	11.2	85	2100		included in the KIT 305 437 300 113			S	CAN	C	E	D	L	H	60	
Audi A4 Avant inc. Quattro + S4 exc. RS 4	01/96-11/01			305 179 600 001		150	18.0	10.1	75	1800													
				305 220 600 001	→ 	120	19.0	10.1	75	1800													
Audi A4 Avant B6 Quattro and S-Line, exc. S4	11/01-11/04			305 205 600 001		120	18.5	10.3	85	2000					S	CAN	C	E	D1	--	H	75	
				305 206 600 001		120	20.0	10.3	85	2000		305 215 300 113			S	CAN	C	E	D1	--	H	75	
		KIT		305 205 900 113		120	20.5	10.3	85	2000		included in the KIT 305 215 300 113			S	CAN	C	E	D1	--	H	75	
		KIT		305 206 900 113		120	22.0	10.3	85	2000		included in the KIT 305 215 300 113			S	CAN	C	E	D1	--	H	75	
Audi A4 Avant B7 inc. Quattro, S-line exc. RS4/S4	11/04-08	KIT		305 301 900 153		120	22.0	10.4	100	2000		included in the KIT 305 208 300 153			S	CAN	C	--	D1	L1	H	100	
		KIT		305 302 900 153		120	22.0	10.4	100	2000		included in the KIT 305 208 300 153			S	CAN	C	--	D1	L1	H	100	
Audi A4 Avant B7 inc. Quattro, S-line exc. RS4/S4	11/04-05/08			305 301 600 001		120	20.0	10.4	100	2000		305 208 300 147			S	CAN	C	--	--	--	H	100	
				305 302 600 001		120	20.0	10.4	100	2000		305 208 300 153			S	CAN	C	--	D1	L1	H	100	























Audi

Audi A4 Avant B8 inc. S4, S-Line, Quattro exc.RS Attention: Depending on the engine variation it may be necessary to change the cooling system of the vehicle.	04/08-11/15			305 443 600 001		90	19.0	11.1	90	2000		305 214 300 113			S	CAN	C	E	D	L1	H	60
		KIT		305 324 900 113		90	21.0	11.1	90	2000		included in the KIT 305 214 300 113			S	CAN	C	E	D	L1	H	60
Audi A4 Avant B8 inc. S4, S-Line, Quattro Sport exc.RS For S4 please order extended socket holder, order no. 921740650001. Attention: Depending on the engine variation it may be necessary to change the cooling system of the vehicle. RECEPTION TUBE FOR TOWBALL VISIBLE	04/08-11/15			305 571 600 001		90	25.1	11.1	90	2100		305 214 300 113			S	CAN	C	E	D	L1	H	60
		KIT		305 571 900 113		90	26.8	11.1	90	2100		included in the KIT 305 214 300 113			S	CAN	C	E	D	L1	H	60
Audi A4 Avant B9 CNG: Please check if there is a towing capacity in the car documents.	05/15-			305 450 600 001		90	24.0	11.2	85	2100		305 417 300 113	→		S	A	C1	E2	D	L1	H	60
				305 447 600 001		90	25.5	11.2	85	2100		305 437 300 113			S	CAN	C	E	D	L	H	60
				305 447 300 113								305 447 300 113			S	CAN	C	E	D	L1	H	60
		KIT		305 531 900 113		90	25.1	11.2	85	2100		included in the KIT 305 437 300 113			S	CAN	C	E	D	L	H	60
Audi A4 Avant B9 for vehicles without preliminary setup exc. RS inc. AdBlue CNG: Please check if there is a towing capacity in the car documents.	05/15-	KIT		305 577 900 113		60	30.9	10.7	90	2100		included in the KIT 300 001 300 153	not available individually		S	CAN	C	E	D	L1	H	60
Audi A4 Convertible B6, exc. S4	05/02-05			305 205 600 001		120	18.5	10.3	85	2000		305 215 300 113			S	CAN	C	E	D1	--	H	75
		KIT		305 205 900 113		120	20.5	10.3	85	2000		included in the KIT 305 215 300 113			S	CAN	C	E	D1	--	H	75

Audi A4 Convertible B6 inc. S-Line, exc. S4	05/02-05			305 206 600 001		120	20.0	10.3	85	2000		305 215 300 113			S	CAN	C	E	D1	--	H	75
		KIT		305 206 900 113		120	22.0	10.3	85	2000		included in the KIT 305 215 300 113			S	CAN	C	E	D1	--	H	75
Audi A4 Convertible B7 inc. S-line exc. RS4/S4	10/05-	KIT		305 301 900 153		120	22.0	10.4	100	2000		included in the KIT 305 208 300 153			S	CAN	C	--	D1	L1	H	100
		KIT		305 302 900 153		120	22.0	10.4	100	2000		included in the KIT 305 208 300 153			S	CAN	C	--	D1	L1	H	100
Audi A4 Convertible B7 inc. S-line exc. RS4/S4	10/05-03/09			305 301 600 001		120	20.0	10.4	100	2000		305 208 300 147			S	CAN	C	--	--	--	H	100
				305 302 600 001		120	20.0	10.4	100	2000		305 208 300 153			S	CAN	C	--	D1	L1	H	100
Audi A4 Saloon B5 inc. Quattro + S4	11/94-11/00			305 179 600 001		150	18.0	10.1	75	1800		300 078 300 113	03/99-		--	FRE	--	--	D1	L1	V	
				305 220 600 001	→ 	120	19.0	10.1	75	1800												
Audi A4 Saloon B6 Quattro and S-Line, exc. S4	11/00-11/04			305 205 600 001		120	18.5	10.3	85	2000		305 215 300 113			S	CAN	C	E	D1	--	H	75
				305 206 600 001		120	20.0	10.3	85	2000												
		KIT		305 205 900 113		120	20.5	10.3	85	2000		included in the KIT 305 215 300 113			S	CAN	C	E	D1	--	H	75
		KIT		305 206 900 113		120	22.0	10.3	85	2000		included in the KIT 305 215 300 113			S	CAN	C	E	D1	--	H	75
Audi A4 Saloon B7 inc. Quattro, S-line exc. RS4/S4	11/04-09/07			305 301 600 001		120	20.0	10.4	100	2000		305 208 300 147			S	CAN	C	--	--	--	H	100
				305 302 600 001		120	20.0	10.4	100	2000		305 208 300 153			S	CAN	C	--	D1	L1	H	100

Audi

























Audi

Audi A4 Saloon B7 inc. Quattro, S-line exc. RS4/S4	11/04-09/07	KIT		305 301 900 153		120	22.0	10.4	100	2000		included in the KIT 305 208 300 153			S	CAN	C	--	D1	L1	H	100
		KIT		305 302 900 153		120	22.0	10.4	100	2000		included in the KIT 305 208 300 153			S	CAN	C	--	D1	L1	H	100
Audi A4 Saloon B8 inc. S4, S-Line, Quattro exc.RS Attention: Depending on the engine variation it may be necessary to change the cooling system of the vehicle.	09/07-11/15			305 443 600 001		90	19.0	11.1	90	2000		305 214 300 113			S	CAN	C	E	D	L1	H	60
		KIT		305 324 900 113		90	21.0	11.1	90	2000		included in the KIT 305 214 300 113			S	CAN	C	E	D	L1	H	60
Audi A4 Saloon B8 inc. S4, S-Line, Quattro Sport exc.RS For S4 please order extended socket holder, order no. 905323608001. Attention: Depending on the engine variation it may be necessary to change the cooling system of the vehicle. RECEPTION TUBE FOR TOWBALL VISIBLE	09/07-11/15			305 571 600 001		90	25.1	11.1	90	2100		305 214 300 113			S	CAN	C	E	D	L1	H	60
		KIT		305 571 900 113		90	26.8	11.1	90	2100		included in the KIT 305 214 300 113			S	CAN	C	E	D	L1	H	60
Audi A4 Saloon B9 CNG: Please check if there is a towing capacity in the car documents.	05/15-			305 450 600 001		90	24.0	11.2	85	2100		305 417 300 113	→		S	A	C1	E2	D	L1	H	60
				305 447 600 001		90	25.5	11.2	85	2100		305 437 300 113			S	CAN	C	E	D	L	H	60
				305 447 300 113											S	CAN	C	E	D	L1	H	60
		KIT		305 531 900 113		90	25.1	11.2	85	2100		included in the KIT 305 437 300 113			S	CAN	C	E	D	L	H	60
		KIT		305 532 900 113		90	26.6	11.2	85	2100		included in the KIT 305 437 300 113			S	CAN	C	E	D	L	H	60
Audi A4 Saloon B9 for vehicles without preliminary setup exc. RS inc. AdBlue CNG: Please check if there is a towing capacity in the car documents.	05/15-	KIT		305 577 900 113		60	30.9	10.7	90	2100		included in the KIT 300 001 300 153	not available individually		S	CAN	C	E	D	L1	H	60

























Audi A5 Convertible B8 inc. S5, S-Line, Quattro exc.RS Attention: Depending on the engine variation it may be necessary to change the cooling system of the vehicle.	09-09/16			305 443 600 001		90	19.0	11.1	90	2000		305 214 300 113			S	CAN	C	E	D	L1	H	60
		KIT		305 324 900 113		90	21.0	11.1	90	2000		included in the KIT 305 214 300 113			S	CAN	C	E	D	L1	H	60
Audi A5 Convertible B8 inc. S5, S-Line, Quattro Sport exc.RS For S5 please order extended socket holder, order no. 905323608001. Attention: Depending on the engine variation it may be necessary to change the cooling system of the vehicle. RECEPTION TUBE FOR TOWBALL VISIBLE	09-09/16			305 571 600 001		90	25.1	11.1	90	2100		305 214 300 113			S	CAN	C	E	D	L1	H	60
		KIT		305 571 900 113		90	26.8	11.1	90	2100		included in the KIT 305 214 300 113			S	CAN	C	E	D	L1	H	60
Audi A5 Convertible (F57) CNG: Please check if there is a towing capacity in the car documents.	09/16-			305 450 600 001		90	24.0	11.2	85	2100		305 417 300 113	→		S	A	C1	E2	D	L1	H	60
				305 447 600 001		90	25.5	11.2	85	2100		305 437 300 113			S	CAN	C	E	D	L	H	60
				305 447 300 113								305 447 300 113			S	CAN	C	E	D	L1	H	60
		KIT		305 531 900 113		90	25.1	11.2	85	2100		included in the KIT 305 437 300 113			S	CAN	C	E	D	L	H	60
		KIT		305 532 900 113		90	26.6	11.2	85	2100		included in the KIT 305 437 300 113			S	CAN	C	E	D	L	H	60
Audi A5 Coupé B8 inc. S5, S-Line, Quattro exc.RS Attention: Depending on the engine variation it may be necessary to change the cooling system of the vehicle.	06/07-09/16			305 443 600 001		90	19.0	11.1	90	2000		305 214 300 113			S	CAN	C	E	D	L1	H	60
		KIT		305 324 900 113		90	21.0	11.1	90	2000		included in the KIT 305 214 300 113			S	CAN	C	E	D	L1	H	60



























Audi

Audi A5 Coupé B8 inc. S5, S-Line, Quattro Sport exc.RS For S5 please order extended socket holder, order no. 905323608001. Attention: Depending on the engine variation it may be necessary to change the cooling system of the vehicle. RECEPTION TUBE FOR TOWBALL VISIBLE	06/07-09/16			305 571 600 001		90	25.1	11.1	90	2100		305 214 300 113				S	CAN	C	E	D	L1	H	60
		KIT		305 571 900 113		90	26.8	11.1	90	2100		included in the KIT 305 214 300 113			S	CAN	C	E	D	L1	H	60	
Audi A5 Coupé B9 CNG: Please check if there is a towing capacity in the car documents.	09/16-			305 450 600 001		90	24.0	11.2	85	2100		305 417 300 113	→			S	A	C1	E2	D	L1	H	60
				305 447 600 001		90	25.5	11.2	85	2100		305 437 300 113			S	CAN	C	E	D	L	H	60	
					305 447 300 113							305 447 300 113			S	CAN	C	E	D	L1	H	60	
		KIT		305 531 900 113		90	25.1	11.2	85	2100		included in the KIT 305 437 300 113			S	CAN	C	E	D	L	H	60	
		KIT		305 532 900 113		90	26.6	11.2	85	2100		included in the KIT 305 437 300 113			S	CAN	C	E	D	L	H	60	
Audi A5 Sportback B8 inc. S5, S-Line, Quattro exc.RS Attention: Depending on the engine variation it may be necessary to change the cooling system of the vehicle.	09/09-04/17			305 443 600 001		90	19.0	11.1	90	2000		305 214 300 113				S	CAN	C	E	D	L1	H	60
		KIT		305 324 900 113		90	21.0	11.1	90	2000		included in the KIT 305 214 300 113			S	CAN	C	E	D	L1	H	60	
Audi A5 Sportback B8 inc. S5, S-Line, Quattro Sport exc.RS For S5 please order extended socket holder, order no. 905323608001. Attention: Depending on the engine variation it may be necessary to change the cooling system of the vehicle. RECEPTION TUBE FOR TOWBALL VISIBLE	09/09-04/17			305 571 600 001		90	25.1	11.1	90	2100		305 214 300 113				S	CAN	C	E	D	L1	H	60
		KIT		305 571 900 113		90	26.8	11.1	90	2100		included in the KIT 305 214 300 113			S	CAN	C	E	D	L1	H	60	





























Audi A5 Sportback B9 CNG: Please check if there is a towing capacity in the car documents.	05/17-			305 450 600 001		90	24.0	11.2	85	2100		305 417 300 113	→		S	A	C1	E2	D	L1	H	60
				305 447 600 001		90	25.5	11.2	85	2100		305 437 300 113			S	CAN	C	E	D	L	H	60
				305 447 300 113								305 447 300 113			S	CAN	C	E	D	L1	H	60
		KIT		305 531 900 113		90	25.1	11.2	85	2100		included in the KIT 305 437 300 113			S	CAN	C	E	D	L	H	60
		KIT		305 532 900 113		90	26.6	11.2	85	2100		included in the KIT 305 437 300 113			S	CAN	C	E	D	L	H	60
Audi A6 Allroad C7 Please order spoiler at Audi dealers.	06/12-10/14	KIT		305 407 900 113		90	22.0	12.6	100	2500		included in the KIT 305 385 300 113	-10/14		S	CAN	C	E	D	L1	H	45
Audi A6 Allroad C7 Please order spoiler at Audi dealers.	06/12-09/18			305 407 600 001		90	20.0	12.6	100	2500		305 385 300 113	-10/14		S	CAN	C	E	D	L1	H	45
												305 387 300 113	10/14-		S	CAN	C	E	D	L	H	60
Audi A6 Allroad (C8) inc. AdBlue	10/18-			305 601 600 001		90	26.1	12.6	150	2500		305 486 300 113			S	CAN	C	E	D	L	H	90
		KIT		305 601 900 113	→ 	90	27.9	12.6	150	2500		included in the KIT 305 486 300 113			S	CAN	C	E	D	L	H	90
Audi A6 Avant with steel springs inc. S6 and Quattro, exc. RS6, exc. S-Line	03/05-09/11			305 564 600 001		60	25.8	12.0	90	2200		305 268 300 113			S	CAN	C	E	D	L1	H	45
				305 565 600 001		60	25.8	12.0	90	2400												
		KIT		305 565 900 113		60	27.6	12.0	90	2400		included in the KIT 305 268 300 113			S	CAN	C	E	D	L1	H	45
Audi A6 Avant with height control inc. Quattro, S6, S-line, exc. RS6 For optimal fit, order bumper reinforcement Westfalia no. 905269619001 in combination with Audi no. 4F0 807 381.	03/05-09/11			305 291 600 001	→ 	120	24.5	12.0	90	2200		305 268 300 113			S	CAN	C	E	D	L1	H	45
Audi A6 Avant exc. RS6 inc. Quattro, S-line	09/11-10/14	KIT		305 428 900 113		90	22.0	12.6	100	2500		included in the KIT 305 385 300 113	-10/14		S	CAN	C	E	D	L1	H	45





















Audi

Audi A6 Avant exc. RS6 inc. Quattro, S-line	09/11-10/14	KIT		305 429 900 113		90	23.0	12.6	100	2500		included in the KIT 305 385 300 113	-10/14	S	CAN	C	E	D	L1	H	45
Audi A6 Avant exc. RS6 inc. Quattro, S-line	09/11-08/18			305 428 600 001		90	20.0	12.6	100	2500		305 385 300 113	-10/14	S	CAN	C	E	D	L1	H	45
				305 429 600 001		90	21.0	12.6	100	2500		305 387 300 113	10/14-08/18	S	CAN	C	E	D	L	H	60
Audi A6 Avant exc. RS6 inc. Quattro, S-line	10/14-08/18	KIT		305 438 900 113		90	22.0	12.6	100	2500		included in the KIT 305 387 300 113	10/14-08/18	S	CAN	C	E	D	L	H	60
Audi A6 Avant	05/18-			305 557 600 001	→ 	60	21.3	11.4	135	2100		305 486 300 107	→ 05/18-	S	CAN	C	E	--	--	H	90
				305 558 600 001	→ 	60	24.2	11.4	135	2100		305 486 300 113	05/18-	S	CAN	C	E	D	L	H	90
		KIT		305 557 900 113		90	22.6	12.6	150	2500		included in the KIT 305 486 300 113	05/18-	S	CAN	C	E	D	L	H	90
		KIT		305 558 900 113		90	25.2	12.6	150	2500		included in the KIT 305 486 300 113	05/18-	S	CAN	C	E	D	L	H	90
Audi A6 Avant (C8) inc. AdBlue	05/18-			305 602 600 001		90	23.6	12.6	150	2500		305 486 300 113	05/18-	S	CAN	C	E	D	L	H	90
				305 603 600 001		90	26.3	12.6	150	2500											
Audi A6 Saloon with steel springs inc. S6 and Quattro, exc. RS6, exc. S-Line	04/04-03/11			305 565 600 001		60	25.8	12.0	90	2400		305 268 300 113		S	CAN	C	E	D	L1	H	45
				KIT		305 565 900 113		60	27.6	12.0	90	2400		included in the KIT 305 268 300 113		S	CAN	C	E	D	L1
Audi A6 Saloon with height control inc. Quattro, S6, S-Line, exc. RS6	04/04-03/11			305 291 600 001	→ 	120	24.5	12.0	90	2200		305 268 300 113		S	CAN	C	E	D	L1	H	45
Audi A6 Saloon with steel springs inc. S6 and Quattro, exc. RS6, nicht für S-Line	03/05-09/11			305 564 600 001		60	25.8	12.0	90	2200		305 268 300 113		S	CAN	C	E	D	L1	H	45

Audi A6 Saloon	03/11-10/14	KIT		305 428 900 113		90	22.0	12.6	100	2500	included in the KIT 305 385 300 113	-10/14	S	CAN	C	E	D	L1	H	45
		KIT		305 429 900 113		90	23.0	12.6	100	2500	included in the KIT 305 385 300 113	-10/14	S	CAN	C	E	D	L1	H	45
Audi A6 Saloon	03/11-02/18			305 428 600 001		90	20.0	12.6	100	2500	305 385 300 113	-10/14	S	CAN	C	E	D	L1	H	45
				305 429 600 001		90	21.0	12.6	100	2500	305 387 300 113	10/14-02/18	S	CAN	C	E	D	L	H	60
Audi A6 Saloon	10/14-02/18	KIT		305 438 900 113		90	22.0	12.6	100	2500	included in the KIT 305 387 300 113	10/14-02/18	S	CAN	C	E	D	L	H	60
Audi A6 Saloon	02/18-			305 557 600 001	→ 	60	21.3	11.4	135	2100	305 486 300 107	→ 02/18-	S	CAN	C	E	--	--	H	90
				305 558 600 001	→ 	60	24.2	11.4	135	2100	305 486 300 113	02/18-	S	CAN	C	E	D	L	H	90
		KIT		305 557 900 113		90	22.6	12.6	150	2500	included in the KIT 305 486 300 113	02/18-	S	CAN	C	E	D	L	H	90
		KIT		305 558 900 113		90	25.2	12.6	150	2500	included in the KIT 305 486 300 113	02/18-	S	CAN	C	E	D	L	H	90
Audi A6 Saloon (C8) inc. AdBlue	02/18-			305 602 600 001		90	23.6	12.6	150	2500	305 486 300 113	02/18-	S	CAN	C	E	D	L	H	90
				305 603 600 001		90	26.3	12.6	150	2500										
Audi A7 Sportback inc. S-line + S7	10/10-10/14	KIT		305 428 900 113		90	22.0	12.6	100	2500	included in the KIT 305 385 300 113	-10/14	S	CAN	C	E	D	L1	H	45
		KIT		305 429 900 113		90	23.0	12.6	100	2500	included in the KIT 305 385 300 113	-10/14	S	CAN	C	E	D	L1	H	45



















Audi























Audi A7 Sportback inc. S-line + S7	10/10-01/18			305 428 600 001		90	20.0	12.6	100	2500		305 385 300 113	-10/14	S	CAN	C	E	D	L1	H	45
				305 429 600 001		90	21.0	12.6	100	2500		305 387 300 113	10/14-01/18	S	CAN	C	E	D	L	H	60
Audi A7 Sportback inc. S-line + S7	10/14-01/18	KIT		305 438 900 113		90	22.0	12.6	100	2500		included in the KIT 305 387 300 113	10/14-01/18	S	CAN	C	E	D	L	H	60
Audi A7 Sportback C8 inc. AdBlue inc. Hybrid	04/18-			305 602 600 001		90	23.6	12.6	150	2500		305 486 300 113		S	CAN	C	E	D	L	H	90
Audi A7 Sportback C8 inc. AdBlue inc. Hybrid	04/18-			305 603 600 001		90	26.3	12.6	150	2500		305 486 300 113		S	CAN	C	E	D	L	H	90
		KIT		305 557 900 113		90	22.6	12.6	150	2500		included in the KIT 305 486 300 113		S	CAN	C	E	D	L	H	90
		KIT		305 558 900 113		90	25.2	12.6	150	2500		included in the KIT 305 486 300 113		S	CAN	C	E	D	L	H	90
Audi A8	03/10-10/17			305 384 600 001		60	26.0	12.6	100	2200		305 384 300 113	-10/13	S	CAN	C	E	D	L1	H	60
Audi-E-Tron GEN inc. Sportback	09/18-			305 600 600 001		75	17.0	11.4	135	1800		305 437 300 113 305 447 300 113		S	CAN	C	E	D	L	H	60
		KIT		305 600 900 113		75	18.6	11.4	135	1800		included in the KIT 305 437 300 113		S	CAN	C	E	D	L	H	60
Audi Q2	11/16-			317 131 600 001		60	19.0	10.3	85	2000		305 407 300 113	with preliminary setup	S	CAN	C	E	D	L	H	30
				317 132 600 001		60	19.0	10.3	85	2000		305 408 300 107	without preliminary setup	S	CAN	C	E	--	--	V	60
												305 408 300 113	without preliminary setup	S	CAN	C	E	D	L	V	60
Audi Q2 without preliminary setup	11/16-	KIT		305 408 900 113		60	19.0	10.3	85	2000		included in the KIT 305 408 300 113	without preliminary setup	S	CAN	C	E	D	L	V	60
		KIT		305 409 900 113		60	21.0	10.3	85	2000		included in the KIT 305 408 300 113	without preliminary setup	S	CAN	C	E	D	L	V	60

Audi Q2 with preliminary setup	11/16-	KIT		317 154 900 113		60	20.5	10.3	85	2000		included in the KIT 305 407 300 113		with preliminary setup	S	CAN	C	E	D	L	H	30
		KIT		317 155 900 113		60	20.5	10.3	85	2000		included in the KIT 305 407 300 113		with preliminary setup	S	CAN	C	E	D	L	H	30
Audi Q3 inc. S-line, inc. Quattro RS Vehicles from year 2015- require a new cover with cut-out. Please order from the Audi dealer.	09/11-06/18			305 421 600 001		90	19.0	12.0	100	2500		305 410 300 113	→	-06/18	S	CAN	C	E	D	L1	V	120
				305 423 600 001		90	21.0	12.0	140	2500												
Audi Q3 F3B inc. S-Line	07/18-			344 121 600 001		60	14.0	12.3	150	2500		305 407 300 113		with preliminary setup	S	CAN	C	E	D	L	H	30
				344 120 600 001		60	16.6	12.3	150	2500		305 408 300 107		without preliminary setup	S	CAN	C	E	--	--	V	60
												305 408 300 113		without preliminary setup	S	CAN	C	E	D	L	V	60
Audi Q3 F3B with preliminary setup inc. S-Line	07/18-	KIT		344 071 900 113		60	15.5	12.3	150	2500		included in the KIT 305 407 300 113		with preliminary setup	S	CAN	C	E	D	L	H	30
Audi Q3 Sportback F3N inc. S-Line	06/19-			344 121 600 001		60	14.0	12.3	150	2500		305 407 300 113		with preliminary setup	S	CAN	C	E	D	L	H	30
												305 408 300 107			S	CAN	C	E	--	--	V	60
												305 408 300 113		without preliminary setup	S	CAN	C	E	D	L	V	60
Audi Q3 Sportback F3N with preliminary setup inc. S-Line	06/19-	KIT		344 071 900 113		60	15.5	12.3	150	2500		included in the KIT 305 407 300 113		with preliminary setup	S	CAN	C	E	D	L	H	30
Audi Q3 Sportback F3N inc. S-Line	06/19-			344 120 600 001		60	16.6	12.3	150	2500		305 407 300 113		with preliminary setup	S	CAN	C	E	D	L	H	30
												305 408 300 107			S	CAN	C	E	--	--	V	60
												305 408 300 113			S	CAN	C	E	D	L	V	60











Audi





















Audi













Audi Q5 inc. S-Line, inc. SQ5 Attention: Depending on the engine variation it may be necessary to change the cooling system of the vehicle.	10/08-05/16			305 411 600 001		90	21.0	12.1	100	2400		305 216 300 113			S	CAN	C	E	D	L1	H	60
				327 068 600 001		90	21.0	12.1	100	2400												
		KIT		305 351 900 113		90	23.0	12.1	100	2400			included in the KIT 305 216 300 113									
		KIT		305 412 900 113		90	26.0	12.1	100	2400			included in the KIT 305 216 300 113									
Audi Q5 (FYG,FYB) inc. SQ5 inc. Plugin Hybrid	06/16-			305 579 600 001		60	20.3	12.3	150	2400		305 437 300 113	inc. Hybrid	S	CAN	C	E	D	L	H	60	
				305 580 600 001		60	23.0	12.3	150	2400				305 447 300 113	S	CAN	C	E	D	L1	H	60
		KIT		305 579 900 113		60	21.9	12.3	150	2400		included in the KIT 305 437 300 113	inc. Hybrid	S	CAN	C	E	D	L	H	60	
		KIT		305 580 900 113		60	24.6	12.3	150	2400		included in the KIT 305 437 300 113		S	CAN	C	E	D	L	H	60	
Audi Q5 (FYG,FYB) inc. SQ5 inc. S-Line inc. Plugin Hybrid inc. AdBlue	06/16-	KIT		305 578 900 113	 	90	30.7	12.3	150	2400		included in the KIT 300 000 300 153	not available individually	S	CAN	C	E	D	L1	H	60	

Audi Q5 Sportback (FYT) inc. SQ5 inc. S-Line inc. Plugin Hybrid inc. AdBlue	10/20-			305 579 600 001		60	20.3	12.3	150	2400		305 437 300 113	10/20-	S	CAN	C	E	D	L	H	60	
				305 580 600 001		60	23.0	12.3	150	2400		305 447 300 113		S	CAN	C	E	D	L1	H	60	
		KIT		305 579 900 113		60	21.9	12.3	150	2400		included in the KIT 305 437 300 113		10/20-	S	CAN	C	E	D	L	H	60
		KIT		305 580 900 113		60	24.6	12.3	150	2400		included in the KIT 305 437 300 113		10/20-	S	CAN	C	E	D	L	H	60
		KIT		305 578 900 113	→ 	90	30.7	12.3	150	2400		included in the KIT 300 000 300 153		not available individually	S	CAN	C	E	D	L1	H	60
Audi Q7 inc. S-Line Please order separately spoiler at Audi dealer.	01/06-07/15			305 415 600 001		120	34.0	16.4	140	3500		305 500 300 001	Additional kit for vehicles without electrical tailgate	S							H	
											305 500 300 113	for vehicles with electric tailgate		S	CAN	C	E	D	L1	H	60	
		KIT		305 314 900 113		120	36.0	16.4	140	3500		included in the KIT 305 500 300 113		for vehicles with electric tailgate	S	CAN	C	E	D	L1	H	60
												305 500 300 001	Additional kit for vehicles without electrical tailgate	S							H	
Audi Q7 4MB,4MG inc. Q7 3.0 TDI e-tron	07/15-			305 437 600 001		90	21.0	16.4	140	3500		305 417 300 113	→	S	A	C1	E2	D	L1	H	60	
											305 437 300 113	S		CAN	C	E	D	L	H	60		
												305 447 300 113		S	CAN	C	E	D	L1	H	60	
Audi Q7 inc. Q7 3.0 TDI e-tron	07/15-	KIT		305 437 900 113	→ 	90	23.7	16.4	140	3500		included in the KIT 305 417 300 113	→	S	A	C1	E2	D	L1	H	60	
Audi Q8 4MN	02/18-			322 064 600 001		60	27.0	15.7	191	3500		305 437 300 113		S	CAN	C	E	D	L	H	60	
											305 447 300 113	S		CAN	C	E	D	L1	H	60		
		KIT		322 064 900 113		60	28.0	15.7	191	3500		included in the KIT 305 437 300 113		S	CAN	C	E	D	L	H	60	













Audi





















BMW 1 Series Convertible E88 135i is not homologated for towing.	01/08-01/14			303 323 600 001		60	20.0	8.0	90	1400		303 460 300 113			S	CAN	--	E2	D	L1	H	60
		KIT		303 323 900 113		60	22.0	8.0	90	1400		included in the KIT 303 460 300 113			S	CAN	--	E2	D	L1	H	60
BMW 1 Series Coupé E82 135i is not homologated for towing.	11/07-01/14			303 323 600 001		60	20.0	8.0	90	1400		303 460 300 113			S	CAN	--	E2	D	L1	H	60
		KIT		303 323 900 113		60	22.0	8.0	90	1400		included in the KIT 303 460 300 113			S	CAN	--	E2	D	L1	H	60
BMW 1 Series, 3/5 doors Hatchback F20/F21 inc. M-Sport-Package Please order separately thermal-insulation plate for socket holder,no. 7 277 733 at BMW dealers. 135i is not permitted to tow by manufacturer. For vehicles with petrol engines, please check whether it is necessary to replace the rear exhaust silencer.	09/11-03/14	KIT		303 317 900 113			22.0	8.8	75	1500		included in the KIT 303 460 300 113	-03/14		S	CAN	--	E2	D	L1	H	60
BMW 1 Series, 3/5 doors Hatchback F20/F21 exc. M models, exc. M-Sport-Package 135i is not permitted to tow by manufacturer. For vehicles with petrol engines, please check whether it is necessary to replace the rear exhaust silencer.	09/11-03/14	KIT		303 320 900 113			19.5	8.8	75	1500		included in the KIT 303 460 300 113	-03/14		S	CAN	--	E2	D	L1	H	60
BMW 1 Series, 3/5 doors Hatchback F20/F21 exc. M models, inc. M-Sport-Package Please order separately thermal-insulation plate for socket holder,no. 7 277 733 at BMW dealers. 135i is not permitted to tow by manufacturer. For vehicles with petrol engines, please check whether it is necessary to replace the rear exhaust silencer.	09/11-07/19			303 317 600 001		60	20.0	8.8	75	1500		303 460 300 113	-03/14		S	CAN	--	E2	D	L1	H	60
												303 481 300 113	03/14-07/19		S	CAN	--	E2	D	L1	H	90

BMW 2 Series Active Tourer F45 exc. hybrid	09/14-10/21			303 355 600 001		90	17.5	10.4	80	2000		303 372 300 113	→		S	CAN	--	E	D	L1	V	105
				303 372 600 001		90	21.0	10.4	80	2000		303 480 300 113		09/14-	S	CAN	--	E	D	L1	V	105
		KIT		303 355 900 113	→		90	22.5	10.4	80	2000	included in the KIT 303 372 300 113	→		S	CAN	--	E	D	L1	V	105
		KIT		303 373 900 113			90	19.5	10.4	80	2000	included in the KIT 303 480 300 113		09/14-	S	CAN	--	E	D	L1	V	105
		KIT		303 372 900 113			90	24.0	10.4	80	2000	included in the KIT 303 372 300 113	→		S	CAN	--	E	D	L1	V	105
		KIT		303 374 900 113			90	21.0	10.4	80	2000	included in the KIT 303 480 300 113		09/14-	S	CAN	--	E	D	L1	V	105
BMW 2 Series Active Tourer U06	11/21-			303 516 600 001		75	18.0	8.3	75	1400												
				303 517 600 001		75	20.0	8.3	75	1400												
BMW 2 Series Convertible F23 exc. M models	02/15-07/21			303 320 600 001		60	17.5	8.8	75	1500		303 481 300 113		02/15-21	S	CAN	--	E2	D	L1	H	90
				303 317 600 001		60	20.0	8.8	75	1500												
		KIT		303 002 900 113		60	19.2	8.8	75	1500		included in the KIT 303 481 300 113		02/15-21	S	CAN	--	E2	D	L1	H	90
		KIT		303 001 900 113		60	20.5	8.8	75	1500		included in the KIT 303 481 300 113		02/15-21	S	CAN	--	E2	D	L1	H	90











BMW 3 Series Compact F11 fits M-Sport	07/13-01/17	KIT		303 007 900 113		45	24.7	11.8	100	2200		included in the KIT 303 481 300 113	07/13-01/17	S	CAN	--	E2	D	L1	H	90
BMW 3 Series Coupé E46 (E46/2) steel construction exc. M3, fits M-Sport Please order separately cover for bumper cutout at BMW dealer's, BMW no.: model -12/03: 5112 8244 380, model 12/03 -: 5112 7112 481.	04/99-08/06			303 230 600 001		150	17.0	9.9	75	1940											
BMW 3 Series Coupé E92 fits M-Sport angular position of the towball, receptor tube is not in centre inc. models 335i and 335td and/or vehicles with turbocharger please order extra carriers for exhaust, order no. 303266600015	09/06-09/13			303 266 600 001			27.0	10.0	75	1800		303 460 300 113		S	CAN	--	E2	D	L1	H	60
BMW 3 Series Gran Turismo F34 BMW recommend fitting a heat shield for the detachable mechanism on petrol engines only - Order mounting bracket 303352613001 and heat shield separately from BMW dealers.	06/13-09/20			303 366 600 001		60	19.0	10.2	75	1800		303 460 300 113 303 481 300 113	-03/14 06/13-09/20	S S	CAN CAN	-- --	E2 E2	D D	L1 L1	H H	60 90
		KIT		303 003 900 113		60	23.2	10.2	75	1800		included in the KIT 303 481 300 113	06/13-09/20	S	CAN	--	E2	D	L1	H	90
BMW 3 Series Saloon E46 (E46/2) steel construction exc. M3 Please order separately cover for bumper cutout at BMW dealer's, BMW no.: model -09/01: 5112 8238 819, model 09/01 -: 5112 7045 526	04/98-03/05			303 230 600 001		150	17.0	9.9	75	1940											
BMW 3 Series Saloon E90 exc. M3, fits M Sport angular position of the towball, receptor tube is not in centre With vehicles year of construction 03/05 the fixed towbar attachment bolts on the vehicle must be changed at a BMW garage. For models 335i and 335td and/or vehicles with turbocharger please order extra carriers for exhaust, order no. 303240600015	03/05-01/12			303 330 600 001		75	26.5	10.0	75	1800		303 460 300 113	-03/14	S	CAN	--	E2	D	L1	H	60
		KIT		303 330 900 113		75	27.5	10.0	75	1800		included in the KIT 303 460 300 113	-03/14	S	CAN	--	E2	D	L1	H	60



















BMW

BMW 3 Series Saloon E90 exc. M3, fits M Sport. Angular position of the towball exc. 335i and 335td and/or vehicles with turbocharger With vehicles year of construction -03/05 the fixed towbar attachment bolts on the vehicle must be changed at a BMW garage.	03/05-01/12	KIT		303 331 900 113		75	21.0	9.2	75	1800		included in the KIT 303 460 300 113	-03/14	S	CAN	--	E2	D	L1	H	60
BMW 3 Series Saloon F30 exc. M3, fits M Sport, exc. 330e	02/12-03/14	KIT		303 351 900 113		60	23.0	10.0	75	1800		included in the KIT 303 460 300 113	-03/14	S	CAN	--	E2	D	L1	H	60
BMW 3 Series Saloon F30 exc. M3, fits M Sport, exc. 330e BMW recommend fitting a heat shield for the detachable mechanism on petrol engines only - Order mounting bracket 303352613001 and heat shield separately from BMW dealers.	02/12-03/14	KIT		303 352 900 113		60	23.5	10.0	75	1800		included in the KIT 303 460 300 113	-03/14	S	CAN	--	E2	D	L1	H	60
BMW 3 Series Saloon F30 exc. M3, fits M Sport, exc. 330e	02/12-11/18			303 351 600 001		60	21.0	10.0	75	1800		303 460 300 113 303 481 300 113	-03/14 03/14-11/18	S S	CAN CAN	-- --	E2 E2	D D	L1 L1	H H	60 90
BMW 3 Series Saloon F30 exc. M3, fits M Sport, exc. 330e BMW recommend fitting a heat shield for the detachable mechanism on petrol engines only - Order mounting bracket 303352613001 and heat shield separately from BMW dealers.	02/12-11/18			303 352 600 001		60	21.5	10.0	75	1800		303 460 300 113 303 481 300 113	-03/14 03/14-11/18	S S	CAN CAN	-- --	E2 E2	D D	L1 L1	H H	60 90
BMW 3 Series Saloon F30 exc. M3, fits M Sport, exc. 330e	03/14-11/18	KIT		303 004 900 113		60	20.7	10.0	75	1800		included in the KIT 303 481 300 113	03/14-11/18	S	CAN	--	E2	D	L1	H	90























BMW 3 Series Saloon G20 inc. M-Sport	11/18-			303 499 600 001		60	15.9	10.0	120	1800		303 504 300 113	11/18-	S	CAN	--	E2	D	L1	H	75
				303 500 600 001		60	18.2	10.0	120	1800											
		KIT		303 499 900 113		60	17.6	10.0	120	1800		included in the KIT 303 504 300 113	11/18-	S	CAN	--	E2	D	L1	H	75
		KIT		303 500 900 113		60	19.9	10.0	120	1800		included in the KIT 303 504 300 113	11/18-	S	CAN	--	E2	D	L1	H	75
BMW 3 Series Touring E46 (E46/3) fits M-Sport Please order separately cover for bumper cutout at BMW dealer' s, BMW no. 5112 8227 569.	99-09/05			303 232 600 001		150	17.0	9.9	75	1940											
BMW 3 Series Touring E91 inc. M Sport, exc. M3. Angular position of the towball, receptor tube is not in centre For models 335i and 335td and/or vehicles with turbocharger please order extra carriers for exhaust, order no. 303240600015	09/05-08/12			303 330 600 001		75	26.5	10.0	75	1800		303 460 300 113	-03/14	S	CAN	--	E2	D	L1	H	60
		KIT		303 330 900 113		75	27.5	10.0	75	1800		included in the KIT 303 460 300 113	-03/14	S	CAN	--	E2	D	L1	H	60
BMW 3 Series Touring E91 inc. M Sport, exc. M3. Angular position of the towball exc. 335i and 335td and/or vehicles with turbocharger	09/05-08/12	KIT		303 331 900 113		75	21.0	9.2	75	1800		included in the KIT 303 460 300 113	-03/14	S	CAN	--	E2	D	L1	H	60
BMW 3 Series Touring F31 exc. M3, fits M Sport, exc. 330e	09/12-03/14	KIT		303 351 900 113		60	23.0	10.0	75	1800		included in the KIT 303 460 300 113	-03/14	S	CAN	--	E2	D	L1	H	60
BMW 3 Series Touring F31 exc. M3, fits M Sport, exc. 330e BMW recommend fitting a heat shield for the detachable mechanism on petrol engines only - Order mounting bracket 303352613001 and heat shield separately from BMW dealers.	09/12-03/14	KIT		303 352 900 113		60	23.5	10.0	75	1800		included in the KIT 303 460 300 113	-03/14	S	CAN	--	E2	D	L1	H	60
BMW 3 Series Touring F31 exc. M3, fits M Sport, exc. 330e	09/12-06/19			303 351 600 001		60	21.0	10.0	75	1800		303 460 300 113	-03/14	S	CAN	--	E2	D	L1	H	60
												303 481 300 113	03/14-06/19	S	CAN	--	E2	D	L1	H	90

























BMW

BMW 3 Series Touring F31 exc. M3, fits M Sport, exc. 330e BMW recommend fitting a heat shield for the detachable mechanism on petrol engines only - Order mounting bracket 303352613001 and heat shield separately from BMW dealers.	09/12-06/19			303 352 600 001		60	21.5	10.0	75	1800		303 460 300 113	-03/14	S	CAN	--	E2	D	L1	H	60																												
												303 481 300 113	03/14-06/19	S	CAN	--	E2	D	L1	H	90																												
BMW 3 Series Touring F31 exc. M3, fits M Sport, exc. 330e	03/14-06/19	KIT		303 004 900 113		60	20.7	10.0	75	1800		included in the KIT 303 481 300 113	03/14-06/19	S	CAN	--	E2	D	L1	H	90																												
BMW 3 Series Touring G21 inc. M-Sport	07/19-			303 499 600 001		60	15.9	10.0	120	1800		303 504 300 113	07/19-	S	CAN	--	E2	D	L1	H	75																												
																								303 500 600 001		60	18.2	10.0	120	1800																			
																															KIT		303 499 900 113		60	17.6	10.0	120	1800	included in the KIT 303 504 300 113	07/19-	S	CAN	--	E2	D	L1	H	75















BMW 4 Series Coupé F32 exc. M models fits M Sport	10/13-03/14	KIT		303 351 900 113		60	23.0	10.0	75	1800		included in the KIT 303 460 300 113	-03/14	S	CAN	--	E2	D	L1	H	60	
BMW 4 Series Coupé F32 ekskl. M models fits M Sport BMW recommend fitting a heat shield for the detachable mechanism on petrol engines only - Order mounting bracket 303352613001 and heat shield separately from BMW dealers.	10/13-03/14	KIT		303 352 900 113		60	23.5	10.0	75	1800		included in the KIT 303 460 300 113	-03/14	S	CAN	--	E2	D	L1	H	60	
BMW 4 Series Coupé F32 exc. M models fits M Sport	10/13-11/20			303 351 600 001		60	21.0	10.0	75	1800		303 460 300 113 303 481 300 113	-03/14 03/14-11/20	S S	CAN CAN	-- --	E2 E2	D D	L1 L1	H H	60 90	
BMW 4 Series Coupé F32 exc. M models fits M Sport. BMW recommend fitting a heat shield for the detachable mechanism on petrol engines only - Order mounting bracket 303352613001 and heat shield separately from BMW dealers.	10/13-11/20			303 352 600 001		60	21.5	10.0	75	1800		303 460 300 113 303 481 300 113	-03/14 03/14-11/20	S S	CAN CAN	-- --	E2 E2	D D	L1 L1	H H	60 90	
BMW 4 Series Coupé F32 fits M Sport	03/14-11/20	KIT		303 004 900 113		60	20.7	10.0	75	1800		included in the KIT 303 481 300 113	03/14-11/20	S	CAN	--	E2	D	L1	H	90	
BMW 4 Series Coupé G22 exc. M4	12/20-			303 499 600 001		60	15.9	10.0	120	1800		303 504 300 113	11/20-	S	CAN	--	E2	D	L1	H	75	
				303 500 600 001		60	18.2	10.0	120	1800												
		KIT		303 499 900 113		60	17.6	10.0	120	1800		included in the KIT 303 504 300 113	11/20-	S	CAN	--	E2	D	L1	H	75	
		KIT		303 500 900 113		60	19.9	10.0	120	1800		included in the KIT 303 504 300 113	11/20-	S	CAN	--	E2	D	L1	H	75	



























BMW

BMW 4 Series Gran Coupé F36 fits M Sport exc. M models	06/14-06/21			303 351 600 001		60	21.0	10.0	75	1800		303 481 300 113	06/14-06/21	S	CAN	--	E2	D	L1	H	90
		KIT		303 004 900 113		60	20.7	10.0	75	1800		included in the KIT 303 481 300 113	06/14-06/21	S	CAN	--	E2	D	L1	H	90
BMW 4 Series Gran Coupé F36 fits M Sport exc. M models BMW recommend fitting a heat shield for the detachable mechanism on petrol engines only - Order mounting bracket 303352613001 and heat shield separately from BMW dealers.	06/14-06/21			303 352 600 001		60	21.5	10.0	75	1800		303 481 300 113	06/14-06/21	S	CAN	--	E2	D	L1	H	90
BMW 4 Series Gran Coupé G26	07/21-			303 514 600 001		75	17.1	12.3	145	2250		303 504 300 113	07/21-	S	CAN	--	E2	D	L1	H	75
		KIT		303 514 900 113		75	18.8	12.3	145	2250		included in the KIT 303 504 300 113	07/21-	S	CAN	--	E2	D	L1	H	75
BMW 5 Series Gran Turismo F07 Please order additionally the lower part of the bumper at a BMW dealer.	09/09-07/13			303 336 600 001		90	17.0	11.9	100	2100		303 460 300 113		S	CAN	--	E2	D	L1	H	60
BMW 5 Series Gran Turismo F07 facelift Please order additionally lower part of the bumper at BMW dealer.	07/13-05/17			303 370 600 001		90	17.0	11.9	100	2100		303 481 300 113	07/13-05/17	S	CAN	--	E2	D	L1	H	90
		KIT		303 006 900 113		90	18.7	11.9	100	2100		included in the KIT 303 481 300 113	07/13-05/17	S	CAN	--	E2	D	L1	H	90
BMW 5 Series Saloon E60 exc. M5, only for vehicles with sport equipment Please order separately cover for bumper cutout 5112 7120 005 at BMW dealer's.	07/03-02/10			303 235 600 001		150	20.0	11.4	90	2200		303 460 300 113	-07/13	S	CAN	--	E2	D	L1	H	60
		KIT		303 235 900 113		150	22.0	11.4	90	2200		included in the KIT 303 460 300 113	-07/13	S	CAN	--	E2	D	L1	H	60
BMW 5 Series Saloon E60 exc. M5, exc. vehicles with sport equipment	07/03-02/10			303 294 600 001		100	20.0	11.4	90	2200		303 460 300 113	-07/13	S	CAN	--	E2	D	L1	H	60
		KIT		303 294 900 113		100	22.0	11.4	90	2200		included in the KIT 303 460 300 113	-07/13	S	CAN	--	E2	D	L1	H	60



























BMW 5 Series Saloon F10 exc. M5 fits M-Sport	03/10-07/13	KIT		303 337 900 113		45	25.0	11.8	100	2200		included in the KIT 303 460 300 113	-07/13	S	CAN	--	E2	D	L1	H	60
		KIT		303 338 900 113		45	30.0	11.8	100	2200		included in the KIT 303 460 300 113	-07/13	S	CAN	--	E2	D	L1	H	60
BMW 5 Series Saloon F10 exc. M5 fits M-Sport	03/10-01/17			303 397 600 001		45	23.0	11.8	100	2200		303 460 300 113	-07/13	S	CAN	--	E2	D	L1	H	60
				303 398 600 001		45	28.0	11.8	100	2200		303 481 300 113	07/13-01/17	S	CAN	--	E2	D	L1	H	90
BMW 5 Series Saloon F10 exc. M5 fits M-Sport	07/13-01/17	KIT		303 007 900 113		45	24.7	11.8	100	2200		included in the KIT 303 481 300 113	07/13-01/17	S	CAN	--	E2	D	L1	H	90
		KIT		303 008 900 113		45	20.2	11.8	100	2200		included in the KIT 303 481 300 113	07/13-01/17	S	CAN	--	E2	D	L1	H	90
BMW 5 Series Saloon G30	02/17-	KIT		303 012 900 113		60	21.8	11.9	990	2000		included in the KIT 303 504 300 113	02/17-	S	CAN	--	E2	D	L1	H	75
		KIT		303 013 900 113		60	24.1	11.9	90	2000		included in the KIT 303 504 300 113	02/17-	S	CAN	--	E2	D	L1	H	75
BMW 5 Series Touring E61 exc. M5, only for vehicles with sport equipment Please order separately cover for bumper cutout 5112 7126 377 at BMW dealer's.	07/04-09/10			303 235 600 001		150	20.0	11.4	90	2200		303 460 300 113	-07/13	S	CAN	--	E2	D	L1	H	60
		KIT		303 235 900 113		150	22.0	11.4	90	2200		included in the KIT 303 460 300 113	-07/13	S	CAN	--	E2	D	L1	H	60
BMW 5 Series Touring E61 exc. M5, exc. vehicles with sport equipment	07/04-09/10			303 294 600 001		100	20.0	11.4	90	2200		303 460 300 113	-07/13	S	CAN	--	E2	D	L1	H	60
		KIT		303 294 900 113		100	22.0	11.4	90	2200		included in the KIT 303 460 300 113	-07/13	S	CAN	--	E2	D	L1	H	60
BMW 5 Series Touring F11 fits M-Sport	09/10-07/13	KIT		303 337 900 113		45	25.0	11.8	100	2200		included in the KIT 303 460 300 113	-07/13	S	CAN	--	E2	D	L1	H	60
		KIT		303 338 900 113		45	30.0	11.8	100	2200		included in the KIT 303 460 300 113	-07/13	S	CAN	--	E2	D	L1	H	60





















BMW

BMW 5 Series Touring F11 fits M-Sport	09/10-01/17			303 397 600 001		45	23.0	11.8	100	2200		303 460 300 113	-07/13	S	CAN	--	E2	D	L1	H	60	
				303 398 600 001		45	28.0	11.8	100	2200		303 481 300 113	07/13-01/17	S	CAN	--	E2	D	L1	H	90	
BMW 5 Series Touring F11 fits M-Sport	07/13-01/17	KIT		303 008 900 113		45	20.2	11.8	100	2200		included in the KIT 303 481 300 113	07/13-01/17	S	CAN	--	E2	D	L1	H	90	
BMW 5 Series Touring G31	02/17-	KIT		303 012 900 113		60	21.8	11.9	990	2000		included in the KIT 303 504 300 113	02/17-	S	CAN	--	E2	D	L1	H	75	
				303 013 900 113		60	24.1	11.9	90	2000		included in the KIT 303 504 300 113	02/17-	S	CAN	--	E2	D	L1	H	75	
BMW 6 Series is not permitted to tow by the vehicle manufacturer.																						
BMW 6 Series Gran Turismo G32	06/17-	KIT		303 012 900 113		60	21.8	11.9	990	2000		included in the KIT 303 504 300 113	06/17-	S	CAN	--	E2	D	L1	H	75	
				303 013 900 113		60	24.1	11.9	90	2000		included in the KIT 303 504 300 113	06/17-	S	CAN	--	E2	D	L1	H	75	
BMW M5 Towbar is only available at the BMW dealer's.																						
BMW X1 E84 exc. vehicles fitted with the BMW factory fitted bike rack inc. M-Sport-package / X-drive	10/09-10/15	KIT		303 313 900 113		90	19.0	10.3	80	2000		included in the KIT 303 460 300 113		S	CAN	--	E2	D	L1	H	60	
				303 314 900 113		90	20.0	10.3	80	2000		included in the KIT 303 460 300 113		S	CAN	--	E2	D	L1	H	60	
BMW X1 E84 exc. vehicles fitted with the BMW factory fitted bike rack inc. M-Sport-package / X-drive	10/09-10/15			303 393 600 001		90	17.0	10.3	80	2000		303 460 300 113		S	CAN	--	E2	D	L1	H	60	
				303 394 600 001		90	18.0	10.3	80	2000												

BMW X1 F48 fits M-Sport For vehicles with a tailgate sensor, the sensor cable must be adapted.	10/15-10/22			303 355 600 001		90	17.5	10.4	80	2000		303 372 300 113	→		S	CAN	--	E	D	L1	V	105	
				303 372 600 001		90	21.0	10.4	80	2000		303 480 300 113		10/15-	S	CAN	--	E	D	L1	V	105	
		KIT		303 355 900 113	→		90	22.5	10.4	80	2000		included in the KIT 303 372 300 113	→		S	CAN	--	E	D	L1	V	105
		KIT		303 373 900 113			90	19.5	10.4	80	2000		included in the KIT 303 480 300 113		10/15-	S	CAN	--	E	D	L1	V	105
		KIT		303 372 900 113	→		90	24.0	10.4	80	2000		included in the KIT 303 372 300 113	→		S	CAN	--	E	D	L1	V	105
		KIT		303 374 900 113			90	21.0	10.4	80	2000		included in the KIT 303 480 300 113		10/15-	S	CAN	--	E	D	L1	V	105
BMW X2 F39 exc. M35i only for vehicles with a single tailpipe on the right and left	11/17-			303 475 600 001		75	29.0	12.0	130	2500		303 372 300 113	→		S	CAN	--	E	D	L1	V	105	
				303 476 600 001		75	29.0	12.0	130	2500		303 480 300 113		11/17-	S	CAN	--	E	D	L1	V	105	
		KIT		303 476 900 113	→		75	30.5	12.0	130	2500		included in the KIT 303 372 300 113	→		S	CAN	--	E	D	L1	V	105
		KIT		303 480 900 113			75	31.0	12.0	130	2500		included in the KIT 303 480 300 113		11/17-	S	CAN	--	E	D	L1	V	105
BMW X3 Depending upon equipment partial cutout + cover is necessary. Please order separately with the BMW dealer.	01/04-11/10			303 304 600 001			21.0	12.6	100	2200		303 189 300 113			S	FRE	--	E	D	L1	V	120	
		KIT		303 304 900 113				23.0	12.6	100	2200		included in the KIT 303 189 300 113			S	FRE	--	E	D	L1	V	120
BMW X3	01/04-11/10			303 327 600 001			16.0	10.9	85	2000		303 189 300 113			S	FRE	--	E	D	L1	V	120	
		KIT		303 327 900 113				18.0	10.9	85	2000		included in the KIT 303 189 300 113			S	FRE	--	E	D	L1	V	120















BMW











BMW X3 F25 inc. M-Sport	11/10-09/14	KIT		303 339 900 113		60	18.5	12.5	100	2400		included in the KIT 303 460 300 113	-09/14	S	CAN	--	E2	D	L1	H	60
		KIT		303 340 900 113		60	19.5	12.5	100	2400		included in the KIT 303 460 300 113	-09/14	S	CAN	--	E2	D	L1	H	60
BMW X3 F25 inc. M-Sport	11/10-06/17			303 339 600 001		60	16.0	12.0	100	2400		303 460 300 113	-09/14	S	CAN	--	E2	D	L1	H	60
				303 404 600 001		60	16.8	12.6	100	2400		303 481 300 113	10/14 -06/17	S	CAN	--	E2	D	L1	H	90
BMW X3 F25 inc. M-Sport	10/14-06/17	KIT		303 009 900 113		60	16.7	12.0	100	2400		included in the KIT 303 481 300 113	10/14 -06/17	S	CAN	--	E2	D	L1	H	90
		KIT		303 010 900 113		60	17.5	12.6	100	2400		included in the KIT 303 481 300 113	10/14 -06/17	S	CAN	--	E2	D	L1	H	90
BMW X3 G01 inc. M-Sport inc. facelift exc. iX3	07/17-			303 496 600 001		60	20.0	12.5	100	2400		303 504 300 113	07/17-	S	CAN	--	E2	D	L1	H	75
		KIT		303 014 900 113		60	20.2	12.5	100	2400		included in the KIT 303 504 300 113	07/17-	S	CAN	--	E2	D	L1	H	75
		KIT		303 015 900 113		60	23.7	12.5	100	2400		included in the KIT 303 504 300 113	07/17-	S	CAN	--	E2	D	L1	H	75
BMW X4 F26 inc. M-Sport	06/14-04/18			303 404 600 001		60	16.8	12.6	100	2400		303 481 300 113	06/14 -04/18	S	CAN	--	E2	D	L1	H	90
		KIT		303 010 900 113		60	17.5	12.6	100	2400		included in the KIT 303 481 300 113	06/14 -04/18	S	CAN	--	E2	D	L1	H	90
BMW X4 G02 inc. M-Sport inc. facelift 21-	05/18-			303 483 600 001		75	19.0	12.5	100	2400		303 504 300 113	05/18-	S	CAN	--	E2	D	L1	H	75
		KIT		303 016 900 113		75	21.8	12.5	100	2400		included in the KIT 303 504 300 113	05/18-	S	CAN	--	E2	D	L1	H	75

BMW X5 E53 inc. M-Sport No towbar can be mounted on vehicles with US-specification.	06/00-12/06			303 207 600 001				34.0	15.5	150	3500		303 137 300 113		for prepared vehicles	S	FRE	--	E	D	--	H	30
BMW X5 E53 with preliminary setup incl. M-Sport No towbar can be mounted on vehicles with US-specification.	06/00-12/06	KIT		303 207 900 113				36.0	15.5	150	3500		included in the KIT 303 137 300 113		for prepared vehicles	S	FRE	--	E	D	--	H	30
BMW X5 E70 fits X5 M Sport package	01/07-10/13			303 368 600 001			90	26.5	16.0	150	3500		303 368 300 113	→	11/13-07/18 exc. X5M motors	S	CAN	--	E2	D	L1	H	45
													303 451 300 107		-11/13 exc. X5M motors	S	CAN	--	E	--	--	H	45
													303 451 300 113		-11/13 exc. X5M motors	S	CAN	--	E	D	L1	H	45
													303 481 300 113		11/13-07/18 exc. X5M motors	S	CAN	--	E2	D	L1	H	90
BMW X5 E70 inc. X5 M-Sport package	01/07-11/13	KIT		303 273 900 113			60	31.0	15.5	150	3500		included in the KIT 303 451 300 113		-11/13 exc. X5M motors	S	CAN	--	E	D	L1	H	45
BMW X5 F15 inc. M-Sport	11/13-07/18	KIT		303 368 900 113	→		90	28.5	16.0	150	3500		included in the KIT 303 368 300 113	→	11/13-07/18 exc. X5M motors	S	CAN	--	E2	D	L1	H	45
		KIT		303 011 900 113			90	25.2	16.0	150	3500		included in the KIT 303 481 300 113		11/13-07/18 exc. X5M motors	S	CAN	--	E2	D	L1	H	90
BMW X5 F15 inc. M-Sport package	11/13-07/18			303 368 600 001			90	26.5	16.0	150	3500		303 368 300 113	→	11/13-07/18 exc. X5M motors	S	CAN	--	E2	D	L1	H	45
BMW X5 G05 inc. M-Sport	08/18-			303 485 600 001			60	23.6	16.3	140	3500												
		KIT		303 485 900 113			60	25.4	16.3	140	3500		included in the KIT 303 504 300 113		08/18-	S	CAN	--	E2	D	L1	H	75
BMW X6 inc. X6M. Hybrid models are not permitted to tow by the vehicle manufacturer. Please order separately cover for bumper cutout at BMW dealers.	05/08-12/14			303 290 600 001				31.5	16.0	140	3500		303 451 300 107		exc. X6M motors	S	CAN	--	E	--	--	H	45
													303 451 300 113		exc. X6M motors	S	CAN	--	E	D	L1	H	45
		KIT		303 290 900 113				33.5	16.0	140	3500		included in the KIT 303 451 300 113		exc. X6M motors	S	CAN	--	E	D	L1	H	45





BMW



















BMW

BMW X6 F16	12/14-19			303 368 600 001		90	26.5	16.0	150	3500		303 368 300 113	→	-19 exc. X6M motors	S	CAN	--	E2	D	L1	H	45	
												303 481 300 113		12/14-19 exc. X5M motors	S	CAN	--	E2	D	L1	H	90	
		KIT		303 368 900 113	→		90	28.5	16.0	150	3500		included in the KIT 303 368 300 113	→	-19 exc. X6M motors	S	CAN	--	E2	D	L1	H	45
		KIT		303 011 900 113			90	25.2	16.0	150	3500		included in the KIT 303 481 300 113		12/14-19 exc. X5M motors	S	CAN	--	E2	D	L1	H	90
BMW X6 G06 inc. M-Sport	08/19-			303 485 600 001		60	23.6	16.3	140	3500													
		KIT		303 485 900 113			60	25.4	16.3	140	3500		included in the KIT 303 504 300 113		08/19-	S	CAN	--	E2	D	L1	H	75
BMW i4 G26	11/21-			303 514 600 001		75	17.1	12.3	145	2250		303 504 300 113		11/21-	S	CAN	--	E2	D	L1	H	75	
		KIT		303 514 900 113			75	18.8	12.3	145	2250		included in the KIT 303 504 300 113		11/21-	S	CAN	--	E2	D	L1	H	75
BMW iX3 G08	09/20-			303 513 600 001		60	15.9	5.8	75	750		303 504 300 113		09/20-	S	CAN	--	E2	D	L1	H	75	
		KIT		303 513 900 113			60	17.6	5.8	75	750		included in the KIT 303 504 300 113		09/20-	S	CAN	--	E2	D	L1	H	75







Chevrolet Captiva (S3X)	06/06-09/18		342 217 600 001		90	21.5	12.3	150	2500	342 027 300 113	→	for vehicles with preparation	S	FRE	--	E1	D	L1	H	30	
																	S	A	--	--	D
Chevrolet Trax	03/13-06/19		314 511 600 001		60	21.5	8.6	75	1400	314 386 300 113			S	CAN	--	E	D	L1	V	90	
					314 510 600 001		60	21.0	8.6				75	1400				S	CAN	--	E
		KIT		314 511 900 113		60	25.0	8.6	75	1400	included in the KIT 314 386 300 113			S	CAN	--	E	D	L1	V	90
		KIT		314 497 900 113		60	23.0	7.5	75	1200	included in the KIT 314 386 300 113			S	CAN	--	E	D	L1	V	90















Chrysler





















Chrysler Sebring (JS) exc. convertible	01/07-12/10		342 128 600 001			150	23.0	8.8	85	1500	300 210 300 113				--	A	--	E1	D1	L1	V	90
Chrysler Ypsilon	07/11-04/17		306 385 600 001			60	19.0	6.1	70	1000												

Citroën Berlingo Van, minibus Multispace	11/96-04/08			304 054 600 001		90	14.8	7.8	70	1350																
				304 132 600 001		60	13.0	7.8	70	1350																
Citroën Berlingo First	04/08-			304 054 600 001		90	14.8	7.8	70	1350																
				304 132 600 001		60	13.0	7.8	70	1350																
Citroën Berlingo L1 short wheelbase, vehicle length = 4380 mm fits Multispace, inc. Berlingo E- Car	04/08-11/11	KIT		304 091 900 113		90	17.0	8.7	64	1600		included in the KIT 304 400 300 113	-11/11 -> OPR12775	S	CAN	C1	E	D	L1	H	105					
				304 092 900 113		90	21.0	8.7	64	1600		included in the KIT 304 400 300 113	-11/11 -> OPR12775	S	CAN	C1	E	D	L1	H	105					
Citroën Berlingo L1 short wheelbase, vehicle length = 4380 mm fits Multispace, inc. Berlingo E- Car	04/08-08/18			304 091 600 001		90	15.0	8.7	64	1600		304 400 300 113	-11/11 -> OPR12775	S	CAN	C1	E	D	L1	H	105					
				304 092 600 001		90	19.0	8.7	64	1600		304 402 300 113	11/11- OPR12776->	S	CAN	C1	E	--	--	V	105					
													11/11- OPR12776->	S	CAN	C1	E	D	L1	V	105					
Citroën Berlingo L1 inc. Berlingo Van inc. towball	09/18-			304 118 600 001		90	17.0	8.4	64	1600		314 594 300 113	inc. WLC 2.0	S	A	C	E	D	L	V	90					
Citroën Berlingo L1 inc. Berlingo Van	09/18-			304 207 600 001		60	20.0	8.6	75	1500																
				304 209 600 001		60	20.5	8.6	75	1500		314 594 300 113	inc. WLC 2.0	S	A	C	E	D	L	V	90					
		KIT		304 207 900 113		60	21.2	8.6	75	1500		included in the KIT 314 594 300 113	inc. WLC 2.0	S	A	C	E	D	L	V	90					
		KIT		304 209 900 113		60	21.8	8.6	75	1500		included in the KIT 314 594 300 113	inc. WLC 2.0	S	A	C	E	D	L	V	90					
Citroën Berlingo L2 long wheelbase, vehicle length = 4628 mm	04/08-11/11	KIT		304 129 900 113		90	18.3	8.7	64	1600		included in the KIT 304 400 300 113	-11/11 -> OPR12775	S	CAN	C1	E	D	L1	H	105					











Citroën

















Citraën Berlingo L2 long overhang, vehicle length = 4628 mm	04/08-08/18		304 129 600 001			90	16.3	8.7	64	1600		304 400 300 113	-11/11 -> OPR12775	S	CAN	C1	E	D	L1	H	105	
													304 402 300 107	11/11- OPR12776->	S	CAN	C1	E	--	--	V	105
													304 402 300 113	11/11- OPR12776->	S	CAN	C1	E	D	L1	V	105
Citraën Berlingo L2 inc. Berlingo Van	09/18-		304 210 600 001			60	21.0	8.6	75	1500		314 594 300 113	inc. WLC 2.0	S	A	C	E	D	L	V	90	
				304 212 600 001			60	21.5	8.6	75	1500											
		KIT		304 210 900 113			60	22.2	8.6	75	1500		included in the KIT 314 594 300 113	inc. WLC 2.0	S	A	C	E	D	L	V	90
		KIT		304 212 900 113			60	22.8	8.6	75	1500		included in the KIT 314 594 300 113	inc. WLC 2.0	S	A	C	E	D	L	V	90
Citraën C Crosser	09/07-01/12		340 094 600 001			90	27.0	10.9	100	2000		340 075 300 113		S	FRE	--	E	D	L	H	75	
			KIT		340 094 900 113			90	29.0	10.9	100	2000		included in the KIT 340 075 300 113		S	FRE	--	E	D	L	H
Citraën C3	11/16-		315 184 600 001			60	12.0	7.2	53	1300												
				315 185 600 001			60	12.0	7.2	53	1300											
Citraën C3 Aircross II 120HP turbo S&S EAT6 (DV5RC / AT6): Please check if there is a towing capacity in the vehicle's documents	06/17-		314 583 600 001			60	23.0	6.4	78	1000												
				314 584 600 001			60	24.5	6.4	78	1000											
Citraën C3 Picasso	03/09-07/17		304 127 600 001			60	15.2	7.3	61	1200		304 402 300 107		S	CAN	C1	E	--	--	V	105	
												304 402 300 113		S	CAN	C1	E	D	L1	V	105	
		KIT		304 127 900 113		60	17.2	7.3	61	1200		included in the KIT 304 402 300 113		S	CAN	C1	E	D	L1	V	105	











Citraën C4 Aircross	03/12-04/17		340 092 600 001		90	22.0	8.5	70	1400	340 093 300 113				S	A	--	--	D	L	H	60
			340 093 600 001		90	24.0	8.5	70	1400												
			KIT	340 092 900 113		90	24.0	8.5	70					1400	included in the KIT 340 093 300 113						
			KIT	340 093 900 113		90	26.0	8.5	70					1400	included in the KIT 340 093 300 113						
Citraën C4 Cactus exc. AdBlue	09/14-09/20		304 159 600 001			17.0	5.2	55	780	315 185 300 107	-03/18	S	CAN	C	E	--	--	V	60		
			304 160 600 001			17.0	5.2	55	780	315 185 300 113	-03/18	S	CAN	C	E	D	L1	V	60		
Citraën C4 Grand Picasso	11/06-01/11		304 099 900 113		60	24.0	9.7	75	1700	included in the KIT 304 401 300 113	-01/11 ->OPR12531	S	CAN	C1	E	D	L1	V	105		
			304 100 900 113			60	24.7	9.7	80	1700	included in the KIT 304 401 300 113	-01/11 ->OPR12531	S	CAN	C1	E	D	L1	V	105	
Citraën C4 Grand Picasso	11/06-09/13		315 177 600 001		120	21.0	10.0	75	1550	304 401 300 113	-01/11 ->OPR12531	S	CAN	C1	E	D	L1	V	105		
			315 178 600 001		90	22.5	9.7	80	1700	315 109 300 113	01/11- OPR12530->	S	CAN	C	E	D	L1	V	105		
Citraën C4 Grand Picasso / Grand Space Tourer inc. AdBlue	10/13-		304 151 600 001		90	21.0	9.5	75	1750												
			304 152 600 001		90	24.0	9.5	75	1750												
Citraën C4 III exc. ë-C4	10/20-		304 213 600 001		90	23.7	8.5	103	1400												

Citraën C5 Estate	05/08-05/17			304 135 600 001		90	25.4	10.4	75	1900		304 400 300 113			S	CAN	C1	E	D	L1	H	105
		KIT		304 146 900 113		120	29.0	10.4	80	1900		included in the KIT 304 400 300 113			S	CAN	C1	E	D	L1	H	105
		KIT		304 145 900 113		120	31.4	10.4	80	1900		included in the KIT 304 400 300 113			S	CAN	C1	E	D	L1	H	105
Citraën C5 Saloon	05/08-05/17			304 135 600 001		90	25.4	10.4	75	1900		304 400 300 113			S	CAN	C1	E	D	L1	H	105
		KIT		304 146 900 113		120	29.0	10.4	80	1900		included in the KIT 304 400 300 113			S	CAN	C1	E	D	L1	H	105
		KIT		304 145 900 113		120	31.4	10.4	80	1900		included in the KIT 304 400 300 113			S	CAN	C1	E	D	L1	H	105
Citraën DS4	04/11-10/15			304 148 600 001		60	19.0	9.2	75	1550		304 144 300 113			S	CAN	C	E	D	L	V	90
		KIT		304 148 900 113		60	21.0	9.2	75	1550		included in the KIT 304 144 300 113			S	CAN	C	E	D	L	V	90
Citraën DS5 exc. hybrid	02/12-07/15			304 149 600 001		120	29.0	8.5	75	1500		304 144 300 113			S	CAN	C	E	D	L	V	90
Citraën Van inc. towball	02/95-06/06			306 329 600 001	→	60	29.0	12.5	130	2000		306 216 300 113	03/02-		S	FRE	--	E	D1	L1	V	75
Citraën Van For vehicles with long superstructure L4/XL please order separately a set distance tubes to strengthen the framework, no. 906270650003. Some vehicles 03/08- do not have chassis bores. In this case it is necessary to bore them subsequent. For the mounting time will last 120 min. longer.	06/06-			306 491 600 001		120	32.0	16.9	150	3000		300 210 300 107	-02/11chassis no. 1948840		--	A	--	E1	--	--	V	90
												306 510 300 113	-02/11 chassis no. 1948840		S	FRE	--	E	D1	L1	V	105
													306 553 300 113	02/11- from chassis no. 1948841		S	FRE	--	E	D1	L1	V











Citroën

































Citroën Van inc. towball For vehicles with long superstructure L4/XL please order separately a set distance tubes to strengthen the framework, no. 906270650003. Some vehicles 03/08- do not have chassis bores. In this case it is necessary to bore them subsequent. For the mounting time will last 120 min. longer.	06/06-			306 490 600 001		120	32.0	16.9	150	3000		300 210 300 107	-02/11chassis no. 1948840	--	A	--	E1	--	--	V	90	
												306 510 300 113	-02/11 chassis no. 1948840	S	FRE	--	E	D1	L1	V	105	
												306 553 300 113	02/11- from chassis no. 1948841	S	FRE	--	E	D1	L1	V	105	
Citroën Van inc. towball Some vehicles 03/08- do not have chassis bores. In this case it is necessary to bore them subsequent. For the mounting time will last 120 min. longer.	06/06-			306 357 600 001		60	29.0	15.8	150	3000		300 210 300 107	-02/11chassis no. 1948840	--	A	--	E1	--	--	V	90	
												306 510 300 113	-02/11 chassis no. 1948840	S	FRE	--	E	D1	L1	V	105	
												306 553 300 113	02/11- from chassis no. 1948841	S	FRE	--	E	D1	L1	V	105	
Citroën Van For vehicles with long superstructure L4/XL please order separately a set distance tubes to strengthen the framework, no. 906270650003. Some vehicles 03/08- do not have chassis bores. In this case it is necessary to bore them subsequent. For the mounting time will last 120 min. longer.	06/06-02/11	KIT		306 271 900 113		120	34.0	16.9	150	3000			included in the KIT 306 510 300 113	-02/11 chassis no. 1948840	S	FRE	--	E	D1	L1	V	105
	Citroën Van inc. towball For vehicles with long superstructure L4/XL please order separately a set distance tubes to strengthen the framework, no. 906270650003. Some vehicles 03/08- do not have chassis bores. In this case it is necessary to bore them subsequent. For the mounting time will last 120 min. longer.	06/06-02/11	KIT		306 330 900 113		120	34.0	16.9	150	3000			included in the KIT 306 510 300 113	-02/11 chassis no. 1948840	S	FRE	--	E	D1	L1	V
Citroën Van For vehicles with long superstructure L4/XL please order separately a set distance tubes to strengthen the framework, no. 906270650003. Some vehicles 03/08- do not have chassis bores. In this case it is necessary to bore them subsequent. For the mounting time will last 120 min. longer.		02/11-	KIT		306 491 900 113		120	32.8	16.9	150	3000			included in the KIT 306 553 300 113	02/11- from chassis no. 1948841	S	FRE	--	E	D1	L1	V

Citroën Van inc. towball For vehicles with long superstructure L4/XL please order separately a set distance tubes to strengthen the framework, no. 906270650003. Some vehicles 03/08- do not have chassis bores. In this case it is necessary to bore them subsequent. For the mounting time will last 120 min. longer.	02/11-	KIT		306 490 900 113		120	32.2	16.9	150	3000				included in the KIT 306 553 300 113		02/11- from chassis no. 1948841	S	FRE	--	E	D1	L1	V	105
Citroën Van inc. towball Some vehicles 03/08- do not have chassis bores. In this case it is necessary to bore them subsequent. For the mounting time will last 120 min. longer.	02/11-	KIT		306 553 900 113		>150	31.0	15.8	150	3000			included in the KIT 306 553 300 113		02/11- from chassis no. 1948841	S	FRE	--	E	D1	L1	V	105	
Citroën Relay Chassis Cab inc. towball	02/95-06/06			306 329 600 001		60	29.0	12.5	130	2000			300 052 300 113 300 060 300 113		03/02- -03/02	--	FRE	--	E1	D1	--	V		
Citroën Relay Chassis Cab inc. towball For vehicles with long superstructure L4/XL please order separately a set distance tubes to strengthen the framework, no. 906270650003.	06/06-			306 492 600 001		120	35.0	15.9	150	3000														
Citroën Relay Chassis Cab inc. towball	06/06-			306 357 600 001		60	29.0	15.8	150	3000														
Citroën Relay Motor homes no towbar offered	06/06-												306 553 300 183			S	FRE	--	E1	D	L1	V		
Citroën Dispatch	01/07-06/16			306 331 600 001		75	22.5	12.2	122	2200			304 400 300 113		-06/16	S	CAN	C1	E	D	L1	H	105	
				306 333 600 001		75	22.5	12.2	122	2200														
		KIT		306 331 900 113		75	22.5	12.2	122	2200			included in the KIT 304 400 300 113		-06/16	S	CAN	C1	E	D	L1	H	105	
		KIT		306 333 900 113		75	24.5	12.2	122	2200			included in the KIT 304 400 300 113		-06/16	S	CAN	C1	E	D	L1	H	105	

Cupra Ateca KH7	09/18-		344 121 600 001		60	14.0	12.3	150	2500	305 407 300 113	with preliminary setup	S	CAN	C	E	D	L	H	30
			344 124 600 001		60	17.7	12.3	150	2500	305 408 300 107	without preliminary setup	S	CAN	C	E	--	--	V	60
									305 408 300 113	without preliminary setup	S	CAN	C	E	D	L	V	60	
Cupra Ateca KH7 with preliminary setup	09/18-	KIT 	344 071 900 113		60	15.5	12.3	150	2500	included in the KIT 305 407 300 113	with preliminary setup	S	CAN	C	E	D	L	H	30
			344 072 900 113		60	19.2	12.3	150	2500	included in the KIT 305 407 300 113	with preliminary setup	S	CAN	C	E	D	L	H	30
Cupra Formentor KM7 exc. VZ5	11/20-		344 121 600 001		60	14.0	12.3	150	2500	305 408 300 107	without preliminary setup	S	CAN	C	E	--	--	V	60
			344 124 600 001		60	17.7	12.3	150	2500	305 408 300 113	without preliminary setup	S	CAN	C	E	D	L	V	60
Cupra Leon KL1 inc. Hybrid	10/20-		305 555 600 001		60	17.9	9.0	109	2100	322 080 300 113	10/20- without preliminary setup	S	CAN	C	E	D	L	V	120

DS







DS 4	11/15-12/18			304 148 600 001		60	19.0	9.2	75	1550		304 144 300 113			S	CAN	C	E	D	L	V	90
		KIT		304 148 900 113		60	21.0	9.2	75	1550		included in the KIT 304 144 300 113			S	CAN	C	E	D	L	V	90
DS 4 Crossback	11/15-12/18			304 148 600 001		60	19.0	9.2	75	1550		304 144 300 113			S	CAN	C	E	D	L	V	90
		KIT		304 148 900 113		60	21.0	9.2	75	1550		included in the KIT 304 144 300 113			S	CAN	C	E	D	L	V	90
DS 5 exc. Hybrid	08/15-05/19			304 149 600 001		120	29.0	8.5	75	1500		304 144 300 113			S	CAN	C	E	D	L	V	90

























Dacia Sandero B52	01/13-12/16	KIT		316 343 900 113		90	15.0	6.5	75	1100		included in the KIT 316 340 300 113	-12/16	S	A	--	--	D1	L1	H	60
		KIT		316 344 900 113		90	17.0	6.5	75	1100		included in the KIT 316 340 300 113	-12/16	S	A	--	--	D1	L1	H	60
Dacia Sandero B52	01/13-01/21			316 343 600 001		90	14.0	6.5	75	1100		316 340 300 113	-12/16	S	A	--	--	D1	L1	H	60
				316 344 600 001		90	16.0	6.5	75	1100		316 434 300 107	01/17-	S	A	--	E2	--	--	V	120
				316 344 600 001		90	16.0	6.5	75	1100		316 434 300 113	01/17-	S	A	--	E2	D1	L1	V	120
Dacia Sandero B52	01/17-01/21	KIT		316 434 900 113		90	17.5	6.5	75	1100		included in the KIT 316 434 300 113	01/17-	S	A	--	E2	D1	L1	V	120
		KIT		316 435 900 113		90	19.5	6.5	75	1100		included in the KIT 316 434 300 113	01/17-	S	A	--	E2	D1	L1	V	120
Dacia Sandero II Stepway exc. vehicles with GPL/gas drive	01/13-12/16	KIT		316 343 900 113		90	15.0	6.5	75	1100		included in the KIT 316 340 300 113	-12/16	S	A	--	--	D1	L1	H	60
		KIT		316 344 900 113		90	17.0	6.5	75	1100		included in the KIT 316 340 300 113	-12/16	S	A	--	--	D1	L1	H	60
Dacia Sandero II Stepway exc. vehicles with GPL/gas drive	01/13-12/20			316 343 600 001		90	14.0	6.5	75	1100		316 340 300 113	-12/16	S	A	--	--	D1	L1	H	60
				316 344 600 001		90	16.0	6.5	75	1100		316 434 300 107	01/17-	S	A	--	E2	--	--	V	120
				316 344 600 001		90	16.0	6.5	75	1100		316 434 300 113	01/17-	S	A	--	E2	D1	L1	V	120
Dacia Sandero II Stepway exc. vehicles with GPL/gas drive	01/17-12/20	KIT		316 434 900 113		90	17.5	6.5	75	1100		included in the KIT 316 434 300 113	01/17-	S	A	--	E2	D1	L1	V	120
		KIT		316 435 900 113		90	19.5	6.5	75	1100		included in the KIT 316 434 300 113	01/17-	S	A	--	E2	D1	L1	V	120
Dacia Sandero III	01/21-			316 490 600 001		90	22.4	7.0	85	1100											
				316 491 600 001		90	22.7	7.0	85	1100											

Dacia

Daihatsu Charade	05/11-01/13			335 455 600 001		75	18.7	6.8	50	1150		335 383 300 113			S	FRE	--	--	D1	L1	V	120	
		KIT		335 383 900 113		75	20.7	6.8	50	1150		included in the KIT 335 383 300 113			S	FRE	--	--	D1	L1	V	120	





Dodge









Dodge Avenger	01/07-12/14		342 128 600 001	→ 	150	23.0	8.8	85	1500	300 210 300 107				--	A	--	E1	--	--	V	90
																					--
Dodge Journey, JC 49	01/08-12/20		342 198 600 001		90	13.3	9.6	80	1600	300 078 300 113				--	FRE	--	--	D1	L1	V	
			342 199 600 001			90	15.8	9.6	80					1600							
Dodge Nitro fits SXT with 20" spare wheel but not SRT	03/08-12/12		342 131 600 001		90	30.0	15.3	140	3500	300 210 300 107				--	A	--	E1	--	--	V	90
																					--

Fiat 500 inc. Convertible exc. Abarth - 135 HP exc. 500S exc. ELECTRIC	07/07-			306 503 600 001		60	14.8	5.1	60	800		306 311 300 113	07/15-	S	FRE	--	E	D1	--	V	105	
Fiat 500 inc. Convertible exc. Abarth - 135 HP exc. ELECTRIC	07/07-			306 506 600 001		60	18.0	5.0	60	800		306 311 300 113	07/15-	S	FRE	--	E	D1	--	V	105	
Fiat 500 inc. Convertible exc. Abarth - 135 HP exc. 500S exc. ELECTRIC	07/15-	KIT		306 503 900 113		60	15.9	5.1	60	800		included in the KIT 306 311 300 113	07/15-	S	FRE	--	E	D1	--	V	105	
Fiat 500 inc. Convertible exc. Abarth - 135 HP exc. ELECTRIC	07/15-	KIT		306 506 900 113		60	19.1	5.0	60	800		included in the KIT 306 311 300 113	07/15-	S	FRE	--	E	D1	--	V	105	
Fiat 500 L inc. Trekking and Living exc. Cross	10/12-06/17			306 401 600 001		60	18.0	7.5	90	1200		306 397 300 113		S	FRE	--	E	D1	L1	V	120	
				306 400 600 001		60	21.0	7.5	90	1200												
		KIT		306 401 900 113		60	20.0	7.5	90	1200		included in the KIT 306 397 300 113		S	FRE	--	E	D1	L1	V	120	
		KIT		306 400 900 113		60	23.0	7.5	90	1200		included in the KIT 306 397 300 113		S	FRE	--	E	D1	L1	V	120	
Fiat 500 S inc. Convertible exc. Abarth - 135 HP	02/16-			306 505 600 001		60	15.0	5.0	60	800		306 311 300 113		S	FRE	--	E	D1	--	V	105	
				306 506 600 001		60	18.0	5.0	60	800												
		KIT		306 505 900 113		60	16.0	5.0	60	800		included in the KIT 306 311 300 113		S	FRE	--	E	D1	--	V	105	
		KIT		306 506 900 113		60	19.1	5.0	60	800		included in the KIT 306 311 300 113		S	FRE	--	E	D1	--	V	105	

Fiat











Fiat

















Fiat 500 X inc. Cross inc. AdBlue inc. Yacht Club exc. Sport	09/14-		342 301 600 001		60	23.3	10.2	95	1900	306 527 300 113			S	FRE	--	E	D1	L1	V	120
			342 302 600 001		60	26.3	10.2	95	1900											
	KIT		306 196 900 113		60	24.5	10.2	95	1900	included in the KIT 306 527 300 113			S	FRE	--	E	D1	L1	V	120
	KIT		306 197 900 113		60	28.3	10.2	95	1900	included in the KIT 306 527 300 113			S	FRE	--	E	D1	L1	V	120
Fiat Doblo Cargo WorkUp Pick up exc. AdBlue	08/11-		306 393 600 001		90	28.0	9.3	100	1500	306 392 300 113			S	FRE	--	E1	D1	--	V	90
Fiat Doblò inc. Doblo Cargo	11/00-02/10		306 278 600 001	→ 	120	20.0	8.4	90	1300	300 078 300 113	-09/05		--	FRE	--	--	D1	L1	V	
Fiat Doblò II + Doblò II Cargo exc. vehicles with gas drive (CNG) exc. vehicles with park distance control	02/10-06/22		306 368 600 001		60	23.0	9.2	100	1500	306 605 300 107 306 605 300 113			S	FRE	--	E	--	--	V	90
		KIT		306 368 900 113		45	25.0	9.2	100	1500	included in the KIT 306 605 300 113			S	FRE	--	E	D1	L1	V
Fiat Doblò II + Doblò II Cargo exc. vehicles with gas drive (CNG)	02/10-06/22		306 369 600 001		60	25.0	9.2	100	1500	306 605 300 107 306 605 300 113			S	FRE	--	E	--	--	V	90
		KIT		306 369 900 113		60	27.0	9.2	100	1500	included in the KIT 306 605 300 113			S	FRE	--	E	D1	L1	V
Fiat Doblò II + Doblò II Cargo inc. towball for vehicles with gas drive (CNG)	02/10-06/22		306 382 600 001		60	25.0	7.0	75	1000	306 605 300 107 306 605 300 113			S	FRE	--	E	--	--	V	90
		KIT		306 382 900 113		60	27.0	7.0	75	1000	included in the KIT 306 605 300 113			S	FRE	--	E	D1	L1	V

Fiat Doblò L1 510, 511 inc. E-Doblò	06/22-		304 207 600 001			60	20.0	8.6	75	1500		314 594 300 113	06/22- Doblò	inc. E-	S	A	C	E	D	L	V	90
			304 209 600 001			60	20.5	8.6	75	1500												
	KIT		304 207 900 113			60	21.2	8.6	75	1500		included in the KIT 314 594 300 113	06/22- Doblò	inc. E-	S	A	C	E	D	L	V	90
	KIT		304 209 900 113			60	21.8	8.6	75	1500		included in the KIT 314 594 300 113	06/22- Doblò	inc. E-	S	A	C	E	D	L	V	90
Fiat Doblò L2 510, 511 inc. E-Doblò	06/22-		304 210 600 001			60	21.0	8.6	75	1500		314 594 300 113	06/22- Doblò	inc. E-	S	A	C	E	D	L	V	90
			304 212 600 001			60	21.5	8.6	75	1500												
	KIT		304 210 900 113			60	22.2	8.6	75	1500		included in the KIT 314 594 300 113	06/22- Doblò	inc. E-	S	A	C	E	D	L	V	90
	KIT		304 212 900 113			60	22.8	8.6	75	1500		included in the KIT 314 594 300 113	06/22- Doblò	inc. E-	S	A	C	E	D	L	V	90
Fiat Ducato Van inc. towball	02/95-06/06		306 329 600 001	→		60	29.0	12.5	130	2000		306 216 300 113	03/02-		S	FRE	--	E	D1	L1	V	75
Fiat Ducato Van For vehicles with long superstructure L4/XL please order separately a set distance tubes to strengthen the framework, no. 906270650003. Some vehicles 03/08- do not have chassis bores. In this case it is necessary to bore them subsequent. For the mounting time will last 120 min. longer.	06/06-		306 491 600 001			120	32.0	16.9	150	3000		300 210 300 107	-02/11chassis no. 1948840	--	A	--	E1	--	--	V	90	
											306 510 300 113	-02/11 chassis no. 1948840	S	FRE	--	E	D1	L1	V	105		
											306 553 300 113	02/11- from chassis no. 1948841	S	FRE	--	E	D1	L1	V	105		

Fiat















Fiat





























Fiat Ducato Van inc. towball For vehicles with long superstructure L4/XL please order separately a set distance tubes to strengthen the framework, no. 906270650003. Some vehicles 03/08- do not have chassis bores. In this case it is necessary to bore them subsequent. For the mounting time will last 120 min. longer.	06/06-		306 490 600 001		120	32.0	16.9	150	3000	300 210 300 107	-02/11chassis no. 1948840	--	A	--	E1	--	--	V	90	
					306 510 300 113	-02/11 chassis no. 1948840	S	FRE	--		E	D1	L1	V	105					
					306 553 300 113	02/11- from chassis no. 1948841	S	FRE	--		E	D1	L1	V	105					
Fiat Ducato Van inc. towball Some vehicles 03/08- do not have chassis bores. In this case it is necessary to bore them subsequent. For the mounting time will last 120 min. longer.	06/06-		306 357 600 001		60	29.0	15.8	150	3000	300 210 300 107	-02/11chassis no. 1948840	--	A	--	E1	--	--	V	90	
					306 510 300 113	-02/11 chassis no. 1948840	S	FRE	--		E	D1	L1	V	105					
					306 553 300 113	02/11- from chassis no. 1948841	S	FRE	--		E	D1	L1	V	105					
Fiat Ducato Van For vehicles with long superstructure L4/XL please order separately a set distance tubes to strengthen the framework, no. 906270650003. Some vehicles 03/08- do not have chassis bores. In this case it is necessary to bore them subsequent. For the mounting time will last 120 min. longer.	06/06-02/11	KIT		306 271 900 113		120	34.0	16.9	150	3000	included in the KIT 306 510 300 113	-02/11 chassis no. 1948840	S	FRE	--	E	D1	L1	V	105
Fiat Ducato Van inc. towball For vehicles with long superstructure L4/XL please order separately a set distance tubes to strengthen the framework, no. 906270650003. Some vehicles 03/08- do not have chassis bores. In this case it is necessary to bore them subsequent. For the mounting time will last 120 min. longer.	06/06-02/11	KIT		306 330 900 113		120	34.0	16.9	150	3000	included in the KIT 306 510 300 113	-02/11 chassis no. 1948840	S	FRE	--	E	D1	L1	V	105
Fiat Ducato Van For vehicles with long superstructure L4/XL please order separately a set distance tubes to strengthen the framework, no. 906270650003. Some vehicles 03/08- do not have chassis bores. In this case it is necessary to bore them subsequent. For the mounting time will last 120 min. longer.	02/11-	KIT		306 491 900 113		120	32.8	16.9	150	3000	included in the KIT 306 553 300 113	02/11- from chassis no. 1948841	S	FRE	--	E	D1	L1	V	105

Fiat Ducato Van inc. towball For vehicles with long superstructure L4/XL please order separately a set distance tubes to strengthen the framework, no. 906270650003. Some vehicles 03/08- do not have chassis bores. In this case it is necessary to bore them subsequent. For the mounting time will last 120 min. longer.	02/11-	KIT		306 490 900 113		120	32.2	16.9	150	3000				included in the KIT 306 553 300 113		02/11- from chassis no. 1948841	S	FRE	--	E	D1	L1	V	105
Fiat Ducato Van inc. towball Some vehicles 03/08- do not have chassis bores. In this case it is necessary to bore them subsequent. For the mounting time will last 120 min. longer.	02/11-	KIT		306 553 900 113		>150	31.0	15.8	150	3000			included in the KIT 306 553 300 113		02/11- from chassis no. 1948841	S	FRE	--	E	D1	L1	V	105	
Fiat Ducato Chassis Cab inc. towball	02/95-06/06			306 329 600 001		60	29.0	12.5	130	2000			300 052 300 113 300 060 300 113		03/02- 03/02-	--	FRE	--	E1	D1	--	V		
Fiat Ducato Chassis Cab inc. towball For vehicles with long superstructure L4/XL please order separately a set distance tubes to strengthen the framework, no. 906270650003.	06/06-			306 492 600 001		120	35.0	15.9	150	3000														
Fiat Ducato Chassis Cab inc. towball	06/06-			306 357 600 001		60	29.0	15.8	150	3000														
Fiat Fiorino Van / Qubo (225) exc. vehicles with gas drive	02/08-			306 349 600 001		150	16.5	7.5	75	1300			306 580 300 107 306 580 300 113				S	FRE	--	E	--	--	V	120
		KIT		306 349 900 113		150	18.5	7.5	75	1300			included in the KIT 306 580 300 113			S	FRE	--	E	D1	L1	V	120	
Fiat Fiorino Van / Qubo (225) inc. towball exc. vehicles with gas drive	02/08-			306 351 600 001		150	17.0	7.5	75	1300			306 580 300 107 306 580 300 113				S	FRE	--	E	--	--	V	120
																S	FRE	--	E	D1	L1	V	120	

Fiat





















Fiat





Fiat Freemont exc. Freemont Cross	09/11-12/16		342 198 600 001		90	13.3	9.6	80	1600	300 078 300 113									--	FRE	--	--	D1	L1	V		
			342 199 600 001		90	15.8	9.6	80	1600																		
Fiat Fullback Double Cab inc. towball	06/16-07/20		340 124 600 001		60	31.5	14.7	125	3100	340 136 300 107	→								S	C2	--	--	--	--	V	90	
			340 136 300 113																	S	C2	--	--	D	L1	V	90
		KIT		340 124 900 113		60	35.5	14.7	125	3100	included in the KIT 340 136 300 113									S	C2	--	--	D	L1	V	90
Fiat Grande Punto	10/05-10/09		306 375 600 001		90	19.0	6.7	75	1100																		
			306 374 600 001		90	19.0	6.7	75	1100																		
Fiat Panda type 169 front wheel drive inc. Panda Sporting inc. Panda Classic 2012- Vehicles with gas drive are not permitted to tow by the vehicle manufacturer.	09/03-01/12		306 248 600 001	→	180	17.0	6.9	75	1300																		
Fiat Panda front wheel drive exc. vehicles with gas drive (LPG/ CNG)	02/12-		306 385 600 001		60	19.0	6.1	70	1000	306 394 300 107									S	FRE	--	E	--	--	V	105	
			306 394 300 113																	S	FRE	--	E	D1	--	V	105
Fiat Panda front wheel drive exc. vehicles with gas drive (LPG/ CNG)	02/12-		306 394 600 001	→		60	19.5	6.1	70	1000	306 394 300 107								S	FRE	--	E	--	--	V	105	
			306 394 300 113																	S	FRE	--	E	D1	--	V	105
		KIT		306 385 900 113			60	21.0	6.1	70	1000	included in the KIT 306 394 300 113								S	FRE	--	E	D1	--	V	105

Fiat Panda 4x4 inc. Trekking exc. vehicles with gas drive (LPG/ CNG)	10/12-		306 388 600 001		60	18.0	5.8	60	900	306 394 300 107		S	FRE	--	E	--	--	V	105
			306 389 600 001		60	19.5	5.8	60	900	306 394 300 113		S	FRE	--	E	D1	--	V	105
	KIT		306 388 900 113		60	21.0	5.8	60	900	included in the KIT 306 394 300 113		S	FRE	--	E	D1	--	V	105
	KIT		306 389 900 113		60	22.0	5.8	60	900	included in the KIT 306 394 300 113		S	FRE	--	E	D1	--	V	105
Fiat Panda Cross Vehicles with gas drive are not permitted to tow by manufacturer.	10/14-		306 388 600 001		60	18.0	5.8	60	900	306 394 300 107		S	FRE	--	E	--	--	V	105
			306 389 600 001		60	19.5	5.8	60	900	306 394 300 113		S	FRE	--	E	D1	--	V	105
	KIT		306 388 900 113		60	21.0	5.8	60	900	included in the KIT 306 394 300 113		S	FRE	--	E	D1	--	V	105
	KIT		306 389 900 113		60	22.0	5.8	60	900	included in the KIT 306 394 300 113		S	FRE	--	E	D1	--	V	105
Fiat Punto EVO	10/09-08/18		306 375 600 001		90	19.0	6.7	75	1100	306 375 300 113		S	CAN	--	E	D	--	V	105
			306 374 600 001		90	19.0	6.7	75	1100										
Fiat Qubo / Qubo Trekking (225) exc. vehicles with gas drive	02/08-		306 349 600 001		150	16.5	7.5	75	1300	306 580 300 107	→	S	FRE	--	E	--	--	V	120
			306 349 900 113		150	18.5	7.5	75	1300	306 580 300 113		S	FRE	--	E	D1	L1	V	120
Fiat Qubo / Qubo Trekking (225) inc. towball exc. vehicles with gas drive	02/08-		306 351 600 001		150	17.0	7.5	75	1300	306 580 300 107	→	S	FRE	--	E	--	--	V	120
			306 351 900 113		150	17.0	7.5	75	1300	306 580 300 113		S	FRE	--	E	D1	L1	V	120

Fiat

















Fiat























Fiat Scudo	01/07-06/16			306 331 600 001		75	22.5	12.2	122	2200		304 400 300 113			S	CAN	C1	E	D	L1	H	105
				306 333 600 001		75	22.5	12.2	122	2200												
		KIT		306 331 900 113		75	22.5	12.2	122	2200		included in the KIT 304 400 300 113			S	CAN	C1	E	D	L1	H	105
		KIT		306 333 900 113		75	24.5	12.2	122	2200		included in the KIT 304 400 300 113			S	CAN	C1	E	D	L1	H	105
Fiat Sedici	04/06-12/14			306 276 600 001	→ 	120	24.0	7.1	70	1200		300 072 300 107			--	FRE	--	--	--	--	V	
Fiat Talento	07/16-			316 312 600 001		60	25.0	12.1	80	2000		316 312 300 113			S	FRE	--	E2	D1	L1	H	90
Fiat Talento inc. towball	07/16-			316 408 600 001		60	25.0	12.1	80	2000		316 312 300 113			S	FRE	--	E2	D1	L1	H	90
			KIT		316 311 900 113		60	26.3	12.1	80	2000		included in the KIT 316 312 300 113			S	FRE	--	E2	D1	L1	H
Fiat Tipo Cross sw Please order additionally: Extension for socket holder, Art. No. 921740650001	04/21-			306 407 600 001		90	21.0	9.0	60	1500		306 470 300 113	for vehicles with rear LED lights		S	FRE	--	--	D1	L1	V	120
Fiat Tipo Cross Hatchback	04/21-			306 405 600 001		90	22.0	8.7	60	1500		306 470 300 113	for vehicles with rear LED lights		S	FRE	--	--	D1	L1	V	120
Fiat Tipo sw exc. Cross	09/16-			306 407 600 001		90	21.0	9.0	60	1500		306 469 300 113	exc. vehicles with rear LED lights		S	FRE	--	E	D1	L1	V	120
												306 470 300 113	04/21- for vehicles with rear LED lights		S	FRE	--	--	D1	L1	V	120
Fiat Tipo sw exc. vehicles with rear LED lights exc. Cross	09/16-	KIT		306 407 900 113		90	22.3	9.0	60	1500		included in the KIT 306 469 300 113	exc. vehicles with rear LED lights		S	FRE	--	E	D1	L1	V	120

Fiat Tipo Hatchback exc. Tipo Sport	09/16-		306 405 600 001		90	22.0	8.7	60	1500		306 469 300 113	exc. vehicles with rear LED lights	S	FRE	--	E	D1	L1	V	120
											306 470 300 113	04/21- for vehicles with rear LED lights	S	FRE	--	--	D1	L1	V	120
Fiat Tipo Hatchback exc. Tipo Sport exc. vehicles with rear LED lights	09/16-	KIT 	306 405 900 113		90	23.3	8.7	60	1500		included in the KIT 306 469 300 113	exc. vehicles with rear LED lights	S	FRE	--	E	D1	L1	V	120

Fiat



















Ford























Ford B-Max	09/12-09/17			307 333 600 001			70	19.5	6.8	65	900		307 397 300 107	→		S	A	--	E	--	--	V	60
													307 397 300 113	→		S	A	--	E	D1	L1	V	60
	KIT		307 333 900 113	→		70	21.5	6.8	65	900		included in the KIT 307 397 300 113	→		S	A	--	E	D1	L1	V	60	
Ford B-Max exc. vehicles with park distance control	09/12-09/17			307 397 600 001			70	18.5	6.8	65	900		307 397 300 107	→		S	A	--	E	--	--	V	60
												307 397 300 113	→		S	A	--	E	D1	L1	V	60	
	KIT		307 397 900 113	→		70	20.5	6.8	65	900		included in the KIT 307 397 300 113	→		S	A	--	E	D1	L1	V	60	
Ford C-Max without preliminary setup	09/10-06/19	KIT		307 402 900 113			60	21.0	10.0	90	1800		included in the KIT 307 402 300 113			S	CAN	C	E	D	L1	H	45
Ford C-Max without preliminary setup	09/10-06/19	KIT		307 441 900 113			60	23.0	10.0	90	1800		included in the KIT 307 402 300 113			S	CAN	C	E	D	L1	H	45
Ford C-Max	09/10-06/19			307 508 600 001			60	19.2	10.0	90	1800		307 402 300 107			S	CAN	C	E	--	--	H	45
												307 402 300 113			S	CAN	C	E	D	L1	H	45	
					307 507 600 001			60	25.0	10.0	90	1800		307 539 300 113		06/15- for vehicles with preparation	S	FRE	C	E2	D	L1	H
Ford C-Max for vehicles with preparation	06/15-06/19	KIT		307 508 900 113			60	23.0	10.0	90	1800		included in the KIT 307 539 300 113		06/15- for vehicles with preparation	S	FRE	C	E2	D	L1	H	90
		KIT		307 507 900 113			60	29.0	10.0	90	1800		included in the KIT 307 539 300 113		06/15- for vehicles with preparation	S	FRE	C	E2	D	L1	H	90
Ford Ecosport exc. 4 WD only for vehicles with holes in the vehicle frame	10/17-			307 636 600 001			60	21.7	7.0	80	1100		307 489 300 113		10/17- with preliminary setup, inc. WLC 2.0	S	FRE	C	E2	D1	L1	H	60
				307 637 600 001			60	24.8	7.0	80	1100												

Ford Ecosport with preliminary setup exc. 4 WD only for vehicles with holes in the vehicle frame	10/17-	KIT		307 636 900 113		60	23.3	7.0	80	1100		included in the KIT 307 489 300 113		10/17- with preliminary setup, inc. WLC 2.0	S	FRE	C	E2	D1	L1	H	60
		KIT		307 637 900 113		60	26.4	7.0	80	1100		included in the KIT 307 489 300 113		10/17- with preliminary setup, inc. WLC 2.0	S	FRE	C	E2	D1	L1	H	60
Ford Edge	07/16-			307 495 600 001		90	28.5	11.6	90	2200		307 495 300 113			S	CAN	C	E	D	L1	H	45
		KIT		307 495 900 113		90	30.9	11.6	90	2200		included in the KIT 307 495 300 113			S	CAN	C	E	D	L1	H	45
Ford Fiesta exc. ST / 150 HP Please check if there is a towing capacity in the car documents.	04/02-10/08			307 283 600 001		75	13.7	6.3	75	1050		300 072 300 107		-10/05	--	FRE	--	--	--	--	V	
												300 072 300 113		-10/05	--	FRE	--	--	D1	L1	V	
Ford Fiesta exc. Titanium, Sport, Zetec S inc. Fiesta Van 2011-	10/08-06/17			307 363 600 001		90	14.0	6.5	50	1100		307 123 300 113		02/13-06/17	S	FRE	--	--	D1	L1	H	60
				307 330 600 001		90	17.0	6.5	50	1100												
Ford Fiesta exc. Titanium, Sport, Zetec S inc. Fiesta Van 2011-	02/13-06/17	KIT		307 365 900 113		90	14.0	6.5	50	1100		included in the KIT 307 123 300 113		02/13-06/17	S	FRE	--	--	D1	L1	H	60
		KIT		307 341 900 113		90	19.0	6.5	50	1100		included in the KIT 307 123 300 113		02/13-06/17	S	FRE	--	--	D1	L1	H	60
Ford Fiesta MK8 Vehicles with electric panoramic sunroof: towbar only for vehicles with 1.1 l engines	07/17-	KIT		307 599 900 113		75	20.6	6.1	65	1000		included in the KIT 307 599 300 113		07/17- inc. WLC 2.0	S	A	C1	E2	D1	L1	V	90
		KIT		307 600 900 113		75	23.5	6.1	65	1000		included in the KIT 307 599 300 113		07/17- inc. WLC 2.0	S	A	C1	E2	D1	L1	V	90
Ford Fiesta Van exc. ST / 150 HP	07-12/10			307 283 600 001		75	13.7	6.3	75	1050												























Ford



















Ford

Ford Focus C-Max Van	10/03-11/10		307 264 600 001		120	21.0	8.7	75	1590	307 264 300 113			S	FRE	--	E	D1	--	H	45
			343 038 600 001		90	21.5	8.7	75	1590											
	KIT		307 438 900 113		120	23.0	8.7	75	1590	included in the KIT 307 264 300 113			S	FRE	--	E	D1	--	H	45
	KIT		307 407 900 113		90	22.5	8.7	75	1590	included in the KIT 307 264 300 113			S	FRE	--	E	D1	--	H	45
Ford Focus Coupé-Convertible fits CC-3 and CC3D turbo models	04/07-09/10		343 038 600 001		90	21.5	8.7	75	1590	300 072 300 107 300 072 300 113			--	FRE	--	--	--	--	V	
Ford Focus Hatchback 3/5 doors inc. ST170 exc. special model Edition	10/98-10/04		307 234 600 001		90	14.4	7.3	85	1320	300 072 300 107	for vehicles without central plug connection	--	FRE	--	--	--	--	V		
										300 072 300 113	for vehicles without central plug connection	--	FRE	--	--	D1	L1	V		
										307 235 300 155	additional kit for 307234300107/113 08/03-	S	--	--	--	--	H	15		
Ford Focus Hatchback exc. ST / 225 HP, exc. RS / 300 HP inc. vehicles 01/08-	10/04-03/11		307 264 600 001		120	21.0	8.7	75	1590											
			343 038 600 001		90	21.5	8.7	75	1590											
Ford Focus Hatchback 06/12-: With vehicles with 1,0 GTDi motor it could be possible that an additional water pump is necessary. Please find details in TSB 35/2012. exc. EcoBoost S / Individual Styling Package inc. facelift 11/2014-	03/11-08/18		307 459 600 001		60	21.0	10.0	90	1500	307 402 300 107			S	CAN	C	E	--	--	H	45
			307 461 600 001		60	21.0	9.5	90	1500	307 402 300 113			S	CAN	C	E	D	L1	H	45

Ford Focus Hatchback without preliminary setup 06/12-: With vehicles with 1,0 GTDi motor it could be possible that an additional water pump is necessary. Please find details in TSB 35/2012. exc. EcoBoost S / Individual Styling Package inc. facelift 11/2014-	03/11-08/18	KIT		307 459 900 113			60	23.0	10.0	75	1500		included in the KIT 307 402 300 113			S	CAN	C	E	D	L1	H	45
		KIT		307 461 900 113			60	23.0	10.0	75	1500		included in the KIT 307 402 300 113			S	CAN	C	E	D	L1	H	45
Ford Focus Hatchback HN 5 doors inc. ST-Line inc. Activ	09/18-			307 652 600 001			60	21.7	9.5	90	1800		307 489 300 113		09/18- with preliminary setup, inc. WLC 2.0	S	FRE	C	E2	D1	L1	H	60
				307 653 600 001			60	24.7	9.5	90	1800		307 490 300 113		09/18- without preliminary setup, inc. WLC 2.0	S	CAN	C	E	D	L1	V	75
Ford Focus Hatchback HN without preliminary setup 5 doors inc. ST-Line inc. Activ	09/18-	KIT		307 652 900 113			60	23.4	9.5	90	1800		included in the KIT 307 490 300 113		09/18- without preliminary setup, inc. WLC 2.0	S	CAN	C	E	D	L1	V	75
		KIT		307 653 900 113			60	26.4	9.5	90	1800		included in the KIT 307 490 300 113		09/18- without preliminary setup, inc. WLC 2.0	S	CAN	C	E	D	L1	V	75
Ford Focus Hatchback Active HP 5 doors	01/19-			307 652 600 001			60	21.7	9.5	90	1800		307 489 300 113		01/19- with preliminary setup, inc. WLC 2.0	S	FRE	C	E2	D1	L1	H	60
				307 653 600 001			60	24.7	9.5	90	1800		307 490 300 113		01/19- without preliminary setup, inc. WLC 2.0	S	CAN	C	E	D	L1	V	75
Ford Focus Hatchback Active HP without preliminary setup 5 doors	01/19-	KIT		307 652 900 113			60	23.4	9.5	90	1800		included in the KIT 307 490 300 113		01/19- without preliminary setup, inc. WLC 2.0	S	CAN	C	E	D	L1	V	75
		KIT		307 653 900 113			60	26.4	9.5	90	1800		included in the KIT 307 490 300 113		01/19- without preliminary setup, inc. WLC 2.0	S	CAN	C	E	D	L1	V	75
Ford Focus Estate exc. ST / 225 HP	03/05-04/11			307 337 600 001			150	20.5	8.5	75	1500		300 072 300 113		for vehicles without central plug connection	--	FRE	--	--	D1	L1	V	
				307 338 600 001	→		150	26.0	8.5	75	1500												

























Ford



























Ford Focus Estate exc. ST / 225 HP Please order separately: foam carrier for antenna for vehicles with keyless entry, order no. 907456630001. 06/12-: With vehicles with 1,0 GTDi motor it could be possible that an additional water pump is necessary. Please find details in TSB 35/2012 exc. EcoBoost S / Individual Styling Package inc. facelift 11/2014-	04/11-08/18			307 456 600 001		90	23.0	10.0	90	1500		307 402 300 107								S	CAN	C	E	--	--	H	45
				307 458 600 001		90	24.0	10.0	90	1500		307 402 300 113								S	CAN	C	E	D	L1	H	45
Ford Focus Estate without preliminary setup exc. ST / 225 HP Please order separately: foam carrier for antenna for vehicles with keyless entry, order no. 907456630001. 06/12-: With vehicles with 1,0 GTDi motor it could be possible that an additional water pump is necessary. Please find details in TSB 35/2012 exc. EcoBoost S / Individual Styling Package inc. facelift 11/2014-	04/11-08/18	KIT		307 456 900 113		90	25.0	10.0	90	1500		included in the KIT 307 402 300 113								S	CAN	C	E	D	L1	H	45
				307 458 900 113		90	26.0	10.0	90	1500		included in the KIT 307 402 300 113								S	CAN	C	E	D	L1	H	45
Ford Focus Estate HP inc. ST-Line exc. Active exc. Vignale	09/18-			307 652 600 001		60	21.7	9.5	90	1800		307 489 300 113								S	FRE	C	E2	D1	L1	H	60
				307 653 600 001		60	24.7	9.5	90	1800		307 490 300 113								S	CAN	C	E	D	L1	V	75
Ford Focus Estate HP without preliminary setup inc. ST-Line exc. Active exc. Vignale	09/18-	KIT		307 652 900 113		60	23.4	9.5	90	1800		included in the KIT 307 490 300 113								S	CAN	C	E	D	L1	V	75
				307 653 900 113		60	26.4	9.5	90	1800		included in the KIT 307 490 300 113								S	CAN	C	E	D	L1	V	75
Ford Fusion exc. vehicles with park distance control exc. Calero	04/02-12/12			307 289 600 001		75	15.8	6.3	75	1050		300 072 300 107								--	FRE	--	--	--	--	V	
				307 289 600 001		75	15.8	6.3	75	1050		300 072 300 113								--	FRE	--	--	D1	L1	V	
Ford Galaxy thermal-insulation plate inc. inc. 4WD bumper bracket is not necessary	05/00-06			321 665 600 001		90	24.0	12.5	100	2500		321 458 300 107	→							S	FRE	--	E	--	--	H	60
				321 665 600 001		90	24.0	12.5	100	2500		321 458 300 113								S	FRE	--	E	D1	L1	H	60

Ford Galaxy 7 seater without height control	05/06-09/15		307 306 600 001		90	17.0	12.1	90	2000	307 400 300 113	S	C	E	D	L1	45			
			307 355 600 001		90	19.5	12.1	90	2000										
	KIT		307 306 900 113		90	19.0	11.1	90	2000	included in the KIT 307 400 300 113	S	C	E	D	L1	45			
	KIT		307 355 900 113		90	21.5	11.1	90	2000	included in the KIT 307 400 300 113	S	C	E	D	L1	45			
Ford Galaxy III 7 seater CK without height control exc. vehicles with tailgate that opens by sensor (foot sensor) inc. Plugin-Hybrid	09/15-		307 496 600 001		90	20.0	12.1	90	2000										
Ford Galaxy III 7 seater CK without height control Please order separately cover for bumper cutout at Ford dealer's. exc. vehicles with tailgate that opens by sensor (foot sensor) inc. Plugin-Hybrid	09/15-		307 497 600 001		90	20.0	12.1	90	2000										
Ford Galaxy III 7 seater CK with height control Please order separately cover for bumper cutout at Ford dealer' s. exc. vehicles with tailgate that opens by sensor (foot sensor) inc. Plugin-Hybrid	09/15-		307 498 600 001		90	20.0	12.1	90	2000										
Ford Grand C-Max without preliminary setup inc. Titanium	09/10-06/19	KIT		307 402 900 113		60	21.0	10.0	90	1800	included in the KIT 307 402 300 113	S	CAN	C	E	D	L1	H	45
		KIT		307 441 900 113		60	23.0	10.0	90	1800	included in the KIT 307 402 300 113	S	CAN	C	E	D	L1	H	45
Ford Grand C-Max inc. Titanium	09/10-06/19		307 508 600 001		60	19.2	10.0	90	1800	307 402 300 107 307 402 300 113	S	CAN	C	E	--	--	H	45	
			307 507 600 001		60	25.0	10.0	90	1800	307 539 300 113	S	CAN	C	E	D	L1	H	45	
											06/15- for vehicles with preparation	S	FRE	C	E2	D	L1	H	90























Ford























Ford

Ford Grand C-Max inc. Titanium for vehicles with preparation	06/15-06/19	KIT		307 508 900 113			60	23.0	10.0	90	1800		included in the KIT 307 539 300 113	06/15- for vehicles with preparation	S	FRE	C	E2	D	L1	H	90
		KIT		307 507 900 113		60	29.0	10.0	90	1800		included in the KIT 307 539 300 113	06/15- for vehicles with preparation	S	FRE	C	E2	D	L1	H	90	
Ford KA+	06/16-	KIT		307 658 900 113		75	20.7	6.1	65	1000		included in the KIT 307 576 300 113	inc. WLC 2.0	S	A	C1	E	D1	--	V	90	
		KIT		307 659 900 113		90	23.6	6.1	65	1000		included in the KIT 307 576 300 113	inc. WLC 2.0	S	A	C1	E	D1	--	V	90	
Ford Kuga	05/08-04/13			307 564 600 001		120	26.0	10.6	105	2100		307 280 300 113		S	FRE	--	E	D1	L1	H	90	
				307 565 600 001		120	26.0	10.6	105	2100												
		KIT		307 564 900 113		120	28.0	10.6	100	2100		included in the KIT 307 280 300 113		S	FRE	--	E	D1	L1	H	90	
		KIT		307 565 900 113		120	27.0	10.6	105	2100		included in the KIT 307 280 300 113		S	FRE	--	E	D1	L1	H	90	
Ford Kuga	04/13-06/19			307 566 600 001		120	23.0	11.0	100	2100												
				307 567 600 001		120	25.0	11.0	100	2100												
Ford Kuga III inc. Plugin Hybrid inc. AdBlue	07/19-			307 643 600 001		75	21.9	10.8	100	2100		307 489 300 113	with preliminary setup, inc. WLC 2.0, inc. Plugin Hybrid	S	FRE	C	E2	D1	L1	H	60	
				307 644 600 001		75	24.8	10.8	100	2100		307 490 300 113	without preliminary setup, inc. WLC 2.0, inc. Plugin Hybrid	S	CAN	C	E	D	L1	V	75	
Ford Kuga III without preliminary setup inc. Plugin Hybrid inc. AdBlue	07/19-	KIT		307 643 900 113		75	23.9	10.8	100	2100		included in the KIT 307 490 300 113	without preliminary setup, inc. WLC 2.0, inc. Plugin Hybrid	S	CAN	C	E	D	L1	V	75	
		KIT		307 644 900 113		75	26.8	10.8	100	2100		included in the KIT 307 490 300 113	without preliminary setup, inc. WLC 2.0, inc. Plugin Hybrid	S	CAN	C	E	D	L1	V	75	

















Ford Kuga III with preliminary setup inc. Plugin Hybrid inc. AdBlue	07/19-	KIT		307 489 900 113		75	23.4	10.8	100	2100		included in the KIT 307 489 300 113		with preliminary setup, inc. WLC 2.0, inc. Plugin Hybrid	S	FRE	C	E2	D1	L1	H	60		
		KIT		307 490 900 113		75	26.3	10.8	100	2100		included in the KIT 307 489 300 113		with preliminary setup, inc. WLC 2.0, inc. Plugin Hybrid	S	FRE	C	E2	D1	L1	H	60		
Ford Mondeo Saloon/ Hatchback 5 doors	06/07-12/14			307 329 600 001	→ 	90	17.0	11.6	90	2120		307 400 300 113			S		C	E	D	L1		45		
		KIT		307 329 900 113	→ 	90	19.0	11.6	90	2120		included in the KIT 307 400 300 113			S		C	E	D	L1			45	
Ford Mondeo Estate inc. vehicles with height control exc. ST220	11/00-06/07			307 431 600 001		120	19.0	11.0	85	2000														
Ford Mondeo Estate exc. vehicles with height control	06/07-12/14			307 403 600 001		150	17.5	11.6	90	2120		307 400 300 113			S		C	E	D	L1			45	
				307 455 600 001		150	19.5	11.6	90	2120														
		KIT		307 403 900 113		150	19.5	11.6	90	2120		included in the KIT 307 400 300 113			S		C	E	D	L1				45
		KIT		307 455 900 113		150	21.5	11.6	90	2120		included in the KIT 307 400 300 113			S		C	E	D	L1				45
Ford Mondeo V Saloon/ Hatchback 4/5 doors exc. vehicles with height control, exc. for "Vignale"	01/15-04/22			307 475 600 001		90	22.5	11.9	100	2500		307 478 300 107	→		S	A	C1	E2	--	--	H		90	
												307 478 300 113			S	A	C1	E2	D1	L1	H		90	
		KIT		307 475 900 113		90	24.5	11.9	100	2500		included in the KIT 307 478 300 113			S	A	C1	E2	D1	L1	H			90
Ford Mondeo V Saloon/ Hatchback 4/5 doors inc. vehicles with height control, exc. for "Vignale"	01/15-04/22			307 476 600 001		90	25.0	11.9	100	2500		307 478 300 107	→		S	A	C1	E2	--	--	H		90	
												307 478 300 113			S	A	C1	E2	D1	L1	H		90	
		KIT		307 476 900 113		90	27.0	11.9	100	2500		included in the KIT 307 478 300 113			S	A	C1	E2	D1	L1	H			90













Ford

Ford Mondeo V Turnier exc. vehicles with height control, exc. for "Vignale"	01/15-04/22			307 475 600 001		90	22.5	11.9	100	2500		307 478 300 107	→		S	A	C1	E2	--	--	H	90
												307 478 300 113			S	A	C1	E2	D1	L1	H	90
		KIT		307 475 900 113		90	24.5	11.9	100	2500		included in the KIT 307 478 300 113			S	A	C1	E2	D1	L1	H	90
Ford Mondeo V Turnier inc. vehicles with height control, exc. for "Vignale"	01/15-04/22			307 476 600 001		90	25.0	11.9	100	2500		307 478 300 107	→		S	A	C1	E2	--	--	H	90
												307 478 300 113			S	A	C1	E2	D1	L1	H	90
		KIT		307 476 900 113		90	27.0	11.9	100	2500		included in the KIT 307 478 300 113			S	A	C1	E2	D1	L1	H	90
Ford Mustang Mach-E CGW	07/21-			307 673 600 001		60	16.7	5.7	30	750		307 490 300 113		07/21- without preliminary setup	S	CAN	C	E	D	L1	V	75
			KIT		307 673 900 113		60	18.7	5.7	30	750		included in the KIT 307 490 300 113		07/21- without preliminary setup	S	CAN	C	E	D	L1	V
Ford Puma	09/19-			307 640 600 001		70	19.5	7.5	90	1100		307 489 300 113		with preliminary setup, inc. WLC 2.0	S	FRE	C	E2	D1	L1	H	60
					307 641 600 001		75	22.0	7.5	90	1100		307 490 300 113		without preliminary setup, inc. WLC 2.0	S	CAN	C	E	D	L1	V
Ford Puma without preliminary setup	09/19-	KIT		307 640 900 113		75	21.0	7.5	90	1100		included in the KIT 307 490 300 113		without preliminary setup, inc. WLC 2.0	S	CAN	C	E	D	L1	V	75
		KIT		307 641 900 113		75	23.9	7.5	90	1100		included in the KIT 307 490 300 113		without preliminary setup, inc. WLC 2.0	S	CAN	C	E	D	L1	V	75
Ford Ranger III towball inc. for vehicles with integrated step in the bumper	03/12-02/16	KIT		307 613 900 113		30	35.6	16.4	225	3500		included in the KIT 343 069 300 113		-02/16	S	CAN	C	E	D	--	V	60
Ford Ranger III inc. towball for vehicles with bumper with integrated step	03/16-	KIT		307 556 900 113		30	35.6	16.4	225	3500		included in the KIT 307 556 300 113		03/16-	S	CAN	C1	E2	D1	L1	V	90





















Ford S-Max without height control with styling package by Ford Individual + for S-Max Titanium S = visible cutout	05/06-09/15		307 304 600 001		90	17.7	12.1	90	2000	307 400 300 113	S	C	E	D	L1	45			
			307 305 600 001		90	19.5	12.1	90	2000										
	KIT		307 304 900 113		90	19.7	11.1	90	2000	included in the KIT 307 400 300 113	S	C	E	D	L1	45			
	KIT		307 305 900 113		90	21.5	11.1	90	2000	included in the KIT 307 400 300 113	S	C	E	D	L1	45			
Ford S-Max CJ without height control Please order separately cover for bumper cutout at Ford dealer's. exc. vehicles with tailgate that opens by sensor (foot sensor) inc. Plugin-Hybrid	09/15-		307 497 600 001		90	20.0	12.1	90	2000										
Ford S-Max CJ with height control Please order separately cover for bumper cutout at Ford dealer's. exc. vehicles with tailgate that opens by sensor (foot sensor) inc. Plugin-Hybrid	09/15-		307 498 600 001		90	20.0	12.1	90	2000										
Ford S-Max CJ without height control exc. vehicles with tailgate that opens by sensor (foot sensor) inc. Plugin-Hybrid	09/15-		307 496 600 001		90	20.0	12.1	90	2000										
Ford Transit Connect Tourneo exc. vehicles with LPG /gas drive	01/03-12/13		307 262 600 001		120	16.0	8.1	75	1250	307 360 300 107		S	FRE	--	E1	--	--	H	60
			307 262 600 001		120	16.0	8.1	75	1250	307 360 300 113		S	FRE	--	E1	D1	L1	H	60
		KIT		307 262 900 113		120	18.0	8.1	75	1250	included in the KIT 307 360 300 113		S	FRE	--	E1	D1	L1	H

Ford

Ford Tourneo Connect II with preliminary setup exc. Active	02/14-08/18	KIT		307 500 900 113		90	16.6	8.3	75	1250		included in the KIT 307 500 300 113	-08/18 for vehicles with preparation	S	CAN		E	D	L1	H	60	
		KIT		307 501 900 113		90	16.6	8.3	75	1250		included in the KIT 307 500 300 113	-08/18 for vehicles with preparation	S	CAN		E	D	L1	H	60	
Ford Tourneo Connect II exc. Active	02/14-01/22			307 500 600 001		90	15.5	8.3	75	1250		307 500 300 107	-08/18 for vehicles with preparation	S	CAN		E	--	--	H	60	
				307 501 600 001		90	15.5	8.3	75	1250		307 500 300 113	-08/18 for vehicles with preparation	S	CAN		E	D	L1	H	60	
												307 576 300 113	09/18- WLC 2.0	inc.	S	A	C1	E	D1	--	V	90
Ford Tourneo Connect II exc. Active	09/18-01/22	KIT		307 576 900 113		90	16.6	8.3	75	1250		included in the KIT 307 576 300 113	09/18- WLC 2.0	inc.	S	A	C1	E	D1	--	V	90
		KIT		307 577 900 113		90	16.6	8.3	75	1250		included in the KIT 307 576 300 113	09/18- WLC 2.0	inc.	S	A	C1	E	D1	--	V	90
Ford Tourneo Connect III	02/22-			322 088 600 001		90	20.0	9.8	119	1620												
				322 089 600 001		90	23.0	9.8	119	1620		322 088 300 113	02/22- with preliminary setup	S	CAN	C	E	D	L	H	30	
Ford Tourneo Courier exc. AdBlue	06/14-			307 638 600 001		45	18.9	5.9	50	910												
				307 639 600 001		45	20.3	5.9	50	910		307 573 300 113			S	A	C1	E1	D1	--	H	75
		KIT		307 638 900 113		45	20.6	5.9	50	910		included in the KIT 307 573 300 113			S	A	C1	E1	D1	--	H	75
		KIT		307 639 900 113		45	22.0	5.9	50	910		included in the KIT 307 573 300 113			S	A	C1	E1	D1	--	H	75
Ford Tourneo Custom Van V362	11/12-			307 382 600 001		30	17.2	14.9	120	2800		307 386 300 113	-05/16	S	CAN	C	E	D	L1	V	90	
											307 624 300 113	06/16-	S	C2	C1	E2	D	L1	V	60		
Ford Tourneo Custom Van	11/12-			307 385 600 001		30	23.0	14.9	120	2800		307 386 300 113	-05/16	S	CAN	C	E	D	L1	V	90	



Ford Tourneo Custom Van V362 inc. towball	11/12-05/16	KIT		307 382 900 113			30	19.0	14.9	120	2800		included in the KIT 307 386 300 113		-05/16	S	CAN	C	E	D	L1	V	90		
Ford Tourneo Custom Van V362	11/12-05/16	KIT		307 385 900 113			30	25.0	14.9	120	2800		included in the KIT 307 386 300 113		-05/16	S	CAN	C	E	D	L1	V	90		
Ford Transit Connect inc. RS with double tube exhaust System exc. vehicles with LPG /gas drive	01/03-12/13			307 262 600 001	→		120	16.0	8.1	75	1250		307 360 300 107	→		S	FRE	--	E1	--	--	H	60		
					307 262 600 001	→		120	16.0	8.1	75	1250		307 360 300 113	→		S	FRE	--	E1	D1	L1	H	60	
		KIT		307 262 900 113	→		120	18.0	8.1	75	1250		included in the KIT 307 360 300 113	→		S	FRE	--	E1	D1	L1	H	60		
Ford Transit Connect II with preliminary setup exc. Active	02/14-08/18	KIT		307 500 900 113			90	16.6	8.3	75	1250		included in the KIT 307 500 300 113		-08/18 for vehicles with preparation	S	CAN		E	D	L1	H	60		
		KIT		307 501 900 113			90	16.6	8.3	75	1250		included in the KIT 307 500 300 113		-08/18 for vehicles with preparation	S	CAN		E	D	L1	H	60		
Ford Transit Connect II exc. Active	02/14-01/22			307 500 600 001			90	15.5	8.3	75	1250		307 500 300 107		-08/18 for vehicles with preparation	S	CAN		E	--	--	H	60		
				307 501 600 001			90	15.5	8.3	75	1250		307 500 300 113		-08/18 for vehicles with preparation	S	CAN		E	D	L1	H	60		
					307 501 600 001			90	15.5	8.3	75	1250		307 576 300 113		09/18- WLC 2.0	inc.	S	A	C1	E	D1	--	V	90
Ford Transit Connect II exc. Active	09/18-01/22	KIT		307 576 900 113			90	16.6	8.3	75	1250		included in the KIT 307 576 300 113		09/18- WLC 2.0	inc.	S	A	C1	E	D1	--	V	90	
		KIT		307 577 900 113			90	16.6	8.3	75	1250		included in the KIT 307 576 300 113		09/18- WLC 2.0	inc.	S	A	C1	E	D1	--	V	90	

























Ford

Honda Accord Saloon (CU) exc. type S	01/08-12/15		338 066 600 001		90	21.0	9.5	75	1700		300 072 300 107				--	FRE	--	--	--	--	V			
													300 072 300 113				--	FRE	--	--	D1	L1	V	
Honda Accord Tourer (CW)	01/08-12/15		338 066 600 001		90	21.0	9.5	75	1700		300 072 300 107				--	FRE	--	--	--	--	V			
													300 072 300 113				--	FRE	--	--	D1	L1	V	
Honda CRV IV (RM) exc. AdBlue	11/12-09/18		338 107 600 001		90	19.0	10.7	100	2000		300 210 300 107				--	A	--	E1	--	--	V	90		
													300 210 300 113				--	A	--	E1	D1	L1	V	90
Honda CRV V (RW) inc. Hybrid exc. vehicles with tailgate that opens by sensor (foot sensor)	10/18-		338 130 600 001		60	25.5	10.6	120	2000															
Honda Civic 5 doors	01/12-08/16		338 103 600 001			22.0	8.3	75	1500		300 210 300 107				--	A	--	E1	--	--	V	90		
													300 210 300 113				--	A	--	E1	D1	L1	V	90
Honda Civic IX Tourer	02/14-02/18		338 120 600 001		75	26.0	8.2	75	1400		300 210 300 107				--	A	--	E1	--	--	V	90		
													300 210 300 113				--	A	--	E1	D1	L1	V	90
Honda Civic VIII 3/5 doors exc. Civic "R"	01/06-09/11		338 091 600 001		60	22.0	8.3	75	1500		300 072 300 107				--	FRE	--	--	--	--	V			
													300 072 300 113				--	FRE	--	--	D1	L1	V	
Honda Civic X Hatchback exc. type R exc. Sport Plus	02/17-		338 127 600 001		60	21.7	8.5	103	1550															
Honda HRV II	09/15-09/21		338 109 600 001		120	21.2	8.1	60	1400															
Honda Jazz exc. Hybrid	11/08-09/15		338 116 600 001			90	21.0	6.6	80	1100		300 210 300 107				--	A	--	E1	--	--	V	90	
													300 210 300 113				--	A	--	E1	D1	L1	V	90

Honda































Honda























Honda Jazz IV GK	09/15-01/20		338 126 600 001		60	22.0	6.2	95	1000	300 210 300 107				--	A	--	E1	--	--	V	90
										300 210 300 113				--	A	--	E1	D1	L1	V	90

Hyundai i 10 is not permitted to tow by manufacturer.	11/13-																																						
Hyundai i 20 3/5 doors	01/09-12/14		346 084 600 001		90	20.0	6.6	50	1200		300 210 300 107				--	A	--	E1	--	--	V	90																	
											300 210 300 113				--	A	--	E1	D1	L1	V	90																	
Hyundai I 20 5 doors exc. I 20 Coupé	01/15-08/20		346 105 600 001		60	20.0	6.8	50	1100		300 210 300 107				--	A	--	E1	--	--	V	90																	
			346 106 600 001		60	23.0	6.8	50	1100		300 210 300 113				--	A	--	E1	D1	L1	V	90																	
Hyundai I 20 Active	01/16-08/20		346 105 600 001		60	20.0	6.8	50	1100		300 210 300 107				--	A	--	E1	--	--	V	90																	
			346 106 600 001		60	23.0	6.8	50	1100		300 210 300 113				--	A	--	E1	D1	L1	V	90																	
Hyundai I 20 III BC3 exc. I 20 N	08/20-		346 173 600 001		60	20.0	7.3	89	1300																														
			346 172 600 001		60	17.8	7.3	89	1300																														
Hyundai I 30 Fastback PDE exc. I 30 N Fastback exc. N-Line	06/17-		346 157 600 001		90	19.9	8.7	101	1500																														
			346 158 600 001		90	23.6	8.7	101	1500																														
Hyundai i 30 Hatchback inc. I30 Coupe 03/13- exc. GT, exc. turbo	03/12-01/17		345 086 600 001		60	20.0	8.3	75	1500		346 071 300 113				S	A	--	E1	D1	--	V	75																	
Hyundai i 30 Hatchback exc. 2.0 N exc. AdBlue	01/17-08/18		346 124 600 001		60	21.8	8.3	80	1500																														
Hyundai i 30 Hatchback exc. 2.0 N exc. AdBlue exc. vehicles with park distance control	01/17-08/18		346 123 600 001		60	21.8	8.3	80	1500																														















Hyundai









Hyundai

Hyundai i 30 Hatchback inc. AdBlue inc. N-Line -06/20	09/18-		346 155 600 001		75	19.8	8.7	106	1620											
				346 156 600 001		75	22.5	8.7	106	1620										
Hyundai 30 Stationwagon exc. 2.0 N exc. AdBlue	07/17-07/20		346 124 600 001		60	21.8	8.3	80	1500	346 145 300 107			S	A	C1	E2	--	--	V	90
Hyundai 30 Stationwagon exc. vehicles with park distance control exc. 2.0 N exc. AdBlue	07/17-07/20		346 123 600 001		60	21.8	8.3	80	1500	346 145 300 107			S	A	C1	E2	--	--	V	90
Hyundai i 30 cw Stationwagon	06/12-06/17		345 111 600 001		60	19.0	8.5	75	1500	346 071 300 113			S	A	--	E1	D1	--	V	75
				345 112 600 001		60	24.5	8.5	75		1500									
Hyundai IX 20	11/10-07/19		346 063 600 001		90	20.0	7.6	75	1300	346 064 300 107			S	A	--	E1	--	--	V	75
				346 064 600 001		90	21.0	7.6	75			1300	346 064 300 113		S	A	--	E1	D1	--
		KIT		346 063 900 113		90	22.0	7.6	75	1300	included in the KIT 346 064 300 113		S	A	--	E1	D1	--	V	75
				346 064 900 113		90	23.0	7.6	75	1300		included in the KIT 346 064 300 113		S	A	--	E1	D1	--	V
Hyundai IX 35	03/10-09/15		346 048 600 001		90	23.0	11.1	96	2400	346 049 300 107		S	A	--	E2	--	--	V	90	
				346 049 600 001		90	28.7	11.1	96		2400	346 049 300 113		S	A	--	E2	D1	L1	V
		KIT		346 048 900 113		90	25.0	11.1	96	2400	included in the KIT 346 049 300 113		S	A	--	E2	D1	L1	V	90
				346 049 900 113		90	30.5	11.1	96	2400		included in the KIT 346 049 300 113		S	A	--	E2	D1	L1	V



Hyundai Ioniq	03/16-			346 122 600 001		60	21.1	6.1	900																
Hyundai Ioniq 5 NE	05/21-			346 175 600 001		90	19.0	10.0	122	1650		345 150 300 113	05/21-	S	A	--	E2	D	L	H	V	75			
		KIT		346 175 900 113		90		10.0	122	1650		included in the KIT 345 150 300 113	05/21-	S	A	--	E2	D	L	H	V	75			
Hyundai Kona with preliminary setup inc. EV inc. AdBlue exc. vehicles with double tube exhaust System Please check if there is a towing capacity in the car documents.	06/17-	KIT		346 125 900 113		60	21.6	8.5	104	1250		included in the KIT 346 146 300 113	with preliminary setup	S	A	--	E2	D1	L1	V	60				
		KIT		346 126 900 113		60	27.7	8.5	104	1250		included in the KIT 346 146 300 113	with preliminary setup	S	A	--	E2	D1	L1	V	60				
Hyundai Kona without preliminary setup inc. EV inc. AdBlue exc. vehicles with double tube exhaust System Please check if there is a towing capacity in the car documents.	06/17-	KIT		346 127 900 113		60	21.6	8.5	104	1250		included in the KIT 346 150 300 113	06/17- inc. WLC 2.0 without preliminary setup, inc. Hybrid	S	CAN	C	E	D1	L1	V	75				
		KIT		346 128 900 113		60	24.7	8.5	104	1250		included in the KIT 346 150 300 113	06/17- inc. WLC 2.0 without preliminary setup, inc. Hybrid	S	CAN	C	E	D1	L1	V	75				
Hyundai Kona inc. EV inc. AdBlue exc. vehicles with double tube exhaust System Please check if there is a towing capacity in the car documents.	06/17-			346 163 600 001		75	18.6	8.5	104	1250		346 146 300 113	with preliminary setup	S	A	--	E2	D1	L1	V	60				
				346 164 600 001		75	21.2	8.5	104	1250		346 150 300 113	06/17- inc. WLC 2.0 without preliminary setup, inc. Hybrid	S	CAN	C	E	D1	L1	V	75				
Hyundai Santa Fe exc. Grand Santa Fe	09/12-11/15	KIT		346 075 900 113	→ 	90	25.0	12.5	100	2500		included in the KIT 346 076 300 113	→ -11/15	S	A	--	--	D	L1	V	90				
		KIT		346 076 900 113	→ 	90	27.0	12.5	100	2500		included in the KIT 346 076 300 113	→ -11/15	S	A	--	--	D	L1	V	90				



Hyundai

























Hyundai Santa Fe exc. Grand Santa Fe	09/12-01/18		346 075 600 001		90	23.0	12.5	100	2500	346 076 300 107	→	-11/15	S	A	--	--	--	--	V	90
			346 076 600 001		90	25.0	12.5	100	2500	346 076 300 113	→	-11/15	S	A	--	--	D	L1	V	90
										346 142 300 107	→	12/15-	S	A	--	E2	--	--	V	90
										346 142 300 113		12/15-	S	A	--	E2	D	L1	V	90
Hyundai Santa Fe IV (TM)	02/18-10/20		345 142 600 001		60	27.2	12.6	135	2500											
			345 143 600 001		60	29.9	12.6	135	2500											
Hyundai Santa Fe IV (TM) inc. Hybrid	11/20-		345 167 600 001		90	20.0	13.0	159	2550											
			345 168 600 001		90	22.0	13.0	159	2550											
Hyundai Tucson	09/04-03/10		346 018 600 001		90	20.6	10.9	90	2200	346 018 300 113	→		S	FRE	--	E1	D1	L1	H	45
Hyundai Tucson	07/15-06/18		346 103 600 001		60	25.0	11.3	100	2200	346 049 300 107		-06/18	S	A	--	E2	--	--	V	90
			346 104 600 001		60	27.0	11.3	100	2200	346 049 300 113		-06/18	S	A	--	E2	D1	L1	V	90
		KIT	346 103 900 113		60	29.0	11.3	100	2200	included in the KIT 346 049 300 113		-06/18	S	A	--	E2	D1	L1	V	90
		KIT	346 104 900 113		60	30.0	11.3	100	2200	included in the KIT 346 049 300 113		-06/18	S	A	--	E2	D1	L1	V	90

Hyundai Tucson TL, TLE inc. N-Line	07/18-11/20			345 140 600 001			75	26.1	10.9	133	2200		346 149 300 113	-11/20	S	A	C1	E2	D1	L1	V	90
				345 141 600 001			75	27.6	10.9	133	2200											
	KIT		345 140 900 113			75	27.2	10.9	133	2200		included in the KIT 346 149 300 113	-11/20	S	A	C1	E2	D1	L1	V	90	
	KIT		345 141 900 113			75	28.7	10.9	133	2200		included in the KIT 346 149 300 113	-11/20	S	A	C1	E2	D1	L1	V	90	
Hyundai Tucson IV NX4E	11/20-			346 165 600 001		60	20.0	11.5	140	2200		345 150 300 113	11/20-	S	A	--	E2	D	L	H	75	
				346 166 600 001		60	22.0	11.5	140	2200												
		KIT		346 165 900 113		60	21.0	11.5	140	2200		included in the KIT 345 150 300 113	11/20-	S	A	--	E2	D	L	H	75	
		KIT		346 166 900 113		60	24.0	11.5	140	2200		included in the KIT 345 150 300 113	11/20-	S	A	--	E2	D	L	H	75	
		KIT		346 171 900 113		90	33.0	11.5	140	2200		included in the KIT 346 001 300 153	not available individually	S	CAN	--	E2	D	L	H	75	

Isuzu









Isuzu D-Max 4x4 exc. 4x2 exc. vehicles with double tube exhaust system inc. towball	06/12-12/20			342 195 600 001			90	29.0	16.1	140	3500												
Isuzu D-Max III TF exc. vehicles with underrun guard	01/21-			342 304 600 001			60	29.7	16.4	245	3500		342 293 300 113		01/21-		S	FRE	--	E	D	L	H 15
		KIT		342 304 900 113			60	30.9	16.4	245	3500		included in the KIT 342 293 300 113		01/21-		S	FRE	--	E	D	L	H 15



















Iveco-Daily VI Van 33 - 50 inc. towball with preliminary setup only for vehicles with a single- layer frame	03/14-			342 284 600 001			45	35.1	21.1	140	3500		342 239 300 113		with preliminary setup	S	FRE	--	--	D	L	H	45	
Iveco-Daily VI Iveco-Daily VI 33 - 50 inc. towball with preliminary setup only for vehicles with a single- layer frame	03/14-			342 284 600 001			45	35.1	21.1	140	3500		342 239 300 113		with preliminary setup	S	FRE	--	--	D	L	H	45	

Jeep Cherokee	03/08-03/14			342 131 600 001			90	30.0	15.3	140	3500		300 210 300 107			--	A	--	E1	--	--	V	90
													300 210 300 113			--	A	--	E1	D1	L1	V	90
Jeep Cherokee Onroad / KL	04/14-09/18			342 207 600 001			60	33.0	12.4	150	2500		342 200 300 113		-09/18	S	A		E2	D	L1	V	150
Jeep Compass (MP) inc. AdBlue inc. Hybrid (4xe) exc. Trailhawk	12/16-			342 301 600 001			60	23.3	10.2	95	1900												
				342 302 600 001			60	26.3	10.2	95	1900												
Jeep Grand Cherokee inc. SRT8 inc. Summit exc. Trackhawk	04/11-06/13	KIT		342 185 900 113			90	23.0	16.0	175	3500		included in the KIT 342 184 300 113		-06/13	S	A	C	--	D	L1	V	120
Jeep Grand Cherokee WK2 inc. Facelift 06/13- exc. SRT8/Summit/Trackhawk	04/11-04/21			342 184 600 001			90	21.0	16.0	175	3500		342 184 300 113		-06/13	S	A	C	--	D	L1	V	120
													342 190 300 113		06/13-	S	A	--	E1	D	L1	V	120
Jeep Grand Cherokee WK2 inc. SRT8 inc. Summit exc. Trackhawk	04/11-04/21			342 221 600 001			90	23.0	16.0	175	3500		342 184 300 113		-06/13	S	A	C	--	D	L1	V	120
													342 190 300 113		06/13-	S	A	--	E1	D	L1	V	120
Jeep Grand Cherokee WK2 inc. SRT8 inc. Summit exc. Trackhawk	06/13-04/21	KIT		342 190 900 113			90	23.0	16.0	175	3500		included in the KIT 342 190 300 113		06/13-	S	A	--	E1	D	L1	V	120
Jeep Renegade inc. AdBlue inc. Hybrid (4xe) inc. Cross exc. Sport exc. Trailhawk	07/14-			342 301 600 001			60	23.3	10.2	95	1900		342 197 300 113		-08/18	S	FRE	--	E	D	L1	V	120
				342 302 600 001			60	26.3	10.2	95	1900		342 300 300 113		09/18-	--	FRE	--	E	D1	L1	V	150
Jeep Renegade inc. AdBlue inc. Hybrid (4xe) inc. Cross exc. Sport exc. Trailhawk	07/14-08/18	KIT		342 196 900 113			60	25.2	10.2	95	1900		included in the KIT 342 197 300 113		-08/18	S	FRE	--	E	D	L1	V	120
		KIT		342 197 900 113			60	28.2	10.2	95	1900		included in the KIT 342 197 300 113		-08/18	S	FRE	--	E	D	L1	V	120

Jeep

























Jeep























Jeep Renegade inc. AdBlue inc. Hybrid (4xe) inc. Cross exc. Sport exc. Trailhawk	09/18-	KIT		342 299 900 113		60	25.2	10.2	95	1900		included in the KIT 342 300 300 113	09/18-	--	FRE	--	E	D1	L1	V	150
		KIT		342 300 900 113		60	28.2	10.2	95	1900		included in the KIT 342 300 300 113	09/18-	--	FRE	--	E	D1	L1	V	150
Jeep Wrangler III (JK) AdBlue models -10/17 inc. towball	04/07-10/17			342 104 600 001		60	12.0	15.0	170	3500		342 105 300 113		S	A	--	E2	D	L1	V	150
Jeep Wrangler III (JK) AdBlue models -10/17	04/07-10/17			306 535 600 001		30	12.0	15.1	140	3500		342 105 300 113		S	A	--	E2	D	L1	V	150
		KIT		306 535 900 113		30	13.6	15.1	140	3500		included in the KIT 342 105 300 113		S	A	--	E2	D	L1	V	150
Jeep Wrangler IV (JL) inc. 4xe Plugin Hybrid	11/17-			306 535 600 001		30	12.0	15.1	140	3500		342 105 300 113		S	A	--	E2	D	L1	V	150
		KIT		306 535 900 113		30	13.6	15.1	140	3500		included in the KIT 342 105 300 113		S	A	--	E2	D	L1	V	150

Kia Carens inc. facelift 08/16-	03/12-12/18		345 091 600 001		90	20.0	9.1	75	1500	300 210 300 107			--	A	--	E1	--	--	V	90
			345 092 600 001		90	22.0	9.1	75	1500	300 210 300 113			--	A	--	E1	D1	L1	V	90
Kia Cee'd 5 doors	06/12-03/18		345 086 600 001		60	20.0	8.3	75	1500	345 086 300 107	→	-03/18	S	A	--	E2	--	--	V	90
			345 086 300 113				-03/18	S	A	--	E2	D1	L1	V	90					
Kia Cee'd 5 doors GT-Line	09/16-03/18		345 115 600 001		60	22.5	8.3	60	1500	345 086 300 113		-03/18	S	A	--	E2	D1	L1	V	90
			KIT 		345 115 900 113	60	24.7	8.3	60	1500	included in the KIT 345 086 300 113		-03/18	S	A	--	E2	D1	L1	V
Kia Cee'd Sporty Wagon	07/07-09/12		345 059 600 001	→ 	90	17.5	8.6	75	1500	300 073 300 113		-09/09	--	FRE	--	--	D1	L1	V	90
Kia Cee'd sw/Sportswagon inc. GT-Line	10/12-03/18		345 111 600 001		60	19.0	8.5	75	1500	345 086 300 107	→	-03/18	S	A	--	E2	--	--	V	90
			345 112 600 001		60	24.5	8.5	75	1500	345 086 300 113		-03/18	S	A	--	E2	D1	L1	V	90
Kia Ceed	03/18-		345 146 600 001		45	19.8	8.4	100	1500											
			345 147 600 001		45	22.5	8.4	100	1500											
Kia Ceed Sportswagon exc. vehicles with park distance control exc. GT-Line	04/18-		345 144 600 001		45	20.3	8.4	100	1500											
Kia Ceed Sportswagon exc. GT-Line	04/18-		345 145 600 001		45	23.0	8.4	100	1500											
Kia Niro I DE exc. e-Niro	01/17-08/22		345 117 600 001		90	20.8	7.6	100	1300	345 173 300 113		10/17- with preliminary setup	S	A	--	E2	D1	L1	H	75





Kia

Kia





























Kia Niro I DE with preliminary setup exc. e-Niro	10/17-08/22	KIT		345 173 900 113		60	21.8	7.6	100	1300		included in the KIT 345 173 300 113	10/17- with preliminary setup	S	A	--	E2	D1	L1	H	75	
		KIT		345 174 900 113		60	24.1	7.6	100	1300		included in the KIT 345 173 300 113	10/17- with preliminary setup	S	A	--	E2	D1	L1	H	75	
Kia Optima Hatchback exc. Hybrid exc. AdBlue	01/16-09/19			345 113 600 001		60	19.0	9.7	80	1800												
Kia Optima Sportswagon exc. Hybrid exc. AdBlue	10/16-09/19			345 113 600 001		60	19.0	9.7	80	1800		345 168 300 113		S	A	C1	E2	D	L1	H	60	
		KIT		345 168 900 113		60	20.0	9.7	80	1800		included in the KIT 345 168 300 113		S	A	C1	E2	D	L1	H	60	
Kia ProCee'd exc. Pro Cee'd GT	03/13-09/18			345 086 600 001		60	20.0	8.3	75	1500		345 086 300 107	→ -03/18	S	A	--	E2	--	--	V	90	
												345 086 300 113	-03/18	S	A	--	E2	D1	L1	V	90	
Kia ProCeed CD	10/18-			345 151 600 001		60	20.9	8.5	104	1500												
				345 152 600 001		60	23.9	8.5	104	1500												
Kia Rio Hatchback IV YB inc. facelift	01/17-			345 127 600 001		75	19.7	6.6	75	1110		345 171 300 113		not for vehicles with automatic drive	S	A	--	E1	D1	--	V	90
		KIT		345 127 900 113		75	20.7	6.6	75	1110		included in the KIT 345 171 300 113		not for vehicles with automatic drive	S	A	--	E1	D1	--	V	90
Kia Sorento	10/09-10/12			345 068 600 001	→ 	90	32.0	12.6	100	2500												
Kia Sorento	10/12-02/15			345 094 600 001	→ 	90	24.0	12.5	100	2500		345 069 300 113			S	A	--	E2	D	L1	V	90
		KIT		345 094 900 113	→ 	90	25.0	12.5	100	2500		included in the KIT 345 069 300 113			S	A	--	E2	D	L1	V	90









Kia Sorento III inc. AdBlue	01/15-03/20		345 142 600 001		60	27.2	12.6	135	2500	345 143 300 113									S	A	--	E2	D	L1	V	90		
				345 143 600 001		60	29.9	12.6	135										2500									
Kia Sorento IV MQ4 inc. Hybrid	03/20-		345 167 600 001		90	20.0	13.0	159	2550	345 150 300 113		03/20-								S	A	--	E2	D	L	H	75	
				345 168 600 001		90	22.0	13.0	159											2550								
		KIT		345 165 900 113		90	21.0	13.0	159	2550	included in the KIT 345 150 300 113		03/20-								S	A	--	E2	D	L	H	75
				345 166 900 113		90	23.0	13.0	159	2550	included in the KIT 345 150 300 113		03/20-									S	A	--	E2	D	L	H
Kia Sportage	12/04-08/10		346 018 600 001		90	20.6	10.9	90	2200																			
Kia Sportage SL	08/10-02/16		345 087 600 001		90	23.0	11.0	80	2400	345 079 300 113											S	A	--	E2	D1	L1	V	90
				345 079 600 001		60	25.0	10.6	80												2300							
		KIT		345 079 900 113		60	27.0	10.6	80	2300	included in the KIT 345 079 300 113											S	A	--	E2	D1	L1	V
Kia Sportage	02/16-05/18		346 103 600 001		60	25.0	11.3	100	2200																			
				346 104 600 001		60	27.0	11.3	100	2200																		
Kia Sportage IV QLE	06/18-09/21		345 140 600 001		75	26.1	10.9	133	2200																			
				345 141 600 001		75	27.6	10.9	133	2200																		

Kia

Lancia Ypsilon	07/11-		306 385 600 001		60	19.0	6.1	70	1000																														
			306 394 600 001	→ 	60	19.5	6.1	70	1000			300 078 300 113				--	FRE	--	--	D1	L1	V																	









Land Rover





Land Rover Discovery Sport L550 7 seats for vehicles with hollow for spare wheel	09/14-04/19			323 181 600 001		60	34.0	11.8	135	2200		323 141 300 113			S	C2	C	E	D	L	H	45
Land Rover Discovery Sport L550 7 seats for vehicles without hollow for spare wheel	02/15-			323 141 600 001		90	28.0	12.5	150	2500		323 141 300 113			S	C2	C	E	D	L	H	45
		KIT		323 141 900 113		90	32.0	12.5	150	2500		included in the KIT 323 141 300 113			S	C2	C	E	D	L	H	45
Land Rover Discovery Sport for vehicles with hollow for spare wheel	05/19-			323 192 600 001		90	39.3	11.3	145	2000		323 189 300 113	05/19-12/20	S	C2	C1	E2	D	L	H	45	
												323 191 300 113	01/21-	S	C2	C1	E2	D	L	H	45	
Land Rover Freelander 2 inc. facelift 2013-	05/07-10/14			323 078 600 001		105	18.5	11.0	150	2000		323 411 300 113	10/12-	S	C2	--	E1	D	L	H	30	
				323 079 600 001		105	20.0	11.0	150	2000												
Range-Rover Evoque L538	09/11-12/18			323 101 600 001		90	18.0	10.6	150	2000		323 102 300 113		S	C2	--	E	D	L	H	30	
				323 102 600 001		90	20.0	10.6	150	2000												
		KIT		323 101 900 113		90	20.0	10.6	150	2000		included in the KIT 323 102 300 113			S	C2	--	E	D	L	H	30
		KIT		323 102 900 113		90	22.0	10.6	150	2000		included in the KIT 323 102 300 113			S	C2	--	E	D	L	H	30
Range-Rover Evoque Cabriolet L538	05/16-12/18			323 101 600 001		90	18.0	10.6	150	2000		323 102 300 113		S	C2	--	E	D	L	H	30	
				323 102 600 001		90	20.0	10.6	150	2000												
		KIT		323 101 900 113		90	20.0	10.6	150	2000		included in the KIT 323 102 300 113			S	C2	--	E	D	L	H	30
		KIT		323 102 900 113		90	22.0	10.6	150	2000		included in the KIT 323 102 300 113			S	C2	--	E	D	L	H	30

Range-Rover Evoque II L551 inc. AdBlue	12/18-		323 189 600 001		60	30.3	11.1	130	2000	323 189 300 113	12/18-12/20	S	C2	C1	E2	D	L	H	45	
			323 190 600 001		60	33.4	11.1	130	2000			323 191 300 113	01/21-	S	C2	C1	E2	D	L	H
Range-Rover IV L405	01/13-10/21		323 107 600 001		120	50.5	16.6	200	3500	323 107 300 113	01/13-10/21	S	C2	C	E2	D	L	H	15	
Range Rover L322 Mounting tube inc. detachable towball, storage bowl and fitting material (only in connection with 323064600001 or 323074600001)	02/02-12		323 063 600 001		15	15.0	16.4	150	3500	323 064 300 113	-09/09	S	FRE	--	E	D	L	H	30	
			323 062 600 001		15	11.5	16.4	150	3500											
Range Rover Sport The vehicle already has a built in towball receptor. Please order additional equipment with Land Rover dealers.	03/05-10/13																			
Range Rover Sport L 494 exc. Plugin Hybrid	10/13-05/22		323 121 600 001		120	51.5	16.6	200	3500	323 107 300 113		S	C2	C	E2	D	L	H	15	
Range-Rover Velar L560 exc. V6 and V8	10/17-		323 171 600 001		60	33.5	12.5	175	2500	323 189 300 113	01/19-12/20	S	C2	C1	E2	D	L	H	45	

Land Rover



Lexus

























Lexus RX 350 / 450 h exc. vehicles with height control	05/09-12/15			335 357 600 001		90	38.0	11.8	85	2100		335 357 300 113			S	FRE	--	--	D	L1	V	105
		KIT		335 357 900 113		90	40.0	11.8	85	2100		included in the KIT 335 357 300 113			S	FRE	--	--	D	L1	V	105
Lexus RX 350 / 450 h for vehicles with height control	05/09-12/15			335 358 600 001		90	38.0	11.9	85	2100		335 357 300 113			S	FRE	--	--	D	L1	V	105
		KIT		335 358 900 113		90	40.0	11.9	85	2100		included in the KIT 335 357 300 113			S	FRE	--	--	D	L1	V	105

MAN TGE Van singel wheels Please order separately ball plate: 329141600001 exc. vehicles with integrated step in the bumper	02/17-		321 946 600 001			30	26.7	17.5	150	3500		321 112 300 107 →	with preliminary setup	S	CAN	--	E	--	--	V	15	
												321 112 300 113	with preliminary setup	S	CAN	--	E	D	L	V	15	
												321 113 300 107	without preliminary setup	S	CAN	C	E	--	--	V	60	
												321 113 300 113	without preliminary setup	S	CAN	C	E	D	L	V	60	
MAN TGE Van twin wheels Please order separately ball plate: 329141600001 exc. vehicles with integrated step in the bumper	02/17-		321 947 600 001			30	27.0	21.0	150	3500		321 112 300 107 →	with preliminary setup	S	CAN	--	E	--	--	V	15	
												321 112 300 113	with preliminary setup	S	CAN	--	E	D	L	V	15	
												321 113 300 107	without preliminary setup	S	CAN	C	E	--	--	V	60	
												321 113 300 113	without preliminary setup	S	CAN	C	E	D	L	V	60	
MAN TGE Van without preliminary setup twin wheels inc. ball plate exc. vehicles with integrated step in the bumper	02/17-	KIT		321 947 900 113			30	30.0	21.0	150	3500		included in the KIT 321 113 300 113	without preliminary setup	S	CAN	C	E	D	L	V	60
MAN TGE Van without preliminary setup single wheels inc. ball plate exc. vehicles with integrated step	02/17-	KIT		321 946 900 113			30	28.5	17.5	150	3500		included in the KIT 321 113 300 113	without preliminary setup	S	CAN	C	E	D	L	V	60
MAN TGE Chassis Cab singel wheels Please order separately ball plate: 329141600001	02/17-		321 948 600 001			30	22.0	21.0	150	3500		321 112 300 107 →	with preliminary setup	S	CAN	--	E	--	--	V	15	
												321 112 300 113	with preliminary setup	S	CAN	--	E	D	L	V	15	
												321 113 300 107	without preliminary setup	S	CAN	C	E	--	--	V	60	
												321 113 300 113	without preliminary setup	S	CAN	C	E	D	L	V	60	

MAN

















MAN













MAN TGE Chassis Cab twin wheels Please order separately ball plate 329141600001	02/17-		321 949 600 001			30	22.0	21.0	150	3500		321 112 300 107 →	with preliminary setup	S	CAN	--	E	--	--	V	15
												321 112 300 113	with preliminary setup	S	CAN	--	E	D	L	V	15
												321 113 300 107	without preliminary setup	S	CAN	C	E	--	--	V	60
												321 113 300 113	without preliminary setup	S	CAN	C	E	D	L	V	60
MAN TGE Chassis Cab without preliminary setup twin wheels inc. ball plate	02/17-	KIT 	321 949 900 113			30	26.5	21.0	150	3500		included in the KIT 321 113 300 113	without preliminary setup	S	CAN	C	E	D	L	V	60
MAN TGE Chassis Cab without preliminary setup single wheels inc. ball plate	02/17-	KIT 	321 948 900 113			30	26.5	21.0	150	3500		included in the KIT 321 113 300 113	without preliminary setup	S	CAN	C	E	D	L	V	60

Mazda 2 exc. Hybrid	02/15-			343 076 600 001		60	20.0	7.0	50	1200		343 076 300 113			S	FRE	--	E	D1	L1	V	90
		KIT		343 076 900 113		60	24.0	7.0	50	1200		included in the KIT 343 076 300 113			S	FRE	--	E	D1	L1	V	90
Mazda 3 Hatchback exc. MPS (260 HP) exc. sportsbumpers	10/03-10/13			343 038 600 001		90	21.5	8.7	75	1590		300 072 300 107	-03/09	--	FRE	--	--	--	--	--	V	
												300 072 300 113	-03/09	--	FRE	--	--	D1	L1	V		
													343 066 300 113	03/09-	S	A	--	--	D1	--	V	75
Mazda 3 Hatchback exc. MPS (260 HP) exc. sportsbumpers	03/09-10/13	KIT		343 038 900 113		60	23.5	8.7	75	1590		included in the KIT 343 066 300 113	03/09-	S	A	--	--	D1	--	V	75	
Mazda 3 Hatchback	10/13-19			343 073 600 001		90	19.0	9.2	75	1800		343 074 300 113	10/13-19	S	A	--	E2	D1	L1	V	90	
				343 074 600 001		90	21.0	9.2	75	1800												
		KIT		343 073 900 113		90	20.0	9.2	75	1800		included in the KIT 343 074 300 113	10/13-19	S	A	--	E2	D1	L1	V	90	
		KIT		343 074 900 113		90	22.0	9.2	75	1800		included in the KIT 343 074 300 113	10/13-19	S	A	--	E2	D1	L1	V	90	
Mazda 3 Hatchback (BP)	11/18-			343 114 600 001		60	28.5	7.7	80	1300		343 114 300 113		S	A	--	E2	D	L1	V	105	
				343 115 600 001		60	31.4	7.7	80	1300												
Mazda 3 Saloon exc. MPS (260 HP) exc. sportsbumpers	10/03-03/09			343 038 600 001		90	21.5	8.7	75	1590		300 072 300 113		--	FRE	--	--	D1	L1	V		
Mazda 3 Saloon	10/13-	KIT		343 080 900 113		90	25.0	9.2	75	1800		included in the KIT 343 074 300 113		S	A	--	E2	D1	L1	V	90	

Mazda



















Mazda

















Mazda 5	10/10-01/18		343 064 600 001		60	19.0	9.8	75	1700	343 063 300 113	S	A	--	E1	D1	L1	105		
			343 063 600 001		60	19.0	9.8	75	1700										
Mazda 6 Estate models 2019- = visible cutout	02/13-		343 070 600 001		90	24.0	10.1	75	1800	343 199 300 113	S	A	--	--	D1	L1	V	90	
			343 071 600 001		90	26.0	10.1	75	1800										
		KIT		343 070 900 113		90	26.0	10.1	75	1800	included in the KIT 343 199 300 113	S	A	--	--	D1	L1	V	90
		KIT		343 071 900 113		90	28.0	10.1	75	1800	included in the KIT 343 199 300 113	S	A	--	--	D1	L1	V	90
Mazda CX-30 inc. Hybrid	01/19-		343 117 600 001		75	23.2	8.3	96	1300										
			343 118 600 001		75	24.9	8.3	96	1300										
Mazda CX3 inc. facelift 2021-	07/15-		343 087 600 001		90	21.0	7.6	75	1200	343 076 300 113	S	FRE	--	E	D1	L1	V	90	
			343 088 600 001		60	23.0	7.6	75	1200										
		KIT		343 087 900 113		60	25.0	7.6	75	1200	included in the KIT 343 076 300 113	S	FRE	--	E	D1	L1	V	90
		KIT		343 088 900 113		60	26.0	7.6	75	1200	included in the KIT 343 076 300 113	S	FRE	--	E	D1	L1	V	90

Mazda CX5	04/12-04/17			343 053 600 001		90	22.0	10.8	100	2100		343 056 300 113	-04/17	S	A	--	E2	D	L1	V	90	
				343 056 600 001		90	25.0	10.8	100	2100												
		KIT		343 053 900 113		90	24.0	10.8	100	2100		included in the KIT 343 056 300 113	-04/17	S	A	--	E2	D	L1	V	90	
		KIT		343 056 900 113		90	27.0	10.8	100	2100		included in the KIT 343 056 300 113	-04/17	S	A	--	E2	D	L1	V	90	
Mazda CX5 KF inc. AdBlue inc. facelift 2021-	05/17-			343 112 600 001		60	23.6	10.8	132	2000		343 099 300 107	→ 05/17-	S	CAN	--	E	--	--	V	90	
											343 099 300 113	05/17-	S	CAN	--	E	D1	L1	V	90		
		KIT		343 112 900 113		60	25.2	10.8	132	2000		included in the KIT 343 099 300 113	05/17-	S	CAN	--	E	D1	L1	V	90	
Mazda Pickup BT50 towball inc. for vehicles with integrated step in the bumper	06/12-02/16	KIT		307 613 900 113		30	35.6	16.4	225	3500		included in the KIT 343 069 300 113	-02/16	S	CAN	C	E	D	--	V	60	

























Mazda

















Mercedes-Benz

Mercedes A Class W168 inc. vehicles with facelift and vehicles with long wheelbase from approx. 04/01 exc. AMG	97-09/04		313 185 600 001	→ 	120	13.0	6.2	50	1000												
Mercedes A Class W169	09/04-09/12		313 171 600 001		120	18.0	8.5	80	1500												
			313 231 600 001		120	18.0	8.5	80	1500	313 231 300 113				S	CAN	C	E	D1	L1	V	90
Mercedes A Class W176 exc. AMG Sport Attention: Depending on the engine variation it may be necessary to change the cooling system of the vehicle.	09/12-05/18		313 396 600 001		60	23.0	9.2	80	1500	313 398 300 107				S	CAN	C	E	--	--	V	105
			313 398 600 001		60	25.0	9.2	80	1500	313 398 300 113				S	CAN	C	E	D	L	V	105
		KIT 	313 396 900 113		60	25.0	9.2	80	1900	included in the KIT 313 398 300 113				S	CAN	C	E	D	L	V	105
		KIT 	313 398 900 113		60	27.0	9.2	80	1500	included in the KIT 313 398 300 113				S	CAN	C	E	D	L	V	105
Mercedes A Class W177 W177 inc. AMG exc. vehicles with aerodynamic package	03/18-		313 639 600 001		60	25.3	10.7	120	2100												
			313 640 600 001		60	26.7	10.7	120	2100	313 215 300 113				S	CAN	C	E	D	L	V	75
		KIT 	313 639 900 113		60	24.9	10.7	120	2100	included in the KIT 313 215 300 113				S	CAN	C	E	D	L	V	75
		KIT 	313 640 900 113		60	28.3	10.7	120	2100	included in the KIT 313 215 300 113				S	CAN	C	E	D	L	V	75





















Mercedes A Class Saloon W177 inc. AMG exc. vehicles with aerodynamic package	09/18-		313 639 600 001		60	25.3	10.7	120	2100	313 215 300 113	S	CAN	C	E	D	L	V	75		
			313 640 600 001		60	26.7	10.7	120	2100											
	KIT		313 639 900 113		60	24.9	10.7	120	2100	included in the KIT 313 215 300 113	S	CAN	C	E	D	L	V	75		
	KIT		313 640 900 113		60	28.3	10.7	120	2100	included in the KIT 313 215 300 113	S	CAN	C	E	D	L	V	75		
Mercedes Atego towing bracket with integral underrun guard (supply in pairs only: 313404600002 + 313404600003) Please check tolerances when mounting (measures see "Universal HGV towing brackets). swap system or automatic bolt coupling permitted suitable towball: 329103600001	01/97-		313 404 600 001		90	69.0	25.1	150	3500	300 201 300 113		--	A	--	E1	D1	--	V		
																				for 12V vehicles
Mercedes B Class W245	06/05-10/11		313 171 600 001		120	18.0	8.5	80	1500	313 231 300 113	S	CAN	C	E	D1	L1	V	90		
			313 231 600 001		120	18.0	8.5	80	1500											
Mercedes B Class W246 exc. AMG and sportmodels exc. Electric Drive B250e Attention: Depending on the engine variation it may be necessary to change the cooling system of the vehicle.	11/11-12/18		313 396 600 001		60	23.0	9.2	80	1500	313 398 300 107	S	CAN	C	E	--	--	V	105		
			313 398 600 001		60	25.0	9.2	80	1500	313 398 300 113	S	CAN	C	E	D	L	V	105		
	KIT		313 396 900 113		60	25.0	9.2	80	1900	included in the KIT 313 398 300 113	S	CAN	C	E	D	L	V	105		
	KIT		313 398 900 113		60	27.0	9.2	80	1500	included in the KIT 313 398 300 113	S	CAN	C	E	D	L	V	105		















Mercedes-Benz

Mercedes B Class W247	12/18-		313 639 600 001		60	25.3	10.7	120	2100	313 215 300 113		S	CAN	C	E	D	L	V	75	
			313 640 600 001		60	26.7	10.7	120	2100											
	KIT		313 639 900 113		60	24.9	10.7	120	2100	included in the KIT 313 215 300 113		S	CAN	C	E	D	L	V	75	
	KIT		313 640 900 113		60	28.3	10.7	120	2100	included in the KIT 313 215 300 113		S	CAN	C	E	D	L	V	75	
Mercedes C Class Convertible C205 exc. AMG C63, AMG C63S inc. AMG look exc. vehicles with height control	07/16-		313 431 600 001		120	21.0	10.5	85	1900	313 445 300 113	07/18- inc. WLC 2.0	S	FRE	C	E	D	L1	H	60	
Mercedes C Class Convertible A205 exc. AMG C63, AMG C63S inc. AMG look inc. vehicles with height control	07/16-		313 432 600 001		120	23.0	10.5	85	1900	313 445 300 113	07/18- inc. WLC 2.0	S	FRE	C	E	D	L1	H	60	
Mercedes C Class Convertible A205 exc. AMG C63, AMG C63S inc. AMG look exc. vehicles with height control	07/18-	KIT		313 445 900 113		120	29.1	10.5	85	1900	included in the KIT 313 445 300 113	07/18- inc. WLC 2.0	S	FRE	C	E	D	L1	H	60
Mercedes C Class Convertible A205 exc. AMG C63, AMG C63S inc. AMG look inc. vehicles with height control	07/18-	KIT		313 446 900 113		120	29.1	10.5	85	1900	included in the KIT 313 445 300 113	07/18- inc. WLC 2.0	S	FRE	C	E	D	L1	H	60
Mercedes C Class Coupé C204 + C204 AMG style	06/11-09/15		313 214 600 001		>150	21.0	10.2	75	1900	313 361 300 107		S	CAN	C	E	--	--	H	45	
			313 438 600 001		120	23.0	10.2	75	1900	313 361 300 113										
	KIT		313 389 900 113		>150	23.0	10.2	75	1900	included in the KIT 313 361 300 113		S	CAN	C	E	D	L	H	45	
	KIT		313 211 900 113		>150	25.0	10.2	75	1900	included in the KIT 313 361 300 113		S	CAN	C	E	D	L	H	45	

















Mercedes C Class Coupé C205 exc. AMG C63, AMG C63S inc. AMG look exc. vehicles with height control	10/15-		313 431 600 001		120	21.0	10.5	85	1900		313 445 300 113	07/18- 2.0	inc. WLC	S	FRE	C	E	D	L1	H	60	
Mercedes C Class Coupé C205 exc. AMG C63, AMG C63S inc. AMG look inc. vehicles with height control	10/15-		313 432 600 001		120	23.0	10.5	85	1900		313 445 300 113	07/18- 2.0	inc. WLC	S	FRE	C	E	D	L1	H	60	
Mercedes C Class Coupé C205 exc. AMG C63, AMG C63S inc. AMG look exc. vehicles with height control	07/18-	KIT 	313 445 900 113		120	29.1	10.5	85	1900		included in the KIT 313 445 300 113	07/18- 2.0	inc. WLC	S	FRE	C	E	D	L1	H	60	
Mercedes C Class Coupé C205 exc. AMG C63, AMG C63S inc. AMG look inc. vehicles with height control	07/18-	KIT 	313 446 900 113		120	29.1	10.5	85	1900		included in the KIT 313 445 300 113	07/18- 2.0	inc. WLC	S	FRE	C	E	D	L1	H	60	
Mercedes C Class Estate S203 with steel springs exc. Sport Coupé, CLK from 05/02, AMG and 4x4	06/01-09/07		313 166 600 001		>150	22.0	9.1	75	1600		313 168 300 113			S	CAN	C	E	D	--	H	60	
			313 167 600 001		>150	23.8	9.1	75	1600						S	CAN	C	E	D	--	H	60
		KIT 	313 166 900 113		>150	24.0	9.1	75	1600		included in the KIT 313 168 300 113				S	CAN	C	E	D	--	H	60
		KIT 	313 167 900 113		>150	25.5	9.1	75	1600		included in the KIT 313 168 300 113				S	CAN	C	E	D	--	H	60
Mercedes C Class Estate S204 exc. vehicles with height control, exc. AMG & sport bumpers inc. vehicles with AMG look (=> visible bumper cutout)	09/07-07/09	KIT 	313 214 900 113		>150	23.0	10.2	75	1900		included in the KIT 313 210 300 113		-07/09 If a SAM- Low control unit is installed, it must be replaced by a higher quality SAM-High. Please observe the manufacturer's specifications.	S	CAN	C	E	D	L	H	45	
		KIT 	313 315 900 113		>150	25.0	10.2	75	1900			included in the KIT 313 210 300 113		-07/09 If a SAM- Low control unit is installed, it must be replaced by a higher quality SAM-High. Please observe the manufacturer's specifications.	S	CAN	C	E	D	L	H	45



























Mercedes-Benz

Mercedes C Class Estate S204 exc. vehicles with height control, exc. AMG & sport bumpers inc. vehicles with AMG look (=> visible bumper cutout)	09/07-08/14		313 214 600 001		>150	21.0	10.2	75	1900	313 210 300 113	-07/09 If a SAM-Low control unit is installed, it must be replaced by a higher quality SAM-High. Please observe the manufacturer's specifications.	S	CAN	C	E	D	L	H	45					
						313 438 600 001		120	23.0			10.2	75	1900	313 361 300 107	07/09-	S	CAN	C	E	--	--	H	45
								313 361 300 113	07/09-			S	CAN	C	E	D	L	H	45					
Mercedes C Class Estate S204 for vehicles with height control exc. AMG & sport bumpers inc. vehicles with AMG look (=> visible bumper cutout)	09/07-08/14		313 439 600 001	→ 	120	23.0	10.2	75	1900	313 210 300 113	-07/09 If a SAM-Low control unit is installed, it must be replaced by a higher quality SAM-High. Please observe the manufacturer's specifications.	S	CAN	C	E	D	L	H	45					
						313 361 300 107		07/09-	S			CAN	C	E	--	--	H	45						
								313 361 300 113	07/09-			S	CAN	C	E	D	L	H	45					
Mercedes C Class Estate S204 exc. vehicles with height control, exc. AMG & sport bumpers inc. vehicles with AMG look (=> visible bumper cutout)	07/09-08/14	KIT 	313 389 900 113		>150	23.0	10.2	75	1900	included in the KIT 313 361 300 113	07/09-	S	CAN	C	E	D	L	H	45					
					KIT 	313 211 900 113		>150	25.0			10.2	75	1900	included in the KIT 313 361 300 113	07/09-	S	CAN	C	E	D	L	H	45
Mercedes C Class Estate S205 exc. AMG C63, AMG C63S inc. AMG look exc. vehicles with height control	09/14-02/21		313 431 600 001		120	21.0	10.5	85	1900	313 445 300 113	07/18- inc. WLC 2.0	S	FRE	C	E	D	L1	H	60					
Mercedes C Class Estate S205 exc. AMG C63, AMG C63S inc. AMG look inc. vehicles with height control	09/14-02/21		313 432 600 001		120	23.0	10.5	85	1900	313 445 300 113	07/18- inc. WLC 2.0	S	FRE	C	E	D	L1	H	60					
Mercedes C Class Estate S205 exc. AMG C63, AMG C63S inc. AMG look exc. vehicles with height control	07/18-02/21	KIT 	313 445 900 113		120	29.1	10.5	85	1900	included in the KIT 313 445 300 113	07/18- inc. WLC 2.0	S	FRE	C	E	D	L1	H	60					
Mercedes C Class Estate S205 exc. AMG C63, AMG C63S inc. AMG look inc. vehicles with height control	07/18-02/21	KIT 	313 446 900 113		120	29.1	10.5	85	1900	included in the KIT 313 445 300 113	07/18- inc. WLC 2.0	S	FRE	C	E	D	L1	H	60					

Mercedes C Class Estate S206 exc. AMG	03/21-			313 709 600 001		90	18.3	10.1	120	1800															
				313 710 600 001		90	21.7	10.1	120	1800															
Mercedes C Class Saloon W203 with steel springs exc. Sport Coupé, CLK from 05/02, AMG	06/00-03/07			313 166 600 001		>150	22.0	9.1	75	1600															
				313 167 600 001		>150	23.8	9.1	75	1600															
		KIT		313 166 900 113		>150	24.0	9.1	75	1600															
		KIT		313 167 900 113		>150	25.5	9.1	75	1600															
Mercedes C Class Saloon W204 exc. vehicles with height control exc. AMG & sport bumpers, vehicles with AMG look	03/07-07/09	KIT		313 214 900 113		>150	23.0	10.2	75	1900															
		KIT		313 315 900 113		>150	25.0	10.2	75	1900															
Mercedes C Class Saloon W204 exc. vehicles with height control exc. AMG & sport bumpers, vehicles with AMG look	03/07-01/14			313 214 600 001		>150	21.0	10.2	75	1900															



















Mercedes-Benz

















Mercedes C Class Saloon W204 exc. vehicles with height control exc. AMG & sport bumpers, vehicles with AMG look	03/07-01/14			313 438 600 001		120	23.0	10.2	75	1900		313 210 300 113 313 361 300 107 313 361 300 113	-07/09 If a SAM-Low control unit is installed, it must be replaced by a higher quality SAM-High. Please observe the manufacturer's specifications. 07/09- 07/09-	S S S	CAN CAN CAN	C C C	E E E	D -- D	L -- L	H H H	45 45 45
Mercedes C Class Saloon W204 inc. vehicles with height control, exc. AMG & sport bumpers	03/07-01/14			313 439 600 001	→ 	120	23.0	10.2	75	1900		313 210 300 113 313 361 300 107 313 361 300 113	-07/09 If a SAM-Low control unit is installed, it must be replaced by a higher quality SAM-High. Please observe the manufacturer's specifications. 07/09- 07/09-	S S S	CAN CAN CAN	C C C	E E E	D -- D	L -- L	H H H	45 45 45
Mercedes C Class Saloon W204 exc. vehicles with height control exc. AMG & sport bumpers, vehicles with AMG look	07/09-01/14	KIT		313 389 900 113		>150	23.0	10.2	75	1900		included in the KIT 313 361 300 113	07/09-	S	CAN	C	E	D	L	H	45
		KIT		313 211 900 113		>150	25.0	10.2	75	1900		included in the KIT 313 361 300 113	07/09-	S	CAN	C	E	D	L	H	45
Mercedes C Class Saloon W205 exc. AMG C63, AMG C63S inc. AMG look exc. vehicles with height control	03/14-02/21			313 431 600 001		120	21.0	10.5	85	1900		313 445 300 113	07/18-02/21 inc. WLC 2.0	S	FRE	C	E	D	L1	H	60
Mercedes C Class Saloon W205 exc. AMG C63, AMG C63S inc. AMG look inc. vehicles with height control	03/14-02/21			313 432 600 001		120	23.0	10.5	85	1900		313 445 300 113	07/18-02/21 inc. WLC 2.0	S	FRE	C	E	D	L1	H	60
Mercedes C Class Saloon W205 exc. AMG C63, AMG C63S inc. AMG look exc. vehicles with height control	07/18-02/21	KIT		313 445 900 113		120	29.1	10.5	85	1900		included in the KIT 313 445 300 113	07/18-02/21 inc. WLC 2.0	S	FRE	C	E	D	L1	H	60
Mercedes C Class Saloon W205 exc. AMG C63, AMG C63S inc. AMG look inc. vehicles with height control	07/18-02/21	KIT		313 446 900 113		120	29.1	10.5	85	1900		included in the KIT 313 445 300 113	07/18-02/21 inc. WLC 2.0	S	FRE	C	E	D	L1	H	60

Mercedes C Class Saloon W206 exc. AMG	03/21-			313 709 600 001		90	18.3	10.1	120	1800													
				313 710 600 001		90	21.7	10.1	120	1800													
Mercedes CLA C117 inc. vehicles with AMG look inc. CLA Shooting Brake (X117) 03/15- Attention: Depending on the engine variation it may be necessary to change the cooling system of the vehicle.	04/13-03/19			313 396 600 001		60	23.0	9.2	80	1500		313 398 300 107			S	CAN	C	E	--	--	V	105	
				313 503 600 001		60	24.5	10.2	80	1900		313 398 300 113			S	CAN	C	E	D	L	V	105	
		KIT		313 396 900 113		60	25.0	9.2	80	1900		included in the KIT 313 398 300 113			S	CAN	C	E	D	L	V	105	
		KIT		313 400 900 113		60	26.0	10.2	80	1900		included in the KIT 313 398 300 113			S	CAN	C	E	D	L	V	105	
Mercedes CLA II Coupé C118 inc. AMG exc. vehicles with aerodynamic package	04/19-			313 640 600 001		60	26.7	10.7	120	2100		313 215 300 113		04/19-	S	CAN	C	E	D	L	V	75	
		KIT		313 639 900 113		60	24.9	10.7	120	2100		included in the KIT 313 215 300 113		04/19-	S	CAN	C	E	D	L	V	75	
		KIT		313 640 900 113		60	28.3	10.7	120	2100		included in the KIT 313 215 300 113		04/19-	S	CAN	C	E	D	L	V	75	
Mercedes CLA II Coupé C118 inc. AMG exc. vehicles with aerodynamic package	04/19-			313 639 600 001		60	25.3	10.7	120	2100		313 215 300 113		04/19-	S	CAN	C	E	D	L	V	75	
Mercedes CLA II Shooting Brake X118 inc. AMG exc. vehicles with aerodynamic package	06/19-			313 639 600 001		60	25.3	10.7	120	2100		313 215 300 113			S	CAN	C	E	D	L	V	75	
				313 640 600 001		60	26.7	10.7	120	2100													
		KIT		313 639 900 113		60	24.9	10.7	120	2100		included in the KIT 313 215 300 113			S	CAN	C	E	D	L	V	75	
		KIT		313 640 900 113		60	28.3	10.7	120	2100		included in the KIT 313 215 300 113			S	CAN	C	E	D	L	V	75	















Mercedes-Benz























Mercedes-Benz

Mercedes CLC is not permitted to tow by the vehicle manufacturer.																							
Mercedes CLS Shooting Brake X218 inc. vehicles with AMG look	10/12-12/17			313 371 600 001			150	26.0	11.5	84	2100		313 361 300 107			S	CAN	C	E	--	--	H	45
				313 373 600 001			150	27.0	11.5	84	2100		313 361 300 113			S	CAN	C	E	D	L	H	45
		KIT		313 371 900 113			150	30.6	11.5	84	2100		included in the KIT 313 361 300 113			S	CAN	C	E	D	L	H	45
		KIT		313 373 900 113			150	32.5	11.5	84	2100		included in the KIT 313 361 300 113			S	CAN	C	E	D	L	H	45
Mercedes Citan length = 4321 + 4705 mm exc. AdBlue	10/12-08/21			316 268 600 001			60	23.0	8.2	75	1350		316 353 300 113			S	FRE	--		D1	L1	H	60
				316 269 600 001			60	23.0	8.2	75	1350												
		KIT		316 352 900 113			60	25.0	8.2	75	1350		included in the KIT 316 353 300 113			S	FRE	--		D1	L1	H	60
		KIT		316 353 900 113			60	25.0	8.2	75	1350		included in the KIT 316 353 300 113			S	FRE	--		D1	L1	H	60
Mercedes Citan II W420	09/21-			316 492 600 001			90	26.7	9.4	114	1500												
Mercedes E Class Convertible A207 exc. AMG vehicles, exc. vehicles with AMG look	03/10-12/16			313 214 600 001		>150	21.0	10.2	75	1900		313 361 300 107			S	CAN	C	E	--	--	H	45	
				313 438 600 001		120	23.0	10.2	75	1900		313 361 300 113			S	CAN	C	E	D	L	H	45	
		KIT		313 389 900 113		>150	23.0	10.2	75	1900		included in the KIT 313 361 300 113			S	CAN	C	E	D	L	H	45	
		KIT		313 211 900 113		>150	25.0	10.2	75	1900		included in the KIT 313 361 300 113			S	CAN	C	E	D	L	H	45	

Mercedes E Class Coupé C207 exc. AMG vehicles, exc. vehicles with AMG look	05/09-12/16			313 214 600 001		>150	21.0	10.2	75	1900		313 361 300 107			S	CAN	C	E	--	--	H	45
				313 438 600 001		120	23.0	10.2	75	1900		313 361 300 113			S	CAN	C	E	D	L	H	45
		KIT		313 389 900 113		>150	23.0	10.2	75	1900		included in the KIT 313 361 300 113			S	CAN	C	E	D	L	H	45
		KIT		313 211 900 113		>150	25.0	10.2	75	1900		included in the KIT 313 361 300 113			S	CAN	C	E	D	L	H	45
Mercedes E Class Estate S211 exc. AMG inc. 4-Matic	03-09/09			313 203 600 001	→	150	23.5	11.5	130	2200		313 196 300 113			S	CAN	C	E	D	--	H	60
				313 204 600 001	→	150	23.0	11.5	130	2200						S	CAN	C	E	D	--	H
		KIT		313 203 900 113	→	150	25.5	11.5	130	2200		included in the KIT 313 196 300 113			S	CAN	C	E	D	--	H	60
		KIT		313 204 900 113	→	150	25.0	11.5	130	2200		included in the KIT 313 196 300 113			S	CAN	C	E	D	--	H	60
Mercedes E Class Estate S212 inc. AMG styling package	09/09-03/16			313 371 600 001		150	26.0	11.5	84	2100		313 361 300 107			S	CAN	C	E	--	--	H	45
				313 373 600 001		150	27.0	11.5	84	2100		313 361 300 113			S	CAN	C	E	D	L	H	45
		KIT		313 371 900 113		150	30.6	11.5	84	2100		included in the KIT 313 361 300 113			S	CAN	C	E	D	L	H	45
		KIT		313 373 900 113		150	32.5	11.5	84	2100		included in the KIT 313 361 300 113			S	CAN	C	E	D	L	H	45

















Mercedes-Benz



















Mercedes E Class Estate S213 inc. vehicles with AMG look Plug-in-Hybrid: Please note D value inc. facelift 2021- exc. E63 AMG	04/16-			313 523 600 001		60	23.8	11.8	140	2100	313 446 300 113				S	CAN	C	E	D	L	H	60
				313 524 600 001		60	25.1	11.8	140	2100												
		KIT		313 523 900 113		60	24.7	11.8	140	2100	included in the KIT 313 446 300 113	S	CAN	C	E	D	L	H	60			
		KIT		313 524 900 113		60	26.0	11.8	140	2100	included in the KIT 313 446 300 113	S	CAN	C	E	D	L	H	60			
Mercedes E Class Saloon W211 exc. AMG, inc. 4-Matic If there are no reinforcements right and left in the boot, it is necessary to mount them. You can buy them at the DC dealer, DC no. A 211 639 0143 and A 211 639 0443. With this reinforcements the coverings of the sides don't fit anymore. You could buy others at the DC dealer, e.g. A 211 690 9425 / 9825. The supercharger of the cooling must have a power of 600 W. The superchargers A 001 500 4493 and A 211 500 0693 fulfil this requirement.	03/02-09			313 195 600 001		150	24.5	11.0	80	2000	313 196 300 113				S	CAN	C	E	D	--	H	60
			KIT		313 195 900 113		150	25.0	11.0	80	2000	included in the KIT 313 196 300 113	S	CAN	C	E	D	--	H	60		
Mercedes E Class Saloon W212	03/09-12/15			313 360 600 001		90	26.0	11.4	84	2100	313 361 300 107				S	CAN	C	E	--	--	H	45
				313 361 600 001		90	31.0	11.4	84	2100	313 361 300 113	S	CAN	C	E	D	L	H	45			
		KIT		313 360 900 113		90	28.0	11.4	84	2100	included in the KIT 313 361 300 113	S	CAN	C	E	D	L	H	45			
		KIT		313 361 900 113		90	32.0	11.4	84	2100	included in the KIT 313 361 300 113	S	CAN	C	E	D	L	H	45			





Mercedes E Class Saloon W213 inc. vehicles with AMG look Plug-in-Hybrid: Please note D value inc. facelift 2021- exc. E63 AMG	01/16-		313 523 600 001		60	23.8	11.8	140	2100	313 446 300 113			S	CAN	C	E	D	L	H	60							
			313 524 600 001		60	25.1	11.8	140	2100																		
	KIT		313 523 900 113		60	24.7	11.8	140	2100	included in the KIT 313 446 300 113	S	CAN	C	E	D	L	H	60									
	KIT		313 524 900 113		60	26.0	11.8	140	2100	included in the KIT 313 446 300 113	S	CAN	C	E	D	L	H	60									
Mercedes EQC N293	05/19-		313 562 600 001		60	26.7	13.3	160	2600	313 445 300 113		05/19- 2.0	inc. WLC	S	FRE	C	E	D	L1	H	60						
Mercedes EQV W447	06/20-		313 435 600 001		90	20.0	13.8	100	2500																		
			313 436 600 001		90	21.0	13.8	100	2500																		
Mercedes G Class only for vehicles with 2-parts rear bumper	02/90-		313 320 600 001		60	12.0	17.2	140	3500	300 210 300 107			--	A	--	E1	--	--	V	90							
									300 210 300 113	--											A	--	E1	D1	L1	V	90
Mercedes GL Class X164/X166 inc. 8 cylinder diesel exc. vehicles with AMG look For vehicles with AdBlue tank please order: holder 913406609103	09/06-12/15		313 421 600 001		120	38.0	16.5	135	3500	313 138 300 113			S	CAN	C	E	D	L	H	45							
									313 430 300 113	X166											S	CAN	C1	E	D	L1	H
Mercedes GLA X156 exc. AMG	03/14-12/19		313 401 600 001		60	21.0	10.2	80	1900	313 398 300 107			S	CAN	C	E	--	--	V	105							
									313 398 300 113	S											CAN	C	E	D	L	V	105
		KIT		313 401 900 113		60	24.0	10.2	80	1900											included in the KIT 313 398 300 113	S	CAN	C	E	D	L
Mercedes GLA X156 inc. vehicles with AMG look (bumper cut necessary)	03/14-12/19		313 503 600 001		60	24.5	10.2	80	1900	313 398 300 107			S	CAN	C	E	--	--	V	105							
									313 398 300 113	S											CAN	C	E	D	L	V	105
		KIT		313 400 900 113		60	26.0	10.2	80	1900											included in the KIT 313 398 300 113	S	CAN	C	E	D	L

Mercedes-Benz



Mercedes-Benz





Mercedes GLA (H247) inc. Hybrid inc. AdBlue inc. GLA 35 + 45 AMG exc. vehicles with aerodynamic package	02/20-	 	313 639 600 001		60	25.3	10.7	120	2100	313 215 300 113										S	CAN	C	E	D	L	V	75
			313 640 600 001		60	26.7	10.7	120	2100																		
		KIT		313 639 900 113		60	24.9	10.7	120											2100	included in the KIT 313 215 300 113						
		KIT		313 640 900 113		60	28.3	10.7	120											2100	included in the KIT 313 215 300 113						
Mercedes GLB (X247) inc. Hybrid inc. AdBlue inc. GLB 35 AMG	08/19-	 	313 639 600 001		60	25.3	10.7	120	2100	313 215 300 113										S	CAN	C	E	D	L	V	75
			313 640 600 001		60	26.7	10.7	120	2100																		
		KIT		313 639 900 113		60	24.9	10.7	120											2100	included in the KIT 313 215 300 113						
		KIT		313 640 900 113		60	28.3	10.7	120											2100	included in the KIT 313 215 300 113						
Mercedes GLC X253 inc. vehicles with height control inc. vehicles with AMG look for vehicles with rear flap sensor - Please regard fitting instruction - wire for sensor must be ajusted For Hybrid only: Order a frame reinforcement kit from the vehicle manufacturer.	09/15-05/22		313 402 600 001		90	23.0	13.2	100	2500	313 445 300 113										S	FRE	C	E	D	L1	H	60
Mercedes GLC X253 inc. vehicles with height control inc. vehicles with AMG look for vehicles with rear flap sensor - Please regard fitting instruction - wire for sensor must be ajusted For Hybrid only: Order a frame reinforcement kit from the vehicle manufacturer.	09/15-05/22		313 403 600 001		90	25.0	13.2	100	2500	313 445 300 113										S	FRE	C	E	D	L1	H	60

Mercedes GLC X253 inc. vehicles with height control inc. vehicles with AMG look for vehicles with rear flap sensor - Please regard fitting instruction - wire for sensor must be adjusted For Hybrid only: Order a frame reinforcement kit from the vehicle manufacturer.	07/19-05/22	KIT		313 404 900 113		60	24.4	13.2	100	2500				included in the KIT 313 445 300 113		07/19- inc. WLC 2.0	S	FRE	C	E	D	L1	H	60
Mercedes GLC X253 inc. vehicles with height control inc. vehicles with AMG look for vehicles with rear flap sensor - Please regard fitting instruction - wire for sensor must be adjusted For Hybrid only: Order a frame reinforcement kit from the vehicle manufacturer.	07/19-07/22	KIT		313 405 900 113		60	27.6	13.2	100	2500				included in the KIT 313 445 300 113		07/19- inc. WLC 2.0	S	FRE	C	E	D	L1	H	60
Mercedes GLE W166 inc. vehicles with AMG look exc. GLE Coupé	04/15-09/18			313 406 600 001		90	50.0	16.8	140	3500				313 430 300 113		-09/18	S	CAN	C1	E	D	L1	H	60
		KIT		313 406 900 113		90	51.8	16.8	140	3500				included in the KIT 313 430 300 113		-09/18	S	CAN	C1	E	D	L1	H	60
Mercedes GLE V167 / W167 exc. Hybrid enc. AMG	10/18-			313 661 600 001		60	34.4	16.0	140	3500				313 446 300 113		10/18- inc. WLC 2.0	S	CAN	C	E	D	L	H	60
				313 662 600 001		60	37.3	16.0	140	3500														
		KIT		313 661 900 113		60	36.1	16.0	140	3500				included in the KIT 313 446 300 113		10/18- inc. WLC 2.0	S	CAN	C	E	D	L	H	60
		KIT		313 662 900 113		60	38.0	16.0	140	3500				included in the KIT 313 446 300 113		10/18- inc. WLC 2.0	S	CAN	C	E	D	L	H	60
Mercedes GLE Coupé C292	03/15-10/19			313 515 600 001		90	40.5	16.8	140	3500				313 430 300 113			S	CAN	C1	E	D	L1	H	60







Mercedes Sprinter The program for Mercedes Sprinter can be found in the appendix.	03/96-03/06																								
Mercedes Sprinter Van without preliminary setup types 209-224 and 309-324 Vehicles with 3,0 and 3,5 t max. total weight, increase to 3,8 t max. total weight is possible For vehicles with integrated step device in the bumper the middle part of the outer bumper must be exchanged (Please order separately at Mercedes dealers.). inc. towball Step DC-IR A906 520 0531 is not utilisable. Utilisable step: 313285600001 or 313440600001	04/06-12/14	KIT		313 376 900 113			120	22.0	18.1	150	3500				included in the KIT 313 105 300 113		-12/14 for vehicles without preparation	S	CAN	C	E	D1	--	V	90
Mercedes Sprinter Van without preliminary setup types 209-224 and 309-324 for vehicles with step Vehicles with 3,0 and 3,5 t max. total weight, increase to 3,8 t max. total weight is possible fitting ball plate 329076600001 exc. wheelbase = 3250 mm	04/06-12/14	KIT		313 105 900 113			60	34.0	17.6	120	2800				included in the KIT 313 105 300 113		-12/14 for vehicles without preparation	S	CAN	C	E	D1	--	V	90
Mercedes Sprinter Van types 411-424 and 509-524 Vehicles with 5,0 t max. total weight, reduction to 4,6 t max. total weight is possible. wheelbase: 3665 mm For vehicles with integrated step device in the bumper the middle part of the outer bumper must be exchanged (Please order separately at Mercedes dealers.). towball: 329141600001 (order seperately) Step DC-IR A906 520 0531 is not utilisable. Utilisable step: 313285600001 or 313440600001	04/06-01/18			313 272 600 001			120	22.0	20.2	150	3500				313 105 300 107 →		-12/14 for vehicles without preparation	S	CAN	C	E	--	--	V	90
															313 105 300 113		-12/14 for vehicles without preparation	S	CAN	C	E	D1	--	V	90
															313 107 300 113		01/15-01/18 for vehicles with preparation	S	CAN	C	E	D1	L1	H	45
															313 108 300 107 →		01/15-01/18 for vehicles without preparation	S	CAN	C	E	--	--	V	90
															313 108 300 113		01/15-01/18 for vehicles without preparation	S	CAN	C	E	D1	L1	V	90
															321 106 300 113		-12/14 vehicles with preparation	S	CAN	C	E	D	--	H	45



Mercedes-Benz

Mercedes Sprinter Van types 411-424 and 509-524 Vehicles with 5,0 t max. total weight, reduction to 4,6 t max. total weight is possible. wheelbase: 4325 mm For vehicles with integrated step device in the bumper the middle part of the outer bumper must be exchanged (Please order separately at Mercedes dealers.). towball: 329141600001 (order seperately) Step DC-IR A906 520 0531 is not utilisable. Utilisable step: 313285600001 or 313440600001	04/06-01/18		313 273 600 001		120	23.0	20.2	150	3500	313 105 300 107	→	-12/14 for vehicles without preparation	S	CAN	C	E	--	--	V	90
										313 105 300 113		-12/14 for vehicles without preparation	S	CAN	C	E	D1	--	V	90
										313 107 300 113		01/15-01/18 for vehicles with preparation	S	CAN	C	E	D1	L1	H	45
										313 108 300 107	→	01/15-01/18 for vehicles without preparation	S	CAN	C	E	--	--	V	90
										313 108 300 113		01/15-01/18 for vehicles without preparation	S	CAN	C	E	D1	L1	V	90
										321 106 300 113		-12/14 vehicles with preparation	S	CAN	C	E	D	--	H	45
Mercedes Sprinter Van types 209-224 and 309-324 frontwheeldrive -01/18 Vehicles with 3,0 and 3,5 t max. total weight, increase to 3,8 t max. total weight is possible For vehicles with integrated step device in the bumper the middle part of the outer bumper must be exchanged (Please order separately at Mercedes dealers.). towball: 329141600001 Step DC-IR A906 520 0531 is not utilisable. Utilisable step: 313285600001 or 313440600001	04/06-01/18		313 376 600 001		120	20.0	18.1	150	3500	313 105 300 107	→	-12/14 for vehicles without preparation	S	CAN	C	E	--	--	V	90
										313 105 300 113		-12/14 for vehicles without preparation	S	CAN	C	E	D1	--	V	90
										313 107 300 113		01/15-01/18 for vehicles with preparation	S	CAN	C	E	D1	L1	H	45
										313 108 300 107	→	01/15-01/18 for vehicles without preparation	S	CAN	C	E	--	--	V	90
										313 108 300 113		01/15-01/18 for vehicles without preparation	S	CAN	C	E	D1	L1	V	90
										321 106 300 113		-12/14 vehicles with preparation	S	CAN	C	E	D	--	H	45













Mercedes Sprinter Van types 209-224 and 309-324 for vehicles with step Vehicles with 3,0 and 3,5 t max. total weight, increase to 3,8 t max. total weight is possible fitting ball plate 329076600001 exc. wheelbase = 3250 mm	04/06-01/18		313 553 600 001		60	31.8	17.6	120	2800	313 105 300 107	→	-12/14 for vehicles without preparation	S	CAN	C	E	--	--	V	90
										313 105 300 113		-12/14 for vehicles without preparation	S	CAN	C	E	D1	--	V	90
										313 107 300 113		01/15-01/18 for vehicles with preparation	S	CAN	C	E	D1	L1	H	45
										313 108 300 107	→	01/15-01/18 for vehicles without preparation	S	CAN	C	E	--	--	V	90
										313 108 300 113		01/15-01/18 for vehicles without preparation	S	CAN	C	E	D1	L1	V	90
										321 106 300 113		-12/14 vehicles with preparation	S	CAN	C	E	D	--	H	45
Mercedes Sprinter Van 907 + 910 not for vehicles with AWD and twin tires Vehicles up to 3.5 tons including ball plate for vehicles without step swap system allowed	02/18-		313 641 600 001		60	21.7	20.2	150	3500	313 217 300 113		02/18- inc. WLC 2.0	S	FRE	C	E	D	L1	V	75
			KIT		313 641 900 113		60	23.4	20.2	150	3500	included in the KIT 313 217 300 113		02/18- inc. WLC 2.0	S	FRE	C	E	D	L1
Mercedes Sprinter Van types 907 and 910 Vehicles with 5,0 t max. total weight, reduction to 4,6 t max. total weight is possible. wheelbase: 3665 mm For vehicles with integrated step device in the bumper the middle part of the outer bumper must be exchanged (Please order separately at Mercedes dealers.). towball: 329141600001 (order seperately) Utilisable step: 313285600001 or 313440600001	02/18-		313 272 600 001		120	22.0	20.2	150	3500	313 217 300 113		02/18- inc. WLC 2.0	S	FRE	C	E	D	L1	V	75

Mercedes-Benz























<p>Mercedes Sprinter Van types 907 and 910 Vehicles with 5,0 t max. total weight, reduction to 4,6 t max. total weight is possible. wheelbase: 4325 mm For vehicles with integrated step device in the bumper the middle part of the outer bumper must be exchanged (Please order separately at Mercedes dealers.). towball: 329141600001 (order seperately) Utilisable step: 313285600001 or 313440600001</p>	02/18-			313 273 600 001		120	23.0	20.2	150	3500		313 217 300 113		02/18- 2.0	inc. WLC	S	FRE	C	E	D	L1	V	75
<p>Mercedes Sprinter Van W910 front wheel drive for vehicles with step</p>	02/18-			313 680 600 001		30	29.0	12.5	150	2000		313 217 300 113		02/18- 2.0	inc. WLC	S	FRE	C	E	D	L1	V	75
<p>Mercedes Sprinter Chassis Cab without preliminary setup types 411-424 and 509-524 Vehicles with 5,0 t max. total weight, reduction to 4,6 t max. total weight is possible wheelbase: 3665 + 4325 mm inc. towball</p>	04/06-12/14	KIT		313 275 900 113		90	20.0	20.2	150	3500		included in the KIT 313 105 300 113		-12/14 for vehicles without preparation		S	CAN	C	E	D1	--	V	90
<p>Mercedes Sprinter Chassis Cab without preliminary setup types 209-224 and 309-324 Vehicles with 3,0 and 3,5 t max. total weight, increase to 3,8 t max. total weight is possible exc. vehicles with underrun guard inc. towball</p>	04/06-12/14	KIT		313 377 900 113		90	22.0	18.1	150	3500		included in the KIT 313 105 300 113		-12/14 for vehicles without preparation		S	CAN	C	E	D1	--	V	90

Mercedes Sprinter Chassis Cab types 411-424 and 509-524 Vehicles with 5,0 t max. total weight, reduction to 4,6 t max. total weight is possible wheelbase: 3665 + 4325 mm towball: 329059600001	04/06-01/18		313 275 600 001		90	18.0	20.2	150	3500		313 105 300 107 →	-12/14 for vehicles without preparation	S	CAN	C	E	--	--	V	90
											313 105 300 113	-12/14 for vehicles without preparation	S	CAN	C	E	D1	--	V	90
											313 107 300 113	01/15-01/18 for vehicles with preparation	S	CAN	C	E	D1	L1	H	45
											313 108 300 107 →	01/15-01/18 for vehicles without preparation	S	CAN	C	E	--	--	V	90
											313 108 300 113	01/15-01/18 for vehicles without preparation	S	CAN	C	E	D1	L1	V	90
											321 106 300 113	-12/14 vehicles with preparation	S	CAN	C	E	D	--	H	45
Mercedes Sprinter Chassis Cab types 209-224 and 309-324 Vehicles with 3,0 and 3,5 t max. total weight, increase to 3,8 t max. total weight is possible exc. vehicles with underrun guard towball: 329059600001	04/06-01/18		313 377 600 001 →		90	20.0	18.1	150	3500		313 105 300 107 →	-12/14 for vehicles without preparation	S	CAN	C	E	--	--	V	90
											313 105 300 113	-12/14 for vehicles without preparation	S	CAN	C	E	D1	--	V	90
											313 107 300 113	01/15-01/18 for vehicles with preparation	S	CAN	C	E	D1	L1	H	45
											313 108 300 107 →	01/15-01/18 for vehicles without preparation	S	CAN	C	E	--	--	V	90
											313 108 300 113	01/15-01/18 for vehicles without preparation	S	CAN	C	E	D1	L1	V	90
											321 106 300 113	-12/14 vehicles with preparation	S	CAN	C	E	D	--	H	45

Mercedes-Benz

Mercedes Sprinter Chassis Cab - 3,8 t types 209-224 and 309-324 exc. vehicles with underrun guard inc. towball	04/06-01/18		313 522 600 001			60	19.6	20.2	240	3500		313 105 300 107	→	-12/14 for vehicles without preparation	S	CAN	C	E	--	--	V	90		
													313 105 300 113		-12/14 for vehicles without preparation	S	CAN	C	E	D1	--	V	90	
														313 107 300 113		01/15-01/18 for vehicles with preparation	S	CAN	C	E	D1	L1	H	45
														313 108 300 107	→	01/15-01/18 for vehicles without preparation	S	CAN	C	E	--	--	V	90
														313 108 300 113		01/15-01/18 for vehicles without preparation	S	CAN	C	E	D1	L1	V	90
														321 106 300 113		-12/14 vehicles with preparation	S	CAN	C	E	D	--	H	45
Mercedes Sprinter Chassis Cab 907 + 910 towball inc. for vehicles without step exc. vehicles with underrun protection under the rear crossmember (EG according to data card C71) exc. vehicles with 5,0 and 5,5 t total weight swap system allowed	02/18-		313 641 600 001			60	21.7	20.2	150	3500		313 217 300 113		02/18- inc. WLC 2.0	S	FRE	C	E	D	L1	V	75		
			KIT		313 641 900 113			60	23.4	20.2	150	3500		included in the KIT 313 217 300 113		02/18- inc. WLC 2.0	S	FRE	C	E	D	L1	V	75
Mercedes Class T W420 exc. vehicles with towbar preparation exc. vehicles with spare wheel	05/22-		316 492 600 001			90	26.7	9.4	114	1500														
Mercedes Class V W447 inc. 4x4	04/14-		313 435 600 001			90	20.0	13.8	100	2500		313 436 300 113			S	CAN	C	E2	D	L1	V	90		
				313 436 600 001			90	21.0	13.8	100	2500													
		KIT		313 435 900 113			90	22.0	13.8	100	2500		included in the KIT 313 436 300 113			S	CAN	C	E2	D	L1	V	90	
		KIT		313 436 900 113			90	23.0	13.8	100	2500		included in the KIT 313 436 300 113			S	CAN	C	E2	D	L1	V	90	





Mercedes Viano / V Class from chassis no. 16793 inc. 4x4	02/04-04/14			313 240 600 001		120	19.0	13.8	150	2500															
Mercedes Viano / V Class from chassis no. 16793 inc. 4x4, exc. Brabus Please order separately cover for bumper cutout at Mercedes dealer's.	02/04-04/14			313 382 600 001		90	20.0	13.5	150	2500															
Mercedes Vito from chassis no. 16793 inc. 4x4, exc. Brabus	02/04-08/14			313 240 600 001		120	19.0	13.8	150	2500															
Mercedes Vito from chassis no. 16793 inc. 4x4, exc. Brabus Please order separately cover for bumper cutout at Mercedes dealer's.	02/04-08/14			313 382 600 001		90	20.0	13.5	150	2500															
Mercedes Vito W447 inc. 4x4 inc. Tourer inc. eVito	09/14-		 	313 435 600 001 313 436 600 001	 	90 90	20.0 21.0	13.8	100	2500								S	CAN	C	E2	D	L1	V	90
Mercedes Vito W447 inc. 4x4 inc. Tourer	09/14-	KIT		313 435 900 113		90	22.0	13.8	100	2500								S	CAN	C	E2	D	L1	V	90
		KIT		313 436 900 113		90	23.0	13.8	100	2500								S	CAN	C	E2	D	L1	V	90
Mercedes class X inc. towball	09/17-05/20	KIT		332 337 900 113		30	32.0	17.2	190	3500								S	FRE	--	E2	D1	L1	H	90

















Mitsubishi ASX I inc. ASX 2019-	06/10-12/22			340 092 600 001		90	22.0	8.5	70	1400		340 093 300 113			S	A	--	--	D	L	H	60
				340 093 600 001		90	24.0	8.5	70	1400												
		KIT		340 092 900 113		90	24.0	8.5	70	1400		included in the KIT 340 093 300 113			S	A	--	--	D	L	H	60
		KIT		340 093 900 113		90	26.0	8.5	70	1400		included in the KIT 340 093 300 113			S	A	--	--	D	L	H	60
Mitsubishi Eclipse Cross exc. AdBlue exc. Plugin Hybrid	10/17-			340 131 600 001		45	24.7	9.0	80	1600		340 099 300 113	exc. Plugin Hybrid	S	A	--	E2	D	L	V	75	
				340 132 600 001		45	26.0	9.0	80	1600												
		KIT		340 131 900 113		45	25.9	9.0	80	1600		included in the KIT 340 099 300 113	exc. Plugin Hybrid	S	A	--	E2	D	L	V	75	
		KIT		340 132 900 113		45	27.2	9.0	80	1600		included in the KIT 340 099 300 113	exc. Plugin Hybrid	S	A	--	E2	D	L	V	75	
Mitsubishi L200 Club-Cab, Single-Cab Double-Cab -07/09 exc. Double-Cab 08/09- inc. towball	01/06-07/15			340 089 600 001		90	35.0	14.7	120	3000		300 052 300 113		--	FRE	--	E1	D1	--	V		
Mitsubishi L200 Double Cab inc. towball exc. AdBlue	07/15-08/19			340 124 600 001		60	31.5	14.7	125	3100		340 136 300 107		S	C2	--	--	--	--	V	90	
												340 136 300 113		S	C2	--	--	D	L1	V	90	
		KIT		340 124 900 113		60	35.5	14.7	125	3100		included in the KIT 340 136 300 113		S	C2	--	--	D	L1	V	90	
Mitsubishi Lancer Saloon inc. Sportback exc. Ralliart	12/07-01/17			340 096 600 001		60	21.0	8.4	75	1400		300 210 300 107		--	A	--	E1	--	--	V	90	
												300 210 300 113		--	A	--	E1	D1	L1	V	90	

Mitsubishi

Multicar				342 067 600 001		90	19.0	17.0	120	2850													
----------	--	--	--	-----------------	---	----	------	------	-----	------	--	--	--	--	--	--	--	--	--	--	--	--	--





















Nissan

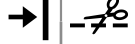









Nissan Interstar Van X62B front wheel drive inc. towball	11/21-		316 318 600 001			60	19.3	14.3	100	2500		316 300 300 113		11/21- for vehicles without central plug connection	S	FRE	--	E2	D1	L1	H	45
Nissan Interstar Van X62B front wheel drive inc. towball for vehicles without central plug connection	11/21-	KIT 	316 318 900 113			60	21.0	14.3	100	2500		included in the KIT 316 300 300 113		11/21- for vehicles without central plug connection	S	FRE	--	E2	D1	L1	H	45
Nissan Interstar Chassis Cab X62B front + rear wheel drive inc. towball not for vehicles with double tires	11/21-		316 347 600 001			60	16.5	13.7	85	2300												
Nissan Juke 2 WD exc. Nismo	10/10-07/19		332 304 600 001			60	25.0	8.5	75	1500		332 305 300 113		-07/19	S	A	--	E1	D1	L1	V	60
		KIT 	332 304 900 113			60	27.0	8.5	75	1500		included in the KIT 332 305 300 113		-07/19	S	A	--	E1	D1	L1	V	60
Nissan Kubistar	01/02-12/09		316 201 600 001			60	12.0	7.6	75	1320												
Nissan Kubistar 4x4	01/02-12/09		316 205 600 001			60	12.0	7.6	75	1320												
Nissan NV 300	01/16-		316 312 600 001			60	25.0	12.1	80	2000		316 312 300 113			S	FRE	--	E2	D1	L1	H	90
Nissan NV 300 inc. towball	01/16-		316 408 600 001			60	25.0	12.1	80	2000		316 312 300 113			S	FRE	--	E2	D1	L1	H	90
		KIT 	316 311 900 113			60	26.3	12.1	80	2000		included in the KIT 316 312 300 113			S	FRE	--	E2	D1	L1	H	90
Nissan NV 400 box/estate X62 front wheel drive inc. towball	03/10-10/21		316 318 600 001			60	19.3	14.3	100	2500		316 300 300 107		for vehicles without central plug connection	S	FRE	--	E2	--	--	H	45
												316 300 300 113		for vehicles without central plug connection	S	FRE	--	E2	D1	L1	H	45
													316 318 300 113		for vehicles with central plug connection	S	FRE	--	E2	D1	L1	H

Nissan NV 400 box/estate X62 front wheel drive inc. towball for vehicles without central plug connection	03/10-10/21	KIT		316 318 900 113			60	21.0	14.3	100	2500			included in the KIT 316 300 300 113		for vehicles without central plug connection	S	FRE	--	E2	D1	L1	H	45
Nissan NV 400 platform X62 front + rear wheel drive inc. towball not for vehicles with double tires	07/10-10/21			316 347 600 001			60	16.5	13.7	85	2300			300 201 300 113 316 319 300 113		for vehicles with preparation	--	A	--	E1	D1	--	V	
Nissan Navara D23 inc. towball	11/15-	KIT		332 337 900 113			30	32.0	17.2	190	3500			included in the KIT 332 354 300 113		11/15-	S	FRE	--	E2	D1	L1	H	90
Nissan Pathfinder	03/05-12/14			332 301 600 001	→		60	15.0	16.4	140	3500			332 303 300 113			S	FRE	--	E2	D1	L1	V	75
		KIT		332 301 900 113	→		60	17.0	16.4	140	3500			included in the KIT 332 303 300 113			S	FRE	--	E2	D1	L1	V	75
Nissan Primastar inc. towball	03-09/14			314 364 600 001			60	21.0	12.3	85	2100			314 860 300 113 314 870 300 113		08/06-03/10 03/10-	S	FRE	--	--	D1	L1	H	60
Nissan Primastar inc. towball	08/06-03/10	KIT		314 364 900 113			60	23.0	12.3	85	2100			included in the KIT 314 860 300 113		08/06-03/10	S	FRE	--	--	D1	L1	H	60
Nissan Primastar inc. towball	03/10-09/14	KIT		314 870 900 113			60	23.0	12.3	85	2100			included in the KIT 314 870 300 113		03/10-	S	FRE	--	--	D1	L1	H	60
Nissan Pulsar exc. AdBlue models	09/14-06/18			332 329 600 001			60	22.5	7.4	75	1200			332 314 300 107 332 314 300 113			S	A	--	--	--	--	V	90
		KIT		332 329 900 113			60	25.0	7.4	75	1200			included in the KIT 332 314 300 113			S	A	--	--	D1	L1	V	90

Nissan























Nissan

Nissan Qashqai III J12	04/21-			332 368 600 001		90	20.7	11.5	100	2100	332 369 300 113	04/21-	S	FRE	--	E2	D1	L1	H	45	
				332 369 600 001		90	21.0	11.5	100	2100											
		KIT		332 368 900 113		90	22.7	11.5	100	2100											included in the KIT 332 369 300 113
		KIT		332 369 900 113		90	23.0	11.5	100	2100											included in the KIT 332 369 300 113
Nissan Qashqai, Qashqai +2 exc. AdBlue	02/07-01/14	KIT		332 246 900 113		120	24.0	9.4	100	1800	included in the KIT 332 262 300 113	-01/14	S	A	--	--	D1	L1	V	75	
				332 247 900 113		120	27.0	9.4	100	1800	included in the KIT 332 262 300 113	-01/14	S	A	--	--	D1	L1	V	75	
Nissan Qashqai, Qashqai +2 exc. AdBlue inc. towball	02/07-12/17			332 266 600 001		120	22.6	8.6	70	1400	332 262 300 113	-01/14	S	A	--	--	D1	L1	V	75	
											332 327 300 107	02/14-07/19 for chassis no. up to U2622270	S	FRE	--	E2	--	--	H	60	
											332 327 300 113	02/14-07/19 for chassis no. up to U2622270	S	FRE	--	E2	D	L1	H	60	
Nissan Qashqai, Qashqai +2 exc. AdBlue	02/07-12/17			332 319 600 001		120	22.0	9.4	100	1800	332 262 300 113	-01/14	S	A	--	--	D1	L1	V	75	
											332 327 300 107	02/14-07/19 for chassis no. up to U2622270	S	FRE	--	E2	--	--	H	60	
											332 327 300 113	02/14-07/19 for chassis no. up to U2622270	S	FRE	--	E2	D	L1	H	60	
Nissan Qashqai, Qashqai +2 exc. AdBlue	02/14-12/17	KIT		332 326 900 113		120	24.0	9.4	100	1800	included in the KIT 332 327 300 113	02/14-07/19 for chassis no. up to U2622270	S	FRE	--	E2	D	L1	H	60	
				332 327 900 113		120	27.0	9.4	100	1800	included in the KIT 332 327 300 113	02/14-07/19 for chassis no. up to U2622270	S	FRE	--	E2	D	L1	H	60	
Nissan Qashqai, Qashqai +2 J11	01/18-07/19	KIT		332 360 900 113		75	27.6	10.1	100	1800	included in the KIT 332 327 300 113	02/14-07/19 for chassis no. up to U2622270	S	FRE	--	E2	D	L1	H	60	

Nissan Qashqai, Qashqai +2 J11	01/18-04/21		332 359 600 001		75	24.1	10.1	100	1800	332 327 300 107	02/14-07/19 for chassis no. up to U2622270	S	FRE	--	E2	--	--	H	60	
				332 360 600 001		75	25.2	10.1	100	1800	332 327 300 113	02/14-07/19 for chassis no. up to U2622270	S	FRE	--	E2	D	L1	H	60
Nissan Townstar XFK for vehicles without spare wheel	12/21-		316 492 600 001		90	26.7	9.4	114	1500											
Nissan X-Trail III T32 inc. AdBlue	07/14-09/22		332 323 600 001		90	27.0	10.9	80	2000	332 327 300 107		S	FRE	--	E2	--	--	H	60	
			KIT		332 323 900 113		90	29.0	10.9	80	2000	included in the KIT 332 327 300 113		S	FRE	--	E2	D	L1	H

Nissan





























Peugeot



























Peugeot 2008	06/13-07/19		315 189 600 001			120	18.0	6.7	55	1150		315 185 300 107	-07/19	S	CAN	C	E	--	--	V	60
			315 190 600 001			120	21.0	6.7	55	1150		315 185 300 113	-07/19	S	CAN	C	E	D	L1	V	60
	KIT		315 189 900 113			120	18.0	6.7	55	1150		included in the KIT 315 185 300 113	-07/19	S	CAN	C	E	D	L1	V	60
	KIT		315 190 900 113			120	21.0	6.7	55	1150		included in the KIT 315 185 300 113	-07/19	S	CAN	C	E	D	L1	V	60
Peugeot 2008 II exc. e-2008	08/19-		315 275 600 001			90	22.3	7.8	95	1200											
			315 269 600 001			60	26.0	7.8	95	1200											
Peugeot 206 XS, Gti, CC, RC 99- XR/XT 04/03- 206+ 09- exc. SW	08/98-12/12		315 170 600 001			90	16.0	6.8	50	1200		300 072 300 107		--	FRE	--	--	--	--	V	
												300 072 300 113		--	FRE	--	--	D1	L1	V	
Peugeot 207 inc. 207 cc convertible, inc. 207 RC - 175 HP, inc. 207 van type WG, inc. Sport	04/06-12/15		315 113 600 001			75	16.5	6.7	60	1200		304 402 300 107		S	CAN	C1	E	--	--	V	105
			315 114 600 001			75	17.5	6.7	60	1200		304 402 300 113		S	CAN	C1	E	D	L1	V	105
	KIT		315 113 900 113			75	18.5	6.7	60	1200		included in the KIT 304 402 300 113		S	CAN	C1	E	D	L1	V	105
	KIT		315 114 900 113			75	19.5	6.7	60	1200		included in the KIT 304 402 300 113		S	CAN	C1	E	D	L1	V	105
Peugeot 207 SW / Estate exc. Outdoor exc. RC (double tube exhaust)	06/07-10/13		315 118 600 001			120	17.5	6.4	46	1150		304 402 300 107		S	CAN	C1	E	--	--	V	105
												304 402 300 113		S	CAN	C1	E	D	L1	V	105
		KIT		315 118 900 113		120	19.5	6.4	46	1150		included in the KIT 304 402 300 113		S	CAN	C1	E	D	L1	V	105

Peugeot 208	04/12-05/19		315 184 600 001			60	12.0	7.2	53	1300		315 185 300 107		-05/19	S	CAN	C	E	--	--	V	60	
			315 185 600 001			60	12.0	7.2	53	1300		315 185 300 113		-05/19	S	CAN	C	E	D	L1	V	60	
Peugeot 208 II exc. e-208	06/19-		314 597 600 001			75	25.0	7.2	83	1200													
Peugeot 3008 exc. Hybrid	06/09-09/16		315 157 600 001			90	22.0	9.2	70	1600		315 109 300 113			S	CAN	C	E	D	L1	V	105	
			315 158 600 001			90	24.0	9.2	70	1600													
		KIT		315 157 900 113			90	24.0	9.2	70	1600		included in the KIT 315 109 300 113			S	CAN	C	E	D	L1	V	105
		KIT		315 158 900 113			90	26.0	9.2	70	1600		included in the KIT 315 109 300 113			S	CAN	C	E	D	L1	V	105
Peugeot 3008 inc. GT-Line exc. Hyrid 4	10/16-		315 243 600 001			120	22.0	10.0	80	2000		315 229 300 113		10/16- inc. WLC 2.0	S	CAN	C	E	D	L1	V	75	
			315 244 600 001			120	24.0	10.0	80	2000													
Peugeot 3008 II Hybrid only Plugin-Hybrid	10/19-		314 599 600 001			90	26.7	8.1	95	1270		315 229 300 113		10/19-	S	CAN	C	E	D	L1	V	75	
Peugeot 308 II Hatchback T9 exc. GT, GTI & GT-Line inc. AdBlue	09/13-06/21		304 151 600 001			90	21.0	9.5	75	1750		315 252 300 113		09/17-06/21 inc. WLC 2.0	S	CAN	C	E	D	L1	V	75	
			304 152 600 001			90	24.0	9.5	75	1750													
Peugeot 308 II Hatchback T9 exc. GT, GTI & GT-Line inc. AdBlue	09/17-06/21	KIT		315 252 900 113			90	22.9	9.5	75	1750		included in the KIT 315 252 300 113	09/17-06/21 inc. WLC 2.0	S	CAN	C	E	D	L1	V	75	
Peugeot 308 II Hatchback T9 exc. GT exc. GTI	09/17-06/21	KIT		315 253 900 113			90	27.4	9.5	75	1750		included in the KIT 315 252 300 113	09/17-06/21 inc. WLC 2.0	S	CAN	C	E	D	L1	V	75	

Peugeot

Peugeot









Peugeot 308 III 5 doors F inc. Plug-in Hybrid	07/21-			314 603 600 001		90	21.7	9.2	90	1650		314 602 300 113		07/21- inc. Plug-in Hybrid	S	CAN	C	E	D	L1	H	75
Peugeot 308 III 5 doors inc. Plug-in Hybrid	07/21-	KIT		314 603 900 113		90	24.2	9.2	90	1650		included in the KIT 314 602 300 113		07/21- inc. Plug-in Hybrid	S	CAN	C	E	D	L1	H	75
Peugeot 308 SW exc. GT & GT-Line inc. AdBlue	05/14-02/18			304 151 600 001		90	21.0	9.5	75	1750		315 252 300 113		09/17-02/18 inc. WLC 2.0	S	CAN	C	E	D	L1	V	75
				304 152 600 001		90	24.0	9.5	75	1750												
Peugeot 308 SW exc. GT & GT-Line inc. AdBlue	09/17-02/18	KIT		315 252 900 113		90	22.9	9.5	75	1750		included in the KIT 315 252 300 113		09/17-02/18 inc. WLC 2.0	S	CAN	C	E	D	L1	V	75
Peugeot 308 SW exc. GT	09/17-02/18	KIT		315 253 900 113		90	27.4	9.5	75	1750		included in the KIT 315 252 300 113		09/17-02/18 inc. WLC 2.0	S	CAN	C	E	D	L1	V	75
Peugeot 4007	09/07-12/12			340 094 600 001		90	27.0	10.9	100	2000		340 075 300 113			S	FRE	--	E	D	L	H	75
		KIT		340 094 900 113		90	29.0	10.9	100	2000		included in the KIT 340 075 300 113			S	FRE	--	E	D	L	H	75
Peugeot 4008	03/12-12/15			340 092 600 001		90	22.0	8.5	70	1400		340 093 300 113			S	A	--	--	D	L	H	60
				340 093 600 001		90	24.0	8.5	70	1400												
		KIT		340 092 900 113		90	24.0	8.5	70	1400		included in the KIT 340 093 300 113			S	A	--	--	D	L	H	60
		KIT		340 093 900 113		90	26.0	8.5	70	1400		included in the KIT 340 093 300 113			S	A	--	--	D	L	H	60
Peugeot 407 Estate / SW	05/04-07/08	KIT		315 104 900 113		90	29.0	10.4	75	1900		included in the KIT 304 401 300 113		-07/08 ->OPR11557	S	CAN	C1	E	D	L1	V	105
		KIT		315 105 900 113		90	31.4	10.4	75	1900		included in the KIT 304 401 300 113		-07/08 ->OPR11557	S	CAN	C1	E	D	L1	V	105

Peugeot 407 Estate / SW	05/04-02/11			304 135 600 001		90	25.4	10.4	75	1900		304 401 300 113	-07/08 ->OPR11557	S	CAN	C1	E	D	L1	V	105
Peugeot 407 Saloon	03/04-03/08			304 135 600 001		90	25.4	10.4	75	1900		304 401 300 113	-07/08 ->OPR11557	S	CAN	C1	E	D	L1	V	105
		KIT		315 105 900 113		90	31.4	10.4	75	1900		included in the KIT 304 401 300 113	-07/08 ->OPR11557	S	CAN	C1	E	D	L1	V	105
Peugeot 5008 exc. vehicles with AD-Blue tank	09/09-12/16			315 177 600 001		120	21.0	10.0	75	1550		304 400 300 113	-12/11	S	CAN	C1	E	D	L1	H	105
				315 178 600 001		90	22.5	9.7	80	1700		315 109 300 113	01/12-03/14	S	CAN	C	E	D	L1	V	105
Peugeot 508 II exc. GT & PSE exc. Plugin Hybrid	09/18-			315 261 600 001		60	26.6	9.6	75	1800		315 228 300 113	09/18- without preliminary setup inc. WLC 2.0	S	CAN	C	E	D1	L1	V	75
				315 262 600 001		60	28.1	9.6	75	1800											
Peugeot 508 II without preliminary setup exc. GT & PSE exc. Plugin Hybrid	09/18-	KIT		315 261 900 113		60	28.3	9.6	75	1800		included in the KIT 315 228 300 113	09/18- without preliminary setup inc. WLC 2.0	S	CAN	C	E	D1	L1	V	75
		KIT		315 262 900 113		60	29.9	9.6	75	1800		included in the KIT 315 228 300 113	09/18- without preliminary setup inc. WLC 2.0	S	CAN	C	E	D1	L1	V	75
Peugeot 508 II sw exc. GT & PSE exc. Plugin Hybrid	12/18-			315 261 600 001		60	26.6	9.6	75	1800		315 228 300 113	12/18- without preliminary setup inc. WLC 2.0	S	CAN	C	E	D1	L1	V	75
				315 262 600 001		60	28.1	9.6	75	1800											
		KIT		315 262 900 113		60	29.9	9.6	75	1800		included in the KIT 315 228 300 113	12/18- without preliminary setup inc. WLC 2.0	S	CAN	C	E	D1	L1	V	75
Peugeot 508 II sw without preliminary setup exc. GT & PSE exc. Plugin Hybrid	12/18-	KIT		315 261 900 113		60	28.3	9.6	75	1800		included in the KIT 315 228 300 113	12/18- without preliminary setup inc. WLC 2.0	S	CAN	C	E	D1	L1	V	75















Peugeot







Peugeot

Peugeot 508 Estate exc. GT exc. RXH	03/11-08/18		315 180 600 001		90	20.5	10.2	75	1900											
			315 182 600 001			90	20.5	10.2	75	1900										
Peugeot 508 Saloon exc. GT/twin exhaust models	03/11-08/18		315 175 600 001		90	20.5	10.2	75	1900											
Peugeot 607	11/00-09/10		315 169 600 001	→ 	120	25.0	9.9	80	1800	300 210 300 107		--	A	--	E1	--	--	V	90	
											300 210 300 113		--	A	--	E1	D1	L1	V	90
Peugeot Bipper + Tepee exc. vehicles with gas drive	02/08-07/18		306 349 600 001		150	16.5	7.5	75	1300	306 580 300 107	→	S	FRE	--	E	--	--	V	120	
										306 580 300 113			S	FRE	--	E	D1	L1	V	120
		KIT 	306 349 900 113		150	18.5	7.5	75	1300	included in the KIT 306 580 300 113		S	FRE	--	E	D1	L1	V	120	
Peugeot Bipper + Tepee inc. towball exc. vehicles with gas drive	02/08-07/18		306 351 600 001		150	17.0	7.5	75	1300	306 580 300 107	→	S	FRE	--	E	--	--	V	120	
										306 580 300 113			S	FRE	--	E	D1	L1	V	120
Peugeot Boxer Van inc. towball	02/95-06/06		306 329 600 001	→	60	29.0	12.5	130	2000	306 216 300 113		S	FRE	--	E	D1	L1	V	75	
Peugeot Boxer Van For vehicles with long superstructure L4/XL please order separately a set distance tubes to strengthen the framework, no. 906270650003. Some vehicles 03/08- do not have chassis bores. In this case it is necessary to bore them subsequent. For the mounting time will last 120 min. longer.	06/06-		306 491 600 001		120	32.0	16.9	150	3000	300 210 300 107		--	A	--	E1	--	--	V	90	
										306 510 300 113		S	FRE	--	E	D1	L1	V	105	
										306 553 300 113		S	FRE	--	E	D1	L1	V	105	

Peugeot Boxer Van inc. towball For vehicles with long superstructure L4/XL please order separately a set distance tubes to strengthen the framework, no. 906270650003. Some vehicles 03/08- do not have chassis bores. In this case it is necessary to bore them subsequent. For the mounting time will last 120 min. longer.	06/06-		306 490 600 001		120	32.0	16.9	150	3000	300 210 300 107	-02/11chassis no. 1948840	--	A	--	E1	--	--	V	90	
										306 510 300 113	-02/11 chassis no. 1948840	S	FRE	--	E	D1	L1	V	105	
										306 553 300 113	02/11- from chassis no. 1948841	S	FRE	--	E	D1	L1	V	105	
Peugeot Boxer Van inc. towball Some vehicles 03/08- do not have chassis bores. In this case it is necessary to bore them subsequent. For the mounting time will last 120 min. longer.	06/06-		306 357 600 001		60	29.0	15.8	150	3000	300 210 300 107	-02/11chassis no. 1948840	--	A	--	E1	--	--	V	90	
										306 510 300 113	-02/11 chassis no. 1948840	S	FRE	--	E	D1	L1	V	105	
										306 553 300 113	02/11- from chassis no. 1948841	S	FRE	--	E	D1	L1	V	105	
Peugeot Boxer Van van / minibus For vehicles with long superstructure L4/XL please order separately a set distance tubes to strengthen the framework, no. 906270650003. Some vehicles 03/08- do not have chassis bores. In this case it is necessary to bore them subsequent. For the mounting time will last 120 min. longer.	06/06-02/11	KIT		306 271 900 113		120	34.0	16.9	150	3000	included in the KIT 306 510 300 113	-02/11 chassis no. 1948840	S	FRE	--	E	D1	L1	V	105
Peugeot Boxer Van inc. towball For vehicles with long superstructure L4/XL please order separately a set distance tubes to strengthen the framework, no. 906270650003. Some vehicles 03/08- do not have chassis bores. In this case it is necessary to bore them subsequent. For the mounting time will last 120 min. longer.	06/06-02/11	KIT		306 330 900 113		120	34.0	16.9	150	3000	included in the KIT 306 510 300 113	-02/11 chassis no. 1948840	S	FRE	--	E	D1	L1	V	105



Peugeot















Peugeot Partner Van L1 inc. Rifter inc. towball	09/18-		304 118 600 001			90	17.0	8.4	64	1600		314 594 300 113			S	A	C	E	D	L	V	90	
Peugeot Partner Van L1 inc. Rifter	09/18-		304 207 600 001			60	20.0	8.6	75	1500		314 594 300 113			S	A	C	E	D	L	V	90	
			304 209 600 001			60	20.5	8.6	75	1500					S	A	C	E	D	L	V	90	
		KIT		304 207 900 113			60	21.2	8.6	75	1500		included in the KIT 314 594 300 113			S	A	C	E	D	L	V	90
		KIT		304 209 900 113			60	21.8	8.6	75	1500		included in the KIT 314 594 300 113			S	A	C	E	D	L	V	90
Peugeot Partner Van L2 inc. Rifter	09/18-		304 210 600 001			60	21.0	8.6	75	1500		314 594 300 113			S	A	C	E	D	L	V	90	
			304 212 600 001			60	21.5	8.6	75	1500					S	A	C	E	D	L	V	90	
		KIT		304 212 900 113			60	22.8	8.6	75	1500		included in the KIT 314 594 300 113			S	A	C	E	D	L	V	90
Peugeot Partner Origin	04/08-		304 132 600 001			60	13.0	7.8	70	1350													
Peugeot Partner Origin	04/08-06/18		304 054 600 001			90	14.8	7.8	70	1350													
Peugeot Rifter L1 inc. Partner	09/18-		304 207 600 001			60	20.0	8.6	75	1500		314 594 300 113	inc. WLC 2.0		S	A	C	E	D	L	V	90	
			304 209 600 001			60	20.5	8.6	75	1500					S	A	C	E	D	L	V	90	
		KIT		304 207 900 113			60	21.2	8.6	75	1500		included in the KIT 314 594 300 113	inc. WLC 2.0		S	A	C	E	D	L	V	90

Peugeot Rifter L2 inc. Partner	09/18-		304 210 600 001			60	21.0	8.6	75	1500		314 594 300 113	inc. WLC 2.0	S	A	C	E	D	L	V	90	
			304 212 600 001			60	21.5	8.6	75	1500												
	KIT		304 210 900 113			60	22.2	8.6	75	1500		included in the KIT 314 594 300 113	inc. WLC 2.0	S	A	C	E	D	L	V	90	
	KIT		304 212 900 113			60	22.8	8.6	75	1500		included in the KIT 314 594 300 113	inc. WLC 2.0	S	A	C	E	D	L	V	90	
Peugeot Rifter L1 inc. Partner	09/18-		304 118 600 001			90	17.0	8.4	64	1600		314 594 300 113	inc. WLC 2.0	S	A	C	E	D	L	V	90	
Peugeot Rifter L1 inc. Partner	09/18	KIT		304 209 900 113			60	21.8	8.6	75	1500		included in the KIT 314 594 300 113	inc. WLC 2.0	S	A	C	E	D	L	V	90

















Peugeot

























Polestar

Polestar 2 P	04/19-			320 187 600 001			60	27.3	9.3	90	1500															
-----------------	--------	--	---	-----------------	--	---	----	------	-----	----	------	--	--	--	--	--	--	--	--	--	--	--	--	--	--	--



















Porsche Cayenne Please order separately cover for bumper cutout at Porsche dealer' s. exc. vehicles with spare wheel on the tailgate	12/02-04/10	KIT		321 500 900 113	→ 	150	36.0	16.4	140	3500		included in the KIT 321 500 300 113	→	-04/10	S	CAN	--	E	D	L1	H	45
Porsche Cayenne	12/02-10/17			321 735 600 001		150	33.5	16.4	140	3500		321 500 300 113	→	-04/10	S	CAN	--	E	D	L1	H	45
												321 765 300 113		04/10-10/17 excl. cars with ACC / distance control	S	CAN	C	E	D	L1	V	180
Porsche Cayenne models 12/02-04/10: Please order separately cover for bumper cutout at Porsche dealer' s. exc. vehicles with spare wheel on the tailgate	12/02-10/17			321 736 600 001		150	34.0	16.4	140	3500		321 500 300 113	→	-04/10	S	CAN	--	E	D	L1	H	45
												321 765 300 113		04/10-10/17 excl. cars with ACC / distance control	S	CAN	C	E	D	L1	V	180
Porsche Cayenne	04/10-10/17	KIT		321 736 900 113		150	36.0	16.4	140	3500		included in the KIT 321 765 300 113		04/10-10/17 excl. cars with ACC / distance control	S	CAN	C	E	D	L1	V	180
Porsche Cayenne (9YA)	11/17-			322 064 600 001		60	27.0	15.7	191	3500												
Porsche Macan	04/14-			327 068 600 001		90	21.0	12.1	100	2400		327 068 300 113			S	CAN	C	E	D	L1	H	30
		KIT		327 068 900 113		90	23.0	12.1	100	2400		included in the KIT 327 068 300 113			S	CAN	C	E	D	L1	H	30









Renault

Renault Alaskan inc. towball	09/17-	KIT		332 337 900 113		30	32.0	17.2	190	3500		included in the KIT 332 354 300 113		S	FRE	--	E2	D1	L1	H	90	
Renault Arkana LCM	03/21-			316 494 600 001		60	19.8	8.8	108	1500												
Renault Captur I	05/13-19			316 354 600 001		90	14.0	7.1	75	1200		316 337 300 113	S	A	--	E2	D1	L1	H	90		
				316 355 600 001		90	16.0	7.1	75	1200			S	A	--	E2	D1	L1	H	90		
		KIT		316 354 900 113		90	16.0	7.1	75	1200		included in the KIT 316 337 300 113	S	A	--	E2	D1	L1	H	90		
		KIT		316 355 900 113		90	18.0	7.1	75	1200		included in the KIT 316 337 300 113	S	A	--	E2	D1	L1	H	90		
Renault Captur II inc. AdBlue inc. Plugin Hybrid Renault holders 82 04 269 02R and 85 04 282 73R are required for vehicles with plastic impact absorbers.	01/20-			316 486 600 001		60	24.0	9.1	106	1500												
Renault Captur II inc. AdBlue inc. Plugin Hybrid	01/20-			316 487 600 001		60	24.9	9.1	106	1500												
Renault Clio II Phase I + II, exc. Phase IV, exc. Clio Sport V6	09/98-10/05			316 187 600 001		90	14.5	6.2	75	1200	300 072 300 113	-05/01 (Phase I)	--	FRE	--	--	D1	L1	V			















Renault Clio III BR Phase I + II exc. Clio Sport 197/201 HP exc. RS-Cup exc. GT	10/05-11/12			316 354 600 001		90	14.0	7.1	75	1200		316 252 300 113		-11/12	S	FRE	--	--	D1	L1	H	45	
				316 355 600 001		90	16.0	7.1	75	1200													
		KIT		316 251 900 113		60	15.0	7.1	75	1200		included in the KIT 316 252 300 113		-11/12	S	FRE	--	--	D1	L1	H	45	
		KIT		316 252 900 113		90	17.0	7.1	75	1200		included in the KIT 316 252 300 113		-11/12	S	FRE	--	--	D1	L1	H	45	
Renault Clio IV Hatchback BH exc. GT exc. Initiale	11/12-06/19			316 354 600 001		90	14.0	7.1	75	1200		316 337 300 113		-06/19	S	A	--	E2	D1	L1	H	90	
				316 355 600 001		90	16.0	7.1	75	1200													
		KIT		316 354 900 113		90	16.0	7.1	75	1200		included in the KIT 316 337 300 113		-06/19	S	A	--	E2	D1	L1	H	90	
		KIT		316 355 900 113		90	18.0	7.1	75	1200		included in the KIT 316 337 300 113		-06/19	S	A	--	E2	D1	L1	H	90	
Renault Clio IV Grandtour	03/13-12/20			316 336 600 001		60	15.0	7.1	75	1200		316 337 300 113			S	A	--	E2	D1	L1	H	90	
				316 337 600 001		60	18.0	7.1	75	1200													
		KIT		316 336 900 113		60	17.0	7.1	75	1200		included in the KIT 316 337 300 113			S	A	--	E2	D1	L1	H	90	
		KIT		316 337 900 113		60	20.0	7.1	75	1200		included in the KIT 316 337 300 113			S	A	--	E2	D1	L1	H	90	
Renault Clio V (BF) exc. AdBlue	06/19-			316 481 600 001		75	22.9	6.1	74	900													
				316 482 600 001		75	24.2	6.1	74	900													















Renault

Renault Espace short wheelbase	09/02-05/15			316 195 600 001			55	31.0	11.3	80	2000		300 078 300 113			--	FRE	--	--	D1	L1	V		
Renault Espace exc. AdBlue	06/15-			316 387 600 001			120	25.0	11.0	80	2000		316 403 300 113	06/15-10/19		S	FRE	--	E2	D1	L1	H	90	
Renault Espace exc. AdBlue	06/15-10/19	KIT		316 387 900 113			120	29.0	11.0	80	2000		included in the KIT 316 403 300 113	06/15-10/19		S	FRE	--	E2	D1	L1	H	90	
Renault Express	05/21-			316 333 600 001			60	19.5	7.3	75	1200													
				316 334 600 001			60	19.5	7.3	75	1200													
Renault Fluence	03/10-			316 308 600 001			120	22.5	7.5	75	1300		300 210 300 107 300 210 300 113			--	A	--	E1	--	--	V	90	
																--	A	--	E1	D1	L1	V	90	
Renault Grand Kangoo 7 seats exc. AdBlue	02/08-04/21			316 268 600 001			60	23.0	8.2	75	1350		316 353 300 113	05/13-		S	FRE	--		D1	L1	H	60	
				316 269 600 001			60	23.0	8.2	75	1350		316 440 300 113	-04/13 exc. vehicles with start-/stop automatic		S	FRE	--	E2	D1	L1	H	45	
Renault Grand Kangoo 7 seats exc. AdBlue	05/13-04/21	KIT		316 352 900 113			60	25.0	8.2	75	1350		included in the KIT 316 353 300 113	05/13-		S	FRE	--		D1	L1	H	60	
		KIT		316 353 900 113			60	25.0	8.2	75	1350		included in the KIT 316 353 300 113	05/13-		S	FRE	--		D1	L1	H	60	
Renault Grand Modus F exc. vehicles with rear end carrier system Velofix	01/08-12/12			316 354 600 001			90	14.0	7.1	75	1200						--	A	--	E1	D1	L1	V	90
				316 355 600 001			90	16.0	7.1	75	1200		300 210 300 113				--	A	--	E1	D1	L1	V	90
Renault Grand Scenic	04/09-08/16			316 297 600 001			90	21.4	8.2	75	1300		316 297 300 113			S	A	--	--	D1	L1	H	60	
		KIT		316 297 900 113			90	23.4	8.2	75	1300		included in the KIT 316 297 300 113			S	A	--	--	D1	L1	H	60	

Renault Grand Scenic	12/16-			316 431 600 001			25.3	10.2	75	1850		316 368 300 107			S	FRE	--	E	--	--	H	90	
												316 368 300 113			S	FRE	--	E	D1	L1	H	90	
Renault Kadjar	06/15-12/18			316 390 600 001			120	21.0	9.8	80	1800												
				316 391 600 001			120	22.0	9.8	80	1800												
Renault Kadjar	01/19-			316 471 600 001			60	26.8	9.6	117	1800												
				316 472 600 001			60	28.8	9.6	117	1800												
Renault Kangoo exc. Kangoo-Rapid-Maxi Campus without limitation of year of construction	05/97-02/08			316 201 600 001			60	12.0	7.6	75	1320	300 061 300 113		-06/02	--	C2	--	--	--	--	V		
Renault Kangoo RX4, 4x4/Pampa/Freeworld exc. Kangoo Rapid	06/01-02/08			316 205 600 001			60	12.0	7.6	75	1320	300 061 300 113		-06/02	--	C2	--	--	--	V			
Renault Kangoo + Kangoo Rapid exc. BeBop, Intense, Grand Intense, Generation, TomTom exc. AdBlue	02/08-04/21			316 268 600 001			60	23.0	8.2	75	1350	316 353 300 113		05/13-	S	FRE	--		D1	L1	H	60	
				316 269 600 001			60	23.0	8.2	75	1350	316 440 300 113		-04/13 exc. vehicles with start-/stop automatic	S	FRE	--	E2	D1	L1	H	45	
Renault Kangoo + Kangoo Rapid exc. BeBop, Intense, Grand Intense, Generation, TomTom exc. AdBlue	05/13-04/21	KIT		316 352 900 113			60	25.0	8.2	75	1350	included in the KIT 316 353 300 113		05/13-	S	FRE	--		D1	L1	H	60	
		KIT		316 353 900 113			60	25.0	8.2	75	1350	included in the KIT 316 353 300 113		05/13-	S	FRE	--		D1	L1	H	60	
Renault Kangoo III exc. vehicles with towbar preparation exc. vehicles with spare wheel	07/21-			316 492 600 001			90	26.7	9.4	114	1500												





















Renault



Renault Koleos inc. Phase I + II 09/11-	09/08-12/15		316 226 600 001			40	21.7	10.5	100	2000	316 410 300 113					S	FRE	--	--	D1	L1	H	60
			316 227 600 001			40	23.8	10.5	100	2000													
Renault Koleos II From facelift 2019, the AdBlue tank must be dismantled.	04/17-		316 454 600 001			75	27.7	10.8	80	2000													
Renault Laguna III Hatchback exc. GT 4 control	09/07-12/15		316 262 600 001					60	22.0	8.8	75	1500	300 210 300 107	-12/15	--	A	--	E1	--	--	V	90	
													300 210 300 113	-12/15	--	A	--	E1	D1	L1	V	90	
Renault Master Van X62B front wheel drive inc. towball	03/10-		316 318 600 001			60	19.3	14.3	100	2500	316 300 300 107	for vehicles without central plug connection	S	FRE	--	E2	--	--	H	45			
											316 300 300 113	for vehicles without central plug connection	S	FRE	--	E2	D1	L1	H	45			
											316 318 300 113	for vehicles with central plug connection	S	FRE	--	E2	D1	L1	H	15			
Renault Master Van X62B front wheel drive inc. towball for vehicles without central plug connection	03/10-	KIT		316 318 900 113		60	21.0	14.3	100	2500	included in the KIT 316 300 300 113	for vehicles without central plug connection	S	FRE	--	E2	D1	L1	H	45			
Renault Master Chassis Cab front + rear wheel drive inc. towball not for vehicles with double tires	07/10-			316 347 600 001		60	16.5	13.7	85	2300	316 319 300 113			S	FRE	--	E1	D1	--	H	15		
Renault Mégane Hatchback 3 / 5 doors exc. GT	11/02-11/08			316 352 600 001		120	18.0	8.7	75	1500	300 072 300 107		--	FRE	--	--	--	--	V				
				316 363 600 001		120	21.0	8.7	75	1500	300 072 300 113	--	FRE	--	--	D1	L1	V					
Renault Mégane Grandtourer exc. GT	06/09-03/16			316 289 600 001		90	20.5	7.7	75	1300	316 290 300 107				S	A	--	--	--	--	V	60	
									316 290 300 113	S	A												--
			KIT		316 289 900 113		90	22.5	7.7	75	1300	included in the KIT 316 290 300 113	S	A	--	--	D1	L1	V	60			

Renault Mégane III 5 doors exc. GT exc. Generation	11/08-01/16			316 352 600 001			120	18.0	8.7	75	1500		300 210 300 107			--	A	--	E1	--	--	V	90	
				316 363 600 001			120	21.0	8.7	75	1500		300 210 300 113			--	A	--	E1	D1	L1	V	90	
Renault Mégane III Coupé exc. Sport 250 HP exc. GT-Line exc. Generation	01/09-08/15			316 352 600 001			120	18.0	8.7	75	1500		300 210 300 107			--	A	--	E1	--	--	V	90	
				316 363 600 001			120	21.0	8.7	75	1500		300 210 300 113			--	A	--	E1	D1	L1	V	90	
Renault Mégane IV Hatchback exc. GT + GT line	09/16--04/20	KIT		316 358 900 113			75	24.2	10.0	75	1900		included in the KIT 316 359 300 113		-04/20	S	FRE	--	E2	D1	L1	V	90	
				316 359 900 113			75	25.2	10.0	75	1900		included in the KIT 316 359 300 113		-04/20	S	FRE	--	E2	D1	L1	V	90	
Renault Mégane cc Convertible	04/10-08/15			316 320 600 001			120	22.1	6.1	75	750		300 210 300 107			--	A	--	E1	--	--	V	90	
				316 320 600 001									300 210 300 113			--	A	--	E1	D1	L1	V	90	
Renault Modus II exc. vehicles with rear end carrier system Velofix	01/08-12/12			316 283 600 001			60	18.0	5.8	75	900		300 210 300 107			--	A	--	E1	--	--	V	90	
				316 283 600 001									300 210 300 113			--	A	--	E1	D1	L1	V	90	
Renault Scenic exc. Grand Scenic, exc. Conquest	07/03-06/09			316 352 600 001			120	18.0	8.7	75	1500		316 207 300 113			S	FRE	--	E2	D1		H	45	
				316 363 600 001			120	21.0	8.7	75	1500													
			KIT		316 206 900 113			90	21.0	8.1	75	1350		included in the KIT 316 207 300 113			S	FRE	--	E2	D1		H	45
			KIT		316 207 900 113			90	22.0	8.1	75	1350		included in the KIT 316 207 300 113			S	FRE	--	E2	D1		H	45



















Renault





















Renault

Renault Scenic inc. Scenic Xmod	06/09-08/16			316 352 600 001			120	18.0	8.7	75	1500		316 294 300 107	→	-08/16	S	A	--	--	--	--	H	60
				316 363 600 001			120	21.0	8.7	75	1500		316 294 300 113		-08/16	S	A	--	--	D1	L1	H	60
		KIT		316 292 900 113			90	20.3	7.9	75	1300		included in the KIT 316 294 300 113		-08/16	S	A	--	--	D1	L1	H	60
		KIT		316 294 900 113			90	24.4	7.9	75	1300		included in the KIT 316 294 300 113		-08/16	S	A	--	--	D1	L1	H	60
Renault Talisman Grandtour exc. vehicles with tailgate that opens by sensor (foot sensor)	04/16-			316 406 600 001	→		75	21.3	10.1	75	1850												
				316 407 600 001			75	24.2	10.1	75	1850												
Renault Talisman Saloon exc. vehicles with tailgate that opens by sensor (foot sensor)	04/16-			316 406 600 001	→		75	21.3	10.1	75	1850												
				316 407 600 001			75	24.2	10.1	75	1850												
Renault Traffic Van inc. towball	05/01-09/14			314 364 600 001			60	21.0	12.3	85	2100		314 860 300 113		08/06-03/10	S	FRE	--	--	D1	L1	H	60
													314 870 300 113		03/10-	S	FRE	--	--	D1	L1	H	60
Renault Traffic Van inc. towball	08/06-03/10	KIT		314 364 900 113			60	23.0	12.3	85	2100		included in the KIT 314 860 300 113		08/06-03/10	S	FRE	--	--	D1	L1	H	60
Renault Traffic Van inc. towball	03/10-09/14	KIT		314 870 900 113			60	23.0	12.3	85	2100		included in the KIT 314 870 300 113		03/10-	S	FRE	--	--	D1	L1	H	60
Renault Traffic Van	10/14-			316 312 600 001			60	25.0	12.1	80	2000		316 312 300 113			S	FRE	--	E2	D1	L1	H	90
Renault Traffic Van inc. towball	10/14-			316 408 600 001			60	25.0	12.1	80	2000		316 312 300 113			S	FRE	--	E2	D1	L1	H	90
			KIT		316 311 900 113			60	26.3	12.1	80	2000		included in the KIT 316 312 300 113			S	FRE	--	E2	D1	L1	H

Renault Twingo exc. model "Sport" inc. Gordini R.S. (a visible cutout is necessary)	06/07-14		316 326 600 001			60	17.0	4.2	65	500	300 210 300 107			--	A	--	E1	--	--	V	90
											300 210 300 113			--	A	--	E1	D1	L1	V	90









Seat









Seat Alhambra thermal-insulation plate inc. inc. 4WD bumper bracket is not necessary	05/00-09/10		321 665 600 001		90	24.0	12.5	100	2500	321 458 300 107	→	S	FRE	--	E	--	--	H	60									
										321 458 300 113										S	FRE	--	E	D1	L1	H	60	
Seat Alhambra	10/10-		321 698 600 001			22.0	12.3	100	2500	321 600 300 153		S	CAN	C	E	D	L1	V	105									
Seat Alhambra Please order separately Spoiler and cover for bumper cutout at Seat dealer's.	10/10-		321 700 600 001			22.0	12.3	100	2500	321 600 300 153		S	CAN	C	E	D	L1	V	105									
Seat Alhambra Please order separately Spoiler and cover for bumper cutout at Seat dealer's.	10/10-	KIT		321 700 900 153		24.0	12.3	100	2500	included in the KIT 321 600 300 153		S	CAN	C	E	D	L1	V	105									
Seat Altea exc. FR	06/04-12/15		344 043 600 001		60	18.0	9.3	100	1650	344 044 300 153		S	CAN	C	E	D	L1	V	90									
Seat Altea inc. FR Please order separately cover for bumper cutout at Seat dealer' s, no. 5P0 803 595.	06/04-12/15		344 044 600 001		60	18.0	9.3	100	1650	344 044 300 153		S	CAN	C	E	D	L1	V	90									
Seat Altea XL + Freetrack	10/06-12/15		344 043 600 001		60	18.0	9.3	100	1650	344 044 300 153		S	CAN	C	E	D	L1	V	90									
Seat Altea XL + Freetrack fitting cover for bumper cutout not available	10/06-12/15		344 048 600 001		60	17.5	9.3	100	1650	344 044 300 153		S	CAN	C	E	D	L1	V	90									
Seat Arona FR: visible cutout exc. TGI	11/17-08/21		344 110 600 001		70	20.4	7.1	55	1200																			
			344 111 600 001		70	21.6	7.1	55	1200																			
Seat Ateca KH7 inc. FR	09/16-		344 124 600 001		60	17.7	12.3	150	2500	305 407 300 113	with preliminary setup	S	CAN	C	E	D	L	H	30									
										305 408 300 107										without preliminary setup	S	CAN	C	E	--	--	V	60
										305 408 300 113										without preliminary setup	S	CAN	C	E	D	L	V	60

Seat Ateca KH7 inc. FR	09/16-		344 121 600 001		60	14.0	12.3	150	2500		305 407 300 113	with preliminary setup	S	CAN	C	E	D	L	H	30
											305 408 300 107	without preliminary setup	S	CAN	C	E	--	--	V	60
											305 408 300 113	without preliminary setup	S	CAN	C	E	D	L	V	60
Seat Ateca KH7 with preliminary setup inc. FR	09/16-	KIT 	344 071 900 113		60	15.5	12.3	150	2500		included in the KIT 305 407 300 113	with preliminary setup	S	CAN	C	E	D	L	H	30
											KIT 	344 072 900 113		60	19.2	12.3	150	2500	included in the KIT 305 407 300 113	with preliminary setup
Seat Exeo Saloon and ST/ Estate	03/09-12/13		344 074 600 001		120	20.0	10.6	100	2000		300 210 300 107		--	A	--	E1	--	--	V	90
Seat Ibiza ST Estate / 3/5 doors	07/08-06/17		344 059 600 001		90	17.5	8.3	75	1400											
Seat Ibiza ST Estate / 3/5 doors Please order separately cover for bumper cutout at Seat dealer's.	07/08-06/17		344 079 600 001		90	22.0	7.7	75	1400											
Seat Ibiza V (KJ1) exc. TGI	02/17-		344 122 600 001		60	17.0	7.5	91	1270											
Seat Ibiza V (KJ1) exc. TGI	02/17-		344 123 600 001		60	18.0	7.5	91	1270											
Seat Leon	99-06		305 223 600 001		120	16.8	8.9	75	1650											
Seat Leon inc. FR exc. FRV Formula Race, Cupra Please order separately cover for bumper cutout at Seat dealer' s, no. -05/09: 5P0 803 595, 05/09-: 1P0 092 595.	09/05-10/12	KIT 	344 044 900 153		60	20.0	9.3	100	1650		included in the KIT 321 600 300 153		S	CAN	C	E	D	L1	V	105
Seat Leon exc. FR + FRV Formula Race, exc. Cupra	09/05-12/12		344 043 600 001		60	18.0	9.3	100	1650		321 600 300 153		S	CAN	C	E	D	L1	V	105























Seat

Seat

Seat Leon inc. FR exc. FRV Formula Race, Cupra Please order separately cover for bumper cutout at Seat dealer's, no. -05/09: 5P0 803 595, 05/09-: 1P0 092 595.	09/05-12/12			344 044 600 001		60	18.0	9.3	100	1650		321 600 300 153			S	CAN	C	E	D	L1	V	105
Seat Leon III (5F) without preliminary setup 5 doors Seat Leon SC, 3 doors Seat Leon ST, Combi inc. FR exc. Cupra	11/12-06/14	KIT		317 131 900 113		60	21.0	10.3	85	2000		included in the KIT 305 406 300 113		-06/14 without preliminary setup	S	CAN	C	E	D	L1	V	150
Seat Leon III (5F) without preliminary setup 5 doors Seat Leon SC, 3 doors Seat Leon ST, Combi inc. FR exc. Cupra Please order separately cover for bumper cutout at Seat dealer's.	11/12-06/14	KIT		317 132 900 113		60	21.0	10.3	85	2000		included in the KIT 305 406 300 113		-06/14 without preliminary setup	S	CAN	C	E	D	L1	V	150
Seat Leon III (5F) 5 doors Seat Leon SC, 3 doors Seat Leon ST, Combi inc. X-Perience 06/14- inc. FR exc. Cupra	11/12-04/20			317 131 600 001		60	19.0	10.3	85	2000		305 403 300 107 → 305 403 300 113 305 406 300 113 305 407 300 113 305 408 300 107 305 408 300 113	-06/14 with preliminary setup -06/14 with preliminary setup -06/14 without preliminary setup 06/14-04/20 with preliminary setup 06/14-04/20 without preliminary setup 06/14-04/20 without preliminary setup	S	CAN	C	E	--	--	H	45	
														S	CAN	C	E	D	L1	H	45	
														S	CAN	C	E	D	L1	V	150	
														S	CAN	C	E	D	L	H	30	
														S	CAN	C	E	--	--	V	60	
														S	CAN	C	E	D	L	V	60	



















Seat Leon III (5F) 5 doors Seat Leon SC, 3 doors Seat Leon ST, Combi inc. X-Perience 06/14- inc. FR exc. Cupra Please order separately cover for bumper cutout at Seat dealer's.	11/12-04/20		317 132 600 001		60	19.0	10.3	85	2000		305 403 300 107 →	-06/14 with preliminary setup	S	CAN	C	E	--	--	H	45	
											305 403 300 113	-06/14 with preliminary setup	S	CAN	C	E	D	L1	H	45	
											305 406 300 113	-06/14 without preliminary setup	S	CAN	C	E	D	L1	V	150	
											305 407 300 113	06/14-04/20 with preliminary setup	S	CAN	C	E	D	L	H	30	
											305 408 300 107	06/14-04/20 without preliminary setup	S	CAN	C	E	--	--	V	60	
											305 408 300 113	06/14-04/20 without preliminary setup	S	CAN	C	E	D	L	V	60	
Seat Leon III (5F) with preliminary setup 5 doors Seat Leon SC, 3 doors Seat Leon ST, Combi inc. X-Perience inc. FR exc. Cupra	06/14-04/20	KIT		317 154 900 113		60	20.5	10.3	85	2000		included in the KIT 305 407 300 113	06/14-04/20 with preliminary setup	S	CAN	C	E	D	L	H	30
Seat Leon III (5F) with preliminary setup 5 doors Seat Leon SC, 3 doors Seat Leon ST, Combi inc. X-Perience inc. FR exc. Cupra Please order separately cover for bumper cutout at Seat dealer's.	06/14-04/20	KIT		317 155 900 113		60	20.5	10.3	85	2000		included in the KIT 305 407 300 113	06/14-04/20 with preliminary setup	S	CAN	C	E	D	L	H	30
Seat Leon III (5F) without preliminary setup 5 doors Seat Leon SC, 3 doors Seat Leon ST, Combi inc. X-Perience inc. FR exc. Cupra	06/14-04/20	KIT		305 408 900 113		60	19.0	10.3	85	2000		included in the KIT 305 408 300 113	without preliminary setup	S	CAN	C	E	D	L	V	60

























Seat

Skoda Enyaq IV 5AC	10/20-			317 184 600 001		60	18.2	9.1	100	1400													
Skoda Fabia I Estate/Saloon exc. GT, inc. Praktik -07	11/00-12/07			317 059 600 001		60	16.5	7.0	50	1200													
Skoda Fabia II Estate exc. RS	01/08-05/10	KIT		317 085 900 113		40	16.5	7.2	86	1200	included in the KIT 317 400 300 113	-05/10	S	C2	C	E	D1	--	H	45			
Skoda Fabia II Estate exc. RS Please order cover for bumper cutout at Skoda dealers.	01/08-05/10	KIT		317 086 900 113		40	16.5	7.2	86	1200	included in the KIT 317 400 300 113	-05/10	S	C2	C	E	D1	--	H	45			
Skoda Fabia II Estate exc. RS Please order cover for bumper cutout at Skoda dealers.	01/08-12/14			317 114 600 001		40	15.0	7.2	86	1200	317 400 300 107	-05/10	S	C2	C	E	--	--	H	45			
											317 400 300 113	-05/10	S	C2	C	E	D1	--	H	45			
Skoda Fabia II Hatchback exc. RS + Monte Carlo	06/07-05/10	KIT		317 085 900 113		40	16.5	7.2	86	1200	included in the KIT 317 400 300 113	-05/10	S	C2	C	E	D1	--	H	45			
Skoda Fabia II Hatchback exc. RS + Monte Carlo Please order cover for bumper cutout at Skoda dealers.	06/07-05/10	KIT		317 086 900 113		40	16.5	7.2	86	1200	included in the KIT 317 400 300 113	-05/10	S	C2	C	E	D1	--	H	45			
Skoda Fabia II Hatchback exc. RS + Monte Carlo Please order cover for bumper cutout at Skoda dealers.	06/07-10/14			317 114 600 001		40	15.0	7.2	86	1200	317 400 300 107	-05/10	S	C2	C	E	--	--	H	45			
											317 400 300 113	-05/10	S	C2	C	E	D1	--	H	45			
Skoda Fabia III Estate inc. facelift 2019- Attention: tube and socket holder are visible	01/15-09/21			317 114 600 001		40	15.0	7.2	86	1200	317 114 300 143	01/15-09/21	S	CAN	C	E	D1	L1	V				
Skoda Fabia III Hatchback (542) inc. facelift 2019- Attention: tube and socket holder are visible	11/14-05/21			317 114 600 001		40	15.0	7.2	86	1200	317 114 300 143	11/14-05/21	S	CAN	C	E	D1	L1	V				
Skoda Fabia IV Hatchback PJ3	06/21-			317 173 600 001		60	16.0	6.6	80	1100													
				317 174 600 001		60	18.3	6.6	80	1100													

Skoda











Skoda





















Skoda Kamiq exc. TGI	07/19-		317 171 600 001		60	19.3	7.7	89	2100													
				317 172 600 001		60	21.4	11.2	130	2100												
Skoda Karoq KU7	11/17-		344 124 600 001		60	17.7	12.3	150	2500		305 407 300 113	with preliminary setup	S	CAN	C	E	D	L	H	30		
												305 408 300 107	without preliminary setup	S	CAN	C	E	--	--	V	60	
													305 408 300 113	without preliminary setup	S	CAN	C	E	D	L	V	60
Skoda Karoq KU7	11/17-		344 121 600 001		60	14.0	12.3	150	2500		305 407 300 113	with preliminary setup	S	CAN	C	E	D	L	H	30		
												305 408 300 107	without preliminary setup	S	CAN	C	E	--	--	V	60	
													305 408 300 113	without preliminary setup	S	CAN	C	E	D	L	V	60
Skoda Karoq KU7 with preliminary setup	11/17-	KIT 	344 071 900 113		60	15.5	12.3	150	2500		included in the KIT 305 407 300 113	with preliminary setup	S	CAN	C	E	D	L	H	30		
				344 072 900 113		60	19.2	12.3	150	2500		included in the KIT 305 407 300 113	with preliminary setup	S	CAN	C	E	D	L	H	30	
Skoda Kodiah NS7 150 BHP Diesel Manual 4x4 7 seats is not permitted to tow by manufacturer. inc. facelift 2021-	10/16-		344 121 600 001		60	14.0	12.3	150	2500		305 408 300 107	without preliminary setup	S	CAN	C	E	--	--	V	60		
												305 408 300 113	without preliminary setup	S	CAN	C	E	D	L	V	60	
Skoda Kodiah NS7 with preliminary setup 150 BHP Diesel Manual 4x4 7 seats is not permitted to tow by manufacturer. inc. facelift 2021-	10/16-	KIT 	344 071 900 113		60	15.5	12.3	150	2500		included in the KIT 305 407 300 113	with preliminary setup	S	CAN	C	E	D	L	H	30		
Skoda Kodiah NS7 150 BHP Diesel Manual 4x4 7 seats is not permitted to tow by manufacturer. inc. facelift 2021-	10/16-		344 120 600 001		60	16.6	12.3	150	2500		305 408 300 107	without preliminary setup	S	CAN	C	E	--	--	V	60		
												305 408 300 113	without preliminary setup	S	CAN	C	E	D	L	V	60	

Skoda Kodiaq NS7 without preliminary setup 150 BHP Diesel Manual 4x4 7 seats is not permitted to tow by manufacturer. inc. facelift 2021-	10/16-	KIT		322 096 900 113		90	31.5	12.3	150	2500		included in the KIT 322 096 300 153			S								
Skoda Octavia I Saloon/Estate type 1U exc. 4 WD, inc. RS Note: For towing capacities of 1400 kg and more please check the operating instructions of your car.	12/96-01/05			317 015 600 001		90	15.0	8.4	60	1500		317 015 300 113			S	FRE	--	E	D1	L1	H	45	
				305 223 600 001		120	16.8	8.9	75	1650													
		KIT		317 015 900 113		90	17.0	8.4	60	1500			included in the KIT 317 015 300 113			S	FRE	--	E	D1	L1	H	45
		KIT		317 016 900 113		90	18.2	8.4	60	1500			included in the KIT 317 015 300 113			S	FRE	--	E	D1	L1	H	45
Skoda Octavia II Estate 1Z / 3T inc. 4 x 4, RS and Scout Facelift 11/08-: cutout is not necessary	01/05-01/13	KIT		317 102 900 153		40	21.0	10.6	100	2000		included in the KIT 321 600 300 153			S	CAN	C	E	D	L1	V	105	
Skoda Octavia II Estate 1Z / 3T inc. 4 x 4, RS and Scout Facelift 11/08-: cutout is not necessary	01/05-12/13			317 104 600 001		40	18.0	10.6	100	2000		321 600 300 153			S	CAN	C	E	D	L1	V	105	
				317 102 600 001		40	19.0	10.6	100	2000													
Skoda Octavia II Saloon 1Z / 3T inc. 4 x 4, RS and Scout Facelift 11/08-: cutout is not necessary	01/05-01/13	KIT		317 102 900 153		40	21.0	10.6	100	2000		included in the KIT 321 600 300 153			S	CAN	C	E	D	L1	V	105	
Skoda Octavia II Saloon 1Z / 3T inc. 4 x 4, RS and Scout Facelift 11/08-: cutout is not necessary	01/05-12/13			317 104 600 001		40	18.0	10.6	100	2000		321 600 300 153			S	CAN	C	E	D	L1	V	105	
				317 102 600 001		40	19.0	10.6	100	2000													
Skoda Octavia III (5E) without preliminary setup Saloon and Estate inc. RS and Scout inc. vehicles with gas drive	02/13-06/14	KIT		317 132 900 113		60	21.0	10.3	85	2000		included in the KIT 305 406 300 113		-06/14 without preliminary setup	S	CAN	C	E	D	L1	V	150	























Skoda





















Skoda

Skoda Octavia III (5E) Saloon and Estate without preliminary setup inc. RS and Scout inc. vehicles with gas drive	02/13-06/14	KIT		317 131 900 113		60	21.0	10.3	85	2000		included in the KIT 305 406 300 113	-06/14 without preliminary setup	S	CAN	C	E	D	L1	V	150	
Skoda Octavia III (5E) Saloon and Estate inc. RS and Scout inc. vehicles with gas drive	02/13-01/20			317 131 600 001		60	19.0	10.3	85	2000		305 403 300 107	→ -06/14 with preliminary setup	S	CAN	C	E	--	--	H	45	
				317 132 600 001		60	19.0	10.3	85	2000		305 403 300 113	-06/14 with preliminary setup	S	CAN	C	E	D	L1	H	45	
													305 406 300 113	-06/14 without preliminary setup	S	CAN	C	E	D	L1	V	150
													305 407 300 113	06/14-01/20 with preliminary setup	S	CAN	C	E	D	L	H	30
													305 408 300 107	06/14-01/20 without preliminary setup	S	CAN	C	E	--	--	V	60
Skoda Octavia III (5E) without preliminary setup Saloon and Estate inc. RS and Scout inc. vehicles with gas drive	06/14-01/20	KIT		305 408 900 113		60	19.0	10.3	85	2000		included in the KIT 305 408 300 113	06/14-01/20 without preliminary setup	S	CAN	C	E	D	L	V	60	
														included in the KIT 305 408 300 113	06/14-01/20 without preliminary setup	S	CAN	C	E	D	L	V
Skoda Octavia III (5E) with preliminary setup Saloon and Estate inc. RS and Scout inc. vehicles with gas drive	06/14-01/20	KIT		317 155 900 113		60	20.5	10.3	85	2000		included in the KIT 305 407 300 113	06/14-01/20 with preliminary setup	S	CAN	C	E	D	L	H	30	
Skoda Octavia III (5E) with preliminary setup Saloon and Estate inc. RS and Scout inc. vehicles with gas drive	06/14-01/20	KIT		317 154 900 113		60	20.5	10.3	85	2000		included in the KIT 305 407 300 113	06/14-01/20 with preliminary setup	S	CAN	C	E	D	L	H	30	



Skoda Octavia IV Combi (NX5) without preliminary setup inc. AdBlue For vehicles without towbar preparation, please order the original spoiler from the vehicle dealer. Please order separately: holder for antenna amplifier 917131632001	01/20-	KIT		322 080 900 113		60	21.0	10.3	85	2000		included in the KIT 322 080 300 113	without preliminary setup	S	CAN	C	E	D	L	V	120
		KIT		322 081 900 113		60	21.0	10.3	85	2000		included in the KIT 322 080 300 113	without preliminary setup	S	CAN	C	E	D	L	V	120
Skoda Octavia IV Combi (NX5) inc. AdBlue For vehicles without towbar preparation, please order the original spoiler from the vehicle dealer. Please order separately: holder for antenna amplifier 917131632001	01/20-			317 131 600 001		60	19.0	10.3	85	2000		322 080 300 113	without preliminary setup	S	CAN	C	E	D	L	V	120
				317 132 600 001		60	19.0	10.3	85	2000											
Skoda Octavia IV Combi (NX5) inc. AdBlue inc. Hybrid For vehicles without towbar preparation, please order the original spoiler from the vehicle dealer.	01/20-			322 093 600 001		60	17.7	12.3	150	2500		322 080 300 113	without preliminary setup	S	CAN	C	E	D	L	V	120
				322 094 600 001		60	17.7	12.3	150	2500											
		KIT		305 625 900 113		60	31.7	10.1	120	2000		included in the KIT 300 006 300 153	not available individually	S	CAN	C	E	D	L	H	90
Skoda Octavia IV Combi (NX5) without preliminary setup inc. AdBlue inc. Hybrid For vehicles without towbar preparation, please order the original spoiler from the vehicle dealer.	01/20-	KIT		322 093 900 113		60	19.6	12.3	150	2500		included in the KIT 322 080 300 113	without preliminary setup	S	CAN	C	E	D	L	V	120
		KIT		322 094 900 113		60	19.6	12.3	150	2500		included in the KIT 322 080 300 113	without preliminary setup	S	CAN	C	E	D	L	V	120
Skoda Octavia IV Saloon (NX3) without preliminary setup inc. AdBlue For vehicles without towbar preparation, please order the original spoiler from the vehicle dealer. Please order separately: holder for antenna amplifier 917131632001	01/20-	KIT		322 080 900 113		60	21.0	10.3	85	2000		included in the KIT 322 080 300 113	without preliminary setup	S	CAN	C	E	D	L	V	120

























Skoda

Skoda Octavia IV Saloon (NX3) inc. AdBlue For vehicles without towbar preparation, please order the original spoiler from the vehicle dealer. Please order separately: holder for antenna amplifier 917131632001	01/20-			317 131 600 001		60	19.0	10.3	85	2000		322 080 300 113		without preliminary setup	S	CAN	C	E	D	L	V	120	
Skoda Octavia IV Saloon (NX3) inc. AdBlue inc. Hybrid For vehicles without towbar preparation, please order the original spoiler from the vehicle dealer.	01/20-			322 093 600 001		60	17.7	12.3	150	2500		322 080 300 113		without preliminary setup	S	CAN	C	E	D	L	V	120	
				322 094 600 001		60	17.7	12.3	150	2500													
		KIT		305 625 900 113		60	31.7	10.1	120	2000		included in the KIT 300 006 300 153	not available individually	S	CAN	C	E	D	L	H	90		
Skoda Octavia IV Saloon (NX3) without preliminary setup inc. AdBlue inc. Hybrid For vehicles without towbar preparation, please order the original spoiler from the vehicle dealer.	01/20-	KIT		322 093 900 113		60	19.6	12.3	150	2500		included in the KIT 322 080 300 113		without preliminary setup	S	CAN	C	E	D	L	V	120	
		KIT		322 094 900 113		60	19.6	12.3	150	2500		included in the KIT 322 080 300 113		without preliminary setup	S	CAN	C	E	D	L	V	120	
Skoda Rapid / Rapid Spaceback inc. Monte Carlo exc. Scoutline	10/12-12/19			317 129 600 001		45	21.5	8.5	50	1200													
				317 130 600 001		45	21.5	8.5	50	1200													
Skoda Roomster inc. Skoda Praktik 07- inc. Scout	09/06-05/10	KIT		317 063 900 113		40	19.0	7.5	50	1200		included in the KIT 317 400 300 113		-05/10	S	C2	C	E	D1	--	H	45	
Skoda Roomster inc. Skoda Praktik 07- inc. Scout Please order cover for bumper cutout at Skoda-dealers, order-no. XEA 77001.	09/06-05/10	KIT		317 064 900 113		40	19.0	7.5	50	1200		included in the KIT 317 400 300 113		-05/10	S	C2	C	E	D1	--	H	45	
Skoda Roomster inc. Skoda Praktik 07- inc. Scout	09/06-04/15			317 063 600 001		40	17.0	7.5	50	1200		317 400 300 107		-05/10	S	C2	C	E	--	--	H	45	
												317 400 300 113		-05/10	S	C2	C	E	D1	--	H	45	

Skoda Roomster inc. Skoda Praktik 07- inc. Scout Please order cover for bumper cutout at Skoda-dealers, order-no. XEA 77001.	09/06-04/15		317 064 600 001		40	17.0	7.5	50	1200	317 400 300 107	-05/10	S	C2	C	E	--	--	H	45	
										317 400 300 113	-05/10	S	C2	C	E	D1	--	H	45	
Skoda Scala exc. CNG Please check if the trailer load is entered in the vehicle documents.	02/19-		317 169 600 001		60	20.9	10.3	120	2000											
			317 170 600 001			60	23.2	10.3	120	2000										
Skoda Superb exc. vehicles with tuning set by M +S	03/02-06/08		321 505 600 001			90	20.8	10.3	85	1800	300 072 300 113		--	FRE	--	--	D1	L1	V	
Skoda Superb Estate II inc. facelift 2013	12/09-	KIT		317 102 900 153		40	21.0	10.6	100	2000	included in the KIT 321 600 300 153		S	CAN	C	E	D	L1	V	105
Skoda Superb Estate II facelift from 06/13-	12/09-05/15		317 104 600 001			40	18.0	10.6	100	2000	321 600 300 153		S	CAN	C	E	D	L1	V	105
			317 102 600 001			40	19.0	10.6	100	2000										
Skoda Superb Estate III (3V5) inc. Sportline inc. Plugin Hybrid (Please check if the trailer load is entered in the vehicle documents.)	03/15-		317 140 600 001			90	15.0	11.5	100	2200	305 407 300 113	with preliminary setup	S	CAN	C	E	D	L	H	30
			317 141 600 001			90	15.9	11.5	100	2200	305 408 300 107	without preliminary setup	S	CAN	C	E	--	--	V	60
											305 408 300 113	without preliminary setup	S	CAN	C	E	D	L	V	60
Skoda Superb Estate III (3V5) without preliminary setup inc. Sportline inc. Plugin Hybrid (Please check if the trailer load is entered in the vehicle documents.)	03/15-	KIT		317 140 900 113		90	19.6	11.5	100	2200	included in the KIT 305 408 300 113	without preliminary setup	S	CAN	C	E	D	L	V	60
		KIT		317 141 900 113			90	19.9	11.5	100	2200	included in the KIT 305 408 300 113	without preliminary setup	S	CAN	C	E	D	L	V
Skoda Superb Saloon II inc. facelift 2013	06/08-	KIT		317 102 900 153			40	21.0	10.6	100	2000	included in the KIT 321 600 300 153		S	CAN	C	E	D	L1	V



Skoda





















<p>Skoda Yeti For the cutout in the bumper a special tool is necessary. We would therefore recommend to let the cutout be made at Skoda dealers. Please order cover and frame for bumper cutout at Skoda dealers.</p>	08/09-12/17			317 128 600 001			40	19.5	10.6	85	2100													
---	-------------	--	---	-----------------	--	---	----	------	------	----	------	--	--	--	--	--	--	--	--	--	--	--	--	--

Subaru Outback (BS)	03/15-07/20		348 062 600 001		60	24.5	10.5	90	2000													
				348 063 600 001		60	26.0	10.5	90	2000												
Subaru Outback BT	05/21-		348 085 600 001		90	19.2	10.8	125	2100													
				348 086 600 001		90	21.5	10.8	125	2100												
Subaru Solterra	06/22-		348 087 600 001		75	19.8	5.7	75	750													
				348 088 600 001		75	19.8	5.7	75	750												
Subaru Trezia	03/11-12/14		335 413 600 001	→ 	60	21.0	5.8	50	900													
				335 414 600 001		60	21.0	5.8	50	900												
		KIT		335 413 900 113	→ 	60	22.9	5.8	50	900												
		KIT		335 414 900 113		60	22.7	5.8	50	900												
Subaru XV (GP)	03/12-10/17		348 037 600 001		90	20.0	8.9	75	1600													
			KIT		348 037 900 113		90	22.0	8.9	75	1600											

Subaru



Subaru

Subaru XV (GT)	10/17-		348 077 600 001	→		75	22.5	8.0	90	1940		348 073 300 113							S	A	C1	E1	D	L1	V	90
			348 078 600 001			75	21.4	8.0	90	1940											S	A	C1	E1	D	L1
		KIT		348 078 900 113			75	22.8	8.0	90	1940		included in the KIT 348 073 300 113							S	A	C1	E1	D	L1	V

























Suzuki Across A5Z inc. Plugin Hybrid exc. vehicles with tailgate that opens by sensor	06/20-		335 510 600 001		60	23.0	10.2	100	2000	335 110 300 113	S	A	--	E2	D	L1	H	45	
			335 511 600 001		60	25.0	10.2	100	2000										
	KIT	06/20-		335 510 900 113		60	24.4	10.2	100	2000	included in the KIT 335 110 300 113	S	A	--	E2	D	L1	H	45
				335 511 900 113		60	26.8	10.2	100	2000									
Suzuki Grand Vitara 3 doors JT for vehicles with spare wheel on tailgate	10/05-12/15		342 098 600 001		90	20.0	8.5	100	1600										
Suzuki Grand Vitara 5 doors JT exc. vehicles with spare wheel on the tailgate	08/10-12/15		341 020 600 001	→ 	90	23.0	10.8	85	2000										
Suzuki Jimny	98-09/18		341 003 600 001		60	26.0	7.0	75	1300	300 072 300 107 300 072 300 113	--	FRE	--	--	--	--	V		
Suzuki Jimny (A6G)	07/18-		341 066 600 001		60	27.5	7.4	90	1500										
			341 067 600 001		30	19.0	7.4	90	1500										
Suzuki S-Cross II	01/22-		341 024 600 001		45	19.0	8.4	75	1500										
Suzuki SX4 exc. saloon, WRC	06/06-09/13		306 276 600 001	→ 	120	24.0	7.1	70	1200										
Suzuki SX4 Classic exc. saloon, WRC	09/13-12/15		306 276 600 001	→ 	120	24.0	7.1	70	1200										

















Suzuki

Suzuki SX4 S-Cross I JY	09/13-			341 024 600 001		45	19.0	8.4	75	1500		341 024 300 107			S	FRE	--	--	--	--	H	60	
												341 024 300 113			S	FRE	--	--	D1	L1	H	60	
		KIT		341 024 900 113		45	22.0	8.4	75	1500		included in the KIT 341 024 300 113			S	FRE	--	--	D1	L1	H	60	
Suzuki Swace AMZ exc. vehicles with tailgate that opens by sensor	10/20-			335 512 600 001		60	19.0	7.5	75	1300													
					335 513 600 001		60	22.0	7.5	75	1300		335 423 300 113	10/20-		S	FRE	--	E2	D	L1	V	120
		KIT		335 512 900 113		60	21.4	7.5	75	1300		included in the KIT 335 423 300 113	10/20-		S	FRE	--	E2	D	L1	V	120	
		KIT		335 513 900 113		60	24.4	7.5	75	1300		included in the KIT 335 423 300 113	10/20-		S	FRE	--	E2	D	L1	V	120	
Suzuki Vitara LY	03/15-09/18			341 024 600 001		45	19.0	8.4	75	1500		341 024 300 107			S	FRE	--	--	--	--	H	60	
												341 024 300 113			S	FRE	--	--	D1	L1	H	60	
		KIT		341 024 900 113		45	22.0	8.4	75	1500		included in the KIT 341 024 300 113			S	FRE	--	--	D1	L1	H	60	
Suzuki Vitara LY	10/18-			341 065 600 001		60	26.7	8.5	103	1550		341 024 300 107			S	FRE	--	--	--	--	H	60	
												341 024 300 113			S	FRE	--	--	D1	L1	H	60	
		KIT		341 065 900 113		60	28.2	8.5	103	1550		included in the KIT 341 024 300 113			S	FRE	--	--	D1	L1	H	60	

Tesla Model 3 (5YJ3) Please check if the trailer load is entered in the vehicle documents.	01/19-			351 008 600 001			60	17.4	6.8	100	1000		351 008 300 113		01/19-	S	FRE	--	E2	--		H	45	
---	--------	--	---	-----------------	--	---	----	------	-----	-----	------	--	-----------------	--	--------	---	-----	----	----	----	--	---	----	--



















Toyota

Toyota Auris 3/5 doors	03/07-09/12			335 412 600 001			60	21.5	8.6	60	1500																
Toyota Auris Touring Sports exc. Hybrid	07/13-03/19			335 424 600 001			90	15.0	8.7	75	1500																
				335 425 600 001			90	17.0	8.7	75	1500	335 423 300 113					S	FRE	--	E2	D	L1	V	120			
		KIT		335 424 900 113			90	17.0	8.7	75	1500	included in the KIT 335 423 300 113					S	FRE	--	E2	D	L1	V	120			
		KIT		335 425 900 113			90	19.0	8.7	75	1500	included in the KIT 335 423 300 113					S	FRE	--	E2	D	L1	V	120			
Toyota Avensis Saloon, 4 doors T27	02/09-10/18			335 343 600 001	 		60	24.0	10.3	80	2000	335 345 300 113					S	FRE	--	--	D	L1	V	105			
Toyota Avensis Hatchback, 5 doors T27	01/09-10/18			335 343 600 001	 		60	24.0	10.3	80	2000	335 345 300 113					S	FRE	--	--	D	L1	V	105			
Toyota Avensis Estate / Touring Sports T27	01/09-10/18			335 345 600 001			60	24.0	10.3	80	2000	335 345 300 113					S	FRE	--	--	D	L1	V	105			
				335 346 600 001			60	24.0	10.3	80	2000																
Toyota C-HR inc. Hybrid	01/17-10/19	KIT		335 495 900 113			60	30.0	7.6	75	1300	included in the KIT 335 494 300 113		-10/19			S	FRE	--	E2	D	L1	H	75			
Toyota Corolla (E21)	10/18-			335 514 600 001			60	18.9	7.6	90	2100	335 423 300 113					S	FRE	--	E2	D	L1	V	120			
				335 515 600 001			60	21.9	7.6	90	2100																
		KIT		335 514 900 113			60	20.6	7.6	90	2100	included in the KIT 335 423 300 113					S	FRE	--	E2	D	L1	V	120			
		KIT		335 515 900 113			60	23.6	7.6	90	2100	included in the KIT 335 423 300 113					S	FRE	--	E2	D	L1	V	120			

Toyota Corolla Saloon	08/07-13		335 343 600 001	→ 	60	24.0	10.3	80	2000		300 072 300 107				--	FRE	--	--	--	--	V		
											300 072 300 113				--	FRE	--	--	D1	L1	V		
Toyota Corolla Touring Sports inc. Hybrid exc. vehicles with tailgate that opens by sensor	02/19-		335 512 600 001		60	19.0	7.5	75	1300		335 423 300 113				S	FRE	--	E2	D	L1	V	120	
			335 513 600 001		60	22.0	7.5	75	1300														
		KIT		335 512 900 113		60	21.4	7.5	75	1300		included in the KIT 335 423 300 113				S	FRE	--	E2	D	L1	V	120
		KIT		335 513 900 113		60	24.4	7.5	75	1300		included in the KIT 335 423 300 113				S	FRE	--	E2	D	L1	V	120
Toyota Corolla Verso	04/04-09		335 323 600 001	→ 	70	24.0	8.6	75	1450														
Toyota Hilux Double Cab, 4x4 inc. towball only vehicles with underrun guard official type ident no. of vehicle's type plate: e11*2007/46*0148	10/10-		335 408 600 001		30	10.0	13.8	120	2500														
Toyota Hilux Double Cab, 4x4 inc. towball only vehicles with underrun guard official type ident no. of vehicle's type plate: e11*2007/46*0148	10/10-08/16		335 408 900 113		30	12.0	13.8	120	2500														
Toyota Hilux Extra Cab, 4x4 inc. towball only vehicles with underrun guard official type ident no. of vehicle's type plate: e11*2007/46*0149	08/10-		335 408 600 001		30	10.0	13.8	120	2500														
Toyota Hilux Extra Cab, 4x4 inc. towball only vehicles with underrun guard official type ident no. of vehicle's type plate: e11*2007/46*0149	08/10-08/16		335 408 900 113		30	12.0	13.8	120	2500														
Toyota Hilux Single Cab, 4x4 inc. towball only vehicles with underrun guard official type ident no. of vehicle's type plate: e11*2007/46*0148	10/10-		335 408 600 001		30	10.0	13.8	120	2500														

Toyota





















Toyota















Toyota Hilux Single Cab, 4x4 inc. towball only vehicles with underrun guard official type ident no. of vehicle's type plate: e11*2007/46*0148	10/10-08/16		335 408 900 113			30	12.0	13.8	120	2500													
Toyota Landcruiser J 12	01/03-10/09		335 294 600 001			75	8.5	16.3	130	3500		300 210 300 107				--	A	--	E1	--	--	V	90
												300 210 300 113				--	A	--	E1	D1	L1	V	90
Toyota Landcruiser J 15 fitting towballs: 329062600001,329042600001, 329072600001. Please order separately cover for bumper cutout at Toyota dealers.	11/09-		335 397 600 001				16.0	16.3	130	3500		300 210 300 107				--	A	--	E1	--	--	V	90
												335 398 300 113				S	A	--	--	D	L1	H	75
Toyota Landcruiser J 15 inc. towball: 329062600001 Please order separately cover for bumper cutout at Toyota dealers.	11/09-	KIT 	335 397 900 113				18.0	15.9	130	3500		included in the KIT 335 398 300 113				S	A	--	--	D	L1	H	75
Toyota Landcruiser V8 / 200	08-		335 359 600 001		→	90	15.0	17.2	140	3500		300 210 300 113				--	A	--	E1	D1	L1	V	90
Toyota Proace	04/12-02/16		306 331 600 001			75	22.5	12.2	122	2200		304 400 300 113				S	CAN	C1	E	D	L1	H	105
			306 333 600 001			75	22.5	12.2	122	2200													
		KIT 	306 331 900 113			75	22.5	12.2	122	2200		included in the KIT 304 400 300 113				S	CAN	C1	E	D	L1	H	105
		KIT 	306 333 900 113			75	24.5	12.2	122	2200		included in the KIT 304 400 300 113				S	CAN	C1	E	D	L1	H	105
Toyota Proace inc. towball	03/16-10/19	KIT 	304 190 900 113			45	31.0	13.9	104	2500		included in the KIT 304 157 300 113		-10/19		S	CAN	C	E	D	L1	H	90
Toyota Proace	03/16-10/19	KIT 	335 106 900 113			60	28.5	13.9	104	2500		included in the KIT 304 157 300 113		-10/19		S	CAN	C	E	D	L1	H	90

Toyota Proace City L1 inc. City Verso	11/19-		304 207 600 001			60	20.0	8.6	75	1500		314 594 300 113	inc. WLC 2.0	S	A	C	E	D	L	V	90									
			304 118 600 001			90	17.0	8.4	64	1600																				
			304 209 600 001			60	20.5	8.6	75	1500																				
		KIT	304 207 900 113			60	21.2	8.6	75	1500	included in the KIT 314 594 300 113											inc. WLC 2.0	S	A	C	E	D	L	V	90
Toyota Proace City L2 inc. City Verso	11/19-		304 210 600 001			60	21.0	8.6	75	1500		314 594 300 113	inc. WLC 2.0	S	A	C	E	D	L	V	90									
			304 212 600 001			60	21.5	8.6	75	1500																				
		KIT	304 210 900 113			60	22.2	8.6	75	1500	included in the KIT 314 594 300 113											inc. WLC 2.0	S	A	C	E	D	L	V	90
		KIT	304 212 900 113			60	22.8	8.6	75	1500	included in the KIT 314 594 300 113											inc. WLC 2.0	S	A	C	E	D	L	V	90
Toyota Proace Verso	03/16-10/19	KIT	335 106 900 113			60	28.5	13.9	104	2500		304 157 300 113	-10/19	S	CAN	C	E	D	L1	H	90									
Toyota Proace Verso inc. towball	03/16-10/19	KIT	304 190 900 113			45	31.0	13.9	104	2500		304 157 300 113	-10/19	S	CAN	C	E	D	L1	H	90									
Toyota RAV4 not with rear step	06/00-02/06		335 246 600 001		>150	16.7	9.8	75	2000																					
Toyota RAV4 all models	03/06-13		335 325 600 001			90	36.0	10.4	80	2000		335 251 300 113		S	FRE	--	--	D1	L1	H	60									
		KIT	335 348 600 001			90	37.0	10.4	80	2000		included in the KIT 335 251 300 113		S	FRE	--	--	D1	L1	H	60									

Toyota











Toyota

































Toyota RAV4 IV A4 exc. vehicles with foot sensor	02/13-12/18			335 418 600 001		120	37.0	10.9	80	2000		335 419 300 113	-12/18	S	A	--	E1	D	L1	H	60
				335 419 600 001		120	38.0	10.9	80	2000											
		KIT		335 418 900 113		120	37.0	10.9	80	2000	included in the KIT 335 419 300 113	-12/18	S	A	--	E1	D	L1	H	60	
		KIT		335 419 900 113		120	40.0	10.9	80	2000	included in the KIT 335 419 300 113	-12/18	S	A	--	E1	D	L1	H	60	
Toyota RAV4 V A5, H5 inc. Plugin Hybrid exc. vehicles with tailgate that opens by sensor	11/18-			335 510 600 001		60	23.0	10.2	100	2000		335 110 300 113		S	A	--	E2	D	L1	H	45
				335 511 600 001		60	25.0	10.2	100	2000											
		KIT		335 510 900 113		60	24.4	10.2	100	2000	included in the KIT 335 110 300 113		S	A	--	E2	D	L1	H	45	
		KIT		335 511 900 113		60	26.8	10.2	100	2000	included in the KIT 335 110 300 113		S	A	--	E2	D	L1	H	45	
Toyota Verso	04/09-08/18			335 400 600 001		90	19.5	9.3	60	1500		335 411 300 107 →	-08/18	S	FRE	--	E1	--	--	V	120
				335 421 600 001		90	22.0	9.3	60	1500											
		KIT		335 400 900 113		90	21.0	9.3	60	1500	included in the KIT 335 411 300 113	-08/18	S	FRE	--	E1	D1	L1	V	120	
		KIT		335 421 900 113		90	23.0	9.3	60	1500	included in the KIT 335 411 300 113	-08/18	S	FRE	--	E1	D1	L1	V	120	

Toyota Verso S	01/11-10/16		335 413 600 001	→ 	60	21.0	5.8	50	900		335 413 300 113	-10/16	S	FRE	--	--	D1	L1	V	105	
			335 414 600 001		60	21.0	5.8	50	900												
	KIT	KIT		335 413 900 113	→ 	60	22.9	5.8	50	900		included in the KIT 335 413 300 113	-10/16	S	FRE	--	--	D1	L1	V	105
				335 414 900 113		60	22.7	5.8	50	900		included in the KIT 335 413 300 113	-10/16	S	FRE	--	--	D1	L1	V	105
Toyota Yaris exc. TS -09/11 exc. Hybrid exc. GRMN	01/06-02/20		335 455 600 001		75	18.7	6.8	50	1150		335 383 300 113	10/11-07/14	S	FRE	--	--	D1	L1	V	120	
											335 411 300 113	-09/11	S	FRE	--	E1	D1	L1	V	120	
Toyota Yaris exc. Hybrid exc. GRMN	08/14-		335 454 600 001		60	19.0	5.9	50	960												
Toyota bZ4X	07/22-		348 087 600 001		75	19.8	5.7	75	750												



Toyota























Vauxhall



























Vauxhall Antara exc. vehicles with bike carrier system Flex-Fix exc. vehicles with height control	02/07-02/15		314 304 600 001			150	24.0	12.3	150	2500		342 027 300 113	→	for vehicles with preparation	S	FRE	--	E1	D	L1	H	30
Vauxhall Astra Coupé	00-03/04		314 236 600 001	→		>150	23.1	8.6	75	1500		300 072 300 107 300 210 300 107 300 210 300 113			--	FRE	--	--	--	--	V	
															--	A	--	E1	--	--	V	90
															--	A	--	E1	D1	L1	V	90
Vauxhall Astra G Hatchback and Saloon	03/98-03/04		314 236 600 001	→		>150	23.1	8.6	75	1500		300 072 300 107 300 210 300 107 300 210 300 113			--	FRE	--	--	--	--	V	
															--	A	--	E1	--	--	V	90
															--	A	--	E1	D1	L1	V	90
Vauxhall Astra H Estate To guarantee an optimal fit of the bumper it is necessary to mount a support, please order from Opel-dealer, order no. 1313 8158 and 1316 8808.	10/04-11/10		314 496 600 001			60	17.0	9.1	75	1650		300 210 300 113		for vehicles without rear central electronic (REC)	--	A	--	E1	D1	L1	V	90
			314 500 600 001			60	18.5	9.1	75	1600		314 300 300 113		for vehicles with rear central electronic (REC)	S	FRE	C	E	D	L1	H	45
		KIT 	314 285 900 113			60	19.0	9.1	75	1650		included in the KIT 314 300 300 113		for vehicles with rear central electronic (REC)	S	FRE	C	E	D	L1	H	45
		KIT 	314 287 900 113			60	19.5	9.1	75	1650		included in the KIT 314 300 300 113		for vehicles with rear central electronic (REC)	S	FRE	C	E	D	L1	H	45
Vauxhall Astra H Hatchback inc. GTC exc. VXR / 240 HP	03/04-12/09		314 299 600 001			60	21.5	9.0	75	1650		300 210 300 113		for vehicles without rear central electronic (REC)	--	A	--	E1	D1	L1	V	90
			314 281 600 001			60	21.5	9.0	75	1650		314 300 300 113		for vehicles with rear central electronic (REC)	S	FRE	C	E	D	L1	H	45
		KIT 	314 299 900 113			60	23.5	9.0	75	1650		included in the KIT 314 300 300 113		for vehicles with rear central electronic (REC)	S	FRE	C	E	D	L1	H	45
		KIT 	314 281 900 113			60	23.5	9.0	75	1650		included in the KIT 314 300 300 113		for vehicles with rear central electronic (REC)	S	FRE	C	E	D	L1	H	45

Vauxhall Astra J Hatchback exc. vehicles with bike carrier system Flex-Fix	12/09-09/15		314 474 600 001		60	23.0	9.6	75	1800	314 386 300 113			S	CAN	--	E	D	L1	V	90	
			314 473 600 001		60	23.0	9.6	75	1800												
	KIT		314 474 900 113		60	25.0	9.6	75	1800	included in the KIT 314 386 300 113			S	CAN	--	E	D	L1	V	90	
	KIT		314 473 900 113		60	25.0	9.6	75	1800	included in the KIT 314 386 300 113			S	CAN	--	E	D	L1	V	90	
Vauxhall Astra J Sports Tourer exc. vehicles with bike carrier system Flex-Fix Please order separately cover for bumper cutout at Vauxhall dealers.	11/10-01/16		314 406 600 001		60	25.0	9.6	75	1800	314 386 300 113			S	CAN	--	E	D	L1	V	90	
		KIT		314 406 900 113		60	31.0	9.6	75	1800	included in the KIT 314 386 300 113			S	CAN	--	E	D	L1	V	90
Vauxhall Astra J Sports Tourer exc. vehicles with bike carrier system Flex-Fix	11/10-01/16		314 407 600 001		60	24.5	9.6	75	1800	314 386 300 113			S	CAN	--	E	D	L1	V	90	
		KIT		314 407 900 113		60	26.5	9.6	75	1800	included in the KIT 314 386 300 113			S	CAN	--	E	D	L1	V	90
Vauxhall Astra K Hatchback 5 doors not for vehicles with CVT transmission	09/15-12/21		314 513 600 001		60	21.0	9.9	75	1700	314 514 300 107				S	CAN	--	E2	--	--	V	90
			314 513 900 113		60	24.0	9.9	75	1700	314 514 300 113			S	CAN	--	E2	D	L1	V	90	
		KIT		314 513 900 113		60	24.0	9.9	75	1700	included in the KIT 314 514 300 113			S	CAN	--	E2	D	L1	V	90
Vauxhall Astra K SW / Sports Tourer not for vehicles with CVT transmission Please order spoiler inc. cover for bumper cutout at Vauxhall-dealers. To guarantee an optimal fit of the bumper it is necessary to mount a polystyrene carrier, please order from Vauxhall-dealer.	03/16-12/21		314 516 600 001		60	19.5	9.9	75	1700	314 514 300 107				S	CAN	--	E2	--	--	V	90
			314 515 600 001		60	20.0	9.9	75	1700	314 514 300 113			S	CAN	--	E2	D	L1	V	90	
		KIT		314 516 900 113		60	23.0	9.9	75	1700	included in the KIT 314 514 300 113			S	CAN	--	E2	D	L1	V	90
		KIT		314 515 900 113		60	24.5	9.9	75	1700	included in the KIT 314 514 300 113			S	CAN	--	E2	D	L1	V	90















Vauxhall



















Opel Astra L 5 doors inc. Plug-in-Hybrid	10/21-			314 603 600 001		90	21.7	9.2	90	1650		314 602 300 113	10/21- inc. Plug-in Hybrid	S	CAN	C	E	D	L1	H	75
		KIT		314 603 900 113		90	24.2	9.2	90	1650		included in the KIT 314 602 300 113	10/21- inc. Plug-in Hybrid	S	CAN	C	E	D	L1	H	75
Vauxhall Combo Van exc. vehicles with gas drive (CNG) exc. vehicles with park distance control	02/12-08/18			306 368 600 001		60	23.0	9.2	100	1500		306 605 300 107 306 605 300 113		S	FRE	--	E	--	--	V	90
		KIT		306 368 900 113		45	25.0	9.2	100	1500		included in the KIT 306 605 300 113		S	FRE	--	E	D1	L1	V	90
Vauxhall Combo Van exc. vehicles with gas drive (CNG)	02/12-08/18			306 369 600 001		60	25.0	9.2	100	1500		306 605 300 107 306 605 300 113		S	FRE	--	E	--	--	V	90
		KIT		306 369 900 113		60	27.0	9.2	100	1500		included in the KIT 306 605 300 113		S	FRE	--	E	D1	L1	V	90
Vauxhall Combo Van inc. towball for vehicles with gas drive (CNG)	02/12-08/18			306 382 600 001		60	25.0	7.0	75	1000		306 605 300 107 306 605 300 113		S	FRE	--	E	--	--	V	90
		KIT		306 382 900 113		60	27.0	7.0	75	1000		included in the KIT 306 605 300 113		S	FRE	--	E	D1	L1	V	90
Vauxhall Combo Van L1 Cargo + Life	09/18-			304 207 600 001		60	20.0	8.6	75	1500		314 594 300 113	inc. WLC 2.0	S	A	C	E	D	L	V	90
				304 209 600 001		60	20.5	8.6	75	1500											
		KIT		304 207 900 113		60	21.2	8.6	75	1500		included in the KIT 314 594 300 113	inc. WLC 2.0	S	A	C	E	D	L	V	90
		KIT		304 209 900 113		60	21.8	8.6	75	1500		included in the KIT 314 594 300 113	inc. WLC 2.0	S	A	C	E	D	L	V	90

Vauxhall Combo Van L2 Cargo + Life	09/18-		304 210 600 001			60	21.0	8.6	75	1500		314 594 300 113	inc. WLC 2.0	S	A	C	E	D	L	V	90	
			304 212 600 001			60	21.5	8.6	75	1500												
	KIT	09/18-		304 210 900 113			60	22.2	8.6	75	1500		included in the KIT 314 594 300 113	inc. WLC 2.0	S	A	C	E	D	L	V	90
	KIT			304 212 900 113			60	22.8	8.6	75	1500											
Vauxhall Combo Van L1 Cargo + Life inc. towball	09/18-		304 118 600 001			90	17.0	8.4	64	1600		314 594 300 113	inc. WLC 2.0	S	A	C	E	D	L	V	90	
Vauxhall Corsa Combo Van exc. vehicles with gas drive (CNG)	03/02-12/12		314 282 600 001			150	16.4	7.5	75	1200		300 072 300 107		--	FRE	--	--	--	--	--	V	
Vauxhall Corsa D exc. vehicles with bike carrier system Flex-Fix exc. VXR, exc. VXR-Line, exc. Gsi	10/06-12/14		314 306 600 001			60	17.0	7.7	55	1200		314 307 300 113		S	A	--	--	D1	--	V	90	
			314 436 600 001			60	18.5	7.7	55	1200												
	KIT	10/06-12/14		314 306 900 113			60	19.0	7.7	55	1200		included in the KIT 314 307 300 113		S	A	--	--	D1	--	V	90
	KIT			314 307 900 113			60	20.5	7.7	55	1200											
Vauxhall Corsa E exc. vehicles with bike carrier system Flex-Fix exc. VXR, exc. VXR-Line, exc. Gsi	01/15-06/19		314 306 600 001			60	17.0	7.7	55	1200		314 436 300 113	-06/19	S	CAN	--	E	D	L1	V	90	
			314 436 600 001			60	18.5	7.7	55	1200												
	KIT	01/15-06/19		314 435 900 113			60	19.0	7.7	55	1200		included in the KIT 314 436 300 113	-06/19	S	CAN	--	E	D	L1	V	90
	KIT			314 436 900 113			60	20.5	7.7	55	1200											





















Vauxhall Insignia Sports Tourer 2 WD, front wheel drive exc. VXR	03/09-05/17			314 390 600 001		90	23.0	11.3	85	2100		314 342 300 107	08/09-05/17	S	CAN	--	E2	--	--	H	45	
				314 342 600 001		90	26.5	11.3	85	2100		314 342 300 113	08/09-05/17	S	CAN	--	E2	D1	L1	H	45	
Vauxhall Insignia Sports Tourer 2 WD, front wheel drive exc. VXR	08/09-05/17	KIT		314 390 900 113		90	27.9	11.3	85	2100		included in the KIT 314 342 300 113	08/09-05/17	S	CAN	--	E2	D1	L1	H	45	
				314 342 900 113		90	28.0	11.3	85	2100		included in the KIT 314 342 300 113	08/09-05/17	S	CAN	--	E2	D1	L1	H	45	
Vauxhall Meriva exc. VXR thermal-insulation plate is necessary	05/03-05/10			314 289 600 001		60	23.0	8.3	60	1300		314 289 300 113		S	FRE	--	E1	D1	--	H	60	
Vauxhall Meriva exc. vehicles with bike carrier system Flex-Fix Please check if there is a towing capacity in the car documents.	06/10-03/17			314 394 600 001		60	19.0	8.3	75	1300		314 386 300 113		S	CAN	--	E	D	L1	V	90	
				314 392 600 001		60	20.0	8.3	75	1300												
		KIT		314 394 900 113		60	21.0	8.3	75	1300		included in the KIT 314 386 300 113		S	CAN	--	E	D	L1	V	90	
				314 392 900 113		60	22.0	8.3	75	1300		included in the KIT 314 386 300 113		S	CAN	--	E	D	L1	V	90	
Vauxhall Mokka exc. vehicles with bike carrier system Flex-Fix exc. vehicles with height control exc. OPC	10/12-08/16	KIT		314 450 900 113		60	23.0	8.6	75	1400		included in the KIT 314 451 300 113	-08/16	S	A	--	E2	D	L1	V	90	
				314 451 900 113		60	25.0	8.6	75	1400		included in the KIT 314 451 300 113	-08/16	S	A	--	E2	D	L1	V	90	
Vauxhall Mokka exc. vehicles with bike carrier system Flex-Fix exc. vehicles with height control exc. OPC	10/12-10/20			314 511 600 001		60	21.5	8.6	75	1400		314 451 300 107	→	-08/16	S	A	--	E2	--	--	V	90
				314 510 600 001		60	21.0	8.6	75	1400		314 451 300 113		-08/16	S	A	--	E2	D	L1	V	90





Vauxhall

Vauxhall Mokka (B)	10/20-			314 601 600 001		60	25.8	7.2	83	1200		314 580 300 113			S	CAN	C1	E2	D1	L1	V	90
		KIT		314 601 900 113		60	27.4	7.2	83	1200		included in the KIT 314 580 300 113			S	CAN	C1	E2	D1	L1	V	90
Vauxhaul Mokka X	09/16-10/20			314 511 600 001		60	21.5	8.6	75	1400		314 386 300 113			S	CAN	--	E	D	L1	V	90
				314 510 600 001		60	21.0	8.6	75	1400						S	CAN	--	E	D	L1	V
		KIT		314 511 900 113		60	25.0	8.6	75	1400		included in the KIT 314 386 300 113			S	CAN	--	E	D	L1	V	90
		KIT		314 510 900 113		60	25.5	8.6	75	1400		included in the KIT 314 386 300 113			S	CAN	--	E	D	L1	V	90
Vauxhall Movano B Van X62B front wheel drive inc. towball	03/10-10/21			316 318 600 001		60	19.3	14.3	100	2500		316 300 300 107	03/10-10/21 for vehicles without central plug connection	S	FRE	--	E2	--	--	H	45	
											316 300 300 113	03/10-10/21 for vehicles without central plug connection	S	FRE	--	E2	D1	L1	H	45		
											316 318 300 113	03/10-10/21 for vehicles with central plug connection	S	FRE	--	E2	D1	L1	H	15		
Vauxhall Movano B Van X62B front wheel drive inc. towball for vehicles without central plug connection	03/10-10/21	KIT		316 318 900 113		60	21.0	14.3	100	2500		included in the KIT 316 300 300 113	03/10-10/21 for vehicles without central plug connection	S	FRE	--	E2	D1	L1	H	45	
Vauxhall Movano B Chassis Cab front + rear wheel drive inc. towball not for vehicles with double tires	07/10-10/21			316 347 600 001		60	16.5	13.7	85	2300		316 319 300 113	07/10-10/21	S	FRE	--	E1	D1	--	H	15	









Vauxhaul Movano C Van U9 inc. towball For vehicles with long superstructure L4/XL please order separately a set distance tubes to strengthen the framework, no. 906270650003.	10/21-			306 490 600 001		120	32.0	16.9	150	3000		306 553 300 113	10/21-	S	FRE	--	E	D1	L1	V	105
Vauxhaul Movano C Van U9 For vehicles with long superstructure L4/XL please order separately a set distance tubes to strengthen the framework, no. 906270650003.	10/21-			306 491 600 001		120	32.0	16.9	150	3000		306 553 300 113	10/21-	S	FRE	--	E	D1	L1	V	105
		KIT		306 491 900 113		120	32.8	16.9	150	3000		included in the KIT 306 553 300 113	10/21-	S	FRE	--	E	D1	L1	V	105
Vauxhaul Movano C Van U9 inc. towball	10/21-			306 357 600 001		60	29.0	15.8	150	3000		306 553 300 113	10/21-	S	FRE	--	E	D1	L1	V	105
		KIT		306 553 900 113		>150	31.0	15.8	150	3000		included in the KIT 306 553 300 113	10/21-	S	FRE	--	E	D1	L1	V	105
Vauxhaul Movano C Van U9 inc. towball For vehicles with long superstructure L4/XL please order separately a set distance tubes to strengthen the framework, no. 906270650003.	10/21-	KIT		306 490 900 113		120	32.2	16.9	150	3000		included in the KIT 306 553 300 113	10/21-	S	FRE	--	E	D1	L1	V	105
Opel Movano C Chassis Cab U9 inc. towball For vehicles with long superstructure L4/XL please order separately a set distance tubes to strengthen the framework, no. 906270650003.	10/21-			306 492 600 001		120	35.0	15.9	150	3000											
Opel Movano C Chassis Cab U9 inc. towball	10/21-			306 357 600 001		60	29.0	15.8	150	3000											
Vauxhall Vectra C Estate	10/03-02/09			314 501 600 001		60	33.5	10.7	85	2000											
Vauxhall Vivaro Van inc. towball	05/01-09/14			314 364 600 001		60	21.0	12.3	85	2100		314 860 300 113 314 870 300 113	08/06-03/10 03/10-09/14	S S	FRE FRE	-- --	-- --	D1 D1	L1 L1	H H	60 60



















Vauxhall

Vauxhall Vivaro Van inc. towball	08/06-03/10	KIT		314 364 900 113		60	23.0	12.3	85	2100		included in the KIT 314 860 300 113	08/06-03/10	S	FRE	--	--	D1	L1	H	60	
Vauxhall Vivaro Van inc. towball	03/10-09/14	KIT		314 870 900 113		60	23.0	12.3	85	2100		included in the KIT 314 870 300 113	03/10-09/14	S	FRE	--	--	D1	L1	H	60	
Vauxhall Vivaro Van	09/14-03/19			316 312 600 001		60	25.0	12.1	80	2000		316 312 300 113		S	FRE	--	E2	D1	L1	H	90	
Vauxhall Vivaro Van inc. towball	09/14-03/19			316 408 600 001		60	25.0	12.1	80	2000		316 312 300 113		S	FRE	--	E2	D1	L1	H	90	
		KIT		316 311 900 113		60	26.3	12.1	80	2000		included in the KIT 316 312 300 113		S	FRE	--	E2	D1	L1	H	90	
Vauxhall Vivaro Tour / Combi+ inc. towball	10/17-03/19			316 408 600 001		60	25.0	12.1	80	2000		316 312 300 113		S	FRE	--	E2	D1	L1	H	90	
Vauxhall Zafira inc. GSI with non-visible cut	04/99-07/05			314 270 600 001	→	150	22.8	8.9	75	1500												
Vauxhall Zafira Tourer exc. CNG exc. vehicles with bike carrier system Flex-Fix To guarantee an optimal fit of the bumper it is necessary to mount a polystyrene carrier, please order from Vauxhall-dealer.	01/12-06/19			314 438 600 001		60	27.0	9.9	75	1500		314 386 300 113		S	CAN	--	E	D	L1	V	90	
				314 437 600 001		60	27.0	9.9	75	1500												
		KIT		314 438 900 113		60	28.0	9.9	75	1500		included in the KIT 314 386 300 113		S	CAN	--	E	D	L1	V	90	
		KIT		314 437 900 113		60	29.0	9.9	75	1500		included in the KIT 314 386 300 113		S	CAN	--	E	D	L1	V	90	
Vauxhall Zafira, Zafira Family inc. facelift 01/08- exc. CNG VXR version and vehicles with sport bumper: in addition to the visible cutout a cutout is necessary. Cover for bumper cutout not available.	07/05-04/15			314 293 600 001		75	17.5	9.6	75	1650		314 300 300 113	for vehicles with rear central electronic (REC)	S	FRE	C	E	D	L1	H	45	
		KIT		314 293 900 113		75	18.5	9.6	75	1650		included in the KIT 314 300 300 113	for vehicles with rear central electronic (REC)	S	FRE	C	E	D	L1	H	45	

Vauxhall Zafira, Zafira Family exc. CNG	07/05-04/15		314 361 600 001		90	19.0	9.6	75	1650		300 210 300 113	for vehicles without rear central electronic (REC)	--	A	--	E1	D1	L1	V	90
											314 300 300 113	for vehicles with rear central electronic (REC)	S	FRE	C	E	D	L1	H	45
	KIT		314 361 900 113		90	21.0	9.6	75	1650		included in the KIT 314 300 300 113	for vehicles with rear central electronic (REC)	S	FRE	C	E	D	L1	H	45





Volkswagen





VW Amarok for vehicles with bumper with integrated step	08/10-05/20			321 831 600 001			30	7.2	15.7	140	3200	321 704 300 107	with preliminary setup	S	CAN	C	E	--	--	H	15
												321 704 300 113	with preliminary setup	S	CAN	C	E	D	--	H	15
VW Amarok for vehicles with bumper with integrated step towing bracket inc. Towball	08/10-05/20			321 835 600 001			30	10.0	15.7	130	3200	321 704 300 107	with preliminary setup	S	CAN	C	E	--	--	H	15
												321 704 300 113	with preliminary setup	S	CAN	C	E	D	--	H	15
VW Arteon	04/17-			322 069 600 001			60	21.7	10.6	125	2100	305 407 300 113	with preliminary setup	S	CAN	C	E	D	L	H	30
												305 408 300 107	without preliminary setup	S	CAN	C	E	--	--	V	60
												322 070 600 001		305 408 300 113	without preliminary setup	S	CAN	C	E	D	L
VW Arteon without preliminary setup	04/17-	KIT		322 069 900 113			60	23.3	10.6	125	2100	included in the KIT 305 408 300 113	without preliminary setup	S	CAN	C	E	D	L	V	60
												322 070 900 113		included in the KIT 305 408 300 113	without preliminary setup	S	CAN	C	E	D	L
VW Arteon with preliminary setup	04/17-	KIT		322 071 900 113			60	22.7	10.6	125	2100	included in the KIT 305 407 300 113	with preliminary setup	S	CAN	C	E	D	L	H	30
												322 072 900 113		included in the KIT 305 407 300 113	with preliminary setup	S	CAN	C	E	D	L
VW Arteon Shooting Brake 3H9 inc. AdBlue inc. R-Line Please order separately: holder for antenna amplifier 917131632001	06/20-			317 140 600 001			90	15.0	11.5	100	2200	305 408 300 107	without preliminary setup	S	CAN	C	E	--	--	V	60
												317 141 600 001		305 408 300 113	without preliminary setup	S	CAN	C	E	D	L
VW Arteon Shooting Brake 3H9 without preliminary setup inc. AdBlue inc. R-Line Please order separately: holder for antenna amplifier 917131632001	06/20-	KIT		317 140 900 113			90	19.6	11.5	100	2200	included in the KIT 305 408 300 113	without preliminary setup	S	CAN	C	E	D	L	V	60
												317 141 900 113		included in the KIT 305 408 300 113	without preliminary setup	S	CAN	C	E	D	L

VW Bora Saloon exc. Syncro - 4-Motion	10/98-05/05			305 222 600 001		120	17.5	8.9	75	1650	321 465 300 113			S	FRE	--	E	D1	L1	H	60
				305 223 600 001		120	16.8	8.9	75	1650											
VW Bora Estate exc. Syncro - 4-Motion	10/98-05/05			305 222 600 001		120	17.5	8.9	75	1650	321 457 300 113			S	FRE	--	E	D1	L1	H	60
				305 223 600 001		120	16.8	8.9	75	1650											
VW CC B7	01/12-	KIT		321 821 900 153		90	17.5	11.3	90	2200	included in the KIT 321 600 300 153			S	CAN	C	E	D	L1	V	105
				321 823 900 153		90	22.0	11.3	90	2200											
VW CC	12-11/16			321 821 600 001		90	17.5	11.3	90	2200	321 600 300 153			S	CAN	C	E	D	L1	V	105
				321 823 600 001		90	20.0	11.3	90	2200											
VW Caddy 4x4 / 4-Motion inc. bumper carrier inc. Caddy Cross 10/13- inc. Caddy Alltrack 16-	10/08-09/20			321 768 600 001		75	19.5	8.9	80	1500	321 661 300 113		01/13- with preliminary setup	S	CAN	C	E	D	L1	H	30
VW Caddy 4x4 / 4-Motion inc. bumper carrier inc. Caddy Cross 10/13- inc. Caddy Alltrack 16- inc. towball	10/08-09/20			321 837 600 001		75	20.5	8.9	80	1500	321 661 300 113		01/13- with preliminary setup	S	CAN	C	E	D	L1	H	30
VW Caddy III + IV / Caddy Life inc. Caddy Maxi inc. Caddy Alltrack 16- inc. bumper carrier 5 seats: inc. vehicles with gas drive 7 seats: exc. vehicles with gas drive	02/04-09/20			321 661 600 001		75	19.5	9.4	80	1650	321 661 300 113		01/13- with preliminary setup	S	CAN	C	E	D	L1	H	30





Volkswagen



Volkswagen

VW Caddy III + IV / Caddy Life inc. Caddy Maxi inc. Caddy Alltrack 16- exc. vehicles with gas drive bracket for bumper inc. Please order at VW dealers: receptor box for detachable ball 2K0 804 969.	02/04-09/20			321 673 600 001			75	18.0	9.4	80	1650		321 661 300 113	01/13- with preliminary setup	S	CAN	C	E	D	L1	H	30	
VW Caddy V	09/20-		 	322 088 600 001 322 089 600 001			90	20.0	9.8	119	1620	322 088 300 113	09/20- with preliminary setup	S	CAN	C	E	D	L	H	30		
VW Crafter Van without preliminary setup types 30/35/38 Vehicles with 3,0 and 3,5 t max. total weight, increase to 3,8 t max. total weight is possible For vehicles with integrated step device in the bumper the middle part of the outer bumper must be exchanged (Please order separately at VW dealers.). inc. towball Step VW is not utilisable. Utilisable step: 313285600001 or 313440600001	04/06-12/14	KIT		313 376 900 113			120	22.0	18.1	150	3500	included in the KIT 313 105 300 113	-12/14for vehicles without preparation	S	CAN	C	E	D1	--	V	90		
VW Crafter Van types 46 and 50 Vehicles with 5,0 t max. total weight, reduction to 4,6 t max. total weight is possible wheelbase: 3665 mm For vehicles with integrated step device in the bumper the middle part of the outer bumper must be exchanged (Please order at VW dealers.). towball: 329141600001 Step VW is not utilisable. Utilisable step: 313285600001 or 313440600001	04/06-12/16			313 272 600 001			120	22.0	20.2	150	3500	313 105 300 107 313 105 300 113 313 107 300 113 313 108 300 107 313 108 300 113 321 106 300 113	→ -12/14 for vehicles without preparation -12/14for vehicles without preparation 01/15- for vehicles with preparation → 01/15- for vehicles without preparation 01/15- for vehicles without preparation -12/14 vehicles with preparation	S	CAN	C	E	--	--	V	90		











VW Crafter Van types 46 and 50 Vehicles with 5,0 t max. total weight, reduction to 4,6 t max. total weight is possible wheelbase: 4325 mm For vehicles with integrated step device in the bumper the middle part of the outer bumper must be exchanged (Please order at VW dealers.). towball: 329141600001 Step VW is not utilisable. Utilisable step: 313285600001 or 313440600001	04/06-12/16		313 273 600 001		120	23.0	20.2	150	3500	313 105 300 107	→	-12/14 for vehicles without preparation	S	CAN	C	E	--	--	V	90
					313 105 300 113		-12/14for vehicles without preparation	S	CAN	C	E	D1	--	V	90					
					313 107 300 113		01/15- for vehicles with preparation	S	CAN	C	E	D1	L1	H	45					
					313 108 300 107	→	01/15- for vehicles without preparation	S	CAN	C	E	--	--	V	90					
					313 108 300 113		01/15- for vehicles without preparation	S	CAN	C	E	D1	L1	V	90					
					321 106 300 113		-12/14 vehicles with preparation	S	CAN	C	E	D	--	H	45					
VW Crafter Van types 30/35/38 Vehicles with 3,0 and 3,5 t max. total weight, increase to 3,8 t max. total weight is possible Only for cars without step. For cars with step order 313553600001. Suitable towball: 329141600001 Step VW is not utilisable.	04/06-12/16		313 376 600 001		120	20.0	18.1	150	3500	313 105 300 107	→	-12/14 for vehicles without preparation	S	CAN	C	E	--	--	V	90
					313 105 300 113		-12/14for vehicles without preparation	S	CAN	C	E	D1	--	V	90					
					313 107 300 113		01/15- for vehicles with preparation	S	CAN	C	E	D1	L1	H	45					
					313 108 300 107	→	01/15- for vehicles without preparation	S	CAN	C	E	--	--	V	90					
					313 108 300 113		01/15- for vehicles without preparation	S	CAN	C	E	D1	L1	V	90					
					321 106 300 113		-12/14 vehicles with preparation	S	CAN	C	E	D	--	H	45					
VW Crafter Van singel wheels Please order separately ball plate: 329141600001 exc. vehicles with integrated step in the bumper Please replace underrun protection if necessary.	01/17-		321 946 600 001		30	26.7	17.5	150	3500	321 112 300 107	→	with preliminary setup	S	CAN	--	E	--	--	V	15
					321 112 300 113		with preliminary setup	S	CAN	--	E	D	L	V	15					
					321 113 300 107		without preliminary setup	S	CAN	C	E	--	--	V	60					
					321 113 300 113		without preliminary setup	S	CAN	C	E	D	L	V	60					





















Volkswagen

VW Crafter Van twin wheels Please order separately ball plate 329141600001 exc. vehicles with integrated step in the bumper Please replace underrun protection if necessary.	01/17-			321 947 600 001			30	27.0	21.0	150	3500		321 112 300 107 →	with preliminary setup	S	CAN	--	E	--	--	V	15
													321 112 300 113	with preliminary setup	S	CAN	--	E	D	L	V	15
													321 113 300 107	without preliminary setup	S	CAN	C	E	--	--	V	60
													321 113 300 113	without preliminary setup	S	CAN	C	E	D	L	V	60
VW Crafter Van without preliminary setup twin wheels inc. ball plate exc. vehicles with integrated step in the bumper Please replace underrun protection if necessary.	01/17-		KIT		321 947 900 113		30	30.0	21.0	150	3500		included in the KIT 321 113 300 113	without preliminary setup	S	CAN	C	E	D	L	V	60
VW Crafter Van without preliminary setup single wheels inc. ball plate exc. vehicles with integrated step in the bumper Please replace underrun protection if necessary.	01/17-		KIT		321 946 900 113		30	28.5	17.5	150	3500		included in the KIT 321 113 300 113	without preliminary setup	S	CAN	C	E	D	L	V	60
VW Crafter Chassis Cab without preliminary setup types 46 and 50 Vehicles with 5,0 t max. total weight, reduction to 4,6 t max. total weight is possible wheelbase: 3665 + 4325 mm towball inc. If there is an underrun guard mounted, please change into VW no. 2E3 805 721 A.	04/06-12/14		KIT		313 275 900 113		90	20.0	20.2	150	3500		included in the KIT 313 105 300 113	-12/14 for vehicles without preparation	S	CAN	C	E	D1	--	V	90
VW Crafter Chassis Cab without preliminary setup types 30/35/38 Vehicles with 3,0 and 3,5 t max. total weight, increase to 3,8 t max. total weight is possible exc. vehicles with underrun guard inc. towball	04/06-12/14		KIT		313 377 900 113	→	90	22.0	18.1	150	3500		included in the KIT 313 105 300 113	-12/14 for vehicles without preparation	S	CAN	C	E	D1	--	V	90

VW Crafter Chassis Cab types 46 and 50 Vehicles with 5,0 t max. total weight, reduction to 4,6 t max. total weight is possible wheelbase: 3665 + 4325 mm towball: 329059600001 If there is an underrun guard mounted, please change into VW no. 2E3 805 721 A.	04/06-12/16		313 275 600 001			90	18.0	20.2	150	3500		313 105 300 107	→	-12/14 for vehicles without preparation	S	CAN	C	E	--	--	V	90
												313 105 300 113		-12/14 for vehicles without preparation	S	CAN	C	E	D1	--	V	90
												313 107 300 113		01/15- for vehicles with preparation	S	CAN	C	E	D1	L1	H	45
												313 108 300 107	→	01/15- for vehicles without preparation	S	CAN	C	E	--	--	V	90
												313 108 300 113		01/15- for vehicles without preparation	S	CAN	C	E	D1	L1	V	90
												321 106 300 113		-12/14 vehicles with preparation	S	CAN	C	E	D	--	H	45
VW Crafter Chassis Cab types 30/35/38 Vehicles with 3,0 and 3,5 t max. total weight, increase to 3,8 t max. total weight is possible exc. vehicles with underrun guard towball: 329059600001	04/06-12/16		313 377 600 001	→		90	20.0	18.1	150	3500		313 105 300 107	→	-12/14 for vehicles without preparation	S	CAN	C	E	--	--	V	90
												313 105 300 113		-12/14 for vehicles without preparation	S	CAN	C	E	D1	--	V	90
												313 107 300 113		01/15- for vehicles with preparation	S	CAN	C	E	D1	L1	H	45
												313 108 300 107	→	01/15- for vehicles without preparation	S	CAN	C	E	--	--	V	90
												313 108 300 113		01/15- for vehicles without preparation	S	CAN	C	E	D1	L1	V	90
												321 106 300 113		-12/14 vehicles with preparation	S	CAN	C	E	D	--	H	45
VW Crafter Chassis Cab types 30/35/38 Vehicles with 3,0 and 3,5 t max. total weight, increase to 3,8 t max. total weight is possible exc. vehicles with underrun guard inc. towball	04/06-12/16		313 522 600 001			60	19.6	20.2	240	3500		313 105 300 113		-12/14 for vehicles without preparation	S	CAN	C	E	D1	--	V	90











Volkswagen









VW Crafter Chassis Cab singel wheels Please order separately ball plate 329141600001.	01/17-		321 948 600 001			30	22.0	21.0	150	3500		321 112 300 107	→	with preliminary setup	S	CAN	--	E	--	--	V	15	
												321 112 300 113		with preliminary setup	S	CAN	--	E	D	L	V	15	
												321 113 300 107		without preliminary setup	S	CAN	C	E	--	--	V	60	
												321 113 300 113		without preliminary setup	S	CAN	C	E	D	L	V	60	
VW Crafter Chassis Cab twin wheels Please order separately ball plate 329141600001	01/17-		321 949 600 001			30	22.0	21.0	150	3500		321 112 300 107	→	with preliminary setup	S	CAN	--	E	--	--	V	15	
												321 112 300 113		with preliminary setup	S	CAN	--	E	D	L	V	15	
												321 113 300 107		without preliminary setup	S	CAN	C	E	--	--	V	60	
												321 113 300 113		without preliminary setup	S	CAN	C	E	D	L	V	60	
VW Crafter Chassis Cab without preliminary setup twin wheels inc. ball plate	01/17-	KIT		321 949 900 113		30	26.5	21.0	150	3500		included in the KIT 321 113 300 113		without preliminary setup	S	CAN	C	E	D	L	V	60	
VW Crafter Chassis Cab without preliminary setup single wheels inc. ball plate	01/17-	KIT		321 948 900 113		30	26.5	21.0	150	3500		included in the KIT 321 113 300 113		without preliminary setup	S	CAN	C	E	D	L	V	60	
VW Eos Coupé/Convertible Please order spoiler inc. cover for bumper cutout at VW-dealers. inc. facelift 01/11-	06/06-12/15			321 543 600 001		75	18.0	9.3	100	1800													
VW Golf III Hatchback and saloon 4x4, convertible from 09/93-97	11/91-09/97		321 331 600 001			90	15.5	8.2	75	1500		321 331 300 107	→		S	C2	--	E1	--	--	H	45	
												321 331 300 113	→		S	C2	--	E1	D1	--	H	45	
VW Golf IV Hatchback exc. Syncro - 4-Motion and convertible exc. Golf R32 / 241 PS	10/97-10/03		305 222 600 001				120	17.5	8.9	75	1650												
			305 223 600 001				120	16.8	8.9	75	1650		321 465 300 113		-10/03		S	FRE	--	E	D1	L1	H

VW Golf IV Estate exc. Syncro - 4-Motion and convertible exc. Golf R32 / 241 PS	10/97-05/07		305 222 600 001		120	17.5	8.9	75	1650	321 457 300 113	-05/07	S	FRE	--	E	D1	L1	H	60	
			305 223 600 001		120	16.8	8.9	75	1650											
VW Golf V Saloon exc. R/RS32 09/05- exc. R/R20 / 270 HP 09- inc. 4-Motion / Gti	11/03-09/08		321 865 600 001		60	17.0	9.4	100	1800	321 600 300 153		S	CAN	C	E	D	L1	V	105	
VW Golf V Saloon exc. R/RS32 09/05- exc. R/R20 / 270 HP 09- inc. 4-Motion / Gti Please order separately: spoiler and cover for bumper cutout at VW dealers.	11/03-09/08		321 885 600 001		60	17.0	9.4	100	1800	321 600 300 153		S	CAN	C	E	D	L1	V	105	
VW Golf V Hatchback and Plus inc. Cross-Golf exc. RS32 09/05- exc. R20 / 270 HP 09- inc. 4-Motion / Gti	03/05-02/09		321 865 600 001		60	17.0	9.4	100	1800	321 600 300 153		S	CAN	C	E	D	L1	V	105	
VW Golf V Hatchback and Plus inc. Cross-Golf exc. RS32 09/05- exc. R20 / 270 HP 09- inc. 4-Motion / Gti Please order separately: spoiler and cover for bumper cutout at VW dealers.	03/05-02/09		321 885 600 001		60	17.0	9.4	100	1800	321 600 300 153		S	CAN	C	E	D	L1	V	105	
VW Golf V Estate inc. 4-Motion Please order spoiler at VW dealers.	06/07-05/09		321 630 600 001		90	17.0	9.3	100	1800	321 600 300 153		S	CAN	C	E	D	L1	V	105	
VW Golf V Estate inc. 4-Motion	06/07-05/09		321 662 600 001		90	17.0	9.3	100	1800	321 600 300 153		S	CAN	C	E	D	L1	V	105	
VW Golf VI Convertible cutout with stencil, alternative: spoiler + cover for cutout from VW dealers	06/11-05/16	KIT		321 873 600 001		60	17.0	9.4	75	1800	305 256 300 113	-05/16	S	CAN	C	E	D1	--	V	120
				321 730 900 113		60	19.0	9.4	75	1800	included in the KIT 305 256 300 113	-05/16	S	CAN	C	E	D1	--	V	120
VW Golf VI Saloon exc. R/RS32 09/05- exc. R/R20 / 270 HP 09- inc. 4-Motion / Gti	10/08-09/12		321 865 600 001		60	17.0	9.4	100	1800	321 600 300 153		S	CAN	C	E	D	L1	V	105	





















Volkswagen





Volkswagen

VW Golf VI Saloon exc. R/RS32 09/05- exc. R/R20 / 270 HP 09- inc. 4-Motion / Gti Please order separately: spoiler and cover for bumper cutout at VW dealers.	10/08-09/12			321 885 600 001		60	17.0	9.4	100	1800		321 600 300 153			S	CAN	C	E	D	L1	V	105
VW Golf VI Hatchback and Plus inc. Cross-Golf exc. RS32 09/05- exc. R20 / 270 HP 09- inc. 4-Motion / Gti	03/09-12/13			321 865 600 001		60	17.0	9.4	100	1800		321 600 300 153			S	CAN	C	E	D	L1	V	105
VW Golf VI Hatchback and Plus inc. Cross-Golf exc. RS32 09/05- exc. R20 / 270 HP 09- inc. 4-Motion / Gti Please order separately: spoiler and cover for bumper cutout at VW dealers.	03/09-12/13			321 885 600 001		60	17.0	9.4	100	1800		321 600 300 153			S	CAN	C	E	D	L1	V	105
VW Golf VI Estate inc. 4-Motion Please order spoiler at VW dealers.	06/09-07/13			321 630 600 001		90	17.0	9.3	100	1800		321 600 300 153			S	CAN	C	E	D	L1	V	105
VW Golf VI Estate inc. 4-Motion	06/09-07/13			321 662 600 001		90	17.0	9.3	100	1800		321 600 300 153			S	CAN	C	E	D	L1	V	105
VW Golf VII Hatchback (AU) without preliminary setup exc. e-Golf	10/12-06/14	KIT		317 131 900 113		60	21.0	10.3	85	2000		included in the KIT 305 406 300 113	-06/14 without preliminary setup	S	CAN	C	E	D	L1	V	150	
VW Golf VII Hatchback (AU) without preliminary setup exc.e-Golf Please order spoiler inc. cover for bumper cutout at VW-dealers.	10/12-06/14	KIT		317 132 900 113		60	21.0	10.3	85	2000		included in the KIT 305 406 300 113	-06/14 without preliminary setup	S	CAN	C	E	D	L1	V	150	



















VW Golf VII Hatchback (AU) exc.e-Golf, GTI TCR, GTI Clubsport	10/12-07/19		317 131 600 001		60	19.0	10.3	85	2000	305 403 300 107	→	-06/14 with preliminary setup	S	CAN	C	E	--	--	H	45		
										305 403 300 113		-06/14 with preliminary setup	S	CAN	C	E	D	L1	H	45		
										305 406 300 113		-06/14 without preliminary setup	S	CAN	C	E	D	L1	V	150		
										305 407 300 113		06/14-07/19 with preliminary setup	S	CAN	C	E	D	L	H	30		
										305 408 300 107		06/14-07/19 without preliminary setup	S	CAN	C	E	--	--	V	60		
										305 408 300 113		06/14-07/19 without preliminary setup	S	CAN	C	E	D	L	V	60		
VW Golf VII Hatchback (AU) exc.e-Golf, GTI TCR, GTI Clubsport Please order spoiler inc. cover for bumper cutout at VW-dealers.	10/12-07/19		317 132 600 001		60	19.0	10.3	85	2000	305 403 300 107	→	-06/14 with preliminary setup	S	CAN	C	E	--	--	H	45		
										305 403 300 113		-06/14 with preliminary setup	S	CAN	C	E	D	L1	H	45		
										305 406 300 113		-06/14 without preliminary setup	S	CAN	C	E	D	L1	V	150		
										305 407 300 113		06/14-07/19 with preliminary setup	S	CAN	C	E	D	L	H	30		
										305 408 300 107		06/14-07/19 without preliminary setup	S	CAN	C	E	--	--	V	60		
										305 408 300 113		06/14-07/19 without preliminary setup	S	CAN	C	E	D	L	V	60		
VW Golf VII Hatchback (AU) without preliminary setup exc. e-Golf, GTI TCR, GTI Clubsport	06/14-07/19	KIT		305 408 900 113		60	19.0	10.3	85	2000		included in the KIT 305 408 300 113		06/14-07/19 without preliminary setup	S	CAN	C	E	D	L	V	60
VW Golf VII Hatchback (AU) without preliminary setup exc. e-Golf, GTI TCR, GTI Clubsport Please order spoiler inc. cover for bumper cutout at VW-dealers.	06/14-07/19	KIT		305 409 900 113		60	21.0	10.3	85	2000		included in the KIT 305 408 300 113		06/14-07/19 without preliminary setup	S	CAN	C	E	D	L	V	60













Volkswagen













VW Golf VII Estate without preliminary setup inc. 4 Motion	08/13-06/14	KIT		321 781 900 113		60	18.0	10.2	80	2000		included in the KIT 305 406 300 113	-06/14 without preliminary setup	S	CAN	C	E	D	L1	V	150
		KIT		321 782 900 113		60	19.0	10.2	80	2000		included in the KIT 305 406 300 113	-06/14 without preliminary setup	S	CAN	C	E	D	L1	V	150
VW Golf VII Estate inc. 4 Motion inc. Alltrack 02/15-	08/13-08/20			321 781 600 001		60	16.0	10.2	80	2000		305 403 300 107	→ -06/14 with preliminary setup	S	CAN	C	E	--	--	H	45
				321 782 600 001		60	17.0	10.2	80	2000		305 403 300 113	-06/14 with preliminary setup	S	CAN	C	E	D	L1	H	45
												305 406 300 113	-06/14 without preliminary setup	S	CAN	C	E	D	L1	V	150
												305 407 300 113	06/14- with preliminary setup	S	CAN	C	E	D	L	H	30
												305 408 300 107	06/14- without preliminary setup	S	CAN	C	E	--	--	V	60
												305 408 300 113	06/14- without preliminary setup	S	CAN	C	E	D	L	V	60
VW Golf VII Estate without preliminary setup inc. 4 Motion inc. Alltrack 02/15-	06/14-08/20	KIT		321 783 900 113		60	18.0	10.2	80	2000		included in the KIT 305 408 300 113	06/14- without preliminary setup	S	CAN	C	E	D	L	V	60
		KIT		321 784 900 113		60	19.0	10.2	80	2000		included in the KIT 305 408 300 113	06/14- without preliminary setup	S	CAN	C	E	D	L	V	60
VW Golf VIII Hatchback CD1 exc. GTI Clubsport Please order separately: holder for antenna amplifier 917131632001	07/19-			317 131 600 001		60	19.0	10.3	85	2000		322 080 300 113	without preliminary setup	S	CAN	C	E	D	L	V	120
				317 132 600 001		60	19.0	10.3	85	2000											
VW Golf VIII Hatchback CD1 without preliminary setup exc. GTI Clubsport Please order separately: holder for antenna amplifier 917131632001	07/19-	KIT		322 080 900 113		60	21.0	10.3	85	2000		included in the KIT 322 080 300 113	without preliminary setup	S	CAN	C	E	D	L	V	120
		KIT		322 081 900 113		60	21.0	10.3	85	2000		included in the KIT 322 080 300 113	without preliminary setup	S	CAN	C	E	D	L	V	120

VW Passat CC inc. 4-Motion exc. R36 Please order additionally lower part of the bumper with cover for bumper cutout at VW dealer.	03/05-12/12			321 546 600 001		90	17.5	11.3	90	2200		321 600 300 153				S	CAN	C	E	D	L1	V	105
VW Passat CC B7 inc. Bluemotion	01/12-	KIT		321 821 900 153		90	17.5	11.3	90	2200		included in the KIT 321 600 300 153				S	CAN	C	E	D	L1	V	105
VW Passat Saloon front wheel drive exc. 4-Motion Support in spare wheel for detachable towball: 3B0 804 993A	10/96-03/05			321 505 600 001		90	20.8	10.3	85	1800													
VW Passat Saloon inc. 4-Motion exc. R36	03/05-10/10			321 544 600 001		90	16.0	11.3	90	2200													
VW Passat Saloon inc. 4-Motion exc. R36 Please order additionally lower part of the bumper with cover for bumper cutout at VW dealer.	03/05-10/10			321 546 600 001		90	17.5	11.3	90	2200		321 600 300 153				S	CAN	C	E	D	L1	V	105
VW Passat Saloon inc. 4-Motion, inc. R36 Please order additionally lower part of the bumper with cover for bumper cutout at VW dealer.	03/05-10/10	KIT		321 546 900 153		90	21.0	11.3	90	2200		included in the KIT 321 600 300 153				S	CAN	C	E	D	L1	V	105
VW Passat Saloon B7 R-Line = visible cut	10/10-11/14		 	321 821 600 001 321 823 600 001	 	90 90	17.5 20.0	11.3 11.3	90 90	2200 2200		321 600 300 153				S	CAN	C	E	D	L1	V	105
VW Passat Saloon B7 inc. Alltrack, Bluemotion R-Line = visible cut	10/10-11/14	KIT		321 823 900 153		90	22.0	11.3	90	2200		included in the KIT 321 600 300 153				S	CAN	C	E	D	L1	V	105
VW Passat Saloon B7 inc. Bluemotion	10/10-11/14	KIT		321 821 900 153		90	17.5	11.3	90	2200		included in the KIT 321 600 300 153				S	CAN	C	E	D	L1	V	105

Volkswagen

















VW Passat Saloon B8 Please order separately: holder for antenna amplifier 917131632001	11/14-			317 140 600 001		90	15.0	11.5	100	2200		305 407 300 113	with preliminary setup	S	CAN	C	E	D	L	H	30
				317 141 600 001		90	15.9	11.5	100	2200		305 408 300 107	without preliminary setup	S	CAN	C	E	--	--	V	60
												305 408 300 113	without preliminary setup	S	CAN	C	E	D	L	V	60
VW Passat Saloon B8 without preliminary setup Please order separately: holder for antenna amplifier 917131632001	11/14-	KIT		317 140 900 113		90	19.6	11.5	100	2200		included in the KIT 305 408 300 113	without preliminary setup	S	CAN	C	E	D	L	V	60
				317 141 900 113		90	19.9	11.5	100	2200		included in the KIT 305 408 300 113	without preliminary setup	S	CAN	C	E	D	L	V	60
VW Passat Estate B7 inc. Bluemotion		KIT		321 821 900 153		90	17.5	11.3	90	2200		included in the KIT 321 600 300 153		S	CAN	C	E	D	L1	V	105
VW Passat Estate front wheel drive exc. 4-Motion from 11/00: To guarantee an optimal fit of the bumper it is necessary to mount a bumper reinforcement, please order from VW-dealer, order no. 3B9 807 251A Support for detachable towball in spare wheel: 3B0 804 993A	04/97-09/05			321 505 600 001		90	20.8	10.3	85	1800											
VW Passat Estate inc. 4-Motion, inc. R36 08/05-: To guarantee an optimal fit of the bumper order bumper reinforcement from VW-dealer order no. 3C9 807 251 A.	09/05-10/10			321 544 600 001		90	16.0	11.3	90	2200											
				321 546 600 001		90	17.5	11.3	90	2200											
VW Passat Estate inc. 4-Motion, inc. R36 08/05-: To guarantee an optimal fit of the bumper order bumper reinforcement from VW-dealer order no. 3C9 807 251 A.	09/05-10/10	KIT		321 546 900 153		90	21.0	11.3	90	2200		included in the KIT 321 600 300 153		S	CAN	C	E	D	L1	V	105
VW Passat Estate B7 inc. Alltrack R-Line = visible cut	10/10-11/14			321 821 600 001		90	17.5	11.3	90	2200		321 600 300 153		S	CAN	C	E	D	L1	V	105
				321 823 600 001		90	20.0	11.3	90	2200											















VW Passat Estate B7 inc. Alltrack, Bluemotion R-Line = visible cut	10/10-11/14	KIT		321 823 900 153		90	22.0	11.3	90	2200		included in the KIT 321 600 300 153			S	CAN	C	E	D	L1	V	105	
VW Passat Estate B8 inc. Alltrack To guarantee an optimal fit of the bumper order bumper reinforcement from VW-dealer order no. 3G9807863B. Please order separately: holder for antenna amplifier 917131632001	11/14-			317 140 600 001		90	15.0	11.5	100	2200		305 407 300 113	with preliminary setup	S	CAN	C	E	D	L	H	V	30	
				317 141 600 001		90	15.9	11.5	100	2200		305 408 300 107	without preliminary setup	S	CAN	C	E	--	--	V	V	60	
													305 408 300 113	without preliminary setup	S	CAN	C	E	D	L	V	V	60
VW Passat Estate B8 without preliminary setup inc. Alltrack To guarantee an optimal fit of the bumper order bumper reinforcement from VW-dealer order no. 3G9807863B. Please order separately: holder for antenna amplifier 917131632001	11/14-	KIT		317 140 900 113		90	19.6	11.5	100	2200		included in the KIT 305 408 300 113	without preliminary setup	S	CAN	C	E	D	L	V	V	60	
				317 141 900 113		90	19.9	11.5	100	2200		included in the KIT 305 408 300 113	without preliminary setup	S	CAN	C	E	D	L	V	V	60	
VW Phaeton Please order from VW dealer: Spoiler V6 Petrol + V 8: 3D5 807 434 F Spoiler V6 Diesel + V10: 3D5 807 434 H Spoiler: V12: 3D5 807 434 G cover for bumper: 3D5 807 397 A V7S clip (2x): 6Q0 807 180 bracket to mount towball in the boot consisting of: bracket:	05/02-01/16			321 525 600 001		90	26.0	13.6	100	2500													
VW Polo If desired for optical reasons, it is possible to get the complete bumper inc. cover at VW dealers. inc. R-Line 2012-extension for socket holder necessary, order no. 921740650010	06/09-04/14	KIT		321 748 900 143		120	18.5	7.0	85	1200		321 527 300 143			S								

VW Polo Gti extension for socket holder necessary, order no. 921740650001	06/09-04/14		321 832 600 001		120	14.5	7.0	50	1200		321 527 300 143			S							
VW Polo Gti Please order cover for bumper cutout at VW dealers. extension for socket holder necessary, order no. 921740650001	06/09-04/14		321 878 600 001		120	16.5	7.0	50	1200		321 527 300 143			S							
VW Polo Hatchback for Polo Fun with permission for the assembly of a towbar by VW exc. GTi / 150 HP inc. facelift from 05/05, Blue Motion Please order the following parts for the bumper cover at VW dealer's: 1 spoiler 6Q6 807 433 B41 1 cover 6Q6 807 397 B41 2 bolt 6Q6 807	11/01-08/09		321 523 600 001		90	16.0	7.0	50	1200		321 523 300 113	-05/05	S	C2	C	E	D1	L1	H	45	
											321 524 300 113	05/05-	S	C2	C	E	D1	L1	H	45	
VW Polo VI (AW1) exc. GTI, exc. R-Line, exc. TGI exc. facelift	06/17-06/21		344 123 600 001		60	18.0	7.5	91	1270												
VW Polo VI (AW1) exc. GTI, exc. R-Line, exc. TGI exc. facelift	06/17-06/21		344 122 600 001		60	17.0	7.5	91	1270												
VW Polo VI AW1 for facelift exc. GTI exc. R-Line exc. TGI	06/21-		322 112 600 001		75	17.0	7.8	95	1200												
VW Sharan thermal-insulation plate inc. inc. 4WD bumper bracket is not necessary. 4-Motion: Please check the operating instructions of the vehicle before fitting the towbar.	05/00-08/10		321 665 600 001		90	24.0	12.5	100	2500		321 458 300 107	→	S	FRE	--	E	--	--	H	60	
											321 458 300 113		S	FRE	--	E	D1	L1	H	60	
VW Sharan	09/10-		321 698 600 001			22.0	12.3	100	2500		321 600 300 153		S	CAN	C	E	D	L1	V	105	

















Volkswagen















Volkswagen

VW Sharan Please order separately Spoiler and cover for bumper cutout at VW dealer's.	09/10-			321 700 600 001		22.0	12.3	100	2500		321 600 300 153			S	CAN	C	E	D	L1	V	105
VW Sharan Please order separately Spoiler and cover for bumper cutout at VW dealer's.	09/10-	KIT		321 700 900 153		24.0	12.3	100	2500		included in the KIT 321 600 300 153			S	CAN	C	E	D	L1	V	105
VW T-Cross (C11) exc. R-Line	12/18-			322 075 600 001		60	19.3	7.9	70	1400											
				322 076 600 001		60	20.6	7.9	70	1400											
VW T-Roc A11 Please order separately: holder for antenna amplifier 917131632001 for vehicles 17/07-12/21: extension for socket holder necessary, order no. 921740650001 inc. facelift 01/22-	07/17-			317 132 600 001		60	19.0	10.3	85	2000	305 407 300 113	with preliminary setup	S	CAN	C	E	D	L	H	30	
											305 408 300 107	without preliminary setup	S	CAN	C	E	--	--	V	60	
											305 408 300 113	without preliminary setup	S	CAN	C	E	D	L	V	60	
VW T-Roc A11 without preliminary setup Please order separately: holder for antenna amplifier 917131632001 for vehicles 17/07-12/21: extension for socket holder necessary, order no. 921740650001 inc. facelift 01/22-	07/17-	KIT		305 409 900 113		60	21.0	10.3	85	2000	included in the KIT 305 408 300 113	without preliminary setup	S	CAN	C	E	D	L	V	60	
VW T-Roc A11 Please order separately: holder for antenna amplifier 917131632001 inc. facelift 01/22-	07/17-			317 131 600 001		60	19.0	10.3	85	2000	305 407 300 113	with preliminary setup	S	CAN	C	E	D	L	H	30	
											305 408 300 107	without preliminary setup	S	CAN	C	E	--	--	V	60	
											305 408 300 113	without preliminary setup	S	CAN	C	E	D	L	V	60	
VW T-Roc A11 without preliminary setup Please order separately: holder for antenna amplifier 917131632001 inc. facelift 01/22-	07/17-	KIT		305 408 900 113		60	19.0	10.3	85	2000	included in the KIT 305 408 300 113	without preliminary setup	S	CAN	C	E	D	L	V	60	



VW T-Roc A11 with preliminary setup Please order separately: holder for antenna amplifier 917131632001 inc. facelift 01/22-	07/17-	KIT		317 154 900 113		60	20.5	10.3	85	2000		included in the KIT 305 407 300 113	with preliminary setup	S	CAN	C	E	D	L	H	30
VW T-Roc A11 with preliminary setup Please order separately: holder for antenna amplifier 917131632001 for vehicles 17/07-12/21: extension for socket holder necessary, order no. 921740650001 inc. facelift 01/22-	07/17-	KIT		317 155 900 113		60	20.5	10.3	85	2000		included in the KIT 305 407 300 113	with preliminary setup	S	CAN	C	E	D	L	H	30
VW T-Roc Convertible Please order separately: holder for antenna amplifier 917131632001	12/19-			317 131 600 001		60	19.0	10.3	85	2000		305 407 300 113	with preliminary setup	S	CAN	C	E	D	L	H	30
												305 408 300 107	without preliminary setup	S	CAN	C	E	--	--	V	60
												305 408 300 113	without preliminary setup	S	CAN	C	E	D	L	V	60
VW T-Roc Convertible Please order separately: holder for antenna amplifier 917131632001 extension for socket holder necessary, order no. 921740650001	12/19-			317 132 600 001		60	19.0	10.3	85	2000		305 407 300 113	with preliminary setup	S	CAN	C	E	D	L	H	30
												305 408 300 107	without preliminary setup	S	CAN	C	E	--	--	V	60
												305 408 300 113	without preliminary setup	S	CAN	C	E	D	L	V	60
VW T-Roc Convertible without preliminary setup Please order separately: holder for antenna amplifier 917131632001	12/19-	KIT		305 408 900 113		60	19.0	10.3	85	2000		included in the KIT 305 408 300 113	without preliminary setup	S	CAN	C	E	D	L	V	60
VW T-Roc Convertible with preliminary setup Please order separately: holder for antenna amplifier 917131632001	12/19-	KIT		317 154 900 113		60	20.5	10.3	85	2000		included in the KIT 305 407 300 113	with preliminary setup	S	CAN	C	E	D	L	H	30
VW T-Roc Convertible without preliminary setup Please order separately: holder for antenna amplifier 917131632001 extension for socket holder necessary, order no. 921740650001	12/19-	KIT		305 409 900 113		60	21.0	10.3	85	2000		included in the KIT 305 408 300 113	without preliminary setup	S	CAN	C	E	D	L	V	60

Volkswagen

VW T-Roc Convertible with preliminary setup Please order separately: holder for antenna amplifier 917131632001 extension for socket holder necessary, order no. 921740650001	12/19-	KIT		317 155 900 113		60	20.5	10.3	85	2000		included in the KIT 305 407 300 113	with preliminary setup	S	CAN	C	E	D	L	H	30
VW T7 Multivan STM, STN inc. Plugin-Hybrid	08/21-			322 100 600 001		90	18.7	11.5	140	2000											
				322 101 600 001		90	18.7	11.5	140	2000											
VW Taigo CS1 inc. R-Line	09/21-			322 111 600 001		90	20.0	7.5	90	1200		344 110 300 137 344 110 300 143	09/21- 09/21-	S S	CAN CAN	C C	E E	-- D	-- L	V V	60 60
VW Tiguan	11/07-	KIT		321 727 900 153		90	21.0	12.0	140	2500		included in the KIT 321 600 300 153		S	CAN	C	E	D	L1	V	105
		KIT		321 728 900 153		90	23.0	12.0	140	2500		included in the KIT 321 600 300 153		S	CAN	C	E	D	L1	V	105
VW Tiguan	11/07-03/16			305 421 600 001		90	19.0	12.0	100	2500											
				305 423 600 001		90	21.0	12.0	140	2500											
VW Tiguan II (AD1) Please order separately: holder for antenna amplifier 917131632001	04/16-			321 906 600 001		60	16.0	12.6	100	2500		305 407 300 113 305 408 300 107 305 408 300 113	with preliminary setup without preliminary setup without preliminary setup	S S S	CAN CAN CAN	C C C	E E E	D -- D	L -- L	H V V	30 60 60
VW Tiguan II (AD1) without preliminary setup	04/16-	KIT		322 096 900 113		90	31.5	12.3	150	2500		included in the KIT 322 096 300 153		S							

VW Touareg exc. vehicles with spare wheel on tailgate To guarantee an optimal appearance of the vehicle it is necessary to order the rear lower spoiler and the cover (depending on the equipment of the vehicle) separately from the VW dealer (see or	11/02-04/10	KIT		321 500 900 113	→ 	150	36.0	16.4	140	3500		included in the KIT 321 500 300 113	→	-04/10	S	CAN	--	E	D	L1	H	45
VW Touareg exc. vehicles with spare wheel on tailgate To guarantee an optimal appearance of the vehicle it is necessary to order the rear lower spoiler and the cover (depending on the equipment of the vehicle) separately from the VW dealer (see or	11/02-10/17		 	321 735 600 001 321 736 600 001	 	150 150	33.5 34.0	16.4	140	3500		321 500 300 113 321 765 300 113 321 766 300 113	→	-04/10 04/10-08/14 exc. vehicles with ACC / distance control 08/14-10/17	S S S	CAN CAN CAN	-- C C	E E E	D D D	L1 L1 L	H V H	45 180 180
VW Touareg exc. vehicles with spare wheel on tailgate To guarantee an optimal appearance of the vehicle it is necessary to order the rear lower spoiler and the cover (depending on the equipment of the vehicle) separately from the VW dealer (see or	04/10-08/14	KIT		321 736 900 113		150	36.0	16.4	140	3500		included in the KIT 321 765 300 113		04/10-08/14 exc. vehicles with ACC / distance control	S	CAN	C	E	D	L1	V	180
VW Touareg exc. vehicles with spare wheel on tailgate To guarantee an optimal appearance of the vehicle it is necessary to order the rear lower spoiler and the cover (depending on the equipment of the vehicle) separately from the VW dealer (see or	08/14-10/17	KIT		321 766 900 113			36.0	16.4	140	3500		included in the KIT 321 766 300 113		08/14-10/17	S	CAN	C	E	D	L	H	
VW Touareg CR7	11/17-			322 064 600 001		60	27.0	15.7	191	3500		305 417 300 113 305 437 300 113 305 447 300 113	→		S S S	A CAN CAN	C1 C C	E2 E E	D D D	L1 L L1	H H H	60 60 60
VW Touareg	11/17-	KIT		322 064 900 113		60	28.0	15.7	191	3500		included in the KIT 305 437 300 113			S	CAN	C	E	D	L	H	60

Volkswagen



VW Touran inc. Cross-Touran 08/10-: Please order separately cover for bumper cutout at VW dealer's.	03/03-	KIT		321 838 900 153		90	22.0	9.9	75	1800		included in the KIT 321 600 300 153			S	CAN	C	E	D	L1	V	105		
VW Touran inc. Cross-Touran	03/03-	KIT		321 536 900 153		90	21.5	9.9	75	1800		included in the KIT 321 600 300 153			S	CAN	C	E	D	L1	V	105		
VW Touran inc. Cross-Touran	03/03-09/15			321 536 600 001		90	19.5	9.9	75	1800		321 600 300 153			S	CAN	C	E	D	L1	V	105		
VW Touran inc. Cross-Touran 08/10-: Please order separately cover for bumper cutout at VW dealer's.	03/03-09/15			321 838 600 001		90	20.0	9.9	75	1800		321 600 300 153			S	CAN	C	E	D	L1	V	105		
VW Touran	09/15-			321 814 600 001		60	15.5	10.8	80	2100		305 407 300 113	with preliminary setup	S	CAN	C	E	D	L	H			30	
				321 815 600 001		60	16.0	10.8	80	2100		305 408 300 107	without preliminary setup	S	CAN	C	E	--	--	V			60	
												305 408 300 113	without preliminary setup	S	CAN	C	E	D	L	V			60	
VW Transporter T4 Van inc. Syncro and Caravelle	01/96-07/03			321 391 600 001		90	20.2	13.4	105	2600		321 318 300 113	09/98-	S	C2	--	--	D1	--				45	
VW Transporter T4 Van inc. Syncro and Caravelle bracket for towball: 921405631005	01/96-07/03			321 405 600 001		90	21.0	13.4	100	2600		321 318 300 113	09/98-	S	C2	--	--	D1	--				45	

VW Transporter T5 Van inc. 4 Motion, exc. Rockton To guarantee an optimal fit of the bumper it is necessary to mount 2 foam carriers, please order from VW-dealer, order no. 7H0 807 252 A Van (without back side windows) 10/09-: To guarantee an optimal fit of the bumper it is ne	04/03-08/15		321 650 600 001			115	18.0	14.0	120	2800		300 028 300 113	charging cable (extension kit) (Please order additionally.)									45
												321 451 300 100	-10/09 additional wire trailer stability systemIt is possible to activate trailer stability system starting from the following chassis numbers:WV2ZZZ7H and WV2ZZZ7HZ5H0597 (Please order additionally.)	S	--	--	E1	--	--	V	60	
												321 451 300 147	-10/09	S	C2	C	E1	--	--	H	45	
												321 454 300 143	10/09- for vehicles without preparation	S	CAN	C	E	D	L1	V	180	
												321 455 300 001	10/09-extension kit for vehicles without fuse box under the drivers seat (Please order additionally.)	S						V	60	
												321 650 300 113	07/11-05/12 for vehicles with preparation	S	CAN	--	E	D	L1	H	30	
												321 652 300 113	05/12-08/15 for vehicles with preparation	S	CAN	--	E	D	L	H	30	

Volkswagen





Volkswagen

VW Transporter T5 Van inc. 4 Motion, exc. Rockton To guarantee an optimal fit of the bumper it is necessary to mount 2 foam carriers, please order from VW-dealer, order no. 7H0 807 252 A Please order also from VW dealer: - bracket for towball: 7H0 804 897 A - tensioning belt: 7H0 867 749 Van (without back side windows) 10/09-: To guarantee an optimal fit of the bumper it is necessary to mount: - 1x plastic rail 7H0 807 723 - 8x gasket 357 853 586 B - 8x Clip 701 867 299	04/03-08/15		321 651 600 001				120	20.0	14.0	120	2800		300 028 300 113	charging cable (extension kit) (Please order additionally.)								45
				321 451 300 100	-10/09 additional wire trailer stability systemIt is possible to activate trailer stability system starting from the following chassis numbers:WV2ZZZ7H and WV2ZZZ7HZ5H0597 (Please order additionally.)	S	--	--	E1	--	--	V	60									
				321 451 300 147	-10/09	S	C2	C	E1	--	--	H	45									
				321 454 300 143	10/09- for vehicles without preparation	S	CAN	C	E	D	L1	V	180									
				321 455 300 001	10/09-extension kit for vehicles without fuse box under the drivers seat (Please order additionally.)	S						V	60									
				321 650 300 113	07/11-05/12 for vehicles with preparation	S	CAN	--	E	D	L1	H	30									
				321 652 300 113	05/12-08/15 for vehicles with preparation	S	CAN	--	E	D	L	H	30									

VW Transporter T5 Van inc. 4 Motion, exc. Rockton inc. towball To guarantee an optimal fit of the bumper it is necessary to mount 2 foam carriers, please order from VW-dealer, order no. 7H0 807 252 A Van (without back side windows) 10/09-: To guarantee an optimal fit of the bumper it is ne	04/03-08/15		321 681 600 001			120	17.5	14.0	100	2800		300 028 300 113	charging cable (extension kit) (Please order additionally.)								45
												321 451 300 100	-10/09 additional wire trailer stability systemIt is possible to activate trailer stability system starting from the following chassis numbers:WV2ZZZ7H and WV2ZZZ7HZ5H0597 (Please order additionally.)	S	--	--	E1	--	--	V	60
												321 451 300 147	-10/09	S	C2	C	E1	--	--	H	45
												321 454 300 143	10/09- for vehicles without preparation	S	CAN	C	E	D	L1	V	180
												321 455 300 001	10/09-extension kit for vehicles without fuse box under the drivers seat (Please order additionally.)	S						V	60
												321 650 300 113	07/11-05/12 for vehicles with preparation	S	CAN	--	E	D	L1	H	30
												321 652 300 113	05/12-08/15 for vehicles with preparation	S	CAN	--	E	D	L	H	30
VW Transporter T5 Chassis Cab high-load flatbed	04/03-08/15		321 973 600 001			60	25.0	13.8	105	2500		300 028 300 113	charging cable (extension kit) (Please order additionally.)								45
												321 455 300 001	10/09-extension kit for vehicles without fuse box under the driver's seat (Please order additionally.)	S						V	60
												321 651 300 113	07/11-05/12 for vehicles with preparation	S	CAN	--	E	D	--	H	15
												321 653 300 113	05/12-08/15 for vehicles with preparation	S	CAN	C	E	D	L	H	30

Volkswagen

Volkswagen

























VW Transporter T6 Van	06/15-		321 650 600 001	115	18.0	14.0	120	2800	300 028 300 113	charging cable (extension kit) (Please order additionally.)									45
			321 651 600 001	120	20.0	14.0	120	2800	321 454 300 143	10/09- for vehicles without preparation	S	CAN	C	E	D	L1	V	180	
										321 455 300 001	extension kit for vehicles without fuse box under the driver's seat (Please order additionally.)	S						V	60
										321 652 300 113	06/15- for vehicles with preparation	S	CAN	--	E	D	L	H	30
										322 074 300 113	10/19- without preliminary setup	S	CAN	C	E	D	L	V	120
VW Transporter T6 Van inc. towball	06/15-		321 681 600 001	120	17.5	14.0	100	2800	300 028 300 113	charging cable (extension kit) (Please order additionally.)									45
										321 454 300 143	10/09- for vehicles without preparation	S	CAN	C	E	D	L1	V	180
										321 455 300 001	extension kit for vehicles without fuse box under the driver's seat (Please order additionally.)	S						V	60
										321 652 300 113	06/15- for vehicles with preparation	S	CAN	--	E	D	L	H	30
										322 074 300 113	10/19- without preliminary setup	S	CAN	C	E	D	L	V	120
VW Transporter T6 Van without preliminary setup	10/19-	KIT		322 073 900 113	115	19.7	14.0	120	2800	included in the KIT 322 074 300 113	10/19- without preliminary setup	S	CAN	C	E	D	L	V	120
			KIT		322 074 900 113	120	21.7	14.0	120	2800	included in the KIT 322 074 300 113	10/19- without preliminary setup	S	CAN	C	E	D	L	V

VW Transporter T6 Chassis Cab	06/15-			321 973 600 001			60	25.0	13.8	105	2500		300 028 300 113	charging cable (extension kit) (Please order additionally.)											45
													321 451 300 100	additional wire trailer stability systemIt is possible to activate trailer stability system starting from the following chassis numbers:WV2ZZZ7H and WV2ZZZ7HZ5H0597 (Please order additionally.)	S	--	--	E1	--	--	V			60	
													321 455 300 001	extension kit for vehicles without fuse box under the driver's seat (Please order additionally.)	S						V			60	
													321 653 300 113	06/15-09/19 for vehicles with preparation	S	CAN	C	E	D	L	H			30	
													322 074 300 113	10/19- without preliminary setup	S	CAN	C	E	D	L	V			120	

Volkswagen



























Volvo

























Volvo S40 / V50 exc. Sports, exc. R design	02/04-12/12		320 059 600 001		40	9.7	8.9	100	1600		300 210 300 113	06/07-	--	A	--	E1	D1	L1	V	90
											320 240 300 107		S	CAN	--	E2	--	--	H	60
													320 240 300 113	S	CAN	--	E2	D	L1	H
Volvo S40 / V50 exc. Sports, exc. R design	06/07-12/12	KIT 	320 059 900 113		40	11.7	8.9	100	1600		included in the KIT 320 240 300 113	06/07-	S	CAN	--	E2	D	L1	H	60
Volvo S60	06/10-01/18		320 071 600 001		90	15.0	10.2	80	1800		300 320 300 183	additional cable for 2nd fog light								
				320 072 600 001		90	17.0	10.2	80	1800			320 543 300 113	-01/18	S	CAN	--	E2	D1	L1
		KIT 	320 071 900 113		90	17.0	10.2	80	1800		included in the KIT 320 543 300 113	-01/18	S	CAN	--	E2	D1	L1	H	45
		KIT 	320 072 900 113		90	19.0	10.2	80	1800		included in the KIT 320 543 300 113	-01/18	S	CAN	--	E2	D1	L1	H	45
Volvo S60 III (224)	02/19-		320 173 600 001		60	24.1	12.6	150	2000											
				320 174 600 001		60	27.0	12.6	150	2000										
Volvo S60/V60 Cross Country	07/15-08/18		320 111 600 001		90	19.0	10.5	90	1900		300 320 300 183	additional cable for 2nd fog light								
				320 112 600 001		90	20.5	10.5	90	1900			320 543 300 113	S	CAN	--	E2	D1	L1	H
		KIT 	320 111 900 113		90	20.8	10.5	90	1900		included in the KIT 320 543 300 113		S	CAN	--	E2	D1	L1	H	45
		KIT 	320 112 900 113		90	22.3	10.5	90	1900		included in the KIT 320 543 300 113		S	CAN	--	E2	D1	L1	H	45

Volvo S90 II 234	09/16-			320 116 600 001		60	22.0	11.7	110	2200		320 165 300 107			S	A	--	E1	--	--	H	75		
				320 117 600 001		60	23.0	11.7	110	2200		320 165 300 113			S	A	--	E2	D	L1	H	75		
		KIT		320 165 900 113		60	25.9	11.7	110	2200		included in the KIT 320 165 300 113			S	A	--	E2	D	L1	H	75		
		KIT		320 166 900 113		60	28.4	11.7	110	2200		included in the KIT 320 165 300 113			S	A	--	E2	D	L1	H	75		
Volvo V40 inc. Cross Country exc. R-design	09/12-07/19			320 107 600 001		90	15.0	8.7	75	1500		320 108 300 113			S	A	--	E2	D	L1	H	60		
				320 108 600 001		90	18.0	8.7	75	1500														
		KIT		320 107 900 113		90	17.0	8.7	75	1500		included in the KIT 320 108 300 113			S	A	--	E2	D	L1	H	60		
		KIT		320 108 900 113		90	20.0	8.7	75	1500		included in the KIT 320 108 300 113			S	A	--	E2	D	L1	H	60		
Volvo V60	11/10-01/18			320 071 600 001		90	15.0	10.2	80	1800		300 320 300 183		additional cable for 2nd fog light										
				320 072 600 001		90	17.0	10.2	80	1800		320 543 300 113		-01/18	S	CAN	--	E2	D1	L1	H	45		
		KIT		320 071 900 113		90	17.0	10.2	80	1800		included in the KIT 320 543 300 113		-01/18	S	CAN	--	E2	D1	L1	H	45		
		KIT		320 072 900 113		90	19.0	10.2	80	1800		included in the KIT 320 543 300 113		-01/18	S	CAN	--	E2	D1	L1	H	45		

Volvo























Volvo

















Volvo V60 II 225	02/18-			320 173 600 001		60	24.1	12.6	150	2000	320 173 300 113			S	A	C1	E2	D	L1	H	75
				320 174 600 001		60	27.0	12.6	150	2000											
		KIT		320 173 900 113		60	28.9	10.7	110	2100	included in the KIT 320 173 300 113			S	A	C1	E2	D	L1	H	75
		KIT		320 174 900 113		60	25.7	12.6	150	2000	included in the KIT 320 173 300 113			S	A	C1	E2	D	L1	H	75
Volvo V60 II Cross Country 227	09/18-			320 181 600 001		60	24.2	12.6	150	2000	320 173 300 113			S	A	C1	E2	D	L1	H	75
				320 182 600 001		60	27.0	12.6	150	2000											
		KIT		320 181 900 113		60	25.7	12.6	150	2000	included in the KIT 320 173 300 113			S	A	C1	E2	D	L1	H	75
		KIT		320 182 900 113		60	28.6	12.6	150	2000	included in the KIT 320 173 300 113			S	A	C1	E2	D	L1	H	75
Volvo V70 inc. AWD exc. XC70	03/00-09/07			320 090 600 001		100	21.0	10.3	80	2000											
Volvo V70 without height control inc. AWD	09/07-04/16			320 069 600 001		90	20.0	11.0	85	2100	300 320 300 183	additional cable for 2nd fog light		S	CAN	--	E2	D1	L1	H	45
				320 075 600 001		60	22.0	11.0	85	2100	320 543 300 113										
		KIT		320 069 900 113		90	22.0	11.0	85	2100	included in the KIT 320 543 300 113			S	CAN	--	E2	D1	L1	H	45
		KIT		320 075 900 113		60	24.0	11.0	85	2100	included in the KIT 320 543 300 113			S	CAN	--	E2	D1	L1	H	45

Volvo V70 with height control inc. AWD	09/07-04/16		320 073 600 001		90	20.0	11.0	85	2100	320 543 300 113	S	CAN	--	E2	D1	L1	H	45	
			320 076 600 001		60	24.0	11.0	85	2100										
	KIT		320 073 900 113		90	22.0	11.0	85	2100	included in the KIT 320 543 300 113	S	CAN	--	E2	D1	L1	H	45	
	KIT		320 076 900 113		60	24.0	11.0	85	2100	included in the KIT 320 543 300 113	S	CAN	--	E2	D1	L1	H	45	
Volvo V90 II 235	09/16-		320 116 600 001		60	22.0	11.7	110	2200	320 117 300 113	S	A	--	E2	D	L1	H	75	
			320 117 600 001		60	23.0	11.7	110	2200										-12/20
Volvo V90 II 235	09/16-12/20	KIT		320 116 900 113		60	23.5	11.7	110	2200	included in the KIT 320 117 300 113	S	A	--	E2	D	L1	H	75
		KIT		320 117 900 113		60	28.4	11.7	110	2200	included in the KIT 320 117 300 113	S	A	--	E2	D	L1	H	75
Volvo V90 II Cross Country 236	11/16-		320 166 600 001		60	21.3	12.1	130	2500	320 117 300 113	S	A	--	E2	D	L1	H	75	
			320 167 600 001		60	22.7	12.1	130	2500										11/16-12/20
Volvo V90 II Cross Country 236	11/16-12/20	KIT		320 167 900 113		60	28.4	12.1	130	2500	included in the KIT 320 117 300 113	S	A	--	E2	D	L1	H	75
Volvo XC 40 Recharge 536	11/20-		320 170 600 001		60	24.3	10.7	110	2100	320 173 300 113	S	A	C1	E2	D	L1	H	75	

Volvo

Volvo

Volvo XC40 (536) inc. Recharge (PHEV & BEV)	10/17-			320 169 600 001		60	23.0	10.7	110	2100		320 173 300 113	inc. Recharge (PHEV & BEV)	S	A	C1	E2	D	L1	H	75	
				320 170 600 001		60	24.3	10.7	110	2100												
	KIT		320 169 900 113		60	25.9	10.7	110	2100		included in the KIT 320 173 300 113	inc. Recharge (PHEV & BEV)	S	A	C1	E2	D	L1	H	75		
	KIT		320 170 900 113		60	28.9	10.7	110	2100		included in the KIT 320 173 300 113	inc. Recharge (PHEV & BEV)	S	A	C1	E2	D	L1	H	75		
Volvo XC60 I exc. R-design	08/08-12/17			320 063 600 001		90	21.0	11.0	90	2000		300 320 300 183	additional cable for 2nd fog light									
				320 115 600 001		90	24.0	11.0	90	2000		320 543 300 113	-12/17	S	CAN	--	E2	D1	L1	H	45	
		KIT		320 063 900 113		90	23.0	11.0	90	2000		included in the KIT 320 543 300 113	-12/17	S	CAN	--	E2	D1	L1	H	45	
		KIT		320 064 900 113		90	26.0	11.0	90	2000		included in the KIT 320 543 300 113	-12/17	S	CAN	--	E2	D1	L1	H	45	
Volvo XC60 II (246)	03/17-			320 172 600 001		60	22.4	12.6	150	2500		320 173 300 113		S	A	C1	E2	D	L1	H	75	
		KIT		320 171 900 113		60	25.9	12.6	150	2500		included in the KIT 320 173 300 113		S	A	C1	E2	D	L1	H	75	
		KIT		320 172 900 113		60	28.9	12.6	150	2500		included in the KIT 320 173 300 113		S	A	C1	E2	D	L1	H	75	

Volvo XC70 without height control	09/07-05/16		320 073 600 001		90	20.0	11.0	85	2100		300 320 300 183	additional cable for 2nd fog light																	
			320 076 600 001		60	24.0	11.0	85	2100		320 543 300 113			S	CAN	--	E2	D1	L1	H	45								
	KIT		320 073 900 113		90	22.0	11.0	85	2100		included in the KIT 320 543 300 113			S	CAN	--	E2	D1	L1	H	45								
	KIT		320 076 900 113		60	24.0	11.0	85	2100		included in the KIT 320 543 300 113			S	CAN	--	E2	D1	L1	H	45								
Volvo XC90	01/03-06/15		320 057 600 001		120	26.2	12.2	140	2250		320 780 300 113		09/04-	S	FRE	--	E2	D	L1	H	60								
Volvo XC90 KIT = towbar inc. electrical kit 13 pins	10/04-06/15	KIT		320 057 900 113		120	28.2	12.2	140	2250		included in the KIT 320 780 300 113		09/04-	S	FRE	--	E2	D	L1	H	60							
Volvo XC90 inc. hybrid	06/15-		320 102 600 001		60	25.0	13.4	140	2700		320 102 300 113			S	A	--	E2	D	L1	H	75								
		KIT		320 102 900 113		60	26.0	13.4	140	2700		included in the KIT 320 102 300 113			S	A	--	E2	D	L1	H	75							

Towing brackets, couplings and special towbars

Universal HGV towing brackets

Please pay attention to the D-value of each component!

Towing bracket

with integral anderrun guard
order no. 313404600001
and towball
order no. 329103600001



under run guard
approval no.: e13-6131

Towball is not included.

	order no.	 kg	D-value kN	 kg	 kg		
Towing bracket with integral anderrun guard for HGV. Swap system permitted.	313404600001	69,0	25,1	150	3000 3500	17000 9400	
towball recommended	329103600001	8,2	25,1	120	3000 3500	17000 9400	

Towing bracket

with integral anderrun guard
order no. 342179600001
and towball
order no. 329103600001

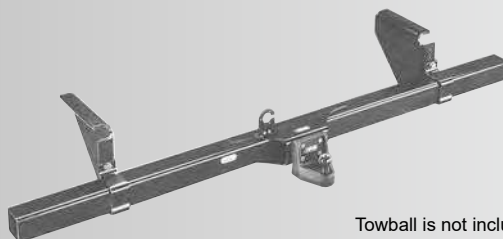

under run guard
approval no.: e13-6130

Towball is not included.

	order no.	 kg	D-value kN	 kg	 kg		
Towing bracket with integral anderrun guard for HGV. Swap system permitted.	342179600001	76,0	23,5	150	3500	z.B. 7500	
towball recommended	329103600001	8,2	25,1	120			

Universal HGV- electrical kits for 12V	order no.	car specific	flash control	coding	PDCcut off	perma- nent plus	charging line	electrical connec- tion	moun- ting time	
	300201300113		A			D1	L1	V		

Technical data for universal HGV towbars

all measurements in mm

Towing brackets universally applicable due to 2-dimensional adjustment (height and width)

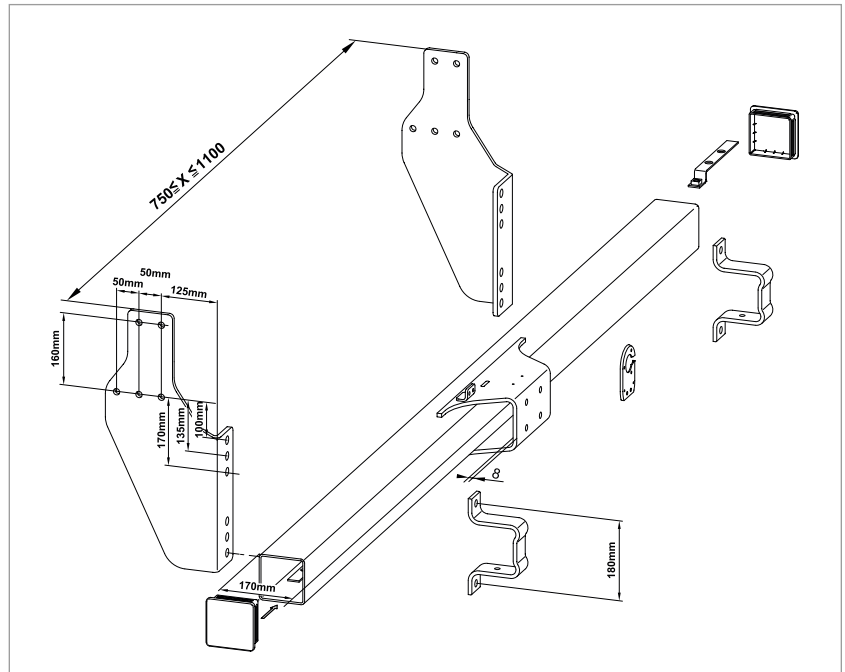





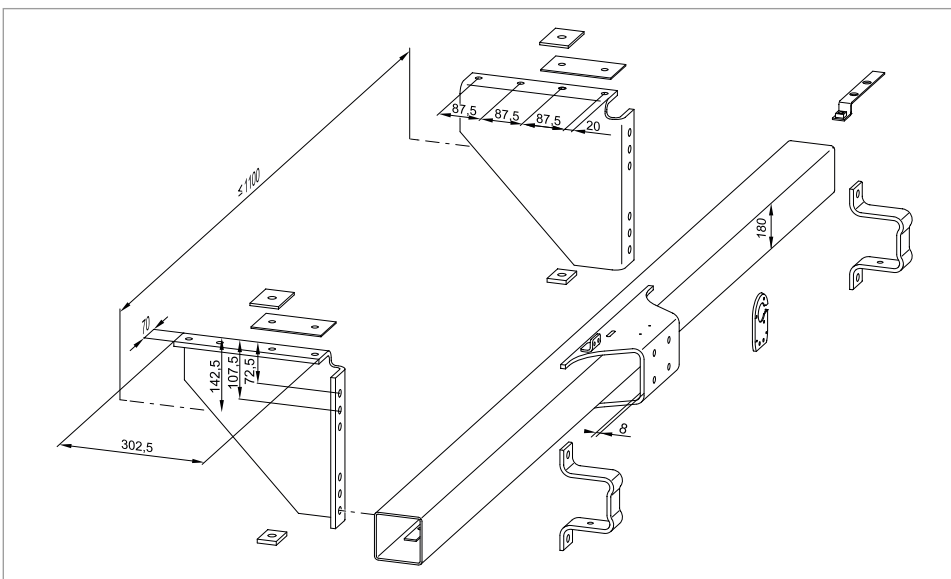

313 404

342 179

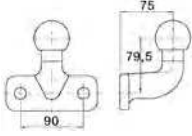
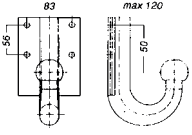
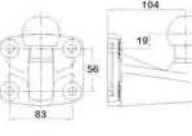
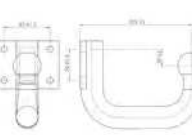
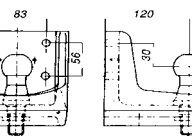
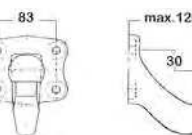
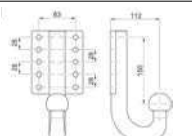
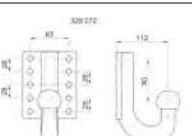
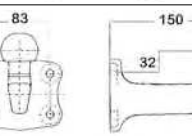

Towballs and Couplings for HGV and Off-Road Vehicles

	order no.		D-Value kN			kg 
	329076600001	2,4	20,55	350	2.500 or 2.200 or 2.000	12.924 or 8.317 or 5.217
	incl. 2 screws M 16 x 50, 8.8					
	329042600001 discontinued model	4,4	17,2	100	2.800 or 2.500 or 2.000	4.700 or 5.800 or 14.200
	329141600001	4,0	24,8	250	3.500 or 3.815 or 3.385	9.115 or 7.500 or 10.000
	329143600001	4,5	17,5	200	4.900 or 6.200 or 3.600	2.800 or 2.500 or 3.500
	329103600001	8,5	25,1	150	3.500 or 2.500 or 3.000	9.400 or 40.000 or 17.000
	329062600001	3,6	23,5	150	2.800 or 3.100 or 3.500	15.000 or 10.000 or 7.500
	329160600001 For vehicles without a brake cable eyelet the brake cable holder 329071631001 is required.	4,1	17,5	150	2.500 oder 2.800 oder 3.500	6.200 oder 4.900 oder 3.600
	329072600001	3,7	17,5	150	2.500 or 2.800 or 3.500	6.200 or 4.900 or 3.600
	329089600001	2,8	17,5	150	2.800 or 2.500 or 3.500	4.900 or 6.200 or 3.600
	329113600001	1,0	17,7	140	2.800 oder 2.500 oder 2.000	4.700 oder 5.800 oder 14.000

Mounting parts for Couplings



traverse of the towing vehicle or towing bracket	towball or coupling (order no. ends with ...600001)	screw kit*
8 - 12 mm	329 042 329 059, 329 062, 329 071, 329 072 329 060, 329 089, 329 103	900 040 632 340 900 045 632 325 900 055 632 552
15 - 20 mm	329 042, 329 057, 329 062, 329 071, 329 072 329 059 329 060, 329 103	900 050 632 424 900 055 632 552 900 060 632 523
60 - 65 mm	329 042, 329 062, 329 071, 329 072 329 059 329 060, 329 103, 329 089	900 095 632 553 900 100 632 527 900 105 632 554
65 - 70 mm	329 042, 329 062, 329 071, 329 072 329 059 329 060, 329 103, 329 089	900 100 632 527 900 105 632 554 900 110 632 505
70 - 75 mm	329 042, 329 062, 329 071, 329 072 329 059 329 060, 329 103, 329 089	900 105 632 554 900 110 632 505 900 115 632 524
75 - 80 mm	329 042, 329 062, 329 071, 329 072 329 059 329 060, 329 103, 329 089	900 110 632 505 900 115 632 524 900 120 632 516
80 - 85 mm	329 042, 329 062, 329 071, 329 072 329 059 329 060, 329 103, 329 089	900 115 632 524 900 120 632 516 900 125 632 504
85 - 90 mm	329 042, 329 062, 329 071, 329 072 329 059 329 060, 329 103, 329 089	900 120 632 516 900 125 632 504 900 130 632 539
90 - 95 mm	329 042, 329 062, 329 071, 329 072 329 059 329 060, 329 103, 329 089	900 125 632 504 900 130 632 539 900 135 632 379

* Each kit contains: 4 screws M10 10.9, 4 nuts, 8 washers.
4th - 6th position of the part no. indicates the length of the screws in mm.

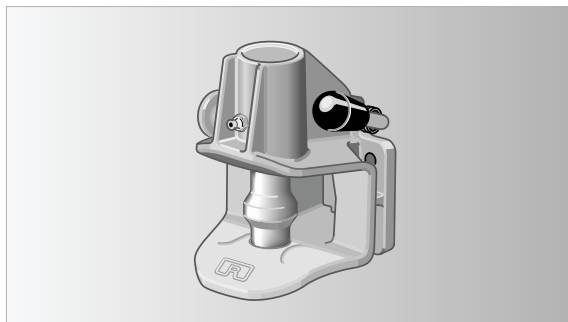
Coupling bolt





Coupling bolt
Rockinger-Nr. 243A11000

order no.	screw-hole circle mm	D-Value kN	Dc-Value kN (depends on the height of the ball)		
342090600001	83 x 56	18,0	min. 18,0 max. 30,0	5,0	250

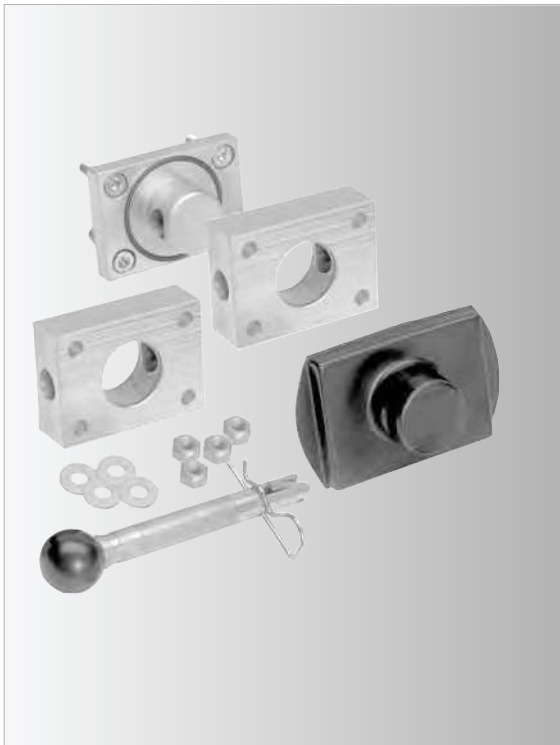
Swap system



order no.	set	screw-hole circle mm	D/Dc-Value kN		
329064600001	1 base plate 2 exchangeable plates 1 cover	83 x 56	18,5	3,5	120

Application in association with:



towball

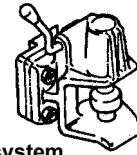

coupling system

*screws / mounting parts (depending on towing brackets and couplings) regard below.

Spare parts for swap system 329064600001

order no.	Bezeichnung
929 064 605 002	base plate
900 001 508 003	O ring
929 064 605 101	exchangeable plate
929 064 630 101	cover
929 064 625 001	bolt

Mounting parts for swap system

screw kit*	Towball or coupling on adapting plate	flange	screws
900 050 636 186	329 042	5 - 10 mm	M 10x50
900 055 636 187	329 059, 329 062, 329 072, 329 089 Rockinger bolt coupling	10 - 15 mm	M 10x55
900 060 636 188	329 060, 329 103	15 - 20 mm	M 10x60

screw kit*	base plate on towing vehicle or towbar	screws
900 040 636 176	8 - 12 mm	M 10x40
900 100 636 180	70 - 75 mm	M 10x100
900 110 636 182	80 - 85 mm	M 10x110
900 130 636 185	95 - 105 mm	M 10x130



* Each kit contains

4 screws M10 (10.9)
4 nuts M10
4 washers 10,5

4th - 6th position of the part no. indicates the length of the screws in mm.

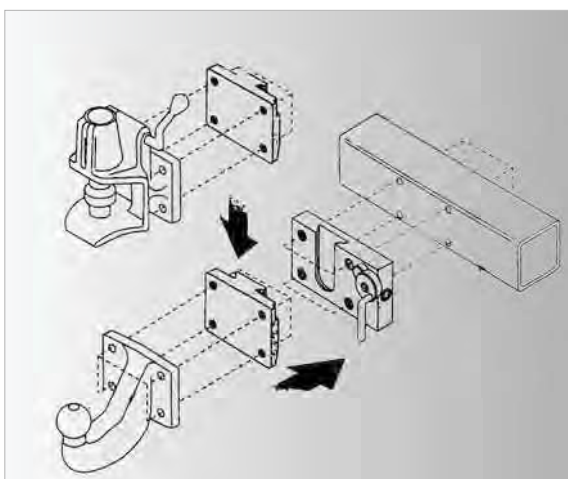
Swap system



order no.	set	screw-hole circle mm	D/Dc-Value kN		
342032600001	1 ground plate 2 exchangeable plates	83x56	30	5,8	120

Application in association with:



towball

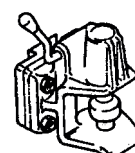

coupling system

*screws / mounting parts (depending on towing brackets and couplings) regard below.

Accessories Special Couplings



Adapter 2-hole-fixing (90 mm) to 4-hole-fixing (83 x 56 mm)

order no.	900 001 005 062
max. total weight kg	3500
vertical load kg	140
D-value kN	20,2
weight kg	3,0

The combination with the swap systems 329064600001 and 329073600001 is not possible.

Special Couplings

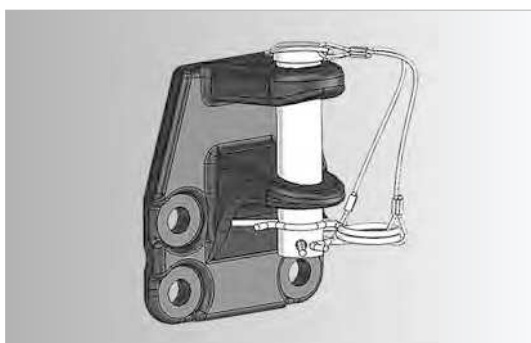

order no.	329 142 600 001
flange plate	
hole Ø mm	17
diameter mm	4-Loch, 90 x 40
max. total weight kg	3500
D-value kN flange	23,4
vertical load kg ball	350
weight kg	3,5



To tow trailers with ring coupling. Perfect for heavy vehicles

order no.	329 091 600 001
flange plate	114 x 73
hole Ø mm	17
diameter mm	2-holes, 90
max. total weight kg	3500
opening mm	50 Ø
D-value kN	27,5
vertical load kg	150
weight kg	3,5



To tow trailers with a ball or ring coupling. Perfect for heavy vehicles

order no.	329 094 600 001	329 090 600001 discontinued	329 131 600 001
flange plate	122 x 91	122 x 91	122 x 91
hole Ø mm	10-11	10-11	17
diameter mm	4-holes, 90	4-holes, 83 x 56	2-holes, 90
max. total weight kg	3500	3500	3500
D-value kN	31	31	31
vertical load kg	340	340	340
weight kg	5,2	5,2	5,2

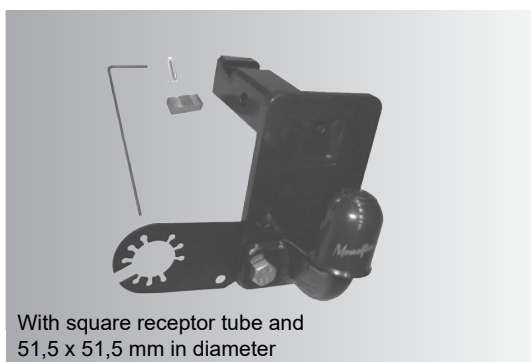

With square receptor tube and 51,5 x 51,5 mm in diameter

order no.	342 311 600 001	900001001850
Set	1 ground plate 1 towball (2-holes) 1 socket holder 1 mounting kit	1 ground plate 1 mounting kit
D/DC Value kN	17,17	17,17
weight kg	8	2,7
vertical load kg	140	140
towing capacity kg	3500	2700



Towbars

Accessories

Spare parts

Accessories



Towball cover (10 pcs.)

package 100 pieces: order no. 917 034 630 100
package 800 pieces: order no. 9170 34 630 101

order no.: 917 034 630 010



Towball cover blue "Baseball cap" (10 pcs.)

package 50 pieces: order no. 300 050 001 909

order no.: 300 010 001 909



Snap gauge

order no.: 900 001 535 051

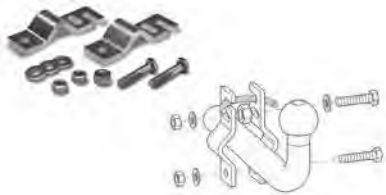

Bracket

for the safety breakaway rope of the trailer

order no.: 935 211 627 001



Bracket 50 mm Ø

for the safety breakaway rope of the trailer

order no.: 921 540 627 001



Bracket 56 mm Ø

for the safety breakaway rope of the trailer

order no.: 905 243 627 001



Bracket 84 mm Ø

for the safety breakaway rope of the trailer

order no.: 905 276 627 001

Accessories



Presentation rack for towbars

(towbars are not included)

order no.: 300 100 600 001

Steps



Step

for Mercedes-Benz Sprinter II and VW LT Crafter 03/06-
(van and minibus)

Only in conjunction with towbars WAM no.:
313 267/272/273/376 600001

order no.: 313 285 600 001



Step universal

for all universal HGV towbars with 4 hole towballs and
universal HGV towbars with 2 hole towballs with a hole
spacing of 90 mm

e.g. Citroen Jumper, Fiat Ducato, Mercedes Sprinter,
Peugeot Boxer, VW Crafter

order no.: 313 440 600 001

Side caps for towing brackets



Side cap (2 pcs.) (measurements: 100x100 mm)

342035, 332110, 342076/313146/313192/313193,
313404/342179

order no.: 900 001 503 587

Spare parts for detachable towbars



Key for lock automatic towball

(package 2 pcs.)

*The last two digits are the numbers that appear on the key head or that you have noted in your manual. Declaration and procedure for ordering keys please find on our website www.westfalia-automotive.com.

order no.: 942 001 513 2xx



Master key set for detachable towbars

order no.: 942 001 513 999



Cover for lock automatic towball

(package 2 pieces)

(package 10 pieces = order no. 905 112 630 101)

order no.: 905 111 630 101



Cover for lock automatic towball

with protection against loss

(package 2 pieces)

(package 10 pieces = 621 534 630 102)

order no.: 921 534 630 101



Skai leather zip bag (for all detachable towbars)

order no.: 900 001 504 923



Metal nut

(incl. 4 steel balls, 1 circlip)

of the ball up to 40 mm

order no.: 914 234 622 101

Towballs and plug covers for detachable towbars

order no.towbar	order no. Towball	order no. sealing plug
303078600001	903078601001	903078630121
303091600001	on demand	921630630121
303095600001	935268601001	913183630121
303113600001	903085601001	903078630121
303123600001	903078601001	903078630121
303124600001	903078601001	903078630121
303127600001	935268601001	903078630121
303130600001	on demand	903078630121
303140600001	906230601003	903140630103
303144600001	935268601001	903078630121
303149600001	903078601001	903078630121
303150600001	903078601001	903078630121
303155600001	906230601003	903078630121
303173600001	903078601001	903078630121
303176600001	903078601001	903078630121
303178600001	903078601001	903078630121
303185600001	903174600011	903140630103
303189600001	903189601090	903078630121
303189600006	903189601090	921630630121
303202600001	903186600003	903140630103
303205600001	915055601001	903078630121
303207600001	903170601006	903137630101
303228600001	935268601001	913183630121
303229600001	935268601001	913183630121
303230600001	903230601005	903078630121
303231600001	903231601005	903078630121
303232600001	903230601005	903078630121
303235600001	903186601003	903140630103
303237600001	903186601003	921630630121
303240600001	914251601090	913183630121
303253600001	903186601003	921630630121
303266600001	914251601090	913183630121
303273600001	903273601009	921630630121
303290600001	903290601009	903137630101
303294600001	903292601019	921630630121
303298600001	915055601001	903078630121
303299600001	903230601005	921630630121
303300600001	903230601005	921630630121
303301600001	903186601003	921630630121
303302600001	903186601003	921630630121
303303600001	914251601090	913183630121
303304600001	903189601090	903078630121
303314600001	907336601090	921630630121
303315600983	921657601050	921630630121
303317600001	903315601006	913183630121
303323600001	915055601001	903078630121
303328600001	903292601019	921630630121
303330600001	914251601090	913183630121

Towballs and plug covers for detachable towbars

order no.towbar	order no. Towball	order no. sealing plug
303332600001	914251601090	913183630121
303333600001	903189601090	921630630121
303336600001	903292601019	921630630121
303338600001	916128601090	903078630121
303340600001	921546601090	921630630121
303352600001	907305601090	903078630121
303354600982	903315601006	921630630121
303366600001	907305601090	921630630121
303368600001	903273601009	921630630121
303370600001	903292601019	921630630121
303372600001	903315601006	903078630121
303388600001	913082601090	921630630121
303394600001	907336601090	921630630121
303398600001	916128601090	913183630121
303404600001	905405601001	921630630121
303431600001	917034601090	921630630121
303431900113	917034601090	921630630121
303433600001	916128601090	913183630121
303433900113	916128601090	913183630121
303441600001	917034601090	921630630121
303441900113	917034601090	921630630121
303476600001	914294601090	913183630121
303476900113	914294601090	913183630121
303478600001	913082601090	913183630121
303478900113	913082601090	913183630121
303483600001	907200601005	921630630121
303483900113	907200601005	921630630121
303485600001	920057601090	913183630121
303487600001	913082601090	913183630121
303496600001	913082601090	913183630121
303496900113	913082601090	913183630121
304056600001	on demand	921630630121
304057600001	904057601001	921630630121
304059600001	on demand	903011630108
304060600001	on demand	903011630108
304068600001	906187601090	913183630121
304072600001	914266601001	913183630121
304073600001	921505601005	913183630121
304079600001	916114601001	913183630121
304092600001	914294601090	921630630121
304100600001	914294601090	913183630121
304100900113	914251601090	913183630121
304128600001	904120601001	-
304131600001	914294601090	921630630121
304135600001	914251601090	913183630121
304137600001	904119601001	-
304139600001	921556601005	921630630121
304144600001	915144601090	921630630121

Towballs and plug covers for detachable towbars

order no.towbar	order no. Towball	order no. sealing plug
304145600001	916165601090	913183630121
304148600001	915144601090	921630630121
304149600001	915144601090	921630630121
304152600001	915144601090	921630630121
304160600001	921556601005	921630630121
304204900113	913082601090	913183630121
304209600001	904189601001	933034630101
304212600001	904189601001	933034630101
305115600001	905071601003	921630630121
305119600001	905071601003	921630630121
305131600001	905117601001	905051630106
305132600001	905117601001	921630630121
305154600001	905071601003	921630630121
305156600001	905112601001	905063630103
305161600001	on demand	905063630103
305162600001	905130601001	921630630121
305195600001	on demand	905063630103
305197600001	905174601001	905063630103
305206600001	905208601001	905146630101
305211600001	905235601001	921630630121
305212600001	on demand	921630630121
305213600001	905235601001	921630630121
305214600001	on demand	921630630121
305220600001	905208601001	905146630101
305223600001	917016601090	903078630121
305224600001	on demand	914234630101
305225600001	905219601001	903140630103
305243600001	905269601005	905063630103
305244600001	905174601001	905063630103
305245600001	905269601005	905063630103
305246600001	905174601001	905063630103
305268600001	905235601001	921630630121
305269600001	905269601005	905063630103
305275600001	on demand	921630630121
305276600001	905221601001	905219630103
305277600001	917016601090	903078630121
305290600001	on demand	921630630121
305291600001	905174601001	905063630103
305300600001	916128601090	913183630121
305302600001	905208601001	905146630101
305303600001	905235601001	921630630121
305304600001	on demand	921630630121
305305600006	905305601001	921630630121
305309600001	923062601001	903137630101
305312600001	on demand	921630630121
305314600001	921605601015	903137630101
305323600001	905305601001	921630630121
305330600001	905269601005	921630630121

Towballs and plug covers for detachable towbars

order no.towbar	order no. Towball	order no. sealing plug
305331600001	905269601005	921630630121
305332600001	905208601001	921630630121
305350600001	920057601090	921630630121
305365600001	905365601001	921630630121
305375600001	905208601001	921630630121
305376600001	905365601001	921630630121
305377600001	916128601090	921630630121
305380600001	905269601005	921630630121
305382600001	905269601005	921630630121
305384600001	907336601090	921630630121
305398600001	905398601005	903137630101
305400600001	907305601090	913183630121
305403600001	921546601090	921630630121
305405600001	921546601090	921630630121
305407600001	921405601090	913183630121
305412600001	920057601090	921630630121
305412900113	907213601090	921630630121
305415600001	921605601015	903137630101
305423600001	903189601090	913183630121
305425600001	905365601001	921630630121
305429600001	907305601090	913183630121
305437600001	906271601001	903137630101
305437600999	913082601090	921630630121
305442600001	920057601090	921630630121
305445600001	905365601001	921630630121
305447600001	903315601006	913183630121
305451600001	903315601006	913183630121
305465600001	913082601090	913183630121
305465900113	913082601090	913183630121
305509600001	921546601090	921630630121
305515600001	914251601090	913183630121
305555600001	913082601090	913183630121
305555900113	913082601090	913183630121
305558600001	306245660001	913183630121
305558900113	306245660001	913183630121
305565600001	913082601090	913183630121
306128600001	906128601001	903011630108
306160600001	on demand	914234630101
306166600001	on demand	903011630108
306168600001	on demand	914234630101
306175600001	on demand	921630630121
306176600001	on demand	903011630108
306178600001	on demand	921630630121
306182600001	on demand	921630630121
306187600001	906187601090	903078630121
306187600006	906187601090	921630630121
306192600001	on demand	921630630121
306195600001	on demand	903011630108

Towballs and plug covers for detachable towbars

order no.towbar	order no. Towball	order no. sealing plug
306197600001	on demand	903011630108
306203600001	906203601002	903011630108
306205600001	on demand	921630630121
306211600001	on demand	903011630108
306215600001	916165601090	903078630121
306217600001	906174601101	914234630101
306218600001	906230601003	903140630103
306220600001	906172601001	914234630101
306222600001	916165601090	903078630121
306225600001	on demand	921630630121
306226600001	on demand	903011630108
306230600001	906230601003	903140630103
306231600001	906224601090	903078630121
306232600001	904060601002	903011630108
306235600001	on demand	903011630108
306238600001	917016601090	913183630121
306240600001	on demand	913183630121
306241600001	917016601090	913183630121
306245660001	906245601005	921630630121
306246600001	917016601090	913183630121
306247600001	916165601090	913183630121
306249600001	915055601001	913183630121
306250600001	906245601005	913183630121
306254600001	915055601001	913183630121
306262600001	914294601090	913183630121
306264600001	on demand	903011630108
306265600001	914294601090	903078630121
306266600001	921657601050	903078630121
306269600001	906224601090	913183630121
306271600001	906271601001	903137630101
306275600001	915144601090	903078630121
306277600001	915144601090	913183630121
306279600001	916165601090	913183630121
306286600001	915144601090	903078630121
306291600001	906224601090	913183630121
306311600001	916211601001	916211630121
306311900113	306245660001	913183630121
306319600001	on demand	933034630101
306321600001	917044601005	913183630121
306323600001	914294601090	913183630121
306333600001	932262601007	933034630101
306350600001	906350601007	933034630101
306353600001	932099601001	913183630121
306356600001	905305601001	921630630121
306363600001	906350601007	921630630121
306364600001	932262601007	921630630121
306367600001	921657601050	921630630121
306369600001	916128601090	913183630121

Towballs and plug covers for detachable towbars

order no.towbar	order no. Towball	order no. sealing plug
306372600001	915144601090	903078630121
306374600001	914251601090	913183630121
306381600001	916220601007	933034630101
306384600001	915144601090	913183630121
306387600001	906423601001	921630630121
306389600001	905305601001	921630630121
306391600001	917034601005	921630630121
306393600001	913082601090	921630630121
306394600001	915144601090	913183630121
306400600001	914357601090	921630630121
306405600001	914354601009	921630630121
306407600001	906423601001	921630630121
306427600001	906423601001	921630630121
306476600001	913082601090	921630630121
306491600001	906271601001	903137630101
306504600001	306245660001	913183630121
306519600001	932098601090	913183630121
306519900113	932098601090	913183630121
306535600001	920057601090	913183630121
307210600001	907213601090	903078630121
307212600001	907212601005	921630630121
907200601005	907200601005	921630630121
307213600006	907213601090	921630630121
307228600006	907228601090	921630630121
307233600001	on demand	914234630101
307235600001	906187601090	903078630121
307237600001	915055601001	903078630121
307239600001	917016601090	903078630121
307242600001	907245601090	903078630121
307245600001	907245601090	903078630121
307247600001	907247601001	903078630121
307261600001	on demand	921630630121
307265600001	916128601090	913183630121
307268600001	on demand	921630630121
307269600001	on demand	903078630121
307274600001	on demand	921630630121
307280600001	on demand	921630630121
307286600001	907286601007	933034630101
307290600001	907286601007	933034630101
307291600001	on demand	933020630101
307293600006	907305601090	921630630121
307296600006	907296601090	921630630121
307305600001	907305601090	913183630121
307308600001	921405601090	913183630121
307329600001	907329601090	921630630121
307329600006	907329601090	921630630121
307330600001	921657601050	913183630121
307330900113	306245660001	913183630121

Towballs and plug covers for detachable towbars

order no.towbar	order no. Towball	order no. sealing plug
307332600001	907329601090	921630630121
307333600001	915144601090	913183630121
307335600001	on demand	921630630121
307336600001	907336601090	921630630121
307336600006	907336601090	921630630121
307338600001	916128601090	913183630121
307340600001	932223601090	913183630121
307341900113	306245660001	913183630121
307343600001	on demand	913183630121
307355600001	916165601090	913183630121
307356600001	907296601090	913183630121
307385600001	933067601090	942097630101
307407600001	915055601001	903078630121
307408600001	on demand	921630630121
307430600001		900001005405
307432600001	on demand	921630630121
307433600001	on demand	921630630121
307434600001	921657601050	921630630121
307436600001	915055601001	903078630121
307441600001	on demand	913183630121
307449600001	907200601005	921630630121
307449900113	907200601005	921630630121
307455600001	907335601001	921630630121
307458600001	913082601090	921630630121
307461600001	914357601090	921630630121
307463600001	914294601090	913183630121
307463600999	914294601090	921630630121
307464600001	932276601090	921630630121
307474600001	907213601090	913183630121
307476600001	914294601090	913183630121
307476900113	914294601090	913183630121
307495600001	915226601090	921630630121
307495900113	915226601090	921630630121
307497600001	907329601090	921630630121
307498600001	907498601001	921630630121
307501600001	916128601090	913183630121
307501900113	916128601090	913183630121
307507600001	916128601090	913183630121
307522600001	913082601090	921630630121
307522900113	913082601090	921630630121
307565600001	932276601090	921630630121
307565900113	932276601090	921630630121
307567600001	907213601090	913183630121
307567900113	907213601090	921630630121
307577900113	916128601090	913183630121
307600900113	306245660001	913183630121
307607600001	917034601090	921630630121
307637600001	306245660001	913183630121

Towballs and plug covers for detachable towbars

order no.towbar	order no. Towball	order no. sealing plug
307637900113	306245660001	913183630121
307639600001	917034601090	913183630121
307639900113	917034601090	921630630121
307653600001	914251601090	913183630121
307659600001	306245660001	913183630121
307659900113	306245660001	913183630121
313062600001	913062601001	903011630108
313082600001	913082601090	921630630121
313082600006	913082601090	921630630121
913082601090	913082601090	921630630121
313090600001	on demand	903011630108
313117600001	906203601002	903011630108
313120600001	on demand	903078630121
313129600001	on demand	913183630121
313131600001	on demand	921630630121
313160600001	913097601009	903078630121
313167600001	916165601090	903078630121
313174600001	917016601090	903078630121
313176600001	913165601001	903078630121
313179600001	913179601090	903078630121
313179600006	913179601090	921630630121
313183600001	913129601001	913183630121
313189600001	913189601001	913183630121
313192600001	913192601005	903137630101
313195600001	916165601090	903078630121
313200600001	921505601005	903078630121
313204600001	935268601001	913183630121
313211600001	916165601090	903078630121
313215600001	913192601005	921630630121
313219600001	on demand	921630630121
313222600001	932099601001	903078630121
313231600001	915055601001	903078630121
313234600001	on demand	913183630121
313239600001	913165601001	903078630121
313241600001	916165601090	903078630121
313252600001	913252601090	921630630121
313252600006	913252601090	921630630121
313276600001	907296601001	903078630121
313286600001	913097601009	921630630121
313287600001	916165601090	921630630121
313288600001	935268601001	913183630121
313289600001	913165601001	921630630121
313290600001	916165601090	921630630121
313314600001	915055601001	903078630121
313315600001	916165601090	921630630121
313340600001	913192601005	903137630101
313345600001	913192601005	921630630121
313361600001	907329601090	921630630121

Towballs and plug covers for detachable towbars

order no.towbar	order no. Towball	order no. sealing plug
313361900113	907329601090	921630630121
313369600001	913252601090	921630630121
313373600001	913082601090	921630630121
313373900113	913082601090	921630630121
313375600001	916165601090	921630630121
313382600001	913165601001	903078630121
313398600001	915055601001	913183630121
313400600001	on demand	913183630121
313403600001	921405601090	913183630121
313403900113	914294601090	913183630121
313406600001	913406601005	903137630101
313421600001	913192601005	903137630101
313432600001	907305601090	913183630121
313432900113	907305601090	921630630121
313434600001	913252601090	921630630121
313436600001	913436601001	921630630121
313438600001	921505601005	903078630121
313439600001	921405601090	903078630121
313446900113	907305601090	921630630121
313454600001	932099601001	921630630121
313460600001	916165601090	921630630121
313461600001	907296601001	921630630121
313503600001	907245601090	913183630121
313507600001	916128601090	913183630121
313507900113	913082601090	913183630121
313515600001	913406601005	903137630101
313524600001	913082601090	913183630121
313524900113	913082601090	913183630121
313556600001	914294601090	913183630121
313556900113	914294601090	913183630121
313562600001	914294601090	913183630121
313562900113	914294601090	913183630121
313640600001	913082601090	913183630121
313640900113	913082601090	913183630121
313662600001	932098601090	913183630121
313662900113	932098601090	913183630121
314234600001	on demand	914234630101
314235600001	on demand	914234630101
314244600001	on demand	914234630101
314251600001	914251601090	913183630121
314251600006	914251601090	913183630121
914251601090	914251601090	913183630121
314254600001	on demand	914234630101
314257600001	914257601090	903078630121
314257600006	914257601090	921630630121
314266600001	914266601001	903078630121
914266601001	914266601001	921630630121
314267600001	on demand	903078630121

Towballs and plug covers for detachable towbars

order no.towbar	order no. Towball	order no. sealing plug
314270600001	914270601001	913183630121
314281600001	921505601005	913183630121
314283600001	914283601001	903078630121
314287600001	on demand	903078630121
314289600001	915055601001	913183630121
314293600001	935268601001	913183630121
914294601090	914294601090	921630630121
314295600001	on demand	903078630121
314305600001	914266601001	913183630121
314307600001	on demand	903078630121
314307900113	306245660001	913183630121
314310600001	907245601090	913183630121
314330600001	on demand	921630630121
314341600001	907305601090	913183630121
314341900113	907305601090	921630630121
314342600001	907305601090	913183630121
314342900113	907305601090	921630630121
314345600001	on demand	921630630121
314346600001	935268601001	913183630121
314372600001	914357601090	921630630121
314377600001	915055601001	903078630121
314386600001	914350601001	921630630121
314392600001	914391601009	921630630121
314397600001	914266601001	921630630121
314406600001	914294601090	903078630121
314406600011	914294601090	921630630121
314409600001	913082601090	921630630121
314414600001	914354601009	921630630121
314416600001	914357601090	921630630121
314420600001	907296601001	916114630120
314436600001	916128601090	913183630121
314436900113	306245660001	913183630121
314437600001	914354601009	903078630121
314440600001	914357601090	921630630121
314448600001	914350601001	921630630121
314451600001	907296601001	913183630121
314461600001	916165601090	913183630121
314470600001	914357601090	921630630121
314472600001	914294601090	903078630121
314473600001	914350601001	921630630121
314486600001	914266601001	913183630121
314500600001	914294601090	903078630121
314501600001	914294601090	903078630121
314502600001	on demand	921630630121
314503600001	914354601009	921630630121
314504600001	on demand	921630630121
314505600001	on demand	921630630121
314506600001	on demand	921630630121

Towballs and plug covers for detachable towbars

order no.towbar	order no. Towball	order no. sealing plug
314507600001	on demand	921630630121
314508600001	914354601009	921630630121
314509600001	on demand	921630630121
314510600001	921405601090	913183630121
314513600001	914354601009	913183630121
314515600001	914493601005	921628630122
314540600001	921405601090	921630630121
314567600001	306245660001	913183630121
314567900113	306245660001	913183630121
314582600001	914294601090	913183630121
314582900113	914294601090	913183630121
314584600001	913082601090	913183630121
314584900113	913082601090	913183630121
314586600001	914294601090	913183630121
314586900113	914294601090	913183630121
314588600001	914294601090	913183630121
314588900113	914294601090	913183630121
315062600001	on demand	903011630108
315074600001	915074601001	903011630108
315076600001	on demand	903011630108
315080600001	on demand	914234630101
315084600001	on demand	903011630108
315085600001	on demand	903011630108
315088600001	on demand	903078630121
315090600001	915055601001	913183630121
315096600001	on demand	903078630121
315097600001	905112601001	903137630101
315100600001	on demand	903011630108
315103600001	914251601090	913183630121
315105600001	907200601005	913183630121
315107600001	916165601090	913183630121
315109600001	923045601090	903078630121
315114600001	915114601007	933034630101
315115600001	915115601070	933034630101
315115600006	915115601070	921630630121
315119600001	923045601005	921630630121
915144601090	915144601090	921630630121
315148600001	915144601090	921630630121
315150600001	906187601005	913183630121
315152600001	906224601001	903078630121
315158600001	914251601090	913183630121
315158900113	914251601090	913183630121
315171600001	916128601001	921630630121
315175600001	914251601090	913183630121
315178600001	914251601090	913183630121
315178900113	914251601090	913183630121
315182600001	917034601005	921630630121
315185600001	915185601001	921630630121

Towballs and plug covers for detachable towbars

order no.towbar	order no. Towball	order no. sealing plug
315187600001	on demand	913183630121
315188600001	915144601090	921630630121
315190600001	915144601090	921630630121
315201600001	on demand	900001059080
315244600001	915226601090	921630630121
315262600001	917034601090	913183630121
315266600001	914294601090	913183630121
316097600001	906126601001	903011630108
316100600001	916100601001	903011630108
316108600001	916108601001	903011630108
316110600001	on demand	914234630101
316112600001	on demand	903011630108
316114600001	916114601001	916114630120
316116600001	on demand	921630630121
316117600001	916117601090	916114630120
316117600006	916117601090	921630630121
316128600006	916128601090	913183630121
316128660001	916128601090	913183630121
316137600001	on demand	913183630121
316140600001	on demand	913183630121
316142600001	on demand	913183630121
316152600001	on demand	913183630121
316156600001	on demand	903078630121
316159600001	on demand	921630630121
316160600001	on demand	921630630121
316162600001	on demand	921630630121
316163600001	on demand	921630630121
316165600005	916165601090	921630630121
316166600001	906224601090	913183630121
316169600001	917016601090	921630630121
316170600001	916170601001	921630630121
316171600001	917016601090	921630630121
316176600001	914251601090	913183630121
316177600001	916170601001	913183630121
316186600001	on demand	903078630121
316192600001	907200601005	903078630121
316194600001	916165601090	903078630121
316197600001	916199601002	907286630001
316207600001	906187601090	913183630121
316209600001	921505601005	913183630121
316211600001	916211601001	921630630121
316214600001	916211601001	916211630121
316217600001	916217601002	907286630001
316222600001	916220601007	933034630101
316227600001	916225601001	921630630121
316252600001	916250601001	916211630121
316262600001	921441601005	921630630121
316265600001	906224601001	903078630121

Towballs and plug covers for detachable towbars

order no.towbar	order no. Towball	order no. sealing plug
316267600001	921556601005	921630630121
316269600001	932262601007	921630630121
316273600001	914251601090	913183630121
316278600001	916250601001	921630630121
316284600001	940067601007	921630630121
316287600001	932262601007	921630630121
316291600001	916298601007	921630630121
316294600001	914251601090	913183630121
316297600001	921556601005	921630630121
316307600001	932262601007	921630630121
316310600001	916276601001	921630630121
316312600001	932262601007	921630630121
316315600001	920057601090	921630630121
316320600001	914251601090	913183630121
316322600001	915144601090	921630630121
316324600001	914251601090	913183630121
316326600001	916220601007	933034630101
316334600001	916335601001	921630630121
316335600001	916335601001	921630630121
316337600001	914294601090	921630630121
316342600001	914294601090	921630630121
316344600001	916276601001	921630630121
316355600001	916335601001	921630630121
316359600001	on demand	913183630121
316363600001	921556601005	921630630121
316366600001	920057601090	921630630121
316387600001	907245601001	903078630121
316389600001	306245660001	913183630121
316391600001	on demand	913183630121
316407600001	907245601090	913183630121
316432600001	914294601090	913183630121
316432900113	914294601090	913183630121
316448600001	915144601090	913183630121
316454600001	914266601001	913183630121
316454900113	914266601001	921630630121
316472600001	914266601001	913183630121
317016600001	917016601090	903078630121
317034600006	917034601090	921630630121
317034660001	917034601090	921630630121
317035600001	on demand	903078630121
317036600001	913082601090	921630630121
317040600001	on demand	921630630121
317046600001	on demand	903078630121
317047600001	917044601005	903078630121
317056600001	on demand	903078630121
317058600001	906224601090	903078630121
317060600001	917016601090	903078630121
317064600001	921546601090	921630630121

Towballs and plug covers for detachable towbars

order no.towbar	order no. Towball	order no. sealing plug
317066600001	921546601090	921630630121
317075600001	906224601090	921630630121
317079600001	917128601005	921630630121
317086600001	921546601090	921630630121
317088600001	906224601090	903078630121
317088600006	917088601090	921630630121
317090600001	921546601090	921630630121
317093600001	906224601090	921630630121
317102600001	917088601090	921630630121
317105600001	917128601005	903078630121
317107600001	907336601090	921630630121
317114600001	905405601001	921630630121
317117600001	917128601005	903078630121
317128600001	917128601005	903078630121
317130600001	907336601090	921630630121
317132600001	905405601001	921630630121
317134600001	913082601090	913183630121
317134900113	913082601090	913183630121
317141600001	905405601001	921630630121
317157600001	913082601090	913183630121
317168600001	913082601090	913183630121
317168900113	913082601090	913183630121
320040600001	920040601001	903078630121
320042600001	906203601002	903011630108
320044600001	on demand	903011630108
320050600001	906224601090	913183630121
320053600001	916165601090	913183630121
320057600001	920057601090	903078630121
920057601090	920057601090	921630630121
320060600001	906224601090	903078630121
320062600001	907286601007	921630630121
320064600001	913252601001	921630630121
320064900113	913252601090	921630630121
320066600001	915055601001	903078630121
320068600001	914251601090	913183630121
320072600001	916165601090	913183630121
320072900113	916165601090	913183630121
320075600001	916165601090	913183630121
320076600001	907296601090	913183630121
320076900113	907296601090	921630630121
320080600001	907200601005	913183630121
320097600001	907329601090	921630630121
320102600001	913252601090	921630630121
320102900113	913252601090	921630630121
320108600001	907305601090	921630630121
320108900113	907305601090	921630630121
320112600001	907296601090	921630630121
320112900113	907296601090	921630630121

Towballs and plug covers for detachable towbars

order no.towbar	order no. Towball	order no. sealing plug
320114600001	914251601090	913183630121
320115600001	913252601090	921630630121
320117600001	914251601090	913183630121
320117900113	914251601090	913183630121
320118600001	on demand	900001059080
320119600001	on demand	900001059080
320167600001	932098601090	913183630121
320167900113	932098601090	913183630121
320170600001	932098601090	913183630121
320172600001	920057601090	913183630121
320174600001	306245660001	913183630121
320182600001	913082601090	913183630121
321330600001	907198601001	903078630121
321399600001	921399601001	903011630108
321405600001	921405601090	903078630121
321407600001	on demand	903011630108
321408600001	921408601001	903011630108
321423600001	921423601001	914234630101
321426600001	921423601001	921630630121
321441600001	921441601005	903078630121
321452600001	on demand	921630630121
321453600001	on demand	903078630121
321468600001	913129601001	903078630121
321500600001	on demand	921630630121
321505600001	921505601005	903078630121
321506600001	921505601005	921630630121
321508600001	921505601005	903078630121
321523600001	921522601001	903078630121
321525600001	921495601001	903137630101
321526600001	921495601001	921630630121
321537600001	on demand	903078630121
321540600001	on demand	903078630121
321543600001	921546601090	921630630121
321545600001	on demand	921630630121
321545900005	921545601019	921630630121
321546600001	921546601090	921630630121
321546600006	921546601090	921630630121
321546600999	on demand	921630630121
321556600001	921558600003	903078630121
321605600001	921605601015	903137630101
321611600001	on demand	921630630121
321626600001	921522601001	903078630121
321629600001	on demand	921630630121
321630600001	921546601090	921630630121
321647601051	921545601009	921630630121
321649600001	on demand	921630630121
321651600001	921546601090	921630630121
321658600001	921558600003	921630630121

Towballs and plug covers for detachable towbars

order no.towbar	order no. Towball	order no. sealing plug
321659600001	921657601050	903078630121
321660600001	on demand	921630630121
321670600001	on demand	921630630121
321673600001	921657601050	903078630121
321675600001	921441601005	921630630121
321686600001	921605601005	921630630121
321689900011	921605601005	921630630121
321691600001	921691601005	913183630121
321700600001	921546601090	921630630121
321717600001	921546601090	921630630121
321718600001	921505601005	921630630121
321719600001	on demand	921630630121
321720600001	on demand	921630630121
321721600001	921546601090	921630630121
321722600001	921546601090	921630630121
321728600001	903189601090	913183630121
321730600001	on demand	921630630121
321736600001	921605601015	903137630101
321738600001	921546601090	921630630121
321748600001	921748601001	903078630121
321751600001	on demand	921630630121
321775600001	921441601005	903078630121
321778600001	921546601090	921630630121
321782600001	921546601090	921630630121
321783600001	921657601050	921630630121
321784600001	903189601090	921630630121
321786600001	on demand	921630630121
321815600001	905405601001	921630630121
321823600001	921546601090	921630630121
321838600001	916128601090	913183630121
321843600001	903292601019	921630630121
321863600001	921546601090	921630630121
321866600001	on demand	921630630121
321869600001	921546601090	921630630121
321873600001	903292601019	921630630121
321878600001	921748601001	921630630121
321879600001	on demand	921630630121
321885600001	903292601019	921630630121
321907600001	913436601001	921630630121
321983600001	913082601090	913183630121
321983900113	913082601090	913183630121
321991600001	913082601090	913183630121
321991900113	913082601090	913183630121
322003600001	916128601090	913183630121
322003900113	916128601090	913183630121
322055600001	913082601090	913183630121
322064600001	920057601090	913183630121
322064900113	920057601090	913183630121

Towballs and plug covers for detachable towbars

order no.towbar	order no. Towball	order no. sealing plug
322070600001	913082601090	913183630121
322070900113	913082601090	913183630121
322072900113	913082601090	913183630121
323052600001	923045601090	905146630101
323062600001	923062601001	923062630101
323063600001	on demand	921630630121
323079600001	907213601090	903078630121
323080600001	923080601005	903078630121
323082600903	923045601090	921630630121
323084600001	923045601090	903078630121
323095600982	on demand	921630630121
323097600001	923045601090	903078630121
323100600001	923045601090	903078630121
323102600001	932276601090	921630630121
323102900113	932276601090	921630630121
323107600001	921605601015	903137630101
323107600011	921605601015	903137630101
323121600001	921605601015	903137630101
323121600011	921605601015	903137630101
323141600001	913179601090	913183630121
323141900113	913179601090	913183630121
323146600001	913082601090	913183630121
323146900113	913082601090	913183630121
323149600001	306245660001	913183630121
323150600001	914251601090	913183630121
323157600001	920057601090	913183630121
323157900113	920057601090	913183630121
323171600001	920057601090	913183630121
323171900113	920057601090	913183630121
323179600001	920057601090	913183630121
323181600001	920057601090	913183630121
323190600001	914294601090	913183630121
324015600001	on demand	914234630101
324019600001	on demand	914234630101
324021600001	924021601001	933020630101
324022600001	924022601007	933034630101
324028600001	914294601090	921630630121
327010600001	on demand	921630630121
327012600001	on demand	921630630121
327014600001	921605601015	903137630101
327033600001	on demand	921630630121
327034600001	on demand	921630630121
327036600001	921605601005	921630630121
327068600001	907213601090	913183630121
327068900113	907213601090	921630630121
327088900113	920057601090	913183630121
332052600001	932052601001	921630630121
332058600001	932052601001	921630630121

Towballs and plug covers for detachable towbars

order no.towbar	order no. Towball	order no. sealing plug
932098601090	932099601001	921630630121
332099600001	932099601001	921630630121
332119600001	915050601001	921630630121
332121600001	915050601001	921630630121
332122600001	915050601001	903011630108
332123600001	on demand	921630630121
332124600001	on demand	903011630108
332134600001	on demand	921630630121
332135600001	on demand	914234630101
332154600001	on demand	903078630121
332186600001	932186601001	903078630121
332198600001	921691601005	903078630121
332206600001	914251601090	913183630121
332218600006	932218601005	921630630121
332223600001	932223601090	903078630121
332223600006	932223601090	921630630121
332227600001	932218601005	903078630121
332232600001	907213601090	903078630121
332235600001	907228601090	903078630121
332241600001	932240601007	933034630101
332247600001	on demand	903078630121
332262600001	932262601007	933034630101
332265600001	932262601007	921630630121
332274600001	907228601090	921630630121
332276600006	932276601090	921630630121
332277600006	on demand	921630630121
332296600001	906187601005	913183630121
332303600001	932218601005	913183630121
332304600001	932276601090	921630630121
332305600001	932276601090	921630630121
332317600001	905305601001	921630630121
332318600001	933067601090	921630630121
332323600001	907213601090	913183630121
332323900113	907213601090	921630630121
332324600001	932276601090	921630630121
332327600001	907245601090	903078630121
332330600001	915144601090	921630630121
332360600001	913082601090	913183630121
332360900113	913082601090	913183630121
335106600001	306245660001	913183630121
335106900113	306245660001	913183630121
335129600001	on demand	921630630121
335184600001	on demand	921630630121
335201600001	on demand	903011630108
335203600001	on demand	921630630121
335210600001	on demand	903011630108
335216600001	on demand	914234630101
335218600001	on demand	903011630108

Towballs and plug covers for detachable towbars

order no.towbar	order no. Towball	order no. sealing plug
335221600001	on demand	903011630108
335236600001	on demand	921630630121
335238600001	on demand	921630630121
335239600001	on demand	913183630121
335240600001	935239601001	916114630120
335250600001	914259601005	903137630101
335252600001	on demand	921630630121
335256600001	on demand	921630630121
335268600001	on demand	913183630121
335269600001	on demand	921630630121
335281600001	on demand	903011630108
335282600001	935282601001	933020630101
335285600001	on demand	913183630121
335289600001	on demand	913183630121
335295600001	913179601090	913183630121
335302600001	923045601090	913183630121
335304600001	923045601090	913183630121
335305600001	935305601001	913183630121
335309600001	923045601090	921630630121
335323600001	906187601090	913183630121
335325600001	917034601090	913183630121
335327600001	915114601007	933034630101
335334600001	916117601090	921630630121
335344600001	916128601090	913183630121
335344900113	916128601090	913183630121
335346600001	916128601090	913183630121
335346900113	916128601090	913183630121
335348600001	917034601090	913183630121
335353600001	916117601090	913183630121
335355600001	917016601090	913183630121
335357600001	920057601090	913183630121
335357900113	920057601090	913183630121
335358600001	913179601090	913183630121
335358900113	913179601090	913183630121
335360600001	921546601090	921630630121
335364600001	on demand	903078630121
335367600001	on demand	903078630121
335383600001	on demand	913183630121
335393600001	on demand	903078630121
335398600001	913179601090	916114630120
335411600001	on demand	903078630121
335414600001	907305601090	913183630121
335414900113	907305601090	921630630121
335419600001	935417601002	921630630121
335421600001	935374601001	903078630121
335423600001	916128601090	913183630121
335425600001	915055601001	921630630121
335450600001	on demand	913183630121

Towballs and plug covers for detachable towbars

order no.towbar	order no. Towball	order no. sealing plug
335455600001	916165601090	913183630121
335455600060	916165601090	921630630121
335467600001	906423601001	921630630121
335495600001	917034601090	913183630121
335495900113	917034601090	921630630121
335511600001	913082601090	913183630121
335513600001	306245660001	913183630121
335515600001	914251601090	913183630121
338038600001	938038601005	903137630101
338056600001	938044601001	921630630121
338058600001	938058601001	907286630001
338059600001	--	903011630108
338062600001	on demand	921630630121
338066600001	916128601090	913183630121
338081600001	916117601001	921630630121
338092600001	on demand	933034630101
338104600001	916117601090	913183630121
338108600001	921546601090	921630630121
338110600001	913082601090	921630630121
338110900113	913082601090	921630630121
338116600001	916117601090	913183630121
338120600001	921657601050	913183630121
338126600001	916128601090	913183630121
338128600001	914251601090	913183630121
338128900113	914251601090	913183630121
338131600001	916128601090	913183630121
340037600001	913097601009	903078630121
340039600001	903078601001	903078630121
340040600001	915055601001	905063630103
340044600001	913097601009	921630630121
340045600001	903078601001	903078630121
340046600001	915055601001	903078630121
340052600001	940052601001	903078630121
340057600001	on demand	921630630121
340059600001	940052601001	921630630121
340066600001	913199601001	913183630121
340068600001	915115601070	933034630101
340072600001	914259601005	921630630121
340074600001	940067601007	933034630101
340081600001	917016601090	913183630121
340093600001	921546601090	921630630121
340093900113	921546601090	921630630121
340094600001	921546601090	921630630121
340095600001	921546601090	921630630121
340097600001	921546601090	921630630121
340099600001	907329601090	921630630121
340099900113	907329601090	921630630121
340132600001	916128601090	913183630121

Towballs and plug covers for detachable towbars

order no.towbar	order no. Towball	order no. sealing plug
340132900113	916128601090	913183630121
341003600001	914259601005	903137630101
341004600001	on demand	914234630101
341006600001	915114601007	933034630101
341016600001	915115601070	933034630101
341018600001	914257601001	921630630121
341021600001	907228601005	903078630121
341024600001	915144601090	913183630121
341024900113	915144601090	913183630121
341030600001	on demand	900001059080
341065600001	914251601090	913183630121
341067600001	on demand	913183630121
342068600001	942068601002	914234630101
342092600001	921505601005	903078630121
342093600001	on demand	903137630101
342097600001	on demand	903137630101
342098600001	914259601005	903137630101
342099600001	914259601005	921630630121
342103600001	920057601090	913183630121
342105600001	920057601090	921630630121
342107600001	942107601007	933034630101
342107600006	942107601007	921630630121
342113600001	914259601005	921630630121
342121600001	914251601090	913183630121
342131600001	932223601090	913183630121
342131600003	935305601001	921630630121
342136600001	942127601001	916211630121
342162600001	942162601010	
342178600001	913252601090	921630630121
342183600001	906187601005	913183630121
342185600001	907336601090	921630630121
342185900113	907336601090	921630630121
342188600001	916128601001	921630630121
342189600001	on demand	913183630121
342190900113	907336601090	921630630121
342197600001	906423601001	921630630121
342199600001	942127601001	921630630121
342207600001	920057601090	913183630121
342209600001	913179601090	913183630121
342217600001	921546601090	921630630121
342221600001	907336601090	921630630121
342235600001	on demand	900001059080
342277600001	914251601090	913183630121
343024600001	on demand	903078630121
343035600001	943035601001	921630630121
343037600001	on demand	933020630101
343038600001	915055601001	913183630121
343040600001	916117601090	913183630121

Towballs and plug covers for detachable towbars

order no.towbar	order no. Towball	order no. sealing plug
343043600001	on demand	933034630101
343044600001	on demand	933034630101
343047600001	906187601090	913183630121
343056600001	913082601090	921630630121
343056900113	913082601090	921630630121
343058600001	906187601005	913183630121
343063600001	907329601090	921630630121
343067600001	907296601090	913183630121
343067900113	907296601090	921630630121
343071600001	913082601090	921630630121
343071900113	913082601090	921630630121
343074600001	907329601090	921630630121
343074900113	907329601090	921630630121
343076600001	916128601090	913183630121
343076900113	916128601090	913183630121
343078600001	913082601090	921630630121
343078900113	913082601090	921630630121
343080600001	917034601090	913183630121
343080900113	917034601090	921630630121
343081600001	on demand	-
343088600001	916128601090	913183630121
343088900113	916128601090	913183630121
343097600001	913082601090	913183630121
343097900113	913082601090	913183630121
343101600001	914294601090	913183630121
343105600001	913082601090	913183630121
343112600001	914294601090	913183630121
343112900113	914294601090	913183630121
344008600001	344006601001	903011630108
344012600001	on demand	921630630121
344017600001	921399601001	921630630121
344024600001	917016601090	903011630108
344027600001	944019601001	903011630108
344028600001	944019601001	921630630121
344030600001	917016601090	921630630121
344031600001	904060601002	903011630108
344036600001	921441601005	921630630121
344039600001	944039601005	903078630121
344044600001	944044601001	913183630121
344048600001	913082601090	921630630121
344050600001	on demand	903078630121
344051600001	944044601001	921630630121
344052600001	on demand	921630630121
344054600001	932099601001	905146630101
344060600001	on demand	921630630121
344074600001	932099601001	905146630101
344079600001	903292601019	921630630121
344094600001	920057601090	913183630121

Towballs and plug covers for detachable towbars

order no.towbar	order no. Towball	order no. sealing plug
344094900113	920057601090	913183630121
344102600001	913082601090	913183630121
344102900113	913082601090	913183630121
344111600001	920057601090	913183630121
344111900113	920057601090	913183630121
344113900113	920057601090	913183630121
345003600001	906126601001	903011630108
345016600001	on demand	903137630101
345021600001	921691601005	903078630121
345023600001	on demand	921630630121
345025600001	on demand	921630630121
345026600001	932240601007	933034630101
345028600001	914257601090	903078630121
345036600001	on demand	903078630121
345039600001	935305601001	903078630121
345047600001	914257601090	921630630121
345059600001	914257601090	903078630121
345062600001	935305601001	921630630121
345065600001	907305601090	913183630121
345068600001	921546601090	921630630121
345070600001	907305601090	913183630121
345077600001	914251601090	913183630121
345079600001	917034601090	913183630121
345080600001	942107601007	921630630121
345082600001	916128601090	913183630121
345082900113	916128601090	913183630121
345084600001	906224601001	903078630121
345086600001	914251601090	913183630121
345086900113	914251601090	913183630121
345089600001	914251601090	913183630121
345089900113	914251601090	913183630121
345090600001	906224601090	913183630121
345090900113	906224601090	921630630121
345092600001	915144601090	913183630121
345094600001	921546601090	921630630121
345096600001	on demand	913183630121
345104900113	907213601090	921630630121
345112600001	914251601090	913183630121
345113600001	907305601090	913183630121
345113900113	907305601090	921630630121
345115600001	906224601090	913183630121
345117600001	913082601090	913183630121
345117900113	913082601090	913183630121
345119600001	907245601090	913183630121
345127600001	306245660001	913183630121
345127900113	306245660001	913183630121
345129600001	914251601090	913183630121
345129900113	914251601090	913183630121

Towballs and plug covers for detachable towbars

order no.towbar	order no. Towball	order no. sealing plug
145139600001	913082601090	913183630121
345139900113	913082601090	913183630121
345141600001	917034601090	913183630121
345141900113	917034601090	921630630121
345143600001	913082601090	913183630121
345145600001	916128601090	913183630121
345145900113	916128601090	913183630121
345147600001	916128601090	913183630121
345147900113	916128601090	913183630121
345152600001	914251601090	913183630121
345152900113	914251601090	913183630121
345156600001	914294601090	913183630121
345168900113	907305601090	921630630121
345174900113	913082601090	913183630121
346016600001	923062601001	903137630101
346017600001	on demand	921630630121
346019600001	946019601001	903078630121
346021600001	921405601090	913183630121
346024600001	915114601007	933034630101
346026600001	on demand	913183630121
346047600001	on demand	900001059080
346049600001	907305601090	913183630121
346049900113	907305601090	921630630121
346057600001	on demand	900001005405
346060600001	914251601090	913183630121
346061600001	906187601005	913183630121
346064600001	906224601090	913183630121
346064900113	906224601090	921630630121
346066600001	915144601090	921630630121
346071600001	914251601090	913183630121
346071900113	914251601090	913183630121
346072600001	914251601090	913183630121
346074600001	914251601090	913183630121
346074900113	914251601090	913183630121
346076600001	921546601090	921630630121
346076900113	921546601090	921630630121
346078900113	921546601090	921630630121
346083600001	915144601090	913183630121
346084600001	906187601090	913183630121
346087600001	913082601090	921630630121
346087900113	913082601090	921630630121
346088600001	914251601090	913183630121
346089600001	on demand	900001059080
346093600001	921556601005	921630630121
346104600001	907213601090	913183630121
346106600001	921657601050	913183630121
346112600001	306245660001	913183630121
346112900113	306245660001	913183630121

Towballs and plug covers for detachable towbars

order no.towbar	order no. Towball	order no. sealing plug
346122600001	916128601090	913183630121
346124600001	306245660001	913183630121
346124900113	306245660001	913183630121
346126600001	914294601090	913183630121
346126900113	914294601090	913183630121
346128600001	914294601090	913183630121
346143900113	913082601090	921630630121
348012600001	906115601001	903011630108
348014600001	948014601001	933020630101
348016600001	914251601090	913183630121
348018600001	on demand	903078630121
348020600001	on demand	900001005405
348022600001	916128601001	921630630121
348024600001	on demand	900001005405
348026600001	907305601090	913183630121
348028600001	903189601090	913183630121
348028900113	903189601090	921630630121
348035600001	932099601001	913183630121
348036600001	917088601090	921630630121
348036600011	917088601090	921630630121
348036900113	917088601090	921630630121
348037600001	907336601090	921630630121
348037600002	907305601090	913183630121
348037600011	907336601090	921630630121
348037900113	907336601090	921630630121
348039600001	913252601090	921630630121
348039600011	913252601090	921630630121
348039900113	913252601090	921630630121
348063600001	913252601090	921630630121
348063600011	913252601090	921630630121
348065600001	907305601090	913183630121
348076600001	920057601090	913183630121
348078600001	920057601090	913183630121
348078900113	920057601090	913183630121
348080600001	914294601090	913183630121
348080600011	914294601090	913183630121
348084600001	913252601090	921630630121
349025600001	921546601090	921630630121
349027600001	921546601090	921630630121
349037600001	921546601090	921630630121
349039600001	907213601090	903078630121
303498600001	916128601090	913183630121
303500600001	913082601090	913183630121
303513600001	932098601090	913183630121
303514600001	914251601090	913183630121
304213600001	914251601090	913183630121
305571600001	914251601090	913183630121
305580600001	913082601090	913183630121

Towballs and plug covers for detachable towbars

order no.towbar	order no. Towball	order no. sealing plug
305601600001	913082601090	913183630121
305603600001	916128601090	913183630121
307641600001	915144601090	913183630121
307644600001	932098601090	913183630121
307673600001	914357601090	921630630121
313710600001	916128601090	913183630121
314597600001	914251601090	913183630121
314599600001	914357601090	921630630121
314601600001	914294601090	913183630121
315269600001	914294601090	913183630121
316482600001	916128601090	913183630121
316487600001	913082601090	913183630121
316491600001	913082601090	913183630121
316495600001	932098601090	913183630121
317170600001	913082601090	913183630121
317172600001	913082601090	903078630121
317174600001	935468601090	921630630121
317184600001	903273601090	921630630121
320187600001	906271601090	903137630101
322076600001	914294601090	913183630121
322089600001	916128601090	913183630121
322091600001	935468601090	921630630121
322094600001	913252601090	921630630121
322101600001	907335601001	921628630122
323192600001	920057601090	913183630121
332367600001	913082601090	913183630121
332369600001	913082601090	913183630121
342302600001	914294601090	913183630121
343115600001	306245660001	913183630121
343118600001	913082601090	913183630121
344120600001	913252601090	921630630121
344123600001	913252601090	921630630121
344124600001	903273601090	921630630121
345139600001	913082601090	913183630121
345166600001	932098601090	913183630121
345168600001	932098601090	913183630121
345172600001	932098601090	913183630121
346156600001	916128601090	913183630121
346158600001	914251601090	913183630121
346164600001	916128601090	913183630121
346166600001	932098601090	913183630121
346172600001	916128601090	913183630121
348086600001	913252601090	921630630121

Wiring Kits

Accessories

Spare parts

Universal wiring kits (12 V on-board electrical systems)

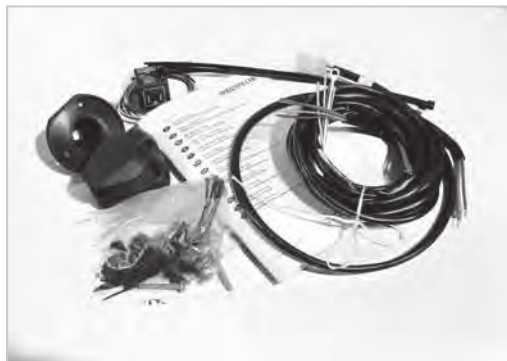

Turn signal monitoring by flash unit with C2 function

Universally applicable for vehicles **without** Checkcontrol system, with European 3-pin replacement flash unit with C2 connection with rear fog light shutdown

order no.

300 060 300 107

300 060 300 113

300 061 300 113 (with adapter for deviant flash unit wiring)

300 096 300 157 (only wire set for vehicles with C2 feature)

300 096 300 163 (only wire set for vehicles with C2 feature)



Turn signal monitoring by control unit with double flashing rate

Universally applicable for vehicles **without** Checkcontrol system, with rear fog light and acoustic parking system shutdown

order no.

300 052 300 113 (socket with screw contacts, extended socket supplyline, e.g.: for flatbed)

300 072 300 107 (socket with screw contacts)

300 072 300 113 (socket with screw contacts)

300 073 300 113 (flat 40 mm socket with crimp contact and cable inlet on the side)



Turn signal monitoring by control unit with double flashing rate

Universally applicable for vehicles **with** Checkcontrol system, with rear fog light and acoustic parking system shutdown

order no.

300 056 300 107 (socket with screw contacts, extended socket supplyline, e.g.: for flatbed) (discontinue model)

300 056 300 113 (socket with screw contacts, extended socket supplyline, e.g.: for flatbed) (discontinue model)



Turn signal monitoring by control unit with acoustic error message

Universally applicable for vehicles **with** Checkcontrol system, partially also for vehicles with data bus technology (CAN), with rear fog light and parking system shutdown

order no.

300 210 300 107 (socket with screw contacts)

300 210 300 113 (socket with screw contacts)

Extension kits



Continuous positive and charging line extension kit

Contains the connection for contact 9 and 10 acc. DIN/ISO 11446 incl. fuse and cut-off relay, 12 V

order no.: 300 025 300 113



10p CCM 506 079 (only complete kit)

Signal amplification for Checkcontrol, continuous positive necessary

order no.: 300 025 300 173



Electric Kit, towbar

(Catalogue identification "D1" in the 16 table column)
Contains the connection for contact 9 (13) acc. DIN/ISO 11446 incl. fuse.

order no.: 300 027 300 113



charging cable (extension kit)

(Catalogue identification "L1" in the 17 table column)
Contains the connection for contact 10 and 11 acc. DIN/ISO 11446 incl. fuse and cut-off relay, 12 V

order no.: 300 028 300 113



Rear fog light / Acoustic parking system switch-over kit

Contains a switch-over relay (12V)/ Connection accessories for changing the polarity of the specific function, for example earth-switched rear fog lights on the vehicle.

order no.: 300 065 300 005

Control units 12V – Signal strenghtening moduls



Identification no. (from the original control unit)		replaced by	part no.
506004	control unit 12V EJH		900001506004
506005	control unit ASTM-12		900001506005
506079	control unit CC-extension		900001506079
506244	control unit ASTM PRO -C1	X	900001506499
506274	control unit ALM 10/1		900001506274
506308	control unit ASG 2000-121	X	900001506274
506434	control unit ASG 2000-221		900001506434
506447	control unit ASG 2000-361		no longer available
506471	control unit Jaeger A52040211		no longer available
506472	control unit EJH 321132-W203		no longer available
506473	control unit EJH 321133-A4	X	900001506434
506499	control unit ASTM Pro V4		900001506499
506542	control unit ASTM 10		900001506542
506578	control unit ECS 5D033 (discontinued model)		900001506578
506623	control unit WAM ASTM-R		900001506623
506633	control unit WESTFALIA-Lightcontrol (LC)		900001506633
506723	control unit 14P. -5030		no longer available
506727	control unit Universal 58 231 021		no longer available
506730	control unit 10P TLM C2+54		no longer available
506848	control unit 14P 321059		900001506848
506857	control unit Vol. SIK 10		no longer available
506862	control unit 9P. 2(4)x21W 321054		no longer available
506906	control unit ASTM PRO B1		no longer available
506907	control unit ASTRA/ ZAFIRA UN17		900001506907
506974	control unit WAM vehicle tester (LCT)		900001506974
506978	control unit ASTM PRO A1	X	900001506499
507042	control unit ECS 5C040		900001507042 (discontinue model)
507044	control unit ASTM PRO V4 TD		900001507044
507059	control unit Lightcontrol (LC-L)-TD		no longer available
507075	control unit EJH 321112		900001507075
507082	control unit EJH 321113		900001507082
507085	control unit EJH 321114		900001507085
507091	control unit 14P. EH 9509		900001507091

Control units 12V – UCC-control units

control units that
are connected to the
CAN net



Example illustration for
UCC moduls

Identification no. (from the original control unit)		replaced by	part no.
506625	Uni CAN controll BMW UCC-1		900001506625
506626	Uni CAN controll PSA UCC-1 with buzzer		900001506626
506627	Uni CAN controll Ford UCC-1		900001506627
506628	Uni CAN controll Volvo UCC-1		no longer available
506629	Uni CAN controll Daimler UCC-1		900001506629
506630	Uni CAN controll VW UCC-1		900001506630
506631	Uni CAN controll Vauxhall UCC-1		900001506631
506632	Uni CAN controll Volvo UCC-2		no longer available
506668	Uni CAN controll Volvo UCC-3		900001506668
506669	Uni CAN controll Volvo UCC-4		no longer availabe
506670	Uni CAN controll MA/FO UCC-1		900001506670
506722	Uni CAN controll BMW UCC-3		no longer available
506737	Uni CAN controll BMW UCC-2		900001506625
506738	Uni CAN controll Ford UCC-2		900001506738
506796	Uni CAN controll PSA UCC-2		no longer available
506822	Uni CAN controll Daimler UCC-2		900001506822
506823	Uni CAN controll Fiat UCC-1 with buzzer		900001506823
506824	Uni CAN controll Fiat UCC 2		no longer available
506867	Uni CAN controll Ford UCC-4		900001506867
506964	Uni CAN controll PSA UCC-3		900001506964
507005	Uni CAN controll Renault UCC V-1		900001507005
507007	Uni CAN controll BMW UCC HV-1		900001507007
507040	Uni CAN controll Daimler UCC V4.0		900001507040
507043	Uni CAN controll Daimler UCC V3		900001507043
507062	Uni CAN controll Ford UCC 5		900001507062
507097	Uni CAN controll VW UCC 2		no longer available
507098	Uni CAN controll VW UCC 3		900001507098

Control units 12V – CAN-Module



Example illustration
for CAN-moduls

Identification no. (from the original control unit)		replaced by	part no.
506156	CAN control unit DC Hella 5DS 008 895		900001506156
506171	CAN control unit DC Hella 5DS 008 102		no longer available
506173	CAN control unit DC Hella 5DS 008 493		900001506173
506195	CAN control unit DC		no longer available
506229	CAN control unit DC		no longer available
506248	CAN control unit DC		no longer available
300001 506573	CAN control unit DC	X	900001506873
300001 506873	CAN control unit DC		900001506873

Control units 12V – CAN-Module



Example illustration
for CAN-moduls

Identification no. (from the original control unit)		replaced by	part no.
506077	CAN control unit AAGG	X	900001506758
506151	CAN control unit AAGG	X	900001506758
506153	CAN control unit AAGG	X	900001506758
506328	CAN control unit AAGG	X	900001506758
506352	CAN control unit AAGG	X	900001506758
300001 506553	CAN control unit AAGG	X	900001506758
300001 506558	CAN control unit AAGG	X	900001506758
300001 506658	CAN control unit AAGG	X	900001506758
300001 506758	CAN control unit AAGG		900001506758
300001 506194	CAN control unit AAGG	X	900001506653
300001 506557	CAN control unit AAGG		900001506557
300001 506560	CAN control unit AAGG		900001506560
300001 506561	CAN control unit AAGG	X	no longer available
300001 506562	CAN control unit AAGG		900001506653
300001 506569	CAN control unit AAGG		900001506569
300001 506667	CAN control unit AAGG		900001506667
300001 506687	CAN control unit AAGG		900001506569
300001 506697	CAN control unit AAGG		900001506697
300001 506821	CAN control unit AAGG		900001506821
300001 506710	CAN control unit AAGSG		900001506710
300001 506790	CAN control unit AAGSG		900001506790
300001 506869	CAN control unit AAGSG	X	900001506869
300001 506870	CAN control unit AAGS (discontinued model)		900001506870
300001 507025	CAN control unit AAGSG		900001506869
300001 507012	CAN control unit AAGSG		900001507012
300001 507014	CAN control unit AAGSG		900001507014
300001 507015	CAN control unit AAGSG		900001507015
300001 507016	CAN control unit AAGSG		900001507016

Relays 12 V



Rear fog light switch-off relay

30 = input (rear fog light switch)
87 a = open contact (rear fog light vehicle)
85 = output socket (rear fog light trailer)

order no.: 900 001 506 053



Turn signal (French)

4-pin (506 148)
C = 49 a output flash unit
+ = 49 input flash unit
- = 31 earth
R = C 1st indicator

order no.: 900 001 506 147



Amplifier up to 25A (changer)

(discontinued model)

1 = 86 = input control wire
2 = 85 = earth control wire
3 = 30 = input connecting contact
4 = 87a = opener connection contact 5
= 87 = closer connection contact

order no.: 900 001 506 186



Warning blinker switch with C2 function

(VW T4 07/98-)

order no.: 900 001 506 287



Amplifier up to 70A

(discontinued model)

1 = 86 = input control wire
2 = 85 = earth control wire
3 = 30 = input connecting contact 4 =
87a = opener connection contact 5 =
87 = closer connection contact

order no.: 900 001 506 464



Relay (Mini-model, e.g. Espace, Alfa, Fiat, ... (506 742))

1 = 86 = input control wire
2 = 85 = earth control wire
3 = 30 = input connecting contact
4 = 87a = opener connection contact
5 = 87 = closer connection contact

order no.: 900 001 506 742



Turn signal (European)

3-pin + C2 (506 811)
B = 49 input flash unit
L = 49 a output flash unit
E = 31 earth

order no.: 900 001 506 811

Relays 12 V



Turn signal (European) (kit with C2 light and cable)

3-pin + C2 (506 811)

B = 49 input flash unit

L = 49 a output flash unit

E = 31 earth

order no.: 900 002 506 811

Control Units and Sockets

Wiring kit	Identification no.	Relay	Socket	
			7 pins	13 pins
Order no.		Order no.	Order no.	Order no.
300025300173	Control unit 10p 506079	only complete wiring kit		
300052300107/113	Control unit 12p ALM12/1/ASTM12/ASG2000-121	900001506005	900001506424	900001506439
300056300107/113	Control unit 30p 506 270 A	900001506499	900001506424	900001506439
300060300107/113	Relay 3p+2p C2 506 811	900001506811	900001506424	900001506680
300061300107/113	Relay 3p+2p C2 506 811	900001506811	900001506424	900001506680
300061300107/113	Adapter	900061305001		
300070300107/113	Control unit 10p ALM 10/1 (former: 582070002)	900001506274	900001506424	900001506680
300071300107/113	Control unit 22p (58 231 024)	900001506104	900001506054	900001506387
300072300107/113	Control unit 12p ALM12/1/ASTM12/ASG2000-121	900001506005	900001506397	900001506001
300073300113	Control unit 12p ALM12/1/ASTM12/ASG2000-121	900001506005	-	900001506124
300076300107/113	Control unit 22p ASG 2000-221	900001506434	900001506424	900001506439
300077300107/113	Control unit 22p 506 434	900001506434	900001506424	900001506439
300077300107/113	Control unit 30p 506 270 A	900001506499	900001506424	900001506439
300078300107/113	Control unit ASTM pro V4 (former: ASTM pro C1)	900001506499	900001506424	900001506439
300080300107/113	Flashadapter EKS 2000	900001506811	900001506424	900001506680
300200300113	Relay 30p 506691	900001506691	-	900001506439
300201300113	Control unit 22p ASTM LC	900001506633	-	900001506439
300210300107/113	Control unit 22p ASTM LC	900001506633	900001506424	900001506439
303056300107/113	Relay 4p Westfalia	900001507786	900001506397	900001506680
303116300107/113	Relay 8p 54 220 003	900001506961	900001506424	900001506680
303117300107/113	Relay 8p 54 220 003	900001506961	900001506424	900001506680
303119300107/113	Relay 8p 54 220 003	900001506961	900001506424	900001506680
303120300107/113	Relay 8p 54 220 003	900001506961	900001506424	900001506680
303121300113	Control unit 15p 6 908 767	900001506563	-	900001506439
303122300113	Relay 8p 54 220 003	900001506961	-	-
303123300113	Control unit 15p 8 369 019 / 6 908 767	900001506563	-	900001506439
303124300113	Control unit 15p 8 369 019 / 6 908 767	900001506563	-	900001506439
303127300113	Control unit 15p 8 369 019 / 6 908 767	900001506563	-	900001506439

Control Units and Sockets

Wiring kit	Identification no.	Relay	Socket	
			7 pins	13 pins
Order no.		Order no.	Order no.	Order no.
303137300113	Control unit 15p 8 369 019 / 6 908 767	900001506563	-	900001506680
303140300107/113	Control unit 15p 8 369 019 / 6 908 767	900001506563	900001506384	900001506439
303180300107/113	Control unit 12p ALM12/1/ASTM12/ASG2000-121	900001506005	900001506424	900001506439
303189300113	Control unit 15p 8 369 019 / 6 908 767	900001506563	-	900001506439
303202300113	Control unit ASTM pro V4 (former: ASTM pro C1)	900001506499	-	900001506386
303205300113	Control unit ASTM pro V4 (former: ASTM pro C1)	900001506499	-	900001506387
303235300113	Control unit ASTM pro V4 (former: ASTM pro C1)	900001506499	-	900001506386
303240300113	Control unit ASTM pro V4 (former: ASTM pro C1)	900001506499	-	900001506387
303338300107/113	Control unit BMW (former: UCC-3) UCC-2	900001506737	900001506397	900001506001
303352300107/113	Control unit BMW UCC-HV-1	900001507007	900001506424	900001506439
303368300113	Control unit BMW UCC-HV-1	900001507007	-	900001506439
303372300113	Control unit BMW UCC-HV-1	900001507007	-	900001506439
303372300113	Control unit BMW UCC-HV-1	900001507007	-	900001506607
303450300113	Control unit 18+10p 506577 (5F001)	900001506577	-	900001506439
303451300107/113	Control unit BMW (former: UCC-1) UCC-2	900001506737	900001506424	900001506439
303460300107/113	Control unit BMW (former: UCC-1) UCC-2	900001506737	900001506424	900001506439
303461300113	Control unit 18+10p 506577 (5F001)	900001506577	-	900001506439
303481300113	UCC2.0 HS BMW (301142)	900001508158	-	900001506439
304047300107/113	Relay 3p+2p C2 506 811	900001506811	900001506424	900001506680
304054300107/113	Control unit 12p ALM12/1/ASTM12/ASG2000-121	900001506005	900001506424	900001506439
304060300107/113	Relay 3p+2p C2 506 811	900001506811	900001506424	900001506680
304061300107/113	Control unit 12p ALM12/1/ASTM12/ASG2000-121	900001506005	900001506424	900001506439
304064300107/113	Control unit 12p ALM12/1/ASTM12/ASG2000-121	900001506005	900001506424	900001506439
304144300113	Control unit PSA (former: UCC-2) UCC-3	900001506964	-	900001506001
304152300107/113	Control unit PSA (former: UCC-2) UCC-3	900001506964	900001506397	900001506001
304157300113	Control unit PSA UCC-3	900001506964	-	900001506439
304157300113	Control unit PSA (former: UCC-2) UCC-3	900001506964	-	900001506439
304157300113	506694	900001506694	900001506424	900001506439

Control Units and Sockets

Wiring kit	Identification no.	Relay	Socket	
			7 pins	13 pins
Order no.		Order no.	Order no.	Order no.
304203300107/113	UCC2.0 LS OPEL PSA	900001508153	900001506424	900001506680
304400300107/113	WA_PSA_UCC-1	900001506626	900001506548	900001506439
304401300107/113	WA_PSA_UCC-1	900001506626	900001506548	900001506439
304402300107/113	WA_PSA_UCC-1	900001506626	900001506548	900001506439
304510300107/113	Relay 3p+2p C2 506 811	900001506811	900001506424	900001506680
305155300107/113	Relay 3p+2p C2 506811	900001506811	900001506424	900001506680
305161300107/113	Control unit 8p 321099/321105/321106	900001506252	900001506397	900001506386
305171300107/113	Control unit ASTM pro V4 (former: ASTM 30)	900001506499	900001506424	900001506439
305177300107/113	Control unit 12p ALM12/1/ASTM12/ASG2000-121	900001506005	900001506397	900001506001
305179300107/113	Control unit 14p 321095	900001506399	900001506054	900001506386
305180300107/113	Control unit 12p ALM12/1/ASTM12/ASG2000-121	900001506005	900001506397	900001506001
305191300107/113	Control unit ASTM pro V4 (former: ASTM 30)	900001506499	900001506424	900001506439
305205300107/113	Control unit 10+14+14op 321133	900001506473	900001506397	900001506001
305206300107/113	Control unit ASTM pro V4 (former: ASTM 30)	900001506499	900001506397	900001506001
305207300107/113	Control unit 14p 321095	900001506399	900001506054	900001506386
305208300107/113	Control unit ASTM pro V4 (former: ASTM pro C1)	900001506499	900001506397	900001506001
305209300107/113	Control unit ASTM pro V4 (former: ASTM pro C1)	900001506499	900001506397	900001506001
305210300107/113	Control unit 5DS 008 408-10	900001506101	900001506397	900001506124
305212300107/113	Control unit 506205	900001506205	900001506397	900001506124
305213300107/113	Control unit 506205	900001506205	900001506397	900001506124
305213300107/113	Control unit 300001506653	900001506653	900001506054	900001506386
305214300107/113	Control unit 300001506562	900001506653	900001506397	900001506124
305215300107/113	Control unit 5DS 008 408-10	900001506653	900001506054	900001506386
305216300107/113	Control unit 300001506557	900001506557	900001506397	900001506124
305220300107/113	Control unit 14p 321095	900001506399	900001506054	900001506386
305221300107/113	Control unit 12p ALM12/1/ASTM12/ASG2000-121	900001506005	900001506397	900001506001
305222300107/113	Control unit 30p ASTM 30	900001506275	900001506397	900001506001
305223300107/113	Control unit 12p ALM12/1/ASTM12/ASG2000-121	900001506005	900001506397	900001506001

Control Units and Sockets

Wiring kit	Identification no.	Relay	Socket	
			7 pins	13 pins
Order no.		Order no.	Order no.	Order no.
305224300107/113	Control unit 10+14+14op 321133	900001506473	900001506397	900001506001
305226300113	Control unit AAG	900001506765	-	900001506386
305227300113	Control unit AAG	900001506765	-	900001506124
305228300107/113	Control unit 30p ASTM 30	900001506499	900001506424	900001506439
305255300107/113	Control unit AAG	900001506328	900001506424	900001506124
305256300107/113	Control unit 300001506558	900001506558	900001506397	900001506124
305268300113	Control unit 300001506560	900001506560	900001506397	900001506124
305269300107	Control unit AAG	900001506765	900001506397	-
305269300113	Control unit AAG	900001506479	-	900001506124
305272300107/113	Control unit AAG	900001506327	900001506397	900001506124
305329300107/113	1K0.907.383.F	900001506658	900001506344	900001506123
305330300107/113	1K0.907.383.F	900001506658	900001506344	900001506123
305384300113	4H0.907.383.C	900001506663	-	900001506123
305385300113	4G8.907.383	900001506710	-	900001506123
305385300113	Control unit spare part 4G8.907.383	900001506710	-	900001506710
305386300113	4G8.907.383	900001506710	-	900001506123
305387300113	Control unit AAG 2. Gen. 4G8.907.383.B	900001507015	-	900001506607
305403300107/113	Control unit AAG	900001506821	900001506397	900001506617
305404300107/113	Control unit AAG	900001506821	900001506397	900001506617
305406300107/113	Control unit AAG	900001506821	900001506397	900001506617
305407300107/113	Control unit AAG 2. Gen. 5Q0.907.383.L	900001507014	900001506548	900001506607
305407300107/113	300001507014	900001507014	900001506397	900001506607
305408300107/113	Control unit AAG 2	900001507014	900001506397	900001506617
305408300107/113	300001507014	900001507014	900001506397	900001506607
305410300107/113	Control unit 506758	900001506153	900001506397	900001506124
305417300107/113	Control unit VW UCC V3	900001507098	900001506424	900001506617
305418300113	UCC2.0 HS VW-AG1 (301173)	900001508151		900001506607
305437300113	Control unit AAGS 2. Gen. 4M0.907.383.F	900001506870	-	900001506617

Control Units and Sockets

Wiring kit	Identification no.	Relay	Socket	
			7 pins	13 pins
Order no.		Order no.	Order no.	Order no.
305437300107/113	Control unit AAGS 2. Gen. 4M0.907.383.F	900001506870	900001506424	900001506617
305466300113	Control unit AAGS 2. Gen. 4M0.907.383.F	900001506870	-	900001506607
305486300107/113	Control unit AAGS 2. Gen. 4M0.907.383.F	900001506870	900001506424	900001506607
305486300113	Control unit AAGS 2. Gen. 4M0.907.383.F	-		900001506607
305500300113	Control unit AAG	900001506569	-	900001506387
306126300113	Control unit 16p 58 231 021/12V	900001506727	-	900001506680
306142300107/113	Relay 3p+2p C2 506811	900001506811	900001506424	900001506680
306150300107/113	Relay 3p+2p C2 506811	900001506811	900001506424	900001506680
306151300107/113	Relay 3p+2p C2 506811	900001506811	900001506424	900001506680
306152300107/113	Relay 3p+2p C2 506811	900001506811	900001506424	900001506680
306153300107/113	Relay 3p+2p C2 506811	900001506811	900001506424	900001506680
306154300107/113	Relay 3p+2p C2 506811	900001506811	900001506424	900001506680
306174300107/113	Control unit 12p ALM12/1/ASTM12/ASG2000-121	900001506005	900001506424	900001506439
306175300107/113	Control unit 30p 506270	900001506499	900001506424	900001506439
306186300107/113	Control unit 30p 506270	900001506499	900001506424	900001506439
306189300113	Control unit 30p 506270	900001506499	-	900001506439
306197300107/113	Relay 4p Westfalia	900001507786	900001506424	900001506680
306201300107/113	Relay 4p Westfalia	900001507786	900001506424	900001506680
306203300113	Control unit 16p 58 231 021/12V	900001506727	-	900001506680
306204300107/113	Control unit 30p 506270	900001506499	900001506424	900001506439
306215300107/113	Control unit 30p 506270	900001506499	900001506424	900001506439
306216300107/113	Control unit 12p ALM12/1/ASTM12/ASG2000-121	900001506005	900001506424	900001506439
306217300001	Control unit ALM12/1/ASTM12/ASG2000-121	900001506005	-	-
306218300113	Control unit 30p 506691	900001506691	-	900001506386
306220300113	Control unit ASTM pro V4 (former: ASTM pro C1)	900001506499	-	900001506386
306221300107/113	Control unit ASTM pro V4 (former: ASTM pro C1)	900001506499	900001506397	900001506386
306224300107/113	Control unit ASTM pro V4 (former: ASTM 31)	900001506499	900001506397	900001506386
306226300107/113	Control unit 12p ALM12/1/ASTM12/ASG2000-121	900001506005	900001506424	900001506439

Control Units and Sockets

Wiring kit	Identification no.	Relay	Socket	
			7 pins	13 pins
Order no.		Order no.	Order no.	Order no.
306227300107/113	Control unit 12p ASTM 12	900001506005	900001506424	900001506438
306231300107/113	Control unit ASTM pro V4 (former: ASTM 31)	900001506499	900001506424	900001506439
306237300107/113	Control unit ASTM pro V4 (former: ASTM 31)	900001506499	900001506397	900001506001
306238300107/113	Control unit ASTM pro V4 (former: ASTM 31)	900001506499	900001506424	900001506439
306239300113	Control unit ASTM pro V4 (former: ASTM 31)	900001506499	-	900001506439
306240300107/113	Control unit ASTM pro V4 (former: ASTM 31)	900001506499	900001506424	900001506439
306249300107/113	Control unit ASTM pro V4	900001506499	900001506397	900001506124
306252300107/113	Control unit ASTM pro V4 (former: ASTM 31)	900001506499	900001506397	900001506386
306254300113	Control unit ASTM pro V4	900001506499	-	900001506124
306260300113	Control unit 30p 506270 A	900001506499	-	900001506124
306263300107/113	Control unit 30p 506270 A	900001506499	900001506397	900001506001
306265300107/113	Control unit ASTM pro V4	900001506499	900001506424	900001506439
306271300107/113	Control unit ASTM pro V4	900001506499	900001506424	900001506439
306353300113	Control unit 30p 506270 A	900001506499	-	900001506001
306371300107/113	Control unit ASTM pro V4	900001506499	900001506397	900001506124
306374300107/113	Control unit ASTM pro V4	900001506499	900001506397	900001506001
306375300107/113	Control unit UCC-1 Fiat		900001506424	900001506001
306383300113	Control unit ASTM pro V4	900001506499	-	900001506439
306392300113	Control unit ASTM pro V4	900001506499	-	900001506439
306394300107/113	Control unit ASTM pro V4	900001506499	900001506424	900001506439
306397300107/113	Control unit ASTM pro V4	900001506499	900001506424	900001506438
306441300113	Control unit ASTM pro V4	900001506499	-	900001506001
306451300113	UCC2.0 HS FCA	900001507189	-	900001506124
306467300113	Control unit ASTM pro V4	900001506499		900001506710
306469300113	Control unit ASTM PRO V4	900001506499	-	900001506123
306507300107/113	Relay 3p+2p C2 506811	900001506811	900001506424	900001506680
306508300107/113	Relay 3p+2p C2 506811	900001506811	900001506424	900001506680
306510300107/113	Control unit 30p 506270 A	900001506499	900001506424	900001506439

Control Units and Sockets

Wiring kit	Identification no.	Relay	Socket	
			7 pins	13 pins
Order no.		Order no.	Order no.	Order no.
306520300113	Control unit 12p ASTM 10	900001506542	-	900001506387
306527300113	Control unit ASTM pro V4	900001506499	-	900001506124
306530300107/113	Control unit 506270 A	900001506499	900001506424	900001506439
306531300107/113	Control unit 506270 A	900001506499	900001506424	900001506439
306531300107/113	Control unit 30p ASTM pro V4	900001506499	900001506424	900001506439
306540300113	Control unit 30p (ASTM pro C1 former) ASTM V4	900001506499	-	900001506439
306550300107/113	Control unit 30p (ASTM pro C1 alt) ASTM V4	900001506499	900001506397	900001506386
306560300113	Control unit 30p (ASTM pro C1 former) ASTM V4	900001506499	-	900001506386
306570300113	Control unit 506270 A	900001506499	-	900001506386
306580300113	Control unit 506270 A	900001506499	900001506424	900001506439
306590300107/113	Control unit Lancia	900001506691	900001506424	900001506439
306592300113	Control unit 7p 58 227 001	900001506540	-	900001506387
306605300107/113	Control unit ASTM pro V4	900001506499	900001506424	900001506439
306606300113	Control unit 506270 A	900001506499	-	900001506001
306640300107/113	Control unit ASTM pro V4	900001506499	900001506424	900001506439
307120300107/113	Control unit 12p ALM12/1/ASTM12/ASG2000-121	900001506005	900001506397	900001506386
307121300107/113	Control unit 12p ASTM 10	900001506542	900001506424	900001506439
307122300113	Control unit 14p 321059	900001506848	-	900001506439
307162300107/113	Relay 3p+2p C2 506811	900001506811	900001506424	900001506680
307194300107/113	Relay 3p+2p C2 506811	900001506811	900001506424	900001506680
307200300107/113	Control unit 12p ASTM 12	900001506005	900001506397	900001506386
307231300107/113	Control unit 12p ASTM 12	900001506005	900001506397	900001506386
307232300107/113	Control unit 12p ASTM 12	900001506005	900001506424	900001506438
307234300107/113	Control unit 10p/12p 5C006 / ASTM 12	900001506398	900001506397	900001506001
307234300107/113	Control unit 10p/12p 5C006 / ASTM 12	900001506005	900001506397	900001506001
307240300107/113	Control unit 12p ALM12/1/ASTM12/ASG2000-121	900001506005	900001506397	900001506386
307242300107/113	Control unit 12p ALM12/1/ASTM12/ASG2000-121	900001506005	900001506424	900001506439
307244300107/113	Control unit 12p ALM12/1/ASTM12/ASG2000-121	900001506005	900001506424	900001506439

Control Units and Sockets

Wiring kit	Identification no.	Relay	Socket	
			7 pins	13 pins
Order no.		Order no.	Order no.	Order no.
307260300113	Control unit 12p ASTM 10	900001506542	-	900001506387
307260300107/113	Control unit 12p ALM12/1/ASTM12/ASG2000-121	900001506005	900001506424	900001506439
307264300107/113	Control unit 12p ALM12/1/ASTM12/ASG2000-121	900001506005	900001506397	900001506439
307280300107/113	Control unit 12p ALM12/1/ASTM12/ASG2000-121	900001506005	900001506397	900001506386
307290300107/113	Control unit 12p ALM12/1/ASTM12/ASG2000-121	900001506005	900001506397	900001506001
307360300107/113	Control unit 12p ALM 12/1 ASTM 10	900001506542	900001506397	900001506386
307376300113	Flash Control - (2+1)* 21 W	900001506786	-	
307385300107/113	Control unit Ford UCC-4	900001506867	900001506424	900001506439
307386300107/113	Control unit Ford UCC-4	900001506867	900001506424	900001506439
307397300107/113	Control unit ASTM LC	900001506633	900001506397	900001506001
307400300107/113	Control unit Ford UCC-1	900001506627	900001506424	900001506439
307402300107/113	Control unit Ford UCC-2 506738	900001506738	900001506397	900001506001
307442300107/113	Control unit Ford UCC-2 506738	900001506738	900001506397	900001506001
307473300113	Control unit Ford UCC-2 506738	900001506738	-	900001506439
307473300107/113	Control unit Ford UCC-2 506738	900001506738	900001506397	900001506001
307474300107/113	Control unit Ford UCC-2 506738	900001506738	900001506397	900001506001
307478300107/113	Control unit Ford UCC-5 506738	900001507062	900001506397	900001506001
307489300113	508157	900001508157	-	900001506493
307490300113	508157	900001508157	-	900001506680
307495300113	Control unit	900001507163	-	-
307499300107/113	Control unit Ford UCC-5 506738	900001507062	900001506397	900001506001
307500300107/113	Control unit Ford UCC-2 506738	900001506738	900001506424	900001506439
307522300113	Control unit 5C040	900001507042	-	900001506439
307556300113	Control unit Ford UCC-5 506738	900001507062	-	900001506439
307573300113	Control unit	900001507042	-	900001506439
307575300113	Control unit Ford UCC-5 506738	900001507062	-	900001506439
307576300107/113	UCC2.0 HS Ford Ka+	900001508155	900001506424	900001506680
307624300113	UCC2.0 HS Ford 02 (301176)	900001508157		900001506439

Control Units and Sockets

Wiring kit	Identification no.	Relay	Socket	
			7 pins	13 pins
Order no.		Order no.	Order no.	Order no.
313004300107	Controll unit 58 211 001	900001507401	900001506424	-
313053300107/113	Control unit 13p 5DK 004 087-02	900001507900	900001506424	900001506680
313061300107/113	Control unit 7p 58 227 001	900001506540	900001506424	900001506680
313067600107/113	Control unit 7p 58 227 001	900001506540	900001506424	900001506680
313072300107	Control unit 12p ALM12/1/ASTM12/ASG2000-121	900001506005	900001506424	-
313082300107/113	Control unit ASTM pro V4 (former: ASTM 30)	900001506499	900001506424	900001506680
313084300107/113	Control unit 14p+22p ASG 2000-361	900001506447	900001506424	900001506439
313084300107/113	Control unit 14p+22p 321132 PA66GS30	900001506472	900001506424	900001506439
313101300107/113	Control unit 7p 58 227 01	900001506540	900001506424	900001506680
313103300107/113	Control unit 12p ALM12/1/ASTM12/ASG2000-121	900001506005	900001506424	900001506439
313105300107/113	Control unit 5DS 008 769-10	900001506172	900001506424	900001506439
313108300113	Control unit AAG A9069009901	900001507050	-	900001506439
313116300107/113	no control unit necessary	-	900001506054	900001506387
313117300107/113	not available	-	900001506397	900001506386
313120300107/113	Control unit 10p ALM 10/1 (former: 58207002)	900001506274	900001506424	900001506680
313120300107/113	Control unit 12p ALM12/1/ASTM12/ASG2000-121	900001506005	900001506424	900001506439
313121300107/113	Control unit 30p (ASTM pro C1 former) ASTM V4	900001506499	900001506397	900001506386
313122300107/113	Control unit 5DS 008 769-10	900001506172	900001506424	900001506439
313134300113	not necessary	-	-	900001506386
313135300113	not necessary	-	-	900001506439
313138300113	not necessary	-	-	900001506438
313167300107/113	Control unit 5DS 008 102-107	900001506171	900001506424	900001506439
313168300107/113	Control unit 5DS 008 769-10	900001506172	900001506692	900001506439
313174300107/113	Control unit 12p ALM12/1/ASTM12/ASG2000-121	900001506005	900001506397	900001506001
313176300107/113	Control unit 30p 506 270	900001506499	900001506424	900001506439
313195300107/113	-	-	900001506397	900001506001
313196300107/113	Control unit 5DS 008 493-107	900001506173	900001506397	900001506386
313208300107/113	Control unit 506 156	900001506156	900001506397	900001506439

Control Units and Sockets

Wiring kit	Identification no.	Relay	Socket	
			7 pins	13 pins
Order no.		Order no.	Order no.	Order no.
313210300107/113	Control unit 506 156	900001506156	900001506397	900001506124
313211300107/113	Control unit 300001506573	900001506573	900001506397	900001506124
313212300107/113	Control unit 300001506573	900001506573	900001506397	900001506124
313215300113	UCC2.0 HS Mercedes	900001508160	-	900001506680
313217300113	UCC2.0 HS Mercedes	900001508160	-	900001507180
313231300107/113	Control unit Daimler UCC-2 506822	900001506822	900001506424	900001506123
313234300107/113	Control unit 12p ALM12/1/ASTM12/ASG2000-121	900001506005	-	900001506438
313361300107/113	Control unit Daimler UCC-1	900001506629	900001506397	900001506124
313386300143	Control unit Daimler UCC-1	900001506629	-	900001506124
313398300107/113	Control unit Daimler UCC-1	900001506629	900001506424	900001506124
313406300113	Control unit Daimler UCC-1	900001506629	-	900001506124
313430300113	Control unit Daimler UCC-1	900001506629	-	900001506124
313432300107/113	Control unit Daimler UCC-4	900001507040	900001506397	900001506124
313432300107/113	Control unit Daimler UCC-4	900001507040	900001506424	900001506710
313436300107/113	Control unit Daimler UCC-3	900001507043	900001506397	900001506001
313445300113	UCC2.0 HS Mercedes	900001508160	-	900001507180
313446300113	UCC2.0 HS Mercedes	900001508160	-	900001507180
314237300107/113	Control unit 12p ALM12/1/ASTM12/ASG2000-121	900001506005	900001506424	900001506439
314244300107/113	Control unit 12p ALM12/1/ASTM12/ASG2000-121	900001506005	900001506424	900001506439
314245300107/113	Control unit 14p/12p 321095	900001506399	900001506054	900001506387
314245300107/113	Control unit 14p/12p ASTM 12	900001506005	900001506054	900001506387
314250300107/113	Relay 3p+2p C2 506811	900001506811	900001506424	900001506680
314251300107/113	Relay 3p+2p C2 509811	900001506811	900001506424	900001506680
314253300107/113	Relay 3p+2p C2 512811	900001506811	900001506424	900001506680
314254300107/113	Relay 3p+2p C2 515811	900001506811	900001506424	900001506680
314256300107/113	Relay 3p+2p C2 518811	900001506811	900001506424	900001506680
314257300107/113	Relay 3p+2p C2 521811	900001506811	900001506424	900001506680
314257300107/113	Control unit 12p ALM12/1/ASTM12/ASG2000-121	900001506005	900001506424	900001506439

Control Units and Sockets

Wiring kit	Identification no.	Relay	Socket	
			7 pins	13 pins
Order no.		Order no.	Order no.	Order no.
314263300107/113	Control unit 12p ALM12/1/ASTM12/ASG2000-121	900001506005	900001506424	900001506439
314263300107/113	Control unit 12p ASTM R	900001506623	900001506424	900001506439
314264300107/113	Control unit 12p ALM12/1/ASTM12/ASG2000-121	900001506005	900001506424	900001506439
314265300107/113	Control unit 12p ALM12/1/ASTM12/ASG2000-121	900001506005	900001506424	900001506439
314267300113	Control unit ASTM R	900001506623	-	900001506439
314274300113	Control unit 321054 / 321130	900001506862	-	900001506439
314275300107/113	Control unit 321054 / 321130	900001506862	-	900001506439
314283300107/113	Control unit 30p ASTM pro A1/C1/V4	900001506499	900001506424	900001506439
314289300107/113	Control unit 12p ALM12/1/ASTM12/ASG2000-121	900001506005	900001506424	900001506439
314295300113	Control unit 16p only available with Vauxhall / Opel dealers	-	-	900001506439
314300300107/113	Control unit 244 538 50	900001506907	900001506424	900001506438
314307300107/113	Control unit ASTM LC	900001506633	900001506424	900001506439
314335300113	Control unit ASTM R	900001506623	-	900001506439
314342300107/113	WA Opel UCC-1	900001506631	900001506424	900001506439
314364300113	not necessary		-	
314373300113	Control unit ASTM 10	900001503907	-	900001506439
314386300107/113	WA_Opel_UCC-1	900001506631	900001506424	900001506439
314390300113	only available with Vauxhall / Opel dealers	-	-	900001506387
314400300107/113	Control unit 30p ASTM pro A1/C1/V4	90001506499	900001506424	900001506439
314402300113	only available with Vauxhall / Opel dealers	-	-	900001506387
314422300113	Control unit ASTM LC	900001506633	-	900001506439
314436300107/113	WA_Opel_UCC-1	900001506631	900001506424	900001506439
314451300107/113	Control unit ASTM LC	900001506633	900001506424	900001506439
314513300107/113	WA_Opel_UCC-1	900001506631	900001506397	900001506001
314513300107/113	WA_Opel_UCC-1	900001506631	900001506424	900001506680
314514300107/113	WA Opel UCC-1	900001506631	900001506424	900001506680
314580300113	Control unit UCC2.0 Opel PSA	900001508153	900001506424	900001506680
314585300113	508153	900001508153	-	900001506439

Control Units and Sockets

Wiring kit	Identification no.	Relay	Socket	
			7 pins	13 pins
Order no.		Order no.	Order no.	Order no.
314594300107/113	UCC2.0 LS OPEL PSA (300757)	900001508153	900001506054	900001506680
314595300113	508153	900001508153	-	900001506439
314596300113	508153	900001508153	-	900001506680
314860300107/113	Control unit ASTM R	900001506623	900001506054	900001506387
314870300107/113	Control unit ASTM R	900001506623	900001506424	900001506439
315072300107/113	Relay 3p+2p C2 506811	900001506811	900001506424	900001506680
315073300107/113	Relay 3p+2p C2 506811	900001506811	900001506424	900001506680
315097300107/113	Relay 3p+2p C2 506811	900001506811	900001506424	900001506680
315109300107/113	Control unit PSA UCC-1 506626	900001506626	900001506424	900001506439
315110300107/113	Control unit PSA UCC-1 506626	900001506626	900001506397	900001506001
315157300113	Control unit PSA UCC-3	900001506964	-	900001506439
315182300113	Control unit PSA UCC-3	900001506964	-	900001506001
315185300113	Control unit PSA UCC-3	900001506964	-	900001506001
315196300113	Control unit PSA UCC-3	900001506964	-	900001506001
316113300107/113	Control unit 12p ALM12/1/ASTM12/ASG2000-121	900001506005	900001506397	900001506001
316114300113	Control unit 10p ALM 10/1 (former: 58207002)	900001506274	-	900001506001
316114300113	Control unit 12p ALM12/1/ASTM12/ASG2000-121	900001506005	-	900001506001
316117300113	Control unit 10p ALM 10/1 (former: 58207002)	900001506274	-	900001506680
316117300113	Control unit 12p ALM12/1/ASTM12/ASG2000-121	900001506005	-	900001506439
316118300107/113	Control unit 12p ALM12/1/ASTM12/ASG2000-121	900001506005	900001506424	900001506439
316120300107/113	Relay 4p+2p C2 70 BGi000	900001506147	900001506424	900001506439
316123300107/113	Control unit 12p ALM12/1/ASTM12/ASG2000-121	900001506005	900001506424	900001506439
316124300107/113	Relay 5p 54 201 126	900001507731	900001506424	900001506680
316126300107/113	Relay 5p 54 201 126	900001507731	900001506424	900001506680
316128300107/113	ALM12/1/ASTM12/ASG2000-121	900001506005	900001506424	900001506680
316130300107/113	Control unit ASTM 10	900001506542	900001506424	900001506439
316135300113	no control unit	-	-	900001506387
316140300107/113	Control unit 12p ALM12/1/ASTM12/ASG2000-121	900001506005	900001506397	900001506001

Control Units and Sockets

Wiring kit	Identification no.	Relay	Socket	
			7 pins	13 pins
Order no.		Order no.	Order no.	Order no.
316142300107/113	Control unit 12p ALM12/1/ASTM12/ASG2000-121	900001506005	900001506397	900001506001
316143300107/113	Control unit 12p ALM12/1/ASTM12/ASG2000-121	900001506005	900001506397	900001506001
316152300113	Control unit 12p ALM12/1/ASTM12/ASG2000-121	900001506005	900001506397	900001506001
316156300107/113	Control unit 12p ASTM 10	900001506542	900001506424	900001506439
316170300107/113	Control unit 12p ALM12/1/ASTM12/ASG2000-121	900001506005	900001506397	900001506001
316174300107/113	Control unit 12p ALM12/1/ASTM12/ASG2000-121	900001506005	900001506397	900001506001
316174300107/113	Control unit 12p ASTM R	900001506623	900001506397	900001506001
316176300113	Control unit 10p TLM C2+54	900001506730	-	900001506680
316187300107/113	Control unit 12p ALM12/1/ASTM12/ASG2000-121	900001506005	900001506397	900001506001
316190300107/113	Control unit ASTM R	900001506623	900001506424	900001506439
316192300107/113	Control unit 12p ALM12/1/ASTM12/ASG2000-121	900001506005	900001506424	900001506439
316205300107/113	no control unit	-	-	900001506680
316207300113	Control unit 321054 / 321130	900001506862	-	900001506001
316214300107/113	Control unit ASTM R	900001506623	900001506424	900001506439
316252300113	Control unit ASTM R	900001506623	-	900001506001
316259300113	Control unit 10p TLM C2+54	900001506730		
316273300107/113	Control unit ASTM LC	900001506633	900001506424	900001506439
316290300107/113	Control unit ASTM LC	900001506633	900001506054	900001506387
316294300107/113	Control unit ASTM LC	900001506633	900001506424	900001506439
316297300107/113	Control unit 22p LC	900001506633	900001506424	900001506439
316300300107/113	no control unit	-	900001506054	900001506387
316312300107/113	Control unit 30p ASTM V4 TD	900001507044	900001506424	900001506439
316315300107/113	Control unit 10p 506623	900001506623	900001506424	900001506439
316318300113	no control unit	-	-	900001506721
316319300113	no control unit	-	-	900001506123
316321300113	Control unit ASTM LC	900001506633	-	900001506439
316333300107/113	Control unit ASTM LC	900001506633	900001506424	900001506439
316334300107/113	Control unit ASTM LC	900001506633	900001506424	900001506439

Control Units and Sockets

Wiring kit	Identification no.	Relay	Socket	
			7 pins	13 pins
Order no.		Order no.	Order no.	Order no.
316337300107/113	Control unit Renault UCC V1	900001507005	900001506424	900001506439
316338300107/113	Control unit ASTM LC	900001506633	900001506424	900001506439
316340300107/113	Control unit ASTM LC	900001506633	900001506424	900001506439
316353300107/113	no control unit	-	900001506054	900001506387
316359300107/113	Control unit ASTM PRO V4_TD	900001507044	900001506548	900001506439
316368300107/113	Control unit ASTM PRO V4_TD	900001507044	900001506548	900001506439
316403300113	Control unit 785087		-	900001506439
316404300113	Control unit 30p ASTM V4 TD	900001507044	-	900001506439
316407300113	Control unit	900001507174	-	900001506439
316410300113	Control unit 10p 506623	900001506623	-	900001506001
316430300107/113	Control unit ASTM LC	900001506633	900001506397	900001506001
316434300107/113	Control unit ASTM LC	900001506633	900001506548	900001506439
316437300113	Control unit 30p ASTM V4 TD	900001507044	-	900001506680
316440300107/113	no control unit	-	900001506054	900001506387
316442300107/113	Control unit 10p 900001506623	900001506623	900001506424	900001506439
316469300113	UCC2.0 HS Dacia Duster II	900001508154	900001506424	900001506680
316482300113	UCC2.0 HS RENAULT 2 (301474)	900001508165		900001506680
317007300107/113	Relay 4p Westfalia	900001507786	900001506424	900001506680
317013300107/113	Relay 4p Westfalia	900001507786	900001506424	900001506680
317015300107/113	Control unit 10p ALM 10/1 (former: 58207002)	900001506274	900001506397	900001506001
317015300107/113	Control unit 12p ALM12/1/ASTM12/ASG2000-121	900001506005	900001506397	900001506001
317043300107/113	Control unit 12p ALM12/1/ASTM12/ASG2000-121	900001506005	900001506397	900001506001
317050300107/113	Control unit 12p ALM12/1/ASTM12/ASG2000-121	900001506005	900001506397	900001506001
317056300107/113	Control unit AAG (former: 506328) 506758	900001506758	900001506397	900001506617
317064300107/113	Control unit not necessary	-	900001506054	900001506617
317079300107/113	Control unit 506153	900001506153	900001506397	900001506617
317114300107/113	Control unit AAG2 300001507014	900001507014	900001506397	900001506607
317400300107/113	Control unit not necessary	-	900001506054	900001506617

Control Units and Sockets

Wiring kit	Identification no.	Relay	Socket	
			7 pins	13 pins
Order no.		Order no.	Order no.	Order no.
317420300107/113	Control unit AAG 300001506758	900001506758	900001506397	900001506617
320039300107/113	Control unit not necessary	-	900001506424	900001506680
320044300107/113	Relay 3p+2p C2 506811	900001506811	900001506424	900001506680
320049300113	without control unit 506464	900001506464	-	900001506439
320051300113	Control unit 30p ASTM pro C1/V4	900001506499	-	900001506439
320058300113	Control unit 30p ASTM pro C1/V4	900001506499	-	900001506439
320076300107/113	Control unit Volvo UCC 3 506668	900001506668		900001506439
320102300107/113	Control unit 22p ASTM LC	900001506633	900001506424	900001506439
320108300107/113	Control unit ASTM LC	900001506633	900001506397	900001506001
320117300113	Control unit ASTM LC	900001506633	-	900001506439
320165300107/113	Control unit ASTM LC	900001506633	900001506548	900001506439
320173300107/113	UCC2.0 HS Volvo	900001508159	900001506424	900001506680
320240300107/113	Control unit 16p UCC 1 oder 3	900001506668	900001506424	900001506439
320320300113	Control unit 30p ASTM pro C1/V4	900001506499	-	900001506439
320400300113	Control unit 30p ASTM pro C1/V4	900001506499	-	900001506386
320540300113	Control unit 12p ALM12/1/ASTM12/ASG2000-121	900001506005	-	900001506001
320542300107/113	WA_Volvo_UCC-3	900001506668	900001506548	900001506438
320543300107/113	WA_Volvo_UCC-3	900001506668	900001506424	900001506680
320780300113	Control unit 12p ALM12/1/ASTM12/ASG2000-121	900001506005	-	900001506439
321044300113	Control unit VW UCC1 506630	900001506630	-	900001506124
321106300113	Control unit 5DS 008 769 - 107	900001506172	-	900001506439
321112300107/113	-	-	900 001 506 424	900001506438
321113300107/113	Control unit AAG2 300001507012	900001507012	900001506424	900001506438
321315300107/113	Relay 3p+2p C2 506811	900001506811	900001506424	900001506680
321316300107/113	WBS 6NO 953 253 C	900001506287	900001506424	900001506680
321317300107/113	WBS 6NO 953 253 C	900001506287	900001506424	900001506680
321318300113	WBS 6NO 953 253 C	900001506287	900001506424	900001506680
321327300107/113	Relay 3p+2p C2 506811	900001506811	900001506424	900001506680

Control Units and Sockets

Wiring kit	Identification no.	Relay	Socket	
			7 pins	13 pins
Order no.		Order no.	Order no.	Order no.
321331300107/113	Relay 3p+2p C2 506811	900001506811	900001506424	900001506680
321360300107/113	Relay 3p+2p C2 506811	900001506811	900001506424	900001506680
321361300107/113	Relay 3p+2p C2 506811	900001506811	900001506424	900001506680
321403300107/113	Relay 3p+2p C2 506811	900001506811	900001506424	900001506680
321451300107/113	without control unit	-	900001506054	900001506387
321452300107/113	without control unit	-	900001506054	900001506387
321454300107/113	Control unit 506758	900001506758	900001506054	900001506387
321455300107/113	Control unit 506558, 506658, 506758	900001506758	900001506054	900001506387
321456300107/113	Control unit 506558, 506658, 506758	900001506758	900001506054	900001506387
321457300107/113	Control unit 8p 321099/105/106	900001506252	900001506397	900001506001
321457300107/113	Control unit 12p 321099/105/106	900001506005	900001506397	900001506001
321458300107/113	Control unit 12p ALM12/1/ASTM12/ASG2000-121	900001506005	900001506397	900001506001
321465300107/113	Control unit 12p ALM12/1/ASTM12/ASG2000-121	900001506005	900001506397	900001506001
321468300107/113	WBS-Relay 1C0 953235 A	900001506022	-	900001506617
321500300113	Control unit AAG 506 107	900001506667	-	900001506439
321505300107/113	Control unit 12p ALM12/1/ASTM12/ASG2000-121	900001506005	900001506397	900001506001
321512300107/113	Control unit 12p ALM12/1/ASTM12/ASG2000-121	900001506005	900001506397	900001506001
321520300107/113	Control unit 12p ALM12/1/ASTM12/ASG2000-121	900001506005	900001506397	900001506001
321523300113	without control unit	-	-	900001506617
321524300107/113	without control unit	-	900001506054	900001506617
321525300107/113	Control unit 506658, 506758	900001506758	900001506054	900001506387
321526300107/113	Control unit 12p ASTM 10	900001506542	900001506424	900001506439
321527300107/113	Control unit AAG 506658, 506758	900001506758	900001506397	900001506617
321529300107/113	Control unit AAG2 300001507012	900001507012	900001506397	900001506607
321534300107/113	Control unit AAG 506658, 506758	900001506758	900001506397	900001506617
321535300107/113	Control unit AAG 506658, 506758	900001506758	900001506397	900001506617
321537300107/113	Control unit AAG 506658, 506758	900001506758	900001506397	900001506617
321538300107/113	Control unit AAG 506658, 506758	900001506758	900001506397	900001506617

Control Units and Sockets

Wiring kit	Identification no.	Relay	Socket	
			7 pins	13 pins
Order no.		Order no.	Order no.	Order no.
321539300107/113	Control unit 30p. ASTM PRO C1 / V4	900001506499	900001506397	900001506617
321540300107/113	Control unit AAG 506658, 506758	900001506758	900001506397	900001506617
321543300107/113	Control unit AAG 506658	506758, 90000150675	900001506397	900001506617
321545300107/113	Control unit AAG 506658, 506758	900001506758	900001506397	900001506617
321546300107/113	Control unit AAG 506658, 506758	900001506758	900001506397	900001506617
321554300107/113	Control unit AAG 506658, 506758	900001506758	900001506348	900001506438
321556300107/113	Control unit AAG 506658, 506758	900001506758	900001506054	900001506387
321557300107/113	Control unit 506658, 506758	900001506758	900001506054	900001506387
321600300107/113	Control unit 506658, 506758	900001506758	900001506397	900001506617
321650300113	Control unit 506758, 506758	900001506758	-	900001506387
321651300113	Control unit 506758	900001506758	-	900001506387
321652300113	-	-	-	900001506387
321653300113	-	-	-	900001506387
321661300113	-	-	-	900001506438
321701300107/113	Control unit AAG 506658, 506758	900001506758		
321702300107/113	Control unit AAG 506658, 506758	900001506758	900001506054	900001506387
321704300107/113	Control unit 506758, 506758	900001506758	900001506054	900001506387
321705300113	Control unit AAG 300001506758	900001506758	-	900001506387
321765300113	Control unit AAG 7P0.907.383.B NAR	900001506660	900001506342	900001506438
321766300113	Control unit AAG2 300001507016	900001507016	-	900001506438
321780300107/113	Control unit VW UCC1 506630	900001506630	900001506397	900001506124
321863300107/113	Control unit VW UCC3 507098	900001507098	-	900001506617
321863300107/113	507098	900001507098	900001503424	900001506617
322080300113			-	900001506607
322081300113			-	900001506607
323040300107/113	not necessary	-	900001506424	900001506680
323045300113	Control unit 15p 8 369 018/908 767	900001506563	-	900001506439
323048300107/113	without control unit	-	90001506424	900001506680

Control Units and Sockets

Wiring kit Order no.	Identification no.	Relay Order no.	Socket	
			7 pins Order no.	13 pins Order no.
323064300113	Control unit 15p 6 908 767	900001506563	-	900001506439
323074300113	not necessary	-	-	900001506437
323080300113	Control unit 30p (ASTM pro C1 former) ASTM V4	900001506499	-	900001506124
323084300113	Control unit 506558	900001506558	-	900001506001
323097300113	Control unit BMW UUC2 506737	900001506625	-	900001506001
323102300113	not necessary	-	-	900001506617
323107300113	not necessary	-	-	900001506437
323141300113	not necessary	-	-	900001506439
323146300113	Control unit UCC	900001507150	-	900001507018
323189300113	UCC2.0 HS JLR 1 (301626)	900001508170	-	900001506439
323410300113	Control unit 506270 A	900001506499	-	900001506439
323411300113	not necessary	-	-	900001506607
324014300107/113	Control unit 14p 321095	900001506399	900001506054	900001506387
327014300113	Control unit 506 107	900001506107	-	900001506439
327068300113	Control unit AAG2 300001507016	900001507016	-	900001506001
332108300107/113	Control unit p3+2p C2 506811	900001506811	900001506424	900001506680
332262300107/113	Control unit ASTM LC	900001506633	900001506548	900001506439
332265300107/113	Control unit 12p ALM12/1/ASTM12/ASG2000-121	900001506005	900001506548	900001506439
332303300113	Control unit 5C018	only complete wiring kit	-	900001506001
332305300113	Control unit ASTM LC	900001506633	-	900001506001
332306300113	Control unit 10p ASTM R	900001503907	-	900001506439
332314300113	Control unit ASTM LC	900001506633	-	900001506001
332327300107/113	Control unit ASTM LC	900001506633	900001506397	900001506001
332366300113	Control unit ASTM LC	900001506633	-	900001506439
332367300113			-	900001506680
332400300107/113	Control unit 30p (former: ASTM 30) ASTM V4	900001506499	900001506424	900001506439
332680300113	Control unit 10p 506079	only complete wiring kit	-	900001506387
335110300113		-	-	-

Control Units and Sockets

Wiring kit	Identification no.	Relay	Socket	
			7 pins	13 pins
Order no.		Order no.	Order no.	Order no.
335229300113	Control unit 10p ASTM 10	900001506542	-	900001506438
335250300113	Control unit 10p ASTM R	900001506623	-	900001506439
335251300107/113	Control unit 10p ASTM 10	900001506542	900001506424	900001506439
335289300113	Control unit p3+2p C2 506811	900001506811	-	900001506439
335289300113	Flash Control - (2+1)*21 W	900001507786	-	900001506680
335299300113	Flash Control - (2+1)*21 W	900001507786	-	900001506680
335302300113	Control unit 10p ASTM 10	900001506542	-	900001506617
335303300113	Control unit 10p ASTM 10	900001506542	-	900001506617
335304300113	Control unit 10p ASTM 10	900001506542	-	900001506617
335305300113	Control unit 30p 506270 A	900001506499	-	900001506617
335323300113	Control unit 10p ASTM 10	900001506542	-	900001506617
335328300107/113	Control unit 12p ALM12/1/ASTM12/ASG2000-121	900001506005		900001506438
335345300113	Control unit ASTM V4	900001506499	900001506397	900001506001
335346300113	Control unit 5C028	900001506578	-	900001506439
335357300107/113	Control unit ASTM V4	900001506499	-	900001506001
335360300113	Control unit 5C028	900001506578	-	
335364300107/113	Control unit 22p 506633	900001506633	900001506397	900001506001
335383300107/113	Control unit ASTM V4	900001506499	900001506424	900001506439
335393300113	Control unit 5C028	900001506578	-	900001506439
335394300113	Control unit ASTM V4	900001506499	-	900001506439
335397300113	Control unit 22p 506633	900001506633	-	900001506439
335398300113	Control unit 5C033	900001506578	-	900001506439
335411300107/113	Control unit ASTM V4	900001506499	900001506397	900001506001
335413300107/113	Control unit ASTM V4	900001506499	900001506424	900001506439
335419300107/113	Control unit ASTM V4	900001506499	900001506424	900001506439
335423300107/113	Control unit ASTM V4	900001506499	900001506397	900001506001
335455300113	Control unit ASTM V4	900001506499	900001506397	900001506439
335456300113	Control unit	900001507131	-	900001506439

Control Units and Sockets

Wiring kit	Identification no.	Relay	Socket	
			7 pins	13 pins
Order no.		Order no.	Order no.	Order no.
335494300113	Control unit 14p 321059	900001506848	-	-
335494300113	Control unit	900001507075	-	-
335600300113	Control unit 12p ASTM 10	900001506542	-	900001506617
338110300107/113	Control unit ASTM LC	900001506633	-	900001506001
338145300107/113	Control unit ASTM LC	900001506633	900001506548	900001506439
338680300113	Control unit 12p ALM12/1/ASTM12/ASG2000-121	900001506005	-	900001506438
340072300113	Control unit 10p TLM C2+54	900001506639	-	900001506680
340075300113	Control unit 10p CCM	900001506079	900001506054	900001506386
340093300113	Control unit ASTM LC	900001506633	-	900001506439
340099300113	Control unit ASTM LC	900001506633	-	900001506001
340136300113	Control unit 9509	900001507091	-	900001506680
340144300113	UCC2.0 HS MITSUBISHI 01 (301365)	900001508164		900001506680
341016300113	Control unit 5C022	only complete wiring kit	-	900001506680
341024300107/113	Control unit 12p ASTM 10	900001506542	-	900001506439
341049300107/113	Control unit ASTM LC	900001506633	900001506548	900001506439
341052300113	Control unit ASTM pro V4	900001508153	-	900001506439
341055300107/113	Control unit ASTM LC	900001506633	900001506424	900001506439
341059300113	Control unit ASTM LC	900001506633	-	900001506439
342033300107/113	Control unit ASTM LC	900001506633	-	900001506439
342041300107/113	Relay 4p Westfalia	900001507786	900001506424	900001506680
342097300113	Control unit 5C033 (former: 5C028)	900001506578	-	900001506439
342099300107/113	Control unit 12p ASTM 10	900001506542	900001506054	900001506387
342103300113	Control unit 5C033 (former: 5C028)	900001506578	-	900001506387
342105300113	506633	900001506633	-	900001506439
342184300113	Control unit 5C033 (former: 5C028)	900001506578	-	900001506680
342190300113	Control unit ASTM LC	900001506633	-	900001506439
342197300113	Control unit ASTM V4	900001506499	900001506397	900001506001
342200300113	Control unit ASTM LC	900001506633	-	900001506001

Control Units and Sockets

Wiring kit	Identification no.	Relay	Socket	
			7 pins	13 pins
Order no.		Order no.	Order no.	Order no.
342239300113	not necessary	-	-	900001506680
342265300113	UCC2.0 HS FCA	900001507189	-	900001506124
343037300113	Control unit 12p ASTM 10	900001506542	-	900001506439
343056300107/113	Control unit ASTM LC	900001506633	900001506424	900001506439
343060300113	Control unit 12p ASTM 10	900001506542	-	900001506439
343063300113	Control unit 5D033 (former: 5C028,5C033)	900001506578	-	900001506387
343066300113	Control unit ASTM LC	900001506633	-	900001506124
343067300113	Flash Control - (2+1)*21 W	900001506744	-	900001506387
343069300113	Control unit UCC-1 MA/FO	900001506670	-	900001506439
343071300107/113	Control unit 5D033 (former: 5C028,5C033)	900001506578	-	900001506001
343074300113	Control unit ASTM LC	900001506633	-	900001506439
343076300113	Control unit 14p 321059	900001506848	-	-
343076300113	Control unit	900001507075	-	-
343099300107/113	UCC2.0 HS Mazda CX	900001508152	900001506424	900001506680
343105300113	Control unit	900001507075	-	900001506680
343117300113			-	900001506680
343400300107/113	Control unit ASTM LC	900001506633	900001506424	900001506439
343660300113	Control unit 12p ASTM 10	900001506542	-	900001506386
344023300107/113	Control unit 12p ALM12/1/ASTM12/ASG2000-121	900001506005	900001506397	900001506001
344027300107/113	Control unit 12p ALM12/1/ASTM12/ASG2000-121	900001506005	900001506424	900001506680
344040300107/113	without control unit	-	900001506424	900001506680
344041300107/113	without control unit	-	900001506424	900001506680
344044300107/113	Control unit AAG 506328, 506758	900001506758	900001506424	900001506617
344095300113	-	-	-	900001506607
344110300113	Control unit ASTM LC	900001507012	-	900001506607
344110300113	507012	900001507012	-	900001506607
344111300137/143	Control unit AAG 2. Gen. 6C0.907.383.F	-	900001506054	900001506607
344250300107/113	Control unit 506558, 506758	900001506758	900001506397	900001506617

Control Units and Sockets

Wiring kit	Identification no.	Relay	Socket	
			7 pins	13 pins
Order no.		Order no.	Order no.	Order no.
344500300107/113	Control unit AAG 506328, 506758	900001506758	900001506424	900001506439
344503300107/113	Relay 3p+2p C2 506811	900001506811	900001506424	900001506680
344504300107/113	Relay 3p+2p C2 506811	900001506811	900001506424	900001506680
345028300113	Control unit ASTM LC	900001506633	-	900001506439
345059300107/113	Control unit ASTM LC	900001506633	900001506055	900001506387
345066300113	Control unit ASTM LC	900001506633	-	900001506439
345068300113	Control unit ASTM LC	900001506633	-	900001506439
345069300113	Control unit ASTM LC	900001506633	-	900001506001
345070300113	TLM C2-FOG-REV-PDC (+)	900001506723	-	900001506680
345079300113	Control unit ASTM LC	900001506633	-	900001506439
345080300113	Control unit ASTM LC	900001506633	-	900001506439
345082300113	Control unit ASTM LC	900001506633	-	900001506439
345084300107/113	Control unit ASTM LC	900001506633	900001506397	900001506001
345086300107/113	Control unit ASTM LC	900001506633	-	900001506001
345086300107/113	Control unit ASTM LC	900001506633	900001506424	900001506439
345096300107/113	Control unit ASTM LC	900001506633	-	900001506001
345134300107/113	UCC2.0 HS Kia	900001508156	900001506424	900001506439
345143300107/113	Control unit ASTM LC	900001506633	-	900001506001
345155300113	Control unit 24p., 507130	900001507130	-	900001506439
345168300113	Control unit ASTM LC	900001506633	-	900001506439
345169300113	Control unit ASTM LC	900001506633	-	900001506439
345171300107/113	Control unit ASTM LC	900001506633	900001506424	900001506439
345172300107/113	Control unit ASTM LC	900001506633	900001506424	900001506439
345173300113	Control unit ASTM LC	900001506633	-	900001506439
345174300113	UCC2.0 HS Kia 01	900001508162	900001506424	900001506680
345220300107	Control unit 12p 506005	900001506005	900001506054	
345480300113	Control unit 12p ASTM 10	900001506542	-	900001506438
345481300113	Control unit 14p., 321059	900001506848	-	900001506680

Control Units and Sockets

Wiring kit	Identification no.	Relay	Socket	
			7 pins	13 pins
Order no.		Order no.	Order no.	Order no.
345760300113	Control unit 12p ALM12/1/ASTM12/ASG2000-121	900001506005	-	900001506387
345880300113	Control unit 12p ALM12/1/ASTM12/ASG2000-121	900001506005	-	900001506124
345881300113	Control unit 12p ALM12/1/ASTM12/ASG2000-121	900001506005	-	900001506124
346018300107/113	Control unit 12p ASTM 10	900001506542	900001506424	900001506439
346049300107/113	Control unit ASTM LC	900001506633	900001506548	900001506439
346057300113	Control unit 5C022	only complete wiring kit	-	900001506680
346059300113	Relay 3p+2p C2 506811	900001506811	-	900001506439
346064300107/113	Control unit ASTM LC	900001506633	900001506424	900001506439
346066300113	Control unit 12p ASTM 10	900001506542	-	900001506439
346071300113	Control unit ASTM LC	900001506633	-	900001506439
346076300107/113	Control unit ASTM LC	900001506633	-	900001506439
346142300107/113	Control unit ASTM LC	900001506633	900001506548	900001506439
346143300107/113	Control unit ASTM LC	900001506633	900001506548	900001506439
346145300113	Control unit ASTM LC	900001506633	-	900001506439
346146300107/113	Control unit ASTM LC	900001506633	900001506424	900001506439
346800300107/113	Control unit 12p ASTM 10	900001506542	900001506424	900001506439
346810300107/113	Control unit 12p ASTM 10	900001506542	900001506424	900001506439
348020300113	Flash Control - (2+1)*21 W	900001507786	-	
348023300113	Flash Control - (2+1)*21 W	900001507786	-	
348026300113	Flash Control - (2+1)*21 W	900001507786	-	
348037300113	Control unit ASTM LC	900001506633	-	900001506439
348054300113	Control unit 14p., 321059	900001506848	-	900001506439
348055300113	Control unit 14p., 321059	900001506848	-	900001506439
348062300113	Control unit 14p 321059	900001506848	-	
348073300113	Control unit ASTM LC	900001506633	-	900001507018
349025300113	Control unit	900001506691	-	900001506439
349039300107/113	Control unit ASTM LC	900001506633	900001506054	900001506386
349049300113	Control unit ASTM LC	900001506633	-	900001506439

Control Units and Sockets

Wiring kit	Identification no.	Relay	Socket	
			7 pins	13 pins
Order no.		Order no.	Order no.	Order no.
349053300113	Control unit ASTM LC	900001506633	900001506424	900001506439

Adapter and plugs



Adapter, short 7/13

from car 7-pins to trailer 13-pins

order no.: 300 100 310 107



Adapter, short 13/7

from car 13-pins to trailer 7-pins

order no.: 300 100 320 113



Plug 13p

order no.: 900 001 506 533



Adapter 13p West

from car 13-pins (DIN/ISO 11446) to trailer 7-/13-pins West

order no.: 900 001 506 997

Sockets and seals



Socket 13-pins

Screw connection (option for cable outlet in the side w. seal 900 001 507 001)
cable outlet on side, with rear fog light disconnecting contact

order no.: 900 001 506 001



Socket 13-pins

Contact sockets with solder connections, double microswitch, axial cable outlet

order no.: 900 001 506 037



Socket 7-pins

Screw connection, microswitch changer, axial cable outlet (N-version DIN/ISO 1724)

order no.: 900 001 506 054



Socket 13-pins

Flat version 40 mm high, crimp contact, microswitch, cable outlet on right side

order no.: 900 001 506 124



Socket 13-pins

West plug system
Screw connection without rear fog light disconnecting contact, axial cable outlet
similar to (N-Version DIN/ISO 1724) + 6 contacts

order no.: 900 001 506 210



Socket 7-pins

Crimp connection, without rear fog light disconnecting contact, axial cable outlet (N-version DIN/ISO 1724)

order no.: 900 001 506 384



Socket 13-pins

Screw connection, microswitch
cable outlet on side

order no.: 900 001 506 386

Sockets and seals



Socket 13-pins

Screw connection, microswitch
axial cable outlet

order no.: 900 001 506 387



Socket 7-pins

Screw connection, rear fog light disconnecting contact,
cable outlet on right side
(N-version DIN/ISO 1724)

order no.: 900 001 506 397



Socket 7-pins

Screw connection, rear fog light disconnecting contact, axial
cable outlet
(N-version DIN/ISO 1724)

order no.: 900 001 506 424



Socket 13-pins

Screw connection (option for cable outlet in the side w. seal
900 001 507 001)
axial cable outlet, without rear fog light disconnecting
contact

order no.: 900 001 506 439



Socket 7-pins

7p. Extension socket for English vehicle market
(S-version DIN/ISO 3732)

order no.: 900 001 506 656



Socket 13-pins

Screw connection (option for cable outlet in the side w. seal
900 001 507 001)
axial cable outlet, with rear fog light disconnecting contact

order no.: 900 001 506 680

Accessories for sockets



Screw connection with bellows, cable outlet on right side

package 10 pieces: order no. 900 010 503 924

order no.: 900 001 503 924



Socket seal, 2 axial cable outlets

order no.: 900 001 506 010



Socket seal with bellows, axial cable outlet

package 10 pieces: order no. 900 010 506 024

order no.: 900 001 506 024



Substitute socket housing 52 mm high, axial cable outlet

order no.: 900 001 506 438



Seal for 900 001 506 439/680/001/, outlet on right side, 2 pieces

package 10 pieces: order no. 900 010 507 001

order no.: 900 001 507 001



Additional socket plate for 2nd socket

(GB market)

order no.: 900 001 535 208



Cable support sleeve angled, for 40 mm car body openings, cable diameter: 6 - 14 mm

(package 10 pieces)

order no.: 900 010 303 015

Accessories for sockets



Socket seal, axial cable outlet
(package 10 pieces)

order no.: 900 010 506 531



Socket base plate for slit holders
(package 10 pieces)

order no.: 900 010 506 616



Spare part kit folding plastic socket holder
with slot

order no.: 907 292 608 001



**Substitute socket holder with slash,
universal**
package 10 pieces: order no. 920 036 608 110

order no.: 920 036 608 001



Substitute socket holder, universal

order no.: 900 001 005 347



Spare part kit folding plastic socket holder
without slot

order no.: 921 504 608 001



Spare part kit folding plastic socket holder
without slot

order no.: =>P J=J A>D >>?

Accessories for wiring kits



Vehicle tester trailer simulation 12 V, for function control and fault simulation

order no.: 900 001 300 198



Signal generator

6 - 24 Volt

order no.: 900 001 300 200



C2 light compl. 12 V (short version)

long version: order no. 900 001 507 809

order no.: 900 001 506 547



Cable connector for cable diameter 0.35-0.75 m²

(package 4 pieces)

order no.: 900 001 506 102



Cable connector

for cable diameter 1.0-2.5 m²

order no.: 900 010 507 391



Relay adapter

(for adapting various different relay assignments)

order no.: 900 061 305 001



C2 cable bridge for older Vauxhall vehicles

order no.: 914 083 303 020

Cycle carrier
BC 60 / BC 70 /
bikelander

Accessories

Spare parts

Load Carrier System BC 60



Bicycle carrier bikelander

with hybride LED lights

- Measurements (W/H/D): 580x220x690 mm (hinged) / 686x1250x678 mm (expanded) -
- Weight: 17,5 kg
- Max. payload: 60,0 kg
- Wheelbase: up to 1300 mm
- Bicycle frame: up to 80 mm diameter
- Section width: up to 70 mm

order no.: 350 050 600 001



Bicycle carrier bikelander classic

with conventional lights

- Measurements (W/H/D): 580x220x690 mm (hinged) / 686x1265x678 mm (expanded) -
- Weight: 17,5 kg
- Max. payload: 60,0 kg
- Wheelbase: up to 1300 mm
- Bicycle frame: up to 80 mm diameter
- Section width: up to 70 mm

order no.: 350 053 600 001



Bicycle carrier bikelander 3 bikes

with hybride LED lights

- Measurements (W/H/D): 580x220x810 mm (hinged) / 686x1250x678 mm (expanded)
- Weight: 20,5 kg
- Max. payload: 60,0 kg
- Wheelbase: up to 1300 mm
- Bicycle frame: up to 80 mm diameter
- Section width: up to 70 mm

order no. 350 050 600 001



Box (for BC 60, BC 70 & bikelander/classic)

Measurements (W/H/D): 1170 x 600 x 425 mm

Weight: 15,0 kg

Max. payload: 45,0 kg

Capacity: 200 l

Colour: anthracite

order no.: 350 002 600 001



Platform (for BC 60, BC 70 & bikelander/classic)

Measurements (W/H/D): 1290 x 230 x 413 mm

Weight: 6,0 kg

Max. payload: 54,0 kg

Colour: anthracite

order no.: 350 004 600 001



Expansion rail for the 3rd bicycle

Exc. bikelander 3 bikes

Max. payload: 20 kg

Weight 5,5 kg

Wheelbase: up to 1300 mm

order no.: 350 014 600 001

Load Carrier System BC 60



Bag

For clean storage of the cycle carrier
Exc. bikelander 3 bikes

order no.: 350 013 600 001



Drive up ramp (for easy loading of heavy cycles) (for BC 60, BC 70 & bikelander/classic)

for models Portilo (year of construction: -12/11: order no. 350 009 600 001

order no.: 350 020 600 001



Wall mounting bracket (for BC 60, BC 70 & bikelander/classic)

Steel construction for easy storage of the BC 60 cycles carrier to any wall

order no.: 350 006 600 001



Additional brake light (for BC 60, BC 70 & bikelander/classic)

Legal requirement if the bikes obscure the 3rd brake light of the vehicle

order no.: 350 000 305 173



Gear belt extension (for BC 60, BC 70 & bikelander/classic)

order no.: 950 000 622 00 (2 pcs.)



Presentation rack cycle carrier (for BC 60, BC 70 & bikelander/classic)

(cycle carrier is not included)

order no.: 950 003 631 001

Load Carrier Spare Parts



Lamp (for BC 60, BC 70 & bikelander classic)
left (without wire)

order no.: 950 000 302 003



Lamp (for BC 60, BC 70 & bikelander classic)
right (without cable)

order no.: 950 000 302 004



Lamp (for bikelander)
left (without wire)

order no.: 950 050 306 001



Lamp (for bikelander)
right (without cable)

order no.: 950 050 306 002



Lamp left + right (for bikelander)
inc. wire

order no.: 950 050 302 001



cover for lamp left (for bikelander)

order no.: 950 050 302 003



cover for lamp right (for bikelander)

order no.: 950 050 302 004

Load Carrier Spare Parts



Light cluster arm left (for BC 60, BC 70 & bikelander classic)

order no.: 950 000 631 001



Light cluster arm right (for BC 60, BC 70 & bikelander classic)

order no.: 950 000 631 002



Light cluster arm left (for bikelander)

order no.: 950 050 631 001



Light cluster arm right (for bikelander)

order no.: 950 050 631 002



holder for licence plate (for bikelander/classic)

order no.: 950 050 631 003



Bracket for licence plate (for BC 60 & BC 70)
(EU-standard size)

order no.: 950 000 631 004



clamp for licence plate (for bikelander/classic)
2 pieces

order no.: 950 050 631 004

Load Carrier Spare Parts



clamp for wire (for bikelander/classic)

6 pieces

order no.: 950 050 642 001



Bracket / bow (for BC 60 & BC 70)

order no.: 950 000 613 001



Bracket / bow (for bikelander/classic)

order no.: 950 050 613 001



Receiver for bracket (for BC 60, BC 70 & bikelander/classic)

inc. 2 x cog wheel
(discontinued model)

order no.: 950 000 621 001



Star grip incl. round head screw (for BC 60, BC 70 & bikelander/classic)

order no.: 950 000 637 001



Claw short incl. key / lock (for BC 60 & BC 70)

inc. keys

order no.: 950 000 633 001



Claw long incl. key / lock (for BC 60 & BC 70)

inc. keys

order no.: 950 035 633 002

Load Carrier Spare Parts



Claw short incl. key / lock (for bikelander/classic)

order no.: 950 050 633 006



Claw long incl. key / lock (for bikelander/classic)

order no.: 950 050 633 007



Claw for 3rd bicycle incl. key / lock

order no.: 950 001 633 004



knob for claw (2 pieces) (2 stk) (for BC 70 & bikelander/classic)

incl. 3 keys
(for version BC 60: part.-no. 950 000 633 003)

order no.: 950 035 633 003



Rubber for gripping lever (for BC 60, BC 70 & bikelander/classic)

order no.: 950 000 503 001



Wing left (for BC70 & bikelander/classic)

(for models Portilo (year of construction: -12/11: order no. 950 000 619 001))

order no.: 950 050 619 002



Wing right (for BC 70 & bikelander/classic)

(for models Portilo (year of construction: -12/11: order no. 950 000 619 001))

order no.: 950 050 619 003

Load Carrier Spare Parts



Locking mechanism for wings (for BC 60, BC 70 & bikelander/classic)
4 pieces

order no.: 950 010 627 001



Gear belt incl. Clothing (ratchet belt) (for BC 70 & bikelander/classic)

(for models Portilo (year of construction: -12/11: order no. 950 000 622 001))
(for models BC 60: order no. 950 010 622 001)

order no.: 950 035 622 001



rim protector (for BC 60, BC 70 & bikelander/classic)

4 pieces

order no.: 950 030 622 001



Key (for BC 60, BC 70 & bikelander/classic)

2 pieces
(xx = key number)

order no.: 950 000 513 3xx



Key (for box & platform)

2 pieces
(xx = key number)

order no.: 950 000 513 1xx



Replacement locks for transport box

(package 2 pieces)

order no.: 950 002 513 300



Replacement lock for transport platform

order no.: 950 004 513 300

Autocode

Autocode



Autocode

Coding tool
- for coding the vehicle for trailer use
- inc. unlimited number of releases in the first year of the subscription

order no.: 900 001 400 199



Autocode-Mini

Coding tool
- for coding the vehicle for trailer use
- no subscription necessary: You can buy only one code or if you want 5 or 10 codes for a preferential price

order no.: 900 001 400 202

Voucher Code Autocode-Mini for 1 Coding

order no.: 900 001 400 203

Voucher Code Autocode-Mini for 5 Codings

order no.: 900 001 400 204

Voucher Code Autocode-Mini for 10 Codings

order no.: 900 001 400 205

Annual subscription

order no.: 900 001 400 208



Autocode-Remote

Coding tool
- for coding the vehicle for trailer use
- no subscription necessary

order no.: 900 001 400 209

Power Springs

Product overview power springs

Car manufacturer	Model	Description	Year of construction	Part no.	System	Mounting time
Audi	A3	inc. 4 WD, exc. level control	04/12-	405403500001	in the spring	45
Audi	A3	inc. 4WD, exc. level control	05/03-08/12	421600500001	in the spring	30
Audi	A3	exc. S3, exc. level control, exc. Quattro (discontinued model)	09/96-05/03	405426500001	in the spring	30
Audi	A3 Saloon	Heavy Duty Set, twist beam axle only, exc. level control	05/13-	421676500001	in the spring	45
Audi	A3 Saloon	Heavy Duty Set, multilink axle only, exc. level control	05/13-	421676500001	in the spring	20
Audi	A3 Saloon	twist beam axle only, exc. level control	05/13-	405403500001	in the spring	20
Audi	A3 Saloon	multilink axle only, exc. level control	05/13-	405403500001	in the spring	45
Audi	A3 Sportback	exc. level control, exc. 4 WD	06/03-08/12	421600500001	in the spring	30
Audi	A3 Sportback	inc. 4 WD, exc. level control	09/12-	405403500001	in the spring	30
Audi	A4	inc. 4 WD, exc. level control	11/07-11/15	405425500001	in the spring	45
Audi	A4 Avant	inc. 4 WD, exc. level control	11/07-11/15	405425500001	in the spring	30
Audi	A5	inc. 4 WD, exc. level control	01/07-07/16	405425500001	in the spring	30
Audi	A5 Sportback	inc. 4 WD, exc. level control	09/09-	405425500001	in the spring	30
Audi	A6	inc. 4 WD, exc. level control	10/14-	405425500001	in the spring	60
Audi	A6 Avant	inc. 4 WD, exc. level control	05/11-	405425500001	in the spring	60
Audi	Q2	(GAB); nicht für SQ2; nur Multilink-Achse; nicht für Niveauregulierung		405403500001	in the spring	45
Audi	Q3	inc. 4WD, exc. level control	06/11-10/18	421600500001	in the spring	30
Audi	Q3	(F3B); nicht für RSQ3; nur Multilink-Achse; nicht für Niveauregulierung		405403500001	in the spring	45
Audi	Q3 Sportback	(F3N); nicht für RSQ3, nur Multilink-Achse; nicht für Niveauregulierung		405403500001	in the spring	45
Audi	Q5	inc. 4 WD, exc. level control	11/08- 05/16	405425500001	in the spring	60
Audi	S3	inc. 4 WD, exc. level control	09/13-	405403500001	in the spring	30
Citroën	Berlingo	short wheelbase, exc. Multispace, exc.Tepee	04/08-	404092500001	alternate spring	30
Citroën	Berlingo	Heavy Duty Set, long wheelbase, L2, exc. Multispace, exc.Tepee	04/08-05/18	404131500001	alternate spring	45
Citroën	C4 Grand Picasso	exc. Hybrid	10/13-	404151500001	in the spring	30
Citroën	C4 Picasso	only for vehicles with 5 seats, exc. level control	10/06-06/13	404092500001	alternate spring	30
Citroën	C4 Picasso	exc. Hybrid	06/13-	404151500001	in the spring	30
Citroën	Berlingo	Heavy Duty Set, SWB doors only, exc. Multispace (discontinued model)	04/08-05/18	415001500001	alternate spring	30
Citroën	Berlingo	Heavy Duty Set, L1 & L2, exc. 4x4, exc. factory increased vehicles, exc. level control	03/18-	404131500001	alternate spring	45
Citroën	Berlingo Multispace	exc. 4 WD, exc. level control, ABS only	04/08-05/18	404335500001	alternate spring	20
Citroën	C-Crosser	exc. level control	02/07-	404334500001	in the spring	30
Citroën	Jumper	30, 33, 35 / 3t, 3,3t, 3,5t, vehicles with ABS only, exc. 4 WD	06/06-	404271500001	in addition to the spring	45

Product overview power springs

Car manufacturer	Model	Description	Year of construction	Part no.	System	Mounting time
Citroën	Jumper	30,33, 35, 40, only for vehicles with ABS, single and double leaf spring, minimum payload 350 kg, inc. E-Jumper	04/06-	406374500001	in addition to the spring	45
Citroën	Jumpy	exc. level control, exc. 4 WD, Pick UP	01/07-05/16	404333500001	in the spring	45
Cupra	Formentor	(KM7); nicht für VZ5; nur Multilink-Achse; nicht für Niveauregulierung	11/20-	405403500001	in the spring	45
Dacia	Logan		11/13-	416343500001	in the spring	45
Dacia	Logan MVC		07/13-	416343500001	in the spring	30
Dacia	Logan Pick UP		03/09-	416343500001	in the spring	60
Dacia	Logan Saloon		09/05-	416343500001	in the spring	45
Dacia	Logan Symbol		01/13-	416343500001	in the spring	45
Dacia	Logan Van		03/09-	416343500001	in the spring	30
Fiat	Doblo		03/01-02/10	406371500001	in addition to the spring	30
Fiat	Doblo II	exc. Cargo, exc. Cargo Work Up	02/10-	406369500001	in the spring	30
Fiat	Doblo II	Cargo	02/10-	406368500001	in the spring	30
Fiat	Ducato	30, 33, 35 / 3t, 3,3t, 3,5t, vehicles with ABS only, exc. 4 WD	06/06-	404271500001	in addition to the spring	30
Fiat	Ducato	30,33, 35, 40, only for vehicles with ABS, single and double leaf spring, minimum payload 350 kg	07/06-	406374500001	in addition to the spring	45
Fiat	Scudo	exc. level control	02/08-	404333500001	in the spring	30
Fiat	Scudo Pick UP	exc. level control	01/07-	404333500001	in the spring	45
Fiat	Talento		06/16-	414364500001	in the spring	45
Ford	Focus C-Max	inc. new models (discontinued model)	09/10-	407458500001	in the spring	45
Ford	Focus II	inc. new models	10/03-10/10	407458500001	in the spring	45
Ford	Focus Wagon II	exc. sport suspension (ST 225CV)	04/11-	407407500001	alternate spring	45
Ford	Focus Wagon III	exc. sport suspension (ST 225CV)	11/04-07/10	407456500001	alternate spring	30
Ford	Kuga		05/14-	407523500001	in the spring	45
Ford	Mondeo	exc. Hybrid	10/14-	407527500001	in the spring	30
Ford	Mondeo Wagon	exc. Hybrid	10/14-	407527500001	in the spring	45
Ford	Transit	Model 00-13, 4WD and rear wheel drive, exc. Chassis Cab	09/14-	407385500001	in addition to the spring	45
Ford	Transit	front wheel drive typ 330,350	04/14-	407530500001	in addition to the spring	45
Ford	Transit Chassis Cabine	front wheel drive	04/14-	407530500001	in addition to the spring	30
Ford	Transit Connect	L1 Heavy Duty Set and L2 Standard Set	11/13-05/18	407526500001	in addition to the spring	20
Ford	Transit Custom	exc. 330, front wheel drive: L1 & L2, exc. level control, exc. Chassis Cabine	12/12-	407528500001	in addition to the spring	45
Ford	Transit Custom	exc. 330, Heavy Duty Set, front wheel drive: L1 & L2, exc. level control, exc. Chassis Cab	12/12-	407525500001	in addition to the spring	45
Hyundai	H300 / H1	for 4-fold leaf spring package only	06/02-10/13	446047500001	in addition to the spring	45
Hyundai	H300 / H1	exc. leaf spring, exc. level control, ABS only	01/08-	446056500001	in the spring	60
Hyundai	i30 CW	exc. level control, ABS only	10/07-06/12	446075500001	alternate spring	30
Hyundai	i30 CW	exc. level control, ABS only	11/11-	446075500001	alternate spring	30
Hyundai	I40		01/08-	446070500001	alternate spring	60
Hyundai	I40 Kombi		02/12-	446070500001	alternate spring	60
Hyundai	ix35	exc. 4 WD, exc. level control, ABS only	01/10-	446075500001	alternate spring	30
Hyundai	Tucson		09/15-	446073500001	in the spring	45

Product overview power springs

Car manufacturer	Model	Description	Year of construction	Part no.	System	Mounting time
Kia	Ceed	exc. level control, ABS only	05/12-03/18	446074500001	alternate spring	60
Kia	Ceed SW	exc. level control, ABS only	09/07-05/12	446075500001	alternate spring	45
Kia	Ceed SW	exc. level control, ABS only	05/12-	446075500001	alternate spring	45
Kia	Sportage	inc. AWD	09/15-	446073500001	in the spring	45
Kia	Sportage	exc. 4 WD, exc. level control, ABS only	07/10-09/15	446075500001	alternate spring	45
Mazda	3	inc. new models	10/03-12/09	407458500001	in the spring	60
Mazda	5	inc. new models	05/05-09/10	407458500001	in the spring	30
Mazda	5	inc. new models	09/10-	407458500001	in the spring	60
Mazda	3 Hatchback	inc. new models	10/03-12/09	407458500001	In the spring	60
Mazda	3 Saloon	inc. new models	07/11-	407458500001	In the spring	45
Mercedes Benz	Vito	Heavy Duty Set, minimum payload 150kg, exc. 4 WD typ 639/5, exc. level control, ABS only	12/14-	413436500001	alternate spring	45
Mercedes Benz	Vito-Tourer	Heavy Duty Set, minimum payload 150kg, exc. 4 WD typ 639/5, exc. level control, ABS only	12/14-	413436500001	alternate spring	45
Mercedes Benz	V class	Heavy Duty Set, minimum payload 150kg, exc. 4 WD typ 639/5, exc. level control, ABS only	12/14-	413436500001	alternate spring	30
Mercedes-Benz	Citan	Heavy Duty Set, exc. 4 WD, short and long version	11/12-	413432500001	in the spring	30
Mercedes-Benz	Sprinter / Chassis	ABS only, exc. twin tyres, exc. 4 WD	06/06-	413376500001	in addition to the spring	60
Mercedes-Benz	V-Class	exc. level control, ABS only, exc. 4WD	12/14-	413435500001	alternate spring	30
Mercedes-Benz	Vito	exc. level control, ABS only, exc. 4 WD	10/03-11/14	413382500001	in the spring	30
Mercedes-Benz	Vito	exc. level control, ABS only, exc. 4 WD	12/14-	413435500001	alternate spring	30
Mercedes-Benz	Vito Tourer	exc. level control, ABS only, exc. 4 WD	12/14-	413435500001	alternate spring	30
Mitsubishi	Outlander II	multilink axle only, exc. level control	11/06-09/12	404334500001	in the spring	60
Nissan	NV 400	front wheel drive only, ABS and single leaf spring, inc. Chassis	11/11-	416318500001	in addition to the spring	45
Nissan	NV300		12/15-	414364500001	in the spring	45
Nissan	Primastar		03/01-08/14	414364500001	in the spring	45
Opel	Astra	exc. Flexride and Sport, exc. level control ABS only, 4 and 5 doors	12/09-06/15	414406500001	in the spring	30
OPEL	Combo	L1 standard payload (650kg) only, exc. 4x4, exc. standard raised vehicles	06/18-	404092500001	alternate spring	30
Opel	Combo	Tour only, exc. level control, ABS only	02/10-05/18	406369500001	in the spring	30
Opel	Combo	exc. Tour, exc. level control, ABS only	02/10-05/18	406368500001	in the spring	30
Opel	Combo	Heavy Duty Set, L1 & L2, exc. 4x4, exc. factory increased vehicles, exc. level control	06/18-	404131500001	alternate spring	30
Opel	Movano	front wheel drive, ABS only, rear single leaf spring, inc. Chassis	11/11-	416318500001	in addition to the spring	30
Opel	Movano Kasten	(U9); single and double leaf spring; minimum payload 350 Kg; only for vehicles with ABS	10/21-	406374500001	in addition to the spring	45
Opel	Movano Pritsche	(U9); single and double leaf spring; minimum payload 350 Kg; only for vehicles with ABS	10/21-	406374500001	in addition to the spring	45
Opel	Vivaro		09/14-06/19	414364500001	in the spring	45

Product overview power springs

Car manufacturer	Model	Description	Year of construction	Part no.	System	Mounting time
Opel	Vivaro	Heavy Duty Set, ABS only, exc. level control	09/14-06/19	414870500001	alternate spring	30
Opel	Vivaro		08/01-08/14	414364500001	in the spring	45
Opel	Zafira	Heavy Duty Set, exc. level control	07/05-	414875500001	in the spring	30
Peugeot	308		10/13-	404151500001	in the spring	45
Peugeot	3008	exc. Hybrid	05/16-	404151500001	in the spring	45
Peugeot	4007	exc. level control	02/07-03/13	404334500001	in the spring	60
Peugeot	5008		02/17-	404151500001	in the spring	45
Peugeot	308 SW		05/14-	404151500001	in the spring	45
Peugeot	Bipper		02/08-	406350500001	alternate spring	30
Peugeot	Boxer	30, 33, 35 / 3t, 3,3t, 3,5t, vehicles with ABS only, exc. 4 WD, inc. Chassis	06/06-	404271500001	in addition to the spring	30
Peugeot	Boxer	single and double leaf spring, minimum payload 350 kg, nur für Fzg. mit ABS, auch für E-Boxer	06/06-	406374500001	in addition to the spring	45
Peugeot	Expert	exc. level control, exc. 4 WD, Pick UP	01/07-05/16	404333500001	in the spring	60
Peugeot	Partner	short wheelbase, exc. Multispace, exc. Tepee	04/08-05/18	404092500001	alternate spring	30
Peugeot	Partner	long wheelbase, L2, exc. Multispace, exc. Tepee, exc. Partner Origin	04/08-05/18	404131500001	alternate spring	60
Peugeot	Partner Tepee	exc. Outdoor, exc. level control, ABS only	04/08-05/18	404335500001	alternate spring	30
Peugeot	Rifter	Heavy Duty Set, L1 & L2, exc. 4x4, exc. factory increased vehicles, exc. level control	09/18-	404131500001	alternate spring	30
Renault	Master	nur für front wheel drive, ABS and Einzelleaf spring	11/11-	416318500001	in addition to the spring	60
Renault	Traffic		09/14-	414364500001	in the spring	45
Renault	Traffic	Heavy Duty Set, ABS only, exc. level control	09/14-	414870500001	alternate spring	60
Renault	Trafic		03/01-08/14	414364500001	in the spring	45
Seat	Leon SC	Heavy Duty Set, twist beam axle only, exc. level control	01/13-	421676500001	in the spring	45
Seat	Alhambra	inc. Ecomotive and 4 WD, exc. level control	10/10-	421600500001	in the spring	60
Seat	Altea	inc. Ecomotive and 4 WD, exc. level control	06/04-	421600500001	in the spring	45
Seat	Altea XL	inc. Ecomotive and 4 WD, exc. level control	11/06-	421600500001	in the spring	60
Seat	Arosa	exc. level control, ABS only	05/97-06/04	417113500001	in the spring	45
Seat	Ateca	multilink axle only	06/16-	405403500001	in the spring	30
Seat	Ibiza	exc. level control, ABS only	03/08-06/17	417113500001	in the spring	45
Seat	Ibiza ST	exc. level control, ABS only	03/08-07/16	417113500001	in the spring	45
Seat	Leon	inc. Ecomotive and 4 WD, exc. level control	09/05-01/13	421600500001	in the spring	60
Seat	Leon	inc. Ecomotive and 4 WD, exc. level control	01/13-	405403500001	in the spring	60
Seat	Leon	Heavy Duty Set, twist beam axle only, exc. level control	01/13-	421676500001	in the spring	30
Seat	Leon	Heavy Duty Set, multilink axle only, exc. level control	01/13-	421676500001	in the spring	30
Seat	Leon SC	Heavy Duty Set, multilink axle only, exc. level control	01/13-	421676500001	in the spring	45
Seat	Leon SC	Heavy Duty Set, multilink axle only, exc. level control	01/13-	421676500001	in the spring	45
Seat	Leon SC	multilink axle only, exc. level control	01/13-	405403500001	in the spring	20
Seat	Leon SC	twist beam axle only, exc. level control	01/13-	405403500001	in the spring	45

Product overview power springs

Car manufacturer	Model	Description	Year of construction	Part no.	System	Mounting time
Seat	Leon ST	inc. Ecomotive and 4 WD, exc. level control	11/13-	405403500001	in the spring	45
Seat	Leon ST	Heavy Duty Set, twist beam axle only, exc. level control	11/13-	421676500001	in the spring	45
Seat	Leon ST	Heavy Duty Set, multilink axle only, exc. level control	11/13-	421676500001	in the spring	60
Seat	Leon IV	(KL1); nur Multilink-Achse; nicht für Niveauregulierung	04/20-	405403500001	in the spring	43
Seat	Leon IV ST	(KL8); nur Multilink-Achse; nicht für Niveauregulierung	04/20-	405403500001	in the spring	44
Seat	Mii	exc. level control, ABS only, exc. EV	10/11-	417113500001	in the spring	45
Seat	Tarraco	Verbandlenker- and Multilink-Achse, inc. 4Drive	09/18-	405403500001	in the spring	45
Seat	Toledo	inc. Ecomotive and 4 WD, exc. level control	11/04-06/09	421600500001	in the spring	60
Skoda	Karoq	(KU7); nur Multilink-Achse; nicht für Niveauregulierung	11/17-	405403500001	in the spring	45
Skoda	Kodiaq	exc. level control, auch für Scout	03/17-	405403500001	in the spring	45
Skoda	Octavia	inc. Greenline and 4 WD, exc. level control, ABS only	09/04-12/08	421600500001	in the spring	45
Skoda	Octavia	inc. Greenline and 4 WD, exc. level control, ABS only	01/09-11/12	421600500001	in the spring	60
Skoda	Octavia	inc. 4 WD, exc. level control	11/12-	405403500001	in the spring	30
Skoda	Octavia	Heavy Duty Set, multilink axle only, exc. level control	11/13-	421676500001	in the spring	60
Skoda	Octavia	Heavy Duty Set, twist beam axle only, exc. level control	11/12-	421676500001	in the spring	60
Skoda	Octavia Combi	inc. 4 WD, exc. level control	11/12-	405403500001	in the spring	30
Skoda	Octavia Combi	Heavy Duty Set, twist beam axle only, exc. level control	11/12-	421676500001	in the spring	20
Skoda	Octavia Combi	Heavy Duty Set, multilink axle only, exc. level control	11/12-	421676500001	in the spring	45
Skoda	Octavia Combi	inc. Greenline and 4 WD, exc. level control, ABS only	02/05-12/08	421600500001	in the spring	30
Skoda	Octavia Combi	inc. Greenline and 4 WD, exc. level control, ABS only	01/09-	421600500001	in the spring	45
Skoda	Octavia Scout	exc. level control, exc. 4 WD	07/09-	421600500001	in the spring	60
Skoda	Superb	inc. Greenline and 4 WD, exc. level control	09/08-	421600500001	in the spring	45
Skoda	Superb	Heavy Duty Set, twist beam axle only, exc. level control	03/15-	421676500001	in the spring	45
Skoda	Superb	Heavy Duty Set, multilink axle only, exc. level control	03/15-	421676500001	in the spring	45
Skoda	Superb	twist beam axle only, exc. level control	03/15-	405403500001	in the spring	20
Skoda	Superb	multilink axle only, exc. level control	03/15-	405403500001	in the spring	45
Skoda	Superb Combi	inc. Greenline and 4 WD, exc. level control	01/10-	421600500001	in the spring	30
Skoda	Superb Combi	Heavy Duty Set, twist beam axle only, exc. level control	04/15-	421676500001	in the spring	45

Product overview power springs

Car manufacturer	Model	Description	Year of construction	Part no.	System	Mounting time
Skoda	Superb Combi	Heavy Duty Set, multilink axle only, exc. level control	04/15-	421676500001	in the spring	45
Skoda	Superb Combi	twist beam axle only, exc. level control	04/15-	405403500001	in the spring	20
Skoda	Superb Combi	multilink axle only, exc. level control	04/15-	405403500001	in the spring	45
Skoda	Yeti	inc. Greenline and 4 WD, exc. level control	09/09-	421600500001	in the spring	30
Suzuki	SX4 S-Cross	2WD and 4WD	09/13-	441001500001	in the spring	30
Suzuki	Vitara	2WD and 4WD	03/15-	441001500001	in the spring	30
Toyota	Auris	inc. Hybrid, exkl. 1.4 diesel, exkl. 1.3 petrol, exc. level control	10/12-	435003500001	in the spring	30
Toyota	Auris TS	inc. 1.8 Hybrid, inc.1.2T, exc. 1.4-4D, exc. 1.6D-4D, exc. 1.3VVTI, exc. level control	07/13-	435003500001	in the spring	30
Toyota	Avensis	exc. level control	02/09-	435003500001	in the spring	45
Toyota	Avensis Wagon	exc. level control	02/09-	435003500001	in the spring	30
Toyota	PROACE	Heavy Duty Set, minimum payload 400 kg, ABS only, exc. level control	12/13-	435001500001	alternate spring	30
Toyota	ProAce	exc. level control	06/13-	404333500001	in the spring	45
Toyota	ProAce City	L1 standard payload (650kg) only, exc. 4x4, exc. factory increased vehicles, exc. level control	10/19-	404092500001	alternate spring	30
Toyota	Proace City	Heavy Duty Set, L1 & L2, exc. 4x4, exc. factory increased vehicles, exc. level control	10/19-	404131500001	alternate spring	30
Volvo	S40 I	exc. AWD, exc. level control	07/04-	407458500001	in the spring	45
Volvo	V50	exc. AWD, exc. level control	08/04-	407458500001	in the spring	45
VW	Arteon		04/17-	405403500001	in the spring	60
VW	Beetle	multilink axle only, exc. level control	04/11-07/19	421600500001	in the spring	30
VW	Beetle Convertible	multilink axle only, exc. level control	04/11-07/19	421600500001	in the spring	30
VW	Caddy (4-Motion, Maxi)	inc. Maxi, Ecofuel and doppelte leaf spring	03/05-	421673500001	in addition to the spring	90
VW	Caravelle	exc. 4 WD	10/10-	421391500001	in the spring	60
VW	Crafter / Chassis	exc. twin tyres	04/06 -08/10	413376500001	in addition to the spring	75
VW	Eos	inc. Bluemotion and 4-Motion, exc. level control	03/06-	421600500001	in the spring	45
VW	Golf	Heavy Duty Set, twist beam axle only, exc. level control, exc. DCC	11/12-	421676500001	in the spring	20
VW	Golf	Heavy Duty Set, multilink axle only, exc. level control, exc. DCC	11/12-	421676500001	in the spring	45
VW	Golf Sportsvan	Heavy Duty Set, twist beam axle only, exc. level control, exc. DCC	06/14-	421676500001	in the spring	20
VW	Golf Sportsvan	Heavy Duty Set, multilink axle only, exc. level control, exc. DCC	06/14-	421676500001	in the spring	30
VW	Golf V	inc. Bluemotion and 4-Motion, exc. level control	11/03-11/08	421600500001	in the spring	30
VW	Golf V Plus	inc. Bluemotion and 4-Motion, exc. level control	06/06-	421600500001	in the spring	45
VW	Golf V Variant	inc. Bluemotion and 4-Motion, exc. level control	09/09 -	421600500001	in the spring	45
VW	Golf Variant	inc. Bluemotion and 4-Motion, exc. level control	09/09 -	421600500001	in the spring	30
VW	Golf Variant	Heavy Duty Set, twist beam- and multilink axle, exc. level control, exc. DCC	07/13-	421676500001	in the spring	30
VW	Golf VI	inc. Bluemotion and 4-Motion, exc. level control	10/08-11/13	421600500001	in the spring	30

Product overview power springs

Car manufacturer	Model	Description	Year of construction	Part no.	System	Mounting time
VW	Golf VI Plus	inc. Bluemotion and 4-Motion, exc. level control	01/05-05/13	421600500001	in the spring	45
VW	Golf VI Variant	inc. Bluemotion and 4-Motion, exc. level control	07/09-07/13	421600500001	in the spring	45
VW	Golf VII	inc. Bluemotion and 4-Motion, exc. level control, exc. DCC	11/12-	405403500001	in the spring	45
VW	Golf VIII	auch für 4WD, exc. level control	08/20-	405403500001	in the spring	45
VW	Golf VIII	Heavy Duty Set auch für 4WD, exc. level control	08/20-	421676500001	in the spring	45
VW	Jetta V	inc. Bluemotion and 4-Motion, exc. level control	09/05-01/11	421600500001	in the spring	45
VW	Jetta VI	inc. Bluemotion and 4-Motion, exc. level control	01/11-	421600500001	in the spring	30
VW	Passat B6 Model 3C	inc. Variant and Bluemotion, exc. level control, inc. 4 WD	03/05-10/10	421600500001	in the spring	30
VW	Passat B7	inc. Bluemotion and 4-Motion, exc. level control	10/10-09/14	421600500001	in the spring	45
VW	Passat B8	inc. Bluemotion and 4-Motion, exc. level control, exc. DCC	10/14-	405403500001	in the spring	45
VW	Passat B8 Variant	inc. Bluemotion and 4-Motion, exc. level control, exc. DCC	10/14-	405403500001	in the spring	30
VW	Passat CC	inc. 4WD, exc. level control	05/08-01/12	421600500001	in the spring	30
VW	Passat Variant	inc. 4WD, exc. level control	08/05-08/14	421600500001	in the spring	30
VW	Sharan	inc. Bluemotion and 4-Motion, exc. level control	05/10-	421600500001	in the spring	45
VW	Sportsvan	inc. Bluemotion and 4-Motion, exc. level control	06/14-	405403500001	in the spring	45
VW	Tiguan	inc. Bluemotion and 4-Motion, exc. level control	09/07-	421600500001	in the spring	45
VW	Tiguan	multilink axle only, auch für Allspace, auch für 4-Motion	01/16-	405403500001	in the spring	60
VW	Touran	inc. Bluemotion and 4-Motion, exc. level control	02/03-02/15	421600500001	in the spring	30
VW	Touran	Heavy Duty Set, multilink axle only, exc. level control	05/15-	421676500001	in the spring	20
VW	Touran	twist beam axle only, exc. level control	05/15-	405403500001	in the spring	20
VW	Touran	multilink axle only, exc. level control	05/15-	405403500001	in the spring	45
VW	Touran	Heavy Duty Set, twist beam axle only, exc. level control	05/15-	421676500001	in the spring	45
VW	Transporter T3	exc. 4 WD	05/79-12/92	421391500001	in the spring	30
VW	Transporter T4	inc. Syncro and Caravelle	07/90-04/03	421391500001	in the spring	45
VW	Transporter T5	inc. Chassis Cab and 4-Motion	04/03-11/09	421675500001	alternate spring	30
VW	Transporter T5/T6	inc. Multivan, Chassis Cab and 4-Motion, ABS only	05/03-	421651500001	in the spring	45
VW	Transporter T6	inc. Chassis Cab and 4-Motion	07/15-	421675500001	alternate spring	30
VW	T-Roc	multilink axle only, auch für 4-Motion, exc. level control	07/17-	405403500001	in the spring	60



Certified delivery to the automobile industry

Westfalia-Automotive GmbH

Am Sandberg 45
33378 Rheda-Wiedenbrück

Telefon: +49 5242 907 0
Telefax: +49 5242 907 195

westfalia-automotive.com

