



# Xylem Water Solutions

PRODUCT CATALOGUE - COAL AUTHORITY FRAMEWORK

**xylem**  
Let's Solve Water

# Xylem: A leading provider of fluid technology and equipment solutions for the planet's most challenging water issues

Xylem was launched on 1st November 2011, following the spin out from the ITT Corporation, creating a unique pure play water technology company. Xylem's market-leading product brands, applications expertise and technological strength enable the transport, treatment, testing and efficient use of water in public utility, residential and commercial building services, industrial and agricultural settings.

The company serves customers in more than 150 countries addressing critical water issues such as growing water scarcity, ageing infrastructure and more stringent environmental regulations.

## Creating Water and Wastewater Solutions

Through its market leading brands, Xylem has over 100 years' experience in the water and wastewater environment, having developed the first electric submersible pump and now offering monitoring and control, ozone and UV treatment in addition to aeration and filtration systems.

[The name Xylem is derived from classical Greek and is the tissue that transports water in plants, highlighting the engineering efficiency of our water-centric business by linking it with the best water transportation of all - that which occurs in nature.]



## Our Business

Xylem is a force to be reckoned with when it comes to providing total solutions for fluid handling and control. We have a zeal for innovation and a determination to offer valid economic solutions to the myriad of liquid handling and treatment problems besetting customers in the 21st century.

From design and engineering, to production, marketing, end user support, maintenance and rental; in each discipline and at all levels, the people of Xylem display a synergy and professionalism that is second to none.

Whether your business is in Construction, Public Utilities, Industry, Mining or other services, Xylem will provide the right solution.

## Our Brands

In the UK, Xylem Water Solutions offers six market leading brands that primarily serve the Public Utilities, municipal and industrial markets with regard to the movement and treatment of clean water and wastewater.

The Flygt, Godwin, Leopold, Lowara, Sanitaire and Wedeco brands are all market leaders, each investing heavily in research and development to provide highly efficient and effective products.

Our brands work together, offering customers access to a greater breadth of products, services and business solutions.

## Our People

We place a very high emphasis on people investment. On-going self improvement is actively encouraged. Employees are respected and a clear diversity policy in place.

As a result we have a very loyal employee base here in the UK. Our people are professional, trustworthy and highly regarded for their technical competence in the markets in which we conduct business.

We have a team of knowledgeable, professional and highly skilled staff, who pride themselves on their ability to help customers optimise their business by providing the right solution every time.

As a corporate entity we also have a clear code of conduct that encompasses how we do business through to how employees must treat one another. At all times our employees must feel safe and secure in what they do and in their workplace.

# Brands and People that make a difference



godwin



LOWARA

SANITAIRE®

WEDECO



The logo consists of the word "FLYGT" in a bold, sans-serif font, enclosed within a stylized white arrow shape pointing to the right.

a xylem brand

In the tradition of groundbreaking innovations comes...

# Flygt Experi<sup>o</sup>r™

Welcome to a new era in wastewater pumping. Where engineering excellence and a pioneering spirit combine with an unmatched understanding of your needs. The result is Flygt Experi<sup>o</sup>r, a uniquely holistic experience that combines state-of-the-art hydraulics, motors, and controls.

Today, Flygt Experi<sup>o</sup>r combines N-technology hydraulics and its adaptive functionality, premium efficiency motors and SmartRun - the all-new intelligent control. Flygt Experi<sup>o</sup>r comes from years of listening to you and applying our knowledge and expertise, to develop the most reliable and energy-efficient wastewater pumping. It is therefore the ultimate in our commitment to you.

**Flygt Experi<sup>o</sup>r™. Inspired by you. Engineered by us.**



For pump sales call 0115 940 0111 or email [sales@flygt.co.uk](mailto:sales@flygt.co.uk)

[flygt.com/FlygtExperi<sup>o</sup>r](http://flygt.com/FlygtExperi<sup>o</sup>r)

Flygt is a brand of Xylem, whose 12,000 employees are dedicated to addressing the most complex issues in the global water market. Let's solve water.

**xylem**  
Let's Solve Water

# Contents

Pumps	6-42
Packaged Pump Stations	43-47
Mixing & Aeration	48-64
UV & Ozone	65-90
Filtration & Clarification	91-96
Monitoring & Control	98-110
Accessories	111
Service & Rental	113-116
Regional Map & Locations	117
TotalCare	118-120
Projects Capabilities	121



# Submersible Pumps

Flygt have been leaders in their field since 1948, developing the very first electric submersible pump for contaminated and abrasive liquids.

The Flygt name is internationally recognised as offering high quality, efficient and versatile products. When choosing a Flygt product, you can be assured of expert help and advice from our knowledgeable, highly skilled technicians, backed up by our network of service centres and site engineers located nationwide, so that your business keeps on moving.

## Wastewater pumping

The Flygt 3000 series wastewater pump range is designed for use across the full spectrum of fluid handling.

These versatile pumps can be used for everything from pumping sewage and sludge to process and raw-water handling, as well as irrigation, other municipal applications and the full breadth of uses within aquaculture and agriculture.

The pumps are made predominantly from cast iron, with the option of specialist materials for more demanding applications, including explosion-proof and industrial configurations for heavy duty work. There's also a choice of hydraulic sections, comprising impeller and volute, to suit different kinds of media.

Our wastewater pumps offer exceptional performance and reduced downtime as a result of the patented N Hydraulic technology and most recently the adaptive N pump.

## Pumps for process

Slurry removal is an essential part of day-to-day operations in a wide range of industries such as mining, ore dressing, sand contracting, ash handling and steel milling.

The applications in these industries make heavy demands on the slurry pumps, particularly in terms of the costs incurred when it comes to wear and tear, repairs and maintenance.

Flygt is the only manufacturer that offers its customers a complete solution for slurry handling through the 5000 series of pumps.

**N Impeller - a unique semi-open, self-cleaning impeller that reduces the risk of clogging**

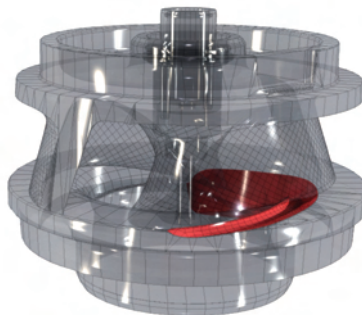

# 3000 Series

## Overview

Although the 3000 series of pumps is primarily designed to pump municipal Wastewater & Sludges, it can also cover many differing solids handling and fresh water applications across different industries due to the various arrangements, materials and impeller options available. The range can be split into 3 discrete sub groups based on common core features. These are:

<b>Small Pumps</b>	<b>3045 – 3068</b>
<b>Core range</b>	<b>3085 – 3127</b>
<b>Mid Range</b>	<b>3153 – 3301</b>

Before we can look at the products, we need to understand the capabilities of the range. The best place to start is with how we name the products and then what each of the letters mean in more detail.

## The 3000 naming systems

For example, an NP3153 is explained below:

Product code	Explanation
N	Impeller Type
P	Installation Type
3	Series
15	Outlet x 10
3	Generation Number

## Duty conditions

To meet different operational demands, 3000 series pumps are designed for different performance characteristics:

Low Pressure	<b>LT</b>	A flat performance curve for large flows at low pressure head.
Medium Pressure	<b>MT</b>	A medium steep performance curve for medium head.
High Pressure	<b>HT</b>	A steep performance curve for high head.
Super High Pressure	<b>SH</b>	A very steep performance curve for very high head.

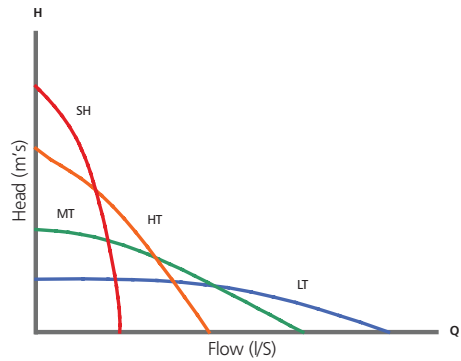

The first letter in name relates to the impeller used. The information on the following page explains the impeller choice and what they do and then demonstrates which product can be used with which impeller.





# Pumps Wastewater

## 3000 Series

### Small Pump Range

Models in range **3: 3045, 3057, 3068**

Max capacity **20l/s**

Max head **31m**

Rated power range (kW) **0.75 to 2.0**

Max temperature **40°C (70°C for warm liquid version\*) where available**

\* No warm liquid version available for explosion proof models.

#### Features

- Class F insulation
- Submersible
- Integrated motor and hydraulics
- Choice of impeller and volute

#### Benefits

- By being submersible less space is taken up with support structure
- Noise and cooling problems are virtually eliminated once submerged
- The integrated motor and hydraulics mean smaller pumping stations
- Different impeller and volute options mean more versatility and application choice

# 3000 Series Small Pump Range

## Overview

The 3000 small pump range offers output ranges up to 2.4kW and 20 litres a second. The standard version of these pumps is made in cast iron with a special industrial configuration being available for more demanding applications.

Explosion proof versions are also available.

## Model: 3045



## Technical

	Model		
	3045	3057	3068
Max flow (l/s)	12	14	20
Max head (m)	16	23	31
Impeller options*	C D	C D	D C F M
Installation options#	F H P S	F P S	F P S H
Max depth	20	20	20
Max starts per hour	15	15	15





# Pumps Wastewater

## 3000 Series

### Core Range

#### Material

3085, 3102, 3127

Impeller	Cast iron
Pump housing	Cast iron
Stator housing	Cast iron
Shaft	Stainless steel
O-rings	Nitrile rubber

#### Impeller options

3085 } High chromium  
 3127 } Cast iron

#### M&C Applicable

- MAS
- Pump Smart
- APP
- Control Panel
- ATU
- Aquaview
- Level Sensors
- Pump Alert

#### Available to rent

# 3000 Series Core Range

## Main Applications

Application surrounds wastewater transport and ultimate application selection depends upon the impeller required.

- Wastewater Transport in Municipal applications (also consider UV, Ozone and Filtration)
- Cooling water (consider the Flygt Clean Water range for clean water applications)
- Storm water (consider the Hydrojet and Flyjet for storm tank cleaning)
- Raw water
- Sludge
- Industrial effluent

## Accessories

Options	3085	3102	3127
Leakage sensor in stator housing	✓	✓	✓
Warm liquid version	✓	✓	✓
Other cables	✓	✓	✓
Zinc anodes	✓	✓	✓
Explosion proof	✓	✓	✓
Surface epoxy treatment	✓	✓	✓
Hydraulic parts in hardened cast iron	1		
High chromium design	2		2

**KEY** 1 = D impeller versions only  
 2 = N impeller / insert ring only



# Pumps Wastewater

## 3000 Series

### Core Range

Models in range **3085**  
**3102, 3127**

Max capacity **110 l/s**

Max head **65m**

Rated power range (kW) **0.77**  
**to 7.4**

Max temperature **40°C (70°C for warm liquid version\*) where available**

\* No warm liquid version available for explosion proof models.

### Features

- Class H insulation
- Submersible and dry installed (immersible)
- Integrated motor and hydraulics
- Choice of impeller and volute
- Thermal switches
- Leakage sensors (optional)

### Benefits

- By being submersible less space is taken up with support structure
- Noise and cooling problems are virtually eliminated once submerged
- The integrated motor and hydraulics mean smaller pumping stations
- Different impeller and volute options mean more versatility and application choice

# 3000 Series Core Range

## Overview

The 3000 core range pumps offer up to 7.4kW output with a max flow of 80l/s. The majority of the core range pumps benefit from being able to use the patented N technology which gives them an enhanced ability to handle rags and troublesome applications where our competitors' pumps clog up.

## Model: 3085



## Technical

	Model		
	3085	3102	3127
Max flow (l/s)	45	65	110
Max head (m)	25	40	65
Impeller options*	N F D C T Z	N F D C T Z	N M D C S T Z
Installation options#	F P S T Z	L P S T Z	L P S T Z
Max depth (m)	20	20	20
Recommended max starts per hour	15	15	15



# Pumps Wastewater

## 3000 Series

### Core Range

#### Material

3085, 3102, 3127

Impeller	Cast iron
Pump housing	Cast iron
Stator housing	Cast iron
Shaft	Stainless steel
O-rings	Nitrile rubber

#### Impeller options

3085	} High chromium Cast iron
3127	

#### M&C Applicable

- MAS
- Pump Smart
- APP
- Control Panel
- ATU
- Aquaview
- Level Sensors
- Pump Alert

#### Available to rent

# 3000 Series Core Range

## Main Applications

Application surrounds wastewater transport and ultimate application selection depends upon the impeller required.

- Wastewater Transport in Municipal applications (also consider UV, Ozone and Filtration)
- Cooling water (consider the Flygt Clean Water range for clean water applications)
- Storm water (consider the Hydrojet and Flyjet for storm tank cleaning)
- Raw water
- Sludge
- Industrial effluent

## Accessories

Options	3085	3102	3127
Leakage sensor in stator housing	✓	✓	✓
Warm liquid version	✓	✓	✓
Other cables	✓	✓	✓
Zinc anodes	✓	✓	✓
Explosion proof	✓	✓	✓
Surface epoxy treatment	✓	✓	✓
Hydraulic parts in hardened cast iron	1		
Hard iron design	2		2

**KEY** 1 = D impeller versions only  
2 = N impeller / insert ring only





# Pumps Wastewater

## 3000 Series

### Mid Range

Models in range **3153, 3171, 3202, 3102, 3127**

Max capacity **630 l/s**

Max head **85m**

Rated power range (kW) **7.5 to 105**

Max temperature **40°C (70°C for warm liquid version)**

### Features

- Dry motor
- Double mechanical seals
- Cast iron shell
- Separate cable sealing
- Multiple installation options
- Various motor sizes
- Various impeller types
- Radical hydraulic end design
- Thermal sensors
- Class H motor
- Inspection chamber
- Smooth shape and design

### Benefits

- Higher efficiency, easier maintenance and reduced risk of environmental contamination
- Double mechanical seal in a 'plug in' cartridge design for easy insertion and reliability
- More corrosion resistant and sturdier than competitors sheet metal pumps
- Reduced risk of leakage and cable damage from improper handling
- Improved flexibility and ease of installation and servicing; can be mounted horizontally or vertically

# 3000 Series Mid Range

## Overview

The latest generation of 3000 wastewater pumps offers improved economy and efficiency. The smooth shape offers ease of service and makes it simpler to clean. This smooth exterior hides the latest N technology inside giving these pumps improved operational economy over the total life cost of the pump. All use class H motors providing improved cooling, heat loss and less wear and tear. The separate inspection chamber for rapid checking and maintenance further improves the serviceability and reduces downtime for routine checks.

## Model: 3153



## Technical

	Model				
	3153	3171	3202	3301	3315
Max Flow (l/s)	240	310	500	630	600
Max Head (m)	67	85	57	75	90
Impeller options*	F N	F N	F N	N	N
Installation options*	P S T Z	P S T Z	P S T Z	P S T Z	P S T Z
Max depth of immersion	20	20	20	20	20
Recommended Max starts per hour	15	15	15	15	15

# 3000 Series Mid Range

## Main Applications

- Wastewater Transport in Municipal applications (also consider UV, Ozone and Filtration)
- Cooling water (consider the Flygt Clean Water range for clean water applications)
- Storm water (consider the Hydroejector and Flyjet for storm tank cleaning)
- Raw water
- Sludge
- Industrial effluent

## Accessories

Options	3153	3171	3202	3301
Leakage sensor in stator housing	✓	✓	✓	✓
Warm liquid version	✓	✓	✓	✓
Other cables	✓	✓	✓	✓
Zinc anodes	✓	✓	✓	✓
Explosion proof	✓	✓	✓	✓
Surface epoxy treatment	✓	✓	✓	✓
High chrome insert ring and IMP	✓	✓	✓	✓
350 cutter version available	3153	3171		
F cutter version with options	✓	✓		
a) Aqua cutting knife	✓	✓		
a) Auger feed control	✓	✓		



## Pumps Wastewater

### 3000 Series

#### Mid Range

#### Benefits continued

- Requires no derating for Variable Frequency Drive (VFD) use (requires cooling jacket)
- Offers a wide range of duties
- Increased application functionality and reliability ensures efficient, reliable and trouble free pumping over long duty periods.
- Able to pump municipal sludge of up to 8% total dry solids

#### Material

3153, 3171, 3202, 3301

Impeller	Cast iron
Impeller option	High chromium Cast iron
Pump housing	Cast iron
Stator housing	Cast iron
Shaft	Stainless steel
O-rings	Nitrile rubber
O-rings option	Fluorinated rubber

#### M&C Applicable

- MAS
- Pump Smart
- APP
- Control Panel
- ATU
- Aquaview
- Level Sensors
- Pump Alert

#### Available to rent

# Flygt Experior™

Inspired by you. Engineered by us.

Welcome to a new era in our ongoing tradition of innovative wastewater pumping: an era where engineering excellence and pioneering spirit combine with an unmatched understanding of your needs.

Now, it's time for you to move up to a revolutionary pumping experience called Flygt Experior. It builds on the premise that the most efficient and reliable pump is only achieved when three keystones work seamlessly and completely together, namely the hydraulics, the control, and the motor.

Flygt Experior is our proud contribution to excellence within pumping. Excellence that can only come from the true leaders within wastewater pumping. It builds on our unbeatable pumping and application knowledge. And it is engineered to lead you into the future.

## Flygt Experior™. Reliability, efficiency, and simplicity

Flygt Experior gives you the freedom to combine the most technologically advanced features and components, most relevant to your wastewater environment. So you actually have the option to select the most perfect pump possible for your needs.

Flygt Experior incorporates state-of-the-art hydraulics, premium efficiency motors, and intelligent controls. In each case, only the products that meet the stringent Flygt demands of reliability and efficiency are selected. Flygt Experior is the stamp of approval that you are getting the best of the best.

The result? State-of-the-art pumping that delivers the ultimate in reliability, efficiency, and simplicity.



Adaptive N-technology

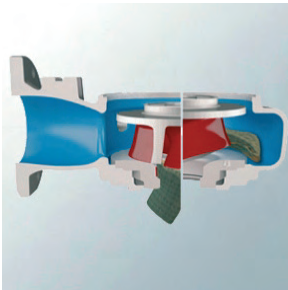

SmartRun™ Controls



Premium Efficiency Motors







#### **SmartRun™ Controls**

This intelligent control features truly simplified, user-friendly functions that make operations reliable and efficient.

#### **Premium efficiency motor**

We design and manufacture all our motors to be optimized for wastewater pumping applications.

#### **N-technology with its Adaptive N-hydraulics**

The self-cleaning, clog-free N-technology featuring the Adaptive N-hydraulics is developed to achieve trouble free and efficient pumping.

#### **Benefits of Flygt N-technology and its Adaptive N-hydraulic**

- Maximum availability due to the self-cleaning, clog-resistance impeller design
- Sustained high efficiency - reduced energy costs up to 25%
- Flexible and modular design to suit any application
- Minimized unplanned maintenance costs

#### **Benefits of SmartRun™**

- Simplified intelligence: pre-programmed and user-friendly setup
- No need for special competence: minimal costs incurred during start-up and operations
- Reduced maintenance costs due to pre-programmed sump and pipe cleaning functions
- The pump cleaning function is automatically triggered in the unlikely event of clogging
- Energy consumption reduced by 30%

#### **Benefits of Premium efficiency motors**

- International premium efficiency standard
- Lower motor temperature prolongs motor and bearing lifespan
- Optimized for wastewater pumping applications
- All common starting methods possible

# Flygt Experior™

## Inspired by you. Engineered by us.

Throughout the years, you have been our portal into the world of wastewater pumping. We have listened to you, and made it our priority to understand your challenges and needs. You have inspired us to achieve engineering excellence through our ideas and innovations. Flygt Experior combines superior

hydraulics, cutting-edge intelligent controls and top-of-the-line motors because these are the critical components to efficient and reliable pumping. And, backed up by the industry's most extensive sales and service organization, this is what Flygt Experior is developed to deliver time and time again.

### Top performance with a broad capacity range

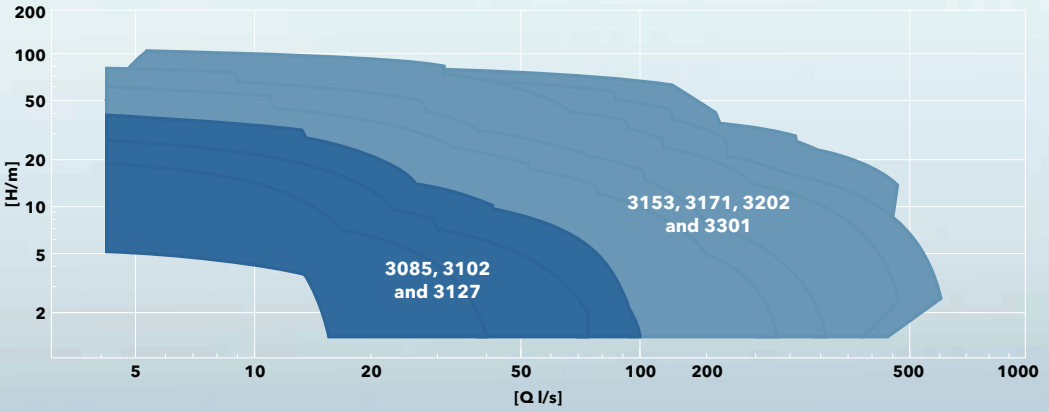

### Power ratings and sizes

Pump model	3085	3102	3127	3153	3171	3202	3301
Rating, kW	1.3-2.4	3.1-4.2	4.7-7.4	7.5-15	15-22	22-47	45-70
Discharge, mm (in)	80 (3")	80 (3")	80 (3")	80 (3")	100 (4")	100 (4")	150 (6")
		100 (4")	100 (4")	100 (4")	150 (6")	150 (6")	250 (10")
		150 (6")	150 (6")	150 (6")	250 (10")	200 (8")	300 (12")
				200 (8") 250 (10")		300 (12")	
<b>SmartRun™</b>	<b>SRC 300-series</b>						
Rating, kW	4	5.5	7.5	15	22	45	75
Current, A	18 9.5	25 14	39 18	61 30	90 46	90	150
Voltage, V	230 380-440	230 380-440	230 380-440	230 380-440	230 380-440	380-440	380-440

### Flygt Experior™

Pump model		3085	3102	3127	3153	3171	3202	3301
Hydraulics	N-technology				•	•	•	•
	Adaptive N	•	•	•				
	Hard-Iron™	•	•	•	•	•	•	•
	Chopper			•	•	•	•	•
Intelligent control	SmartRun™	•	•	•	•	•	•	•
Motor	Premium efficiency motors	•	•	•	•	•	•	•

For more information about Flygt Experior, call Tony Price on 0115 940 7619 or email [tony.price@xyleminc.com](mailto:tony.price@xyleminc.com)

No. of models in range **11**

Max flow **2600/s**

Max head **27m**

Rated power range (kW) **30 to 680**

Max operating temp **40°C**

### Features

- Submersible
- Dry install capable (immersible)
- Motor & hydraulics integrated into one unit
- International standard approval
- Thermal sensors
- Leakage sensors
- Long life bearings
- Deflection resistant shaft
- Strain relief
- Insulation class H
- Cooling jacket

### Benefits

- No need to build expensive constructions to house the pumps as they operate submerged in the liquid being pumped
- To guarantee quality each pump is tested and approved to national and international standards
- Thermal sensors in the stator windings prevent overheating
- N-Impeller available for maximum solids handling capability

# 3001 Series

## Overview

When the duty point exceeds the range of the 3000 series then you need look no further than the 3001. This is the big brother to the 3000 and is known as the 'great & grey' range for its impressive size.

	Depth of immersion (m)	Installation options <sup>#</sup>	Impeller options <sup>*</sup>	No starts per hour
3231	20	P S T Z	C N	15
3240	20	P S T Z	C	15
3306	20	P S T Z	C N	15
3312	20	P S T Z	C N	15
3351	20	P T Z	C	6
3356	20	P T Z	C N	15
3400	20	P T Z	C N	15
3501	20	P T Z	C	15
3531	20	P T Z	C	6 - 15 <sup>†</sup>
3602	20	P T Z	C	6 - 15 <sup>†</sup>
3800	20	P T Z	C	6

<sup>†</sup> Dependant on drive unit

\* For further information, refer to p14, Overview of Pumping.

# For further information, refer to p16, Overview of Pumping.





# Pumps Wastewater 3000 Series

## Main Applications

- Wastewater handling
- Source water pumping
- Cooling water
- Sludge handling
- Storm water handling
- Industrial effluent handling
- Irrigation
- Process water
- Fluid space

## Materials

Pump housing	Cast iron
Stator housing	Cast iron
O-rings	Nitrile rubber

## M&C Applicable

- MAS
- Pump Smart
- APP
- Control Panel
- D7000
- Aquaview
- Level Sensors
- Pump Alert

## Available to rent

# 3001 Series continued

## Options

- Explosion proof versions available
- Leakage sensor in oil
- Analogue temp sensors in stator
- Analogue temp sensor in support bearing
- Other cables
- Surface epoxy treatment
- Zinc anodes
- Leakage sensor in junction box
- Cooling jackets (if dry installed)

# 5000 Series

## Overview

The removal and transportation of abrasive laden slurries is an essential part of the day to day operation for many industries. This process puts heavy demands on the pumps and equipment used. To this end, the 5000 series of pumps has been designed to provide complete wear protection for the wet end of the pump. The 5000 series features a high chrome impeller with a swept back design which gives sustained efficiency and clog free performance.



## Pumps Slurry

### 5000 Series

No. of models in range	8
Max capacity	200l/s
Max head	60m
Rated power range (kW)	7.5 to 215
Max temperature	40°C warm liquid version 70°C
Protection category	IP68

#### Features

- High chrome hydraulics
- Hardened impeller
- Slim, robust and modern design
- Double plug in seal with Spin-Out™
- Class H motors
- Flows to 200 l/s
- Heads to 60 metres
- Full range of sensors
- Easy oil checks
- Built in support stand
- Victaulic® flange and coupling

#### Benefits

- High chrome hydraulics and hardened impeller provide maximum wear resistance and long life
- Slim, robust and modern design mean easy to install and maintain
- Double plug in seal with Spin-Out™
- The Class H motor allows 15 starts/hr
- Full range of sensors for extra operational efficiency
- Easy oil checks: allows rapid investigation of the seal condition
- Built in support stand included allowing the pump to be free standing requiring no additional support structure
- Victaulic® flange and coupling allows fast, easy connection to a wide range of fittings



# Pumps Slurry

## 5000 Series

### Material

#### 5100

Drive unit	Cast iron
Pump house	High chrome Alloyed white Iron
Lifting handle	Stainless steel
Shaft	Stainless steel
O-rings	Nitrile rubber
Impeller	High chrome

#### 5500

Major castings	Cast iron
Lifting handle	Galvanised steel
Shaft	Stainless steel
Impeller	High chrome

### Accessories

- Cooling jackets available for the 5500 series
- Lifting chain available in various lengths
- Agitator: for maximum resuspension of solids

### M&C Applicable

- Level regulator
- Pump Alert
- Pump Smart
- APP
- D7000
- Control Panel
- FCP100

### Available to rent

# 5000 Series continued

## Main Applications

- Quarrying
- Mineral Extraction
- Mining
- Power plants
- Dredging
- Concrete plants
- Steel mills or wherever abrasive liquids need transportation.

A proven solution for severe corrosive and abrasive applications.

## Flygt Agitator use with the 5000 Series

Unique agitator for maximum suspension of solids

The robust axial flow agitator is designed for maximum re-suspension of settled particles. This makes them easier to transport and ensures a cleaner sump at the end of the pumping cycle.

### Standard agitator design vs Flygt agitator

The standard design available on the market for our competitors creates a radial flow, merely stirring the fluid. However, the Flygt agitator creates a vertical thrust force for maximum resuspension of solid particles.

### Side mounted mixer for the really tough jobs

For large sumps with very coarse and heavy particles and/or a need for homogenous slurry, a side mounted mixer is available. The mixer works in combination with the agitator for the toughest jobs where the agitator alone cannot prevent sediment build up.

## Methods of installation

- Permanent dry  
Flood-proof solution for wet well/dry well or in line pumping systems
- Semi-permanent wet  
Cost-effective wet pit installation minimising structural costs
- Portable wet  
Versatile, easy to install, multi-purpose
- Horizontally mounted permanent dry well or in line installation with flange connections for suction and discharge pipework. *The Optional cooling jacket is required.*



# 7000 Series

## Overview

Propeller pumps operate in a very different way to impeller based pumps. The Flygt 7000 series has taken this difference and developed the optimal pump shape designed to create maximum flow. These pumps have no need to be able to generate high heads, they are all about high capacity. For pumping large volumes with low heads, the 7000 series is the ideal choice.

## How it works

The design of the casing is based upon basic physics. The water coming in through the inlet converges towards the propeller where the propeller imparts velocity. The water then moving at a faster rate is passed through the diffuser which recovers the velocity to develop head. The diffuser's purpose is to send the flow in the direction required, this means that high-flow low-head movement of media is created.

## Main Applications

- Storm water
- Raw water
- Flood control
- Return sludge
- Wastewater treatment
- Canoe/leisure courses

## Processes Relevant

- Wastewater
- Sludge
- Leisure
  - Wave machines
  - Theme parks
  - Aqua sports courses



## Pumps Propeller

### 7000 Series

No. of models  
in range **12**

Max capacity **5500l/s**

Max head **12m**

Rated power range (kW) **7.5 to 575**

Max temperature **40°C**

Protection category **IP68**

#### Features

- Extreme high flow generation
- N-propeller
- Tried and proven at almost all Olympic and major sports venues
- Submersible design

#### Benefits

- Extreme high flow generation
- The patented N technique has been adapted to create the N-propeller. A swept back blade design coupled with a relief groove to release debris from the blades prevents clogging without sacrificing performance
- Submersible design means low installation and construction costs with no need for buildings to be constructed

#### Material

##### 7000 Series

Propeller cast iron, stainless steel	Aluminium, bronze,
Outer casing	Cast iron
Wear parts	Polyurethane
Discharge cone	Steel

#### M&C Applicable

- MAS
- Pump Smart
- Pump Alert
- Aquaview
- Control panel

#### Available to rent



# Pumps Slurry

## 8000 Series

No. of models in range	4
Max capacity	75
Max head	35m
Rated power range (kW) to 13kw	1.5
Max temperature	40°C
Protection category	IP68

### Material

#### 8000 Series

Impeller	316 Stainless steel
Outer casing	316 Stainless steel
Shaft	Stainless steel

### Features

- Corrosion resistant
- Non clog vortex design
- Specially designed back vanes on impeller

### Benefits

- Corrosion resistance increases the operating life of the pump
- Non-clog design means fewer blockages and lower maintenance costs
- The back vanes on the impeller help to keep solids out, reduce seal pressure and extend the life of the seal

### Accessories

- Cable protection – available with stainless steel cable sheathing

### M&C Applicable

- Pump Alert
- MAS
- Control Panel
- Aquaview
- APP
- FCP100

# 8000 Series

## Overview

The 8000 series can handle solids up to 150mm thanks to its Vortex impeller and large throughlet. The 8000 series has alternative installation options, which are listed below. The stainless steel construction allows the pump to operate in both acid and alkaline environments (pH 2–14).

Product code	Explanation
D	<b>Impeller type</b> (H = Ni hard 4, D = Cast Iron/Stainless steel)
Y	<b>Installation type</b> (H = Hanging, P = Fixed, F = Freestanding, S = Transportable, Y = Dry installed)
80	<b>Series</b> (80 = 8000)

## Main Applications

	Stainless steel	Cast iron	Ni hard 4	Dry installed
Food processing	✓	✓		✓
Sea water	✓			
Tunnelling	✓	✓		
Drainage in tunnelling inc cleaning agents	✓		✓	
General industry		✓	✓	
Petro chemical (flame-proof)	✓		✓	
Chemical industry	✓		✓	

The chart below shows which material to use given the pH of the fluid being pumped.

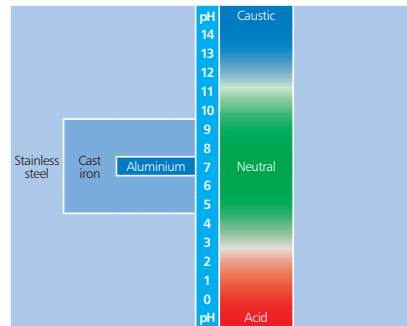

## Processes Relevant

- Slurry
- Wastewater
- Industry

# Flygt Clean Water Range - Industry

## Overview

The Flygt Clean Water Range is made up of three types of pump. Dry installed end suction pumps, Multistage pumps and submersible borehole pumps. Each product has its own specific range of applications and will be covered in more detail over the following pages.

Over 92% of the world's water usage is attributed to industry and agriculture. Clean water forms a big part of this usage.

Water intensive industries are:  $M^3$ /ton product

<b>Steel Mill</b>	<b>20 - 100</b>
<b>Paper Industry</b>	<b>10 - 40</b>
<b>Pump Industry</b>	<b>40 - 90</b>
<b>Mechanical Pulp Industry</b>	<b>20 - 40</b>
<b>Textile Industry</b>	<b>100 - 500</b>
<b>Food Industry</b>	<b>10 - 35</b>
<b>Tannery</b>	<b>40 - 280</b>
<b>Aquaculture</b>	<b>30 - 40</b>

The clean water range has a place in all of these industries.

The range is split into three distinct pump types: End Suction, Multistage & Borehole

<b>Dry installed end suction pumps</b>
L, LM
LSN, LSB ISO 2858/5199
LS, LC, LSP
<b>Multistage pumps</b>
MP, MPA, MPB, MPV
<b>Multistage pumps</b>
P, PVa
<b>Borehole pumps</b>
TV

The range is pictured below

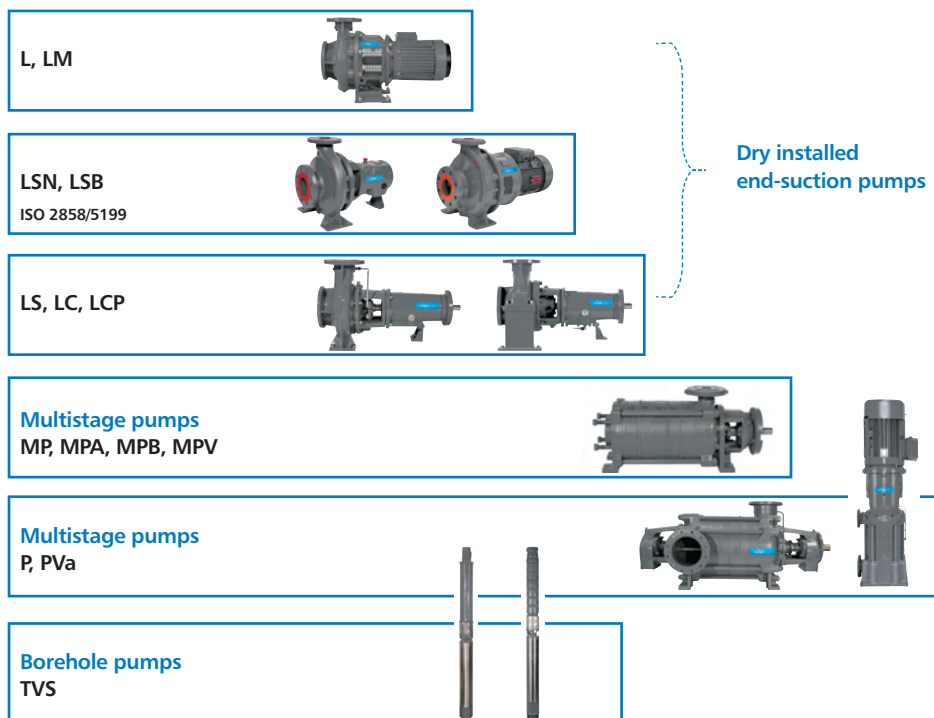

# Flygt Clean Water Range continued

Product	Municipal	Industry	Mining	Construction	Private Building Service
Dry installed end suction pumps  Model: L, LM, LSN, LSB, LS, LC, LCP	<ul style="list-style-type: none"> <li>Fresh water supply</li> <li>Potable water plants</li> <li>Water distribution</li> </ul>	<ul style="list-style-type: none"> <li>Water supply</li> <li>Potable and hygienic water plants</li> <li>Water re-circulation</li> <li>Cooling and heating applications</li> <li>Water collection</li> </ul>	<ul style="list-style-type: none"> <li>Leaching process pumping</li> </ul>	<ul style="list-style-type: none"> <li>Water supply</li> <li>Water re-circulation</li> <li>Washing applications</li> </ul>	<ul style="list-style-type: none"> <li>Water collection</li> <li>Water circulation</li> </ul>
Sales channel	<ul style="list-style-type: none"> <li>Contractors for treatment plants</li> <li>Operators within water companies</li> <li>Contractors</li> </ul>	<ul style="list-style-type: none"> <li>End users</li> <li>Contractors for treatment plants</li> <li>Specialised instillation contractor</li> <li>O.E.M.s</li> </ul>	<ul style="list-style-type: none"> <li>End user</li> <li>Plant contractors</li> <li>Engineering companies</li> <li>Specialised installation contractor</li> <li>Distributors</li> </ul>	<ul style="list-style-type: none"> <li>Contractors</li> <li>O.E.M.s</li> </ul>	<ul style="list-style-type: none"> <li>Contractors</li> <li>Distributors</li> </ul>

Product	Municipal	Industry	Mining	Construction	Private Building Service
Multistage pumps  Model: MP, P, TV	<ul style="list-style-type: none"> <li>Fresh water supply</li> <li>Potable water plants</li> <li>Water distribution</li> </ul>	<ul style="list-style-type: none"> <li>Fresh water supply</li> <li>Ultra filtration processes</li> <li>Water cooling and heating systems</li> </ul>	<ul style="list-style-type: none"> <li>Water supply</li> <li>Active dewatering</li> <li>Passive dewatering</li> <li>Main drainage</li> </ul>	<ul style="list-style-type: none"> <li>Water supply</li> <li>Washing applications</li> </ul>	<ul style="list-style-type: none"> <li>Water collection</li> <li>Water circulation</li> </ul>
Sales channel	<ul style="list-style-type: none"> <li>Contractors for treatment plants</li> <li>Water companies</li> <li>Contractors</li> <li>Distributors</li> </ul>	<ul style="list-style-type: none"> <li>End users</li> <li>Plant contractors</li> <li>Engineering companies</li> <li>Specialised installation contractor</li> <li>Distributors</li> </ul>	<ul style="list-style-type: none"> <li>End users</li> <li>Plant contractors</li> <li>Engineering companies</li> </ul>	<ul style="list-style-type: none"> <li>Contractors</li> <li>Distributors</li> </ul>	<ul style="list-style-type: none"> <li>Contractors</li> <li>Distributors</li> </ul>

Product	Municipal	Industry	Mining	Construction	Private Building Service
Technovar	<ul style="list-style-type: none"> <li>Booster</li> <li>Water distribution</li> </ul>	<ul style="list-style-type: none"> <li>Liquid distribution</li> <li>Process handling</li> <li>Liquid re-circulation</li> <li>Cooling and heating system</li> <li>Boosters</li> </ul>	<ul style="list-style-type: none"> <li>Water supply</li> <li>Washing applications</li> </ul>	<ul style="list-style-type: none"> <li>Water supply</li> <li>Washing applications</li> <li>Boosters</li> </ul>	<ul style="list-style-type: none"> <li>Water supply</li> <li>Water re-circulation</li> <li>Boosters</li> </ul>
Sales channel	<ul style="list-style-type: none"> <li>Water companies</li> <li>Contractors</li> </ul>	<ul style="list-style-type: none"> <li>End users</li> <li>Specialised installation contractor</li> </ul>	<ul style="list-style-type: none"> <li>End users</li> <li>Engineering companies</li> </ul>	<ul style="list-style-type: none"> <li>Contractors</li> <li>O.E.M.s</li> </ul>	<ul style="list-style-type: none"> <li>Contractors</li> <li>Distributors</li> </ul>



# Pumps Clean Water

## Dry Installed End Suction

No. of models in range	6
Max capacity	4600 m <sup>3</sup> /h
Max head	150m
Max temperature	180°C

### Material

L / LM  
Cast iron  
Bronze

LSN / LSB  
Ductile iron  
Stainless steel

LS 12 / LS 16 / LC / LCP  
Cast iron  
Ductile iron

### Processes

- Pulp and paper
- Industry
- Water supply

# Dry Installed End Suction

## Overview

End Suction Pumps are available in either close coupled / monobloc design complete with flange mounted drive motors or long coupled with foot mounted motors.

End Suction Pumps can be found in almost any water based transportation application across all industries.

Complying with recognised International European standards, ensures the design, installation measurements and hydraulic performance is equal or better than that of similar products manufactured to the same standards.

The back pull out design enables ease of maintenance without the need to break into the pipework installation and pumps can be installed in a variety of methods.

High continuous temperature rating of up to 140°C is another positive feature as is of these pumps.



## Applications

- Water supply
  - Industries
  - Farming
  - Pressure boosting
  - Circulation of cold and hot water in heat or air conditioning systems
- Swimming pools
- Cooling water supply
- Hot water circulation
- District heating
- Food and beverages
- Filter systems



# Pumps Clean Water

## Multistage Series

No. of models  
in range **6**

Max capacity **2000  
m<sup>3</sup>/h**

Max head **500m**

Max temperature **140°C**

### Material

MP/MPA/MPB/MPV

Cast iron

Ductile iron

Stainless steel

P / PV

Cast iron

Ductile iron

Stainless steel

### Processes

- Pulp and Paper
- Industry
- Water Supply

# Multistage Series

## Overview

Multistage Pumps are available in either close coupled design with flange mounted drive motor or long coupled with foot mounted motors.

Multistage Pumps provide the ideal solution for pumping clean water at flows of up to 2,200 m<sup>3</sup>/hr and high pressures of up to 500 metres / 48.0 bar and either cold or hot water applications up to 140°C.

Available as either vertical or horizontal installation, the multistage pump provide optimum hydraulic efficiency for these high head applications with a very compact installation footprint.

The multistage pump design most often also means smaller motors can be used, with the added benefit of reduced energy consumption.

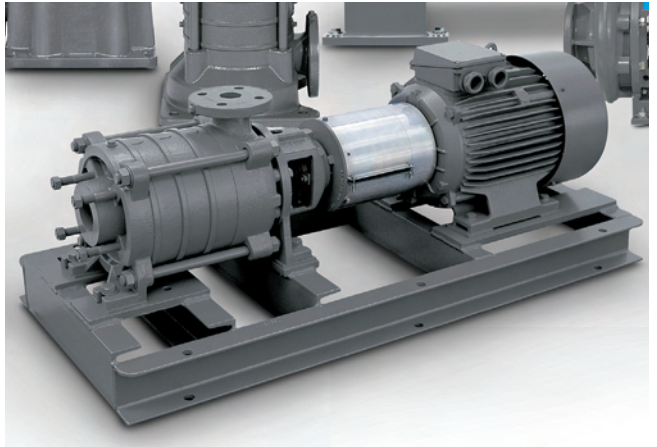

## Applications

- Water supply
- Booster systems
- Irrigation
- Cooling circuits
- Boiler feed
- District heating
- Mining
- Snow-making systems
- Condensate
- Fire fighting
- Industrial boiler feed
- Condensate handling
- Reverse osmosis
- Ultrafiltration
- Tankloading
- Water control in mines



# Pumps Clean Water

## Packaged Pumpsets

No. of models in range	Unlimited
------------------------	-----------

Max capacity (Pumps)	Unlimited
----------------------	-----------

Max head (Pumps)	500m
------------------	------

Rated power range (kW) (Pumps)	560kW
--------------------------------	-------

### Accessories

- Pumps
- Base plates
- Break tanks
- Pipe work
- Valves
- UV Treatment
- Control gear
- Instrumentation
- Telemetry
- Kiosk
- HIAB Delivery
- Installation

### Benefits

- One stop shop for water industry client
- Pre-developed range ensure a rapid response is available for water industry client
- Reduces technical risk for water industry client

### Main Application

- New build capital projects

# Municipal Clean Water Packaged pumpsets

## Overview

For pump manufacturers, the core business in the municipal clean water sector, is in the provision of packaged pumpsets, which are sometimes referred to as booster sets.

As detailed in the photographs below, these can be of virtually any configuration. Any of the clean water pumps previously explained in the handbook, can be packaged in any number, along with base plates, break tanks, control gear, pipe work and valves into an offering developed especially for the municipal market. Ranges have been developed to meet the specifications of Scottish Water, Southern Water and Northern Ireland Water. We will develop ranges to suit the requirements of additional water companies as they approach framework tendering.



No. of models in range	37
Max number of pumps controlled	8
Maximum motor mounting	22kW
Max motor size accommodated	250kW
Control philosophy accommodated	Pressure Flow Level Temperature PH Turbidity

Processes

- Provides complete control solution
- Will achieve duty/assist/standby operation up to 8 pumps
- Auto changeover in the event to failure
- Cyclic changeover
- Dry run protection
- Stationary pump test
- Omits digital and analogue signals for telemetry purposes
- Energy savings of up to 70%
- Increased pump reliability
- Smoother system hydraulics

# Municipal Clean Water Hydrovar

## Overview

It has become the norm for municipal users to specify the use of variable speed drives on new capital plant, to ensure their processes run at their optimum efficiency for the conditions at any given time.

As savings have been proven, municipal users have been applying drives to existing assets to reduce energy costs by preventing unnecessary operation.

Xylem's Hydrovar variable speed pump controller has proven itself in the field, and lends itself to use on both new capital works through the consulting and contracting sector, and retrofit applications through Energy optimisation and Operations team.

Up to 22kw, the Hydrovar can be mounted directly upon the motor, or alternatively and beyond this size can be wall mounted within an IP55 rated enclosure.

It can be used completely on its own with no other control gear, or alternatively incorporated to work with a Form 2 or Form 4 water industry control panel  
Demonstration rig available for shows, exhibitions, internal and external training sessions.

## Applications

- New build capital projects
- Retrofit onto existing assets



# Dewatering Pumps



## Flygt electric submersible pumps

Dewatering is the movement of water from one location to another. The process of dewatering is essential to a broad range of mining, quarrying, construction, tunnelling, industrial and municipal applications.

Dewatering helps build roads and bridges, extract natural resources, recycle industrial process water, remedy flooding and solve a wide range of fluid handling challenges. The Flygt dewatering series offers a range of pumps suitable for a multitude of applications. Our pumps have been designed to work in tough environments and applications. The shape and dimensions of the pumps were specifically designed with accessibility in mind.



## Godwin diesel pumps

In 2010 Xylem acquired Godwin Pumps, bringing with them over 100 years of experience in the design, manufacture, and supply of diesel pumps. Godwin Pumps is renowned for quality, reliability, and long life. Today, the product range is used throughout the world, in construction, industry, oil refineries, chemical plants, mines, specialist offshore pumping, irrigation and water distribution.

The extensive Godwin range includes Dri-Prime automatic self-priming and wet self-prime pumps. Flows up to 3500 cubic metres per hour and heads up to 200 metres can be handled according to the type or system.





# Pumps

## Dewatering

### SX Series

No. of models in range	7
Max capacity	410l/min
Max head	21m
Rated power range (kW)	0.3 to 1.1
Max temperature	50°C
Protection category	IP68

#### Features

- Corrosion resistant construction
- Lightweight
- Easy to use

#### Material

##### SX2, SX3, SXV 3

Impeller	Fibreglass reinforced noryl
Outer casing	Fibreglass reinforced noryl
Stator housing	Stainless steel
Shaft	Stainless steel
O-rings	Nitrile rubber

##### SX 5, 7, 11, 15

Impeller	Stainless steel
Outer casing	Stainless steel
Stator housing	Stainless steel
Shaft	Stainless steel
O-rings	Nitrile rubber

#### Accessories

- Level regulator for three phase versions
- SX2, 3 and SXV3
- RPG Pipe fittings
- Low suction device

#### M&C Applicable

- Level regulator

# SX Series

## Overview

The SX range is a compact high performance stainless steel submersible dewatering pump. Ideal for routine removal of nuisance surface water and truly transportable.

## Main Applications

- Drainage - underpasses, yards, tanks, ditches, trenches, basements
- Removal of domestic and commercial wastewater
- Transfer of raw water
- Transfer of clean/contaminated water
- Food clean up
- Fountains



## Product identity

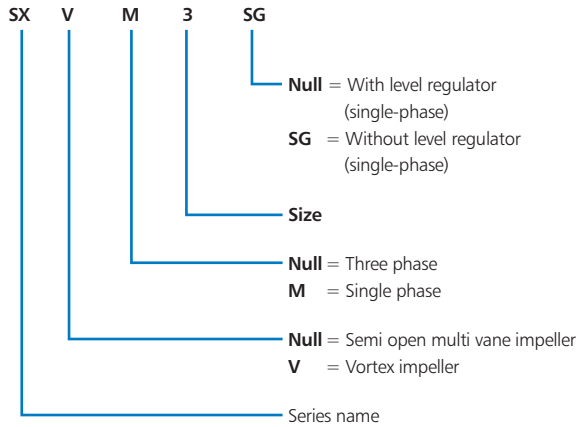

No. of models in range **4**

Max capacity **675l/min**

Max head **15m**

Rated power range (kW) **0.55 to 1.5**

Max temperature **35°C**

Protection category **IP68**

### Features

- Dry motor
- Continuous duty when the pump is completely submerged
- Twin seal system
- Float switch

### Material

Vortex impeller (D)	Stainless steel
Twin channel impeller (C)	Stainless steel
Single channel (C) impeller	Fibreglass reinforced nylon
Outer casing	Stainless steel
Shaft	Stainless steel
Twin seal	Outer mechanical seal in silicon carbide and inner lip seal in nitrile rubber

### Main Applications

- Emptying of sewage collection tanks
- Drainage of nuisance water
- Transfer of dirty water
- Transfer of groundwater
- Flood clean up

### Accessories

- Discharge connections
- Sliding bracket
- Outer bend

### M&C Applicable

- Level regulator

# DX Series

## Overview

The DX offers submersible drainage and wastewater removal for light commercial and domestic use. Available in eight variants with a choice of Vortex (D) or channel type (C) impeller.

## Main Applications

- Drainage - underpasses, yards, tanks, ditches, trenches



## Product identity

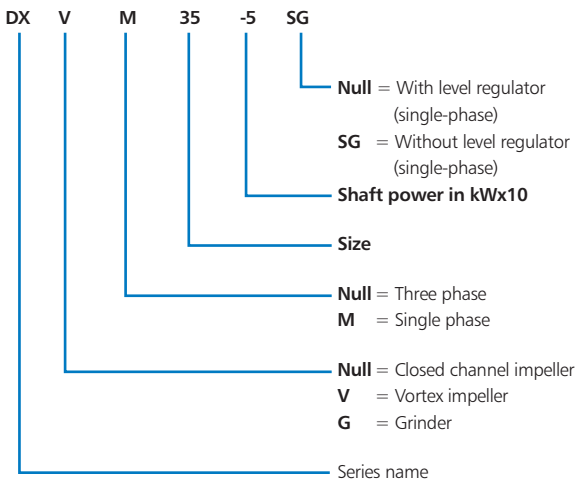





# Pumps

## Dewatering

### Ready Series

No. of models in range	3
Max capacity	7l/s
Max head	14m
Rated power range (kW)	0.4 to 0.9
Max temperature	35°C
Protection category	IP68t

#### Features

- Durable and easy to use
- Rubber Strainer
- Polyurethane Hydraulic parts
- Dual position discharge
- Increased efficiency
- Spin Out™
- Auto Cut
- Vortex Impeller (Ready 8S) – D impeller see Overview of Pumping, page 14

#### Benefits

- Robust design resulting in less downtime
- Dual position discharge provides versatile positioning and use
- Plug in cable allows for easy replacement in the event of damage without sending the pump away from site, therefore less downtime
- Unique impeller design with Spin Out™ reduces clogging and keeps the pump pumping for longert

# Ready Series

## Overview

The Ready range of dewatering pumps are portable and ideally suited for the removal of nuisance water.

The range is truly durable and powerful thanks to the materials used in its construction. It is lightweight (between 10 and 15 kilos) and easy to handle.

There are three models in the range offering pumping solutions for aggressive fluids mixed with sand and gravel.

## Main Applications

- Construction sites
- Industrial use – ideal emergency backup
- Flood clean up
- Nuisance water dewatering

A proven solution for light to medium corrosive and abrasive applications.





# Pumps Dewatering Ready Series

# Ready Series continued

## Features in more detail

- **Auto Cut**  
Automatically switches off the power to prevent overheating when temperatures rise. Cables also switch off automatically to prevent water from leaking into the junction box.
- **Power Cord**  
Easy to replace plug in connector lets you change cables in just a few seconds.
- **Hydraulic Parts**  
Made of highly resistant polyurethane, all hydraulic parts are designed to withstand extreme wear and ensure reliable operation and give longer service life.
- **Volute (8S)**  
Polyurethane casing on the Ready 8S is ideal for solids handling and corrosive environments.
- **Spin-Out™**  
Unique to Flygt, this patented design minimises clogging, protects the outer seal and extends service life by expelling abrasive particles from the seal.

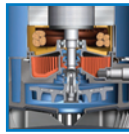

### Material

(Ready 4) + (Ready 8)

Impeller	Polyurethane
Outer casing	Stainless steel
Wear parts	Polyurethane
Stator housing	Stainless steel
Strainer	EPDM rubber (excludes 8's)
Shaft	Stainless steel
O-rings	Nitrile rubber

### Accessories

- Level regulator – will turn the pump on and off based on the water level the pump is operating in
- Low suction collar (Ready 4 & 8 only) – enables the water to be pumped to a very low level when fitted to the pump
- Various discharge connections

### M&C Applicable

- Level regulator



# Pumps Dewatering 2000 Series

No. of models in range	8
Max capacity	270l/s
Max head	198m
Rated power range (kW)	3 to 90
Max temperature	40°C
Protection category	IP68

## Benefits

- Long service life thanks to patented Spin Out and Double Axial Face Seals
- Wear resistant materials make the range ideal for chemically and mechanically aggressive fluids
- Safe for dry running and snoring operations

# 2000 Series

## Overview

With eight pumps in the range, they are capable of handling big jobs with flows up to 300l/s. Designed to withstand tough environments, the casing materials come in light aluminium for heavy construction sites and mines; cast iron for corrosive environments.

## Main Applications

### 2071-2250

- Quarrying
- Mineral extraction
- Mining
- Construction sites
- Industry
- Tunnelling
- Flood clean up

### 2400

- Quarrying
- Mineral extraction
- Mining
- Construction sites
- Large tunnelling



2071



2201



2125



2125.320



2400



2250



# Pumps Dewatering

## 2000 Series

# 2000 Series continued

## Specially Designed Impellers

These specially designed impellers are manufactured with a high chromium content and hardened to HRC 60 to ensure excellent wear resistance, long life and lower maintenance.

## Spin Out™

Unique to Flygt, this unique patented design minimises clogging, protects the outer seal and extends service life by expelling abrasive particles from the seal. Found only on Flygt pumps.

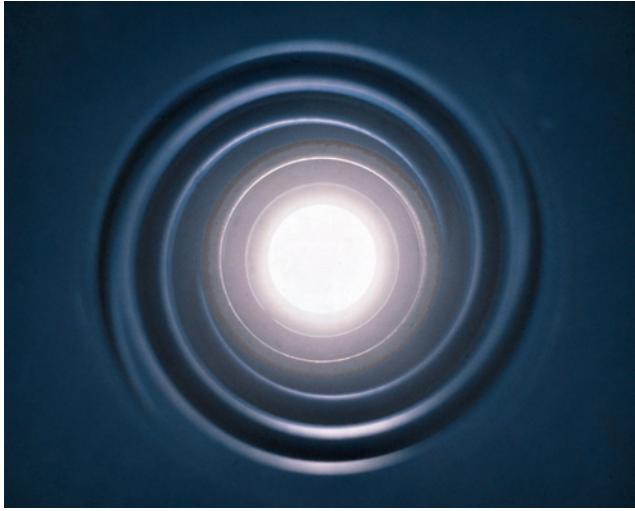

## Double Axial Face Seals

Made of WCCR (corrosion resistant cemented carbide), these specially designed face seals protect the pumps against the ingress of liquids.

## Processes Relevant

Dewatering applications across all industries.

### Material

Impeller	2071, 2075, 2201, 2125, 2400 Hardened steel
	2125, 2201 High chrome alloy cast steel
Stator casing	P2071, 2125, 2201 Aluminium
Strainer	2071 Cast iron
Strainer	2125, 2201, 2075, 2201, 2125, 2400 Galvanised steel
Shaft	2071, 2125, 2201, 2075, 2201, 2125, 2400 Stainless steel

### Accessories

- Level regulator – will turn the pump on and off based on the water level the pump is operating in
- Low suction collar (Ready 4 & 8 only) – enables the water to be pumped to a very low level when fitted to the pump
- Various discharge connections

### M&C Applicable

- FPC 100
- Level regulators

### Available to rent



# Pumps

## Dewatering

### 2600 Series

No. of models in range	17
Max capacity	93l/s
Max head	80m
Rated power range (kW)	1.3 to 18
Max temperature	40°C
Protection category	IP68

#### Features

- Robust design
- Stainless steel strainer
- Rubber shock absorbers
- Fewer components
- Inspection chamber
- Increased efficiency
- Dura Spin™
- Spin Out™
- Plug In Seal
- Available with K and B impeller

#### Benefits

- The new closed B-Impeller with Dura Spin minimises impeller wear and increases durability. Spiral grooves on the suction cover and back vanes on the impeller prevent abrasive particles from reaching the impeller neck
- A proven solution for heavy corrosive and abrasive applications
- Spin Out is unique to Flygt products, this patented design minimises clogging, protects the outer seal and extends service life by expelling abrasive particles from the seal
- The K-Impeller is a high chrome impeller specially designed for high efficiency and wear resistance. Minimises clogging when pumping abrasive water containing large soft particles

# 2600 Series

## Overview

The 2600 range of dewatering pumps offers both portable and static pumping solutions for a vast array of dewatering applications across many harsh environments.

They work harder and last longer than traditional pumps with the 2600 offering extra wear resistance (over 3x more) due to the patented Dura Spin™.

## Main Applications

- Portable dewatering
- Static dewatering
- Quarrying
- Mineral extraction
- Mining
- Construction
- Industry
- Tunnelling
- Flood clean up





## 2600 Series continued

### Plug in Seal ①

This unique easy to service seal incorporates two mechanical seals for double protection against liquid penetration and protects seal surfaces during mounting and disassembly.

### Dura Spin™ ②

This new system minimises impeller wear and increases durability. Spiral grooves on the suction cover and back vanes on the impeller prevent abrasive particles from reaching the impeller neck.

### Spin Out™

Unique to Flygt, this unique patented design minimises clogging, protects the outer seal and extends service life by expelling abrasive particles from the seal. Found only on Flygt pumps.



#### Accessories

- Flygts Plug in Seal is a unique easy to service seal which incorporates two mechanical seals for double protection against liquid penetration and protects seal surfaces during mounting and disassembly meaning longer life and improved uptime

#### Material

Cooling jacket:	2630-2670
	Stainless steel
Stator casing	2610-2620
	Cast aluminium
Shaft and strainer:	2610-2620
	Stainless steel
Impeller:	2630-2660
	Cast aluminium
Suction cover:	2670
	Grey cast iron
Diffuser and 'O' rings:	Stainless steel
	Hi chrome alloy
Shaft and strainer:	Cast steel
	Hi chrome alloy cast steel (Dura Spin™)
Impeller:	Nitrile rubber

#### Accessories

- Optional outlets
- Various hoses
- Subcab™ cable
- Tandem connectors
- Zinc anodes kits
- PFM (pump flotation module)

#### M&C Applicable

- FPC 100
- Level regulators

#### Available to rent



# Sludge Pumps

## 2600 Series

No. of models in range **3**

Max capacity **24 l/s**

Max head **38m**

Rated power range (kW) **1.5 to 5.6**

Max temperature **40°C**

Protection category **IP68**

### Features

- Hard-Iron, Vortex impeller
- Robust design
- Larger pump inlet
- Larger pump volute
- Side discharge design
- Polyurethane-lined pump housing

### Benefits

- Flygt 2600 sludge pumps pass solids up to 80 mm (3.2 in) in size and solids concentrations of approximately 20% by weight, thanks to a larger inlet, pump volute, vortex impeller and side discharge. This ensures maximum uptime for temporary pumping applications
- Flygt sludge pumps are built on the reliable 2600 series platform with its proven design. This enables you to interchange the hydraulic ends to meet changing application requirements and reduce your spare parts inventory. That means you have one dependable pump available for many applications
- Dependable solids-handling. A Hard-Iron™ (60 HRC) vortex impeller and polyurethane lined pump housing enable Flygt 2600 sludge pumps to pass large solids and solids concentrations of approximately 20% by weight with ease
- Easy to service. Fewer components, such as our unique one-piece Plug-In™ seal, and external oil and inspection plugs make maintenance quick and easy. A watertight terminal board provides an additional barrier to water ingress

# 2600 Series Sludge

## Overview

Flygt 2600 sludge pump series tackle the tough challenge of moving sludge and other liquids with ease – without clogging.

Radically engineered from the ground up, these robust, versatile pumps deliver unmatched wear resistance, consistent performance over time and ease of service. The result is lower total cost of ownership when buying the pumps or lower operating and maintenance costs when renting them.

## Main Applications

- Construction
- Tunnelling
- Quarrying
- Mining
- Temporary sewage pumping
- Digester cleaning
- Industrial
- Food processing wastewater



Xylem now has access to Godwin's range of automatic self-priming pumps adding an additional and wider range of Diesel driven Dri - Prime pumps.

The new Godwin pumps can be skid or trailer mounted for use in mobile applications which can provide exceptional energy efficiency and a significantly reduced clogging capability. Godwin CD, HL, Heidra and NC series are now available from Xylem.

## Automatic self-priming from dry

Godwin pumps prime and re-prime automatically from dry. In fact, they are so dependable, you can just turn them on and forget about them. This leads to significantly reduced costs for manually priming and repeated re-priming.

## Robust design for rough handling

Godwin pumps are made from the bottom up to withstand the wear and tear of rental. That's why the pump-end has a close-coupled design and runs dry without damage. And that's also why the castings are 4 mm thicker compared to a permanently installed process pump.

## Correct pump sizing

Reliable pumping is also a question of using the right size pump for the job. With the market's widest range of surface-mounted pumps, we make sure that the right Godwin pump is supplied to every application. This, together with the local and international expertise of TotalCare, ensure efficient pumping solutions.

## System engineering excellence

Accurately predicting flows is key to designing reliable pumping systems. The system engineering competence built up by Godwin - the result of over 100 years of experience - is now rooted in Xylem.

## Close by and available

And finally, reliability is about availability. You will find that Xylem is always close by, ready with pumps for rental or purchase, ready with service technicians to help you and spares to keep your pumps pumping. We call it TotalCare services.



# Godwin CD & HL series

## Godwin CD series

The Godwin CD range is ideal for high volume, medium head pumping and is capable of handling large solids.

All models are available trailer mounted for safe on-highway transportation, with stainless steel pump end construction, and sound attenuated closures.

### The CD series at a glance:

- Flows: 80 to 3,500 m<sup>3</sup>/h
- Solids handling: 125 mm
- Head: 32 to 60 metres
- Elevated head pumps: three models with heads up to 85 meters



## Godwin HL series

The Godwin HL series is ideal for medium volume, high head pumping and is capable of handling solids.

All models are available trailer mounted for safe on-highway transportation, with stainless steel pump end construction, and sound attenuated closures.

### The HL series at a glance:

- Flow: 107 to 1,200 m<sup>3</sup>/h
- Solids handling: 65 mm
- Head: 100 to 160 meters
- Extreme high head pumps: three models with heads up to 193 meters with a single-stage impeller



# Godwin Heidra series

## Godwin Heidra Pump

When the suction lift is greater 8.5 m, Heidra pumps take over where Dri-Prime pumps leave off. Heidra hydraulic submersibles are basically Dri-Prime pumps that have been engineered to work submerged in the liquid they pump. Tough and reliable, Heidra pumps are designed for general pumping of light slurries and municipal sludges

## Liquid bath mechanical seal = dry-running and reduced maintenance costs

Seals in pumps that often run dry can overheat and fail. Godwin mechanical shaft seals run in a liquid bath, which dissipates heat through the pump casing and allows the pump to run dry. This provides more reliable operation, frees operators from closely monitoring the pumps, while reducing maintenance costs.

## Durable pump-end = long lifetime

Cast iron, the standard build, offers excellent durability.

## Open impeller = versatility and fewer stoppages

With their open impeller design, Godwin Heidra pumps handle solids of up to 125mm in diameter, reducing the risk of stoppages. The open impeller also means you can use Godwin pumps in a wide range of applications from water and wastewater, to drilling mud's and industrial fluids.

The Godwin Heidra range includes high volume, vortex, high head and slurry gate versions.

## The Heidra series at a glance:

- Flow: 80 to 1,368 m<sup>3</sup>/h
- Solids handling: 125 mm
- Head: 32 to 60 metres
- Head: 25 to 140 metres





# Godwin NC series

## Godwin NC series

With 2 of the world's market leading pump brands in Flygt and Godwin under the Xylem umbrella, we have now combined the world's most reliable portable pumps with the world's most efficient self-cleaning hydraulics to bring you the most efficient and reliable Godwin pumps ever.

The new range of Godwin NC pumps are not only reliable, they come equipped with the non-clogging, performance of the proven Flygt N-technology.

This breakthrough combination gives you a best-in-class portable pump that delivers sustained hydraulic efficiency to handle tough wastewater pumping applications.

## Self-cleaning Flygt N-technology saves costs

The high efficiency of Flygt N-technology is sustained over time due to its selfcleaning ability, keeping energy/fuel costs to a minimum. Without a doubt, no matter what the challenge, you will always have the peace of mind knowing that our Godwin Dri-Prime NC Series pumps are on the job. Godwin pumps, now with sustained high efficiency and hydraulics

- Self-cleaning reliability
- Hydraulic efficiency
- Non-stop optimum performance
- Long term energy/fuel savings
- Optimized operating speed for low energy/fuel consumption
- Low downtime
- Extended service intervals
- Minimum maintenance
- Service friendly

The Godwin NC range features the unique patented N-technology with its innovative self-cleaning impeller. Able to perform in the toughest conditions, the NC range can handle solids up to 42 mm in diameter. This makes the NC an extremely effective pump, suitable for both sewage and clean water applications and it has proven itself a pump of choice when pumping stringy material and general dewatering applications.

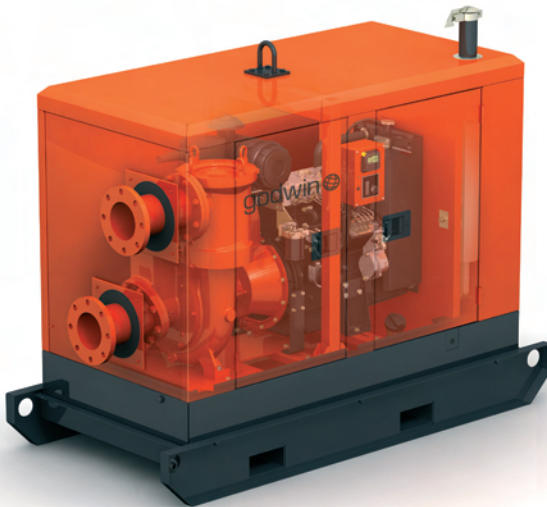

For more information on the individual Godwin pump models please contact our sales department on 0115 940 0111 or email us at [sales@flygt.co.uk](mailto:sales@flygt.co.uk)



# Flygt Packaged Pumping Stations

As we build in more remote and inaccessible areas, the need to pump wastewater to treatment works becomes a key consideration at the planning stage, particularly with developments situated below the gravity sewer, or a considerable distance away.

As such, the traditional solution has been to build a pumping station consisting of a chamber constructed with concrete rings and fitted out with pipes, valves and pumping equipment to move the wastewater to the gravity main. This type of construction is labour intensive, time consuming and requires considerable co-ordination on-site.

## So, is there an alternative solution?

The simple answer is yes! Prefabricated Packaged Pumping Stations, fully kitted out with pump(s), valves and pipe work, can be delivered to site and simply placed in the ground.

As the market leader in submersible pumps, Flygt has developed a comprehensive range of Packaged Pumping Stations (PPS) that are suitable for single dwellings through to large multi-purpose applications.

In developing our product range we have taken into consideration the different demands an application may exert on a product and created a unique and versatile range.



## Range Overview:

### TOPS Series

- For sewage, effluent and storm water applications
- Incorporates the patented selfcleaning TOPS benching unit which reduces accumulation of solids in the sump of the chamber, ensuring the pumps do not get clogged
- Reduced servicing and unplanned maintenance
- The TOPS pumping station can be fully adoptable under the 'Sewers for Adoption' (SFA) standards

### Compit Pumping Station

- Single or dual pump configuration
- Applications include small housing developments, toilet blocks and commercial extensions

### Micro Series

- For domestic wastewater and sewage from individual households
- Suitable for installation above or below ground

The Godwin NC range features the unique patented N-technology with its innovative self-cleaning impeller. Able to perform in the toughest conditions, the NC range can handle solids up to 42 mm in diameter. This makes the NC an extremely effective pump, suitable for both sewage and clean water applications and it has proven itself a pump of choice when pumping stringy material and general dewatering applications.

# Packaged Pump Stations

## Micro Series

### Micro 3, 5 and 7, for indoor installation

These versions, for use in basements and sanitary spaces, are very quick and easy to install.

All incorporate several technical innovations that make them stand out against the competition.

#### Features

- Tank with carrying handle and pictograms with easy-to-install symbols
- Easy to close cover with rubber seal
- Prepared connections for inlet pipe, discharge pipe and power supply
- Connection of discharge pipe with a self-clamping joint

#### Benefits

- Easy handling and direct visual guidance for the various connections, for reliable closure and no odour
- Simplified installation of pipes, everything grouped together at the same location
- Quick connection and easy to remove

# Micro Series

## Overview

For waste and wash-water from single households, extensions and basements.

The Xylem range of Micro pump stations is available in several different sizes and is the ideal solution when domestic wastewater must be delivered to sewer mains located at a higher level, or where gravity drainage is not possible.

Other applications are e.g. ground water or run-off from garage driveways.

The smallest unit can simply be installed on the floor under the sink, and the larger in the basement, in the garage or under the driveway. There is one design for indoor installation and one for installation underground.

The Micro station is delivered pre-assembled with discharge piping and inlet piping prepared for connection.

The stations are made in polyethylene, a lightweight and strong material that makes them easy to handle and install. All are designed according to EN 12050-1 and 2.

## Basic Overview

Denomination	Micro 3	Micro 5 & 7	Micro 5G & 7G
Installation	Indoor	Indoor	Underground
Sump Volume	80 litre	250 litre	250 litre
Dimensions (mm)			



# Micro Series continued

## Micro Model Selection Guide

There are 16 models in the Micro series.  
Please see the table below for details

Pump	Power kW	Indoor installation			Below ground		Outlet Size	EN approval
		Micro 3	Micro 5	Micro 7	Micro 5G	Micro 7G		
SXM 2GT	0,3	83 38 50					1¼"	EN 12050-2
SXM 3GT	0,78	83 38 50					1¼"	EN 12050-2
DXVM 35-5	0,55		83 38 55		83 38 56		1¼"	EN 12050-2
DXM 35-5	0,55		83 38 55		83 38 56		1½"	EN 12050-2
DXVM 50-7	0,75		83 38 51	83 38 52	83 38 53	83 38 54	DN50	EN 12050-1
DXM 50-7	0,75		83 38 51	83 38 52	83 38 53	83 38 54	DN50	EN 12050-1
DXVM 50-11	1,1		83 38 51	83 38 52	83 38 53	83 38 54	DN50	EN 12050-1
DXM 50-11	1,1		83 38 51	83 38 52	83 38 53	83 38 54	DN50	EN 12050-1
DXV 50-15	1,5			83 38 52		83 38 54	DN50	EN 12050-1
DXV 50-11	1,1			83 38 52		83 38 54	DN50	EN 12050-1
DXV 50-15	1,5			83 38 52		83 38 54	DN50	EN 12050-1
DP 3045	1,2			83 38 52		83 38 54	DN50	EN 12050-1
DP 3057	1,5			83 38 52		83 38 54	DN50	EN 12050-1
CP 3057	1,5			83 38 52		83 38 54	DN50	EN 12050-1
CP 3057	1,7			83 38 52		83 38 54	DN50	EN 12050-1
MP 3068	2,4			83 38 52		83 38 54	DN50	EN 12050-1

# Packaged Pump Stations

## Micro Series

### Micro 5G and 7G – for installation below ground

The Micro 5G and 7G series are installed underground for maximum convenience and absolute discretion.

#### Features

- Round tank with reinforcing bulges
- Easy to close cover with rubber seal
- Tank bottom specially designed for optimum pumping of wastewater
- Inlet connection with a rubber seal
- Discharge pipe pre-assembled
- Check valve included as standard

#### Benefits

- The tank is installed below ground, with excellent resistance to soil stress, for reliable closure and no odour
- Less sedimentation and better pumping performance and reliable operation
- Easy and leak-free installation
- Quick and easy connection and secured tightness
- Station complete and ready to use



# Packaged Pump Stations Compit

## Features

### Quick installation

- Compit is complete on delivery and ready for installation and immediate connection
- Its weight excluding the pump is between 181 and 244kg, depending on the version

### Flexible design

- Each pump station can be equipped with one or two pumps for added security of operation

### Reliable operation

- The pump is easily installed by lowering it onto the discharge connection
- All internal discharge piping is made of stainless steel and all fittings are made of surface-treated cast iron
- Check valve and shut-off valve
- Concrete cover
- Loading options of class A (pedestrian) or class B (5 tonnes)
- Stainless steel lifting chain
- DN 150 inlet
- The outlet pipe is equipped with a DN 50 connection
- Flygt ENM-10 float switches supplied as standard

## Benefits

- The Compit is a pre-fabricated pump station for sewage systems and groundwater
- The pump station is made of rotomoulded polyethylene and is easy to handle
- The Compit pump station can be installed at a depth of 1.9 and up to 3 metres using an extension shaft that can be cut to the required length
- The bowl-shaped bottom and smooth inner surface of the pump station act as benching to provide self cleaning during operation

# Compit

## Overview

The Compit is the mid-size pumping station designed for use in small housing developments, toilet blocks and commercial extensions. It can be used with either a 3057 / 3045 or 3068 pump (either single or three phase options can be used dependant on the requirement).

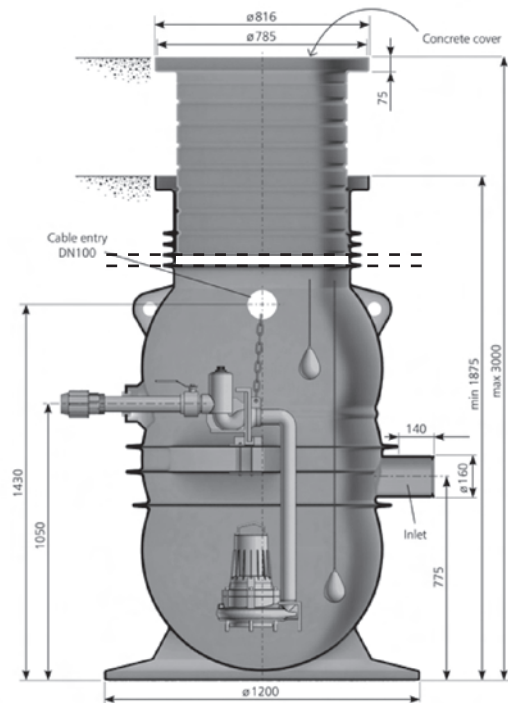

# TOPS Series

## Overview

Flygt TOPS comes in a range of sizes for depths between 2 and 6 metres, and capacities between 4 and 95 litres per second. TOPS pump stations are the perfect choice for situations where civil work and installation time must be kept to a minimum. We assume full responsibility for dimensioning the pump station and completing the order, which reduces project planning and installation costs.

Using PPS reduces the cost of constructing pump stations. But the flat shape of a conventional sump floor still promotes the build up of sludge, which will require regular cleaning. This is not only time-consuming and expensive but also can present safety hazards to personnel. With the Flygt TOPS pump sump, you can forget regular, costly maintenance to remove solids. Designed to be self-cleaning, the geometry of the TOPS sump floor is hydraulically optimised to increase turbulence during pumping. Settled solids are re-suspended so that they can be pumped away, leaving only a minimum of residue beneath the pumps.

Because of its self-cleaning design, you can fit a TOPS pump station and then virtually forget it. The station is made of Glass Fibre Reinforced Polymer (GRP) – a strong, lightweight material with superior resistance to corrosion, guaranteeing your pump station a long life. All raw materials meet ISO 2797 and ISO 2559. All stations are batch tested to BS EN 12050. Combined with Flygt submersible pumps and other Flygt accessories to improve performance, the TOPS station will rarely require maintenance.

The Flygt TOPS packaged pumping station can be fully adoptable under the latest SFA guidelines and has been approved by many of the water companies in the UK.

## TOPS Model Selection Guide

The TOPS comes with a choice of four models, the TOPS 80, TOPS 100, TOPS 150, and the TOPS 150XL.

The different characteristics are listed below:

	Station			
	TOPS 80	TOPS 100S	TOPS 150L	TOPS 150XL
Diameter (mm)	1200	1500	1800	2500
Depth (m)	2.1 to 6	2.1 to 6	2.4 to 6	3 to 6
No. of pumps	2	2	2	2 or 3
Flow rate (l/s)	4 to 30	4 to 40	4 to 95	4 to 95
Motors (kw)	1 to 4.2	1 to 7.5	1 to 22	1 to 22
Pipework diameter (mm)	50/65/80	50/65/80/100	50/65/80/100/150	50/65/80/100/150

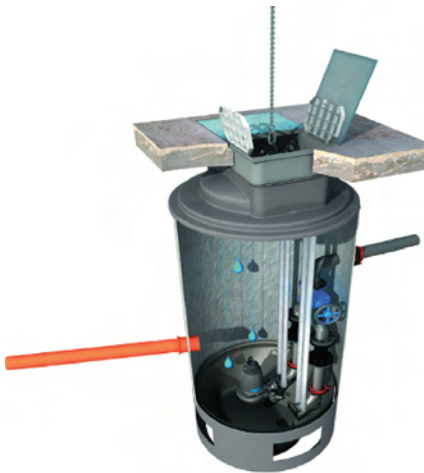

### Features

- TOPS self cleaning design
- Flexibility of design
- Pre-assembled
- Control panel and ENM 10 float switches included
- Quality design
- Quality materials
- Large storage capacity
- Choice of pipe work diameters and access covers available
- Standard max depth of 6m
- Uses genuine Flygt equipment
- A range of Flygt accessories available

### Benefits

- Different depths of installation possible dependant on application
- Less cleaning means cost savings on clean down time
- Safer for personnel when routine maintenance is carried out
- More efficient pumping thanks to the TOPS design
- ISO 2797 and ISO 2559 conformity means comfort in knowing the materials offer quality and reliability
- Bespoke arrangements mean pump valves can be situated inside or outside of the station
- Quick delivery
- Easy Installation
- Fully adoptable under the latest SFA guidelines

# Mixing Capabilities

## Overview

Flygt mixers can be used in a wide range of mixing duties such as solids suspension, liquid blending, mixing thick sludge's and de-stratification. Submersible mixers have a compact design, which together with Flygt's installation methods makes them easy to install in both new and existing tanks.

They can be found in operation at wastewater treatment plants, on oil and gas rigs and supply ships, in aquaculture and agriculture and in the steel and metal industry.

The Flygt compact mixers are engineered for flexibility, versatility and lean installation and designed to easily blend highly contaminated fluids, high-density or high-viscosity liquids, and liquids with fibrous material.

Flygt low speed mixers such as the 'Banana Blade' are ideal for gentle mixing of large fluid volumes and can be used in a range of applications such as in oxidation ditches or can be used in combination with our Sanitaire fine bubble aeration diffusers. Unlike their dry-mounted counterparts, submersible mixers provide unlimited freedom of position and orientation. By utilising this freedom, the mixer jet is allowed to develop and create efficient mixing of the entire volume.

When direct immersion into a liquid is undesirable, Flygt's dry mounted Jet Mixers can be used to provide mixing whilst keeping all moving parts outside the tank for ease of maintenance.

When deep tank mixing is essential for wastewater treatment processes, Flygt top-entry agitators deliver outstanding cost-effective performance for applications that involve all types of fluids, including high DS fibrous sludge.

Top Entry Agitator



Flygt Banana Blade Mixer



Flygt Compact Mixers





# 4400 Series – Mixers

## Overview

4400 Low speed mixers are available with eight different gear ratios and a selection of propeller diameters ranging from 1400mm to 2500mm. By combining different gear ratios and propeller diameters a wide performance envelope is available for you to select a product that matches the requirements of the application. The 4400 is ideal for slow speed bulk flow applications.

### Seal material choice – an important decision

Flygt 4400 slow speed mixers have a single lip seal that is one of the most crucial components in the mixer. The 4400 comes in a choice of two materials: Corrosion resistant tungsten carbide (WCCR) and silicon carbide (SiC) for more aggressive applications.

WCCR has superior sliding properties meaning considerably less wear between the two seal surfaces offering a longer life with less risk of leakage. It offers better mechanical strength and is far less brittle and sensitive to handling damage than SiC. WCCR has a binder where chromium, nickel and molybdenum have been added giving excellent corrosion resistance down to a pH of 3.

SiC has the advantage when the pH is lower than 3 or when mixing small particles that are harder than WCCR.

## Installation options

- **Single guide bar system** – used for shallower tanks up to a depth of 6m
- **Double guide bar system** – a more rigid design for deeper tanks that allows installation of multiple mixers



## Technical

Model 50Hz	4410	4420	4460
Shaft Power (kW)	2.3	4.3	5.7
Max Nominal Thrust (kN)	2.2	3.3	4.6
Propeller diameter (mm)	400 - 2500	400 - 2500	400 - 2500

### Glossary of terms

**Bulk Flow** - the overall flow pattern in a tank generated by one or more mixers

**pH** - a measure of acidity and alkalinity

## Mixing Low Speed Submersible Mixers

### 4400 Series

No. of models in range	3
Output range (kW)	2.3 to 5.7

#### Features

- Installation options
- Self cleaning
- Choice of seal materials
- Choice of resistance coatings for the drive unit optional zinc anodes can also be equipped
- Available with a variable frequency drive (VFD)

#### Benefits

- Choice of installation means ease of installation
- Generates the maximum thrust with the minimum power consumption
- Self-cleaning properties maintain the efficiency where clogging could normally be a problem
- Choice of seal materials
- Choice of resistance coatings for the drive unit is used when chloride levels reach over 200ppm and extra corrosion protection is required

#### Main Applications

- Biological treatment tanks and flow generation
- Sludge holding tanks
- Equalisation tanks
- pH stabilisation tanks
- Chemical flocculation
- Water reservoirs
- Ice prevention
- Can be used in conjunction with ceramic discs

#### Accessories

- Single guide bar system
- Double guide bar
- Davit
- Lifting chain



# Mixing Compact Submersible Mixers

## 4530

### Features

#### Innovative propeller design

The 4530 propeller takes hydraulic efficiency and clog-free performance to new levels. A thin-section design that incorporates generous backsweep and double-curvature, the rigid propeller is built for the best in efficiency and dependability.

#### Patented propeller assembly

Mounting is simple and easy. The attachment of the propeller requires no special tools – the design itself ensures correct mounting so you can be certain of optimal performance. In addition, the propeller bending and torsion loads are not taken by bolts, but rather recessed faces in the hub, for the assurance of reliability.

### Benefits

#### Reliability you can count on

Hundreds of thousands of mixer installations around the world are confirmation of the reliability and robustness of our solutions. Designed and built to the same consistent high standards, the Flygt 4530 ensures minimum maintenance and fewer unexpected process interruptions, which add up to lower overall life-cycle costs.

#### Simplicity in the exchange

Changing out an existing installation is simple with the Flygt 4530. The mid-size mixer can be easily installed on a wall-mounted single guide bar, just like a compact mixer.

#### Proven drive unit

The drive unit design is based on the Flygt low-speed mixer, with its Class H insulation, trickle-impregnated stator and rugged gearbox. Proof of design for the utmost in dependability and non-stop operations is demonstrated in tens of thousands of drive installations worldwide.

# Flygt 4530 – Mixers

## Overview

The newest addition to the Flygt range of innovative mixers and agitators, the Flygt 4530 incorporates a state-of-the-art propeller and proven drive unit for optimal efficiency in medium size treatment tanks. Typical applications are mixing in activated sludge processes, sludge holding tanks, and digesters.

### Improved energy consumption

Our aim is to help you achieve operational efficiency in energy intensive treatment facilities. Getting the right design and size in your mixing application can make the difference for cost effective operations. The Flygt 4530 mixer is an excellent choice when the propeller diameter of a full-size low-speed mixer is too large, but there's room for something larger than a compact mixer. Compared to a direct-drive compact mixer, for example, the energy savings with the Flygt 4530 can be over 50% for a similar duty. With the most advantageous size, you'll also get a dynamic duo of innovative propeller geometry and proven drive unit that's all the better for high efficiency and smaller carbon footprint.



## Technical

Model 50Hz	4530
Thrust range (N) <sup>1</sup>	800 – 2150
Efficiency (N/kW) <sup>1</sup>	up to 780
Propeller speed range (rpm)	33 – 145
Rated motor power	2.3KW or 4.3KW
Propeller diameter	1.2m (47 in.)
Explosion proof versions?	Yes
Installation method	100x100 mm (4x4 in.) guide bar or tripod
	100x150 mm (4x6 in.) guide bar or tripod

<sup>1</sup> Per ISO21630

# Top Entry Agitators

## Overview

All mixing applications require varying degrees of both small-scale turbulence and bulk flow. With a good bulk flow, the contents of the entire tank are put into motion so that all parts are involved in the mixing. The strength of the bulk flow is, in turn, dependent on the total amount of installed thrust and layout.

### Top-entry agitation

When deep tank mixing is essential for wastewater treatment processes, Flygt top-entry agitators deliver outstanding cost-effective performance for applications that involve all types of fluids, including high DS fibrous sludge.

Engineered for energy efficiency, hygienic handling and ease of installation and service, these agitators combine dry-installed drives with submersible shaft and impellers for:

- Digester mixing
- Denitrification processes
- Sludge storage mixing



## Technical

Model 50Hz	4850	4860	4870
Power (kW)	2.2 - 7.5	1.5 - 4.0	5.5 - 15
Impeller speed (rpm)	18 - 44	10 - 24	12 - 23
Propeller diameter (m) - Banana blade - 3 blade steel	2.5 1.5	- 1.5	- 2.0

## Mixing Top Entry Agitators

### 4800 Series

No. of models  
in range **3**

Output range (kW) **2.2 to 15**

Working volumes **Up to 5000m<sup>3</sup>**

#### Benefits

- Maximum uptime
- Strong bulk flow and high mixing efficiency
- High energy efficiency
- Easy to service
- Highly versatile for all fluid types
- Hygienic handling
- Optional three-blade hydrofoil impeller
- Bottom support bearing

#### Features

##### • Sturdy construction

Every component of Flygt top-entry mixers is engineered to withstand tens of thousands of hours of continuous operation. Parallel shaft geared motors combined with rigid drive shaft and specially designed impellers contribute to long-lasting operation

##### • Outstanding impeller design

Whether you choose our standard three-blade hydrofoil impellers or our proven non-clogging Flygt banana blade impellers, you get exceptional thrust and high bulk flow along with excellent energy efficiency. Our signature yellow impeller blades with its backswept design, offers the advantage of self-cleaning properties to ensure clog-free operation, even in the presence of fibrous materials.

##### • Design flexibility for any requirement

Our top-entry agitator portfolio comprises three reliable Flygt models that can be tailored to your process needs. Simply tell us about your agitation requirements. Then let us recommend the configuration that is right for you by specifying the impeller type, number, size, shaft and position.

# Mixing Compact Submersible Mixers

## 4600 Series

No. of models in range **8**

Output range (kW) **0.75 to 25**

### Features

- Easy and quick to install
- Multiple installation options
- Optional jet rings
- Now available with LSPM motors (line-start permanent magnet)

### Benefits

- Easy and quick to install saving the customer time and money
- Multiple installation options – no need to carry out expensive alterations to an existing tank
- Jet rings available for the compact mixers for even higher thrust and mixing capability
- Now with increased ragging capabilities

### Main Applications

- Biological treatment tanks, mixing and flow generation to aeration
- Anoxic and aerobic zone mixing
- Sludge holding tanks
- Equalisation tanks
- pH stabilisation tanks
- Chlorine basins
- Paper pulp chests
- Ore slurry pump sumps
- Lime slurry storage tanks
- Bentonite preparation tanks
- Heat exchanges
- Quenching tanks
- Ice prevention
- Manure tanks

# 4600 Series – Mixers

## Overview

Compact mixers use a standardised range of components and materials across the range of eight models. This modular design, which includes a series of blade angles for each model, provides a comprehensive performance offering.

### Seal material choice – an important decision

Flygt 4600 compact mixers have a double mechanical cartridge seal that is one of the most crucial components in the mixer. The 4600 comes in a choice of two materials: Corrosion-resistant tungsten carbide (WCCR) and silicon carbide (SiC).

WCCR has superior sliding properties meaning considerably less wear between the two seal surfaces offering a longer life with less risk of leakage. It offers better mechanical strength and is far less brittle and sensitive to handling damage than SiC. WCCR has a binder where chromium, nickel and molybdenum have been added giving excellent corrosion resistance down to a pH of 3.

SiC has the advantage when the pH is lower than 3 or when mixing small particles that are harder than WCCR.

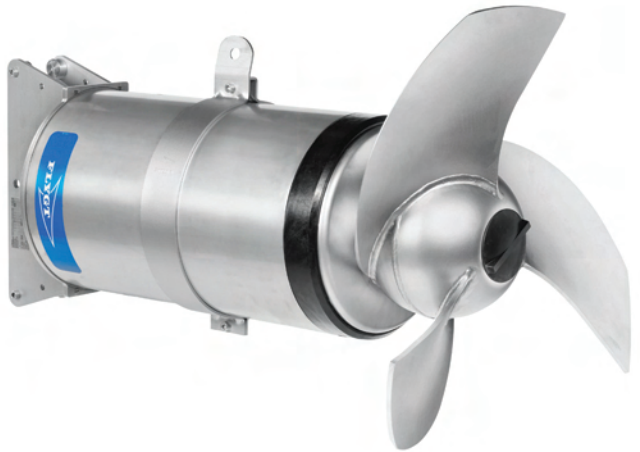

## Technical

Model 50Hz	4610	4620	4630	4640	4650	4660	4670	4680
Shaft Power (kW)	0.75	1.5	1.5	2.5	5.5	10.0	13.0	25.0
Max Nominal Thrust (kN)	0.20	0.34	0.48	0.79	1.9	2.9	3.8	6.4
Propeller diameter (mm)	210	210	368	368	580	580	766	766



# 4600 Series continued

## Compact mixer material options

- ASTM 316L stainless steel contains molybdenum which provides excellent corrosion resistance, especially for liquids containing chlorides and makes it the ideal choice for industry applications and wastewater plants
- ASTM 304 is an alternative material for less corrosive liquids
- Proacid 254 is aimed at highly aggressive media such as sea water and aggressive industrial media
- High chromium white cast iron is the material of choice for ultimate hardness and is ideal for mixing hard mineral slurries. This is an extremely resistant alloy; and it offers limited corrosion resistance and is not recommended below a pH of 5.5

## Installation options

- Guide bar mounting
- Cantilever mounting
- Flange mounting
- Floor mounted

---

### Glossary of terms

**Mechanical Seal** - a mechanical seal containing two rings which are pressed together, one static and one rotating, preventing leakage into the machine along the propeller shaft

## Mixing Compact Submersible Mixers

### 4600 Series

No. of models in range	8
Output range (kW)	0.75 to 25

#### Accessories

- Guidebars
- Davit
- Lifting chains
- Basic repair kits
- Explosion-proof versions available
- Stator leakage detector
- Seal flushing accessories (air or water flushing)
- Vortex protection shield (only able to be fitted when a thrust ring is present)

#### M&C Applicable:

MiniCAS



# Mixing & Aeration Storm Tank Cleaning

## Flyjet & Hydroejector

Max temperature **35°C**

Protection category **IP68**

### Features

- Powerful bulk flow generation
- Choice of materials available
- Choice of pump sizes from the ultra reliable 3000 series N pump range
- Choice of ejector sizes available

### Benefits

- Can operate constantly if the tank is less than 60% full; above this figure the operation is one in four
- The jet will clean all areas of the tank during the three cleaning phases
- The enhanced mixing will re-suspend solids in the water for passing back into the system
- The choice of pump and ejector size helps to create the ideal cleaning system

### Available to rent

### Material

#### Flyjet

Flyjet tube	Stainless steel
Aspiration tube	Galvanised steel
	Stainless steel
Pump	Cast iron

#### Hydroejector

Hydroejector tube	Stainless steel
Discharge nozzle	Cast iron
Pump	Cast iron

### Main Applications

#### Storm Tank cleaning in

- Sewage treatment and the storm overflow Industry

### M&C Applicable

MiniCAS

# Flyjet & Hydroejector

## Overview

The selection of the ideal storm tank cleaner is made according to the shape, size and desired cleaning regime. The Flyjet is used for flushing longer narrow tanks where as the hydroejector is used for shorter wider tanks.

### Flushing narrower basins

The Flyjet uses a mix of air and water as a means of producing a powerful jet flow to aerate the mixing zone whilst submerged. It ensures an effective jet for cleaning long narrow basins when not submerged. The Flyjet is supplied in galvanised or stainless steel and has a selection of N pumps available dependant on the duty.

### Flush-clean wider basins

The hydroejector is a water / water ejector which when submerged helps create a powerful bulk flow. Once the water level starts to fall, the hydroejector automatically turns into a flushing device, ideal for cleaning wider basins.

### Cleaning cycle

The system runs continuously when the tank is 60% or under capacity; above this figure the run time is one in four.

As the storm tank starts to empty the solids in suspension will enter the treatment works, when the level drops further the cleaning jet slides over the surface of the storm water and begins to oscillate so cleaning the far corners and walls of the storm tank.

As the emptying cycle enters its third phase, the water scours the base of the tank removing any solids so leaving the tank clean.

The Hydroejector consists of a cast iron nozzle and stainless steel ejector pipe. It is available in three sizes and is designed to fit the N pump series.

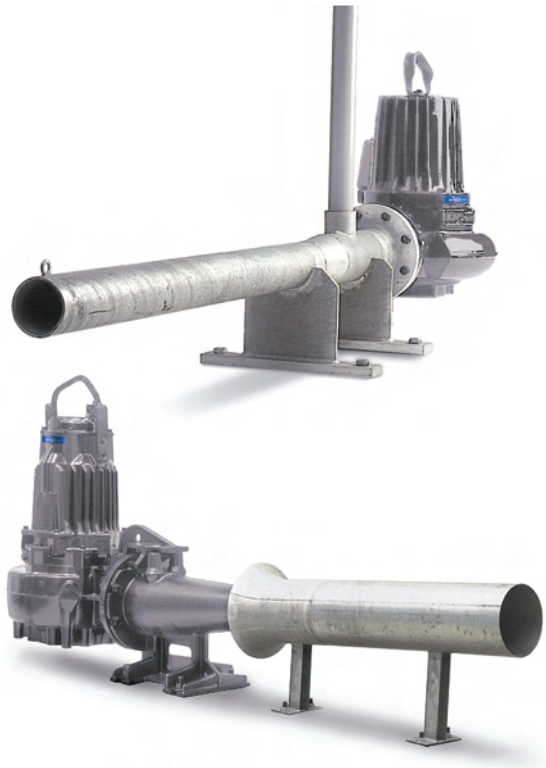



# Sanitaire & Aeration

## Aeration

Aeration accounts for 35-65% of the total energy consumption at a typical wastewater treatment facility. Ensuring the lowest energy consumption is crucial to realizing real energy cost savings. That is why it pays to put your trust in the world's most reliable brand in aeration systems - Sanitaire from Xylem.

Sanitaire is the leading brand in diffused aeration with over 40 years of experience in developing, designing and testing leading edge aeration technologies. With an installed base of over 20 million Sanitaire discs around the world, Xylem offers custom engineered aeration systems that deliver low energy costs, long-term mechanical reliability and minimal maintenance requirements.

Our vast experience, together with applications' know-how in the field and in our R&D centres, enables us to offer the most cost effective and optimized solution for each application.

### Coarse Bubble Diffused Aeration

Our coarse bubble aeration systems feature an innovative air reservoir design with dual horizontal levels of diffusion for uniform air distribution. A pocket of air in the centre of the diffuser reduces clogging, while a bottom deflector prevents debris from entering the diffuser.

Sanitaire coarse bubble aeration systems are suitable for use in everything from aeration tanks, SAS storage and mixing, storm water holding basins and other mixing and air scouring applications.

### Fine Bubble Diffused Aeration

We are able to offer the latest cutting-edge diffused aeration technology, with the recent launch of the Sanitaire Gold Series, a modular diffuser system that offers higher oxygen transfer efficiency, resulting in lower air flow rates, lower back pressure and reduced cost of long term ownership.

The Gold Series diffuser compliments Xylem's already broad portfolio of aeration products such as the well established and time proven Sanitaire Silver Series II membrane diffusers, widely utilised in the municipal water industry; and our LP (Low Pressure) membrane that is an excellent solution for applications where the back pressure allowed on the blower is already defined, such as a refurbishment.

Gold Series



Silver Series II





# Aeration

## Course Bubble Aeration

### Jet Aerator

#### Features

- Can be installed in tanks of any shape
- System optimised to match your needs
- Ease of installation
- Can utilise up to 4 ejectors from one pump
- Extreme reliability
- Can be used on an intermittent basis according to local oxygen requirements (eg increased oxygen requirement during warm summer months)
- N Pump

#### Benefits

- Can be installed without emptying the tank
- Does not require an additional compressor or blower
- Has an excellent mixing characteristic

#### Material

- Galvanised steel
- Stainless steel

#### Monitoring & Control Applicable

MiniCAS

# Jet Aerator

## Overview

The Jet Aerator is a proven solution for oxygenating and mixing small and medium tanks. The system is based on one or more ejectors being connected to an N pump.

## Main Applications

- Municipal oxygenation and mixing applications
- Industrial applications in small and medium tanks
- Provision of increased oxygen

The code system below further demonstrates the flexibility of the system.

<b>JA</b>	Jet Aerator
<b>1</b>	1 ejector
<b>17-</b>	Ejector type (4812 or 4817)
<b>N 3153 -</b>	Npump version 3153
<b>P</b>	Installation type (P or S)
<b>5</b>	50 Hz





SANITAIRE®

## Aeration

### Fine Bubble Aeration

#### Ceramic Disc Aeration

Sanitaire's experience in aeration technology has resulted in high quality Sanitaire fine bubble disc aeration systems being specified more than any other.

##### Diffuser and Holder Features

- Unique contoured ceramic disc diffuser element design promotes dependable, uniform air distribution and bubble release
- Top sealing, threaded retainer ring and holder design ensures airtight seal. As air pressure is increased, so is the sealing force on the o-ring gasket, thereby eliminating leaks
- Diffuser holders are factory solvent welded to the air distribution piping providing superior mechanical strength and eliminating the necessity for field installation and levelling of individual assemblies
- Ceramic disc diffusers are available in 9" (229mm) or 7" (178mm) diameters

##### Benefits

- Power costs can be reduced by 50% or more
- High oxygen transfer efficiency and low system headloss lead to low energy costs
- The diffuser performance is restorable. They can be cleaned in-situ using the Sanitaire In-Place Gas Cleaning System

##### Main Applications

- Aeration tanks
- Channel aeration
- Post aeration tanks

# Ceramic Disc Aeration

## Proven System Components

- The air distribution system incorporates patented locking pipe joints combined with guide type supports that do not positively grip the pipe to accommodate thermal expansion and contraction. The unique system design allows the individual distributor pipes to move freely through the pipe supports
- The patented fixed joint features an airtight o-ring seal, anti-rotational splines and a positive locking threaded retainer ring to prevent air leakage, pipe blow apart and distributor rollover
- PVC air distribution piping system provides long-term mechanical integrity
- Submerged components of corrosion resistant materials
- Unique all stainless steel anchorage system with threaded supports for infinite adjustments on sloped or irregular floors
- Joint components are factory solvent welded to the pipe ends, allowing for quick and easy field assembly of air distribution sections
- Condensate removal with sumps and purge system
- Over 10 million fine bubble diffusers installed worldwide

## Ceramic Disc Diffuser Advantages

- Superior quality PVC air distribution piping systems, time proven over 25 years
- High oxygen transfer efficiency and low system headloss
- Service life exceeding 20 years
- Quiescent surface pattern reduces freezing and airborne aerosol problems
- Gentle mixing promotes excellent floc formation, preventing floc shear
- All components made from corrosion resistant materials, PVC and stainless steel
- Ease of installation – up to 12 units installed per man-hour, step-by-step O&M manuals, educational videos and field service/start up training provided with every system. Factory installed diffuser holders and pipe end fittings for reduced installation time
- Existing aeration tanks can be easily upgraded with ceramic grid aeration, increasing the existing plant's organic capacity without adding tankage
- Convenient shipping – diffusers, supports and piping are delivered in a compact palletised arrangement Install or retrofit your existing system today with field proven, time-tested and cost-saving Sanitaire fine bubble ceramic disc diffusers
- Pressure monitoring and gas cleaning systems available





SANITAIRE®

## Aeration

### Fine Bubble

## Silver Series II

### Wideband Diffuser Features

- Unique slit pattern and slit shape which disperse air bubbles in an extremely fine, uniform pattern for optimal oxygen transfer
- High elasticity and degradation-resistance of specially blended high-grade EPDM elastomer compounds contribute to a service of 10 or more years
- Unique membrane shape ensures reduction in the chimneying effect as the bubbles leave the surface and ensures optimum oxygen transfer. Integrated o-ring and top-sealing threaded retainer ring eliminates possible course bubble leakage from the unit
- Highly effective, integrated check valves enables the aeration zones to easily be shut down for air-on/air-off applications

### Benefits

- Long service life
- Low maintenance
- Low energy consumption
- High oxygen transfer efficiency
- Great application flexibility

### Materials

Xylem's own unique formula of EPDM rubber with high levels of carbon black and elastomers for excellent longevity

### Accessories

- Sanitaire 2300 holder
- Sanitaire 2802 holder
- Both designed to provide superior mechanical strength
- Both feature a base plate and threaded top-sealing retainer ring
- There are other holders available for mounting on either round or square section St/St pipework
- A low cost uPVC screw on holder is also part of the portfolio

# Silver Series II

## Overview

For an excellent combination of high aeration efficiency and low operating costs, there's the Sanitaire Silver Series II membrane diffuser – the most widely used fine bubble diffused aeration system available.

Xylem have over 20 million units installed worldwide and it is considered one of the most robust and highly rated products on the market.

## Main Applications

- Retention basin
- Biological aeration
- Aeration before discharge
- Sludge holding
- Odour control



### Performance curves

Silver Series II

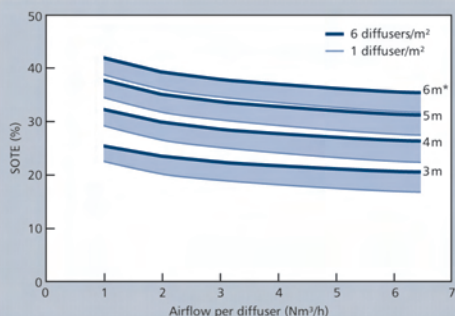

\*Submergence

### Technical data

Disc material	Specially blended high-grade EPDM
Diameter	178 or 229 mm
Airflow range per disc	0.8–7 Nm³/h (0.5–4.5 scfm)
Standard oxygen transfer efficiency (SOTE)	Approx. 6.5% per m submergence (2% per ft.)
Standard aeration efficiency (SAE)	2.5–6 kg O₂/kWh (4–10 lb O₂/hp/h)



SANITAIRE®

# Aeration Fine Bubble

## Gold Series Membrane Diffuser

# Gold Series Membrane Diffuser

### Overview

Sanitaire Gold Series membrane diffuser from Xylem is an advancement in aeration technology, delivering high SOTE while minimising system headloss, for an overall superior aeration performance compared to other high efficiency aeration devices.

An outstanding feature of the Gold Series diffusers is its modular design, which facilitates installation and retrofit. The diffusers come in three lengths, making them highly flexible to suit all basin configurations.



### Performance curves

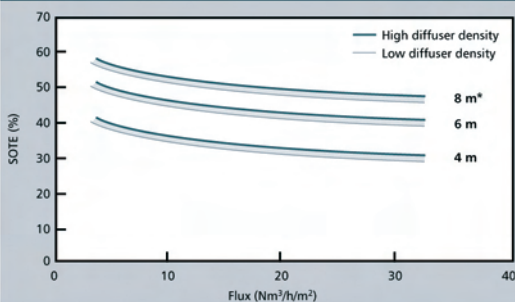

\*Submergence

### Technical data

Membrane material	Polyurethane
Lengths	2,286 mm, 1,500 mm, 700 mm
Airflux range	3.7–37 Nm <sup>3</sup> /h/m <sup>2</sup>
Standard oxygen transfer efficiency (SOTE)	7–10% per m submergence
Standard aeration efficiency (SAE)	3–8 kg O <sub>2</sub> /kWh

### Main Applications

- Wastewater treatment plant

### Features and Benefits

- **Diffuser geometry** - Enables high-density configurations for greater installed surface area and low flux levels through the membrane. The combination of high density and low flux enables the highest possible oxygen transfer utilising least possible energy
- **End fittings and sealing system** - Engineered to ensure a positive, leak proof closure. Continuous independent o-ring seated in the groove prevents excessive stress on the membrane
- **Prevents excessive stress on the membrane** - Large diameter piping generously sized to minimise headlosses. Corrosion and UV resistant piping demonstrated over 20 years life in wastewater
- **Advanced micro punched membrane** - Precision cut perforations engineered to deliver the optimum flow pattern, provide highest aeration efficiency Air is delivered to membrane through multiple air control orifices, assuring a uniform bubble pattern from end to end
- **Different lengths** - Allows diffusers to be fitted to all basin configurations, including circular and unusual geometries
- **Proven piping systems** - Sanitaire piping systems are robust and mechanically reliable with 20 years of field life. The piping systems incorporate fixed joint couplings that ensure steadfast, long-term, trouble free performance
- **Adjustable supports** - Single anchor bolt support for ease of installation, alignment, and removal if required. Infinitely adjustable and available in varying heights for precise leveling, even on sloped tank floors
- **Membrane material** - Ageing tests demonstrate that the thicker polyurethane membrane is highly pliable and less prone to stretching. In fact it outlasts competing materials in accelerated ageing tests
- **Interchangeability** - Diffuser assemblies are compatible with existing Sanitaire systems, allowing for low cost, hassle-free retrofits. Grids of the Gold Series diffusers can be combined with grids of Sanitaire disc diffusers to optimise overall aeration system performance for a treatment facility
- **Complete unit** - Gold Series diffusers are delivered as complete pre-assembled units, saving time and resources during installation
- **Minimal maintenance**



SANITAIRE®

# Aeration Course Bubble

## Wideband Aeration

Stainless Steel

### Wideband Diffuser Features

- Efficient wide band aeration achieved by 48" (122cm) perimeter of air release
- Innovative inverted air reservoir design, with dual horizontal levels of diffusion ports on the diffuser sides for uniform air distribution
- Air reservoir design creates a pocket of air in the centre of the diffuser to reduce clogging associated with other types of diffusers
- Bottom deflector limits debris from entering the diffuser
- Stainless steel material provides corrosion resistance and structural integrity
- Cast stainless steel alloy end cap with ¾" NPT schedule 80 rectangular nipple for long term durability
- Low headloss design provides reduced lower pressure and horsepower requirements
- Available in 24" (61cm) and 12" (30cm) lengths

### Engineering Features

- Van Stone type flanged joints allow individual header sections to rotate independently of adjacent sections during installations. This allows accurate alignment, levelling and rotational adjustments
- Provisions for thermal expansion and contraction are engineered into the system with specially designed supports and pipe joints
- Header system can be installed in any tank configuration
- Full immersion passivation is used after fabrication for cleaning welded stainless steel products to prevent corrosion on both the inside and outside of the pipe
- Corrosion-resistant material (304L/316L stainless steel) resulting in long-term durability

*Continued overleaf*

# Wideband Aeration

## Overview

The coarse bubble diffuser is designed to introduce oxygen and provide mixing in wastewater treatment applications. The diffusers are typically used in high rate, conventional and extended aeration activated sludge processes.

Other applications include aerobic sludge digestion, sludge holding, flow equalisation, channel aeration and any similar application requiring a non-clogging, maintenance free diffuser system.

The Sanitaire diffuser is available in fixed, swing or lift out header configurations depending on the application.

## Main Applications

- Aeration tanks
- Aerated channels
- Nitrification tanks
- Equalization tanks
- Stormwater holding basins
- Aerobic digestors
- Stripping
- Ozone
- Sludge storage
- Grit chambers
- Sequencing batch reactors
- Membrane bioreactors



### Glossary of terms

**Van Stone type flanged joint** - a type of joint that allows sections to rotate independently

**Passivation** - is the process of making another material "passive" in relation to another material prior to using the materials together





SANITAIRE®

Aeration

Course Bubble

# Wideband Aeration

## continued

### Gusseted Diffuser Connector

- Bottom mounted diffuser connector designed to continually purge and exclude solids
- Reinforced gussets for maximum strength provide long term protection from cyclical vibrational forces
- Pulled port with smooth rounded entrance designed for low headloss. Eliminates internal crevices that can be a site for solids adhesion and corrosion

### Swing and Lift Out Adjustable Header Connection

- Reinforced gusseting for maximum strength
- Adjustable flange designed for accurate alignment and levelling of the air header

## Wideband Aeration

Stainless Steel

### Installation Features

- Swing and removable header equipment is adaptable to T or Y wall tank construction
- Header sections are lightweight and easily handled
- Support stands are designed for fast, easy adjustment and installation
- Van Stone type flange joints designed for ease of installation and levelling

### Oxygen Transfer and Power Savings

- Efficient transfer of oxygen
- Up to 5.5 lbs. oxygen per horsepower hour
- Over 400 lbs. of oxygen per 1,000 cubic feet of tank volume per day
- Wideband design for complete mixing and effective floc formation
- Largest oxygen transfer database of any diffused aeration manufacturer for accurate process application



SANITAIRE®

## Aeration

### SBR

# Sanitaire ICEAS

#### ICEAS Features

##### Continuous Inflow

- Provides equal loading and flow to all basins, simplifying operation and process control
- Can be designed to accommodate up to six times average daily flow
- Results in smaller basin size and less equipment, reducing construction and O&M costs
- Eliminates primary and secondary clarifiers and return sludge pumps
- Enables single basin operation for maintenance and low flow conditions

##### Decanter Design

- High quality workmanship and advanced engineering provide a long lasting decanter
- Rugged, corrosion resistant stainless steel construction
- Decants from the top down withdrawing only the uppermost clear water from the basin preventing disruption of the settling solids
- Uses a proprietary scum exclusion float to prevent the carryover of floating material with the treated effluent
- Flow over the decanter weir is visible from the basin walkway providing a check of effluent quality
- Actuator operates via a VFD providing a constant rate of effluent discharge to downstream facilities
- Parked above top water level during react and settling phases serving as an emergency overflow device in the event of extreme storm conditions or power failure
- Actuator drive mounted outside of basin at walkway level for easy maintenance

*continued overleaf*

# Sanitaire ICEAS

## Cost-Effective Wastewater Treatment

Sanitaire has provided the wastewater treatment industry with innovative and cost-effective treatment technologies for over 35 years. This tradition continues with the Sanitaire Intermittent Cycle Extended Aeration (ICEAS) process, which is an advance Sequencing Batch Reactor (SBR) technology for municipal and industrial wastewater treatment.

The conventional SBR, a variant of the activated sludge process, operates on the fill and draw principle. Fill, react, settle, decant and idle phases occur sequentially on a cyclic basis. In the conventional SBR configuration, flow is diverted from the basin during settling and decanting and requires two or more basins or an influent equalization tank to receive flow when settling and decanting. Sanitaire can provide a conventional SBR but recommends the superior flexibility of the ICEAS design, which does not require any flow diversion.

## The ICEAS Process

The advanced Sanitaire ICEAS process is a fully automated and simple to operate biological treatment system that:

- Operates as a time-based control system allowing continuous inflow of wastewater during all phases of the cycle
- Responds to flow and load variations
- Can achieve processes of biological oxidation, nitrification, denitrification, phosphorus removal and liquid/solids separation continuously in a single basin
- Easily expands and produces a high quality effluent
- Provides two treatment zones (pre-react and main-react) separated by a non-hydrostatic baffle wall
- Utilises the pre-react zone as a biological selector for enhancing the growth of desirable organisms
- Offers flexibility for meeting specific application needs with custom engineered process cycles

## Municipal and Industrial Wastewater Treatment

The Sanitaire ICEAS process provides high quality effluent for both municipal and industrial wastewater treatment facilities. Typical industrial applications include waste from meat processing, beverage, pharmaceutical, food processing, pulp and paper and chemical plants.



**Energy Efficient Aeration Systems**

- State of the art aeration systems have been applied worldwide in activated sludge and biological nutrient removal applications. Sanitaire diffusers provide high oxygen transfer efficiency, require minimal maintenance and are time proven for their durability in wastewater treatment processes
- Fine Bubble Membrane aeration systems include advanced membrane material specifically engineered for domestic and industrial applications providing resistance to material property changes. The time proven piping system accommodates thermal expansion and contraction and prevents air leakage, pipe separation and distributor rollover
- Coarse Bubble aeration systems provide efficient wideband aeration and mixing with minimal maintenance. Stainless steel material provides corrosion resistance and structural integrity and is fully passivated after fabrication (available in fixed header and removable header options).

# Sanitaire ICEAS continued

## Biological Nutrient Removal (BNR)

The Sanitaire ICEAS process can be designed as a BNR system for enhanced nitrogen and phosphorus removal.

- Cycles can incorporate alternating periods of 'air on' and 'air off' during the react phase to produce aerobic/anoxic/anaerobic conditions to promote nitrification/denitrification and phosphorus release and uptake
- Mixers can be added for operation during periods of 'air off' to achieve optimum substrate/microorganism contact
- New and existing plants can be designed to accommodate future BNR requirements without requiring additional basins
- Separate aeration drop legs in the pre-react zone can add operational flexibility

## Control System

- Process control with a PLC based system with a graphic operator interface (HMI).
- Uses state of the art Supervisory Control and Data Acquisition (SCADA) software installed on a PC with modem and remote monitoring capabilities

## World Leader in SBR Technology

Sanitaire ICEAS facilities have been installed throughout the world over the past three decades. With all installations, Sanitaire provides complete in-house support through its process, mechanical and control engineering departments. Customer assistance is available through in-house staff and representatives who market our products worldwide.

### Glossary of terms

VFD - Variable Frequency Drive

**Decanter weir** - part of the product that moves the water from one part of the process to another. Is driven into the water to collect the treated wastewater and move it into the next part of the process

**Fill and draw principle** - Fill = Effluent entering the basin for treatment

Draw = treated effluent is discharged using the

decanter weir

**Biological oxidation** - adding of O<sup>2</sup> as a side effect of breaking down biological matter

**Nitrification** - nitrification is the conversion of ammonia (NH<sub>4</sub><sup>+</sup>) to nitrate (NO<sub>3</sub><sup>-</sup>) by bacteria in the presence of oxygen

**Denitrification** - in the absence of oxygen, where bacteria will strip the oxygen from nitrate (NO<sub>3</sub><sup>-</sup>) converting it to nitrogen gas (N<sub>2</sub>)

**Effluent** - an outflowing of wastewater from a man made structure

**Non-hydrostatic baffle wall** - cut outs at the bottom of the wall that equalises pressure between sections, providing cost savings on civil structures

**SBR** - Sequencing batch reactor



## Low Cost Screw On Diffuser

### Features

- Integral ¾" NPT threaded nipple allows quick installation into new and existing applications
- High quality EPDM membrane for reduced head loss and increased oxygen transfer
- Holder can be fitted with either Silver Series II or Low Pressure membranes
- Standardised unit list prices offered (on request)

### Benefits

- Low cost
- High quality
- Same performance as a fabricated system
- Simple installation
- Ideal for industrial and municipal application

### Accessories

- D110 saddle can be supplied if required

### Material

Assembly consists of UPVC screw on holder (with integrated ¾ NPT threaded nipple), EPDM rubber membrane and retainer ring.

# Low Cost Screw On Diffuser

## Overview

The low cost screw on diffuser holder has been designed as a simple easy to install low cost alternative to a fabricated Sanitaire aeration system. It benefits from having only three distinct components which are delivered to the client assembled meaning it can be easily screwed in to a female thread.

The client benefits from the same high levels of quality that they have come to expect from Xylem along with the time proven high end efficiency of the Sanitaire membrane diffusers at a low price.

## Applications

### Customer

- Agricultural (from waste)
- Aqua – culture
- Biogas aerobic and anaerobic digestion
- Brewery waste
- Clothing manufacturing
- Dairy
- Distilleries
- Landfill effluent
- Livestock rendering
- Small municipal WwTW
- Ornamental water features (lakes/ponds)
- Process wastewater
- Pulp and paper

## Process

- Activated sludge tanks
- Activated sludge plants
- Oxidation ditches
- Sequencing Batch Reactors
- Mixing applications (SAS and sludge)
- FOGG plants
- Air stripping applications

# Wedeco & UV Disinfection

With UV Disinfection and Ozone Oxidation, Wedeco has the advanced technologies needed for the chemical-free, environmentally friendly treatment of drinking water, wastewater and process water. Our high-tech water and wastewater treatment systems ensure that water can be recycled, that drinking water is safe, that water treatment does not put an undue burden on the environment and that we provide the most cost-effective solution for our customers.

## Ultraviolet disinfection systems

Wedeco UV technology can be used to disinfect drinking water, wastewater, process water, ultrapure water and swimming pools. It's the chemical-free, environmentally friendly alternative to chlorine disinfection, using rays of UV light to kill dangerous micro-organisms preventing them from multiplying - including bacteria, viruses and yeasts.

Within our UV portfolio we are able to offer both 'Low Pressure' and 'Medium Pressure' lamps.

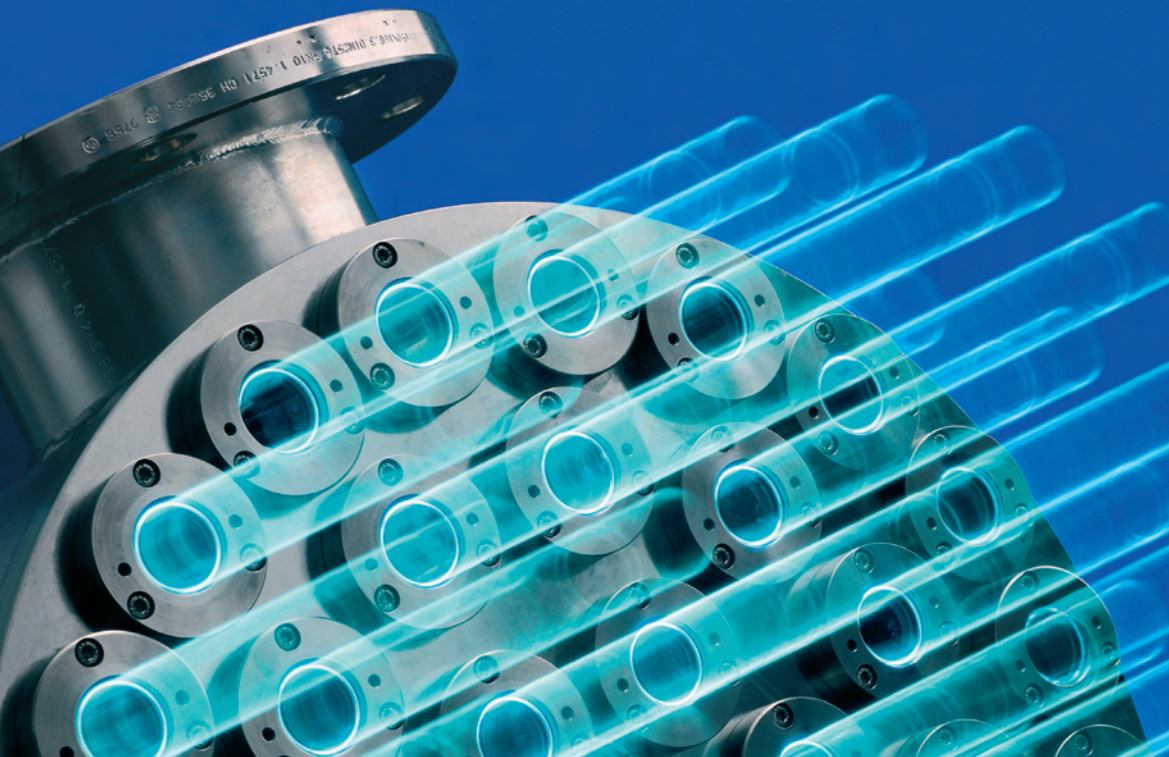

# UV

## Residential UV

### Aquada Series

No. of models in range	15
Water Temperature Recommended Range	5 to 25°C
Possible Range	0 to 35°C
Water UV Transmittance (@254nm, 1cm)	min 80%
Flow capacity (300j/m <sup>2</sup> )	max up to 10.5m <sup>3</sup> /h

#### Features

- Enclosed system
- Tested and proven disinfection capacity
- Electro-polished 316L grade stainless steel disinfection chamber
- High output low pressure UV lamp
- Highly efficient electronic ballast power supply
- Glow-cap lamp operation indicator
- Safety lamp connector (no lamp removal without lamp shut-off)

#### Benefits

- UV enhances overall water safety by destroying dangerous organisms that can pass through other treatment processes
- No residuals or harmful chemical by-products are introduced into the water
- Aquada UV systems are simple to install. UV lamps are easy to replace and only require changing after one full year of use
- Aquada UV systems require less energy than a typical household light bulb

# Aquada Series

## Overview

Aquada UV systems offer reliable, chemical free disinfection of clear fresh water, to meet drinking water standards.

There are three model specifications in the range, each available in five sizes (15 variants), to meet the flow requirements of the home or business where it will be installed.

Every Aquada model is designed to deliver the UV dose recommended by European regulatory and safety agencies.

While other residential water treatment processes such as filters or water softeners will improve the taste and clarity of water, they are not designed to protect against dangerous micro-organisms. UV will instantly and effectively render dangerous organisms harmless.





# Aquada Series continued

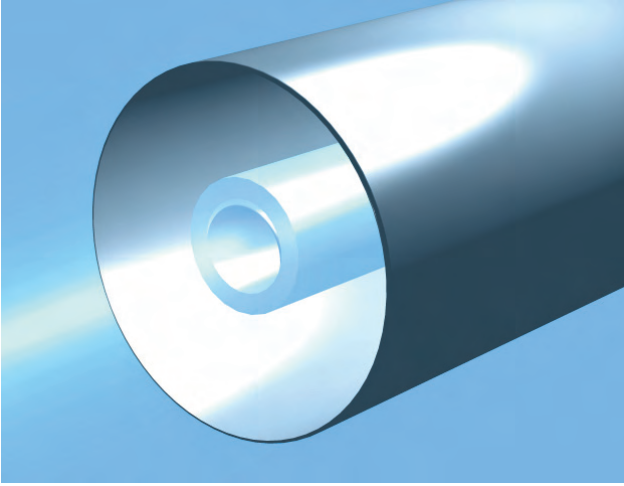

## Aquada UV Model Selection Guide

There are three Aquada model specifications to choose from. Each model is available in five sizes to meet the differing flow requirements of the customer.

Features	ALTIMA	PROXIMA	MAXIMA
Tested and proven disinfection capacity	•	•	•
Electro-polished stainless steel disinfection chamber	•	•	•
High output low pressure UV lamp	•	•	•
High efficient electronic ballast power supply	•	•	•
Glow-cap lamp operation indicator	•	•	•
Safety lamp connector (no lamp removal without lamp shut-off)	•	•	•
Micro-computer control		•	•
Audible alarm plus visual alarm display (lamp failure and end of lamp life)		•	•
Lamp change reminder with 365 days counter		•	•
Alarm and computer reset button		•	•
Digital display / lamp life readout		•	•
Power connection for optional automatic solenoid safety shut-off valve		•	•
Selective UV sensor			•
Digital UV intensity display, low-medium-high			•

WEDECO

# UV Residential UV Aquada Series

## Main Applications

- Drinking water for private homes, schools, farms, hotels, hospitals etc
- Air conditioning systems
- Aquaculture (fresh water fish farming)

## Technical Description

- Single centred low pressure high intensity UV lamp inside a protective quartz sleeve
- Electro-polished UV disinfection chamber with BSP male threaded connections
- Easily removable UV lamp and quartz sleeve assembly from one end of the chamber
- Glow-cap lamp operation indicator
- Three model specifications available, each in five different sizes
- Optional count back 'days remaining' counter and UV-monitoring system
- All units conform with CE standards

## Optional Accessories

- 2/2 way solenoid valve (Maxima and Proxima only) for automatic stop of water supply in case of failure
- Volt free contacts for Maxima and Proxima
- Replacement Spektrotherm® UV lamps

# UV Industrial UV A Series

No. of models in range	3
Water Temperature Recommended Range	5 to 35°C
Possible Range	0 to 60°C
Water UV Transmittance (@254nm, 1cm)	min 80%
Flow capacity (250J/m <sup>2</sup> )	max up to 26.0 m <sup>3</sup> /h
Flow capacity (400 J/m <sup>2</sup> – certified)	max up to 12.5 m <sup>3</sup> /h

## Features

- Enclosed system
- Temperature stable Spektrotherm® UV lamp
- New SEC monitoring electronics with calibrated UV sensor
- Easy to operate front panel
- Option of vertical or horizontal installation to suit existing water pipes

## Benefits

- Reliable disinfection with low power consumption
- Long lamp life
- Easy maintenance
- Simple operation
- Easy cleaning
- Minimal loss of pressure
- Low operating costs

## Optional Accessories

- Stainless steel cleaning valves
- Sampling valve (for A10 and A15)
- Replacement Spektrotherm® UV lamps

## Technical Description

- Single centred low pressure high intensity Wedeco Spektrotherm® UV lamp
- UV lamp and quartz sleeve assembly, easily removable from one end of the chamber
- Calibrated UV intensity monitoring system

# A Series

## Overview

The Type A Series UV systems destroy bacteria, viruses, yeasts, parasites and cryptosporidium efficiently and without using chemicals. These systems are especially suitable for small and medium sized applications.

At the heart of the A series is the high performance Spektrotherm® UV lamp. Its UV-C is efficient and provides outstanding temperature stability. This means that the UV output remains virtually constant, irrespective of whether the surrounding water is hot or cold. In addition, the A series systems have only one Spektrotherm® UV lamp, whereas conventional UV systems need several lamps. This, coupled with the long life of the Spektrotherm® UV lamp, means very low operating costs.

The UV disinfection chamber is made of electropolished high grade stainless steel. The lamp is fitted centrally, with flow baffles which guarantee uniform exposure to the UV radiation, ensuring the best disinfection results.

A Spectrum Emission Controller (SEC) handles all monitoring and control functions of the UV system. The appropriate remote monitoring outputs are provided. An easy to operate front panel with a large display provides continuous information about all operating conditions.



A Series

Spektron Emission Controller

## Main Applications

- Private and municipal drinking water supplies
- Prevention of growth of Legionella in warm water systems
- Process water for industrial uses
- Food and Beverage industry
- Aquaculture (fresh water fish farming)
- Air conditioning systems

## A Series Model Selection Guide

There are three Type A Series models to choose from. Please see the table below for details.

	Model		
	A 4	A 10	A 15
Max flow rate* (m <sup>3</sup> /h)	6.6	12.3	16.1
Pipe connection	1½	DN50	DN80
Power input (W)	105	170	230
Dimensions reactor W x H x D (mm)	210 x 570 x 160	300 x 895 x 160	320 x 1090 x 174
Dimensions reactor W x H x D (mm)	280 x 300 x 180	280 x 300 x 180	280 x 300 x 180

\* UV dose = 400 J/m<sup>2</sup> at the end of lamp lifetime; estimated UV transmittance = 98 % per 1cm.  
All specifications are subject to change without notice.

## Glossary of terms

**Flow Baffles** - device fitted inside UV chamber to optimise flow patterns.

# A/B-PE Series

## Overview

The Wedeco A/B series in high density polyethylene (HDPE) is most suitable for the disinfection of sea water and other corrosive media. The chamber is non-corrosive and temperature stable. The high intensity Spektrotherm® UV lamps guarantee a maximum disinfection level and efficiency in cold and warm water applications.

These UV systems can be mounted horizontally or vertically into existing pipe lines and are equipped with a separate electrical cabinet.

## Technical Description

- High density Polyethylene HDPE chamber with Wedeco Spektrotherm® UV lamps, arranged parallel to the water flow
- UV lamp and quartz sleeve assembly removable from one end of the chamber
- Calibrated UV monitoring system

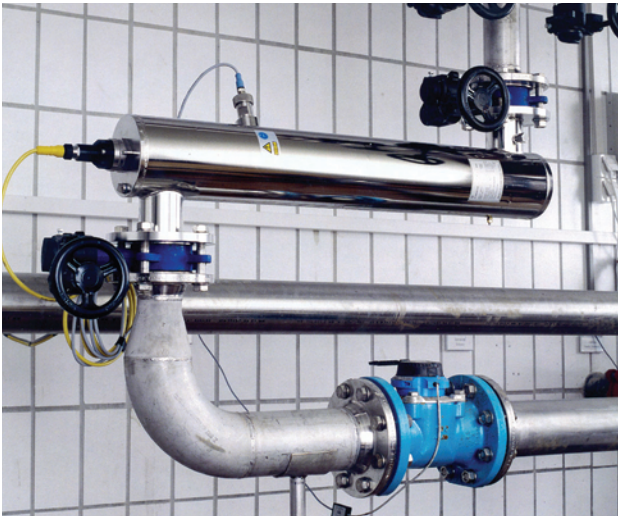

## A/B-PE Series Model Selection Guide

There are six models in the A/B-PE series to choose from. Please see the table below for details.

Type	Max Flow Rate* (m³/h)	Flange connection	Power consumption (kW)	Dimensions W x H x D (mm)
A 10 - PE	10.4	DN65	0.12	895 x 300 x 170
B 32 - PE	32.0	DN100	0.38	950 x 315 x 265
B 60 - PE	67.5	DN150	0.57	1270 x 330 x 253
B 120 - PE	134.4	DN200	0.95	1280 x 420 x 307
B 160 - PE	219.5	DN200	1.33	1290 x 415 x 339
B 300 - PE	393.0	DN300	2.84	1600 x 445 x 391

\* UV dose = 400 J/m²; UV transmission = 98% at end of lamp lifetime.  
All specifications are subject to change without notice.

## UV Industrial UV A/B-PE Series

No. of models in range	6
Water Temperature Recommended Range	5 to 35°C
Possible Range	5 to 40°C
Water UV Transmittance (@254nm, 1cm)	min 80%
Flow capacity (400J/m²)	max 400m³/h

### Features

- Enclosed system
- High quality HDPE chamber
- Spektrotherm® high intensity low pressure UV lamps with excellent temperature stability
- UV monitoring and control by a highly selective, calibrated UV sensor

### Benefits

- Excellent disinfection capacity at low energy consumption
- Spektrotherm® UV lamps offer long lamp life
- Simple operation
- Easy maintenance

### Optional Accessories

- Separate distribution box for distances UV chamber/electrical cabinet 5-30m to enable electrical control cabinet to be mounted further away from the UV chamber if required
- Electrical cabinet material: stainless steel 304 (B-PE only)
- Replacement Spektrotherm® UV lamps

### Main Applications

Disinfection of sea water and other corrosive media to meet relevant biological standards

- Sea water
- Corrosive media
- Aquaculture (fish farming)
- Thermal springs
- Swimming pools

# UV

## Industrial UV

### SA Series

No. of models in range **4**

Water Temperature  
Recommended Range **5 to 25°C**  
for SA 2

Possible Range **0 to 35°C**  
for SA 2

Water Temperature  
Recommended Range **5 to 35°C**  
for SA 4 - SA 15

Possible Range **0 to 60°C**  
for SA 4 - SA 15

Water UV Transmittance (@254nm, 1cm) **min 80%**

Flow capacity **max 26m<sup>3</sup>/h**  
(250J/m<sup>2</sup>)

#### Features

- Enclosed system
- Compact design
- UV monitoring and control by a highly selective, calibrated UV sensor

#### Benefits

- Excellent and reliable disinfection capacity with low energy consumption
- Simple operation
- Easy maintenance
- Easy integration into existing water pipelines

#### Optional Accessories

- Cleaning valves (only for SA4, 10 and 15)
- Solenoid valve (only for SA2 and 4)
- Replacement Spektrotherm® UV lamps

# SA Series

## Overview

The Wedeco SA series systems ensure micro-biologically pure water for passenger ships and ferries, container ships, research ships, military ships and fishing factory ships.

## Technical Description

- Electropolished stainless steel chamber with a single centred Wedeco Spektrotherm® UV lamp

## Main Applications

Disinfection of clear fresh water to meet relevant biological standards

- Drinking water supply on vessels
- Off-shore applications (fresh water)



## SA Series Model Selection Guide

There are four models in the SA series range.

Please see the table below for details.

Type	Max flow rate* (m <sup>3</sup> /h)	Flange connection	Power consumption (W)	Reactor dimensions W x H x D (mm)
SA 2	4.0	¾"	70	130 x 750 x 140
SA 4	7.6	1½"	115	210 x 570 x 160
SA 10	13.8	DN65	140	300 x 900 x 160
SA 15	21.7	DN80	230	320 x 1090 x 174

\* The flow rate depends on the quality of water (UV transmission). WEDECO-Series B is suitable for higher flow rates. All specifications are subject to change without notice. In this case: 300 J/m<sup>2</sup> at the end of lamp life; Transmission = 98% T1cm

# Spektron Series

## Overview

The Spektron series UV systems can be used in a variety of applications, from domestic water supply to industrial uses, to large water plants.

The robust construction makes them suitable for use in water with high humic contents or in environments with increased requirements in terms of electromagnetic compatibility (EMC) protection.

The chamber construction ensures simple installation within virtually any space limitation.

## Technical Description

- Cylindrical stainless steel chamber with Crossmix® flow optimiser (removable)
- Multiple Spektrotherm® UV lamps arranged parallel to the water flow
- Calibrated UV intensity monitoring system
- Electronic UV lamp supervision system with error memory and external interfaces
- Monitoring of chamber temperature and external flow rate signal
- CE and EMC approved



## Glossary of terms

**Humic** - made up of the organic constituent of soil, usually formed by the decomposition of plants or leaves by soil bacteria.

**EMC** - Electromagnetic Compatibility.

**Crossmix flow optimiser** - Patented device to optimise hydraulic flow, making for extremely low head-loss.

WEDECO

## UV Industrial and Municipal UV Spektron Series

No. of models in range	11
Water Temperature Recommended Range	5 to 45°C
Possible Range	0 to 70°C
Water UV Transmittance (@254nm, 1cm)	min 80%
Flow capacity (400J/m <sup>2</sup> - certified)	max 922m <sup>3</sup> /h

## Features

- Enclosed system
- Wedeco Spektrotherm® low pressure UV lamps
- High performance memory and analysis system
- Unique Crossmix® module ensuring maximum and correct distribution of all water flow throughout the entire disinfection chamber

## Benefits

- Safe disinfection
- No harmful by products
- Exceptionally low operating costs
- Very long lamp life
- On-going self monitoring of UV intensity, chamber temperatures and water flow
- Extremely low loss of pressure
- Variable installation positions for easy integration into existing pipeline positions
- Excellent electromagnetic compatibility (EMC) protection, which exceeds industry and household standards

# UV Industrial UV Spektron Series

## Main Applications

Disinfection of clear fresh water to meet relevant biological standards.

- Private and municipal drinking water supplies
- Food and Beverage industry
- Process water for industrial use
- Aquaculture (fresh water fish farming)
- Swimming pools

## Optional Accessories

- Cleaning valve (Spektron 3 and 6)
- Optional 5m chamber cable (standard is 10m)
- 1/4" sample valve
- Replacement Spektrotherm® UV lamps

# Spektron Series continued



## Spektron Series Model Selection Guide

Type	Max flow rate* (m³/h)	Connections (Thread or Flange)	Power consumption (kW)	Dimensions W x H x D (mm)
Spektron 3	2.9	1½"	0.055	350 x 370 x 240
Spektron 6	6.6	2"	0.09	350 x 370 x 240
Spektron 15	20.2	DN65	0.25	350 x 370 x 240
Spektron 25	37.3	DN80	0.38	350 x 370 x 240
Spektron 25S	36.8	DN80	0.3	611 x 370 x 240
Spektron 70	140.3	DN125	0.8	611 x 370 x 240
Spektron 100	164.3	DN150	1.0	611 x 370 x 240
Spektron 150	287.7	DN200	1.5	600 x 600 x 350
Spektron 250	435.2	DN250	2.2	600 x 600 x 350
Spektron 400	665.2	DN300	2.95	600 x 600 x 350
Spektron 600	898.3	DN350	4.35	600 x 600 x 350



# BX Series

## Overview

The chambers of the BX series systems are equipped with low pressure, high intensity UV lamps which are arranged parallel to the water flow inside the reaction chamber. From model BX80 onwards, the most powerful Spekthrotherm® UV lamps are used.

A special baffle plate design creates turbulence which allows the system to achieve high disinfection levels.

These UV systems can be mounted horizontally or vertically into existing pipelines and are equipped with a separate electrical cabinet.

Two optional extra components are dose pacing and an automatic wiping system:

Dose pacing is available as a result of the latest developments with the Spekthrotherm® UV lamp technology, meaning lamps now have variable UV-C output. Not only do the lamps have an enhanced UV-C output, they also allow a continuous variable output from 50-100%. This 'dose pacing' optimises energy consumption and extends lamp life, when applied to the system.

The optional automatic wiping system works by keeping each lamp sleeve clean by several wiper rings, whilst also cleaning the UV sensor window using brushes. By adopting this system, customers will benefit from no downtime to clean the system, lower operational costs and a stable system performance by maintaining maximum UV intensity.



WEDECO

## UV Industrial and Municipal UV BX Series

No. of models in range	13
------------------------	----

Water Temperature Recommended Range (BX 20 and 30)	5 to 25°C
--	-----------

Possible Range	0 to 35°C
----------------	-----------

Water Temperature Recommended Range (BX 50-3200)	5 to 35°C
--	-----------

Possible Range	0 to 60°C
----------------	-----------

Water UV Transmittance (@254nm, 1cm)	min 80%
--------------------------------------	---------

Flow capacity (250J/m <sup>2</sup> )	max 2120m <sup>3</sup> /h
--------------------------------------	---------------------------

### Features

- Enclosed system
- Spekthrotherm® low pressure/high intensity UV lamps
- Highly selective, calibrated UV sensor provides UV monitoring and control
- Optional automatic quartz sleeve wiping system available

### Benefits

- Excellent and reliable disinfection capacity with low energy consumption
- High UV-C output of the lamps allows for a smaller number of lamps relative to the overall flow capacity
- Spekthrotherm® low pressure/high intensity UV lamps provide excellent temperature stability
- Long lamp life expectancy
- Simple operation
- Easy maintenance

# UV

## Industrial UV

### BX Series

#### Optional Accessories

- Stainless steel 304 cabinet enclosure
- Chamber vessel in 'Z' design (not BX 1000)
- Sample valve
- Automatic wiping system (not BX 1000)
- Dose pacing (BX50 – BX3200)
- Cable lengths 7m or 10m (BX20 and BX30)
- Cable lengths 15m or 25m (BX50 – BX3200)
- Replacement Spektrotherm® UV lamps

# BX Series continued

## Technical Description

- Stainless steel chamber with multiple Spektrotherm® UV lamps arranged parallel to the water flow
- Cylindrical chamber with baffles (can be disassembled)
- Easily removable high efficiency, low pressure UV lamps
- Calibrated UV intensity monitoring system
- Electronic UV lamp supervision system
- Optional automatic wiping system (not BX 1000)
- Dose pacing, including variable lamp power

## Main Applications

- Private and municipal drinking water supplies
- Food and Beverage industry
- Process water for industrial use
- Swimming pools

## BX Series Model Selection Guide

There are 13 models in the BX series.  
Please see the table below for details

Type	Max flow rate* (m³/h)	Flange connection	Power consumption (kW)	Reactor dimensions W x H x D (mm)
BX 20	27	DN 80	0.23	260 x 930 x 330
BX 30	41	DN 80	0.34	275 x 930 x 348
BX 50	57	DN 100	0.47	365 x 1,000 x 443
BX 80	112	DN 150	0.8	275 x 1,530 x 368
BX 100	167	DN 150	0.8	365 x 1,535 x 458
BX 200	298	DN 200	1.5	365 x 1,535 x 458
BX 280	435	DN 250	1.5	470 x 1,535 x 565
BX 400	530	DN 250	2.2	470 x 1,535 x 565
BX 650	850	DN 300	3.0	600 x 1,540 x 700
BX 900	1,037	DN 350	3.7	700 x 1,540 x 800
BX 1200	1,039	DN 350	4.5	770 x 2,400 x 825
BX 1800	1,357	DN 400	6.7	730 x 2,400 x 925
BX 3200	2,120	DN 500	11.6	1,060 x 2,400 x 1,380

\* UV dose = 400 J/m² at the end of lamp lifetime; estimated UV transmittance = 98% per 1 cm. Spektrotherm® UV lamps in model BX 50. Spektrotherm® HP lamps in models from BX 80 and larger.

All specifications are subject to change without notice.

# E/ME Series

## Overview

Suitable for applications where high water quality is required (typically pharmaceutical) with the unique design minimising headloss by ensuring no dead-legs or any possible bug traps.

## Technical Description

- Axial quartz glass chamber with externally arranged Spektrotherm® low pressure high intensity UV lamps and reflectors, parallel to the water flow
- 'Positive radiation geometry'
- Special reflectors to focus the UV light inside the quartz chamber
- Compact system with integrated electrical equipment in a stainless steel housing (E Series)
- Electrical equipment in a separate cabinet (ME Series)
- In-line assembly
- Calibrated UV monitoring system

## Main Applications

- Process water and fully deionised water for industrial uses
- Ultrapure water
- Residual ozone destruction



## Glossary of terms

**Positive radiation geometry** - UV lamps installed in optimum positions to achieve maximum disinfection.

WEDECO

## UV Industrial UV

### E/ME Series

No. of models in range	9
Water temperature recommended range (E Series)	5 to 25°C
Possible range (E Series)	0 to 35°C
Water temperature recommended range (ME Series)	5 to 35°C
Possible range (ME Series)	0 to 60°C
Water UV transmittance (@254nm, 1cm)	min 55%
Flow capacity (250J/m <sup>2</sup> ) (E Series)	max 20m <sup>3</sup> /h
Flow capacity (250J/m <sup>2</sup> ) (ME Series)	max 100m <sup>3</sup> /h

## Features

- Enclosed system
- Spektrotherm® high intensity low pressure UV lamps
- UV monitoring and control provided by highly selective, calibrated UV sensor
- Quartz chamber
- Flexible material specifications

## Benefits

- Excellent and reliable disinfection capacity with low energy consumption
- High UV-C output of the lamps allows for a small number of lamps relative to the overall flow capacity
- Excellent temperature stability
- Long lamp life expectancy
- Very low headloss
- Simple operation
- Easy maintenance

## Optional Accessories

The E/ME series can be supplied with a tri-clamp sanitary fitting instead of flanged connections, together with certification of the material and lamps. This then becomes the E/ME Pharma series, suitable for use in the pharmaceutical industry.

The K Series are bespoke systems engineered to suit a wide variety of parameters.

#### Features

- Enclosed system
- Spectrotherm® UV lamps
- Optional automatic variable dose control
- Continuous output regulation of the Spectrotherm® UV lamp
- Fully automatic PLC control and visualisation, with bus or SCADA connection

#### Benefits

- Low operating and lifetime costs
- Low power consumption
- Low investment costs
- Minimal pressure loss
- Spektrotherm® UV lamps
- No harmful by products
- No danger from chemicals
- No accumulation of dangerous micro-organisms
- Cost effective
- Simple lamp installation and operation
- Long lamp life
- Automatic variable dose control
- Constant UV dose irrespective of changes in water quality or flow
- Maximum disinfection reliability
- Optimisation of energy costs
- Easy operation and monitoring

#### Optional Accessories

- Fully automatic dose control
- Replacement Spektrotherm® UV lamps

# K Series

## Overview

The K series UV systems are designed to be installed in large drinking water systems.

UV disinfection is provided by the Spektrotherm® UV lamps which offer reliable inactivation of bacteria, viruses and parasites (eg cryptosporidia and giardia).

The K type systems have been intensively tested to ensure the highest level of reliability.

The system can be optionally equipped with a fully automatic dose control, which enables the output to be exactly adjusted to the water quality and flow. The output of the lamps is continuously controlled and rows of lamps can be switched on or off as necessary e.g. during periods of low consumption.

## Main Applications

- Municipal drinking water supplies

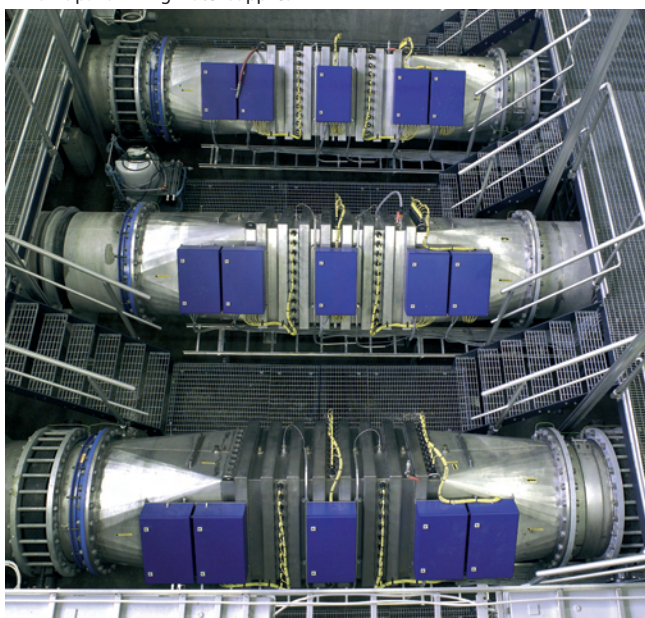

## Technical Description

- Stainless steel chamber with multiple Spektrotherm® UV lamps, positioned perpendicular to the water flow

# LBX Series

## Overview

The LBX systems can be equipped with a fully automatic dose control. This dose pacing is available as a result of the latest developments with the Spektrotherm®

UV lamp technology, meaning lamps now have variable UV-C output.

Not only do the lamps have an enhanced UV-C output, they also allow a continuous variable output from 50-100%. Dose pacing optimises energy consumption and extends lamp life, when applied to the system.

The optional automatic quartz sleeve wiping system works by keeping each lamp sleeve clean by several wiper rings, whilst also cleaning the UV sensor window using brushes. By adopting this system, customers will benefit from no downtime to clean the system, lower operational costs and a stable system performance by maintaining maximum UV intensity.

## Technical Information

- Stainless steel chamber with multiple Spektrotherm® UV lamps, arranged concentrically and parallel to the water flow
- Cylindrical stainless steel chamber with integrated baffle plates
- Easily removable, high efficiency low pressure UV lamps
- Calibrated UV intensity monitoring system
- Electronic UV lamp supervision system
- Optional automatic wiping system
- Optional dose pacing



WEDECO

UV

Industrial/Municipal

## LBX Series

No of models in Range **12**

Water Temperature  
Recommended Range  
(LBX 3-50) **5 to 25°C**

Possible Range **0 to 35°C**

Recommended Range  
(LBX 90-1000) **5 to 35°C**

Possible Range **0 to 60°C**

Water UV Transmittance  
(@254nm, 1cm) **min 35%**

Flow Capacity  
(250 J/m<sup>2</sup>) **max 1,335 m<sup>3</sup>/h**

### Features

- Enclosed system
- Spektrotherm® UV lamps
- Fully automatic PLC control and visualisation via SCADA connection and telemetry

### Benefits

- Constant UV dose irrespective of changes in water quality or flow
- Continuous output regulation of the lamps (for models larger than LBX 90)
- Maximum disinfection reliability
- Optimisation of energy costs
- Longer lamp life
- Easy operation and monitoring

## LBX Series

### Optional Accessories

- Stainless steel 304 cabinet enclosure
- Chamber vessel in 'Z' design
- Sample valve
- Dose pacing
- Automatic wiping system
- Cable length 7m or 10m (LBX 3-50)
- Cable length 15m or 25m (LBX 90-1000)
- Replacement Spektrotherm® UV lamps

# LBX Series continued

## Main Applications

Disinfection of effluents with low or highly variable UV transmittance

- Biologically treated wastewater
- Industrial process water at water treatment plants
- Specific drinking water qualities
- Sugar syrup
- Ballast water

## Other suitable applications are

- Irrigation of fields, parks, golf courses etc
- Waste water disinfection on ships

## LBX Series Model Selection Guide

There are 12 models in the LBX series. Please see the table below for details.

Type	Flow Rate approx* (m <sup>3</sup> /h)	Flange connection	Power consumption (kW/kVA)	Reactor dimensions W x H x D (mm)
LBX 3	3	1 ½	0.10/0.10	935 x 135 x 100
LBX 10	12	DN 50	0.34/0.36	930 x 280 x 200
LBX 20	25	DN 80	0.60/0.63	930 x 323 x 245
LBX 33	34	DN 80	0.76/0.80	930 x 348 x 275
LBX 50	52	DN 100	1.10/1.16	930 x 398 x 315
LBX 90	87	DN 150	1.50/1.58	1,530 x 388 x 275
LBX 120	134	DN 150	2.30/2.42	1,530 x 428 x 315
LBX 200	230	DN 200	3.70/3.89	1,535 x 510 x 400
LBX 400	370	DN 250	5.90/6.21	1,535 x 585 x 470
LBX 550	580	DN 300	8.80/9.26	1,540 x 720 x 600
LBX 750	780	DN 400	11.60/12.21	2,400 x 825 x 700
LBX 1000	1,000	DN 400	14.50/15.26	2,400 x 895 x 770

\* 400 J/m<sup>2</sup>; UV transmittance = 70% per 1cm at the end of the lamp lifetime. Spektrotherm® HP lamp in models larger than the LBX 90.

All specifications are subject to change without notice.



# TAK 55 Series

## Overview

The TAK 55 series systems provide the ultimate solution for wastewater disinfection.

It was specifically engineered for the disinfection of municipal wastewater. Several design configurations are available to meet regulatory requirements and to cope with varying degrees of water quality. Installed in final effluent channels, the modular design of the TAK allows for practically unlimited flow capacities.

The TAK series boasts an automatic wiping system, to ensure the equipment consistently performs well. It prevents organic and inorganic deposits from accumulating on the lamp protective quartz sleeves, allowing the UV light to actually reach the water.

Additionally, TAK can provide true dose pacing as a result of the reliable and automatically cleaned intensity sensors.

System monitoring can be managed locally or remotely depending on application/project requirements.

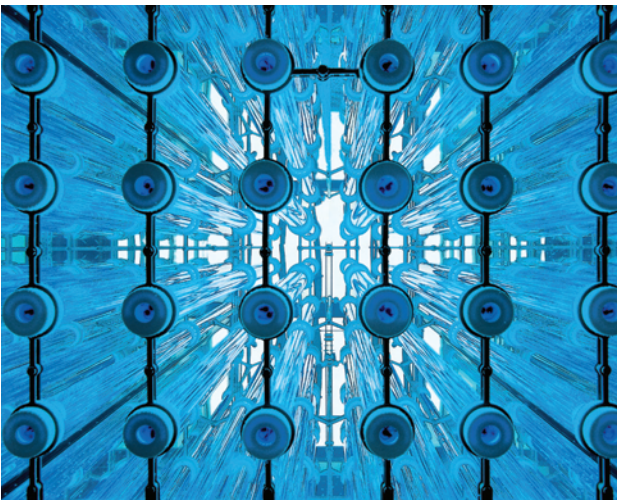

WEDECO

## UV Municipal UV TAK 55 Series

### Modular system

Module sizes available	8
Maximum modules wide	12
Water temperature recommended range	5 to 30°C
Water UV transmittance (@254nm, 1cm)	min 40%
Flow capacity unlimited, several	1000m <sup>3</sup> /h

### Features

- Open channel system
- Compact modular components
- Bespoke design to meet customer requirements
- 'Smart' ballast operation
- Chemical free wiping system
- Spektrotherm® UV lamps
- 'Smart' automatic lamp restart on ignition failure
- Dose pacing control
- Integrated PLC system

### Benefits

- Safe, environmentally friendly UV disinfection
- Chemical free, producing no harmful by-products
- Drastically reduced design/construction costs
- Easy installation/lower installation costs
- Increased disinfection effectiveness
- Low operation and maintenance costs
- Fully automatic operation
- No need for 'post-treatment'
- Very low pressure losses
- Infinite adjustment of UV lamp output
- No overdosing or underdosing concerns

# UV Municipal UV TAK 55 Series

## Main Applications

- Disinfection in open channels

## Technical Description

- UV modules with Spektrotherm® UV lamps positioned parallel to the water flow, designed for installation in concrete channel systems

## TAK Series Model Selection Guide

TAK 55 is a modular system, appropriate for municipal applications. Queries should be referred to Wedeco for further information.

## Optional Accessories

- Prefabricated stainless steel channels to house the UV lamp modules
- Replacement Spektrotherm® UV lamps

# TAK 55 Series continued



# TE/TA Series

## Overview

An industrial application, UV disinfection system comprising a UV lamp module with low pressure, high intensity Spektrotherm® UV lamps.

## Main Applications

Immersion lamps to prevent bacteria growth in water tanks, for the headroom disinfection of storage tanks and the disinfection of surfaces. Operates in warm and cold water, and also in the air.

- Food processing industry
- Pharmaceutical industry
- Cosmetic industry
- Electronic industry
- Aquaculture (fish farming)



## Technical Description

- UV immersion lamp module with low pressure high intensity UV lamps
- Different module lengths available, each with radial radiation geometry
- Easily replaceable UV lamp and separate electrical cabinet
- Stainless steel protection cage, prepared for flange connection

## TE/TA Series Model Selection Guide

There are three models in the TE/TA series range. Please see the table below for details.

Type	Connection	Power consumption (kW/kVA)	Installation length (mm)
1-TE450	DN 50	0.08/0.45	470
1-TE900	DN 50	0.15/0.45	920

\* The flow rate depends on the quality of water (UV transmission). WEDECO-Series B is suitable for higher flow rates. All specifications are subject to change without notice. In this case: 300 J/m<sup>2</sup> at the end of lamplife; Transmission = 98% T1cm

### Glossary of terms

Radial radiation geometry - UV is emitted from the lamp in radial fashion

WEDECO

## UV Industrial UV TE/TA Series

No. of models in range	3
Water temperature Recommended range	5 to 35°C
Water temperature Possible range	0 to 60°C

### Features

- Enclosed system
- Spektrotherm® UV lamps
- Small installation footprint
- Protective stainless steel frame

### Benefits

- Excellent and reliable disinfection capacity
- Low energy consumption
- High UV-C output
- Excellent temperature stability
- Longer lamp life
- Simple operation
- Easy maintenance

### Optional Accessories

- Replacement Spektrotherm® UV lamps

# UV

## Municipal UV

### TAK 55 Series

#### Main Applications

- Industrial
- Municipal

#### Features & Benefits

- Patented OptiCone™ technology provides even flow distribution
- Field bus technology significantly reduces installation time
- High - performance, medium pressure UV lamps
- Consistently high level of disinfection, right into the corners
- Easy maintenance with all fittings easy to access and are arranged along one side of the unit
- Square design reduces pressure loss - no dead zones in the flow

#### System

- Max. flow capacity 4,100 m<sup>3</sup>/h (26 MGD)
- Standards CE, UL
- Certificates & Validations US EPA (UVDGM)

# Wedeco Quadron

## Overview

The WEDECO Quadron™ system is the ideal solution whenever the space available for installing a UV disinfection system is at a premium. With a reactor length of just 1,200 millimetres (47.24") and a maximum flow rate of 4,100 m<sup>3</sup>/h (26 MGD), this UV system offers tremendous flexibility and capability for water treatment plants large and small.

The unique shape, in conjunction with the patented OptiCone™ flow diverter at the inlet, guarantees excellent flow conditions at every installation situation. Even with a close coupled 90 degree bend, the OptiCone™ still ensures even flow distribution without turbulence or cavitations.

Fitted with variable power medium pressure UV lamps, the Quadron™ system is designed for high performance in order to ensure successful disinfection and is ready for every eventuality. The chemical-free cleaning system and one sensor-per lamp monitoring system ensure that correct UV dose is always applied.

Thanks to its compact dimensions, high UV performance and optimized flow conditions, the WEDECO Quadron system is the ideal alternative to chlorination systems or outdated UV systems.

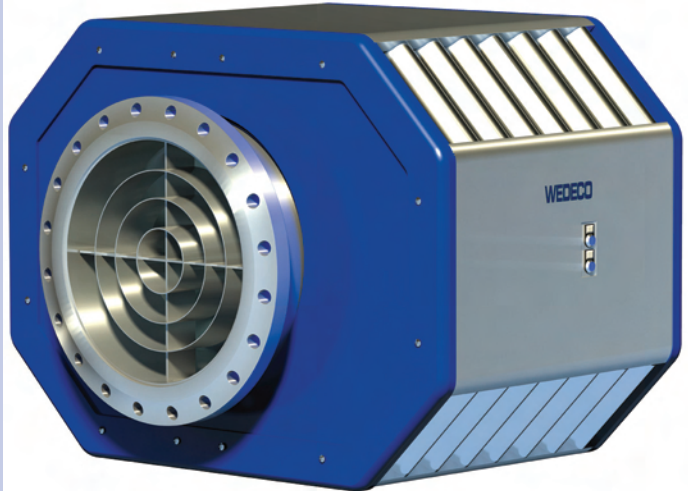

# Ecoray UV Lamps

## Overview

ECORAY is WEDECO's latest generation of high-performance low pressure UV lamps and the associated electronic ballast cards: more efficient, longer-lasting, more stable and more sustainable than any previous WEDECO UV technology.

WEDECO ECORAY UV lamps and ballast cards are the new centrepiece of many WEDECO UV systems and are the perfect replacement parts for many installations throughout the world with excellent operability and a promise of quality.

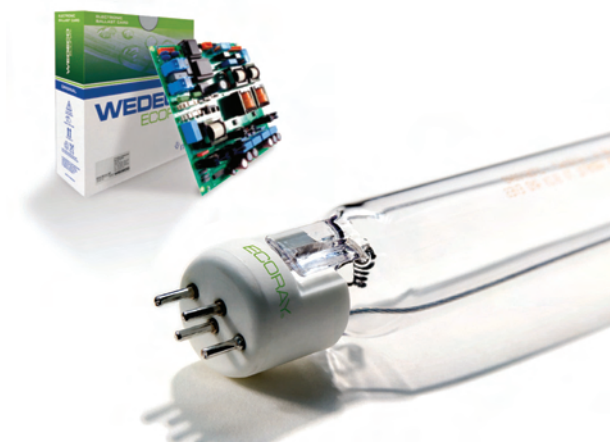

## Benefits:

### Greener

From our choice of materials to production to the operation of the lamps, we have engineered every aspect to be the most environmentally sensible WEDECO UV lamp ever produced.

- Ecoray UV lamps contain up to 80% less mercury\*
- Production and logistics meet the highest environmental standards, certified according to DIN EN ISO 14001
- Up to 500 kg CO2 savings for each UV lamp\* 1,2

How you benefit: a sustainable solution to our environment

### More Efficient

UV lamps are operated in dimmed mode for the greater part of their entire service life, which means far less than 100% power consumption.

We have optimized the Ecoray UV lamps and ballast cards in accordance with this typical mode of operation.

- Lower power consumption with the same UVC output\*
- Higher UVC output in dimmed mode\*
- Longer, more flexible operation possible in dimmed mode

How you benefit: up to 20% energy savings on average

## UV

## UV Lamps

## Wedeco Ecoray

### Features

- Innovative gas-amalgam mix
- New long life coating
- Up to 80% less mercury\*
- Improved physical robustness
- Plug & play for existing installations
- 100% quality control: the UV performance of each Ecoray lamp is tested after production and certified according to DIN EN ISO 9001
- The Ecoray ballast's operating frequency is fine-tuned to the specific requirements of the Ecoray UV lamp's characteristics.

\* Comparison of Ecoray ELR30 with SLR32143 4p HP (Spektrotherm). Variations are possible in the case of other successor articles.

1 Measured on the basis of the entire energy consumption of the guaranteed lamp lifetime.

Based on average emission figures for electricity generation in the USA. Source: [www.carbonfund.org](http://www.carbonfund.org)

2 Depending on the lamp type, ballast used and the operational mode of the UV system.



# Ozone

WEDECO

## Overview

Ozone is suitable in almost all situations where water contains pollutants. Unlike chemical-based technology (including chlorination), it removes unwanted substances without creating any harmful by-products or significant residues. It also operates with reduced energy consumption, lower operating costs, and low oxygen consumption.

We're able to offer a comprehensive combination of standardised ozone generators and engineered solutions, providing treatment solutions for drinking water, process water, cooling water, industrial and municipal wastewater and water from bleaching processes and other industrial applications.





# GSA/GSO

## Overview

Wedeco ozone systems are manufactured in four basic configurations to provide optimal solutions for all applications.

The GSA/GSO approach is to apply the same reliable and efficient ozone technology as used in large plants, to both small and medium demand applications. GSA/GSO ozone generators are compact units, fully assembled and ready to produce ozone economically from air or oxygen. They offer the highest ozone concentration yields at lowest energy demands.

Ozone production levels can be adjusted over a wide range to suit all application requirements. Critical system parameters are monitored and displayed to ensure safe and reliable operation. The result is maximum ozone production, minimum operating costs, and an unmatched reliability.

The OCS System is a compact, modular ozone generation and application package designed for smaller processes. The skid package can be supplied with a contact/reaction vessel included or supplied separately for larger capacity vessels.



**WEDECO**

## Ozone Ozone Generators

### GSA/GSO

#### Key Facts

- Ozone Production: 2-400g/h
- Matches the reliability of Effizon® dielectric technology
- Reduced energy consumption per unit of ozone production
- Reduced oxygen demand due to high ozone production concentrations

#### Features

- Effizon® dielectric tube technology
- Compact design reduces overall footprint

#### Benefits

- Reduced energy consumption per unit of ozone production
- Reduced oxygen demand due to high production concentrations
- Low installation and maintenance requirements
- Low investment and operating costs
- Reliable and safe operation
- Built for permanent operation
- Disinfection by oxidation of bacteria, parasites and deactivation of viruses
- Removal of colour, taste and odour
- No hazardous by-products

## Ozone Ozone Generators

### GSA/GSO

#### Typical system would incorporate

- Ozone Generator
- PSA oxygen generators (for oxygen feedgas versions)
- Introduction system with booster pump and injector
- Ambient air monitoring
- Electric controls with signal exchange
- Stainless steel frame with internal piping and wiring

#### Optional Accessories

- Ozone concentration monitoring
- Residual ozone in water monitoring
- Reaction/degassing tanks in different sizes
- Residual ozone destruction in off gas
- Stainless steel cabinets, piping and injector
- Replacement Spektrotherm® UV lamps

## GSA/GSO continued



### Main Applications

Wedeco ozone generators are ideally suited for all types of processes for the municipal and industrial customer

- Food and Beverage
  - Bottling industry (raw water treatment, rinsing, filling)
  - Product washing for shelf life extension
- Process water loops
  - Demineralised water loops, cosmetic / pharmaceutical industry
  - Wash water recycling
- Small drinking water plants
  - Small villages in remote areas
  - Companies with own water supply
- Aquaculture (fish farming)
- Swimming pools
- Cooling water
- Laboratory systems

OCS Series Ozone systems are designed for small and medium applications in the municipal and industrial marketplace.

---

#### Glossary of terms

**Off gas** - excess ozone , following the contact stage.

**Reaction** - time required for the ozone to oxidise contaminants.

**Spektrotherm** - high performance Wedeco UV lamp.

**OCS** - complete, small, ozone generation and application package.

**PSA** - pressure swing absorption.

# SMA/SMO

## Overview

Wedeco Effizon® HP technology in the SMA/SMO ozone generators provides the most efficient and reliable ozone production element in today's market. These generators can be used wherever compact design, a high performance profile and outstanding reliability are needed.

The options and the instrumentation, input and reaction systems, together with the residual ozone destruction, enable the SMA/SMO systems to be specifically tailored to customer's needs.

As a result of the robust design, there is no need for routine cleaning or regular replacement of the electrodes required by conventional systems.

All Wedeco products meet the requirements for ozone generation systems used in water treatment in accordance with European Standard CEN EN 1278.



## Components

SMA/SMO ozone systems include the following components as standard:

- Ozone generator cell including the Effizon® HP electrodes and connectors
- Power supply unit including medium frequency convertor and high voltage transformer
- PLC-system for internal control and monitoring of the ozone systems
- Local operator interface panel HMI
- Ambient ozone health and safety monitor
- Dewpoint sensor for generators using PSA or air as the feedgas
- Air conditioning systems for electrical cabinets
- Enclosure protection class, IP 54
- Control and monitoring instrumentation
- Complete system, fully assembled, piped and cabled on a skid
- CE-certificate

WEDECO

## Ozone Ozone Generators

### SMA/SMO

#### Features

- 'Plug and Play' systems (completely mounted and instrumented)
- Fast installation and start-up time
- Certified factory test with full ozone capacity prior to shipment

#### Benefits

- Reduced power consumption
- High efficiency at guaranteed ozone production
- Drastically reduced oxygen and air consumption through high ozone concentrations
- Low space requirement
- Reliable – Standard 2 year warranty on equipment
- 10 years replacement warranty on Effizon® HP electrodes
- Easy operation
- Low investment and operating costs
- Robust design for operation under rough ambient conditions
- Low maintenance

#### Main Applications

- Wedeco ozone generators are ideally suited for disinfection and oxidation of all types of processes for the municipal and industrial customer.
- SMA/SMO Series Ozone systems are specifically designed for medium applications in the municipal and industrial marketplace.
- Potable water supplies
- Industrial / Municipal waste water treatment
- Odour Treatment systems
- Ozonolysis / Synthesis
- Bleaching
- Recycling processes
- Food and Beverage industry
- Cooling water
- Fish farming

## Ozone Ozone Generators

### SMA/SMO

#### Key Facts

- Ozone production: 400g-15kg/h
- Ozone concentrations up to 14%wt
- Integrated design providing complete packaged ozone generation plant

#### Additional services

- Feed Gas supply  
Oxygen (LOX)  
PSA (pressure swing absorption)  
Dry air, comprising air compressor, desiccant dryer, filtration etc
- Ozone mixing and contacting  
Side stream injection systems  
Fine bubble diffusers  
Closed reactors  
Degassing tanks
- Electronic process control  
Power distribution MCC panel  
Overall process control Panel
- Ozone destruction in off gas  
Catalytic Ozone Destructors  
Thermal Ozone Destructors  
Blowers Demisters
- Cooling water supply  
Air/water cooled chiller units  
Heat exchangers

## SMA/SMO continued



### Optional Accessories

The following options are available and can be incorporated during manufacture:

- Network communications  
Profibus, Modbus, SCADA etc
- Instrumentation and control  
Ozone concentration / Doserate control  
Ozone residual in water monitoring  
Redox monitoring  
Alarm monitoring and indication

All necessary instrumentation is included to provide the required level of control.

---

#### Glossary of terms

**PLC system** - programmable logic controller system.

**PSA** - pressure swing absorption.

**Ozonolysis** - application of ozone for treatment purposes.

**Synthesis** - use of ozone to chemically adapt a substance.

**Profibus** - Field bus network for instruments, devices and signal integration

**Modbus** - PLC Communication protocol

**SCADA** - Supervisory Control and Data Acquisition

**Redox Monitoring** - to monitor the oxidising potential of a liquid

**LOX** - Liquid Oxygen

# SMA/SMO 900

## Overview

The SMO/SMA 900 series sets new standards among the world wide range of ozone generators. The newly employed 12-pulse rectifier technology and the virtually maintenance free Effizone® HP electrodes combine a cost effective and reliable system for ozone production of more than 20kg/h.

## Main Applications

Wedeco ozone generators are ideally suited for disinfection and oxidation of all types of processes for the municipal and industrial customer

SMA/SMO series ozone systems are specifically designed for medium sized applications in the municipal and industrial market place

- Portable water supplies
- Industrial/municipal wastewater treatment
- Odour treatment systems
- Ozonolysis/synthesis
- Bleaching
- Recycling process
- Food and beverage industry
- Fish farming

Performance Data SMO 900 S (Excerpt)\* Feedgas Lox

Ozone production kg / h	Ozone concentration wt%	Cooling water temp. °C (ΔT5K)	Convert Power kw
21.5	7	15	156
17.3	10	15	158

\*Preliminary performance data

WEDECO

## Ozone Ozone Generators

### SMA/SMO 900

#### Features

- Generating more than 20kg ozone per hour
- Compact and cost effective standard system with the high performance of our larger PDO/PDA series
- Savings potential due to minor footprint and quick supply
- Pre-assembled on a frame so the system comes ready for selection
- 12 pulse technology mains PSU
- The included patent-registered Effizon® HP electrodes are the most efficient and most reliable ozone electrodes on the market

#### Benefits

- Virtually maintenance free
- Cost effective
- Reliable
- High standard and quality
- 10 year warranty
- Compact
- High production capacity



# Ozone Ozone Generators

## PDA/PDO

No. of models in range **18**

Ozone productions **11 to 250kg/h**

Custom designed to satisfy customer requirements

### Features

- Exclusive use of the patented Effizon® HP electrode/dielectric technology
- High performance variable frequency power supply technology (PSU)
- Linear output ozone control as well as wide turndown range (up to 100-1)
- Integrated PLC control systems

### Benefits

- Unmatched reliability – 2 year warranty on equipment with 10 year warranty on dielectric tubes
- Production flexibility
- Cost efficient
- Compact package minimises space requirements and associated facility construction costs
- PDA/PDO ozone generators are the only large scale ozone generators available that are factory pre-assembled and tested prior to delivery

### Main Applications

Wedeco ozone generators are ideally suited for disinfection and oxidation of all types of processes for the municipal and industrial customer.

PDA/PDO Series ozone systems are designed for large applications in the municipal and industrial marketplace.

- Drinking water treatment
- Chemical oxidation and synthesis
- Pollution control
- Pulp and paper bleaching

# PDA/PDO

## Overview

The high capacity PDA/PDO ozone generators offer unmatched reliability, production flexibility and efficiency, all in a compact package that minimises space requirements and associated facility construction costs.

PDA for air fed systems with capacities higher than 8.3kg/h

PDO for oxygen fed systems with capacities higher than 15.6kg/h

These large scale ozone generators are designed specifically for each customer, then produced and factory tested prior to delivery. Factory testing provides customer assurance that they will receive a functioning and efficient system.



## PDA/PDO Model Selection Guide

There are 18 models available in this range.

Please see the table below for details.

	Ozone Production [kg/h]				
	Air Feed		Oxygen Feed		
	30g/m <sup>3</sup>	50g/m <sup>3</sup>	7%wt	10%wt	12%wt
PDA/PDO 1000	14	11	26	21	18
PDA/PDO 1500	16	12	30	24	20
PDA/PDO 2000	19	14	35	28	24
PDA/PDO 2500	21	16	38	32	27
PDA/PDO 3000	24	18	44	36	30
PDA/PDO 3500	26	20	49	40	34
PDA/PDO 4000	29	23	55	45	38
PDA/PDO 4500	36	28	67	55	46
PDA/PDO 5000	43	33	80	65	55
PDA/PDO 5500	51	39	94	77	65
PDA/PDO 6000	59	45	110	89	76
PDA/PDO 6500	68	52	126	102	87
PDA/PDO 7000	78	60	144	118	100
PDA/PDO 7500	88	68	163	133	113
PDA/PDO 8000	99	76	183	149	126
PDA/PDO 8500	108	83	200	164	138
PDA/PDO 9000	122	93	225	184	155
PDA/PDO 9500	134	103	247	202	171



# Filtration & Clarification

## Overview

Through the Leopold brand we provide all the necessary components for a complete operating system, whilst our full spectrum of engineering services ensures our products and systems work to meet customers unique requirements.

Our product support continues long after your Leopold system has been commissioned, with a full range of field services and product services available.



## Universal Type S and SL

No. of models in range **2**

Retrofit and new build

Combined air and water backwash lateral length **up to 15m from point of entry**

Air rate capability **20 to 90 m/hr**

Water wash rate capability **8 to 60+ m/hr**

Equivalent nozzles per m<sup>2</sup> **248**

Maldistribution across a 10m x 10m filter **+/- 2.5%**

### Features

- Bespoke systems which can be engineered for wastewater applications
- Modular design, suitable for all filter dimensions
- Easy assembly and installation, no special tools required
- Constructed of corrosion resistant, high density polyethylene (HDPE)
- Approved for use in contact with drinking water under UK regulations

### Benefits

#### Underdrain

- Fast installation compared to conventional systems
- Lower civil engineering costs
- Increased filter media depth potential
- Retrofit old filter with deeper media
- Improved water quality
- Improved filter run times
- Low clean bed headloss
- Zero maintenance

#### IMS Cap

- Eliminates support gravel
- Lightweight
- Easy change to deeper media or carbon
- Proven flow distribution
- Removable for inspection
- Compatible with water treatment chemicals

# Universal S and SL

## Overview

The underdrain supports the filter media and retains it within the filter. During filtration mode it evacuates filtered water and when the filter requires cleaning, it introduces water and air for backwashing.

## Technical Description

The universal underdrain offers a maintenance free system that is capable of delivering combined air and water backwashing in both drinking water and wastewater filters. It is suitable for both new build and retrofitting, being able to operate with existing filter control systems, pumps and air blowers.

## Main Applications

- Drinking water e.g. solids removal, manganese reduction, Granular Activated Carbon (GAC)
- Wastewater filtration e.g. solids removal, phosphorous reduction and nitrate reduction
- IMS cap suitable for drinking water applications only

## Optional Accessories

- The IMS cap is available as a replacement for the support gravel layers otherwise needed on underdrain systems. Made of plastic beads bonded together, it is lightweight, and easy to handle and install. Where specified, the IMS cap is factory-installed on top of the underdrain block.
- Stainless steel air header pipe work

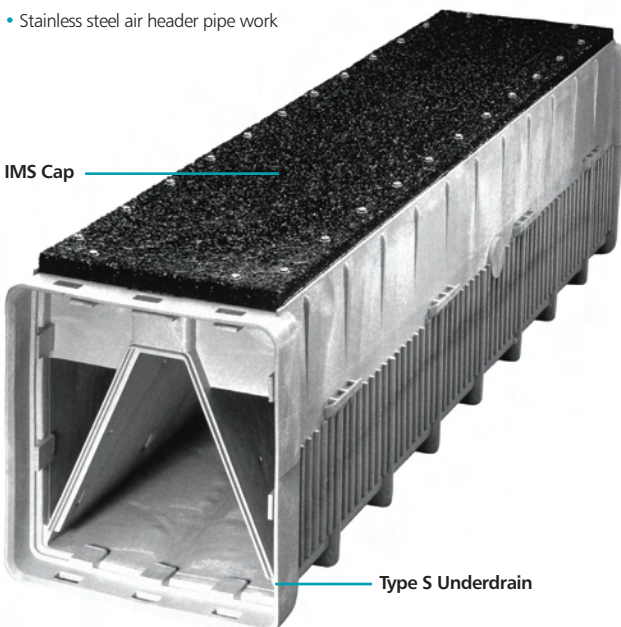

## Model Selection

There are two models in the Universal underdrain system range. The S underdrain is ideal for designs requiring longer laterals, while the SL features a lower profile, making it ideal for shallow filters where greater media depth is required.

# CT2

## Overview

The CT2 is a submerged sludge collection system which normally uses a simple differential head to drive sludge from the basin. Where sufficient differential head is not available, a pump can be mounted on the system outlet.

It provides variable sludge removal rates and low sludge disturbance on withdrawal.

The CT2 is automatic, simple and cost effective, offering low power consumption, with low capital and maintenance costs.

## Technical Description

The CT2 comprises a suction header which is mounted to a guide rail which spans the length of the tank. The header is moved up and down the tank by means of a cable system. The drive unit is mounted external to the tank for ease of maintenance. Variable control is provided by externally mounted control panel which can be configured to interface with a site SCADA system if required.

## Main Applications

- Drinking water clarifiers
- Wash water recovery tanks on drinking water plants
- Final settlement tanks on bacteria bed wastewater treatment plants

## Model Selection

Each system will be designed to meet the needs of the application.

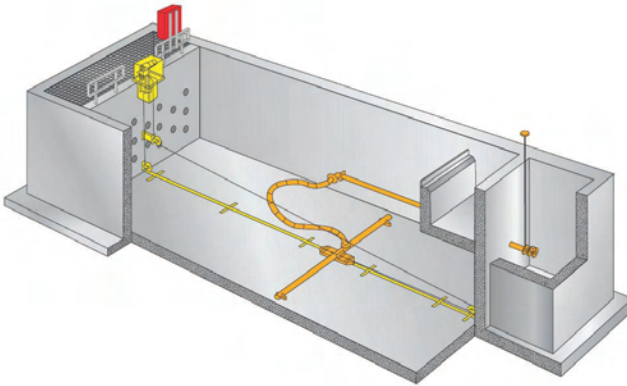

## Clarification Sludge Collectors

### CT2

No. of models in range **1**

Submerged sludge collector

Simple design

Variable control

Suitable for new build and retrofitting

Suitable for flat or sloping bottomed tanks

#### Features

- Multiple pass control
- Controlled sludge withdrawal rate via sludge pump option
- Can be used to optimise sludge concentration
- Submerged materials manufactured from stainless steel or other corrosion resistant materials
- Can be fitted beneath high rate tube and plate settlers

#### Benefits

- Reliable operation
- Low maintenance costs
- Efficient sludge production
- Easy operator control

#### Optional Accessories

Sludge withdrawal pump and control system

#### Glossary of terms

**Clarifiers** - separates liquids and solids during the process

# Clarification

## Sludge Collectors

### Clari-Vac

No. of models in range **1**

Floating pipe bridge

Suitable for rectangular settlement tanks

Suitable for flat bottomed tanks

Can be retrofitted

95% of the tank can be cleared of sludge

#### Features

- Surface skimmer, which removes floating material to scum removal trough
- Variable control to allow optimal sludge removal
- Positive sludge removal
- Simple design
- Complete control system supplied as part of the package

#### Benefits

- Low power consumption
- Low capital cost compared to other systems
- Low maintenance costs
- Variable sludge removal rates
- Low sludge disturbance on withdrawal

#### Optional Accessories

- Effluent and scum collection troughs
- Scum skimming system

# Clari-Vac

## Overview

The Clari-Vac is a floating sludge collector which offers powerful sludge removal using a vacuum system. It removes material, produces high solids concentration, lowers sludge disposal costs, drastically reduces power costs and virtually eliminates maintenance. It is energy efficient, with up to 80% less power required than other systems. It can also feature a simple mechanical skimming system.

## Technical Description

The Clari-Vac removes settled sludges via a collection header which is suspended from a floating pipe bridge. It traverses rectangular settlement tanks removing settled material by means of a vacuum system.

## Main Applications

- Suitable for drinking water clarifiers and wash water recovery tanks
- Suitable for final settlement wastewater tanks including those on activated sludge plants

## Model Selection

Each system will be designed to meet the needs of the application.

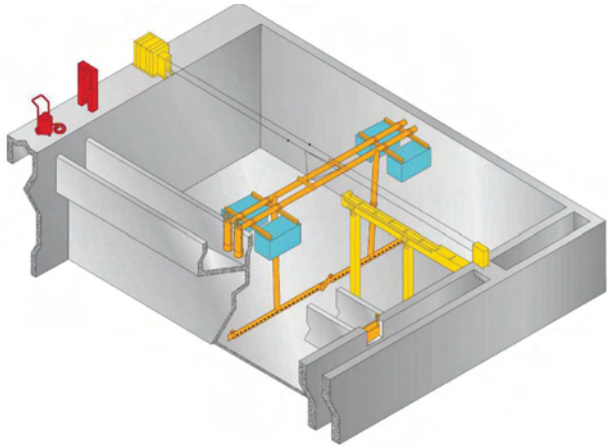

# Sanitaire Drum Filter

## Overview

The internally fed, continuous flow Drum Filter is a cost-effective method for removing fine particulate matter. In some tertiary treatment applications it can eliminate the need for chemical addition or intensive mechanical energy to achieve treatment goals. The filtration cycle operates on the same principle as a mechanical sieve utilising gravity. An automatic backwash cycle operates at a pre-determined hydraulic set point to remove solids via rotation of the drum and a high pressure spray back-wash. The solids are in turn collected in an internal trough and conveyed for further treatment or recycled.

## Features

- Acid-resistant polyester fabric screens encapsulated in modular polypropylene injection-molded panels for durability.
- Elastomeric drive end plate consisting of a flexible disk to reduce shaft stress.
- Corrosion resistant stainless steel drum support frame.
- Quick change spray nozzles located on easily accessible spray bar.

## RFS Series Drum Filter

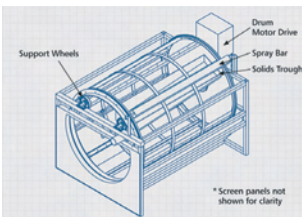

## RF Series Drum Filter

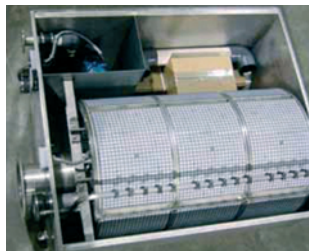
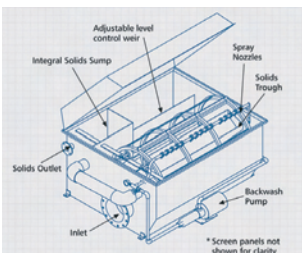

## Sanitaire Drum Filter

### Main Applications

- Tertiary effluent treatment – filtration.
- Integration into process streams – both new and existing
- Polishing final flows from Sequencing Batch Reactors and final clarifiers
- Recirculation system filtration
- Industrial or food processing product recovery
- Potable water filtration prior to sand filters, membranes, or ultraviolet disinfection
- Industrial and power plant intake water filtration

### Benefits

- Minimal head loss through entire system
- Wide range of capacities - flows from 100 to 2,500 gallons per minute (gpm)
- Continuous operation
- Low energy consumption (power only required during backwash cycle)
- Industrial or food processing product recovery
- Pall enclosed models provide for simple installation (rfs and rfm series)
- IEasy retrofit utilizing existing tankage (rf series)
- Low backwash requirements (typically 1 to 3% of process throughput)
- Small footprint
- Simple maintenance

### Material

- Stainless steel, polypropylene & UPVC (Enclosure available in fiberglass – RFM series)

### Accessories

Available with the following enclosure options:

- RF Series - No enclosure
- RFM Series - Fiberglass reinforced plastic
- RFS Series - Stainless steel enclosure





## Filtration

## Wash-Water

# Trough Equipment

No. of models  
in range

1

Various capacity and dimensions,  
to meet design requirements

Fibreglass reinforced plastic

Self supporting up to 5m

### Features

- Maintenance-free, reinforced construction
- Resin-rich interior surface
- Mounting brackets, hardware and stabilisers all made of stainless steel
- Approved for use in contact with drinking water in the UK

### Benefits

- Durable, and corrosion resistant
- The reinforced construction gives strength and rigidity
- Even flow due to resin-rich interior surface

### Optional Accessories

- Media retention baffles (Troughguard)
- Media retention testing facility available
- Wash-trough stabilisers
- Weir plates

# Wash-Water Trough Equipment

## Overview

Leopold fibreglass wash-troughs are used in water and wastewater filters to provide uniform removal of wash-water during back-washing.

Moulded from densely laminated fibreglass-reinforced plastic, the wash-troughs are corrosion resistant and constructed for maintenance-free durability and long service life.

If filter depth is insufficient, the wash-troughs can be provided with media retention baffles to eliminate significant media loss during combined backwashing.

## Main Applications

- Water and wastewater filters

## Model Selection

The Leopold fibreglass wash-troughs are available in a wide range of dimensions and capacities to meet the requirements of individual applications.

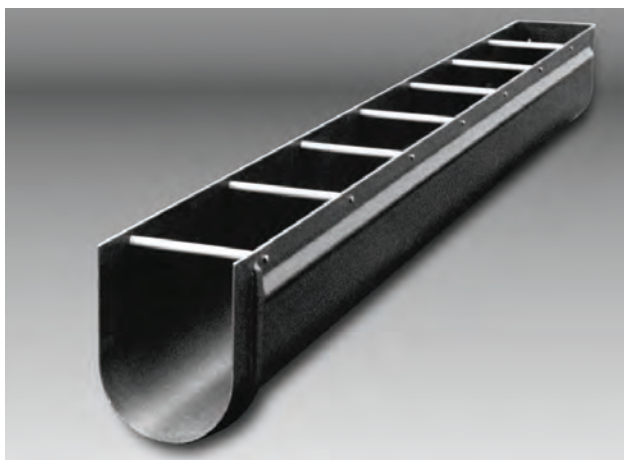



**xylem**  
Let's Solve Water

# TotalCare services

For secure, optimal operations



Xylem TotalCare is a comprehensive, integrated portfolio of services that ensures your business keeps running at its best. Our portfolio comes backed by deep systems knowledge and expertise in water and wastewater applications. Which gives you the operational security and more time to focus on your core business.

What can Xylem do for you?  
Call 0115 940 0111 or visit  
[www.xylem.com/totalcare](http://www.xylem.com/totalcare)



godwin



WEDECO

# Monitoring & Control

## Overview

The same great knowledge and experience that builds the best pumps in the world lets you control and monitor your assets.

At Xylem we are continually striving to find ways to improve our customer experience, through the development of new systems and products to remotely monitor and control essential equipment, providing cost effective intelligent solutions.

As well as supplying the hardware such as pump controllers, sensors, electrical start equipment and control panels; we also have software for running the system.

The Flygt AquaView supervision software provides PC based SCADA (Supervision, Control and Data Acquisition) know-how. The applications range from those operating in wastewater treatment plants and pump stations to products pumping ground water from building sites.

By combining these new system controls with our TotalCare provision, we can help to ensure the on-going quality and life of customers' pumps, whilst weekly electronic preventative checks increase the pumps operational effectiveness.

- Pump control panels
- Starters
- Level/pump sensors
- Pump controller / supervision
- SCADA software systems
- Inverters VFD/VSD – PumpSmart
- WITS accredited Telemetry Outstations / RTU's / Pump Controllers





## Monitoring & Control SCADA System

### AquaView

#### Features

- Simple to use graphical interface
- Gives alarm visibility and control
- Multiple communication options
- Accurate real time reporting
- Secure system security
- Rota alarm handling

#### Benefits

- Cost savings
- Enhanced system awareness
- Preventative measures awareness
- Single source of information for the complete system
- Reports can be manipulated giving greater visibility of the system
- Historical data helps with diagnosis and analysis
- Easy to expand the system

#### Applications

- Suitable for use in any environment where the customer needs to remotely monitor, log and trend a number of pumps/assets

# AquaView - SCADA Software

## Overview

AquaView control system enables customised, swift and easy control of pumping stations and remote assets.

AquaView provides more effective control for wastewater and water treatment applications through acting as a central information and control point. By connecting RTUs (Remote Terminal Units) you can precisely and effectively monitor and control the flow in and out of the system. AquaView generates alarms in the case of failures, logs data for reports, trends and events, and continuously monitors the state of linked pumps, mixers and valves.

## Making your budget go further

Using RTUs you can build a control system that is right for your customers' needs. By optimising the pumping operation, these products can help reduce the amount of manual supervision required onsite, simplify service and maintenance, and lower operational and service costs.

AquaView provides a complete picture of the plant to the users' fingertips and delivers on-screen information through a series of simple graphic representations of the system and plant, all of which can be tailored to your customers' needs.

The software presents an overview map and will show operational values and status from the facility of the users' choice.





## Monitoring & Control SCADA System

### AquaView

#### Operating a secure system

The security of your customers' operational network can be made safer and easier through AquaView. You can ensure that only authorised personnel gain access to the system by giving each individual user a personal ID.

Users may also be classified by groups, and access to all or part of the system can be configured as required.

#### Cost effective plant

AquaView monitoring and control system offers a completely new way of working. The earlier rolling schedule with technicians on the road visiting different pump stations with alarm interruptions and recurring emergency turn-outs can to a great extent be replaced with planned maintenance and service.

A controlled flow results in less clogging and overflows. The pressure on pumps and the main systems is reduced, and the processes controlling pH values and oxidation.

Besides the possibility to process more water, a reliable monitoring and control system saves energy.

Measuring the capacity allows you to optimise your operations, running the pumps at a low, even level.

# AquaView continued

## Compiling reports

Periodical reports comprise data such as running times, number of starts, inflow and outflow volumes. The report format of AquaView gives your customer the ability to tailor it to their own unique operational requirements. Information can be displayed either as graphs for easy visual evaluation of trends, or as lists.

Data can be retrieved when needed, and is stored as segments in day values. These values can then be compiled for presentation on a daily, weekly, monthly, quarterly or yearly basis. Trend values from analogue measurements are stored as 1 or 30 minute average values.

Alarm handling through AquaView gives access to a wide range of alarms, ranging from overflow warnings to pump service indicators and pump failure. Alarms are classified according to priority, and can be distributed as required (for instance, overflow warning alarms can be passed via modem to off-duty site supervisors in the case of an emergency). Receipt times can also be set, and special alarm conditions established for important sites. Alarm reports can be generated to cover a wide range of possibilities, such as active alarms, type of alarm and point of time.

## A total package for optimum control

AquaView provides your customer with a complete picture of their system and is ideal to use with existing control hardware. It enables them to investigate individual station status, compile flow trend reports, monitor alarms, etc, from a centralized control office and gives operators an effective overall picture of the plant function and performance.

## Complete range of pump controllers

Flygt offers a complete range of pump controllers to suit all sizes of pump stations, including those used in retention basins and wastewater treatment plants.

The series of pump controllers have been especially designed for pumping applications. The standardized features and control mean that users can easily operate the entire range. All pump controllers have a user friendly front panel with self-instructive symbols, and can be connected to supervisory control.

## Seeing problems before they arise

By gathering and presenting information from the RTUs in the system, AquaView enables your customer to predict where they may need extra capacity in the system, allowing them to tackle problems and prevent incidents before they occur. This is made possible by the tools for analysing the large amounts of data available in the database. In the event of an incident, AquaView allows them to trace the sequence of events through alarm reports and trends. All reports can be tailored and presented in the format that best suits their requirements.

## Open communication platform

The software package offers an open communication platform. It enables AquaView to communicate with different communication protocols supporting a number of RTUs on the market. All data collected is stored in a SQL database. The structure of AquaView is network ready and data storage can be made on a file server anywhere on the network. It offers your customer the possibility of expanding their system step by step without locking them into a single, set solution. Above all, it turns monitoring and control into a safe and simple process.



### ATU

#### Features

- Ultra Low power consumption
- Robust, weatherproof connectors
- "Green" - alkaline and NiMH batteries with lower environmental impact
- Alarm dial-out to multi-users (e.g. Masterstation and SMS)
- Multi-logging facility (event, alarm & sequence)
- Intelligent charging techniques to maximise battery capacity and service life
- Highly accurate level measurement – up to 16-bit
- Powerful on-board sequencing, providing local control
- Industry standard communication protocols – Modbus, DNP3 and WITS DNP3
- Wide range of communications media options available (see 'Making your budget go further')

#### Benefits

The ATU Series provides an 'easy to use' approach and all products in the range have a local user interface. Mains, DC and battery powered units are available. The battery unit, still offering full alarm monitoring, logging and remote communication, can operate on a single set of standard 'D' cell batteries for over 5 years. Ideal for those hard to reach areas where costs to date have proved too high to justify installation.

All outstations in the ATU range can operate over a wide communications media, which can either be selected at the time of order placement or retro fitted later at site.

#### Available to rent

# Alarmed Telemetry Units-ATU

## Overview

The Flygt ATU range monitors more than just the pump; it will monitor, control and relay data from key assets with the aim of reducing any downtime. We have been listening to what our customers have been asking for in a general controller and the Flygt ATU series has been built using the knowledge and expertise built up over many years by our team of R&D engineers.

Due to its modular approach regarding I/O and communication you can select only what best suits the application. With such a wide selection it's a high probability that the ATU series will suit the vast majority with just an I/O or communication change. A range of protocols is available thus reducing potential IT top end charges and staff training is greatly reduced as the HMI is not only intuitive but common throughout the ATU series.

## Making your budget go further

The following communication media are available as modular plug-in devices:

- PSTN (Public Switched Telephone Network) & SMS
- GSM & SMS (Vodafone, O<sup>2</sup> & Orange as a minimum)
- GPRS (General Packet Radio Service)
- Radio (unlicensed band & licensed band)
- RS232 / 485 / 422 (point-to-point or multi-drop configurations)
- Private Wire / Leased Line
- Satellite (Low Earth Orbit (LEO) or TSAT)
- Bluetooth



## Glossary of terms

HMI - Human/Machine Interface

I/O - Inputs and Outputs



# Monitoring & Control Pump Controller

## APP

### Features

- Easy to use
- Robust design, suited for water supply and sewer systems
- Extremely easy menu handling
- Maintenance pump run
- Automatic alternation
- Start and running time counters
- High and low level alarm
- Automatic sensor check
- Relay output for combined alarm
- Remote communication
- Emergency operation
- ATEX (EX) operation
- Overflow monitoring
- Personal alarm for on-site safety
- Alarm log
- Random start level
- Maximum run time
- Start and flushing operation
- Advanced pump supervision, including capacity, running times, leakage and temperature alarms
- Accurate flow measurement of incoming and pumped volumes

### Benefits

- Doesn't require any training to use
- No need to use screws; simply mount the unit on the DIN rail provided
- Save personnel and energy costs
- Overflow alarms help operators react quickly to spillage. By keeping track of previous overflows, a monitoring and control system can help prevent future discharges

# APP

## Overview

The APP range of pump controllers have several models in the range all designed for controlling pumps.

The APP series offers a robust pump controller for controlling one or more pumps, with or without alternation. It is available as stand-alone or with communication as an option and can easily be installed in your existing control panel. The APP series is also intended for installation in existing stations without pump controllers where external hardware as contactors, current sensors and level sensors are present.

The pump control features are carefully chosen for easy monitoring and maintenance. In addition, four general inputs enable you to configure optional features for the specific pump station.

## Model Selection Guide

The choice for the APP700 range is made according to application and is shown

Applications	APX 711	APX 521/721	APX 541/741	APX 751	APX 761
Pump stations with 1-2 pumps		•			
Pump stations with 3-4 pumps			•		
Pump stations with >4 pumps					•
Retention basins				•	
Alarm receiver/transmitter	•				
Wastewater and treatment plant applications					•

## Remote control

When connecting the APP to Flygt's SCADA (Supervisory Control And Data Acquisition) system AquaView, you can remotely read status, alarms and operational data. You can also remotely control the pump and change set points.

The connection can be made via radio, telephone lines or GSM communication. Together with a SCADA system APP obtains full control of the operation of the pump station.

Mandatory service and pump station visits, reporting and compiling of data and statistics will be reduced to a minimum. As potential problems can be identified and corrected before they become critical, there will also be fewer emergency calls. The APP range definitely contributes to a reliable and cost effective operation.





## Monitoring & Control Supervision Units

### MAS 711

#### Features

- 'Black box' function in case of pump failure
- 'Plug-n-play' with back-up
- Monitors the pump's temperature, leakage, vibration, current and power (optional)
- Communication options
- Essential data about the pump useful for installation, servicing and maintenance (stored in the pump memory) is automatically synchronized with the corresponding data in the base unit every two hours
- Uses the pump's data plate information stored electronically in the base unit and the pump memory to authenticate the pump during synchronization
- The base unit stores all measurement data in an extensive database on its embedded server
- Powerful, user-friendly tools can then be used in a standard web browser to present this data and analyze alarm events in order to optimize pump operation
- Quick overview mode gives the operator a snapshot of the pump's status
- Where an alarm has been triggered, a red or yellow indicator notifies the operator
- The operator can set application specific alarm limits
- Settings for the customer's selection of sensors are factory-preloaded

# MAS 711 – Pump Monitoring & Supervision

## Overview

MAS 711 is a pump monitoring system designed to remember, record and present pump events fast and easily. As part of a complete Flygt pumping system, it helps reduce costs over the pump's lifetime by facilitating maintenance and assuring safe operation, thereby increasing reliability and availability.

Detailed operation data can be accessed via MAS 711 for immediate analysis using a standard web browser on a PC (no special software required), or alternatively transferred to a higher level system such as a SCADA system.

With the many functions and features of MAS 711, you have Flygt's decades of knowledge and experience in monitoring and control of submersible pumps literally at your fingertips.

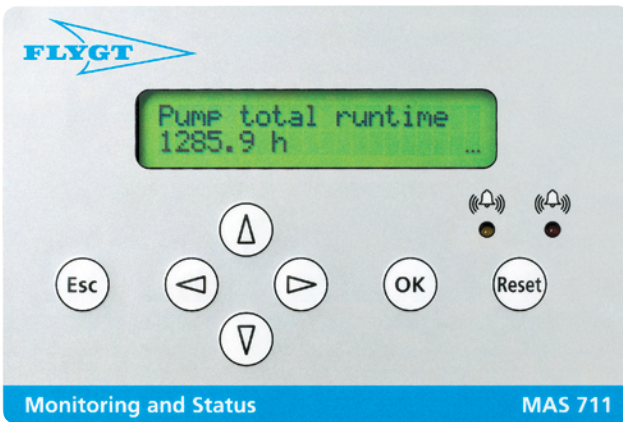



## Monitoring & Control Supervision Units

### MAS 711

#### Benefits

- Communicates with the pump's memory for fast and easy, 'plug-n-play' installation and routine back-up/synchronization of operation data and settings
- With its ethernet, Modbus and modem communications ports, MAS 711 can communicate with most Supervision Control and Data Acquisition (SCADA) systems on the market
- MAS 711 monitors and stores measurements from the customer's selection of factory-installed sensors
- Settings for the customer's selection of sensors are factory-preloaded. These are uploaded to the base unit at installation, greatly simplifying set-up and assuring safety through the use of appropriate alarm limits based on Flygt's decades of experience
- Routinely backs up operation data from the pump memory. Based on this data, MAS 711 can be set to prompt for servicing via the operator panel display on a preset date, or after a set number of starts or operating hours – for high availability and low maintenance costs
- Should the pump be modified during its life, relevant data, service notes, etc, can also be recorded and stored in the pump memory via MAS 711

## MAS 711 continued

### What happens if an alarm is triggered?

When an unhealthy condition arises, MAS 711 triggers an alarm and may also stop the pump. A flashing light on the operator panel alerts the operator and a text appears in the display describing the alarm.

The alarm is also added to the alarm list on a browser page accessed from the base unit. Clicking on a purple alarm allows the operator to display one or more graphs of the data measurements leading up to and surrounding the alarm.

Trained operators can then use this data to establish the cause of the alarm and take appropriate remedial action. If necessary, the operator then restarts the pump with the reset key.

---

#### Glossary of terms

**Ethernet** - communication system for local networks

# FGC

## Overview

The FGC is a compact and robust, single or dual pump controller for systems up to 5,5 kW that you can modify and accessorise according to your pump station's specific needs. The affordably priced FGC controller is perfect for small residential areas in almost any location and is ideal for pressurized sewage systems.

Features such as display, communication, outdoor cabinet or other accessories can be added as needed.

## Model Selection Guide

The range is shown in the table below:

		FGC 300, S	FGC 300, M	FGC 300, L	FGC 200, S	FGC 300, M
Size (HxWxD)	W	180	360	400	130	255
	H	255	255	300	180	180
	D	100	150	180	85	100
Application						
<4,5 kW at 400 V		•	•	•	•	•
<4,5 kW at 400 V		1	1	1		
1-pump		•	•	•	•	•
2-pump		•		•		
Display		•	•	•	•	•
No display		•	•			
Communication		*	*	*		
Extra space for breakers			•	•		•
Accessories		2	2	2	3	3

**KEY** 1 = Only single pump running over 4,5kW at 400V  
 2 = (FGC 300) Communication module, high performance battery, hand held terminal, hour counter, high level sensor, relay card, LON, audible alarm unit, cast bell, pneumatic level sensor  
 3 = (FGC 200) High level sensor, audible alarm unit, cast bell, pneumatic level sensor  
 \* = Optional



# Monitoring & Control Pump Controller

## FGC

### Features

- Data is provided via mobile phone, telephone line or radio
- Alarms are displayed locally in the alarm log and are instantly delivered via SMS or to a SCADA system
- EX-mode
- Backup control
- Starting and power on delay
- Stopping delay
- Flexible level control
- Motor protection
- Built in overload protection and supervision of net and phase failures
- A built-in heater
- Menus to specify the pump operating sequences e.g. alternation
- Maintenance run
- Supervision of level sensor

### Benefits

- FGC keeps you informed at all times
- Together with a SCADA system, you can expect reduced operational costs and total control of your entire pumping station
- EX classified environment, prevents the pumps from starting if no liquid is detected in the sump
- A backup function intervenes to start a secondary pump when receiving a high level signal.
- Starting and power on delay prevents the pumps in an installation from starting simultaneously to limit the total start current
- Works together with both pressure and level switches



## Monitoring & Control Supervisory Services

### PumpAlert

#### Features

- Intelligent Rota Awareness
- Weekly preventative 'dial out' checks
- Internet access and control – via SCADA system
- Sends either text message or e-mail or both (no other system has the capability to send distress e-mails)
- Alarm information includes vital station statistics (dependant on other M&C devices fitted such as level monitoring etc)
- Full range of communication options
- Small and compact

#### Benefits

- Developed by Flygt for pumps
- Gives greater remote control and access to remote stations/installations
- Signals can be routed through our 24 hour service centre and be instantly managed
- Can be linked to our service contract system for greater piece of mind
- Minimised downtime and operational fees
- Remove the worry and increase operational effectiveness
- Reduced risk of pollution or flooding incident
- Monitoring and repair 365 days a year 24 hours a day (if used in conjunction with our service team)
- This can be fitted to any brand of pump, not just Flygt

# PumpAlert – Supervisory Services

## Overview

PumpAlert has been developed to intelligently raise alarms when a fault is detected. It is ideal for monitoring remote stations and equipment and helps to minimise routine maintenance checks.

## The options in more detail

**Option 1.** A text message or e-mail to the customers' designated engineer or recipient. Multiple recipients can be activated to receive the alert thanks to the intelligent rota system. No need for the information to be handled by the Xylem Water Solutions Service Department.

**Option 2.** A signal from the control device sent to our customer care centre tells us to call your customers' designated person with a request to visit the premises after having interrogated the pump on-line. Your customer will be given the option and a quote for Xylem Engineers to attend your site and carry out the work required.

**Option 3.** We receive all signals and Xylem Engineers carry out any necessary work meaning your customers' pump can be repaired in the fastest possible time\*.

\* Work carried out to a pre-agreed spend level to ensure your customers' costs are controlled.



## PumpSmart

### Features

- Pre-programmed for wastewater pumping
- Communicates with other pump controllers and SCADA systems
- Increased pump efficiency
- Energy savings – adjusts pump speed to system demand
- Advanced pressure control
- Integrated PID control
- Cavitation control – not found on other standard VFD systems
- Improved system reliability – reduces stresses on electrical and hydraulic systems
- Enhanced process control – matches flow and head to system requirements
- Greater flexibility – optimises dimensioning in new and retrofit installations
- Automatic backflushing
- Sensorless flow measurement

### Benefits

- Less clogging, less trouble, more output
- Using a standard variable frequency drive usually means derating pumps but with PumpSmart you can expect all the advantages of speed regulation, plus top pumping efficiency
- A standard VFD can be used in many different applications and a large number of parameters need to be set – manually. However, as pump experts, we know exactly what our customer needs. So, we preset almost 90% of the parameters that they need to drive their pumps
- To reduce the risk of clogging, we have developed a special program to help keep impellers clean. When a PumpSmart senses an excessive load, it triggers a cleaning sequence to free the impeller of build-up. Not only does this improve reliability, it also means fewer emergency call-outs

*continued overleaf*

# PumpSmart – Variable Frequency Drives

## Overview

A standard variable frequency drive can be used in dozens of different applications but regulating pump speed is not easy: to avoid problems you need to pay special attention to flow and head.

Flygt PumpSmart is a concept that has been tailored for driving wastewater pumps specifically.



## Main Applications

- Wastewater pumping
- Water supply
- Process water
- Sludge pumping
- Mixer applications
- PD pumping
- Other

Although PumpSmart is made for working together with Flygt pumps it can also be used with centrifugal or positive displacement pumps from any manufacturer.

Changing the speed of a pump with a relatively flat head capacity curve is no easy matter. That's because a small adjustment can lead to a large swing in flow. The result can be unstable flow, which can make control difficult. So, instead of changing the speed, PumpSmart varies pump flow by altering torque. This transforms a relatively flat performance curve into a steep one that is easy to control.

### Glossary of terms

**PID** - Proportional Integral Derivative.

**Algorithm** - A process or rule for calculation.



## Monitoring & Control Variable Frequency Drives

### PumpSmart

#### Benefits continued

- Sensorless flow-meter – captures more data without having to invest in a separate flow-meter. PumpSmart gives sensorless flow measurement that is accurate to within  $\pm 5\%$  of the rated flow. PumpSmart is able to capture real-time data such as speed, torque and power and use this information to calculate the flow of the pump

# PumpSmart continued

## Integrated PID control cuts installation costs

Flygt PumpSmart offers an integrated controller that automatically controls the pump by analysing feedback from a process transmitter. Since it is pre-programmed with pump specific algorithms, Flygt's PID control is quick and easy to setup.

PumpSmart is ideal for all pumps that can benefit from simple and automatic control.

Typical applications with PID control include pressure, flow, level, temperature and differential pressure. Not only does integrated PID control increase system reliability, but as an integral part of PumpSmart it cuts installation time and costs.

## Multi-pump control cuts energy bills and boosts reliability

In some multi-pump systems, all the pumps are set to run all the time. This leads to high vibrations, pressure build-up and, not surprisingly, excess energy consumption.

PumpSmart does things in a SMART way by only running the pumps that are needed at the time. In addition, it ensures that flow is balanced between the pumps that are in operation.

The advantages with multi-pump control are two-fold, you get lower energy bills and you boost the reliability of pumps and the surrounding system. PumpSmart can be used to coordinate the operation of 2 to 4 pumps.

To protect the pump you should pay special attention to:

- Variable torque load
- Mechanical losses
- Volumetric efficiency
- Eddy current losses
- Pump wear
- Casting variations
- Pump type (Ns)



# Compact Range of Panels

## Overview

A comprehensive range of pump control panels from the simplest type with basic start and stop functions to highly sophisticated, intelligent Smart panels using state-of-the-art monitoring and control systems, developed by Xylem.

## The Range

### Economy

Compact control panels

A range of economy Single and Three phase Direct Online (DOL) control panels for the automatic or manual control of one or two pumps with level control via Flygt ENM10 level regulators or NFS float switches.



### Basic

This is our basic model with start and stop functions, single or 3 phase DOL or ASD, for up to 2 pumps in duty/standby or duty assist.

As with all our panels it comes prewired for connection to a telemetry unit which will inform the operator if there is pump failure.



### Standard

Takes the basic Compact and incorporates an 'intelligent' Flygt APP 521 pump controller to monitor and control pump operations, whilst tracking and recording the pumps operation and performance at all times.



### Advanced

Takes the basic compact panel to a new dimension when using Variable Frequency Drives by including Smart monitoring and control.

Provides a turnkey solution to customers using our PumpSmart suite of software solutions.



## Compact Range Of Panels

### Features and Benefits

#### Economy Range

- Door interlocked main isolator
- Hand-Off/Reset-Run selector for each pump
- Pump Running Indicator for each pump
- Pump Tripped Indicator for each pump
- High Level Alarm Indicator
- Duty / Assist operation for Dual pump panels
- Terminals for connection of a alarm remote beacon
- Combined overload and short circuit protection for each pump
- Motor over temperature protection for each pump
- Non simultaneous starting for dual pump panels
- Volt free contact for a common pump failed alarm

#### Basic Range

- Basic operation with start and stop functions for up to 2 pumps in duty
- 10 variants to choose from including for use with ATEX certified pumps
- Single and Three Phase
- Front panel indication
- Automatic or manual control
- Audible alarm
- Prewired for energy saving optional accessory
- Prewired for connection to telemetry or building management system
- Simple to install and operate. Local front panel indication of pump status
- Can be used with centrifugal or positive displacement pumps from any manufacturer

#### Standard Range

- Takes the basic Compact and incorporates an 'intelligent' Flygt APP 521 pump controller that will monitor and control pump operations whilst tracking and recording the pumps operation and performance at all times
- 4 variants to choose from including for use with ATEX certified pumps
- Up to two pumps
- Three phase only

*continued overleaf*



## Monitoring & Control Pump Control Panels

### Compact Range Of Panels

#### Features and Benefits continued

##### Standard Range

- LCD display
- Automatic or manual control
- Prewired for energy saving optional accessory
- Prewired for connection to telemetry or building management
- Simple to install and operate
- Can operate from level switches or analogue level inputs
- Provides a 24/7 'virtual engineer' at site monitoring the pumps during operation
- Provides clear and defined information to the operator via a display in the front panel
- Can provide details of inflow, outflow, overflow, pump capacity, and sump level data - from one level input
- Can be used with centrifugal or positive displacement pumps from any manufacturer

##### Advanced Range

- Takes the basic compact panel to a new dimension when using Variable Frequency Drives (VFD) by including Smart monitoring and control
- Provides a turnkey solution to our customers using our PumpSmart suite of software solutions
- 8 variants to choose from including for use with ATEX certified pumps
- One or Two pumps
- Three phase only
- LCD display
- Automatic or manual control
- Prewired for connection to telemetry or building management system
- Increased pump efficiency
- Energy savings – adjusts pump speed to system demand
- Improved system reliability – reduces stresses on electrical and hydraulic systems
- Monitors and displays flow
- Enhanced process control – matches flowhead to system requirements
- Can be used with centrifugal or positive displacement pumps from any manufacturer

# Compact Range of Panels Continued

## Monitoring

By using Flygt pump controllers in your control panel, without any additional equipment, you can accurately and efficiently monitor the status of the pump station through pump status, number of pump starts, pump run time, pump capacity, operating trends, pump station inflow, outflow and overflow.

## Control

Our Basic 'Compact' control panel has the start/stop function activated by floats or level switches.

Moving up to the Standard 'iCompact' control panel with a state-of-the-art Flygt pump controller which can operate from level switches or an analogue level sensor. The pump controller offers a range of flexible control systems and is capable of providing logged data including; pump status, number of pump starts, pump run time and local alarms; up to highly sophisticated monitoring and control systems with advanced data logging to provide statistics and trend reports. In addition, all Standard 'iCompact' control panels can be configured to run regular cleaning cycles automatically.

Our Advanced 'SmartCompact' control panel is tailored to incorporate Variable Frequency Drives (VFD) and provides the complete solution for connection to your pump. PumpSmart software provides motor operating and control characteristics for driving wastewater pumps at optimum efficiency in wastewater applications.

## SCADA Systems

For full remote control of your pump stations, it is essential that you are connected to a SCADA system. Flygt's own SCADA system, 'AquaView', can reduce operation and maintenance costs by providing you with a complete picture of your system. It minimises the need for onsite supervision and gives operators an effective picture of the pump station's function, performance and through trend analysis, enables condition assessment, without the costs associated with inspecting the pumps.

## Communication

Flygt Control Panel Range\* offers a range of options for communication links with a remote operator and/or SCADA system using industry standard protocols including WITS, MODBUS, COMLI over dedicated or dial-up phone line, Ethernet (IP), radio link or GSM/GPRS (mobile phone) systems.

### Easylift

#### Features

- Easy and quick to assemble
- Conforms to the working at heights regulation
- Stable construction
- Load can be moved without needing to pull the equipment from its centre of gravity
- Operative is safe and secure

#### Material

- Lightweight Aluminium

#### Accessories

- Transport trolley
- Load Locking pin
- Fall arrest unit
- Man riding bracket & winch
- Electric motorised chain hoist
- Spreader beam\*

#### \*Spreader Beam

This unique accessory allows the easy removal of manhole covers and other access points. A range of keys are supplied, which simply connect to the cover via the spreader beam. The Easylift is then used to safely lift the cover up and away from the open access point in the ground.



# Easylift

## Overview

The Easylift is a versatile portable frame, designed to meet the working at heights regulations. Easylift has been designed to lift a pump out from a sump in a safe manner and for the operative to then simply slide it to one side for safe inspection. To ensure the safety of the operative, a fall arrest harness can be attached to the frame which also has been designed for single man riding.

## Main Applications

- Working on pumping stations
- Working over open man holes
- Confined space entries
- Man riding & retrieval



## Features

- Man riding

Easylift has a single man riding trolley point located under the main beam which allows the operative to slide over the open area ensuring that it does not limit the movement of the operative.

- Level adjustment

A built in spirit level helps the operative ensure that the Easylift frame is level before use.

- Load trolley

The sliding trolley allows the operative to slide the pump to a safe working area to the side of the opening in the ground. This fully conforms to the latest lifting regulations and ensures the safety of the operative by eliminating the need to pull the load away from its centre of gravity.

- Fall arrest

Two fall arrest points are located on the main beam and provide a stable point for operatives. It can utilise an inertia type fall arrest device.

- Adjustable size

Both the height of the legs and the length of the beam can be adjusted. This allows the operative to increase or decrease the size of the footprint dependant on the space available to work.

- Simple assembly

Easylift is designed so that it can be erected safely by one person. It is designed to be stable even during assembly.



# Flygt spare parts

Extend the life of your Flygt products and ensure you achieve maximum efficiency and performance.

Make sure you get official spare parts direct from Flygt.



Call : 0115 940 0111

Email: [spares@flygt.co.uk](mailto:spares@flygt.co.uk)



# Service

## Repair and maintenance

Providing our customers with a fully comprehensive aftercare service is a core element to our offering.

Across the UK we have strategically located workshops, manned by experienced, professional technicians. Our aim is to provide a 24/7 response which can involve both an engineer arriving on site to assess and diagnose, through to full strip down and repair of the pump or mixer in our workshop.

Our service teams have their own fleet of vehicles that carry all necessary equipment to carry out basic repairs on site. Our engineers are experts in their field and can work with all major brands.

At the heart of our whole life cycle management is preventative maintenance. Within our service offering we can provide annual maintenance contracts that will meet your needs and budget; in fact we can go as far as offering you fixed priced repairs on Flygt pumps.

## Installation and commissioning

Flygt Service goes beyond just providing maintenance and service!

Our service team is experienced in the refurbishment of pump stations and the installation and commissioning of supplied product. The company is an NICEIC approved contractor.

On larger schemes our service team will join forces with our projects team, bringing together the 'know how' and skills to deliver complex refurbishments involving a cross section of our products, including; pumps, monitoring and control, UV lamps, and diffusers from the range of brands we offer.

## Service Structure

Service is split into two areas, on-site and workshop departments with a central administration function supporting both in Nottingham. The administration department consists of a customer care centre with a team answering customer calls, schedulers who manage the workload for their respective area and service contract and quotation administrative support.

The site repair business is split into four regions (North, East, South East & South West) and have an area manager, home based site engineers and a Nottingham based scheduler.

The workshops are split into two areas (North & South) and have an area manager and a Nottingham based scheduler who will coordinate with the customer.

Customer response is available 24/7, 365 days of the year.

## Sales support

The service department also supports sales and marketing for things like installations, try and buy schemes, undertaking pump conversions and modifications and providing on site assistance and expertise. To take advantage of these support functions please contact your service area manager or the central team.

## Maintenance Contracts

We offer a broad selection of planned maintenance service contracts to meet our customers requirements. From a Bronze agreement providing annual (various visit frequencies are available) inspections through to fully comprehensive Gold contracts that include parts and labour allowing costs to be budgeted.

### Bronze

A Bronze contract allows for one annual maintenance visit. All parts used and other site visits etc. are charged extra to the contract. Bronze contracts are available for any model and make of pump.

### Silver

With a Silver contract for one payment you will receive one free maintenance visit from our engineers per year. Routine maintenance spare parts are included but limited to impeller, wear rings, o-rings and oil. Customers on this contract benefit from knowing they are covered for the prime wear parts when they need replacing. Only available on Flygt pumps.

### Gold

Under the Gold contract the customer receives their comprehensive maintenance visit with all pump/panel spares included. Any breakdowns between regular services are included so customers can leave all the maintenance of their pumping station to Xylem. Only available on Flygt pumps.

For tendering or contract purposes service contracts can be offered as part of a larger bespoke total solution offering. Please contact Nottingham for further details. To help please have the number and model of pumps you intend to offer.

\*Standard additional charges apply for site attendance associated with pump blockages, power failures, abortive visits and vandalism.

Larger customers can benefit from bespoke arrangements to suit their individual requirements.



## Pump Alert

As an addition to our preventative maintenance contracts, we now offer remote pump monitoring and alarm notification, utilising equipment from our monitoring and control division.

Our Pump Alert system comprises of a Monitoring & Control outstation installed in the customer's control panel that communicates to our central AquaView system. In the event of an alarm, the customer can choose to have an email or text sent directly to a nominated contact or through to our service customer care centre who will contact the customer or arrange to attend site.

Pump Alert offers differing levels of service as an option to the current service contracts. Pump Alert should be offered where it is difficult to monitor an audio or visual alarm.

**Pump Alert can be sold stand alone via our Monitoring & Control team.**

## Workshop Repair

Xylem have a national network of strategically located repair centres staffed by experienced engineers offering a top quality repair for their equipment (non-Flygt pumps are also repaired). All our repairs come with a 12 month warranty on the whole pump and not just the parts replaced.

Our repair centres are able to undertake Ex and ATEX approved repairs, allowing all Flygt products to **maintain the original certification** rather than a repairer's generic certificate, thus providing end users with the peace of mind of a fully auditable route.

Both workshop or on-site N pump conversions can be undertaken allowing older pumps to benefit from new technology without the expense of a new pump.

Also available are pump adaptations to allow Flygt pumps to fit most other manufacturers submersible configurations.

## Fixed Price Pump Repair

Our fixed price pump repair allows the customer to get their pump repaired as quickly as possible minimising downtime. When the customer calls in with a repair, a price can be advised promptly for their pump to be repaired and once it is in our workshop the pump will be stripped, assessed and repaired without the need for a quotation.

Fixed price repairs are available on Flygt pumps up to 70kW, but if you have a larger pump then please call the workshop area manager to discuss your requirements.

## Pump Station Refurbishment

Our nationwide network of experienced field based site engineers are available to undertake pump station upgrades and refurbishments.

The Xylem Water Solutions service business has extensive experience of pump station refurbishment ranging from simple replacement of stools and guide rails through to full station refurbishment and optimisation including mechanical (utilising selection of the latest pumping technology), electrical, monitoring & control and minor civil works.

# Rental

Xylem specialises in the rental of Flygt electric submersible pumps, mixers, aerators, Godwin prime assisted diesel pumps and Wedeco and Sanitaire treatment systems.

We are unique in the market place, as we only rent pumps that we manufacture and therefore with unprecedented technical backup.

Our skilled team of engineers design bespoke pumping and treatment systems, whether temporary or semi-permanent, for anything from a small amount of nuisance water to the movement of sewage and major flow diversion schemes.

By choosing Flygt Rental, you gain automatic access to a wealth of experience and technical knowledge. Our engineers can assess your needs, design your pumping system and install it.

Flygt Rental also offer a 24/7 rapid response service, with fully owned transportation including lifting cranes and regional depots located throughout the UK.

For more information contact our national call centre on 0845 707 8012.

- 24/7 emergency response capabilities
- National coverage with 12 regional centres
- Rent directly from the manufacturer
- Rapid response
- Expert technical assistance
- Largest fleet of ATEX certified pumps available to rent



# Regional map & locations

## Key

- Scotland
- North East
- North West
- Midlands
- South West
- Anglian
- Thames
- Southern
- Northern Ireland
- Republic of Ireland

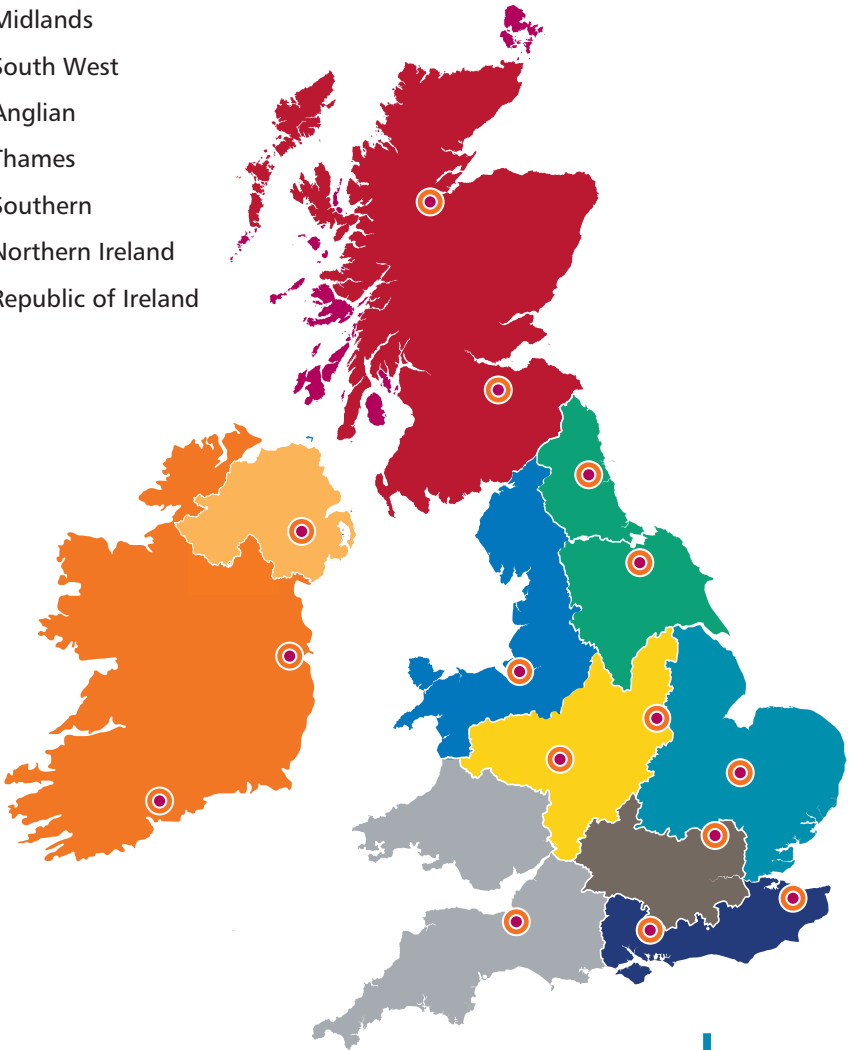

Please Note: The regions shown are for guidance only

**xylem**  
Let's Solve Water

# TotalCare

Xylem TotalCare is a comprehensive, integrated portfolio of services that ensures your business keeps running at its best. Our portfolio comes backed by deep systems knowledge and expertise in water and wastewater applications, which gives you operational security and more time to focus on your core business.

## Solutions expertise

Access the deep system expertise and know-how built into Xylem product brands to ensure they're always up and running. Our standardized service packages let you use our service and support on your terms.

## Select the service level you need

Our standardized service packages meet your every need - from the very basic to the advanced. The more basic the service, the easier on your budget. The more advanced, the greater your peace of mind.

## Reliable service

Our global expertise and local presence means you can rely on us as your trustworthy partner. We assure prompt service delivery worldwide. With Xylem TotalCare services, you're just one phone call away from integrated service and support that you won't find anywhere else.





## Design & Consultancy

Access the deep system expertise and know-how built into Xylem product brands to ensure they're always up and running. Our standardized service packages let you use our service and support on your terms.



## Monitoring & Supervision

Save time and money through efficient management of individual installations or your entire plant. We provide basic alarm distribution as well as optimization and performance benchmarking services.



## Repair & Maintenance

Our standardized service packages meet your every need - from the very basic to the advanced. The more basic the service, the easier on your budget. The more advanced, the greater your peace of mind.



## Maintenance Contracts

Use a cost-effective service level agreement to enhance operational reliability through preventative maintenance of your equipment and various warranty options.



## Installation & Commissioning

Our global expertise and local presence means you can rely on us as your trustworthy partner. We assure prompt service delivery worldwide. With Xylem TotalCare services, you're just one phone call away from integrated service and support that you won't find anywhere else.



## Inspection & Auditing

Minimize downtime and maximize profitability with regular inspections by our qualified service engineers. Services also include audits for energy efficiency, equipment condition and reliability.



## Plant Operation & Maintenance

Focus on your core business and entrust us with plant operation and maintenance. Our experts provide broad services from effective troubleshooting and root cause analysis to partial or full turnkey responsibility.



## Training & Technical Support

Make sure your equipment operators and service staff have the knowledge and skills to optimize equipment and plant performance. Let our engineers provide the training and technical support you need.



## Asset Refurbishments

Protect the value of your ageing assets and minimize capital expenditures. Upgrade a single piece of equipment or renovate your entire plant by conducting a site audit and designing anew.



## Rental & OnSite services

Rent best-in-class dewatering or bypass pumping equipment on your terms without the capital expenditure costs. Choose from short-term, long-term, try-before-you-buy and everything in between.



## Parts & Logistics

Enjoy the peace of mind that comes with knowing the equipment and spares you need are always on hand and readily available - whether for regularly scheduled maintenance or emergency callouts.



## Financial Solutions

We can offer bespoke solutions to suit your budget.

For more information on how TotalCare can help your business, contact 0115 940 0111 or visit [www.xyleminc.com/totalcare](http://www.xyleminc.com/totalcare) to find out more.



# Who's who in Xylem?

## Water Solutions

Provide a range of wastewater and dewatering pumps, biological treatment, filtration and disinfection products for municipal and industrial wastewater movement and treatment.

We help with the efficient movement of water and its treatment within the municipal market and maximise water usage and the impact on the environment for our industrial customers.

## Flow Control

Provide highly engineered pumps and valves for specific industrial uses, particularly in harsh environments where durability is essential.

We serve the marine, beverage dispensing, hygienic, oil & gas, specialty industrial and rural markets including solar applications.

## Analytics

Quality instruments for precise measurement for the use in industry, education and environmental work

We use advanced analysis instruments to ensure that water is pure for drinking.

## Residential and Commercial Water

Support the efficient movement and use of water in homes, commercial buildings, light industry and agriculture and irrigation.

We help heat and cool buildings, push water to the tops of skyscrapers and remove wastewater with our powerful water systems.

**LET'S SOLVE WATER.**

**LET'S PUSH IT**  
UP 80-FLOOR BUILDINGS  
AND UP AND AWAY FROM  
3,000-FOOT MINESHAFTS.

LET'S TURN UNLIVABLE LAND INTO  
**ABUNDANT FARMLAND.**

**LET'S**  
ANALYZE,  
PURIFY AND  
**REUSE**  
WASTEWATER.

LET'S CHANNEL THE ENERGY AND  
THINKING OF 12,000 DEDICATED PEOPLE.  
LET'S UNITE FOR A COMMON PURPOSE:  
**INNOVATIVE SOLUTIONS TO  
GLOBAL WATER CHALLENGES.**