



WIENER Product Catalog

Electronics for Research and Industry

wiener
Power Electronics

Werk für
Industrie-
elektronik
Nuklear-
elektronik
Regelungs-
technik



Company

For more than 50 years WIENER has followed the tradition of developing new technologies in advanced electronics for the benefit of science and industry. In the half century between 1959 when the company was founded by Hans Wiener and now the staff members created an impressive range of high sophisticated products with innovative spirit and technical excellence. This catalog shows the current versions of our products.

From the beginning WIENER worked closely with nuclear physics laboratories. As a result development and production of NIM crates and electronics started in the 1980's. CAMAC modules and crates came in addition, followed by FASTBUS, VME and VXI, VME64x, VIPA and today's high-speed switched fabric technologies. Furthermore, WIENER began to specialize in custom high quality multi-channel power supplies for medium and high power applications.

WIENER crates and power supplies are known to provide the highest possible power output combined with lowest noise and are built with highest quality. Featuring modular construction and incorporating a unique level of local and remote diagnostic and control tools, WIENER products are state of the art and often are used as design reference.

All our products meet the requirements of the leading research centers around the world. We produce in accordance with ISO-Quality standards and CE rules.

The LHC activities led to the development of new radiation hard and magnetic field tolerant power supplies and special VME- and other crates. Since 2006 WIENER shipped about 2000 crates and power supplies, standard and radiation-hard versions, for the CERN LHC experiments.

During the 20 years of Manfred Plein's chairmanship WIENER became an internationally distinguished supplier for electronic instrumentation for Particle Physics and related science with a worldwide operating sales and service network.

Since 1992 the company has operated as "WIENER, Plein & Baus GmbH" under the ownership of Manfred Plein and Jürgen Baus. The USA sales and support center "WIENER, Plein & Baus, Corp." was established 1997 in Ohio in order to service the North American market.

In 2008 the WIENER companies became subsidiaries of the Phoenix Mecano AG, a Swiss based global player in the components, packaging and electronics market. Phoenix Mecano components and enclosures are found in German high speed trains as well as in Airbus airplanes. They are used in the automotive industry, the home and hospital care sector and in all areas of the machine and electronics industry.

Future synergies with our sister company Hartmann Elektronik, a specialist for bus backplanes, as well as with other companies of the Phoenix Mecano group will benefit development and production of new technologies. In this path WIENER will continue to serve the scientific research community and industry customers with excellent, high quality and state-of-the-art electronic instrumentation, chassis and power supplies.

We invite you to browse our catalog and look at our products. Please contact us or one of our representatives in Europe or Overseas if you are interested in our products.

Worldwide – Industrial Electronics – Nuclear Electronics – Resources

W-IE-NE-R, Power Electronics GmbH

Linde 18

D - 51399 Burscheid, Germany

Tel (+49) 2174 678 0

Fax (+49) 2174 678 55

www.wiener-d.com

info@wiener-d.com

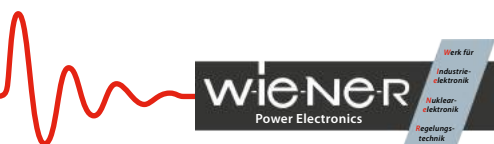

A Phoenix Mecano Company

WIENER World-wide Sales Network

Head Quarter

W-IE-NE-R, Power Electronics GmbH
Linde 18
D - 51399 Burscheid, Germany
Tel +49 2174 678 0
Fax +49 2174 678 55
info@wiener-d.com

Australia

Nu Scientific
P.O. Box 3384
Wareemba NSW. 2046., Australia
Tel +61 438754546
Fax +61 (2) 96471566
sales@nuscientific.com.au

Belgium

ISI INTERCONTINENTAL SERVICES INC.
Rue du Doyenne 3
Dekenijstr. 1180 Brussels, Belgium
Tel +32 (2) 343 30 81
Fax +32 (2) 343 12 05
isi@unicall.be

PEO B.V.

Postbus 194
6600 AD Wijchen, Netherlands
Tel +31 (0) 24 648 86 88
Fax +31 (0) 24 366 19 84
info@gotoPEO.com

Canada

W-IE-NE-R, Power Electronics Corp.
202N Limestone Street, Suite 320
Springfield, OH 45503, USA
Tel +1 (937) 324 2420
Fax +1 (937) 324 2425
sales@wiener-us.com

P.R. of China

Mecano Components (Shanghai) Co., Ltd.
No. 1001, Jiaqian Road, Nanxiang,
Jiading District,
Shanghai, China, 201802
www.ni-group.com.cn
Tel +86 21 69176590-217
Lambert.Hu@mecano.com.cn

France

Ludovic RUSE/ PHYSICAL Instruments
47, Chemin du Vieux Chene
38240 Meylan, France
www.physical-instruments.fr

India

PARSRAM & COMPANY PVT. LTD.
C-5E, 207, "Keshava",
Bandra-Kurla Complex,
Bandra (East),
Mumbai- 400 051, India
Tel +91-22 2659 0288 / 2659 1600
Fax +91 22 2659 1119
parsram@vsnl.in

Italy

**Technology Nuclear Electronics (TNE)
S.p.A.**
Via Leonardo da Vinci, 11
I - 20060 Cassina de Pecchi (MILANO), Italy
Tel +39 029 5299 309
paolo.rizzacasa@tnenuclear.com

Japan

REPIC CORPORATION
1-28-3, Kita Otsuka, Toshima-ku
Tokyo, 170-0004, Japan
Tel +81 33918 5110
naoi@repic.co.jp

SEIKO EG&G Co. Ltd

Sales and Administration Dept.
Grande Bldg., 2-26-9, Hatchobori,
Chuo-ku, Tokyo 104-0032, Japan
Tel +81 47 392 7888
norihisa.fujioka@sii.co.jp

Korea

WIENER-K Inc.
#209 Gaya Sanga,
Sanho-dong, Changwon-si
Gyeongnam, 631-764, Korea
Tel +82 (0) 70 8843 5569
Fax +82 (0) 10 2890 1123
wiener_k@naver.com

Mexico

W-IE-NE-R, Power Electronics Corp.
202N Limestone Street, Suite 320
Springfield, OH 45503, USA
Tel +1 (937) 324 2420
Fax +1 (937) 324 2425
sales@wiener-us.com

Netherlands

PEO B.V.
Postbus 194
6600 AD Wijchen, Netherlands
Tel +31 (0) 24 648 86 88
Fax +31 (0) 24 366 19 84
info@gotoPEO.com

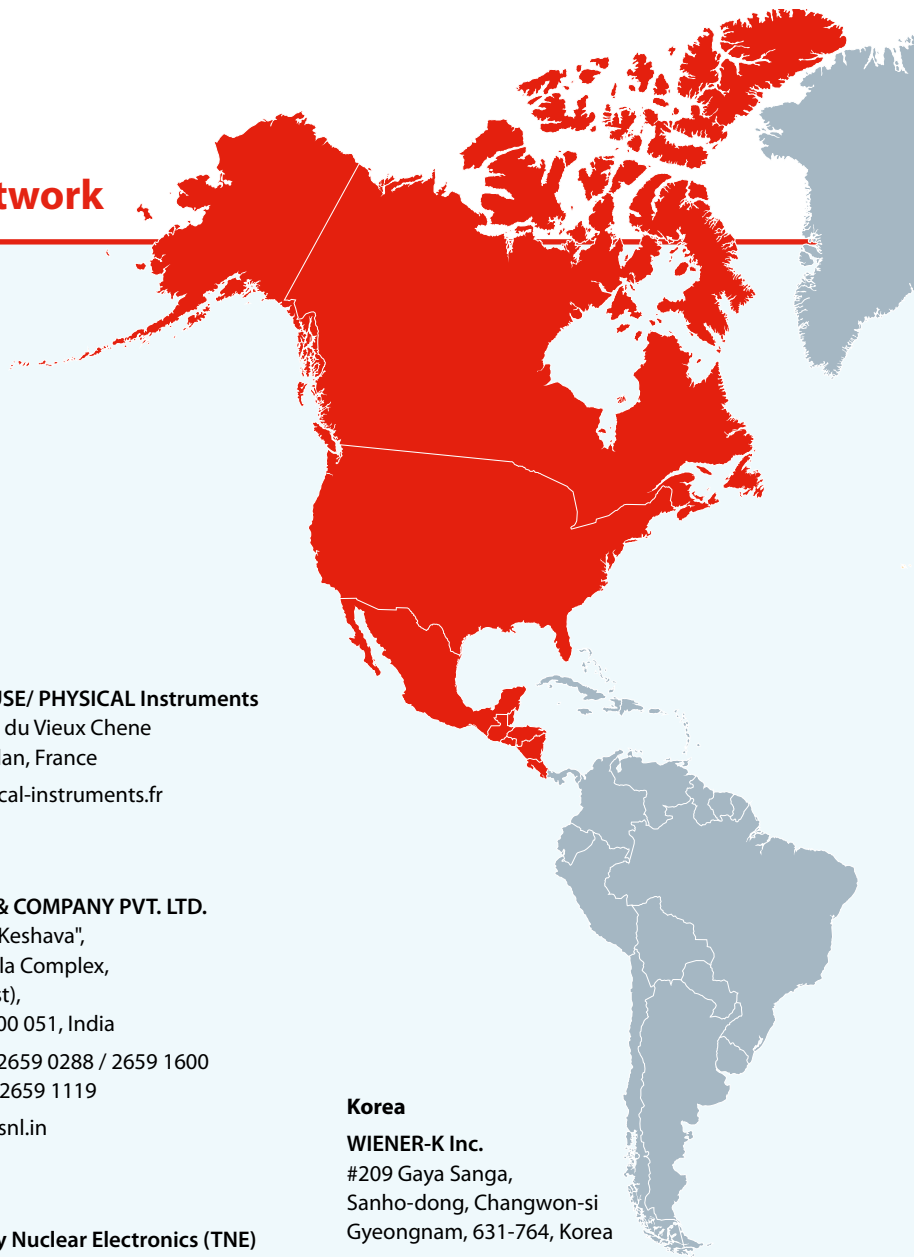

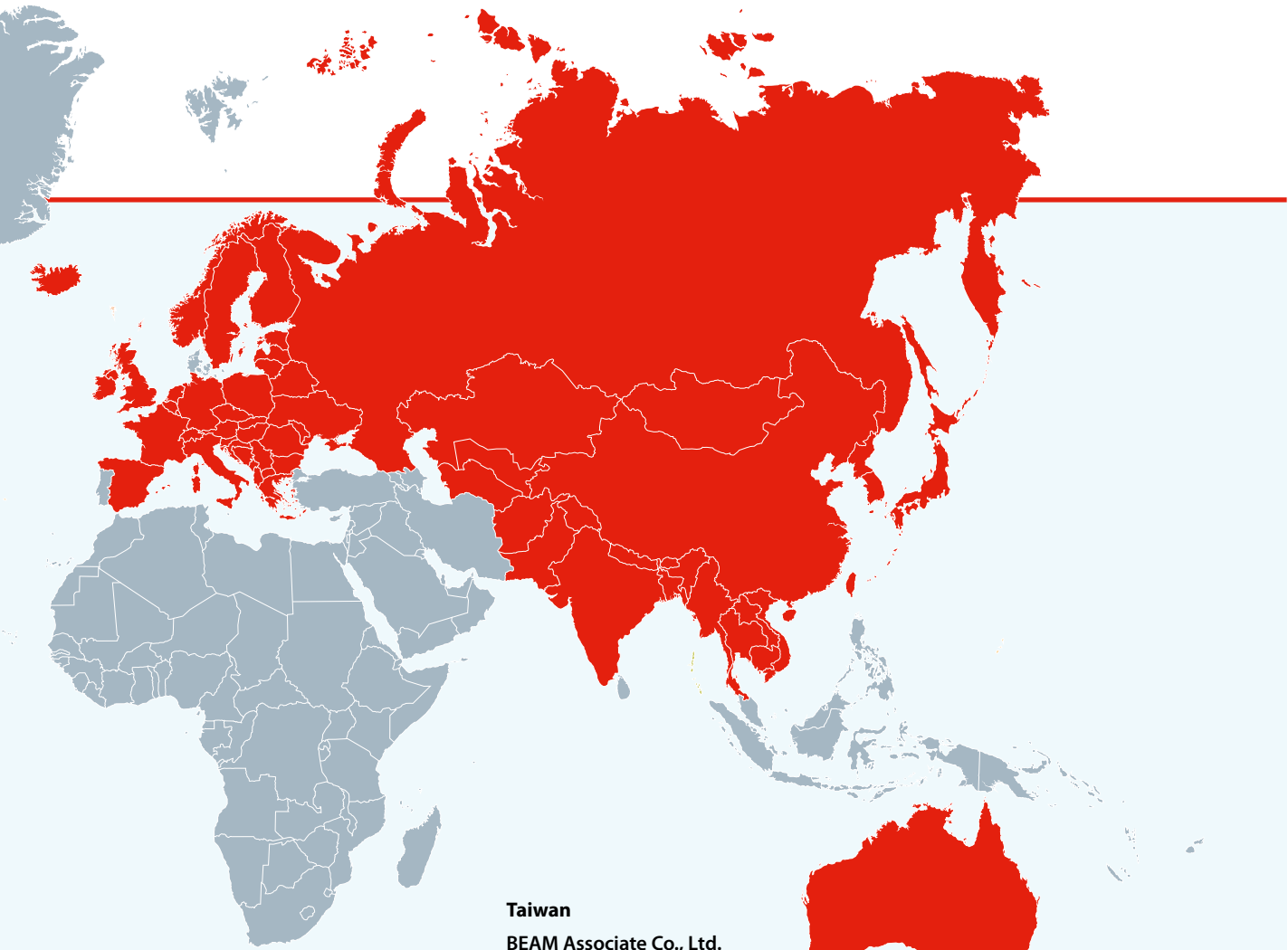

Romania

CORALGON Instruments
Str. Grigore Manolescu nr. 15-17
Bucuresti, Romania
Tel +407 45 932 499
bogdan.sacagiu@coralgon.ro

Spain

Aciron Tecnic S.L
c/ C/ San Bernardo nº122 planta 3
28015 Madrid, Spain
Tel +34 629 845 302
acirontecnic@acirontecnic.com

Switzerland

W-IE-NE-R Power Electronics
Linde 18
D-51399 Burscheid
Tel +41 754 114 301
Schaefer@wiener-d.com

Taiwan

BEAM Associate Co., Ltd.
3F-1, No.127, Lane 235
Bau Chiau Road
Shindian, Taipei 231
Taiwan, ROC
Tel +886 2 89191161
Fax +886 2 89191477
chris.lee@beamassociate.com

United Kingdom

Newwood Solutions Ltd.
15 Kings Croft,
Allestree,
Derby, DE22 2FP, England
Tel +44 (0)1332 721326
sales@newwoodsolutions.co.uk

Southern Scientific Ltd.
Scientific House, The Henfield Business Park
Shoreham Road
Henfield,
West Sussex, BN5 9SL, England
Tel +44(0)1273 497600
Fax +44(0)1273 497626
info@southernscientific.co.uk

United States of America W-IE-NE-R,

Power Electronics Corp.
202N Limestone Street, Suite 320
Springfield, OH 45503, USA
Tel +1 (937) 324 2420
Fax +1 (937) 324 2425
sales@wiener-us.com



Content of this Catalog

WIENER NIM & CAMAC Crates

Page **5**

WIENER VME / VXI / VXS and Customized Crates

Page **27**

Modules NIM / CAMAC / VME / VXS

Page **81**

WIENER Power Supplies

Page **93**

WIENER Remote Interfaces

Page **111**

Collaborations & Complementary Product Lines

Page **117**



NIM / CAMAC Crates

WIENER NIM & CAMAC Crates

Page

Introduction to NIM and CAMAC	6
NIM Crates	9
NIM Compact.....	9
NIM Portable	9
NIMpact Low Cost Series.....	10
NIM CERN spec. / CE	11
NIM CERN 6000 Crate Series	16
CAMAC Crates	17
CAMAC Mini Crate.....	17
CAMAC CERN spec. / CE.....	18
Technical details of WIENER NIM and CAMAC Crates	21
NIM Bins Compact	21
CAMAC Bin 7U.....	22
NIM CAMAC Fan Tray UEL03M.....	23
CERN Monitoring / CE Versions.....	23
NIM Power Supplies	24
CAMAC Power Supplies.....	25

Introduction to NIM and CAMAC

The Nuclear Instrumentation Module (NIM) standard defines mechanical and electrical specifications for electronics modules used in experimental particle and nuclear physics. First defined by the U.S. Atomic Energy Commission's report TID-20893 in 1968-1969, NIM was most recently revised in 1990 (DOE/ER-0457T).

The NIM standard provides a common footprint for electronic modules (amplifiers, ADC's, DAC's, discriminators, etc.), which plug into a larger chassis (NIM crate, or NIM bin). The crate must supply $\pm 12V$, $\pm 24V$ DC and 110V AC power to the modules via a backplane; the newer standard also specifies $\pm 6V$.

Full size NIM bins for 19" rack mounting have 12 slots and should be equipped with an excellent, low noise linear regulated power supply (150W ... 600W). Due to the low power consumption of NIM modules typically no forced air cooling is required. However, there are NIM modules with high power dissipation and heat production which benefit from a NIM bin with integrated fan tray for cooling.

In a step to further improve and standardize NIM crates and power supplies the European High Energy Physics Lab. CERN created in 1977 standards for modular NIM (CERN NIM-120-6U) and CAMAC (CERN CAMAC Note 46-04) crates with interchangeable power supplies and fan trays. Most of the WIENER NIM crates are compliant to the CERN standard.

Standard NIM modules are required to have a height of 222mm (8.75") / depth of 246mm (9.68"), and must have a width which is a multiple of 3.43cm (1.35"). Modules with a width of 3.43cm (1.35") are referred to as single width modules and modules with a width of 6.86cm (2.7") are double width modules, etc. On the lower rear side the module has a multi-pin connector, which plugs into mating one on the bin in order to provide the power to the module (see connector schema).

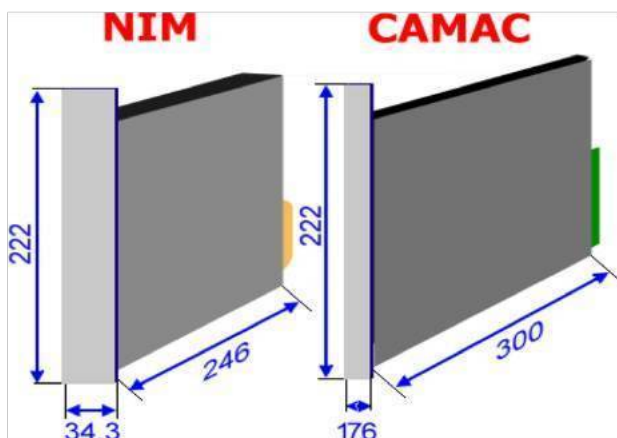

NIM is the perfect standard for small and flexible setups for high resolution measurements with analogue electronics (amplifier, high resolution analog to digital converter), timing modules, noise sensitive electronics as well as for low / high voltage supplies.

Taking advantage of modern high-speed serial interfaces as USB-2 or Ethernet today the NIM standard encounters a renaissance for universal test and measurement applications including high speed digitizers and complex logic and timing functions. Please see the WIENER NIMbox/Nembox series in NIM Modules chapter.

NIM standard module connector pins

Pin #	Function	Pin #	Function
1		2	
3		4	
5		6	
7		8	
9		10	+6V
11	-6V	12	
13		14	
15		16	+12V
17	-12V	18	
19		20	
21		22	
23		24	
25		26	
27		28	+24V
29	-24V	30	
31		32	
33	117 Vac (hot)	34	Power Rtn Gnd
35		36	
37		38	
39		40	
41	117 Vac (neutral)	42	High Quality Gnd
G	Gnd Guide Pin		

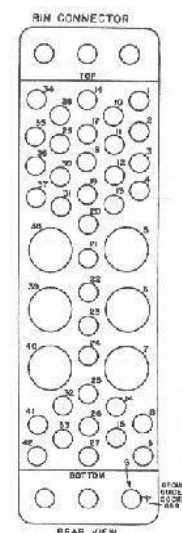

CAMAC - "Computer Aided Measurement And Control" is a joint specification of the U.S. NIM and the European ESONE committees for a modular, high-performance, real-time data acquisition and control system concept. CAMAC was introduced in 1969 by ESONE and fully defined in 1971 with the standards EUR4100 and EUR4600 / IEEE Standard 583-1982 (reaffirmed 1994) "Modular Instrumentation and Digital Interface System (CAMAC)". It represents a complementation of the NIM standard for computer based experiment control and data acquisition. Main field of CAMAC use are computer based control and data acquisition systems in nuclear and high-energy physics experiments but in the past also in industrial applications, aerospace, and defense test systems.

CAMAC modules have half of NIM width but are with 300mm (11.81") deeper and are outfitted with a rear side 86-pin edge card connector. This connector plugs into the CAMAC Dataway which provides module power, address bus, control bus and data bus. including 48 digital data transfer lines (24 read, 24 write), strobe signal lines as well as address and control lines.

WIENER CAMAC crates are modular designed and compliant to the CERN standard, i.e. the CAMAC crate consist of the bin with the CAMAC bus (Dataway), a fan tray for module ventilation and a low noise power supply which has to provide $\pm 6V$, $\pm 12V$ (optional), $\pm 24VDC$ and 110V AC (secondary). Power supplies with all 6 DC voltages are exchangeable with NIM bins.

CAMAC crates for 19" rack mounting have 25 slots. Station 25, the rightmost station, is reserved for a CAMAC Crate Controller whereas slots 1 to 24 are "normal stations". Standard CAMAC crate controllers are doublewide and use the two rightmost slots 24 and 25. They are outfitted with an interface to other bus systems ("branch" as per ESONE EUR4600 for type A controller in large CAMAC installations, VME, GPIB, ...) or computers (parallel, USB, Ethernet). Today in most cases CAMAC controllers are connected directly to PC's. WIENER provides controllers with high speed 32bit parallel and USB-2 interfaces (see CAMAC module section CC32 and CC-USB).

CAMAC Pin assignment (viewed from front)

Controller station		Normal station	
P1	B	P1	B
P2	F16	P2	F16
P3	F8	P3	F8
P4	F4	P4	F4
P5	F2	P5	F2
X	F1	X	F1
I	A8	I	A8
C	A4	C	A4
P6	A2	N	A2
P7	A1	L	A1
S1	Z	S1	Z
S2	Q	S2	Q
L24	N24	W24	W23
L23	N23	W22	W21
L22	N22	W20	W19
L21	N21	W18	W17
L20	N20	W16	W15
L19	N19	W14	W13
L18	N18	W12	W11
L17	N17	W10	W9
L16	N16	W8	W7
L15	N15	W6	W5
L14	N14	W4	W3
L13	N13	W2	W1
L12	N12	R24	R23
L11	N11	R22	R21
L10	N10	R20	R19
L9	N9	R18	R17
L8	N8	R16	R15
L7	N7	R14	R13
L6	N6	R12	R11
L5	N5	R10	R9
L4	N4	R8	R7
L3	N3	R6	R5
L2	N2	R4	R3
L1	N1	R2	R1
-12	-24	-12	-24
NC	-6	NC	-6
NC	NC	NC	NC
Y1	E	Y1	E
12	24	+12	+24
Y2	6	Y2	6
0	0	0	0



F	FUNCTION	F16	F8	F4	F2	F1	F0
0	Read Group 1 Register	0	0	0	0	0	0
1	Read Group 2 Register	0	0	0	0	1	1
2	Read and Clear Group 1 R.	0	0	0	1	0	2
3	Read Compl. of Group 1 R.	0	0	0	1	1	3
4	Non-standard	0	0	1	0	0	4
5	Reserved	0	0	1	0	1	5
6	Non-standard	0	0	1	1	0	6
7	Reserved	0	0	1	1	1	7
8	Test Look-at-Me	0	1	0	0	0	8
9	Clear Group 1 Register	0	1	0	0	1	9
10	Clear Look-at-Me	0	1	0	1	0	10
11	Clear Group 2 Register	0	1	0	1	1	11
12	Non-standard	0	1	1	0	0	12
13	Reserved	0	1	1	0	1	13
14	Non-standard	0	1	1	1	0	14
15	Reserved	0	1	1	1	1	15
16	Overwrite Group 1 R.	1	0	0	0	0	16
17	Overwrite Group 2 R.	1	0	0	0	1	17
18	Selective Set Group 1 R.	1	0	0	1	0	18
19	Selective Set Group 2 R.	1	0	0	1	1	19
20	Non-standard	1	0	1	0	0	20
21	Selective Clear Group 1 R.	1	0	1	0	1	21
22	Non-standard	1	0	1	1	0	22
23	Selective Clear Group 2 R.	1	0	1	1	1	23
24	Disable	1	1	0	0	0	24
25	Execute	1	1	0	0	1	25
26	Enable	1	1	0	1	0	26
27	Test Status	1	1	0	1	1	27
28	Non-standard	1	1	1	0	0	28
29	Reserved	1	1	1	0	1	29
30	Non-standard	1	1	1	1	0	30
31	Reserved	1	1	1	1	1	31

STROBE SIGNALS (S1 AND S2)

Two strobe signals S1 and S2 are generated and used for command execution timing. S1 defines the time for the first phase. All units which accept data from the DATAWAY in a Read or Write operation do so in response to S1. S2 initiates actions that may change the state of DATAWAY signals, for example, clearing a register whose output is connected to the DATAWAY.

Data

Up to 24 bits of data may be transferred in parallel between the controller and the selected module. Independent lines (Read and Write) are provided for the two directions of transfer.

THE WRITE LINES (W1-W24)

The controller or other common data source generates data signals on the W bus lines at the beginning of any „Write“ operation. The W signals reach a steady state before S1, and are maintained until the end of the operation, unless modified by S2.

THE READ LINES (R1-R24)

Data signals are set up on the R bus lines by the module as soon as a „Read“ command is recognized. The R signals reach a steady state before S1, and are maintained for the full duration of the DATAWAY operation, unless the state of the data source is changed by S2. The controller or other data receiver strobos the data from the R bus lines at the time of the Strobe S1.

Status Information

Status information is conveyed by signals on the Look-at-Me (L), Busy (B), Command Accepted (X) and Response (Q) lines.

Look-At-Me (LAM / L)

The LAM line, is an individual connection from each station to the control station to indicate a service request. When there is no DATAWAY operation in progress (no B present) any unit may generate a signal on its L line to indicate that it requires attention. A LAM request can be reset by Clear LAM, initialize or by the performance of the specific action which generated the request.

In a typical DATAWAY operation, the crate controller issues a CAMAC COMMAND which includes a station number (N), a sub-address (A), and function code (F) to the module in slot N. In response, the module will generate valid command accepted (X response) and act on the command. If this command requires data transfer, the (R) or write (W) line will be used (terms Read and Write apply to the controller). The CAMAC cycle for this operation takes about 1.2µs.

All CAMAC bus signals are TTL logic levels as given in the following table:

	Logic 0	Logic 1
Input must accept	+2.0 to 5.5V	0 to +0.8V
Output must accept	+3.5 to 5.5V	0 to +0.5V

STATION NUMBER (N)

Each normal station is addressed by a signal on an individual station number line coming from the control station. The stations are numbered in decimal from the left side as viewed from the front, beginning with slot 1.

SUBADDRESS (A8, A4, A2, A1)

Different sections of a module are addressed by signals on the four A bus lines. These signals are decoded in the module to select one of up to 16 sub-addresses, numbered in decimal from 0 to 15.

FUNCTION (F16, F8, F4, F2, F1)

The function to be performed at the specified sub-address in the selected module or modules is defined by the Function code. CAMAC module function codes have to match the following definitions:

DATAWAY BUSY (B)

The Busy signal is used to interlock various aspects of a system which can compete for the use of the DATAWAY. Specifically, it is generated during DATAWAY command or common control operations. Whenever N is present, B is present, and for the duration of B, all L signals are gated off the DATAWAY lines.

COMMAND ACCEPTED (X)

Whenever an addressed module recognizes a command, it must generate X = 1.

RESPONSE (Q)

The Q bus line is used during a DATAWAY operation to transmit a signal indicating the status of a selected feature of the module. On all Read and Write commands the signal on the Q bus line remains static from the time the command is received until S2. For all other commands the signal on the Q bus line may change at any time.

Common Controls

Common control signals operate on all modules connected to them without the need to be addressed separately by a command. In order to provide protection against spurious signals, the initialize (Z) and Clear (C) signals must be accompanied by Strobe S2.

INITIALIZE (Z)

The initialize signal has absolute priority over all other signals or controls. It sets all units to a defined initial / basic state. It is always accompanied by S2 and B.

INHIBIT (I)

The presence of this signal inhibits any activity (for example, data taking). It must either not change when B is present or have rise and fall times not less than 200 nsec.

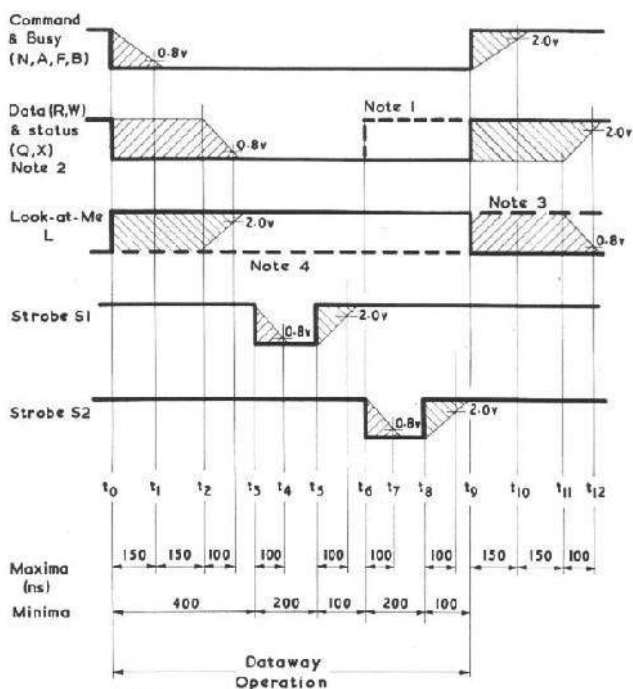

CLEAR (C)

This command signal clears all registers or bi-stables connected to it. Units which generate C must also cause S2 and B to be generated. Modules which accept C gate it with S2 as a protection against spurious signals on the C line.

FASTCAMAC is a proposed extension to the CAMAC data acquisition standard, which substantially increases the data transfer rate of CAMAC systems while retaining full compatibility with standard CAMAC. This extension provides an increase in data transfer rate of 2.5 to 20 times that of normal CAMAC (up to 60 Mbytes/s).

These increased speeds are achieved while maintaining full forward and backward compatibility with the existing CAMAC standard. Normal CAMAC modules and the new FASTCAMAC modules will work together in the same crate at their respective speeds. The proposed standard has 3 levels of increasing complexity.

FASTCAMAC level one provides an increase in the maximum data transfer rate to 7.5 Mbytes/s (x2.5 normal CAMAC) by using multiple S1 strobes without increasing dataway speed or replacing driver chips. Currently several commercially available CAMAC modules which include the WIENER CAMAC controllers CC32 and CC-USB support this protocol.

For maximum data transfer speeds of up to 60MB/s FASTCAMAC level 2 and 3 foresee a two edge protocol with multiplexing R and W lines to allow 48bit wide transfers. These changes require significant module re-designs including tri-state bus drivers and are not common practice as of today.

WIENER NIM products:

- Powered NIM crates
- NIM modules
- Blank NIM mechanics and NIM parts

WIENER CAMAC products:

- Powered CAMAC crates
- CAMAC controllers / interfaces
- CAMAC modules
- Blank CAMAC mechanics
- NIM to CAMAC power adapter



NIM Compact 150W Crates

The WIENER NIM compact series is the low-cost entry into the NIM world. This is achieved by combining the economic steel-aluminum UEN 04 bin with a very compact 150W slot power supply.

The result is a lightweight NIM crate with reduced depth. To be compatible to all NIM modules the UEP15 provides all standard (6) DC voltages as well as 115V AC.



NIM 150 Compact

UEN 04 NIM Compact Bin:

- 12 slot non-ventilated NIM bin UEN 04 (10 slots free)
- Stabilized stainless steel card guide structure
- Bin equipped with long-life NIM connectors and completely
- Dimensions: 19" (483mm) x 5U (222.3mm) x 340 mm [whd], weight: ca. 5 Kg

UEP 15 power supply:

- Front side plug-in slot power supply 2.5 NIM slots wide, 150W power output
- 6-fold DC outputs (+/-6V, +/-12V, +/-24V), stabilized by adjustable monolithic voltage regulators switch-off protection for over / under voltage and over temperature failures
- Power distribution rear side via standard NIM connector
- Front panel with mains switch and control LED's for status and failure
- AC input 230V/50 Hz or 110V/60Hz
- Dimensions: width 2 1/2 NIM, height 183mm, depth 249mm, weight: 7.5 Kg
- CE Conformity

Standard configurations (other possible on request)

Type	Slots	+6V/-6V	+12V/-12V	+24V/-24V	115VAC	Type/Power	Order Code
NIM 150C	12 (10)*	5A/5A	3A/3A	1.5A/1.5A	0.25A	UEP15 / 150W	NC2AEU000005

AC input voltage, factory default is 230V AC
Other AC input voltages upon request



UEP15

NIM Portable 150W Crates

For portable applications this transportable mini NIM crate is suited best for providing 7 NIM slots, (2 1/2 slots used by UEP15 power supply), in a solid steel-aluminum construction. The top cover is equipped with a handle and has a side perforation for convection cooling airflow. The crate is equipped with the very compact UEP15 - 150W, slot power supply providing all 6 DC voltages.

UEN 04T NIM portable bin:

- 7 1/2 slot non-ventilated NIM bin UEL 04T, (5 slots free)
- Stabilized stainless steel card guide structure, top cover with handle
- Bin equipped with long-life NIM connectors, all DC lines wired,
- Dimensions: 273mm x 273mm x 340mm [whd], weight: ca. 3 Kg

UEP 15 power supply:

- Front side plug-in slot power supply 2.5 NIM slots wide, 150W power output
- 6-fold DC outputs (+/-6V, +/-12V, +/-24V), stabilized by adjustable monolithic voltage regulators switch-off protection for over / under voltage and over temperature failures
- Power distribution rear side via standard NIM connector
- Front panel with mains switch and control LED's for status and failure
- AC input 230V/50Hz or 110V/60Hz
- Dimensions: width 2 1/2 NIM, height 183mm, depth 249mm, weight: 7.5 Kg
- CE Conformity

Standard configurations (other possible on request)

Type	Slots	+6V/-6V	+12V/-12V	+24V/-24V	115VAC	Type/Power	Order Code
NIM 150T	7 (5)*	5A/5A	3A/3A	1.5A/1.5A	0.25A	UEP15 / 150W	NC25EU000005

AC input voltage, factory default is 230V AC
Other AC input voltages upon request



NIM portable



portable NIM bin

NIMpact 300W Crate

NIMpact Crates are low cost crates that meet EUR4100 and CE specifications. They are outfitted with a 300W power supply with overload and over temperature protection.

5U NIMpact crates are without fan tray.

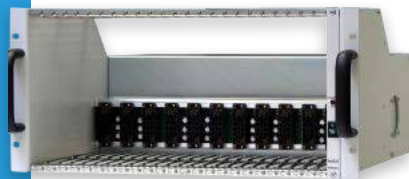

Nimpack 5U



NIMpact 5U rear view

- Fully wired 12 slot crate, 5U
- Stabilized steel card guide structure
- Simplified control panel with On/Off switch and status LED
- Bin equipped with long-life NIM connectors, all lines wired according to CERN or CE specifications
- Integrated linear regulated 300W power supply UEP 24
- AC input 230V/50Hz or 110V/60Hz
- Dimensions: 19" (483mm) x 5U (222.3mm) x 518mm [whd], weight: ca. 26 Kg
- CE Conformity
- Optional crate monitoring with ETHERNET interface

Standard Crate configurations (others possible on request)

Type	+6V/-6V	+12V/-12V	+24V/-24V	115V AC	Type / Power	Order Code
NIMpact I23	11.5A / 11.5A	3.4A / 3.4A	3.4A / 3.4A	0.5A	UEP24 / 300W	ND2CE120000S
NIMpact I24	15A / 15A	3.4A / 3.4A	3.4A / 3.4A	0.5A	UEP24 / 300W	ND2CE130000S
NIMpact I26	7A / 7A	15A / 15A		0.5A	UEP24 / 300W	ND2CE140000S
NIMpact I27	8.6A / 8.6A	3.4A / 3.4A	6.9A / 6.9A	0.5A	UEP24 / 300W	ND2CE150000S

AC input voltage, factory default is 230V AC

Other AC input voltages upon request

NIMpact 300W Crate with fan tray

NIMpact Crates are low cost crates that meet EUR4100 and CE specifications. They are outfitted with a 300W power supply with over load and over temperature protection.

7U NIMpact crates are with fan tray.



NIMpact 7U

- Fully wired 12 slot crate, 19" x 7U
- Stabilized steel card guide structure
- Simplified control panel with On/Off switch and status LED
- Bin equipped with long-life NIM connectors, all lines wired according to CERN or CE specifications
- Fan tray with 3 DC fans for cooling, front or bottom air inlet
- Integrated linear regulated 300W power supply UEP 24
- AC input 230V/50 Hz or 110V/60Hz
- Dimensions: 19" (483mm) x 7U (311.2mm) x 518mm [whd], weight: ca. 26 Kg
- CE Conformity
- Optional crate monitoring with ETHERNET interface

Standard Crate configurations (others possible on request)

Type	+6V/-6V	+12V/-12V	+24V/-24V	115V AC	Type / Power	Order Code
NIMpact I23 L	11.5A / 11.5A	3.4A / 3.4A	3.4A / 3.4A	0.5A	UEP24 / 300W	ND2CE120300S
NIMpact I24 L	15A / 15A	3.4A / 3.4A	3.4A / 3.4A	0.5A	UEP24 / 300W	ND2CE130300S
NIMpact I26 L	7A / 7A	15A / 15A		0.5A	UEP24 / 300W	ND2CE140300S
NIMpact I27 L	8.6A / 8.6A	3.4A / 3.4A	6.9A / 6.9A	0.5A	UEP24 / 300W	ND2CE150300S

AC input voltage, factory default is 230V AC

Other AC input voltages upon request

NIM CERN / NIM CE 300W Crate

The CERN spec./CE NIM crate series represents modular designed NIM crates with linear regulated power supplies in excellent and proven WIENER quality, conforming to EUR4100 and CERN specifications. These NIM crates are outfitted with 300W linear regulated, low noise plug-in power supplies for standard applications.

The modular concept of the CERN NIM and CAMAC standard allows to easily insert / remove and exchange fan trays (if outfitted with) and power supplies. All CERN spec. parts as bins, fan trays and power supplies are interchangeable between different NIM and even CAMAC crates. All power supplies support the features defined by the CERN standard including the monitoring connector and provide protection against short circuit, over / under voltage and over temperature.

The "CE" versions provide improved AC wiring according to CE safety rules.

UEN/CEN 03 NIM Bins

- 5U high bin UEN 03 without fan tray space
- CERN compatible bin mechanics and wiring, extreme solid / heavy construction, prepared for rear-side plug-in power supply
- 12 wired NIM connectors with long life - high quality massive, gold plated contacts
- 1/2 NIM width control panel with mains switch, control LED's and LED's / test pins for all outputs
- CE conform versions provide improved AC wiring between power supply and bin.
- Dimensions: 19" (483mm) x 5U (222.3mm) x 530mm [whd], weight: ca. 5 - 6 Kg
- Optional crate monitoring with ETHERNET interface



5U CERN spec NIM Crate

UEP/CEP 22M NIM 300W Power Supplies

- CERN spec. high precision linear regulated NIM power supplies for 300W power output, all 6 DC voltages +/-6V, +/-12V +/-24V provided, lowest noise (<3mVpp) technology, special version with increased +/-12V current available (no +/-6V)
- Power supplies to be plugged-in to the rear of the NIM bin for easy exchange
- Protected against short circuit, over / under voltage and over temperature
- Equipped with status control and CERN-spec. monitoring output (PG28)
- 100V, 110V, 230V or 240V 50Hz/60Hz AC input (to be selected / changeable)
- CE conform versions provide improved AC wiring.
- Dimensions: 429mm x 131mm x 215mm [whd], weight: 16.5 Kg



UEP 22 M

Standard Crate configurations (other possible on request)

Type	Height	Fan	P.S.	+6V/-6V	+12V/-12V	+24V/-24V	115VAC	Power	Order Code
NIM300CE	5U	-	CEP 22M	17A/17A	3.4A/3.4A	3.4A/3.4A	0.5A	300W	NA2CEC10000S
NIM300	5U	-	UEP 22M	17A/17A	3.4A/3.4A	3.4A/3.4A	0.5A	300W	NA2CEU10000S

AC input voltage, factory default is 230V AC
Other AC input voltages upon request

NIM CERN / NIM CE 300W Crate with fan tray

The CERN spec./CE NIM Crate series represents modular designed NIM crates with linear regulated power supplies in excellent and proven WIENER quality, conforming to EUR4100 and CERN specifications. These NIM crates are outfitted with 300W linear regulated, a fan tray and 300W low noise plug-in power supplies for standard applications.

The modular concept of the CERN NIM and CAMAC standard allows to easily insert / remove and exchange fan trays (if outfitted with) and power supplies. All CERN spec. parts as bins, fan trays and power supplies are interchangeable between different NIM and even CAMAC crates. All power supplies support the features defined by the CERN standard including the monitoring connector and provide protection against short circuit, over / under voltage and over temperature.

The "CE" versions provide improved AC wiring according to CE safety rules.



7U CERN spec CE NIM crate



UEN 01 with CEL03 M removed



UEL 03 M



UEP22 M

UEN 01 NIM Bins

- 7U bin UEN 01 for 12 NIM slots with 2 U fan tray space
- Extremely solid construction, prepared for rear-side plug-in power supply
- 12 wired NIM connectors with long life - high quality massive, gold plated contacts
- CERN compatible bin mechanics and wiring
- Dimensions: 19" (483mm) x 7U (311.2mm) x 530mm [whd], weight: ca. 5 – 6 Kg

UEL/CEL 03M Fan Tray

- Intelligent fan tray with 3 controlled DC-fans (variable fan speed)
- 3 status LED's and high visibility alpha-numeric display / diagnostic system
- Optional CAN-bus interface for crate remote control
- CE version with separated AC wiring to power supply
- Dimensions: 19" (483mm) x 2U (86mm) x 260mm [whd], weight: ca. 5 Kg

UEP/CEP 22M 300W Power Supply

- CERN spec. high precision linear regulated NIM power supplies for 300W power output,
- All 6 DC voltages +/-6V, +/-12V +/-24V provided, lowest noise (<3mVpp) technology, special version with increased +/-12V current available (no +/-6V)
- Power supplies are plugged-in to the rear of the NIM bin for easy tool free exchange
- All power supplies are protected against short circuit, over / under voltage and over temperature
- Equipped with status control and CERN-spec. monitoring output (PG28)
- 100V, 110V, 230V or 240V 50Hz/60Hz AC input (to be selected / changeable)
- CE conform versions provide improved AC wiring.
- Dimensions: 429mm x 131mm x 215mm [whd], weight: 16.5 Kg

Standard Crate configurations (other possible on request)

Type	Height	Fan	P.S.	+6V/-6V	+12V/-12V	+24V/-24V	115VAC	Power	Order Code
NIM300LCE	7U	CEL03M	CEP 22M	17A/17A	3.4A/3.4A	3.4A/3.4A	0.5A	300W	NA2CGC10000S
NIM300LSCE	7U	CEL03M	CEP 22MS	-	15A/15A	1A/1A	0.5A	300W	NA2CGC20000S
NIM300L	7U	UEL03M	UEP 22M	17A/17A	3.4A/3.4A	3.4A/3.4A	0.5A	300W	NA2CGU10000S
NIM300LS	7U	UEL03M	UEP 22MS	-	15A/15A	1A/1A	0.5A	300W	NA2CGU20000S

AC input voltage, factory default is 230V AC

Other AC input voltages upon request

NIM CERN / NIM CE 600W Crate

The CERN spec./CE NIM Crate series represents modular designed NIM crates with linear regulated power supplies in excellent and proven WIENER quality, conforming to EUR4100 and CERN specifications. These NIM crates are outfitted with 600W linear regulated, low noise plug-in power supplies for demanding applications.

The modular concept of the CERN NIM and CAMAC standard allows to easily insert / remove and exchange fan trays (if outfitted with) and power supplies. All CERN spec. parts as bins, fan trays and power supplies are interchangeable between different NIM and even CAMAC crates. All power supplies support the features defined by the CERN standard including the monitoring connector and provide protection against short circuit, over / under voltage and over temperature.

The "CE" versions provide improved AC wiring according to CE safety rules.

UEN/CEN 03 NIM Bins

- 5U high bin UEN 03 without fan tray space
- CERN compatible bin mechanics and wiring, extreme solid / heavy construction, prepared for rear-side plug-in power supply
- 12 wired NIM connectors with long life - high quality massive, gold plated contacts
- 1/2 NIM width control panel with mains switch, control LED's and LED's / test pins for all outputs
- CE conform versions provide improved AC wiring between power supply and bin.
- Dimensions: 19" (483mm) x 5U (222.3mm) x 530mm [whd], weight: ca. 5 - 6 Kg
- Optional crate monitoring with ETHERNET interface



5U CERN spec NIM crate

UEP/CEP 10Mxx NIM 600W Power Supply

- CERN spec. high precision regulated NIM power supplies for 300W power output, all 6 DC voltages +/-6V, +/-12V +/-24V provided, lowest noise (<3mVpp) technology, special version with increased +/-12V current available
- Power supplies are plugged-in to the rear of the NIM bin for easy tool free exchange
- All power supplies are protected against short circuit, over / under voltage and over temperature
- Equipped with status control and CERN-spec. monitoring output (PG28)
- 100V, 110V, 230V or 240V 50Hz/60Hz AC input (to be selected / changeable)
- CE conform versions provide improved AC wiring.
- Dimensions: 429mm x 172mm x 215mm [whd], weight: 17.5 Kg



UEP 10M 88

Standard Crate configurations (other possible on request)

Type	Height	Fan	P.S.	+6V/-6V	+12V/-12V	+24V/-24V	115VAC	Power	Order Code
NIM600CE	5U	-	CEP 10M88	45A/45A	8A/8A	8A/8A	0.5A	600W	NA2CEC40000S
NIM600SCE	5U	-	CEP 10M66	20A/20A	15A/15A	2A/2A	0.5A	600W	NA2CEC30000S
NIM600	5U	-	UEP 10M88	45A/45A	8A/8A	8A/8A	0.5A	600W	NA2CEU40000S
NIM600S	5U	-	UEP 10M66	20A/20A	15A/15A	2A/2A	0.5A	600W	NA2CEU30000S

AC input voltage, factory default is 230V AC
Other AC input voltages upon request

NIM CERN / NIM CE 600W Crate with fan tray

The CERN spec./CE NIM Crate series represents modular designed NIM crates with linear regulated power supplies in excellent and proven WIENER quality, conforming to EUR4100 and CERN specifications. These NIM crates are outfitted with 600W linear regulated, low noise plug-in power supplies and a fan tray for demanding applications.

The modular concept of the CERN NIM and CAMAC standard allows to easily insert / remove and exchange fan trays (if outfitted with) and power supplies. All CERN spec. parts as bins, fan trays and power supplies are interchangeable between different NIM and even CAMAC crates. All power supplies support the features defined by the CERN standard including the monitoring connector and provide protection against short circuit, over / under voltage and over temperature.

The "CE" versions provide improved AC wiring according to CE safety rules.



7U CERN spec CE NIM Crate



UEN 01 with CEL03 M removed



UEL 03 M



UEP10 M 88

UEN 01 NIM Bin

- 7U bin UEN 01 for 12 NIM slots with 2 U fan tray space
- Extremely solid construction, prepared for rear-side plug-in power supply
- 12 wired NIM connectors with long life - high quality massive, gold plated contacts
- CERN compatible bin mechanics and wiring
- Dimensions: 19" (483mm) x 7U (311.2mm) x 530mm [whd], weight: ca. 5 – 6 Kg

UEL/CEL 03M Fan Tray

- Intelligent fan tray with 3 controlled DC-fans (variable fan speed) for UEN 01 bin only
- 3 status LED's and high visibility alpha-numeric display / diagnostic system
- Optional CAN-bus, HS CAENET or GPIB interfaces for crate remote control
- CE version with separated AC wiring to power supply
- Dimensions: 19" (483mm) x 2U (86mm) x 260mm [whd], weight: ca. 5 Kg

UEP/CEP 10Mxx 600W Power Supply

- CERN spec. high precision regulated NIM power supplies for 600W power output, all 6 DC voltages +/-6V, +/-12V +/-24V provided, lowest noise (<3mVpp) technology, special versions with increased +/-12V current available
- Power supplies are plugged-in to the rear of the NIM bin for easy tool free exchange
- All power supplies are protected against short circuit, over / under voltage and over temperature
- Equipped with status control and CERN-spec. monitoring output (PG28)
- 100V, 110V, 230V or 240V 50Hz/60Hz AC input (to be selected / changeable)
- CE conform versions provide improved AC wiring.
- Dimensions: 429mm x 172mm x 215mm [whd], weight: 17.5 Kg

Standard Crate configurations (other possible on request)

Type	Height	Fan	P.S.	+6V/-6V	+12V/-12V	+24V/-24V	115VAC	Power	Order Code
NIM600LCE	7U	CEL03M	CEP 10M88	45A/45A	8A/8A	8A/8A	0.5A	600W	NA2CGC40000S
NIM600LCE	7U	CEL03M	CEP 10M66	20A/20A	15A/15A	2A/2A	0.5A	600W	NA2CGC30000S
NIM600L	7U	UEL03M	UEP 10M88	45A/45A	8A/8A	8A/8A	0.5A	600W	NA2CGU40000S
NIM600LS	7U	UEL03M	UEP 10M66	20A/20A	15A/15A	2A/2A	0.5A	600W	NA2CGU30000S

AC input voltage, factory default is 230V AC

Other AC input voltages upon request

NIM CERN / NIM CE 1920W Crate with fan tray

This CERN spec./CE NIM Crate series represents modular designed NIM bins combined with high power /low noise, microprocessor controlled, switching mode power supplies in excellent and proven WIENER quality, conforming to EUR4100 and CERN specifications. For ultimate requirements the NIM crate provides up to 1920W DC power and is outfitted with a fan tray for cooling, monitoring and control.

The modular concept of the CERN NIM and CAMAC standard allows to easily insert / remove and exchange fan trays (if outfitted with) and power supplies. All CERN spec. parts as bins, fan trays and power supplies are interchangeable between different NIM and even CAMAC crates. All power supplies support the features defined by the CERN standard including the monitoring connector and provide protection against short circuit, over / under voltage and over temperature.

The "CE" versions provide improved AC wiring according to CE safety rules.

UEN 01 NIM Bin

- 7U bin UEN 01 for 12 NIM slots with 2 U fan tray space
- Extremely solid construction, prepared for rear-side plug-in power supply
- 12 wired NIM connectors with long life - high quality massive, gold plated contacts
- CERN compatible bin mechanics and wiring
- Dimensions: 19" (483mm) x 7U (311.2mm) x 530mm [whd], weight: ca. 5 – 6 Kg

UEL/CEL 03M Fan Tray

- Intelligent fan tray with 3 controlled DC-fans (variable fan speed) for UEN 01 bin only
- 3 status LED's and high visibility alpha-numeric display / diagnostic system
- Optional CAN-bus, HS CAENET or GPIB interfaces for crate remote control
- CE version with separated AC wiring to power supply
- Dimensions: 19" (483mm) x 2U (86mm) x 260mm [whd], weight: ca. 5 Kg

PS/CS236 NIM CERN/CE 1920W Power Supply

- Micro-processor controlled, high precision, low-noise switching power supply with programmable voltage and current limits, 1900W DC output, all 6 DC voltages +/-6V, +/-12V, +/-24V provided, (no 115VAC!)
- Power supplies are plugged-in to the rear of the NIM bin for easy tool free exchange
- All power supplies are protected against short circuit, over / under voltage and over temperature
- Equipped with status control and CERN-spec. monitoring output (PG28)
- 100V, 110V, 230V or 240V 50Hz/60Hz AC input (to be selected / changeable)
- Dimensions: 429mm x 133mm x 220mm [whd], weight: 12.9 Kg
- CE conform versions provide improved AC wiring.

Standard Crate configurations (other possible on request)

Type	Height	Fan	P.S.	+6V/-6V	+12V/-12V	+24V/-24V	115VAC	Power	Order Code
NIM1920LCE	7U	CEL03M	CS 236	80A/80A	20A/20A	10A/10A	-	1920W	NA2CG110000H
NIM1920L	7U	UEL03M	PS 236	80A/80A	20A/20A	10A/10A	-	1920W	NA2CG100000H

AC input voltage, factory default is 230V AC
Other AC input voltages upon request



7U CERN spec CE NIM Crate



UEN 01 with CEL03 M removed



UEL 03 M



CS236, 1900W (CE conform)

NIM 6000 Crate Series

The WIENER NIM 6000 Series combines the technical advantages of the VME 6000 high efficient, low noise switching power supplies with the high reliability CERN spec. conform WIENER NIM chassis. The modular concept of WIENER NIM 6000 series crates allows fan trays and power supplies to be easily inserted and removed without tools.

The NIM connectors of slot 1+2, 4, 6+7, 9, 11+12 feature additional pins for temperature measurement inside inserted NIM modules. These 8 probes, if connected, will be automatically processed by the system monitoring. Two temperature thresholds can be programmed to protect high sophisticated NIM modules. In case the first limit is exceeded the fans turns to maximum speed. When exceeding the second level the power supply will be switched off.

The NIM 6000 series has all features of the WIENER local and remote monitoring and control which includes a web-ready Ethernet communication.



NIM 6000 crate



NIM 6000 crate rear view



UEL 6020 Fan Tray



UEP 6021 Power Supply

UEN06 NIM Bin

- 19" x 7 U enclosure for 12 NIM modules
- Very rugged steel-aluminum construction features 5mm thick heavy duty side plates with zero-tolerance countersink screw positioning of all horizontal rails, stainless steel card guide rails
- Dimensions: 19" x 7U x 570mm (620mm with power supply) [whd], weight: ca. 12 Kg

UEL 6020 Fan Tray

- Designed to provide superior cooling of NIM modules in bottom-to-top air flow
- Equipped with 6 individually controlled long-life DC fans, MTBF >65 000h
- Integrated fan speed and thermal monitoring, adjustable fan speed (1200 ... 3200 RPM)
- Micro-processor controlled with alphanumeric high-visibility LED display for all fan tray, bin and power supply parameters (voltages, currents, power, temperatures, set-up data, ...)
- Built-in combo interface (Ethernet, RS232, CAN-bus) for remote monitoring and control
- Dimensions: 430mm x 2U (89mm) x 340mm [whd], weight: ca. 5.4 Kg

UEP 6021 Power Supply

- High density / lowest-noise power supply in WIENER "Cavity-VHF" switching technology with excellent RF-shielding, < 10mVpp
- Modular and expandable design with self-ventilated universal power blocks, individually sensed and floating DC outputs
- Micro-processor controlled, programmable voltage adjustment, current limits and over-/ under voltage trip off points, temperature limits
- Self-protected against any failure as under/over voltage, over current, over temperature, ...
- 94V – 260V world-wide auto-range AC input, with power factor correction, CE
- High power density, up to 3 kW DC output power,
- Dimensions: 430mm x 3U (133mm) x 250mm [whd], weight: 12,5kg (with +/-6V/90A max, +/-12V/23A max, +/-24V/11,5A max output)

Standard Crate configurations (other possible on request)

Crate Version	Slots	+6V/-6V	+12V/-12V	+24V/-24V	115VAC	Power	Order Code
NIM 6021-1500	12	30A	23A	11.5A	-	1464W	NE2CG160000H
NIM 6021-2000	12	90A	23A	11.5A	-	2184W	NE2CG170000H
NIM 6021-2700S	12	90A	46A	11.5A	-	2736W	NE2CG190000H
NIM 6021-2700	12	90A	23A	23A	-	2736W	NE2CG180000H

Other power supply configurations on request

CAMAC Mini Crate Series

The WIENER CAMAC Mini Crate is the perfect choice for small setups with only a few CAMAC modules. The crate offers 11 CAMAC slots in a compact designed chassis with integrated low noise power supply and cooling fan. The mini crate can be used on the desk either as a desktop or up-right unit or be installed in a 19" rack.

Based on the 6000 series it has a built-in microprocessor controlled low-noise power supply technology and provides all local and remote monitoring and control features.

The WIENER CAMAC mini crate is available "DAQ-ready" in a package configuration with high speed USB-2 CAMAC controller.

Technical details

- CAMAC-MINI-Bin mechanics for 11 CAMAC modules, suitable either for 19" racks, as tower- or desktop box
- 11 slot CAMAC data way backplane with controller slot 10/11
- Front and rear cover / screen for module space, cable duct between front- and rear-side of the card cages with space for one or more 2,5" hard / floppy-disks
- Micro-processor controlled with alphanumeric high-visibility LED display, 4 status LED's
- Efficient DC blower, adjustable speed (1200 ... 3200 RPM,) temperature controlled
- Integrated fan and thermal monitoring (optional 8 temperature sensor ports, 5 ports free for custom applications) with temperature display (C/F), programmable over temperature protection
- Ethernet /RS232 / CAN-bus combo interface for crate remote monitoring and control
- Built-in Power-Supply designed in low noise VHF switching technology, noise and ripple typically less than 10mV(pp) or 3mV(rms)
- 4 (+6V, +24V) or 6 (+6V, +12V, +24V) output voltages at 650W/>100VAC output power, world wide range AC-input 94 to 260V AC 50Hz/60Hz
- CE-conformity
- Dimensions: 19" (482mm) x 5U (178mm) x 480mm [whd], weight: ca. 25 Kg



CAMAC Mini crate

Standard configurations (other possible on request)

Crate Version	+6V / -6V	+12V / -12V	+24V / -24V	118VAC	Order Code
MiniCAMAC 400	17A/17A	3.4A / 3.4A	3.4A / 3.4A	-	CB1BXX0000H
MiniCAMAC 600	38A/38A	8A / 8A	8A / 8A	-	CB1BXX0200H
MiniCAMAC 400x	17A/17A	-	3.4A / 3.4A	-	CB1BXX0100H
MiniCAMAC 600x	38A/38A	-	8A / 8A	-	CB1BXX0300H

CAMAC CERN / CAMAC CE Crates 300W

WIENER offers a line of modular designed CAMAC crates compliant with ESONE and CERN standards. This CAMAC crates series is configured with 300W linear regulated, low noise plug-in power supplies.

The modular concept of the CERN NIM and CAMAC standard allows you to easily insert / remove and exchange fan trays and power supplies. All CERN spec. components' as bins, fan trays and power supplies are interchangeable between other WIENER CAMAC and even NIM crates.

All power supplies show the features defined by the CERN standard including the monitoring connector and provide protection against short circuit, over / under voltage and over temperature.

The CE versions provide improved internal AC wiring.



CERN CE CAMAC crate

UEC 01VH12 CAMAC bin

- 7U bin UEC 01 for 25 CAMAC slots with 2U space for fan tray
- Heavy duty steel-aluminum construction with stainless-steel card guide frame
- 25 slot multilayer CAMAC dataway, noise reduced design, current rails up to 100A
- Protected high performance CAMAC connectors
- CERN compatible bin mechanics and wiring
- Dimensions: 19" (482mm) x 7U (311mm) x 525mm [whd], 550mm deep with inserted power supply

UEL/CEL 03M Fan Tray

- Intelligent fan tray with 3 controlled DC-fans (variable fan speed)
- 3 status LED's and high visibility alpha-numeric display / diagnostic system
- Optional CAN-bus interface for crate remote control
- CE version with separated AC wiring to power supply
- Dimensions: 19" (483mm) x 2U (86mm) x 260mm [whd], weight: ca. 5 Kg

UEP/CEP 22M CAMAC Power Supply

- CERN spec. high precision linear regulated CAMAC power supplies for 300W power output,
- All 6 DC voltages +/-6V, +/-12V +/-24V provided, lowest noise (<3mVpp) technology
- Power supplies are protected against short circuit, over / under voltage and over temperature
- 100V, 110V, 230V or 240V 50Hz/60Hz AC input (to be selected / changeable)
- Power supplies are equipped with status control and CERN-spec. monitoring output (PG28)
- "CE" power supplies have improved AC to fan connection
- Dimensions: 430mm x 132mm



UEC 01 with UEL 03M removed



UEL 03 M

Standard Crate configurations (other possible on request)

Type	Height	Fan	P.S.	+6V/-6V	+12V/-12V	+24V/-24V	115VAC	Power	Order Code
CAMAC300CE	7U	CEL03M	CEP22M	17A/17A	3.4A/3.4A	3.4A/3.4A	0.5A	300W	CA1GC10000S
CAMAC300	7U	UEL03M	UEP22M	17A/17A	3.4A/3.4A	3.4A/3.4A	0.5A	600W	CA1GU10000S

AC input voltage, factory default is 230V AC
Other AC input voltages upon request



UEP22 M

CAMAC CERN / CAMAC CE Crates 600W

WIENER offers a line of modular designed CAMAC crates compliant with ESONE and CERN standards. This CAMAC crates series is configured with 600W ... 650W linear regulated, low noise plug-in power supplies.

The modular concept of the CERN NIM and CAMAC standard allows you to easily insert / remove and exchange fan trays and power supplies. All CERN spec. components` as bins, fan trays and power supplies are interchangeable between other WIENER CAMAC and even NIM crates.

All power supplies show the features defined by the CERN standard including the monitoring connector and provide protection against short circuit, over / under voltage and over temperature.

The CE versions provide improved internal AC wiring.

UEC 01VH12 CAMAC bin

- 7U bin UEC 01 for 25 CAMAC slots with 2U space for fan tray
- Heavy duty steel-aluminum construction with stainless-steel card guide frame
- 25 slot multilayer CAMAC dataway, noise reduced design, current rails up to 100A
- Protected high performance CAMAC connectors
- CERN compatible bin mechanics and wiring
- Dimensions: 19" (482mm) x 7U (311mm) x 525mm (whd), 550mm deep with inserted power supply



7U CERN spec CE CAMAC Crate

UEL 03M Fan Tray

- Microprocessor controlled fan tray
- With 3 individually controlled high performance DC-fans, variable fan speed
- 3 status LED's and high visibility alpha-numeric display for voltages, currents, fan speed / diagnostic system
- Optional CAN-bus, HS CAENET or GPIB interfaces for crate remote control
- Dimensions: 19" (482mm) x 2U (89mm) x 260mm (whd), weight: ca. 5 – 6 Kg



UEC 01 with CEL03 M removed

UEP/CEP 10Mxx 600W Power Supply

- CERN spec. high precision regulated CAMAC power supplies for 600W / 650W power output, 4 or 6 DC voltages +/-6V, +/-12V +/-24V provided, lowest noise (<3mVpp) technology
- Power supplies are plugged-in to the rear of the CAMAC bin for easy tool free exchange
- UEP10M52 and UEP10M53 are special CAMAC version with increased + or -6V power and no +/-12V
- Provide short circuit, over / under voltage and over temperature protection
- 230V/50Hz or 110V/60Hz AC input
- Power supplies are equipped with status control and CERN-spec. monitoring output (PG28)
- Dimensions: 430mm x 172mm x 215mm (whd), weight: 17.5 Kg



UEL 03 M

Standard Crate configurations (other possible on request)

Type	Height	Fan	P.S.	+6V/-6V	+12V/-12V	+24V/-24V	115VAC	Power	Order Code
CAMAC600_CE	7U	CEL03M	CEP10M88	45A/45A	8A/8A	8A/8A	0.5A	600W	CA1GC40000S
CAMAC600	7U	UEL03M	UEP10M88	45A/45A	8A/8A	8A/8A	0.5A	600W	CA1GU40000S

AC input voltage, factory default is 230V AC

Other AC input voltages upon request



UEP10 M 88

CAMAC CERN / CAMAC CE Crates 1920W with fan tray

WIENER provides a line of modular designed CAMAC crates compliant with ESONE and CERN standards. These CERN spec. CAMAC crates are configurable with linear regulated, low noise plug-in power supplies in the 300W ... 600W DC power range or up to 1900W with PS236 low-noise switching power supplies. For ultimate requirements this CAMAC crate provides up to 1920W DC power and is outfitted with a fan tray for cooling, monitoring and control.

The modular concept of the CERN NIM and CAMAC standard allows you to easily insert / remove and exchange fan trays and power supplies. All CERN spec. parts as bins, fan trays and power supplies are interchangeable between other WIENER CAMAC and even NIM crates. All power supplies support the features defined by the CERN standard including the monitoring connector and provide protection against short circuit, over / under voltage and over temperature.

The "CE" versions provide improved AC wiring according to CE safety rules.



7U CERN spec CE CAMAC Crate



UEC 01 with CEL03 M removed



UEL 03 M



CS236, 1900W (CE conform)

UEC 01VH12 CAMAC bin

- 7U bin UEC 01 for 25 CAMAC slots with 2U space for fan tray
- Heavy duty steel-aluminum construction with stainless-steel card guide frame
- 25 slot multilayer CAMAC dataway, noise reduced design, current rails up to 100A
- Protected high performance CAMAC connectors
- CERN compatible bin mechanics and wiring
- Dimensions: 19" (482mm) x 7U (311mm) x 525mm [whd], 550mm deep with inserted power supply

UEL /CEL03M Fan Tray

- Intelligent fan tray with 3 controlled DC-fans (variable fan speed) for UEN 01 bin only
- 3 status LED's and high visibility alpha-numeric display / diagnostic system
- Optional CAN-bus, HS CAENET or GPIB interfaces for crate remote control
- CE version with separated AC wiring to power supply
- Dimensions: 19" (483mm) x 2U (86mm) x 260mm [whd], weight: ca. 5 Kg

PS236/CS236 CAMAC CERN/CE Power Supply

- Micro-processor controlled, high precision, low-noise switching power supply with programmable voltage and current limits, 1900W DC output, all 6 DC voltages +/-6V, +/-12V
- +/-24V provided, (no 115VAC!)
- Power supplies are plugged-in to the rear of the CAMAC bin for easy tool free exchange
- All power supplies are protected against short circuit, over / under voltage and over temperature
- Equipped with status control and CERN-spec. monitoring output (PG28)
- 100V, 110V, 230V or 240V 50Hz/60Hz AC input (to be selected / changeable)
- Dimensions: 429mm x 133mm x 220mm [whd], weight: 12.9kg
- CE conform versions provide improved AC wiring

Standard Crate configurations (other possible on request)

Type	Height	Fan	P.S.	+6V/-6V	+12V/-12V	+24V/-24V	115VAC	Power	Order Code
CAMAC1920CE	7U	CEL03M	CS236	80A/80A	20A/20A	10A/10A	-	1900W	CA1G110000H
CAMAC1920	7U	UEL03M	PS236	80A/80A	20A/20A	10A/10A	-	1900W	CA1G100000H

Technical details of WIENER NIM and CAMAC crates

UEN 01 NIM Bin 7U

7U NIM-Bin for 12 high powered NIM-Modules, rugged heavy-duty construction with 6mm side panels depth 525mm. Power supply is plugged in and locked from rear side. The bin provides 2U space for a fan tray unit. The power-bus-system is equipped with 12 high-quality long-life NIM connectors parallel wired. Connector pins made of massive brass, gold plated.

Current rail system for +/-6V and Ground. Spliced wiring and additional power-connector pins have been used to allow currents of 25A for +/-12V lines now. CERN specifications are fulfilled entirely. The wiring across the NIM connectors is achieved under a screening cover.

When used according to CERN specifications the bin wiring carries mains voltage. All this mains cable are arranged as screened lines to prevent effects of mains distortions to secondary circuits. Due to not fulfilling the restrictions of EN 60950, UL 1950, etc., power supply and fan tray are not CE-marked. When used in combination with CE conform power supplies (CEP) and fan tray (CEL) mains voltage will be conducted through a separated power cord to the fan tray. This power cord is fixed at fan tray side and has to be plugged to the power supply. The bin is free of mains voltage then.

Current max. ratings:

Voltage Line	Current / slot	Current / bin	Comment
+/-6V	13A	65A	sensed
+/-12V	13A	26A	sensed
+/-24V	13A	13A	sensed
GND	13		
115V AC		0.5A	Secondary

UEN 03 NIM Bin 5U

Non-ventilated 525mm deep 5U NIM bin with 12 slot. Same mechanical performance as UEN 01 above. Control panel with mains switch, mains lamp (yellow/red), LED's for status (green), overheat (yellow), overload (red), Alarm output (LEMO 00, open collector), test sockets and monitor LED's for all DC-Voltages according to CERN specifications.

Current max. ratings:

Voltage Line	Current / slot	Current / bin	Comment
+/-6V	13A	65A	sensed
+/-12V	13A	13A (optional 26A)	sensed
+/-24V	13A	13A	sensed
GND	13		
115V AC		0.5A	Secondary

UEN 04 NIM Bin Compact 5U

Rigid non ventilated construction for powering by UEP 15 Slot-Power-Supply. Wired for use of 10 NIM slots. Slot 11 and 12 occupied by power supply. DC-power feed in via standard NIM connector on slot 12 position. For +/-6V and ground each line has two pins in parallel to reduce the transition resistance.

Current max. ratings:

Voltage Line	Current / slot	Current / bin	Comment
+/-6V	13A	26A	not sensed
+/-12V	13A	13A	not sensed
+/-24V	13A	13A	not sensed
GND	13	13A	
115V AC		0.5A	Secondary

UEN 04T NIM Bin Compact transportable

7½ slot portable mini NIM bin with 5 slots free for NIM modules, 2½ slots occupied by UEP 15 power supply. Solid steel- aluminum construction.

The top cover is equipped with a handle and has lateral perforation in order to make convection cooling efficient. 22mm high rubber feet for non-destructive table top operation enables also an adequate cooling air entrance to bottom side. The power cord is plugged to the rear side of the power supply directly.

All NIM bins have clean earth wired with 0,25mm²



UEN 01 Bin



UEN 03 Bin



UEN 04 Bin



UEN 04 Portable



UEC 01VH12 CAMAC bin



CAMAC dataway

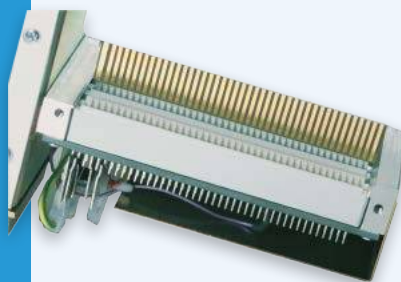

CAMAC connector



CAMAC bin with fan tray removed

UEC01 CAMAC Bin 7U

7U CAMAC bin, 25 slot, depth 525mm acc. to CERN-CAMAC-Note 46-04 with 2U fan tray space. Power bus system with current ratings of 78A for +/-6V. Module connectors have been centered by metal guides before plugging into CAMAC dataway. Power supply plugged in and locked from rear side, fan tray from front side.

VH12 technology uses Y1 / Y2 in parallel to the +/-6V rails for enlarged current capability of the +/-6V. 6V-, Y-, and Ground-Pins are contacted to large current bus bars to obtain connector pin cooling and excellent low drop power distribution. Current max. ratings:

Current max. ratings:

Voltage	Current / slot	Current / bin	Comment
+/-6V	13A	65A	sensed
+/-12V	13A	13A (26A optional)	sensed
+/-24V	13A	5A / 5A	sensed
115V AC		0.5A	Secondary

Details of construction

CERN specifications consider for 7U bins easily interchangeable fan trays. The fan tray has been fixed by two knurled head screws at front side. With these screws extraction and insertion of fan trays becomes possible without use of special tools.

Plug and socket connections are floated arranged with leading locating pins. Also fan tray connectors are assembled with lathed massive brass contacts, gold-plated.

Leading protection earth pin!

25 Slot CAMAC Dataway

Modern, multilayer CAMAC backplane with press-in 86-pin edge card connectors, compact designed with integrated current rails. The WIENER CAMAC dataway is outfitted with connectors having two-point contacts, for optimized contacting of old CAMAC boards. Older and frequently plugged modules make an impact of weak connections due to galling and corrosion of the module connector part. The springy two-point contact makes it possible to work smooth even with worn module connectors.

RF filter capacitors, assembled at the back side, improve the dynamic response with varying load currents and reduce any influence of RF distortions.

Centering of CAMAC modules

Before gliding into the bin connector the CAMAC module edge card is vertically centered by the upper and lower cross aluminum made girder of the dataway board. Thus dataway connector damages due to the given mechanical tolerance levels of Cassettes and Bin are avoided.

The V-shaped scoop card guide of the connector housings centers the modules horizontally.

Shape (edges and alongside) of the module connector must be chamfered to 45° as noted in CAMAC module- specification for easy and trouble free frequently plugging.

CERN specified Rugged construction

CERN spec. bins are made with 6mm thick side panels and heavy transversal module guiding grids. Power supply (and fan tray) are designed for exchanging easily. The power supply slips in and has been fixed by a locking slider only.

When power supplies are inserted, the total mounting depth will increased to 570mm. The electrical connection between power supply and bin is made by means of mechanically floating plug connection.

Intelligent NIM / CAMAC Fan Tray UEL03 / CEL03

CERN spec. conform fan tray unit equipped with alphanumeric monitoring and three long life DC axial fans, either with frontal or bottom air entry (400m³/h or >540m³/h airflow). Static pressure up to 8 mm H₂O column. MFOT (Maintenance Free Operation Time) > 65 000h / 40°C. Fan speed is variable from 1200 to 3000 rpm.

The monitoring can be toggled to display: voltages, currents, fan speed, temperature of incoming air, total power dissipation by inserted modules, network address (if installed). Displayed currents are scaleable to obtain true values. In case of malfunction the type of error will be displayed.

Additional LED information is showing:

- Status (Green): all values inside tolerance
- Fan fail (Yellow): one or more fans fail
- Over Heat (Yellow): power supply overheated

The fan tray monitoring can be set to Programming Mode. This mode allows programming of all key functions and for 236-power supply values like current limits, status thresholds, etc.. The Status Signal is superposed by an additional pulse modulated information (from PS/CS 236 only) to extend the CERN spec. monitoring and control.

Different Remote Control Interface are installable.

1. CAN-bus
2. HS CEANET
3. IEC Bus

CAN-bus Remote Control and Monitoring Software can control up to 126 crates within a network. The user can control and program remotely every crate parameter and On/Off via the interface such as:

- Crate Identification
- All voltages, currents and temperature, status signals
- Over- under voltage trip off points and current limit adjustment (with 336 only)
- Average fan speed and display of every single fan
- Configuration and adjustment (for service and maintenance)

CERN Spec. Monitor Connector

Important signals of the »M« power supplies have been wired to the 36 pin ribbon connector.

This connector monitors:

- Power fail
- Overload
- Overheat cut off
- Status (pot. free contact)
- All output voltages (Voltage outputs are internally protected by resistors against short circuit.)

Disable signal prevents cut-off function

Inhibit signal keeps DC off and stops acoustic alarms

Ethernet Remote Control

5U WIENER NIM Crates can be outfitted with an ethernet based remote monitoring and control circuit (CML01)

CE conform Crate versions / CE conform mains connection

CERN spec. wired bins allow to switch crates on and off via the mains switch at the fan tray. Current rules as CE60950 and UL1950 claim for primary to secondary isolations, which are not considered in the appropriate CERN specifications. Therefore WIENER formed a compromise to fulfill CE and UL safety restriction as well as CERN specifications by separating the mains wiring.



UEL 03 M



CERN spec. monitoring connector



Optional Ethernet Interface



NIM Power Supply UEP15



UEP10M88, 600W

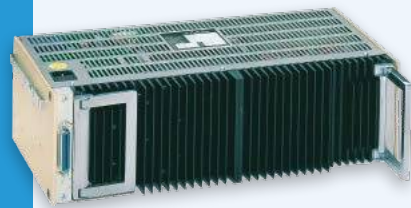

UEP22 M 300W

Power Supplies linear regulated

NIM Compact Slot Power Supply UEP 15

Plug in power supply for use in UEN 04 bins or for powering every non-powered extant NIM bin. UEP 15 features all 6 voltages, stabilized by adjustable monolithic voltage regulators, on rear NIM connector with standard NIM pin out. Ground and 6V outputs are spliced-wired to two pins for minimized voltage drop.

The integrated blower cools heat sink, components and the toroid transformer. Voltage regulators and transformer are protected against over temperature. Over- under voltage detector (limits ca. +/-3% of nominal voltages) activates mains cutting relay (red signal "bad status" at front panel).

Mains voltages: 100, 115, 225, 240VAC by use of different internal transformer taps.

Optional CAN-bus interface for DC voltage monitoring and remote on/off via rear 9 pin sub D connector.

NIM / CAMAC Power Supply UEP 22M

Linear regulated low noise power supply with 300W DC output, cut-off-protection for "overload", "over voltage", and "over temperature"-failures. Outfitted with same monitoring and control facilities as UEP 10M88, the UEP 22M can be used to power NIM- or CAMAC-Crates. After cut off, caused by invalid operation, reset of »M« power supplies is possible by toggling the mains switch off and on again or feeding a 24VDC signal to the "rearming" input at the monitor connector. Standard mains voltage range is 230 / 115VAC, selectable internally. Special ones for 100VAC available. UEP 22M is foreseen for convection cooling at full output performance. Forced air-cooling can increase the total power availability up to 400W.

NIM / CAMAC Power Supply UEP 10M88

Linear regulated low noise power supply with 600W DC output, cut-off-protection for "overload", "over voltage", and "over temperature"-failures. Power Supplies »M« are equipped with monitoring, status and all alarming facilities according to CERN-CAMAC-Note 46-04. Status output »good« if all DC-Voltages are within their tolerance.

UEP 10M88 has a built in long life fan to cool heat sink, transformer and other components. The volume to power relation of high density, high sophisticated power supplies like the UEP 10M88 is extremely low for a high precision linear regulated 600W. Experience and energy management knowledge at WIENER resulted in a special designed filter and storage capacitor bank, the "Energy-Tank" of UEP 10M. A special capacitor development with very low internal resistance and non-inductive bonding forms UEP 10 as a reference for power und reliability. Different versions for either 100VAC or 115VAC or 230VAC (standard) are available.

Power configurations

Power supply	+6V	-6V	+12V	-12V	+24	-24V	115VAC	max. power	regulation	application
UEP10M88	45A	45A	8A	8A	8A	8A	0.5A	600W	linear	NIM/CAMAC
UEP10M66	20A	20A	15A	15A	2A	2A	0.5A	600W	linear	NIM
UEP15	5A	5A	3A	3A	1,5A	1,5A		150W	linear	NIM
UEP22M	17A	17A	3,4A	3,4A	3,4A	3,4A	0.5A	300W	linear	NIM /CAMAC

Technical specification

UEP/CEP10M88 / 66	UEP/CEP22M	UEP15
Input voltage, 47-63Hz		
100V(+/-10%), 115V or 230V	100V(+/-10%) , 115V or 230V	100V-240V(+/-10%), 5 taps int.
Soft start		
yes	yes	yes
Output: Noise and Ripple: Full load / 80% rated output		Full load +/-6 / 12 / 24V
<3mVpp / 1mVpp, <0,6mVRMS	<3mVpp / 1mVpp, <0,6mVRMS	<3mVpp / <5mVpp / <10mVpp
Regulation static: Change of output voltage versus load change 10-100%		
<0,05%	<0,05%	<0,2% for 6V, 0,1% for 12/24V
Regulation static: change of output voltage versus line change +/-10%		
<0,02%	<0,02%	0,02%
Recovery time versus load change 10-100%		
<0,15ms	<0,15ms	<0,15ms
Output impedance: Static / Dynamic(at 100kHz)		
0,2mOhm / 0,3 Ohm	0,2mOhm / 0,5 Ohm	1,5mOhm / 0,5 Ohm
Temperature Error		
<0,005%/K	<0,005%/K	<0,02%/K
Thermal Protection (No. of thermal switches)		
(3x)	(3x)	(1x) and Regulators internally
Output Current Characteristics (Ishort <3A in foldback regulators), reverse bias diodes!		
Foldback and trip off	Foldback and trip off	Constant current and trip off
Dual tracking for complementary outputs		
yes	yes	no
Calibration ranges Voltage / Currents		
+/-5% / 20%	+/-5% / 20%	+/-5% / fix limits
Sense compensation ranges, all DC voltages		
0,5V	0,5V	0V
Status Control for all voltages (Over- Under-Voltage Comparator, defaults +/-0,3%)		
bad/good, Status LED-signal	bad/good, Status LED-signal	Bad Status red LED, unit trips off
Oversvoltage Protection, trip off thresholds (defaults)		
Crow bars 7,3V, 14,5V, 24,5V	Crow bars 7,3V, 14,5V, 24,5V	+/-0,3% of nom voltages
Derating		
>40°C with 2% up to 60°C max.	>40°C with 2% up to 60°C max.	>40°C with 2% up to 60°C max.



UEP 10 "Energy Tank"

CAMAC Power Supplies

Linear regulated

Four-fold linear regulated low noise power supply with 600W power output, cut-off-protection for "overload", "oversvoltage", and "overtemperature"-failures according to CERN-CAMAC-Note 46-04.

Equipped with monitoring, status control and all alarming facilities. Status output »good« if all DC-Voltages are within their tolerance. UEP 10M52 / 53 have an integrated long life fan to cool heat sink, transformer and other components inside. Constructed in the same way as UEP 10M88.

DC Outputs: +/-6V, +/-24V

Different versions for either 100VAC or 115VAC or 230VAC (standard) are available.

Low noise switching Power Supply

High density ultra high power CAMAC power supply in WIENER low-noise-cavity technology, considering both: CERN-CAMAC-Note 46-04 and EP 82-01. The PS236 power supplies use the status signal to superpose additional digital monitoring information to the fan tray. This enlarged the monitoring and control features. Wide range mains input 92-265VDC, 47-63Hz.

DC Outputs: +/-6V, +/-12V, +/-24V. Current limits can be adjusted via UEL/CEL03 fan tray or remotely, when the fan tray has corresponding remote interface installed.

In case high power is required, fan trays with bottom only air entry should be used, otherwise no adequate cooling airflow through the CAMAC modules is produced.

Power configurations



UEP10M52, 650W



CS236, 1900W (CE conform)

Power supply	+6V	-6V	+12V	-12V	+24	-24V	max. power (*: 92-265VAC)	regulation	application
UEP10M52	65A	32A	-	-	6A	6A	650W	linear	CAMAC
UEP10M53	32A	65A	-	-	6A	6A	650W	linear	CAMAC
PS236VH12	80A	80A	20A	20A	10A	10A	1100-1900W*	switched	CAMAC

Technical specification

UEP/CEP10M52 / 53	PS/CS 236
Input voltage, 47-63Hz	
100V (+/-10%) or 115V or 230V	92V-265V, <16A sinusoidal
Soft start	
yes	yes
Output: Noise and Ripple: Full load / 80% rated output (0-20Mhz Bandwidth)	
<3mVpp / <1mVpp, <0,6mVRMS	<10mVpp / <10mVpp, <2mVRMS
Regulation static: Change of output voltage versus load change 10-100%	
<0,05%, <0,1% for 65A	<0,1% or <15mV
Regulation static: Change of output voltage versus line change +/-10%	
<0,02%	<0,02%
Regulation dynamic: Change of output voltage versus load change +/-25%	
	<0,7% or 100mV.
Recovery time versus load change 10-100% Recovery time versus load change +/-25%	
<0,15ms	<0,2ms for <1% deviation
Output impedance: Static / Dynamic(at 100kHz, 6V output)	
0,15mOhm / 0,3 Ohm	0,2mOhm / 50mOhm
Temperature Error	
<0,005%/K	<0,02%/K
Thermal Protection (No. of thermal switches)	
(3x)	(5x)
Output- Current Characteristics, reverse bias diodes!	
Foldback (Ishort <3-5A) and trip off	Constant current and trip off
Dual tracking for complementary outputs	
yes	Voltage rise time 50ms, Off with crow bar discharge
Calibration ranges Voltage / Currents (manually)	(programmable)
+/-5% / 20%	+15%-50% / 0-100%
Sense compensation ranges, all DC voltages	
0,5V	0,5V
Status Control for all voltages (Over- Under-Voltage Comparator, defaults +/-0,3%)	
bad/good- signal, Status LED- output	Status control, LED-signal, trip off circuit
Overvoltage Protection, trip off thresholds (defaults)	
Crow bars 7,3V, 14,5V, 24,5V	Crow bars 7,3V, 14,5V, 24,5V
Derating, max. operating temperature	
>40°C with 2% up to 60°C max.	no derating up to 50°C, 50°C max.



Powered Crates

WIENER VME / VXI / VXS and Customized Crates

Page

Introduction VME / VXI / VXS Standards	28
VME/VME64 Crates	40
6U VME 195/395/475/554 Mini Crates	40
6U VME 6021 Series	42
6U VME 6023 Series	43
9U VME 6021 Series	44
9U VME 6023 Series	45
VME 430 Crates	46
6U VME-430 6021 Series	46
6U VME-430 6023 Series	47
9U VME-430 6021 Series	48
9U VME-430 6023 Series	49
VME 64x Crates	50
6U VME64x 195x/395x Mini Crates	50
6U VME64x 475x/554x Mini Crates	51
6U VME64x 6021 Series	52
6U VME64x 6023 Series	53
9U VME64x 6021 Series	54
9U VME64x 6023 Series	55
VXS Crates	56
64 VXS 6021 Series	56
6U VXS 6023 -JL Series	57
VXI Crates	58
6U VXI-C Series	58
6U VXI-D Series	59
6U VXI-C 4600 RR Series	60
6U VXI-C High Power Receiver Crate	61
6U VXI-C Size Front-Load Crate	62
Custom Specific Crates	63
6U/cPCI, PXI, PXIe Mini Crates	63
CERN LHC Crates	64
6U VME VME64x 6023-JLAB Crates	65
6U VME 64x 6023 SNS Crates	66
6U VME64x 3200 Crate Series	67
6U VME 64/64x NIX-I Crate Series	67
Technical details of WIENER VME / VXI / VXS Crates	68
Backplanes 3U/6U VME-J1- J2	68
Backplanes 3U/6U VME64x J1/J0/J2	68
Backplanes 6U VXS J1/J0/J2	69
VXI-bus Backplane / VXI-4 Backplane	70
Compact PCI (cPCI) Backplanes	71
PXI Backplanes	71
UEV 6021 / UEV 6023 Bins	73
UEP 6021 Power Supplies	77
Fan trays UEL 6020 / Control & Interface	79

Image: BABAR detector, courtesy of SLAC, USA

Introduction to VME/VXI/VXS Standards

ANSI VITA VME Standard (VME32/VME64)

VME bus is a computer bus standard, originally developed for the Motorola 68000 line of CPUs, but later widely used for many applications and standardized by the IEC as ANSI/IEEE 1014-1987. It is physically based on the Eurocard sizes, mechanics and connectors, but uses its own signaling system. It was first developed in 1981 and continues to see widespread use today.

Since its creation 25 years ago the original VME bus standard has seen a number of extensions and add-ons.

Year	Standard	Features	Page
1982	VME32 rev.A	32bit parallel bus, A32, D32 max 40MB/s 3 row DIN connectors P1, P2	22
1987	ANSI/IEEE 1014-1987	Standard adopted based on VME Rev. C	22
1987	VXI	VME extension for instrumentation	25
1990	VME430	CERN nuclear VME 30 pin Paux connector additional -5.2V, -2V, +/-15V	28
1982	VME64	Multiplexed 64 bit, A64, D64 max 80MB/s	22
1996	VME64x	New 160 pin connectors, metric P0 connector EMC, ESD (IEEE 1101.10) additional +3.3V (opt. 48V)	29
1998	VME64xP	VIPA (Physics), redefined P0 add. 9U x 400mm size	30
2003	VME 2eSST	Up to 320MB/s	30
2003	VXS	Serial high speed fabric (P0)	31

History

In 1979 Jack Kister and John Black, engineers at Motorola, began creating a new processor bus system to go with the MC68000 CPU. As more designers became involved and the system was further refined, it later became known as the VME bus.

The new VME bus had many advantages and was soon adopted as a standard for a number of other companies that were involved with the Motorola 68000. The first Official VME bus standard was released by the IEC as IEC 821 and by ANSI and IEEE as ANSI/IEEE 1014-1987. Development continues today primarily driven by the VME International Trade Association (VITA).

VME originally featured a 24-bit address bus and 16-bit data bus. Several updates to the system allow wider bus widths. The current VME64 standard defines a full 64-bit bus in 6U-sized cards and 32-bit in 3U cards. The VME64 protocol has a maximum data transfer rate of 80 MByte/s.

In the late 1990's, VITA defined synchronous protocols to improve the data transfer bandwidth on existing VME64 backplanes. A new 2eSST protocol was approved in ANSI/VITA 1.5 in 1999, which allows up to 320 Mbytes/s.

Many extensions have been added to the VME interface, providing 'sideband' channels of communication in parallel to VME itself. Some examples are IP Module, RACEway Interlink, SCSA, Gigabit Ethernet on VME64x Backplanes, PCI Express, RapidIO, StarFabric and Infini-Band and VXI.

VME is a multi-master bus. A bus arbiter, in the left-most slot (slot 1) determines which of several competing masters acquires the bus. Arbitration can be prioritized with 7 bus request levels or round robin. VME also defines a flexible prioritized interrupt subsystem.

Hardware Description

VME card mechanical dimensions meet the Eurocard Standard. The connection between the module and the backplane is made by two 96-pin DIN 41612 connectors. The number of connectors used determines the address space of the card and the card size. Uncommitted pins on the connectors provide support for application specific buses and rear transition modules. 9-U modules may provide a third connector for application specific use.

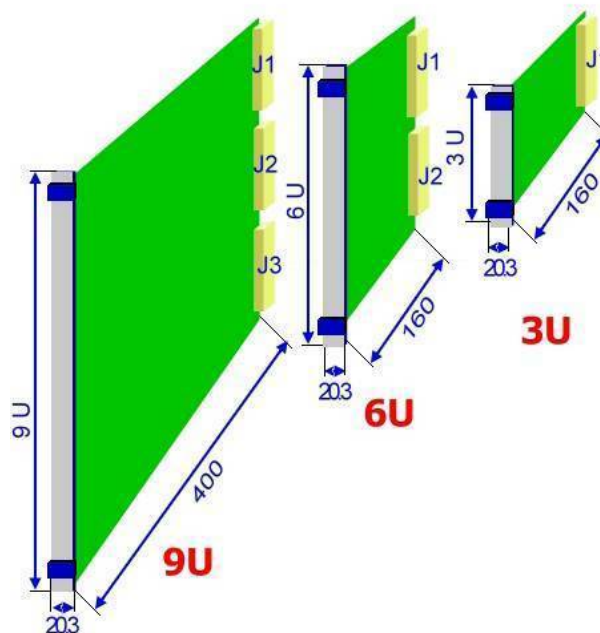

VME card sizes and connector positions

VME modules come in three sizes. 3U x 160mm cards have one backplane connector (J1) and have a 24-bit/16-bit address/data space. 6U x 160mm cards are the most common ones and have two backplane connectors (J1 & J2) allowing for 32 bits of address/data space. Large 9U x 400mm cards also have 32 address/data lines and 2 connectors (J1 & J2). Each VME card is 20.3mm wide. Twenty-one cards will fit into a 19 rack mounted VME crate.

VME crates, or chassis, provide the mechanical support with card guides and the VME bus backplane into which the modules are plugged. The crate typically has a power supply, which provides power to the backplane. Standard VME voltages are 5V and +/-12V. For proper cooling the crate should be outfitted with a cooling fan or fan tray.

Bus Description

Address Lines

The VME bus has 31 address lines. The first 23 lines are present on J1 and the remainder being on J2. The lowest address bit (A0) is implied by the transfer cycle and is not present on the backplane. VME64 can multiplex address and data lines allowing 31 address bits on J1 and an additional 32 address bits on J2.

Data Lines

The VME bus has 32 data lines. The low order 16 data lines are on J1, the high order 16 on J2. VME modules with only J1 can only do 16 bit wide transfers, while those with both J1 and J2 can do 32 bit wide transfers. VME64 modules multiplex address and data allowing 32 bit transfers on J1, and 64 bit wide transfers when both connectors are present.

Pin No.	J1/P1 (top)		
	Row A	Row B	Row C
01	D00	BBSY*	D08
02	D01	BCLR	D09
03	D02	ACFAIL*	D10
04	D03	BG0IN*	D11
05	D04	BG0OUT*	D12
06	D05	BG1IN*	D13
07	D06	BG1OUT*	D14
08	D07	BG2IN*	D15
09	GND	BG2OUT*	GND
10	SYSCLK	BG1IN*	SYSFAIL*
11	GND	BG3OUT*	BERR*
12	DS1*	BR0*	SYSRESET*
13	DS0*	BR1*	LWORD*
14	WRITE*	BR2*	AM5
15	GND	BR3*	A23
16	DTACK*	AM0	A22
17	GND	AM1	A21
18	AS*	AM2	A20
19	GND	AM3	A19
20	IACK*	GND	A18
21	IACKIN*	SERCLK	A17
22	IAOUT*	SERDAT	A16
23	AM4	GND	A15
24	A07	IRQ7*	A14
25	A06	IRQ6*	A13
26	A05	IRQ5*	A12
27	A04	IRQ4*	A11
28	A03	IRQ3*	A10
29	A02	IRQ2*	A09
30	A01	IRQ1*	A08
31	-12V	+5V STDBY	+12V
32	+5V	+5V	+5V

J2/P2 (bottom)		
Row A	Row B	Row C
User defined	+5V	User defined
User defined	GND	User defined
User defined	Reserved	User defined
User defined	A24	User defined
User defined	A25	User defined
User defined	A26	User defined
User defined	A27	User defined
User defined	A28	User defined
User defined	A29	User defined
User defined	A30	User defined
User defined	A31	User defined
User defined	GND	User defined
User defined	+5V	User defined
User defined	D16	User defined
User defined	D17	User defined
User defined	D18	User defined
User defined	D19	User defined
User defined	D20	User defined
User defined	D21	User defined
User defined	D22	User defined
User defined	D23	User defined
User defined	GND	User defined
User defined	D24	User defined
User defined	D25	User defined
User defined	D26	User defined
User defined	D27	User defined
User defined	D28	User defined
User defined	D29	User defined
User defined	D30	User defined
User defined	D31	User defined
User defined	GND	User defined
User defined	+5V	User defined

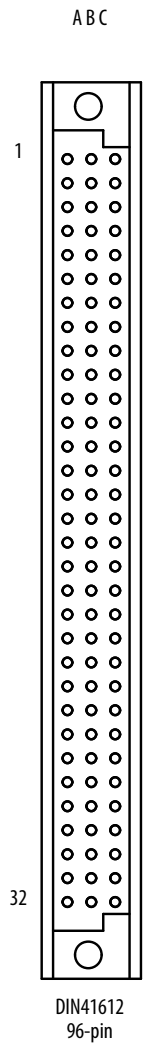

VME Backplane connectors and pin layout

Bus Arbitration

A VME Bus master requests the bus by asserting one of the bus request lines BR0*-BR3*. The slot 1 bus arbiter (some masters include bus arbitration logic) will grant the bus by asserting the corresponding bus grant signal (BG0OUT-BG3OUT). The arbiter can cyclically scan the BRn* lines (round robin arbitration), or treat higher numbered BRn* lines as being a higher priority request (prioritized arbitration). The bus grant forms a daisy chain. Each module monitors BG0IN-BG3IN if it is not requesting the bus it reproduces these signals on BG0OUT-BG3OUT which are inputs to the next slot to the right on the backplane. If the module is requesting the bus on the corresponding BRn* it claims the bus by driving BBSY*.

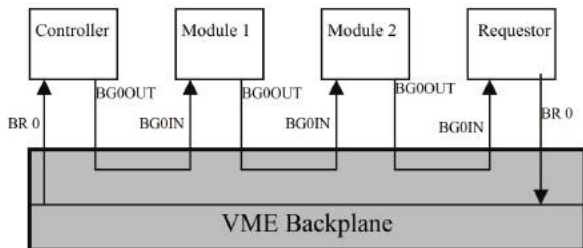

Bus request and grant daisy chain

Address Strobe Line

The Address strobe Line (AS*) is driven low by a master to indicate it is driving a valid address.

Data Acknowledge Line

DTACK* is an open-collector signal generated by slaves. The falling edge of this signal indicates that valid data is available on the data bus during a read cycle, or that the slave has accepted data during a write cycle. The rising edge of DTACK indicates when the slave's data is no longer present at the end of a read cycle.

Interrupt Handling

Any module on the VME bus may request an interrupt by driving one of the interrupt request lines IRQ1*-IRQ7*. Any bus master module can respond to any of the interrupt request lines by arbitrating for the bus, asserting IACK* and echoing the interrupt level on A1-A3. The bus arbiter places the IACKOUT* on an interrupt daisy chain (similar to the bus grant daisy chain). The interrupting module will then provide a status-id on the data bus that allow the interrupt handler to distinguish between interrupters sharing the same interrupt request level.

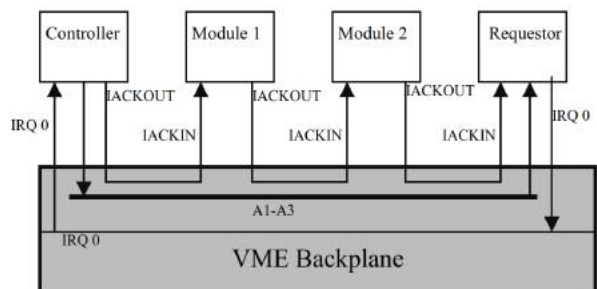

VME Interrupt handling

Clock

SYSCLK is a totem pole signal that provides a constant 16 MHz clock signal from the system controller.

System Fail Line

The SYSFAIL* line is an open-collector signal that indicates when a failure has occurred in the system. Any board in the system can generate this signal.

System Reset

The SYSRESET requests that all bus modules perform power-up initialization.

Write Line

WRITE* is a three-state signal generated by the master to indicate whether the data transfer cycle is a read or write. A high level indicates a read operation; a low level indicates a write operation.

Address Modifiers

VME provides for large number of data transfer types. The VME Address modifier lines (AM0*-AM5*) are asserted by a bus master during an address cycle to indicate the type of data transfer requested.

AM	Address	Description
0x3F	24	A24 supervisory block transfer (BLT)
0x3E	24	A24 supervisory program access
0x3D	24	A24 supervisory data access
0x3C	24	A24 supervisory 64-bit block transfer (MBLT)
0x3B	24	A24 non-privileged block transfer (BLT)
0x3A	24	A24 non-privileged program access
0x39	24	A24 non-privileged data access
0x38	24	A24 non-privileged 64-bit block transfer, MBLT
0x37	40	A40BLT [MD32 data transfer only]
0x35	40	A40 lock command (LCK)
0x34	40	A40 access
0x32	24	A24 lock command (LCK)
0x2F	24	CR / CSR space
0x2D	16	A16 supervisory access
0x2C	16	A16 lock command (LCK)
0x29	16	A16 non-privileged access
0x21	32/64	2eVME for 3U bus modules (address size in XAM code)
0x20	32/64	2eVME for 6U bus modules (address size in XAM code)
0x0F	32	A32 supervisory block transfer (BLT)
0x0E	32	A32 supervisory program access
0x0D	32	A32 supervisory data access
0x0C	32	A32 supervisory 64-bit block transfer (MBLT)
0x0B	32	A32 non-privileged block transfer (BLT)
0x0A	32	A32 non-privileged program access
0x09	32	A32 non-privileged data access
0x08	32	A32 non-privileged 64-bit block transfer MBLT
0x05	32	A32 lock command (LCK)
0x04	64	A64 lock command (LCK)
0x03	64	A64 block transfer (BLT)
0x01	64	A64 single access transfer
0x00	64	A64 64-bit block transfer (MBLT)

List of VME address modifiers

Long Word

The LWORD* line is used in conjunction with DS0*, DS1*, to specify the width of a data transfer.

Serial Data

The SERCLK and SERDAT lines implement a serial data bus. SERCLK provides a synchronization clock for the serial data that can be transferred on SERDAT

Bus Busy and Bus Clear

The master that has been granted the bus assert BBSY* to indicate the bus is in use. In priority arbitration, the bus arbiter can assert BCLR* if a bus request at a higher priority than the currently granted master is present. The current bus master is then expected to release the bus when convenient by releasing BBSY, to allow the new arbitration cycle to complete.

AC FAIL

The ACFAIL line is driven low when there is an AC failure for the VME power supply.

Bus Errors

The bus arbiter often implements address timeout logic and asserted BERR* if no module responds to an address cycle within the timeout. Slaves may also assert BERR* if they are not able to honor a requested cycle (e.g. they do not support the requested address modifier).

VME Bus Timing

Address Cycle

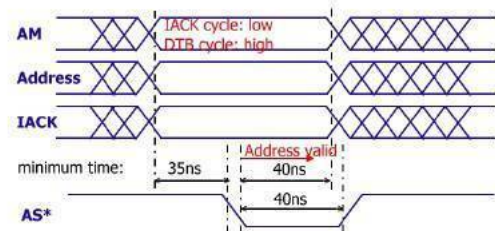

During an address cycle, a VME bus master holds IACK high and places the address and AM [0-5] codes on the bus. Once the lines have been valid for at least 35ns the Master drives the Address Strobe [AS*] indicating a valid address is on the bus. For interrupt acknowledge cycles the IACK line is driven low, the interrupt priority is encoded on A1-A3 and the AM lines are ignored.

Data Cycle

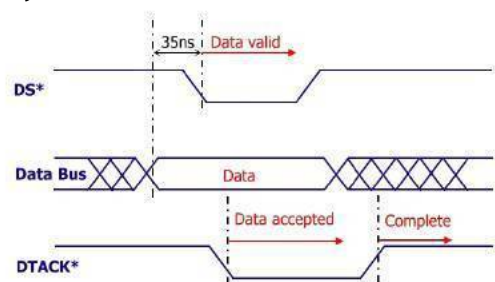

VME Data cycles can be writes (Master to Slave) or reads (Slave to Master). Regardless of the cycle type, the Master uses LWORD*, DS0* and DS1* to indicate the width of the transfer. At least one of DS0*, DS1* will be driven. For a write cycle, DS0* and DS1* also indicate that the Master has stable data on the data bus for the slave. In a read cycle, DS0* and DS1* indicate the master is ready to receive data from the slave. In a write cycle, DTACK* is asserted by the slave when it has accepted the data transfer. In a read cycle DTACK* indicates the slave has stable data on the bus for the master. Regardless of the cycle type, the release of both DS0* and DS1*, and subsequent release of DTACK* by the slave indicates completion of the cycle.

Data Transfer

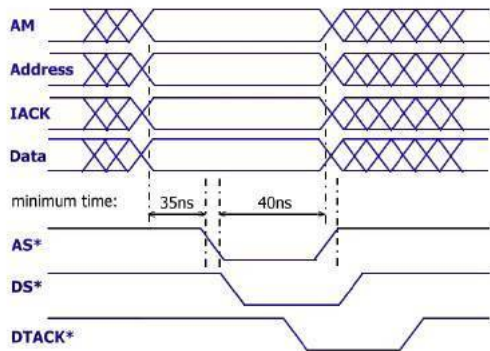

Data transfer requires an address and a data cycle. Address cycles may overlap the previous data cycle.

Block Transfers

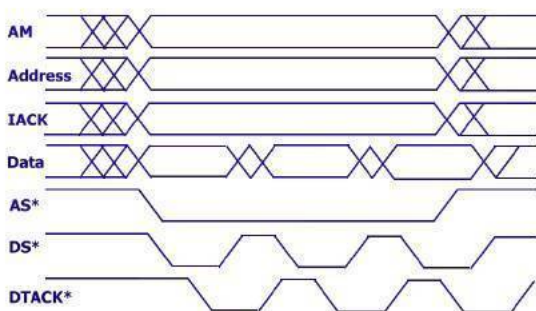

A VME bus Block Transfer [BLT] consists of a single Address cycle followed by up to 256 bytes of Data transfer before another address cycle is required. VME64 adds the Multiplexed Block Transfer [MBLT]. MBLT transfer data on both the address and data lines to achieve a 64 bit transfer width.

Bus Request

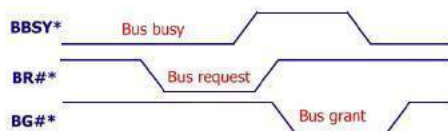

The master requesting the bus does so by driving a Bus Request (BR#*) line low. The VME bus arbiter hands control of the bus to a master by asserting the corresponding BG#* line.

VXI Standard (IEEE 1155)

The VXI bus architecture is an open standard platform for automated test instruments based upon VMEbus, the Eurocard standards, and other instrumentation standards such as IEEE-488.2. VXI's core market is in Telecommunication, Military and Aerospace automatic test systems and data acquisition applications.

The original standard for "VME eXtensions for Instrumentation System Specification" VXI-1 Revision 1 was introduced in August 1987 by the VXI Bus Consortium which included companies as Colorado Data Systems, Hewlett-Packard, Racal Dana, and Tektronix. Revision 3 added VME64 64-bit transfers and features. The VXI-1 specification has been adopted by the IEEE as IEEE Std 1155-1992. For more information see <http://www.vxibus.org/>.

VXI implements the VME bus protocol for data transfers between modules but implements a number of significant enhancements towards data acquisition and automated test applications. Especially the VXI mechanical and power supply specifications provide an excellent electrical environment for low-level, high accuracy analog circuitry.

- Larger card size to increase VXI board space, provides space for sophisticated analog circuits, signal conditioning and better analog to digital isolation
- 1.2" module spacing, fully shielded mechanical design of modules to minimize noise pickup and provides more front panel space
- 3 different module sizes (B, C, D-size)
- Mandatory analog power supply voltages (-5.2V, -2V, +/-24V) and strict limits for power supply noise
- Specifications for cooling and measurement of cooling performance (VXI-8) to allow use of high power electronic circuits in VXI modules.
- VXI Backplane provides precision clocks and trigger lines for common clocking and triggering / event handling across VXI modules
- Geographic addressing, dynamic address allocation
- Local bus for inter-module communication
- Power-up self test (status register bit indicates whether the module passed self-test or not)
- Definition of module standard registers including: manufacturer ID, Serial Number, Module Hardware / Firmware Revision Level

VXI System and Sub-system

A VXI system can have up to 256 devices, including one or more VXI bus subsystems. A VXI bus subsystem consists of a central timing /controller module in Slot 0 (Slot-0 controller) with up to twelve additional instrument modules. The Slot 0 module is responsible for managing system resources such as the VXI bus mandated timing generation, the VME bus system controller functions and a possible data communication ports such as Ethernet, RS232 or IEEE 488.

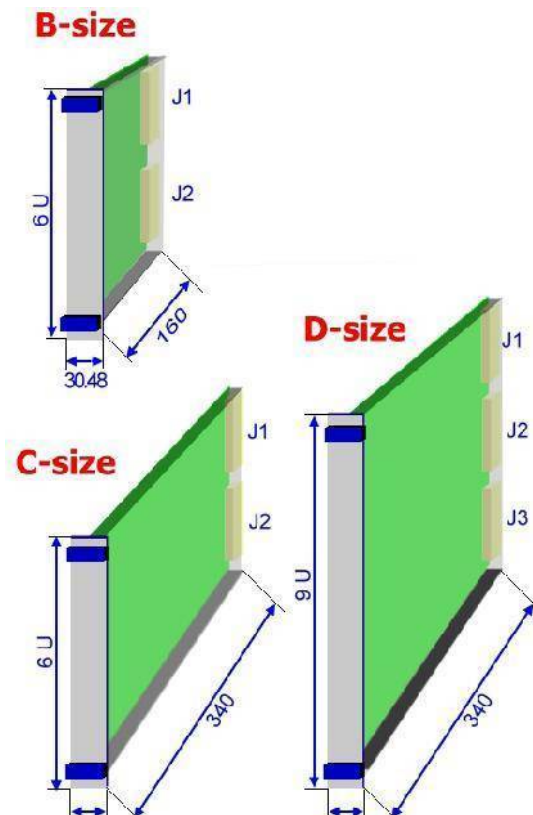

A typical VXI crate has 13 slots (numbered 0 through 12 from the left as viewed from the front). The VXI crate provides power for the following DC voltages:

- +5V, +/-12V (as per VME spec.),
- 5.2V, -2V (for ECL devices / termination),
- +/-24V (for analog circuits)

Maximum allowed power supply DC noise levels at 10MHz bandwidth are 50mVpp with the exception of +/-24V line (150mVpp). All WIENER VXI crates have lowest noise power supplies with <10mVpp.

To guarantee proper cooling of all plugged in modules the VXI crate has to be outfitted with a fan tray. The provided airflow and distribution has to comply with VXI-8 specification.

There are 3 sizes of VXI modules: B, C and D. B-size modules are the same size as standard 6U VME modules and have identical 96-pin DIN connectors P1 and P2. Most popular is the C-size with the same 6U height but 340mm deep modules. The D-size module is a triple height Eurocard (9U) and can be outfitted with an additional P3 connector, which requires a special 9U backplane.

The VXI backplane for B- and C-size applications is a 6U high monolithic backplane with 13 slots. The pin layout is identical to VME for the top J1 connector as well as the center row of the lower J2 connector.

On the J2/P2 outer A and C rows (not used by VME) VXI adds a 10 MHz ECL clock, ECL and TTL trigger lines, an analog summing bus, a module identification line, the local bus and additional DC voltages:

- 5.2V, -2V, ±24V and additional +5V power
- 10 MHz differential clock
- 2 parallel ECL trigger lines
- 8 parallel TTL trigger lines
- 12 lines of defined local bus (daisy chain)
- 50 Ω terminated analog summing bus
- Module identification pin

VXI D-sized modules have a third connector J3/P3 on the bottom of the 9U high backplane. This J3/P3 connector adds of the similar resources as J2/P2. To support higher performance instrumentation it also includes a 100 MHz clock and sync signal as well as high precision star trigger system where ECL trigger signals are routed through Slot 0 acting as a cross point switch. Further 24 additional lines of daisy chain local bus are defined on P3/J3.

- Additional +5V, -5.2V, -2V, ±24V and ±12V power.
- 100 MHz differential clock (synchronous with CLK10)
- Synchronizing signal for 100 MHz clock edge selection
- 4 additional ECL trigger lines, (total of 6)
- 24 additional local bus lines (total of 36)
- Star Trigger lines for precision module to module timing

CLK10 - Differential Clock

CLK10 is a 10 MHz system clock. It is sourced from Slot 0 and distributed to Slots 1-12 on P2. The Slot 0 output is differential ECL, which is buffered on the backplane and distributed to each module slot as a single source, single destination differential ECL signal.

CLK100 – Differential Clock (D-size only)

CLK100 is a 100 MHz system clock distributed via J3/P3. It is sourced from Slot 0, buffered on the backplane and distributed to each module slot as a single source, single destination differential ECL signal. Distribution delays have to be matched to provide a tight timing relationship between modules. CLK100 has to be synchronous to CLK10.

Pin No.	J2/P2 (SLOT 0)		
	Row A	Row B	Row C
01	ECLTRG0	+5V	CLK10+
02	-2V	GND	CLK10-
03	ECLTRG1	Reserved	GND
04	GND	A24	-5.2V
05	LBUSA00	A25	LBUSC00
06	LBUSA01	A26	LBUSC01
07	-5.2V	A27	GND
08	LBUSA02	A28	LBUSC02
09	LBUSA03	A29	LBUSC03
10	GND	A30	GND
11	LBUSA04	A31	LBUSC04
12	LBUSA05	GND	LBUSC05
13	-5.2V	+5V	-2V
14	LBUSA06	D16	LBUSC06
15	LBUSA07	D17	LBUSC07
16	GND	D18	GND
17	LBUSA08	D19	LBUSC08
18	LBUSA09	D20	LBUSC09
19	-5.2V	D21	-5.2V
20	LBUSA10	D22	LBUSC10
21	LBUSA11	D23	LBUSC11
22	GND	GND	GND
23	TTLTRG0*	D24	TTLTRG1*
24	TTLTRG2*	D25	TTLTRG3*
25	+5V	D26	GND
26	TTLTRG4*	D27	TTLTRG5*
27	TTLTRG6*	D28	TTLTRG7*
28	GND	D29	GND
29	RSV2	D30	RSV3
30	MODID	D31	GND
31	GND	GND	+24V
32	SUMBUS	+5V	-24V

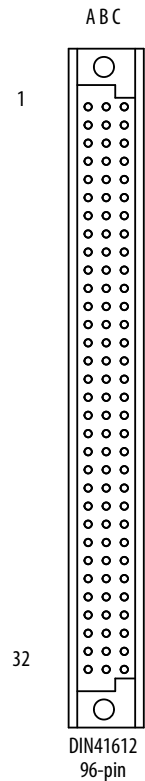

Pin No.	J2/P2 (SLOT 1-12)		
	Row A	Row B	Row C
01	ECLTRG0	+5V	CLK10+
02	-2V	GND	CLK10-
03	ECLTRG1	Reserved	GND
04	GND	A24	-5.2V
05	LBUSA00	A25	LBUSC00
06	LBUSA01	A26	LBUSC01
07	-5.2V	A27	GND
08	LBUSA02	A28	LBUSC02
09	LBUSA03	A29	LBUSC03
10	GND	A30	GND
11	LBUSA04	A31	LBUSC04
12	LBUSA05	GND	LBUSC05
13	-5.2V	+5V	-2V
14	LBUSA06	D16	LBUSC06
15	LBUSA07	D17	LBUSC07
16	GND	D18	GND
17	LBUSA08	D19	LBUSC08
18	LBUSA09	D20	LBUSC09
19	-5.2V	D21	-5.2V
20	LBUSA10	D22	LBUSC10
21	LBUSA11	D23	LBUSC11
22	GND	GND	GND
23	TTLTRG0*	D24	TTLTRG1*
24	TTLTRG2*	D25	TTLTRG3*
25	+5V	D26	GND
26	TTLTRG4*	D27	TTLTRG5*
27	TTLTRG6*	D28	TTLTRG7*
28	GND	D29	GND
29	RSV2	D30	RSV3
30	MODID	D31	GND
31	GND	GND	+24V
32	SUMBUS	+5V	-24V

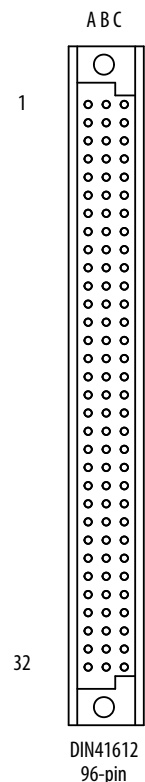

Pin No.	J3/P3 (SLOT 0)		
	Row A	Row B	Row C
01	ECLTRG2	+24 V	+12 V
02	GND	-24 V	-12 V
03	ECLTRG3	GND	RSV4
04	-2 V	RSV5	+5 V
05	ECLTRG4	-5.2 V	RSV6
06	GND	RSV7	GND
07	ECLTRG5	+5 V	-5.2 V
08	-2 V	GND	GND
09	STARY12+	+5 V	STARX01+
10	STARY12-	STARY01-	STARX01-
11	STARY12+	STARY12-	STARX01+
12	STARY11+	GND	STARX02+
13	STARY11-	STARY02-	STARX02-
14	STARY11+	STARY11-	STARX02+
15	STARY10+	+5 V	STARX03+
16	STARY10-	STARY03-	STARX03-
17	STARY10+	STARY10-	STARX03+
18	STARY09+	-2 V	STARX04+
19	STARY09-	STARY04-	STARX04-
20	STARY09+	STARY09-	STARX04+
21	STARY08+	GND	STARX05+
22	STARY08-	STARY05-	STARX05-
23	STARY08+	STARY08-	STARX05+
24	STARY07+	+5 V	STARX06+
25	STARY07-	STARY06-	STARX06-
26	STARY07+	STARY07-	STARX06+
27	GND	GND	GND
28	STARY+	-5.2 V	STARY+
29	STARY-	GND	STARY-
30	GND	-5.2 V	-5.2 V
31	CLK100+	-2 V	SYNC100+
32	CLK100-	GND	SYNC100-

J3/P3 Pin Layout (Slot 0)

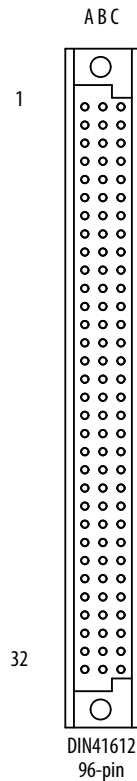

Pin No.	J3/P3 (SLOT 1 – 12)		
	Row A	Row B	Row C
01	ECLTRG2	+24 V	+12 V
02	GND	-24 V	-12 V
03	ECLTRG3	GND	RSV4
04	-2 V	RSV5	+5 V
05	ECLTRG4	-5.2 V	RSV6
06	GND	RSV7	GND
07	ECLTRG5	+5 V	-5.2 V
08	-2 V	GND	GND
09	LBUSA12	+5 V	LBUSC12
10	LBUSA13	LBUSC15	LBUSC13
11	LBUSA14	LBUSA15	LBUSC14
12	LBUSA16	GND	LBUSC16
13	LBUSA17	LBUSC19	LBUSC17
14	LBUSA18	LBUSA19	LBUSC18
15	LBUSA20	+5 V	LBUSC20
16	LBUSA21	LBUSC23	LBUSC21
17	LBUSA22	LBUSA23	LBUSC22
18	LBUSA24	-2 V	LBUSC24
19	LBUSA25	LBUSC27	LBUSC25
20	LBUSA26	LBUSA27	LBUSC26
21	LBUSA28	GND	LBUSC28
22	LBUSA29	LBUSC31	LBUSC29
23	LBUSA30	LBUSA31	LBUSC30
24	LBUSA32	+5 V	LBUSC32
25	LBUSA33	LBUSC35	LBUSC33
26	LBUSA34	LBUSA35	LBUSC34
27	GND	GND	GND
28	STARX+	-5.2 V	STARY+
29	STARX-	GND	STARY-
30	GND	-5.2 V	-5.2 V
31	CLK100+	-2 V	SYNC100+
32	CLK100-	GND	SYNC100-

J3/P3 Pin Layout (Slot 1 - 12)

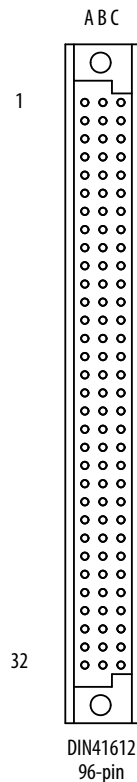

ECLTRG0-5 - ECL Trigger lines

The 6 ECLTRG lines (C-size:0, 1 only) are used as an inter-module timing resource and can be accessed by any VXI module. These lines are single-ended ECL with 50 ohm impedance (terminated with 50Ω to -2 V on backplane). ECLTRG lines have a set of defined protocols corresponding to the TTLTRG* protocols.

LOCAL BUS

The Local Bus is a daisy chained bus structure with 36 lines (C-size:12 lines only) which allows several types of signal levels to be transmitted via this bus. For protection a keying mechanism is provided. The Local Bus key provides support for TTL, ECL and analog communication.

Number	Class	Range
1	TTL	-0.5 V ... +5.5 V
2	ECL	-5.46 V ... 0.0 V
3	ANALOG LOW	-5.5 V ... +5.5 V
4	ANALOG MED	-16.0 V ... +16.0 V
5	ANALOG HIGH	-42.0 V ... +42.0 V
6	RESERVED	

TTLTRG0-7* - TTL Trigger Lines

These open collector TTL lines are used for inter-module communication as trigger, handshake, clock or logic state transmission. Any module, including Slot 0, can drive these lines and receive information on these lines. Some standard allocation procedures and protocols as synchronous (SYNC), asynchronous (ASYN) and start/stop (STST) are defined.

SUMBUS

The SUMBUS is an analog summing node that is bussed on the VXI backplane. Any module can drive it via an analog current source or receive from this line using a high impedance receiver. The SUMBUS is terminated to ground through 50ohm on both ends of the backplane.

STARX and STARY

Bi-directional STAR trigger lines provide inter-module asynchronous communication. Two STAR lines are connected between each module slot and Slot 0. Slot 0 may provide a cross-point switch that can be programmed to route signals between any two STARX or STARY lines. It may also broadcast a signal to a group of STAR lines.

SYNC100

Is used to synchronize multiple devices with respect to a given rising edge of CLK100 in order to provide very tight time coordination between modules. SYNC100 is distributed from Slot 0 to slots 1-12, with individual backplane buffers for each slot. A Slot 0 module implementing the SYNC100 function must provide an arbiter to synchronize external events to CLK100 that meets the guaranteed setup and hold times for the SYNC100 signal. This guarantees that all affected modules will trigger on the same CLK100 clock edge. SYNC100 is nominally a 10 ns pulse and may be initiated by any type of external or internal event.

VXI Address Space Definition

VXI assigns non-conflicting portions of the VME bus address space to its devices. 256 devices may exist in a VXI system and are referred to by logical device addresses 0 through 255. The VXI bus system configuration space is the upper 16k of the 64k A16 address space. Each device is granted a total of 64 bytes in this space.

If a device needs more space a dynamic memory assignment is performed at power-on. The „resource manager“ reads the requirements and assigns the requested memory space by writing the module's new.

VME bus address into the device's offset register. This method positions a device's additional memory space in the A24, A32, or A64 address space.

VXI bus Registers

VXI defines standard registers for use as configuration, communication and memory. VXI modules also have standard registers to provide manufacturer ID, Serial Number, Module Hardware / Firmware Revision Level.

The VXI bus specification defines further protocols, command and event formats and is supplemented by additional standards such as VXI plug & play to simplify it's use.

CERN VME 430 / "Nuclear VME" Standard

In order to make the VME bus suitable for data acquisition systems in nuclear and high energy physics experiments and to standardize used electronic equipment the European Physics Laboratory CERN developed in 1990 several VME crate specifications. These standards defined the VME crate design; mechanics, power supply and cooling. CERN VME crates were a modular designed, consisting of a VME bin with backplane and card cage with plug-in fan tray and power supply. This modularity made it easy to quickly exchange failing fan trays and power supplies.

The CERN V422 standard described a 21 slot standard VME (VME64) crate. The V430 "VME 430 - nuclear VME" specification used a modified backplane to add bus lines and DC voltages needed for data acquisition applications.

As of today the original V422/V430 crates are not produced anymore however, there are still many modules and VME crates available and in use, which comply with the VME430 backplane.

The VME 430 backplane is a monolithic 6U backplane with 3 connector rows J1/Jaux/J2. Both J1 and J2 are outfitted with 3-row DIN-96pin type connectors with standard VME pinouts. This provides backwards compatibility, i.e. any standard VME / VME64 module will work in a CERN VME 430 compliant crate. The CERN VME 430 backplane adds a third dataway and connector row Jaux. Jaux was added in the middle between J1 and J2 to provide additional pins for DC power, geographic addressing and 3 differential bussed signals (clocks / timing).

Pin No.	Jaux/Paux (middle)		
	Row A	Row B	Row C
01	SN1	GND	SN2
02	SN3	GND	SN4
03	SN5	GND	GND
04	CK*	GND	CK
05	SG*	GND	SG
06	CL*	GND	CL
07	-2V	-2V	-2V
08	-15V	CE	+15V
09	-5,2V	-5,2V	-5,2V
10	-5,2V	-5,2V	-5,2V

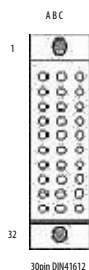

CERN V430 Jaux Pin Layout

CE - Clean Earth

Un-bussed line without termination

CK - Clock signal

Is a bussed differential line terminated on both sides of the backplane (2 resistors to ground and 1 resistor in between the two lines according to the impedance).

CK positive logic /

CK* negative logic

CL - Clear

Is a bussed differential line terminated like CK lines.

CL positive logic

CL* negative logic

Geographical address

VME430 provides geographical addressing on the Jaux connector via SN1... SN5. The addresses are binary coded according to the slot numbers as shown in the following table (NC = No Connection represents H-level and can be generated by 5k6 resistor on VME module for TTL, e.g.):

Slot	SN1	SN2	SN3	SN4	SN5
01	NC	GND	GND	GND	GND
02	GND	NC	GND	GND	GND
03	NC	NC	GND	GND	GND
04	GND	GND	NC	GND	GND
05	NC*	GND	NC	GND	GND
06	GND	NC	NC	GND	GND
...
20	GND	GND	NC	GND	NC
21	NC	GND	NC	GND	NC

Geographic address coding

SG - Start / Stop Gate

Is a bussed differential line terminated like CK lines for timing applications:

SG positive logic

SG* negative logic

VME 430 DC / Power Supply Requirements

In addition to the regular VME DC voltages of 5V and +/-12V the CERN VME 430 specifies also -5.2V and -2V (for fast ECL logic) as well as optionally +/-15V. These voltages are supplied via the Jaux/Paux connectors. VME430 compliant modules often require these voltages for proper operation and may not function in a standard VME crate.

+5V, +/-12V (as per VME spec.),

-5.2V, -2V (for ECL devices / termination),

+/-15V (optional, for analog circuits)

VME Fan tray / cooling

A front side plug-in fan tray provides air flow for VME module cooling. The air temperature increase shall not exceed 10C. The fan tray has to be equipped with a fan fail detection system, which issues on a fan fail a local and remote warning and also can shut down the DC.

CERN Monitoring and Remote Control

According to the CERN V 430 specification for remote control and monitoring the following signal lines are available at a monitoring and control connector (CANON Type DAC 15-S-FO), which is placed at the bin backside.

Line	Description
STATUS	status monitor output
FAN FAILURE	fan failure output
A.C.POWER INHIBIT	remote on / off
SYSRESET	manual system reset
0V SIGNAL	common control return line
DISABLE	global trip-off disable input
GND	ground

CERN V430 remote control & monitoring signals

STATUS and FAN FAILURE are switched by relay contacts. In correct operation, they are close to the return lines. The system-reset circuit is activated by a short circuit between the SYSRESET and the GND signal line. For trouble shooting purposes the global trip-off can be disabled by a jumper connection between INHIBIT and 0V SIGNAL lines.

ANSI / VITA VME64x Standard

In 1997 the VITA Standards Organization (VSO) adopted a superset to the VME64 standard called the VME64 Extensions (VITA 1.1, VME64x). VME64x adds new features and capabilities such as:

- A new 160 pin connector family
- A 95 pin P0/J0 connector
- 3.3 V power supply pins
- More +5 VDC power supply pins
- Geographical addressing
- Higher bandwidth (up to 160 Mbytes/sec)
- 141 more user-defined I/O pins
- Rear plug-in units (transition modules)
- Live insertion / hot-swap capability
- Injector / ejector locking handles
- EMC (Electro Magnetic Compatible) front panels
- ESD (Electrostatic Discharge) features

Backplane

The main and obvious difference is the use of new 160-pin connectors, which are backwards compatible to the "old" 96-pin DIN connector. The 3 row "core" is identical to the VME/VME64 specification. All new bus and power lines are routed to the outer "z" and "d" rows. This makes all legacy VME and VME64 modules forward compatible to VME64x backplanes and sub-racks; i.e. these modules can be plugged into and used in VME64x crates.

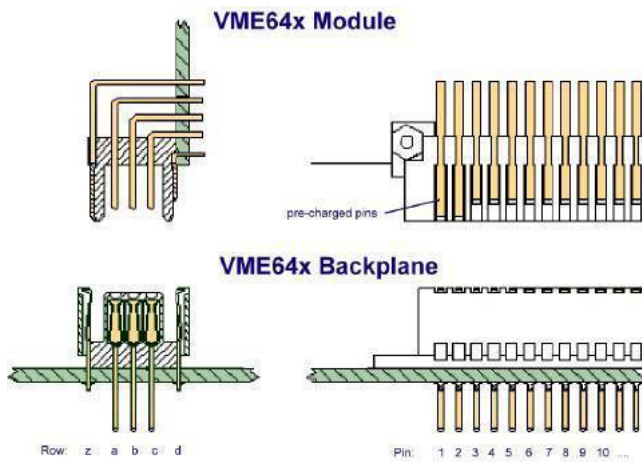

VME64x 5-row connectors

The reverse of plugging a VME64x module into an older VME backplane or crate is mechanically possible however, will work only if the VME64x module does not make use of the 3.3VDC power. Further none of the new VME64x features as geographic addressing live insertion, or 64 bit transfer widths would be available. The monolithic backplane PCB must include both J1 and J2 connectors.

The VME64x standard also adds a new metric style P0/J0 connector in the middle between the top and bottom connectors. All pins except the outer rows (GND) are feed-through connections for I/O. The P0 connector is optional on the backplane.

IEEE1101.10 Mechanics

With VME64x new card rail and front panel mechanics with enhanced EMC/EMD features according to the IEEE 1101.10 standard are used:

- Front panel with guiding and coding pins, EMC strip
- Card guides with ground ESD clips
- Injector / ejector locking handles
- EMC strips on chassis

The new EMC style front panels/handles can have incompatibilities with older VME card cages outfitted according to the CERN VME430 standard.

Pin Assignment for the VME64x P1/J1 Connector					
Pin	Row z	Row A	Row B	Row C	Row d
01	MPR	D00	BBSY*	D08	VPC
02	GND	D01	BCLR	D09	GND
03	MCLK	D02	ACFAIL*	D10	+V1
04	GND	D03	BGOIN*	D11	+V2
05	MSD	D04	BG0OUT*	D12	RsvU
06	GND	D05	BG1IN*	D13	-V1
07	MMD	D06	BG1OUT*	D14	-V2
08	GND	D07	BG2IN*	D15	RsvU
09	MCTL	GND	BG2OUT*	GND	GAP*
10	GND	SYSCLK	BG1IN*	SYSFAIL*	GA0*
11	RESP*	GND	BG3OUT*	BERR*	GA1*
12	GND	DS1*	BR0*	SYSRESET*	+3.3V
13	RsvBus	DS0*	BR1*	LWORD*	GA2*
14	GND	WRITE*	BR2*	AM5	+3.3V
15	RsvBus	GND	BR3*	A23	GA3*
16	GND	DTACK*	AM0	A22	+3.3V
17	RsvBus	GND	AM1	A21	GA4*
18	GND	AS*	AM2	A20	+3.3V
19	RsvBus	GND	AM3	A19	RsvBus
20	GND	IACK*	GND	A18	+3.3V
21	RsvBus	IACKIN*	SERA	A17	RsvBus
22	GND	IAOUT*	SERB	A16	+3.3V
23	RsvBus	AM4	GND	A15	RsvBus
24	GND	A07	IRQ7*	A14	+3.3V
25	RsvBus	A06	IRQ6*	A13	RsvBus
26	GND	A05	IRQ5*	A12	+3.3V
27	RsvBus	A04	IRQ4*	A11	LI/I*
28	GND	A03	IRQ3*	A10	+3.3V
29	RsvBus	A02	IRQ2*	A09	LI/O*
30	GND	A01	IRQ1*	A08	+3.3V
31	RsvBus	-12 V	+5V STDBY	+12 V	GND
32	GND	+5 V	+5 V	+5 V	VPC

P1/J1 Pin Layout (row ABC identical to VME/VME64)

Pin Assignment for the VME-64x P2/J2 Connector					
Pin	Row z	Row a	Row b	Row c	Row d
01	UsrDef	UsrDef	+5 VDC	UsrDef	UsrDef
02	GND	UsrDef	GND	UsrDef	UsrDef
03	UsrDef	UsrDef	RETRY*	UsrDef	UsrDef
04	GND	UsrDef	A24	UsrDef	UsrDef
05	UsrDef	UsrDef	A25	UsrDef	UsrDef
06	GND	UsrDef	A26	UsrDef	UsrDef
07	UsrDef	UsrDef	A27	UsrDef	UsrDef
08	GND	UsrDef	A28	UsrDef	UsrDef
09	UsrDef	UsrDef	A29	UsrDef	UsrDef
10	GND	UsrDef	A30	UsrDef	UsrDef
11	UsrDef	UsrDef	A31	UsrDef	UsrDef
12	GND	UsrDef	GND	UsrDef	UsrDef
13	UsrDef	UsrDef	+5 VDC	UsrDef	UsrDef
14	GND	UsrDef	D16	UsrDef	UsrDef
15	UsrDef	UsrDef	D17	UsrDef	UsrDef
16	GND	UsrDef	D18	UsrDef	UsrDef
17	UsrDef	UsrDef	D19	UsrDef	UsrDef
18	GND	UsrDef	D20	UsrDef	UsrDef
19	UsrDef	UsrDef	D21	UsrDef	UsrDef
20	GND	UsrDef	D22	UsrDef	UsrDef
21	UsrDef	UsrDef	D23	UsrDef	UsrDef
22	GND	UsrDef	GND	UsrDef	UsrDef
23	UsrDef	UsrDef	D24	UsrDef	UsrDef
24	GND	UsrDef	D25	UsrDef	UsrDef
25	UsrDef	UsrDef	D26	UsrDef	UsrDef
26	GND	UsrDef	D27	UsrDef	UsrDef
27	UsrDef	UsrDef	D28	UsrDef	UsrDef
28	GND	UsrDef	D29	UsrDef	UsrDef
29	UsrDef	UsrDef	D30	UsrDef	UsrDef
30	GND	UsrDef	D31	UsrDef	UsrDef
31	UsrDef	UsrDef	GND	UsrDef	GND
32	GND	UsrDef	+5 VDC	UsrDef	VPC

P2/J2 Pin Layout (row ABC identical to VME/VME64)

Pin Assignment for the VME64x P0/J0/RJ0/RP0 Connector							
Pin	Row f	Row e	Row d	Row c	Row b	Row a	Row z
01	GND	UD	UD	UD	UD	UD	GND
02	GND	UD	UD	UD	UD	UD	GND
03	GND	UD	UD	UD	UD	UD	GND
04	GND	UD	UD	UD	UD	UD	GND
05	GND	UD	UD	UD	UD	UD	GND
06	GND	UD	UD	UD	UD	UD	GND
07	GND	UD	UD	UD	UD	UD	GND
08	GND	UD	UD	UD	UD	UD	GND
09	GND	UD	UD	UD	UD	UD	GND
10	GND	UD	UD	UD	UD	UD	GND
11	GND	UD	UD	UD	UD	UD	GND
15	GND	UD	UD	UD	UD	UD	GND
16	GND	UD	UD	UD	UD	UD	GND
17	GND	UD	UD	UD	UD	UD	GND
18	GND	UD	UD	UD	UD	UD	GND
19	GND	UD	UD	UD	UD	UD	GND

P0/J0 Pin Layout

Transition Card Cage

For I/O a rear side card cage can house 6U x 80mm transition modules (101.11 rear I/O transition board standard). These use the feed-through pins of J0/RJ0 and J2/RJ2 to connect to the front side VME64x modules.

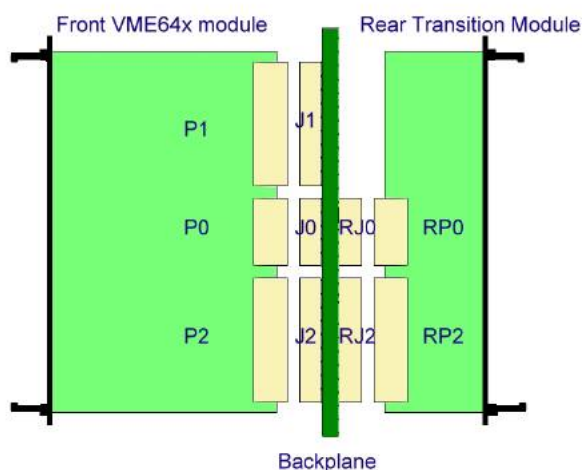

VME64x front and rear card/connector scheme

DC Voltages

In addition to the standard VME voltages (+5V, +/-12V) VME64x provides +3.3V. Two optional voltages V1 and V2 can be defined and used (mostly for +48V). Additional pins are foreseen for +5V (VPC) and Ground.

The resulting maximum power per board can be up to 200W with a total of 4kW per crate. This may require high performance power supplies and efficient, temperature controlled cooling.

Geographic Addressing

VME64x introduces 6 Geographic Addressing pins GA(4:0)*, GAP* on the J1/P1 d row allowing modules to be addressed by their slot (Geographically). This can replace the switches or jumpers that define base addresses on older VME modules. In order to be compatible to legacy VME bus systems VME64x may have both geographic and switch selectable base addressing.

Live Insertion

The VME64x standard also meets High Availability and Live Insertion (Hot Swap) standards. In combination with Geographic Addressing this makes it possible to remove and insert modules without shutting down the crate and supports automatically recognizing and configuring the modules in a “plug and play” way.

Increased Bandwidth

VME64x defines new protocols that increase the bandwidth of the parallel VME bus. The 2eVME protocol allows peak block data rate of up to 160 MB/sec by using master and slave terminated two-edge handshaking for each VME transfer.

A further improvement was introduced with 2eSST (VME 320 / VITA 1.5-2003), which defines a synchronous data strobe mode and achieves 320 Mbyte/s bandwidth.

These new protocols have to be implemented in the master and slave modules. The VME crate must be outfitted with a backplane capable of high-speed data transfers. All WIENER VME64x crates are tested for 2eVME and 2eSST transfers.

Topology	Bus Cycle	Maximum Speed
VMEbus / IEEE-1014	BLT	40 Mbyte/sec
VME64	MBLT	80 Mbyte/sec
VME64x	2eVME	160 Mbyte/sec
VME64x/VME320	2eSST	320 — 500+ Mbyte/sec

VME64xP - VIPA

In 1998, the “VME-bus International Physics Association” defined an extension for VME64x for use in nuclear and high energy physics experiments. This standard, VITA 23 (see also DOE/SC-0013 “Designer and User Guide”), uses a 9U x 400mm card size and defines some user-defined pins of the VME64x connector.

Further VME64xP adds 4 more DC voltages (Vw, Vx, Vy, Vz), which can be defined by the user. These should be used for low voltages as -2V or -5.2V. The VME64xV1 and V2 voltages should be used for +48V to power on board dc-to-dc converter.

VME64xP introduced the CBLT (chained Block Transfer) and MCST (multi cast writes). These modes allow consecutive read-out of several adjacent modules with one large block transfer. The end of the CBLT cycle is indicated by a BERR, which has to be processed accordingly by the VME master.

As of today the VME64xP standard is only used in a few applications however the CBLT and MCST protocols can be used on regular VME64x bus systems if they have a CBLT compatible backplane. WIENER VME64x backplanes can be ordered CBLT capable.

Pin Assignment for the VME64xP / VIPA P0/J0/RJ0/RP0 Connector							
Pin	Row f	Row e	Row d	Row c	Row b	Row a	Row z
01	COM	+5V	+5V	+5V	+5V	+5V	COM
02	COM	RET_WX	UD	+5V	TBUS1+	TBUS1-	COM
03	COM	RET_WX	UD	UD	TBUS2+	TBUS2-	COM
04	COM	Vw	UD	user I/O	user I/O	user I/O	COM
05	COM	Vw	UD	user I/O	user I/O	user I/O	COM
06	COM	RET_WX	UD	user I/O	user I/O	user I/O	COM
07	COM	AREF_WX	UD	user I/O	user I/O	user I/O	COM
08	COM	RET_WX	UD	user I/O	user I/O	user I/O	COM
09	COM	Vx	UD	user I/O	user I/O	user I/O	COM
10	COM	Vx	UD	user I/O	user I/O	user I/O	COM
11	COM	Vy	UD	user I/O	user I/O	user I/O	COM
12	COM	Vy	UD	user I/O	user I/O	user I/O	COM
13	COM	RET_YZ	UD	user I/O	user I/O	user I/O	COM

14	COM	AREF_YZ	UD	user I/O	user I/O	user I/O	COM
15	COM	RET_YZ	UD	user I/O	user I/O	user I/O	COM
16	COM	Vz	UD	user I/O	user I/O	user I/O	COM
17	COM	Vz	UD	UD	Tbus3+	Tbus3-	COM
18	COM	RET_yl	UD	UD	Tbus4+	Tbus4-	COM
19	COM	RET_yl	UD	UD	Tbusoc1	Tbusoc2	COM

ANSI / VITA VXS Standard

“VME-bus switched serial” VXS is a new ANSI / VITA standard which combines the 32-bit parallel VME-bus with high speed switched serial interconnect fabrics in order to increase the data transfer bandwidth to several GB/s.

VITA 41 / VXS was approved in May 2006 and consist of the base standard ANSI/VITA 41.0-2006 and additional, layered sub-specifications. VXS offers the following enhancements and new features:

- Standardized multi-GB/s switched serial interconnects to the parallel bus VME bus
- Standard open technology for the serial switched links
- Payload Modules with high speed differential RT2 connectors at J0/P0
- Switch modules with high-speed differential RT connectors (no VME J1/J2!)
- Additional D.C. power onto each VME module
- Backward compatibility with VME/VME64x

VITA 41.0 VXS provides the following specifications

- VXS.0:** base specification for mechanics, power, switch slot and payload card definitions
- VXS.1:** InfiniBand™ 4X link technology specification
- VXS.2:** Serial RapidIO™ 4X link technology specification
- VXS.3:** 1/10 Gigabit Ethernet technology
- VXS.4:** PCI Express 4X technology
- VXS.5:** Aurora Link 4X technology
- VXS.6:** 1 Gigabit Ethernet Control Channel Layer
- VXS.7:** Redundant Processor Mesh
- VXS.10:** Live Insertion Specification
- VXS.11:** Rear transition module Specification

Switch Fabric Architecture

VXS defines an interconnected network (fabric) of switched serial input and output ports with point-to-point connection with differential signals. An active switching device manages data transfers from inputs to outputs. For VXS all active switching devices are located on a special switch card. Depending on the VXS backplane size and configuration one or two switch card slots may be used.

All other modules that connect to the switch cards are called payload cards.

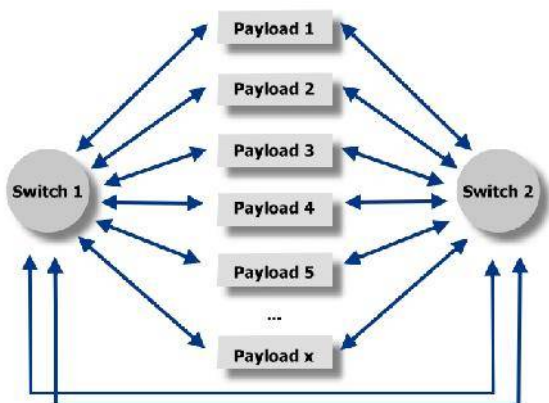

Dual Star configuration example

The switch fabric architecture supports connections from every payload card to one or two switch cards in a star, dual star or mesh topology. The availability of 2 switch boards supports redundant connections for high availability applications. This centralized switching scheme uses 16 pairs of differential signals, which are assigned, each pair is a bi-directional serial port. Ports can be used in parallel (trunked) for higher performance.

Switch Cards

A VXS compliant chassis can have one or two switch cards which have point-to-point connections to all payload cards. and allow all or a subset of the payload boards connected to it to intercommunicate.

Switch slots/boards are 6U x 160mm and have a new connector setup with 5 high speed MultiGig RT connectors (Tyco: 1410421-1, 1410137-1, 1410138-1 and 1410139-1 types for P1-P5) which is not compatible to the “VME P1/P2”. The lower P1 is defined as sideband connector for lower speed signals provides sideband communication between boards in the chassis.

Further switch cards are outfitted with a special, dedicated power connector (PWR1) and keying/alignment (A1-2, K1-2). The top rear above A2 and K2 is for user defined I/O. Switch cards shall conform to the VITA 41.10 live insertion standard.

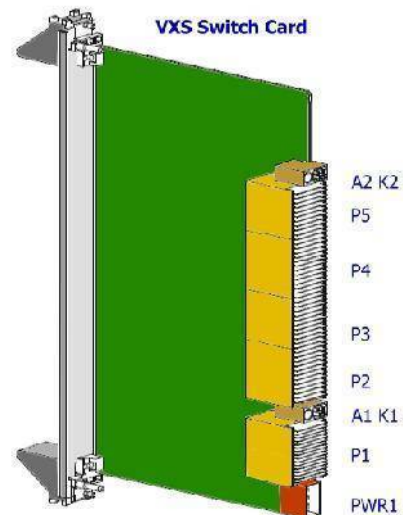

The following tables show the pin assignment for the pairs of differential connections. The actual pin usage is defined in the appropriate protocol layer definition.

Switch Board P5 Connector						
	L/K	J/I	H/G	F/E	D/C	B/A
01	GND	D5-3-/+	GND	D5-2-/+	GND	D5-1-/+
02	D5-6-/+	GND	D5-5-/+	GND	D5-4-/+	GND
03	GND	D5-9-/+	GND	D5-8-/+	GND	D5-7-/+
04	D5-12-/+	GND	D5-11-/+	GND	D5-10-/+	GND
05	GND	D5-15-/+	GND	D5-14-/+	GND	D5-13-/+
06	D5-18-/+	GND	D5-17-/+	GND	D5-16-/+	GND
07	GND	D5-21-/+	GND	D5-20-/+	GND	D5-19-/+
08	D5-24-/+	GND	D5-23-/+	GND	D5-22-/+	GND
09	GND	D5-27-/+	GND	D5-26-/+	GND	D5-25-/+
10	D5-30-/+	GND	D5-29-/+	GND	D5-28-/+	GND
11	GND	D5-33-/+	GND	D5-32-/+	GND	D5-31-/+
12	D5-36-/+	GND	D5-35-/+	GND	D5-34-/+	GND
13	GND	D5-39-/+	GND	D5-38-/+	GND	D5-37-/+
14	D5-42-/+	GND	D5-41-/+	GND	D5-40-/+	GND
15	GND	D5-45-/+	GND	D5-44-/+	GND	D5-43-/+
16	D5-48-/+	J/I	D5-47-/+	GND	D5-46-/+	GND

Switch Board P4 Connector						
	L/K	J/I	H/G	F/E	D/C	B/A
01	GND	D4-3-/+	GND	D4-2-/+	GND	D4-1-/+
02	D4-6-/+	GND	D4-5-/+	GND	D4-4-/+	GND
03	GND	D4-9-/+	GND	D4-8-/+	GND	D4-7-/+
04	D4-12-/+	GND	D4-11-/+	GND	D4-10-/+	GND
05	GND	D4-15-/+	GND	D4-14-/+	GND	D4-13-/+
06	D4-18-/+	GND	D4-17-/+	GND	D4-16-/+	GND
07	GND	D4-21-/+	GND	D4-20-/+	GND	D4-19-/+
08	D4-24-/+	GND	D4-23-/+	GND	D4-22-/+	GND
09	GND	D4-27-/+	GND	D4-26-/+	GND	D4-25-/+
10	D4-30-/+	GND	D4-29-/+	GND	D4-28-/+	GND
11	GND	D4-33-/+	GND	D4-32-/+	GND	D4-31-/+
12	D4-36-/+	GND	D4-35-/+	GND	D4-34-/+	GND
13	GND	D4-39-/+	GND	D4-38-/+	GND	D4-37-/+
14	D4-42-/+	GND	D4-41-/+	GND	D4-40-/+	GND
15	GND	D4-45-/+	GND	D4-44-/+	GND	D4-43-/+
16	D4-48-/+	J/I	D4-47-/+	GND	D4-46-/+	GND

Switch Board P3 Connector						
	L/K	J/I	H/G	F/E	D/C	B/A
01	GND	D3-3-/+	GND	D3-2-/+	GND	D3-1-/+
02	D3-6-/+	GND	D3-5-/+	GND	D3-4-/+	GND
03	GND	D3-9-/+	GND	D3-8-/+	GND	D3-7-/+
04	D3-12-/+	GND	D3-11-/+	GND	D3-10-/+	GND
05	GND	D3-15-/+	GND	D3-14-/+	GND	D3-13-/+
06	D3-18-/+	GND	D3-17-/+	GND	D3-16-/+	GND
07	GND	D3-21-/+	GND	D3-20-/+	GND	D3-19-/+
08	D3-24-/+	GND	D3-23-/+	GND	D3-22-/+	GND
09	GND	D3-27-/+	GND	D3-26-/+	GND	D3-25-/+
10	D3-30-/+	GND	D3-29-/+	GND	D3-28-/+	GND
11	GND	D3-33-/+	GND	D3-32-/+	GND	D3-31-/+
12	D3-36-/+	GND	D3-35-/+	GND	D3-34-/+	GND
13	GND	D3-39-/+	GND	D3-38-/+	GND	D3-37-/+
14	D3-42-/+	GND	D3-41-/+	GND	D3-40-/+	GND
15	GND	D3-45-/+	GND	D3-44-/+	GND	D3-43-/+
16	D3-48-/+	J/I	D3-47-/+	GND	D3-46-/+	GND

Switch Board P2 Connector						
	L/K	J/I	H/G	F/E	D/C	B/A
01	GND	D2-3-/+	GND	D2-2-/+	GND	D2-1-/+
02	D2-6-/+	GND	D2-5-/+	GND	D2-4-/+	GND
03	GND	D2-9-/+	GND	D2-8-/+	GND	D2-7-/+
04	D2-12-/+	GND	D2-11-/+	GND	D2-10-/+	GND
05	GND	D2-15-/+	GND	D2-14-/+	GND	D2-13-/+
06	D2-18-/+	GND	D2-17-/+	GND	D2-16-/+	GND
07	GND	D2-21-/+	GND	D2-20-/+	GND	D2-19-/+
08	D2-24-/+	GND	D2-23-/+	GND	D2-22-/+	GND
09	GND	D2-27-/+	GND	D2-26-/+	GND	D2-25-/+
10	D2-30-/+	GND	D2-29-/+	GND	D2-28-/+	GND
11	GND	D2-33-/+	GND	D2-32-/+	GND	D2-31-/+
12	D2-36-/+	GND	D2-35-/+	GND	D2-34-/+	GND
13	GND	D2-39-/+	GND	D2-38-/+	GND	D2-37-/+
14	D2-42-/+	GND	D2-41-/+	GND	D2-40-/+	GND
15	GND	D2-45-/+	GND	D2-44-/+	GND	D2-43-/+
16	D2-48-/+	J/I	D2-47-/+	GND	D2-46-/+	GND

Switch Board P1 Connector								
	H	G	F	E	D	C	B	A
01	SYS RST*	SYS FAIL*	AC FAIL*	+5V STBY	SERB	SERA	RFU	PEN*
02	S1-16	LI/I	GAP*	GA4*	GA3*	GA2*	GA1*	GA0*
03	S1-24	S1-23	S1-22	S1-21	S1-20	S1-19	S1-18	S1-17
04	S1-32	S1-31	S1-30	S1-29	S1-28	S1-27	S1-26	S1-25
05	S1-40	S1-39	S1-38	S1-373	S1-363	S1-35	S1-34	S1-33
06	S1-48	S1-47	S1-46	S1-453	S1-443	S1-43	S1-42	S1-41
07	S1-56	S1-55	S1-54	S1-533	S1-523	S1-51	S1-50	S1-49
08	S1-64	S1-63	S1-62	S1-613	S1-603	S1-59	S1-58	S1-57
09	S1-72	S1-71	S1-70	S1-693	S1-683	S1-67	S1-66	S1-65
10	S1-80	S1-79	S1-78	S1-773	S1-763	S1-75	S1-74	S1-73
11	S1-88	S1-87	S1-863	S1-853	S1-843	S1-83	S1-82	S1-81
12	S1-96	S1-95	S1-94	S1-93	S1-92	S1-91	S1-90	S1-89
13	S1-104	S1-103	S1-102	S1-101	S1-100	S1-99	S1-98	S1-97
14	S1-112	S1-111	S1-110	S1-109	S1-108	S1-107	S1-106	S1-105
15	S1-120	S1-119	S1-118	S1-117	S1-116	S1-115	S1-114	S1-113
16	S1-128	S1-127	S1-126	S1-125	S1-124	S1-123	S1-122	S1-121

Payload Cards

Payload cards are outfitted with VME P1 and P2 connectors as well as with a new high-speed connector for switched serial at the P0 position. Payload cards can use the VME bus only, both the VME bus and switched serial lines or only use the switched serial interconnects.

The VME-bus connectors P1 and P2 are as specified in the VME64x standard 5-row 160-pin connectors with identical pin layout (see VME64x section). All board mechanics as front panels and handles have to comply with IEEE 1101.10 (ESD / EMC enhanced).

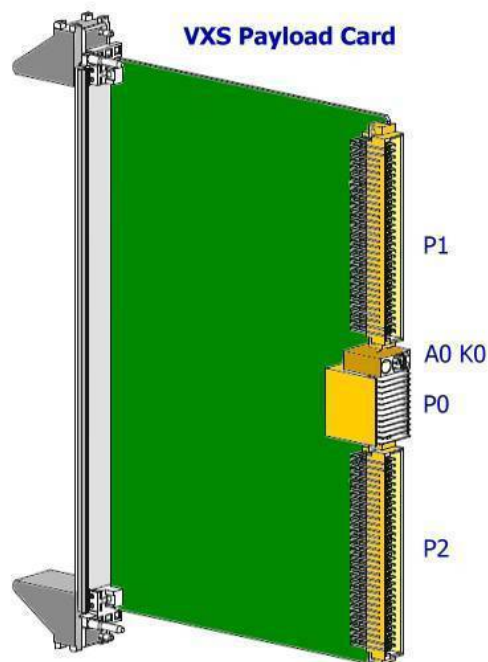

The high-speed P0 connector (Tier 2, 7-Row, Tyco 1410147-1) has both differential pairs (DP) as well as single ended (SE) and ground (GND) lines. The individual pin usage depends on the implemented switched technology and is given in the protocol layer standards.

From the remaining P0 pins, one pin is defined to support live insertion (PEN*). Other pins are reserved for Future Use (RFU).

Payload P0 Pin Layout							
	G	F	E	D	C	B	A
01	SE1	GND	DP2-	DP2+	GND	DP1-	DP1+
02	GND	DP4-	DP4+	GND	DP3-	DP3+	GND
03	SE2	GND	DP6-	DP6+	GND	DP5-	DP5+
04	GND	DP8-	DP8+	GND	DP7-	DP7+	GND
05	RFU	GND	RFU	RFU	GND	RFU	RFU
06	GND	RFU	RFU	GND	RFU	RFU	GND
07	RFU	GND	RFU	RFU	GND	RFU	RFU
08	GND	RFU	RFU	GND	RFU	RFU	GND
09	RFU	GND	RFU	RFU	GND	RFU	RFU
10	GND	RFU	RFU	GND	RFU	RFU	GND
11	PEN*	GND	RFU	RFU	GND	RFU	RFU
12	GND	DP24-	DP24+	GND	DP23-	DP23+	GND
13	SE7	GND	DP26-	DP26+	GND	DP25-	DP25+
14	GND	DP28-	DP28+	GND	DP27-	DP27+	GND
15	SE8	GND	DP30-	DP30+	GND	DP29-	DP29+

Each payload card is outfitted with one keying (K0) and alignment (A0) pin receptacle.

VXS Backplane

A 19" sub rack can hold a backplane with a maximum configuration of 18 payload slots and 2 switch slots. Backplanes with fewer payload or switch slots are allowed and can be configured in different topologies.

The VXS backplane design depends on the switch fabric topology, which can be one of:

- **Star:** each of up to 18 payload cards connects to a single switch card, no redundancy
- **Dual Star:** each of up to 18 payload cards connects to two separate switch cards, switch cards are interconnected, provides redundancy, most common configuration
- **Mesh:** each payload card is directly connected to every other card, with the 2 available ports up to 3 cards can be connected in a mesh without using a switch, used only on small backplanes
- **Daisy Chain:** each payload card is connected to its nearest neighbors, no switch is required however low (shared) bandwidth and limited reliability

In a Dual Star configuration the VXS backplane requires two switch cards and a maximum of 18 payload cards resulting in a maximum of 20 slots. However, a standard VME64x slot can be added to get a full size 21-slot backplane.

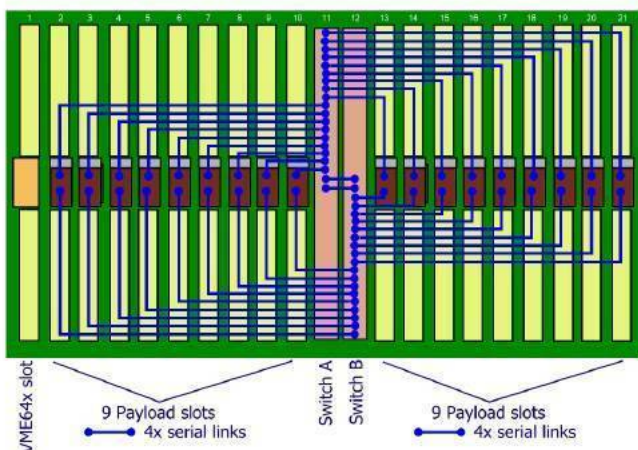

21-slot VXS backplane

WIENER VME/VXI/VXS Crate Configurations and Options

WIENER crates feature a modular design so that we can provide any required configuration of mechanics, backplanes or power supply based on standard WIENER components and parts.

9U VME-430 6023 crate example:

- 1) UEL6020 EX fan tray with combo interface, plugged in from front
- 2) Optional air dust filter
- 3) 1U Plenum chamber for homogeneous air distribution (6023 style)
- 4) Optional Vario divider with 6 slots 6Ux160mm
- 5) Optional J3 backplane
- 6) Optional rear side card cage
- 7) UEP 6021 power supply plugged in from rear

VXS Power and Cooling

ANSI/VITA 1.7-2003 increased the maximum allowed currents for the 96 pin & 160 pin DIN/IEC connectors from the original 1A to 2A per pin. This allows higher crate power supply currents, and consequently higher power dissipation on the VXS boards which will be needed to fully utilize the high performance switch fabric capabilities.

This requires a better-designed chassis with improved ventilation that can adequately cool the higher power VXS boards. All WIENER crates can provide maximum DC power and are outfitted with high efficiency temperature controlled and monitored cooling fans.

VXS Layered Switch Fabric Standards

InfiniBand (VITA 41.1): with data rates of 16 Gb/s per 4x link, full duplex is designed for servers with ultra-high bandwidth. Infiniband operates at 2.5 Gb/s per pair.

Serial RapidIO (VITA 41.2): is a new high-speed serial physical layer using the "old" parallel RapidIO protocol. RapidIO is designed for communications inside a system rather than between systems. Serial RapidIO operates at 1.25 Gb/s, 2.5 Gb/s, or 3.125 Gb/s per pair. VITA 41.2 draft standard supports data rates of up to 20 Gbps per 4x link, full duplex.

Gigabit Ethernet (VITA 41.3): Gigabit Ethernet is a well-established serial protocol. VITA 41.3 supports data rates of up to 8 Gb/s per 4x link, full duplex.

PCI Express (VITA 41.4): PCI Express has been selected by the PCI-SG as the next generation successor to the PCI bus. PCI Express operates at 3.125 Gb/s per pair. The VXS VITA 41.4 draft standard supports data rates of up to 20 Gb/s per 4x link, full duplex.

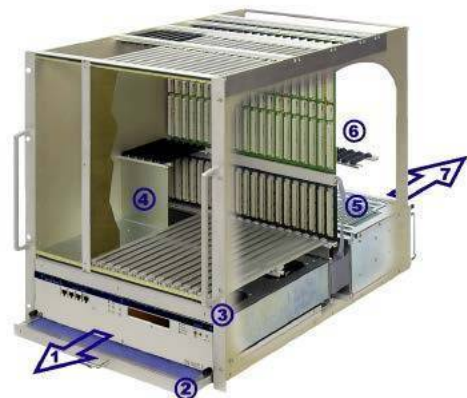

WIENER VME / VXI / VXS Products:

- Powered crates
- VME Controllers
- VME modules

6U VME 195 Mini Crate Series

The VME195 Mini Crate is the perfect choice for small setups with only a few VME modules. The crate offers 9 VME slots in a compact designed chassis with integrated low noise power supply and cooling fan. The mini crate can be used on the desk either as a desktop or up-right unit or be installed in a 19" rack.

Based on the 6000 series it has a built-in microprocessor controlled low-noise power supply technology and provides all local and remote monitoring and control features.



VME 195 Mini Crate



VME 195 Mini Crate rear view

Technical Details

- VME-MINI-Bin mechanics for 6U 160mm VME modules, suitable either for 19" racks, as tower- or desktop box
- 9 slot monolithic backplane VME/VME64
- Free rear access for 6U transition modules, standard transition cage for 6U 160mm modules, provisions for 80 and 120mm foreseen. Special depth on request
- Front and rear cover / screen for module space, cable duct between front- and rear-side of the card cages with space for one or more 2.5" hard / floppy-disks
- Micro-processor controlled with alphanumeric high-visibility LED display, 4 status LED's
- Efficient DC blower, adjustable speed (1200 ... 3200 RPM)
- Integrated fan and thermal monitoring (8 temperature sensor ports, 5 ports free for custom applications) with temperature display (C/F), programmable over temperature protection
- Ethernet / CAN-bus combo interface for crate remote monitoring and control
- Free RS232 connection accessible via Ethernet, e.g. to control VME boards during boot
- Built-in power supply designed in low noise VHF switching technology, noise and ripple typically less than 10mV(pp) or 3mV(rms), CE-conformity
- 94V – 265V world-wide auto-range AC input, with power factor correction, CE-conformity
- Dimensions: 19" (482mm) x 5U (215mm) x 480mm [whd], weight: ca. 25 kg

Standard configurations (other possible on request)

Crate Version	Backplane	+5V	+12V	-12V	Order Code
VME 195	VME/VME64	45A	11.5A	11.5A	VF39E200000T
VME 195 Special	VME/VME64	115A	23A	23A	VF39E200100T

6U VME 395 Mini Crate Series

The VME395 Mini Crate Series offers hot-swappable, redundant power supplies in 9 slots, compact but modular designed VME chassis. A front-side-plug high performance DC fan is used for cooling with front to rear air flow. One or two redundant operating plug-in 250W cPCI power supplies provide sufficient power for all applications.

The VME card sized CML shelf manager allows full remote monitoring and control of power supply, fan and chassis. The mini crate can be used on the desk either as a desktop or up-right unit or be installed in a 19" rack.



VME 395 Minicrate



VME 395 Minicrate rear view

Technical Details

- VME-MINI-Bin mechanics for 6U 160mm VME modules, suitable either for 19" racks, as tower- or desktop box
- 9 slot monolithic backplane VME/VME64
- Free rear access for 6U transition modules, standard transition cage for 6U 80mm modules, provisions for 160 and 120mm foreseen. Special depth on request
- Alphanumeric high-visibility LED display for voltages, currents, fan speed, temperatures and settings / programming, 4 status LED's
- WIENER CML Shelf Manager for local and remote monitoring and control, monitors and controls power supply, fan, remote on/off, SYSRES, thermal monitoring, user I/O programming, with Ethernet and USB interfaces, rear side plugged in
- Programmable under / over voltage and over current trip points, active DC output discharge front or side mounted, removable High-RPM DC blower, adjustable speed (1200 ... 6200 RPM), temperature controlled
- Outfitted with one or two 250W cPCI power supplies, plugged in from rear, hot swappable, redundant operation, CE-conformity, 300W power supplies on request
- 100V – 240V world-wide auto-range AC input, with power factor correction, CE-conformity
- Dimensions: 19" (482mm) x 5U (215mm) x 417mm [whd], weight: ca. 20 Kg

Standard configurations (other possible on request)

Crate Version	Backplane	+5V	+12V	-12V	Order Code
VME 395_1	VME/VME64	33A	6A	1A	VG39E210000T
VME 395_2	VME/VME64	66A	12A	2A	VG39E210100T

6U VME 475 Mini Crate Series

The VME475 Mini Crate Series offers hot-swappable, redundant power supplies in 7 slots, compact but modular designed VME chassis. A front-side-plug high performance DC fan is used for cooling with front-to-rear or side-to-side air flow. One or two redundant operating plug-in 250W cPCI power supplies provide sufficient power for all applications.

The VME card sized CML shelf manager allows full remote monitoring and control of power supply, fan and chassis. The mini crate can be used on the desk either as a desktop or up-right unit or be installed in a 19" rack.

Technical Details

- VME-MINI-Bin mechanics for 6U 160mm VME modules, suitable either for 19" racks, as tower- or desktop box
- 7 slot monolithic backplane VME/VME64
- Free rear access for 6U transition modules, standard transition cage for 6U 80mm modules, provisions for 160 and 120mm foreseen. Special depth on request
- Alphanumeric high-visibility LED display for voltages, currents, fan speed, temperatures and settings / programming, 4 status LED's
- WIENER CML Shelf Manager for local and remote monitoring and control, monitors and controls power supply, fan, remote on/off, SYSRES, thermal monitoring, user I/O programming, with Ethernet and USB interfaces
- Programmable under / over voltage and over current trip points, active DC output discharge front or side mounted
- Removable High-RPM DC blower, adjustable speed, temperature controlled, flexible cooling air flow direction: front-to-rear or side-to-side possible
- Outfitted with one or two 250W cPCI power supplies, plugged in from rear, hot swappable, redundant operation, CE-conformity, 300W power supplies on request
- 100V – 240V world-wide auto-range AC input, with power factor correction, CE-conformity
- Dimensions: 19" (482mm) x 5U (215mm) x 417mm [whd], weight: ca. 20 Kg

Standard configurations (other possible on request)

Crate Version	Backplane	+5V	+12V	-12V	Order Code
VME 475_1	VME/VME64	33A	6A	1A	VH37E21000T
VME 475_2	VME/VME64	66A	12A	2A	VH37E210100T



VME 475 Minicrate



VME 475 Minicrate rear view

6U VME 554 Mini Crate Series

The VME 554 Mini Crate Series offers hot-swappable, redundant power supplies in a 5 slot, compact and portable VME64x chassis. One or two redundant operating plug-in 250W cPCI power supplies provide sufficient power for all applications. The VME card sized CML shelf manager allows full local and remote monitoring and control of power supply, fan and chassis.

Technical Details

- Portable VME-MINI-Bin for 6U 160mm VME modules, desktop
- 5 slot monolithic backplane VME/VME64
- Alphanumeric high-visibility LED display for voltages, currents, fan speed, temperatures and settings / programming, 4 status LED's
- WIENER CML Shelf Manager for local and remote monitoring and control, monitors and controls power supply, fan, remote on/off, SYSRES, thermal monitoring, user I/O programming, with Ethernet and USB interfaces
- Programmable under / over voltage and over current trip points
- Outfitted with one or two 250W cPCI power supplies, hot swappable, redundant operation, CE-conformity, 300W power supplies on request
- 100V – 240V world-wide auto-range AC input, with power factor correction, CE-conformity
- Dimensions: 14" (337mm) x 5U (200mm) x 325mm, weight ca. 11 Kg

Standard configurations (other possible on request)

Crate Version	Backplane	+5V	+12V	-12V	Order Code
VME 554_1	VME/VME64	33A	6A	1A	VM35E21000T
VME 554_2	VME/VME64	66A	12A	2A	VM35E210100T



VME 554 Minicrate



VME 554 Minicrate rear view

6U VME 6021 Crate Series

The WIENER VME 6021 Crate Series is the newest generation of 19" integrated packaging system for standard VME/VME64 bus systems with 6Ux160mm cards. Designed primarily for applications in data acquisition, control and test instrumentation, it combines superior mechanical quality with lowest noise power supply technology.

Featuring microprocessor controlled power supplies and fan trays it provides advanced integrated diagnostic and monitoring capabilities. For remote monitoring and control the VME6021 crates are outfitted with Ethernet and CAN-bus interfaces. A unique flexibility is given by the modular packaging approach. The VME 6021 crate consists of the UEV 6021 bin, the UEL 6020 fan tray unit and the UEP 6021 power supply. Different power supply configurations as well as a variety of crate options are offered.



6U VME 6021 Crate



6U VME 6021 Crate rear view

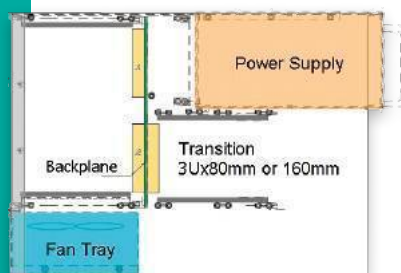

side view - schematic illustration

UEV 6021 Bin

- 19" x 8U enclosure for 21 VME64 bus cards 6U x 160mm
- Very rugged steel-aluminum construction features 5mm thick heavy duty side plates with zero-tolerance countersink screw positioning of all horizontal rails
- Monolithic 6U VME/VME64 backplane (J1/J2), 8 layer PCB, active termination, active automatic-daisy-chain
- 2 U space for fan tray unit in front (bottom), power supply in rear top position (behind J1)
- Free rear side access of VME backplane at J2, optional 3U rear side transition card cage 80mm/120mm/160mm/220mm deep
- Optional up to 8 temperature sensors in VME card cage above modules
- Dimensions: 19" (482mm) x 8U (355mm) x 480mm [whd], weight: ca. 13 – 14 Kg

UEL 6020 EX Fan Tray

- Designed to provide superior cooling of VME modules in bottom-to-top air flow
- Equipped with 3 individually controlled long-life DC fans, MTBF >65 000h
- Integrated fan speed and thermal monitoring, adjustable fan speed (1200 ... 3600 RPM)
- Microprocessor controlled with alphanumeric high-visibility LED display for all fan tray, bin and power supply parameters (voltages, currents, power, temperatures, set-up data, ...)
- Built-in combo interface (Ethernet, CAN-bus) for remote monitoring and control
- Free RS232 connection accessible via Ethernet, e.g. to control VME boards during boot
- Dimensions: 430mm x 2U (89mm) x 175mm [whd], weight: ca. 3.5 Kg – 3 DC fans

UEP 6021 Power Supply

- High density power supply in WIENER "Cavity-VHF" switching technology with excellent RF-shielding, optionally ultra low noise < 3mVpp (all voltages <12V), other rails <10mV
- Modular and expandable design with self-ventilated universal power blocks, individually sensed and floating DC outputs
- Micro-processor controlled, programmable voltage adjustment, current limits and over-/ under voltage trip off points, temperature limits
- Self-protected against any failure as under/over voltage, over current, over temperature, etc.
- 94V – 260V world-wide auto-range AC input, with power factor correction, CE
- High power density, up to 3 kW DC output power
- 3U or 6U high power box
- Dimensions: 430mm x 3U (133mm) or 6U (267mm) x 250mm [whd], weight: from 9.6 to 20 Kg depending on the number of power modules

Standard configurations (other possible on request)

Crate Version	Backplane	+5V	+12V	-12V	Order Code
VME 6021-611	VME/VME64	115A	23A	23A	V13LH6X1100S
VME 6021-613	VME/VME64	230A	23A	23A	V13LH6X1300S
VME 6021-614	VME/VME64	345A	23A	23A	V13LH6X1400S
VME 6021-620	VME/VME64	115A	46A	46A	V13LH6X2000S
VME 6021-621	VME/VME64	230A	46A	46A	V13LH6X2100S
VME 6021-622	VME/VME64	345A	46A	46A	V13LH6X2200S

6U VME 6023 Crate Series

The WIENER VME 6023 Crate Series is the newest generation of 19" integrated packaging system for standard VME/VME64 bus systems with 6Ux160mm cards. Designed primarily for applications in data acquisition, control and test instrumentation it combines superior mechanical quality with lowest noise power supply technology.

Featuring microprocessor controlled power supplies and fan trays it provides advanced integrated diagnostic and monitoring capabilities. For remote monitoring and control the VME6023 crates are outfitted with Ethernet, and CAN-bus interfaces. A unique flexibility is given by the modular design, i.e. the VME 6023 crate consists of the UEV 6023 bin, the UEL 6020 fan tray unit and the UEP 6021 power supply. A 1U air compression chamber between the fan tray and the VME bus area enhances the VME 6023 bin construction. This made it possible to locate the power supply in the bottom behind the fan tray unit leaving the rear of the VME backplane completely accessible.

Different power supply configurations as well as crate options are offered.

UEV 6023 VME Bin

19" x 9U enclosure for 21 VME bus cards 6U x 160mm

- Very rugged steel-aluminum construction features 5mm thick heavy duty side plates with zero-tolerance countersink screw positioning of all horizontal rails
- Monolithic 6U VME backplane (J1/J2), VME64 compliant, 8 layer PCB, active termination, active automatic-daisy-chain
- 2 U space for fan tray unit in front bottom position + 1 U plenum (air compression) chamber, power supply in rear bottom position
- Completely free rear side access of VME backplane with optional rear side transition card cage 3U/6U/ x 80mm/120mm/160mm/220mm
- Optional up to 8 temperature sensors in VME card cage above modules
- Dimensions: 19" (482mm) x 9U (400mm) x 480mm [whd], weight: ca. 14 Kg



6U VME 6023 Crate

UEL 6020 EX Fan Tray

- Designed to provide superior cooling of VME modules in bottom-to-top air flow
- Equipped with 3 individually controlled long-life DC fans, MTBF >65 000h
- Integrated fan speed and thermal monitoring, adjustable fan speed (1200 ... 3200 RPM)
- Microprocessor controlled with alphanumeric high-visibility LED display for all fan tray, bin and power supply parameters (voltages, currents, power, temperatures, set-up data, ...)
- Built-in combo interface (Ethernet, CAN-bus) for remote monitoring and control
- Free RS232 connection accessible via Ethernet, e.g. to control VME boards during boot
- Dimensions: 430mm x 2U (89mm) x 175mm [whd], weight: ca. 3,5 Kg



6U VME 6023 Crate rear side with power supply

UEP 6021 Power Supply

- High density power supply in WIENER "Cavity-VHF" switching technology with excellent RF-shielding, optionally ultra low noise < 3mVpp (all voltages < 12V), other rails < 10mV
- Modular and expandable design with self-ventilated universal power blocks, individually sensed floating DC outputs
- Self-protected against any failure as under/over voltage, over current, over temperature, ...
- Micro-processor controlled, programmable voltage adjustment, current limits and over-/ under voltage trip off points, temperature limits
- High power density, up to 3 kW DC output power, 3U high power box
- 94V - 260V world-wide auto-range AC input, with power factor correction, CE-conformity
- Dimensions: 430mm x 3U (133mm) or 6U (267mm) x 250mm [whd], weight: from 9.6 to 20 Kg depending on the number of power modules



side view - schematic illustration

Standard Crate configurations (other possible on request)

Crate Version	Backplane	+5V	+12V	-12V	Order Code
VME 6023-611	VME/VME64	115A	23A	23A	VJ3L16X1100S
VME 6023-613	VME/VME64	230A	23A	23A	VJ3L16X1300S
VME 6023-614	VME/VME64	345A	23A	23A	VJ3L16X1400S
VME 6023-620	VME/VME64	115A	46A	46A	VJ3L16X2000S
VME 6023-621	VME/VME64	230A	46A	46A	VJ3L16X2100S
VME 6023-622	VME/VME64	345A	46A	46A	VJ3L16X2200S

9U VME 6021 Crate Series

WIENER VME 6021 Crate Series is the newest generation of 19" integrated packaging system for VME/VME64 bus systems with 9Ux400mm cards. Designed primarily for applications in data acquisition, control and test instrumentation it combines superior mechanical quality with lowest noise power supply technology.

Featuring microprocessor controlled power supplies and fan trays it provides advanced integrated diagnostic and monitoring capabilities. For remote monitoring and control the VME6021 crates are outfitted with Ethernet and CAN-bus interfaces.

A unique flexibility is given by the modular packaging approach. The VME 6021 crate consists of the UEV 6021 bin, the UEL 6020 fan tray unit and the UEP 6021 power supply. Different power supply configurations as well as a variety of crate options are offered.



9U VME 6021 Crate



9U VME 6021 C rate rear side with power supply



side view - schematic illustration

UEV 6021 VME Bin

- 19" x 11U enclosure for 9U x 400mm VME bus cards
- Vario option with mixed 6U x 160mm and 9U x 400mm card cages
- Very rugged steel-aluminum construction features 5mm thick heavy duty side plates with zero-tolerance countersink screw positioning of all horizontal rails
- Monolithic 6U VME/VME64 backplane (J1/J2), 8 layer PCB, active termination, active automatic-daisy-chain
- 2 U space for fan tray unit in front (bottom), power supply in rear top position (behind J1)
- Free rear side access of VME backplane at J2 and lower J3, optional 3U (J2) or 6U (J2/J3) rear side transition card cage 80mm/120mm/160mm/220mm deep
- Optional up to 8 temperature sensors in VME card cage above modules
- Dimensions: 19" (482mm) x 11U (489mm) x 720mm [whd], weight: ca. 16 - 17 Kg

UEL 6020 EX Fan Tray

- Designed to provide superior cooling of VME modules in bottom-to-top air flow
- Equipped with 4, 6 or 9 individually controlled long-life DC fans, MTBF >60 000h
- Integrated fan speed and thermal monitoring, adjustable fan speed (1200 ... 3600 RPM)
- Microprocessor controlled with alphanumeric high-visibility LED display for all fan tray, bin and power supply parameters (voltages, currents, power, temperatures, set-up data, ...)
- Built-in combo interface (Ethernet, CAN-bus) for remote monitoring and control
- Free RS232 connection accessible via Ethernet, e.g. to control VME boards during boot
- Dimensions: 430mm x 2U (89mm) x 415mm [whd], weight: ca. 6.8 Kg - 6 DC fans

UEP 6021 Power Supply

- High density power supply in WIENER "Cavity-VHF" switching technology with excellent RF-shielding, optionally ultra low noise < 3mVpp (all voltages <12V), other rails <10mV
- Modular and expandable design with self-ventilated universal power blocks, individually sensed floating DC outputs
- Self-protected against any failure as under/over voltage, over current, over temperature, ...
- Micro-processor controlled, programmable voltage adjustment, current limits and over-/ under voltage trip off points, temperature limits
- 94V - 260V world-wide auto-range AC input, with power factor correction, CE-conformity
- High power density, up to 3 kW/6kW output power for 3U/6U high power box
- Dimensions: 430mm x 3U (133mm) or 6U (267mm) x 250mm [whd], weight: from 9.6 to 20 Kg depending on the number of power modules

Standard configurations (other possible on request)

Crate Version	Backplane	+5V	+12V	-12V	Order Code
VME 6021-911	VME/VME64	115A	23A	23A	-
VME 6021-913	VME/VME64	230A	23A	23A	-
VME 6021-914	VME/VME64	345A	23A	23A	-
VME 6021-916	VME/VME64	460A	23A	23A	-
VME 6021-920	VME/VME64	115A	46A	46A	-
VME 6021-921	VME/VME64	230A	46A	46A	-
VME 6021-922	VME/VME64	345A	46A	46A	-
VME 6021-923	VME/VME64	460A	46A	46A	-

9U VME 6023 Crate Series

The WIENER VME 6023 Crate Series is the newest generation of 19" integrated packaging system for VME/VME64 bus systems with 9Ux400mm cards. Designed primarily for applications in data acquisition, control and test instrumentation it combines superior mechanical quality with lowest noise power supply technology.

Featuring microprocessor controlled power supplies and fan trays it provides advanced integrated diagnostic and monitoring capabilities. For remote monitoring and control the VME6023 crates are outfitted with Ethernet and CAN-bus interfaces.

A unique flexibility is given by the modular design, i.e. the VME 6023 crate consists of the UEV 6023 bin, the UEL 6020 fan tray unit and the UEP 6021 power supply. A 1U air compression chamber between the fan tray and the VME bus area enhances the VME 6023 bin construction. This made it possible to locate the power supply in the bottom behind the fan tray unit leaving the rear of the VME backplane completely accessible. Different power supply configurations as well as crate options are offered.

UEV 6023 VME Bin

- 19" x 12U enclosure for 21 VME bus cards 9U x 400mm
- Vario option with mixed 6U x 160mm and 9U x 400mm card cages
- Very rugged steel-aluminum construction features 5mm thick heavy duty side plates with zero-tolerance countersink screw positioning of all horizontal rails
- Monolithic 6U VME backplane (J1/J2), VME64 compliant, 8 layer PCB, active termination, active automatic-daisy-chain
- 2 U space for fan tray unit in front bottom position + 1 U plenum (air compression) chamber, power supply in rear bottom position
- Completely free rear side access of VME backplane with optional rear side transition card cage 3U/6U/9U x 80mm/120mm/160mm/220mm
- Optional up to 8 temperature sensors in VME card cage above modules
- Dimensions: 19" (482mm) x 12U (533mm) x 720mm [whd], weight: ca. 17 Kg

UEL 6020 EX Fan Tray

- Designed to provide superior cooling of VME modules in bottom-to-top air flow
- Equipped with 4, 6 or 9 individually controlled long-life DC fans, MTBF >60,000h
- Integrated fan speed and thermal monitoring, adjustable fan speed (1200 ... 3600 RPM)
- Microprocessor controlled with alphanumeric high-visibility LED display for all fan tray, bin and power supply parameters (voltages, currents, power, temperatures, set-up data, ...)
- Built-in combo interface (Ethernet, CAN-bus) for remote monitoring and control
- Free RS232 connection accessible via Ethernet, e.g. to control VME boards during boot
- Dimensions: 430mm x 2U (88.9mm) x 340mm [whd], weight: ca. 6.8 Kg

UEP 6021 Power Supply

- High density power supply in WIENER "Cavity-VHF" switching technology with excellent RF-shielding, optionally ultra low noise < 3mVpp (all voltages <12V), other rails <10mV
- Modular and expandable design with self-ventilated universal power blocks, individually sensed floating DC outputs
- Self-protected against any failure as under/over voltage, over current, over temperature, ...
- Micro-processor controlled, programmable voltage adjustment, current limits and over-/ under voltage trip off points, temperature limits
- 94V – 260V world-wide auto-range AC input, with power factor correction, CE-conformity
- High power density, up to 3 kW output power for 3U high power box
- Dimensions: 430mm x 3U (133mm) x 250mm [whd], weight: from 9.6 to 20 Kg, depending on the number of power modules

Standard configurations (other possible on request)

Crate Version	Backplane	+5V	+12V	-12V	Order Code
VME 6021-911	VME/VME64	115A	23A	23A	-
VME 6021-913	VME/VME64	230A	23A	23A	-
VME 6021-914	VME/VME64	345A	23A	23A	-
VME 6021-916	VME/VME64	460A	23A	23A	-
VME 6021-920	VME/VME64	115A	46A	46A	-
VME 6021-921	VME/VME64	230A	46A	46A	-
VME 6021-922	VME/VME64	345A	46A	46A	-
VME 6021-923	VME/VME64	460A	46A	46A	-

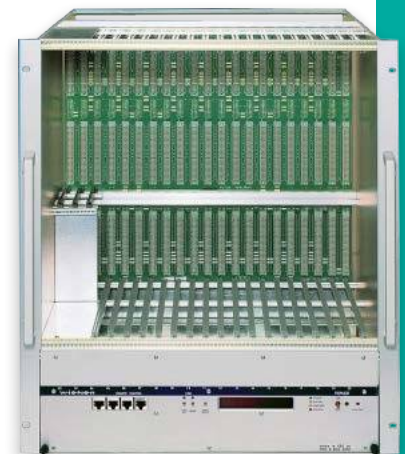

9U VME 6023 Crate



9U VME 6023 Crate rear side without power supply



side view - schematic illustration

6U CERN VME430 6021 Series

The WIENER VME 6021 Crate Series is the newest generation of 19" integrated packaging system according to the CERN VME430 standard. Designed primarily for applications in nuclear and high energy physics data acquisition, beam line control and test instrumentation it combines superior mechanical quality with lowest noise power supply technology.

Featuring microprocessor controlled power supplies and fan trays it provides advanced integrated diagnostic and monitoring capabilities. For remote monitoring and control the VME6021 crates are outfitted with Ethernet and CAN-bus interfaces. A unique flexibility is given by the modular packaging approach. The VME 6021 crate consists of the UEV 6021 bin, the UEL 6020 fan tray unit and the UEP 6021 power supply.

Different power supply configurations as well as a variety of crate options are offered.



6U VME 6021 Crate



6U VME 6021 Crate rear side with power supply

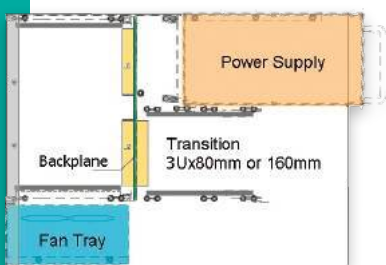

side view - schematic illustration

UEV 6021 VME Bin

- 19" x 8U enclosure for 21 VME64x bus cards 6U x 160mm
- Very rugged steel-aluminum construction features 5mm thick heavy duty side plates with zero-tolerance countersink screw positioning of all horizontal rails
- Monolithic 6U VME430 backplane (J1/Jaux/J2), 10 layer PCB, active termination, active automatic-daisy-chain
- 2 U space for fan tray unit in front (bottom), power supply in rear top position (behind J1)
- Free rear side access of VME backplane at J2, optional 3U rear side transition card cage 80mm/120mm/160mm/220mm deep
- Optional up to 8 temperature sensors in VME card cage above modules
- Dimensions: 19" x 8U x 480mm [whd], weight: ca. 14 Kg

UEL 6020 EX Fan Tray

- Designed to provide superior cooling of VME modules in bottom-to-top air flow
- Equipped with 3 individually controlled long-life DC fans, MFOT >65,000h/40°C
- Integrated fan speed and thermal monitoring, adjustable fan speed (1200 ... 3600 RPM)
- Microprocessor controlled with alphanumeric high-visibility LED display for all fan tray, bin and power supply parameters (voltages, currents, power, temperatures, set-up data, ...)
- Built-in combo interface (Ethernet, CAN-bus) for remote monitoring and control
- Free RS232 connection accessible via Ethernet, e.g. to control VME boards during boot
- Dimensions: 430 x 2U x 175mm [whd], weight: ca. 3.5 Kg – 3 DC fans
- Dimensions: 430 x 2U x 415mm [whd], weight: ca. 6.8 Kg – 6 DC fans (for transition cage)

UEP 6021 Power Supply

- High density power supply in WIENER "Cavity-VHF" switching technology with excellent RF-shielding, optionally ultra low noise < 3mVpp (all voltages < 12V), other rails < 10mVpp
- Modular and expandable design with self-ventilated universal power blocks, individually sensed and floating DC outputs
- Micro-processor controlled, programmable voltage adjustment, current limits and over-/ under voltage trip off points, temperature limits
- Self-protected against any failure as under/over voltage, over current, over temperature
- 94V – 265VAC world-wide auto-range AC input, with power factor correction, CE- Conformity
- High power density, up to 3 kW/6kW DC output power for 3U or 6U high power box
- Dimensions: 430 x 3U or 6U x 250mm [whd], weight: from 13.2 to 20 kg, depending on number of power modules

Standard Crate configurations (other possible on request)

Crate Version	Backplane	+5V	+12V	-12V	-5.2V	-2V	+/-15V	Order Code
VME 6021-631	VME430	115A	23A	23A	115A	115A	-	V15LH6X3100S
VME 6021-634	VME430	115A	23A	23A	115A	115A	11.5A	V15LH6X3400S
VME 6021-635	VME430	115A	45A	45A	115A	115A	11.5A	V15LH6X3500S
VME 6021-641	VME430	230A	23A	23A	115A	115A	-	V15LH6X3600S
VME 6021-642	VME430	230A	23A	23A	115A	115A	11.5A	V15LH6X4100S
VME 6021-650	VME430	115A	45A	45A	115A	115A	-	V15LH6X5000S
VME 6021-670	VME430	345A	23A	23A	115A	-	-	V15LH6X7000S
VME 6021-671	VME430	115A	23A	23A	230A	-	-	V15LH6X7100S
VME 6021-672	VME430	230A	23A	23A	115A	-	-	V15LH6X7200S

6U CERN VME430 6023 Crate Series

The WIENER VME 6023 Crate Series is the newest generation of 19" integrated packaging system for standard VME/VME64 bus systems with 6Ux-160mm cards. Designed primarily for applications in nuclear and high energy physics data acquisition, beam line control and test instrumentation it combines superior mechanical quality with lowest noise power supply technology.

Featuring microprocessor controlled power supplies and fan trays it provides advanced integrated diagnostic and monitoring capabilities. For remote monitoring and control the VME6023 crates are outfitted with Ethernet and CAN-bus interfaces. A unique flexibility is given by the modular design, i.e. the VME 6023 crate consists of the UEV 6023 bin, the UEL 6020 EX Fan Tray unit and the UEP 6021 Power Supply. A 1U air compression chamber between the fan tray and the VME bus area enhances the VME 6023 bin construction. This made it possible to locate the power supply in the bottom behind the fan tray unit leaving the rear of the VME backplane completely accessible.

Different power supply configurations as well as crate options are offered.

UEV 6023 VME Bin

- 19" x 9U enclosure for 21 VME bus cards 6U x 160mm
- Very rugged steel-aluminum construction features 5mm thick heavy duty side plates with zero-tolerance countersink screw positioning of all horizontal rails
- Monolithic 6U VME430 backplane (J1/Jaux/J2), 10 layer PCB, active termination, active automatic-daisy-chain
- 2 U space for fan tray unit in front bottom position + 1 U plenum (air compression) chamber, power supply in rear bottom position
- Completely free rear side access of VME backplane with optional rear side transition card cage 3U/6U x 80mm/120mm/160mm/220mm
- Optional up to 8 temperature sensors in VME card cage above modules
- Dimensions: 19" x 9U x 480mm [whd], weight: ca. 14 Kg

UEL 6020 EX Fan Tray

- Designed to provide superior cooling of VME modules in bottom-to-top air flow
- Equipped with 3 individually controlled long-life DC fans, MFOT >60,000h/40°C
- Integrated fan speed and thermal monitoring, adjustable fan speed (1200 ... 3600 RPM)
- Microprocessor controlled with alphanumeric high-visibility LED display for all fan tray, bin and power supply parameters (voltages, currents, power, temperatures, set-up data, ...)
- Built-in combo interface (Ethernet, CAN-bus) for remote monitoring and control
- Free RS232 connection accessible via Ethernet, e.g. to control VME boards during boot
- Dimensions: 430 x 2U x 175mm [whd], weight: 3.5 kg

UEP 6021 Power Supply

- High density power supply in WIENER "Cavity-VHF" switching technology with excellent RF-shielding, optionally ultra low noise < 3mVpp (all voltages <12V), other rails <10mVpp
- Modular and expandable design with self-ventilated universal power blocks, individually sensed floating DC outputs
- Self-protected against any failure as under/over voltage, over current, over temperature, ...
- Microprocessor controlled, programmable voltage adjustment, current limits and over-/ under voltage trip off points, temperature limits
- 94V – 265VAC world-wide auto-range AC input, with power factor correction, CE-Conformity
- High power density, up to 3 kW DC output power, 3U high power box
- Dimensions: 430 x 3U x 250mm [whd], weight: from 13.2 to 20 kg, depending on the number of power modules

Standard Crate configurations (other possible on request)

Crate Version	Backplane	+5V	+12V	-12V	-5.2V	-2V	+/-15V	Order Code
VME 6023-631	VME430	115A	23A	23A	115A	115A	-	VJ5L16X3100S
VME 6023-634	VME430	115A	23A	23A	115A	115A	11.5A	VJ5L16X3400S
VME 6023-635	VME430	115A	45A	45A	115A	115A	11.5A	VJ5L16X3500S
VME 6023-641	VME430	230A	23A	23A	115A	115A	-	VJ5L16X4100S
VME 6023-642	VME430	230A	23A	23A	115A	115A	11.5A	VJ5L16X4200S
VME 6023-650	VME430	115A	45A	45A	115A	115A	-	VJ5L16X5000S
VME 6023-670	VME430	345A	23A	23A	115A	-	-	VJ5L16X7000S
VME 6023-671	VME430	115A	23A	23A	230A	-	-	VJ5L16X7100S
VME 6023-672	VME430	230A	23A	23A	115A	-	-	VJ5L16X7200S



6U VME 6023 Crate



6U VME 6023 Crate rear side with power supply



side view - schematic illustration

9U CERN VME430 6021 Crate Series

WIENER VME 6021 Crate Series is the newest generation of generation CERN VME430 compliant VME crates for large size 9Ux400mm cards. Designed for applications in nuclear and high energy physics data acquisition, beam line control and test instrumentation it combines superior mechanical quality with lowest noise power supply technology.

Featuring microprocessor controlled power supplies and fan trays it provides advanced integrated diagnostic and monitoring capabilities. For remote monitoring and control the VME 6021 crates are outfitted with Ethernet and CAN-bus interfaces. A unique flexibility is given by the modular packaging approach. The VME 6021 crate consists of the UEV 6021 VME bin, the UEL 6020 EX Fan Tray unit and the UEP 6021 power Supply. Different power supply configurations as well as a variety of crate options are offered.



9U VME 6021 Crate
with optional divider and no J3 backplane



9U VME 6021 Crate rear side
with power supply



side view - schematic illustration

UEV 6021 VME Bin

- 19" x 11U enclosure for 9U x 400mm VME bus cards
- Vario option with mixed 6U x 160mm and 9U x 400mm card cages
- Very rugged steel-aluminum construction features 5mm thick heavy duty side plates with zero-tolerance countersink screw positioning of all horizontal rails
- Monolithic 6U backplane (J1/Jaux/J2), 10 layer PCB, active termination, auto daisy-chain
- 2 U space for fan tray unit in front (bottom), power supply in rear top position (behind J1)
- Free rear side access of VME backplane at J2 and lower J3, optional 3U (J2) or 6U (J2/J3) rear side transition card cage 80mm/120mm/160mm/220mm deep
- Optional up to 8 temperature sensors in VME card cage above modules
- Dimensions: 19" x 11U x 720mm [whd], weight: ca. 16 – 17 Kg

UEL 6020 EX Fan Tray

- Designed to provide superior cooling of VME modules in bottom-to-top air flow
- Equipped with 4, 6 or 9 individually controlled long-life DC fans, MFOT >60,000h/40°C
- Integrated fan speed and thermal monitoring, adjustable fan speed (1200 ... 3600 RPM)
- Microprocessor controlled with alphanumeric high-visibility LED display for all fan tray, bin and power supply parameters (voltages, currents, power, temperatures, set-up data, ...)
- Built-in combo interface (Ethernet, CAN-bus) for remote monitoring and control
- Free RS232 connection accessible via Ethernet, e.g. to control VME boards during boot
- Dimensions: 430 x 2U x 415mm [whd], weight: ca. 6.8 Kg - 6 DC fans

UEP 6021 Power Supply

- High density power supply in WIENER "Cavity-VHF" switching technology with excellent RF-shielding, optionally ultra low noise < 3mVpp (all voltages < 12V), other rails < 10mVpp
- Modular, expandable design. Self-ventilated power blocks, individually sensed floating outputs
- Self-protected against any failure as under/over voltage, over current, over temperature ...
- Micro-processor controlled, programmable voltage adjustment, current limits and over / under voltage trip off points, temperature limits
- 94V – 265VAC world-wide auto-range AC input, with power factor correction, CE-Conformity
- High power density, up to 3 kW/6kW output power for 3U/6U high power box
- Dimensions: 430 x 3U or 6U x 250mm [whd], weight: from 9.6 to 20 Kg, depending on the number of power modules

Standard Crate configurations (other possible on request)

Crate Version	Backplane	+5V	+12V	-12V	-5.2	-2V	+/-15V	Order Code
VME 6021-931	VME430	115A	23A	23A	115A	115A	-	-
VME 6021-934	VME430	115A	23A	23A	115A	115A	11.5A	-
VME 6021-935	VME430	115A	45A	45A	115A	115A	11.5A	-
VME 6021-941	VME430	230A	23A	23A	115A	115A	-	-
VME 6021-942	VME430	230A	23A	23A	115A	115A	11.5A	-
VME 6021-943	VME430	115A	23A	23A	115A	115A	35A	-
VME 6021-944	VME430	230A	23A	23A	115A	115A	35A	-
VME 6021-950	VME430	115A	45A	45A	115A	115A	-	-
VME 6021-970	VME430	345A	23A	23A	115A	-	-	-
VME 6021-971	VME430	115A	23A	23A	230A	-	-	-
VME 6021-972	VME430	230A	23A	23A	115A	-	-	-

9U CERN VME430 6023 Crate Series

The WIENER VME 6023 Crate Series is the newest generation CERN VME430 compliant VME crates for large size 9Ux400mm cards. Designed for applications in nuclear and high-energy physics data acquisition, beam line control and test instrumentation it combines superior mechanical quality with lowest noise power supply technology.

Featuring microprocessor controlled power supplies and fan trays it provides advanced integrated diagnostic and monitoring capabilities. For remote monitoring / control VME6023 crates are equipped with Ethernet and CAN-bus interfaces. A unique flexibility is given by the modular design, i.e. the VME 6023 crate consists of the UEV 6023 VME bin, the UEL 6020 EX Fan Tray unit and the UEP 6021 Power Supply. A 1U air compression chamber between the fan tray and the VME bus area enhances the VME 6023 bin construction. This made it possible to locate the power supply in the bottom behind the fan tray unit leaving the rear of the VME backplane completely accessible.

Different power supply configurations as well as crate options are offered.

UEV 6023 VME Bin

- 19" x 12U enclosure for 21 VME bus cards 9U x 400mm
- Vario option with mixed 6U x 160mm and 9U x 400mm card cages
- Very rugged steel-aluminum construction features 5mm thick heavy duty side plates with zero-tolerance countersink screw positioning of all horizontal rails
- Monolithic 6U backplane (J1/Jaux/J2), 10 layer PCB, active termination, auto daisy-chain
- 2 U space for fan tray unit in front bottom position + 1 U plenum (air compression) chamber, power supply in rear bottom position
- Completely free rear side access of VME backplane with optional rear side transition card cage 3U/6U/9U x 80mm/120mm/160mm/220mm
- Optional up to 8 temperature sensors in VME card cage above modules
- Dimensions: 19" x 12U x 720mm [whd], weight: ca. 17 Kg

UEL 6020 EX Fan Tray

- Designed to provide superior cooling of VME modules in bottom-to-top air flow
- Equipped with 4, 6 or 9 individually controlled long-life DC fans, MFOT >60,000h/40°C
- Integrated fan speed and thermal monitoring, adjustable fan speed (1200 ... 3600 RPM)
- Microprocessor controlled with alphanumeric high-visibility LED display for all fan tray, bin and power supply parameters (voltages, currents, power, temperatures, set-up data, ...)
- Built-in combo interface (Ethernet, CAN-bus) for remote monitoring and control
- Free RS232 connection accessible via Ethernet, e.g. to control VME boards during boot
- Dimensions: 430 x 2U x 415mm [whd], weight: ca. 3.5 Kg

UEP 6021 Power Supply

- High density power supply in WIENER "Cavity-VHF" switching technology with excellent RF-shielding, optionally ultra low noise < 3mVpp (all voltages <12V), other rails <10mVpp
- Modular and expandable design with self-ventilated universal power blocks, individually sensed floating DC outputs
- Self-protected against any failure as under/over voltage, over current, over temperature
- Micro-processor controlled, programmable voltage adjustment, current limits and over-/ under voltage trip off points, temperature limits
- 94V – 265VAC world-wide auto-range AC input, with power factor correction, CE-Conformity
- High power density, up to 3 kW output power for 3U high power box
- Dimensions: 430 x 3U x 250mm [whd], weight: from 9.6 to 20 Kg, depending on the number of power modules

Standard Crate configurations (other possible on request)

Crate Version	Backplane	+5V	+12V	-12V	-5.2	-2V	+/-15V	Order Code
VME 6023-931	VME430	115A	23A	23A	115A	115A	-	-
VME 6023-934	VME430	115A	23A	23A	115A	115A	11.5A	-
VME 6023-935	VME430	115A	45A	45A	115A	115A	11.5A	-
VME 6023-941	VME430	230A	23A	23A	115A	115A	-	-
VME 6023-942	VME430	230A	23A	23A	115A	115A	11.5A	-
VME 6023-943	VME430	115A	23A	23A	115A	115A	35A	-
VME 6023-944	VME430	230A	23A	23A	115A	115A	35A	-
VME 6023-950	VME430	115A	45A	45A	115A	115A	-	-
VME 6023-970	VME430	345A	23A	23A	115A	-	-	-
VME 6023-971	VME430	115A	23A	23A	230A	-	-	-
VME 6023-972	VME430	230A	23A	23A	115A	-	-	-



9U VME 6023 Crate
with optional divider and J3 backplane



9U VME 6023 Crate rear side
without power supply



side view - schematic illustration

6U VME64x 195-x Mini Crate Series

The VME195-x Mini Crate is the perfect choice for small setups with only a few VME64x modules. The crate offers 9 VME64x slots in a compact designed chassis with integrated low noise power supply and cooling fan. The mini crate can be used on the desk either as a desktop or upright unit or be installed in a 19" rack.

Based on the 6000 series it has a built-in microprocessor controlled low-noise power supply technology and provides all local and remote monitoring and control features.



VME 195-xP0 Mini Crate



VME 195-xP0 Mini Crate rear view

Technical Details

- VME-MINI-Bin mechanics for 6U 160mm VME64x modules, suitable either for 19" racks, as tower- or desktop box, IEEE 1101.10 compliant mechanics with enhanced EMC / ESD
- 9 slot monolithic backplane VME64x backplane, optionally with P0 connectors
- Free rear access for 6U transition modules, standard transition cage for 6U x 80mm modules, provisions for 120 and 160mm foreseen. Special depth on request
- Front and rear cover / screen for module space, cable duct between front- and rear-side of the card cages with space for one or more 2.5" hard / floppy-disks
- Microprocessor controlled with alphanumeric high-visibility LED display, 4 status LED's
- Efficient DC blower, adjustable speed (1200 ... 3200 RPM,) temperature controlled
- Ethernet / CAN-bus combo interface for crate remote monitoring and control
- Free RS232 connection accessible via Ethernet, e.g. to control VME boards during boot
- Built-in Power-Supply designed in low noise VHF switching technology, noise and ripple typically less than 10mV(pp) or 3mV(rms). Up to six different output voltages at 650W/>100VAC output power. For special configurations up to 1000W
- World wide range AC-input 94V – 260V with power factor correction, CE-conformity
- Dimensions: 19" x 5U x 480mm (whd), weight: ca. 26 Kg

Standard configurations (other possible on request)

Crate Version	Backplane	+5V	+3.3V	+12V	-12V	Order Code
VME 195-x	J1/J2 VME64x	45A	45A	11.5A	11.5A	VF49E200000T
VME 195-xP0	J1/J0/J2 VME64x	45A	45A	11.5A	11.5A	VF49E200100T

6U VME64x 395-x Mini Crate Series

The VME395-x Mini Crate Series offers hot-swappable, redundant power supplies in a 9 slot, compact but modular designed VME64x chassis. A front-side-plug high performance DC fan is used for cooling with front to rear air flow.

One or two redundant operating plug-in 250W cPCI power supplies provide sufficient power for all applications. The VME card sized CML shelf manager allows full remote monitoring and control of power supply, fan and chassis. The mini crate can be used on the desk either as a desktop or up-right unit or be installed in a 19" rack.



VME 395x Mini Crate (front view)



VME 395x Mini Crate (rear view)

Technical Details

- VME-MINI-Bin mechanics for 6Ux160mm, VME64x modules, suitable either for 19" rack, as a tower- or a desktop box. IEEE 1101.10 compliant mechanics with enhanced EMC / ESD
- 9 slot monolithic VME64x backplane, optional P0 connectors
- Free rear access for 6U transition modules, standard transition cage for 6U 80mm modules, provisions for 160 and 120mm foreseen. Special depth on request
- Alphanumeric high-visibility LED display for voltages, currents, fan speed, temperatures and settings / programming, 4 status LED's
- WIENER CML Shelf Manager for local and remote monitoring and control, monitors and controls power supply, fan, remote on/off, SYSRES, thermal monitoring, user I/O programming, with Ethernet and USB interfaces, rear side plugged in
- Front side mounted, removable High-RPM DC blower, adjustable speed (1200 ... 3200 RPM), temperature controlled
- Programmable under / over voltage and over current trip points, active DC output discharge
- Outfitted with one or two 250W cPCI power supplies, plugged in from rear, hot swappable, redundant operation, CE-conformity, 300W power supplies on request
- 100V – 240V world-wide auto-range AC input, with power factor correction, CE-conformity
- Dimensions: 19" (482mm) x 5U (215mm) x 417mm [whd], weight: ca. 20 Kg

Standard Crate configurations (other possible on request)

Crate Version	Backplane	+5V	+3.3V	+12V	-12V
VME 395x_1	J1/J2 VME64x	33A	33A	6A	1A
VME 395x_2	J1/J2 VME64x	66A	66A	12A	2A
VME 395x_1_P0	J1/J0/J2 VME64x	33A	33A	6A	1A
VME 395x_2_P0	J1/J0/J2 VME64x	66A	66A	12A	2A

6U VME64x 475-x Mini Crate Series

The VME475-x Mini Crate Series offers hot-swappable, redundant power supplies in a 7 slot, compact but modular designed VME64x chassis. A front-side-plug high performance DC fan is used for cooling with front-to-rear or side-to-side air flow.

One or two redundant operating plug-in 250W cPCI power supplies provide sufficient power for all applications. The VME card sized CML shelf manager allows full remote monitoring and control of power supply, fan and chassis. The mini crate can be used on the desk either as a desktop or up-right unit or be installed in a 19" rack.

Technical Details

- VME-MINI-Bin mechanics for 6Ux160mm, VME64x modules, suitable either for 19" rack, as a tower- or a desktop box. IEEE 1101.10 compliant mechanics with enhanced EMC / ESD
- 9 slot monolithic VME64x backplane, optional P0 connectors
- Free rear access for 6U transition modules, standard transition cage for 6U 80mm modules, provisions for 160 and 120mm foreseen. Special depth on request
- Alphanumeric high-visibility LED display for voltages, currents, fan speed, temperatures and settings / programming, 4 status LED's
- WIENER CML Shelf Manager for local and remote monitoring and control, monitors and controls power supply, fan, remote on/off, SYSRES, thermal monitoring, user I/O programming, with Ethernet and USB interfaces
- Front side mounted, removable DC blower, adjustable speed, temperature controlled, flexible cooling air flow direction: front-to-rear or sides-to-side possible
- Programmable under / over voltage and over current trip points, active DC output discharge
- Outfitted with one or two 250W cPCI power supplies, plugged in from rear, hot swappable, redundant operation, CE-conformity, 300W power supplies on request
- 100V – 240V world-wide auto-range AC input, with power factor correction, CE-conformity
- Dimensions: 19" (482mm) x 5U (215mm) x 417mm [whd], weight: ca. 20 Kg



VME 475x Mini Crate (front view)



VME 475x Mini Crate (rear view)

Standard Crate configurations (other possible on request)

Crate Version	Backplane	+5V	+3.3V	+12V	-12V
VME 475x_1	J1/J2 VME64x	33A	33A	6A	1A
VME 475x_2	J1/J2 VME64x	66A	66A	12A	2A
VME 475x_1_P0	J1/J0/J2 VME64x	33A	33A	6A	1A
VME 475x_2_P0	J1/J0/J2 VME64x	66A	66A	12A	2A

6U VME64x 554-x Mini Crate Series

The VME 554-x Mini Crate Series offers hot-swappable, redundant power supplies in a 5 slot, compact and portable VME64x chassis. One or two redundant operating plug-in 250W cPCI power supplies provide sufficient power for all applications. The VME card sized CML shelf manager allows full local and remote monitoring and control of power supply, fan and chassis.

Technical Details

- VME-MINI-Bin for 6Ux160mm, VME64x modules, in a desktop box. IEEE 1101.10 compliant mechanics with enhanced EMC / ESD
- 5 slot monolithic VME64x backplane, optional P0 connectors
- Alphanumeric high-visibility LED display for voltages, currents, fan speed, temperatures and settings / programming, 4 status LED's
- WIENER CML Shelf Manager for local and remote monitoring and control, monitors and controls power supply, fan, remote on/off, SYSRES, thermal monitoring, user I/O programming, with Ethernet and USB interfaces
- Outfitted with one or two 250W cPCI power supplies, plugged in from rear, hot swappable, redundant operation, CE-conformity, 300W power supplies on request
- 100V – 240V world-wide auto-range AC input, with power factor correction, CE-conformity
- Dimensions: 14" (337mm) x 5U (200mm) x 325mm, weight ca. 11 Kg



VME 554x Mini Crate (front view)



VME 554x Mini Crate (rear view)

Standard Crate configurations (other possible on request)

Crate Version	Backplane	+5V	+3.3V	+12V	-12V
VME 554x_1	J1/J2 VME64x	33A	33A	6A	1A
VME 554x_2	J1/J2 VME64x	66A	66A	12A	2A
VME 554x_1_P0	J1/J0/J2 VME64x	33A	33A	6A	1A
VME 554x_2_P0	J1/J0/J2 VME64x	66A	66A	12A	2A

6U VME64x 6021 Crate Series

The WIENER VME64x 6021 Crate Series represents a new generation integrated packaging system for 6U x 160mm VME64x/VIPA bus cards. Designed primarily for applications in data acquisition, C as well as test instrumentation it combines superior mechanical quality with lowest noise power supply technology.

Featuring microprocessor controlled power supplies and fan trays it provides advanced integrated diagnostic and monitoring capabilities. Outfitted with IEEE 1101.10 compatible mechanics this crate series offers excellent EMC and ESD shielding. A unique flexibility is given by the modular packaging approach. The VME 6021 crate consists of the UEV 6021 bin, the UEL 6020 fan tray unit and the UEP 6021 power supply.



6U VME6021x Crate



6U VME6021x rear view



side view - schematic illustration

UEV 6021-S VME Bin

- 19" x 8U enclosure for 21 VME64x bus cards 6U x 160mm
- Fully compliant to IEEE 1101.10/P, advanced EMC / ESD shielding
- Very rugged steel-aluminum construction features 5mm thick heavy duty side plates with zero-tolerance countersink screw positioning of all horizontal rails
- Monolithic 6U VME64x backplane (J1/J2, optional J0), 10 layer PCB, active termination, active automatic-daisy-chain, VIPA backplane optional
- 2 U space for fan tray unit in front (bottom), power supply in rear top position (behind J1)
- Free rear side access of VME backplane at J2, optional 3U rear side transition card cage 80mm/120mm/160mm/220mm deep
- Optional up to 8 temperature sensors in VME card cage above modules
- Dimensions: 19" x 8U x 480mm (whd), weight: ca. 14 kg

UEL 6020 EX Fan Tray

- Designed to provide superior cooling of VME modules in bottom-to-top air flow
- Equipped with 3 individually controlled long-life DC fans, MTBF >65 000h
- Integrated fan speed and thermal monitoring, adjustable fan speed (1200 ... 3600 RPM)
- Microprocessor controlled with alphanumeric high-visibility LED display for all fan tray, bin and power supply parameters (voltages, currents, power, temperatures, set-up data ...)
- Built-in combo interface (Ethernet, CAN-bus) for remote monitoring and control
- Dimensions: 430mm x 2U (89mm) x 175mm [whd], weight: ca. 3.5 kg – 3 DC fans

UEP 6021 Power Supply

- High density power supply in WIENER "Cavity-VHF" switching technology with excellent RF-shielding, optionally ultra low noise < 3mVpp (all voltages <12V), other rails <10mVpp
- Modular and expandable design with self-ventilated universal power blocks, individually sensed and floating DC outputs
- Micro-processor controlled, programmable voltage adjustment, current limits and over-/ under voltage trip off points, temperature limits
- Self-protected against any failure as under/over voltage, over current, over temperature, etc.
- 94V – 260V world-wide auto-range AC input, with power factor correction, CE-conformity
- High power density, up to 3 kW/6kW DC output power for 3U or 6U high power box
- Dimensions: 430mm x 3U (133mm) or 6U (267mm) x 250mm [whd], weight: from 9.6 to 20 kg depending on the number of power modules

Standard configurations (other possible on request)

Crate Version	Backplane	+5V	+12V	-12V	+3.3V	+48V	PS Height	Order Code
VME 6021x610	VME64x	115A	23A	23A	115A	-	3U	V14LH6X1000S
VME 6021x612	VME64x	230A	23A	23A	115A	-	3U	V14LH6X1200S
VME 6021x615	VME64x	345A	23A	23A	115A	-	3U	V14LH6X1500S
VME 6021x617	VME64x	115A	23A	23A	230A	-	3U	V14LH6X1700S
VME 6021x618	VME64x	230A	23A	23A	230A	-	3U	V14LH6X1800S
VME 6021x620	VME64x	115A	45A	45A	115A	-	3U	V14LH6X2000S
VME 6021x624	VME64x	230A	45A	45A	115A	-	3U	V14LH6X2400S
VME 6021x627	VME64x	115A	45A	45A	230A	-	3U	V14LH6X2700S
VME 6021x631	VME64x	115A	23A	23A	115A	13.5A	3U	V14LH6X3100S
VME 6021x632	VME64x	230A	23A	23A	115A	13.5A	3U	V14LH6X3200S
VME 6021x633	VME64x	115A	23A	23A	230A	13.5A	3U	V14LH6X3300S
VME 6021x635	VME64x	115A	23A	23A	115A	27A	3U	V14LH6X3500S
VME 6021x636	VME64x	230A	23A	23A	115A	27A	6U	V14LH6X3600S
VME 6021x637	VME64x	115A	23A	23A	230A	27A	6U	V14LH6X3700S
VME 6021x638	VME64x	230A	23A	23A	230A	27A	6U	V14LH6X3800S
VME 6021x650	VME64x	115A	45A	45A	115A	13.5A	6U	V14LH6X5000S

6U VME 64x 6023 Crate Series

The WIENER VME 6023 Crate Series is the newest generation of 19" integrated packaging system for standard VME/VME64 bus systems with 6Ux160mm cards. Designed primarily for applications in data acquisition, control and test instrumentation it combines superior mechanical quality with lowest noise power supply technology.

Featuring microprocessor controlled power supplies and fan trays it provides advanced integrated diagnostic and monitoring capabilities. For remote monitoring and control the VME 6023 crates are outfitted with Ethernet and CAN-bus interfaces. A unique flexibility is given by the modular design, i.e. the VME64x 6023 crate consists of the UEV 6023 S-bin, the UEL 6020 EX Fan Tray unit and the UEP 6021 Power Supply. A 1U air compression chamber between the fan tray and the VME bus area enhances the VME 6023 bin construction. This made it possible to locate the power supply in the bottom behind the fan tray unit leaving the rear of the VME backplane completely accessible.

Different power supply configurations as well as crate options are offered.

UEV 6023-S VME Bin

- 19" x 9U enclosure for 21 VME64x bus cards 6U x 160mm
- Fully compliant to IEEE 1101.10/P, advanced EMC / ESD shielding
- Very rugged steel-aluminum construction features 5mm thick heavy duty side plates with zero-tolerance countersink screw positioning of all horizontal rails
- Monolithic 6U VME64X backplane (J1/J2, optional J0), 10 layer PCB, active termination, active automatic-daisy-chain, CBLT conform and VIPA backplane optional
- 2 U space for fan tray unit in front bottom position + 1 U plenum (air compression) chamber, power supply in rear bottom position
- Completely free rear side access of VME backplane with optional rear side transition card cage 3U/6U/ x 80mm/120mm/160mm/220mm
- Optional up to 8 temperature sensors in VME card cage above modules
- Dimensions: 19" (482mm) x 9U (400mm) x 480mm [whd], weight: ca. 14 Kg

UEL 6020 EX Fan Tray

- Designed to provide superior cooling of VME modules in bottom-to-top air flow
- Equipped with 3 individually controlled long-life DC fans, MTBF >65 000h
- Integrated fan speed and thermal monitoring, adjustable fan speed (1200 ... 3600 RPM)
- Microprocessor controlled with alphanumeric high-visibility LED display for all fan tray, bin and power supply parameters (voltages, currents, power, temperatures, set-up data ...)
- Built-in combo interface (Ethernet, CAN-bus) for remote monitoring and control
- Dimensions: 430mm x 2U (89mm) x 175mm [whd], weight: ca. 3.5 Kg
- UEP 6021 Power Supply
- High density power supply in WIENER "Cavity-VHF" switching technology with excellent RF-shielding, optionally ultra low noise < 3mVpp (all voltages <12V), other rails <10mVpp
- Modular and expandable design with self-ventilated universal power blocks, individually sensed floating DC outputs
- Self-protected against any failure as under/over voltage, over current, over temperature, etc.
- Micro-processor controlled, programmable voltage adjustment, current limits and over-/ under voltage trip off points, temperature limits
- 94V – 260V world-wide auto-range AC input, with power factor correction, CE-conformity
- High power density, up to 3 kW DC output power, 3U high power box
- Dimensions: 430mm x 3U (133mm) [whd], weight: from 9.6 to 20 Kg, depending on the number of power modules

Standard configurations (other possible on request)

Crate Version	Backplane	+5V	+12V	-12V	+3.3V	+48V	PS Height
VME 6023x610	VME64x	115A	23A	23A	115A	-	3U
VME 6023x612	VME64x	230A	23A	23A	115A	-	3U
VME 6023x615	VME64x	345A	23A	23A	115A	-	3U
VME 6023x617	VME64x	115A	23A	23A	230A	-	3U
VME 6023x618	VME64x	230A	23A	23A	230A	-	3U
VME 6023x620	VME64x	115A	45A	45A	115A	-	3U
VME 6023x624	VME64x	230A	45A	45A	115A	-	3U
VME 6023x627	VME64x	115A	45A	45A	230A	-	3U
VME 6023x631	VME64x	115A	23A	23A	115A	13.5A	3U
VME 6023x632	VME64x	230A	23A	23A	115A	13.5A	3U
VME 6023x633	VME64x	115A	23A	23A	230A	13.5A	3U
VME 6023x635	VME64x	115A	23A	23A	115A	27A	3U



6U VME 6023x Crate



VME 6023x Crate rear view



side view - schematic illustration

9U VME64x 6021 Crate Series

WIENER VME 6021 Crate Series is the newest generation of 19" integrated packaging system for VME/VME64x bus systems with 9Ux400mm cards. Designed primarily for applications in data acquisition, control and test instrumentation it combines superior mechanical quality with lowest noise power supply technology.

Featuring microprocessor controlled power supplies and fan trays it provides advanced integrated diagnostic and monitoring capabilities. For remote monitoring and control the VME6021 crates are outfitted with Ethernet and CAN-bus interfaces. A unique flexibility is given by the modular packaging approach. The VME 6021 crate consists of the UEV 6021 Bin, the UEL 6020 EX Fan Tray unit and the UEP 6021 Power Supply.



9U VME 6021x Crate



9U VME 6021x Crate rear view



side view - schematic illustration

UEV 6021-S VME Bin

- 19" x 11U enclosure for 9U x 400mm VME bus cards, fully compliant to IEEE 1101.10/P with advanced EMC / ESD shielding
- Vario option with mixed 6U x 160mm and 9U x 400mm card cages
- Very rugged steel-aluminum construction features 5mm thick heavy duty side plates with zero-tolerance countersink screw positioning of all horizontal rails
- Monolithic 6U VME64x backplane (J1/J2, optional J0), 10 layer PCB, active termination, active automatic-daisy-chain, CBLT conform and VIPA backplane optional
- 2 U space for fan tray unit in front (bottom), power supply in rear top position (behind J1)
- Free rear side access of VME backplane at J2 and lower J3, optional 3U (J2) or 6U (J2/J3) rear side transition card cage 80mm/120mm/160mm/220mm deep
- Optional up to 8 temperature sensors in VME card cage above modules
- Dimensions: 19" (482mm) x 11U (489mm) x 720mm [whd], weight: ca. 16 - 17 Kg

UEL 6020 EX Fan Tray

- Designed to provide superior cooling of VME modules in bottom-to-top air flow
- Equipped with 4, 6 or 9 individually controlled long-life DC fans, MTBF >60,000h
- Integrated fan speed and thermal monitoring, adjustable fan speed (1200 ... 3600 RPM)
- Microprocessor controlled with alphanumeric high-visibility LED display for all fan tray, bin and power supply parameters (voltages, currents, power, temperatures, set-up data, ...)
- Built-in combo interface (Ethernet, CAN-bus) for remote monitoring and control
- Free RS232 connection accessible via Ethernet, e.g. to control VME boards during boot
- Dimensions: 430mm x 2U (89mm) x 415mm [whd], weight: ca. 6.8 Kg - 6 DC fans

UEP 6021 Power Supply

- High density power supply in WIENER "Cavity-VHF" switching technology with excellent RF-shielding, optionally ultra low noise < 3mVpp (all voltages <12V), other rails <10mVpp
- Modular and expandable design with self-ventilated universal power blocks, individually sensed floating DC outputs
- Self-protected against any failure as under/over voltage, over current, over temperature, etc.
- Micro-processor controlled, programmable voltage adjustment, current limits and over-/ under voltage trip off points, temperature limits
- 94V - 260V world-wide auto-range AC input, with power factor correction, CE-conformity
- High power density, up to 3 kW/6kW output power for 3U/6U high power box
- Dimensions: 430mm x 3U (133mm) or 6U (267mm) x 250mm [whd], weight: from 9.6 to 20 Kg

Standard configurations (other possible on request)

Crate Version	Backplane	+5V	+12V	-12V	+3.3V	+48V	PS Height	Order Code
VME 6021x910	VME64x	115A	23A	23A	115A	-	3U	-
VME 6021x912	VME64x	230A	23A	23A	115A	-	3U	-
VME 6021x915	VME64x	345A	23A	23A	115A	-	3U	-
VME 6021x917	VME64x	115A	23A	23A	230A	-	3U	-
VME 6021x918	VME64x	230A	23A	23A	230A	-	3U	-
VME 6021x920	VME64x	115A	45A	45A	115A	-	3U	-
VME 6021x924	VME64x	230A	45A	45A	115A	-	3U	-
VME 6021x927	VME64x	115A	45A	45A	230A	-	3U	-
VME 6021x931	VME64x	115A	23A	23A	115A	13.5A	3U	-
VME 6021x932	VME64x	230A	23A	23A	115A	13.5A	3U	-
VME 6021x933	VME64x	115A	23A	23A	230A	13.5A	3U	-
VME 6021x935	VME64x	115A	23A	23A	115A	27A	3U	-
VME 6021x936	VME64x	230A	23A	23A	115A	27A	6U	-
VME 6021x937	VME64x	115A	23A	23A	230A	27A	6U	-
VME 6021x938	VME64x	230A	23A	23A	230A	27A	6U	-

9U VME64x 6023 Crate Series

The WIENER VME 6023 Crate Series is the newest generation of 19" integrated packaging system for VME/VME64 bus systems with 9Ux400mm cards. Designed primarily for applications in data acquisition, control and test instrumentation it combines superior mechanical quality with lowest noise power supply technology.

Featuring microprocessor controlled power supplies and fan trays it provides advanced integrated diagnostic and monitoring capabilities. For remote monitoring and control the VME64x 6023 crates are outfitted with Ethernet and CAN-bus interfaces.

A unique flexibility is given by the modular design, i.e. the VME 6023 crate consists of the UEV 6023 bin, the UEL 6020 Fan Tray unit and the UEP 6021 Power Supply. A 1U air compression chamber between the fan tray and the VME bus area enhances the VME 6023 bin construction. This made it possible to locate the power supply in the bottom behind the fan tray unit leaving the rear of the VME backplane completely accessible.

UEV 6023-S VME Bin

- 19" x 12U enclosure for 21 VME bus cards 9U x 400mm
- Vario option with mixed 6U x 160mm and 9U x 400mm card cages
- Very rugged steel-aluminum construction features 5mm thick heavy duty side plates with zero-tolerance countersink screw positioning of all horizontal rails
- Monolithic 6U VME64x backplane (J1/J2, optional J0), 10 layer PCB, active termination, active automatic-daisy-chain, CBLT conform and VIPA backplane optional
- 2 U space for fan tray unit in front bottom position + 1 U plenum (air compression) chamber, power supply in rear bottom position
- Completely free rear side access of VME backplane with optional rear side transition card cage 3U/6U/9U x 80mm/120mm/160mm/220mm
- Optional up to 8 temperature sensors in VME card cage above modules
- Dimensions: 19" x 12U x 720mm (whd), weight: ca. 17 Kg

UEL 6020 EX Fan Tray

- Designed to provide superior cooling of VME modules in bottom-to-top air flow
- Equipped with 4, 6 or 9 individually controlled long-life DC fans, MTBF >60,000h
- Integrated fan speed and thermal monitoring, adjustable fan speed (1200 ... 3600 RPM)
- Microprocessor controlled with alphanumeric high-visibility LED display for all fan tray, bin and power supply parameters (voltages, currents, power, temperatures, set-up data ...)
- Built-in combo interface (Ethernet, CAN-bus) for remote monitoring and control
- Free RS232 connection accessible via Ethernet, e.g. to control VME boards during boot
- Dimensions: 430 x 2U x 415mm (whd), weight: ca. 6.8 kg

UEP 6021 Power Supply

- High density power supply in WIENER "Cavity-VHF" switching technology with excellent RF-shielding, optionally ultra low noise < 3mVpp (all voltages <12V), other rails <10mVpp
- Modular and expandable design with self-ventilated universal power blocks, individually sensed floating DC outputs
- Self-protected against any failure as under/over voltage, over current, over temperature, etc.
- Micro-processor controlled, programmable voltage adjustment, current limits and over-/ under voltage trip off points, temperature limits
- 94V – 260V world-wide auto-range AC input, with power factor correction, CE-conformity
- High power density, up to 3 kW output power for 3U high power box
- Dimensions: 430mm x 3U (133mm) x 250mm [whd], weight: from 9.6 to 20 Kg, depending on the number of power modules

Standard configurations (other possible on request)

Crate Version	Backplane	+5V	+12V	-12V	+3.3V	+48V	PS Height	Order Code
VME 6023x910	VME64x	115A	23A	23A	115A	-	3U	-
VME 6023x912	VME64x	230A	23A	23A	115A	-	3U	-
VME 6023x915	VME64x	345A	23A	23A	115A	-	3U	-
VME 6023x917	VME64x	115A	23A	23A	230A	-	3U	-
VME 6023x918	VME64x	230A	23A	23A	230A	-	3U	-
VME 6023x920	VME64x	115A	45A	45A	115A	-	3U	-
VME 6023x924	VME64x	230A	45A	45A	115A	-	3U	-
VME 6023x927	VME64x	115A	45A	45A	230A	-	3U	-
VME 6023x931	VME64x	115A	23A	23A	115A	13.5A	3U	-
VME 6023x932	VME64x	230A	23A	23A	115A	13.5A	3U	-
VME 6023x933	VME64x	115A	23A	23A	230A	13.5A	3U	-
VME 6023x935	VME64x	115A	23A	23A	115A	27A	3U	-



9U VME 6023x Crate



9U VME 6023x Crate rear view



side view - schematic illustration

6U VXS 6021 Crate Series

The WIENER VXS 6023 Crate Series adds high performance Switch Fabrics according to VITA 41 specification to VME based systems. Designed primarily for high speed applications in data acquisition, as well as military / aerospace test and instrumentation it combines superior mechanical quality with lowest noise power supply technology. Featuring microprocessor controlled power supplies and fan trays it provides advanced integrated diagnostic and monitoring capabilities. Outfitted with IEEE 1101.10 compatible mechanics this crate series offers excellent EMC and ESD shielding.

A unique flexibility is given by the modular packaging approach. The VME 6021 crate consists of the UEV 6021S bin, the UEL 6020 fan tray unit and the UEP 6021 power supply.

Different power supply configurations as well as a variety of crate options are offered.



6U VXS 6021x Crate



6U VXS 6021x Crate rear view

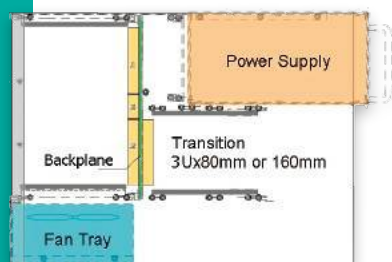

side view - schematic illustration

UEV 6021-S VME Bin

- 19" x 8U enclosure for 21 VME64x bus cards 6U x 160mm
- Fully compliant to IEEE 1101.10/P, advanced EMC / ESD shielding
- Very rugged steel-aluminum construction features 5mm thick heavy duty side plates with zero-tolerance countersink screw positioning of all horizontal rails
- Monolithic 21 slot 6U VXS backplane in dual star topology according to VITA 41 standard for switched serial fabric for VME-bus (VXS), 2 Switch Card slots (slot 10 and 11), 18 Payload Card slots, 1 legacy J1/J2 VME64x slot (slot1), other backplane configurations optional
- 2 U space for fan tray unit in front (bottom), power supply in rear top position (behind J1)
- Free rear side access of VME backplane at J2, optional 3U rear side transition card cage 80mm/120mm/160mm/220mm deep
- Optional up to 8 temperature sensors in VME card cage above modules
- Dimensions: 19" x 8U x 480mm (whd), weight: ca. 14 Kg

UEL 6020 EX Fan Tray

- Designed to provide superior cooling of VME modules in bottom-to-top air flow
- Equipped with 3 individually controlled long-life DC or HRPM fans, MTBF >65 000h
- Integrated fan speed and thermal monitoring, adjustable fan speed (1200 ... 3600 / 6100 RPM)
- Microprocessor controlled with alphanumeric high-visibility LED display for all fan tray, bin and power supply parameters (voltages, currents, power, temperatures, set-up data, ...)
- Built-in combo interface (Ethernet, CAN-bus) for remote monitoring and control
- Free RS232 connection accessible via Ethernet, e.g. to control VME boards during boot
- Dimensions: 430mm x 2U (89mm) x 175mm [whd], weight: ca. 3.5 Kg – 3 DC fans

UEP 6021 Power Supply

- High density power supply in WIENER "Cavity-VHF" switching technology with excellent RF-shielding, optionally ultra low noise < 3mVpp (all voltages <12V), other rails <10mVpp
- Modular and expandable design with self-ventilated universal power blocks, individually sensed and floating DC outputs
- Micro-processor controlled, programmable voltage adjustment, current limits and over-/ under voltage trip off points, temperature limits
- Self-protected against any failure as under/over voltage, over current, over temperature, etc
- 94V – 260V world-wide auto-range AC input, with power factor correction, CE-conformity
- High power density, up to 3 kW/6kW DC output power for 3U or 6U high power box
- Dimensions: 430mm x 3U (133mm) or 6U (267mm) x 250mm [whd], weight: from 9.6 to 20 Kg, depending on the number of power modules

Standard Crate configurations (other possible on request)

Crate Version	Backplane	+5V	+12V	-12V	+3.3V	+48V	PS Height	Order Code
VXS 6021x610	VXS	115A	23A	23A	115A	-	3U	-
VXS 6021x612	VXS	230A	23A	23A	115A	-	3U	-
VXS 6021x615	VXS	345A	23A	23A	115A	-	3U	-
VXS 6021x618	VXS	230A	23A	23A	230A	-	3U	-
VXS 6021x624	VXS	230A	45A	45A	115A	-	3U	-
VXS 6021x627	VXS	115A	45A	45A	230A	-	3U	-
VXS 6021x631	VXS	115A	23A	23A	115A	13.5A	3U	-
VXS 6021x632	VXS	230A	23A	23A	115A	13.5A	3U	-
VXS 6021x636	VXS	230A	23A	23A	115A	27A	6U	-
VXS 6021x638	VXS	230A	23A	23A	230A	27A	6U	-
VXS 6021x650	VXS	115A	45A	45A	115A	13.5A	6U	-

6U VXS 6023 JL Crate Series

The WIENER VXS 6023 Crate Series adds high performance Switch Fabrics according to VITA 41 specification to VME based systems. Designed primarily for high speed applications in data acquisition, as well as military / aerospace test and instrumentation it combines superior mechanical quality with lowest noise power supply technology. Featuring microprocessor controlled power supplies and fan trays it provides advanced integrated diagnostic and monitoring capabilities. Outfitted with IEEE 1101.10 compatible mechanics this crate series offers excellent EMC and ESD shielding.

A unique flexibility is given by the modular design, i.e. the VXS 6023 crate consists of the UEV 6023S bin, the UEL 6020 fan tray unit and the UEP 6021 power supply. An air compression chamber between fan tray and VME bus area enhances the UEV 6023S bin. This made it possible to locate the power supply in the bottom behind the fan tray unit leaving the rear of the VXS backplane accessible. Different power supply configurations and options are offered.

UEV 6023-S VME Bin

- 19" x 9U enclosure for 21 VME64x bus cards 6U x 160mm
- Fully compliant to IEEE 1101.10/P, advanced EMC / ESD shielding
- Very rugged steel-aluminum construction features 5mm thick heavy duty side plates with zero-tolerance countersink screw positioning of all horizontal rails
- Monolithic 21 slot 6U VXS backplane in dual star topology according to VITA 41 standard for switched serial fabric for VME-bus (VXS), 2 Switch Card slots (slot 10 and 11), 18 Payload Card slots, 1 legacy J1/J2 VME64x slot (slot1), other backplane configurations optional
- 2 U space for fan tray unit in front (bottom) + 2U air inlet in front bottom position, 1U top air guide, air flow front to rear, power supply in rear bottom position with air guides
- Free rear side access of VXS backplane, optional 6U rear side transition card cage
- Dimensions: 19" (482mm) x 8U (355mm) x 480mm [whd], weight: ca. 16 Kg

UEL 6020 EX Fan Tray

- Designed to provide superior cooling of VME modules in bottom-to-top air flow
- Equipped with 3 individually controlled long-life DC or HRPM fans, MTBF >65 000h
- Integrated fan speed and thermal monitoring, adjustable fan speed (1200 ... 3600 / 6100 RPM)
- Microprocessor controlled with alphanumeric high-visibility LED display for all fan tray, bin and power supply parameters (voltages, currents, power, temperatures, set-up data ...)
- Built-in combo interface (Ethernet, CAN-bus) for remote monitoring and control
- Free RS232 connection accessible via Ethernet, e.g. to control VME boards during boot
- Dimensions: 430mm x 2U (89mm) x 175mm [whd], weight: ca. 3.5 Kg

UEP 6021 Power Supply

- High density power supply in WIENER "Cavity-VHF" switching technology with excellent RF-shielding, optionally ultra low noise < 3mVpp (all voltages <12V), other rails <10mVpp
- Modular and expandable design with self-ventilated universal power blocks, individually sensed floating DC outputs
- Self-protected against any failure as under/over voltage, over current, over temperature, etc.
- Micro-processor controlled, programmable voltage adjustment, current limits and over-/ under voltage trip off points, temperature limits
- 94V – 260V world-wide auto-range AC input, with power factor correction, CE-conformity
- High power density, up to 3 kW DC output power, 3U high power box
- Dimensions: 430mm x 3U (133mm) [whd], weight: from 9.6 to 20 Kg, depending on the number of power modules

Standard configurations (other possible on request)

Crate Version	Backplane	+5V	+12V	-12V	+3.3V	+48V	PS Height
VXS 6023x610_JL	VXS	115A	23A	23A	115A	-	3U
VXS 6023x612_JL	VXS	230A	23A	23A	115A	-	3U
VXS 6023x615_JL	VXS	345A	23A	23A	115A	-	3U
VXS 6023x617_JL	VXS	115A	23A	23A	230A	-	3U
VXS 6023x618_JL	VXS	230A	23A	23A	230A	-	3U
VXS 6023x620_JL	VXS	115A	45A	45A	115A	-	3U
VXS 6023x624_JL	VXS	230A	45A	45A	115A	-	3U
VXS 6023x627_JL	VXS	115A	45A	45A	230A	-	3U



6U VME 6023 JLAB Crate



6U VME 6023 JLAB Crate rear view



side view - schematic illustration

6U VXI-C Size 6021 Crate Series

WIENER C-size VXI mainframes of the 6021 deliver highest performance and reliability. Incorporating high density & lowest noise power supply technology the 6021 VXI series is the best choice for any demanding test and measurement VXI application.

Up to 6kW DC power can be provided and distributed to the VXI modules. The required superior cooling is provided by the high pressure / high volume fan tray unit. Featuring microprocessor controlled power supplies and fan trays it provides advanced integrated diagnostic and monitoring capabilities. A unique flexibility is given by the modular packaging approach. The VXI 6021 Crate consists of the UEV 6021 Bin, the UEL 6020 EX Fan Tray unit and the UEP 6021 Power Supply.



6U VXI 6021 C-size Crate



6U VXI 6021 C-size Crate rear view, special version with upright power box

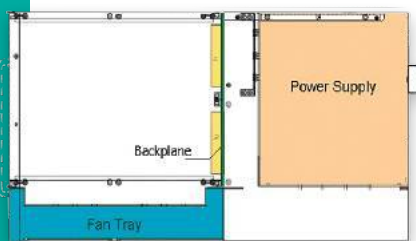

side view - schematic illustration

UEV 6021 VXI-C Bin

- 19" x 8U enclosure for 13 VXI modules 6U x 340mm
- Very rugged steel-aluminum construction features 5mm thick heavy duty side plates with zero-tolerance countersink screw positioning of all horizontal rails
- Monolithic 13 slot 6U VXI backplane (J1/J2), 8 layer PCB, active termination, active automatic daisy-chain
- 2 U space for fan tray unit in front bottom position, power supply in rear top position
- Optional up to 8 temperature sensors above VXI modules
- Dimensions: 19" (482.3mm) x 8U (355.6mm) x 660mm [whd], weight: 15 Kg

UEL 6020 EX Fan Tray

- Designed to provide superior cooling of VXI modules in bottom-to-top air flow
- Equipped with 6 individually controlled long-life DC fans, MTBF >60,000h/40° C
- Integrated fan speed and thermal monitoring, adjustable fan speed (1200 ... 3600 RPM)
- Microprocessor controlled with alphanumeric high-visibility LED display for all fan tray, bin and power supply parameters (voltages, currents, power, temperatures, set-up data, etc. ...)
- Built-in combo interface (Ethernet, CAN-bus) for remote monitoring and control
- Free RS232 connection accessible via Ethernet, e.g. to control VME boards during boot
- Dimensions: 430mm x 2U (88.9mm) x 340mm [whd], weight: ca. 8 Kg

UEP 6021 Power Supply

- High density power supply in WIENER "Cavity-VHF" switching technology with excellent RF-shielding, optionally ultra low noise < 3mVpp (all voltages <12V), other rails <10mVpp
- Modular and expandable design with self-ventilated universal power blocks, individually sensed and floating DC outputs
- Micro-processor controlled, programmable voltage adjustment, current limits and over-/ under voltage trip off points, temperature limits
- Self-protected against any failure as under/over voltage, over current, over temperature, etc.
- 94V – 260V world-wide auto-range AC input, with power factor correction, CE-conformity
- High power density, up to 3 kW/6kW DC output power for 3U or 6U high power box
- Dimensions: 430mm x 3U (133mm) or 6U (267mm) x 250mm [whd], weight: from 15 to 30 Kg depending on the number of power modules

Standard configurations (other possible on request)

Crate Version	Backplane	+5V	+12V	-12V	-5.2V	-2V	+24V	-24V	Height	Order Code
VXI 6021 C631	VXI	115A	23A	23A	115A	115A	-	-	3U	-
VXI 6021 C634	VXI	115A	23A	23A	115A	115A	11.5A	11.5A	3U	-
VXI 6021 C635	VXI	115A	45A	45A	115A	115A	11.5A	11.5A	6U	-
VXI 6021 C641	VXI	230A	23A	23A	115A	115A	-	-	3U	-
VXI 6021 C642	VXI	230A	23A	23A	115A	115A	11.5A	11.5A	6U	-
VXI 6021 C643	VXI	230A	23A	23A	115A	115A	23A	23A	6U	-
VXI 6021 C644	VXI	115A	23A	23A	115A	115A	23A	23A	6U	-
VXI 6021 C645	VXI	230A	23A	23A	230A	115A	23A	23A	6U	-
VXI 6021 C646	VXI	230A	23A	23A	230A	115A	23A	23A	6U	-
VXI 6021 C650	VXI	115A	45A	45A	115A	115A	-	-	6U	-
VXI 6021 C651	VXI	230A	45A	45A	115A	115A	-	-	6U	-
VXI 6021 C652	VXI	230A	45A	45A	115A	115A	-	-	6U	-
VXI 6021 C653	VXI	115A	45A	45A	115A	115A	23A	23A	6U	-
VXI 6021 C654	VXI	230A	45A	45A	115A	115A	23A	23A	6U	-
VXI 6021 C655	VXI	230A	45A	45A	115A	115A	23A	23A	6U	-
VXI 6021 C656	VXI	115A	45A	45A	230A	115A	23A	23A	6U	-

6U VXI-D Size 6021 Crate Series

WIENER D-size VXI mainframes of the 6021 deliver highest performance and reliability. Incorporating high density & lowest noise power supply technology the 6021 VXI series is the best choice for any demanding test and measurement VXI application.

Up to 6kW DC power can be provided and distributed to the VXI modules. The required superior cooling is provided by the high pressure / high volume fan tray unit. Featuring microprocessor controlled power supplies and fan trays it provides advanced integrated diagnostic and monitoring capabilities. A unique flexibility is given by the modular packaging approach. The VXI 6021 Crate consists of the UEV 6021 Bin, the UEL 6020 EX Fan Tray unit and the UEP 6021 Power Supply.

Different power supply configurations as well as a variety of crate options are offered.

UEV 6021 VXI-D Bin

- 19" x 11U enclosure for 13 VXI modules 9U x 340mm
- Very rugged steel-aluminum construction features 5mm thick heavy duty side plates with zero-tolerance countersink screw positioning of all horizontal rails
- Monolithic 13 slot 9U VXI backplane (J1/J2/J3), 8 layer PCB, active termination, active automatic daisy-chain
- 2 U space for fan tray unit in front bottom position, power supply in rear top position
- Optional up to 8 temperature sensors above VXI modules
- Dimensions: 19" (482.3mm) x 11U (489mm) x 640mm [whd], weight: 15 Kg

UEL 6020 EX Fan Tray

- Designed to provide superior cooling of VXI modules in bottom-to-top air flow
- Equipped with 6 individually controlled long-life DC fans, MTBF >65,000h
- Integrated fan speed and thermal monitoring, adjustable fan speed (1200 ... 3600 RPM)
- Microprocessor controlled with alphanumeric high-visibility LED display for all fan tray, bin and power supply parameters (voltages, currents, power, temperatures, set-up data, etc. ...)
- Built-in combo interface (Ethernet, CAN-bus) for remote monitoring and control
- Free RS232 connection accessible via Ethernet, e.g. to control VME boards during boot
- Dimensions: 430mm x 2U (88.9mm) x 340mm [whd], weight: ca. 8 Kg

UEP 6021 Power Supply

- High density power supply in WIENER "Cavity-VHF" switching technology with excellent RF-shielding, optionally ultra low noise < 3mVpp (all voltages <12V), other rails <10mVpp
- Modular and expandable design with self-ventilated universal power blocks, individually sensed and floating DC outputs
- Micro-processor controlled, programmable voltage adjustment, current limits and over-/ under voltage trip off points, temperature limits
- Self-protected against any failure as under/over voltage, over current, over temperature, etc.
- 94V – 260V world-wide auto-range AC input, with power factor correction, CE-conformity
- High power density, up to 3 kW/6kW DC output power for 3U or 6U high power box
- Dimensions: 430mm x 3U (133mm) or 6U (267mm) x 250mm [whd], weight: from 15 to 29 Kg depending on the number of power modules



6U VXI 6021 D-size Crate

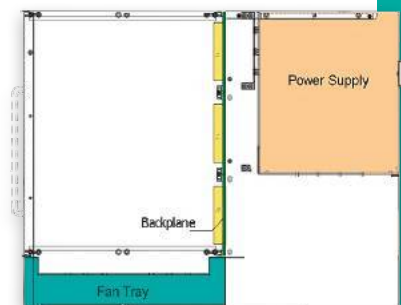

side view - schematic illustration

Standard configurations (other possible on request)

Crate Version	Backplane	+5V	+12V	-12V	-5.2V	-2V	+24V	-24V	Height
VXI 6021 D631	VXI	115A	23A	23A	115A	115A	-	-	3U
VXI 6021 D634	VXI	115A	23A	23A	115A	115A	11.5A	11.5A	3U
VXI 6021 D635	VXI	115A	45A	45A	115A	115A	11.5A	11.5A	6U
VXI 6021 D641	VXI	230A	23A	23A	115A	115A	-	-	3U
VXI 6021 D642	VXI	230A	23A	23A	115A	115A	11.5A	11.5A	6U
VXI 6021 D643	VXI	230A	23A	23A	115A	115A	23A	23A	6U
VXI 6021 D644	VXI	115A	23A	23A	115A	115A	23A	23A	6U
VXI 6021 D645	VXI	230A	23A	23A	230A	115A	23A	23A	6U
VXI 6021 D646	VXI	230A	23A	23A	230A	115A	23A	23A	6U
VXI 6021 D650	VXI	115A	45A	45A	115A	115A	-	-	6U
VXI 6021 D651	VXI	230A	45A	45A	115A	115A	-	-	6U
VXI 6021 D652	VXI	230A	45A	45A	115A	115A	-	-	6U
VXI 6021 D653	VXI	115A	45A	45A	115A	115A	23A	23A	6U
VXI 6021 D654	VXI	230A	45A	45A	115A	115A	23A	23A	6U
VXI 6021 D655	VXI	230A	45A	45A	115A	115A	23A	23A	6U
VXI 6021 D656	VXI	115A	45A	45A	230A	115A	23A	23A	6U

6U VXI-C size 4600 RR Crate Series

Designed for high performance automated test and scientific applications. The-RR VXI mainframe series (RR=cooling intake and exhaust at rear side), takes advantage of WIENER's 50-years experience as a leading manufacturer of powered crates for scientific research and industry. The 4600 series is a compact design with high density, highly sophisticated modular designed power supplies. The power supply features medium output power up to 3kW, with extremely low noise and ripple (PARD). The 8U, 13-slot chassis offers superior cooling, due to an efficient air guiding system. The fan tray has three high efficient DC-fans, situated at the lower rear side in a removable fan tray with optional air filter.

Different power supply configurations as well as a variety of crate options are offered.



6U VXI 4600 C-size RR Crate



6U VXI 4600 C-size RR Crate

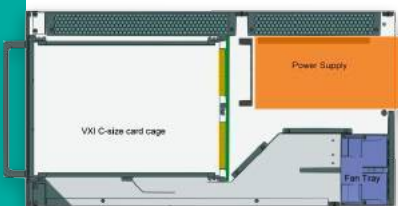

side view - schematic illustration

UEV 4600 VXI-C Bin

- 19" x 8U enclosure for 13 VXI modules 6U x 340mm
- Very rugged steel-aluminum construction features 5mm thick heavy duty side plates with zero-tolerance countersink screw positioning of all horizontal rails
- Optional with side extensions for receiver card mounting
- Monolithic 13 slot VXI backplane (J1/J2), 8 layer PCB, active termination and active automatic-daisy-chain
- 1U air compression chamber below the VXI module card cage
- 1U air exhaust above VXI module card cage
- WIENER Shelf Manager for local and remote monitoring and control, monitors and controls power supply, fan, remote on/off, SYSRES, thermal monitoring
- Alphanumeric high-visibility LED display, switches, I/O and Ethernet / ports on front top panel
- Free RS232 connection accessible via Ethernet, e.g. to control VME boards during boot
- Optional up to 8 temperature sensors in VME card cage above modules
- Dimensions: 19" x 8U x 480mm [whd], weight: ca. 15 Kg

UEL 4600 Fan Tray

- Designed to provide efficient cooling of C-size VXI modules
- Cooling capacity of 2kW optionally up to 2.6kW
- High efficient 3- channel air guiding system
- 3 high efficiency / high RPM long-live DC muffin fans situated in a 3U fan tray at lower rear side.
- Individual fan speed and thermal monitoring, adjustable fan speed (1200 ... 6100 RPM)
- Optional with air filter
- Dimensions: 430mm x 3U x 250mm [whd], weight: ca. 8 Kg

UEP 6021 Power Supply

- High density power supply in WIENER "Cavity-VHF" switching technology with excellent RF-shielding, optionally ultra low noise < 3mVpp (all voltages < 12V), other rails < 10mVpp
- Modular and expandable design with self-ventilated universal power blocks, individually sensed and floating DC outputs
- Micro-processor controlled, programmable voltage adjustment, current limits and over-/ under voltage trip off points, temperature limits
- Self-protected against any failure as under/over voltage, over current, over temperature, etc.
- 94V – 260V world-wide auto-range AC input, with power factor correction, CE-conformity
- High power density, up to 3 kW/6kW DC output power for 3U or 6U high power box
- Dimensions: 430mm x 3U (133mm) x 250mm [whd], weight: from 15 to 19 Kg, depending on the number of power modules

Standard Crate configurations (other possible on request)

Crate Version	Backplane	+5V	+12V	-12V	-5.2V	-2V	+24V	-24V	Height	Order Code
VXI 4600 RR631	VXI	115A	23A	23A	45A	45A	11.5A	11.5A	3U	-
VXI 4600 RR634	VXI	115A	23A	23A	115A	115A	11.5A	11.5A	3U	-
VXI 4600 RR635	VXI	115A	45A	45A	45A	45A	11.5A	11.5A	3U	-
VXI 4600 RR641	VXI	230A	23A	23A	45A	45A	11.5A	11.5A	3U	-

6U VXI-C Size High Power Receiver Crate

The WIENER high power C-size VXI receiver mainframe is optimized for test applications with demanding power requirements. Up to 6kW DC power can be provided and distributed to the VXI modules. Optimum cooling is provided by the temperature controlled high pressure / high air volume fan tray unit with air filter. Featuring microprocessor controlled power supplies and fan trays it provides advanced integrated diagnostic and monitoring capabilities.

A unique flexibility is given by the modular packaging approach. The VXI 6021 crate consists of the UEV 6021 Receiver bin, the UEL 6020 fan tray unit and the UEP 6021 power supply. Different power supply configurations as well as a variety of crate options are offered.

UEV 6021 VXI-C Receiver Bin

- 19" x 10U enclosure for 13 VXI modules 6U x 340mm, recessed VXI card cage (using front side panel extensions)
- Very rugged steel-aluminum construction features 5mm thick heavy duty side plates with zero-tolerance countersink screw positioning of all horizontal rails
- Monolithic 13 slot 6U VXI backplane (J1/J2), active termination, active automatic-daisy-chain
- 3 U space for fan tray unit in front bottom position, air flow from bottom / side with top rear / side outlet
- air filter and power supply plugged in from rear
- Optional up to 8 temperature sensors above VXI modules
- Dimensions: 19" (482.3mm) x 10U (444.5mm) x 674mm [whd], weight: 26 kg

UEL 6020 EX Fan Tray

- Designed to provide superior cooling of VXI modules in bottom-to-top air flow, 340mm deep
- Equipped with individually controlled long-life DC fans (either 6 standard or H RPM or 4 Super blower fans)
- Integrated fan speed and thermal monitoring, adjustable fan speed
- Microprocessor controlled with alphanumeric high-visibility LED display for all fan tray, bin and power supply parameters (voltages, currents, power, temperatures, set-up data, ...)
- Built-in combo interface (Ethernet, CAN-bus) for remote monitoring and control
- Free RS232 connection accessible via Ethernet, e.g. to control VME boards during boot
- Dimensions: 415mm x 2U (88.9mm) x 340mm [whd], weight: 8 kg

UEP 6021 Power Supply

- High density power supply in WIENER "Cavity-VHF" switching technology with excellent RF-shielding, Low noise and ripple < 10mVpp (all voltages <12V), other <15mV
- Modular and expandable design with self-ventilated universal power blocks, individually sensed floating DC outputs
- Self-protected against any failure as under/over voltage, over current, over temperature, ...
- Micro-processor controlled, programmable voltage adjustment, current limits and over-/ under voltage trip off points, temperature limits
- 94V - 260V world-wide auto-range AC input, with power factor correction, CE
- High power density, up to 3 or 6 kW DC output power, 3U or 6U high power box
- Dimensions: 430mm x 6U (266.7mm) x 250mm [whd], weight: 15 to 29 kg

Standard configurations (other possible on request)

Crate Version	Backplane	+5V	+12V	-12V	-5.2V	-2V	+24V	-24V	Height	Order Code
VXI 6021 R631	VXI	115A	23A	23A	115A	115A	-	-	3U	-
VXI 6021 R634	VXI	115A	23A	23A	115A	115A	11.5A	11.5A	3U	-
VXI 6021 R635	VXI	115A	45A	45A	115A	115A	11.5A	11.5A	6U	-
VXI 6021 R641	VXI	230A	23A	23A	115A	115A	-	-	3U	-
VXI 6021 R642	VXI	230A	23A	23A	115A	115A	11.5A	11.5A	6U	-
VXI 6021 R643	VXI	230A	23A	23A	115A	115A	23A	23A	6U	-
VXI 6021 R644	VXI	115A	23A	23A	115A	115A	23A	23A	6U	-
VXI 6021 R645	VXI	230A	23A	23A	230A	115A	23A	23A	6U	-
VXI 6021 R646	VXI	230A	23A	23A	230A	115A	23A	23A	6U	-
VXI 6021 R650	VXI	115A	45A	45A	115A	115A	-	-	6U	-
VXI 6021 R651	VXI	230A	45A	45A	115A	115A	-	-	6U	-
VXI 6021 R652	VXI	230A	45A	45A	115A	115A	-	-	6U	-
VXI 6021 R653	VXI	115A	45A	45A	115A	115A	23A	23A	6U	-
VXI 6021 R654	VXI	230A	45A	45A	115A	115A	23A	23A	6U	-
VXI 6021 R655	VXI	230A	45A	45A	230A	115A	23A	23A	6U	-
VXI 6021 R656	VXI	115A	45A	45A	230A	115A	23A	23A	6U	-
VXI 6021 R657	VXI	150A	44A	44A	115A	81A	34A	34A	6U	-



6U VXI 6021 C-size High Power Receiver crate



6U VXI 6021 C-size High Power Receiver Crate rear view

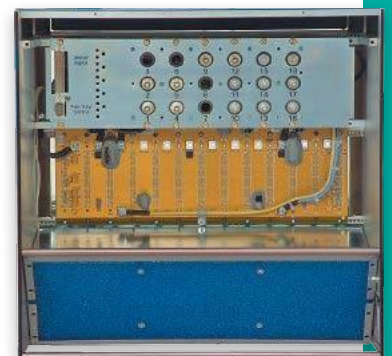

6U VXI 6021 C-size High Power Receiver Crate rear view without power supply

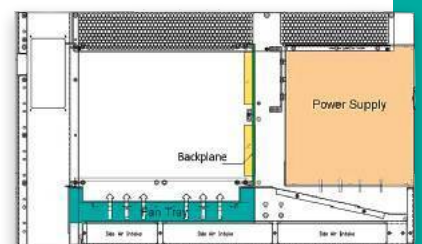

side view - schematic illustration

6U VXI-C Size Front-Load Crate

WIENER C-size VXI mainframes of the 6000 series deliver highest performance and reliability. Incorporating high density & lowest noise power supply technology the 6000 VXI series is the best choice for any demanding test and measurement VXI application.

The VXI6025 "front-load" VXI-C mainframe is based on the 6000 series technology but provides full front side accessibility in a very compact chassis design. Both the power supply as well as the cooling fans are front side removable.

Featuring microprocessor controlled power supplies and fan trays it provides advanced integrated diagnostic and monitoring capabilities. A unique flexibility is given by the modular packaging approach.



8.5U front load VXI6025 chassis



10U front load VXI6025 chassis

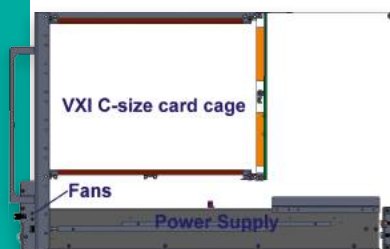

Schematic View 8.5U VXI6025 chassis

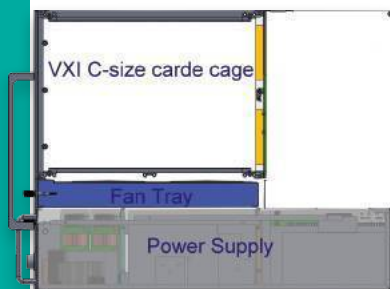

Schematic View 10U VXI6025 chassis

UEV 6025 VXI-C Front-Load Bin

- 119" x 8.5 or 10U enclosure for 13 VXI modules 6U x 340mm
- Very rugged steel-aluminum construction features 5mm thick heavy duty side plates with zero-tolerance countersink screw positioning of all horizontal rails
- Monolithic 13 slot 6U VXI backplane (J1/J2), active termination, active automatic-daisy-chain
- Front side accessible fan tray and power supply
- Optional up to 8 temperature sensors above VXI modules

UEL 6025 EX Fan Tray

- Designed to provide superior cooling of VXI modules in front/bottom-to-top air flow
- 340mm deep, equipped 6 with individually controlled long-life HRPM DC fans
- Integrated fan speed and thermal monitoring, adjustable fan speed
- Microprocessor controlled with alphanumeric high-visibility LED display for all fan tray, bin and power supply parameters (voltages, currents, power, temperatures, set-up data, ...)
- Built-in Ethernet interface for remote monitoring and control

UEP 6025 Power Supply

- Front-load high density power supply in WIENER "Cavity-VHF" switching technology with excellent RF-shielding, high power density, up to 3 or 5 kW DC output power
- Low noise and ripple < 10mVpp (all voltages <12V), other <15mV
- Modular and expandable design with self-ventilated universal power blocks, individually sensed floating DC outputs
- Self-protected against any failure as under/over voltage, over current, over temperature, ...
- Micro-processor controlled, programmable voltage adjustment, current limits and over-/ under voltage trip off points, temperature limits
- 94V - 260V single or 3-phase, auto-range AC input, with power factor correction, CE

Standard configurations (other possible on request)

Crate Version	Backplane	+5V	+12V	-12V	-5.2V	-2V	+24V	-24V	Height
VXI 6025 C630	VXI	115A	23A	23A	115A	40A	15A	15A	8.5U
VXI 6025 C631	VXI	115A	23A	23A	115A	115A	15A	15A	8.5U
VXI 6025 C650	VXI	115A	45A	45A	115A	115A	15A	15A	10U
VXI 6025 C651	VXI	230A	45A	45A	115A	115A	15A	15A	10U
VXI 6025 C652	VXI	230A	45A	45A	115A	115A	30A	30A	10U

6U cPCI / PXI / PXIe 195 Mini Crate Series

The 395-x Mini Crate Series offers hot-swappable, redundant power supplies in a 8 slot, compact but modular designed chassis for cPCI, PXI or PXIe applications. A front-side-plug high performance DC fan is used for cooling with front to rear air flow.

One or two redundant operating plug-in 250W cPCI power supplies provide sufficient power for II applications. The CML shelf manager allows full remote monitoring and control of power supply, fan and chassis. The mini crate can be used on the desk either as a desktop or up-right unit or be installed in a 19" rack.

Main Features

- MINI-Bin mechanics for 6Ux160mm, cPCI, PXI or PXIe modules, suitable either for 19" rack, as a tower- or a desktop box
- IEEE 1101.10 compliant mechanics with enhanced EMC / ESD
- Hartmann Elektronik cPCI backplane, 6Ux8 slots, 33MHz, 64bit, system slot right, 5VI/O, or other cPCI, PCI serial, PXI or PXIe backplane
- Alphanumeric high-visibility LED display for voltages, currents, fan speed, temperatures and settings / programming, 4 status LED's
- WIENER CML Shelf Manager for local and remote monitoring and control, monitors and controls power supply, fan, remote on/off, thermal monitoring, user I/O programming, with Ethernet and USB interfaces, rear side plugged in
- Front side mounted, removable High-RPM DC blower, adjustable speed (1200 ... 3200 RPM), temperature controlled
- Outfitted with one or two 250W cPCI power supplies, plugged in from rear, hot swappable, redundant operation, CE-conformity, 300W power supplies on request



6U cPCI 395x Mini Crate

6U cPCI / PXI / PXIe 6021 Series

The WIENER 6021 Crate Series can be outfitted with cPCI, PXI or PXIe backplanes to provide high performance chassis with highly reliable low-noise power supplies for these bus standards. Typical applications are data acquisition, beam line control and test instrumentation. Featuring microprocessor controlled power supplies and fan trays it provides advanced integrated diagnostic and monitoring capabilities. For remote monitoring and control the VME6021 crates are outfitted with Ethernet, RS232 and CAN-bus interfaces.

A variety of crate and backplanes options as well as matching power supply configurations are offered.

UEV 6021 Bin

- 19" x 8U enclosure for 21 cPCI, PXI or PXIe bus cards 6U x 160mm
- Very rugged steel-aluminum construction features 5mm thick heavy duty side plates with zero-tolerance countersink screw positioning of all horizontal rails
- Choice of different backplanes cPCI, PXI, PXIe, up to 4 backplanes per chassis
- Free rear side access of VME backplane at J2, optional 3U rear side transition card cage 80mm/120mm/160mm/220mm deep

UEL 6020 EX Fan Tray

- Designed to provide superior cooling of VME modules in bottom-to-top air flow
- Equipped with 3 individually controlled long-life DC fans, MFOT >65 000h/40°C
- Integrated fan speed and thermal monitoring, adjustable fan speed (1200 ... 3200 RPM)
- Microprocessor controlled with alphanumeric high-visibility LED display
- Built-in combo interface (Ethernet, CAN-bus) for remote monitoring and control
- Free RS232 connection accessible via Ethernet, e.g. to control VME boards during boot

UEP6021 Power Supply

- High density / lowest-noise power supply in WIENER "Cavity-VHF" switching technology with excellent RF-shielding, < 10mVpp
- Modular and expandable design with self-ventilated universal power blocks, individually sensed and floating DC outputs, up to 8 different floating DC outputs
- Micro-processor controlled, programmable voltage adjustment, current limits and over-/ under voltage trip off points, temperature limits
- Self-protected against any failure as under/over voltage, over current, over temperature
- 94V – 265VAC world-wide auto-range AC input, with power factor correction, CE
- High power density, up to 3 kW DC output power



6U cPCI 6021 Crate
outfitted with four 5-slot 6U backplanes



6U cPCI 6021 Crate
outfitted with four 5-slot 6U backplanes rear view

CERN LHC Crates

For CERN a special version of the VME64x 6021 Crate Series was developed to be used by the four LHC experiments, ALICE, ATLAS, CMS and LHCb. The sub-racks are all constructed to the IEEE1101.10 mechanical specifications as used for VME-bus and Compact PCI, for modules in both 6U and 9U form-factors.

VME64x backplanes and associated power supplies as well as integrated cooling are available as standard. Sub-racks may be equipped with rear „transition module“ card cages according to IEEE1101.11 (depth of module 220mm or 160mm in 9U sub-racks and 160mm in 6U sub-racks). LHC VME crates can be powered by remote power supplies. All technical information details are described within the “Technical Specification for Sub-racks for LHC Experiments”. For details see the CERN ESS web site at <http://ess.web.cern.ch/ESS/CrateProject>.

The LHC-VME64x 6021 crates consist of the UEV 6021-S Bin, The UEL 6020 EX Fan Tray unit and the UEP 6021 Power Supply. CAN-bus or Ethernet remote monitoring and control and a 6U/160mm rear side transition board card cages are commonly selected options.



9U LHC Crate



9U LHC Crate side view

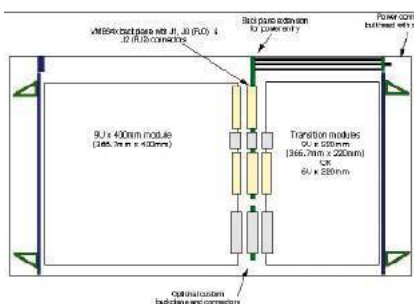

side view - schematic illustration

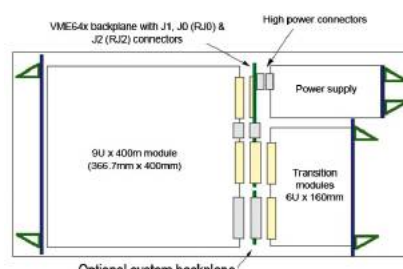

side view - schematic illustration

UEV 6021 Bin

- 19" enclosure for 21 VME64x cards 6U x 160mm or 9U x 400mm
- Variant 1 type for 6U and 9U cards with remote power supplies
- Variant 2 type for 6U and 9U cards with integrated power supply
- VME64x version fully compliant to IEEE 1101.10/P, advanced EMC / ESD shielding
- Very rugged steel-aluminum construction features 5mm thick heavy duty side plates with zero-tolerance countersink screw positioning of all horizontal rails equipped with monolithic
- 6U VME64x backplane (J1/J0/J2), 10 layer PCB, active termination, automatic-daisy-chain
- Free rear side access to J2 and J3 (9U size), optional rear side transition card cage
- Dimensions: 19" wide, all other dimensions depend on the variant type

UEL 6020 EX Fan Tray

- Designed to provide superior cooling of VXI modules in bottom-to-top air flow
- Equipped with 3 or 6 individually controlled long-life DC fans, MTBF >60,000h/40°C
- Integrated fan speed and thermal monitoring, adjustable fan speed (1200 ... 3600 RPM)
- Microprocessor controlled with alphanumeric high-visibility LED display for all fan tray, bin and power supply parameters (voltages, currents, power, temperatures, set-up data, etc. ...)
- Built-in combo interface (Ethernet, CAN-bus) for remote monitoring and control
- Free RS232 connection accessible via Ethernet, e.g. to control VME boards during boot
- Dimensions: 430mm x 2U (88.9mm) x 340mm [whd], weight: ca. 8 Kg

UEP 6021 Power Supply

- High density power supply in WIENER "Cavity-VHF" switching technology with excellent RF-shielding, optionally ultra low noise < 3mVpp (all voltages < 12V), other rails < 10mVpp
- Modular and expandable design with self-ventilated universal power blocks, individually sensed and floating DC outputs
- Micro-processor controlled, programmable voltage adjustment, current limits and over-/ under voltage trip off points, temperature limits
- Self-protected against any failure as under/over voltage, over current, over temperature, etc.
- 94V – 260V world-wide auto-range AC input, with power factor correction, CE-conformity
- High power density, up to 3 kW/6kW DC output power for 3U or 6U high power box
- Dimensions: 430mm x 3U (133mm) or 6U (267mm) x 250mm [whd], weight: from 15 to 30 Kg depending on the number of power modules

Standard Crate configurations (other possible on request)

Type	Backplane		Power Supply		Rear Card Cage	
	VME64x	Custom	Remote	Local	9U / 6U	6U
9U Variant 1	•		•		•	
9U Variant 1a		•	•		•	
9U Variant 2	•			•		•
9U Variant 2a		•		•		•
6U Variant 1a	•		•			•
6U Variant 1a		•	•			•
6U Variant 2	•			•		None
6U Variant 2a		•		•		None

6U VME VME64x 6023-JLAB Crates

For the Thomas Jefferson National Accelerator Facility (JLAB) in Virginia (USA), a special version of the VME 6023 crate series with front to rear air-cooling was developed. "JLAB style" VME crates are available with standard VME/VME64 backplane and mechanics as well as with VME64x or VXS (see VXS section) backplane and IEEE 1101.10 compatible mechanics, (enhanced EMC and ESD shielding).

The VME64x 6023-JL crates consists of the UEV 6023(S)-JL bin, the UEL 6020 EX Fan Tray unit and the UEP 6021 Power Supply. The power supply is located in the bottom behind the fan tray unit leaving the rear of the VME backplane completely accessible. Ethernet remote monitoring and control and a 6U/160mm rear side transition board card cages are standard options for the EX fan tray version.

Different power supply configurations as well as crate options are offered.

UEV 6023-JL VME Bin

- 19" x 11 U enclosure for 21 VME or VME64x cards 6U x 160mm
- VME64x version fully compliant to IEEE 1101.10/P, advanced EMC / ESD shielding
- Very rugged steel-aluminum construction features 5mm thick heavy duty side plates with zero-tolerance countersink screw positioning of all horizontal rails, solid aluminum card guide rails
- VME/VME64 version: monolithic 6U VME/VME64 backplane (J1/J2), 8 layer PCB, active automatic-daisy-chain / termination
- VME64x version: fully compliant to IEEE 1101.10/P, advanced EMC / ESD shielding, equipped with monolithic 6U VME64x backplane (J1/J0/J2), 10 layer PCB, active termination, active automatic-daisy-chain, CBLT compatible
- 2U space for fan tray unit + 2U air inlet in front bottom position, 1U top air guide, power supply in rear bottom position, air flow front to rear
- Completely free rear side access of VME backplane, with rear side transition card cage 6Ux160mm
- Dimensions: 19" x 11U x 480mm [whd], weight: ca. 14 Kg



6U VME 6023x JLAB Crate

UEL 6020 EX Fan Tray

- Designed to provide superior cooling of VME modules in bottom-to-top air flow
- Equipped with 3 individually controlled long-life DC fans, MTBF >60,000h/40° C
- Integrated fan speed and thermal monitoring, adjustable fan speed (1200 ... 3600 RPM)
- Microprocessor controlled with alphanumeric high-visibility LED display for all fan tray, bin and power supply parameters (voltages, currents, power, temperatures, set-up data, etc.)
- Built-in combo interface (Ethernet, CAN-bus) for remote monitoring and control
- Free RS232 connection accessible via Ethernet, e.g. to control VME boards during boot
- Dimensions: 430mm x 2U (89mm) x 175mm [whd], weight: ca. 3.5 Kg



6U VME 6023x JLAB Crate rear side without power supply

UEP 6021 Power Supply

- High density power supply in WIENER "Cavity-VHF" switching technology with excellent RF-shielding, optionally ultra low noise < 3mVpp (all voltages <12V), other rails <10mVpp
- Modular and expandable design with self-ventilated universal power blocks, individually sensed floating DC outputs
- Self-protected against any failure as under/over voltage, over current, over temperature, etc.
- Micro-processor controlled, programmable voltage adjustment, current limits and over-/ under voltage trip off points, temperature limits
- 94V – 260V world-wide auto-range AC input, with power factor correction, CE-Conformity
- High power density, up to 3 kW DC output power, 3U high power box
- Dimensions: 430mm x 3U (133mm) [whd], weight: from 9.6 to 20 Kg, depending on the number of power modules

Standard Crate configurations (other possible on request)

Crate Version	Backplane	+5V	+12V	-12V	+3.3V	+48V	Order Code
VME 6023-611-JL	VME64/VME64	115A	23A	23A	-	-	-
VME 6023x610-JL	VME64x	115A	23A	23A	115A	-	-
VME 6023x617-JL	VME64x	115A	23A	23A	230A	-	-



side view - schematic illustration

6U VME64x 6023 SNS Crates

The Spallation Neutron Source (SNS) in Oak Ridge (USA) is using WIENER VME64x Crates of the 6023 style with front to rear cooling similar to the JLAB-style however, with simplified fan trays without display and interfaces.

The VME64x 6023-JL crates consists of the UEV 6023(S)-JL bin, the UEL 6020 EX Fan Tray unit and the UEP 6021 Power Supply. The power supply is located in the bottom behind the fan tray unit leaving the rear of the VME backplane completely accessible. Ethernet remote monitoring and control and a 6U/160mm rear side transition board card cages are standard options for the EX fan tray version.

Different power supply configurations as well as crate options are offered.



6U VME 6023x SNS Crate



6U VME 6023x SNS Crate rear side without power supply

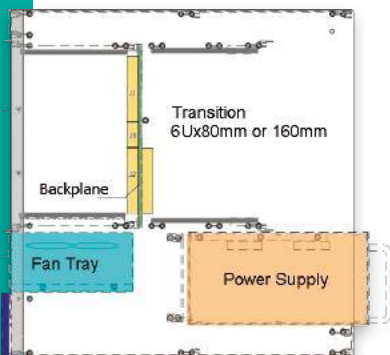

side view - schematic illustration

UEV 6023-JL VME Bin

- 19" x 11 U enclosure for 21 VME64x cards 6U x 160mm
- Fully compliant to IEEE 1101.10/P, advanced EMC / ESD shielding
- Very rugged steel-aluminum construction features 5mm thick heavy duty side plates with zero-tolerance countersink screw positioning of all horizontal rails, solid aluminum card guide rails
- Equipped with monolithic 6U VME64x backplane (J1/J0/J2), 10 layer PCB, active termination, active automatic-daisy-chain, CBLT compatible
- 2U space for fan tray unit + 2U air inlet in front bottom position, 1U top air guide, power supply in rear bottom position, air flow front to rear
- Completely free rear side access of VME backplane, with rear side transition card cage 6Ux160mm
- Dimensions: 19" x 11U x 480mm [whd], weight: ca. 14 Kg

UEL 6020 EX Fan Tray

- Designed to provide superior cooling of VME modules in bottom-to-top air flow
- Equipped with 3 individually controlled long-life DC fans, MTBF >60,000h/40° C
- with LED's and test pins for all DC voltages, no display, no interfaces
- with front side air filter
- Dimensions: 430mm x 4U (178mm) x 175mm [whd], weight: ca. 3.5 Kg

UEP 6021 Power Supply

- High density power supply in WIENER "Cavity-VHF" switching technology with excellent RF-shielding, optionally ultra low noise < 3mVpp (all voltages <12V), other rails <10mVpp
- Modular and expandable design with self-ventilated universal power blocks, individually sensed floating DC outputs
- Self-protected against any failure as under/over voltage, over current, over temperature, etc.
- Micro-processor controlled, programmable voltage adjustment, current limits and over-/ under voltage trip off points, temperature limits
- 94V – 260V world-wide auto-range AC input, with power factor correction, CE-Conformity
- High power density, up to 3 kW DC output power, 3U high power box
- Dimensions: 430mm x 3U (133mm) [whd], weight: from 9.6 to 20 Kg, depending on the number of power modules

Standard Crate configurations (other possible on request)

Crate Version	Backplane	+5V	+12V	-12V	+3.3V	+48V	Order Code
VME 6023x617-SNS	VME64x	115A	23A	23A	230A	-	-

6U VME64x 3200 Crate Series

The VME 3200 Crate Series provides industry standard VME crates with redundant and hot-swappable front-side plugged in 500W cPCI power supplies in a compact and rugged design. The VME card sized CML shelf manager allows full remote monitoring and control of power supply, fan and chassis.

Efficient cooling of VME modules is done by the 1U fan tray which is removable and completely controlled.

Technical Details

- 7U VME-Bin VM4 with 16 Slots for 6Ux160mm VME modules, slot 17 used for CML, rugged construction with 3mm thick side panels
- 16 slot J1/J2 monolithic VME64x backplane, J0 optional, 8 layer PCB, active termination, active automatic-daisy-chain
- Plug-in, replaceable VME fan tray UL 4 with high efficient 3- fold DC fan tray blowers, one unit height, air inlet from bottom, optionally watched by temperature sensors and / or variable fan speed, fan fail detection
- WIENER CML01 Shelf manager for local and remote monitoring and control, monitoring of all DC voltages (under/over voltage, temperatures, detection and generation of VME signals (SYSRES, SYSFAIL, ACFAIL), local / remote ON/OFF and SYSRES, Ethernet interface with integrated web-server and SNMP protocol, USB interface for local PC control, 8 digital inputs and outputs and 4 analog inputs, 10 LED's on front panel
- 100V – 240V world-wide auto-range AC input, with power factor correction, CE-conformity
- Dimensions: 19" (482mm) x 7U (311mm) x 298mm [whd]
- Weight: ca. 11 Kg, (with CML and one cPCI power supply)

Standard configurations (other possible on request)

Crate Version	Backplane	+5V	+3.3V	+12V	-12V	Order Code
VME64x 3200_1	J1/J2 VME64x	50A	40A	5A	2A	-
VME64x 3200_2	J1/J2 VME64x	100A	80A	10A	4A	-
VME64x 3200_1P0	J1/J0/J2 VME64x	50A	40A	5A	2A	-
VME64x 3200_2P0	J1/J0/J2 VME64x	100A	80A	10A	4A	-



6U VME 3200x Crate

6U VME64/VME64x NIX-I Crate Series

The low-cost / industry standard VME/VME64 NIX-I series, provides basic, full size VME crates with low noise 6000 series based power supply technology and a removable fan tray

Technical Details

- 7U VME-Bin VM4 with 21 Slots for 6U x 160mm VME/VME64 modules,
- 21 slot J1/J2 VME monolithic backplane
- Plug-in, replaceable VME fan tray UL 4 with high efficient 3- fold DC fan tray blowers, one unit height, air inlet from bottom, optionally watched by temperature sensors and / or variable fan speed
- VME-Power-Supply UEP4, low noise VHF switching technology based, up to 650W output power, rear side mounted (behind J1 area!, no 6U transition possible)
- CE-conformity
- Dimensions: 19" (482mm) x 7U (311mm) x 325mm [whd], weight: ca. 11.7 Kg

Standard configurations (other possible on request)

Crate Version	Backplane	+5V	+12V	-12V	+3.3V	Order Code
NIX-I	J1/J2 VME/VME64	45A	11.5A	11.5A		VN3LG220000S
NIX-I x	J1/J2 VME64x	45A	11.5A	11.5A	45A	VN4LG220000S
NIX-I xP0	J1/J0/J2 VME64x	45A	11.5A	11.5A	45A	-

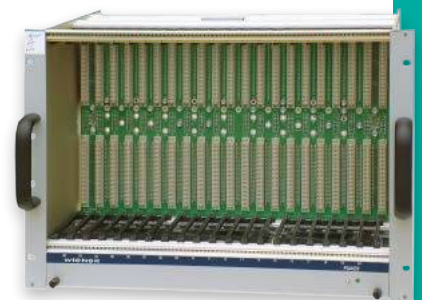

6U VME NIX-I Crate

Technical Details of WIENER VME/VME64x/VXI/VXS Crates

VME / VME 430 / VME64x / VXS / VXI Backplanes

Features of all WIENER Multi-layer Backplanes:

- Strip line technology suitable for data rates of 320Mbyte/s (64bit)
- High power distribution by current multiplayer / bus bar system
- Excellent RF shielding
- Well dispersed filter-capacitors
- Minimized ground shift and cross talk
- Automatic daisy chain
- Plugged flat cable for sense and control
- Provision for up to 8 temperature sensors (module temp. checking)
- Sense circuit protection by PTC- resistors (Optionally)

On board filter capacitors (electrolytic and ceramic) are widely distributed. Together with a prudent power layer design this provides the highest filter effect against power supply and signal noise. Ground shielding layer encircles all signal lines which results in low crosstalk. A large current bus-bar system prevents effective DC ground shift.

5, 7, and 10 slot types can be mounted together as a common ground Multi-VME-bus system. It is then possible to operate separate busses within one VME crate. A diode blocks on board generated Sys- Reset signals against the other backplanes. External generated Sys- Reset reach all backplanes in parallel.

3U VME J1 and VME64x J1 Backplane

10 layer actively terminated backplane with active automatic daisy chain and active termination. 3U high VME J1 with 96pin DIN connectors meets IEEE-1014-1987. VME64x (VME 64 Extension) versions are equipped with 5-row (160pin) connectors. Available with up to 21 slots.

6U VME64 J1/J2 Backplane

Meets ANSI/VITA 1-1994 and IEEE-1014-1987. Extended power layers and special current rails permit high power distribution. The 21 slot monolithic VME backplane features more than 300A current capability for the 5V, 15A per slot (at 70°C) with 96 pin connectors. Available with 7, 9, 10 or 21 slots. Optional the J2 can be equipped with 160pin 5-row connectors.

6U VME430 J1/Jaux/J2 Backplane (CERN spec.)

Based on VME 64 with J1/J2 the same performance is given. Meets CERN spec. V430 entirely. Five row 160-pin connectors are optionally available. Available with 9 or 21 slots. Jaux features:

- Geographical address
- Bussed and terminated differential signals: clock, start/stop gate, and clear
- Clean earth,
- +/-15V (Optional)
- ECL voltages -2V and -5V

6U VME64x J1/J0/J2 Backplane

The 6U monolithic WIENER J1/J2 backplane fully complies with the VME64 Extensions specification according to ANSI/VITA 1.1-1997 and 1.3-997. It is designed as a 10-layer board in strip-line technology. Monolithic VME64x backplanes are available with 7, 10 or 21 (full size) slots. The backplane is actively terminated and provides active automatic daisy chaining. On request the active automatic daisy chain is available compatible to the CBLT.

The extended power layers and special current rails permit highest power distribution. The 21 slot monolithic J1/J2 backplane has more than 300A current capability on 5V, which corresponds to 15A per slot (at 70°C). For power distribution and connection a flat sandwich-like structure of copper sheets is mounted on the back of the upper J1 area. All DC wiring from this high-current multi-layer structure to the power supply situated in the bottom is integrated into the backplane layout by using the space between the connector shrouds.

The VME64x backplane outfitted with 5-row 160 pin J1/J2. Optionally with 133 pin hard metric J0 connectors. WIENER's special current multilayer made of z-bended copper sheets, further stiffens the 4.8mm thick board.

- Strip line technology suitable for maximum data rates of (320Mbyte/s, 64bit)
- Optimized RF shielding and Well dispersed filter-capacitors
- Minimized ground shift and cross talk
- Maximum Power capabilities



VME-J1

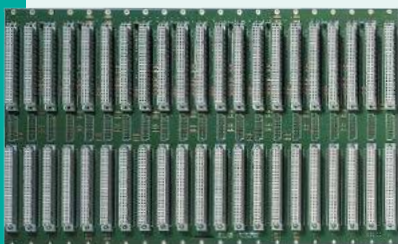

VME64 J1/J2



VME 430 J1/Jaux/J2 (CERN)

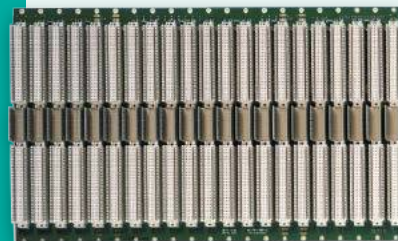

VME64x J1/J0/J2 / VME64xP (VIPA)

6U VME64xP J1/J0/J2 Backplane

VME64xP like 64x but 18 layers with some special defined pins, and higher current ratings according to IEEE and VIPA specifications. Available with 21 slots only. VME64xP is also known as 64x Standard for Physics or VIPA- Standard

6U VME64x J1/Jaux/J2 Backplane

Our 2 in 1 backplane, compatible to 64x (without J0) applications and V430 modules. Features all voltages of both standards and full Jaux pin out:

VME64x: 3,3V, 5V, +/-12V, 48V and

V430: -2V, -5,2V, +-15V (via Jaux).

6U VME64 J1/J2 Backplane with power distribution (P47)

Meets ANSI/VITA 1-1994 and IEEE-1014-1987. Extended power layers and special current rails permit high power distribution.

The 16 slot monolithic has two P47 power connectors for cPCI power supplies on both left and right side and a control slot for the WIENER CML (slot 17)

3U Power Distribution Backplane

Especially designed for J3 position to provide special VME modules with additional voltages via 96pin DIN connectors. 10 different voltage layers can be used separate or in parallel.

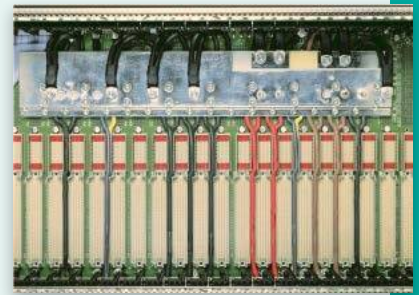

Multi layer power distribution



21 Slot VXs bus

WIENER Backplanes 6U VXs J1/J0/J2

VXS (VME Switched Serial) represents an extension of the VME family according to VITA 41.0. This system is downward-compatible to VME and VME64x, so that assemblies with VME 96-pin or 160-pin DIN connectors can still be used, while adopting the use of serial signals such as Gigabit Ethernet, PCI Express, Serial Rapid I/O, and other fabrics.

VXS uses a straightforward Star or Dual Star centralized architecture with defined pin outs for interoperability.

VXS uses the MultiGig RT 2 connector for P0 connector. Transmission speed for VXs is 2.5 GByte for each pair of cards. Following a dual star topology the 21 slot VXs backplane design is based on a HIGH-SPEED DESIGN concept. Low reflection is achieved by means of uniform signal surge impedance. Shielding of each individual signal line assures minimal coupling, even when expanded to the 64-bit mode with the 2eSST protocol (320 Mbytes/s).

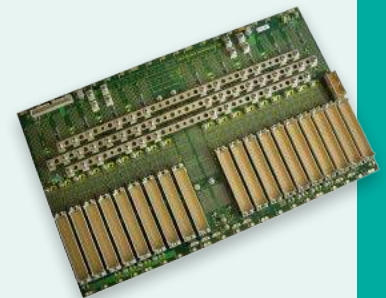

21 Slot VXs bus, rear side

Technical Details

- monolithic 21 slot HARTMANN ELEKTRONIK VXs bus, 10 layers
- Dual star topology with 2 switch slots, 18 Payload slots and one legacy VME64x slot (slot 1), all Payload slots outfitted with 5-row VME64x J1/J2 as per IEC 61076-4-113 and MultiGig RT2 VXs J0 connectors
- Every switch is connected to every VXs connector
- HIGH SPEED Transmission VME: 40 MByte/s to 320Mbyte/s, VXs: 2.5GByte/s for every slot in the same time
- Two switch slots located in the middle of the backplane to minimize time differences in high speed lines, maximum. of 1n8 ns Skew
- TERMINATION: active or passive 3,3V or passive 5V
- Daisy-Chain: Automatic Daisy Chain according to the Wiener Patent with CBLT
- Utility Connector: 40 pole Latch
- Protocol: VITA 41.1 Infiniband or VITA 41.2 Rapid I-O, difference is the coding key
- Flat cable style connector for sense and control
- Provision for up to 8 temperature sensors (module temp. checking)
- Sense circuit protection by PTC- resistors (Optionally)
- Excellent power distribution capability by current rails

VXI-bus Backplane

The 13 slot monolithic Hartmann Elektronik VXI-backplane is based on a HIGH SPEED DESIGN concept. Low reflection is achieved by means of uniform signal line surge impedance. Shielding of each line assures minimum coupling and crosstalk. In order to prevent interference on signal lines which might result from reflection at open line ends, these lines must be terminated. Passive as well as active termination is available. The advantage of active termination is the reduced closed-circuit current consumption. Passive termination features better frequency response.

For this VXI backplane electronic automatic daisy chaining is provided. For power distribution current bars are used.

Technical Details

- Monolithic J1/J2 HARTMANN VXI backplane, 13 slots
- High speed technology with optimized RF shielding and minimized cross talk
- Solid electrically conducting GND surface in mounting area
- Automatic daisy chain (mechanically or electronic)
- Flat cable style connector for sense and control
- Provision for up to 8 temperature sensors (module temp. checking)
- Excellent power distribution capability by current bars and M6 terminals
- IPMBPPWR power management connector

WIENER VXI-4 Backplane

The WIENER 6U VXI-4 backplane is the first VXI bus available with features according to the new VXI-4 standard which add VME64x and VXS features into the VXI world. The backplane is fully compliant to VXI 1.4, VME rev. C.1, UL 796, and 94V-0 and implements the VME64x type connectors, 3.3V DC power and the LVDS lines LCLK100 and LSYNC100 as well as the LVDS Star Trigger from the VXI-4 standard.

This monolithic backplane in a 14 layer, all-strip line technology is outfitted with 5-row 160 pin HARTING connectors on J1 and J2. The backplane is actively terminated and provides active automatic daisy chaining which is compatible to the CBLT.

The extended power layers and special current rails permit highest power distribution. For power distribution and connection a flat sandwich-like structure of copper sheets is mounted on the back of the upper J1 area.

Technical Details

- Monolithic J1/J2 WIENER VXI-4 backplane, 14 layers
- J1 and J2 outfitted with 5 row 160-pin connectors according to VXI-4 specification
- STAR trigger LVDS lines, LCLK100 and LSYNC100, all routed with equal line lengths from slot 0 to all other slots (<4.4ns timing difference)
- Strip line technology suitable for maximum data rates of (320Mbyte/s, 64bit 2esst)
- Optimized RF shielding, well dispersed filter-capacitors
- Minimized ground shift and cross talk
- Electronic automatic daisy chain
- Flat cable style connector for sense and control
- Provision for up to 8 temperature sensors (module temp. checking)
- Sense circuit protection by PTC- resistors (Optionally)
- Excellent power distribution capability by current multi-layer structure for 5V, 3.3V, -5.2V, -2V and GND

VXI-D size Backplane

9U monolithic D-size backplane, all-strip line technology, 8 layer design with .125" (3.2mm) board thickness. Clock skew on CLK100 line is less than 200ps, automatic daisy chain. Fully compliant to VXI 1.4, VME rev. C.1, UL 796, and 94V-0.

WIENER VXI crates are available with completely screened backplane rear side and provisions for keeping noise and ripple lower than 5mVpp (0-300Mhz bandwidth)

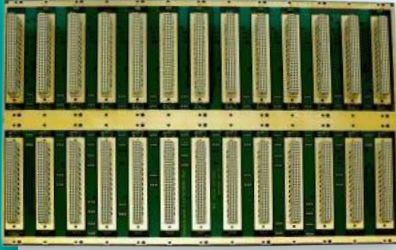

13 slot 6U VXI bus (C-size)

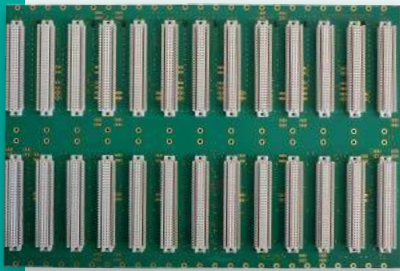

13 slot VXI 4 bus

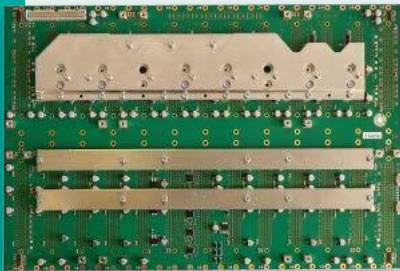

VXI 4 bus rear side with current rails

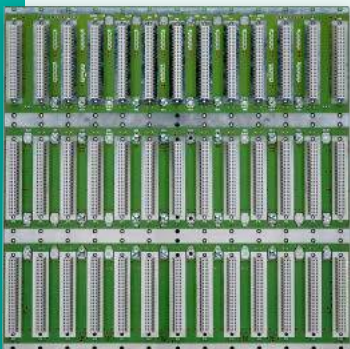

13 slot VXI-D bus

Compact PCI (cPCI) Backplanes

This Hartmann Elektronik cPCI backplane design is based on the HIGH-SPEED concept, and fully complies with the PICMG 2.0 R 3.0 specification. The designs are distinguished by an energy buffering feature which works across the entire frequency range. This guarantees improved reliability thanks to more stable supply voltages directly at the slot in conjunction with fluctuating loads.

Compact PCI backplanes are available either in 3U or 6U height and for different slot sizes. The dedicated system slot can be either on the right or on the left side.

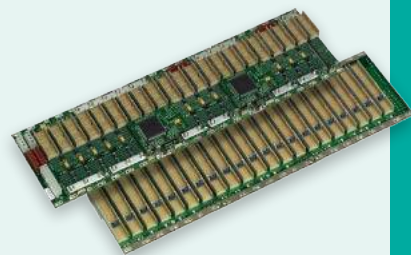

3U cPCI backplane

Technical Details

- 3U with system slot either left or right, available with 1 to 20 slots
- 6U, system slot right, available with 1 to 20 slots
- Electrical power via ATX connector
- 32 or 64 bit; 33 and 66MHz (< 5 slots), 3.3V and 5V I/O, fixed or selectable
- Available with rear I/O
- Optimized for best HF behavior. Outer layers designed as shielding areas
- PCB material FR-4, UL recognized 94-VO, 3.4mm (.13" thick)
- Conforms to PICMG 2.0 R 3.0, and 2.1 R1.0 (Hot Swap) Specifications
- RoHS compliant

PXI Backplanes

PICMG 2.8 defines pins of the J2 connector for instrumentation systems based on CompactPCI. The Hartmann Elektronik PXI backplane design is based on the HIGH-SPEED DESIGN concept. Low reflection is achieved by means of uniform signal surge impedance

Design features an energy buffering feature which works across the entire frequency range. This guarantees improved reliability due to more stable supply voltages directly at each slot in conjunction with fluctuating loads. Main operating voltages are supplied via terminal bars/screws.

Continuous electrically conductive chassis GND surface located in the area where the backplane is mounted on the card rack. An M3 screw connection is available to connect chassis ground.

By installing a connecting bracket or bus bar, chassis GND can be connected to ground in a low-resistance star arrangement. Plug-in connectors for external connection of the JTAG and IPMB busses are standard.



6U cPCI backplane

Technical Details

- 3U, various slot counts available, electrical power via bus bars / screws
- System slot left
- 33MHz
- 3.3 and 5V I/O, 32 bit with and without rear I/O all slots
- Shielded high-speed layout design guarantees optimal, synchronized timing and interference-free operation. Outer layers designed as shielding areas
- PCB material FR-4, UL recognized 94-VO, 2.8mm (.11" thick)
- Conforms to PICMG 2.8 Specification
- RoHS compliant

CompactPCI Serial Backplanes

CompactPCI Serial (PICMG CPCI-S.O) moves the existing CompactPCI parallel bus architecture to serial high-speed interconnects. Using a new rugged connector allows for a signal density of up to 184 pin pairs (3u) and transmission frequencies of 12 Gb/s.

System slot supports 8 PCI Express Links (6 by 4 lanes, 2 by 8 lanes), 8 SATA/SAS, 8 USB 2.0/3.0 and 8 Ethernet interfaces plus signals for general system management (reset, IPMB, hot swap, geographical addressing, etc).

Peripheral slots offer 1 PCI Express link, 1 SATA/SAS and 1 USB 2.0/3.0 interface. Each slot can support up to 8 Ethernet interfaces to build a full mesh. All interfaces are accessible at the same time. It is supplied with 12V (60W per 3u, 120W per 6U slot)

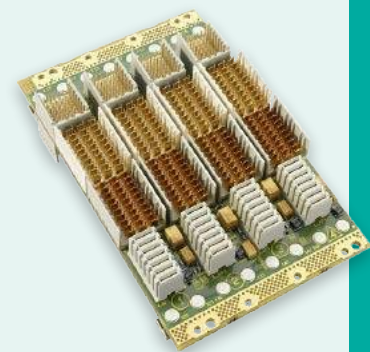

3U CompactPCI-Serial backplane

Backplane Current Ratings

Power Distribution per slot (at 20 / 70°C)	VME J1	VME J2	VME 64 J1-J2	VME 430 J1-Jaux-J2
3,3V				
5V	9,5A / 7,5A	9,5A / 7,5A	19A / 15A	19A / 15A
+/-12V	3,2A / 2,5A		3,2A / 2,5A	3,2A / 2,5A
+/-15V				3,2A / 2,5A
-5,2V				19A / 15A
-2V				9,5A / 7,5A
V1, V2				
Layers	8 / 10	4	8/10	10

Power distribution per slot (at 20°C / 70°C)	VME 64x J1	VME 64x J1-J0-J2	VME 64x-V430 J1-Jaux-J2 spec. V 430	VME64xP J1-J0-J2 Slot 2- 21
3,3V	17A / 12A	17A / 12A	17A / 12A	17A / 12A
5V	8,5/6A	15,3A / 10,8A	15,3A / 10,8A	27A / 19A
+/-12V	1,7A / 1,2A	1,7A / 1,2A	1,7A / 1,2A	1,7A / 1,2A
+/-15V			3,2A / 2,5A	
-5,2V			19A / 15A	
-2V			9,5A / 7,5A	
+/-24V				
Vw, Vx, Vy, Vz				4A / 3A
V1, V2	1,7A / 1,2A	1,7A / 1,2A	1,7A / 1,2A	1,7A / 1,2A
Layers	10	10	10	18

Power distribution per slot (at 20°C / 70°C)	VXI C size J1-J2 13 slot	VXI D size J1-J2 13 slot	VXI-1 Rev 4 J1-J2 13 slot
3,3V			20A / 15A
5V	14A / 10,5A	24A / 18A	14A / 10,5A
+/-12V	3,2A / 2,5A	6,4A / 5A	3,2A / 2,5A
+/-15V			
-5,2V	10A / 7,5A	20A / 5A	10A / 7,5A
-2V	4A / 3A	10A / 7,5A	4A / 3A
+/-24V	2A / 1,5A	4A / 3A	2A / 1,5A
Vw, Vx, Vy, Vz			
V1, V2			
Layers	10	10	14

5V Stand by voltage is not considered in the above table. Putting it parallel to the 5V the maximum current ratings may rise (one additional pin per slot).

Listed current ratings are only valid if each other connector pin leads less than 100mA continuously.

On slot 1 of the 64xP backplane the current capability for +5V is only **15.3/10.8A**. Slot 1 J0 does not have additional 5V pins.

UEV 6021 / UEV 6023 Bins

The UEV 6021/6023 bins combine the 6U or 9U high bus card cage with a 2U high fan tray below it and a power supply, which is plugged into the rear of the bin. The modular concept of WIENER VME 6000 series crates allows fan trays and power supplies to be easily inserted and removed without tools.

Different bin versions with various depths for 6U and 9U VME / VXI, VXS or PCI / PXI bus system cards are available. In addition to the standard crate types shown in the catalog the 6000 series crates are easily customized match any customer specified configuration by using standard components. The bins are prepared to take any kind of single or multiple card cage(s) and backplane(s).

The UEV 6021/6023 bins are rigidly constructed of steel and aluminum using 5mm thick side panels. All horizontal rails are positioned and locked by zero-tolerance countersink Allen-screws. The card guides of 280, 340, and 400mm deep card cages get additional support from additional transversal members (extrusions). Excellent EMC shielding is given by low resistive screw-connections of all bin parts. All aluminum parts are conductive treated.

The power supply is mounted in the rear of the crate behind the backplane either, in top (6021) or bottom (6023) position. The UEV6021/6023 bins are equipped with a power supply connector terminal for up to 8 channels of high power DC. The terminals for 5 of these channels can support up 230A each, normally used for +5, +3.3V and other low voltages with high current. The remaining channels have terminals with max. 120A (12V, 24V, 48V, ...). The power distribution on WIENER backplanes is done via copper current rails.

Common and/or isolated ground connections are selected on the backplane side. This is possible because of the floating DC outputs of the UEP 6021 power supplies. No DC- ground shifts will occur, even when different grounds are necessary.

The 6000 series crates offer excellent electrical safety. The UEV 6021 / 6023 bins have no AC mains installation inside the bin and fan tray. All power comes from well-isolated DC low voltages (EN60950, UL1950). The Power Protect Memory (PPM) further protects the crate by preventing incompatible power supplies from powering up.

Standard Bin Sizes (other on request)

For 6U module height: 160-220-280 and 340 (VXI C-size)mm depth

For 9U module height: 280-340 (VXI D-size) and 400mm depth

6021 Crate Style

The 6021 Bin has a 2U high fan tray space below the front and optional rear card cages for the UEL6020 fan tray. The total height of the 6021 bin is either 8U (6U VME) or 11U (9U VME).

The power supply is plugged into the top rear position. For this purpose the DC power terminal is located behind the backplane / top connector row. For a 3U power supply, this blocks the rear of J1 but leaves J2 and J3 (for 9U cards) freely accessible. A 6U high power supply will occupy the space behind both J1 and J2.

Dimensions of 6021 standard crates (depth: +25mm for inserted power supply)

For 6U/160mm boards: 19" (483mm) x 8U (356mm) x 480mm [whd]

For 9U/400mm boards: 19" (483mm) x 11U (489mm) x 720mm [whd]

6023 Crate Style

The UEV6023 is built with a 3U high fan tray space below the front module cage which is used for the 2U fan tray UEL6020 and a 1U "plenum pressure chamber". This air compression space between fan tray and modules creates a more homogenous cooling airflow through all slots. The total height of the 6023 bin is either 9U (6U VME) or 12U (9U VME).

The power supply (3U box) as well as the DC power terminal is placed in the bottom rear, behind the fan tray. This gives free access to rear side of the backplane. Routing the power cables between the J2 connector shrouds, cables are kept the rear of backplane accessible.

An air shutter at the rear side of the plenum space either aims the cooling airflow to the front side module space only or alternatively, divides the cooling air into a front and transition air stream.

Dimensions of 6023 crates (depth: +25mm for inserted power supply)

For 6U/160mm boards: 19" (483mm) x 9U (400mm) x 480mm [whd]

For 9U/400mm boards: 19" (483mm) x 12U (533mm) x 720mm [whd]



UEV 6021 6U format, front view



UEV 6021 bin 6U format, rear view



UEV 6023 6U format, front view



UEV 6023 bin 6U format, rear view



E-Bin option



JLAB style VX5 Bin



S-bin option (IEEE 1101.10 compliant)

Remotely powered Sub-Racks

Under certain conditions such as high magnetic field or radiation, power supplies have to be placed away from the crate or sub-rack. For this purpose the UEV 6021 sub-rack can be used in combination with external power supplies and external cooling. The UEV6021 sub-rack is available in two sizes: 7U high for 6Ux160mm modules and 10U high for 9U x 400mm modules

Similar to all crates of the WIENER 6000 series the sub-racks are rigidly constructed of steel and aluminum using 5mm thick side panels. The S-version crates are outfitted with IEEE 1101.10 conform mechanics (EMC springs and gaskets, ground clips). Optionally available as VARIO bin for mixed 9U x 400mm and 6U x 160mm formats, any 6 / 9U dividing is possible.

All sub-racks are outfitted with a rear side DC terminal and sense board in 1U high space above the backplane. The terminal board is compatible to WIENER PL508 and MARATON power supplies.

Dimensions of UEV 6021 sub-racks:

For 6U/160mm boards: 19" (483mm) x 7U (311mm) x 480mm [whd]

For 9U/400mm boards: 19" (483mm) x 10U (445mm) x 480mm [whd]

Please see the WIENER power supply section for matching stand-alone power supplies as PL506, PL508, PL512 and MARATON (radiation hard and magnetic field tolerant). For cooling of sub-racks powered with PL508 optionally the UEL6020 fan tray can be used. DC power and control of the UEL6020 fan tray is provided by the power supply for distances up to 35m.

WIENER Bin Options

6023 - JLAB Style Option with "Front to Rear air flow"

The "JLAB style" bin is a special version of the UEV6023 with front to rear airflow. The bin is completely closed on top and bottom, which allows installation in mixed racks with blocked vertical airflow. The total height of the crate is 11U. The JLAB style option is only available for 6Ux160mm card systems. All 6023 VME, VME64x and VX5 crates listed in this catalog can be ordered with the JLAB style option.

Both, fan tray and power supply take fresh air through an easily exchangeable air filter pad placed in front of the fan tray. At bottom side an air channel is formed to guide adequate cooling air to both the fan tray and to the rear power supply.

The power supply takes the air in from the bottom and guides it through the transition region to the upper rear outlet. All hot air exhausts to the top rear. The forced air can be variably directed to front and transition modules by a mechanically adjustable air baffle.

S-Bin Option (IEEE 1101.10 compliant)

WIENER crates or sub-racks in the S-version are outfitted with all mechanical parts as extrusions and card guides according to IEEE 1101.10. Typically VME64x, VME64x-P (VIPA) as well as PCI/PXI crates are built in this style.

The card guides heads have holes for a set of coding pins and for the card guiding pin and are further equipped with a grounding clip for electrostatic discharge. EMC gaskets are mounted on the sidewalls of the bin and on both front members.

E-Bin Option (IEEE 1101.10 compatible)

The E-Version is equipped with front bars for modules operating with IEEE 1101.10 extraction handles. However, no EMC gaskets or other ESD or EMC provisions are installed.

Top Cover Option

Perforated top covers can be mounted above the front and rear card cage / power terminal area for EMC screening and safety / protection.

J3 Backplane Cover Option

J3 backplane cover / air baffle installed instead of a J3-backplane for 9U form factors systems.

Transition Cage Option

WIENER UEV Bins can be outfitted with a rear side card cage, which is often used for transition modules. The bin side panels have all provisions to take a transition card cage in any of the offered sizes. Transition card cages can be ordered as an option for a new crate or separately for upgrading of existing crates.

The UEV 6021 bin with the power supply in rear top position allows rear side card cages only to J2 (3U), or to J2 and J3 (6U) for 9U VME format. The 6023 style has full access to all backplane levels, i.e. to either J1 or J2 (3U) or J1 and J2 (6U) for 6U front side cards, or to J1/J2/J3 (3U ... 9U) for a 9U form factor system.

Standard sizes 3U, 6U or 9U with depth:

- 6U format 80mm / 120mm / 160mm / 220mm / 250mm,
- 9U format 80mm / 120mm / 160mm / 220mm / 250mm / 280mm

VARIO-Divider Option (mixed 6U/9U)

The VARIO-Divider Option offers the mixed use of standard unmodified 9U and 6U high modules in the same crate. The front panel of the modules with minor depth will be recessed mounted.

The VARIO option can be chosen for 9U form factor crates is available in two different versions with or without an air baffle. This air baffle between the 6U and 9U slots prevents any cooling losses and provides higher mechanically stability but occupies one slot.

The provision without air baffle keeps all 21 slots available, but has open gaps to the front. Also the solder side of the leftmost 9U module becomes exposed to the 6U card cage and modules.

Version 1: No Air Baffle

1 to 4 of 21 slots for 6U VME modules. The first right adjacent 9U module acts as an air guide. It must be placed for proper cooling of all modules

Version 2: With Air Baffle

3 or 4 up to 18 slots (in steps of 2) of 20 slots for 6U VME modules. An air baffle closes the gap between 6U and 9U modules. This ensures an optimized cooling of all slots without air losses.

Temperature Probes Option

Temperature sensors (max. 8) can be installed in the bins above the module card rails. Temperatures are monitored and used for temperature control cooling operation / protection. For each temperature probe the user can define 2 limits. Exceeding the first limit (+ 45°C default) the fan tray switches the fan speed to the maximum value. If temperature exceeds the second threshold the power supply would perform an emergency off. In order to reduce the temperature in the card cage the fans will continue to run after power-off for the time defined (default 1 minute).

Temperature probes can be ordered with the crates or separately to upgrade existing crates.

Dust Filter Options

All 6021/6023 bins can be outfitted with a 1/2 U high dust filter tray that is mounted below the fan tray. By reducing the plenum chamber of the UEV6023 bin to 1/2U, the overall height of the crate remains the same. UEV 6021 bins with dust filter will be 1/2U taller. The UEV6023 – JLAB style comes with a front air filter by default.

All WIENER air filters guarantee maximum air flow while providing excellent dust filtering. Replacement filters can be ordered.

Easy Lever Option

The Easy Lever option provides a large handle on the power supply. This handle is moved down to lock the power supply into the crated and pushed up to allow it to be removed. Additionally, the handle can be used to comfortably carry the power supply.

This option consists of handle mechanics and locking guides for the bin. The Easy Lever does stick out of the back of the crate further than the standard power supply.

Other options are possible on request!



VARIO divider option (version 1 left, version 2 right)



Optional temperature probe

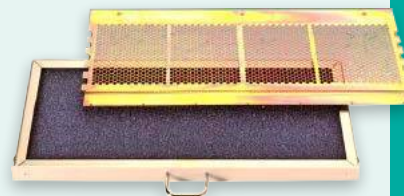

Optional air filter (160mm) and top cover



Easy Lever option

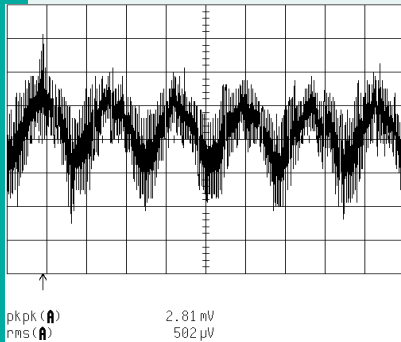

Noise and ripple
5V/100A with 200MHz bandwidth
(measured at backplane)

Noise and ripple: MEH 2-7V: <10mVpp, (0-20MHz) <2mVrms (0-30MHz)
other: <15mVpp, (0-20MHz) <2mVrms (0-30MHz)

In **VXI** application 50% of above pp-values, measured with 0-300MHz bandwidth

EMC Compatibility

EMA.	EN 61 000-6-3:2001	[RF emission]
	EN 55 022:1998 + Corr:2001 + A1:2000 Class B	conducted noise
	EN 55 022:1998+ Corr:2001 + A1:2000 Class B	radiated noise
	EN 61 000-3-2:2001	harmonics
	EN 61 000-3-3:1995 +Corr:1997 +A1:2001	flicker
EMB	EN 61 000-6-2:2001	[immunity]
	EN 61 000-4-6:1996 + A1:2001	injected HF currents
	EN 61 000-4-3:1996 + A1:1998 + A2:2001	radiated HF fields incl. "900MHz"
	EN 61 000-4-4:1995 + A1:2001	Burst
	EN 61 000-4-5:1995 + A1:2001	Surge
	EN 61 000-4-11:1994 + A1:2000	voltage variations
	EN 61 000-4-2:1995 + A1:1998 + A2:2001	ESD

Other Limits and Protection Provisions

Operation temperature: 0... 50°C ambient without derating, Storage:-30°C ... +85°C

Water cooled versions:

Water temperature: 20... 70°C, Storage: +5°C ... +80°C

Water flow rate: 1l/min per 1kW DC output power with water temperature rise of 5°C

Max. pressure: 8bar (peak 10 bar)

Temperature coefficient: < 0,2% / 10K

Stability: 10mV or 0,1% / 24 hours, 25mV or 0,3% / 6 month
(under constant conditions)

Current limits: adjustable to any lower level

Voltage rise characteristics: monotonic 50ms, processor controlled.

Overvoltage protection: crow bar protection trip off adjusted to 125% of nominal voltage each output

DC Off (trip off): within 5ms if >5% deviation from adjusted nominal values, after overload, overheat, overvoltage, undervoltage (bad status), and fan fail, if temperatures exceed 125°C at heat sinks
Limits programmable. Outputs discharged by crow bars, when power supply tripped- or switched Off.

Efficiency: 75% ... 85%, depends on used modules

M F O T (Maintenance Free Operation Time):

internal blowers: 40°C ambient >65 000 h 25°C ambient 100 000 h

electronics: 40°C ambient >100 000 h

Water cooled power supplies: 40°C water >100 000 h

Special Power Supplies

For use in strong magnetic fields and high level radiation special versions of power supplies are available.

Fan trays UEL 6020 / Control & Interface

The UEL6020 is the plug in fan and control unit for all crates of the 6000 family. Matching the crate card cage size fan trays are available in 160mm, 220mm, 340mm, 400mm and 600mm depth. In addition to providing a cooling airflow through the front card cage optionally rear side transition board cooling is possible.

All UEL 6020 fan trays are outfitted with long life individually controlled DC fans for bottom to top air flow operation. Depending on the required air flow and crate size either "standard" or "super blower" fans are used.

	Blower type 1134 574 (Standard) 118x118 mm	Blower type 1450 352 (Super) 150 mm	Blower type 1510341.A0 (Hyper) 118x118 mm
Static pressure at 3000 RPM:	8 mm H2O column	14 mm H2O column	27 mm H2O column
Max. Speed of Rotation:	>3000 RPM	>3000 RPM	>6000 RPM
Power Consumption	6-8W typical	12-15W typical	20W
Start up Current:	Limited by soft start circuit		
Operating Voltage:	Fan tray 30VDC, internal Blowers 0-24VDC,		
Most gainful operating Range:	2- 3,8 mm H2O	4- 5,5 mm H2O	13-15 mm H2O
Operating Temperature:	0... 70°C		
MFOT:	>65 000 h at 40°C ambient, > 85 000 h at 25°C ambient		
MFOT = Maintenance Free Operation Time			
Size (depth)	"standard", number of fans	"super blower", number of fans	"hyper blower", number of fans
160mm	3	Not available	3
220mm	3	Not available	3
340mm	6	4	6*
400mm	6	4	6*
600mm	9	6	Not available

* requires special power supply for toll speed

All fan trays (except the 6U / 160mm fan tray for frontal entry) are equipped with a topped plenum pressure chamber, 25mm high, for optimized air flow homogenization through all slots as well as for mixed module depths. This construction features a second chamber below the installed blowers, a sucking plenum. In case of installation of a heat exchanger directly below the fan tray this keeps the whole heat exchanger surface efficient and the pressure of the blowers, too.

UEL 6020 fan trays have a built-in microprocessor for fan control, communication with the power supply and display / networking. Default version is the EX type which has a high visibility alphanumeric display and combo interface (Ethernet, CAN-bus, RS232) for remote monitoring and control. This interface allows the crate, including power supply, fan tray and bin temperature sensors, to be controlled and monitored remotely using either Ethernet or CAN-bus. A built in web server allows the crate health to be monitored via a web browser on a PC attached to the appropriate network, while SNMP provides a convenient way to tailor a control system to a given application. All network connectors are RJ45 type.

Variable fan speed is manually or remotely selectable from 1200 to >3000rpm. In case optional bin temperature probes are installed the fan can run in temperature-controlled mode. Running with lower fan speed all temperatures are monitored. Exceeding the first limit (user defined, default 45°C) all fans run with maximum speed in order to provide full cooling. In case the temperature passes the second limit (user defined, default XXX) the power supply switches off. Adjustable "after-running" of fans guarantees further cooling after power off

The intelligent EX- fan trays are prepared for **hot swapping**. An uncritical power supply operating time remains after fan tray extraction. Exceeding of given swap time switches the power supply off.

Front panel outfitted with 4 status LED showing:

- Status Green: all values inside tolerance
- Fan fail Yellow: one or more fans fail
- Overheat Yellow: power supply overheated
- Sys fail Red: VMEbus generates sysfail

A manual SysRest button on the front panel is recessed to avoid it being pressed accidentally.

All EX- fan tray monitoring can be set to Programming Mode. This feature allows all key functions and values of the power supply, like current limits and other trip off points, to be programmed. The programming can be done either locally via the front panel, or remotely via the Ethernet or CANbus interface.



UEL6020 EX-3, 160mm deep



UEL6020-6, 400mm deep



UEL6020-4, 400mm deep, with Super blower fans



UEL6020-9, 600mm deep



NIM / CAMAC / VME / VXS Modules

Modules

Page

NIM Modules	83
NAD4 Flash ADC / Logic Module	84
NDA8 Flash DAC / Logic Module	84
NPL20 Logic Module	84
NDL8 Discriminator / Logic Module	85
NIMbox DNAE/ADNN ADC / DAC / Discriminator / Logic	85
ISEG NHQ and NHS High Voltage Modues	86
Blank NIM Mechanics / Cassettes	86
CAMAC Modules	87
CC-USB CAMAC Controller with USB Interface	87
CFB CAMAC-to-FERA Bridge	87
CMDGG8 CAMAC Multifunctional Logic Unit	88
CQ16 - 16 Channel Charge Integrating ADC	88
Blank CAMAC Mechanics / Cassettes	89
CAMAC to NIM Power Adapter	89
ISEG CHQ High Voltage Modues	89
VME / VXS modules	90
VM-USB VME Controller with USB-2 Interface	90
VM-DBA VME Display and Bus Analyzer Module	90
MDGG-8 multi functional VME Logic Module	91
MDGG-16 multi functional VME Logic Module	91
ISEG VME High Voltage Modues	92
VME and CPCI Load Cards	92

(Image: VERITAS Detector, first setup stage, Arizona USA)



ISEG NHQ and NHS modules

ISEG NHQ and NHS High Voltage Modules

ISEG NHQ high voltage supplies are single or dual channel single wide NIM modules with high voltages of up to 8kV. NHQ modules have highly stabilized, lowest noise HV outputs. Polarity is switchable. All units offer multi-turn trimmers for voltage setting, numeric display for voltage and current and 10-position switches for voltage and current maximum. The Standard and High Precision series is outfitted with RS232 or CAN-bus interface for remote control.

The new ISEG NHS series offers 6 channels high voltage up to 6kV with fixed polarity in a single wide NIM module available with standard or high precision. The unit can be programmed via the front panel TFT display or remotely through USB / CAN-bus.

NHQ / NHS Features

- Single wide NIM module with 1 or 2 high voltage channels (NHQ: switchable polarity) or 6 channels with fixed polarity (NHS: positive, negative or mixed)
- Digital display for voltage and current and manual control, RS232 / USB / CAN interfaces for remote monitoring and control
- NHQ Low cost series: <50mVpp noise, without interface
- NHQ Standard Series: <2mVpp (up to 4kV) noise
- NHQ high Precision Series: current resolution up to 100pA, voltage resolution up to 100mV

Standard configurations (other possible on request)

Module	Channels	Polarity	Interface	Vmax	I _{max}	Ripple
NHQ 1x2M/2x2M	1 or 2	Switchable	RS232 or CAN-bus	2 kV	6 mA	2 mVp-p
NHQ 1x3M/2x3M	1 or 2	Switchable	RS232 or CAN-bus	3 kV	4 mA	2 mVp-p
NHQ 1x4M/2x4M	1 or 2	Switchable	RS232 or CAN-bus	4 kV	3 mA	2 mVp-p
NHQ 1x5M/2x5M	1 or 2	Switchable	RS232 or CAN-bus	5 kV	2 mA	5 mVp-p
NHQ 1x6L/2x6L	1 or 2	Switchable	RS232 or CAN-bus	6 kV	1 mA	5 mVp-p
NHQ 108L/208L	1 or 2	Switchable	RS232 or CAN-bus	8 kV	1 mA	50 mVp-p
NHQ 1010M/2010 p/n	1 or 2	Fixed	RS232 or CAN-bus	10 kV	0.5mA	50 mVp-p

Standard configurations (other possible on request)

Module	Channels	Polarity	Interface	Vmax	I _{max}	Ripple
NHS 6y 01 p/n/m	6	Fixed	USB, CAN-bus	100 V	10 mA	3 mVp-p
NHS 6y 05 p/n/m	6	Fixed	USB, CAN-bus	500 V	15 mA	5 mVp-p
NHS 6y 10 p/n/m	6	Fixed	USB, CAN-bus	1 kV	8 mA	5 mVp-p
NHS 6y 20 p/n/m	6	Fixed	USB, CAN-bus	2 kV	4 mA	5 mVp-p
NHS 6y 30 p/n/m	6	Fixed	USB, CAN-bus	3 kV	3 mA	5 mVp-p
NHS 6y 40 p/n/m	6	Fixed	USB, CAN-bus	4 kV	2 mA	5 mVp-p
NHS 6y 60 p/n/m	6	Fixed	USB, CAN-bus	6 kV	1 mA	5 mVp-p

NHQ: x = 0 standard series, x=1 low cost series (no interface, 50mV ripple), x=2 high precision

NHS: y = 0 standard series (10mV ripple), y=2 high precision series (5mV ripple, dual current range)

Blank NIM Mechanics / Cassettes

New designed extremely rigid and solid construction. All parts, i.e. bottom, top, front and side panels are secured by screws. Various possibilities for electrical board mounting inside by use of special mounting blocks with variable positions. Optimized design for maximum space inside, several boards can be placed within one cassette.

NIM Mechanics Features

- Set includes Aluminum front panel (blank), mounting blocks / holders for PCB, screw set and NIM front locking screw
- Rear panel cut out for standard NIM connector
- High efficient shielding due to low resistive screw connections
- High insulated inner side of mechanic by hard eloxation
- Thermodynamically optimised design of top and bottom panels with large air entries, 2280mm² (1/12 size) / 4560mm² (2/12 size)

NIM Mechanics

Item	Description	Order Code
NIM 1/12	NIM cassette 1/12 slot wide with front panel	141 00 22
NIM 2/12	NIM cassette 2/12 slot wide with front panel	141 00 33
NIM 3/12	NIM cassette 3/12 slot wide with front panel	141 00 66
NIM connector	NIM connector, 10 pins, wired (200mm long cables)	141 06 66
NIM 1/12 low cost	NIM cassette with front panel – restricted features	141 00 23



NIM and CAMAC mechanics (assembled)

CC-USB CAMAC Controller with USB interface

The CCUSB is a full-featured CAMAC Crate controller with integrated high speed USB-2 interface and full CAMAC dataway display. It supports Master and Slave operations with complete CAMAC arbitration as well as auxiliary CAMAC controller operation.

For fast data acquisition applications the CCUSB has a built-in command list sequencer with data buffering in a 22kB size FIFO. Combined with the front panel I/O ports this allows CAMAC operation and data taking without any PC or USB activity. The integrated CAMAC dataway display as well as additional LED's for the controller / USB mode provides all necessary system Information. A XILINX Spartan 3 family FPGA performs all CCUSB logic and functions. Upon power-up the FPGA firmware is loaded from a flash memory. The configuration flash memory can be reprogrammed via the USB port, allowing convenient updates of the firmware. Up to 4 different firmware versions can be stored and selected for boot.

Technical Details

- High speed USB2 interface, auto-selecting USB2/USB1
- 3 user-programmable NIM inputs (LEMO), 3 user-programmable NIM outputs (LEMO) with pre-defined functions as trigger, counter, gate and delay generator, pulser, time stamp
- Visual data and status display with 54 red/green/yellow LED's (N, F, A, R/W data, Q, X, C, Z, user defined)
- FASTCAMAC level 1 support
- Built-in CAMAC list sequencer for DAQ readout mode, readout triggered either via USB link, LAM or by a trigger signal into NIM input
- DAQ readout modes:

Standard Crate configurations (other possible on request)

Item	Description
CC-USB	CC-USB, USB-2 interface cable, CD-ROM with manual and software



CC-USB Module

CFB CAMAC-to-FERA Bridge

The WIENER CFB is an intelligent, programmable, re-configurable CAMAC-to-FERA bridge with sequencer that allows one to interface both, common and custom-made CAMAC modules to FERA-readout-based data acquisition systems.

When triggered, the CFB executes a user-programmed „stack“ of CAMAC commands and stores the retrieved CAMAC data in its fast FIFO. With the first word written into FIFO, the CFB requests control of the FERA bus, and as soon as the control is granted (via ECL REN signal), it commences transmitting of its FIFO content to the remote FERA receiver. The two processes, the slower CAMAC readout and the faster (up to 10MHz) FERA transmission may proceed, hence, concurrently, with the latter pausing, whenever FIFO becomes transiently empty.

Technical Details

- Ports compatible with LeCroy, Ortec, Silena and CMC FERA modules
- 16-bit and 24-bit CAMAC readout at rates of 2.5MHz and higher
- CAMAC module readout timings individually adjustable for rates of 2.5MHz or higher
- FASTCAMAC Levels 1 support
- Up to four FPGA configurations stored in a 1-Mbyte flash memory
- FPGA configuration memory is re-programmable in-system, via CAMAC port
- 28k FIFO

Standard Crate configurations (other possible on request)

Item	Description
CFB	CFB-module, CD-ROM with manual



CFB Module



CMDGG-8 Module

CMDGG8 – CAMAC Multifunctional Logic Unit

The CMDGG-8 is a multi functional FPGA based delay, logic and timing module which provide often needed functions such as gate, delay & pulse generator, logic fan in / fan out, coincidence register and scaler / pre-scaler. The module has 8 NIM/TTL inputs and 8 NIM/TTL outputs, which are free configurable in regards to their used functionality.

The CMDGG-8 is based on a XC3S400 FPGA with 36kB of block RAM. Two FPGA configuration files can be stored in the on-board flash memory from which the FPGA can boot at power-on (selection by a jumper).

Technical Details

- Single wide CAMAC module
- 8 inputs (NIM/TTL) and 8 outputs (NIM/TTL) with LEMO 00 connectors
- All outputs have LED indicator and can be programmed to be inverted / non-inverted
- Control input (NIM/TTL) LEMO
- LAM capability
- Built-in functions (firmware)
 - Programmable delay / gate / pulse generators, start/stop latches or pre-scalers (8 steps)
 - Gated or latching scalers with 1k x 32 FIFO per channel
 - 4 combinatorial gates (2 fold OR of 8 fold AND)
 - Flexible configuration and multiplexing of NIM inputs / outputs and logic devices
 - Programmable Veto inputs

Standard configurations

Item	Description
CMDGG-8	CMDGG-8, CD-ROM

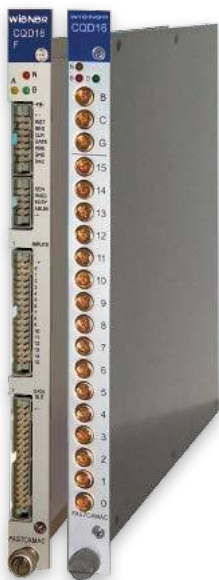

CQ16 (left) and CQ16A Module

CQ16 - 16 Channel Charge Integrating ADC

The CQ16 is a 16-channel 12bit, fast converting charge-integrating ADC for CAMAC. To provide compatibility to older CAMAC ADC's it can be switched into an 11-bit mode. All data read-out is provided either via CAMAC commands or through the fast FERA bus on the front of the module.

The high performance CQ16A is enhanced by providing an 18 bit dynamic range in 3 overlapping 12-bit bands in order to process pulses in a wide dynamic range with high resolution. The built in data processing includes sliding scale, pedestal subtraction and threshold suppression to reduce data volume and readout time. The onboard data buffer can store up to 51 events. Instead of the front side FERA bus the CQ16A is using the FASTCAMAC protocol, which allows buffers to be read out at up to 30 MB/s.

CQ16 Features

- Single wide 16 channel charge integrating ADC (QDC)
- 11-bit or 12-bit (selectable) ADC resolution
- Two ranges, 8:1, full scale 2nC or 250pC
- CQ16A: 18bit dynamic range (via 3 12bit bands), most sensitive range 25fC/count, full scale 6,000pC
- Fast conversion, dead time 8.5µs in FERA mode and <5.5µs for CQ16A
- Common gate with 20ns to 500 ns width (CQ16A: 10ns minimum)
- Built-in sliding scale, differential non-linearity <1%
- Pedestal memory and subtraction, zero and overflow suppression
- Separate sparse readout thresholds independent of pedestal subtraction
- FIFO buffers for both FERA and CAMAC readout, up to 51 events
- High data rate performance, up to 16MB/s (CAMAC) and 30MB/s (FASTCAMAC, CQ16A only)

Standard configurations

Item	Description
CQ16	16 channel fast 11/12bit charge ADC with FERA read-out
CQ16A	16 channel fast 18 bit dynamic range charge ADC with FAST CAMAC read-out

Blank CAMAC Mechanics / Cassettes

New designed extremely rigid and solid construction. All parts , i.e. bottom, top, front and side panels are secured by screws. Various possibilities for electrical board mounting inside by use of special mounting blocks with variable positions. Optimized design for maximum space inside, several boards can be placed within one cassette.

CAMAC Mechanics Features

- Set includes Aluminum front panel (blank), mounting blocks / holders for PCB, screw set and NIM front locking screw
- Rear panel cut out for standard CAMAC card / connector
- High efficient shielding due to low resistive screw connections
- High insulated inner side of mechanic by hard eloxation
- Thermodynamically optimised design of top and bottom panels with large air entries, 2280mm² (1/12 size) / 4560mm² (2/12 size)

Standard configurations

Item	Description	Order Code
CAMAC 1/25	NIM cassette 1/12 slot wide with front panel	141 00 00
CAMAC 2/25	NIM cassette 2/12 slot wide with front panel	141 00 11
CAMAC 3/25	NIM cassette 3/12 slot wide with front panel	142 73 25

CAMAC to NIM Power Adapter

An adapter to power a NIM module within a CAMAC crate.

Standard configurations

Items	Description
4 MUC	with power converter (+/-12V NIM from +/-24V CAMAC, 12W / 24W peak)
6 MU	Without power converter, for CAMAC Crates with +/-12V on board

ISEG CHQ High Voltage Modules

Multi functional VME Delay Gate Generator / Logic Module ISEG offers single or dual channel high voltage supplies in CAMAC with voltages of up to 6kV. CHQ modules have highly stabilized, lowest noise HV outputs. Polarity is switchable.

All units offer multi-turn trimmers for voltage setting, numeric display for voltage and current and 10-position switches for voltage and current maximum. In addition to the manual control for remote monitoring and control is given via CAMAC commands.

CHQ Features

- Double wide CAMAC module with 1 or 2 high voltage channels, switchable polarity
- Multi-turn trimmer for output voltage, 10-position switches for hardware max. voltage and current limit, inhibit
- Digital display for voltage and current
- Low noise, <2mVpp (up to 4kV) other 5mVpp
- Manual or CAMAC control,
- High Precision Series: current resolution up to 100pA and voltage resolution up to 100mV

Standard configurations (other possible on request)

Module	Channels	Series	Interface	V _{max}	I _{max}	Ripple
CHQ 102M/202M	1 or 2	Standard	CAMAC	2 kV	6 mA	2 mVp-p
CHQ 103M/203M	1 or 2	Standard	CAMAC	3 kV	4 mA	2 mVp-p
CHQ 104M/204M	1 or 2	Standard	CAMAC	4 kV	3 mA	2 mVp-p
CHQ 105M/205M	1 or 2	Standard	CAMAC	5 kV	2 mA	5 mVp-p
CHQ 106L/206L	1 or 2	Standard	CAMAC	6 kV	1 mA	5 mVp-p
CHQ 222M	2	High Precision	CAMAC	2 kV	6 mA	2 mVp-p
CHQ 223M	2	High Precision	CAMAC	3 kV	4 mA	2 mVp-p
CHQ 224M	2	High Precision	CAMAC	4 kV	3 mA	2 mVp-p
CHQ 225M	2	High Precision	CAMAC	5 kV	2 mA	5 mVp-p
CHQ 226L	2	High Precision	CAMAC	6 kV	1 mA	5 mVp-p



NIM and CAMAC mechanics (assembled)



NIM-CAMAC power adapter



ISEG CHQ Module



VM-USB module

VM-USB VME Controller with USB-2 Interface

The VM-USB is a VME master with high speed USB2 interface. Enhanced functionality is given by the programmable internal FPGA logic which provides a VME command sequencer with 4kB stack and 28kB data buffer. Combined with the 4 front panel I/O ports this allows VME operation and data acquisition / buffering without any PC or USB activity.

All VM-USB logic is controlled by the XILINX Spartan 3 family FPGA. Upon power-up the FPGA boots from a flash memory. The configuration flash memory can be reprogrammed via the USB port, allowing convenient updates of the firmware.

Technical Details

- System controller capability with slot-one bus arbitration and/or interrupt handling.
- Full interrupt capability, VM-USB responds to all 7 interrupt requests IRQ1-7 and can generate any of the 7 interrupts.
- All logical operations are performed by a Spartan 3 series FPGA (XC3S400)
- 4 firmware / configurations selectable on front panel rotary switch for FPGA boot upon power-up, all four sectors of the firmware / configuration flash are reprogrammable via USB.
- 2 NIM/TTL input and 2 NIM/TTL output ports with user-programmable functionality including trigger, counter, delay-gate-generator, pulser.
- 4 user-programmable diagnostic LED's
- VME sequencer: Internal FPGA can be programmed to operate as command sequencer with 4kB command stack and 28kB for data buffering (FIFO or dual-port RAM), stack is programmable via USB or VME.
- Read-out modes
 - Single word transfer D16, D24, D32, block mode BLT
 - Addressing modes A16, A24, A32
 - Autonomous (intelligent) readout pursuant to user-programmed stack. May include conditional readout controlled by the content of a hit register. May include multiple, conditional command stacks, action triggered by either USB, VME or external signal
 - Total block memory of 32-kBytes that can be divided between the data buffer (FIFO) with programmable level of transfer trigger and command stack in a way different from the default 28/4 split.
- Microsoft Windows (XP...W8 32-bit/64) and Linux support, LabView VI's (version 7.1 and higher), supported by scientific data acquisition software packages:
 - MSU NSCL DAQ (Linux)

Standard configurations

Item	Description
VM-USB	VM-USB, USB cable, CD-ROM



VM-DBA module

VM-DBA VME Display and Bus Analyzer Module

VM-DBA is a new test and diagnostic module for VME-bus systems which visualizes activities on all VME bus lines on the set of front-panel LEDs, but also allows one to digitize individual wave forms of all these lines into 2kBit -long storage memories, for a subsequent readout via VME or USB interfaces. The digitization of waveforms is triggered by a programmable selection of conditions, including an external signal received at the front-panel LEMO connector.

Technical Details

- Single-width VME slave module with LED indicators for all VME bus lines
- Conform to VME-bus ANSI/IEEE STD 1014, IEC821 and IEC297
- Functionality based on a Xilinx XC6SLX100 FPGA
- LED's for all VME bus lines as address, data, IRQ, power, ..., 4 user defined LED's
- User-programmable trigger for waveform digitization
- Two on-board, user-programmable SPI memories to store two different FPGA configurations.
- Selection of user-programmable registers and memories for comprehensive testing of VME bus operations, including IRQ handling and bus arbitration
- Dual user interface - VME and USB

Standard configurations

Item	Description
VM-DBA	VME display and bus analyzer

MDGG-8 multi functional VME Logic Module

The MDGG-8 is a single wide 6U VME multi functional FPGA based delay logic and timing module which provides often needed functions as gate, delay & pulse generator, logic fan in - fan out, coincidence register and scaler / pre-scaler. The module has 8 inputs and 8 outputs with NIM levels, which are free configurable in regards to their used functionality.

The MDGG-8 is based on a XC3S400 FPGA with 36kB of block RAM. Two FPGA configuration files can be stored in the on-board flash memory from which the FPGA can boot at power-on (selection by a jumper). The flash memory can be reprogrammed via VME for firmware upgrades.

MDGG-8 can be readily customized within the constraints set by the hardware resources. It may be considered an 9-input/8-output/12-diagnostic LED universal logical module for which the user can develop his own firmware using the free XILINX WebPack software.

Technical Details

- Single wide 6U A24/D32 VME slave module
- 8+1 NIM inputs (LEMO connectors), 8 NIM outputs (LEMO connectors), can be programmed to be inverted / non-inverted, 8 channel and 4 diagnostic LED's
- Interrupt capable, IRQ selected by jumper
- Built-in functions (firmware dependent), Firmware upgradable via VME
 - Programmable delay / gate / pulse generators, start/stop latches or pre-scalers (8 ns steps)
 - Gated or latching scalars with 1kx32FIFO per channel
 - 8 bit coincidence register, programmable Veto inputs
 - Combinatorial gates (2 fold OR of 8 fold AND)
 - Flexible configuration and multiplexing of NIM inputs / outputs and logic devices
 - VME triggering of logic devices and reset of scalars

Standard configurations

Item	Description
MDGG-8	8 Channel MDGG-8 with LEMO I/O

MDGG-16 multi functional VME Logic Module

The MDGG-16 is a single wide 6U VME multi functional FPGA based delay logic and timing module which provides often needed functions as gate generator & pulse generator, logic fan in - fan out, coincidence register and scaler / pre-scaler. The module has 16 LVDS/ECL inputs and 16 ECL outputs on pin headers and 2 NIM inputs as well as 4 NIM outputs (Lemo), which are free configurable in regards to their functionality.

The MDGG-16 is based on a XC3S500E FPGA with 36kB of block RAM. One FPGA configuration file can be stored in the on-board flash memory from which the FPGA can boot at power-on. The flash memory can be reprogrammed via VME for firmware upgrades. The required logic functionality can be programmed in a easy way by the writing configuration data into MDGG-16 registers via VME D32 A24 „write“ commands.

MDGG-16 can be readily customized within the constraints set by the hardware resources. It may be considered an 18-input/20-output/7-diagnostic LED universal logical module for which the user can develop his own firmware using the free XILINX WebPack software.

Technical Details

- Single wide 6U A24/D32 VME slave module
- Inputs: 16 ECL/LVDS (pin header) + 2 NIM (LEMO connectors), Outputs: 16 ECL / optional LVDS (pin header) + 4 NIM (LEMO connectors), 8 diagnostic LED's
- IRQ capable, IRQ level selected by a jumper.
- Built-in functions (firmware dependent), Firmware upgradable via VME
 - Programmable delay / gate / pulse generators, start/stop latches or pre-scalers (8 ns steps)
 - Gated or latching scalars with 1k x 32 FIFO per channel
 - 8 bit coincidence register, programmable Veto inputs
 - Combinatorial gates (2 fold OR of 8 fold AND)
 - Flexible configuration and multiplexing of NIM inputs / outputs and logic devices
 - VME triggering of logic devices and reset of scalars
 - Individually programmable output polarity for all NIM (4) and ECL (16) outputs

Standard configurations

Item	Description
MDGG-16	16 Channel MDGG-16 with 34 pin header connector and LEMO I/O

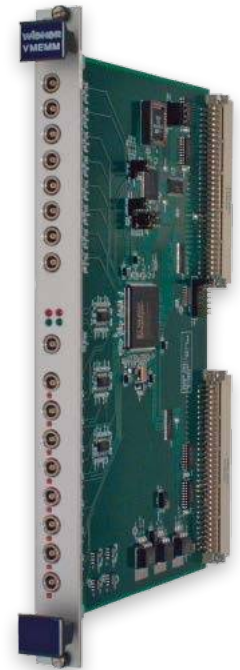

MDGG8



MDGG16



ISEG VHS, VDS and VHQ

ISEG VME High Voltage

ISEG VME high voltage modules are available with 2, 4, 8, 12 or 24 channels in maximum voltages from 500V up to 10kV.

The flexible VHQ series modules provide full front panel control and monitoring in addition to VME control. They are double VME wide VME modules and include a small display for voltages and currents. Polarity is switchable making these units ideal for small setups and labs. Output voltage and current are hardware limited in steps of 10% of the maximum voltage via front panel switches.

The VHS series are available with 4-channels (single width) or 12-channels (double width). The high density low current VDS series adds single wide 8-channel and double wide 24 channel modules. They are controlled exclusively through the VME backplane. The polarity of all VHS/VDS channels is the same and factory fixed. These modules are ideal for mid-size experiments and when extra VME slots are available.

Standard Modules (other possible on request)

Module	Channels	Vmax	I _{max} (mA)	Ripple
VHQ 202M	2	2 kV	3	2 mVp-p
VHQ 202M-h	2	2 kV	6	2 mVp-p
VHQ 203M	2	3 kV	2	2 mVp-p
VHQ 203M-h	2	3 kV	4	2 mVp-p
VHQ 204M	2	4 kV	1	2 mVp-p
VHQ 204M-h	2	4 kV	3	2 mVp-p
VHQ 205M	2	5 kV	1	5 mVp-p
VHQ 205M-h	2	5 kV	2	5 mVp-p
VHS 40 05x_156	4	500 V	15	< 5 mVp-p
VHS C0 05x_106	12	500 V	10	< 5 mVp-p
VHS 40 10x_805	4	1 kV	8	< 5 mVp-p
VHS C0 10x_605	12	1 kV	6	< 5 mVp-p

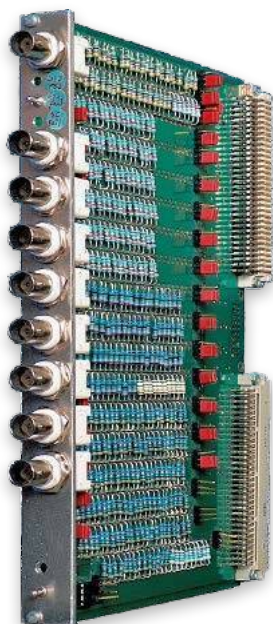

VML Lg

VME and CPCI Load Cards

WIENER VME load boards are designed to test VME crate power supplies and fan trays by drawing power from the VME backplane and dissipating it as heat. A series of switches on the module front panel allows for easy adjustment of the current draw for each voltage channel.

By monitoring exhaust air temperature above a VME load board it is possible to locate VME slots with cooling issues. VME load boards also provide an easy way to test the maximum current of a crate power supply and to confirm current trip points behave as expected.

Technical Details

- VME64x card, 6U, single wide format
- Front Panel switches to control current load
- Up to 10A load per board for 5V and 3.3V
- Up to 3A load per board for +12 and -12V
- Different versions for each VME specification to test every voltage
- High power versions available for testing high power 5V systems
- LED indicator lights to show current draw
- Pulse load with variable frequency
- Protected BNC connectors for noise measurement

Standard configurations

Item	Description
VML-64	VME load board for VME crates (+5V, +/-12V)
VML-64x	VME load board for VME64x crates (+3.3V, +5V, +/-12V)
VML-V430	VME load board for VME-430 crates (+2V, +5V, -5.2V, +/-12V)
VML-5V	5V VME load board for additional 5V load

CPI available on request



WIENER Power Supplies

Introduction Power Supplies	94
Magnetic and Radiation Tolerant Power Supplies	99
Summary WIENER Low and High Voltage Power Supplies	99
Universal Multichannel Low- and High- Voltage System	100
MPOD	100
Mpod Micro Crate	100
Mpod Mini Crate	101
Multichannel High Voltage Modules	102
Multichannel Low Voltage Modules	103
1000W MTCA.4 Power Supply	104
PL 504	104
PL 506	105
PL 508	106
PL 512	107
PL 516	108
MARATON	109
MARATON HHE - power supply system for Hazardous Hostile Radiation Environment	109
Standard Power Supplies	110
VITA 62 VPX Power Supplies	110

(Image: MINOS Near Detector DAQ racks at FNAL, Batavia USA)

Introduction to High and Low Voltage Power Supplies

The definition of high and low voltages is not univocal, and the usage of these expressions in the research community and in the electro technical industry may differ significantly.

The International Electrotechnical Commission and its national counterparts (IEE in the UK, VDE in Germany, etc.) classify high and low voltage circuits as follows:

	AC	DC
High Voltage (HV)	> 1000 V	> 1500 V
Low Voltage (LV)	50 – 1000 V	120 – 1500V
Extra Low Voltage (ELV)	< 50 V	< 120 V
Safety ELV (SELV)	25V	60V

In the United States 2005 National Electrical Code (NEC), high voltage is any voltage over 600 V (article 490.2).

In the scientific community and in the spin-off industry the difference between low and high voltage is sometimes related to the application.

For example, "high voltage" is used in many particle detectors to create an electric field that allows to amplify particle signals and therefore to detect particles. Therefore, a high voltage unit could be the 3kV power supply for a photomultiplier as well as the high precision 100V power supply for the bias of a semiconductor detector. On the other hand, low voltage is used to feed the analog and digital electronics integrated in the detectors or into other applications.

All Wiener power supplies are DC power supplies with the following properties:

- Modular design
- High degree of reliability
- Robust construction
- Sophisticated hardware protection against over currents, over/under voltage, shorts
- Availability of remote controlling and monitoring

Power Supplies for Particle Detection

Photomultiplier

Photomultiplier tubes (PMT's) are extremely sensitive detectors of light in the ultraviolet, visible and near infrared spectrum. Using the photoelectric effect, electrons are produced which are then multiplied in the electric field of electrodes (dynodes) with increasing high voltage. The signal is taken off the Anode. PMT's multiply the signal produced by incident light by as much as 108, allowing single photon detection.

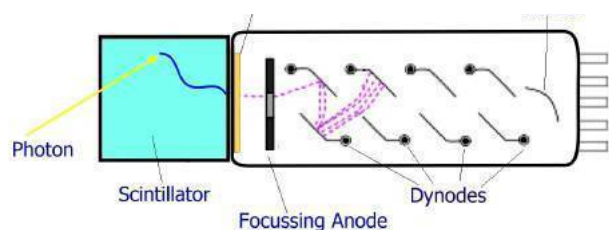

Scintillating detector with Photomultiplier

PMT's typically require 1000V to 3000V operation voltage for proper operation. Negative high voltage supplies are usually preferred. The high voltages are divided and distributed to the dynodes by a passive resistive or active voltage divider in the PMT socket.

While powered, photomultipliers must be shielded from ambient light to prevent their destruction through over excitation.

In case used in a location with magnetic fields PMT's have to be shielded by a layer of mu-metal (nickel-iron alloy with very high μ , i.e. magnetic permeability).

PMT Power Supply Requirements

Typical Voltage	1 – 3 kV
Typical Current	0.1 ... 3mA
Polarity	Positive or Negative (common)

Photodiode

A photodiode is a semiconductor diode that functions as a photo detector. When light of sufficient photon energy strikes the diode, it excites an electron thereby creating a mobile electron and a positively charged electron hole. If the absorption occurs in the junction's depletion region, or one diffusion length away from it, these carriers are swept from the junction by the built-in field of the depletion region, producing a photocurrent.

In zero bias mode, light falling on the diode causes a current across the device, leading to forward bias which in turn induces "dark current" in the opposite direction to the photocurrent. This is called the photovoltaic effect, and is the basis for solar cells.

Reverse bias induces only little currents (known as saturation or back currents) along its direction. But a more important effect of reverse bias is widening of the depletion layer (Therefore expanding the reaction volume) and strengthening the photocurrent. Circuits based on this effect are more sensitive to light than ones based on the photovoltaic effect.

Photo Diode Power Supply Requirements

Typical Voltage	5V to 100V
Typical Current	1 μ A to 10 mA
Polarity	Positive or Negative

Avalanche Photodiode

Avalanche photodiodes (APDs) are photo detectors with high internal gain, a semiconductor analog to photomultipliers. By applying a reverse bias voltage (typically 100-200 V in silicon), APDs show an internal current gain effect (typically around 100) due to impact ionization. Some silicon APDs employ alternative doping and beveling techniques that allow greater voltage to be applied (> 1500V) before breakdown is reached and hence a greater operating gain (> 1000). In general, the higher the reverse voltage the higher the gain.

Since APD gain varies strongly with the applied reverse bias and temperature, the reverse voltage should be stable and monitored in order to keep a stable gain. Power supplies with high monitoring and setting resolution are often necessary.

If very high gain is needed (105 to 106), certain APDs can be operated with a reverse voltage above the APDs breakdown voltage. In this case, the APD needs to have its signal current limited and quickly diminished, for example through active or passive current quenching. APDs in high-gain regime operate in Geiger mode. This mode is particularly useful for single photon detection provided that the dark count event rate is sufficiently low.

APD Power Supply Requirements

Typical Voltage	50 – 2000 V
Typical Current (Anode)	1 – 10 mA
Polarity	Positive or Negative

Silicon PMT

Silicon photomultipliers are new, semiconductor photon sensitive devices build from an avalanche photodiode matrix on common silicium substrate.

The dimension of each single APD micro-cell can vary from 20 to 100 microns with a possible density of up to 1000 per mm². Every micro-cell APD operates in Geiger mode and is decoupled from the others by a polysilicon quenching resistor. A parallel readout of all micro-cells results in a large dynamic range from a single photon up to 1000 photons per mm². The supply voltage depends on junction type and varies from a minimum of about 30V up to 70V.

The total quantum efficiency of 20% as well as the gain of about 106 are very similar to a traditional PMT's, however the G/V curve is linear and not exponential like for a PMT. Silicon PMT's have a fast time response of about 100ps for single photo electron. The small, light and compact design as well as it's independence of magnetic fields is a big advantage for detector applications.

Silicon PMT Power Supply Requirements

Typical Voltage	25V to 70V
Typical Current	10 to 30 mA
Typical Voltage (electronics)	5V
Typical Current (electronics)	40 to 100 mA
Polarity	Positive or Negative

Silicon Strips and Silicon Pixel Detector

With semiconductor detectors it is also possible to detect charged particles. Narrow (usually around 100 micrometres wide) strips of doped silicon work as diodes, which can be reverse biased in order to enlarge the depletion zone and therefore achieve a higher sensitivity. The thicker the strip is, the higher is the bias voltage required to obtain full depletion. As charged particles pass through these strips, they cause small ionization currents which can be detected and measured. Arranging thousands of these detectors around a collision point in a particle accelerator can give an accurate picture of what paths particles take. Silicon detectors have a much higher resolution in tracking charged particles than older technologies such as cloud chambers or wire chambers. The drawback is that silicon detectors are much more expensive than these older technologies and require sophisticated cooling to reduce leakage currents (noise source) as well as suffer degradation over time from radiation.

Silicon micro-strip detectors frequently operate in high radiation environments and require a bias voltage which should be adjustable on a wide range, typically from 0 to 500V, with a remote monitoring and controlling system for voltages and currents, in order to guarantee a constant gain over time.

High precision is also required as current trips should be set for each channel and range from some nA up to some uA and calibration procedures must be executed with high accuracy in order to avoid breakdown.

Si Detectors Power Supply Requirements

Typical Voltage (bias)	50 – 500 V
Typical Current (bias)	1 mA
Typical Voltage (electronics)	2 – 5V
Typical Current (electronics)	40 to 500 mA
Polarity	Positive or Negative

Germanium detector

Germanium detectors are mostly used for detecting gammas, especially for spectroscopy in nuclear physics. While silicon detectors cannot be thicker than a few millimeters, germanium can have a depleted, sensitive thickness of centimeters, and therefore can be used as a total absorption detector for gamma rays up to few MeV.

An accurate calibration procedures is necessary.

Ge Detectors Power Supply Requirements

Typical Voltage (bias)	Up to 4500 V
Typical Current (bias)	0,1 – 1 mA
Typical Voltage (electronics)	2 – 5V
Typical Current (electronics)	40 to 500 mA
Polarity	Positive or Negative

Wire Chambers

A wire chamber is a detector for particles of ionizing radiation which constitutes a further development of the Geiger counter and of the proportional counter.

A wire carrying a high voltage passes through a metal tube or cavity whose walls are held at ground potential. Any ionizing particle that passes through the tube causes a current to flow. This allows the experimenter to count particles and, in the case of proportional counter operation mode, to determine their energy. Further developments of the wire chambers are drift chambers and time projection chambers, where the timing of the currents are used to infer the minimum distance of the particle trajectory from the wire.

Modern wire chamber need a wide range of voltages: 0,5 to 10 kV for the high voltage wires, and 0 to 1 kV for monitoring the gas purity and the conditions of the electrodes. This monitoring is very important for maintaining a high efficiency throughout the operation, where the chamber is exposed to high beam intensity. This monitoring typically involves running voltage plateau curves in many voltage steps, and an accuracy of 0,5 V is often necessary.

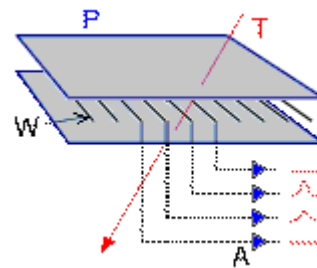

Wire chamber with cathod plates (P), wires (W), preamp (A) and crossing particle (T)

Wire Chambers Power Supply Requirements

Typical Voltage	0,5 – 10 kV
Typical Current	1 – 30 mA/ch
Polarity	Positive (common) or Negative

Resistive Plate Chamber

Resistive plate chambers (RPCs) are gaseous parallel plate detectors that combines the spatial resolution of the wire chambers with the good time resolution typical of a scintillation counter. It is therefore well suited for fast space-time particle tracking as required by many trigger circuits in particle and nuclear physics. RPCs do not use wires, are very simple to manufacture and commercially available.

RPCs usually operate with voltage differences between 9 and 12 kV, which may also be achieved using both positive and negative high voltage power supplies.



Resistive plate chamber

RPC Detectors Power Supply Requirements

Typical Voltage	9 – 12 kV
Typical Current	1 μ A / m ²
Polarity	Positive and Negative

GEMs

The Gas Electron Multiplier (GEM) is a proven gas detector technique that can be used for detecting ionizing radiations such as charged particles, photons, X-rays and neutrons, and has therefore a wide range of application, from healthcare to instrumentation for high energy physics.

It uses a thin sheet of plastic coated with metal on both sides and chemically pierced by a regular array of holes a fraction of a millimetre across and apart. Applying a voltage across the GEM (300 – 500 V typically), the resulting high electric field in the holes makes an avalanche of ions and electrons pour through each. The electrons are collected by a suitable device, here a pickup electrode with x- and y-readout.

Multichannel HV/LV power supplies are the best choice for GEMs.

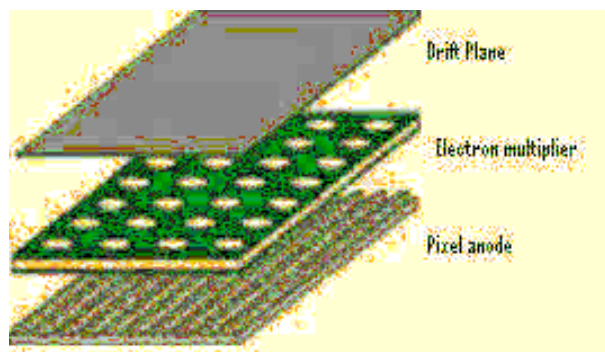

Gas electron multiplier

GEM Detectors Power Supply Requirements

Typical Voltage	300 – 500 V
Typical Current	1 – 10 mA
Polarity	Positive or Negative

Electrostatic lenses

Electrostatic lenses are often used for beam line steering and diagnostics as well as in a wide variety of applications like time-of-flight and mass spectrometry, ion traps, ionization experiments, ...

Power supply requirements depend on the application and can cover a large voltage range between a few 100V up to hundreds of kilo volts. Typically only low currents are needed. In some case bipolar high voltage may be needed to allow changing polarity of the electrostatic lenses.

Electrostatic Lenses Power Supply Requirements

Typical Voltage	0 to 100 kV (may vary)
Typical Current	1 μ A .. 10 mA
Polarity	Positive and Negative, Bipolar

Low Voltage Power Supplies

Powering Analog and Digital Front End Electronics

In the last decades, thanks to the miniaturization trend in microelectronics, it has been possible to integrate more and more electronic components into particle detectors, in order to achieve significant noise reduction and faster processing. Every detector with built in electronics needs stable low voltages for analog and digital circuits. Multichannel silicon strip detectors, PMTs, wire chambers, RPCs may require low voltages, and since each detector type has its own geometry and space constraints, the cable length to the power supply may range from centimeters to several hundreds of meters.

Wiener offers approaches to all LV installation challenges: power supplies which are able to maintain a constant voltage over long distances, magnetic and radiation tolerant power supplies which must operate very close to detectors, multichannel HV/LV integrated power supplies, high power devices.

LV Power Supply Requirements

Typical Voltage	1.5 – 60 V
Typical Current	1 – 200 A
Polarity	Positive or Negative

Power Supplies for Magnets

Power supplies for conventional magnets are usually low or medium voltage, high current units. Depending on the size and coil design of the magnet DC power of a few Watt to hundred of kilo watts can be needed.

Power supplies for quadrupole magnets are typically in the 1 to 6kW class, with maximum currents of 10 to 50A and voltages below 100V. Since most standard magnets have inductances of ten Henries or less, already 10V across the magnet will produce a minimum charge rate of up to 1A/s. Common slew rate requirements are 1A/s up to 50A/s. The resistive load of the magnet coil is often below a few Ohms.

Depending on the application either a true bipolar current output, i.e. a power supply that is able to ramp continuously from full negative current to full positive current, or a polarity switching at zero crossing may be needed.

In order to achieve high precision magnet operation there are extremely high requirements for the resolution of current setting and measurement, in particular the stability and reproducibility. Typically a smooth continuous operation with high setting resolution and low drift over time of 100ppm or less is required. Changing currents has to be possible with adjustable slew rate and should run without overshooting or ringing upon reaching the new operating current. Correction and hysteresis cycles require a defined reproducibility.

Magnet power supplies should have low noise DC outputs, especially in the low frequency range. Due to the large impedance of the magnet, the high frequency noise of the power supply is often less important than the stability, or long term drift of the current.

For integration in the beam control system remote control and monitoring of the power supply in addition to local operation is often required.

Wiener is developing high precision FET current controlled bipolar power supplies that will be launched in the near future. Primary powered with a high efficient low noise switching power supply the full bridge bipolar FET current regulator is feed only with minimum necessary voltage. That keeps the unit cool and dimensions low.

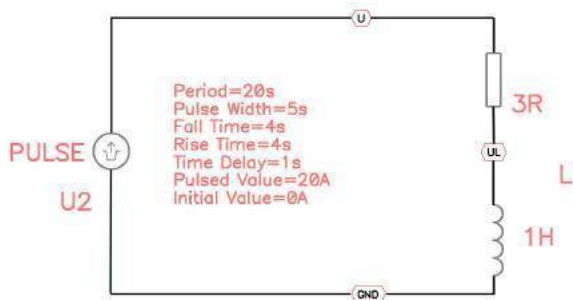

Simulation of operation of a bipolar power supply (source diagramm)

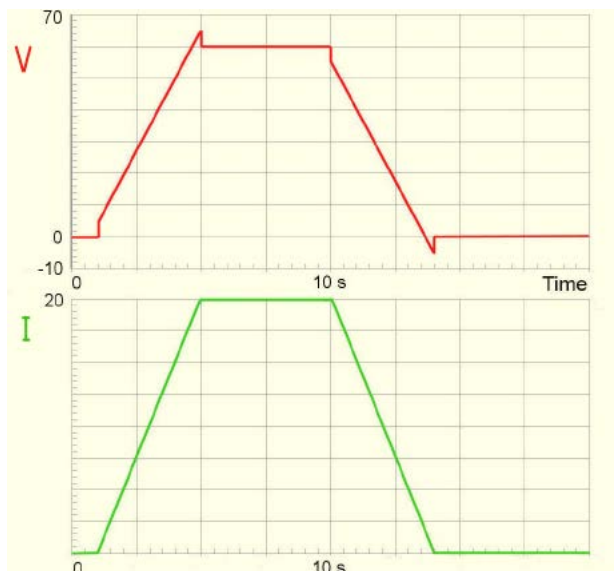

Simulation of operation of a bipolar current controlled power supply (voltage and current vs time)

Introduction to power supplies and regulation

A voltage regulator is an electrical regulator designed to automatically maintain a constant voltage level.

Most active voltage regulators operate by comparing the actual output voltage to some internal fixed reference voltage. Any difference is amplified and used to control the regulation element. This forms a negative feedback servo control loop. If the output voltage is too low, the regulation element is commanded to produce a higher voltage. For some regulators if the output voltage is too high, the regulation element is commanded to produce a lower voltage; however, many just stop sourcing current and depend on the current draw of whatever it is driving to pull the voltage back down. In this way, the output voltage is held roughly constant. The control loop must be carefully designed to produce the desired tradeoff between stability and speed of response.

Linear Regulated Power Supplies

Linear regulated power supplies consist of a big transformer operating at the mains frequency of 50/60 Hz that produces the low voltage, a rectifier that lets the current flow in one direction only, a regulating device (FET or bipolar transistor operated in its linear region, Zener diode operated in the breakdown region) that keeps the voltage constant and many capacitors.

The regulating device is made to act like a variable resistor, continuously adjusting a voltage divider network to maintain a constant output voltage.

Linear regulated power supplies have the advantage of very "clean" output with little noise introduced into their DC output.

Switching Mode Power Supplies

A switching mode power supply is an electronic power supply unit that incorporates an input rectifier and filter, an electronic switch (chopper) whose AC output at typical frequencies of 50 kHz to 1 MHz is connected to the primary winding of a high frequency transformer, an output rectifier and output filter and a feedback circuit for the regulation that stabilizes the voltage by controlling the timing of the chopper.

Switching regulators are used as replacements for the linear regulators when higher efficiency, smaller size or lighter weight are required. They are, however, more complicated and their switching currents can cause high frequency noise problems if not carefully suppressed.

Comparing linear vs. switching power supplies

In order to determine whether a linear or a switching power supply should be chosen for an application, some facts must be taken into consideration:

- Linear power supplies are best when low output noise is required
 - Linear power supplies are best when a fast response to input and output disturbances is required
 - Switching power supplies are best when power efficiency is critical
 - Switching power supplies are required when only DC is available as input and a higher output voltage is required
 - The low frequency transformer of a linear power supply is several times larger and heavier than a corresponding transformer in a switching power supply
 - Switching power supplies operating with AC input from the main require a Power Factor Corrector (PFC) in many countries
 - Switching power supplies produce radio frequency noise
- In many cases either one would work.

Voltage Loss on Cables

Voltage drop is the reduction in voltage in an electrical circuit between the source and load. This voltage reduction may be neglected when the impedance of the interconnecting conductors is small relative to the other components of the circuit. Excessive voltage drop will result in unsatisfactory operation of electrical equipment.

In electronic design, various techniques are used to compensate for the effect of voltage drop on long circuits or where voltage levels must be accurately maintained.

Voltage drop can be reduced with large cable sections, but the drawbacks are higher costs and larger cable capacitance.

The general formula to calculate voltage drop is

$$V \sim \rho I L / \sigma$$

where ρ is the conductor resistivity, I is the current, L is the length of the cables and σ is the cables section. Assuming constant resistivity (although resistivity may depend strongly on temperature and purity), it is possible to draw tables of voltage drop's dependency on the other three variables.

Voltage drop table for 10 A over 100 m of copper wire (in red cells the cable section is not allowed for 10A)

mm	mm ²	AWG	Ω/m	Ω	ΔV
0.81	0.52	20	0.352	3.52	35.2
1.04	0.85	18	0.207	2.07	20.7
1.26	1.25	16	0.141	1.41	14.1
1.60	2	14	0.0879	0.879	8.79
1.95	3	12	0.0586	0.586	5.86
2.52	5	10	0.0352	0.352	3.52
3.19	8	8	0.0220	0.22	2.20
5.25	20	4	0.00879	0.0879	0.879

Voltage drop table for 100 A over 100 m of copper wire (in red cells the cable section is not allowed for 100A)

mm	mm ²	AWG	Ω/m	Ω	ΔV
5.25	20	4	0.00879	0.0879	8.79
6.68	35	1	0.00502	0.0502	5.02
7.98	50	0	0.00352	0.0352	3.52
9.44	70	000	0.00251	0.0251	2.51
11.0	95	0000	0.00185	0.0185	1.85
12.36	120	250kcmil	0.00147	0.0147	1.47

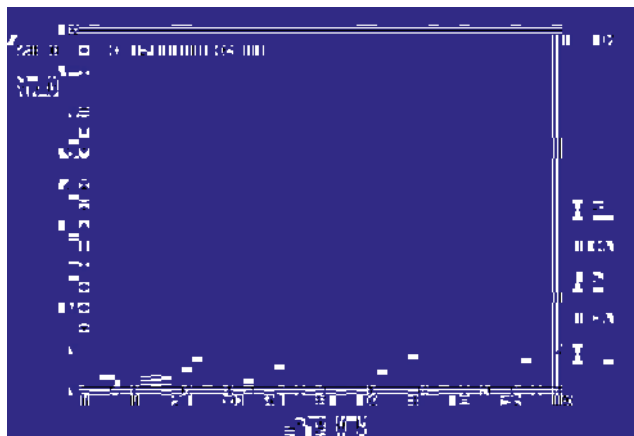

Above: voltage drop as a function of cable length. Below: some materials resistivities are reported for reference.

Material	Resistivity (Ωm) at 20°C
Silver	1.47×10 ⁻⁸
Copper	1.72×10 ⁻⁸
Gold	2.44×10 ⁻⁸
Aluminum	2.82×10 ⁻⁸
Tungsten	5.6×10 ⁻⁸
Brass	0.8×10 ⁻⁷
Iron	1.0×10 ⁻⁷
Platinum	1.1×10 ⁻⁷
Lead	2.2×10 ⁻⁷

Power Supplies over Long Distances

Long cables are often required to keep power supplies away from hostile environments or to meet particular requirements with space constraints.

Then main challenge that is faced when powering low voltage lines (as low as 1.6 - 2V) over long distances is to get a stable voltage at the load without increasing cable sections too much. The voltage drop along the cables is often considerably higher than the voltage required by the load. In order to determine whether a particular setup will actually provide a stability that satisfy user requirements, many parameters such as cable capacitance, resistance, voltage regulation time, etc. should be evaluated and optimized within a simulation.

Wiener has a long track record of references in successfully providing long distance power supply and has simulation tools to make sure that user requirements are met. The example below is a preliminary estimation for a 500 meter distant multichannel sink with constraints on cable diameter.

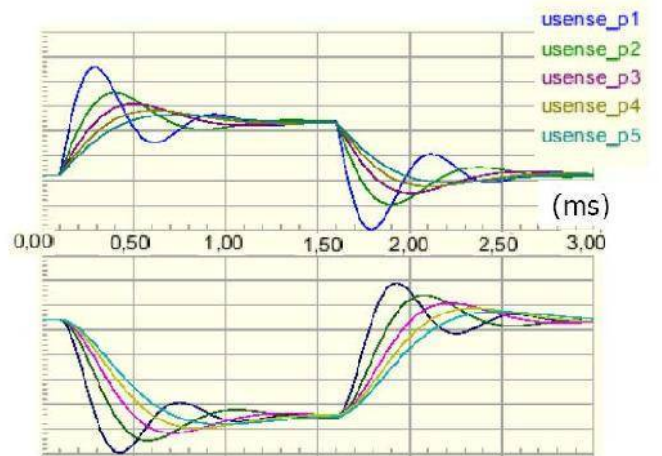
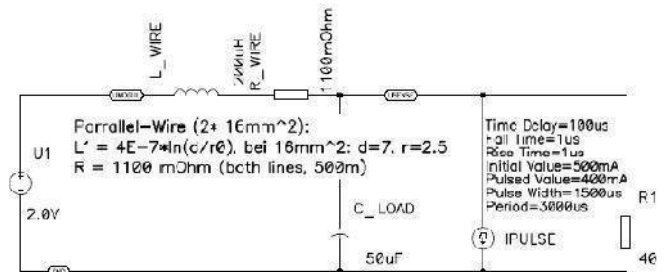

Simulation for a 500m distant sink. Sensed voltage and current versus time for 1,5 ms long current pulses. p1, p2 - p5 equivalent to C load 50, 100 - 250µF

Magnetic and Radiation Tolerant Power Supplies

In many cases it may be more convenient to operate the power supplies close to the detector, even in a hostile environment, rather than using long cables. This makes sense whenever the power supply is able to withstand the hostile conditions for a sufficient long time.

While standard Wiener power supplies can work in lower magnetic fields without further provisions, for higher than 300 G B-fields special screenings for the magnetic sensitive parts inside the power box have to be foreseen.

To provide sufficient cooling, even in higher magnetic fields where motor driven fans are not able to work, a high efficient water cooling system has been developed.

The PL 5-/PL 6- and MARATON series power supplies can be divided into:

1. suitable for safe environment only (PL 500 /PL 6-)
2. suitable for moderately hazardous environment with low B-field and low radiation (PL 5-WC² / PL 6-WC)
3. suitable for hazardous environments with up to 1500G B-field and full CERN LHC radiation spectrum / dose (MARATON, MAgnetism and RAdiation TOLerant New Power Supply System).

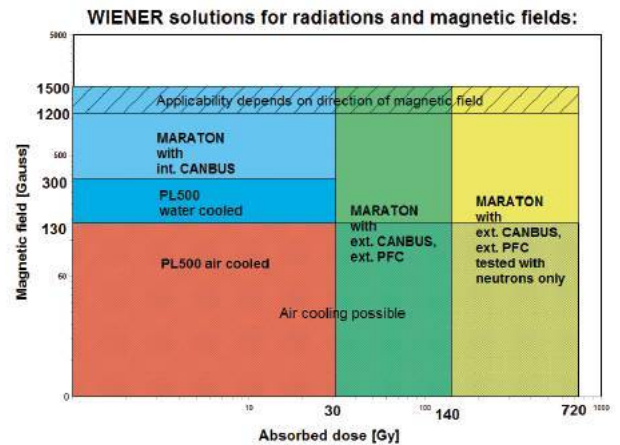

Summary WIENER Low and High Voltage Power Supplies

Device	Voltage Range	Wiener Solution
PMTs	1 – 3 kV	Mpod HV
Si PMTs	25 – 70 V	Mpod LV
APDs	50 – 2 kV +/- 5V	Mpod HV-LV
Si detectors	50 – 500 V +/- 2 to 5V	Mpod HV-LV
Ge detectors	4,5 kV +/- 2 to 5V	Mpod HV-LV
Wire chambers	0,5 – 10 kV	Mpod HV, special HV
RPCs	9 – 12 kV	Mpod HV
GEMs	300 – 500V	Mpod HV
Special LVs for A/D	1,5 – 60 V	PL508, PL512: I > 10A/ch
Special LVs for A/D	1,5 – 60 V	Mpod LV, I < 10A/ch.
Electrostatic Lenses	0 – 100kV	Mpod for up to 10kV

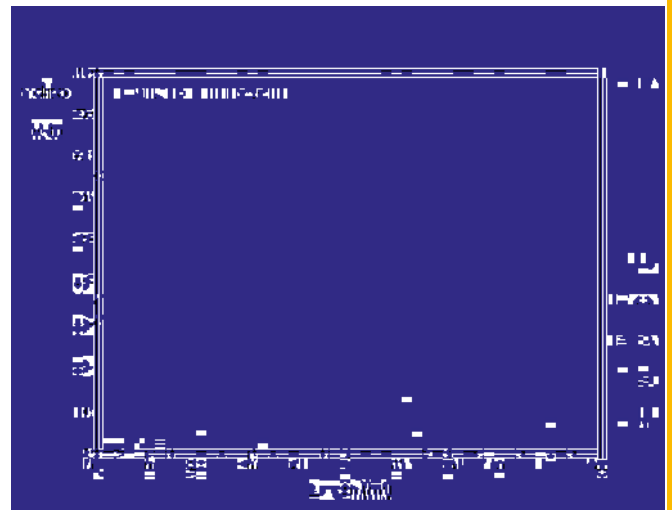

Voltage and current requirements and Wiener solutions (per channel).

² WC: Water Cooled

Universal Multichannel Low- and High Voltage System

WIENER presents with Mpod a new, universal multi-channel low voltage (LV) and high voltage (HV) computer controlled power supply system. Offering highest channel density the MPOD mainframe can house up to 10 plug-in modules which results in 80 up to nearly 500 individually controlled channels per mainframe. Built in a modular way MPOD consists of the mainframe / bin, a front side plug-in controller with Ethernet and USB ports, a fan tray and a power supply which is located in the back.

In order to tailor the system to individual hardware needs MPOD can be configured as „low-voltage only“, „high voltage only“ or „mixed configuration“. Further the MPOD mainframe is configurable to have all LV / HV connectors either on the front or rear side. Different control and monitoring options are offered. The MPOD controller with a interfaces for 10/100 Ethernet, CAN bus and USB-2 provides a variety of network capabilities. Local control is available by using the optional LCD display.



Mpod LX



MPOD EC



MPOD-9 slot VME64x mixed crate with air filter

Technical Details

- 19" rack mountable bin with module cage for 10 LV or HV modules, compact design with ruggedized mechanics, mixed version MPOD + VME64(x) or MPOD + cPCI (and other backplanes) available
- Two mounting modes: outputs at front- or at rear side
- 8U bin for bottom cooling air intake, 9U high for front air intake, optional with dust filter
- Modular design: fan tray and primary power supply easily removed
- Module size 6U x 8PU, 220mm deep
- LV and HV modules freely mixable
- High Voltage modules (ISEG) with 8 ... 48 channels of 500V ... 30kV, floating or common ground, low noise and ripple, up to 480 HV channels per mainframe possible
- Low Voltage modules (WIENER) with 8 channels in 0-8V ... 0 - 120V ranges, up to 50W/channel max., low noise and ripple
- Lowest noise and ripple
- High precision / resolution for monitoring and setting
- Mpod Controller with Ethernet, CAN-bus, USB interface, and interlock input, TCP/IP with Web-server and SNMP protocol
- Primary power supply based on UEP6021 technology, low noise / high reliability design
- 94V - 265VAC world-wide auto-range AC input, with power factor correction, CE
- Graphic display for local monitoring and programming with dual rotary/push- buttons (optional)
- Dimensions: 19" x 460mm (depth) x 8U (bottom air intake) or 9U (front air intake)
- Weight: ca. 20 Kg, depending on options

Type	Graphic display local control	Slots	Primary HV-power	Output position	Backplane supports	Order Code
Mpod EC	-	10	600W	Front	HV/LV	MQAAH250000S
Mpod EC-R	-	10	600W	Rear	HV/LV	MQAAH250100S
Mpod LX	LCD	10	600W	Front	HV/LV	MQAAH250200S
Mpod LX-R	LCD	10	600W	Rear	HV/LV	MQAAH250300S
Mpod EC LV	-	10	-	Front	LV	MQBAH250000S
Mpod EC LV-R	-	10	-	Rear	LV	MQBAH250100S
Mpod EC HV	-	10	600W	Front	HV	MQCAH250400S
Mpod EC HV-R	-	10	600W	Rear	HV	MQCAH250500S
Mpod LX LV	LCD	10	-	Front	LV	MQBAH250300S
Mpod LX LV-R	LCD	10	-	Rear	LV	MQBAH250400S
Mpod LX HV	LCD	10	600W	Front	HV	MQCAH250600S
Mpod LX HV-R	LCD	10	600W	Rear	HV	MQCAH250700S
Mpod 2H	-	10	1200W	Front	HV	MQCAH250000S
Mpod 2H-R	-	10	1200W	Rear	HV	MQCAH250300S
Mpod 2H LX	LCD	10	1200W	Front	HV	MQCAH250100S
Mpod 2H LX-R	LCD	10	1200W	Rear	HV	MQCAH250200S

Mpod Micro Crate

The Mpod Micro Crate is the small and low cost option for the WIENER multi-channel high and low voltage power supply system. The Mpod mini mainframe can house one plug-in low or high voltage modules. The integrated Mpod controller card provides 10/100 Ethernet, CAN bus and USB-2 interfaces.

High voltage modules are available with 8 up to 48 channels in the voltage range of 500V ... 30kV. All low voltage modules have 8 channels with a maximum of 50W / channel in different voltage ranges. All HV and LV channels are individually controlled and monitored.

In order to tailor the system to the individual hardware needs Mpod micro is available as „low-voltage only“ or „high voltage only“ configuration. Local control is available by using the optional LCD display.

Mpod Micro Crate

Technical Details

- 19" x 1,5U or 3U micro bin with module cage for 1 or 2 LV or HV modules, can be used as desktop or rack mountable
- 1 slot version available for HV only or LV only
- 2 slots for LV and HV modules
- Up to 48 channels high voltage possible, ISEG EHS/EDS/EBS modules with 8 ... 48 channels in a range of 500V up to 30kV, floating or common ground
- Up to 8 channels low voltage per chassis, WIENER MPV 8xxx series 4- or 8-channel low voltage modules in 0... 8V up to 0... 120V ranges
- Built-in primary power supply (600W), low noise and ripple
- Integrated cooling fan
- Mpod controller card with Ethernet 10/100, CAN-bus and USB-2 interfaces, Interlock connector
- Integrated web-server and TCP/IP communication via SNMP, OPC server, DHCP capable
- 94V – 265V world-wide auto-range AC input, with power factor correction, CE-conformity
- Dimensions: 19" (482mm) x 1,5U (67mm) or 3U (134mm) x 480mm [whd], weight: ca. 10 Kg



MPOD Micro



MPOD Micro 2

Type	Graphic display local control	Slots	Primary HV-power	Output position	Backplane supports	Order Code
Mpod Micro-LV	No	1	No	Front	LV	MPB1P230000T
Mpod Micro-HV	No	1	200W	Front	HV	MPC1P230000T
Mpod Micro 2	No	2	300W	Front	HV / LV	-
Mpod Micro 2 LX	LCD	2	300W	Front	HV / LV	-

Mpod Mini Crate

The Mpod Mini Crate is the small and low cost option for the WIENER multi-channel high and low voltage power supply system. The Mpod mini mainframe can house up to 4 plug-in low or high voltage modules. The integrated Mpod controller card provides 10/100 Ethernet, CAN bus and USB-2 interfaces.

High voltage modules are available with 8 up to 48 channels in the voltage range of 500V ... 10kV. All low voltage modules have 8 channels with a maximum of 50W / channel in different voltage ranges. All HV and LV channels are individually controlled and monitored.

In order to tailor the system to the individual hardware needs Mpod mini can be configured as „low-voltage only“, „high voltage only“ or „mixed configuration“. Local control is available by using the optional LCD display.

Technical Details

- 19" x 5U Mini Bin with module cage for 4 LV or HV modules, can be used as desktop, mini tower or rack mountable
- Versions available for HV only, LV only or mixed LV/HV
- 4 slots for modules, LV and HV modules freely combinable
- Up to 192 channels high voltage possible, ISEG EHS/EDS/EBS modules with 8 ... 48 channels in a range of 500V up to 10kV, floating or common ground
- Up to 32 channels low voltage per chassis, WIENER MPV 8xxx series 8-channel low voltage modules in 0... 8V up to 0... 120V ranges
- Built-in primary power supply (600W), low noise and ripple
- Integrated cooling fan
- Mpod controller card with Ethernet 10/100, CAN-bus and USB-2 interfaces, Interlock connector
- Integrated web-server and TCP/IP communication via SNMP, OPC server, DHCP capable
- 94V – 265V world-wide auto-range AC input, with power factor correction, CE-conformity
- Dimensions: 19" (482mm) x 4U (178mm) x 480mm [whd], weight: ca. 25 Kg



MPOD Mini LX



MPOD Mini EC

Type	Graphic display local control	Slots	Primary HV-power	Output position	Backplane supports	Order Code
Mpod Mini	No	4	600W	Front	HV/LV	MQA4E240000T
Mpod Mini - LX	Yes	4	600W	Front	HV/LV	MQA4E240300T
Mpod Mini - HV	No	4	600W	Front	HV	MQC4E240000T
Mpod Mini - HV-LX	Yes	4	600W	Front	HV	MQC4E240200T
Mpod Mini - LV	No	4	-	Front	LV	MQB4E240000T
Mpod Mini - LV-LX	Yes	4	-	Front	LV	MQB4E240100T

Multichannel High Voltage Modules

WIENER presents with Mpod an universal multi-channel low voltage (LV) and high voltage (HV) computer controlled power supply system. Offering highest channel density the MPOD mainframe can house up to 10 plug-in modules which can be mixed in type and parameters. Up to 480 individually controlled high voltage channels are available in one mainframe.

MPOD high voltage modules of the ISEG, ESS, EBS, EHS and EDS series have 1, 2, 4, 8, 16, 24, 32 or 48 channels with different maximum voltage and current ranges. Based on the patented sine-wave resonance inverter technology all ISEG MPOD high voltage modules are characterized by extremely low noise and ripple. Further all channels are individually controlled and monitored and have a variety of programmable features. The high voltage modules for Mpod are available with common ground or floating outputs.



ISEG SHV



ISEG REDEL

Technical Details

- 1, 2, 4, 8, 16, 24, 32 or 48 channels per module
- Voltages up to 30 kV and currents up to 15 mA / channel
- High voltage channels with common GND or floating (20V or optional 200V/2000V max potential difference)
- Output connectors: 8 channel modules SHV
- 16 channel modules SHV or REDEL multi pin
- 24, 32, 48 channel modules REDEL multi pin
- Low ripple and noise (typically <10mVpp, high precision series <5mVpp)
- 16 or 21 bit voltage setting and measurement resolution
- 16 or 21 bit current measurement resolution
- Hardware current and voltage limit per module
- Programmable fast hardware current trip or software controlled trip for each channel
- Protection circuitry e.g. safety loop, optional individual channel inhibit
- Each channel fully remote controllable via software (CAN-bus or Ethernet)
- Dimensions: 6U x 40.64mm x 220mm Dimensions: 6U x 40.64mm x 220mm
- Weight: ca. 2 Kg

Series	Vmax	Description
ESS 10 ...	10 - 30kV	1 ch. 2-quadrant HV modules ESS 10 vvv with Floating-GND
EBS 180 ...	3kV	24 ch. bipolar 4-quadrant distributor HV modules with Common-Floating-GND
EBS 80 ...	500V	8 ch. bipolar 4-quadrant distributor HV modules with Common-Floating-GND
EBS C0 ...	3kV	12 ch. bipolar 4-quadrant distributor HV modules with Common-Floating-GND
EBS F0 ...	500V	16 ch. bipolar 4-quadrant distributor HV modules with Common-Floating-GND
EDS 181 ...	500V or 3kV	24 ch. distributor HV modules with Common Floating-GND
EDS 183 ...	500V or 3kV	24 ch. distributor HV modules - low cost - with Common Floating-GND
EDS 301 ...	500V or 3kV	48 ch. distributor HV modules with Common Floating-GND
EDS 303 ...	500V or 3kV	48 ch. distributor HV modules - low cost -with Common Floating-GND
EHS 201 ...	0,5 - 4kV	32 ch. HV modules with Common-GND
EHS 203 ...	0,5 - 4kV	32 ch. HV modules with Common-GND
EHS 40 ...	8 - 20kV	4 ch. HV modules with Common-Floating-GND
EHS 42 ...	8 - 20kV	4 ch. HIGH PRECISION HV modules with Common-Floating-GND
EHS 44 ...	8 - 20kV	4 ch. HIGH PRECISION HV modules with Floating-GND
EHS 46 ...	8 - 20kV	4 ch. HV module with Floating-GND
EHS 80 ...	0,1 - 6kV	8 ch. HV modules with Common-Floating-GND
EHS 82 ...	0,1 - 6kV	8 ch. HIGH PRECISION HV modules with Common-Floating-GND
EHS 84 ...	0,1 - 6kV	8 ch. HIGH PRECISION HV modules with Floating-GND
EHS 86 ...	0,1 - 6kV	8 ch. HV modules with Floating-GND
EHS F0 ...	0,1 - 6kV	16 ch. HV modules with Common-Floating-GND
EHS F1 ...	0,5 - 4kV	16 ch. HV modules with Common-GND
EHS F2 ...	0,1 - 6kV	16 ch. HIGH PRECISION HV modules with Common-Floating-GND
EHS F3 ...	0,5 - 4kV	16 ch. HV module Low Noise with Common-GND
EHS F4 ...	0,1 - 6kV	16 ch. HIGH PRECISION HV modules with Floating-GND
EHS F6 ...	0,1 - 6kV	16 ch. HV modules with Floating-GND

Multichannel Low Voltage Modules

WIENER presents with Mpod a new, universal multi-channel low voltage (LV) and high voltage (HV) computer controlled power supply system. Offering highest channel density the MPOD mainframe can house up to 10 plug-in modules which can be mixed in type and parameters. Up to 80 individually controlled low voltage channels are available in one mainframe

All Mpod low voltage modules have 4 or 8 channels with a maximum of 50W per channel in different voltage ranges. All channels are individually controlled and monitored and have floating, individually sensed outputs. A control input for each channel can be used for Interlock / Inhibit or external hardware ON/OFF.

Technical Details

- Low Voltage floating modules with 4 or 8 channels of 50 or 100W max. with 0-8V, 0-16V, 0-30V, 0-60V and 0-120V ranges
- 6U height, 220mm deep fully shielded mechanics
- All DC outputs with individual return lines, individually sensed, floating channel to channel and channel to chassis ground (125V, 500V tested)
- Extremely low noise and ripple: <3mVpp (0-20 MHz)
- Very low output earth leakage current
- Voltage and current settings / monitoring for each channel, 15 bit resolution, accuracy +/-0.1% of full scale value
- Current monitoring and limiting for each channel, 15 bit resolution, accuracy +/-0.05% of full scale value
- High stability, 0.2%/10k
- Programmable channel parameters:
 - Terminal and load voltage, under voltage / over voltage trip points
 - Current limit (current or voltage controlled mode)
 - Power, regulation type, internal / external sense
 - Ramping speed up and down (1V/s ... 500V/s)
 - Group features / error handling
- Programming and monitoring via Mpod controller Ethernet (TCP/IP) and USB ports
- Output Connectors: 2 x 37 pin sub-D for DC and sense (4 channels each)
- Front panel multi-color Status LED for each channel
- Dimensions: 6U x 40.64mm x 220mm
- Weight: ca. 2 Kg

Type	Channels	Voltage	I Max	Peak Power	V-Res	I-Res	Ripple & Noise
MPV 4008I	4	0 - 8V	20A	100W / ch.	0.5mV	0.5mA	<3mVpp
MPV 4016I	4	0 - 16V	10A	100W / ch.	1mV	0.25mA	<2mVpp
MPV 4030I	4	0 - 30V	5A	100W / ch.	2mV	0.12mA	<2mVpp
MPV 4060I	4	0 - 60V	2A	100W / ch.	4mV	0.06mA	<2mVpp
MPV 8008I	8	0 - 8V	10A	50W / ch.	0.5mV	0.5mA	<3mVpp
MPV 8016I	8	0 - 15V	5A	50W / ch.	1mV	0.25mA	<2mVpp
MPV 8030I	8	0 - 30V	2.5A	50W / ch.	2mV	0.12mA	<2mVpp
MPV 8060I	8	0 - 60V	1A	50W / ch.	4mV	0.06mA	<2mVpp
MPV 8120I	8	0 - 120V	100mA	50W / ch.	4mV	4 μ A	<2mVpp

Connectors are IEC807-3/DIN41652 conform. Custom made cable sets are available



4 channel LV modules



8 channel LV modules

1000W MTCA.4 Power Supply

The WIENER MTCA.4 is a low noise and ripple / high power density power supply in a double height / double width form factor. Designed according to the PICMIC MTCA-4 standard it provides 800W for 12V payload power as well as 3.3V management power.

The WIENER MTCA.4 includes the AC mains filter, the low noise AC-to-DC converter in switching technology as well as the digital power controller for up to 16 slots.

Being designed with applying the classical rules for common mode suppression and ground loop reduction the WIENER MTCA.4 power supply is essential for enhanced DAQ performance in noise sensitive applications in science and industry. The integrated MTCA.4 Digital

Power Controller together with the hub protects the whole MTCA.4 crate and its modules. It also monitors the complete chain from mains input, PFC and DC/DC-converter stages to the outputs to prevent the unit from any uncontrolled operation.



MTCA.4 1000W power supply



MTCA chassis with MTCA4 power supply

MTCA-4 Power Supply Features

- 1000W power supply according to MTCA-4 standard
- Lowest noise and ripple, < 10mV peak to peak (0 - 20 MHz)
- Very low output earth leakage current
- Integrated MTCA.4 Digital Power Controller
- DC Outputs: 16 channels 12V/8.4A (payload power); 16 channels 3.3V/0.2A (management power)
- AC Input: Wide range, 90-264 VAC, 50/60 Hz; Inrush current < 10A; IEC 320-C14 connector
- Power Factor 0.99 typical
- Remote monitoring via IPMI or USB
- Measurement of all voltages, individual output currents and critical temperatures
- Programmable trip points and trip delay
- Fast (hardware) channel wise switch off in case of too high current
- Redundant operation possible according to MTCA.4 specification
- Synchronous switching allows ultra-high efficiency and keeps the device cold
- EMI EN 55022, class B; Safety EN60950 (CE)
- Double height - double width size, dimensions: 187.3 mm x 170.0 mm x 59.4 mm (7.37" x 6.69" x 2.89")

Standard configurations

Item	Description	Order Code
MTCA.4	MTCA.4 power supply 1000W	0400.TCA01

PL504 Laboratory Power Supply System

The PL504 is providing 4 independent programmable low-voltage channels in a Desktop form factor.

The PL504 can be controlled either locally per touchscreen color LCD display with a complete user interface or remotely via USB or Ethernet.



PL504



PL504 rear view

PL504 Features

- Up to 4 independent, potential free DC 0-60V outputs, 250W each, total up to 1000W output power
- Extremely low noise and ripple
- Channels can be operated in Master-Slave mode for paralleling of two or more outputs (current boosting).
- Floating range: +/-100V (default, optimal for low noise).
- Can be increased up to +/- 500V
- Programmable voltages and thresholds on voltages, currents and temperatures, ramp rates, fully controlled, programmable trip levels and action / group behavior, voltage or current controlled mode
- CE conform EN 50 081/82 part 1 (EN 50 022 B), safety in accordance with EN 60 950
- Ethernet and USB interfaces for remote monitoring and control, Web interface / SNMP
- 94V - 265VAC world-wide auto-range AC input, with power factor correction / sinusoidal mains current EN 61000-3-2, CE
- DC Output connections: 4mm plugin sockets, pole clamp
- LCD Multicolor touchscreen display
- Sense lines
- Dimension: 4U x 365mm x 350mm

PL506 Power Supply System

The PL 506 is a high sophisticated, high density, programmable 6-channel floating low-voltage power supply system. Using the remote monitoring and control features either via USB or Ethernet it can be used to supply external load-channels with high power consumption also over long distances. Up to 3kW (3Ubox) DC output power can be provided.

Voltages, currents, temperatures and output power are programmable and controlled by the internal processor. Illegal modes as well as failure conditions will be detected. Dynamic behavior is programmable via USB port (long-moderate-short sensed distances to loads).

The modular construction with a 19" rack mountable power bin and a plug-in power supply box allows to swap the power supply without any tools and within shortest time.

PL506 Features

- Up to 6 independent, potential free DC outputs, 600W each, total up to 3 kW output power
- Extremely low noise and ripple
- Channels can be operated in Master-Slave mode for paralleling of two or more outputs (current boosting)
- Floating range: +/-100V (default, optimal for low noise). Can be increased up to +/- 500V
- Programmable voltages and thresholds on voltages, currents and temperatures, ramp rates, fully controlled, programmable trip levels and action / group behavior, voltage or current controlled mode
- CE conform EN 50 081/82 part 1 (EN 50 022 B), safety in accordance with EN 60 950
- Ethernet and USB interfaces for remote monitoring and control, Web interface / SNMP
- 94V - 265VAC world-wide auto-range AC input, with power factor correction / sinusoidal mains current EN 61000-3-2, CE
- DC Output connections: 6mm threaded bolts (M6-150A), Sense and temperature sensor connections: 9 pin Sub D female connector for 2 channels, senses wired to terminals on rear side
- Optional alphanumeric display
- Optional with Power fail- and System Reset-Signal
- Optional with Interlock input
- Optional direct water cooling with same size as air cooled ones
- Dimensions: 430mm x 3U (133mm) x 325mm [whd], weight: from 9.6 to 19 Kg, depending on the number of power modules

PL506 consists of:

- Power Bin: 19" bin for rack mounting hosting a power box

Type	Dimensions	Features
PBN506 – 3U RASO	3U x 19" x 445mm	Folded metal case
PBN506 – 4U	4U x 19" x 445mm	Aluminum side panels

- Power Box containing a PFC mains input module, a control card and slots for up to 6 modules (MEH type, single channel, 550W to 650W) for a maximum of 6 channels. The power box includes the Ethernet/USB combo card and can be outfitted with an optional display (EX version) as well as individual channel interlock feature (I option)

Type	Dimensions	Features
PBX506	3U x 19" x 445mm	Ethernet, USB, "Easy Lever" extraction mechanism
PBX506 – EX	3U x 19" x 445mm	Display, Ethernet, USB, "Easy Lever" extraction mechanism

Power Modules integrated into Power Box slots for a maximum of 6 modules / 6 channels

Standard MEH power modules (up to 6)

Type	optimal Voltage range	Channels	Peak output / Channel
MEH – 02/07	2V ... 7V	1	115A / 550W
MEH – 06/10	6V ... 10V	1	80A / 550W
MEH – 07/16	7V ... 16V	1	46A / 550W
MEH – 12/30	12V ... 30V	1	23A / 550W
MEH – 30/60	30V ... 60V	1	13,5A / 650W



PL506 with Display and RASO bin



PL506 rear with RASO bin view



PL506 rear with bin

PL508 Power Supply System

The PL508 is a high sophisticated, high density, programmable 8-channel moderate floating low-voltage power supply system. Using the remote monitoring and control features it can be used to supply a large numbers of external load-channels with high power consumption also over long distances. Dynamic behavior is adjustable via internal jumpers (long-medium-short sensed distances to loads). Voltages, currents, temperatures and output power are programmed and controlled by the internal processor and illegal modes as well as failure will be detected.

The modular construction with a 19" rack mountable power bin and a plug-in power supply box allows to swap the power supply without any tools and within shortest time.



PL508 with display



PL508 rear view



PL508 without display

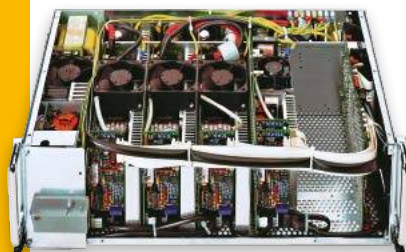

PL508 inside

PL508

- Up to 8 independent, potential free outputs, total up to 3/6 kW DC output power
- Fully self controlled (under / over voltage, over temperature, over current), programmable trip levels, voltage or current controlled operation
- Programmable voltages and thresholds on voltages, currents and temperatures
- Extremely low noise and ripple
- CE conform EN 50 081/82 part 1 (EN 50 022 B), safety in accordance with EN 60 950
- 94V - 265VAC world-wide auto-range AC input, with power factor correction / sinusoidal mains current EN 61000-3-2
- CAN-bus interface for remote monitoring and control available on all PL508s
- Optionally with Power fail- and System Reset-Signals
- Optional direct water cooling with same size as air cooled ones

PL508 consists of:

- Power Bin: 19" enclosure with CANbus (optional display / Ethernet) hosting Power Box
 - LX option: Alphanumeric display and CANbus connector on front panel
 - EX option: Alphanumeric display, Ethernet (TCP/IP), web interface
 - ELV option: "Easy Lever" power box extraction mechanism

Type	Dimensions	Features
PBN508 LX – 3U	3U x 19"	CANbus on front panel, Display, bottom air entry
PBN508 EX – 3U	3U x 19"	Display, Ethernet, bottom air entry
PBN508 RAAO – 3U	3U x 19"	Locking guides for power box extraction lever, no front panel
PBN508 LX – 4U	4U x 19"	CANbus on front panel, Display, front/bottom air entry
PBN508 EX – 4U	4U x 19"	Display, Ethernet, front/bottom air entry
PBN508 LX – 7U	6U x 19"	CANbus on front panel, Display, front/bottom air entry
PBN508 EX – 7U	6U x 19"	Display, Ethernet, front/bottom air entry

- Power Box containing a PFC mains input module, a control card and 5 to 10 slots
 - I option: Interlock input
 - GR option: Direct ON/OFF mains switch
 - ELV option: "Easy Lever" power box extraction mechanism

Type	Dimensions	Interlock	Slots for MEH, MDH, MDL	ON/OFF Switch
PBX508 – 3U	3U x 19"	Option – I	5 (3kW)	Option – GR
PBX508 – 3U+	3U x 19"	Option – I	6 (3kW)	Option – GR
PBX508 – 6U	6U x 19"	Option – I	10 (3kW)	Option – GR
PBX508 – 6UK	6U x 19"	Option – I	10 (6kW)	Option – GR

- Power Modules integrated into Power Box slots for a maximum of 5 modules (3U box) or 10 modules (6U box) with a maximum of 8 channels, single channel power modules are named MEH, two channel MDH or MDL.

Type	Voltage range	Channels per module	Peak output / Power
MEH	2V ... 7V	1	115A / 550W
MEH	7V ... 16V	1	46A / 550W
MEH	12V ... 30V	1	23A / 550W
MEH	30V ... 80V	1	13,5A / 650W
MDH	2V ... 7V	2	+/- 30A / 210W (420W total)
MDH	7... 16V	2	+/- 20A / 250W (500W total)
MDL	7... 24V	2	+/- 11,5A / 275W (550W total)

PL512 Power Supply System

The PL 512 is a high sophisticated, high density, programmable 6-channel floating low-voltage power supply system. Using the remote monitoring and control features either via USB or Ethernet it can be used to supply external load-channels with high power consumption also over long distances. Up to 3kW (3Ubox) DC output power can be provided.

Voltages, currents, temperatures and output power are programmable and controlled by the internal processor. Illegal modes as well as failure conditions will be detected. Dynamic behavior is programmable via USB port (long-moderate-short sensed distances to loads).

The modular construction with a 19" rack mountable power bin and a plug-in power supply box allows to swap the power supply without any tools and within shortest time.

PL512 Features

- Up to 12 independent, potential free DC outputs, 250W each, total up to 3 kW output power
- Extremely low noise and ripple
- Channels can be operated in Master-Slave mode for paralleling of two ore more outputs (current boosting)
- Floating range: +/-100V (default, optimal for low noise). Can be increased up to +/- 500V
- Programmable voltages and thresholds on voltages, currents and temperatures, ramp rates, fully controlled, programmable trip levels and action / group behavior, voltage or current controlled mode
- CE conform EN 50 081/82 part 1 (EN 50 022 B), safety in accordance with EN 60 950
- Ethernet and USB interfaces for remote monitoring and control, Web interface / SNMP
- 94V - 265VAC world-wide auto-range AC input, with power factor correction / sinusoidal mains current EN 61000-3-2, CE
- DC Output connections: 4mm (M4-80A), Sense and temperature sensor connections: 9 pin Sub D female connector for 2 channels, senses wired to terminals on rear side
- Optional alphanumeric display
- Optionally with Power fail- and System Reset-Signal
- Optionally with Interlock input
- Optional direct water cooling with same size as air cooled ones
- Dimensions: 430mm x 3U (133mm) x 325mm [whd], weight: from 9.6 to 19 kg, depending on the number of power modules

PL512 consists of:

- Power Bin: 19" bin for rack mounting hosting a power box

PL512 19" Power Bin

Type	Dimensions	Features
PBN512 – 3U RASO	3U x 19" x 445mm	Folded metal frame
PBN512 – 4U	4U x 19" x 445mm	Aluminum side panels

- Power Box containing a PFC mains input module, a control card and slots for up to 6 modules (MDH/MDL types, dual channel, 250W) for a maximum of 12 channels. The power box includes the Ethernet/USB combo card and can be outfitted with an optional display (EX version) as well as individual channel interlock feature (I option)

PL512 Power Box for insertion in Power Bin

Type	Dimensions	Features
PBX512	3U x 19" x 445mm	Ethernet, USB, "Easy Lever" extraction mechanism
PBX512– EX	3U x 19" x 445mm	Display, Ethernet, USB, "Easy Lever" extraction mechanism

- Power Modules integrated into Power Box for a maximum of 6 modules / 12 channels

Standard MDH/MDL power modules (up to 6)

Type	optimal Voltage range	Channels	Peak output / Channel
MDL – 07/24	7V ... 24V	2	+/- 11,5A / 275W (550W total)
MDH – 02/07	2V ... 7V	2	+/- 30A / 210W (420W total)
MDH – 07/16	7V ... 16V	2	+/- 20A / 250W (500W total)



PL512 with Display and RASO bin



PL512 rear view



PL512 without bin



PL512 rear view without bin

PL516 Power Supply System

The PL516 is a high sophisticated, high density, programmable 16-channel with full redundancy low-voltage power supply system. Using the remote monitoring and control features it can be used to supply a large numbers of external load- channels with high power consumption also over long distances.

Dynamic behavior is adjustable via software (long-medium-short sensed distances to loads). Voltages, Currents, temperatures and output power are programmed and controlled by the internal processor and illegal modes as well as failure will be detected.

The modular construction with a 19" rack mountable power bin and two plug-in power supply boxes.



PL516 Power Supply System



PL516 power bin front view



PL516 power bin rear view

PL516 Features

- Up to 2x 8 independent, potential free DC outputs, 250W /550W each, total up to 4 kW output power
- Output channels with fully redundancy
- Extremely low noise and ripple
- Channels can be operated in Master-Slave mode for paralleling of two ore more outputs (current boosting).
- Floating range: +/-100V (default, optimal for low noise). Can be increased up to +/- 500V
- Programmable voltages and thresholds on voltages, currents and temperatures, ramp rates, fully controlled, programmable trip levels and action / group behavior, voltage or current controlled mode
- CE conform EN 50 081/82 part 1 (EN 50 022 B), safety in accordance with EN 60 950
- Ethernet and USB interfaces for remote monitoring and control, Web interface / SNMP
- 94V - 265VAC world-wide auto-range AC input, with power factor correction / sinusoidal mains current EN 61000-3-2, CE
- DC Output connections: bin with customized DC connectors including Sense and temperature sensor connections
- Dimensions:3U (133mm) x 19" x 450mm , weight: depending on the number of power modules

PL516 consists of:

- Power Bin: 19" bin for rack mounting hosting a power box
 - Up to 8 low noise DC outputs
 - Available modules (up to 4 per Unit)

Type	Channels per Module	Optimal Voltage Range	Peak Output Current	Continuous Output Power
MDH	2	2V ... 7V / 8V	2*40A	2*230W
MDH	2	5 / 7V ... 15V / 16V	2*23A	2*250W
MDH	2	7V ... 24V	11.5A	2*275W
MEH	1	2 ... 7V	115A	550W
MEH	1	6 ... 10V	80A	550W
MEH	1	7 ... 16V	46A	550W
MEH	1	12 ... 30V	23A	550W
MEH	1	30V ... 80V	13.5A	550W

MARATON HHE - Power Supply System for Hazardous Hostile Radiation Environment

MARATON is a family of MAGnetic field and RADIation TOLeraNt power supplies developed for CERN LHC. MARATON HHE is the 12 channel version for use in a hazardous hostile environment.

Magnetic field tolerance is achieved by water cooling (up to 300G) and shielded components (up to 1200G). For radiation hardness (<30Gy) a quasi-redundant principle of power conversion is combined with special components. Further radiation sensible components are placed at remote locations.

The modular construction with a 19" rack mountable power bin and a plug-in power supply box allows to swap the power supply without any tools and within shortest time.

MARATON HHE Features

- Up to 12 independent, potential free outputs, total up to 3 kW DC output power (at nominal 385VDC input), 3.6kW power water cooled
- Fully controlled, adjustable trip levels
- Adjustable voltages, current limits, temperature limits and OVP-trip levels
- Extremely low noise and ripple
- CE conform EN 50 081/82 part 2 or 1, safety in accordance with EN 60 950
- VME compatible remote monitoring and control module for 12 channels with Ethernet (TCP/IP) interface (for Standard Environment)
- 385VDC input from PFC module (with standard mains input) placed on remote bin
- Water cooled (recommended) or by forced air

MARATON Remote Controller (RCM) Features

- 6U VME Board Form Factor, 160 mm, 4 TE
- Measurement of MARATON Voltage & Current Monitor Outputs
- 12 Channels (1x12 or 2 x <6), groups free definable
- Connection to MARATON power supplies via DSUB37 front panel connectors, alternative connection via J2 „User Defined“ and „Reserved“ Pins

MARATON consists of:

Power Bin: 19" bin for rack mounting hosting a power box

Type	Dimensions	Features
PBNMARA – 3U RASO	3U x 19" x 445mm	Folded metal frame
PBNMARA – 4U	4U x 19" x 445mm	Aluminum side panels

Power Box containing a PFC mains input module, a control card and slots for up to 6 modules (MDM / MDC types, dual channel, 250W) for a maximum of 12 channels. The power box includes the CAN-bus interface and can be outfitted with an individual channel interlock feature (I option)

Type	Dimensions	Features
PBXMARA	3U x 19" x 445mm	Ethernet, USB, "Easy Lever" extraction mechanism

Power Modules integrated into Power Box for a maximum of 6 modules / 12 channels

Type AL (up to 300G)	Voltage range	Channels	Peak output / Power
MDC – 02/07	2V ... 7V/8V	2	2 x 55A or 1 x 110A / 330W (660W total)
MDC – 07/16	5/7V ... 15/16V	2	2 x 22A or 1 x 44A / 330W (660W total)
MDC – 07/24	7V ... 24V	2	2 x 11,5A or 1 x 23A / 275W (550W total)
MDC – 30/60	30V ... 60V	2	2 x 6,6A or 1 x 13,2A / 330W (660W total)

Type FE (up to 1200G)	Voltage range	Channels	Peak output / Power
MDM – 02/07	2V ... 7V/8V	2	2 x 55A or 1 x 110A / 330W (660W total)
MDM – 07/16	5/7V ... 15/16V	2	2 x 22A or 1 x 44A / 330W (660W total)
MDM – 07/24	7V ... 24V	2	2 x 11,5A or 1 x 23A / 275W (550W total)
MDM – 30/60	30V ... 60V	2	2 x 6,6A or 1 x 13,2A / 330W (660W total)

- The RCM control card is placed on a remote VME crate
- The mains input module with PFC is placed in a remote bin

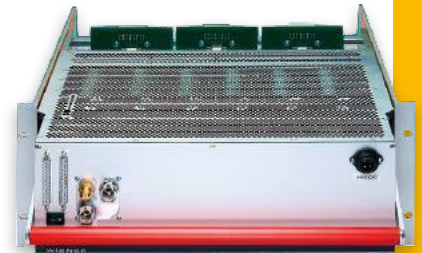

MARATON HHE



MARATON rear view



MARATON open view



RCM

VITA 62 VPX Power Supplies

WIENER VPX power supplies are commercial off-the-shelf (COTS), conduction cooled single stage converters according to the ANSI/VITA 62.0 specification. They can be used to power a VPX chassis and will fit into the standard envelope defined by VITA 48.0 specifications.

Using state of the art switching power technology a wide input voltage range as well as high overall efficiency is achieved.

The VPX power supply mechanical dimensions are 3U x 4HP (0.80" slot) and they are outfitted with connectors, keying and alignment mechanism as per VITA 62.

The VPX340 and VPX315 series is designed in compliance with relevant MIL STD 461, 704 and 1275. They can be outfitted with an optional hold up circuit as per MIL 704 with either internal or external capacitor bank.

An embedded microprocessor allows monitoring and control via I2C bus.



3U VPX conduction cooled ATR box



VPX340DMA front side



VPX340DMA back side
with wedge lock



VPX340DMA back side
with wedge lock

VPX371 - High Power

- Compliant to VITA 62 baseline specification
- Up to 715 W maximum / 600 W continuous power, parallel mode with Hartman Electronic Power-Backplanes possible
- Up to 88% peak efficiency
- 19 ... 35 V DC input voltage
- Voltage sense controlled, Over Voltage, Under Voltage, Over Current, Over Temperature protection

VPX340 - High Efficiency / Medium Power

- Compliant to VITA 62 specification and relevant MIL STD 461, 704, 1275
- Up to 400W output power
- High efficiency up to >90%
- Wide input voltage range: 16 ... 50 V DC, reverse polarity protection
- Voltage sense controlled, Over Voltage, Under Voltage, Over Current, Over Temperature protection
- Microprocessor controlled with via I2C bus communication for monitoring (status, input and output voltages and currents)

VPX315 - High Efficiency / Low Power

- Compliant to VITA 62 specification and relevant MIL STD 461, 704, 1275
- Up to 150 W output power
- High efficiency up to >90%
- Wide input voltage range: 16 ... 50 V DC, reverse polarity protection
- Voltage sense controlled, Over Voltage, Under Voltage, Over Current, Over Temperature protection
- Microprocessor controlled with via I2C bus communication for monitoring (status, input and output voltages and currents)

VPX Power Supply versions

Version	Size	Power	+12V	+3.3V	+5V	+12Vaux	-12Vaux	+3.3Vaux	DC-in
VPX371D	3U	715W	21A	50A	40A	4.2A	4.2A	7A	28V
VPX340DMA	3U	400W	15A	20A	40A	1A	1A	4A	28V
VPX315DMA	3U	150W	1A	3.3A	24A	-	1A	-	28V



Remote Interfaces

WIENER Remote Interfaces

Page

Remote Control - Introduction	112
CAN-bus	112
CAN-bus Introduction	112
WINCRM Software	112
CAN-bus OPC Server	112
Ethernet	113
Ethernet	113
WIENER Web Server	113
SNMP Introduction	113
SNMP OPC Server	114
SNMP Labview	114
Serial	114
Serial Introduction	114
USB	114
USB Introduction	114
WIENER USB Control	114
Troubleshooting / Configuration interface - Introduction	115
UEP6000 Software	115
Control, Measurement and Data Logging	116
CML01	116

The ability to remotely monitor and control power supply parameters has become increasingly more important over the years. WIENER recognizes this and provides many possibilities for remote monitoring. Whether you are working with a standard power supply or a highly customized crate, you will find a control interface that fits your application.

The table below is a guideline to the WIENER control interfaces and the products for which they will work. For more information about a specific interface and what software is available for that interface, please see the section specific to that interface.

	CAN-bus	SNMP Web server	Serial	USB
6000 Series Crates	•	•		
Maraton / RCM		•		•
MPOD		•		
Mini Crates 195	•	•		
Mini Crates 395		•		•
NIM/CAMAC Crates	•			
PL508	•	•	•	
PL506/PL512		•		•

CAN-bus Introduction

Controller Area Network (CAN) is a broadcast, differential serial bus standard, developed by Robert Bosch GmbH in the 1980s. Originally it was designed to connect electronic control units (ECUs). CAN was specifically designed to be robust in electromagnetically noisy environments and can use a differentially balanced line. Typically twisted pair cables are used for even better resistance to noise. Although initially adopted for automotive purposes, today CAN is used in many embedded control applications that may require resistance to noise. CAN-bus features an automatic, 'arbitration free' transmission. A CAN message transmitted with highest priority will 'win' the arbitration, and the node transmitting the lower priority message will sense this and back off and wait. This is ideal for system monitoring because it allows a node with a problem to send an unsolicited package, informing of the issue.

The data rate for CAN-bus is dependent upon the lengths in the network. For lengths less than 40m up to 1Mbit/s is possible. Lengths of up to 1000m are possible with a rate of only 50 kbit/s. The maximum data rates for various network lengths are shown in the table below.

CAN-bus Network Length	Data rate
< 40m	1 Mbit/s
< 100m	500 kbit/s
< 500m	100 kbit/s
< 1000m	50 kbit/s

The physical layer is not well defined in the CAN-bus standards, although there are some suggestions. The most common connector for CAN-bus is a 9-pin Dsub. More recently RJ45 connectors have become popular because of their low cost and ready availability. The CAN-bus signal must be terminated with 120Ω at both sides of the bus.

CAN-bus has been an option available on WIENER VME crates since 1995. The pin layout used for RJ45 connectors is shown above. The CAN-bus option is now standard on WIENER 6000/195 series crates as part of the WIENER combination interface board. It is also available for PL5xx and Maraton power supplies, MPOD, and some CAMAC crates.

RJ45	Pin	Signal	Comment
	1	CAN-H	
	2	CAN-L	
	3	GND	
	4	n.c.	
	5	n.c.	
	6	reserved	
	7	GND	
	8	n.c.	

CAN-bus Software: WINCRM

WIENER has developed WINcrm, which is a small CAN-bus monitoring application for controlling WIENER VME crates. This program allows up to 127 crates to be monitored from a single location. WINcrm can be downloaded from www.wiener-d.com or by contacting your WIENER representative.

The screen shots below show the WINCRM software with a large number of crates connected. The top image is an over view screen showing all of the crates connected to the network. The lower image shows the details of one of the crates in from the over view.

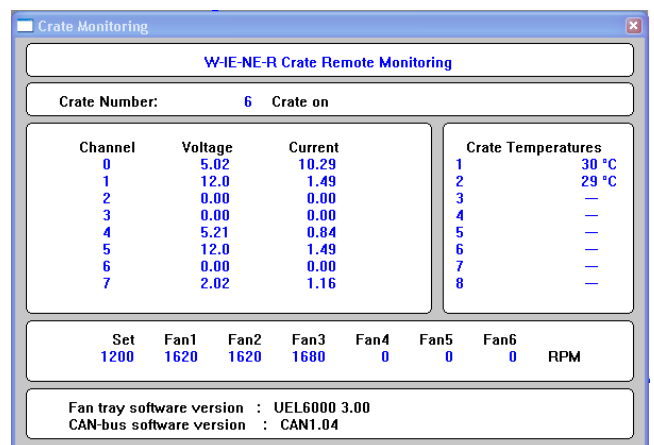
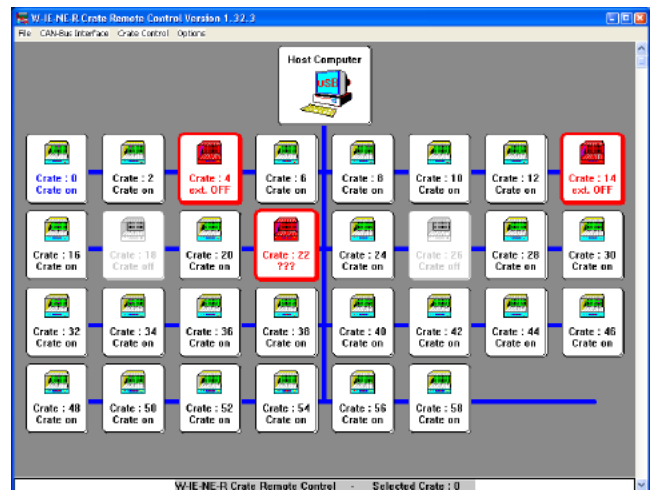

CAN-bus Software: OPC Server

The OLE Process Control (OPC) standard was first specified in 1996 to provide a unified API for the monitoring and control of many different types of devices. A WIENER developed OPC server is available and is capable of using either CAN-bus or Ethernet interfaces.

The WIENER OPC server runs as a service on a Windows XP computer. The server itself doesn't display any monitoring information. Instead the server gathers data from all connected devices and provides a way to access the data from an OPC client simply.

The server information is organized hierarchically. To access specific item a complete path must be provided. An example of the structure can be seen in image below.

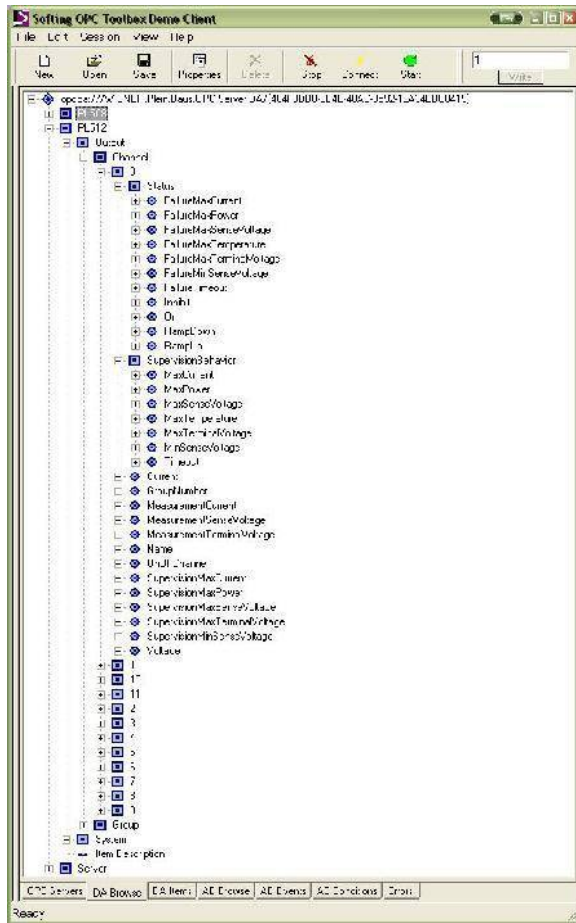

There are several options for OPC client software; WIENER uses the Softing Client. The client communicates with the OPC to request information. The server translates the request into a hardware level command (CAN-bus or SNMP) and returns the results from the command. The screenshot below shows an OPC client reporting data back from a PL512 power supply.

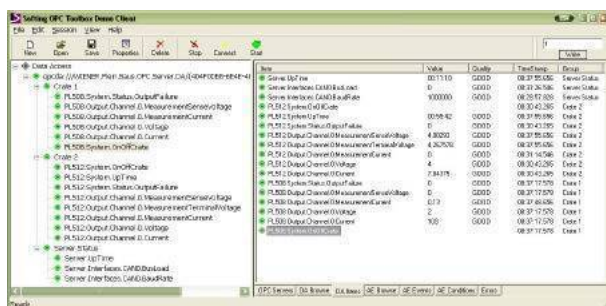

Ethernet

Ethernet is a large, diverse family of frame-based computer networking technologies for local area networks (LANs). Since many institutions already have an existing Ethernet infrastructure, it is often easy to connect to that infrastructure for monitoring.

WIENER 6000/195 series crates use Ethernet for monitoring in a number of ways. All WIENER 6000/195 series crates and MPOD come with an Ethernet interface by default as part of the combination interface board. It can optionally be added for PL508 and PL512 power supplies.

The Ethernet interface supplies one 10/100Mbit/s port with RJ45 connector. The IP address can be obtained automatically via BOOTP/DHCP, or set manually via USB (PL512 & MPOD) or a connected display (MPOD, VME crates). The interface can be accessed using a built in webserver or SNMP.

Ethernet Software: Web Server

All Ethernet equipped WIENER products have a built-in web server for easy monitoring capability. The biggest advantage of this interface is its simplicity, since it doesn't require any extra software to be developed or installed. To access the web server simply type the ip address of the crate or power supply you wish to monitor into any modern web browser (Internet Explorer, Firefox, Opera, etc.). The following picture shows the monitoring page for crates / PL5xx power supplies.

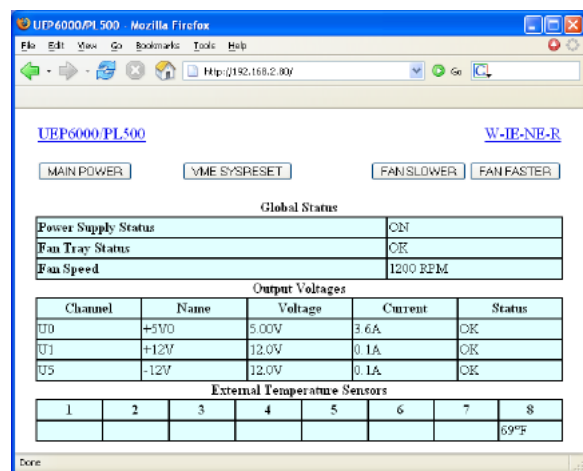

The function buttons, which allows the main power to be cycled, VME sysreset sent, or fan speeds to be changed, are all password protected to prevent unauthorized access.

Also MPOD low and high voltage power systems can be monitored via the web interface however; there are no control functions provided

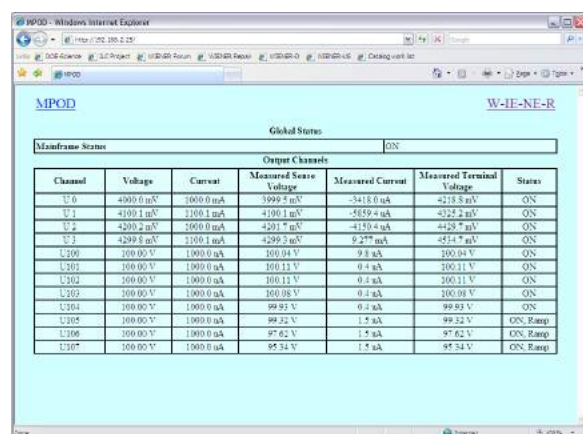

Ethernet Software: SNMP

Small network management protocol (SNMP) is an open standard used to monitor and control network devices. SNMP is commonly used to monitor the health of network switches, routers, printers, firewalls, etc. It is also well suited for monitoring and controlling WIENER crates and power supplies.

For every SNMP device a MIB file exists that provides a textual name for each parameter the device provides. For WIENER products all parameters are included in the **WIENER-CRATE-MIB.txt** file. In the case of the VME/VXI crates this includes fan speeds, power supply configuration, power supply status, and control bits. In addition the PL5xx and MPOD allow control of ramp speeds.

There are several software packages for interacting with SNMP devices and many different ways it can be done. WIENER suggests the use of the **netSNMP** open source library. This package provides C/C++, and command line interfaces. In addition WIENER has developed and makes available a small sample C++ library for working with WIENER devices. For MS Windows DLL libraries are provided. Also Labview VI's have been developed based on SNMP.

Web based monitoring and control applications are possible by using SNMP functions offered by PHP. This solution is very flexible and allows a custom application to be designed with minimal effort. The screenshot below shows a small example application for monitoring voltages and fan speeds from a single crate.

Using PHP it is possible to develop applications that monitor/control many parameters of an unlimited number of crates.

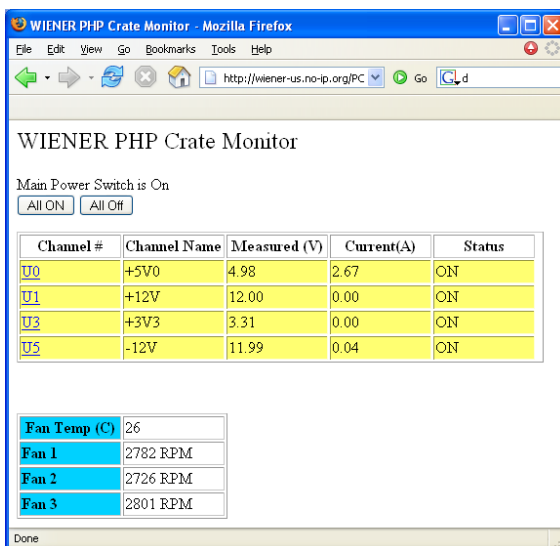

The SNMP objects available for WIENER crates are divided into four access level groups, and different privileges are necessary for access. So it is possible to allow view-only access to one user group, and full access to others.

Ethernet Software: OPC Server

The OLE Process Control (OPC) standard was first specified in 1996 to provide a unified API for the monitoring and control of many different types of devices. A WIENER developed OPC server is available and is capable of using either CAN-bus or Ethernet interfaces.

Ethernet Software: SNMP Labview

In an effort to make integrating WIENER devices in to a setup easier, WIENER has developed, and makes freely available, Labview VIs that can be used to monitor or control a WIENER VME crate or PL5xx power supply.

With these VI's a group that commonly uses Labview can quickly add monitoring information to the data stream and make remote power cycling easy to accomplish. Below is a control panel built of these VIs that shows possibilities for remote monitoring and control.

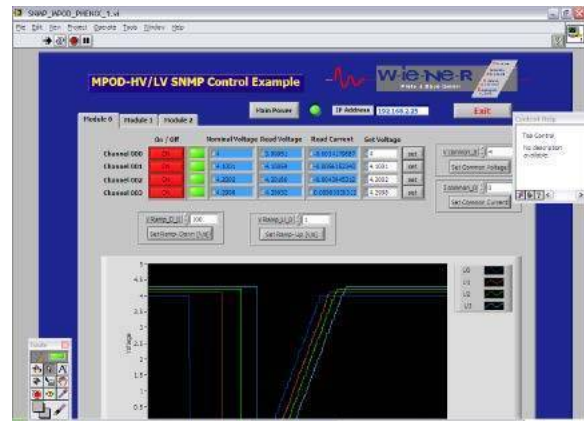

Serial

The WIENER combination interface, which provides CAN-bus and Ethernet control, also provides a serial interface for maintenance. The serial port uses a RJ45 connector with the pin out shown below.

RJ45	Pin	Signal	Comment
	1	n.c.	
	2	n.c.	
	3	n.c.	
	4	GND	
	5	RXD	Output
	6	TXD	Input
	7	CTS	Output
	8	RTS	Input

This serial port cannot be used for remote monitoring but is used mostly for firmware upgrades. The 6000-Series crates allow access of this port via the TELNET protocol, e.g. to get BIOS control or catch boot log messages of VME cards.

USB

Universal Serial Bus (USB) is one of the fastest growing communication protocols used today. This makes it ideal for a control bus since most modern computers have several USB ports and extras are easy to add. However, USB is limited to 10m before additional measures are needed.

USB2.0, the most recent revision, added USB high speed that is capable of up to 480Mbit/s. However this is only possible when transferring large data blocks. For system monitoring, the time for a small transfer is more important. The USB cycle timing varies by operating system but around 400µs is typical. This limits USB monitoring to 2.5kHz.

USB interfaces are available on WIENER PL5xx power supplies and RCM (maraton) control modules. Additionally WIENER offer VME and CAMAC crate controllers with a USB interface.

USB Software: MUSEcontrol

MuseControl is a WIENER developed program for control, setup and monitoring of WIENER USB equipped power supplies. It can also be used to setup the network interface so that Ethernet control can be used in the future.

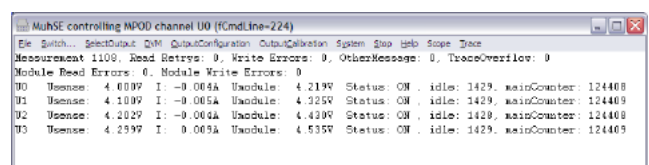

The figure below shows the output configuration screen of muse Control. This screen allows the user to easily adjust channel parameters and trip points.

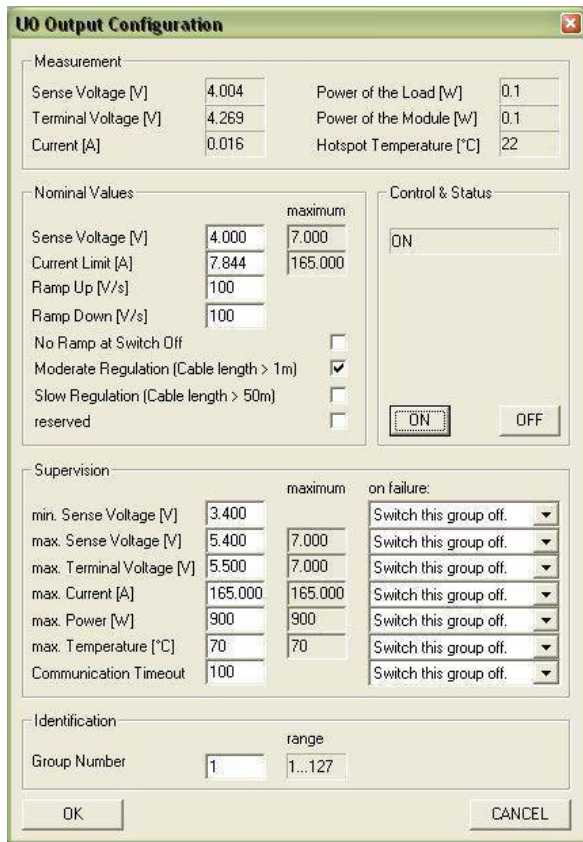

Troubleshooting/Configuration Interface

One of the most powerful features of WIENER power supplies is the ease of troubleshooting and configuring. This is particularly important for our 6000 series VME crates.

For troubleshooting and configuration a serial interface is used. However, it is necessary to build a small adapter, below, to separate the serial Rx, Tx, and ground lines as well as protect your PC from being damaged.

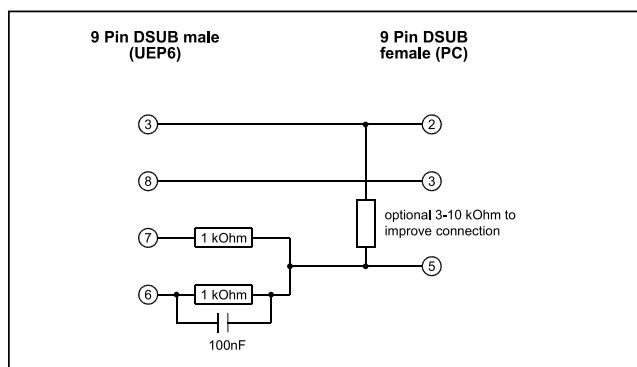

UEP6000 Software

WIENER provides the UEP6000 software as a way to troubleshoot and configure your power supply, shown below. Some of the data shown in the UEP6000 software is write protected to protect the power supply calibration. However some parameters, such as nominal set points, are not write protected and could lead to serious damage of they are adjusted carelessly.

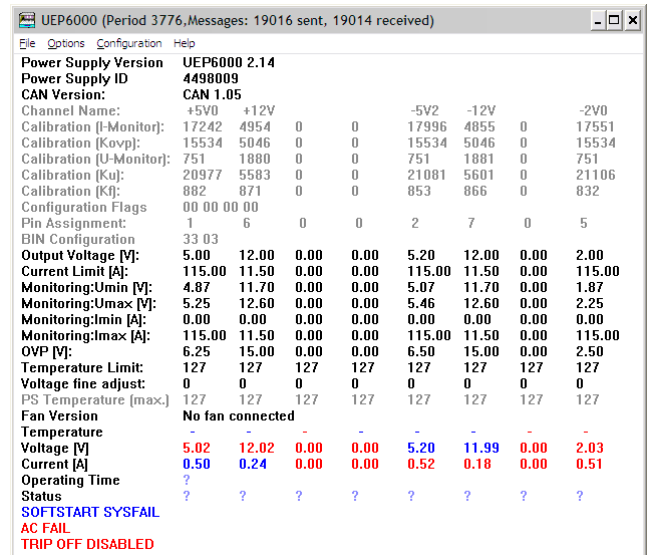

From the UEP 6000 software it is possible to change most of the parameters of a power supply including set points, Vmax, Vmin, Imax, and TEMPmax.

SYScontrol

Control of all systems with Ethernet/SNMP interface. Available for Windows and Linux operating systems.

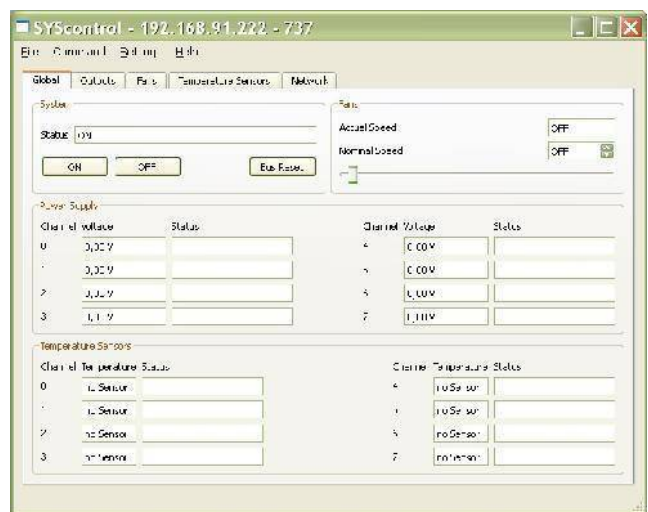

This program can be connected via USB, too, using the USB2IP proxy utility (Useful if the Ethernet settings are unknown and have to be changed).

WIENER Interface Software Summary

	Windows DLL	Linux Library	Labview	WinCRM	OPCServer	WebServer	UEP 6000	MUSEcontrol	SYScontrol
CAN-bus	•			•	•		•		
Ethernet	•	•	•		•	•			•
USB								•	•
Serial							•		



**W-IE-NE-R,
Power Electronics GmbH**

Linde 18
D - 51399 Burscheid, Germany
Tel (+49) 2174 6780
Fax (+49) 2174 678 55
www.wiener-d.com

**W-IE-NE-R,
Power Electronics Corp.**

202N Limestone Street, Suite 320
Springfield, OH 45503, USA
Tel +1 (937) 324 2420
www.wiener-us.com



A Phoenix Mecano Company