

Master

FINAL ENVIRONMENTAL IMPACT STATEMENT

Waste Isolation Pilot Plant

DISCLAIMER

This book was prepared as an account of work sponsored by an agency of the United States Government. Neither the United States Government nor any agency thereof, nor any of their employees, makes any warranty, express or implied, or assumes any legal liability or responsibility for the accuracy, completeness, or usefulness of any information, apparatus, product, or process disclosed, or represents that its use would not infringe privately owned rights. Reference herein to any specific commercial product, process, or service by trade name, trademark, manufacturer, or otherwise, does not necessarily constitute or imply its endorsement, recommendation, or favoring by the United States Government or any agency thereof. The views and opinions of authors expressed herein do not necessarily state or reflect those of the United States Government or any agency thereof.

Volume 2 of 2

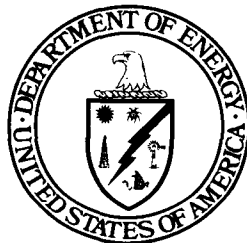

October 1980

U.S. DEPARTMENT OF ENERGY
Assistant Secretary of Defense Programs
Washington, D.C. 20585

DISTRIBUTION OF THIS DOCUMENT IS UNLIMITED



Table of Contents

Volume 2

	<u>Page</u>
Appendix A ALTERNATIVE GEOLOGIC ENVIRONMENTS	
A.1 General Basis for Choosing a Rock Medium.....	A-1
A.2 Salt.....	A-3
A.3 Crystalline Rocks.....	A-5
A.4 Argillaceous Rocks.....	A-8
A.5 Tuff.....	A-9
References.....	A-12
Appendix B THE NATIONAL WASTE TERMINAL STORAGE PROGRAM AND ALTERNATIVE GEOLOGIC REGIONS	
B.1 Regional Studies.....	B-1
B.2 Safety Studies.....	B-2
B.3 Status of Site-Selection Studies.....	B-2
B.3.1 Gulf Interior Salt Domes.....	B-3
B.3.2 Hanford Basalt.....	B-3
B.3.3 Nevada Test Site.....	B-4
B.3.4 Paradox Basin.....	B-5
B.3.5 Permian Basin.....	B-5
B.3.6 Salina Region.....	B-5
B.4 Permian Region.....	B-6
B.4.1 Geology.....	B-6
B.4.2 Hydrology.....	B-9
B.4.3 Climate.....	B-10
B.4.4 Background Radiation.....	B-11
B.4.5 Demographic, Socioeconomic, and Land-Use Systems.....	B-11
B.4.6 Terrestrial Ecosystems.....	B-12
B.4.7 Aquatic Ecosystems.....	B-12
B.5 Salina Region.....	B-13
B.5.1 Geology.....	B-13
B.5.2 Hydrology.....	B-15
B.5.3 Climate.....	B-17
B.5.4 Background Radiation.....	B-18
B.5.5 Demographic, Socioeconomic, and Land-Use Systems.....	B-18
B.5.6 Terrestrial Ecosystems.....	B-19
B.5.7 Aquatic Ecosystems.....	B-20
B.6 Paradox Region.....	B-20
B.6.1 Geology.....	B-20
B.6.2 Hydrology.....	B-22

CONTENTS (continued)

Volume 2

	<u>Page</u>
B.6.3 Climate.....	B-23
B.6.4 Background Radiation.....	B-24
B.6.5 Demographic, Socioeconomic, and Land-Use Systems.....	B-24
B.6.6 Terrestrial Ecosystems.....	B-24
B.6.7 Aquatic Ecosystems.....	B-25
B.7 Gulf Interior Salt-Dome Region.....	B-25
B.7.1 Geology.....	B-25
B.7.2 Hydrology.....	B-27
B.7.3 Climate.....	B-29
B.7.4 Background Radiation.....	B-30
B.7.5 Demographic, Socioeconomic, and Land-Use Systems.....	B-30
B.7.6 Terrestrial Ecosystems.....	B-32
B.7.7 Aquatic Ecosystems.....	B-33
B.8 The Hanford Site.....	B-33
B.8.1 Geology.....	B-33
B.8.2 Hydrology.....	B-35
B.8.3 Climate.....	B-36
B.8.4 Demography.....	B-36
B.8.5 Historic and Archaeological Sites.....	B-36
B.8.6 Ecology.....	B-36
References.....	B-37
 Appendix C PRESIDENT CARTER'S MESSAGE TO CONGRESS ON THE MANAGEMENT OF RADIOACTIVE WASTE AND THE FINDINGS AND RECOMMENDATIONS OF THE INTERAGENCY REVIEW GROUP ON NUCLEAR WASTE MANAGEMENT	
C.1 President's Message.....	C-1
C.2 Findings and Recommendations of the Interagency Review Group On Nuclear Waste Management.....	C-5
References.....	C-8
 Appendix D SELECTION CRITERIA FOR THE WIPP SITE	
D.1 Geologic Criterion and Site-Selection Factors.....	D-1
D.2 Hydrologic Criterion and Site-Selection Factors.....	D-4
D.3 Tectonic Stability Criterion and Site-Selection Factors.....	D-5
D.4 Physicochemical Compatibility Criterion and Site-Selection Factors..	D-7
D.5 Economic and Social Compatibility Criterion and Site-Selection Factors.....	D-8
References.....	D-10

CONTENTS (continued)

Volume 2

	<u>Page</u>
Appendix E DESCRIPTIONS OF WASTE TYPES	
Appendix F INCINERATION AND IMMOBILIZATION PROCESSES	
F.1 Incineration Processes.....	F-1
F.1.1 Processes for Radioactive-Waste Incineration.....	F-1
F.1.2 Processes for the Incineration of Commercial or Municipal Waste.....	F-2
F.2 Immobilization Processes.....	F-3
Reference.....	F-4
Appendix G METHODS USED TO CALCULATE RADIATION DOSES FROM RADIO- NUCLIDE RELEASES DURING OPERATION	
G.1 Introduction.....	G-1
G.2 Meteorological Routine.....	G-1
G.3 Dose Routine.....	G-6
G.4 Input Data.....	G-8
References.....	G-10
Appendix H DESCRIPTION OF THE <u>LOS MEDANOS</u> SITE	
H.1 Scenic, Historic, and Cultural Resources.....	H-1
H.1.1 General Appearance.....	H-1
H.1.2 History.....	H-1
H.1.3 Registered Historic Sites.....	H-2
H.1.4 Settlement.....	H-2
H.1.5 Archaeology.....	H-4
H.2 Population.....	H-11
H.2.1 Population Trends and Distribution.....	H-11
H.2.2 Social Characteristics.....	H-15
H.3 Economic Setting.....	H-27
H.3.1 General Economic Characteristics.....	H-27
H.3.2 Labor Force.....	H-32
H.3.3 Housing and Land Use.....	H-35
H.3.4 Community Facilities.....	H-38
H.3.5 Local Government.....	H-62
H.4 Meteorology.....	H-77
H.4.1 Regional Climate.....	H-77
H.4.2 Site Climate.....	H-82

CONTENTS (continued)

Volume 2

	<u>Page</u>
H.4.3 Short-Term (Accident) Diffusion Estimates.....	H-91
H.4.4 Long-Term (Routine) Diffusion Estimates.....	H-92
H.4.5 Air Quality.....	H-94
H.4.6 Paleoclimatology.....	H-96
H.5 Ecology.....	H-99
H.5.1 Introduction.....	H-99
H.5.2 Terrestrial Ecology.....	H-101
H.5.3 Aquatic Ecology.....	H-133
H.5.4 Endangered and Threatened Species.....	H-137
H.5.5 Preexisting Environmental Stresses.....	H-140
H.6 Background Radiation.....	H-142
H.7 Noise Background.....	H-147
H.8 The Future of the Site.....	H-148
H.8.1 Climatic Changes.....	H-148
H.8.2 Demographic Changes.....	H-148
H.8.3 Land-Use Changes.....	H-149
H.8.4 Geologic Changes.....	H-149
References.....	H-151
Annex Meteorological Tables	
Appendix I CORRESPONDENCE ON ARCHAEOLOGY, HISTORIC SITES, PRIME FARM LAND, AND ENDANGERED SPECIES	
Appendix J EFFLUENT AND ENVIRONMENTAL MEASUREMENTS AND MONITORING PROGRAMS	
J.1 Preoperational Environmental Programs.....	J-1
J.1.1 Geology.....	J-1
J.1.2 Hydrology.....	J-11
J.1.3 Meteorology.....	J-16
J.1.4 Air Quality.....	J-19
J.1.5 Ecology.....	J-22
J.1.6 Radiation Monitoring.....	J-24
J.2 Proposed Operational Monitoring Programs.....	J-27
J.2.1 Geology.....	J-28
J.2.2 Hydrology.....	J-29
J.2.3 Meteorology.....	J-30
J.2.4 Air Quality.....	J-30
J.2.5 Ecology.....	J-30
J.2.6 Radiation Monitoring.....	J-30
J.3 Postoperational Monitoring Program.....	J-33

CONTENTS (continued)

Volume 2

	<u>Page</u>
J.4 Related Environmental Programs by Others.....	J-35
J.4.1 Bureau of Land Management.....	J-35
J.4.2 New Mexico Environmental Improvement Division.....	J-35
J.4.3 U.S. Geological Survey.....	J-35
J.4.4 Environmental Protection Agency, Las Vegas, Nevada.....	J-36
J.4.5 Potash Industry.....	J-36
J.4.6 National Oceanic and Atmospheric Administration.....	J-36
J.4.7 New Mexico Department of Game and Fish.....	J-36
J.4.8 Ongoing Regional Ecological Studies.....	J-37
References.....	J-39
 Appendix K METHODS USED IN LONG-TERM SAFETY ANALYSES	
K.1 Hydrologic Transport.....	K-1
K.1.1 Introduction.....	K-1
K.1.2 Reservoir Model Equations.....	K-2
K.2 Application of the Transport Model to the WIPP Site.....	K-9
K.2.1 Data Interpretation and Regional Hydrologic Modeling.....	K-9
K.2.2 Modeling of Liquid-Breach Scenarios.....	K-20
K.2.3 Modeling of Radionuclide Transport.....	K-23
K.3 Direct-Access Scenarios.....	K-24
K.3.1 Method for Calculating Radionuclide Transport in Air.....	K-25
K.3.2 Uncertainties in the Calculation.....	K-27
References.....	K-28
 Appendix L AN OUTLINE OF THE INPUT-OUTPUT MODEL AND THE IMPACT PROJECTIONS METHODOLOGY	
L.1 Input-Output Model.....	L-1
L.1.1 Base Model.....	L-2
L.1.2 Household Compensation for Labor and Personal Consumption in the Area.....	L-2
L.2 Output Multiplier.....	L-3
L.3 Employment Multipliers.....	L-3
L.3.1 Wages.....	L-18
L.3.2 Calculating Indirect Job Impact.....	L-18
L.4 Population.....	L-39
L.4.1 Factors Affecting Population.....	L-39
L.4.2 Population Impact Calculations.....	L-40
L.5 Personal Income.....	L-50
L.5.1 General.....	L-50
L.5.2 Explanation and Values.....	L-50

CONTENTS (continued)

Volume 2

	<u>Page</u>
L.6 Housing, Land Use, and Community Services.....	L-54
L.6.1 Housing and Land Use.....	L-54
L.6.2 Community Services and Facilities.....	L-56
L.7 Fiscal Impact Analysis.....	L-58
L.7.1 Revenues.....	L-58
L.7.2 Expenditures.....	L-62
L.7.3 Net Fiscal Impacts.....	L-62
Bibliography.....	L-64
Annex A Non-Survey Technique for Constructing a Direct Requirements Regional Input-Output Table.....	L-66
Appendix M SOCIOECONOMIC EFFECTS OF PLANT CONSTRUCTION AND OPERATION: SUPPORTING DATA	
Appendix N EFFECTS OF LEAVING THE TRU WASTE AT IDAHO	
N.1 Leaving the Waste in Place, as Is.....	N-1
N.1.1 Description of Operations.....	N-1
N.1.2 Environmental Effects.....	N-1
N.1.3 Radiological Risk to the Public.....	N-2
N.1.4 Hazards to Workers.....	N-3
N.1.5 Costs.....	N-4
N.2 Improving In-Place Confinement of Stored Waste.....	N-4
N.2.1 Description of Operations.....	N-4
N.2.2 Environmental Effects.....	N-4
N.2.3 Radiological Risk to the Public.....	N-5
N.2.4 Hazards to Workers.....	N-5
N.2.5 Costs.....	N-6
N.3 Retrieving, Processing, and Disposing of the Waste at the INEL.....	N-7
N.3.1 Description of Facilities and Operations.....	N-7
N.3.2 Environmental Effects.....	N-8
N.3.3 Radiological Risks to the Public.....	N-9
N.3.4 Hazards to Workers.....	N-11
N.3.5 Costs.....	N-12
N.4 Conclusions.....	N-12
References.....	N-15

CONTENTS (continued)

Volume 2

	<u>Page</u>
Appendix O INTERPRETATION OF THE RADIATION DOSES PREDICTED IN THIS DOCUMENT	
O.1 Radiation Doses and Dose Commitments.....	O-1
O.2 Methods for Interpreting Predictions of Radiation Doses.....	O-2
O.2.1 Method 1: Comparison with Natural Background Radiation.....	O-2
O.2.2 Method 2: Comparison with Official Standards.....	O-4
O.2.3 Method 3: Estimates of Health Effects.....	O-4
References.....	O-8
Appendix P COMMENTS FROM FEDERAL AND STATE AGENCIES ON THE DRAFT ENVIRONMENTAL IMPACT STATEMENT FOR THE WASTE ISOLATION PILOT PLANT	
Appendix Q REPORT OF THE HEARINGS PANEL ON THE DRAFT ENVIRONMENTAL IMPACT STATEMENT FOR THE WASTE ISOLATION PILOT PLANT	

Appendix A

ALTERNATIVE GEOLOGIC ENVIRONMENTS

CONTENTS

	<u>Page</u>
A.1 General Basis for Choosing a Rock Medium.....	A-1
A.2 Salt.....	A-3
A.3 Crystalline Rocks.....	A-5
A.4 Argillaceous Rocks.....	A-8
A.5 Tuff.....	A-9
References.....	A-12

LIST OF TABLES

	<u>Page</u>
A-1 Comparison of Geologic Media.....	A-4

LIST OF FIGURES

	<u>Page</u>
A-1 Map of rock-salt deposits in the United States.....	A-6
A-2 Granite and basalt deposits in the United States.....	A-8
A-3 Deposits of argillaceous rock in the United States.....	A-10
A-4 Tuff deposits in the United States.....	A-11

Appendix A

ALTERNATIVE GEOLOGIC ENVIRONMENTS

For the near future (10 to 15 years), the only method available for the permanent disposal of transuranic (TRU) and high-level wastes is emplacement in cavities mined in a geologic formation. Several types of geologic formations show promise as burial environments--salt, crystalline rock, argillaceous rock, and tuff. Which of these is to be used for a repository depends on when the choice among them is to be made; the longer one waits to make this decision, the greater the number of choices that are open. The time scales for these choices are summarized in Chapter 3 of this document.

As background material for the discussions in the main text of this document, this appendix briefly describes the properties of the four candidate types of rock. The U.S. Department of Energy (DOE) is investigating these four media for possible use with high-level waste as well as the TRU waste to be received at the WIPP. Reflecting the investigations, this appendix includes some discussion of properties like thermal conductivity that are critical to the design of repositories for high-level waste, but are not of major importance to the WIPP.

The current investigations of alternative geologic media are extensive, and this brief review is not intended to cover them thoroughly. A comprehensive review of the candidate geologic media appears in the draft generic environmental impact statement (GEIS) for the management of commercially generated radioactive waste (DOE, 1979). Another recent review has been made by the Interagency Review Group (IRG) on Nuclear Waste Management, whose reports (IRG, 1979; IRG Subgroup, 1978) contain recommendations about the choice of geologic media. References to other reviews and to detailed data appear in the GEIS and in the IRG reports.

After presenting background material that explains the bases for choosing a rock medium, this appendix reviews each of the four candidate media.

A.1 GENERAL BASIS FOR CHOOSING A ROCK MEDIUM

The selection of a specific medium depends on two major properties: geologic and hydrologic characteristics, which must resist forces that might expose the buried waste to the biosphere, and structural characteristics, which must permit the construction of a mined cavity without disturbing the geologic and hydrologic characteristics. A satisfactory rock medium must present little threat that its hydrologic and geologic characteristics could provide a mechanism or pathway by which the waste could return to the surface in harmful quantities.

The geologic characteristics are important because the purpose of a waste repository is to provide a place in which a solid material can be buried permanently. As long as the material remains solid, it has little chance of leaving its place of burial because it can do so only if some process opens the earth to the depth of the burial point or if the surface is removed to

that depth. Therefore geologic formations that have been stable for long periods are sought for repository locations, on the assumption that the long-inactive disruptive forces in the earth there will remain inactive.

Material buried in solid form might return to the surface in another way: by being engulfed in a stream of water that dissolves the material and carries it to the surface. Because the forces that influence the flow of underground water are less catastrophic (and potentially more likely) than those that might uncover a deeply buried solid, the hydrologic characteristics of a medium may have greater influence on its selection than the geologic characteristics.

The structural characteristics of the rock are important because a repository must be designed, constructed, and operated in such a fashion that it will not upset the geologic and hydrologic characteristics. Because a repository is an engineered structure, its ability to isolate the waste will depend on the material in which it is constructed. Consequently, the selection of the geologic medium must facilitate the engineering design of a structure that will have a minimum probability of releasing its contents.

To be able to design the underground structure to minimize its impact on the hydraulic environment, the burial medium must be chosen with special attention to its mechanical, physical, and chemical properties. In repositories that contain heat-producing waste, the burial medium must be able to withstand the thermal stresses induced by that waste. Furthermore, establishing an effective design requires analytical models for the structure that take into account the properties of the geologic medium; without meeting this fundamental requirement, it would be extremely difficult to be confident that the design of the repository meets the fundamental requirements. The ability to conduct the engineering analysis depends strongly on a thorough knowledge of the properties of a proposed medium. For this reason, the preferred medium must have well-studied properties.

To decide in detail whether the properties of a geologic medium are satisfactory requires that several questions be answered, including the following:

- Will the subsurface structure be able to remain open and operable over the planned lifetime of the repository?
- Can the structure be used for waste disposal without adversely affecting the surrounding geologic and hydrologic environments?
- Can the structure be used without adversely affecting its own structural integrity?
- Will the structural material be adversely affected by heat, and will it react chemically with the waste?
- Will the surrounding geologic material react chemically with the waste?

By reviewing these questions along with others, it is possible to identify specifically the important properties of a geologic medium. Among the chemical properties, it is necessary to understand the solubility and chemical stability of the medium, its ability to resist chemical change during heating, and the corrosiveness of fluids it contains. Important mechanical properties include tensile and compressive strength and stress-strain relationships as

expressed by elastic and bulk moduli. Important physical properties include thermal conductivity, thermal expansion, heat capacity, and decrepitation temperature. These properties are not known equally well for all the candidate media.

In addition to knowing these basic data, it is important to have a well-developed mathematical model for predicting the mechanical behavior of a repository in the chosen medium. This model must predict the stresses, deformations, and temperatures that the geologic medium will experience. It must model the mechanisms by which the structure or its surroundings can fail; it can then test the conditions (stress, temperature, etc.) under which failure could occur.

Each of the four sections that follow reviews a geologic medium in the context of this discussion. Table A-1 compares the three major geologic media according to a number of important properties.

A.2 SALT

When geologic media were first evaluated for the emplacement of radioactive waste, salt was judged to be the best choice for a number of reasons, including long-term geologic stability, spatial predictability, suitability for engineering analysis, thermal and mechanical properties, ease of repository construction, freedom from circulating groundwater, chemical stability, and the existence of extensive masses of uniform material. The original report of a committee established by the National Academy of Sciences-National Research Council (1957) recommended that salt be evaluated as a storage medium because it has excellent thermal and physical properties. The report pointed out that the existence of salt formations for several hundred million years demonstrates that they have been isolated from disturbing forces on the surface and from circulating groundwater; consequently, there is an extremely high probability that they will remain isolated in the future. Other desirable features of salt formations are their uniform consistency, simple geologic structure, and predictable stratigraphic character over large regions. Furthermore, the mechanical and physical properties of salt are known well enough to provide a good basis for the engineering analyses necessary for designing a repository.

Experiments to confirm the evaluation of salt as a suitable geologic medium began in 1965 under Project Salt Vault (Bradshaw and McClain, 1971), which operated for 2 years. Other experiments have been conducted over the past decade at the Asse experimental repository in the Federal Republic of Germany (Kuehn et al., 1976). The experiments have confirmed the basic understanding of the fundamental properties of salt and the engineering analysis required to design a repository in salt.

Project Salt Vault brought to the attention of repository designers the phenomenon of brine migration: small amounts of brine that occur in salt (usually less than 1% by weight) move toward emplaced heat sources. It has been asserted that accumulations of brine in salt can lower its mechanical strength. As long as the brine remains distributed, however, its impact on strength will be minimal. Migration phenomena and reduction in strength can be considered potential problems only when elevated temperatures with large

Table A-1. Comparison of Geologic Media

Property	Salt	Basalt or granite	Shale
BASIC PROPERTIES			
Plasticity	High	None	Variable
Solubility	High	Very low	Very low
Sorptive capacity	Low (depends on impurities)	Fair	High
Compressive strength	Moderate	High	Moderate
Thermal diffusivity	High	Low	Low
Thermal stability against chemical decomposition	High	High; potential dewatering of clay in basalt	High; potential dewatering of clay
IN-SITU PROPERTIES			
Porosity	0.5%, interstitial	1%, cracks	5-30%, cracks
Permeability	Essentially none	Decreases with depth	Very low
Water presence	Isolated from flowing groundwater	Present, open to flowing groundwater	Present, open to flowing groundwater
Corrosiveness of indigenous fluid	High	Low to moderate	Low to moderate
Tectonic stability	Very stable	Very stable areas can be found	Very stable areas can be found
Geologic structure	Relatively simple areas can be found	Fracture systems often complex	Like salt
Hydrology	Moderately difficult to characterize	Difficult to characterize	Difficult to characterize
PRACTICAL MATTERS			
Availability	Good	Good	Good
Need to use explosives	No	Yes	Possibly
Understanding of medium for repository use	Well studied	Not well studied	Not well studied
Waste rock	Reuse some; pile needs protection from erosion and runoff	Reuse some; pile probably does not need protection	Reuse some; pile needs protection, but less than salt
Mathematical modeling	Relatively simple; well developed	Relatively complex; not fully developed	Relatively complex; not fully developed

thermal gradients are present. The migration of brine toward heat sources is being investigated to determine whether it can increase the water content of the salt near hot waste and affect the strength of the salt there.

In a TRU-waste repository, reduced strength of salt due to the presence of brine is of minimal significance because little heat-producing waste will be emplaced there. For centuries underground mines have been built in salt; the stability of these mines has not been measurably affected by the presence of brine. The TRU waste in the repository will not provide significant heat-induced perturbing forces on the structure or its surroundings.

The intrinsic properties that make salt an attractive medium include uniformly low permeability, high thermal conductivity, abundance in thick masses, and plasticity that enables fractures to heal themselves at feasible repository depths. However, the high solubility of salt requires that extensive knowledge of regional and site hydrology be obtained before a repository site is selected; it will be necessary to develop an understanding about possible future groundwater flow at a chosen site.

The solubility of rock salt in water is two orders of magnitude greater than that of any other candidate medium. If man-made or natural events caused a breach in the repository, circulating groundwater could release the radionuclides in the waste, although the sorptive capacity of the geologic materials along the flow paths would retard the release of these nuclides. A thorough knowledge of these sorption properties is required for the particular rocks and the particular groundwaters at a repository. Generally, the sorptive capacity of salt is low and dependent on the impurities in salt.

Extensive salt mining in many locations around the United States and abroad has resulted in a well-developed salt-mining technology. One particular advantage associated with salt mining is that, after shaft construction, explosives are not needed. Electrically powered continuous-mining machines can construct the storage rooms; diesel-powered carriers haul the mined salt to branch-corridor conveyors, which are frequently extended to keep the hauling distances as short as possible.

Salt differs from basalt and shale in the potential environmental impacts of the waste rock from mining that has to be stored at the surface. The surface-storage pile would have to be designed to limit wind erosion and precipitation runoff in order to minimize potential environmental impacts during and after repository operation.

In summary, salt is the best understood of all candidate geologic media with respect to its possible use as a waste-repository medium, and it offers advantages in thermal properties and plasticity. It is found in many places in the United States (Figure A-1).

A.3 CRYSTALLINE ROCKS

Basalt, granite, and other crystalline igneous and metamorphic rocks have been proposed as geologic media for a repository; extensive deposits that have been stable for millions of years exist in the United States. The evaluation of these media is in an early stage of data collection, and an effort is under

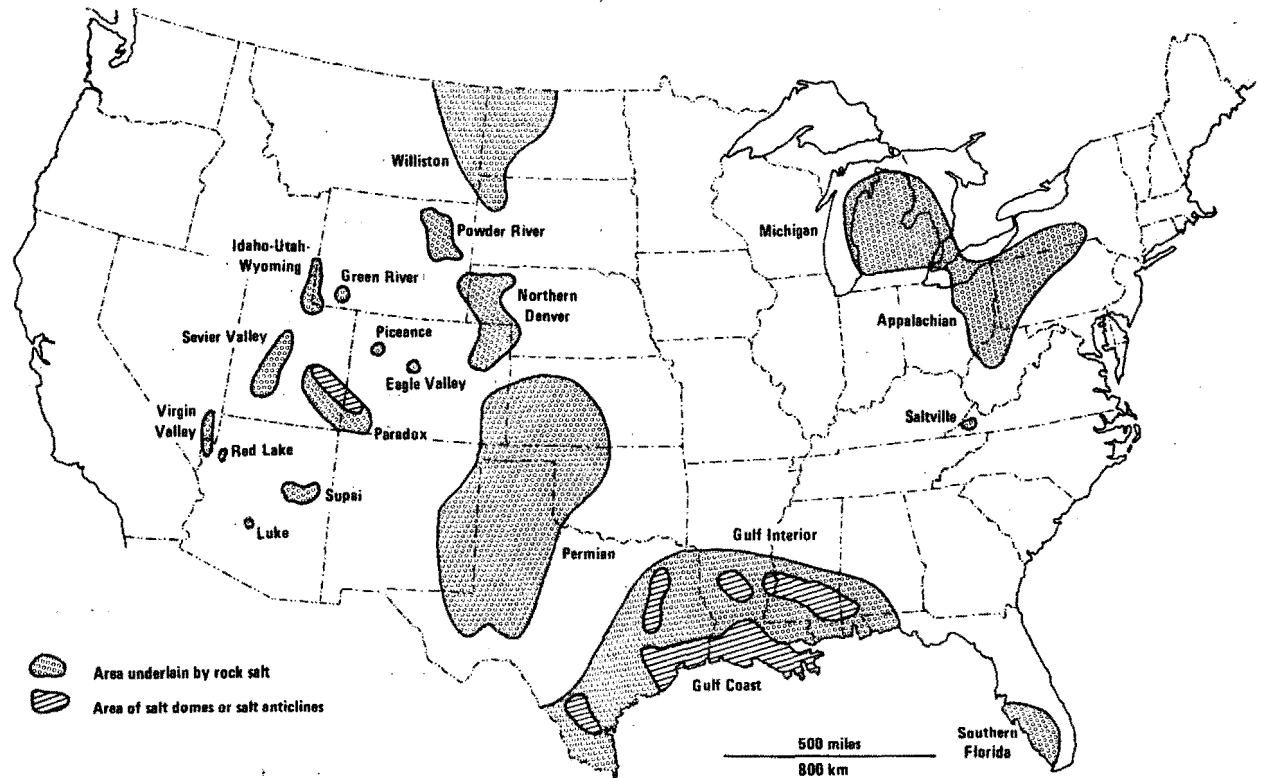

Figure A-1. Map of rock-salt deposits in the United States.

way to compile the information systematically. The basic mechanical properties (compressive strength, tensile strength, modulus of elasticity, etc.) of these rocks have been established through laboratory tests. The properties of the aggregate are, however, considered to be substantially different from those of the small samples of whole rock because crystalline rocks are fractured and cannot be reconstituted (unlike fractured salt, which will "weld" under lithostatic pressure). It is technically possible to build openings in crystalline rocks; still under development are analytical procedures that will completely evaluate the impact of thermal loads on mine structures in such rock or the surrounding rock formations.

Crystalline rocks do not dissipate heat as well as salt does; the thermal conductivities of crystalline rocks are about one-fourth that of salt. Each repository in crystalline rocks will be designed with heat loads adjusted to the thermal conductivity prevailing at the site. For some time heat transfer through crystalline rock has been considered a potential problem because the effects of cracks on thermal conductivity are not well known; heat dissipation in a medium with a random pattern of cracks is presently difficult to analyze. Experiments measuring heat conduction in granite are under way in Sweden and at the Nevada Test Site (NTS). The test at NTS showed that the cracks in NTS rocks affected the thermal conductivity by less than 10%. Tests conducted at both locations confirm that temperature distributions in hard rock can be calculated with a high level of accuracy.

Although large formations of salt, while soluble in water, are impervious to the flow of water, large formations of crystalline rocks are full of fractures that would provide convenient paths for water flow. In a backfilled, sealed repository built below the water table in crystalline rock, the cracks and void spaces may eventually fill with water. Because the cracks throughout the formation are mostly small, the ratio of water volume to rock volume is small. Nevertheless, a major drawback is that it is not yet possible to calculate the total flow and mass transport under the fracture-flow conditions. In addition, it is not yet possible to identify the effects that thermal loading will exert on the flow of water into or out of a sealed repository. Techniques for making these calculations are being developed.

Flow through a fractured medium will depend on the connectedness and size of the fractures. Their size is controlled to a large extent by the normal stresses acting across the fractures; since these stresses increase with depth, the permeability of crystalline rock usually decreases with depth. Although a model has not been established to accurately evaluate fracture flow, experience has shown that at depths of 1500 feet or more below the surface the fracture permeability is so low that it may not be a significant threat even when conservatively evaluated.

Because the water in crystalline rocks is more mobile than the water in salt, it may contribute to slow leaching of the radioactive nuclides from the waste. Although this condition might appear to be a problem, the magnitude of the problem is diminished because granite and basalt have sorptive properties that cause the radioactive elements in the water to be removed by chemical reactions with the rock. Furthermore, the typically low ionic strength of the water found in these formations reduces the possibility of adverse effects on these sorptive properties. Because of these favorable natural conditions, it appears that the corrosion of waste canisters stored in a crystalline-rock repository will be slow; the canister may maintain its integrity over many hundreds of years.

A major difference between repositories in crystalline rock and in salt will be in the methods of construction. While it will be possible in salt to use mining machines, crystalline rock will require drill-and-blast techniques whose impact on the integrity of a repository is still unknown. Such techniques might adversely affect the rock within a few meters around the mined openings. Since the rock beyond this affected volume will provide the required isolation, it is not clear that drill-and-blast construction will affect the long-term integrity of a repository. Experiments will be necessary to answer this question.

Major formations of granite and basalt exist in the United States; Figure A-2 shows their general locations. Reconnaissance studies have shown that the attractive granite formations include those in New England, the Rocky Mountain uplift, the Sierra Nevada Mountain Range, the Appalachian Mountains, and the Canadian Shield in northern Minnesota and Wisconsin. The basalt formations of interest are the Columbia Plateau Flood Basalts in Washington, Oregon, and Idaho. Because both the granite and the basalt formations are extensive, there is ample opportunity to find suitable sites. Field studies on the suitability of crystalline rocks are being conducted by the DOE at the Hanford Site, at the Nevada Test Site, and in Sweden. Sweden and Canada also have such programs.

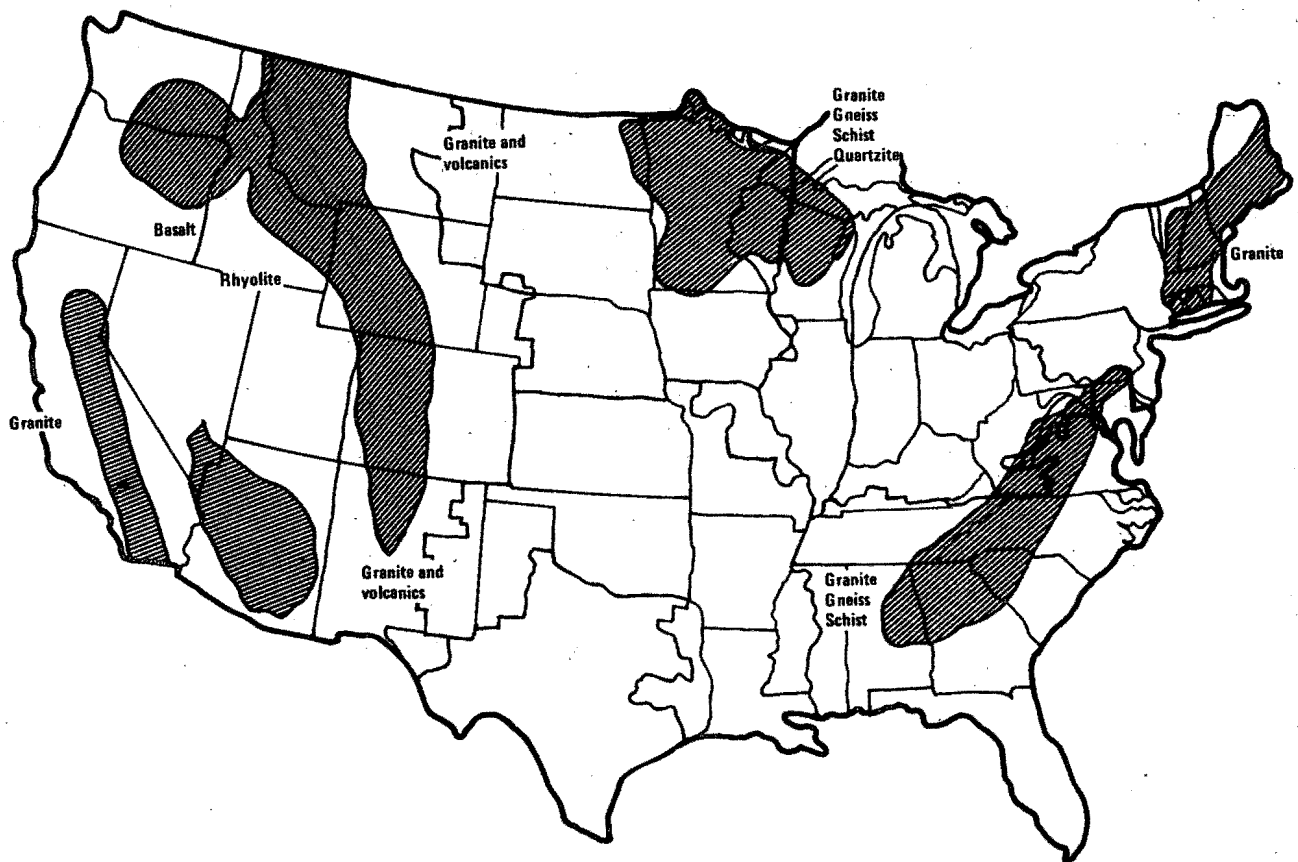

Figure A-2. Granite and basalt deposits in the United States.

A.4 ARGILLACEOUS ROCKS

Argillaceous rocks, especially shales, have also been proposed as geologic media for repositories. Argillaceous rocks vary widely in their characteristics: some shales are relatively plastic, with a high water content; others are relatively brittle, with a low water content. Because of the variation in their structure, these rocks vary widely in mechanical properties. Their strength in a direction perpendicular to the layers is often substantially different from their strength parallel to the layers. Shales exhibit good strength properties in compression but little or no strength under tensile load. Shales with a high water content may be highly plastic, deforming slowly under in-situ stresses; while good for closing cracks, this feature is poor for designing, constructing, and operating a mine that must remain open for 20 years. The anisotropy of shale and the possible variations in its properties make shale repositories difficult to model and analyze generically. Site-specific analyses and designs will be necessary for each proposed shale repository.

The ability of argillaceous rock to dissipate heat is comparable to that of crystalline rock. While facilitating uniform heat flow, the presence of substantial quantities of water in shale may set a relatively low upper limit

on the temperature of the waste to avoid producing high-pressure gas through the conversion of water to steam. The design of a repository in shale will adjust the thermal output of the waste to avoid this possibility. Experiments with heaters have been conducted in two different types of shale. The results of tests in wet layered shale are consistent with the above picture. Tests in nonlayered low-water-content shale indicate heat-dissipation characteristics similar to those of granite and basalt. These tests confirm that temperature distributions in different types of shale can be calculated with an acceptable level of accuracy (Tyler et al., 1979).

Shale, a material of low in-situ permeability (Magara, 1971), is insoluble in water; it deforms under lithostatic loads, closing inherent joints. Because of these properties, water does not move easily through shale, even though shale may contain substantial quantities of formation water. Although heat could produce a major driving force to move the water, most of the waste to be received at a TRU-waste repository will not provide such a heat load.

Argillaceous rocks, like crystalline rocks, may provide an aqueous environment conducive to slow corrosive attack on the encapsulated waste. Water entrapped in shale is of intermediate ionic strength, which moderately inhibits corrosive action on canisters. After a canister has been penetrated, the dissolution of the waste inside would also be slow because of the intermediate-level ionic strength of the water. The presence of radio-nuclides in the water will be mitigated by two major factors: the slow rate of water movement through the tight shale formations and the strong sorptive capacity of the shale minerals, which reduces the concentration of radio-nuclides in the water through chemical reactions.

The methods for constructing a repository in shale will vary: the soft layered type of shale could be mined with machines, while the harder argillites might require drill-and-blasting techniques. A major concern about the construction and operation of a repository in shale is the possible occurrence of squeezing zones: thin layers of unusually soft, plastic material that could be squeezed by lithostatic forces into mined openings. A study of the Eleana argillite at the Nevada Test Site showed that a repository in this type of formation would require substantial expenditures for necessary structural supports underground because of the presence of squeezing zones (Fenix and Scisson, 1978; Yaner and Owen, 1978).

Large formations of argillaceous material are located in the United States; the largest is the Pierre Shale, in portions of North Dakota, South Dakota, Colorado, Montana, and Wyoming. Figure A-3 shows the location of this and other major argillaceous formations in the United States.

A.5 TUFF

Tuff is composed of material ejected from volcanoes; some of the best tuff formations are located in volcano calderas. It has only recently been considered for repositories; data on its suitability have been gathered for approximately 1 year. Figure A-4 shows regions in the United States where tuff

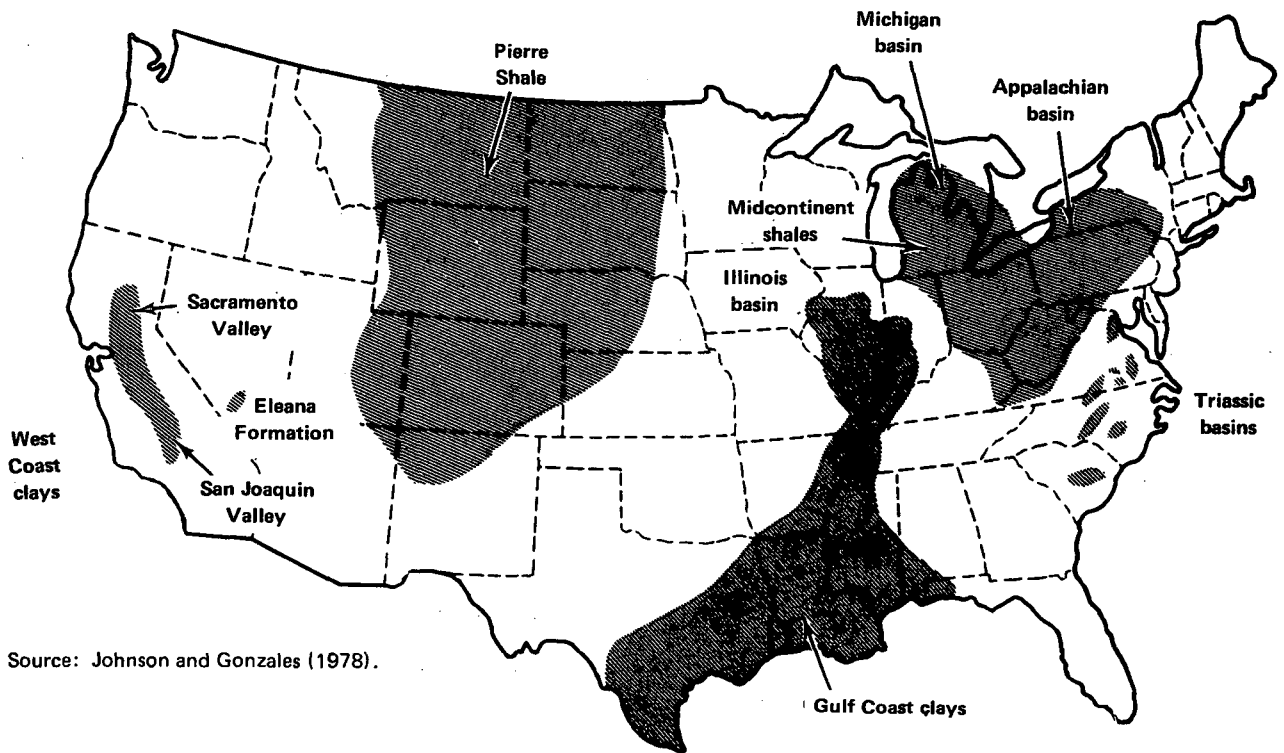

Figure A-3. Deposits of argillaceous rock in the United States.

deposits are found. None of these regions are in the eastern part of the country; material originally ejected from volcanoes there has metamorphosed and is not classified as tuff.

There are two types of tuff to consider. Welded tuff has low porosity, low permeability, high strength, good thermal stability, and moderate chemical sorptivity. Nonwelded tuff has high porosity, low permeability, high water content, low strength, good thermal stability when dry, unusual thermal expansion properties, and extremely high chemical sorptivity. The first investigations of these materials suggest that they are promising media for the geologic disposal of waste.

Because of the process by which tuffs are deposited, the welded tuff is usually surrounded by at least a partial envelope of nonwelded tuff. If a repository were built in such a formation, the welded tuff would provide high mechanical strength and thermal stability while the surrounding nonwelded tuff would provide strong sorption of radionuclides. This arrangement could be a nearly ideal set of multiple barriers under the proper mineralogical and hydrologic conditions. Because the arrangement is complex, the engineering design of a repository in tuff will be difficult; however, the benefits could be significant.

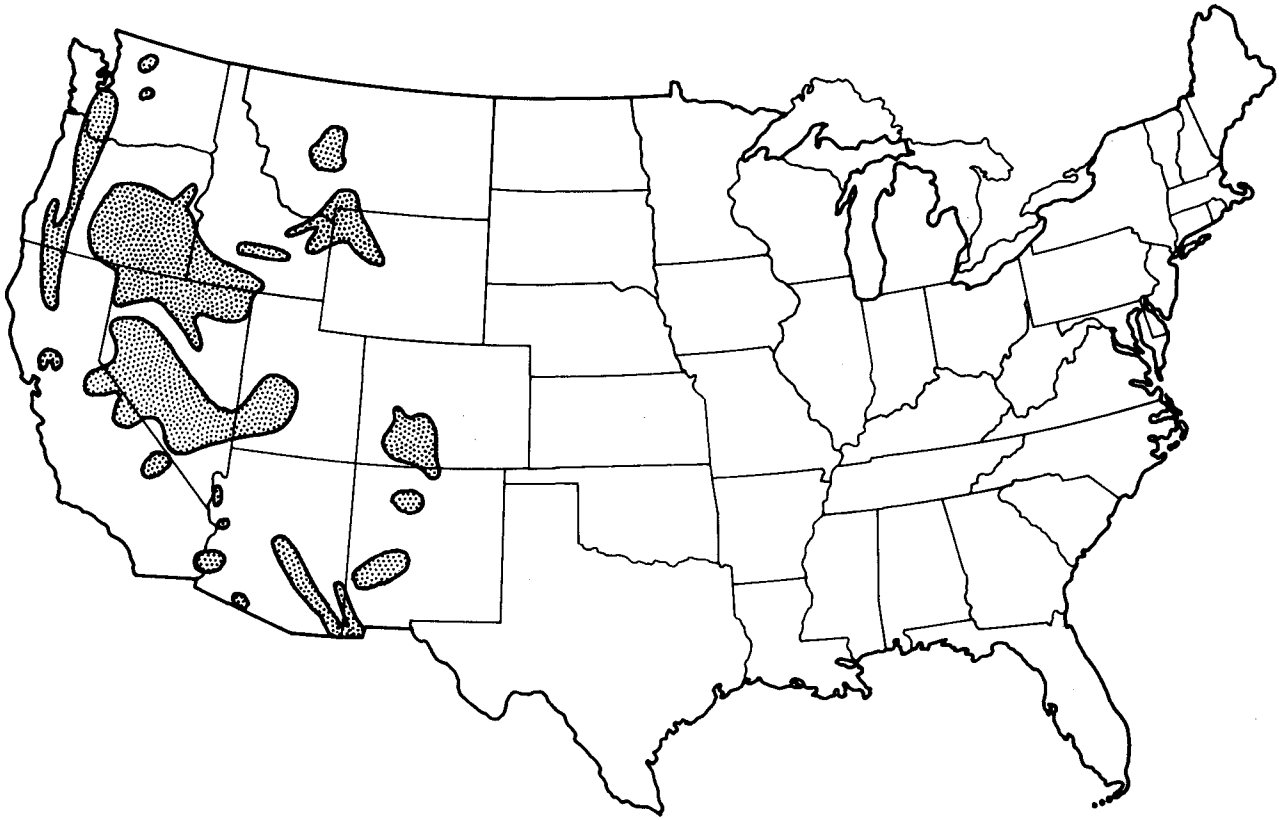

Figure A-4. Tuff deposits in the United States.

REFERENCES

- Bradshaw, R. L., and W. C. McClain, 1971. Project Salt Vault: Demonstration of the Disposal of High-Activity Solidified Wastes in Underground Salt Mines, ORNL-4555, Oak Ridge National Laboratory, Oak Ridge, Tenn.
- DOE (U.S. Department of Energy), 1979. Environmental Impact Statement: Management of Commercially Generated Radioactive Waste, DOE/EIS-0046-D, two volumes prepared by the Pacific Northwest Laboratory, Richland, Wash.
- Fenix and Scisson, Inc., 1978. Minability Study of the Terminal Waste Storage Program--Eleana Investigation, NVO-0038-15, prepared for the U.S. Department of Energy.
- IRG (Interagency Review Group), 1979. Report to the President by the Interagency Review Group on Nuclear Waste Management, TID-29442, U.S. Department of Energy, Washington, D.C.
- IRG Subgroup (Interagency Review Group), 1978. Alternative Technology Strategies for the Isolation of Nuclear Waste (draft), TID-28818, U.S. Department of Energy, Washington, D.C.
- Johnson, K. S., and S. Gonzales, 1978. Salt Deposits in the United States and Regional Geologic Characteristics Important for Storage of Radioactive Waste, Y/OWI/SUB-7414/1, Office of Waste Isolation, Union Carbide Corporation, Oak Ridge, Tenn.
- Kuehn, K., et al., 1976. "Recent Results and Developments on the Disposal of Radioactive Waste in the Asse Salt Mine," IAEA/NEA International Symposium on Management of Radioactive Wastes from the Nuclear Fuel Cycle.
- Magara, K., 1971. "Permeability Considerations in Generation of Abnormal Pressures," Journal of the Society of Petroleum Engineers, Vol. 11, pp. 236-242.
- National Academy of Sciences-National Research Council, 1957. The Disposal of Radioactive Waste on Land, A Report of the Committee on Waste Disposal, Division of Earth Sciences, Publication 519.
- Tyler, L. D., J. F. Cuderman, J. L. Krumhausl, and A. R. Lappin, 1979. "Near-Surface Heater Experiments in Argillaceous Rocks," in Proceedings OECD/NEA Meeting on in situ Heating Experiments in Geologic Formations, September 12-15, 1978.
- Yaner, P. I., and G. N. Owen, 1978. Nevada Test Site Terminal Waste Storage Program Subtask 1.3: Facility Hardening Studies: Design Cost Scoping Studies, JAB-99-123, prepared for the U.S. Department of Energy by John Blume and Associates.

Appendix B

**THE NATIONAL WASTE TERMINAL STORAGE PROGRAM
AND ALTERNATIVE GEOLOGIC REGIONS**

CONTENTS

	<u>Page</u>
B.1 Regional Studies	B-1
B.2 Safety Studies.....	B-2
B.3 Status of Site-Selection Studies.....	B-2
B.3.1 Gulf Interior Salt Domes.....	B-3
B.3.2 Hanford Basalt.....	B-3
B.3.3 Nevada Test Site.....	B-4
B.3.4 Paradox Basin.....	B-5
B.3.5 Permian Basin.....	B-5
B.3.6 Salina Region.....	B-5
B.4 Permian Region.....	B-6
B.4.1 Geology.....	B-6
B.4.2 Hydrology.....	B-9
B.4.3 Climate.....	B-10
B.4.4 Background Radiation.....	B-11
B.4.5 Demographic, Socioeconomic, and Land-Use Systems.....	B-11
B.4.6 Terrestrial Ecosystems.....	B-12
B.4.7 Aquatic Ecosystems.....	B-12
B.5 Salina Region	B-13
B.5.1 Geology.....	B-13
B.5.2 Hydrology.....	B-15
B.5.3 Climate.....	B-17
B.5.4 Background Radiation.....	B-18
B.5.5 Demographic, Socioeconomic, and Land-Use Systems.....	B-18
B.5.6 Terrestrial Ecosystems.....	B-19
B.5.7 Aquatic Ecosystems.....	B-20
B.6 Paradox Region.....	B-20
B.6.1 Geology.....	B-20
B.6.2 Hydrology.....	B-22
B.6.3 Climate.....	B-23
B.6.4 Background Radiation.....	B-24
B.6.5 Demographic, Socioeconomic, and Land-Use Systems.....	B-24
B.6.6 Terrestrial Ecosystems.....	B-24
B.6.7 Aquatic Ecosystems.....	B-25
B.7 Gulf Interior Salt-Dome Region.....	B-25
B.7.1 Geology.....	B-25
B.7.2 Hydrology.....	B-27
B.7.3 Climate.....	B-29

CONTENTS (continued)

	<u>Page</u>
B.7.4 Background Radiation.....	B-30
B.7.5 Demographic, Socioeconomic, and Land-Use Systems.....	B-30
B.7.6 Terrestrial Ecosystems.....	B-32
B.7.7 Aquatic Ecosystems.....	B-33
B.8 The Hanford Site.....	B-33
B.8.1 Geology.....	B-33
B.8.2 Hydrology.....	B-35
B.8.3 Climate.....	B-36
B.8.4 Demography.....	B-36
B.8.5 Historic and Archaeological Sites.....	B-36
B.8.6 Ecology.....	B-36
References.....	B-37

LIST OF FIGURES

	<u>Page</u>
B-1 The Permian bedded-salt basin.....	B-7
B-2 The Salina bedded-salt region.....	B-14
B-3 The Paradox bedded-salt region.....	B-21
B-4 The Gulf interior salt-dome region.....	B-26
B-5 Location of the Columbia Plateau basalts.....	B-34

Appendix B

THE NATIONAL WASTE TERMINAL STORAGE PROGRAM AND ALTERNATIVE GEOLOGIC REGIONS

The National Waste Terminal Storage (NWTS) program of the U.S. Department of Energy (DOE, 1979) is directed at the development of facilities for the emplacement and disposal of high-level and transuranic (TRU) waste within deep geologic formations in order to provide safe, long-term isolation of the waste from human activities and from the environment. The program contains several elements:

1. Geologic studies to identify suitable geologic media and potential sites in various geographic regions.
2. Analysis of the behavior of radioactive waste in candidate geologic structures.
3. Engineering and design of operating repositories and associated specialized equipment.
4. Development of packaging and storage methods for unprocessed spent fuel.

This appendix discusses the nature and status of the first program element listed above.

B.1 REGIONAL STUDIES

Site-evaluation activities include geologic investigations and supporting studies of the surface environment. These start on a broad national scale and subsequently narrow to candidate regions and then to investigations of areas within regions, finally resulting in work at specific sites. The confirmation of a potential repository site requires a detailed study of the geologic, hydrologic, environmental, and socioeconomic characteristics of the site. For a site to be acceptable, it must be established, in the framework of licensing regulations, that no credible circumstances would be encountered that would result in releases of radionuclides from the emplaced waste to the biosphere in quantities that would constitute a hazard to the public.

Geologic media being studied include salt domes, bedded salt, granite, shale, and basalt. These are found in many parts of the United States. Other materials, such as tuff and carbonate rocks, may also meet the requirements for a candidate host rock.

Most investigations of geologic disposal to date have centered on salt formations, and the primary emphasis of the NWTS program remains on salt domes and bedded-salt formations. Regional studies have been completed on the Permian basin of the Central United States, the Salina region (comprised of the Michigan and Appalachian basins) in the northeast, the Paradox basin of Utah, and the salt domes inland from the Gulf of Mexico. In addition, because

they are DOE sites already committed to nuclear purposes, the Hanford Site in south-central Washington and the Nevada Test Site are being examined to determine whether suitable sites exist among the rocks they contain. The status of the site-selection studies is summarized in Section B.3. Sections B.4 through B.8 describe the regional studies and the work at the Hanford Site.

B.2 SAFETY STUDIES

A systematic evaluation of the safety and reliability of geologic disposal of radioactive waste is required in order to insure the viability of specific designs at specific sites being considered for repositories. In the NWTS program this evaluation is almost entirely in terms of the disposal of commercial high-level waste. These studies contain the following elements:

1. Models for analyzing disruptive events, both natural and man-induced.
2. Thermal analysis models.
3. Studies of interactions between the emplaced waste and the surrounding rock and groundwater.
4. Waste-migration models.
5. Borehole-plugging studies.
6. Systems analysis for linking all those effects together.

A basic program containing these elements, the Waste Isolation Safety Assessment Program (WISAP), is in progress. This program is independent of that used for the safety analysis reported in Chapter 9 of this document; one of its tasks, therefore, is to make analyses that parallel the Chapter 9 analyses. The principal purpose of the WISAP, however, is to aid in the site-selection and site-characterization activities of the NWTS program and eventually to enter into the environmental assessments required by the National Environmental Policy Act of 1969 for whatever sites are on the final list of alternative candidate sites.

B.3 STATUS OF SITE-SELECTION STUDIES

The earliest dates for the qualification of sites are as follows:

<u>Geologic medium and location</u>	<u>Date</u>
Bedded salt (other than Los Medanos)	1985
Dome salt (Gulf interior region)	1983
Basalt (Hanford)	1984
Nevada Test Site	1985
Other hard-rock sites	1985

B.3.1 Gulf Interior Salt Domes

The Gulf interior salt-dome region contains several hundred domes scattered across northeastern Texas, northern Louisiana, and central Mississippi. Picking a site in this region amounts to picking a particular dome, as they are discrete entities. At this point the main criteria are size, depth to top, and the nature of previous disturbances. Attention has been narrowed to eight domes, three each in Texas and Mississippi and two in Louisiana. Hydrologic characteristics, on the other hand, can be and are being studied regionally.

Most of the early knowledge of these domes has been obtained from the study and analysis of information from U.S. Geological Survey and state files and of drill-hole, seismic, and other geophysical data purchased from commercial interests. Indirect geophysical methods, such as aerial photogrammetry and infrared remote sensing, have also been used.

Early field evaluations resulted in the elimination of the Palestine Dome (Texas) in October 1979. Studies of the remaining seven domes are continuing. They include hydrologic studies of the three sedimentary basins in which the domes occur as well as dome-specific geologic and hydrologic studies. The understanding of dome locations is being further refined by gravity surveys, high-resolution seismic reflection and refraction surveys, and borehole evaluations. All of the seven domes being investigated are considered to be tectonically stable; no capable faults are known to exist in their vicinity. In late 1980, two or three domes will be recommended for further examination in the "location" study phase of the site-exploration process.

Salt domes appear to be viable alternatives to bedded-salt sites. Several European countries are considering salt domes seriously, and the Federal Republic of Germany has operated an experimental repository in a salt-flow structure for 13 years.

B.3.2 Hanford Basalt

The Columbia Plateau basalts cover a vast region of central Washington, northern Oregon, and western Idaho; much of it might in principle be of interest for waste disposal. For the practical reason that the Hanford Site in the State of Washington is already Federal land administered by the DOE for nuclear purposes, the detailed investigation of these basalts has centered on those of the Pasco basin, in which Hanford lies.

Geologic study of the area was begun more than a decade ago. Studies in the present context started in 1976; since then much mapping and geophysical work has been done, and 16 new holes have been drilled for cores, logging, and hydrologic tests.

The basic geologic structure consists of a series of lava flows separated by porous, water-bearing beds. There has been essentially no mineral exploration in these basalts, and there is little prospect for it. This, plus the extensiveness of the flows, implies that if any part of the structure proves

satisfactory for waste disposal, there will probably be a great deal of choice in site selection.

The use of basalt can rely but little on experience and analysis made for salt. Therefore high on the program is the measurement of the physical, thermal, and chemical properties of the basalt, both alone and in the presence of groundwater. A Near-Surface Test Facility is being built in the northeastern portion of the Hanford Site for in-situ testing, especially with electrical heaters.

B.3.3 Nevada Test Site

The Nevada Test Site (NTS) is a large site, about 40 by 60 miles in size. It lies in the Basin and Range physiographic province and at the northern edge of the Mohave Desert ecosystem. Elevations range from 3000 to 7000 feet, and the climate and biological features vary greatly with elevation.

The primary mission of the NTS is the underground testing of nuclear weapons. Indeed, it is the only test site for this purpose now available to the United States. Because of the presence of residual fission products and transuranic nuclides on the surface and under the ground, the NTS is committed for the indefinite future to retention and care by the U.S. Government.

The NTS contains a variety of geologic environments that might be considered for waste disposal. However, potential interference with or by nuclear testing restricts areas that might be considered to those in the southwestern portion of the Site. Four such areas are under consideration; two are granite areas, one is shale, and one is tuff.

All four areas have been investigated by surface geologic mapping and geophysics, and two by drilling. Drilling into one of the granite areas was discouraging: the granite was encountered much deeper than aeromagnetic surveys had implied. The other area drilled was in tuff, and it continues to look promising.

At present only the Yucca Mountain location is being explored. This location is underlain by approximately 6000 feet of interbedded welded to nonwelded tuffs. An ideal geologic setting for a repository in tuff is a thermally conductive, mechanically strong, welded tuff enveloped by a low-permeability, highly sorptive, nonwelded zeolitized tuff. Field mapping, core drilling, and geophysical surveying are in progress to assess the extent to which these conditions exist at Yucca Mountain. A 6000-foot core and hydrologic test hole is being drilled into the study area; the results will be correlated with data from a 2500-foot hole drilled earlier. The water-bearing properties of inferred fracture zones in the Yucca Mountain area will be evaluated by hydrologic testing and geophysical surveys.

The NTS is in seismic risk zone 2, near zone 3. The Basin and Range province is well known to be seismically active. It is therefore necessary to find a block of material that has suitable properties and is sufficiently distant from active faults. Closely related is the question of volcanism; 12 to 13 miles southwest of the NTS there is evidence of volcanic activity as recently as 280,000 to 300,000 years ago.

The hydrologic characteristics of the NTS and its environs are well studied in the areas used or affected by nuclear testing but not in the southwestern area being considered for waste disposal.

B.3.4 Paradox Basin

Regional geology is still being studied in the Paradox basin in southeastern Utah and southwestern Colorado. In addition, three holes have been drilled in a structure called the Salt Valley anticline, one of the salt diapirs of the basin. The deepest of the three was continuously cored to a depth of about 4000 feet. Several types of geophysical logs have been run in these holes, and open-hole injection, pumping, and swabbing hydrologic tests have been conducted. The most recent activity has been vertical seismic profiling, in which a seismic source in one hole is detected in another hole.

In the near future, at least two deep holes, one in the Gibson dome area and one in the Oil Ridge area, will be cored, logged, and extensively tested. Preliminary results indicate that bedded-salt layers of sufficient volume are present at suitable depths in the Utah portions of the Paradox basin. The area is being investigated for historical evidence of earthquakes, especially in the basin itself. Studies of potential resource conflict and groundwater-flow systems are also in progress.

B.3.5 Permian Basin

Permian basin studies have concentrated on the Texas Panhandle. There is essentially no Federal land in the area, and access for drilling and other direct field work is difficult. Nevertheless a great deal of information is available from geophysical measurements and holes drilled by oil companies, and there have been a few holes drilled and logged by the NWTS program on the east edge of the Palo Duro basin.

B.3.6 Salina Region

The Salina bedded-salt region includes parts of Michigan, Ohio, Pennsylvania, New York, West Virginia, and Ontario. Regional studies for the New York and Ohio portions of the Salina basin have identified areas that appear to be geologically favorable to justify more detailed investigations. The Michigan portion of the Salina basin has not been studied in similar detail, but it is known that Michigan has salt beds of sufficient thickness and extent at suitable depths to meet general specifications for waste repositories. No field investigations have been carried out by the DOE in the Salina basin. Some field work in support of repository siting has been conducted in New York and Pennsylvania by the U.S. Geological Survey. Much additional information is needed before a potential repository site can be identified in the Salina basin. At present, no part of the basin has been investigated enough for a judgment of its acceptability as a repository site.

B.4 PERMIAN REGION*

B.4.1 Geology

The Permian region is located in portions of Texas, New Mexico, Oklahoma, Colorado, and Kansas, the entire region encompassing approximately 189,000 square miles (Figure B-1). The land surface consists predominantly of flat plains and tablelands, but some hilly and low mountainous areas exist east of the Midland basin in Texas and along the Wichita Mountains uplift in Oklahoma. Elevations range from 1500 to 2000 feet above the mean sea level in the eastern portion of the region to 5000 feet above the mean sea level in the west.

The Permian region has been tilted, warped, eroded, and invaded by at least one major sea since Permian time (280 to 220 million years ago). Rocks that predate the Permian period show local faulting and complex folding, but the Permian and younger strata are virtually free of deformation and in most areas have a dip of less than 0.5 degree. Most of the modern structures are probably of shallow origin and do not appear to reflect recurrent movement along Paleozoic or older structures.

The Permian region had a complex tectonic history during the Precambrian and Paleozoic Eras, culminating in the Wichita, Ouachita, and Arbuckle periods of mountain building, all of which occurred during the Pennsylvanian period (approximately 310 to 280 million years ago). It was in this tectonic framework that the region developed. A second period of mountain building, referred to as the Laramide orogeny, resulted in the uplifting of the Rocky Mountains just to the west of the Permian region about 65 million years ago, but this affected the region very little. In summary, the Pennsylvanian period of basin formation and crustal uplift is the only major tectonic activity that has affected the Permian region since Precambrian time, approximately 1 billion years ago. Structural readjustments since the Pennsylvanian have had little effect on the post-Permian rock units, including the extensive salt sequences.

The entire Permian region lies within seismic risk zone 1, which indicates that ground rupture should not be anticipated in the region. Recorded seismic activity is low compared with that of most other parts of the United States. Earthquakes with modified Mercalli intensities of V to VII are scattered sparsely over the region. Of the region underlain by salt, the only part that has undergone significant activity is the area on the flanks of the Amarillo uplift and along its west-northwesterly continuation across the Bravo dome and the Dalhart basin.

The Permian region has long been one of the major oil- and gas-producing regions of the United States. The hydrocarbon reservoirs of eastern New Mexico and west Texas range from Ordovician to Permian in age. Limestones deposited during Permian and Pennsylvanian time served as stratigraphic traps for hydrocarbons and have been the major producing strata in the Silurian, Devonian, and Ordovician systems. Future exploration is anticipated to the

*Data from Environmental Characterization of Bedded Salt Formation and Overlying Areas of the Permian Basin (NUS, 1979a).

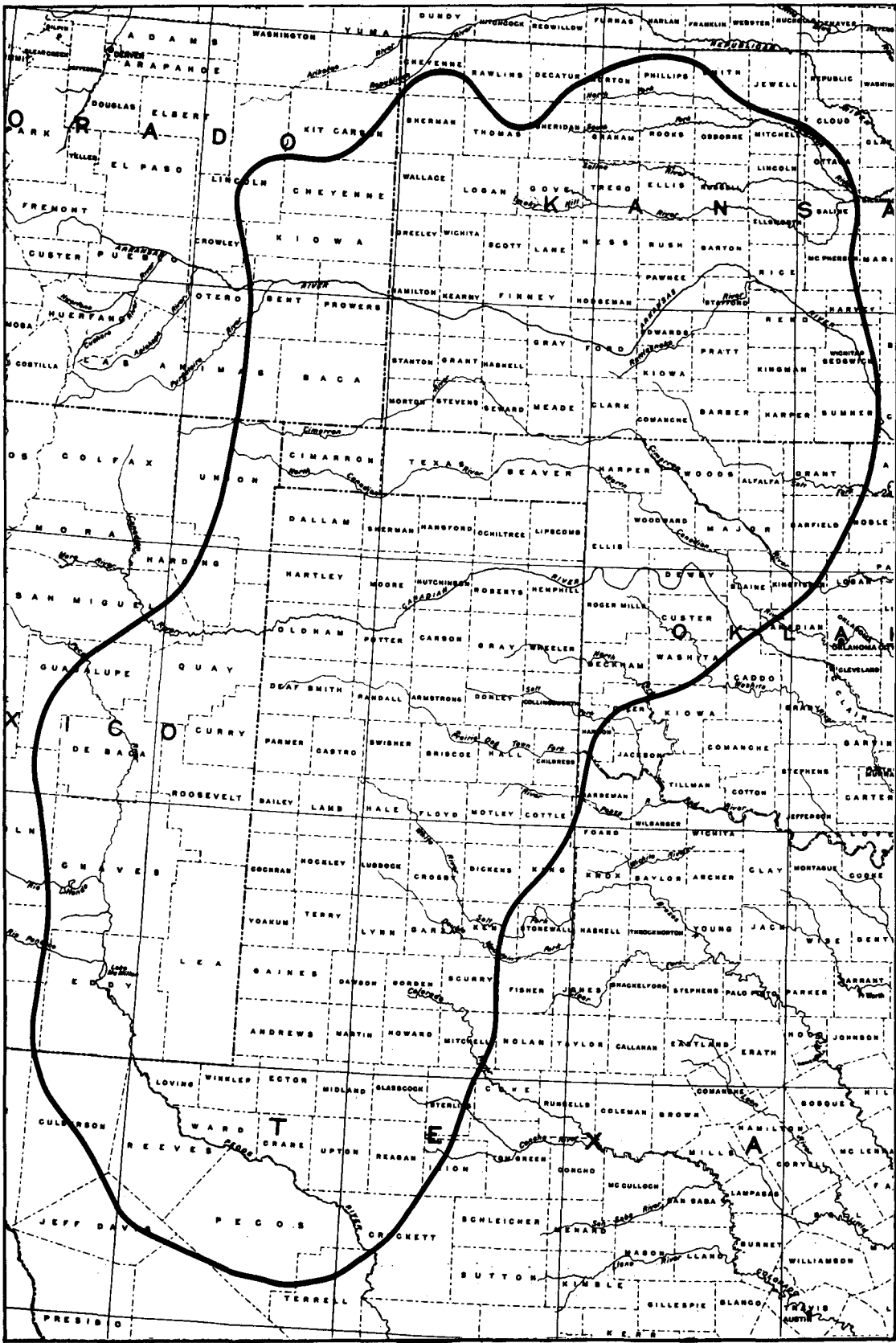

Figure B-1. The Permian bedded-salt basin.

north of the presently producing fields in southeastern New Mexico. In relation to the Upper Permian salt-bearing formations, most of the drilling for development and exploration will be at depths greater than those of the salt formations.

Major natural gas fields are present in western Oklahoma and the Texas Panhandle. There is some oil production in the area but far less than that of natural gas. The hydrocarbon-production zones in western Oklahoma and the Texas Panhandle are mainly lower Permian and Pennsylvanian strata. Most of the successful wildcat wells have found production horizons in Pennsylvanian and Mississippian strata, but deeper drilling is finding producing zones at depths of 25,000 feet in Silurian and Devonian systems. The principal oil-producing stratum is Pennsylvanian in age. Oil is also produced along the south side of the Palo Duro basin, along the crest of the Matador arch. Production is small from these basins. In addition to oil and gas, helium is produced at three localities, and carbon dioxide is produced from Permian rocks. On the basis of current leasing and drilling activity, it is anticipated that there will be exploration and development efforts for hydrocarbon zones below the Permian salt formations in western Oklahoma and the Texas Panhandle.

The southeastern Colorado portion of the Permian region supports oil and gas production that is small in comparison with that of the other producing provinces in the region. Principal hydrocarbon-production zones for this area are Pennsylvanian and Mississippian strata. Future drilling activity in southeastern Colorado will be in Pennsylvanian and Mississippian strata, which are stratigraphically below the Permian salt formations.

Major natural gas occurrences extend northward from western Oklahoma and the Texas Panhandle into Kansas. Hydrocarbon-production zones for the Kansas portion of the Permian region are in Cretaceous, Permian, Pennsylvanian, Mississippian, and Ordovician strata. It is expected that future drilling efforts for Paleozoic strata will continue at a high rate in southwestern Kansas. Helium is also produced in the Kansas portion of the region.

Lignite deposits occur in north-central Kansas, although production from this area is sparse. Lignite has also been mined from limited seams in Cimarron County, Oklahoma, for domestic heating purposes.

Uranium resources are scattered in small deposits across the south-central portion of the Permian region in eastern New Mexico, the Texas Panhandle, and western Oklahoma. A few local deposits are also present in the southeastern Colorado portion of the region. Production has been small because of the limited size of the deposits.

There are no known metal occurrences within the Permian region, though iron and titanium are found near its periphery in Kiowa County, Oklahoma.

The production of various nonmetals has been, and continues to be, one of the major industries in the Permian region. The nonmetallic mineral industry in the region includes construction materials (e.g., stone, sand and gravel, volcanic ash, and scoria). These nonmetals are extracted from depths of usually less than a few hundred feet, and thus extraction would not interact with the salt deposits under consideration. Evaporite (e.g., potash and anhydrite) deposits are also located extensively over much of the region.

B.4.2 Hydrology

The Permian region has a semiarid climate characterized by low rainfall and runoff, high evaporation, and frequent strong winds. The rivers in the region generally rise on the eastern slopes of the Rocky Mountains and flow southeastward across nearly flat plains, which slope eastward at 5 to 15 feet per mile. Rainfall and runoff increase and evaporation decreases to the east. The mean annual precipitation varies from less than 16 inches in the western part to about 30 inches in the eastern part. The mean annual runoff varies from less than 0.2 to about 4 inches from west to east. The quality of many streams in the region is poor because of natural contamination (salt, sulfates, silt) and man-made sources (oil-field brine, feedlot drainage, irrigation runoff, municipal and industrial discharges). In many areas, river water is unsuitable for most municipal, industrial, and agricultural water-supply purposes. Although major floods occur infrequently, localized flooding may occur as a result of intense local precipitation. In most areas, such floods are characterized by rapidly rising and falling peak discharges and high water velocities. Flooding is controlled or mitigated by reservoirs and flood-control dams on many streams in the region. Reservoirs are also used for minimum flow maintenance.

The largest single user of water in the region is agriculture (about 87% of the total consumption). Domestic uses, manufacturing, and steam-electricity generation account for most of the remaining water consumption.

Because of the limited availability and variable quality of surface water, groundwater has become the dominant water resource in the region. Sixty-three percent of the water withdrawn in the region comes from groundwater. Aquifer types include stream-valley alluvium; terrace alluvium; carbonate and gypsum; sand and sandstone; and undifferentiated sandstone, carbonate rock, shale, and basalt. The Ogallala aquifer is a terrace-alluvium aquifer extending from southwest Texas across parts of New Mexico and Colorado, and western Colorado, Oklahoma, and Kansas. It is the most important source of water in the region and is one of the most intensively developed in the United States. The zone of saturation ranges from a few feet to more than 250 feet, and the depth to water ranges from less than 50 to more than 300 feet. The yields of wells range up to 1500 gallons per minute (gpm), depending largely on the saturated thickness. The water is generally of good quality but can be hard locally. Virtually all of the withdrawal in the heavily pumped areas comes from storage (i.e., the water is being mined).

Alluvium and terrace deposits represent deposits of the major streams formed during the period of dissection of the High Plains and consist largely of reworked material derived from the Ogallala Formation. The alluvium and terrace deposits are nearly continuous along the major streams, although there are gaps along some of the streams where alluvial deposits are thin or absent. The zone of saturation ranges from 0 to 150 feet, and well yields range from less than 100 to 3500 gpm. The water ranges from fresh to highly saline.

The Edwards-Trinity (Plateau) aquifer is a sand and sandstone aquifer at the southern boundary of the Permian region. It consists of massively bedded limestone interbedded with shale. Although the yields of wells in most places average about 250 gpm, they can exceed 3000 gpm in places where the secondary permeability of the limestone is well developed. Water in the aquifer is

generally fresh, although the concentrations of total dissolved solids can reach about 3500 mg/l.

The Rush Springs and Gerber-Wellington aquifers in Oklahoma and the Roswell artesian aquifer in New Mexico lie primarily outside the Permian region but do provide an important water resource to the portions of the region that they include.

B.4.3 Climate

The Permian region is in the Southern Plains and Lowlands climatic zone. In general, climatic changes are gradual across the zone because there are no significant climatic barriers. Differences in climatic conditions within this zone are controlled primarily by latitude, general air mass and other storm movements, elevation, and distance to sources of moisture.

The climate is predominantly continental, with cold winters and warm to hot summers. The western portion of the region has a dry climate because of the blocking effect of the mountains to the west. The modifying effect of the Gulf of Mexico results in a warm, humid, and rainy climate for the eastern portion of the region. The northern portions of the region are frequently affected by cold polar and arctic air masses during the winter and less frequently during the summer. Wind and precipitation patterns indicate a relatively high erosion potential.

Fundamental changes in the climate of the region have occurred over the last million years (the Pleistocene Epoch). During this period there have been four ice ages, the most recent of which ended about 10,000 years ago. Although glaciers did not extend to the Permian region, the climate was probably cooler, wetter, and stormier than at present. Flooding was probably more frequent. The current epoch (Holocene) is considered to be interglacial, and there are indications that a long-term global cooling trend is under way at present.

In the Permian region the 24-hour maximum rainfall with a 100-year recurrence interval ranges from 5 inches in the northwestern portion to 8 inches in the eastern portion. These values are typical for the contiguous United States. The frequency of tornadoes is noticeably greater in the central, northern, and eastern portions of the region. (Texas, Oklahoma, and Kansas are within an area of the United States that is associated with frequent occurrences of tornadoes.) Similarly, most of the northern and central portions of the region experience 100-year maximum winds with speeds of more than 90 mph, which is relatively high in comparison with typical values in the United States. Restrictive-dispersion conditions (inversions) are relatively infrequent in the region compared with the rest of the contiguous United States. The occurrence of restrictive-dispersion episodes increases from east to west across the region.

Air-quality statutes and regulations restrict development in areas that are not attaining the national ambient air-quality standards (unless certain offset criteria are satisfied) or where emissions would result in violations of the standards or would exceed increments established by the Clean Air Act Amendments of 1977. Data indicate that the national ambient air-quality

secondary standards for particulates are being exceeded throughout the western half of the region and in some eastern areas. Furthermore, the particulate concentrations in the area between Amarillo and Midland, Texas, exceed the national primary ambient air-quality standards for particulates.

B.4.4 Background Radiation

Background radiation is ubiquitous, resulting from cosmic, terrestrial, and fallout sources. The limited data available for the Permian region reveal no anomalous areas.

B.4.5 Demographic, Socioeconomic, and Land-Use Systems

The Permian region is sparsely populated. Only three urban areas in the region support a population of more than 100,000 inhabitants: Wichita, Kansas (approximately 300,000), Lubbock, Texas (approximately 150,000), and Amarillo, Texas (less than 130,000). Odessa and Midland, Texas, have populations of just over 80,000 and 60,000, respectively. The largest urban area within 75 miles of the region is Oklahoma City, Oklahoma (approximately 580,000).

Total earnings for the Permian region in 1970 amounted to approximately 11 billion dollars; by the year 2000, earnings will be approximately 27 billion dollars. The dominant land use is agriculture. The livestock industry yields more earnings than all the field crops combined. Earnings from agriculture, forestry, and fisheries accounted for about 14% of all earnings; manufacturing accounted for approximately 13%. Mining and other extractive industries accounted for approximately 5% of the total earnings. Approximately 68% of the earnings was produced by retail and wholesale trade, government, and institutions. This percentage is expected to increase, whereas the percentages for agriculture and mining are expected to decrease in the coming decades.

Sensitive or conflicting commitments of land areas larger than 10,000 acres include 142,200 acres of Indian lands (trust areas) in Oklahoma. Also within the region are 2 national parks (93,720 acres), 5 national forests (639,321 acres), 3 wildlife refuges (64,606 acres), 11 recreation areas on Bureau of Reclamation projects (1,143,921 acres), 1 military installation (33,848 acres), and other military areas (primarily restricted air spaces), totaling 23,850,624 acres. The area committed to these activities is approximately 22.86% of the Permian region. The bulk of the land is range, agricultural, and open land, with some areas preempted for urban and residential development and for transportation networks.

The Permian region is traversed by a network of highways and rail lines. The highway system is the dominant mode of transportation throughout the region. Railroad trackage has been developed most intensively around major rail hubs within or near the northeastern portion of the region.

B.4.6 Terrestrial Ecosystems

The Permian region covers some 189,000 square miles and includes a variety of soil, topographic, and land-use patterns. About 98% of the region is classified as range or pasture (58%) or cropland (40%).

Most of the natural vegetation in the region is classified as grassland and shrubsteppe (97%), but forests (3%) are scattered along the major river drainages in Kansas, Oklahoma, and eastern Colorado and in the low mountains in the western portion of the region. Forests are not commercially valuable in the region because of their limited distribution. Nevertheless, they provide important wildlife habitats. Wetlands are scarce. However, six typical wetland areas are identified, one of which (the Great Salt Plains in Oklahoma) has been proposed for Registered National Landmark status. The region contains seven national wildlife refuges in wetland areas. The Society of American Foresters has identified two natural areas in Kansas that are set aside for scientific, educational, or recreational purposes. The Nature Conservancy has designated at least three natural areas in the Oklahoma portion of the region. Twenty-four plant species that are proposed for the Federal list of endangered species occur within the region.

Regional wildlife includes some 85 species of mammals, at least 350 species of birds, and more than 100 species of amphibians and reptiles. Forestland, shrubland, and openland species are well represented. Important wildlife includes game species, furbearers, and one species on the Federal list of endangered species, the black-footed ferret. At least 35 game birds and 26 game mammals are found in the region, and hunting and trapping are important. The white-tailed deer, mule deer, and pronghorn are important big-game animals. Cottontail, jackrabbit, and fox squirrel are important small-game mammals. Nonmigratory game birds include the turkey, ring-necked pheasant, lesser prairie chicken, bobwhite, and scaled quail; migratory game birds include waterfowl and the mourning dove. Birds on the Federal list of endangered species include the brown pelican, Mexican duck, bald eagle, peregrine falcon, whooping crane, and Eskimo curlew.

The major land uses in the Permian region are cropland and range and pasture. The major cropland areas are in Kansas and Texas; Texas and New Mexico have the largest amounts of range and pasture land. Important crops include winter wheat, sorghum, and cotton. Cattle, sheep, hogs, and milk cows are important livestock.

B.4.7 Aquatic Ecosystems

A large portion of the Permian region is semiarid, with intermittent streams as the only aquatic habitat. These streams, when flowing, are generally high in mineral content from natural sources (salt springs, brine seeps, or gypsum overburden) and from human activities (petroleum and natural gas production or irrigation return flows). As a result, the most suitable (often the only available) aquatic habitats are near the peripheral portions of the region.

In the northern portion of the region, streams of the Smoky Hill River system, which drain ultimately to the Missouri River, are turbid and

moderately salty. During low-flow periods in summer months, particularly in the upper reaches, these streams become ephemeral. Near the northeastern boundary of the region and below the confluence of the Saline and Solomon Rivers, the Smoky Hill River system maintains adequate flow and supports a marginal recreational fishery for catfish and carp. The Topeka shiner, a threatened fish in Kansas, has been recorded from the Smoky Hill and Saline Rivers within the Permian region.

Rivers of the north-central Permian region, including the Arkansas, Cimarron, Canadian, and Red Rivers, have poor water quality as a result of natural and man-induced pollution. These streams (with a possible exception of the Arkansas River) have their origin in semiarid regions and frequently exhibit no flow or subsurface flow conditions. Consequently, suitable habitats for aquatic organisms are mainly outside or near the eastern periphery of the region. A few locally endangered or threatened species may occur in the north-central portion of the region but are expected primarily in the head-water areas of Colorado and New Mexico or near the eastern boundary of the region, where the streams become larger and flow continuously.

Much of the central Permian region, although within the watersheds of the Brazos and Colorado Rivers, consists of playa lakes and dry creeks and is essentially noncontributing. Aquatic habitats are therefore few in number and, when present, are generally not suitable for fish and aquatic invertebrates because of the naturally high salt content of surface waters. A few tributaries (e.g., the Concho River of the Colorado River system, which is essentially spring-fed) maintain flows and water quality that support exploitable fish populations. Such streams are generally near the eastern boundary of the region.

In the south and southwest portions of the Permian region, the Pecos River, although polluted from natural brines and irrigation return flows, supports a diverse fish fauna in tributaries to the main-stem river. Many of the species and subspecies of this region (particularly the several species of desert pupfish and gambusia) have been isolated by natural barriers and are restricted to specific habitats (often a single tributary or spring). Because of their highly restricted distributions and dependence on unique habitats for survival as a species or subspecies, many of these fishes are considered to be endangered.

B.5 SALINA REGION*

B.5.1 Geology

The Salina region includes portions of New York, Pennsylvania, Ohio, Michigan, West Virginia, and Ontario (Figure B-2). The entire region encompasses approximately 80,000 square miles of land area in the United States.

About half of the Salina region is in the Great Lakes section of the Central Lowland physiographic province. The lakes and terrain features, such

*Data from Environmental Characterization of Bedded Salt Formation and Overlying Areas of the Salina Basin (NUS, 1979b).

as moraines and drumlins, reflect the prominent effects of Pleistocene glaciation in this section. The remainder of the region is a part of the Appalachian Plateaus physiographic province. It is composed of shallow river valleys and broad ridges, with escarpments that provide abrupt changes in elevation. Local elevations generally vary by no more than 300 to 400 feet; however, the elevation increases in going from west to east from about 1000 feet above sea level in Ohio to about 2000 feet above sea level in New York.

The Salina region lies within two major tectonic divisions: the Central Stable region in the west and the orogenic belts of the Atlantic margin in the east. The Central Stable region is founded on Precambrian rocks that compose the stable interior of the North American continent. The eastern areas of the region contain mountainous areas uplifted and deformed during the Paleozoic Era. Separating the eastern and western portions of the region are a series of arches--areas that were stable or gently uplifted and deformed during the Paleozoic Era, when the Appalachian and Michigan basins were subsiding. It was during these periods of subsidence that salt beds were formed. All these structures are extremely old, with no major movements in the earth's crust for approximately 190 million years. Indeed, the Salina region has experienced no major internal tectonic activity since Precambrian time (1 billion years ago). Major structural features within the region are few, uncomplicated, and broad in extent. Minor structures within the region are also relatively few and simple.

The Salina region is one of low seismicity. Earthquakes in the eastern portion of the region are attributed to readjustment of the earth's crust after the most recent Ice Age. Major surface faulting is uncommon. Several seismic events have occurred in the vicinity of Attica in western New York. These earthquakes have been related to the Clarendon-Linden Fault, a north-south-trending tectonic feature. Several moderate earthquakes (modified Mercalli intensity of V) have occurred near Cleveland, Ohio. Portions of the Salina region in Michigan, Pennsylvania, and West Virginia have been virtually earthquake-free.

Oil and gas fields have been developed in all parts the Salina region. Primary, secondary, and tertiary recovery efforts, which include water flooding and fracturing, may have affected portions of the Silurian salt layers. The most abundant oil and gas fields are in Pennsylvania, West Virginia, and Ohio. Major bituminous coal reserves occur in Pennsylvania, West Virginia, Ohio, and Michigan. Much of the coal is within 300 feet of the surface, well above the salt beds. Metallic ores in the region are of low grade and of limited economic importance. Several nonmetallic minerals of economic importance are extracted in the region: salt, salt brines, silica, and construction materials (sand, gravel, gypsum, etc.). With the exception of salt brines, it is not expected that current or future recovery of these minerals would affect waste-repository siting.

B.5.2 Hydrology

The Salina region is subdivided into three Hydrologic Regions (HR): HR I, southeastern Great Lakes basin; HR II, Susquehanna River headwaters; and HR III, northeastern Ohio River basin.

Hydrologic Region I covers the drainage area of Lake Huron, Lake Erie, and Lake Ontario. The terrain is characterized by flat land, lakes, marshes, and peat bogs, reflecting the poor development of regional drainage systems. Streams are relatively short and follow the lows of the once-glaciated terrain. The terrain is therefore more conducive to infiltration than to direct, rapid surface runoff. Water available for withdrawal and use in HR I comes primarily from precipitation within the area. Annual precipitation ranges from 28 to 37 inches; approximately one-third, nearly 12 inches, becomes runoff. Water is generally nonsaline throughout HR I.

Major floods and most damaging floods are usually the result of rain and snowmelt on frozen or nearly saturated ground. Intense summer storms have created destructive floods, but these are ordinarily confined to local areas. Dams are used for flood control and for water-resource management. The largest single use of water in the region is for cooling steam-electricity generating plants. Manufacturing facilities and domestic consumption are also major water users.

Although water-bearing formations underlie all of HR I, the depth to the water table varies with the season, local geologic characteristics, and terrain. With the exception of the lower Michigan Peninsula, productive aquifers (yielding to a well at least 50 gpm of water containing not more than 2000 ppm of dissolved solids) are located only along some of the main watercourse alluvial valleys. Because of the abundance of surface-water supplies in HR I, groundwater usage has not been extensively developed and constitutes generally less than 10% of the total water use.

Hydrologic Region II is located in the headwaters area of the Susquehanna River, which flows southeasterly from south-central New York through Pennsylvania and Maryland. The two major tributaries of the Susquehanna River that flow through HR II are the West Branch of the Susquehanna River and the Chemung River. Hydrologic Region II is characterized by deeply eroded, steep-sided, flat-bottomed valleys and flat to gently rolling plateaus varying in relief from several hundred feet in New York to nearly 2000 feet in Pennsylvania. This type of landscape tends to shorten the time for precipitation to run off into streams and consequently promotes the possibility of flooding. Precipitation averaging nearly 38 inches annually in HR II is the major source of water supply. The mean annual runoff varies from about 15 to 25 inches, about half of this occurring during the 3-month period from March through May. Some tributaries of the West Branch of the Susquehanna River are heavily influenced by acid mine drainage. Nevertheless, the dissolved-solids concentration of most streams in HR II seldom exceeds 800 ppm. Generally, floods occur each year in HR II; major flooding can occur in all seasons. Flooding is, however, more frequent in early spring, usually in March. Major floods have been caused by heavy rainfall on top of heavy snowfall and by heavy rainfall on previously saturated ground. Occasionally, local flooding is caused by ice jams or from thunderstorms during the summer months. As in HR I, major water uses are for steam-electricity generation, manufacturing, and domestic consumption.

The abundant water in the Susquehanna River basin is looked to by communities outside the area as a supply source for the future. Currently significant quantities of water are piped to Chester, Pennsylvania, and Baltimore, Maryland. Rural water supply needs will also increase rapidly in the future. This includes rural domestic use, consumption by livestock, and irrigation.

The increases are not as dramatic as in the urban areas, but they are nevertheless substantial and must be planned for, particularly where they compete directly with urban needs.

Groundwater in HR II occurs in appreciable quantities in rock strata and is generally of good quality, except near coal mines below Tioga County, Pennsylvania. Deep aquifers in the region may be saline or brackish. Highly permeable glacial deposits along most of the valleys are significant sources of groundwater. These aquifers are very productive and readily recharged. Since most urban communities are situated on water-bearing glacial deposits in the valleys, groundwater has not been widely utilized. Although water-use data are not available for HR II, data for the entire Susquehanna River basin, which includes HR II, indicate that 17% of the total water consumption is supplied by groundwater. Total groundwater use is expected to increase as water demands grow in the region.

Hydrologic Region III lies in the northeastern section of the Ohio River basin. Major streams in this region are the Allegheny River, Monongahela River, Muskingum River, Beaver River, and the main stem of the Ohio River. Hydrologic Region III is located in the Appalachian Plateaus physiographic province, which is characterized by a rugged terrain resulting from the differing resistance of the rock to weathering and runoff. Extensive forest cover, poor-quality soils, narrow valleys, steep stream gradients, and flash floods during the dry seasons are characteristic of this area. Vegetation is generally sufficient to retard runoff and minimize erosion. Precipitation averages about 45 inches annually; runoff ranges from about 11 to 25 inches annually. Many minor tributary streams throughout the area normally cease flowing during the dry season, with drought periods adding to their number. Often during late summer and early fall, stream flow from precipitation is negligible, the only flow being from groundwater seepage. Waters of the region are nonsaline, although some tributaries have high concentrations of dissolved solids. In order of gross consumption, major water-usage categories are steam-electricity generation, manufacturing, and domestic use.

Valley-fill sediments, consisting both of glacial outwash and recent alluvium, are the most important source of groundwater in HR III. Highest yields occur generally in the valleys of the Ohio River and its north-side tributaries. Most bedrock systems in the area are relatively poor water bearers, although productive aquifers do occur in some limited rock strata that underlie portions of HR III. High iron concentrations are often found in these waters. Groundwater supplies have been developed in the valley-fill-sediment aquifers primarily for use at the point of need. Because of the large areas covered by these aquifers, most of the stored water has been untouched by current development.

B.5.3 Climate

The Salina region is located primarily within the Great Interior climatic zone. Differences in climate are controlled primarily by latitude, general air mass and storm movements, elevation, and distance to sources of moisture. Modifications to the climatic patterns are introduced by the Great Lakes and by the lifting effects of the Appalachian Mountains. The climate is generally characterized as cool in the northern section and warm temperate and rainy in

the southern section. Wind and precipitation patterns indicate a very low erosion potential in the region.

Fundamental changes in the climate of the region have occurred over the last million years (the Pleistocene Epoch). In this period there have been four ice ages, during which glaciers covered much of the Salina region.

The most recent ice age (Wisconsin Glacial) ended about 10,000 years ago, although continuous ice sheets still exist in the polar regions. The current epoch (Holocene) is considered to be interglacial; however, there are indications that a long-term global cooling trend is under way at present.

In the Salina region, severe-weather conditions are rather typical of those occurring in most areas of the contiguous United States. The maximum 24-hour rainfall with a 100-year recurrence interval ranges from 4 to 6 inches. The frequency of tornadoes is noticeably greater in southern Michigan and eastern Ohio than in other sections of the region. However, the frequency is significantly lower than that in the Central United States. Most of the Salina Region experiences 100-year maximum winds of less than 90 mph, which is typical for most of the continental United States.

Restrictive dispersion conditions are relatively frequent in the extreme southern section of the Salina Region compared with the rest of the region and with the contiguous United States. Sections of the Salina Region experience less than 25 to nearly 40 episode-days in 5 years.

Air-quality statutes and regulations restrict development in areas that are not attaining the national ambient air-quality standards (unless certain offset criteria are satisfied) or where emissions would result in violations of the standards or would exceed increments established by the Clean Air Act Amendments of 1977. Data indicate that the national ambient air-quality secondary standards for particulates are being exceeded around all major cities and in eastern Ohio, southwestern Pennsylvania, and northern West Virginia.

B.5.4 Background Radiation

Background radiation is ubiquitous, resulting from cosmic, terrestrial, and fallout sources. Limited data available for the Salina region reveal no anomalous areas. Dose rates range from 68.8 mrem/yr at Charlevoix, Michigan, to 116.7 mrem/yr at Wheeling, West Virginia.

B.5.5 Demographic, Socioeconomic, and Land-Use Systems

Many areas within the Salina region are highly urbanized. The heaviest concentrations of urban areas (over 50,000 inhabitants) in the region occur in Ohio, southern Michigan, and western Pennsylvania. The largest urban areas in or near the region include Detroit (nearly 4 million inhabitants), Cleveland and Pittsburgh (nearly 2 million inhabitants each), and Buffalo (over 1 million inhabitants).

Total earnings for the Salina region in 1970 amounted to 66 billion dollars; by the year 2000 earnings will be about 181 billion dollars. Manufacturing accounted for approximately 41% of the total earnings in 1970. Although agriculture and forestry are the dominant land uses, they produce, together with fisheries, about 1% of the total earnings of the region. Mining and other extractive industries likewise account for about 1% of the regional earnings. Retail and wholesale trade, government, institutions, and other services account for approximately 56% of earnings. This percentage is expected to increase, and the percentage for manufacturing is expected to decrease, in the coming decades.

Sensitive or conflicting commitments of land areas larger than 10,000 acres consist of the Allegany Indian Reservation, 10 parks, 8 forests, 3 wildlife refuge, 8 recreation projects, 14 airports, 2 military reservations, and 4 military operations areas. The area committed to these activities totals less than 6% of the Salina region. The bulk of the remaining land is agricultural and open land, with some areas preempted for urban and residential development and for transportation networks.

The Salina region is traversed by a well-developed network of highways, rail lines, and waterways used for commercial transportation.

B.5.6 Terrestrial Ecosystems

The broad mosaic of land-use patterns in the Salina region has a significant influence on the distribution and abundance of terrestrial resources. Major land-use patterns in the region are forestland (44%), cropland (31%), pastureland (6%), and other rural land (6%).

Four ecoregion categories occur in the Salina region: Northern Hardwoods, Beech-Maple Forest, Appalachian Oak Forest, and Mixed Mesophytic Forest. Important natural vegetation includes commercially valuable timber, wetlands, natural areas, and proposed endangered plant species. Commercial forestland in the region is about 90% hardwoods and 10% softwoods. Forestland is about equally divided among sawtimber, poletimber, and seedling/sapling stands. Approximately 2% of the region is classified as wetlands with some importance to waterfowl. Some 28 representative wetland areas and 5 National Wildlife Refuges (predominantly in wetland areas) are located in the region. (Only three wildlife refuges are reported in Section B.5.5 as sensitive or conflicting commitments of land because of the size criterion--10,000 acres or more.) The Society of American Foresters has identified 10 natural areas in the region. Five plant species that are proposed for the Federal list of endangered species occur in the region.

Regional wildlife includes some 65 species of mammals, at least 400 species of birds, and 73 species of amphibians and reptiles. Forestland, shrubland, and openland species are well represented. Important wildlife includes game species, furbearers, and endangered species. At least 31 game birds and 23 game mammals are found in the region, and hunting and trapping are important. The white-tailed deer is the most important big-game animal; rabbits and tree squirrels are important small-game mammals. Nonmigratory game birds include the ring-necked pheasant, bobwhite, and ruffed grouse; migratory game birds include waterfowl and the mourning dove. Species on the

the Federal list of endangered species are the Indiana myotis, Kirtland's warbler, peregrine falcon, and bald eagle.

Farming is important in the Salina region. Major crops are corn, hay, winter wheat, and oats. Cattle, swine, and sheep are important livestock.

B.5.7 Aquatic Ecosystems

The Great Lakes provide the most extensive commercial fishery within the Salina region. Although shifts have occurred in the abundance of various species because of fishing pressures, introduction of predators, and pollution, commercial harvesting of fish remains a significant industry in the Great Lakes. The Ohio River drainage presents a more limited fishery resource. The commercial fish harvest in this drainage may be considered negligible, as are the present-day collections of mussels and clams. The Great Lakes and the Finger Lakes in upstate New York support a diverse sport fishery. Appalachian streams offer trout fishing; in many lower stretches of tributaries and in the main-stem rivers of the Salina region a warm-water fishery exists. Many streams and lakes are augmented with stocked species to enhance sport fishing. Only two fish species and one invertebrate on the Federal list of endangered species occur in the region.

B.6 PARADOX REGION*

B.6.1 Geology

The Paradox region (Figure B-3) is located in southeastern Utah and southwestern Colorado. The entire region encompasses roughly 10,000 square miles; about 60% of this land area is in Utah. The Paradox region is a tectonic unit (Paradox Fold and Fault Belt) of the Colorado Plateau and is also a feature of Thornbury's (1965) rugged Canyon Lands section of the Colorado Plateau. As such, it has a diverse and varied physiography and exhibits the landforms associated with tectonic and igneous activities as well as with extensive wind and water erosion. Most of the region is above 5000 feet in elevation, often with high relief and rugged terrain. The area contains some of the most spectacular scenery in the United States.

The rocks of the Paradox region consist of at least 15,000 feet of clastic and evaporitic sediments resting nonconformably on a basement complex of granitics and metasediments. The age of the basement rocks is Precambrian, while the sedimentary strata range in age from Cambrian to Cretaceous. Disconformities and hiatuses abound, some of very long duration. Ordovician and Silurian rocks, for example, are completely absent, and no marine deposition has occurred since the close of the Mesozoic Era. The only Tertiary rocks of significance are intrusive volcanics. The Quaternary is represented only by fluvial deposits, a substantial amount of wind-blown sediments, and minor amounts of gravel and till.

*Data from Regional Characterization Report for the Paradox Bedded Salt Region and Surrounding Territory (Bechtel, 1978a).

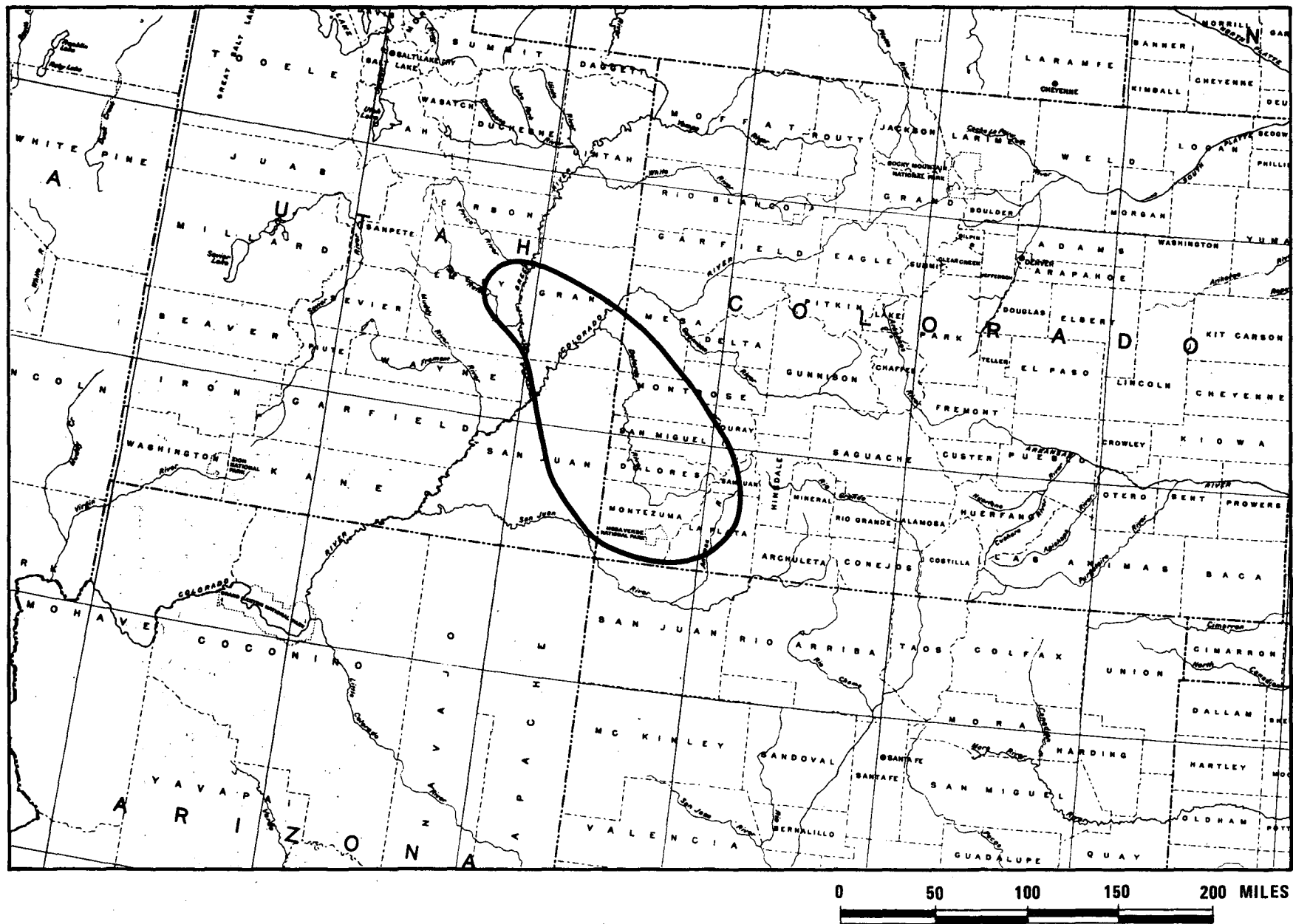

Figure B-3. The Paradox bedded-salt region.

The Colorado Plateau Province, of which the Paradox region is a part, is a mildly deformed platform surrounded by the more highly deformed Rocky Mountains. The principal tectonic elements of the Plateau include uplifts, monoclinical flexures, domes of igneous intrusion, platforms, slopes, saddles, and fold-and-fault belts. In addition, the region displays numerous igneous plugs, diatremes, caldron sinks, dikes, and multitudinous systems of joints and small faults.

The Paradox region is one of low seismic activity. Fifty-four earthquakes with a maximum intensity equal to or greater than V on the modified Mercalli scale of 1931 are known to have occurred in or within 100 miles of the Paradox region from 1853 to 1976.

The tectonic history of the region was eventful. Evidence indicates that the region was under water for a long period of time before the start of the Cambrian period. During the Paleozoic Era much activity occurred, with periods of uplift and erosion alternating with periods of inundation and sedimentation. The formation of the Paradox basin salt occurred during the latter part of this era. By comparison, the Mesozoic Era was relatively quiescent. No major mountain-building activity occurred in the region during the Triassic and Jurassic periods, but the shallow seas moved in and out to deposit occasional layers of marine sediments. The powerful uplifts that raised the Colorado Plateau province to its present elevation began in the last half of the Cretaceous. During the early Cenozoic Era the mountain building continued until the Rocky Mountains were formed. Volcanism was also widespread and frequent during the Cenozoic Era, when most of the prominent surface features of the region were formed.

The Paradox region and surrounding territory have supplied important energy resources for nearly three decades. Petroleum, natural gas, and uranium from this area have made substantial contributions to the nation's energy needs and have played an important role in the local economy. Energy and mineral production is still increasing. A few metals and industrial minerals are also present in the region, but they have been produced on a small scale compared to exploitation of the energy reserves.

B.6.2 Hydrology

Surface water is a valuable resource in the semiarid Paradox region. The principal rivers in the and surrounding territory of the Upper Colorado Water Resource Region (UCWRR) are the Colorado and the Green, and their major tributaries are the Price, San Rafael, Dolores, and San Juan Rivers. No large natural freshwater lakes or wetlands occur in the region. Precipitation is light and varies with ground elevation. Maximum stream flow occurs in late spring; it is due to snowmelt runoff from mountainous areas. Localized flooding can occur, especially when periods of snowmelt coincide with intense thunderstorms. Areas most prone to flooding are along the floodplains of rivers or streams. Most serious damage occurs in broad floodplains where agricultural or urban developments exist. Flood control is accomplished by watershed management and land-treatment programs in the UCWRR. Flood-control reservoirs are normally multipurpose and may provide power generation, irrigation, and recreational benefits. Surface-water quality is generally good, although high dissolved-solids concentrations pose a problem in some waterways

of the UCWRR. Water availability is limited, and demand, especially for good-quality irrigation water, is growing.

Groundwater occurs in the Paradox region under both water-table and artesian conditions, and the quality of this water ranges from fresh to near-saturated brines (in excess of 350,000 mg/l of total dissolved solids). Water-table conditions commonly exist in the shallow alluvial aquifers, in recharge areas, and near the surface in relatively flat-lying rocks that are found over large portions of the region. Most of the groundwater underlying the region has dissolved-solids concentrations in excess of 3000 mg/l and is unsuitable for most uses. Usable fresh water is present only in near-surface aquifers and is seldom found at depths greater than 200 feet. The only source of fresh water is precipitation falling on the region; principal areas of recharge are the highlands of the region and other areas where aquifers crop out.

B.6.3 Climate

The Paradox region is largely a cool, semiarid, mid-latitude steppe with isolated areas classified as mid-latitude deserts or humid continental regimes. The region is very dry, with an average annual precipitation of approximately 8.3 inches. The dry conditions provide the region with a relatively high potential for wind erosion.

Fundamental changes in the climate of the region have occurred during the last million years, apparently resulting from changes in global temperature. Four major glaciations occurred during the Pleistocene Epoch, but the region is located more than 500 kilometers southwest of the southernmost limit of the ice cover and was not glaciated.

The region is relatively free from severe-weather hazards and can expect a maximum 100-year rainfall of only 3 inches in a 24-hour period. It is also in an area of low tornado activity; this part of Utah reported no tornadoes from 1955 to 1967. Similarly, high winds are not frequent; a maximum wind speed of about 85 mph has a 100-year mean recurrence interval. However, local channeling effects might alter the maximum speed at specific sites.

Inversions are relatively common in the Paradox region in comparison with the United States as a whole: the region has experienced about 180 episode-days in 5 years. These conditions are related to the terrain of the region, which is a complex system of valleys surrounded by high terrain. This type of terrain allows the formation of frequent temperature inversions that could pose a major problem for the dispersion of emissions from a waste repository. In addition, poor dispersion conditions occur during the frequent stagnation of large-scale high-pressure systems.

With regard to existing air quality (Prevention of Significant Deterioration), all national parks and wilderness areas within the Paradox region are classified as Class I areas. The remainder of the region is a Class II area. The law generally allows no or minimal industrial development in Class I areas and moderate development in Class II areas.

B.6.4 Background Radiation

Virtually no data specific to the Paradox region are available. In general, the mountain states are higher than the national average in both natural terrestrial and cosmic background radiation, although the regional variations appear to be of minor significance.

B.6.5 Demographic, Socioeconomic, and Land-Use Systems

The Paradox region is a rural area with many small towns of less than 1000 people scattered along highways. Farmington, New Mexico, and Grand Junction, Colorado, are the only two cities in the areas adjacent to the region with more than 20,000 inhabitants. There are no cities this large within the region. The total population of the region was approximately 240,000 in 1970. Most of the counties in the region showed a 10 to 20% increase in population between 1970 and 1975.

The economy of the region is dependent on the continued long-term development of extractive industries and the processing of petroleum, coal, molybdenum, vanadium, natural gas, and other mineral and energy resources. Growth in these and related support industries will, to a large extent, determine the rate of economic growth for the region, primarily because of their export value.

Agriculture is also important in the region, although productivity is limited by local climatic factors. The low annual rainfall, combined with areas of marginal soil productivity, limits agricultural activities to livestock grazing and local hay and grain production. Livestock is the only major agricultural product exported from the region. Other industries are of lesser importance.

Land uses of interest include Federal and state recreational and natural areas (which occupy 29% of the land area within the region), urban areas (less than 1%), and Indian lands (16%). The bulk of the remaining land is open range, with small areas preempted for transportation networks.

B.6.6 Terrestrial Ecosystems

The Paradox region contains vast areas of relatively undisturbed natural habitat. Fifteen natural vegetation systems occur in the region; these range from pine or fir forests to scrublands, steppes, and barrenlands. Six ecological reserves have been established or proposed for the region; these "natural areas" would insure the preservation of a typical or unusual vegetation type in as near an undisturbed condition as possible. A great variety of wildlife inhabits the region, including many furbearing species, numerous big- and small-game species, and several threatened or endangered species.

Major range types within the region include grasslands, three types of desert shrubs, and pinyon-juniper woodlands. This range is well utilized, and the market value of livestock is normally 50 to 60% of the value of all agricultural products in the region. Lands having good soil on moderate slopes

are generally dry-farmed or irrigated. A variety of crops are grown; these typically account for 40 to 50% of the market value of all agricultural products. Although extensive forested areas occur in the region, forest products contribute less than 1% of the total value of all agricultural crops.

B.6.7 Aquatic Ecosystems

Most aquatic habitats in the Paradox region are cold-water trout streams, generally above 5000 feet in elevation. The native game fish, mainly cut-throat trout and whitefish, have been largely replaced by introduced game species, principally rainbow trout. Very little warm-water-stream habitat is found in the region; the warm-water habitats that do exist frequently contain both cold- and warm-water fish species. Although a considerable number of sport fish are taken annually, the fishery resource is relatively poor because of the high sediment load of many streams. Four threatened or endangered fish species have been identified in the region; all are found in the Colorado River or its tributaries.

B.7 GULF INTERIOR SALT-DOME REGION*

B.7.1 Geology

The Gulf interior region of Alabama, Mississippi, Louisiana, and Texas lies within the Gulf Coastal Plain physiographic province (Figure B-4). It includes parts of 11 major physiographic subdivisions.

The basement of the Gulf interior region consists of structurally deformed incipient or weakly metamorphic late Paleozoic and older rocks and crystalline materials of unknown age. These rocks are overlain by a great thickness of Mesozoic and Cenozoic that regionally thickens in successive wedges toward the Gulf. The top of the Paleozoic basement occurs at depths of about 13,000 feet at the northern boundary of the region and reaches almost 30,000 feet in depth at the southern limit. Local structure modifies this general trend.

The region lies within a large structural downwarp known as the Mississippi Embayment, which extends north into southern Illinois, east into Alabama, south to the vicinity of Baton Rouge, Louisiana, and as far west as eastern Texas. A variety of smaller structural elements modifies this general framework and defines the immediate structural parameters of the storage rock unit. These features include basins and domes or uplifts, flexures and faults, and salt domes.

The region is one of low seismicity. Within 100 miles of the Gulf interior region there were only 20 earthquakes between 1886 and 1974 whose maximum intensities were equal to or greater than V on the modified Mercalli scale of 1931.

*Data from Regional Environmental Characterization Report for the Gulf Interior Region and Surrounding Territory (Bechtel, 1978b).

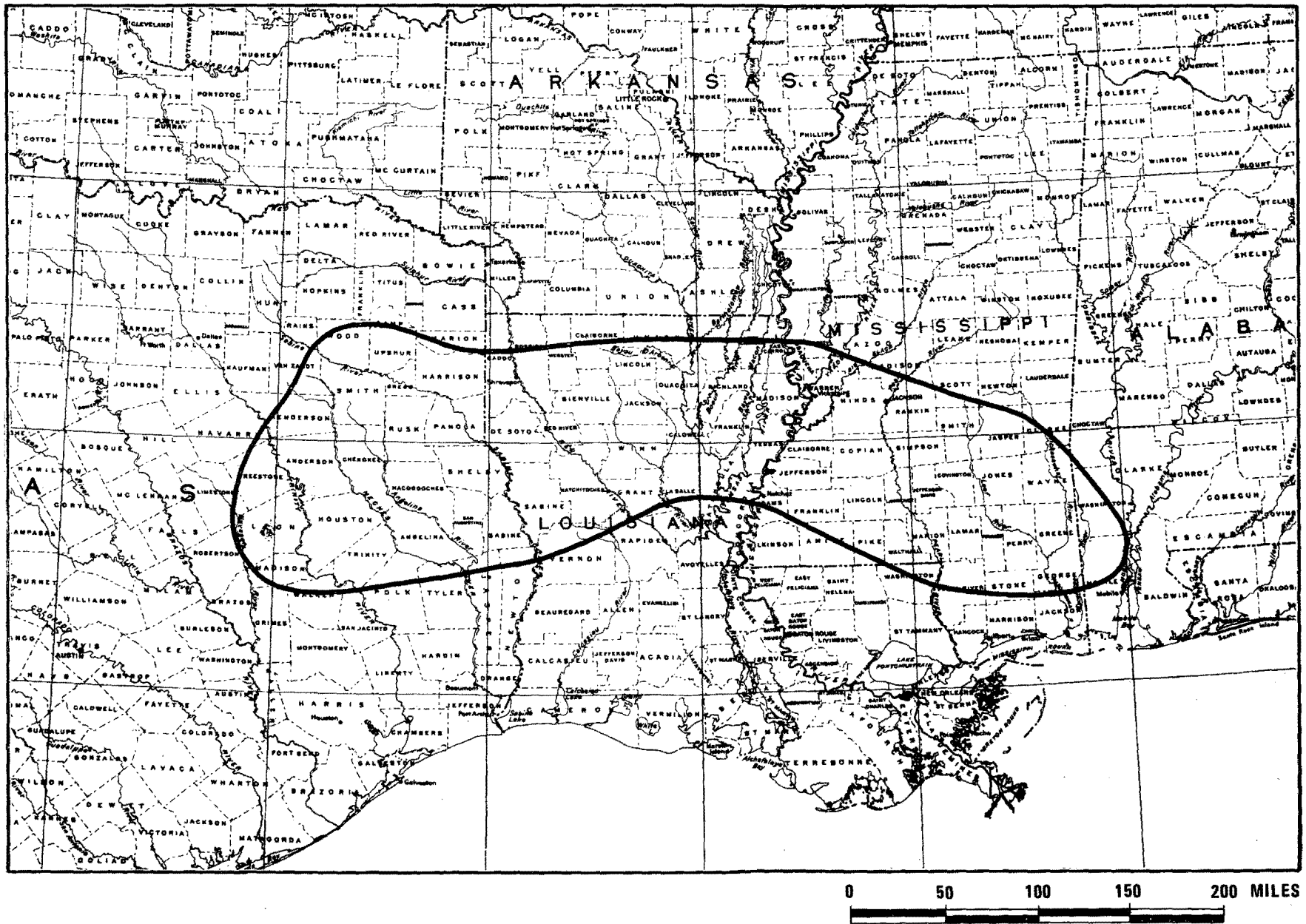

Figure B-4. The Gulf interior salt-dome region.

The early tectonic history of the Gulf Coastal area before Jurassic time is conjectural because of lack of data. Currently, there are two trends of thought concerning the origin of the Gulf. One theory holds that the Gulf in some form existed since late Precambrian; the more popular theory holds that the Gulf was initiated by plate tectonics (sea-floor spreading) during early Mesozoic. By early Jurassic time, marine water had entered the area from the west, and a major evaporite-deposition cycle was initiated. At this time the area was probably landlocked. By the late Cretaceous, the area was open to the sea, and the salt deposition had ceased. Various episodes of uplift prior to the Recent (Holocene) Epoch have resulted in the deposition of up to as much as 30,000 feet of material.

Oil and natural gas are the chief mineral industries of the area and have been for the past 50 years. However, other industries, based on processing such materials as ceramic and nonceramic clays, iron ore, and salt, are also well developed in relation to available markets.

B.7.2 Hydrology

The surface-water resources of the Gulf interior region can best be summarized by briefly reviewing the surface-water characteristics of each of four Water Resource Regions (WRRs): the Arkansas-White-Red, Texas Gulf, Lower Mississippi, and South Atlantic Gulf Regions. The various surface-water parameters described for each WRR--including precipitation, runoff, flood history, and surface-water quality, availability, and demand--may vary significantly between and within WRRs.

The Arkansas-White-Red Region (AWRR), which consists of 265,000 square miles in Oklahoma, Louisiana, Arkansas, Texas, Missouri, Kansas, New Mexico, and Colorado, intersects only a small midwestern portion of the Gulf interior region. Precipitation and runoff decrease greatly from the humid eastern areas to the semiarid western areas of the AWRR. The AWRR averages 3200 to 113,000 cfs of runoff, with the maximum stream flow generally occurring from April to June. Major rivers include the Arkansas, White, Red, and Canadian. Eastern lowlands of the AWRR are subject to severe rainstorms and recurrent flash flooding; flooding in the western and central portions results from intense and infrequent rainstorms of short duration. Flood-control problems have been reduced, particularly in eastern areas, by the construction of numerous reservoirs along major rivers. Surface-water quality in several major waterways of the AWRR is poor because of widespread natural and man-induced pollution, including natural mineralization, mine discharges, erosion, and municipal and industrial effluents. The availability of many AWRR surface waters for agricultural, municipal, industrial, and recreational uses is severely limited by the low quantities and qualities of surface waters in some parts of the AWRR. In general, most water supplies are derived from groundwater sources in the western and central AWRR.

The Texas Gulf Region (TGR), which consists of 173,000 square miles in Texas, Louisiana, and New Mexico, intersects roughly one-third of the western Gulf interior region. Precipitation and runoff decrease dramatically from the Texas Gulf Coast northwest to the central and western areas of the TGR. Average runoff is 30 million acre-ft/yr and is principally from the eastern one-fourth of the TGR. Major rivers in the TGR include the Sabine, Neches,

Trinity, and Brazos. Flooding in the TGR typically results from tropical storms originating in the Gulf of Mexico; the largest floods have occurred in late summer and early fall from hurricanes. Total-dissolved-solids concentrations in the TGR vary from less than 100 to over 2500 mg/l, with the upper reaches of the Brazos River having the poorest water quality observed. Approximately half the TGR's water needs are met from surface-water sources, and surface-water use is expected to triple by the year 2020. Although the regional supply of surface water is expected to meet that demand, the unequal geographic distribution of surface-water supply and demand may pose problems.

The Lower Mississippi Region (LMR) consists of about 102,700 square miles in Louisiana, Mississippi, Arkansas, Missouri, Tennessee, and Kentucky; it intersects the central quarter of the Gulf interior region. Average annual precipitation varies from 64 inches along the Gulf Coast to 44 inches in southern Missouri. Runoff is rather uniform throughout the LMR, decreasing from 26 to 14 inches per year from coastal to central areas, respectively. Roughly 116,380 cfs of annual discharge is generated within the LMR. Major rivers include the Mississippi, St. Francis, White, Arkansas, and Yazoo. Flooding generally results during late winter or spring from heavy rains and rapid snowmelt throughout the Ohio and Mississippi River valleys or in late summer or early fall from tropical storms and hurricanes along the Gulf Coast. Areas subject to flooding are floodplains and adjacent areas of the Mississippi River, its major tributaries, and coastal areas. By 1970, LMR flood-control storage totaled 6,028,000 acre-feet, and over 3780 miles of levees and floodwalls were in place. Surface-water quality throughout the LMR is variable and dependent on location; in general, however, most streams have good natural quality. Varying degrees of man-induced pollution require selective use and some pretreatment of surface waters in some areas of the LMR. The LMR is one of the most water-rich WRRs in the United States, with 85 million acre-feet of runoff generated within the LMR and a total of 485 million acre-feet discharged annually from its waterways into the Gulf of Mexico. Large increases in surface-water demand are projected by the year 2020, and no shortages are expected.

The South Atlantic-Gulf Region (SAGR) consists of 276,000 square miles in South Carolina, Florida, Virginia, North Carolina, Georgia, Alabama, Louisiana, and Mississippi; it encompasses roughly the eastern third of the Gulf interior region. Precipitation is generally plentiful and uniformly distributed throughout the SAGR. Average runoff is 305,000 cfs. Seasonal highs in runoff occur from November to April and from June to October, resulting from broad cyclonic disturbances and tropical hurricanes, respectively. Major rivers in the SAGR include the Alabama, Tombigbee, Apalachicola, Santee, and Altamaha. Widespread, disastrous flooding is uncommon, although an estimated (in 1968) additional 3.3 million acres of land require flood protection by 1980. Seasonal flood potential is highest from December to April and from August to October. Areas most prone to flooding include the floodplains of major rivers and coastal areas. Numerous watershed and flood-control projects have been constructed throughout the SAGR for flood protection. Natural surface-water quality is generally excellent, with dissolved-solids concentrations averaging less than 100 mg/l. In some coastal plain streams, high turbidity and high sediment loads are not uncommon. In some localized areas, municipal, industrial, and agricultural sources of pollution have caused restricted use of surface waters and an increased reliance on upstream reservoir storage and groundwater for municipal water supplies. Because of abun-

dant surface-water and groundwater supplies within the SAGR, no current or projected water shortages are expected.

Good-quality groundwater is present throughout the Gulf interior region, and it is used extensively for domestic, municipal, and industrial purposes. Several aquifers or hydrologic units are recognized in the post-Cretaceous coastal plain sediments. They comprise a thick sequence of interbedded sands, clays, and marls in which the more permeable materials provide aquifers confined between the less permeable clays and marls. Important water-bearing units or aquifers in the region include the Wilcox-Carrizo units, the Sparta (Kosciusko) Formation, Miocene sands, and Pleistocene to Recent alluvial valley deposits. The water-bearing formations receive recharge in their outcrop areas from precipitation and stream flow, although under present conditions the aquifers are full, and most of the water available for recharge is rejected, moving laterally and discharging to low stream valleys.

B.7.3 Climate

The Gulf interior region lies within a humid temperate zone with moderately high winter temperatures and moderate amounts of rainfall throughout the year. These conditions indicate a relatively low potential for wind erosion.

Although this area has experienced significant temperature decreases (9-28.8°F) in the recent geologic past, indications of glaciation within that period are absent. In fact, the previous glacial boundary appears to be more than 435 miles north of this region.

Severe-weather occurrences in the Gulf interior region generally take the form of high winds and precipitation associated with hurricanes that intrude inland from the Gulf of Mexico. The 100-year-recurrence events for these two meteorological phenomena are 11 inches of precipitation within a 24-hour period and winds of 90 mph. Another severe-weather phenomenon experienced in this region is the occasional tornado (ranging from 6 in a 12-year period on the Louisiana-Mississippi border to 43 or more in portions of northeast Texas during the same period).

Generally moderate mixing levels together with moderate wind speeds and rolling terrain make the Gulf interior region unlikely to experience inversions. Stations within and near this region have reported 13 to 28 episode-days of poor dispersion within a 5-year period.

The region, like most of the country, experiences periods when the national ambient air-quality standards (NAAQS) for particulates are exceeded. Trends in air quality, as evaluated by the Environmental Protection Agency (EPA), indicate a very gradual improvement in this condition in the Gulf interior region, primarily as a result of improved pollution-control technology. There are also a number of areas within this region that have been designated by the EPA as areas of concern for the control of photochemical oxidants. In most cases, these areas, consisting of large metropolitan sites and their immediate surroundings, are presently exceeding NAAQS for this pollutant.

With regard to the Prevention of Significant Deterioration, the region lies within a Class II area, which allows for moderate industrial development. The nearest (presently defined) Class I areas are more than 100 miles away.

B.7.4 Background Radiation

Data for approximately 38 locations in the Gulf interior region and surrounding territory indicate that the region is about average in natural terrestrial and cosmic background radiation. The highest reported background radiation values are in Texas, but regional variations appear to be insignificant.

B.7.5 Demographic, Socioeconomic, and Land-Use Systems

In eastern Texas, the Gulf interior region is a rural area with many small towns. The major cities within the area are Tyler and Longview, but large urban areas such as Dallas, Fort Worth, Waco, and Austin are adjacent to the region. Approximately 75% of the population is white; the remaining is black (except for the 0.7% that is Indian, Chinese, Japanese, or other). The total population of the area was 766,154 in 1970, and most of the counties showed a population-growth rate of more than 7% between 1970 and 1975. Per capita income for the region was \$3119.

The Gulf interior region in Louisiana encompasses 298 parishes in the northern part of the State and includes the cities of Shreveport, Monroe, and Alexandria. The total population of this area was 1,062,685 in 1970. Population growth was slower in Louisiana than in Texas, and many parishes had a net decline of up to 10% between 1970 and 1975. Annual per capita income in 1974 for the region was \$2788.

There are 35 counties in the Gulf interior region in Mississippi. The largest cities in the region are Jackson, Meridian, Hattiesburg, and Vicksburg. The total population for the area was 778,158 in 1970 and increased to 1,064,217 (estimated) in 1975. Six counties experienced a decline in population between 1970 and 1975, and counties other than those having the major cities mentioned above had a slower growth rate than the rest of the nation and the slowest for all states in the Gulf interior region. Nearly 66% of the 1970 population was white, 34% was black, and less than 1% was of other origin. Per capita income grew by 50 to 70% between 1969 and 1974, and the regional average annual per-capita income was \$2826 in 1974.

The economy of the eastern Texas region is largely resource oriented. Extractive industries such as mining, petroleum, and natural gas extraction, manufacturing based on regional resources, and agriculture comprise the core of the export economic base. In rural counties in eastern Texas, tourism is an important element in the local economy. Mining and manufacturing activities account for 33% of the total employment. Eastern Texas is a producer of agricultural crops and livestock; some counties produce considerable amounts of livestock and poultry for export to other states.

Much of the region in Louisiana is rural and is used for agricultural crops, grazing, or forests. More than 64% of the total employment is located in the Shreveport, Monroe, or Alexandria urban areas. The State is one of the largest producers of natural gas and petroleum. Manufacturing is located near the larger urban areas, and industries based on lumber and wood products, food products, primary metal products, fabricated metal products and appliances, textiles and apparel, and chemicals all have notable employment. In 1970 the agricultural production of crops was centered in the lowland region along the Mississippi River; livestock production was concentrated in upland areas. Total agricultural income in 1974 was \$445 million, up 114% from 1969, with approximately 70% attributed to crops and hay.

Manufacturing accounts for 31% of the total employment in the Mississippi portion of the Gulf interior region and represents the largest single employment sector. Extractive industries (natural gas and petroleum, sand and gravel, and other minerals) employ less than 20% of the labor force. Agriculture is also a significant contributor to the local economy. Lowland counties of the Mississippi River basin are intensively cultivated for field and row crops; upland counties are extensively used for livestock grazing.

The majority of the population in the eastern Texas Gulf interior region lies in the Tyler and Longview urban areas. As much as 10% of the area is in urban uses, and the average population density throughout the area is 0.02 person per acre. Vast expanses of woodlands and agricultural land characterize the area. Eastern Texas has three national forests totaling 507,012 acres: Angelina, Davy Crockett, and Sabine. Recreational uses of lakes and reservoirs and parks in the area are rapidly growing, and second-home development around some lakes (i.e., the Cedar Creek Reservoir) has occurred recently. The Federal Government maintains and is acquiring jurisdiction over sizable land areas to meet growing demands for various recreational uses. Airports are common throughout eastern Texas; restricted or prohibited airspaces with various altitude and aircraft-operation limitations are also present. Highway and rail systems are extensive throughout the area. One Indian reservation exists in Polk County, Texas.

In Louisiana most urban land in residential, commercial, and industrial uses is around the cities of Shreveport, Monroe, and Alexandria. Outside these urban areas, small towns are numerous, but rural areas are, for the most part, devoted to agriculture or forests. Upland parishes in northwestern Louisiana have less field and row crops and more livestock-grazing land than do lowland parishes along the Mississippi River. The Kisatchie National Forest is distributed in several parcels throughout Louisiana; the total acreage of all parcels is 500,302 acres, or 6.1% of the land in the area. State fish and wildlife management areas and state forests provide abundant recreational uses. Airports of varying size are found throughout the area; restricted and prohibited airspaces with varying limitations are also present. Rail and highway systems are well developed in all of Louisiana. One Indian reservation is located in the area.

The largest cities in the Gulf interior region in Mississippi are Jackson (166,572), Meridian (46,256), Hattiesburg (38,097), and Vicksburg (29,726). Like Louisiana, the area is largely rural, with agricultural lands predominating. Five national forests in the area cover 1.7 million acres, or 15% of the area. Many types of uses are provided, including recreation as well as timber harvesting. Airports of various sizes are found throughout the area,

as are restricted airspaces. Rail and highway systems are well developed. One Indian reservation is located in Leake County, outside the Gulf interior region.

B.7.6 Terrestrial Ecosystems

In the Gulf interior region and surrounding territory in Texas there are nine potential vegetation types, ranging from mixed hardwood-softwood forests to open prairies and savannahs. No ecological reserves have been established in the basin, but a number of locally administered natural areas do insure preservation of habitats in as near an undisturbed condition as possible. Important animal species include approximately 9 furbearers, several game animals, and 20 protected, threatened, or endangered species.

Major range types in the Texas Gulf interior region include grasslands, shrublands and chaparral, and pinyon-juniper woodlands. The rangeland has a relatively high productivity compared to the typical western range, and live-stock and livestock products accounted for the highest portion of all agricultural products sold in the Texas Gulf interior region in 1974 (47%). This was followed by poultry and poultry products (36%), crops and hay (12%), nursery and greenhouse products (3%), and forest products on farms (1%). Harvested hay, sorghum, and cotton were the crops covering the greatest land area in 1974. Commercial forests in counties within the east Texas Piney Woods region cover about 63% of the region. Forest types with the most coverage are loblolly-shortleaf pine, oak-pine, and oak-hickory.

Only four potential vegetation types occur within the Gulf interior region of Louisiana--prairie and three kinds of mixed hardwood-and-softwood forests. However, the variation within these vegetation types, due to man's activities as well as the natural soil and climatic variations, contributes to diverse wildlife habitats. In addition to one ecological reserve, the Bayou Boeuf Natural Area, there are several State, private, and Federal wildlife areas. Important animal species include approximately 13 furbearers, 11 game mammals, and 6 threatened or endangered species.

Livestock grazing occurs on cultivated pasture as well as in forested lands. Livestock and livestock products represented only 18% of the value of agricultural products sold in 1974. Principal livestock types produced in the area in 1974 were beef and dairy cattle. Livestock productivity varies throughout the area, as does the productivity of agricultural crops and timber resources, the most productive livestock parishes being De Soto, Caddo, Richland, Natchitoches, and Rapides. Agricultural crop production was largest in Morehouse, East Carrol, Madison, and Avoyelles Parishes; crops and hay represented 70% of all agricultural products sold in the Louisiana Gulf interior region in 1974. Cotton was the crop with the largest harvested area, followed by soybeans, rice, corn, sorghum, wheat, and sugarcane. There are three major forest types in Louisiana: southern pine, upland hardwood (oak-hickory), and bottomland hardwood. Commercial southern pine forests are mostly longleaf and slash pines in the southern half of the State and short-leaf and loblolly pines in the north. Bottomland hardwoods include such species as oak, gum, cypress, elm, ash, and cottonwood. The production of timber resources was highest in Ouachita, Caldwell, Winn, Natchitoches, Sabine, and Caddo Parishes.

In Mississippi, as in Louisiana, there are only four potential natural vegetation types, but one, the blackbelt, is limited to the Gulf interior region of Mississippi and Alabama. Six ecological natural areas have been established in the Gulf interior region of Mississippi for the preservation of vegetation types and wildlife habitat. Important animal species include approximately 11 furbearers, 11 game animals, and 13 species on the Federal list of threatened and endangered species.

In the Mississippi Gulf interior region, poultry and poultry products accounted for the highest portion of all agricultural products sold in 1974 (45%), followed by crops and hay (30%), and livestock and livestock products (22%). Rangeland and wooded pasture are extensively distributed throughout the area. Soybeans, hay, and cotton were the crops with the largest harvested area in 1974. Commercial forests are extensive, covering about 62% of the land area in Mississippi. Commercial forests with the largest areas are oak-hickory, loblolly-shortleaf pine, oak-pine, and oak-gum-cypress.

B.7.7 Aquatic Ecosystems

The Gulf interior region is noted for its extensive and valuable recreational and commercial warm-water stream and lake fisheries. Stream and lake habitats in the region can be divided into bottomland and upland habitat types. Bottomland habitats are generally in the larger, deeper, slow-moving, and turbid streams and rivers that meander through the interior region. Upland habitats are generally in the smaller, faster-moving creeks and streams that are the tributaries of the major waterways within the region. Six endangered fish species have been identified in the Gulf interior region; all six species are found in the State of Mississippi.

B.8 THE HANFORD SITE*

The Hanford Site is a 600-square-mile tract in the southeastern part of Washington State. It is semiarid, and the closest population center is Richland, 5 kilometers to the south.

B.8.1 Geology

The Hanford Site is in the Columbia Plateau physiographic province, which is characterized by the occurrence of a thick sequence of tholeiitic basalts and varies significantly in topographic expression as well as structure (Figure B-5). The Columbia basin section is a broad geologic and structural basin in the interior of the province; the Hanford Site is located in the Pasco basin, which is one of several subbasins.

*Source: Private communication from K. R. Fecht, Rockwell Hanford Operations, December 1978.

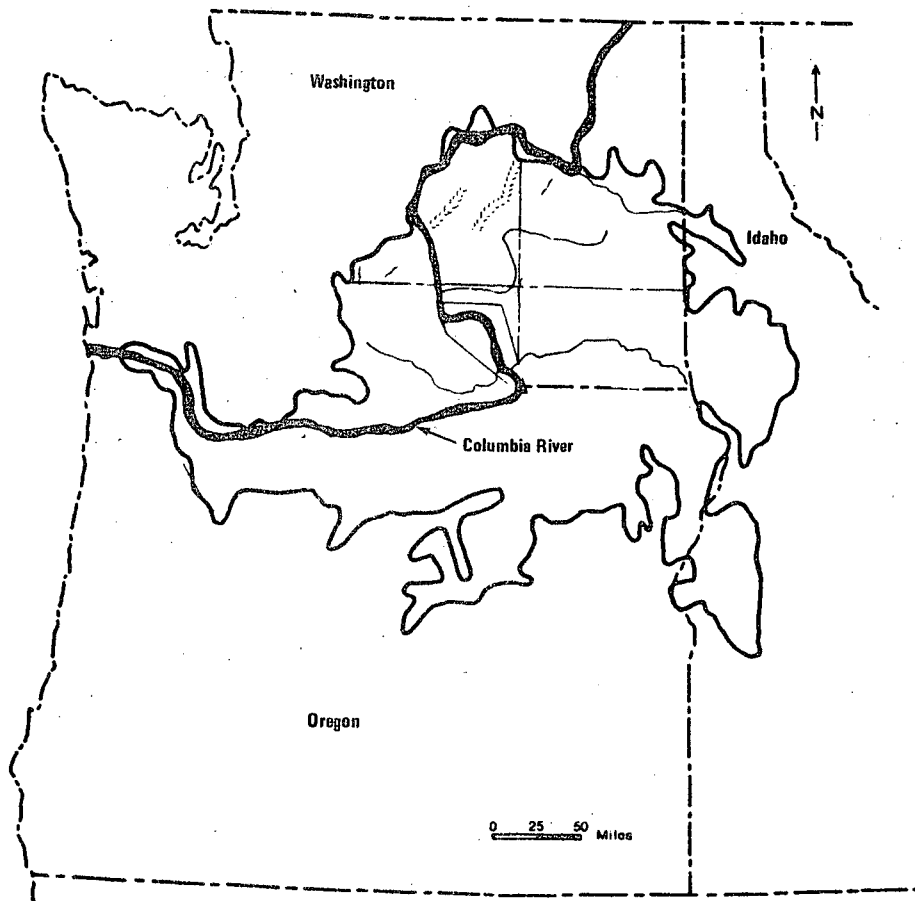

Figure B-5. Location of the Columbia Plateau basalts.

The Columbia basin contains the Channeled Scablands formed at the close of Pleistocene glaciation by multiple catastrophic floods. The floods occurred as ice-dammed lakes released torrents of water and ice when the ice dams were breached.

The regional geology is dominated by Cenozoic rocks and structures. During the Cenozoic Era, numerous basalt magma outpourings from extensive fissure systems flowed across the Columbia Plateau and into regional areas of subsidence, such as the Pasco basin, where thick sections of basalt accumulated. The thickness of the basalt sequence is an average of 1800 feet in the Columbia Plateau and is more than 10,000 feet in the Pasco basin. The frequency and size of the eruptions decreased and then ceased during the late Tertiary period (about 6 million years before the present).

Regional subsidence continued and was accompanied by regional north-south compression, which has resulted in folding of the basalt sequence and in the formation of a number of roughly east-west-trending anticlinal ridges in the central part of the Columbia Plateau. At the Hanford Site, this ridge system is represented by the Rattlesnake Mountains, the Yakima Ridge, and the Umtanum-Gable Mountain Ridge.

Within and on top of the basalt sequence are sedimentary deposits. The interbeds between basalt flows consist of tuffs, tuffaceous sediments, and, in some locations, stream-carried sediments. Interbeds are more prevalent in the upper part of the basalt sequence.

The top of the basalt sequence is covered with fluvial, glaciofluvial, and eolian deposits. In the Pasco basin, the basalt is covered by up to 1000 feet of fluvial sediments (the Ringold Formation) overlain with up to 300 feet of glaciofluvial sediments (informally named the Hanford Formation). Eolian deposits overlie the Ringold Formation in the western part of the Hanford Site. The basement rocks below the basalt sequence are of uncertain composition but are probably sandstones and shale. Granitic rocks are probably below that.

Mineral resources are sand and gravel, basalt, and possibly natural gas. Natural gas has not been detected in the recent drilling of deep boreholes.

The Columbia basin is a region of low seismicity in which moderate earthquakes have occurred. Microseismic activity at the Hanford Site indicates low levels of stress relief, generally shallow focal depths, and no obvious relationship to any geologic structure. The maximum known earthquake intensity in the vicinity of the site was less than IV on the modified Mercalli scale.

Faults in the region are associated with folds in the basalt and appear to reflect local adjustments to folding. They are relatively short in length (less than 30 miles), with generally small displacements (less than 500 feet).

B.8.2 Hydrology

The Pasco basin is a series of confined aquifers overlain by an unconfined aquifer. The area is bounded by ridges to the north, south, and west and by a broad regional monocline to the east.

The confined aquifers are primarily the permeable interbeds and interflow zones in the basalt sequence. The interflow zones are characterized by vesicular rock or by interconnected fracturing caused by rapid cooling of the basalt magma. There is very little hydraulic interconnection between aquifers since the central volume of the basalt flows is dense and has a very low permeability. Fractures in the basalt have been filled with secondary mineralization products such as montmorillonite. The confined aquifers are recharged by precipitation, stream runoff, and infiltration from the overlying unconfined aquifer or distant recharge points. Discharge of the upper aquifer is to the Columbia River.

The unconfined aquifer occurs above the basalt sequence up to about the top of the Ringold Formation. The groundwater movement is distorted by local geologic structures and has been modified by waste-disposal activities at the Hanford Site.

Between the top of the unconfined aquifer and the land surface is the vadose zone. This unsaturated zone is up to about 300 feet thick and is extremely dry below about 30 feet. In this desiccated zone, there is nearly no downward movement of water.

B.8.3 Climate

The climate of the Columbia basin region is dominated by the Cascade Mountain Range to the west and by the prevalent direction of storm fronts from the Pacific Ocean. Summers are relatively hot and dry, most of the average 6 inches of precipitation falls during the winter, and there are occasional periods of high winds. Prevailing winds are from the northwest.

Tornadoes are infrequent. It has been estimated that the probability of a specific surface structure's being hit by a tornado is only 6 in one million.

Thunderstorm activity is low. The estimated annual lightning strike frequency is 0.022 for a typical Hanford building.

B.8.4 Demography

There are an estimated 250,000 people within 50 miles of the Hanford Site. The estimated mean growth rate to the year 2000 is 0.7%.

B.8.5 Historic and Archaeological Sites

There are five locations listed as historic sites or as natural landmarks within 50 miles of the Hanford Site. None are on the site. There are over 200 Indian archaeological sites in the Hanford area, and many of them are along the Columbia River where it passes through the Hanford Site.

B.8.6 Ecology

The ecological aspects of the Hanford Site are consistent with the semi-arid climate. The principal plant community is the sagebrush-cheatgrass-bluegrass association; mammals include the coyote, the rabbit, mule deer, and small rodents; birds include the chukar partridge, western meadowlark, migratory ducks and geese, and several species of predatory birds. There are several thousand insect species and about 15 species of snakes and lizards. The aquatic ecosystem consists of the Columbia River and a few ponds and ditches.

Rare, threatened, and endangered species inhabiting the Hanford site include three plant species and seven bird species. The status of some of the latter has not been determined.

REFERENCES

- Bechtel, 1978a. Regional Environmental Characterization Report for the Paradox Region and Surrounding Territory, ONWI/Sub/78/512-01600-2, prepared by Bechtel National, Inc., for the Office of Nuclear Waste Isolation, Battelle Memorial Institute, Columbus, Ohio.
- Bechtel, 1978b. Regional Environmental Characterization Report for the Gulf Interior Region and Surrounding Territory, ONWI/Sub/78/512-01600-1, prepared by Bechtel National, Inc., for the Office of Nuclear Waste Isolation, Battelle Memorial Institute, Columbus, Ohio.
- NUS, 1979a. Environmental Characterization of Bedded Salt Formation and Overlying Areas of the Permian Basin, ONWI-27, prepared by NUS Corporation for the Office of Nuclear Waste Isolation, Battelle Memorial Institute, Columbus, Ohio.
- NUS, 1979b. Environmental Characterization of Bedded Salt Formation and Overlying Areas of the Salina Basin, ONWI-16, prepared by NUS Corporation for the Office of Nuclear Waste Isolation, Battelle Memorial Institute, Columbus, Ohio.
- DOE (U.S. Department of Energy), 1979. Nuclear Waste Management Program Summary Document, Washington, D.C.
- Thornbury, W. D., 1965. Regional Geomorphology of the United States, John Wiley & Sons, Inc., New York.

Appendix C

**PRESIDENT CARTER'S MESSAGE TO CONGRESS
ON THE MANAGEMENT OF RADIOACTIVE WASTE**

AND

**THE FINDINGS AND RECOMMENDATIONS OF THE INTERAGENCY
REVIEW GROUP ON NUCLEAR WASTE MANAGEMENT**

Appendix C

PRESIDENT CARTER'S MESSAGE TO CONGRESS ON THE MANAGEMENT OF RADIOACTIVE WASTE

AND

THE FINDINGS AND RECOMMENDATIONS OF THE INTERAGENCY REVIEW GROUP ON NUCLEAR WASTE MANAGEMENT

Two documents have been especially important in establishing a national policy for the management of radioactive waste: President Carter's message to Congress on February 12, 1980, and the 1979 report of the Interagency Review Group. This appendix contains the entire message and excerpts from the report.

C.1. PRESIDENT'S MESSAGE

On February 12, 1980, President Carter established a comprehensive program for the management of radioactive waste. His message to the Congress of the United States stated the objectives of that program and outlined the steps to be taken in carrying it out. The message specifically mentioned the WIPP project and the site near Carlsbad, New Mexico. The remainder of this section is a complete text of President Carter's message.

PRESIDENT CARTER'S MESSAGE TO CONGRESS

(February 12, 1980)

TO THE CONGRESS OF THE UNITED STATES:

Today I am establishing this Nation's first comprehensive radioactive waste management program. My paramount objective in managing nuclear wastes is to protect the health and safety of all Americans, both now and in the future. I share this responsibility with elected officials at all levels of our government. Our citizens have a deep concern that the beneficial uses of nuclear technology, including the generation of electricity, not be allowed to imperil public health or safety now or in the future.

For more than 30 years, radioactive wastes have been generated by programs for national defense, by the commercial nuclear power program, and by a variety of medical, industrial, and research activities. Yet, past governmental efforts to manage radioactive wastes have not been technically adequate. Moreover, they have failed to involve successfully the States, local governments, and the public in policy or program decisions. My actions today lay the foundation for both a technically superior program and a full cooperative Federal-State partnership to ensure public confidence in a waste management program.

My program is consistent with the broad consensus that has evolved from the efforts of the Interagency Review Group on Radioactive Waste Management (IRG) which I established. The IRG findings and analysis were comprehensive, thorough, and widely reviewed by public, industry and citizen groups, State and local governments, and members of the Congress. Evaluations of the scientific and technical analyses were obtained through a broad and rigorous peer review by the scientific community. The final recommendations benefited from and reflect this input.

My objective is to establish a comprehensive program for the management of all types of radioactive wastes. My policies and programs establish mechanisms to ensure that elected officials and the public fully participate in waste decisions, and direct Federal departments and agencies to implement a waste management strategy which is safe, technically sound, conservative, and open to continuous public review. This approach will help ensure that we will reach our objective--the safe storage and disposal of all forms of nuclear waste.

Our primary objective is to isolate existing and future radioactive waste from military and civilian activities from the biosphere and pose no significant threat to public health and safety. The responsibility for resolving military and civilian waste management problems shall not be deferred to future generations. The technical program must meet all relevant radiological protection criteria as well as all other applicable regulatory requirements. This effort must proceed regardless of future developments within the nuclear industry--its future size, and resolution of specific fuel cycle, and reactor design issues. The specific steps outlined below are each aimed at accomplishing this overall objective.

First, my Administration is committed to providing an effective role for State and local governments in the development and implementation of our nuclear waste management program. I am therefore taking the following actions:

- By Executive Order, I am establishing a State Planning Council which will strengthen our intergovernmental relationships and help fulfill our joint responsibility to protect public health and safety in radioactive waste matters. I have asked Governor Riley of South Carolina to serve as Chairman of the Council. The Council will have a total of 19 members: 15 who are Governors or other elected officials, and 4 from the Executive departments and agencies. It will advise the Executive Branch and work with the Congress to address radioactive waste management issues, such as planning and siting, construction, and operation of facilities. I will submit legislation during this session to make the Council permanent.
- In the past, States have not played an adequate part in the waste management planning process--for example, in the evaluation and location of potential waste disposal sites. The States need better access to information and expanded opportunity to guide waste management planning. Our relationship with the States will be based on the principle of consultation and concurrence in the siting of high level waste repositories. Under the framework of consultation and concurrence, a host State will have a continuing role in Federal decisionmaking on the siting, design, and construction of a high level waste repository. State consultation and concurrence, however, will lead to an acceptable solution to our waste disposal problem only if all the States participate as partners in the program I am putting forth. The safe disposal of radioactive waste, defense and commercial, is a national, not just a Federal, responsibility.
- I am directing the Secretary of Energy to provide financial and technical assistance to States and other jurisdictions to facilitate the full participation of State and local government in review and licensing proceedings.

Second, for disposal of high level radioactive waste, I am adopting an interim planning strategy focused on the use of mined geologic repositories capable of accepting both waste from reprocessing and unprocessed commercial spent fuel. An interim strategy is needed since final decisions on many steps which need to be taken should be preceded by a full environmental review under the National Environmental Policy Act. In its search for suitable sites for high level waste repositories, the Department of Energy has mounted an expanded and diversified program of geologic investigations that recognizes the importance of the interaction among geologic setting, repository host rock, waste form, and other engineered barriers on a site-specific basis. Immediate attention will focus on research and development, and on locating and characterizing a number of potential repository sites in a variety of different geologic environments with diverse rock types. When four to five sites have been evaluated and found potentially suitable, one or more will be selected for further development as a licensed full-scale repository.

It is important to stress the following two points: First, because the suitability of a geologic disposal site can be verified only through detailed and time-consuming site specific

evaluations, actual sites and their geologic environments must be carefully examined. Second, the development of a repository will proceed in a careful step-by-step manner. Experience and information gained at each phase will be reviewed and evaluated to determine if there is sufficient knowledge to proceed with the next stage of development. We should be ready to select the site for the first full-scale repository by about 1985 and have it operational by the mid-1990's. For reasons of economy, the first and subsequent repositories should accept both defense and commercial wastes.

Consistent with my decision to expand and diversify the Department of Energy's program of geologic investigation before selecting a specific site for repository development, I have decided that the Waste Isolation Pilot Plant project should be cancelled. This project is currently authorized for the unlicensed disposal of transuranic waste from our National defense program, and for research and development using high level defense waste. This project is inconsistent with my policy that all repositories for highly radioactive waste be licensed, and that they accept both defense and commercial wastes.

The site near Carlsbad, New Mexico, which was being considered for this project, will continue to be evaluated along with other sites in other parts of the country. If qualified, it will be reserved as one of several candidate sites for possible use as a licensed repository for defense and commercial high level wastes. My fiscal year 1981 budget contains funds in the commercial nuclear waste program for protection and continued investigation of the Carlsbad site. Finally, it is important that we take the time to compare the New Mexico site with other sites now under evaluation for the first waste repository.

Over the next five years, the Department of Energy will carry out an aggressive program of scientific and technical investigations to support waste solidification, packaging, and repository design and construction including several experimental, retrievable emplacements in test facilities. This supporting research and development program will call upon the knowledge and experience of the Nation's very best people in science, engineering, and other fields of learning, and will include participation of universities, industry, and the government departments, agencies, and national laboratories.

Third, during the interim period before a disposal facility is available, waste must and will continue to be cared for safely. Management of defense waste is a Federal responsibility; the Department of Energy will ensure close and meticulous control over defense waste facilities which are vital to our national security. I am committed to maintaining safe interim storage of these wastes as long as necessary and to making adequate funding available for that purpose. We will also proceed with research and development at the various defense sites that will lead the processing, packaging, and ultimate transfer to a permanent repository of the high level and transuranic wastes from defense programs.

In contrast, storage of commercial spent fuel is primarily a responsibility of the utilities. I want to stress that interim spent fuel storage capacity is not an alternative to permanent disposal. However, adequate storage is necessary until repositories are available. I urge the utility industry to continue to take all actions necessary to store spent fuel in a manner that will protect the public and ensure efficient and safe operation of power reactors. However, a limited amount of government storage capacity would provide flexibility to our national waste disposal program and an alternative for those utilities which are unable to expand their storage capabilities.

I reiterate the need for early enactment of my proposed spent nuclear fuel legislation. This proposal would authorize the Department of Energy to: (1) design, acquire or construct, and operate one or more away-from-reactor storage facilities, and (2) accept for storage, until permanent disposal facilities are available, domestic spent fuel, and a limited amount of foreign spent fuel in cases when such action would further our non-proliferation policy objectives. All costs of storage, including the cost of locating, constructing, and operating permanent geologic repositories, will be recovered through fees paid by utilities and other users of the services and will ultimately be borne by those who benefit from the activities generating the wastes.

Fourth, I have directed the Department of Energy to work jointly with states, other government agencies, industry and other organizations, and the public, in developing national plans to establish regional disposal sites for commercial low level waste. We must work together to resolve the serious near-term problem of low level waste disposal. While this

task is not inherently difficult from the standpoint of safety, it requires better planning and coordination. I endorse the actions being taken by the Nation's governors to tackle this problem and direct the Secretary of Energy to work with them in support of their effort.

Fifth, the Federal programs for regulating radioactive waste storage, transportation, and disposal are a crucial component of our efforts to ensure the health and safety of Americans. Although the existing authorities and structures are basically sound, improvements must be made in several areas. The current authority of the Nuclear Regulatory Commission to license the disposal of high level waste and low level waste in commercial facilities should be extended to include spent fuel storage, and disposal of transuranic waste and non-defense low level waste in any new government facilities. I am directing the Environmental Protection Agency to consult with the Nuclear Regulatory Commission to resolve issues of overlapping jurisdiction and phasing of regulatory actions. They should also seek ways to speed up the promulgation of their safety regulations. I am also directing the Department of Transportation and the Environmental Protection Agency to improve both the efficiency of their regulatory activities and their relationships with other Federal agencies and state and local governments.

Sixth, it is essential that all aspects of the waste management program be conducted with the fullest possible disclosure to and participation by the public and the technical community. I am directing the departments and agencies to develop and improve mechanisms to ensure such participation and public involvement consistent with the need to protect national security information. The waste management program will be carried out in full compliance with the National Environmental Policy Act.

Seventh, because nuclear waste management is a problem shared by many other countries and decisions on waste management alternatives have nuclear proliferation implications, I will continue to encourage and support bilateral and multilateral efforts which advance both our technical capabilities and our understanding of spent fuel and waste management options, which are consistent with our non-proliferation policy.

In its role as lead agency for the management and disposal of radioactive wastes and with cooperation of the other relevant Federal agencies, the Department of Energy is preparing a detailed National Plan for Nuclear Waste Management to implement these policy guidelines and other recommendations of the IRG. This Plan will provide a clear road map for all parties and will give the public an opportunity to review the entirety of our program. It will include specific program goals and milestones for all aspects of nuclear waste management. A draft of the comprehensive National Plan will be distributed by the Secretary of Energy later this year for public and Congressional review. The State Planning Council will be directly involved in the development of this Plan.

The Nuclear Regulatory Commission now has underway an important proceeding to provide the Nation with its judgment on whether or not it has confidence that radioactive wastes produced by nuclear power reactors can and will be disposed of safely. I urge that the Nuclear Regulatory Commission do so in a thorough and timely manner and that it provide a full opportunity for public, technical, and government agency participation.

Over the past two years as I have reviewed various aspects of the radioactive waste problem, the complexities and difficulties of the issues have become evident--both from a technical and, more importantly, from an institutional and political perspective. However, based on the technical conclusions reached by the IRG, I am persuaded that the capability now exists to characterize and evaluate a number of geologic environments for use as repositories built with conventional mining technology. We have already made substantial progress and changes in our programs. With this comprehensive policy and its implementation through the FY 1981 budget and other actions, we will complete the task of reorienting our efforts in the right direction. Many citizens know and all must understand that this problem will be with us for many years. We must proceed steadily and with determination to resolve the remaining technical issues while ensuring full public participation and maintaining the full cooperation of all levels of government. We will act surely and without delay, but we will not compromise our technical or scientific standards out of haste. I look forward to working with the Congress and the states to implement this policy and build public confidence in the ability of the government to do what is required in this area to protect the health and safety of our citizens.

JIMMY CARTER

THE WHITE HOUSE

C.2 FINDINGS AND RECOMMENDATIONS OF THE INTERAGENCY REVIEW GROUP ON NUCLEAR WASTE MANAGEMENT

An important document in the development of the national waste-management program has been the report of the Interagency Review Group on Nuclear Waste Management (IRG, 1979). After a brief review of the purpose of this Group and its major technical findings, this section presents quotations taken from two parts of the Group's report: the sections dealing with the disposal of transuranic (TRU) waste and with the disposal of high-level waste (HLW). Although high-level waste would not be disposed of at the WIPP, the quotations dealing with high-level waste are included here as reference material supporting the discussion of alternatives in Chapters 3 and 4.

The Interagency Review Group was formed in order to guide the national waste-management program. President Carter called for a review of the waste-management program in his April 1977 National Energy Plan. In response to this request, the DOE established an internal task force and published a draft report in March 1978. The President then created the formal Interagency Review Group on Nuclear Waste Management and instructed it to make policy and program recommendations to him, using the draft report of the DOE task force as one input. This group, chaired by the DOE, comprised representatives of 14 agencies. It developed a draft report to the President that was published for public comment in October 1978 (IRG, 1978). After the review of public comment, the Interagency Review Group published a revised report (IRG, 1979).

The Interagency Review Group consulted extensively with the scientific and technical community, including independent geologic and environmental experts. The Group's summary of the major technical findings of this activity (IRG, 1979, p. 42) is quoted in full below.

Present scientific and technological knowledge is adequate to identify potential repository sites for further investigation. No scientific or technical reason is known that would prevent identifying a site that is suitable for a repository provided that the system's view is utilized rigorously to evaluate the suitability of sites and designs, and in minimizing the influence of future human activities. A suitable site is one at which a repository would meet predetermined criteria and which would provide a high degree of assurance that radioactive waste can be successfully isolated from the biosphere for periods of thousands of years. For periods beyond a few thousand years, our capability to assess the performance of the repository diminishes and the degree of assurance is therefore reduced. The feasibility of safely disposing of high-level waste in mined repositories can only be assessed on the basis of specific investigations at and determinations of suitability of particular sites. Information obtained at each successive step of site selection and repository development will permit reevaluation of risks, uncertainties, and the ability of the site and repository to meet regulatory standards. Such reevaluations would lead either to abandonment of the site or a decision to proceed to the next step. Reliance on conservative engineering practices and multiple independent barriers can reduce some risks and compensate for some uncertainties. However, even at the time of decommissioning, some uncertainty about repository performance will still exist. Thus, in addition to technical evaluation, a societal judgment that considers the level of risk and the associated uncertainty will be necessary.

IRG Discussion of a Generic Approach to TRU-Waste Disposal

The Interagency Review Group raised an important issue about TRU waste disposal: should a dedicated TRU-waste repository be built if an opportunity exists to do so, or should TRU-waste disposal await the availability of high-

level-waste repositories and take place there? The IRG report states (IRG, 1979, p. 73) that "the IRG still considers that proceeding with a dedicated TRU repository, if an opportunity is available, is consistent with a conservative and stepwise approach."

It should be noted, however, that the Interagency Review Group approached this question generically, as an appropriate interim strategic-planning basis until the environmental-review provisions of the National Environmental Policy Act (NEPA) have been carried out. The discussion by the Interagency Review Group (IRG, 1979, pp. 69-70) of strategies for TRU-waste disposal is reproduced in full below.

As with choosing a strategy for HLW disposal, the choice of a TRU waste disposal strategy must await completion of an appropriate environmental impact statement and its adoption through the NEPA process. In the meantime, Federal actions regarding the management of TRU waste must not prejudice the choice of strategies for their disposal. Nevertheless, an interim strategic planning basis will be necessary to guide the TRU-waste management programs and R&D activities before that choice is made.

In laying out the following technical strategies for TRU waste disposal, the IRG assumed that all TRU waste, whether generated by commercial or defense operations, would be disposed of in the same manner because no technical reason exists to treat them differently. The two strategies examined by the IRG are:

Strategy 1. No special action would be taken to pursue TRU waste disposal prior to the opening of a high-level-waste repository. TRU waste would be disposed of in high-level-waste repositories whenever they become available.

Strategy 2. If an opportunity can be found, the program would proceed with an early dedicated TRU repository as soon as a site could be appropriately qualified and NEPA requirements fulfilled.

Enough TRU waste now exists stored above ground to warrant the opening of a repository dedicated to TRU. Such a facility could probably hold all the TRU waste to be generated through the end of this century. Of course, once a high-level-waste repository were available, decisions on the location for disposal of then existing TRU wastes could be made on a case by case basis to maximize convenience and minimize transportation. A second repository dedicated to TRU waste alone would seem to be unnecessary.

Because of the presence in TRU waste of substantial quantities of transuranic radionuclides, issues related to long-term containment (such as the potential for groundwater transport, any possibilities of repository breachment, and concerns about mineral resources or tectonism) are identical for TRU and HLW repositories. However, the problems associated with heat generation and increases in temperature are absent and the TRU wastes are not as difficult to handle as HLW. The operational demands on a disposal system designed for TRU waste alone would be more modest than those associated with a HLW repository. In addition, because of the absence of heat-related considerations, the regulatory review of a dedicated TRU repository would be somewhat simplified compared with that for a HLW repository.

Proceeding with an early, dedicated TRU repository would therefore be consistent with the previously recommended philosophy of [conservatism] and proceeding stepwise into the most difficult disposal problem and would signal the government's determination to proceed in a timely manner with disposal of nuclear wastes. There would, of course, be some additional costs associated with the opening of a dedicated TRU facility.

Having considered these various matters, the IRG recommends adopting, as an interim strategic planning basis pending NEPA review, the concept of proceeding with an early TRU repository if an opportunity exists to do so.

IRG Discussion of High-Level-Waste Disposal

The Interagency Review Group defined four technical strategies for high-level-waste disposal (IRG, 1979, pp. 49-50):

- Strategy I provides that only mined repositories would be considered and that only geological environments with salt as the emplacement media would be considered for the first several repositories. As a result of past focusing on salt, there is a large volume of information available. In addition, one body of opinion holds that salt is the best, or at least an acceptable, emplacement medium and that suitable sites can be found where salt is the host rock.
- Strategy II provides that, for the first few facilities, only mined repositories would be considered. A choice of site for the first repository would be made from among whatever types of environments have been adequately characterized at the time of choice. Because generic understanding of engineering features of a salt repository are most advanced, the first choice is expected to be made from environments based on salt geology. Sites from a wider range of geologic environments would be available for selection somewhat later.
- Strategy III provides that, for the first facility only mined repositories would be considered. However, three to five geological environments possessing a wide variety of emplacement media would be examined before a selection was made. Other technological options would be contenders as soon as they had been shown to be technologically sound and economically feasible.
- Strategy IV provides that the choice of technical options and, if appropriate, geological environment be made only after information about a number of environments and other technical options has been obtained.

These strategies were intended to illustrate the range of possible strategic approaches. They were not intended to be a complete list of possible strategies or comprehensive descriptions of a strategic planning basis that might actually be adopted by the waste disposal program. For the latter purpose, they are admittedly incomplete.

IRG Discussion of Key Elements of Interim Strategic-Planning Basis for High-Level Waste

As a result of comments on its draft report, the IRG (1979, pp. 61-62) expanded and clarified its views on the interim strategic-planning basis for high-level waste, restating them as follows:

- The approach to permanent disposal of nuclear waste should proceed on a stepwise basis in a technically conservative manner....
- Near-term R&D and site characterization programs should be designed so that at the earliest date feasible, sites selected for location of a repository can be chosen from among a set with a variety of potential host rock and geohydrological characteristics. To accomplish this, R&D on several potential emplacement media and site characterization work on a variety of geologic environments should be increased promptly.
- A number of potential sites in a variety of geologic environments should be identified and early action should be taken to reserve the option to use them if needed at an appropriate time. In order to avoid working toward and ultimately having a single national repository, near-term options should create the option to have at least two (and possibly three) repositories become operational within this century, ideally and insofar as technical considerations permit, in different regions of the country. In pursuing a regional approach to siting, geologic, hydrologic, tectonic and other technical characteristics of sites must remain the primary basis for selection.

- Construction and operation of a repository should proceed on a stepwise basis and initial emplacement of waste in at least the first repository should be planned to proceed on a technically conservative basis and permit retrievability of the waste for some initial period of time. Further definition of the retrievability concept, the circumstances in which waste would be retrieved and the technical aspects (including development of waste packaging, containers and handling) is necessary.

All IRG members agreed with the above elements of the recommended interim strategic-planning basis for high-level waste. They asserted further (IRG, 1979, p. 63) that these elements

- do not prejudice the NEPA process
- require the Federal government to maintain a technically conservative approach
- call for resolution of uncertainties by increasing the technical and program breadth with respect to the near-term repository characterization program
- do not preclude subsequent adoption of longer term technologies inasmuch as they call for increased R&D to develop selected alternatives
- support a step-wise approach to the development of a HLW repository, while maintaining storage capacity for managing wastes until emplacement and disposal opportunities are available

The IRG did not come to a consensus on the basis for selecting the site for the first high-level-waste repository.

REFERENCES

- IRG (Interagency Review Group), 1978. Report to the President by the Interagency Review Group on Nuclear Waste Management (draft), TID-28817, U.S. Department of Energy, Washington, D.C.
- IRG (Interagency Review Group), 1979. Report to the President by the Interagency Review Group on Nuclear Waste Management, TID-29442, U.S. Department of Energy, Washington, D.C.

Appendix D

SELECTION CRITERIA FOR THE WIPP SITE

CONTENTS

	<u>Page</u>
D.1 Geologic Criterion and Site-Selection Factors.....	D-1
D.2 Hydrologic Criterion and Site-Selection Factors.....	D-4
D.3 Tectonic Stability Criterion and Site-Selection Factors.....	D-5
D.4 Physicochemical Compatibility Criterion and Site-Selection Factors.....	D-7
D.5 Economic and Social Compatibility Criterion and Site-Selection Factors.....	D-8
References.....	D-10

Appendix D

SELECTION CRITERIA FOR THE WIPP SITE

This appendix briefly describes how the geologic, hydrologic, and other characteristics of the WIPP site in southeastern New Mexico meet site-selection criteria and factors. The criteria and factors given here are from the Geological Characterization Report (Powers et al., 1978, pp. 2-15ff) and are based on criteria suggested earlier by the Oak Ridge National Laboratory (ORNL, 1973), the International Atomic Energy Agency (1977), and Brunton and McClain (1977).

The site-selection criteria described here were originally formulated under the expectation that the WIPP would be a repository that would contain spent fuel from nuclear reactors. The heat emitted by spent fuel would have had important effects on the salt in which it was emplaced; for that reason, some of the criteria were specifically intended to insure the safety of spent-fuel emplacement. The WIPP mission no longer includes the disposal of spent fuel or any other high-level waste. Furthermore, the design of the WIPP no longer includes the separate mined cavity for high-level waste called the "lower repository" or the "lower horizon" in the criteria. Accordingly, not all the criteria presented here are applicable to the WIPP under its current mission and design. Because the site was, however, actually selected under these criteria, no effort has been made to revise them for this document.

D.1 GEOLOGIC CRITERION AND SITE-SELECTION FACTORS

The geology of the site will be such that the repository will not be breached by natural phenomena while the waste poses a significant hazard to man. The geology must also permit safe operation of the WIPP repository.

Topography. The terrain must permit access for transportation. The effect on inducing salt flow during excavation must be considered. Surface-water flow and the potential for flooding must be evaluated.

The maximum relief over the WIPP repository is 120 feet. The regional relief is low and easily accommodates the required transportation corridors. The location near a broad surface and groundwater divide will minimize the development of future relief. Differential stress in the salt due to surface relief is not a significant factor in causing deformation in the salt. (See Powers et al., 1978, Sections 3.2 and 4.2.)

Depth. Repository horizons should be deeper than 1000 feet to insure that erosion and consequences of surficial phenomena are not a major concern. The depth of suitable horizons will not exceed 3000 feet to limit the rate of salt deformation around the excavations.

The selected repository bed for heat-producing waste varies between depths of 2750 and 2250 feet over the potential excavation area. The bed for TRU

waste ranges from 2200 to 1800 feet deep through the repository region. These depths are based on interpretations of seismic reflection data. (See Powers et al., 1978, Sections 3.3, 4.3, and 9.2.)

Thickness. The total thickness of the salt deposits should be several hundred feet to buffer thermal and mechanical effects. The desired thickness for the repository bed is 20 feet or more to mitigate the thermal and mechanical effects at nonhalite units.

The halite unit in which the heat-producing waste will be placed is about 100 feet thick. The total thickness of the evaporite section provides about a 1300-foot buffer above and below the repository horizons. This distance to the nearest potential aquifers insures that the thermal effects at these aquifers will be insignificant. (See Powers et al., 1978, Sections 4.3.2 and 9.2.)

Lateral extent. The distance to structural or dissolution boundaries must be adequate to provide for future site integrity. For the Los Medanos area a distance of 5 miles to the Capitan reef and 1 mile to regional Salado dissolution has been established.

From seismic data and drill-hole information, the selected horizons are believed to extend well beyond the repository site. The separations from the deformed salt belt parallel to the Capitan reef and from the natural dissolution fronts are adequate to insure the required site integrity. (See Powers et al., 1978, Sections 3.3, 4.3, and 6.3.)

Lithology. Purity of the salt beds is desirable. Brine in the salt could induce geochemical interactions; pending further investigations, 3% brine is established as a desirable upper limit for the heat-producing waste horizon. Additional geochemical interactions must be considered if significant chemical or mineral impurities are present.

The horizon within the lower Salado that will accommodate the heat-producing wastes averages more than 97% halite from the samples analyzed. Brine content averages less than 0.5%. (See Powers et al., 1978, Sections 4.3 and 7.2 through 7.6.)

Stratigraphy. Continuity of beds, character of interbedding, and nature of beds overlying and underlying the salt are important considerations in the construction of the facility; they are also important in insuring the long-term integrity of the repository.

There are no beds of clay or polyhalite near enough to the lower repository horizon to affect repository construction and operation or to affect the long-term performance of the repository. The significant nonhalite beds adjacent to the heat-producing-waste horizons are principally anhydrite, which has favorable thermal, mechanical, and chemical properties for bounding layers. The upper (TRU-waste) level of the repository can also be located to avoid rock-mechanics instabilities due to interbeds of nonhalite rock. (See Powers et al., 1978, Sections 3.3, 3.4, 4.3, and 4.4.)

Structure. Relatively flat bedding (less than 3 degrees) is desirable for operational purposes. Steep anticlines and major faults are to be avoided.

Seismic-reflection data and drill-hole information have been interpreted as showing relatively flat (less than 1 degree) bedding over most of the 3-square-mile repository horizon. Seismic data do show a small anticline at the northern edge of control zone II. Drilling on this anticline (WIPP-12) has shown that the elevation difference of the repository beds, from ERDA-9 at the center of the repository to WIPP-12, is less than 200 feet, an average of about 2 degrees. Photography, satellite imagery, surface mapping, geophysical techniques, and drilling have been used to search for indications of significant faulting. No post-Permian faults are known to exist in the site area. Seismic indications of faulting in older, deeper rocks do not extend through the Permian evaporite section.

The lack of severe structure and recent faulting satisfactorily meets the desired conditions for this factor. (See Powers et al., 1978, Sections 3.4 and 4.4.)

Erosion. While the depth of the repository reduces concern about erosion, it is desirable to avoid features that would tend to localize or accelerate erosion.

The site is located near a broad surface-water divide, and the local base level is at an elevation of about 2900 feet. Consequently, future erosion will proceed less rapidly over the site than in the established drainage channels. The expected erosion rates will not expose the Salado salt within the required lifetime of the repository. Future climatic changes will not alter this assessment, and glaciation is not expected to be a concern at this location. (See Powers et al., 1978, Sections 3.2.3, 3.6, 4.2, and 6.2.)

Dissolution. Regional and/or local dissolution must not breach the repository while the wastes represent a significant hazard to people. While there are various suggestions for the time a repository should remain isolated from the biosphere, a period of 250,000 years (10 half-lives of plutonium-239) is commonly used to represent the time over which the wastes are significantly hazardous.

Studies by the U.S. Geological Survey indicate that the maximum rate of horizontal progression of the salt-dissolution front in Nash Draw, averaged over the past 500,000 years, has been 6 to 8 miles per million years and less than 500 feet vertically per million years. The nearest active solution front is to the west, in Nash Draw. This is far enough from the site to provide repository isolation for more than 2 million years. (See Powers et al., 1978, Section 6.3.6.)

Subsidence. Subsidence due to dissolution of salt will be avoided when the subsidence adversely affects the repository beds or unduly accelerates the rate of dissolution to the jeopardy of the long-term integrity of the repository.

Subsidence has occurred over the western portion of the WIPP site area because of the natural removal of salt from the Rustler Formation. Hydrologic data from this region indicate that the major aquifers in the Rustler have different potential heads, and thus this regional subsidence has not caused them to be interconnected by permeable fractures. No sinks due to localized solutioning are present at the site.

D.2 HYDROLOGIC CRITERION AND SITE-SELECTION FACTORS

The hydrology of the site must provide high confidence that natural dissolution will not breach the site while the waste poses a significant hazard to man. Accidental penetrations should not result in undue hazards to mankind.

Surface water. Present and future runoff patterns, flooding potential, etc., should not endanger the penetrations into the repository while these openings are unplugged.

Because the site is near a broad surface-water divide, lacks established drainage, and is well above the Pecos River, simple construction techniques will prevent flooding of the repository. (See Powers et al., 1978, Section 6.2.)

Aquifers. For the WIPP, the overlying and underlying aquifers represent a secondary barrier if the salt is breached. Consequently, low permeability and transmissivity are desirable but not mandatory. Accurate knowledge of aquifer parameters is important to construction, decommissioning, and realistic calculation of the consequences of failure scenarios.

Aquifers above and below the repository have low transmissivity. Consequently, flooding of the repository during its operation through shafts or drill holes is not credible. These access points can readily be plugged to prevent water inflow after decommissioning.

The quantity of water carried by the major aquifers above and below the WIPP beds is too small to be useful. Furthermore, the water carries too many salts to be potable or otherwise useful.

The hydrologic parameters of the aquifers do not permit rapid flow of water. The low permeability would limit the flow even if heads were to be modified in future pluvial cycles. (See Powers et al., 1978, Section 6.3.)

Hydrologic transport. For the WIPP, this is a secondary factor that must be evaluated to allow quantitative calculations of the consequences of various failure scenarios. Slow transport of isotopes is acceptable if more critical factors have been satisfied.

Calculations based on various postulated failure scenarios show that the transport of radionuclides through the overlying and underlying aquifers would be so slow that a significant hazard to people would not exist even if the salt beds were breached. The nearest natural discharge point is near Malaga Bend on the Pecos River, over 14 miles away. At the maximum measured rate of water movement, it would take about 1700 years after a breach for the first trace of nonretarded nuclides (i.e., iodine-129) to appear at the Pecos. The long-lived transuranic nuclides would be retarded by the sorption of ions and would not begin to appear at Malaga Bend until 35,000 years after a postulated breach of the salt beds. The concentrations of radionuclides (or possible radiation doses) would never reach significant hazard levels in the Pecos River. (See Powers et al., 1978, Sections 6.3, 9.3, and 10.6.)

Climatic fluctuations. Possible pluvial cycles must be considered in estimating the effects of the hydrologic factors.

The dissolution and erosion rates established as averages over the past 500,000 years include the effects of several past pluvial cycles. It is expected that future cycles would also be shorter than the isolation time sought for the repository. Transport rates under different climates (rainfall) can be estimated by appropriate boundary conditions on the hydrologic model. The low permeability of the major aquifers above the site will not be significantly altered by the climatic changes expected for this area, and the resultant flow in the aquifers will not be grossly altered by changed climatic conditions. (See Powers et al., 1978, Sections 3.6 and 4.5, Chapter 6, and Section 10.3.)

Man-made penetrations. The effect of drill holes and mining operations must be included in evaluating the potential effects of dissolution.

The repository and control zone III are free of preexisting boreholes that extend through the salt, shafts, and mining activity. Any existing or future holes in any of the WIPP zones must be adequately plugged when abandoned.

D.3 TECTONIC STABILITY CRITERION AND SITE-SELECTION FACTORS

Natural tectonic processes must not result in a breach of the site while the wastes represent a significant hazard to people and should not require extreme precautions during the operational period of the repository.

Seismic activity. The frequency and magnitude of seismic activity impact facility design and safety of operation. Low levels of seismicity are desirable, but facility design can accommodate higher levels as well.

The WIPP site is in an area of relatively low seismic activity. The nearest seismic activity has been 10 or more miles north of the site and of small magnitude. It is not known whether the three nearest events were tectonic, related to salt dissolution, or a result of human activity. No faulting has been observed in the area of these seismic events. In any case, they and the potential future events pose no hazard for a properly constructed repository and are no threat to its long-term integrity. (See Powers et al., 1978, Chapter 5 and Section 10.5.)

Faulting and fracturing. While open faults, fractures, or joints are not expected in salt, the more brittle units within and surrounding the salt may support such features that can enhance dissolution and hydrologic transport. Major faults and pronounced linear structural trends should be avoided.

No major structural trends of recent geologic age are known to exist in the site area. The nearest recent faulting observed is on the west side of the Guadalupe Mountains, some 70 miles away. Seismic-reflection data have indicated small faults in deep, old rocks below the Salado Formation. There are no known tectonic faults in post-Permian rocks at the site area. Thousands of miles of drift in the potash mines in the Salado salt have not encountered any open fractures or faults through which groundwater had penetrated.

Salt-flow anticlines. Major deformation of salt beds by flow can fracture brittle rock and create porosity for brine accumulations. Major anticlines resulting from salt flow should be avoided or evaluated to check on brine presence and anhydrite fracturing.

The only anticlines within the site are relatively minor features. Both have been drilled, however, and the cores show little fracturing or porosity and no accumulation of fluids. These small anticlines will not hinder repository construction or jeopardize its long-term safety. (See Powers et al., 1978, Section 4.4.)

Diapirism. An extreme result of salt flow, this feature will be avoided for WIPP siting.

There are no known or indicated diapirs (salt domes) at the WIPP site. (See Powers et al., 1978, Section 4.4.)

Regional stability. Areas of pronounced regional uplift or subsidence should be avoided since such behavior makes prediction of future dissolution, erosion, and salt flow more uncertain.

Geologic mapping has failed to reveal any indicators of regional instability. Caliche formation and attitude indicate stable conditions in the site region over the last half-million years. The lack of scarps and the natural seismicity are consistent with regional stability. (See Powers et al., 1978, Sections 3.4, 4.4, and 10.3.2.)

Igneous activity. Areas of active or recent volcanism or igneous intrusion should be avoided to minimize these hazards to the repository.

No recent igneous activity is known in the region. Geophysical surveys, mining, and drill-hole intercepts have shown that an intrusive dike exists 9 miles northwest of the site. Radiometric dating shows it to be 35 million years old. No other intrusive features are known to exist in the region. (See Powers et al., 1978, Section 3.5.)

Geothermal gradient. Abnormally high geothermal gradients should be avoided to allow construction in salt at 3000 feet. High gradients may also be indicative of recent igneous or tectonic activity.

The geothermal gradient as determined in the AEC-8 drill hole shows a normal geothermal gradient averaging about 0.58°F per 100 feet. The heat flow is about one heat-flow unit. (See Powers et al., 1978, Section 4.4.1.)

D.4 PHYSICOCHEMICAL COMPATIBILITY CRITERION AND SITE-SELECTION FACTORS

The repository medium must not interact with the waste in ways that create unacceptable operational or long-term hazards.

Fluid content. The repository bed containing high-level waste should not contain more than 3% brine. The limit for TRU waste has not been established, but the value used for high-level waste is acceptable.

The average brine content of the lower repository is less than 0.5% by weight. The average brine content of the upper repository horizon beds is less than 1% by weight. (See Powers et al., 1978, Sections 7.5 and 10.7.8.)

Thermal properties. To avoid undesirable temperature rises, no major natural thermal barriers should exist closer than 20 feet of the repository horizons.

This is of significance to the lower horizon, where the halite unit of interest is about 100 feet thick. The adjoining beds are anhydrite, which, even though far enough away, has similar thermal conductivity and does not represent a thermal barrier in any case. (See Powers et al., 1978, Section 9.2.3.)

Mechanical properties. The medium must safely support excavation of openings even while thermally loaded. Clay seams and zones of unusual structural weakness should be avoided in the selection of the repository horizon.

The halite bed at the lower level is sufficiently thick and devoid of clay seams that stability of openings will not be a problem for repository operation. Clay seams and polyhalite beds are more common in the area selected for the upper repository level, but construction levels can be located to avoid significant structural stability problems from such nonhalite beds. (See Powers et al., 1978, Section 9.2.4.)

Chemical properties and mineralogy. Beds that are of unusual composition or contain minerals with bound water should not occur within 20 feet of the waste horizon. This will lessen the uncertainties with regard to thermally driven geochemical interactions.

The heat-producing waste horizon is quite pure halite, with more than 97% NaCl. No polyhalite, clay, or other water-bearing minerals occur near this horizon. The upper horizon beds are more than 92% NaCl, with impurities being mostly potassium and magnesium salts and clay. These impurities have no known negative implications for TRU-waste isolation and, in fact, have been shown to absorb radionuclides from brine. (See Powers et al., 1978, Sections 4.3 and 7.2 through 7.5.)

Radiation effects. While no unacceptably deleterious effects are postulated, these phenomena are best quantified in halite, and thus the purer rock salt beds are desired for high-level waste.

Samples of WIPP salt show no characteristics that would produce undesirable effects under irradiation. The low brine content will limit the amount and effects of radiolytic disassociation of water. (See Powers et al., 1978, Chapter 9.)

Permeability. Salt has a very low permeability. It is necessary to evaluate the permeability only of the interbeds and the surrounding media. Low permeability is desirable, but quantitative limits need not be specified for site selection. Salt permeability to gases may be important in establishing waste-acceptance criteria.

Laboratory measurements on cores show very low permeability. On a large scale, measurements at the WIPP horizons have not been made. Experience in other drill holes (absence of aquifers in salt and presence of small high-pressure gas pockets) would argue for very low in-situ permeability on larger scales. (See Powers et al., 1978, Section 9.2.3.)

Nuclide mobility. This is a secondary factor in siting since confinement by the salt and isolation from water are the basic isolation premises. Ion sorption must be determined to allow quantification of safety analyses and to indicate whether engineered barriers (clay) would be beneficial.

The distributed impurities in the rock salt provide significant ion-sorption capability for many radionuclides. The clay layers in higher salt beds will be still more sorptive. These properties will tend to minimize radionuclide migration due to such local mechanisms as brine migration in thermal gradients. (See Powers et al., 1978, Section 9.3.)

D.5 ECONOMIC AND SOCIAL COMPATIBILITY CRITERION AND SITE-SELECTION FACTORS

The site must be operable at reasonable economic cost and should not create unacceptable impacts on natural resources or the biological and social environment.

Natural resources. Unavoidable conflict of the repository with actual or potential resources will be minimized to the extent possible.

This factor is not well satisfied by the WIPP site. Both hydrocarbons and potash exist in potentially economic quantities within the site. While salt itself may be considered a valuable mineral, its economic potential at the site is very low. Since both potash and hydrocarbons may be recovered from control zone IV, the amounts that may be restricted from development within zones I, II, and III are the critical amounts. These quantities are not large in terms of national supply (even the langbeinite product is synthesized in quantity from brine lakes). These minerals may prove an enticement for future exploration and exploitation. For this reason, studies are under way to examine the effects of recovering the potash ore from above control zone III. Very little potash exists above the repository (zone II) itself. Similarly, once adequate borehole plugging is demonstrated, drilling in zone III could be permitted or the same zones developed from zone IV by slant drilling. The expectation, but one that cannot yet be guaranteed, is that these minerals may

be recovered in the decades ahead should they be economically attractive. Certainly the time frame for their development would be within the next century, while the site is still under administrative control. The small amounts of either resource within zone III would not be of significant interest in the absence of other production in the area. (See Powers et al., 1978, Chapter 8.)

Man-made penetrations. Boreholes or shafts that penetrate through the salt into underlying aquifers will be avoided within 1 mile of the repository. Existing mining activity, unrelated to the repository, should not be present within 2 miles of the repository. Future, controlled mining will be allowable up to 1 mile from the repository. Future studies may permit still closer mining and drilling if properly controlled.

The present site adequately fulfills this present restriction on man-made penetrations. (See Powers et al., 1978, Section 2.3 and Chapter 4.)

Transportation. Transportation should be capable of ready development. Avoidance of population centers by transportation routes is not a factor in the siting of the repository.

The present site meets this requirement and would utilize a spur line of the Santa Fe Railroad now running to the Duval mine.

Accessibility. The site should be readily accessible for transportation and utilities.

The site presents no problems for access by road, railroad, or utility lines.

Land jurisdiction. Siting will be on Federal land to the extent possible.

Of the 18,960 acres to be withdrawn by the DOE if this site is approved, 17,200 are Federal land controlled by the Bureau of Land Management and 1760 acres belong to the State of New Mexico. There are no private lands within the site.

Population density. Proximity to population centers and rural habitats will be considered in siting. A low population density in the immediate site area is desirable.

There are 16 permanent residents within 10 miles of the site. There is a transient population at potash mines. The nearest town is Loving, New Mexico, with a population of 1600. Carlsbad is 26 miles west and has a population of 28,600. Low population is not necessary to siting but, all other factors being equal, is desirable.

Effects on ecology and cultural resources. Major impacts on ecology due to construction and operation should not occur. Archaeological and historic features of significance should be preserved.

No major or unusual impacts on the environment or the ecologic system are expected from the construction and the operation of the repository. No endangered species of plants or animals are known to occur at the site. No significant archaeological sites will be destroyed by repository construction.

Sociological impacts. Demographic and economic effects should not result in unacceptable sociological impacts.

There was no a priori reason to expect any severe or unacceptable socio-economic impacts attributable to the site location. This assessment has been substantiated by the socioeconomic studies reported in Section 9.4 of this document.

REFERENCES

Brunton, G. D., and W. C. McClain, 1977. Geological Criteria for Radioactive Waste Repositories, Y/OWI/TM-47, Office of Waste Isolation, Union Carbide Corporation, Oak Ridge, Tenn.

International Atomic Energy Agency, 1977. Site Selection Factors for Repositories of Solid High-Level and Alpha-Bearing Waste in Geological Formations, Technical Report Series No. 177, Vienna, Austria.

Oak Ridge National Laboratory (ORNL), 1973. Site Selection Factors for the Bedded Salt Pilot Plant, ORNL-TM-4219, Oak Ridge, Tenn.

Powers, D. W., S. J. Lambert, S.-E. Shaffer, L. R. Hill, and W. D. Weart (eds.), 1978. Geological Characterization Report, Waste Isolation Pilot Plant (WIPP) Site, Southeastern New Mexico, two volumes, SAND78-1596, Sandia Laboratories, Albuquerque, N.M.

Appendix E

DESCRIPTIONS OF WASTE TYPES

CONTENTS

	<u>Page</u>
Table E-1 Defense Contact-Handled TRU Waste (Drum).....	E-2
Table E-2 Defense Contact-Handled TRU Waste (Box).....	E-3
Table E-3 Defense Remotely Handled TRU Waste.....	E-4
Table E-4 Commercial High-Level Waste.....	E-5
Table E-5 Commercial Spent PWR Fuel.....	E-6
References.....	E-7
REPORT FOR THE WIPP WASTE ACCEPTANCE CRITERIA STEERING COMMITTEE: DETAILED CHARACTERIZATION OF DOE STORED TRU WASTE.....	E-8

Appendix E

DESCRIPTIONS OF WASTE TYPES

This appendix contains four tables that describe the types of waste to be emplaced in the WIPP and the containers used for transportation and storage. Isotope inventories and maximum and average activity levels at the time of emplacement are included. Curves illustrating the radioactive decay of the contact-handled and remotely handled transuranic (TRU) wastes to be disposed of in the WIPP are also presented.

This appendix also includes a detailed report characterizing defense TRU waste now held in retrievable storage; it was compiled by James E. Dieckhoner of the U.S. Department of Energy. The report concludes with a description of the types of waste stored and the containers used at the Idaho National Engineering Laboratory (Annexes 1 and 2, respectively).

Table E-1. Defense Contact-Handled TRU Waste--Drum

Type of container	DOT-17C 55-gal steel drum	Rocky Flats Plant Standard SX-200
Liner (if used)	0.09-in.-thick rigid- polyethylene inner liners	Rocky Flats Plant Standard SX-202
Weight of container	840 lb (maximum gross)	
Volume of waste	Approximately 7.3 ft ³ (207 liters)	
Surface-dose rate	≤200 mrem/hr	Waste-acceptance criterion
Surface contamination	5% of limit in 49 CFR 173.397	Waste-acceptance criterion
Waste properties	<p>Combustible: paper, cardboard boxes, wooden boxes, plastic bags, rubber scrap, rags, surgical gloves, clothing, etc.</p> <p>Noncombustible: residues from chemical process- ing, building rubble, metal, glassware and acids</p>	

Radionuclide	Mass present ^a (grams)	Activity ^b		Surface contamination (Ci/drum)
		Ci/drum	Ci/liter	
Pu-238	2.5-3 ^c	4.2-2	2.0-4	7.0-10
Pu-239	7.5	4.6-1	2.2-3	7.5-9
Pu-240	5.0-1	1.1-1	5.3-4	1.8-9
Pu-241 ^d	2.7-2	2.8	1.3-2	1.0-7
Pu-242	2.4-3	9.4-6	4.5-8	1.6-13
Am-241	<u>1.5-3</u>	<u>5.2-3</u>	<u>2.5-5</u>	<u>8.5-11</u>
Total	8	3.4	1.6-2	1.1-7
Total fissile content	7.5 g			
Total Pu	8 g			

^aAverage condition; maximum fissile content is 200 grams, based on transportation regulations.

^bFor activity of maximum container, multiply by 25 (200/8).

^c2.5-3 = 2.5 x 10⁻³.

^dA beta emitter and hence not strictly speaking a TRU nuclide as defined in Section 5.1.2.

Table E-2. Defense Contact-Handled TRU Waste--Box

Type of container	DOT-7A 4 x 4 x 7-ft plywood box	Rocky Flats Plant Standard SX-211 (plywood box) and SX-207 (fiberglass-reinforced-polyester coating)
Weight of container	Maximum 5000 lb; typical 3000 lb	
Volume of waste	Approximately 100 ft ³ (2800 liters)	
Surface-dose rate	≤200 mrem/hr	Waste-acceptance criterion
Surface contamination	5% of limit in 49 CFR 173.397	Waste-acceptance criterion
Waste properties	Combustible: same as drums (see Table E-1) Noncombustible: same as drums (see Table E-1) Equipment and materials too large for 55-gal drums	

Radionuclide	Mass present ^a (grams)	Activity ^b		Surface contamination (Ci/box)
		Ci/box	Ci/liter	
Pu-238	4.0-3 ^c	6.8-2	2.4-5	4.5-9
Pu-239	1.2+1	7.5-1	2.7-4	5.0-8
Pu-240	8.1-1	1.8-1	6.5-5	1.2-8
Pu-241 ^d	4.4-2	4.5	1.6-3	6.5-7
Pu-242	3.9-3	1.5-5	5.4-9	1.0-12
Am-241	<u>2.5-3</u>	<u>8.4-3</u>	<u>3.0-6</u>	<u>5.5-10</u>
Total	13	5.5	2.0-3	7.0-7
Total fissile content	12.2 g			
Total Pu	13 g			

^aAverage condition; maximum fissile content is 350 grams but not exceeding 5 grams in any cubic foot, based on transportation regulations.

^bFor activity of maximum container, multiply by approximately 27 (350/13).

^c4.0-3 = 4.0 x 10⁻³.

^dA beta emitter and hence not strictly speaking a TRU nuclide as defined in Section 5.1.2.

Table E-3. Defense Remotely Handled TRU Waste

Type of container	Carbon-steel canister, 10 feet long	
Weight of container	Maximum 7000 lb	
Volume of waste	Approximately 25 ft ³ (708 liters)	
Surface-dose rate	100 rem/hr	Waste-acceptance criterion
Surface contamination	5% of limit in 49 CFR 173.397	Waste-acceptance criterion
Waste properties	Primarily noncombustible: concrete, steel, dried process sludges, etc.	

Expected Average Conditions^a

Radionuclide	Mass present (grams)	Activity		Surface contamination (Ci/canister)
		Ci/canister	Ci/liter	
Co-60	1.4-3 ^b	1.6	2.2-3	2.0-8
Sr-90	1.8	2.5+2	3.5-1	3.1-6
Y-90	4.6-4	2.5+2	3.5-1	3.1-6
Rh-106	1.6-7	2.2	3.1-3	2.7-8
Ru-106	6.5-4	2.2	3.1-3	2.7-8
Cs-137	1.4-2	1.2	1.8-3	1.5-8
Ba-137m	2.4-9	1.2	1.8-4	1.5-8
Eu-152	1.7-3	3.1-1	4.4-4	3.9-9
Eu-154	8.6-3	1.2	1.8-3	1.5-8
Pu-238	3.7-3	6.5-2	9.1-5	4.1-8
Pu-239	1.2+1	7.5-1	1.1-3	4.8-7
Pu-240	7.9-1	1.8-1	2.5-4	1.1-7
Pu-241 ^c	4.1-2	4.6	6.5-3	5.7-9
Am-241	<u>3.8-3</u>	<u>1.2-2</u>	<u>1.8-5</u>	<u>7.7-9</u>
Total	1.5+1	5.1+2	7.2-1	7.0-6

Table E-3. Defense Remotely Handled TRU Waste (continued)

Radionuclide	Expected Maximum Conditions ^d			
	Mass present (grams)	Activity		Surface contamination (Ci/canister)
		Ci/canister	Ci/liter	
Co-60	9.3-2	9.9+1	1.4-1	6.4-7
Sr-90	5.9+1	7.8+3	1.1+1	1.0-4
Y-90	1.5-2	7.8+3	1.1+1	1.0-4
Rh-106	2.1-8	6.8+1	9.6-2	9.2-7
Ru-106	2.2-2	6.8+1	9.6-2	9.2-7
Cs-137	5.0-1	3.9+1	5.5-2	5.2-7
Ba-137m	7.3-8	3.9+1	5.5-2	5.2-7
Eu-152	1.1-1	2.0+1	2.8-2	1.3-7
Eu-154	3.1-2	7.8+1	1.1-1	5.2-7
Pu-238	4.2-2	6.5-1	9.2-4	3.9-8
Pu-239	1.3+2	7.1	1.0-2	4.6-7
Pu-240	8.7	1.7	2.4-3	1.1-7
Pu-241 ^c	4.6-1	4.3+1	6.1-2	1.9-6
Am-241	2.5-2	7.8-2	1.1-4	7.4-9
Total	2.0+2	1.6+4	2.3+1	2.1-4

^aExpected average activity in canisters for use in analyses in which a large number of canisters are involved.

^b1.4-3 = 1.4×10^{-3} .

^cA beta emitter and hence not strictly speaking a TRU nuclide as defined in Section 5.1.2.

^dMaximum activity in individual canister for calculating shielding requirements and the consequences of single-canister accidents.

Table E-4. Postulated Defense High-Level Waste for Experiments

Type of container	Steel canister
Weight of container	Maximum 1000 lb
Volume of waste	3.8 ft ³ (107 liters)
Surface-dose rate	>4500 rem/hr
Physical form	Glass (or calcine)

Radionuclide ^a	Mass present (grams)	Activity	
		Ci/canister	Ci/liter
Co-60	4.5-2 ^b	5.0+1	4.7-1
Se-79	6.0-1	4.1-2	3.8-4
Rb-87	2.4+1	2.0-6	1.9-8
Sr-89	6.0-10	1.7-5	1.6-7
Sr-90	6.5+1	9.2+3	8.6+1
Y-90	1.7-2	9.2+3	8.6+1
Y-91	1.4-8	3.3-4	3.1-6
Zr-93	7.0+1	2.8-1	2.6-3
Zr-95	1.4-7	2.8-3	2.6-5
Nb-95	1.6-7	6.0-3	5.7-5
Nb-95m	9.3-11	3.6-5	3.3-7
Tc-99	4.4+1	7.3-1	7.0-3
Ru-106	1.6-1	5.3+2	5.0
Rh-106	1.5-7	5.3+2	5.0
Pd-107	6.3	3.3-3	3.0-5
Sn-121m	4.2-2	2.5	2.3-2
Ag-110	2.1-9	8.8	8.2-2
Sn-123	9.6-6	7.9-2	7.4-4
Sn-126	1.4-1	4.0-3	3.8-5
Sb-124	2.9-12	5.1-8	4.8-10
Sb-125	2.0-1	2.2+2	2.0
Sb-126	6.6-9	5.6-4	5.3-6
Sb-126m	5.2-11	4.0-3	3.8-5
Te-125m	2.9-3	5.3+1	5.0-1
Te-127	1.1-8	3.0-2	2.9-4
Te-127m	3.3-6	3.1-2	2.9-4
Cs-134	1.5	1.9+3	1.8+1
Cs-135	1.7+1	2.1-2	1.9-4
Cs-137	2.2+3	1.9+5	1.8+3
Ba-137m	3.3-4	1.9+5	1.8+3
Ce-142	1.2+2	2.9-6	2.7-8
Ce-144	1.1	3.4+3	3.2+1
Pr-144	4.4-5	3.4+3	3.2+1

Table E-4. Postulated Defense High-Level Waste for Experiments
(continued)

Radionuclide ^a	Mass present (grams)	Activity	
		Ci/canister	Ci/liter
Pr-144m	2.2-8	4.1+1	3.8-1
Pm-147	7.2	6.7+3	6.3+1
Sm-147	2.0+1	4.6-7	4.3-7
Sm-151	1.7	4.2+1	3.9-1
Eu-152	2.4-3	7.5-1	7.0-3
Eu-154	9.3-1	2.7+2	2.5
Eu-155	2.4-1	1.1+2	1.1
Tb-160	5.3-11	6.0-7	5.6-9
U-232	6.0-5	1.3-3	1.2-5
Tl-208	1.8-12	5.3-4	4.9-6
U-233	2.1-5	1.9-7	1.8-9
U-234	2.4-1	1.5-3	1.4-5
U-235	9.0	1.9-5	1.8-7
U-236	6.0	3.7-4	3.4-6
U-238	1.5+2	5.1-5	4.8-7
Np-237	6.2	4.3-3	4.0-5
Pu-236	1.7-1	1.6-2	1.5-4
Pu-238	2.3+1	3.8+2	3.6
Pu-239	2.1+6	1.3+1	1.2-1
Pu-240	3.6+1	7.9	7.3-4
Pu-241	1.7+1	1.7+3	1.6+1
Pu-242	2.8	1.1-2	1.0-4
Am-241	4.6	1.6+1	1.5-1
Am-242	2.5-8	2.0-2	1.8-4
Am-242	2.1-3	2.0-2	1.8-4
Am-243	2.4-2	4.6-3	4.3-5
Cm-242	1.5-5	5.0-2	4.7-4
Cm-243	2.0-4	9.4-3	8.8-5
Cm-244	1.7-3	1.3-1	1.3-3
Cm-245	3.4-5	6.1-6	5.7-8
Cm-246	<u>2.1-6</u>	<u>6.2-7</u>	<u>5.8-9</u>
Total	3.0+3	4.3+5	4.0+3

^aOnly radionuclides with a specific activity greater than 10^{-10} Ci/liter are listed. The reason for deleting radionuclides with a lower concentration is twofold. First, their contribution to the total radioactivity of the mixture is minimal, and the product of their hazard index and concentration is small in comparison with the radionuclides listed.

^b $4.5-2 = 4.5 \times 10^{-2}$.

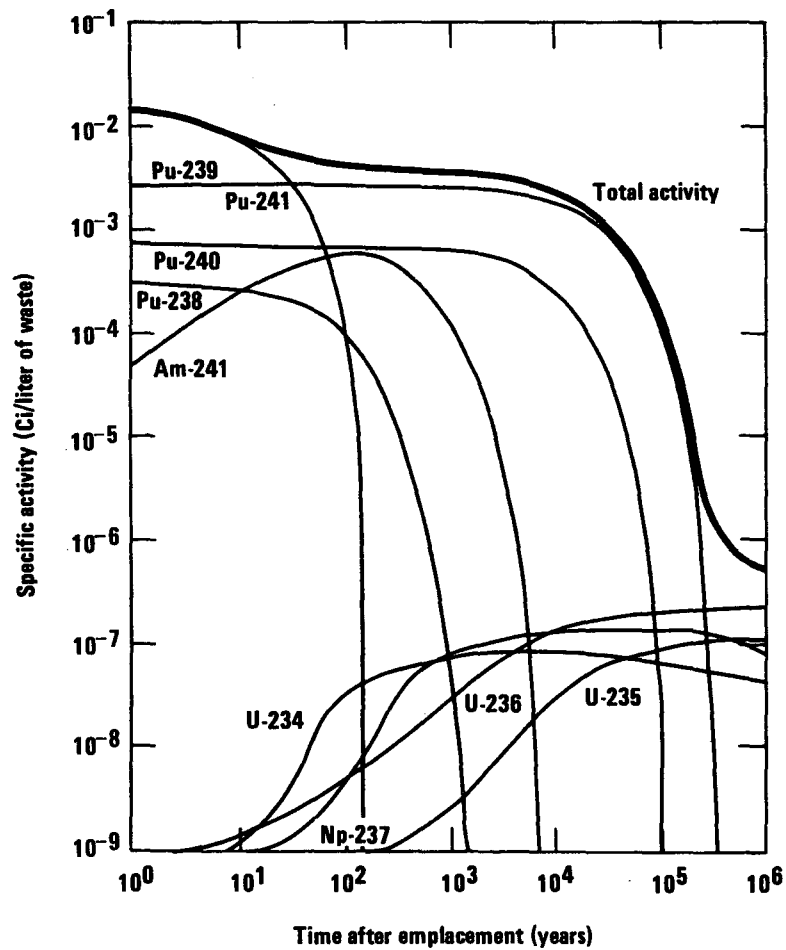

Figure E-1. Radioactive decay of contact-handled TRU waste. The activities shown are for a DOT-17C 55-gallon steel drum containing 8 grams of plutonium.

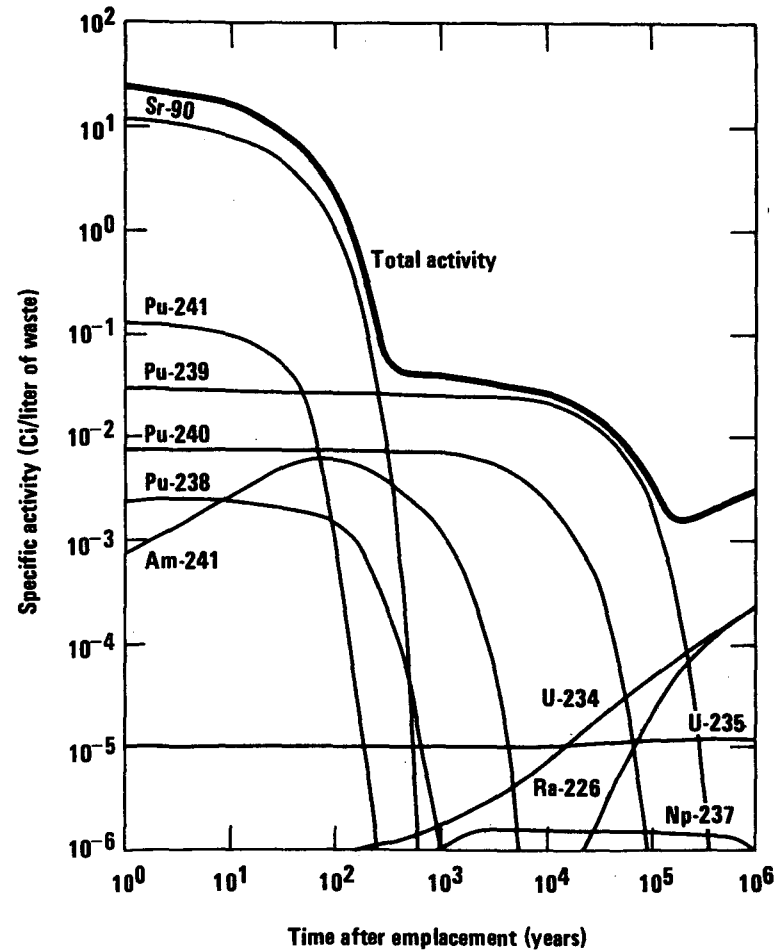

Figure E-2. Radioactive decay of remotely handled TRU waste.

REPORT FOR THE WIPP
WASTE ACCEPTANCE CRITERIA STEERING COMMITTEE
DETAILED CHARACTERIZATION
OF DOE STORED TRU WASTE

Compiled by James E. Dieckhoner

Office of Nuclear Waste Management
Division of Waste Products
Operations Branch

June 16, 1978

Introduction

This report was prepared in response to a request of the WIPP Waste Acceptance Criteria Steering Committee (WACSC) at their meeting on March 2. All DOE field offices conducting TRU retrievable storage operations were asked to provide the Operations Branch with certain specific information concerning the TRU waste currently on hand and projected for the future. A copy of the request for data is included as Appendix A. Copies of the data supplied are included as Appendices B through G. The remainder of this record is a condensation of these responses and a restructuring of the data into a format where the WACSC can obtain an overall perspective on the DOE-wide situation. The reader is encouraged to consult the individual replies or to contact the respective field offices for more detailed information.

NOTE: Only one of the appendices mentioned above (Appendix F) is included here: the data on wastes stored at the Idaho National Engineering Laboratory (see Annex 1, pp. E-23 through E-42).

Section I

Qualitative Description of Available Waste Characterization Information

A. Contact-Handled TRU Waste:

LASL - Waste generators are required to complete a form containing information on the radionuclide content (including error estimates and how the amount was determined), package construction, package radiation level, and waste type. The LASL lists 33 different waste types (see Appendix C [not included here] for details). In addition, the form also permits the inclusion of additional data. Examples of typically recorded information include the identification of equipment items or types, and of chemical contaminants on or in the waste.

Sandia Lab - The waste will be in the form of glassware, equipment, solidified liquids, ceramic waste, etc., and contains Np-239, Pu-238, Pu-239, Pu-241, Am-241, and Cm-244. All waste is packaged in DOT 17-C containers.

Pantex - Data currently available include: container size, volume, weight and type; chemical and physical form of the waste; isotopic composition and curie amount; and surface radiation reading.

ORNL - The computer system contains data by container: date received, source of waste, shipper, location in storage area, estimated amount of combustibles and noncombustibles, and estimated amount of U-233 and transuranics. Essentially all of this waste is from glovebox and hot cell operations. Since no assays were done, the isotopic composition data, if not reported by the generator, can be implied from the source (i.e., building). The package size and construction is well known, but the precise weight is not. No information on compactibility is available. Although some knowledge of the chemical and physical forms of the waste can be inferred from its source, no specific information has been recorded. No information is available on nonradioactive constituents.

Hanford - Each waste shipment is accompanied by a shipping ticket which physically describes the material content, the source of the waste, any special conditions, the type of radioactivity (specific radionuclides, etc.), quantity (curies or grams), and the radiation level. The TRU waste containers must also be identified as combustible or noncombustible. The locations of the TRU containers are also recorded.

INEL - The following information is recorded for each shipment: waste generator and building number, gross volume, gross weight, curie content, type and number of containers, unit container volume, waste description, nuclide identification and storage location. No data are currently available on non-radioactive toxic constituents in the TRU waste. Some may be obtained from a records search, although initial indications are that any such information would be very limited and superficial. Compilations of some of these data can be found in Appendix F [reproduced here as Annex 1, pp. E-23 through E-42].

NTS - For retrievably stored, contact-handled TRU waste the gram content, curie content, isotopic composition, package size with weight and construction, and combustibility information are available.

SR - Early records contain only waste volumes and activities. However, since July 1, 1974, combustibles and noncombustibles are segregated and placed in separate drums and marked accordingly. The material composition of the waste can only be inferred from sample observations of the waste packaging operations and estimation by the production personnel. Results of such a survey can be found in Appendix B [not included here].

B. Remote-Handled TRU Waste:

LASL - The same type of information will be available as previously indicated for contact-handled TRU waste.

Sandia Lab - The same type of information would be available as previously indicated for contact-handled TRU waste.

Pantex - No waste of this type is stored at Pantex.

ORNL - Essentially all of this type waste is from hot cells (90 percent from one facility) and gloveboxes. It includes plastics, paper wipes, various kinds of equipment, equipment racks, etc. No assays of waste to determine isotopic composition were made but the source and knowledge of the process may give some indication. The package size, weight, and construction are well-known. An estimate of the combustibility is available, but there is no information on its compactibility, nor on the presence of nonradioactive toxic constituents. The chemical form varies--nitrides, chlorides, oxides, and others.

Hanford - The same type of information is available as previously indicated for contact-handled TRU waste.

INEL - The same type of information is available as previously indicated for contact-handled TRU waste.

NTS - No waste of this type is stored at NTS.

SR - No waste of this type is stored at SR.

C. TRU Waste Disposed of by Shallow Land Burial:

LASL - Waste management personnel have kept logbook-type records on all waste disposed of since the late 1940's. Work is underway to convert the pre-1971 records into the current computer system. The major problem with these old records will be the actual identification of which wastes contain >10 nCi/gm. Where buried TRU wastes can be identified, information as to waste matrix, packaging, radiation level, TRU content, and burial location should be available.

Sandia Lab - The waste is in the form of glassware, equipment, paper products, contaminated experiments, etc., and contains about 1 gram of Pu-239.

Pantex - The same type of information is available as previously indicated for contact-handled TRU waste.

ORNL - Due to an accidental loss of records, no detailed information is available for the pre-1969 buried TRU waste, estimated to be about 200,000 ft³ in volume. Since field separation of TRU waste began in 1970, about 63 containers of equipment were buried, in an essentially nonretrievable fashion, that were judged to be contaminated marginally above the 10 nCi/gm level. About 90 percent contained hoods and gloveboxes. No assays were made and the data is based on the judgment of the generator. The size and composition of the containers are known, the weights are estimates based on actual weights of a few. An estimate of the combustibility is available, but no information on the compactibility or on the presence of nonradioactive toxic constituents is available.

Hanford - The same general type of information is available as previously indicated for contact-handled TRU waste, except for knowledge of where the buried TRU-contaminated (>10 nCi/gm) waste is located among the non-TRU-contaminated waste.

INEL - The data available at the present time on the subsurface disposed TRU are limited to hand tabulations of quantities shipped from Rocky Flats Plant and estimates of Pu quantities.

NTS - No waste of this type is buried at NTS.

SR - Much of the waste sent to the burial ground was contained in cardboard cartons which were dumped into the waste trenches and covered with soil. Bulky waste was wrapped in plastic and buried, or wrapped waste was placed in wooden boxes. Test retrievals indicate that the waste package in plastic will be well preserved; however, the cellulosic materials in contact with the soil will be degraded. Because early records are lacking, activity content and volume of waste buried before 1961 can only be estimated.

NOTE: The preceding are only brief synopses of the lengthier information submitted by the field. The reader is encouraged to consult the Appendices [in the original report] for more details, and to directly contact the field organizations to resolve difficulties in interpretation or to obtain specific additional information.

Section II

Inventory Data

All of the field offices were asked to present estimates of the approximate volumes of TRU waste in the following three categories (i.e., retrievably stored, contact-handled, retrievably stored, remote-handled; and TRU waste disposed of by shallow land burial) as of the start of FY 1978 and expected to have been accumulated as of the start of FY 1986. Estimates of the accuracy of these data were also requested. A compilation of the site submitted data is presented in Table 1, and a summary of the DOE-wide situation in Table 2.

TABLE 1

APPROXIMATE VOLUMES OF DOE TRU WASTE AND ESTIMATES OF THEIR ACCURACY

Waste Category	Site	As of 10/1/77		As of 10/1/84	
		Volume (ft ³)	Accuracy	Volume (ft ³)	Accuracy
Stored, Contact- Handled TRU Waste	LASL	54,020	+ 5%	200,000	+ 25%
	SLA	0	-	3,500	+ 30%
	Pantex	38	+ 10%	57	+ 15%
	ORNL	9,600	- 5% (4)	18,750 (4)	+ 25% (4)
	Hanford	247,000	+ 10%	770,000	+ 30%
	INEL	1,201,917	+ 10%	2,036,682	+ 30%
	NTS	6,116	+ 10% (3)	35,314	+200% - 50% (3)
	SRP	56,168	+ 5% (1)	95,100	+ 25% (1)
		<u>1,574,859</u> ft ³	+ (5-10)%	<u>3,195,403</u> ft ³	+ 30%
Stored, Remote- Handled TRU Waste	LASL	0	-	8,000	+ 50%
	SLA	0	-	50	+ 30%
	Pantex	0	-	0	-
	ORNL	26,550	+ 5%	47,350 (4)	+ 25% (4)
	Hanford	2,940	+ 5%	7,900	+100% - 50%
	INEL	304	+ 10%	14,442	+ 50%
	NTS	0	-	0	-
	SRP	0	-	0	-
		<u>29,794</u> ft ³	+ (5%)	<u>77,742</u> ft ³	+ 50%
Buried TRU Waste	LASL	580,045	+ 50%	580,045 (2)	+ 50%
	SLA	60	+ 50%	60	+ 50%
	Pantex	1,143	+ 10%	1,143	+ 10%
	ORNL	200,000 (5)	+ 50% (5)	200,000 (5)	+ 50% (5)
		15,000	+ 10% (4)	22,000	+ 25% (4)
	Hanford	5,483,000	+200% - 50%	5,483,000	+200% - 50%
	INEL	2,102,000	+ 30%	2,102,000	+200% - 50%
	NTS	0	-	- (3)	-
	SRP	1,084,740	+ 5% (1)	1,084,740	+ 5% (1)
		<u>9,465,988</u> ft ³	+125% - 40%	<u>9,472,988</u> ft ³	+125% - 40%

- (1) Telecon with J. Covell, SR, 6/6/78.
- (2) Telecon with J. Warren, LASL, 6/6/78. The figure in Appendix C was reduced since no burial of >10 nCi/gm is planned.
- (3) Telecon with B. Church and P. Fitzsimmons, NV, 6/6/78. The figure in Appendix G was reduced since no burial of >10 nCi/gm waste is planned. The $1 \times 10^4 \text{ m}^3$ referred to <10 nCi/gm waste.
- (4) Telecon with B. Brockelsby, OR, 6/6/78. The changes in Appendix D reflect re-estimates by ORNL for 1984 and the accuracy values. These buried TRU volumes refer to bulky equipment.
- (5) This buried TRU volume refers to waste buried prior to the initiation of TRU retrievable storage operations at ORNL. Confirmed by telecon with B. Brockelsby, OR, 6/6/78.

Table 2

Summary of DOE TRU Waste Volumes

<u>Waste Category</u>	<u>As of 10/1/77</u>		<u>As of 10/1/84</u>	
	<u>Volume (ft³)</u>	<u>Accuracy</u>	<u>Volume (ft³)</u>	<u>Accuracy</u>
Stored Contact-Handled	1.6 x 10 ⁶	+ (5-10)%	3.2 x 10 ⁶	+ 30%
Stored Remote-Handled	3.0 x 10 ⁴	+ 5%	7.8 x 10 ⁴	+ 50%
Buried (1) (2)	9.5 x 10 ⁶	+ 125% - 40%	9.5 x 10 ⁶	+ 125% - 40%

- (1) An unknown fraction of the buried TRU waste may be in concentrations less than the 10 nCi/gm level, and therefore may be incorrectly included as "TRU" waste.
- (2) Due to the degradation of the original container, the total volume of material resulting from any operations to recover this material may be a factor of 2 to 3 larger than the original waste volume. In addition, such recovery operations would also generate an additional waste volume.

Section III

Obtaining More Detailed Waste Characterization Data

The estimated time and funding required at the TRU waste retrievable storage sites to obtain significantly better data varied from site to site. Following is a synopsis of the individual replies:

LASL - For the retrievably stored waste, very little, if anything, can be done to improve significantly the available data.

Pantex - It was estimated that it would require 80 man-days and \$6,400 to obtain more detailed waste characterization data. This would not include opening of the containers, only verification with instruments. It would also not lead to the establishment of an actual weight of TRU material, since it is mixed with non-TRU materials and processing would be required.

ORNL - For the contact-handled TRU waste there might be two possible methods:

- The first would require the development of an instrument system that can detect and quantify a variety of radionuclides through the wall of a storage drum. Employment of such a system would cost about \$100/drum. This method would not, however, give any additional information on percent combustibles, compactibility, the presence of nonradioactive toxic materials, etc.
- The second method would involve construction of a facility where the drums would be opened and the contents analyzed and repackaged. Construction cost would be about \$1M and operating costs about \$1K/drum.

For the remote-handled TRU waste, improvement of the isotopic composition data is essentially not possible. The waste is heavily shielded so it would have to be removed from the casks in hot cells for further study, after being excavated. Construction would cost about \$2M, excavation about \$0.6K/cask and operation about \$3K/cask. It would take about two to four years.

Hanford - It is estimated that rough estimates for the missing data for 300 Area burial grounds could be obtained in about one year and cost about \$75K. The cost to improve the quality of the available data would take about one to two years and cost \$250-\$500K.

INEL - If the timing of additional waste characterization studies could be arranged to coincide with the ongoing program, it is anticipated that it could be done in four months for about \$375K. If the timing could not be arranged, it would take two more months and cost an additional \$100-\$125K. An additional \$100K would be needed to characterize the Pu in the soil surrounding the buried waste.

NTS - Estimates of the funding and time required to obtain significantly more detailed waste characterization data appear to be minimal.

SR - A more detailed waste characterization study of retrievably stored waste would cost about \$160K and take about one year. It would characterize, in detail, current waste as it is prepared for storage. Sampling waste now in storage would be more difficult and costly.

Section IV

References

The following published reports contain specific additional data on the DOE stored and buried TRU waste. Additional data is contained in internal memos, burial records and shipping records.

1. "History and Environmental Setting of LASL Near-Surface Land Disposal Facilities for Radioactive Wastes (Areas, A, B, C, D, E, F, G, and T). A Source Document," LA-6848-MS, Vol. I and II, Margaret Anne Rogers, June 1977.
2. "Radioactive Waste Management Site Plan, Los Alamos Scientific Laboratory," updated June 1977 (available from AL).
3. "Radioactive Waste Management Site Plan, Sandia Laboratories--Albuquerque," updated 1977 (available from AL).
4. "Radioactive Waste Management Site Plan, Pantex Plant, Amarillo, Texas," updated 1977 (available from AL).
5. "ORNL Solid Waste Disposal Log," ORNL Computer Report, PCS-0673.
6. "Radioactive Waste Management Site Plan - ORNL," updated 1977 (available from OR).
7. ERDA-1538, "Final Environmental Statement, Waste Management Operations, Hanford Reservation, Richland, Washington," December 1975.
8. BNWL-MA-88, "Resource Book - Disposition (D&D) of Retired Contaminated Facilities at Hanford," August 1975.
9. RHO-CD-27-3Q, "Summary of Radioactive Solid Waste Burials in the 200 Areas During the First Three Quarters of 1977," J. D. Anderson and B. E. Porcurba, December 7, 1977.
10. "Radioactive Waste Management Site Plan - Hanford," updated 1977 (available from RL).
11. ERDA-1536, "Final Environmental Statement, Waste Management Operations, Idaho National Engineering Laboratory, Idaho," September 1977.
12. IDO-10054(77), "Radioactive Waste Information 1977, Summary and Record to Date."
13. IDO-10055(77), "Radioactive Waste Management Information for 1977."
14. WMP-77-3, "History of Buried Transuranic Waste at INEL," D. H. Card, March 1977.
15. "Radioactive Waste Management Site Plan - INEL," updated 1977 (available from ID).

16. "Reports of the DOE Solid Waste Information Management System (SWIMS) (available from ID).
17. E. L. Albenesius, H. E. Hootman, "Characterize TRU Waste Inventories and Relate Characterization to Proposed Criteria," TRU Waste Form and Package Criteria Meeting, pp. 49-60, SAND 77-1178, August 1977.
18. E. L. Albenesius, W. C. Reinig, "Long Range Management of Transuranium-Contaminated Solid Wastes at Savannah River," Proceedings of the Seminar on the Management of Plutonium-Contaminated Solid Wastes, Marcoule, France, 1974, OECD, 1976.
19. M. O. Boersma, H. E. Hootman, P. H. Permar, "Development of an Integrated Facility for Processing TRU Wastes at the Savannah River Plant," paper presented at NEA-IAEA Technical Seminar on the Treatment, Conditioning and Storage of Solid Alpha-Bearing Wastes and Cladding Hulls, Paris, France, December 6-7, 1977.
20. J. W. Fenimore, R. L. Hooker, "The Assessment of Solid Low-Level Waste Management at the Savannah River Plant," DPST-77-300, August 1977.
21. J. H. Horton, J. C. Corey, "Storing Solid Radioactive Wastes at the Savannah River Plant," DP-1366, June 1976.
22. SRO-TWM-77-1, "Integrated Radioactive Defense Waste Management Plan," Savannah River Plant, Aiken, S.C., July 1977.

Annex 1

DATA ON WASTES STORED AT
THE IDAHO NATIONAL ENGINEERING LABORATORY

April 23, 1978

Mr. J. B. Whitsett, Chief
Radioactive Waste Programs Branch
Idaho Operations Office - DOE
Idaho Falls, ID 83401

TRU WASTE DATA - Duf-73-78

Ref.: J. P. Hamric ltr to L. P. Duffy, same subject, Mar. 22, 1978

Dear Mr. Whitsett:

The referenced letter requested that TRU waste data be furnished for the WIPP Steering Committee. The following information and attached tables fulfill that request. The data are furnished in the same sequences as requested in the referenced letter.

- (1) The information presently available on TRU waste is provided by the Waste Management Information System (WMIS) and the Transuranic Contaminated Waste Container Information System (TCWCIS). The start of the WMIS data file presently coincides with the initiation of retrievable storage at INEL (10/70) and the TCWCIS started in September 1971.

The WMIS data base includes the following data for each solid waste shipment: waste generator and building number, gross volume, gross weight, curie content, type and number of containers, unit container volume, waste description, nuclide identification and storage or disposal location. Routine monthly reports include disposed waste by nuclides, stored waste by nuclides, waste compaction data, number of stored or disposed containers, and detailed and summary reports by generator or disposal/storage location.

All retrievably stored waste, both contact and remote-handled, are included in the WMIS. The first year of data for retrievable storage is not available in the TCWCIS. The data available at the present time on the subsurface disposed TRU are limited to hand tabulations of quantities shipped from Rocky Flats plant and estimations of Plutonium quantities.

- (2) Table I lists the quantities of TRU waste in each of the three requested categories. The retrievable storage data are derived from the WMIS data bank. The subsurface volume data are based on the information published in IDO-10055 (77) and have been modified to reflect the retrieval operations through 12-31-77. The quantity

listed for the Transuranic Disposal Area reflects the >10 nCi/gm TRU portion of the total waste disposed on Pad-A. Table II lists the volume projections for TRU waste through 10-1-84, based on the waste generator's forecasts. There is no projected subsurface disposal of TRU.

- (3) The data for TRU waste presently in retrievable storage are the container volumes and are considered to be accurate within $\pm 10\%$. The projected container volumes for contact-handled TRU is $\pm 30\%$ based on generator forecasts. For remote-handled TRU (ILTSF), the projected volume may vary $\pm 50\%$. This projection includes the first years waste from SAREF. The subsurface disposed TRU quantities are container volumes, based on tabulations of containers shipped, and do not reflect a review of waste shipment records. The disposed volume probably is accurate within $\pm 30\%$. However, due to container degradation, the mixing of waste with soil along with the TRU waste generation associated with retrieval operations; the total TRU retrieved volume may be a factor of 2 to 3 larger than the original waste volume.
- (4) The WMIS data are published annually by DOE-ID. The documents are:
IDO-10054 (77) Radioactive Waste Management Information 1977 Summary and Record to Date.
IDO-10055 (77) Radioactive Waste Management Information for 1977.

The TCWCIS data are not published formally; however, several tabulations from this system are attached. Another information source is "History of Buried Transuranic Waste at INEL," WMP-77-3, March 1977, J.H. Card. A review of available past data records has been initiated with the objective of producing a WMIS type data base for all solid waste prior to October 1970. Also some additional Rocky Flats drum logs may allow the TCWCIS data base to be extended back to include the TRU waste of 1969-1971.

- (5) The time and costs required to obtain significantly more detailed waste characterization data are dependent upon the scheduling of the project relative to the current waste retrieval operations. It is anticipated that upon completion of the Initial Drum Retrieval (IDR) project, the TSA-1 will be opened for a visual inspection of the exterior surfaces of the waste containers. This operation could also be the first step in obtaining retrievable containers for waste characterization. Also the Early Waste Retrieval (EWR) project, currently scheduled through December 1973 provides the basic containment structure and equipment for the characterization project. If the waste characterization project could be scheduled to operate concurrently with the final portion of the EWR project or directly afterwards, the costs of reactivating a mothballed EWR facility would be circumvented.

Utilizing the TSA-1 container inspection program to obtain the drums and an active EWR facility as a basic containment facility, it is anticipated that the costs of the waste characterization program would be 375,000 dollars and require 4 months of operation. A separate entry into the TSA to obtain the drums and reactivation of the EWR facility to conduct the waste characterization would add 2 months and 100-125,000 dollars to the program.

Another area of investigation which is very critical to the waste volume shipped to WIPP is the amount and degree of Plutonium soil contamination surrounding the subsurface waste. It is proposed that core samples be obtained in and around the early waste pits and trenches to better quantify the soil volume that will have to be processed. It is estimated that such a project could be accomplished for approximately 100,000 dollars.

The specifications for current waste packages are given in Appendix A. These specifications are applicable to drummed waste received after December 1972 and boxed waste received after June 1972. Consequently, it is estimated that TSA-1 and TSA-4 contain 1262 boxes which were not fibreglassed and 60,119 drums without liners.

Table III lists the isotopic composition by weight percent for the TRU nuclides in the contact-handled TRU waste. Table IV gives the average weight for the boxes and drums in the contact-handled TRU waste by year of storage. The increase in drum weight for the period of 1970-1977 is very significant and probably the result of better package utilization. Table V lists the combustibility and compactibility for the contact-handled TRU waste. Utilizing normal compaction and incinerating techniques, about 71% of the waste is not treatable. Table VI gives the plutonium loading in the Rocky Flats boxes and runs by year of storage. Again, the drums show a significant increase in Plutonium content in the latest waste (1970-1977).

A sampling of the contact-handled TRU waste by container content is given in Table VII. This table contains the data from several waste generators. Consequently, duplicate or near duplicate content descriptions may be encountered.

No data are currently available on nonradioactive toxic constituents in the TRU waste. Some information may be obtained from our record search.

J. B. Whitsett
April 28, 1978
Duf-73-78
Page 4

However, the initial indications are that any information of this type will be very limited and superficial.

Very truly yours,

L. P. Duffy, Manager
Waste Management Program

HMB:lf

Attachment - Appendix A

cc: R. W. Kiehn, EG&G Idaho

TABLE I

TRU WASTE AT INEL
AS OF 12/31/77

Retrievably Stored - Contact-Handled TRU

Storage Area	Volume		Curies	Box	Barrel	Bin	Pu	Grams	
	m ³	Cu. ft.						Am-241	U-233
TSA #1 (1) 10/70-10/75	27,450	969,260	120,900	4,241	64,519	83	148,400	11,290	40,590
TSA #2 10/75-12/77	4,583	161,825	44,390	787	8,728	78	49,480	2,230	15,040
TSARI (2) 1/77-12/77	<u>2,006</u>	<u>70,832</u>	<u>9,469</u>	-	<u>9,378</u>	<u>11</u>	<u>12,140</u>	<u>946</u>	-
TOTALS	34,039	1,201,917	174,759	5,028	82,625	172	210,020	14,466	55,630

Retrievably Stored - Remote-Handled TRU

11 TSF (3) 11/76-12/77	9	304	54	-	76	-	19	-	-
---------------------------	---	-----	----	---	----	---	----	---	---

Subsurface Disposal TRU

						Cartons			
SDA (4) 1954-10/70	59,522	2,102,000	191,000	6,042	182,250	12,783	344,000	-	-
TDA (5)	7,190	253,800	3,494	1,243	15,000	-	11	-	-

- (1) Transuranic Storage Area - 20 year retrievable storage
 (2) Transuranic Storage Area - Retrieved waste from subsurface disposal
 (3) Intermediate Level Transuranic Storage Area - Intermediate gamma TRU waste
 (4) Subsurface Disposal Area - Shallow land burial TRU wastes
 (5) Transuranic Disposal Area - Pad disposal of >10 nCi/gm TRU

TABLE II

TRU WASTE AT INEL

As of 10/1/84Retrievably Stored - Contact-Handled TRU

As of 12/31/77	34,039 m ³	or	1,201,917 cu. ft.
Projection thru 1984	<u>23,641 m³</u>	or	<u>834,766 cu. ft.</u>
Totals	57,680 m ³	or	2,036,682 cu. ft.

Retrievably Stored - Remote-Handled TRU

As of 12/31/77	9 m ³	or	318 cu. ft.
Projection thru 1984	<u>400 m³</u>	or	<u>14,124 cu. ft.</u>
Totals	409 m ³	or	14,442 cu. ft.

Subsurface Disposal TRU

As of 12/31/77	59,522 m ³	or	2,102,000 cu. ft.
Projection thru 1984	<u>0</u>	or	<u>0</u>
Totals	59,522 m ³	or	2,102,000 cu. ft.

TABLE III

ISOTOPIC COMPOSITION OF TRU NUCLIDES IN TSA WASTE

<u>Nuclide</u>	<u>Weight %</u>
Am-241	5.15
Pu-238	0.34
Pu-239	69.57
Pu-240	4.36
Pu-241	0.30
Pu-242	0.01
U-233	20.27

TABLE IV

AVERAGE WEIGHT TRU WASTE CONTAINERS

	<u>Drums</u>		<u>Average</u>
	<u># Drums</u>	<u>Weight (lbs)</u>	<u>Weight</u>
1970*	9,378	1,787,825	190.6
1971*	2,726	871,646	319.6
1972	15,690	5,641,154	363.2
1973	9,097	3,000,723	329.9
1974	6,860	2,444,782	356.9
1975	8,782	3,261,068	371.3
1976	4,279	1,596,536	372.4
1977	<u>3,464</u>	<u>1,471,801</u>	<u>424.9</u>
	60,266	19,975,565	331.5 (45 lbs/ft ³)

	<u>Boxes</u>		<u>Average</u>
	<u># Boxes</u>	<u>Weight (lbs)</u>	<u>Weight</u>
1971*	562	1,205,060	2183.1
1972	975	3,063,110	3141.7
1973	944	2,813,612	2980.0
1974	774	2,006,220	2692.0
1975	613	1,316,289	2566.9
1976	492	1,359,950	2764.1
1977	<u>514</u>	<u>1,415,634</u>	<u>2754.2</u>
	4,764	13,179,875	2766.6 (25 lbs/ft ²)

*Partial year's data.

TABLE V

COMBUSTIBILITY AND COMPACTIBILITY - TSA WASTE

9/71 - 12/77*

<u>Unit Count</u>	<u>Total</u>	<u>Comp Comb</u>	<u>Comp NComb</u>	<u>NComp Comb</u>	<u>NComp NComb</u>
Drums	48,917	15,677	1,190	408	31,842
Boxes	4,766	404	423	205	3,734
Bins	161	160	1	-	-
<u>Volume (m²)</u>					
Drums	10,374	3,325	252	87	6,710
Boxes	14,849	1,259	1,318	639	11,633
Bins	547	544	3	-	-
Total	25,770	5,128	1,573	726	18,343
%		19.9	6.1	2.8	71.2

*Does not include retrieved wastes.

TABLE VI

AVERAGE PLUTONIUM LOADING ROCKY FLATS WASTE

<u>Year</u>	<u>Drums</u>		
	<u># of Units</u>	<u>Weight (gms)</u>	<u>Gms Pu/ Container</u>
1971*	2,726	2,555	0.94
1972	15,690	27,744	1.76
1973	8,978	12,705	1.42
1974	6,119	28,595	4.67
1975	3,556	30,894	8.69
1976	2,765	15,519	5.61
1977	<u>2,660</u>	<u>27,198</u>	<u>10.2</u>
TOTAL	48,494	145,210	3.42 (Ave.)

<u>Year</u>	<u>Boxes</u>		
	<u># of Units</u>	<u>Weight (gms)</u>	<u>Gms Pu/ Container</u>
1971*	552	769	1.39
1972	975	5,383	5.52
1973	944	11,554	12.24
1974	776	6,612	8.39
1975	302	1,047	3.47
1976	492	1,858	3.78
1977	<u>466</u>	<u>4,993</u>	<u>10.71</u>
TOTAL	4,507	32,116	7.13 (Ave.)

*Partial year's data.

TABLE VII

TRANSURANIC STORAGE AREA DATA
9/71 thru 12/76
TABULATED BY CONTENT CODE

<u>Content Description</u>	<u>Drums</u>	<u>Volume Cu. Ft.</u>	<u>Boxes</u>	<u>Volume Cu. Ft.</u>	<u>Weight lbs.</u>	<u>Pu Grams</u>	<u>AM Grams</u>
Not Recorded - Unknown	1,903	21,088			392,805	3,241	32
First Stage Sludge	4,957	37,821			2,537,489	26,224	10,249
Second Stage Sludge	6,472	48,842			3,469,429	1,523	16
Organic Set Ups (Oil Solids)	3,366	27,581			1,784,055	1,837	0
Special Set Ups (Cement)	851	6,812			508,472	910	7
Evaporated Salts	12	107	1	112	10,692	6	7
Combustibles (Rags, Gloves, Poly)	865	6,623			164,845	-0-	-0-
Non-compressible, Non-combust.	777	5,762			184,474	-0-	-0-
Solidified Grinding Sludge, Etc.	41	305			9,880	-0-	-0-
Solid Binary Scrap Powder, Etc.	12	88			2,950	-0-	-0-
Dirt	135	993			83,535	-0-	-0-
Sludge	23	169			6,800	-0-	-0-
Alpha Hot Cell Waste	40	160			3,674	16	-0-
American Process Residue	120	897			43,997	150	-0-
Sludge, Filter	1	7			145	14	-0-
Cemented Sludge	73	537			19,072	1,061	-0-
Graphite	758	5,619			197,179	6,274	-0-
Graphite Cores	32	235			8,327	405	-0-
Benelex and Plexiglas	16	118	16	1,792	63,728	67	-0-
Graphite Scarfings	16	118			3,827	81	-0-
Graphite Heels	4	41	1	112	3,500	783	-0-
Tantalum	192	1,412			48,365	2,372	18
Paper and Rags - Dry	4,945	36,835	323	36,176	1,576,644	2,662	91
Filters, Absolute (8x8)	110	809			16,912	215	7
Paper and Rags - Moist	7,293	53,738	8	896	1,455,248	2,212	11
Plastics, Teflon, Hash, PVC	1,832	13,625	9	1,000	333,056	1,145	39
Insulation & CWS Filter Media	253	1,860	78	8,736	195,774	6,501	0
Leaded Rubber Gloves & Aprons	509	3,743			172,042	14,025	16
Insulation	239	1,761	1	112	36,138	217	0
Insulation Heel	1	11			411	199	0
Crucible, Lead	30	221			11,448	91	0
Brick, Fire	886	6,519	24	2,688	387,140	2,789	0
Grit	5	37			2,220	21	0
Blacktop Concrete Dirt and Sand	937	6,890	81	9,072	669,417	647	0

TABLE VII (Continued)

<u>Content Description</u>	<u>Drums</u>	<u>Volume Cu. Ft.</u>	<u>Boxes</u>	<u>Volume Cu. Ft.</u>	<u>Weight lbs.</u>	<u>Pu Grams</u>	<u>AM Grams</u>
Oil Dirt Residues From Incinerator	11	81			4,209	10	0
Cement Insul. & Filter Media	206	1,515	2	224	56,971	5,253	17
Crucible and Sand	1	7			282	35	0
Sand, Slag and Crucibles	6	67			2,700	1,164	0
Sand, Slag, and Crucible Heels	8	59			1,707	1,468	0
Electrorefining Salt	2	15			476	24	0
Ash, Incinerated (Virgin)	8	59			3,212	359	0
Soot	13	96			2,826	702	0
Resin, Ion Column Unleached	29	266			11,528	2,716	0
Resin, Leached	6	59			2,389	263	0
Resin, Leached and Cemented Glass	139	1,022			40,500	2,964	21
Raschig Rings, Unleached	761	5,881	1	112	190,594	3,841	16
Raschig Rings, Leached	1,096	8,060			215,924	11,562	0
Washables, Rubber, Plastics	22	166			6,545	46	0
Gloves, Drybox	6	67			2,813	81	0
Plexiglass and Benelex	53	510			19,533	759	0
Metal Scrap (Non SS)	48	364			12,971	90	0
Metal, Leached (Non SS)	1,669	12,718	2,589	289,702	7,981,075	27,319	43
Filters CWS	457	3,361	1	112	141,841	13,531	3
Equipment Boxes	58	460	466	52,192	886,546	5,548	13
High Level Acid			12	1,344	12,687	88	0
High Level Caustic	235	1,728			75,815	17	0
High Level Sludge/Cement	691	5,081			229,878	20	0
16 nCi/gm Non-Combustible	1,998	14,692			1,260,952	7	0
Contaminated Soil	1	7			335	0	0
LSA 100 nCi/gm Combustible			36	4,032	160,002	1	0
LSA 100 nCi/gm Non-Combustible	103	757			23,168	0	0
LSA Paper, plastics, Etc.	110	609			22,782	0	0
LSA Metal, Glass, Etc.	352	2,611	6	672	82,244	1	0
Concrete, Asphalt, Etc.	110	809	334	37,492	918,936	68	0
Wood	704	5,233	171	10,426	1,022,373	326	0
Bldg. 776 Process Sludge	24	176	54	6,055	123,892	467	0
Laundry Sludge	5	37	19	2,128	89,887	23	0
Equipment			11	1,232	46,980	43	0
Dirt	1	7			178	11	0
Sludge	470	3,456			255,463	0	0
	296	2,177	8	896	176,751	64	0
TOTALS	47,404	363,658	4,252	467,323	28,492,732	154,559	10,606

NUCLIDE DISTRIBUTION - TSA STORED WASTE (CURIES)

Nuclide	1971	1972	1973	1974	1975	1976	1977	Total	Fraction	% > .1
Ac-227	-0-	-0-	-0-	-0-	7.290E-02	-0-	-0-	7.290E-02	4.273E-07	-
Am-241	6.630E+03	1.193E+04	7.351E+03	4.574E+03	5.600E+03	3.722E+03	5.936E+03	4.574E+04	2.601E-01	26.8
Am-243	-0-	1.000E-04	-0-	-0-	9.250E-04	6.117E-05	-0-	1.086E-03	6.366E-09	-
Ce-144	-0-	-0-	-0-	-0-	-0-	4.200E-01	-0-	4.200E-01	2.462E-06	-
Cf-252	-0-	-0-	-0-	-0-	1.342E-04	-0-	-0-	1.342E-04	7.866E-10	-
Cm-244	-0-	6.000E-01	1.112E+03	-0-	4.854E-01	3.640E-02	-0-	1.113E+03	6.524E-03	.6
Co-58	-0-	-0-	8.300E-01	-0-	-0-	-0-	-0-	8.300E-01	4.865E-06	-
Co-60	-0-	-0-	6.200E+00	-0-	-0-	-0-	-0-	6.200E+00	3.634E-05	-
Cr-51	-0-	-0-	1.450E+00	-0-	-0-	-0-	-0-	1.450E+00	8.499E-06	-
Cs-137	2.460E+00	-0-	3.000E+00	-0-	1.082E-01	4.200E-01	-0-	6.076E+00	3.562E-05	-
Eu-152	-0-	-0-	-0-	-0-	1.690E-01	-0-	-0-	1.690E-01	9.906E-07	-
H-3	-0-	-0-	-0-	-0-	-0-	8.541E-06	-0-	8.541E-06	5.006E-11	-
HAP	-0-	-0-	8.495E-02	-0-	-0-	-0-	-0-	8.495E-02	4.979E-07	-
HFP	2.743E-01	1.000E-01	3.750E-01	2.160E+01	1.717E+01	1.897E+01	1.626E+01	7.475E+01	4.382E-04	-
Mn-54	-0-	-0-	1.400E-01	-0-	-0-	-0-	-0-	1.400E-01	8.206E-07	-
Np-237	-0-	6.445E-04	-0-	-0-	1.206E-04	-0-	7.050E-06	7.732E-04	4.532E-03	-
Pm-147	-0-	-0-	-0-	-0-	4.640E+02	-0-	-0-	4.640E+02	2.720E-03	-
Pu-238	2.334E+01	4.219E+01	5.030E+01	5.797E+01	2.462E+01	4.712E+02	1.301E+04	1.612E+04	9.449E-02	9.4
Pu-239	7.747E+02	1.641E+03	1.726E+03	1.921E+03	2.534E+03	8.985E+02	2.220E+03	1.172E+04	6.870E-02	6.9

NUCLIDE DISTRIBUTION - TSA STORED WASTE (CURIES)

Nuclide	1971	1972	1973	1974	1975	1976	1977	Total	Fraction	x > .1
Pu-240	1.902E+02	4.029E+02	4.252E+02	4.718E+02	6.185E+02	2.144E+02	5.331E+02	2.856E+03	1.674E-02	1.6
Pu-241	6.294E+03	1.367E+04	1.390E+04	1.639E+04	2.068E+04	5.611E+03	1.539E+04	9.194E+04	5.389E-01	53.9
Pu-242	1.075E-02	2.213E-02	2.341E-02	3.858E-02	4.702E-02	1.743E-02	4.643E-02	2.058E-01	1.206E-06	-
Ra-228	-0-	-0-	-0-	-0-	2.750E-01	-0-	-0-	2.750E-01	1.612E-06	-
Ru-106	-0-	-0-	-0-	8.000E-01	-0-	-0-	-0-	8.000E-01	4.689E-06	-
Sr-90	-0-	-0-	-0-	-0-	-0-	3.000E-01	-0-	3.000E-01	1.758E-06	-
Tc-99	-0-	-0-	-0-	-0-	1.390E-03	-0-	-0-	1.390E-03	8.148E-09	-
Th-232	-0-	-0-	1.202E-03	5.665E-02	6.123E-02	4.201E-02	5.886E-03	1.670E-01	9.789E-07	-
U-232	-0-	-0-	-0-	3.483E+00	3.537E+00	1.999E+00	2.604E-01	9.279E+00	5.439E-05	-
U-233	-0-	1.000E-02	2.562E+00	2.003E+02	1.959E+02	1.132E+02	1.475E+01	5.267E+02	3.037E-03	.3
U-234	-0-	-0-	1.098E-04	1.658E+00	1.674E+00	-0-	-0-	3.332E+00	1.953E-05	-
U-235	1.778E-05	-0-	2.390E-04	1.141E-04	1.876E-04	1.446E-04	5.902E-04	1.293E-03	7.579E-09	-
U-236	-0-	-0-	1.750E-06	2.639E-04	2.666E-04	-0-	-0-	5.323E-04	3.120E-09	-
U-238	1.332E-06	1.465E-05	4.040E-05	3.433E-05	1.363E-03	2.740E-04	2.423E-04	1.970E-03	1.155E-08	-
Un-Id-B & G	-0-	-0-	1.400E+00	-0-	-0-	-0-	-0-	1.400E+00	8.206E-06	-
TOTAL	1.392E+04	2.769E+04	2.458E+04	2.365E+04	3.258E+04	1.105E+04	3.712E+04	1.706E+05		

NUCLIDE DISTRIBUTION - DISPO. WASTE (CURIES)

Nuclide	1971	1972	1973	1974	1975	1976	1977	Total	Fraction	% > .1
Pu-240	9.060E-04	1.775E-03	6.975E-02	1.312E-01	9.430E-03	1.360E-03	1.026E-02	2.247E-01	1.148E-07	-
Pu-241	1.000E-04	6.062E-02	3.199E-01	4.646E+00	3.227E-01	3.564E-02	2.885E-02	5.414E+00	2.734E-06	-
Pu-242	-0-	9.777E-08	5.557E-07	1.088E-05	7.709E-07	1.065E-07	6.979E-08	1.248E-05	6.303E-12	-
Sa-225	5.576E+00	1.250E+00	2.299E-01	1.000E+00	3.382E-08	2.021E-01	-0-	8.258E+00	4.171E-06	-
Rb-86	-0-	4.210E+00	4.160E+00	6.322E+01	5.851E+00	-0-	-0-	7.744E+01	3.911E-05	-
Ru-103	2.570E-02	9.558E+03	1.076E+00	9.644E-02	2.033E+00	8.026E-02	2.980E-02	9.561E+03	4.829E-03	.5
Ru-106	8.307E+00	1.093E+01	1.989E+02	3.379E+02	2.614E+02	1.358E+02	1.530E+02	1.106E+03	5.586E-04	-
Sb-125	1.931E+01	1.915E+00	8.932E+01	1.074E+02	7.997E+01	6.260E+01	6.833E+01	4.288E+02	2.166E-04	-
Sc-46	4.948E+00	3.121E+00	-0-	-0-	-0-	-0-	-0-	8.069E+00	4.075E-06	-
Sr-153	-0-	-0-	-0-	-0-	-0-	3.302E+00	-0-	3.302E+00	1.677E-06	-
Sr-89	-0-	-0-	-0-	-0-	-0-	1.008E-01	-0-	1.008E-01	5.091E-08	-
Sr-90	1.678E+01	2.103E+01	1.872E+02	1.579E+03	1.764E+03	2.817E+02	2.546E+02	4.104E+03	2.073E-03	.2
Ta-182	-0-	-0-	-0-	-0-	-0-	7.310E-02	-0-	7.310E-02	3.692E-08	-
Tc-99	-0-	-0-	-0-	-0-	-0-	3.961E-07	3.200E-09	3.993E-07	2.017E-13	-
Th-230	-0-	-0-	-0-	-0-	5.405E-09	-0-	-0-	5.405E-09	2.730E-15	-
Th-232	2.180E-04	1.090E-07	5.450E-05	4.695E-05	1.091E-02	9.810E-08	3.646E-04	1.159E-02	5.854E-09	-
U-232	-0-	-0-	-0-	-0-	8.360E+00	-0-	-0-	8.360E+00	4.222E-06	-
U-233	-0-	6.000E-06	-0-	1.040E-08	-0-	9.527E-03	-0-	9.533E-03	4.815E-09	-
U-234	3.710E-04	-0-	1.857E-05	1.123E-05	1.760E-04	6.178E-04	2.782E-02	2.901E-02	1.465E-08	-

B-37

NUCLIDE DISTRIBUTION - DISPOSED WASTE (CURIES)

Nuclide	1971	1972	1973	1974	1975	1976	1977	Total	Fraction	% > 1
J-235	1.018E-01	1.072E-01	6.434E-02	6.481E-02	7.012E-02	2.764E-02	4.606E-02	4.820E-01	2.434E-07	-
J-236	1.584E-06	-0-	-0-	-0-	2.280E-06	3.170E-05	2.049E-04	2.405E-04	1.215E-10	-
J-238	7.735E+00	8.274E+00	4.723E+00	4.875E+00	5.211E+00	1.768E+00	3.147E+00	3.575E+01	1.806E-05	-
In-1d-Alpha	-0-	3.020E-01	4.368E-01	1.604E-02	1.791E-03	-0-	-0-	7.566E-01	3.821E-07	-
In-1d-B & G	2.864E+03	1.782E+04	8.048E+01	2.882E+01	1.056E+01	1.318E+02	8.995E+00	2.094E+04	1.058E-02	1.0
I-107	5.298E+00	-0-	-0-	-0-	-0-	-0-	-0-	5.298E+00	2.676E-06	-
In-65	4.272E+00	-0-	-0-	3.665E+02	4.000E-01	1.701E+00	5.960E-02	3.669E+02	1.853E-04	-
In-95	5.130E-02	1.374E+05	1.453E+01	-0-	2.318E+00	3.199E+00	5.295E+01	1.375E+05	6.944E-02	6.9
In-11b-95	3.554E+04	2.736E+00	1.237E+02	1.536E+02	1.142E+02	8.912E+01	1.068E+01	3.603E+04	1.820E-02	1.8
TOTAL CURIES	3.509E+05	2.147E+05	3.399E+05	1.832E+04	1.319E+04	2.188E+05	8.241E+05	1.980E+05		

NUCLIDE DISTRIBUTION - ILTSF (CURIES)

Nuclide	1971	1972	1973	1974	1975	1976	1977	Total	Fraction	% > .1
MFP	-0-	-0-	-0-	-0-	-0-	1.890E+01	2.043E+01	4.733E+01	9.443E-01	94.4
Pu-238	-0-	-0-	-0-	-0-	-0-	-0-	5.193E-02	5.193E-02	1.036E-03	.1
Pu-239	-0-	-0-	-0-	-0-	-0-	2.526E+00	1.479E-01	2.674E+00	5.335E-02	5.3
Pu-240	-0-	-0-	-0-	-0-	-0-	-0-	6.135E-04	6.135E-04	1.224E-05	-
Pu-241	-0-	-0-	-0-	-0-	-0-	-0-	5.975E-02	5.975E-02	1.192E-03	.1
Pu-242	-0-	-0-	-0-	-0-	-0-	-0-	4.477E-06	4.477E-06	8.933E-08	-
U-233	-0-	-0-	-0-	-0-	-0-	-0-	1.733E-04	1.733E-04	3.458E-06	-
U-235	-0-	-0-	-0-	-0-	-0-	-0-	4.247E-05	4.247E-05	8.474E-07	-
TOTAL	-0-	-0-	-0-	-0-	-0-	2.143E+01	2.869E+01	5.012E+01		

NUCLIDE DISTRIBUTION - ILTSF (CURIES)

Nuclide	1971	1972	1973	1974	1975	1976	1977	Total	Fraction	% > .1
Eu-155	-0-	-0-	-0-	2.422E+01	2.154E+01	9.000E-02	2.001E+01	6.506E+01	3.326E-05	-
Fe-59	2.935E+04	6.701E+02	5.918E+02	1.440E+03	5.630E+02	1.865E+04	6.319E+04	1.145E+05	5.703E-02	5.8
H-3	5.000E-01	-0-	2.300E-01	-0-	-0-	-0-	-0-	7.300E-01	3.687E-07	-
Hf-181	2.805E-01	-0-	-0-	-0-	4.882E-02	7.310E-02	5.960E-02	4.620E-01	2.333E-07	-
I-131	1.569E+00	-0-	-0-	-0-	8.167E-03	8.800E-01	5.500E+00	7.957E+00	4.019E-06	-
Ia-130	3.533E-01	3.775E-01	-0-	-0-	2.053E+00	5.890E+01	-0-	6.168E+01	3.115E-05	-
MAR	2.219E+00	1.003E+01	2.309E+04	9.224E+01	1.367E+01	3.074E+01	1.009E+02	2.334E+04	1.179E-02	1.2
HFP	6.709E+01	3.037E+01	1.292E+02	7.614E+02	2.866E+02	2.133E+02	2.613E+02	1.750E+03	8.830E-04	-
Mn-54	1.241E+00	4.370E+00	2.081E+04	7.201E+01	3.669E+02	2.973E+01	7.391E+04	9.519E+04	4.808E-02	4.8
Mn-56	1.405E+00	2.600E+01	-0-	-0-	5.530E+02	-0-	-0-	5.813E+02	2.936E-04	-
Na-22	-0-	-0-	-0-	-0-	-0-	-0-	1.160E-06	1.160E-06	5.859E-13	-
Na-24	3.537E+00	-0-	-0-	-0-	-0-	2.499E+01	-0-	2.853E+01	1.441E-05	-
Na-26	3.724E+00	-0-	-0-	3.196E-01	3.096E-01	2.671E+00	5.503E+01	6.205E+01	3.134E-05	-
Ni-59	5.000E+02	1.299E+03	9.931E+02	3.200E+03	-0-	-0-	-0-	5.992E+03	3.026E-03	.3
Np-237	-0-	-0-	6.345E-07	-0-	-0-	4.200E-06	-0-	4.835E-06	2.442E-12	-
Pm-147	-0-	-0-	7.400E-01	-0-	-0-	-0-	-0-	7.400E-01	3.737E-07	-
Po-210	1.100E-01	-0-	-0-	-0-	-0-	-0-	-0-	1.100E-01	5.556E-08	-
Pu-238	-0-	2.181E-04	1.231E-03	1.679E-02	1.183E-03	1.052E-03	2.287E-01	2.492E-01	1.259E-07	-
Pu-239	1.842E-01	8.807E-03	2.467E-01	5.355E-01	1.275E-01	8.660E-03	1.555E-01	1.267E+00	6.494E-07	-

NUCLIDE DISTRIBUTION - DISPOSED WASTE (CURIES)

nuclide	1971	1972	1973	1974	1975	1976	1977	Total	Fraction	% > .1
Ag-110M	2.338E-02	-0-	-0-	-0-	-0-	2.180E-01	5.960E-02	3.010E-01	1.520E-07	-
Mn-241	-0-	1.000E-05	-0-	-0-	1.850E-07	-0-	3.240E-07	1.051E-05	5.308E-12	-
Na-133	-0-	-0-	-0-	-0-	-0-	4.000E-07	3.400E-08	4.340E-07	2.192E-13	-
La-La-140	2.022E+00	8.629E+00	-0-	-0-	1.430E+00	4.368E+01	-0-	5.576E+01	2.816E-05	-
Te-110	4.290E+00	-0-	1.000E+01	-0-	-0-	-0-	-0-	1.429E+01	7.217E-06	-
Bi-210	-0-	-0-	-0-	-0-	-0-	3.930E-08	-0-	3.930E-08	1.985E-14	-
C-14	-0-	-0-	-0-	-0-	-0-	2.870E-07	-0-	2.870E-07	1.449E-13	-
Co-109	-0-	-0-	-0-	-0-	-0-	-0-	1.180E-06	1.180E-06	5.960E-13	-
Eu-141	2.944E+01	2.789E+04	2.954E+00	1.717E+00	1.895E+00	2.889E+01	1.316E+01	2.797E+04	1.413E-02	1.4
Eu-144	5.465E+01	1.093E+01	4.130E+02	8.047E+02	9.517E+02	3.981E+02	2.092E+03	4.725E+03	2.386E-03	0.2
Li-35	-0-	-0-	-0-	-0-	-0-	3.970E-08	-0-	3.970E-08	2.005E-14	-
Mo-57	-0-	-0-	-0-	-0-	-0-	-0-	1.110E-06	1.110E-06	5.555E-13	-
Co-58	8.477E+00	6.108E+00	3.900E+03	2.079E+00	3.154E-01	3.080E+01	1.061E+05	1.100E+05	5.556E-02	5.5
Co-60	4.610E+04	1.444E+05	2.082E+05	7.662E+03	7.289E+03	4.689E+04	6.217E+04	3.928E+05	1.994E-01	19.8
Cr-51	2.359E+05	5.163E+03	8.003E+04	8.170E+01	2.233E+02	1.512E+05	5.147E+05	9.873E+05	4.986E-01	49.9
Cs-134	2.119E+00	3.288E+00	5.243E+01	6.636E+01	4.619E+01	5.713E+00	1.706E+01	1.932E+02	9.758E-05	-
Cs-137	4.005E+02	2.700E+02	8.947E+02	1.424E+03	5.697E+02	4.726E+02	6.683E+02	4.700E+03	2.374E-03	.2
Eu-152	-0-	-0-	-0-	-0-	1.060E+00	4.308E-01	1.630E+02	1.645E+02	8.308E-05	-
Eu-154	-0-	-0-	-0-	4.199E+01	3.521E+01	5.008E-01	7.656E+01	1.543E+02	7.793E-05	-

B-41

E-42

Annex 2

INEL CONTAINERS FOR TRU WASTE

STANDARD CONTAINERS

Standardized containers are used at the INEL Radioactive Waste Management Complex (RWMC). These containers are designed to provide safety, integrity, and improved space utilization of the RWMC. The following containers are approved by the Department of Transportation (DOT) and by DOE-10 for use at INEL. DOE-ID will provide the procurement specifications, noted below, upon request.

- (1) The DOT 17C 55-gallon drum, per procurement specification S72001, is standard steel drum, constructed of 16-gauge materials, with a removable head (see Figure 1).
- (2) The DOT 6M packaging consist of a DOT 17C 55-gallon drum with fiberboard centering media and a DOT spec 2R inner containment vessel (see Figure 2). DOT 6M packaging is acceptable at the INEL for storage only when the drums have no mechanism for venting. This requires the generator to obtain approval for modification to the DOT 6M packaging which may be obtained when the 6M package is shipped inside another DOT approved transport device.

The DOT specification 2R, or equivalent, containment vessel must be made of stainless steel, malleable iron, brass or other material having equivalent physical strength. The vessel shall be less than 25 3/4 inches overall length and have a maximum outside vessel diameter of 5 inches. Ends of the vessel must be fitted with a screw-type closure, flanges of welded or brazed plate. The waste generator must submit the details of the 6M packaging, including 2R containment vessel to DOE-ID and EG&G WMPO for information prior to usage.

- (3) The DOT 1/H 30-gallon drum, per procurement specification 572006, is a standard steel drum constructed of 18-gauge material with a removable head (see Figure 3).
- (4) Two styles of DOT 7A boxes are acceptable (see Figures 4 and 5). Packaging of transuranic waste per Section V, Table II, requires the box to be coated with 1/8" of fiberglass per procurement specification 572013 as shown on Figure 4.
 - (a) The DOT 7A wooden box, per procurement specification 572016, is an externally cleated plywood box, normally 4' x 4' x 7' long (see Figure 5). These boxes are being replaced by the box shown in Figure 6.
 - (b) The DOT 7A wooden box, per procurement specification 572011, is a plywood box with internal stiffeners, normally 4' x 4' x 7' (see Figure 6).
- (5) The DOT 7A steel box, per procurement specification 572010, is a rectangular steel box of dimensions 50 3/8" x 58 3/8" x 72 3/8" (see Figure 7). When used as an overpack it will hold eight (8) 17C 55-gallon drums in two (2) layers of four (4) drums each or twelve

(12) 17M 30-gallon drums in two (2) layers of six (6) drums each. This box does not require a security seal when it is used as an overpack, provided each of the DOT approved inner containers is properly sealed.

- (6) See Section VIII Exceptions of Special Shipment Requirements for use of containers that do not meet the above criteria.

DOT SPEC. 17C STEEL DRUM (55 gallon)

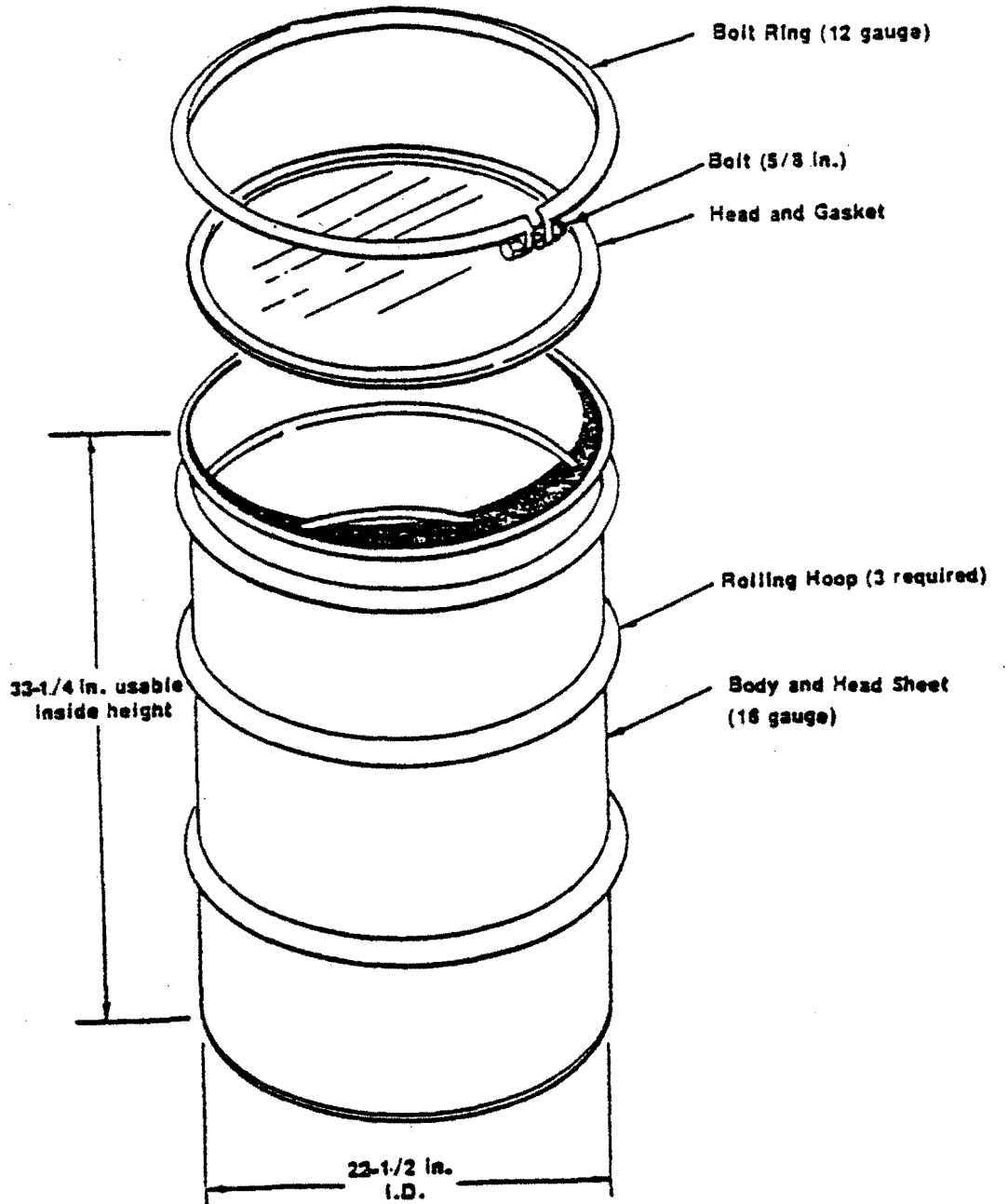

Figure 1

DOT SPEC. 6M Packaging
(CFR 49 § 178.104)

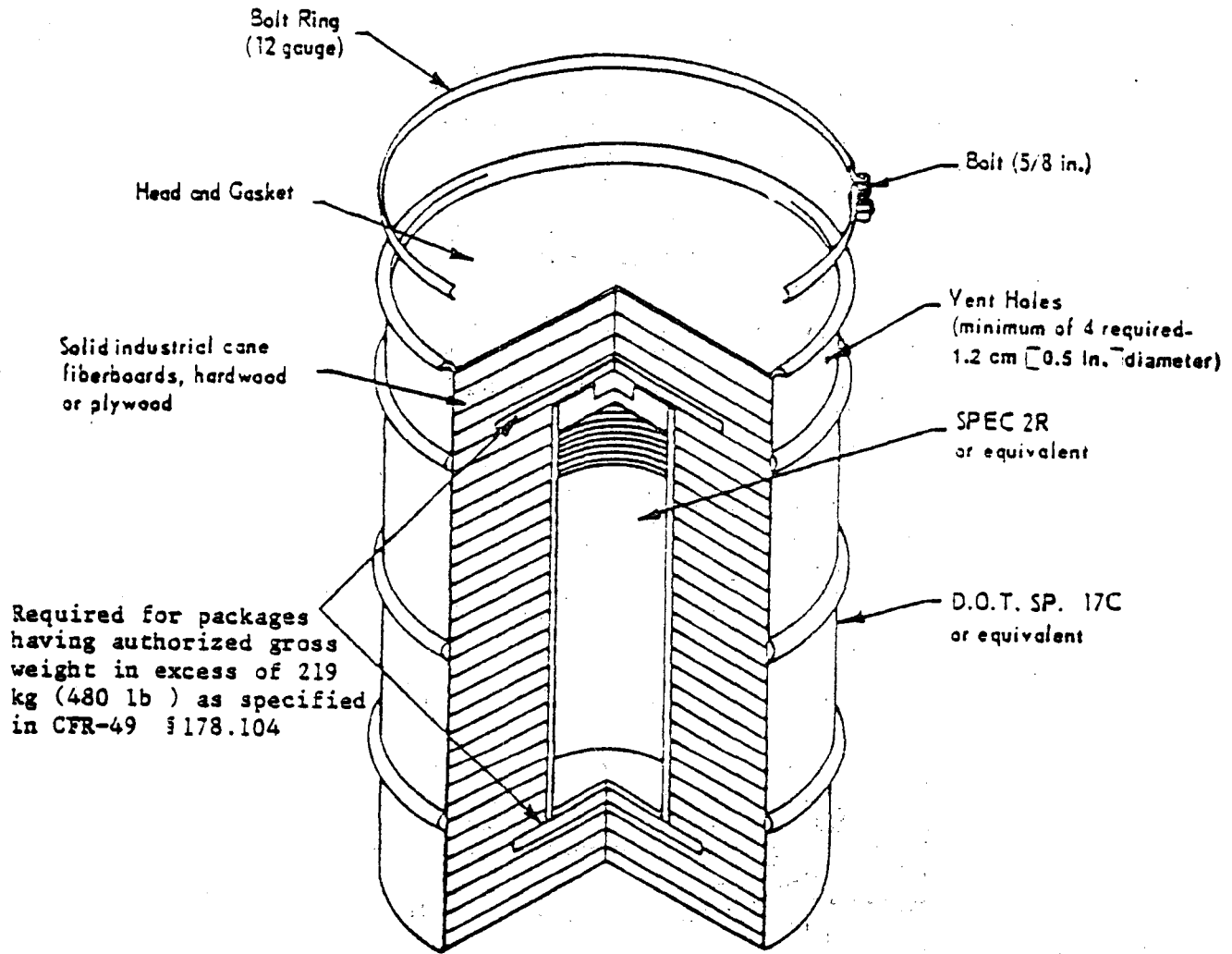

Figure 2

DOT SPEC. 17H STEEL DRUM (30 gallon)

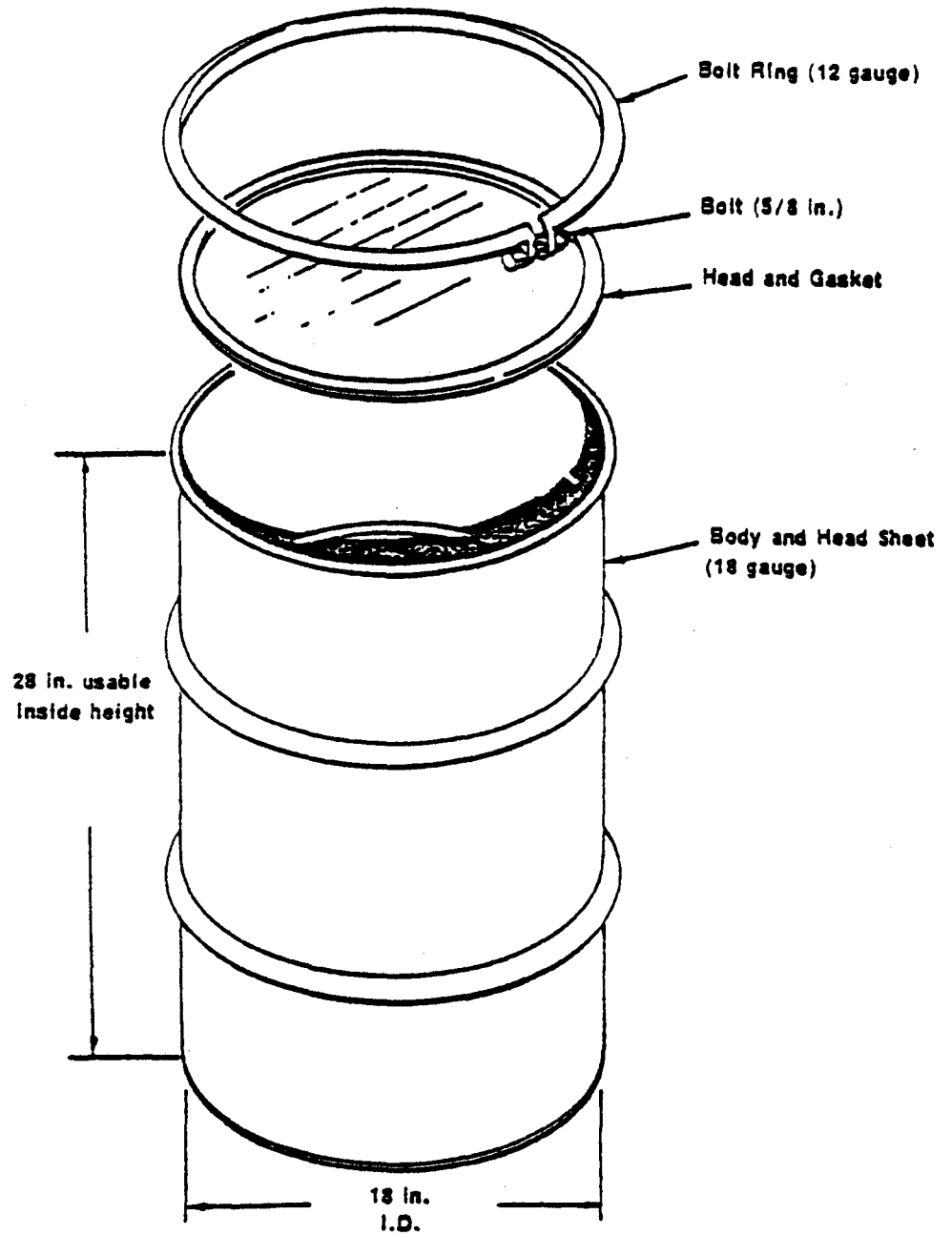
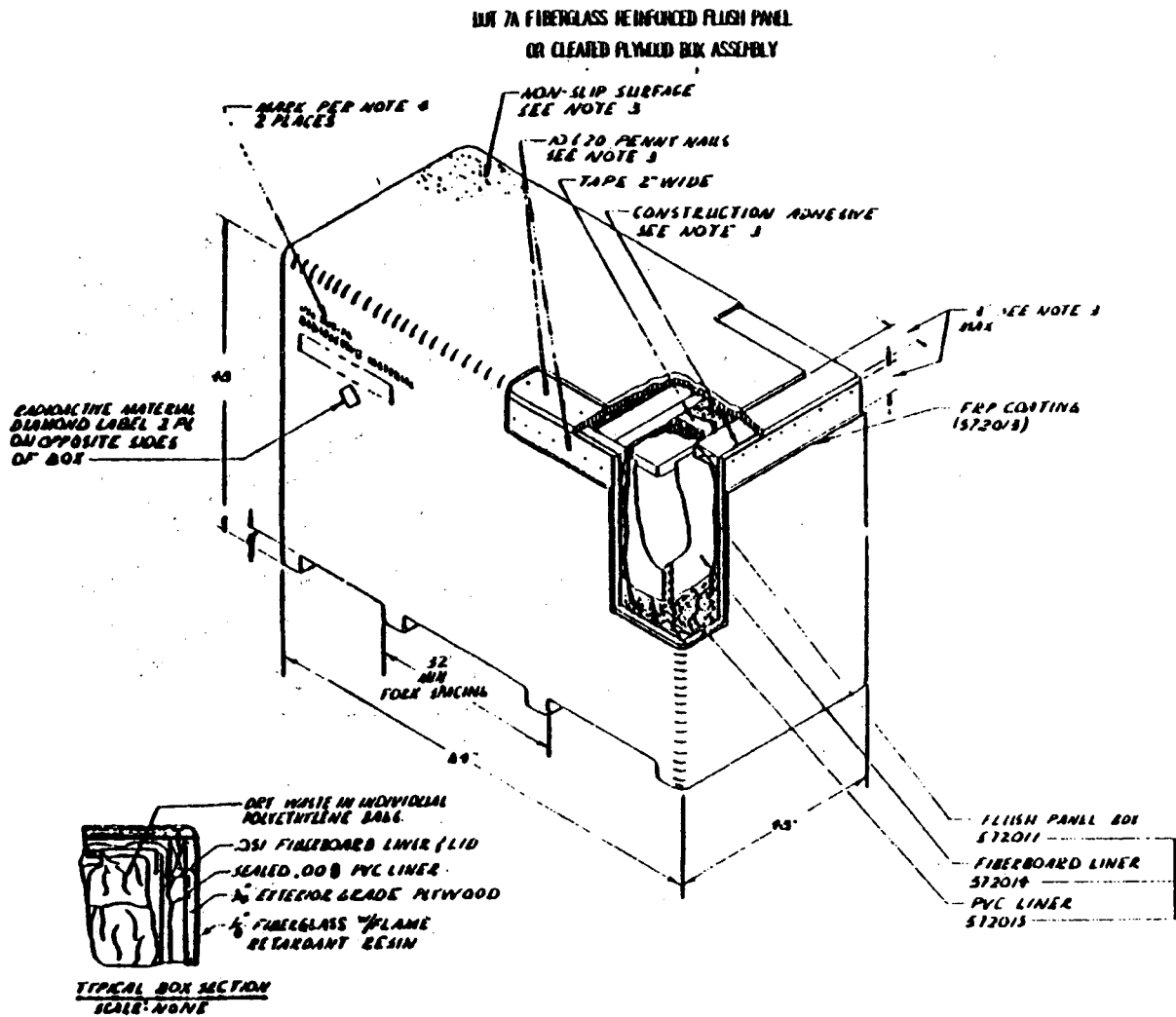

Figure 3

Figure 4



NOTES:

1. SECURELY BLOCK LARGE, HEAVY ITEMS WITHIN THE BOX TO PREVENT MOVEMENT. TIGHTLY PACK OTHER MATERIAL IN INDIVIDUAL PLASTIC BAGS AS APPROPRIATE. ALL MATERIAL SHALL BE FREE OF LIQUID.
2. PLACE LID ON FIBERBOARD LINER, FOLD OVER PVC LINER AND SEAL WITH TAPE.
3. FASTEN LID ON BOX USING CONSTRUCTION ADHESIVE AND CEMENT-COATED NAILS PER THE APPLICABLE BOX ASSEMBLY DRAWING. ADD FRP COATING PER 572013 IN AREA THREE INCHS EITHER SIDE OF JOINT TO SEAL BOX. SPRAY TOP OF BOX WITH A LIGHT COAT OF RESIN AND DISTRIBUTE ABOUT ONE QUART OF FINE GRAYEL INTO WET RESIN TO PROVIDE A NON-SLIP SURFACE.
4. DURABLY AND LEGIBLY MARK "USA DOT-7A", "RADIOACTIVE MATERIAL", NAME AND ADDRESS OF USER, AND GROSS WEIGHT USING CHARACTERS AT LEAST 1.0 INCH HIGH, 2 PLACES, ON OPPOSITE SIDES OF BOX.
5. ALL DIMENSIONS ARE IN INCHES AND ARE GIVEN FOR REFERENCE ONLY. SEE THE APPLICABLE BOX ENGINEERING DRAWING FOR DETAILS. FLUSH PANEL BOX, SHOWN. BOXES MAY BE ORDERED IN TWO HEIGHTS. SEE TABLE FOR SIZES.
6. WHEN USING 24x48x84 BOX, CUT FIBERBOARD AND PVC LINERS TO FIT.

INITIAL BOX SIZE	OVERALL HEIGHT
48x48x84	52
24x48x84	28

OR

FLUSH PANEL BOX
572014

FIBERBOARD LINER
572017

PVC LINER
572016

DOT 7A Cleated Plywood Box Assembly

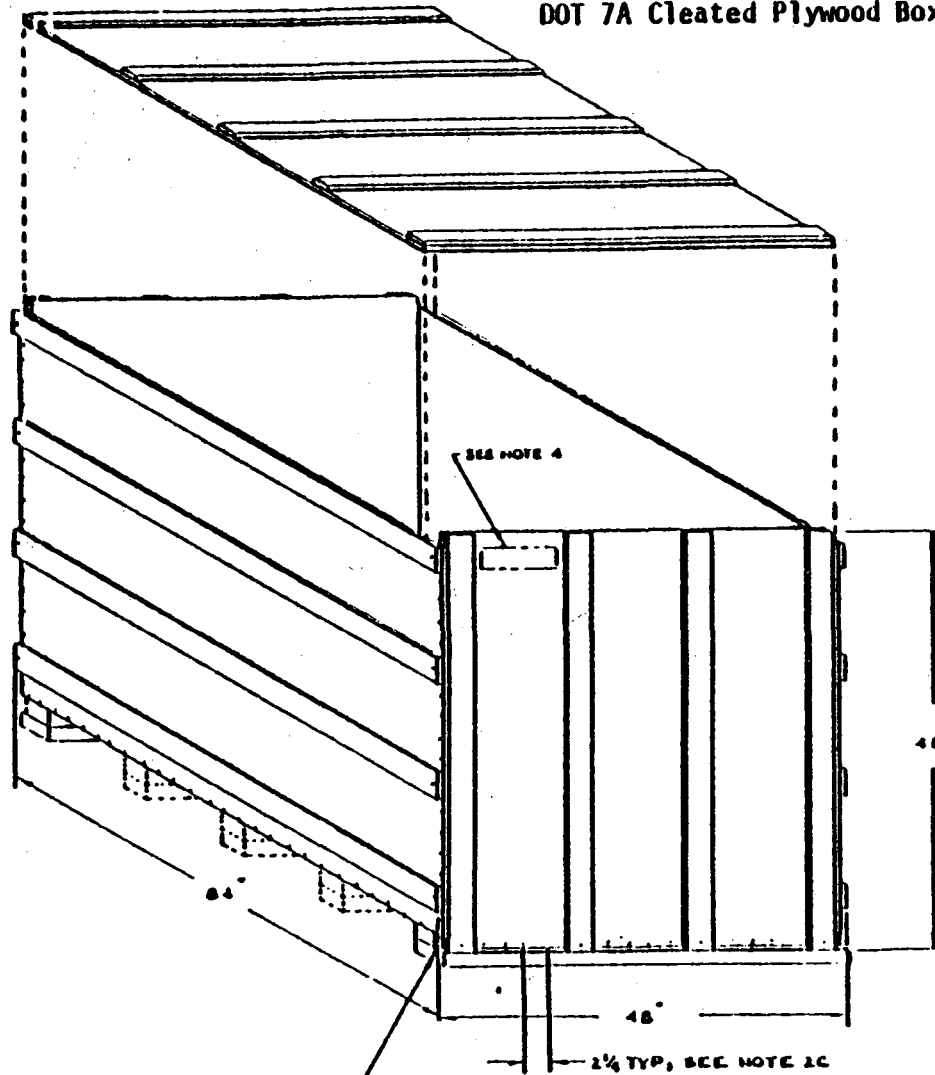

NOTES:

1. BOX DIMENSIONS BEFORE FIBERGLASSING:
 OUTSIDE: 84" x 48" x 48-1/2" = 185 FT³
 INSIDE: 81" x 45" x 42-1/2" = 80 FT³
2. ASSEMBLE BOX WITH THREE-WAY CORNERS AS FOLLOWS:
 - A. APPLY ELASTOMERIC CONSTRUCTION ADHESIVE (E.P. GOODRICH PL-200 OR APPROVED EQUIVALENT) IN A CONTINUOUS BEAD OF 1/4 INCH MINIMUM DIAMETER ALONG EACH PLYWOOD-TO-PLYWOOD JOINT. REMOVE EXCESS ADHESIVE FROM OUTSIDE OF BOX.
 - B. EACH END OF EACH CLEAT SHALL BE FASTENED WITH AT LEAST ONE 16 PENNY CEMENT-COATED BOX NAIL.
 - C. APPLY 8 PENNY CEMENT-COATED BOX NAILS OR 2 INCH PLASTIC COATED STAPLES THRU THE PLYWOOD INTO THE APPROPRIATE CLEAT OR STRINGER AS SHOWN. FASTENERS SHALL BE FLUSH TO 1/16 INCH MIN BELOW SURFACE. STAPLE EDGES SHALL EMIT GRAIN OF FIRST PLY AT NOT LESS THAN A 40° ANGLE. INTERIOR OF BOX SHALL BE FREE OF PROTRUDING FASTENERS.
3. FIBERGLASS BOX AND ASSEMBLY SHEETS PER SHEET 3. COATING MAY BE DONE ON INDIVIDUAL PANELS OR ON ASSEMBLED BOX.
4. DURABLY AND LEGIBLY MARK MANUFACTURER'S NAME OR SYMBOL AND DATE OF MANUFACTURE 2 PLACES ON OPPOSITE ENDS OF BOX, USING CHARACTERS AT LEAST 1/4 INCH HIGH. A PAPER LABEL WITH RESIN COVERCOAT ACCEPTABLE.
5. WHEN THE PURCHASE ORDER SPECIFIES A NON-FIBERGLASSED BOX, OMIT ASSEMBLY SHEETS PER NOTE 3. ATTACH SHEETS PER SHEET 2 OF THIS DRAWING SERIES. TEMPORARILY SECURE LTD WITH CARBIDE HEADED NAILS OR OTHER SUITABLE FASTENERS TO RESIST BLOWING IN HIGH WINDS DURING STORAGE OR TRANSPORTATION.
6. FINAL LTD CLOSURE BY USER SHALL BE MADE USING CONSTRUCTION ADHESIVE AND 8 PENNY CEMENT COATED NAILS OR 2 INCH PLASTIC COATED STAPLES.

OPTIONAL VOID IN CORNER MAY BE FILLED TO FACILITATE FIBERGLASSING

Figure 5.

DOT 7A Flush Panel Plywood Box Assembly

E-51

Figure 6

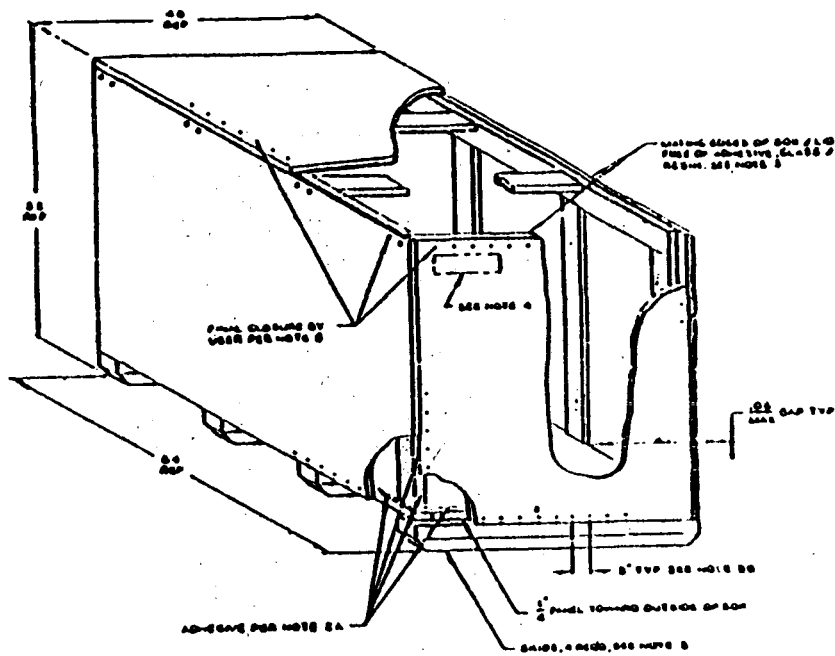

NOTES:

1. NOMINAL BOX SIZE: 1'
 - TYPE 1 - 40 x 40 x 04; OVERALL HEIGHT 52
 - TYPE 2 - 26 x 40 x 04; OVERALL HEIGHT 20
- ALL DIMENSIONS ARE IN INCHES, EXCEPT AS NOTED
2. ASSEMBLE BOX AS FOLLOWS:
 - A. APPLY ELASTOMERIC CONSTRUCTION ADHESIVE (E.F. GOODRICH PI-200 OR APPROVED EQUIVALENT) IN A CONTINUOUS BEAD OF 3/4 INCH MINIMUM DIAMETER ALL AROUND 3/4 INCH BOTTOM PANEL AND ON BOTH SIDE EDGES OF END PANELS. APPLY A BEAD OF ADHESIVE BETWEEN VERTICAL END STUDS AND END PANELS. REMOVE EXCESS ADHESIVE FROM OUTSIDE OF BOX.
 - B. FASTEN PANELS USING 10 PENNY CEMENT-COATED BOX NAILS OR 2 INCH PLASTIC-COATED STAPLES WITH 3 INCH MAXIMUM SPACING. FASTENERS SHALL BE DRIVEN FLUSH TO 1/16 MAXIMUM BELOW SURFACE. STAPLE CRUMBS SHALL CROSS GRAIN OF FIRST PLY AT NOT LESS THAN A 40° ANGLE. INTERIOR OF BOX SHALL BE FREE OF PHOTOGRAPHIC FASTENERS AND SPLIT LAMINER.
 - C. EDGES OF SIDE AND END PANELS SHALL BE FLUSH TO 1/16 MAXIMUM ABOVE BOTTOM OF BOX.
3. FIBERGLASS BOX AND ASSEMBLY SKIDS PER 572013. COATING MAY BE DONE ON INDIVIDUAL PANELS OR ON ASSEMBLED BOX. MATING EDGES OF BODY AND END SHALL BE FREE OF GLASS AND MEASURABLE RESIN OVER-SPRAY. BOX EDGES MAY BE BROKEN 3/4 MAXIMUM RADIUS OR CHAMFER TO FACILITATE FIBERGLASSING.
4. DURABLY AND LEGIBLY MARK MANUFACTURER'S NAME & SYMBOL, DATE OF MANUFACTURE, 2 PLACES ON OPPOSITE ENDS OF BOX USING CHARACTERS AT LEAST 1/4 INCH HIGH (MAY BE PAPER LABEL WITH RESIN OVERCOAT.)
5. USER SHALL MAKE FINAL BOX CLOSURE WITH THE MATERIALS SPECIFIED IN NOTE 2. APPLY ADHESIVE ALL AROUND TOP EDGES OF VERTICAL 3/4 INCH PANELS. IN ADDITION TO 10 PENNY CEMENT-COATED BOX NAILS USE 20 PENNY CEMENT-COATED NAILS THROUGH SIDE PANEL INTO EACH 2x4 ON TOP PANEL (8 PLACES)
6. WHEN THE PURCHASE ORDER SPECIFIES A NON-FIBER GLASSED BOX, OMB ASSEMBLY STEPS PER NOTE 3. ATTACH SKIDS PER SHEET 2 OF THIS DRAWING SERIES. TEMPORARILY SECURE LID WITH DOUBLE-HEADED NAILS OR OTHER SUITABLE FASTENERS TO RESIST BLOWING OFF IN HIGH WINDS DURING STORAGE OR TRANSPORTATION.

DOT SPEC. 7A STEEL BOX

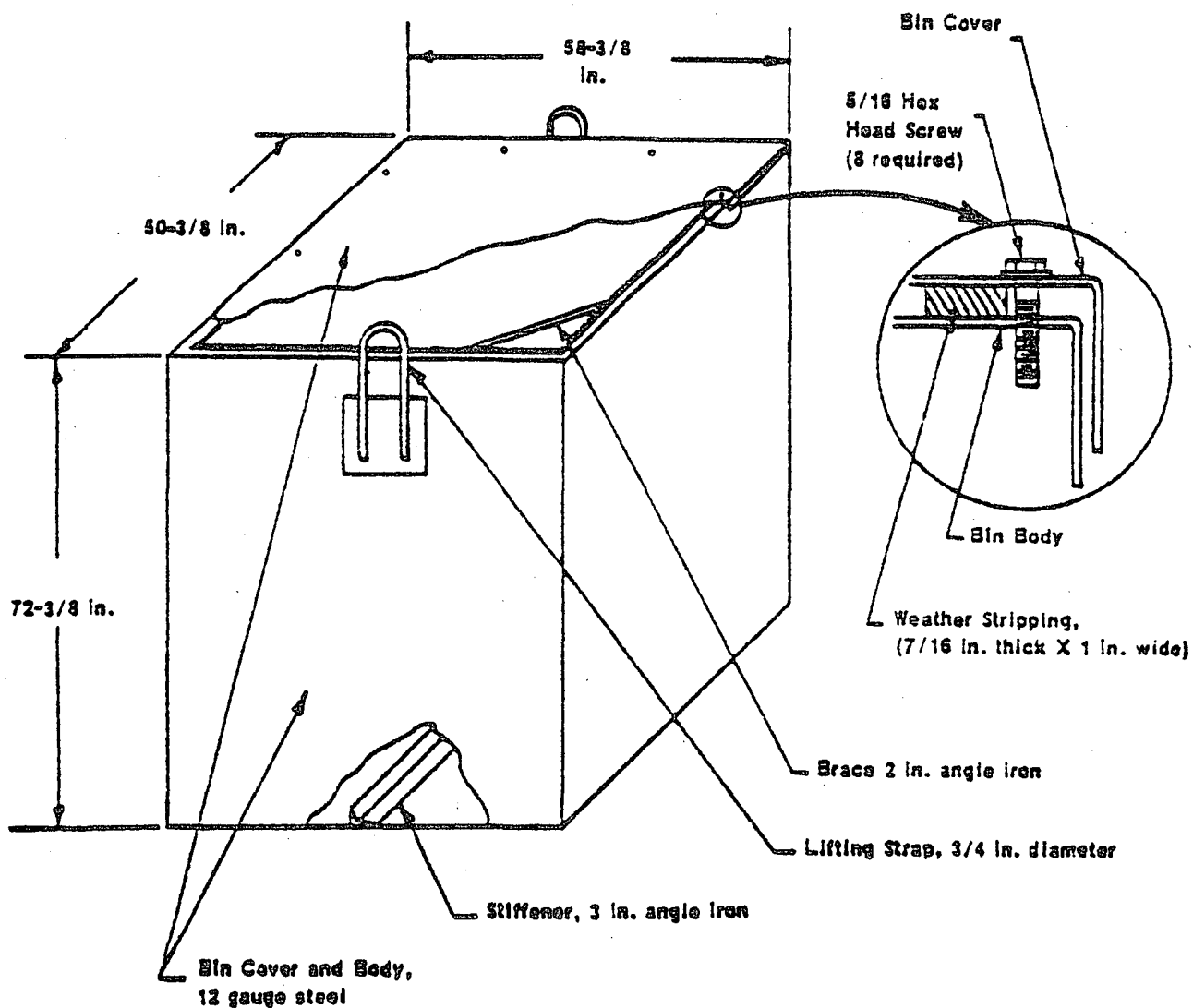

Figure 7

Appendix F

INCINERATION AND IMMOBILIZATION PROCESSES

CONTENTS

	<u>Page</u>
F.1 Incineration Processes.....	F-1
F.1.1 Processes for Radioactive-Waste Incineration.....	F-1
F.1.2 Processes for the Incineration of Commercial or Municipal Waste.....	F-2
F.2 Immobilization Processes.....	F-3
Reference.....	F-4

Appendix F

INCINERATION AND IMMOBILIZATION PROCESSES

As explained in Section 5.3, several studies of the processing of transuranic waste have been carried out at the Idaho National Engineering Laboratory. One of these analyses, performed by the FMC Corporation (1977), evaluated 17 incineration processes (nine for radioactive waste and eight for municipal or commercial waste) and 11 immobilization processes. This appendix briefly describes these processes.

F.1 INCINERATION PROCESSES

F.1.1 Processes for Radioactive-Waste Incineration

An acid-digestion process is being developed at the Westinghouse Hanford Company, Richland, Washington. This system treats combustibles with sulfuric and nitric acids at about 240°C. The residue from this process consists of inorganic sulfates and oxides in a salt-cake form.

An agitated hearth is an adaptation of a commercial incinerator. This operation is being developed by Rockwell International at Rocky Flats, Colorado. In this process a batch of contaminated combustible material is charged into a primary chamber where rotating rabble arms agitate the combustible material to improve the burning. The output is a dry ash.

A controlled-air incinerator, also a modification of commercially available equipment, is under construction at the Los Alamos National Scientific Laboratory, Los Alamos, New Mexico. This incinerator uses a starved-air primary chamber with an oxygen-rich secondary chamber. The offgas is treated by wet scrubbing. The output of this process is also a dry ash.

A cyclone-drum incinerator is being operated at the Mound Facility, Miamisburg, Ohio. Contaminated laboratory waste is burned in a vortex-type incinerator inside a 55-gallon drum. The contaminated waste may be handled both in and out of the incinerator in the 55-gallon drums. The residue from the combustible portion of this process is almost completely oxidized.

A fluidized-bed incinerator is being developed by Rockwell International at Rocky Flats, Colorado. This process feeds combustible material into a hot fluidized bed of sodium carbonate. The hot air that fluidizes the bed provides immediate ignition for combustibles, which are burned. The ash is separated in a cyclone. A second fluidized bed is used for complete oxidation. The residue is an ash collected in the cyclone separator. The sodium carbonate provides in-situ neutralization of the hydrogen chloride and other acidic gases formed during the oxidation.

The molten-salt incinerator was developed by Atomic International for the Idaho National Engineering Laboratory. This process feeds finely divided combustibles and noncombustibles, including metals, into a molten-salt bath.

The combustibles immediately oxidize within the bath, and the ash is captured there along with the metal oxides and other noncombustibles. When the bath is fully loaded with noncombustible material, it is drained along with the captured incinerator residue. The sodium carbonate in the molten bath provides in-situ neutralization of the acid gases formed during the oxidation process.

A controlled-air pyrolysis incinerator is being developed by E. I. du Pont de Nemours & Company, Inc., at Savannah River, South Carolina. This process moves combustible material into a refractory-lined chamber heated to 1000°C by electric heaters. The oxygen is maintained below stoichiometric levels to obtain flameless incineration. Under these conditions the volatile materials are driven off and oxidized in an oxygen-rich secondary chamber. The principal residue of this process is a char relatively high in carbon.

A commercial rotary-kiln incinerator, adapted for radioactive waste, is under construction for the Rocky Flats Plant in Colorado. The contaminated waste material is fed into the upper end of the rotary kiln and oxidized as the kiln rotates. The dry ash is continuously removed from the bottom of the kiln. The offgases are burned in an afterburner.

A slagging-process incinerator, installed at the CEN-SCK waste facility in Mol, Belgium, is a commercial incinerator adapted for radioactive-waste disposal. The waste material is shredded before being fed into a waste hopper that surrounds the incineration chamber. As the waste material feeds into the incineration chamber, it is oxidized, and the noncombustible materials are melted into a slag at 1600°C. The slag output material drips continuously from the hearth into a water quench tank below the incinerator. The output material is a basaltlike glassy slag.

F.1.2 Processes for the Incineration of Commercial or Municipal Waste

The commercial controlled-air incinerator is similar to the radioactive-waste unit; it uses a "starved-air" primary combustion chamber process to produce a low level of turbulence that minimizes the transfer of particulate matter to the offgas. An oxygen-enriched secondary chamber with vigorous air turbulence is used to completely oxidize the offgas.

Commercial fluidized-bed incinerators (FBIs), although similar in principle to the Rocky Flats FBI, are quite different. All commercial FBIs operate at high temperatures and consequently use refractory linings. Physical sizes and capacities are much larger. Usually the feed material they process can be in much larger chunks that need not be shredded as fine.

The commercial application of molten-salt incinerators is in the development stage. The molten-salt incinerator developmental programs are in the areas of coal gasification, flue-gas purification, etc. Production rates vary from 1 to 3 metric tons per hour.

The commercial moving-grate is a common type of municipal solid-waste incinerator or combustion system for waste-heat boilers, etc. This incinerator

requires finely shredded combustible feed material with little foreign noncombustible material. The maximum capacities of these units in tons per hour are large.

The commercial multiple-hearth combustor is used frequently for incinerating municipal and industrial sludges, shredded solid wastes, etc. An advantage of the multiple hearth is a long residence time in the incinerator and varying temperature ranges for the individual hearths so that the top hearths may be drying the waste, the middle hearths pyrolyzing the waste, the lower hearths oxidizing the waste, and the bottom hearth cooling the waste. Because the individual hearths are vertically above each other, the units are efficient in operation, utilizing all the waste heat of combustion. The maximum capacities of multiple-hearth units can be more than 100 tons per hour.

The commercial versions of the pyrolysis incinerators are operated more nearly as a controlled-air process than as a pure pyrolysis process. These units completely oxidize the pyrolysis char residue in the primary chamber to provide a dry inert ash. A secondary combustion chamber oxidizes the tars and other volatile products of pyrolysis.

The rotary kiln is another large-capacity, standard incinerator for commercial or municipal waste. Rotary kilns are also used for hazardous-waste incineration in which 55-gallon drums of material are directly fed into the rotating kiln with little deleterious effect on the kiln lining.

The slagging-pyrolysis process is a relatively new form of municipal-waste incineration. The original objective of this process was to generate gas from a pyrolysis zone that could be used as fuel for industrial or municipal operations. In this process waste material is loaded into a vertical shaft chamber. As the material descends, it passes through a drying zone, a pyrolysis zone, an oxidation zone, and, finally, a slagging zone in the bottom of the chamber. The hot gases driven off each zone rise and form the fuel for the upper zones. In the pyrolysis zone, the volatile gases are collected; they may be used as fuel in a steam boiler or oxidized in an afterburner, with the hot gases running to heat exchangers. The output of this process is a basalt-like glassy slag that entraps the ash along with metals and noncombustibles in the waste material.

F.2 IMMOBILIZATION PROCESSES

Bitumen. Any form of waste residue may be encapsulated in bitumen (asphalt) that can be handled by the bitumen mixer. This process has been used primarily for waste residues that are to be disposed of in the sea.

Cement. Hydraulic cement may be used to stabilize ash, salt, or even small pieces of metal and other noncombustibles, so long as these materials can be handled by the mixer. The cement with embedded waste materials may be cast into any desired form for handling. Steel reinforcements are used to increase the strength of the packages.

Ceramic. In this process, the waste material in the form of a calcine is combined with glass frit to produce glass ceramics. For immobilizing high-level waste, the output ceramic is embedded in a metal matrix for heat dispersion.

Clay. Radioactive waste in the form of sodium-salt solutions combines chemically with clays to immobilize the waste. The clay may be formed into bricks, which are fired at 700 to 900°C; this firing decreases the leach rate.

Glass (solution). Various waste materials may be combined with glass-forming materials and melted at high temperatures. When the forms of the output materials are finely ground ash, salts, oxides, or calcines, they dissolve and are dissolved in the glass matrix.

Glass (encapsulation). Small pieces of metals and other noncombustible materials are encapsulated in molten glass poured over them.

Metal matrix. Metals are used to stabilize the radioactive-waste materials that are in the form of vitrified pellets or beads or in some other calcined form. The principal advantages of the metal matrices are high impact strength and high thermal conductivity.

Pellets. The radioactive material and ash are ground very finely and mixed with high-alumina cement. This powder is then pressed into pellets and sintered. The principal advantage of this process is that the concentration of radioactive waste in the pellets (80%) is higher than that obtained with other techniques. For example, in the glass-solution process the radioactive-waste concentration is 50% at a maximum.

Plastic materials. A variety of resins and plastic materials have been used as matrices to immobilize ash, salts, and oxides. These materials could be used to stabilize small pieces of metal and noncombustibles. The primary disadvantage is that these resins are combustible.

Salt cake. The cast salt cake taken directly from the output of the molten-salt incinerator or the acid-digestion process adequately immobilizes the fine ash material. However, the salt cake has a very high leach rate and thus will not meet stabilization requirements.

Slag. The product of the slagging incinerator is a granular basaltlike glassy slag. Glass formers may be added to the waste-material feed in the incinerator to improve the vitrified output.

REFERENCE

FMC Corporation, 1977. Selection of Waste Treatment Process for Retrieved TRU Waste at Idaho National Engineering Laboratory, R-3689.

Appendix G

**METHODS USED TO CALCULATE
RADIATION DOSES
FROM RADIONUCLIDE RELEASES
DURING OPERATION**

CONTENTS

	<u>Page</u>
G.1 Introduction.....	G-1
G.2 Meteorological Routine.....	G-1
G.3 Dose Routine.....	G-6
G.4 Input Data.....	G-8
References.....	G-10

LIST OF TABLES

	<u>Page</u>
G-1 Formulas recommended by Briggs for σ_y and σ_z for open-country conditions.....	G-3
G-2 Sources of input data for the analyses.....	G-9

LIST OF FIGURES

	<u>Page</u>
G-1 Flow of information in the AIRDOS-II code.....	G-2
G-2 Virtual point source.....	G-4

Appendix G

METHODS USED TO CALCULATE RADIATION DOSES FROM RADIONUCLIDE RELEASES DURING OPERATION

G.1 INTRODUCTION

The radiation-dose calculations for radionuclide releases during operation were performed with a modified version of the computer code AIRDOS-II. Because excellent documentation describing the code and its input instructions is available (Moore, 1977), this appendix only highlights the major features of the code and outlines modifications made to the code.

Generally, AIRDOS-II is primarily intended to calculate doses from a continuous release of radionuclides, but, with the proper adjustments of input parameters, it can be used for a pulse release--that is, a release over a short time that would resemble a release resulting from an accident. The unmodified code calculates its own atmospheric-dilution factors (X/Q values); it was used in Chapter 6 to calculate doses from transportation-accident releases. In calculating doses from normal and accidental releases from the WIPP in Chapter 9, site-specific X/Q values were desired. These values were obtained with the integrated-puff model MESODIF, described in Appendix H, Section H.4. In order to use these X/Q values, it was necessary to write a subroutine that allows the direct input of X/Q values into AIRDOS-II.

The general flow of information in the code is indicated in Figure G-1. The MAIN subroutine drives the code as it differentiates between user options and directs the logical calculation process. MAIN first calls either CONCEN or COMPAG. CONCEN estimates ground-level air concentrations and surface-deposition rates. CONCEN calls QX, which accounts for plume depletion over the study area. COMPAG inputs previously calculated X/Q values and then calculates surface-deposition rates. Once the concentrations and deposition rates are calculated, MAIN calls DOSE to compute the dose delivered to people. DOSE then calls DOSMIC, which simply provides a structured output of DOSE results.

G.2 METEOROLOGICAL ROUTINE

The AIRDOS-II code consists of two major calculation routines: the meteorological routine and the dose routine. The meteorological routine is based on a dispersion model that considers plume rise, plume depletion, and an inversion lid. The equation used to estimate plume dispersion is the Gaussian plume equation of Pasquill, as modified by Gifford (1972):

$$X = \frac{Q}{2\pi\sigma_y\sigma_z u} \exp\left[-\frac{1}{2}\left(\frac{y}{\sigma_y}\right)^2\right] \left\{ \exp\left[-\frac{1}{2}\left(\frac{z-H}{\sigma_z}\right)^2\right] + \exp\left[-\frac{1}{2}\left(\frac{z+H}{\sigma_z}\right)^2\right] \right\}$$

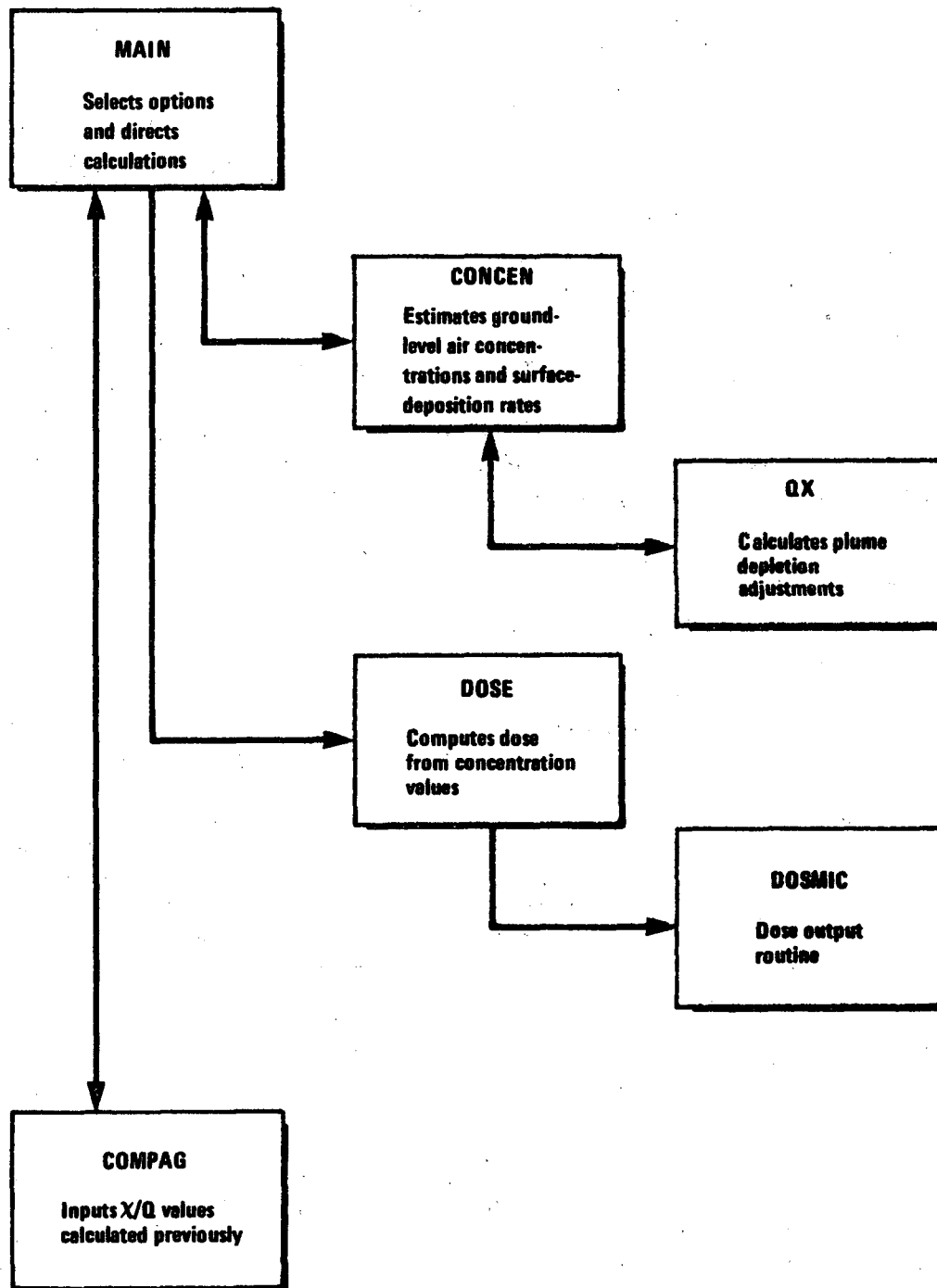

Figure G-1. Flow of information in the AIRDOS-II code.

where

- χ = concentration in air at x meters downwind, y meters crosswind, and z meters above the ground (pCi/m³)
- Q = uniform emission rate from the stack (pCi/sec)
- u = mean wind speed (m/sec)
- σ_y = horizontal dispersion coefficient (m)
- σ_z = vertical dispersion coefficient (m)
- H = effective stack height (physical stack height h plus the plume rise Δh) (m)
- y = crosswind distance (m)
- z = vertical distance (m)

For calculating ground-level concentrations, this equation may be reduced to the following:

$$\chi = \frac{Q}{\pi \sigma_y \sigma_z u} \exp \left[-\frac{1}{2} \left(\frac{H}{\sigma_z} \right)^2 \right]$$

The values of the dispersion coefficients are calculated from equations developed by G. A. Briggs of the National Oceanic and Atmospheric Administration. They are described in Table G-1 for each Pasquill category.

Table G-1. Formulas Recommended by Briggs^a for σ_y and σ_z for Open-Country Conditions^b

Pasquill category	σ_y (meters)	σ_z (meters)
A	$0.22d(1 + 0.0001d)^{-1/2}$	0.20d
B	$0.16d(1 + 0.0001d)^{-1/2}$	0.12d
C	$0.11d(1 + 0.0001d)^{-1/2}$	$0.08d(1 + 0.0002d)^{-1/2}$
D	$0.08d(1 + 0.0001d)^{-1/2}$	$0.06d(1 + 0.0015d)^{-1/2}$
E	$0.06d(1 + 0.0001d)^{-1/2}$	$0.03d(1 + 0.0003d)^{-1}$
F	$0.04d(1 + 0.0001d)^{-1/2}$	$0.016d(1 + 0.0003d)^{-1}$

^aG. A. Briggs, Air Resources Atmospheric Turbulence and Diffusion Laboratory, National Oceanic and Atmospheric Administration, Oak Ridge, Tennessee.

^bThe quantity d is the downwind distance in meters.

In calculations performed for the transportation-impact analysis, a distributed source of finite size was represented by an upwind virtual point source that produced a plume with dimensions matching the assumed height of the distributed source (see Figure G-2). To match these dimensions, the distance to the virtual source was calculated by simultaneously solving two equations:

$$H = 4.3 \sigma_z$$

$$\sigma_z = 0.016d(1 + 0.0003d)^{-1}$$

The first equation defines the distributed-source height, and the second defines the standard deviation of the vertical distribution coefficient for type F stability as indicated above. The resultant equation for the distance between the virtual source and the distributed source is

$$d(1 + 0.0003d)^{-1} = 14.5H$$

The value of d is the virtual source distance for a source of height H . Once the distance of the virtual source from the actual distributed source is calculated, the distance used in the diffusion equations is the sum of the distances x and d in Figure G-2.

The Rupp model for momentum-dominated plume rise is used. The Rupp equation for momentum-dominated plumes is

$$\Delta h = 1.5vd/u$$

where

- Δh = plume rise (m)
- v = effluent stack-gas velocity (m/sec)
- d = inside stack diameter (m)
- u = wind speed (m/sec)

As the plume extends in size, some of the particles it contains will be deposited on the ground or on water surfaces by dry deposition or by scavenging. Dry deposition is a process by which particles are removed from the plume at the ground surface by impingement, electrostatic attraction, or chemical interaction with the ground cover or ground surface. The rate of dry deposition is determined by the following equation:

$$R_d = V_d X$$

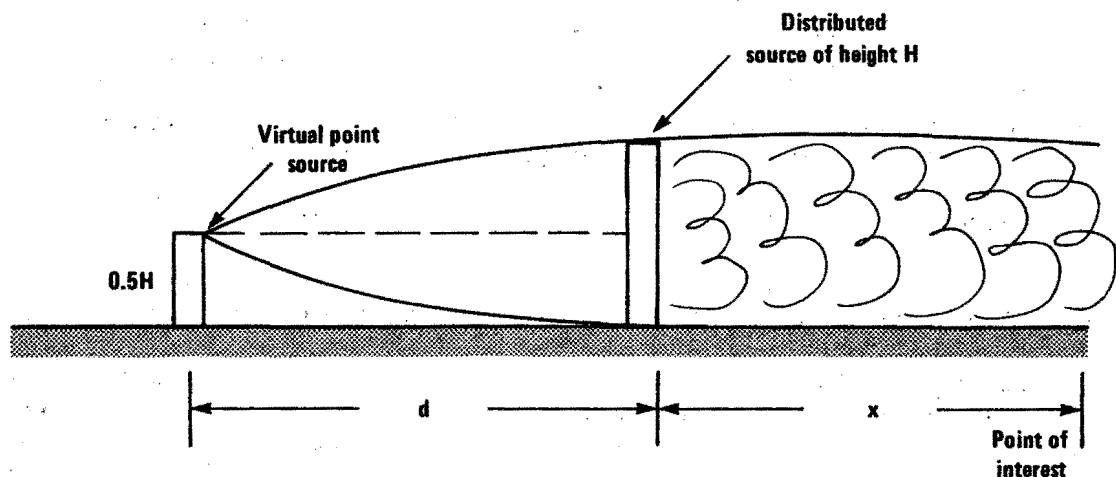

Figure G-2. Virtual point source.

where

R_d = surface-deposition rate (pCi/cm²-sec)
 V_d = deposition velocity (cm/sec)
 χ = ground-level concentration in air (pCi/cm³)

Rain or snow scavenges particles in a plume by depositing them on the ground. The rate of scavenging deposition is defined by

$$R_s = L\phi\chi_{va}$$

where

R_s = surface-deposition rate (pCi/cm²-sec)
 L = lid height (cm)
 ϕ = scavenging coefficient (sec⁻¹)
 χ_{va} = average concentration in vertical column up to lid height (pCi/cm³)

The AIRDOS-II code accounts for the effect of these depletion processes by calculating a reduced release rate (source term) at each downwind distance and by using this reduced release rate in place of the input source term. It also accounts for depletion by radionuclide decay.

Often throughout a typical year, a stable air mass will reside above an unstable one. This condition, commonly referred to as an atmospheric inversion, produces a ceiling, or lid, above which a plume will not disperse. Consequently, above the lid altitude no vertical dispersion will occur. AIRDOS-II accounts for the increase in ground-level concentration by allowing the user to input an inversion-lid altitude. The average concentration of particulates is adjusted by means of this input parameter as is the surface-deposition rate.

For releases from the WIPP, atmospheric-dilution factors (χ/Q values) were calculated by another code. Consequently, it was not necessary to use the CONCEN subroutine. CONCEN was circumvented by writing COMPAG, which is a subroutine that allows the direct input of concentrations into DOSE.

Calculations were also performed for releases of radioactive material from the WIPP during accidents in order to determine the resultant dose to a maximally exposed individual at the site boundary. As discussed earlier, the input was modified to accommodate an instantaneous release. To maximize the site-boundary dose, it was assumed that the mixing depth was limited by the worst-case lid height and that the individual exposed remains at the site boundary for the duration of the passage of the plume. An elevated release (momentum-dominated) based on the ventilation-system design was used for these calculations. The site-boundary χ/Q value used in the calculations is the elevated equivalent of the 5% ground-level 1-hour-duration χ/Q value at the boundary. In order to calculate the maximum site-boundary dose that could result from accidents, the atmospheric dispersion was limited to a single wind direction under class F conditions with a wind speed of 2 meters per second. These conditions very nearly approximate the 5% χ/Q value at 5 kilometers from the point of release.

G.3 DOSE ROUTINE

The dose routine calculates the radiation dose delivered to people through several major pathways. It considers internal exposure resulting from the inhalation and ingestion of radionuclides and external exposure resulting from immersion in air, immersion in water, and standing on contaminated surfaces. The dose from the inhalation of radionuclides is estimated from the following equation:

$$D_{inh} = (1.0 \times 10^{-6}) (8760) \times B_r C_{inh}$$

where

$$\begin{aligned} D_{inh} &= \text{inhalation dose (rem/yr)} \\ \chi &= \text{ground-level concentration of the radionuclide in air (pCi/cm}^3\text{)} \\ B_r &= \text{breathing rate (cm}^3\text{/hr)} \\ C_{inh} &= \text{dose-conversion factor for inhalation (rem/\mu Ci)} \\ 1.0 \times 10^{-6} &= \mu\text{Ci/pCi} \\ 8760 &= \text{hr/yr} \end{aligned}$$

The only parameter that is calculated by the code is the ground-level concentration; the other values are user inputs. The analyses of normal and accidental releases were performed with the same dose routine but different user inputs.

The dose from ingestion is calculated by using the terrestrial model of Booth et al. (1971). The code considers radionuclide intake only through the ingestion of vegetables, beef, and milk. It takes into account both radionuclides deposited on the surfaces of vegetables and those absorbed through the root system; it does the same for grass in the beef- and milk-intake pathways. General agricultural and demographic information must be input by the user for ingestion-dose calculations.

External doses from gamma radiation emitted by the radionuclides in the plume are calculated as follows:

$$D_{imm} = (1.0 \times 10^{-6}) (8760) \times C_{imm}$$

where

$$\begin{aligned} D_{imm} &= \text{air-immersion dose (rem/yr)} \\ \chi &= \text{ground-level concentration of the radionuclide in air (pCi/cm}^3\text{)} \\ C_{imm} &= \text{dose-conversion factor for immersion in an infinite cloud} \\ &\quad \text{(rem-cm}^3\text{/}\mu\text{Ci-hr)} \\ 1.0 \times 10^{-6} &= \mu\text{Ci/pCi} \\ 8760 &= \text{hr/yr} \end{aligned}$$

Once again, the code used calculated concentrations and user-input dose-conversion factors.

A similar treatment is used for estimating doses that result from immersion in water on which radionuclides have been allowed to deposit. This is

seldom a significant exposure pathway, but the dose contribution is calculated from the equation

$$D_{wimm} = (1.0 \times 10^{-6}) (8760) \frac{R_t}{d} \frac{1 - \exp(-\lambda_T t)}{T} (3600) (24) C_{wimm}$$

where

D_{wimm} = water-immersion dose (rem/yr)
 R_t = surface-deposition rate (pCi/cm²-sec)
 d = depth of water (cm)
 λ_T = radioactive-decay constant + environmental-decay constant for water (day⁻¹)

t = time allotted for buildup in water (days)

C_{wimm} = dose-conversion factor for immersion in a body of water of infinite dimensions (rem-cm³/μCi-hr)

1.0×10^{-6} = μCi/pCi

8760 = hr/yr

3600 = sec/hr

24 = hr/day

As can be seen in the equation, a shallow body of water makes a more significant contribution to the resultant dose than does a deep body of water. The deposition rate is calculated by the code; the other parameters are input.

The final pathway--exposure resulting from standing on a contaminated surface--is evaluated by using the following equation:

$$D_{surf} = (1.0 \times 10^{-6}) (8760) R_t \frac{1 - \exp(-\lambda_T t)}{T} (3600) (24) C_{surf}$$

where

D_{surf} = dose from surface exposure (rem/yr)

R_t = surface-deposition rate (pCi/cm²-sec)

λ_T = radioactive-decay constant + environmental-decay constant (day⁻¹)

t = time allotted for surface buildup (days)

C_{surf} = dose-conversion factor for surface exposure to an infinite plane at a point 1 m above the ground (rem-cm²/μCi-hr)

1.0×10^{-6} = μCi/pCi

8760 = hr/yr

3600 = sec/hr

24 = hr/day

The expression

$$R_t \frac{1 - \exp(-\lambda_T t)}{T} (3600) (24)$$

represents the surface concentration after time t in days. The value of t used in analyses for the WIPP was a conservative 15 years. The deposition rate is calculated by the code, and the other parameters are input by the user.

G.4 INPUT DATA

Input data for the WIPP analyses performed with AIRDOS-II were obtained from published documents and interviews with county agents. These sources are listed by category in Table G-2.

Table G-2. Sources of Input Data for the Analyses

Category	Source
Meteorological data	Appendix H, Section H.4
Scavenging coefficients	Moore, 1977 NCRP, 1975
Physical and dimensional data	Chapter 8 and the WIPP conceptual design (as of December 1978)
Radiological data	
Decay constants	Lederer, 1967
Biological decay constants	Ng et al., 1968 NRC, 1977a
Dose-conversion factors	Killough et al., 1976
External exposure	Moore, 1977
Internal exposure	NRC, 1977a
Biological data	NRC, 1977b Wolfe et al., 1977 Killough et al., 1976 Ng et al., 1968 Discussions with Lea County Agent, R. Henard, January 25, 1978, and January 18, 1979 Eddy County Agent, D. Liesner, January 26, 1978, and January 19, 1979
Living patterns	NRC, 1977b Discussions with Lea County Agent, R. Henard, January 25, 1978, and January 18, 1979 Eddy County Agent, D. Liesner, January 26, 1978, and January 19, 1979

REFERENCES

- Booth, R. S., et al., 1971. "A Systems Analysis Methodology for Predicting Dose to Man from a Radioactively Contaminated Terrestrial Environment," in Proceedings of the Third National Symposium on Radioecology, May 10-12, 1971, D. J. Nelson, ed., CONF-710501, pp. 877-893.
- Gifford, F. A., Jr., 1972. "Atmospheric Transport and Dispersion Over Cities," Nuclear Safety, Vol. 13, No. 5, p. 391.
- Killough, G. G., et al., 1976. Methodology for Calculating Radiation Doses from Radioactivity Released to the Environment, ORNL-4992, Oak Ridge National Laboratory, Oak Ridge, Tenn.
- Lederer, C. M., 1967. Table of Isotopes, John Wiley & Sons, Inc., New York.
- Moore, R. E., 1977. The AIRDOS-II Computer Code for Estimating Radiation Dose to Man from Airborne Radionuclides in Areas Surrounding Nuclear Facilities, ORNL-5245, Oak Ridge National Laboratory, Oak Ridge, Tenn.
- NCRP, 1975. Krypton-85 in the Atmosphere--Accumulation, Biological Significance, and Control Technology, Report No. 44, National Council on Radiation Protection and Measurements, Washington, D.C.
- Ng, Y. C., et al., 1968. "Prediction of the Maximum Dosage to Man from the Fallout of Nuclear Devices," Part IV, Handbook for Estimating the Maximum Internal Doses from Radionuclides Released to the Environment, UCRL-50163, Lawrence Livermore Laboratory, Livermore, Calif.
- NRC, 1977a. Age-Specific Radiation Dose Commitment Factors for a One-Year Chronic Intake, prepared by the Pacific Northwest Laboratory for the U.S. Nuclear Regulatory Commission.
- NRC, 1977b. Regulatory Guide 1.109, "Calculation of Annual Doses to Man from Routine Releases of Reactor Effluents for the Purpose of Evaluating Compliance with 10 CFR 50, Appendix I," U.S. Nuclear Regulatory Commission, Washington, D.C.
- Wolfe, H. G., et al. (eds.), 1977. An Environmental Baseline Study of the Los Medanos Waste Isolation Pilot Plant (WIPP) Project Area of New Mexico: A Progress Report (Addendum), SAND77-7018, Sandia Laboratories, Albuquerque, N.M.

Appendix H

DESCRIPTION OF THE LOS MEDANOS SITE

CONTENTS

	<u>Page</u>
H.1 Scenic, Historic, and Cultural Resources.....	H-1
H.1.1 General Appearance.....	H-1
H.1.2 History.....	H-1
H.1.3 Registered Historic Sites.....	H-2
H.1.4 Settlement.....	H-2
H.1.5 Archaeology.....	H-4
H.2 Population.....	H-11
H.2.1 Population Trends and Distribution.....	H-11
H.2.2 Social Characteristics.....	H-15
H.3 Economic Setting.....	H-27
H.3.1 General Economic Characteristics.....	H-27
H.3.2 Labor Force.....	H-32
H.3.3 Housing and Land Use.....	H-35
H.3.4 Community Facilities.....	H-38
H.3.5 Local Government.....	H-62
H.4 Meteorology.....	H-77
H.4.1 Regional Climate.....	H-77
H.4.2 Site Climate.....	H-82
H.4.3 Short-Term (Accident) Diffusion Estimates.....	H-91
H.4.4 Long-Term (Routine) Diffusion Estimates.....	H-92
H.4.5 Air Quality.....	H-94
H.4.6 Paleoclimatology.....	H-96
H.5 Ecology.....	H-99
H.5.1 Introduction.....	H-99
H.5.2 Terrestrial Ecology.....	H-101
H.5.3 Aquatic Ecology.....	H-133
H.5.4 Endangered and Threatened Species.....	H-137
H.5.5 Preexisting Environmental Stresses.....	H-140
H.6 Background Radiation.....	H-142
H.7 Noise Background.....	H-147
H.8 The Future of the Site.....	H-148
H.8.1 Climatic Changes.....	H-148
H.8.2 Demographic Changes.....	H-148
H.8.3 Land-Use Changes.....	H-149
H.8.4 Geologic Changes.....	H-149
References.....	H-151

LIST OF TABLES

	<u>Page</u>
H-1 Sites on the State Register of Cultural Properties Within 30 Miles of the WIPP Site.....	H-3
H-2 Sites Identified by the State Historic Engineering Sites Survey Within 30 Miles of the WIPP Site.....	H-4
H-3 Population in Eddy and Lea Counties: 1960-1979.....	H-11
H-4 Characteristics of the Population in Eddy and Lea Counties.....	H-12
H-5 Percentage Age Distribution of Population.....	H-13
H-6 1979 Resident Population Within 50 Miles of the Site.....	H-16
H-7 Median Earnings by Occupation, Ethnic Group, and Sex, Eddy and Lea Counties, 1969.....	H-17
H-8 Income and Poverty Status of Families by Ethnic Group and Sex of Household Head, Eddy and Lea Counties, 1969.....	H-17
H-9 Employment Distribution by Industry, Sex, and Ethnic Group, Eddy and Lea Counties, 1969.....	H-18
H-10 Unions Represented in Eddy and Lea Counties, 1978.....	H-19
H-11 Social Services in Carlsbad-Loving, New Mexico.....	H-20
H-12 Social Services in Hobbs, New Mexico.....	H-23
H-13 Banking Activity in Eddy and Lea Counties.....	H-30
H-14 Employment Sectors.....	H-33
H-15 Major Employers in Eddy and Lea Counties.....	H-34
H-16 Housing Stock in Carlsbad, 1978.....	H-36
H-17 Housing Stock in Hobbs, 1978.....	H-37
H-18 Housing Stock in Loving, 1979.....	H-38
H-19 Carlsbad School District Enrollment.....	H-39
H-20 Hobbs School District Enrollment in the 1978-1979 School Year.....	H-40
H-21 Loving School District Enrollment in the 1978-1979 School Year.....	H-40

LIST OF TABLES (Continued)

	<u>Page</u>
H-22 Area Medical Facilities.....	H-49
H-23 Solid-Waste-Disposal Systems.....	H-61
H-24 Carlsbad Municipal Revenues for 1978-1979.....	H-63
H-25 Carlsbad Municipal Expenditures for 1978-1979.....	H-64
H-26 Hobbs Municipal Revenues for 1978-1979.....	H-66
H-27 Hobbs Municipal Expenditures for 1978-1979.....	H-67
H-28 Loving Municipal Revenues for 1978-1979.....	H-68
H-29 Loving Municipal Expenditures for 1978-1979.....	H-69
H-30 Eddy County Revenues for 1978-1979.....	H-70
H-31 Eddy County Expenditures for 1978-1979.....	H-71
H-32 Lea County Revenues for 1978-1979.....	H-72
H-33 Lea County Expenditures for 1978-1979.....	H-73
H-34 School District Revenues for 1978-1979.....	H-75
H-35 School District Expenditures for 1978-1979.....	H-76
H-36 Precipitation Rates for Southeastern New Mexico.....	H-79
H-37 Normal Mean Wind Speeds for Roswell, New Mexico, 1941-1970.....	H-80
H-38 Maximum Cumulative Rainfall at Roswell, New Mexico, for Various Time Periods.....	H-80
H-39 Fastest-Mile Wind Speeds at Roswell, New Mexico.....	H-81
H-40 Recurrence Intervals for High Winds in Southeastern New Mexico.....	H-81
H-41 Seasonal Frequencies of Inversions.....	H-82
H-42 Daily Mixing Depths: Seasonal Values.....	H-82
H-43 Distribution of Wind Directions at the Site, June 1977-May 1979.....	H-85
H-44 Temperatures at Roswell and the WIPP Site, 1976-1979.....	H-86

LIST OF TABLES (Continued)

	<u>Page</u>
H-45 Roswell and WIPP Precipitation.....	H-89
H-46 Dew Point and Temperature at Roswell and the WIPP Site, June 1977 Through May 1979.....	H-90
H-47 Monthly Frequency of Stability Categories at the WIPP Site, June 1977 Through May 1979.....	H-91
H-48 Frequency of Stability Conditions at Roswell and at the WIPP Site.....	H-93
H-49 WIPP Site Long-Term Average /Q Calculations.....	H-93
H-50 Ambient Air-Quality Standards.....	H-95
H-51 Pollutants Measured at the WIPP Site During 1976.....	H-95
H-52 A Brief Chronology of the Climate of the Southwestern United States in the Last 10,000 Years.....	H-98
H-53 Ecological Characteristics of Soils at the WIPP Site.....	H-103
H-54 Plants Reported in the Terrestrial Ecology Study Area and at Nearby Sites During 1978 and 1979.....	H-107
H-55 Game Mammals and Furbearers of the Two-County Region.....	H-120
H-56 Mammals Observed in the Terrestrial Ecology Study Area.....	H-122
H-57 Mammalian Species Potentially Inhabiting but Not Observed in the Terrestrial Ecology Study Area.....	H-123
H-58 Game Birds in the Two-County Region.....	H-124
H-59 Birds Observed in the Terrestrial Ecology Study Area and at Nearby Aquatic Sites.....	H-125
H-60 Estimated Densities of Bird Species at, or in the Vicinity of, the WIPP Site.....	H-129
H-61 Amphibians and Reptiles Observed in the Terrestrial Ecology Study Area.....	H-131
H-62 Amphibians and Reptiles Potentially Inhabiting but Not Observed at, or in the Vicinity of, the WIPP Site.....	H-132

LIST OF TABLES (Continued)

	<u>Page</u>
H-63 Range Condition of the Land at the WIPP Site.....	H-134
H-64 Endangered Terrestrial Vertebrates in the Region of the Site.....	H-138
H-65 Endangered Fish in the Region of the Site.....	H-140
H-66 Background Radiation Measured in 1977 at the WIPP Site With a Reuter-Stokes Pressurized Ionization Chamber.....	H-144
H-67 Thermoluminescent-Dosimeter Data Collected in the Area of the WIPP Site in 1977-1979.....	H-145
H-68 Monthly Average Gross Beta Concentrations in Air at the WIPP Site.....	H-146

LIST OF FIGURES

	<u>Page</u>
H-1 Classification of archaeological sites according to various authorities.....	H-6
H-2 Archaeological sites in the area of the WIPP site.....	H-7
H-3 Overview of an archaeological site looking toward the east and oval basin metate	H-8
H-4 Population within a 10-mile radius of the site.....	H-14
H-5 Area covered by a 50-mile radius of the site.....	H-15
H-6 Map of Carlsbad floodway.....	H-31
H-7 Municipal facilities, water system, and sewage-treatment plants, Carlsbad.....	H-42
H-8 Municipal facilities, water system, and sewage-treatment plant, Hobbs.....	H-43
H-9 Municipal facilities, water system, and sewage-treatment plants, Loving.....	H-45
H-10 Average daily traffic flow in the area of the WIPP site, 1978.....	H-51
H-11 Average daily traffic flow on NM 31, 1977.....	H-53
H-12 Road conditions and traffic flow on NM 128, selected sections.....	H-54
H-13 Road conditions and traffic flow on US 62-180, selected sections.....	H-55
H-14 Major recreational facilities in Lea and Eddy Counties.....	H-59
H-15 Annual wind roses for the WIPP site, Roswell, New Mexico, and Midland-Odessa, Texas.....	H-84
H-16 Worldwide temperature variations.....	H-96
H-17 Map of the site showing bioplot locations.....	H-100
H-18 Soil microclimate station.....	H-101
H-19 Vegetation map.....	H-106
H-20 Sand dunes at the WIPP site.....	H-118

LIST OF FIGURES (Continued)

	<u>Page</u>
H-21 Typical view of the WIPP site.....	H-118
H-22 Blowout area.....	H-119
H-23 Typical stabilized dunes.....	H-119
H-24 Map of Aquatic collecting stations.....	H-135
H-25 Locations of thermoluminescent dosimeters in the site area.....	H-143

Appendix H

DESCRIPTION OF THE LOS MEDANOS SITE

H.1 SCENIC, HISTORIC, AND CULTURAL RESOURCES

H.1.1 General Appearance

The Los Medanos site* in Eddy County, New Mexico, is covered with vegetation characteristic of semiarid climates. The land is used for ranching, and cattle are often to be seen. Ranch buildings are miles apart; in between there are a few windmills, several stock-watering tanks, and an occasional drilling rig. There are many roads in the area, the better ones surfaced with caliche, the poorer ones often little more than tracks in the sand. The most noticeable man-made features are the potash mines and processing plants, the latter with large buildings and stacks. Their emissions often create a haze heavy enough locally to block the view of the mountains 40 to 60 miles to the west.

The overall scenic quality of the study area was evaluated in April 1975 by the Bureau of Land Management (BLM) for an environmental analysis related to potash leasing (BLM, 1975). The Bureau has a standard quality-evaluation scoring system that takes into account landform, color, water, vegetation, uniqueness, and intrusions. On a scale of 1 to 24, with 24 high, the scores from 16 observation points about the study area averaged 8.3 ± 2.9 . (The same BLM scoring system applied to the center of the WIPP site resulted in a score of 8.) Only one of the 16 observation points received a rating as high as 15; it was a view from New Mexico highway 31 of a salt lake in the lower end of Nash Draw. This observation point is 13 miles west-southwest of the site.

H.1.2 History

The State of New Mexico has an extensive history of Spanish exploration and settlement, dating from the reconnaissance of Marcos de Niza in 1539, which was sparked by reports brought to Mexico by Cabeza de Vaca, telling of enormous wealth in the land to the north. De Vaca himself probably passed through New Mexico near present-day Carlsbad in 1534 or 1535. However, most Spanish exploration and settlement took place in the Rio Grande valley to the west. The next entry of Spaniards into southeastern New Mexico was in 1583, when an expedition led by Antonio de Espejo traveled down the Pecos River on the way back from the north. In 1590, an expedition led by Gaspar Castano de Sosa traveled north up the Pecos to the village of Pecos and then turned west to the Rio Grande.

For almost three centuries after de Sosa passed through the area, there were only two significant recorded entries by white men. The first was in 1775, when Commandant-General Hugh O'Connor conducted military campaigns

*In this appendix the terms "Los Medanos site" and "WIPP site" are synonymous.

against the Apaches in the Pecos Valley. The second occurred in 1854, when Brevet Captain John Pope conducted a survey of a possible route for a railroad to the Pacific through southern New Mexico.

H.1.3 Registered Historic Sites

The WIPP site contains no sites listed by the National or the State Register of Historic Sites. There are, however, historic sites in the vicinity of the site. Nine miles south-southwest is the Project Gnome site, which is presently undergoing the nomination procedure. It was the site of the first underground nuclear detonation (December 1961) of the Plowshare program, the AEC's program of search for nonmilitary uses of nuclear explosions. North of the site two areas believed to be of National Register quality are also undergoing the nomination procedure: Laguna Plata, 15 miles north, and Maroon Cliffs, 11.5 miles northwest of the center of the site. Another site being nominated is Pope's Wells, near the State line 20 to 26 miles to the south.

Nearby sites now on the State Register include Rattlesnake Draw, Monument Springs, the Lusk Ranch, and Boot Hill (listed as the Red Tank Archaeological Site), all on private land. Rattlesnake Draw is said to contain the best stratigraphic sequences found to date in southeastern New Mexico. Monument Springs consists of pit-house ruins and a large midden. The Lusk Ranch is the site of a mammoth-bison kill dating from 9000 B.C. Boot Hill dates from A.D. 900-1300 and contains a series of Jornada Mogollon pit houses.

Table H-1 lists the sites on the State Register of Cultural Properties that are within 30 miles of the WIPP site; these sites are recorded in the office of the State Historic Preservation Officer. Table H-2 lists similar sites identified in a survey of historic engineering sites. Most of the latter have not been evaluated for registration purposes.

H.1.4 Settlement

Aboriginally, the study area was inhabited by wandering bands of American Indians, predominantly Lipan Apaches. Occasional parties of Mescalero Apaches, Comanches, and Kiowas probably crossed the area on hunting or raiding forays. With the coming of the cattlemen, there were occasional encounters between white men and Indians, but these were infrequent, and by the 1880s Indians were no longer a significant presence in the Pecos area. Today the nearest group of Indians is the Mescalero Apaches 100 miles to the northwest.

Ownership of New Mexico changed from Spain to the Republic of Mexico in 1821 and from Mexico to the United States in 1848. Southeastern New Mexico played no part in these changes other than being a small portion of large tracts of land changing hands.

It was the coming of the cattlemen, led by Charles Goodnight and Oliver Loving in 1866, that started the modern development of southeastern New Mexico. When the Army and the Indian Bureau called for bids to furnish beef

Table H-1. Sites on the State Register of Cultural Properties Within 30 Miles of the WIPP Site

Listing	Name	Distance (miles)	Direction
007	Carlsbad Reclamation Project, Carlsbad ^{a, b}	25	W
280	Eddy & Bissell Livestock Company headquarters, Carlsbad	25	W
208	Eddy National Bank, Carlsbad ^a	25	W
472	Hagerman House, Carlsbad	25	W
557	Lake Avalon, 4 miles north of Carlsbad	28	WNW
159	Lusk Ranch site, 20 miles east and 12 miles north of Carlsbad	15	N
474	Phenix Adobe, Carlsbad	25	W
240	Pope's Wells Site, 8 miles east of the confluence of the Delaware and Pecos Rivers	24	S
567	Original potash bullwheel, 10 miles southeast of Carlsbad	19	WSW
168	Red Tank Archaeological Site (Boot Hill), 5 miles north and 7 miles west of Maljamar	39 ^c	N
167	Rattlesnake Draw Site, 12 miles west and 3 miles south of Buckeye	28	N
162	Monument Springs Site, 4 miles west of Monument	32 ^c	NE

^aListed on the National Register of Historic Places.

^bNational Historic Landmark.

^cIncluded in table because mentioned in text.

for the Navajos and Mescalero Apaches who had been forced onto a reservation at Fort Sumner, New Mexico, local ranchers and farmers could not meet the demand. Goodnight and Loving drove a mixed herd of Texas cattle across the southern part of the Llano Estacado and up the Pecos River to Fort Sumner. In the next year John Simpson Chisum followed the Goodnight-Loving trail with another herd. When the contractors would not accept cows with calves, Chisum placed these unacceptable cattle on the range south of Fort Sumner. Eventually, with the addition of unacceptable cattle from subsequent drives, Chisum had cattle grazing along the Pecos River all the way to the Texas border. Trading posts catering to the needs of the cowboys were established, and settlement of southeastern New Mexico was begun. One such trading post was located near the present-day town of Malaga, south of Carlsbad.

In 1888, another cattleman, Charles Bishop Eddy, founded the Pecos Valley Land and Ditch Company to build irrigation ditches and canals. Carlsbad was founded in 1889 as the town of Eddy.

The twentieth century in southeastern New Mexico has seen the development of other industries. The Hammond well, and later the Brown well, produced oil near Artesia in 1909; oil and gas development started in earnest in Lea County and adjacent Texas in 1934. Oil drilling led to the discovery of potash in 1925, and the commercial exploitation of these resources began in 1931. Mining is now the principal industry of Eddy County.

Table H-2. Sites Identified by the State Historic Engineering Sites Survey Within 30 Miles of the WIPP Site

Listing	Name	Date	Distance from WIPP site (miles)	Direction
35010	Lake Avalon (CRP) ^{a-c}	1891	28	WNW
35039	Carlsbad Water Works	1920	25	W
35151	Carlsbad Irrigation District Flume ^{a,d}	1903	25	W
35155	Carlsbad Municipal Building	1955	25	W
35287	United Salt Supply	1937		
35365	Pecos River Railroad Bridge	ca. 1900	36	NW
35421	Salt Draw Bridge	1932	19	SW
35447	Six Mile Dam	1920	19	W
35462	Tansill Dam	1888	25	W
35515	Judkins Mill	1900		
35539	Harroun Dam	1930	16	WSW
35441	Pecos River Railroad Bridge, Carlsbad	1940	25	W
35617	Southern Main Canal ^c	1906	25	W
35618	East Canal ^c	1906	25	W
35677	Black River Canal ^c	ca. 1890	17	SW

^aListed on the State Register.

^bNational Historic Landmark.

^cPart of the Carlsbad Reclamation Project.

^dListed on the National Register of Historic Places.

H.1.5 Archaeology

Little archaeological research has been done in southeastern New Mexico. Interest has instead tended to focus on areas to the north and west, partly because of the more spectacular ruins there--such as Chaco Canyon and Mesa Verde--and partly because of the possibility of relating these ruins to the present Pueblo Indians. These northern areas were felt to be the major cultural centers, whereas southeastern New Mexico has been regarded as a less fruitful area for investigation than areas to the north and west. More recently, however, the marginal nature of the southeastern environment has been recognized as offering opportunities for studies on the relationship between environment and culture.

Studies by Mera (1943), Lehmer (1948), and Jelinek (1967) are the three basic sources of information on the archaeology of southeastern New Mexico. Lehmer synthesized the knowledge of the archaeology of the area and incorporated Mera's data to define what he called the Jornada branch of Mogollon culture. This did not include the more easterly portions of southern New Mexico or the area of the WIPP site. Jelinek conducted a survey of the Pecos Valley north of Roswell. The earliest phase he identified, his "Early 18 Mile" (A.D. 800 to 900), was generally similar to late Archaic. The area appears to have been abandoned for some time after the mid-14th century. The

studies of Lehmer and Jelinek and later field observations in Lea and Eddy Counties have led to the extension of the boundaries of Lehmer's Jornada Mogollon to include the rest of southeastern New Mexico.

Sites in southeastern New Mexico are generally classified as Paleo-Indian (before 500 B.C.), Archaic (500 B.C. to A.D. 950), Jornada Mogollon (A.D. 950 to 1400), or Historic (since A.D. 1400). The Jornada Mogollon, being particularly rich in sites and in pottery types, has been subdivided by several authors (Figure H-1). Lehmer's classification, as the names he used imply, was based on work considerably to the west of the site area; Jelinek's, on work on the middle Pecos River valley to the north of the site. Corley's classification (1965) is based on work nearer the site. Corley, in fact, saw the Jornada Mogollon as having three regional variants: Lehmer's north and south, and his own eastern variant.

Various groups of expert amateurs, especially the Lea County Archaeological Society, have been active in the excavation, survey, and publication of the archaeological values of southeastern New Mexico. Contract archaeological firms have also been active in the Carlsbad Potash District immediately west and north of the WIPP study area.

A Bureau of Land Management study (BLM, 1975, p. II-254) has estimated the density of archaeological sites in the potash areas, using data gathered by the Eastern New Mexico University (ENMU) on a survey to the north and projections made by Schaafsma (1975) from similar areas elsewhere in New Mexico. It concluded that the "site densities within the potash basin may be expected to range between 12 and 15 sites per square mile. The majority of sites will be located in dunes, on cliffs, in close proximity to playas, or a combination of these. The majority of sites will be of the Archaic and Jornada Mogollon time periods, with pithouses and surface structures not uncommon." Earlier, the Bureau, drawing on Schaafsma (1975), indicated that, at a density of 12 sites per square mile, one site would be Paleo-Indian, ten would be Archaic, and one would be Jornada Mogollon. The Bureau's own partial survey indicated more Jornada Mogollon than Archaic sites, with the reason for the discrepancy unknown, though possibly "a result of reporting biases."

Prehistoric dwellings are rare in southeastern New Mexico. Until recently, the known dwellings nearest to the WIPP site were those at Maroon Cliffs, 11.5 miles northwest. The presence of pit houses has not been confirmed there, but year-round occupation is suggested by a deep midden recently excavated by the ENMU. The Lea County Archaeological Society reported pit houses at Laguna Plata, 15 miles north, though J. L. Haskell (ENMU, personal communication, 1977) questions its conclusions. The nearest confirmed pit houses are at the Marchant site (southwest of Hobbs and about 18 miles east of the site), excavated by the Lea County Archaeological Society in the 1960s (Leslie, 1965).

In the summer of 1976, the ENMU surveyed the central 4 square miles of the WIPP site, including all of control zones I and II (sites ENM 10201 through ENM 10246 in Figure H-2). They found 64 isolated artifact sites and 33 archaeological sites (three outside the 4 square miles). The latter were taken to be localities that had been used and occupied by prehistoric man. One such site, with a metate, is shown in Figure H-3.

The number of archaeological sites corresponds to an average density of 7.5 per square mile, significantly fewer than the Bureau of Land Management

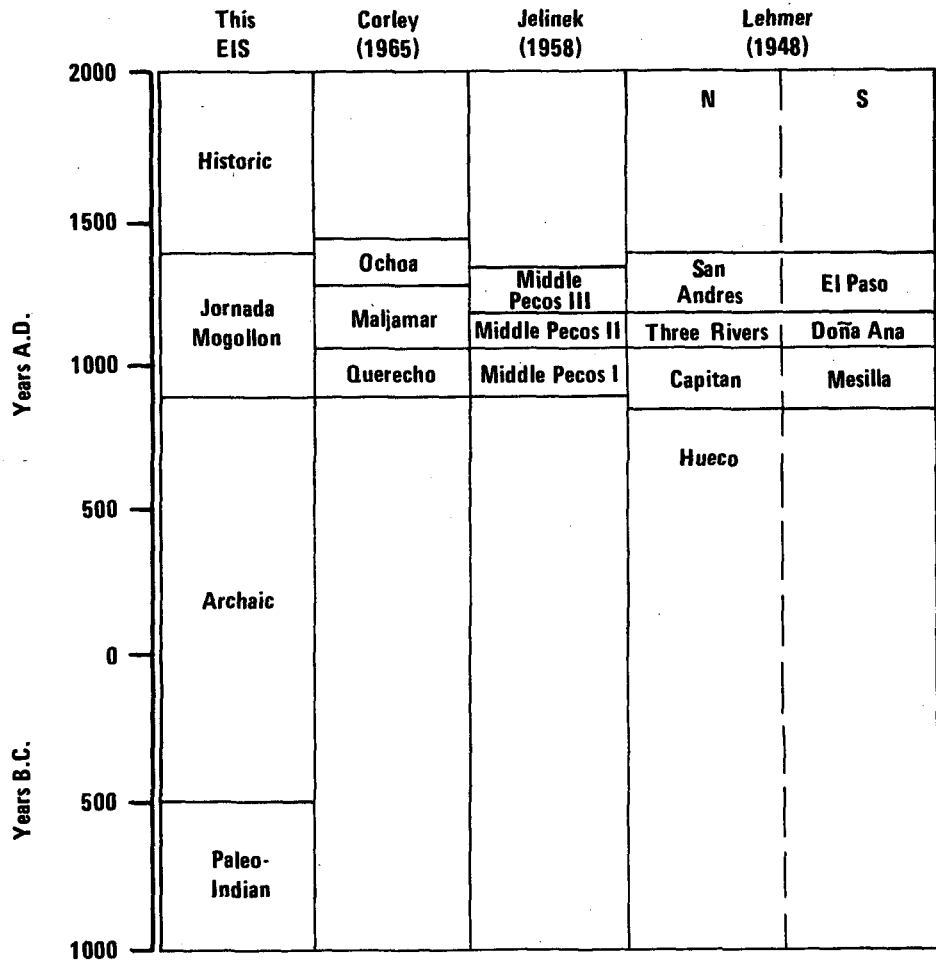

Figure H-1. Classification of archaeological sites according to various authorities.

had inferred from earlier surveys. The ENMU classified the 33 sites according to a scale defined by the School of American Research: Task Locus, Special Activity Zone, Limited Base, Home Base, Central Base, and Occupation Zone. By this scale, twenty-seven of the sites (including the one shown in Figure H-3) are Task Locuses and the remaining six are Special Activity Zones. No pit houses, permanent structures, or other indications of heavy use were found at that time. (As indicated below, some have been found since.)

The main conclusions of the ENMU at that time were as follows (Nielsen, 1976, p. 23):

Cultural resources are remarkably uniform across the area. Groundstone consists of wedge-shaped manos, and oval-shaped metates. Although few in number, potsherds belong to the El Paso Brown, Jornada Brown, and Chupadero Black-on-White types, which date between A.D. 900-1300. These resources are tied to the

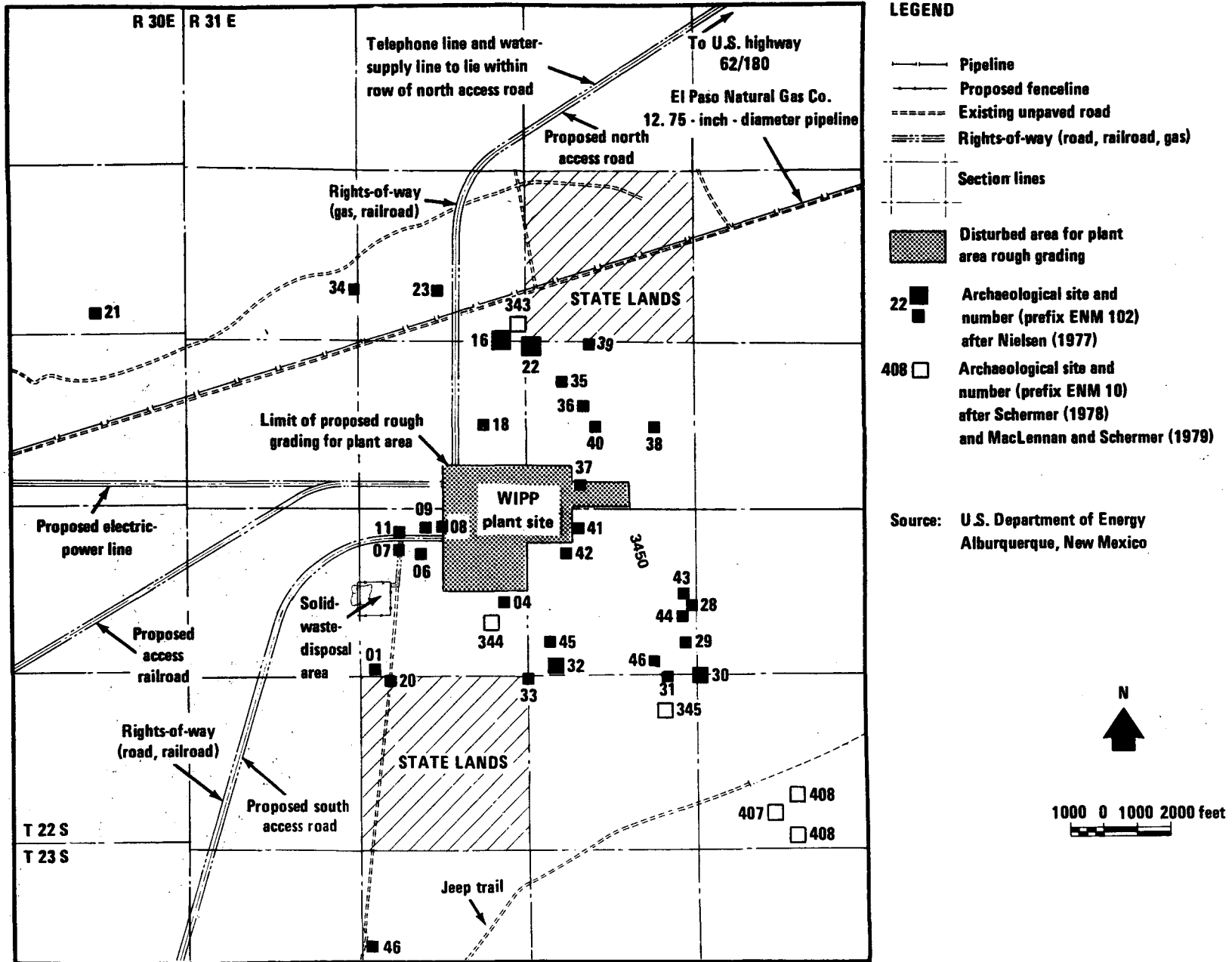

Figure H-2. Archaeological sites in the area of the WIPP site.

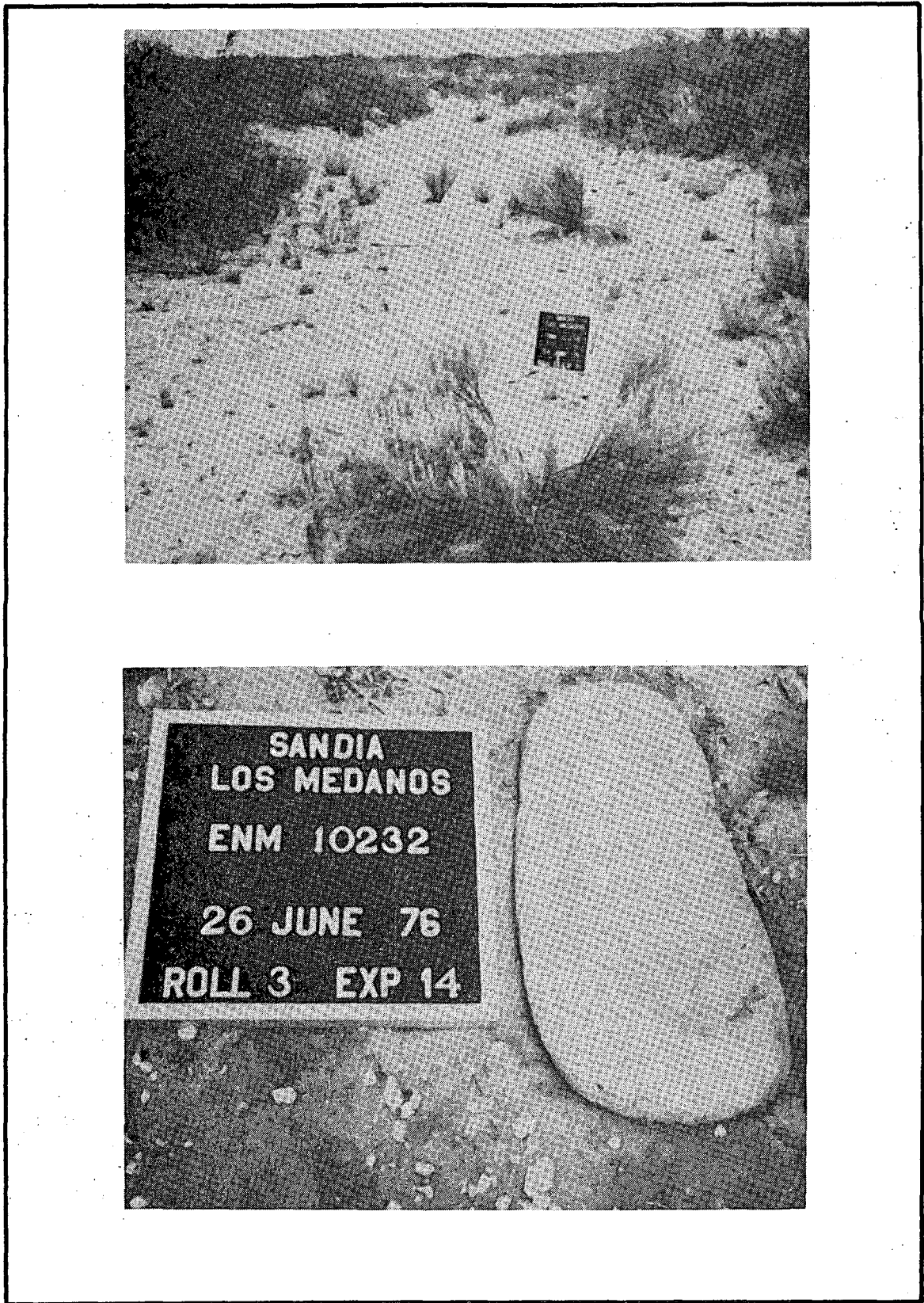

Figure H-3. Overview of an archaeological site looking toward the east (top) and oval basin metate (bottom).

Jornada Branch of the Mogollon. Of the seven projectile points found, one was from the Archaic period (4000 B.C. to A.D. 500). The others were probably of Jornada Mogollon authorship. . . . Hearths were often noted, with their presence being indicated either by a dark stain in the soil, or by a scatter of burned caliche or sandstone.

It is believed that the area was occupied seasonally by hunting/gathering bands. The prime resources are acorns, mesquite beans, rabbit, and deer. Owing to the relatively large number of groundstone fragments, it seems likely that these acorns and mesquite beans were probably primary resources of these people.

As a result of these surveys, and at the instance of Thomas S. Merlan, State Historic Preservation Officer, the WIPP site has been declared eligible for nomination as an archaeological district (Appendix I) because the 33 sites located in the first archaeological survey, when taken together, are considered likely to yield significant information on prehistoric occupation. Subsequent surveys have turned up two prehistoric structures, thus adding to interest in the area. These structures are described below.

Continued site investigation has so far (June 1980) required building about 30 miles of new road, drilling 56 holes or hole complexes, installing a meteorological tower, running 156 miles of off-road seismic lines, and making about 9000 off-road resistivity measurements. Much of this work was outside the original 4 square miles surveyed in 1976 and required archaeological clearance. In addition, surveys were made of the rights-of-way for the two access roads and for the railroad. In the process, 15 new sites were discovered, eight of them Special Activity Areas. Also found were two structures and one possible structure.

On the other hand, in the areas where the new surveys overlapped the original one, eight of the previous sites could no longer be found. In mid-1978, a survey was made for a seismic line along the northern edge of the original 4 square miles. Schermer (1978, pp. 17-18) reports that "three previously described sites lie along this corridor. . . . Of these sites, ENM 10222 and ENM 10239 were not encountered during this survey although the areas in which they are supposedly located were surveyed. These areas have been previously impacted, and the sites may have been destroyed." On the right-of-way for the south access road, six sites (ENM 10206, ENM 10207, ENM 10208, ENM 10209, ENM 10211, and ENM 10212) could no longer be found. Of them, MacLennan and Schermer (1979, pp. 6-7) say that "during both the August, 1978, seismic survey (Schermer, 1978) and this reconnaissance, these sites could not be relocated. Due to the extremely low artifact density within these sites and to the extensive activity in this area, ACA the Agency for Conservation Archaeology of ENMU feels that these sites either do not exist or are not identifiable."

The first of the three structures was found on an extension of a site identified earlier outside the original 4 square miles (Schermer, 1978, pp. 13-14). His description of the site is as follows:

ENM 10230 is a massive site which follows the southwest face of a ridge for more than 1/4 mile. The site is shaped roughly

like a boot The ridge top and area immediately surrounding the site are occupied by moderately large dunes (up to 3 m high). The majority of the site area is covered by a dense lithic and ceramic scatter with evidence of numerous hearths. Lithic materials include primary and secondary decortication flakes, bifaces, utilized flakes, and numerous ground stone fragments. Ceramics include Jornado Brown, Carlsbad Brown, Chupadero Black-on-White, and an unidentified red-on-brown ware.

The most important addition to the description of this site is the location of at least one room block. The room block is an L-shaped sandstone foundation which measures 8.5 x 7.6 meters. The structure consists of at least four rooms The foundation is located five to eight ft below the crest of the ridge and on the southwest face. In addition to this structure, two more possible structures were located further north. These areas contain rectangular concentrations of small fragments of caliche, approximately 3 to 5 m square. Concentrations of caliche as described above also occur at ENM 10229 and ENM 10407.

The second of these structures (ENM 10408) is in a newly discovered site well outside the original 4 square miles. Of it, Schermer (1978, p. 16) says only that "the site consists of a rectilinear concentration of caliche which appears to be the remains of a three to four room jacal structure. The structure appears to have measured 3 x 5 meters. Several metate fragments occur in the surrounding area."

Finally, another possible structure was reported in the southeast corner of Section 17, just outside the original 4 square miles (Schermer 1978, p. 18). However, it has since been established that this site is a modern campsite established by field workers for the WIPP biology program.

Areas not yet surveyed archaeologically include most of control zones III and IV as well as the rights-of-way for the electric-power line from the northwest and for the water line to the north of U.S. Highway 62/180.

In summary, the area of the WIPP site seems to have been lightly but pervasively used by pre-Western man. It is not unique but is much like its surroundings. Indeed, the number of sites so far found is considerably smaller than would be inferred from the Bureau of Land Management estimates. It is principally of interest archaeologically for the light it might shed on how man can live in a marginal environment.

H.2 POPULATION

H.2.1 Population Trends and Distribution

In 1912, when New Mexico became a state, Eddy County contained approximately 9600 people. Between 1920 and 1930 the population grew to 15,842. After the start of potash mining in 1931, the population increased again (24,311 persons in 1940) and continued to grow from 1940 to 1960, principally because of the mining operations. By 1960 the population had reached 50,783 (BBER, 1962). After 1960 the potash industry in the area became severely depressed, and the population dropped to 41,119 by 1970. Since 1970 the economy of the area has improved, and the population has again increased. The 1979 population estimate compiled for this report shows that Eddy County had 48,200 inhabitants, an increase of approximately 7100 people over the 1970 Census figure. Since 1931 the population has fluctuated basically with activity in the potash-mining industry. The county contains four municipalities: Artesia, Carlsbad, Loving, and Hope. Carlsbad, the largest, had an estimated 28,600 inhabitants in mid-1979, up from the 25,541 in 1960 and 21,297 in 1970 (Table H-3).

Lea County was organized in 1917 from parts of Chaves and Eddy Counties and had 3545 residents in 1920. Oil exploration, begun in southeastern New Mexico in 1924, brought substantial growth: by 1930 the population had increased to 6144 and by 1940 had more than tripled to 21,154. Continued growth raised the population to 53,429 in 1960 (BBER, 1962). Between 1960 and 1970 Lea County sustained a population decrease of approximately 7.3%, owing mainly to decreased oil and gas exploration or production (USDC, 1970a). After 1970 the population increased from 49,554 to 57,500 in mid-1979 (Adcock, 1979). Most of the growth was related to increased activity in the oil and gas industry after 1973. Lea County has five municipalities: Hobbs, Lovington, Eunice,

Table H-3. Population in Eddy and Lea Counties: 1960-1979

Location	Distance from site ^a (miles)		Population		
	Air	Road	1960 ^b	1970 ^b	1979 ^c
Eddy County	NA	NA	50,783	41,119	47,300
Artesia	47	64	12,000	10,315	10,950
Carlsbad	26	33	25,541	21,297	28,600
Loving	18	23	1,646	1,192	1,600
Hope	61	80	108	90	190
Lea County	NA	NA	53,429	49,554	57,500
Eunice	35	49	3,531	2,641	2,550
Hobbs	41	51	26,275	26,025	32,600
Jal	37	47	4,133	3,241	2,700
Lovington	45	55	9,660	8,915	9,500
Tatum	64	77	1,168	982	900

^aDistance rounded to the nearest mile; NA = not applicable.

^bData from USDC (1970b).

^cData from Adcock (1979).

Jal, and Tatum (Table H-3). Hobbs, the largest incorporated place in the county, had an estimated 1979 population of 32,600.

Both counties are fairly homogeneous racially and ethnically (Table H-4), with a relatively small Spanish-origin ethnic group (statewide average 30.3%). The American Indian population is also relatively low: 0.3%, or 258 individuals in 1970 (statewide average 7.2%) (USDC, 1970c).

The age distribution of the population in the two-county area differs slightly between the counties, as well as between New Mexico as a whole and the United States. In both Eddy and Lea Counties the median age (27.2 and 25.9, respectively) is below that of the United States as a whole but significantly above New Mexico's median age of only 23.9 years in 1970. The population of Carlsbad has a relatively low percentage in the less-than-20 age group and a relatively high percentage in the over-50 age group (39.4% and 26.7%, respectively). The number of residents who are 65 or older is significantly higher in Carlsbad than the statewide average and the average for either Eddy or Lea County. An active program to attract retirees is supported by the Carlsbad area. The median age in Hobbs (25.5 years) is lower than that in Carlsbad (29.4 years) (Table H-5).

Table H-4. Characteristics of the Population in Eddy and Lea Counties^a

Characteristic	Percentage of population ^b	
	Eddy County	Lea County
Race		
White	97.1	93.7
Black	2.2	5.3
Other	0.7	1.1
Spanish origin or descent	25.4	10.9
Residence		
Urban	76.9	81.1
Rural, nonfarm	18.1	15.1
Rural, farm	5.0	3.8

^aData from USDC (1970c).

^bPercentages may not add to 100.00% because of rounding errors.

Net-population-migration figures indicate significant changes during the last few years. In the 1960-70 period the two-county area was somewhat depressed because of reduced hydrocarbon exploration and potash mining. As a result, Eddy County experienced a net loss of more than 11,000 individuals during a 5-year period and Lea County a loss of approximately 5200 (USDC, 1977). Since the 1970 Census, however, there has been a significant change in the net migration trend, with both counties showing a reversal: Eddy County received a net migration gain of 3700 during 1970-79 and Lea County a net gain of 2100 (Adcock, 1979).

Table H-5. Percentage Age Distribution of Population (1970 Census)^a

Age	Percentage age distribution					
	United States	New Mexico	Eddy County	Lea County	Carlsbad	Hobbs
Under 5	8.5	9.5	8.2	9.0	8.2	9.4
5-14	20.1	23.8	22.3	22.8	20.8	22.8
15-19	9.4	10.4	10.9	10.7	10.4	10.5
20-29	14.5	14.6	11.3	12.5	11.2	13.0
30-39	11.1	11.6	10.5	12.7	9.9	12.9
40-49	11.8	11.0	12.0	13.4	12.6	12.9
50-59	10.4	8.9	11.3	9.9	12.1	9.6
60-64	4.3	3.4	4.5	3.6	4.9	3.6
65+	9.9	6.9	8.8	5.4	9.7	5.3
Median age	28.1	23.9	27.2	25.9	29.4	25.5

^aData from USDC (1970a).

Although net migration during the last 9 years has been positive, major growth in the two counties has been caused by natural increase (births minus deaths): about 3400 persons in Eddy County and 5800 persons in Lea County, or about 1.5 times the growth caused by in-migration (Adcock, 1979).

Population densities in the two counties are relatively low but slightly higher than the 1979 statewide average of about 10.1 persons per square mile. The population density in Eddy County was 9.9 in 1970 and is now approximately 11.6 persons per square mile. The population density in Lea County was 11.3 in 1970 and is now estimated at 13.1 persons per square mile. It should be noted that the density figures are somewhat misleading because most of the population in Eddy County live in Carlsbad and Artesia. In Lea County slightly fewer than 85% of the total population live in four urban places. Thus, except for the six urban places, the two-county area is very sparsely populated (USDC, 1970b; Adcock, 1979).

Within 10 miles of the site, there are currently 16 permanent residents and three commercial mining operations (Figure H-4) with a total daytime employment of about 650 persons and considerably smaller swing shifts and night shifts (Adcock, 1979).

Within 50 miles of the site (Figure H-5) there were more than 102,000 inhabitants in 1979 (Table H-6). The major population centers are listed in Table H-3.

Population projections to the year 2010 are presented in Appendix M. From 1980 to 2010 Eddy County is projected to grow at a compound annual rate of 1.7% and Carlsbad at an annual rate of just more than 1.8%. Lea County growth for the 30-year period is approximately 1.3% per year, and the projected annual growth rate for Hobbs is about 1.4% (Adcock, 1979).

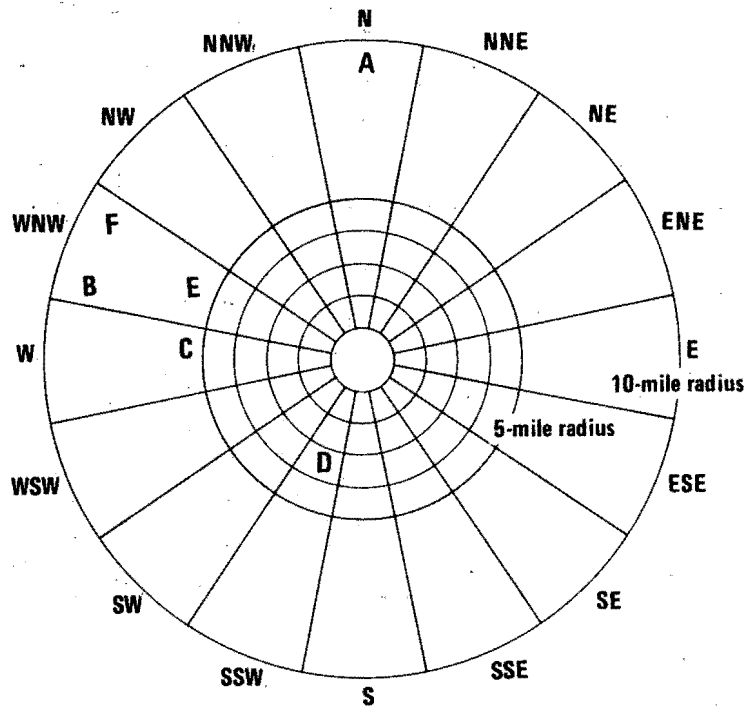

- A Kerr-McGee plant and mine: 151 employees (maximum), day shift
- B International Minerals and Chemical Corporation: 450 employees (maximum), day shift
- C Duval Corporation (Nash Draw Mine): 46 employees (maximum), day shift
- D James Ranch: six permanent residents (six seasonal part-time employees)
- E Smith (Crawford) Ranch: seven permanent residents (18 seasonal part-time)
- F Pue's Store: three permanent residents

Figure H-4. Population within a 10-mile radius of the site.

Demographic changes

Few demographic changes are expected within 10 miles of the site in the foreseeable future. Interviews with ranch owners and managers indicate that one ranch house is expected to be built in the next 5 years, at the Mobley ranch just south of NM 128, approximately 8 miles west-southwest of the center of the site (Figure H-4).

One other demographic change may occur north-northeast of the site, just outside the 10-mile radius. A small trailer park (approximately 20 units) is being built in and around the commercial establishment now known as the Half-way Bar. Future plans for further trailer-park development are reported to be partially contingent on the construction of the WIPP (Adcock, 1979).

The population of workers at various mining operations in the 10-mile radius may vary from one period to another. During 1960-1970, the employment level dropped significantly because of a decreased demand for potash produced in the Carlsbad area. Potash production now appears to have stabilized, at least for the near future. This work force is not expected to change significantly in the next few years.

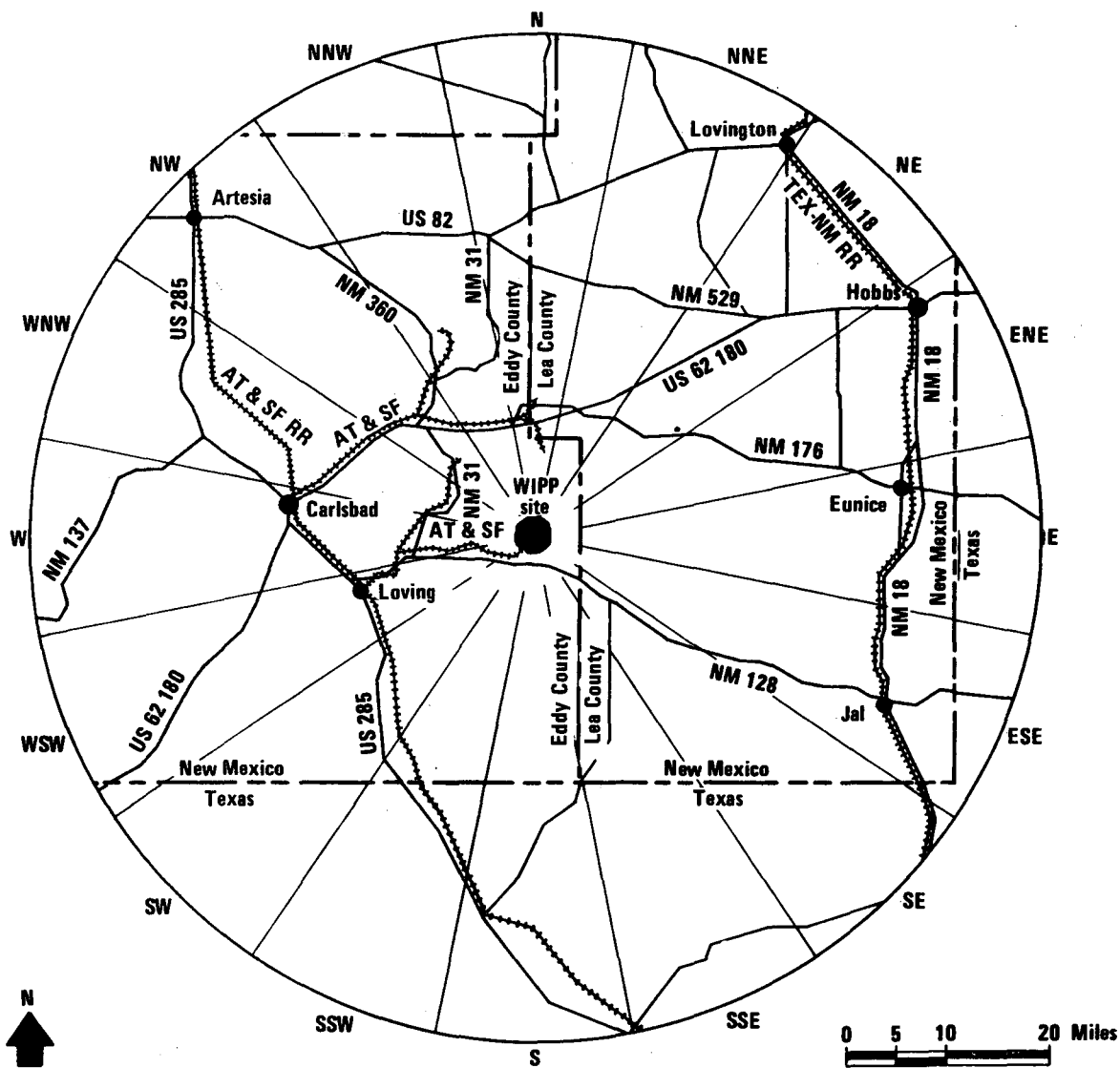

Figure H-5. Area covered by a 50-mile radius of the site.

Maintenance workers for oil and gas wells are transients in the area. The number of active oil and gas wells in Eddy County has been increasing during the past few years, and there are many active wells within 10 miles of the site. Although the average number of workers in the area is not known, it is not expected to increase significantly during the next few years.

H.2.2 Social Characteristics

Employment structure and unions

In 1970 nearly 90% of the employed in Eddy County were wage and salary workers (74% in the private sector, 16% in the government sector), approxi-

Table H-6. 1979 Resident Population Within 50 Miles of the Site^{a,b}

Sector	Distance from site (miles)						Total
	0-5	5-10	10-20	20-30	30-40	40-50	
North	0	0	35	25	175	25	260
North-northeast	0	0	25	5	55	5,610	5,695
Northeast	0	0	0	25	75	8,660	8,760
East-northeast	0	0	15	70	205	33,200	33,490
East	0	0	5	15	3,240	155	3,415
East-southeast	0	0	5	10	3,035	295	3,345
Southeast	0	0	5	15	25	30	75
South-southeast	0	0	0	25	10	40	75
South	0	0	5	15	55	15	95
South-southwest	6	0	5	30	90	15	145
Southwest	0	0	55	30	10	45	140
West-southwest	0	0	1750	200	50	65	2,065
West	0	0	70	31,780	40	35	31,925
West-northwest	0	10	5	190	55	50	310
Northwest	0	0	30	20	65	12,055	12,170
North-northwest	0	0	15	5	220	10	280
Radius total	6	10	2025	32,460	7,440	60,305	102,245
Cumulative total	6	16	2040	34,500	41,940	102,245	--

^aPopulation estimated by Adcock and Associates (1977-1979).

^bFigures for all areas beyond the 10-mile radius have been rounded to the nearest 5.

mately 9% were self-employed, and 1% were unpaid family workers. In Lea County a slightly larger proportion of wage and salary workers were in the private sector and a correspondingly smaller proportion (12%) were in the government sector (USDC, 1970b, 1975-1979).

A large proportion of employed workers are blue collar (craftsmen and foremen, operatives, nonfarm laborers, and farm laborers), with 45% of Eddy County workers and 49% of Lea County workers belonging in this category in 1970 (USDC, 1970b). Data on earnings, poverty, and employment are given in Tables H-7, H-8, and H-9.

Five unions are represented in Eddy and Lea Counties (Table H-10); the largest is the United Steelworkers Union. Four unions have local headquarters in Eddy County.

Sociocultural conditions

During September and October 1979, unstructured discussions were held with approximately 200 persons in the Carlsbad area. A number of general topics were covered in an attempt to determine the sociocultural attitudes of residents in the general area of the WIPP. The persons interviewed were asked to describe their feelings about their local communities and various issues related to the quality of life in the area. The topics of discussion included attachment to the community, political processes, and land use.

Table H-7. Median Earnings by Occupation, Ethnic Group, and Sex, Eddy and Lea Counties, 1969^a

Occupation	Median earnings					
	Eddy County			Lea County		
	All groups	Spanish	Black	All groups	Spanish	Black
Males 16 and older						
with earnings	\$7068	\$4286	\$4820	\$7695	\$4883	\$4225
Professional, managers	9158	4808	--	9909	8000	--
Crafts, foremen	8050	6667	4375	8127	6085	5211
Operatives	7244	5019	7078	7629	4477	4853
Nonfarm labor	4297	3306	5469	3793	3800	3500
Farmers and managers	6729	5533	--	4944	--	--
Farm laborers and foremen	2960	2871	--	3608	3350	--
Females 16 and older with earnings	\$2810	\$1596	\$ 994	\$2707	\$1435	\$1066
Clerical	3551	2575	--	3551	1875	--
Operatives	1241	830	--	2079	848	875

^aData from USDC (1970c).

Table H-8. Income and Poverty Status of Families by Ethnic Group and Sex of Household Head, Eddy and Lea Counties, 1969^a

Families with income below poverty level	Percentage of all families	
	Eddy County	Lea County
All families	17.8	12.5
Spanish	41.5	31.5
Black	24.4	50.7
Families with female head	50.0	47.0

^aData from USDC (1970c).

A clear majority of the interviewees rated the Carlsbad area as an above-average area in which to live. Their reasons included climate, the friendliness of residents, access to recreational facilities, and the rural nature of the area. Those rating it average or below average cited excessive heat, high living costs, a lack of adequate commerce, and a dearth of cultural amenities as reasons.

A significant majority of those interviewed expressed a sense of belonging to the community, but a small percentage felt that they were excluded from the political process. Some people voiced concern about racial or ethnic relationships, though most interviewees suggested that the problem was less serious now

Table H-9. Employment Distribution by Industry, Sex, and Ethnic Group, Eddy and Lea Counties, 1969^a

Industry	Distribution (%) in Eddy County					Distribution (%) in Lea County				
	Total	Male	Female	Spanish	Black	Total	Male	Female	Spanish	Black
Total number employed, 16 and older	14,145	9374	4771	3046	364	18,255	12,745	5510	1571	729
Agriculture	7	9	1	17	4	5	6	1	10	3
Mining	21	38	3	11	12	27	45	6	19	7
Construction	6			6	2	6			14	12
Manufacturing	5	6	3	6	7	5	6	3	4	1
Transportation, communications, and public utilities	7	8	4	6	6	7	8	5	4	5
Wholesale trade	3	4	1	2	--	3	4	1	2	2
Food, bakery dairy stores	2	2	4	3	--	3	2	4	3	2
Eating and drinking establishments	3	1	6	3	2	4	1	11	7	5
Other retail	11	10	13	12	9	12	10	16	14	6
Finance, insurance and real estate	3	3	5	1	4	3	2	5	2	2
Business and repairs	2	3	2	2	--	4	4	3	3	3
Personal and other services	7	3	16	10	32	5	2	14	8	32
Entertainment and recreation	1	1	1	1	3	1	1	1	1	6
Health services and hospitals	6	2	13	4	2	3	1	8	2	3
Education	9	5	18	10	5	7	3	14	3	6
Other professions	4	3	6	3	5	3	2	5	2	4
Public administration	4	4	4	3	7	3	3	3	1	1

^aData from the 1970 Census of Population.

Table H-10. Unions Represented in Eddy and Lea Counties, 1978^{a,b}

Name of union	Number of members	Area and activities covered
Carpenters' Local 1245	266	Carlsbad, Hobbs, Roswell Portales, Clovis, Tucumcari; construction contractors
International Brotherhood of Electrical Workers Local 693	259	Eddy and Lea Counties; electrical workers at potash mines (Duval, Potash Company of America, and Mississippi Chemical); four out of five local construction contractors
Iron Workers Local 775	40	Eddy and Lea Counties; local construction contractors, potash mines
Retail Clerks Local 462 ^c	325	Eddy and Lea Counties; retail stores, grocery and department stores
United Steel Workers Locals 177, 178A, 181, 183, 187, 188A, 8507	1560	Eddy and Lea Counties; potash mines, Carlsbad city employees, school custodial and maintenance workers

^aData from Adcock (1979).

^bLocal offices in Carlsbad unless otherwise indicated.

^cLocal offices in Las Cruces.

than it had been in the past. A large number stressed that there were no problems. It is important to note that very few persons perceived any conflict between old and new residents. Overall, the interviewed persons characterized local residents as friendly, helpful, honest, and good.

In contrast to the positive attitudes about the community, approximately half the interviewees felt they had no meaningful chance of affecting political events. They felt that their involvement in the political process did not count. Furthermore, many of the responding persons saw no reason for becoming involved and were not interested in doing so. Only a small minority perceived an ability to influence decisionmaking.

Attitudes toward elected officials and their representation of the local constituency were generally consistent with the feelings about ability to affect local government decisions. Approximately half the interviewees felt well represented, while the other half did not. Those who did perceive a lack of good representation believed that only the wealthy and special interests are taken into account.

Local residents show a general preference for the current environment in the Carlsbad area. The local consensus on land-use patterns leaned toward no changes or only very minor ones. The changes most desired are increased agricultural development, mineral development, and urbanization-industrialization.

Churches and community organizations

Carlsbad has 60 churches and 1 synagogue; Hobbs has 70 churches and 1 synagogue; Loving has 3 churches. Of these churches, two in Carlsbad and one each in Hobbs and Loving are Catholic. Many of the remaining churches are Protestant (BBER, 1977a,b; Adcock, 1979).

There are 22 major civic and community organizations in Hobbs, 13 in Carlsbad, and 2 in Loving. Most of these are fraternal organizations, with membership in many restricted to men, although many have auxiliaries for wives (Adcock, 1979).

Social services

The social services available in both the Carlsbad-Loving area and in the municipality of Hobbs are rather extensive and cover a wide range of activities. The organizations providing these services are listed in Tables H-11 and H-12 for Carlsbad-Loving and Hobbs, respectively.

Community planning capabilities

Carlsbad and Hobbs are experiencing considerable growth in population and housing; this growth is expected to continue throughout the mid-1980s and probably into the year 2000. Both communities have planning agencies and various other city agencies that analyze and assist in the management of growth. The village of Loving, which has also experienced growth since 1970, currently has no municipal planning department (Adcock, 1979).

Table H-11. Social Services in Carlsbad-Loving, New Mexico^a

Type of service or facility	Total staff ^b	Total participants ^c	Program or activity
MENTAL HEALTH AND HEALTH SERVICES			
Carlsbad Area Resource and Counseling Center	19	373	Rape Crisis Center Hotline Crisis Center First offenders program Mental-health services Treasure House Activity Center Youth service counseling Family counseling Parents Anonymous Testing and evaluation Drug-abuse clinic
Alcoholism Council of South Eddy County	6	60	Outpatient counseling Group counseling Seminars and lectures Initial screening for Cavern Lodge Halfway house

Table H-11. Social Services in Carlsbad-Loving, New Mexico^a (continued)

Type of service or facility	Total staff ^b	Total participants ^c	Program or activity
MENTAL HEALTH AND HEALTH SERVICES (continued)			
El Centro Rural de Salud	6	500	Primary medical care Prenatal care Family planning Social worker Counseling
Eddy County Health Center	16	3000-5000	Family planning Prenatal care Child-care clinic Maternity education Immunization program Crippled-children's services Social worker, South Eddy County Women's, Infants', Children's Nutrition Program Vital statistics
SENIOR CITIZENS SERVICES			
Eddy County Senior Citizens Program	NA	200 daily	Senior Citizens Nutritional Mealsite Recreation
Senior Recreation Center	4	550 daily	Recreation Club meetings Classes
Loving Mealsite Nutritional Program	NA	50 daily	Senior Citizens Nutritional Mealsite Recreation
DAY CARE AND PRESCHOOL SERVICES			
Cottage Preschool	4	34	Informal education, day care
Hillcrest Day Care Center	6	35	Informal education, day care
Harding Webster Preschool	NA	NA	Informal education, day care
First United Methodist Preschool	4	39	Informal education, day care
YOUTH SERVICES			
Campfire Girls	NA	NA	Informal education and vocational guidance Recreation

Table H-11. Social Services in Carlsbad-Loving, New Mexico^a (continued)

Type of service or facility	Total staff ^b	Total participants ^c	Program or activity
YOUTH SERVICES (continued)			
Boys Club of Carlsbad	3	600	Organized sports Recreation Library
OTHER SERVICES			
American Red Cross	2	200	Water safety training Blood-donor program Cardiopulmonary resuscitation training First-aid training Disaster relief Blood-pressure screening Services to military families
EDUCATIONAL, VOCATIONAL, AND REHABILITATION SERVICES			
Carlsbad Child Development Center	2	6-20	Preschool--handicapped children Family counseling
Carlsbad Association of Retarded Citizens Farm	NA	20-25	Counseling Vocational rehabilitation Recreation
STATE AND FEDERAL SERVICES			
Community Action Programs	125	550-600	Family planning Head Start Program Rural Health Clinic, Loving Weatherization program Rural housing program Senior Citizens Nutritional Program Summer youth recreation Emergency energy assistance Crisis intervention program Youth tutoring Home education livelihood program
New Mexico Social Services Division	14	463	Referrals Protective service for children and adults Disease investigation Adult services Adoption Foster care

Table H-11. Social Services in Carlsbad-Loving, New Mexico^a (continued)

Type of service or facility	Total staff ^b	Total participants ^c	Program or activity
STATE AND FEDERAL SERVICES (continued)			
			Nursing-home discharge planning Homemakers service permanency planning for children Day care Family planning Health support Critical in-home care Drug abuse Youth services Legal services Emergency shelter Family counseling
Employment Services Division	20	463	Employment information and referral Aid to Families with Dependent Children

^aData from Adcock (1979).

^bData for 1979; NA = not available.

^cMonthly estimates unless otherwise indicated.

Table H-12. Social Services in Hobbs, New Mexico^a

Type of service or facility	Total staff ^b	Total participants ^c	Program or activity
MENTAL HEALTH AND HEALTH SERVICES			
Crisis Center of Lea County	25	500	Day activities for senior citizens Group therapy Alcohol abuse Child services Parent education services Drug abuse Medication program Methadone program Educational programs for public schools Rape crisis program Volunteer Shelter Bed

Table H-12. Social Services in Hobbs, New Mexico^a (continued)

Type of service or facility	Total staff ^b	Total participants ^c	Program or activity
MENTAL HEALTH AND HEALTH SERVICES (continued)			
Parents Anonymous (prevention and treatment of child abuse)	4	200	Telephone hotline and referral Group meetings
Mental Health Activity Center	1	119	Recreation, socials Special education, gifts and parties Special Olympics Annual scholarships
SENIOR CITIZENS SERVICES			
Senior Citizens Center	6	1070	Classes Dances Workshops Luncheons Meals on Wheels Information and referral Occasional transportation services
Good Samaritan Village	68	124	Residence, recreation, entertainment
La Siesta Retirement Center	37	55	Nursing, residence, recreation
EDUCATIONAL, VOCATIONAL, AND REHABILITATION SERVICES			
Child Development Center of Lea County	4	79	Level D special education Speech therapy Physical therapy
Vocational Rehabilitation (oil-field injuries)	2	35	Medical treatment Counseling Reeducation Arranging financial assistance
Lea Work Activity Center (for the handicapped)	7	36	Recreation Community services Transportation
STATE SERVICES			
Social Services Division	24	600	Counseling services Limited critical in-home care Family planning

Table H-12. Social Services in Hobbs, New Mexico^a (continued)

Type of service or facility	Total staff ^b	Total participants ^c	Program or activity
STATE SERVICES (continued)			
			Health support Homemaker services Information and referral Adoption services Day care Protective services for children Foster care
Employment Services Division	9	337	Information and referral Aid to Families with Dependent Children
DAY CARE AND PRESCHOOL SERVICES			
Kinder Care Learning Centers, Inc.	9	88	Informal education, day care
Washington Nursery	10	90	Day care
Little Peoples Kountry Kindergarten	3	21	Informal education, day care
YOUTH SERVICES.			
Boys Club of Hobbs	5	1300	Indoor recreation Library Television Organized sports
Girl Scout House	1	1000	World of Arts World of People World of the Out-of-Doors World of Well-Being
Junior Achievement of Hobbs	NA	NA	Recreation Community service
OTHER SERVICES			
American Red Cross	1	270	Services to military families Disaster relief Blood-pressure screening Water safety training Blood-donor program

Table H-12. Social Services in Hobbs, New Mexico^a (continued)

Type of service or facility	Total staff ^b	Total partic- ipants ^c	Program or activity
OTHER SERVICES (continued)			
			Cardiopulmonary resuscitation training
			First-aid training

^aData from Adcock (1979).

^bData for 1979; NA = not available.

^cMonthly estimates unless otherwise indicated.

H.3 ECONOMIC SETTING

H.3.1 General Economic Characteristics

As defined by standard economic-base theory, there are three basic economic sectors in Eddy and Lea Counties: mining, manufacturing, and agriculture. Although government is a basic industry* in many parts of New Mexico because of heavy Federal activity, most governmental activity in Eddy and Lea Counties is only a supportive function (USDC, 1975-1979). The nonbasic sectors in the two counties include contract construction; transportation, communications, and utilities; trade; finance, insurance, and real estate; and services. Certain activities in the retail-and-services sector are larger than might be expected because of heavy tourist traffic (Carlsbad Caverns). Transportation facilities and the transportation sector in the area are well developed because of the heavy industry.

Basic industries

Mining, which includes oil and gas extraction, is the major industry in both counties. In 1978 mining employed approximately 3600 and 6000 persons in Eddy and Lea Counties, respectively. In both counties employment in mining was substantially higher than in any other industrial sector (NMESD, 1975-1979). In Eddy County potash mining employs more than nine out of ten persons working in this sector. Figures for 1977 showed that New Mexico (Eddy and Lea Counties) supplied 93% of the total potash mined in the United States (USBM, 1978). In Lea County mining is centered on oil and gas (5800 employees in 1978); mining in potash, sand and gravel, rock salt, and caliche employed fewer than 200 people in 1977 (NMESD, 1975-1979).

In Eddy County personal income from mining accounted for more than 24.6% of total personal income in 1977. In Lea County this figure was just more than 31.2%. Moreover, the impact of mining is increasing: personal income from mining rose approximately 170% from 1970 through 1977, while personal income from other services rose 118% over the same period (USDC, 1975-1979).

At the beginning of 1978, there were 43 manufacturing companies with approximately 920 employees in Eddy County and 51 manufacturing companies with approximately 1085 employees in Lea County. In 1976 manufacturing was second in income generated by a basic industry. However, the total personal income from manufacturing was only 5.2% of all personal income generated in the two-county area (NMESD, 1975-1979).

In 1975 the principal subsector of agriculture in the two-county area was meat animals and livestock. In the immediate area of the WIPP site (10-mile radius), agriculture is restricted to cattle grazing. Personal income from agriculture in 1975 was less than 4% of the total personal income derived in the two-county area.

*Basic industries are those whose level of activity is not closely tied to the level of economic activity in the local community (Tiebout, 1962, p. 74).

Trade and services

The 1972 Census of Business shows 454 retail outlets in Eddy County and 614 in Lea County, for a total of 1068. In Eddy County the majority, 281, are located in Carlsbad. The total sales volume in 1972 was about \$185.9 million, or just over 8% of the statewide total of more than \$2.3 billion. Although little sales-volume information is available after 1972, retail sales in the area have increased substantially. During the period 1972-1978, employment in wholesale and retail trade increased from an average of 2500 to approximately 3500 in Eddy County and from approximately 3600 to 5200 in Lea County (NMESD, 1975-1979).

The Rand-McNally 1978 Commercial Atlas and Marketing Guide shows both Eddy and Lea Counties as basic trade areas (i.e., areas in which normal retail-trade purchases are made). Rand-McNally defines 50 major trade areas with a major central city from which substantial retailing and wholesaling operations are conducted. The Carlsbad basic trade area, Eddy County, is in the major trade area of El Paso; the Hobbs trade area, Lea County, is in the major trade area of Dallas. It is important to note that the basic trade areas for both Carlsbad and Hobbs do not extend beyond their respective county limits to any significant degree. Therefore, Rand-McNally notes few leakages in normal retail purchases from the two-county area. However, for major retail purchases and wholesaling there is substantial leakage out of the State into El Paso and Dallas.

There were 835 service establishments (e.g., hotels, motels, barber shops, advertisers, business services, repair shops) at the time of the 1972 Census of Business. Activity in this sector increased substantially during the period 1972-1978, with service-sector employment in Eddy County rising from approximately 1900 to 2700 and in Lea County from approximately 1800 to 2300 (NMESD, 1975-1979).

Tourism

Tourism contributes substantially to economic activity in the two-county area, particularly in Eddy County. The main tourist attraction in the area is Carlsbad Caverns National Park, which is approximately 22 miles southwest of Carlsbad and 41 miles west-southwest of the site. In 1978 it received 867,276 visitors, or nearly 44% of the visitors to all 11 national parks and monuments throughout the State (USDI, 1970-1978). Nearby parks (Guadalupe Mountains National Park, Living Desert State Park, the Presidents' Park in Carlsbad, and others) also attract local residents and tourists.

The effects of tourism in the area can be readily seen in employment statistics, with retail trade and selected services being most affected. For example, employment in eating and drinking establishments more than triples in the three summer months, and summer employment in lodging increases 60% to 70% over winter employment (NMESD, 1975-1979). Other secondary and tertiary services affected by tourism (e.g., curio sales, barber shops, cleaners) also show substantial increases.

Tourism is highly seasonal, with visits to Carlsbad Caverns fluctuating from a high of 187,970 in July 1977 to a low of 25,350 in January (USDI, 1970-1978). To support the tourist industry, the City of Carlsbad, which receives

most of the impact from the national park, has a total of 20 motels and hotels with approximately 1100 rooms (data from the Carlsbad Department of Development, 1979).

Financial resources

In Eddy and Lea Counties there are a total of nine chartered banks--four holding state charters and five holding national charters. Five of these eight banks (three state and two national) are in Eddy County. Assets, liabilities, and deposits as of December 31, 1978, are reported in Table H-13.

There are four savings and loan institutions in the two-county area. The three with main offices in Eddy County are mutual savings and loan institutions that have combined assets of more than \$148.3 million and total savings accounts of more than \$118.9 million. The savings and loan institution with a main office in Lea County at Hobbs is a capital-stock institution; it has total assets of more than \$27.4 million and about \$21.3 million in total savings accounts.

There are three credit unions in the two-county area. The two credit unions in Eddy County (one in Carlsbad and one in Artesia) are for school employees; both are insured by the National Credit Union Administration. They have combined assets of more than \$2.7 million and combined shares and deposits of just over \$2.2 million. The credit union in Lea County at Lovington, insured by the New Mexico Credit Union Insurance Corporation, has total assets of over \$1.4 million and total shares and deposits of \$1.2 million.

Nineteen small-loan licensees are doing business in the two-county area. Ten are in Eddy County: six in Carlsbad, three in Artesia, and one in Loving. Nine are in Lea County: six in Hobbs, one in Jal, and two in Lovington (NMDB, 1979).

In Carlsbad long-term (25-30 years) financing for residential mortgage loans is provided primarily by the savings and loan associations. The banks do provide some short-term and interim financing.

The availability of mortgage loans has fluctuated in accordance with the credit (interest-rate) conditions throughout the nation. The State of New Mexico Usury Law requires any mortgage loan with an interest rate higher than 10% to be sold in the "secondary" mortgage-loan market. Secondary-market funds have also fluctuated in accordance with the credit conditions and interest rates.

The Carlsbad municipal area is regulated by the existence of a 100-year floodway, as defined by the Federal Insurance Administration's Flood Insurance Study. Because the local government has rejected the criteria that establish qualification for Federal flood insurance, local mortgage loans are available only for developments outside the boundaries of the 100-year floodway (Figure H-6).

Periodically, the State of New Mexico Finance Authority (NMFA) provides funds for residential mortgage loans. The financial institutions in Carlsbad do participate in the distribution of these funds when they are available.

Table H-13. Banking Activity in Eddy and Lea Counties^a

Location	State banks	Branches	National banks	Branches	Total assets ^b	Total liability ^b	Equity capital ^b	Total deposits ^b
New Mexico	46	113	40	111	4904.7	4547.1	323.8	4296.3
Eddy County	3	4	2	1	231.9	213.3	16.9	211.2
Carlsbad	2	4	2	1	143.2	133.0	9.4	131.0
Artesia	1	0	1	0	88.7	81.2	7.5	80.1
Lea County	1	7	3	8	342.0	317.9	19.4	302.4
Hobbs	1	7	2	5	297.7	276.3	17.4	261.2
Lovington	0	0	1	3	44.3	41.6	2.0	41.3

^aData from Sixty-fourth Annual Report, New Mexico Department of Banking, issued 1979 (December 31, 1978, data).

^bMillions of dollars.

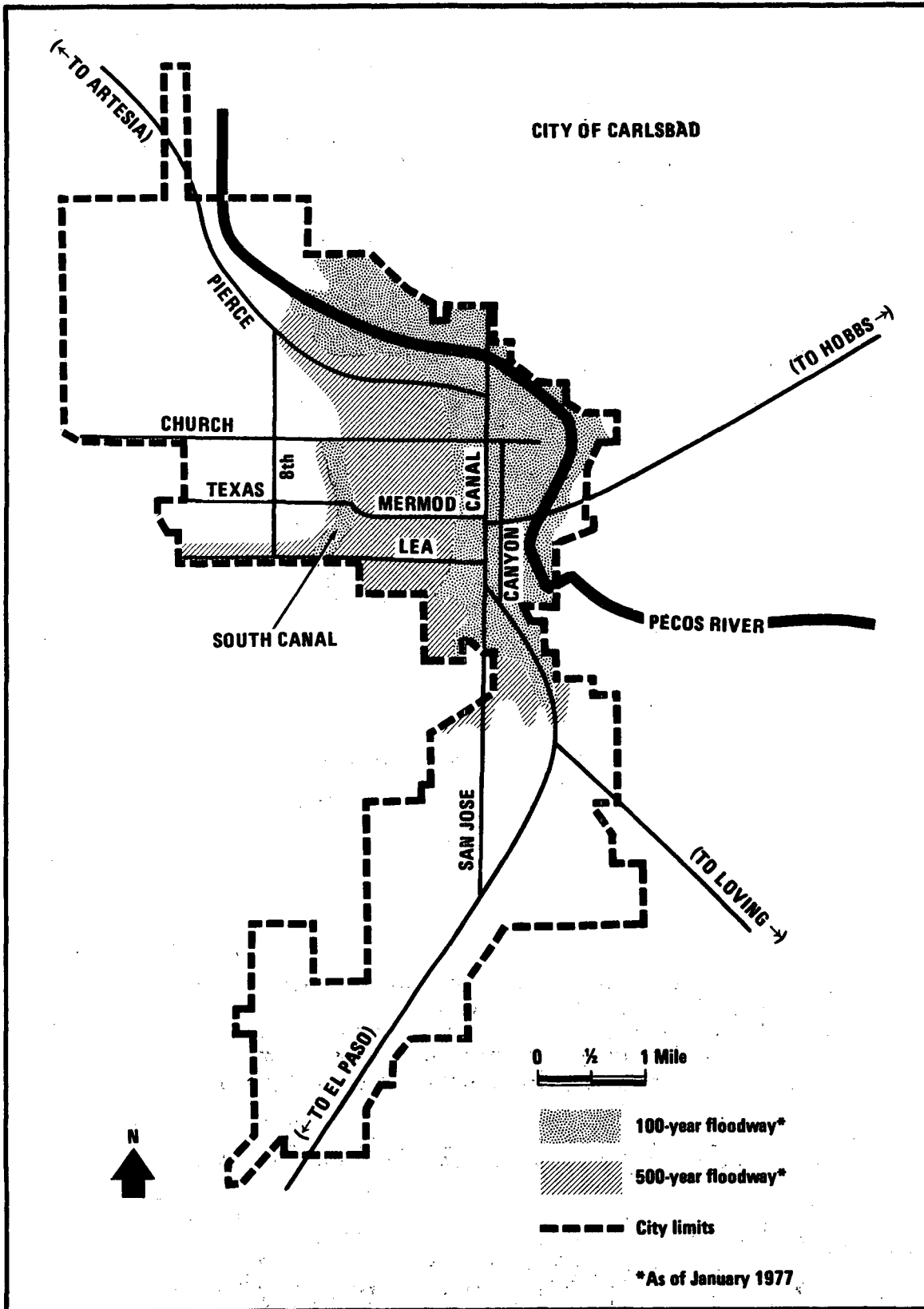

Figure H-6. Map of Carlsbad floodway.

During 1979, NMFA funds bearing a 7.75% interest rate were available throughout Eddy and Lea Counties; demand for the NMFA loans liquidated the available funds soon after they became available.

Currently, neither the savings and loan associations nor the banks extend mortgage loans for commercial establishments in Carlsbad.

In Hobbs the savings and loan associations and the banks provide financing for long- and short-term mortgage loans. Generally, the availability of residential and commercial loans has fluctuated, the conditions being similar to those described for Carlsbad. A municipal bond issue has recently provided funds for residential mortgage loans.

Because of Loving's proximity to Carlsbad (12 miles), its residential and commercial mortgage-loan market reflects the conditions existing in Carlsbad.

H.3.2 Labor Force

Labor force is defined by the U.S. Department of Labor as persons who are employed and those who are unemployed and are actively seeking employment. In the first 6 months of 1979 the combined total labor force in Eddy (19,905) and Lea (25,815) Counties was approximately 45,700. Total employment in the two-county area was 43,855 (NMESD, 1975-1979).

Between 1974 and 1978 the economy of both counties expanded, the total labor force increasing by approximately 7800 individuals (20.6% for the period, 4.8% annually). The overall growth of employment for the 4-year period was 22.4%, or about 5.2% annually. Therefore, the number and the percentage of unemployed persons have decreased during the last 4 years. Although the combined unemployment rate for the two counties in the first 6 months of 1979 was approximately 4.1%, the rate varies significantly between Eddy (4.3%) and Lea (3.9%) Counties (NMESD, 1975-1979).

Employment

Mining is by far the largest employer in the two-county area. Accurate figures on agricultural employment are difficult to obtain and are normally out of date; the latest available credible information shows just under 2000 employees in the two counties in 1977 (USDC, 1975-1979). In 1978 manufacturing employed approximately 2000 persons: 921 in Eddy County and 1087 in Lea County (NMESD, 1975-1979).

The distribution of employment among industrial sectors is presented in Table H-14.

Unemployment

Unemployment in the two-county area is lower than the State average; the 1978 average rates were 4.5% in Eddy County and 4.0% in Lea County. Seasonal unemployment rates vary significantly, with higher rates during June and lower rates in late spring and late fall. The variations occur primarily because of fluctuations in the summer-month employment patterns of agricultural, student, and certain noncontract school personnel (NMESD, 1975-1979).

Table H-14. Employment Sectors

Industry	Percentage distribution ^a
Agriculture	5
Mining	26
Manufacturing	5
Construction	6
Transportation, communications, and utilities	9
Wholesale and retail trade	24
Finance, insurance, and real estate	4
Services	13
Government	12

^aData from the New Mexico Employment Security Department NMESD (1975-1979). Percentages do not add to 100% because of rounding.

Applications for work through the New Mexico Employment Security Department (formerly the Employment Security Commission) reveal that a large number of people with technical skills, many directly connected with construction and mining, and a large number of clerical and secretarial workers are available in the area.

Underemployment and disguised unemployment

The unemployment rate computed by the State and Federal governments is based on persons actively seeking employment. An area may sometimes have a concurrent low level of defined unemployment and significant underemployment (i.e., occupations or jobs that do not take full advantage of an employee's potential). Although labor statistics and wage rates indicate that there may be some underemployment because of seasonal employment patterns in the two-county area, underemployment does not appear to be significant in the labor market.

Disguised unemployment may exist when many persons who are not actively seeking employment would take a job if one were available in the area. Disguised unemployment is measured by labor-force participation rates. In the two-county area the labor-force participation rate for males is higher than the State average, while the rate for females is lower than the State average (USDC, 1970b). These data imply that not all females who are willing to work are actively seeking employment and that the labor-force availability for females may be greater than current statistics indicate.

Major employers

Nine of the 20 major employers in the two-county area are mining or service-to-mining companies (Table H-15). Only two of the 20 major employers, Levi Strauss and the Holly and Navajo Corporation, are listed by the Employment Security Department as manufacturing companies.

Table H-15. Major Employers in Eddy and Lea Counties^a

Number of employees	Company	Services
EDDY COUNTY		
151-250	Mississippi Chemical Lakeview Christian Home Holly and Navajo Corporation	Mining Retirement home Refining
251-500	Kerr-McGee Corporation Duval Corporation Amax Chemical Guadalupe Medical Center	Mining Mining Mining Medical
501-750	Potash Company of America (Ideal Basic Industries) International Minerals	Mining Mining
Not known	Evangelical Lutheran Center	Nursing home
LEA COUNTY		
100-150	Halliburton Company Moran Company First National Bank	Oil field Oil-well drilling Banking
151-250	B&M (well service) Levi Strauss General Telephone	Oil field Manufacturing Utility
251-750	Lea County Regional Hospital El Paso Natural Gas National Potash	Medical Refining natural gas Mining
Not known	M.G.F. Drilling Company	Oil-well drilling

^aData from the Carlsbad Department of Development (1977-1979) and the Industrial Development Corporation of Lea County (1979).

Personal income

The total annual personal income in 1977 was listed by the Bureau of Economic Analysis as \$276.8 million in Eddy County and \$360.5 million in Lea County. The two-county area accounts for about 9% of the total annual personal income of all State residents. The total annual personal income in Lea County has been showing steady increases in recent years. Because of declines in the potash industry during the middle and late 1960s, Eddy County sustained a decrease in the total personal income in 1968 and in 1969 barely reached the level established in 1967; since 1968, however, it has shown

increases. While information after 1977 is not available, trends in the area and in the State indicate that the total personal income in the two-county area has been increasing at more than 12% per year since 1976 (USDC, 1975-1979).

The per-capita income in the two counties is higher than that in the State: in 1977 it was \$6811 in Lea County, or approximately 16.5% above the \$5846 registered statewide level, and \$6089 in Eddy County, about 4.2% above the statewide level. In Lea County the per-capita income increased 118.5% between 1970 and 1977, while in Eddy County the increase was only slightly less at 101.7%. The statewide level increased 99.8% during the same period; thus the per-capita income for the two-county area is increasing faster than the statewide average. It is important to note that the per-capita income in both counties is above the national average for non-SMSA (Standard Metropolitan Statistical Area) counties. In Lea County the per-capita income is 118.2% of the non-SMSA county national average, while the Eddy County level is 106.0% (USDC, 1975-1979).

H.3.3 Housing and Land Use

Carlsbad

According to officials of the City of Carlsbad, between June 1977 and August 1979 Carlsbad annexed 8544 acres of land, thereby increasing the land area within its city limits to 13,335 acres. With the addition of the annexed land, most of which is vacant, the total vacant land area in Carlsbad amounts to approximately 7500 acres, which is 57% of the total municipal acreage.

Land-use patterns inside the city limits are currently changing. Much of the city is being rezoned, with the outcome of the rezoning in doubt. Until rezoning is settled, it is not possible to accurately predict either the location or the total amount of land to be available for future residential, commercial, and industrial development.

Information from the City of Carlsbad shows that, during the period 1970-1977, new housing units were added to the city's housing stock at a rate of approximately 160 per year. Actual construction averaged approximately 180 units per year for that period, with approximately 25 of the new construction units replacing structures that were classified as "demolitions." Concurrently, the vacancy rate decreased from approximately 3% in 1970 to 1% by 1977. In 1978 construction activity increased, with 257 new housing units being constructed. However, demolitions and population growth maintained the vacancy rate at an average of approximately 1%. If the vacancy rate were to have been reestablished at a level of 3%, generally accepted as the desirable vacancy rate that permits orderly population and community growth, it would have been necessary to construct an additional 153 housing units in 1978.

By mid-1979, the Carlsbad housing stock was estimated to be approximately 10,198 units (Table H-16). The most recent information from the City of Carlsbad (1979) indicates that the vacancy rate has remained at a level of approximately 1%.

Temporary housing is available on a seasonal basis in Carlsbad's 20 motels, which have a total of about 1100 rooms. Between Memorial Day and Labor Day occupancy rates are about 100%. Nonsummer occupancy rates on weekends are as low as 50% in some motels but 95% to 100% on weekdays (data from the Carlsbad Department of Development, 1979).

The Federal Housing Authority's Section 8 program provides rent and utility assistance (75%) to qualified renters. Generally, to qualify, a person must be more than 62 years old, disabled, or handicapped and have an income of less than \$8500 (single-person limit). In November 1979 there were 91 program participants and approximately 25 to 30 applicants for the program (personal communication from J. Haut, U.S. Department of Housing and Urban Development, Roswell, New Mexico, 1979).

Table H-16. Housing Stock in Carlsbad, 1978

Type	Total	Occupied	Unoccupied
All units	10,198 ^a	10,045 ^b	153
Single-family units	8,166 ^a	8,044 ^c	122
Multifamily units	1,101 ^a	1,084 ^c	17
Mobile homes	931 ^d	917 ^c	14

^aBased on data from the U.S. Department of Commerce, 1970 Census of Housing (USDC, 1970c), and subsequent building-permit and demolition data.

^bBased on population and household-size estimates prepared for this report.

^cOccupancy rates assumed identical for all housing types.

^dDatum from Adcock (1979).

Hobbs

According to current information from the City of Hobbs (1979), the total land area inside the Hobbs city limits, including the Hobbs Industrial Air Park, is about 14,830 acres. Not including the Air Park, approximately 1070 acres are vacant and available for residential, commercial, or industrial development. Virtually the total area of the Air Park is vacant at present, providing an additional 3500 acres for industrial development. Since Hobbs has no zoning ordinance, there are no figures on the total amount of land available for specific types of use.

From 1970 to 1977, new housing units were added to the Hobbs housing stock at a rate of about 215 per year. Actual construction averaged 254 units per year for the period, with about 40 units per year replacing condemned or removed structures. This relatively low rate of addition to the housing stock caused the vacancy rate to decline from nearly 9% in 1970 to just over 1% in 1975. In 1976 and 1977 construction activity increased, with 414 new housing units added in 1976 and 611 units in 1977, and vacancy rates increasing to

about 2% because of the recent construction activity. At the end of 1977, the housing stock in Hobbs was estimated at 10,879 units. The year 1978 saw a continuation of increased housing construction, with 466 new units added. However, demolitions and population growth maintained the vacancy rate at an average of approximately 2%. If a vacancy rate of 3% were to have been re-established, it would have been necessary to construct 114 additional housing units in 1978.

At the end of 1978, the Hobbs housing stock was estimated to be approximately 11,345 units (Table H-17). The most recent information from the City of Hobbs (1979) indicates that the vacancy rate has remained at a level of approximately 2%.

Temporary housing in Hobbs is available in 11 motels with 482 rooms. Seasonal occupancy patterns are very similar to those for Carlsbad. On a year-round basis, occupancy averages 84%, with the Memorial Day to Labor Day rate at 95% or higher. Nonsummer occupancy is lower than summer occupancy on the average, but midweek occupancy is very high even in nonsummer months.

The Federal Housing Authority's Section 8 Program currently provides rent and utility assistance to 39 qualified renters in Hobbs, and there are approximately five applicants on the waiting list (personal communication from J. Haut, U.S. Department of Housing and Urban Development, Roswell, New Mexico, 1979).

Table H-17. Housing Stock in Hobbs, 1978^a

Type	Total	Occupied	Unoccupied
All units	11,345	11,119	226
Single-family units	8,677	8,503	174
Multifamily units	1,295	1,269	26
Mobile homes	1,373	1,345	28

^aData from the City of Hobbs, 1979. Occupancy based on a vacancy-rate estimate in this housing count, with vacancy rates assumed to be identical for all housing types.

Loving

During the period 1970 through October 1979, the housing stock in Loving increased by 19.9% from 403 (USDC, 1970c) to 483 housing units (Table H-18) (Adcock, 1979). The vacancy rate decreased from 27% (109 units) in 1970 (USDC, 1970c) to 4.3% (21 units) in October 1979 (Adcock, 1979).

Official information regarding the current (November 1979) quality of housing is not available; the most recent information is for 1974. According to the results of a 1974 housing survey conducted by the Southeastern New Mexico Economic Development District (SENM EDD), 58% of the housing units were of sound condition, 26% were deteriorating, and 16% were dilapidated.

The 1974 SENM EDD survey used the number of mobile homes in the community as a measure of the quality of housing stock; mobile homes are considered to be inferior to other types of structurally sound housing units. Recently, the number of mobile homes in Loving has been increasing. During the period 1974-1979, mobile homes increased from the 14 units counted in the above-mentioned survey to 49 units (Adcock, 1979), an increase of 250%.

The results of the 1979 Loving structure inventory compiled by Larry Adcock and Associates show that neither the overall numbers nor the percentages of sound versus deteriorating and dilapidated housing units have changed significantly since 1974.

The Federal Housing Authority's Section 8 Program had no recipients in Loving as of October 1979 (personal communication from J. Haut, U.S. Department of Housing and Urban Development, Roswell, New Mexico, 1979).

Table H-18. Housing Stock in Loving, 1979^a

Type	Total	Occupied	Unoccupied
All units	483	462	21
Single-family units	410	389	21
Multifamily units	24	24	NA ^b
Mobile homes	49	49	NA ^b

^aData from Larry Adcock and Associates (1979), Residential, Commercial, and Service Structure Inventory.

^bNA = not applicable.

H.3.4 Community Facilities

Education

There are three public school districts in Eddy County and five in Lea County, with a combined 1978-1979 enrollment of 21,927. Three public school districts appear likely to experience substantial impacts from the WIPP. Special education, adult education, and technical-vocational programs are offered through the municipal school systems in Carlsbad and Hobbs.

Three institutions of higher education are in the vicinity of the WIPP site: a branch of the New Mexico State University in Carlsbad and the New Mexico Junior College and the College of the Southwest (a small 4-year institution) in Hobbs. The Eastern New Mexico University maintains a branch in Roswell, about 75 miles north of Carlsbad, and has its main campus in Portales, approximately 110 miles north of Hobbs. The New Mexico Military Institute is also located in Roswell. Somewhat farther from the site are the New Mexico State University, with a main campus in Las Cruces and a branch in Alamogordo, and the University of Texas at El Paso.

Carlsbad. Information obtained in 1979 from the Carlsbad School District shows that the Carlsbad school system consists of ten elementary schools, two

junior high schools, one mid-high school, and one senior high school, with a combined enrollment of about 6620 students. This enrollment is well below the capacity of 10,000 students. As shown in Table H-19, the excess capacity exists at all grade levels.

Table H-19. Carlsbad School District Enrollment^a

Year	K-6 ^b	Grade			Total
		7-8	9-10	11-12	
ENROLLMENT CAPACITY ^c					
	4600	1860	1770	1870	10,000
ACTUAL ENROLLMENT ^d					
1977-1978	3178	1390	1132	1037	6737
1978-1979	3501	982	1178	960	6621

^aData from the Carlsbad School District (1979).

^bIncludes special education "C" and "D" kindergarten students counted as full time.

^cAssumes a capacity of 24 students per classroom.

^dCarlsbad 40-day average daily membership reports.

The Carlsbad school system has a complete special education program that conforms to standards set by the State of New Mexico. With approximately 455 students at present, the special education program serves mentally retarded persons between the ages of 5 and 21 and also assists children with speech and learning disabilities.

Adult-education programs are provided through the public school system. These programs offer training in basic skills as well as classes leading up to General Education Development Tests.

Technical-vocational training programs are provided by both the high schools and the branch of the New Mexico State University. There are also work/study and other vocational training programs for the mentally retarded.

Hobbs. The Hobbs school system currently consists of ten elementary schools (kindergarten through grade 6), three junior high schools (grades 7 through 9), and one high school (grades 10 through 12). According to information from the Hobbs School District, the total enrollment for the 1978-1979 school year was about 7630 students (Table H-20). This enrollment is somewhat below the estimated capacity of 8350 students.

Special education programs are offered for persons between the ages of 6 and 21. There are also programs for children in grades 1 through 6 with learning disabilities.

Table H-20. Hobbs School District Enrollment in the 1978-1979 School Year^a

K-6 ^b	Grade		Total
	7-9	10-12	
ENROLLMENT CAPACITY ^c			
4630	1990	1730	8350
ACTUAL ENROLLMENT ^d			
4237	1715	1677	7629

^aData from the Hobbs School District (1979).

^bIncludes special education "C" and "D" kindergarten students counted as full time.

^cAssumes a capacity of 24 students per classroom.

^dHobbs 40-day average daily membership reports.

Table H-21. Loving School District Enrollment in the 1978-1979 School Year^a

K ^b	Grade		Total
	1-6	7-9	
ENROLLMENT CAPACITY ^c			
48	240	140	428
ACTUAL ENROLLMENT ^d			
35	188	199	342

^aData from the Loving School District (1979).

^bIncludes special education "C" and "D" kindergarten students counted as full time.

^cAssumes a capacity of 24 students per classroom.

^dLoving 40-day average daily membership reports.

Adult education classes that upgrade basic skills to the eighth-grade level are offered. Classes preparing for the General Education Development Tests are also provided.

Technical-vocational programs are provided by the high school and the New Mexico Junior College. There is also a special vocational rehabilitation program for the mentally retarded.

Loving. The Loving school system currently consists of two schools: one elementary and one junior high school. According to information obtained in 1979 from the Loving School District, some 120 high-school-age students from the Loving district currently attend classes in Carlsbad schools. The district's combined enrollment totals 342 full-time students (Table H-21). The enrollment is well below the school-district capacity of approximately 430 pupils. This excess capacity exists at all levels except the fourth and sixth grades.

Municipal water systems

Carlsbad. According to information provided by city officials in 1979, Carlsbad obtains its water from a well field in the Capitan Reef (Figure H-7) and through a pipeline from the Double Eagle System to the northeast of the city. There are eight wells presently pumping water from the Capitan field and 22 wells in the Double Eagle field. In addition, there are three wells within the city limits that are not used because the water under Carlsbad is of lower quality than water outside the city limits.

The city has rights to 9200 acre-feet per year in the Capitan Reef and 7648 acre-feet per year in the Double Eagle field. In addition, Carlsbad has rights to 10,640 acre-feet per year from a well field north of the city in the Ogallala Formation, giving the city total rights to over 27,000 acre-feet per year.

Current (1979) consumption averages about 5.8 million gallons per day (mgd) in Carlsbad. Peak consumption is about 16 mgd, well within the current 26.4-mgd capacity of the delivery system.

Hobbs. Information obtained in 1979 from city officials shows that Hobbs currently has rights to 18,888 acre-feet of water per year from ground-water sources (primarily inside city limits) in the Ogallala Formation. In addition, it has an allocation of 15,340 acre-feet per year from the proposed Eastern New Mexico Water Supply System, which would deliver water from the Ute Reservoir to 10 communities in eastern New Mexico. The status of this project is currently very uncertain, and it is not known when, if ever, the delivery of water to Hobbs will begin.

Municipal water is supplied from 28 wells located in and around the city (Figure H-8). The current potential yield of the wells is about 14 mgd.

Average consumption is currently about 12 mgd. Peak daily consumption, normally about double the average daily rate in this area, is limited by the capacity of the delivery-and-storage system to just over 14 mgd. Thus, although the total water rights in the Ogallala Formation are adequate for current demands (about 7050 acre-feet per year), there is a need for additional wells and storage-and-delivery facilities. The recent completion of four additional wells will partially alleviate the existing water system's limitations.

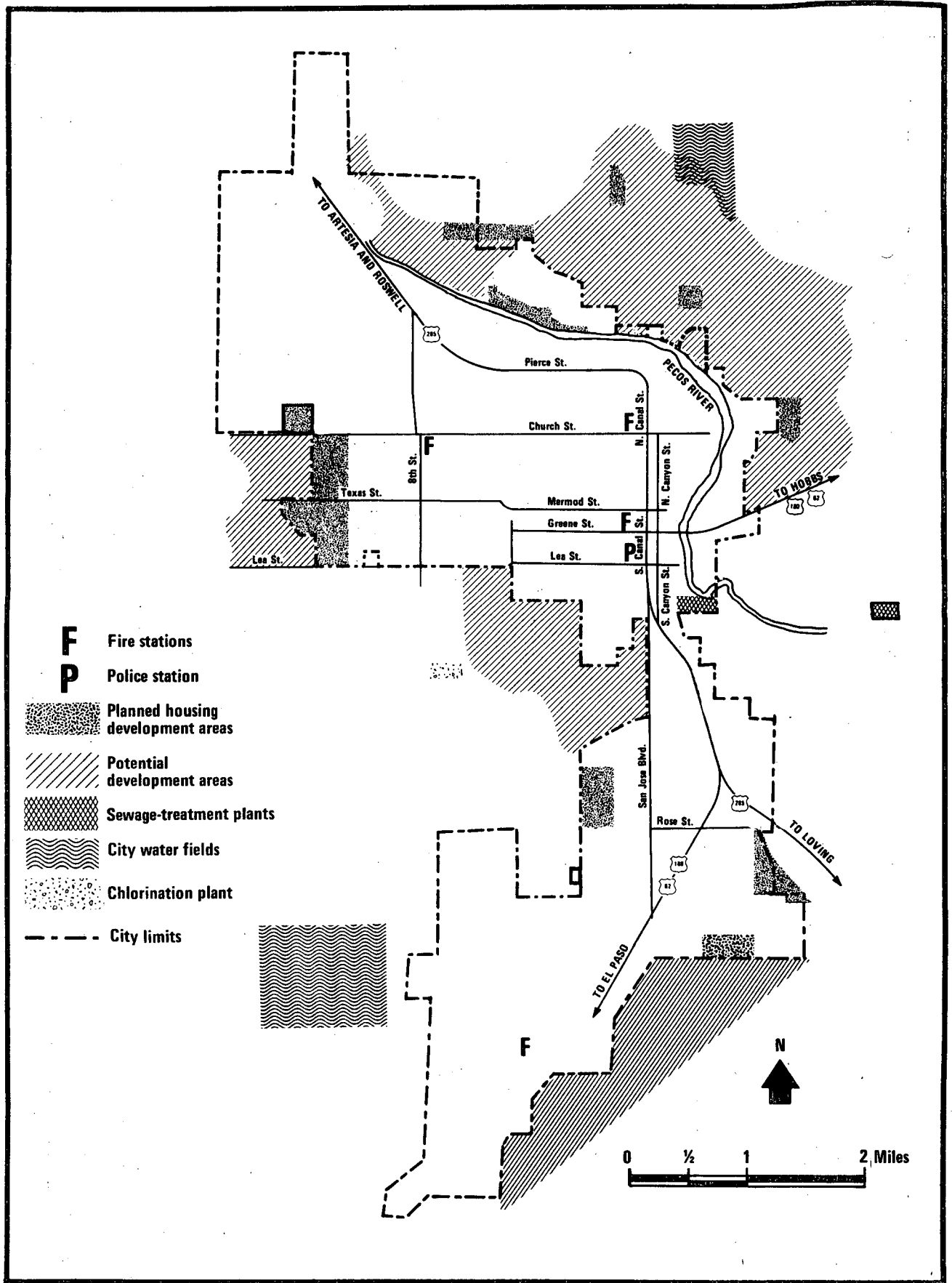

Figure H-7. Municipal facilities, water system and sewage-treatment plants, Carlsbad.

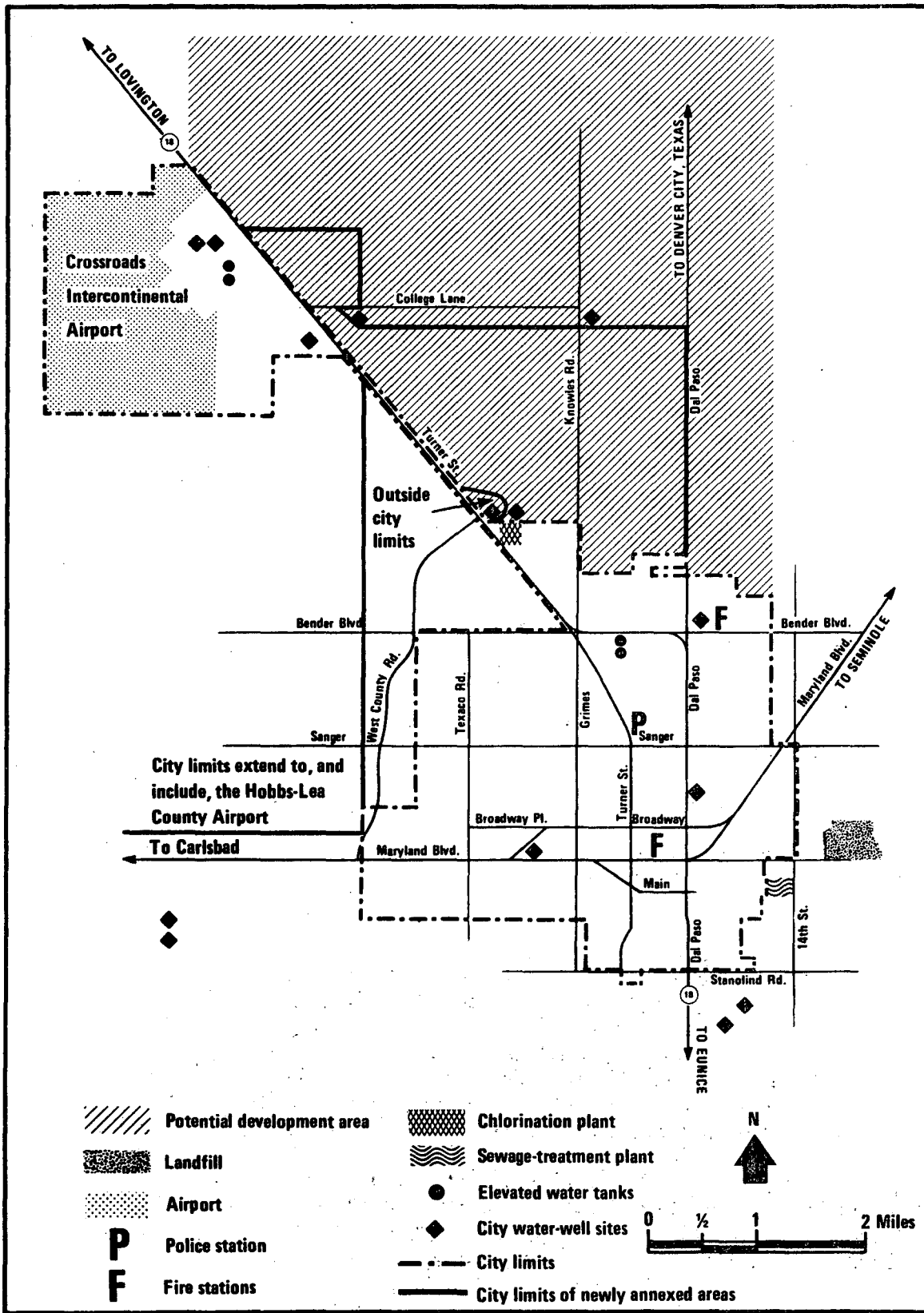

Figure H-8. Municipal facilities, water system, and sewage-treatment plant, Hobbs.

Loving. Loving currently obtains its water supply from four wells located about 7 miles from the community (Figure H-9). The village purchased the system in 1960 from a private firm. The system contains one 125,000-gallon and one 150,000-gallon storage tank. Water is also supplied to the community of Malaga, which is south of Loving (communication from Molzen-Corbin and Associates, Albuquerque, New Mexico, 1979).

The available water rights of 800 acre-feet per year are sufficient to meet the current and future needs of the community, considering its relatively slow growth.

The current average consumption is approximately 91 million gallons per year, or 258,000 gallons per day. The peak consumption of approximately 500,000 gallons per day exceeds the present system's delivery and storage capacity of 250,000 gallons per day (data from Molzen-Corbin and Associates, Albuquerque, New Mexico, 1979).

To meet the current water demand, the existing 6- and 8-inch pipeline is scheduled to be replaced by a 10-inch pipeline. In addition, a new 500,000-gallon storage facility is to be constructed at the well site. Bids for the water-system improvements were opened in October 1979.

Municipal wastewater systems*

Carlsbad. The Carlsbad municipal sewage-treatment plant, inadequate for current needs, is being expanded and upgraded, with construction expected to be completed by September 1981. On completion, the plant will have a design capacity adequate to serve 50,000 people. Effluent waste will be used to irrigate a 700-acre farm owned by the city.

Sewage-collection facilities provide service to the entire city (Figure H-7). Residential areas outside city limits use septic systems. About 25% to 30% of the developing areas in the vicinity of the city are currently not suited to the use of conventional percolation septic systems and must use the somewhat more expensive evapotranspiration septic systems.

Hobbs. The construction of a new municipal sewage-treatment plant is under way, with completion expected in early 1980. The new plant will have an initial capacity of 5 mgd and a capability to expand to 6 mgd.

There are also plans to expand and upgrade the main sewer lines in the city. Two of the three existing main trunk lines will be affected, with one being rebuilt and one being paralleled by a new bypass line. The completion of the project is expected early in 1980.

Since April 1, 1978, developing areas north of Hobbs (Figure H-8) have been restricted by the New Mexico Environmental Improvement Division to the use of evapotranspiration septic systems because of past problems with sewage from percolation systems seeping into local water supplies. The use of the

*Data obtained from the City of Carlsbad (1979), the City of Hobbs (1979), and the New Mexico Environmental Improvement Division (1978), unless otherwise stated.

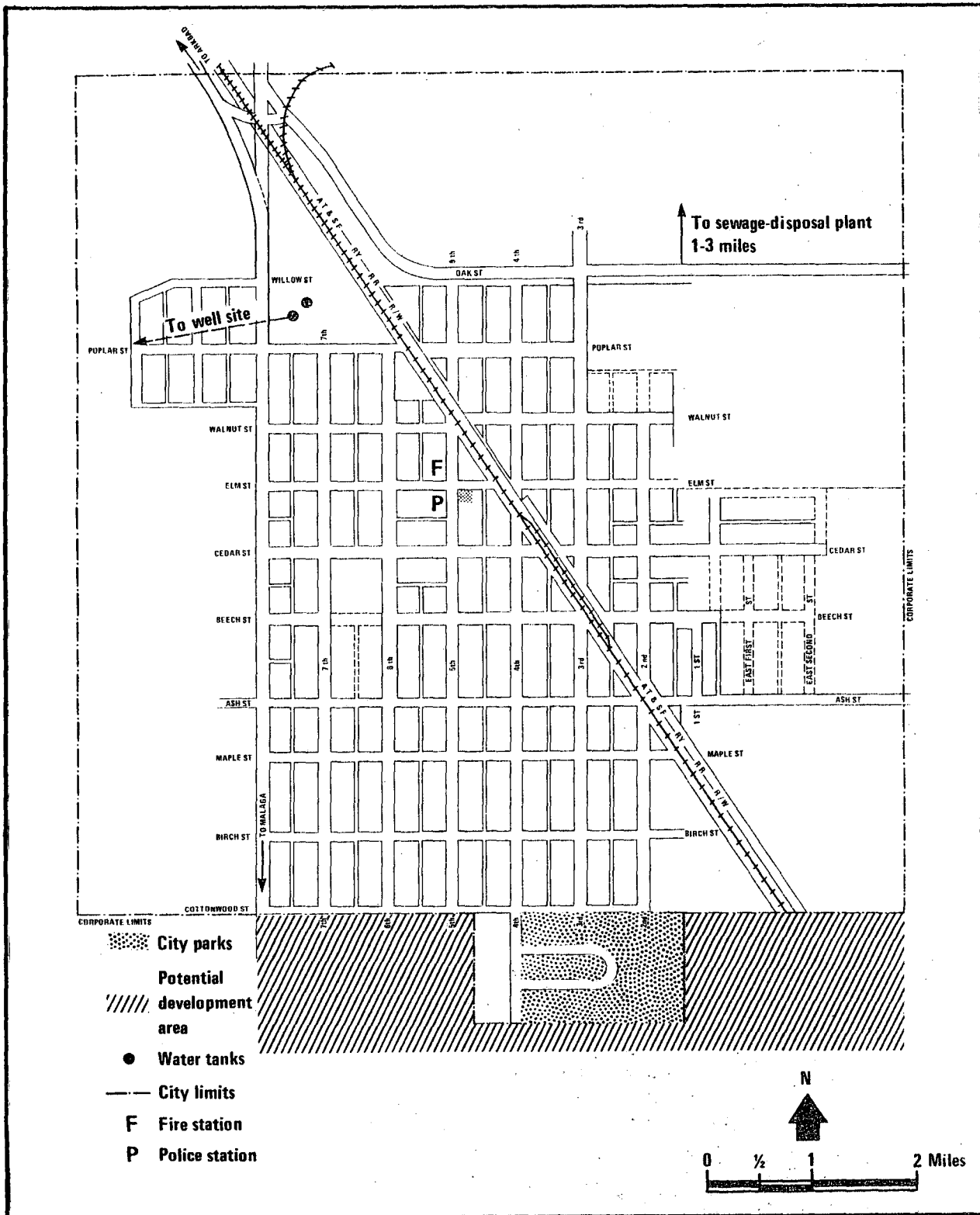

Figure H-9. Municipal facilities, water system, and sewage-treatment plants, Loving.

evapotranspiration systems is expected to prevent further problems with residential sewage in areas not connected to the Hobbs municipal sewage system.

Loving. The municipal sewage-treatment plant built in 1950 does not meet current effluent standards set by the New Mexico Water Quality Commission. Consequently, the village has received a Federal grant to construct a new treatment facility. At present, the appropriated funds (\$300,000) equal approximately 50% of the design and construction costs for an adequate plant. Loving is still seeking additional funding to start the project (information from Molzen-Corbin and Associates, Albuquerque, New Mexico, 1979).

The treatment plant now in use is a primary system and has a rated capacity of 0.15 mgd. According to the Southeastern New Mexico Economic Development District, it is experiencing a demand of 55% to 60%. The sewage facility serves approximately 1600 people (Adcock, 1979).

Sewage-collection facilities provide service to the majority of Loving's residents. The only exception is the extreme eastern section of Cedar Street (Figure H-9). Because this area's elevation is lower than that of the current system, a lift station would be required to provide collection services. The residents of the area now use individual septic tanks.

Electric service*

Carlsbad and Loving. Eddy County obtains electricity from the Southwestern Public Service Company. In April 1979, the area including Carlsbad, Loving, and the surrounding rural area contained 12,536 customers. Of this total, 11,247 were residential and 1289 were commercial or industrial customers. Although the residential customers were numerically the largest class of electricity users, they accounted for only 22% of electricity demand; the commercial, industrial, and miscellaneous customers accounted for the remaining 78%. Approximately 75% of the power is currently generated by natural-gas plants and 25% by coal-fired plants. Another coal-fired plant will become operational in June 1980, changing the ratio of power-generation sources to 65% for natural gas and 35% for coal. In addition, it is expected that one coal-fired plant will be completed in each of the years 1982 and 1984; the effect of the two additional coal-fired plants on the ratio of natural-gas to coal-fired generation cannot now be ascertained.

Hobbs. The New Mexico Electric Service Company supplies electricity to Hobbs. In September 1979, New Mexico Electric served 13,607 customers in the area within the Hobbs School District boundaries. Of this total, 11,548 were residential, 1747 were commercial, and 312 were industrial customers. Although the residential customers were numerically the largest class of electricity users, they accounted for only 16% of electricity demand; the commercial and industrial customers accounted for 15% and 69%, respectively, of electricity demand. The electricity is generated by a single natural-gas plant. The company is studying the feasibility of using coal, but no decision on a conversion has been made.

*Data obtained in 1979 from the Southwestern Public Service Company (Carlsbad and Loving) and the New Mexico Electric Service Company (Hobbs).

Natural-gas service*

Carlsbad. In January 1979, the Gas Company of New Mexico was supplying natural gas to 9816 customer accounts in the Carlsbad area (8845 residential, 856 commercial, 17 industrial, and 98 miscellaneous). The residential, commercial, industrial, and miscellaneous users accounted for 16%, 6%, 76%, and 2%, respectively, of the natural-gas demand in Carlsbad.

Hobbs. In January 1979, the Hobbs Gas Company was supplying natural gas to 10,712 customer accounts in the Hobbs area (9415 residential, 1245 commercial, 6 industrial, and 46 miscellaneous). The residential, commercial, industrial, and miscellaneous users accounted for 64%, 27%, 2%, and 7%, respectively, of the natural-gas demand in Hobbs.

Loving. In January 1979, the Gas Company of New Mexico was supplying natural gas to 453 customers in the Loving area (395 residential, 34 commercial, 1 industrial, and 23 miscellaneous). The residential, commercial, industrial, and miscellaneous users accounted for 56%, 7%, 28%, and 9%, respectively, of the natural-gas demand in Loving.

Fire protection**

Carlsbad and Eddy County. The Carlsbad Fire Department has 30 full-time employees, or about 1.04 per 1000 people, operating out of the main fire station and four substations (Figure H-7). Major equipment includes two 1500-gpm pumpers, one 1000-gpm pumper, three 750-gpm pumpers, and a dry-chemical truck at the airport. The primary service area for the department is the city, but occasional trips are made outside the city limits to assist the all-volunteer Eddy County Fire Department. These trips are made on the basis of a verbal mutual-aid agreement between the city and the county.

Hobbs and Lea County. The Hobbs Fire Department currently has 44 full-time employees, including two dispatchers, or about 1.35 per 1000 people. There are two fire stations (Figure H-8) and seven fire trucks. Approximately one-third of the department's calls are outside the city limits to assist the all-volunteer Lea County Fire Department.

Loving. The Loving Fire Department currently is an all-volunteer organization composed of 25 members. The department operates out of one station (Figure H-9) and is equipped with three pumpers and one emergency vehicle. The general service area for the department is the Village of Loving, but service to areas adjacent to the village limits is also provided.

Police protection**

Carlsbad and Eddy County. The Carlsbad Police Department has 48 full-time employees, or about 1.7 per 1000 people. The primary area served by the

*Data obtained in 1979 from the Gas Company of New Mexico (Carlsbad and Loving) and the Hobbs Gas Company.

**Data obtained in 1979 from the cities of Carlsbad, Hobbs, and Loving unless otherwise stated.

department is the city, but officers go outside the city limits to assist New Mexico State police or Eddy County Sheriff's officers on request. City police also have Eddy County Sheriff's commissions to facilitate their activities outside city limits.

The Eddy County Sheriff's office has about 23 full-time employees. In addition, as discussed above, the office can call on Carlsbad police officers for assistance if needed (data from the Eddy County Sheriff's Office, 1979).

Eddy County had a total of 89 officers (State Police, Sheriff's Office, and Police Department) in 1978, or 1.9 per 1000 people (Adcock, 1979).

Hobbs and Lea County. The Hobbs Police Department has 81 full-time employees, or about 2.5 per 1000 people. Moreover, Hobbs has developed a program (Operation Saturation) in which off-duty police officers use marked patrol cars. The effect of the program is to increase the apparent size of the department by making police officers visible, whether on or off duty. The police department serves the city primarily, with only occasional calls outside city limits.

The Lea County Sherriff's department has approximately 33 full-time employees. In addition, the department can call on Hobbs police officers for assistance if needed.

Lea County had 124 officers (State Police, Sheriff's Office, and Police Department) in 1978, or approximately 2 per 1000 people.

Loving. The Loving Police Department has two full-time employees and three vehicles. The department services the city, with only occasional calls outside the village limits.

Health care*

Carlsbad and Eddy County. The Guadalupe Medical Center in Carlsbad is the principal short-term hospital in Eddy County. It opened in late 1977 and has 134 beds. There is also the 34-bed Artesia General Hospital. On the basis of mid-1978 Eddy County population estimates, the 168-bed county total amounts to 3.5 per 1000 population. This is below the national average of 4.0 beds per 1000, but it is representative of the State of New Mexico's average of 3.5 per 1000. Nonetheless, the mid-1979 Guadalupe Medical Center occupancy rate of 65% is below the Federal standard of 80% proposed for all nonfederal, general, short-term hospitals (Bennett, 1977). Additional medical facilities available in the area are indicated in Table H-22.

There are 35 physicians in Eddy County, 30 of whom use the facilities of the Guadalupe Medical Center. Twenty-one of the county's physicians provide primary care, or about 0.5 per 1200 population. Although there are no generally accepted standards for primary care physician-to-population ratios, the Eddy County ratio of 0.5 is only half the suggested level of 1.0 per 1200 (Bennett, 1977). Eddy County was classified as a medically underserved area

*Data obtained in 1979 from the Guadalupe Medical Center (Carlsbad and Eddy County), the Lea Regional Medical Center (Hobbs and Lea County), the City of Carlsbad, and the Village of Loving, unless otherwise stated.

Table H-22. Area Medical Facilities^a

Facility	Carlsbad	Eddy County ^b	Hobbs	Lea County ^c
Short-term hospitals	1	2	1	2
Hospital beds (plus basinettes)	134 (18)	168 (NA)	180 (20)	203 (20)
Nursing homes	2	2	2	3
Intermediate-care facilities and home health agencies	NA ^d	3	NA	3
Clinics (including mental health)	NA	6	NA	4
Primary-care clinics	0	1	1	1
Pharmacies	14	17	8	18

^aData from the New Mexico Health Resources Registry, Guadalupe Medical Center, Lea Regional Medical Center, and Adcock (1979).

^bIncludes Carlsbad.

^cIncludes Hobbs.

^dNot available.

in 1976 by the Secretary of Health, Education, and Welfare for purposes of determining eligibility for Health Maintenance Organization funding (Bennett, 1977). In addition, there are 17 dentists in Eddy County (NMHRR, 1979).

Emergency medical services are provided by a Dallas, Texas, company that has a contract with the Guadalupe Medical Center. The emergency services operate a 24-hour emergency room staffed by three physicians, of whom one is always in attendance and specializes in emergency treatment.

Ambulance service is provided by the Carlsbad Fire Department. There are currently four vehicles in use, and a fifth has been ordered. Ambulance service normally covers an area within about 30 miles of the city. Each ambulance is staffed by two emergency medical technicians (EMTs). The Fire Department has three full-time EMTs on the staff, and 25 additional paid volunteer (part-time) EMTs are available.

Hobbs and Lea County. Lea County has two short-term hospitals: the Lea Regional Medical Center in Hobbs, with 180 beds, and the Community General Hospital in Jal, with 23 beds. Population estimates for mid-1978 show that Lea County has 3.6 hospital beds per 1000 population, which is less than the national average of 4.0 beds per 1000 and more than the New Mexico average of 3.5 per 1000. Nevertheless, the mid-1979 Lea Regional Medical Center occupancy rate of 65% is below the Federal standard of 80% proposed for all non-federal, general, short-term hospitals.

Additional medical facilities in Lea County (Table H-22) include five clinics, one of which, located in Hobbs, provides primary care. In addition, there are three nursing homes and three intermediate-care and home health agencies (NMHRR, 1978).

There are 33 physicians in Lea County, 25 of whom are located in Hobbs. Thirty of the physicians provide primary care, or 0.6 per 1200 people. This

ratio is considerably lower than the ratio suggested by Bennett (1977) of 1.0 per 1200. Partly as a result of this low ratio of primary-care physicians to the population, Lea County was classified as a medically underserved area in 1976 by the Secretary of Health, Education, and Welfare for purposes of determining eligibility for Health Maintenance Organization funding (Bennett, 1977). In addition, there are 12 dentists in Lea County (NMHRR, 1979).

Emergency medical services are provided by a Dallas, Texas, company that has a contract with the Lea Regional Medical Center. The emergency room is open 24 hours per day, with one physician who specializes in emergency treatment always in attendance.

Ambulance service is provided by the Hobbs Fire Department, which currently operates three ambulances. The ambulance service area extends to Lovington on the north, the county line on the west, into Texas on the east, and about 15 miles to the south of Hobbs. Each ambulance carries two EMTs on all calls. The Hobbs Fire Department employs 40 EMTs full time, which is to say that most fire-department personnel are qualified as EMTs. The department also employs one EMT instructor.

Loving. The community of Loving has only one medical facility, El Centro Rural de Salud. It opened in 1977 and has a staff of six. Federally funded, the health center specializes in primary medical care. Services at the clinic include prenatal care, family planning, counseling, and medical advice and referral.

Short-term hospitalization is available in Carlsbad at the Guadalupe Medical Center. Ambulance service is available from either the Loving or the Carlsbad Fire Department.

Traffic and transportation: regional

Pipeline transportation. According to information obtained in 1979 from the El Paso Natural Gas Company, a 12.75-inch natural-gas pipeline passes through the WIPP site about a mile north of its center, running in an east-west direction. This pipeline was built in the 1940s. Approximately 8 to 9 miles south of the site is a 26-inch El Paso Natural Gas line that also runs east-west.

Air transportation. The commercial airport nearest to the WIPP site is the Cavern City Air Terminal, about 30 miles to the west. To the east-north-east lies the Hobbs-Lea County Airport, about 35 miles away. There are no landing strips within 10 miles of the site. The site, however, is traversed by commercial air traffic between Carlsbad and Hobbs.

Highway transportation. Figure H-10 shows the average daily traffic flow in the environs of the site (the annual average daily traffic flow at selected control locations is shown in Figures H-11, H-12, and H-13). Data for the overall flow of vehicles indicate sufficient capacity for the highway: capacity ratings vary from 20 to 29 on a scale of 30 on the section of road between Carlsbad and Hobbs.

Portions of NM 31 and NM 128 lie within 10 miles of the site, and U.S. Highway 62-180 runs east to west about 10 miles north of the site. U.S. Highway 62-180, part of the Federal Aid Primary System, is a four-lane divided

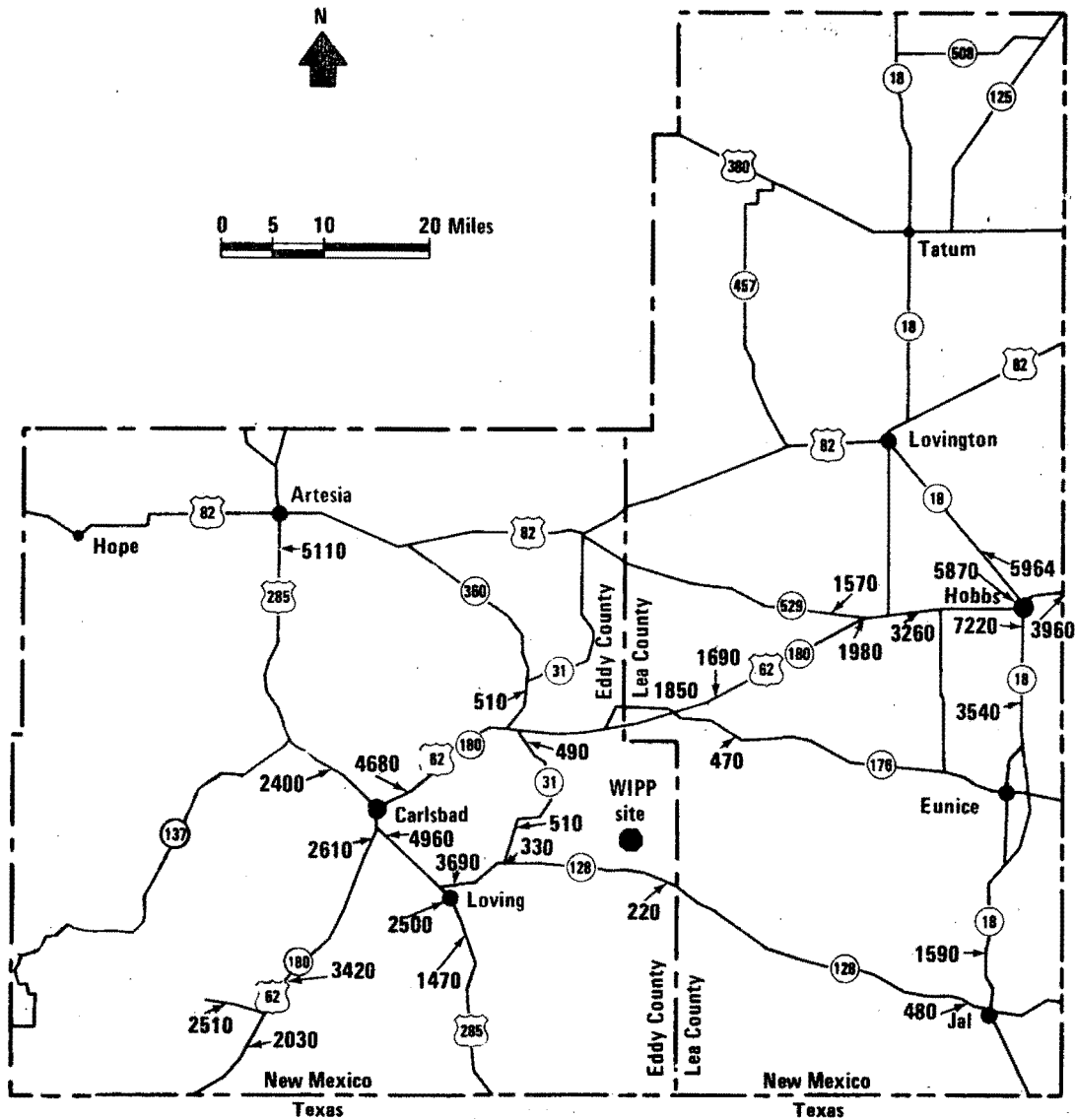

Figure H-10. Average daily traffic flow in the area of the WIPP site, 1978.

highway from Carlsbad to the Lea County line. For 17 miles east of the Lea County line, the highway has two lanes; for the rest of the distance into Hobbs, it is again a divided four-lane highway.

New Mexico 31, a two-lane road with a bituminous surface, runs north to south about 10 miles west of the site. There is little or no shoulder on certain portions of the highway. According to the New Mexico State Highway Department (1979), one section within 10 miles of the site has an overall pavement width of 18 feet and a total roadway width of 20 feet.

New Mexico 128, running east to west, traverses the southern portion of the 10-mile radius. This State-maintained two-lane bituminous-surface highway is part of the Rural Federal Aid Secondary System, as is NM 31. Pavement widths vary between 20 and 22 feet for sections within 10 miles of the

site, and the roadbed is at least 22 feet wide. From the intersection of NM 31 and NM 128 to the present access road to the site, the highway traverses several small salt lakes or ponds; here there is virtually no shoulder, and in some areas there is an abrupt drop of 2 to 3 feet from the paved surface level to the pond or lakebed level. Several inspection trips revealed a significant amount of maintenance along these areas on NM 128 and along similar areas on NM 31. Surface and safety ratings and Figures H-11 and H-12 show significant deficiencies along certain portions of NM 128 and 31. It is suspected that these low ratings are caused partially by the presence of certain low areas that collect salt water and turn into salt lakes or ponds (Adcock, 1979).

Railroad transportation. In the two-county area, two companies operate rail systems: the Atchison, Topeka and Santa Fe, and the Texas-New Mexico Railroad. The Atchison, Topeka and Santa Fe enters New Mexico from the south, running parallel to U.S. 285. It connects the communities of Loving, Carlsbad, and Artesia in Eddy County and proceeds north to connect with the Atchison, Topeka and Santa Fe main line at Clovis. Spur lines to the potash-mining area have also been constructed.

The spur line to the Duval Nash Draw mine offers the closest access to the WIPP site. The proposed extension of this spur will connect the site with the Atchison, Topeka and Santa Fe line. The Texas-New Mexico line enters at the southeast corner of Lea County and parallels NM 18, connecting the communities of Jal, Eunice, Hobbs, and Lovington. The line ends just north of Lovington.

Carlsbad transportation system

Current traffic-flow levels are well within the existing capacity of the street system. Inspection of the street system shows few unpaved streets within the city limits. The condition of the street system appears to be good and shows adequate maintenance.

Commercial air service is provided by three airlines: Air Midwest, Crown Aviation, and Permian Airways. Each airline company has two daily scheduled arrivals and departures. Commercial air service is provided for transportation between Carlsbad and Hobbs and Albuquerque, New Mexico, and Midland, Odessa, and El Paso, Texas.

The Santa Fe Railway provides the area with freight service. Piggyback service is available, and daily switching service is sustained.

Three interstate motor-freight carriers (Apex Freight Lines, Sun Freightways, and Sundance Transportation) serve Carlsbad. Each freight-carrier company has terminal facilities in Carlsbad.

Intrastate and interstate bus transportation is available through the New Mexico Transportation Company, Inc., an affiliate of Greyhound Bus Lines. A private carrier provides mass transportation to the commercial mining operations. Currently there are 28 round trips per day to the mining sites in the Carlsbad area. There are no public-transit facilities in Carlsbad other than a taxicab company that operates four vehicles (Adcock, 1979).

RD SECT ¹ LOC #	FLOW ² DIR	SECT ³ LENG	SURF ⁴ TYPE	WIDTH IN FEET		ADT ⁷	FDNT ⁸	CONDITION RATING			CAP ¹²	OVAL ¹³ RATG
				PAVT ⁵	RDWY ⁶			SUR ⁹	DR ¹⁰	SAF ¹¹		
1	N	7.7	Bit	20	22	663	10	11	09	02	27	56
2	N	8.7	Bit	20	20	250	10	11	07	01	29	63
3	N	3.4	Bit	18	20	272	10	10	05	02	29	60
4	N	2.9	Bit	24	28	487	10	09	10	02	29	60

Source: Ratings for Highway Improvements, Rural Federal-Aid Secondary System, 1976, New Mexico State Highway Department, Planning and Programming Division, in cooperation with U.S. Department of Transportation, Federal Highway Administration.

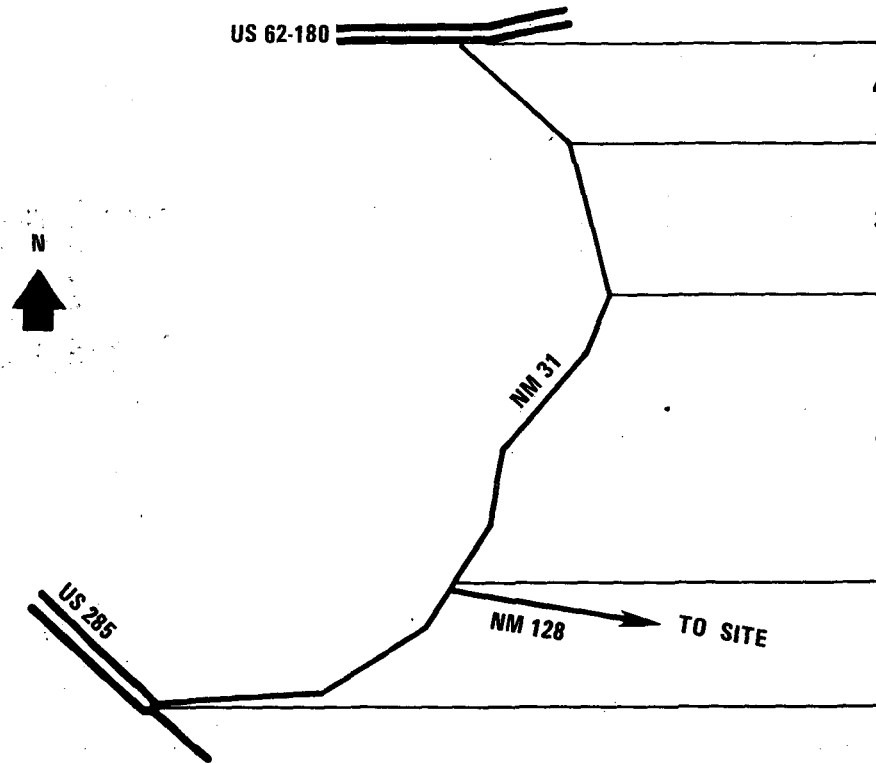

Figure H-11. Average daily traffic flow on NM 31, 1977. (See page H-56 for explanation.)

RD SECT ¹ LOC #	FLOW ² DIR	SECT ³ LENG	SURF ⁴ TYPE	WIDTH IN FEET		ADT ⁷	FDNT ⁸	CONDITION RATING			CAP ¹²	OVAL ¹³ RATG
				PAVT ⁵	RDWY ⁶			SUR ⁹	DR ¹⁰	SAF ¹¹		
1	E	9.1	Bit	20	22	237	10	10	06	01	29	62
2	E	9.8	Bit	22	22	168	10	12	07	02	29	68
3	E	9.5	Bit	22	22	271	10	11	06	02	29	62

Source: Ratings for Highway Improvements, Rural Federal-Aid Secondary System, 1976, New Mexico State Highway Department, Planning and Programming Division, in cooperation with U.S. Department of Transportation, Federal Highway Administration.

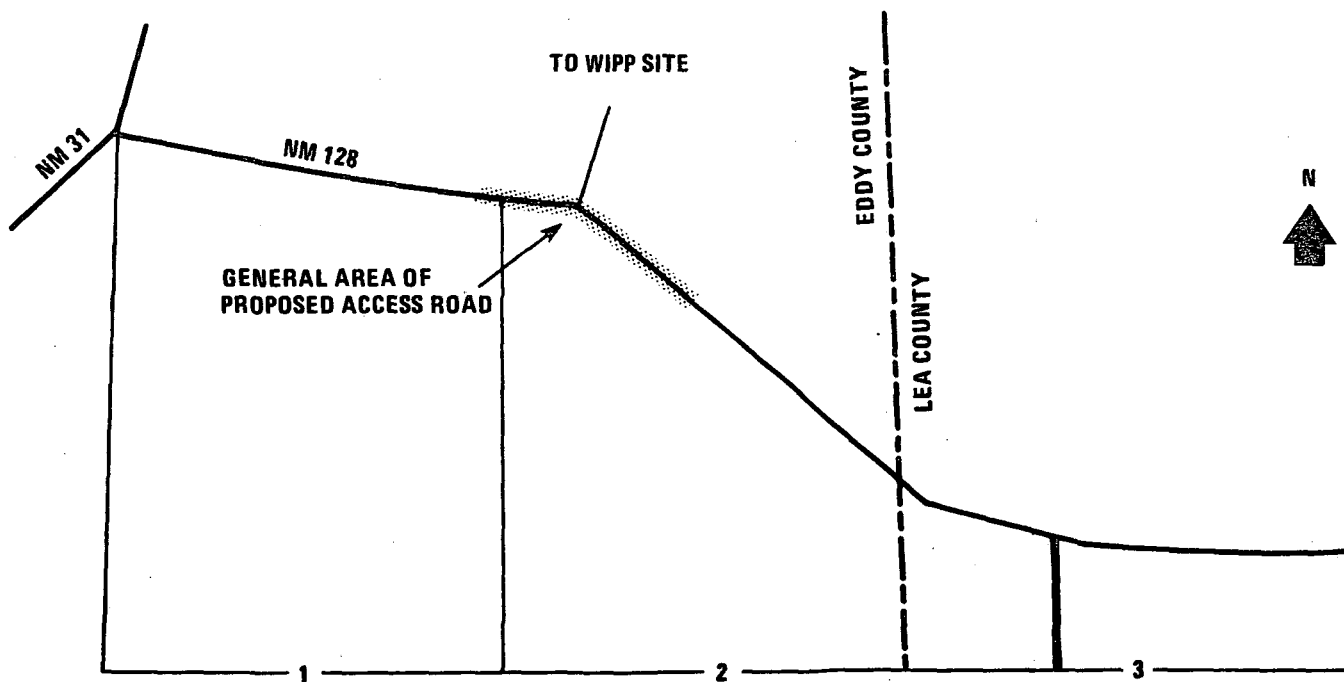

Figure H-12. Road conditions and traffic flow on NM 128, selected sections. (See page H-56 for explanation.)

RD SECT ¹ LOC #	FLOW ² DIR	SECT ³ LENG	SURF ⁴ TYPE	WIDTH IN FEET		ADT ⁷	FDNT ⁸	CONDITION RATING			CAP ¹²	OVAL ¹³ RATG
				PAVT ⁵	RDWY ⁶			SUR ⁹	DR ¹⁰	SAF ¹¹		
9	E	2.3	Bit	24	36	2,409	10	15	10	03	28	63
9	W	2.3	Bit	22	28	2,409	10	12	10	03	28	59
10	E	4.1	Bit	24	40	2,123	10	24	10	04	28	75
10	W	4.1	Bit	20	26	2,123	10	16	10	02	28	64
11	E	5.3	Bit	24	40	2,031	10	27	10	20	28	95
11	W	5.3	Bit	20	30	2,031	10	16	10	04	28	67
12	E	1.4	Bit	24	40	1,854	10	27	10	20	28	95
12	W	1.4	Bit	20	26	1,854	10	16	09	03	29	66
13	0	8.4	Bit	22	30	1,881	10	12	09	03	20	53

Source: Ratings for Highway Improvements, Rural Federal-Aid Primary System, Interstate System Included, 1977, New Mexico State Highway Department in cooperation with U.S. Department of Transportation, Federal Highway Administration.

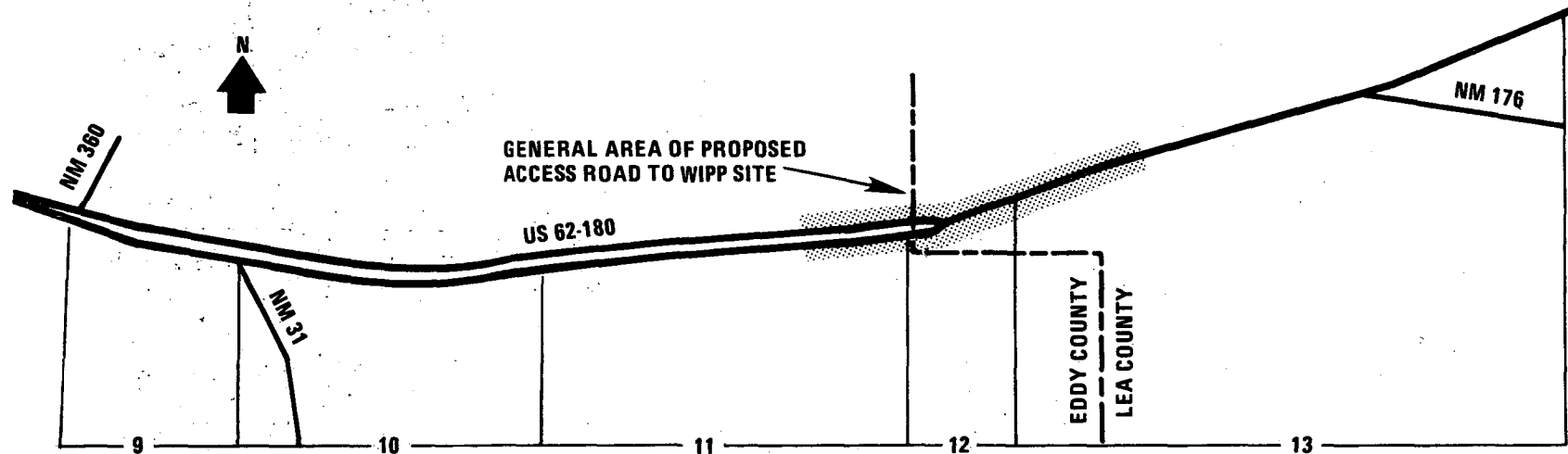

Figure H-13. Road conditions and traffic flow on US 62-180, selected sections. (See page H-56 for explanation.)

EXPLANATION OF TERMS FOR
Figures H-11, H-12, and H-13

1. RD SECT, LOC #: Number on route map identifying the subject location.
2. FLOW DIR: Traffic flow or direction. O - undivided highway; N - northbound; E - eastbound; W - westbound.
3. SECT LENG: Length of the rating section in miles and tenths.
4. SURF TYPE: Bit - bituminous.
5. WIDTH IN FEET/PAVT: Width of bituminous surface recorded in an even number of feet.
6. WIDTH IN FEET/RDWDY: The distance between outside shoulder lines.
7. ADT: Average daily traffic, the average number of vehicles passing a given point on the highway in a typical 24-hour period of up to 72 hours; count in both directions on the divided highways.
8. FDNT: Foundation rating - 10 points. Foundation can be rated only 10 for adequacy or 0 for inadequacy. A rating of 0 is given to sections if any of the following conditions exist: 1 - traveled way less than 18 feet wide; 2 - lack of adequate and uniform cross section, including side ditches; 3 - paved surface indicating failure that could not be corrected by the addition of a few inches of surface material.
9. SUR: Surface. The surface receives a rating on the scale of 0 to 30. If surface is in relatively good condition but showing first signs of deterioration, it receives a rating of 15. More advanced decay, while still in fair, usable condition, is rated between 10 and 15. Pavement in a condition justifying replacement is assigned a rating of 10. Increasingly poor conditions to the point of complete deterioration are rated 10 to 0.
10. DR: Drainage - 10 points. Lack or inadequacy of drainage facilities reduces the total of 10 points allotted for completely adequate drainage. The amount of reduction is proportional to the relative lengths of the deficient segment to the total rating section and the degree of the deficiency.
11. SAF: Safety - 20 points. The other conditions that are rated also involve features of safety; however, this rating is concerned with certain conditions as follows: 1 - stopping sight distance less than permitted by the design speed; 2 - horizontal curves sharper than permitted by the design speed; 3 - bridges narrower than the traveled way width; and 4 - dips.
12. CAP: Capacity. A rating between 0 and 30 is assigned to represent the capacity characteristic of the rating section. From a rating of 30, indicating full capability to carry the actual existing traffic load (ADT), to a rating of 0 to 10 indicating a deficient section, the decreasing numerical value indicates the increasing presence of significant factors contributing to the decline of the traffic-carrying capability of the roadway.
13. OVAL RATG: Overall rating. This overall condition rating is an adjusted indicator representing a weighted average of the previous five categories. The formula used to arrive at this adjusted rating from the total rating takes into account the average traffic volume for the system of which it is a part.

Hobbs transportation system

Current traffic-flow levels are well within the existing capacity of the street system. Inspection of the street system shows few unpaved streets within the city limits. The condition of the street system appears to be good and shows adequate maintenance.

The Hobbs area is served by the Hobbs-Lea County Airport, 3.2 miles west of Hobbs on a paved four-lane highway. The Federal Aviation Administration maintains a control tower and provides air and ground communications. The longest runway at this airport is 7400 feet. At present, three commercial carriers provide air service to Hobbs: Air Midwest, Crown Aviation, and Permian Airways. Air Midwest has six, Crown has three, and Permian has two daily arrivals and departures. These carriers give Hobbs connecting service with Albuquerque and Carlsbad, New Mexico and Lubbock, Midland, and El Paso, Texas.

Hobbs is served by the Texas-New Mexico Railroad, a subsidiary of the Texas and Pacific Railway. This railroad provides daily freight service to the Hobbs area and operates piggyback service from Lubbock, Texas.

Six interstate and intrastate motor-freight carriers serve the Hobbs area: APEX Freight Lines, C-B Motor Freight, Illinois-California Express, OEA Express, Texas and Pacific Motor Freight, and Yellow Freight Systems, Inc. In addition, several trucking firms provide specialized or custom hauling of heavy equipment. United Parcel Service serves the Hobbs area for the shipment of small packages and envelopes. Bus service is provided by Texas-New Mexico and Oklahoma Coaches, Inc., with nine arrivals and departures daily. There are no public-transit facilities in Hobbs other than two taxicab companies operating a total of five vehicles.

Loving transportation system

Traffic-flow levels within Loving are well within the existing capacity of the street system. According to information obtained in 1979 from the Village of Loving, no unpaved streets inside the corporate limits were left after the paving construction completed by the New Mexico State Highway Department in 1978. Traffic-flow statistics published by the New Mexico State Highway Department are only for urban areas with a population of 5000 or more. Therefore, no statistics for Loving are available to the public.

Air transportation for the city is available at the Cavern City Municipal Airport in Carlsbad.

The Santa Fe Railroad, which passes directly through Loving, offers piggyback services in Carlsbad for area residents. The New Mexico Transportation Company (Greyhound Bus Lines) provides six scheduled departures daily. Three of these proceed north to Carlsbad, while three continue south to Pecos, Texas. Motor-freight service is available in Carlsbad. Local bus or taxi service is not available.

Loving has no public-transit facilities. However, the Eddy County Community Action Corporation operates a low-income transportation service. The Carlsbad Association for Retarded Citizens Farm also provides transportation for its Loving clients.

Communications services and facilities

Information on communications services and facilities was obtained in 1979 from the General Telephone Company of the Southwest, which serves Carlsbad, Loving, and Hobbs.

Carlsbad. In September 1979, the General Telephone Company of the Southwest had 12,302 main stations in the Carlsbad area. Of this total, 10,069 were residential customers and 1811 were business customers. The remaining 422 main stations include mobile services, pay stations, rural services, and four-party business services.

Hobbs. In September 1979, 10,688 main stations were in service. Of this total, 7403 were residential customers, 3200 were business customers, and 85 were mobile business customers.

Loving. In September 1979, 539 main stations were in service, with 476 residential and 52 business customers. The remaining 11 main stations included four-party business, mobile services, and rural services.

Recreation

The State Comprehensive Outdoor Recreation Plan produced in 1976 lists a variety of popular activities in the two-county area. The 10 most popular activities, in decreasing order of popularity, are park visits, picnicking, attending sports events, bicycling, walking for pleasure, sightseeing, swimming in pools, fishing, tennis, and camping.

The many recreation facilities shown in Figure H-14 meet the demand for these activities. Primary among these facilities are the Lincoln National Forest in the Guadalupe Mountains, the Presidents' Park along the Pecos River in the City of Carlsbad, the Carlsbad Caverns National Park, the Living Desert State Park, and several small fishing lakes. New Mexico Highway 137, which enters the Lincoln National Forest, has been proposed as a scenic route.

Both Eddy and Lea Counties offer a variety of opportunities for hunting birds and game.

Recreation within 10 miles of the site consists mainly of scattered bird hunting on Bureau of Land Management property, recreational-vehicle driving, or trail-biking. The area within the 10-mile radius offers very few unique sightseeing attractions. Interviews with ranchers indicate that birdhunters frequent the area mainly for quail. Some target practice and rabbit hunting have been noted. However, none of these activities occur on a large scale or appear to be coordinated among the local inhabitants.

Regarding the future, there are plans for developing new recreational facilities and for expanding and improving existing facilities throughout Eddy and Lea Counties.

The communities of Carlsbad, Hobbs, and Loving have plans for developing, expanding, and improving their recreational facilities (parks, tennis courts, shooting ranges, etc.) under the auspices of the Heritage Conservation and Recreation Service Grants Program of the U.S. Department of the Interior.

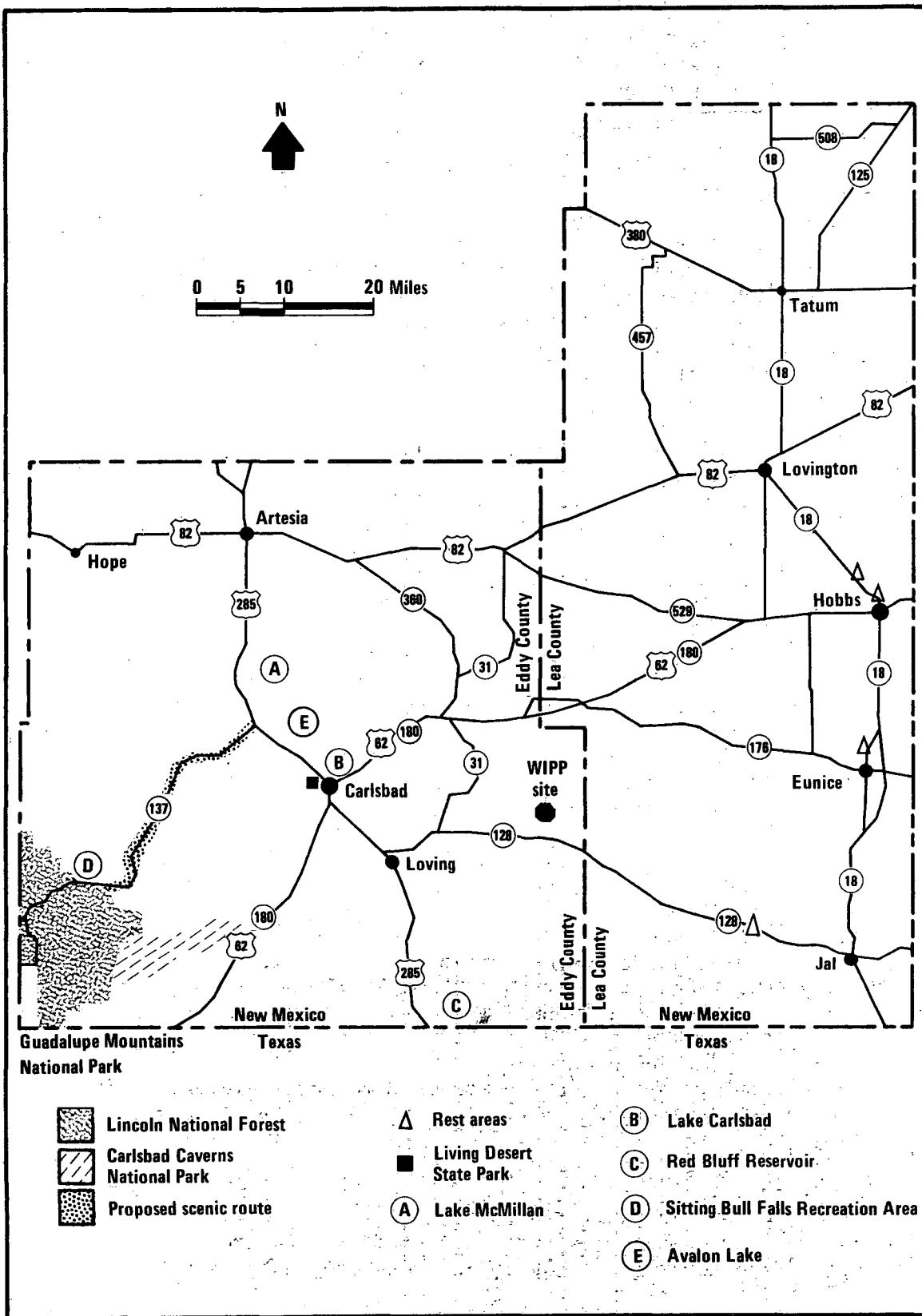

Figure H-14. Major recreational facilities in Lea and Eddy Counties.

Outside the communities, primary examples of projects with future development plans are the Living Desert State Park (State of New Mexico Parks and Recreation Department), Cottonwood Cave (U.S. Forest Service) and the McKittrick Hill Caves (Bureau of Land Management).

Carlsbad. The City of Carlsbad has numerous recreational facilities: more than 100 playing fields; 12 tennis courts; 2 golf courses; 1 dirt auto-race track; 1 bowling alley; 1 indoor and 1 outdoor movie theater; and 1 rollerskating rink. There are 17 municipal parks and 3 others just outside the city. Other main attractions within the city limits include the Carlsbad Municipal Museum and the complex of Lake Carlsbad and Presidents' Park. At Lake Carlsbad there is an overnight campground as well as many picnic tables. In addition, there is a senior citizens' recreation center. One KOA campground is within the city limits and one is 20 miles south, at the entrance to the Carlsbad Caverns National Park at White City (Adcock, 1979).

Hobbs. The recreational facilities include 28 tennis courts, 2 golf courses, 4 swimming pools, and 2 bowling alleys. There are 12 municipal parks, 16.5 acres of public picnic grounds, and a variety of playground equipment at the city parks. There are various ball parks throughout the city and an active Little League. In addition, the State of New Mexico is constructing a 120-acre state park at the Industrial Air Park just north of the city's center. Completion is expected in late 1983 or early 1984.

Just north of Hobbs, at Humble City, there is a dirt track for auto racing. To the south there is a motor cross track on the Kornegay Ranch. Each year in the Hobbs area there is a national soaring meet for sailplanes.

Other local recreational amenities include three fully enclosed handball courts and many outdoor courts. There are a gun club and target range with trap shooting nearby and several rodeo arenas (Adcock, 1979).

Loving. The recreational facilities available in the community of Loving are primarily located in the village's two parks. A small children's park containing a basketball court is located near the city hall. The larger Guevara Park and recreational complex is in the southern part of town. The park contains two baseball fields, a tennis court, a children's playground, and a community center and picnic area. Other local recreational facilities include the junior-high-school gymnasium and adjacent playing fields (Adcock, 1979).

Residents of Loving have access in Carlsbad to entertainment facilities like swimming pools, movie theaters, bowling alleys, golf courses, etc. (Adcock, 1979).

Solid-waste management

Data on solid-waste management were obtained in 1979 from the cities of Carlsbad, Hobbs, and Loving. A summary is presented in Table H-23.

Carlsbad. Solid-waste collection and disposal service for Carlsbad is provided by the city. The landfill site, northeast of the city (Figure H-7), is operated in conjunction with Eddy County, which excavates the disposal trenches. The landfill site is new and has an estimated life of 30 years.

Table H-23. Solid-Waste-Disposal Systems^a

Item	Carlsbad	Hobbs	Loving
COLLECTION			
Responsible agency	Municipal	Private	Municipal
Residential			
Frequency	Twice per week	Twice per week	Once per week
Monthly fee	\$3.00	\$3.00	\$2.00
Number of routes	7	4	1
Commercial			
Frequency	1-6 per week	1-6 per week	None
Monthly fee	Based on time to collect	Based on container size and frequency	
Number of routes	1	2	
Number of vehicles by age			
Two years or less	7	3	0
Three to five years	4	2	0
More than five years	3	3	1
SANITARY LANDFILL			
Responsible agency	Municipal and county	Private and county	Municipal and county
Type of landfill	Trench and area	Trench	Trench and area
Size of landfill	~50 acres	480 acres	50
Estimated remaining life	30 years	30 years	30 years
Pieces of equipment	1 ^b	2 ^b	1 ^b
Disposal fee	None	None	None
PERSONNEL			
Number of employees	45 ^b	25 ^b	2 ^b

^aData from the Carlsbad Sanitation Department (October 1979), Waste Control of New Mexico (Hobbs, October 1978), and the Village of Loving (October 1979).

^bFigures given do not include equipment or personnel provided by the county for excavation.

The city uses 14 garbage trucks, three of which are at least 5 years old, to cover one commercial and seven residential routes. The service area is defined by the city limits.

Hobbs. Solid-waste collection and disposal in Hobbs is provided by a private firm using eight vehicles to cover the four residential and two commercial routes in the city. The landfill site for Hobbs, located east of the city (Figure H-8), is operated in conjunction with Lea County. The 480-acre site has an estimated life of 30 years.

Loving. Solid-waste collection and disposal service for Loving is provided by the village. The landfill site, located northeast of Carlsbad, is operated in conjunction with Eddy County, which excavates the disposal trenches at the landfill site. The site is new and has an estimated life of 30 years.

Loving has one vehicle to provide this service to the area defined by the village limits shown in Figure H-9. The vehicle is more than 5 years old.

H.3.5 Local Government

Carlsbad. A mayor-council form of city government serves the City of Carlsbad. The mayor is elected for a 2-year term; the council members are elected for 4-year terms.

Revenues for Carlsbad were about \$10.4 million in fiscal year 1978-1979 (Table H-24).

About 64% of Carlsbad revenues came from intergovernmental transfers in 1978-1979, with State gross-receipts-tax distributions accounting for most of the State transfers. In fact, gross-receipts-tax revenues constitute the largest single source of revenues for the city, accounting for more than 22% of the 1978-1979 total. More than 52% of Carlsbad's own-source revenues came from utilities in 1978-1979. On the other hand, as in most New Mexico communities, property taxes contributed very little to total revenues, about 1% of general-fund revenues in 1978-1979 and an additional 1% to general-obligation-bond revenues for the year.

In 1978-1979, Carlsbad municipal expenditures were \$10.2 million (Table H-25). One-third of all spending in the most recent fiscal year was for personal services, 20% went to operating expenses, and 40% of the total spending was for capital improvements. Debt service accounted for 7% of the total expenditures.

The Constitution of the State of New Mexico limits the amount of general-obligation bonded debt that a municipality may incur without voter approval to 20 mills, or \$20 per \$1000 of assessed property value. On the basis of an assessed valuation at the start of the 1978-1979 fiscal year of \$47.2 million (NMDFA, 1979a), the general-obligation bonded-debt limit without voter approval for Carlsbad is \$944,000. As of June 30, 1979, Carlsbad had an outstanding general-obligation bonded debt in the amount of \$825,000 (NMDFA, 1979b).

There are no limits on the amount of bonded debt for bonds other than general-obligation bonds, although many debt issues require voter approval. The total debt outstanding for Carlsbad as of June 30, 1979, was \$6.7 million (NMDFA, 1979b).

Hobbs. Hobbs has a commission-manager form of government, with a five-member commission. Commission members are elected at large to 4-year overlapping terms. A mayor is elected from the commission for a term of 2 years. A professional city manager is hired by the commission.

Table H-24. Carlsbad Municipal Revenues for 1978-1979
(Thousands of Dollars)^a

Source of revenue	Actual revenues ^a	Revenues in constant 1979 dollars ^b
OWN-SOURCE REVENUES		
Taxes	<u>620</u>	<u>648</u>
Property	213	223
Franchise	213	223
Occupation	113	118
Lodgers	80	84
Charges and miscellaneous	<u>3,102</u>	<u>3,242</u>
Licenses, permits, and fees	72	75
Charges for services		
Utilities	1,941	2,028
Solid-waste disposal	377	394
Other	222	232
Fines and forfeits	118	124
Interest on investments	27	29
Sale of bonds	150	157
Miscellaneous	194	203
INTERGOVERNMENTAL TRANSFERS		
State	<u>2,679</u>	<u>2,800</u>
Gasoline tax	188	196
Cigarette tax	117	122
Gross-receipts tax	2,302	2,406
Fire-district allocation	30	32
Auto-license distribution	2	2
Grants	40	41
Federal	<u>942</u>	<u>985</u>
Revenue sharing	224	234
Grants	718	751
Transfers, n.e.c. ^c	<u>3,109</u>	<u>3,248</u>
Total	10,453	10,922

^aBased on the Carlsbad Budget Report, June 30, 1979, the Carlsbad Municipal Quarterly Cash Report, June 30, 1979, and the Carlsbad Municipal Quarterly Report, June 30, 1978. Because of the level of detail in the sources, it was necessary to estimate the values for some revenue categories. Detail may not equal total because of rounding.

^bActual revenues adjusted by the Gross National Product Price Index. Index values for third and fourth quarters estimated.

^cNot elsewhere classified. Source of these transfers not clear.

Table H-25. Carlsbad Municipal Expenditures for 1978-1979
(Thousands of Dollars)^a

Service function	Actual expenditures ^a	Expenditures in constant 1979 dollars ^b
General government	<u>1,946</u>	<u>2,033</u>
Personal services	338	354
Operating expense	375	392
Capital outlay	1,233	1,288
Public safety	<u>1,388</u>	<u>1,450</u>
Personal services	1,124	1,174
Operating expense	187	195
Capital outlay	77	80
Public works	<u>5,435</u>	<u>5,679</u>
Personal services	1,627	1,700
Operating expense	1,141	1,192
Capital outlay	2,667	2,786
Health and welfare	<u>31</u>	<u>32</u>
Personal services	29	31
Operating expense	1	1
Capital outlay	0	0
Recreation and culture	<u>689</u>	<u>720</u>
Personal services	326	341
Operating expense	287	300
Capital outlay	76	79
Debt service	<u>732</u>	<u>765</u>
General-obligation bonds	85	89
Revenue bonds	647	676
Total	10,221	10,680

^aBased on the Carlsbad Budget Report, June 30, 1979, the Carlsbad Municipal Quarterly Cash Report, June 30, 1979, and the Carlsbad Municipal Quarterly Report, June 30, 1978. Because of the level of detail in the sources, it was necessary to estimate the values of some expenditure items. Detail may not equal total because of rounding.

^bActual expenditures adjusted by the Gross National Product Price Index. Index values for third and fourth quarters estimated.

Hobbs municipal revenues were about \$13.5 million in 1978-1979 (Table H-26). Intergovernmental transfers accounted for about 52% of 1978-1979 revenues, mostly in the form of gross-receipts-tax distributions from State and Federal grants. Utility operations provided a second major source of revenues--19% of own-source revenues and 9% of total revenues. Property taxes, including those allocated to debt service, accounted for about 2% of revenues in 1978-1979.

Expenditures for Hobbs were \$13.5 million in 1978-1979 (details are given in Table H-27). Spending for personal services amounted to approximately 30% of the total spending for 1978-1979. During the same period operating expenses were about 19% of the total, and capital outlays were about 47%. Debt service required an additional 4%.

With an assessed valuation of \$58 million (NMDFA, 1979a), Hobbs has a debt limit of \$1.06 million on general-obligation bonds that may be issued without voter approval. The bonded debt may exceed the limit with voter approval.

The current (June 30, 1979) general-obligation bonded debt for the city is \$4.8 million. The total outstanding bonded debt as of June 30, 1979, was \$7.97 million (NMDFA, 1979b).

Loving. Loving has a mayor-council form of government. The mayor and the five council members are elected for 4-year terms.

Loving municipal revenues were \$278,500 in 1978-1979 (Table H-28). Utility fees were the largest single revenue source, contributing 35% of total revenues in 1978-1979. Local sources accounted for about 58% of total revenues, and intergovernmental transfers provided about 42%.

Expenditures for Loving were \$285,500 in 1978-1979, or about \$7000 more than revenues (Table H-29). Personal services and operating expenses each required about 30% of 1978-1979 expenditures, while capital outlays accounted for 32%. Debt service was 7% of spending for the year.

An assessed valuation of nearly \$1.1 million as of June 30, 1978, gave Loving a general-obligation debt limit of \$21,560. Loving has no outstanding general-obligation bonds. As of June 30, 1978, the city had \$102,000 in revenue bonds outstanding (NMDFA, 1979c).

Eddy County. Eddy County revenues for fiscal year 1978-1979 were \$5.2 million (Table H-30). In 1978-1979, 74% of the revenues were from county sources, with taxes on oil-and-gas production and equipment contributing 24% of total revenues. Property taxes accounted for about 17% of the total for the year.

Eddy County expenditures for 1978-1979 totaled \$4.1 million (Table H-31). General governmental functions and public works accounted for most of the spending in 1978-1979, with the former requiring more than 30% and the latter 41% of total county expenditures.

The assessed valuation of property in the county as of August 1, 1978, was \$455 million (NMDFA, 1979a). With the New Mexico limit on county general-obligation bonded debt of 4% of assessed valuation, Eddy County had a bonding limit of \$18.2 million. As of mid-1979, the county had no general-obligation bonds outstanding.

Table H-26. Hobbs Municipal Revenues for 1978-1979
(Thousands of Dollars)

Source of revenue	Actual revenues ^a	Revenues in constant 1979 dollars ^b
OWN-SOURCE REVENUES		
Taxes	<u>997</u>	<u>1,042</u>
Property	379	396
Franchise	257	269
Occupation	16	17
Gross receipts	321	336
Oil and gas	23	24
Charges and miscellaneous	<u>7,375</u>	<u>7,706</u>
Licenses, permits, and fees	41	43
Charges for services		
Utilities	1,629	1,702
Solid-waste disposal	619	647
Other	307	320
Fines and forfeits	190	198
Interest on investments	729	761
Sale of bonds	3,716	3,883
Miscellaneous	145	151
INTERGOVERNMENTAL TRANSFERS		
State	<u>4,704</u>	<u>4,916</u>
Gasoline tax	268	280
Cigarette tax	173	181
Gross-receipts tax	3,831	4,003
Fire-district allocation	24	25
Auto-license distribution	81	84
Grants	328	342
Federal	<u>4,561</u>	<u>4,765</u>
Revenue sharing	144	151
Grants	4,416	4,615
Transfers, n.e.c. ^c	<u>4</u>	<u>4</u>
Total	17,640	18,433

^aData from the Hobbs Municipal Report, June 30, 1979. Detail may not equal total because of rounding.

^bActual revenues adjusted by the Gross National Product Price Index. Index values for third and fourth quarters estimated.

^cNot elsewhere classified. Source of these transfers not clear.

Table H-27. Hobbs Municipal Expenditures for 1978-1979
(Thousands of Dollars)^a

Service function	Actual expenditures ^a	Expenditures in constant 1979 dollars ^b
General government	<u>1,644</u>	<u>1,718</u>
Personal services	602	629
Operating expense	670	700
Capital outlay	373	390
Public safety	<u>2,106</u>	<u>2,201</u>
Personal services	1,912	1,998
Operating expense	123	129
Capital outlay	71	74
Public works	<u>7,935</u>	<u>8,292</u>
Personal services	846	884
Operating expense	1,339	1,399
Capital outlay	5,751	6,009
Health and welfare	<u>540</u>	<u>564</u>
Personal services	164	171
Operating expense	334	349
Capital outlay	42	44
Recreation and culture	<u>765</u>	<u>799</u>
Personal services	486	508
Operating expense	132	138
Capital outlay	147	154
Debt service	<u>522</u>	<u>545</u>
General-obligation bonds	173	181
Revenue bonds	348	364
Total	13,512	14,120

^aData from the Hobbs Municipal Report, June 30, 1979. Detail may not equal total because of rounding.

^bActual expenditures adjusted by the Gross National Product Price Index. Index values for third and fourth quarters estimated.

Table H-28. Loving Municipal Revenues for 1978-1979
(Thousands of Dollars)^a

Source of revenue	Actual revenues ^a	Revenues in constant 1979 dollars ^b
OWN-SOURCE REVENUES		
Taxes	<u>16.7</u>	<u>17.4</u>
Property	2.6	2.7
Franchise	8.2	8.6
Occupation	1.8	1.8
Gross receipts (1/4%)	4.2	4.3
Charges and miscellaneous	<u>145.8</u>	<u>152.4</u>
Licenses, permits, and fees	1.3	1.4
Charges for services		
Utilities	98.3	102.7
Solid-waste disposal	14.6	15.2
Other	18.7	19.6
Fines and forfeits	9.5	9.9
Miscellaneous	3.4	3.5
INTERGOVERNMENTAL TRANSFERS		
State	<u>41.8</u>	<u>43.7</u>
Gasoline tax	5.0	5.2
Cigarette tax	2.8	3.0
Gross-receipts tax	16.6	17.3
Fire-district allocation	15.9	16.6
Grants	1.4	1.5
Federal	<u>16.3</u>	<u>17.0</u>
Revenue sharing	16.1	16.8
Grants	0.2	0.2
Local	<u>57.9</u>	<u>60.5</u>
Total	<u>278.5</u>	<u>291.0</u>

^aData from the Loving Municipal Report, June 30, 1979. Detail may not equal total because of rounding.

^bActual revenues adjusted by the Gross National Product Price Index. Index values for third and fourth quarters estimated.

Table H-29. Loving Municipal Expenditures for 1978-1979
(Thousands of Dollars)

Service function	Actual expenditures ^a	Expenditures in constant 1979 dollars ^b
General government	<u>32.1</u>	<u>33.5</u>
Personal services	11.6	12.2
Operating expense	20.2	21.1
Capital outlay	0.2	0.2
Public safety	<u>70.0</u>	<u>73.2</u>
Personal services	30.4	31.8
Operating expense	16.2	16.9
Capital outlay	22.6	23.6
Lease purchase payment	0.8	0.8
Public works	<u>148.7</u>	<u>155.4</u>
Personal services	40.5	42.3
Operating expense	45.4	47.4
Capital outlay	62.8	65.6
Health and welfare	<u>5.3</u>	<u>5.6</u>
Personal services	4.4	4.6
Operating expense	0	0
Capital outlay	0.9	1.0
Recreation and culture	<u>9.8</u>	<u>10.2</u>
Personal services	0.2	0.2
Operating expense	3.6	3.8
Capital outlay	6.0	6.2
Debt service	<u>19.7</u>	<u>20.6</u>
General-obligation bonds	0	0
Revenue bonds	<u>19.7</u>	<u>20.6</u>
Total	285.5	298.4

^aData from the Loving Municipal Quarterly Report, June 30, 1979. Detail may not equal total because of rounding.

^bActual expenditures adjusted by the Gross National Product Price Index. Index values for third and fourth quarters estimated.

Table H-30. Eddy County Revenues for 1978-1979
(Thousands of Dollars)

Source of revenue	Actual revenues ^a	Revenues in constant 1979 dollars ^b
OWN-SOURCE REVENUES		
Taxes	<u>2231</u>	<u>2331</u>
Property	910	951
Oil and gas	1259	1316
Lodgers	16	17
Special	45	47
Charges and miscellaneous	<u>1632</u>	<u>1706</u>
Licenses, permits, and fees	116	121
Charges for services	1	1
Fines and forfeits	1	1
Interest on investments	380	397
Payment in lieu of taxes	916	957
Miscellaneous	218	228
INTERGOVERNMENTAL TRANSFERS		
State	<u>557</u>	<u>582</u>
Gasoline tax	28	29
Cigarette tax	3	3
Motor-vehicle tax	429	448
Fire-district allotments	93	97
Miscellaneous	5	5
Federal	<u>802</u>	<u>838</u>
Revenue sharing	752	786
Taylor Grazing Act	44	46
Miscellaneous	6	6
Total	<u>5222</u>	<u>5457</u>

^aData from the Eddy County Treasurer's Financial Report for June 1979. Detail may not equal total because of rounding.

^bActual revenues adjusted by the Gross National Product Price Index. Index values for the third and fourth quarters estimated.

Table H-31. Eddy County Expenditures for 1978-1979
(Thousands of Dollars)

Service function	Actual expenditures ^a	Expenditures in constant 1979 dollars ^b
General government	<u>1270</u>	<u>1327</u>
Personal services	518	541
Operating expense	670	700
Capital outlay	83	86
Public safety	<u>713</u>	<u>745</u>
Personal services	360	377
Operating expense	252	263
Capital outlay	100	105
Public works	<u>1671</u>	<u>1746</u>
Personal services	717	750
Operating expense	687	718
Capital outlay	267	279
Health and welfare	<u>349</u>	<u>365</u>
Personal services	16	16
Operating expense	316	330
Capital outlay	18	19
Recreation and culture	<u>96</u>	<u>100</u>
Personal services	0	0
Operating expense	51	54
Capital outlay	44	46
Total	4099	4284

^aEddy County Budget Report for month ending June 30, 1979. Detail may not equal total because of rounding.

^bAnnual expenditures adjusted by the Gross National Product Price Index. Index values for third and fourth quarters estimated.

Lea County. Lea County revenues in fiscal year 1978-1979 were \$5.5 million (Table H-32). At \$1.9 million, oil-and-gas production and equipment taxes provided 35% of county revenues in 1978-1979. Property taxes contributed an additional 16%. Overall, county sources accounted for 73% of total revenues.

Expenditures for 1978-1979 were \$4.2 million (Table H-33). Spending on public works accounted for 45% of county expenditures in 1978-1979, and general government functions required 30%.

The total assessed valuation of property in Lea County as of August 1, 1978, was \$596 million. The general-obligation-bonded debt limit (4% of assessed valuation) was \$23.8 million in mid-1978. Lea County has no outstanding general-obligation bonds.

Table H-32. Lea County Revenues for 1978-1979
(Thousands of Dollars)

Source of revenue	Actual revenues ^a	Revenues in constant 1979 dollars ^b
OWN-SOURCE REVENUES		
Taxes	<u>2810</u>	<u>2937</u>
Property	889	929
Oil and gas	1921	2007
Charges and miscellaneous	<u>1233</u>	<u>1289</u>
Licenses, permits, and fees	110	115
Charges for services	100	104
Fines and forfeits	25	26
Interest on investments	639	667
Payment in lieu of taxes	307	321
Miscellaneous	53	56
INTERGOVERNMENTAL TRANSFERS		
State	<u>518</u>	<u>542</u>
Gasoline tax	10	11
Motor-vehicle tax	484	506
Cigarette tax	2	2
Fire-district allotments	22	24
Federal	<u>980</u>	<u>1024</u>
Revenue sharing	625	653
Taylor Grazing Act	21	22
Grants	<u>334</u>	<u>350</u>
Total	5542	5791

^aData from the Lea County Budget Officers Report (Detail of Receipts), June 29, 1979. Detail may not equal total because of rounding.

^bActual revenues adjusted by the Gross National Product Price Index. Index values for the third and fourth quarters estimated.

Table H-33. Lea County Expenditures for 1978-1979
(Thousands of Dollars)

Service function	Actual expenditures ^a	Expenditures in constant 1979 dollars ^b
General government	<u>1,293</u>	<u>1,351</u>
Personal services	487	509
Operating expense	398	416
Capital outlay	407	425
Public safety	<u>674</u>	<u>704</u>
Personal services	405	423
Operating expense	161	168
Capital outlay	108	112
Public works	<u>1,895</u>	<u>1,980</u>
Personal services	724	756
Operating expense	648	677
Capital outlay	523	547
Health and welfare	<u>372</u>	<u>388</u>
Personal services	46	48
Operating expense	201	210
Capital outlay	125	130
Recreation and culture	<u>10</u>	<u>10</u>
Personal services	0	0
Operating expense	10	10
Capital outlay	0	0
Total	4,243	4,433

^aData from the Lea County Budget Officers Report, June 30, 1979. Detail may not equal total because of rounding.

^bActual expenditures adjusted by the Gross National Product Price Index. Index values for third and fourth quarters estimated.

School-district finances

Carlsbad. Carlsbad School District C, which encompasses most of southern Eddy County, had total revenues of \$23.1 million in 1978-1979 (Table H-34). Some 42% of total resources were allocated to the operational fund. State sources provided 77% of operational fund income; local sources provided 22%. The largest single source of income for the year was a bond sale, which yielded \$9.23 million, or nearly 40% of receipts for 1978-1979.

District expenditures totaled \$15.2 million in 1978-1979, about \$8 million less than income (Tables H-34 and H-35). Operational expenditures accounted for 68% of total spending, with direct-instruction costs contributing the largest single share (34%).

The total assessed valuation of property in the district in 1977 was \$214 million, up 17% from the previous year. A total school-district tax rate of \$10.925 per \$1000 of assessed valuation was in effect during both 1976-1977 and 1977-1978. In 1978-1979 the tax rate was \$17.509 (NMPSFD, 1978).

Hobbs. Hobbs School District 16, which includes much of central Lea County, had a 1978-1979 income of \$12.6 million (Table H-34). About 85% of the total district income went to the operational fund. State sources provided more than 82% of operational-fund revenues, while local sources provided 17%.

A total of \$12.7 million was spent by the district in 1978-1979 (Table H-35). Of this total, \$10.6 million, or 84%, were operational expenditures, chiefly for direct instruction.

The property in the district had a total assessed value of \$164 million in 1977, an increase of 9.5% over the previous year. The district tax rate for 1978-1979 was \$11.580 per \$1000 of assessed valuation, down from \$11.780 for the previous year (NMPSFD, 1978).

Loving. Loving School District 10, which runs in a narrow band from Loving to the Eddy and Lea County line, had total revenues of \$752,000 in 1978-1979 (Table H-34). Operational-fund revenues accounted for 74% of the total. State sources, primarily from property-tax equalization, provided 69% of operational fund revenues, while local sources provided 30%.

District expenditures amounted to \$785,000 in 1978-1979 (Table H-35). Operational-fund expenditures accounted for nearly 80% of total spending, while special projects accounted for the remaining expenditures.

The total assessed valuation of property in the Loving district in mid-1977 was \$6.6 million, up 3.4% from the previous year. The district tax levy in effect for the 1978-1979 school year was \$10.925 per \$1000 of assessed valuation, the same tax rate as that for the previous 2 years (NMPSFD, 1978).

Table H-34. School District Revenues for 1978-1979
(Thousands of Dollars)

Source of revenue	Actual revenues ^a			Revenues in constant 1979 dollars ^b		
	Carlsbad	Hobbs	Loving	Carlsbad	Hobbs	Loving
Operational fund	9,706	10,621	553	10,142	11,098	578
Local sources						
District school-						
tax levy	1,988	1,623	146	2,077	1,695	153
Other	105	203	20	110	212	21
State sources						
State equalization	6,951	8,392	350	7,263	8,769	366
Transportation	372	275	25	389	287	26
Other	158	84	5	165	87	5
Federal sources						
Public Law 874	146	0	3	153	0	3
Other	34	43	4	36	44	4
Abatements	(42)	(3)	0	(44)	(3)	0
Debt service funds	1,220	457	(c)	1,275	478	(c)
Interest fund	453	56	(c)	474	58	(c)
Principal fund	767	401	(c)	801	419	(c)
Building funds	9,726	21	0	10,163	22	0
Sale of bonds	9,230	0		9,645	0	
Earnings from						
investments	494	20		516	21	
Other	2	(c)		2	(c)	
Federal-projects fund	754	326	103	788	341	108
Capital-improvement fund	467	76	42	488	79	44
Activity and cafeteria						
funds	1,026	1,052	54	1,072	1,099	56
Other funds	243	0	0	254	0	0
Total	23,142	12,553	752	24,182	13,117	786

^aData from the "Monthly Cash Report" and the "Monthly Activity Report," 1978-1979, for the Carlsbad, Hobbs, and Loving School Districts. Detail may not equal total because of rounding.

^bActual revenues adjusted by the Gross National Product Price Index. Index values for the third and fourth quarters estimated.

^cLess than \$500.

Table H-35. School District Expenditures for 1978-1979
(Thousands of Dollars)

Expenditures	Actual expenditures ^a			Expenditures in constant 1979 dollars ^b		
	Carlsbad	Hobbs	Loving	Carlsbad	Hobbs	Loving
Administration	327	309	37	342	323	38
Direct instruction	5,163	5,873	307	5,395	6,137	321
Instructional support	1,349	1,140	82	1,409	1,192	85
Health services	76	47	4	79	50	4
Pupil transportation	402	273	25	420	285	26
Operation of plant	815	930	50	851	972	52
Maintenance of plant	357	316	8	373	330	9
Fixed charges	1,319	1,237	78	1,378	1,292	82
Food services	8	0	0	8	0	0
Noninstructional support	172	71	4	180	74	5
Community services	34	57	17	35	60	18
Capital outlay	179	339	15	187	352	16
Special projects	<u>47</u>	<u>23</u>	<u>0</u>	<u>49</u>	<u>24</u>	<u>0</u>
Subtotal	10,247	10,613	627	10,707	11,090	655
Building fund	2,223	62	0	2,323	65	0
Debt service	252	572	0	263	598	0
Special projects	<u>2,445</u>	<u>1,447</u>	<u>158</u>	<u>2,555</u>	<u>1,512</u>	<u>165</u>
Total	15,168	12,695	785	15,849	13,266	820

^aData from the "Monthly Budget Report," 1978-1979, for the Carlsbad, Hobbs, and Loving School Districts. Detail may not equal total because of rounding.

^bActual expenditures adjusted by the Gross National Product Price Index. Values for the third and fourth quarters estimated.

H.4 METEOROLOGY

H.4.1 Regional Climate

The information used to evaluate the climate of the region surrounding the WIPP site consisted of Climatological Data summaries for recording stations in New Mexico, Local Climatological Data summaries for Roswell, New Mexico, and wind summaries for Lubbock, Midland-Odessa, and El Paso, Texas. The climatological data were obtained from the National Climatic Center of the National Oceanic and Atmospheric Administration. Precipitation and temperature summaries from stations at Carlsbad, the Duval potash mine, Jal, Pearl, and Ochoa were also included because of their proximity to the WIPP site. The Local Climatological Data summaries provided extreme and normal values of the meteorological parameters (for the period of record at the Roswell Municipal Airport and more recent data from the Roswell Industrial Air Center) that were used to characterize the regional climate.

General climate

The climate of the region is semiarid, with generally mild temperatures, low precipitation and humidity, and a high evaporation rate. Winds are most commonly from the southeast and moderate. During the winter, the weather is dominated by a high-pressure system often situated in the central portion of the Western United States and a low-pressure system commonly located in north-central Mexico. During the summer, the region is affected by a low-pressure system normally situated over Arizona. The regional climate is significantly affected by these large-scale pressure systems and their seasonal variations (EDS, 1968; Baldwin, 1973; NOAA, 1974).

The region, meteorologically referred to in New Mexico as the Southeastern Plains, is an area of over 30,000 square miles that marks the western extremity of the Great Plains, which end at the Sacramento and Guadalupe Mountains 40 to 60 miles west of the site. It is bounded on the east and south by an erosional escarpment in central Texas. Elevations range from less than 3000 feet in the south and east to more than 4000 feet in the north, with the down-slope to the east and south averaging 600 feet per 100 miles. The terrain is characterized by gently rolling hills of moderate relief, dissected by many small stream valleys.

Moderate temperatures are typical throughout the year, although seasonal changes are distinct. Mean annual temperatures in southeastern New Mexico are near 60°F (Eagleman, 1976). Temperatures in December through February show a large diurnal variation, averaging 36°F at Roswell (the nearest National Weather Service station with appropriate data and an adequate period of record). Although on approximately 75% of winter days morning temperatures are below freezing, afternoon maximum temperatures average well up in the fifties, and afternoon winter temperatures of 70°F or more are not uncommon. Night-time lows average near 23°F, occasionally dipping as low as 14°F. There are perhaps only 2 or 3 winter days when the temperature fails to rise above freezing. The lowest recorded temperature at Roswell was -29°F, in February 1905. During June through August, the temperature is above 90°F approximately 75% of the days, with readings of 100°F or higher occurring on a number of afternoons. However, even the hottest month, July, with average daily

temperatures in the upper seventies, will have morning lows below 68°F. The highest recorded temperature at Roswell was 110°F, in July 1958 (NOAA, 1974).

Precipitation in the region is light and unevenly distributed through the year, averaging 11 to 13 inches (Table H-36) (NOAA, 1972-1976). Winter is the season of least precipitation, averaging less than 0.6 inch of rainfall per month. Snow averages about 5 inches per year (Baldwin, 1973) and seldom remains on the ground for more than a day at a time because of the typically above-freezing temperatures in the afternoon. Approximately half the annual precipitation comes from frequent thunderstorms in June through September. Rains are usually brief but occasionally intense when moisture from the Gulf of Mexico spreads over the region. The minimum annual precipitation measured during the last 40 years at Roswell was 4.35 inches, in 1956; the maximum recorded was 32.92 inches, in 1941. The maximum monthly precipitation was 9.56 inches, in August 1916; the maximum 24-hour rainfall was 5.65 inches, in November 1901 (NOAA, 1974).

Prevailing winds are from the south. The normal mean wind speed at Roswell is 9.6 mph (see Table H-37) (NOAA, 1974).

Heavy precipitation

The maximum cumulative rainfall (Jennings, 1963) at Roswell is shown in Table H-38; the maximum 24-hour rainfall was 5.65 inches, in October 1901. The maximum 24-hour snowfall in Roswell was 15.3 inches, in December 1960. The greatest snow accumulation over a 1-month period was 23.3 inches, in February 1905 (NOAA, 1974).

Thunderstorms and hail

The region experiences about 33 thunderstorm days annually, with about 80% occurring from May to September (NOAA, 1978). A thunderstorm day is recorded if thunder is heard; the record is not related to observations of rain or lightning and does not indicate the severity of the storms experienced in the region.

Hail is most likely in April through June and is not likely to develop more than three times a year. During a 39-year period at Roswell, hail was observed 97 times (about 2.5 times per year), occurring nearly two-thirds of the time between April and June (U.S. Army, 1958). For the 1-degree square surrounding the WIPP site (32° to 33° N by 103° to 104° W) hailstones 0.75 inch or larger were reported eight times from 1955 to 1967 (slightly less than once per year) and windstorms with speeds of 50 knots or higher occurred 10 times--approximately one per year (Pautz, 1969).

Tornadoes

For the period 1916-1958, 75 tornadoes were reported in New Mexico on 58 tornado days (Wolford, 1960). Data for 1956 through 1974 indicate a state-wide total of 191 tornadoes on 141 tornado days (NOAA, 1975), or an average of 10 tornadoes per year on 7 tornado days. The greatest number of tornadoes in 1 year was 18; the least was 2. Most tornadoes occur in May and June (Pautz, 1969). From 1955 through 1967, 15 tornadoes were reported in the 1-degree square containing the site (Markee et al., 1974).

Table H-36. Precipitation Rates for Southeastern New Mexico^a

Station and distance from WIPP (mi)	Elevation above MSL (ft)	Precipitation (inches)												Ann.	1972	1973	1974	1975	1976
		Jan.	Feb.	Mar.	Apr.	May	June	July	Aug.	Sep.	Oct.	Nov.	Dec.						
Carlsbad, 25	3,120	0.37 (0.45)	0.78 (0.30)	0.24 (0.51)	0.07 (0.48)	1.07 (1.51)	1.31 (1.44)	2.46 (1.62)	1.54 (1.76)	4.51 (1.61)	1.94 (1.47)	0.38 (0.35)	0.28 (0.41)	14.96 (11.91)	18.74	11.47	23.11	10.22	11.26
Duval potash mine ^b 12	3,520	0.53	0.67	0.37	0.33	1.24	0.50	3.11	1.79	4.29	1.92	0.46	0.24	15.46	17.31	11.91	19.49	13.92	14.69
Jal, 31	3,149	0.43 (0.51)	0.53 (0.30)	0.36 (0.48)	0.51 (0.65)	1.23 (1.52)	1.15 (1.31)	2.40 (1.63)	1.72 (1.60)	2.88 (1.48)	1.33 (1.39)	0.28 (0.74)	0.14 (0.42)	12.96 (11.67)	8.16	9.83	20.57	13.68	12.56
Pearl, 25	3,799	0.35 (0.40)	0.69 (0.34)	0.32 (0.52)	0.32 (0.64)	2.01 (1.79)	2.19 (1.68)	3.74 (2.11)	2.08 (1.95)	3.81 (1.80)	1.50 (1.31)	0.39 (0.33)	0.20 (0.43)	17.54 (13.32)	17.92	11.62	22.10	24.68	11.87
Ochoa, 22	3,458	0.53 (0.49)	0.55 (0.30)	0.31 (0.51)	0.24 (0.63)	1.15 (1.38)	0.89 (1.35)	2.25 (1.48)	2.18 (1.19)	3.16 (1.53)	0.96 (1.24)	0.25 (0.40)	0.13 (0.32)	12.74 (11.17)	8.86	9.43	19.14	11.65	14.64

^aMonthly and annual average precipitation for the years 1971-1976, and normal precipitation (shown in parentheses; based on period 1941-1970) for stations in southeastern New Mexico.

^bNormal values not available.

Table H-37. Normal Mean Wind Speeds for Roswell, New Mexico, 1941-1970

Month	Mean wind speed (mph)	Month	Mean wind speed (mph)
January	8.4	July	9.4
February	9.8	August	8.4
March	11.5	September	8.3
April	11.8	October	8.2
May	11.4	November	8.5
June	10.8	December	8.4

Table H-38. Maximum Cumulative Rainfall at Roswell, New Mexico, for Various Time Periods^a

	5 min	Maximum cumulative rainfall (inches)			60 min
		10 min	15 min	30 min	
Roswell	0.55	1.01	1.34	1.71	2.22
Date	6/6/30	6/6/30	5/12/50	5/12/50	9/14/23
	<u>2 hr</u>	<u>3 hr</u>	<u>6 hr</u>	<u>12 hr</u>	<u>24 hr</u>
Roswell	2.88	3.38	4.82	5.19	5.65
Date	9/16/23	8/8/16	8/7/16	8/7/16	10/31/01

^aPeriod of record 1905-1961, except for the 24-hour rainfall, for which the period of record is 1895-1961.

Thom (1963) has developed a procedure for estimating the probability of a tornado's striking a given point. The method uses a mean tornado path length and width and a site-specific frequency. Applying Thom's method to the WIPP site yields a point probability of 0.00081 on an annual basis, or a recurrence interval of 1235 years. An analysis by Fujita (1978) yields a point tornado-recurrence interval of 2832 years in the Pecos River valley.

According to Fujita (1978), the design-basis tornado with a million-year return period has a maximum wind speed of 183 mph, a rotational speed of 146 mph, a maximum translational speed of 37 mph, a minimum translational speed of 5 mph, a maximum-rotational-speed radius of 150 feet, a pressure drop of 0.69 psi, and a pressure-drop rate of 0.08 psi/sec.

Freezing precipitation

The region can expect about 1 day of freezing rain or drizzle per year (U.S. Army, 1958). An ice accumulation of more than 0.25 inch has not been observed. Any ice accumulation that does occur is thin because of the scarcity of precipitation during the winter months and because daytime temperatures rise well above freezing.

Strong winds

The fastest-mile winds* recorded at the Roswell Industrial Air Center during a 6-year period of record are shown in Table H-39 (NOAA, 1978). The fastest observed 1-minute wind ever recorded at Roswell was 75 mph from the west in April 1953 (NOAA, 1978). The 100-year-recurrence 30-foot-level wind speed in southeastern New Mexico is 82 mph. The mean recurrence interval for high wind speeds at 30 feet above the ground in southeastern New Mexico is shown in Table H-40 (ANSI, 1972; Thom, 1968).

Table H-39. Fastest-Mile Wind Speeds at Roswell, New Mexico

Month	Speed (mph)	Direction	Month	Speed (mph)	Direction
January	47	NW	July	42	NE
February	56	NW	August	44	NW
March	52	NW	September	40	NE
April	48	SW	October	44	(a)
May	60	NW	November	65	NE
June	73	NW	December	58	SW

^aThis speed was measured on a 1-minute anemometer as 44 mph from 220 degrees (approximately southwest).

Table H-40. Recurrence Intervals for High Winds^a
in Southeastern New Mexico^b

Recurrence (years)	Speed (mph) ^c
2	58
10	68
25	72
50	80
100	82

^aFastest mile.

^bData from Thom (1968).

^cAt 30 feet above the ground.

*The fastest-mile wind speed listed for each month is the fastest speed determined during that month by measuring the time taken for a 1-mile-long column of air to pass a measuring instrument. These are averages, for example, over a period of 1.25 minutes at 48 mph.

Table H-41. Seasonal Frequencies of Inversions^a

Season	Inversion frequency (% of total hours)	Frequency (%) of 24-hr periods with at least 1 hr of inver- sion based below 500 ft
Spring	32	65
Summer	25	68
Fall	36	72
Winter	47	80

^aData from Hosler (1961).

Inversions and high air-pollution potential

Hosler (1961) and Holzworth (1972) have analyzed records from several National Weather Service stations with the objective of characterizing the atmospheric-dispersion potential. Seasonal frequencies of inversions based below 500 feet for the region are shown in Table H-41. A large number of these inversions are diurnal (induced by solar radiation) as a consequence of the elevation and the continental climate.

Holzworth (1972) gives estimates of the average depth of vertical mixing, which indicates the thickness of the atmospheric layer available for the mixing and dispersion of effluents. The seasonal afternoon mixing depths for the region (Table H-42) range from 1320 meters in the winter to 3050 meters in the summer.

Table H-42. Daily Mixing Depths: Seasonal Values

Season	Daily afternoon mixing depth (meters)
Spring	2800
Summer	3050
Fall	2000
Winter	1320
Annual	2400

H.4.2 Site Climate

On-site meteorological data were used to characterize the local meteorology of the site. The meteorology station was located in Section 11, R 31 E, T 22 S, from January to June 1976 and in Section 15 from June 1976 to May 1977; it has been in Section 21 since May 1977. These locations are representative of local terrain conditions. Until May 1977, a 10-meter tower was used primarily to collect wind, temperature, and precipitation (surface)

data. Subsequently, the station was upgraded to a 30-meter tower designed to comply with most of the criteria of Regulatory Guide 1.23 of the Nuclear Regulatory Commission (NRC). The primary measurements obtained include wind, temperature, and the temperature difference (ΔT) between 3 and 10 meters, and between 10 and 30 meters above the ground. Additional climatological data (e.g., dew point, precipitation, solar and terrestrial radiation, etc.) are also collected. In September 1978 the 30-meter-level instruments were raised to 40 meters to improve the accuracy of ΔT measurements in compliance with Regulatory Guide 1.23. All data are recorded by a data logger and backup stripchart recorders. A detailed description of the data-collection program is given in Appendix J.

Available summary on-site meteorological data presented in this document include temperature and precipitation data for the period May 1976 through May 1979 as well as wind and atmospheric-stability data for June 1977 through May 1979. The representativeness of the on-site data-collection period has been established by comparison of concurrent data from the Roswell Industrial Air Center with long-term data.

Normal and extreme values of meteorological parameters

Wind summaries. Wind-direction and wind-speed measurements were obtained from the 2-year site data collected at the 30-foot level. Wind roses for the site and for Roswell, New Mexico, for the period June 1, 1977, to May 31, 1979, are shown in Figure H-15. Long-term (1973-1976) annual wind roses for Roswell and Midland-Odessa, Texas (the next nearest National Weather Station with suitable data) are also shown in this figure. Differences between station summaries are attributed to regional terrain effects and variations in the periods of record used.

The 2-year site wind record (Table H-43) shows the southeast, south-southeast, and east-southeast winds occurring most frequently (18.9%, 15.2%, and 9.1% of the time, respectively). All other directions are about equally represented at 2.9% to 8.4% of the time. Monthly wind-rose data are presented in Tables 1 through 24 in Annex 1.

Temperatures. Monthly average, average daily maximum, and average daily minimum temperatures for June 1, 1976, through May 31, 1979, are presented in Table H-44, which also shows corresponding data and normal values for Roswell (NOAA, 1977, 1978, 1979).

Average temperatures at the site show large seasonal differences, ranging from 37.2°F in the winter to 82.6°F in the summer. The highest and lowest temperatures recorded at the Roswell Industrial Air Center between January 1, 1973, and December 31, 1978, were 107°F (June 1977) and 3°F (January 1977) (NOAA, 1978), respectively; the highest and lowest temperatures recorded at the site between June 1, 1976, and May 31, 1979, were 103.1 and 0.7°F, respectively. At the site, the average winter minimum temperatures are consistently higher than those in Roswell, and the summer maximum temperatures are lower. These differences can be mainly attributed to the locations of the temperature sensors (30 feet above the surface at the site and 5 feet at Roswell).

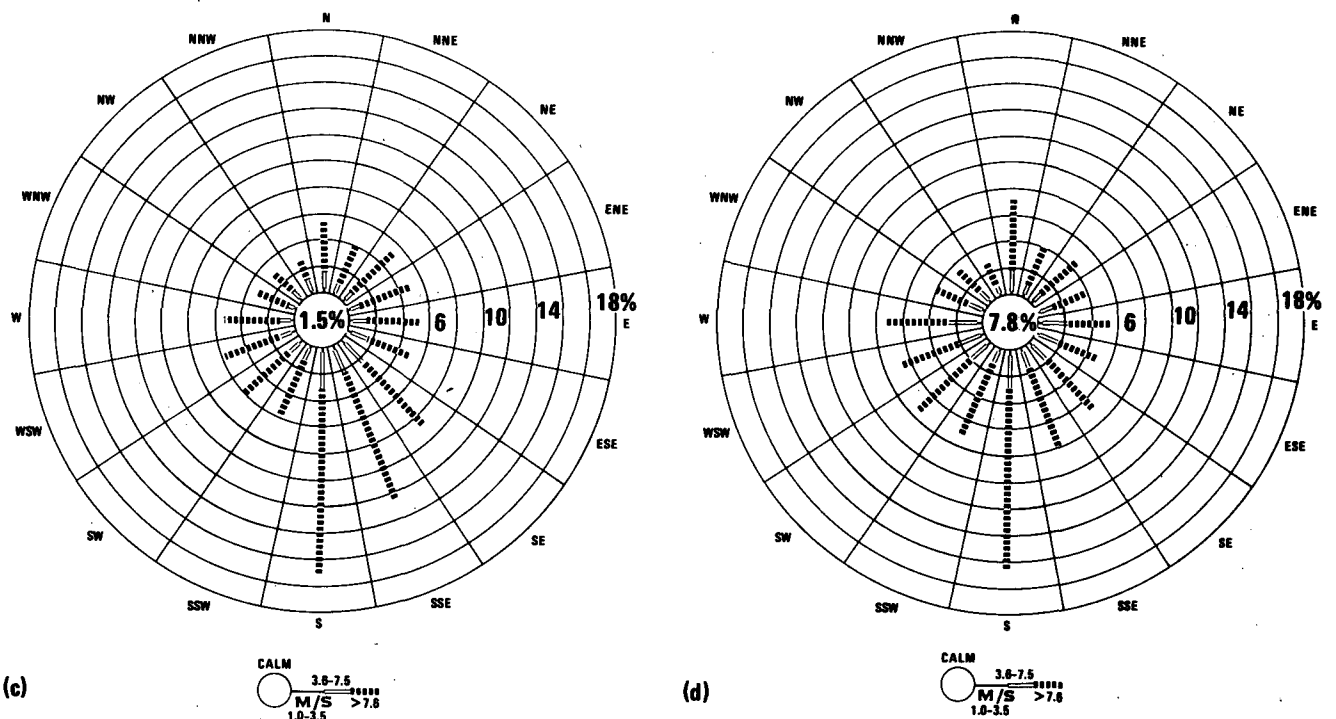
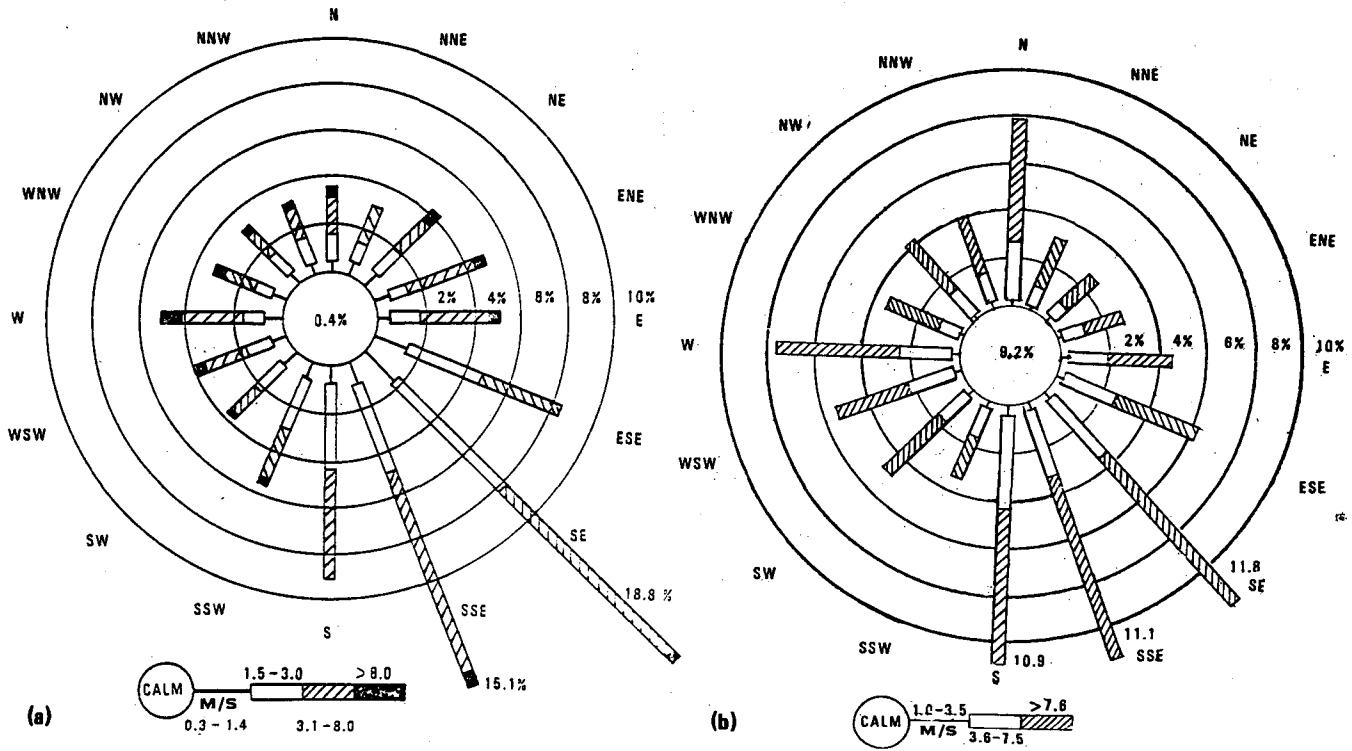

Note: wind direction is defined as the direction from which the wind is flowing.

Figure H-15. Annual wind roses for (a) the WIPP site, June 1, 1977, to May 31, 1979; (b) Roswell, June 1, 1977, to May 31, 1979; (c) annual average (1973-1976) for Midland-Odessa, Texas; and (d) annual average for Roswell (1973-1976).

Table H-43. Distribution of Wind Directions at the Site, June 1977-May 1979

Month	Direction																
	NNE	NE	ENE	E	ESE	SE	SSE	S	SSW	SW	WSW	W	WNW	NW	NNW	N	Calm
January	4.3	3.1	4.5	6.4	9.2	16.3	17.3	11.0	5.0	2.0	2.5	5.2	3.9	2.1	3.3	3.5	0.6
February	3.9	7.4	5.8	5.1	6.6	13.6	14.0	8.3	4.0	4.1	4.5	5.0	5.0	4.7	3.5	3.7	0.5
March	2.8	2.9	3.4	8.9	6.6	15.2	12.0	7.8	4.0	3.9	6.7	8.9	4.5	3.4	3.2	4.0	0.2
April	2.9	3.8	5.1	5.0	8.8	15.7	9.3	7.5	4.7	5.6	8.3	7.5	4.5	3.4	3.5	3.5	0.2
May	3.9	3.0	3.5	4.0	8.2	17.0	13.2	9.6	7.0	5.6	4.9	7.2	3.4	2.5	3.3	4.7	0.2
June	2.8	3.7	4.6	5.4	8.2	27.8	22.9	9.2	4.0	2.3	0.9	1.0	0.9	1.8	2.7	1.9	0.2
July	1.1	2.4	3.1	3.8	11.0	37.0	24.8	7.9	3.3	1.8	0.7	0.6	0.2	0.3	0.8	1.0	0.2
August	1.5	3.4	5.9	4.2	8.8	21.9	20.2	12.8	5.8	2.2	2.2	2.3	1.9	1.9	2.4	2.3	0.3
September	3.7	6.4	5.9	4.5	6.5	17.8	13.9	6.9	6.2	4.2	4.2	5.9	2.4	3.3	4.4	3.3	0.3
October	2.8	4.5	4.1	4.1	12.4	18.9	13.0	11.4	6.9	2.8	3.5	3.7	2.3	2.9	2.5	3.3	0.8
November	5.6	6.1	6.3	5.6	9.7	15.3	11.6	8.2	4.7	3.8	3.4	4.3	3.9	3.2	3.2	4.9	0.2
December	5.0	5.4	5.3	4.8	5.0	10.7	10.5	8.4	6.2	6.7	6.4	6.9	4.9	5.0	3.9	4.2	0.6

H-85

Table H-44a. Temperatures at Roswell and the WIPP Site, 1976-1977.

Month	Temperature (°F)								
	Monthly average			Average daily maximum			Average daily minimum		
	Roswell		Site,	Roswell		Site,	Roswell		Site,
	Normal	6/76-5/77	6/76-5/77	Normal	6/76-5/77	6/76-5/77	Normal	6/76-5/77	6/76-5/77
January	38.1	38.6	38.7	55.4	52.5	51.6	20.8	24.7	27.1
February	42.9	48.2	48.6	60.9	63.0	61.9	24.8	33.4	36.9
March	49.3	52.1	54.3	57.7	68.2	67.6	30.9	35.9	40.6
April	59.7	62.3	63.5	78.2	76.7	77.2	41.2	47.9	48.6
May	68.5	73.3	73.8	86.4	87.5	86.9	50.5	59.1	61.9
June	77.0	79.3	78.4	94.2	93.4	91.2	59.8	65.2	65.1
July	79.2	78.6	75.4	94.7	90.1	87.8	63.7	67.1	65.1
August	77.9	80.3	78.6	93.4	93.1	91.2	62.3	67.4	66.7
September	70.4	71.2	70.3	86.5	82.9	82.0	54.3	59.4	60.8
October	59.6	56.2	56.1	77.0	70.3	69.6	42.2	42.1	44.2
November	46.9	42.7	46.4	64.8	56.5	58.1	29.0	28.9	34.5
December	39.3	39.3	42.1	56.8	56.1	57.0	21.8	22.5	28.9
Annual	59.1	60.2	60.5	76.3	74.2	73.5	41.8	46.1	48.4

Table H-44b. Temperatures at Roswell and the WIPP Site, 1977-1978

Month	Temperature (°F)								
	Monthly average			Average daily maximum			Average daily minimum		
	Roswell		Site,	Roswell		Site,	Roswell		Site,
	Normal	6/77-5/78	6/77-5/78	Normal	6/77-5/78	6/77-5/78	Normal	6/77-5/78	6/77-5/78
January	38.1	36.04	37.2	55.4	47.6	48.7	20.8	24.3	28.6
February	42.9	43.6	39.6	60.9	55.7	51.3	24.8	31.5	32.2
March	49.3	55.6	55.6	57.7	71.1	67.8	30.9	40.1	43.2
April	59.7	66.2	66.9	78.2	82.3	79.2	41.2	50.1	53.8
May	68.5	71.5	72.0	86.4	86.1	83.7	50.5	56.8	59.5
June	77.0	81.6	78.6	94.2	96.1	91.4	59.8	67.0	61.3
July	79.2	84.2	81.1	94.7	97.4	93.7	63.7	70.9	68.5
August	77.9	83.0	81.7	93.4	95.0	94.3	62.3	71.0	70.2
September	70.4	78.4	57.7	86.5	92.2	90.9	54.3	64.6	66.2
October	59.6	64.1	63.3	77.0	77.5	76.1	42.2	50.6	54.0
November	46.9	53.1	53.6	64.8	68.9	65.8	29.0	37.3	42.4
December	39.3	47.0	49.5	56.8	62.9	60.8	21.8	31.1	37.8
Annual	59.1	63.7	61.4	76.3	77.7	75.3	41.8	49.6	51.5

Table H-44c. Temperatures at Roswell and the WIPP Site, 1978-1979

Month	Temperature (°F)								
	Monthly average			Average daily maximum			Average daily minimum		
	Roswell		Site,	Roswell		Site,	Roswell		Site,
	Normal	6/78-5/79	6/78-5/79	Normal	6/78-5/79	6/78-5/79	Normal	6/78-5/79	6/78-5/79
January	38.1	34.9	37.0	55.4	45.5	46.8	20.8	24.2	28.6
February	42.9	43.6	45.7	60.9	59.2	57.9	24.8	28.0	35.1
March	49.3	50.5	52.9	67.7	65.6	63.5	30.9	35.3	43.2
April	59.7	60.6	62.8	78.2	75.8	73.8	41.2	45.3	44.6
May	68.5	67.5	68.0	86.4	81.2	79.5	50.5	53.7	57.2
June	77.0	79.37	78.4	94.2	92.7	90.9	59.8	65.8	66.6
July	79.2	83.4	82.6	94.7	96.2	93.0	63.7	70.5	72.1
August	77.9	78.0	79.0	93.4	89.9	89.6	62.3	66.0	68.7
September	70.4	69.2	70.2	86.5	79.8	78.6	54.3	58.6	62.6
October	59.6	60.3	61.7	77.0	74.1	72.9	42.2	46.5	52.2
November	46.9	49.0	52.0	64.8	58.7	60.3	29.0	39.3	44.4
December	39.3	37.2	42.3	56.8	50.7	52.7	21.8	23.7	32.2
Annual	59.1	59.5	61.1	76.3	72.5	71.6	41.8	46.4	50.6

Precipitation and atmospheric moisture. Precipitation data for the site are available for June 1, 1976, through May 31, 1979. Table H-45 shows the monthly totals for Roswell and the WIPP site, as well as the average monthly normals for Roswell (NOAA, 1977, 1978, 1979).

Monthly cumulative precipitation at the site ranged from a trace in December 1977 to 5.19 inches in September 1978. At Roswell it ranged from 0.00 inch in December 1976 to 4.45 inches in August 1977 (normal ranges for Roswell are 0.29 and 1.48 inches).

The differences between the Roswell 2-year data and the site are typical of precipitation spatial variations in the area.

The dew-point temperature is the temperature to which the air must be cooled to become saturated with water vapor (pressure and water-vapor content remaining constant). Thus the difference between the ambient and the dew-point temperatures (the dew-point spread) is a measure of the atmospheric moisture content.

The annual average and dew-point temperatures at Roswell and at the WIPP site are shown in Table H-46. The data periods are June 1, 1977, through May 31, 1979. At Roswell, 78.8% of the time the dew-point spread was greater than 8.1°F. At the site, this value was exceeded 88.9% of the time.

Atmospheric stability

Estimates of the average dispersion of effluents by atmospheric fluctuations over extended periods are generally based on the joint probability of

Table H-45. Roswell and WIPP Precipitation^a

Month	Roswell				WIPP site		
	Normal	76-77	77-78	78-79	76-77	77-78	78-79
June	1.24	1.55	0.25	4.31	0.67	1.09	3.74
July	1.71	2.44	0.46	0.52	0.65	0.69	0.63
August	1.48	1.98	4.45	3.49	0.57	0.57	2.01
September	1.47	2.29	0.29	3.58	3.29	2.09	5.19
October	1.22	0.69	0.62	1.47	0.67	2.02	1.33
November	0.29	0.41	0.48	1.25	0.11	0.19	3.51
December	0.47	0.00	0.02	0.43	0.08	(b)	0.65
January	0.40	0.07	0.50	0.41	0.24	0.07	0.13
February	0.37	0.36	0.48	0.44	0.07	0.43	0.59
March	0.47	0.27	0.39	0.13	0.38	0.07	0.04
April	0.49	1.25	0.02	0.32	0.55	0.20	0.15
May	1.00	2.43	1.81	1.25	1.31	1.63	2.22
Annual	10.61	13.74	9.77	17.60	8.59	9.05	20.19

^aMeasured in inches. Data for Roswell collected at the Industrial Air Center.

^bTrace amount.

Table H-46. Dew Point and Temperature at Roswell and the WIPP Site, June 1977 Through May 1979

	Roswell		WIPP site	
	Temperature (°F)	Dew point (°F)	Temperature (°F)	Dew point (°F)
Average	61.3	38.8	62.2	34.0
Average max.	73.9	44.7	73.6	40.3
Average min.	49.3	32.9	51.4	27.3

wind-speed, wind-direction, and atmospheric-stability frequencies. These frequencies have been estimated (Table H-47) from data collected at the site by the temperature-difference method outlined in NRC Regulatory Guide 1.23.

The joint frequencies of these stability categories with winds (Annex 1, Tables 25 through 32) show two dominant trends. The first is the very unstable category (category A), where southeast to south winds in the 3.1- to 5.0-m/sec range are most frequent. The second is in the slightly stable (E) and extremely stable (G) categories (and, to a lesser degree, categories D and F), where the southeast wind in the 1.5- to 5.0-m/sec range predominates.

A comparison of available stability data for Roswell is presented in Table H-48. Different methods were used in categorizing the Roswell and the WIPP-site data since the hourly data for Roswell obtained from the National Climatic Center did not contain the data needed for the temperature-difference method (temperature difference ΔT and standard deviation of the horizontal wind direction). The method used for the Roswell data (Turner, 1964) is based primarily on surface wind speed and net solar radiation. This method tends to be biased toward the neutral category D, as evident in Table H-48, while the ΔT method tends to be biased toward the extremely stable and unstable categories.

Table H-47. Monthly Frequency of Stability Categories at the WIPP Site, June 1977 Through May 1979

Category	J	F	M	A	M	J	J	A	S	O	N	D
A	28.7	31.1	34.2	41.5	44.7	46.3	48.1	44.3	36.9	32.7	26.5	27.7
B	2.4	1.7	1.5	0.7	0.2	1.0	0.7	1.2	0.7	1.3	1.5	0.8
C	1.2	0.9	0.8	0.3	0.5	0.7	0.2	0.3	0.3	0.6	0.6	0.7
D	10.7	6.7	2.7	3.2	2.6	4.5	3.6	4.8	2.0	4.0	3.4	4.1
E	13.1	14.0	6.8	5.8	8.9	10.5	9.6	9.6	8.3	10.0	9.9	4.9
F	8.6	7.7	10.0	11.0	14.1	23.9	15.6	18.0	13.3	10.3	11.2	7.8
G	35.8	38.1	44.1	37.5	29.1	13.4	22.8	20.4	38.5	41.1	46.9	54.0

Table H-48. Frequency of Stability Conditions at Roswell and at the WIPP Site

Stability condition	Frequency (%)		
	Roswell, ^a 1973-1976	Roswell, ^a June 1977-May 1979	WIPP site, ^b June 1977-May 1979
A, extremely unstable	1.3	2.1	36.7
B, unstable	7.6	8.6	1.1
C, slightly unstable	16.2	14.1	0.6
D, neutral	37.0	38.1	4.2
E, slightly stable	15.9	14.7	9.2
F, stable	17.0	17.0	12.4
G, extremely stable	5.1	5.3	35.7

^aBased on the Turner method.

^bBased on the temperature-difference method.

H.4.3 Short-Term (Accident) Diffusion Estimates

Conservative (5% probability level), realistic (50% probability level), as well as worst-case estimates of the local atmospheric-diffusion factors (X/Q) for the site have been prepared for the site boundary (control zone IV radius of 3 miles) and distances of 0.5, 1.5, 2.5, 3.5, 4.5, 7.5, 15, 25, 35, and 45 miles. Calculations were made for a 1-hour effluent-release period from hourly data collected at the site for the period June 1977 through May 1979.

The ground-level atmospheric-diffusion factors for the site were calculated from Gaussian plume-diffusion models for a continuously emitting ground-level source (a conservative assumption). Hourly centerline X/Q values were computed from the concurrent hourly mean wind speed, wind, and stability category. The wind speed at the 10-meter-level sensor was used since a ground-level release was assumed for conservatism. The stability class was determined by the temperature-difference method. Calms were assigned a wind-speed value equal to the starting speed of the wind vane (0.6 mph) and the wind direction in the last noncalm hour. Cumulative frequency distributions were prepared to determine the X/Q values that were exceeded only 5% and 50% of the time as well as worst-case values.

Gaussian plume-diffusion models for a ground-level concentration were used to describe the downwind spread of effluents from the WIPP. A continuous ground-level release of effluents at a constant emission rate and total reflection of the plume at ground level were assumed in the diffusion estimates. Since it allows for no depletion by deposition or reaction at the surface, this assumption is conservative. For each hour in the 2 years of record X/Q values were calculated as follows:

$$\frac{X}{Q} = \frac{1}{\pi \sum_y \sigma_z u_{10}} \quad (1)$$

$$\frac{\chi}{Q} = \frac{1}{\pi \sigma_y \sigma_z u_{10}} \quad (2)$$

where

χ/Q = the relative centerline concentration (sec/m^3) at ground level.

u_{10} = wind speed (m/sec) at 10 meters above the ground.

Σ_y = lateral plume spread (meters), a function of atmospheric stability, wind speed, and downwind distance from the point of release. For distances of up to 800 meters, $\Sigma_y = M_{\sigma_y}$, M being a function of atmospheric stability and wind speed. For more than 800 meters, $\Sigma_y = (M - 1) \sigma_y(800 \text{ m}) + \sigma_y(x)$.

σ_y, σ_z = lateral and vertical plume spread (meters), respectively, as a function of atmospheric stability and distance.

For neutral to stable conditions (categories D to G) with wind speeds at the 10-meter level of less than 6 m/sec, equation 1 was used. For all other stability or wind-speed conditions, χ/Q was calculated from equation 2. This technique of calculating concentration from vents or other building penetrations is described in NRC Regulatory Guide 1.145 (Atmospheric Dispersion Models for Potential Accident Consequence Assessments at Nuclear Power Plants; issued for comment, August 1979).

From the 2 years of 1-hour χ/Q values, cumulative frequency distributions were prepared for each of 16 wind sectors and for several distances from the release point. The values of χ/Q exceeded only 5% and 50% of the time are presented in Table 33 of Annex 1.

H.4.4 Long-Term (Routine) Diffusion Estimates

Annual average diffusion factors were computed for routine releases from WIPP operations. The MESODIF model was run (Start and Wendell, 1974) with meteorological data recorded at the site from June 1977 through May 1979.

MESODIF uses an integrated puff model that differs from other Gaussian puff models in that it allows released materials to be transported back over the source should the wind shift. The effluent is treated as a string of puffs released every hour through the year of record into the wind field recorded by the on-site meteorological station. Individual puffs are tracked until they are too dilute to be of significance or until they leave the area being considered. Concentrations are integrated for the year and then averaged to yield the mean expectation for single puffs. A ground-level release was assumed for conservatism. The results are listed in Table H-49 for the 2 years of record. The strong lobe of concentration in the northwest sector in Table H-49 is consistent with the prevailing winds, which are from the southeast.

Table H-49. WIPP Site Long-Term Average χ/Q Calculations
(Period of Record June 1977 through May 1979)

Downwind sector	χ/Q (sec/m ³) at downwind distance (miles)											
	0.5	1.5	2.5	3.5	4.5	5.0	7.5	10.0	15.0	25.0	35.0	45.0
N	2.8-5 ^a	2.4-6	1.0-6	6.2-7	4.4-7	3.6-7	1.8-7	1.0-7	3.9-8	1.7-8	7.2-9	8.4-9
NNE	1.1-5	1.4-6	5.7-7	3.7-7	21.-7	1.7-7	9.0-8	4.6-8	2.0-8	9.0-9	3.3-9	2.6-9
NE	9.3-6	2.8-6	6.8-7	4.0-7	2.3-7	2.0-5	1.1-7	6.5-8	3.0-8	1.2-8	4.4-9	3.1-8
ENE	1.1-5	1.1-6	5.4-7	2.9-7	1.8-7	1.5-7	5.7-8	2.8-8	1.5-8	5.4-9	1.1-9	8.6-10
E	7.7-6	4.4-7	4.8-7	2.3-7	1.6-7	1.2-7	4.8-8	1.5-7	1.2-8	4.2-9	1.3-9	1.1-9
ESE	2.3-5	4.0-7	4.5-7	2.0-7	1.4-7	1.1-7	4.2-8	2.7-8	1.1-8	4.7-9	1.0-9	7.3-10
SE	1.0-5	1.4-6	4.3-7	2.0-7	1.4-5	1.1-7	5.3-8	3.0-8	1.6-8	6.2-9	1.7-9	1.5-9
SSE	1.1-5	1.4-6	5.2-7	3.0-7	2.0-7	1.6-7	7.7-8	4.8-8	2.3-8	3.6-7	4.0-9	2.7-9
S	1.1-5	1.6-6	6.4-7	3.7-7	2.5-7	2.1-7	1.1-7	6.7-8	3.0-8	1.0-8	6.0-9	3.21-9
SSW	1.1-5	1.8-6	8.5-7	4.4-7	3.1-7	2.8-7	1.4-7	8.0-8	3.9-8	1.8-8	6.8-9	5.2-9
SW	1.5-5	2.2-6	9.6-7	6.7-7	4.0-7	3.3-7	1.6-7	9.5-8	5.0-8	1.8-8	8.8-9	4.8-9
WSW	1.2-5	1.9-6	8.5-7	5.1-7	3.6-7	2.9-7	1.4-7	7.5-8	3.5-8	1.2-8	5.6-9	3.1-9
W	1.9-5	2.8-6	1.2-6	7.5-7	5.3-7	4.0-7	1.9-7	1.8-7	5.0-8	1.7-8	7.8-9	4.5-9
WNW	5.0-5	6.1-6	2.5-6	1.2-6	9.5-7	7.9-7	3.8-7	2.5-7	1.0-7	3.9-8	1.9-8	9.5-9
WNW	5.0-5	6.1-6	2.5-6	1.2-6	9.5-7	7.9-7	3.8-7	2.5-7	1.0-7	3.9-8	1.9-8	9.5-9
NW	4.9-5	9.3-6	3.2-6	2.0-6	1.6-6	1.4-6	7.6-7	5.0-7	2.5-7	1.1-7	5.5-8	3.2-8
NNW	3.0-5	5.9-6	3.0-6	1.5-6	1.2-6	1.1-6	5.8-7	3.5-7	2.5-7	7.8-8	4.6-8	2.6-8

^a2.8-5 = 2.8×10^{-5} .

H.4.5 Air Quality

The United States has been divided by the Environmental Protection Agency (EPA) (40 CFR 81) into Air Quality Control Regions (AQCRs). The EPA has divided its programs in the country into administrative regions. The WIPP site is located in AQCR 155 and is administered by EPA Region VI. The New Mexico Environmental Improvement Division (NMEID) has designated a seven-county area, including Eddy and Lea Counties, as State Air Quality Control Region 5 (Chapter 277, Laws of 1967 as amended).

Existing air pollution in the vicinity of the site consists mostly of high concentrations of total suspended particulates. The entire State experiences occasional high concentrations of total suspended particulates from natural wind-blown dust; near the site, the concentrations are even higher because of potash operations. According to the most recent EPA State Attainment Status Report (Federal Register, September 11, 1978), air quality in the region meets primary and secondary national ambient air-quality standards, except locally near industries.

To better define the ambient air quality at the site, the levels of selected air pollutants have been monitored since January 1976 and will be used to analyze the effects of WIPP construction and operation on air quality locally and regionally. The parameters being measured are total suspended particulates, chemical species in particulates, nitrogen dioxide, sulfur dioxide, hydrogen sulfide, carbon monoxide, and ozone (Metcalf and Brewer, 1977).

Table H-50 presents State and Federal air-quality standards. State standards are not to be exceeded at any time, while Federal standards are not to be exceeded more than once a year. The Federal standards are divided into

Table H-50. Ambient Air-Quality Standards^a

Pollutant	New Mexico standard	Federal standards	
		Primary	Secondary
Sulfur dioxide (SO ₂)			
24-hour average	0.10 ppm (260 µg/m ³)	0.14 ppm (365 µg/m ³)	
Annual arithmetic mean	0.02 ppm (52 µg/m ³)	0.03 ppm (80 µg/m ³)	
3-hour average			0.50 ppm (1300 µg/m ³)
Total suspended particulates			
24-hour average	150 µg/m ³	260 µg/m ³	150 µg/m ³
7-day average	110 µg/m ³		
30-day average	90 µg/m ³		
Annual geometric mean	60 µg/m ³	75 µg/m ³	60 µg/m ³
Carbon monoxide (C)			
8-hour average	8.7 ppm	9 ppm	9 ppm
1-hour average	13.1 ppm	35 ppm	35 ppm
Photochemical oxidants (ozone),			
1-hour average	0.06 ppm	0.12 ppm	0.12 ppm
Hydrocarbons (nonmethane),			
3-hour average	0.19 ppm	0.24 ppm	0.24 ppm
Nitrogen dioxide (NO ₂)			
24-hour average	0.1 ppm (200 µg/m ³)		
Annual arithmetic average	0.05 ppm (100 µg/m ³)	0.05 ppm (100 µg/m ³)	0.05 ppm (100 µg/m ³)

^astate standards--State of New Mexico ambient air-quality data summaries (1973-1976). Federal standards--40 CFR 50.

primary and secondary standards, which are defined in 40 CFR 50.2: "National primary ambient air-quality standards define levels of air quality which the Administrator [Administrator of the EPA] judges are necessary, with an adequate margin of safety to protect the public health. National secondary ambient air-quality standards define levels of air quality which the Administrator judges necessary to protect the public welfare from any known or anticipated adverse effects of a pollutant."

The concentrations of pollutants measured at the WIPP site are presented in Table H-51. The only concentrations that exceeded New Mexico standards during 1976 are the 1-hour carbon monoxide concentration and the 1-hour ozone concentration. The carbon monoxide value does not exceed Federal standards, however. The high ozone concentrations may be at least partially explained by the fact that the concentrations were measured by ultraviolet techniques instead of chemiluminescence; the ultraviolet techniques generally produce higher values. Chemiluminescence is now used for measurements, but no new values are available.

Table H-51. Pollutants Measured at the WIPP Site During 1976

Pollutant	Measured concentration	New Mexico standard
Nitrogen dioxide, annual arithmetic mean	32.19 $\mu\text{g}/\text{m}^3$	100 $\mu\text{g}/\text{m}^3$
Sulfur dioxide ^a Annual arithmetic mean	4.29 $\mu\text{g}/\text{m}^3$	52 $\mu\text{g}/\text{m}^3$
24-hour average	38 $\mu\text{g}/\text{m}^3$	260 $\mu\text{g}/\text{m}^3$
Total suspended particulates Annual arithmetic mean	18.47 $\mu\text{g}/\text{m}^3$	^b 60 $\mu\text{g}/\text{m}^3$
24-hour average	77.7 $\mu\text{g}/\text{m}^3$	150 $\mu\text{g}/\text{m}^3$
Carbon monoxide 1-hour average	17 ppm	13.1 ppm
Daily mean	3.17 ppm	
Ozone 1-hour average	0.167 ppm	0.06 ppm
Daily mean	0.02 ppm	
Hydrogen sulfide, daily mean	0.11 $\mu\text{g}/\text{m}^3$	(c)

^aBelow the detection capability of the method used.

^bGeometric mean.

^cThe standards are 0.003 ppm (1-hour average) for all parts of New Mexico except the Pecos-Permian Basin Intrastate Air Quality Control Region and 0.1 ppm (30-minute average) for that region.

H.4.6 Paleoclimatology

The climatic record of the past indicates long-term variabilities of the climate in a region and provides a basis for postulating the bounds in future climatic changes that may affect the long-term impact of a repository. In evaluating the long-term performance of a repository, the most significant historic period is the last 10,000 to 100,000 years. Detailed climatological information is not available for this historic period. However, qualitative estimates of temperature and precipitation regimes have been made, and the extent of glaciation and flooding can be fairly accurately estimated from geologic evidence. Much of the available paleoclimatological information refers to large geographical areas (continents, hemispheres, etc.), and climatic conditions for the region of a particular site frequently must be inferred from these generic descriptions. However, limited geologic investigations have provided some specific information directly applicable to the region of the WIPP site.

Periodically, at intervals of about 250 million years, there have been major advances of glaciers from the polar regions, advances that lasted on the order of millions of years (Sellers, 1965). The Pleistocene Epoch, which began about 1 to 2 million years ago, is the latest glacial period (Sellers, 1965; NAS-NRC, 1975, 1977; John, 1977). Within the Pleistocene there have been several glacier advances (glacials) and retreats (interglacials), as illustrated by worldwide temperature variations in Figure H-16 (Norwine, 1977). This epoch ended some 10,000 years ago with the beginning of the Holocene Epoch, although continuous ice sheets are still present in the polar regions.

Continental ice sheets of the Pleistocene Epoch did not advance south of Montana and Idaho, and glacial action does not appear to be a threat to the integrity of the WIPP site. However, during these glaciations, individual mountain glaciers were widespread throughout the Rocky Mountains from Canada to central New Mexico, and local ice caps were present in a number of ranges (Richmond, 1965). Mountain glaciers developed as far south as latitude 33° 22' N (Sierra Blanca, peak elevation 13,000 feet, west of Roswell) during the glaciations of late-Pleistocene time. The average end moraines of late-Pleistocene glaciers are at elevations of between 10,200 and 11,400 feet at this latitude (Richmond, 1965). Summer temperatures were about 7 to 16°F colder than at present, but winter temperatures were much the same as at present (Richmond, 1965; Gates, 1976).

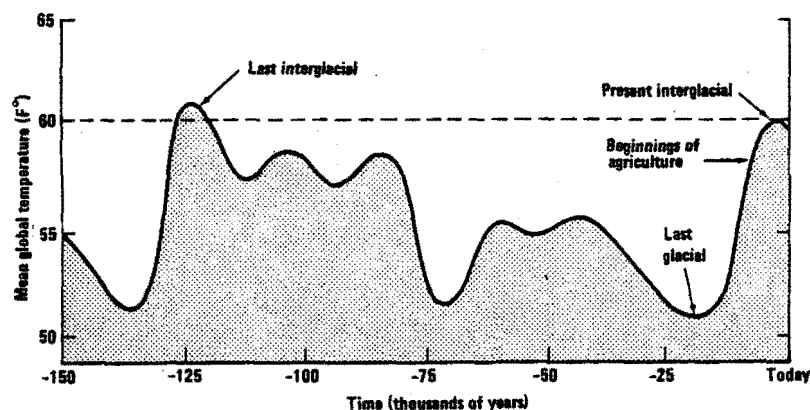

Figure H-16. Worldwide temperature variations.

The advance of glaciers was initially associated with a cold, damp climate, followed by a cold, dry climate that developed over the contiguous ice sheet itself (Schwarzbach, 1963). Precipitation over this area was probably less than that over the same region at present. During these periods, the weather was much more variable than at present. Winters were longer; spring, fall, and summer were shorter; and diurnal and day-to-day variations were greater (Kukla, 1976).

During glaciation periods in North America, the westerly wind belt was displaced toward the equator (Brooks, 1970; Schwarzbach, 1963). This change resulted in some areas south of the continental glacier receiving increased (pluvial) precipitation (Schwarzbach, 1963). In the United States, pluvial effects occurred in the central and western regions. Several lakes were formed or expanded during the pluvial, especially in the Western United States, in areas that are now deserts (Flint, 1967; Schwarzbach, 1963). The climate of New Mexico during this period was characterized by more precipitation (about 64% more than at present), less evaporation (only about 73% of present), and a mean June-September temperature about 18°F lower than at present (Antevs, 1954).

In summary, it can be inferred that the climate of the region during the glacial/pluvial periods of the Pleistocene was probably cooler, wetter, and stormier than at present. Therefore, flooding was also probably more frequent. The geologic history of the region that indicates such effects has been addressed in Section 7.3.

Major glacial epochs have been alternating with interglacials on a 100,000-year cycle (Norwine, 1977). These interglacials have previously lasted 11,000 to 15,000 years. The present global climate is considered interglacial and has lasted approximately 10,000 to 12,000 years (Richmond, 1972; Sellers, 1965), although this has varied by region, and glacial advances have at times occurred. The interglacials of the Pleistocene were typically free of ice and were drier than the present (Sellers, 1965). Moreover, temperatures were similar or at times slightly warmer than those at present: average world temperatures were approximately 3°F above those at present (Sellers, 1965). In the Rocky Mountains, the present interglacial has been less arid and colder than previous interglacials (Richmond, 1972).

A brief summary of the climate of the current epoch is presented in Table H-52. The most significant events are the Cochrané Glacial Readvance (6800 to 5600 B.C.), the Climate Optimum (5600 to 2500 B.C.), and the Little Ice Age (A.D. 1500 to 1900). However, the oscillations of the interglacial climate in the United States during the Holocene have been less severe than those experienced during the Pleistocene, when conditions varied between glacial and interglacial (Lamb, 1966). There are indications that a long-term global cooling trend is still under way, although there has been a relatively recent short-term period (approximately 40 to 100 years ending in about 1950) of global warming (Kukla and Matthews, 1972; Lamb, 1966; Alexander, 1974).

Table H-52. A Brief Chronology of the Climate of the Southwestern United States in the Last 10,000 Years^a

Dates	Climate
9000-6000 B.C.	Warm and arid in southern Arizona.
6800-5600 B.C.	Cool and dry, with possible extinction of mammals, particularly in Arizona and New Mexico.
5600-2500 B.C.	Warm and moist, becoming warm and dry by 3000 B.C. (Climate Optimum). Intermittent drought in the Western United States after 5500 B.C.
2500-500 B.C.	Generally warm and dry with periods of heavy rain (after 660 B.C.) and intense droughts (near 510 B.C.) in the Western United States.
A.D. 330	Drought.
800	Start of moist period in Mexico.
1180-1215	Wet in the West.
1220-1290	Drought in the West.
1276-1299	"Great Drought" in the Southwest.
1300-1330	Wet in the West.
1500-1900	Generally cool and dry (Little Ice Age). Periodic glacial advances in North America (1700-1750). Drought in the southwestern United States from 1573 to 1593.
1880-1940	Increase of winter temperatures by 1.5°C. Drop of 5.2 meters in the level of the Great Salt Lake. Alpine glaciation reduced by 25% and arctic ice by 40%.
1920-1958	25% decrease in mean annual precipitation in the Southwest.
1942-present.	Worldwide temperature decrease and halt of glacial recession.

^aData from Sellers (1965).

H.5 ECOLOGY

H.5.1 Introduction

This section discusses the terrestrial and aquatic ecology of the Los Medanos site and its environs, describes the ecological resources at the site, and characterizes preexisting environmental stresses.

The terrestrial ecology study area is the area within a 5-mile radius of the center of the site (Figure H-17). Eighty-nine study plots have been established in the study area and nearby. Seven are fenced for studies of grazing effects, etc.; the remainder are enclosed. In addition, there are 11 soil microclimate stations, also fenced (Figure H-18). Aquatic habitats within the study area are limited to stock-watering ponds and tanks. Sampling stations have been established at a nearby playa, at Laguna Grande de la Sal, and along the Pecos River (see Section H.5.3.1).

This section is based on data collected since 1975. Early studies were carried out by the New Mexico Environmental Institute. The results are published in two progress reports (Wolfe et al., 1977a,b). In 1977, the biology team was reorganized, and ecological studies continued. Methods and data are discussed in a report published in 1979 (Best and Neuhauser, 1979); more recent data will be published later.

The studies provide baseline data for the assessment of environmental impacts. The emphasis is on characterizing terrestrial and aquatic habitats and important plant and animal species. Important species are defined (NRC, 1976) as follows:

- a. The species is commercially or recreationally valuable.
- b. The species is threatened or endangered.
- c. The species is critical to the well-being of some important species within criterion a or b.
- d. The species is critical to the structure and function of the ecological system or is a biological indicator of radionuclides in the environment.

These baseline data are of further use in the development of an ecological monitoring program at the site. The emphasis is on (a) documenting the range of natural variation and its cause(s) for important plant and animal communities; (b) characterizing critical pathways and processes in the local ecosystem, including pathways of radionuclide transfer; and (c) predicting, where possible, the kind and the degree of change that may result from WIPP-related activities (e.g., changes in vegetation within control zone II due to the exclusion of cattle).

In order to expand the ecology data base and thereby make it more useful, field studies are continuing.

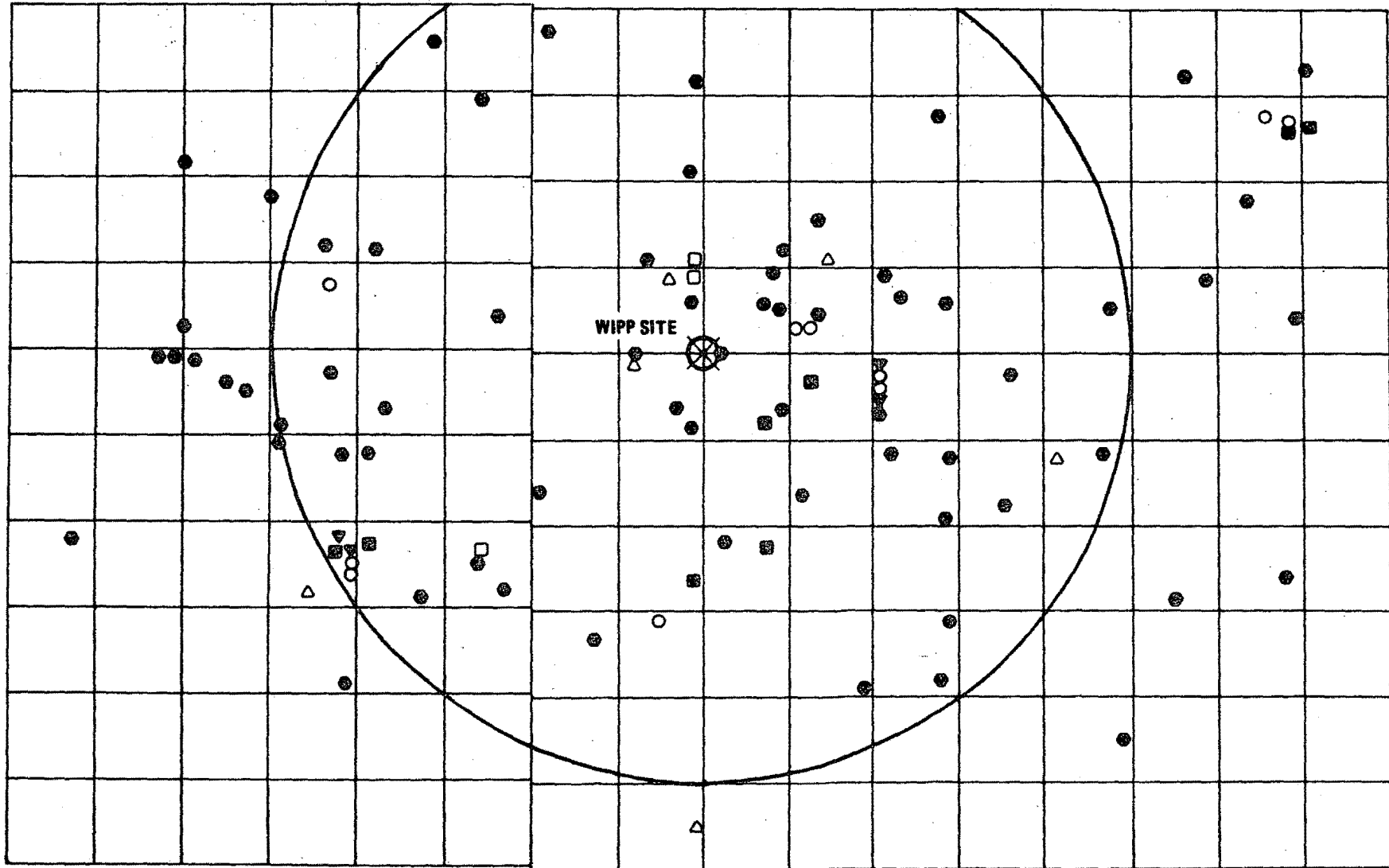

- Terrestrial vertebrate study sites
- Floristics study sites
- △ Plant succession study sites
- Arthropod sampling sites
- Avifauna study sites
- ▼ Soils/plant productivity study sites
- Soil microclimate stations
- ⊕ Center of WIPP site

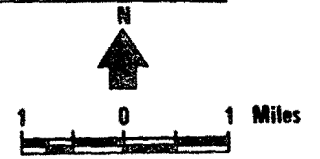

Figure H-17. Map of the site showing biplot locations.

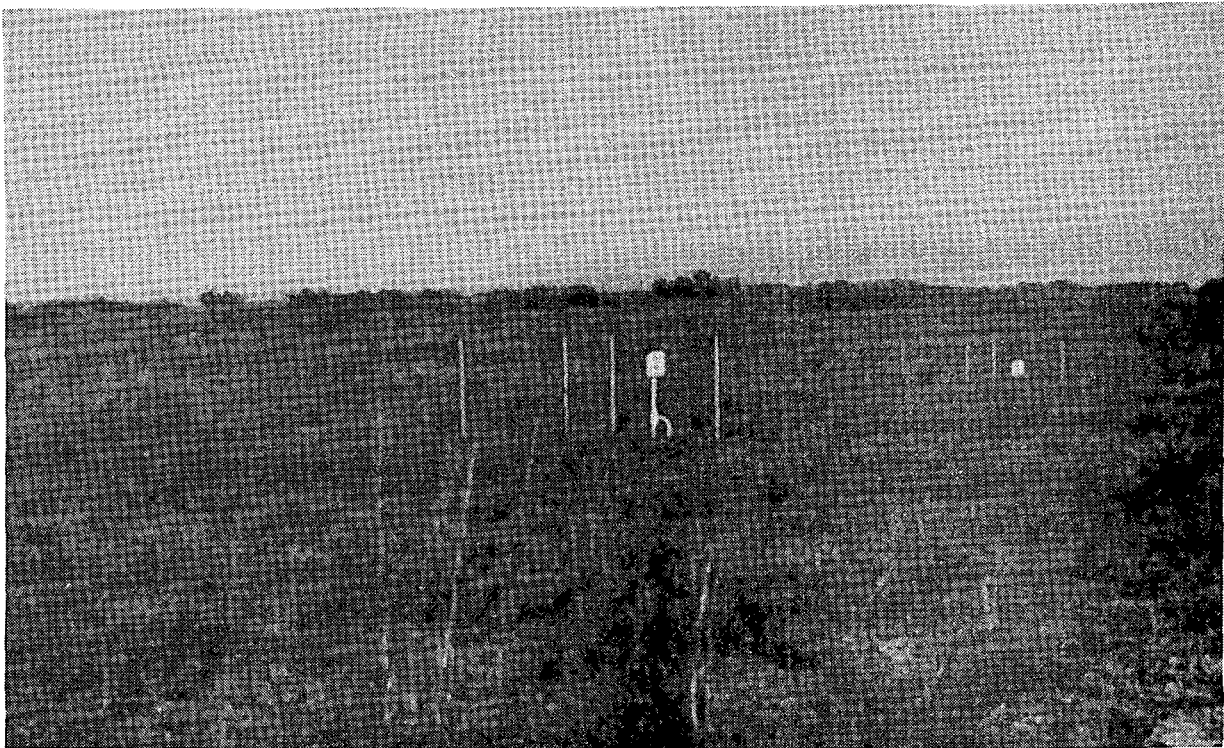

Figure H-18. Soil microclimate station.

To give a regional perspective, the ecology of the two-county region (Eddy and Lea Counties), excluding the Guadalupe Mountains, is discussed below.

H.5.2 Terrestrial Ecology

H.5.2.1 Soil and agricultural resources

The two-county region lies in the Southern Desert Basins, Plains, and Mountains Land Resource Area of the Western Range and Irrigated Land Resource Region (Austin, 1972). Climate and soil limit agriculture to ranching and some irrigated and dry-land farming, with the major cultivated areas being along the Pecos and Black Rivers in Eddy County and in eastern Lea County. Irrigated lands produce sorghum, cotton, alfalfa, and small-grain crops. Over 90% of the region is grazing land, and beef-cattle ranching is the major agricultural enterprise. Grazing areas are used the year round.

The major soils in the region are Aridisols, which occur in arid locales and contain low amounts of organic matter, and Mollisols, found in more moist areas with dark, organic-matter-rich surface horizons. The major suborders of the Aridisols, which are used primarily for rangeland and some irrigated crops, are the Orthids, which have accumulations of calcium carbonate, gypsum, or other salts more soluble than gypsum but no horizontal clay accumulation; and the Argids, which have clay accumulations with or without alkali (sodium). Ustols, the major suborder of Mollisols in the site region, are

intermittently dry during the warm season and have subsurface horizons in which salts or carbonates have accumulated. They are used for wheat or small grains and some irrigated crops.

Other soil orders are present, including Entisols, recent soils with no horizon development, and Alfisols, which have a gray to brown surface horizon and a subsurface horizon of clay accumulations. Entisols are used primarily as rangeland. The Alfisols are being used as rangeland, for dry-land farming of small grain, and for irrigated crops.

Terrestrial ecology

The three soil associations that occur in the study area are described in Section 7.3.8. All are Aridisols (Argids and Orthids) or Entisols. The two soil mapping units that occur on the site proper are in the Kermit-Berino Soil Association (Table H-53). Approximately half the site is mapped as Berino complex and the other half as Kermit-Berino fine sands. Both mapping units are Class VII soils--unsuitable for cultivation and suitable only for pasture and wildlife habitat. These sandy soils are subject to severe wind erosion. They are generally stabilized by shinnery oak, mesquite, and other vegetation.

The soils at the site include sandy surface soils with wind-blown particles, a thin (1-mm-thick) soil crust, and a layer of moist subsoil. The wind-blown soil and subsoil contain sparsely distributed bacteria attached to the surfaces of the sand grains but few fungi or algae. The surface material, however, contains partially degraded plant detritus and relatively dense fungal hyphae. This thin crust resists wind erosion and covers much of the site (Caldwell, 1978).

A hard caliche layer, up to 10 feet thick, underlies these soils. Depth to caliche varies from a few centimeters to several meters. The caliche is fully exposed along parts of Livingston Ridge.

H.5.2.2 Native vegetation

Vegetation in the two-county region

The site lies in a region that is an area of transition between the Great Plains Short-Grass Prairie and the Chihuahuan Desert. Since early in the twentieth century, salt cedar trees, naturalized from Eurasia, have invaded major drainageways. Another introduced species--the Russian thistle, or tumbleweed--is a common invader in highly disturbed areas; it is found in the study area. Shrubs and grasses are the most prominent components of the local flora. Vegetative cover is largely controlled by water availability and live-stock grazing. The development of specific plant communities is dependent on such factors as the infiltration rate of the surface soil, depth to a restrictive layer (i.e., caliche), and the extent to which the surface soil has been reworked by wind or water erosion.

According to Bailey's (1976) ecoregion classification, the two-county area is in the Grama-Tobosa Section and the Tarbush-Creosote Bush Section of the Chihuahuan Desert and the Grama-Buffalo Grass Section of the Great Plains Shortgrass Prairie. The Grama-Tobosa Section is a climax desert grassland

Table H-53. Ecological Characteristics of Soils at the WIPP Site^a

Soil mapping unit	Soil series	Soil order/ suborder	Soil capability unit	Soil-management considerations	
				Agricultural potential ^b	Management considerations
Berino complex 0-3% slopes, eroded	Berino	Aridisol Aridid	VIIe-1	Unsuitable for dryland farming. Soils are too sandy and rainfall too low and un dependable. Suitable only for native pasture and wildlife habitat.	Soils subject to severe wind erosion if vegetation cover not maintained. Natural revegetation of eroded areas is difficult and slow. Soils must be constantly protected from overgrazing.
Kermit-Berino fine sands, 0-3% slopes:	Kermit	Entisol Psamment			
Kermit fine sand			VIIe-3	Unsuitable for dryland farming. Rainfall is low and un dependable and soil texture is too coarse. Suitable for wildlife habitat and native pasture.	Soils subject to severe wind erosion if vegetative cover not maintained. Natural fertility and organic-matter content are low. Grasses should not be overgrazed.
Berino fine sand			VIIe-3	Unsuitable for dryland farming. Rainfall is low and un dependable and soil texture is too coarse. Suitable for wildlife habit and native pasture.	Soils subject to severe wind erosion if vegetative cover not maintained. Natural fertility and organic-matter content are low. Grasses should not be overgrazed.

^aBased on data from the Soil Conservation Service (1971).

^bNone of the soils at the site or in the vicinity are suitable for irrigated farmland. Because of the physical and chemical characteristics of the soils, there is a lack of an adequate supply of good-quality water in the site region.

community. At lower elevations in this section, dense stands of shrubs are common. The Tarbush-Creosote Bush Section has been described as a disclimax shrub type that was originally desert grassland (Castetter, 1956). Overgrazing has caused an increase in shrub species that once occupied only isolated areas (Gardner, 1951). The Grama-Buffalo Grass Section is a short-grass prairie found in arid areas where the growing season is short and precipitation is not retained in the soil (Weaver and Albertson, 1956).

Kuechler (1975) has described the potential natural vegetation of the region largely as Trans-Pecos Scrub Savanna in the southern and central portions, Grama-Buffalo Grass in the north and east, and Grama-Tobosa Shrubsteppe and Creosote Bush-Tarbush in the north and west.

More recently, Donart et al. (1978) have described Eddy County as belonging largely to the Chihuahuan Region of the Grassland Formation and the Chihuahuan Region of the Desert Shrub Formation; the potential natural vegetation of Lea County is classified as the Chihuahuan Region, the Plains Region, and the Prairie Region of the Grassland Formation. The following Chihuahuan Region associations occur:

- Creosote/Bush Muhly--at one time predominantly grasslands with scattered creosote bush; principal grasses were black grama, bush muhly, and scattered tobosa.
- Catclaw--primarily an Arizona shrub, it dominates an association of limited distribution around Carlsbad and in southwestern New Mexico.

The Chihuahuan Region of the Grassland Formation contains four associations in the two-county region (Donart et al., 1978):

- Burrograss--dominated by burrograss in association with tobosa and inclusions of gyp grama, gyp dropseed, coldenia, and fluffgrass.
- Mixed Grama/Three-Awn--dominated by black grama and three-awns in association with moderate amounts of blue, hairy, and sideoats grammas and occasional plants of mesa and sand dropseed.
- Black Grama/Mixed Dropseed--dominated by black grama in association with mesa dropseed, sand dropseed, spike dropseed, giant dropseed, and scattered yucca.
- Mixed Dropseed/Black Grama--dominated by dropseed species in association with black grama, yucca, and, in some areas, sand sagebrush.

Several authors have characterized the successional patterns in the region. Shantz (1917) described the area as a grazing disclimax. Explanations for the shift of vegetation from tall and mid-grasses to shrubs (notably sagebrush, shinnery oak, mesquite, and creosote bush) include the exclusion of fire (Sauer, 1950; Humphrey, 1953; Wingfield, 1955), overgrazing by cattle (Campbell, 1929; Whitfield and Anderson, 1938; Whitfield and Beuther, 1938), and changing climate. York and Dick-Peddie (1969) have attributed the recent occupation by mesquite in southern New Mexico to the effects of cattle and note that the appearance of grazing is the only event that coincides with the time of this spectacular change in vegetation.

Several plant species in the region are important to wildlife. For example, mesquite provides abundant forage for herbivorous and granivorous species, such as scaled quail (BLM, 1977). Mesquite, shinnery oak, and other shrubs provide forage and cover for a variety of game and nongame species, such as mule deer and mourning dove.

Vegetation in the study area

The vegetation of the study area consists of shrub-dominated seral communities that are at least partly a result of severe overgrazing in the late 1800s. No crops are cultivated.

The area is floristically heterogeneous (Figure H-19 and Table H-54). This heterogeneity has a number of causes, which include site-specific terrain features, changes in soil type and depth, etc.

Five terrain-related or topographic-edaphic zones of vegetation can be distinguished within the study area. These are discussed separately below.

Mesquite grassland ("mesa") zone. A low mesa, the Divide, lies on the eastern edge of the study area (see Powers et al., 1978, Section 4.2.2, pp. 4-7 to 4-9, for a discussion of the surficial geology). It supports fairly typical desert grassland vegetation. Honey mesquite (Prosopis glandulosa) and snakeweed (Gutierrezia sarothrae) are the dominant shrub and subshrub, respectively; grasses are also abundant. Important species include burrograss (Scleropogon brevifolius), black grama (Bouteloua eriopoda), bush muhly (Muhlenbergia porteri), and fluffgrass (Tridens pulchellus).

Cacti, especially varieties of prickly pear (Opuntia phaeacantha), are present but not common. Yucca torreyi, also uncommon, is completely absent from the dune plains, where another species, Y. campestris, is common. This area is heavily grazed. Further deterioration in its range condition in future could lead to increased shrub density.

Central dune zone. This zone actually is made up of three dune-related subzones: stabilized dunes, oak-mesquite hummocks, and active dunes.

Stabilized dunes make up the greatest part of the central dune zone. This is reflected in the traditional name for the area, Los Medanos ("the dunes"). Shinnery oak (Quercus havardii), honey mesquite (Prosopis glandulosa), sand sagebrush (Artemisia filifolia), snakeweed (Gutierrezia sarothrae), and dune yucca (Yucca campestris) are the dominant shrubs. In certain sites, all of these species are present; in other sites, one or more is either missing entirely or very low in density. Localized variations in soil type and depth appear to be the major causes of this heterogeneity. The stabilized-dune subzone, therefore, consists of a "patchwork" of closely related but distinct floristic associations. Grasses are common throughout the subzone. Purple three-awn (Aristida purpurea) is found at the majority of the study sites and is the most common perennial grass in the zone. Other frequent species are red three-awn (A. longiseta), sand dropseed (Sporobolus cryptandrus), giant dropseed (S. giganteus), black grama (Bouteloua eriopoda), hairy grama (B. hirsuta), and fall witchgrass (Leptoloma cognata).

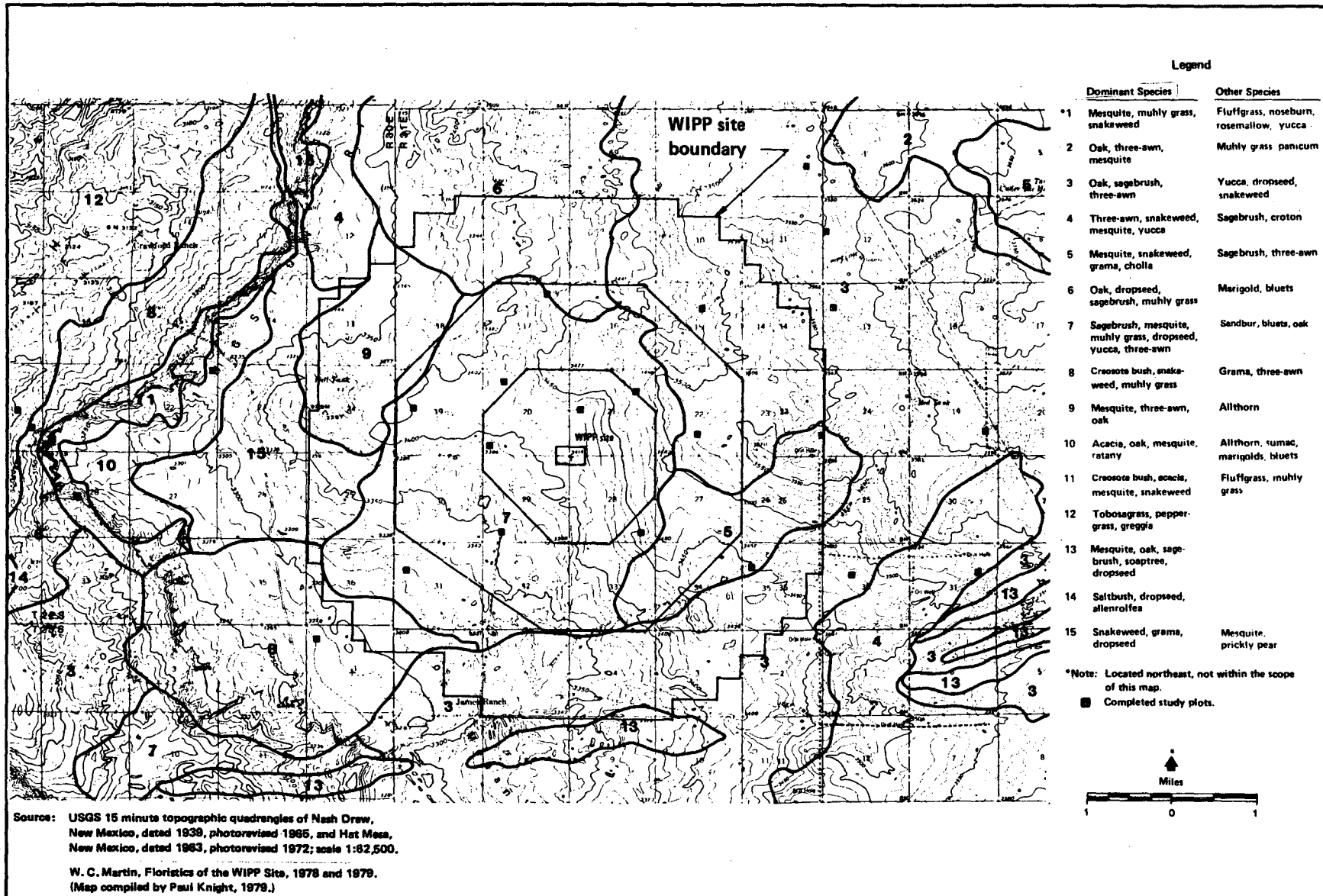

Figure H-19. Vegetation map.

Table H-54. Plants Reported in the Terrestrial Ecology Study Area and at Nearby Sites During 1978 and 1979^a

Taxon	Common name	Growth form ^b
Agavaceae		
* <u>Yucca campestris</u>	Dune yucca	S
<u>Y. elata</u>	Palmilla, soaptree yucca	S
<u>Y. torreyi</u>	Torrey yucca, Spanish dagger	S
Aizoaceae		
<u>Mollugo verticillata</u>	Indian chickweed	A
Amaranthaceae		
* <u>Amaranthus albus</u>	Tumbleweed amaranth	A
<u>A. blitoides</u>	Prostrate pigweed	A
<u>A. hybridus</u>	Green amaranth	A
<u>A. palmeri</u>	Giant amaranth	A
<u>A. prostrata</u>		
* <u>Froelichia floridana</u>		
var. <u>campestris</u>	Snakecotton	A
<u>Guilleminea densa</u>		
var. <u>aggregata</u>	Cottonflower	P
<u>Tidestromia lanuginosa</u>	Woolly tidestromia	A
Amaryllidaceae		
<u>Zephyranthes longifolia</u>	Zephyr-lily	P
Anacardiaceae		
<u>Rhus microphylla</u>	Littleleaf sumac	S
Asclepiadaceae		
* <u>Asclepias arenaria</u>	Dune milkweed	P
<u>A. nyctaginifolia</u>	Four-o'clock milkweed	P
<u>A. oenotherioides</u>	Primrose milkweed	P
<u>A. viridiflora</u>	Green-flowered milkweed	P
Bignoniaceae		
<u>Chilopsis linearis</u>	Desert willow	S
Boraginaceae		
<u>Amsinckia intermedia</u>	Fiddleneck	A
<u>Coldenia canescens</u>	Spreading coldenia	SS
<u>C. hispidissima</u>	Hispid coldenia	SS
<u>Cryptantha angustifolia</u>	Narrowleaved hiddenflower	A
* <u>C. jamesii</u> var. <u>laxa</u>	James hiddenflower	B, P
<u>C. jamesii</u> var. <u>setosa</u>	Setose hiddenflower	B, P
* <u>Heliotropium convolvulaceum</u>	Bindweed heliotrope	A
<u>H. curassavicum</u>	Salt heliotrope	P
<u>H. curassavicum</u> var. <u>obovatum</u>	Bluntleaf heliotrope	P
<u>H. greggii</u>	Desert heliotrope	P
<u>Lithospermum multiflorum</u>	Stoneseed	P

Table H-54. Plants Reported in the Terrestrial Ecology Study Area and at Nearby Sites During 1978 and 1979^a (continued)

Taxon	Common name	Growth form ^b
Cactaceae		
<u>Coryphantha macromeris</u>	Pincushion cactus	P, SS
<u>Echinocactus texensis</u>	Texas devilshhead	SS
<u>Echinocereus caespitosus</u>	Caespitose hedgehog	SS
* <u>E. fendleri</u>	Fendler hedgehog	SS
<u>Opuntia davisii</u>	Davis cholla	SS
<u>O. kleiniae</u>	Klein cholla	SS
<u>O. leptocaulis</u>	Christmas cactus	SS
* <u>O. phaeacantha</u>	Prickly pear	SS
Caryophyllaceae		
<u>Paronychia jamesii</u>	Nailwort	SS
Chenopodiaceae		
<u>Allenrolfea occidentalis</u>	Pickleweed	S
<u>Atriplex canescens</u>	Four-wing saltbush	S
<u>Chenopodium desiccatum</u>	Thickleaf goosefoot	A
<u>C. hians</u>	Fetid goosefoot	A
<u>C. incanum</u>	Gray goosefoot	A
* <u>Cycloloma atriplicifolia</u>	Winged pigweed	A
* <u>Salsola kali</u> var. <u>tenuifolia</u>	Russian thistle, tumbleweed	A
Commelinaceae		
<u>Commelina dianthifolia</u>	Birdbill dayflower	P
* <u>C. erecta</u> var. <u>angustifolia</u>	Erect dayflower	P
<u>Tradescantia occidentalis</u>	Western spiderwort	P
Compositae		
<u>Ambrosia artemisifolia</u>	Short ragweed	A
<u>Aphanostephus ramosissimus</u>	Lazy daisy	A
<u>Artemisia filifolia</u>	Sand sagebrush	SS
<u>A. ludoviciana</u>	Wormwort	P
<u>Baccharis wrightii</u>	Wright baccharis	SS
<u>Bahia pedata</u>	Bahia	A
<u>Baileya multiradiata</u>	Desert marigold	A, P
<u>Berlandiera lyrata</u>	Lyrate greeneyes	P
<u>Chrysothamnus pulchellus</u>	Southwest rabbitbrush	S
<u>C. spathulatus</u>	Bluntleaf rabbitbrush	S
<u>Cirsium</u> spp.	Thistle (rosette)	P
<u>Conyza coulteri</u>	Coulter conyza	A
<u>Dyssodia acerosa</u>	Acerose dogweed	SS

Table H-54. Plants Reported in the Terrestrial Ecology Study Area and at Nearby Sites During 1978 and 1979^a (continued)

Taxon	Common name	Growth form ^b
Compositae (continued)		
<u>Dyssodia pentachaeta</u> var. <u>hartwegii</u>	Hartweg dogweed	P
<u>Erigeron bellidiastrum</u>	Western fleabane	A
<u>E. bigelovii</u> Gray	Bigelow fleabane	P
<u>Flourensia cernua</u>	Tarbush	S
<u>Franseria confertiflora</u>	Bursage	A
<u>Gaillardia pinnatifida</u>	Pinwheel	P
<u>G. pulchella</u>	Firewheel	A
<u>Gutierrezia microcephala</u>	Smallhead snakeweed	SS
* <u>G. sarothrae</u>	Snakeweed, broom snakeweed	SS
<u>Haplopappus spinulosus</u> var. <u>australis</u>	Spiny yellow aster	P
<u>H. spinulosus</u> var. <u>glaberrimus</u>		P
<u>H. spinulosus</u> var. <u>scabrellus</u>		P
* <u>Helianthus petiolaris</u>	Prairie sunflower	A
<u>H. petiolaris</u> subsp. <u>fallax</u>	Prairie sunflower	A
* <u>Heterotheca psammophila</u>	Camphorweed	A
<u>Hymenopappus flavescens</u> var. <u>cano-tomentosus</u>	White ragweed	A, B
<u>Hymenoxys scaposa</u> var. <u>glabra</u>	Smooth hymenoxys	P
<u>H. scaposa</u> var. <u>scaposa</u>	Scapose hymenoxys	P
<u>Leucelene ericoides</u>	Baby white aster	P
<u>Machaeranthera tanacetifolia</u>	Cutleaf aster	A
<u>Melampodium cinereum</u>	Blackfoot	P
* <u>M. leucanthum</u>	Blackfoot	P
* <u>Palafoxia sphacelata</u>		A
<u>Parthenium confertum</u>	Desert feverfew	P, B
* <u>Pectis angustifolia</u>	Fetid marigold	A
<u>Perezia nana</u>	Dwarf holly	P
<u>P. wrightii</u>	Wright desert holly	P
<u>Psilostrophe tagetina</u>	Paper daisy	P
<u>P. villosa</u>	Desert paperflower	B
<u>Ratibida tagetes</u>	Marigold coneflower	P
<u>Sartwellia flaveriae</u>	Gypsumweed	A
* <u>Senecio multicapitatus</u>	Groundsel	P
<u>S. douglasii</u> var. <u>longilobus</u>	Longlobed groundsel	SS
<u>Stephanomeria pauciflora</u>	Wire lettuce	P
<u>Thelesperma megapotamicum</u>	Greenthread	P
* <u>Verbesina encelioides</u>	Golden crownbeard	A
<u>Xanthocephalum texanum</u>	Snakeweed	SS
* <u>Zinnia grandiflora</u>	Wild zinnia	P
Convolvulaceae		
<u>Cuscuta leptantha</u>	Dodder	A
<u>Evolvulus nuttallianus</u>		P
<u>E. pilosus</u>		P

Table H-54. Plants Reported in the Terrestrial Ecology Study Area and at Nearby Sites During 1978 and 1979^a (continued)

Taxon	Common name	Growth form ^b
Cruciferae		
<u>Descurainia pinnata</u> var. <u>halictorum</u>	Tansy mustard	A
<u>D. pinnata</u> var. <u>ochroleuca</u>	Tansy mustard	A
<u>Dithyrea wislizenii</u>	Spectacle pod	A
<u>Draba brachycarpa</u>	Twistpod	A, WA
<u>Erysimum asperum</u>	Western wallflower	P, A
<u>Greggia camporum</u> var. <u>linearifolium</u>		P
<u>Lepidium montanum</u>	Mountain peppergrass	B, P
* <u>L. virginicum</u> var. <u>medium</u>	Peppergrass	B, A
<u>Lesquerella fendleri</u>	Fendler bladderpod	P
<u>L. gracilis</u>	Smooth bladderpod	A
<u>Streptanthus carinatus</u>	Wright twistflower	A
Cucurbitaceae		
* <u>Cucurbita foetidissima</u>	Buffalogourd	P
* <u>C. texana</u>	Texas gourd	A
<u>Citrullus vulgaris</u> var. <u>citroides</u>	Citron melon	A
<u>Ibervillea tenuisecta</u>	Cutleaf globeberry	P
<u>I. tripartita</u>	Three-lobed globeberry	P
Cyperaceae		
* <u>Cyperus schweinitzii</u>	Flatsedge	P
Euphorbiaceae		
<u>Argythamnia humilus</u> var. <u>laevis</u>	Wild mercury	P
* <u>Croton dioicus</u>	Doveweed	P
<u>C. glandulosa</u> var. <u>lindheimeri</u>	Croton	A
<u>C. pottsii</u>	Leatherweed	P
* <u>C. texensis</u>	Texas croton	A
<u>Ditaxis neomexicana</u>	New Mexico mercury	P
<u>Euphorbia fendleri</u>	Fendler spurge	P
<u>E. glyptosperma</u>	Ridge-seed spurge	A
<u>E. heterophylla</u>	Catalina	A
<u>E. lata</u>	Spurge	P
<u>E. micromera</u>	Spurge	A
* <u>E. missurica</u>	Spreading spurge	A
<u>E. missurica</u> var. <u>intermedia</u>	Spreading spurge	A
<u>E. prostrata</u>	Flat spurge	A
* <u>E. serpens</u>	Serpent spurge	A
<u>E. serpyllifolia</u>	Thymeleaf spurge	A
<u>E. serrula</u>	Serrulate spurge	A
<u>Phyllanthus abnormis</u>	Leaf-flower	A
<u>Reverchonia arenaria</u>	Dune reverchonia, duneweed	A
<u>Tragia stylaris</u>	Noseburn	P

Table H-54. Plants Reported in the Terrestrial Ecology Study Area and at Nearby Sites During 1978 and 1979^a (continued)

Taxon	Common name	Growth form ^b
Ephedraceae		
<u>Ephedra torreyana</u>	Joint-fir, Mormon tea	S
Fagaceae		
* <u>Quercus havardii</u>	Havard oak, shinnery oak	S
<u>Q. havardii</u> X <u>Q. muhlenbergii</u> (hybrid)		S
Gentianaceae		
<u>Centaurium calycosum</u> var. <u>breviflorum</u>	Small-flowered rosita	P
<u>C. calycosum</u> var. <u>calycosum</u>	Rosita	P
Gramineae		
<u>Andropogon barbinodis</u>	Cane bluestem	P
<u>A. scoparius</u>	Little bluestem	P
* <u>Aristida barbata</u>	Havard three-awn	P
* <u>A. longiseta</u>	Red three-awn	P
<u>A. pansa</u>	Wooton three-awn	P
<u>A. parishii</u>	Parish three-awn	P
* <u>A. purpurea</u>	Purple three-awn	P
<u>A. wrightii</u>	Wright three-awn	P
<u>Avena sativa</u>	Common oat	A
<u>Bouteloua barbata</u>	Sixweeks grama	A
<u>B. curtipendula</u>	Side-oats grama	P
<u>B. eriopoda</u>	Black grama	P
* <u>B. hirsuta</u>	Hairy grama	P
* <u>Brachiaria ciliatissima</u>	False buffalograss	P
* <u>Bromus catharticus</u> (<u>B. unioloides</u>)	Rescue grass	A
* <u>Cenchrus insertus</u>	Sandbur	P
<u>Chloris cucullata</u>	Hooded fingergrass	P
<u>Enneapogon desvauxii</u>	Spike pappusgrass	P
<u>Eragrostis arida</u>	Desert lovegrass	A
* <u>E. secundiflora</u>	Mexican lovegrass	P
<u>E. silveana</u>		P
<u>Hilaria mutica</u>	Tobosa	P
* <u>Leptoloma cognata</u>	Fall witchgrass	P
<u>Muhlenbergia arenacea</u>	Ear muhly	P
* <u>M. porteri</u>	Bush muhly	P
<u>M. torreyi</u>	Ring muhly	P
* <u>Munroa squarrosa</u>	False buffalograss	A
* <u>Panicum capillare</u>	Common witchgrass	A
<u>P. obtusum</u>	Vine-mesquite	P
* <u>Paspalum setaceum</u>	Knotgrass	P
<u>P. stramineum</u>	Stramineous knotgrass	P
* <u>Scleropogon brevifolius</u>	Burrograss	P
<u>Setaria leucopila</u>	Bristlegrass	P

Table H-54. Plants Reported in the Terrestrial Ecology Study Area and at Nearby Sites During 1978 and 1979^a (continued)

Taxon	Common name	Growth form ^b
Gramineae (continued)		
* <u>S. macrostachya</u>	Plains bristlegrass	P
<u>Sporobolus contractus</u>	Spike dropseed	P
* <u>S. cryptandrus</u>	Sand dropseed	P
<u>S. flexuosus</u>	Mesa dropseed	P
* <u>S. giganteus</u>	Giant dropseed	P
<u>Stipa neomexicana</u>	New Mexico needlegrass	P
<u>Trichachne californica</u>	Arizona cottontop	P
<u>Tridens muticus</u>	Slim tridens	P
<u>T. pulchellus</u>	Fluffgrass	P
* <u>Triplasis purpurea</u>	Purple sandgrass	A
Hydrophyllaceae		
<u>Nama carnosum</u>	Perennial nama	P, SS
<u>N. hispidum</u>	Hispid nama	A
<u>Phacelia corrugata</u>	Corrugate scorpionweed	A
<u>P. integrifolia</u>	Small-lobed scorpionweed	A, B
<u>P. intermedia</u>	Wooton scorpionweed	A, B?
Koeberliniaceae		
<u>Koeberlinia spinosa</u>	Allthorn	S
Labiatae		
* <u>Monarda punctata</u> var. <u>lasiodonta</u>	Spotted horsemint	A
<u>Scutellaria drummondii</u>	Drummond skullcap	A
<u>Teucrium canadense</u>	Germander	P
Leguminosae		
<u>Acacia constricta</u>	Mescat acacia	S
<u>A. neovernicosa</u>		S
<u>Cassia bauhinioides</u>	Senna	P
<u>Dalea formosa</u>	Featherbush	S
<u>D. lanata</u>	Woolly dalea	P
<u>Hoffmanseggia brachycarpa</u>		SS
<u>H. densiflora</u>	Hog potato	P
<u>H. drepanocarpa</u>	Sicklepod rushpea	P
<u>H. glauca</u>	Smooth rushpea	P
<u>H. jamesii</u>	Hog potato	P
<u>Krameria lanceolata</u>	Lanceleaf ratany	P
<u>K. glandulosa</u>	Sticky ratany	S
<u>Mimosa biuncifera</u> var. <u>glabrescens</u>	Catclaw mimosa	S
* <u>Prosopis glandulosa</u>	Honey mesquite	S
Linaceae		
* <u>Linum aristatum</u>	Plains flax	P
* <u>L. aristatum</u> var. <u>australe</u>	Southern Plains flax	P
<u>L. puberulum</u>	Plains flax	P

Table H-54. Plants Reported in the Terrestrial Ecology Study Area and at Nearby Sites During 1978 and 1979^a (continued)

Taxon	Common name	Growth form ^b
Loasaceae		
<u>Cevallia sinuata</u>	Stinging stickleaf	P
<u>Mentzelia humilis</u>	Stickleaf	P
<u>M. pumila</u>	Golden blazingstar	P, B
<u>M. pumila</u> var. <u>multiflora</u>	Golden blazingstar	P, B
<u>M. reverchonii</u>	Reverchon stickleaf	P
<u>M. strictissima</u>	Prairie stickleaf	P
Malvaceae		
<u>Sida physocalyx</u>	Sida	P
<u>Sphaeralcea coccinea</u>	Rosemallow	P
<u>S. digitata</u>	Digitate rosemallow	P
<u>S. subhastata</u>	Coulter rosemallow	P
Martyniaceae		
<u>Proboscidea sabulosa</u>	Dune unicornplant	A
Nyctaginaceae		
* <u>Abronia fragrans</u>	Snowball sandverbena	A
<u>Acleisanthes longiflora</u>	Angel trumpets	P
<u>Ammocodon chenopodioides</u>	Goosefoot moonpod	P
<u>Boerhaavia intermedia</u>	Spiderling	A
<u>Oxybaphus albidus</u>	White four-o'clock	P
<u>O. glaber</u>	Smooth four-o'clock	P
* <u>O. linearis</u> var. <u>decipiens</u>	Narrow-leaved four-o'clock	P
<u>Selinocarpus diffusus</u>	Spreading moonpod	P
Oleaceae		
<u>Menodora scabra</u> var. <u>ramosissima</u>	Rough menodora	SS
Onagraceae		
<u>Calylophus drummondianus</u>	Drummond primrose	P, A
<u>C. hartwegii</u> subsp. <u>pubescens</u>	Hartweg primrose	P, SS
* <u>C. serrulatus</u>		P
<u>Gaura coccinea</u>	Scarlet gaura	P
<u>G. suffulta</u> subsp. <u>nealleyi</u>	Nealley gaura	A
* <u>G. villosa</u>	Hairy gaura	SS
* <u>Oenothera albicaulis</u>	Whitestem evening primrose	A
<u>O. biennis</u> subsp. <u>centralis</u>	Dune primrose	P
<u>O. engelmannii</u>		A
<u>O. neomexicana</u>	New Mexico evening primrose	A
Orobanchaceae		
<u>Orobanche multiflora</u>	Broomrape	A

Table H-54. Plants Reported in the Terrestrial Ecology Study Area and at Nearby Sites During 1978 and 1979^a (continued)

Taxon	Common name	Growth form ^b
Papaveraceae		
<u>Argemone aenea</u>	Prickly poppy	A, B, P
Polemoniaceae		
<u>Ipomopsis longiflora</u>	Blue gilia	A
<u>I. pumila</u>		A
Polygonaceae		
<u>Eriogonum abertianum</u>	Abert buckwheat	A, B
<u>E. annum</u>	Winged buckwheat	A
<u>E. leptocladon</u>		P
<u>E. polycladon</u>	Woolly buckwheat	A
* <u>E. rotundifolium</u>	Roundleaf buckwheat	A
<u>Rumex hymenosepalus</u>	Wild rhubarb	P
Polypodiaceae		
<u>Notholaena sinuata</u> var. <u>chochisensis</u>	Cloakfern	P
Portulacaceae		
* <u>Portulaca parvula</u>	Small purslane	A
<u>P. retusa</u>	Retuse purslane	A
<u>Talinum angustissimum</u>	Fameflower	P
Ranunculaceae		
<u>Delphinium ajacis</u>	Rocket larkspur	A
<u>D. vierescens</u> subsp. <u>wootonii</u>	Plains larkspur	P
Rhamnaceae		
<u>Microrhamnus ericoides</u>	Javelinabush	S
<u>Ziziphus obtusifolia</u>	Lotebush	S
Rubiaceae		
* <u>Hedyotis humifusa</u>	Bluets	A
Rutaceae		
<u>Thamnosma texana</u>	Dutchman's breeches	P
Sapindaceae		
* <u>Sapindus drummondii</u>	Drummond soapberry	T
Scrophulariaceae		
<u>Castilleja sessiliflora</u>	Desert paintbrush	P
<u>Linaria texana</u>	Texas toadflax	A
* <u>Maurandya wislizenii</u>	Vining snapdragon	HV, P
* <u>Penstemon ambiguus</u>	Plains beardtongue	SS
<u>P. buckleyi</u>	Buckley beardtongue	P
<u>P. fendleri</u>	Fendler beardtongue	P

Table H-54. Plants Reported in the Terrestrial Ecology Study Area and at Nearby Sites During 1978 and 1979^a (continued)

Taxon	Common name	Growth form ^b
Solanaceae		
<u>Chamaesaracha conioides</u>	False nightshade	P
<u>C. villosa</u>	Villous false nightshade	P
<u>Lycium berlandiera</u>	Wolfberry	S
<u>Nicotiana trigonophylla</u>	Wild tobacco	B, P
<u>Physalis lobata</u>	Lobed ground-cherry	A
<u>P. hederifolia</u> var. <u>cordifolia</u>	Clammy ground-cherry	P
<u>P. hederifolia</u> var. <u>puberula</u>		P
* <u>Solanum elaeagnifolium</u>	Horsenettle	P
<u>S. rostratum</u>	Spiny nightshade	A
Tamaricaceae		
<u>Tamarix pentandra</u>	Salt cedar	T, S
Ulmaceae		
<u>Celtis reticulata</u>	Netleaf hackberry	T
Umbelliferae		
<u>Eurytaenia texana</u>	Texas spreadwing	A
Verbenaceae		
<u>Aloysia wrightii</u>	Wright lemon verbena	S
<u>Tetradlea coulteri</u>	Coulter tetradlea	P
<u>Verbena bracteata</u>	Prostrate vervain	A
<u>V. ciliata</u>	Ciliate vervain	A
<u>V. plicata</u>	Fanleaf vervain	A
<u>V. wrightii</u>	Desert vervain	A
Violaceae		
<u>Hybanthus verticillatus</u>	Green violet	P
Zygophyllaceae		
<u>Kallstroemia grandiflora</u>	Desert poppy	A
<u>Larrea tridentata</u>	Creosote bush	S
<u>Peganum mexicanum</u>	Garbancillo	P
* <u>Tribulus terrestris</u>	Goathead	A

^aTaxa arranged alphabetically by family, genus, and specific epithet. Those marked with an asterisk have been found within 2 km of ERDA-9.

^bGrowth form: A = annual; WA = winter annual; B = biennial; P = perennial; SS = suffrutescent; S = shrubby; T = arborescent; HV = herbaceous vine; WV = woody vine.

Sandbur (Cenchrus incertus) is locally abundant in sandy spots. Muhly (Muhlenbergia spp.) occur sporadically on compact soils. Scattered bluestem (Andropogon spp.) occur at many sites. False buffalograss (Munroa squarrosa) is the most common annual grass, being very dense in spring and early summer in some years.

In certain areas the sand is only partially stabilized by vegetation. Stabilized "islands" of shinnery oak and mesquite-anchored soil are separated by stretches of bare sand. The bare sand is highly susceptible to erosion. Thus wind erosion forms depressions, or blowouts, in the bare-sand areas, leaving the stabilized portions as slightly elevated hummocks. The vegetation is not greatly different from that found in shinnery oak-mesquite associations in the fully stabilized dune area. Its configuration in isolated hummocks is what is most distinctive about this subzone. The potential for wind erosion is, of course, greater in years of low rainfall, when ground cover is lowest, than in years of good rainfall.

A relatively small zone of active dunes running east-west is located just southeast of the James Ranch headquarters. Vegetation is sparse, but includes stands of a small tree, western soapberry (Sapindus drummondii), and the annual dune reverchonnia (Reverchonnia arenaria). Perennials are snowball sandverbena (Abronia fragrans) and species of unicornplant (Proboscidea spp.). All but Reverchonnia occur sporadically elsewhere in the central dune area.

Creosote flats. West and southwest of the central dune area, the soils become relatively dense and shallow (often only a few centimeters deep). The caliche may even be exposed in places. The floristic composition changes drastically. Creosote bush (Larrea tridentata) becomes dominant. Snakeweed (G. sarothrae) is the dominant subshrub. Shinnery oak and sand sagebrush are absent. Species of the perennial muhlys (Muhlenbergia spp.) are quite dense here, as are purple three-awn and black grama. Mesquite is present, sporadically occurring in clumps in depressions, but does not have significant cover value.

Livingston Ridge. In this area the soil remains compact and shallow, with occasional outcrops of rock or caliche. Creosote bush gives way to an Acacia-dominated association at the top of the ridge. In addition to mesquit acacia (A. constricta), also known as white thorn acacia, Q. havardii, G. sarothrae, and Y. campestris are the shrubby dominants here. A croton (Croton dioicus) and a ratany (Krameria lanceolata) are common perennial herbs. Muhlenbergia porteri is the most abundant perennial grass.

Tobosa flats. The western face of Livingston Ridge drops abruptly about 200 feet to a broad valley floor ("flats") densely populated with tobosa grass (Hilaria mutica). This species is uncommon elsewhere in the study area. Purple three-awn (Aristida purpurea) is the only other grass of significance. Creosote bush and ratany reappear; acacia is absent. Snakeweed is unimportant here. Sparse stands of Yucca torreyi are found.

Studies have concentrated on the central dunes area because it includes all of control zones I and II. In the four sections around ERDA-9, the vegetation has been examined in detail. It is a relatively homogeneous stabilized-dune area supporting a shinnery oak, sand sagebrush, and dune yucca association.

Mesquite is not a prominent shrub, although it is frequently a dominant elsewhere in the dune area. Very dense stands of shinnery oak are common. They exist as low shrubs usually less than 1 meter tall. Thickets form by vegetative reproduction (root sprouts); thus many of the oak stands are genetically single entities (i.e., clones). Acorn formation depends on rainfall. The failure of the spring rains in 1978 inhibited pistillate flower formation and resulted in very few acorns that year. In 1979, a relatively "wet" year, the crop was larger than in 1978. Snakeweed (Gutierrezia sarothrae) is sparse in the ERDA-9 area.

Annuals are especially abundant; bindweed heliotrope (Heliotropium convolvulaceum), desert bluets (Hedyotis humifusa), and fetid marigold (Pectis angustifolia) are most common.

False buffalograss (Munroa squarrosa) in some years is the most abundant grass (up to 310,000 plants per hectare). Other common grasses are black grama (Bouteloua eriopoda) and species of three-awn (Aristida). Species of Sporobolus (dropseed) and Muhlenbergia (muhly), and purple sandgrass (Triplasis purpurea) occur late in the growing season.

All taxa collected and identified in the area around ERDA-9 are listed in Table H-54. Typical views of the site are shown in Figures H-20 through H-23.

H.5.2.3 Wildlife

Typical grassland and shrubland species dominate the fauna of Eddy and Lea Counties; their distribution and abundance are strongly affected by water availability. The limited areas of cropland are of special importance to many species of wildlife because they provide both food and water. Stock ponds on rangelands are water sources for wildlife as well as cattle.

Mammals

About 46 species representing nine mammalian orders are reported to occur within the two-county region. Among these are 15 species of bats, few of which have ever been observed east of the Pecos River. Some species form very large colonies (e.g., the Brazilian free-tailed bat in the Carlsbad Caverns area). The one ground-dwelling insectivore, the desert shrew, is widely distributed but scarce throughout its range.

Lagomorphs (rabbits and hares) include the desert cottontail and black-tailed jack rabbit. Both are common in desert-shrub communities, but they also occur in grassland and farmland.

Desert-dwelling rodent species include kangaroo rats, grasshopper mice, and pocket mice. Two introduced species, the house mouse and the Norway rat, are typically found near human habitations.

Several carnivore species are widespread and relatively common (e.g., coyote, gray fox, badger, striped skunk, bobcat).

Four game and ten furbearer species (Table H-55) are found in the region. Furbearers that are closely associated with water (e.g., beaver and muskrat)

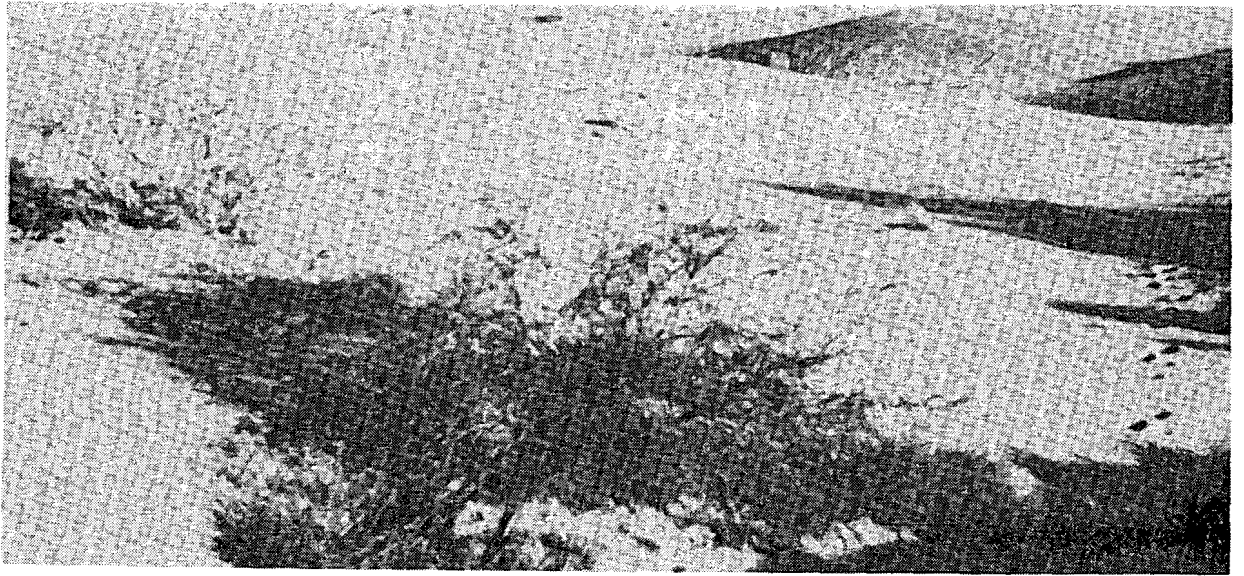

Figure H-20. Sand dunes at the WIPP site.

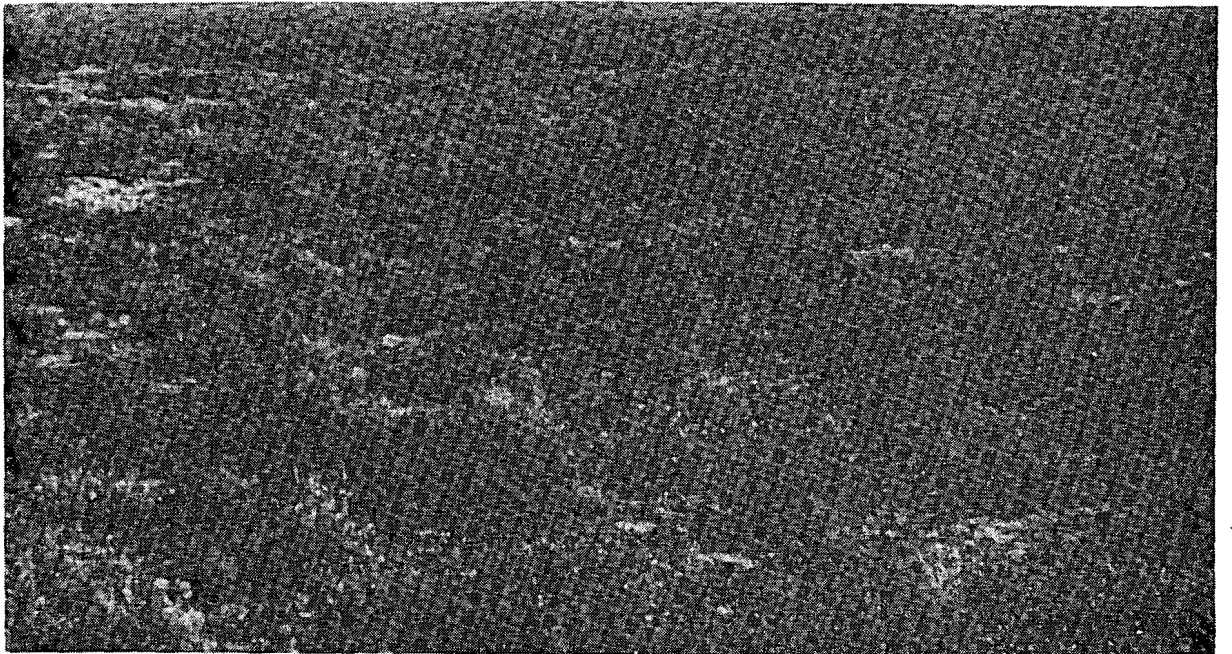

Figure H-21. Typical view of the WIPP site.



Figure H-22. Blowout area.



Figure H-23. Typical stabilized dunes.

Table H-55. Game Mammals and Furbearers of the Two-County Region

Common name ^a	Scientific name ^a	Status ^b
Beaver	<u>Castor canadensis</u>	F
Muskrat	<u>Ondatra zibethicus</u>	F
Swift fox	<u>Vulpes velox</u>	F
Gray fox	<u>Urocyon cinereoargenteus</u>	F
Ringtail	<u>Bassariscus astutus</u>	F
Raccoon	<u>Procyon lotor</u>	F
Long-tailed weasel	<u>Mustela frenata</u>	F
Badger	<u>Taxidea taxus</u>	F
Western spotted skunk	<u>Spilogale gracilis</u>	F
Striped skunk	<u>Mephitis mephitis</u>	F
Mountain lion	<u>Felis concolor</u>	G
Mule deer	<u>Odocoileus hemionus</u>	G
White-tailed deer	<u>Odocoileus virginianus</u>	G
Pronghorn	<u>Antilocapra americana</u>	G

^aCommon and scientific names follow Jones et al. (1975).

^bGame status from 1977 hunting and trapping regulations: F = furbearer; G = game species.

are not common and occur only along the Pecos River, more than 10 miles from the site. Coyote are trapped intensively throughout the region. Mule deer are an important game animal in the region. The pronghorn is basically a plains animal, but it is also found in desert-shrub and desert-grassland habitats in the arid southwest (Wallmo, 1975).

Mammals of the study area

Thirty-nine species of mammals are known to occur within the study area.

Three species of bats have been collected during two summer seasons of bat study. None of these were previously reported east of the Pecos in southeastern New Mexico. The most commonly collected bat at the site, the cave myotis (Myotis velifer), almost certainly roosts nearby because heavily pregnant females with limited flight ranges were collected in 1978 and 1979. It is likely that roost sites occur along Livingston Ridge, but none have been located. The Brazilian free-tailed bat (Tadarida brasiliensis), which inhabits Carlsbad Caverns, was first collected at the site in 1979. All specimens of bats were collected at stock tanks at the site.

Several small mammals are abundant. The desert cottontail and the blacktailed jackrabbit occur in all habitats.

Among the rodents, there are obvious habitat preferences. Ord's kangaroo rat (Dipodomys ordii), for example, is found in all habitats of the central dunes zone and on the mesa, but not on the creosote bush flats, which are inhabited by Merriam's and bannertail kangaroo rats (D. merriami and D. spectabilis). The Southern Plains woodrat (Neotoma micropus) is found in all habitats. The spotted ground squirrel (Spermophilus spilosoma), on the other hand, is only found in the oak-mesquite associations of the stabilized-dune area.

The mammals observed at the site and their habitat preferences are listed in Table H-56; those potentially inhabiting the site are listed in Table H-57.

Certain species recorded for Eddy County, such as the rock mouse (Peromyscus difficilis) and the brush mouse (P. boylii), that are only found west of the Pecos are not included in Table H-57 because it is highly unlikely that they inhabit the study area even though suitable habitat may be present.

The desert shrew probably does occur in the study area, but has not been collected. It is very difficult to trap and is always scarce.

The southern grasshopper mouse (Onychomys torridus) cannot be definitely distinguished anatomically from the northern grasshopper mouse (O. leucogaster) without examining the skulls of specimens (Traut, 1963). Their habitat preferences are distinct, however; O. torridus prefers dense soil while O. leucogaster prefers sandy soils (Gennaro, 1968). Thus, it is possible that some specimens identified as O. leucogaster, especially those collected in creosote bush areas, are in fact O. torridus (see Table H-56).

Mule deer and pronghorn have been observed in the study area. Mule deer are common; they frequent the oak-mesquite associations of the stabilized-dune area and the various stock-watering tanks and ponds, but are also sighted in the creosote bush association.

The most common predator is the coyote (Canis latrans), which is frequently observed in all habitats of the study area. The swift fox (Vulpes velox) and the elusive gray fox (Urocyon cinereoargenteus) are uncommon.

The house mouse (Mus musculus), an introduced species, has been collected in the central dune area.

Domestic animals are included in the mammal list because they are frequently encountered in the study area. Cattle and horses are pastured, usually separately, throughout the study area and are the most abundant large herbivores.

Birds

A large variety of bird species are recorded for Eddy and Lea Counties.

Among the typical birds of the region is the white-necked raven, a year-round resident in much of the region. Other fairly common breeding species are the mockingbird, the pyrrhuloxia, and the loggerhead shrike. The lark bunting is a common migrant throughout the area, as are several warblers and sparrows. Black-necked stilts breed on the salt flats. Common raptors in the region include the marsh hawk, the American kestrel, Swainson's hawk, and the Harris hawk.

Mourning dove and scaled quail are widespread and heavily hunted; the lesser prairie chicken and the bobwhite are also hunted. Bobwhite are generally restricted to wooded or brushy river valleys. The mourning dove is common in agricultural land and is outnumbered only by scaled quail in total numbers harvested. The game birds of the region are listed in Table H-58.

Table H-56. Mammals Observed in the Terrestrial Ecology Study Area

Common name	Scientific name	Food type ^a	Abundance ^b	Habitat ^c
Bats				
Cave myotis	<u>Myotis velifer</u>	IV	C	A
Pallid bat	<u>Antrozous pallidus</u>	IV	U	A
Brazilian free-tailed bat	<u>Tadarida brasiliensis</u>	IV	U	A
Lagomorphs				
Desert cottontail	<u>Sylvilagus audubonii</u>	P	VC	OM, M, CB, D, HM
Black-tailed jackrabbit	<u>Lepus californicus</u>	P	VC	OM, M, CB, D, HM
Rodents				
Mexican ground squirrel	<u>Spermophilus mexicanus</u>	P, S, IV, SV	C	CB, OM
Spotted ground squirrel	<u>S. spilosoma</u>	P, S, IV, SV	VC	OM
Plains pocket gopher	<u>Geomys bursarius</u>	R	VC	OM
Yellow-faced pocket gopher	<u>Pappogeomys castanops</u>	S, P, IV	VC	CB
Silky pocket mouse	<u>Perognathus flavus</u>	S, P, IV	C	OM, CB
Plains pocket mouse	<u>P. flavescens</u>	S, P, IV	C	OM, M
Hispid pocket mouse	<u>P. hispidus</u>	S, P, IV	U	OM, M
Desert pocket mouse	<u>P. penicillatus</u>	S, P, IV	C	D, HM, CB
Ord's kangaroo rat	<u>Dipodomys ordii</u>	P, S	VC	OM, (M), D, HM
Banner-tailed kangaroo rat	<u>D. spectabilis</u>	P, S	VC	M, CB
Merriam's kangaroo rat	<u>D. merriami</u>	P, S	VC	D, HM, M
Western harvest mouse	<u>Reithrodontomys megalotis</u>	P, IV	U	OM, CB
Deer mouse	<u>Peromyscus maniculatus</u>	S, P, IV	U	OM
White-footed mouse	<u>P. leucopus</u>	S, P, IV	C	OM, M, CB, D, HM
Northern grasshopper mouse	<u>Onychomys leucogaster</u>	S, IV, SV	VC	OM, (CB), (M), HM, D
Hispid cotton rat	<u>Sigmodon hispidus</u>	P	U	OM, M, (CB)
Southern Plains woodrat	<u>Neotoma micropus</u>	S, F, P	VC	OM, D, HM, M, (CB)
White-throated woodrat	<u>N. albigula</u>	S, P	C	CB, M
House mouse	<u>Mus musculus</u>	S, P, IV	U	OM
Porcupine	<u>Erethizon dorsatum</u>	P	U	OM, M, CB, HM, D
Carnivores				
Coyote	<u>Canis latrans</u>	V, IV, P	VC	OM, CB, D, HM, M, A
Swift fox	<u>Vulpes velox</u>		U	CB
Gray fox ^d	<u>Urocyon cinereoargenteus</u>		U	?
Badger	<u>Taxidea taxus</u>	SM	U	OM, M
Striped skunk	<u>Mephitis mephitis</u>	C, P	U	OM
Bobcat	<u>Lynx rufus</u>	V	U	OM
Ungulates				
Mule deer	<u>Odocoileus hemionus</u>	P	C	OM, CB, A
Pronghorn	<u>Antilocapra americana</u>	P	U	M
Domestic species^e				
Dog	<u>Canis familiaris</u>			
Cat	<u>Felis catus</u>			
Goat	<u>Capra sp.</u>			
Cattle	<u>Bos taurus</u> (and <u>B. indicus</u>)			
Horse	<u>Equus caballus</u>			

^aFood type: P = plant tissue; F = fruit; S = seeds; K = roots and tubers; IV = invertebrates; SV = small vertebrates; V = vertebrates; SM = small mammals; C = carrion.

^bAbundance: VC = very common; C = common; U = uncommon.

^cHabitat descriptions are based on vegetation. Edaphic factors are frequently of equal importance in distribution. Key: OM = oak-mesquite associations; CB = creosote bush associations; M = mesa (mesquite grassland); HM = hummock mesquite associations; A = aquatic (stock pond or tank); D = active dunes.

^dBased on tracks and collection of a single gray-fox skull in 1979.

^eGoats are penned; all other domestic species may occur in all six habitats.

Table H-57. Mammalian Species Potentially Inhabiting but Not Observed in the Terrestrial Ecology Study Area^a

Common name	Scientific name
Desert shrew	<u>Notiosorex crawfordi</u>
Townsend's big-eared bat	<u>Plecotus townsendii</u>
Western pipistrelle	<u>Pipistrellus hesperus</u>
Long-eared myotis	<u>Myotis evotis</u>
Fringed myotis ^b	<u>M. thysanodes</u>
California myotis ^b	<u>M. californicus</u>
Yuma myotis ^b	<u>M. yumanensis</u>
Long-legged myotis ^b	<u>M. volans</u>
Small-footed myotis	<u>M. leibii</u>
Silver-haired bat ^b	<u>Lasionycteris noctivagans</u>
Big brown bat ^b	<u>Eptesicus fuscus</u>
Red bat ^b	<u>Lasiurus borealis</u>
Big free-tailed bat ^b	<u>Tadarida macrotis</u>
Pocketed free-tailed bat	<u>T. femorosacca</u>
Plains harvest mouse	<u>Reithrodontomys montanus</u>
Southern grasshopper mouse ^c	<u>Onychomys torridus</u>
Kit fox	<u>Vulpes macrotis</u>
White-tailed deer	<u>Odocoileus virginianus</u>

^aCommon and scientific names follow Jones et al. (1975).

^bNever reported east of the Pecos River.

^cSee discussion in Section H.5.2.3 under "Mammals of the Study Area."

Migratory birds that might be hunted in the region include several species of waterfowl. The region is not an important breeding area for waterfowl.

The region is in the Central Flyway (a Federal administrative management unit for waterfowl). Mallards, pintails, blue-winged teal, and green-winged teal are the most common dabbling ducks in the region; the first two species constitute one-half to two-thirds of the annual harvest of waterfowl in the Central Flyway (Buller, 1964). The redhead, the canvasback, and the lesser scaup are common diving ducks in the Flyway.

Birds of the study area. One hundred and twenty-two species of birds have been observed in the study area and nearby areas: Laguna Grande de la Sal and the intersection of New Mexico Highway 31 and the Pecos River (Table H-59). Six of these (mallard, blue-winged teal, green-winged teal, bobwhite, scaled quail, and mourning dove) are classified as game species. Only the scaled quail and the mourning dove, however, are present in huntable numbers (J. Herring, New Mexico Game and Fish Department, personal communication, August 2, 1978). The three duck species were rare visitors observed on stock ponds near the site (Wolfe et al., 1977a).

In addition to the scaled quail and the mourning dove, the mockingbird, the loggerhead shrike, the pyrrhuloxia, the black-throated sparrow, the western meadowlark, the lark bunting, the vesper sparrow, Cassin's sparrow, and the white-crowned sparrow are the avian species present in greatest densities

Table H-58. Game Birds in the Two-County Region^a

Common name	Scientific name ^b	Status ^c
Canada goose	<u>Branta canadensis</u>	1
White-fronted goose	<u>Anser albifrons</u>	1
Snow goose	<u>Chen caerulescens</u>	1
Mallard	<u>Anas platyrhynchos</u>	1
Gadwall	<u>A. strepera</u>	1
Pintail	<u>A. acuta</u>	1
Green-winged teal	<u>A. crecca</u>	1
Blue-winged teal	<u>A. discors</u>	1
Cinnamon teal	<u>A. cyanoptera</u>	1
American wigeon	<u>A. americana</u>	1
Northern shoveler	<u>A. clypeata</u>	1
Redhead	<u>Aythya americana</u>	1
Ring-necked duck	<u>A. collaris</u>	1
Canvasback	<u>A. valisineria</u>	1
Lesser scaup	<u>A. affinis</u>	1
Common goldeneye	<u>Bucephala clangula</u>	1
Bufflehead	<u>B. albeola</u>	1
Ruddy duck	<u>Oxyura jamaicensis</u>	1
Common merganser	<u>Mergus merganser</u>	1
Lesser prairie chicken	<u>Tympanuchus pallidicinctus</u>	2
Bobwhite	<u>Colinus virginianus</u>	2
Scaled quail	<u>Callipepla squamata</u>	2
Ring-necked pheasant	<u>Phasianus colchicus</u>	2
Sandhill crane	<u>Grus canadensis</u>	1
Virginia rail	<u>Rallus limicola</u>	1
Sora	<u>Porzana carolina</u>	1
American coot	<u>Fulica americana</u>	1
Common snipe	<u>Capella gallinago</u>	1
Mourning dove	<u>Zenaida macroura</u>	1

^aRanges from Bellrose (1976) and Johnsgard (1973, 1975).

^bNomenclature follows the American Ornithologists' Union (1957, 1973, 1976).

^cKey: 1 = migratory species, hunting regulations controlled by the Federal Government; 2 = permanent resident.

in the study area (Table H-60). The Harris hawk, the white-necked raven, Swainson's hawk, the marsh hawk, and the American kestrel are never more numerous than one per 100 hectares, but are sighted consistently. Many other species are present in low densities and in only one or a few months. Many of these are migrants, such as the blue-winged teal, the yellow-rumped warbler, Wilson's warbler, and the clay-colored sparrow.

Rocky escarpments along Livingston Ridge (4 to 5 miles northwest of the site) provide suitable nesting habitat for several raptor species. The marsh hawk, a ground-nesting species, may nest in undisturbed areas near the site.

Table H-59. Birds Observed in the Terrestrial Ecology Study Area and at Nearby Aquatic Sites^a

Common name ^b	Scientific name	Food type ^c	Abundance ^d	Season ^e
Grebes	Podicipedidae			
*Pied-billed grebe	<u>Podilymbus podiceps</u>	C ₂ , C ₃	I	M
Herons and egrets	Ardeidae			
Great blue heron	<u>Ardea herodias</u>	C ₃ , C ₂	UC	S
*Green heron	<u>Butorides virescens</u>	C ₃ , C ₂	UC	S
Little blue heron	<u>Florida caerulea</u>	C ₃ , C ₂	UC	S
Cattle egret	<u>Bubulcus ibis</u>	C ₃ , C ₂	UC	S
Snowy egret	<u>Egretta thula</u>	C ₃ , C ₂	UC	S
Black-crowned night heron	<u>Nycticorax nycticorax</u>	C ₃ , C ₂	UC	S
Ducks	Anatidae			
Mallard	<u>Anas platyrhynchos</u>	C ₁ , C ₂ , C ₃	UC	M
*Northern shoveler	<u>A. clypeata</u>	C ₁ , C ₂ , C ₃	UC	M
Green-winged teal	<u>A. crecca</u>	C ₁ , C ₂ , C ₃	UC	M
Blue-winged teal	<u>A. discors</u>	C ₁ , C ₂ , C ₃	UC	M
Vultures	Cathartidae			
Turkey vulture	<u>Cathartes aura</u>	C ₃ , C ₂	C	S
Hawks and eagles	Accipitridae			
*Sharp-shinned hawk	<u>Accipiter striatus</u>	C ₂ , C ₃	UC	M
Red-tailed hawk	<u>Buteo jamaicensis</u>	C ₂ , C ₃	C	Y
Swainson's hawk	<u>B. swainsoni</u>	C ₂ , C ₃	UC	S
Ferruginous hawk	<u>B. regalis</u>	C ₂ , C ₃	UC	W
Harris' hawk	<u>Parabuteo unicinctus</u>	C ₂ , C ₃	UC	Y
Golden eagle	<u>Aquila chrysaetos</u>	C ₂ , C ₃	UC	Y
Marsh hawk	<u>Circus cyaneus</u>	C ₂ , C ₃	C	W
Falcons	Falconidae			
Peregrine falcon	<u>Falco peregrinus</u>	C ₃ , C ₂	I	M
Prairie falcon	<u>F. mexicanus</u>	C ₃ , C ₂	UC	W
American kestrel	<u>F. sparverius</u>	C ₂ , C ₃	C	M
Grouse	Tetraonidae			
Lesser prairie chicken	<u>Tympanuchus pallidicinctus</u>	C ₁	UC	Y
Quail	Phasianidae			
Bobwhite	<u>Colinus virginianus</u>	C ₁	UC	Y
Scaled quail	<u>Callipepla squamata</u>	C ₁	UC	Y
Cranes	Gruidae			
Sandhill crane	<u>Grus canadensis</u>	C ₁ , C ₂	UC	M
Rails, coots, gallinules	Rallidae			
*American coot	<u>Fulica americana</u>		I	M
Plovers	Charadriidae			
Snowy plover	<u>Charadrius alexandrinus</u>	C ₂ , C ₃	C	S
Killdeer	<u>C. vociferus</u>	C ₂ , C ₃	C	M
*Mountain plover	<u>Eupoda montana</u>	C ₂ , C ₃	UC	M
Sandpipers	Scolopacidae			
Common snipe	<u>Capella gallinago</u>	C ₂ , C ₃	UC	M
*Long-billed curlew	<u>Numenius americanus</u>	C ₂ , C ₃	UC	M
Spotted sandpiper	<u>Actitis macularia</u>	C ₂ , C ₃	UC	M
Solitary sandpiper	<u>Tringa solitaria</u>	C ₂ , C ₃	UC	M
*Greater yellowlegs	<u>T. melanoleucus</u>	C ₂ , C ₃	UC	M
*Least sandpiper	<u>Calidris minutilla</u>	C ₂ , C ₃	UC	M
*Stilt sandpiper ^f	<u>Micropalama himantopus</u>	C ₂ , C ₃	I	M
*Western sandpiper	<u>Calidris mauri</u>	C ₂ , C ₃	UC	M

Table H-59. Birds Observed in the Terrestrial Ecology Study Area and at Nearby Aquatic Sites^a (continued)

Common name ^b	Scientific name	Food type ^c	Abundance ^d	Season ^e
Avocets, stilts	Recurvirostridae			
American avocet	<u>Recurvirostra americana</u>	C ₂ , C ₃	C	S
Black-necked stilt	<u>Himantopus mexicanus</u>	C ₂ , C ₃	C	S
Phalaropes	Phalaropodidae			
Wilson's phalarope	<u>Steganopus tricolor</u>	C ₂ , C ₃	C	M
*Northern phalarope	<u>Lobipes lobatus</u>	C ₂ , C ₃	UC	M
Gulls and terns	Laridae			
Least tern	<u>Sterna albifrons</u>	C ₁ , C ₂ , C ₃	I	M
Pigeons and doves	Columbidae			
Mourning dove	<u>Zenaida macroura</u>	C ₁	VC	Y
Cuckoos	Cuculidae			
Yellow-billed cuckoo	<u>Coccyzus americanus</u>	C ₂ , C ₃	UC	M
Roadrunner	<u>Geococcyx californianus</u>	C ₂ , C ₃	C	Y
Barn owl	Tytonidae			
Barn owl	<u>Tyto alba</u>	C ₃ , C ₂	UC	Y
Owls	Strigiformes			
Great-horned owl	<u>Bubo virginianus</u>	C ₃ , C ₂	C	Y
Burrowing owl	<u>Athene cunicularia</u>	C ₃ , C ₂	C	Y
*Short-eared owl	<u>Asio flammeus</u>	C ₃ , C ₂	I	M
Nightjars	Caprimulgidae			
Poor-will	<u>Phalaenoptilus nuttallii</u>	C ₂ , C ₃	UC	S
Common nighthawk	<u>Chordeiles minor</u>	C ₂ , C ₃	VC	S
Kingfishers	Alcedinidae			
Belted kingfisher	<u>Megaceryle alcyon</u>	C ₂ , C ₃	UC	M
Woodpeckers	Picidae			
Common flicker	<u>Colaptes auratus</u>	C ₂ , C ₃	C	M
Ladder-backed woodpecker	<u>Picoides scalaris</u>	C ₂ , C ₃	C	
Flycatchers	Tyrannidae			
Western kingbird	<u>Tyrannus verticalis</u>	C ₂ , C ₃	C	S
*Cassin's kingbird	<u>T. vociferans</u>	C ₂ , C ₃	I	M
Scissor-tailed flycatcher	<u>Muscivora forficata</u>	C ₂ , C ₃	C	S
Ash-throated flycatcher	<u>Myiarchus cinerascens</u>	C ₂ , C ₃	C	S
Say's phoebe	<u>Sayornis saya</u>	C ₂ , C ₃	C	M, W
*Traill flycatcher	<u>Empidonax traillii</u>	C ₂ , C ₃	UC	M
*Least flycatcher	<u>E. minimus</u>	C ₂ , C ₃	UC	M
	<u>E. sp.⁹</u>	C ₂ , C ₃	UC	M
Western wood pewee	<u>Contopus sordidulus</u>	C ₂ , C ₃	C	S, M
*Olive-sided flycatcher	<u>Nuttallornis borealis</u>	C ₂ , C ₃	UC	M
Larks	Alaudidae			
Horned lark	<u>Eremophila alpestris</u>	C ₁ , C ₂ , C ₃	UC	M, W
Swallows, martins	Hirundinidae			
*Violet-green swallow	<u>Tachycineta thalassina</u>	C ₂ , C ₃	UC	M
Barn swallow	<u>Hirundo rustica</u>	C ₂ , C ₃	UC	S
Cliff swallow	<u>Petrochelidon pyrrhonota</u>	C ₂ , C ₃	UC	S
Crows, ravens, and jays	Corvidae			
White-necked raven	<u>Corvus cryptoleucus</u>	C ₁ , C ₂ , C ₃	VC	S
Chickadees, titmice	Paridae			
*Mountain chickadee	<u>Parus gambeli</u>	C ₂ , C ₃	I	M

Table H-59. Birds Observed in the Terrestrial Ecology Study Area and at Nearby Aquatic Sites^a (continued)

Common name ^b	Scientific name	Food type ^c	Abundance ^d	Season ^e
Wrens	Troglodytidae			
House wren	<u>Troglodytes aedon</u>	C ₂ , C ₃	UC	M
Bewick's wren	<u>Thryomanes bewickii</u>	C ₂ , C ₃	UC	M
Carolina wren ^f	<u>T. ludovicianus</u>	C ₂ , C ₃	I	M
Cactus wren	<u>Campylorhynchus</u> <u>brunneicapillus</u>	C ₂ , C ₃	VC	S
Rock wren	<u>Salpinctes obsoletus</u>	C ₂ , C ₃		
Mockingbirds, thrashers	Mimidae			
Mockingbird	<u>Mimus polyglottos</u>	C ₂ , C ₃	C	S
Brown thrasher	<u>Toxostoma rufum</u>	C ₂ , C ₃	I	M
*Bendire's thrasher ^f	<u>T. bendirei</u>	C ₂ , C ₃	I	M
Curve-billed thrasher	<u>T. curvirostre</u>	C ₂ , C ₃	C	Y
Crissal thrasher	<u>T. dorsale</u>	C ₂ , C ₃	C	Y
Sage thrasher	<u>Oreoscoptes montanus</u>	C ₂ , C ₃	C	W
Thrushes, bluebirds	Turdidae			
*Mountain bluebird	<u>Sialia currocoides</u>	C ₁ , C ₂ , C ₃	UC	M
Shrikes	Laniidae			
Loggerhead shrike	<u>Lanius ludovicianus</u>	C ₂ , C ₃	VC	Y
Starlings	Sturnidae			
Starling	<u>Sturnus vulgaris</u>	C ₂ , C ₃	UC	Y
Warblers	Parulidae			
*Orange-crowned warbler	<u>Vermivora celata</u>	C ₂ , C ₃	UC	M
Yellow-rumped warbler	<u>Dendroica coronata</u>	C ₂ , C ₃	UC	M
*MacGillivray's warbler	<u>Oporornis tolmiei</u>	C ₂ , C ₃	UC	M
Yellow-breasted chat	<u>Icteria virens</u>	C ₂ , C ₃	UC	M
Wilson's warbler	<u>Wilsonia pusilla</u>	C ₂ , C ₃	UC	M
Weaver finches	Ploceidae			
House sparrow	<u>Passer domesticus</u>	C ₂ , C ₃	C	Y
Blackbirds, orioles	Icteridae			
Eastern meadowlark	<u>Sturnella magna</u>	C ₂ , C ₃	C	S, (Y?)
Western meadowlark	<u>S. neglecta</u>	C ₂ , C ₃	VC	Y
Yellow-headed blackbird	<u>Xanthocephalus</u> <u>xanthocephalus</u>	C ₂ , C ₃	C	M
Red-winged blackbird	<u>Agelaius phoeniceus</u>	C ₂ , C ₃	C	M
*Scott's oriole	<u>Icterus parisorum</u>	C ₂ , C ₃	C	S
Northern oriole	<u>I. galbula</u>	C ₂ , C ₃	C	S
Brewer's blackbird	<u>Euphagus cyanocephalus</u>	C ₂ , C ₃	C	M
Brown-headed cowbird	<u>Molothrus ater</u>	C ₂ , C ₃	C	S
Tanagers	Thraupidae			
*Western tanager	<u>Piranga ludoviciana</u>	C ₂ , C ₃	I	M
Grosbeaks, finches, sparrows, buntings	Fringillidae			
Pyrrhuloxia	<u>Cardinalis sinuata</u>	C ₁ , C ₂	VC	Y
Blue grosbeak	<u>Guiraca caerulea</u>	C ₁ , C ₂	C	S
*Lazuli bunting	<u>Passerina amoena</u>	C ₁ , C ₂	I	M
House finch	<u>Carpodacus mexicanus</u>	C ₁ , C ₂	C	Y
Pine siskin	<u>Carduelis pinus</u>	C ₁ , C ₂	UC	M
American goldfinch	<u>C. tristis</u>	C ₂ , C ₂	UC	M
*Lesser goldfinch	<u>C. psaltria</u>	C ₁ , C ₂	I	M
Green-tailed towhee	<u>Pipilo chlorurus</u>	C ₁ , C ₂	UC	M
Rufous-sided towhee	<u>P. erythrophthalmus</u>	C ₁ , C ₂	UC	M
*Brown towhee	<u>P. fuscus</u>	C ₁ , C ₂	I	M

Table H-59. Birds Observed in the Terrestrial Ecology Study Area and at Nearby Aquatic Sites^a (continued)

Common name ^b	Scientific name	Food type ^c	Abundance ^d	Season ^e
Grosbeaks, finches, sparrows, buntings (continued)	Fringillidae (continued)			
Lark bunting	<u>Calamospiza melanocorys</u>	C ₁ , C ₂	VC	M
Savannah sparrow	<u>Passerculus sandwichensis</u>	C ₁ , C ₂	I	M
Vesper sparrow	<u>Poocetes gramineus</u>	C ₁ , C ₂	C	W
Baird's sparrow ^f	<u>Ammodramus bairdii</u>	C ₁ , C ₂	I	M
Lark sparrow	<u>Chondestes grammacus</u>	C ₁ , C ₂	C	M
Cassin's sparrow	<u>Aimophila cassinii</u>	C ₁ , C ₂	VC	S
Black-throated sparrow	<u>Amphispiza bilineata</u>	C ₁ , C ₂	VC	Y
Sage sparrow	<u>A. belli</u>	C ₁ , C ₂	C	W
Dark-eyed junco	<u>Junco hyemalis</u>	C ₁ , C ₂	C	W
*Chipping sparrow	<u>Spizella passerina</u>	C ₁ , C ₂	UC	M
Clay-colored sparrow	<u>S. pallida</u>	C ₁ , C ₂	I	M
Brewer's sparrow	<u>S. breweri</u>	C ₁ , C ₂	C	M, W
White-crowned sparrow	<u>Zonotrichia leucophrys</u>	C ₁ , C ₂	VC	W
*Song sparrow	<u>Melospiza melodia</u>	C ₁ , C ₂	UC	M

^aIncludes stock tanks in area, nearby salt lakes, and Pecos River.

^bAn asterisk indicates species added to the list during October 1978 through September 1979.

^cTrophic levels (C₁ = primary consumer; C₂ = secondary consumer; C₃ = tertiary consumer) listed in order of relative importance.

^dAbundance: VC = very common; C = common; UC = uncommon; I = incidental (seen only once or twice).

^eSeason: S = summer only; W = winter only; M = migrant; Y = year-round resident.

^fRecord questionable, reported without details.

^gEmpidonax difficilis removed from checklist because substantiating evidence is lacking and because field identification is extremely difficult. All observations were recorded as Empidonax sp. until a specimen was collected.

Reptiles and amphibians

Amphibians are not an important part of the fauna at the WIPP site because suitable habitat is limited. However, several amphibian species are adapted to arid-land habitats. Others occur along the Pecos River and in irrigated cropland. Characteristic reptiles in the region include the western box turtle, the side-blotched lizard, the western whiptail, the bullsnake, and the western rattlesnake.

Twenty-nine species (6 amphibians and 23 reptiles) are observed in the site vicinity (Table H-61). Suitable habitat for amphibians and aquatic reptiles is limited to stock tanks. Sand dunes, rocky outcrops, and the various shrub associations provide a variety of habitats. Species potentially inhabiting the site vicinity are listed in Table H-62.

The amphibian species (e.g., tiger salamander, green toad, and plain's spadefoot) are adapted for survival in relatively arid situations. All require water for breeding and for the aquatic stages of development, but adults can survive periods of drought.

One aquatic and one terrestrial species of turtle are observed. The yellow mud turtle is commonly found in stock tanks and ponds. The western box turtle inhabits much of the study area but avoids habitats dominated by creosote bush.

Table H-60. Estimated Densities of Bird Species at, or in the Vicinity of, the WIPP Site

Species	Density (number per 100 hectares)															
	1975				1976				1977							
	S	O	N	D	J	F	M	J	J	A	M	A	M	J	J	A
Ducks																
Mallard	<1															
Green-winged teal		<1														
Blue-winged teal		<1														
Hawks and allies																
Turkey vulture	<1	<1					<1	<1	<1			<1	<1			
Red-tailed hawk					<1	<1		<1								
Swainson's hawk	<1	<1					<1	<1	<1		<1	<1	<1	<1		<1
Ferruginous hawk					<1	<1								<1		
Harris' hawk		<1						<1	<1		<1	<1	<1	<1	<1	<1
Marsh hawk	<1	<1	<1	<1	<1	<1	<1				<1	<1	<1			
American kestrel	<1	<1	<1	<1	<1	<1	<1	<1								<1
Quails																
Bobwhite								<1	<1							
Scaled quail	4	3	7	4	3	3	6	3	1	7	3	2	2	2	3	7
Cranes																
Sandhill crane	<1															
Doves																
Mourning dove	19	7	5	4	1			<1	1	2	<1	<1	<1	<1	2	2
Cuckoos																
Yellow-billed cuckoo	<1															
Roadrunner	<1	<1			<1	<1		<1	<1	<1		<1	<1	<1	<1	<1
Owls																
Great horned owl										<1						<1
Burrowing owl								<1	<1	<1						
Nighthawks																
Common nighthawk								4	2	2			1	2		<1
Woodpeckers																
Ladder-backed woodpecker					<1	<1		<1	<1				<1	<1		
Red-shafted flicker											<1					
Perching birds																
Western kingbird	<1							1		<1		<1	<1		1	
Scissor-tailed flycatcher	<1								<1				<1			
Ash-throated flycatcher								<1				<1		<1	<1	
Say's phoebe	<1	<1										<1				<1
Western empidonax fly-catcher	<1	1														
Western wood pewee	<1											<1				
Cliff swallow	<1															

Table H-60. Estimated Densities of Bird Species at, or in the Vicinity of, the WIPP Site (continued)

Species	Density (number per 100 hectares)															
	1975				1976						1977					
	S	O	N	D	J	F	M	J	J	A	M	A	M	J	J	A
Blue jay	<1															
White-necked raven	1	<1			<1	<1	<1	1	<1		<1	<1	<1	<1	<1	<1
House wren	<1				<1											
Carolina wren	<1				1											
Cactus wren				1		1	1	1	2	2	<1		<1	<1	<1	
Rock wren									<1							
Mockingbird	1	<1						4	1	<1	<1	<1	4	2	<1	<1
Brown thrasher	<1										<1	<1				
Curve-billed thrasher	<1													<1		
Crissal thrasher	<1							<1	<1	<1			<1	<1	<1	<1
Sage thrasher	<1															
Loggerhead shrike	4	3	3	2	4	3	4	3	3	4	5	4	4	5	6	3
Yellow-rumped warbler	<1	<1														
Wilson's warbler	2															
Western meadowlark ^a	<1	2	13	6	12	12	6	<1	<1		5		<1			
Bullock's oriole	<1								<1				<1			
Brewer's blackbird								<1								
Brown-headed cowbird	<1								2				<1	<1		<1
Pyrrhuloxia	1	4	7	10	4	4	6	10	9	5	4	8	4	10	10	6
House-finch				1												
Lark bunting	10	9	7	21	9	12	25	1	1	10			<1			<1
Pine siskin				1	31	2	19									
American goldfinch				3		2										
Green-tailed towhee		1	2													
Rufous-sided towhee		1	1													
Baird's sparrow		<1														
Vesper sparrow	1	8	9	6	3	1	10									
Lark sparrow	1											<1	<1	<1		
Cassin's sparrow	11							<1								
Black-throated sparrow	1	1	1		4	1	3	2	3	1	4	2	3	2	<1	<1
Sage sparrow					<1	4										
Chipping sparrow																<1
Dark-eyed (Oregon) junco				1		1										
Clay-colored sparrow	<1	<1														
Brewer's sparrow		<1														
White-crowned sparrow		9	9	18	16	12	8					<1				

^aMay include eastern meadowlarks; species are difficult to distinguish.

Table H-61. Amphibians and Reptiles Observed in the Terrestrial Ecology Study Area

Common name	Scientific name	Food type ^a	Abundance ^b	Habitat ^c
Amphibians				
Tiger salamander	<u>Ambystoma tigrinum</u>	I	C	A, M
Couch's spadefoot	<u>Scaphiopus couchi</u>	I	UC	A, CB
Plain's spadefoot	<u>S. bombifrons</u>	I	C	A, OM
Texas toad	<u>Bufo speciosus</u>	I	UC	A
Great Plains toad	<u>B. cognatus</u>	I	UC	A, OM
Green toad	<u>B. debilis</u>	I	C	A
Reptiles				
Yellow mud turtle	<u>Kinosternon flavescens</u>	P, I, SV	VC	A, M, OM
Western box turtle	<u>Terrapene ornata</u>	P, F, I	VC	OM, M, D, HM
Collared lizard	<u>Crotaphytus collaris</u>	I	UC	M
Leopard lizard	<u>C. wislizenii</u>	I, SV	UC	D, HM, OM
Lesser earless lizard	<u>Holbrookia maculata</u>	I	UC	OM
Greater earless lizard	<u>H. texana</u>	I	UC	CB
Side-blotched lizard	<u>Uta stansburiana</u>	I	VC	OM, (CB), (M), D, HM
Texas horned lizard	<u>Phrynosoma cornutum</u>	I	C	OM, M
Round-tailed horned lizard	<u>E. modestum</u>	I	UC	M
Western whiptail	<u>Cnemidophorus tigris</u>	I	VC	OM, CB, D, HM, M
Texas spotted whiptail	<u>C. gularis</u>	I	VC	CB
Six-lined racerunner	<u>C. sexlineatus</u>	I	UC	OM
Great Plains skink	<u>Eumeces obsoletus</u>	I	UC	OM, CB
Texas blind snake	<u>Leptotyphlops dulcis</u>	SV	UC	OM
Western hognose snake	<u>Heterodon nasicus</u>	I, SV	C	OM
Coachwhip	<u>Masticophis flagellum</u>	I, SV	C	OM, CB
Glossy snake	<u>Arizona elegans</u>	SV	C	OM
Bullsnake	<u>Pituophis melanoleucus</u>	SV	C	OM, CB
Long-nosed snake	<u>Rhinocheilus lecontei</u>	SV	UC	OM, CB
Night snake	<u>Hypsiglena torquata</u>	SV	UC	OM
Massasauga	<u>Sistrurus catenatus</u>	SV	UC	OM
Western diamondback rattlesnake	<u>Crotalus atrox</u>	SV	UC	OM, CB, M
Western rattlesnake	<u>C. viridis</u>	SV	VC	OM, CB, HM, D

^aKey: P = plant tissue; F = fruit; I = invertebrates; SV = small vertebrates.

^bAbundance: VC = very common; C = common; UC = uncommon.

^cHabitat: OM = oak-mesquite associations; CB = creosote bush associations; M = mesa (mesquite grassland); D = dunes; HM = hummock mesquite associations; A = aquatic (stock pond or tank).

Lizards (11 species) are the most abundant and conspicuous reptiles, with the side-blotched lizard and the western whiptail common in most habitats. The Texas horned lizard is common in oak-mesquite associations and on the mesa. All species are diurnal and primarily insectivorous.

Several species of snakes are common in the area, including the western hognose snake, the coachwhip, and the western rattlesnake. Less common are the night snake, the long-nosed snake, and the massasauga. All species are carnivorous.

Terrestrial invertebrates

Important crop pests are the alfalfa caterpillar, cutworms, and aphids, which damage alfalfa; and the cotton boll worm and stinkbugs, which attack cotton. Grasshoppers are the principal range pest, destroying both domestic and wildlife forage. The fleas that transmit plague are the only important disease vectors.

Table H-62. Amphibians and Reptiles Potentially Inhabiting but Not Observed at, or in the Vicinity of, the WIPP Site

Common name	Scientific name
Amphibians	
Western spadefoot	<u>Scaphiopus hammondi</u>
Woodhouse's toad	<u>Bufo woodhousei</u>
Red-spotted toad	<u>B. punctatus</u>
Barking frog	<u>Eleutherodactylus augisti</u>
Cricket frog	<u>Acris gryllus</u>
Leopard frog	<u>Rana pipiens</u>
Bullfrog	<u>R. catesbeiana</u>
Reptiles	
Snapping turtles	<u>Chelydra serpentina</u>
Pond slider	<u>Pseudemys scripta</u>
Spiny soft-shelled turtle	<u>Trionyx spiniferus</u>
Eastern fence lizard	<u>Sceloporus undulatus</u>
Sagebrush lizard ^a	<u>S. graciosus</u>
Checkered whiptail	<u>Cnemidophorus tesselatus</u>
Little striped whiptail	<u>C. inornatus</u>
Plain-bellied water snake	<u>Natrix erythrogaster</u>
Western hognose snake	<u>Heterodon nasicus</u>
Corn snake	<u>Elaphe guttata</u>
Common kingsnake	<u>Lampropeltis getulus</u>
Checkered garter snake	<u>Thamnophis marcianus</u>
Common garter snake	<u>T. sirtalis</u>
Ground snake	<u>Sonora episcopa</u>
Western hooked-nosed snake	<u>Ficimia cana</u>
Great Plains black-headed snake	<u>Tantilla nigriceps</u>

Sand crickets, ground beetles, darkling beetles, ants, and termites are the most abundant ground-dwelling insects found. Most of the arthropods collected are scavengers, plant feeders, and granivores. Predatory forms include scorpions, whiptails, spiders, praying mantids, and ants. Termites, ants, and grasshoppers are common in all plant communities. Termites are by far the most significant detritivores in the study area. They form large subterranean colonies in the stabilized dunes, on the mesa, and on the creosote bush flats. Their biomass is at least as large as that of the cattle grazing the surface.

Domestic livestock and range management

Domestic livestock. Ranching is the main agricultural enterprise in the region, and beef cattle are the principal livestock. Most of the cattle are kept on the range throughout the year and are given supplementary feed in winter. In summer, sudangrass, bermuda grass, and stubble are used for temporary grazing while native grasses rest during part of the growing season and produce seed for regrowth (SCS, 1971, 1974).

In 1969, there were about 123,000 beef cattle in Eddy and Lea Counties (BLM, 1973). Other livestock raised in the region are hogs (approximately 12,400 in 1969), sheep (approximately 42,300 in 1969), and a few thousand dairy cows (BLM, 1973). Horses are less common and are used mainly for ranching and recreation. Domestic-poultry farming is quite limited.

Range management. The WIPP site lies entirely within the Deep Sand and Sand Hills range sites (Table H-63). The site vicinity also includes Sandy, Rocky Land, Loamy, Salty Bottomland, and Bottomland range sites (SCS, 1971).

There are three BLM grazing allotments in the study area: 7032, 7027, and 7033 (BLM, 1978). The site itself is all on allotment 7032, which BLM classifies as in fair condition for livestock grazing. The recent licensed use of this allotment (BLM, State, and private land) has been, on the average, a little over six head per section. The carrying capacity of the allotments in the site region (an animal unit is defined as the amount of feed required to sustain one adult for a year) varies greatly from one section to the next and from one year to the next, depending on rainfall. In addition, allotment 7032 has an allotment-management plan that BLM revised in 1973. According to the plan, the actual qualifications for allotment 7032 are for 13,239 animal-unit months (a little over nine head per section). The plan specifies grazing deferments of various pastures for different lengths of time. Preliminary revised BLM data for allotment 7032 indicate a suggested stocking rate varying from 7 to 21 acres per animal-unit month, based on a 40% to 60% range utilization. This stocking rate is roughly equivalent to 7.6 to 2.5 head per section, assuming yearlong grazing.

Mesquite-control programs have been implemented in allotments 7033 and 7027, and, according to BLM (1977), have been fairly successful. After the spraying of mesquite, native grasses have increased, thus supporting the historical record that much of the area was once productive grassland.

Plants potentially poisonous to livestock occur throughout the area, but cause little trouble except in extreme weather conditions (BLM, 1977). Shiny oak, which is poisonous to cattle during about 6 weeks in the spring, and snakeweed are common.

H.5.3 Aquatic Ecology

H.5.3.1 Two-county region

Aquatic habitats

The two-county region is in the basin of the Pecos River, which originates in the Sangre de Cristo Mountains in northern New Mexico. The Pecos River flows to the south through New Mexico and into the Red Bluff Reservoir, continues in a southeasterly direction across western Texas, eventually joining the Rio Grande. It has an overall length of about 500 miles and drains about 25,000 square miles in New Mexico and 17,000 square miles in Texas. The hydrologic characteristics of the region are discussed in Section 7.4.

Table H-63. Range Condition of the Land at the WIPP Site^a

Soil mapping unit	Range site	Annual production (lb) ^b	Potential vegetation		
			Key decreases	Key increases	Key invaders
Berino complex, 0-3% slopes, eroded	Deep sand	400-2400	Little bluestem Sand bluestem Black grama Bush muhly Side-oats grama Plains bristle grass	Blue grama Hairy grama Sand dropseed Three-awn Mesquite Shinnery oak	Broom snakewood Annuals
Kermit-Berino sand, 0-3% slopes Kermit fine sand	Sand hill	800-3000	Bush muhly Little bluestem Black grama Sand bluestem Plains bristle grass Indian rice grass Switchgrass	Blue grama Red lovegrass Halls panicum Sand dropseed Tall dropseed Sand muhly Mesquite Little soaptree Yucca Shinnery oak Sand sagebrush Catclaw mimosa	Broom snakewood Ring muhly Annuals
Berino fine sand	Deep sand	400-2400	See Berino complex above	See Berino complex above	See Berino complex above

^aBased on data from the Soil Conservation Service (SCS, 1971).

^bLow numbers indicate average annual production of air-dry grazable forage on sites in poor condition; high numbers indicate production on sites in excellent condition.

The area is semiarid. Away from the river aquatic habitats are limited to intermittent streams and livestock-watering ponds. Poor water quality is characteristic of much of the Pecos River basin in the lower sections. Both surface water and groundwater contain salt from natural sources (salt springs, brine seeps, or gypsum overburden) and from human activities (e.g., irrigation return flow, potash mining). An important natural source of salt is the concentrated brine springs at Malaga Bend, which increase the salt content of the Pecos River by an estimated 340 tons per day. These sources progressively concentrate salts downstream.

Seasonally wet, shallow lakes (playas) and permanent salty lakes occur in the area. An example of the latter is the Laguna Grande de la Sal about 11 miles west-southwest of the WIPP site.

Aquatic biota

Because of high salinity due to natural brines and irrigation return flows, the lower Pecos River basin supports a depauperate flora and fauna. According to J. E. Sublette (personal communication, 1978), the aquatic fauna of the Pecos River and the Red Bluff Reservoir are probably the least known in New Mexico in both species and population density. Thirteen sampling stations have been established to study the faunal composition of aquatic habitats in the study area and nearby (Figure H-24).

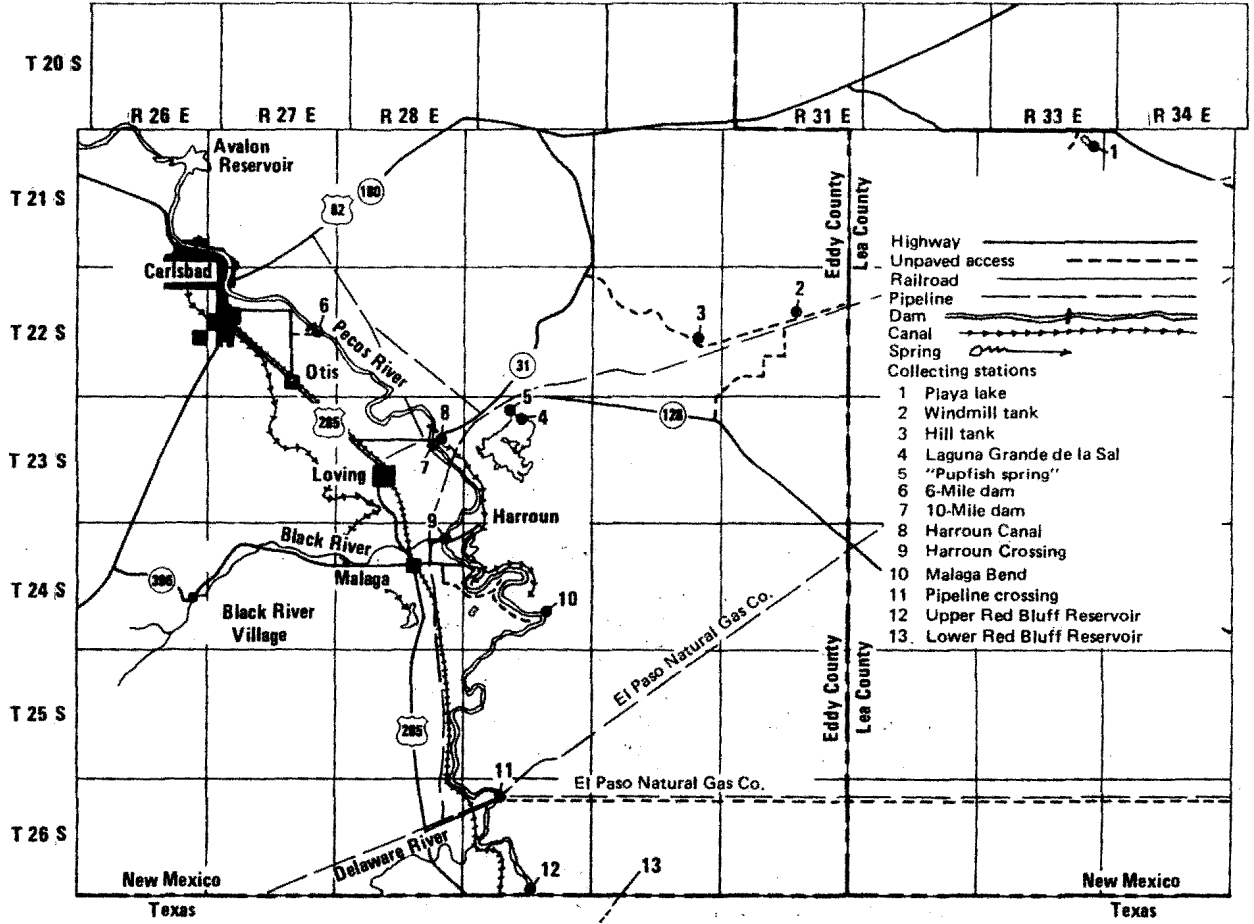

Figure H-24. Map of aquatic collecting stations.

Fish

Fish have been studied in more detail than other aquatic organisms in the region.

At present, there is no active commercial fishery in the site region (R. R. Patterson, New Mexico Game and Fish Department, personal communication, January 20, 1978), although several suitable species (carp, carpsucker, small-mouth buffalo) occur throughout the Pecos River basin.

A limited recreational fishery--based on such warm-water species as channel catfish, white bass, bluegill, green sunfish, and large-mouth bass--is located in the lower Pecos River basin. Because of the poor water quality of the lower Pecos mainstem, most of the recreational fishing activity is concentrated in impoundments on the upper reaches of the Pecos and its tributaries (R. R. Patterson, personal communication, January 20, 1978), although the Red Bluff Reservoir offers a modest sport fishery.

Both warm- and cold-water sport fish are stocked in Chaves, Eddy, and Lea Counties. In the 1973-1974 fiscal year, a total of 1,242,086 fish (trout, channel catfish, and walleye) were stocked (USDA, 1975).

Macroinvertebrates

Studies of the macroinvertebrate communities in the site region began in the spring of 1978. Chironomidae (nonbiting midges) were very abundant in many of the habitats investigated. At Harroun Crossing, the caddisfly family, Hydropsychidae, was also very abundant.

The invertebrate fauna of windmill-pumped water and playa lakes of eastern New Mexico and western Texas has been studied by Sublette and Sublette (1978). Most of the species that successfully invade the windmill-pumped waters are strong fliers and are able to travel considerable distances. The playa lakes contain many temporary pond forms, including the fairy, tadpole, and clam shrimps.

Microorganisms and plankters

Investigations of the microbial biochemistry of the site region include studies of surface waters, subterranean aquifers, and surface soils (Caldwell, 1978).

Diatoms are the principal planktonic producers in the fresh surface waters of the site region. The flora of Laguna Grande de la Sal consists of Halobacterium spp. and Dunaliella spp. A layer of cyanobacteria and photosynthetic sulfur bacteria is found below the salt crust surrounding the salt lake (Caldwell, 1978). Periphyton (epiphyton, epipelon, and filamentous algae) probably account for most of the production in the Pecos River. No blue-green algae were dominant in the Pecos River at certain sites and seasons (Sublette and Sublette, 1979).

Vascular plants

Other primary producers include the vascular aquatic plants. A rather extensive survey of vascular plants has been completed in Chaves, Eddy, and Lea Counties (Martin, cited by Sublette and Sublette, 1978).

H.5.3.2 Aquatic biota of the study area

Surface waters in the study area are limited to earthen livestock-watering ponds and metal stock tanks. Ephemeral surface waters (i.e., puddles) may form after a thunderstorm. This rainfall is generally of brief duration, but is occasionally intense. The temporary surface waters on the site provide minimal aquatic habitat.

The windmill tank (station 2, Figure H-24) and the hill tank (station 3) are being monitored for physical and for biotic characteristics. No macro-invertebrates were found in the February 1978 sampling of the windmill tank, but substantial numbers of seed shrimp (Ostracoda), nonbiting midges (Chironomidae), biting midges (Ceratopogonidae), fingernail clams (Sphaeriidae), aquatic worms (Oligochaeta), and copepods (Copepoda), were collected in the hill tank.

No fish species are known to occur within the study area.

H.5.4 Endangered and Threatened Species

H.5.4.1 Terrestrial species

Plants

The cactus Coryphantha sneedii var. leei, which is on the Federal list of endangered plants (FWS, 1976) in Eddy County, like most of the proposed species, is located in the Guadalupe Mountains. Proposed species include a milkwort (Polygala rimulicola), wild columbine (Aquilegia chaplinei), and bladderpod (Lesquerella valida). Another is a wild buckwheat (Eriogonum gypsophilum) that occurs on gypsum outcrops about 20 miles north of Carlsbad (Spellenberg, 1977). No species have been proposed for the Federal list of endangered plants for Lea County.

New Mexico does not have an official State list of rare, threatened, or endangered plant species. However, the New Mexico Plant Protection Act of 1953 protects all or some species in 23 plant families and includes some of the species proposed for the Federal list of endangered species in the State.

No plants proposed for the Federal list of endangered or threatened species have been observed within the study area, and the lack of suitable habitat makes their occurrence at the site unlikely.

Terrestrial vertebrates

Table H-64 lists the endangered terrestrial vertebrates that have been recently observed in the two-county region. Most of these species are associated with habitats that are not on or in the vicinity of the site.

Only two of these species, the bald eagle and the peregrine falcon, are included in the Federal list. Both species usually forage in the vicinity of large bodies of water like the Pecos River and associated reservoirs. It is unlikely that either species would be more than an occasional visitor at the site.

Table H-64. Endangered Terrestrial Vertebrates in the Region of the Site^a

Common name	Scientific name	Status ^b
Mammals		
Nelson's pocket mouse	<u>Perognathus nelsoni canescens</u>	NM II
Birds		
Mississippi kite	<u>Ictinia mississippiensis</u>	NM II
Bald eagle	<u>Haliaeetus leucocephalus</u>	FE, NM II
Peregrine falcon	<u>Falco peregrinus anatum</u>	FE, NM I
Aplomado falcon	<u>F. femoralis septentrionalis</u>	NM I
Red-headed woodpecker	<u>Melanerpes erythrocephalus caurinus</u>	NM II
Varied bunting	<u>Passerina versicolor</u>	NM II
Baird's sparrow ^c	<u>Ammodramus bairdii</u>	NM II
McCown's longspur	<u>Calcarius mccownii</u>	NM II
Reptiles		
(Texas) slider turtle	<u>Chrysemys concinna texana</u>	NM II
(Sand dune) sagebrush lizard	<u>Sceloporus graciosus arenicolous</u>	NM II
(Blotched) plain-bellied water snake	<u>Natrix erythrogaster transversa</u>	NM II
(Pecos) western ribbon snake	<u>Thamnophis proximus diabolicus</u>	NM II
Amphibians		
(Eastern) barking frog	<u>Hylactophryne augusti latrans</u>	NM II
(Blanchard's) cricket frog	<u>Acris crepitans blanchardi</u>	NM II

^aInformation on status and distribution from Hubbard et al. (1978).

^bKey: FE = on the Federal list of endangered species; NM I = New Mexico endangered Group I; NM II = New Mexico endangered Group II.

^cObserved in site vicinity during project field studies.

One mammal, eight bird, four reptile, and two amphibian species listed as endangered by the State of New Mexico may occur in the site region (Hubbard et al., 1978).

Nelson's pocket mouse is known from a single specimen collected 4 miles west of White City in western Eddy County (Webb, 1954). It is highly unlikely that the species inhabits the study area.

Three of the eight endangered bird species (Mississippi kite, bald eagle, and peregrine falcon) usually forage and nest near water and would not be expected to inhabit the study area. In New Mexico the red-headed woodpecker is strictly associated with planted groves of trees and lower-elevation riparian woodland (Hubbard et al., 1978). These habitats do not occur on, or in the vicinity of, the site. The four remaining species (Aplomado falcon, varied bunting, Baird's sparrow, and McCown's longspur) occupy habitats similar to those on and near the site and could occur there. In New Mexico the Aplomado falcon is typically found in areas with yucca grasslands and associated shrubby habitats at lower elevations. Baird's sparrow and McCown's longspur are grass-

land species. There is a recorded sighting of a single Baird's sparrow in the vicinity of the site on October 19, 1975.

Three of the four endangered reptiles inhabiting the site region (Texas slider turtle, blotched plain-bellied water snake, and Pecos western ribbon snake) are associated with aquatic environments and are not likely to be found in the study area. The fourth species, sand dune sagebrush lizard, occurs only on or near active sand dunes. Suitable habitat is available in the study area.

Both amphibian species listed as endangered in New Mexico are common elsewhere in their ranges. Blanchard's cricket frog inhabits moist terrestrial habitats associated with permanent water, like those along the Pecos River. The Eastern barking frog is associated with rocky ledges (usually limestone) and might inhabit the area along Livingston Ridge northwest of the site.

H.5.4.2 Aquatic species

Fish

A number of fish species in the Pecos River basin are considered to be threatened or endangered (Table H-65) because of their highly restricted distributions and dependence on unique habitats. Two categories of endangered species are recognized by the State of New Mexico: Group I includes those whose prospects of survival or recruitment in the State are in jeopardy; Group II includes species whose prospects of survival or recruitment in the State may be jeopardized in the foreseeable future. Nine species are known to occur in the region (or to have been extirpated within historical times).

The species in Group I include the blue sucker, the gray redhorse, the silverband shiner, and the Pecos shiner (bluntnose shiner). The blue sucker is known in New Mexico only from the lower Pecos drainage. Recent records of the blue sucker and the gray redhorse are from the Black River and the Pecos River south of Lake McMillan (Hubbard et al., 1978). The Pecos shiner occurs only in the Pecos River of New Mexico. Sublette (1975) collected two specimens of this species from Chaves County, and in 1977 considerable numbers were found below McMillan Dam in Eddy County (Hubbard et al., 1978). Hubbard et al. (1978) stress that reduced flows of the Pecos River have contributed to its reduction.

Four fish species belong to the New Mexico Group II of endangered species (Table H-65). Of these, the Pecos gambusia is perhaps the most widely publicized because of its Federal status as an endangered species (FWS, 1977). It occurs in seven isolated populations in the Bitter Lakes National Wildlife Refuge northeast of Roswell and in a 2-mile portion of Blue Spring (Bednarz, 1975).

Aquatic invertebrates

The only aquatic invertebrate presently listed in either group, the Socorro isopod (Exosphaeroma thermophilum), does not occur in the two-county region.

Table H-65. Endangered Fish in the Region of the Site^a

Common name	Scientific name	Status ^b
Blue sucker	<u>Cycleptus elongatus</u>	NM I
Gray redbhorse	<u>Moxostoma congestum</u>	NM I
Silverband shiner	<u>Notropis shumardi</u>	NM I
Bluntnose shiner	<u>N. simus</u>	NM I
Mexican tetra	<u>Astyanax mexicanus</u>	NM II
Greenthroat darter	<u>Etheostoma lepidum</u>	NM II
Pecos gambusia	<u>Gambusia nobilis</u>	FEC ^c , NM II
Bigscale logperch	<u>Percina macrolepidia</u>	NM II

^aInformation from Hubbard et al. (1978) and F. H. Olson, New Mexico Department of Game and Fish (private communications).

^bNM I = fish species whose prospects of survival or recruitment in New Mexico are in jeopardy; NM II = species whose prospects of survival or recruitment in New Mexico may be jeopardized in the foreseeable future.

^cFE = species on the Federal list of endangered species (Federal Register, Vol. 42, pp. 36420-31, 1977).

H.5.5 Preexisting Environmental Stresses

Several natural and man-induced factors stress the terrestrial and aquatic ecosystems throughout the region.

Vegetation often undergoes water stress because of the variable and generally low rainfall in the area. In addition, the sandy soils in the site vicinity retain little water and are susceptible to wind erosion if vegetative cover is removed. The active dunes in the study area are probably a result of loss of cover due to overgrazing in the past near the James Ranch wells.

The great quantity of salt naturally occurring in the area is also a major ecological stress in the region. Surface water and groundwater are often salty. A lack of nearby good-quality watering areas is an important limiting factor for many of the wildlife species in the area. Adding to the natural salt loads are the brine effluent and dust (primarily potassium chloride, langbeinite, and potassium sulfate) from potash refineries. The potash industry uses approximately 12,000 acre-feet of fresh water annually and discharges approximately 10,000 acre-feet as brine. This waste commonly goes into tailings ponds from which some brine seeps into the ground. Estimated at about 200 million tons in 1976 and increasing at 14 million tons annually, these tailings consist principally of sodium chloride. Small quantities of these tailings are also airborne; however, the amount airborne is small compared to the 55 tons per day of dust emitted by the potash refineries in the site region.

Vegetation has been severely affected by the potash-mining operations, with a reduction or elimination of vegetation around potash plants, tailings piles, and tailings ponds. The soil under the tailings piles and brine-disposal areas is essentially sterile. The distance from the potash refinery to areas where salt no longer visibly affects vegetation varies, depending on

such factors as the level of emission, prevailing wind direction, terrain, and soil types. The zone of effect ranges from no effect beyond the refinery site to effects observable nearly a mile away. At some refineries, all native vegetation within 0.25 mile has been killed. Beyond 0.25 mile, the salt-intolerant species (e.g., greythorn, allthorn, mesquite, and catclaw) have been defoliated, while salt-tolerant species such as saltbush appear to be growing well. These vegetational modifications in the area have, in turn, modified the wildlife habitat (BLM, 1975).

The most severe ecological stresses identified within the study area are heavy grazing by livestock and the limiting water supply. Historically many rangelands in the region have been subject to overgrazing and mismanagement ever since livestock were introduced into the area in the late 1800s (BLM, 1977; Humphrey, 1958). It has been estimated that overuse by livestock coupled with fire prevention has resulted in increased shrub densities. These factors, together with insect depredations and drought, have reduced forage production in the region to about half its potential (SCS, 1975). Persistent heavy grazing by livestock affects floristic composition and cover and thus influences available wildlife forage throughout the area. In addition, livestock can compete with herbivorous wildlife species such as deer, rodents, and granivorous birds for grasses, forbs, and palatable browse. However, direct competition is probably less important than changes in species composition that result from livestock mismanagement.

The construction of roads and the use of off-road vehicles has also affected the native vegetation and wildlife. Indiscriminate off-road use of vehicles has led to significant animal disturbance, vegetation damage, and soil erosion (BLM, 1977).

H.6 BACKGROUND RADIATION

This section discusses the existing background-radiation levels, presents the data currently available, and discusses additional information that will be obtained.

The major components of the external background radiation at any location are (a) cosmic rays, (b) terrestrial radiation sources like potassium-40 and the decay products of the uranium and thorium series in the earth's crust, and (c) global fallout from nuclear tests in the atmosphere. The background-radiation level can vary between geographical locations by more than twofold. At a specific location, it can also vary, to a lesser extent, over time and with weather conditions. Therefore, the natural variability of background-radiation levels at the site must be well documented to determine any facility contribution above this ambient level.

Some preliminary measurements of background radiation were begun at the WIPP site early in 1976, in conjunction with the on-site meteorological program. Direct measurements have been made with a Reuter-Stokes pressurized ionization chamber, and a number of thermoluminescent dosimeters (TLDs) have been emplaced in the area (Figure H-25). Sampling to determine the average gross beta-particle concentration in air has also begun. The results of these measurements are summarized in Tables H-66, H-67, and H-68; some have been discussed in a separate report (Metcalf and Brewer, 1977). Additional data will be required to permit accurate comparison of preoperational and operational dose contributions at specific locations or by specific pathways.

From data published by the National Council on Radiation Protection and Measurements (NCRP, 1975), the annual external whole-body exposure rates at the site from cosmic rays, terrestrial sources, and global fallout are estimated to be 37, 26, and 1 millirad, respectively, for a total of 64 millirads (or 64 millirem if a quality factor of 1 is assumed). These data were partly based on a flyover of an area that now includes the site. The aerial survey was part of the Aerial Radiological Measurement Surveys (ARMS), conducted for the U.S. Atomic Energy Commission during the period 1958 to 1963. A second aerial survey of the site area was made in September 1977 under the Aerial Measuring Systems Program, the successor to the ARMS program (Jobst, 1977). The second flyover was made both to verify the data collected by the first aerial survey and to locate any areas of abnormally high radiation levels (hot spots). The second survey covered only a small portion of the WIPP site, and no hot spots were located. The data tend to confirm the data taken on the surface with thermoluminescent dosimeters and the Reuter-Stokes instrument.

The data published by the NCRP (1975) and the latest flyover data can be compared with the background-radiation data presented in Tables H-66 and H-67, which were collected with ground-based monitoring equipment. For example, between August 22 and December 31, 1977, the average dose rate measured in the area with the Reuter-Stokes pressurized ionization chamber was 7.9 micro-roentgens per hour (approximately 69 milliroentgens per year), with a maximum of 14.8 micro-roentgens per hour and a minimum of 5.8 micro-roentgens per hour (Table H-66).

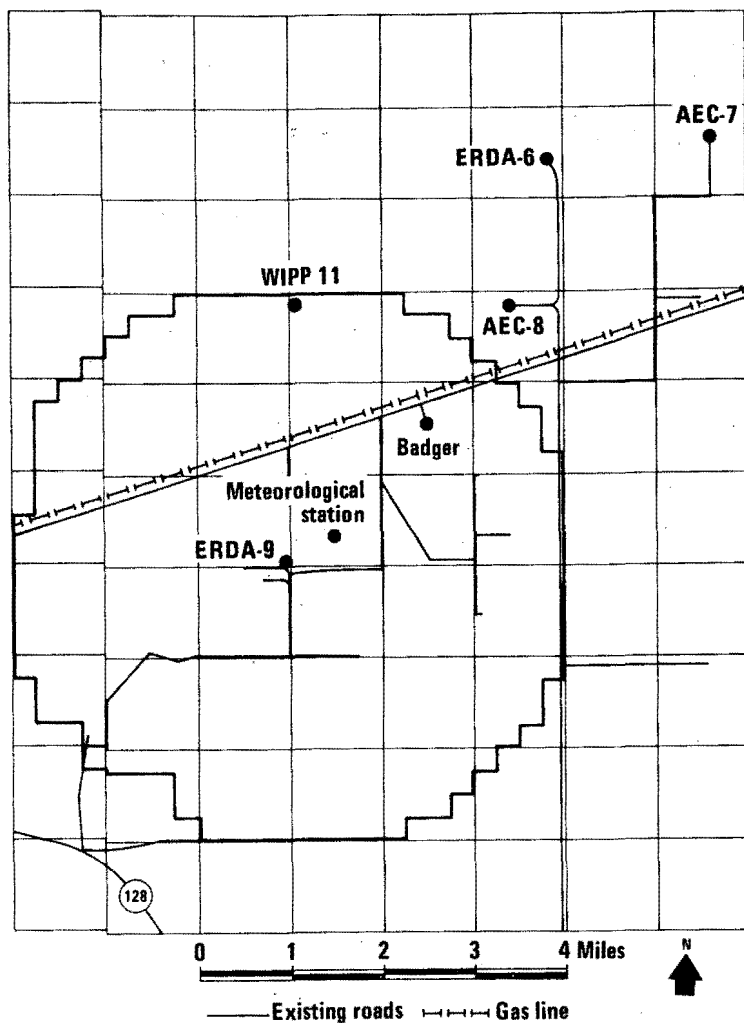

Figure H-25. Locations of thermoluminescent dosimeters in the site area.

The average dose rate compares favorably with the NCRP data. The dose rates measured by the thermoluminescent dosimeters (Table H-67) indicate a somewhat higher background-radiation level, but no significant differences are noted. Background-radiation levels at the WIPP site are expected to be similar to, or lower than, those in other parts of the Mountain States--lower especially than the levels at higher elevations, where cosmic-ray doses are greater.

Naturally occurring sources of radiation (e.g., potassium-40) are present in the human body and contribute an internal component to the total background-radiation dose. Thus, if an internal annual whole-body dose of 25 millirem (EPA, 1977) is added to the 64-millirem external dose, the estimated background-radiation whole-body dose at the site is approximately 90 millirem.

Table H-66. Background Radiation Measured in 1977 at the WIPP Site with a Reuter-Stokes Pressurized Ionization Chamber^a

Exposure period		Radiation exposure ($\mu\text{R/hr}$)		
Begin	End	Average	Maximum	Minimum
8/22	8/28	7.83	9.30	6.82
8/29	9/4	7.74	10.27	6.52
9/5	9/11	7.78	9.73	6.30
9/12	9/18	7.83	9.66	6.36
9/19	9/25	7.77	9.57	6.33
9/26	10/2	7.88	9.64	6.69
10/3	10/9	7.99	11.58	6.84
10/10	10/16	7.81	9.02	6.52
10/17	10/23	8.04	11.30	6.54
10/24	10/30	7.93	10.24	6.86
10/31	11/6	7.89	10.71	5.98
11/7	11/13	7.97	11.45	5.94
11/14	11/20	8.01	12.12	5.79
11/21	11/27	8.00	12.29	6.12
11/28	12/4	8.04	12.39	6.28
12/5	12/11	8.14	14.18	6.68
12/12	12/18	8.06	12.95	6.65
12/19	12/25	7.99	14.80	6.47
12/26	12/31	<u>8.11</u>	<u>10.78</u>	<u>6.58</u>
Yearly average		7.94 ^b	11.16	6.44

^aData for 1978 and 1979 have not yet been reduced.

^bA similar average measurement in Albuquerque showed an exposure rate of about 15 microroentgens per hour, which illustrates the types of spatial variation that can be expected in the Mountain States, where elevations vary greatly.

In December 1961 a nuclear device was detonated at the Project Gnome site, 9 miles south-southwest of the WIPP site. Radioactive material vented during the explosion as well as various activities after the detonation contaminated nearby ground surfaces. Sampling programs conducted by the EPA have shown that there would be no significant radiological hazard to man from ingesting the meat of resident wild animals that were possibly affected by the Gnome event. The plume of vented material went to the northwest from the Gnome site; therefore the contribution of the Gnome event to the background-radiation levels at the WIPP site is negligible.

Table H-67. Thermoluminescent-Dosimeter Data Collected in the Area of the WIPP Site in 1977-1979

Location	First quarter		Second quarter		Third quarter		Fourth quarter	
	mR	$\mu\text{R/hr}$	mR	$\mu\text{R/hr}$	mR	$\mu\text{R/hr}$	mR	$\mu\text{R/hr}$
1977								
Sandia office, Carlsbad	28.1±3.7	12.7±1.6	25.1±2.3	10.8±1.0	24.4±4.4	12.6±2.3	22.0±3.1	9.8±1.4
Meteorological station					18.6±3.9	9.6±2.0	19.0±2.7	8.4±1.2
Old Badger drill site	24.4±4.2	11.0±1.9	19.7±2.4	8.5±1.0	22.8±3.7	11.7±1.9	19.0±3.1	8.4±1.4
ERDA-6	25.7±3.6	11.6±1.6	19.9±2.6	8.5±1.1	21.3±3.8	11.0±2.0	21.5±3.3	9.5±1.5
AEC-7	24.9±3.7	11.3±1.7	22.5±2.8	9.7±1.2	21.4±3.6	11.0±1.9	19.7±3.0	8.7±1.3
AEC-8	24.4±4.1	11.0±1.9	20.1±2.4	8.6±1.0	18.0±3.2	9.3±1.6	16.7±3.1	7.4±1.4
ERDA-9	26.8±3.6	12.1±1.6	19.2±2.3	8.2±1.0	17.0±3.8	8.7±2.0	17.7±2.8	7.8±1.2
1978								
Sandia office, Carlsbad	21.5±3.8	9.1±1.6	20.0±1.5	9.1±0.7	19.5±2.7	9.0±1.3	21.5±2.5	11.3±1.3
Meteorological station	17.3±3.5	7.4±1.5	14.8±1.0	6.7±0.5	14.8±2.6	6.9±1.2	16.5±2.1	8.7±1.1
Old Badger drill site	18.7±3.4	8.0±1.4	15.5±1.3	7.0±0.6	16.0±2.3	7.4±1.1	17.0±2.0	9.0±1.1
ERDA-6	18.0±3.3	7.7±1.4	16.0±1.2	7.2±0.5	16.2±2.2	7.5±1.0	16.5±2.1	8.7±1.1
AEC-7	20.0±3.4	8.5±1.4	17.3±1.2	7.8±0.5	17.1±2.2	7.9±1.0	18.5±2.3	9.8±1.2
AEC-8	18.7±3.6	8.0±1.5	15.6±1.2	7.1±0.5	15.5±2.3	7.2±1.1	17.0±2.0	9.0±1.1
ERDA-9	18.5±3.4	7.9±1.4	15.0±1.0	6.8±0.5	15.0±2.0	6.9±0.9	16.5±2.2	8.7±1.2
WIPP-11	18.2±3.4	7.7±1.4	15.0±1.1	6.8±0.5	14.8±2.0	6.9±0.9	16.5±2.5	8.7±1.3
1979								
Meteorological station	14.8±2.3	6.0±0.9	15.2±1.5	6.8±0.7				
Old Badger drill site	--	--	16.2±1.5	7.3±0.7				
ERDA-6	15.6±2.5	6.3±1.0	14.4±1.5	6.5±0.7				
AEC-7	--	--	15.6±1.5	7.0±0.7				
AEC-8	15.5±2.4	6.3±1.0	16.9±1.5	7.6±0.7				
ERDA-9	16.9±2.7	6.8±1.1	14.3±1.5	6.4±0.7				
WIPP-11	15.2±2.4	6.1±1.0	14.1±1.5	6.3±0.7				

NOTES

1. The dates of collection for 1977 are as follows: first quarter, January 10 to April 12; second quarter, April 12 to July 18; third quarter, July 18 to October 7; fourth quarter, October 7 to January 9, 1978. The dates for 1978 are as follows: first quarter, January 9 to April 17; second quarter, April 17 to July 18; third quarter, July 18 to October 16; fourth quarter, October 16 to January 3, 1979. The first quarter in 1979 was January 3 to April 16; the second quarter, April 16 to July 18.
2. The reported precision of each measurement includes a statistical propagation of errors resulting from calibration procedures, the correction for dosimeter response during transit and storage, and variations in the TLD response of the five chips at each measurement location.
3. The differences between the TLD and ion-chamber data are probably due to differences in the wall thicknesses of the two systems (240 mg/cm² for TLDs and approximately 2400 mg/cm² for the ion chamber).
4. Variations in TLD data from quarter to quarter are probably due to the method of field installation of the TLD package. The dosimeters are exposed in a hollow pipe capped on the end that is above the ground. This pipe may act as a reservoir for radon and thoron emanations, increasing the local radiation field around the dosimeter package. This effect would be more apparent in the dry climate of the WIPP area, which has periods of precipitation alternating with dry periods.
5. The effects mentioned in notes 3 and 4 will be studied further in the 1979 calendar year.
6. Preliminary data for calendar year 1979 indicate that earlier TLD results are probably biased high, perhaps by 10 to 20%. This is especially true for quarters in which rainfall or snow cover was present in the WIPP area. The TLD results obtained after modifying the method of field installation show better agreement with the Reuter-Stokes data.

Table H-68. Monthly Average Gross Beta Concentrations in Air at the WIPP Site

Month	Average gross beta concentration (pCi/m ³)	Month	Average gross beta concentration (pCi/m ³)
1976			
February	0.016	August	0.019
March	0.024	September	0.017
April	0.019	October	0.427 ^a
May	0.020	November	0.226 ^a
June	0.017	December	0.075 ^a
July	0.012		
1977			
January	0.041	July	0.101
February	0.048	August	0.045
March	0.082	September	0.753 ^b
April	0.127	October	0.111
May	0.175	November	0.075
June	0.173	December	0.072
1978			
January	0.074	July	0.035
February	0.058	August	0.028
March	0.124 ^c	September	0.028
April	0.137 ^c	October	0.035
May	0.083	November	0.024
June	0.056	December	0.027
1979			
	January		0.044
	February		0.032
	March		0.008

^aIncrease because of nuclear explosions in the atmosphere conducted by the People's Republic of China on September 26 and November 17, 1976.

^bThe People's Republic of China conducted a nuclear test in the atmosphere on September 17, 1977.

^cThe People's Republic of China conducted a nuclear test in the atmosphere on March 14, 1978.

H.7 NOISE BACKGROUND

The location of the site has been remote from human intrusion and thus from man-induced noise. Measurements indicate background noise levels in the range of 26 to 28 dBA. Noise sources were animals (birds, cattle), wind, occasional traffic, aircraft, intermittent use of heavy equipment, and (in the distance) potash-mine ventilation fans. The movement of drilling machinery to and from the site has led to the construction of a number of unimproved roads. The occasional use of these roads introduces a new, but minor, noise source to the area.

H.8 THE FUTURE OF THE SITE

H.8.1 Climatic Changes

Future climate changes cannot be predicted with great certainty at this time because of the complexity of atmospheric-oceanic-extraterrestrial interactions (Mitchell, 1968), complicated by the impacts of human activities. Although climatic experts have varying opinions, there appears to be a consensus (National Defense University, 1978) that there will not be a catastrophic climatic change during the next couple of decades. The long-term (thousands of years) natural trend is for another ice age (Keeling and Bacastow, 1977; Mitchell, 1978). However, man's impact on the climate could counterbalance this trend or result in a warming trend, possibly a global warming of 4.5 to 13°F or more, with greater aridity in the Western United States starting in the next century (Kukla and Matthews, 1972; Norwine, 1977). The possible climatic variability in the next 10,000 to 20,000 years in the site region, even allowing for man's influence, is similar to that experienced during the latter portion of the Pleistocene and the Holocene, as described in Section H.4.6. The climate of New Mexico may range from that associated with glaciers to the north (about 60% to 70% more rainfall than at present and summer temperatures about 20°F lower than at present) to that associated with interglacial periods (global temperatures about 3°F warmer and greater aridity in the Southwest than at present).

If continental glaciation returns, there is no possibility that the site itself will be glaciated, judging from the Pleistocene record; the increased rainfall, however, will increase the amount of water in the Pecos River, will increase the amount of vegetation in the region, and will cause the composition of the vegetation to shift toward prairie grasslands. If, on the other hand, man's influence causes a global warming, flow in the Pecos will decrease, the region will shift toward the flora of the Chihuahuan desert, and wind-driven processes will increase.

H.8.2 Demographic Changes

The population of the area is expected to change very little in the next few decades. It will grow slowly. The number of workers at nearby mines and at oil and gas wells in the area is not expected to change significantly. A ranch house will probably be built about 8 miles west-southwest of the site. A small trailer park is being built on private land along U.S. Highway 62-180 east of the intersection with N.M. Highway 360.

Population changes beyond the next few decades cannot be predicted in any detail. However, the return of glaciation would probably result in an increase in population and in intensity of land use as the mass of the human population is forced to move south. A global warming would be expected to induce little, if any, change in population.

H.8.3 Land-Use Changes

There is very little private land within 30 miles of the WIPP site. Most of the land is owned by the State or by the Federal Government. The dominant use of the land in and near the site is grazing, at levels of six to eight animals per square mile. There are also many active oil and gas wells. The only agricultural land within 30 miles is along the Pecos River near Carlsbad and Loving. With or without the WIPP, this pattern of land use is expected to change little in the near future.

Beyond the next few decades, the return of glaciation and the accompanying increase in rainfall would probably mean an increase in land use, perhaps including a shift from grazing to dry-land farming. A global warming would be expected to make little change in land use.

H.8.4 Geologic Changes

The last major tectonic activity at the WIPP site, the subsidence of the Delaware basin, ended in the Permian Period, about 225 million years ago. Evidence of lesser tectonic activity since then has been superimposed on the basin. Igneous activity in the vicinity of the site (9 miles northwest at the closest) is restricted to a dike or a series of dikes dated as being about 35 million years old. A gentle eastward tilting of the basin (1°) that has occurred is broadly estimated as mid-Tertiary in age. This tilt may be contemporaneous with the initial formation of the west Texas salt-flat graben 70 miles to the southwest; the salt-flat graben is the closest structure to the site exhibiting geologic evidence of Quaternary or Recent tectonic activity. The tilting of the basin has also been postulated as a cause of deformation within the evaporite beds. Furthermore, the deposition of the Late Miocene-Pliocene Ogallala Formation indicates tectonic activity along the western margin of the Guadalupe-Sacramento Mountains 65 miles to the west. Thus the post-Permian tectonic history shows some gentle, broad effects of some tilting; intermittent periods of erosion indicate some relative uplift. Nearby recent tectonic changes are restricted to the salt-flat graben-Diablo Plateau area southwest of the site. The prognosis for the reasonably near geologic future is that the site may experience some erosion because of the slight relative uplift and that the salt-flat graben will be a source of earthquakes resulting in minor ground motion at the site.

Erosion and deposition as well as salt dissolution and collapse are responsible for many of the landforms at the site and in the region. In the past these processes and the resulting features have been significantly affected by changes in climate. Although there have been many small climatic cycles, past worldwide glacial-ice advances and interglacial periods have been alternating in 100,000-year cycles (Norwine, 1977). As indicated in Section H.4.6, the stage of the glacial-interglacial period cycle has a great effect on the climate of the Delaware basin. During interglacial times, the site has been warm and dry, while during glacial periods, the climate has been cooler and more humid. If, as Norwine (1977) suggests, the worldwide climate continues to move along 100,000-year cycles, two glacial periods and two interglacial periods are possible during the next 250,000 years.

Bachman (in preparation) infers, however, from the presence of Mescalero caliche at the site that the climate must have been semiarid since the formation of the caliche beginning about 500,000 years ago. The presence of this caliche is reasonable evidence that the average annual precipitation did not exceed 25 to 30 inches over any extended period during the last half million years.

It has been suggested that time and erosion could remove "evidence of a repository's existence, thereby increasing the potential violation of the site by drilling and mining." Burial by wind-blown sand might also conceal surface evidence of a repository.

Surface and near-surface processes can be used to some degree to estimate future erosion and deposition at the site. For the last million years, erosion at the site has exceeded deposition; however, the thickness of the resistant caliche cover at the site indicates that there has been no significant erosion since its formation 500,000 years ago. This layer will resist erosion while climatic conditions at the site are semiarid. If the site becomes more humid, water runoff will drain toward and along Nash Draw and San Simon Swale, increasing headward erosion in these areas. Since the site is adjacent to a low divide between these two features and has a very poorly developed drainage, it will not be significantly affected by fluvial erosion. Active and stabilized dunes in the area of the site mean that wind erosion can be expected to produce blowouts and dunes in the near future, though wind-induced features will be minor and local.

The process of salt dissolution and collapse can be expected to continue. The solution front at the Rustler-Salado interface will move over the site. From Bachman and Johnson's (1973) estimate of dissolution rates, it can be calculated that surface subsidence resulting from the dissolution of the top of the Salado will lower the land surface by about 125 feet over the next 250,000 years. (Bachman (in preparation) indicates that these rates are conservatively high because the dissolution that preceded Ogallala time was not taken into account in these estimates.) Related collapse features (sink holes, solution troughs, downwarps, fractured strata, and breccias) can be expected to form in future subsidence areas.

REFERENCES

- Adcock, Larry, and Associates, 1977-1979. Demographic analysis using personal interviews with county officials: Clerk, Lee County, February 1978; Clerk, Eddy County, New Mexico, February 1978; Clerk, Loving County, New Mexico, February 1978; Clerk, Winkler County, Texas, March 19, 1978; various U.S. Geological Survey maps; Bureau of Land Management, land-use maps; and quadrangles of the State of New Mexico, 1963 and 1965, from the New Mexico Highway Department, Planning Division.
- Adcock, Larry, and Associates, 1977-1978. Demographic analysis utilizing data obtained from various sources.
- Adcock, Larry, and Associates, 1979. Demographic analysis utilizing data obtained from various sources.
- Alexander, T., 1974. "Ominous Changes in the World's Weather," Fortune, Vol. 89, No. 2, pp. 90-95ff.
- American Ornithologists' Union, 1957. Checklist of North American Birds, 5th ed., Baltimore, Md.
- American Ornithologists' Union, 1973. "Thirty-second Supplement to the American Ornithologists' Union Check-list of North American Birds," Auk, Vol. 90, pp. 411-419.
- American Ornithologists' Union, 1976. "Thirty-third Supplement to the American Ornithologists' Union Check-list of North American Birds," Auk, Vol. 93, pp. 875-879.
- ANSI (American National Standards Institute), 1972. "Building Code Requirements for Minimum Design Loads in Buildings and Other Structures," ANSI A58.1-1972, revised A58.1-1955.
- Antevs, E., 1954. "Climate of New Mexico During the Last Glacio-Pluvial," Journal of Geology, Vol. 62, pp. 182-191.
- Austin, M. E., 1972. Land Resource Regions and Major Land Resource Areas of the United States, U.S. Department of Agriculture, Soil Conservation Service, Washington, D.C.
- Bailey, R. D., 1976. Ecoregions of the United States, U.S. Department of Agriculture, Forest Service, Ogden, Utah.
- Baldwin, J. L., 1973. Climates of the United States, National Oceanic and Atmospheric Administration, Washington, D.C.
- BBER (Bureau of Business and Economic Research), 1962. New Mexico Population Since 1910, Business Information Series No. 40.
- BBER (Bureau of Business and Economic Research), 1977a. Community Profile: Carlsbad-Eddy County, University of New Mexico.

- BBER (Bureau of Business and Economic Research), 1977b. Community Profile: Hobbs-Lea County, University of New Mexico.
- Bednarz, J., 1975. A Study of the Pecos Gambusia, unpublished report to Endangered Species Program, New Mexico Department of Game and Fish, 30 pp.
- Bellrose, F. L., 1976. Ducks, Geese and Swan of North America, Stackpole, Harrisburg, Pa.
- Bennett, M. D., 1977. "Medically Underserved Areas of New Mexico," working paper, School of Medicine, University of New Mexico.
- Best, T. L. and S. Neuhauser, eds., 1979. A Report of Biological Investigations at the Los Medanos WIPP Area of New Mexico During FY 1978, SAND79-0368, Sandia Laboratories, Albuquerque, N.M.
- BLM (U.S. Bureau of Land Management), 1973. Socio-Economic Data Systems, Roswell, New Mexico, BLM Office, computer printouts by county, unpublished.
- BLM (U.S. Bureau of Land Management), 1975. Preliminary Regional Environmental Analysis Record--Potash Leasing in Southeastern New Mexico, Department of the Interior, New Mexico State Office.
- BLM (U.S. Bureau of Land Management), 1977. East Eddy Planning Unit; Unit Resource Analysis, Department of the Interior, Roswell, N.M.
- BLM (U.S. Bureau of Land Management), 1978. Unpublished files of Grazing Allotments No. 7027, No. 7032, and No. 7033, Department of the Interior, Roswell, N.M.
- Brooks, C. E. P., 1970. Climate Through the Ages (2nd revised ed.), Dover Publications, Inc., New York.
- Buller, R. J., 1964. "Central Flyway," in Waterfowl Tomorrow, pp. 209-232, J. P. Linduska, ed., U.S. Department of the Interior, Fish and Wildlife Service, Washington, D.C.
- Burt, W. H., and R. P. Grossenheider, 1976. A Field Guide to the Mammals, Houghton Mifflin, Boston, Mass.
- Caldwell, D. E., 1979. "Microbial Biogeochemistry," in T. L. Best and S. Neuhauser, eds., A Report of Biological Investigations at the Los Medanos WIPP Area of New Mexico During FY 1978, SAND79-0368, Sandia Laboratories, Albuquerque, N.M.
- Campbell, R. S., 1929. "Vegetative Succession in the Prosopis Sand Dunes of Southern New Mexico," Ecology, Vol. 10, No. 4, pp. 392-398.
- Castetter, E. F., 1956. "The Vegetation of New Mexico," University of New Mexico, Albuquerque, N.M., Third Annual Research Lecture, pp. 257-288.

- Corley, 1965. "A Proposed Eastern Extension of the Jornada Branch of the Mogollon," Southeastern and West Texas Symposium Papers, Bulletin 1.
- Donart, G. B., D. D. Sylvester, and W. C. Hickey, 1978. Potential Natural Vegetation of New Mexico, U.S. Department of the Interior, Soil Conservation Service, Portland, Ore.
- Eagleman, J. R., 1976. The Visualization of Climate, D. C. Heath and Co., p. 2.
- EDS (Environmental Data Service), 1968. Weather Atlas of the United States (originally titled Climatic Atlas of the United States), reprinted in 1975 by the Gale Research Co.
- EPA (U.S. Environmental Protection Agency), 1977. A Compilation of Air Pollutant Emission Factors, AP-42, 3rd ed.
- Flint, R. F., 1967. Glacial and Pleistocene Geology, John Wiley & Sons, Inc., New York.
- Fujita, T. T., 1978. A Site-Specific Study of Wind and Tornado Probabilities at the WIPP Site in Southeast New Mexico, Research Project, Department of Geophysical Sciences, University of Chicago, SMRP Research Paper No. 155.
- FWS (U.S. Fish and Wildlife Service), 1976. "Endangered and Threatened Species," Department of the Interior, Washington, D.C.; Federal Register, Vol. 41, No. 117, pp. 24524-24572.
- FWS (U.S. Fish and Wildlife Service), 1977. "Endangered and Threatened Wildlife and Plants," Department of the Interior, Washington, D.C.; Federal Register, Vol. 42, No. 135, pp. 36420-36431.
- Gardner, J. L., 1951. "Vegetation of the Creosote Bush Area of the Rio Grande Valley in New Mexico," Ecological Monographs, Vol. 21, pp. 379-403.
- Gates, W. L., 1976. "Modeling the Ice-Age Climate," Science, Vol. 191, No. 4232, pp. 1138-1144.
- Gennaro, A. L., 1968. "Northern Geographic Limits of Four Desert Rodents of the Genera Peromyscus, Perognathus, Dipodomys, and Onychomys in the Rio Grande Valley," American Midland Naturalist, Vol. 80, pp. 277-293.
- Holzworth, G. C., 1972. Mixing Heights, Wind Speeds and Potential for Urban Air Pollution Throughout the Contiguous United States, U.S. Environmental Protection Agency (EPA), Research Triangle Park, N.C.
- Hosler, C. R., 1961. "Low-Level Inversion Frequency in the Contiguous United States," Monthly Weather Review, Vol. 89, No. 9, pp. 319-339.
- Hubbard, J. P., M. C. Conway, H. Campbell, G. Schmitt, and M. D. Hatch, 1978. Handbook of Species Endangered in New Mexico, New Mexico Department of Game and Fish.
- Humphrey, R. R., 1953. "The Desert Grassland, Past and Present," Journal of Range Management, Vol. 6, pp. 159-164.

- Humphrey, R. R., 1958. "The Desert Grassland," Botanical Revue, Vol. 24, No. 4, pp. 200-265.
- Industrial Development Corporation of Lea County, 1979. Data, Hobbs, New Mexico.
- Jelinek, A., 1967. A Prehistoric Sequence in the Mid-Pecos Valley, Museum of Anthropology, University of Michigan, Anthropological Paper No. 31.
- Jennings, A. H., 1963 (rev.). Maximum Recorded U.S. Point Rainfall, Weather Bureau Technical Paper No. 2, U.S. Department of Commerce.
- Jobst, J., 1977. "The Aerial Measuring Systems (AMS) Program, Equipment and Instrumentation," presented at the American Nuclear Topical Symposium: Aerial Techniques for Environmental Monitoring, March 8.
- John, B. S., 1977. The Ice Age Past and Present, William Collins Sons & Co., Ltd., London, p. 144.
- Johnsgard, P. A., 1973. North American Game Birds of Upland and Shoreline, University of Nebraska, Lincoln, Neb.
- Johnsgard, P.A., 1975. Grouse and Quails of North America, University of Nebraska, Lincoln, Neb.
- Jones, J. K., Jr., D. C. Carter, and H. H. Genoways, 1975. "Revised Checklist of North American Mammals North of Mexico," Occas. Papers Mus., Texas Tech University, Vol. 28, pp. 1-14.
- Kuechler, A. W., 1975. "Potential Natural Vegetation of the Conterminous United States," American Geographical Society, New York.
- Kukla, G. J., 1976. "Around the Ice Age World," Natural History, Vol. 85, pp.56-61.
- Kukla, G. J., and R. K. Matthews, 1972. "When Will the Present Interglacial End?" Science, Vol. 178, No. 4057, pp. 190-191.
- Lamb, H. H., 1966. The Changing Climate, Methuen & Co., Ltd., London, England.
- Lehmer, D. J., 1948. "Jornada Branch of the Mogollon," University of Arizona, Social Science Bulletin, Vol. 19, No. 17.
- Leslie, R., 1965. The Merchant Site (a Mogollon Site), Southeastern New Mexico and West Texas Symposium Papers, Bulletin 1.
- MacLennan, R. B., and S. C. Schermer, 1979. An Archaeological Survey for the Waste Isolation Pilot Plant: Access Roads and Railroad Right-of-Way, Agency for Conservation Archaeology, Eastern New Mexico University, Portales, N.M.
- Markee, E. H., Jr., J. G. Beckerly, and K. E. Sanders, 1974. Technical Basis for Interim Regional Tornado Criteria, WASH-1300, U.S. Atomic Energy Commission, Washington, D.C.

- Mera, H. P., 1943. "An Outline of Ceramic Developments in Southern and South-eastern New Mexico," Technical Series, Bulletin 11, Laboratory of Anthropology, Eastern New Mexico University, Portales, N.M.
- Metcalf, J. H., and L. W. Brewer, 1977. Environmental Monitoring at the WIPP Site, CY 1976, SAND77-1021, Sandia Laboratories, Albuquerque, N.M.
- Mitchell, J. M., Jr., ed., 1968. "Causes of Climate Changes," Meteorological Monograph, American Meteorological Society, Vol. 8, No. 30, pp. 155-159.
- NAS-NRC (National Academy of Sciences-National Research Council), 1975. Understanding Climate Change, A Program for Action, Washington, D.C., pp. 43-46.
- NAS-NRC (National Academy of Sciences-National Research Council), 1977. Climate, Climate Change and Water Supply, Washington, D.C., pp. 43-45.
- NCRP (National Council on Radiation Protection and Measurements), 1975. Natural Background Radiation in the United States, NCRP Report No. 45, Washington, D.C.
- National Defense University, February 1978. Climate Change to the Year 2000, A Survey of Expert Opinions, Defense Documentation Center, Alexandria, Va., pp. xvii-xx.
- Nielsen, J., 1976. An Archaeological Reconnaissance of Sandia Laboratories' Los Medanos Nuclear Waste Disposal Facility, Eddy County, New Mexico, SAND77-7024, Sandia Laboratories, Albuquerque, N.M.
- NMDB (New Mexico Department of Banking), 1979. Sixty-fourth Annual Report, 1979.
- NMDFA (New Mexico Department of Finance and Administration), 1979a. New Mexico Local Governments and the Property Tax.
- NMDFA (New Mexico Department of Finance and Administration), 1979b. Annual Report, New Mexico County and Municipal Governments, various years.
- NMDFA (New Mexico Department of Finance and Administration), 1979c. Municipal Quarterly Cash Reports (unpublished report filed by each incorporated New Mexico municipality).
- NMESD (New Mexico Employment Security Department), 1975-1979. Research and Statistics Division, various published and unpublished data.
- NMHRR (New Mexico Health Records Registry), 1979. New Mexico Statistical Summary.
- NMPSFD (New Mexico Public School Finance District), 1978. Statistics.
- NOAA (National Oceanic and Atmospheric Administration), 1972-1976. Climatological Data, National Climatic Center, Asheville, N.C.
- NOAA (National Oceanic and Atmospheric Administration), 1974. Climates of the United States, Vol. 2--Western States, Roswell, New Mexico, Water Information Center, Inc., Port Washington, N.Y., p. 883.

- NOAA (National Oceanic and Atmospheric Administration), 1975. Climatological Data, National Summary: Annual, 1974, Vol. 25, No. 13, Asheville, N.C.
- NOAA (National Oceanic and Atmospheric Administration), 1977. Local Climatological Data, Annual Summary (1976) with Comparative Data, Roswell, New Mexico, National Climatic Center, Asheville, N.C.
- NOAA (National Oceanic and Atmospheric Administration), 1978. Local Climatological Data, Annual Summary (1977) with Comparative Data, Roswell, New Mexico, National Climatic Center, Asheville, N.C.
- NOAA (National Oceanic and Atmospheric Administration), 1979. Local Climatological Data, Annual Summary (1978) with Comparative Data, Roswell, New Mexico, National Climatic Center, Asheville, N.C.
- Norwine, J., 1977. "A Question of Climate," Environment, Vol. 19, No. 8, pp. 6-27.
- NRC (U.S. Nuclear Regulatory Commission), 1976. "Preparation of Environmental Reports for Nuclear Power Stations," Regulatory Guide 4.2, NUREG-0099, July.
- Pautz, M. E., ed., 1969. "Severe Local Storm Occurrences, 1955-1967," Technical Memorandum WBTM FCST 12, Environmental Sciences and Services Administration (ESSA), U.S. Department of Commerce, Silver Spring, Md.
- Powers, D. W., S. J. Lambert, S.-E. Shaffer, L. R. Hill, and W. D. Weart, eds., 1978. Geological Characterization Report for the Waste Isolation Pilot Plant (WIPP) Site, Southeastern New Mexico, two volumes, SAND78-1596, Sandia Laboratories, Albuquerque, N.M.
- Rand-McNally, 1978. 1978 Commercial Atlas and Marketing Guide.
- Richmond, G. M., 1965. "Glaciations of the Rocky Mountains," in The Quaternary of the United States, H. E. Wright, Jr., and D. E. Grey, eds., Princeton University Press, Princeton, N.J.
- Richmond, G. M., 1972. "Appraisal of the Future Climate of the Holocene in the Rocky Mountains," Quaternary Research, Vol. 2, pp. 315-322.
- Sauer, C. O., 1950. "Grassland Climax, Fire, and Man," Journal of Range Management, Vol. 3, pp. 16-21.
- Schaafsma, C., 1975. "Archaeological Clearance for Four Gathering Lines Near Carlsbad, New Mexico," Sch. Amer. Res.
- Schermer, S. C., 1978. Archaeological Clearance Report for Sandia Laboratories, Agency for Conservation Archaeology, Eastern New Mexico University, Portales, N.M.
- Schwarzbach, M., 1963. Climates of the Past, An Introduction to Paleoclimatology, R. O. Muir (trans. and ed.), D. Van Nostrand Company, Ltd., Princeton, N.J.

- SCS (U.S. Soil Conservation Service), 1971. Soil Survey of Eddy Area, New Mexico, U.S. Department of Agriculture, Government Printing Office, Washington, D.C.
- SCS (U.S. Soil Conservation Service), 1974. Soil Survey of Lea County, New Mexico, U.S. Department of Agriculture, Government Printing Office, Washington, D.C.
- SCS (U.S. Soil Conservation Service), 1975. Surest Resource Conservation and Development Project, Department of Agriculture Program Action, prepared by the Resource Conservation and Development Council.
- Sellers, W. D., 1965. Physical Climatology, University of Chicago Press, Chicago, Ill.
- Shantz, H. L., 1917. "Plant Succession on Abandoned Roads in Eastern Colorado," Journal of Ecology, Vol. 5, pp. 19-42.
- Spellenberg, R., 1977. "A Synopsis of Federally Proposed Threatened or Endangered Plant Species in New Mexico," prepared for the U.S. Bureau of Reclamation, El Paso, Tex.
- Start, G. E., and L. L. Wendell, 1974. Regional Effluent Dispersion Calculations Considering Spatial and Temporal Meteorological Variations, NOAA TM ERL ARL-44, Air Resources Laboratories, Idaho Falls, Idaho.
- Sublette, J. E., 1975. A Survey of the Fishes of the Pecos, Canadian and Arkansas Drainage in New Mexico, unpublished report to Endangered Species Program, New Mexico Department of Game and Fish.
- Sublette, J. E., and M. Sublette, 1978. Quarterly Progress Reports--Aquatic Ecosystems, Contract No. 07-1489 (December 15, 1977-February 15, 1978), unpublished.
- Sublette, J. E., and M. Sublette, 1979. "Aquatic Ecosystems of the Lower Pecos Drainage, Eddy County, N.M.," in A Report of Biological Investigations at the Los Medanos WIPP Area of New Mexico During FY 1978, T. L. Best and S. Neuhauser, eds., SAND79-0368, Sandia Laboratories, Albuquerque, N.M.
- Thom, H. C. S., 1963. "Tornado Probabilities," Monthly Weather Review, October-December, pp. 730-736.
- Thom, H. C. S., 1968. New Distributions of Extreme Winds in the United States, American Society of Civil Engineers.
- Tiebout, C., 1962. "The Community Economic Base Study," Supplementary Paper 16, p. 74, Committee for Economic Development.
- Traut, G., 1963. "Comparative Morphology of the Two Species of Grasshopper Mice, Genus Onychomys, in New Mexico," master's thesis, University of New Mexico, Albuquerque, N.M.
- Turner, D. B., 1964. "A Diffusion Model for an Urban Area," Journal of Applied Meteorology, Vol. 3, pp. 83-91.

- U.S. Army, Quartermaster Research and Engineering Center, 1958. Hail Size and Distribution, Technical Report EP-83.
- USBM (U.S. Bureau of Mines), 1978. Annual Mineral Industry Survey, Department of the Interior, Washington, D.C.
- USDA (U.S. Department of Agriculture), 1975. Sureste Resource Conservation and Development Project, Program Action, prepared by the Resource Conservation and Development Council.
- USDC (U.S. Department of Commerce), Bureau of the Census, 1970a. Census of Population, Series PC (1)-A-33.
- USDC (U.S. Department of Commerce), Bureau of the Census, 1970b. Census of Population, 4th Count Summary (Computer) Tapes for New Mexico.
- USDC (U.S. Department of Commerce), Bureau of the Census, 1970c. Census of Housing.
- USDC (U.S. Department of Commerce), Bureau of Economic Analysis, 1975-1979. Regional Measurement Division, unpublished data (computer printouts).
- USDC (U.S. Department of Commerce), Bureau of the Census, 1977. "Gross Migration by County 1965 to 1970," Current Population Reports, Series P-25, No. 701, May.
- USDI (U.S. Department of the Interior), National Park Service, Southwest Region, 1970-1978. Public Use in the Southwest Region, various monthly issues.
- Wallmo, O. C., 1975. "Important Game Animals and Related Recreation in Arid Shrublands of the United States," Arid Shrublands, Proceedings of the Third Workshop of the United States/Australia Rangelands Panel, pp. 98-107, Tucson, Ariz.
- Weaver, J. E., and F. W. Albertson, 1956. Grasslands of the Great Plains, Johnsen Publishing Company, Lincoln, Neb.
- Webb, O., 1954. "Perognathus nelsoni canescens in New Mexico," Journal of Mammalogy, Vol. 35, pp. 453.
- Whitfield, C. J., and H. L. Anderson, 1938. "Secondary Succession in the Desert Plains Grassland," Ecology, Vol. 19, No. 2, pp. 171-180.
- Whitfield, C. J., and E. L. Beuther, 1938. "Natural Vegetation in the Desert Plains Grassland," Ecology, Vol. 19, pp. 26-37.
- Wingfield, D. W., 1955. "Trees Versus Water and Grass," Journal of Range Management, Vol. 4, pp. 149-150.
- Wolfe, H. G., et al. (eds.), 1977a. An Environmental Baseline Study of the Los Medanos Waste Isolation Pilot Plant (WIPP) Project Area of New Mexico: A Progress Report, SAND77-7017, Sandia Laboratories, Albuquerque, N.M.

Wolfe, H. G., et al. (eds.), 1977b. An Environmental Baseline Study of the Los Medanos Waste Isolation Pilot Plant (WIPP) Project Area of New Mexico: A Progress Report, An Addendum, SAND77-7018, Sandia Laboratories, Albuquerque, N.M.

Wolford, C. W., 1960. Tornado Occurrences in the United States, Technical Paper No. 20, U.S. Department of Commerce.

York, J. C., and W. A. Dick-Peddie, 1969. "Vegetation Changes in Southern New Mexico During the Past One Hundred Years," Arid Lands in Perspective, W. G. McGinnies and B. J. Goldman (eds.), University of Arizona Press, Tucson, Ariz.

ANNEX 1

METEOROLOGICAL TABLES

Contents

List of Tables

<u>Number</u>	<u>Title</u>	<u>Page</u>
1	Distribution of Wind Directions and Speeds at the WIPP Site, All Stabilities Combined, June 1977	5
2	Distribution of Wind Directions and Speeds at the WIPP Site, All Stabilities Combined, July 1977	6
3	Distribution of Wind Directions and Speeds at the WIPP Site, All Stabilities Combined, August 1977	7
4	Distribution of Wind Directions and Speeds at the WIPP Site, All Stabilities Combined, September 1977	8
5	Distribution of Wind Directions and Speeds at the WIPP Site, All Stabilities Combined, October 1977	9
6	Distribution of Wind Directions and Speeds at the WIPP Site, All Stabilities Combined, November 1977	10
7	Distribution of Wind Directions and Speeds at the WIPP Site, All Stabilities Combined, December 1977	11
8	Distribution of Wind Directions and Speeds at the WIPP Site, All Stabilities Combined, January 1978	12
9	Distribution of Wind Directions and Speeds at the WIPP Site, All Stabilities Combined, February 1978	13
10	Distribution of Wind Directions and Speeds at the WIPP Site, All Stabilities Combined, March 1978	14
11	Distribution of Wind Directions and Speeds at the WIPP Site, All Stabilities Combined, April 1978	15
12	Distribution of Wind Directions and Speeds at the WIPP Site, All Stabilities Combined, May 1978	16
13	Distribution of Wind Directions and Speeds at the WIPP Site, All Stabilities Combined, June 1978	17
14	Distribution of Wind Directions and Speeds at the WIPP Site, All Stabilities Combined, July 1978	18
15	Distribution of Wind Directions and Speeds at the WIPP Site, All Stabilities Combined, August 1978	19
16	Distribution of Wind Directions and Speeds at the WIPP Site, All Stabilities Combined, September 1978	20

List of Tables (continued)

<u>Number</u>	<u>Title</u>	<u>Page</u>
17	Distribution of Wind Directions and Speeds at the WIPP Site, All Stabilities Combined, October 1978	21
18	Distribution of Wind Directions and Speeds at the WIPP Site, All Stabilities Combined, November 1978	22
19	Distribution of Wind Directions and Speeds at the WIPP Site, All Stabilities Combined, December 1978	23
20	Distribution of Wind Directions and Speeds at the WIPP Site, All Stabilities Combined, January 1979	24
21	Distribution of Wind Directions and Speeds at the WIPP Site, All Stabilities Combined, February 1979	25
22	Distribution of Wind Directions and Speeds at the WIPP Site, All Stabilities Combined, March 1979	26
23	Distribution of Wind Directions and Speeds at the WIPP Site, All Stabilities Combined, April 1979	27
24	Distribution of Wind Directions and Speeds at the WIPP Site, All Stabilities Combined, May 1979	28
25	Distribution of Wind Directions and Speeds at the WIPP Site, Stability A, June 1, 1977-May 31, 1979	29
26	Distribution of Wind Directions and Speeds at the WIPP Site, Stability B, June 1, 1977-May 31, 1979	30
27	Distribution of Wind Directions and Speeds at the WIPP Site, Stability C, June 1, 1977-May 31, 1979	31
28	Distribution of Wind Directions and Speeds at the WIPP Site, Stability D, June 1, 1977-May 31, 1979	32
29	Distribution of Wind Directions and Speeds at the WIPP Site, Stability E, June 1, 1977-May 31, 1979	33
30	Distribution of Wind Directions and Speeds at the WIPP Site, Stability F, June 1, 1977-May 31, 1979	34
31	Distribution of Wind Directions and Speeds at the WIPP Site, Stability G, June 1, 1977-May 31, 1979	35
32	Distribution of Wind Directions and Speeds at the WIPP Site, All Stabilities Combined, June 1, 1977-May 31, 1979	36
33	One-Hour Frequency Distribution χ/Q Values for the WIPP Site	37

Table 1. Distribution of Wind Directions and Speeds at the WIPP Site, All Stabilities Combined, June 1977

SPEED (MPS)	DIRECTION																TOTAL
	NNE	NE	ENE	E	ESE	SE	SSE	S	SSW	SW	WSW	W	WNW	NW	NNW	N	
0.3- 1.4	1	0	2	2	11	6	2	1	2	3	0	1	1	2	2	2	38
(1)	0.3	0.0	0.6	0.6	3.2	1.7	0.6	0.3	0.6	0.9	0.0	0.3	0.3	0.6	0.6	0.6	11.0
(2)	0.3	0.0	0.6	0.6	3.2	1.7	0.6	0.3	0.6	0.9	0.0	0.3	0.3	0.6	0.6	0.6	11.0
1.5- 3.0	10	3	6	5	29	27	12	8	6	9	2	4	2	2	5	0	130
(1)	2.9	0.9	1.7	1.4	8.4	7.8	3.5	2.3	1.7	2.6	0.6	1.2	0.6	0.6	1.4	0.0	37.7
(2)	2.9	0.9	1.7	1.4	8.4	7.8	3.5	2.3	1.7	2.6	0.6	1.2	0.6	0.6	1.4	0.0	37.7
3.1- 5.0	3	4	4	4	9	35	24	14	9	5	1	1	0	1	0	1	115
(1)	0.9	1.2	1.2	1.2	2.6	10.1	7.0	4.1	2.6	1.4	0.3	0.3	0.0	0.3	0.0	0.3	33.3
(2)	0.9	1.2	1.2	1.2	2.6	10.1	7.0	4.1	2.6	1.4	0.3	0.3	0.0	0.3	0.0	0.3	33.3
5.1- 8.0	1	1	1	3	2	23	14	2	1	0	0	0	0	0	1	0	49
(1)	0.3	0.3	0.3	0.9	0.6	6.7	4.1	0.6	0.3	0.0	0.0	0.0	0.0	0.0	0.3	0.0	14.2
(2)	0.3	0.3	0.3	0.9	0.6	6.7	4.1	0.6	0.3	0.0	0.0	0.0	0.0	0.0	0.3	0.0	14.2
8.1-10.4	0	1	0	1	0	4	3	0	0	0	0	0	1	0	0	0	10
(1)	0.0	0.3	0.0	0.3	0.0	1.2	0.9	0.0	0.0	0.0	0.0	0.0	0.3	0.0	0.0	0.0	2.9
(2)	0.0	0.3	0.0	0.3	0.0	1.2	0.9	0.0	0.0	0.0	0.0	0.0	0.3	0.0	0.0	0.0	2.9
OVER 10.4	0	0	0	0	0	0	2	0	0	0	0	0	0	0	1	0	3
(1)	0.0	0.0	0.0	0.0	0.0	0.0	0.6	0.0	0.0	0.0	0.0	0.0	0.0	0.0	0.3	0.0	0.9
(2)	0.0	0.0	0.0	0.0	0.0	0.0	0.6	0.0	0.0	0.0	0.0	0.0	0.0	0.0	0.3	0.0	0.9
ALL SPEEDS	15	9	13	15	51	95	57	25	18	17	3	6	4	5	9	3	345
(1)	4.3	2.6	3.8	4.3	14.8	27.5	16.5	7.2	5.2	4.9	0.9	1.7	1.2	1.4	2.6	0.9	100.0
(2)	4.3	2.6	3.8	4.3	14.8	27.5	16.5	7.2	5.2	4.9	0.9	1.7	1.2	1.4	2.6	0.9	100.0

(1) = PERCENT OF ALL GOOD OBS FOR THIS PAGE
 (2) = PERCENT OF ALL GOOD OBS FOR THE PERIOD

345 GOOD HRS

0 HRS (0.0 PCT) LESS THAN 0.3 MPS

720 HRS IN THE TIME PERIOD

47.9 PCT DATA RECOVERY

Table 2. Distribution of Wind Directions and Speeds at the WIPP Site, All Stabilities Combined, July 1977

SPEED (MPS)	DIRECTION															TOTAL	
	NNE	NE	ENE	E	ESE	SE	SSE	S	SSW	SW	WSW	W	WNW	NW	NNW		N
0.3- 1.4	0	0	3	1	10	26	2	2	1	3	0	2	1	1	2	0	54
(1)	0.0	0.0	0.5	0.2	1.6	4.1	0.3	0.3	0.2	0.5	0.0	0.3	0.2	0.2	0.3	0.0	8.6
(2)	0.0	0.0	0.5	0.2	1.6	4.1	0.3	0.3	0.2	0.5	0.0	0.3	0.2	0.2	0.3	0.0	8.6
1.5- 3.0	2	3	2	4	27	79	17	5	7	7	3	3	1	2	4	1	172
(1)	0.3	1.3	0.3	0.6	4.3	12.5	2.7	0.8	1.1	1.1	0.5	0.5	0.2	0.3	0.6	0.2	27.3
(2)	0.3	1.3	0.3	0.6	4.3	12.5	2.7	0.8	1.1	1.1	0.5	0.5	0.2	0.3	0.6	0.2	27.3
3.1- 5.0	3	3	6	10	33	100	53	28	12	7	1	3	1	1	1	2	264
(1)	0.5	0.5	1.0	1.6	5.2	15.9	8.4	4.4	1.9	1.1	0.2	0.5	0.2	0.2	0.2	0.3	41.9
(2)	0.5	0.5	1.0	1.6	5.2	15.9	8.4	4.4	1.9	1.1	0.2	0.5	0.2	0.2	0.2	0.3	41.9
5.1- 8.0	0	2	3	7	9	33	61	7	3	0	0	0	0	0	0	1	126
(1)	0.0	0.3	0.5	1.1	1.4	5.2	9.7	1.1	0.5	0.0	0.0	0.0	0.0	0.0	0.0	0.2	20.0
(2)	0.0	0.3	0.5	1.1	1.4	5.2	9.7	1.1	0.5	0.0	0.0	0.0	0.0	0.0	0.0	0.2	20.0
8.1-10.4	0	1	0	0	1	2	9	0	0	0	0	0	0	0	0	0	13
(1)	0.0	0.2	0.0	0.0	0.2	0.3	1.4	0.0	0.0	0.0	0.0	0.0	0.0	0.0	0.0	0.0	2.1
(2)	0.0	0.2	0.0	0.0	0.2	0.3	1.4	0.0	0.0	0.0	0.0	0.0	0.0	0.0	0.0	0.0	2.1
OVER 10.4	0	0	0	0	0	1	0	0	0	0	0	0	0	0	0	0	1
(1)	0.0	0.0	0.0	0.0	0.0	0.2	0.0	0.0	0.0	0.0	0.0	0.0	0.0	0.0	0.0	0.0	0.2
(2)	0.0	0.0	0.0	0.0	0.0	0.2	0.0	0.0	0.0	0.0	0.0	0.0	0.0	0.0	0.0	0.0	0.2
ALL SPEEDS	5	14	14	22	83	241	142	42	23	17	4	8	3	4	7	4	630
(1)	0.8	2.2	2.2	3.5	12.7	38.3	22.5	6.7	3.7	2.7	0.6	1.3	0.5	0.6	1.1	0.6	100.0
(2)	0.8	2.2	2.2	3.5	12.7	38.3	22.5	6.7	3.7	2.7	0.6	1.3	0.5	0.6	1.1	0.6	100.0

(1) = PERCENT OF ALL GOOD OBS FOR THIS PAGE
 (2) = PERCENT OF ALL GOOD OBS FOR THE PERIOD

630 GOOD HRS

0 HRS (0.0 PCT) LESS THAN 0.3 MPS

744 HRS IN THE TIME PERIOD

84.7 PCT DATA RECOVERY

Table 3. Distribution of Wind Directions and Speeds at the WIPP Site, All Stabilities Combined, August 1977

SPEED (MPS)	DIRECTION															TOTAL	
	NNE	NE	ENE	E	ESE	SE	SSE	S	SSW	SW	WSW	W	WNW	NW	NNW		N
0.3- 1.4	1	2	2	1	5	13	4	1	1	0	2	7	2	1	2	1	45
(1)	0.1	0.3	0.3	0.1	0.7	1.9	0.6	0.1	0.1	0.0	0.3	1.0	0.3	0.1	0.3	0.1	6.6
(2)	0.1	0.3	0.3	0.1	0.7	1.9	0.6	0.1	0.1	0.0	0.3	1.0	0.3	0.1	0.3	0.1	6.6
1.5- 3.0	3	4	6	3	36	69	17	13	16	3	5	6	2	3	10	6	202
(1)	0.4	0.6	0.9	0.4	5.3	10.1	2.5	1.9	2.3	0.4	0.7	0.9	0.3	0.4	1.5	0.9	29.6
(2)	0.4	0.6	0.9	0.4	5.3	10.1	2.5	1.9	2.3	0.4	0.7	0.9	0.3	0.4	1.5	0.9	29.6
3.1- 5.0	5	9	10	14	28	83	42	24	17	6	3	2	1	2	3	2	251
(1)	0.7	1.3	1.5	2.0	4.1	12.2	6.1	3.5	2.5	0.9	0.4	0.3	0.1	0.3	0.4	0.3	36.7
(2)	0.7	1.3	1.5	2.0	4.1	12.2	6.1	3.5	2.5	0.9	0.4	0.3	0.1	0.3	0.4	0.3	36.7
5.1- 8.0	2	2	12	7	11	33	60	26	2	2	0	0	2	0	0	1	160
(1)	0.3	0.3	1.8	1.0	1.6	4.8	8.8	3.8	0.3	0.3	0.0	0.0	0.3	0.0	0.0	0.1	23.4
(2)	0.3	0.3	1.8	1.0	1.6	4.8	8.8	3.8	0.3	0.3	0.0	0.0	0.3	0.0	0.0	0.1	23.4
8.1-10.4	0	1	6	4	3	1	4	1	0	0	0	0	0	0	0	0	20
(1)	0.0	0.1	0.9	0.6	0.4	0.1	0.6	0.1	0.0	0.0	0.0	0.0	0.0	0.0	0.0	0.0	2.9
(2)	0.0	0.1	0.9	0.6	0.4	0.1	0.6	0.1	0.0	0.0	0.0	0.0	0.0	0.0	0.0	0.0	2.9
OVER 10.4	0	0	2	2	1	0	0	0	0	0	0	0	0	0	0	0	5
(1)	0.0	0.0	0.3	0.3	0.1	0.0	0.0	0.0	0.0	0.0	0.0	0.0	0.0	0.0	0.0	0.0	0.7
(2)	0.0	0.0	0.3	0.3	0.1	0.0	0.0	0.0	0.0	0.0	0.0	0.0	0.0	0.0	0.0	0.0	0.7
ALL SPEEDS	11	18	38	31	84	199	127	65	36	11	10	15	7	6	15	10	683
(1)	1.6	2.6	5.6	4.5	12.3	29.1	18.6	9.5	5.3	1.6	1.5	2.2	1.0	0.9	2.2	1.5	100.0
(2)	1.6	2.6	5.6	4.5	12.3	29.1	18.6	9.5	5.3	1.6	1.5	2.2	1.0	0.9	2.2	1.5	100.0

(1) = PERCENT OF ALL GOOD HRS FOR THIS PAGE

(2) = PERCENT OF ALL GOOD HRS FOR THE PERIOD

683 GOOD HRS

0 HRS (0.0 PCT) LESS THAN 0.3 MPS

744 HRS IN THE TIME PERIOD

91.8 PCT DATA RECOVERY

Table 4. Distribution of Wind Directions and Speeds at the WIPP Site, All Stabilities Combined, September 1977

SPEED (MPS)	DIRECTION																TOTAL
	NNE	NE	ENE	E	ESE	SE	SSE	S	SSW	SW	WSW	W	WNW	NW	NNW	N	
0.3- 1.4	2	7	7	1	25	21	7	8	5	5	2	5	2	4	5	2	108
(1)	0.3	1.0	1.0	0.1	3.5	2.9	1.0	1.1	0.7	0.7	0.3	0.7	0.3	0.6	0.7	0.3	15.1
(2)	0.3	1.0	1.0	0.1	3.5	2.9	1.0	1.1	0.7	0.7	0.3	0.7	0.3	0.6	0.7	0.3	15.1
1.5- 3.0	11	16	13	6	25	30	21	13	15	19	11	17	4	9	12	8	230
(1)	1.5	2.2	1.8	0.8	3.5	4.2	2.9	1.8	2.1	2.7	1.5	2.4	0.6	1.3	1.7	1.1	32.2
(2)	1.5	2.2	1.8	0.8	3.5	4.2	2.9	1.8	2.1	2.7	1.5	2.4	0.6	1.3	1.7	1.1	32.2
3.1- 5.0	12	23	15	9	8	33	43	23	17	3	5	14	10	11	13	11	250
(1)	1.7	3.2	2.1	1.3	1.1	4.6	6.0	3.2	2.4	0.4	0.7	2.0	1.4	1.5	1.8	1.5	35.0
(2)	1.7	3.2	2.1	1.3	1.1	4.6	6.0	3.2	2.4	0.4	0.7	2.0	1.4	1.5	1.8	1.5	35.0
5.1- 8.0	2	4	8	5	1	12	27	9	8	5	10	7	2	1	3	5	109
(1)	0.3	0.6	1.1	0.7	0.1	1.7	3.8	1.3	1.1	0.7	1.4	1.0	0.3	0.1	0.4	0.7	15.2
(2)	0.3	0.6	1.1	0.7	0.1	1.7	3.8	1.3	1.1	0.7	1.4	1.0	0.3	0.1	0.4	0.7	15.2
8.1-10.4	0	0	0	3	0	1	3	0	0	0	4	4	0	0	0	1	16
(1)	0.0	0.0	0.0	0.4	0.0	0.1	0.4	0.0	0.0	0.0	0.6	0.6	0.0	0.0	0.0	0.1	2.2
(2)	0.0	0.0	0.0	0.4	0.0	0.1	0.4	0.0	0.0	0.0	0.6	0.6	0.0	0.0	0.0	0.1	2.2
OVER 10.4	0	0	0	0	0	0	0	0	0	0	0	0	0	0	0	0	0
(1)	0.0	0.0	0.0	0.0	0.0	0.0	0.0	0.0	0.0	0.0	0.0	0.0	0.0	0.0	0.0	0.0	0.0
(2)	0.0	0.0	0.0	0.0	0.0	0.0	0.0	0.0	0.0	0.0	0.0	0.0	0.0	0.0	0.0	0.0	0.0
ALL SPEEDS	27	50	43	24	59	97	101	53	45	32	32	47	18	25	33	27	713
(1)	3.8	7.0	6.0	3.4	8.3	13.6	14.1	7.4	6.3	4.5	4.5	6.6	2.5	3.5	4.6	3.8	99.7
(2)	3.8	7.0	6.0	3.4	8.3	13.6	14.1	7.4	6.3	4.5	4.5	6.6	2.5	3.5	4.6	3.8	99.7

(1) = PERCENT OF ALL GOOD OBS FOR THIS PAGE
(2) = PERCENT OF ALL GOOD OBS FOR THE PERIOD

715 GOOD HRS 2 HRS (0.3 PCT) LESS THAN 0.3 MPS 720 HRS IN THE TIME PERIOD 99.3 PCT DATA RECOVERY

Table 5. Distribution of Wind Directions and Speeds at the WIPP Site, All Stabilities Combined, October 1977

SPEED (MPS)	DIRECTION																TOTAL
	NNE	NE	ENE	E	ESE	SE	SSE	S	SSW	SW	WSW	W	WNW	NW	NNW	N	
0.3- 1.4	3	4	4	5	34	26	6	3	10	2	4	7	7	3	3	6	127
(1)	0.4	0.6	0.6	0.7	4.7	3.6	0.8	0.4	1.4	0.3	0.6	1.0	1.0	0.4	0.4	0.8	17.5
(2)	0.4	0.6	0.6	0.7	4.7	3.6	0.8	0.4	1.4	0.3	0.6	1.0	1.0	0.4	0.4	0.8	17.5
1.5- 3.0	4	8	7	5	30	51	35	35	33	11	9	10	10	5	12	4	269
(1)	0.6	1.1	1.0	0.7	4.1	7.0	4.8	4.8	4.5	1.5	1.2	1.4	1.4	0.7	1.7	0.6	37.1
(2)	0.6	1.1	1.0	0.7	4.1	7.0	4.8	4.8	4.5	1.5	1.2	1.4	1.4	0.7	1.7	0.6	37.1
3.1- 5.0	14	12	8	13	22	28	44	40	8	7	5	4	5	2	3	6	221
(1)	1.9	1.7	1.1	1.8	3.0	3.9	6.1	5.5	1.1	1.0	0.7	0.6	0.7	0.3	0.4	0.8	30.4
(2)	1.9	1.7	1.1	1.8	3.0	3.9	6.1	5.5	1.1	1.0	0.7	0.6	0.7	0.3	0.4	0.8	30.4
5.1- 8.0	4	5	1	13	3	8	16	6	0	0	8	6	2	1	0	0	73
(1)	0.6	0.7	0.1	1.8	0.4	1.1	2.2	0.8	0.0	0.0	1.1	0.8	0.3	0.1	0.0	0.0	10.1
(2)	0.6	0.7	0.1	1.8	0.4	1.1	2.2	0.8	0.0	0.0	1.1	0.8	0.3	0.1	0.0	0.0	10.1
8.1-10.4	0	3	1	1	0	1	4	0	0	0	3	5	0	0	0	0	18
(1)	0.0	0.4	0.1	0.1	0.0	0.1	0.6	0.0	0.0	0.0	0.4	0.7	0.0	0.0	0.0	0.0	2.5
(2)	0.0	0.4	0.1	0.1	0.0	0.1	0.6	0.0	0.0	0.0	0.4	0.7	0.0	0.0	0.0	0.0	2.5
OVER 10.4	0	4	2	0	0	0	0	0	0	0	0	2	0	0	0	0	8
(1)	0.0	0.6	0.3	0.0	0.0	0.0	0.0	0.0	0.0	0.0	0.0	0.3	0.0	0.0	0.0	0.0	1.1
(2)	0.0	0.6	0.3	0.0	0.0	0.0	0.0	0.0	0.0	0.0	0.0	0.3	0.0	0.0	0.0	0.0	1.1
ALL SPEEDS	25	36	23	37	89	114	105	84	51	20	29	34	24	11	18	16	716
(1)	3.4	5.0	3.2	5.1	12.3	15.7	14.5	11.6	7.0	2.8	4.0	4.7	3.3	1.5	2.5	2.2	98.6
(2)	3.4	5.0	3.2	5.1	12.3	15.7	14.5	11.6	7.0	2.8	4.0	4.7	3.3	1.5	2.5	2.2	98.6

(1) = PERCENT OF ALL GOOD OBS FOR THIS PAGE
(2) = PERCENT OF ALL GOOD OBS FOR THE PERIOD

726 GOOD HRS

10 HRS (1.4 PCT) LESS THAN 0.3 MPS

744 HRS IN THE TIME PERIOD

97.6 PCT DATA RECOVERY

Table 6. Distribution of Wind Directions and Speeds at the WIPP Site, All Stabilities Combined, November 1977

SPEED (MPS)	DIRECTION															TOTAL	
	NNE	NE	ENE	E	ESE	SE	SSF	S	SSW	SW	WSW	W	WNW	NW	NNW		N
0.3- 1.4	7	7	4	5	21	18	12	7	7	3	8	6	6	5	4	2	122
(1)	1.0	1.0	0.6	0.7	3.1	2.7	1.8	1.0	1.0	0.4	1.2	0.9	0.9	0.7	0.6	0.3	18.2
(2)	1.0	1.0	0.6	0.7	3.1	2.7	1.8	1.0	1.0	0.4	1.2	0.9	0.9	0.7	0.6	0.3	18.2
1.5- 3.0	14	13	6	13	24	41	26	26	17	10	5	3	6	7	10	21	242
(1)	2.1	1.9	0.9	1.9	3.6	6.1	3.9	3.9	2.5	1.5	0.7	0.4	0.9	1.0	1.5	3.1	36.1
(2)	2.1	1.9	0.9	1.9	3.6	6.1	3.9	3.9	2.5	1.5	0.7	0.4	0.9	1.0	1.5	3.1	36.1
3.1- 5.0	16	12	11	20	6	26	27	24	11	12	9	10	9	4	3	5	205
(1)	2.4	1.8	1.6	3.0	0.9	3.9	4.0	3.6	1.6	1.8	1.3	1.5	1.3	0.6	0.4	0.7	30.6
(2)	2.4	1.8	1.6	3.0	0.9	3.9	4.0	3.6	1.6	1.8	1.3	1.5	1.3	0.6	0.4	0.7	30.6
5.1- 8.0	7	3	7	5	0	2	4	1	2	6	3	6	2	1	7	7	63
(1)	1.0	0.4	1.0	0.7	0.0	0.3	0.6	0.1	0.3	0.9	0.4	0.9	0.3	0.1	1.0	1.0	9.4
(2)	1.0	0.4	1.0	0.7	0.0	0.3	0.6	0.1	0.3	0.9	0.4	0.9	0.3	0.1	1.0	1.0	9.4
8.1-10.4	0	0	5	2	3	0	0	0	0	5	1	6	1	1	2	4	27
(1)	0.0	0.0	0.7	0.3	0.0	0.0	0.0	0.0	0.0	0.7	0.1	0.9	0.1	0.1	0.3	0.6	4.0
(2)	0.0	0.0	0.7	0.3	0.0	0.0	0.0	0.0	0.0	0.7	0.1	0.9	0.1	0.1	0.3	0.6	4.0
OVER 10.4	0	0	3	0	0	0	0	0	0	0	0	1	0	0	1	5	10
(1)	0.0	0.0	0.4	0.0	0.0	0.0	0.0	0.0	0.0	0.0	0.0	0.1	0.0	0.0	0.1	0.7	1.5
(2)	0.0	0.0	0.4	0.0	0.0	0.0	0.0	0.0	0.0	0.0	0.0	0.1	0.0	0.0	0.1	0.7	1.5
ALL SPEEDS	44	35	36	45	51	87	69	58	37	36	26	32	24	18	27	44	669
(1)	6.6	5.2	5.4	6.7	7.6	13.0	10.3	8.6	5.5	5.4	3.9	4.8	3.6	2.7	4.0	6.6	99.7
(2)	6.6	5.2	5.4	6.7	7.6	13.0	10.3	8.6	5.5	5.4	3.9	4.8	3.6	2.7	4.0	6.6	99.7

(1) PERCENT OF ALL GOOD OBS FOR THIS PAGE
 (2) PERCENT OF ALL GOOD OBS FOR THE PERIOD

671 GOOD HRS

2 HRS (0.3 PCT) LESS THAN 0.3 MPS

720 HRS IN THE TIME PERIOD

93.2 PCT DATA RECOVERY

Table 7. Distribution of Wind Directions and Speeds at the WIPP Site, All Stabilities Combined, December 1977

SPEED (MPS)	DIRECTION																TOTAL
	NNE	NE	ENE	E	ESE	SE	SSE	S	SSW	SW	WSW	W	WNW	NW	NNW	N	
0.3- 1.4	7	6	10	5	14	23	9	7	5	5	3	6	6	3	3	5	117
(1)	1.0	0.8	1.4	0.7	2.0	3.2	1.3	1.0	0.7	0.7	0.4	0.8	0.8	0.4	0.4	0.7	16.5
(2)	1.0	0.8	1.4	0.7	2.0	3.2	1.3	1.0	0.7	0.7	0.4	0.8	0.8	0.4	0.4	0.7	16.5
1.5- 3.0	9	12	6	3	10	39	23	21	21	19	13	9	14	20	10	7	236
(1)	1.3	1.7	0.8	0.4	1.4	5.5	3.2	3.0	3.0	2.7	1.8	1.3	2.0	2.8	1.4	1.0	33.2
(2)	1.3	1.7	0.8	0.4	1.4	5.5	3.2	3.0	3.0	2.7	1.8	1.3	2.0	2.8	1.4	1.0	33.2
3.1- 5.0	10	5	8	6	4	19	47	15	8	15	32	26	12	11	9	9	236
(1)	1.4	0.7	1.1	0.8	0.6	2.7	6.6	2.1	1.1	2.1	4.5	3.7	1.7	1.5	1.3	1.3	33.2
(2)	1.4	0.7	1.1	0.8	0.6	2.7	6.6	2.1	1.1	2.1	4.5	3.7	1.7	1.5	1.3	1.3	33.2
5.1- 8.0	5	5	1	0	1	1	5	3	4	3	10	16	6	7	6	7	86
(1)	0.7	0.7	0.1	0.0	0.1	0.1	0.7	0.4	0.6	0.4	1.4	2.3	0.8	1.0	0.8	1.0	12.1
(2)	0.7	0.7	0.1	0.0	0.1	0.1	0.7	0.4	0.6	0.4	1.4	2.3	0.8	1.0	0.8	1.0	12.1
8.1-10.4	0	0	0	1	0	0	0	0	0	0	1	7	0	1	1	0	11
(1)	0.0	0.0	0.0	0.1	0.0	0.0	0.0	0.0	0.0	0.0	0.1	1.0	0.0	0.1	0.1	0.0	1.5
(2)	0.0	0.0	0.0	0.1	0.0	0.0	0.0	0.0	0.0	0.0	0.1	1.0	0.0	0.1	0.1	0.0	1.5
OVER 10.4	0	0	2	2	0	0	0	0	0	0	1	8	6	0	0	0	19
(1)	0.0	0.0	0.3	0.3	0.0	0.0	0.0	0.0	0.0	0.0	0.1	1.1	0.8	0.0	0.0	0.0	2.7
(2)	0.0	0.0	0.3	0.3	0.0	0.0	0.0	0.0	0.0	0.0	0.1	1.1	0.8	0.0	0.0	0.0	2.7
ALL SPEEDS	31	28	27	23	29	82	84	46	38	42	60	72	44	42	29	28	705
(1)	4.4	3.9	3.8	3.2	4.1	11.5	11.8	6.5	5.3	5.9	8.4	10.1	6.2	5.9	4.1	3.9	99.2
(2)	4.4	3.9	3.8	3.2	4.1	11.5	11.8	6.5	5.3	5.9	8.4	10.1	6.2	5.9	4.1	3.9	99.2

(1)=PERCENT OF ALL GOOD OBS FOR THIS PAGE
 (2)=PERCENT OF ALL GOOD OBS FOR THE PERIOD

711 GOOD HRS

6 HRS (0.8 PCT) LESS THAN 0.3 MPS

744 HRS IN THE TIME PERIOD

95.6 PCT DATA RECOVERY

Table 8. Distribution of Wind Directions and Speeds at the WIPP Site, All Stabilities Combined, January 1978

SPEED (MPS)	DIRECTION															TOTAL	
	NNE	NE	ENE	E	ESE	SE	SSE	S	SSW	SW	WSW	W	WNW	NW	NNW		N
0.3- 1.4	4	4	6	9	3	15	12	3	3	4	3	3	3	5	3	3	83
(1)	0.6	0.6	0.9	1.4	0.5	2.3	1.9	0.5	0.5	0.6	0.5	0.5	0.5	0.8	0.5	0.5	12.9
(2)	0.6	0.6	0.9	1.4	0.5	2.3	1.9	0.5	0.5	0.6	0.5	0.5	0.5	0.8	0.5	0.5	12.9
1.5- 3.0	9	11	5	15	39	52	47	19	14	6	4	3	6	5	6	6	247
(1)	1.4	1.7	0.8	2.3	6.1	8.1	7.3	3.0	2.2	0.9	0.6	0.5	0.9	0.8	0.9	0.9	38.5
(2)	1.4	1.7	0.8	2.3	6.1	8.1	7.3	3.0	2.2	0.9	0.6	0.5	0.9	0.8	0.9	0.9	38.5
3.1- 5.0	11	5	6	13	21	29	47	30	7	3	7	3	5	4	10	7	208
(1)	1.7	0.8	0.9	2.0	3.3	4.5	7.3	4.7	1.1	0.5	1.1	0.5	0.8	0.6	1.6	1.1	32.4
(2)	1.7	0.8	0.9	2.0	3.3	4.5	7.3	4.7	1.1	0.5	1.1	0.5	0.8	0.6	1.6	1.1	32.4
5.1- 8.0	6	6	10	6	8	1	8	3	3	0	3	4	2	3	6	10	79
(1)	0.9	0.9	1.6	0.9	1.2	0.2	1.2	0.5	0.5	0.0	0.5	0.6	0.3	0.5	0.9	1.6	12.3
(2)	0.9	0.9	1.6	0.9	1.2	0.2	1.2	0.5	0.5	0.0	0.5	0.6	0.3	0.5	0.9	1.6	12.3
8.1-10.4	0	1	4	5	0	0	0	0	0	0	0	0	0	0	4	1	15
(1)	0.0	0.2	0.6	0.8	0.0	0.0	0.0	0.0	0.0	0.0	0.0	0.0	0.0	0.0	0.6	0.2	2.3
(2)	0.0	0.2	0.6	0.8	0.0	0.0	0.0	0.0	0.0	0.0	0.0	0.0	0.0	0.0	0.6	0.2	2.3
OVER 10.4	0	0	2	1	0	0	0	0	0	0	0	0	0	0	0	0	3
(1)	0.0	0.0	0.3	0.2	0.0	0.0	0.0	0.0	0.0	0.0	0.0	0.0	0.0	0.0	0.0	0.0	0.5
(2)	0.0	0.0	0.3	0.2	0.0	0.0	0.0	0.0	0.0	0.0	0.0	0.0	0.0	0.0	0.0	0.0	0.5
ALL SPEEDS	30	27	33	49	71	97	114	55	27	13	17	13	16	17	29	27	635
(1)	4.7	4.2	5.1	7.6	11.1	15.1	17.3	8.6	4.2	2.0	2.7	2.0	2.5	2.7	4.5	4.2	99.1
(2)	4.7	4.2	5.1	7.6	11.1	15.1	17.8	8.6	4.2	2.0	2.7	2.0	2.5	2.7	4.5	4.2	99.1

(1)=PERCENT OF ALL GOOD OPS FOR THIS PAGE
 (2)=PERCENT OF ALL GOOD OBS FOR THE PERIOD

641 GOOD HRS

6 HRS (0.9 PCT) LESS THAN 0.3 MPS

744 HRS IN THE TIME PERIOD

86.2 PCT DATA RECOVERY

Table 9. Distribution of Wind Directions and Speeds at the WIPP Site, All Stabilities Combined, February 1978

SPEED (MPS)	DIRECTION															TOTAL	
	NNE	NE	ENE	E	ESE	SE	SSE	S	SSW	SW	WSW	W	MNW	NW	NNW		N
0.3- 1.4	2	3	2	4	9	7	7	8	7	8	7	4	5	6	4	3	86
(1)	0.4	0.6	0.4	0.6	1.7	1.3	1.3	1.5	1.3	1.5	1.3	0.8	0.9	1.1	0.8	0.6	16.3
(2)	0.4	0.6	0.4	0.8	1.7	1.3	1.3	1.5	1.3	1.5	1.3	0.8	0.9	1.1	0.8	0.6	16.3
1.5- 3.0	2	14	6	4	11	35	28	19	9	4	10	3	6	14	6	5	176
(1)	0.4	2.7	1.1	0.8	2.1	6.6	5.3	3.6	1.7	0.8	1.9	0.6	1.1	2.7	1.1	0.9	33.4
(2)	0.4	2.7	1.1	0.8	2.1	6.6	5.3	3.6	1.7	0.8	1.9	0.6	1.1	2.7	1.1	0.9	33.4
3.1- 5.0	6	7	8	12	7	31	34	8	4	7	2	5	5	2	7	8	153
(1)	1.1	1.3	1.5	2.3	1.3	5.9	6.5	1.5	0.8	1.3	0.4	0.9	0.9	0.4	1.3	1.5	29.0
(2)	1.1	1.3	1.5	2.3	1.3	5.9	6.5	1.5	0.8	1.3	0.4	0.9	0.9	0.4	1.3	1.5	29.0
5.1- 8.0	8	11	5	16	6	6	8	2	0	0	3	6	6	6	2	0	85
(1)	1.5	2.1	0.9	3.0	1.1	1.1	1.5	0.4	0.0	0.0	0.6	1.1	1.1	1.1	0.4	0.0	16.1
(2)	1.5	2.1	0.9	3.0	1.1	1.1	1.5	0.4	0.0	0.0	0.6	1.1	1.1	1.1	0.4	0.0	16.1
8.1-10.4	0	3	1	1	0	0	0	0	0	0	1	4	7	0	0	0	17
(1)	0.0	0.6	0.2	0.2	0.0	0.0	0.0	0.0	0.0	0.0	0.2	0.8	1.3	0.0	0.0	0.0	3.2
(2)	0.0	0.6	0.2	0.2	0.0	0.0	0.0	0.0	0.0	0.0	0.2	0.8	1.3	0.0	0.0	0.0	3.2
OVER 10.4	0	0	2	0	0	0	0	0	0	0	0	3	1	0	0	0	6
(1)	0.0	0.0	0.4	0.0	0.0	0.0	0.0	0.0	0.0	0.0	0.0	0.6	0.2	0.0	0.0	0.0	1.1
(2)	0.0	0.0	0.4	0.0	0.0	0.0	0.0	0.0	0.0	0.0	0.0	0.6	0.2	0.0	0.0	0.0	1.1
ALL SPEEDS	18	38	24	37	33	79	77	37	20	19	23	25	30	28	19	16	523
(1)	3.4	7.2	4.6	7.0	6.3	15.0	14.6	7.0	3.8	3.6	4.4	4.7	5.7	5.3	3.6	3.0	99.2
(2)	3.4	7.2	4.6	7.0	6.3	15.0	14.6	7.0	3.8	3.6	4.4	4.7	5.7	5.3	3.6	3.0	99.2

(1) = PERCENT OF ALL GOOD OPS FOR THIS PAGE
 (2) = PERCENT OF ALL GOOD OPS FOR THE PERIOD

527 GOOD HRS

4 HRS (0.8 PCT) LESS THAN 0.3 MPS

672 HRS IN THE TIME PERIOD

78.4 PCT DATA RECOVERY

Table 10. Distribution of Wind Directions and Speeds at the WIPP Site, All Stabilities Combined, March 1978

SPEED (MPS)	DIRECTION															TOTAL	
	NNE	NE	ENE	E	ESE	SE	SSE	S	SSW	SW	WSW	W	WNW	NW	NNW		N
0.3-1.4	4	2	5	1	8	13	7	4	3	2	1	4	2	3	3	4	66
(1)	0.5	0.3	0.7	0.1	1.1	1.8	1.0	0.5	0.4	0.3	0.1	0.5	0.3	0.4	0.4	0.5	9.0
(2)	0.5	0.3	0.7	0.1	1.1	1.8	1.0	0.5	0.4	0.3	0.1	0.5	0.3	0.4	0.4	0.5	9.0
1.5-3.0	3	11	10	13	20	48	29	23	16	8	12	7	11	11	9	8	239
(1)	0.4	1.5	1.4	1.8	2.7	6.6	4.0	3.1	2.2	1.1	1.6	1.0	1.5	1.5	1.2	1.1	32.7
(2)	0.4	1.5	1.4	1.8	2.7	6.6	4.0	3.1	2.2	1.1	1.6	1.0	1.5	1.5	1.2	1.1	32.7
3.1-5.0	3	4	18	19	8	48	36	27	6	12	18	15	11	15	9	5	254
(1)	0.4	0.5	2.5	2.6	1.1	6.6	4.9	3.7	0.8	1.6	2.5	2.1	1.5	2.1	1.2	0.7	34.7
(2)	0.4	0.5	2.5	2.6	1.1	6.6	4.9	3.7	0.8	1.6	2.5	2.1	1.5	2.1	1.2	0.7	34.7
5.1-8.0	7	1	11	19	3	16	8	0	3	5	9	21	9	4	5	11	132
(1)	1.0	0.1	1.5	2.6	0.4	2.2	1.1	0.0	0.4	0.7	1.2	2.9	1.2	0.5	0.7	1.5	18.1
(2)	1.0	0.1	1.5	2.6	0.4	2.2	1.1	0.0	0.4	0.7	1.2	2.9	1.2	0.5	0.7	1.5	18.1
8.1-10.4	1	0	4	3	0	1	5	3	1	0	3	4	5	1	3	1	35
(1)	0.1	0.0	0.5	0.4	0.0	0.1	0.7	0.4	0.1	0.0	0.4	0.5	0.7	0.1	0.4	0.1	4.8
(2)	0.1	0.0	0.5	0.4	0.0	0.1	0.7	0.4	0.1	0.0	0.4	0.5	0.7	0.1	0.4	0.1	4.8
OVER 10.4	0	0	0	0	0	0	0	0	0	0	0	4	0	0	1	0	5
(1)	0.0	0.0	0.0	0.0	0.0	0.0	0.0	0.0	0.0	0.0	0.0	0.5	0.0	0.0	0.1	0.0	0.7
(2)	0.0	0.0	0.0	0.0	0.0	0.0	0.0	0.0	0.0	0.0	0.0	0.5	0.0	0.0	0.1	0.0	0.7
ALL SPEEDS	16	18	48	55	39	126	85	57	29	27	43	55	38	34	30	29	731
(1)	2.5	2.5	6.6	7.5	5.3	17.2	11.6	7.8	4.0	3.7	5.9	7.5	5.2	4.7	4.1	4.0	100.0
(2)	2.5	2.5	6.6	7.5	5.3	17.2	11.6	7.8	4.0	3.7	5.9	7.5	5.2	4.7	4.1	4.0	100.0

(1) = PERCENT OF ALL GOOD OBS FOR THIS PAGE
 (2) = PERCENT OF ALL GOOD OBS FOR THE PERIOD

731 GOOD HRS 0 HRS (0.0 PCT) LESS THAN 0.3 MPS 744 HRS IN THE TIME PERIOD 98.3 PCT DATA RECOVERY

14

Table 11. Distribution of Wind Directions and Speeds at the WIPP Site, All Stabilities Combined, April 1978

SPEED (MPS)	DIRECTION																TOTAL
	NNE	NE	ENE	E	ESE	SE	SSE	S	SSW	SW	WSW	W	WNW	NW	NNW	N	
0.3- 1.4	2	2	3	2	8	12	3	6	0	7	3	1	3	2	4	2	60
(1)	0.3	0.3	0.5	0.3	1.2	1.8	0.5	0.9	0.0	1.1	0.5	0.2	0.5	0.3	0.6	0.3	9.2
(2)	0.3	0.3	0.5	0.3	1.2	1.8	0.5	0.9	0.0	1.1	0.5	0.2	0.5	0.3	0.6	0.3	9.2
1.5- 3.0	7	9	8	3	15	20	17	18	19	19	15	5	8	9	6	12	190
(1)	1.1	1.4	1.2	0.5	2.3	3.1	2.6	2.8	2.9	2.9	2.3	0.8	1.2	1.4	0.9	1.8	29.2
(2)	1.1	1.4	1.2	0.5	2.3	3.1	2.6	2.8	2.9	2.9	2.3	0.8	1.2	1.4	0.9	1.8	29.2
3.1- 5.0	10	16	5	4	7	26	20	15	17	6	12	17	8	10	8	10	191
(1)	1.5	2.5	0.8	0.6	1.1	4.0	3.1	2.3	2.6	0.9	1.8	2.6	1.2	1.5	1.2	1.5	29.4
(2)	1.5	2.5	0.8	0.6	1.1	4.0	3.1	2.3	2.6	0.9	1.8	2.6	1.2	1.5	1.2	1.5	29.4
5.1- 8.0	2	5	4	6	1	20	13	10	12	7	21	20	4	10	0	10	145
(1)	0.3	0.8	0.6	0.9	0.2	3.1	2.0	1.5	1.8	1.1	3.2	3.1	0.6	1.5	0.0	1.5	22.3
(2)	0.3	0.8	0.6	0.9	0.2	3.1	2.0	1.5	1.8	1.1	3.2	3.1	0.6	1.5	0.0	1.5	22.3
8.1-10.4	0	0	3	3	0	3	5	1	1	2	14	17	7	1	0	0	57
(1)	0.0	0.0	0.5	0.5	0.0	0.5	0.8	0.2	0.2	0.3	2.2	2.6	1.1	0.2	0.0	0.0	8.8
(2)	0.0	0.0	0.5	0.5	0.0	0.5	0.8	0.2	0.2	0.3	2.2	2.6	1.1	0.2	0.0	0.0	8.8
OVER 10.4	0	0	0	0	0	1	0	0	0	0	2	2	1	0	0	0	6
(1)	0.0	0.0	0.0	0.0	0.0	0.2	0.0	0.0	0.0	0.0	0.3	0.3	0.2	0.0	0.0	0.0	0.9
(2)	0.0	0.0	0.0	0.0	0.0	0.2	0.0	0.0	0.0	0.0	0.3	0.3	0.2	0.0	0.0	0.0	0.9
ALL SPEEDS	21	32	23	18	31	82	58	50	49	41	67	62	31	32	18	34	649
(1)	3.2	4.9	3.5	2.8	4.8	12.6	8.9	7.7	7.5	6.3	10.3	9.5	4.8	4.9	2.8	5.2	99.8
(2)	3.2	4.9	3.5	2.8	4.8	12.6	8.9	7.7	7.5	6.3	10.3	9.5	4.8	4.9	2.8	5.2	99.8

(1) = PERCENT OF ALL GOOD OBS FOR THIS PAGE

(2) = PERCENT OF ALL GOOD OBS FOR THE PERIOD

650 GOOD HRS

1 HRS (0.2 PCT) LESS THAN 0.3 MPS

720 HRS IN THE TIME PERIOD

90.3 PCT DATA RECOVERY

Table 12. Distribution of Wind Directions and Speeds at the WIPP Site, All Stabilities Combined, May 1978

SPEED (MPS)	DIRECTION															TOTAL	
	NNE	NE	ENE	E	ESE	SE	SSE	S	SSW	SW	WSW	W	WNW	NW	NNW		N
0.3- 1.4	2	3	3	2	2	11	7	9	4	6	4	4	4	2	3	2	68
(1)	0.3	0.5	0.5	0.3	0.3	1.7	1.1	1.4	0.6	0.9	0.6	0.6	0.6	0.3	0.5	0.3	10.3
(2)	0.3	0.5	0.5	0.3	0.3	1.7	1.1	1.4	0.6	0.9	0.6	0.6	0.6	0.3	0.5	0.3	10.3
1.5- 3.0	6	5	7	3	19	27	14	18	12	11	9	5	5	6	5	6	158
(1)	0.9	0.8	1.1	0.5	2.9	4.1	2.1	2.7	1.8	1.7	1.4	0.8	0.8	0.9	0.8	0.9	23.9
(2)	0.9	0.8	1.1	0.5	2.9	4.1	2.1	2.7	1.8	1.7	1.4	0.8	0.8	0.9	0.8	0.9	23.9
3.1- 5.0	4	5	9	6	7	33	36	31	7	11	14	19	7	8	10	10	217
(1)	0.6	0.8	1.4	0.9	1.1	5.0	5.4	4.7	1.1	1.7	2.1	2.9	1.1	1.2	1.5	1.5	32.8
(2)	0.6	0.8	1.4	0.9	1.1	5.0	5.4	4.7	1.1	1.7	2.1	2.9	1.1	1.2	1.5	1.5	32.8
5.1- 8.0	0	2	11	5	4	28	34	15	4	9	11	27	8	1	4	7	170
(1)	0.0	0.3	1.7	0.8	0.6	4.2	5.1	2.3	0.6	1.4	1.7	4.1	1.2	0.2	0.6	1.1	25.7
(2)	0.0	0.3	1.7	0.8	0.6	4.2	5.1	2.3	0.6	1.4	1.7	4.1	1.2	0.2	0.6	1.1	25.7
8.1-10.4	1	1	0	6	1	3	5	0	1	5	6	8	0	2	1	2	42
(1)	0.2	0.2	0.0	0.9	0.2	0.5	0.8	0.0	0.2	0.8	0.9	1.2	0.0	0.3	0.2	0.3	6.3
(2)	0.2	0.2	0.0	0.9	0.2	0.5	0.8	0.0	0.2	0.8	0.9	1.2	0.0	0.3	0.2	0.3	6.3
OVER 10.4	0	0	3	0	0	0	0	0	0	0	0	1	0	0	0	0	4
(1)	0.0	0.0	0.5	0.0	0.0	0.0	0.0	0.0	0.0	0.0	0.0	0.2	0.0	0.0	0.0	0.0	0.6
(2)	0.0	0.0	0.5	0.0	0.0	0.0	0.0	0.0	0.0	0.0	0.0	0.2	0.0	0.0	0.0	0.0	0.6
ALL SPEEDS	13	16	33	22	33	102	96	73	28	42	44	64	24	19	23	27	659
(1)	2.0	2.4	5.0	3.3	5.0	15.4	14.5	11.0	4.2	6.3	6.6	9.7	3.6	2.9	3.5	4.1	99.5
(2)	2.0	2.4	5.0	3.3	5.0	15.4	14.5	11.0	4.2	6.3	6.6	9.7	3.6	2.9	3.5	4.1	99.5

(1)=PERCENT OF ALL GOOD OBS FOR THIS PAGE
 (2)=PERCENT OF ALL GOOD OBS FOR THE PERIOD

662 GOOD HRS

3 HRS (0.5 PCT) LESS THAN 0.3 MPS

744 HRS IN THE TIME PERIOD

89.0 PCT DATA RECOVERY

Table 13. Distribution of Wind Directions and Speeds at the WIPP Site, All Stabilities Combined, June 1978

SPEED (MPS)	DIRECTION																TOTAL
	NNE	NE	ENE	E	ESE	SE	SSE	S	SSW	SW	WSW	W	WNW	NW	NNW	N	
0.3- 1.4	3	3	2	4	7	10	2	2	3	3	2	1	1	2	2	1	48
(1)	0.4	0.4	0.3	0.6	1.0	1.4	0.3	0.3	0.4	0.4	0.3	0.1	0.1	0.3	0.3	0.1	6.8
(2)	0.4	0.4	0.3	0.6	1.0	1.4	0.3	0.3	0.4	0.4	0.3	0.1	0.1	0.3	0.3	0.1	6.8
1.5- 3.0	5	4	6	7	14	46	20	9	8	3	2	2	5	6	10	6	153
(1)	0.7	0.6	0.8	1.0	2.0	6.5	2.8	1.3	1.1	0.4	0.3	0.3	0.7	0.8	1.4	0.8	21.5
(2)	0.7	0.6	0.8	1.0	2.0	6.5	2.8	1.3	1.1	0.4	0.3	0.3	0.7	0.8	1.4	0.8	21.5
3.1- 5.0	3	12	13	12	12	69	53	47	9	1	0	1	0	5	6	7	250
(1)	0.4	1.7	1.8	1.7	1.7	9.7	7.5	6.6	1.3	0.1	0.0	0.1	0.0	0.7	0.8	1.0	35.2
(2)	0.4	1.7	1.8	1.7	1.7	9.7	7.5	6.6	1.3	0.1	0.0	0.1	0.0	0.7	0.8	1.0	35.2
5.1- 8.0	3	6	7	13	3	61	87	14	4	0	1	1	0	1	1	2	204
(1)	0.4	0.8	1.0	1.8	0.4	8.6	12.3	2.0	0.6	0.0	0.1	0.1	0.0	0.1	0.1	0.3	28.7
(2)	0.4	0.8	1.0	1.8	0.4	8.6	12.3	2.0	0.6	0.0	0.1	0.1	0.0	0.1	0.1	0.3	28.7
8.1-10.4	1	5	3	5	0	11	23	0	0	0	0	0	0	0	0	0	48
(1)	0.1	0.7	0.4	0.7	0.0	1.5	3.2	0.0	0.0	0.0	0.0	0.0	0.0	0.0	0.0	0.0	6.8
(2)	0.1	0.7	0.4	0.7	0.0	1.5	3.2	0.0	0.0	0.0	0.0	0.0	0.0	0.0	0.0	0.0	6.8
OVER 10.4	0	0	2	1	0	1	0	0	0	0	0	0	0	0	0	1	5
(1)	0.0	0.0	0.3	0.1	0.0	0.1	0.0	0.0	0.0	0.0	0.0	0.0	0.0	0.0	0.0	0.1	0.7
(2)	0.0	0.0	0.3	0.1	0.0	0.1	0.0	0.0	0.0	0.0	0.0	0.0	0.0	0.0	0.0	0.1	0.7
ALL SPEEDS	15	30	33	42	36	198	185	72	24	7	5	5	6	14	19	17	708
(1)	2.1	4.2	4.6	5.9	5.1	27.9	26.1	10.1	3.4	1.0	0.7	0.7	0.8	2.0	2.7	2.4	99.7
(2)	2.1	4.2	4.6	5.9	5.1	27.9	26.1	10.1	3.4	1.0	0.7	0.7	0.8	2.0	2.7	2.4	99.7

(1) = PERCENT OF ALL GOOD OBS FOR THIS PAGE
 (2) = PERCENT OF ALL GOOD OBS FOR THE PERIOD

710 GOOD HRS

2 HRS (0.3 PCT) LESS THAN 0.3 MPS

720 HRS IN THE TIME PERIOD

98.6 PCT DATA RECOVERY

Table 14. Distribution of Wind Directions and Speeds at the WIPP Site, All Stabilities Combined, July 1978

SPEED (MPS)	DIRECTION															TOTAL	
	NNE	NE	ENE	E	ESE	SE	SSE	S	SSW	SW	WSW	W	WNW	NW	NNW		N
0.3- 1.4	1	0	2	1	9	13	7	5	6	4	3	0	0	0	0	0	51
(1)	0.1	0.0	0.3	0.1	1.3	1.9	1.0	0.7	0.9	0.6	0.4	0.0	0.0	0.0	0.0	0.0	7.5
(2)	0.1	0.0	0.3	0.1	1.3	1.9	1.0	0.7	0.9	0.6	0.4	0.0	0.0	0.0	0.0	0.0	7.5
1.5- 3.0	7	5	7	7	39	83	22	30	9	1	1	0	0	0	4	6	221
(1)	1.0	0.7	1.0	1.0	5.7	12.2	3.2	4.4	1.3	0.1	0.1	0.0	0.0	0.0	0.6	0.9	32.5
(2)	1.0	0.7	1.0	1.0	5.7	12.2	3.2	4.4	1.3	0.1	0.1	0.0	0.0	0.0	0.6	0.9	32.5
3.1- 5.0	2	4	8	13	15	107	87	26	5	1	1	0	0	0	0	2	271
(1)	0.3	0.6	1.2	1.9	2.2	15.7	12.8	3.8	0.7	0.1	0.1	0.0	0.0	0.0	0.0	0.3	39.8
(2)	0.3	0.6	1.2	1.9	2.2	15.7	12.8	3.8	0.7	0.1	0.1	0.0	0.0	0.0	0.0	0.3	39.8
5.1- 6.0	0	8	6	5	1	38	64	1	0	0	0	0	0	0	0	1	124
(1)	0.0	1.2	0.9	0.7	0.1	5.6	9.4	0.1	0.0	0.0	0.0	0.0	0.0	0.0	0.0	0.1	18.2
(2)	0.0	1.2	0.9	0.7	0.1	5.6	9.4	0.1	0.0	0.0	0.0	0.0	0.0	0.0	0.0	0.1	18.2
8.1-10.4	0	0	3	1	0	3	3	0	0	0	0	0	0	0	0	0	10
(1)	0.0	0.0	0.4	0.1	0.0	0.4	0.4	0.0	0.0	0.0	0.0	0.0	0.0	0.0	0.0	0.0	1.5
(2)	0.0	0.0	0.4	0.1	0.0	0.4	0.4	0.0	0.0	0.0	0.0	0.0	0.0	0.0	0.0	0.0	1.5
OVER 10.4	0	1	0	1	0	0	0	0	0	0	0	0	0	0	0	0	2
(1)	0.0	0.1	0.0	0.1	0.0	0.0	0.0	0.0	0.0	0.0	0.0	0.0	0.0	0.0	0.0	0.0	0.3
(2)	0.0	0.1	0.0	0.1	0.0	0.0	0.0	0.0	0.0	0.0	0.0	0.0	0.0	0.0	0.0	0.0	0.3
ALL SPEEDS	10	18	26	28	64	244	183	62	27	6	5	0	0	0	4	9	679
(1)	1.5	2.6	3.8	4.1	9.4	35.8	26.9	9.1	2.9	0.9	0.7	0.0	0.0	0.0	0.6	1.3	99.7
(2)	1.5	2.6	3.8	4.1	9.4	35.8	26.9	9.1	2.9	0.9	0.7	0.0	0.0	0.0	0.6	1.3	99.7

(1)=PERCENT OF ALL GOOD OBS FOR THIS PAGE
(2)=PERCENT OF ALL GOOD OBS FOR THE PERIOD

681 GOOD HRS

2 HRS (0.3 PCT) LESS THAN 0.3 MPS

744 HRS IN THE TIME PERIOD

91.5 PCT DATA RECOVERY

Table 15. Distribution of Wind Directions and Speeds at the WIPP Site, All Stabilities Combined, August 1978

SPEED (MPS)	DIRECTION																TOTAL
	NNE	NE	ENE	E	ESE	SE	SSE	S	SSW	SW	WSW	W	MNW	NW	NNW	N	
0.3- 1.4	2	5	1	1	10	9	4	4	7	4	3	2	6	0	5	4	67
(1)	0.3	0.8	0.2	0.2	1.6	1.4	0.6	0.6	1.1	0.6	0.5	0.3	0.9	0.0	0.8	0.6	10.6
(2)	0.3	0.8	0.2	0.2	1.6	1.4	0.6	0.6	1.1	0.6	0.5	0.3	0.9	0.0	0.8	0.6	10.6
1.5- 3.0	3	5	5	6	15	37	24	33	25	10	11	7	5	8	6	9	209
(1)	0.5	0.8	0.8	0.9	2.4	5.9	3.8	5.2	4.0	1.6	1.7	1.1	0.8	1.3	0.9	1.4	33.1
(2)	0.5	0.8	0.8	0.9	2.4	5.9	3.8	5.2	4.0	1.6	1.7	1.1	0.8	1.3	0.9	1.4	33.1
3.1- 5.0	4	14	13	8	1	36	62	54	7	3	5	5	6	10	6	5	239
(1)	0.6	2.2	2.1	1.3	0.2	5.7	9.8	8.5	1.1	0.5	0.8	0.8	0.9	1.6	0.9	0.8	37.8
(2)	0.6	2.2	2.1	1.3	0.2	5.7	9.8	8.5	1.1	0.5	0.8	0.8	0.9	1.6	0.9	0.8	37.8
5.1- 8.0	0	3	18	9	6	7	47	12	1	1	0	1	1	1	0	2	109
(1)	0.0	0.5	2.8	1.4	0.9	1.1	7.4	1.9	0.2	0.2	0.0	0.2	0.2	0.2	0.0	0.3	17.2
(2)	0.0	0.5	2.8	1.4	0.9	1.1	7.4	1.9	0.2	0.2	0.0	0.2	0.2	0.2	0.0	0.3	17.2
8.1-10.4	0	0	3	0	0	0	1	0	0	0	0	0	0	0	0	0	0
(1)	0.0	0.0	0.5	0.0	0.0	0.0	0.2	0.0	0.0	0.0	0.0	0.0	0.0	0.0	0.0	0.0	0.6
(2)	0.0	0.0	0.5	0.0	0.0	0.0	0.2	0.0	0.0	0.0	0.0	0.0	0.0	0.0	0.0	0.0	0.6
OVER 10.4	0	0	0	0	0	0	0	0	0	0	0	0	0	0	0	0	0
(1)	0.0	0.0	0.0	0.0	0.0	0.0	0.0	0.0	0.0	0.0	0.0	0.0	0.0	0.0	0.0	0.0	0.0
(2)	0.0	0.0	0.0	0.0	0.0	0.0	0.0	0.0	0.0	0.0	0.0	0.0	0.0	0.0	0.0	0.0	0.0
ALL SPEEDS	9	27	40	24	32	89	138	103	40	18	19	15	18	19	17	20	628
(1)	1.4	4.3	6.3	3.8	5.1	14.1	21.8	16.3	6.3	2.8	3.0	2.4	2.8	3.0	2.7	3.2	99.4
(2)	1.4	4.3	6.3	3.8	5.1	14.1	21.8	16.3	6.3	2.8	3.0	2.4	2.8	3.0	2.7	3.2	99.4

(1) = PERCENT OF ALL GOOD OBS FOR THIS PAGE

(2) = PERCENT OF ALL GOOD OBS FOR THE PERIOD

632 GOOD HRS

4 HRS (0.6 PCT) LESS THAN 0.3 MPS

744 HRS IN THE TIME PERIOD

84.9 PCT DATA RECOVERY

Table 16. Distribution of Wind Directions and Speeds at the WIPP Site, All Stabilities Combined, September 1978

SPEED (MPS)	DIRECTION																TOTAL
	NNE	NE	ENE	E	ESE	SE	SSE	S	SSW	SW	WSW	W	WNW	NW	NNW	N	
0.3- 1.4	3	10	1	3	2	9	6	9	7	4	3	8	7	4	7	4	87
(1)	0.5	1.6	0.2	0.5	0.3	1.4	0.9	1.4	1.1	0.6	0.5	1.3	1.1	0.6	1.1	0.6	13.7
(2)	0.5	1.6	0.2	0.5	0.3	1.4	0.9	1.4	1.1	0.6	0.5	1.3	1.1	0.6	1.1	0.6	13.7
1.5- 3.0	10	15	9	13	15	41	30	18	14	11	11	6	5	10	11	7	226
(1)	1.6	2.4	1.4	2.1	2.4	6.5	4.7	2.8	2.2	1.7	1.7	0.9	0.8	1.6	1.7	1.1	35.6
(2)	1.6	2.4	1.4	2.1	2.4	6.5	4.7	2.8	2.2	1.7	1.7	0.9	0.8	1.6	1.7	1.1	35.6
3.1- 5.0	8	6	9	15	12	72	40	10	17	7	4	5	2	6	8	6	226
(1)	1.3	0.9	1.3	2.4	1.9	11.4	6.3	1.6	2.7	1.1	0.6	0.8	0.3	0.9	1.3	0.9	35.6
(2)	1.3	0.9	1.3	2.4	1.9	11.4	6.3	1.6	2.7	1.1	0.6	0.8	0.3	0.9	1.3	0.9	35.6
5.1- 8.0	2	6	16	6	0	20	9	2	1	3	6	12	0	0	1	0	84
(1)	0.3	0.9	2.5	0.9	0.0	3.2	1.4	0.3	0.2	0.5	0.9	1.9	0.0	0.0	0.2	0.0	13.2
(2)	0.3	0.9	2.5	0.9	0.0	3.2	1.4	0.3	0.2	0.5	0.9	1.9	0.0	0.0	0.2	0.0	13.2
8.1-10.4	0	0	3	0	0	1	2	1	0	0	0	2	0	0	0	0	9
(1)	0.0	0.0	0.5	0.0	0.0	0.2	0.3	0.2	0.0	0.0	0.0	0.3	0.0	0.0	0.0	0.0	1.4
(2)	0.0	0.0	0.5	0.0	0.0	0.2	0.3	0.2	0.0	0.0	0.0	0.3	0.0	0.0	0.0	0.0	1.4
OVER 10.4	0	0	0	0	0	0	0	0	0	0	0	0	0	0	0	0	0
(1)	0.0	0.0	0.0	0.0	0.0	0.0	0.0	0.0	0.0	0.0	0.0	0.0	0.0	0.0	0.0	0.0	0.0
(2)	0.0	0.0	0.0	0.0	0.0	0.0	0.0	0.0	0.0	0.0	0.0	0.0	0.0	0.0	0.0	0.0	0.0
ALL SPEEDS	23	37	37	37	29	143	87	40	39	25	24	33	14	20	27	17	632
(1)	3.6	5.8	5.8	5.8	4.6	22.6	13.7	6.3	6.2	3.9	3.8	5.2	2.2	3.2	4.3	2.7	99.7
(2)	3.6	5.8	5.8	5.8	4.6	22.6	13.7	6.3	6.2	3.9	3.8	5.2	2.2	3.2	4.3	2.7	99.7

(1)=PERCENT OF ALL GOOD OBS FOR THIS PAGE
 (2)=PERCENT OF ALL GOOD OBS FOR THE PERIOD

634 GOOD HRS

2 HRS (0.3 PCT) LESS THAN 0.3 MPS

720 HRS IN THE TIME PERIOD

88.1 PCT DATA RECOVERY

Table 17. Distribution of Wind Directions and Speeds at the WIPP Site, All Stabilities Combined, October 1978

SPEED (MPS)	DIRECTION															TOTAL	
	NNE	NE	ENE	E	ESE	SE	SSE	S	SSW	SW	WSW	W	WNW	NW	NNW		
0.3- 1.4	2	7	4	6	8	9	6	6	5	7	5	6	2	6	2	8	89
(1)	0.3	1.0	0.6	0.8	1.1	1.3	0.8	0.8	0.7	1.0	0.7	0.8	0.3	0.8	0.3	1.1	12.4
(2)	0.3	1.0	0.6	0.8	1.1	1.3	0.8	0.8	0.7	1.0	0.7	0.8	0.3	0.8	0.3	1.1	12.4
1.5- 3.0	2	4	2	12	31	50	36	29	21	8	11	10	5	13	10	6	250
(1)	0.3	0.6	0.3	1.7	4.3	7.0	5.0	4.1	2.9	1.1	1.5	1.4	0.7	1.8	1.4	0.8	34.9
(2)	0.3	0.6	0.3	1.7	4.3	7.0	5.0	4.1	2.9	1.1	1.5	1.4	0.7	1.8	1.4	0.8	34.9
3.1- 5.0	6	10	14	0	51	80	32	30	19	5	4	2	2	12	6	9	282
(1)	0.8	1.4	2.0	0.0	7.1	11.2	4.5	4.2	2.7	0.7	0.6	0.3	0.3	1.7	0.8	1.3	39.4
(2)	0.8	1.4	2.0	0.0	7.1	11.2	4.5	4.2	2.7	0.7	0.6	0.3	0.3	1.7	0.8	1.3	39.4
5.1- 8.0	4	4	7	4	0	19	9	16	3	0	2	2	0	0	0	9	79
(1)	0.6	0.6	1.0	0.6	0.0	2.7	1.3	2.2	0.4	0.0	0.3	0.3	0.0	0.0	0.0	1.3	11.0
(2)	0.6	0.6	1.0	0.6	0.0	2.7	1.3	2.2	0.4	0.0	0.3	0.3	0.0	0.0	0.0	1.3	11.0
8.1-10.4	1	1	9	0	0	0	0	0	0	0	0	0	0	0	0	0	11
(1)	0.1	0.1	1.3	0.0	0.0	0.0	0.0	0.0	0.0	0.0	0.0	0.0	0.0	0.0	0.0	0.0	1.5
(2)	0.1	0.1	1.3	0.0	0.0	0.0	0.0	0.0	0.0	0.0	0.0	0.0	0.0	0.0	0.0	0.0	1.5
OVER 10.4	0	3	0	0	0	0	0	0	0	0	0	0	0	0	0	0	3
(1)	0.0	0.4	0.0	0.0	0.0	0.0	0.0	0.0	0.0	0.0	0.0	0.0	0.0	0.0	0.0	0.0	0.4
(2)	0.0	0.4	0.0	0.0	0.0	0.0	0.0	0.0	0.0	0.0	0.0	0.0	0.0	0.0	0.0	0.0	0.4
ALL SPEEDS	15	29	36	22	90	158	83	81	48	20	22	20	9	31	18	32	714
(1)	2.1	4.1	5.0	3.1	12.6	22.1	11.6	11.3	6.7	2.8	3.1	2.8	1.3	4.3	2.5	4.5	99.7
(2)	2.1	4.1	5.0	3.1	12.6	22.1	11.6	11.3	6.7	2.8	3.1	2.8	1.3	4.3	2.5	4.5	99.7

(1)=PERCENT OF ALL GOOD OBS FOR THIS PAGE
 (2)=PERCENT OF ALL GOOD OBS FOR THE PERIOD

716 GOOD HRS

2 HRS (0.3 PCT) LESS THAN 0.3 MPS

744 HRS IN THE TIME PERIOD

96.2 PCT DATA RECOVERY

Table 18. Distribution of Wind Directions and Speeds at the WIPP Site, All Stabilities Combined, November 1978

SPEED (MPS)	DIRECTION																TOTAL
	NNE	NE	ENE	E	ESE	SE	SSE	S	SSW	SW	WSW	W	WNW	NW	NNW	N	
0.3- 1.4	9	8	4	6	5	9	14	10	8	2	5	4	4	4	2	5	99
(1)	1.3	1.1	0.6	0.9	0.7	1.3	2.0	1.4	1.1	0.3	0.7	0.6	0.6	0.6	0.3	0.7	14.2
(2)	1.3	1.1	0.6	0.9	0.7	1.3	2.0	1.4	1.1	0.3	0.7	0.6	0.6	0.6	0.3	0.7	14.2
1.5- 3.0	10	12	8	9	31	52	36	33	10	4	4	11	11	15	10	16	272
(1)	1.4	1.7	1.1	1.3	4.4	7.4	5.2	4.7	1.4	0.6	0.6	1.6	1.6	2.1	1.4	2.3	39.0
(2)	1.4	1.7	1.1	1.3	4.4	7.4	5.2	4.7	1.4	0.6	0.6	1.6	1.6	2.1	1.4	2.3	39.0
3.1- 5.0	10	19	20	10	41	43	21	11	3	7	9	5	11	7	5	2	229
(1)	1.4	2.7	2.9	1.4	5.9	6.2	3.0	1.6	1.1	1.0	1.3	0.7	1.6	1.0	0.7	0.3	32.8
(2)	1.4	2.7	2.9	1.4	5.9	6.2	3.0	1.6	1.1	1.0	1.3	0.7	1.6	1.0	0.7	0.3	32.8
5.1- 8.0	3	6	11	5	5	18	19	0	2	3	3	4	3	0	0	0	82
(1)	0.4	0.9	1.6	0.7	0.7	2.6	2.7	0.0	0.3	0.4	0.4	0.6	0.4	0.0	0.0	0.0	11.7
(2)	0.4	0.9	1.6	0.7	0.7	2.6	2.7	0.0	0.3	0.4	0.4	0.6	0.4	0.0	0.0	0.0	11.7
8.1-10.4	0	3	7	1	0	1	0	0	0	0	0	3	0	0	0	0	15
(1)	0.0	0.4	1.0	0.1	0.0	0.1	0.0	0.0	0.0	0.0	0.0	0.4	0.0	0.0	0.0	0.0	2.1
(2)	0.0	0.4	1.0	0.1	0.0	0.1	0.0	0.0	0.0	0.0	0.0	0.4	0.0	0.0	0.0	0.0	2.1
OVER 10.4	0	0	0	0	0	0	0	0	0	0	0	0	0	0	0	0	0
(1)	0.0	0.0	0.0	0.0	0.0	0.0	0.0	0.0	0.0	0.0	0.0	0.0	0.0	0.0	0.0	0.0	0.0
(2)	0.0	0.0	0.0	0.0	0.0	0.0	0.0	0.0	0.0	0.0	0.0	0.0	0.0	0.0	0.0	0.0	0.0
ALL SPEEDS	32	48	50	31	82	123	90	54	28	16	21	27	29	26	17	23	697
(1)	4.6	6.9	7.2	4.4	11.7	17.6	12.9	7.7	4.0	2.3	3.0	3.9	4.2	3.7	2.4	3.3	99.9
(2)	4.6	6.9	7.2	4.4	11.7	17.6	12.9	7.7	4.0	2.3	3.0	3.9	4.2	3.7	2.4	3.3	99.9

(1)=PERCENT OF ALL GOOD OBS FOR THIS PAGE
 (2)=PERCENT OF ALL GOOD OBS FOR THE PERIOD

698 GOOD HRS 1 HRS (0.1 PCT) LESS THAN 0.3 MPS 720 HRS IN THE TIME PERIOD 96.9 PCT DATA RECOVERY

Table 19. Distribution of Wind Directions and Speeds at the WIPP Site, All Stabilities Combined, December 1978

SPEED (MPS)	DIRECTION																TOTAL
	NNE	NE	ENE	E	ESE	SE	SSE	S	SSW	SW	WSW	W	WNW	NW	NNW	N	
0.3- 1.4	2	3	5	4	8	7	5	9	6	4	5	3	4	3	2	4	79
(1)	0.3	1.2	0.7	0.6	1.2	1.0	0.7	1.3	0.9	0.6	0.7	0.4	0.6	0.4	0.3	0.6	11.5
(2)	0.3	1.2	0.7	0.6	1.2	1.0	0.7	1.3	0.9	0.6	0.7	0.4	0.6	0.4	0.3	0.6	11.5
1.5- 3.0	16	15	8	8	17	40	32	24	12	13	10	7	9	9	7	13	240
(1)	2.3	2.2	1.2	1.2	2.5	5.8	4.7	3.5	1.8	1.9	1.5	1.0	1.3	1.3	1.0	1.9	35.0
(2)	2.3	2.2	1.2	1.2	2.5	5.8	4.7	3.5	1.8	1.9	1.5	1.0	1.3	1.3	1.0	1.9	35.0
3.1- 5.0	17	18	18	21	16	20	21	27	24	17	7	8	5	5	15	7	246
(1)	2.5	2.6	2.6	3.1	2.3	2.9	3.1	3.9	3.5	2.5	1.0	1.2	0.7	0.7	2.2	1.0	35.9
(2)	2.5	2.6	2.6	3.1	2.3	2.9	3.1	3.9	3.5	2.5	1.0	1.2	0.7	0.7	2.2	1.0	35.9
5.1- 8.0	4	6	11	9	0	1	5	11	6	13	4	6	6	7	2	6	97
(1)	0.6	0.9	1.6	1.3	0.0	0.1	0.7	1.6	0.9	1.9	0.6	0.9	0.9	1.0	0.3	0.9	14.2
(2)	0.6	0.9	1.6	1.3	0.0	0.1	0.7	1.6	0.9	1.9	0.6	0.9	0.9	1.0	0.3	0.9	14.2
8.1-10.4	0	0	5	2	0	0	0	0	1	5	1	0	0	4	0	1	19
(1)	0.0	0.0	0.7	0.3	0.0	0.0	0.0	0.0	0.1	0.7	0.1	0.0	0.0	0.6	0.0	0.1	2.8
(2)	0.0	0.0	0.7	0.3	0.0	0.0	0.0	0.0	0.1	0.7	0.1	0.0	0.0	0.6	0.0	0.1	2.8
OVER 10.4	0	0	0	0	0	0	0	0	0	0	2	0	0	0	0	0	2
(1)	0.0	0.0	0.0	0.0	0.0	0.0	0.0	0.0	0.0	0.0	0.3	0.0	0.0	0.0	0.0	0.0	0.3
(2)	0.0	0.0	0.0	0.0	0.0	0.0	0.0	0.0	0.0	0.0	0.3	0.0	0.0	0.0	0.0	0.0	0.3
ALL SPEEDS	39	47	47	44	41	68	63	71	49	52	29	24	24	28	26	31	683
(1)	5.7	6.9	6.9	6.4	6.0	9.9	9.2	10.4	7.2	7.6	4.2	3.5	3.5	4.1	3.8	4.5	99.7
(2)	5.7	6.9	6.9	6.4	6.0	9.9	9.2	10.4	7.2	7.6	4.2	3.5	3.5	4.1	3.8	4.5	99.7

(1)=PERCENT OF ALL GOOD OBS FOR THIS PAGE

(2)=PERCENT OF ALL GOOD OBS FOR THE PERIOD

685 GOOD HRS

2 HRS (0.3 PCT) LESS THAN 0.3 MPS

744 HRS IN THE TIME PERIOD

92.1 PCT DATA RECOVERY

Table 20. Distribution of Wind Directions and Speeds at the WIPP Site, All Stabilities Combined, January 1979

SPEED (MPS)	DIRECTION																TOTAL
	NNE	NE	ENE	E	ESE	SE	SSE	S	SSW	SW	WSW	W	WNW	NW	NNW	N	
0.3- 1.4	2	3	2	2	8	8	12	6	5	5	1	2	3	1	2	3	65
(1)	0.3	0.4	0.3	0.3	1.2	1.2	1.8	0.9	0.7	0.7	0.1	0.3	0.4	0.1	0.3	0.4	9.6
(2)	0.3	0.4	0.3	0.3	1.2	1.2	1.8	0.9	0.7	0.7	0.1	0.3	0.4	0.1	0.3	0.4	9.6
1.5- 3.0	4	2	8	19	19	45	44	36	20	5	5	6	7	3	3	2	228
(1)	0.6	0.3	1.2	2.8	2.8	6.6	6.5	5.3	2.9	0.7	0.7	0.9	1.0	0.4	0.4	0.3	33.6
(2)	0.6	0.3	1.2	2.8	2.8	6.6	6.5	5.3	2.9	0.7	0.7	0.9	1.0	0.4	0.4	0.3	33.6
3.1- 5.0	14	6	8	11	17	39	48	38	10	3	5	13	11	3	2	3	231
(1)	2.1	0.9	1.2	1.6	2.5	5.7	7.1	5.6	1.5	0.4	0.7	1.9	1.6	0.4	0.3	0.4	34.0
(2)	2.1	0.9	1.2	1.6	2.5	5.7	7.1	5.6	1.5	0.4	0.7	1.9	1.6	0.4	0.3	0.4	34.0
5.1- 8.0	7	1	8	3	6	26	10	10	4	1	3	14	8	4	3	8	116
(1)	1.0	0.1	1.2	0.4	0.9	3.8	1.5	1.5	0.6	0.1	0.4	2.1	1.2	0.6	0.4	1.2	17.1
(2)	1.0	0.1	1.2	0.4	0.9	3.8	1.5	1.5	0.6	0.1	0.4	2.1	1.2	0.6	0.4	1.2	17.1
8.1-10.4	0	2	0	0	0	0	0	0	0	0	2	13	4	0	2	3	26
(1)	0.0	0.3	0.0	0.0	0.0	0.0	0.0	0.0	0.0	0.0	0.3	1.9	0.6	0.0	0.3	0.4	3.8
(2)	0.0	0.3	0.0	0.0	0.0	0.0	0.0	0.0	0.0	0.0	0.3	1.9	0.6	0.0	0.3	0.4	3.8
OVER 10.4	0	0	0	0	0	0	0	0	0	0	0	7	2	0	2	0	11
(1)	0.0	0.0	0.0	0.0	0.0	0.0	0.0	0.0	0.0	0.0	0.0	1.0	0.3	0.0	0.3	0.0	1.6
(2)	0.0	0.0	0.0	0.0	0.0	0.0	0.0	0.0	0.0	0.0	0.0	1.0	0.3	0.0	0.3	0.0	1.6
ALL SPEEDS	27	14	26	35	50	118	114	90	39	14	16	55	35	11	14	19	677
(1)	4.0	2.1	3.8	5.2	7.4	17.4	16.8	13.3	5.7	2.1	2.4	8.1	5.2	1.6	2.1	2.8	99.7
(2)	4.0	2.1	3.8	5.2	7.4	17.4	16.8	13.3	5.7	2.1	2.4	8.1	5.2	1.6	2.1	2.8	99.7

(1) = PERCENT OF ALL GOOD OBS FOR THIS PAGE
 (2) = PERCENT OF ALL GOOD OBS FOR THE PERIOD

679 GOOD HRS

2 HRS (0.3 PCT) LESS THAN 0.3 MPS

744 HRS IN THE TIME PERIOD

91.3 PCT DATA RECOVERY

Table 21. Distribution of Wind Directions and Speeds at the WIPP Site, All Stabilities Combined, February 1979

SPEED (MPS)	DIRECTION																TOTAL
	NNE	NE	ENE	E	ESE	SE	SSE	S	SSW	SW	WSW	W	WNW	NW	NNW	N	
0.3- 1.4	5	6	5	4	8	6	3	6	4	9	6	9	4	2	5	8	90
(1)	0.9	1.0	0.9	0.7	1.4	1.0	0.5	1.0	0.7	1.5	1.0	1.5	0.7	0.3	0.9	1.4	15.4
(2)	0.9	1.0	0.9	0.7	1.4	1.0	0.5	1.0	0.7	1.5	1.0	1.5	0.7	0.3	0.9	1.4	15.4
1.5- 3.0	5	14	10	4	12	36	33	26	13	11	12	4	1	8	5	10	209
(1)	0.9	2.4	1.7	0.7	2.1	6.2	6.5	4.5	2.2	1.9	2.1	0.7	0.2	1.4	0.9	1.7	35.8
(2)	0.9	2.4	1.7	0.7	2.1	6.2	6.5	4.5	2.2	1.9	2.1	0.7	0.2	1.4	0.9	1.7	35.8
3.1- 5.0	12	18	14	7	17	23	24	14	5	4	12	6	3	10	5	5	179
(1)	2.1	3.1	2.4	1.2	2.9	3.9	4.1	2.4	0.9	0.7	2.1	1.0	0.5	1.7	0.9	0.9	30.7
(2)	2.1	3.1	2.4	1.2	2.9	3.9	4.1	2.4	0.9	0.7	2.1	1.0	0.5	1.7	0.9	0.9	30.7
5.1- 8.0	3	6	5	3	3	7	14	9	2	2	4	7	6	2	6	2	81
(1)	0.5	1.0	0.9	0.5	0.5	1.2	2.4	1.5	0.3	0.3	0.7	1.2	1.0	0.3	1.0	0.3	13.9
(2)	0.5	1.0	0.9	0.5	0.5	1.2	2.4	1.5	0.3	0.3	0.7	1.2	1.0	0.3	1.0	0.3	13.9
8.1-10.4	0	0	4	0	0	0	0	0	0	0	3	3	1	2	4	0	17
(1)	0.0	0.0	0.7	0.0	0.0	0.0	0.0	0.0	0.0	0.0	0.5	0.5	0.2	0.3	0.7	0.0	2.9
(2)	0.0	0.0	0.7	0.0	0.0	0.0	0.0	0.0	0.0	0.0	0.5	0.5	0.2	0.3	0.7	0.0	2.9
OVER 10.4	0	0	2	2	0	0	0	0	0	0	0	2	1	0	0	0	7
(1)	0.0	0.0	0.3	0.3	0.0	0.0	0.0	0.0	0.0	0.0	0.0	0.3	0.2	0.0	0.0	0.0	1.2
(2)	0.0	0.0	0.3	0.3	0.0	0.0	0.0	0.0	0.0	0.0	0.0	0.3	0.2	0.0	0.0	0.0	1.2
ALL SPEEDS	25	44	40	20	40	72	79	55	24	26	37	31	16	24	25	25	583
(1)	4.3	7.5	6.8	3.4	6.8	12.3	13.5	9.4	4.1	4.5	6.3	5.3	2.7	4.1	4.3	4.3	99.8
(2)	4.3	7.5	6.8	3.4	6.8	12.3	13.5	9.4	4.1	4.5	6.3	5.3	2.7	4.1	4.3	4.3	99.8

(1)=PERCENT OF ALL GOOD OBS FOR THIS PAGE

(2)=PERCENT OF ALL GOOD OBS FOR THE PERIOD

584 GOOD HRS

1 HRS (0.2 PCT) LESS THAN 0.3 MPS

672 HRS IN THE TIME PERIOD

86.9 PCT DATA RECOVERY

Table 22. Distribution of Wind Directions and Speeds at the WIPP Site, All Stabilities Combined, March 1979

SPEED (MPS)	DIRECTION														TOTAL		
	NNE	NE	ENE	E	ESE	SE	SSE	S	SSW	SW	WSW	W	WNW	NW		NNW	N
0.3- 1.4	5	4	2	4	5	6	7	5	5	2	7	1	5	1	1	5	65
(1)	0.7	0.5	0.3	0.5	0.7	0.8	1.0	0.7	0.7	0.3	1.0	0.1	0.7	0.1	0.1	0.7	8.9
(2)	0.7	0.5	0.3	0.5	0.7	0.8	1.0	0.7	0.7	0.3	1.0	0.1	0.7	0.1	0.1	0.7	8.9
1.5- 3.0	12	14	4	8	12	29	35	22	17	17	11	11	5	3	6	16	222
(1)	1.6	1.9	0.5	1.1	1.6	4.0	4.8	3.0	2.3	2.3	1.5	1.5	0.7	0.4	0.8	2.2	30.4
(2)	1.6	1.9	0.5	1.1	1.6	4.0	4.8	3.0	2.3	2.3	1.5	1.5	0.7	0.4	0.8	2.2	30.4
3.1- 5.0	4	4	10	17	24	36	37	19	7	8	12	14	6	12	7	3	220
(1)	0.5	0.5	1.4	2.3	3.3	4.9	5.1	2.6	1.0	1.1	1.6	1.9	0.8	1.6	1.0	0.4	30.1
(2)	0.5	0.5	1.4	2.3	3.3	4.9	5.1	2.6	1.0	1.1	1.6	1.9	0.8	1.6	1.0	0.4	30.1
5.1- 8.0	2	2	5	36	17	25	7	11	0	3	15	31	6	0	3	4	167
(1)	0.3	0.3	0.7	4.9	2.3	3.4	1.0	1.5	0.0	0.4	2.1	4.2	0.8	0.0	0.4	0.5	22.9
(2)	0.3	0.3	0.7	4.9	2.3	3.4	1.0	1.5	0.0	0.4	2.1	4.2	0.8	0.0	0.4	0.5	22.9
8.1-10.4	0	1	1	10	0	0	5	0	0	0	6	13	2	0	0	2	40
(1)	0.0	0.1	0.1	1.4	0.0	0.0	0.7	0.0	0.0	0.0	0.8	1.8	0.3	0.0	0.0	0.3	5.5
(2)	0.0	0.1	0.1	1.4	0.0	0.0	0.7	0.0	0.0	0.0	0.8	1.8	0.3	0.0	0.0	0.3	5.5
OVER 10.4	0	0	0	0	0	0	0	0	0	0	4	5	4	0	0	0	13
(1)	0.0	0.0	0.0	0.0	0.0	0.0	0.0	0.0	0.0	0.0	0.5	0.7	0.5	0.0	0.0	0.0	1.8
(2)	0.0	0.0	0.0	0.0	0.0	0.0	0.0	0.0	0.0	0.0	0.5	0.7	0.5	0.0	0.0	0.0	1.8
ALL SPEEDS	23	25	22	75	58	96	91	57	29	30	55	75	28	16	17	30	727
(1)	3.2	3.4	3.0	10.3	7.9	13.2	12.5	7.8	4.0	4.1	7.5	10.3	3.8	2.2	2.3	4.1	99.6
(2)	3.2	3.4	3.0	10.3	7.9	13.2	12.5	7.8	4.0	4.1	7.5	10.3	3.8	2.2	2.3	4.1	99.6

(1) = PERCENT OF ALL GOOD OBS FOR THIS PAGE
 (2) = PERCENT OF ALL GOOD OBS FOR THE PERIOD

730 GOOD HRS

3 HRS (0.4 PCT) LESS THAN 0.3 MPS

744 HRS IN THE TIME PERIOD

98.1 PCT DATA RECOVERY

Table 23. Distribution of Wind Directions and Speeds at the WIPP Site, All Stabilities Combined, April 1979

SPEED (MPS)	DIRECTION																TOTAL
	NNE	NE	ENE	E	ESE	SE	SSE	S	SSW	SW	WSW	W	WNW	NW	NNW	N	
0.3- 1.4	4	0	3	3	4	7	2	2	2	4	1	3	4	1	3	1	44
(1)	0.6	0.0	0.4	0.4	0.6	1.0	0.3	0.3	0.3	0.6	0.1	0.4	0.6	0.1	0.4	0.1	6.5
(2)	0.6	0.0	0.4	0.4	0.6	1.0	0.3	0.3	0.3	0.6	0.1	0.4	0.6	0.1	0.4	0.1	6.5
1.5- 3.0	4	8	5	10	21	19	13	27	10	11	12	3	3	7	10	4	167
(1)	0.6	1.2	0.7	1.5	3.1	2.8	1.9	4.0	1.5	1.6	1.8	0.4	0.4	1.0	1.5	0.6	24.8
(2)	0.6	1.2	0.7	1.5	3.1	2.8	1.9	4.0	1.5	1.6	1.8	0.4	0.4	1.0	1.5	0.6	24.8
3.1- 5.0	2	7	12	12	43	61	31	17	10	7	10	5	9	3	3	3	235
(1)	0.3	1.0	1.8	1.8	6.4	9.1	4.6	2.5	1.5	1.0	1.5	0.7	1.3	0.4	0.4	0.4	34.9
(2)	0.3	1.0	1.8	1.8	6.4	9.1	4.6	2.5	1.5	1.0	1.5	0.7	1.3	0.4	0.4	0.4	34.9
5.1- 8.0	8	3	13	20	18	34	15	3	1	10	7	6	4	0	7	4	153
(1)	1.2	0.4	1.9	3.0	2.7	5.0	2.2	0.4	0.1	1.5	1.0	0.9	0.6	0.0	1.0	0.6	22.7
(2)	1.2	0.4	1.9	3.0	2.7	5.0	2.2	0.4	0.1	1.5	1.0	0.9	0.6	0.0	1.0	0.6	22.7
8.1-10.4	0	0	11	3	0	5	4	0	0	1	7	9	5	2	3	0	50
(1)	0.0	0.0	1.6	0.4	0.0	0.7	0.6	0.0	0.0	0.1	1.0	1.3	0.7	0.3	0.4	0.0	7.4
(2)	0.0	0.0	1.6	0.4	0.0	0.7	0.6	0.0	0.0	0.1	1.0	1.3	0.7	0.3	0.4	0.0	7.4
OVER 10.4	0	0	0	0	0	0	0	0	0	0	6	11	4	0	3	0	24
(1)	0.0	0.0	0.0	0.0	0.0	0.0	0.0	0.0	0.0	0.0	0.9	1.6	0.6	0.0	0.4	0.0	3.6
(2)	0.0	0.0	0.0	0.0	0.0	0.0	0.0	0.0	0.0	0.0	0.9	1.6	0.6	0.0	0.4	0.0	3.6
ALL SPEEDS	18	18	44	48	86	126	65	49	23	33	43	37	29	13	29	12	673
(1)	2.7	2.7	6.5	7.1	12.8	18.7	9.6	7.3	3.4	4.9	6.4	5.5	4.3	1.9	4.3	1.8	99.9
(2)	2.7	2.7	6.5	7.1	12.8	18.7	9.6	7.3	3.4	4.9	6.4	5.5	4.3	1.9	4.3	1.8	99.9

(1) = PERCENT OF ALL GOOD OBS FOR THIS PAGE
 (2) = PERCENT OF ALL GOOD OBS FOR THE PERIOD

674 GOOD HRS

1 HRS (0.1 PCT) LESS THAN 0.3 MPS

720 HRS IN THE TIME PERIOD

93.6 PCT DATA RECOVERY

Table 24. Distribution of Wind Directions and Speeds at the WIPP Site, All Stabilities Combined, May 1979

SPEED (MPS)	DIRECTION															TOTAL	
	NNE	NE	ENE	E	ESE	SE	SSE	S	SSW	SW	WSW	W	WNW	NW	NNW		N
0.3- 1.4	3	1	4	3	3	3	5	2	5	3	1	2	3	1	1	2	42
(1)	0.5	0.2	0.6	0.5	0.5	0.5	0.8	0.3	0.8	0.5	0.2	0.3	0.5	0.2	0.2	0.3	6.5
(2)	0.5	0.2	0.6	0.5	0.5	0.5	0.8	0.3	0.8	0.5	0.2	0.3	0.5	0.2	0.2	0.3	6.5
1.5- 3.0	6	13	6	10	20	23	21	23	18	6	9	6	7	5	6	13	192
(1)	0.9	2.0	0.9	1.5	3.1	3.6	3.2	3.6	2.8	0.9	1.4	0.9	1.1	0.8	0.9	2.0	29.7
(2)	0.9	2.0	0.9	1.5	3.1	3.6	3.2	3.6	2.8	0.9	1.4	0.9	1.1	0.8	0.9	2.0	29.7
3.1- 5.0	10	5	1	13	36	49	33	23	19	11	3	16	7	6	10	9	251
(1)	1.5	0.8	0.2	2.0	5.6	7.6	5.1	3.6	2.9	1.7	0.5	2.5	1.1	0.9	1.5	1.4	38.8
(2)	1.5	0.8	0.2	2.0	5.6	7.6	5.1	3.6	2.9	1.7	0.5	2.5	1.1	0.9	1.5	1.4	38.8
5.1- 8.0	7	3	1	4	15	42	17	5	12	6	4	6	3	2	3	11	141
(1)	1.1	0.5	0.2	0.6	2.3	6.5	2.6	0.8	1.9	0.9	0.6	0.9	0.5	0.3	0.5	1.7	21.8
(2)	1.1	0.5	0.2	0.6	2.3	6.5	2.6	0.8	1.9	0.9	0.6	0.9	0.5	0.3	0.5	1.7	21.8
8.1-10.4	0	1	1	0	0	3	1	0	7	5	3	0	0	0	0	0	21
(1)	0.0	0.2	0.2	0.0	0.0	0.5	0.2	0.0	1.1	0.8	0.5	0.0	0.0	0.0	0.0	0.0	3.2
(2)	0.0	0.2	0.2	0.0	0.0	0.5	0.2	0.0	1.1	0.8	0.5	0.0	0.0	0.0	0.0	0.0	3.2
OVER 10.4	0	0	0	0	0	0	0	0	0	0	0	0	0	0	0	0	0
(1)	0.0	0.0	0.0	0.0	0.0	0.0	0.0	0.0	0.0	0.0	0.0	0.0	0.0	0.0	0.0	0.0	0.0
(2)	0.0	0.0	0.0	0.0	0.0	0.0	0.0	0.0	0.0	0.0	0.0	0.0	0.0	0.0	0.0	0.0	0.0
ALL SPEEDS	26	23	13	30	74	120	77	53	61	31	20	30	20	14	20	35	647
(1)	4.0	3.6	2.0	4.6	11.4	18.5	11.9	8.2	9.4	4.8	3.1	4.6	3.1	2.2	3.1	5.4	100.0
(2)	4.0	3.6	2.0	4.6	11.4	18.5	11.9	8.2	9.4	4.8	3.1	4.6	3.1	2.2	3.1	5.4	100.0

(1) = PERCENT OF ALL GOOD OBS FOR THIS PAGE
 (2) = PERCENT OF ALL GOOD OBS FOR THE PERIOD

647 GOOD HRS

0 HRS (0.0 PCT) LESS THAN 0.3 MPS

744 HRS IN THE TIME PERIOD

87.0 PCT DATA RECOVERY

Table 25. Distribution of Wind Directions and Speeds at the WIPP Site, Stability A, June 1, 1977-May 31, 1979

SPEED (MPS)	DIRECTION																TOTAL
	NNE	NE	ENE	E	ESE	SE	SSE	S	SSW	SW	WSW	W	WNW	NW	NNW	N	
0.3- 1.4	13	10	17	12	20	26	28	34	35	39	27	28	23	25	17	12	366
(1)	0.2	0.2	0.3	0.2	0.3	0.4	0.5	0.6	0.6	0.7	0.5	0.5	0.4	0.4	0.3	0.2	6.3
(2)	0.1	0.1	0.1	0.1	0.1	0.2	0.2	0.2	0.2	0.2	0.2	0.2	0.1	0.2	0.1	0.1	2.3
1.5- 3.0	44	39	39	45	109	191	153	223	212	121	92	76	67	86	79	64	1640
(1)	0.8	0.7	0.7	0.8	1.9	3.3	2.6	3.9	3.7	2.1	1.6	1.3	1.2	1.5	1.4	1.1	28.4
(2)	0.3	0.2	0.2	0.3	0.7	1.2	1.0	1.4	1.3	0.8	0.6	0.5	0.4	0.5	0.5	0.4	10.4
3.1- 5.0	51	58	65	97	95	254	390	415	218	105	102	98	64	97	70	55	2234
(1)	0.9	1.0	1.1	1.7	1.6	4.4	6.7	7.2	3.8	1.8	1.8	1.7	1.1	1.7	1.2	1.0	38.6
(2)	0.3	0.4	0.4	0.6	0.6	1.6	2.5	2.6	1.4	0.7	0.6	0.6	0.4	0.6	0.4	0.3	14.2
5.1- 8.0	45	41	64	66	23	116	214	145	66	58	91	115	36	22	34	59	1195
(1)	0.8	0.7	1.1	1.1	0.4	2.0	3.7	2.5	1.1	1.0	1.6	2.0	0.6	0.4	0.6	1.0	20.7
(2)	0.3	0.3	0.4	0.4	0.1	0.7	1.4	0.9	0.4	0.4	0.6	0.7	0.2	0.1	0.2	0.4	7.6
8.1-10.4	2	7	15	3	2	12	15	5	10	18	45	77	16	12	13	5	262
(1)	0.0	0.1	0.3	0.1	0.0	0.2	0.3	0.1	0.2	0.3	0.8	1.3	0.3	0.2	0.2	0.1	4.5
(2)	0.0	0.0	0.1	0.1	0.0	0.1	0.1	0.0	0.1	0.1	0.3	0.5	0.1	0.1	0.1	0.0	1.7
OVER 10.4	0	3	2	1	0	1	0	0	0	0	13	35	11	0	6	3	75
(1)	0.0	0.1	0.0	0.0	0.0	0.0	0.0	0.0	0.0	0.0	0.2	0.6	0.2	0.0	0.1	0.1	1.3
(2)	0.0	0.0	0.0	0.0	0.0	0.0	0.0	0.0	0.0	0.0	0.1	0.2	0.1	0.0	0.0	0.0	0.5
ALL SPEEDS	155	158	262	229	249	600	800	822	541	341	370	429	217	242	219	198	5772
(1)	2.7	2.7	3.5	4.0	4.3	10.4	13.8	14.2	9.4	5.9	6.4	7.4	3.8	4.2	3.8	3.4	99.8
(2)	1.0	1.0	1.3	1.5	1.6	3.8	5.1	5.2	3.4	2.2	2.3	2.7	1.4	1.5	1.4	1.3	36.6

(1)=PERCENT OF ALL GOOD OBS FOR THIS PAGE
 (2)=PERCENT OF ALL GOOD OBS FOR THE PERIOD

5782 HRS ON THIS PAGE 10 HRS (0.2 PCT) LESS THAN 0.3 MPS (0.1 PCT OF ALL HRS)

Table 26. Distribution of Wind Directions and Speeds at the WIPP Site, Stability B, June 1, 1977-May 31, 1979

SPEED (MPS)	DIRECTION															TOTAL	
	NNE	NE	ENE	E	ESE	SE	SSE	S	SSW	SW	WSW	W	WNW	NW	NNW		N
0.3- 1.4	1	1	1	0	0	3	2	2	3	1	3	4	1	3	3	2	30
(1)	0.6	0.6	0.6	0.0	0.0	1.7	1.1	1.1	1.7	0.6	1.7	2.3	0.6	1.7	1.7	1.1	17.2
(2)	0.0	0.0	0.0	0.0	0.0	0.0	0.0	0.0	0.0	0.0	0.0	0.0	0.0	0.0	0.0	0.0	0.2
1.5- 3.0	4	0	1	5	6	5	5	6	1	3	0	6	4	3	4	3	56
(1)	2.3	0.0	0.6	2.9	3.4	2.9	2.9	3.4	0.6	1.7	0.0	3.4	2.3	1.7	2.3	1.7	32.2
(2)	0.0	0.0	0.0	0.0	0.0	0.0	0.0	0.0	0.0	0.0	0.0	0.0	0.0	0.0	0.0	0.0	0.4
3.1- 5.0	1	2	9	6	4	9	8	4	0	2	0	1	0	0	0	0	46
(1)	0.6	1.1	5.2	3.4	2.3	5.2	4.6	2.3	0.0	1.1	0.0	0.6	0.0	0.0	0.0	0.0	26.4
(2)	0.0	0.0	0.1	0.0	0.0	0.1	0.1	0.0	0.0	0.0	0.0	0.0	0.0	0.0	0.0	0.0	0.3
5.1- 8.0	2	0	2	5	2	3	5	0	1	2	0	1	0	1	1	3	28
(1)	1.1	0.0	1.1	2.9	1.1	1.7	2.9	0.0	0.6	1.1	0.0	0.6	0.0	0.6	0.6	1.7	16.1
(2)	0.0	0.0	0.0	0.0	0.0	0.0	0.0	0.0	0.0	0.0	0.0	0.0	0.0	0.0	0.0	0.0	0.2
8.1-10.4	0	0	2	3	1	1	0	0	0	0	0	1	1	0	0	0	9
(1)	0.0	0.0	1.1	1.7	0.6	0.6	0.0	0.0	0.0	0.0	0.0	0.6	0.6	0.0	0.0	0.0	5.2
(2)	0.0	0.0	0.0	0.0	0.0	0.0	0.0	0.0	0.0	0.0	0.0	0.0	0.0	0.0	0.0	0.0	0.1
OVER 10.4	0	0	1	1	0	0	0	0	0	0	0	1	0	0	0	1	4
(1)	0.0	0.0	0.6	0.6	0.0	0.0	0.0	0.0	0.0	0.0	0.0	0.6	0.0	0.0	0.0	0.6	2.3
(2)	0.0	0.0	0.0	0.0	0.0	0.0	0.0	0.0	0.0	0.0	0.0	0.0	0.0	0.0	0.0	0.0	0.0
ALL SPEEDS	8	3	16	20	13	21	20	12	5	8	3	14	6	7	8	9	173
(1)	4.6	1.7	9.2	11.5	7.5	12.1	11.5	6.9	2.9	4.6	1.7	8.0	3.4	4.0	4.6	5.2	99.4
(2)	0.1	0.0	0.1	0.1	0.1	0.1	0.1	0.1	0.0	0.1	0.0	0.1	0.0	0.0	0.1	0.1	1.1

(1)=PERCENT OF ALL GOOD OBS FOR THIS PAGE
 (2)=PERCENT OF ALL GOOD OBS FOR THE PERIOD

174 HRS ON THIS PAGE

1 HRS (0.6 PCT) LESS THAN 0.3 MPS

(0.0 PCT OF ALL HRS)

Table 27. Distribution of Wind Directions and Speeds at the WIPP Site, Stability C, June 1, 1977-May 31, 1979

SPEED (MPS)	DIRECTION															TOTAL	
	NNE	NE	ENE	E	ESE	SE	SSE	S	SSW	SW	WSW	W	MNW	NW	NNW		N
0.3- 1.4	1	0	0	0	0	0	0	1	0	2	1	1	1	0	0	0	7
(1)	1.1	0.0	0.0	0.0	0.0	0.0	0.0	1.1	0.0	2.2	1.1	1.1	1.1	0.0	0.0	0.0	7.5
(2)	0.0	0.0	0.0	0.0	0.0	0.0	0.0	0.0	0.0	0.0	0.0	0.0	0.0	0.0	0.0	0.0	0.0
1.5- 3.0	1	5	0	0	2	4	4	3	2	2	1	1	0	2	2	1	30
(1)	1.1	5.4	0.0	0.0	2.2	4.3	4.3	3.2	2.2	2.2	1.1	1.1	0.0	2.2	2.2	1.1	32.3
(2)	0.0	0.0	0.0	0.0	0.0	0.0	0.0	0.0	0.0	0.0	0.0	0.0	0.0	0.0	0.0	0.0	0.2
3.1- 5.0	3	4	3	2	3	5	5	2	2	1	1	1	0	1	0	1	34
(1)	3.2	4.3	3.2	2.2	3.2	5.4	5.4	2.2	2.2	1.1	1.1	1.1	0.0	1.1	0.0	1.1	36.6
(2)	0.0	0.0	0.0	0.0	0.0	0.0	0.0	0.0	0.0	0.0	0.0	0.0	0.0	0.0	0.0	0.0	0.2
5.1- 8.0	3	0	2	3	1	0	0	0	0	2	0	2	0	1	0	0	14
(1)	3.2	0.0	2.2	3.2	1.1	0.0	0.0	0.0	0.0	2.2	0.0	2.2	0.0	1.1	0.0	0.0	15.1
(2)	0.0	0.0	0.0	0.0	0.0	0.0	0.0	0.0	0.0	0.0	0.0	0.0	0.0	0.0	0.0	0.0	0.1
8.1-10.4	0	0	2	2	3	1	0	0	0	1	1	0	0	0	0	0	7
(1)	0.0	0.0	2.2	2.2	0.0	1.1	0.0	0.0	0.0	1.1	1.1	0.0	0.0	0.0	0.0	0.0	7.5
(2)	0.0	0.0	0.0	0.0	0.0	0.0	0.0	0.0	0.0	0.0	0.0	0.0	0.0	0.0	0.0	0.0	0.0
OVER 10.4	0	0	0	0	0	0	0	0	0	0	0	1	0	0	0	0	1
(1)	0.0	0.0	0.0	0.0	0.0	0.0	0.0	0.0	0.0	0.0	0.0	1.1	0.0	0.0	0.0	0.0	1.1
(2)	0.0	0.0	0.0	0.0	0.0	0.0	0.0	0.0	0.0	0.0	0.0	0.0	0.0	0.0	0.0	0.0	0.0
ALL SPEEDS	3	9	7	7	6	10	9	6	4	8	4	6	1	4	2	2	93
(1)	8.6	9.7	7.5	7.5	6.5	10.8	9.7	6.5	4.3	9.6	4.3	6.5	1.1	4.3	2.2	2.2	100.0
(2)	0.1	0.1	0.0	0.0	0.0	0.1	0.1	0.0	0.0	0.1	0.0	0.0	0.0	0.0	0.0	0.0	0.6

(1)=PERCENT OF ALL GOOD OBS FOR THIS PAGE
(2)=PERCENT OF ALL GOOD OBS FOR THE PERIOD

93 HRS ON THIS PAGE 0 HRS (0.0 PCT) LESS THAN 0.3 MPS (0.0 PCT OF ALL HRS)

Table 28. Distribution of Wind Directions and Speeds at the WIPP Site, Stability D, June 1, 1977-May 31, 1979

SPEED (MPS)	DIRECTION																TOTAL
	NNE	NE	ENE	E	ESE	SE	SSE	S	SSW	SW	WSW	W	MNW	NW	NNW	N	
0.3- 1.4	4	3	5	2	5	2	6	5	5	8	7	5	7	3	4	4	75
(1)	0.6	0.4	0.7	0.3	0.7	0.3	0.9	0.7	0.7	1.2	1.0	0.7	1.0	0.4	0.6	0.6	11.2
(2)	0.0	0.0	0.0	0.0	0.0	0.0	0.0	0.0	0.0	0.1	0.0	0.0	0.0	0.0	0.0	0.0	0.5
1.5- 3.0	5	8	7	13	24	25	20	15	18	9	8	2	4	6	5	5	174
(1)	0.7	1.2	1.0	1.9	3.6	3.7	3.0	2.2	2.7	1.3	1.2	0.3	0.6	0.9	0.7	0.7	26.0
(2)	0.0	0.1	0.0	0.1	0.2	0.2	0.1	0.1	0.1	0.1	0.1	0.0	0.0	0.0	0.0	0.0	1.1
3.1- 5.0	13	13	27	27	27	31	25	28	8	4	4	6	2	1	1	1	218
(1)	1.9	1.9	4.0	4.0	4.0	4.6	3.7	4.2	1.2	0.6	0.6	0.9	0.3	0.1	0.1	0.1	32.6
(2)	0.1	0.1	0.2	0.2	0.2	0.2	0.2	0.2	0.1	0.0	0.0	0.0	0.0	0.0	0.0	0.0	1.4
5.1- 8.0	9	7	25	32	14	11	15	7	2	2	7	7	1	4	2	5	150
(1)	1.3	1.0	3.7	4.8	2.1	1.6	2.2	1.0	0.3	0.3	1.0	1.0	0.1	0.6	0.3	0.7	22.5
(2)	0.1	0.0	0.2	0.2	0.1	0.1	0.1	0.0	0.0	0.0	0.0	0.0	0.0	0.0	0.0	0.0	1.0
8.1-10.4	1	2	11	10	2	2	2	1	0	1	2	1	1	0	1	0	37
(1)	0.1	0.3	1.6	1.5	0.3	0.3	0.3	0.1	0.0	0.1	0.3	0.1	0.1	0.0	0.1	0.0	5.5
(2)	0.0	0.0	0.1	0.1	0.0	0.0	0.0	0.0	0.0	0.0	0.0	0.0	0.0	0.0	0.0	0.0	0.2
OVER 10.4	0	0	6	1	1	0	0	0	0	0	0	2	1	0	0	1	12
(1)	0.0	0.0	0.9	0.1	0.1	0.0	0.0	0.0	0.0	0.0	0.0	0.3	0.1	0.0	0.0	0.1	1.8
(2)	0.0	0.0	0.0	0.0	0.0	0.0	0.0	0.0	0.0	0.0	0.0	0.0	0.0	0.0	0.0	0.0	0.1
ALL SPEEDS	32	33	81	85	73	71	68	56	33	24	28	23	16	14	13	16	666
(1)	4.8	4.9	12.1	12.7	10.9	10.6	10.2	8.4	4.9	3.6	4.2	3.4	2.4	2.1	1.9	2.4	99.7
(2)	0.2	0.2	0.5	0.5	0.5	0.5	0.4	0.4	0.2	0.2	0.2	0.1	0.1	0.1	0.1	0.1	4.2

(1)=PERCENT OF ALL GOOD OBS FOR THIS PAGE
 (2)=PERCENT OF ALL GOOD OBS FOR THE PERIOD

668 HRS ON THIS PAGE 2 HRS (0.3 PCT) LESS THAN 0.3 MPS (0.0 PCT OF ALL HRS)

Table 29. Distribution of Wind Directions and Speeds at the WIPP Site, Stability E, June 1, 1977-May 31, 1979

SPEED (MPS)	DIRECTION																TOTAL
	NNE	NE	ENE	E	ESE	SE	SSE	S	SSW	SW	WSW	W	WNW	NW	NNW	N	
0.3- 1.4	4	6	7	7	10	17	11	7	9	6	9	7	9	4	10	9	132
(1)	0.3	0.4	0.5	0.5	0.7	1.2	0.8	0.5	0.6	0.4	0.6	0.5	0.6	0.3	0.7	0.6	9.1
(2)	0.0	0.0	0.0	0.0	0.1	0.1	0.1	0.0	0.1	0.0	0.1	0.0	0.1	0.0	0.1	0.1	0.8
1.5- 3.0	11	15	12	20	49	68	31	43	17	9	8	7	4	16	12	12	334
(1)	0.8	1.0	0.8	1.4	3.4	4.7	2.1	3.0	1.2	0.6	0.6	0.5	0.3	1.1	0.8	0.8	23.0
(2)	0.1	0.1	0.1	0.1	0.3	0.4	0.2	0.3	0.1	0.1	0.1	0.0	0.0	0.1	0.1	0.1	2.1
3.1- 5.0	31	42	34	38	62	111	62	42	8	11	3	7	2	7	14	22	496
(1)	2.1	2.9	2.3	2.6	4.3	7.6	4.3	2.9	0.6	0.8	0.2	0.5	0.1	0.5	1.0	1.5	34.2
(2)	0.2	0.3	0.2	0.2	0.4	0.7	0.4	0.3	0.1	0.1	0.0	0.0	0.0	0.0	0.1	0.1	3.1
5.1- 8.0	17	27	40	41	40	61	56	9	4	4	4	16	4	4	5	19	351
(1)	1.2	1.9	2.8	2.8	2.8	4.2	3.9	0.6	0.3	0.3	0.3	1.1	0.3	0.3	0.3	1.3	24.2
(2)	0.1	0.2	0.3	0.3	0.3	0.4	0.4	0.1	0.0	0.0	0.0	0.1	0.0	0.0	0.0	0.1	2.2
8.1-10.4	1	9	31	19	0	10	13	0	0	2	3	3	7	2	1	5	106
(1)	0.1	0.6	2.1	1.3	0.0	0.7	0.9	0.0	0.0	0.1	0.2	0.2	0.5	0.1	0.1	0.3	7.3
(2)	0.0	0.1	0.2	0.1	0.0	0.1	0.1	0.0	0.0	0.0	0.0	0.0	0.0	0.0	0.0	0.0	0.7
OVER 10.4	0	3	11	5	0	1	2	0	0	0	0	4	2	0	2	0	30
(1)	0.0	0.2	0.8	0.3	0.0	0.1	0.1	0.0	0.0	0.0	0.0	0.3	0.1	0.0	0.1	0.0	2.1
(2)	0.0	0.0	0.1	0.0	0.0	0.0	0.0	0.0	0.0	0.0	0.0	0.0	0.0	0.0	0.0	0.0	0.2
ALL SPEEDS	64	102	135	130	161	268	175	101	38	32	27	44	28	33	44	67	1449
(1)	4.4	7.0	9.3	9.0	11.1	18.5	12.1	7.0	2.6	2.2	1.9	3.0	1.9	2.3	3.0	4.6	99.9
(2)	0.4	0.6	0.9	0.8	1.0	1.7	1.1	0.6	0.2	0.2	0.2	0.3	0.2	0.2	0.3	0.4	9.2

(1) = PERCENT OF ALL GOOD OPS FOR THIS PAGE
 (2) = PERCENT OF ALL GOOD OPS FOR THE PERIOD

1451 HRS ON THIS PAGE

2 HRS (0.1 PCT) LESS THAN 0.3 MPS (0.0 PCT OF ALL HRS)

Table 30. Distribution of Wind Directions and Speeds at the WIPP Site, Stability F, June 1, 1977-May 31, 1979

SPEED (MPS)	DIRECTION																TOTAL
	NNE	NE	ENE	E	ESE	SE	SSE	S	SSW	SW	WSW	W	WNW	NW	NNW	N	
0.3- 1.4	6	10	5	4	22	16	10	6	7	5	0	2	8	3	5	13	122
(1)	0.3	0.5	0.3	0.2	1.1	0.8	0.5	0.3	0.4	0.3	0.0	0.1	0.4	0.2	0.3	0.7	6.2
(2)	0.0	0.1	0.0	0.0	0.1	0.1	0.1	0.0	0.0	0.0	0.0	0.0	0.1	0.0	0.0	0.1	0.8
1.5- 3.0	9	22	9	23	94	132	39	17	7	11	6	7	6	4	7	19	412
(1)	0.5	1.1	0.5	1.2	4.8	6.7	2.0	0.9	0.4	0.6	0.3	0.4	0.3	0.2	0.4	1.0	21.0
(2)	0.1	0.1	0.1	0.1	0.6	0.8	0.2	0.1	0.0	0.1	0.0	0.0	0.0	0.0	0.0	0.1	2.6
3.1- 5.0	15	27	33	36	97	224	140	45	4	0	9	9	6	4	17	11	677
(1)	0.8	1.4	1.7	1.8	4.9	11.4	7.1	2.3	0.2	0.0	0.5	0.5	0.3	0.2	0.9	0.6	34.5
(2)	0.1	0.2	0.2	0.2	0.6	1.4	0.9	0.3	0.0	0.0	0.1	0.1	0.0	0.0	0.1	0.1	4.3
5.1- 8.0	7	15	31	43	26	198	229	6	0	3	8	28	13	11	2	12	637
(1)	0.4	0.8	1.6	2.4	1.3	10.1	11.7	0.3	0.0	0.2	0.4	1.4	0.7	0.6	0.1	0.6	32.5
(2)	0.0	0.1	0.2	0.3	0.2	1.3	1.5	0.0	0.0	0.0	0.1	0.2	0.1	0.1	0.0	0.1	4.0
8.1-10.4	0	4	10	4	0	14	41	0	0	1	3	8	4	0	4	4	97
(1)	0.0	0.2	0.5	0.2	0.0	0.7	2.1	0.0	0.0	0.1	0.2	0.4	0.2	0.0	0.2	0.2	4.9
(2)	0.0	0.0	0.1	0.0	0.0	0.1	0.3	0.0	0.0	0.0	0.0	0.1	0.0	0.0	0.0	0.0	0.6
OVER 10.4	0	2	0	0	0	1	0	0	0	0	2	3	5	0	0	1	14
(1)	0.0	0.1	0.0	0.0	0.0	0.1	0.0	0.0	0.0	0.0	0.1	0.2	0.3	0.0	0.0	0.1	0.7
(2)	0.0	0.0	0.0	0.0	0.0	0.0	0.0	0.0	0.0	0.0	0.0	0.0	0.0	0.0	0.0	0.0	0.1
ALL SPEEDS	37	80	88	115	239	585	459	74	18	20	28	57	42	22	35	60	1959
(1)	1.9	4.1	4.5	5.9	12.2	29.8	23.4	3.8	0.9	1.0	1.4	2.9	2.1	1.1	1.8	3.1	99.9
(2)	0.2	0.5	0.6	0.7	1.5	3.7	2.9	0.5	0.1	0.1	0.2	0.4	0.3	0.1	0.2	0.4	12.4

(1) = PERCENT OF ALL GOOD OBS FOR THIS PAGE
 (2) = PERCENT OF ALL GOOD OBS FOR THE PERIOD

1961 HRS ON THIS PAGE

2 HRS (0.1 PCT) LESS THAN 0.3 MPS (0.0 PCT OF ALL HRS)

Table 31. Distribution of Wind Directions and Speeds at the WIPP Site, Stability G, June 1, 1977-May 31, 1979

SPEED (MPS)	DIRECTION																TOTAL
	NNE	NE	ENE	E	ESE	SE	SSE	S	SSW	SW	WSW	W	WNW	NW	NNW	N	
0.3- 1.4	47	65	51	54	170	223	94	70	52	38	32	44	36	24	31	37	1068
(1)	0.8	1.2	0.9	1.0	3.0	4.0	1.7	1.2	0.7	0.7	0.6	0.8	0.6	0.4	0.6	0.7	19.0
(2)	0.3	0.4	0.3	0.3	1.1	1.4	0.6	0.4	0.3	0.2	0.2	0.3	0.2	0.2	0.2	0.2	6.8
1.5- 3.0	90	136	92	84	247	594	385	221	105	71	82	49	53	63	74	88	2434
(1)	1.6	2.4	1.6	1.5	4.4	10.5	6.8	3.9	1.9	1.3	1.5	0.9	0.9	1.1	1.3	1.6	43.2
(2)	0.6	0.9	0.6	0.5	1.6	3.8	2.4	1.4	0.7	0.5	0.5	0.3	0.3	0.4	0.5	0.6	15.4
3.1- 5.0	75	82	76	63	157	492	312	59	23	45	62	77	62	40	47	47	1719
(1)	1.3	1.5	1.3	1.1	2.8	8.7	5.5	1.0	0.4	0.8	1.1	1.4	1.1	0.7	0.8	0.8	30.5
(2)	0.5	0.5	0.5	0.4	1.0	3.1	2.0	0.4	0.1	0.3	0.4	0.5	0.4	0.3	0.3	0.3	10.9
5.1- 8.0	4	11	18	20	17	92	42	11	5	8	17	34	26	8	16	10	339
(1)	0.1	0.2	0.3	0.4	0.3	1.6	0.7	0.2	0.1	0.1	0.3	0.6	0.5	0.1	0.3	0.2	6.0
(2)	0.0	0.1	0.1	0.1	0.1	0.6	0.3	0.1	0.0	0.1	0.1	0.2	0.2	0.1	0.1	0.1	2.2
8.1-10.4	0	2	3	6	0	0	6	0	1	0	1	8	4	0	1	1	33
(1)	0.0	0.0	0.1	0.1	0.0	0.0	0.1	0.0	0.0	0.0	0.0	0.1	0.1	0.0	0.0	0.0	0.6
(2)	0.0	0.0	0.0	0.0	0.0	0.0	0.0	0.0	0.0	0.0	0.0	0.1	0.0	0.0	0.0	0.0	0.2
OVER 10.4	0	0	0	1	0	0	0	0	0	0	0	0	0	0	0	0	1
(1)	0.0	0.0	0.0	0.0	0.0	0.0	0.0	0.0	0.0	0.0	0.0	0.0	0.0	0.0	0.0	0.0	0.0
(2)	0.0	0.0	0.0	0.0	0.0	0.0	0.0	0.0	0.0	0.0	0.0	0.0	0.0	0.0	0.0	0.0	0.0
ALL SPEEDS	216	296	240	228	591	1401	339	361	186	162	194	212	181	135	169	183	5594
(1)	3.8	5.3	4.3	4.0	10.5	24.9	14.9	6.4	3.3	2.9	3.4	3.8	3.2	2.4	3.0	3.2	99.3
(2)	1.4	1.9	1.5	1.4	3.7	8.9	5.3	2.3	1.2	1.0	1.2	1.3	1.1	0.9	1.1	1.2	35.5

(1)=PERCENT OF ALL GOOD OBS FOR THIS PAGE
 (2)=PERCENT OF ALL GOOD OBS FOR THE PERIOD

5633 HRS ON THIS PAGE 39 HRS (0.7 PCT) LESS THAN 0.3 MPS (0.2 PCT OF ALL HRS)

Table 32. Distribution of Wind Directions and Speeds at the WIPP Site, All Stabilities Combined, June 1, 1977-May 31, 1979

SPEED (MPS)	DIRECTION																TOTAL
	NNE	NE	ENE	E	ESE	SE	SSE	S	SSW	SW	WSW	W	WNW	NW	NNW	N	
0.3- 1.4	76	95	86	79	227	287	151	125	111	99	79	91	85	62	70	77	1800
(1)	0.5	0.6	0.5	0.5	1.4	1.8	1.0	0.8	0.7	0.6	0.5	0.6	0.5	0.4	0.4	0.5	11.4
(2)	0.5	0.6	0.5	0.5	1.4	1.8	1.0	0.8	0.7	0.6	0.5	0.6	0.5	0.4	0.4	0.5	11.4
1.5- 3.0	164	225	160	190	531	1019	637	528	362	226	197	148	138	180	183	192	5080
(1)	1.0	1.4	1.0	1.2	3.4	6.5	4.0	3.3	2.3	1.4	1.2	0.9	0.9	1.1	1.2	1.2	32.2
(2)	1.0	1.4	1.0	1.2	3.4	6.5	4.0	3.3	2.3	1.4	1.2	0.9	0.9	1.1	1.2	1.2	32.2
3.1- 5.0	189	228	247	269	445	1126	942	595	263	168	181	199	136	150	149	137	5424
(1)	1.2	1.4	1.6	1.7	2.8	7.1	6.0	3.8	1.7	1.1	1.1	1.3	0.9	1.0	0.9	0.9	34.4
(2)	1.2	1.4	1.6	1.7	2.8	7.1	6.0	3.8	1.7	1.1	1.1	1.3	0.9	1.0	0.9	0.9	34.4
5.1- 8.0	87	101	162	215	123	481	561	178	78	79	127	203	80	51	60	108	2714
(1)	0.6	0.6	1.2	1.4	0.8	3.1	3.6	1.1	0.5	0.5	0.8	1.3	0.5	0.3	0.4	0.7	17.2
(2)	0.6	0.6	1.2	1.4	0.8	3.1	3.6	1.1	0.5	0.5	0.8	1.3	0.5	0.3	0.4	0.7	17.2
8.1-10.4	4	24	74	52	5	40	77	6	11	23	55	98	33	14	20	15	551
(1)	0.0	0.2	0.5	0.3	0.0	0.3	0.5	0.0	0.1	0.1	0.3	0.6	0.2	0.1	0.1	0.1	3.5
(2)	0.0	0.2	0.5	0.3	0.0	0.3	0.5	0.0	0.1	0.1	0.3	0.6	0.2	0.1	0.1	0.1	3.5
OVER 10.4	0	8	20	9	1	3	2	0	0	0	15	46	19	0	8	6	137
(1)	0.0	0.1	0.1	0.1	0.0	0.0	0.0	0.0	0.0	0.0	0.1	0.3	0.1	0.0	0.1	0.0	0.9
(2)	0.0	0.1	0.1	0.1	0.0	0.0	0.0	0.0	0.0	0.0	0.1	0.3	0.1	0.0	0.1	0.0	0.9
ALL SPEEDS	520	681	769	814	1332	2956	2370	1432	825	595	654	785	491	457	490	535	15706
(1)	3.3	4.3	4.9	5.2	8.5	18.8	15.0	9.1	5.2	3.8	4.1	5.0	3.1	2.9	3.1	3.4	99.6
(2)	3.3	4.3	4.9	5.2	8.5	18.8	15.0	9.1	5.2	3.8	4.1	5.0	3.1	2.9	3.1	3.4	99.6

(1)=PERCENT OF ALL GOOD OBS FOR THIS PAGE
(2)=PERCENT OF ALL GOOD OBS FOR THE PERIOD

15762 GOOD HRS 56 HRS (0.4 PCT) LESS THAN 0.3 MPS 17520 HRS IN THE TIME PERIOD 90.0 PCT DATA RECOVERY

Table 33. One-Hour Frequency Distribution X/Q Values for the WIPP Site

DOWNWIND SECTOR	DISTANCE (METERS)	MAXIMUM CHI/Q	5 PCT CHI/Q	50 PCT CHI/Q
(SEC PER CUBIC METER)				
SSW	805	0.110E-02	0.284E-03	0.606E-04
SW	805	0.110E-02	0.276E-03	0.621E-04
WSW	805	0.110E-02	0.265E-03	0.421E-04
W	805	0.110E-02	0.276E-03	0.543E-04
WNW	805	0.110E-02	0.329E-03	0.633E-04
NW	805	0.110E-02	0.259E-03	0.619E-04
NNW	805	0.110E-02	0.230E-03	0.569E-04
N	805	0.110E-02	0.231E-03	0.279E-04
NNE	805	0.110E-02	0.253E-03	0.155E-04
NE	805	0.110E-02	0.269E-03	0.302E-04
ENE	805	0.110E-02	0.277E-03	0.244E-04
E	805	0.110E-02	0.251E-03	0.255E-04
ESE	805	0.822E-03	0.268E-03	0.508E-04
SE	805	0.110E-02	0.257E-03	0.452E-04
SSE	805	0.110E-02	0.276E-03	0.519E-04
S	805	0.110E-02	0.250E-03	0.580E-04
ALL		0.110E-02	0.263E-03	0.531E-04

Table 33. One-Hour Frequency Distribution X/Q Values for the WIPP Site (Continued)

DOWNWIND SECTOR	DISTANCE (METERS)	MAXIMUM CHI/Q	5 PCT CHI/Q (SEC PER CUBIC METER)	50 PCT CHI/Q
SSW	2414	0.450E-03	0.111E-03	0.139E-04
SW	2414	0.450E-03	0.954E-04	0.156E-04
WSW	2414	0.450E-03	0.930E-04	0.857E-05
W	2414	0.450E-03	0.902E-04	0.104E-04
WNW	2414	0.450E-03	0.133E-03	0.192E-04
NW	2414	0.450E-03	0.927E-04	0.153E-04
NNW	2414	0.450E-03	0.740E-04	0.108E-04
N	2414	0.450E-03	0.820E-04	0.425E-05
NNE	2414	0.450E-03	0.940E-04	0.175E-05
NE	2414	0.450E-03	0.953E-04	0.496E-05
ENE	2414	0.450E-03	0.844E-04	0.405E-05
E	2414	0.450E-03	0.839E-04	0.432E-05
ESE	2414	0.338E-03	0.905E-04	0.106E-04
SE	2414	0.450E-03	0.800E-04	0.917E-05
SSE	2414	0.450E-03	0.904E-04	0.113E-04
S	2414	0.450E-03	0.820E-04	0.116E-04
ALL		0.450E-03	0.908E-04	0.114E-04

Table 33. One-Hour Frequency Distribution X/Q Values for the WIPP Site (Continued)

DOWNWIND SECTOR	DISTANCE (METERS)	MAXIMUM CHI/Q	5 PCT CHI/Q (SEC PER CUBIC METER)	50 PCT CHI/Q
SSW	4023	0.293E-03	0.697E-04	0.703E-05
SW	4023	0.293E-03	0.615E-04	0.797E-05
WSW	4023	0.293E-03	0.586E-04	0.412E-05
W	4023	0.293E-03	0.563E-04	0.500E-05
WNW	4023	0.293E-03	0.880E-04	0.104E-04
NW	4023	0.293E-03	0.592E-04	0.780E-05
NNW	4023	0.293E-03	0.470E-04	0.518E-05
N	4023	0.293E-03	0.521E-04	0.179E-05
NNE	4023	0.293E-03	0.583E-04	0.693E-06
NE	4023	0.293E-03	0.613E-04	0.223E-05
ENE	4023	0.293E-03	0.550E-04	0.130E-05
E	4023	0.293E-03	0.513E-04	0.198E-05
ESE	4023	0.220E-03	0.566E-04	0.515E-05
SE	4023	0.293E-03	0.506E-04	0.449E-05
SSE	4023	0.293E-03	0.569E-04	0.554E-05
S	4023	0.293E-03	0.515E-04	0.566E-05
ALL		0.293E-03	0.580E-04	0.554E-05

Table 33. One-Hour Frequency Distribution X/Q Values for the WIPP Site (Continued)

DOWNWIND SECTOR	DISTANCE (METERS)	MAXIMUM CHI/Q	5 PCT CHI/Q (SEC PER CUBIC METER)	50 PCT CHI/Q
SSW	5633	0.219E-03	0.521E-04	0.454E-05
SW	5633	0.219E-03	0.453E-04	0.517E-05
WSW	5633	0.219E-03	0.434E-04	0.255E-05
W	5633	0.219E-03	0.419E-04	0.314E-05
WNW	5633	0.219E-03	0.679E-04	0.698E-05
NW	5633	0.219E-03	0.443E-04	0.512E-05
NNW	5633	0.219E-03	0.338E-04	0.323E-05
N	5633	0.219E-03	0.389E-04	0.104E-05
NNE	5633	0.219E-03	0.427E-04	0.410E-06
NE	5633	0.219E-03	0.450E-04	0.130E-05
ENE	5633	0.219E-03	0.400E-04	0.107E-05
E	5633	0.219E-03	0.381E-04	0.118E-05
ESE	5633	0.164E-03	0.420E-04	0.323E-05
SE	5633	0.219E-03	0.391E-04	0.277E-05
SSE	5633	0.219E-03	0.428E-04	0.359E-05
S	5633	0.219E-03	0.372E-04	0.359E-05
ALL		0.219E-03	0.434E-04	0.350E-05

Table 33. One-Hour Frequency Distribution X/Q Values for the WIPP Site (Continued)

DOWNWIND SECTOR	DISTANCE (METERS)	MAXIMUM CHI/Q	5 PCT CHI/Q (SEC PER CUBIC METER)	50 PCT CHI/Q
SSW	7242	0.176E-03	0.423E-04	0.315E-05
SW	7242	0.176E-03	0.377E-04	0.370E-05
WSW	7242	0.176E-03	0.349E-04	0.180E-05
W	7242	0.176E-03	0.326E-04	0.223E-05
WNW	7242	0.176E-03	0.524E-04	0.526E-05
NW	7242	0.176E-03	0.356E-04	0.367E-05
NNW	7242	0.176E-03	0.265E-04	0.230E-05
N	7242	0.176E-03	0.303E-04	0.685E-06
NNE	7242	0.176E-03	0.333E-04	0.256E-06
NE	7242	0.176E-03	0.363E-04	0.981E-06
ENE	7242	0.176E-03	0.311E-04	0.725E-06
E	7242	0.176E-03	0.297E-04	0.825E-06
ESE	7242	0.132E-03	0.327E-04	0.229E-05
SE	7242	0.176E-03	0.305E-04	0.198E-05
SSE	7242	0.176E-03	0.333E-04	0.257E-05
S	7242	0.176E-03	0.292E-04	0.259E-05
ALL		0.176E-03	0.341E-04	0.249E-05

Table 33. One-Hour Frequency Distribution X/Q Values for the WIPP Site (Continued)

DOWNWIND SECTOR	DISTANCE (METERS)	MAXIMUM CHI/Q	5 PCT CHI/Q (SEC PER CUBIC METER)	50 PCT CHI/Q
SSW	12070	0.111E-03	0.275E-04	0.164E-05
SW	12070	0.111E-03	0.235E-04	0.192E-05
WSW	12070	0.111E-03	0.223E-04	0.891E-06
W	12070	0.111E-03	0.198E-04	0.113E-05
WNW	12070	0.111E-03	0.346E-04	0.283E-05
NW	12070	0.111E-03	0.224E-04	0.194E-05
NNW	12070	0.111E-03	0.164E-04	0.117E-05
N	12070	0.111E-03	0.192E-04	0.298E-06
NNE	12070	0.111E-03	0.212E-04	0.115E-06
NE	12070	0.111E-03	0.226E-04	0.404E-06
ENE	12070	0.111E-03	0.214E-04	0.326E-06
E	12070	0.111E-03	0.186E-04	0.384E-06
ESE	12070	0.835E-04	0.200E-04	0.115E-05
SE	12070	0.111E-03	0.194E-04	0.981E-06
SSE	12070	0.111E-03	0.213E-04	0.130E-05
S	12070	0.111E-03	0.184E-04	0.131E-05
ALL		0.111E-03	0.218E-04	0.127E-05

Table 33. One-Hour Frequency Distribution X/Q Values for the WIPP Site (Continued)

DOWNWIND SECTOR	DISTANCE (METERS)	MAXIMUM CHI/Q	5 PCT CHI/Q (SEC PER CUBIC METER)	50 PCT CHI/Q
SSW	24140	0.599E-04	0.139E-04	0.692E-06
SW	24140	0.599E-04	0.123E-04	0.803E-06
WSW	24140	0.599E-04	0.116E-04	0.363E-06
W	24140	0.599E-04	0.102E-04	0.471E-06
WNW	24140	0.599E-04	0.182E-04	0.126E-05
NW	24140	0.599E-04	0.117E-04	0.831E-06
NNW	24140	0.599E-04	0.852E-05	0.493E-06
N	24140	0.599E-04	0.100E-04	0.101E-06
NNE	24140	0.599E-04	0.111E-04	0.398E-07
NE	24140	0.599E-04	0.114E-04	0.145E-06
ENE	24140	0.599E-04	0.111E-04	0.111E-06
E	24140	0.599E-04	0.945E-05	0.148E-06
ESE	24140	0.450E-04	0.105E-04	0.479E-06
SE	24140	0.599E-04	0.997E-05	0.395E-06
SSE	24140	0.599E-04	0.111E-04	0.526E-06
S	24140	0.599E-04	0.957E-05	0.534E-06
ALL		0.599E-04	0.114E-04	0.527E-06

Table 33. One-Hour Frequency Distribution X/Q Values for the WIPP Site (Continued)

DOWNWIND SECTOR	DISTANCE (METERS)	MAXIMUM CHI/Q	5 PCT CHI/Q (SEC PER CUBIC METER)	50 PCT CHI/Q
SSW	40233	0.383E-04	0.878E-05	0.368E-06
SW	40233	0.383E-04	0.803E-05	0.445E-06
WSW	40233	0.383E-04	0.763E-05	0.195E-06
W	40233	0.383E-04	0.649E-05	0.256E-06
WNW	40233	0.383E-04	0.114E-04	0.711E-06
NW	40233	0.383E-04	0.779E-05	0.466E-06
NNW	40233	0.383E-04	0.536E-05	0.269E-06
N	40233	0.383E-04	0.647E-05	0.472E-07
NNE	40233	0.383E-04	0.706E-05	0.174E-07
NE	40233	0.383E-04	0.749E-05	0.714E-07
ENE	40233	0.383E-04	0.706E-05	0.513E-07
E	40233	0.383E-04	0.603E-05	0.740E-07
ESE	40233	0.287E-04	0.641E-05	0.249E-06
SE	40233	0.333E-04	0.644E-05	0.210E-06
SSC	40233	0.383E-04	0.717E-05	0.279E-06
S	40233	0.383E-04	0.646E-05	0.289E-06
ALL		0.383E-04	0.746E-05	0.286E-06

Table 33. One-Hour Frequency Distribution X/Q Values for the WIPP Site (Continued)

DOWNWIND SECTOR	DISTANCE (METERS)	MAXIMUM CHI/Q	5 PCT CHI/Q	50 PCT CHI/Q
(SEC PER CUBIC METER)				
SSW	56327	0.288E-04	0.659E-05	0.251E-06
SW	56327	0.288E-04	0.603E-05	0.297E-06
WSW	56327	0.288E-04	0.552E-05	0.130E-06
W	56327	0.288E-04	0.478E-05	0.174E-06
WNW	56327	0.288E-04	0.854E-05	0.490E-06
NW	56327	0.288E-04	0.570E-05	0.322E-06
NNW	56327	0.288E-04	0.398E-05	0.182E-06
N	56327	0.288E-04	0.481E-05	0.274E-07
NNE	56327	0.288E-04	0.522E-05	0.109E-07
NE	56327	0.288E-04	0.542E-05	0.445E-07
ENE	56327	0.288E-04	0.513E-05	0.298E-07
E	56327	0.288E-04	0.443E-05	0.477E-07
ESE	56327	0.216E-04	0.481E-05	0.169E-06
SE	56327	0.288E-04	0.495E-05	0.138E-06
SSE	56327	0.288E-04	0.525E-05	0.185E-06
S	56327	0.288E-04	0.472E-05	0.192E-06
ALL		0.288E-04	0.540E-05	0.192E-06

Table 33. One-Hour Frequency Distribution X/Q Values for the WIPP Site (Continued)

DOWNWIND SECTOR	DISTANCE (METERS)	MAXIMUM CHI/Q	5 PCT CHI/Q (SEC PER CUBIC METER)	50 PCT CHI/Q
SSW	72420	0.234E-04	0.532E-05	0.182E-06
SW	72420	0.234E-04	0.504E-05	0.221E-06
WSW	72420	0.234E-04	0.468E-05	0.961E-07
W	72420	0.234E-04	0.380E-05	0.132E-06
WNW	72420	0.234E-04	0.691E-05	0.382E-06
NW	72420	0.234E-04	0.481E-05	0.243E-06
NNW	72420	0.234E-04	0.324E-05	0.138E-06
N	72420	0.234E-04	0.384E-05	0.192E-07
NNE	72420	0.234E-04	0.427E-05	-0.999E 10
NE	72420	0.234E-04	0.423E-05	0.328E-07
ENE	72420	0.234E-04	0.417E-05	0.213E-07
E	72420	0.234E-04	0.364E-05	0.353E-07
ESE	72420	0.176E-04	0.387E-05	0.125E-06
SE	72420	0.234E-04	0.390E-05	0.101E-06
SSE	72420	0.234E-04	0.420E-05	0.135E-06
S	72420	0.234E-04	0.376E-05	0.145E-06
ALL		0.234E-04	0.453E-05	0.144E-06

Appendix I

**CORRESPONDENCE ON ARCHAEOLOGY,
HISTORIC SITES, PRIME FARMLAND,
AND ENDANGERED SPECIES**

Appendix I

CORRESPONDENCE ON ARCHAEOLOGY, HISTORIC SITES, PRIME FARMLAND, AND ENDANGERED SPECIES

The preparation of this environmental impact statement has required consultation with government agencies about the archaeological, historic, and agricultural values of the land in the area of the WIPP site and about the endangered species of plants and animals that might be found there. This appendix contains copies of the official correspondence through which the consultation was carried out.

<u>From</u>	<u>To</u>	<u>Date</u>
M. L. Merritt Sandia Laboratories	Thomas W. Merlan New Mexico State Historic Preservation Officer	November 15, 1976
Thomas W. Merlan New Mexico State Historic Preservation Officer	M. L. Merritt Sandia Laboratories	February 16, 1977
Colin A. Heath, Manager DOE WIPP Program	William J. Murtagh Keeper of the National Register	No date
William J. Murtagh Keeper of the National Register	Thomas W. Merlan New Mexico State Historic Preservation Officer	No date
Thomas W. Merlan New Mexico State Historic Preservation Officer	William J. Murtagh Keeper of the National Register	April 28, 1978
William J. Murtagh Keeper of the National Register	Colin A. Heath, Manager DOE WIPP Program	No date
D. T. Schueler, Manager DOE WIPP Project	Thomas W. Merlan New Mexico State Historic Preservation Officer	November 8, 1978
Thomas W. Merlan New Mexico State Historic Preservation Officer	D. T. Schueler, Manager DOE WIPP Project	November 30, 1979

<u>From</u>	<u>To</u>	<u>Date</u>
D. T. Schueler, Manager DOE WIPP Project	Thomas W. Merlan New Mexico State Historic Preservation Officer	March 21, 1980
Thomas W. Merlan New Mexico State Historic Preservation Officer	D. T. Schueler, Manager DOE WIPP Project	April 10, 1980
Thomas W. Merlan New Mexico State Historic Preservation Officer	D. T. Schueler, Manager DOE WIPP Project	May 8, 1980
D. T. Schueler, Manager DOE WIPP Project	Louis S. Wall, Chief Western Division of Project Review Advisory Council on Historic Preservation	May 20, 1980
M. L. Merritt Sandia Laboratories	Albert W. Hamelstrom State Conservationist U.S. Department of Agriculture	November 3, 1976
Albert W. Hamelstrom State Conservationist U.S. Department of Agriculture	M. L. Merritt Sandia Laboratories	November 11, 1976
D. T. Schueler, Manager DOE WIPP Project	W. O. Nelson, Jr. Regional Director Endangered Species Office U.S. Fish and Wildlife Service	October 17, 1979
Jerry L. Stegman Acting Regional Director Endangered Species Office U.S. Fish and Wildlife Service	D. T. Schueler, Manager DOE WIPP Project	November 15, 1979
Harold F. Olson, Director New Mexico Department of Game and Fish	D. T. Schueler, Manager DOE WIPP Project	April 7, 1980

Santia Laboratories

Albuquerque, New Mexico 87115

November 15, 1976

Mr. Thomas W. Merlan
State Historic Preservation Officer
State Planning Office
505 Don Gaspar
Santa Fe, New Mexico 87503

Dear Sir:

I am working on the environmental assessment for the proposed Waste Isolation Pilot Plant east of Carlsbad. It has come to my attention that we need a determination from you as State Historic Preservation Officer on the existence of any cultural resources that may exist on or near the proposed project, and that the project may impact, and in particular we need to know about the existence of any sites on the State Register or being considered for the register on or near our location.

I enclose a xerox copy of the report on the archaeological survey of the central four sections of the area under consideration, made by the Agency of Conservation Archaeology, Eastern New Mexico University (ENMU), and will send you a copy of the formal report when it is printed. We have not yet had an archaeological survey made of the necessary rights of way, but intend to have one made in the near future.

I also enclose two maps of the area, showing the proposed withdrawal area for the projects and the rights of way that will be required for highway, railroad, and electric power line access (other utilities will be routed over one or the other of these rights of way). I should add that most of the 28 square miles of withdrawal area is to be used merely as a buffer zone with no change in surface use. Only in the central three square miles (included within the four square miles of the ENMU survey) will there be mining, and all surface facilities will be in a 100-acre plot on the edge of this core area.

Yours,

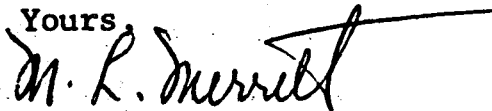
M. L. Merritt, Supv.
Environmental Assessment
Division 1151

MLM:1151:vf

Enclosure

Copy to:

ALO W. P. Armstrong, wo/enc.

ALO
1140

J. D. Shaykin, wo/enc.

W. D. Weart, wo/enc.

STATE OF NEW MEXICO



STATE PLANNING OFFICE

GREER BUILDING
505 DON GASPER
SANTA FE, 87503
(505) 827-2073

GRACIELA (GRACE) OLIVAREZ
STATE PLANNING OFFICER

JERRY APODACA
GOVERNOR

February 16, 1977

Mr. M.L. Merritt, Supervisor
Environmental Assessment Division, 1115
Sandia Laboratories
Albuquerque, New Mexico 87115

Dear Mr. Merritt:

With reference to your request for comments on cultural resources which may be affected by the proposed Waste Isolation Pilot Plant east of Carlsbad the report: An Archaeological Reconnaissance of Sandia Laboratories' Los Medanos Nuclear Waste Disposal Facility, Eddy County, New Mexico by Jeffrey Nielsen has been reviewed by this office.

The recommendations for mitigation of adverse effects on cultural resources located by this survey should be followed and avoidance of sites accomplished whenever possible. Sites which cannot be avoided should be excavated or tested as indicated in these recommendations before clearance can be granted. Those rights of way which have not yet been surveyed should be surveyed as soon as possible so that recommendations for the mitigation of adverse effects on any resources located within these areas may be included in the overall mitigation proposal.

Several of the sites located by the survey may meet the criteria for eligibility for nomination to the National Register of Historic Places. However, there are currently no sites located within the 28 square mile withdrawal which are entered in either the National Register or the State Register of Cultural Properties.

Should you have any further questions regarding this matter, please do not hesitate to contact this office.

Sincerely,

A handwritten signature in cursive script, appearing to read "Thomas W. Merlan".

Thomas W. Merlan
State Historic
Preservation Officer

TWM:jf



Department of Energy
Washington, D.C. 20545

Dr. William Murtagh
Keeper of the National Register
Heritage, Conservation and Recreation Service
U. S. Department of the Interior
Washington, D. C. 20240

Dear Dr. Murtagh:

Your opinion respecting the eligibility of certain sites associated with the proposed Waste Isolation Pilot Plant (WIPP), for inclusion in the National Register, is hereby requested under the provisions of 36 CFR 800.4(a)(2).

The Department of Energy (DOE) has been investigating a site in southeastern New Mexico for a deep geological repository. DOE will seek congressional authorization for the WIPP and legislative action to acquire land and rights-of-way needed. The WIPP will be licensed by the Nuclear Regulatory Commission.

The WIPP will be used for the demonstration of safe permanent disposal of transuranic wastes produced as a result of the United States defense program. The WIPP will also be used for experiments related to the permanent disposal of solidified high level radioactive wastes.

The WIPP plans call for the use of 17,200 acres of Federal land and 1760 acres of State land for the site (and 691 acres for rights-of-way). Construction would remove 487 acres of land from grazing temporarily and 448 acres for an extended period of time. Surface facilities for radioactive waste handling will require about 100 acres above ground. There will also be extensive underground handling and storage facilities in the salt formation at the WIPP site.

Mr. Thomas W. Merlan, State Historic Preservation Officer, State of New Mexico, State Planning Office, Greer Building, 505 Don Gaspar, Santa Fe, New Mexico, 87503, can be contacted for details concerning the review performed by the State of New Mexico. T. Merlan stated, in a letter to M. Merritt, Sandia Laboratories, on February 16, 1977 - "Several of the sites located by the survey may meet the criteria for eligibility for nomination to the National Register of Historic Places. However, there are currently no sites located within the 28 square mile withdrawal which are entered in either the National Register or the State Register of Cultural Properties."

Dr. William Murtagh

- 2 -

Report SAND77-7024, "An Archaeological Reconnaissance of a Proposed Site for the Waste Isolation Pilot Plant (WIPP)," October 1977, by Jeffrey Nielsen, Agency of Conservation Archaeology, Eastern New Mexico University, Portales, New Mexico, is enclosed for your use.

Your opinion concerning the eligibility of the sites associated with the WIPP will be included in the Draft Environmental Impact Statement now being prepared by DOE for issuance in October 1978. If there are any questions, we would be pleased to respond.

Sincerely,

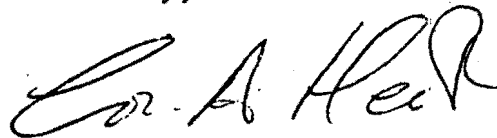

Colin A. Heath
WIPP Program Manager
Division of Waste Management

Enclosure:
Report SAND77-7024

cc w/o encl:
T. W. Merlan, State Historic
Preservation Officer, NM



United States Department of the Interior

NATIONAL PARK SERVICE
WASHINGTON, D.C. 20240

IN REPLY REFER TO:
H32-880

Mr. Thomas W. Merlan, SHPO
State Planning Office
Santa Fe, New Mexico 87503

Dear State Historic Preservation Officer:

As you will note from the enclosed letter, we have received a request for a determination of eligibility for inclusion in the National Register, pursuant to Executive Order 11593 or the National Historic Preservation Act of 1966, as amended, as implemented by the procedures of the Advisory Council on Historic Preservation (36 CFR 800).

Since determinations of eligibility are made in consultation with the State Historic Preservation Officer, we would appreciate receiving your opinion on the eligibility of the property(s) which appear in the enclosed material along with any documentation which you have on it and its significance within three weeks of receipt of this letter. Copies of documentation submitted with the request(s) are enclosed for your review, as appropriate.

We look forward to hearing from you in the near future. Please do not hesitate to consult the National Register staff if you have any questions concerning this property.

We appreciate your assistance in this matter.

Sincerely yours,

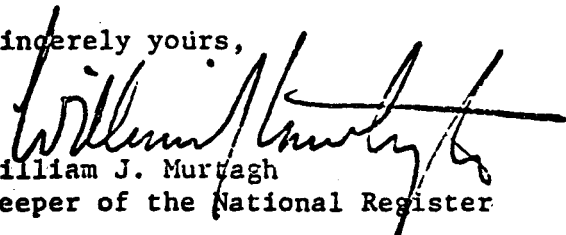
William J. Murtagh
Keeper of the National Register

Enclosure(s)

cc: Mr. Colin A. Heath
WIPP Program Manager
Division of Waste Management
Department of Energy
Washington, D.C. 20545

Mr. Gregory J. Cavanaugh, Director
Division of Real Estate and Facilities Management
Department of Energy
Washington, D.C. 20545
Attn: Mr. William R. Cochran

Advisory Council on Historic Preservation
Denver Office
Box 25085
Denver, Colorado 80225
Attn: Louis Wall

HISTORIC PRESERVATION PROGRAM
Department of Educational Finance & Cultural Affairs
c/o New Mexico State Library
P.O. Box 1000
Santa Fe, New Mexico 87503
(505) 827-2108

April 28, 1978

Dr. William J. Murtagh
Keeper of the National Register
National Park Service
1100 L Street, N.W. - Room 3209
Washington, D.C. 20005

Dear Dr. Murtagh:

This office has been requested by the Department of Energy to provide an opinion on the eligibility for nomination to the National Register of Historic Places of several archaeological sites located in southeastern New Mexico.

The sites in question were located by an archaeological survey of a four section area and related right-of-way which constitutes the core area of the proposed Waste Isolation Pilot Plant project. Information on the survey area, survey techniques, and descriptions of the individual sites is included in the report entitled An Archaeological Reconnaissance of a Proposed Site from the Waste Isolation Pilot Plant (WIPP) By Jeffrey Nielsen, Agency of Conservation Archaeology, Eastern New Mexico University, July, 1976.

All of the 33 sites located by this survey appear, on the basis of survey data, to be associated culturally and temporally, and related to a specific economic activity. The archaeological investigation of this group of sites is in our opinion likely to yield significant information on the prehistoric occupation and utilization of the Los Medanos region. Some theoretical considerations for such a study are outlined in the above referenced report.

Therefore, we believe that the 33 sites because of their relationship, are contributing elements of an archaeological district meeting the criteria of eligibility for nomination to the National Register. The significance of the information which can be obtained through the scientific investigation of these sites becomes even more important in view of the so far poorly defined prehistory of this area.

The boundaries of the archaeological district can be arbitrarily defined as the approximately 2,600 acre, four section, core area and right-of-way covered by the archaeological survey. Indications from subsequent archaeological surveys of drill pad, access roads, and test plots are that similar archaeological sites can be expected to occur throughout the 18,960 acre withdrawal area.

Mr. William J. Murtagh
April 28, 1978
Page 2

Should you have any questions regarding our opinion regarding the significance of these archaeological sites, do not hesitate to contact this office.

Sincerely,

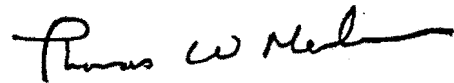

Thomas W. Merlan
State Historic Preservation Officer

TWM:jf

cc: Smokey O'Connor
Colin A. Heath



United States Department of the Interior

HERITAGE CONSERVATION AND RECREATION SERVICE
WASHINGTON, D. C. 20240

IN REPLY REFER TO:

H32-NR

Mr. Colin A. Heath
WIPP Program Manager
Division of Waste Management
Department of Energy
Washington, D.C. 20545

Dear Mr. Heath:

Thank you for your letter requesting a determination of eligibility for inclusion in the National Register pursuant to Executive Order 11593 or the National Historic Preservation Act of 1966, as amended. Our determination appears on the enclosed material.

As you understand, your request for our professional judgment constitutes a part of the Federal planning process. We urge that this information be integrated into the National Environmental Policy Act analysis in order to bring about the best possible program decisions. This determination does not serve in any manner as a veto to uses of property, with or without Federal participation or assistance. Any decision on the property in question and the responsibility for program planning concerning such properties lie with the agency or block grant recipient after the Advisory Council on Historic Preservation has had an opportunity to comment.

We are pleased to be of assistance in the consideration of historic resources in the planning process.

Sincerely yours,

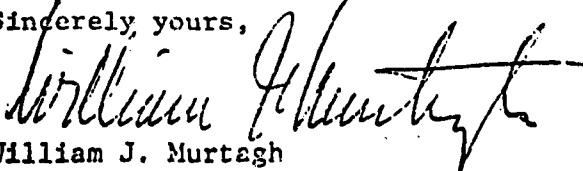

William J. Murtagh
Keeper of the National Register

Enclosure

DETERMINATION OF ELICIBILITY
NOTIFICATION DISTRIBUTION

cc: State Historic Preservation Officer: Mr. Thomas W. Merlan, New Mexico

Federal Representative: Mr. Gregory J. Cavanaugh

Bureau Liason:

Advisory Council on Historic Preservation: Denver

Mr. George Sherwood
Acting Chief
Environmental Safety
& Effects Division
Reactor, Research and Technology
US. Department of Energy
Washington, D.C. 20545

E.O. 11593

DETERMINATION OF ELIGIBILITY NOTIFICATION
NATIONAL REGISTER OF HISTORIC PLACES
OFFICE OF ARCHEOLOGY AND HISTORIC PRESERVATION
HERITAGE CONSERVATION AND RECREATION SERVICE

Request submitted by: DOE Colin A. Heath

Date request received: 2/24/78 additional information received 5/5/78

Name of property: Archeological Sites, Waste Isolation Pilot Plant State: New Mexico

Location: S.E. of Carlsbad, New Mexico

Opinion of the State Historic Preservation Officer:

Eligible Not eligible No response

Comments: "All of the 33 sites located by this survey appear, on the basis of survey data, to be associated culturally and temporally, and related to a specific economic activity... (and are) likely to yield significant information on the prehistoric occupation and utilization of the Los Medanos region... we believe that the 33 sites, because of their relationship, are contributing elements of an archaeological district..."

The Secretary of the Interior has determined that this property is:

Eligible Applicable criteria: D

Comments: **36 CFR Part 63.3
Determination**

Not eligible

Comments:

Documentation insufficient (see accompanying sheet explaining additional materials required)

William J. Murtagh (Sgd.)

Keeper of the National Register

Date: MAY 24 1978

WASO-183
9/75



Department of Energy
Albuquerque Operations Office
P.O. Box 5400
Albuquerque, New Mexico 87115

NOV 8 1979

Mr. Thomas W. Merlan
State Historic Preservation Officer
State Planning Office
Santa Fe, New Mexico 87503

Dear Mr. Merlan:

The Department of Energy (DOE) is submitting this letter to appraise you of our intention to construct site verification shafts and an underground (in-situ) experimentation facility at the site proposed for the Waste Isolation Pilot Plant (WIPP) near Carlsbad (Figure 1). This construction program, herein referred to as the SPDV (Site Preliminary Design Verification), is an extension of the earlier site characterization program and is intended to provide the additional data necessary before a final site commitment can be made. We request your concurrence in determination of effect for archaeological sites affected by the SPDV. The locations of the shafts and attendant facilities are indicated on the enclosed Figure 2. The access road to the site was previously constructed for borehole drilling (ERDA-9).

Three major archaeological surveys have been conducted by the Agency for Conservation Archaeology of Eastern New Mexico University on the entire proposed WIPP site:

- J. Nielson conducted a reconnaissance of the core area (Sections 20, 21, 29, and 28) and tentative rights-of-way in 1976.
- S. C. Schermer conducted a survey of 27 miles of seismic survey lines in 1978.
- R. B. MacLennan and S. C. Schermer conducted a survey of proposed access roads and railroad rights-of-way in 1979.

The first report was forwarded to you on November 15, 1976. The latter two are enclosed. In addition, archaeological surveys have been conducted

NOV 8 1979

for each of the borehole drilling pads and access roads constructed as part of the overall WIPP Project.

All archaeological sites discovered in the site area during these surveys are indicated on Figure 2. Table 1 summarizes site descriptions and recommended mitigation measures for those sites which will be affected or possibly affected by construction of the SPDV.

Prior to the start of construction of the SPDV facilities, all sites affected by construction and "borderline" sites will be accurately mapped by a field surveying crew. Fences will then be constructed around each of the archaeological sites. DOE and its contractors will supply the needed support to the State Historic Preservation Officer and/or his designees to allow proper removal of artifacts from all affected sites. We believe these mitigation measures will preserve the archaeological resources present, yet allow construction of the SPDV facilities to proceed.

In previous correspondence with Dr. William Murtagh, Keeper of the National Register, and yourself, on May 24, 1978, the 33 sites located in the 1976 Nielson survey were determined eligible for nomination to the National Register of Historic Places under applicable Criterion D of 36 CFR Part 63.3. DOE plans to conduct further archaeological surveys as soon as practicable including sample surveys throughout the remaining outer Control Zones of the site. Upon completion of those surveys and prior to construction of the full WIPP repository, DOE will consult with you to comply with the requirements of Section 106 of the National Historic Preservation Act as detailed in regulations detailed in the January 30, 1979 Federal Register (Title 36, Chapter VIII, Part 800) to identify any additional eligible properties, request a determination of effect and implement a consultation process to mitigate or minimize any adverse effects from full repository construction.

We request your formal comments on our proposed plan for the SPDV program with regard to archaeological resources and the mitigation of any adverse impacts. A response by December 14, 1979 would be appreciated.

If you require further information or clarification, please contact Mr. J.M. McGough of my staff (505-766-3884).

Sincerely,

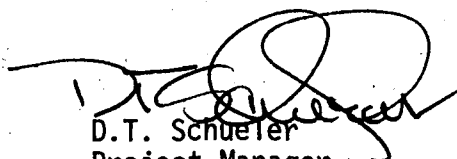
D.T. Schueller
Project Manager
WIPP Project Office

WIP:JMM(2570)

Enclosures,



BRUCE KING
GOVERNOR

DAVID W. KING
SECRETARY

STATE OF NEW MEXICO
DEPARTMENT OF
FINANCE AND ADMINISTRATION
PLANNING DIVISION

ANITA HEISENBERG
DIRECTOR

505 DON GASPAR AVENUE
SANTA FE, NEW MEXICO 87503
(505) 827-2073
(505) 827-5191
827-2108

November 30, 1979

Dr. D.T. Schueler, Project Manager
WIPP Project Office
Department of Energy
Post Office Box 5400
Albuquerque, New Mexico 87115

Dear Dr. Schueler:

Your proposal for the mitigation of adverse effects resulting from construction of Site Preliminary Design Verification facilities at the Waste Isolation Pilot Plant has been reviewed by this office.

We concur with your determination that several significant archeological resources will be affected by construction of the SPDV facilities, that these effects have been identified as being adverse, and that measures will be required to mitigate adverse effects.

We also concur with the procedures you propose to accomplish the required mitigation with the understanding that several additional steps are to be accomplished before the mitigation proposal is submitted to the Advisory Council. These include:

1. Accurate mapping of the site locations in relation to the SPDV facilities.
2. Site specific determination of effect and proposed mitigation procedure. (protection and avoidance or data recovery.)
3. Preparation of a statement of problem orientation and research design for the data recovery program for those sites which cannot be avoided.

Upon submission of the detailed mitigation plan, we are prepared to request a determination of no adverse effect thru satisfactory mitigation.

We will be looking forward to receiving your completed mitigation proposal. If you have any questions regarding our recommendations do not hesitate to contact us.

Sincerely,

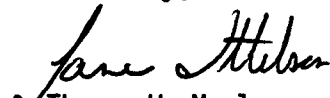
for Thomas W. Merlan

State Historic Preservation Officer
Historic Preservation Bureau

TWM:DER:dg
cc: Jack Mobley



Department of Energy
Albuquerque Operations Office
P.O. Box 5400
Albuquerque, New Mexico 87115

MAR 21 1980

Mr. Thomas Merlan
State Historic Preservation Officer
State Planning Office
Santa Fe, NM 87503

Dear Mr. Merlan:

ARCHAEOLOGICAL MITIGATION PLAN FOR SITE & PRELIMINARY DESIGN VALIDATION
AT WIPP SITE

As requested by your letter of November 30, 1979, the WIPP Project Office has prepared a plan to mitigate adverse impacts to archaeological resources resulting from Site and Preliminary Design Validation (SPDV) activities for the Waste Isolation Pilot Plant (WIPP). This mitigation plan is based on the results of an archaeological survey conducted by Mr. Scott Schermer of the Agency for Conservation Archaeology at Eastern New Mexico University. This survey covered the four square mile area surrounding the ERDA-9 drill-hole at the WIPP Site.

Subsequent to the submittal of Mr. Schermer's findings, DOE modified SPDV surface design features so as to avoid impacts to some of the archaeological sites. Furthermore, DOE plans to impose administrative controls at the site to lessen the adverse impacts of human presence near archaeological resources. Artifacts will be collected and analyzed at some sites as well. Details are given in the enclosed "Plan to Mitigate Effects on Archaeological Sites."

Included as an appendix to this report is a copy of Mr. Schermer's letter of March 3, 1980, in which he states his concurrence with the DOE proposed mitigative actions. Also enclosed is one copy of the findings of Mr. Schermer's survey "A Report on the Archaeological Site Locations in the WIPP Core Area with Mitigation Recommendations."

We request your review of the proposed mitigation plan and accompanying materials to ensure full DOE compliance with the requirements of Section 106 of the National Historic Preservation Act. We will contact you soon to arrange a meeting on the mitigation plan.

Sincerely,
ORIGINAL SIGNED BY
D. T. SCHUELER
D. T. Schueler
Project Manager

WIP:JMM(2853)

See page 2

Enclosures:

1. SPDV Mitigation Plan
2. Archaeological Site Locations In the WIPP Core Area with Mitigation Recommendations

cc w/encl # 1 only:



J. McGough, DOE, WIPP
J. Gervers, Governor's Task Force for WIPP, SF
R. Neill, EEG, SF

cc wo/encl: G. Hohmann, Westinghouse WIPP



BRUCE KING
GOVERNOR

DAVID W. KING
SECRETARY

STATE OF NEW MEXICO
DEPARTMENT OF
FINANCE AND ADMINISTRATION
PLANNING DIVISION

ANITA HEISENBERG
DIRECTOR

April 10, 1980

505 DON GASPAR AVENUE
SANTA FE, NEW MEXICO 87503
(505) 827-2073
(505) 827-5191
827-2108

Dr. D.T. Schueler
Project Manager
Waste Isolation Pilot Plant
Department of Energy
Post Office Box 5400
Albuquerque, New Mexico 87115

Dear Dr. Schueler:

The Plan to Mitigate Effects on Archeological Resources; Site and Preliminary Design Validation (SPDV), Waste Isolation Pilot Plant, Eddy County, New Mexico by J.S. Hart and L.M. Brausch has been reviewed by this office.

It is our opinion that procedures outlined in the plan are adequate to mitigate direct and indirect adverse effects of the SPDV facility on significant cultural resources. This determination is applicable only to the SPDV facility as presently designed. A decision to proceed with full development of WIPP will of course require consideration of additional mitigative actions.

We also believe that data recovery and analysis procedures to be employed at those sites to be collected, tested, or excavated are appropriate and will insure the preservation of archeological information contained within sites which cannot be protected by other means.

Scott C. Schermer's A Report on the Archeological Site Locations in the WIPP Core Area with Mitigation Recommendations for Bechtel National, Inc. was also reviewed with interest. The information contained in this report satisfies certain inadequacies previously noted in the archeological program for WIPP. We are pleased with your efforts to insure that archeological information in the WIPP area is adequately recorded and understood.

Should you have any questions regarding our comments on the SPDV mitigation plan, do not hesitate to contact this office.

Sincerely,

Thomas W. Merlan
State Historic Preservation Officer
Historic Preservation Bureau

TWM:DER:dg
cc: Louis S. Wall
John Gervers



BRUCE KING
GOVERNOR

DAVID W. KING
SECRETARY

STATE OF NEW MEXICO
DEPARTMENT OF
FINANCE AND ADMINISTRATION
PLANNING DIVISION

ANITA HISENBERG
DIRECTOR

505 DON GASPAR AVENUE
SANTA FE, NEW MEXICO 87503
(505) 827-2073
(505) 827-5191

May 8, 1980

Dr. D.T. Schueler
Project Manager
WIPP Project Office
Albuquerque Operations Office
Department of Energy
Post Office Box 5400
Albuquerque, New Mexico 87115

Dear Dr. Schueler:

As I stated in My April 10, 1980 letter, it is my opinion that the Plan to Mitigate Effects on Archeological Resources; Site and Preliminary Design Validation (SPDV), Waste Isolation Pilot Plant contains adequate data recovery and protection measures to satisfactorily mitigate adverse effects on significant cultural resources.

I therefore concur with your determination of no adverse effect for this undertaking provided that the mitigation plan is implemented as stated. It is my opinion that the criteria and requirements set forth in Parts I and II of the Advisory Council's Guidelines for Making "Adverse Effect" and No Adverse Effect Determinations for Archeological Resources in Accordance with 36 CFR Part 800 are being met. Specifically, I can certify that the affected archeological resources meet Part I: Criteria 2 and 3a, b, and c.

Should you have any questions regarding my concurrence with this determination, do not hesitate to contact this office.

Sincerely,

Thomas W. Merlan
State Historic Preservation Officer

TWM:DER;dg
cc: Louis S. Wall
John Gervers



Department of Energy
Albuquerque Operations Office
P.O. Box 5400
Albuquerque, New Mexico 87115

MAY 20 1980

Mr. Louis S. Wall, Chief
Western Division of Project Review
Advisory Council on Historic Preservation
44 Union Boulevard, Suite 616
Lakewood, Colorado 80226

Dear Mr. Wall:

REQUEST FOR COUNCIL COMMENTS

Enclosed are three (3) copies of the "Plan to Mitigate Effects on Archaeological Resources," for the Site and Preliminary Design Validation Program for the Waste Isolation Pilot Plant Site in Eddy County, New Mexico. This report was prepared to comply with the requirements of Section 106 of the National Historic Preservation Act of 1966 and Section 2(b) of Executive Order 11593.

Correspondence documenting approval of the plan by Mr. Thomas W. Merlan, the New Mexico State Historic Preservation Officer, is included as Appendix A of the report. Also included in Appendix A are letters from Mr. Merlan and Mr. Scott Schermer of the Agency for Conservation Archaeology supporting a determination of "No Adverse Effect" to archaeological resources as a result of SPDV activities at the WIPP Site. Appendix B of the report consists of specific responses to the information requirements required by 36 CFR 800.13(a).

Also enclosed are two (2) copies of Scott Schermer's "A Report on the Archaeological Site Locations in the WIPP Core Area with Recommendations for Bechtel National, Inc." This document details characteristics of the archaeological sites discussed in our mitigation plan.

We believe that this information meets our responsibilities for documentation of a determination of "No Adverse Effect" to

Mr. Louis S. Wall

2

MAY 20 1980

archaeological resources. We request that the Advisory Council on Historic Preservation comment on this determination pursuant to 36 CFR 800.6.

Sincerely,

ORIGINAL SIGNED BY

D. T. SCHUELER

D. T. Schueler

Project Manager

WIPP Project Office

WIP:JMM

Enclosures:

1. "Plan to Mitigate Effects on Archaeological Resources for SPDV" (3 copies)
2. "A Report on the Archaeological Site Locations in the WIPP Core Area with Mitigation Recommendations" (2 copies)

cc w/encl no. 1 (1 copy). J. McGough, WIPP P/O, ALO
J. Gervers, WIPP Task Force
R. Neill, EEG, Santa Fe
A. Zimmerman, BLM, Santa Fe
A. Ramage, BLM, Roswell

cc w/o encl: G. Hohmann, W-WIPP Proj.

Sandia Laboratories

Albuquerque, New Mexico 87115

November 3, 1976

Mr. Albert W. Hamelstrom
517 Gold Avenue SW
P. O. Box 2007
Albuquerque, NM 87103

Dear Sir:

I am in the process of preparing inputs for a Draft Environmental Impact Statement on the proposed Waste Isolation Pilot Plant to be used for experiments related to the storage of low and intermediate level nuclear wastes in the bedded salt of the Delaware Basin, east of Carlsbad, New Mexico.

I have just been informed that I must solicit a determination from the USDA Rural Development Committee on whether there are any "prime or unique farmlands" located within the project area. I would be very much surprised if there were, but nevertheless I need a formal statement on the subject.

The area proposed includes all or part of Sections 7-11, 14-23, 26-35 of T. 22 S., R. 33 E.; Sections 2-6 of T. 23 S., R. 31 E.; Sections 12-13, 24-25, 36 of T. 22 S., R. 30 E.; and Section 1, T. 23 S., R. 30 E. Most of this land will merely be buffer zone; the area which would overlie the underground workings includes only Sections 20-21 and 28-29, T. 22 S., R. 31 E. All the land mentioned is in Eddy County, New Mexico--see map enclosed.

If there are any further questions, please phone me at 264-3540. Thank you for your cooperation.

Yours,



M. L. Merritt, Supervisor
Environmental Assessment Div. 1151

MLM:1151:jeh

Enclosure

Copy to:

SAO L. P. Apodaca w/encl.
ALO W. P. Armstrong w/encl.
1140 W. D. Weart w/encl.

UNITED STATES DEPARTMENT OF AGRICULTURE

SOIL CONSERVATION SERVICE

Box 2007, Albuquerque, NM 87103

November 11, 1976

Mr. M. L. Merritt, Supervisor
Environmental Assessment Division 1151
Sandia Laboratories
Albuquerque, NM 87115

Dear Mr. Merritt:

In response to your request of November 3, 1976, the site and buffer zone for the proposed Waste Isolation Pilot Plant in Eddy County, New Mexico, does not include prime or unique farm lands according to Soil Conservation Service criteria. The area considered was that shown on the map provided with your letter.

Sincerely,



A. W. Hamelstrom
State Conservationist



OCT 17 1979

Mr. W. O. Nelson, Jr.
Regional Director
U. S. Fish & Wildlife Service
Endangered Species Office
P. O. Box 1306
Albuquerque, NM 87103

Dear Mr. Nelson:

REQUEST FOR LIST OF ENDANGERED SPECIES AFFECTED BY WIPP SITE

The Department of Energy (DOE) is considering the construction of a Waste Isolation Pilot Plant (WIPP) at a site near Carlsbad, New Mexico. The WIPP will be a permanent repository for low- and intermediate-level defense related nuclear wastes which will be emplaced in a bedded salt formation underlying the site. As a part of this program, the Sandia Laboratories, under contract to the DOE, has funded extensive studies of the environmental biology of the site. These studies are intended to provide information for use in the Environmental Impact Statement as well as to establish Baseline data for the long-term ecological monitoring of the site.

This letter constitutes a formal request for your Office to provide a list of threatened and endangered species that may be affected by the proposed WIPP facility, as required by Section 7 of the 1978 amendments to the Endangered Species Act of 1973.

You may find the following information useful in assembling such a list.

The WIPP site is about 25 miles east of Carlsbad in Eddy County, New Mexico and covers an area of 18,960 acres, all federal and state land. Biological studies have encompassed a somewhat larger area. The floral associations on the site are characteristic of the Chihuahuan Regions of the Desert Shrub and Grassland Formations. Some Plains Region components are present as well.* The site region is grazed by cattle throughout the year and is stocked at a level of about six head per section.

*Donart, G. B., D. D. Sylvester, and W. C. Hickey, 1978. Potential Natural Vegetation of New Mexico. U. S. Department of the Interior, Soil Conservation Service, Portland, Oregon.

	WIPP	WIPP	WIPP	WIPP	WIPP
→	SAFETY ASSESS	PROJ CONTROL	FIN MGMT BR	DEP PROJ MGR	PROJ MGR
	McGough:srk	Bellows	Dintaman	Rudolph	Schueler
	10/17/79	10/ /79	10/ /79	10/ /79	10/ /79

OCT 17 1979

Proposed construction at the site consists of surface and underground facilities. Surface structures will include, in addition to buildings, a storage pile for the mined rock (much of which will be salt), an evaporation pond for sewage-treatment effluents, a disposal area for construction spoils, and a sanitary landfill. Also planned are a railroad spur, paved access roads, and a power line. The proposed locations of these facilities are shown on the accompanying map.

The portion of the Draft Environmental Impact Statement (DOE/EIS-0026-D) is enclosed that details the information available to us concerning threatened and endangered species on or near the site. Field data obtained since the DEIS was prepared necessitates some modifications of the statements concerning threatened and endangered fish species. Dr. James Sublette of Eastern New Mexico University (ENMU) in Portales, NM, the principal investigator for the aquatic studies portion of the WIPP Biology Program, has conducted field studies in 1978 and 1979 at eight sampling stations on the Pecos River between Six Mile Dam and Red Bluff Reservoir. His 1978 findings (summarized in the table attached) included the following information. Of the nineteen species of fish in the length of the Pecos River under study, three are currently listed by the State of New Mexico as being threatened or endangered. They are: the Pecos River Pupfish, the Rainwater fish, and the Gray Redhorse. Dr. Sublette found several thriving populations of the first two species and has recommended that they be "delisted." The third is rare in the Pecos but moderate populations are found in the Black River drainage. The Black river joins the Pecos near Malaga west-southwest of the WIPP site.

Five additional species of fish on the state list were found to occur in the Black River drainage but not in the Pecos. They are: the Blue Sucker, the Banded Tetra, the Blunt Nose Minnow, the Green-throated Darter, and the Pecos Gambusia. The last two occur only in the Blue Spring Run; the last species is also on the federal list of threatened and endangered species.

To our knowledge, the Pecos Gambusia is the only federally listed species of threatened and endangered fish that is found anywhere near the WIPP site. The only known populations within the aquatic study area are in the Black River drainage, which is well buffered from any direct association with drainage from the WIPP site into the Pecos.

The foregoing information is contained in the FY78 annual report of the WIPP Biology Program soon to be published as Sandia document (SA-79-0368). Your office has been placed on the mailing list for distribution.

With regard to the avifauna, it should be emphasized that the single sighting of Baird's sparrow (New Mexico endangered species) mentioned in the DEIS (Vol. 2, page H-90) is questionable. The sighting, made by a graduate student of Dr. A. L. Gennaro of ENMU, did not permit a truly positive identification (A. L. Gennaro, personal communication; Dr. Gennaro has conducted the mammalian and reptilian portions of the WIPP studies for several years). Dr. David Ligon of the University of New Mexico is now responsible for avian studies.

OCT 17 1979

The terminology used in the DEIS may require some clarification. "The region of the site" refers to the large area consisting of those parts of Eddy and Lea counties east of the Pecos. The term "the site vicinity" is more restrictive and refers to the area within a 5-mile radius of the center of the proposed WIPP site. Species checklists assembled for the "region of the site" understandably contain species never sighted in the "vicinity of the site" because the range of habitats in the larger area is, of course, more diverse than those encountered in the immediate neighborhood of the WIPP site. Similarly, the aquatic species discussed in the DEIS are those that occur within the "site region" whereas the aquatic study area is confined to water bodies close to the site (tanks, playas, etc.) and to that region of the Pecos which may receive drainage from the site and continuing downstream to Red Bluff Reservoir.

A copy of the entire DEIS is being mailed to you under separate cover for your information.

If you require further information on these biological studies, please contact Sieglinde Neuhauser (264-5364) or M. L. Merritt (264-3540) at Sandia Laboratories. Questions concerning the project itself should be addressed to me at 766-3884.

Sincerely,

Original Signed by
D. T. SCHUELER
D. T. Schueler
Project Manager
WIPP Project Office

WIP:JMM(2527)

Enclosures:

1. Map of WIPP Site Area
2. Section H.5.4 of DEIS
3. List of Threatened & Endangered Species of Fish

cc w/o encl. K. Neuhauser, Org. 4514, SLA
M. Merritt, Org. 4514, SLA
G. Hohmann, Westinghouse WIPP Proj
J. McGough, WIPP Proj Ofc, ALO



IN REPLY REFER TO:

UNITED STATES
DEPARTMENT OF THE INTERIOR
FISH AND WILDLIFE SERVICE

SE

POST OFFICE BOX 1306
ALBUQUERQUE, NEW MEXICO 87103
WIPP PROJECT OFFICE

November 15, 1979

Act Info Init Date

Act	Info	Init	Date
Schueler			
Mr. Schueler			
Project Manager			
WIPP Project Office			
Department of Energy			
Albuquerque Operations Office			
P.O. Box 5400			
Albuquerque, New Mexico 87115			
Carlsbad			
WIPP Project Office			
FILE			

Mr. D. T. Schueler
Project Manager, WIPP Project Office
Department of Energy
Albuquerque Operations Office
P.O. Box 5400
Albuquerque, New Mexico 87115

Dear Mr. Schueler:

This is in reply to your October 17, 1979 letter which requested information about species which are listed or proposed to be listed as threatened or endangered as provided by the Endangered Species Act. Your area of interest is the Waste Isolation Pilot Plant site 25 miles east of Carlsbad, Eddy County, New Mexico.

As provided by Section 7(c) of the Endangered Species Act Amendments of 1978, the Fish and Wildlife Service is required to furnish a list of those species, both proposed and listed, that may be or are present in the area involving Federal construction activities.

Upon receipt of the Fish and Wildlife Service's species list, the Federal agency authorizing, funding, or carrying out the construction action is required to conduct a biological assessment for the purpose of identifying listed species which are likely to be affected by such action. Proposed species are included on the list even though they do not have legal protection under the Act. Their inclusion recognizes that they may be listed anytime and have the portent to cause delays or modifications to the proposed action. In light of this, we recommend that those species be included in the biological assessment.

The biological assessment shall be completed within 180 days after receipt of the species list, unless it is mutually agreed to extend this period. The biological assessment should include: 1) the results of a comprehensive survey; 2) results of any studies undertaken to determine the nature and extent of any impacts on identified species; 3) consideration of the cumulative effects upon the species or its critical habitat; 4) study methods used; 5) difficulties encountered in obtaining data and completing the proposed study; 6) conclusions including recommendations as to further studies, and 7) any other relevant information.



Save Energy and You Serve America!

For purposes of providing interim guidance, the Fish and Wildlife Service considers construction projects to be any action conducted or contracted by the Federal agency designed primarily to result in the building or erection of man-made structures, such as dams, buildings, roads, pipelines, and the like. This includes consideration of major Federal actions such as permits, grants, licenses, or other forms of Federal authorization or approval which may result in construction and which significantly affect the quality of the human environment. In addition, other actions that have the potential of becoming or are controversial, may be considered as construction.

If the biological assessment reveals that the proposed project may affect listed species, the formal consultation process shall be initiated by writing to the Regional Director, Region 2, U.S. Fish and Wildlife Service, P.O. Box 1306, Albuquerque, New Mexico 87103. If no affect is evident, there is no need for further consultation. We would, however, appreciate the opportunity to review your biological assessment.

The attached sheet provides information on species which may occur in the proposed project area. If we may be of further assistance, do not hesitate to call upon us (505-766-3972; FTS 474-3972).

Sincerely yours,

Acting

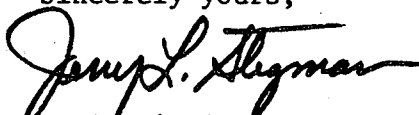
Regional Director

Attachment

cc: Phoenix Area Office (SE), Phoenix, Arizona
Ecological Services Field Office, Albuquerque, New Mexico

WASTE ISOLATION PILOT PLANT
Eddy County, New Mexico

LISTED SPECIES

BIRDS

Peregrine falcon (Falco peregrinus) - Medium sized falcon, slate gray above, dark head with "mustaches" below each eye. Long pointed wings. May occur as a spring or winter migrant.

Bald eagle (Haliaeetus leucocephalus) - Large eagle with white head and tail in the adult. Immatures are dark, feet bare of feathers. May occur as a spring or fall migrant. Winters around lakes and along rivers in project area.

MAMMALS

Black-footed ferret (Mustela nigripes) - Extremely rare and possibly extinct in area. Generally found in association with prairie dog towns.

FISH

Pecos gambusia (Gambusia nobilis) - Known from several locations near the project area. Found in springs and free-flowing streams.

PLANTS

Lee pincushion cactus (Coryphantha sneedii leei) - Listed as threatened effective November 26, 1979 (FR 10/25/79, Vol. 44, #208, 61554). A small pincushion-like cactus with white spines. Known only from the eastern edge of the Guadalupe Mountains in southwest Eddy County, New Mexico within Carlsbad Caverns National Park.

PROPOSED SPECIES

None.

CRITICAL HABITAT

None.

State of New Mexico

GOVERNOR
BRUCE KING

DIRECTOR AND SECRETARY
TO THE COMMISSION
HAROLD F. OLSON



DEPARTMENT OF GAME AND FISH

STATE CAPITOL
SANTA FE
87503

STATE GAME COMMISSION

EDWARD MUNOZ, CHAIRMAN
GALLUP

J.W. JONES
ALBUQUERQUE

ROBERT H. FORREST
CARLSBAD

ROBERT P. GRIFFIN
SILVER CITY

BILL LITRELL
CIMARRON

April 7, 1980

Mr. D. T. Schueler
Department of Energy
Albuquerque Operations Office
P. O. Box 5400
Albuquerque, New Mexico 87115

Dear Mr. Schueler:

We have reviewed the "Biological Assessment. Potential Impacts on State-designated Endangered Species from the Proposed Construction and Operation of the Waste Isolation Pilot Plant (WIPP)" and find it a generally acceptable treatment of the subject. I would like to request any specific information on the least tern occurrence (p. 29 in Table 5) for our records. In addition, we question the occurrence of Bendire's thrasher (p. 30 in Table 5) in the area, as it is not verified from eastern New Mexico.

As for the FEIS, we have comments as follows:

- p. H-126 - add Ross' Goose and white-winged dove to the table.
- p. H-127 - (also p. 29 in TME 3010) - Butorides veresans = virescens
Spatula = Anas
- p. H-128 - (also p. 29 in TME 3010) - Totanus = Tringa
Erolia = Calidris
Ereunetes = Calidris
- pp. H-129/H-130 - these pages are reversed in sequence.
- p. H-134 - Elsewhere the ferruginous hawk is listed as yearlong (e.g. H-127; p. 30 in TME 3010), but here the data show winter occurrences only. The latter status is more likely to be correct.
- p. H-135 - The lesser nighthawk is listed here but not elsewhere in the reports.
- p. H-136 - Oregon = dark-eyed junco.
- p. H-145 - Some of the species were delisted in May 1979, i.e. little blue heron and osprey; the bald eagle is now NM II.
- p. H-147 - Some of the species were delisted in May 1979, i.e. American eel, roundnose minnow, Pecos pupfish, and rainwater killifish; the Pecos gambusia, now NM II, is not listed here.

Mr. D. T. Schueler

-2-

April 7, 1980

We have not reviewed the plant occurrences and related aspects in detail, but I shall request this from the New Mexico Heritage Program. If they have comments, they can write to you direct.

Sincerely,

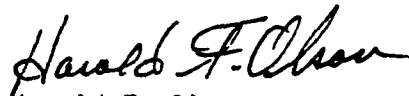

Harold F. Olson
Director

cc: Bill Huey

Appendix J

**EFFLUENT AND ENVIRONMENTAL
MEASUREMENTS AND MONITORING PROGRAMS**

CONTENTS

	<u>Page</u>
J.1 Preoperational Environmental Programs.....	J-1
J.1.1 Geology.....	J-1
J.1.2 Hydrology.....	J-11
J.1.3 Meteorology.....	J-16
J.1.4 Air Quality.....	J-19
J.1.5 Ecology.....	J-22
J.1.6 Radiation Monitoring.....	J-24
J.2 Proposed Operational Monitoring Programs.....	J-27
J.2.1 Geology.....	J-28
J.2.2 Hydrology.....	J-29
J.2.3 Meteorology.....	J-30
J.2.4 Air Quality.....	J-30
J.2.5 Ecology.....	J-30
J.2.6 Radiation Monitoring.....	J-30
J.3 Postoperational Monitoring Programs.....	J-33
J.4 Related Environmental Programs by Others.....	J-35
J.4.1 Bureau of Land Management.....	J-35
J.4.2 New Mexico Environmental Improvement Division.....	J-35
J.4.3 U.S. Geological Survey.....	J-35
J.4.4 Environmental Protection Agency, Las Vegas, Nevada.....	J-36
J.4.5 Potash Industry.....	J-36
J.4.6 National Oceanic and Atmospheric Administration.....	J-36
J.4.7 New Mexico Department of Game and Fish.....	J-36
J.4.8 Ongoing Regional Ecological Studies.....	J-37
References.....	J-39

LIST OF TABLES

	<u>Page</u>
J-1	Exploratory drill holes in the vicinity of the site..... J-3
J-2	Summary of meteorological measurements J-19
J-3	Specifications on meteorological sensors used..... J-20
J-4	Outline of the post-decommissioning monitoring program..... J-34

LIST OF FIGURES

	<u>Page</u>
J-1	Exploratory drill holes in the WIPP site..... J-2
J-2	Industry seismic data and WIPP data from 1976..... J-5
J-3	Seismic program, 1977..... J-6
J-4	Location map of gradient resistivity array..... J-7
J-5	Location map for resistivity soundings..... J-8
J-6	Location of drill holes used for hydrologic testing..... J-13
J-7	Plan view showing the configuration of the H-2 three-hole array..... J-14
J-8	Configuration of completed H-2 holes..... J-15
J-9	Location of the meteorology and air-quality- monitoring station..... J-18
J-10	Proposed air-particulate-monitoring stations..... J-25
J-11	Locations of thermoluminescent dosimeters in the site area..... J-26
J-12	Groundwater-sampling locations..... J-28

Appendix J

EFFLUENT AND ENVIRONMENTAL MEASUREMENTS AND MONITORING PROGRAMS

This appendix discusses the materials and methods used to collect the data presented in this report. It also discusses the proposed monitoring programs for assessing the environmental impacts of the WIPP.

J.1 PREOPERATIONAL ENVIRONMENTAL PROGRAMS

The preoperational survey programs have been designed to describe the existing geologic, hydrologic, meteorologic, biologic, and radiologic characteristics of the region surrounding the WIPP site in Eddy County, New Mexico.

J.1.1 Geology

The purposes of the site geologic studies and the geology sections presented in this report are given in Section 7.3. Investigation methods for geology and seismology are discussed in more detail in the Geological Characterization Report (Powers et al., 1978).

Geologic studies for the site fall into three different phases: preliminary site-selection activities, site characterization, and studies on long-range geologic processes affecting a repository. Site characterization at the present site began in 1975 with the drilling of a hole at the center of the site and the start of seismic reflection work. Site characterization is intended to provide data concerning the geologic acceptability of the site. Results up to late 1978 have been reported in the Geological Characterization Report (Powers et al., 1978). Studies of long-term processes that might affect the integrity of a repository are now the major geotechnical activity of the project personnel. These studies are concerned with the age of significant features and the rates and processes that have produced them.

This section summarizes the geophysical and geologic methods used in characterizing the New Mexico study area. Sixteen stratigraphic holes have been drilled to date (June 1980) in support of this program; one (ERDA-9) is at the center of the site. Figure J-1 shows boreholes within and near the site. Table J-1 has the location, depth, and purpose of boreholes drilled specifically for the WIPP. These boreholes were extensively logged, cored, and drill-stem tested in the evaporite section. The cores form the basis for several continuing laboratory studies important to an understanding of the physical and chemical phenomena associated with the site and contributing to general knowledge about the formation of evaporites. Two boreholes have been drilled well outside the immediate area to obtain data on salt dissolution.

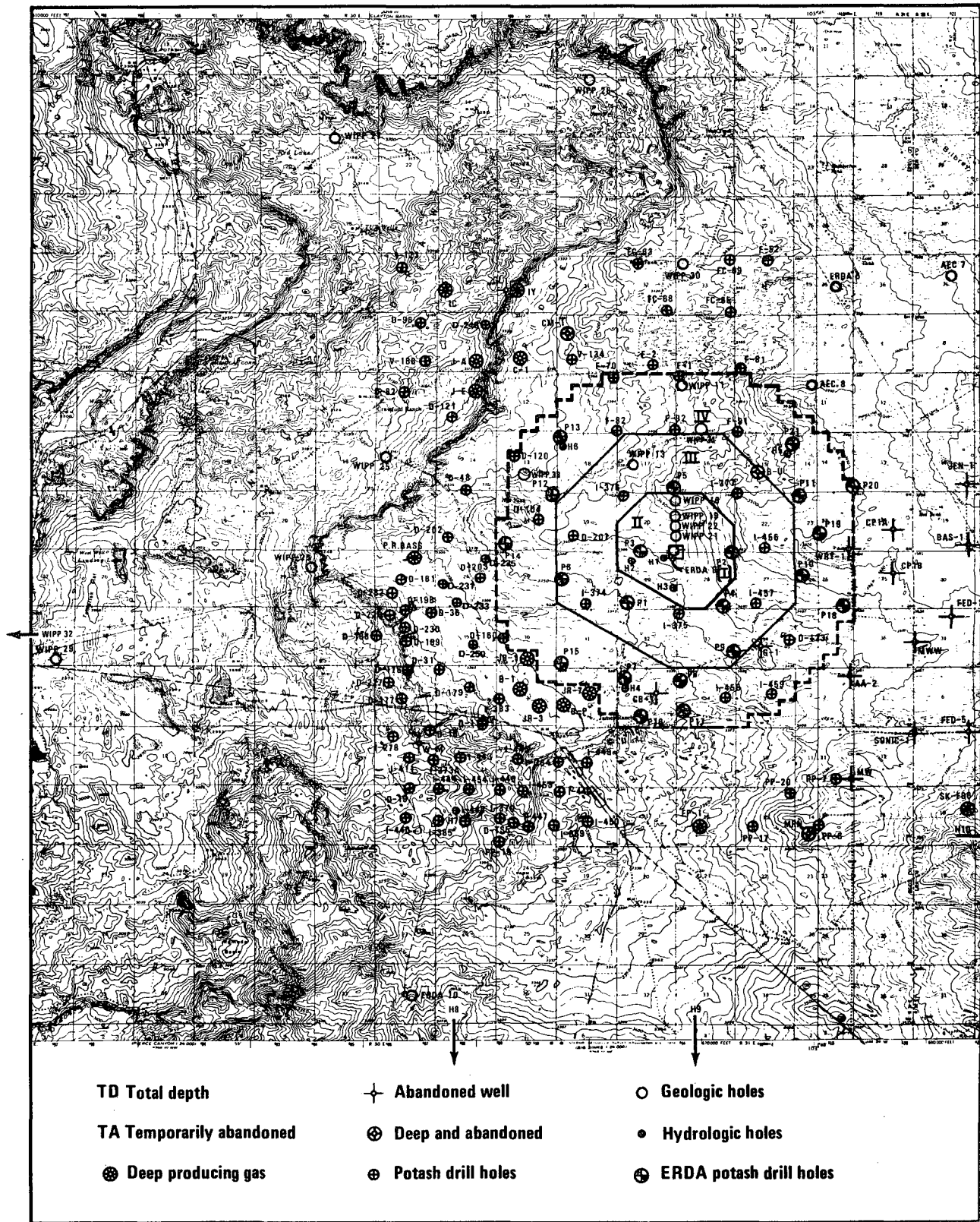

Figure J-1. Exploratory drill holes in the WIPP site.

Table J-1. Exploratory Drill Holes in the Vicinity of the Site

Designation	Start date	Purpose	Total depth (ft)
AEC-7	3-74	Stratigraphic	3918
AEC-7	3-74	Stratigraphic	3918
AEC-8	5-74	Stratigraphic	
(deepened)	6-76	Deep hydrologic	4910
ERDA-6	6-13-75	Stratigraphic	2776
ERDA-9	4-28-76	Stratigraphic	2886
ERDA-10	8-18-77	Deep dissolution	4431.5
P-1	8-23-76	Potash	1591
P-2	8-25-76	Potash	1895
P-3	8-26-76	Potash	1676
P-4	8-27-76	Potash	1857
P-5	9-10-76	Potash	1830
P-6	9-3-76	Potash	1573
P-7	9-4-76	Potash	1574
P-8	9-8-76	Potash	1660
P-9	9-16-76	Potash	1796
P-10	9-24-76	Potash	2009
P-11	9-24-76	Potash	1940
P-12	9-17-76	Potash	1598
P-13	9-17-76	Potash	1576
P-14	9-24-76	Potash and hydrologic	1545
P-15	10-4-76	Potash and hydrologic	1465
P-16	9-27-76	Potash	1585
P-17	10-18-76	Potash and hydrologic	1660
P-18	10-19-76	Potash and hydrologic	1998
P-19	10-19-76	Potash	2000
P-20	10-6-76	Potash	1995
P-21	10-15-76	Potash	1915
H-1	5-20-76	Hydrologic	856
H-2A	2-14-77	Hydrologic	563
H-2B	2-7-77	Hydrologic	661
H-2C	2-28-77	Hydrologic	795
H-3	7-25-76	Hydrologic	902
H-4A	5-16-78	Hydrologic	415
H-4B	5-14-78	Hydrologic	529
H-4C	4-30-78	Hydrologic	661
H-5A	6-13-78	Hydrologic	824
H-5B	6-4-78	Hydrologic	925
H-5C	6-24-78	Hydrologic	1076

Table J-1. Exploratory Drill Holes in the Vicinity
of the Site (continued)

Designation	Start date	Purpose	Total Depth (ft)
H-6A	7-7-78	Hydrologic	525
H-6B	6-28-78	Hydrologic	640
H-6C	6-21-78	Hydrologic	741
H-7A	9-18-79	Hydrologic	154
H-7B	9-13-79	Hydrologic	286
H-7C	9-6-79	Hydrologic	420
H-8A	9-7-79	Hydrologic	505
H-8B	8-6-79	Hydrologic	624
H-8C	7-27-79	Hydrologic	808
H-9A	7-9-79	Hydrologic	559
H-9B	8-14-79	Hydrologic	708
H-9C	8-1-79	Hydrologic	816
H-10A	8-21-79	Hydrologic	1318
H-10B	10-7-79	Hydrologic	1398
H-10C	8-11-79	Hydrologic	1538
WIPP-11	2-5-78	Stratigraphic	3577
WIPP-12	11-9-78	Stratigraphic	2790
WIPP-13	7-26-78	Stratigraphic	1025
WIPP-15	2-8-78	Paleoclimatologic	810
WIPP-16	1-11-80	Stratigraphic	1330
WIPP-18	2-13-78	Stratigraphic	1060
WIPP-19	4-5-78	Stratigraphic	1038
WIPP-21	5-24-78	Stratigraphic	1045
WIPP-22	5-8-78	Stratigraphic	1450
WIPP-25	8-28-78	ND-1 Hydrologic	655
WIPP-26	8-28-78	ND-2 Hydrologic	503
WIPP-27	9-12-78	ND-3 Hydrologic	592
WIPP-28	8-7-78	ND-4 Hydrologic	801
WIPP-29	10-3-78	ND-5 Hydrologic	376
WIPP-30	9-8-78	ND-6 Hydrologic	913
WIPP-31	9-18-78	Stratigraphic	810
WIPP-32	8-7-79	Stratigraphic	390
WIPP-33	7-13-79	Stratigraphic	840
WIPP-34	8-16-79	Stratigraphic	1820
B-25	12-1-78	Stratigraphic	902

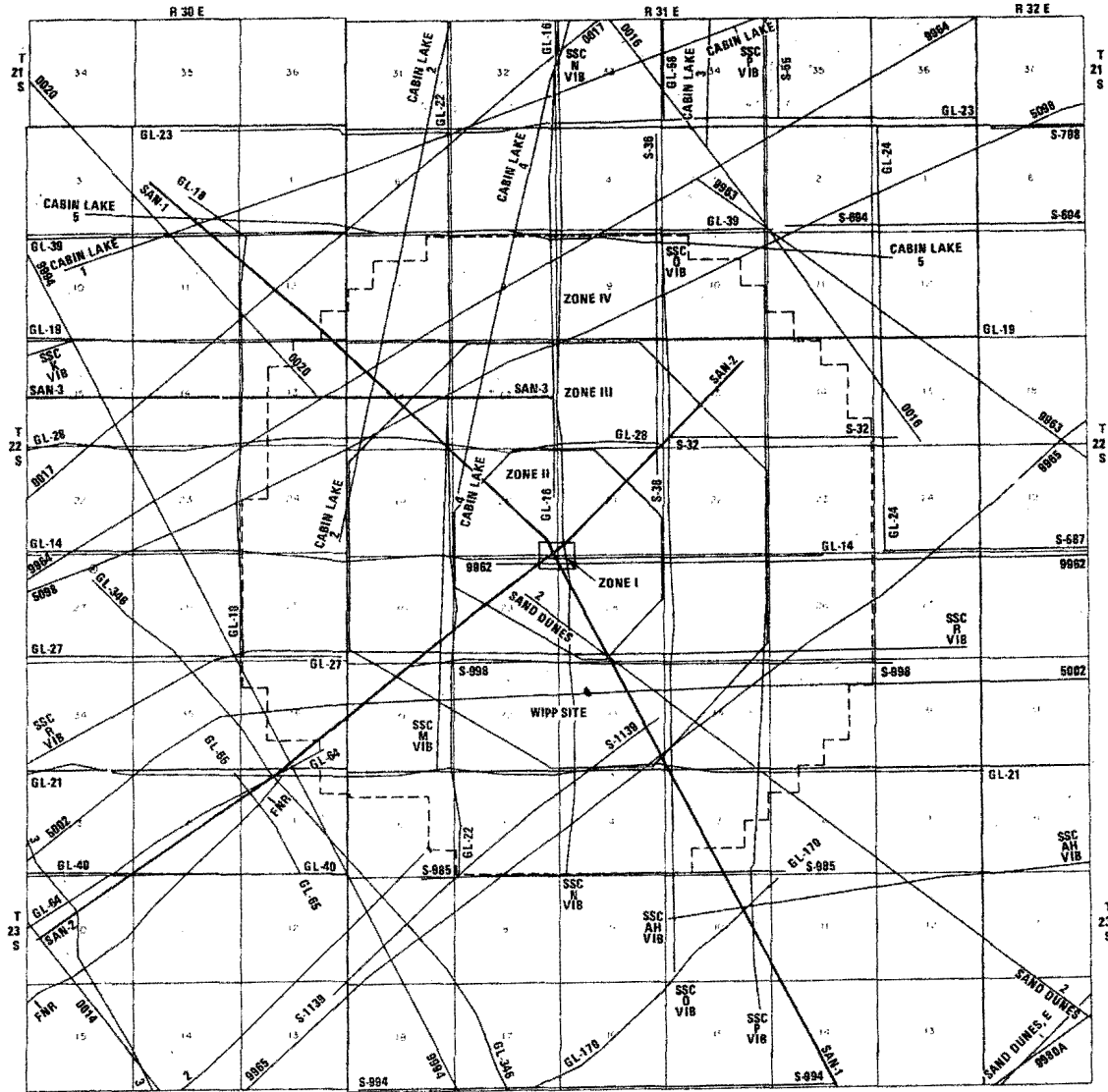

Figure J-2. Industry seismic data and WIPP data from 1976.

Many line-miles of seismic reflection data were available for the study area from petroleum companies, and 26 line-miles of such data were initially obtained by the DOE (Figure J-2), using standard techniques for the petroleum industry. The data are excellent for interpreting deeper structure, but are not as useful for showing reflecting interfaces in the upper 3000 feet. In 1977 about 48 line-miles of new data (Figure J-3) were obtained using shorter spacings for geophones, higher frequencies from Vibroseis units, and higher rates of data sampling. These data show much improved reflections from, and better resolution in, the shallow depths of interest. Resistivity has also been extensively used. Field tests indicate that resistivity can detect certain types of solution features; more than 9000 measurements have been taken in the study area to search for such features (Figure J-4). Additional measurements of resistivity using expander arrays have been made to study resistivity changes with depth and to help interpret the detailed measurements (Figure J-5).

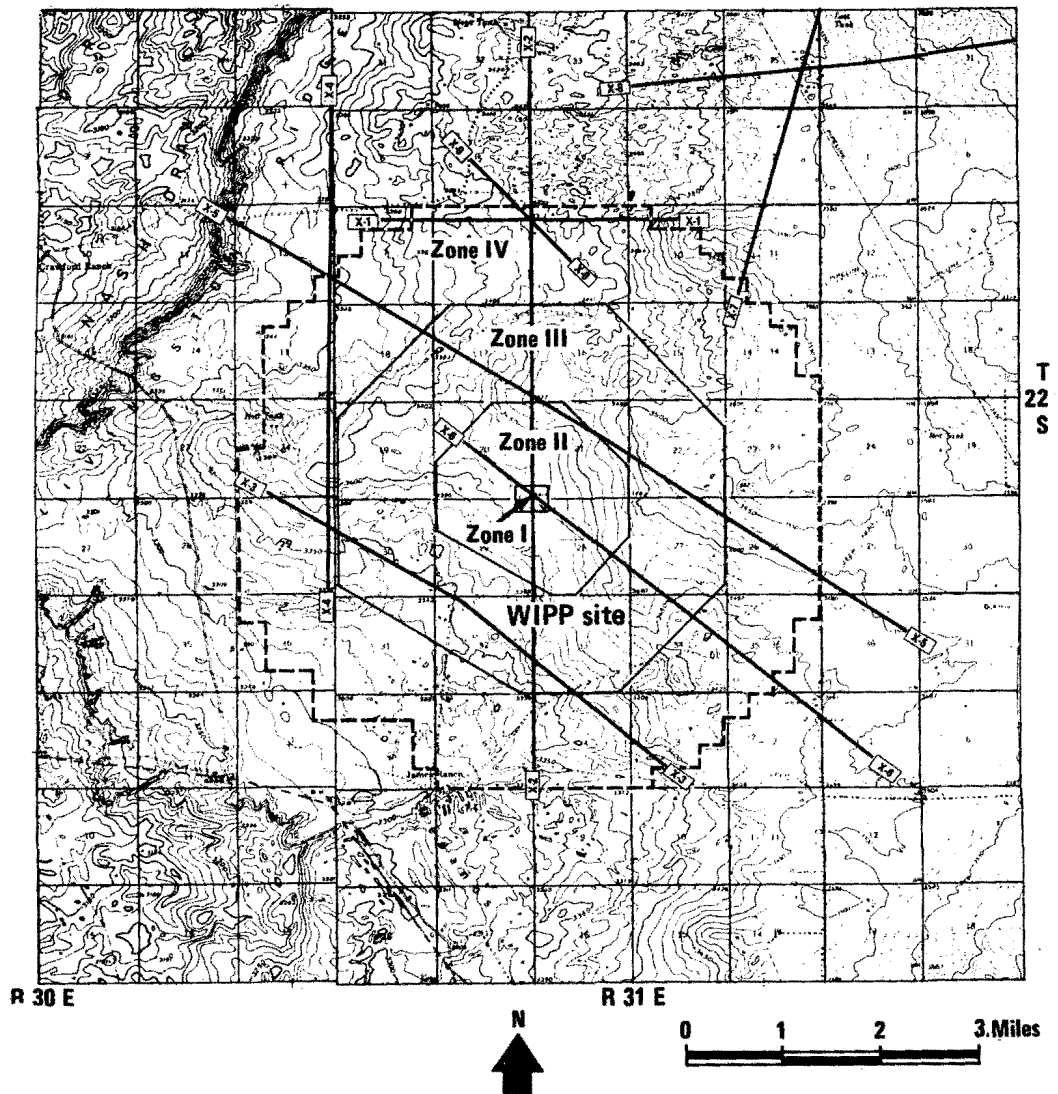

Figure J-3. Seismic program, 1977.

Investigation methods used at the site fall into the major categories of field geology, geophysics, geochemistry, and rock mechanics. The application of these disciplines to studies relevant to the WIPP is outlined below.

Field geology

While all the methods to be discussed may be considered fundamental in the geologic sciences, the term "field geology" is here restricted to the investigations and correlations of regional and local features that are available to the geologist through surface mapping, aerial photography, satellite imagery, and interpretation of borehole and other subsurface data.

The basic starting point of the present investigations was the preparation of a good base map on which the topographic, geomorphologic, and surface-geologic characteristics could be displayed. Existing USGS topographic

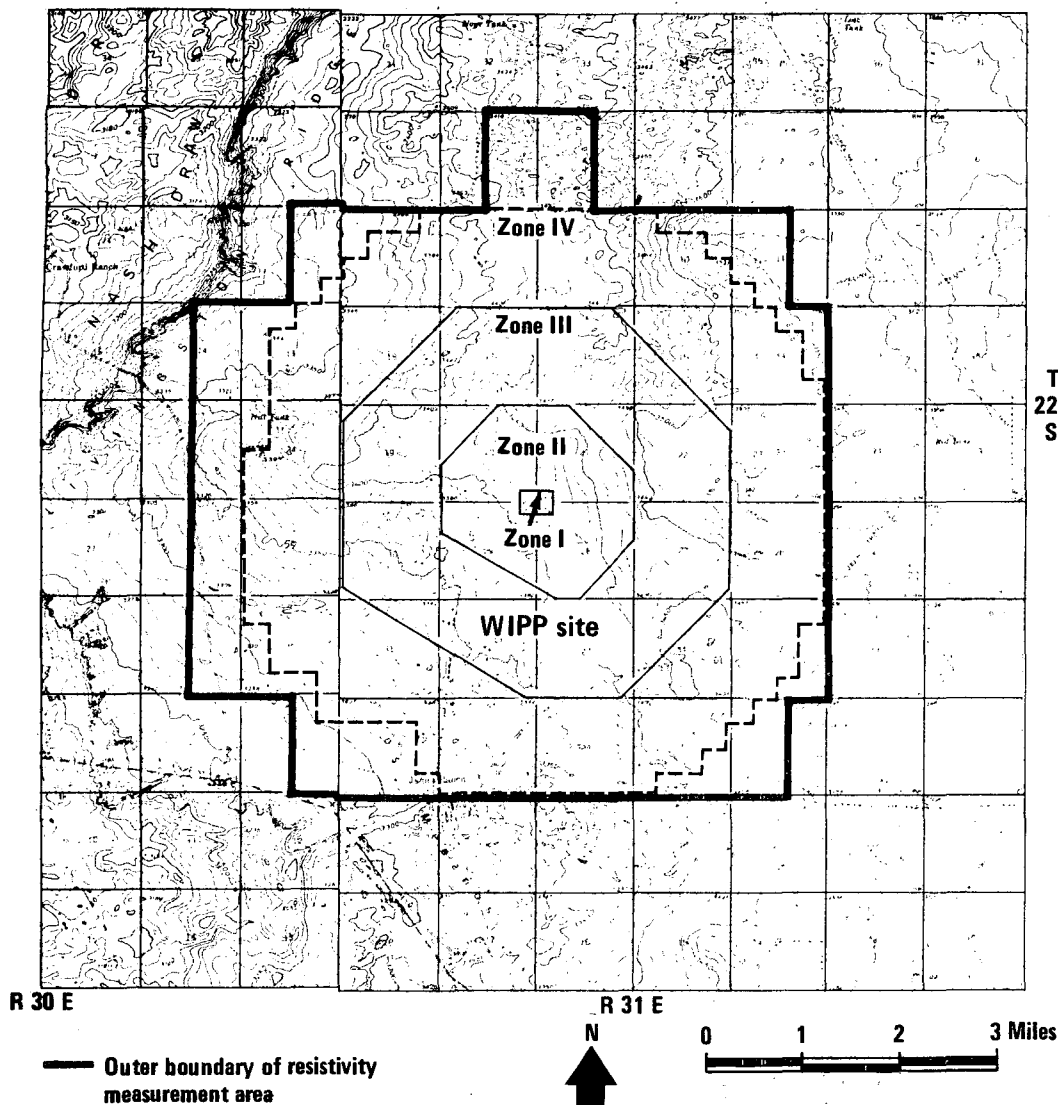

Figure J-4. Location map of gradient resistivity array.

quadrangle maps and aerial photographs were used for this purpose. Aerial photographs, in both color and black and white, were used for the surface mapping of geologic features. Larger-scale features were derived from satellite imagery in reconnaissance style for the southern New Mexico-west Texas area.

Data on surface geology were compiled starting with reports on earlier investigations of the area. It was necessary to supplement this work with more detailed mapping of geologic units in the immediate vicinity of the site. Visual inspection and identification of rock units is necessary at this stage and requires months of field work. Observations of geomorphology and vegetation changes were useful in identifying geologic features for mapping.

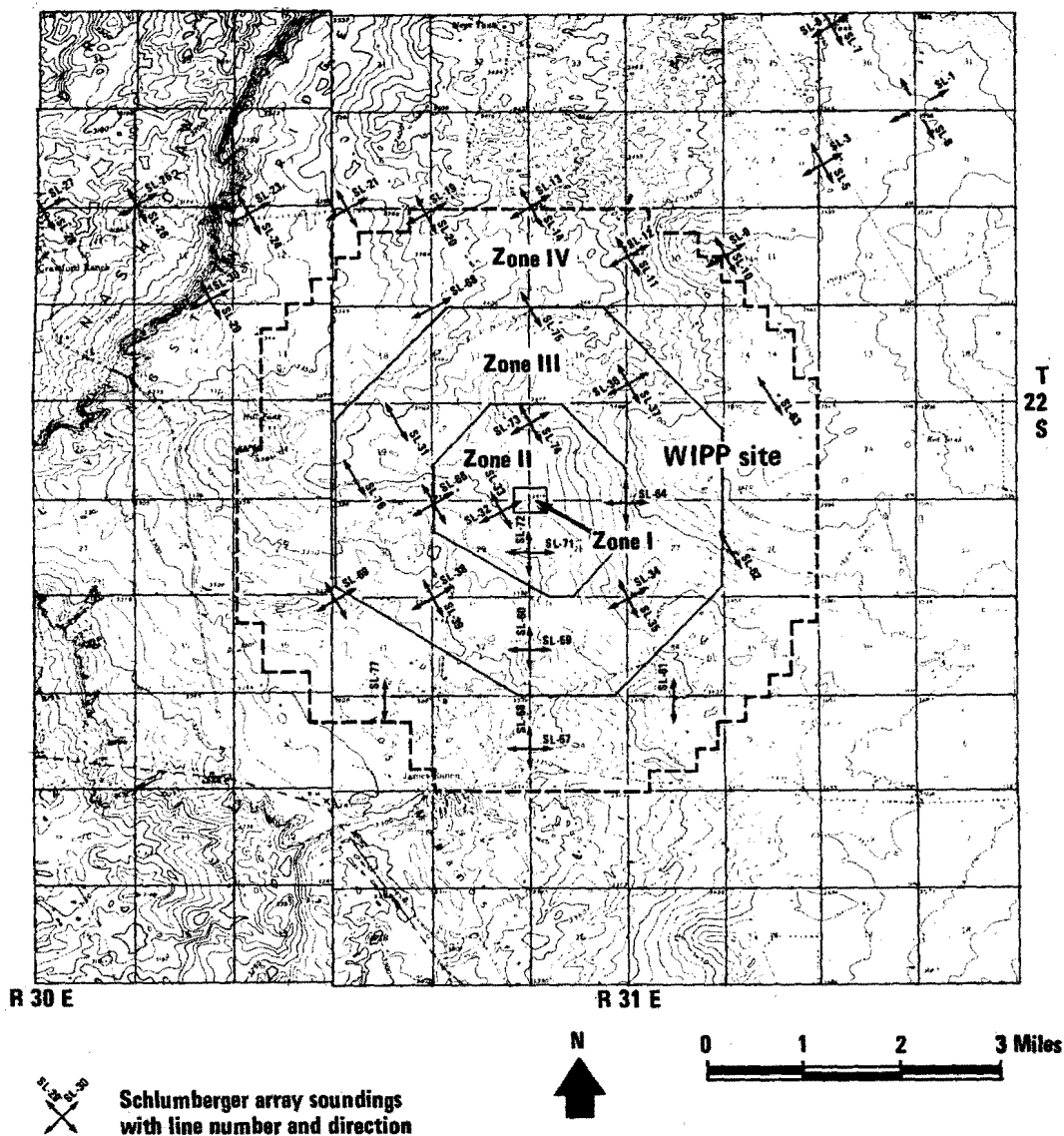

Figure J-5. Location map for resistivity soundings.

Subsurface geology was established using several lines of evidence. Data reported in the literature were the starting point. These were supplemented, and sometimes amended, by proprietary data from petroleum and potash companies that have conducted exploration in the region. Vast quantities of information exist on southeastern New Mexico, both from drill-hole and geophysical tests. Final details were provided by drilling and coring holes for stratigraphic information and conducting geophysical studies to help map formations between boreholes. Cores from boreholes were measured and located relative to the ground surface, described and identified in field notes, and photographed. Lithologic and stratigraphic logs were prepared from examination of the samples. Portions not used in subsequent analyses and tests were sealed in plastic bags, labeled, and stored. All this information is assembled into structural contour and isopach maps for the different geologic formations of interest.

Geomorphologic, topographic, surface, and subsurface geologic maps are all used to interpret the geologic history and tectonic setting of the area. In certain instances, paleontological or paleobotanical information is useful in establishing the chronology of events. Micropaleontology is being used to provide a more thorough understanding of solutioning processes and their rates since Pleistocene time. Samples are obtained by coring deposits in solution sinks in the Delaware basin. Coupled with the physical and geochemical studies, a chronology of events can be developed that allows an estimate of process rates and provides some confidence that forecasts into the near geologic future will not be unreasonable.

Geophysics

Early in the preliminary site evaluation, 1500 line-miles of petroleum-company reflection data were examined for evidence of major faults and other structures in the deep (over 4000 feet) formations. The nature of the data limited its usefulness for the examination of shallow (less than 4000 feet) horizons. Information on shallow horizons was acquired by special seismic reflection surveys. Conventional oil-field gear (Vibroseis) was used, with geophone spacing and instrument recording adjusted to provide better resolution at depths of less than 5000 feet. Experience has shown that this technique can provide good information on reflectors in the Castile Formation and below but must be used with a great deal of caution in attempting to define the attitude of the top of the Salado. Reflections from this horizon and depth are erratic.

Only a limited amount of seismic refraction work was carried out to determine weathering conditions for the reflection work. Where possible, sonic logs or uphole surveys were preferred for this purpose.

Electrical resistivity proved to be a valuable tool in searching for dissolution-related features in the Delaware basin. Resistivity surveys over known solution features, such as "breccia pipes," give characteristic signatures. Consequently, closely spaced resistivity surveys were made over the site to examine it for these anomalies. Indicated anomalies were then confirmed or denied by test drilling. The surveys were run along lines 500 feet apart over the entire 30 square miles of the site area and resulted in about 9000 data points. Two different measurement configurations were used. The modified Werner electrode placement was used for the areal survey described above, and an "expander" array was used to investigate changes in resistivity with depth at a given location. The latter configuration was used to determine whether low resistivities were associated with the presence of the shallow-dissolution zone.

Magnetic methods were employed to search for both regional and local features expected to show magnetic contrast. Existing aeromagnetics of the Delaware basin was examined for indications of major faulting or igneous intrusions. An igneous dike 9 miles northwest of the site was all that was observable in these data; a higher-resolution survey will be used to examine the region near the site for similar but less evident intrusives. Ground surveys and detailed aeromagnetic surveys were tried but were found to be ambiguous in detecting solution-collapse features.

Gravity data for the Delaware basin were examined for indications of major geologic structures and for their utility in detecting collapse features. The

absence of the former in the site and the failure of collapse features to exhibit significant density differentials limited the usefulness of the gravity technique.

First-order level-line surveys tied into the national grid established by the National Geodetic Survey (NGS) were made by NGS within the region and locally, in a more dense pattern, in and near the site. These permanent stations will be periodically reoccupied to detect tectonic movements and subsidence due to dissolution and potash mining.

Geochemistry

Geochemical measurements include techniques used to determine the mineral composition, chemical composition, fluid content and composition, age of rocks, and postdepositional history of recrystallization. Mineral composition has been determined through visual inspection, petrographic microscope examination, and X-ray diffraction. When large numbers of samples are involved, X-ray diffraction has been the preferred technique.

Chemical composition has been obtained by analytical-chemistry and atomic-absorption methods. For most purposes atomic absorption is satisfactory and more rapid than wet-chemistry techniques.

Fluid inclusions in salt are counted by microscopic examination. The mass of the fluid is determined by crushing, heating, and recording the weight loss of the sample. In favorable samples the effluent is analyzed by gas chromatography or mass spectrometry. Inferences on fluid-inclusion composition are also obtained by cooling the sample and observing the "freezing" point.

Brines are studied for clues to their past history by applying mass spectrometry to obtain oxygen-18/oxygen-16 and deuterium/hydrogen ratios.

Age dating of evaporites may be attempted by examining rubidium/strontium ratios. Dating of old brines has been attempted through analysis of the uranium-234/uranium-238 disequilibrium. Satisfactory age-dating techniques for old brines and evaporites are not well developed.

Rock mechanics

The rock-mechanics methods described here include both physical and thermal tests applied to rock specimens.

The elastic and strength properties of the salt and other rock samples are determined by stressing machined specimens under conditions of both uniaxial and triaxial stress. Special creep-test apparatus has been built to test rheological properties as a function of temperature and pressure applied over long periods of time.

The permeability of salt to various gases (helium, nitrogen, hydrogen) has been established by laboratory tests on single crystals and on rock cores. Variations in permeability as a function of pressure are also measured. In-situ tests will be conducted in potash mines in the future.

Thermal properties have been measured on laboratory samples and at bench scale. Parameters determined are thermal conductivity, thermal diffusivity,

thermal expansion coefficient, and specific heat capacity. Radiant heat transfer has also been examined and found to be relatively minor. These properties are determined by standard laboratory techniques. On larger, bench-scale samples, holes are drilled into the block for heater elements, thermocouples, and strain gauges. These tests allow the determination of average properties more representative of in-situ conditions.

Radiation effects on salt have also been examined in laboratory tests. Induced crystal-lattice defects resulting in "stored energy" are found to be similar in magnitude to those described in the literature for other salts.

Seismology

Information about the regional seismicity around the site falls into two groups. The first includes information obtained before 1962, when no specialized instrumentation existed close to the area. During that period, there were not enough seismic stations in the southwestern United States to provide instrumental coverage of southeastern New Mexico. Therefore, these data describe earthquakes that people felt and that were reported in the technical literature, including the annual publication U.S. Earthquakes. Sanford and Topozada (1974) gathered other information from newspaper accounts, recollections of long-time residents, records of museums, historical societies, and the like. The principal weakness of these early seismic data is that they are partly a function of population density.

The second group of data began to be collected after instrumentation was established in 1960 and 1962 at Socorro by the New Mexico Institute of Mining and Technology and at Sandia Base near Albuquerque by the Atomic Energy Commission and the Coast and Geodetic Survey. Additional Coast and Geodetic Survey stations, established in 1962 in Las Cruces, New Mexico; Payson, Arizona; and Fort Sill, Oklahoma, permitted epicenters to be determined for local events. Since April 1974, A. R. Sanford of the New Mexico Institute of Mining and Technology has operated a vertical, single-component, continuously recording seismograph station (CLN), 4 miles east-northeast of the site, to monitor seismicity near the site. An array of several additional stations is being deployed at and around the WIPP site in fiscal year 1980 to provide additional information on the rare seismic events within 40 miles of the site. Useful information has also been obtained from a seismograph station operated at Fort Stockton, Texas, from June 21, 1964, to April 12, 1965, as part of the federally sponsored Long Range Seismic Measurement (LRSM) system. From November 1975 to October 1979, the USGS operated a 10-station seismic array near Kermit, Texas, about 60 miles southeast of the site, to monitor seismicity in the Central Basin platform.

J.1.2 Hydrology

Hydrology is a major consideration in examining the feasibility of a site for radioactive-waste disposal. Two factors are directly related to hydrology: (1) the geologic stability of the formation in which the waste will be stored and (2) the presence of groundwater as a transport medium. Because unsaturated waters migrating along the surfaces of salt beds will dissolve salts, an examination of the integrity of the Salado Formation is directed into three study areas: (1) the Rustler-Salado contact beneath the site, to determine

whether dissolution is presently occurring; (2) the front of the shallow-dissolution zone in Nash Draw, to more precisely map active dissolution boundaries; and (3) the estimated rates of dissolution at the top and the bottom of the salt, to refine analyses of hazards to the site. Further definition of the hydraulic gradients and rates of fluid movement in the fluid-bearing zones that overlie the Salado will aid in refining the estimates of potential groundwater transport of radionuclides.

Inventory of test holes

The objectives of the hydrologic testing program at the WIPP site are to determine the potentiometric head, the hydraulic character of the rock strata, and the chemistry of formation waters. These hydrologic tests are commonly made in exploratory test holes either during drilling or after the holes have been drilled to total depth.

As of June 1980, hydrologic tests had been conducted at 16 locations in exploratory test holes at the site. Of the 16 locations investigated, ten were specifically designed for hydrologic testing: H-1 through H-10 (Figure J-6). The first three of these were drilled in a triangular array 0.5 mile on a side for the purpose of determining hydraulic gradients in the fluid-bearing zones above the Salado Formation near ERDA-9.

The potash test holes P-14, P-15, P-17, and P-18 shown in Figure J-6 were not drilled specifically for hydrologic testing, but for exploring potash mineral deposits. These holes have been used, however, for determinations of potentiometric head in the fluid-bearing zones above the salt under the southern perimeter of the site.

Two other holes, AEC-8 and ERDA-10, were used for testing fluid-bearing zones below the Salado salt section. The AEC-8 hole, drilled before the WIPP project began, was deepened for testing fluid-bearing zones in the Castile Formation and the Delaware Mountain Group. Similar testing of the Delaware Mountain Group was conducted in ERDA-10.

After drilling and testing holes H-1 through H-3, eight triangular arrays--at locations H-2 and H-4--were designed and drilled at a spacing of about 100 feet. These three-hole complexes, in addition to providing long-term open-hole testing, permit static fluid-level monitoring and pump testing to check for vertical or horizontal communications between fluid-bearing zones. Together with P-14, P-15, P-17, and P-18, the three-hole complexes form part of a network of holes, 2 to 3 miles apart, completely encircling the site.

Finally, six holes (WIPP-25 through WIPP-30) have been drilled in Nash Draw to the west. Their purpose is to define the hydrologic character of Nash Draw in relation to that of the WIPP site. They are being tested now; testing will be complete by October 1980.

General methods used in drilling

Air-rotary drilling was used to drill the holes designed specifically for hydrologic testing at the site. This method differs from standard rotary drilling in that the fluid or mud gel usually used to cool the bit and remove cuttings is replaced by compressed air. The air method was used to make it

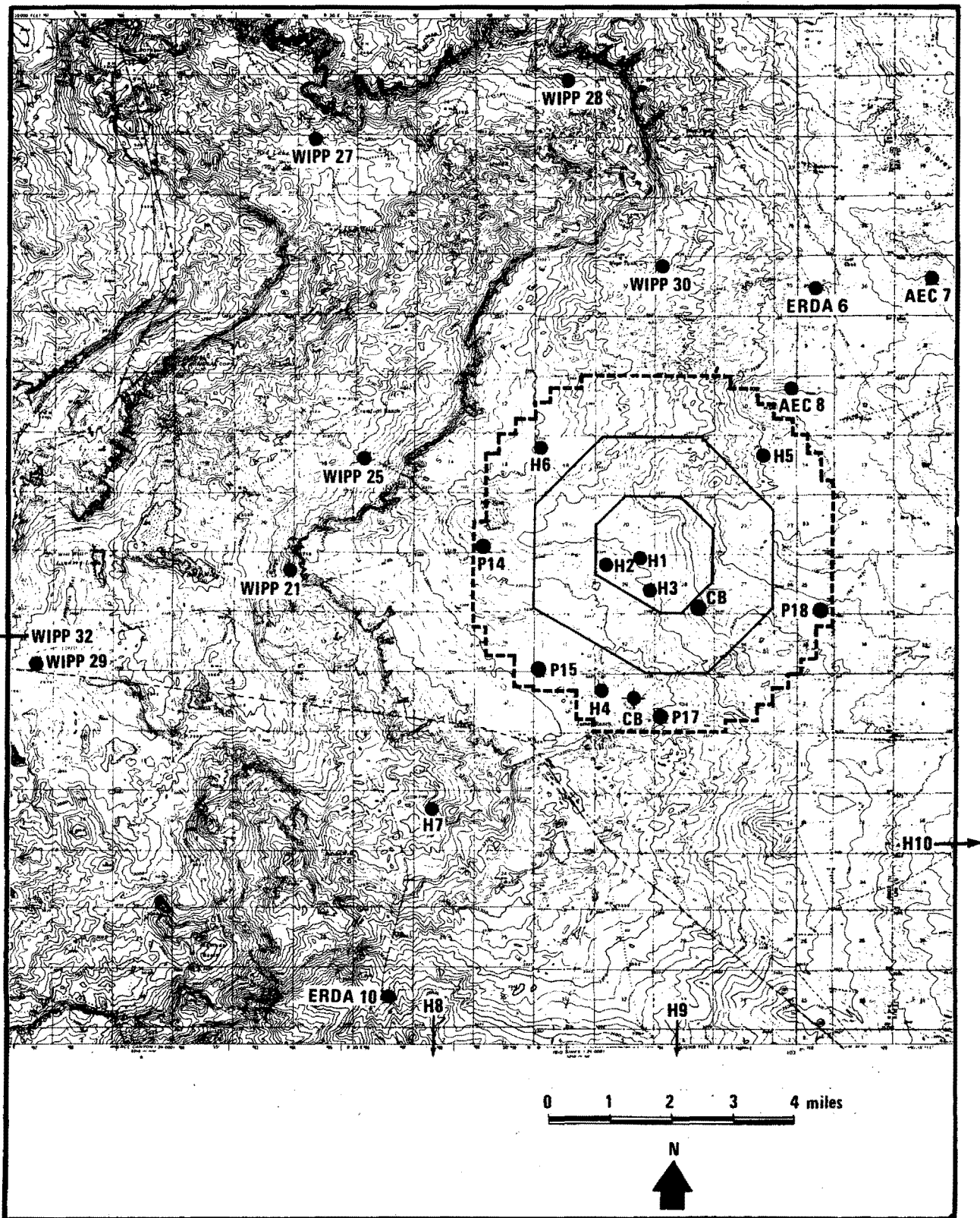

Figure J-6. Location of drill holes used for hydrologic testing.

easier to identify zones that might contain fluid and to prevent the plugging of the aquifer test zones, which may occur when standard drilling fluids are used.

Detailed strategies for drilling and testing

The hydrologic complexes have been drilled and tested following generalized criteria. To date complexes 2 and 4 through 10 (each complex consisting of three holes) have been completed. The H-2 complex is described below as an example of the strategy that was used.

The H-2 complex consists of three holes spaced as shown in Figure J-7. Hole 2a penetrates the Magenta aquifer, hole 2b the Culebra aquifer, and hole 2c the Rustler-Salado contact (Figure J-8). This three-hole configuration makes possible four types of study: independent open-hole testing of the Magenta and Culebra aquifers and the Rustler-Salado contact without interference from the other zones, convenient monitoring of the three formations without the use of downhole hardware such as packers, pump tests of low-yield formations in closely spaced holes, and tracer-injection tests. Each hole was drilled to within 10 feet of its intended depth, casing was set and cemented, and then the hole was cored to total depth.

Investigations usually began with the geophysical logging of the open borehole to obtain information on changes in rock strata, formational characteristics, potential zones of water yield, and borehole-diameter changes. These

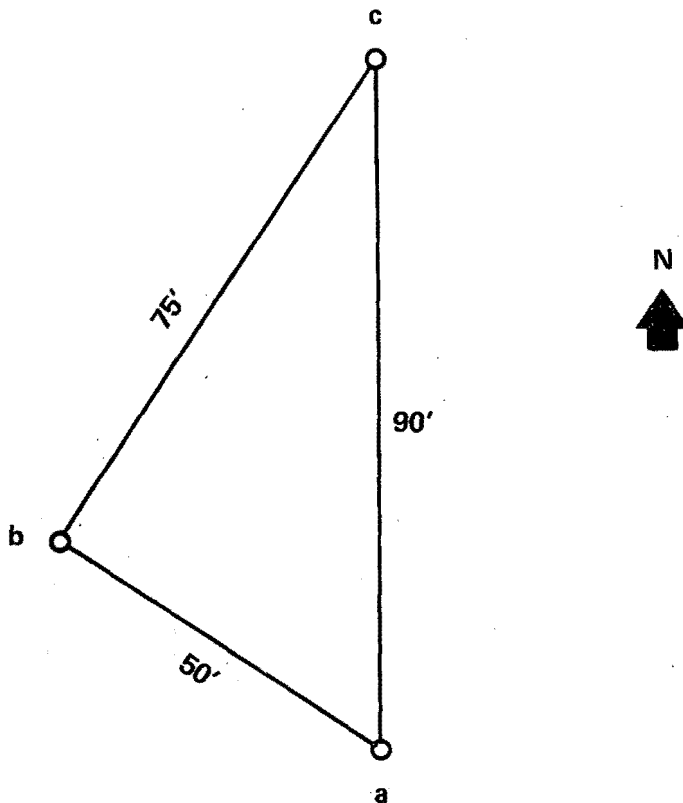

Figure J-7. Plan view showing the configuration of the H-2 three-hole array.

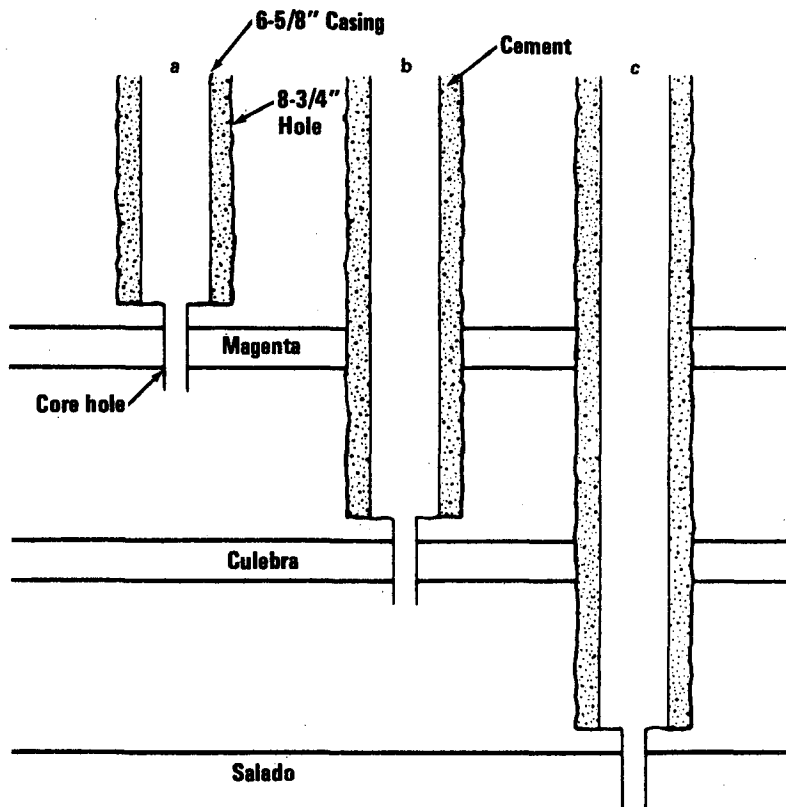

Figure J-8. Configuration of completed H-2 holes.

parameters aided in the selection of borehole intervals to be tested in detail and provided useful information on hole conditions needed in the selection of packer seats. The following logs were run in the deepest of the three-hole array, H-2c: natural gamma and density, caliper, compensated density, compensated neutron gamma ray, dual-induction laterolog, microlaterolog, temperature, acoustic, and 16-inch electric. All holes were surveyed for lateral deviation with a Sperry-Sun directional survey.

After logging, the proposed test zone was isolated by an inflatable packer or packers, and a preliminary drill-stem test (DST) was conducted. The DST is designed to provide a representative sample of formational fluid, undisturbed formation pressure, and estimates of formational permeability. Standard oil-field DSTs were run with slight modifications applied to measuring formation pressures.

Hydrologic tests at the site--whether DSTs, open-hole tests, or cased-hole tests--generally consisted of bailing a known volume of fluid from the borehole. Hydraulic parameters such as hydraulic conductivity, storage, transmissivity, and potentiometric head could be determined by the analysis of observed fluid recovery.

Radioactive-tracer tests are conducted in some hydrologic test holes after they have been cased and perforated at selected intervals. The objective of these tests is to check the quality of cement bonding between the casing and the borehole wall and to provide estimates of the vertical distribution of permeability across the test interval.

Water samples were obtained by bailing only after measurements of conductivity, temperature, and density had indicated that representative formation water was being retrieved.

Rationale for establishing hydrologic complexes

Discussions between WIPP hydrologists and mathematical modelers revealed special data requirements for hydrologic data collection. The general philosophy of hydrologic data collection for the WIPP is outlined in a report (Lambert and Mercer, 1977) that establishes a set of procedures for the collection of data describing the hydrogeologic system of the Rustler Formation at a certain point. The goal of the data collection is to determine a distribution of data values that can establish practical bounds on the spatial nonuniformity of hydrologic parameters and on the variations in experimental results.

Like tests in other hydrologic test holes, these tests are intended to add to the bank of data describing the potentiometric surface, the hydraulic conductivity, and the water quality within the Magenta and the Culebra aquifers of the Rustler Formation and the zone of contact between the Rustler and the Salado. A closely spaced system of holes is required for multihole testing of particular water-bearing, yet low-yielding, zones. Close spacing provides an opportunity for two-hole testing in a finite amount of time, even with the expected low water velocities in the Rustler Formation (Mercer and Orr, 1977).

The locations of hydrologic complexes were based on the need for the following information:

1. Hydraulic definition near the center of the site and at its boundaries (local hydrology)
2. Hydraulic definition outside the boundary of the site (regional hydrology)
3. Location of salt-dissolution fronts and dissolution rates along the western edge of the site
4. Data between already existing holes drilled for other purposes
5. Location of hydraulic boundaries proper for mathematical modeling
6. Location of recharge and discharge areas
7. Verification of assumed directions of groundwater flow

J.1.3 Meteorology

The primary source of meteorological data is the site meteorological station, which has been operating since mid-1976. The three locations of the station are shown in Figure J-9. Specifically, the latest location, 26 miles east of Carlsbad in Section 21, T 22 S, R 31 E, is at elevation 1050 meters, latitude 32 degrees 22.48 minutes north, and longitude 103 degrees 47.24 minutes west.

Until May 1977 the meteorological monitoring system consisted of the following sensors:

- Average wind speed, 10 meters
- Wind direction, 10 meters
- Humidity, 10 meters
- Pressure, 1 meter
- Precipitation, 1 meter
- Ionizing radiation, 1 meter
- Sky radiation, 3 meters
- Temperature, 10 meters

These sensors were interfaced with signal conditioners; their output was recorded by a data logger and a strip-chart recorder. The data logger sequentially sampled data at about three channels per second and displayed output voltages on paper tape. Appropriate calibrations were made to convert this information to engineering units. Computer programs were written to convert and store the data. Peak wind speed was obtained by visually scanning the wind-speed strip chart and finding the maximum wind speed during the hour preceding the report hour.

From November 1977 through March 1980 the meteorological system provided data as described in Table J-2. The on-site meteorological system was designed to comply with most of the criteria in NRC Regulatory Guide 1.23. In September 1978 the 30-meter instruments were raised to 40 meters to insure compliance with this regulatory guide.

The data are managed and processed with a system of two PDP 11/03 mini-computers, each capable of managing 40 channels of information. Recording is made directly on a nine-track incremental magnetic tape. The wind speed and wind direction continue to be recorded on a strip chart for a backup record.

The sensors in the present system are supplied by the Climatronics Corporation. An exception is the rain gauge, which is supplied by Texas Electronics. The sensors are described in Table J-3.

In addition to the above sensors, four solar and terrestrial radiation sensors have been added to the system at a height of 3 meters. Of two pyranometers, one measures the direct component of sunlight and the diffuse, short-wave component of the skylight; the other measures the reflected short-wave component from the surface. Of two pyrgeometers, one measures the long-wave skylight components from the downward emission of atmospheric gases; the other measures the upward emission and reflection by natural surfaces and atmospheric gases.

The pyranometer (Eppley Model PSP) has the following specifications:

Sensitivity	9 mV/(W/m ²)
Impedance	650 ohms
Temperature dependence	+1% over -20 to +40°C
Linearity	+0.5% from 0 to 1800 W/m ²
Mechanical vibration	Tested to 20g

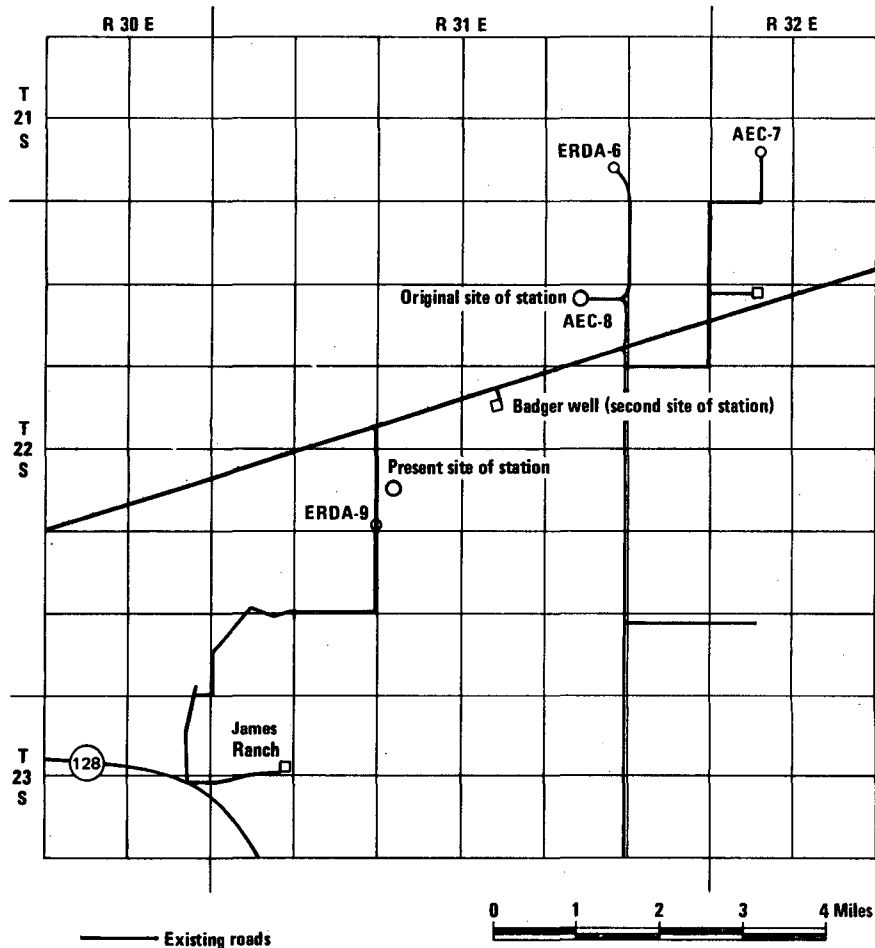

Figure J-9. Location of the meteorology and air-quality-monitoring station.

The pyrgeometer is an Eppley Model PIR; it has the following specifications:

Sensitivity	3 mV/(W/m ²)
Impedance	700 ohms
Temperature dependence	+2% over -20 to +40°C
Linearity	+1% from 0 to 700 W/m ²
Mechanical vibration	Tested to 20g

Maintenance and calibration of all the sensors are performed on a formal, periodic basis.

Additional sources of surface meteorological data used in the site meteorological analysis are the Carlsbad-airport, Hobbs, and Roswell stations that report to the National Climatic Center. Upper-air data have come from the Albuquerque, El Paso, Midland-Odessa, and Lubbock stations that report to the National Climatic Center.

Table J-2. Summary of Meteorological Measurements

Parameter	Height (meters)	Sampling interval	Recording interval	Units
Pressure	3	1 hour	1 hour	mb
Precipitation	1	1 hour	1 hour	cm
Dew point	3	1 hour	1 hour	°C
Temperature	3, 10, 30 ^a	15 sec	15 sec	°C
Wind speed	3, 10, 30 ^a	0.1 sec ^b	15 sec	m/sec
Wind direction	3, 10, 30 ^a	0.1 sec	15 sec	degrees clock- wise from north
Temperature difference	10-3, 30-3, 30-10	15 sec	15 sec	°C

^aThis height was raised to 40 m in September 1978.

^bFor each of the three levels of wind data, the 10-per-second samples are processed to produce 15-second values of mean component values (east-west, north-south), standard deviation of each component, coefficient of correlation between the two components, standard deviations of downwind and crosswind components, and downwind and crosswind components of turbulence intensity.

J.1.4 Air Quality

Air-quality measurements have been made at the meteorological station, which has been at three locations since data collection began in early 1976 (Figure J-9). From January to June 1976 the measurements were made at the AEC-8 drilling pad. The location was changed in June 1976 to the site of the old Badger well in Section 15, R 31 E, T 22 S, and in May 1977 to the most recent location in Section 21. Air-quality measurements were suspended in October 1979.

The air-quality data collected at the site and the methods of collection have been documented by Brewer and Metcalf (1977). Air-quality samples are analyzed for total suspended particulates, sulfur dioxide, nitrogen dioxide, hydrogen sulfide, carbon monoxide, and ozone. The program as operated before November 1977 is described below.

Total-suspended-particulate samples were taken with a high-volume air sampler that originally had its collector head attached to the instrument trailer tower 4 feet above the trailer roof. The samples were collected on glass fiber or on Whatman 41 4-inch-diameter filters. Samples were collected for 24 hours at a constant sampling rate of 18.5 ft³/min. The sampling rate was maintained by flow controllers. Each sample was analyzed for the concentration of sodium, potassium, calcium, magnesium, silicon, iron, aluminum, chloride, and sulfate. These elements and species were selected because they are effluents released by the nearby potash-refining plants. The water-soluble metals, sulfate, and chloride were extracted from the filter by heating in an aqueous solution for 2 hours. Sulfates and chlorides were analyzed by turbidimetric and colorimetric methods, respectively. After extraction, the filters were dissolved in concentrated nitric acid, and the elements were analyzed by atomic-absorption spectrophotometry.

Table J-3. Specifications on Meteorological Sensors Used

WIND SPEED	
Threshold	0.33 m/sec
Distance constant	1.5 meters
Accuracy	0.1 m/sec or $\pm 1\%$, whichever greater
Range	0.3 to 50 m/sec
Linearity	$\pm 0.1\%$ of full scale
Stability	$\pm 0.1\%$ of full scale
Survivability	Gusts to 45 m/sec, sustained to 33 m/sec

WIND DIRECTION	
Threshold	0.33 m/sec
Distance constant	1.5 meters
Accuracy	± 2.5 degrees
Damping ratio	0.4 degree at 10-degree angle of attack
Range	0 to 540 degrees
Linearity	$\pm 0.1\%$ of full scale
Stability	$\pm 0.1\%$ of full scale
Survivability	Gusts to 45 m/sec, sustained to 33 m/sec

TEMPERATURE	
Range	-30 to $+50^{\circ}\text{C}$
Accuracy	$\pm 0.25^{\circ}\text{C}$
Linearity	$\pm 0.2^{\circ}\text{C}$

DEW POINT	
Range	-40 to $+42^{\circ}\text{C}$
Accuracy	$\pm 0.5^{\circ}\text{C}$
Response time	$1^{\circ}\text{C}/\text{min}$

TEMPERATURE DIFFERENTIAL	
Accuracy	0.1°C
Range	-2 to $+10^{\circ}\text{C}$

STATION PRESSURE	
Range	850 to 975 mb
Linearity	$\pm 0.3\%$
Sensitivity	0.2%

RAIN GAUGE	
Type	Tipping bucket
Measurement	0.01-inch water per tip
Signal out	Momentary switch closure

Air samples for particle-size determination and mineralogical analysis were taken for periods of 5 to 7 days once a month. A Sierra Cascade impactor with five stages was used. The impactor was originally located on the trailer roof, about 12 feet above the ground.

Sulfur dioxide, hydrogen sulfide, and nitrogen dioxide were determined by wet-chemistry techniques. The sampling frequency was once a week on a random-day basis. The wet-chemistry sampler was located about 3 feet above the roof of the meteorological trailer. The sampling rate was 200 ml/min in high-efficiency bubblers. The sulfur dioxide and nitrogen dioxide samples were analyzed colorimetrically; the hydrogen sulfide samples were titrated. The methods used were standardized through the use of samples of known concentrations.

Carbon monoxide was detected with a continuous nondispersive infrared analyzer. An average concentration for each 24 hours was calculated. The monitor was calibrated weekly by means of a carbon monoxide-in-nitrogen gas standard. The monitor sampling inlet was inside the housing of the Sierra Cascade impactor.

Ozone was measured continuously with an automated ultraviolet-absorption detection technique. An average concentration for each 24 hours was calculated. The ozone monitor was calibrated weekly by electronic methods.

After November 1977, changes were made to the original system for air-quality monitoring. The system was automated to reduce recording by personnel. Of primary importance was the introduction of a redundant system of PDP 11/03 minicomputers to manage data input from the sampling devices. The concentrations of all monitored species are monitored by the minicomputers. The data are averaged and recorded every 15 seconds. The species continuously monitored are ozone, oxides of nitrogen, carbon monoxide, total hydrocarbons, sulfur dioxide, and hydrogen sulfide.

Changes in pollutant-detection techniques after November 1977 included new methods for sulfur dioxide and hydrogen sulfide, which were then measured with pulsed-ultraviolet-fluorescence detectors; total hydrocarbons, which were then measured with a flame-ionization detector; and oxides of nitrogen, which were then measured by a chemiluminescence technique. Total-particulate samples were analyzed for lead for about 6 months. This analysis was in addition to the other elements measured before November 1977. No lead was detected in any of the samples during this 6-month interval, and the analysis was therefore discontinued. All elements are analyzed by atomic-absorption spectrometry.

The location of some of the sampling equipment was also changed. The Sierra Cascade impactor was relocated 12 feet above the ground on a sampling platform. The high-volume sampler and the wet-chemistry sampler inlet, a chemical sampler now used as a backup system, are also on the platform at heights of 10 and 8 feet, respectively. The preoperational program samplers will remain at these levels.

J.1.5 Ecology

From 1975 through 1977, the New Mexico Environmental Institute (NMEI) carried out environmental baseline studies for the DOE in the area of the WIPP site. Their results are published in two progress reports (Wolfe et al., 1977a, 1977b).

During 1977, the biological team was reorganized. Baseline studies were continued and in some cases augmented. The area within a 5-mile radius of the center of the WIPP site was designated the Terrestrial Ecology Study Area. Semipermanent transects, unfenced plots, and exclosures have been established in connection with these studies. Some will be retained as permanent sites for ecological monitoring during and after the operational period. Field and laboratory methods are detailed in the annual report for fiscal year 1978 (Best and Neuhauser, 1979).

All major habitats within the study area have been and are being sampled seasonally for plants, mammals, birds, reptiles, amphibians, terrestrial invertebrates, and aquatic species. In addition, microbial flora, soils, and nutrient cycling have been and are being studied.

Soil studies

The objectives of the soil studies are (1) to confirm and refine the physical and chemical descriptions of the major soils series in the study area; (2) to study soil-water-plant relationships; and (3) to characterize biologically mediated chemical transformations in the soil. These activities are being carried out in close cooperation with the vegetation mapping work because plant community composition is often strongly influenced by soil characteristics.

Microbial processes in terrestrial and aquatic communities are being studied to determine primary productivity and to assess what impact these processes may have on radionuclide mobilization or demobilization. Furthermore, soil crusts of cyanobacteria and lichens have been described at the site; they cover large areas of soil and are thought to contribute significantly to soil stabilization. The affects of climatic variation on these crusts and the rate of colonization of freshly bared surfaces are of interest because the magnitude of wind and water erosion at the site may be influenced by changes in the soil crust.

Botanical studies

The objectives of botanical studies are (1) to obtain as complete a species list as possible, with special attention to possible rare, threatened, or endangered species; and (2) to gather density and distribution data in order to construct a vegetation map and to determine primary productivity. The reproductive and vegetative phenophases of dominant species are also being determined. These data can be correlated with soil data, as noted above, and with data on consumers (amphibians, reptiles, birds, and mammals) to provide a picture of trophic relationships at the site. Annual and seasonal variations due to changes in rainfall and other climatic factors are recorded. These variations, which directly affect many populations of primary consumers, are often extreme in this semiarid region. Baseline data covering several years will, however, provide a reliable estimate of the magnitude of natural variation.

The succession of plant communities that occurs in disturbed areas and the impact of grazing pressure on existing plant communities are also being studied because WIPP construction must inevitably cause at least localized disturbances that will alter the structure of plant communities as defined by the baseline data. The objective of these studies is to obtain data that will make it possible to predict the kind and the magnitude of changes induced by such disturbances.

Terrestrial invertebrate studies

In addition to providing an inventory list of invertebrates in the study area, the studies focus on the role of soil arthropods, especially termites, in the cycling of soil nutrients and detritus. In addition to density and distribution data, feeding rates and estimates of the quantities and types of material transported and consumed are being made; the effects of termites on soil movement and redistribution are also being measured. Aside from their crucial role in nutrient cycling in this ecosystem, the termites may affect the distribution of radionuclides deposited on soil and plant surfaces.

Terrestrial vertebrate studies

The species composition and density distribution of terrestrial vertebrates within the study area are being studied, as are the feeding habits, population dynamics, and reproductive phenology of selected species. These studies include amphibians, reptiles, birds, and mammals. Significant annual changes in densities are correlated with plant density and weather data. Special attention is given to the possible presence of rare, threatened, or endangered species.

Aquatic studies

The objective of the aquatic studies is to establish baseline levels for parameters of significance at the aquatic study sites. These include physical-chemical water-quality data, density, and population dynamics data for flora and fauna at major trophic levels. Study sites are located at stock tanks within the terrestrial study area, nearby playas, Laguna Grande de la Sal, and several stations along the Pecos River. The possible presence of rare, threatened, or endangered species is given special attention.

Radioecological monitoring

As a result of the above studies, indicator organisms will be selected for long-term monitoring. Factors involved in the selection process will include trophic level, sensitivity to other ecological stresses, and difficulty and expense of monitoring. Organisms at high trophic levels should be included to detect biomagnification. However, several otherwise suitable species--for example, hawks--are rare and/or protected by law. Thus, the selection process must consider such factors as well as strictly technical considerations. Final development of a monitoring program cannot take place until all baseline data are analyzed.

J.1.6 Radiation Monitoring

A radiation-monitoring program has been established at the WIPP site to assess the level of natural background radiation in the area and its variations with time. This program will continue at its present level until about 2 years prior to the expected beginning of plant operation. At that time, the program will be increased in scope to be consistent with the requirements of ERDA Manual Chapter 0513--the current DOE regulations for preoperational environmental monitoring.

When the current environmental sampling program was instituted, no site-specific meteorological data were available to use in choosing sampling locations, nor had a potential site been selected for the WIPP surface facilities. Therefore, several sites were selected that would be accessible and would provide information on the variability of the radiation background within the boundaries of the site. With the meteorological data now available, the selection of future sampling locations can be based on EPA guidelines for nuclear power plants (EPA ORD/SID 72-2), taking into account local terrain, population distribution, and meteorological conditions.

The preoperational program is characterized below, although it cannot be described in detail until the WIPP is nearer to operation. The construction of the WIPP will have no effect on the radiological levels of the environment except that the accumulation of mined-salt piles, which contain naturally occurring potassium-40, radon-220, and radon-222, may increase the site background levels slightly. More detail will be added when the full program begins 2 years before the expected commencement of operation. Instrument detection limits and sensitivities will be selected to insure that radiation levels well below standards can be detected. In addition, a strict quality-assurance program will be followed. Procedures will be written and standardized for each type of analysis. Accuracy and standardization will be maintained by routine quality-control procedures. The quality-assurance program will also insure samples of sufficient size to provide accurate measurements.

Air particulates

Air-particulate samples have been taken at the site meteorological station (Figure J-10). Samples were taken three times a week for 24 hours by a high-volume air sampler (18.5 ft³/min) with Whatman-41 filter media. Gross beta concentrations are measured by a beta proportional counter. If the beta activity exceeds 0.06 pCi/m³, a gamma scan may also be taken.

For the preoperational monitoring program a network of air samplers will be established at and in the vicinity of the WIPP site. Sampling sites will be determined based on population distribution, meteorological conditions, and other factors to insure that both maximum and representative conditions can be detected. Gross alpha and gross beta counting will be performed on the filter media, and analyses of the collected particulates will be performed.

If the results of the initial counting indicate that higher than normal concentrations are present, additional analyses will be performed to determine the source and type of nuclides in the samples.

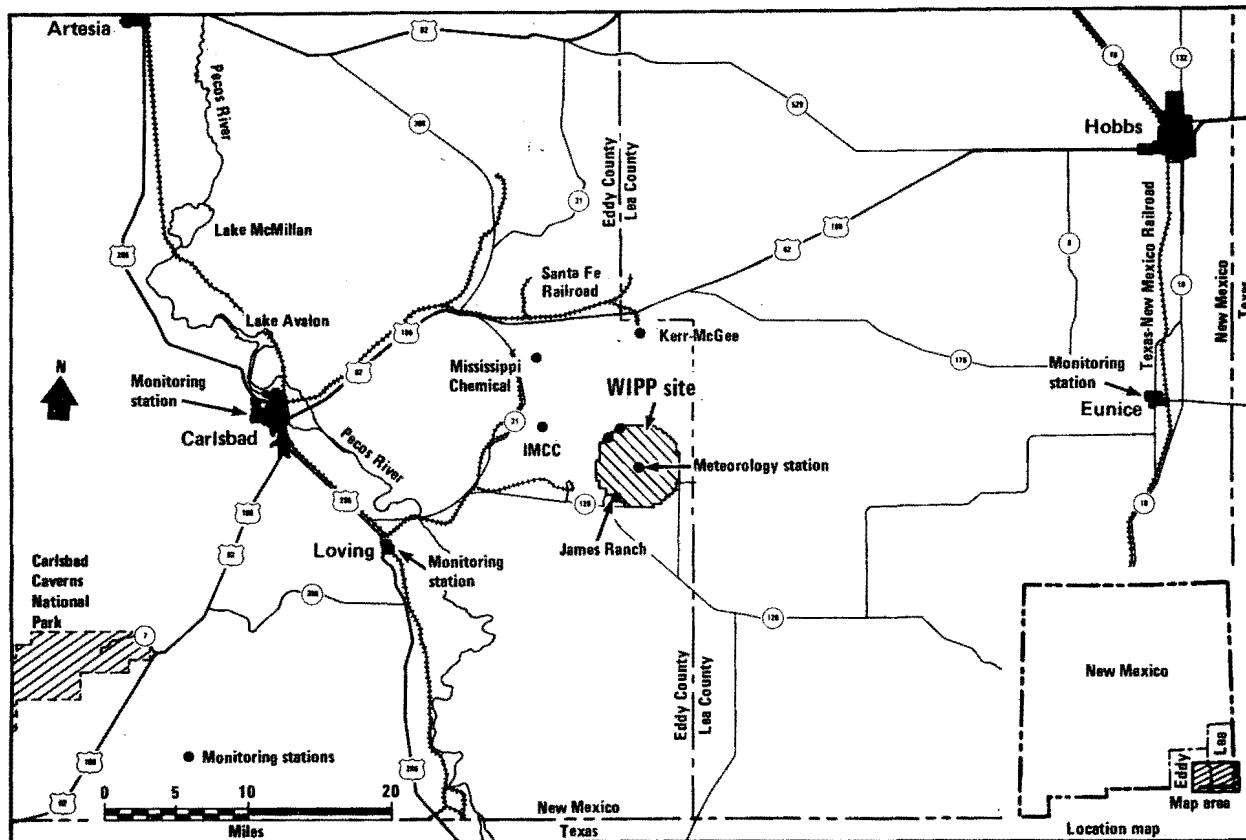

Figure J-10. Proposed air-particulate-monitoring stations.

Soil samples

Radionuclides in soil can be determined by laboratory analyses of soil samples taken at several locations in the vicinity of the WIPP site or by field gamma spectroscopy at selected locations. Gamma-emitting radionuclides could be determined by either technique, but the presence of plutonium would have to be inferred from the measurement of americium-241 if the in-situ technique is used. Initial soil profile samples would be necessary to determine the vertical distribution of any radionuclides present.

Direct gamma radiation

Levels of direct gamma radiation currently are being measured at the site. This program will be continued on a limited basis until 2 years before operation. The present program uses one Reuter-Stokes pressurized ionization chamber at the meteorological station. The radiation level is measured continuously and averaged on a weekly basis. Gamma-radiation measurements are also made at seven different locations (Figure J-11) by thermoluminescent dosimeters (TLDs). At each location, five TLD-100 chips are placed approximately 1 meter above the ground; these are exchanged and evaluated quarterly.

Two years before operation begins, the preoperational monitoring program will be increased in scope to include TLD stations at several additional sites in the vicinity of the WIPP site.

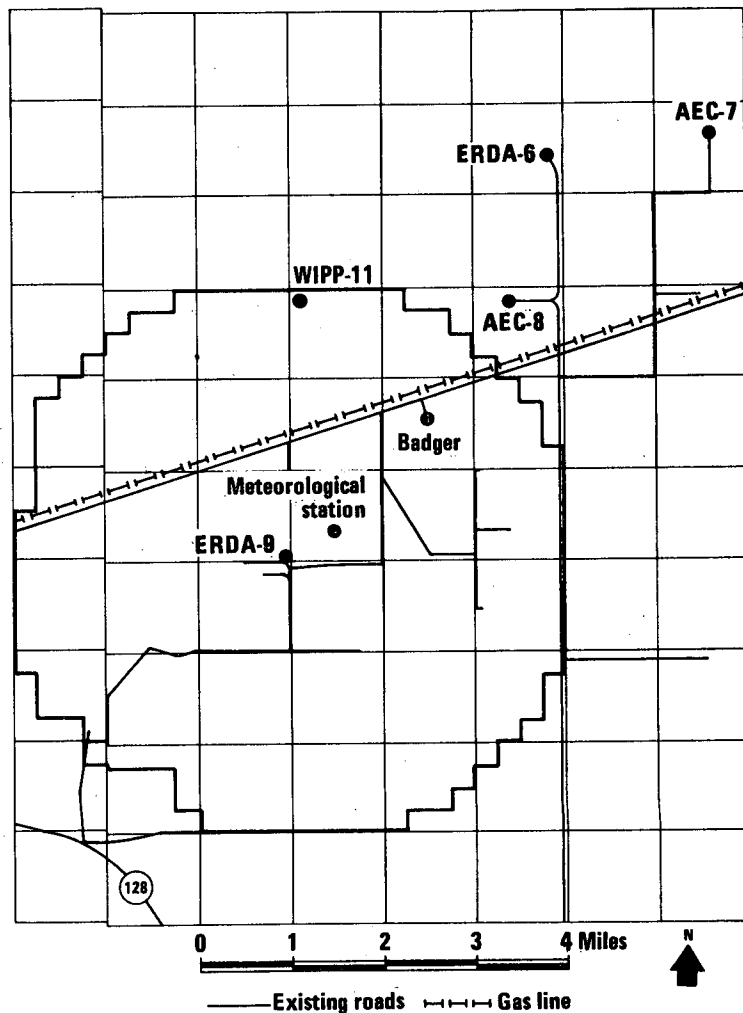

Figure J-11. Locations of thermoluminescent dosimeters in the site area. An additional thermoluminescent dosimeter will be located in Carlsbad.

Water sampling

One of the most important aspects of the radiological monitoring program will be to monitor groundwater at available sampling locations (Figure J-12). Considerable attention will be given to groundwater monitoring, since groundwater is a potential pathway for radionuclide transport. Sampling locations at the site will be established and sampling begun 2 years before operation. All sites will be monitored quarterly for gross alpha and gross beta concentrations. Isotopes present in the water will be identified by the analysis of gamma-ray spectra.

Beginning 2 years before the start of operations, surface-water samples from the Pecos River will be taken on a routine schedule and possibly after periods of rainfall. Surface-water samples will be evaluated by gamma-spectrum isotope analyses.

No well whose water is used for human consumption exists within 5 miles of the site. Public drinking water supplies in Carlsbad, Loving, and Malaga are presently being monitored annually by the EPA as a result of the Gnome project in 1961. That monitoring program is discussed elsewhere in this appendix.

Sediment, benthic organisms, aquatic plants, fish, and shellfish

No sampling of benthic organisms, aquatic plants, fish, or shellfish is planned because the nearest surface water, excluding water tanks, an impoundment, and salt lakes, is 14 miles away from the site at its closest point. However, to account for the extremely remote possibility of radionuclide buildup on sediments over long periods of time, baseline radiation levels in sediments of the Pecos River will be determined; these will be compared with data obtained after operation commences. Such samples will be taken along with surface-water samples and will be subjected to gamma-spectrum isotope analyses.

Milk

No milk sampling is planned since the nearest dairy farm is more than 40 miles away. No commercial feed crops are grown within 10 miles of the site.

Fruits and vegetables

No food crops for public consumption are grown within 10 miles of the site. Therefore, there are no plans to sample food crops except for green leafy vegetables and representative fruits from any private garden plot that may come to exist within 5 miles of the site. Sampling will be performed at each harvest. The edible portions of these fruits and vegetables will be subjected to a gamma-spectrum isotope analysis. The green leafy vegetables will also be analyzed for tritium. The sampling of existing private garden plots will start 2 years before operation begins.

Meat and poultry

At least one sample each of meat, poultry, and eggs from fowl, if any, feeding on land within 10 miles of the site in the prevailing downwind direction will be collected annually. One of the major game species, the mourning dove, will be collected in season. One sample of beef from cattle grazing within 10 miles of the site in the prevailing downwind direction will be taken annually, if available. This sampling will commence 2 years before the WIPP begins operating. Edible portions will be analyzed for gamma-emitting radioisotopes and the predominant actinides expected to be present in the waste emplaced in the WIPP.

J.2 PROPOSED OPERATIONAL MONITORING PROGRAMS

The preoperational monitoring programs described in this appendix will form the basis of the operational monitoring programs. The operational programs, however, will profit from the experience and the techniques developed during the preoperational phase.

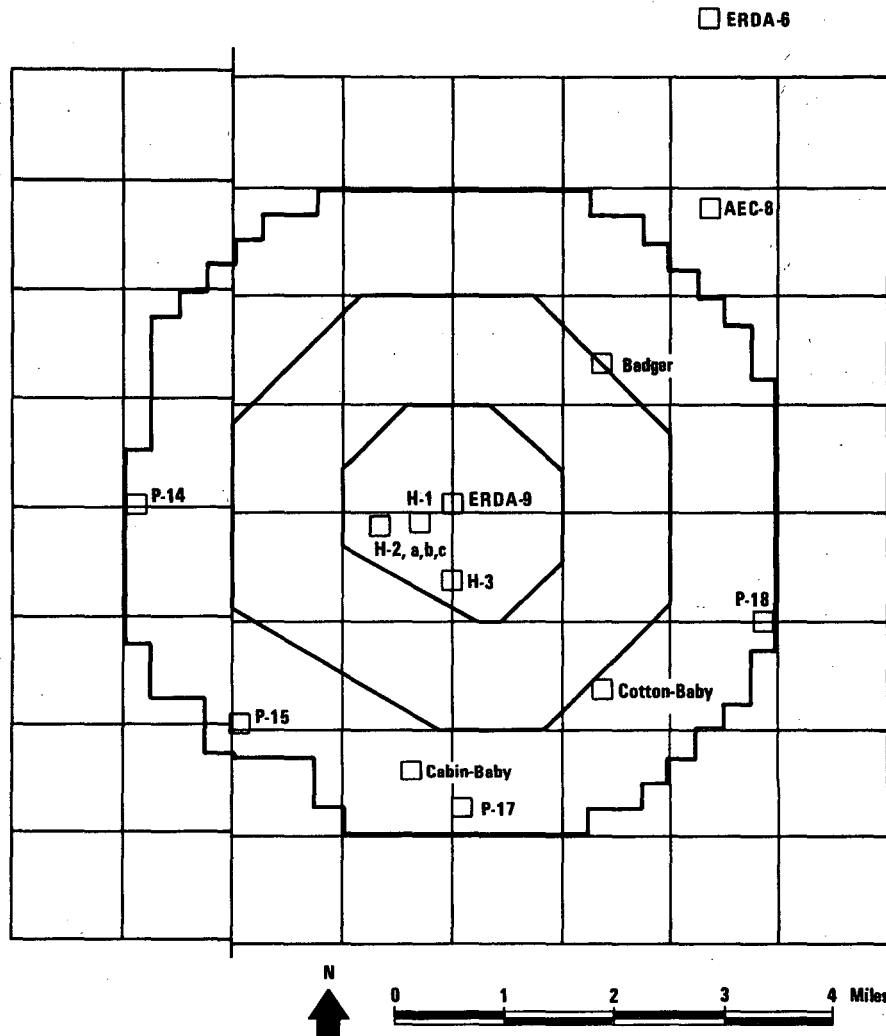

Figure J-12. Groundwater-sampling locations.

J.2.1 Geology

During the construction and routine operation of the WIPP, several monitoring programs will be conducted to insure that no unacceptable geologic conditions are encountered or caused by development of the facility.

Underground monitoring

As shafts are sunk and drifts are mined into the salt, geologic mapping of stratigraphic units and structural features will be conducted regularly. Before mining drifts, horizontal pilot holes will be cored along the drift paths and the rock examined to provide information on physical properties. When suitable, radar sounding will be used to probe in advance of mining for pockets of brine or gas.

Deformation gauges will be installed at important locations in the shaft pillar region and in major haulage-and-access drifts. These gauges will be monitored regularly and compared with expected deformations calculated by rock-mechanics computer codes. The shafts will be regularly inspected to detect any unusual movement of the shaft walls.

Bulk salt samples obtained from the waste-storage and experiment rooms will be analyzed to determine the chemical makeup, brine content, mechanical properties, and thermal properties. This sampling will establish whether the medium has been adequately described from earlier, more limited, samples. If the deviations in properties are significant, new calculations will be performed to describe the repository behavior.

Surface measurements of geologic parameters

Continuous monitoring of seismic activity will be conducted by seismometers located near the surface buildings but remote enough to avoid microseisms produced by human activities. This station will monitor regional and local natural seismicity and microseisms that may develop from subsidence; it will document the ground motions imposed on surface facilities.

Surface level-line stations that have been and will be installed over the site will be resurveyed regularly, perhaps every 1 to 5 years, to detail the movement of the surface in response to thermal loading and room collapse. The results will be compared with calculated results to monitor room collapse after individual rooms or sections of the WIPP have been closed.

J.2.2 Hydrology

The hydrologic program described in this appendix is expected to extend well beyond the operational lifetime of the WIPP. Long-term proposals include the installation of water-level recorders in all monitored wells. The continuous output from the recorders will be correlated with barometric data from the local weather station to eliminate atmospheric influences in water-level fluctuations.

The surface hydrology of the region will be defined in terms of the major components that contribute to surface flows and water quality. Water balances in critical areas of interest or local watersheds will be investigated to establish the scope of aquifer recharge and to predict hydrologic changes. Measurement programs for spring flows, potash effluent, and other surface runoff will be carried out.

It is expected that groundwater sampling for long-term monitoring will be performed on an annual basis. However, after mining for the WIPP has started, sampling will be quarterly until conditions stabilize. The increased frequency of measurement will permit early detection of changes in groundwater systems from mining and construction activities.

J.2.3 Meteorology

The operational monitoring program will follow the preoperational program very closely. The measurements taken during the preoperational phase will continue to be taken at a permanently established monitoring station. The increased amounts of data will be used to better characterize the meteorological conditions at the site.

J.2.4 Air Quality

The operational air-quality monitoring program is expected to be identical with the preoperational program. The program will remain flexible, however, to meet the requirements of new sampling regulations and guidelines, either State or Federal. The program, in all cases, will be adequate to establish whether or not State and Federal air-quality standards are being met.

J.2.5 Ecology

The operational ecological monitoring program, building on the foundation established through preoperational ecological monitoring, will document the ecological effects of construction and operation. The proposed monitoring plan will be flexible to permit modifications. Initial experience may suggest such modifications as changes in instrumentation, addition or deletion of parameters, adjustments in the number and location of sampling stations, or alterations in the frequency of observations and the number of replications.

Sampling methods and strategy will follow those presented in the preoperational biological monitoring program, unless there is substantial reason to modify them. However, operational monitoring will focus primarily on indicator organisms and selected abiotic parameters. Biological data will be collected near meteorological and radiation-monitoring stations (when possible) to facilitate correlation with data collected at these stations. Samples will be collected during each season at biologically significant times (as determined through preoperational monitoring). When unusual trends are observed, sampling will be intensified to elucidate the cause. Unusual trends will not necessarily be attributable to the WIPP because biota respond dramatically to fluctuations in rainfall and resource availability.

Information generated by the operational (and preoperational) monitoring program will be published by the principal investigators in recognized professional journals and presented at appropriate meetings and symposia. In addition, all work will be reviewed by an independent committee of scientists from appropriate fields. These practices will insure that data are being collected and interpreted according to the most up-to-date professional standards.

J.2.6 Radiation Monitoring

The radiation-monitoring program provides data on measurable levels of radioactivity in effluents and the environment. This monitoring is done to

assist in evaluating the relationships between the radioactivity released in effluents and the resultant radiation doses received by people beyond the boundaries of the site through credible pathways of exposure.

The off-site environmental radiation monitoring program, coupled with on-site effluent monitoring, performs the following functions:

1. It identifies measurable changes in off-site radiation levels or quantities of biologically significant radionuclides.
2. It provides a means of determining whether off-site radiation exposures are maintained as low as reasonably achievable and are within applicable limits.
3. It provides a means of evaluating the impact of WIPP operations on the environment.

Both the on-site and off-site effluent and environmental monitoring programs are discussed below.

Effluent monitoring

The gaseous-exhaust systems provide potential pathways for the release of airborne radionuclides. The effluent monitoring system located at each release point will consist of measuring devices that sample airborne particulate radioactivity.

Samplers will be installed at the release points to collect the particulate activity from a representative fraction of the total volume of air being discharged at the release point. The samplers will consist of a probe into the air stream, a filter holder, and a vacuum supply. The sampling probe will be designed in accordance with ANSI N13.1-1969. The sampling flow rate and probe will be designed so that the particle velocity in the effluent stream will be the same as the particle velocity in the sample probe. This will eliminate particle-size biases in the sampler. A sample flow-rate controller will maintain constant sample flow as the filter collects dust. This will increase the pressure drop across the filter and tend to reduce sample flow.

Other design features to be incorporated to improve sampling efficiency include the following:

1. Electrically grounding the probe to minimize electrostatic deposition
2. Designing the interior finish and general arrangement of the probe to minimize turbulent deposition
3. Locating the filter holder as close to the probe as possible to minimize particle fallout in the transport line
4. Insulating and, if necessary, electrically heating the lines between the probe and the filter holder to eliminate condensation
5. Providing a flush line to allow periodic cleaning of the probe and the transport line if necessary

The filter holder will be designed to prevent leakage of ambient air into the filter holder and to support the filter paper under the design pressure of the vacuum supply. Furthermore, the holder will be designed so that particulate matter is uniformly deposited on the filter paper to avoid inefficiencies in sample counting.

The samplers will provide a record of the total airborne particulate radioactivity discharged. In order to provide the lowest minimum detectable concentration at the discharge point, the sampling periods will be as long as possible so that the largest practical volume of air is sampled.

Both alpha and beta-gamma continuous air monitors will be located at the release points. These instruments will sample air from the release point through a probe similar to that designed for the filter sampler. The sample flow will be split so that half of the air being sampled is directed to each of the instruments.

The sensitivity of the beta instrument will be such that a concentration of 1×10^{-12} microcurie of strontium-90 and yttrium-90 per cubic centimeter produces a response of about 11 counts per minute after 4 hours at a sampling flow of 60 liters per minute. Alpha instrument sensitivity will be such that the release-point maximum permissible plutonium-239 concentration (2×10^{-12} microcurie per cubic centimeter) can be detected in 4 hours at a sampling flow rate of 60 liters per minute. The instruments will be designed to meet the requirements of ANSI N13.10-1974. The radionuclide inventory of the WIPP will be such that there will be no need to monitor continuously for either iodine or noble gases.

The effluent-monitoring systems will be designed to withstand the effects of a design-basis earthquake and supplied with emergency power to allow monitoring in the event of a power failure.

Environmental radiation monitoring

After the WIPP begins operating, a program for monitoring environmental radiation levels will be operated continuously in order to verify projected or expected radioactivity concentrations and related public exposures in accordance with ERDA Manual Chapter 0513. When operations begin, the operational monitoring program is expected to be essentially identical with the preoperational monitoring program. Initially, at least, the same media will be sampled, the same sampling locations will be monitored, and the same types of analyses will be made. However, the operational program will be flexible; it will be continually reevaluated and modified if needed. A strict quality-control program will be followed to insure the accuracy of samples and measurements. If any additional radioactivity is detected beyond the levels expected from preoperational monitoring results, an immediate program of evaluation will be undertaken to discover and eliminate the cause.

Equipment sensitivities

The equipment used for measurement during operation will meet or exceed the sensitivities required to detect radiation levels below the limits described in 10 CFR 20, Appendix B. State-of-the-art equipment and instruments will continually be evaluated for incorporation into the monitoring program.

Data reporting

Annual reports will summarize the environmental-sample monitoring. These reports will provide applicable data in the format required by ERDA Manual Chapter 0513. They will include the results of environmental activities and assessments of observed environmental impacts.

J.3 POSTOPERATIONAL MONITORING PROGRAMS

The basic purpose of geologic disposal is to isolate wastes from the biosphere so that surveillance will not be needed after the repository is closed. Indeed, the WIPP will not be closed up at all if there is any serious concern regarding the post-decommissioning risk.

For a limited time after the WIPP is decommissioned, monitoring will continue. This monitoring will, for the most part, be a continuation of the operational monitoring program. The rationale for the postoperational monitoring program is presented in this section.

The objective of postoperational monitoring is to give timely warning of radionuclide releases or of events or processes that may precede the release of radionuclides to the environment. This goal will require measures to assure people in the future that no gross underestimate of risks has been made. It is expected that this can be accomplished by periodic, rather than continuous, observations and that the monitoring program would not be complex.

Three kinds of post-decommissioning monitoring appear to be appropriate: geologic, hydrologic, and radiologic. Possible measurements are outlined in Table J-4. Much of the operational monitoring program is designed to detect impacts associated with the operation of the WIPP. Portions of the operational monitoring program, like measurements of effluents and meteorological parameters, will no longer be appropriate.

Geologic monitoring is primarily concerned with detecting variations in geologic parameters that may reveal a release of radioactivity, whether the variations are caused by natural geologic events or by the presence of the repository. The fundamental measurement will be periodic resurveys of the surface to observe the depth and areal extent of subsidence associated with closure of the subsurface cavities. In addition, a periodic surface geologic reconnaissance will be conducted for fractures and other phenomena indicative of subsurface movement. Borehole monitoring would not be undertaken because holes located close enough to the waste to measure geologic movement and subsurface temperatures would at the same time breach the natural integrity of the strata over or near the waste.

The postoperational radiation-monitoring program will include measurements of activity levels in biological indicator species. The sampling program will give direct assurance that some unanticipated event has not bypassed the natural and man-made barriers against release of radioactivity and that radionuclides have not been missed in the radiobiological monitoring of down-gradient groundwater. Useful indicator species will be designated before decommissioning. At the surface above the disposal area, such sampling might be

Table J-4. Outline of the Post-Decommissioning Monitoring Program

Measurement	Location	Frequency	Objective
HYDROLOGIC MONITORING			
Borehole measurement and sampling			
Gross alpha activity Gross beta activity Chemistry	Holes down-gradient at a distance of 2 miles or more	5-10 years	To detect migration of radionuclides out of disposal area
Head measurements			To detect any change in hydrology
GEOLOGIC MONITORING			
Resurvey of surface topography	Level lines across surface of site	5-10 years	To detect and measure subsidence and/or uplift
RADIOLOGICAL MONITORING			
Sampling of indicator species	At and near site	5-10 years	To detect releases directly
Sampling of water, indicator species	At groundwater discharge points	5-10 years	To detect releases directly

of grasses and game birds. At the groundwater discharge points in lower Nash Draw and along the Pecos River, such sampling might be of water and periphyton.

Hydrologic monitoring will continue almost undiminished from the operational phase because groundwater is the most likely pathway for radionuclide transport in the long term. The basic hydrologic monitoring will consist of periodic sampling and radiobiological analysis of water from open boreholes downgradient from the disposal area. There are at present five hydrologic holes in control zone IV that could be used for this purpose (holes P-14, P-15, P-17, P-18, and H-4), and it may be necessary to drill more holes to eliminate the possibility that a plume of released radionuclides might pass between monitoring holes without being observed. The hydrologic test holes in control zone II and all upgradient test holes will be plugged. The latter will not be needed, and to leave the former open would be to leave a potential connection between aquifers and Salado salt.

J.4 RELATED ENVIRONMENTAL PROGRAMS BY OTHERS

J.4.1 Bureau of Land Management

In 1974, the Bureau of Land Management (BLM) began preparation of a preliminary regional environmental assessment record (EAR) (BLM, 1976a) in order to fulfill responsibilities outlined in the National Environmental Policy Act of 1969. The compilation of an EAR was the major step toward the resumption of potash leasing and prospecting in the Carlsbad area. The preliminary document was published in October 1975, and the Executive Summary and Supplement (BLM, 1976a and b) was completed in 1976. Public-reference copies of this document are available in the city libraries of Carlsbad, Hobbs, and Albuquerque, as well as at the BLM offices in Santa Fe and Albuquerque.

J.4.2 New Mexico Environmental Improvement Division

The New Mexico Environmental Improvement Agency (now Division) performed an air-quality assessment of the potash-mining activities in the general area of the WIPP site. The assessment was undertaken after apparent violations of the State and Federal air-quality standards were mentioned in the environmental assessment record of the BLM. The assessment analyzes the impact of the potash industry on the air; the analysis used computer-modeling techniques to predict average air-particulate levels in the vicinity of the local potash mines.

The Air Quality Division of the NMEID monitors air quality throughout the State and provides data on the concentrations of total suspended particulates, sulfur dioxide, carbon monoxide, and ozone. The information recently gathered in the vicinity of the site is in the Municipal Building in Carlsbad. Only total suspended particulates are measured at the site. Other sites of interest are at Artesia, Hobbs, and Lovington; data are available on microfiche on a semiannual basis.

J.4.3 U.S. Geological Survey

The U.S. Geological Survey (USGS) has had major involvement in characterizing the hydrology and geology of the area surrounding the site. The involvement was further intensified when the DOE (and its predecessors, ERDA and AEC) and BLM requested detailed studies in the area. The AEC needed site characterization for Project Gnome in 1961; the USGS performed a detailed hydrologic and geologic study of the Gnome site during the period between 1958 and 1961. The BLM needed assistance in preparing the preliminary environmental analysis record and requested input from the USGS. Also, the State of New Mexico has received assistance in the preparation of hydrologic reports for many parts of the State, including the site. On a routine monitoring basis, the USGS issues an annual generic water-data report. The report describes water resources in the State of New Mexico (USGS, 1977). The detailed data include discharge rates of streams and water levels of selected wells in the site area. Some chemical analyses of selected water samples are also documented in the same report. Furthermore, the USGS performs environmental analyses for proposed oil and gas operations. Through this process, an assessment of environmental

impacts would be made before any further development of Federal mineral resources would be allowed.

J.4.4 Environmental Protection Agency, Las Vegas, Nevada

The Environmental Protection Agency (EPA) has performed environmental monitoring surveys in the vicinity of the site as a result of Project Gnome. Except at the Nevada Test Site, the EPA monitors wells, springs, and spring-fed surface-water sources at sites where underground nuclear detonations have taken place; the monitoring looks for the migration of radionuclides resulting from the movement of groundwater. Consequently, a number of wells in the vicinity of the Gnome site are monitored annually by the EPA. In addition to the water monitoring, the EPA has monitored radionuclide concentrations in plant and animal tissues collected at the Gnome site.

J.4.5 Potash Industry

Some detailed environmental monitoring of the potash industry before 1976 resulted from the preliminary environmental assessment record. Although the monitoring included soil and well-water sampling, the potash mines in the Carlsbad area do not generally have extensive environmental monitoring programs. Present levels of monitoring are beginning to increase as a result of interaction with the NMEID. The most extensive monitoring programs include the collection of meteorological data and high-volume air sampling for total suspended particulates; such programs are conducted at two of the seven potash mines in the vicinity of the WIPP site. As State guidelines for high-volume sampling are formulated, similar programs can be expected at other mines.

J.4.6 National Oceanic and Atmospheric Administration

The National Oceanic and Atmospheric Administration provides a Climatological Data Publication, which is published by the National Climatic Center (NCC). It is a compendium of reports from selected weather stations throughout the United States, and it includes such data as temperature, daily precipitation, wind speed, humidity, and sky cover. More detailed data are available through the NCC for selected sites. This information is available to the general public through a monthly subscription service. However, meteorological data specific to the WIPP site are not available from the NCC.

J.4.7 New Mexico Department of Game and Fish

A study being conducted by the New Mexico Department of Game and Fish will provide information related to the WIPP biological monitoring program. This study monitors conditions and trends of range lands grazed by livestock and wildlife in four southern New Mexico counties (including Eddy County).

J.4.8 Ongoing Regional Ecological Studies

In addition to the comprehensive ecological studies being carried out by the WIPP project, several ecological investigations are being carried out in the region by governmental agencies and university researchers.

The Roswell District of the BIM is completing an extensive preliminary draft environmental statement (PDES) on proposed livestock-grazing practices on public lands in southeastern New Mexico, east of the Pecos River. In addition, the BIM is sponsoring a groundwater study related to potash mining in the Region (A. Gebel, personal communication, August 25, 1978). The primary questions to be answered by the BIM study are the following:

1. Is fresh water in the Carlsbad potash area in danger of contamination from current or expanded potash-mining activity?
2. Is the brackishness of the Pecos River below Malaga Bend in whole or in part attributable to mining activities?
3. Is the amount of leakage from brine-disposal ponds significant when compared to the tremendous volumes of naturally occurring brines?

The hydrology investigation also includes an evaluation of phreatophytes and wetland vegetation as water-quality indicators and a botanical evaluation of Nash Draw (Geohydrology Associates, 1978).

The Bureau of Reclamation at Amarillo, Texas, is continuing to update the project history of the Malaga Bend Division-McMillan Delta Project. The Malaga Bend Division was an experimental salinity-alleviation project intended to improve the water quality in the Pecos River by lowering the head of the brine aquifer at Malaga Bend and thus diverting the brine. In 1976 active monitoring on the project was discontinued.

The Bureau of Reclamation at Amarillo is also currently preparing a supplement to its final environmental impact statement on the Brantley Dam project, which is located on the Pecos River approximately 12 miles northwest of Carlsbad. Fishery studies have been conducted by the State of New Mexico to determine the fish species present in the area and to develop possible mitigation measures to protect the rare fish in Major Johnson Springs.

Reynolds Electrical & Engineering Co., Inc., has been conducting a radiological survey for the DOE Nevada Operations Office at the Gnome site. Project Gnome was the first scientific experiment in the Plowshare Program in December 1961. Portions of the 1-square-mile site were contaminated during mine-back operations and postshot activities. The survey involves monitoring radiation levels and includes decontamination and decommissioning of the site (D. D. Jackson, DOE, personal communication, September 26, 1978).

Various projects are being carried out in the site area by university researchers. For example, graduate students at Eastern New Mexico University have been studying the fish fauna in the Black River, an endemic subspecies of white-tailed deer at the Mescalero Sands in northern Eddy County, and pocket mice in eastern Eddy County (A. L. Gennaro and J. E. Sublette, Eastern New Mexico University, personal communication, September 21, 1978).

The study being conducted by the New Mexico Department of Game and Fish, which will provide information of use to the WIPP biological monitoring program, was discussed earlier.

REFERENCES

- Best, T. L., and K. S. Neuhauser (eds.), 1979. Report of Biological Investigations at the Los Medanos Waste Isolation Pilot Plant (WIPP) Area of New Mexico During FY 1978, SAND79-036B, Sandia Laboratories, Albuquerque, N.M.
- BLM (U.S. Bureau of Land Management), 1976a. Environmental Assessment Record, U.S. Department of the Interior, New Mexico State Office.
- BLM (U.S. Bureau of Land Management), 1976b. Executive Summary and Supplement to Preliminary Potash EAR, U.S. Department of the Interior, New Mexico State Office.
- Brewer, L. W., and J. H. Metcalf, 1977. Environmental Monitoring at the WIPP Site, CY 1976, SAND77-1201, Sandia Laboratories, Albuquerque, N.M.
- Geohydrology Associates, 1978. Ground-Water Study Related to Proposed Expansion of Potash Mining near Carlsbad, New Mexico, prepared for U.S. Bureau of Land Management, Denver, Colo.
- Lambert, S. J., and J. W. Mercer, 1977. Hydrologic Investigations of the Los Medanos Area, Southeastern New Mexico, 1977, SAND77-1401, Sandia Laboratories, Albuquerque, N.M.
- Mercer, J. W., and B. R. Orr, 1977. Review and Analysis of Hydrogeologic Conditions Near the Site of a Potential Nuclear-Waste Repository, Eddy and Lea Counties, New Mexico, Open-File Report 77-123, U.S. Geological Survey.
- Powers, D. W., S. J. Lambert, S. E. Shaffer, L. R. Hill, and W. D. Weart (eds.), 1978. Geological Characterization Report, Waste Isolation Pilot Plant (WIPP) Site, Southeastern New Mexico, 2 vols., SAND78-1596, Sandia Laboratories, Albuquerque, N.M.
- Sanford, A. R., and T. R. Topozada, 1974. Seismicity of Proposed Radioactive Waste Disposal Site in Southeastern New Mexico, Circular 143, New Mexico Bureau of Mines and Mineral Resources, New Mexico Institute of Mining and Technology, Socorro, N.M.
- USGS (U.S. Geological Survey), 1977. Water Resources Data for New Mexico--Water Year 1976, NM-76-1, Albuquerque, N.M.
- Wolfe, H. G., et al. (eds.), 1977a. An Environmental Baseline Study of the Los Medanos Waste Isolation Pilot Plant (WIPP) Project Area of New Mexico: A Progress Report, SAND77-7017, prepared by the New Mexico Environmental Institute for Sandia Laboratories, Albuquerque, N.M.
- Wolfe, H. G., et al. (eds.), 1977b. An Environmental Baseline Study of the Los Medanos Waste Isolation Pilot Plant (WIPP) Project Area of New Mexico: A Progress Report--An Addendum, SAND77-701B, prepared by the New Mexico Environmental Institute for Sandia Laboratories, Albuquerque, N.M.

Appendix K

METHODS USED IN LONG-TERM SAFETY ANALYSES

CONTENTS

	<u>Page</u>
K.1 Hydrologic Transport.....	K-1
K.1.1 Introduction.....	K-1
K.1.2 Reservoir Model Equations.....	K-2
K.2 Application of the Transport Model to the WIPP Site.....	K-9
K.2.1 Data Interpretation and Regional Hydrologic Modeling.....	K-9
K.2.2 Modeling of Liquid-Breach Scenarios.....	K-20
K.2.3 Modeling of Radionuclide Transport.....	K-23
K.3 Direct-Access Scenarios.....	K-24
K.3.1 Method for Calculating Radionuclide Transport in Air.....	K-25
K.3.2 Uncertainties in the Calculation.....	K-27
References.....	K-28

LIST OF TABLES

	<u>Page</u>
K-1 Nomenclature.....	K-7
K-2 Summary of hydrologic data.....	K-18
K-3 Summary of geochemical data.....	K-20

LIST OF FIGURES

	<u>Page</u>
K-1 Hydrologic modeling region.....	K-10
K-2 Geologic section of the Los Medanos area.....	K-11
K-3 Hydraulic potentials measured in the Rustler Formation.....	K-12
K-4 Hydraulic potentials measured in the Capitan aquifer and in the Delaware Mountain Group.....	K-12
K-5 Calculated hydraulic potentials for the Rustler Formation.....	K-13
K-6 Calculated hydraulic potentials for the Delaware Mountain Group.....	K-14

LIST OF FIGURES (continued)

	<u>Page</u>
K-7 Hydraulic conductivities in the Rustler aquifers.....	K-15
K-8 Hydraulic conductivities in the shallow-dissolution zone.....	K-16
K-9 Hydraulic conductivities in the Capitan aquifer and the Castile Formation.....	K-17
K-10 Hydraulic conductivities in the Delaware Mountain Group.....	K-19
K-11 Flow rate as a function of hydraulic conductance for two values of pressure-head difference: two-aquifer communication.....	K-22

Appendix K

METHODS USED IN LONG-TERM SAFETY ANALYSES

K.1 HYDROLOGIC TRANSPORT

K.1.1 Introduction

The numerical model used for hydrologic-transport calculations was developed by Intera Environmental Consultants, Inc., for the Nuclear Regulatory Commission (Dillon et al., 1977). It is a modified version of a deep-well-disposal model developed for the U.S. Geological Survey (INTERCOMP, 1976). The model is three-dimensional and uses finite-difference methods to solve a set of partial differential equations describing fluid flow, energy, salinity, and radionuclide concentration in a porous medium. The basic equations are coupled by two properties of the fluid: density and viscosity.

Three basic coupled equations describe the conservation of total liquid mass, the conservation of energy, and the conservation of the mass of a single solute in the fluid. In addition, there are coupled equations describing the conservation of mass for each of the radioactive constituents dissolved in the fluid; these equations are coupled by terms that account for radioactive decay and the production of daughter radionuclides from decaying parent radionuclides.

This set of equations predicts the concentrations of radioactive constituents and of the specified inert components. It also predicts the temperature and pressure patterns that result from the flow and discharge of liquid waste. The aquifer fluid properties are permitted to be functions of the concentration and temperature of liquid chemical waste.

The basic physical assumptions contained in the model equations are as follows:

1. Flow is three-dimensional, transient, and laminar.
2. Fluid density can be a function of the pressure, temperature, and concentration of the inert component. Fluid viscosity can be a function of temperature and concentration.
3. Injected wastes can mix with the in-place fluids.
4. Aquifer properties vary with position; i.e., porosity, permeability, thickness, and elevation can be specified for each numerical grid block in the model.
5. Hydrodynamic dispersion is a function of fluid velocity.

6. Radioactive constituents are present in trace quantities only; that is, fluid properties are independent of the concentrations of these contaminants.
7. Chemical reactions among the radioactive trace constituents and chemical species on the porous rock surfaces go to equilibrium instantaneously.
8. The energy equation can be described as "enthalpy in - enthalpy out = change in the internal energy of the system." This is rigorous except for kinetic energy and potential energy, which have been neglected.
9. Boundary conditions allow for natural water movement in the aquifer, heat losses to adjacent formations, and the location of injection, production, and observation points anywhere within the system.

A more technical description of the model equations is provided in the next subsection.

K.1.2 Reservoir Model Equations

Let x, y, z be a Cartesian coordinate system and let $Z(x, y, z)$ be the height of a point above a horizontal reference plane. The basic equation describing single-phase flow in a porous medium combines the continuity equation

$$\nabla \cdot \rho \underline{u} + q' = -\frac{\partial}{\partial t}(\phi \rho) \quad (K-1)$$

and Darcy's law in three dimensions,

$$\underline{u} = -\frac{k}{\mu}(\nabla p - \rho g \nabla Z) \quad (K-2)$$

(Symbols are defined in Table K-1.) The basic flow equation is then

$$\nabla \cdot \frac{\rho k}{\mu}(\nabla p - \rho g \nabla Z) - q' = \frac{\partial}{\partial t}(\phi \rho) \quad (K-3)$$

The energy balance defined as (enthalpy in - enthalpy out = change in internal energy) is described by the energy equation

$$\begin{aligned} & \nabla \cdot \left[\frac{\rho H k}{\mu}(\nabla p - \rho g \nabla Z) \right] + \nabla \cdot \underline{E}_H \cdot \nabla T - q'_L - q'_H - q'_H \\ & = \frac{\partial}{\partial t} [\phi \rho U + (1 - \phi)(\rho C_p)_R T] \end{aligned} \quad (K-4)$$

The five terms on the left-hand side of Equation K-4 describe net energy convection, conduction, heat loss to surrounding strata, enthalpy accompanying a fluid source, and energy not accompanying a fluid source. A material balance for the solute produces the solute-concentration equation.

$$\nabla \cdot \left[\rho \hat{C} \frac{k}{\mu} (\nabla p - \rho g \nabla Z) \right] + \nabla \cdot \rho \underline{E}_c \cdot \nabla \hat{C} - q' \hat{C} = \frac{\partial}{\partial t} (\rho \phi \hat{C}) \quad (K-5)$$

The three terms on the left-hand side of Equation K-5 represent net convection, dispersion, and production of the solute. A similar material balance for N radioactive components results in N component equations. For component i,

$$\begin{aligned} \nabla \cdot \left[\rho C_{i\mu} \frac{k}{\mu} (\nabla p - \rho g \nabla Z) \right] + \nabla \cdot \rho \underline{E}_c \cdot \nabla C_i - q'_i \\ + \sum_{j=1}^N k_{ij} K_j \rho \phi C_j - \sum_{k=1}^N k_{ki} K_i \rho \phi C_i = \frac{\partial}{\partial t} (\phi \rho K_i C_i) \end{aligned} \quad (K-6)$$

where

$$k_{ki} K_i \rho \phi C_i = k_{ki} \rho \phi C_i + k_{ki} \rho_s (1 - \phi) C_{si} \quad (K-7)$$

The two summation terms describe the generation of component i from the decay of other radionuclides and the decay of component i to other radionuclides. Implicit in Equation K-6 is the approximation

$$\frac{\partial}{\partial t} (\phi \rho K_i C_i) \approx \frac{\partial}{\partial t} (\phi \rho C_i) + \frac{\partial}{\partial t} [(1 - \phi) \rho_s C_s] \quad (K-8)$$

The equilibrium adsorption constant is defined as follows:

$$K_i = 1 + \frac{\rho_B (K_d)_i}{\phi} \quad (K-9)$$

where $(K_d)_i$ is the distribution coefficient for compound i.

The system of Equations K-3, K-4, K-5, and K-6--along with the fluid-property dependence on pressure, temperature, and concentration--describes the reservoir flow due to the discharge of wastes into an aquifer. This nonlinear system of partial differential equations must be solved numerically by high-speed digital computers. Equations K-3, K-4, and K-5 are coupled through fluid-property dependence. Since it is assumed that the radioactive components are present in trace quantities only and the fluid properties are independent of these concentrations, Equation K-6 is uncoupled from the other equations.

These equations are solved by dividing the region of interest into three-dimensional grid blocks and constructing finite-difference approximations to all partial derivatives in this grid. The resulting set of finite-difference equations have numerical solutions that closely approximate the analytic solutions of Equations K-3, K-4, K-5, and K-6 in certain simplified (one-dimensional) geometries. The finite-difference equations in three dimensions are as follows:

Basic flow equation

$$\Delta[T_w(\Delta p - \rho g \Delta Z)] - q = \frac{V}{\Delta t} \delta(\phi \rho) \quad (K-10)$$

Energy equation

$$\begin{aligned} \Delta[T_w H(\Delta p - \rho g \Delta Z)] + \Delta(T_H \Delta T) - q_L - q_H - q_H \\ = \frac{V}{\Delta t} \delta[\phi \rho U + (1 - \phi)(\rho C_p)_R T] \end{aligned} \quad (K-11)$$

Solute equation

$$\Delta[T_w \hat{C}(\Delta p - \rho g \Delta Z)] + \Delta(T_c \Delta \hat{C}) - \hat{C}q = \frac{V}{\Delta t} \delta(\rho \phi \hat{C}) \quad (K-12)$$

Trace-component equation

$$\begin{aligned} \Delta[T_w C_i(\Delta p - \rho g \Delta Z)] + \Delta(T_c \Delta C_i) - q_i + v_p \sum k_{ij} K_j C_j \\ - v_p K_i C_i \sum k_{ik} = \frac{V K_i \rho}{\Delta t} \delta C_i \end{aligned} \quad (K-13)$$

The difference operators in space are defined by

$$\Delta(T_w \Delta p) = \Delta_x(T_w \Delta_x p) + \Delta_y(T_w \Delta_y p) + \Delta_z(T_w \Delta_z p) \quad (K-14)$$

with

$$\begin{aligned} \Delta_x(T_w \Delta_x p) = T_{w,i+1/2,j,k} (P_{i+1,j,k}^{n+1} - P_{i,j,k}^{n+1}) \\ - T_{w,i-1/2,j,k} (P_{i,j,k}^{n+1} - P_{i-1,j,k}^{n+1}) \end{aligned} \quad (K-15)$$

The symbol δ denotes variation over a single time step; for any quantity χ ,

$$\delta \chi = \chi^{n+1} - \chi^n \quad (K-16)$$

The terms

$$T_w = \frac{kA\rho}{\mu l} \quad (K-17)$$

$$T_H = \frac{E_H A}{l} \quad (K-18)$$

$$T_c = \rho \frac{E_c A}{l} \quad (K-19)$$

have been introduced for notational convenience; since all of them are position-dependent, a further expansion is illustrated as

$$T_{w,i+1/2,j,k} = \frac{2\Delta y_j \Delta z_k}{\left(\frac{\Delta x}{k_x}\right)_i + \left(\frac{\Delta x}{k_x}\right)_{i+1}} \left(\frac{\rho}{\mu}\right)_{i+1/2,j,k} \quad (K-20)$$

For radial geometry, the term

$$\frac{2\Delta y_j \Delta z_k}{\Delta x_i + \Delta x_{i+1}}$$

becomes $2\pi\Delta z_k / \ln(r_{i+1}/r_i)$. The volume term is written as $\pi\Delta r_i^2 \Delta z_k$.

Two terms, the constituent-dispersion tensor $\underline{\underline{E}}_c$ and the effective heat-conductivity tensor $\underline{\underline{E}}_H$ need additional description. In the present model both depend on hydrodynamic dispersivity, which is a function of local fluid velocity. For an isotropic porous medium there can be no more than two independent dispersivity factors; this requirement insures that the dispersion tensor is invariant under coordinate transformations. These two dispersivities are longitudinal, in the direction of flow, and transverse, perpendicular to flow. Generally, both are functions of the magnitude of the flow velocity:

$$D_l = \alpha_l |\underline{u}|$$

and

$$D_t = \alpha_t |\underline{u}|$$

When the velocity vector is divided into components along three coordinate axes, nine components of both the dispersivity and the conductivity tensors occur.

More general expressions for the dispersivity and the conductivity tensors can be written in terms of molecular properties and hydrodynamic dispersivity:

$$\underline{E}_C \equiv \phi \underline{\alpha}u/\phi + D_m$$

and

(K-21)

$$\underline{E}_H \equiv \phi \underline{\alpha}u/\phi (\rho C_p)_w + K_m$$

where the dispersivity coefficient α is a vector quantity. The apparent conductivity due to hydrodynamic dispersion in the porous medium has been taken as the product of the dispersivity and velocity multiplied by fluid volumetric heat capacity. The ordinary molecular heat conductivity of fluid plus rock, K_m , has been treated as an additive constant. The concept expressed in Equations K-21 is that the microscopic heterogeneity in convective flow creates the same dispersive effect in temperature that it creates in the concentration of constituents.

Table K-1. Nomenclature

A	Area perpendicular to flow--either $\Delta x \Delta y$, $\Delta x \Delta z$, or $\Delta y \Delta z$
C	Concentration, mass fraction
\hat{C}	Concentration of solute, salinity
C_p	Specific heat (at constant pressure)
C_s	Concentration of radioactive component on rock
D	Diffusion coefficient
E	Dispersion coefficient
$\underline{\underline{E}}_C$	Constituent-dispersion tensor
$\underline{\underline{E}}_H$	Effective heat-conductivity tensor (including hydrodynamic dispersion)
g	Acceleration due to gravity
H	Enthalpy
k	Permeability
k_{ij}	Rate of decay of component j to component i
K	Thermal conductivity
K_d	Distribution coefficient
K_i	Equilibrium adsorption constant defined in Equation K-9
Δ	Distance between grid-block centers
p	Pressure
q	Mass source per grid block
q'	Mass source per unit of porous-medium volume
q_H	Energy stored without fluid input per grid block
q_H'	Energy stored without fluid input per unit of porous-medium volume
q_L	Rate of heat loss per grid block
q_L'	Rate of heat loss per unit of porous-medium volume
r	Radial space coordinate
t	Time
T	Temperature

Table K-1. Nomenclature (continued)

T_H, T_w, T_C	Transmissibility of energy, flow, and contaminant; defined by Equations K-17, K-18, K-19
u	Superficial (Darcy) fluid velocity in the porous rock
U	Internal energy
V	Grid-block volume
x, y, z	Cartesian space coordinates
Z	Elevation above reference plane
<u>Subscripts</u>	
av	Average over depth increment
R	Rock
S	Solid material (always rock)
i, j, k	Indices labeling radioactive components or, in Equations K-15 and K-20, indices labeling grid blocks
w	Liquid
l, t	Longitudinal and transverse, respectively
m	Molecular properties in porous media
<u>Superscripts</u>	
n	Time level n
<u>Greek</u>	
α	Dispersivity coefficient
ϕ	Porosity
ρ_B	Bulk density = $(1 - \phi)\rho_S$
ρ_S	Density of rock
ρ	Density of fluid
μ	Viscosity (kinematic)
Δt	Time increment
$\Delta x, \Delta y, \Delta z$	Grid-block dimensions

K.2 APPLICATION OF THE TRANSPORT MODEL TO THE WIPP SITE

This section describes in detail applications of the hydrologic-transport model described in Section K.1 to the modeling of phenomena at the WIPP site for the long-term safety assessment.

The modeling of hydrologic-transport phenomena has involved a three-step approach: data interpretation and regional hydrologic modeling, the calculation of waste-release rates for the various scenarios, and the calculation of the transport of radionuclides assumed in each of the scenarios. These three parts of the modeling effort are discussed in this section under separate headings.

K.2.1 Data Interpretation and Regional Hydrologic Modeling

The objectives of this part of the modeling effort are as follows:

1. To check consistency or lack of it between various sets of hydrologic data.
2. To calculate the extent of communication (vertical permeabilities) between various hydrologic units.
3. To delineate heterogeneities existing within each geologic formation. Heterogeneity here refers to the spatial variation of permeability values.
4. To calculate potentials and/or hydraulic conductivities in areas where data are lacking.
5. To calculate boundary conditions for local scenario and nuclide-transport modeling.

The calculational procedure is straightforward. Permeability values determined by laboratory or well tests are used as initial values in the calculations. Permeability distributions are adjusted until the calculated potentials are in satisfactory agreement with a consistent set of measured potential values.

The hydrologic data used in this work were obtained primarily from a report by Mercer and Orr (1977), who reviewed and summarized all data existing through February 1977. After the report by Mercer and Orr was issued, the U.S. Geological Survey (USGS) conducted well tests in the Los Medanos area; some data from a draft USGS report to Sandia National Laboratories were used to check consistency and obtain permeabilities immediately above the WIPP site. Other sources of data were Griswold (1977), Rai and Mason (1977), Lambert (1978), and Lambert and Mercer (1977); laboratory-measured distribution coefficients in unpublished form were also used.

A map of the modeled region is shown in Figure K-1, and a geologic cross section of the Los Medanos area looking toward the northwest is presented in Figure K-2. The Santa Rosa Sandstone is a moderately permeable formation

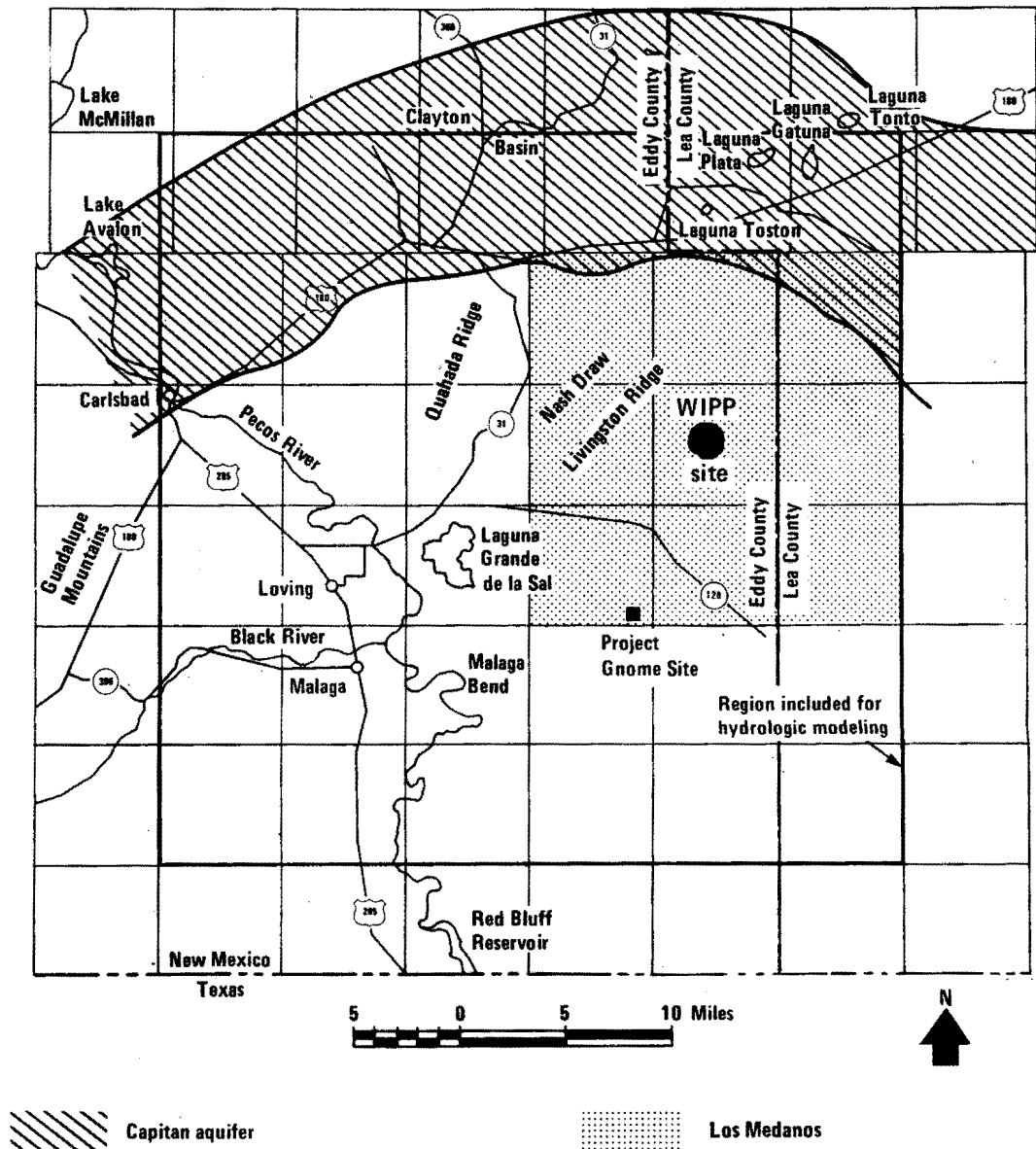

Figure K-1. Hydrologic modeling region.

containing relatively fresh water. However, the low permeability of the Dewey Lake Red Beds prevents significant seepage of water from the Santa Rosa Sandstone to the Rustler Formation. Two thin aquifers, the Magenta and the Culebra, are contained in the Rustler Formation, which is predominantly composed of impervious anhydrites, polyhalites, and gypsum. The WIPP will be in the Salado Formation. The Castile Formation, composed of very pure halite and anhydrite, contains no water-bearing strata. Beneath it lies the Delaware Mountain Group, approximately 3000 feet thick, which contains aquifers.

The Santa Rosa Sandstone does not extend beyond the WIPP to the west, and the intermediate Dewey Lake Red Beds are essentially confining beds. Therefore, for the purpose of regional hydrologic modeling, the upper surface of the Rustler was assumed impermeable and the Santa Rosa Sandstone was not included in the calculations.

Within the hydrologic region modeled in this study, the Rustler Formation aquifers (Culebra and Magenta) apparently do not communicate hydrologically with any of the aquifers below the Salado Formation or with the shallow-dissolution zone. The Magenta and the Culebra are modeled as one aquifer, the Rustler aquifer, with a total thickness equal to the combined thicknesses of the two actual aquifers. The regional flow in the Rustler aquifer is generally to the southwest. As can be seen from Figure K-3, discharge from the Rustler is into the Pecos River at Malaga Bend, about 15 miles from the WIPP site, and possibly at points south of Malaga Bend. (The reader who is unfamiliar with the conventions of groundwater hydrology can easily deduce the flow pattern from sets of hydraulic-potential curves, such as the ones in Figures K-3 and K-4, by drawing a set of nonintersecting curved lines that are everywhere orthogonal to the potential curves; the direction of flow is then along these curved lines, proceeding from the highest values of potential to the lowest values.)

More recent data obtained by the U.S. Geological Survey and presented by Mercer and Orr (1978) suggest that flow immediately above the repository in the Culebra is toward the southeast. However, combining the map in Figure K-3 with the recent data shows that the flow toward the southeast is only local; on a larger scale the flow in the Rustler Formation is toward the Pecos River.

Potentials in the Delaware Mountain Group (Figure K-4, solid lines) show that flow there is essentially toward the northeast. The Delaware Mountain aquifers communicate with the Capitan aquifer, though the degree of communication will vary considerably at different locations. In the regional modeling, the Capitan aquifer was combined with the aquifers of the Delaware Mountain Group.

Finally, the existence of a shallow-dissolution zone along the Rustler-Salado interface in Nash Draw is known. This feature is roughly 50 feet

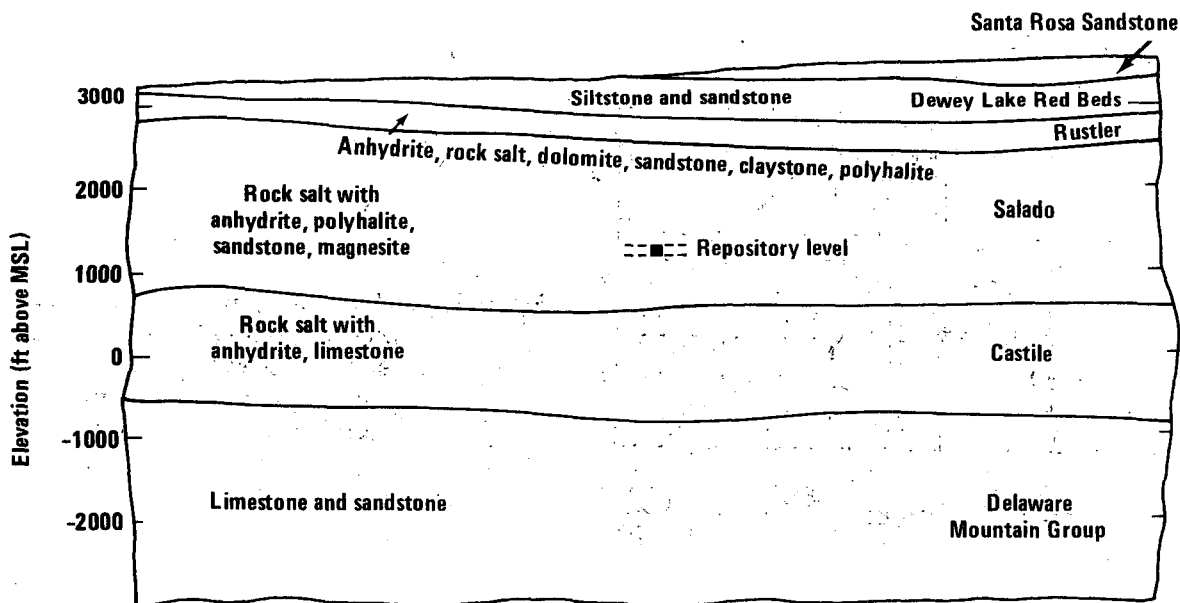

Figure K-2. Geologic section of the Los Medanos area.

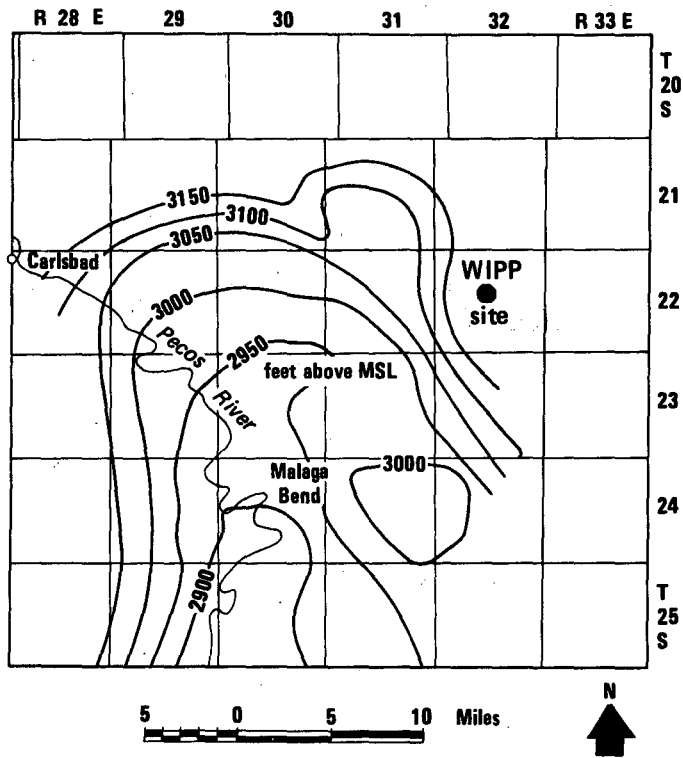

Figure K-3. Hydraulic potentials (feet above MSL) measured in the Rustler Formation.

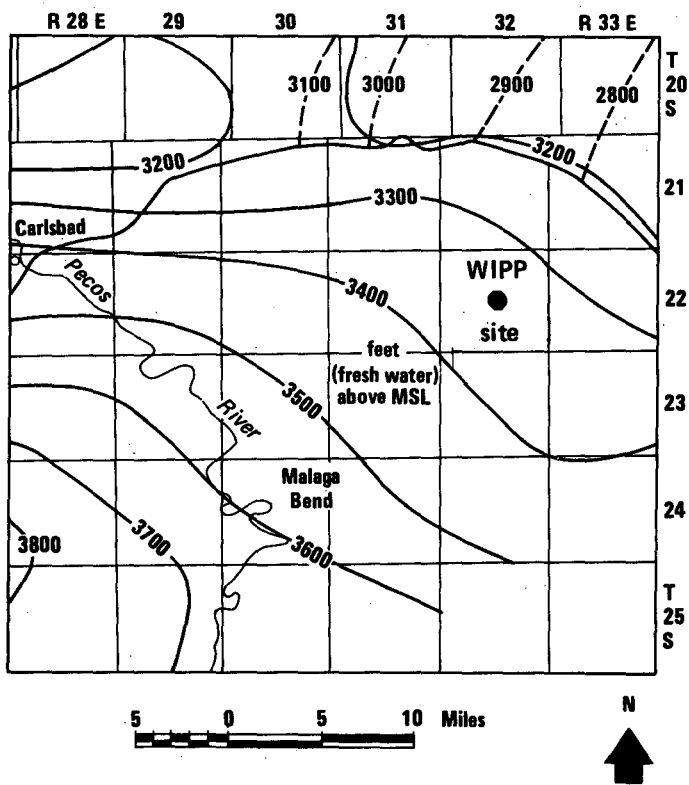

Figure K-4. Hydraulic potentials (feet above MSL) measured in the Capitan aquifer (broken lines) and in the Delaware Mountain Group (solid lines).

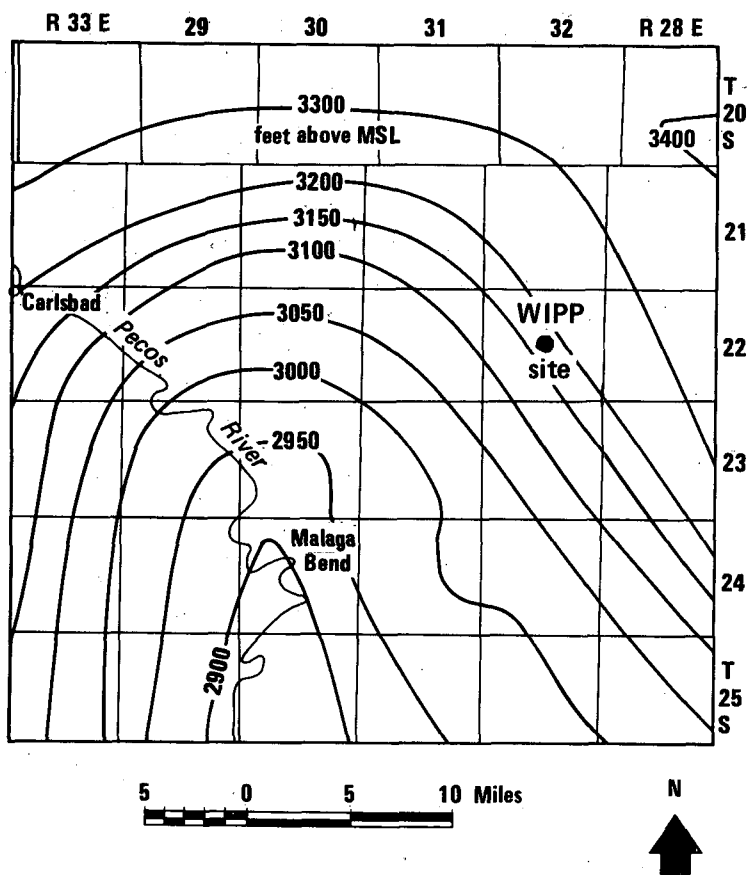

Figure K-5. Calculated hydraulic potentials (feet above MSL) for the Rustler Formation.

thick, 30 miles long, and 2 to 10 miles wide. Its nearest edge is several miles west of the repository.

The Rustler Formation, the shallow-dissolution zone, the Delaware Mountain Group, and the Capitan reef were modeled to obtain a match with the observed potentials. Modeling of intervening anhydrite and salt layers showed that the anhydrite and salt had to be essentially impermeable; an upper limit to the vertical hydraulic conductivity in these formations was calculated to be 10^{-6} ft/day. It was difficult to simultaneously match potentials in different layers with a higher value. Calculated potentials in the Rustler and the Delaware Mountain Group are shown in Figures K-5 and K-6. The match of measured and calculated potentials in the Rustler (Figures K-3 and K-5, respectively) is especially reasonable for this analysis, in which only the potentials between the site and Malaga Bend determine the flow path. The match of the potentials in the Delaware Mountain Group (Figures K-4 and K-6) is adequate; these, however, are of little importance to the transport of radio-nuclides from the repository.

A set of calculated hydraulic conductivities in various layers is shown in Figures K-7 to K-10. It is important to note that these conductivity

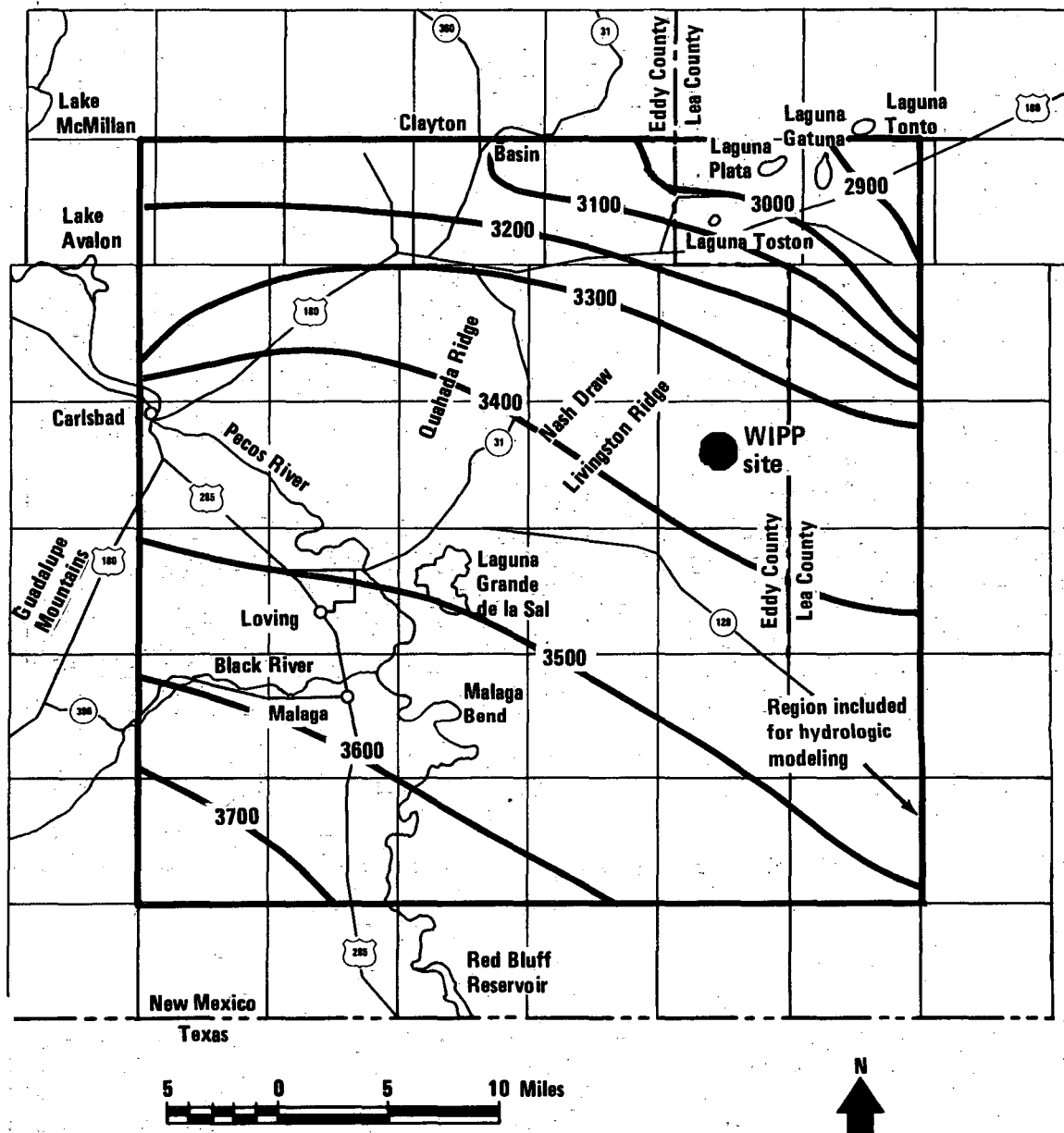

Figure K-6. Calculated hydraulic potentials (feet above MSL) for the Delaware Mountain Group.

values are not unique. Any set of conductivity values scaled up or down by a constant factor will produce exactly the same results; the velocities and flow rates will differ by the same factor. Therefore, it is necessary to "calibrate" with one or more conductivity values obtained from well tests. Based on the available data, two values of the conductivity in the Rustler aquifers can be used to describe upper and lower bounds. The lower-bound conductivities are lower by a factor of 20 than the values shown in Figure K-7.

Calculated natural water velocities in the Rustler aquifers ranged from 0.075 to 15 ft/yr, and in the Delaware Mountain Group aquifer the velocities

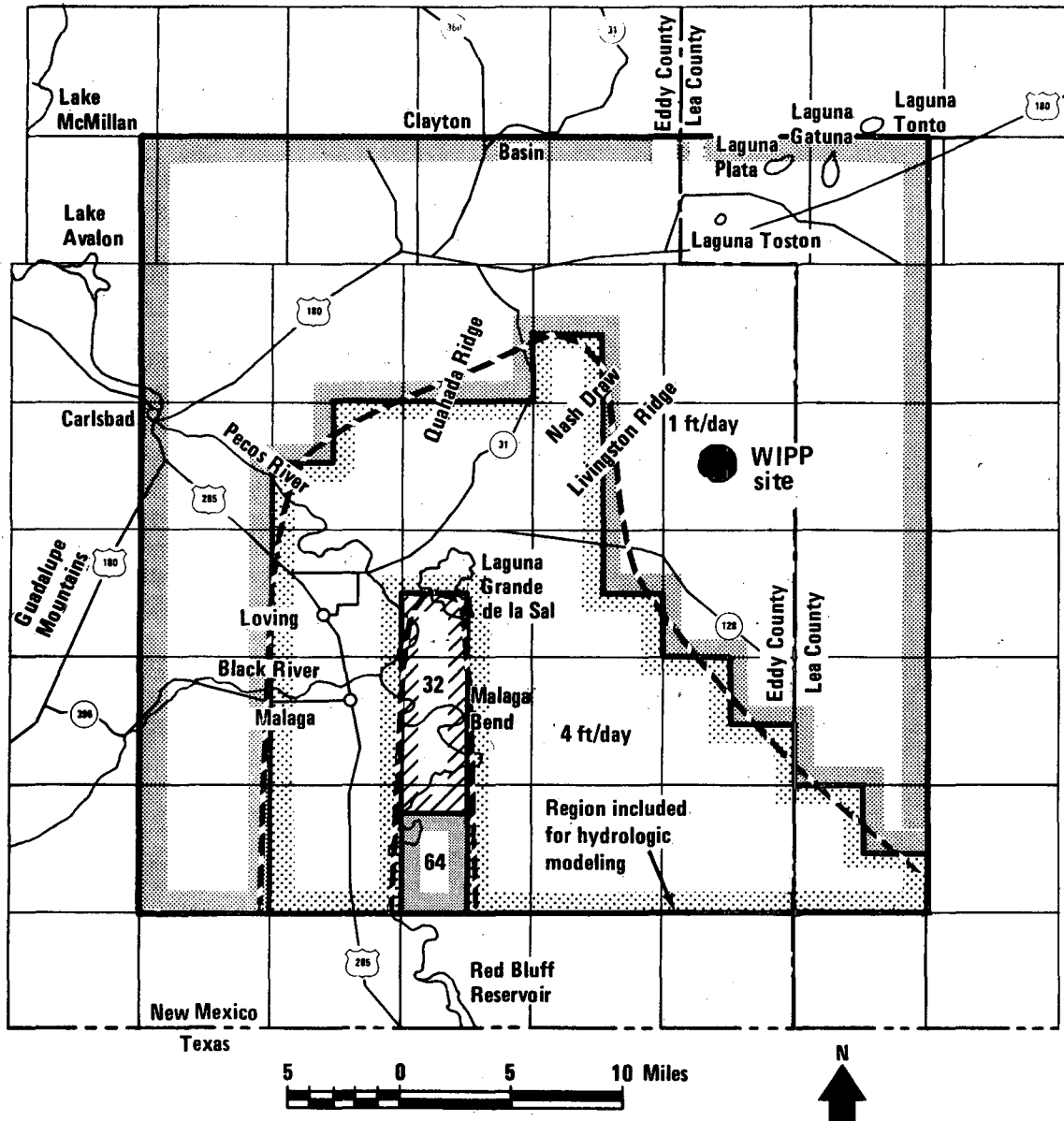

Figure K-7. Hydraulic conductivities in the Rustler aquifers.

are less than 0.1 ft/yr. A direct travel path to the shallow-dissolution zone for any waste released from the repository would have to be either through salt or along the Salado-Rustler interface; water velocities along these paths are essentially zero at the site. A path to the Capitan aquifer would have to be through the Delaware Mountain Group aquifer. Consequently, the time needed for the waste to travel from the repository to either the shallow-dissolution zone or the Capitan aquifer would be very long and of little concern.

The Rustler aquifers are of primary importance in the WIPP safety analysis for two reasons: the travel times to the biosphere are shorter there than in the Delaware Mountain Group, and the greater hydraulic potentials in the Delaware Mountain Group provide a driving force for upward water flow into the Rustler. A degree of uncertainty is nevertheless associated with the hydrologic data for

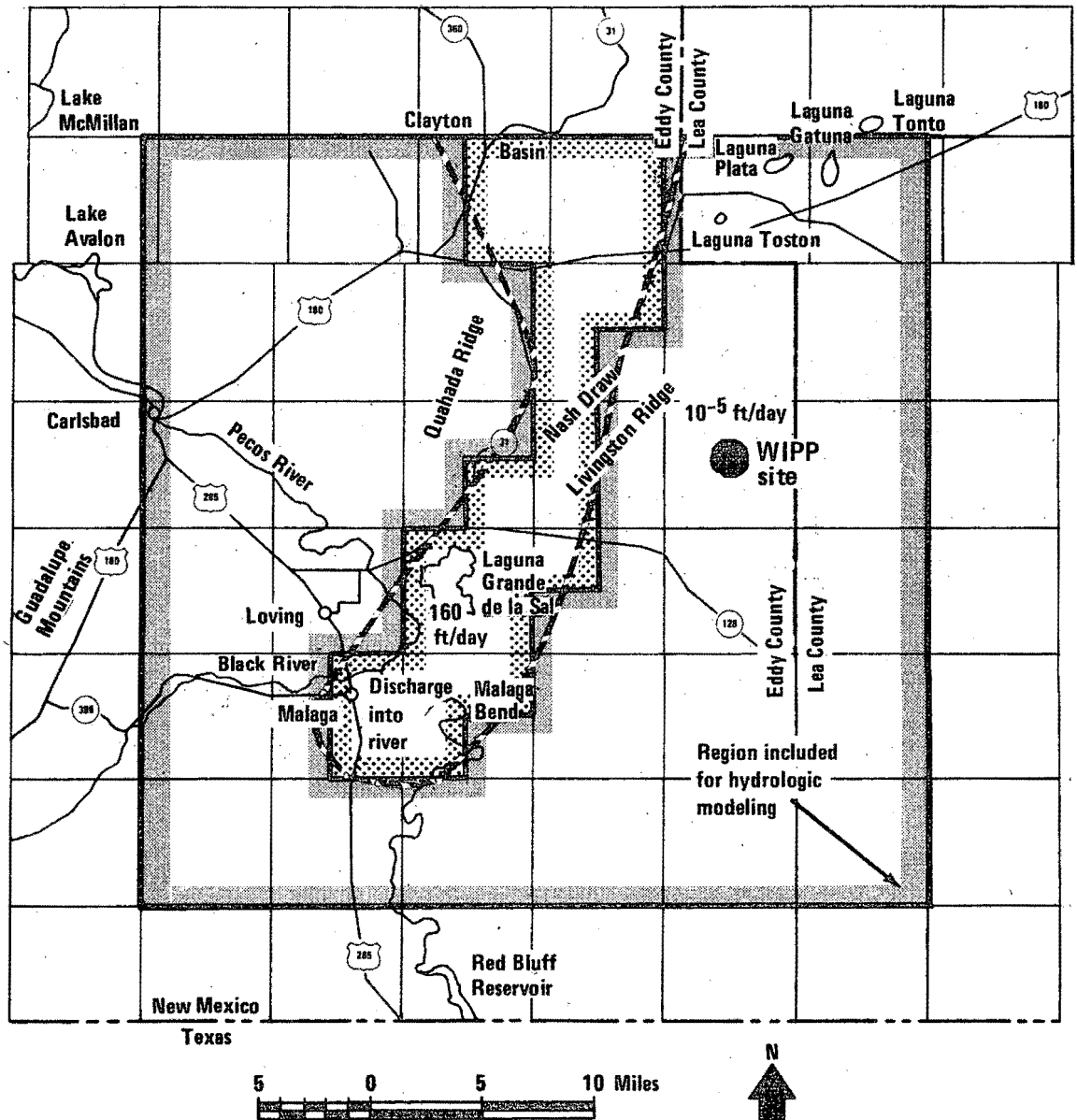

Figure K-8. Hydraulic conductivities in the shallow-dissolution zone.

the Rustler, as was mentioned above. Uncertainty in the hydraulic conductivity induces uncertainty in predicted transport rates. A preliminary analysis (Tang and Pinder, 1977) shows that

1. Changes in groundwater velocity, within the range used here, generated relatively little change in the mass concentrations at long times.
2. Increases in groundwater velocity together with increases in dispersivity cause earlier arrivals at points where concentrations are being

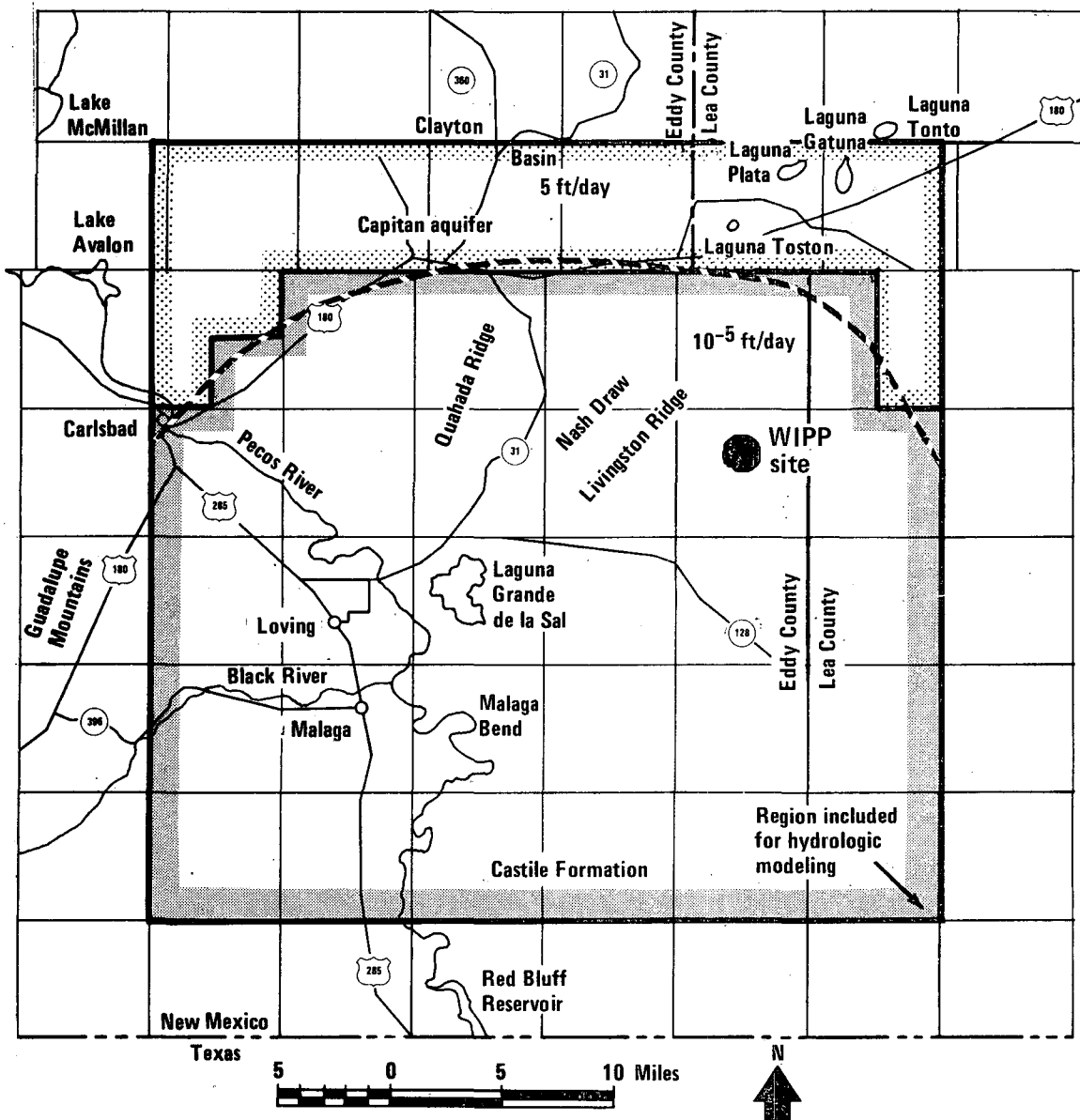

Figure K-9. Hydraulic conductivities in the Capitan aquifer and the Castile Formation.

determined. Therefore, calculations that take dispersion into account may predict earlier arrival times than those reported here, although the differences would not be great.

3. To a high degree of confidence, in each scenario the actual geosphere transport must lie within the results predicted by calculations with the two transmissivities.
4. The use of the higher transmissivity value gives conservative results.

The present analysis accounts for uncertainty by using conservative, upper-bound values in all safety-assessment calculations.

Table K-2. Summary of Hydrologic Data

Property	Formation	Reported value	Reference	Value used in this work
Thickness, ft	Rustler	210	Griswold, 1977	210
	Rustler--Culebra	20	Griswold, 1977	
	Rustler--Magenta	20		40 (total)
	Shallow-dissolution zone	50	Mercer and Orr, 1977	50
	Salado	1600	Griswold, 1977	2000
	Capitan aquifer	1600	Mercer and Orr, 1977	
	Castile	1000 to 1500	Griswold, 1977	1000
	Delaware Mountain Group	3000	Mercer and Orr, 1977	3000
Hydraulic transmissivity, ft ² /day	Rustler	0 to 500	Griswold, 1977	Not used
	Rustler--Culebra	10 ⁻⁴ to 140	Mercer and Orr, 1978	2 to 1280 (total)
	Rustler--Magenta	1 to 40	Mercer and Orr, 1978	
	Shallow-dissolution zone	8000	Mercer and Orr, 1977	8000
	Delaware Mountain Group	50	Mercer and Orr, 1977	1 to 200
Hydraulic conductivity, ft/day	Capitan aquifer	1 to 25, average	Mercer and Orr, 1977	5
	Salado, Castile, and Rustler anhydrite	4 x 10 ⁻⁶ to 2 x 10 ⁻⁵	Lambert and Mercer, 1977	10 ⁻⁵
Porosity	Rustler	0.1	Mercer and Orr, 1977	0.1
	Shallow-dissolution zone			0.2
	Capitan aquifer			0.15
	Delaware Mountain Group	0.1565	Mercer and Orr, 1977	0.16
	Salado, Castile, and Rustler anhydrite			0.005

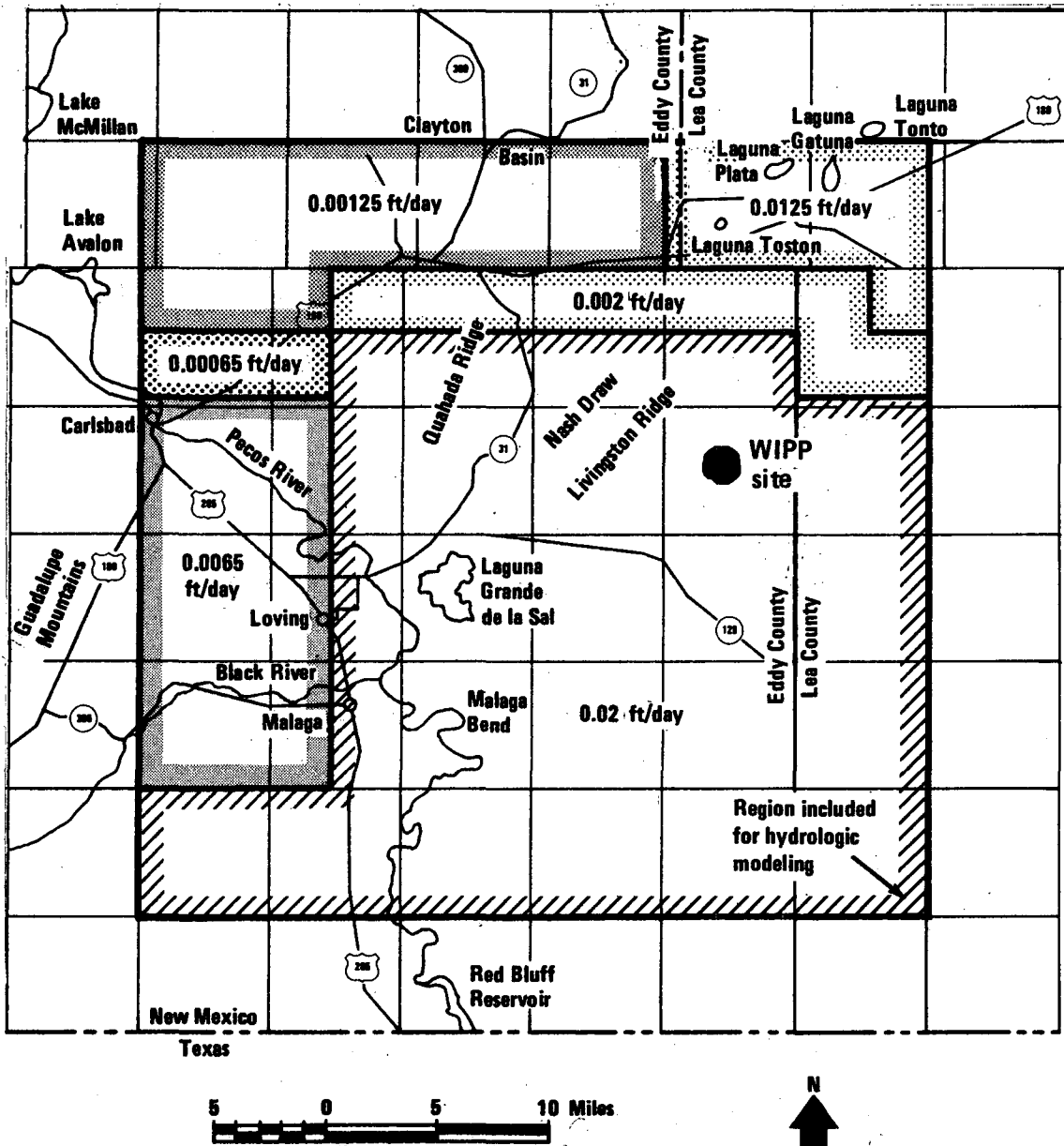

Figure K-10. Hydraulic conductivities in the Delaware Mountain Group.

A summary of available hydrologic data and the values used in this work are given in Table K-2. As can be seen from the table, the values used are reasonably conservative; that is, they are upper bounds on conductivity and permeability. They are, however, consistent with the measured data.

The total thickness of the upper aquifer was taken to be 40 feet, although the effective hydraulic thickness may actually be much smaller. The larger value of 40 feet was used because the calculated communication flow through the repository is then conservatively calculated on the high side.

A summary of reported water-quality data is given in Table K-3 along with the values of distribution coefficients used in this work. Ideally, the

Table K-3. Summary of Geochemical Data

Formation	Water quality		Value used in this work
	Reported value (mg/l)	Reference	
Rustler	3,350-35,600 TDS ^a	Lambert, 1978	Not used
Rustler--Culebra	23,720-118,290 TDS 17,900-89,200 NaCl	Mercer and Orr, 1978	8,000 TDS
Rustler--Magenta	10,350-20,680 TDS 6,800-24,300 NaCl	Mercer and Orr, 1978	
Delaware Mountain Group	296,400 TDS	Lambert, 1978	230,000 TDS

Distribution coefficients in the Rustler aquifer^b

Element	Distribution coefficient (ml/g)
Americium	1460
Neptunium	350
Uranium	10
Thorium	2190
Plutonium	2100
Radium	25

^aTDS = total dissolved solids.

^bSee text for the sources of the distribution coefficients.

geochemical data required for complete modeling would consist of water quality, the distribution coefficient for each radionuclide, nuclide solubilities in the Rustler water, and waste leach rates. For a real repository the rates at which radionuclides could enter the water would be limited by the solubility of the waste and by the rate at which the nuclides could be leached from the waste. This analysis took no advantage of these reductions; the waste-dissolution rate was assumed to be the same as the rate at which the salt formation is dissolved. A number of distribution coefficients have been measured at Sandia National Laboratories (Dosch and Lynch, 1978) for the WIPP-site rock material. Site-specific adsorption data were, however, not available for some radionuclides included in the modeling here. The distribution coefficients for these nuclides were estimated from the ratios of distribution coefficients for similar elements, measured at Sandia National Laboratories in WIPP-site rock and at the Pacific Northwest Laboratory (Rai and Mason, 1977) in desert soil.

K.2.2 Modeling of Liquid-Breach Scenarios

Four of the scenarios selected for analysis in this study involve the movement of water, salt, and waste products through a connection developed

between the repository and one or more aquifers. To distinguish them from the direct-access scenarios (Section K.3), the term "liquid-breach scenario" is used. The reasons for choosing the four scenarios out of the many possible liquid-breach scenarios are outlined in Section 9.7.1.2; the discussion in this subsection centers on the modeling processes necessary for the four scenarios that were chosen.

Given a hydraulic communication between an aquifer and the waste repository, there are three mechanisms that can transfer waste from the repository to the aquifer:

1. Forced convection--fluid flow along a pressure or potential gradient.
2. Natural convection--fluid flow along a density gradient.
3. Molecular diffusion--transport along a concentration gradient.

Each of the four scenarios selected for analysis postulates a hydraulic connection. Because the driving mechanism is largely determined by the properties of the connection, detailed modeling of this small set of scenarios predicts the consequences of many scenarios. Of the four liquid-breach scenarios, three specify forced convection and one specifies molecular diffusion. None of them specify natural convection, which is expected to produce much weaker effects in the absence of a significant heat load in the repository.

Two types of scenario involving forced convection were modeled:

1. A hydrologic communication exists (or develops) between the Rustler aquifer and aquifers of the Delaware Mountain Group. The communication could be a wellbore or some natural feature. Water flows up or down the feature, depending on the relative hydraulic potentials or pressures in the two aquifers.
2. A hydrologic communication exists (or develops) between the Rustler aquifer and the repository through two wellbores (or perhaps natural channels). This situation is also known as a U-tube communication. Water flows down through one leg of the U-tube, through the repository, and up the other leg.

In each type of forced-convection scenario, the rate of waste release is assumed to be proportional to the rate of water flow through the repository.

A parametric study (Intera Environmental Consultants, personal communication, September 1979) has shown that, for both types of forced-convection scenario, the critical variables controlling water flow are the pressure or the potential difference between the inlet and the outlet of the communication, and the hydraulic conductance of the communication. Hydraulic conductance is the reciprocal of hydraulic resistance; it is defined as kA/L , where k is the hydraulic conductivity (feet per day), A is the cross-sectional area available for flow, and L is the effective length of the flow medium.

There are, however, limits to the control exercised by the hydraulic conductance of the communication. This fact is illustrated in Figure K-11, which shows the water-flow rate as a function of the hydraulic conductance of a communication between the upper and the lower aquifer. The figure applies to forced convection between two aquifers, the first type of scenario mentioned

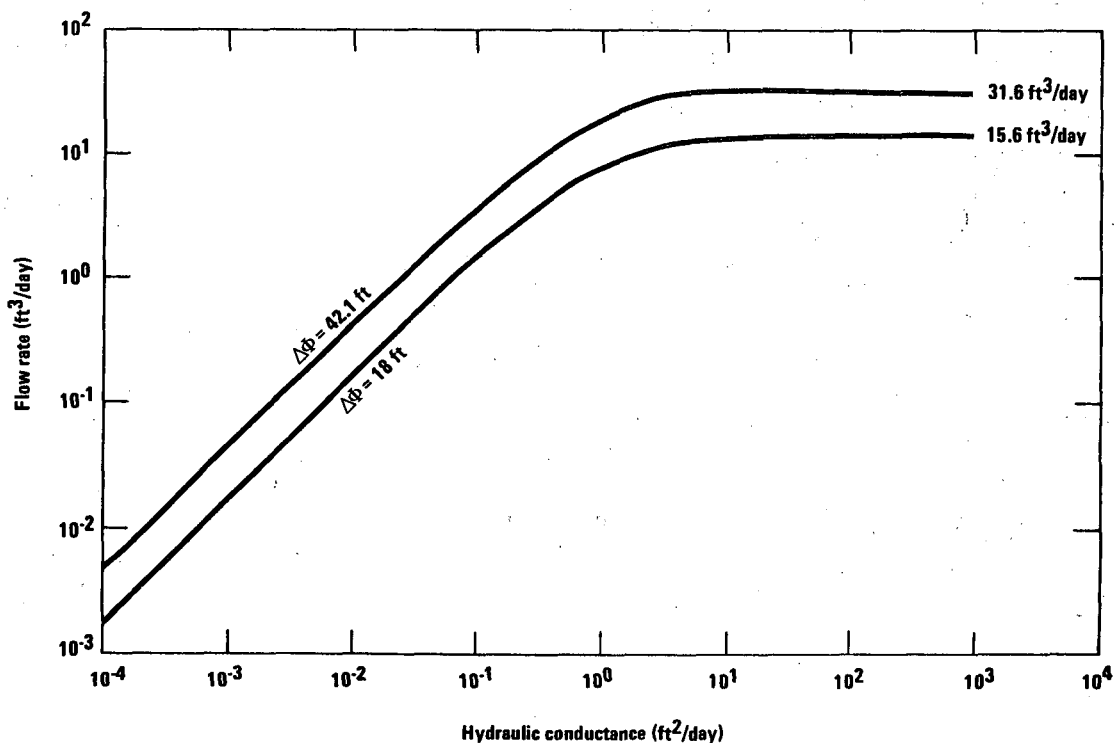

Figure K-11. Flow rate as a function of hydraulic conductance for two values of pressure-head difference: two-aquifer communication.

above. Two values of natural (undisturbed) pressure-head difference are shown. It is seen that the flow rate is proportional to the hydraulic conductance only for a limited range of values of that parameter; if the conductance is higher than about $1 \text{ ft}^2/\text{day}$, the flow rate asymptotically becomes a constant. This effect can be explained by noting that large flow rates are limited by the natural pressure-head difference and combined resistance of the two aquifers involved; in other words, the ultimate controlling parameter is the amount of fluid that can be supplied by the aquifers for flow through the repository. Similar studies were conducted for the case of a single-aquifer communication, the second type of scenario mentioned above. The qualitative behavior of the flow-rate versus conductance curves was identical with the behavior of the curves shown in Figure K-11; but in the former case the asymptotic limit is determined by natural pressure-head differences in, and the conductivity of, the single aquifer to which the U-tube is connected.

The functional dependence of flow rate on hydraulic conductance exhibited by the parametric studies can be used to support a claim made earlier: the small set of forced-convection scenarios modeled in the present study are capable of predicting the consequences of a wider class of events. If the flow rate is large enough, the nature, size, and origin of the assumed communication (i.e., whether it is a wellbore, a breccia pipe, or a conducting fault) do not really matter in determining the consequences of a waste-release scenario. The upper-limit values of conductance used in the scenarios of the text (Section 9.7.1) are judged to be sufficiently near the appropriate asymp-

toxic limiting values so that these scenarios could cover a wide class of events leading to the release of waste.

Parametric studies for the liquid-breach scenario based on molecular diffusion are presented directly in the results for that scenario given in Section 9.7.1.4 of the text. The limiting parameters for molecular diffusion are the area of the communication (which cannot be larger than the area of the repository) and, implicitly, the rate at which the Rustler aquifers can supply water to carry away waste products that have diffused upward from the breached repository. It is assumed that waste products diffuse as rapidly as salt does through the stagnant water in the communication.

In the modeling of liquid-breach scenarios, potentials, waste-dissolution rates, and fluid-flow rates are based on hydrologic steady states. This assumption is reasonable because the time required to reach the steady state is small in comparison with the total waste-dissolution times. Furthermore, all fluid coming out of the repository into an aquifer is assumed to be saturated brine, with a total-dissolved-solids concentration of 410,000 ppm by weight. Fluid enters the repository at the total-dissolved-solids concentration listed in Table K-3. The salt formation and waste material are assumed to dissolve uniformly and at the same rate, bringing the total-dissolved-solids concentration up to the indicated saturated-brine concentration. For modeling convenience, both the contact-handled and the remotely handled wastes are assumed to be uniformly distributed throughout the volumes of their disposal areas at the time the scenario begins; specifications for the disposal areas are given in the text (Section 9.7.1).

K.2.3 Modeling of Radionuclide Transport

The transport of waste radionuclides away from the repository through the action of flowing groundwater is modeled in essentially four steps:

1. The determination of the flow lines (direction and speed) in the Rustler aquifer over the repository, under the disturbed conditions postulated in the scenario.
2. The determination of the rate of waste discharge into the Rustler aquifer, under the disturbed conditions postulated in the scenario.
3. The integration of the radionuclide-transport equations along a set of the flow lines determined in step 1, using the waste-discharge rate determined in step 2 as a source term. The integration is carried along each flow line until the line reaches a discharge point. (In all scenarios, discharge points were on the Pecos River.)
4. The determination of the total rate of discharge for each radionuclide into the Pecos River as a function of time. This step is performed by summing the integrated contributions from each of the flow lines of step 1 that reach the river.

In this study, steps 1 and 2 were performed in parallel by applying the three-dimensional regional hydrologic model on a limited but finely zoned grid centered on the repository. Hydrologic parameters for grid blocks were

assigned to reflect the initial disturbed conditions for each liquid-breach scenario. Potentials and flows at the boundaries of the limited region were set according to the undisturbed potentials and flows determined by the large-scale regional modeling. It is believed that the size of the limited grid was large enough to insure that such boundary conditions were appropriate.

Step 3 was performed by numerically integrating one-dimensional versions of the coupled set of radionuclide-transport equations (Equations K-6 of Section K.1.2) along selected flow lines, taking into account changes in the hydrologic parameters (hydraulic conductivity mainly) in the regional grid blocks crossed by the flow lines. The one-dimensional transport equations do not account for hydraulic dispersion transverse to the flow lines and generally lead to overestimates of the peak concentrations of the trace constituent at a fixed time and position along the flow line. However, a good estimate of the net discharge to the Pecos is obtained by integrating the one-dimensional flux at the terminus of each flow line over the projected area of the envelope of flow lines at the discharge point. This is the procedure indicated in step 4 above.

In all transport calculations performed for this study, it was assumed that the events of the scenarios began either 1000 years (scenarios 1 through 3) or 50,000 years (scenario 4) after the repository is sealed. The calculations were carried out for the important isotopes of actinides listed in Table K-3. Shorter-lived fission products, present in modest amounts in the remotely handled TRU waste, contribute little activity to the inventory 1000 years after emplacement. Since nearly all of the considered actinides are long-lived isotopes, the nuclide inventory changes slowly during the unfolding of the scenario.

These 1000-year-event calculations are believed to be conservative predictions of direct consequences of events that could begin after many thousands of years. Although there would be a diminished radionuclide inventory in scenarios beginning later than 1000 years after burial, the consequences of such scenarios would not be radically different from the consequences of the ones considered; the only effect would be a displacement of the peak discharge rate at Malaga Bend to a later point in time. As stated in the text, the time at which maximum consequences are realized is not considered valuable information for this safety assessment, owing to the lack of a consensus on the times after which the waste products could be considered safe.

K.3 DIRECT-ACCESS SCENARIOS

The direct-access scenarios for the WIPP arise from the assumption that at some future time people will be motivated to drill into or mine in the unguarded and unmarked site. Specifically, these scenarios consider the consequences of drilling at the site in the course of exploring for mineral resources and the more serious consequences of solution mining for salt at the site. With one exception, the methods used to analyze these scenarios are straightforward and are described in Section 9.7.1 of the text along with results of the analyses. The exception is the method used to calculate the transport in air and the airborne concentrations of radionuclides suspended from a drilling-mud pit. Details of this method are given below.

K.3.1 Method for Calculating Radionuclide Transport in Air

It is assumed that a drill hole penetrates either the disposal area for remotely handled TRU waste or the disposal area for contact-handled TRU waste. In the process, waste materials are intercepted by the drill bit and radionuclides are uniformly mixed with the drilling mud. The contaminated mud is brought to the surface and directed to a mud pit, where it is left to dry uncovered and undisturbed. Thereafter wind erodes the surface, transporting contaminants downwind.

Drilling mud is pure clay (usually bentonite) with additives to adjust its density and pH. The surface of the mud pit is likely to dry to a crusted bricklike consistency, which would not present much opportunity for wind erosion. However, it is assumed that sand particles from the surrounding plain will scour the surface of the mud pit, and the material thus loosened will be resuspended to the same degree as material from the rest of the plain.

Provided the area of the mud pit is small (less than 100 square meters), the suspended material transported to distances greater than, say, 100 meters from the pit may be assumed to come from a point source. The Reactor Safety Study uses a squared Gaussian plume model for air concentration downwind (NRC, 1975, Appendix VI, p. 4-1, and Appendix A). The expression is

$$X = \frac{2Q}{3\sigma_y \sqrt{2\pi} \sigma_z u}$$

where

X = ground-level air concentration (Ci/m³)

Q = source strength (Ci/sec)

$3\sigma_y$ = lateral width of the assumed uniform distribution (m)

σ_z = vertical standard deviation (m)

u = average wind speed (m/sec)

The quantity Q can be expressed as the upward flux of suspended particles multiplied by the area of the source (Healy, 1977). The resuspension rate, in reciprocal units of sec⁻¹, multiplied by the surface concentration gives the value of the upward flux. The resuspension rate measured for desert soil at the Nevada Test Site is 10⁻¹³ sec⁻¹ and varies as the cube of the wind speed (Healy, 1977). Thus the transport of suspended material is described by the equation

$$X_1 = \frac{2 \rho d_0 A K \Omega_i (10^4)}{\sqrt{2\pi} 3\sigma_y \sigma_z u}$$

where

Ω_i = concentration of isotope i in the drilling mud (Ci/g)

ρ = density of the drilling mud (assumed to be 2 g/cm³)

d_0 = depth from which material is available for resuspension (assumed to be 1 cm)

K = resuspension rate (sec^{-1}); $K = 10^{-13}(u/u_0)^3$; u_0 is assumed to be 1 m/sec

A = area of the mud pit (m^2)

10^4 = factor for converting from square meters to square centimeters

The expressions for σ_y and σ_z for slightly unstable to neutral conditions typical of the desert southwest (Pasquill stability category C) are

$$\sigma_y = 0.11d(1 + 10^{-4}d)^{-\frac{1}{2}}$$

$$\sigma_z = 0.08d(1 + 2 \times 10^{-4}d)^{-\frac{1}{2}}$$

where d is the downwind transport distance expressed in meters. The mud-pit areas assumed are 720 square feet (66.9 square meters) for a 10-inch drill hole and 144 square feet (13.4 square meters) for a 3-inch drill hole. To allow for the finite size of these pits, a virtual point source is created upwind of the pond such that $3\sigma_y = A^{\frac{1}{2}}$ at the leeward side of the pond. Thus for the 10- and 3-inch drill holes the virtual point source is taken to be 24.8 and 11.1 meters, respectively, upwind of the leeward side. Using these values, a short table giving X_i as a function of Ω_i and distance can be constructed. (All downwind transport distances d' given below are measured from the middle of the pond.)

d' (m)	X_i (Ci/m ³)	
	10-inch drill hole	3-inch drill hole
100	$3.58 \times 10^{-9}\Omega_i$	$8.73 \times 10^{-10}\Omega_i$
500	$2.04 \times 10^{-10}\Omega_i$	$4.25 \times 10^{-11}\Omega_i$
1000	$5.67 \times 10^{-11}\Omega_i$	$1.16 \times 10^{-11}\Omega_i$

The subsequent surface deposition of suspended radionuclides is also required for the analyses. It is assumed that dry deposition is the dominant mechanism. The dry-deposition flux is the product of the deposition velocity and the air concentration near the ground ($\text{Ci/m}^2\text{-sec} = V_d X$). The deposition velocity V_d is taken to be 0.01 m/sec, which corresponds to a particle about 1 micron in diameter. The particle-size distribution of the suspended material can be related to the particle-size distribution of the surface source. Healy (1977) indicates that for clays the aerodynamic mean activity diameter of these particles is 1 micron or less. Thus 1 micron is taken to be the nominal value for the suspended and transported material.

K.3.2 Uncertainties in the Calculation

Air concentrations and surface depositions previously described as applying to the direct-access scenario have been obtained using generally conservative assumptions and parameters. However, it is worthwhile to understand how uncertainties in these assumptions and parameters may affect the results.

Radionuclide distribution in the drilling mud. If radionuclides are uniformly distributed in the drilling mud, their concentration and hence the resulting dose will vary inversely with the total mass of the mud. However, to the extent that the heavy elements settle to the bottom of the pond, they will not be resuspended in significant quantities even if the mass of the mud is greatly reduced.

Resuspension factor. The dried drilling mud (clay) is most likely to have a bricklike consistency that, if left in an undisturbed state, is not liable to produce as much suspendable material as the surface at the Nevada Test Site, where small and large particles are more intimately but more loosely mixed. This tendency is likely to persist even if the surface is mechanically disturbed after drying, provided the thickness of the mud is on the order of feet.

Atmospheric stability. Values cited above are for slightly unstable atmospheric conditions. Under very stable conditions, air concentrations downwind of the source would increase by more than a factor of 10. Under very unstable conditions, they would decrease by about a factor of 5. However, the exposures being estimated are long-term exposures, and for this purpose median stability conditions are in order.

Wind direction. In directions other than the usual downwind direction, concentrations and hence exposures will be smaller than those estimated.

Particle deposition. The assumption used in the transport and deposition calculation above holds that the dust cloud is not depleted by surface deposition as it travels downwind. In fact, material is continuously lost from the cloud; thus all downwind concentrations are overestimated, roughly by a factor of 2.

REFERENCES

- Dillon, R. T., R. B. Lantz, and S. B. Pahwa, 1977. Risk Methodology for Geologic Disposal of Radioactive Waste: The Sandia Waste Isolation Flow and Transport (SWIFT) Model, SAND78-1267, Sandia Laboratories, Albuquerque, N.M.
- Dosch, R. G., and G. W. Lynch, 1978. Interaction of Radionuclides with Geomedia Associated with the Waste Isolation Pilot Plant (WIPP) Site in New Mexico, SAND78-0297, Sandia Laboratories, Albuquerque, N.M.
- Griswold, G. B., 1977. Site Selection and Evaluation Studies of the Waste Isolation Pilot Plant (WIPP), Los Medanos, Eddy County, New Mexico, SAND77-0946, Sandia Laboratories, Albuquerque, N.M.
- Healy, J. W., 1977. An Examination of the Pathways from Soil to Man for Plutonium, LA-6741-MS, Los Alamos Scientific Laboratory, Los Alamos, N.M.
- INTERCOMP Resource Development and Engineering Inc., 1976. Development of Model for Calculating Disposal in Deep Saline Aquifers, Parts I and II, PB-256903, National Technical Information Service, Washington, D.C.
- Lambert, S. J., 1978. "The Geochemistry of Delaware Basin Groundwaters," in Geology and Mineral Deposits of Ochoan Rocks in Delaware Basin and Adjacent Areas, New Mexico Bureau of Mines and Mineral Resources, Circular 159, pp. 33-38.
- Lambert, S. J., and J. W. Mercer, 1977. Hydrologic Investigations of the Los Medanos Area, Southeastern New Mexico, SAND77-1401, Sandia Laboratories, Albuquerque, N.M.
- Mercer, J. W., and B. R. Orr, 1977. Review and Analysis of Hydrogeologic Conditions Near the Site of a Potential Nuclear-Waste Repository, Eddy and Lea Counties, New Mexico, U.S. Geological Survey Open File Report 77-123.
- Mercer, J. W., and B. R. Orr, 1978. Geohydrology of the Proposed Waste Isolation Pilot Plant, Southeast New Mexico, U.S. Geological Survey, under contract to Sandia Laboratories, Albuquerque, N.M.
- NRC (U.S. Nuclear Regulatory Commission), 1975. Reactor Safety Study--An Assessment of Accident Risks in U.S. Commercial Nuclear Power Plants, WASH-1400, Washington, D.C.
- Rai, D., and M. J. Mason, 1977. K_d Measurements of Nuclides to Estimate Migration Potential at the Proposed Waste Isolation Pilot Plant in New Mexico, PNL-2448, Pacific Northwest Laboratory, Richland, Wash.
- Tang, D. H., and G. F. Pinder, 1977. "Simulation of Groundwater Flow and Mass Transport Under Uncertainty," Advances in Water Resources, Vol. 1, No. 1, pp. 25-30.

Appendix L

**AN OUTLINE OF THE INPUT-OUTPUT MODEL
AND THE METHODS USED IN PROJECTING
SOCIOECONOMIC IMPACTS**

CONTENTS

	<u>Page</u>
L.1 Input-Output Model.....	L-1
L.1.1 Base Model.....	L-2
L.1.2 Household Compensation for Labor and Personal Consumption in the Area.....	L-2
L.2 Output Multiplier.....	L-3
L.3 Employment Multipliers.....	L-3
L.3.1 Wages.....	L-18
L.3.2 Calculating Indirect Job Impact.....	L-18
L.4 Population	L-39
L.4.1 Factors Affecting Population.....	L-39
L.4.2 Population Impact Calculations.....	L-40
L.5 Personal Income.....	L-50
L.5.1 General.....	L-50
L.5.2 Explanation and Values.....	L-50
L.6 Housing, Land Use, and Community Services.....	L-54
L.6.1 Housing and Land Use.....	L-54
L.6.2 Community Services and Facilities.....	L-56
L.7 Fiscal-Impact Analysis.....	L-58
L.7.1 Revenues.....	L-58
L.7.2 Expenditures.....	L-62
L.7.3 Net Fiscal Impacts.....	L-62
Bibliography.....	L-64
Annex A Non-Survey Technique for Constructing a Direct Requirements Regional Input-Output Table.....	L-66

LIST OF TABLES

	<u>Page</u>
L-1 Input/Output Tables, Lea and Eddy Counties, November 1979: Direct Coefficients.....	L-4
L-2 Input/Output Tables, Lea and Eddy Counties, November 1979: Direct, Indirect, and Induced Coefficients.....	L-11
L-3 Estimated Annual Wages and Labor Costs per Employee in Lea and Eddy Counties, 1979.....	L-19
L-4 Indirect Impact of the WIPP Project in 1980, Dollar Volume and Jobs Supported by Subsector.....	L-22
L-5 Indirect Impact of the WIPP Project in 1981, Dollar Volume and Jobs Supported by Subsector.....	L-24
L-6 Indirect Impact of the WIPP Project in 1982, Dollar Volume and Jobs Supported by Subsector.....	L-26
L-7 Indirect Impact of the WIPP Project in 1983, Dollar Volume and Jobs Supported by Subsector.....	L-28
L-8 Indirect Impact of the WIPP Project in 1984, Dollar Volume and Jobs Supported by Subsector.....	L-30
L-9 Indirect Impact of the WIPP Project in 1985 and 1986, Dollar Volume and Jobs Supported by Subsector.....	L-32
L-10 Indirect Impact of the WIPP Project, Average Year, 1987 After Dollar Volume and Jobs Supported by Subsector.....	L-34
L-11 Indirect Impact of the WIPP Project 1980-1983 and There- after, Dollar Volume and Jobs Supported by Major Sector.....	L-36
L-12 Indirect Impact of the WIPP Project 1984-1987 and There- after, Dollar Volume and Jobs Supported by Major Sector.....	L-37
L-13 Jobs Created or Supported by the Construction and Operation of the WIPP Project 1980-1987 and Thereafter.....	L-38
L-14 Baseline Population Estimates and Projections.....	L-49
L-15 Personal Income in Eddy County by Major Source, 1972-1977.....	L-51
L-16 Personal Income in Lea County by Major Source, 1972-1977.....	L-52
L-17 Personal Income from the WIPP.....	L-53
L-18 Housing-Type Demand.....	L-55
L-19 Revenue Categories and Projection Methods Used for New Mexico Municipalities and Counties.....	L-59

Appendix L

AN OUTLINE OF THE INPUT-OUTPUT MODEL AND THE METHODS USED IN PROJECTING SOCIOECONOMIC IMPACTS

L.1 INPUT-OUTPUT MODEL

A static model in the form of a regional input-output model was constructed for Eddy and Lea Counties, New Mexico. The original derivation of the input-output model is described in a paper published in the Proceedings of the 1975 Conference of the Association of University Business and Economic Research; that paper is attached to this appendix as an annex. The procedure described in that document was, in general, followed in building the regional input-output model.

Since the publication of that document, better information on the agricultural sector in New Mexico has become available, and its credibility is believed to be such that the variation experienced in the original model has been decreased. Regardless of the accuracy of the agricultural information, the effect of the construction and operation of the WIPP on the agricultural sector is believed to be less than 1% in terms of employment and income. Therefore, the agricultural sector and the reliability of agricultural information exert little effect on the overall modeling process.

This model has been used to assess the economic impacts of the following projects for the following agencies: the San Juan power plant (units 1, 3, and 4) for the Public Service Company of New Mexico; the Gallup-Navajo Indian Water Supply Project for the Bureau of Reclamation; a proposed nuclear power plant at Cementon, New York, for Harbridge House, Inc., an agent for the Power Authority of the State of New York; two sites for nuclear or fossil-fuel power plants for Harbridge House, Inc., an agent for the New York State Electric & Gas Corporation; four coal-development scenarios in northwest New Mexico for Harbridge House, Inc., an agent for the Bureau of Land Management; and the proposed New Mexico Generating Station for the Public Service Company of New Mexico. It has also been used to study general economic impacts (an ongoing process) for the Bureau of Business and Economic Research, University of New Mexico.

During or about the same time this study was being conducted, the model was used for analyzing the economic impacts of a proposed coal-fired power plant for Burns and McDonnell, an agent for the Plains Electric Cooperative; industrial linkages in Cecil County, Maryland, for Harbridge House, Inc., an agent for the Cecil County Development Agency; and the economic impacts of decreased grazing allocations in the Roswell, New Mexico, Grazing District for Harbridge House, Inc., an agent for the Bureau of Land Management. Thus, the model has been used extensively and is accepted as a tool for determining the economic impacts of proposed new facilities and developments.

L.1.1 Base Model

The regional model adjusts a national model by means of location quotients and aggregating techniques. The national, or base, model contains 407 economic categories, or subsectors of the economy, 389 of which represent the private economy and 18 of which represent other activities, including the public sector. The 389 private subsectors were used in the model; the government impact was computed from four of the public subsectors supplemented by a final demand pattern from the business-service subsector.

The base model is an updated version of the 1967 National Input-Output Model constructed by the Department of Commerce, Bureau of Economic Analysis. Two important changes in the 1967 version have been made. First, the mining sectors have been expanded to 44 subsectors. Second, the Lawrence Berkeley Laboratory has mathematically updated the 1967 version to a 1972 version by using data from the 1972 Census of Business.

As already mentioned, the detailed modeling process and technical procedures are discussed in the annex. However, several important aspects of this particular model for Eddy and Lea Counties should be noted. First, detailed information on employment, by category, was determined from information supplied by the New Mexico Employment Security Department (NMESD), formerly the Employment Security Commission. From this information, detailed location quotients for manufacturing were determined at the four-digit SIC code level, and this added credibility and accuracy to the modeling process.

Second, because of the makeup of retail and wholesale subsectors in Eddy and Lea Counties, a detailed analysis of the types of outlets present in the area was conducted. Basic information from the 1972 Census of Business was used with updated information from the employment files for this analysis.

Finally, once the location quotients had been determined, 1972 Census data and various other State and local data sources were used to identify the output per employee for subsectors whose location quotients were computed through employment statistics. A total-output figure was derived for these subsectors. In turn, the total-output figures were used to aggregate the 389 subsectors in the base model into 37 private-business subsectors and one governmental subsector for the regional model.

Subsectors for WIPP aboveground construction (1980, 1981, 1982, 1983, and 1984), WIPP management and design, WIPP belowground construction (1980, 1981, 1982, 1983, and 1984), and WIPP operation--aboveground operation, remote handling and security, and belowground operation--were derived from data supplied by Sandia National Laboratories, Bechtel, Inc., and the Westinghouse Electric Corporation. There are a total of 52 subsectors in the model for Eddy and Lea Counties and two additional subsectors to account for labor compensation.

L.1.2 Household Compensation for Labor and Personal Consumption in the Area

The average percentages of cost going to labor from the technical production process (direct coefficients) were determined from the 1972 national input-output model. Personal-consumption figures were adjusted by weighting the location quotients of each of the 37 private-business subsectors and the

government subsector in the regional model. An additional personal-consumption column adjusted for reduced local purchases was incorporated into the model to allow for lower local consumption by construction workers who commute weekly. The labor coefficients for the 14 WIPP subsectors were derived from data supplied by Sandia, Bechtel, and Westinghouse. For the five WIPP aboveground-construction subsectors and the five WIPP belowground-construction subsectors, labor coefficients for construction workers who commute and those who reside in the two-county area were assigned by using comparable factors from the Construction Worker Profile.

The direct coefficients obtained by determining location quotients and the aggregation process are listed in Table L-1. The aggregated direct, indirect, and induced coefficients are given in Table L-2.

L.2 OUTPUT MULTIPLIER

The volume of activity generated in the private sector by a \$1 exogenous increase in a subsector can be determined through the input-output process. For example, for WIPP aboveground construction in 1982, subsector 40, we find the column sum of 1.67062 in Table L-2. Thus, \$1.67 in total activity will result in the region from a \$1 exogenous increase in WIPP aboveground-construction (1982) activity; that is, an additional \$0.67 of indirect activity, including payments to labor, will be generated in Eddy and Lea Counties.

It should be noted at this point that the output multiplier is not of primary concern in determining the overall impact of new developments in the area. The employment and income multipliers are believed to be of greater importance, and they may vary significantly from the 1.67 output multiplier.

L.3 EMPLOYMENT MULTIPLIERS

To determine the employment multipliers for WIPP-related development, three basic calculations must be performed. First, wages for the area under consideration must be determined in constant dollars--in this case 1979 dollars. Second, the change in the total annual output for an exemplary year must be calculated in constant 1979 dollars. Third, the actual number of dollars spent directly for labor must be computed.

Once the annual labor costs for each subsector have been determined, the average labor unit cost is divided into each gross amount to find the actual number of jobs supported in that specific subsector by an exogenous increase in the specific activity being investigated, such as WIPP aboveground construction, belowground construction, or aboveground operation.

Table L-1. Input-Output Tables, Lea and Eddy Counties,
November 1979: Direct Coefficients

Industry Selling		Industry purchasing								
		1	2	3	4	5	6	7	8	
Livestock and livestock products	1	0.30891	0.02889	0.09777	0.01457	0.14889	0.00151	0.00000	0.00000	1
Cotton	2	0.00000	0.01636	0.00000	0.00000	0.00000	0.00095	0.00000	0.00000	2
Grains and seeds	3	0.26662	0.00000	0.02988	0.00000	0.00000	0.00772	0.00000	0.00000	3
Fruits and vegetables	4	0.00049	0.00000	0.00000	0.00378	0.00000	0.00090	0.00000	0.00000	4
Forestry and fishery products	5	0.00000	0.00000	0.00000	0.00000	0.07198	0.00000	0.00000	0.00000	5
Agricultural services	6	0.00263	0.10165	0.01289	0.05881	0.02604	0.00000	0.00000	0.00000	6
Miscellaneous metallic and nonmetallic minerals	7	0.00000	0.00009	0.00020	0.00008	0.00000	0.00000	0.00836	0.00000	7
Crude petroleum	8	0.00000	0.00000	0.00000	0.00000	0.00000	0.00000	0.00000	0.00250	8
Natural gas and liquid petroleum	9	0.00000	0.00000	0.00000	0.00000	0.00000	0.00000	0.00000	0.00000	9
Stone, gravel, and sand	10	0.00001	0.00137	0.00184	0.00094	0.00000	0.00000	0.00000	0.00000	10
Potash mining	11	0.00000	0.00071	0.00120	0.00056	0.00000	0.00000	0.00000	0.00000	11
Residential construction	12	0.00000	0.00000	0.00000	0.00000	0.00000	0.00000	0.00000	0.00000	12
Nonresidential construction	13	0.00000	0.00000	0.00000	0.00000	0.00000	0.00000	0.00000	0.00000	13
All other construction	14	0.00000	0.00000	0.00000	0.00000	0.00000	0.00000	0.00000	0.00000	14
Construction maintenance	15	0.00387	0.01065	0.00935	0.00702	0.00000	0.00000	0.00222	0.02719	15
Food products	16	0.02322	0.00000	0.00000	0.00000	0.01580	0.00003	0.00000	0.00000	16
Fabrics and apparel	17	0.00000	0.00000	0.00000	0.00000	0.00000	0.00000	0.00000	0.00000	17
Wood and lumber products	18	0.00000	0.00000	0.00000	0.00000	0.00000	0.00000	0.00000	0.00000	18
Printing	19	0.00001	0.00003	0.00002	0.00002	0.00000	0.00000	0.00000	0.00000	19
Chemical products	20	0.00079	0.00507	0.00659	0.00247	0.00056	0.00000	0.02144	0.00319	20
Plastics and petroleum products	21	0.00328	0.03672	0.03285	0.01250	0.03032	0.00012	0.00205	0.00426	21
Glass and stone products	22	0.00000	0.00000	0.00000	0.00000	0.00000	0.00000	0.00000	0.00000	22
Primary metal products	23	0.00000	0.00000	0.00000	0.00000	0.00000	0.00000	0.00000	0.00000	23
Fabricated metal products	24	0.00000	0.00000	0.00000	0.00000	0.00001	0.00000	0.00000	0.00008	24
Machinery	25	0.00008	0.00024	0.00011	0.00010	0.00000	0.00000	0.01063	0.00008	25
Electrical products	26	0.00000	0.00000	0.00000	0.00000	0.00000	0.00000	0.00000	0.00000	26
Transportation and warehousing	27	0.01356	0.01047	0.01312	0.00868	0.00522	0.00065	0.00984	0.00139	27
Communications	28	0.00146	0.00296	0.00184	0.00133	0.00000	0.00000	0.00282	0.00078	28
Electrical utility	29	0.00186	0.00738	0.00161	0.00281	0.00021	0.00003	0.01118	0.01071	29
Gas utility	30	0.00002	0.00000	0.00000	0.00000	0.00028	0.00003	0.00239	0.00159	30
Water and sewer	31	0.00018	0.00832	0.00720	0.00770	0.00000	0.00000	0.00000	0.00050	31
Wholesale trade	32	0.01542	0.03706	0.02949	0.02561	0.02824	0.00047	0.00958	0.00409	32
Retail trade	33	0.01004	0.02745	0.02302	0.01103	0.00893	0.00023	0.00119	0.00382	33
Finance, insurance, and real estate	34	0.00868	0.07375	0.04181	0.02078	0.01685	0.00107	0.00815	0.09158	34
Lodging and personal and repair services	35	0.00330	0.00862	0.00442	0.00377	0.00575	0.00002	0.00051	0.00216	35
Businesses and miscellaneous services	36	0.00139	0.02915	0.02602	0.01550	0.00005	0.00000	0.00816	0.01375	36
Medical and nonprofit	37	0.00051	0.00056	0.00085	0.00040	0.00000	0.00000	0.00121	0.00028	37
WIPP surface construction, 1980	38	0.00000	0.00000	0.00000	0.00000	0.00000	0.00000	0.00000	0.00000	38
WIPP surface construction, 1981	39	0.00000	0.00000	0.00000	0.00000	0.00000	0.00000	0.00000	0.00000	39
WIPP surface construction, 1982	40	0.00000	0.00000	0.00000	0.00000	0.00000	0.00000	0.00000	0.00000	40
WIPP surface construction, 1983	41	0.00000	0.00000	0.00000	0.00000	0.00000	0.00000	0.00000	0.00000	41
WIPP surface construction, 1984	42	0.00000	0.00000	0.00000	0.00000	0.00000	0.00000	0.00000	0.00000	42
WIPP construction management and design	43	0.00000	0.00000	0.00000	0.00000	0.00000	0.00000	0.00000	0.00000	43
WIPP underground construction, 1980	44	0.00000	0.00000	0.00000	0.00000	0.00000	0.00000	0.00000	0.00000	44
WIPP underground construction, 1981	45	0.00000	0.00000	0.00000	0.00000	0.00000	0.00000	0.00000	0.00000	45
WIPP underground construction, 1982	46	0.00000	0.00000	0.00000	0.00000	0.00000	0.00000	0.00000	0.00000	46
WIPP underground construction, 1983	47	0.00000	0.00000	0.00000	0.00000	0.00000	0.00000	0.00000	0.00000	47
WIPP underground construction, 1984	48	0.00000	0.00000	0.00000	0.00000	0.00000	0.00000	0.00000	0.00000	48
WIPP general surface operations	49	0.00000	0.00000	0.00000	0.00000	0.00000	0.00000	0.00000	0.00000	49
WIPP security and remote handling	50	0.00000	0.00000	0.00000	0.00000	0.00000	0.00000	0.00000	0.00000	50
WIPP underground operations	51	0.00000	0.00000	0.00000	0.00000	0.00000	0.00000	0.00000	0.00000	51
Government	52	0.00007	0.00014	0.00010	0.00012	0.00032	0.00000	0.00154	0.00037	52
Households/EC weekly	53	0.00000	0.00000	0.00000	0.00000	0.00000	0.00000	0.00000	0.00000	53
Households/EC local	54	0.04276	0.07285	0.07285	0.07285	0.20020	0.35031	0.32507	0.11930	54
Column sums		0.70916	0.48049	0.41450	0.27144	0.55967	0.36404	0.42633	0.28762	

Table L-1. Input-Output Tables, Lea and Eddy Counties,
November 1979: Direct Coefficients (Continued)

Industry Selling		Industry Purchasing									
		9	10	11	12	13	14	15	16		
Livestock and livestock products	1	0.00000	0.00000	0.00000	0.00000	0.00000	0.00000	0.00000	0.00000	0.07348	1
Cotton	2	0.00000	0.00000	0.00000	0.00000	0.00000	0.00000	0.00000	0.00000	0.10494	2
Grains and seeds	3	0.00000	0.00000	0.00000	0.00000	0.00031	0.00013	0.00018	0.00000	0.02323	3
Fruits and vegetables	4	0.00000	0.00000	0.00000	0.00000	0.00000	0.00000	0.00000	0.00000	0.00155	4
Forestry and fishery products	5	0.00000	0.00000	0.00000	0.00000	0.00000	0.00000	0.00000	0.00000	0.00000	5
Agricultural services	6	0.00000	0.00000	0.00000	0.00139	0.00077	0.00285	0.00047	0.00000	0.00000	6
Miscellaneous metallic and nonmetallic minerals	7	0.00000	0.00000	0.00000	0.00000	0.00000	0.00000	0.00000	0.00000	0.00005	7
Crude petroleum	8	0.00000	0.00000	0.00000	0.00000	0.00000	0.00000	0.00000	0.00000	0.00000	8
Natural gas and liquid petroleum	9	0.14584	0.00000	0.00000	0.00000	0.00000	0.00000	0.00000	0.00000	0.00000	9
Stone, gravel, and sand	10	0.00000	0.00446	0.00000	0.00201	0.00271	0.02103	0.00657	0.00012	0.00012	10
Potash mining	11	0.00000	0.00048	0.01395	0.00000	0.00000	0.00000	0.00000	0.00000	0.00000	11
Residential construction	12	0.00000	0.00000	0.00000	0.00000	0.00000	0.00000	0.00000	0.00000	0.00000	12
Nonresidential construction	13	0.00000	0.00000	0.00000	0.00000	0.00000	0.00000	0.00000	0.00000	0.00000	13
All other construction	14	0.00000	0.00000	0.00000	0.00000	0.00000	0.00000	0.00000	0.00000	0.00000	14
Construction/maintenance	15	0.03218	0.00796	0.00205	0.00025	0.00036	0.00034	0.00015	0.00244	0.00244	15
Food products	16	0.00000	0.00000	0.00000	0.00000	0.00000	0.00000	0.00000	0.00000	0.02480	16
Fabrics and apparel	17	0.00000	0.00000	0.00000	0.00098	0.00003	0.00061	0.00010	0.00019	0.00019	17
Wood and lumber products	18	0.00000	0.00000	0.00000	0.03789	0.01187	0.00210	0.00382	0.00000	0.00000	18
Printing	19	0.00000	0.00000	0.00000	0.00000	0.00000	0.00000	0.00000	0.00131	0.00131	19
Chemical products	20	0.00803	0.00646	0.01969	0.00049	0.00191	0.00263	0.00032	0.00106	0.00106	20
Plastics and petroleum products	21	0.00441	0.01289	0.00574	0.00601	0.00944	0.02759	0.00749	0.00317	0.00317	21
Glass and stone products	22	0.00000	0.05511	0.00000	0.02664	0.03524	0.02147	0.00287	0.00000	0.00000	22
Primary metal products	23	0.00000	0.00000	0.00000	0.00000	0.00000	0.00000	0.00000	0.00000	0.00000	23
Fabricated metal products	24	0.00003	0.00000	0.00000	0.00196	0.00309	0.00187	0.00047	0.00000	0.00000	24
Machinery	25	0.00011	0.00509	0.01535	0.00038	0.00058	0.00051	0.00024	0.00000	0.00000	25
Electrical products	26	0.00000	0.00000	0.00000	0.00020	0.00029	0.00023	0.00007	0.00000	0.00000	26
Transportation and warehousing	27	0.00167	0.01329	0.00977	0.02637	0.02787	0.04716	0.02166	0.02313	0.02313	27
Communications	28	0.00093	0.00020	0.00259	0.00316	0.00471	0.00431	0.00211	0.00465	0.00465	28
Electrical utility	29	0.00574	0.02649	0.02001	0.00055	0.00084	0.00077	0.00037	0.00600	0.00600	29
Gas utility	30	0.01419	0.00291	0.02469	0.00012	0.00017	0.00015	0.00007	0.00187	0.00187	30
Water and sewer	31	0.00105	0.00281	0.00000	0.00029	0.00044	0.00036	0.00017	0.00040	0.00040	31
Wholesale trade	32	0.00923	0.03455	0.00250	0.05106	0.04953	0.04327	0.03911	0.02976	0.02976	32
Retail trade	33	0.00448	0.01193	0.00138	0.08578	0.04874	0.03914	0.06360	0.00185	0.00185	33
Finance, insurance, and real estate	34	0.10845	0.03037	0.00694	0.00697	0.01026	0.00916	0.00484	0.00709	0.00709	34
Lodging and personal and repair services	35	0.00255	0.01085	0.00064	0.00488	0.00730	0.00801	0.00354	0.00341	0.00341	35
Businesses and miscellaneous services	36	0.01627	0.03144	0.00860	0.05413	0.07157	0.04270	0.01936	0.00810	0.00810	36
Medical and nonprofit	37	0.00033	0.00009	0.00119	0.00078	0.00115	0.00106	0.00052	0.00060	0.00060	37
WIPP surface construction, 1980	38	0.00000	0.00000	0.00000	0.00000	0.00000	0.00000	0.00000	0.00000	0.00000	38
WIPP surface construction, 1981	39	0.00000	0.00000	0.00000	0.00000	0.00000	0.00000	0.00000	0.00000	0.00000	39
WIPP surface construction, 1982	40	0.00000	0.00000	0.00000	0.00000	0.00000	0.00000	0.00000	0.00000	0.00000	40
WIPP surface construction, 1983	41	0.00000	0.00000	0.00000	0.00000	0.00000	0.00000	0.00000	0.00000	0.00000	41
WIPP surface construction, 1984	42	0.00000	0.00000	0.00000	0.00000	0.00000	0.00000	0.00000	0.00000	0.00000	42
WIPP construction management and design	43	0.00000	0.00000	0.00000	0.00000	0.00000	0.00000	0.00000	0.00000	0.00000	43
WIPP underground construction, 1980	44	0.00000	0.00000	0.00000	0.00000	0.00000	0.00000	0.00000	0.00000	0.00000	44
WIPP underground construction, 1981	45	0.00000	0.00000	0.00000	0.00000	0.00000	0.00000	0.00000	0.00000	0.00000	45
WIPP underground construction, 1982	46	0.00000	0.00000	0.00000	0.00000	0.00000	0.00000	0.00000	0.00000	0.00000	46
WIPP underground construction, 1983	47	0.00000	0.00000	0.00000	0.00000	0.00000	0.00000	0.00000	0.00000	0.00000	47
WIPP underground construction, 1984	48	0.00000	0.00000	0.00000	0.00000	0.00000	0.00000	0.00000	0.00000	0.00000	48
WIPP general surface operations	49	0.00000	0.00000	0.00000	0.00000	0.00000	0.00000	0.00000	0.00000	0.00000	49
WIPP security and remote handling	50	0.00000	0.00000	0.00000	0.00000	0.00000	0.00000	0.00000	0.00000	0.00000	50
WIPP underground operations	51	0.00000	0.00000	0.00000	0.00000	0.00000	0.00000	0.00000	0.00000	0.00000	51
Government	52	0.00043	0.00022	0.00115	0.00046	0.00068	0.00070	0.00031	0.00092	0.00092	52
Households/PC weekly	53	0.00000	0.00000	0.00000	0.00000	0.00000	0.00000	0.00000	0.00000	0.00000	53
Households/PC local	54	0.11930	0.32507	0.27808	0.32535	0.32535	0.32535	0.49419	0.14492	0.14492	54
Column sums		0.47521	0.58268	0.41431	0.63840	0.61502	0.60383	0.67271	0.46901		

Table L-1. Input-Output Tables, Lea and Eddy Counties,
November 1979: Direct Coefficients (Continued)

Industry Selling	Industry Purchasing								
	17	18	19	20	21	22	23	24	
Livestock and livestock products	1	0.00568	0.00000	0.00000	0.00000	0.00000	0.00000	0.00000	1
Cotton	2	0.03292	0.00000	0.00000	0.00000	0.00000	0.00000	0.00000	2
Grains and seeds	3	0.00000	0.00000	0.00000	0.00006	0.00000	0.00000	0.00000	3
Fruits and vegetables	4	0.00000	0.00000	0.00000	0.00114	0.00000	0.00000	0.00000	4
Forestry and fishery products	5	0.01529	0.00000	0.00000	0.00374	0.00000	0.00000	0.00000	5
Agricultural services	6	0.00000	0.00000	0.00000	0.00000	0.00000	0.00000	0.00000	6
Miscellaneous metallic and nonmetallic minerals	7	0.00000	0.00000	0.00000	0.00124	0.00004	0.00000	0.00000	7
Crude petroleum	8	0.00000	0.00000	0.00000	0.00000	0.45740	0.00000	0.00000	8
Natural gas and liquid petroleum	9	0.00000	0.00000	0.00000	0.00231	0.02337	0.00000	0.00000	9
Stone, gravel, and sand	10	0.00000	0.00000	0.00000	0.00038	0.00000	0.06606	0.00000	10
Potash mining	11	0.00000	0.00000	0.00000	0.00755	0.00000	0.00000	0.00000	11
Residential construction	12	0.00000	0.00000	0.00000	0.00000	0.00000	0.00000	0.00000	12
Nonresidential construction	13	0.00000	0.00000	0.00000	0.00000	0.00000	0.00000	0.00000	13
All other construction	14	0.00000	0.00000	0.00000	0.00000	0.00000	0.00000	0.00000	14
Construction maintenance	15	0.00131	0.00294	0.00000	0.00431	0.01019	0.00289	0.00000	15
Food products	16	0.00001	0.00000	0.00000	0.00088	0.00000	0.00000	0.00000	16
Fabrics and apparel	17	0.10091	0.00080	0.00143	0.00021	0.00007	0.00047	0.00000	17
Wood and lumber products	18	0.00000	0.00791	0.00000	0.00000	0.00000	0.00000	0.00000	18
Printing	19	0.00001	0.00004	0.01586	0.00004	0.00000	0.00008	0.00000	19
Chemical products	20	0.00080	0.00274	0.01263	0.05002	0.00578	0.00123	0.00000	20
Plastics and petroleum products	21	0.00093	0.00272	0.00236	0.05459	0.05487	0.00919	0.00000	21
Glass and stone products	22	0.00000	0.00034	0.00000	0.00000	0.00001	0.02440	0.00000	22
Primary metal products	23	0.00000	0.00000	0.00000	0.00000	0.00000	0.00000	0.00000	23
Fabricated metal products	24	0.00000	0.00000	0.00000	0.00005	0.00001	0.00000	0.00000	24
Machinery	25	0.00000	0.00191	0.00000	0.00002	0.00001	0.00308	0.00000	25
Electrical products	26	0.00000	0.00001	0.00002	0.00002	0.00000	0.00000	0.00000	26
Transportation and warehousing	27	0.00945	0.02748	0.01179	0.02047	0.02876	0.12118	0.00000	27
Communications	28	0.00319	0.00406	0.01098	0.00326	0.00067	0.00573	0.00000	28
Electrical utility	29	0.00687	0.00674	0.00499	0.01371	0.00569	0.00645	0.00000	29
Gas utility	30	0.00048	0.00134	0.00096	0.01014	0.01029	0.00399	0.00000	30
Water and sewer	31	0.00049	0.00000	0.00062	0.00235	0.00188	0.00008	0.00000	31
Wholesale trade	32	0.02700	0.04642	0.01965	0.01909	0.00657	0.02680	0.00000	32
Retail trade	33	0.00261	0.00177	0.00510	0.00247	0.00045	0.00175	0.00000	33
Finance, insurance, and real estate	34	0.01053	0.01530	0.01723	0.01438	0.01657	0.01788	0.00000	34
Lodging and personal and repair services	35	0.00102	0.00163	0.00339	0.00129	0.00048	0.00418	0.00000	35
Businesses and miscellaneous services	36	0.00681	0.00877	0.02700	0.01384	0.00968	0.01648	0.00000	36
Medical and nonprofit	37	0.00043	0.00049	0.00156	0.00056	0.00015	0.00078	0.00000	37
WIPP surface construction, 1980	38	0.00000	0.00000	0.00000	0.00000	0.00000	0.00000	0.00000	38
WIPP surface construction, 1981	39	0.00000	0.00000	0.00000	0.00000	0.00000	0.00000	0.00000	39
WIPP surface construction, 1982	40	0.00000	0.00000	0.00000	0.00000	0.00000	0.00000	0.00000	40
WIPP surface construction, 1983	41	0.00000	0.00000	0.00000	0.00000	0.00000	0.00000	0.00000	41
WIPP surface construction, 1984	42	0.00000	0.00000	0.00000	0.00000	0.00000	0.00000	0.00000	42
WIPP construction management and design	43	0.00000	0.00000	0.00000	0.00000	0.00000	0.00000	0.00000	43
WIPP underground construction, 1980	44	0.00000	0.00000	0.00000	0.00000	0.00000	0.00000	0.00000	44
WIPP underground construction, 1981	45	0.00000	0.00000	0.00000	0.00000	0.00000	0.00000	0.00000	45
WIPP underground construction, 1982	46	0.00000	0.00000	0.00000	0.00000	0.00000	0.00000	0.00000	46
WIPP underground construction, 1983	47	0.00000	0.00000	0.00000	0.00000	0.00000	0.00000	0.00000	47
WIPP underground construction, 1984	48	0.00000	0.00000	0.00000	0.00000	0.00000	0.00000	0.00000	48
WIPP general surface operations	49	0.00000	0.00000	0.00000	0.00000	0.00000	0.00000	0.00000	49
WIPP security and remote handling	50	0.00000	0.00000	0.00000	0.00000	0.00000	0.00000	0.00000	50
WIPP underground operations	51	0.00000	0.00000	0.00000	0.00000	0.00000	0.00000	0.00000	51
Government	52	0.00180	0.00103	0.00664	0.00076	0.00050	0.00080	0.00000	52
Households/PC weekly	53	0.00000	0.00000	0.00000	0.00000	0.00000	0.00000	0.00000	53
Households/PC local	54	0.29852	0.28617	0.23671	0.38320	0.10374	0.31907	0.31473	54
Column sums		0.52704	0.42061	0.38203	0.61209	0.73718	0.63258	0.31473	0.42805

Table L-1. Input-Output Tables, Lea and Eddy Counties,
November 1979: Direct Coefficients (Continued)

Industry Selling		Industry Purchasing								
		25	26	27	28	29	30	31	32	
Livestock and livestock products	1	0.00000	0.00000	0.00000	0.00000	0.00000	0.00000	0.00000	0.00000	1
Cotton	2	0.00000	0.00000	0.00000	0.00000	0.00000	0.00000	0.00000	0.00000	2
Grains and seeds	3	0.00000	0.00000	0.00133	0.00000	0.00000	0.00000	0.00000	0.00000	3
Fruits and vegetables	4	0.00000	0.00000	0.00000	0.00000	0.00000	0.00000	0.00000	0.00000	4
Forestry and fishery products	5	0.00000	0.00000	0.00002	0.00000	0.00000	0.00000	0.00000	0.00000	5
Agricultural services	6	0.00000	0.00000	0.00000	0.00000	0.00000	0.00000	0.00000	0.00117	6
Miscellaneous metallic and nonmetallic minerals	7	0.00000	0.00000	0.00004	0.00000	0.00000	0.00000	0.00000	0.00000	7
Crude petroleum	8	0.00000	0.00000	0.00065	0.00000	0.00059	0.02381	0.00000	0.00001	8
Natural gas and liquid petroleum	9	0.00000	0.00000	0.00405	0.00000	0.00361	0.14625	0.00000	0.00004	9
Stone, gravel, and sand	10	0.00001	0.00000	0.00000	0.00000	0.00001	0.00000	0.00000	0.00002	10
Potash mining	11	0.00000	0.00000	0.00000	0.00000	0.00001	0.00000	0.00000	0.00000	11
Residential construction	12	0.00000	0.00000	0.00000	0.00000	0.00000	0.00000	0.00000	0.00000	12
Nonresidential construction	13	0.00000	0.00000	0.00000	0.00000	0.00000	0.00000	0.00000	0.00000	13
All other construction	14	0.00000	0.00000	0.00000	0.00000	0.00000	0.00000	0.00000	0.00000	14
Construction maintenance	15	0.00168	0.00245	0.02048	0.01411	0.02801	0.01443	0.06484	0.00095	15
Food products	16	0.00000	0.00000	0.00005	0.00000	0.00000	0.00000	0.00000	0.00327	16
Fabrics and apparel	17	0.00070	0.00088	0.00036	0.00012	0.00022	0.00009	0.00031	0.00093	17
Wood and lumber products	18	0.03302	0.00000	0.00000	0.00000	0.00000	0.00000	0.00000	0.00035	18
Printing	19	0.00000	0.00235	0.00037	0.00016	0.00001	0.00000	0.00001	0.00064	19
Chemical products	20	0.00029	0.00000	0.00015	0.00001	0.00086	0.00000	0.00154	0.00072	20
Plastics and petroleum products	21	0.00562	0.00735	0.02989	0.00193	0.01204	0.00076	0.00334	0.00877	21
Glass and stone products	22	0.00000	0.00002	0.00001	0.00000	0.00000	0.00000	0.00000	0.00048	22
Primary metal products	23	0.00000	0.00000	0.00000	0.00000	0.00000	0.00000	0.00000	0.00000	23
Fabricated metal products	24	0.00002	0.00000	0.00000	0.00000	0.00000	0.00000	0.00000	0.00001	24
Machinery	25	0.01938	0.00000	0.00017	0.00000	0.00000	0.00000	0.00000	0.00004	25
Electrical products	26	0.00081	0.01076	0.00000	0.00000	0.00000	0.00000	0.00000	0.00006	26
Transportation and warehousing	27	0.01890	0.01110	0.08829	0.00146	0.02086	0.00020	0.00232	0.01572	27
Communications	28	0.00339	0.00726	0.00861	0.01282	0.00250	0.00210	0.00443	0.01173	28
Electrical utility	29	0.00541	0.00596	0.01622	0.00553	0.07355	0.00260	0.02800	0.00382	29
Gas utility	30	0.00134	0.00193	0.00338	0.00110	0.03353	0.36157	0.01650	0.00046	30
Water and sewer	31	0.00047	0.00013	0.00114	0.00125	0.00097	0.00065	0.00091	0.00168	31
Wholesale trade	32	0.04501	0.02005	0.02379	0.00304	0.00623	0.00063	0.00463	0.01558	32
Retail trade	33	0.00664	0.00762	0.01069	0.00492	0.00168	0.00156	0.00329	0.01564	33
Finance, insurance, and real estate	34	0.01276	0.01924	0.01853	0.01229	0.00464	0.00549	0.01416	0.02239	34
Lodging and personal and repair services	35	0.00082	0.00193	0.02424	0.06180	0.00203	0.00034	0.00783	0.01772	35
Businesses and miscellaneous services	36	0.00679	0.01306	0.00894	0.00983	0.00417	0.00455	0.00751	0.02311	36
Medical and nonprofit	37	0.00045	0.00127	0.00052	0.00059	0.00027	0.00025	0.00051	0.00099	37
WIPP surface construction, 1980	38	0.00000	0.00000	0.00000	0.00000	0.00000	0.00000	0.00000	0.00000	38
WIPP surface construction, 1981	39	0.00000	0.00000	0.00000	0.00000	0.00000	0.00000	0.00000	0.00000	39
WIPP surface construction, 1982	40	0.00000	0.00000	0.00000	0.00000	0.00000	0.00000	0.00000	0.00000	40
WIPP surface construction, 1983	41	0.00000	0.00000	0.00000	0.00000	0.00000	0.00000	0.00000	0.00000	41
WIPP surface construction, 1984	42	0.00000	0.00000	0.00000	0.00000	0.00000	0.00000	0.00000	0.00000	42
WIPP construction management and design	43	0.00000	0.00000	0.00000	0.00000	0.00000	0.00000	0.00000	0.00000	43
WIPP underground construction, 1980	44	0.00000	0.00000	0.00000	0.00000	0.00000	0.00000	0.00000	0.00000	44
WIPP underground construction, 1981	45	0.00000	0.00000	0.00000	0.00000	0.00000	0.00000	0.00000	0.00000	45
WIPP underground construction, 1982	46	0.00000	0.00000	0.00000	0.00000	0.00000	0.00000	0.00000	0.00000	46
WIPP underground construction, 1983	47	0.00000	0.00000	0.00000	0.00000	0.00000	0.00000	0.00000	0.00000	47
WIPP underground construction, 1984	48	0.00000	0.00000	0.00000	0.00000	0.00000	0.00000	0.00000	0.00000	48
WIPP general surface operations	49	0.00000	0.00000	0.00000	0.00000	0.00000	0.00000	0.00000	0.00000	49
WIPP security and remote handling	50	0.00000	0.00000	0.00000	0.00000	0.00000	0.00000	0.00000	0.00000	50
WIPP underground operations	51	0.00000	0.00000	0.00000	0.00000	0.00000	0.00000	0.00000	0.00000	51
Government	52	0.00060	0.00187	0.00308	0.00254	0.00267	0.01382	0.57360	0.00282	52
Households/PC weekly	53	0.00000	0.00000	0.00000	0.00000	0.00000	0.00000	0.00000	0.00000	53
Households/PC local	54	0.36951	0.33341	0.40647	0.39097	0.13980	0.13980	0.13980	0.42500	54
Column sums		0.53363	0.44863	0.67151	0.52446	0.33824	0.71889	0.87351	0.57453	

L-7

Table L-1. Input-Output Tables, Lea and Eddy Counties,
November 1979: Direct Coefficients (Continued)

Industry Selling		Industry Purchasing									
		33	34	35	36	37	38	39	40		
Livestock and livestock products	1	0.00000	0.00034	0.00109	0.00000	0.00003	0.00000	0.00000	0.00000	0.00000	1
Cotton	2	0.00000	0.00006	0.00001	0.00000	0.00000	0.00000	0.00000	0.00000	0.00000	2
Grains and seeds	3	0.00000	0.00067	0.00337	0.00000	0.00000	0.00006	0.00006	0.00006	0.00006	3
Fruits and vegetables	4	0.00000	0.00003	0.00001	0.00000	0.00002	0.00000	0.00000	0.00000	0.00000	4
Forestry and fishery products	5	0.00000	0.00001	0.00000	0.00000	0.00001	0.00000	0.00000	0.00000	0.00000	5
Agricultural services	6	0.00000	0.00028	0.00020	0.00000	0.00000	0.00032	0.00032	0.00032	0.00032	6
Miscellaneous metallic and nonmetallic minerals	7	0.00000	0.00000	0.00000	0.00000	0.00000	0.00000	0.00000	0.00000	0.00000	7
Crude petroleum	8	0.00000	0.00006	0.00000	0.00000	0.00000	0.00000	0.00000	0.00000	0.00000	8
Natural gas and liquid petroleum	9	0.00000	0.00037	0.00000	0.00000	0.00000	0.00000	0.00000	0.00000	0.00000	9
Stone, gravel, and sand	10	0.00000	0.00004	0.00001	0.00000	0.00000	0.00744	0.00744	0.00744	0.00744	10
Potash mining	11	0.00000	0.00001	0.00000	0.00000	0.00000	0.00000	0.00000	0.00000	0.00000	11
Residential construction	12	0.00000	0.00000	0.00000	0.00000	0.00000	0.00000	0.00000	0.00000	0.00000	12
Nonresidential construction	13	0.00000	0.00000	0.00000	0.00000	0.00000	0.00000	0.00000	0.00000	0.00000	13
All other construction	14	0.00000	0.00000	0.00000	0.00000	0.00000	0.00000	0.00000	0.00000	0.00000	14
Construction maintenance	15	0.00280	0.01757	0.00743	0.00494	0.00900	0.00000	0.00000	0.00000	0.00000	15
Food products	16	0.00017	0.00012	0.00000	0.00000	0.00032	0.00000	0.00000	0.00000	0.00000	16
Fabrics and apparel	17	0.00005	0.00010	0.00148	0.00000	0.00018	0.00000	0.00000	0.00000	0.00000	17
Wood and lumber products	18	0.00000	0.00001	0.00000	0.00000	0.00000	0.00000	0.00000	0.00000	0.00000	18
Printing	19	0.00049	0.00299	0.00009	0.00051	0.00300	0.00000	0.00000	0.00000	0.00000	19
Chemical products	20	0.00005	0.00013	0.00030	0.00090	0.00017	0.00000	0.00000	0.00000	0.00000	20
Plastics and petroleum products	21	0.00540	0.00357	0.00838	0.00430	0.00884	0.00047	0.00047	0.00047	0.00047	21
Glass and stone products	22	0.00001	0.00002	0.00004	0.00001	0.00000	0.00000	0.00000	0.00000	0.00000	22
Primary metal products	23	0.00000	0.00000	0.00000	0.00000	0.00000	0.00000	0.00000	0.00000	0.00000	23
Fabricated metal products	24	0.00000	0.00000	0.00000	0.00001	0.00000	0.00136	0.00136	0.00136	0.00136	24
Machinery	25	0.00005	0.00011	0.00387	0.00238	0.00000	0.00011	0.00011	0.00011	0.00011	25
Electrical products	26	0.00000	0.00000	0.00009	0.00009	0.00084	0.00000	0.00000	0.00000	0.00000	26
Transportation and warehousing	27	0.00172	0.00350	0.00487	0.00803	0.00349	0.00431	0.00431	0.00431	0.00431	27
Communications	28	0.00559	0.01517	0.00644	0.01478	0.01308	0.00439	0.00439	0.00439	0.00439	28
Electrical utility	29	0.01428	0.00966	0.01214	0.00214	0.01781	0.00094	0.00094	0.00094	0.00094	29
Gas utility	30	0.00314	0.00194	0.00265	0.00262	0.00352	0.00000	0.00000	0.00000	0.00000	30
Water and sewer	31	0.00225	0.00393	0.00340	0.00118	0.00646	0.00000	0.00000	0.00000	0.00000	31
Wholesale trade	32	0.00573	0.00635	0.02391	0.01323	0.02089	0.06613	0.06613	0.06613	0.06613	32
Retail trade	33	0.00383	0.00913	0.01504	0.01652	0.01888	0.00000	0.00000	0.00000	0.00000	33
Finance, insurance, and real estate	34	0.03464	0.08665	0.03929	0.03435	0.06246	0.00830	0.00830	0.00830	0.00830	34
Lodging and personal and repair services	35	0.00793	0.00453	0.03926	0.01584	0.02056	0.00211	0.00211	0.00211	0.00211	35
Businesses and miscellaneous services	36	0.00795	0.05356	0.01151	0.05497	0.02381	0.00000	0.00000	0.00000	0.00000	36
Medical and nonprofit	37	0.00082	0.00689	0.00191	0.00221	0.00340	0.00008	0.00008	0.00008	0.00008	37
WIPP surface construction, 1980	38	0.00000	0.00000	0.00000	0.00000	0.00000	0.00000	0.00000	0.00000	0.00000	38
WIPP surface construction, 1981	39	0.00000	0.00000	0.00000	0.00000	0.00000	0.00000	0.00000	0.00000	0.00000	39
WIPP surface construction, 1982	40	0.00000	0.00000	0.00000	0.00000	0.00000	0.00000	0.00000	0.00000	0.00000	40
WIPP surface construction, 1983	41	0.00000	0.00000	0.00000	0.00000	0.00000	0.00000	0.00000	0.00000	0.00000	41
WIPP surface construction, 1984	42	0.00000	0.00000	0.00000	0.00000	0.00000	0.00000	0.00000	0.00000	0.00000	42
WIPP construction management and design	43	0.00000	0.00000	0.00000	0.00000	0.00000	0.00000	0.00000	0.00000	0.00000	43
WIPP underground construction, 1980	44	0.00000	0.00000	0.00000	0.00000	0.00000	0.00000	0.00000	0.00000	0.00000	44
WIPP underground construction, 1981	45	0.00000	0.00000	0.00000	0.00000	0.00000	0.00000	0.00000	0.00000	0.00000	45
WIPP underground construction, 1982	46	0.00000	0.00000	0.00000	0.00000	0.00000	0.00000	0.00000	0.00000	0.00000	46
WIPP underground construction, 1983	47	0.00000	0.00000	0.00000	0.00000	0.00000	0.00000	0.00000	0.00000	0.00000	47
WIPP underground construction, 1984	48	0.00000	0.00000	0.00000	0.00000	0.00000	0.00000	0.00000	0.00000	0.00000	48
WIPP general surface operations	49	0.00000	0.00000	0.00000	0.00000	0.00000	0.00000	0.00000	0.00000	0.00000	49
WIPP security and remote handling	50	0.00000	0.00000	0.00000	0.00000	0.00000	0.00000	0.00000	0.00000	0.00000	50
WIPP underground operations	51	0.00000	0.00000	0.00000	0.00000	0.00000	0.00000	0.00000	0.00000	0.00000	51
Government	52	0.01696	0.02965	0.00350	0.01293	0.01238	0.00000	0.00000	0.00000	0.00000	52
Households/PC weekly	53	0.00000	0.00000	0.00000	0.00000	0.00000	0.02612	0.01410	0.03087	0.03087	53
Households/PC local	54	0.42500	0.36153	0.34761	0.42166	0.51489	0.16734	0.09038	0.19783	0.19783	54
Column sums		0.53885	0.61897	0.53788	0.61362	0.74405	0.28948	0.20050	0.32472		

Table L-1. Input-Output Tables, Lea and Eddy Counties,
November 1979: Direct Coefficients (Continued)

Industry Selling		Industry Purchasing								
		41	42	43	44	45	46	47	48	
Livestock and livestock products	1	0.00000	0.00000	0.00000	0.00000	0.00000	0.00000	0.00000	0.00000	1
Cotton	2	0.00000	0.00000	0.00000	0.00000	0.00000	0.00000	0.00000	0.00000	2
Grains and seeds	3	0.00006	0.00006	0.00000	0.00000	0.00000	0.00000	0.00000	0.00000	3
Fruits and vegetables	4	0.00000	0.00000	0.00000	0.00000	0.00000	0.00000	0.00000	0.00000	4
Forestry and fishery products	5	0.00000	0.00000	0.00000	0.00000	0.00000	0.00000	0.00000	0.00000	5
Agricultural services	6	0.00032	0.00032	0.00000	0.00000	0.00000	0.00000	0.00000	0.00000	6
Miscellaneous metallic and nonmetallic minerals	7	0.00000	0.00000	0.00000	0.00000	0.00000	0.00000	0.00000	0.00000	7
Crude petroleum	8	0.00000	0.00000	0.00000	0.00000	0.00000	0.00000	0.00000	0.00000	8
Natural gas and liquid petroleum	9	0.00000	0.00000	0.00000	0.00000	0.00000	0.00000	0.00000	0.00000	9
Stone, gravel, and sand	10	0.00744	0.00744	0.00000	0.00268	0.00268	0.00268	0.00268	0.00268	10
Potash mining	11	0.00000	0.00000	0.00000	0.00000	0.00000	0.00000	0.00000	0.00000	11
Residential construction	12	0.00000	0.00000	0.00000	0.00000	0.00000	0.00000	0.00000	0.00000	12
Nonresidential construction	13	0.00000	0.00000	0.00000	0.00000	0.00000	0.00000	0.00000	0.00000	13
All other construction	14	0.00000	0.00000	0.00000	0.00000	0.00000	0.00000	0.00000	0.00000	14
Construction maintenance	15	0.00000	0.00000	0.00494	0.00000	0.00000	0.00000	0.00000	0.00000	15
Food products	16	0.00000	0.00000	0.00000	0.00000	0.00000	0.00000	0.00000	0.00000	16
Fabrics and apparel	17	0.00000	0.00000	0.00000	0.00000	0.00000	0.00000	0.00000	0.00000	17
Wood and lumber products	18	0.00000	0.00000	0.00000	0.00000	0.00000	0.00000	0.00000	0.00000	18
Printing	19	0.00000	0.00000	0.00051	0.00000	0.00000	0.00000	0.00000	0.00000	19
Chemical products	20	0.00000	0.00000	0.00090	0.00000	0.00000	0.00000	0.00000	0.00000	20
Plastics and petroleum products	21	0.00047	0.00047	0.00430	0.00000	0.00000	0.00000	0.00000	0.00000	21
Glass and stone products	22	0.00000	0.00000	0.00001	0.00000	0.00000	0.00000	0.00000	0.00000	22
Primary metal products	23	0.00000	0.00000	0.00000	0.00000	0.00000	0.00000	0.00000	0.00000	23
Fabricated metal products	24	0.00136	0.00136	0.00001	0.00051	0.00051	0.00051	0.00051	0.00051	24
Machinery	25	0.00011	0.00011	0.00238	0.00141	0.00141	0.00141	0.00141	0.00141	25
Electrical products	26	0.00000	0.00000	0.00009	0.00000	0.00000	0.00000	0.00000	0.00000	26
Transportation and warehousing	27	0.00431	0.00431	0.00803	0.00401	0.00401	0.00401	0.00401	0.00401	27
Communications	28	0.00439	0.00439	0.01478	0.00067	0.00067	0.00067	0.00067	0.00067	28
Electrical utility	29	0.00094	0.00094	0.00214	0.00882	0.00882	0.00882	0.00882	0.00882	29
Gas utility	30	0.00000	0.00000	0.00262	0.00000	0.00000	0.00000	0.00000	0.00000	30
Water and sewer	31	0.00000	0.00000	0.00118	0.00000	0.00000	0.00000	0.00000	0.00000	31
Wholesale trade	32	0.06613	0.06613	0.01323	0.07448	0.07448	0.07448	0.07448	0.07448	32
Retail trade	33	0.00000	0.00000	0.01652	0.00000	0.00000	0.00000	0.00000	0.00000	33
Finance, insurance, and real estate	34	0.00830	0.00830	0.31435	0.00347	0.00347	0.00347	0.00347	0.00347	34
Lodging and personal and repair services	35	0.00211	0.00211	0.01584	0.00236	0.00236	0.00236	0.00236	0.00236	35
Businesses and miscellaneous services	36	0.00000	0.00000	0.05497	0.00000	0.00000	0.00000	0.00000	0.00000	36
Medical and nonprofit	37	0.00008	0.00008	0.00221	0.00011	0.00011	0.00011	0.00011	0.00011	37
WIPP surface construction, 1980	38	0.00000	0.00000	0.00000	0.00000	0.00000	0.00000	0.00000	0.00000	38
WIPP surface construction, 1981	39	0.00000	0.00000	0.00000	0.00000	0.00000	0.00000	0.00000	0.00000	39
WIPP surface construction, 1982	40	0.00000	0.00000	0.00000	0.00000	0.00000	0.00000	0.00000	0.00000	40
WIPP surface construction, 1983	41	0.00000	0.00000	0.00000	0.00000	0.00000	0.00000	0.00000	0.00000	41
WIPP surface construction, 1984	42	0.00000	0.00000	0.00000	0.00000	0.00000	0.00000	0.00000	0.00000	42
WIPP construction management and design	43	0.00000	0.00000	0.00000	0.00000	0.00000	0.00000	0.00000	0.00000	43
WIPP underground construction, 1980	44	0.00000	0.00000	0.00000	0.00000	0.00000	0.00000	0.00000	0.00000	44
WIPP underground construction, 1981	45	0.00000	0.00000	0.00000	0.00000	0.00000	0.00000	0.00000	0.00000	45
WIPP underground construction, 1982	46	0.00000	0.00000	0.00000	0.00000	0.00000	0.00000	0.00000	0.00000	46
WIPP underground construction, 1983	47	0.00000	0.00000	0.00000	0.00000	0.00000	0.00000	0.00000	0.00000	47
WIPP underground construction, 1984	48	0.00000	0.00000	0.00000	0.00000	0.00000	0.00000	0.00000	0.00000	48
WIPP general surface operations	49	0.00000	0.00000	0.00000	0.00000	0.00000	0.00000	0.00000	0.00000	49
WIPP security and remote handling	50	0.00000	0.00000	0.00000	0.00000	0.00000	0.00000	0.00000	0.00000	50
WIPP underground operations	51	0.00000	0.00000	0.00000	0.00000	0.00000	0.00000	0.00000	0.00000	51
Government	52	0.00000	0.00000	0.00000	0.00000	0.00000	0.00000	0.00000	0.00000	52
Households/PC weekly	53	0.04351	0.03817	0.00000	0.04873	0.05452	0.05462	0.05265	0.04802	53
Households/PC local	54	0.27879	0.24445	0.53737	0.27294	0.30537	0.30590	0.29485	0.26896	54
Column sums		0.41832	0.37864	0.71638	0.42019	0.45841	0.45904	0.44602	0.41550	

Table L-1. Input-Output Tables, Lea and Eddy Counties,
November 1979: Direct Coefficients (Continued)

Industry Selling		Industry Purchasing						Row Sums	
		49	50	51	52	53	54		
Livestock and livestock products	1	0.00000	0.00000	0.00000	0.00000	0.00024	0.00095	1	0.68235
Cotton	2	0.00000	0.00000	0.00000	0.00000	0.00000	0.00000	2	0.15525
Grains and seeds	3	0.00000	0.00133	0.00000	0.00001	0.00010	0.00041	3	0.33565
Fruits and vegetables	4	0.00000	0.00000	0.00000	0.00000	0.00020	0.00078	4	0.00889
Forestry and fishery products	5	0.00000	0.00002	0.00000	0.00000	0.00021	0.00083	5	0.09210
Agricultural services	6	0.00000	0.00000	0.00000	0.00001	0.00007	0.00026	6	0.21110
Miscellaneous metallic and nonmetallic minerals	7	0.00000	0.00004	0.00000	0.00000	0.00000	0.00000	7	0.01016
Crude petroleum	8	0.00000	0.00065	0.00000	0.00001	0.00000	0.00000	8	0.48568
Natural gas and liquid petroleum	9	0.00000	0.00405	0.00000	0.00006	0.00000	0.00000	9	0.32996
Stone, gravel, and sand	10	0.00000	0.00000	0.00000	0.00000	0.00000	0.00001	10	0.15828
Potash mining	11	0.00000	0.00000	0.00000	0.00000	0.00000	0.00000	11	0.02447
Residential construction	12	0.00000	0.00000	0.00000	0.00000	0.00000	0.00000	12	0.00000
Nonresidential construction	13	0.00000	0.00000	0.00000	0.00000	0.00000	0.00000	13	0.00000
All other construction	14	0.00000	0.00000	0.00000	0.00000	0.00000	0.00000	14	0.00000
Construction maintenance	15	0.00494	0.02048	0.00205	0.02145	0.00000	0.00000	15	0.37554
Food products	16	0.00000	0.00005	0.00000	0.00000	0.00417	0.01668	16	0.08958
Fabrics and apparel	17	0.00000	0.00036	0.00000	0.00004	0.00001	0.00003	17	0.11240
Wood and lumber products	18	0.00000	0.00000	0.00000	0.00000	0.00000	0.00000	18	0.09763
Printing	19	0.00051	0.00037	0.00000	0.00014	0.00072	0.00287	19	0.03316
Chemical products	20	0.00090	0.00015	0.00000	0.00149	0.00013	0.00053	20	0.16379
Plastics and petroleum products	21	0.00430	0.02989	0.00000	0.00406	0.00047	0.01901	21	0.49214
Glass and stone products	22	0.00001	0.00001	0.00000	0.00002	0.00000	0.00001	22	0.16691
Primary metal products	23	0.00000	0.00000	0.00000	0.00000	0.00000	0.00000	23	0.00000
Fabricated metal products	24	0.00001	0.00000	0.00000	0.00001	0.00000	0.00000	24	0.01841
Machinery	25	0.00238	0.00017	0.01535	0.00337	0.00012	0.00048	25	0.12043
Electrical products	26	0.00009	0.00000	0.00000	0.00006	0.00000	0.00000	26	0.01375
Transportation and warehousing	27	0.00803	0.08829	0.00977	0.01274	0.00395	0.01578	27	0.83680
Communications	28	0.01478	0.00861	0.00259	0.01371	0.00280	0.01119	28	0.26830
Electrical utility	29	0.00214	0.01622	0.04470	0.00445	0.00354	0.01416	29	0.48067
Gas utility	30	0.00262	0.00338	0.00000	0.00377	0.00207	0.00828	30	0.53547
Water and sewer	31	0.00118	0.00114	0.00000	0.00119	0.00085	0.00340	31	0.06831
Wholesale trade	32	0.01323	0.02379	0.00250	0.01423	0.01102	0.04406	32	1.59229
Retail trade	33	0.01652	0.01069	0.00138	0.00674	0.03834	0.15335	33	0.72415
Finance, insurance, and real estate	34	0.03435	0.01853	0.00694	0.03167	0.01140	0.04561	34	1.16017
Lodging and personal and repair services	35	0.01584	0.02424	0.00064	0.01177	0.01291	0.05163	35	0.44278
Businesses and miscellaneous services	36	0.05497	0.00894	0.00000	0.01345	0.00179	0.00714	36	0.80892
Medical and nonprofit	37	0.00221	0.00052	0.00119	0.00188	0.00238	0.00953	37	0.05452
WIPP surface construction, 1980	38	0.00000	0.00000	0.00000	0.00000	0.00000	0.00000	38	0.00000
WIPP surface construction, 1981	39	0.00000	0.00000	0.00000	0.00000	0.00000	0.00000	39	0.00000
WIPP surface construction, 1982	40	0.00000	0.00000	0.00000	0.00000	0.00000	0.00000	40	0.00000
WIPP surface construction, 1983	41	0.00000	0.00000	0.00000	0.00000	0.00000	0.00000	41	0.00000
WIPP surface construction, 1984	42	0.00000	0.00000	0.00000	0.00000	0.00000	0.00000	42	0.00000
WIPP construction management and design	43	0.00000	0.00000	0.00000	0.00000	0.00000	0.00000	43	0.00000
WIPP underground construction, 1980	44	0.00000	0.00000	0.00000	0.00000	0.00000	0.00000	44	0.00000
WIPP underground construction, 1981	45	0.00000	0.00000	0.00000	0.00000	0.00000	0.00000	45	0.00000
WIPP underground construction, 1982	46	0.00000	0.00000	0.00000	0.00000	0.00000	0.00000	46	0.00000
WIPP underground construction, 1983	47	0.00000	0.00000	0.00000	0.00000	0.00000	0.00000	47	0.00000
WIPP underground construction, 1984	48	0.00000	0.00000	0.00000	0.00000	0.00000	0.00000	48	0.00000
WIPP general surface operations	49	0.00000	0.00000	0.00000	0.00000	0.00000	0.00000	49	0.00000
WIPP security and remote handling	50	0.00000	0.00000	0.00000	0.00000	0.00000	0.00000	50	0.00000
WIPP underground operations	51	0.00000	0.00000	0.00000	0.00000	0.00000	0.00000	51	0.00000
Government	52	0.00000	0.00000	0.00000	0.03548	0.02100	0.08500	52	0.83762
Households/PC weekly	53	0.00000	0.00000	0.00000	0.00000	0.00000	0.00000	53	0.41131
Households/PC local	54	0.57448	0.56290	0.54173	0.45300	0.00000	0.00000	54	15.35617
Column sums		0.75349	0.82482	0.62884	0.63481	0.11849	0.49198		

L-10

Table L-2. Input-Output Tables, Lea and Eddy Counties, November 1979:
Direct, Indirect, and Induced Coefficients

Industry Selling		Industry Purchasing								
		1	2	3	4	5	6	7	8	
Livestock and livestock products	1	1.51090	0.04604	0.15328	0.02313	0.24603	0.00534	0.00194	0.00110	1
Cotton	2	0.00433	1.01744	0.00089	0.00050	0.00327	0.00184	0.00090	0.00050	2
Grains and seeds	3	0.41657	0.01399	1.07351	0.00712	0.06893	0.00995	0.00110	0.00069	3
Fruits and vegetables	4	0.00102	0.00038	0.00031	1.00402	0.00051	0.00127	0.00042	0.00022	4
Forestry and fishery products	5	0.00024	0.00030	0.00026	0.00019	1.07792	0.00041	0.00053	0.00025	5
Agricultural services	6	0.01001	0.10394	0.01452	0.05937	0.03017	1.00057	0.00034	0.00022	6
Miscellaneous metallic and nonmetallic minerals	7	0.00009	0.00011	0.00023	0.00009	0.00002	0.00000	1.00846	0.00001	7
Crude petroleum	8	0.01322	0.02325	0.02150	0.00923	0.02268	0.00558	0.00774	1.00833	8
Natural gas and liquid petroleum	9	0.00206	0.00297	0.00260	0.00147	0.00298	0.00178	0.00301	0.00194	9
Stone, gravel, and sand	10	0.00091	0.00157	0.00212	0.00105	0.00020	0.00005	0.00007	0.00023	10
Potash mining	11	0.00055	0.00080	0.00137	0.00061	0.00010	0.00002	0.00018	0.00003	11
Residential construction	12	0.00000	0.00000	0.00000	0.00000	0.00000	0.00000	0.00000	0.00000	12
Nonresidential construction	13	0.00000	0.00000	0.00000	0.00000	0.00000	0.00000	0.00000	0.00000	13
All other construction	14	0.00000	0.00000	0.00000	0.00000	0.00000	0.00000	0.00000	0.00000	14
Construction maintenance	15	0.01447	0.01803	0.01623	0.01079	0.00665	0.00343	0.00699	0.03197	15
Food products	16	0.04040	0.00657	0.00814	0.00411	0.03027	0.00810	0.00840	0.00453	16
Fabrics and apparel	17	0.00015	0.00017	0.00014	0.00010	0.00017	0.00011	0.00016	0.00010	17
Wood and lumber products	18	0.00010	0.00012	0.00010	0.00007	0.00007	0.00004	0.00042	0.00015	18
Printing	19	0.00108	0.00141	0.00111	0.00081	0.00148	0.00153	0.00165	0.00120	19
Chemical products	20	0.00477	0.00643	0.00835	0.00313	0.00217	0.00061	0.02340	0.00380	20
Plastics and petroleum products	21	0.02844	0.05023	0.04648	0.01986	0.04896	0.01173	0.01613	0.01224	21
Glass and stone products	22	0.00013	0.00018	0.00020	0.00012	0.00007	0.00003	0.00005	0.00012	22
Primary metal products	23	0.00000	0.00001	0.00000	0.00000	0.00000	0.00000	0.00000	0.00000	23
Fabricated metal products	24	0.00001	0.00086	0.00001	0.00001	0.00002	0.00000	0.00001	0.00010	24
Machinery	25	0.00061	0.00002	0.00064	0.00046	0.00057	0.00053	0.01154	0.00049	25
Electrical products	26	0.00001	0.02361	0.00002	0.00001	0.00002	0.00001	0.00003	0.00001	26
Transportation and warehousing	27	0.03758	0.01150	0.02700	0.01647	0.02285	0.01141	0.02348	0.00956	27
Communications	28	0.00934	0.01802	0.00898	0.00617	0.00853	0.00766	0.01163	0.00736	28
Electrical utility	29	0.01161	0.00781	0.01038	0.00888	0.01108	0.00989	0.02340	0.01873	29
Gas utility	30	0.00589	0.01079	0.00638	0.00457	0.00847	0.00784	0.01326	0.00828	30
Water and sewer	31	0.00496	0.05887	0.00955	0.00904	0.00280	0.00225	0.00246	0.00225	31
Wholesale trade	32	0.05286	0.08122	0.05080	0.03878	0.05948	0.02457	0.03643	0.02022	32
Retail trade	33	0.06697	0.11283	0.06936	0.04510	0.07780	0.07313	0.07814	0.04827	33
Finance, insurance, and real estate	34	0.05689	0.03111	0.07563	0.04115	0.05798	0.03306	0.04404	0.12074	34
Lodging and personal and repair services	35	0.02492	0.04582	0.02352	0.01783	0.03298	0.02759	0.03039	0.01928	35
Businesses and miscellaneous services	36	0.02349	0.00473	0.04065	0.02363	0.01368	0.00872	0.01922	0.02643	36
Medical and nonprofit	37	0.00402	0.00000	0.00374	0.00285	0.00467	0.00488	0.00646	0.00384	37
WIPP surface construction, 1980	38	0.00000	0.00000	0.00000	0.00000	0.00000	0.00000	0.00000	0.00000	38
WIPP surface construction, 1981	39	0.00000	0.00000	0.00000	0.00000	0.00000	0.00000	0.00000	0.00000	39
WIPP surface construction, 1982	40	0.00000	0.00000	0.00000	0.00000	0.00000	0.00000	0.00000	0.00000	40
WIPP surface construction, 1983	41	0.00000	0.00000	0.00000	0.00000	0.00000	0.00000	0.00000	0.00000	41
WIPP surface construction, 1984	42	0.00000	0.00000	0.00000	0.00000	0.00000	0.00000	0.00000	0.00000	42
WIPP construction management and design	43	0.00000	0.00000	0.00000	0.00000	0.00000	0.00000	0.00000	0.00000	43
WIPP underground construction, 1980	44	0.00000	0.00000	0.00000	0.00000	0.00000	0.00000	0.00000	0.00000	44
WIPP underground construction, 1981	45	0.00000	0.00000	0.00000	0.00000	0.00000	0.00000	0.00000	0.00000	45
WIPP underground construction, 1982	46	0.00000	0.00000	0.00000	0.00000	0.00000	0.00000	0.00000	0.00000	46
WIPP underground construction, 1983	47	0.00000	0.00000	0.00000	0.00000	0.00000	0.00000	0.00000	0.00000	47
WIPP underground construction, 1984	48	0.00000	0.00000	0.00000	0.00000	0.00000	0.00000	0.00000	0.00000	48
WIPP general surface operations	49	0.00000	0.00000	0.00000	0.00000	0.00000	0.00000	0.00000	0.00000	49
WIPP security and remote handling	50	0.00000	0.00000	0.00000	0.00000	0.00000	0.00000	0.00000	0.00000	50
WIPP underground operations	51	0.00000	0.00000	0.00000	0.00000	0.00000	0.00000	0.00000	0.00000	51
Government	52	0.02872	0.03973	0.03253	0.02583	0.04067	0.04454	0.04891	0.02978	52
Households/PC weekly	53	0.00000	0.00000	0.00000	0.00000	0.00000	0.00000	0.00000	0.00000	53
Households/PC local	54	0.24680	0.30595	0.25042	0.19910	0.39272	0.45748	0.47816	0.25761	54
Column sums		2.62411	2.04678	1.96093	1.58565	2.27698	1.76597	1.90946	1.64059	

L-11

Table L-2. Input-Output Tables, Lea and Eddy Counties, November 1979:
Direct, Indirect, and Induced Coefficients (Continued)

Industry Selling	Industry Purchasing									
	9	10	11	12	13	14	15	16		
Livestock and livestock products	1	0.00144	0.00234	0.00174	0.00255	0.00248	0.00246	0.00302	0.12352	1
Cotton	2	0.00064	0.00109	0.00081	0.00121	0.00115	0.00115	0.00143	0.11033	2
Grains and seeds	3	0.00090	0.00141	0.00100	0.00182	0.00162	0.00169	0.00176	0.05911	3
Fruits and vegetables	4	0.00029	0.00047	0.00037	0.00050	0.00049	0.00049	0.00061	0.00193	4
Forestry and fishery products	5	0.00034	0.00055	0.00047	0.00058	0.00056	0.00056	0.00068	0.00030	5
Agricultural services	6	0.00030	0.00045	0.00030	0.00189	0.00125	0.00331	0.00103	0.01259	6
Miscellaneous metallic and nonmetallic minerals	7	0.00002	0.00001	0.00003	0.00001	0.00001	0.00001	0.00001	0.00008	7
Crude petroleum	8	0.00811	0.01468	0.00990	0.01160	0.01313	0.02214	0.01335	0.00938	8
Natural gas and liquid petroleum	9	1.17713	0.00426	0.00916	0.00313	0.00323	0.00387	0.00348	0.00247	9
Stone, gravel, and sand	10	0.00032	1.00839	0.00007	0.00391	0.00522	0.02274	0.00689	0.00047	10
Potash mining	11	0.00008	0.00055	1.01431	0.00002	0.00003	0.00005	0.00002	0.00017	11
Residential construction	12	0.00000	0.00000	0.00000	1.00000	0.00000	0.00000	0.00000	0.00000	12
Nonresidential construction	13	0.00000	0.00000	0.00000	0.00000	1.00000	0.00000	0.00000	0.00000	13
All other construction	14	0.00000	0.00000	0.00000	0.00000	0.00000	1.00000	0.00000	0.00000	14
Construction maintenance	15	0.04434	0.01570	0.00762	0.00720	0.00743	0.00808	1.00715	0.00922	15
Food products	16	0.00589	0.01007	0.00751	0.01085	0.01065	0.01043	0.01321	1.03388	16
Fabrics and apparel	17	0.00014	0.00027	0.00015	0.00139	0.00139	0.00095	0.00037	0.00037	17
Wood and lumber products	18	0.00021	0.00030	0.00059	0.03830	0.01209	0.00224	0.00395	0.00007	18
Printing	19	0.00159	0.00209	0.00148	0.00223	0.00220	0.00214	0.00262	0.00254	19
Chemical products	20	0.01050	0.00788	0.02170	0.00162	0.00308	0.00403	0.00143	0.00282	20
Plastics and petroleum products	21	0.01588	0.03098	0.01890	0.02455	0.02802	0.04750	0.02830	0.01987	21
Glass and stone products	22	0.00017	0.05705	0.00005	0.02762	0.03650	0.02337	0.00341	0.00009	22
Primary metal products	23	0.00000	0.00000	0.00000	0.00000	0.00000	0.00000	0.00000	0.00000	23
Fabricated metal products	24	0.00006	0.00001	0.00001	0.00197	0.00310	0.00188	0.00048	0.00001	24
Machinery	25	0.00068	0.00628	0.01642	0.00156	0.00182	0.00167	0.00130	0.00053	25
Electrical products	26	0.00002	0.00003	0.00003	0.00023	0.00032	0.00026	0.00010	0.00002	26
Transportation and warehousing	27	0.01275	0.03849	0.02270	0.05020	0.05228	0.07166	0.04317	0.03909	27
Communications	28	0.00996	0.01234	0.01066	0.01654	0.01802	0.01692	0.01634	0.01229	28
Electrical utility	29	0.01685	0.04348	0.03226	0.01718	0.01685	0.01719	0.01875	0.01617	29
Gas utility	30	0.03337	0.01743	0.04859	0.01230	0.01224	0.01231	0.01389	0.00958	30
Water and sewer	31	0.00358	0.00602	0.00226	0.00376	0.00383	0.00374	0.00411	0.00358	31
Wholesale trade	32	0.03213	0.06957	0.02708	0.08919	0.08641	0.07947	0.08083	0.05706	32
Retail trade	33	0.06323	0.10556	0.07059	0.18599	0.14757	0.13595	0.18448	0.05893	33
Finance, insurance, and real estate	34	0.16625	0.07980	0.04067	0.06006	0.06247	0.06105	0.06298	0.04640	34
Lodging and personal and repair services	35	0.02541	0.04856	0.02751	0.04626	0.04833	0.04827	0.05147	0.02661	35
Businesses and miscellaneous services	36	0.03654	0.04972	0.01914	0.07343	0.09163	0.06142	0.03756	0.02324	36
Medical and nonprofit	37	0.00508	0.00669	0.00594	0.00776	0.00806	0.00776	0.00876	0.00438	37
WIPP surface construction, 1980	38	0.00000	0.00000	0.00000	0.00000	0.00000	0.00000	0.00000	0.00000	38
WIPP surface construction, 1981	39	0.00000	0.00000	0.00000	0.00000	0.00000	0.00000	0.00000	0.00000	39
WIPP surface construction, 1982	40	0.00000	0.00000	0.00000	0.00000	0.00000	0.00000	0.00000	0.00000	40
WIPP surface construction, 1983	41	0.00000	0.00000	0.00000	0.00000	0.00000	0.00000	0.00000	0.00000	41
WIPP surface construction, 1984	42	0.00000	0.00000	0.00000	0.00000	0.00000	0.00000	0.00000	0.00000	42
WIPP construction management and design	43	0.00000	0.00000	0.00000	0.00000	0.00000	0.00000	0.00000	0.00000	43
WIPP underground construction, 1980	44	0.00000	0.00000	0.00000	0.00000	0.00000	0.00000	0.00000	0.00000	44
WIPP underground construction, 1981	45	0.00000	0.00000	0.00000	0.00000	0.00000	0.00000	0.00000	0.00000	45
WIPP underground construction, 1982	46	0.00000	0.00000	0.00000	0.00000	0.00000	0.00000	0.00000	0.00000	46
WIPP underground construction, 1983	47	0.00000	0.00000	0.00000	0.00000	0.00000	0.00000	0.00000	0.00000	47
WIPP underground construction, 1984	48	0.00000	0.00000	0.00000	0.00000	0.00000	0.00000	0.00000	0.00000	48
WIPP general surface operations	49	0.00000	0.00000	0.00000	0.00000	0.00000	0.00000	0.00000	0.00000	49
WIPP security and remote handling	50	0.00000	0.00000	0.00000	0.00000	0.00000	0.00000	0.00000	0.00000	50
WIPP underground operations	51	0.00000	0.00000	0.00000	0.00000	0.00000	0.00000	0.00000	0.00000	51
Government	52	0.03963	0.06004	0.04429	0.06363	0.06263	0.06095	0.07548	0.03393	52
Households/PC weekly	53	0.00000	0.00000	0.00000	0.00000	0.00000	0.00000	0.00000	0.00000	53
Households/PC local	54	0.33318	0.56905	0.42858	0.60984	0.59955	0.58792	0.74892	0.30990	54
Column sums		2.04698	2.27161	1.89298	2.38085	2.34460	2.32560	2.44131	2.03090	

Table L-2. Input-Output Tables, Lea and Eddy Counties, November 1979:
Direct, Indirect, and Induced Coefficients (Continued)

Industry Selling	Industry Purchasing									
	17	18	19	20	21	22	23	24		
Livestock and livestock products	1	0.01735	0.00186	0.00164	0.00359	0.00142	0.00250	0.00161	0.00191	1
Cotton	2	0.03825	0.00090	0.00080	0.00128	0.00065	0.00117	0.00076	0.00092	2
Grains and seeds	3	0.00543	0.00110	0.00096	0.00185	0.00089	0.00163	0.00090	0.00111	3
Fruits and vegetables	4	0.00042	0.00037	0.00034	0.00171	0.00029	0.00050	0.00033	0.00039	4
Forestry and fishery products	5	0.01878	0.00044	0.00044	0.00481	0.00034	0.00057	0.00037	0.00044	5
Agricultural services	6	0.00474	0.00037	0.00031	0.00065	0.00028	0.00046	0.00027	0.00035	6
Miscellaneous metallic and nonmetallic minerals	7	0.00001	0.00001	0.00002	0.00133	0.00006	0.00001	0.00000	0.00000	7
Crude petroleum	8	0.00794	0.00764	0.00674	0.03651	0.49197	0.01495	0.00474	0.00828	8
Natural gas and liquid petroleum	9	0.00245	0.00260	0.00223	0.01051	0.03421	0.00502	0.00155	0.00315	9
Stone, gravel, and sand	10	0.00012	0.00009	0.00007	0.00052	0.00023	0.06838	0.00003	0.00016	10
Potash mining	11	0.00005	0.00003	0.00011	0.00808	0.00007	0.00006	0.00001	0.00001	11
Residential construction	12	0.00000	0.00000	0.00000	0.00000	0.00000	0.00000	0.00000	0.00000	12
Nonresidential construction	13	0.00000	0.00000	0.00000	0.00000	0.00000	0.00000	0.00000	0.00000	13
All other construction	14	0.00000	0.00000	0.00000	0.00000	0.00000	0.00000	0.00000	0.00000	14
Construction maintenance	15	0.00688	0.00793	0.00777	0.01292	0.03091	0.01268	0.00287	0.00708	15
Food products	16	0.00948	0.00805	0.00649	0.01184	0.00597	0.01070	0.00709	0.00828	16
Fabrics and apparel	17	1.11241	0.00109	0.00176	0.00045	0.00022	0.00081	0.00010	0.00101	17
Wood and lumber products	18	0.00007	1.00811	0.00007	0.00010	0.00015	0.00022	0.00003	0.00152	18
Printing	19	0.00177	0.00167	1.01754	0.00221	0.00140	0.00230	0.00136	0.00166	19
Chemical products	20	0.00186	0.00355	0.01409	1.05419	0.00887	0.00276	0.00047	0.00141	20
Plastics and petroleum products	21	0.01672	0.01600	0.01416	0.07794	1.07140	0.03134	0.00994	0.01724	21
Glass and stone products	22	0.00007	0.00043	0.00006	0.00011	0.00013	1.02896	0.00003	0.00025	22
Primary metal products	23	0.00000	0.00000	0.00000	0.00000	0.00000	0.00000	1.00000	0.00000	23
Fabricated metal products	24	0.00001	0.00001	0.00001	0.00006	0.00007	0.00001	0.00000	1.00142	24
Machinery	25	0.00066	0.00258	0.00061	0.00097	0.00057	0.00445	0.00047	0.02475	25
Electrical products	26	0.00002	0.00003	0.00004	0.00005	0.00002	0.00003	0.00001	0.00005	26
Transportation and warehousing	27	0.02509	0.04246	0.02383	0.04131	0.04417	0.15385	0.00928	0.02917	27
Communications	28	0.01316	0.01316	0.01936	0.01518	0.00909	0.01879	0.00673	0.01392	28
Electrical utility	29	0.02016	0.01832	0.01519	0.03091	0.02165	0.02568	0.00869	0.01811	29
Gas utility	30	0.01022	0.01077	0.00932	0.03013	0.02642	0.01917	0.00689	0.01421	30
Water and sewer	31	0.00347	0.00241	0.00280	0.00579	0.00437	0.00364	0.00192	0.00253	31
Wholesale trade	32	0.05970	0.07267	0.04255	0.05487	0.03035	0.06691	0.02103	0.05073	32
Retail trade	33	0.08485	0.07546	0.06942	0.10223	0.05998	0.10247	0.06455	0.08448	33
Finance, insurance, and real estate	34	0.05319	0.05122	0.04991	0.06656	0.09850	0.07117	0.02776	0.04912	34
Lodging and personal and repair services	35	0.03333	0.03134	0.02968	0.04050	0.02450	0.04715	0.02441	0.03106	35
Businesses and miscellaneous services	36	0.02081	0.02072	0.03904	0.03070	0.03077	0.03610	0.00734	0.02036	36
Medical and nonprofit	37	0.00603	0.00556	0.00608	0.00744	0.00457	0.00768	0.00432	0.00576	37
WIPP surface construction, 1980	38	0.00000	0.00000	0.00000	0.00000	0.00000	0.00000	0.00000	0.00000	38
WIPP surface construction, 1981	39	0.00000	0.00000	0.00000	0.00000	0.00000	0.00000	0.00000	0.00000	39
WIPP surface construction, 1982	40	0.00000	0.00000	0.00000	0.00000	0.00000	0.00000	0.00000	0.00000	40
WIPP surface construction, 1983	41	0.00000	0.00000	0.00000	0.00000	0.00000	0.00000	0.00000	0.00000	41
WIPP surface construction, 1984	42	0.00000	0.00000	0.00000	0.00000	0.00000	0.00000	0.00000	0.00000	42
WIPP construction management and design	43	0.00000	0.00000	0.00000	0.00000	0.00000	0.00000	0.00000	0.00000	43
WIPP underground construction, 1980	44	0.00000	0.00000	0.00000	0.00000	0.00000	0.00000	0.00000	0.00000	44
WIPP underground construction, 1981	45	0.00000	0.00000	0.00000	0.00000	0.00000	0.00000	0.00000	0.00000	45
WIPP underground construction, 1982	46	0.00000	0.00000	0.00000	0.00000	0.00000	0.00000	0.00000	0.00000	46
WIPP underground construction, 1983	47	0.00000	0.00000	0.00000	0.00000	0.00000	0.00000	0.00000	0.00000	47
WIPP underground construction, 1984	48	0.00000	0.00000	0.00000	0.00000	0.00000	0.00000	0.00000	0.00000	48
WIPP general surface operations	49	0.00000	0.00000	0.00000	0.00000	0.00000	0.00000	0.00000	0.00000	49
WIPP security and remote handling	50	0.00000	0.00000	0.00000	0.00000	0.00000	0.00000	0.00000	0.00000	50
WIPP underground operations	51	0.00000	0.00000	0.00000	0.00000	0.00000	0.00000	0.00000	0.00000	51
Government	52	0.05222	0.04633	0.04722	0.06385	0.03859	0.06236	0.03950	0.04763	52
Households/PC weekly	53	0.00000	0.00000	0.00000	0.00000	0.00000	0.00000	0.00000	0.00000	53
Households/PC local	54	0.49854	0.45192	0.39293	0.61410	0.33882	0.60640	0.40704	0.46956	54
Column sums		2.12624	1.90719	1.82400	2.33523	2.38191	2.41090	1.66242	1.91802	

Table L-2. Input-Output Tables, Lea and Eddy Counties, November 1979:
Direct, Indirect, and Induced Coefficients (Continued)

Industry Selling	Industry Purchasing									
	25	26	27	28	29	30	31	32		
Livestock and livestock products	1	0.00232	0.00203	0.00304	0.00248	0.00111	0.00170	0.00277	0.00303	1
Cotton	2	0.00112	0.00098	0.00131	0.00111	0.00053	0.00080	0.00129	0.00160	2
Grains and seeds	3	0.00135	0.00117	0.00325	0.00159	0.00067	0.00099	0.00165	0.00177	3
Fruits and vegetables	4	0.00047	0.00041	0.00056	0.00048	0.00022	0.00035	0.00056	0.00053	4
Forestry and fishery products	5	0.00053	0.00047	0.00065	0.00053	0.00026	0.00039	0.00063	0.00060	5
Agricultural services	6	0.00045	0.00037	0.00054	0.00042	0.00021	0.00032	0.00053	0.00168	6
Miscellaneous metallic and nonmetallic minerals	7	0.00001	0.00000	0.00006	0.00000	0.00000	0.00001	0.00001	0.00001	7
Crude petroleum	8	0.01032	0.01003	0.02553	0.00837	0.01224	0.04419	0.01266	0.01249	8
Natural gas and liquid petroleum	9	0.00308	0.00293	0.01031	0.00284	0.01605	0.27118	0.00860	0.00323	9
Stone, gravel, and sand	10	0.00008	0.00007	0.00023	0.00015	0.00025	0.00027	0.00061	0.00012	10
Potash mining	11	0.00001	0.00001	0.00002	0.00001	0.00003	0.00003	0.00003	0.00002	11
Residential construction	12	0.00000	0.00000	0.00000	0.00000	0.00000	0.00000	0.00000	0.00000	12
Nonresidential construction	13	0.00000	0.00000	0.00000	0.00000	0.00000	0.00000	0.00000	0.00000	13
All other construction	14	0.00000	0.00000	0.00000	0.00000	0.00000	0.00000	0.00000	0.00000	14
Construction maintenance	15	0.00745	0.00762	0.03048	0.01997	0.03500	0.03746	0.08606	0.00768	15
Food products	16	0.01014	0.00876	0.01204	0.01021	0.00478	0.00733	0.01188	0.01456	16
Fabrics and apparel	17	0.00104	0.00115	0.00071	0.00040	0.00037	0.00028	0.00062	0.00126	17
Wood and lumber products	18	0.03403	0.00007	0.00018	0.00012	0.00016	0.00018	0.00045	0.00045	18
Printing	19	0.00202	0.00419	0.00282	0.00220	0.00097	0.00157	0.00252	0.00292	19
Chemical products	20	0.00121	0.00074	0.00143	0.00079	0.00159	0.00301	0.00359	0.00168	20
Plastics and petroleum products	21	0.02176	0.02115	0.05300	0.01754	0.02201	0.01405	0.02520	0.02647	21
Glass and stone products	22	0.00009	0.00008	0.00016	0.00010	0.00014	0.00015	0.00034	0.00056	22
Primary metal products	23	0.00000	0.00000	0.00000	0.00000	0.00000	0.00000	0.00000	0.00000	23
Fabricated metal products	24	0.00003	0.00001	0.00002	0.00001	0.00002	0.00003	0.00005	0.00002	24
Machinery	25	1.02056	0.00066	0.00119	0.00100	0.00039	0.00068	0.00301	0.00137	25
Electrical products	26	0.00086	1.01089	0.00003	0.00003	0.00001	0.00002	0.00007	0.00009	26
Transportation and warehousing	27	0.38686	0.02503	1.11581	0.01637	0.03271	0.01249	0.03041	0.03355	27
Communications	28	0.01451	0.01691	0.02248	1.02385	0.00824	0.01220	0.02594	0.02412	28
Electrical utility	29	0.01963	0.01821	0.03560	0.01996	1.08655	0.01655	0.04938	0.01948	29
Gas utility	30	0.01281	0.01242	0.01976	0.01262	0.06233	1.58053	0.04357	0.01268	30
Water and sewer	31	0.00345	0.00274	0.00494	0.00440	0.00256	0.00362	1.00528	0.00508	31
Wholesale trade	32	0.07915	0.04771	0.06482	0.03620	0.02363	0.02800	0.05375	1.05116	32
Retail trade	33	0.09930	0.08823	0.12321	0.10029	0.04809	0.07356	0.12172	0.11892	33
Finance, insurance, and real estate	34	0.05733	0.05846	0.07615	0.05806	0.02929	0.07663	0.08804	0.07305	34
Lodging and personal and repair services	35	0.03749	0.03383	0.07072	0.10101	0.02020	0.02806	0.05894	0.05936	35
Businesses and miscellaneous services	36	0.02096	0.02572	0.02736	0.02375	0.01254	0.02464	0.03459	0.03938	36
Medical and nonprofit	37	0.00680	0.00686	0.00820	0.00712	0.00337	0.00541	0.00932	0.00816	37
WIPP surface construction, 1980	38	0.00000	0.00000	0.00000	0.00000	0.00000	0.00000	0.00000	0.00000	38
WIPP surface construction, 1981	39	0.00000	0.00000	0.00000	0.00000	0.00000	0.00000	0.00000	0.00000	39
WIPP surface construction, 1982	40	0.00000	0.00000	0.00000	0.00000	0.00000	0.00000	0.00000	0.00000	40
WIPP surface construction, 1983	41	0.00000	0.00000	0.00000	0.00000	0.00000	0.00000	0.00000	0.00000	41
WIPP surface construction, 1984	42	0.00000	0.00000	0.00000	0.00000	0.00000	0.00000	0.00000	0.00000	42
WIPP construction management and design	43	0.00000	0.00000	0.00000	0.00000	0.00000	0.00000	0.00000	0.00000	43
WIPP underground construction, 1980	44	0.00000	0.00000	0.00000	0.00000	0.00000	0.00000	0.00000	0.00000	44
WIPP underground construction, 1981	45	0.00000	0.00000	0.00000	0.00000	0.00000	0.00000	0.00000	0.00000	45
WIPP underground construction, 1982	46	0.00000	0.00000	0.00000	0.00000	0.00000	0.00000	0.00000	0.00000	46
WIPP underground construction, 1983	47	0.00000	0.00000	0.00000	0.00000	0.00000	0.00000	0.00000	0.00000	47
WIPP underground construction, 1984	48	0.00000	0.00000	0.00000	0.00000	0.00000	0.00000	0.00000	0.00000	48
WIPP general surface operations	49	0.00000	0.00000	0.00000	0.00000	0.00000	0.00000	0.00000	0.00000	49
WIPP security and remote handling	50	0.00000	0.00000	0.00000	0.00000	0.00000	0.00000	0.00000	0.00000	50
WIPP underground operations	51	0.00000	0.00000	0.00000	0.00000	0.00000	0.00000	0.00000	0.00000	51
Government	52	0.05780	0.05196	0.07246	0.06157	0.03168	0.06621	0.66433	0.06802	52
Households/PC weekly	53	0.00000	0.00000	0.00000	0.00000	0.00000	0.00000	0.00000	0.00000	53
Households/PC local	54	0.57183	0.49829	0.68086	0.58435	0.27216	0.41856	0.67710	0.63849	54
Column sums		2.13683	1.96017	2.46992	2.11990	1.73037	2.73144	2.02550	2.23361	

L-1A

Table L-2. Input-Output Tables, Lea and Eddy Counties, November 1979:
Direct, Indirect, and Induced Coefficients (Continued)

Industry Selling	Industry Purchasing									
	33	34	35	36	37	38	39	40		
Livestock and livestock products	1	0.00251	0.00323	0.00454	0.00272	0.00338	0.00119	0.00078	0.00135	1
Cotton	2	0.00118	0.00128	0.00114	0.00126	0.00156	0.00056	0.00037	0.00064	2
Grains and seeds	3	0.00146	0.00241	0.00555	0.00162	0.00199	0.00075	0.00052	0.00084	3
Fruits and vegetables	4	0.00050	0.00054	0.00047	0.00055	0.00068	0.00023	0.00015	0.00027	4
Forestry and fishery products	5	0.00056	0.00059	0.00054	0.00061	0.00074	0.00026	0.00017	0.00030	5
Agricultural services	6	0.00043	0.00077	0.00070	0.00048	0.00060	0.00060	0.00053	0.00062	6
Miscellaneous metallic and nonmetallic minerals	7	0.00000	0.00001	0.00001	0.00001	0.00001	0.00000	0.00000	0.00000	7
Crude petroleum	8	0.01037	0.01012	0.01159	0.01071	0.01468	0.00401	0.00283	0.00448	8
Natural gas and liquid petroleum	9	0.00373	0.00398	0.00356	0.00371	0.00487	0.00123	0.00084	0.00139	9
Stone, gravel, and sand	10	0.00009	0.00025	0.00014	0.00011	0.00016	0.00053	0.00075	0.00075	10
Potash mining	11	0.00001	0.00003	0.00002	0.00002	0.00002	0.00001	0.00001	0.00001	11
Residential construction	12	0.00000	0.00000	0.00000	0.00000	0.00000	0.00000	0.00000	0.00000	12
Nonresidential construction	13	0.00000	0.00000	0.00000	0.00000	0.00000	0.00000	0.00000	0.00000	13
All other construction	14	0.00000	0.00000	0.00000	0.00000	0.00000	0.00000	0.00000	0.00000	14
Construction maintenance	15	0.00957	0.02649	0.01434	0.01231	0.01877	0.00274	0.00201	0.00303	15
Food products	16	0.01092	0.01117	0.00990	0.01167	0.01440	0.00519	0.00339	0.00590	16
Fabrics and apparel	17	0.00025	0.00032	0.00190	0.00023	0.00049	0.00015	0.00013	0.00016	17
Wood and lumber products	18	0.00008	0.00017	0.00024	0.00018	0.00014	0.00006	0.00005	0.00006	18
Printing	19	0.00270	0.00553	0.00216	0.00294	0.00602	0.00104	0.00069	0.00117	19
Chemical products	20	0.00092	0.00115	0.00119	0.00191	0.00140	0.00046	0.00034	0.00051	20
Plastics and petroleum products	21	0.02166	0.02104	0.02439	0.02241	0.03079	0.00844	0.00597	0.00942	21
Glass and stone products	22	0.00007	0.00014	0.00013	0.00010	0.00012	0.00048	0.00047	0.00048	22
Primary metal products	23	0.00000	0.00000	0.00000	0.00000	0.00000	0.00000	0.00000	0.00000	23
Fabricated metal products	24	0.00001	0.00002	0.00001	0.00002	0.00001	0.00137	0.00136	0.00137	24
Machinery	25	0.00091	0.00119	0.00486	0.00350	0.00120	0.00057	0.00045	0.00062	25
Electrical products	26	0.00002	0.00004	0.00012	0.00012	0.00089	0.00001	0.00001	0.00001	26
Transportation and warehousing	27	0.01744	0.02115	0.02051	0.02601	0.02490	0.01283	0.01047	0.01376	27
Communications	28	0.01726	0.02945	0.01786	0.02849	0.02931	0.01032	0.00861	0.01100	28
Electrical utility	29	0.02966	0.02630	0.02715	0.01837	0.03877	0.00799	0.00578	0.00886	29
Gas utility	30	0.01683	0.01568	0.01539	0.01658	0.02145	0.00517	0.00342	0.00586	30
Water and sewer	31	0.00547	0.00763	0.00661	0.00481	0.01089	0.00157	0.00108	0.00176	31
Wholesale trade	32	0.03917	0.04298	0.05636	0.05078	0.06582	0.08269	0.07735	0.08481	32
Retail trade	33	1.10289	0.11349	0.10672	0.12510	0.14936	0.04668	0.03028	0.05318	33
Finance, insurance, and real estate	34	0.08293	0.14469	0.08719	0.08937	0.12952	0.03119	0.02414	0.03398	34
Lodging and personal and repair services	35	0.04664	0.04656	1.07664	0.05986	0.07271	0.02127	0.01507	0.02372	35
Businesses and miscellaneous services	36	0.02301	0.07614	0.02748	0.07449	0.04643	0.00801	0.00614	0.00874	36
Medical and nonprofit	37	0.00775	0.01460	0.00841	0.00986	1.01268	0.00328	0.00218	0.00371	37
WIPP surface construction, 1980	38	0.00000	0.00000	0.00000	0.00000	0.00000	1.00000	0.00000	0.00000	38
WIPP surface construction, 1981	39	0.00000	0.00000	0.00000	0.00000	0.00000	0.00000	1.00000	0.00000	39
WIPP surface construction, 1982	40	0.00000	0.00000	0.00000	0.00000	0.00000	0.00000	0.00000	1.00000	40
WIPP surface construction, 1983	41	0.00000	0.00000	0.00000	0.00000	0.00000	0.00000	0.00000	0.00000	41
WIPP surface construction, 1984	42	0.00000	0.00000	0.00000	0.00000	0.00000	0.00000	0.00000	0.00000	42
WIPP construction management and design	43	0.00000	0.00000	0.00000	0.00000	0.00000	0.00000	0.00000	0.00000	43
WIPP underground construction, 1980	44	0.00000	0.00000	0.00000	0.00000	0.00000	0.00000	0.00000	0.00000	44
WIPP underground construction, 1981	45	0.00000	0.00000	0.00000	0.00000	0.00000	0.00000	0.00000	0.00000	45
WIPP underground construction, 1982	46	0.00000	0.00000	0.00000	0.00000	0.00000	0.00000	0.00000	0.00000	46
WIPP underground construction, 1983	47	0.00000	0.00000	0.00000	0.00000	0.00000	0.00000	0.00000	0.00000	47
WIPP underground construction, 1984	48	0.00000	0.00000	0.00000	0.00000	0.00000	0.00000	0.00000	0.00000	48
WIPP general surface operations	49	0.00000	0.00000	0.00000	0.00000	0.00000	0.00000	0.00000	0.00000	49
WIPP security and remote handling	50	0.00000	0.00000	0.00000	0.00000	0.00000	0.00000	0.00000	0.00000	50
WIPP underground operations	51	0.00000	0.00000	0.00000	0.00000	0.00000	0.00000	0.00000	0.00000	51
Government	52	0.08058	0.09927	0.06277	0.08188	0.09844	0.02844	0.01841	0.03241	52
Households/PC weekly	53	0.00000	0.00000	0.00000	0.00000	0.00000	0.02612	0.01410	0.03087	53
Households/PC local	54	0.61520	0.63006	0.55908	0.66581	0.80134	0.27800	0.17761	0.31778	54
Column sums		2.15278	2.35848	2.15966	2.32859	2.60450	1.60043	1.42324	1.67062	

L-15

Table L-2. Input-Output Tables, Lea and Eddy Counties, November 1979:
Direct, Indirect, and Induced Coefficients (Continued)

Industry Selling		Industry Purchasing								
		41	42	43	44	45	46	47	48	
Livestock and livestock products	1	0.00178	0.00160	0.00328	0.00174	0.00192	0.00192	0.00186	0.00172	1
Cotton	2	0.00084	0.00076	0.00152	0.00083	0.00091	0.00092	0.00089	0.00082	2
Grains and seeds	3	0.00108	0.00098	0.00193	0.00100	0.00110	0.00110	0.00106	0.00099	3
Fruits and vegetables	4	0.00036	0.00032	0.00066	0.00035	0.00039	0.00039	0.00037	0.00035	4
Forestry and fishery products	5	0.00039	0.00035	0.00074	0.00039	0.00043	0.00043	0.00042	0.00038	5
Agricultural services	6	0.00069	0.00066	0.00057	0.00038	0.00041	0.00041	0.00040	0.00037	6
Miscellaneous metallic and nonmetallic minerals	7	0.00000	0.00000	0.00001	0.00000	0.00000	0.00000	0.00000	0.00000	7
Crude petroleum	8	0.00572	0.00519	0.01230	0.00546	0.00595	0.00596	0.00579	0.00539	8
Natural gas and liquid petroleum	9	0.00180	0.00162	0.00422	0.00186	0.00203	0.00203	0.00197	0.00184	9
Stone, gravel, and sand	10	0.00754	0.00754	0.00011	0.00274	0.00275	0.00275	0.00275	0.00274	10
Potash mining	11	0.00001	0.00001	0.00002	0.00001	0.00001	0.00001	0.00001	0.00001	11
Residential construction	12	0.00000	0.00000	0.00000	0.00000	0.00000	0.00000	0.00000	0.00000	12
Nonresidential construction	13	0.00000	0.00000	0.00000	0.00000	0.00000	0.00000	0.00000	0.00000	13
All other construction	14	0.00000	0.00000	0.00000	0.00000	0.00000	0.00000	0.00000	0.00000	14
Construction maintenance	15	0.00380	0.00347	0.01298	0.00380	0.00411	0.00411	0.00401	0.00376	15
Food products	16	0.00780	0.00700	0.01412	0.00772	0.00848	0.00849	0.00823	0.00762	16
Fabrics and apparel	17	0.00019	0.00018	0.00026	0.00020	0.00021	0.00021	0.00020	0.00020	17
Wood and lumber products	18	0.00007	0.00007	0.00019	0.00012	0.00012	0.00012	0.00012	0.00012	18
Printing	19	0.00153	0.00138	0.00341	0.00150	0.00165	0.00165	0.00160	0.00148	19
Chemical products	20	0.00063	0.00058	0.00205	0.00060	0.00065	0.00065	0.00063	0.00059	20
Plastics and petroleum products	21	0.01202	0.01092	0.02576	0.01143	0.01247	0.01249	0.01213	0.01130	21
Glass and stone products	22	0.00049	0.00049	0.00010	0.00022	0.00023	0.00023	0.00023	0.00022	22
Primary metal products	23	0.00000	0.00000	0.00000	0.00000	0.00000	0.00000	0.00000	0.00000	23
Fabricated metal products	24	0.00137	0.00137	0.00002	0.00051	0.00052	0.00052	0.00052	0.00051	24
Machinery	25	0.00075	0.00069	0.00362	0.00202	0.00207	0.00207	0.00205	0.00201	25
Electrical products	26	0.00002	0.00002	0.00013	0.00002	0.00002	0.00002	0.00002	0.00002	26
Transportation and warehousing	27	0.01624	0.01519	0.02900	0.01597	0.01697	0.01698	0.01664	0.01585	27
Communications	28	0.01279	0.01203	0.03060	0.00895	0.00968	0.00969	0.00944	0.00886	28
Electrical utility	29	0.01118	0.01020	0.02129	0.01937	0.02030	0.02032	0.02000	0.01925	29
Gas utility	30	0.00770	0.00692	0.01887	0.00798	0.00872	0.00874	0.00848	0.00789	30
Water and sewer	31	0.00227	0.00206	0.00545	0.00223	0.00243	0.00244	0.00237	0.00220	31
Wholesale trade	32	0.09043	0.08804	0.05781	0.09844	0.10071	0.10075	0.09997	0.09817	32
Retail trade	33	0.07043	0.06311	0.14726	0.06944	0.07638	0.07650	0.07413	0.06858	33
Finance, insurance, and real estate	34	0.04140	0.03825	0.09844	0.03568	0.03867	0.03872	0.03770	0.03532	34
Lodging and personal and repair services	35	0.03025	0.02748	0.06809	0.02997	0.03259	0.03264	0.03174	0.02964	35
Businesses and miscellaneous services	36	0.01071	0.00987	0.07678	0.01032	0.01111	0.01113	0.01086	0.01023	36
Medical and nonprofit	37	0.00487	0.00438	0.01133	0.00480	0.00527	0.00528	0.00512	0.00475	37
WIPP surface construction, 1980	38	0.00000	0.00000	0.00000	0.00000	0.00000	0.00000	0.00000	0.00000	38
WIPP surface construction, 1981	39	0.00000	0.00000	0.00000	0.00000	0.00000	0.00000	0.00000	0.00000	39
WIPP surface construction, 1982	40	0.00000	0.00000	0.00000	0.00000	0.00000	0.00000	0.00000	0.00000	40
WIPP surface construction, 1983	41	1.00000	0.00000	0.00000	0.00000	0.00000	0.00000	0.00000	0.00000	41
WIPP surface construction, 1984	42	0.00000	1.00000	0.00000	0.00000	0.00000	0.00000	0.00000	0.00000	42
WIPP construction management and design	43	0.00000	0.00000	1.00000	0.00000	0.00000	0.00000	0.00000	0.00000	43
WIPP underground construction, 1980	44	0.00000	0.00000	0.00000	1.00000	0.00000	0.00000	0.00000	0.00000	44
WIPP underground construction, 1981	45	0.00000	0.00000	0.00000	0.00000	1.00000	0.00000	0.00000	0.00000	45
WIPP underground construction, 1982	46	0.00000	0.00000	0.00000	0.00000	0.00000	1.00000	0.00000	0.00000	46
WIPP underground construction, 1983	47	0.00000	0.00000	0.00000	0.00000	0.00000	0.00000	1.00000	0.00000	47
WIPP underground construction, 1984	48	0.00000	0.00000	0.00000	0.00000	0.00000	0.00000	0.00000	1.00000	48
WIPP general surface operations	49	0.00000	0.00000	0.00000	0.00000	0.00000	0.00000	0.00000	0.00000	49
WIPP security and remote handling	50	0.00000	0.00000	0.00000	0.00000	0.00000	0.00000	0.00000	0.00000	50
WIPP underground operations	51	0.00000	0.00000	0.00000	0.00000	0.00000	0.00000	0.00000	0.00000	51
Government	52	0.04296	0.03849	0.08208	0.04221	0.04646	0.04653	0.04508	0.04169	52
Households/PC weekly	53	0.04351	0.03817	0.00000	0.04873	0.05452	0.05462	0.05265	0.04802	53
Households/PC local	54	0.42339	0.37860	0.80638	0.41573	0.45809	0.45878	0.44435	0.41053	54
Column sums		1.85702	1.77799	2.54136	1.85273	1.92831	1.92956	1.90380	1.84345	

Table L-2. Input-Output Tables, Lea and Eddy Counties, November 1979:
Direct, Indirect, and Induced Coefficients (Continued)

Industry Selling		Industry Purchasing						Row Sums	
		49	50	51	52	53	54		
Livestock and livestock products	1	0.00347	0.00383	0.00295	0.00286	0.00128	0.00513	1	2.23268
Cotton	2	0.00161	0.00169	0.00139	0.00133	0.00060	0.00242	2	1.22548
Grains and seeds	3	0.00204	0.00369	0.00168	0.00170	0.00071	0.00287	3	1.72453
Fruits and vegetables	4	0.00070	0.00072	0.00060	0.00058	0.00027	0.00106	4	1.03169
Forestry and fishery products	5	0.00078	0.00083	0.00067	0.00064	0.00029	0.00117	5	1.12606
Agricultural services	6	0.00060	0.00067	0.00050	0.00052	0.00022	0.00085	6	1.26417
Miscellaneous metallic and nonmetallic minerals	7	0.00001	0.00005	0.00000	0.00001	0.00000	0.00001	7	1.01085
Crude petroleum	8	0.01286	0.02785	0.00930	0.01115	0.00165	0.01505	8	2.12687
Natural gas and liquid petroleum	9	0.00440	0.01108	0.00360	0.00426	0.00108	0.00492	9	1.67548
Stone, gravel, and sand	10	0.00012	0.00025	0.00008	0.00022	0.00002	0.00010	10	1.17864
Potash mining	11	0.00002	0.00002	0.00001	0.00002	0.00000	0.00002	11	1.02776
Residential construction	12	0.00000	0.00000	0.00000	0.00000	0.00000	0.00000	12	1.00000
Nonresidential construction	13	0.00000	0.00000	0.00000	0.00000	0.00000	0.00000	13	1.00000
All other construction	14	0.00000	0.00000	0.00000	0.00000	0.00000	0.00000	14	1.00000
Construction maintenance	15	0.01332	0.03182	0.00929	0.02940	0.00214	0.00913	15	1.76049
Food products	16	0.01496	0.01552	0.01290	0.01230	0.00561	0.02254	16	1.58688
Fabrics and apparel	17	0.00028	0.00075	0.00022	0.00028	0.00008	0.00031	17	1.13592
Wood and lumber products	18	0.00020	0.00020	0.00060	0.00028	0.00003	0.00011	18	1.10804
Printing	19	0.00357	0.00348	0.00251	0.00265	0.00107	0.00431	19	1.13032
Chemical products	20	0.00210	0.00165	0.00093	0.00257	0.00033	0.00149	20	1.23028
Plastics and petroleum products	21	0.02693	0.05786	0.01934	0.02321	0.00331	0.03158	21	2.31894
Glass and stone products	22	0.00010	0.00017	0.00007	0.00016	0.00002	0.00009	22	1.18561
Primary metal products	23	0.00000	0.00000	0.00000	0.00000	0.00000	0.00000	23	1.00000
Fabricated metal products	24	0.00002	0.00002	0.00001	0.00003	0.00000	0.00001	24	1.01902
Machinery	25	0.00367	0.00140	0.01652	0.00451	0.00037	0.00149	25	1.16641
Electrical products	26	0.00013	0.00003	0.00003	0.00009	0.00001	0.00003	26	1.01516
Transportation and warehousing	27	0.03010	0.12032	0.02934	0.03238	0.00718	0.02950	27	2.71340
Communications	28	0.03139	0.02574	0.01542	0.02761	0.00531	0.02140	28	1.82307
Electrical utility	29	0.02231	0.03985	0.06459	0.02151	0.00680	0.02760	29	2.20222
Gas utility	30	0.01968	0.02312	0.01530	0.01904	0.00536	0.02189	30	2.38613
Water and sewer	31	0.00567	0.00588	0.00363	0.00492	0.00150	0.00609	31	1.22293
Wholesale trade	32	0.06029	0.07511	0.04246	0.05407	0.01657	0.06683	32	4.19660
Retail trade	33	0.15487	0.15491	0.11948	0.12146	0.05099	0.20510	33	6.08939
Finance, insurance, and real estate	34	0.10171	0.08967	0.05945	0.08775	0.02161	0.08821	34	4.54199
Lodging and personal and repair services	35	0.07097	0.08268	0.04586	0.05737	0.01927	0.07756	35	3.20018
Businesses and miscellaneous services	36	0.07765	0.03091	0.01466	0.03161	0.00570	0.02334	36	2.61442
Medical and nonprofit	37	0.01184	0.01032	0.00916	0.00983	0.00341	0.01374	37	1.35884
WIPP surface construction, 1980	38	0.00000	0.00000	0.00000	0.00000	0.00000	0.00000	38	1.00000
WIPP surface construction, 1981	39	0.00000	0.00000	0.00000	0.00000	0.00000	0.00000	39	1.00000
WIPP surface construction, 1982	40	0.00000	0.00000	0.00000	0.00000	0.00000	0.00000	40	1.00000
WIPP surface construction, 1983	41	0.00000	0.00000	0.00000	0.00000	0.00000	0.00000	41	1.00000
WIPP surface construction, 1984	42	0.00000	0.00000	0.00000	0.00000	0.00000	0.00000	42	1.00000
WIPP construction management and design	43	0.00000	0.00000	0.00000	0.00000	0.00000	0.00000	43	1.00000
WIPP underground construction, 1980	44	0.00000	0.00000	0.00000	0.00000	0.00000	0.00000	44	1.00000
WIPP underground construction, 1981	45	0.00000	0.00000	0.00000	0.00000	0.00000	0.00000	45	1.00000
WIPP underground construction, 1982	46	0.00000	0.00000	0.00000	0.00000	0.00000	0.00000	46	1.00000
WIPP underground construction, 1983	47	0.00000	0.00000	0.00000	0.00000	0.00000	0.00000	47	1.00000
WIPP underground construction, 1984	48	0.00000	0.00000	0.00000	0.00000	0.00000	0.00000	48	1.00000
WIPP general surface operations	49	1.00000	0.00000	0.00000	0.00000	0.00000	0.00000	49	1.00000
WIPP security and remote handling	50	0.00000	1.00000	0.00000	0.00000	0.00000	0.00000	50	1.00000
WIPP underground operations	51	0.00000	0.00000	1.00000	0.00000	0.00000	0.00000	51	1.00000
Government	52	0.08674	0.08868	0.07244	1.10787	0.03094	0.12551	52	4.60289
Households/PC weekly	53	0.00000	0.00000	0.00000	0.00000	1.00000	0.00000	53	1.41131
Households/PC local	54	0.85437	0.88099	0.73940	0.70171	0.07172	1.29330	54	27.27817
Column sums		2.61947	2.79177	2.31439	2.37592	1.26546	2.10475		

L.3.1 Wages

First, the level of wages must be determined. The average annual wages and labor costs for each of the 37 private subsectors and the government subsector (State, local, and Federal) are listed in Table L-3.

Average employee costs for all of the 38 subsectors in the input-output model were computed from information obtained from the New Mexico Employment Security Department. Since complete 1979 data were not available, the 1978 average wages for the area were derived from the quarterly report Covered Employment and Wages and the increase in wages from 1978 to 1979 was estimated for each sector.

Expected fringe benefits were then added to the wages for each subsector. The fringe benefits were computed in several ways. Information on fringe benefits was obtained from several companies in the construction, petroleum, and mining industries. For subsectors that are not dominated by large companies, averages reflecting minimum fringe benefits at various salary levels were used. Thus, the labor cost per employee is the estimated annual wages paid in 1979 plus the expected fringe-benefit percentage. Table L-3 gives the annual wages, fringe-benefit percentage, and estimated annual labor cost for the 38 economic subsectors. The annual wages for the government subsector were derived from Bureau of Economic Analysis data.

L.3.2 Calculating Indirect Job Impact

Given below is a sample calculation that illustrates the procedure used to estimate the number of new indirect jobs created by the WIPP in the two-county area.

The first step is to determine the annual flow of dollars through the economy from an increase in activity in a specific economic subsector. The example used here is aboveground construction and the year is 1983. It is estimated that the new dollars brought to the area by aboveground construction in 1983 will be \$53.113 million. This direct construction impact is then multiplied by the coefficients given in Table L-2 (the inverted input-output table listing the direct, indirect, and induced effects) for the activity of interest (column 41: aboveground construction--1983).

The process for determining the impact on indirectly affected economic subsectors is illustrated in the following equations:

$$I_{ij} \times AIMP_{1983} = \$IMP_{ij}$$

$$(0.01279 \times \$53,113,200 = \$679,318)$$

where

I_{ij} = coefficient from Table L-2 for row i and column entry j ;
 $i = 1, \dots, 52$ and $j = 1, \dots, 52$. Example uses $i = 28$
(communications subsector) and $j = 41$, (aboveground
construction in 1983); $I_{28,41} = 0.01279$.

$AIMP_{1983}$ = aboveground-construction impact for 1983 (e.g., \$53,113,200).

Table L-3. Estimated Annual Wages and Labor Costs per Employee in Eddy and Lea Counties, 1979^a

Subsector	Estimated 1979 annual wages ^b	Estimated fringe benefits ^c (%)	Estimated annual labor costs per employee, 1979 ^d
1. Livestock and livestock products	\$ 9,320	10.0	\$10,252
2. Cotton	7,585	10.0	8,343
3. Grains and seeds	7,585	10.0	8,343
4. Fruits and vegetables	7,585	10.0	8,343
5. Forestry and fishery products	9,298	16.0	10,786
6. Agricultural services	9,298	16.0	10,786
7. Miscellaneous metals and other minerals	17,321	28.0	22,171
8. Crude petroleum	16,567	28.0	21,206
9. Natural gas and liquid petroleum	16,567	28.0	21,206
10. Stone, gravel, and sand	17,321	28.0	22,171
11. Potash mining	17,321	28.0	22,171
12. Residential construction	10,545	20.0	12,654
13. Nonresidential construction	12,808	25.0	16,010
14. All other construction	11,573	25.0	14,466
15. Construction maintenance	11,052	15.0	12,710
16. Food products	10,181	16.0	11,810
17. Fabrics and apparel	7,818	17.0	9,147
18. Wood and lumber products	11,097	16.0	12,873
19. Printing	9,989	16.0	11,587
20. Chemical products	18,618	15.0	21,411
21. Plastics and petroleum products	21,227	15.0	24,411
22. Glass and stone products	12,666	16.0	14,693
23. Primary metal products	(e)	(e)	(e)
24. Fabricated metal products	12,323	16.0	14,295
25. Machinery	13,177	16.0	15,285
26. Electrical products	10,399	16.0	12,063
27. Transportation and warehousing	12,850	16.0	14,906
28. Communications	10,917	16.0	12,664
29. Electrical utility	18,821	15.0	21,644
30. Gas utility	18,821	15.0	21,644
31. Water and sewer	10,536	16.0	12,222
32. Wholesale trade	13,946	16.0	16,177
33. Retail trade	7,751	17.0	9,069
34. Finance, insurance, and real estate	11,068	16.0	12,839
35. Lodging and personal and repair services	6,541	17.0	7,653

Table L-3. Estimated Annual Wages and Labor Costs per Employee
Employee in Eddy and Lea Counties, 1979^a (continued)

Subsector	Estimated 1979 annual wages ^b	Estimated fringe benefits ^c (%)	Estimated annual labor costs per employee, 1979 ^d
36. Businesses and miscellaneous services	11,142	16.0	12,925
37. Medical and nonprofit	9,049	16.0	10,497
52. Government	12,944	16.0	15,015

^aThese wages and labor costs are for jobs supported in indirectly affected subsectors. Jobs created by (directly associated with) the construction and operation of the WIPP project have annual wages that are not included in the listed figures.

^bDerived from Covered Employment and Wages, Quarterly Report, New Mexico Employment Security, 1978. Wages were estimated for 1979 by using an adjustment factor specific to major sectors.

^cDetermined from interviews with private companies and unions. Minimum applicable percentage applies to most secondary and tertiary subsectors.

^dPer employee costs are representative of the annual wage and not necessarily of a 40-hour average week.

^eNo activity in this subsector in the two-county area.

$\$IMP_{ij}$ = dollar indirect impact in subsector i from an exogenous increase in subsector j ; that is, impact on the communications subsector from an increase in aboveground-construction activity.

From this calculation it is apparent that the model estimates that the increase in the communications subsector during 1983 will be about \$680,000.

The next step is to determine the amount of money in the communications subsector that will be expended for labor (i.e., labor costs). The following equation illustrates this:

$$\$IMP_{ij} \times LC_{54i} = \$LC_{ji}$$

$$(\$679,318 \times 0.39097 = \$265,593)$$

where

LC_{54i} = coefficient for labor costs in subsector i from Table L-1; $i = 1, \dots, 52$ (e.g., $LC_{54,28} = 0.39097$ represents the coefficient for labor cost in subsector $i = 28$, communications).

$\$LC_{ji}$ = dollars flowing to labor cost in subsector i from an increase in activity in subsector j (i.e., total labor cost in communications (i = 28) as an indirect result of an increase in aboveground construction (j = 41) of \$53,113,200 in 1983).

After determining that just more than \$265,000 will flow into labor costs during 1983 through the communications subsector from increased aboveground-construction activity, the remaining step is to determine how many jobs this \$265,000 will support during 1983. This is accomplished by the following mathematical operation:

$$\$LC_{ji} \div \text{annual } ULC_i = \text{indirect job}_{ji}$$

$$(\$265,593 \div \$12,664 = 21.0)$$

where

Annual ULC_i = annual average per-unit labor cost in subsector i (e.g., in subsector i = 28, communications, annual ULC_i = \$12,664).

Indirect Job_{ji} = number of jobs in subsector i supported by new activity in subsector j (e.g., i = 41, aboveground construction, \$53,113,200, supports 21.0 jobs in i = 28, communications).

This example shows that the resulting impact on jobs in this subsector--communications--will be 21.0 jobs for 1983. Obviously the number of jobs supported indirectly by the WIPP project will vary from year to year. Tables L-4 through L-10 list the indirect effects of the WIPP for each year from 1980 through 1986 and for an average operations year thereafter. These tables list the estimated dollar volume flow into the 38 indirectly affected subsectors of the two-county economy (37 private and 1 government) and the number of jobs indirectly created in each one of these subsectors.

Tables L-11 and L-12 list the indirect employment impacts by major sector (including government) and give the employment multiplier for each year. Table L-13 gives the total number of direct, private indirect, and government jobs supported by the WIPP project for the years 1980 through 1986 before the plant becomes fully operational.

Table L-4. Indirect Impact of the WIPP Project in 1980: Dollar Volume and Jobs Supported by Subsector

Subsector	Surface operations		Management and design		Underground operations	
	Estimated volume ^a	Jobs supported	Estimated volume ^a	Jobs supported	Estimated volume ^a	Jobs supported
1. Livestock and livestock products	0.2	0.0	2.0	0.0	11.2	0.0
2. Cotton	0.1	0.0	0.9	0.0	5.3	0.0
3. Grains and seeds	0.1	0.0	1.2	0.0	6.4	0.1
4. Fruits and vegetables	0.0	0.0	0.4	0.0	2.2	0.0
5. Forestry and fishery products	0.0	0.0	0.4	0.0	2.5	0.0
6. Agricultural services	0.1	0.0	0.3	0.0	2.4	0.1
7. Miscellaneous metals and other minerals	0.0	0.0	0.0	0.0	0.0	0.0
8. Crude petroleum	0.7	0.0	7.5	0.0	34.9	0.2
9. Natural gas and liquid petroleum	0.2	0.0	2.6	0.0	11.9	0.1
10. Stone, gravel, and sand	1.3	0.0	0.1	0.0	17.5	0.3
11. Potash mining	0.0	0.0	0.0	0.0	0.1	0.0
12. Residential construction ^b	0.0	0.0	0.0	0.0	0.0	0.0
13. Nonresidential construction	0.0	0.0	0.0	0.0	0.0	0.0
14. All other construction	0.0	0.0	0.0	0.0	0.0	0.0
15. Construction maintenance	0.5	0.0	7.9	0.3	24.3	0.9
16. Food products	0.9	0.0	8.6	0.1	49.3	0.6
17. Fabrics and apparel	0.0	0.0	0.2	0.0	1.3	0.0
18. Wood and lumber products	0.0	0.0	0.2	0.0	0.8	0.0
19. Printing	0.2	0.0	2.1	0.0	9.6	0.2
20. Chemical products	0.1	0.0	1.2	0.0	3.8	0.1
21. Plastics and petroleum products	1.5	0.0	15.7	0.1	73.1	0.3
22. Glass and stone products	0.1	0.0	0.1	0.0	1.4	0.0
23. Primary metal products	0.0	0.0	0.0	0.0	0.0	0.0
24. Fabricated metal products	0.2	0.0	0.0	0.0	3.3	0.1
25. Machinery	0.1	0.0	2.2	0.1	12.9	0.3
26. Electrical products	0.0	0.0	0.1	0.0	0.1	0.0
27. Transportation and warehousing	2.3	0.1	17.6	0.5	102.1	2.8
28. Communications	1.8	0.1	18.6	0.6	57.3	1.8
29. Electrical utility	1.4	0.0	12.9	0.1	123.9	0.8
30. Gas utility	0.9	0.0	11.5	0.1	51.1	0.3
31. Water and sewer	0.3	0.0	3.3	0.0	14.2	0.2
32. Wholesale trade	14.8	0.4	35.1	0.9	629.6	16.5

Table L-4. Indirect Impact of the WIPP Project in 1980: Dollar Volume and Jobs Supported by Subsector (continued)

Subsector	Surface operations		Management and design		Underground operations	
	Estimated volume ^a	Jobs supported	Estimated volume ^a	Jobs supported	Estimated volume ^a	Jobs supported
33. Retail trade	8.3	0.4	89.5	4.2	444.1	20.8
34. Finance, insurance, and real estate	5.6	0.2	59.8	1.7	228.2	6.4
35. Lodging and personal and repair services	3.8	0.2	41.4	1.9	191.6	8.7
36. Businesses and miscellaneous services	1.4	0.0	46.7	1.5	66.0	2.2
37. Medical and nonprofit	<u>0.6</u>	<u>0.0</u>	<u>6.9</u>	<u>0.3</u>	<u>30.7</u>	<u>1.5</u>
Total indirect impact	47.9	1	396.8	13	2213.1	65

Source: Larry Adcock and Associates, 1979.

Note: Detail may not equal total due to rounding.

^aThousands of 1979 dollars.

^bA portion of the construction impact is assigned to the finance, insurance, and real estate subsector because of the procedures followed in building the national model by the Bureau of Economic Analysis, Department of Commerce. The exact impacts of the construction-subsector portions cycled through the fire, insurance, and real estate subsector are not available.

Table L-5. Indirect Impact of the WIPP Project in 1981: Dollar Volume and Jobs Supported by Subsector

Subsector	Surface operations		Management and design		Underground operations	
	Estimated volume ^a	Jobs supported	Estimated volume ^a	Jobs supported	Estimated volume ^a	Jobs supported
1. Livestock and livestock products	15.7	0.1	13.7	0.1	31.6	0.1
2. Cotton	7.4	0.1	6.4	0.1	15.1	0.1
3. Grains and seeds	10.5	0.1	8.1	0.1	18.1	0.2
4. Fruits and vegetables	3.0	0.0	2.8	0.0	6.4	0.1
5. Forestry and fishery products	3.4	0.1	3.1	0.1	7.1	0.1
6. Agricultural services	10.7	0.3	2.4	0.1	6.7	0.2
7. Miscellaneous metals and other minerals	0.0	0.0	0.0	0.0	0.1	0.0
8. Crude petroleum	57.2	0.3	51.3	0.3	98.1	0.6
9. Natural gas and liquid petroleum	17.0	0.1	17.6	0.1	33.4	0.2
10. Stone, gravel, and sand	151.9	2.2	0.5	0.0	45.3	0.7
11. Potash mining	0.2	0.0	0.1	0.0	0.2	0.0
12. Residential construction ^b	0.0	0.0	0.0	0.0	0.0	0.0
13. Nonresidential construction	0.0	0.0	0.0	0.0	0.0	0.0
14. All other construction	0.0	0.0	0.0	0.0	0.0	0.0
15. Construction maintenance	40.6	1.6	54.2	2.1	67.7	2.6
16. Food products	68.4	0.8	58.9	0.7	139.7	1.7
17. Fabrics and apparel	2.6	0.1	1.1	0.0	3.4	0.1
18. Wood and lumber products	1.0	0.0	0.8	0.0	2.0	0.0
19. Printing	14.0	0.3	14.2	0.3	27.2	0.6
20. Chemical products	6.9	0.1	8.6	0.2	10.7	0.2
21. Plastics and petroleum products	120.6	0.5	107.5	0.5	205.4	0.9
22. Glass and stone products	9.6	0.2	0.4	0.0	3.7	0.1
23. Primary metal products	0.0	0.0	0.0	0.0	0.0	0.0
24. Fabricated metal products	27.5	0.6	0.1	0.0	8.5	0.2
25. Machinery	9.2	0.2	15.1	0.4	34.1	0.8
26. Electrical products	0.2	0.0	0.5	0.0	0.3	0.0
27. Transportation and warehousing	211.5	5.8	121.0	3.3	279.5	7.6
28. Communications	173.8	5.4	127.7	3.9	159.4	4.9
29. Electrical utility	116.8	0.8	88.8	0.6	334.5	2.2
30. Gas utility	69.1	0.4	78.7	0.5	143.7	0.9
31. Water and sewer	21.8	0.2	22.7	0.3	40.1	0.5
32. Wholesale trade	1561.7	41.0	241.3	6.3	1659.2	43.6

Table L-5. Indirect Impact of the WIPP Project in 1981: Dollar Volume and Jobs Supported by Subsector (continued)

Subsector	Surface operations		Management and design		Underground operations	
	Estimated volume ^a	Jobs supported	Estimated volume ^a	Jobs supported	Estimated volume ^a	Jobs supported
33. Retail trade	611.4	28.7	614.6	28.8	1258.5	59.0
34. Finance, insurance, and real estate	487.4	13.7	410.8	11.6	637.1	17.9
35. Lodging and personal and repair services	304.2	13.8	284.2	12.9	537.0	24.4
36. Businesses and miscellaneous services	124.0	4.0	320.5	10.5	183.1	6.0
37. Medical and nonprofit	44.0	2.2	47.3	2.3	86.8	4.3
Total and indirect impact	4303.2	124	2725.0	86	6083.4	181

Source: Larry Adcock and Associates, 1979.

Note: Detail may not equal total due to rounding.

^aThousands of 1979 dollars.

^bA portion of the construction impact is assigned to the finance, insurance, and real estate subsector because of the procedures followed in building the national model by the Bureau of Economic Analysis, Department of Commerce. The exact impacts of the construction-subsector portions cycled through the fire, insurance, and real estate subsector are not available.

Table L-6. Indirect Impact of the WIPP Project in 1982: Dollar Volume and Jobs Supported by Subsector

Subsector	Surface operations		Management and design		Underground operations	
	Estimated volume ^a	Jobs supported	Estimated volume ^a	Jobs supported	Estimated volume ^a	Jobs supported
1. Livestock and livestock products	75.8	0.3	32.9	0.1	69.3	0.3
2. Cotton	35.9	0.3	15.3	0.1	33.1	0.3
3. Grains and seeds	47.3	0.4	19.3	0.2	39.6	0.3
4. Fruits and vegetables	15.0	0.1	6.6	0.1	14.0	0.1
5. Forestry and fishery products	16.7	0.3	7.4	0.1	15.5	0.3
6. Agricultural services	35.0	1.1	5.7	0.2	14.7	0.5
7. Miscellaneous metals and other minerals	0.1	0.0	0.1	0.0	0.1	0.0
8. Crude petroleum	251.8	1.4	123.4	0.7	215.1	1.2
9. Natural gas and liquid petroleum	78.0	0.4	42.3	0.2	73.3	0.4
10. Stone, gravel, and sand	423.9	6.2	1.2	0.0	99.2	1.5
11. Potash mining	0.6	0.0	0.2	0.0	0.3	0.0
12. Residential construction ^b	0.0	0.0	0.0	0.0	0.0	0.0
13. Nonresidential construction	0.0	0.0	0.0	0.0	0.0	0.0
14. All other construction	0.0	0.0	0.0	0.0	0.0	0.0
15. Construction maintenance	170.4	6.6	130.2	5.1	148.4	5.8
16. Food products	332.1	4.1	141.6	1.7	306.5	3.8
17. Fabrics and apparel	9.2	0.3	2.6	0.1	7.5	0.2
18. Wood and lumber products	3.6	0.1	1.9	0.0	4.4	0.1
19. Printing	65.9	1.3	34.2	0.7	59.6	1.2
20. Chemical products	28.5	0.5	20.5	0.4	23.5	0.4
21. Plastics and petroleum products	529.9	2.3	258.3	1.1	450.7	1.9
22. Glass and stone products	27.2	0.6	1.0	0.0	8.2	0.2
23. Primary metal products	0.0	0.0	0.0	0.0	0.0	0.0
24. Fabricated metal products	76.8	1.7	0.2	0.0	18.6	0.4
25. Machinery	34.9	0.8	36.3	0.9	74.8	1.8
26. Electrical products	0.8	0.0	1.3	0.0	0.7	0.0
27. Transportation and warehousing	774.3	21.1	290.8	7.9	612.9	16.7
28. Communications	618.5	19.1	306.8	9.5	349.7	10.8
29. Electrical utility	498.6	3.2	213.4	1.4	733.3	4.7
30. Gas utility	329.9	2.1	189.2	1.2	315.3	2.0
31. Water and sewer	99.1	1.1	54.6	0.6	87.9	1.0
32. Wholesale trade	4770.6	125.3	579.7	15.2	3636.2	95.5

Table L-6. Indirect Impact of the WIPP Project in 1982: Dollar Volume and Jobs Supported by Subsector (continued)

Subsector	Surface operations		Management and design		Underground operations	
	Estimated volume ^a	Jobs supported	Estimated volume ^a	Jobs supported	Estimated volume ^a	Jobs supported
33. Retail trade	2,991.3	140.2	1476.6	69.2	2,761.0	129.4
34. Finance, insurance, and real estate	1,911.5	53.8	987.1	27.8	1,397.5	39.4
35. Lodging and personal and repair services	1,334.5	60.6	682.8	31.0	1,178.0	53.5
36. Business and miscellaneous services	491.9	16.0	769.9	25.1	401.6	13.1
37. Medical and nonprofit	208.9	10.2	113.6	5.6	190.4	9.3
Total and indirect impact	16,288.4	482	6547.1	206	13,340.9	396

Source: Larry Adcock and Associates, 1979.

Note: Detail may not equal total due to rounding.

^aThousands of 1979 dollars.

^bA portion of the construction impact is assigned to the finance, insurance, and real estate subsector because of the procedures followed in building the national model by the Bureau of Economic Analysis, Department of Commerce. The exact impacts of the construction-subsector portions cycled through the fire, insurance, and real estate subsector are not available.

Table L-7. Indirect Impact of the WIPP Project in 1983: Dollar Volume and Jobs Supported by Subsector

Subsector	Surface operations		Management and design		Underground operations	
	Estimated volume ^a	Jobs supported	Estimated volume ^a	Jobs supported	Estimated volume ^a	Jobs supported
1. Livestock and livestock products	94.5	0.4	57.2	0.2	23.4	0.1
2. Cotton	44.7	0.4	26.6	0.2	11.2	0.1
3. Grains and seeds	57.5	0.5	33.7	0.3	13.4	0.1
4. Fruits and vegetables	18.9	0.2	11.5	0.1	4.7	0.0
5. Forestry and fishery products	21.0	0.4	12.8	0.2	5.2	0.1
6. Agricultural services	36.9	1.2	10.0	0.3	5.0	0.2
7. Miscellaneous metals and other minerals	0.2	0.0	0.1	0.0	0.0	0.0
8. Crude petroleum	303.6	1.7	214.8	1.2	72.8	0.4
9. Natural gas and liquid petroleum	95.6	0.5	73.7	0.4	24.8	0.1
10. Stone, gravel, and sand	400.7	5.9	2.0	0.0	34.5	0.5
11. Potash mining	0.6	0.0	0.4	0.0	0.1	0.0
12. Residential construction ^b	0.0	0.0	0.0	0.0	0.0	0.0
13. Nonresidential construction	0.0	0.0	0.0	0.0	0.0	0.0
14. All other construction	0.0	0.0	0.0	0.0	0.0	0.0
15. Construction maintenance	201.6	7.8	226.6	8.8	50.4	2.0
16. Food products	414.3	5.1	246.5	3.0	103.5	1.3
17. Fabrics and apparel	10.1	0.3	4.6	0.2	2.6	0.1
18. Wood and lumber products	3.9	0.1	3.4	0.1	1.5	0.0
19. Printing	81.5	1.7	59.5	1.2	20.1	0.4
20. Chemical products	33.5	0.6	35.8	0.6	8.0	0.1
21. Plastics and petroleum products	638.4	2.7	449.8	1.9	152.5	0.6
22. Glass and stone products	26.1	0.6	1.8	0.0	2.8	0.1
23. Primary metal products	0.0	0.0	0.0	0.0	0.0	0.0
24. Fabricated metal products	72.6	1.6	0.4	0.0	6.5	0.1
25. Machinery	39.6	1.0	63.1	1.5	25.8	0.6
26. Electrical products	0.9	0.0	2.2	0.1	0.2	0.0
27. Transportation and warehousing	862.7	23.5	506.4	13.8	209.2	5.7
28. Communications	679.6	21.0	534.3	16.5	118.7	3.7
29. Electrical utility	594.0	3.8	371.6	2.4	251.4	1.6
30. Gas utility	409.2	2.6	329.4	2.1	106.7	0.7
31. Water and sewer	120.7	1.4	95.1	1.1	29.7	0.3
32. Wholesale trade	4,802.9	126.2	1,009.4	26.5	1256.8	33.0

Table L-7. Indirect Impact of the WIPP Project in 1983: Dollar Volume and Jobs Supported by Subsector (continued)

Subsector	Surface operations		Management and design		Underground operations	
	Estimated volume ^a	Jobs supported	Estimated volume ^a	Jobs supported	Estimated volume ^a	Jobs supported
33. Retail trade	3,740.6	175.3	2,571.2	120.5	931.9	43.7
34. Finance, insurance, and real estate	2,198.7	61.9	1,718.7	48.4	473.9	13.3
35. Lodging and personal and repair services	1,606.5	73.0	1,188.8	54.0	399.0	18.1
36. Businesses and miscellaneous services	568.6	18.5	1,340.6	43.7	136.5	4.5
37. Medical and nonprofit	258.6	12.7	197.7	9.7	64.3	3.2
Total and indirect impact	18,438.5	553	11,399.9	359	4547.2	135

Source: Larry Adcock and Associates, 1979.

Note: Detail may not equal total due to rounding.

^aThousands of 1979 dollars.

^bA portion of the construction impact is assigned to the finance, insurance, and real estate subsector because of the procedures followed in building the national model by the Bureau of Economic Analysis, Department of Commerce. The exact impacts of the construction-subsector portions cycled through the fire, insurance, and real estate subsector are not available.

Table L-8. Indirect Impact of the WIPP Project in 1984: Dollar Volume and Jobs Supported by Subsector

Subsector	Surface operations		Management and design		Underground operations	
	Estimated volume ^a	Jobs supported	Estimated volume ^a	Jobs supported	Estimated volume ^a	Jobs supported
1. Livestock and livestock products	13.9	0.1	40.5	0.2	1.6	0.0
2. Cotton	6.6	0.1	18.8	0.2	0.8	0.0
3. Grains and seeds	8.5	0.1	23.8	0.2	0.9	0.0
4. Fruits and vegetables	2.8	0.0	8.2	0.1	0.3	0.0
5. Forestry and fishery products	3.1	0.1	9.1	0.2	0.4	0.0
6. Agricultural services	5.8	0.2	7.1	0.2	0.4	0.0
7. Miscellaneous metals and other minerals	0.0	0.0	0.1	0.0	0.0	0.0
8. Crude petroleum	45.1	0.3	151.8	0.9	5.1	0.0
9. Natural gas and liquid petroleum	14.1	0.1	52.1	0.3	1.8	0.0
10. Stone, gravel, and sand	65.5	1.0	1.4	0.0	2.6	0.0
11. Potash mining	0.1	0.0	0.3	0.0	0.0	0.0
12. Residential construction ^b	0.0	0.0	0.0	0.0	0.0	0.0
13. Nonresidential construction	0.0	0.0	0.0	0.0	0.0	0.0
14. All other construction	0.0	0.0	0.0	0.0	0.0	0.0
15. Construction maintenance	30.1	1.2	160.2	6.2	3.6	0.1
16. Food products	60.8	0.7	174.3	2.1	7.3	0.1
17. Fabrics and apparel	1.5	0.1	3.3	0.1	0.2	0.0
18. Wood and lumber products	0.6	0.0	2.4	0.1	0.1	0.0
19. Printing	12.0	0.2	42.1	0.9	1.4	0.0
20. Chemical products	5.0	0.1	25.3	0.5	0.6	0.0
21. Plastics and petroleum products	94.8	0.4	318.0	1.4	10.8	0.0
22. Glass and stone products	4.2	0.1	1.2	0.0	0.2	0.0
23. Primary metal products	0.0	0.0	0.0	0.0	0.0	0.0
24. Fabricated metal products	11.9	0.3	0.2	0.0	0.5	0.0
25. Machinery	6.0	0.1	44.6	1.1	1.9	0.0
26. Electrical products	0.1	0.0	1.6	0.0	0.0	0.0
27. Transportation and warehousing	131.9	3.6	357.9	9.8	15.1	0.4
28. Communications	104.5	3.2	377.7	11.7	8.5	0.3
29. Electrical utility	88.6	0.6	262.7	1.7	18.4	0.1
30. Gas utility	60.1	0.4	232.9	1.5	7.5	0.0
31. Water and sewer	17.9	0.2	67.2	0.8	2.1	0.0
32. Wholesale trade	764.7	20.1	713.5	18.7	93.7	2.5

Table L-8. Indirect Impact of the WIPP Project in 1984: Dollar Volume and Jobs Supported by Subsector (continued)

Subsector	Surface operations		Management and design		Underground operations	
	Estimated volume ^a	Jobs supported	Estimated volume ^a	Jobs supported	Estimated volume ^a	Jobs supported
33. Retail trade	548.1	25.7	1817.4	85.2	65.5	3.1
34. Finance, insurance, and real estate	332.2	9.4	1214.8	34.2	33.7	0.9
35. Lodging and personal and repair services	238.7	10.8	840.3	38.2	28.3	1.3
36. Businesses and miscellaneous services	85.8	2.8	947.6	30.9	9.8	0.3
37. Medical and nonprofit	38.0	1.9	139.8	6.9	4.5	0.2
Total and indirect impact	2803.0	84	8057.8	254	327.6	10

Source: Larry Adcock and Associates, 1979.

Note: Detail may not equal total due to rounding.

^aThousands of 1979 dollars.

^bA portion of the construction impact is assigned to the finance, insurance, and real estate subsector because of the procedures followed in building the national model by the Bureau of Economic Analysis, Department of Commerce. The exact impacts of the construction-subsector portions cycled through the fire, insurance, and real estate subsector are not available.

Table L-9. Indirect Impact of the WIPP Project in 1985 and 1986:
Dollar Volume and Jobs Supported by Subsector

Subsector	Management and design, 1985		Management and design, 1986	
	Estimated volume ^a	Jobs supported	Estimated volume ^a	Jobs supported
1. Livestock and livestock products	49.2	0.2	68.7	0.3
2. Cotton	22.9	0.2	31.9	0.3
3. Grains and seeds	29.0	0.3	40.5	0.4
4. Fruits and vegetables	9.9	0.1	13.9	0.1
5. Forestry and fishery products	11.0	0.2	15.4	0.3
6. Agricultural services	8.6	0.3	12.0	0.4
7. Miscellaneous metals and other minerals	0.1	0.0	0.1	0.0
8. Crude petroleum	184.8	1.0	258.0	1.5
9. Natural gas and liquid petroleum	63.4	0.4	88.5	0.5
10. Stone, gravel, and sand	1.7	0.0	2.4	0.0
11. Potash mining	0.3	0.0	0.4	0.0
12. Residential construction ^b	0.0	0.0	0.0	0.0
13. Nonresidential construction	0.0	0.0	0.0	0.0
14. All other construction	0.0	0.0	0.0	0.0
15. Construction maintenance	194.9	7.6	272.2	10.6
16. Food products	212.1	2.6	296.1	3.6
17. Fabrics and apparel	4.0	0.1	5.5	0.2
18. Wood and lumber products	2.9	0.1	4.0	0.1
19. Printing	51.2	1.0	71.5	1.5
20. Chemical products	30.8	0.0	43.0	0.8
21. Plastics and petroleum products	386.9	1.6	540.3	2.3
22. Glass and stone products	1.5	0.0	2.1	0.0
23. Primary metal products	0.0	0.0	0.0	0.0
24. Fabricated metal products	0.3	0.0	0.4	0.0
25. Machinery	54.3	1.3	75.8	1.8
26. Electrical products	1.9	0.1	2.7	0.1
27. Transportation and warehousing	435.6	11.9	608.2	16.6
28. Communications	459.6	14.2	641.7	19.8
29. Electrical utility	319.7	2.1	446.4	2.9
30. Gas utility	283.4	1.8	395.7	2.6
31. Water and sewer	81.8	0.9	114.2	1.3
32. Wholesale trade	868.2	22.8	1,212.3	31.8

Table L-9. Indirect Impact of the WIPP Project in 1985 and 1986: Dollar Volume and Jobs Supported by Subsector (continued)

Subsector	Management and design, 1985		Management and design, 1986	
	Estimated volume ^a	Jobs supported	Estimated volume ^a	Jobs supported
33. Retail trade	2211.6	103.6	3,088.0	144.7
34. Finance, insurance, and real estate	1478.3	41.6	2,064.2	58.1
35. Lodging and personal and repair services	1022.6	46.4	1,427.8	64.9
36. Businesses and miscellaneous services	1153.1	37.6	1,610.1	52.5
37. Medical and nonprofit	170.1	8.3	237.5	11.6
Total and indirect impact	9805.6	309	13,691.7	437

Source: Larry Adcock and Associates, 1979.

Note: Detail may not equal total due to rounding.

^aThousands of 1979 dollars.

^bA portion of the construction impact is assigned to the finance, insurance, and real estate subsector because of the procedures followed in building the national model by the Bureau of Economic Analysis, Department of Commerce. The exact impacts of the construction-subsector portions cycled through the fire, insurance, and real estate subsector are not available.

Table L-10. Indirect Impact of the WIPP Project, Average Year 1987 and Thereafter:
Dollar Volume and Jobs Supported by Subsector

Subsector	Surface operations		Management and design		Underground operations	
	Estimated volume ^a	Jobs supported	Estimated volume ^a	Jobs supported	Estimated volume ^a	Jobs supported
1. Livestock and livestock products	47.3	0.2	9.0	0.0	22.0	0.1
2. Cotton	22.0	0.2	4.0	0.0	10.4	0.1
3. Grains and seeds	27.8	0.2	8.6	0.1	12.5	0.1
4. Fruits and vegetables	9.6	0.1	1.7	0.0	4.5	0.0
5. Forestry and fishery products	10.6	0.2	2.0	0.0	5.0	0.1
6. Agricultural services	8.2	0.3	1.6	0.1	3.7	0.1
7. Miscellaneous metals and other minerals	0.1	0.0	0.1	0.0	0.0	0.0
8. Crude petroleum	175.5	1.0	65.3	0.4	69.4	0.4
9. Natural gas and liquid petroleum	60.1	0.3	26.0	0.1	26.8	0.2
10. Stone, gravel, and sand	1.6	0.0	0.6	0.0	0.6	0.0
11. Potash mining	0.3	0.0	0.0	0.0	0.1	0.0
12. Residential construction ^b	0.0	0.0	0.0	0.0	0.0	0.0
13. Nonresidential construction	0.0	0.0	0.0	0.0	0.0	0.0
14. All other construction	0.0	0.0	0.0	0.0	0.0	0.0
15. Construction maintenance	181.7	7.1	74.6	2.9	69.3	2.7
16. Food products	204.1	2.5	36.4	0.4	96.3	1.2
17. Fabrics and apparel	3.8	0.1	1.8	0.1	1.6	0.1
18. Wood and lumber products	2.7	0.1	0.5	0.0	4.5	0.1
19. Printing	48.7	1.0	8.2	0.2	18.7	0.4
20. Chemical products	28.7	0.5	3.9	0.1	7.0	0.1
21. Plastics and petroleum products	367.5	1.6	135.7	0.6	144.3	0.6
22. Glass and stone products	1.4	0.0	0.4	0.0	0.5	0.0
23. Primary metal products	0.0	0.0	0.0	0.0	0.0	0.0
24. Fabricated metal products	0.3	0.0	0.0	0.0	0.1	0.0
25. Machinery	50.1	1.2	3.3	0.1	123.3	3.0
26. Electrical products	1.7	0.0	0.1	0.0	0.3	0.0
27. Transportation and warehousing	410.7	11.2	282.1	7.7	218.9	6.0
28. Communications	428.4	13.2	60.4	1.9	115.1	3.6
29. Electrical utility	304.4	2.0	93.4	0.6	481.9	3.1
30. Gas utility	268.5	1.7	54.2	0.4	114.1	0.7
31. Water and sewer	77.4	0.9	13.8	0.2	27.1	0.3
32. Wholesale trade	822.6	21.6	176.1	4.6	316.8	8.3

Table L-10. Indirect Impact of the WIPP Project Average Year, 1987 and Thereafter:
Dollar Volume and Jobs Supported by Subsector (continued)

Subsector	Surface operations		Management and design		Underground operations	
	Estimated volume ^a	Jobs supported	Estimated volume ^a	Jobs supported	Estimated volume ^a	Jobs supported
33. Retail trade	2133.0	99.0	363.3	17.0	891.4	41.8
34. Finance, insurance, and real estate	1387.7	39.1	210.3	5.9	443.5	12.5
35. Lodging and personal and repair services	968.3	44.0	193.9	8.8	342.2	15.5
36. Businesses and miscellaneous services	1059.4	34.6	72.5	2.4	109.4	3.6
37. Medical and nonprofit	161.5	7.9	24.2	1.2	68.3	3.4
Total and indirect impact	9255.6	292	1927.8	56	3749.5	108

Source: Larry Adcock and Associates, 1979.

Note: Detail may not equal total due to rounding.

^aThousands of 1979 dollars.

^bA portion of the construction impact is assigned to the finance, insurance, and real estate subsector because of the procedures followed in building the national model by the Bureau of Economic Analysis, Department of Commerce. The exact impacts of the construction-subsector portions cycled through the fire, insurance, and real estate subsector are not available.

Table L-11. Indirect Impact of the WIPP Project, 1980-1983: Dollar Volume and Jobs Supported by Major Sector

Major sector	Total 1980		Total 1981		Total 1982		Total 1983	
	Estimated volume ^a	Jobs supported	Estimated volume ^a	Jobs supported	Estimated volume ^a	Jobs supported	Estimated volume ^a	Jobs supported
Agriculture	35.9	0.3	171.8	1.8	499.2	5.2	488.3	5.0
Mining	76.8	0.6	472.9	4.4	1,309.6	12.0	1,223.9	10.9
Construction ^b	32.7	1.2	162.5	6.3	449.0	17.5	478.6	18.6
Manufacturing	189.0	2.0	902.3	9.6	2,561.3	26.8	2,511.3	25.7
Transportation, communication, and utilities	419.2	7.2	1,989.3	37.3	5,474.4	102.6	5,218.9	100.3
Trade	1221.3	43.3	5,946.7	207.4	16,215.4	574.8	14,312.8	525.2
Finance, insurance, and real estate	293.6	8.3	1,535.3	43.2	4,296.0	121.0	4,391.3	123.6
Services	<u>389.1</u>	<u>16.3</u>	<u>1,931.0</u>	<u>80.3</u>	<u>5,371.5</u>	<u>224.5</u>	<u>5,760.7</u>	<u>237.3</u>
Subtotal (private sector)	2657.6	79.2	13,111.8	390.3	36,176.4	1084.4	34,385.8	1,046.6
Government	<u>324.9</u>	<u>9.8</u>	<u>1,479.7</u>	<u>44.6</u>	<u>4,325.6</u>	<u>130.5</u>	<u>4,281.7</u>	<u>129.1</u>
Total	2982.5	89.0	14,591.5	434.9	40,502.0	1214.9	38,677.3	1175.7
Employment multiplier (additive)	1.44	1.54			1.32		1.24	

Source: Larry Adcock and Associates, 1978.

Note: Detail may not equal total due to rounding.

^aIn thousands of 1979 dollars.

^bA portion of the construction impact is assigned to the finance, insurance, and real estate sector because of the procedures followed in building the national model by the Bureau of Economic Analysis, Department of Commerce. The exact impact of the construction-sector portion cycled through the finance, insurance, and real estate sector is not available.

Table L-12. Indirect Impact of the WIPP Project, 1984-1987 and Thereafter:
Dollar Volume and Jobs Supported by Major Sector

Major sector	Total 1984		Total 1985		Total 1986		Total 1987 and each year thereafter	
	Estimated volume ^a	Jobs supported	Estimated volume ^a	Jobs supported	Estimated volume ^a	Jobs supported	Estimated volume ^a	Jobs supported
Agriculture	\$ 152.3	1.5	\$ 130.7	1.2	\$ 182.4	1.7	\$ 210.4	1.9
Mining	340.0	2.6	250.3	1.4	349.5	2.0	426.5	2.5
Construction ^b	193.9	7.5	194.9	7.6	272.2	10.6	325.6	12.7
Manufacturing	832.9	8.3	745.8	7.4	1,041.4	10.4	1,295.5	14.0
Transportation, communica- tion, and utilities	1,753.0	34.3	1,580.0	30.9	2,206.2	43.1	2,950.3	53.4
Trade	4,002.8	155.2	3,079.8	126.5	4,300.4	176.6	4,683.4	192.4
Finance, insurance, and real estate	1,580.7	44.5	1,478.3	41.6	2,064.2	58.1	2,041.5	57.5
Services	2,332.8	93.1	2,345.8	92.4	3,275.4	129.0	2,999.7	121.4
Subtotal (private sector)	11,188.4	347.1	9,805.6	309.0	13,691.7	431.5	14,932.9	455.8
Government	1,387.1	41.9	1,232.7	37.2	1,721.2	51.9	1,931.8	58.3
Total	12,575.5	389.0	11,038.3	346.2	15,412.9	483.4	16,864.7	514.1
Employment multi- plier (additive)	1.31		1.29		1.16		1.17	

Source: Larry Adcock and Associates, 1979.

Note: Detail may not equal total due to rounding.

^aIn thousands of 1979 dollars.

^bA portion of the construction impact is assigned to the finance, insurance, and real estate sector because of the procedures followed in building the national model by the Bureau of Economic Analysis, Department of Commerce. The exact impact of the construction-sector portion cycled through the finance, insurance, and real estate sector is not available.

Table L-13. Jobs Created or Supported by the Construction and the Operation of the WIPP Project, 1980-1987 and Thereafter

Activity	1980	1981	1982	1983	1984	1985	1986	1987	After 1987
Surface construction									
Direct jobs	1	68	415	551	79	--	--	--	--
Private indirect jobs	2	124	482	553	84	--	--	--	--
Government Jobs	1	11	55	69	10	--	--	--	--
Total jobs	3	203	952	1173	173	--	--	--	--
Annual new jobs	3	200	749	221	(1000)	(173)	--	--	--
Management and design									
Direct jobs	5	52	152	281	208	269	417	--	--
Private indirect jobs	13	86	206	359	254	309	432	--	--
Government Jobs	1	10	25	43	31	37	52	--	--
Total jobs	19	148	383	684	493	615	901	--	--
Annual new jobs	19	129	235	301	(191)	122	286	(901)	--
Underground construction									
Direct jobs	56	162	355	119	9	--	--	--	--
Private indirect jobs	66	181	396	135	10	--	--	--	--
Government Jobs	8	23	51	17	1	--	--	--	--
Total jobs	130	366	802	271	20	--	--	--	--
Annual new jobs	130	236	436	(531)	(251)	(20)	--	--	--
Surface operations (general)									
Direct jobs	--	--	--	0	(a)	(a)	(a)	256	256
Private indirect jobs	--	--	--	0	(a)	(a)	(a)	292	292
Government Jobs	--	--	--	0	(a)	(a)	(a)	36	36
Total jobs	--	--	--	0	(a)	(a)	(a)	584	584
Annual new jobs	--	--	--	0	(a)	(a)	(a)	584	--
Operations: remote storage and security									
Direct jobs	--	--	--	0	(a)	(a)	(a)	44	44
Private indirect jobs	--	--	--	0	(a)	(a)	(a)	56	56
Government Jobs	--	--	--	0	(a)	(a)	(a)	6	6
Total jobs	--	--	--	0	(a)	(a)	(a)	106	106
Annual new jobs	--	--	--	0	(a)	(a)	(a)	106	--
Underground operations									
Direct jobs	--	--	--	0	(a)	(a)	(a)	140	140
Private indirect jobs	--	--	--	0	(a)	(a)	(a)	108	108
Government Jobs	--	--	--	0	(a)	(a)	(a)	16	16
Total jobs	--	--	--	0	(a)	(a)	(a)	264	264
Annual new jobs	--	--	--	0	(a)	(a)	(a)	264	--
Total all activities									
Direct jobs	62	282	922	951	296	269	417	440	440
Private indirect jobs	81	391	1084	1047	348	309	432	456	456
Government Jobs	10	44	131	129	42	37	52	58	58
Total jobs	152	717	2137	2128	686	615	901	954	954
Annual new jobs	152	565	4274	(9)	(1442)	(71)	286	53	--

Note: Detail may not equal total due to rounding.

^aThe years 1984-1986 are transition years, and some jobs listed as management and design will continue into operation positions.

L.4 POPULATION

L.4.1 Factors Affecting Population

Three critical economic parameters must be analyzed in order to determine the overall impact generated by an exogenous increase in a specific activity within a region: employment increases, increases in the flow of dollars, including personal income, and population changes. The order in which these specific categories are computed is important to the methods demonstrated in this appendix.

Changes in employment and increases in dollar flows can be derived directly from the results of the input-output model. Population migration, however, is dependent on the increase in employment derived from the input-output model. While the derivation of employment depends on assumptions concerning certain coefficients and factors drawn from previous studies, increases in population may be significantly influenced by changes in activity in other areas of the economy that cannot be predicted with reasonable accuracy. Specific conditions of uncertainty involve mining, which supports much of the economic activity in the two-county area.

Recent examples of fluctuation in economic activity that make it difficult to determine exact population-migration figures are evident. Between 1960 and 1970 both Eddy and Lea Counties lost population principally because of decreased levels of activity in mining. During the 10-year period, the population of Eddy County decreased by 19%, and the population loss in Lea County was just more than 7%. Before this decreasing trend was recognized, in the middle and early 1960s, population projections by the Bureau of Business and Economic Research (BBER), the official State population-projecting agency, were relatively high, indicating that professional demographic researchers felt that the area would continue to grow. Later population projections by the Federal Government and the BBER indicated somewhat lower levels of population growth. Since 1970, and particularly since the energy crisis, both counties have maintained high levels of growth. Growth in Eddy County is correlated with the end of potash "dumping" on the U.S. market by Canadian firms. In Lea County higher levels of oil and gas exploration and continued production have increased the population.

While the current outlook--particularly during the last 5 or 6 years--has been one of high expectations in terms of population growth in the near future, population growth is influenced by a number of outside factors. For example, high prices and limited supplies of petroleum have indirectly created growth in Lea County and in the City of Hobbs. Should these conditions change, the degree of growth in the area could also change. The potash industry of Eddy County (the major basic industry) now supplies between 80% and 90% of all potash sold in U.S. markets. Should the demand for potash decrease, the mining sector in Eddy County would be significantly affected.

Personal interviews with industrial development executives for Hobbs and Carlsbad indicate that a determined effort is under way to diversify the economy of both counties in order to stabilize their economic bases. Because of the high level of activity in the extractive industries, the availability of labor for certain occupations in Eddy and Lea Counties may require the

in-migration of a number of laborers into the area. However, recent developments while this study was being conducted indicate that there is a reasonable labor supply for many of the needed occupations in the area.

Employment-application records from the NMESD were examined to determine the availability of labor for various occupations. From this examination the percentage of workers needed for occupations directly connected with the construction and operation of the WIPP was determined. Economic activity within an area can change rather rapidly. As the level of economic activity changes, available labor in certain occupations also changes. Migration to work on a large construction project or to operate a facility like the WIPP depends on many factors. These include the recruitment procedure for employees, the availability of labor within an area, the construction-company subcontracting practices, and the availability of community facilities.

Many of the major factors affecting in-migration can be recognized, but dealing with them in a quantitative manner is difficult. Researchers tend to rely on previous studies conducted to determine the degree of migration and/or specific analogous case studies of construction projects. Possibly one of the best studies in recent years is the Construction Worker Profile, completed for the Old West Regional Commission (OWRC) in early 1976. A large number of the migration factors contained in this appendix have been drawn from that document. However, there is very little information that can be used in estimating the number of people who will move into the area to fill jobs in secondary and tertiary sectors (i.e., spinoff jobs from the construction and operation of the WIPP). These facts should be recognized while reading this appendix.

L.4.2 Population Impact Calculations

The impact on population of WIPP construction and operation was calculated from the results of the employment portion of the model. The calculations for each year are too extensive to give here. However, sample calculations and formulas are given below to illustrate the procedure used in determining the annual population impact. For illustrative purposes only, the year 1981, the second year of construction, and the year 1987, the first full year of operation, have been used in the sample calculations.

The calculation of population impact consists of three major steps. The first step calculates the number of people who are expected to move into the area because of WIPP construction. The formulas are as follows:

$$AGC_{1981} \times MigCON_A = AGCJM_{1981}$$

$$(68 \times 0.539 = 37)$$

$$BGC_{1981} \times MigCON_B = BGCJM_{1981}$$

$$(162 \times 0.606 = 98)$$

$$MDE_{1981} \times MigCON_N = MDEJM_{1981}$$

$$(52 \times 0.498 = 26)$$

$$AGCJM_{1981} + BGCJM_{1981} = CJM_{1981}$$

$$(37 + 98 = 135)$$

$$MDEJM_{1981} = MOWH_{1981}$$

$$(26 = 26)$$

$$CJM_{1981} \times HCWF = MCWH_{1981}$$

$$(139 \times 0.985 = 133)$$

$$MCWH_{1981} \times CWHSZ = MCP_{1981}$$

$$(133 \times 2.28 = 303)$$

$$MOWH_{1981} \times OWHSZ_{1981} = MOP_{1981}$$

$$(26 \times 2.75 = 72)$$

$$MCP_{1981} + MOP_{1981} = MDP_{1981}$$

$$(303 + 72 = 375)$$

where

AGC_{1981} = the total number of WIPP-associated aboveground-construction jobs in 1981.

BGC_{1981} = the total number of WIPP-associated belowground-construction jobs in 1981.

MDE_{1981} = the total number of WIPP-associated management and design jobs in 1981.

$MigCON_A$ = the proportion of total aboveground-construction jobs expected to be filled by newcomers to the area. The factor 0.539 was derived from Construction Worker Profile figures for the Four Corners Region in 1975 (Arizona, Colorado, New Mexico, and Utah).

$MigCON_B$ = the proportion of total belowground-construction jobs expected to be filled by newcomers to the area. The factor 0.606 was determined by matching needed occupations and skill levels to present availability (first quarter of 1977 and third quarter of 1978 and 1979) of labor.

$MigCON_N$ = the proportion of total nonconstruction jobs expected to be filled by newcomers to the area. The factor 0.498 is the weighted average of the final operational migration factors.

- JM₁₉₈₁ = the total number of jobs expected to be filled by newcomers to the area; AGCJM = aboveground-construction JM; BGCJM = belowground-construction JM; MDE = management-and-design JM; CJM = construction JM.
- HCWF = the factor that accounts for more than one construction worker per household (0.985).
- MCWH₁₉₈₁ = the number of newcomer construction-worker households expected in the area in 1981.
- MOWH₁₉₈₁ = the number of newcomer management-and-design worker households in 1981.
- CWHSZ = the average size of newcomer construction-worker households (2.28--Construction Worker Profile).
- OWHSZ₁₉₈₁ = the average size of newcomer nonconstruction-worker households in 1981 (see pages L-54 and L-55).
- MCP₁₉₈₁ = the expected number of individuals in-migrating directly for WIPP-construction jobs in 1981.
- MOP₁₉₈₁ = the expected number of individuals in-migrating directly for management-and-design jobs at the WIPP in 1981.
- MDP₁₉₈₁ = the expected number of individuals in-migrating directly for jobs at the WIPP in 1981.

The sources of data are extremely important in computing the population in-migrating to take new jobs in the construction and operation of the WIPP. The average number of employees by year for construction or operation was derived from data supplied by the Bechtel Corporation (October 23, 1979) and the Westinghouse Electric Corporation (November 1978). The proportion of new jobs expected to be filled by newcomers to the area is derived from the Construction Worker Profile. That OWRC study involved 14 large construction projects (six projects in the Four Corners Region) and showed that the percentage of local workers varied from a high of more than 79% to a low of 3.3% for all projects and a high of 79% to a low of 32% for the six projects in the Southwest (Arizona, Colorado, New Mexico, and Utah). The average percentage of local workers employed on the southwestern projects was 46.1%, indicating that 53.9% of the construction workers were not residents of the area before the construction activity (Four Corners Region only). A review of job applications in the computer files of the NMESD supports this distribution. Thus, approximately 54% of the construction workers for these six projects had migrated to the area for construction work. This percentage has been used to compute the number of aboveground jobs that would be filled by individuals not in the area before the construction began.

As construction workers move into the area to fill these positions, they bring with them other members of their households. Certain of these members--the older children and spouse--may take up jobs in the area of the construction site. The OWRC study indicates that about 1.5% of the new households contain two construction workers. This means that 985 households will supply

1000 construction workers to the project, on the average. Thus, the number of needed households has been decreased by 1.5% to account for the two-construction-worker households. This factor of 0.985 is identified in the formula above as HCWF. The final formula above yields the total number of individuals in-migrating to take new construction jobs. This number is computed by taking the average household size and multiplying it by the needed number of households to fill construction positions. In this case the average household size of 2.28 is the average household size determined from the OWRC study of all 14 construction projects in the West and Southwest. (For the explanation of the nonconstruction employment in-migration, see the section below on operation-associated in-migration.)

After the population in-migration due directly to construction has been calculated, the change due to operation must be computed. This is determined in the same way and is given by the following formulas:

(Note: The example year is 1987 because the full operational impact does not occur before 1987.)

$$OAG_{1987} \times MigOPP_{AG} = OAGJM_{1987}$$

$$(256 \times 0.498 = 127)$$

$$OBG_{1987} \times MigOPP_{BG} = OBGJM_{1987}$$

$$(140 \times 0.498 = 70)$$

$$OST_{1987} \times MigOPP_{OST} = OSTJM_{1987}$$

$$(44 \times 0.498 = 22)$$

$$OAGJM_{1987} + OBGJM_{1987} + OCNJM_{1987} = OJM_{1987}$$

$$(127 + 70 + 22 = 219)$$

$$OJM_{1987} = MOWH_{1987}$$

$$(219 = 219)$$

$$MOWH_{1987} \times AVHSZ_{1987} = MOP_{1987}$$

$$(219 \times 2.71 = 594 \quad 600)$$

where

OAG_{1987} = the total number of WIPP-associated aboveground-operation jobs in 1987.

OBG_{1987} = the total number of WIPP-associated belowground-operation jobs in 1987.

OST_{1987} = the total number of WIPP-associated disposal-operation jobs in 1987.

- MigOPP_{AG} = the proportion of total aboveground-operation jobs expected to be filled by newcomers to the area. The factor 0.498 was determined from occupation and skill-level data supplied by Sandia National Laboratories, a review of available occupations and skills in the two-county area, and information supplied by the Westinghouse Electric Corporation.
- MigOPP_{BG} = the proportion of total belowground-operation jobs to be filled by newcomers to the area. The factor 0.498 is the same factor that was used in the general projections for above-ground operation.
- MigOPP_{OST} = the proportion of total disposal-operation jobs to be filled by newcomers to the area. The factor 0.498 is the same as the factor used for other operation jobs.
- JM₁₉₈₇ = the number of total operational jobs expected to be filled by newcomers to the area; OAGJM = aboveground-operation JM, OBGJM = belowground-operation JM, OSTJM = remote handling and security JM, OJM = total.
- MOWH₁₉₈₇ = the number of newcomer operational-worker households in 1987.
- AVHSZ₁₉₈₇ = the average size of household for the in-migrating operational workers.
- MOP₁₉₈₇ = the population in-migrating directly to take operational jobs at the WIPP.

Again, sources of information for the formulas above are extremely important. The direct operational employment is determined from information supplied by Westinghouse. The proportion of operational jobs to be filled by newcomers to the area is determined to be 0.498. Literature searches indicate no directly applicable research projects that would give the average number of operational jobs filled by newcomers to the area. In order to determine this factor, NMESD job-application records, currently available occupational skill levels, and the occupations and skill levels needed for the operation phase were reviewed. In addition, information on the activities of operating contractors was obtained from the Westinghouse Electric Corporation.

Data on the average sizes of newcomer households were drawn directly from Bureau of the Census publications on projected household sizes and family sizes. The figures used within the calculations represent Series I population figures and Series D household sizes. These are the high-range household sizes of the 12 projections listed by the Bureau of the Census in Current Population Reports, Series P-25, No. 805, May 1979.

The last quantity needed to determine the overall population impact is the number of people taking jobs generated indirectly by the construction and operation of the WIPP. These population changes are computed much like the preceding calculations, with one major exception. Construction workers and operational workers who have moved into the area bring with them other household members. Some of these household members take up employment in other areas of the economy. These people must be accounted for in determining the

overall in-migration of people to the area. Thus, the following formulas differ somewhat from the preceding calculations:

$$IDE_{1981} \times MigID = IDJM_{1981}$$

$$(435 \times 0.50 = 218)$$

$$IDJM_{1981} - ADCE_{1981} - ADOE_{1981} = \text{Net } IDJM_{1981}$$

$$(218 - 26 - 8 = 184)$$

$$\text{Net } IDJM_{1981} \times HWF = MIDWH_{1981}$$

$$(184 \times 0.769 = 141)$$

$$MIDWH_{1981} \times AVHSZ_{1981} = MIDP_{1981}$$

$$(141 \times 2.75 = 388)$$

where

- IDE_{1981} = the number of new indirect jobs (private and government) supported by the construction or operation of the WIPP (example year is 1981).
- $MigID$ = the proportion of indirect jobs to be filled by newcomers to the area (0.50).
- $IDJM_{1981}$ = the number of indirect jobs in 1981 to be filled by newcomers to the area.
- $ADCE_{1981}$ = the expected number of indirect jobs in 1981 filled by members of households moving into the area to take new construction jobs ($0.195 \times MCWH$).
- $ADOE_{1981}$ = the number of indirect jobs filled by members of households moving into the area in 1981 to take new management-and-design jobs ($0.30 \times MOWH$).
- $\text{Net } IDJM_{1981}$ = the net number of jobs in 1981 to be filled by newcomers moving into the area to take jobs created indirectly by the construction or operation of the WIPP.
- HWF = the factor that accounts for more than one worker per household in in-migrating households (0.769).
- $MIDWH_{1981}$ = the number of newcomer households attracted to the area in 1981 primarily by jobs indirectly created by the construction or operation of the WIPP.
- $AVHSZ_{1981}$ = the average household size in 1981 of persons moving into the area for jobs indirectly created by the construction or operation of the WIPP.

MIDP₁₉₈₁ = the population moving into the area in 1981 for jobs indirectly created by the construction or operation of the WIPP.

From the above formulas, it is apparent that several new characteristics have entered the calculations of population impacts. The quantity IDE is determined from calculations explained in the employment section of this appendix. It is a direct result of the input-output modeling process. The quantity MigID is a subjective number based on an evaluation of the area in terms of labor availability and the skill levels needed for indirect new jobs. In this case, the factor is 0.5, which indicates that half of the new jobs created in indirectly affected sectors will be filled by newcomers to the area.

As workers move into the area to work in construction or operation, they bring with them households that contain members who also become part of the labor force and are available to fill newly created positions in the area under impact. The quantity ADCE accounts for these additional workers brought by construction-worker households. The OWRC Construction Worker Profile indicates that between 19 and 29 additional workers for each 100 newcomer construction-worker households will take jobs in indirectly affected sectors. In this study, a factor of 0.195 was used to determine the number of additional workers in each household in-migrating directly for construction work.

The term ADCE accounts for the number of new workers brought by households in-migrating directly for operation jobs. The Construction Worker Profile indicates that this number is substantially larger than the factor for the construction-worker households. Between 30 and 31 additional workers will be brought in for each 100 households moving in to take direct operation jobs. A factor of 30% was used in this appendix to account for those additional workers. It is also apparent that the households moving in to work in sectors indirectly affected by construction and operation may contain more than one worker per household. Again, this number is approximately 30 to 31 additional workers for 100 new households. Thus, for 100 households, just about 130 workers would be available for positions in indirectly affected sectors. In order to account for these multiple-worker households, a factor of $1/1.3 = 0.769$ was used to decrease the number of needed households moving into the area.

Finally, the actual size of the households moving into the area was calculated from Bureau of the Census data on projected household and family sizes (specifically Population Series I and Household Series C).

The final step in determining the population impact of WIPP construction and operation is to add the three quantities that determine population change: the change caused directly by construction, the change caused directly by operation, and the change caused indirectly by construction and operation.

Because the economy may be somewhat slow to react to new jobs, population changes are assumed to lag in the indirectly affected sectors. In order to account for this lag in the model, it is assumed that only half the expected in-migration will occur within the first year of impact. The remaining indi-

viduals are assumed to in-migrate during the next year. This assumption allows for a 6-month to 1-year lag in the spinoff effects of construction and operation.

It should be noted that the assumption allowing for a 6-month to 1-year lag in filling indirect jobs with newcomers does not necessarily affect the time at which the impact on the economy is calculated to occur. The impact on the economy is incurred when local purchases or payments to direct labor are made; therefore, the support for the jobs to be filled by the newcomers occurs before the jobs are actually filled. This means, for example, that persons who receive income from the construction of the WIPP do not wait to spend their income until population-serving businesses increase their employment. For the economic entities that are indirectly affected by WIPP construction and operation, there will be a period of time in which new economic activity creates support for new jobs, but those jobs have not yet been filled. This means that the productivity of employees will have to increase above the average until employers recognize the need for new employees and hire them. Therefore, there is no discrepancy between calculating the impact of the WIPP and assuming that the economy does not instantaneously react in terms of new employees in sectors that are indirectly affected.

The total in-migrating population for a given year is determined by adding the population attracted by construction, the population attracted by operation, and the population attracted by new activity in indirectly affected economic sectors. The formula that is used is as follows:

$$MCP_{1981} + MOP_{1981} + 0.5 MIDP_{1981} + 0.5 MIDP_{1981-1} = MP_{1981}$$

$$(303 + 72 + 194 + 39 = 608 \approx 600)$$

where

MCP_{1981} = population in-migrating directly for construction jobs.

MOP_{1981} = population in-migrating directly for management-and-design (or operational) jobs.

$MIDP_{1981}$ = population in-migrating for jobs supported indirectly by construction and operation.

MP_{1981} = total in-migrating population for 1981 (= 608 \approx 600).

$MIDP_{1981-1}$ = population in-migrating for jobs supported indirectly by construction and management and design (or operational) jobs in 1980.

A final word of caution is needed. The sample calculations for 1981 above are for impacts during the second year of construction. The annual number of people moving into the area in following years is not necessarily the same. Calculations must also be made for each succeeding year.

As the construction phase of the WIPP ends and the full operational phase begins (1987), the job situation will change drastically. From the end of 1984 through 1986 a transitional period between construction and operation will cause significant changes in the population. These population changes--that is, negative changes, or outflows--are computed like the preceding example. However, other studies, such as the Construction Worker Profile, indicate that individuals do not leave immediately. This lag has been taken into account in determining the impacts occurring during the transitional phase of the project. The final results of all of the calculations appear in Table L-14.

The population-impact predictions have been made for two different population-distribution scenarios. The first scenario assumes that 99% of the direct impact and 90% of the indirect impact will go to Eddy County, with only 1% of the direct impact and 10% of the indirect impact going to Lea County. The second scenario assumes that 42% of the combined impact will occur in Lea County and 58% of the combined impact will occur in Eddy County.

The two different scenarios resulted from interviews with six large potash-mining operations in the area. Carlsbad is the center of potash-mining activity, and more than 95% of the present potash miners live in Eddy County. However, one company recruits mainly in the Hobbs area, and as a result 42% of its employees live in Lea County.

The construction and operation of the WIPP will be similar to a combination of construction, mining, and warehousing operations and hence similar to the potash-mining activities in the area. Thus, the first scenario assumes that the major impact will be felt in Eddy County, including about 88% in Carlsbad. It was assumed that the contractors would recruit employees from the Carlsbad area for WIPP construction and operation.

Subsequent discussions suggested the possibility that the construction and operation contractors might recruit from the Hobbs area, with the major impact being felt in Lea County and the City of Hobbs. To account for this possibility, a second scenario was developed, as outlined above.

It should also be noted that population predictions for the cities listed include only the population within the incorporated limits and do not include the fringe areas. In Hobbs and Carlsbad, these fringe areas contain from 3000 to 5000 additional people.

Table L-14. Baseline Population Estimates and Projections (without WIPP Project)

Year	Eddy County	Carlsbad	Carlsbad School District	Loving	Loving School District	Lea County	Hobbs	Hobbs School District
1970	41,119	21,297	25,961	1,192	1,350	49,554	26,025	29,858
1975	42,900	N/A	N/A	N/A	N/A	51,600	N/A	N/A
1976	45,300	25,500	29,300	N/A	N/A	53,100	29,600	33,400
1977	46,200	26,600	30,400	1,488	1,650	55,100	30,550	34,500
1978	47,300	27,900	31,600	1,550	1,700	56,300	31,650	35,650
1979	48,200	28,600	32,400	1,600	1,750	57,500	32,600	36,650
1980	49,300	29,500	33,300	1,650	1,800	58,700	33,450	37,550
1981	50,200	30,200	34,100	1,650	1,800	60,000	34,400	38,550
1982	51,600	31,300	35,300	1,700	1,850	61,200	35,250	39,450
1983	52,000	31,600	35,700	1,700	1,850	62,500	36,200	40,450
1984	52,900	32,300	36,400	1,750	1,900	63,800	37,150	41,450
1985	53,800	32,800	37,000	1,800	1,950	65,200	38,150	42,500
1986	55,100	33,600	37,900	1,800	1,950	66,500	38,900	43,350
1987	56,400	34,400	38,800	1,850	2,000	67,700	39,600	44,150
1988	57,800	35,300	39,800	1,900	2,050	68,800	40,250	44,850
1989	59,200	36,100	40,700	1,950	2,100	69,900	40,900	45,600
1990	60,600	37,000	41,700	2,000	2,150	70,900	41,500	46,250
1995	64,300	39,200	44,200	2,100	2,250	75,100	43,950	49,000
2000	68,300	41,700	47,000	2,250	2,450	79,000	46,200	51,500

Source: 1970 data from 1970 Census of Population. All other data collected for this report by Larry Adcock and Associates, 1979.

N/A = Not available.

L.5 PERSONAL INCOME

L.5.1 General

The change in total annual personal income in the two-county area is determined from the direct wages paid during the construction and operation of the WIPP, allowing for a certain amount of fringe benefits. The indirect total personal income generated is computed by determining what proportion of labor costs will enter the total personal-income stream from the total number of dollars allocated to labor costs.

In addition to wages, dividends, interest, and rents account for a portion of the total personal income. That portion has been estimated from unpublished regional data for the two-county area provided by the Bureau of Economic Analysis to the Bureau of Business and Economic Research at the University of New Mexico (Tables L-15 and L-16).

From Tables L-15 and L-16 it is apparent that the total labor and proprietors' income in 1977 (the latest year available) amounted to some \$526.3 million in the two-county area. Interest, dividends, and rents accounted for \$72.3 million (13.7%) in additional income. Further calculations indicate a variation of approximately 4% from this figure, depending on which year of the last few years is examined. The actual figure used for this study was 14%.

The other major factor considered in calculating the total annual personal income is transfer payments. As shown by the data from the Bureau of Economic Analysis, the flow of transfer payments to the area is positive. However, during the construction of the WIPP, the impact of transfer payments on the total-personal-income stream is assumed to be negative because more Social Security payments will flow out than flow in from these jobs created and supported by the construction phase. During the operational phase, however, the impact of transfer payments on the total-personal-income stream may be either negative or positive. In the early years of operation it should be positive; however, as individuals retire from jobs or positions created by the operation of the WIPP, the transfer payments will return. Therefore, it is assumed that transfer payments are neutral during the operation of the WIPP.

L.5.2 Explanation and Values

Table L-17 summarizes some of the information presented in this section. Details appear in the text below.

During the construction period (mid-1980 through mid-1984) and for the period before full operation (mid-1984 through 1986), it is expected that a total of just over \$93 million will flow directly into wages and salaries from the construction of the plant and associated management-and-design employment. In addition, there will be almost \$46 million in wages and salaries in businesses indirectly affected by construction.

Personal income from interest, dividends, and rent is expected to total an estimated \$20 million during the 6.5-year period. A total of about \$140.5 million is expected to be derived both directly and indirectly in the private

Table L-15. Personal Income in Eddy County by Major Source, 1972-1977
(thousands of dollars)

Item	1972 ^a	1973 ^a	1974 ^a	1975 ^b	1976 ^b	1977 ^b
TOTAL LABOR AND PROPRIETORS' INCOME BY PLACE OF WORK^c						
By type						
Wage and salary disbursements	85,032	91,736	103,723	132,147	148,472	168,934
Other labor income	6,294	7,229	8,999	12,082	14,360	17,385
Proprietors' income ^d	16,270	19,194	21,864	18,827	23,839	26,427
Farm	5,258	9,482	7,227	5,701	6,883	6,752
Nonfarm ^d	11,012	9,712	14,637	13,126	16,956	19,675
By industry						
Farm	6,975	11,392	9,041	7,732	9,103	9,121
Nonfarm	100,621	106,769	125,545	155,324	177,568	203,625
Private	86,225	91,476	109,280	136,552	155,724	179,886
Agricultural services, forestry, fishing, and other ^e	426	425	486	553	524	587
Mining	33,166	32,344	41,966	50,315	57,698	68,140
Construction	5,744	6,771	7,631	13,926	15,736	17,159
Manufacturing	5,844	6,655	8,430	11,765	14,964	16,879
Nondurable goods	4,459	5,041	6,547	9,705	11,425	13,012
Durable goods	1,385	1,614	1,883	2,060	3,539	3,867
Transportation and public utilities	7,355	8,860	9,812	11,336	13,607	16,054
Wholesale trade	3,522	4,012	4,959	7,656	7,136	8,330
Retail trade	12,370	13,227	15,300	16,666	18,613	21,368
Finance, insurance, and real estate Services	3,295	3,397	3,616	4,274	5,316	6,156
Government and government enterprises	14,503	15,785	17,080	20,061	22,130	25,213
Federal, civilian	2,447	2,583	2,794	3,162	3,803	4,009
Federal, military	478	526	531	540	579	592
State and local	11,471	12,184	12,940	15,070	17,462	19,138
DERIVATION OF PERSONAL INCOME BY PLACE OF RESIDENCE						
Total labor and proprietors' income by place of work	107,596	118,161	134,586	163,056	186,671	212,746
Less: personal contributions for social insurance by place of work	5,085	6,102	7,194	8,948	10,027	11,338
Net labor and proprietors' income by place of work	102,511	112,059	127,392	154,108	176,644	201,408
Plus: residence adjustment	201	218	425	-62	-208	-192
Net labor and proprietors' income by place of residence	102,712	112,277	127,817	154,046	176,436	201,216
Plus: dividends, interest, and rents ^f	20,098	22,278	26,687	31,728	34,838	39,023
Plus: transfer payments	18,529	21,646	25,236	29,529	33,919	36,536
Personal income by place of residence	141,339	156,201	179,740	215,303	245,193	276,775
Per capita personal income (dollars)	3,442	3,781	4,332	5,018	5,415	6,089
Total population (thousands)	41.1	41.3	41.5	42.9	45.3	45.5

Source: Regional Economics Information System, Bureau of Economic Analysis.

^aEstimates based on 1967 SIC.

^bEstimates based on 1972 SIC.

^cConsists of wage and salary disbursements, other labor income, and proprietors' income.

Primary source for private nonfarm wages: ES-202 covered wages, New Mexico Employment Security Commission.

^dIncludes the capital consumption adjustment for nonfarm proprietors.

^eIncludes wage and salaries of U.S. residents working for international organizations.

^fIncludes the capital consumption adjustment for rental income of persons.

Table L-16. Personal Income in Lea County by Major Source, 1972-1977
(thousands of dollars)

Item	1972 ^a	1973 ^a	1974 ^a	1975 ^b	1976 ^b	1977 ^b
TOTAL LABOR AND PROPRIETORS' INCOME BY PLACE OF WORK ^c						
By type						
Wage and salary disbursements	121,107	133,089	163,925	190,942	207,111	236,570
Other labor income	10,982	12,343	16,397	20,650	23,585	28,379
Proprietors' income ^d	21,399	24,521	37,549	31,241	42,417	48,604
Farm	7,993	13,766	13,746	12,818	12,430	13,779
Nonfarm ^d	13,406	10,755	23,803	18,423	29,987	34,825
By industry						
Farm	9,579	15,673	15,689	14,991	14,805	16,312
Nonfarm	143,909	154,280	202,182	227,842	258,308	297,241
Private	127,968	137,470	184,385	207,165	234,457	271,081
Agricultural services, forestry, fishing, and other ^e	635	694	(D)	(D)	692	804
Mining	42,573	46,162	74,419	79,026	93,976	112,645
Construction	8,287	8,498	13,051	14,417	14,724	16,645
Manufacturing	7,545	8,284	10,021	12,609	13,070	16,539
Nondurable goods	5,172	6,127	7,775	9,562	11,329	13,229
Durable goods	2,373	2,157	2,246	3,047	2,741	3,310
Transportation and public utilities	22,591	23,952	27,343	32,506	36,330	39,662
Wholesale trade	9,162	9,972	12,329	15,502	17,642	20,483
Retail trade	15,846	16,810	18,842	21,100	23,541	26,650
Finance, insurance, and real estate services	4,838	5,296	(D)	(D)	8,173	9,812
Government and government enterprises	16,491	17,802	22,090	24,728	25,309	27,841
Federal, civilian	15,941	16,810	17,797	20,677	23,851	26,160
Federal, military	1,294	1,428	1,575	1,827	2,043	2,258
State and local	494	534	537	564	599	643
State and local	14,153	14,848	15,685	18,286	21,209	23,259
DERIVATION OF PERSONAL INCOME BY PLACE OF RESIDENCE						
Total labor and proprietors' income by place of work	153,488	169,953	217,871	242,833	273,113	313,553
Less: personal contributions for social insurance by						
Place of work	7,050	8,651	11,376	12,850	14,226	16,146
Net labor and proprietors' income by place of work	146,438	161,302	206,495	229,983	258,887	297,407
Plus: residence adjustment	807	-114	-1,689	-986	-924	-896
Net labor and proprietors' income by place of residence	147,245	161,188	204,806	228,997	257,963	296,511
Plus: dividends, interest, and rent ^f	18,505	19,678	23,907	28,132	29,909	33,269
Plus: transfer payments	15,440	18,055	20,878	25,018	28,468	30,674
Personal income by place of residence	181,190	198,921	249,591	282,147	316,340	360,454
Per-capita personal income (dollars)	3,643	4,028	5,014	5,464	5,954	6,811
Total population (thousands)	49.7	49.4	49.8	51.6	53.1	52.9

Source: Regional Economics Information System, Bureau of Economic Analysis.

^aEstimates based on 1967 SIC.

^bEstimates based on 1972 SIC.

^cConsists of wage and salary disbursements, other labor income, and proprietors' income. primary source for private Nonfarm wages: ES-202 Covered Wages, New Mexico Employment Security Commission.

^dIncludes the capital consumption adjustment for nonfarm proprietors.

^eIncludes wage and salaries of U.S. residents working for international organizations. Includes the capital consumption adjustment for rental income of persons.

^fNot shown to avoid disclosure of confidential information, data are included in totals.

Table L-17. Personal Income From The WIPP
(Millions of 1979 Dollars)

Income type	Construction ^a							Total before full operation	Operation each year-- 1987 and after
	1980	1981	1982	1983	1984	1985	1986		
Direct wages and salaries	2.2	9.3	28.1	27.8	8.4	7.3	10.1	93.2	11.9
Indirect wages and salaries	1.0	4.9	13.7	13.0	4.2	3.7	5.2	45.7	5.5
Interest, dividends, and rents	0.5	2.1	6.1	6.0	1.9	1.6	2.2	20.4	2.5
Total private-sector income	3.7	16.3	47.9	46.8	14.5	12.6	17.5	159.3	19.9
Public-sector income	0.1	0.6	1.8	1.8	0.6	0.5	0.7	6.1	0.8
Net transfer payments	(0.2)	(0.9)	(2.6)	(2.6)	(0.8)	(0.3)	(0.5)	(7.9)	(b)
Net personal income	3.6	16.0	47.1	46.0	14.3	12.7	17.8	157.5	20.7

SOURCE: Larry Adcock and Associates, 1979.

^aThe figures for the construction period 1980 through 1986 include management and design activity.

^bTransfer payments during the operational phase are assumed to be neutral over time.

sector. In the public sector, about \$6 million in personal income will come from the increased activity in the area from additional State and local government and the indirect Federal-agency employment required for support. Thus, the total personal income added to the area during the construction phase of the WIPP project is expected to be \$165 million from the beginning of construction until full operation at the beginning of 1987. However, net loss from transfer payments (generally Social Security payments) will decrease this total to just less than \$158 million.

The personal income to be derived from the operation of the WIPP project will be significantly different from that derived in the construction phase. The amount of money flowing directly into the local economy during a normal year of operation will be approximately \$16.9 million. Although this amount may vary with expenditure patterns in the operation of the plant, this appendix uses a constant figure of \$16.9 million. This figure is significantly different from the total direct expenditures of \$40 to 42 million annually during the peak years of the construction period.

The estimated \$16.9 million annual flow directly associated with the operation of the plant with local procurement and labor will mean that (1) approximately \$11.9 million will be realized in personal income by persons connected directly with the plant; (2) wages and salaries derived from indirectly affected businesses in the area will amount to almost \$5.5 million; (3) government expenditures required by additional activity and flowing into personal income will total about \$0.8 million per year; (4) new dividends, interest, and rents will create approximately \$2.5 million in personal income; and (5) during the first years of operation, net transfer payments will be negative, but later they will have a net positive effect. Because of this balancing effect, transfer payments for an average year have been considered neutral. The net result, therefore, will be an annual increase in total personal income of approximately \$20.7 million.

L.6 HOUSING, LAND USE, AND COMMUNITY SERVICES

L.6.1 Housing and Land Use

The demand for new housing depends on population and household size. The housing-demand projections developed for the impact analysis prepared in conjunction with this appendix are based on population projections discussed previously and household-size projections derived from several sources.

Household size for the baseline population is based on household-size projections in Bureau of the Census Publication P-25, No. 607, adjusted to 1970 household size in the impact area (derived from the 1970 Census of Housing). Thus, if the 1970 household size in the impact area is above the U.S. average in that year, the projected household size in the impact area will be adjusted upward from the projected U.S. average.

Household sizes for WIPP-induced population changes come from two basic sources. For construction workers and their families, household size is based on information in the Construction Worker Profile (Old West Regional Commission, Washington, D.C., 1975). For operation employees and for persons migrat-

ing for indirectly created jobs, household size depends on the likely place of origin of the individuals moving into the area. If there is no obvious or logical single place of origin, then the U.S. average household size (from Bureau of Census Publication P-25, No. 607) will be used. If it appears that most of the individuals will be likely to come from elsewhere in New Mexico, then U.S. household-size projections will be adjusted to account for past State differences from the U.S. average.

Once household sizes have been projected, the demand for housing units is determined by dividing the household size into the appropriate population component. For baseline population changes, the population component is essentially the entire population, with a small adjustment for the portion of the population not living in housing units. This latter group is generally a small fraction of the total population, comprised primarily of people living in nursing homes. The population components for project-related populations are derived by methods discussed earlier in this appendix.

The demand for occupied housing units provides the base for a second set of calculations that show the housing stock necessary to maintain a 3% vacancy rate. This is found simply by dividing the demand for occupied units by 0.97.

The amount of construction activity needed to meet the demand for housing at a 3% vacancy rate is then calculated. It is based on the present assessment of housing and vacancy-rate figures and projected housing requirements.

Finally, housing requirements are allocated to housing types (single family, multifamily, and mobile home) based on information in the Construction Worker Profile. Table L-18 shows the housing-type demands of three classes of population: newcomer construction workers, other newcomers, and long-time residents. Baseline populations are assumed to have the same housing-type demands as the long-time residents, while the preferences of newcomer construction workers are used to allocate housing types for construction newcomers attracted by the project. The in-migrants attracted by indirectly created jobs are assumed to have the same preferences as the other newcomers.

Table L-18. Housing-Type Demand

Type of unit	Newcomer construction workers	Other newcomers	Long-time residents
Single family	34	55	81
Multifamily	11	17	5
Mobile home and other	56	27	14
Totals ^a	101	99	100

Source: Old West Regional Commission, Construction Worker Profile, Washington, D.C., 1975, p. 103.

^aTotals do not add to 100 because of rounding.

Methods used to calculate land requirements for projected population increases depend on the relative scale of population changes, both under baseline and impact conditions. For small relative changes in population (and therefore small changes in housing demand) the principal demand for land is for housing units and roads. In this case, land-use requirements are calculated on the basis of a relatively generous average lot size (e.g., one-quarter acre) per housing unit. The assumption is that relatively small increases in population will not require proportional increases in all municipal land-use categories. For example, a 5% population increase should not require a 5% increase in land requirements associated with such public facilities as city hall, police stations, and fire stations. In essence, it is assumed that there is some excess capacity in the land associated with such facilities.

For larger relative population increases, the basic assumption is that land requirements for virtually all types of land use will grow in proportion to the housing stock. In this situation, the total land occupied in the municipality is divided by the amount of housing to obtain the land required for each unit of housing.

Finally, it should be noted that for different purposes either of the methods above may be appropriate in determining land-use requirements. For example, the baseline population growth may be substantial, calling for the use of a large land-use figure for each housing unit, while the marginal change associated with the impact population is small, thus requiring only a small land-use figure. Conversely, there are instances in which baseline growth is expected to be small while the project impact is expected to be large, which indicates that a small baseline land-use figure and a large impact figure are appropriate.

L.6.2 Community Services and Facilities

Population increases in a community usually generate two types of impact on community services and facilities. First, in most cases there will be an increase in the demand for services, more or less in proportion to population or housing increases. For example, more people will require more water, generate more sewage, and need more medical assistance. As a result of the increased demand, personnel requirements and operating expenses will generally rise. (For a discussion of operating expenses, see Section L.7, Fiscal-Impact Analysis.)

The second type of impact is an overloading of some part of the system that has a fixed capacity. Generally, fixed capacity implies some type of capital facility, such as a school or a sewage-treatment plant, but it also includes water rights.

The analysis of impacts on community services and facilities therefore requires two basic steps. First, changes in the demand for variable parts of the system (e.g., personnel, cubic feet of natural gas) must be projected. Then, projected increases in demand must be compared with the existing capacity of those parts of the system that are not readily varied in small increments. In other words, an important part of the analysis is to determine

whether one of the impacts of a proposed action is to require the construction of, for example, a new sewage-treatment plant.

Two basic methods are used to project the demand for services: the per-capita multiplier and the per-household multiplier (or its equivalent, the multiplier for each occupied housing unit). (For a discussion of the appropriate application and the advantages and disadvantages of these methods, see R. Burchell et al., The Fiscal Impact Handbook, Center for Urban Policy Research, New Brunswick, New Jersey, 1978.) Generally, the per-household multiplier is used to project demands for natural-gas, electricity, and telephone service, while the per-capita method is used to project the demands for water, sewage treatment, solid-waste disposal, fire and police protection, and medical services. With slight modifications, the per-capita multiplier is used to project traffic flows as well.

The multipliers used in each approach are based on recent actual per-capita or per-household figures in the impact area, with adjustments made where appropriate. Adjustments are made when national, regional, or local data indicate that recent per-capita or per-household levels may not remain unchanged over time. For example, in projecting water demand for New Mexico communities, per-capita use rates are changed over time in the same proportion as the changes projected by the New Mexico State Engineer in the "County Profile" series (New Mexico Interstate Stream Commission and New Mexico State Engineer Office, County Profile (various counties), Santa Fe, New Mexico, 1975).

Adjustments are also made if very recent changes in some key factor have caused historical per-capita or per-household use rates to be unreliable for future projections. For example, if a water-price increase has occurred in the past year, resulting in less than a full year's data at the new rate, per-capita use rates will be adjusted on the basis of water-demand price elasticity estimates. (For a discussion of water-demand price elasticity estimates, see G. Bonem et al., Water Demand and Supply in the Albuquerque Greater Urban Area, Bureau of Business and Economic Research, University of New Mexico, December 1977.)

Once demand for a service has been projected, it is compared with the service capacity of the fixed components of the system. This is generally a straightforward numerical comparison (e.g., acre-feet per year of water demand versus annual water rights). The areas in which demand exceeds existing capacity are identified, and the implications of the excess demand are noted.

For several reasons, the level of detail varies considerably in the analysis of each community-service category. First, an investigation of the existing service capacity may show that there is considerable excess capacity, more than needed to accommodate any potential change in demand from baseline or impact population changes. A similar situation exists when the impact area is small in relation to the service area, as often happens with natural-gas, electricity, and telephone service. In this case, even relatively large baseline or impact population changes in the impact area have little effect on the overall service area. In both situations (significant excess capacity and

small impact area in relation to the service area) a detailed analysis is generally unwarranted.

At the other extreme, sometimes a proposed action may exert a large relative impact on the demand for a service. In this instance, every effort is made to determine in detail the extent of the impact. This often involves extensive interviews with the manager or other personnel of the agency or company providing the service.

Finally, baseline projections often use less-sophisticated techniques (e.g., unadjusted per-capita multipliers) than do impact projections. This is because baseline projections generally are intended to provide a background against which impacts are evaluated, and not to be a precise projection of service-level demands under baseline conditions. The key factor in the analysis of baseline projections is the effect on system capacity. If a new sewage-treatment plant or school is required under baseline conditions during the period under analysis, then the capital cost of the facility is not assigned to the proposed action whose impact is being studied. On the other hand, if capital facilities or water rights are adequate under baseline conditions but inadequate under impact conditions, the burden of reduced service levels or increased capital costs rests on the proposed action. A more detailed discussion of the treatment of costs is presented in Section L.7.

L.7 FISCAL-IMPACT ANALYSIS

L.7.1 Revenues

Projection techniques for county and municipal revenues are essentially the same. The first step is to collect data on past revenue levels. For New Mexico counties the source is generally the Department of Finance and Administration, New Mexico County Governments, Annual Report. For New Mexico municipalities the source is the equivalent annual report series, New Mexico Municipal Governments. During the period that follows the end of the fiscal year but precedes the publication of the annual reports, county and municipal governments are contacted to obtain reports for the most recent fiscal year.

Once data covering several years have been collected, a preliminary analysis is made. This involves putting each major revenue category (fund) in constant dollars, using the Gross National Product Price Index as a deflator, and examining the record for pronounced trends or major changes. If such trends or changes are found, they are considered in making projections. However, trends generally are gradual and are usually ignored. Major changes usually result from increases in revenues that are not expected to continue each year. These are generally revenues from bond sales or from special government transfers (e.g., drought relief). Such changes are noted and considered in subsequent stages of the projection process, as described below.

After the preliminary examination of the budget is completed, the revenues for the most recent fiscal year are separated into the categories shown in Table L-19. These categories present a clear picture of the type and source of revenues, a picture that is not evident when revenues are classified by fund, as they generally are in municipal or county budgets.

Table L-19. Revenue Categories and Projection Methods
Used for New Mexico Municipalities and Counties^a

Revenue Type	Municipal	County
OWN-SOURCE REVENUE		
Taxes		
Property	PH	PH
Franchise (M)	PC	
Occupation (M)	PC	
Oil and gas	NC/T	NC/T
Lodgers	PC	PC
Gross receipts	PC	PC
Charges and miscellaneous		
Licenses, permits, and fees	PC	PH
Charges for services	PC	PC
Fines and forfeits	PC	PC
Utilities (M)	PH	
Interest on investments	PC	PC
Payments in lieu of taxes	PC	PC
Miscellaneous	PC	PC
INTERGOVERNMENTAL TRANSFERS		
State		
Gasoline taxes	PC	PC
Auto-license distribution (M)	PC	
Cigarette taxes	PC	PC
Gross receipts taxes (M)	PC	
Motor vehicle (C)		PC
Fire allotment	PC	PC
Grants	PC	PC
Miscellaneous (C)		PC
Federal		
Revenue sharing and grants	PC	PC
Miscellaneous (C)		PC
Local (M)	PC	
Other ^b	PC	PC

Source: Adcock and Associates, 1979.

^aKey: C, county revenue item only; M, municipal revenue item only; PH, projection on per-housing-unit basis; PC, projection on per-capita basis; NC, no change projected.

^bIncluded in "other" are revenues not clearly assignable to specific sources.

Once revenues have been allocated to the proper categories, projections are made. The revenue-projection method is based on modifications of methods suggested in The Fiscal Impact Handbook. For baseline projections, most revenue items are projected on a per-capita basis. A smaller group are projected per housing unit, and occasionally a revenue item is projected to show no change.

For most revenue items the most recent actual annual per-capita or per-housing-unit level is taken as the most reliable guide to future levels. Although budgeted levels for the coming fiscal year are checked for major changes from past amounts, budgets are felt to be an unreliable basis for projections. For one thing, they are themselves projections, and their accuracy depends on the skill of the municipal or county officials making them. There is also a tendency for budgets to include a rather large "other" category with unspecified components. Finally, comparisons of past budgeted revenues with actual revenues show a rather large discrepancy between budgeted and actual amounts.

In choosing the most recent actual revenue levels as the guide to the future, several assumptions are made. First, it is assumed that tax rates will not change. While this is probably not a reliable assumption, the alternative is to project the behavior of elected officials, many of whom have not yet been elected, since it is these officeholders who set tax rates. The "no change" assumption seems the more conservative of the two alternatives.

A similar set of assumptions (that is, no change) applies to the level of charges for services, such as utility rates, and distribution formulas for State and Federal transfers. Again, it is not felt that these items will never change, but that predicting the direction and timing of such changes is less reliable than assuming no change.

In essence, the use of the most recent actual revenue level combined with the per-capita or per-housing-unit projection method indicates what revenue levels would be if current conditions continued into the future.

There are some exceptions to the use of the per-capita or per-housing-unit projection method. Some revenue sources are clearly independent of local population or household levels, because of the nature of the tax base or because of the distribution formula. For example, in some counties in New Mexico, oil and gas production (severance) taxes are an important revenue source. These taxes are based on the level of oil and gas production in these counties, a tax base that is not influenced by population or the housing stock.

Four alternatives are available for the projection of such a revenue source. First, an independent projection of the tax base may be used. However, such projections are frequently unavailable. A second possibility is to generate a projection of the base, a process that is usually too time-consuming (and expensive) for an impact analysis. The third approach is to rely on recent trends in the base--or in the tax revenue itself. This is often the best alternative, given the limits of time and budget, but there are situations in which it is not appropriate. For example, in the case of the oil and gas production taxes mentioned above, the recent history of the industry shows great fluctuations in this source of revenue in some counties. As a result, no statistically reliable recent trend can be isolated. This makes it necessary to use the fourth method, which is to assume no change in the total (as

opposed to per-capita) level of this source of revenue. While this is the most conservative assumption under the circumstances, it leads to problems when projected revenues are compared with projected expenditures. More will be said about this problem after expenditure-projection methods are discussed below.

There are also exceptions to the use of the most recent actual revenue level for projections, even when per-capita or per-housing-unit projections are used. These exceptions are generally made for those nonrecurring revenue items mentioned above (bond proceeds and government transfers) that may have occurred in the most recent year. In the case of bond proceeds, it is generally assumed that no bond sales will occur unless a specific bond issue has been planned. For government transfers, the general rule is that the most recent year is used except for those programs that are obviously not recurring.

The same general methods are used to project revenues resulting from the impact of the proposed action. However, if the proposed action requires major capital expenditures that would not be required under baseline conditions, an attempt is made to project the magnitude and timing of bond revenues to finance the expenditures.

Table L-19 shows the specific projection methods used for municipalities and counties in New Mexico. In most instances the per-capita multiplier is used. There are three reasons for choosing this method. First, in many cases (e.g., gross receipts taxes) it is clearly the best available alternative.

In some cases it is used even though some other method is clearly better. An example of this is Taylor Grazing Act fees (a Federal transfer) going to the county. Since the base is independent of population, these fees would not be expected to rise in proportion to county population. However, the actual amount of revenue from this source is so small that making an independent projection or assuming no change would involve computational complexities not offset by a measurable improvement in the reliability of the overall revenue projection. Therefore, this source is included with other Federal transfers, and the entire subgroup is projected on a per-capita basis.

A third group of revenue items is projected on a per-capita basis even though population represents only one of the determining factors in the revenue level. This group includes gasoline-tax, cigarette-tax, and auto-license distributions from the State, all of which have distribution formulas in which population is only one factor. However, it can be shown that, if the other items in the distribution formula increase in proportion to population, then per-capita projection methods are appropriate. This condition is likely to be met fairly closely when comparing revenues under baseline and impact conditions. For example, in calculating gasoline-tax distributions the ratio of roads in the local jurisdiction to roads in the State is used along with population. If the number of miles of road in a local area (e.g., municipality) is higher under impact conditions than under baseline conditions in rough proportion to the relative population levels under the two conditions, then the per-capita share of gasoline-tax distributions will be the same under both conditions. Thus, the use of the per-capita projection method may somewhat bias the baseline revenue projections, but will be relatively accurate in comparing baseline and impact conditions.

Revenue items projected on the basis of housing units include utility fees, property taxes, and fees (e.g., building permits), since these are more closely related to the number of housing units than to population.

The only item projected to show no change in the total revenue level in the two examples shown is the oil and gas tax category for the county.

L.7.2 Expenditures

As with revenues, the projection methods used for county and municipal expenditures are essentially the same. The process begins with the acquisition of data from the same sources as those for revenues. Spending for several years is then converted to constant dollars by using the Gross National Product Price Index. Municipal expenditures are allocated by fund, while county expenditures are allocated by service function (e.g., public works, public safety), as dictated by the format of the original data.

Once the data are in constant dollars, they are examined for major trends and nonrecurring items, which are noted and accounted for in the projection process.

After a preliminary analysis of the data, the projections are made. The methods used are a combination of the per-capita multiplier and the case study method, as set forth in The Fiscal Impact Handbook. Basically, this involves projecting future expenditures on the basis of the most recent actual per-capita levels, except that nonrecurring capital-spending items are excluded.

The projections made in the analysis of demands for community services and facilities provide the basis for the capital-spending forecasts. If these projections indicate excess capacity for a particular capital facility for the period under analysis, only recurring capital expenditures are included in the service function. On the other hand, if a capital facility is projected to become inadequate in the future, estimates of expansion costs are included in the forecasts. Recurring capital spending is based on statewide, county, or municipal averages, derived from Department of Finance and Administration annual reports. Capital-facility costs are derived from various sources generally in the building industry; they are expressed in terms of annual debt service.

The same general methods apply to baseline and impact projections. In both cases the approach is to isolate the factors that will result in deviations from recent per-capita spending levels and to incorporate those changes into spending projections.

L.7.3 Net Fiscal Impacts

The underlying philosophy used to make baseline projections of revenues and expenditures is somewhat different from that used to make impact projections, although the methods used in each case are similar. Baseline projections are

used to judge impacts. As a result, less detail goes into the baseline projections. For example, for counties, all spending is projected to grow in proportion to population under baseline conditions, while some revenue items may not be projected to grow. This can result in a projected deficit for a county. However, the proper interpretation of this result is not that the county is necessarily facing fiscal difficulties, but rather that, if spending grows in proportion to population, some revenue sources will have to increase by more than the projected amount. As an alternative, spending (and service) levels may be reduced from current per-capita levels.

No matter what fiscal adjustments may be made under baseline conditions, the baseline projections are intended to indicate orders of magnitude for spending and revenues during the period under analysis.

On the other hand, fiscal-impact projections are intended to show, with as much accuracy as possible, given historical data and information obtained in interviews with local officials, the actual likely fiscal effect of the proposed action. Every effort is made to include in the analysis only the fiscal impacts induced by the proposed action. Thus, a projected fiscal deficit or surplus associated with the proposed action should be interpreted as such. Not only is greater detail incorporated into impact projections, but generally these projections can be made with greater reliability than can baseline projections. For example, projecting oil and gas tax revenues causes problems under baseline conditions, but since oil and gas production generally is not expected to be affected by the proposed project, no change in these revenues is attributable to the project, regardless of what happens to oil and gas taxes.

BIBLIOGRAPHY

- Association for University Business and Economic Research, Proceedings 1975 Conference, "Federal Data for University Research," Williamsburg, Va., 1975, pp. 110-137.
- Association of Western Railways, Railroad Facts, 1977, Chicago, Ill., 1977.
- Bonem, G., M. Gisser, J. Myers, and M. Resta, Water Demand and Supply in the Albuquerque Greater Urban Area, Bureau of Business and Economic Research, University of New Mexico, Albuquerque, N.M., December 1977.
- Burchell, R. W., D. Listokin, et al., The Fiscal Impact Handbook, Center for Urban Policy Research, New Brunswick, N.J., 1978.
- Bureau of Business and Economic Research, New Mexico Statistical Abstract, 1977 edition, the University of New Mexico, 1977.
- Bureau of Economic Analysis, Regional Economic Information System, "Employment by Type and Broad Industrial Sources 1971-1975, Full and Part-Time Wage and Salary Employment Plus Number of Proprietors" (unpublished data).
- Bureau of Economic Analysis, Regional Economic Information System, "Per Capita Personal Income in SMSAs, Counties and Independent Cities, in Selected Years, 1967-1975" (unpublished data).
- Bureau of Economic Analysis, Regional Economics Information System, "Personal Income by Major Sources 1970-1975" (unpublished data).
- Herkenhoff, Gordon and Associates, Inc., Water and Wastewater Master Plan, 1975-1995, Water Supply Study, City of Hobbs, N.M., 1975.
- Industrial Development Corporation of Lea County, Hobbs, New Mexico, Hobbs, N.M.
- Mountain West Research, Inc., Construction Worker Profile, a study for the Old West Regional Commission, 1975.
- New Mexico Department of Finance and Administration, New Mexico County Governments, annual report (various years), Santa Fe, N.M.
- New Mexico Department of Finance and Administration, New Mexico Municipal Governments, annual report (various years), Santa Fe, N.M.
- New Mexico Employment Security Commission, "Estimates of Average Size of Household and Family, 1940 to 1974, and Projections, 1975 to 1990, for the United States" (unpublished data).
- New Mexico Interstate Stream Commission and New Mexico State Engineer Office, County Profile (various counties), Santa Fe, N.M.
- Tiebout, C. M., The Community Economic Base Study, Committee for Economic Development, New York, 1962.

- U.S. Bureau of the Budget, Standard Industrial Classification Manual, 1967 and 1972, U.S. Government Printing Office, Washington, D.C., 1967 and 1972.
- U.S. Bureau of the Census, Census of Manufacturers, "1972 Area Series, New Mexico," MC72(3)-32, U.S. Government Printing Office, Washington, D.C., 1975.
- U.S. Bureau of the Census, Census of Manufacturers, "1972 Industry Series," MC72, U.S. Government Printing Office, Washington, D.C., 1974-1975.
- U.S. Bureau of the Census, Census of Mineral Industries, "1972 Area Series, Mountain States," MIC72(2)-8, U.S. Government Printing Office, Washington, D.C., 1975.
- U.S. Bureau of the Census, Census of Mineral Industries, "1972 Subject Series," MIC72, U.S. Government Printing Office, Washington, D.C., 1975.
- U.S. Bureau of the Census, Census of Population: 1970, General Population Characteristics, Final Report PC(1)-B33, New Mexico, U.S. Government Printing Office, Washington, D.C., 1971.
- U.S. Bureau of the Census, Census of Population: 1970, General Social and Economic Characteristics, Final Report PC(1)-B33, New Mexico, U.S. Government Printing Office, Washington, D.C., 1971.
- U.S. Bureau of the Census, U.S. Census of Population: 1970, Number of Inhabitants, Final Report PC(1)-A33, New Mexico, U.S. Government Printing Office, Washington, D.C., 1971.
- U.S. Bureau of the Census, Current Population Reports, Series P-25, No. 640, Estimates of the Population of States with Components of Change: 1970 to 1975, U.S. Government Printing Office, Washington, D.C., 1976.
- U.S. Bureau of the Census, Current Population Reports, Series P-25, No. 607, The Number of Households and Families, 1975-1990, U.S. Government Printing Office, Washington, D.C., 1976.
- U.S. Bureau of the Census, Census of Housing, General Housing Characteristics, New Mexico, June, 1971.
- U.S. Bureau of the Census, Federal-State Cooperative Program for Population Estimates, Series P-26, No. 76-31, U.S. Government Printing Office, Washington, D.C., 1977.
- U.S. Bureau of Mines, Minerals Yearbook, 1974, Vols. 1-3, U.S. Government Printing Office, Washington, D.C., 1974.
- U.S. Department of Agriculture, Agricultural Statistics, 1975, U.S. Government Printing Office, Washington, D.C., 1975.
- U.S. Department of Labor, Employment and Wages, 1975, U.S. Government Printing Office, Washington, D.C., 1976.
- Zink, L. B., "A Note on Population Projections," New Mexico Business, August 1972, pp. 23-29.

ANNEX

A NON-SURVEY TECHNIQUE FOR CONSTRUCTING
A DIRECT REQUIREMENTS REGIONAL INPUT-OUTPUT TABLE

by

Larry Adcock, Associate Director & Economist
Bureau of Business & Economical Research
University of New Mexico

Larry Waldman, Doctoral Candidate
Department of Economics
University of New Mexico

In an article entitled "An Appraisal of Non-Survey Techniques for Estimating Regional Input-Output Models," David G. McMenamin and Joseph Haring state that:

"Non-survey or minimum-survey methods for constructing regional input-output tables are attractive to model builders because of the relatively small cost involved as compared with full survey models." (9)

McMenamin and Haring go on to state that many of the non-survey techniques have not been highly successful in the past, but recently accuracy seems to have improved by the use of newly developed techniques. Indeed, the full survey method of building input-output tables is costly. While records are rather poor, it is estimated that the 1960 New Mexico table cost approximately \$100,000 to construct and work was accomplished over a three-year period. Recent estimates indicate that a new table for New Mexico of the full-survey type would probably cost well over \$100,000.

Such costs for a full-survey table for relatively small states makes the non-survey technique desirable in terms of available resources. However, the level of accuracy of the non-survey technique table is still in question. Therefore, in this study, an in-depth examination of several aspects of the location quotient adjustment process for deriving a non-survey input-output table from national coefficients was undertaken. In performing the task, two basic questions were answered: (1) can the table be constructed with available data and available techniques? and (2) how does the table compare with a full-survey based table?

The results of this study could be extremely important not only to the research work being conducted at the University of New Mexico, but to the State in general. Since the 1960 New Mexico full-survey table was compiled, little updating has occurred (2, Appendix A). In early 1970 an examination was made of this original survey-based table to determine if a household sector could be added to the direct coefficients table given the information available from the national level. This was accomplished in 1971. Basically, this constitutes the updating of the original 1960 table.

It is apparent that since the economic sector mix and the level of sophistication of the economy has changed significantly since 1960, the value of the 1960 table for research work is questionable. In this study, a non-survey 1960 table was derived from available information and then compared to the full-survey table in order to determine the level of accuracy of the non-survey technique. Since the tests proved positive, the BBER used the technique to construct a non-survey 1972 table for the State.

METHOD

The basic method employed in this study centers around the use of loca-

tion quotients for determining the adjustment to be made to the direct coefficients of the United States input-output table in order to produce a regional direct coefficient input-output table. The result is a non-survey input-output table of direct coefficients for the New Mexico economy of 1960. Consequently, the location quotients were those for the period 1960 while the national survey coefficients are from 1963. The method therefore makes the naive assumptions that the coefficients did not change between 1960 and 1963, and that on the average the techniques of production in New Mexico are similar to those in the United States, at least in the 1960-1963 period.

The objective of this paper is not to engage in a digression of the relative positive and negative aspects of the input-output technique itself, but it does seem in order to discuss the assumption that the techniques used in production are constant to a specific industry regardless of its geographic location or size. Basically, a survey-derived input-output table for a specific region should point out the various techniques used in production when that table is compared with a table compiled for any other region. We would expect some differences; for example, the use of labor as a quantity input to production would vary from region to region depending upon the alternative costs in the production of a product, recognizing the fact that the producer minimizes his cost and that the labor costs relative to the price of other inputs vary from region to region.

The non-survey technique employed in this study, however, cannot take the varying techniques of production under consideration because the process of adjustment does not account for them. In this way the non-survey table differs from the region-specific survey type model.

Although many other minor dissimilarities can be distinguished, one other major distinction in this method exists. This variation concerns an assumption that normally occurs, not in the building of the model but in its use. In employing an I-O model for deriving the impact of changes to a specific industry in terms of size or production levels, or for the addition or deletion of industries in an area, normally we make the assumption that a specific industry or firm buys input products from other firms in the area that appear to produce those needed products for the production of the buyer's products. In other words, under normal conditions, the input-output process is not refined to the degree needed to adjust for the absence of a specific product needed from the existing industry that appears to produce the input simply because the Standard Industrial Classification code listing encompasses that specific input.

In the building of a survey-type input-output model this assumption is not needed, since the inputs are traced to domestic producers in the existing economy or the input is designated as an import. However, in the non-survey technique of building the input-output model, an assumption is also made that if the industry exists in the area, the product is bought in the area, and thus it is available. The location quotient does nothing more than adjust the level of purchasing of that specific input. Therefore, under normal conditions, it may be assumed that the non-survey technique employed in this study could slightly overestimate the purchasing of the required input-product from existing industries in the area by another existing industry. This could possibly underestimate the importation of needed inputs by any one specific industry. On the other hand, since a firm is classified by the major product

(or service) it produces, then some product identification is obscured through classification and the result is an underestimate of available products. The latter situation appears to be the lesser of the two-sided problem.

Turning to the specific method used in this study, the first matter to consider is that of the adjustment technique, specifically, the location-quotient derivation and its application to the U.S. table. Two types of location quotients were used in this study. The first is the traditional type, which is a comparison of the relative importance of an industry in a region with its relative importance in the Nation, by use of employment figures. Secondly, the output-location quotient accomplishes the same comparison; however, instead of employment, the dollar volume of output is used.

The following is a description of the location quotients employed.

LOCATION QUOTIENTS

Employment Location Quotient

In its simplest form the employment-location quotient is defined for the i^{th} industry as:

$$ELQ = \frac{e_i/e}{E_i/E}$$

where:

ELQ is defined as the Employment-Location Quotient;
 e_i is the regional (New Mexico) employment in the i^{th} industry;
 e is the total employment in the region (New Mexico);
 E_i is the national (total) employment in the i^{th} industry;
 E is the total national employment (13,14).

If the location quotient is equal to 1, we assume that the region is self-sufficient in that industry. That is, on the average, the region is producing its domestic needs specific to that industry. If the location quotient is less than 1, the region is probably not producing its domestic needs in relation to that industry, and therefore part of the industry-specific consumption of that region is necessarily imported. On the other hand, if the location quotient is more than one, we assume that the region is producing goods for export./ Several basic qualifications are necessary in order for the location quotient to be a realistic tool.

One necessary assumption is that the consumption patterns for each region are analogous to those of the nation as a whole, and that all production in the United States is consumed domestically. We can easily see that if the consumption is not 100 percent domestic, then a location quotient for any specific industry which is equal to unity does not necessarily mean that that industry is just self-sufficient. It may in fact be a net exporter.

Moreover, if national consumption of a specific product warrants importation of that product, a location quotient greater than unity may be needed

for an industry to be self-sufficient in the production of that specific product. However, if we assume that the consumption patterns are fairly equal from region to region, and that imports and exports are small relative to total production, then the location quotient concept is intuitively a logical tool for the adjustment process.

Output-Location Quotients

Basically, those deficiencies and positive aspects of the employment-location quotient hold true for the output-location quotient. The output-location quotient is defined as:

$$XLQ = \frac{x_i/x}{X_i/X}$$

where:

- XLQ is defined as the dollar output-location quotient;
- x_i is the dollar output of the i^{th} industry in the region (New Mexico);
- x is the dollar output of all industry (Gross State Product) in the region (New Mexico);
- X_i is the dollar output nationally of the i^{th} industry;
- X is the total dollar output of all industry (Gross National Product) in the nation.

We should note at this point that the output-location quotient is a non-traditional location quotient. The use of the output-location quotient is necessary in this study simply because employment location quotients do not properly represent an adjustment factor for certain industries. This is true because of the incompleteness of data on employment in certain industries or the simple non-existence of certain types of data needed to make the employment-location quotient a workable tool for other industries (particularly agriculture).

Direct Coefficients

The objective of this study is to produce a table of direct coefficients for a region by adjusting the national technical direct coefficients from the 1963 national study. The U.S. study used in this research consists of 352 endogenous sectors plus 27 exogenous sectors including such things as household, inventory-evaluation adjustment, net inventory change and government expenditures in addition to net exports and imports (23).

Procedure for Adjustment

Theoretically, the use of location quotients to adjust the national input-output coefficients can be justified by the assumption that if an industry in an area is not of average size, then it cannot supply all of the needs of other industries in terms of product inputs. The adjustment procedure using location

quotients assumes that the selling industries are able to supply a product to the buying industries in relation to their size. Their size in the study is determined by both the industry's employment and output.

The location quotients, having once been computed, are used as adjustment factors on a row-by-row basis to the national table. Any location quotient which is greater than 1 indicates in the most basic terms that that industry is an exporting industry. That is, since it produces more, or employs more people than the average industry employs for the domestic location in which it is set, then the excess product is exported and it becomes a net exporting industry. For those industries which had a location quotient greater than 1, we assumed that they continued to buy input products in a similar fashion to that of the average industry across the United States; therefore, any upward adjustment in the direct coefficients on the national table would indicate that that specific industry is selling more of a product, percentage-wise, to a region-specific industry than that industry can use. This assumption, of course, would be unrealistic. Therefore, all location quotients which were greater than 1 were set to a constant factor of unity. This situation means that the selling industry, with a location quotient of unity, provides no more or no less than the products needed as inputs to other industries.

Data Limitations and Location-Quotient Computation

In trying to gather data to compute the needed location quotients for 352 endogenous sectors, the obvious conclusion is that the finer the break-out of the sub-industries of any major industry, the more limited the data. For example, excellent wage- and salary-employment statistics are available for a complete year at the two-digit SIC code level for all manufacturing industries. However, when the industries are disaggregated to a basic four-digit SIC code level, then the data becomes harder to obtain. Those employment data which are available at the four-digit SIC code level are published only once a year for the first quarter of the year. Therefore, when computing the employment location quotients, use of year-round data at the four-digit SIC code level was impossible, and only first-quarter information was used.

This situation could lead to a problem: the first quarter may not be representative of the employment in the industry, since (1) the industry may expand or contract throughout the year and the level in the first quarter is not the average for the year and (2) many industries are beset with seasonal employment and the first quarter nationwide is normally the slowest quarter of the year. Therefore, employment in the first quarter in many cases would not be representative of the total year because of seasonal fluctuation.

To eliminate part of the problem of using first-quarter data, the 1960 first-quarter data could be averaged with the 1961 data to produce a figure which probably would be closer to the 1960 average than that produced by using the first-quarter data. However, since this procedure would involve averaging two quarters from the same time of the year, no adjustment would be made for seasonal fluctuation. The effort in making such an averaging adjustment appeared to be a fruitless task since in computation of the location quotients by both methods, very little difference occurs in the results. This fact can

be accounted for because a region in most cases would experience the same fluctuations in employment for any specific industry that the nation would in the very short run. Therefore, it was decided that the use of first-quarter data for 1960 would be as relevant to the situation as the average of the first quarters of 1960 and 1961. The employment-location quotients were therefore applied to all of the manufacturing sectors.

While it would have been preferable to use employment-location quotients for all sectors defined in the national table, such a plan was not possible considering the limitations of the data. For example, very little information is available on employment in the agricultural sector for the sub-industry categories listed on the national table. A figure for employment in all agriculture, of course, is available (24). However, when trying to locate employment in dairy farms, or for poultry and egg production, or in meat animal and miscellaneous livestock products, or in cotton, etc., the task is highly difficult if not impossible. Furthermore, if figures can be located, there is no guarantee that those figures are inclusive of the total employment in that industry, since many of the production units in the agricultural industry are nothing more than "ma and pa" operations, with employment of the proprietor rarely counted in the employment statistics at the sub-industry level. Therefore, after careful examination of the problems involved in trying to use employment-location quotients for the agricultural sector, a decision was made to use a non-traditional location quotient which we have called an output-location quotient (as explained in the foregoing section of this paper).

AGGREGATION OF THE NATIONAL TABLE

While the objective of this study is to produce a nonsurvey input-output table, the overall result of the study can be said to include a comparison of the nonsurvey table with a survey data table for New Mexico of 1960. The 1960 New Mexico table contained 42 endogenous sectors (2). In order to make such a comparison, the 352 endogenous sectors in the national table must be aggregated to the 42 sector level. Note that 292 of the 352 sectors are specific to manufacturing basically at the four-digit SIC code level. Therefore, the manufacturing portion of the table makes up nearly 83 percent of the total sectors defined in the national table. While aggregation is necessary due to the objective of the study, it should also be desirable for any region which could be defined below the national level because a high probability exists that something less than the 292 defined manufacturing sectors exist in that region. This premise is particularly true in New Mexico with its small manufacturing sector that comprised approximately 7 percent of total wage and salary employment in 1960 (33).

The aggregation process could have been accomplished using several means. First, a simple averaging of the coefficients for each by adding together each of the national sectors into its respective New Mexico sector, and then dividing by the number of sectors included. Obviously, this is a naive approach. Secondly, the sectors could have been averaged by weighting them as to their employment, which was apparently done in previous research (Shaffer, etc.) using the location-quotient method (13, 14). However, a third method exists which appeared to be better. Estimated output for each of the identified

national sectors was computed and these sectors were weighted by their output. Obviously, one of the effects of this method would be the same as using employment as a weight -- that is, to give the larger industries in the state more influence in the determination of the direct coefficients than the smaller industries when two or more industries of unequal size are aggregated together. However, the third method did something more than the aggregation by employment size was able to accomplish. The aggregation by volume of output accounted for varying levels of productivity which exist from industry to industry. For those industries which had been adjusted by output location quotients the output figures already existed for the aggregation process.

For other industries which had been adjusted by employment-location quotients, estimating output in 1960 was necessary. Luckily, output data for 1958 and 1963 existed from the various detailed Censuses of Manufacturing, Business, etc. for those industries which had been adjusted by employment-location quotients (26). Therefore, the procedure was to arrive at an estimated level of output per employee (productivity) using a weighted average for the two data years. That output per employee is applied to the number of employees to get an estimated total output for that industry or sub-industry in 1960. Where possible, the level of productivity was specific to that State. However, some sub-industries were so small that no information on a state level was given in the various censuses. Therefore, productivity at the regional or national level had to be used.

The question arose as to how productivity at the national level compares with productivity for the individual states. In order to determine whether or not national productivity would be valid measure of local productivity, a random sample of five industries was chosen and an analysis was completed with from 10 to 20 observations, by state. The results of this analysis showed that the variation in productivity was negligible in the five industries among the states tested. Therefore, based on this random selection of five industries, we concluded that national productivity was a valid alternative to statewide productivity when necessary for use in computing estimated output.

COMPARISON

In this portion of the study, a description of the comparison between the 1960 survey-based table and the 1960 non-survey table is given. This comparison was performed with 39 and not 42 columns. Three sectors from the survey-based 1960 New Mexico table had to be deleted as they were defined differently in the non-survey table. A comparison test was performed that was similar to the test described by Shaffer and Chu in their article on non-survey based input-output techniques (14).

To test the accuracy of the non-survey table, χ^2 was computed for each column in the direct requirements table, taking as the true values the technical coefficients from the survey-based 1960 New Mexico Input-Output Table published by the UNM Bureau of Business Research. Two comparisons were made between the survey-based table and the direct requirements table with function weights: (1) a non-survey table aggregated without the use of location quotients to the 1960 survey-based table; and (2) a direct requirements table with both function weights and location quotients to the 1960 survey-based

table. The null hypothesis was that the non-survey technique would yield direct requirements coefficients which were the same as those in the survey-based table. An evaluation was made of the results of the tests at the 95 percent level with 38 degrees of freedom. The results of the tests were as follows: for the direct requirements table without location quotients the χ^2 statistic in 22 of 39 columns was in the rejection interval,¹ indicating that function weights alone are not enough to produce reasonable accuracy. However, for the table with the location quotients, the χ^2 statistic was in the rejection interval in only 8 of the 39 columns. This figure indicates that the location-quotient method produces results that are reasonably close to the 1960 survey value.

CONCLUSION

In the introduction we stated that two questions were to be answered in this study: (1) can the table be constructed with available data and techniques? and (2) how does the table compare with a full survey-based table?

First, a non-survey based table obviously can be constructed in the manner by which it was accomplished in this project. The methodology in this study was considerably more time consuming and difficult than the location-quotients adjustment procedure described in the recent literature (9, 11, 13, 14). The procedure of adjusting coefficients previous to aggregation should be more accurate. Unfortunately, the study cannot attest to a difference in accuracy; however, obtaining data for the 352 endogenous sectors listed in the national input-output tables of 1963 and 1967 is more detailed and difficult than locating data for the more highly aggregated sectors, such as those appearing in the New Mexico and Washington state tables (1, 3, 4).

The advantage of the lower-cost non-survey technique is significant. Compared with a survey-based table, the total time involved in producing a non-survey based table is minimal. (A 1972 New Mexico non-survey table was produced in five weeks using this technique. The cost was less than \$5,000).

The comparison of the location-quotient adjusted non-survey based table with the full survey table showed that some columns were significantly different. However, analysis of the columns which varied significantly in the two tables indicates that certain major sectors accounted for a large portion of that variation. For example, five of the six sub-sectors in agriculture showed significant variation, and one of the six sub-sectors of the mining industry varied significantly. Both of these major sectors were adjusted by output-location quotients and since the mining sector

¹ $\chi^2_{.05}$ with 38 d.f. was computed according to the formula:

$$\chi^2_{\alpha} = n \left(1 - \frac{2}{9n} + Z_{\alpha} \frac{2}{9n} \right)^3 \quad \text{where } n = 38 \text{ and } Z_{\alpha} = 1.645.$$

(Z_{α} is the normal deviate at the 95 percent level.)

Thus $\chi^2_{.05} = 53.380$.

Column
Number

Industry

χ^2 Value Without
Location Quotient
Adjustment

χ^2 Value With
Location Quotient
Adjustment

Column Number	Industry	χ^2 Value Without Location Quotient Adjustment	χ^2 Value With Location Quotient Adjustment
1	Meat Animals	1837.86908	1836.52435
2	Dairy Products	3.91990	1.98851
3	Feed Grains	121.61327	110.09386
4	Cotton	68.22235	63.40295
5	Other Farm Products	79.11645	66.52820
6	Agricultural Services	1500.84171	535.16665
7	Copper Mining	156.29900	18.90447
8	Non-ferrous Ores Mining	126.60604	11.98700
9	Crude Oil & Petroleum	19.60852	11.60208
10	New Construction, Other	569.80825	70.58260
11	Chemical Mining	9.83117	0.80598
12	Coal, Stone & Clay Mining & Quarrying	157.44106	15.11602
13	Meat Products, Processed	334.29984	54.75327
14	Dairy Products, Processed	64.18916	0.17410
15	Grain Mill & Baked Products	466.76550	8.19718
16	Miscellaneous Food Products	107.07334	3.11619
17	Lumber, Wood & Furniture	56.70250	9.85470
18	Printing & Publishing	1155.28348	11.25779
19	Chemicals, Plastics & Rubber	94.98391	11.31261
20	Petroleum Refining	29.28434	0.92766
21	Concrete & Stone Products	10.50268	2.07352
22	Electrical Equipment & Machinery	95.06541	0.28200
23	Fabricated Metal Products	613.84833	0.25926
24	Miscellaneous Manufacturing	153.26054	0.92913
25	Railroads	20.06416	3.00616
26	Other Transportation	7.69775	0.51413
27	Gas & Oil Pipelines	17.40511	15.08370
28	Communications	11.00637	6.57453
29	Electric & Water Utilities	39.57436	2.81252
30	Gas Utilities	3321.07094	3320.87176
31	Wholesale Trade	21.68048	4.12142
32	Retail Trade	4.84526	0.13118
33	Finance & Insurance	2.77826	0.67102
34	Real Estate	4.20676	1.98422
35	Hotels & Motels	3.75628	0.28428
36	Personal Services	69.65323	1.18209
37	Business Services	1.58041	0.22846
38	Auto Repair	340.81264	1.46602
39	Medical & Educational	28.18200	0.15089

fares well in the test there is no reason to believe that the output-location quotient adjustment accounted for the variation in agriculture. Therefore, concerning agriculture and mining, six of the twelve columns varied significantly between the two tables. These columns account for three quarters of the total columns which had χ^2 in the unacceptable range.

In manufacturing, only one column showed significant variation between the two tables. This column was meat packing (closely related to the agricultural sector). This χ^2 (54.75) could be said to be in a marginal range of acceptance. The gas-utilities column had the largest χ^2 of any of the columns. The variation in the gas-utilities column could be expected since the gas-utilities in New Mexico are different in activity compared with the national average. The New Mexico gas utilities are both producers and distributors and therefore the national coefficients should not and do not reflect this vertical integration.

Considering these results, we believe that the non-survey based technique used to build a 1960 table for New Mexico is an acceptable procedure and gives valid results in a majority of the columns. For those columns that have χ^2 significantly different from the survey-based 1960 table, most problems occur in the one sector (agriculture) for which data is very limited.

REFERENCES

1. Association of Western Railways, Railroad Facts, 1961 (Chicago: Association of Western Railways, 1961).
2. Blumenfeld, Arthur A., et al, "A Preview of the Input-Output Study," New Mexico Business (October, 1965).
3. Bourque, Philip J., "Forecasting with Input-Output," Business Studies, No. 5 (Seattle: University of Washington, 1971).
4. Bourque, Philip J., et al, "The Washington Economy: An Input-Output Study," Business Studies, No. 3 (Seattle: University of Washington, 1967).
5. Eastern Railroad Presidents Conference, Yearbook of Railroad Information, 1961 (New Jersey, 1961).
6. Harmston, Floyd K., and Lunc, Richard E., Application of an Input-Output Framework to a Community Economic System (Columbia, Missouri: University of Missouri Press, 1967).
7. Isard, Walter, Methods of Regional Analysis: An Introduction to Regional Science (Boston, Massachusetts: The MIT Press, 1960).
8. McPhee, Gordon, Local Economic Base Studies Using Input-Output Analysis (U.S. Department of Commerce, 1969).
9. McMenamin, David, and Haring, Joseph, "An Appraisal of Nonsurvey Techniques for Estimating Regional Input-Output Models," J Regional Science (August, 1974).
10. Miernyk, William H., A Primer of Input-Output Economics (Boston: Northeastern University, 1957).
11. Morrison, W. I., and Smith, P., "Nonsurvey Input-Output Techniques at the Small Area Level: An Evaluation," J Regional Science (April, 1974).
12. New Mexico Department of Agriculture, New Mexico Agricultural Statistics, Vol. 1 (Las Cruces, New Mexico: New Mexico State University, 1966).
13. Schaffer, William A., "Estimating Regional Input-Output Coefficients," Review of Regional Studies (Volume 2, 1972).
14. Schaffer, William A., and Chu, Kong, "Nonsurvey Techniques for Constructing Regional Interindustry Models," The Regional Science Association Papers (Volume 23).
15. The United States Bureau of the Budget, Standard Industrial Classification Manual, 1957 (Washington, D. C.: U.S. Government Printing Office, 1957).
16. The United States Bureau of the Budget, Standard Industrial Classification Manual, 1967 (Washington, D.C.: U.S. Government Printing Office, 1967).

17. The United States Bureau of Mines, Minerals Yearbook, 1960, Vols. 1-3 (Washington, D. C.: U.S. Government Printing Office, 1960).
18. The United States Department of Agriculture, Agricultural Statistics, 1960 (Washington, D. C.: U.S. Government Printing Office, 1960).
19. The United States Department of Agriculture, Agricultural Statistics, 1961 (Washington, D.C.: U.S. Government Printing Office, 1961).
20. The United States Department of Agriculture, Agricultural Statistics, 1963 (Washington, D. C.: U.S. Government Printing Office, 1963).
21. The United States Department of Agriculture, Seeds, The Yearbook of Agriculture, 1961 (Washington, D. C.: U.S. Government Printing Office, 1961).
22. The United States Department of Commerce, Bureau of the Census, County Business Patterns, 1962 (Washington, D. C.: U.S. Government Printing Office, 1963).
23. The United States Department of Commerce, Input-Output Structure of the U.S. Economy: 1963, Vols. 1 - 3 (Washington, D.C.: U.S. Government Printing Office, 1969).
24. The United States Department of Commerce, Bureau of the Census, Statistical Abstract of the United States, 1961 (Washington, D. C.: U.S. Government Printing Office, 1961).
25. The United States Department of Commerce, Bureau of the Census, Statistical Abstract of the United States, 1962 (Washington, D. C.: U.S. Government Printing Office, 1962).
26. The United States Department of Commerce, Bureau of the Census, 1963 Census of Business, various volumes (Washington, D. C.: U.S. Government Printing Office, 1966).
27. The United States Department of Commerce, Bureau of the Census, 1958 Census of Manufactures, Vols. 1 - 3 (Washington, D. C.: U.S. Government Printing Office, 1961).
28. The United States Department of Commerce, Bureau of the Census, 1963 Census of Manufactures, various volumes (Washington, D. C.: U.S. Government Printing Office, 1965).
29. The United States Department of Commerce, Bureau of the Census, 1963 Census of Mineral Industries, various volumes (Washington, D.C.: U.S. Government Printing Office, 1963).
30. The United States Department of Commerce, Bureau of the Census, United States Census of Agriculture, 1959, various volumes (Washington D.C.: U.S. Government Printing Office, 1962).
31. The United States Department of Commerce, Bureau of the Census, United States Census of Agriculture, 1964, various volumes (Washington, D.C.: U.S. Government Printing Office, 1967).

32. The United States Department of Labor, Bureau of Labor Statistics, Employment and Earnings, United States, 1909-71 (Washington, D.C.: U.S. Government Printing Office, 1972).
33. The United States Department of Labor, Employment and Wages, 1960 (Washington, D.C.: U.S. Government Printing Office, 1960).
34. Tiebout, Charles M., The Community Economic Base Study (New York: Committee for Economic Development, 1962).
35. F. W. Dodge Division, McGraw-Hill Information Systems Co., "Region VIII Bulletin," Dodge Construction Potentials Bulletins, appropriate years.

Attachment A

TABLE B.—TECHNICAL COEFFICIENTS: DIRECT REQUIREMENTS PER DOLLAR OF OUTPUT, NEW MEXICO, 1960

[Each entry shows direct purchases by the sector at top, per dollar of its output, from sector of left.]

INDUSTRY PURCHASING

Industry Selling	Agriculture						Mining						Manufacturing										Transport & Utilities				Trade			Finance			Services			R & D													
	Meat animals	Dairy & poultry	Food grains & field crops	Cotton & cottonseed	Vegetables, fruits, & fl.	Agricultural services	Copper	Uranium	Oil & gas field services	Potash	Other mining	Meat packing	Processed dairy products	Grain mill & bakery products	Manufactured food products	Lumber & wood products	Printing & publishing	Chemical	Textiles & apparel	Machinery & electrical equipment	Transportation equipment	Other manufacturing	Railroad	Trucking & other transportation	Gas & petroleum pipelines	Telephone & telegraph	Electric light & power	Gas utilities	Wholesale	Retail trade	Finance & insurance	Real estate	Hotels & motels	Personal services	Business services	Auto & other repair services	Medical & professional	Research & development											
Meat animals 1											.5680												.0021																										
Dairy & poultry 2		.0144									.0001				.0436	.3385	.0075	.0005																															
Food grains & field crops 3	.1113	.3229	.0163	.0020	.0032									.0231	.3211																																		
Cotton & cottonseed 4		.0046		.0025												.0544																																	
Vegetables, fruits, & fl. 5					.0038					.0002							.0358		.0001																														
Agricultural services 6	.0070	.0099	.0390	.1681	.0296																																												
Copper 7							.0166																																										
Uranium 8							.1926																																										
Petroleum & natural gas 9								.0004															.1450	.2760																									
Oil & gas field services 10								.0702	.0592																																								
Potash 11										.0369													.0109																										
Other mining 12						.0570	.0177			.0091	.0034											.0032	.0170																										
Meat packing 13						.0001				.0001	.0008	.0001	.0001				.0001	.0001	.0002	.0002	.0002	.0002	.0002	.0002	.0001	.0002			.0023	.0004	.0005						.0006	.0004	.0011	.0005	.0005	.0003	.0001	.0002	.0003	.0001	.0004		
Processed dairy products 14											.0004	.0001	.0001			.0587			.0001	.0001	.0001	.0001	.0001	.0001	.0001	.0001			.0009	.0002	.0003						.0003	.0002	.0007	.0003	.0002	.0002	.0001	.0001	.0002	.0001	.0002		
Grain mill & bakery products 15	.0445	.1376	.0010	.0006	.0010						.0001					.0159														.0003	.0001	.0001						.0001	.0001	.0002	.0001	.0001	.0001	.0001	.0001	.0001	.0001	.0001	.0001
Miscellaneous food products 16	.0017	.0059									.0002				.0005		.0101		.0001	.0001	.0001	.0001	.0001	.0001	.0001			.0097	.0138	.0001	.0002					.0002		.0004	.0002	.0002	.0001		.0001	.0001		.0008	.0001		
Lumber & wood products 17	.0014	.0019	.0017	.0011	.0007		.0027	.0020			.0006					.1777						.0011	.0006						.0029							.0004									.0070		.0007		
Printing & publishing 18						.0006	.0002			.0037	.0009	.0003	.0014	.0011	.0020	.0028	.0013	.0044	.0017	.0004	.0013	.0016	.0020	.0018	.0003	.0055	.0003	.0046	.0027					.0183	.0099	.0109	.0115	.0113	.0110	.0099	.0080	.0070	.0050	.0058	.0007	.0018			
Chemicals 19	.0009	.0019	.0015	.0027	.0018						.0008				.0003							.0046							.0008	.0008	.0001																.0009		
Petroleum refining 20	.0004	.0050	.0246	.0126	.0138	.0209	.0013	.0041	.0099	.0252	.0033	.0150	.0015	.0043	.0039	.0060	.0023	.0021	.0023	.0380	.0035	.0027	.0005	.0036	.0383	.0132	.0012	.0009	.0010	.0011				.0106	.0022	.0028	.0030	.0014	.0022	.0030	.0043	.0068	.0034	.0001	.0010				
Concrete & stone products 21	.0009	.0013	.0011	.0008	.0005						.0002											.1158							.0009		.0042																.0045		
Machinery & electrical equipment 22			.0005	.0004							.0013	.0005			.0002		.0017					.0038	.0117	.0144	.0098				.0002						.0001		.0012		.0003				.0165		.0003	.0077	.0022		
Fabricated metal products 23										.0014	.0003											.0088	.0018	.0431	.0098											.0001		.0012		.0002				.0165		.0003	.0064	.0023	
Miscellaneous manufacturing 24																						.0156														.0012		.0005		.0016	.0031			.0020		.0004	.0024		
Railroads 25		.0012					.0001	.0404	.0013	.0006	.0019	.0119	.0013	.0019	.0006	.0002	.0004	.0106	.0007	.0280	.0003	.0009	.0004	.0019	.0016	.0054	.0005	.0004	.0003	.0007	.0015				.0103												.0002	.0010	
Trucking & other transportation 26	.0035	.0034		.0346				.0004	.0039	.0011	.0190	.0029	.0031	.0010	.0020	.0036	.0017	.0130	.0021	.0017	.0011	.0026	.0012	.0028	.0058			.0246	.0035	.0002	.0009	.0021			.0111	.0077	.0003				.0006	.0002	.0001	.0021	.0056	.0004	.0011	.0008	
Gas & petroleum pipelines 27										.0005												.1584	.3047																										
Telephone & telegraph 28	.0025	.0038	.0034	.0043	.0020	.0050	.0011	.0014	.0024	.0058	.0028	.0054	.0021	.0029	.0043	.0057	.0068	.0079	.0075	.0026	.0075	.0061	.0062	.0040	.0014	.0159	.0054	.0132	.0115	.0006				.0169	.0167	.0180	.0012	.0148	.0122	.0256	.0130	.0202	.0094	.0132	.0044	.0048			
Electric light & power 29	.0036	.0035	.0036	.0036	.0036	.0164	.0024	.0046	.0022	.0001	.0246	.0116	.0028	.0150	.0046	.0255	.0111	.0065	.0147	.0060	.0036	.0043	.0056	.0034	.0008	.0051	.0038	.0062	.0533	.0025					.0042	.0082	.0194	.0096	.0034	.0035	.0410	.0152	.0031	.0068	.0082	.0017	.0029		
Gas utilities 30						.0315	.0156	.0097		.0018	.0180	.0016	.0030	.0068	.0054	.0101	.0021	.0019	.0028	.0054	.0061	.0018	.0028	.0017	.0005	.0029		.0010	.1116						.0029	.0058	.0174	.0056	.0011	.0025	.0325	.0105	.0016	.0031	.0050	.0001	.0010		
Wholesale 31	.0144	.0278	.0083	.0052	.0060	.0064	.0115	.0243	.0308	.0467	.0177	.0403	.0052	.0047	.0173	.0377	.0121	.0204	.0094	.0073	.0188	.0284	.0042	.0085	.0096	.0145	.0039	.0091	.0044	.0032				.0211	.0054	.0053	.0056	.0021	.0009	.0160	.0179	.0111	.0161	.0116	.0017	.0017			
Gasoline service stations 32	.0061	.0048	.0233	.0119	.0130	.0198		.0003	.0002	.0021	.0003	.0005	.0015	.0041	.0037	.0056	.0022	.0020	.0022	.0020	.0050	.0025	.0006	.0034			.0162	.0011	.0008	.0007	.0011				.0059	.0100	.0021	.0026	.0028	.0013	.0021	.0028	.0028	.0065	.0032	.0004	.0029		
Eating & drinking places 33							.0004	.0002	.0003	.0005	.0059	.0009	.0004	.0003	.0003	.0004	.0009	.0017	.0016	.0016	.0013	.0013	.0006	.0016				.0043	.0026	.0043	.0002					.0044	.0030	.0088	.0036	.0038	.0025	.0006	.0011	.0014	.0007	.0024	.0004	.0033	
Other retail trade 34	.0432	.0876	.0248	.0155	.0180	.0291		.0003	.0010	.0007		.0001	.0002	.0005	.0006	.0015	.0032	.0016	.0016	.0007	.0055	.0057	.0005	.0012	.0020	.0038	.0027	.0027	.0002	.0002				.0044	.0018	.0027	.0071	.0028	.0049	.0051	.0043	.0064	.0050	.0037	.0002	.0024			
Finance & insurance 35	.0300	.0201	.0282	.0410	.0147	.0219	.0099	.0007	.0009	.0219	.0094	.0142	.0100	.0060	.0115	.0177	.0138	.0227	.0203	.0048	.0112	.0092	.0136	.0002	.0152	.0194	.0018	.0383	.0013					.0090	.0245	.0327	.0202	.0251	.0269	.0104	.0122	.0120	.0200	.0114	.0007	.0013			
Real estate 36	.0105	.0118	.0062	.0082	.0015	.0038	.0010	.0034	.0035	.0046	.0066	.0006	.0017	.0180	.0110	.0205	.0040	.0210	.0181	.0061	.0080	.0147	.0024	.0228	.0018	.0243	.0040	.0092	.0025	.0043				.0298	.0442	.0475	.0588	.0233	.0160	.0268	.0059	.0187	.0276	.0242	.0007	.0026			
Hotels & motels 37							.0004	.0002	.0002	.0004	.0010	.0009	.0008	.0003	.0003	.0004	.0004	.0008	.0026	.0014	.0017	.0003	.0005	.0004	.0013				.0010	.0025	.0037	.0002				.0018	.0023	.0002	.0023	.0034	.0005	.0009	.0006	.0007	.0006	.0029	.0001	.0013	
Personal services 38							.0006																																										

Attachment B-1

With Location Quotient Adjustment

NEW MEXICO INPUT-OUTPUT MODEL, 1960
TECHNICAL COEFFICIENTS: DIRECT REQUIREMENTS PER DOLLAR OF OUTPUT

INDUSTRY PURCHASING

		1	2	3	4	40	41	42	****	ROW SUMS	****
I N D U S T R Y	MEAT ANIMALS	1	0.27096	0.00300	0.05196	0.0441	0.00000	0.00000	0.00000	1	0.94268
	DAIRY PRCDOC	2	0.00295	0.00000	0.01007	0.006	0.00000	0.00000	0.00000	2	0.34722
	FEED GRAINS	3	0.20623	0.23408	0.02256	0.001	0.00000	0.00010	0.00000	3	0.66950
	COTTON	4	0.00000	0.00000	0.00000	0.001	0.00000	0.00000	0.00000	4	0.23377
	OTHER FARM P	5	0.00355	0.00002	0.00000	0.001	0.00000	0.00379	0.00000	5	0.19605
	AGRICULTURAL	6	0.00000	0.03689	0.02692	0.115	0.00000	0.00004	0.00000	6	0.21494
	COPPER MININ	7	0.00000	0.00000	0.00000	0.000	0.00000	0.00000	0.00000	7	0.29950
	NONFERRCLS D	8	0.00000	0.00000	0.00000	0.000	0.00000	0.00000	0.00000	8	0.16612
	CRUDE OIL &	9	0.00300	0.00000	0.00000	0.000	0.00000	0.00000	0.00000	9	0.67426
	NEW CONSTRUC	10	0.00000	0.00000	0.00000	0.000	0.00000	0.00000	0.00000	10	0.00000
	CHEMICAL MIN	11	0.00300	0.00000	0.00173	0.000	0.00000	0.00000	0.00000	11	0.07378
	COAL, STONE	12	0.00303	0.00014	0.00261	0.001	0.00000	0.00806	0.00000	12	0.13382
	MEAT PRCDOC	13	0.00000	0.00000	0.00000	0.001	0.00000	0.00000	0.00000	13	0.06155
	DAIRY PRCDOC	14	0.00000	0.00000	0.00000	0.001	0.00000	0.00000	0.00000	14	0.12100
	GRAIN MILL &	15	0.05223	0.16519	0.00000	0.001	0.00000	0.00000	0.00000	15	0.34171
	MISC. FCCD P	16	0.00613	0.00648	0.00000	0.001	0.00000	0.00001	0.00000	16	0.06534
	LUMBER, WOOD	17	0.00300	0.00000	0.00030	0.001	0.00000	0.02505	0.00000	17	0.26494
	PRINTING & P	18	0.00001	0.00001	0.00001	0.001	0.00080	0.00000	0.00395	18	0.02796
	CHEMICALS, P	19	0.00121	0.00116	0.01625	0.010	0.00008	0.00220	0.00022	19	0.17898
	PETROLEUM RE	20	0.00379	0.00635	0.03222	0.020	0.00375	0.01244	0.00462	20	0.39807
	CONCRETE & S	21	0.00000	0.00000	0.00000	0.000	0.00000	0.06121	0.00000	21	0.26486
	ELECTRICAL &	22	0.00007	0.00009	0.00046	0.000	0.00006	0.00056	0.00002	22	0.11071
	FABRICATED M	23	0.00001	0.00001	0.00002	0.000	0.00000	0.02206	0.00000	23	0.06663
	MISC. MANUFA	24	0.00044	0.00025	0.00032	0.000	0.00000	0.00093	0.00000	24	0.09434
	RAILROADS	25	0.00495	0.00716	0.00546	0.003	0.00036	0.01320	0.00055	25	0.29136
	OTHER TRANSP	26	0.01225	0.02493	0.00489	0.003	0.0049	0.01913	0.00070	26	0.40760
	GAS & OIL PI	27	0.00010	0.00017	0.00086	0.000	0.0006	0.00014	0.00009	27	0.04018
	COMMUNICATIO	28	0.00161	0.00269	0.00311	0.002	0.00182	0.00272	0.01021	28	0.26010
	ELECTRIC & W	29	0.00240	0.00471	0.00458	0.002	0.00233	0.00229	0.03280	29	0.43888
	GAS UTILITIE	30	0.00000	0.00089	0.00000	0.000	0.00296	0.00040	0.00300	30	0.51581
	WHOLESALE TR	31	0.01563	0.01606	0.01339	0.009	0.00480	0.02921	0.00508	31	0.58733
	RETAIL TRADE	32	0.00718	0.01308	0.01322	0.013	0.01906	0.03863	0.00786	32	0.32881
	FINANCE & IN	33	0.00332	0.00385	0.00664	0.009	0.00438	0.00362	0.00286	33	0.37696
	REAL ESTATE	34	0.01030	0.01234	0.08643	0.127	0.05412	0.00475	0.10525	34	1.43631
	HOTELS & MOT	35	0.00000	0.00000	0.00000	0.001	0.00000	0.00000	0.00000	35	0.00432
	PERSONAL SER	36	0.00000	0.00000	0.00000	0.001	0.00000	0.00000	0.00204	36	0.19501
	BUSINESS SER	37	0.00566	0.00050	0.03871	0.02	0.01606	0.00694	0.01607	37	0.53671
	AUTO REPAIR	38	0.00273	0.00355	0.00591	0.001	0.00659	0.00363	0.00803	38	0.18152
	MEDICAL & ED	39	0.00181	0.00408	0.00000	0.000	0.00000	0.00000	0.00491	39	0.02043
	MISC. PROFES	40	0.00129	0.00145	0.00156	0.001	0.00982	0.04089	0.01416	40	0.33638
	NEW CONSTRUC	41	0.00666	0.00933	0.01467	0.014	0.0046	0.00026	0.04110	41	0.55663
	NONPROFIT OR	42	0.00027	0.00503	0.00038	0.000	0.0074	0.00085	0.00067	42	0.04476
*** C COLUMN SUMS ***		0.62377	0.56049	0.36507	0.426	0.0874	0.30309	0.26408			

18-1

Complete tables will be furnished upon request to the Bureau of Business and Economic Research, University of New Mexico, Albuquerque, NM 87131.

Attachment B-2

Without Location Quotient Adjustment

NEW MEXICO INPUT-OUTPUT MODEL, 1960
TECHNICAL COEFFICIENTS; DIRECT REQUIREMENTS PER DOLLAR OF OUTPUT

		INDUSTRY PURCHASING								*** ROW SUMS ***	
		1	2	3	4	40	41	42			
INDUSTRY SELLING	MEAT ANIMALS 1	0.27096	0.00000	0.05196	0.04412	0.00000	0.00000	0.00000	1	0.94268	
	DAIRY PRODUC 2	0.00521	0.00000	0.01934	0.0124	0.00000	0.00000	0.00000	2	0.69955	
	FELD GRAINS 3	0.28783	0.32670	0.03148	0.00000	0.00000	0.00015	0.00000	3	0.93440	
	COTTON 4	0.00000	0.00000	0.00000	0.00000	0.00000	0.00000	0.00000	4	0.23377	
	OTHER FARM P 5	0.00425	0.00000	0.00000	0.00000	0.00000	0.00382	0.00000	5	0.27395	
	AGRICULTURAL 6	0.00000	0.03689	0.02692	0.11	0.00000	0.00004	0.00000	6	0.21494	
	COPPER MININ 7	0.00000	0.00000	0.00000	0.00000	0.00000	0.00000	0.00000	7	0.30597	
	NONFERROUS O 8	0.00000	0.00000	0.00000	0.00000	0.00000	0.00000	0.00000	8	0.16612	
	CRUDE OIL & 9	0.00000	0.00000	0.00000	0.00000	0.00000	0.00000	0.00000	9	0.67426	
	NEW CONSTRUC 10	0.00000	0.00000	0.00000	0.00000	0.00000	0.00000	0.00000	10	0.00000	
	CHEMICAL MIN 11	0.00000	0.00000	0.00173	0.00091	0.00000	0.00000	0.00000	11	0.07378	
	COAL, STONE 12	0.00004	0.00051	0.00395	0.0026	0.00000	0.01222	0.00000	12	0.26821	
	MEAT PRODUCT 13	0.00000	0.00000	0.00000	0.00000	0.00000	0.00000	0.00000	13	0.15089	
	DAIRY PRODUCT 14	0.00000	0.00000	0.00000	0.00000	0.00000	0.00000	0.00000	14	0.18967	
	GRAIN MILL & 15	0.05816	0.18486	0.00000	0.00000	0.00000	0.00000	0.00000	15	0.47391	
	MISC. FOOD P 16	0.01635	0.02272	0.00000	0.00000	0.00000	0.00000	0.00000	16	0.43149	
	LUMBER, WOOD 17	0.00011	0.00116	0.00012	0.00000	0.00082	0.05798	0.00035	17	1.01735	
	PRINTING & P 18	0.00016	0.00022	0.00028	0.00000	0.00000	0.00000	0.00000	18	0.21111	
	CHEMICALS, P 19	0.00434	0.00599	0.00676	0.06	0.00010	0.01131	0.00069	19	0.89618	
	PETROLEUM RE 20	0.00511	0.00858	0.04352	0.02	0.00506	0.02149	0.00623	20	0.54868	
	CONCRETE & S 21	0.00014	0.00139	0.00139	0.00	0.00000	0.13758	0.00000	21	1.07423	
	ELECTRICAL & 22	0.00081	0.00090	0.01389	0.00	0.00057	0.04247	0.00059	22	1.23212	
	FABRICATED M 23	0.00022	0.00375	0.00180	0.00000	0.00000	0.10477	0.00000	23	0.48542	
	MISC. MANUFA 24	0.00235	0.00284	0.00727	0.004	0.00000	0.10477	0.00000	24	0.59791	
	RAILROADS 25	0.00495	0.00716	0.00545	0.0034	0.0036	0.01320	0.00055	25	0.29136	
	OTHER TRANSP 26	0.01308	0.02553	0.00676	0.0053	0.0064	0.02065	0.00095	26	0.58462	
	GAS & OIL PI 27	0.00010	0.00017	0.00086	0.00000	0.00000	0.00014	0.00000	27	0.04018	
	COMMUNICATIO 28	0.00161	0.00269	0.00311	0.00271	0.01182	0.00272	0.01021	28	0.26010	
	ELECTRIC & W 29	0.00243	0.00475	0.00830	0.00974	0.01434	0.00269	0.03411	29	0.48629	
	GAS UTILITIE 30	0.00000	0.00089	0.00000	0.00000	0.00295	0.00040	0.00300	30	0.51581	
	WHOLESALE TR 31	0.02229	0.02291	0.01910	0.01390	0.00685	0.04165	0.00724	31	0.83761	
	RETAIL TRADE 32	0.00718	0.01308	0.01322	0.01357	0.01906	0.03863	0.00786	32	0.32881	
	FINANCE & IN 33	0.00561	0.00671	0.01204	0.0152	0.00682	0.00651	0.00634	33	0.57405	
	REAL ESTATE 34	0.01030	0.01234	0.08643	0.1241	0.05412	0.00475	0.10525	34	1.43631	
	HOTELS & MOT 35	0.00000	0.00000	0.00000	0.00000	0.00000	0.00000	0.00000	35	0.00432	
	PERSONAL SER 36	0.00000	0.00000	0.00000	0.00000	0.00000	0.00000	0.00241	36	0.19902	
	BUSINESS SER 37	0.00571	0.00050	0.03871	0.0215	0.00000	0.00783	0.01760	37	0.75762	
	AUTO REPAIR 38	0.00273	0.00355	0.00591	0.0051	0.0059	0.00363	0.00803	38	0.18152	
	MEDICAL & ED 39	0.00371	0.00639	0.00000	0.00000	0.00000	0.00000	0.00746	39	0.03568	
	MISC. PROFES 40	0.00129	0.00145	0.00156	0.0011	0.00000	0.04089	0.01416	40	0.33638	
	NEW CONSTRUC 41	0.00666	0.00933	0.01467	0.0141	0.0046	0.00026	0.04110	41	0.55663	
	NONPROFIT OR 42	0.00000	0.00000	0.00000	0.00000	0.00000	0.00000	0.00000	42	0.04641	
*** COLUMN SUMS ***	0.74399	0.72111	0.48092	0.51685	0.22892	0.58791	0.29752				

L-82

Complete tables will be furnished upon request to the Bureau of Business and Economic Research, University of New Mexico, Albuquerque, NM 87131.

FLOW CHART FOR CREATING A NON-SURVEY REGIONAL INPUT-OUTPUT MODEL

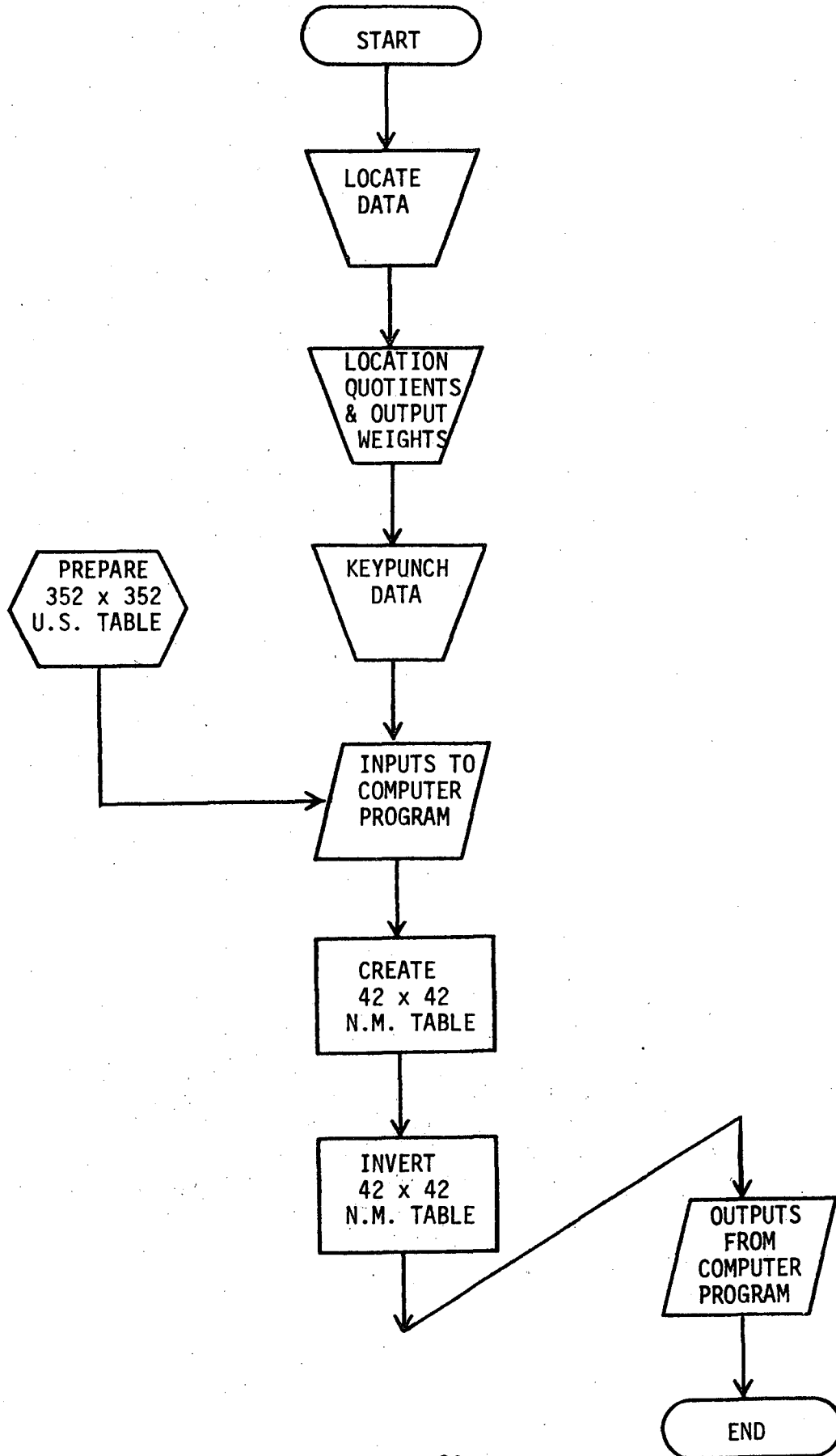

Appendix M

**SOCIOECONOMIC EFFECTS OF PLANT
CONSTRUCTION AND OPERATION:
SUPPORTING DATA**

CONTENTS

<u>Table</u>	<u>Title</u>	<u>Page</u>
M-1	Population Estimates and Projections: WIPP Scenario I.....	M-1
M-2	Population Estimates and Projections: WIPP Scenario II.....	M-2
M-3	1980 Resident Population Within 50 Miles of the WIPP..... Site (Maximum Impact--Scenarios I and II)	M-3
M-4	1990 Resident Population Within 50 Miles of the WIPP..... Site (Maximum Impact--Scenarios I and II)	M-4
M-5	2000 Resident Population Within 50 Miles of the WIPP..... Site (Maximum Impact--Scenarios I and II)	M-5
M-6	2010 Resident Population Within 50 Miles of the WIPP..... Site (Maximum Impact--Scenarios I and II)	M-6
M-7	Carlsbad Municipal Finances: Baseline.....	M-7
M-8	Carlsbad Municipal Finances: Impact of the WIPP Project	M-8
M-9	Loving Municipal Finances: Baseline.....	M-9
M-10	Loving Municipal Finances: Impact of the WIPP Project	M-10
M-11	Eddy County Finances: Baseline.....	M-11
M-12	Eddy County Finances: Impact of the WIPP Project	M-12
M-13	Hobbs Municipal Finances: Baseline.....	M-13
M-14	Hobbs Municipal Finances: Impact of the WIPP Project	M-14
M-15	Lea County Finances: Baseline.....	M-15
M-16	Lea County Finances: Impact of the WIPP Project	M-16
M-17	Carlsbad School District Finances: Baseline.....	M-17
M-18	Carlsbad School District Finances: Impact of the WIPP Project	M-18
M-19	Loving School District Finances: Baseline.....	M-19
M-20	Loving School District Finances: Impact of the WIPP Project	M-20
M-21	Hobbs School District Finances: Baseline.....	M-21
M-22	Hobbs School District Finances: Impact of the WIPP Project	M-22

Table M-1. Population Estimates and Projections: WIPP Scenario I^a

Year	Eddy County (99%, 90%) ^b	Carlsbad (88%, 80%) ^b	Carlsbad School District (93%, 85%) ^b	Loving (6%, 3%) ^b	Loving School District (6%, 3%) ^b	Lea County (1%, 10%) ^b
1970	41,119	21,297	25,498	1,192	1,350	49,554
1975	42,900	NA	NA	1,400	NA	51,600
1976	45,300	25,500	29,300	1,450	1,600	53,100
1977	46,200	26,600	30,400	1,500	1,650	55,100
1978	47,300	27,900	31,600	1,550	1,700	56,300
1979	48,200	28,600	32,400	1,600	1,750	57,500
1980	49,425	29,600	33,410	1,660	1,810	58,710
1981 ^c	50,780	30,710	34,640	1,680	1,830	60,030
1982	53,430	32,930	37,020	1,790	1,940	61,280
1983	54,120	33,480	37,690	1,800	1,950	62,620
1984	53,880	33,170	37,320	1,790	1,940	63,870
1985	54,430	33,360	37,590	1,830	1,980	65,230
1986	55,950	34,360	38,700	1,840	1,990	66,540
1987	57,340	35,230	39,680	1,900	2,050	67,740
1988	58,750	36,140	40,690	1,950	2,100	68,850
1989	60,150	36,940	41,590	2,000	2,150	69,950
1990	61,550	37,840	42,590	2,050	2,200	70,950
1995 ^d	65,250	40,040	45,090	2,150	2,300	75,150
2000	69,250	42,540	47,890	2,300	2,500	79,050
2010	73,150	44,940	50,590	2,450	2,600	88,150

^aIn scenario I, the direct impact of the WIPP (construction and operation) is assumed to be distributed as follows: Carlsbad, 88%; Loving, 6%; rest of Eddy County, 5%; Lea County, 1%. The indirect impact is distributed as follows: Carlsbad, 80%; Loving, 3%; rest of Eddy County, 7%; Lea County, 10%. Data computed by Larry Adcock and Associates; NA = not available.

^bThe percentages given in parentheses are the direct and indirect population migration, respectively, resulting from the WIPP. Percentages may vary because of rounding.

^cConstruction of the WIPP assumed to begin in 1980. All impacts assumed to be static after 1987.

^dProjections for years beyond 1995 assume continued activity in the oil and gas industry at a stable but constant level. Present production levels measured against proved oil and gas reserves and recovery rates indicate that activity could decrease before 1990. However, secondary and tertiary (oil only) recovery procedures could prolong activity beyond the year 2010.

Table M-2. Population Estimates and Projections: WIPP Scenario II^a

Year	Eddy County (58%) ^b	Carlsbad (54%) ^b	Remainder of Eddy County (4%) ^b	Lea County (42%) ^b	Hobbs (36%) ^b	Remainder of Lea County (6%) ^b	Hobbs School District (39%) ^b
1970	41,119	21,297	19,822	49,554	26,025	23,529	29,858
1975	42,900	NA	NA	51,600	NA	NA	33,300
1976	45,300	25,500	19,800	53,100	29,600	23,500	35,600
1977	46,200	26,600	19,600	55,100	30,550	24,550	36,900
1978	47,300	27,900	19,400	56,300	31,650	24,650	37,400
1979	48,200	28,600	19,600	57,500	32,600	24,900	37,950
1980	49,370	29,560	19,800	58,750	33,490	25,260	37,600
1981 ^c	50,550	30,530	20,020	60,250	34,620	25,630	38,790
1982	52,710	32,330	20,380	62,000	35,940	26,060	39,200
1983	53,300	32,810	20,490	63,440	37,000	26,440	41,320
1984	53,510	32,870	20,640	64,240	37,530	26,710	41,860
1985	54,180	33,160	21,010	65,480	38,390	27,090	42,760
1986	55,620	34,080	21,540	66,870	39,220	27,650	43,700
1987	56,970	34,930	22,040	68,110	39,950	28,160	44,530
1988	58,380	35,840	22,540	69,220	40,610	28,610	45,240
1989	59,780	36,640	23,140	70,320	41,260	29,060	45,960
1990 ^d	61,180	37,540	23,640	71,320	41,860	29,460	46,640
1995	64,880	39,740	25,140	75,520	44,310	31,210	49,390
2000	68,880	41,240	26,640	79,420	46,560	32,860	51,890
2010	72,780	44,640	28,140	88,520	51,910	36,610	57,840

^aIn scenario II, the distribution of direct and indirect impacts is assumed to be as follows: Carlsbad, 54%; rest of Eddy County, 4%; Hobbs, 36%; rest of Lea County, 6%. NA = not available.

^bThe percentages given in parentheses are the gross population migration resulting from the WIPP project. Percentages may vary because of rounding.

^cConstruction of the WIPP assumed to begin in 1980. All impacts assumed to be static after 1987.

^dProjections for years beyond 1995 assume continued activity in the oil and gas industry at a stable but constant level. Present production levels measured against proved oil and gas reserves and recovery rates indicate that activity could decrease before 1990. However, secondary and tertiary (oil only) recovery procedures could prolong activity beyond the year 2010.

Table M-3. 1980 Resident Population Within 50 Miles of the WIPP Site (Maximum Impact--Scenarios I and II)

Sector	Miles from site						Total
	0-5	5-10	10-20	20-30	30-40	40-50	
N	0	0	35	25	175	25	260
NNE	0	0	25	5	55	5,690	5,775
NE	0	0	0	25	75	8,785	8,885
ENE	0	0	10	70	205	34,100	34,385
E	0	0	5	15	3,290	160	3,470
ESE	0	0	5	10	3,080	270	3,365
SE	0	0	5	20	20	30	75
SSE	0	0	0	25	10	40	75
S	0	0	5	15	50	15	85
SSW	6	0	5	30	95	15	150
SW	0	5	55	30	10	40	140
WSW	0	0	1,810	200	50	65	2,125
W	0	0	70	32,660	40	30	32,800
WNW	0	10	5	190	55	40	300
NW	0	0	30	20	65	12,260	12,375
NNW	0	0	15	5	220	10	250
Radius total	6	15	2,080	33,345	7,495	61,575	104,515
Cumulative total	6	21	2,100	35,445	42,940	104,515	

Note: See Tables M-1 and M-2 for a description of the distribution of direct and indirect impacts associated with scenarios I and II.

Population allocations into the various geographic sectors have been based on the maximum impact of both scenarios I and II. This procedure leads to some double counting in a few areas, but increases the population count by a maximum of only 0.3% (approximately 400 people) in the overall area.

Table M-4. 1990 Resident Population Within 50 Miles of the WIPP Site (Maximum Impact--Scenarios I and II)

Sector	Miles from site						Total
	0-5	5-10	10-20	20-30	30-40	40-50	
N	0	0	30	20	160	20	230
NNE	0	0	20	5	50	6,640	6,715
NE	0	0	0	20	65	10,860	10,945
ENE	0	0	10	65	185	42,625	42,885
E	0	0	5	15	3,840	140	4,000
ESE	0	0	5	10	3,595	255	3,865
SE	0	0	5	15	20	25	65
SSE	0	0	0	25	10	40	75
S	0	0	5	15	45	15	80
SSW	6	0	5	30	100	15	155
SW	0	5	50	15	10	40	120
WSW	0	0	2,245	175	50	65	2,535
W	0	0	65	41,145	40	35	41,285
WNW	0	10	5	185	50	45	295
NW	0	0	30	20	60	15,975	16,085
NNW	0	0	15	5	235	10	265
Radius total	6	15	2,495	41,765	8,515	76,805	129,600
Cumulative total	6	21	2,515	44,280	52,795	129,600	

Note: See Tables M-1 and M-2 for a description of the distribution of direct and indirect impacts associated with scenarios I and II.

Population allocations into the various geographic sectors have been based on the maximum impact of both scenarios I and II. This procedure leads to some double counting in a few areas, but increases the population count by a maximum of only 0.3% (approximately 400 people) in the overall area.

Table M-5. 2000 Resident Population Within 50 Miles of the WIPP Site (Maximum Impact--Scenarios I and II)

Sector	Miles from site						Total
	0-5	5-10	10-20	20-30	30-40	40-50	
N	0	0	30	20	150	20	220
NNE	0	0	20	5	45	7,385	7,455
NE	0	0	0	20	60	12,070	12,150
ENE	0	0	10	60	175	47,335	47,580
E	0	0	5	15	4,080	135	4,235
ESE	0	0	5	10	3,890	240	4,145
SE	0	0	5	15	15	25	60
SSE	0	0	5	20	10	35	70
S	0	0	5	15	45	15	80
SSW	6	0	5	30	100	15	155
SW	0	5	60	15	10	50	140
WSW	0	0	2,545	195	50	70	2,860
W	0	0	75	46,225	40	35	46,375
WNW	0	10	5	205	60	50	330
NW	0	0	30	20	70	14,915	15,035
NNW	0	0	15	5	260	5	285
Radius total	6	15	2,820	46,875	9,060	82,400	141,175
Cumulative total	6	21	2,840	49,715	58,775	141,175	

Note: See Tables M-1 and M-2 for a description of the distribution of direct and indirect impacts associated with scenarios I and II.

Population allocations into the various geographic sectors have been based on the maximum impact of both scenarios I and II. This procedure leads to some double counting in a few areas, but increases the population count by a maximum of only 0.3% (approximately 400 people) in the overall area.

Table M-6. 2010 Resident Population Within 50 Miles of the WIPP Site (Maximum Impact--Scenarios I and II)

Sector	Miles from site						Total
	0-5	5-10	10-20	20-30	30-40	40-50	
N	0	0	30	20	160	20	230
NNE	0	0	25	5	50	8,300	8,380
NE	0	0	0	25	70	13,500	13,595
ENE	0	0	10	70	195	52,850	53,125
E	0	0	5	15	4,605	135	4,760
ESE	0	0	5	10	4,335	240	4,590
SE	0	0	5	20	20	25	70
SSE	0	0	0	20	10	35	65
S	0	0	5	15	45	15	80
SSW	6	0	5	30	100	15	155
SW	0	5	65	15	10	50	145
WSW	0	0	2,645	205	55	75	2,980
W	0	0	80	49,465	40	35	49,620
WNW	0	10	5	230	65	55	365
NW	0	0	30	20	75	15,770	15,895
NNW	0	0	15	5	275	5	300
Radius total	6	15	2,930	50,170	10,110	91,125	154,355
Cumulative total	6	21	2,950	53,120	63,230	154,355	

Note: See Tables M-1 and M-2 for a description of the distribution of direct and indirect impacts associated with scenarios I and II.

Population allocations into the various geographic sectors have been based on the maximum impact of both scenarios I and II. This procedure leads to some double counting in a few areas, but increases the population count by a maximum of only 0.3% (approximately 400 people) in the overall area.

Table M-7. Carlsbad Municipal Finances: Baseline^a

Revenue source or expenditure	1980-81	1981-82	1982-83	1983-84	1984-85	1985-86	1986-87	1987-88	1988-89
REVENUES (thousands of 1979 dollars)									
Own source									
Taxes	690	710	730	740	760	770	790	810	830
Charges and miscellaneous	3,300	3,410	3,500	3,560	3,640	3,720	3,810	3,900	4,000
Intergovernmental transfers									
State	2,960	3,050	3,120	3,170	3,230	3,290	3,370	3,450	3,540
Federal	1,040	1,070	1,100	1,110	1,130	1,160	1,180	1,210	1,240
Other	3,430	3,540	3,620	3,670	3,740	3,820	3,910	4,010	4,100
TOTAL	11,420	11,780	12,060	12,260	12,500	12,760	13,060	13,390	13,720
EXPENDITURES (thousands of 1979 dollars)									
General government	1,190	1,230	1,260	1,280	1,300	1,330	1,360	1,390	1,430
Public safety	1,530	1,580	1,610	1,640	1,670	1,700	1,740	1,790	1,830
Public works	7,890	4,140	4,250	4,330	4,430	4,520	4,630	4,750	4,860
Health and welfare	60	60	60	60	60	70	70	70	70
Recreation and culture	760	780	800	810	830	850	870	890	910
Debt service	760	810	810	810	900	800	620	620	620
TOTAL	12,210	8,610	8,800	8,940	9,190	9,270	9,290	9,510	9,730

^aData computed by Larry Adcock and Associates. Detail may not equal total because of rounding.

Table M-8. Carlsbad Municipal Finances: Impact of the WIPP Project^a

Revenue source or expenditure	1980-81	1981-82	1982-83	1983-84	1984-85	1985-86	1986-87	1987-88	1988-89
REVENUES (thousands of 1979 dollars)									
Own source									
Taxes	6	22	39	34	20	16	18	19	20
Charges and miscellaneous	38	130	211	162	81	74	90	94	95
Intergovernmental transfers									
State	30	106	174	136	71	65	79	83	83
Federal	5	18	29	23	12	11	13	14	14
Other	20	70	114	90	46	43	52	54	55
TOTAL	99	346	567	445	231	209	251	265	266
EXPENDITURES (thousands of 1979 dollars)									
General government	12	43	70	55	28	26	32	33	34
Public safety	16	55	90	71	37	34	41	43	43
Public works	47	161	262	200	99	90	109	115	116
Health and welfare	1	2	4	3	1	1	2	2	2
Recreation and culture	8	27	45	35	18	17	20	21	21
TOTAL	83	288	470	363	184	169	204	214	216

^aData computed by Larry Adcock and Associates. Detail may not equal total because of rounding.

Table M-9. Loving Municipal Finances: Baseline^a

Revenue source or expenditure	1980-81	1981-82	1982-83	1983-84	1984-85	1985-86	1986-87	1987-88	1988-89
REVENUES (thousands of 1979 dollars)									
Own source									
Taxes	18	18	19	19	20	20	20	21	21
Charges and miscellaneous	162	165	168	170	176	178	181	186	191
Intergovernmental transfers									
State	46	46	47	48	49	50	51	52	53
Federal	18	18	18	19	19	19	20	20	21
Local	63	64	65	66	68	69	70	72	74
TOTAL	307	312	317	322	332	337	342	351	360
EXPENDITURES (thousands of 1979 dollars)									
General government	35	36	36	37	38	38	39	40	41
Public safety	77	78	79	80	82	84	85	87	89
Public works	165	169	172	175	180	183	186	191	196
Health and welfare	6	6	6	6	6	6	6	7	7
Recreation and culture	11	11	11	11	11	12	12	12	12
Debt service	20	21	22	23	24	25	26	28	29
TOTAL	314	320	326	332	342	348	354	364	375

^aData computed by Larry Adcock and Associates. Detail may not equal total because of rounding.

Table M-10. Loving Municipal Finances: Impact of the WIPP Project^a

Revenue source or expenditure	1980-81	1981-82	1982-83	1983-84	1984-85	1985-86	1986-87	1987-88	1988-89
REVENUES (thousands of 1979 dollars)									
Own source									
Taxes	(b)	1	1	1	(b)	(b)	1	1	1
Charges and miscellaneous	3	8	13	9	4	5	5	6	6
Intergovernmental transfers									
State	1	2	3	2	1	1	1	1	1
Federal	(b)	1	1	1	(b)	(b)	(b)	1	1
Local	1	1	1	1	1	1	1	1	1
TOTAL	5	12	19	14	7	7	8	9	9
EXPENDITURES (thousands of 1979 dollars)									
General government	1	1	2	2	1	1	1	1	1
Public safety	2	3	4	3	2	2	2	2	2
Public works	3	9	14	10	5	5	6	6	6
Health and welfare	(b)	(b)	(b)	(b)	(b)	(b)	(b)	(b)	(b)
Recreation and culture	(b)	(b)	(b)	(b)	(b)	(b)	(b)	(b)	(b)
Debt service	(b)	(b)	(b)	1	1	1	1	1	2
TOTAL	6	14	22	16	9	9	10	12	12

^aData computed by Larry Adcock and Associates. Detail may not equal total because of rounding.

^bLess than \$500.

01-M-10

Table M-11. Eddy County Finances: Baseline^a

11-11

Revenue source or expenditure	1980-81	1981-82	1982-83	1983-84	1984-85	1985-86	1986-87	1987-88	1988-89
REVENUES (thousands of 1979 dollars)									
Own source									
Taxes	2,380	2,420	2,440	2,460	2,490	2,510	2,540	2,570	2,600
Charges and miscellaneous	1,780	1,820	1,850	1,880	1,910	1,950	2,000	2,040	2,090
Intergovernmental transfers									
State	610	620	630	640	650	660	680	700	710
Federal	870	890	910	920	940	960	980	1,000	1,030
TOTAL	5,640	5,750	5,840	5,900	5,980	6,080	6,190	6,310	6,440
EXPENDITURES (thousands of 1979 dollars)									
General government	1,380	1,410	1,440	1,460	1,480	1,510	1,550	1,590	1,620
Public safety	780	790	810	820	830	850	870	890	910
Public works	1,820	1,860	1,890	1,920	1,950	1,990	2,040	2,090	2,140
Health and welfare	380	390	400	400	410	420	430	440	450
Recreation and culture	100	110	110	110	110	110	120	120	120
TOTAL	4,460	4,570	4,650	4,700	4,780	4,880	5,000	5,120	5,250

^aData computed by Larry Adcock and Associates. Detail may not equal total because of rounding.

Table M-12. Eddy County Finances: Impact of the WIPP Project^a

Revenue source or expenditure	1980-81	1981-82	1982-83	1983-84	1984-85	1985-86	1986-87	1987-88	1988-89
REVENUES (thousands of 1979 dollars)									
Own source									
Taxes	4	20	40	44	28	18	19	21	22
Charges and miscellaneous	6	20	32	25	13	12	14	15	15
Intergovernmental transfers									
State	4	15	24	19	10	9	11	11	12
Federal	6	20	33	26	13	12	15	16	16
TOTAL	20	74	129	113	64	51	59	64	64
EXPENDITURES (thousands of 1979 dollars)									
General government	10	33	55	43	22	20	25	26	26
Public safety	5	19	31	24	12	12	14	15	15
Public works	12	44	72	57	29	27	33	34	34
Health and welfare	3	9	15	12	6	6	7	7	7
Recreation and culture	1	2	4	3	2	2	2	2	2
TOTAL	31	108	177	139	72	66	80	84	85

^aData computed by Larry Adcock and Associates. Detail may not equal total because of rounding.

M-12

Table M-13. Hobbs Municipal Finances: Baseline^a

Revenue source or expenditure	1980-81	1981-82	1982-83	1983-84	1984-85	1985-86	1986-87	1987-88	1988-89
REVENUES (thousands of 1979 dollars)									
Own source									
Taxes	1,110	1,140	1,180	1,210	1,250	1,280	1,310	1,330	1,350
Charges and miscellaneous	4,070	4,190	4,310	4,440	4,560	4,680	4,760	4,840	4,890
Intergovernmental transfers									
State	5,190	5,330	5,470	5,610	5,760	5,900	6,010	6,110	6,170
Federal	1,220	1,250	1,280	1,320	1,350	1,380	1,410	1,430	1,440
TOTAL^b	11,590	11,920	12,240	12,580	12,930	13,240	13,490	13,720	13,860
EXPENDITURES (thousands of 1979 dollars)									
General government	1,810	1,860	1,910	1,960	2,010	2,060	2,100	2,140	2,160
Public safety	2,320	2,380	2,450	2,510	2,580	2,640	2,690	2,740	2,760
Public works	3,580	3,690	3,800	3,920	4,040	4,140	4,220	4,290	4,330
Health and welfare	600	610	630	640	660	680	690	700	710
Recreation and culture	710	730	750	770	790	810	820	840	840
Debt service	670	670	670	670	670	670	670	670	650
TOTAL^b	9,690	9,950	10,200	10,470	10,750	10,990	11,180	11,360	11,450

^aData computed by Larry Adcock and Associates. Detail may not equal total because of rounding.

^bTotal includes approximately \$4000 in transfers not classified as State or Federal.

Table M-14. Hobbs Municipal Finances: Impact of the WIPP Project^a

Revenue source or expenditure	1980-81	1981-82	1982-83	1983-84	1984-85	1985-86	1986-87	1987-88	1988-89
REVENUES (thousands of 1979 dollars)									
Own source									
Taxes	3	13	23	21	12	9	11	12	12
Charges and miscellaneous	17	60	97	75	38	35	42	44	44
Intergovernmental transfers									
State	20	69	114	90	47	43	51	54	55
Federal	4	15	24	19	10	9	11	12	12
TOTAL	45	157	259	206	108	96	115	122	122
EXPENDITURES (thousands of 1979 dollars)									
General government	7	24	40	32	16	15	18	19	19
Public safety	9	31	51	40	21	19	23	24	24
Public works	16	55	89	69	34	31	37	39	40
Health and welfare	2	8	13	10	5	5	6	6	6
Recreation and culture	3	9	16	12	6	6	7	7	7
TOTAL	37	128	209	163	84	76	91	96	97

^aData computed by Larry Adcock and Associates. Detail may not equal total because of rounding.

M-14

Table M-15. Lea County Finances: Baseline^a

Revenue source or expenditure	1980-81	1981-82	1982-83	1983-84	1984-85	1985-86	1986-87	1987-88	1988-89
REVENUES (thousands of 1979 dollars)									
Own source									
Taxes	3,260	3,440	3,620	3,810	4,010	4,230	4,450	4,680	4,920
Charges and miscellaneous	1,340	1,380	1,400	1,430	1,460	1,500	1,520	1,550	1,570
Intergovernmental transfers									
State	560	580	590	600	610	630	640	650	660
Federal	1,070	1,090	1,110	1,140	1,160	1,180	1,210	1,230	1,250
TOTAL	6,240	6,480	6,730	6,980	7,250	7,530	7,820	8,110	8,400
EXPENDITURES (thousands of 1979 dollars)									
General government	1,410	1,440	1,470	1,500	1,530	1,560	1,590	1,620	1,650
Public safety	730	750	760	780	800	810	830	840	860
Public works	2,060	2,110	2,150	2,200	2,240	2,290	2,340	2,380	2,410
Health and welfare	400	410	420	430	440	450	460	460	470
Recreation and culture	10	10	10	10	10	10	10	10	10
Debt service	0	0	0	0	0	0	0	0	0
TOTAL	4,620	4,720	4,820	4,920	5,020	5,130	5,230	5,320	5,400

^aData computed by Larry Adcock and Associates. Detail may not equal total because of rounding.

Table M-16. Lea County Finances: Impact of the WIPP Project^a

Revenue source or expenditure	1980-81	1981-82	1982-83	1983-84	1984-85	1985-86	1986-87	1987-88	1988-89
REVENUES (thousands of 1979 dollars)									
Own source									
Taxes	2	7	14	15	10	6	6	7	7
Charges and miscellaneous	3	9	15	12	6	6	7	7	7
Intergovernmental transfers									
State	1	5	8	6	3	3	4	4	4
Federal	2	6	10	8	4	4	4	5	5
TOTAL	7	27	47	41	23	19	21	23	23
EXPENDITURES (thousands of 1979 dollars)									
General government	4	12	21	16	8	8	9	10	10
Public safety	2	6	11	8	4	4	5	5	5
Public works	5	18	30	24	12	11	14	14	14
Health and welfare	1	4	6	5	2	2	3	3	3
Recreation and culture	(b)	(b)	(b)	(b)	(b)	(b)	(b)	(b)	(b)
TOTAL	12	41	68	54	28	25	30	32	32

^aData computed by Larry Adcock and Associates. Detail may not equal total because of rounding.

^bLess than \$500.

Table M-17. Carlsbad School District Finances: Baseline^a

Revenue source or expenditure	1980-81	1981-82	1982-83	1983-84	1984-85	1985-86	1986-87	1987-88	1988-89
REVENUES (thousands of 1979 dollars)									
Operational fund	10,090	10,210	10,160	10,370	10,470	10,750	11,060	11,420	11,850
Other funds	3,960	4,040	4,070	4,160	4,220	4,320	4,440	4,570	4,720
TOTAL	14,060	14,250	14,230	14,530	14,690	15,070	15,500	15,990	16,580
EXPENDITURES (thousands of 1979 dollars)									
Operational fund	10,660	10,780	10,720	10,950	11,060	11,350	11,680	12,050	12,520
Other funds	2,660	2,690	2,670	2,730	2,760	2,830	2,910	3,010	3,120
Debt service	280	280	280	280	280	280	280	280	280
TOTAL	13,590	13,740	13,670	13,950	14,090	14,450	14,870	15,340	15,910

^aData computed by Larry Adcock and Associates. Detail may not equal total because of rounding.

M-17

Table M-18. Carlsbad School District Finances: Impact of the WIPP Project^a

Revenue source or expenditure	1980-81	1981-82	1982-83	1983-84	1984-85	1985-86	1986-87	1987-88	1988-89
REVENUES (thousands of 1979 dollars)									
Operational fund	109	372	617	493	262	240	290	305	309
Other funds	36	131	231	206	119	94	109	117	119
TOTAL	145	504	848	699	381	335	398	422	428
EXPENDITURES (thousands of 1979 dollars)									
Operational fund	115	393	652	521	276	254	306	322	327
Other funds	29	98	162	130	69	63	76	80	81
TOTAL	143	491	814	650	345	317	382	402	408

^aData computed by Larry Adcock and Associates. Detail may not equal total because of rounding.

M-18

Table M-19. Loving School District Finances: Baseline^a

Revenue source or expenditure	1980-81	1981-82	1982-83	1983-84	1984-85	1985-86	1986-87	1987-88	1988-89
REVENUES (thousands of 1979 dollars)									
Operational fund	600	600	610	620	640	640	650	670	680
Other funds	210	220	220	220	230	230	240	240	250
TOTAL	810	820	830	840	860	880	890	910	930
EXPENDITURES (thousands of 1979 dollars)									
Operational fund	670	680	690	700	720	730	740	760	780
Other funds	170	170	180	180	180	180	190	190	200
Debt service	10	10	20	20	30	40	50	60	70
TOTAL	850	870	890	900	930	950	980	1,010	1,040

^aData computed by Larry Adcock and Associates. Detail may not equal total because of rounding.

M-19

Table M-20. Loving School District Finances: Impact of the WIPP Project^a

Revenue source or expenditure	1980-81	1981-82	1982-83	1983-84	1984-85	1985-86	1986-87	1987-88	1988-89
REVENUES (thousands of 1979 dollars)									
Operational fund	3	17	27	24	12	10	14	17	17
Other funds	1	4	7	6	3	3	4	4	4
TOTAL	<u>4</u>	<u>21</u>	<u>34</u>	<u>30</u>	<u>15</u>	<u>13</u>	<u>17</u>	<u>21</u>	<u>21</u>
EXPENDITURES (thousands of 1979 dollars)									
Operational fund	4	19	31	27	13	11	15	19	19
Other funds	1	5	8	7	3	3	4	5	5
Debt service	(b)	(b)	(b)	1	1	2	2	3	3
TOTAL	<u>5</u>	<u>24</u>	<u>39</u>	<u>34</u>	<u>18</u>	<u>16</u>	<u>21</u>	<u>27</u>	<u>27</u>

^aData computed by Larry Adcock and Associates. Detail may not equal total because of rounding.

^bLess than \$500.

Table M-21. Hobbs School District Finances: Baseline^{a, b}

Revenue source or expenditure	1980-81	1981-82	1982-83	1983-84	1984-85	1985-86	1986-87	1987-88	1988-89
REVENUES (thousands of 1979 dollars)									
Operational fund	11,220	11,230	11,270	11,310	11,480	11,690	11,830	11,950	12,040
Other funds	2,030	2,040	2,060	2,090	2,130	2,170	2,200	2,230	2,250
TOTAL	13,250	13,280	13,330	13,400	13,610	13,870	14,030	14,180	14,300
EXPENDITURES (thousands of 1979 dollars)									
Operational fund	11,210	11,230	11,260	11,300	11,480	11,690	11,820	11,940	12,030
Other funds	1,590	1,600	1,600	1,610	1,630	1,660	1,680	1,700	1,710
Debt service	590	610	620	640	660	680	700	710	730
TOTAL	13,400	13,430	13,480	13,550	13,720	14,020	14,200	14,350	14,480

^aData computed by Larry Adcock and Associates. Detail may not equal total because of rounding.

^bThe effect of possible new school buildings is not included.

Table M-22. Hobbs School District Finances: Impact of the WIPP Project^{a,b}

Revenue source or expenditure	1980-81	1981-82	1982-83	1983-84	1984-85	1985-86	1986-87	1987-88	1988-89
REVENUES (thousands of 1979 dollars)									
Operational fund	42	150	252	203	108	98	119	124	124
Other funds	7	26	45	39	22	18	21	23	23
TOTAL	49	176	297	242	131	117	140	147	147
EXPENDITURES (thousands of 1979 dollars)									
Operational fund	42	150	252	202	108	98	119	124	124
Other funds	6	21	36	29	15	14	17	18	18
TOTAL	48	172	288	231	124	112	136	142	142

^aData computed by Larry Adcock and Associates. Detail may not equal total because of rounding.

^bThe effect of possible new school buildings is not included.

M-22

CONTENTS

	<u>Page</u>
N.1 Leaving the Waste in Place, as Is.....	N-1
N.1.1 Description of Operations.....	N-1
N.1.2 Environmental Effects.....	N-1
N.1.3 Radiological Risk to Public.....	N-2
N.1.4 Hazards to Workers.....	N-3
N.1.5 Costs.....	N-4
N.2 Improving In-Place Confinement of Stored Waste.....	N-4
N.2.1 Description of Operations.....	N-4
N.2.2 Environmental Effects.....	N-4
N.2.3 Radiological Risk to Public.....	N-5
N.2.4 Hazards to Workers.....	N-5
N.2.5 Costs.....	N-6
N.3 Retrieving, Processing, and Disposing of the Waste at the INEL....	N-7
N.3.1 Description of Facilities and Operations.....	N-7
N.3.2 Environmental Effects.....	N-8
N.3.3 Radiological Risk to the Public.....	N-9
N.3.4 Hazards to Workers.....	N-11
N.3.5 Costs.....	N-12
N.4 Conclusions.....	N-12
References.....	N-15

LIST OF FIGURES

	<u>Page</u>
N-1 Summary of consequences from dominant long-term release scenarios for all on-site disposal methods discussed.....	N-11

LIST OF TABLES

	<u>Page</u>
N-1 Summary of dose commitments for leaving the stored waste in place, as is.....	N-3
N-2 Summary of dose commitments from disruptive events for approach with in-place immobilization of waste.....	N-6
N-3 Nonradiological impacts of disposal.....	N-10
N-4 Estimated costs of on-site disposal for stored waste.....	N-13

Appendix N

**EFFECTS OF LEAVING THE
TRU WASTE AT IDAHO**

Appendix N

EFFECTS OF LEAVING THE TRU WASTE AT IDAHO

If no TRU-waste repository away from the current storage locations becomes available, there will be three general alternatives for managing stored TRU waste:

1. The waste could be left in place, as is. A delay in making a decision on what to do with the waste would amount to a temporary selection of this alternative.
2. Improved in-place confinement could be provided for the waste.
3. The waste could be retrieved, processed, and disposed of at another location at the storage site.

This appendix discusses these alternatives in terms of the methods that might be used at the Idaho National Engineering Laboratory (INEL), the source of the waste to be received at the WIPP; similar methods might be used at other storage locations.

This appendix is based on a detailed report (DOE, 1979) that contains the full analyses and discussions. The evaluations presented here cover only the TRU waste expected to have been stored at the INEL Radioactive Waste Management Complex (RWMC) by 1985. The effects of waste that might be received after 1985 are addressed in the detailed report.

N.1 LEAVING THE WASTE IN PLACE, AS IS

N.1.1 Description of Operations

In this alternative, the stored TRU waste would be left in place, as is. A cover of plywood, polyvinyl sheeting, and 3 feet of earth over the waste would be maintained. The present environmental monitoring and sampling procedures would be continued, with improved procedures incorporated as they are developed. In accordance with the proposed criteria of the Environmental Protection Agency (EPA, 1978), it was conservatively assumed that the maintenance and monitoring procedures would continue for only 100 years.

N.1.2 Environmental Effects

In the near future (i.e., up to 100 years after the implementation of a waste-management alternative), the environmental effects of this alternative would be essentially the same as those measured to date for operations in the Transuranic Storage Area (TSA) at the INEL. Radiation doses received by people near the covered waste would be approximately the natural-background doses. The nonradiological effects normally associated with construction projects (e.g., excavation of soil, use of motor fuels, emissions from construction

equipment, and socioeconomic impacts from an influx of workers) would not be present. Thus, the effects on the environment, in the near term, would be the smallest of any of the alternatives considered.

The long-term environmental effects of this alternative would be associated with the disruptions caused by natural disasters or human intrusion.

N.1.3 Radiological Risk to the Public

The hundred years of monitored, normal waste-management operations would not be a hazard to the public under this alternative. Rather, the hazards in both the near and the distant future would be associated with waste disruption by natural disasters. Table N-1 shows the results of dose-commitment evaluations for the most important natural disasters. The evaluations were based on hypothetical releases occurring in the year 2085, when the monitoring was assumed to stop. The effects from releases occurring in the more distant future are presented in Section N.3, where they are compared with the long-term effects of other alternatives. Risks were not evaluated because of the great uncertainties in estimating the probabilities of disruptive events many years in the future.

The scenarios leading to the largest dose commitments involve waste disruption by volcanic action or by future populations inadvertently intruding upon the site. The RWMC lies near the edge of the Arco Volcanic Rift Zone, which was the site of volcanic action as recently as 10,500 years ago and is likely to become active in the future (Kuntz, 1978). In an explosive eruption, molten lava encounters groundwater at a relatively small depth beneath the surface of the earth; a small but significant number of eruptions in the eastern Snake River Plain have been of this type in the past. A fraction of the waste could thereby become airborne and be carried off the site. This event is of extremely low probability.

In a related scenario, lava flow from outside the immediate area could cover the RWMC. The waste could be disrupted, and a fraction could become airborne and be carried off the site. The lava-flow scenario is the more probable of these two scenarios, because eruptions originating in a larger area could deliver flows to the RWMC. As long as the cover over the waste were maintained, the effects would probably be minimal. However, if the waste were left in place indefinitely after maintenance operations cease, the cover would erode away, and releases of radionuclides could occur (Table N-1). The relative severities of the two scenarios for volcanic action are the subject of continuing studies. The results presented here are based on conservative assumptions and may overestimate greatly the quantity of radionuclides that would be released.

Another important scenario is future intrusion by small groups of people onto the waste site after institutional controls have lapsed. These people are assumed to live on the waste site, plow the land, eat food raised there, and dig into the waste looking for artifacts or construction materials. Over a 50-year period people living on the waste site could receive the dose commitments listed in Table N-1.

Table N-1. Summary of Dose Commitments for Leaving the Stored Waste in Place, as Is^a

Disruptive event	Maximum individual 50-year dose commitment (rem)		
	Whole body ^b	Bone	Lung
Explosive volcano	6 x 10 ⁻³	8	20
Earthquake	2 x 10 ⁻⁸	2 x 10 ⁻⁵	4 x 10 ⁻⁵
Mackay Dam failure	3 x 10 ⁻⁹	1 x 10 ⁻⁴	NA ^e
Volcanic lava flow ^{c,d}	3 x 10 ⁻²	50	90
Intrusion			
Ingestion	7	400	NA
Inhalation	10	500	700

Disruptive event	Population ^f 50-year dose commitment (man-rem)		
	Whole body ^g	Bone	Lung
Explosive volcano	40	40,000	80,000
Earthquake	1 x 10 ⁻⁴	1 x 10 ⁻¹	2 x 10 ⁻¹
Mackay Dam failure	1 x 10 ⁻⁸	5 x 10 ⁻⁴	NA
Volcanic lava flow ^{c,d}	100	200,000	400,000
Intrusion			
Ingestion	70	4,000	NA
Inhalation	90	4,000	6,000

^aData from DOE (1979).

^bThe whole-body dose received from natural background radiation during the 50 years is about 7.5 rem.

^cOverburden is assumed to resist lava flow as long as maintenance is continued. Release is assumed to occur 100 years after implementation, when maintenance has been discontinued.

^dThe dose-commitment calculations for this scenario are subject to large uncertainties.

^eNA = not applicable.

^fPopulation = 130,000 except for intrusion, where it is 10.

^gThe whole-body population dose received from the natural background radiation during the 50 years is about 1,000,000 man-rem for the larger population and about 75 man-rem for the population affected by intrusion.

Flooding of the RWMC could result from failure of the Mackay Dam, which is about 42 miles upstream on the Big Lost River. The dam could fail because of faulty design or construction, degradation, or seismic activity. This disruptive event is also listed in Table N-1.

N.1.4 Hazards to Workers

Experience at the RWMC indicates that hazards to workers for this alternative would be small. Maintenance and surveillance workers would receive radiation doses that are barely distinguishable from those delivered by natural background radiation.

N.1.5 Costs

The estimated cost of continuing the present program of maintenance and surveillance for the Transuranic Storage Area is \$600,000 annually. (The number of years for which maintenance and surveillance would be continued cannot be projected with confidence.) Upgrading the program could increase this cost. In addition, capital costs for the periodic replacement of some equipment items would be less than one-tenth of the operations cost.

N.2 IMPROVING IN-PLACE CONFINEMENT OF STORED WASTE

N.2.1 Description of Operations

This alternative provides additional in-place protection for the waste. Protection would be provided against penetration by water and intrusion by people, animals, and plant roots. This discussion covers two approaches for constructing confinement barriers for the waste (a barrier over the top and sides and barriers over the top, sides, and bottom) and one immobilization approach.

In the top-and-side-barrier approach, an additional 10-foot cover of compacted clay and a 3-foot cover of basalt riprap would be built up over the existing mounds on the storage pads.

In the top-side-and-bottom-barrier approach, increased isolation would be provided by pressure-grout sealing of the sediments beneath the asphalt pad. As long as the grout remained intact, it would be an additional barrier against downward migration of the waste. Assurance cannot be given, however, that the grout would remain intact for the thousands of years required for the radionuclides to become innocuous.

In the immobilization approach, the waste would be immobilized in place by injecting grout into the waste and into the sediments beneath the pad. The waste would thereby be encased in a massive, impermeable block of grout. The grout would not penetrate sound waste containers, which would be surrounded by the grout. This immobilization method would make any future retrieval extremely difficult.

For all of these methods of improved confinement, maintenance and surveillance would be continued as discussed in Section N.1.

N.2.2 Environmental Effects

Under normal operational conditions, there would be no near-term releases of radioactivity from any of the three improved-confinement methods and hence no dose commitments to the public. Direct radiation from the stored waste would be reduced by the shielding of the mound over the waste, and radiation exposures at the surface of the mound would be expected to be near background levels. Long-term environmental effects would be associated with the disruptive events considered in the risk analysis below.

Nonradiological effects would be those resulting from the use of materials, energy, and labor. For example, it is estimated that 30,000 cubic yards of clay and 12,000 cubic yards of basalt riprap would be required for the additional protective cover over the waste. An estimated 1000 cubic yards of grout and 13,000 cubic yards of concrete would be required for grouting beneath the waste. The immobilization approach would require an estimated 34,000 cubic yards of grout. The waste-management area is already disturbed, so there would be no additional loss of habitat or use of lands. A possible habitat loss might be expected at the playas from which clay would be extracted to construct the waste overburden. This impact would be minor.

N.2.3 Radiological Risk to the Public

For the three confinement approaches discussed, the risk associated with the confinement operations themselves would be essentially zero. Only in the immobilization operation, in which grout-injection pipes would be forced through the clay cover and the pad, can a release scenario associated with operations be postulated. During insertion and withdrawal, the grout-injection pipes would be provided with external containment to prevent the spread of contamination. The hazards from waste-management operations would be much smaller than those from the disruption of the waste by such events as volcanic activity or human intrusion.

The ability of improved confinement to resist disruptive natural events is difficult to assess. This ability would undoubtedly decrease as the engineered barriers deteriorate. A credit, ranging in value from a factor of 1 to a factor of 1000, has been taken for the beneficial effects of the barriers in reducing the release quantities.

The dose commitments for disruptive-event scenarios, assumed to occur in the year 2085, were estimated. (The effects from releases occurring in the more distant future are presented in Section N.3.) For the two approaches involving confinement barriers, the dose commitments are similar to the corresponding dose commitments listed in Table N-1. The similarity stems from the worst-case assumption that the maintenance of the confinement barriers would cease in the year 2085 and that the erosion of the barriers would occur immediately thereafter.

The dose-commitment results for the immobilization approach are summarized in Table N-2. A comparison of these data with those in Table N-1 shows the beneficial effects of the immobilization in reducing the severity of releases, at least for 100 years.

N.2.4 Hazards to Workers

For this alternative, hazards to workers would be only slightly greater than those for the alternative of leaving the waste as is. A low level of hazard would exist during immobilization operations, but waste-confinement measures for the immobilization operations are being developed.

Table N-2. Summary of Dose Commitments from Disruptive Events for Approach with In-Place Immobilization of Waste^a

Disruptive event	Maximum individual 50-year dose commitment (rem)		
	Whole body ^b	Bone	Lung
Explosive volcano	6×10^{-5}	8×10^{-2}	2×10^{-1}
Earthquake	2×10^{-10}	2×10^{-7}	4×10^{-7}
Mackay Dam failure	3×10^{-11}	1×10^{-6}	NA ^e
Volcanic lava flow ^{c,d}	3×10^{-4}	5×10^{-1}	9×10^{-1}
Intrusion			
Ingestion	7×10^{-2}	4	NA
Inhalation	0.1	5	7
50-year background dose	7.5		

Disruptive event	Population ^f 50-year dose commitment (man-rem)		
	Whole body ^g	Bone	Lung
Explosive volcano	0.4	400	800
Earthquake	1×10^{-6}	1×10^{-3}	2×10^{-3}
Mackay Dam failure	1×10^{-10}	5×10^{-6}	NA
Volcanic lava flow ^{c,d}	1	2000	4000
Intrusion			
Ingestion	0.7	40	NA
Inhalation	0.9	40	60
50-year background dose	1×10^6		

^aData from DOE (1979).

^bThe whole-body dose received from natural background radiation during the 50 years is about 7.5 rem.

^cOverburden is assumed to resist lava flow as long as maintenance is continued. Release is assumed to occur 100 years after implementation, when maintenance has been discontinued.

^dThe dose-commitment calculations for this scenario are subject to large uncertainties.

^eNA = not applicable.

^fPopulation is 130,000 except for intrusion, where it is 10.

^gThe whole-body population does received from natural background radiation during the 50 years is about 1,000,000 man-rem for the larger population and about 75 man-rem for the population affected by intrusion.

N.2.5 Costs

The estimated costs for improving the confinement of TRU waste stored at the Transuranic Storage Area are summarized below. The number of years for which maintenance and surveillance would be continued cannot be projected with confidence. The costs are in millions of 1979 dollars (DOE, 1979).

Method	Capital	Annual operations and maintenance
Top and side barrier	1.9	0.6
Top, side, and bottom barriers	5.4	0.6
Immobilization	21	0.6

N.3 RETRIEVING, PROCESSING, AND DISPOSING OF THE WASTE AT THE INEL

In this alternative, the stored TRU waste would be retrieved from its present location, processed, and shipped to a disposal facility elsewhere at the INEL. The retrieval and processing of the stored waste would begin in 1985 or as soon thereafter as practicable.

N.3.1 Description of Facilities and Operations

Retrieval

The waste would be retrieved as described in Section 9.8.2.

Processing

Three possible methods were analyzed for processing the stored waste: (1) incineration by slagging pyrolysis, followed by packaging; (2) compaction, immobilization, and packaging; and (3) repackaging only. The first and third of these methods provide upper and near-lower bounds for the environmental effects of any waste-processing method that might ultimately be selected and implemented. The effects of these two bounding methods are presented here. The effects from compaction, immobilization, and packaging methods are discussed elsewhere (DOE, 1979) and are intermediate in magnitude.

Slagging pyrolysis and repackaging only are discussed in Section 9.8.3. The details of processing would be affected very little by the choice of the ultimate destination for the waste product.

On-site shipment

On-site shipment of processed waste would be by semitrailers pulled by standard truck tractors. The cast slag from slagging pyrolysis would be shipped in DOT-17C 55-gallon drums; each drum would weigh about 1360 pounds. The repackaged waste would be shipped in DOT-17C drums with 90-mil polyethylene liners; each drum would weigh about 260 pounds.

On-site disposal

Four on-site disposal methods were analyzed and are discussed below. Waste processed by any of the methods discussed previously could be disposed of by any of these disposal methods. All disposal methods would be designed to allow retrieval of the waste, if necessary, during an observation period.

Deep-rock disposal: shaft access. This method involves waste disposal in a vault a minimum of 800 feet below ground. Access to the vault would be provided by two shafts. The repository would be similar to the WIPP in design, but smaller and less complex. After waste emplacement and a retrievability period, the shafts would be filled with rock and plugged with concrete.

The conceptual location is in calcareous rocks in the Lemhi Mountain Range, in the northwestern corner of the INEL. Although this location is the only portion of the INEL that is not underlain by the Snake River Plain aquifer, it is believed to be hydrologically coupled to the aquifer. There is

also a possibility that limestone in the vault area would be found to be water-saturated. For these reasons, the area would have to be explored by core drilling and hole testing before proceeding further.

Deep-rock disposal: tunnel access. The conceptual location studied for this disposal method is about 3 miles from that studied for deep-rock disposal with shaft access. Two tunnels and a subsurface repository for the waste would be constructed. The repository would be identical with that described for the shaft-access disposal.

Engineered shallow burial at Site 14. This method involves engineered shallow burial in lacustrine sediments at the central area of the INEL known as Site 14. This area has the deepest known surface sediments at the INEL.

The facility would consist of underground concrete structures in a rectangular array. Each structure would be buried so that its top would be well below the original ground surface. Each structure would contain rooms running the length of the structure and would have a high ratio of solid material to void, obtained by the use of massive interlocking concrete blocks and by the use of a thick layer of natural material (clay and basalt riprap) to protect the concrete from the environment. Two hypothetical designs were used in the analysis, one with a less massive construction than the other in order to reduce cost.

Disposal in an engineered surface facility near the RWMC. The location studied for the engineered surface-disposal facility is in the southeastern corner of the RWMC, extending outside and to the south of the present fence. The surface soil in this area is typically 15 feet thick above a layer of basalt approximately 100 feet thick.

The engineered surface-disposal facility would consist of elongated, earth-covered concrete structures, each resting on the basalt base. Including the cover material, each structure would stand considerably above ground level. Each structure would contain a number of disposal rooms extending its full length.

The structure would be massive, with the intention of providing long-term containment of the waste. It would have a high ratio of solid material (reinforced concrete) to void, obtained by the use of massive interlocking concrete blocks. A thick layer of natural material (clay and basalt riprap) on top of the concrete would protect the concrete from the environment.

N.3.2 Environmental Effects

The environmental effects of retrieval, slagging pyrolysis, and repackaging are given in Section 9.8.

The shipment and disposal of waste at the INEL disposal locations would not result in significant radiological effects, at least in the near term (up to 100 years). The waste would be packaged to prevent the release of contamination during normal handling and shipping. There would be no exposure to the general population from normal operations because the waste would be shipped on committed roadways.

After the waste had been put in the disposal facility and the facility closed, long-term environmental effects of disposal would be associated principally with the disruption of the waste by natural disasters.

Nonradiological impacts would result from the use of land, energy, resources, and labor. These impacts are summarized in Table N-3 for the four disposal locations, including the less-massive variation of engineered shallow burial. Implementation of this variation would greatly reduce the amount of concrete required, as shown in the table.

The construction of roadways would remove some sagebrush habitat. The use of Site 14 would cause the loss of some of the crested wheatgrass, which was introduced to increase the grazing area on the INEL. Both of these effects would be minor. The use of either Lemhi Range site would cause a loss of 8000 acres of grazing land for cattle and sheep. (All but about 200 acres of this total would be in the form of a 2-mile-wide buffer zone around the disposal site. The buffer zone might be judged unnecessary after operations ceased, because of the protection afforded by the disposal facility itself.) About 200 acres of wildlife habitat would also be lost in the Lemhi Range, mostly because of the construction of the roadway.

N.3.3 Radiological Risk to the Public

The radiological risks associated with retrieval, slagging pyrolysis, and repackaging of waste are discussed in Sections 9.8.2.3 and 9.8.3.3.

For waste processed by slagging pyrolysis, the risk to the public during waste shipment and the operational phase of disposal would be thousands of times smaller than that associated with processing the waste. For the repackaged waste, the risk from shipment and from disposal operations would be about the same as that from processing.

Some of the disposal methods are designed for long-term integrity of the containment. Thus, calculations of hypothetical releases occurring in the year 2085 are of limited value. Figure N-1 shows the consequences of more distant releases (DOE, 1979) as a function of the time at which they occur. (Risks were not evaluated because of the uncertainties in estimating the probabilities of disruptive events thousands of years in the future.) For perspective, results are also shown for the other two alternatives discussed in this appendix. The figure is simplified in that the degradation of the waste confinement is assumed to occur instantaneously, rather than gradually. The increase in population dose shown for the first 100 years is a result of assumed population growth during that period.

In terms of population dose commitment, the dominant hypothetical release event after disposal is volcanic action, either an eruption up through the waste or lava flow over it from a nearby eruption. A fraction of the waste could thereby become airborne and be carried off the site.

All the other evaluated scenarios were found to produce lower population doses. Flooding is among these. The RWMC could be flooded by high water in the Big Lost River or by failure of the Mackay Dam. Such water would pond on the INEL, where most of it would evaporate. To reach the Snake River Plain

Table N-3. Nonradiological Impacts of Disposal^a

Disposal method and location	Construction				Operations		
	Man-months ^b	Particulate emissions ^b (10 ³ lb)	Diesel fuel ^b (10 ³ gal)	Land ^{b,c} (acres)	Concrete ^c (10 ³ yd ³)	Personnel ^c	Electricity ^c (10 ⁶ kW-hr/yr)
Deep-rock disposal: shaft access	924	36	330	205-210	2	39	3-6
Deep-rock disposal: tunnel access	924	36	330	206-211	5	31	2-4
Engineered shallow land disposal at Site 14	393	10.3	94	288-493	510-1200	19-28	0.13 - 0.26
Less-massive construction than above	288	8.3	76	185-266	14-41	10-19	0.13 - 0.26
Engineered surface disposal near the RWMC	246	8.1	73	41-115	380-1100	21-30	0.10 - 0.17

^aData from DOE (1979).

^bIncludes committed roadway.

^cRanges of values reflect the different output volumes of waste from the three processing methods studied. Higher values are for the repackage-only approach; lower values are for slagging pyrolysis.

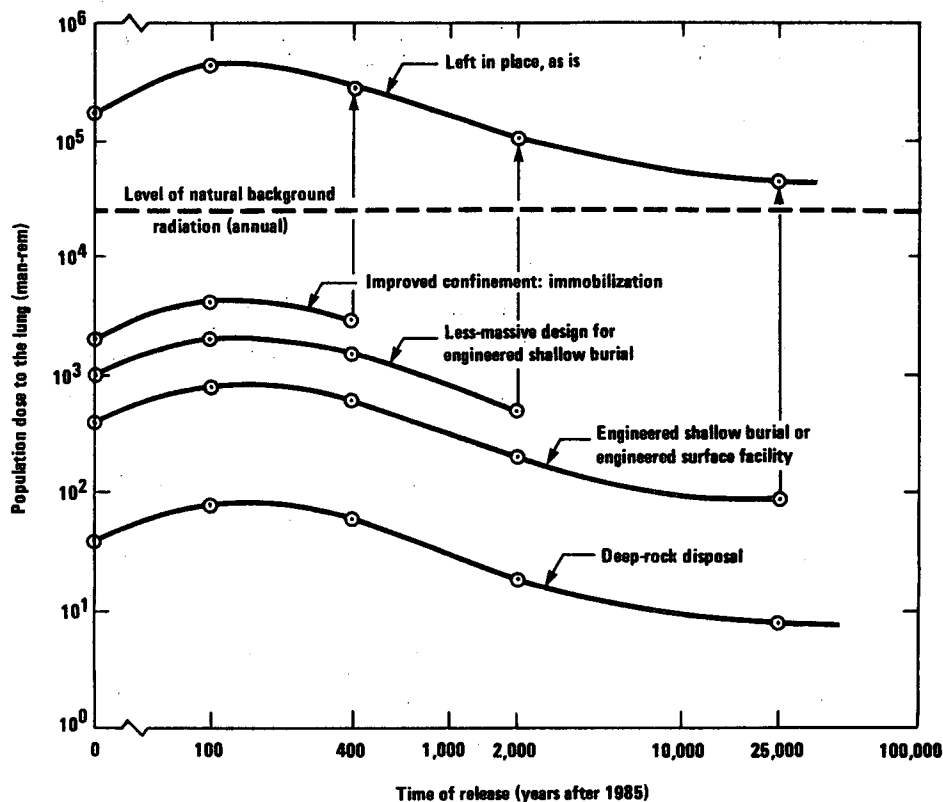

Figure N-1. Summary of consequences from dominant long-term release scenarios for all on-site disposal methods discussed.

aquifer, water would have to percolate downward through 580 feet of sediments and basalt. Flow in the aquifer is at the rate of 4 to 20 feet per day, but sorption would greatly slow the transport of TRU nuclides. Dispersion and decay would cause the resultant concentrations to be low. Indeed, the analysis indicates a greater, but still minor, hazard from the resuspension of TRU nuclides left on the surface after the evaporation of ponded water (DOE, 1979).

A significant scenario from the standpoint of individual doses is future intrusion on the waste site by individuals or small groups of people. These scenarios could result in individual doses as high as 200 rem to the bone or the lung. The population dose would be small because of the small number of people involved.

N.3.4 Hazards to Workers

The hazards to workers during waste-retrieval and processing operations are discussed in Sections 9.8.2.4 and 9.8.3.4, respectively.

During on-site shipment and disposal of waste, small radiation exposures would occur to the work force from direct radiation. Physical controls and

administrative procedures would be implemented to keep the radiation doses received by workers as low as practicable and within DOE standards (ERDA, 1977). Present experience with the handling of TRU waste shows that individuals directly involved in the operations do not receive maximum doses near the radiation-worker limit of 5 rem per year.

N.3.5 Costs

The estimated costs of retrieval and of processing for each of the three alternative methods evaluated are given below. These costs are identical with those given in Section 9.8.2.5 and 9.8.3.5; they are in millions of dollars (DOE, 1979).

Operation	Capital	Total O&M ^a	D&D ^b	Total
Retrieval	9	20	1	30
Slagging pyrolysis and packaging	372	226	13	635
Repackaging only	109	92	11	212

^aOperations and maintenance.

^bDecontamination and decommissioning.

The estimated costs for on-site shipment and disposal are summarized in Table N-4. For each disposal method, the costs are given for managing the waste form resulting from the two processing methods discussed. The estimated cost of the less-massive version of engineered shallow burial is consequently less than that of the other version; the difference is due principally to the smaller quantity of concrete required.

N.4 CONCLUSIONS

The result of having no off-site TRU-waste repository would be that the TRU waste stored in Idaho could be (1) left in place as is; (2) left in place with improved confinement being provided; or (3) retrieved, processed, and disposed of at the INEL.

No normal operational releases of radioactivity would be associated with the leave-in-place alternative or the improved-confinement alternative. In the short term (i.e., up to about 100 years), the alternative with retrieval, processing, and disposal at the INEL would result in a greater radiological impact than the two other alternatives. The largest radiological impact would result from normal operational releases from the slagging-pyrolysis process. During processing, a whole-body dose commitment of 1.9×10^{-7} millirem per year of operation or 3.6×10^{-3} millirem to the bone could be expected at the point of maximum airborne concentration (Table 9-70).

Table N-4. Estimated Costs of On-Site Disposal for Stored Waste
(Millions of Dollars)^a

Disposal method	Shipping	Capital	Total O&M ^b	D&D ^c	Total
Deep disposal in rock: shaft					
Slagging pyrolysis	2.7	36	103	0.3	142
Repackaging only	1.1	37	111	0.3	149
Deep disposal in rock: tunnel					
Slagging pyrolysis	2.7	37	96	0.3	136
Repackaging only	1.1	38	108	0.3	147
Engineered shallow burial					
Slagging pyrolysis	2.3	263	69	0.3	335
Repackaging only	1.4	604	73	0.4	679
Less-massive variation of engineered shallow burial					
Slagging pyrolysis	2.3	34	65	0.3	102
Repackaging only	1.4	79	69	0.4	150
Disposal in an engineered surface facility					
Slagging pyrolysis	NA ^d	154	70	0.2	225
Repackaging only	NA	451	74	0.2	526

^aData from DOE (1979).

^bFor each entry in this column, \$60 million of the operations-and-maintenance (O&M) costs stemmed from 100 years of maintenance and surveillance.

^cIncludes only costs associated with decontamination and decommissioning (D&D) of service facilities such as maintenance facilities. No D&D would take place for the disposal facilities themselves.

^dNA = not applicable.

During handling associated with shipment of processed waste to the INEL disposal locations, workers would be exposed to direct radiation from the waste packages. Experience indicates that the doses received by the workers will be well below the 5-rem/yr limit for radiation workers.

There would be no radiological exposures to the general population during normal operations for disposing of the waste at the INEL. The dominant waste-handling accident would be associated with the waste that has only been repackaged.

Over the long term (i.e., over more than about 100 years), natural disasters (floods, volcanoes, etc.) could occur, disrupting the waste and releasing radionuclides. Also, individuals and small groups of people could inadvertently come into contact with the waste. In terms of radiation doses to the surrounding population, volcanic action was determined to be the predominant

event for all of these alternatives. Although significant 50-year dose commitments could be delivered to maximally exposed persons in the volcanic-lava-flow scenario (90 rem to the lung) and the intrusion scenario (500 rem to the bone, 700 rem to the lung), no near-term fatalities from radiation would be expected to result from such events. Dose commitments this large are predicted only for the alternative of leaving the waste as is, without improving its confinement.

Nonradiological effects from any of the three alternatives discussed above would generally be limited to minor commitments of energy, resources, and labor. An exception is the large requirement of concrete for the massive structures for engineered surface disposal and for engineered shallow burial. The latter facility can be made less massive, using less concrete, with some sacrifice in long-term safety. This reduction in mass is probably not possible for the engineered surface-disposal facility, which would be openly exposed to the elements in an area of severe winters; significant rates of deterioration of the containment would then be expected over the long term.

Slagging pyrolysis would be the most costly of the processing methods studied, but the resulting waste product would be the safest. Furthermore, the reduced disposal costs resulting from the decreased volume of waste processed by slagging pyrolysis would tend to offset the increased cost of processing, particularly for disposal in massive concrete structures. Deep-rock disposal and the less-massive variation of engineered disposal would cost much less than the other disposal methods studied.

REFERENCES

DOE (U.S. Department of Energy), 1979. Environmental and Other Evaluations of Alternatives for Long-Term Management of Stored INEL Transuranic Waste (revised). DOE/ET-0081, Washington, D.C.

EPA (U.S. Environmental Protection Agency), 1978. Criteria for Radioactive Wastes, Federal Register, Vol. 43, No. 221, pp. 53262-53268, November 15, 1978.

ERDA (U.S. Energy Research and Development Administration), 1977. ERDA Manual, Chapter 0524, "Standards for Radiation Protection," Washington, D.C.

Kuntz, M. A., 1978. Geology of the Arco-Big Southern Butte Area, Snake River Plain, and Potential Volcanic Hazards to the Radioactive Waste Management Complex, and Other Waste Storage and Reactor Facilities at the Idaho National Engineering Laboratory, Idaho, Open-File Report 78-691, U.S. Geological Survey.

Appendix O

**INTERPRETATION OF THE RADIATION DOSES
PREDICTED IN THIS DOCUMENT**

CONTENTS

	<u>Page</u>
0.1 Radiation Doses and Dose Commitments.....	0-1
0.2 Methods for Interpreting Predictions of Radiation Doses.....	0-2
0.2.1 Method 1: Comparison with Natural Background Radiation.....	0-2
0.2.2 Method 2: Comparison with Official Standards.....	0-4
0.2.3 Method 3: Estimates of Health Effects.....	0-4
References.....	0-8

LIST OF TABLES

	<u>Page</u>
0-1 Estimated annual average whole-body doses from natural radiation in the United States.....	0-3
0-2 Health-effects risk factors used in this statement.....	0-7
0-3 Illustration of the use of risk factors to calculate radiation-induced deaths.....	0-7

LIST OF FIGURES

	<u>Page</u>
0-1 Suggested methods of determining the effects of low-level radiation by the extrapolation of existing data for high levels.....	0-6

Appendix O

INTERPRETATION OF THE RADIATION DOSES PREDICTED IN THIS DOCUMENT

Some of the analyses in this document predict the radiation doses and dose commitments that people may receive from activities associated with the WIPP. This appendix begins with a brief discussion of the meaning of these two quantities. It then describes the methods that this document uses for interpreting them.

O.1 RADIATION DOSES AND DOSE COMMITMENTS

The impacts of radiation from the WIPP are predicted in terms of two different quantities--dose and dose commitment--because people can receive two types of exposure to radiation: external exposure and internal exposure. An external exposure comes from a source outside the body; if the source is removed or the person moves away from it, the external exposure stops. A person who stands, for example, on a contaminated surface may receive an external exposure until he moves away from the surface. Internal exposure, on the other hand, comes from radioactive material inside the body. If such material is inhaled or ingested, part of it continues to irradiate body tissues until it decays or is eliminated by biological processes.

When this environmental impact statement predicts that a person will receive an external exposure to radiation, it also evaluates the biological damage done during the exposure by calculating the dose delivered to the person. Strictly speaking, it calculates the quantity called "dose equivalent," but this document, like most others of its type, uses the less awkward term "dose."

Internal exposures are evaluated in terms of "dose commitment," a quantity describing the effects of irradiation that continues after radioactive material has entered the body. A dose commitment is calculated by integrating, or summing, the annual dose received from radioactive nuclides inside the body; usually this integration is performed for a period of 50 years after intake. The integrated dose resulting from 1 year's intake of the material is then, by definition, the 50-year dose commitment from that intake. For radionuclides that decay quickly or are eliminated quickly, most of the dose commitment is received in a short period of time at the beginning of the 50 years; for longer-lived or longer-retained materials, it may be received over the entire 50 years. Tritium, for example, would deliver a dose commitment early in the 50-year period. Among the radionuclides that would deliver a dose commitment over a longer time are the actinide elements that are in the waste to be received at the WIPP.

Both dose and dose commitment are expressed in terms of a unit called rem, a measure of biological damage done by radiation.

When more than a few people are exposed to radiation, the quantities commonly used to describe the effects are population dose and population dose

commitment. Expressed in man-rem, these quantities are calculated by multiplying the number of exposed people by the average dose or dose commitment they receive. From estimates of population dose and dose commitment, it is possible, as explained below, to predict the health effects resulting from exposure.

0.2 METHODS FOR INTERPRETING PREDICTIONS OF RADIATION DOSES

Because most people are not familiar with measurements of radiation doses and dose commitments, the main text of this document provides, in addition to the predictions themselves, information intended to help the readers judge their significance. In providing such information, documents like this one can use three convenient methods: comparison of a predicted dose with the dose received from naturally occurring background radiation, comparison of a predicted dose with official standards intended to insure public safety, and estimation of the health effects that might arise from a predicted dose. This appendix briefly discusses these three methods of interpretation and explains how they are used in this document.

The remainder of this appendix is primarily a short summary of the more complete discussion in the draft generic environmental impact statement (GEIS) on the Management of Commercially Generated Radioactive Waste (U.S. Department of Energy, 1979). This appendix is not intended to be a complete tutorial essay on the effects of low-level radiation, nor does it take a position in the current controversies about the effects of low-level radiation. Interested readers can find full discussions elsewhere; the GEIS, for example, contains an extensive list of references, only a few of which are repeated here.

0.2.1 Method 1: Comparison with Natural Background Radiation

All people are exposed to radioactivity from natural sources. Cosmic rays from space arrive constantly at the earth; people receive radiation doses from the rays directly and from interactions between the rays and matter on earth. People also receive radiation doses from terrestrial sources: radioactive elements that exist in the earth's crust and in living tissue and radioactive elements that are produced when cosmic rays interact with stable elements. Because some of the radioactive elements exist inside the human body, the terrestrial sources contribute internal radiation doses as well as external radiation doses.

The doses received from these natural radiation sources vary from place to place. For example, the dose from cosmic rays increases with elevation, the average dose at about 6600 feet above sea level being double the dose at sea level; the external dose from terrestrial sources is higher in places where the rocks near the surface of the ground are richer in natural radioactive elements. The GEIS contains tables and text describing the doses from natural background radiation, and detailed discussions appear in the references cited there. Table O-1, taken from the GEIS, summarizes the average doses from natural radiation. In the text of this document the value usually used for the average

whole-body dose from natural radiation is 0.1 rem per year, slightly lower than the value in the table. This choice insures that the comparisons do not overestimate background doses even though they vary from place to place as explained above. When discussing events in Idaho, the text uses 0.15 rem per year because in that state the average annual dose from natural radiation is about 0.17 rem.

Table O-1. Estimated Annual Average Whole-Body Doses from Natural Radiation in the United States

Source	Annual dose (rem)
Cosmic rays	0.045
Terrestrial radiation	
External	0.060
Internal	<u>0.025</u>
Total	0.130

This document uses natural-background doses as a reference for comparison with the doses it predicts. Such a comparison is useful for at least two reasons. First, the natural-background dose has been reliably measured and is well understood; it is a number that is not likely to change significantly with new studies or with advances in the understanding of radiation effects. Second, comparisons with natural background are comparisons with radiation levels that all people have experienced; readers may use their own feelings about background radiation in evaluating the significance of the doses that the WIPP may add to the natural doses.

In spite of these two reasons, some opposition to comparisons with natural background radiation was expressed in public comments on the draft of this environmental impact statement. Some commentators seemed to feel that in making these comparisons the statement was tacitly assuming that natural-background levels are safe. Whether natural background radiation is dangerous or not is a complex question. Some authors have suggested that as many as 50% of human cancers are caused by natural radiation. Other investigators have pointed out that this hypothesis is not supported by available data, such as the observed cancer rates in different places where natural radiation varies widely; some investigators have even found negative correlations between natural radiation and health effects. According to the majority of studies, the effects of natural radiation are so small that they are likely to be undetectable among the effects of other sources of human ill health.

Like the GEIS, this document does not take a position on the question of whether natural background radiation is responsible for health effects in human beings. It uses the doses received from natural background radiation only as an easily understood reference. Reasoning from the information that the predicted doses are lower than natural-background doses, members of the public and government officials can decide for themselves whether radiation from the WIPP would be significant.

0.2.2 Method 2: Comparison with Official Standards

Radiation standards are set at levels that, in the judgment of experts, will protect people from ill effects. Comparing predicted doses with these standards is, therefore, a simple way of identifying doses that can be labeled "safe" in a way that has a well-defined meaning.

A difficulty with explaining radiation doses by such comparisons is the confusion that can arise because standards are subject to change. The agencies that set radiation standards have, in fact, recently received requests both to lower and to raise some current standards. A further confusion sometimes arises because the standards that apply to members of the general public are different from those that apply to workers in industries that use radiation. For these reasons, this document seldom uses official standards as a reference for comparison with predicted doses.

0.2.3 Method 3: Estimates of Health Effects

Acute effects

The doses predicted for the routine operation of the WIPP are too low to produce acute, or prompt, health effects, which appear only at higher doses. According to the National Council on Radiation Protection and Measurements (1974a, pp. 44-46), changes in white blood cells are not found easily at doses below 50 rem. Specialized analyses of chromosomes can detect changes from doses in the range of 5 to 25 rem, but "the biological significance, if any, of these changes is unknown at present." The lowest doses that produce visible evidence that a person has been affected by radiation are in the range of 75 to 125 rem, which is the "minimal dose likely to produce vomiting in about 10% of people so exposed." The routine operation of the WIPP is not predicted to deliver doses in even the lowest of these ranges.

The analysis of accidents during the transportation of waste predicts upper-limit dose commitments of 3T rem to the bone from the worst accidents, which are highly unlikely. These doses would be delivered over a 50-year period and would therefore not be expected to produce acute health effects.

The only higher doses predicted in this document appear in the analyses that study upper limits to intentional destructive acts (Chapter 6) and to hypothetical long-term releases of waste left in storage at Idaho (Appendix N). These whole-body dose commitments might reach levels that would produce nausea and vomiting in some people if the doses were delivered in brief external exposures rather than over 50 years. While such prompt effects are not to be expected from 50-year dose commitments, it is difficult to predict whether they might occur at some time during the 50 years. As the National Council on Radiation Protection and Measurements points out, there are no reliable data on the relation between internal dose and whole-body external dose (1974b, p. 37).

Delayed effects

Although there is little possibility of acute illness from the doses predicted in this document, exposure to them might be expected to produce effects

noticeable after times measured in years. These delayed health effects are of two types: somatic effects, which are principally cancers, and genetic effects, which arise from alterations or rearrangements of genes in living cells. The GEIS lists four kinds of disease associated with genetic effects, and it points out that there may also be other genetic influences on physical and mental health. Because these other influences are poorly defined, however, the studies that try to predict the genetic effects of low-level radiation simply assume values that appear to be the highest possible ones.

Using health effects as a method of explaining radiation doses has the apparent advantage that the public can understand numerical predictions of deaths more easily than predictions of doses expressed in unfamiliar units. The disadvantage of using health effects is that interpreting predictions of possible deaths is less simple than it might appear to be; the scientific basis for such predictions is complex and controversial.

The complexity and controversy stem from the difficulty of measuring the effects of low-level radiation. The doses predicted in this statement lie far below the doses for which health effects in people have been measured directly. Almost all of the directly measured data are for doses near 100 rem and higher; they show that the magnitude of health effects increases with the radiation dose (Figure O-1). To predict the effects of lower doses requires extrapolation of these data, and extrapolation to doses like those predicted for the WIPP is subject to large uncertainty; the doses from the routine operation of the WIPP generally lie in the range below 0.1 rem, a thousand times lower than the direct measurements. Some authorities feel that the direct data can be meaningfully extrapolated to lower doses simply by drawing a straight line on a graph that shows health effects as a function of dose (Figure O-1). Other investigators feel that this linear extrapolation underestimates health effects at low doses; they prefer a "superlinear" extrapolation like the one shown in Figure O-1. Still other investigators feel that at low doses the human body can at least partially repair the damage induced by radiation; this theory would support an extrapolation like the one labeled "sublinear" in Figure O-1.

It is difficult to decide experimentally which extrapolation procedure is correct, because the effects of radiation at low doses are almost impossible to separate from similar effects exerted by other agents in the biosphere. In the absence of definitive experiments, most groups of experts recommend the use of the linear hypothesis for making predictions intended to protect the health of the public. The predictions made in this document therefore implicitly contain the linear extrapolation. Because the linear hypothesis remains unproved at low doses, however, the health effects of radiation doses below natural-background levels must be predicted as possibilities, not as certainties.

For the interpretation of radiation doses, the GEIS presents "risk factors" that convert predictions of population doses to predictions of health effects. These risk factors were derived from the literature dealing with the somatic and the genetic effects of low-level radiation. A discussion of the derivation appears in Appendix E of the GEIS. For convenience, the references consulted in the derivation are listed here: the BEIR Report issued by the National Academy of Sciences (1972), the UNSCEAR Report issued by the United Nations Scientific Committee on the Effects of Atomic Radiation (1977), publications on the uranium fuel cycle issued by the U.S. Environmental Protection Agency (1973a, 1973b, 1976), the Reactor Safety Study issued by the U.S. Nuclear Regulatory

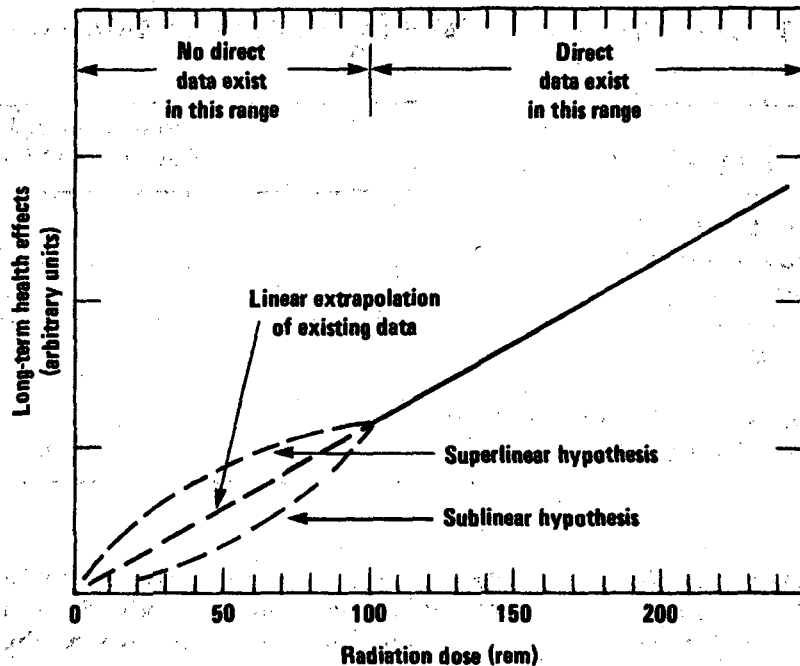

Figure 0-1. Suggested methods of determining the effects of low-level radiation by the extrapolation of existing data for high levels. For clarity, the curves exaggerate the differences from the linear extrapolation. Predicted doses from the WIPP are mostly in the dose range below 1 rem, where extrapolations are highly uncertain.

Commission (1975), and a report issued by the Medical Research Council in England (1975).

Table 0-2, taken from the GEIS, lists the health-effects risk factors used in this statement. There are two types of risk factors in Table 0-2: those expressing somatic effects as numbers of fatal cancers and those expressing genetic effects. The somatic effects are further divided among cancers arising from four different kinds of exposure. The health effects predicted by the risk factors in Table 0-2 are delayed effects that would occur years after the exposure. The predicted deaths would occur throughout the lifetimes of the people who receive the dose; the genetic effects are the total numbers that would occur in all generations after the exposure. Because the reports listed above do not agree on single values for each of these risk factors, the entries in Table 0-2 are ranges that encompass the reported values.

Table O-2. Health-Effects Risk Factors Used in This Statement

Type of effect	Predicted incidence per 1 million man-rem
Fatal cancers from	
Whole-body exposure	50-500
Lung exposure	5-50
Bone exposure	2-10
Thyroid exposure	3-15
Genetic effects in all generations from whole-body exposure	50-300

The risk factors in Table O-2 can be explained by the example of whole-body exposure. If a population received a total whole-body dose of 1 million man-rem, the number of fatal cancers induced by the exposure might lie between 50 and 500. Such a population dose could arise, for example, if each of 1 million people received a dose of 1 rem; it could arise if each of 100 million people received a dose of 0.01 rem.

Table O-3 illustrates the use of the risk factors. It presents the numbers of fatal cancers that might develop if populations of various sizes received whole-body doses of various magnitudes. The risk factors that count other effects of exposure can be used similarly.

Table O-3. Illustration of the Use of Risk Factors To Calculate Radiation-Induced Deaths

Population	Average whole-body dose (rem)	Population dose (man-rem)	Predicted fatal cancers
10,000	0.01	100	0.005-0.05
10,000	0.1	1,000	0.05-0.5
100,000	0.001	100	0.005-0.05
100,000	0.01	1,000	0.05-0.5
100,000	0.02	2,000	0.1-1
100,000	0.1	10,000	0.5-5
1,000,000	0.1	100,000	5-50

REFERENCES

- Medical Research Council, 1975. Toxicology of Plutonium, London, England.
- National Academy of Sciences-National Research Council, 1972. The Effects on Populations of Exposure to Low Levels of Ionizing Radiation, a report by the Advisory Committee on the Biological Effects of Ionizing Radiations, Washington, D.C.
- National Council on Radiation Protection and Measurements, 1974a. Basic Radiation Protection Criteria, NCRP Report No. 39, second reprinting, Washington, D.C.
- National Council on Radiation Protection and Measurements, 1974b. Radio-logical Factors Affecting Decision-Making in a Nuclear Attack, NCRP Report No. 42, Washington, D.C.
- U.S. Department of Energy, 1979. Draft Environmental Impact Statement, Management of Commercially Generated Radioactive Waste, DOE/EIS-0046-D, Washington, D.C.
- U.S. Environmental Protection Agency, 1973a. Environmental Analysis of the Uranium Fuel Cycle, Part I, "Fuel Supply," EPA-520/9-73-003-B, Wash-ington, D.C.
- U.S. Environmental Protection Agency, 1973b. Environmental Analysis of the Uranium Fuel Cycle, Part II, "Nuclear Fuel Reprocessing," EPA-520/9-73-003-D, Washington, D.C.
- U.S. Environmental Protection Agency, 1976. Environmental Radiation Protection for Nuclear Power Operations, Proposed Standard (40 CFR 190), Washington, D.C.
- U.S. Nuclear Regulatory Commission, 1975. Reactor Safety Study--An Assess-ment of Accident Risks in U.S. Commercial Nuclear Power Plants, Appendix VI, WASH-1400 (NUREG-75/014), Washington, D.C.

Appendix P

**COMMENTS FROM FEDERAL AND STATE AGENCIES
ON THE DRAFT ENVIRONMENTAL IMPACT STATEMENT
FOR THE WASTE ISOLATION PILOT PLANT**

CONTENTS

	<u>Page</u>
<u>Comments from Federal Agencies</u>	
Congress of the United States, Representative Kent Hance	P-5
U.S. Arms Control and Disarmament Agency	P-8
U.S. Department of Health, Education and Welfare	P-10
U.S. Department of the Interior	P-12
U.S. Environmental Protection Agency	P-37
U.S. Nuclear Regulatory Commission	P-52
U.S. Water Resources Council	P-110
 <u>Comments from State Agencies</u>	
Alaska (State of), Office of the Governor, Division of Policy Development and Planning.....	P-113
Arizona (State of), Clearinghouse	P-115
California (State of), Department of Conservation, Division of Mines and Geology	P-116
California (State of), Energy Resources Conservation and Development Commission.....	P-117
Colorado (State of), Department of Local Affairs, Division of Planning.....	P-119
Delaware (State of), Executive Department, Office of Management, Budget and Planning.....	P-120
Florida (State of), Department of Administration, Division of State Planning.....	P-121
Georgia (State of), Executive Department, Office of Planning and Budget.....	P-130
Illinois (State of), Executive Office of the Governor, Bureau of the Budget.....	P-132
Indiana (State of), State Board of Health.....	P-133
Kansas (State of), Department of Administration, Division of State Planning and Research.....	P-135

CONTENTS (continued)

	<u>Page</u>
Kentucky (Commonwealth of), Department of Natural Resources and Environmental Protection.....	P-136
Maryland (State of), Department of State Planning.....	P-137
Mississippi (State of), Office of the Governor, Planning and Coordination.....	P-138
Missouri (State of), Office of Administration.....	P-140
Nevada (State of), Governor's Office of Planning Coordination.....	P-141
New Mexico (State of), The Honorable Bruce King, Governor.....	P-142
New Mexico (State of), Bureau of Mines and Mineral Resources.....	P-145
New Mexico (State of), Department of Finance and Administration, Planning Division.....	P-146
New Mexico (State of), Department of Health and Environment, Environmental Evaluation Group.....	P-147
New Mexico (State of), Governor's Advisory Committee on WIPP	P-148
New Mexico, Office of the Attorney General, Department of Justice.....	P-150
New Mexico, Southeastern New Mexico Economic Development District.....	P-151
New York, Yates County Planning Board.....	P-153
North Carolina (State of), Department of Administration.....	P-155
North Dakota (State of), State Planning Division.....	P-156
Ohio (State of), State Clearinghouse.....	P-157
Oregon (State of), Executive Department, Intergovernmental Relations Division.....	P-160
Pennsylvania (Commonwealth of), Pennsylvania State Clearinghouse.....	P-161
Rhode Island (State of and Providence Plantations), Department of Administration, Statewide Planning Program.....	P-162

CONTENTS (continued)

	<u>Page</u>
South Dakota (State of), Office of Executive Management, State Planning Bureau.....	P-163
Texas (State of), Office of the Governor.....	P-164
Texas, Ward County (Richard Sitz, Judge).....	P-165
Utah (State of), Division of Policy and Planning Coordination.....	P-168
Vermont (State of), Office of the Governor, State Planning Office.....	P-170

Appendix P

COMMENTS FROM FEDERAL AND STATE AGENCIES
ON THE DRAFT ENVIRONMENTAL IMPACT STATEMENT
FOR THE WASTE ISOLATION PILOT PLANT

This appendix contains comments from Federal and state agencies on the draft environmental impact statement for the Waste Isolation Pilot Plant. Only the cover letters of the state government agencies are presented in this appendix. Copies of these comment letters in their entirety as well as all letters received from citizens groups and private persons, are available for public review at the following DOE public reading rooms:

Albuquerque Public Library
501 Copper Avenue Northwest
Albuquerque, New Mexico 87102

Carlsbad Public Library
Public Document Room
101 South Halaguene Street
Carlsbad, New Mexico 88220

Hobbs Public Library
509 North Shipp
Hobbs, New Mexico 88248

Thomas Brannigan Library
106 West Hadley
Las Cruces, New Mexico 88001

Roswell Public Library
301 North Pennsylvania Street
Roswell, New Mexico 88201

New Mexico Technical Library
Campus Station
Socorro, New Mexico 87801

Zimmerman Library
University of New Mexico
Albuquerque, New Mexico 87138

National Atomic Museum
Kirtland Air Force Base - East
Albuquerque, New Mexico 87115

COMMENTS FROM FEDERAL AGENCIES

KENT HANCE
18TH DISTRICT, TEXAS

DISTRICT OFFICES:
FEDERAL BUILDING, ROOM 611
LUSBOCK, TEXAS 79401
(806) 763-1611
FEDERAL BUILDING, ROOM 208
MIDLAND, TEXAS 79701
(915) 883-5407

Congress of the United States
House of Representatives
Washington, D.C. 20515

May 25, 1979

Mr. Eugene Beckett
Department of Energy
WIPP Project Office
MS B-107
Washington, D.C. 20545

Dear Mr. Beckett:

You will find attached written comments for inclusion and consideration at the public hearings being held on the draft environmental impact statement, DOE/EIS-0026-D, Waste Isolation Pilot Plant, Eddy County, New Mexico.

If you would please keep me advised as to the progress of this project, I would appreciate it.

Sincerely,

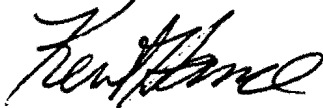

Kent Hance

KH:mpo

Attachment

ECTOR COUNTY DEMOCRATIC WOMEN'S CLUB
P. O. BOX 2944
ODESSA, TEXAS 79760

May 18, 1979

The Honorable Kent Hance
The House of Representatives
1039 Longworth Building
Washington, D. C. 20515

Re: Waste Isolation Pilot Plant
Near Carlsbad, New Mexico

Dear Congressman Hance:

The members of the Ector County Democratic Women's Club are opposed to the building of the Waste Isolation Pilot Plant (WIPP) near Carlsbad, New Mexico. The club reached his decision after consulting with members of the League of Women Voters of Odessa, Texas, and reviewing the League's in-depth study of this pilot plant. We agree with the League that this site is not sufficiently safe for long-term storage of large quantities of nuclear waste for the following reasons:

1. According to the hydrological studies conducted there are high pressure deposits of natural gas and water underlying the site which are potentially dangerous if the high pressure gas should ever force the water into the WIPP site. These natural gas deposits are potentially valuable sources of natural gas, but the WIPP site will remove them from usefulness.
2. There have been earthquakes as recently as the spring of 1978 in Winkler County, Texas, which is adjacent to Eddy County, New Mexico, the location of the proposed WIPP site.
3. The aquifers of southeastern New Mexico and southwestern Texas are too close to the chosen site. If any leakage should occur and seep into these water supplies, it could pollute a portion or the entire water supply of the area.

In addition wastes being delivered to the plant would be transported through the State of Texas, which is certainly a potential hazard to residents along the route.

If, however, the Carlsbad site is chosen we would like to see the following safeguards instituted as recommended by the League:

1. There should be monitoring of the mine until the mine site is no more radioactive than the natural radioactivity of the region.
2. There should be monitoring of private and public water supplies of southeast New Mexico and southwest Texas as long as it is necessary to monitor the mine. The monitoring should be at the expense of the United States government, not at the expense of the individual water user.

The Honorable Kent Hance
May 18, 1979
Page 2
WIPP - Carlsbad, New Mexico

3. If pollution of any water supply should occur from the Waste Isolation Pilot Plant, the water supply should be replaced with potable water. This good, usable water should not be at the expense of the property owner/owners, but rather at the expense of the United States government.
4. There should be security provisions for the transportation of the radionuclear waste to the site.
5. The radioactive waste should be isolated in as retrievable a manner as possible, pending future technology when the waste can be safely disposed of or utilized for fuel.

We feel confident that you will weigh these considerations carefully and help protect the residents of Texas.

Sincerely yours,

Caroline Ater

Mrs. Gene Ater
President



UNITED STATES ARMS CONTROL AND DISARMAMENT AGENCY
WASHINGTON

GENERAL COUNSEL

June 26, 1979

Dear Mr. Beckett:

The U.S. Arms Control and Disarmament Agency (ACDA) has reviewed the Department of Energy's draft Environmental Impact Statement (DOE/EIS-0026-D) on the proposed Waste Isolation Pilot Plant (WIPP) which was forwarded to us for comment by Assistant Secretary Clusen's letter dated April 18, 1979.

ACDA would prefer to see more emphasis placed in the draft EIS on the importance to our national nuclear waste management program of the intermediate-scale facility (ISF) demonstration component of the WIPP project. This could be handled relatively easily by placing additional balancing text from the Interagency Review Group Report (1979, p.55) at the end of the third paragraph on p. 2-15 of the draft EIS. Specifically, we would suggest using the following statements:

"An ISF would also provide valuable experience in constructing, operating, and maintaining facilities and equipment for waste packaging, handling, transporting, emplacement, and retrieval," and
"Exercising the licensing process for at least one ISF at an early date would be extremely useful preparation for the later licensing proceeding of the first full-scale repository."

We recognize that these statements appear as part of a verbatim

Mr. Eugene Beckett
WIPP Project Office
Mail Stop B-107
Department of Energy
Washington, D.C. 20545

reproduction of selected IRG material in Appendix C, but believe they are likely to be overlooked if not included in the main text.

In this regard, it is important to keep in mind that progress in demonstrating that nuclear spent fuel can be stored acceptably in geological repositories has important implications for U.S. nuclear non-proliferation policy. Again quoting from the Interagency Review Group Report (1979, p.68):

While it is difficult to predict what impact any particular strategic planning basis for the United States waste disposal program would have on other countries, it is fair to say that a strategy perceived as indecisive would almost certainly reduce our influence on achieving overall non-proliferation objectives at the international level. This is important to the United States because of our concern about possible proliferation consequences of nuclear power, our need to influence other countries with regard to the feasibility of permanent disposal of spent fuel, and our desire to protect the global environment by working with other countries to devise acceptable approaches to spent fuel management and waste disposal.

The ISF demonstration could be an important factor in convincing other nations that the U.S. is moving decisively ahead in solving its spent fuel management problems.

Sincerely,

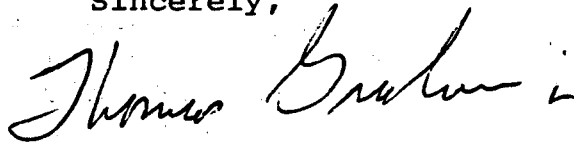

Thomas Graham, Jr.



DEPARTMENT OF HEALTH EDUCATION AND WELFARE
OFFICE OF THE SECRETARY
WASHINGTON, D.C. 20201

SEP 21 1979

Mr. Eugene Beckett
WIPP Project Office
U.S. Department of Energy
Washington, D.C. 20545

Dear Mr. Beckett:

Thank you for the opportunity to review the Draft Environmental Impact Statement (EIS) for Waste Isolation Pilot Plant (DOE/EIS-0026-1). We offer the following comments for consideration in preparing the final EIS.

Since this is a new pilot undertaking, we were not able to review the adequacy of the design objectives for meeting radiation protection standards associated with potential individual doses.

The impact statement does not contain a specific criteria for radiological protection relative to general population exposure and occupational exposure. The summary of major impacts described in Table 3-10 is presented as a percent of background radiation for the general population and the current standards for occupational exposure. In order to enable a better evaluation of the radiological impact, DOE should include a discussion of the radiological protection criteria that they consider applicable to the Waste Isolation Pilot Plant (WIPP) operation. Furthermore, such criteria should address the range of doses that DOE considers acceptable as a result of accidents. For example, on page 3-15 the EIS states that as a result of drilling into the stored spent fuel 100 years after a repository is sealed, the drill-crew geologist could receive a dose of 90 rem (18 times occupational dose of 5 rem/year). Please note that section 2.2 and Appendix G of DOE/EIS-0046-D on the management of commercially generated radioactive wastes contains such a discussion.

In assessing the acceptability of the proposed WIPP, the radiological impact from transportation, normal operations, operational accidents, and long-term impacts are critical considerations. Section 1.4 presents an environmental analysis of alternatives. A summary table or matrix showing the radiological impact of each alternative would serve to more clearly identify such impacts.

There needs to be a discussion of the facility emergency plan, particularly with respect to coordination with state emergency radiation plans. Such a discussion should also include coordination efforts with local medical facilities.

There is insufficient information for determining whether environmental pathways and models provide accurate estimates of doses that the population would be subjected to under normal operating conditions and accident situations.

Section 9.2.10 describes the impact of routine releases of radioactivity from facility operations. The estimates of population and individual exposure are estimated using the AIRDOS-II Code. It is not evident from the presentation that there are uncertain ties in the input data that should be identified. It would be helpful to know the range of doses associated with the estimates presented in Tables 9-17 through 9-27.

The use of AIRDOS-II Code to compute doses to populations from environmental pathways as a basis for population dose carries with it an accuracy connotation that may or may not exist. It is not evident from the DEIS or its reference that the dose model has been verified by means of field testing and analysis of real time monitoring data.

Finally, the impact statement lacks information on monitoring associated with drinking water, human food, animal feed and their products, such as milk, and the disposal of radioactive plant wastes.

Sincerely yours,

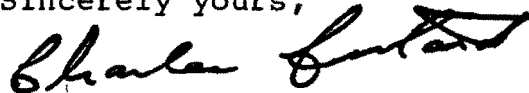

Charles Custard
Director
Office of Environmental Affairs



United States Department of the Interior

OFFICE OF THE SECRETARY
WASHINGTON, D.C. 20240

ER 79/388

OCT 3 1979

Honorable Ruth Clusen
Assistant Secretary for Environment
Department of Energy
Washington, D.C. 20545

Dear Ms. Clusen:

Thank you for your letter of April 18, 1979, transmitting copies of the draft environmental impact statement for the Waste Isolation Pilot Plant, Eddy County, New Mexico.

As you may be aware, the IRG review of the nuclear waste management program as well as the DOE draft Environmental Impact Statement for Commercially Generated Waste has identified a number of outstanding scientific and technical concerns associated with the disposal of high-level and transuranic wastes. Many of these concerns are reflected in our comments on the review of the WIPP GEIS since the WIPP GEIS contains proposals for the disposal of high-level and transuranic wastes. We are also aware that the WIPP project has been substantially altered in the FY '80 authorization process and that the President is currently deliberating the role of the WIPP Project in the overall nuclear waste management program.

Our comments are principally addressed to the proposal contained in the WIPP GEIS and specifically to the disposal of high-level waste/spent fuel at that site. From a NEPA and FLPMA viewpoint, we believe the current GEIS will have to be substantially revised and supplemented in order for this Department to make use of it in support of any land withdrawal decisions we may wish to make at that site. Thus, our specific concerns are discussed in each of the sections below with a view that DOE's subsequent impact statement will be revised to take into account our concerns, especially those concerns under FLPMA. We will be pleased to work with you in the revision of the WIPP GEIS to the extent that we have the capability to do so.

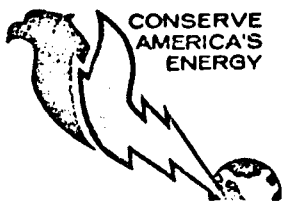

Relationship to the IRG Report

The President has recognized the immediate and long-term problems of nuclear waste management. In March 1978, he established a Federal Interagency Review Group (IRG) for nuclear waste management. The IRG published a final report in March 1979 specifying recommendations for the overhaul and reorientation of the Federal Government's waste management program. Additionally, the IRG work is considered to be the baseline of policy expertise in the Federal Government. The IRG report devotes considerable attention to the development of an intermediate-scale facility. Although the IRG report does provide that the intermediate-scale facility could be contemplated at the WIPP site, the IRG also defines a process of site selection for high-level, spent fuel, and transuranic wastes in differing geologic media in diverse geologic environments. The final statement should evaluate the WIPP Project in light of the IRG alternatives with a view of how the proposed WIPP Project conforms with the recommended process laid out by the IRG. This should be done in a thorough manner so that it can be readily implemented.

For example, the IRG report indicates that although more is known about the engineering aspects of a repository in salt than other media, on purely technical grounds, no particular geologic host medium is an obvious preferred choice at this time. The IRG report also indicates that the capability must be developed to characterize and evaluate media in a number of geologic environments for possible use as repositories built with conventional mining technology. The WIPP DEIS only discusses salt as a host medium. However, the IRG report discusses the existing and potential alternatives for geologic and hydrologic conditions necessary to store nuclear waste. Thus, the EIS is inadequate because of the omission of a credible discussion of alternative geologic host environments. This point is distinct from programmatic alternatives for disposal of nuclear waste such as burial at sea, rocketing the waste into outer space, etc.

The ultimate criterion for geologic host media is the successful isolation of radioactive waste (TRU, HLW, etc.) for periods of time ranging from 1,000 years to 250,000 years. During such a long time frame, a number of factors may change including climate, geologic stability, and the existence of man on earth, etc. The WIPP DEIS does not offer a credible discussion, in simple English, of the expertise that would be necessary to characterize the integrity of a nuclear waste disposal site for 100,000 years or more, let alone provide institutional surety that such a site could be maintained over that time period.

The Environmental Protection Agency is now preparing final regulations for standards on acceptable levels of radioactivity in the environment. EPA's standards are general rather than site-specific. The IRG and EPA have recognized that zero release of radioactivity cannot be assured. The IRG urges that it is more feasible to defer the choice of waste technology so the ultimate choice of disposal options will factor in EPA's criteria. The WIPP DEIS does not address the need for application of the criteria to an intermediate-scale facility. This issue should be addressed in the final statement. Secondly, since the purpose of the GEIS is to establish the scientific feasibility of pursuing mined repositories and defining the necessary supporting programs, e.g., R&D, etc., to accomplish that purpose, the WIPP EIS should also address the relationship between the WIPP Project and the overall waste management program and its specific role in the overall program.

Outstanding Technical Issues

We recognize that some of the proposals contained in the document may be moot because of Presidential and Congressional decisions. Nonetheless we have responded to the document as it exists.

Before any waste is emplaced on a retrievable basis, the waste-form question will obviously have to be settled. Before any waste that produces significant amounts of heat is emplaced on a retrievable basis, the exact mechanism and significance of migration of fluid inclusions in the salt to the heat source must be determined.

Before large amounts of waste are emplaced on a nonretrievable basis, the hydrologic flow system must be more completely characterized, especially the question of radionuclide retardation and the details of flow-through features in the Rustler Formation. In addition, the permeability and effectiveness of backfill materials and the potential for the successful sealing of shafts must be known. Assurances that there are no large brine pockets in the vicinity of the site must be available. A more precise estimate of long-term risk must also be made including tectonic, climatic, or other factors which might initiate a release from the repository (such as by breccia pipe formation), shorten the flow

path between the repository and Malaga Bend, or result in loss of dilution by the Pecos River at Malaga Bend. Work on all of these topics is currently underway.

Before a decision is made to proceed with licensing at the WIPP site, the difficult issue of future human intrusion and the risk posed by it must be resolved. Whether or not alternative sites and media are indeed comparable in long-term risk, and superior or inferior as regards attractiveness for future intrusion, should be assessed at an early date. An R&D effort to make these comparisons should be part of the national program to achieve satisfactory means of waste disposal. These are all significant technical issues that must be resolved before reliance on the risk assessments model results as contained in the draft EIS can be undertaken with any degree of confidence and credibility.

Format of the Draft Statement

The format of this environmental impact statement is disorganized and confusing. For example, a description of the proposal should be systematically set forth. Without a complete understanding of the proposal, it is not possible to understand the impacts on the environment of that proposal. Unfortunately, the proposal is not clearly set forth in any one section in the EIS. That part of the proposal relating to transportation of the radioactive waste is found in the first half of Chapter 6. Other parts of the proposal are found in the latter part of Chapter 8. To learn of the waste forms that are part of the overall plan one must turn to Chapter 5 and the central section of Chapter 5. The description of geology, hydrology and archaeology are found in Chapter 7. The land use description is partially located at the beginning of Chapter 8 and partially in Chapter 12. A description of the scenic, historic and cultural resources is located in Appendix H in Volume 2 of the document. Appendix I in Volume 1 of the document contains a description of three other environmental parameters. In other words, the description of the environment is spread through three chapters and two appendices. For the reader to put it together is a major undertaking.

Impacts from the proposal are likewise spread throughout various sections in the document. In the alternatives chapter (Chapter 3) the alternative of "no action" is considered in two pages. However, this alternative is not fully discussed there. Part of the alternative of "no action" is to leave the waste in Idaho. The impact of that can be found in Section 7 of Chapter 9. Similar problems can be found within Chapters 6 and 9.

We also recommend that additional effort be taken to reduce technical jargon to make the statement more understandable.

We believe that the exact nature of the proposed action must be described, along with alternatives to the proposed action, the environmental consequences of the proposed action and alternatives; and possible termination of the withdrawal. This site could be disqualified for technical or institutional reasons, found to be ultimately unsuitable, or, alternatively, retrievability problems could occur. We believe the draft EIS fails to adequately analyze these issues. Moreover, the site characterization and evaluation fails to comply with the Federal Land Policy and Management Act of 1976 (FLPMA) and the National Environmental Policy Act of 1969 (NEPA) and hence, is inadequate for the purposes of considering a withdrawal of public lands. Finally, if the Department of Energy has changed the purpose of the WIPP since the draft EIS was released, then the current document is inadequate by definition. In such case, a supplemental EIS will be required at a minimum.

Analysis

The EIS contains outdated data and a consistent lack of an analysis of the environmental impacts of the proposed action in a number of areas. Additionally, a lot of facts and statistics are given, but pragmatic analysis of the effects on the environment of those facts and figures is lacking. Impacts are frequently split up into constituent parts and are not evaluated cumulatively. For example, the analysis of the impacts of noise by the operation of the plant is found in Section 9.2.5 on page 9-26. It begins with a short statement as to what noise standards are. Why this is contained in the impact section rather than the environmental setting section is unknown. Moreover, the criteria used are outdated. The criteria used were established by the Department of Housing and Urban Development prior to the passage of the Noise Control Act of 1972 and thus are outdated. Additionally, the applicability of HUD standards (for urban areas) to a rural site is also unexplained. We believe the use of more recent criteria developed by the Environmental Protection Agency could alter this analysis.

The material on noise is then broken down into six categories; however, the impacts in each of these categories are not examined cumulatively. For each category the EIS states what the noise level is expected to be with no analysis of what that noise level means. Several times the document states that wildlife "will become accustomed" to the noise levels. However, the probability of, or the length of time for, wildlife acclimitization are not evaluated. Specific effects upon wildlife from noise are not evaluated.

In the transportation of the nuclear wastes the impacts of "intentional destructive acts," discussed in a few lines at Section 6.8, are dismissed by saying that the wastes are packaged so well, the packaging could hardly be breached. And if for some reason they are breached, there would be "relatively limited consequences." Evidence of analysis to support that conclusion should have been presented, particularly since we are unaware of what the state-of-the-art on packaging is today, or what the proposed waste form is likely to be since the Department of Energy doesn't plan making this decision before the early 1980's. In addition, considerable additional information about the transport of radioactive wastes to this specific site should have been included.

It is difficult to find any assessment of mitigation actions in Section 9.1.5. For example, under landscape restoration the analysis is as follows: "At the completion of construction, all areas disturbed by construction and not required for permanent facilities will be regraded and seeded." That is the entire discussion. Issues such as seeded with what sort of vegetation; in what areas; how large of an area; will the reseeding work; what will be the impact of the regrading and reseeding of the area are never addressed. This entire section should be revised to assess the effectiveness of the mitigation actions proposed.

There has been a lot of information in the public press recently on radiation exposure to workers in uranium mines and other high risk areas over past years. We believe the discussion of exposure should be expanded in the final statement. Very little discussion of the indirect impacts on plant and animal life (livestock) attributable to radiation exposure to soils and forage plants near the site, nor at intervals from that site has been presented. Additionally, an explanation should be given as to how radioactivity is measured and how the various units of measure relate to human health and safety. The effects of certain radiation doses should be described so that they may be compared with those possible in the repository area based on dosage estimates given in the draft statement.

The draft statement utilizes three sources of data in various sections of the document which address the amounts of resources and reserves of potash mineralization present in the WIPP area. These sources consist of the Geological Survey Open-file Report 78-828, 1978; U.S. Bureau of Mines report, November 1977, and the American Institute of Mining Engineering report, 1978. Large differences exist in the resource-reserve estimates presented by these documents. These differences are largely due to variations in criteria chosen by each source to evaluate resources and reserves under the definitions of Geological Survey Bulletin 1450-A. Values used in the draft statement have been selected and used without any clear explanation as to why they were chosen.

There also appears to be little evidence of follow-through in the document. For example, Section 9.2.13 is a discussion of mitigation of impacts caused by plant operation. Three of the impacts mentioned in the impact section on plant operation are (a) effects of non-radioactive-waste discharges, (b) impact of routine releases of radioactivity, and (c) radiation exposure of the work force. These three areas of impacts are not even mentioned in the mitigation section. The EIS concludes that the proposed action and all of its aspects throughout 100 years of its life, including the transportation of the waste product, the excavation of the mine, the storage, the testing, the various different radioactive waste products, potential accidents, leakage, etc., and all impacts are small "save two": first, a long-term denial of access of 3 percent of the United States reserves of the mineral langbeinite and, second, if there is any drilling in the site during the next 100 years, members of the drilling crew could be exposed to doses of "above permissible occupational exposures." In view of the many outstanding scientific and technical uncertainties in the GEIS, we do not understand how these conclusions can be supported.

Treatment of Alternatives

A most serious deficiency in the WIPP draft EIS is its treatment of alternatives. The entire discussion of alternatives is limited to 33 pages, approximately half of which is a discussion of the impacts of the proposed action. Six other alternatives are discussed, five of which relate to variations within the proposal and only one is an alternative outside of the proposal, namely, the "no action" alternative. Three deficiencies exist: (1) failure to treat a number of other reasonable alternatives; (2) failure to provide a sufficient analysis of those alternatives which are considered; and (3) failure to comply with the provisions of FLPMA by providing analyses as to why the WIPP site is the best site for its intended use under section 204(c). We believe these must be remedied in the revised draft.

There is some discussion in the EIS of sites in Washington and Oregon. These are lava formations geologically identified as the Columbia River basalts. This formation is very extensive in southeastern Washington and northeastern Oregon. Surface and subsurface management on many tracts in these areas is under the jurisdiction of this Department's Bureau of Land Management. As a result, we are concerned that the statement does not identify environmental impacts for these alternative sites which may be on public lands.

Additionally, the statement does not contain sufficient data to identify or utilize impacts on water resources, range land use for livestock and wildlife, forestry, cultural resources, wilderness, areas of critical environmental concern, oil and gas exploration and extraction, and nonenergy minerals; nor does it quantify impacts to any relevant degree. The GEIS deals only in generalizations with regard to environmental impacts associated with alternatives to the proposed action. We believe these impacts must be more fully addressed in the revised EIS.

Site Selection and Land Withdrawal

The process of selection used between 1973 and 1976 to select the WIPP site included consideration of numerous alternative sites in salt environments only. The process also involved the tacit assumption that complete containment would be provided by the salt formations. Groundwater flow paths from the potential repository to the biosphere were considered in the analysis of alternate sites but not from a regional viewpoint early in the analysis. Sorptive capacity of the rocks along the flow path, as a significant barrier to nuclide movement, was not a factor in the site selection criteria (Powers, et al., 1978, p. 9-23). The approach used to select the WIPP site reflected the historical view at the time that salt would be the emplacement medium. Recently, however, emphasis on the total geohydrologic system in the site-selection process has become the key item of concern. (Interagency Review Group, 1979, p. 42) While we are sympathetic with the notion that it is difficult to retrofit new criteria to existing sites, because of health and safety considerations, we believe the WIPP site-selection process should be reviewed in light of recent technical findings and the systems approach.

An important criterion for suitable geologic host formations is that they have not been extensively drilled, mined, or altered by the hand of man. This is also a prime characteristic for existing and potential wilderness areas. The statement fails to discuss any relationship between potential alternative geologic media and possible environmental impacts on the integrity of existing or potential wilderness areas, such as the WIPP site. The Bureau of Land Management is reviewing public

lands for potential wilderness values under Section 603 of the Federal Land Policy and Management Act of 1976 (43 U.S.C. 1782), and Section 2(c) of the Wilderness Act of 1964 (16 U.S.C. 1131). BLM's wilderness review process and all identified potential wilderness areas must be taken into consideration in any discussion of the environmental impacts associated with alternative geologic formations considered for nuclear waste disposal sites. The Bureau's greatest concern is that the site selection, characterization, and evaluation process will involve many potential locations on public lands and subsequent application for withdrawals for future sites, including alternatives to the WIPP site. These must be addressed in order to comply with FLPMA.

A land withdrawal for 250,000 years is necessarily an irreversible and irretrievable commitment of resources. A credible discussion of alternative sites should address the relationship between current, local, short-term uses of man's environment and enhancement of long-term productivity. The argument has been made in the statement that a demonstrated capability to isolate nuclear wastes in geologic host media is necessary to promote safe use of nuclear materials for the nation. However, the trade-offs between storage of nuclear waste and existing uses of public lands have not been given the attention they deserve in the WIPP draft EIS.

For example, section 8.1.3 states that two 5-acre and two 20-acre biological study plots will be formed out of control zone II. However, there is no discussion of the studies to be conducted there nor how the results of this monitoring will be used to promote public safety, or prevent direct impacts of radiation on plants and animals. In section 2.3.2 it is stated that 17,200 acres of public rangelands would be required for the WIPP withdrawal, which, in turn, would require cancellation of existing grazing and mineral leases. However, section 8.1.3 also states that grazing would be allowed in control zones II, III and IV. There is no discussion of how this grazing use would be managed, either by BLM, the WIPP site manager, the State of New Mexico, etc. Similarly, there is a reference that mining may be allowed in zone IV with no discussion of how this mining use would be managed in a way not to interfere with the integrity of the repository. Without this information it is not possible to quantify the economic effects of the withdrawal nor design alternative allotment management plans to attempt to mitigate these effects.

As is the case for all withdrawals, compliance with the requirements of the Federal Land Policy and Management Act of 1976 and the National Environmental Policy Act of 1969 is mandatory. The requirements in FLPMA and NEPA applicable to site characterization and evaluation of a potential site are equally applicable to the proposed action and its alternatives as described in the WIPP draft statement.

The Department of Energy has described the WIPP site as being designed for defense wastes (TRU, HLW), and also for commercial spent nuclear fuel. If the WIPP site is intended as a repository for high-level wastes, and not merely for research and development, then the potential environmental impacts of that proposed action, and alternatives, must be described accordingly. Failure to do so would leave the document inadequate by definition.

In addition, section 9.2.10 describes the impact of routine releases of radioactivity and exposure pathways in the environment, and section 9.3 describes the environmental impacts of accidental releases of radioactivity on humans. A description is needed of the potential adverse environmental impacts of the release of radioactivity, planned or not, on soils, plants, water; and especially the long-term effects of radioactive residuals in the environment. It is not possible to completely evaluate the short- and long-term impacts of the WIPP site on management of adjacent public lands without the above information.

The WIPP statement does not identify socioeconomic impacts of new population moving to the area to build or manage the WIPP site. Such impacts would include required increases in municipal services, infrastructure, etc., and the parallel need for additional tax revenues or other sources of funding to pay for these new services and infrastructure. Additional impacts might be created by increased demand for open space and recreational use of the public lands, especially hunting, fishing and use of off-road vehicles. Further impacts would be experienced after the employment associated with the construction phases left the Carlsbad area. These impacts must also be addressed.

Unsuitability, Retrievability, and Termination of the Land Withdrawal

The WIPP site could ultimately be disqualified for technical or institutional reasons; could be found unsuitable, or, alternatively, retrievability problems could occur. Additionally, after 10, perhaps 20 years, the Department of Energy may decide that an alternative site or sites are more suitable for permanent storage of nuclear waste. If any of these events were to occur, the waste then on the site and all associated infrastructure would be removed and the project would be terminated. Termination of the project and a withdrawal would potentially involve either complete return of the site to multiple use resource management or stipulations as to limitations on use.

The draft statement should discuss how termination of the WIPP site, under a variety of circumstances, would take place and what limitations or restrictions to assure public health and safety might be necessary to return the withdrawal area to multiple use resource management. In other words, the draft statement should indicate whether any radioactive materials would remain, and if so, how would DOE arrange to prevent these materials from having adverse environmental impacts on plants, animals, humans, and the environment in general.

Further, it is unclear whether retrieval is to be considered for 10 years or 20 years. Page 2-18 states (number 1, last sentence) ". . . it can be retrieved during a 20-year period if it becomes necessary to do so." This 20-year figure does not correspond with the figure of 10 years given on page 1-2. The period for which waste can be retrieved must be represented consistently as it has a direct bearing on termination of the withdrawal if an alternative site is ever sought.

These issues should be addressed.

Ground Water

It is stated on page 1-4 that the dissolution front at the top of the Salado Formation is about two miles west of the center of the site and is advancing toward the east at a rate estimated to be 6 to 8 miles per million years. The location of the front is shown on figure 7-25. It would thus appear that with current arid climatic conditions and current hydrogeologic conditions the dissolution front at the top of the Salado would reach the center of the site in about 250,000 to 300,000 years. Furthermore, because changes in climatic conditions are realistically probable within the time frame involved (e.g., U.S. Committee for the Global Atmospheric Research Program, 1975, Understanding climatic

change, a program for action: National Academy of Sciences, Washington, D.C., p. 182-190), the statement should also assess "worst-case" effects with respect to the dissolution front that may result from great increases in precipitation. Page 7-75 of the statement suggests that current rates for the dissolution of salt may be slower than those suggested by present geologic conditions; however, an adequate analysis should include effects of the progression of the dissolution front through the project area both with and without accelerated solutioning such as that apparently produced by climatic change during Wisconsin time. Inclusion of at least brief discussion of present knowledge of past and probable future climatic change would aid in the assessment.

It is stated on page 7-66 that lows in the potentiometric surface of the Santa Rosa Sandstone aquifer suggest recharge into underlying rocks, possibly through collapse zones. Because the underlying Dewey Lake Red Beds are said to function as a confining bed (p. 7-65), the regional extent of the Dewey Lake beds should be discussed and the possible significance of such downward leakage should be assessed for the vicinity of the proposed project.

Mineral Resources

A major weakness of the statement is that it failed to address properly the mining problems associated with developing an underground disposal site. Major concerns are the stability of the opening and disposal of mined waste material.

The impact of the surface disposal and storage of the mined rock can be lessened by lining the storage site with hypalon liners and using chemical stabilizers to control wind and water erosion, if the salt crust is not sufficient. Then, after the mined material is returned to the underground areas, the site can be restored.

It is likely that some ground movement will occur; however, with the improvements expected in underground backfilling technology, surface subsidence and induced faulting of the overlying strata could be negligible. If significant faulting did occur, some groundwater penetration could be expected.

The statement did not discuss the necessity of ground and surface water monitoring (i.e., equipment, sampling grid, amount and time intensity of gathering data). This subject should be discussed in the final statement. The statement should also review the problems of maintaining water quality in a disposal site.

One potential accident scenario that should be included in Section 9-3 is the possibility of an undetected high pressure gas pocket located near the storage facility. Over periods of time, carbonaceous material will tend to decompose and produce gases which may build up pressure to the point of fracturing the formation, thereby comprising its integrity. Moreover, during the operating life of the disposal site, the potential for fire and explosion is present whether originating from spontaneous combustion or leakage of methane or other gases. In the confined space of an underground mine, such a fire is usually more serious and more damaging than it would be above ground. Consequently, we urge that all wastes, including radioactive combustibles, be placed in a chemically stable condition before emplacement in the repository.

There is a great deal of discussion on heating of the bedrock and subsequent effects on aquifers and surface uplift. Of equal importance is the deformation of the rock during and after the cooling stage. Generally, fractures and microcracks generated in the bedrock from thermally induced stress would tend to open during cooling and affect air and water flow patterns through increased permeability.

WIPP will not impact significantly on domestic reserves of sylvinitic and this aspect of the draft report will not be addressed here. However, according to 10-K reports filed for 1978 by two langbeinite producers, the total U.S. reserves of recovered langbeinite, all near Carlsbad, is 11 million short tons of K20 equivalent. The 4.4 million K20 tons of langbeinite identified in the WIPP site in our IPOC November 1977 report for DOE then equals about 40 percent of Carlsbad reserves of this material, instead of the 11.6 percent given in the third paragraph of page 9-20 of the subject report. The total langbeinite resource in the Carlsbad area is unknown although a consulting firm, Agricultural and Industrial Minerals, Inc., has recently estimated it to be 14 million tons of K20. We suggest that this is overly conservative.

Total langbeinite capacity of the two producers is about 300,000 tons per year. It follows, then, that langbeinite reserve in the WIPP site would be depleted in about 15 years at the current rate of extraction. The 5-year depletion figure given in the first paragraph of page 9-18 of the subject report is, then, incorrect.

The statement contains two other errors on page 9-20. First, the third paragraph gives langbeinite resource and reserve in K20 equivalents; this should be as langbeinite which contains 22 percent K20 and the data should be multiplied accordingly by 0.22 to give resource and reserve figures of 13.9 and 8.4 million tons of K20, respectively. Second, the fourth paragraph shows a langbeinite mining rate that is about 3 times too high; the actual current rate is roughly 300,000 tons per year of K20.

The obvious conclusion from all of the above is that the langbeinite reserves in the Carlsbad area will be impacted by WIPP more significantly than indicated in the subject report. However, the seriousness of this is decreased greatly by the following factors: (a) about three-quarters of the langbeinite reserves in the WIPP are in outer zone 4 of the site and could, according to a likely scenario, be mined at a later date, perhaps in this century, (b) mixtures of potassium sulfate and magnesium sulfate, both of which are in ample domestic reserve or can readily be synthesized, appear to be a viable alternative to langbeinite for agricultural use, and (c) loss of the langbeinite reserve in the WIPP site would not threaten the economic stability of the Carlsbad area or the United States. Nevertheless, we believe that this problem of the withdrawal of mineral resources in the WIPP area should be more fully addressed in the final statement.

A more basic concern, however, was never addressed in the draft statement. The single Waste Isolation Plant may not have a significant impact on the mineral resources nationally; however, this is just a pilot for a number of similar facilities. If these are all to be located in similar salt deposits, the potential loss of mineral resources for the vital production of food and energy may be quite significant. On page 11-1 the document states that development of the repository will deny access to 25 billion cubic feet of natural gas, and 350,000 barrels of distillate. This denial seems to be a high price to pay for a dump, albeit a very necessary one. For this reason, the final statement should include projections on the number of Waste Isolation Plant sites needed and the future demand for the mineral resources. This information may show that alternative burial materials should be used in preference to salt that is in close association with agricultural minerals and petroleum resources.

The geology sections of the statement should mention the potential for scientifically valuable fossils, especially in the Rustler formation. Page 9-11 should contain a discussion of the actions which would be taken to preserve any scientifically valuable fossils if found on site.

Cultural Resources

We are pleased to see the extent of the Department of Energy's commitment to protecting the archeological resources of the Waste Isolation Pilot Plant (WIPP) area. However, we wish to point out that the long-term management of the area, which includes nearly 20,000 acres, requires more than project-specific archeological survey and mitigation work confined to control zones I and II and proposed rights-of-way. Although

much of the area will not be directly affected by the physical facilities and construction associated with the WIPP, at least 11,400 acres will be available for oil, gas and potash development leasing, and the entire area is open for stock grazing. Therefore, as mandated by Executive Order 11593, section 2(a), the Department of Energy should initiate surveys of all the area as soon as possible in consultation with the New Mexico State Historic Preservation Officer in order to identify the archeological or other cultural resources under its jurisdiction and control.

The final statement should include plans for avoidance and/or mitigation of the 33 archeological sites determined eligible for the National Register as an archeological district, future cultural resource management for the area, and the appropriate recommendations and opinions of the State Historic Preservation Officer and the Advisory Council on Historic Preservation.

Recreation

The impact of the additional workforce on nearby recreational areas should be addressed. It is mentioned that the primary recreational use of the proposed site is for hunting. However, it is not mentioned if this use or other recreational uses will be permitted on those portions of the site which will not be extensively developed or utilized.

This project does not appear to have impacts or potential impacts on any existing unit of the National Park System or on areas under study or recommendation for possible inclusion in this System.

The WIPP System: Long-term Impacts

The long-term effects, which are the center of earth science concerns for all hazardous waste repositories, are judged in the statement to be very slight, based on a consequence analysis in which the worst possible future scenarios are postulated and their long-term effects calculated. The judgment that long-term effects will be slight stems partly from the low concentrations and low total amount of some radionuclides proposed to be emplaced in the WIPP. If it were planned to emplace higher concentrations and amounts of these nuclides, a new EIS would be required. If a decision is made to incinerate TRU waste as a criterion for acceptance at WIPP, a substantially larger amount of TRU could be disposed of than is considered in this EIS. Such a decision is very probable because of gas generation from radiolysis, hydrolysis, and bacteriological activity in nonincinerated TRU wastes, and also the hazard from mine fires in non-incinerated waste. The waste form for incinerated TRU waste (presumably

a concrete?) should contribute an as yet unspecified amount toward commitment. The low level of effects in scenarios involving moving ground water also stems from the assignment of significant retardation for certain long-lived nuclides along the natural flow path from the repository to its present discharge point. The actual degree of retardation has yet to be determined in situ or in comparable rock systems. This optimistic assumption regarding retardation is partly offset by the pessimistic assumption that the release rate for the waste is the same as the rate of dissolution of salt in the invading waters. These latter assumptions are necessary because the form for the TRU waste has not yet been specified. Thus, this EIS does not fully evaluate the total waste disposal system at the WIPP and vicinity because significant parts of the system are either unspecified (waste form and total amount) or uncertain (retardation effects).

The natural geohydrologic system at the WIPP site and vicinity appears to be favorable for containment in many respects. The postulated flow path from the repository to discharge is relatively long and the estimated times of water transit range from 5,000 to 100,000 years depending on the hydraulic conductivity used in the calculations. This hydrologic path should provide a barrier for the short-lived fission products from the spent fuel. Water movement is downward in the rocks above the flow path along its length making the likelihood of short-circuiting by natural or human activities slight. This water would also be nonpotable and unlikely to be utilized by humans. The transit time in itself is not an adequate barrier, however, for the long-lived transuranics; significant retardation must take place along the path if the dissolution rates are as assumed. Sandia has begun experiments to determine the degree of retardation, and the results are encouraging. There are many acknowledged uncertainties, however. One of the principal uncertainties concerns the extent of retardation in the Magenta and Culebra members in which ground water flow is largely through fractures in dolomite and dolomitic sandstone. In such flow, the fluids may be in contact with much less of the sorbing materials than they would be in flow through a porous medium. If retardation in the Magenta and Culebra is substantially reduced for the transuranics, concentrations of these nuclides in the Pecos River at Malaga Bend would still be low but considerably closer to the background unless leach times were on the order of 10^6 to 10^7 years (see GEIS, app. I, fig. 1.3). Given the recent increased concern with low levels of radiation, whether such a risk would be acceptable is not clear. The possible effects of lower retardation are not discussed in the EIS.

The same uncertainties concerning flow through fractures may also affect the estimates of the regional hydrologic flow pattern. The direction, volume, and rate of flow in the fractured Magenta and Culebra aquifers all have large attached uncertainties without more hydrologic data than was used in preparation of the EIS. Values of transmissivity given on page 7-65 for the Rustler are estimated, not "calculated." The 10 percent porosity value for the Rustler, same page, comes from one measurement (Gnome site) and is not an average.

Another important assumption in the long-term impact analysis in the EIS is that the diluting effect of the Pecos River at Malaga Bend will remain constant or possibly increase. Should tectonic, geomorphic, and climatic factors combine to reduce or halt the flow of the Pecos River at the discharge point, the transported transuranics would build up at that point. The hazard from such a buildup would be about the same as that of a sandstone uranium deposit which might or might not be deemed an acceptable risk. The possible impact of such a buildup is not discussed in the EIS.

In summary, the statement does not provide a complete analysis of the system of barriers to waste migration. Even though the waste form has not yet been specified, leach rates over a plausible range of values could be assumed. Additional values for the uncertain hydraulic conductivity of the principal aquifer could be used in addition to those presented. Retardation values could be varied over reasonable ranges including possible low values for flow through fractured media. Analysis of the total system of any proposed repository is called for in the Interagency Review Group's report on waste management, not merely an estimate of worst case conditions.

Engineering Geology

We believe that the EIS should include more engineering details on the proposed underground excavations at the WIPP site. The stability of the underground rooms will be critical to any retrieval of the radioactive wastes.

The "Herring Bone" pattern of the underground CH waste storage area shown on Fig. 8-11 will create areas of weakness at the "points" of the pillars. Experience has shown that the pillars will fail at these places. This is true of mining depths of 700 to 1,100 feet and will certainly be true at 2,100 feet. It does not necessarily create a major hazard, and the oblique angle turns would probably be easier for rubber-tired or mono-rail transportation to negotiate, at least coming from one direction. However, the spalling would need cleanup and/or extra support. If the planned entry widths would not allow turnoffs of 90 degrees, possibly the corners could be stubbed.

Comparison of WIPP with Other Alternative Sites

The EIS states in chapters 3 and 4 that proceeding with WIPP fulfills objectives for TRU recommended by both the Deutch and the IRG reports. The Department's U.S. Geological Survey agrees. It is also argued in chapter 3 and the first page of chapter 4 that in terms of long-term effects, there really is no technical basis for choosing between salt and basalt because "site selection will ensure no increase in predicted risk" (tables 3-12, 3-13) at basalt sites. With regard to shale and granite, the EIS claims that the GEIS "predicts impacts approximately like those of salt and basalt repositories" (p. 3-32). In summarizing the environmental impacts, the EIS asserts (p. 4-1), "the impacts of the remaining six alternatives (2 through 7), on the other hand, are small in both the near term and the long term (centuries and longer) and are not different enough from each other to afford a basis for choice on environmental grounds. The choice must therefore rest on programmatic considerations."

CEQ's "Regulations for Implementing the Procedural Provisions of the National Environmental Policy Act" (43 FR 55978-56007, November 29, 1978, 40 CFR Parts 1500-1508) requires that an agency "rigorously explore and objectively evaluate all reasonable alternatives" (paragraph 1502.14). We would argue that a statement that "site selection will ensure no increase in predicted risk" (tables 1-12, 3-13) merely defines a comparison as unnecessary because the problem is solvable. A meaningful comparison would be an in-depth comparison between WIPP, other salt sites, basalt (above and below water table), alluvium (above water table) and tuff, shale and granite (above and below water table). Such a comparison is lacking.

In none of the routine comparisons of impacts from construction of TRU and HLW repositories (or combinations of the two) in alternate locations or media (sec. 3.0) is there any discussion of potential alternate system in which isolation of radionuclides might be more confidently predicted than at the WIPP reference site. As noted earlier, if retardation of radionuclides at WIPP is not as efficient as postulated, small increments to the long-term radiological hazard result (depending on the release rate) which could nonetheless be crucial in the final acceptance of the site. The present discussion of alternatives implies that the hydrology is the same in all regions being considered for HLW and TRU waste disposal, which is certainly not the case. Potential radionuclide transport downdip from gulf coast salt domes, for example, would be in porous media with very long flow paths; prediction of radionuclide containment might be much surer in that environment than at the WIPP. As the EIS notes, there has not been a complete analysis of other sites and systems with which to make a rational comparison; however, as noted above, neither

has there been for the WIPP. Contrary to the statement at the top of page 3-27, future studies can significantly change the predicted impacts and risks both at WIPP and in alternate systems.

In summary, the EIS asserts that all sites are likely to be, or can be engineered to be, equal to WIPP. This is unlikely to be the case for hydrology and definitely not the case for future human intrusion.

Future Human Intrusion

A major potential problem with the WIPP site is future human intrusion. The IRG (p. 39) recognized that "it is not possible to predict or to restrict the activities of future generations" and, therefore, "site selection guidelines, site suitability criteria, and repository design criteria must be developed in such a way as to minimize potentially deleterious effects of human activities." The Committee on Radioactive Waste Management of the National Academy of Sciences has stated "no areas with a present or past record of resource extraction, other than for bulk materials won by surface quarrying, should be considered as a geological site for radioactive wastes" (Geological criteria for repositories for high-level radioactive wastes, 1978, p. 13-14).

The EIS acknowledges that there might be future drilling at the site through a spent fuel assembly; and it computes the radiological dose to a geologist examining a core of the fuel. The EIS also correctly points out that the potash ores are above the proposed TRU repository horizons and, moreover, that both the potash and oil and gas (beneath the repository) can be exploited without breaching the TRU waste horizon. The USGS agrees with these statements. Not taken seriously though is the issue of trying to predict the actions of humans 500, 1000, or 10,000 years hence. The presence of mineral wealth is an open invitation to our descendants to explore the subsurface in ways we cannot begin to imagine.

In addition to our general comments, we also have specific comments with regard to the WIPP EIS which can be found in Attachment 2.

We hope these comments will be helpful to you, particularly in light of the fact that the direction of the WIPP program is changing and will continue to do so as the final decisions flowing from the IRG are made and implemented. As noted earlier, we will be more than pleased to work with your staff in revising the additional informational requirements that are necessary to meet our concerns under FLPMA for the revision of the WIPP EIS.

Sincerely,

LARRY E. MEIEROTTO

Assistant SECRETARY

Attachment 1

Specific Comments

It is implied in paragraph 3 on page 2-24 that synthetic high-level waste may have to be used for test purposes. If these tests are to be meaningful, both from a chemical and radiation intensity standpoint, real high-level wastes must be employed. This issue should be discussed.

Page 7-8 in volume 1 and H-83 in volume 2. Mention is made that amphibians are not an important part of the regional fauna. This statement is not accurate and needs to be revised. Thirteen of the 24 species of amphibians found in New Mexico occur in the southeastern portion of the State. These species occur in a variety of habitats and many are well adapted to the most arid habitats of this area.

Page 7-20. In general, oil and gas appears to have been given light treatment in the geology and mineral resources sections. The Pennsylvanian system deserves more detailed discussion as it contains the hydrocarbon reservoir of interest in the area.

Page 7-43, fig. 7-15. Locations of holes D-231, D-233, D-235, D-248, and D-250 should be shown on figure 7-15.

Pages 7-42 through 7-51. It should be noted that the southwest boundary of the withdrawal area was drawn to avoid existing gas wells in the area. It can be shown that the oil and gas industry has interest in drilling within the withdrawal area since there have been six applications to drill approved there. These applications and the subsequent condemnation of the drill sites by ERDA were not mentioned in the EIS. Five of the proposed wells are on Federal mineral leases. Their locations are as follows:

<u>Operator</u>	<u>Well Name</u>	<u>Location</u>
Continental Oil Co.	James Ranch No. 8	Lot 3, sec. 31, T. 22 S., R. 31 E.
Continental Oil Co.	James Ranch No. 8A	SW1/4 NW1/4, sec. 31, T. 22 S., R. 31 E.
Perry Bass	James Ranch No. 10	SW1/4 NE1/4, sec. 30, T. 22 S., R. 31 E.
Perry Bass	James Ranch No. 12	NE1/4 SW1.4, sec. 20 T. 22 S., R. 31 E.
Perry Bass	James Ranch No. 14	NE1/4 SW1/4, sec. 17, T. 22 S., R. 31 E.

One well was proposed by Gulf Oil Company on State land in sec. 32, T. 22 S., R. 31 E.

This aspect of oil and gas activity deserves mention in the EIS.

Page 7-44, table 7-5 and text. The Geological Survey also evaluated reserves. The standards cited in table 7-5 are called resource standards. In fact, the Survey report uses the low-class standard for resources and the lease, and high-class standards for reserves. The lease class standard is based on current economic mining conditions in the Carlsbad area. (John, et al., 1978, p. 26).

Page 7-44, last par. What is the source of the average grade data cited in the first sentence of the paragraph? With regard to the second sentence of the paragraph, the Geological Survey considers the median standard, termed "lease," to be equivalent to current mining costs and market prices.

Pages 7-45 and 7-46, table 7-6, fig. 7-16. The results of the Geological Survey evaluation are treated as resources in the draft statement. In fact, the Survey reports both resources and reserves (John, et al., table 4-A-C). Table 7-6 does not reflect this. Only the low-grade category is reported as resources in the Survey report. Lease grade and high grade are reported as reserves. This fact is not reflected in figure 7-16 either.

Page 7-46. No mention of the specific criteria used in the Bureau of Mines report is given. This information would help clarify the range of values that exist between the Summary and the Bureau of Mines reports. Table 7-7 represents a summary of the Bureau of Mines findings. The findings are based on specific criteria and assumptions which these numbers are dependent upon. An explanation of these factors would put the numbers in proper perspective.

An addition should be made to the first sentence under table 7-7. It should read "only mining unit B-1 meets today's market prices under the Bureau of Mines criteria (\$42 per ton of muriate, \$94 per ton of 'sulfate' (K_2SO_4), and \$48 per ton of langbeinite)." Some explanation as to the source of this price data would also be helpful.

Page 7-49. The Sipes, Williamson, and Aycock study of economic reserves appears to present the most realistic estimates of hydrocarbon resources.

Page 7-51. An attempt should be made at placing a monetary value on the hydrocarbon reserves, as was done for potash reserves on page 7-47.

Water: page 7-61 (para. 2, first sentence) states, "12,000 acre-feet" should be changed to 19,800 acre-feet, and "10,000 acre-feet" should be changed to 19,100 acre-feet. This information is based on a BLM report (1978) - Groundwater Study to the Proposed Expansion of Potash Mining Near Carlsbad, New Mexico.

Section 8.1.4 describes the new highway and railroad rights-of-way to be acquired for the WIPP site, but does not discuss whether these ROW will be fenced. Fencing could have adverse environmental impacts on existing grazing use and also on wildlife use of existing habitat. Similarly, a description is needed of any possible adverse environmental impacts associated with the construction, operation and maintenance of fenced ROW for railroads, paved roads, dirt construction trails, pipelines, or electric transmission lines. Mitigation measures should be specified, if necessary.

Page 9-9. Mention is made that raptor deaths may be caused by electrocution on utility lines. It is unclear if these deaths will result from project-constructed power lines. However, we would like to point out that proper design and construction of power lines can minimize electrocution impacts to raptors. Your agency may wish to consult the publication "Suggested Practices for Raptor Protection on Powerlines" by Dean Miller, et al., Raptor Research Foundation, Provo, Utah.

Roadway construction causes loss of habitat which results in reduced productivity for fish and wildlife resources. Secondary effects may include vehicle accidents and limiting animal movements. While some type of beneficial vegetation may be reestablished in roadway right-of-ways, the establishment of creosote bush would not be highly desirable. This species of vegetation provides little habitat value for food or cover.

Pages 9-9 and 9-10. Mention is made that wildlife species will be displaced from lost habitats. As presented on page 9-9, these habitat losses result in long-term losses when carrying capacities are reached. One mitigative effect that could be considered is management of adjacent habitats to increase carrying capacities and productivity of the habitat and offset losses.

Pages 9-9 and 9-22. Revegetation is one measure that is proposed for mitigation. Grasses, forbes and shrub species of value for wildlife food and cover should be used in the revegetation of disturbed areas. It may be important to manage grazing to insure adequate establishment of vegetation.

Pages 9-11 through 9-19. Estimates of the total potash resource and reserve are considered by the Geological Survey to be accurate within + 20 percent, based on the present drill hole spacing. We agree that 1,000-foot drill spacing would increase this accuracy. It is reasonable to expect that additional drilling would show increased reserves in

some areas and decreased in others. This point should be considered. The Survey has made a preliminary estimate of langbeinite reserves for the Carlsbad district since the publication of Geological Survey Open-file Report 78-828.

Our preliminary figures show 1.14×10^9 tons of langbeinite reserves at 6.6 percent K_2O weighted average grade present in the Carlsbad district.

Page 9-15, Summary. This section deals with the impact of denial of potash resources, and it is within this section that the variation in reserve estimates between the Bureau of Mines and the Geological Survey have the greatest effect. The criteria used by each group should be related to the presentation of data listed in tables 9-9, 9-10, and 9-11.

Page 9-16, table 9-9. Geological Survey data are here treated strictly as resource numbers. If the data were presented as in the open-file report, sylvite ore resources would be 133.2×10^6 tons, and langbeinite ore resources would be 351.0×10^6 tons. Table 9-10 would show the following reserves using Survey data: sylvite ore reserves-- 89.1×10^6 tons at weighted average K_2O , equivalent of 11.8 percent; langbeinite ore reserves-- 264.2×10^6 tons at weighted average K_2O , equivalent of 6.10 percent. These figures would also appear in table 9-11. The 500×10^6 -ton figure for regional resources in table 9-11 is questionable. John, et al., (1978) report 5.4 billion tons of potash ore reserves for the region. The 38×10^6 tons K_2O as langbeinite for reserves in the region needs more explanation. The WIPP area is reported to represent 11.6 percent of the total reserves of langbeinite. Recent estimates by the Survey after publication of the open-file report suggest that it may represent as much as 20 percent of total reserves.

Pages 9-20 through 9-21. Discussion of the AIM study referred to in this section needs to be elaborated. What were the criteria used in the study, and how do they compare with those used in the Survey and Bureau of Mines studies?

Page 9-24 in "Effects of Plan Operation" should contain a paragraph on the potential effects of the WIPP action on fossil resources. An important secondary effect of the action is the access to remote areas that would be opened by the new roads created for the WIPP site. While amateur fossil collectors would not have significant impacts, commercial (i.e., illegal) collection of fossils might occur on wholesale basis. Similarly, page B-8 should contain a statement in the geology section, "Permian Beds in this general area are reported to have provided the world's most complete record of early Permian amphibians and reptiles."

Page 9-86. The references to the Bureau of Outdoor Recreation should be corrected to read the Heritage Conservation and Recreation Service.

Page H-62 should reflect the following information: While Colorado had some ice fields during the pleistocene, the ice sheet in the Rocky Mountains went no further south than Montana and Idaho. Thus, glacial action does not appear to be a threat to the integrity of the site.

Pages J-38 and J-39, sec. J.4.3. There should be mention in this section of the environmental analyses that are prepared by the Geological Survey for proposed oil and gas operations. It should be noted that, through this process, an assessment of environmental impacts would be made before any further development of Federal mineral resources would be allowed.

Editorial Comments

In order to make the EIS more intelligible to other professionals and concerned lay people, editorial improvement is essential.

An index map showing the precise location should be one of the first figures in the report.

The WIPP site should be located on maps wherever practical and it should appear at the same place on all maps. It is badly mislocated on figure 7-12. Township and Range should be shown on maps where practical (fig. 7-12, for example).

Page 7-7, fig. 7-2. It is now generally agreed that the Pleistocene Epoch probably began between 2 million and 3 million years ago (e.g., Holmes, Arthur, 1964, Principles of physical geology, 2nd edition: New York, Ronald Press, p. 360-361; Obradovich, J.D., 1965, Age of marine Pleistocene of California: Am. Assoc. Petroleum Geologists, v. 49, no. 7, p. 1037).

Page 7-7, fig. 7-2. Deposition of Ogallala fan sediments and the formation of the caliche capping these sediments occurred during the Pliocene rather than during the Pleistocene, as shown.

Page 7-28, fig. 7-11. "pre-Cambrian" in upper left should be "Permian."

Page 7-59, table 7-14. "Dayton, Texas" should be "Dayton, New Mexico."

Page 7-64, fig. 7-22. An explanation of units and patterns, a scale, and location of WIPP site are needed.

Page 7-65, par. 4, line 4. "west" should be "east."

Page 7-68. The heading "Groundwater Quality" refers only to the succeeding paragraph. The rest of pages 7-68 and 7-69 is part of "Groundwater Flow."

Page 7-73, par. 3. "Jones (1972)" should be "Jones (1973)."

Page 7-74, fig. 7-27. A better explanation is needed. Show WIPP site; show line of section on a map; identify "solution front" referred to in text; label irregular line "Top of Rustler salt" not "Top of Rustler."

Page 7-76, par. 1. Add reference "Nicholson and Clebsch (1961)."

Page 8-39, last par., first line. This should read "Southwestern Public Service Company," not "Pacific Service Company."

Page 9-112, par. 5. The proper figure number would appear to be K-3 and/or K-5 rather than K-6.

Page H-101, line 3. Loving County is in Texas, not New Mexico.



UNITED STATES ENVIRONMENTAL PROTECTION AGENCY
WASHINGTON, D.C. 20460

SEP 28 1979

Mr. Eugene Beckett
WIPP Project Office, Mail Stop B-107
U.S. Department of Energy
Washington, D.C. 20545

Dear Mr. Beckett:

In accordance with Section 309 of the Clean Air Act, as amended, we have reviewed the Draft Environmental Impact Statement for the Waste Isolation Pilot Plant (WIPP), DOE/EIS-0026-D. Our detailed comments are enclosed.

The final environmental statement should bring out more conclusively the adequacy of the site and the bedded-salt host medium, and, further, that the deficiencies revealed in this environmental statement are no worse than might be expected at other carefully selected sites. If sufficient information cannot be provided in the final environmental statement to this end, a program for resolving those matters should be specified and a course of action proposed that will be taken if the results are not favorable to the WIPP project.

The question of the adequacy of the site relates in part to the continuing integrity of the salt formation and the probability of adequately sealing boreholes and shafts against subsidence stresses and other phenomena. The draft statement does not adequately address the problem of detection of existing boreholes and of small-scale dissolution features within the repository formation. There appears to be little information on dissolution below the host salt formation and the potential for failure from below. The hydrologic modeling appears to have the potential for large uncertainties, and the analysis should treat the sensitivity of the results to the range of potential error.

A major concern is the assumption implied in this proposal, that transuranic wastes and spent fuel are compatible with each other and with the bedded salt and hydrology of this site in the proposed repository configuration. No case is made for putting spent fuel, with its high radionuclide content but chemically resistant uranium dioxide ceramic form, in a repository selected for its chemical barriers to radionuclide migration and, likewise, putting into the same repository transuranic waste with its multitude of chemicals. Although it is

desirable to combine disposal facilities to decrease costs, such combining of facilities should be supported by an assessment in the final environmental statement of the compatibility of the different waste forms. The presence of organic chemicals in the TRU waste should receive particular attention in this assessment.

The EPA is also greatly concerned with the lack of a positive commitment in the DEIS to the development of mitigation plans. We are equally concerned about the need to monitor environmental impact conditions, and implement mitigation measures during all phases of construction and operation of the WIPP. Mitigation and monitoring is needed, not only to avoid violation of existing standards, but also to minimize negative impacts on the environment. The mitigation plans should allow the inclusion of "current knowledge" and "best management practices" as developed after initiation of operations at the selected site. The EPA strongly urges that DOE require the design of a dynamic monitoring and mitigation plan before either licensing or approving construction of WIPP.

On the basis of these concerns, we have environmental reservations about the actions proposed in this draft statement and consider that the statement provides insufficient information. Therefore, we have rated this draft statement ER-2, i.e., environmental reservations and insufficient information.

Should you or your staff have any questions about our comments, please call Ms. Betty Jankus (NEPA matters, 755-0770) of my staff, or Dr. Jerry J. Swift (technical matters, 557-7604) of EPA's Office of Radiation Programs.

Sincerely yours,

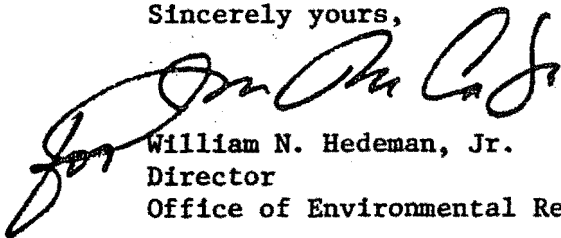

William N. Hedeman, Jr.
Director
Office of Environmental Review

Enclosure

U.S. ENVIRONMENTAL PROTECTION AGENCY

Detailed Comments
on the
Department of Energy's
Draft Environmental Impact Statement
for the
Waste Isolation Pilot Plant

General Comments

The final statement should bring out clearly the adequacy of the site and long-term integrity of the host medium, and, further, that the deficiencies revealed in this environmental statement are no worse than might be expected at other carefully selected sites.

The combination of a facility for the disposal of transuranic wastes with facilities for testing of high-level waste forms and disposal of spent nuclear fuel is not adequately supported. There should be a showing in the final environmental statement that the differences in waste forms and the configuration of the repository do not significantly diminish the protection that would be provided by separate facilities. It is not clear that the proposed approach is consistent with the near-term objective "to proceed by deliberate steps in a technically conservative manner."

The principal problems with the proposed projects are:

1. It has apparently been assumed that transuranic wastes and spent fuel are compatible for disposal in this repository. The list of alternatives considered is limited and rests heavily upon this same assumption.
2. There are appreciable mineral resources at the site. There is also a reliance on long-term institutional controls to prevent human intrusion. The DEIS addresses only the point that natural resources in the WIPP area will be lost for future exploitation because of the presence of the repository. However, it should also consider that institutional control could be lost after hundreds or thousands of years while the hazard from the waste remains substantial. The natural resources could be explored without knowledge of the remaining hazard.
3. The host salt formation is under solution attack from above and from the side and may also be under attack from below.

4. The groundwater Eh may be in the range where it will make actinide elements more mobile.

5. The assessment of potential impacts on the surrounding population appears to disregard the workers at the potash mines nearby.

6. There has apparently been no question of the desirability of having two levels in the repository rather than one.

7. Impacts of potential releases of radionuclides are regarded in this draft environmental statement as short-term impacts; the potential impacts of releases of radioactivity over long time periods should be addressed.

8. As a research tool, the project should provide valuable information on the effectiveness of various waste disposal methods. Much of this data, of a generic nature, should be applicable to future waste disposal projects.

9. Criteria for the acceptance of the various waste forms have not yet been made firm. Firm criteria would help resolve the nature of the interactions that might occur between the wastes, the salt, and any water that is present.

10. The site selection process has been successful in finding a location with a low population density, much lower than in Michigan, Kansas, and Ohio. This is a clearly advantageous feature of the Los Medanos site. With respect to site selection criteria, however, some of the data gathered from WIPP may not prove useful in future siting decisions, primarily because of differing geologic formations. Other geologic structures, such as salt domes, basalt, granite, shale, and tuff are currently being investigated, and the EIS notes that future sites will be evaluated on a case-by-case basis. We believe that the recognition of site specific differences is critical to the selection of regional repositories, and strongly endorse this approach.

11. The EPA is also greatly concerned with the lack of a positive commitment in the DEIS to the development of mitigation plans. We are equally concerned about the need to monitor environmental impact conditions, and implement mitigation measures during all phases of construction and operation of the WIPP. Mitigation and monitoring is needed, not only to avoid violation of existing standards, but also to minimize negative impacts on the environment. The mitigation plans should allow the inclusion of "current knowledge" and "best management practices" as developed after initiation of operations at the selected site. The EPA strongly urges that DOE require the design of a dynamic monitoring and mitigation plan before either licensing or approving construction of WIPP.

Detailed Comments

12. In addressing the population distribution around the site, there are statements like that on page 1-3, "Sixteen people live within 10 miles of the center of the proposed site." This overlooks the approximately 650 workers at potash mines and mills within 12 miles, plus other people employed in the oil and gas producing industry. Table 2-2, "Application of Site-Selection Criteria," also shows this distortion. Another example is on page 7-1, "Thirteen people live within 10 miles of the proposed site." Such pertinent features as the potash mines should also be shown on the maps of the area; e.g. in Figure 8-1, the railroad spurs are shown — they probably end at potash refineries.

13. Although the low annual rainfall and limited runoff are mentioned in several places (e.g. page 7-59), the flash flooding associated with rainstorms in arid lands is not mentioned, nor is there mention of its potential for influencing the repository or transportation accidents. Section 9.3.3.2 should be revised to include discussion of the potential for flash flooding, which may occur much closer than the Pecos River.

14. Comparison of radiation exposures to those from natural background can be meaningful when they are exposures to an individual. When the exposures are to a population group, they become less meaningful because the relative values can be altered by including more people who get the same background exposure but little or none from the other source in question. Such comparisons should always include the maximum individual exposures. The last statement on page 1-6 is an example: "An accident of the extreme severity postulated in the transportation analysis could deliver a 50-year radiation-dose commitment that might reach 25 percent of the dose from natural background radiation." This provides only the average value and does not provide information on those most affected.

15. It is correctly indicated on page 1-8 that for an alternative action involving a delay in construction, the estimated additional costs of \$280 million are mostly due to inflation and therefore do not represent real additional resource expenditures. If put into 1978 dollars, this large sum would become almost zero. Its use in this statement tends to be misleading.

16. This draft statement quotes various solution rates for the Salado salt, such as the 500 feet per million years (on page 2-12). The final statement should also provide the uncertainty in the solution rates.

17. The second "basic reason" given on page 2-16 is illogical. This draft statement proposes to use the facility for both transuranic waste and 1000 spent fuel elements; therefore, it is not "dedicated only to TRU waste."

18. The second basic reason on page 2-16 contains a clear example of the concept that there is no significant loss in safety or protection of the environment occasioned by putting more than one type of radioactive waste in a repository. This concept, used extensively throughout the draft statement, appears without scientific support. The IRG objective, stated on page 1-2, "to combine compatible facilities, where suitable," must certainly have been written in the belief that compatibility and suitability would be established rather than assumed. The result of disregarding the differences in the

chemical nature of waste types is seen in the statement on page 3-26, "There is no reason to expect that adding TRU waste to a HLW repository at either site would appreciably increase the probability of long-term releases of radioactive material." The TRU waste contains various organic substances which can form complexes and greatly increase the mobility of the actinide elements.

19. It is recommended that the final statement be revised to state a practical purpose for the reference repository as designed. On page 2-22, the draft statement states, "The reference repository is intended for the disposal of only that amount of readily retrievable waste expected to be stored at INEL through 1990," and further, "Some 100 acres of repository space will be more than adequate for this purpose." As the design is for a 2000 acre facility and a 30 year lifetime, it is only practical to specify instead that the facility is intended to be used to capacity (70 million cubic feet, per Table 2-3). If the design is successful, to use it at such a small fraction (2.4 million cubic feet) of its capacity would be wasteful.

20. The statement on page 2-23 regarding the policy announced on October 18, 1977, should be corrected to state clearly that the fee includes disposal costs as well as storage costs.

21. The draft statement, on page 2-28, contains the peculiar argument that "while some useful generic information could be obtained from a stand-alone ISF (Appendix C), only a portion of that information could be transferred to another site." It appears, however, that unless it is intended to use the WIPP site for large-scale disposal of spent fuel or high-level waste, only about the same information can be transferred from WIPP to another site, i.e., the amount of information gained is essentially the same. This statement and Figure 8-11 also raise the question again as to what eventual use will be made of this repository and whether it would not be a better approach to seek approval for full utilization at this time.

22. In Table 3-10, all estimated accidental exposures are compared to background except the case of drilling through spent fuel, which is compared to occupational exposure limits. Because there is no reason to believe the drillers would have been classified as radiation workers, there is no justification for comparing their estimated exposures to occupational limits.

23. The comparison of the impacts is not correctly constructed in the case (on page 3-16) where leaving spent fuel in storage pools "is estimated to give a worldwide population exposure of 10^{-7} of background." Spent fuel in storage pools cannot reasonably be considered to irradiate a significant fraction of the public, much less the worldwide population.

24. It is questioned whether, as the discussion on page 3-19 asserts, heat-producing waste can be emplaced more densely in basalt than in salt. Such an approach would appear to subject high-level waste, for example, to significantly higher temperatures than emplacement in salt, and would raise the repository to higher ambient temperatures. Other technical documents have indicated that, because of the poorer thermal conductivity and heat capacity of basalt, a spent fuel or high-level waste repository in basalt should be loaded to a lower heat generation density than in salt.

25. The discussions in Section 3.5.2 indicate that no conceptual designs exist for TRU repositories in dome salt and basalt. This suggests that consideration of these alternative media was quite limited, and perhaps not adequate as a consideration of alternatives required by NEPA.

26. The question of whether pyrophorics will be permitted to be included with the TRU wastes does not appear to be adequately answered. It is stated that "small quantities" of pyrophoric materials may be accepted (page 5-3), but the waste acceptance criteria include the criterion of "no pyrophoric materials." The absence of pyrophorics is assumed in predicting the environmental impacts of shipping and handling, and yet the impact estimations are described as yielding "maximum environmental-impact predictions." If pyrophoric materials are to be permitted in TRU waste packages, the term "small quantities" should be defined in numerical terms (as was done for gas-generating materials in Table 5-1) and the acceptance criterion given in Section 5.1.2. If significant quantities are to be permitted, appropriate assumptions should be factored into the impact analyses for the retrieval, transportation, handling, storage, and accident scenarios.

27. Additional criteria appear to be needed for waste forms that "cannot be immobilized" (page 5-3). With few exceptions radioactive waste can be immobilized if the resources are available to do so. For some waste categories, immobilization may not be practical in terms of cost versus cost of overpacking, or low potential dose savings per dollar spent, or because of excessive volume of the final waste product. The final EIS should contain numerical criteria on immobilization requirements so potential impacts can be better evaluated.

28. The discussion of transportation in Chapter 6 would be greatly improved by the addition of expected doses to individuals in the public in the discussion of routine, non-accident exposures. Statements such as "it exposes the nearby population at a very low dose rate" (page 6-15) immediately raise the question of very low relative to what. The collective exposures of Tables 6-9, 6-10, and 6-11, while they are good information, only set upper bounds to the individual dose.

29. The discussion of possible transportation accidents in Section 6.7 indicates that exposures to airborne radioactive materials released by accidents in urban areas are calculated using a dispersion model and parameters (page 6-23) appropriate to flat, smooth, open terrain, and thus inappropriate to a location where buildings interfere with the airflow. Turbulences around buildings, while providing more mixing action for dilution, could also bring the plume to ground level much closer than one half mile and perhaps appreciably increase maximum individual exposures. Similarly, although a low wind-speed is conservative once the material is in the plume, it is clearly not conservative with regard to lifting the material from the ground into the air. Furthermore, even if a low-wind speed is the existing condition, a larger fraction of the material might be entrained in the plume by locally higher wind speeds induced by fire or by passing vehicles during the period before authorities close off the area.

30. The food pathway should be examined again; while health authorities, acting after an accident, would remove contaminated food from distribution, they would have to notify people quickly in order to intercept food being eaten.

31. Frequencies such as in the last column of Table 6-16 tend to mislead when they include a fraction for the stability category and wind direction. In an urban area, almost 100 percent of the time the wind will carry the material in the direction of a number of people. Therefore the risk from such an accident is greater than that indicated by the combination of Table 6-15 and the last column of Table 6-16.

32. The Final EIS should identify the sources of high-level waste and possible transportation routes available to carry this material to the WIPP site. The transportation scenarios developed in the Draft EIS used a maximum city size equal to Albuquerque, New Mexico. In Figure 6-1, on page 6-9, the typical rail routes depicted for transportation of waste materials pass through metropolitan areas much larger than Albuquerque. Transportation scenarios should be developed under worst possible conditions for each type of waste material to be transported to the WIPP site (TRU, HLW, spent fuel canisters). These scenarios should depict the adverse impacts which might be incurred in a densely populated metropolitan area such as Dallas or Houston.

33. At the end of Chapter 6 there is a short section devoted to the possibility and consequences of "intentional destructive acts." It claims that the consequences from an intentional act of terrorism or sabotage "will not produce consequences more significant than the accident consequences calculated in Section 6.7." Acts of terrorism (using explosives for example) could create more serious situations than conceivable truck or train wrecks.

34. In the section on accidents involving contact-handled TRU waste (beginning on page 6-23), a fire should be assumed to be taking place. Surely this would create a worse hazard than if a fire was not present. Previously on that page, DOE stated, "...the conditions that lead to the greatest population dose have been chosen." This statement and the cited scenario do not seem to correspond. In addition, the release fractions used on page 6-26 should be documented.

35. In Section 6.7.3, Results of the Analysis, the results were not converted from person-rem to health effects. In this case, one accident yields non-negligible impacts, the accident involving spent fuel. Based on DOE estimates this accident will result in a 50-year whole body dose commitment of 3700 person-rem for a small urban area and 8300 person-rem for a large urban area. Using EPA's conversion factor of 600 health effects per million person-rem, estimates of total health impacts are about 2 and 5, respectively.

36. There appears to be a considerable seismic risk. An earthquake with an epicenter at the WIPP site could disrupt the repository and break containers; this would result in wastes coming into direct contact with salt sooner than anticipated. Considering the magnitude of possible consequences, this scenario should be explored further. The final statement should include among the accident cases it discusses, the case of an earthquake-induced rock fall in the repository (analogous to those reported in the nearby potash mines). Such a rock fall could damage a number of waste containers in open rooms. Though unlikely, an earthquake could also simultaneously degrade the HEPA filter installation.

37. The discussion of rates of removal of salt by dissolution (page 7-74 ff) illustrates well the difficulty in determining such rates. First one estimate is referenced of 0.33 foot vertical per thousand years average but the suggestion is made that most of the dissolution occurred long ago at a faster rate, and that the present rate is slower. Then an alternative approach is referenced which gives a present vertical dissolution rate of 0.5 foot of salt in 1000 years. Although it is unlikely that these estimates are so greatly in error that there would be a threat to the repository in the next thousand years or so, it would, in any case, help the presentation in the final statement if the uncertainty in these estimates were presented.

38. The physical properties of vertical solution features and wells can be very similar relative to ground water movement. Chapter 7, page 74, states that "extensive investigations" at the site show no evidence of continuing deep dissolution. Small scale vertical solution features are very difficult to detect utilizing surface geophysical

methods such as the resistivity surveys mentioned in the report. The probability of locating a vertical "chimney" while drilling a test hole is even more remote.

39. On page 7-75, the last paragraph states, "The rate of deep dissolution is difficult to assess, and Anderson (1978) does not believe that estimates can be made with any degree of confidence from the available data." Then, without further support or reference, the conclusion is drawn "In any case, deep dissolution does not occur near the site." We recommend that this conclusion be deleted unless some evidence in support of it can be referenced. Whether the limestone under the site is subject to dissolution like that in neighboring Carlsbad Caverns should be discussed.

40. On page 8-28 is stated "The amount of material released through cracks is assumed to be proportional to the ratio of the area of the cracks to the total area of the drum." In view of widespread current experience with salt shakers and the past record of hourglasses, in which all the material has exited the holes, this assumed limitation on the amount of material released needs experimental verification to give it credibility. The final statement should provide at least a supporting reference to such verification.

41. On page 8-39, it is indicated that a 24-inch waterline is proposed to bring water to the site from a tie-in with an existing 10-inch main; this appears to be a typographical error. If not, it should be explained.

42. The use of carbon-steel pipe (page 8-49) for canisters for the spent-fuel assemblies as indicated in this draft statement represents a much better use of natural resources than earlier proposals for thick canisters of stainless steel containing large amounts of chromium and nickel.

43. On page 8-50, it is indicated that "The backfilling of the storage drifts will not greatly affect the results of the demonstration or monitoring program." It should be explained why the ventilation air will not carry away heat that would otherwise be stored in and conducted through the salt, raising its temperature.

44. On page 8-52, the statement indicates that stress-induced creep closure of the storage room "may possibly" damage the waste containers. If, in due time, such closure is expected to eliminate almost all voids in the salt, damage to the containers would seem a certainty.

45. The Demonstration of Spent-Fuel Disposal (Section 8.10) has some serious problems. Based upon the distribution coefficients on page K-20 it appears that the overlying aquifer is oxidizing. This is inferred from the high mobility of U and Tc. It is possible that the high distribution coefficient for Np is either from a selective adsorption of NpO_2^+ or from reduction of that species to NpO_2 . Because the overlying aquifer, if diverted by natural or human factors through the repository, will dissolve the spent fuel, the risk is much higher (a thousand times or more) than it would be if the overlying aquifer were reducing. This oxidizing aquifer raises serious questions concerning the site suitability for spent fuel disposal. This consideration does not affect the impact from the TRU wastes so severely, since those wastes (mostly Pu) are not as sensitive to oxidation. It appears that either the rock is such that it makes a Ph and Eh condition where Np is reduced to Np (IV), or the rock selectively removes NpO_2^+ from solution. C-14 should be added to the distribution coefficient table portion of table K-3. It would also be helpful if the density and porosity of the Rustler formation were used to translate the distribution coefficients which are given, into Equilibrium Adsorption Constants, as defined by Equation K-9. These Equilibrium Adsorption Constants (sometimes called "Retardation Factors") are more directly useful in groundwater migration calculations than distribution coefficients. It is also likely that some of the distribution coefficients have a high degree of error associated with them; presentation of the percent error will indicate those values for which the uncertainty is high.

46. The environmental impacts of the experiments to be performed (pages 8-45 to 8-53) cannot be evaluated without more information on the nature, and especially the scale, of the experiments. There appear to be no plans for participation in decisions on the experimental program by non-DOE agencies. There should certainly be a review process before plans for the experiments are finalized.

47. In view of the concerns expressed in years past about existing drill holes at the Lyons, Kansas site, it is surprising to read (page 8-56) "that the long-term consequences analysis (Section 9.5.1) shows that an unplugged hole has but small environmental or safety consequences." It would, perhaps, be reassuring to include a comparison of the Los Medanos site with the Lyons, Kansas site. Section 9.5.1 contains several scenarios which have been modeled for calculations. Scenario 1 is postulated to be the worst case. However, there are several factors which could be reasonably expected to alter Scenario 1 such as the pressure difference between the Rustler and the Bell Canyon aquifers, the number of undiscovered boreholes, the amount of casing in the boreholes, waste container leaks, etc. Appendix Section D-2 flatly states that "the repository and control zone III are

free of pre-existing holes that extend through the salt, shafts, and mining activity." This statement is questionable on its face value in the absence of conclusive data -- none appeared to be provided. There is no mention of holes in the remainder of Control Zone I and in Zones II and IV.

48. In Section 9.1.5, Plans for Mitigation of Impacts, the discussion of erosion control should also address controls against wind erosion for those parts of the site where the soil is particularly susceptible. As indicated on page 7-53, the potential for wind erosion is high if the vegetative cover is seriously depleted. On page 7-72, it is indicated that Laguna Plata and Laguna Gatuna were formed as blowouts. The discussion should also address controls for any areas that may be subject to flash flooding. In addition, when impacts of the proposed action are being discussed in several places (page 9-8) mitigating measures are discussed as optional approaches. If a decision is made to proceed with a repository at this site, the decision should include a positive commitment to utilize those measures to limit pollutant impacts.

49. It should be made clear in Section 9.2.10.2 how the populations of miners at the potash mines, and of oil and gas workers in the vicinity, are included in the exposure calculations. The draft statement indicates that the miners are treated as if they were home in Carlsbad rather than at the mines. The discussion on page 9-55 also should be enlarged to specify how potash miners and oil workers are treated in the calculations.

50. In as much as use of diesel-powered waste transporters is contemplated (Chapter 8), among the conceivable accidents that should be considered in Chapter 9 should be those including fires involving the transporter and its fuel tanks.

51. On page 9-51, the air-entrainment factor is quoted at 0.014 percent per hour, one tenth the factor quoted earlier in the draft statement; this discrepancy should be cleared up.

52. The Department of Energy has put together a high quality evaluation of the economic and social impacts of the WIPP project. The economic impacts are based on an input-output analysis of the direct and indirect impacts of both the construction and the operation periods of the project. The draft points out the uncertainties inherent in the economic impact projections, due to the uncertainty in projected alternative employment opportunities, specifically in mining and in a projected large dam project in the area. A minor criticism of the analysis is that the input-output evaluation of indirect impacts should have been based on an area somewhat larger than Eddy and Lea Counties. It is appropriate that the direct effects be measured for those two counties only, but the indirect effects can be expected to impact an area larger than these two counties. If the analysis had encompassed a larger area, the estimated multipliers of the input-output analysis would be expected to be somewhat larger.

53. The cost estimates of the WIPP are given in 1978 dollars: construction--\$225 million; engineering, construction management, and technical support--\$205 million; yearly operation--\$36 million. An estimate of these costs, however rough, needs to be made using 1980 dollars. Also, the effects of lengthened construction time on total costs in constant dollars should be discussed.

54. In Section 9.4.1.2, mention is made of a reservoir project on the Pecos River between Artesia and Carlsbad. The final statement should address the potential of this reservoir to induce seismic events as a result of the load from its filling, and its potential to induce changes in the ground water flows.

55. The discussion (in Section 9.5) of ground water flows and their potential transport of leached materials from the site should also address the potential for changes to be induced in the ground water flows, and for transport of leached materials to Carlsbad Caverns.

56. Although some of the assumptions used in Section 9.5 provide bounding analyses that appear to be beyond potential differences due to leaching, waste-matrix degradation, and changes in the valence states of important radionuclides, these matters and their potential impacts on radionuclide transport should be addressed directly or by reference in the final statement.

57. The labels of Tables 9-43 and 9-44 are unclear. If they present concentrations in waste in still-intact and unaltered containers, this should be specifically stated.

58. The suitability of the hydrologic transport model employed in the dose rate analysis for the postulated four scenarios is questionable. As was stated in Appendix K, Section K.1.2, the basic equation used in the numerical model was multi-dimensional and temperature dependent. However, the actual models representing scenarios 1, 2, 3, and 4 were one-dimensional and temperature independent. Therefore, the basic system equations for the numerical model could be greatly simplified. The result of reducing the numerical model from multi-dimension and temperature dependent to a single-dimension and temperature-independent model may result in inducing additional unnecessary error of analysis. The combination of the above error and the additional numerical error for a transport distance of 70 meters has been demonstrated by the Intera Environmental Consultants, Inc. in a report to the U.S. Nuclear Regulatory Commission. The report analyzed the transport of a radionuclide with a half-life of 433 years, in an aquifer with hydraulic conductivity of 2 ft/day, by the same numerical model and by the analytical solution

model. The concentrations of radionuclide at a distance of 70 meters were 10^{-4} and 1.5×10^{-3} of the original mass respectively for the numerical model and for the analytical model. The combined error was evaluated to be 10 or 1000 percent at a distance of 70 meters. This combined error is expected to increase exponentially with the increase in the transport distance. Therefore, the results of the analysis using the numerical model could have large uncertainties.

59. On page 9-100 is a discussion of compilations of scenarios. The work by S.E. Logan and M. C. Berbano (EPA 520/6-78-005) seems to be appropriate for inclusion in this discussion. This work was specific to this New Mexico site.

60. Section 9.5 should also include discussion of the potential use of waste-contaminated water closer to the site than Malaga Bend, via wells for drinking water or stock watering. Figures 7-23 and 7-24 indicate a number of wells closer than Malaga Bend. While it is unlikely that anyone would drink water that is 100,000 ppm salt, they might use some that had been diluted by other ground water. Any potential pathway through the Laguna Grande de la Sal should also be discussed.

61. Section 9.5.1.5 should have its sequence of "events that must occur" revised:

(a) For the first event, it is only necessary that institutional control fail rather than be lost. There are many examples of institutional controls failing; a recent one is the waste tank leak at Hanford that went uncorrected for over a month although monitoring duly recorded the decreasing level of waste in the tank. Perhaps the state of fire prevention at the Browns Ferry Nuclear Power Plant in January 1975 could also be put in this class.

(b) With regard to the second event, it is not necessary that knowledge of the repository be lost. Fear of its hazards could be overcome by avarice, as may have happened with kepone in Hopewell, Virginia. It is also not unheard of for people to become complacent about hazards; experience in this respect is given by flood-control levees being allowed to fall into disrepair when the period between floods grows long.

62. Section 9.5 addresses subsidence (page 9-131 ff) and concludes that 1 to 1.6 feet of subsidence will be insignificant. The discussion should be enlarged to include the effects of subsidence and its concomitant distortion of the rock strata upon the borehole and shaft sealing, and whether it could induce failures that should be included in the radionuclide release scenarios. In this respect,

although it is reassuring that water has not flowed into the local potash mines in spite of more severe subsidence, the experience time period is relatively short.

63. The subject of liquid inclusions in the salt at the WIPP site and brine migrations along thermal gradients is important. In the discussion of brine migration in Section 9.5.3.2, some mention should be made of the potential case in which brine migrates to open spaces around the canisters and then evaporates and moves through the voids in the backfill salt upward to the room above. It is not clear that the bounding analyses of radioactive releases (Section 9.5) are so broad that they envelope all potential problems from brine migration and canister corrosion.

64. In the course of salt closure in the repository, in perhaps 200 years (page 9-135) it is possible that volumes of noncondensable gases will be trapped and pressurized by the inward creeping salt. The discussion of scenario 5 (Section 9.5.1.5) should be expanded to address the potential for drilling into a pressurized gas volume, including the possibility that the gas includes radionuclides released from the wastes. This drilling sequence should also be examined for any mode in which it could trigger a release of stored energy from radiation damage.

65. The discussion of stored energy in Section 9.5.3.5 appears to consider only the case in which the radionuclides remain in the waste containers. The discussion should be expanded to cover the potential for nuclide migration into the salt where the beta and alpha energy would also be available.

66. In preparing the TRU waste from INEL, the slagging pyrolysis process uses makeup soil blended with the waste in the ratio 1.5 pound per pound of waste (page 9-155). This will require some 50,000 to 100,000 tons of soil through 1985. The draft EIS makes no mention of the source of soil or soil type to be used. We suggest that TRU-contaminated soil be obtained and used for this purpose. This activity appears to present a rare opportunity to solve at least part of some existing waste disposal problems at several locations around the country.

67. The criteria in D.1 and D.3 that the repository will not be breached while the wastes remain hazardous should be qualified. Minor breaches may and probably will occur. The period should be stated more definitely.

68. The discussion on page D-8 should address the effect of the brine on the ion-exchange properties of the geology. Brines are used to remove adsorbed nuclides from ion-exchange systems.



UNITED STATES
NUCLEAR REGULATORY COMMISSION
WASHINGTON, D. C. 20555

SEP 24 1979

Mr. Eugene Beckett
WIPP Project Leader
U.S. Department of Energy
WIPP Project Office
MS B-107
Washington, D.C. 20545

Dear Mr. Beckett:

The U.S. Nuclear Regulatory Commission (NRC) staff has reviewed the draft environmental impact statement issued by the U.S. Department of Energy (DOE) related to the Waste Isolation Pilot Plant (WIPP) located near Carlsbad, New Mexico. On the basis of our review, the staff offers the following general comments. Detailed comments on the WIPP draft environmental impact statement (DEIS) are enclosed.

Background

The DEIS evaluates the environmental effects of the WIPP reference repository along with six other alternatives. The DEIS assumes that all options would be licensed by NRC except option 1. The seven options presented in the DEIS on page 1-5 are as follows:

1. No action. No ISF is built, and TRU waste remains stored at the Idaho National Engineering Laboratory and elsewhere as it is now.
2. The WIPP reference repository in southeastern New Mexico. This includes an Intermediate Scale Facility (ISF) with up to 1000 commercial spent fuel elements as well as limited military high-level waste.
3. The WIPP reference repository, but without the ISF.
4. Disposal of TRU waste in the first available HLW repository. By 1982 or soon thereafter, sites in the Gulf Interior region salt domes and Hanford basalt should be available for consideration. An HLW repository would be built at one such site, and TRU waste would be put into it. The initial retrievable-storage phase of the repository would take the place of the ISF.
5. Delay of Alternative 2. By 1982 or so, the WIPP may also have the choice of dome salt and basalt sites as well as the bedded salt site at Carlsbad.

Mr. Eugene Beckett

6. Delay of Alternative 3, similarly.
7. A longer delay. By 1985 or somewhat thereafter, sites may also be available in granite, tuff, or shale for a HLW repository as in Alternative 4.

The DEIS concludes that none of the alternatives is superior to the others based on environmental considerations; however, alternative 1 does not appear viable over the long term. The DEIS further concludes that from a programmatic standpoint, alternatives 2, 3, and 5 appear attractive. While the DEIS does not explicitly state which of these alternatives is the preferred option, the document implies that the WIPP reference repository is the alternative that will be pursued. Indeed, most of the document is devoted to an evaluation of environmental impacts resulting from the development of this option.

The WIPP reference repository as described in the DEIS could provide for the ultimate disposal of 70 million cubic feet of TRU waste. However, current plans call only for the disposition of that amount of readily retrievable waste expected to be stored at the Idaho National Engineering Laboratory (INEL) through 1990. This waste will amount to about three million cubic feet or about 800 kg of TRU. The DEIS states that the WIPP reference repository will have the capacity to receive TRU waste from the dismantling and decontamination of obsolete weapons-production facilities such as the Hanford plutonium reactors. Estimates of the volume of such waste range from 5 to 95 million cubic feet. The transportation impact analysis, however, does not evaluate the effects of shipping any of this dismantling and decommissioning waste to WIPP.

Comments

1. The NRC staff considers that the EIS does not present the basic information needed to make a reasonable comparative assessment of the alternatives. For example, cost information which would permit a rigorous comparison is not explicitly provided. In addition, where comparative information is discussed, it is done in a rather judgmental and qualitative way which does not facilitate independent review and assessment (e.g., land use, resources, transport, socioeconomic, potential for future disruption, isolation potential). The staff considers that a more rigorous comparative analysis of the alternatives may indeed sharpen the differences among them and lead to clearer conclusions regarding which alternatives are preferred.
2. In re-evaluating the alternatives on a more rigorous basis, the NRC staff considers that particular attention should be given to the following points:
 - (a) The DEIS states that the capital cost of the WIPP reference facility (alternative 2) is about \$430 million. This would result in a construction cost of more than \$500,000 per kilogram. Figuring in the operating costs would likely run the costs up to in the order of \$1,000,000 per kilogram of TRU disposed.

The DEIS points out that alternatives such as 4 and 7 could result in a 40 percent reduction in land use while increasing the cost of the HLW repository only four to ten percent. This would appear to be an enormous cost advantage.

This evaluation should be made explicit and quantitative so a direct cost comparison can be made.

- (b) The DEIS states that although the WIPP reference facility is sized for disposal of 70 million cubic feet of TRU, only the material expected to be stored at INEL through 1990 is being definitely intended for disposal at this time. The DEIS implies, however, that this additional capacity could in the future be used for the large quantities of TRU waste which would result from dismantling of surplus facilities largely at Hanford (estimates range up to 95 million cubic feet).

Elsewhere, the DEIS observes that there would be a small transportation advantage if the TRU (at INEL) were eventually disposed of at a HLW repository at Hanford; however, the DEIS goes on to conclude that this advantage is small since the differential distance from INEL to Hanford and Carlsbad is small.

If all of the TRU material requiring disposal at the other DOE sites (particularly Hanford) is considered in the transport effects, however, substantially different conclusions would likely emerge. The NRC staff feels that consideration of the known TRU requiring disposal should be explicitly considered.

- (c) The DEIS discusses generally that the mineral resources situation at the WIPP reference site would have two adverse impacts. Firstly, resources would be denied to future generations; and secondly, the existence of resources at and near the site could invite future disruption. The DEIS concludes that these effects are small. The DEIS points out, however, that these undesirable effects could probably be avoided with almost all the other alternatives.

The treatment of this issue in the DEIS is general and somewhat qualitative. DOE should reassess this important issue on a quantitative basis as possible comparing it with the other alternatives.

The potash and hydrocarbon resources at the WIPP site should be monetized and factored into the alternative site analysis. Mineral resources at alternative sites, if they exist, should also be considered in the comparison of sites. Furthermore, the final environmental impact statement should elaborate on any tentative

Mr. Eugene Beckett

plans for recovering these resources prior to construction, during operation, or after closure of the repository. Any such discussion should put primary emphasis on the potential consequences these recovery operations might have on the integrity of the repository to function satisfactorily.

- (d) The Final Statement should reconsider the relative merits of proceeding ahead at the WIPP reference site without comparative information which will be available in the mid-1980's from several other site characterization efforts resulting from the HLW program. The merits of proceeding to fully characterize (i.e., at depth exploration and R&D) the WIPP reference site in parallel with those being evaluated in the HLW program (but not making any construction commitments to the site until the comparative exploration and R&D information is available) should be quantitatively analyzed.
3. The analysis for the WIPP referenced facility (alternative 2) assumes it will be licensed by NRC. The DEIS emphasizes that this will provide an opportunity to try the licensing process at an early date and discusses the institutional advantages of this approach. The WIPP reference case also emphasizes the considerable technical advantages of an early ISF using spent fuel where experiments involving high temperature HLW could be performed and evaluated at an early date.

Recently, DOE officials have stated that DOE no longer will pursue WIPP as a licensed facility nor the ISF involving the 1000 fuel elements. This would appear to greatly reduce the utility of the reference alternative from a technical development standpoint and would appear to render any previously positive institutional advantages non-existent or negative.

The changed nature of the reference alternative should be explicitly included in the more rigorous comparative analysis discussed in comment 2 above.

Finally, it must be pointed out that by commenting on the DEIS, the NRC staff does not intend to preclude itself or the Commission in any way from (1) carrying out a licensing review, if subsequently authorized by law, in accordance with procedural and substantive rules and statements of policy of the Commission, or (2) denying a license or incorporating conditions on any license that may be issued for the WIPP facility at a later date that may reflect a more restrictive position than that taken in these comments on the DEIS.

Mr. Eugene Beckett

SEP 24 1979

Thank you for providing the NRC with the opportunity to comment on the WIPP DEIS. We hope that these comments will be of assistance in preparing the final environmental impact statement. We would be pleased to discuss these comments with you or members of your staff if you so desire.

Sincerely,



John B. Martin, Director
Division of Waste Management

Enclosure: NRC Comments on
WIPP DEIS

COMMENTS ON
DRAFT ENVIRONMENTAL IMPACT STATEMENT
FOR THE
WASTE ISOLATION PILOT PLANT
(U.S. DEPARTMENT OF ENERGY, DOE/EIS-0026-D)
APRIL 1979

BY
THE STAFF OF THE
U.S. NUCLEAR REGULATORY COMMISSION

AUGUST, 1979

Specific Comments - Chapter 1

The document does not address the issue of safeguards requirements for protection of WIPP facilities or for protection of waste materials in transit to or between such facilities. The Final Environmental Impact Statement should discuss safeguards requirements for the facility and the impacts of these requirements.

Section 1.1, page 1-1, second paragraph The location in the text containing the definitions for HLW and TRU should be referenced.

Section 1.1, page 1-1, third paragraph The document states that "progressive elimination of less desirable sites led to the bedded salt of southeastern New Mexico and to the WIPP reference site described later in this document." Either in Chapter 1 or at some other appropriate point in the text, the process of site elimination should be discussed. Included in such a discussion should be the basis, including both the technical and economic factors, for elimination of the less desirable sites.

Section 1.2, page 1-2, item 1 It is recommended that the following revision be made in line 7: "for the disposal of TRU wastes from other DOE sites."

Section 1.2, pages 1-2 and 1-3, items 1 and 3 The waste retrieval period is stated to be 10 years for TRU waste and 20 years for spent fuel. The current staff opinion regarding retrievability of wastes disposed in deep geologic repositories is that the repository design should permit the waste to be retrieved throughout the operating life of the repository and 50 years thereafter.

Section 1.1, page 1-3, Geology, second paragraph The last sentence states that there will be ". . . only a temporary denial of access to approximately one-third of the natural gas, three-quarters of the langbeinite, and all of the sylvite at the reference site." This implies that zone IV will be exploited for hydrocarbons and potash. However, on page 9-21 it is stated that "mining and drilling may be allowed in this zone if they would not affect the integrity of the site," which means that potash mining may not be permitted. Therefore, the sentence should be reworded to state that there may be only a temporary denial rather than there will be only a temporary denial.

If it is necessary to indefinitely deny the extraction of resources at WIPP, then this would apparently require long-term reliance on institutional controls. However, this requirement conflicts with EPA's draft criteria for radioactive waste disposal, which states that "Controls which are based on institutional functions should not be relied upon for longer than 100 years." Therefore, the final environmental statement should address DOE's plans for denying these resources after 100 years.

Section 1.2, page 1-2, Item 1 The document states that WIPP will receive TRU waste from the Idaho National Engineering Laboratory (INEL). However, a recent Department of Energy document (DOE/ET-0081) states on page 1-4 of that document that "Before a decision is made for long-term management of INEL TRU stored waste, a Programmatic EIS, covering both buried and stored waste, will

be prepared." The document further states on page 7-5 that the draft EIS will be completed in late 1979. It would appear that the issuance of the WIPP EIS should have been subsequent to the issuance of the programmatic EIS discussed in DOE/ET-0081. The final environmental statement on WIPP should reconcile and discuss the sequencing and objectives of the various environmental impact statements that have been or will be issued by DOE.

Section 1.2, pages 1-2 and 1-3 An important concern about mineral resources at the WIPP site is the probability that these resources will attract future exploration and intrusion. The final environmental statement should discuss the impacts that future mineral exploration activities could have on repository performance.

Section 1.2, page 1-3, Geology, third paragraph The basis for stating the "low seismicity" of the site area should be provided.

Section 1.2, page 1-4, fourth paragraph The document indicates that underground dissolution of salt is an active process in the region of the site ("At the site itself dissolution has removed some salt from above the Salado"). Although Anderson (1978) believes that the site is in an area of the Delaware Basin that is relatively free of deep dissolution features, he indicates that localized features are present in the vicinity (see page 7-74). He also indicates that the rates of deep dissolution are difficult to assess and does not believe that estimates can be made with any degree of confidence from the available data (see page 7-75). Thus, the draft statement does not convey confidence that dissolution processes or rates are sufficiently understood to locate WIPP in an area of active dissolution processes. The staff believes that additional information is needed on current rates of dissolution and on changes which might occur in dissolution rates in the future. The final statement should discuss the effects that boreholes, wells, changes in hydrological conditions, and mineral exploration activities could have on dissolution rates in the site vicinity.

Section 1.3, page 1-5, first paragraph The document states that the reference site in southeastern New Mexico and the plant design were chosen because they were "the most completely analyzed of the alternatives." The selection of the reference case should be based on a comparative evaluation of the relevant environmental, economic, and technical factors of each alternative considered.

Section 1.3, pages 1-9, third paragraph This document states that the alternative of no action (i.e., leaving the TRU waste at INEL) is unacceptable in the long term. However, a comparison of Table 3-1, which illustrates the long-term radiological consequences of no action, with Table 3-5, which displays the radiological impacts of transportation of waste to the WIPP site, shows that the radiological impacts are of the same order of magnitude. For example, the exposure resulting from a transportation accident involving a rail shipment of CH TRU waste is provided in Table 3-5 to be 0.49 rem, 0.025 rem, and 0.012 rem to the bone, lung, and whole body respectively. Table 3-1 shows that for improved confinement at INEL, the respective doses assuming a lava flow release mechanism would be 0.5, 0.9, and 0.0003 rems, respectively.

In view of the similar long-term impacts between the reference case (WIPP) and the no action alternative, the final environmental statement should examine in greater detail the need for the proposed action.

Section 1.4, page 1-6, fourth paragraph Justification should be given for the statement that, ". . . an estimated 3% of the U.S. reserves of this mineral (langbeinite) would be denied for perhaps several decades." This statement implies that the langbeinite in control zones I, II, and III will be mined in perhaps several decades. Such a statement should be accompanied with a full analysis of the impacts of mining in control zones I, II, and III with special emphasis on waste isolation.

Use of the WIPP site may entail the long-term denial of mineral resources in control zones I, II, III, and IV. These resources are stated in Section 9.1.4.2 to include 11.6% of the U.S. reserves of langbeinite. This statistic should be included in Section 1.4.

Section 1.4, page 1-6, sixth paragraph It is suggested that the 50 year dose commitment to the maximally exposed individual and to the population from the postulated transportation accident should be stated numerically as well as a percentage of natural background.

Section 1.4, page 1-8, second paragraph An expected release is equal to the sum of the probabilities of release times the amount of release. Since the probabilities for all releases are not zero, the expected release of radioactivity is not zero.

Section 1.4, page 1-8, fourth paragraph For clarification, the basis for the \$280 million cost estimate should be referenced.

Section 1.4, page 1-9, second paragraph The following statement is made: "It appears that the alternative of no action (alternative 1) is unacceptable for the long term and that there is no clear environmental basis for choosing among the remaining alternatives." No discussion is presented for the acceptance or rejection of the no action alternative for the short-term. Please provide the omitted discussion. Also, it is not obvious that, "there is no clear environmental basis" for choosing among the alternatives. The environmental impacts addressed throughout this section should be evaluated and compared. An analysis based upon "policy objectives" is not sufficient for an environmental impact statement.

Specific Comments - Chapter 2

The draft statement should consider alternative disposal methods for the DOE TRU wastes.

Section 2.1.2, page 2-2, third paragraph It appears that "desiderata" should be "criteria."

Section 2.1.3, pages 2-3 through 2-6, Stage 1 of the process The DEIS does not provide the logic needed to proceed from stage 1 of the site selection process to stage 2. Stage 1 is defined in Table 2-1 (page 2-3) as the step which would "select storage media; define geographic regions where they occur; consider their characteristics in terms of tentative selection criteria." The discussion presented does not provide the rationale or supporting data for selecting bedded salt as the preferred media or eastern New Mexico as a region for further study.

Section 2.1.3, pages 2-3 through 2-12 Table 2-1 (page 2-3) describes a four-stage site selection process, however, the text presents only three steps.

Section 2.1.3, pages 2-7 through 2-12, Stage 3 of the process Table 2-1 on page 2-3 states that stage 3 of the site selection process will include conducting detailed field studies of candidate sites. However, the discussion of the stage 3 process does not indicate that detailed field studies were undertaken for the eight candidate sites.

It is not clear whether the criteria outlined on pages 2-7 and 2-8 were developed prior to the selection of the eight site areas identified in Table 2-2 (page 2-10), or if the sites were selected and the criteria developed and applied later. If the criteria were used to select a site, then one could question why several of the sites were selected for comparison. For example, the first criterion states that "the site should be at least 6 miles from the Capitan reef." Yet five of the eight sites do not comply with this criterion. If sites within 6 miles are not viable sites, then the analysis presented in Table 2-2 compares only three real alternatives.

The alternative site investigation should contain information and comparisons of the relative environmental effects of each of the alternative sites. For example, Table 2-2 (page 2-10) contains no information on the relative importance of the ecological aspects of each site.

Table 2-2, page 2-10 The weight (i.e., degree of importance) given to each criterion should be shown. Those criteria which, if not complied with, would rule out the use of a site should be identified.

Criterion 2 (central 3 miles should not be in potash district) and 4 (avoid known oil and gas trends) should take into account future exploration that may result from the known presence of potash, oil and gas. Although this future exploration is acknowledged in the text, it is treated as a non-problem. Substantiation for the non-problem view should be provided.

Criterion 5 (at least one mile from the nearest dissolution front) considers only present or accumulative rate of dissolution. The discussion should clarify whether consideration was given to potential increases in rate of dissolution due to climatic changes in the distant future, i.e., the extreme rates of dissolution.

Criterion 9 (distance and population of nearest town) considers only present population. It should consider future growth.

Section 2.1.3, page 2-11, fifth paragraph References to the analyses in the document should be given to support the conclusion that the remaining questions in area 1 (i.e., criteria in conflict) "either do not affect repository integrity or are found to be nonproblems."

Section 2.2.2, page 2-16, item 2 The document points out that it is unlikely that there will be another opportunity to build a repository dedicated only to TRU wastes because future HLW repositories are expected to be available for storage of both HLW and TRU waste. This is not necessarily correct unless it includes a basis for assuming that TRU wastes and HLW will be compatible (after breach of the respective containers). For example, TRU wastes from dismantling and decommissioning may contain chemicals that could increase the mobility of radionuclides in HLW.

Section 2.3.3, page 2-22, second paragraph The document states that WIPP has the capacity to receive some TRU waste from dismantling and decontamination of obsolete weapons production facilities. It should be noted that dismantling and decommissioning (D&D) wastes can be very radioactive and provisions for assuring their safe disposal should be discussed. Further, the DEIS states that the transportation impact analyses presented later in the document do not assume that any of the D&D waste is sent to the WIPP. The assumption that none of this D&D waste is transported to the WIPP is not conservative. The final statement should include D&D waste in the transportation impact analyses.

Section 2.3.3, page 2-24, first paragraph For completeness, a brief discussion should be included concerning the ultimate disposal of the experimental waste recovered and removed from the WIPP. The discussion should also address whether the waste would be processed or packaged at the WIPP for transportation.

Section 2.3.3, page 2-24, second paragraph Provide the basis for stating that "little defense high-level waste has been produced."

Section 2.4.1, page 2-26, second paragraph, second item This item states that the commitment to remove all nuclear waste brought into the experimental area means that the experiments introduce no long-term environmental risks of their own. The experiments may result in providing a pathway for water migration or may increase the risk of mechanical failure, particularly when thermal testing is performed. Therefore, long-term effects may result from the experiments and this possibility should be factored into the analysis.

A more specific system of referencing should be used. The statement that is referenced should be keyed to the reference. Page numbers of the references, where applicable, should be given.

Specific Comments - Chapter 3

Chapter 3 In the economic comparisons between alternatives, the document does not clearly specify which cost differences are for the WIPP project alternatives (e.g., WIPP costs with an ISF vs. WIPP costs without an ISF) and which represent the difference in cost to society (e.g., cost of interim storage for spent fuel and saved opportunity cost of the WIPP investment).

There should be a section that compares the relative costs and benefits of alternatives. The comparison should include a cost estimate in constant dollars and an estimate of the environmental impacts (both radiological and nonradiological) for each alternative.

Section 3.1, page 3-1, second paragraph This discussion indicates that no releases of radioactivity are expected to occur at INEL as a result of natural disasters for the next 100 years. The discussion should state the basis for this assertion and why such events are not expected during this period. A stronger case should be made for the urgency of moving the wastes to the WIPP.

In the third line, "produce in" should be "produce."

Section 3.1, pages 34 and 32 The alternatives that are offered are either no action or programmatic delays of 2-6 years to qualify other sites in salt (bedded and domed) and in other geologic media. The statement points out that there is no significant increase in risk to the health and safety of the public over the near term if the TRU waste intended for the WIPP repository remains in INEL. Thus, without an urgent need for geologic disposal of the TRU waste at INEL, the draft statement fails to make a strong case for the proceeding with WIPP before the analyses of alternate geologic media and alternate sites are completed.

Section 3.1, page 3-2, first paragraph This discussion predicts that an individual lung dose of 9 rem and references Table 3-1, Subalternative 3. However, Table 3-1, Subalternative 3 shows a lung dose of 0.2 rem. The discrepancy (a factor of 45) should be resolved.

Table 3-1, page 3-2 The basis for the estimated doses due to volcanism and intrusion should be discussed. It seems unlikely that consequences of a future volcanic eruption and resulting lava flow would be ten times higher than that resulting from intrusion by man. Also, there appear to be other release mechanisms that are not accounted for but which should be assessed, i.e., releases due to accidents (plane crash, nearby explosions), glaciation, climatic changes and tornadoes. The action of groundwater should be accounted for.

The individual bone dose of 0.8 rem for the volcano mechanism, Subalternative 2, should be 0.08 rem (see Table 9-63, page 9-171).

Section 3.2, page 3-3, second paragraph The denial of mineral resources should be added to the list of site impacts resulting from WIPP.

Specific Comments - Chapter 3

Chapter 3 In the economic comparisons between alternatives, the document does not clearly specify which cost differences are for the WIPP project alternatives (e.g., WIPP costs with an ISF vs. WIPP costs without an ISF) and which represent the difference in cost to society (e.g., cost of interim storage for spent fuel and saved opportunity cost of the WIPP investment).

There should be a section that compares the relative costs and benefits of alternatives. The comparison should include a cost estimate in constant dollars and an estimate of the environmental impacts (both radiological and nonradiological) for each alternative.

Section 3.1, page 3-1, second paragraph This discussion indicates that no releases of radioactivity are expected to occur at INEL as a result of natural disasters for the next 100 years. The discussion should state the basis for this assertion and why such events are not expected during this period. A stronger case should be made for the urgency of moving the wastes to the WIPP.

In the third line, "produce in" should be "produce."

Section 3.1, pages 34 and 32 The alternatives that are offered are either no action or programmatic delays of 2-6 years to qualify other sites in salt (bedded and domed) and in other geologic media. The statement points out that there is no significant increase in risk to the health and safety of the public over the near term if the TRU waste intended for the WIPP repository remains in INEL. Thus, without an urgent need for geologic disposal of the TRU waste at INEL, the draft statement fails to make a strong case for the proceeding with WIPP before the analyses of alternate geologic media and alternate sites are completed.

Section 3.1, page 3-2, first paragraph This discussion predicts that an individual lung dose of 9 rem and references Table 3-1, Subalternative 3. However, Table 3-1, Subalternative 3 shows a lung dose of 0.2 rem. The discrepancy (a factor of 45) should be resolved.

Table 3-1, page 3-2 The basis for the estimated doses due to volcanism and intrusion should be discussed. It seems unlikely that consequences of a future volcanic eruption and resulting lava flow would be ten times higher than that resulting from intrusion by man. Also, there appear to be other release mechanisms that are not accounted for but which should be assessed, i.e., releases due to accidents (plane crash, nearby explosions), glaciation, climatic changes and tornadoes. The action of groundwater should be accounted for.

The individual bone dose of 0.8 rem for the volcano mechanism, Subalternative 2, should be 0.08 rem (see Table 9-63, page 9-171).

Section 3.2, page 3-3, second paragraph The denial of mineral resources should be added to the list of site impacts resulting from WIPP.

Table 3-2, page 3-4 The footnote states the TRU waste volume from INEL for the CH level as 2.4×10^6 ft³, and full capacity of the CH level as 70×10^6 ft³. Provide the source(s) of the TRU for the remaining 67.6×10^6 ft³ of TRU waste not from INEL. Also, it is previously stated in Section 1.2 (page 1-4, ninth paragraph) that the receipt rate is 1.2×10^6 ft³/yr. At this rate, approximately 60 years would be required to receive and store the 70×10^6 ft³ of waste, contrary to the 30 year design life (Section 1.2, page 1-4, eighth paragraph).

Table 3-3, page 3-5 The 11.6% of U.S. reserves estimate for langbeinite should refer to footnote "b" rather than "a."

Section 3.2.1, page 3-6, first paragraph The first sentence states that mineral resources "will eventually" be released for exploitation. The second sentence states that subsurface development "would probably" be allowed in the outer control zone (emphasis added). These statements are not entirely consistent with one another and should be reconciled. If the conclusion is that mineral resources will be recovered, justification for that conclusion should be provided.

The reference to Section 8.1.2 in the second sentence should be Section 8.1.3.

Rules under which some of the subsurface development rights could be restored are not clearly defined in either this section or in Section 8.1.3.

Section 3.2.3, page 3-9, first paragraph Radiological dose estimates in this section should be made on an annual basis. For example, if a truck driver receives an average exposure of 40 mrem per trip and makes a few trips during a one-year period, the total annual exposure would be on the order of background. Additionally, transport workers, although they may receive an occupational radiation dose, are not considered to be radiation workers in accordance with the definition in 10 CFR 19. It may be more proper to compare their exposure to the levels permitted in unrestricted areas which should not result in an exposure exceeding 500 mrem in a year.

Tables 3-6 through 3-9, pages 3-10 through 3-13 These tables present dose or dose commitments to individuals and the population. The 50-year dose commitments calculated are due to repository operation in a period of one year. However, the natural background dose commitment was obtained by multiplying the natural background radiation received in one year times 50 years of exposure. This is not a consistent comparison. The latter is not a 50 year dose commitment due to one year's exposure, but is a cumulation of 50 years of background exposure. To be consistent, the background radiation dose commitment for one year's exposure (~ 0.1 rem) should be presented. This will in turn alter the percentage comparisons between exposure due to repository operation and natural background. Such comparisons should be revised accordingly throughout the document.

Section 3.2.5, page 3-10, first paragraph The document states that no release of radioactive material is expected after the repository is sealed.

The basis for this assumption should be presented taking into account all the reasonably likely events that could affect the repository. (See comment on Section 9.5.)

Table 3-7, page 3-11 The superscript on "worst sector" should be "b" instead of "a."

Section 3.2.7, pages 3-13 and 3-14, second paragraph, item 1 It is stated that "about one-thirtieth of the known U.S. reserves of the mineral langbeinite will be kept from exploitation for a long time, possibly several decades." This statement implies that the langbeinite will be mined at some time in the near future (several decades). Such a statement should be accompanied by a full analysis of the potential impacts of mining with special emphasis on waste isolation.

Table 3-10, page 3-14 Please clarify how the employment percentage figures presented under Socioeconomic impacts were calculated (i.e., whether the figures apply to population, employment, or labor force).

Section 3.3, pages 3-17 and 3-18 The summary fails to emphasize the degree change of environmental impacts between a TRU/ISF facility and a TRU facility. It is not apparent that the reduction of doses from normal operation, transportation, and accidents is insignificant. For example, this summary conflicts with the statement presented in the discussion on possible long-term impacts in Section 3.4, page 3-25: "In the analysis of long-term impacts at the reference repository, the releases from spent fuel have much more severe effects than the releases from TRU waste (Table 3-7 and Section 9.5.1)."

Section 3.4, page 3-23, fifth paragraph Please provide the references or the employment predictions ranging from 1,000 to 1,500 employees at a HLW repository in salt.

Section 3.4, page 3-24, fourth paragraph For clarification, it is suggested that a numerical comparison be made between the estimated dose commitment for a HLW repository and the doses received from natural background sources.

Section 3.4, page 3-25, Possible long-term impacts The discussion should clarify whether the effect of mixing chelating agents and organics (that may have been added to TRU wastes to facilitate dismantling and decommissioning) upon the mobilization of HLW was considered.

Section 3.5.1, page 3-27, second paragraph The document implies that the generation rate of defense TRU waste is dependent upon the timing of WIPP. It is not apparent how the delay of WIPP would increase the quantities of defense TRU waste.

Section 3.5.1, page 3-27, fourth paragraph Please explain in greater detail how the estimated delay cost of \$280 million was calculated. Does it include (1) the saved opportunity cost of the WIPP investment, and (2) the cost of interim storage elsewhere? Also this figure should be recalculated and presented in constant dollars to reflect the true cost of delay and reinitiation of present efforts.

Section 3.5.2, page 3-31, second paragraph The document states that "no rigorous comparison of the long-term impacts of TRU-waste repositories at alternative sites can be made." It is the view of the NRC staff that such an analysis is required to perform a proper NEPA analysis.

Section 3.5.2, page 3-31, second paragraph The document states that studies to date have shown no reason to expect that any of the sites are clearly safer than the others. A repository in basalt may have a significant advantage over the other considered media due to a reduced potential for intrusion (e.g., basalt sites are not likely to be explored for oil and gas).

Specific Comments - Chapter 4

Chapter 4, page 4-1, second paragraph Since it is the judgment of the NRC that the DEIS does not present a detailed and comprehensive analysis of alternatives, we cannot accept the conclusion that the choice between alternatives rests "largely on programmic considerations."

Chapter 4 The programmatic impacts should include a discussion of whether the concept of co-storage of TRU and HLW is feasible from the standpoint of interactions between the two types of waste. Although compatibility is assumed, it may not be true. Thus, some alternatives may not be feasible.

Chapter 4, page 4-5, Summary It is not apparent from the summary that alternative 6 does not merit favorable consideration since it is a combination of alternative 3 (i.e., no ISF) and alternative 5 (i.e., delay and possibly relocate). Please provide the rationale for alternative 6 not receiving more favorable consideration.

Specific Comments - Chapter 5

Chapter 5 This chapter sets forth the acceptance criteria for waste forms. However, the document does not provide a description of the anticipated waste forms and associated packaging. The final statement should provide a detailed description of the anticipated waste forms, including a description of the containers, packages, overpacks, and any other additional engineered barriers, for all radioactive wastes to be emplaced in the WIPP facility.

This chapter considers alternative processing techniques for finalizing the waste form of TRU waste. A similar analysis should be provided which evaluates the various techniques for processing spent fuel into other waste forms. The analysis should consider on a comparative basis the environmental impacts of each alternative, including the one which is proposed.

Section 5.1, pages 5-1 through 5-7 The criteria and design measures for insuring the preclusion of criticality events should be provided.

Section 5.1, page 5-1, second paragraph The document states that a final waste form acceptance criteria document will be published in July 1979. Please relate whether this document has been published yet for public dissemination.

Section 5.1.1, page 5-2, third paragraph Combustible materials are defined herein as any material that will sustain combustion in air at a temperature of 1475°F for a period of five minutes. The technical basis for this definition should be stated, including the testing method and environment, or the applicable industry code (e.g., ASTM).

Section 5.1.1, page 5-2, fourth paragraph Gas producing materials are defined herein "as any material that produces gas during its decomposition." This definition seems so all inclusive that it should be made more restrictive.

Section 5.1.2, page 5-2, first paragraph Contact handled wastes are defined as waste packages with surface dose rates no higher than 200 mrem per hour. The technical basis for this limit should be presented.

Section 5.1.2, page 5-3, third paragraph The document states that waste form criteria must exclude hazardous materials. Hazardous materials should be defined and the technical support for exclusion of these materials should be provided.

The document sets a limit of 10 percent by weight per room for gas-generating waste. As noted in an earlier comment regarding the definition of gas producing materials, any discussion involving gas generating waste has no meaning until "gas generating waste" is defined more specifically.

Section 5.1.2, page 5-3, fourth paragraph It is stated that any combustible container must be overpacked with a disposable steel container. The final statement should clarify whether steel is the only allowable overpack material and whether the DOT-7A plywood box must be overpacked with a steel box.

Section 5.1.2, page 5-3, fifth paragraph; Table 5-1, page 5-4; and Section 5.1.2, page 5-6, third paragraph The design life of the waste container for CH and RH TRU waste is given as at least 10 years in order that containers may be retrieved intact." This assumes that the required period of retrievability will be less than 10 years. It is the current NRC staff opinion that for a deep geologic repository the wastes should be capable of being retrieved during the operating period and the time period necessary to retrieve the waste.

Table 5-1, pages 5-4 and 5-5 Paragraph 2 of Section 5.1 states that the Waste Acceptance Criteria Steering Committee (WACSC) "reconciles the interests of various agencies involved with the production, treatment, and disposal of defense TRU wastes." The section then goes on to discuss interim criteria for waste forms. It is not clear if the interim criteria listed in Table 5-1 represents the present views of the WACSC on acceptance criteria. Furthermore, it is not known whether the table is a complete listing of the acceptance criteria as they are presently envisioned.

The criteria for containers and packages should be specified as DOT Type A requirements.

The criteria assumed in Section 5.2 indicate that there will be no pressurized gases and no pyrophoric materials in the TRU waste. However, this table, which sets forth the interim acceptance criteria, does not identify pressurized gases as a consideration in setting criteria and indicates that small quantities of pyrophorics may be accepted. Please resolve these discrepancies.

Section 5.1.3, page 5-6 Acceptance criteria for spent fuel should be developed and presented in the final environmental impact statement. These criteria should be consistent with the criteria applied in the environmental evaluations (e.g., Section 9.2.7). In addition, a detailed description of the anticipated waste forms and their associated packaging for spent fuel should be provided in the final statement.

Section 5.1.4, page 5-7, first paragraph Acceptance criteria for the experimental waste form and associated packaging should be described in the final statement. These criteria should be consistent with the criteria applied in the environmental evaluations (e.g., Section 9.3.1).

Section 5.2, page 5-7, second paragraph This section assumes criteria, (stated to be conservative) in estimating the environmental impacts of shipping TRU waste and handling it at the reference repository. These criteria are:

- . No explosive materials
- . No pyrophoric materials
- . No pressurized gases
- . No free liquids
- . 25 percent combustibles
- . 10 percent dispersible powder

The above criteria are not conservative in predicting maximum environmental impacts because there is the potential that the TRU waste will not conform to the assumed criteria. For example, there is potential for small amounts of pyrophoric materials to be included in the waste, and some free liquids could be present. Furthermore, NRC considers there should be no combustibles and the waste form should be non-dispersible. A detailed analysis should be presented to show that the assumed criteria are indeed conservative and that the use of these assumptions would really result in the maximum environmental impact.

Section 5.3.1, page 5-9, fourth paragraph This section presents the DOE finding that the slagging pyrolysis incinerator is "the superior process and holds the highest promise for producing non-combustible, immobile waste products that are free of gas-producing material." The final statement should contain a comparative analysis of the environmental effects of each of the processing methods and the basis for selecting the slagging pyrolysis incineration system should be provided.

Specific Comments - Chapter 6

Section 6.1, page 6-1 It is incorrect to state that DOT "has primary responsibility" for transportation regulations. A description of the overlapping responsibilities of DOT and NRC would be appropriate in addition to a description of their assigned functions under their memorandum of understanding. For example, although the discussion in Section 6.2 recognizes that packages must meet DOT regulations, NRC certification of packages is not mentioned. Although NRC certification of packages used solely by DOE contractors is not required by law, the DOE has been requiring its contractors to obtain NRC certification of their packages (an arrangement not discussed in this chapter). If the WIPP facility were to receive packages from NRC licensees, the NRC regulations would require NRC certification of a Type B package, not authorized as a DOT specification package.

Section 6.2, pages 6-1 and 6-2 It is suggested that the discussion on regulations be expanded. Also, it should be noted that the discussion regarding route control needs to be updated (see comment on Section 6.2.3 regarding route control).

Section 6.2.1, page 6-2, second paragraph The qualification that heat dissipation is important to containment features of package design also applies to shielding and subcriticality features.

Section 6.2.1, page 6-2, Regulations to insure adequate containment, first paragraph The proper reference in the first sentence should be 49 CFR 173.

The word "size" should be replaced by the word "quantity."

In proposed revisions of regulations (revised 10 CFR Part 71; new 49 CFR Part 127 to replace 49 CFR 173.389-173.398), which are still under review, the concept of large quantity is eliminated.

Type A and Type B packages differ not only in quantity of contents, but also in response to the transportation environment. Type A packages must be determined (by the user, with the requirement that the documentation be kept on file at least one year after the latest shipment (49 CFR 173.395 (a) (1))) to meet standards for normal transportation conditions. Type B packages must be certified by the NRC to meet standards for both normal transportation conditions and transportation accident conditions.

Section 6.2.1, page 6-3, first paragraph In place of the clause in the fifth sentence describing Type B package requirements, the following rewording is suggested: "...a Type B package must be designed to withstand a series of specified impact, puncture, and fire environments, providing reasonable assurance that the package will withstand most severe transportation accidents..."

The last sentence in this paragraph is misleading. The regulations require Type B packaging for Large Quantities but there is no Large Quantity package. Thus, no difference exists for Type B packages containing smaller amounts of radioactive materials. One regulation does exist, however, for which the

sentence is true concerning advance notice of fabrication for packages designed for decay heat load in excess of 5 kw or for operating pressure in excess of 15 psig.

Section 6.2.2, page 6-4 In the last sentence, the word "special" should be "concept".

Section 6.2.3, page 6-4 Two recently initiated government activities regarding route control should be recognized in the final statement: (1) the DOT rulemaking proceeding on highway movements of radioactive materials (43 FR 36492, August 17, 1978), and (2) the NRC interim regulation on physical protection of spent fuel shipments (44 FR 34466, June 15, 1979). These activities invalidate the sentences stating or implying there are no federal routing controls.

Section 6.2.3, page 6-4, first paragraph In the last sentence, the word "standards" should be "regulations."

Section 6.3.1, page 6-5, second paragraph The use of the ATMX railcar is questionable because it does not meet the requirements of a Type B package.

Section 6.4, page 6-8, second paragraph The statement that the volume of RH TRU waste at ORNL is included in determining the number of shipments, even though the RH TRU waste at ORNL is not readily retrievable, is a non sequitur.

Section 6.4, page 6-9, first paragraph The NFS storage facility at West Valley, New York, may be another source of spent fuel.

Section 6.4, page 6-9, second paragraph Commercial shipments of spent fuel must comply with new NRC requirements for physical protection and route planning. The spirit of this regulation should be observed by DOE contractor shipments as well.

Section 6.4, page 6-10, first partial paragraph This discussion regarding risk is too speculative. Increased chance of accident due to extra mileage is infinitesimal until the extra mileage is on the order of one million miles. It may be useful to point out that the fatality rate for travel on interstate highways is about half that on secondary roads. (Consult the National Highway Traffic Safety Administration, Statistics Division, (202) 426-1470.)

Section 6.4, page 6-10, first paragraph Are random routes ordinarily practiced? It seems to require a conscious managerial decision not to use particular routes, even though they might not be called dedicated, to minimize exposure to particular populations.

Effects of dedicated routes other than routine exposure from route selections should be analyzed and discussed: enhancement of emergency response, political advantages and disadvantages, etc.

Section 6.4, page 6-11, first partial paragraph Please describe why reduced speed and controlled passing, as would be associated with special trains, do not reduce the radiological risk significantly when, as explained on the previous page, the extra mileage from special routes may increase the probability of accidents.

Section 6.5 through 6.7, pages 6-11 through 6-20 Although the impact due to routine transportation of the experimental high-level waste may be negligible compared to routine shipment of the other wastes, a HLW transportation accident may be the worst case accident situation. It is recommended that these sections address the information and analysis to determine the impact. The accident dose resulting from HLW shipments should be included in Tables 6-13 through 6-15. Table 6-16 should then be revised to show that the frequency of this accident is very low and hence the contribution to the total risk (consequence x frequency) from HLW accidents is very small.

Section 6.5.1, page 6-12, first paragraph Some indication should be provided regarding the impact of having to build additional ATMX cars and Super Tigers needed to work off the backlog over the 10-year period.

Section 6.6, page 6-15 This paragraph should also recognize NRC regulatory control.

Section 6.6.1, page 6-15, second paragraph Tables 6-9 through 6-11 do not contain data to support the conclusion described in this paragraph that handlers and nearby workers receive exposures exceeding those of the vehicle crew. Please provide information to support this conclusion and identify whether the handlers and nearby workers are defined as radiation workers in the facilities of the consignor or consignee.

People near the shipments may receive the greatest doses, but the document should state that the observed doses are small.

Section 6.6.2, page 6-15, first paragraph It should be noted that NUREG-0170 analyzed the transportation of radioactive material in general, not just radioactive waste.

Section 6.7, page 6-20, second paragraph It would be useful to clarify that empirical data were used for parameters in the accident analysis which differ considerably from the conservative assumptions used in the NUREG-0170 analysis.

Section 6.7.2, page 6-23, first paragraph The meteorological conditions used are not conservative for the scenario described of a transportation accident in an urban area. The relationships among the release mode, meteorological conditions, evacuation timing, and resuspension of spilled powders should be reviewed to assure the desired conservatism remains in the analysis.

For an assumed effective release height of 20 meters, a Class F stability condition is not conservative for assessing ground-level concentrations. Rather unstable stability conditions will produce higher ground-level

concentrations within several hundred meters of the release. For example, within 200 meters of a 20-meter high release point, ground-level concentrations assuming a Class B stability can be 3 to 15 orders of magnitude greater than if a Class F stability condition was assumed. Also a ground-level release and a Class F stability would provide a more conservative approach from a meteorological standpoint. In an urban area with many buildings, it is more likely that an initially elevated plume will be entrained into the wakes of the buildings and act more like a ground-level release.

Section 6.7.2, page 6-23, third paragraph The removal of contaminated food from distribution does not completely eliminate the food pathway although it may render the pathway as being an insignificant contribution to the dose. Another course of action that local health authorities might take to eliminate the ingestion hazard is to impound contaminated land.

Section 6.7.2, page 6-24, first partial paragraph Please provide the reference for the discussion on the solidification of CH TRU waste after 1981.

Section 6.7.2, page 6-24, second paragraph Provide the basis for selecting a windspeed of 2.5 mph for determining air entrainment of dry powders, and the basis for then increasing the entrainment percentage by a factor of 10. For a conservative assessment, a windspeed should be selected to provide the highest downwind concentration considering both resuspension and atmospheric dispersion.

Are the empirical formulas by Mishima and Schwendiman valid for wind speeds greater than 2.5 mph?

Section 6.7.2, page 6-25, third paragraph The word "breeching" in the fourth sentence should be "breaching"

Section 6.7.3, page 6-26, second paragraph Please explain the basis for determining that the maximum dose for an individual is at one-half mile from the accident (e.g., time for release to occur, release concentrations). Discuss the effects on people at distances within the one-half mile radius. Describe what evacuation measures will be taken, particularly for faster transport resulting from more likely windspeeds of greater than one meter per second.

Section 6.7.3, page 6-27, third paragraph The first sentence is unclear regarding the results of the four hypothetical accidents. Compounding unlikely circumstances make the consequences appear larger, not relatively unimportant. Only when probability is considered will the sentence be true.

Tables 6-13, 6-14, and 6-15, pages 6-27 and 6-28 For clarification, these tables should note that they apply to an assumed transportation accident.

Section 6.8, page 6-29 This discussion does not accurately describe the results of the study by DuCharme. While the results of the DuCharme study may not be applicable to the transport of aged defense wastes, the consequences he described of the successful sabotage of a shipment of spent fuel were certainly significant. It is suggested that this section be expanded to provide elaboration of the topics.

Specific Comments - Chapter 7

Section 7.1, page 7-3, second paragraph Please state the length of the proposed extension to the railroad spur.

Section 7.2.5, pages 7-26 through 7-31 This section lacks any discussion of the tectonic development of the region with respect to plate-tectonics. Such a discussion should be included. Additionally, discussion of percent tectonic activity in addition to earthquakes should be included (i.e., geodetic movements, residual and tectonic stresses, rates of present day uplift or subsidence).

Section 7.2.6, page 7-32, eighth paragraph The discussion notes that water injection into wells has been used for recovery of hydrocarbon resources. The effect of this injection on salt dissolution in the site vicinity should be assessed.

Figure 7-13, page 7-38 The figure is considered inadequate for proper seismic assessment. It should delineate major structural features, historic earthquakes, locations of seismic instruments, mines, and producing and abandoned oil and gas wells.

Section 7.2.6, pages 7-39 and 7-40, Earthquakes in the Central Basin platform Salt water disposal wells and secondary hydrocarbon recovery operations exist in the Delaware Basin. The effects of these activities on seismicity and waste isolation should be considered. Studies of these types of activities should consider the likely increase in secondary recovery operations in the future as hydrocarbon resources become more valuable.

Section 7.2.6, page 7-40, second paragraph The earthquake risk analysis starting on page 7-40 is based on the assumption given in this paragraph that the Central Basin Platform structure limits earthquake magnitude. However, the document states that evidence supports the explanation that minor shocks observed were caused by human activity (see item 3, page 7-40). Justification should be given for ignoring the assumption that minor seismic shocks are related to human activity.

Section 7.2.7, page 7-42, second paragraph Estimates of reserves are based on "present economic conditions." Estimates based on extrapolations of present economic conditions in the near term and far term should be considered. Also, differences in costs resulting from changes in economic or social structure or the development of more efficient mining methods should be evaluated.

Section 7.2.7, pages 7-42 through 7-46, Methods used to determine potash resources at the reference site Formal resource criterion have been established by the U.S. Geologic Survey (USGS) and U.S. Bureau of Mines (USBM). Resources are defined as naturally occurring materials such that, "...economic extraction of a commodity is currently or potentially feasible" (USGS Bulletin 1450-A, 1976). WIPP potash resources should be classified according

to such a standard definition and justification given for classifying mineral occurrences as being subresource quality or not potentially feasible.

Section 7.2.7, page 7-44, fourth paragraph More distinction should be made between average and minimum richnesses.

Figure 7-16, page 7-46 Justification for the abrupt decline of the dashed extrapolations should be provided.

Section 7.2.7, pages 7-46 and 7-47, Methods used to determine potash reserves at the WIPP reference site The potash reserve estimate is subject to change since it is based on variable prices and production costs. Future changes in potash and potash product prices and production costs should be predicted and their effects on reserve quantity should be estimated. Since waste isolation may necessitate the long-term denial of WIPP site mineral resources, resource denial analyses should consider long-term impacts.

Estimates of the magnitude of potash reserves denied by WIPP are given only in terms of the amount present within WIPP site boundaries. However, restrictions on mining within the WIPP site may prevent the profitable exploitation of potash reserves in adjacent areas, thereby effectively denying reserves outside WIPP site boundaries. Similarly, denial of the mineral reserves of control zones I, II, and III may result in the effective denial of control zone IV deposits (see Section 9.1.4.7). This aspect of mineral resource denial should be considered.

Section 7.2.7, page 7-47, fourth paragraph and Table 7-8, page 7-49 The hydrocarbon resource estimation was considered complete since, "All potentially productive zones were considered in the evaluation . . ." It would appear from Foster, 1974, that some potential resources exist in the Ordovician interval. Justification should be given for not assigning any potential hydrocarbon resources to this interval.

Section 7.2.7, page 7-48, first paragraph The hydrocarbon study by the New Mexico Bureau of Mines and Mineral Resources identified reserves by calculating past and future production. Justification should be given for the presentation of these identified reserves as resources in the final statement. Precise definitions directly applicable to hydrocarbons should be given for reserves and resources.

Section 7.2.7, page 7-50, first paragraph The uncertainty of hydrocarbon resource and reserve estimates should be determined and characterized. Consideration should be given to the uncertainty of decline curve reserve estimates used to define hydrocarbon production. The decline curve estimates made by Sipes, Williamson, and Aycock were based on relatively short production spans which ended in 1976. Discuss how recent hydrocarbon well production figures have affected new well decline curve reserve estimates. Describe whether this updated information would affect hydrocarbon reserve estimates at the WIPP site.

Section 7.2.7, page 7-50, first paragraph The document states that "there has been no actual drilling within control zones I through III." This statement conflicts with the drill holes in zones I through III depicted in Figure 7-15, page 7-43, and Figure J-1, page J-2. Please resolve this discrepancy.

Section 7.2.7, pages 7-50 and 7-51, Results of the hydrocarbon - reserve estimate It is stated in the document that only a single zone, the Morrow Formation of Pennsylvanian age, is worthy of exploration risk. The 1976 Sipes, Williamson, and Aycock study included reserves in the Strawn and Atoka formations as well as the Morrow zone.

The 1976 Sipes, Williamson, and Aycock study identified substantial hydrocarbon reserves in the Bone Springs and Delaware Mountain Group of the Los Medanos field. The reserve potential of pay zones other than the Pennsylvanian should be considered.

Possible drill sites are identified on the basis of subsurface rock structure. Since stratigraphic and combination stratigraphic/structural Pennsylvanian traps may be more common than structural traps in the Delaware Basin (Foster, 1974), the potential for hydrocarbon reserves in WIPP site stratigraphic and combination stratigraphic/structural traps should be assessed.

Justification should be given for the per well estimates of 1.33 billion to 2.09 billion cubic feet for Pennsylvanian natural gas production, particularly in view of New Mexico Bureau of Mines and Mineral Resources estimates ranging from 3.2 to 7.2 bcf per Pennsylvanian well.

No Atoka hydrocarbon reserves were assigned to proposed drill sites 3, 14, and 15 in the Sipes, Williamson, and Aycock study (see Table 3 of the study). Atoka formation hydrocarbon reserves should be evaluated and included for proposed drill sites 3, 14, and 15.

Possible drill sites are ranked according to hydrocarbon presence potential. (For example, see Figure 7-18 which identifies proved undeveloped probable and possible rankings.) Since these rankings (or drilling risk factors) are used to estimate WIPP site reserves, quantitative justification for their magnitudes should be provided.

Potential drill sites in the Los Medanos area of the WIPP site are spaced at about 160 acres per well, while those located at other points at the WIPP site have per well spacing of 320 acres (see page 23 of the Sipes, Williamson, and Aycock study). Justification should be given for per well reserve estimates in light of unequal well spacing.

According to the Sipes, Williamson, and Aycock study, page 20, a large (35.9 bcf) natural gas reservoir exists in the Atoka formation of the Los Medanos field just outside the WIPP site boundary. The potential for the presence of such a large reservoir within the WIPP site should be evaluated.

The results of hydrocarbon resource estimates indicate potential hydrocarbon resources under the site. Thus, detailed discussion appears warranted as to

why the site is considered suitable in light of potential future drilling for hydrocarbons.

Section 7.3.2, pages 7-62 through 7-69 Given the importance of hydrology to long-term repository performance, the discussion of hydrologic characteristics of the various formations seems to lack the detail necessary for an assessment. For example, quantitative information such as hydraulic conductivity and porosity is stated without stating how the data was collected, how representative it is, or if local variations are to be expected (as gleaned from the site and off-site measurements). Descriptions of some formations employ terms such as "low hydraulic conductivity" and "confining bed." Such terms should be described quantitatively. In conventional usage, a formation may be a confining bed; however, in assessing long-term performance of the repository, a quantitative assessment of hydrologic properties is needed (even for "confining beds" and beds with "low hydraulic conductivity").

Section 7.3.2, pages 7-62 through 7-69 The document states on page 9-62 that an earthen dam (Brantley Dam) will be constructed on the Pecos River between Artesia and Carlsbad. Would the reservoir created by the Brantley Dam have any effect on the regional groundwater hydrology or any other safety or environmental aspect of the proposed WIPP facility?

Figure 7-21, page 7-63 The title block should state "southeastern New Mexico" instead of "southwestern New Mexico."

Section 7.3.2, page 7-68, third paragraph The document notes that stable isotope measurements indicate that sampled groundwater comes from rainwater. More information should be provided on this assessment since it may bear on assessments of long-term ground water flow. Also, some indication should be provided whether the rainwater comes from the site or some distance away. Additionally, some attempt should be made to date the groundwater.

Specific Comments - Chapter 8

Section 8.1.3, page 8-6, second paragraph It is stated that permission for mineral exploitation in control zones I, II, and III is contingent upon the results of evaluations in progress. Describe the nature, scope, and timetable for completion of these evaluations.

Section 8.1.3, page 8-6, third paragraph The document states that continuous or drill-and-blast mining in control zone IV for potash may be permitted under DOE restrictions and that new wells for oil and gas production may be drilled in conformance with DOE standards. (emphasis added) These DOE standards and restrictions should be detailed in the Final Environmental Impact Statement.

Section 8.1.3, page 8-6, fourth paragraph The document states that DOE will exercise no control over land outside of control zone IV. Discuss what consideration has been given to the effects of secondary hydrocarbon recovery, salt water disposal, solution mining, and other subsurface operations outside Control Zone IV on the long-term isolation capabilities of the repository. The Final Environmental Impact Statement should address these effects.

Section 8.1.4, pages 8-6 through 8-8 Alternatives to the proposed rights-of-way should be presented and compared with that proposed. An evaluation should be presented which demonstrates that the proposed rights-of-way are the preferred alternatives.

Section 8.2, page 8-15, first paragraph It should be mentioned that surface facilities, particularly where there are accesses to the mine shafts, will be designed to withstand the effects of locally severe precipitation and floods.

Section 8.6, pages 8-27 through 8-34 This section does not discuss the potential release of radioactive materials by the liquid pathways. Although it is recognized that airborne releases are of major concern, as evidenced by the release mechanisms outlined in Table 8-5 (page 8-29), the liquid pathway should not be completely ignored.

Section 8.7.3, page 8-36, third paragraph The infiltration estimate used is not considered reasonable for thunderstorms. The rainfall used in the evaluation is most likely the result of a thunderstorm, and losses during such an event are usually minimal because the rainfall intensity is much greater than the infiltration rate for short periods of time. Also, a 10-year rainfall event is not severe enough even to use in this analysis. A 50 to 100-year event would be a more standard hydrologic engineering design basis.

Section 8.9, pages 8-41 through 8-48 This section takes the position that the experimental and developmental programs to be conducted in the WIPP will result in no environmental impacts. Justification for this position should be provided. The descriptions of the R&D program should be greatly expanded to discuss details of the programs. A partial list of items that should be included follows:

- a. A description of the effect of these experiments on the repository environment as a whole or on the long-term behavior of other parts of the repository.
- b. A description of experiments with bare spent fuel assemblies or fuel assemblies with exposed fuel pellets.

Section 8.9.2, page 8-43, Studies of radionuclide movement, item 2 This item mentions that studies of leaching of contact handled waste will be conducted to determine the extent to which water can mobilize radionuclides from combustible and non-combustible wastes. Current staff opinion is that no combustibles will be allowed in a repository (see the comment on Section 5.2).

Section 8.9.2, page 8-44, item 3 This item states that laboratory studies of actinide mobility are underway and will be checked by less-extensive in-situ monitoring. The staff comment is that in-situ testing of actinide mobility is as important as laboratory testing and therefore it should be as extensive, not less extensive. To date, lab testing has not been able to represent in-situ conditions adequately.

Section 8.9.3, page 8-44, second paragraph The document states that studies of the interactions of waste with bedded salt were performed between 1965 and 1967 in Project Salt Vault near Lyons, Kansas. A brief summary of the results should be given along with a discussion of how they will affect the current programs.

Section 8.9.5, pages 8-47, Experiments with bare waste Describe what provisions will exist for the retrievability of bare waste. Describe the retrievability process for recovery of the bare waste.

Section 8.10, pages 8-48 through 8-51 The acceptance criteria should be defined for the 1000 spent fuel assemblies that will be emplaced in the facility.

Traceability (i.e., records) of these spent fuel assemblies should be maintained.

Methods of handling breached canisters should be described.

A contingency plan should be presented for the retrieval of the spent fuel assemblies in case the demonstration program does not meet expectations.

Section 8.10, page 8-48 This section is based upon a retrieval period of 20 years for spent fuel. The reference case, as described in Section 2.3.2 (page 2-19), states the retrieval period as 10 years. Please clarify this discrepancy. Also see the applicable comment on Section 1.2 regarding retrievability.

Section 8.10.2, page 8-49 The criteria for determining the storage area configuration are not presented. The proposed configuration may meet the specified thermal loading of approximately 30 kW/acre, but may not provide an optimal thermal distribution in the storage area.

Section 8.10.2, page 8-49, second paragraph The proposed canister for the spent fuel assemblies is described as a single overpack fabricated from a carbon steel pipe. The basis for selection of carbon steel as the canister material should be given, i.e., a comparison of carbon steel with alternatives should be presented together with selection criteria.

Section 8.10.3, page 8-50 If retrieval of either the spent fuel or the TRU waste were required at some point in the future, describe the plans for storing or disposing of the retrieved waste from WIPP.

A more detailed description of the spent fuel retrieval system should be provided. The description should contain the method that will be used for spent fuel retrieval, the anticipated time that would be required, and the plan for retrieving damaged or deteriorated canisters.

If retrieval of spent fuel were ultimately required, describe how the wastes emplaced at the higher level (i.e., CH waste at the 2,100 foot level) would be affected. Describe the measures that would be used to control the adverse effects of subsidence resulting from retrieval related underground openings.

Section 8.10.4, page 8-51, second paragraph The document states that significant corrosion effects of spent fuel assemblies in canisters "will probably be minimal or nonexistent." The basis for this statement should be provided, including test data and results of analyses.

Section 8.11, page 8-51 The DEIS states (p.8-51) that the retrievability period for waste stored in the WIPP facility is ten years for TRU waste and 20 years for spent fuel. As DOE is aware, the NRC staff has been considering various approaches to the question of retrievability of waste. A possible approach to the retrievability issue is that the design of the repository facility and the stability of the site be such as to allow the waste to be retrieved throughout the operating life of the repository, and as much as 50 years thereafter. The design should be such that the waste could be retrieved with the same or less effort and in the same or less overall time frame in which it was emplaced. Waste canisters should remain intact during this period. In this manner, if some unfavorable information is developed during the operational life of the repository that indicates the long-term performance objectives will not be achieved, corrective action can be taken. It also provides future generations the option to maintain surveillance of the wastes before closure of the repository, if they choose to do so.

Section 8.11, pages 8-51 through 8-53 The plan for disposition of the contaminated materials (i.e., waste, contaminated backfill and work materials) should be described.

Section 8.12.2, pages 8-55 and 8-56 The reference repository description contained in the document does not take advantage of several types of engineered barriers to radionuclide release that the staff feels could enhance repository performance. The staff feels that consideration should be given to the use of the backfill as a barrier to radionuclide migration, engineered plugs to retard water movement within the repository and radionuclide migration from the repository and multicomponent shaft and borehole seals.

Section 8.12.3, page 8-56 The estimated time period and respective criteria for the administrative controls should be provided. Describe the provisions, if any, that will mitigate the calculated accident exposure resulting from intrusion (i.e., drilling into the stored spent fuel 100 years after closure). This section should discuss the size of the area (i.e., distance from the repository) over which post-decommissioning controls would be exercised to prevent activities that could adversely affect the hydrology of the site or its long-term containment capabilities. This is particularly important for the WIPP site because of the mineral resources at and near the WIPP site.

Specific Comments - Chapter 9

The report should address uncertainties, probabilities and statistics in much greater detail. These subjects are essentially unaddressed in the DEIS. For example, numerical values are shown in tables and figures (Figure 9-2, page 9-29, is one of many examples) with no indication of the error band or uncertainty in the numbers.

Section 9.1.1.2, page 9-3, third paragraph It is stated that soil impacts from water lines and electrical power lines will be brief because the soil will recover after construction is completed. Please describe the nature of recovery (e.g., protective vegetation) and the estimated duration of the impact.

Tables 9-2 and 9-3, page 9-4 Please provide the references for the numerical estimates of the construction vehicles and equipment and their respective sound levels.

Section 9.1.1.3, page 9-4, third paragraph The reference to "spherical divergence" should read "hemispherical divergence." Also, the amount of attenuation of sound due to the ground cover in the noise path should be indicated and referenced. This figure should be used to support the estimate of excess attenuation beyond the 6dB per doubling of distance attenuation due to divergence and air losses for the predicted noise level at the James Ranch.

Section 9.1.1.3, page 9-4, fourth paragraph If ambient sound level data is available for the receptor site (i.e., the James Ranch), it should be provided.

Section 9.1.1.3, page 9-5, first paragraph The meaning of the term "broad based" in the first sentence should be defined. Perhaps this term should be "broad band."

Section 9.1.1.3, page 9-5, second and third paragraph The overall period of time over which blasting operations will take place, the estimated frequency of blasts, time of day when such activities will occur and estimate of peak overpressure and corresponding dB level to which blasting will be limited should be presented in the Shaft sinking section.

Section 9.1.1.3, page 9-5, fourth paragraph Schedules and time of duration of the other construction activities should be provided as bases for impact assessments.

Section 9.1.1.3, page 9-5, sixth paragraph If available, estimates of the number of truck deliveries per day should be provided along with an estimated equivalent sound level (L_{eq}) for the delivery routes (which should be identified) so that an estimate of the likely total affected population may be prepared.

Section 9.1.1.5, page 9-9, fourth paragraph The referenced documentation by Anderson, Mann, and Schugart, 1977, describes the positive effect of right-of-way corridors on bird populations in the forest of Tennessee. The same conclusion does not necessarily apply to desert vegetation.

Section 9.1.1.6, page 9-10 Appendix I of the DEIS contains correspondence between DOE and its consultants and various federal and state agencies involved in the preservation of archeological and historical resources. A letter on this subject in Appendix I (see pages I-12 through I-13) concludes that there are 33 sites within the survey area that are eligible for the National Register of Historic Places. However, the statement does not address whether construction and operation of the WIPP facility will have an adverse impact on these sites. The final environmental impact statement should set forth any adverse impacts resulting from construction and operation of WIPP on the 33 sites and, if adverse impacts do result, determine whether there is a feasible and prudent alternative to avoid or satisfactorily mitigate any adverse impacts.

Section 9.1.2.1, page 9-11 This section is very brief and, on the surface, appears to underestimate water consumption. Please provide a description of how the estimates were derived.

Section 9.1.3.1, page 9-13 This section does not address the impacts to the terrain and soils resulting from the salt particles discharged from the ventilation exhaust (see Section 8.7.5, page 8-37, second paragraph). To evaluate the effects of the release of these salt aerosols, it would be necessary to know the number and locations of the facility discharges and the dispersion characteristics (i.e., distance and concentration).

Table 9-11, page 9-17 It is not clear whether this table compares WIPP site resources and reserves with deposits that have not yet been exploited or that also include previously exploited deposits. Site resources and reserves should be compared with similarly in-place resources and reserves. Please clarify.

Sections 9.1.4.3 and 9.1.4.4, pages 9-18 through 9-21 The present and projected dollar values of WIPP site mineral resources and reserves should be included in the final statement.

The socioeconomic impacts of the early denial of WIPP site mineral resources are not considered in the WIPP DEIS. For example, it is stated in Sections 9.1.4.4 and 11.2 that construction and operation of WIPP could shorten the life of Carlsbad area langbeinite production by about five years. The effects of the early curtailment of Carlsbad langbeinite production on area socio-economics should be considered.

The final statement should fully analyze the significance of WIPP site potash deposits, including quantitative economic analysis of alternatives to langbeinite, analysis of the development of future potassium and magnesium sources, and the future worth of WIPP site potash and other minerals. Specifically, such minerals as polyhalite, kieserite, and kainite should be considered. Mineral significance analyses should address impacts over long-term time spans.

Section 9.1.4.4, page 9-20, third paragraph Langbeinite resource and reserve estimates by Agricultural and Industrial Minerals, Inc. (AIM) are cited. Describe how AIM defines resources and reserves.

Agricultural and Industrial Minerals, Inc. estimates of Carlsbad area langbeinite reserves and resources are quoted in the DEIS in terms of tons K₂O equivalent. However, in the AIM study, the same numbers refer to tons product. The figures in the statement should be made consistent with the AIM estimates. Since the origin of these estimates is not described in the document or the AIM study, the Carlsbad area langbeinite reserve and resource estimates should be justified.

Section 9.1.4.4, page 9-20, fourth paragraph WIPP site langbeinite reserves are estimated to correspond to five years production at the current Carlsbad area rate. This is based on an annual production rate of 900,000 tons K₂O as langbeinite. This rate may be too high and should be checked. A lower rate of production would increase the production year equivalent of WIPP site potash.

Section 9.1.4.5, page 9-21 Regional and national hydrocarbon resource and reserve statistics are compared with the WIPP site estimated occurrences. It is not clear whether the regional and national figures include previously exploited deposits. Site resources and reserves should be compared with the national and regional amounts of similarly in-place hydrocarbons. Consideration should be given to the long-term relative importance of WIPP site hydrocarbon resources.

Section 9.1.4.6, page 9-21 The present and projected dollar values of WIPP site hydrocarbon reserves and resources should be included in the final statement.

Section 9.1.4.7, page 9-21, first paragraph The impacts of control zone IV exploitation (mining, drilling, solution mining, secondary oil recovery, etc.) on WIPP waste containment should be considered.

Potash mine pillars for the Carlsbad area are often removed or "robbed" to increase the recovery of ore. As stated in this paragraph, it may be necessary to leave a number of pillars in-place in control zone IV mines in order to control subsidence. This would lead to low extraction efficiency and the effective denial of significant quantities of langbeinite in control zone IV. Therefore, more than one-quarter of the langbeinite at the WIPP site may be denied despite the exploitation of control zone IV.

Section 9.1.5, page 9-24, second and third paragraph The construction phase noise impact assessment does not address traffic (i.e., materials delivery and commuter) related noises due to the facility. The areas most likely to be affected and the numbers of people involved in each should be presented.

Section 9.2.5.1, page 9-26, Noise standards The Department of Housing and Urban Development has recently proposed standards, requirements and guidelines on noise abatement and control replacing those previously set forth in HUD

Circular 1390.2 (see 43 FR 60396-60401). These new criteria propose the adoption of the guidelines put forth by the U.S. Environmental Protection Agency in its document entitled "Information on Levels of Environmental Noise Requisite to Protect Public Health and Welfare with an Adequate Margin of Safety" for the HUD Exterior Noise Goal. This document recommends the use of the Normalized Day Night Sound Level as an indicator of likely effects and community response. Consideration of the use of this indicator should be given for preparation of the final statement.

Section 9.2.7, pages 9-28 through 9-30 It appears that the evaluation set forth in this section relies solely on a thermal loading density of 30 kW/acre to assess creep effects of salt. An evaluation should be presented which assesses near-field creep effects resulting from maximum canister wall temperatures. The evaluation should include the bases for this assessment, including such items as the maximum canister wall temperatures, and physical and mechanical properties of salt at the specified temperatures.

The elevated temperatures discussed in this section and illustrated in Figure 9-2 should be considered when retrievability concepts are evaluated. For example, machinery used in the retrievability operations will have to function properly at temperatures at least as high as about 44°C (120°F).

Figure 9-2, page 9-29 The figure shows the temperature increase in the mined tunnel containing spent fuel elements up to 25 years after emplacement. The figure should be expanded to include an estimate of temperature increase up to several centuries after emplacement (after which the decay heat rate will be greatly reduced).

Section 9.2.10, page 9-32 This section states that releases resulting from routine handling will be held to levels as low as reasonably achievable. Numerical estimates of maximum, routine radioactive releases should be made and the basis for the estimates should be discussed.

Tables 9-18 and 9-19, page 9-38 The dose comparison between calculated exposures and background should be presented as suggested in the comment on Tables 3-6 through 3-9.

The tables should show the period of exposure that corresponds to these dose commitments, for example, "annual" if that is applicable.

Section 9.2.11, pages 9-39 and 9-40 This section discusses the occupational exposure to four job categories. This section should also include an estimate of the number of workers in all job categories, the estimated exposure to each worker and the estimated total annual occupational exposure for the entire facility.

Table 9-23, page 9-51 For clarification, the table should have a column showing the quantity of each radioactive isotope assumed to be in a drum. Also, there should be a discussion of the basis for the assumptions.

Section 9.3.1, page 9-55, third paragraph The distance from the point of release to the James Ranch that was used to estimate dose commitments to the maximally exposed individual should be stated.

Section 9.3.1, page 9-57, second paragraph It is stated that the scenario with the greatest impact (i.e., spent fuel) would result in an individual lung dose of 1.0×10^5 rem, and a comparison is made to the dose a person would receive during a 5-hour jet-plane trip. However, consideration should be given to the uncertainties associated with the estimates of scenario consequences to make such comparisons meaningful.

Section 9.3.1, page 9-57, sixth and seventh paragraph The analysis of the accidents considered during facility operation assume that the HEPA filters will be highly effective (by a factor of 10^6) in removal of particulate activity prior to release to the environment. The document presents the doses that might be experienced if the "HEPA filters were not working" and conclude that even in such an event the above dose to the nearest resident would be well below background. This conclusion may be premature; further consideration should be given to the analysis of the consequences of a large fire which simultaneously causes a release of radioactivity and renders the filters ineffective and where any activity previously trapped on the HEPA filters may be released. The statement should indicate the range of consequences of such events and how their probability would be minimized.

Section 9.3.3, pages 9-59 and 9-60 Because of high winds and soil characteristics, dust storms are relatively common in the site area. Therefore, the effects of dust storms on facility operation should be evaluated (e.g., emergency diesels, filters).

Natural gas is commonly found associated with salt deposits. The potential for the occurrence of gas within the mined area and the attendant hazard to both people and the facilities should be assessed.

Section 9.3.3.1, page 9-59, first paragraph Provide an estimate of the maximum earthquake(s) expected to occur at the site following closure of the surface facility and the possible effect of that earthquake(s) on the integrity of the underground facilities.

Section 9.3.3.1, page 9-59, third paragraph Acquisition of comprehensive, accurate data relative to the underground effects of earthquakes is considered quite important. Without this information, extremely conservative assumptions may have to be made to make an impact assessment. Estimates should be made of the effects of ground shaking on the mined shafts and cavities during the operating life of the facility as well as after closure.

Ground displacement and the attendant effects upon both groundwater regimes and natural gas deposits should be addressed. In the event ground rupture were to occur, such that communication between the natural gas/groundwater and the repository were made possible, the potential for an induced explosion or gas/water seepage into the cavities should be addressed. Such an event should

be considered during the operational life of the facility as well as following closure.

It has been suggested that seismic events have been induced as a result of mining activities. The likelihood of this type of event should be assessed.

Seismicity, induced as a result of secondary hydrocarbon production (i.e., water injection) has been hypothesized as ~~seismic~~ seismic events in Texas and elsewhere. The potential for such occurrences resulting from secondary (or tertiary) recovery operations in present and future nearby gas fields should be assessed. The resultant effects of induced seismicity (from any scenario) on the proposed surface and subsurface facilities should be determined.

Section 9.3.3.2, page 9-60, fourth paragraph The discussion does not adequately address the effects of locally severe rainfall on the site. Thunderstorms have intense rainfall for short periods of time. Infiltration, even in desert areas, will not normally prevent some ponding and local flooding. Since thunderstorms can be expected often during the operational life of the plant, consideration should be given to mitigating any adverse effects on the plant.

Section 9.3.3.3, page 9-60 Provide the design criteria of the buildings and systems for their resistance to "tornado-force winds, tornado-driven missiles, and sudden pressure changes."

Section 9.4, pages 9-61 through 9-97 There should be a presentation of an established mechanism through which mitigation efforts related to socio-economic impacts would be identified, monitored and handled between the applicant and the cognizant officials of impacted jurisdictions.

Section 9.4.1, pages 9-61 and 9-62, seventh paragraph The document states that the employee-location pattern for scenario II is based on the pattern established by a large mining company in the area. Please provide the basis for assuming that past employee-location patterns for mining companies are indicative of projected patterns for WIPP.

Section 9.4.1.2, page 9-62, second paragraph The construction overlap between the WIPP project and the Brantley Dam project is discussed. Because of a lack of a comparative analysis and discussion of the schedule overlaps of the two projects, it is unclear what changes in anticipated impacts would occur if either of the schedules should change. Please provide this information.

Section 9.4.1.2, page 9-65, second paragraph An anticipated drop in the unemployment rate during the construction period is projected. Are the types of workers expected to be unemployed just prior to the construction period the same kinds of workers likely to be employed by the WIPP project? How many workers does this estimate include?

Section 9.4.3, page 9-70, first and second paragraph The discussion presented on the projected social structure would benefit from expansion to substantiate the broad statements made. For example, provide the basis for assuming that the in-movers would be of similar background, occupations, and transiency.

Sections 9.4.5.2 and 9.4.5.3, pages 9-75 through 9-80 These sections project a housing shortage for the Carlsbad and Hobbs areas; however, mechanisms for relieving the shortage are not addressed. Preference for mobile homes is mentioned but no discussion of constraints, if any, to mobile home expansion is presented. If housing supply is anticipated to be tight, describe what plans are being considered to alleviate this expected impact.

Section 9.4.6.1, pages 9-85 through 9-87 and 9-92 through 9-94 The discussion should also include the socioeconomic impacts associated with increased traffic through Carlsbad and Hobbs. There may be justification for a bypass highway around each of these population centers to accommodate the increases in general traffic arising from site activities.

Section 9.4.6.2, page 9-89, Education--Hobbs School District The discussion states that the enrollment capacity at the Hobbs municipal schools will be exceeded beginning in either 1982 or 1983, depending upon the assumed scenario. The discussion does not address the time duration of this excessive capacity and what efforts will be taken to mitigate this occurrence.

Section 9.5, pages 9-98 through 9-146 This section presents an analysis of long-term effects considering a broad spectrum of events that could result in environmental impacts from the facility. Although the document is not meant as a risk assessment, it would be beneficial to include further discussions of (a) uncertainties in data values used in the consequence calculations, (b) possible variations in the geohydrologic system over the time period of concern and the effect of these variations on the consequence calculations, and (c) the compilation of release scenarios for the WIPP site and the reduction to the five scenarios considered for analysis.

Section 9.5, page 9-98, first paragraph An expected release is equal to the sum of probabilities of release time the amount of release. Since the probabilities for all releases are not zero, the phrase "the expected release of radioactive material is zero" should be revised to read "no radioactive material is expected to enter the biosphere."

Section 9.5.1.1, page 9-98, third paragraph The DEIS states that the safety analysis indicates that the waste and its containers are not important in hindering the release of radioactivity. The NRC's preliminary thoughts on this matter are that the repository should consist of a series of multiple barriers. The primary barrier to release of radioactive materials is the waste form system. The waste form system includes the waste form, canister, overpacks, absorbent materials, and the first few inches of surrounding rock. For spent fuel, the waste form system should contain the radioactive materials for 1,000 years and as long thereafter as is reasonably achievable assuming early saturation of the repository after closure. This will allow the short-lived nuclides that control the initial hazard associated with the waste to decay to innocuous levels. Beyond that period of time, the waste form system should maintain releases as low as is reasonably achievable but less than ten ppm per year. The limit of ten ppm per year for the release rate is considered by NRC to be achievable based on information presented in the Draft Generic Environmental Impact Statement on the Management of Commercially Generated Radioactive Waste and to be sufficiently low to protect the public health and safety.

maintain releases as low as is reasonably achievable but less than 0.1 ppm per year. The limit of 0.1 ppm per year for the release rate is considered by NRC to be achievable based on information presented in the Draft Generic Environmental Impact Statement on the Management of Commercially Generated Radioactive Waste and to be sufficiently low to protect the public health and safety.

Section 9.5.1.2, page 9-101, Selection of scenarios for analysis This section discusses the four scenarios for liquid breach and transport (see Scenarios 1, 2, 3, and 4 on page 9-101). The discussion of scenario 4 may lead the reader to believe that it is much less likely to occur than the other three scenarios; however, the discussion neglects the possibility that scenario 2 would evolve naturally into scenario 4 through dissolution of salt along the flow paths. The analysis of scenario 2, therefore, is deficient because it does not consider enlargement of flow paths as a result of salt dissolution and it also fails to consider salt replacement by creep. This analysis should compare the rate of salt removal by dissolution with the rate of salt replacement by creep for all credible initiating events (e.g., faulting, shaft seal failures). This comparison will determine events for which the repository is "self-healing" and the events that result in massive repository failure.

This section should describe the basis for selecting these five scenarios from the 94 identified through fault tree analysis.

The potential for liquid breach and transport (Scenarios 1 through 4) appears to be directly dependent upon (1) inadequate sealing of known boreholes/shafts, or (2) flow through unlocated boreholes or other openings. Careful, well-planned investigations and procedures before, during, and particularly following site closure can prevent these scenarios from occurring for the most part. Long-term surveillance both of surface drilling operations and salinity monitoring of the overlying and underlying aquifers may provide assurance that the suggested scenarios, or versions thereof do not occur.

Section 9.5.1.3, page 9-102, seventh paragraph It is stated that Tables 9-43 and 9-44 list the radionuclides that are the "most important in long-term consequence assessments." Describe how the radionuclides are considered "most important" (e.g., significant contributions to risk, highest inventory, greatest toxicity, most likely to reach biosphere).

It is not apparent whether the radiological impact of carbon-14 was considered since it is not included in the list of fission products modeled. Because of the importance of carbon in biological systems, its radiological impact could be significant even when the inventory of the radionuclide is relatively small.

Table 9-43, page 9-103 The table should clarify whether the concentrations given are per liter of waste material or per liter of repository volume.

Section 9.5.1.3, page 9-103, first paragraph The document states that the model assumes upper bounds on the amounts of waste released by assuming that when water comes into contact with waste, the radionuclides dissolve with the salt. This assumption does not give an upper bound because the water that comes in contact with the wastes is brackish and will dissolve the salt slowly; however, this brackish water may corrode or leach the waste, thus

producing an accelerated release of radionuclides. The estimate of radioactive releases should take this possibility into consideration.

Section 9.5.1.3, page 9-103, second paragraph The document states that the numerical model used in the geosphere-transport calculations is based on a model developed for USGS and modified for the NRC. The staff wishes to point out that the modified geosphere-transport code is under development and NRC has not released it for general use. At this time, the code has not been validated by the NRC and, therefore, the results from the use of this code may not provide an accurate assessment of the geologic transport.

The statement that a detailed mathematical discussion of the model (and its application to the analysis) appears in Appendix K is erroneous. Appendix K presents 6 pages of mathematics; it should be expanded to show how to use the model in an analysis. (See the comment on Appendix K.)

Section 9.5.1.3, page 9-104, item 2 It appears that "fluid velocity" should be changed to "fluid viscosity."

Section 9.5.1.3, page 9-105, first paragraph, item 1 The document states that a computer code modeled the Delaware basin hydrology. The code used should be identified. Also, a reference should be provided for the test information mentioned in the last sentence (i.e., "tested the consistency between model-generated numbers and hydrologic measurements in the field").

Section 9.5.1.3, page 9-105, Biosphere-transport calculations, first paragraph An important factor that will influence consequences is the path length to the point of release because it will affect the decay time prior to release and thus the activity levels. The path length assumed for the analysis is 14 miles (i.e., Malaga Bend). The effect of shortening the path length should also be investigated. For example, stock watering wells may be drilled which could effectively shorten the path length.

Section 9.5.1.3, page 9-106, first complete sentence The document states that the analysis calculates the yearly intake of radionuclides by a person exposed through the biosphere pathways. The modeling of the biosphere pathways should be clarified. For example, the assumed population distributions and usage factors should be defined as well as the pathways that were evaluated.

Section 9.5.1.3, page 9-107, third paragraph The document states that the permeability of the wellbore was calculated. Rather than permeability, it appears that hydraulic resistance was calculated. If not, explain what is meant by permeability.

Section 9.5.1.3, pages 9-111 and 9-112, Rates of dissolution Varying rates of dissolution of the salt as a result of water flow through the medium are addressed, and the resultant eventual dose to man is estimated; however, one obvious effect on the environment as a direct result of continuing salt dissolution does not appear to be considered. This is the collapse of the overlying strata with a gradual propagation to the surface resulting in an

ever-enlarging depression. The collapse structure could serve as a collector for rainfall and, because of the resulting direct communication with the aquifer(s) and the salt, accelerate the solutioning process. Once collapse of the salt between the repository levels and the overlying strata occur, corrective measures, such as attempts to seal the breached repository, may not be feasible. Please address this occurrence.

Section 9.5.1.3, page 9-113, second paragraph Identify the daughter products in secular equilibrium with their parents and, therefore, not included in the geosphere-transport model.

Table 9-45, page 9-114 Table 9-45 shows the transport rate of I-129 dropping from 4.5×10^{-3} Ci/yr to 5.4×10^{-17} Ci/yr in a period of 3500 years for the 3 mile distance. The Malaga Bend (14 miles) transportation rate increases from 3.3×10^{-7} Ci/yr to 4.6×10^{-3} Ci/yr. Figure 9-14 indicates that the transport rate should be increasing or steady. These discrepancies should be resolved.

Table 9-46, page 9-115 This table is not consistent with Table 9-45, page 9-114. Table 9-45 shows an I-129 transport rate of 4.5×10^{-3} Ci/yr at 3 miles, for scenario 2, upper transmissivity. Table 9-46 shows a transport rate of 5.8×10^{-5} Ci/yr for the same conditions. Both values are for the same period of time, i.e., 3500 years.

Section 9.5.1.3, page 9-115, first paragraph, item 3 This item states that "to a high degree of confidence, in each scenario the actual geosphere transport must lie within the results predicted by calculations with the two transmissivities." Although the statement may be correct, it is meaningless because, for time spans up to 40,000 years, the range of predicted values for transport rates indicated in Figure 9-14 (page 9-113) is 20 orders of magnitude.

Section 9.5.1.4, page 9-115, first paragraph The document states that exposure pathways for man include ingestion of fish and water, boating, swimming and shoreline activities. Consideration should also be given to the irrigation of crops and long-term buildup in soils and sediments as exposure pathways for man. An explanation should also be given for why only radio-nuclides originating in spent fuel and CH TRU waste, and not RH TRU waste, were used in the calculations.

Section 9.5.1.4, page 9-121, Summary for liquid breach and transport The doses received by the maximally exposed person from scenarios 1 and 4 are presented. The population exposure should also be given.

Section 9.5.1.6, page 9-127, item 3 The numerical range of maximum doses from CH TRU waste and spent fuel should be given to show the effect resulting from a factor-of-20 difference between the flow rates for upper and lower transmissivities.

Section 9.5.2.2, page 9-132, fifth paragraph The document states that one foot of surficial subsidence is estimated as a result of 70% backfill in a

16 foot cavity. Communication between the Rustler aquifer and the waste repository as a result of subsidence and fracturing of the intervening strata is not presented as a scenario for evaluation. It is suggested that this scenario be considered for analysis.

Section 9.5.3.1, page 9-135, third paragraph The statement regarding the gas generation time span (i.e., much longer than 200 years) is inconsistent with the assumed time span of 100 years for gas production calculations identified in the first partial paragraph of page 9-136. This discrepancy should be resolved.

Section 9.5.3.1, page 9-135, fourth paragraph Please provide the reference for the computer code used to describe the diffusion of gas from the repository.

Section 9.7.1, pages 9-166, last line It is not clear whether the low probability event (4×10^{-9} per year) refers to the occurrence of a volcano or the waste becoming airborne and carried off the site. If it is the former, then clarification is needed for the statement on page 3-2, third paragraph, that states that "volcanic action is quite probable."

References for Chapter 9 The Dillion reference should be revised to show that the report was published October 1978.

Specific Comments - Chapter 10

Chapter 10 There is no discussion which presents the unavoidable adverse impacts resulting from construction and operation of the WIPP facility on the 33 sites identified in Appendix I as eligible for the National Register of Historic Places. (See the comment on Section 9.1.1.6.)

Section 10.2, page 10-2, sixth paragraph The dose comparison should be presented as suggested in the comment on Tables 3-6 through 3-9.

Specific Comments - Chapter 11

Chapter 11 There is no discussion which presents the irreversible and irretrievable commitment of historical and archeological resources (i.e., the 33 sites identified in Appendix I as eligible for the National Register of Historic Places) associated with WIPP facility. (See the comment on Section 9.1.1.6.)

Section 11.3, page 11-2 It is stated that the total construction resource requirements do not exceed 1% of the U.S. production during the construction period. A more significant basis of reference would be the local impact on such resources as water, fuel, electricity, and lumber.

Section 11.4, page 11-2 The listing of resources for operation should also include those major resources consumed (either onsite or offsite) for packaging and containment of the waste.

Specific Comments - Chapter 13

Chapter 13, page 13-1, third paragraph It is stated that approximately 620 acres of land will be used for surface facilities, transportation routes, and the mined-rock pile. Please define what portion of the 620 acres is considered "disturbed area" and provide an estimate of the area which will return to its natural state.

Specific Comments - Chapter 14

Section 14.1, page 14-2, fourth paragraph Please provide the name of the bird species on the State list of rare and endangered species which is likely to be in jeopardy.

Section 14.3, page 14-8, item 7 There should be a discussion on the status of federal impact fund availability as well as a listing of existing federal program funds and assistance for which the impacted jurisdictions would be qualified.

Specific Comments - Glossary

Glossary The following terms and their definitions are suggested for inclusion in the glossary: tectonics, caprock.

Specific Comments - Appendix A

Section A.2, page A-3, third paragraph Since brine migration is apparently initiated only when elevated temperatures with thermal gradients are present, an alternative would be the placement of that waste capable of generating adverse temperatures in a temporary storage area until manageable heat levels were attained, then movement of the waste to the permanent repository location. Please address this alternative to mitigate brine migration.

Section A.2, page A-5, second paragraph Since explosives are not required for mining, another advantage of salt over the other host media being considered (shale, granite, and basalt) is that only minimal fracturing of the cavity walls and floors may occur. This characteristic increases both the integrity of the mined opening as well as improves the ability to grout (seal) the cavity drifts and shafts.

Section A.2, page A-5, third paragraph Although "waste" salt will result from the mining operations, the possibility of selling some or all of this material by competitive bidding is not addressed. It is suggested that some effort should be made to investigate the marketing potential for this common, but not valueless, natural resource.

The drainage basins of southeastern New Mexico, like adjacent areas of Colorado, Kansas, Oklahoma, and Texas, discharge considerable quantities (many tens of tons) of sodium chloride per day, (Swenson, F. A., 1974, Rates of Salt Solution in the Permian Basin; U.S. Geol. Survey Jour. Research, Vol. 2, No. 2). Therefore, the introduction of salt (per se) into the repository surface runoff systems would not necessarily present a uniquely undesirable environmental impact at least in the Permian Basin.

Section A.3, page A-6, second paragraph Although it is true that crystalline rock may contain innumerable fractures filled with water, it is likewise true that extensive granite quarries, immediately adjacent to and well below the nearby water level, are essentially dry. A careful and systematic search of those areas of the country underlain by crystalline rock may identify regions not permeated with excessive groundwater.

Section A.3, page A-7, third paragraph Drill and blast techniques for mining crystalline rock create numerous fractures in the access shafts and in the drifts, thus accentuating the potential for groundwater migration from overlying water-filled zones. The created fractures will complicate the adequate long-term sealing of the shafts.

Section A.3, page A-7, fourth paragraph Considerable number of areas in the north-central United States are underlain by ancient crystalline rocks. These areas have undergone several periods of glaciation. If future glacial advance into these areas were to occur, it would have the potential, because of the weight of the ice mass, to temporarily decrease the fracture size thus

decreasing permeability and hence, water flow. However, glacial retreat may lead to isostatic rebound and extensive fracturing.

Section A.4, page A-7 and A-8, first paragraph It should be noted that inclusions of iron pyrite, marcasite, and other minerals are common within large shale bodies and will contribute to the variables involved in assessing a shale repository.

Section A.4, pages A-7 through A-9 The document does not discuss that, although essentially impermeable, near-commercial quantities of natural gas have been found within the shale at many locations, especially in the Ohio-Michigan area. These areas, because of their sedimentary origin, are likewise in regions underlaid occasionally by extensive oil and gas deposits and evaporites. A potential preemption of natural resources may result if repositories are considered in these areas. Likewise extensive drilling, related to exploration for oil, gas, and other resources, has occurred over a period of nearly 100 years. The locations of many of these holes have not been recorded and this would present problems in assessing the integrity of a repository.

Section A.5, pages A-9 and A-10 Since tuff, by definition, is located in volcanic areas, the potential for renewed volcanic activity should be considered for assuring long-term isolation of the waste.

Specific Comments - Appendix B

Section B.3.3, page B-5, first paragraph The definition of an "active" fault should be presented. The definition should address (1) when a fault is classified as "active" and (2) what constitutes a level of activity such that the fault is considered inactive.

Please define what constitutes a sufficient period of quiescence such that the volcanic hazard is nonexistent.

Section B.5.1, page B-15, second paragraph Though the seismicity in the Salina region may be low, the selection of the design earthquake should not necessarily be based upon an event occurring in the Salina Basin. For example, although numerous nuclear power plants are located within the Salina Basin, the design earthquake for each of these plants is based upon an event in western Ohio, near Anna. A similar approach should be taken for selecting the controlling earthquake for a repository located in the Salina region.

Section B.5.1, page B-15, third paragraph Hydrocarbon exploration has been conducted within this region for nearly a century. Many of the older exploratory wells may have penetrated the salt beds; however, the locations of many of these wells are unknown and not recorded. If well sealing was inadequate, salt solutioning through communication with underlying and/or overlying aquifers may have occurred. The detection of these forgotten, perhaps solutioned, wells may prove to be difficult within any proposed repository site area.

Section B.4 through B.8, pages B-6 through B-36 In the geology discussions for the regional studies, it should be noted that the site selection process should be cognizant of and minimize the preemption of natural resources.

Section B.6.1, page B-22, second paragraph Since more tectonic activity has probably taken place within the Paradox Basin (even some activity within the Tertiary period) than the other basins, this aspect of siting should receive closer scrutiny.

Section B.7.1, page B-27, first paragraph It should be noted that the potential for additional hydrocarbon exploration within and adjacent to the many domes in the region will probably continue.

Section B.8.1, page B-35, first and second paragraph As in the case of other candidate areas, current NRC siting positions resulting from nuclear power plant reviews (regarding capable faults, design earthquakes, etc.) should be considered when selecting a waste repository site, since three nuclear plants are presently located at the Hanford site.

Specific Comments - Appendix D

Section D.2, page D-5, Man-made penetrations The potential hazard of dissolution due to groundwater migration through man-made openings (e.g., shafts, boreholes) can be minimized if effective long-term sealing techniques are developed and used.

Section D.5, page D-9, Natural resources The recoverable mineral resources underlying and overlying the site should receive careful evaluation. Since this is one of the few site selection criteria (i.e., minimizing the unavoidable conflicts with actual or potential resources) over which control can be exercised, caution should be exercised before finalizing the actual site location. The success of administrative controls to restrict the access and exploitation of natural resources, such as potash, cannot be assured beyond the short-term.

Specific Comments - Appendix F

Appendix F The discussion should be expanded to describe in greater detail the various incineration and immobilization processes and the properties of the resulting products.

Specific Comments - Appendix G

Section G.2, pages G-1 through G-4 It was stated in Section G.1 that X/Q values were calculated using the MESODIF model instead of AIRDOS-II. Therefore, the AIRDOS-II X/Q routine description should be replaced with a brief summary of MESODIF.

Section G.3, page G-5, second equation The volumetric units are not consistent for X (pCi/m^3) and C_{imm} ($\text{rem}\text{-cm}^3/\text{uCi}\text{-hr}$).

Specific Comments - Appendix H

Section H.4.1, page H-48, first paragraph Based upon the methodology presented in Regulatory Guide 1.76 and WASH-1300, it is estimated that the Design Basis Tornado (DBT) would be greater than 300 mph rather than the 183 mph value stated.

Section H.4.3 and H.4.4, pages H-57 and H-58 It has been observed that the vertical growth of plumes in a desert environment are less than the growth reflected by the Pasquill/Gifford plume spread parameters. Therefore, for atmospheric dispersion calculations, it is suggested that the use of the spread parameters which reflect the lessened vertical growth of plumes in a desert environment be considered. (For example, see G. R. Yansky, E. H. Markee, Jr., A. P. Richter (1966): Climatology of the National Reactor Testing Station, IDO-12048, Air Resources Field Research Office, Idaho Falls, Idaho.)

Section H.4.3, page H-58, first paragraph It is not clear if the entire model described in draft Regulatory Guide 1.XXX was used. (For example, was the probability level used in addition to the X/Q equations?) Please describe the use of the draft guide.

Section H.4.6, pages H-61 through H-64 A discussion with conclusions should be included regarding the possible climatic changes that could adversely affect the repository in the long-term future (e.g., glaciation, temperature, and precipitation changes).

Section H.4.6, page H-63, fourth paragraph In the discussion on present and future glaciation, the effect of CO₂ atmospheric buildup, which could cause excessive warming, should be addressed.

Section H.8.4, page H-100, first paragraph Describe the effects resulting from man-induced atmospheric changes, resulting in either increased or decreased temperatures and rainfall and consequent increased alluviation or erosion. Also, the impact of time and erosion on the removal of evidence of a repository's existence, thereby increasing the potential violation of the site by drilling and mining, should be addressed.

Specific Comment - Appendix J

Figure J-1, page J-2 This figure depicts drill holes of various types in the vicinity of the WIPP reference site, including a number of deep producing and abandoned gas wells. These wells penetrate the salt horizons as well as several aquifers. Since borehole communication with aquifers and the salt could result in uncontrolled solutioning, an assessment should be made of this potential multiple-source solutioning and the effect of this potential hazard on the proposed site. The effectiveness (principally longevity) and nature of the well sealing upon abandonment of each well should be addressed.

Considering the multitude of hydrocarbon related drill holes in the study area, it is imperative that all existing holes be located, particularly within zones I, II, and III on Figure J-1. A detailed description of the procedures and verification methods used to determine the presence (or absence) of hydrocarbon holes within the study area should be presented.

Section J.1.1, page J-1, third paragraph Since a number of exploratory holes have been made within the site area, any hole sealing that may have been completed should be evaluated with respect to any potential solutioning or repository integrity hazards which may have been created.

Discuss the methodology being considered to remove existing borehold sealant, if it was determined necessary to do so.

Section J.1.1, page J-1, fourth paragraph Please discuss the procedures used by DOE in selecting the 26 line miles of seismic data. The discussion should address whether all of the available data were examined for evidence of structural anomalies instead of using a select (or random) sampling of data.

Figure J-2, page J-4 The figure should delineate the 26 line miles of seismic data actually obtained by DOE (see Section J.1.1, page J-1, fourth paragraph).

Section J.1.1, page J-6, second paragraph A clearer assessment of the probable subsurface conditions expected to be encountered within the salt horizons can be made by inspecting working mines. Therefore, to accommodate this assessment, please provide a common map showing the reference site, working and abandoned mines of all types within at least 15 miles of the reference site, and designating those mines examined closely by DOE or its contractors.

Section J.2.1, page J-32, second paragraph As in the case of subsurface verification at nuclear power plant sites, it is recommended that photographic coverage be made of all shafts and drifts for review by cognizant agencies or individuals. Intensive geologic mapping should be conducted at those areas deserving special attention.

Section J.2.1, page J-32, fifth paragraph In addition to surface seismometers, subsurface instruments established at varying levels either within the mined area or elsewhere may prove valuable in assessing the variation of any possible ground motion with increasing depth. The information obtained may permit a more economical design of shafts and drifts, as well as enclosed equipment. Additionally, such information may be useful in providing future guidance in selecting one of the many alternative disposal methods suggested in the GEIS. Perhaps these instruments could be installed prior to construction in order to acquire potentially valuable background data. Some consideration should be given to the possibility of maintaining some instrumentation beyond the operational phase of the facility in order to acquire information that can be applied toward the design of future repositories.

Specific Comments - Appendix K

Appendix K More detail should be provided on the hydrologic transport model. For example, the method used to represent (simulate) the WIPP system using the model should be discussed in detail. (See the applicable comment on Section 9.5.1.3, page 9-103.)

Section K.2.1, pages K-9 through K-20 This section discusses the aquifer system in the WIPP area. A group of schematics showing the relationship of the aquifers in the WIPP area to accessible waters (e.g., Pecos River) in the region would be helpful in reviewing the basis for the release scenario selection and the points of reference in the consequence calculations (see Section 9.5.1.3).

Section K.2.2, page K-21, second paragraph The document states that the transport calculations "generally assume that the events in the scenarios begin 1,000 years after the repository is sealed." It is implied in Section 9.1.5.4 (page 9-115, first paragraph) that calculations are made for determining event consequences assuming that the repository is breached after 100 years. Please clarify this apparent discrepancy.

Section K.2.2, page K-21, fourth paragraph The document concludes that the consequences of a scenario beginning with a 100-year breach "are not affected significantly if it begins 900 years later." Section 9.5.1.4 is referenced for containing the calculational results for supporting this conclusion. However, Section 9.5.1.4 presents only the results of a Cs-137 concentration calculation for 100 years (see Figure 9-21, page 9-121). To provide a basis for the conclusion in question, the results of a 100-year repository breach should be elaborated with at least a figure similar to Figure 9-20, page 9-121 (i.e., bounding calculation for the concentration of all radionuclides).

The document states that it is not important to model events at early times because "the travel times to the biosphere are so long that only the long-lived nuclides are still active when the contaminated aquifer water is discharged." The staff points out that this conclusion is valid only for long travel times. The two controlling parameters are path length (assumed as 14 miles) and rate of nuclide release (assumed to be equal to rate of salt dissolution). The values assumed for each of these two controlling parameters are not conservative. Thus, early time events may be important and should be factored into the model.

Section K.3.1, page K-23 In the first sentence after the third equation on the page, "13.4 square miles" should be changed to "13.4 square meters."

Section K.3.3, page K-24 The effects of uncertainties in radionuclide transport by groundwater estimations should be discussed, including some estimation of their magnitude. For example, would uncertainties in the values for the distribution coefficients be encompassed by the upper values for transmissivities presented in the consequence calculations in Section 9.5?



UNITED STATES WATER RESOURCES COUNCIL

SUITE 800 • 2120 L STREET, NW WASHINGTON, DC 20037

JUL 12 1979

Mr. Eugene Beckett
WIPP Project Office
Mail Stop B-107
Department of Energy
Washington, D.C. 20545

Dear Mr. Beckett:

This to acknowledge receipt of the draft environmental impact statement (EIS) titled, "Waste Isolation Pilot Plant" (DOE/EIS-0026-D).

The Water Resources Council has no comments to offer regarding this EIS.

Sincerely,

Leo M. Eisel
Director

COMMENTS FROM STATE AGENCIES

STATE OF ALASKA

JAY S. HAMMOND, Governor

OFFICE OF THE GOVERNOR

DIVISION OF POLICY DEVELOPMENT AND PLANNING

POUCH AD
JUNEAU, ALASKA 99811
PHONE: 465-3512

June 28, 1979

Mr. Eugene Beckett
WIPP Project Office
Mail Stop B-107
Department of Energy
Washington, D.C. 20545

Subject: Waste Isolation Pilot Plant DEIS
State I.D. No. 79052302ES

Dear Mr. Beckett:

The State Clearinghouse has completed its review of the subject proposal. The following comment was received from the Alaska Department of Commerce and Economic Development:

"The subject of the EIS is obscured by omission of the main purpose from the title. The word 'radioactive' should be included for clarity. WIPP appears to be as good an acronym as any but for clarity, some indication of the nuclear purpose should be provided.

"The purpose of the waste isolation plant appears to be eventual permanent storage of nuclear wastes. Retrieval, however, may become more desirable in the future, when new techniques and treatment of processes can make the present waste valuable. The discussion of the waste handling facility, meanwhile, speaks in terms of ten and twenty year retrieval periods and capacity to year 2000. This appears inconsistent except for a strictly experimental installation. Investment in the plant will be considerable, however, and long-term use should also be part of the plan. The proposed waste disposal and experimental plant is essential to developing acceptable procedures for nuclear power and other applications or radioactive materials.

"The objective appears to be to get a positive program developed and operating at the earliest opportunity. Alternative #2 seems to fit that objective, and also appears to have sufficient room for expansion as new information is developed.

"One very definite requirement for all government documents which deal with acronym designations should be a listing of the acronym's meanings."

We would stress that this DEIS refers to one specific method operating in one pilot plant. The future of nuclear development will depend largely on the provision of safe storage and disposal of nuclear wastes. All methods of disposal and storage should be explored, at least theoretically, while realizing that specific applications will be subject to the EIS process prior to implementation.

Thank you for the opportunity to comment.

Sincerely,

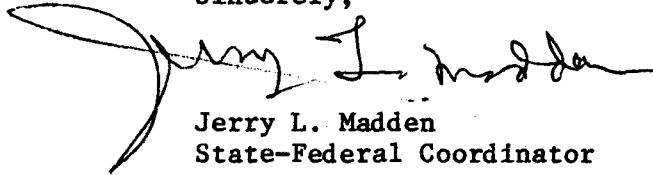
A handwritten signature in cursive script, appearing to read "Jerry L. Madden". The signature is written in dark ink and is positioned above the typed name and title.

Jerry L. Madden
State-Federal Coordinator

JLM:BR:c1

cc: Bertram Wagnon, CED

Related to 79-80-0040

SIGNOFF

OMB Approval No. 29-R0218

FEDERAL ASSISTANCE		2. Applicant's application		3. State application identifier	
		a. Number		a. Number AZ 79-80-0039	
		b. Date 19 Year Month Day		b. Date Year month day Assigned 1979 05 25	
1. Type Of Action (Mark appropriate box) <input type="checkbox"/> Preapplication <input type="checkbox"/> Application <input type="checkbox"/> Notification Of Intent (Opt.) <input type="checkbox"/> Report Of Federal Action		Leave Blank AUGUST 3, 1979		Terry Murray Terry Murray	
4. Legal Applicant/Recipient				5. Federal Employer Identification No.	
a. Applicant Name : Department of Energy					
b. Organization Unit : WIPP Project Office					
c. Street/P.O. Box : Mail Stop B-107					
d. City : Washington				e. County :	
f. State : D.C.				g. Zip Code : 20545	
h. Contact Person : Mr. Eugene Beckett (Name & telephone no.) (301) 353-3253					
7. Title and description of applicant's project WASTE ISOLATION PILOT PLANT - DRAFT ENVIRONMENTAL IMPACT STATEMENT - DOE/EIS-0026-D (2 Volumes) Seven alternatives are covered: No action; alternatives: to TRU waste disposal; for the intermediate-scale facility; time schedules & potential locations, including AZ. Transportation of nuclear waste with possible routes across AZ. Construction & operations of a waste isolation pilot plant (WIPP) for disposal of transuranic nuclear wastes (TRU), experimental research & development with high level waste forms & for potential disposal of spent fuel assemblies.				6. Program (From Federal Catalog) a. Number 810099 b. Title Unknown Department of Energy	
10. Area of project impact (Names of cities, counties, states, etc.) Statewide, Arizona				8. Type of applicant/recipient A-State G-Special Purpose District B-Interstate H-Community Action Agency C-Substate District I-Higher Educational Institution D-County J-Indian Tribe E-City K-Other F-School District (Specify): Federal Agency Enter appropriate letter <input checked="" type="checkbox"/> F	
13. Proposed Funding		14. Congressional Districts Of:		9. Type of assistance	
a. Federal \$.00		a. Applicant		A-Basic Grant D-Insurance B-Supplemental Grant E-Other C-Loan Enter appropriate letter(s) <input type="checkbox"/> E	
b. Applicant .00		b. Project 01 02 03 04		12. Type of application A-New C-Revision E-Augmentation B-Renewal D-Continuation Enter appropriate letter <input type="checkbox"/>	
c. State .00		16. Project Start Date Year month day 19		15. Type of change For 12c or 12c A-Increase Dollars F-Other Specify: B-Decrease Dollars C-Increase Duration D-Decrease Duration E-Cancellation Enter appropriate letter(s) <input type="checkbox"/>	
d. Local .00		17. Project Duration Months		19. Existing federal identification number	
e. Other 1 .00		18. Estimated date to be submitted to federal agency 19 Year month date			
f. Total \$ 1 .00					
20. Federal agency to receive request (Name, city, state, zip code)				21. Remarks added <input type="checkbox"/> Yes <input checked="" type="checkbox"/> No	
22. The Applicant Certifies That		a. To the best of my knowledge and belief, data in this preapplication/application are true and correct, the document has been duly authorized by the governing body of the applicant and the applicant will comply with the attached assurances if the assistance is approved.		b. If required by OMB Circular A-95 this application was submitted, pursuant to instructions therein, to appropriate clearinghouses and all responses are attached: (1) Arizona State Clearinghouse <input type="checkbox"/> No <input checked="" type="checkbox"/> Response attached (2) <input type="checkbox"/> <input type="checkbox"/> (3) <input type="checkbox"/> <input type="checkbox"/>	
23. Certifying representative		a. Typed name and title		b. Signature	
				c. Date signed Year month day 19	
24. Agency name				25. Application received 19 Year month day	
26. Organizational Unit				27. Administrative office	
29. Address				28. Federal application identification	
31. Action taken				30. Federal grant identification	
<input type="checkbox"/> a. Awarded				Year month day	
<input type="checkbox"/> b. Rejected				34. Starting date 19 Year month day	
<input type="checkbox"/> c. Returned for amendment				35. Contact for additional information (Name and telephone number)	
<input type="checkbox"/> d. Deferred				36. Ending date 19 Year month day	
<input type="checkbox"/> e. Withdrawn				37. Remarks added <input type="checkbox"/> Yes <input type="checkbox"/> No	
38. Federal agency A-95 action		a. In taking above action, any comments received from clearinghouses were considered. If agency response is due under provisions of Part 1, OMB Circular A-95, it has been or is being made.		b. Federal Agency A-95 Official (Name and telephone number)	

Section I - Applicant / Recipient Data

Section II - Certification

Section III - Federal Agency Action

DEPARTMENT OF CONSERVATION
DIVISION OF MINES AND GEOLOGY
DIVISION HEADQUARTERS
1416 NINTH STREET, ROOM 1341
SACRAMENTO, CA 95814
(Phone 916-445-1825)



September 19, 1979

Eugene Beckett
Waste Isolation Pilot Plant Project Office
Mail Stop B-107
Department of Energy
Washington, D.C. 20545

Dear Mr. Beckett:

Enclosed please find a discussion of the "Waste Isolation Pilot Plant" Department of Energy draft Environmental Impact Statement 0026-D. I hope this information will be useful to you. If I can be of further service please advise.

Sincerely,

A handwritten signature in cursive script, appearing to read "James F. Davis".

James F. Davis
State Geologist

Enclosure

**ENERGY RESOURCES CONSERVATION
AND DEVELOPMENT COMMISSION**1110 HOWE AVENUE
SACRAMENTO, CALIFORNIA 95825

(916)920-6815

September 6, 1979

Mr. Eugene Beckett
WIPP Project Office
Mail Stop B-107
Department of Energy
Washington, D.C. 20545

Dear Mr. Beckett:

The Nuclear Fuel Cycle Committee of the California Energy Commission is pleased to submit the attached comments on the Draft Environmental Impact Statement on the Waste Isolation Pilot Plant (DOE/EIS-0026-D). Our comments are specific to the DEIS as sent out for review; however, because the DOE has tentatively changed the scope of WIPP because of Congressional desires, we have included an addendum addressing some of the implications of having an unlicensed TRU waste repository.

We have been cheered by the inciteful review of the federal waste management program in the "Report of the Task Force for Nuclear Waste Management" and the "Report to the President by the Interagency Review Group on Nuclear Waste Management", the "IRG Report". The WIPP DEIS is out of step with its predecessors. The WIPP DEIS uses the IRG Report to provide a set of "programmatic objectives" by which to rank alternatives, but it fails to fulfill the promise of the IRG that TRU waste management strategies would be thoroughly evaluated in subsequent documents. Instead the WIPP DEIS uses tentative policy objectives as though they were firm policy based on alternatives analyses. Such an approach not only comprises the faith that the public has placed in the DOE, but it also violates the proper order of formulating programmatic objectives subsequent to environmental considerations.

The major fault of the WIPP DEIS is fundamental: it is not an environmental impact assessment at all. Instead of evaluating alternatives, including no action, on the basis of environmental criteria as required under the National Environmental Policy Act of 1969, the no action alternative is rejected as being unacceptable in the long term, and the remaining alternatives are ranked on the basis of tentative programmatic rather than environmental criteria because allegedly "there is no clear environmental basis for choosing among the remaining alternatives."

Mr. Eugene Beckett
Page 2
September 6, 1979

Environmental bases for ranking have been compromised in part by proposing a selected suite of alternatives. We propose the alternative of an extensive research and development program at WIPP without the premature disposal options. This alternative has lower short term and long term adverse impacts than the ranked alternatives in the WIPP DEIS.

Because the WIPP DEIS clearly fails to fulfill NEPA requirements, I recommend that it be withdrawn until the maturity of the scientific basis for the geologic disposal concept is sufficient to justify the issuance of a considerably restructured DEIS.

Sincerely,



EMILIO E. VARANINI, III
Commissioner
Presiding Member, Nuclear Fuel
Cycle Committee

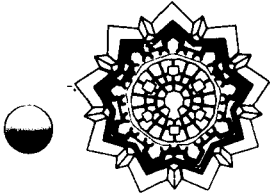

Department of Local Affairs Colorado Division of Planning

Philip H. Schmuck, Director



Richard D. Lamm, Governor

September 4, 1979

Mr. Eugene F. Beckett
WIPP Project Leader
Office of Nuclear Waste Management
Department of Energy
Washington, D.C. 20545

SUBJECT: Draft Environmental Impact Statement
Waste Isolation Pilot Plant

Dear Mr. Beckett:

The Colorado Clearinghouse has received the above-referenced Draft Environmental Impact Statement and has distributed it to interested state agencies. Comments received from the State Highway Department and the Office of Energy Conservation are enclosed for your information.

Thank you for the opportunity to review this matter.

Sincerely,

Stephen O. Ellis
Chief Planner

SE/MK/vt
Enclosures

cc: Office of the Governor
Department of Highways
Office of Energy Conservation



STATE OF DELAWARE
EXECUTIVE DEPARTMENT
OFFICE OF MANAGEMENT, BUDGET, AND PLANNING
DOVER, DELAWARE 19901

OFFICE OF THE
DIRECTOR

PHONE: (302) 678-4271

June 5, 1979

Mr. Eugene Beckett
WIPP Project Office
Mail Stop B-107
Department of Energy
Washington, D.C. 20545

Dear Mr. Beckett:

RE: DRAFT EIS, DOE/EIS-0026-D, WASTE ISOLATION PILOT PLANT

The Office of Management, Budget and Planning, in its function as the State Clearinghouse, has reviewed the subject EIS and has no comments to offer at this time.

Sincerely,

A handwritten signature in cursive script that reads "Nathan Hayward III".

Nathan Hayward III
Director

fb



STATE OF FLORIDA

Department of Administration

Division of State Planning

Room 530 Carlton Building

TALLAHASSEE

32304

(904) 488-2401

May 30, 1979

R.G. Whittle, Jr.
STATE PLANNING DIRECTOR

Bob Graham

GOVERNOR

SECRETARY OF ADMINISTRATION
Jim Tait

Mr. Eugene Beckett
WIPP Project Office
Mail Stop B-107
Department of Energy
Washington, D.C.

Dear Mr. Beckett:

Functioning as the state planning and development clearinghouse contemplated in U.S. Office of Management and Budget Circular A-95, we have reviewed the following draft environmental impact statement: Waste Isolation Pilot Plant, SAI 79-2123E.

During our review we referred the environmental impact statement to the following agencies, which we identified as interested: Department of Environmental Regulation, Department of Health and Rehabilitative Services, Department of Natural Resources, Bureau of Land and Water Management, and the State Energy Office.

Agencies were requested to review the statement and comment on possible effects that actions contemplated could have on matters of their concern. As of this date the reviewing agencies have not submitted any comments regarding this project. If letters of review and comment are received by this clearinghouse we shall forward them immediately.

In accordance with the Council on Environmental Quality guidelines concerning statement on proposed federal actions affecting the environment, as required by the National Environmental Policy Act of 1969, and U.S. Office of Management and Budget Circular A-95, this letter, with attachments, should be appended to the final environmental impact statement on this project. Comments regarding this statement and project contained herein or attached hereto should be addressed in the statement.

We request that you forward us copies of the final environmental impact statement prepared on this project.

Sincerely,

P-121

R. G. Whittle, Jr., Director

RGWjr:cy

TWIN TOWERS OFFICE BUILDING
2600 BLAIR STONE ROAD
TALLAHASSEE, FLORIDA 32301

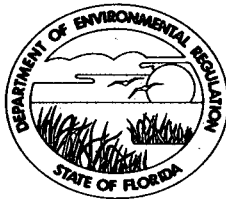

BOB GRAHAM
GOVERNOR
JACOB D. VARN
SECRETARY

STATE OF FLORIDA

DEPARTMENT OF ENVIRONMENTAL REGULATION

July 27, 1979

Mr. Eugene Beckett
WIPP Project Office
Mail Stop B-107
Department of Energy
Washington D.C. 20545

Dear Mr. Beckett:

Please consider this public document. As a systems analyst, it expresses a number of my own concerns regarding the WIPP project.

Sincerely,

J. S. Sherman

JSS/js

Enclosure

INTEROFFICE MEMORANDUM

For Routing To District Offices And/Or To Other Than The Addressee	
To: _____	Loctn.: _____
To: _____	Loctn.: _____
To: _____	Loctn.: _____
From: _____	Date: _____

TO: John Outland, Intergovernmental Programs Review Section
FROM: Don Kell, Bureau of Permitting *DK*
DATE: June 21, 1979
SUBJECT: Draft EIS, Waste Isolation Pilot Plant (WIPP),
Appendices, and Attachments, DOE

I have reviewed subject documents and am concerned about the following initial statements:

"This...(EIS) has been prepared...to assess the environmental impacts of constructing and operating...(WIPP)."

"The draft EIS is intended to serve as environmental input (sic) into future decisions..."

"Analyses show that there are (sic) no significant radiological health impacts resulting from the alternatives considered, and that there are no clear environmental bases for choosing among alternatives..."

I believe it can be shown that subject documents cannot stand as a legitimate statement of the long term environmental impacts of WIPP. The bulk of this memorandum is devoted to supporting this view.

If subject documents cannot stand as a legitimate WIPP environmental impact statement, then they cannot logically serve as input for future decision making regarding these impacts.

If DOE's first two statements are false, then the third, that WIPP would present no significant radiological health impacts, would be meaningless at best.

If all three statements are false, then an extreme positive bias toward waste isolation and burial would be demonstrated on the part of DOE.

Consider the following sample of quotations taken from subject documents which illustrate the breath of DOE's apparent bias:

John Outland Memo
June 21, 1979
Page Two

"Southeastern New Mexico is arid...The site (Figure 7-1) is monotonous in aspect and covered with desert vegetation... Ranch buildings are many miles apart...one sees an occasional windmill,...drilling rig, or grasshopper pump."

Even ice ages take place within 10% of the time required for some of the wastes that would be associated with WIPP to decay. Populations come and go following climatic changes. Entire civilizations last but 40 - 50 generations, while these wastes would still be hazardous after 50,000 generations. Except for immediate impacts concerning construction and socioeconomic interactions (on the order of 0.01% of total WIPP radiation-impact time), these statements appear to be entirely irrelevant, and further demonstrate a positive bias on the part of DOE toward waste burial in repositories.

"...(WIPP) is part of the national program for the permanent disposal of radioactive waste. It stems from two decades of analytical, laboratory, and field study..."

This statement conveys the impression of steady, unbroken progress at full effort for 20 years in each of the waste disposal areas. In fact, that 20 years of effort represents a series of relatively minor, uncoordinated attempts at providing a "technological fix" for the nuclear waste problem, each attempt meeting ultimately with failure as the record shows.

"This document is concerned only with decisions concerning atransuranic-waste depository, an intermediate-scale facility, and associated experiments."

The entire WIPP review process has become too highly fragmented. Looking only at small pieces of the project conveniently avoids analysis of the project's total impacts. Bergson's argument that a collection of anatomical parts cannot comprise a living, functioning human being is applicable and profound. A description of man's separate components would miss all the essential elements of humanity.

"...experiments performed with all types of nuclear waste will answer technical questions about the disposal of waste, including HLW, in salt...thus gaining further experience in designing repositories."

This statement contradicts the original justification for utilizing burial facilities, which claimed that the needed "technology already exists". The clause, to "build a base of empiracle data," implies that even the basic information upon which tentative repository designs would be based does not exist, a fact abundantly reflected in other DOE documents.

John Outland Memo
June 21, 1979
Page Three

"...the Waste Acceptance Criteria Steering Committee (still has not developed workable criteria)...Data for quantifying the criteria are being developed...The criteria are constantly evolving and...reflect only interim proposals...continually subject to revision."

A circular argument has been developed: WIPP cannot be designed without WACST criteria, yet these criteria cannot be finalized until WIPP is completed and put into operation. But WIPP cannot legitimately be put into operation until this data is compiled.

"...to avoid unnecessary costs..."

Cost cannot be an object concerning research on a facility of such unprecedented import. Already there are in existence upwards of a thousand billion curies of HLW that would be buried in repositories. To subject research on these materials to the agencies of economy and haste would be to foredoom the project to "expediencies" voiced by vested industrial, financial, and political interests.

"Sixteen people live within 10 miles of the center of the proposed site (page 1-3)...Thirteen people live within 10 miles of the proposed site (page 7-1)."

Such a glaring contradiction of even unimportant data belies DOE's solemn presentation of "hard scientific fact".

"This is a truncated list of the isotopes present in commercial high-level waste (Table E-4, Appendices)...This is a truncated list of the isotopes present in one spent-fuel assembly (Table E-5, Appendices)."

Such "truncated lists" conveniently eliminate more than 80% of all actinides and daughters, and 95% of fission products from the high level wastes, and more than 70% of all actinides and daughters, and 95% of all fission products from the spent-fuel assembly. This represents an incredible omission of fact, and is further evidence of DOE's bias toward waste burial in repositories.

"Hamstra (1975)...compared the hazards of buried waste to those of buried uranium ore and concluded that deeply buried high-level waste is safe after about 1,000 years of burial...; Gera (1975)..compared the hazard of nuclear waste to the hazard of unburied uranium - mill tailings piles...Gera concluded that the waste decays to a safe level in 100,000 years."

Aside from the fact that these positively biased guesstimates vary from each other by 2 orders of magnitude in time, both conveniently ignore the fact that the kinds of materials and radiation in nuclear

John Outland Memo
June 21, 1979
Page Four

wastes differ fundamentally from those in the original Uranium ore and tailings. Compared with some 37 naturally occurring species of Uranium, Thorium, and respective daughter products in both the ore and tailings, some 68 actinides and daughters, 300 fission products, and an indefinite number of neutron activation products have been identified in spent fuel and HLW. There are, whatismore, no Plutonium and higher transuranides (such as Americium) in Uranium ore or mill tailings. The biochemical properties of most of the spectrum of radionuclides in spent fuel and HLW is unknown.

"The site...is near a drainage divide...separating two major and actively developing solution-erosion features...The principal groundwater aquifer of the region is the Capitan Formation...Groundwater in the Capitan...has been heavily pumped for oil field flooding. These withdrawals have lowered the potentiometric surface (of the Capitan)..."

Depending upon final hydraulic gradients, contaminated groundwater from the site could move into the Capitan aquifer which currently is in heavy use. The movement of contaminants into the Capitan might be slow if the relatively low transmissibilities reported are true; however, later statements regarding "rocks (that are) strongly jointed, cavernous, and locally brecciated" cast doubt on the pump test derived transmissibilities. Furthermore, the million years required for the decay of much of the waste components would provide ample opportunity both for the transmission of contaminated wastes into the Capitan, and for major climatic and tectonic events which might completely alter the present geohydrology of the area.

"Deformation related to salt flow has occurred...accompanied by artesian brine flows...rocks exposed there are strongly jointed, cavernous, and brecciated...The Pecos Valley (in which the WIPP site is located) has widespread solution-subsidence features."

"The greatest deformation in the evaporite sequence at...the site seems to be spatially related to a structural trough trending northwest - southeast and parallel to the base of the Capitan 8 miles north of the site. This trough is 3 to 4 miles wide... The belt of deformation includes salt flow structure...Anderson (1978) has attributed some localized depressions within the evaporite units to "deep dissolution"...these "deep-seated sinks" may be related to other collapse features...as different stages of a general erosion...dissolution of 100 - 200 feet of salt has modified the surface and subsurface structure...In the...mining district...there has been subsidence during and after underground mining."

John Outland Memo
June 21, 1979
Page Five

Wells have penetrated major faults beneath the burial area. Major structural features lie to the East of the site a few miles. The old Ouachita mountain range and structures lie to the Southeast only 125 miles. The argument that, because an area has been tectonically stable for millions of years, that area is suitable for waste disposal activities is not a good one. Tectonic activity may be long overdue and might erupt at any time through reactivation of the old structures. Who would drive across a million year old bridge? That such a bridge were still standing would be amazing; it would definitely not be safe to drive across.

"(The site lies within a) seismic zone where the probable maximum intensity would be VIII...From April 1974 to October 1977, 291 events identified as earthquakes were recorded by a station (CLN) 4 miles from the center of the site...rock-falls and ground cracking were reported at an active potash mine (following earthquake events on July 26, 1972 and November 29, 1974)...Very little is known of the effects of earthquakes underground."

Even if major earthquakes occurred with a frequency of only one per 1,000 years, the repository would still be subject to 1,000 major seismic events before most of its waste had decayed to safe levels.

To any competent geologist, the aforementioned statements on earthquakes and structures would appear ominous. It is incredible that their significance has been omitted or gone completely unrecognized by DOE. The following statements thereby are rendered absurd:

"Ventilated air...will pass through a filtration system before release to the atmosphere (which could not prevent the release of H^3 , C^{14} , Kr^{85} , I^{129} , I^{131} , Xe^{133} and other gases). The release will be continuously monitored...administrative controls will be established to prevent deep drilling, mining, or other activities...fences and other security measures (like sealed doors and periodic inspection) will be needed to prevent public access."

To speak of administrative controls, monitoring, filtration systems, and fences that would need to be maintained for several million years is absurd. Even if man and organized society still existed, and these stopgaps could be so maintained, the spectacular costs associated would reduce WIPP's B/C ratio to essentially zero. Such stopgaps, furthermore, imply the embryogeny of a "garrison state" so widely predicted by critics.

Because truth regarding the future impacts of nuclear waste burial is evidently unknowable now, and must remain unknowable for at least a half million years, due to the infinite number of "incalculables" that lie in the far future, the determination of "truth"

John Outland Memo
June 21, 1979
Page Six

has evidently been deemed not only unnecessary by DOE, but positively undesirable. My recommendations follow accordingly:

Regarding the five major decisions under consideration by DOE (page iii):

"1. Whether to pursue the construction of the proposed ... (WIPP), a mined repository for the disposal of transuranic wastes, with an initial period of retrievable emplacement."

No; unless only for purposes of pure research on a small scale (no more than 100 spent fuel assemblies, a corresponding amount of HLW, and positive prohibitions against use of the facility for disposal for 100 years or more). * Accordingly there could be no plans for retrievability of wastes other than those wastes which had been used for pure research. Retrievability would have the effect of jeopardizing the integrity of any repository design. If wastes are perceived as having value, then they are obviously not wastes, and should be stored at the reactor site.

"2. Whether the WIPP should include an intermediate-scale facility in which up to 1,000 assemblies of spent fuel from commercial electricity-generating reactors would be disposed of, with an initial period of retrievable emplacement."

No; covered under 1. above.

"3. Whether the WIPP should include a research-and-development facility in which experiments with all types of nuclear waste, including high level waste, can be performed."

Only under conditions described for 1. above.

"4. What the timing and location of the WIPP should be."

1990 - 2090, under conditions described for 1. above.

"5. Whether to commit land now for a potential repository site in Eddy County, New Mexico".

No; this would be premature. Any such commitment should be predicated upon 100 years of pure research as in 1. above. New Mexico was picked partly because it is not politically strong. Repeated surveys have revealed that the New Mexican people are overwhelmingly against such a commitment. Even DOE's review of letters received revealed that New Mexican citizens were opposed 2 to 1.

Regarding DOE's actions and intentions to date, the following words by W.H. Auden seem particularly apt:

John Outland Memo
June 21, 1979
Page Seven

"Oh dear white children casual as birds,
playing among the ruined languages,
so small beside their large confusing words,
so gay against the greater silences;

Of dreadful things you did, oh hang the head
impetuous child with the tremendous brain.
Oh weep child, Oh
weep away the stain..."

* DOE should be given ample opportunity to demonstrate its continued faith in the perfectability of science and technology in the future. Experimental facilities, constructed with prohibitions against future uses, should be designed, built, and adequately tested by exhaustive means. If, eventually, such experimental development results in a prototype repository unit suitable for actual use, that unit should be mothballed for at least 100 years while second, third, and even fourth generation units are developed. If these later units could be developed, then earlier units would, by definition, be inferior, and thereby unsuitable for use in a project of such import that any imperfection whatsoever could be of incalculable impact.

In the meantime, above ground, plant-site disposition of wastes could provide for adequate storage, access, retrievability, and monitoring, as well as for decreased transportation hazards, a realistic public vision of the magnitude of the waste storage problem, and the elimination of the current propensity toward "expeditious" burial of wastes in an out of sight, out of mind fashion. Should solar disposal prove feasible during the time of advanced repository development, or should waste generation for one reason or another be terminated, then solar disposal should be seriously considered, as should those other alternatives of promise being simultaneously explored.

Above ground containment of spent fuel for a hundred years or more would provide a more nearly sufficient time period for thermal cooling of those wastes. Such a period would minimize thermal geologic disturbances and consequent damages to any repository that might come to be employed, thus minimizing the likelihood of jeopardizing that repository's containment integrity in a fashion that could not provide for safe, permanent isolation of materials which, by the year 2000, could provide enough radiation to kill or deform every person on earth 1000 times.

DK/js



Office of Planning and Budget
Executive Department

Clark T. Stevens
Director

GEORGIA STATE CLEARINGHOUSE MEMORANDUM

TO: Mr. Eugene Beckett,
WIPP Project Office, Mail Stop B107
Department of Energy
Washington, D.C. 20545

FROM:  Charles H. Badger, Administrator
Georgia State Clearinghouse
Office of Planning and Budget

DATE: September 17, 1979

SUBJECT: RESULTS OF STATE-LEVEL REVIEW

Applicant: Energy, U. S. Department

Project: Draft EIS DOE/EIS - 0026-D
Waste Isolation Pilot Plant

State Clearinghouse Control Number: 79-05-14-10

The State-level review of the above-referenced document has been completed. As a result of the environmental review process, the activity this document was prepared for has been found to be consistent with those State social, economic, physical goals, policies, plans, and programs with which the State is concerned.

The following State agencies have been offered the opportunity to review and comment on this project: Department of Natural Resources
Office of Planning & Budget, Executive Dept.

cc: Barbara Hogan, DNR

Enclosure: Comments prepared by Department of Natural Resources, dated Sept. 10, 1979

CHB:if



Joe H. Turner
COMMISSIONER

Department of Natural Resources

270 WASHINGTON ST., S.W.
ATLANTA, GEORGIA 30334
(404) 656-3500

September 10, 1979

MEMORANDUM

TO: Chuck Badger, Administrator
State Clearinghouse

FROM: Barbara A. Hogan, Coordinator *BAH/PS*
Comprehensive Review

ISSUE: Completion of Department of Natural Resources Review of
State Clearinghouse Control Number 79-05-14-10

APPLICANT: U.S. Dept. of Energy

PROJECT: Draft EIS - Waste Isolation Pilot Plant

FEDERAL AGENCY: DOE

COMMENTS

Because of the location of this project and constraints on staff time, the Department of Natural Resources does not have any comments to offer on this project at this time.

BAH/ps:lh

cc: Jim Benson

STATE OF ILLINOIS
EXECUTIVE OFFICE OF THE GOVERNOR
BUREAU OF THE BUDGET
SPRINGFIELD 62706

June 22, 1979

Mr. Eugene Beckett
WIPP Project Office
Mail Stop B-107
Department of Energy
Washington, D.C. 20545

Dear Mr. Beckett:

RE: DEIS: Waste Isolation Pilot Plant, DOE/EIS-0026-D
SAI #79 05 09 60

The Illinois State Clearinghouse has reviewed the referenced subject pursuant to the National Environmental Policy Act of 1969, OMB Circular A-95, Revised and the administrative policy of the State. State agencies which are authorized to develop and enforce environmental standards have been given the opportunity to comment on this subject. No comments have been received on the referenced subject.

Thank you for your assistance.

Respectfully yours,

TE Hornbacher/sed

T. E. Hornbacker, Director
Illinois State Clearinghouse

TEH/li

STATE OF INDIANA



INDIANAPOLIS

STATE BOARD OF HEALTH
An Equal Opportunity Employer

Address Reply to:
Indiana State Board of Health
1330 West Michigan Street
Indianapolis, IN 46206

May 29, 1979

TO: Mr. Roland J. Mross
Federal Aid Director
Harrison Building

Attention Indiana State Clearinghouse

FROM: William T. Paynter, M. D. *WTP*
State Health Commissioner

SUBJECT: A-95 Project Review
State Identification No. 7905010000

*DEIS
Waste Isolation Pilot Plant
General*

The Indiana State Board of Health has reviewed the documents forwarded from your office on May 11, 1979, relative to the subject project and offers the comments as checked below.

- No comments.
- No objections to this proposal. However, plans and specifications for the indicated (x) health and sanitary features must be submitted for review and recommendations for appropriate approvals prior to construction.

- Water production
- Water distribution
- Sewage collection
- Sewage treatment
- Solid waste management
- Fuel combustion and incineration
- Long-term nursing care facilities
- Schools, hospitals, community health facilities, jails
- Other

RECEIVED

Cannot endorse this proposal for the following reasons:

MAY 31 1979

- The community is on the sewer ban list so additional sanitary sewer connections are prohibited.
- The project site is inadequate for the intended purpose.
- The economic soundness of the proposal is questioned.
- Other

**INDIANA STATE CLEARINGHOUSE
A-95 RESPONSE**

State Identification No.	<u>79 0501 0000</u>
Date Received	<u>5/9/79</u>
Review Terminated	<u>6/9/79</u>

TO: Mr. Eugene Beckett

Project Description (Nature, Purpose, Location):

Draft Environmental Impact Statement (DOE/EIS-0026-D) Waste Isolation Pilot Plant
USDOE

Federal Program Title; Agency and FDA Catalog Number.

Amount of Funds Requested

The following agencies have reviewed the above project and make the following disposition concerning this application:

<u>Department of Natural Resources</u>	<u>John Feingold</u>
Reviewing Agency	Contact Person
FAVORABLY <u>xx</u>	UNFAVORABLY _____ WITH COMMENTS _____

<u>Board of Health</u>	<u>Jon Satrom</u>
Reviewing Agency	Contact Person
FAVORABLY <u>No comments</u>	UNFAVORABLY _____ WITH COMMENTS _____

<u>Energy Group</u>	<u>Clarence Broadus</u>
Reviewing Agency	Contact Person
FAVORABLY <u>No comment.</u>	UNFAVORABLY _____ WITH COMMENTS _____

The A-95 response, along with any reviewing agency comments is to be attached to your formal application being submitted to the appropriate Federal Agency. These comments will be kept on file in the State Clearinghouse for one year.

A P Eaglesfield
 Indiana State Clearinghouse
 State Planning Services Agency
 143 West Market Street, Suite 300
 Indianapolis, Indiana 46204
 317/633-4346
 State Form 3162

June 18, 1979
 Date

STATE OF KANSAS

Department of  Administration

DIVISION OF STATE PLANNING AND RESEARCH

5th Floor—Mills Building

109 W. 9th

Topeka, Kansas 66612

May 30, 1979

Dr. Colin A. Heath
Division of Waste Isolation
Mail Stop B-107
U.S. Department of Energy
Washington, D.C. 20545

Re: U.S. Dept. of Energy
Draft Environmental Impact Statement
Waste Isolation Pilot Plant
#DEIS/DOE - 7208

The referenced project has been processed by the Division of State Planning and Research under its clearinghouse responsibilities described in Circular A-95.

After review by interested state agencies, it has been found that the proposed project does not adversely affect state plans. Enclosed are comments concerning this project for your information and referral. We do ask that you submit 2 copies of your final grant application for our files at the time you submit your application to the funding agency. Please be sure to include our State Application Identifier (SAI) number on the application and any future correspondence.

Sincerely,



Paul V. DeGaeta
A-95 Coordinator

PVD:jc

cc:

C. Frank Harscher, III
Secretary



Julian R. Brown
Governor

COMMONWEALTH OF KENTUCKY
DEPARTMENT FOR NATURAL RESOURCES AND ENVIRONMENTAL PROTECTION
OFFICE OF THE SECRETARY
OFFICE OF POLICY AND PROGRAM ANALYSIS
CAPITAL PLAZA TOWER
FRANKFORT, KENTUCKY 40601
PHONE (502) 564-7320

October 2, 1979

Mr. Eugene Beckett
W.I.P.P. Project Office
Mail Stop B-107
Department of Energy
Washington, D. C. 20545

RE: Draft Environmental Impact Statement on Waste Isolation
Pilot Plant

Dear Mr. Beckett:

The Draft Environmental Impact Statement prepared on the proposed Eddy County, New Mexico, Waste Isolation Pilot Plant has been circulated to selected Kentucky Environmental Review Agencies for their comments. No comments have been returned by them. We would like to review the final report when it becomes available.

Sincerely,

A handwritten signature in cursive script that reads "Boyce R. Wells".

Boyce R. Wells
Environmental Review Coordinator

BRW:bsc



Harry Hughes
GOVERNOR

MARYLAND
DEPARTMENT OF STATE PLANNING

301 WEST PRESTON STREET
BALTIMORE, MARYLAND 21201
TELEPHONE: 301-383-2451

Constance Lieder
SECRETARY OF STATE PLANNING

June 25, 1979

Mr. Eugene Beckett
WIPP Project Office
Mail Stop B-107
Dept. of Energy
Washington, D. C. 20545

SUBJECT: ENVIRONMENTAL IMPACT STATEMENT (EIS) REVIEW
Applicant: U. S. Department of Energy
Project: Draft EIS - Nuclear Waste Isolation Pilot Plant
(DOE # EIS-0026-D)
State Clearinghouse Control Number: 79-5-1203
State Clearinghouse Contact: James W. McConnaughay (383-2467)

Dear Mr. Beckett:

The State Clearinghouse has reviewed the above Statement. In accordance with the procedures established by the Office of Management and Budget Circular A-95, the State Clearinghouse received comments from the following:

Department of Natural Resources, Department of Economic and Community Development, including their Historical Trust section, Department of Transportation, Department of Agriculture, and our staff noted that the Statement appears to adequately cover those areas of interest to their agencies.

Environmental Health Administration provided comments (copy attached) indicating that continued indecision on the part of the national leadership regarding a national nuclear spent full waste management policy will probably cause less desirable temporary and local alternatives to be utilized.

The State Clearinghouse appreciates your agency's attention to the A-95 review process and hopes that the referenced comments will be useful in your continuing evaluation of this project.

Sincerely,

James W. McConnaughay
Chief, State Clearinghouse

JWM:BG:mmk

cc: Lowell Frederick/ Wm. Wadsworth/ Clyde Pyers/ Max Eisenberg/ Henry Silbermant



OFFICE OF THE GOVERNOR
 Planning & Coordination
 1303 Walter Sillers Building
 JACKSON, MISSISSIPPI 39201
 354-7018

CLIFF FINCH
 GOVERNOR

STATE CLEARINGHOUSE FOR FEDERAL PROGRAMS

GEORGE F. NEWMAN
 DIRECTOR

TO: United States Department of Energy STATE CLEARINGHOUSE NUMBER
 WIPP Project Office
 Mial Stop B-107
 Washington, D.C. 20545

79051710

DATE: September 7, 1979

Attn: Mr. Eugene Beckett

PROJECT DESCRIPTION: NATIONWIDE

Draft Environmental Impact Statement (DOE/EIS-0026-D) Waste
 Isolation Pilot Plant. Volume 1 of 2.

The State Clearinghouse, in cooperation with the state agencies interested or possibly affected, has completed the A-95 review of the project described above.

None of the state agencies involved in the review had comments or recommendations to offer at this time. This concludes the State Clearinghouse review, and we encourage appropriate action as soon as possible.

A copy of this letter is to be attached to the application as evidence of compliance with the A-95 requirements.

Lester Howell, Coordinator
 Clearinghouse for Federal Programs



OFFICE OF THE GOVERNOR
Planning & Coordination
1303 Walter Sillers Building
JACKSON, MISSISSIPPI 39201
354-7018

CLIFF FINCH
GOVERNOR

STATE CLEARINGHOUSE FOR FEDERAL PROGRAMS

GEORGE F. NEWMAN
DIRECTOR

TO: United States Department of Energy STATE CLEARINGHOUSE NUMBER
WIPP Project Office
Mail Stop B-107
Washington, D.C. 20545

79051711

DATE: September 7, 1979

Attn: Mr. Eugene Beckett

PROJECT DESCRIPTION: NATIONWIDE

Draft Environmental Impact Statement, Waste Isolation Pilot Plant.
DOE/EIS - 0026-D. Volume 2 of 2 Appendices.

The State Clearinghouse, in cooperation with the state agencies interested or possibly affected, has completed the A-95 review of the project described above.

None of the state agencies involved in the review had comments or recommendations to offer at this time. This concludes the State Clearinghouse review, and we encourage appropriate action as soon as possible.

A copy of this letter is to be attached to the application as evidence of compliance with the A-95 requirements.

A handwritten signature in cursive script that reads "Lester Howell".

Lester Howell, Coordinator
Clearinghouse for Federal Programs



State of Missouri
OFFICE OF ADMINISTRATION
P.O. Box 809
Jefferson City 65102

Joseph P. Teasdale
Governor

William D. Dye, Director
Division of Budget and Planning

June 26, 1979

Mr. Eugene Beckett
WIPP Project Office
Mail Stop B-107
Department of Energy
Washington, D.C. 20545

Dear Mr. Beckett:

Subject: 79050148 (Waste Isolation Pilot Plant)

The Division of Budget and Planning, as the designated State Clearinghouse, has coordinated a review of the above referred draft environmental impact statement with various concerned or affected state agencies pursuant to Section 102(2)(c) of the National Environmental Policy Act.

Enclosed please find the comments received. None of the other state agencies involved in the review had comments or recommendations to offer at this time.

We appreciate the opportunity to review the statement and anticipate receiving the final environmental impact statement when prepared.

Sincerely,

A handwritten signature in cursive script that reads "Lois Pohl".

Lois Pohl *c.m.*
Chief, Grants Coordination

LP:cm

Enclosure



JUL 12 1979
24

RECEIVED

STATE OF NEVADA
GOVERNOR'S OFFICE OF PLANNING COORDINATION
CAPITOL COMPLEX
CARSON CITY, NEVADA 89710
(702) 885-4865

JUL 11 AM 8 35

July 5, 1979

Dr. Colin A. Heath
Division of Waste Isolation
Mail Stop B-107
U.S. Dept Energy
Washington D.C. 20545

RE: SAI NV # 79300067 Project: DOE/EIS 0046-D
79300068 DOE/EIS 0026-D

Dear Dr. Heath:

Attached are the comments from the following affected State Agencies: Division of Environmental Protection, and Dept. of Energy concerning the above referenced projects.

These comments constitute the State Clearing house review of this proposal. Please address these comments in the final or summary report.

Sincerely,

Mike Nolan for
Robert M. Hill
State Planning Coordinator

RMH:md

Enclosures

7-31-79 - Xerox cy to:
E. Hardin, AL and 1 cy to R.M. Nelson, NV.



STATE OF NEW MEXICO
OFFICE OF THE GOVERNOR
SANTA FE
87503

September 6, 1979

BRUCE KING
GOVERNOR

The Honorable Charles Duncan
Secretary of Energy
U.S. Department of Energy
Mail Stop 8G-031
Forrestal Building
Washington, D. C. 20585

Attention: Mr. Eugene Beckett
WIPP Project Leader

Dear Secretary Duncan:

I wish to congratulate you on your recent appointment as Secretary of Energy. I know your work will be rewarding and the challenge you have accepted will have a tremendous impact on the future of our country. I look forward to working cooperatively with you and your administration to meet the energy needs of our Nation.

As you know, the State of New Mexico and the Department of Energy (DOE) have been working cooperatively through a process of consultation and concurrence to review and evaluate the proposed Waste Isolation Pilot Plant (WIPP) in Southeastern New Mexico. An important stage in this process has been the issuance of a Draft Environmental Impact Statement (DEIS) by your Department. Our review of this draft was carried out under the leadership of Secretary of Finance and Administration David W. King in conjunction with the Radioactive Waste Consultation Task Force, and includes comments from all relevant Cabinet Departments, the Environmental Evaluation Group (EEG), and the Governor's Advisory Committee on WIPP. These comments are enclosed for your consideration.

We have found three major deficiencies in the DEIS--those portions dealing with transportation, emergency preparedness, and socioeconomics. These problem areas have been recognized by both federal agencies and Congressional delegates, and various efforts have been initiated to remedy them. Of equal importance to the three major DEIS deficiencies cited are the health and environmental concerns expressed by the EEG and the Governor's Advisory Committee on WIPP which have analyzed the scientific and technical aspects of the DEIS. Their evaluations have revealed a number of areas that should be addressed in the final EIS or supplemental documents.

The Honorable Charles Duncan

September 6, 1979

Page Two

It is my request that the transportation and emergency preparedness issues be adequately addressed through the preparation of supplements to the DEIS and that these supplements be reviewed by New Mexico prior to completion of the final EIS and prior to the initiation of Title II activities. We consider it important that progress on the project itself should be synchronized with progress in the area of transportation, since the success of the project will depend on the resolution of a number of important technical and institutional issues pertaining to transportation.

The socioeconomic issue, currently being studied by the State of New Mexico under a grant from the DOE, must also be thoroughly evaluated as to its ultimate impact on the State. Because the study completion date and the final EIS date are not the same, the State and the DOE need to jointly define how the socioeconomic study results can be fully incorporated through the consultation and concurrence process. A similar definition needs to be determined with respect to the technical and scientific issues raised by the EEG. These issues should be addressed in the context of the current negotiation with the State on consultation and concurrence.

In the event that the DOE is unable to issue supplements on the inadequate portions of the DEIS for timely review prior to the publication of the final EIS, then I must declare the entire DEIS inadequate. It is my hope that supplemental studies can be prepared and the weaker sections of the DEIS can be brought up to standard in time to be incorporated in the final EIS.

Since the issuance of the DEIS in April, there have been important changes in the mission of the WIPP project. When the State initiated the DEIS reviews, it was anticipated that commercial spent fuel would be included in the scope of the project. Commercial waste has now been eliminated, and the project has reverted to a facility for the permanent disposal of defense transuranic wastes and for research and development on high-level waste. This raises the question of whether the DEIS in its present form is an adequate representation of the proposed scope of the project. Under the circumstances, I would request that references to commercial waste be removed prior to the publication of the final EIS.

With this change of mission, it also appears that the sense of national urgency associated with a spent fuel disposal capability has been removed from the project. We understand from hearings before the House Oversight and Investigations Subcommittee and other federal sources that there is no immediate hazardous condition existing at current transuranic waste storage sites, and that we have gained sufficient time to adequately evaluate all aspects of the WIPP as well as other alternative disposal sites. In this connection, it is important that the final EIS should specifically identify the intended scope of the project, including estimates of the amounts and types of radioactive material to be permanently or temporarily located in the repository. We expect to participate in the

The Honorable Charles Duncan
September 6, 1979
Page 3

determination of the final scope of the project with the DOE through the consultation and concurrence process which is now being defined.

Because of the complexity of the WIPP, it is necessary that the final EIS address and respond to all issues identified in the review process. State agencies identified many potential costs in reviewing the effects of this project on their operations. These costs must be further explained and quantified in the final statement. Of great importance among these costs is the liability resulting from loss of life or property related to a project accident or nuclear waste transportation accident. We believe that this issue should be comprehensively addressed in the final EIS, including an evaluation of the adequacy of the Price-Anderson Act and the extent of federal and state liability.

We have stated on many occasions that the WIPP should be licensed by the Nuclear Regulatory Commission. The licensing process will help ensure that the health and safety of New Mexicans will not be compromised. The process of consultation and concurrence will also help to meet our concern for health and safety by providing for active State participation in decision making on the WIPP. The EIS process is an integral part of consultation and concurrence, but it must be appreciated that any approval given to the final EIS will not represent the State's final concurrence on the WIPP project.

To assure continued positive communication and coordination, the flow of information and documentation must be further improved. In addition to the EEG, the State's Radioactive Waste Consultation Task Force and the A-95 Clearinghouse should receive pertinent documentation and notification of all meetings or hearings. Financing should continue to be provided to enable the State to carry out its own independent evaluation of the project.

We further suggest that a summary of the main conclusions of the final EIS should be provided in both English and Spanish languages. Consideration should also be given to translation into appropriate Indian languages for those tribes likely to be impacted by the WIPP.

The attached review provide details of the State's DEIS review. We sincerely hope that our comments aid you in the evaluation of such a complex project and we stand ready to assist you in whatever way we can.

Sincerely,



BRUCE KING
Governor

Attachment



New Mexico Bureau of Mines & Mineral Resources
Socorro, NM 87801

A DIVISION OF
NEW MEXICO INSTITUTE OF MINING & TECHNOLOGY

September 5, 1979

ormatt 05/835-5420
lication 05/835-5410

Mr. Dennis Rivera
State Planning Division
527 Don Gaspar Santa Fe, NM 87503

Dear Mr. Rivera:

Our economic geologists, petroleum geologists, hydrogeologist, environmental geologist, chemist, mining engineer, petrologist, mineralogist and mining geologist reviewed the draft EIS for WIPP, April 1979. We had reviewed in detail a draft of Geological Characterization Report WIPP Site, prepared by Powers et al., Sandia Labs, 1978.

Some aspects of the detailed geologic controls, transportation, mining and depository construction, hydrogeology and mineral resources development are site specific and require constant investigation as work proceeds. Minor modifications of development plan are needed to adjust to minor variances in these factors.

The area is tectonically stable, salt solution appears to be relatively slow, and other geologic factors are reasonably favorable. Transportation safeguards appear adequate. Mining and construction plan for subsurface and surface facilities is conservative with safety aspects emphasized.

Potash reserves probably will be lost; slant drilling may recover gas and oil resources. Loss of these mineral resources is our major criticism of the site.

Sincerely yours,

Frank E. Kottlowski
Director

FEK/jp

cc: Eugene Beckett



BRUCE KING
GOVERNOR

DAVID W. KING
SECRETARY

STATE OF NEW MEXICO
DEPARTMENT OF
FINANCE AND ADMINISTRATION
PLANNING DIVISION

ANITA HISENBERG
DIRECTOR

505 DON GASPAR AVENUE
SANTA FE, NEW MEXICO 8
(505) 827-2073
(505) 827-5191

September 11, 1979

Mr. Don Schueler
Project Manager
WIPP Project Office
U.S. Department of Energy
Albuquerque Operations Office
Post Office Box 5400
Albuquerque, New Mexico 87115

Dear Mr. Schueler:

Enclosed for your information is a copy of the State of New Mexico's review of the Draft Environmental Impact Statement (DEIS) on the Waste Isolation Pilot Plant (WIPP). This review constitutes the State's official response to the Department of Energy on the DEIS of the proposed WIPP project.

This review is comprised of four sections based on reviews compiled by the State Planning Division, the Governor's Advisory Committee on WIPP, the University of New Mexico's Economic Resource Group and the Environmental Evaluation Group. The report conducted by the Environmental Evaluation Group is not provided in the enclosed document. That review will be sent to you or can be acquired by direct request to them.

If you desire further information on this matter, please contact Dennis Rivera in Santa Fe at 827-5191.

Sincerely,

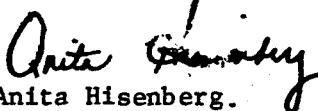
Anita Hisenberg.
Director

AH:jeh

Enclosure

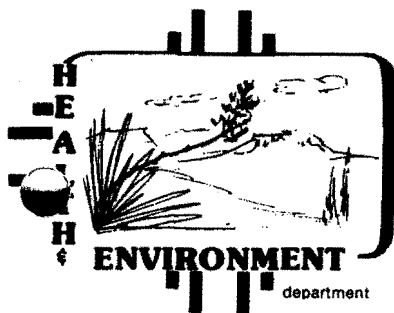

"equal opportunity employer"

STATE OF NEW MEXICO

ENVIRONMENTAL EVALUATION GROUP

320 E. Marcy Street
P. O. Box 968
Santa Fe, N.M. 87503
(505) 827-5481

September 7, 1979

Mr. Don T. Schueler
WIPP Project Manager
Department of Energy
Albuquerque Operations Office
P. O. Box 5400
Albuquerque, New Mexico 87115

Dear Mr. Schueler:

Enclosed you will find an advanced copy of our "Radiological Health Review of the Draft Environmental Impact Statement (DOE/EIS-0026-D) Waste Isolation Pilot Plant, U. S. Department of Energy", which is now being readied for distribution. I was sure that you would like to have a copy in advance of the release to the news media.

I am estimating that the main distribution of this document will begin Tuesday, September 11, 1979. The release to the news media will be on September 11 or 12.

Very truly yours,

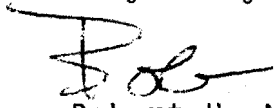
Robert H. Neill
Director

RHN:pt

Enclosure: one

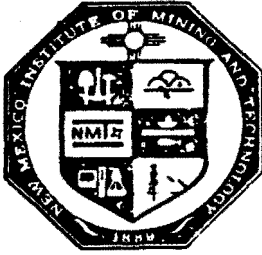

NEW MEXICO TECH

SOCORRO, NEW MEXICO 87801

THE GRADUATE OFFICE

(505) 835-5513

May 18, 1979

Governor Bruce King
State Capitol Building
Santa Fe, New Mexico 87503

Dear Governor King:

We are writing to report another recent action of our Advisory Committee on WIPP.

The following statement relative to Mineral Resources and the Waste Isolation Pilot Plant has been adopted by unanimous agreement:

We endorse the findings of the Foster Report to the extent that mineral resources at the WIPP Site represent a threat to long term integrity of a waste repository. Judging from the NAS criterion*, this would be a basis for questioning the suitability of the WIPP Site.

*No area with a present or past record of resource extraction other than for bulk materials won by surface quarrying, should be considered as a geological site for radioactive wastes. Geological Criteria for Repositories for High-Level Radioactive Wastes, Committee on Radioactive Waste Management, National Academy of Science, p. 13-15, August 3, 1978.

A copy of Roy Foster's report entitled "Mineral Resources and the WIPP Site," is attached. If there are any questions that you or members of the Task Force have concerning this action or the report itself please don't hesitate to contact Roy or members of our Committee.

Sincerely,

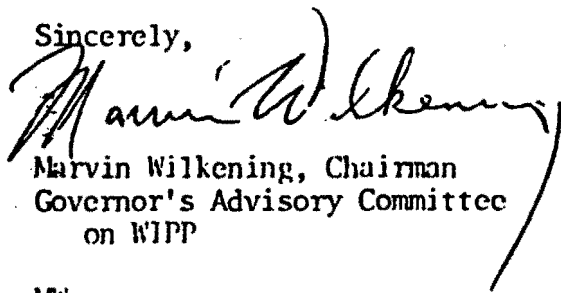

Marvin Wilkening, Chairman
Governor's Advisory Committee
on WIPP

MW:ceg

Attachment



RESOURCE ECONOMICS GROUP
DEPARTMENT OF ECONOMICS
THE UNIVERSITY OF NEW MEXICO, ALBUQUERQUE

A CRITICAL REVIEW OF THE SOCIO-ECONOMIC
PORTIONS OF THE DOE'S DEIS CONCERNING
THE WASTE ISOLATION PILOT PROJECT

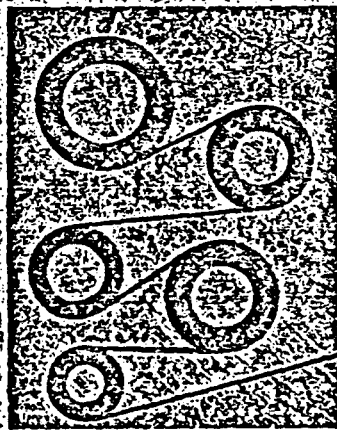
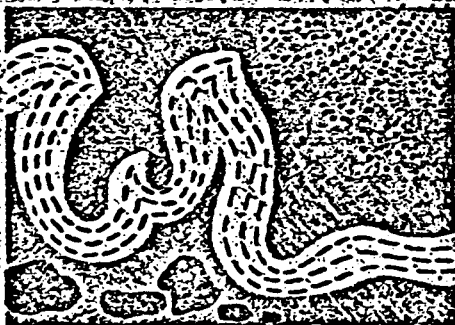
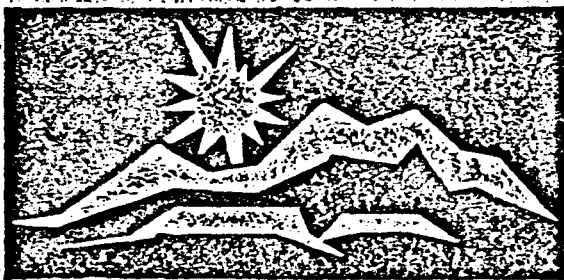

**program
in
resource
economics**

working paper series



STATE OF NEW MEXICO

Office of the Attorney General

DEPARTMENT OF JUSTICE

P.O. Drawer 1508

Santa Fe, N. M. 87501

August 30, 1979

JEFF BINGAMAN
ATTORNEY GENERAL

United States Department of Energy
Washington, D. C. 20545

Re: DOE/EIS-0026-D, Waste Isolation Pilot Plant
Our Ref. No. 30401-201/204/206

Dear DOE:

As comments by the Attorney General on the above indicated draft environmental impact statement, which DOE prepared in response to a request we made in April, 1978, enclosed please find a copy of the testimony given by Attorney General Jeff Bingaman on August 10, 1979, to the House Subcommittee on Oversight and Investigations of the Interior Committee. Our comments address the following legal issues: (1) the Price Anderson Act (discussed in the DEIS at pp. 14-2, 2nd paragraph, and 14-7, paragraph 3); and (2) New Mexico's role of "consultation and concurrence" with respect to the establishment of WIPP.

Technical comments on non-legal issues raised by the DEIS will be provided by other state agencies.

Very truly yours,

STEVEN ASHER
Assistant Attorney General
Director, Energy Unit
Consumer and Economic Crimes Division

SA:pgg
Encl.

ccs: Governor Bruce King
State Planning Division
Attn: Mr. Dennis Rivera

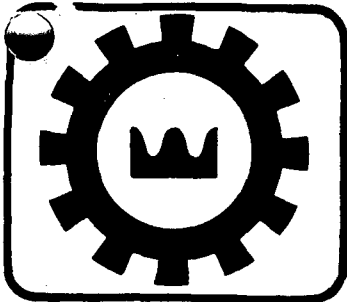

**SOUTHEASTERN NEW MEXICO
ECONOMIC DEVELOPMENT DISTRICT**

P. O. BOX 6639 R. I. A. C. ROSWELL, NEW MEXICO 88201 505- 347-5425

NICK J. PAPPAS Executive Director

September 6, 1979

Mr. Eugene Beckett
Department of Energy
WIPP Project Office
Mail Stop 8G-031
Washington, D.C. 20585

RE: Draft Environmental Impact Statement - Waste Isolation Pilot Plant

Dear Mr. Beckett:

In accordance with OMB Circular A-95, the Southeastern New Mexico Economic Development District (SNMEDD) has reviewed the above referenced statement and offer the following comments:

1. The SNMEDD will defer judgement on potential environmental impacts to the Governor's Special Task force on WIPP which has the greatest expertise available for analysis of project related environmental concerns.
2. The SNMEDD, which works closely with communities throughout this part of the state, feels that the WIPP project can have positive benefits on the Lea and Eddy County economies and could also provide much needed diversification of the regions economic base. The project must, however, be carefully phased and properly funded so as not to create negative impacts that are typical of rapid growth or "sudden rise" boom town situations.
3. The proposed project will directly benefit low and moderate income wage earners, including minorities, as the construction work force could approach 800 people, many of which will be hired locally.
4. The SNMEDD Board has endorsed the WIPP project as a disposal site for defense generated waste and as a small-scale experimental site for diposal of commercial waste. The SNMEDD has not shown any support for permanent storage of large amounts of commercial waste.

The project obviously represents a decision of enormous regional and statewide impact. This office will not pretend to speak for anyone other than an association of local governments, who had given preliminary endorsement to a concept that has been revised and amended substantially over the past five years. Please do not hesitate to contact this office if we can be of further assistance.

Sincerely,

Nick J. Pappas
Executive Director



BY:
Ivan L. Hall
Chief Planner

ILH/dlg

cc: Dennis Rivera - SPO

DIRECTOR-

Steven LaBrake

CHAIRMAN-

Howard A. McGee

VICED

CHAIRMAN-

Roy Wood

SECRETARY-

Charles Ingram

YATES COUNTY PLANNING BOARD

County Building Annex
431 Liberty Street
Penn Yan, New York 14527

Phone (315) 536-2531

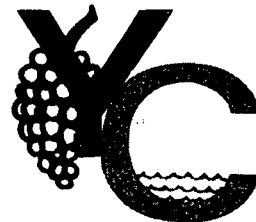

August 2, 1979

Waste Isolation Pilot Plant Project Office
Department of Energy
MS B-107
Washington, D.C. 20545

Dear Sir:

As a county identified for nuclear waste disposal within the Salina Salt Basin, there is particular interest among citizens and public organizations to monitor the ongoing research and development, and any proposed plans dealing with nuclear waste disposal.

The Y.C.P.B. reviewed the Draft E.I.S. for the Waste Isolation Pilot Plant in Carlsbad, N.M., and unanimously supports the enclosed resolution for submittal as public comment.

The Board recognizes the increasing need to develop pilot plants for further research on waste disposal; yet, a project the scope of the proposed WIPP is a large commitment financially and to the concept of waste disposal in salt beds. Rather than the WIPP, the Board supports more extensive research on all possible geologic environments and development of pilot plants of lesser magnitude.

We appreciate the opportunity to comment on the proposed project.

Sincerely,

YATES COUNTY PLANNING BOARD

Howard A. McGee

Chairman

HAM/ml

Enc.

DIRECTOR-
Steven LaBrake
CHAIRMAN-
Howard A. McGee
VICE-CHAIRMAN-
Roy Wood
SECRETARY-
Charles Ingram

YATES COUNTY PLANNING BOARD

County Building Annex
431 Liberty Street
Penn Yan, New York 14527
Phone (315) 536-2531

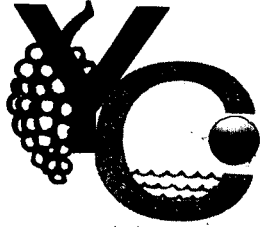

TITLE: Resolution to support further research and development of Waste Isolation Pilot Plants

WHEREAS, The United States Department of Energy has requested input from the general public regarding the proposed Waste Isolation Pilot Plant in Carlsbad, New Mexico, and

WHEREAS, this project will be a pilot program to determine the suitability of salt beds for the disposal of radioactive wastes and,

WHEREAS, Yates County, New York has been identified as part of a general region of possible suitability for radioactive waste disposal due to the Salina salt bed geologic formation, now therefore be it;

RESOLVED THAT, the Yates County Planning Board encourages the comprehensive research of use of all possible radioactive waste disposal media and further be it;

RESOLVED THAT, the Yates County Planning Board hereby encourages the development of small scale on-site pilot projects for the testing of all possible radioactive waste disposal media and further;

RESOLVED THAT, the Yates County Planning Board supports curtailed pilot projects which would not involve the high cost and facility capacity of the proposed Carlsbad, New Mexico, Waste Isolation Pilot Plant.

North Carolina 
Department of Administration
116 West Jones Street Raleigh 27611

James B. Hunt, Jr., Governor
Joseph W. Grimsley, Secretary

Division of State Budget and Management
John A. Williams, Jr., State Budget Officer
(919) 733-7061

July 3, 1979

Mr. Eugene Beckett
WIPP Project Office
Mail Stop B-107
Department of Energy
Washington, D. C. 20545

Dear Mr. Beckett:

RE: SCH #118-79, Draft Environmental Impact Statement
(DOE/EIS-0026-D) Waste Isolation Pilot Plant - US
Department of Energy

The State Clearinghouse has received and reviewed the above referenced project. As a result of this review, the State Clearinghouse finds that no comment is necessary on this project at this time.

Sincerely,



Chrys Baggett (Mrs.)
Clearinghouse Director

CB:maw

NORTH DAKOTA STATE PLANNING DIVISION

STATE CAPITOL - NINTH FLOOR - BISMARCK, NORTH DAKOTA 58505
701-224-2818

June 14, 1979

STATE INTERGOVERNMENTAL CLEARINGHOUSE "LETTER OF CLEARANCE"
ON PROJECT REVIEW IN COMFORMANCE WITH OMB CIRCULAR NO. A-95

To: U.S. Department of Energy

STATE APPLICATION IDENTIFIER: 7905169556

Mr. Eugene Beckett
WIPP Project Office
Mail Stop B-107
Department of Energy
Washington, D.C. 20545

Dear Mr. Beckett:

Subject: Draft Environmental Impact Statement for the Waste Isolation
Pilot Plant.

This Draft EIS was received in our office on May 15, 1979.

Thank you for submitting your draft environmental impact statement for
review and comment through the North Dakota State Intergovernmental
Clearinghouse.

Your draft was referred to the appropriate agencies, and no comments
were received to this date.

Please send me copies of the final environmental impact statement and
any supplemental impact statements to the North Dakota agencies that
have commented on the draft, and to this office. The opportunity to
review your draft is appreciated, and if this office as Clearinghouse
can be of further assistance with this project, please let me know.

Sincerely yours,

Mrs. Leonard E. Banks
Associate Planner

BAB/gd



STATE CLEARINGHOUSE

30 EAST BROAD STREET • 39TH FLOOR • COLUMBUS, OHIO 43215

• 614 / 466-7461

June 28, 1979

Mr. Eugene Beckett
Waste Isolation Pilot
Plant Project Office
Mail Stop B-107
U. S. Department of Energy
Washington, D. C. 20545

RE: Review of Environmental Impact Statement/Assessment
Title: Draft Environmental Impact Statement, Waste Isolation Pilot
Plant, April, 1979, U. S. Department of Energy
SAI Number: 36-471-0002

Dear Mr. Beckett:

The State Clearinghouse coordinated the review of the above referenced environmental impact statement/assessment.

Comments from the Ohio Environmental Protection Agency state that inasmuch as the operations described in the subject document are out of the jurisdiction of the State of Ohio, there is no immediate concern with this Draft Environmental Impact Statement (EIS). However, since Ohio has a well-established ongoing interest in fuel cycle and radioactive waste disposal matters, this document has been examined with considerable interest. The following comments are offered.

At present, Ohio has an active commercial reactor building program; one unit is operation, three are under construction, one has been decommissioned, and four more are in the planning stage. In addition, radioactive waste is generated at the Portsmouth isotope separations facility, the Mound Laboratories and the Fernald uranium feed facility. If the spent fuel from these reactors must ultimately be stored at a Federal Repository, such a program would be more easily established if the management of defense matters were fully in harmony with the commercial waste program.

It is also becoming increasingly apparent that the radioactive waste disposal is beset with a number of (non-technical) institutional, political and social barriers which are more evident in the case of commercial reactor spent fuel elements than for defense related wastes. This EIS does not take these conditions into account.

Mr. Eugene Beckett
June 28, 1979
Page 2
WIPP

Concerning the specific alternatives which are presented there are several comments which you will find pertinent.

1. Alternative 1, continue storage at the Idaho National Engineering Laboratory (INEL). While this "No Action" alternative might be cheapest, environmentally benign and backed by the greatest experience, it also has the disadvantages of contributing nothing new or progressive to the state of the art of radioactive waste management. It also might add to a public perception of the U. S. Department of Energy's (DOE) inability or indecision to dispose successfully of defense wastes.
2. Concerning the other alternatives. It appears that if the Department of Energy really wishes to move carefully in incremental steps, it would be politic to plan the facility originally to handle only CH (contact handling) waste, as much as this would take care of the greatest bulk of the INEL waste easily and expeditiously. After the Waste Isolation Pilot Plant (WIPP) and the Department of Energy have demonstrated the ability to handle this satisfactorily, the facilities for storage of RH (remote handling) waste and spent reactor fuel can be added.

On institutional problems, it is hoped that you would be cognizant of the workshops held throughout the country. Enclosed is a copy of the "Recommendations Toward Establishing a Publicly Responsive and Acceptable National Nuclear Waste Management Policy", adopted at the Denver workshop, for inclusion in the Final Environmental Statement. It is expected that DOE will be responsive to these recommendations. It would be appropriate to include a complete section on institutional problems and how DOE intends to deal with them.

Generally, the draft EIS is thorough and well done. However, it is felt that DOE has been rather vague about the process of decommissioning; also, about what would be done with retrieved fuel or waste.

Specific comments made are that on Page 2-4 et. seq., there are no institutional criteria listed there which point to our general remarks about institutional problems. Page 2.6, if mining the salt beds in the Williston Basin would not be feasible for the WIPP, it would not be feasible for "the richest potash deposits in North America" either so that statement is quite superfluous.

Page 2-7, do "drill holes" include small exploratory core drilling as well as larger holes, page 2-17, Section 2.2.3, point 2. It should be pointed out that transuranic (TRU) waste as compared with high-level waste (HLW) not only generates less heat but also requires little if any shielding and, therefore, under normal operating conditions results in lesser radiation fields and less occupational exposure.

Mr. Eugene Beckett
June 28, 1979
Page 3
WIPP

Page 2-26. We concur with the conclusions on this page beginning with the second paragraph.

Page 9-17 and 14-9, the denial of resources to the state and the industry, especially of langbeinite seems the greatest drawback of the present WIPP site, yet the EIS makes no mention of possible monetary compensation for this denial.

It is stated by the Department of Natural Resources that they concur with the elimination of the Salina region for siting of the WIPP. The Silurian rock salt in Ohio would meet few of the tentative selection criteria.

Also, it should be noted the the Ohio Department of Energy has made a specific request to review the final environmental impact statement when it has been completed.

In conclusion, it is recommended that the above comments be addressed in the final environmental impact statement and that there be a expeditious solution to the nuclear waste problem.

Sincerely,

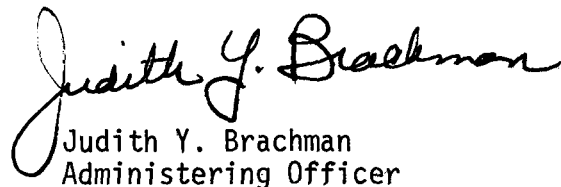
Judith Y. Brachman
Administering Officer

JYB/lew

cc: DNR, Mike Colvin
OPEA, Gene Wright

Enclosure

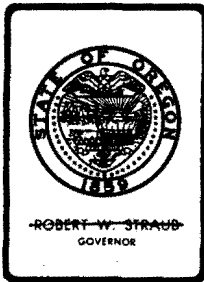

Executive Department
INTERGOVERNMENTAL RELATIONS DIVISION
ROOM 306, STATE LIBRARY BLDG., SALEM, OREGON 97310

June 26, 1979

Mr. Eugene Beckett
WIPP Project Office
Mail Stop B-107
Department of Energy
Washington D.C. 20545

WASTE ISOLATION PILOT PLANT
PNRS 7905 4 890

Thank you for submitting your draft supplement to the final Environmental Impact Statement for State of Oregon review and comment.

Your draft was referred to the appropriate state agencies for review. The consensus among reviewing agencies was that the draft adequately described the environmental impact of your proposal.

We will expect to receive copies of the final statement as required by Council of Environmental Quality Guidelines.

Kay F. Wilcox
KAY WILCOX, A-95 COORDINATOR

KW:jh



Pennsylvania State Clearinghouse

P.O. BOX 1323 - HARRISBURG, PA. 17120 - (717) 787-8046
783-3133

July 6, 1979

GOVERNOR'S OFFICE
OFFICE OF THE BUDGET

PSCH # 57905006

Mr. Eugene Beckett,
WIPP Project Office
Mail Stop B-107
Department of Energy
Washington, D.C. 20545

Dear Mr. Beckett:

The Pennsylvania State Clearinghouse has received from your Office copies of the Draft Environmental Impact Statement (DOE/EIS-0026-D) for the Waste Isolation Pilot Plant.

Please be advised that the State Clearinghouse has no comments to make on the Draft. We would appreciate, however, a copy of the Final Statement.

Sincerely,

Richard A. Heiss ^{a.R.}

Richard A. Heiss, Supervisor
Pennsylvania State Clearinghouse

RAH:ar

cc: File (2)



STATE OF RHODE ISLAND AND PROVIDENCE PLANTATIONS

Department of Administration
STATEWIDE PLANNING PROGRAM
265 Melrose Street
Providence, Rhode Island 02907

July 12, 1979

Mr. Eugene Beckett
WIPB Project Office
Mail Stop B-107
Dept. of Energy
Washington, D.C. 20545

Dear Mr. Beckett:

This office, in its capacity of clearinghouse designate under OMB Circular Number A-95, Part II, has reviewed the Draft Environmental Impact Statement (DOE/EIS-0026-D), Waste Isolation Pilot Plant, U.S. Department of Energy, dated April 1979, as received in this office on April 11, 1979.

The Technical Committee of the Office of State Planning was presented the staff findings as a result of the review along with the staff's recommendation at its meeting of July 6, 1979. The Committee's decision is that the clearinghouse has no comment on the draft.

We thank you for the opportunity to review this document.

Yours very truly,

Rene J. Fontaine
A-95 Coordinator

RJF/sjc
Reference File: EIS-79-07

STATE PLANNING BUREAU

State Capitol
Pierre, South Dakota 57501
605/224-3661

SOUTH



Office of

Executive Management

July 10, 1979

Mr. Eugene Beckett
WIPP Project Office
Mail Stop B-107
Department of Energy
Washington, D.C. 20545

Re: Draft Environmental Impact Statement (DOE/EIS-0026-D)
EIS 111079
Waste Isolation Pilot Plant

Dear Mr. Beckett:

The State Clearinghouse has distributed for review the above stated draft environmental impact statement. No comments were received. Thank you for the opportunity to review and comment.

Sincerely,

James R. Richardson
Commissioner
State Planning Bureau

JRR/mjn



OFFICE OF THE GOVERNOR

WILLIAM P. CLEMENTS, JR.
GOVERNOR

July 2, 1979

Mr. Eugene Beckett
WIPP Project Office
Mail Stop B-107
Department of Energy
Washington, D.C. 20545

Dear Mr. Beckett:

The draft environmental impact statement (DOE/EIS-0026-D) pertaining to the Waste Isolation Pilot Plant, has been reviewed by the Budget and Planning Office and interested State agencies. The comments of the Department of Water Resources, Air Control Board, Parks and Wildlife Department, State Department of Highways and Public Transportation, Railroad Commission and the Department of Health are enclosed for your information and use.

The Budget and Planning Office appreciates the opportunity to review this document. If we can be of any further assistance during the application process, please do not hesitate to call.

Sincerely,

A handwritten signature in cursive script that reads "Donald E. Harley".

Donald E. Harley, Manager
Economics and Natural Resources
Budget and Planning Office

Enclosures: Comments of -
Department of Water Resources
Air Control Board
Parks and Wildlife Department
State Department of Highways and Public Transportation
Texas Railroad Commission
Department of Health

DEH:jl

P-164



WARD COUNTY

MONAHANS, TEXAS 79756

March 30, 1979

RICHARD SITZ
COUNTY JUDGE

Honorable Jimmy Carter
President of the United States of America
Washington, D. C. 20510

Dear Mr. President:

Enclosed is a copy of a resolution passed by our Court on March 26, 1979,
which is self explanatory.

We would like to have a response from you concerning this resolution to
enter into our court records. Even though the final decision has not been
made on the site location, we feel it is particularly necessary for you to
reply to item # 3 of the resolution.

Yours very truly,

Richard Sitz
County Judge

RS:bw



RICHARD SITZ
COUNTY JUDGE

WARD COUNTY

MONAHANS, TEXAS 79756

The following is a true and correct copy of the Resolution passed by the Ward County Commissioners' Court at Monahans, Texas, on March 26, 1979, with said Resolution recorded in the Minutes of Commissioners' Court. All members on the Court were present at the meeting, to wit; H. A. Collins, Commissioner Precinct 1, Robert R. Spinks, Commissioner Precinct 2, J.H. Raglin, Commissioner Precinct 3, Lenora Price, Commissioner Precinct 4 and Richard Sitz, County Judge.

R E S O L U T I O N

We recognize the need for the United States to find a place to store the accumulated waste of our nuclear programs. However, there are some basic problems of the proposed Waste Isolation Pilot Plant near Carlsbad, New Mexico, which have not been solved.

First, according to the hydrological studies conducted by Sandia Laboratories in Albuquerque, New Mexico, there are high pressure deposits of natural gas and water underlying the site which are potentially dangerous if the high pressure gas should ever force the water into the WIPP site.

These natural gas deposits are potentially valuable sources of natural gas, but the WIPP site will remove them from usefulness. Also the potash deposits of the area will be rendered useless by the proposed choice of site.

Second, there have been earthquakes as recently as the spring of 1978 in Winkler County, Texas, which is adjacent to Eddy County, New Mexico, the location of the proposed WIPP site. These quakes show the area is not as geologically inactive as has been claimed by the Department of Energy.

Third, the aquifers of southeastern New Mexico and southwestern Texas are too close to the chosen site. The Santa Rosa limestones are actually present in the boundaries of the mine area. If any leakage should occur and seep into these water supplies, it could pollute a portion or the entire water supply of the area.

Because of the above reasons, we feel this site is not sufficiently safe for long-term storage of large quantities of nuclear waste.

If, however, the President of the United States and the Department of Energy choose this site in southeastern New Mexico, we would like to see the following precautions:

1. There should be monitoring of the mine until the mine site is no more radioactive than the natural radioactivity of the region.
2. There should be monitoring of private and public water supplies of southeast New Mexico and southwest Texas as long as it is necessary to monitor the mine. The monitoring should be at the expense of the United States government, not at the expense of the individual water user.
3. If pollution of any water supply should occur from the Waste Isolation Pilot Plant, the water supply should be replaced with potable water. This good, usable water should not be at the expense of the property owner/owners, but rather at the expense of the United States government.
4. There should be security provisions for the transportation of the radioactive waste to the site.
5. The radioactive waste should be isolated in as retrievable a manner as possible, pending future technology when the waste can be safely disposed of or utilized for fuel.

If the present plans of the Department of Energy are carried out by the United States, the Carlsbad WIPP site will ultimately contain the largest (or one of the largest) concentrations of radionuclear waste in one place that has ever been gathered together in the history of mankind. We certainly feel this justifies extraordinary precautions and safety measures for the humans and animals which populate the area. Also, there are many unique features of the land which need preservation -- to name but two -- Guadalupe National Park in Texas and Carlsbad Caverns National Park in New Mexico.

Introduced and passed by the Commissioners' Court of Ward County, Texas, this 26th day of March, 1979.

Attest:

Pat V. Finley
PAT V. FINLEY, County Clerk

Richard Sitz
RICHARD SITZ, County Judge



STATE OF UTAH

Scott M. Matheson
Governor

Kent Briggs
State Planning Coordinator

Division of Policy and Planning Coordination
Intergovernmental Relations Section
Lorayne Tempest, Assistant State Planning Coordinator
124 State Capitol
Salt Lake City, Utah 84111
533-4981

A/95
State Clearinghouse
533-4976
533-4971

Environmental
Coordinating
Committee
533-5794

Human Resources
Coordinating
Committee
533-6081

A/85
Federal/State
Coordination
533-6083

Federal Resource
Information
Center
533-4983

June 27, 1979

Mr. Eugene Beckett
WIPP Project Office,
Mail Stop B-107
Department of Energy
Washington, D.C. 20545

Dear Mr. Beckett:

The Utah State Environmental Coordinating Committee has reviewed the Draft Environmental Impact Statement; Waste Isolation Pilot Plant. The Committee offers the following comments.

1. Bottom of Page 1-2 and top of Page 1-3

". . . the WIPP will receive as many as 1000 assemblies emplaced in such a manner that they can be retrieved for 20 years if necessary, but without the expectations of doing so."

This last phrase (underlined) should not be voiced as a part of the mission. A change in the White House occupancy could enable the Nation to pursue the reasonable course of fuel reprocessing and breeder reactors for power generation.

2. Page 6-8 - "There are no shipping casks in existence designed specifically for transporting HLW canisters."

If these High-Level Wastes are moved, most of them would probably go through Utah and Salt Lake City. It is also anticipated that much of the spent fuel will be transported through Utah. The proposed cask for HLW would probably be limited to rail transportation because of its weight (-100 tons). We would hope all of the High-Level Waste could be sent by rail to minimize contact with the public.

If the WIPP is to be constructed, Utah will need an increased capability of monitoring shipments to assure its citizens that they are being protected from unnecessary hazards. We will also need additional emergency response capability and it is our feeling that the added responsibility imposed by a Federal program should be supported by Federal funds.

Thank you for the opportunity to comment.

Sincerely,

Lorayne Tempest

Lorayne Tempest
Assistant State Planning Coordinator

LT/dk
790515138



STATE OF VERMONT
MONTPELIER, VERMONT 05602

MEMORANDUM

To: Mr. Eugene Beckett, WIPP Project Office
Mail Stop B-107, Department of Energy
Washington, D. C. 20545

From: Emily Neary, A-95 Coordinator *EN*

Date: June 27, 1979

Re: Draft Environmental Impact Statement, DOE/EIS-0026-D,
Waste Isolation Pilot Plant (WIPP)

As the State Clearinghouse under OMB Circular A-95 we have notified other public agencies with a possible interest in your:

Copies of comments received are attached: from the Division for Historic Preservation.

:enclosure

Appendix Q

**REPORT OF THE HEARINGS PANEL ON THE
DRAFT ENVIRONMENTAL IMPACT STATEMENT
FOR THE WASTE ISOLATION PILOT PLANT**

Appendix Q

REPORT OF THE HEARINGS PANEL
ON THE ENVIRONMENTAL IMPACT STATEMENT
FOR THE WASTE ISOLATION PILOT PLANT

This appendix contains the report of the hearings panel on the draft environmental impact statement for the Waste Isolation Pilot Plant. The report identifies the significant issues raised during public hearings at Odessa, Texas, on October 1, 1979; Hobbs, New Mexico, on October 2, 1979; and Santa Fe, New Mexico, on October 5, 1979.

November 6, 1979

Ms. Lynda Brothers
Acting Deputy Assistant
Secretary for the Environment
Department of Energy
Washington, D.C.

Dear Ms. Brothers:

The attached report of the hearing panel on the Waste Isolation Pilot Plant Draft Environmental Impact Statement (DOE/EIS-0026-D) identifies the significant issues raised during public hearings held on the draft environmental impact statement on the following dates at the following locations:

Odessa, Texas	-	October 1, 1979
Hobbs, New Mexico	-	October 2, 1979
Santa Fe, New Mexico	-	October 5, 1979.

These hearings were held pursuant to a notice published in the Federal Register on September 5, 1979 (44 Fed. Reg. 51848). Advertisements were also placed in the local press in Spanish and in English in various cities and towns in New Mexico and Texas to encourage participation in these hearings. Earlier hearings on the same DEIS were held in Idaho Falls, Idaho, June 5, 1979, Albuquerque, New Mexico, June 7 and 8, 1979, and Carlsbad, New Mexico, June 9, 1979.

The Panel for the hearings consisted of Robert W. Hamilton, Vinson and Elkins Professor of Law at The University of Texas School of Law, the presiding officer, Dr. John Cumberland, Professor of Economics at the University of Maryland, and Dr. Irwin C. Remson, Professor of Applied Earth Sciences and Professor of Geology at Stanford University.

Since no member of the Panel is an employee of DOE the record of the hearing was not compiled by the Board. That function is being performed by the Albuquerque office of DOE. The attached report is limited to the issues raised in the oral presentations and testimony at the hearings and does not address issues that may have been raised in the voluminous written comments on the DEIS, which have not been examined or reviewed by the Panel.

The Panel has not undertaken to resolve the substantive issues raised or to render judgment on the desirability of the

Ms. Lynda Brothers
Acting Deputy Assistant
Secretary for the Environment
November 6, 1979
Page Two

WIPP Project. In a few instances in the attached report, the Panel has made substantive observations or suggestions which it believes will be of assistance to DOE in evaluating the record of this hearing.

Respectfully submitted,

Robert W. Hamilton
Robert W. Hamilton
Presiding Officer

John H. Cumberland
Dr. John Cumberland

Irwin Remson
Dr. Irwin Remson

November 6, 1979

Report of the Panel Identifying
Significant Issues on the Draft
Environmental Impact Statement
on the Waste Isolation Pilot
Plant DOE/EIS-0026-D

This Report describes the significant issues raised at public hearings on the above draft environmental impact statement (DEIS) held on October 1, 1979 at Odessa, Texas, on October 2, 1979 at Hobbs, New Mexico, and on October 5, 1979 at Santa Fe, New Mexico. These hearings were held pursuant to the ground rules established in the notice of the hearings, published at 44 Fed. Reg. 51848.

This Report considers only the issues raised at these public hearings. The Panel has not reviewed the numerous written comments received by the Department of Energy (DOE) relating to the Waste Isolation Pilot Plant (WIPP) project. The full record of these hearings is being developed by DOE.

The format of these hearings was unusual in two respects. First, all members of the Panel were drawn from outside DOE. Second, the morning of each session was devoted to a public presentation by DOE and its contractors on various aspects of the WIPP project. Members of the Panel questioned closely each person taking part in the DOE presentation and a relatively few written questions were asked about this presentation by members of the general public. The afternoon, and where necessary the evening, sessions were devoted to the testimony of interested members of the general public who had requested an opportunity to testify, and to unscheduled presentations by members of the audience.

Many of the significant issues and comments described below were developed during the morning sessions when DOE employees and its contractors made presentations subject to questioning by the Panel. At these sessions the DOE presentation summarized the principal objections to the Project made at the earlier public hearings and in the written comments, and responded to them. In the view of the members of the Panel, this format provides a useful and meaningful role for non-DOE Panel members.

The DOE presentation addressed the following substantive areas:

- (1) Transportation of waste to the WIPP site;
- (2) Conflict with energy and mineral resources at the site;
- (3) Potential contamination of west Texas water supplies;
- (4) Geologic suitability of the site;
- (5) Effects of low level radiation;
- (6) Retrievability capabilities for the waste; and
- (7) Socioeconomic impact of the project.

In many of these areas, the DOE presentation adequately responded to questions and concerns that had been raised previously, and clarified precisely what was being proposed at the WIPP project. It would be desirable for the final EIS to incorporate portions of these presentations.

In the view of the Panel the following are the principal problem areas that remain to be addressed by DOE:

I. Recent Changes in the WIPP Project.

As a result of Congressional decisions, there have been two significant changes in the WIPP project since the DEIS was released last

April: the proposal for the intermediate storage facility involving the storage of up to 1000 spent commercial fuel rod assemblies has been deleted and it is no longer proposed that the facility be reviewed and licensed by the Nuclear Regulatory Commission (NRC). (Tr 1073-74) Of course, at a minimum the final EIS should reflect these revisions.

The decision to eliminate the commercial spent fuel rod assemblies increases the conservatism of the project in several respects: the amount of high level waste that must be transported to the site has been greatly reduced, possible problems relating to the effect of long-term heat and radioactivity on salt formations have been eliminated, and the amount of radioactivity released during some of the "worst possible" scenarios discussed in the DEIS has been greatly reduced. (Tr 1075) Since all aspects of this change appear to reduce the possible adverse environmental affects of the WIPP proposal, this change appears to require no further procedural steps other than changing the DEIS so that the final EIS accurately reflects the current scope of the project.

The elimination of NRC licensing presents other problems, however. Several witnesses, including particularly representatives of the State of New Mexico, continued to call for NRC licensing despite the Congressional decision to eliminate it. (E.g., Tr 1210, 1213-14, 1757). In its most definitive statement, the State of New Mexico called for "the creation of an independent review process at the national level" and "a second opinion . . . to provide adequate assurance of the safety of the project." (Tr 1757) DOE employees

commented that DOE possessed the technical capability to review the safety of the proposed project with the same degree of sophistication as the NRC, (Tr 1087) but this appeared unacceptable to the State of New Mexico, whose representative objected that "self-regulation should not be relied upon to protect public health and safety when complex and potentially hazardous technologies are involved." (Tr 1757).

The hearings demonstrated that the issues surrounding the WIPP project are as much political as they are engineering and scientific. The question of NRC licensing clearly raises a political issue. In the view of the Panel it is unlikely that an unstructured internal review process by DOE employees, no matter how competent and impartial, will satisfy the persons calling for NRC licensing. DOE should consider the development of an "independent" board of safety review within DOE with scientific and engineering capability to provide a final review of projects such as WIPP. Similar boards have been created by other agencies to investigate air disasters, naval accidents, nuclear accidents, and other similar events. While the safety issues underlying WIPP are prospective rather than retrospective, the procedures would appear to provide the desired "second opinion." (See generally Tr 1451-53)

II. Should DOE Now Proceed to the Final Environmental Impact Statement?

On several occasions during the recent hearings DOE personnel stated that DOE planned to move promptly to the development of a final environmental impact statement. The State of New Mexico, on the other hand, called on DOE to issue "supplements" to the DEIS on

the following broad areas:

- (a) Transportation;
- (b) Emergency Preparedness; and
- (c) Socioeconomics. (Tr 1205-1206)

The statement of the New Mexico representative concludes that "in the event that the DOE is unable to issue supplements on the inadequate portions of the DEIS for timely review prior to the publication of the final EIS, the Governor has stated that he will have to declare the entire DEIS inadequate." (Tr 1753-54)

While the DOE presentations at the hearings may have provided some of the detailed information desired by the State of New Mexico, it is clear that some of the information requested by the State was not presented at the hearing and, indeed, may not currently be in existence. The State requested, for example, a "clear" identification of the proposed routes for shipment of waste materials, procedures for monitoring shipments through the state, and the capability of hospitals to respond to a nuclear accident along those routes. (Tr 1749) However, the identification of specific routes has not been made. (Tr 1302)

One witness argued that the DEIS so far failed to meet the regulations of the Council on Environmental Quality that an entirely new DEIS should be prepared. (Tr 1456) This witness also called attention to a number of minor inconsistencies and errors in the DEIS, which should be reviewed in connection with the preparation of the final EIS.

III. Possible Future Changes in the Scope of the WIPP Project.

At the hearings DOE representatives were questioned about the binding nature of the final EIS and the possibility that the project might be increased in scope or magnitude in the future. (Tr 1493) The Panel was advised that any substantial change would require an amendment to the final EIS. (Tr 1497)

The project is described as involving only contact handled TRU waste from the Idaho National Engineering Laboratory (INEL), plus experimentation relating to the effect of high level waste on salt formations. (DEIS 1-1, Tr 1073-74) However, the DEIS contains numerous references and statements that may be construed as authorizing shipment to and storage at the WIPP site of contact and remote handled TRU waste from numerous other locations, e.g., Hanford, Los Alamos, and Savannah River. (See, e.g., DEIS, 6-8 to 6-12).

The low estimates relating to the traffic generated by WIPP at the hearing are all based on the project being limited to INEL stored TRU waste. Yet, again, the DEIS contains data implying that annual shipments will be made from various locations in addition to INEL. (See e.g., DEIS 6-13). For example, Table 6-4 of the DEIS indicates an annual total of 181 rail and 187 truck shipments from INEL but a total of 338 rail and 487 truck shipments.

IV. The Role of the State of New Mexico in Connection with the Approval of the Project.

At the time of the hearings, representatives of both DOE and the State of New Mexico referred to negotiations that were then taking place relating to the precise definition of "consultation and concurrence," the phrase used by the President's Interagency Review Group

to describe the role of States in connection with nuclear waste disposal facilities. (Tr 1074-75, 1756) One witness stated that Congressional sources objected to the concept that "concurrence" amounted to a veto (Tr 1273, 1453); the State of New Mexico, however, testified that "a right of concurrence also implies the right of nonconcurrence." (Tr 1209-10)

Assuming that agreement is reached on the appropriate role of the State of New Mexico, this role should be described in the final EIS. In the event agreement is not reached, the final EIS should at least describe the role DOE is willing for the State of New Mexico to play in the final decisional process.

IV. Transportation of Waste.

The DOE presentation gave considerable emphasis to the various issues relating to the transportation of nuclear waste to the WIPP site for disposal. Several members of the general public as well as the representative of the State of New Mexico also concentrated on issues relating to the transportation of waste. Several different problems were raised:

(a) Objections were made that the DEIS was vague and imprecise. Specific routes are not designated, the packaging in which the waste is to be transported is not described (since it is still under development), (Tr 1217-19) and even the form in which the waste is transported is not identified. (Tr 1172, 1299; DEIS 5-2 to 5-3). While it seems clear that absolute precision as to data is neither required nor desirable, additional information and data should be incorporated into the final EIS to the extent it is available.

(b) The most important observation is that problems related to transportation as presented by DOE witnesses at the hearing gave a picture of a safer and more responsible operation than does the DEIS. (Tr 1310) For example, the consequence analysis assumes and starts with an accident and a leak. (DEIS 6-20) This analysis ignores the extensive engineering that is apparently going into packaging and leak reduction, which appears to reduce significantly the probability of a leak in the event of an accident. The analysis in the DEIS is misleading because it assumes that a leak will occur without indicating the low probability of an accident severe enough to breach the packaging. As a result, transportation dangers appear to be overemphasized by orders of magnitude. (Tr 1519)

The possibility of injuries from excess radioactivity in an accident is a function of several possible variables:

- (i) The probability of the occurrence of an accident;
- (ii) The probability that the package will be breached in the accident; and
- (iii) The probability that the accident will occur in an area in which people may be exposed to radioactivity.

These variables, it was felt, should be more specifically addressed in the transportation section of the DEIS. (See Tr 1521-22)

Even though possibility (ii) described above is a small number because of the design of the packaging, there is always the possibility of human error, e.g., in correctly closing the package. Thus, discussion of the "worst possible" scenarios in the transportation area seems appropriate so long as the plausibility of the scenarios are put into perspective. (Tr 1308-10) Indeed, a DEIS that posited

no excess radioactivity for every conceivable type of accident might lack credibility with the general public in light of well publicized instances of releases of radioactivity in accidents involving non-defense products.

(c) At the hearing, a number of transportation accidents involving commercial radioactive materials were described. (Tr 1630-32) Many were explained on the ground that applicable regulations were not being followed. (Tr 1498-99, 1518) The DEIS may understate the risks of exposure caused by human error despite the existence of adequate regulations. The DEIS should be reassessed in this regard.

(d) Similarly, the risks of exposure due to terrorism also appear to be understated. Both the DEIS and the DOE presentation give no information with respect to terrorism on the theory that such information may give persons contemplating terrorist acts a "cook-book" (Tr 1100) A question may be raised whether in the long run withholding of such information does more harm than good. (Tr 1524) At the hearing, the possibility of terrorism was minimized on the theory that waste shipments are not attractive targets. (Tr 1100; 1294-95, 1515) No documentation to support this theory was set forth.

(e) Information in the DEIS about increases in traffic are related to traffic in the entire State of New Mexico on the theory that routes will be selected by commercial carriers. This obviously understates the impact of the WIPP project on specific routes to the extent those routes are actually to be used by many or all WIPP-bound vehicles. More precise information about impact on specific routes should be provided where feasible. (Tr 1302-1303)

(f) Consideration should also be given to possible benefits and costs of DOE transport, convoys, or escorts. (Tr 1297-99)

V. Geology and Hydrology. (The comments in this section are principally though not exclusively those of Dr. Remson).

(a) Good practice requires aquifer-wide hydrological analysis and consideration of all formations rather than analysis of a small area. (Tr 1329) It appears that the DEIS modeled only a portion of the aquifer which was done before the hydrologic investigation was complete. (Tr 1331) These facts make one wonder how and where boundary conditions were set on the models. Apparently the hydrological modeling did not consider natural aquifer extensions into Texas either. (See DEIS, § 7.3) As a result, it is difficult to see how conclusions expressed at this hearing relating to scenarios involving a radioactive leak into an aquifer and the effects of aquifer depletions in Texas can be justified. (Tr 1329-30) Furthermore, the possible failure to delineate the boundary conditions accurately raises a question as to the validity of the entire modeling effort. (Tr 1329) A broader regional analysis should be undertaken to include a description of systems hydrologically connected with the WIPP site, including the Pecos River and aquifers that receive recharge from the Pecos River. (Tr 1232)

(b) In connection with the hydrology study the need for additional wells for ground water samples was emphasized. It was pointed out that wells downgradient from the disposal site are more than a mile apart. It was also suggested that the frequency of sampling be increased from a quarterly to a monthly schedule. (Tr 1233)

(c) Questions were raised at the hearing about the shallow-dissolution zone. (Tr 1135) The DEIS is confusing in this regard. Figure 7-25 shows the shallow dissolution to the west of the site while Figure 7-27 shows the Rustler thinning, presumably due to dissolution under the site. Conceivably the ambiguity arises from the definition of "shallow dissolution" which may refer either to "near surface dissolution" or to all dissolution above the Salado Formation.

An experienced geologist testified that he believed the thinning of the Salado salt section was due more to offlap than to dissolution. (Tr 1405, 1409) The DOE contractor gave similar testimony which disagrees with a study by Anderson. (Tr 1410-11, 1414) This issue should be clarified in the DEIS.

(d) One witness refers to a "dome" under the site. (Tr 1189). This possibility should be referred to (or negated) in the final EIS.

(e) It appears to be desirable to drill out some of the "dissolution pipes" south of the site. (See Tr 1415)

(f) One experienced geologist proposed that the questions relating to subsurface conditions should be reviewed by an independent panel of geologists. (Tr 1732-3)

(g) The use of groundwater for various purposes (domestic, livestock, etc.) from the Rustler and Santa Rosa aquifers between the site and the Pecos River should be tabulated. (Tr 1231)

(h) The groundwater monitoring program (DEIS, App. J) should be broadened to include chemical analysis of groundwater for dissolved

solids such as sodium chloride as well as radionuclides in order to evaluate the effect of WIPP construction on water quality. (Tr 1232-33)

(i) The DEIS should describe measures that will be taken if significant radionuclide contamination of groundwater actually occurs. (Tr 1233)

VI. Socioeconomic Information.

While additional socioeconomic information was presented at the hearing, (Tr 1582-90) additional information was requested in several other areas:

(a) The socioeconomic indicators such as probable effects on crime, divorce, alcoholism, drug abuse, child abuse, and other "boom town effects." (Tr 1183, 1185, 1615)

(b) Energy requirements, e.g., for gasoline and electricity. (Tr 1384)

(c) Quantities of household, sanitary, solid and municipal waste, both primary and secondarily generated, by type and source. (Tr 1382)

(d) Additional state and local fiscal information on added revenues and added costs, by time periods, with the number of unemployed persons specified. (Tr 1380-81)

VII. Damage to Health by Low Level Radiation.

The Panel recognizes that there is lively scientific controversy over the long-term effects of low level radiation. (Tr 1355) However, a comparison of energy levels between nuclear waste and electric light bulbs seems both irrelevant and self-serving. (Tr 1356) Indeed the

public interest and concern about this issue is so great that any attempted justification of low levels of radiation by a representative of a contractor who may actually operate the project if it is approved is likely to be considered not credible because of a potential conflict of interest. (Tr 1361-62)

(b) The DEIS does not discuss health effects as such but consistently uses doses of radiation as an index of hazard. Such dose related data should be translated into anticipated health effects such as the total number of incremental cancers, person days lost, hospital days, and shortening of life. (Tr 1152-53) The Panel recognizes that such estimates are ranges rather than precise data but suggests that they give a clearer perspective as to the effect of exposure to radiation. (Tr 1154)

(c) Dose related data impacts should be separately estimated, where possible, for high risk groups such as children and pregnant women.

(d) The practice in the DEIS of describing exposure to radiation as a percentage of background, while technically accurate and generally accepted, tends to mask the harmful effect of exposure, which, of course, is in addition to natural background radiation that will be absorbed in any event. (Tr 1554)

(e) The DEIS describes exposures from a variety of different sources, e.g., from transportation and from emplacement of the waste in WIPP. Nowhere is there an aggregation of total exposure of the US population to radiation as a result of the contemplated construction and operation of the WIPP project and the number of health

consequences of such exposure. (Tr 1156-57)

(f) The Panel believes that if the credibility of additional information in this area is to be improved, it may be appropriate to have additional studies prepared by respected and competent persons or organizations who are not otherwise connected with the WIPP project.

VIII. The Nature of the High Level Waste Experiments.

The DEIS describes the high level waste experiments only in very general terms. While some additional information about the nature of the experiments and the amount of radioactivity involved was presented at the hearing (Tr 1076, 1495, 1552, 1760-2), additional information about these experiments should be presented in the EIS to the extent feasible. (Tr 1203-1205)

IX. Compensation to Adversely-Affected Persons.

Dr. John Cumberland, a member of the Panel, was particularly concerned about comments that residents of New Mexico were being asked to share an unreasonable portion of the cost of nuclear waste. He raised with several witnesses the question whether compensation might help to alleviate that imbalance. (Tr 1400, 1538, 1684) This suggestion is broader in scope than nuclear waste management since it would be potentially applicable to many projects having adverse environmental consequences, and probably would require enabling legislation. However, the idea has merit. A fuller statement by Dr. Cumberland explaining his suggestion follows:

"THE POTENTIAL CONTRIBUTION OF ECONOMIC INCENTIVES

"One of the major opportunities which has been missed in the

WIPP proposal is to make use of the helpful role which financial incentives could play in achieving a more equitable and efficient distribution of benefits and costs of nuclear waste disposal. A major concern in proposals for large governmental and other projects is the discrepancy between the benefits and costs as between individuals, groups, locations, and generations. Presumably, the entire nation benefits from nuclear weapons (although many would dispute this). What is clear is that the costs are very unequally distributed. In this case, residents of New Mexico are being asked to bear the heaviest burdens as would others along the transportation routes. Therefore, providing financial assistance to those who wanted to move could offer a more equitable distribution of the costs. While most parties would probably reject the concept of a "national sacrifice area," even low levels of risk cause perceived damages which, are true psychological and therefore real social costs, above and beyond any real actuarial risk. While many at the hearings totally rejected the idea of economic assistance for moving, or other forms of financial compensation on the basis that residential preference is an entirely different matter from economic compensation, (Tr 1684) others indicated that for some who are highly risk averse and would like to move, offering relocation assistance would open a new option not previously available. (Tr 1400-1401) This option could be especially valuable to pregnant women and children who might bear a disproportionate amount of risk.

"Providing such relocation assistance need not be especially costly to the government if aid were limited to fair market value of residences and some reasonable amount of relocation and retraining aid with appropriate limitations. This would be an efficient solution, since less risk averse persons could then be offered an opportunity to purchase affected residences and move into any vacated jobs. The fair market value should be determined before the institution of WIPP, as adjusted for inflation.

"Another dimension of equity in sharing the benefits and costs would be to compensate the State of New Mexico for tax revenues lost on minerals at the site. Offers could also be made to provide alternative water supplies for any whose water was contaminated and/or to provide land purchase and relocation for those engaged in agriculture, commerce, or industry which would be adversely affected by WIPP.

"Additional economic instruments should be considered in the case of health and property damage to those who remain as a result of accidents or other types of exposure. The Department of Energy and the Federal Government should address

several aspects of this problem which currently are unclear, such as: would the existence of workman's compensation laws prevent adequate compensation to any injured or damaged? If so, alternative adequate compensation should be established. Additionally, a long carcinogenic lag might prevent compensation to those whose health damage was not apparent for many years. In the interest of fairness, appearance of radiation-related types of health damage should be presumed to result from the WIPP project, even if it could not be statistically or medically proven.

"Establishment of these forms of compensation and aid would not satisfy all of those who object to potential damage to their health, property, and land, but it might reduce the perceived level of injustice and recurring discrepancy between the benefits and costs of major nuclear and even other energy facilities and large projects which people now view as beyond their control."

X. Miscellaneous.

During the course of the hearings a number of miscellaneous suggestions and recommendations were made on a variety of subjects, including the following:

(a) Emphasis should be given to the objective of proceeding with waste disposal "by deliberate steps in a technically conservative manner." (Tr 1233-34)

(b) A continuing reassessment of plans for the disposal of transuranic waste at the WIPP site should be undertaken, particularly with respect to other disposal sites. If other sites are shown to provide equally safe storage for this kind of waste, it was suggested, the advantages of reduced quantities of waste storage at a single site should be carefully considered. (Tr 1234) In a similar vein, several persons suggested that the WIPP project should be deferred until other sites are investigated, (Tr 1427) though it was also pointed out that the question is whether this site is suitable, not

whether it is the best possible site. (Tr 1077) It was pointed out that with the elimination of spent fuel assemblies, the urgency behind the project has decreased. (Tr 1207) However, the Panel also wishes to point out that earlier hearings revealed that the wastes are currently stored in areas that overlie important aquifers in Idaho, and therefore their present location is not suitable.

(c) Section 7.2.6 of the DEIS should be expanded to describe the effect maximum accelerations caused by seismic effects might have on the stability of the waste-storage area, the retrievability of stored waste, and the potential for liquid breach of the site. If no such effects are likely, the EIS should so state. (Tr 1231)

(d) The DEIS is internally inconsistent since it states that groundwater from the Santa Rosa and Rustler is used only for livestock and potash mining. (Section 7.3.2) but later states that water is used for human consumption at the James ranch (DEIS, J-28). (Tr 1231) This minor inconsistency should be corrected.

(e) It was suggested that analysis of the four scenarios involving breach of the WIPP site by water should be broadened by estimating the effects of a breach immediately following site closure (as well as the 100 year and 1000 year assumptions). (Tr 1232)

(f) One witness pointed out an inconsistency in the DEIS treatment of endangered species, stating in one place that there were no endangered species known to inhabit the site but referring to endangered species at another place. (Tr 1462-63)

(g) While the hearing produced some information about the

availability of insurance for accident or injury, (Tr 1292-94, 109-99) it was suggested that the EIS should contain information about the location of liability (as among the Federal Government, commercial operators and commercial transportation facilities) (Tr 1208, 1362) for such events. The possible effects of workmen's compensation and the Price-Anderson Act should also be discussed. (Tr 1362-63)